

BILSTEIN Suspensions

2014

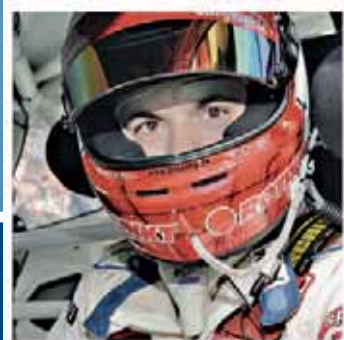

NEW



The benchmark in technology and quality.



Foreword

A warm welcome to the world of BILSTEIN: a name which, for over 50 years now, has been synonymous with the highest level of quality in suspension technology. Countless national and international motor sports successes with BILSTEIN products at the wheel and “Best Brand” media accolades can all testify to this. As part of their serial development, the world’s most renowned automotive brands place their trust in the innovation and quality of BILSTEIN suspension technology. As a result, we have been able to offer tailored shock absorbers and suspension technology for a number of cars over recent decades – whether for timely and efficient repairs, suspension optimisation, or the high demands of motor sports. Here, you can get a detailed insight into our world and range of products - but the only way you can truly experience BILSTEIN is to set off on your first journey and savour the feel of BILSTEIN products at the helm. We hope you enjoy it.

ThyssenKrupp BILSTEIN GmbH
Division Aftermarket



ISO/TS 16949:2002
Zertifikat: 01 111 5591

Contents

The BILSTEIN Brand

Nordschleife Test Programme	M2
Motor Sports Success Stories	M4
Automotive Fine-Tuning	M6

Technology Highlights M8

BILSTEIN Technologies	M10
Lowering / Round Threads	M12
Adjustment Range / It's all about the setting	M14
BILSTEIN Road Testing	M16

Sport and Threaded Ride Height Adjustable Kits M18

BILSTEIN B12 Pro-Kit - B12 Sportline	M20
BILSTEIN B14 - B16	M22

Electronic Suspensions M24

BILSTEIN B16 ridecontrol® & BILSTEIN iRC	M26
BILSTEIN B16 DampTronic®	M28

Clubsport Suspensions M29

BILSTEIN Clubsport	M30
--------------------	-----

Motor sports/individual suspensions M31

BILSTEIN Motorsport	M32
---------------------	-----

Always there for you. Also online.	M33
------------------------------------	-----

BILSTEIN-Shock-Finder	M34
-----------------------	-----

Catalogue range 1

Old order number – New order number	156
-------------------------------------	-----

New order number – Old order number	158
-------------------------------------	-----

Professional accessories	162
--------------------------	-----

Current certificates for download	163
-----------------------------------	-----

Notes and explanations	164
------------------------	-----

Catalogue range

Alfa Romeo	1	Ford USA	60	Mini	78	Vauxhall	119
Alpina	3	Holden	60	Mitsubishi	81	Volvo	129
Audi	4	Honda	63	Nissan	81	Changan Volvo	130
Audi-FAW	26	Hyundai	65	Opel	82	VW	130
BMW	28	Infinity	66	Peugeot	92	SVW	155
Brilliance BMW	47	Jaguar	66	Porsche	96		
Buick	48	Kia	66	Renault	100		
Buick SGM	49	Lancia	67	Saab	100		
Chevrolet	49	Land Rover	67	Seat	101		
SGM Chevrolet	50	Lexus	67	Škoda	109		
Chrysler	50	Lotus	67	SVW Škoda	114		
Citroën	51	Mahindra Renault	67	Smart	114		
Dacia	53	Maruti Suzuki	67	Subaru	116		
Daewoo	53	Mazda	67	Suzuki	117		
Fiat	54	Changan Mazda	69	Changan Suzuki	118		
Ford	56	Mercedes Benz	70	Toyota	118		
Changan Ford Mazda	60	Mercedes Benz (BBDC)	78	Guangzhou Toyota	119		

20,832 kilometers on the grünen Hölle: lik to a Hamburg – Munich trip every day for a

Some combinations are simply unbeatable. Take, for example, the “Genius on Wheels” plus the “grünen Hölle“: Walter Röhrl on the Nordschleife of the Nürburgring. There’s no better combination for putting a car’s suspension through its paces. Why? This kind of devilish testing programme – combining the merciless Eifel mountain range with one of the most skilful rally drivers of all time – soon separates the good suspensions from the perfect ones. What’s more, this is the minimum requirement prescribed by all of our test engineers – whether it takes place on the Nürburgring itself or the test track in Papenburg. Because we know you won’t settle for anything less than perfection.



Subjecting a suspension
year, only faster!



**All of them have two things in common:
their innate driving ability that makes them**



unique, and perfect equipment.

There's no future without a past. Take Formula 1 champions like Niki Lauda and Alain Prost, 24-hour winners such as Jacky Ickx and Hans-Joachim Stuck, rally champions like Walter Röhrl and DTM champions like Bernd Schneider. All of them have two things in common: their innate driving ability that makes them unique, and the perfect equipment. And for all of them, the biggest success stories have happened with BILSTEIN suspensions. For over 40 years, we have been right by the side of international motor sports, offering innovative technology such as threaded ride height adjustable kits, gas pressure technology, Upside-Down technology and parallel damping adjustment. Our experience and commitment equips every ambitious racing driver with the right tools for success, at all levels, in all of our roles – whether acting as the equipment manufacturer for the HWA team of the DTM or for the Land Porsche in the VLN – and on every track around the world.



There's nothing we can't enhance. That goes for **individuality** too.



We share a motto in common with the world's best-known motor vehicle tuners: Making good even better. That's why we support all the big names – from AC Schnitzer to BRABUS, right through to TechArt – in their endeavours to offer you the ultimate in individual vehicle settings and excellent driving dynamics. It's not just our level of competence in terms of high-tech quality and sportiness that ensures this, but also our meticulous and comprehensive testing programme on the toughest of courses, such as the Nürburgring. Because we know that we'll gladly go through hell to give you a heavenly driving experience!



**ABT//PROJEKTZWO//BRABUS//RUF
TECHART//AC SCHNITZER//HARTGE
CARGRAPHIC//CARLSSON//**

Our technology highlights at a glance.

Technology transferred from motor sports and original equipment manufacturing

OE

Threaded body adjustable range

20 TÜV

60/40

30

30-50

Lowering

Mono-tube technology

Twin-tube technology





Air suspension



Gas pressure technology



Road-test



Adjustment system



Active suspension control



Triple-C-Technology®



Round threads



Don't settle for standard: go for **BILSTEIN** technology.



BILSTEIN Original Equipment

The world's foremost automotive brands put their confidence in our quality. Why? Because we develop and series-produce suspension components in collaboration with our partners from the automotive industry. By placing your trust in our experience too, you'll be opting for the BILSTEIN driving experience when you exchange your suspension components.

- Technology transfer from original equipment manufacturing and motor sports
- Expert knowledge of the world's most renowned brands, such as Mercedes-Benz, Porsche, BMW, Audi, Bugatti, Ferrari, Lotus, Jaguar and many more
- Comprehensive product range
- High market coverage and availability



BILSTEIN gas pressure technology

Over time, the mono-tube gas pressure technology developed by BILSTEIN has established itself as a standard in automotive construction. This technology involves keeping the oil in the absorber under pressure, which prevents it from foaming when temperatures and loads are increasing. As a result, full damping power is retained even when the system is placed under extreme stress, a feature that can be observed in the self-lowering piston.

- Ensures a high level of traction and more precise handling
- A must-have for powerful sport suspensions
- Added safety in all dynamic driving situations

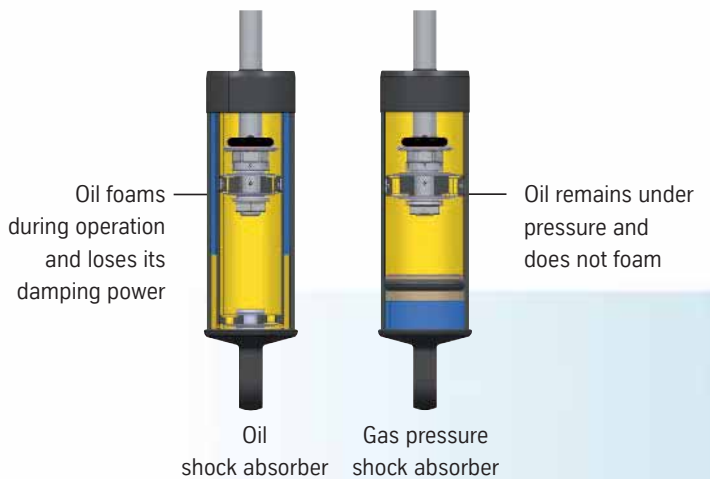



BILSTEIN mono-tube/Upside-Down technology

The original and best: The original mono-tube gas pressure shock absorbers bore the BILSTEIN name, and we're still responsible for producing the best there is. BILSTEIN's mono-tube technology is the number-one choice in motor sports and series-production sports cars: no other type gives engineers the same freedom to choose the perfect installation location or position (e.g. Upside-Down technology).

- Large effective surface on the working piston creates increased damping power and better handling
- Improved dissipation of thermal energy outwards enables a consistently high level of absorber performance
- Sturdy structure for added safety in Upside-Down technology



Twin-tube technology

The proven technology of a twin-tube absorber is applied in the vast majority of all vehicles. BILSTEIN's twin-tube absorbers, featuring "original equipment manufacturer" quality that has undergone rigorous testing, offer a marked improvement in driving characteristics with universal spare parts replaced in a timely and efficient manner.

- Oil or gas pressure technology
- Only tested, OEM quality is provided
- A favourably priced alternative at the highest level
- Technology transfer from series production



BILSTEIN lowering at the highest level.

When it comes to lowering, not only must the vehicle's character be kept in mind, but the driver's too. A multitude of tests involving a wide variety of equipment helps our test engineers determine what the perfect lowering height should be. During this process, we consider aerodynamics, residual spring travel, driving characteristics, comfort, suitability for everyday use, behaviour in limited applications, and aesthetics. This gives rise to our three tenets of lowering.



Wedge-shaped suspensions involve lowering of approx. 60 mm at the front axle and approx. 40 mm at the rear axle. This creates a sporty appearance which packs a huge visual punch.

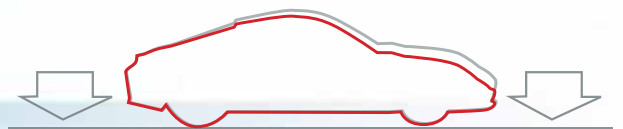

With uniform lowering, the entire vehicle is lowered by approx. 30 mm. This accentuates the sporty appearance and emphasises the driving dynamics, without compromising on comfort and or spring travel.

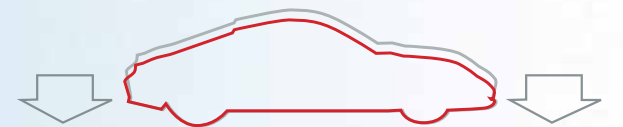

The threaded ride height adjustable kit enables variable and uniform lowering by approx. 30-50 mm, allowing you to create your own personal balance of sportiness and comfort.

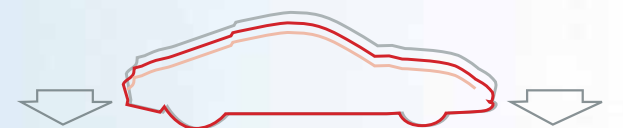

The perfect balance in no time at all.

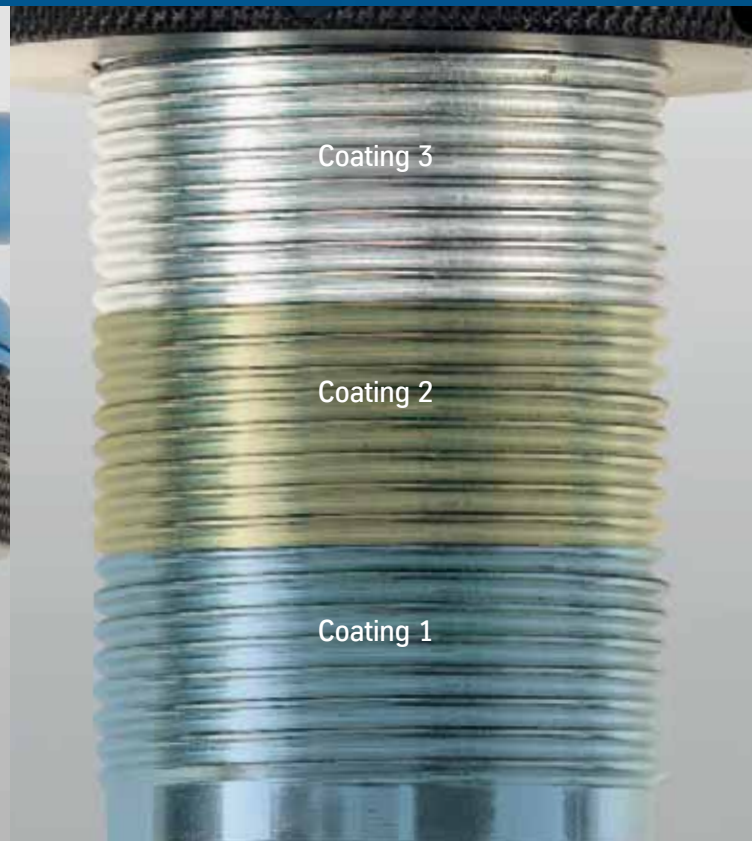

BILSTEIN round threads

To ensure that you can fine-tune your vehicle exactly how you want it, our threaded ride height adjustable kits are easy to adjust – even when they're installed. Allowing you to find the perfect balance for your vehicle.

- The special thread has no sharp edges that could be open to aggressive environmental influences
- The secured aluminium spring plates ensure the utmost level of safety
- The right hook spanners are provided in the scope of supply



BILSTEIN-Triple-C-Technology®

Our 3-layer coating system, developed especially with threaded ride height adjustable kits in mind, guarantees high-quality, enduring corrosion protection.

Coating 1: The special zinc alloy ensures excellent adherence to the base material, and forms the basis for long-lasting corrosion protection.

Coating 2: The middle coating transforms the zinc layer into a closed-formation, homogenous surface.

Coating 3: Not only is the top coat aesthetically pleasing, it also provides additional, long-term protection against mechanical wear and corrosion. Endurance tests to DIN 50021 SS also testify to this.

As individual as you are.



+/-20



Threaded body adjustable range

Just as no two vehicles are the same, each driver has their own unique style too. As a result, our threaded ride height adjustable kits even enable you to alter the height of your vehicle when they are installed.

- Spring plates and lock nuts made from a special aluminium alloy ensure maximum stability at a minimum weight
- Specially developed round threads and coating technology for easy adjustment by up to 20 mm; with German TÜV certificate
- Perfect pre-tensioning of sport springs made from highly durable material, at each setting and in every situation, for solid driving characteristics

Air suspension

- Perfect support for the functionality of the car manufacture's active suspension systems



The perfect settings for every setting.

It's all about the setting

Take the children to school in the morning, go to the shops in convenience and comfort in the afternoon – and get the most out of every curve in the road in between. For drivers who don't want to compromise on comfort or sportiness, our engineers have developed the perfect technology.

- Characteristic curve pairs given a multitude of road tests
- Parallel settings in rebound and compression cycles, for balanced driving characteristics
- Driving characteristics settings that suit individual needs perfectly



PSS 9/10

- 9/10 settings for parallel damping adjustment
- Option of making settings while kit is installed, by simply turning the adjustment wheel on the absorber



Clubsport

- 100 setting variations that can be experienced and manually selected with tangible differences
- Adjustment wheels with clearly visible and distinct scaling from 1 (soft) to 10 (hard)



ridecontrol®

- An exclusive system that enables settings to be made by means of pushbutton inside the car/or on the dashboard
- Lightning-quick switching from convenient “normal” mode to high-powered “sport” setting



Active suspension control

- Precision adjustment of the three preset auto-modes (Comfort, Normal and Sport) to create an individual suspension setting



SOFT/COMFORT

HARD/SPORT

You can never get enough of some good things. Like **experience**, for example.



Road-tested by BILSTEIN

To achieve that celebrated BILSTEIN driving experience, our BILSTEIN engineers rely on not only technology that is truly at the cutting edge, but also something that has withstood the test of time: how it feels to the driver. As a result, all of our high-performance absorbers, as well as our sport suspensions and threaded ride height adjustable kits, undergo a rigorous testing programme. On the Nürburgring and in our own test centre at the Papenburg test track, our drivers test how balanced the driving characteristics of various vehicles are in a variety of different driving situations. Only when they have passed this programme of tests with distinction are they allowed to bear the BILSTEIN name. This way, we can guarantee that celebrated BILSTEIN driving experience.

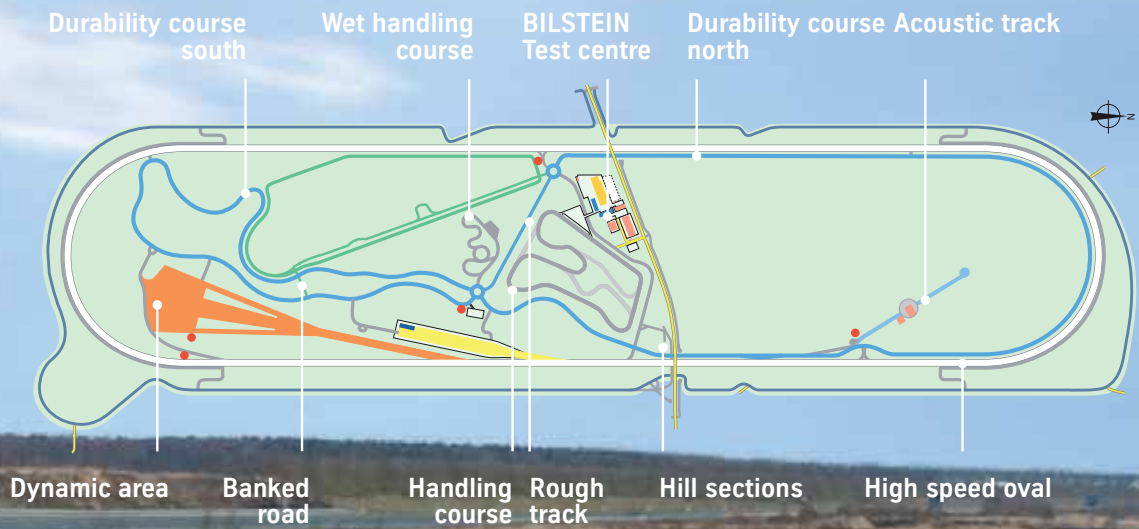

ATP Automotive Testing Papenburg

BILSTEIN-TECHNOLOGY *tested on*
NÜRBURGRING-NORDSCHLEIFE





A new dimensions in sportiness: sport suspensions and threaded ride height adjustable kits



BILSTEIN B12 Pro-Kit

The choice of professionals.



If you're looking for the perfect combination of a superior appearance, sporty dynamics and high performance, you're on exactly the right track with this sport suspension.

The product benefits at a glance:

- Professional Cornering System PCS
- Precise response, excellent driving performance and high reserves of safety
- Lowering up to 40 mm
- EIBACH Pro-Kit performance springs with progressive characteristic
- Springs and shock absorbers road-tested and fine-tuned to complement one other perfectly
- BILSTEIN gas pressure technology
- BILSTEIN mono-tube/Upside-Down technology
- German TÜV certificate
- Made in Germany



BILSTEIN B12 Sportline

Sporty look and technology for great performance.



You will impress others with the sporty lowering – and yourself with the fantastic handling: precise responses, dynamics and comfort rolled into one.

The product benefits at a glance:

- Professional Cornering System Sport PCSS
- Direct response, good driving performance and sporty look
- Lowering up to 50 mm
- EIBACH Sportline Performance sports springs with progressive characteristic
- Springs and shock absorbers road-tested and fine-tuned to complement one other perfectly
- BILSTEIN gas pressure technology
- BILSTEIN mono-tube/Upside-Down technology
- German TÜV certificate
- Made in Germany

BILSTEIN B14

Sport makes you flexible.



With the BILSTEIN B14 threaded ride height adjustable kit, we're bringing technology from the race track onto the street.

The product benefits at a glance:

- Threaded body adjustable range of 20 mm at both axles, while installed
- Lowering of approx. 30-50 mm at front and rear
- Road-tested by BILSTEIN under motor sports conditions and fine-tuned
- Spring plates and lock nuts made from a special aluminium alloy
- Surface coating using Triple-C-Technology® for long-lasting corrosion resistance
- Round threads for ease of adjustment
- Quality sport springs made from highly durable material
- BILSTEIN gas pressure technology
- BILSTEIN mono-tube/Upside-Down technology, made in Germany
- German TÜV certificate

BILSTEIN-TECHNOLOGY tested on
NÜRBURGRING-NORDSCHLEIFE



BILSTEIN B16

Driving enjoyment – it's all about the setting



The new power class created by BILSTEIN engineers aims to achieve the ultimate in driving enjoyment based on individual requirements.

The product benefits at a glance:

- 9/10 characteristic curve pairs can be selected by adjustment wheel while installed
- Threaded body adjustable range of 20 mm at both axles while installed
- Individual settings ranging from extreme sportiness right up to the highest level of driving comfort
- Lowering of approx. 30-50 mm at front and rear
- Road-tested by BILSTEIN under motor sports conditions and fine-tuned
- Spring plates and lock nuts made from a special aluminium alloy
- Surface coating using Triple-C-Technology® for long-lasting corrosion resistance
- Round threads for ease of adjustment
- Quality sport springs made from highly durable material
- BILSTEIN gas pressure technology
- BILSTEIN mono-tube/Upside-Down technology, made in Germany
- German TÜV certificate

BILSTEIN-TECHNOLOGY tested on
NÜRBURGRING-NORDSCHLEIFE





The benchmark in sportiness and comfort: electronic suspensions.



BILSTEIN B16 ridecontrol®

Sportiness at the touch of a button.



BILSTEIN-TECHNOLOGY tested on
NÜRBURGRING-NORDSCHLEIFE



In the blink of an eye, you can switch the suspension setting from “comfort” to “sport” mid-journey by simply touching a button in the cockpit.

The product benefits at a glance:

- “Comfort” mode creates smooth compensation for uneven surfaces
- “Sport” mode for excellent driving dynamics and maximum power reserves in all situations
- Illuminated operator button for controlling settings
- Threaded body adjustable range of 20 mm at both axles, while installed
- Lowering of approx. 30-50 mm at front and rear
- Road-tested by BILSTEIN under motor sports conditions and fine-tuned
- Spring plates and lock nuts made from a special aluminium alloy
- Surface coating using Triple-C-Technology® for long-lasting corrosion resistance
- Round threads for ease of adjustment
- Quality sport springs made from highly durable material
- BILSTEIN gas pressure technology
- BILSTEIN mono-tube/Upside-Down technology, made in Germany
- German TÜV certificate



BILSTEIN iRC

Adjustment with that special touch.



A convenient feature has been added to the famous BILSTEIN ride-control suspension system: smartphone control. The active suspension control allows individual setting and every driver grows to his own suspension engineer.

The product benefits at a glance:

- Compatible with all BILSTEIN RC suspensions
- Easy retrofitting
- Precision adjustment of the three preset auto-modes (Comfort, Normal and Sport) by varying the acceleration thresholds, switching times and filter parameters to create an individual suspension setting
- The optimum basic setting of the auto modes for the shock absorbers determined through BILSTEIN driving trials
- Graphic output of the longitudinal and transverse acceleration on the smartphone
- Saving the modes and the precision adjustment parameters
- „sport+“ mode for superb vehicle dynamics and maximum reserves of performance when driving at the limit
- „comfort+“ mode for gentle compensation of bumps in the road
- Real-time adjustment while driving possible
- Filtering of vertical accelerations (variable)
- Individual configuration of the illumination of the RC-button
- Outstandingly clear layout and easy handling of the BILSTEIN-iRC-App



BILSTEIN-TECHNOLOGY *tested on*
NÜRBURGRING-NORDSCHLEIFE



BILSTEIN B16 DampTronic®

Dynamics without compromise.



An exclusive power class for exclusive cars: Porsche or Nissan GT-R owners, who have already chosen to experience the pleasure of a groundbreaking active suspension (in the case of the Nissan GT-R, a series), can now get better acquainted with this individual solution.

The product benefits at a glance:

- Perfectly adapted to suit series-production electronic adjustment system
- Superior driving dynamics with three setting levels
- Ability to switch rapidly from comfortable, everyday mode to sporty setting for journeys across rural roads and right up to a racing setting for championship sport
- Threaded body adjustable range of 20 mm at both axles, while installed
- Lowering of approx. 30-50 mm at front and rear
- Road-tested by BILSTEIN under motor sports conditions and fine-tuned
- Spring plates and lock nuts made from a special aluminium alloy
- Surface coating using Triple-C-Technology® for long-lasting corrosion resistance
- Round threads for ease of adjustment
- Quality sport springs made from highly durable material
- BILSTEIN gas pressure technology
- BILSTEIN mono-tube/Upside-Down technology, made in Germany
- German TÜV certificate



BILSTEIN-TECHNOLOGY tested on
NÜRBURGRING-NORDSCHLEIFE



Racing and road driving united: Clubsport suspension kits.



BILSTEIN Clubsport

Racing and road driving united.



The BILSTEIN Clubsport suspension kit is a fully street-legal, TÜV-certified high-end coilover package that is also designed for uncompromising use in the fields of racing and clubsport. The suspension combines the tried-and-tested BILSTEIN mono-tube gas pressure technology with the highest levels of engineering from the field of motor sport.

The product benefits at a glance:

- 100 setting variations that can be experienced and manually selected with tangible differences
- Adjustment wheels with clearly visible and distinct scaling from 1 (soft) to 10 (hard)
- Clear click resolution and colour-coding: red for rebound force, blue for bump force
- Simple setup changes in installed state without additional tools
- Camber adjustment with uniball supporting bearing
- Weight and Installation Space advantages thanks to integrated reservoir
- Quality racing springs made from highly durable material
- Spring plates and lock nuts made from special aluminium alloy
- Aluminium uniball supporting bearing
- Aluminium adjustment wheels
- Highest force closure by BILSTEIN mono-tube gas pressure technology from the field of motorsport „Made in Germany“
- 2-way adjustment system, independent adjustment of rebound and bump force
- Surface coating using Triple-C-Technology® for long-lasting corrosion resistance
- Foundation for further customisations for use in the field of racing
- Street-legal: German TÜV certificate

BILSTEIN-TECHNOLOGY tested on
NÜRBURGRING-NORDSCHLEIFE



No more Limits. Motor sports/individual suspensions.

www.motorsport.bilstein.de



BILSTEIN Motorsport

Motorsport suspensions.



Racing cars fitted with our BILSTEIN Motorsport suspensions experience maximum contact between the tire and the road. Many racing teams trust the BILSTEIN MDS with its independently adjustable rebound and compression settings and use these suspensions for a podium finish.

The product benefits at a glance:

- 2-way adjustment system, independent adjustment of rebound and bump force
- 100 setting variations that can be experienced and manually selected with tangible differences
- Adjustment wheels with clearly visible and distinct scaling from 1 (soft) to 10 (hard)
- Clear click resolution and colour-coding: red for rebound force, blue for bump force
- Simple setup changes in installed state without additional tools
- Highest force closure by BILSTEIN mono-tube gas pressure technology
- Damper body and fittings precision-machined in aluminium
- Lightest possible weight
- Minimal friction in all moving parts
- Easy Clip System for rapid spring changes
- Bump stop can be replaced quickly simply by removing and replacing the adjuster head

BILSTEIN-TECHNOLOGY tested on
NÜRBURGRING-NORDSCHLEIFE



Always there for you. Also online.

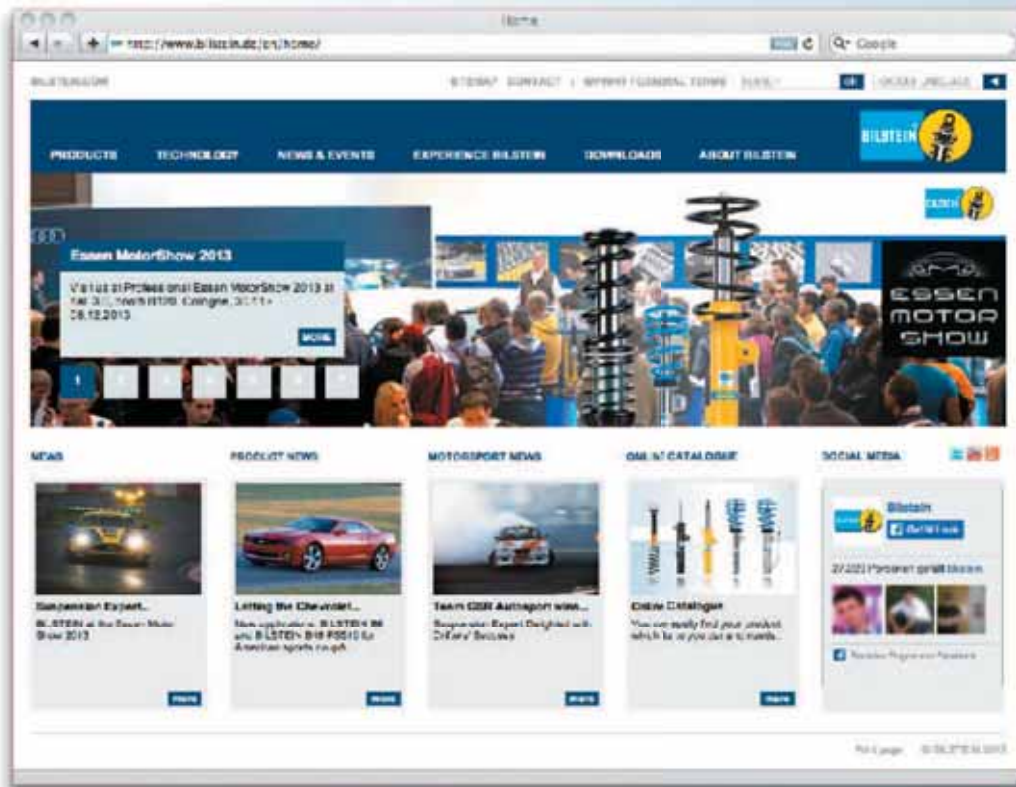



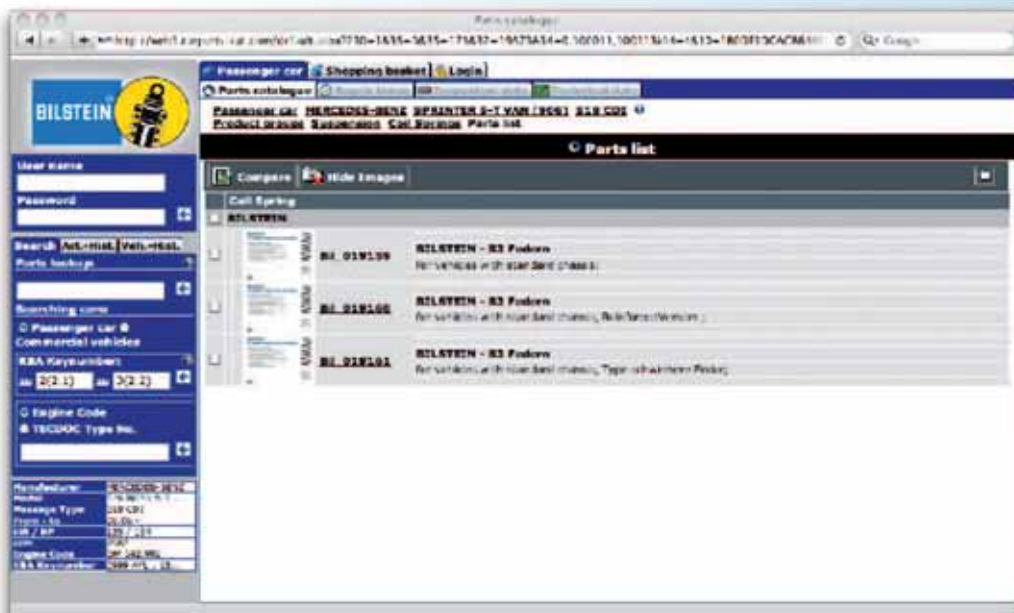

You will find further information about our products and our company at our website at www.bilstein.de.



The BILSTEIN online catalogue offers a quick and easy solution to find the right product for your vehicle.

BILSTEIN-Shock-Finder: All products at a glance.

					
ALFA ROMEO					
ALFA ROMEO 147 (937)					
B12 PK	1.6 16V T.SPARK, 1.6 16V T.SPARK ECO, 2.0, 2.0 16V T.SPARK 01/01 - 77 - 121 kW	46-182852	30	30	Conditions see certificates; without ride height adjustment VA: axle load to: 980 kg HA: axle load to: 980 kg
B12 PK	1.9 JTD, 1.9 JTD 16V, 1.9 JTDM 16V, 1.9 JTDM 8V, 3.2 GTA 02/03 - 74 - 184 kW	46-182853	30	30	Conditions see certificates; without ride height adjustment VA: axle load to: 1040 kg HA: axle load to: 980 kg

Product range

Year

Vehicle manufacturer

Vehicle type and model





Engine





Part-No.





Front axle





Rear axle

Note

									
ALFA ROMEO									
ALFA ROMEO 147 (937)									
B12 PK	1.6 16V T.SPARK, 1.6 16V T.SPARK ECO, 2.0, 2.0 16V T.SPARK 01/01 - 03/10 77 -121 kW	46-182852	30	30	without ride height adjustment; Conditions see certificates VA: axle load to: 980 kg HA: axle load to: 980 kg				
B12 PK	1.9 JTD, 1.9 JTD 16V, 1.9 JTDM 16V, 1.9 JTDM 8V, 3.2 GTA 02/03 - 03/10 74 -184 kW	46-182883	30	30	without ride height adjustment; Conditions see certificates VA: axle load to: 1040 kg HA: axle load to: 980 kg				
B12 SL	1.6 16V T.SPARK, 1.6 16V T.SPARK ECO, 1.9 JTD, 1.9 JTD 16V, 1.9 JTDM 16V, 1.9 JTDM 8V, 2.0 16V T.SPARK 11/00 - 03/10 74 -125 kW	46-182937	45-50	40	without ride height adjustment; Conditions see certificates VA: axle load to: 1040 kg HA: axle load to: 980 kg				
B14	1.6 16V T.SPARK, 1.6 16V T.SPARK ECO, 1.9 JTD, 1.9 JTD 16V, 1.9 JTDM 16V, 1.9 JTDM 8V, 2.0, 2.0 16V T.SPARK, 3.2 GTA 11/00 - 03/10 74 -184 kW	47-119215	30-50	30-50	with standard chassis; without ride height adjustment; Conditions see certificates; Only in connection with 2 x 60613572 VA: axle load to: 1060 kg HA: axle load to: 1000 kg				
B16 PSS9	1.6 16V T.SPARK, 1.6 16V T.SPARK ECO, 1.9 JTD, 1.9 JTD 16V, 1.9 JTDM 16V, 1.9 JTDM 8V, 2.0, 2.0 16V T.SPARK, 3.2 GTA 11/00 - 03/10 74 -184 kW	48-100724	30-50	30-50	with standard chassis; Conditions see certificates; Only in connection with 2 x 60613572 VA: axle load to: 1060 kg HA: axle load to: 1000 kg				
ALFA ROMEO 156 (932)									
B12 PK	1.6 16V T.SPARK, 1.8 16V T.SPARK, 2.0 16V T.SPARK, 2.0 GLX, 2.0 JTS 09/97 - 09/05 88 -122 kW	46-182739	30	30	without ride height adjustment; Conditions see certificates VA: axle load to: 1060 kg HA: axle load to: 1000 kg				
B12 PK	1.9 JTD, 1.9 JTD 16V, 2.4 D, 2.4 JTD, 2.5 V6 24V, 3.2 GTA 09/97 - 09/05 77 -184 kW	46-182753	30	30	without ride height adjustment; Conditions see certificates VA: axle load to: 1060 kg HA: axle load to: 1000 kg				
B12 SL	1.6 16V T.SPARK, 1.8 16V T.SPARK, 2.0 16V T.SPARK, 2.0 GLX, 2.0 JTS 09/97 - 09/05 88 -122 kW		45-50	45-50	without ride height adjustment; Conditions see certificates VA: axle load to: 990 kg HA: axle load to: 980 kg				
B12 SL	1.9 JTD, 1.9 JTD 16V, 2.4 D, 2.4 JTD, 2.5 V6 24V, 3.2 GTA 09/97 - 09/05 77 -184 kW	46-182920	45-50	45-50	without ride height adjustment; Conditions see certificates VA: axle load to: 1060 kg HA: axle load to: 980 kg				
B14	1.6 16V T.SPARK, 1.8 16V T.SPARK, 1.9 JTD, 1.9 JTD 16V, 2.0 16V T.SPARK, 2.0 GLX, 2.0 JTS, 2.4 JTD, 2.5 V6 24V, 3.2 GTA 09/97 - 09/05 77 -184 kW	47-119215	30-50	30-50	with standard chassis; without ride height adjustment; Conditions see certificates VA: axle load to: 1060 kg HA: axle load to: 1000 kg				
B16 PSS9	1.6 16V T.SPARK, 1.8 16V T.SPARK, 1.9 JTD, 1.9 JTD 16V, 2.0 16V T.SPARK, 2.0 GLX, 2.0 JTS, 2.4 JTD, 2.5 V6 24V, 3.2 GTA 09/97 - 09/05 77 -184 kW	48-100724	30-50	30-50	with standard chassis; without ride height adjustment; Conditions see certificates VA: axle load to: 1060 kg HA: axle load to: 1000 kg				
ALFA ROMEO 156 Sportwagon (932)									
B12 PK	1.6 16V T.SPARK., 1.8 16V T.SPARK, 2.0 16V T.SPARK, 2.0 JTS 05/00 - 05/06 88 -122 kW	46-182739	30	30	without ride height adjustment; Conditions see certificates VA: axle load to: 1060 kg HA: axle load to: 1000 kg				
B12 PK	1.9 JTD, 1.9 JTD 16V, 2.4 JTD, 2.5 V6 24V, 3.2 GTA 05/00 - 05/06 77 -184 kW	46-182753	30	30	without ride height adjustment; Conditions see certificates VA: axle load to: 1060 kg HA: axle load to: 1000 kg				
B12 SL	1.6 16V T.SPARK., 1.8 16V T.SPARK, 2.0 16V T.SPARK, 2.0 JTS 05/00 - 05/06 88 -122 kW		45-50	45-50	without ride height adjustment; Conditions see certificates VA: axle load to: 990 kg HA: axle load to: 980 kg				
B12 SL	1.9 JTD, 1.9 JTD 16V, 2.4 JTD, 2.5 V6 24V, 3.2 GTA 05/00 - 05/06 77 -184 kW	46-182920	45-50	45-50	without ride height adjustment; Conditions see certificates VA: axle load to: 1060 kg HA: axle load to: 980 kg				

									
ALFA ROMEO									
ALFA ROMEO 156 Sportwagon (932)									
B14	1.6 16V T.SPARK., 1.8 16V T.SPARK, 1.9 JTD, 1.9 JTD 16V, 2.0 16V T.SPARK, 2.0 JTS, 2.4 JTD, 2.5 V6 24V, 3.2 GTA 05/00 - 05/06 77 -184 kW	47-119215	30-50	30-50	without ride height adjustment; Conditions see certificates; Only in connection with 2 x 60613572 VA: axle load to: 1060 kg HA: axle load to: 1000 kg				
B16 PSS9	1.6 16V T.SPARK., 1.8 16V T.SPARK, 1.9 JTD, 1.9 JTD 16V, 2.0 16V T.SPARK, 2.0 JTS, 2.4 JTD, 2.5 V6 24V, 3.2 GTA 05/00 - 05/06 77 -184 kW	48-100724	30-50	30-50	without ride height adjustment; Conditions see certificates; Only in connection with 2 x 60613572 VA: axle load to: 1060 kg HA: axle load from: 1000 kg				
ALFA ROMEO 159									
B12 PK	1.8 MPI, 1.8 TBi, 1.9 JTDM 16V, 1.9 JTDM 8V, 1.9 JTS, 2.0 JTDM, 2.2 JTS 09/05 - 11/11 85 -147 kW	46-182760	30-35	30-35	without ride height adjustment; Conditions see certificates VA: axle load to: 1200 kg HA: axle load to: 1100 kg				
B12 PK	2.4 JTDM, 3.2 JTS 09/05 - 11/11 147 -191 kW	46-182777	30-35	30-35	without ride height adjustment; Conditions see certificates VA: axle load to: 1300 kg HA: axle load to: 1100 kg				
B12 PK	2.4 JTDM Q4, 3.2 JTS Q4 12/05 - 11/11 154 -191 kW	46-182807	30-35	30	without ride height adjustment; Conditions see certificates VA: axle load to: 1300 kg HA: axle load to: 1100 kg				
B12 SL	1.8 MPI, 1.8 TBi, 1.9 JTDM 16V, 1.9 JTDM 8V, 1.9 JTS, 2.0 JTDM, 2.2 JTS 09/05 - 11/11 85 -147 kW		40-45	45-50	without ride height adjustment; Conditions see certificates VA: axle load to: 1200 kg HA: axle load to: 1000 kg				
B14	1.8 MPI, 1.8 TBi, 1.9 JTDM 16V, 1.9 JTDM 8V, 1.9 JTS, 2.0 JTDM, 2.2 JTS, 2.4 JTDM, 2.4 JTDM Q4, 3.2 JTS, 3.2 JTS Q4 12/05 - 11/11 85 -191 kW	47-139275	30-50	30-50	Conditions see certificates VA: axle load to: 1300 kg HA: axle load to: 1100 kg				
B16 PSS10	1.8 MPI, 1.8 TBi, 1.9 JTDM 16V, 1.9 JTDM 8V, 1.9 JTS, 2.0 JTDM, 2.2 JTS, 2.4 JTDM, 2.4 JTDM Q4, 3.2 JTS, 3.2 JTS Q4 12/05 - 11/11 85 -191 kW	48-139243	30-50	30-50	Conditions see certificates VA: axle load to: 1300 kg HA: axle load to: 1100 kg				
ALFA ROMEO 159 Sportwagon									
B12 PK	1.8 MPI, 1.8 TBi, 1.9 JTDM 16V, 1.9 JTDM 8V, 1.9 JTS, 2.0 JTDM, 2.2 JTS 03/06 - 11/11 85 -147 kW	46-182784	30-35	25-30	without ride height adjustment; Conditions see certificates VA: axle load to: 1200 kg HA: axle load to: 1100 kg				
B12 PK	2.4 JTDM, 3.2 JTS 03/06 - 11/11 147 -191 kW	46-182791	30-35	25-30	without ride height adjustment; Conditions see certificates VA: axle load to: 1300 kg HA: axle load to: 1100 kg				
B12 PK	2.4 JTDM Q4, 3.2 JTS Q4 03/06 - 11/11 154 -191 kW	46-182814	30-35	30	without ride height adjustment; Conditions see certificates VA: axle load to: 1300 kg HA: axle load to: 1100 kg				
B12 SL	1.8 MPI, 1.8 TBi, 1.9 JTDM 16V, 1.9 JTDM 8V, 1.9 JTS, 2.0 JTDM, 2.2 JTS 03/06 - 11/11 85 -147 kW		40-45	45-50	without ride height adjustment; Conditions see certificates VA: axle load to: 1200 kg HA: axle load to: 1000 kg				
B14	1.8 MPI, 1.8 TBi, 1.9 JTDM 16V, 1.9 JTDM 8V, 1.9 JTS, 2.0 JTDM, 2.2 JTS, 2.4 JTDM, 2.4 JTDM Q4, 3.2 JTS, 3.2 JTS Q4 03/06 - 11/11 85 -191 kW	47-139275	30-50	30-50	Conditions see certificates VA: axle load to: 1300 kg HA: axle load to: 1100 kg				
B16 PSS10	1.8 MPI, 1.8 TBi, 1.9 JTDM 16V, 1.9 JTDM 8V, 1.9 JTS, 2.0 JTDM, 2.2 JTS, 2.4 JTDM, 2.4 JTDM Q4, 3.2 JTS, 3.2 JTS Q4 03/06 - 11/11 85 -191 kW	48-139243	30-50	30-50	Conditions see certificates VA: axle load to: 1300 kg HA: axle load to: 1100 kg				
ALFA ROMEO BRERA									
B12 PK	2.4 JTDM 20V, 3.2 JTS Q4 01/06 - 147 -191 kW	46-000064	25-30	25	without ride height adjustment; all-wheel drive; Conditions see certificates VA: axle load to: 1300 kg HA: axle load to: 1100 kg				
B12 PK	2.4 JTDM 20V, 3.2 JTS 01/06 - 147 -191 kW	46-000071	25-30	25	without ride height adjustment; front wheel drive; Conditions see certificates VA: axle load to: 1300 kg HA: axle load to: 1100 kg				





   					
ALFA ROMEO					
ALFA ROMEO BRERA					
B14	1.8 TBi, 2.0 JTDM, 2.2 JTS, 2.4 JTDM 20V, 3.2 JTS, 3.2 JTS Q4 01/06 - 120 -191 kW	47-139275	30-50	30-50	Conditions see certificates VA: axle load to: 1300 kg HA: axle load to: 1100 kg
B16 PSS10	1.8 TBi, 2.0 JTDM, 2.2 JTS, 2.4 JTDM 20V, 3.2 JTS, 3.2 JTS Q4 01/06 - 120 -191 kW	48-139243	30-50	30-50	Conditions see certificates VA: axle load to: 1300 kg HA: axle load to: 1100 kg
ALFA ROMEO GIULIETTA (940)					
B12 PK	1.6 JTDM, 1.8 TBi, 2.0 JTDM 04/10 - 77 -173 kW	46-223500	30-35	30	Conditions see certificates VA: axle load to: 1100 kg HA: axle load to: 850 kg
ALFA ROMEO GT					
B12 PK	1.8 TS, 1.9 JTD, 2.0 JTS 11/03 - 09/10 103 -125 kW	46-188434	25	25	Conditions see certificates VA: axle load to: 990 kg HA: axle load to: 980 kg
B12 PK	3.2 GTA 11/03 - 09/10 176 kW	46-188441	20	25	Conditions see certificates VA: axle load to: 1040 kg HA: axle load to: 980 kg
B14	1.8 TS, 1.9 JTD, 2.0 JTS, 3.2 GTA 11/03 - 09/10 103 -176 kW	47-119215	30-50	30-50	with standard chassis; Conditions see certificates VA: axle load to: 1060 kg HA: axle load to: 1000 kg
B16 PSS9	1.8 TS, 1.9 JTD, 2.0 JTS, 3.2 GTA 11/03 - 09/10 103 -176 kW	48-100724	30-50	30-50	with standard chassis; Conditions see certificates VA: axle load to: 1060 kg HA: axle load to: 1000 kg
ALFA ROMEO MITO (ZAR 955)					
B12 PK	0.9, 1.3 JTDM, 1.4, 1.4 TB, 1.4 Turbo 09/08 - 51 -125 kW	46-182890	30	30	without electronic suspension control; Conditions see certificates VA: axle load to: 955 kg HA: without ride height adjustment; axle load to: 850 kg
B12 PK	1.6 JTDM 09/08 - 85 -88 kW	46-182906	30	30	without electronic suspension control; Conditions see certificates VA: axle load to: 1000 kg HA: without ride height adjustment; axle load to: 850 kg
B14	0.9, 1.3 JTDM, 1.4, 1.4 TB, 1.4 Turbo, 1.6 JTDM 09/08 - 51 -125 kW	47-164499	35-45	30-45	VA: Conditions see certificates; axle load to: 1000 kg HA: axle load to: 850 kg
ALFA ROMEO SPIDER (939)					
B12 PK	3.2 JTS Q4 09/06 - 191 kW	46-000040	20	20	without ride height adjustment; Conditions see certificates VA: axle load to: 1300 kg HA: axle load to: 1100 kg
B12 PK	2.4 JTDM, 3.2 JTS 04/07 - 147 -191 kW	46-000095	20	20	without ride height adjustment; Conditions see certificates VA: axle load to: 1300 kg HA: axle load to: 1100 kg
B14	1.8 TBi, 2.0 JTDM, 2.2 JTS, 2.4 JTDM, 3.2 JTS, 3.2 JTS Q4 09/06 - 120 -191 kW	47-139275	30-50	30-50	Conditions see certificates VA: axle load to: 1300 kg HA: axle load to: 1100 kg
B16 PSS10	1.8 TBi, 2.0 JTDM, 2.2 JTS, 2.4 JTDM, 3.2 JTS, 3.2 JTS Q4 09/06 - 120 -191 kW	48-139243	30-50	30-50	Conditions see certificates VA: axle load to: 1300 kg HA: axle load to: 1100 kg
ALPINA					
ALPINA D3 Estate (E90)					
B14	2.0 12/05 - 147 -157 kW	47-120471	15-35	15-35	Conditions see certificates VA: axle load to: 1020 kg HA: axle load to: 1200 kg
B16 PSS10	2.0 12/05 - 147 -157 kW	48-131636	15-35	15-35	Conditions see certificates VA: axle load to: 1020 kg HA: axle load to: 1200 kg
B16 PSS10	2.0 12/05 - 147 -157 kW	48-195232	5-25	5-25	Conditions see certificates VA: axle load to: 1020 kg HA: axle load to: 1200 kg





					
ALPINA					
ALPINA D3 Estate (E90)					
B16 RC	2.0 12/05 - 147 -157 kW	49-131543 14-230615	15-35	15-35	Conditions see certificates VA: axle load to: 1020 kg HA: axle load to: 1200 kg





AUDI					
AUDI A1					
B12 PK	1.2 TFSI, 1.4 TFSI 05/10 - 63 -136 kW	46-195197	20	15	Conditions see certificates VA: axle load to: 880 kg HA: axle load to: 800 kg
B12 PK	1.4 TFSI, 1.6 TDI 05/10 - 66 -136 kW	46-195203	20	15	Conditions see certificates VA: axle load to: 930 kg HA: axle load to: 800 kg
B14	1.2 TFSI, 1.4 TFSI, 1.6 TDI, 2.0 TDI 05/10 - 63 -136 kW	47-168091	30-45	30-45	Conditions see certificates VA: axle load to: 920 kg HA: axle load to: 775 kg
B16 PSS9	1.2 TFSI, 1.4 TFSI, 1.6 TDI, 2.0 TDI 05/10 - 63 -136 kW	48-168229	30-45	30-45	Conditions see certificates VA: axle load to: 920 kg HA: axle load to: 775 kg





AUDI A1 Sportback (8XA)					
B12 PK	1.2 TFSI, 1.4 TFSI 11/11 - 63 -136 kW	46-195197	20	15	Conditions see certificates VA: axle load to: 880 kg HA: axle load to: 800 kg
B12 PK	1.4 TFSI, 1.6 TDI 11/11 - 66 -136 kW	46-195203	20	15	Conditions see certificates VA: axle load to: 930 kg HA: axle load to: 800 kg
B14	1.2 TFSI, 1.4 TFSI, 1.6 TDI, 2.0 TDI 11/11 - 63 -136 kW	47-168091	30-45	30-45	Conditions see certificates VA: axle load to: 920 kg HA: axle load to: 775 kg
B16 PSS9	1.2 TFSI, 1.4 TFSI, 1.6 TDI, 2.0 TDI 11/11 - 63 -136 kW	48-168229	30-45	30-45	Conditions see certificates VA: axle load to: 920 kg HA: axle load to: 775 kg





AUDI A3 (8L1)					
B10	1.6, 1.8, 1.8 T, 1.9 TDI 09/96 - 05/03 66 -132 kW	46-111890	50	40	Conditions see certificates VA: axle load to: 980 kg HA: axle load to: 1070 kg
B10	1.6, 1.8, 1.8 T, 1.9 TDI 09/96 - 05/03 66 -132 kW	46-111906	50	40	Conditions see certificates VA: axle load from: 981 kg HA: axle load to: 1070 kg
B12 PK	1.6, 1.8, 1.8 T 09/96 - 05/03 74 -132 kW	46-180148	30	25	manual transmission; Conditions see certificates VA: axle load to: 990 kg HA: without ride height adjustment; axle load to: 930 kg
B12 PK	1.8 T, 1.9 TDI 09/96 - 05/03 66 -132 kW	46-180162	30	30	automatic transmission; Conditions see certificates VA: axle load to: 1020 kg HA: without ride height adjustment; axle load to: 930 kg
B12 PK	1.8 T quattro, 1.9 TDI quattro 12/96 - 05/03 96 -132 kW	46-180179	30	25	Conditions see certificates VA: axle load to: 1050 kg HA: without ride height adjustment; axle load to: 1120 kg
B12 PK	S3 quattro 03/99 - 05/03 154 -165 kW	46-180186	25	20	Conditions see certificates VA: axle load to: 1050 kg HA: without ride height adjustment; axle load to: 1120 kg
B12 PK	1.9 TDI 09/96 - 05/03 66 -96 kW	46-180155	30	25	manual transmission; Conditions see certificates VA: axle load to: 990 kg HA: without ride height adjustment; axle load to: 930 kg
B12 SL	1.6, 1.8, 1.8 T, 1.9 TDI 09/96 - 05/03 66 -132 kW	46-180216	45-50	35-40	Conditions see certificates VA: axle load to: 950 kg HA: without ride height adjustment; axle load to: 1000 kg
B12 SL	1.8, 1.8 T, 1.9 TDI 09/96 - 05/03 66 -132 kW	46-180223	45-50	35-40	Conditions see certificates VA: axle load to: 1000 kg HA: without ride height adjustment; axle load to: 1000 kg
B14	1.6, 1.8, 1.8 T, 1.9 TDI 09/96 - 05/03 66 -132 kW	47-124851	25-45	20-40	Spacers required for several wheel/tyre combinations; Conditions see certificates VA: axle load to: 1060 kg HA: axle load to: 1010 kg

					
AUDI					
AUDI A3 (8L1)					
B14	1.8 T quattro, 1.9 TDI quattro, S3 quattro 12/96 - 05/03 96 -165 kW	47-080416	30-50	30-50	Spacers required for several wheel/tyre combinations; Conditions see certificates VA: axle load to: 1110 kg HA: axle load to: 1080 kg
B16 PSS9	1.6, 1.8, 1.8 T, 1.9 TDI 09/96 - 05/03 66 -132 kW	48-080651	25-45	20-40	Spacers required for several wheel/tyre combinations; Conditions see certificates VA: axle load to: 1060 kg HA: axle load to: 1010 kg
B16 PSS9	1.8 T quattro, 1.9 TDI quattro, S3 quattro 12/96 - 05/03 96 -165 kW	48-080422	30-50	30-50	Spacers required for several wheel/tyre combinations; Conditions see certificates VA: axle load to: 1110 kg HA: axle load to: 1080 kg
AUDI A3 (8P1)					
B12 PK	1.2 TSI, 1.4 TFSI, 1.6 TDI, 1.8 T, 1.8 TFSI, 1.9 TDI, 2.0, 2.0 FSI, 2.0 TFSI 09/04 - 08/12 66 -147 kW	46-183095	30	30	mark: G02; without electronic suspension control; outside diameter strut 50 mm; Conditions see certificates; With General Certification (ABE) VA: axle load to: 1065 kg HA: axle load to: 1005 kg
B12 PK	1.2 TSI, 1.4 TFSI, 1.6 TDI, 1.8 T, 1.8 TFSI, 1.9 TDI, 2.0, 2.0 FSI, 2.0 TFSI 09/04 - 08/12 66 -147 kW	46-194541	30	30	mark: G07,G08; without electronic suspension control; outside diameter strut 55 mm; Conditions see certificates; With General Certification (ABE) VA: axle load to: 1065 kg HA: axle load to: 1005 kg
B12 PK	1.6, 1.6 FSI 05/03 - 08/12 75 -85 kW	46-183088	30	30	mark: G02; manual transmission; disconnect DCC; outside diameter strut 50 mm; Conditions see certificates VA: axle load to: 980 kg HA: axle load to: 1005 kg
B12 PK	1.6, 1.6 FSI 05/03 - 08/12 75 -85 kW	46-183095	30	30	mark: G02; automatic transmission; disconnect DCC; outside diameter strut 50 mm; Conditions see certificates VA: axle load to: 1065 kg HA: axle load to: 1005 kg
B12 PK	1.6, 1.6 FSI 05/03 - 08/12 75 -85 kW	46-194534	30	30	mark: G07, G08; manual transmission; disconnect DCC; outside diameter strut 55 mm; Conditions see certificates VA: axle load to: 980 kg HA: axle load to: 1005 kg
B12 PK	1.6, 1.6 FSI 05/03 - 08/12 75 -85 kW	46-194541	30	30	mark: G07,G08; automatic transmission; disconnect DCC; outside diameter strut 55 mm; Conditions see certificates VA: axle load to: 1065 kg HA: axle load to: 1005 kg
B12 PK	1.8 TFSI quattro, 2.0 TDI 16V quattro, 2.0 TDI quattro, 2.0 TFSI quattro 09/04 - 08/12 100 -147 kW	46-183125	30	30	mark: G02; without electronic suspension control; outside diameter strut 50 mm; Conditions see certificates; With General Certification (ABE) VA: axle load to: 1155 kg HA: axle load to: 1125 kg
B12 PK	1.8 TFSI quattro, 2.0 TDI 16V quattro, 2.0 TDI quattro, 2.0 TFSI quattro 09/04 - 08/12 100 -147 kW	46-194565	30	30	mark: G07, G08; without electronic suspension control; outside diameter strut 55 mm; Conditions see certificates; With General Certification (ABE) VA: axle load to: 1155 kg HA: axle load to: 1125 kg
B12 PK	3.2 V6 quattro 07/03 - 05/09 184 kW	46-183118	30	30	mark: G07, G08; without electronic suspension control; outside diameter strut 55 mm; Conditions see certificates; With General Certification (ABE) VA: axle load to: 1155 kg HA: axle load to: 1125 kg
B12 PK	1.6 TDI, 1.8 T, 1.8 TFSI, 1.9 TDI, 2.0, 2.0 FSI, 2.0 TDI, 2.0 TFSI 09/04 - 08/12 66 -147 kW	46-183101	30	30	mark: G02; without electronic suspension control; outside diameter strut 50 mm; Conditions see certificates; With General Certification (ABE) VA: axle load to: 1155 kg HA: axle load to: 1005 kg
B12 PK	1.6 TDI, 1.8 T, 1.8 TFSI, 1.9 TDI, 2.0, 2.0 FSI, 2.0 TDI, 2.0 TFSI 09/04 - 08/12 66 -147 kW	46-194558	30	30	mark: G07, G08; without electronic suspension control; outside diameter strut 55 mm; Conditions see certificates; With General Certification (ABE) VA: axle load to: 1155 kg HA: axle load to: 1005 kg
B12 SL	1.2 TSI, 1.4 TFSI, 1.6, 1.6 FSI, 1.6 TDI, 1.9 TDI, 2.0, 2.0 FSI 05/03 - 08/12 66 -120 kW	46-183408	45-50	35-40	mark: G02; disconnect DCC; outside diameter strut 50 mm; Conditions see certificates; With General Certification (ABE) VA: axle load to: 1040 kg HA: axle load to: 1010 kg
B12 SL	1.2 TSI, 1.4 TFSI, 1.6, 1.6 FSI, 1.9 TDI, 2.0, 2.0 FSI 05/03 - 08/12 75 -120 kW	46-194657	45-50	35-40	mark: G07, G08; disconnect DCC; outside diameter strut 55 mm; Conditions see certificates; With General Certification (ABE) VA: axle load to: 1040 kg HA: axle load to: 1010 kg





					
AUDI					
AUDI A3 (8P1)					
B12 SL	1.8 T, 1.8 TFSI, 1.9 TDI, 2.0, 2.0 FSI, 2.0 TDI, 2.0 TDI 16V, 2.0 TFSI 09/04 - 08/12 77 -147 kW	46-194664	45-50	35-40	mark: G07, G08; without electronic suspension control; outside diameter strut 55 mm; Conditions see certificates; With General Certification (ABE) VA: axle load to: 1130 kg HA: axle load to: 1010 kg
B12 SL	1.6 TDI, 1.8 T, 1.8 TFSI, 1.9 TDI, 2.0, 2.0 FSI, 2.0 TDI, 2.0 TDI 16V, 2.0 TFSI 09/04 - 08/12 66 -147 kW	46-183422	45-50	35-40	mark: G02; without electronic suspension control; outside diameter strut 50 mm; Conditions see certificates; With General Certification (ABE) VA: axle load to: 1130 kg HA: axle load to: 1010 kg
B14	1.2 TSI, 1.4 TFSI, 1.6, 1.6 FSI, 1.6 TDI, 1.8 T, 1.8 TFSI, 1.8 TFSI quattro, 1.9 TDI, 2.0, 2.0 FSI, 2.0 TDI, 2.0 TDI 16V, 2.0 TDI 16V quattro, 2.0 TDI quattro, 2.0 TFSI, 2.0 TFSI quattro 09/04 - 08/12 66 -147 kW	47-128347	30-50	30-50	disconnect DCC; outside diameter strut 50 mm; Conditions see certificates VA: mark: G02; axle load to: 1200 kg HA: axle load to: 1100 kg
B14	1.2 TSI, 1.4 TFSI, 1.6, 1.6 FSI, 1.6 TDI, 1.8 T, 1.8 TFSI, 1.8 TFSI quattro, 1.9 TDI, 2.0, 2.0 FSI, 2.0 TDI, 2.0 TDI 16V, 2.0 TDI 16V quattro, 2.0 TDI quattro, 2.0 TFSI, 2.0 TFSI quattro, 3.2 V6 quattro 07/03 - 08/12 66 -184 kW	47-127708	30-50	30-50	Øa: 55 mm; mark: G07, G08; disconnect DCC; Conditions see certificates VA: axle load to: 1200 kg HA: axle load to: 1100 kg
B14	S3 quattro 11/06 - 08/12 188 -195 kW	47-127708	20-30	10-30	Øa: 55 mm; without electronic suspension control; Conditions see certificates VA: axle load to: 1210 kg HA: axle load to: 1100 kg
B16 PSS10	1.2 TSI, 1.4 TFSI, 1.6, 1.6 FSI, 1.6 TDI, 1.8 T, 1.8 TFSI, 1.8 TFSI quattro, 1.9 TDI, 2.0, 2.0 FSI, 2.0 TDI, 2.0 TDI 16V, 2.0 TDI 16V quattro, 2.0 TDI quattro, 2.0 TFSI, 2.0 TFSI quattro 09/04 - 08/12 66 -147 kW	48-135238	30-50	30-50	disconnect DCC; outside diameter strut 50 mm; Conditions see certificates VA: mark: G02; axle load to: 1210 kg; Øa: 50 mm HA: axle load to: 1100 kg
B16 PSS10	1.2 TSI, 1.4 TFSI, 1.6, 1.6 FSI, 1.6 TDI, 1.8 T, 1.8 TFSI, 1.8 TFSI quattro, 1.9 TDI, 2.0, 2.0 FSI, 2.0 TDI, 2.0 TDI 16V, 2.0 TDI 16V quattro, 2.0 TDI quattro, 2.0 TFSI, 2.0 TFSI quattro, 3.2 V6 quattro 07/03 - 08/12 66 -184 kW	48-135245	30-50	30-50	Øa: 55 mm; disconnect DCC; Conditions see certificates VA: mark: G07,G08; axle load to: 1210 kg; Øa: 55 mm HA: axle load to: 1100 kg
B16 PSS10	S3 quattro 11/06 - 08/12 188 -195 kW	48-135245	20-30	10-30	Øa: 55 mm; without electronic suspension control; Conditions see certificates VA: axle load to: 1210 kg HA: axle load to: 1100 kg
B16 RC	1.2 TSI, 1.4 TFSI, 1.6, 1.6 FSI, 1.6 TDI, 1.8 T, 1.8 TFSI, 1.8 TFSI quattro, 1.9 TDI, 2.0, 2.0 FSI, 2.0 TDI, 2.0 TDI 16V, 2.0 TDI 16V quattro, 2.0 TDI quattro, 2.0 TFSI, 2.0 TFSI quattro, 3.2 V6 quattro 07/03 - 08/12 66 -184 kW	49-196849 14-230615	20-40	20-40	Øa: 55 mm; mark: G07, G08, G09, G11; disconnect DCC; Conditions see certificates VA: axle load to: 1140 kg HA: axle load to: 1040 kg
B16 RC	S3 quattro 02/07 - 08/12 188 kW	49-196849 14-230615	10-20	10-30	Øa: 55 mm; mark: G07, G08, G09, G11; disconnect DCC; Conditions see certificates VA: axle load to: 1140 kg HA: axle load to: 1040 kg
B16 RC	S3 quattro 11/06 - 08/12 195 kW	49-196849 14-230615	20-30	10-30	Øa: 55 mm; mark: G07, G08, G09, G11; disconnect DCC; Conditions see certificates VA: axle load to: 1140 kg HA: axle load to: 1040 kg
B16 BCS	2.0 TDI, 2.0 TDI quattro, 2.0 TFSI, 2.0 TFSI quattro, 3.2 V6 quattro, S3 quattro 07/03 - 08/12 125 -195 kW	48-215909	10-20	10-30	Øa: 55 mm; Conditions see certificates VA: axle load to: 1210 kg HA: axle load to: 1110 kg





					
AUDI					
AUDI A3 Sportback (8PA)					
B12 PK	1.4 TFSI, 1.6 TDI, 1.8 TFSI, 1.9 TDI, 2.0, 2.0 FSI, 2.0 TFSI 09/04 - 66 -147 kW	46-183156	30	30	mark: G02; disconnect DCC; outside diameter strut 50 mm; Conditions see certificates; With General Certification (ABE) VA: axle load to: 1065 kg HA: axle load to: 1005 kg
B12 PK	1.4 TFSI, 1.6 TDI, 1.8 TFSI, 1.9 TDI, 2.0, 2.0 FSI, 2.0 TFSI 09/04 - 66 -147 kW	46-194589	30	30	mark: G07, G08; disconnect DCC; outside diameter strut 55 mm; Conditions see certificates; With General Certification (ABE) VA: axle load to: 1065 kg HA: axle load to: 1005 kg
B12 PK	1.6, 1.6 FSI 09/04 - 75 -85 kW	46-183132	30	30	mark: G02; manual transmission; outside diameter strut 55 mm; Conditions see certificates; With General Certification (ABE) VA: axle load to: 980 kg HA: axle load to: 1005 kg
B12 PK	1.6, 1.6 FSI 09/04 - 75 -85 kW	46-183156	30	30	mark: G02; automatic transmission; outside diameter strut 50 mm; Conditions see certificates; With General Certification (ABE) VA: axle load to: 1065 kg HA: axle load to: 1005 kg
B12 PK	1.6, 1.6 FSI 09/04 - 75 -85 kW	46-194572	30	30	mark: G07, G08; manual transmission; outside diameter strut 50 mm; Conditions see certificates; With General Certification (ABE) VA: axle load to: 980 kg HA: axle load to: 1005 kg
B12 PK	1.6, 1.6 FSI 09/04 - 75 -85 kW	46-194589	30	30	mark: G07, G08; automatic transmission; outside diameter strut 55 mm; Conditions see certificates; With General Certification (ABE) VA: axle load to: 1065 kg HA: axle load to: 1005 kg
B12 PK	1.8 TFSI, 2.0 TDI, 2.0 TDI 16V 09/04 - 100 -125 kW	46-183163	30	30	mark: G02; outside diameter strut 50 mm; Conditions see certificates; With General Certification (ABE) VA: axle load to: 1155 kg HA: axle load to: 1005 kg
B12 PK	1.8 TFSI, 2.0 TDI, 2.0 TDI 16V 09/04 - 100 -125 kW	46-194596	30	30	mark: G07, G08; outside diameter strut 55 mm; Conditions see certificates; With General Certification (ABE) VA: axle load to: 1155 kg HA: axle load to: 1005 kg
B12 PK	1.8 TFSI quattro, 2.0 TDI 16V quattro, 2.0 TDI quattro, 2.0 TFSI quattro 09/04 - 103 -147 kW	46-194640	30	30	mark: G07, G08; without electronic suspension control; outside diameter strut 55 mm; Conditions see certificates; With General Certification (ABE) VA: axle load to: 1155 kg HA: axle load to: 1125 kg
B12 PK	1.8 TFSI quattro, 2.0 TDI 16V quattro, 2.0 TDI quattro, 2.0 TFSI quattro 09/04 - 103 -147 kW	46-183187	30	30	mark: G02; without electronic suspension control; outside diameter strut 50 mm; Conditions see certificates; With General Certification (ABE) VA: axle load to: 1155 kg HA: axle load to: 1125 kg
B12 PK	3.2 V6 quattro 09/04 - 05/09 184 kW	46-183170	30	30	mark: G07, G08; outside diameter strut 55 mm; Conditions see certificates; With General Certification (ABE) VA: axle load to: 1155 kg HA: axle load to: 1125 kg
B12 PK	1.6 TDI, 2.0 TFSI 09/04 - 66 -147 kW	46-183163	30	30	mark: G02; automatic transmission; outside diameter strut 50 mm; Conditions see certificates; With General Certification (ABE) VA: axle load to: 1155 kg HA: axle load to: 1005 kg
B12 PK	1.6 TDI, 2.0 TFSI 09/04 - 66 -147 kW	46-194596	30	30	mark: G07, G08; automatic transmission; outside diameter strut 55 mm; Conditions see certificates; With General Certification (ABE) VA: axle load to: 1155 kg HA: axle load to: 1005 kg
B12 SL	1.4 TFSI, 1.6, 1.6 FSI, 1.6 TDI, 1.9 TDI, 2.0, 2.0 FSI 09/04 - 66 -120 kW	46-183439	45-50	35-40	mark: G02; disconnect DCC; outside diameter strut 50 mm; Conditions see certificates; With General Certification (ABE) VA: axle load to: 1040 kg HA: axle load to: 1005 kg
B12 SL	1.4 TFSI, 1.6 TDI, 1.8 TFSI, 1.9 TDI, 2.0, 2.0 FSI, 2.0 TDI, 2.0 TDI 16V, 2.0 TFSI 09/04 - 66 -147 kW	46-183446	45-50	35-40	mark: G02; disconnect DCC; outside diameter strut 50 mm; Conditions see certificates; With General Certification (ABE) VA: axle load to: 1130 kg HA: axle load to: 1005 kg
B12 SL	1.4 TFSI, 1.6, 1.6 FSI, 1.6 TDI, 1.9 TDI, 2.0, 2.0 FSI 09/04 - 66 -120 kW	46-194671	45-50	35-40	mark: G07, G08; disconnect DCC; outside diameter strut 55 mm; Conditions see certificates; With General Certification (ABE) VA: axle load to: 1040 kg HA: axle load to: 1010 kg
B12 SL	1.4 TFSI, 1.6 TDI, 1.8 TFSI, 1.9 TDI, 2.0, 2.0 FSI, 2.0 TDI, 2.0 TDI 16V, 2.0 TFSI 09/04 - 66 -147 kW	46-194688	45-50	35-40	mark: G07, G08; disconnect DCC; outside diameter strut 55 mm; Conditions see certificates; With General Certification (ABE) VA: axle load to: 1130 kg HA: axle load to: 1010 kg





					
AUDI					
AUDI A3 Sportback (8PA)					
B14	1.2 TSI, 1.4 TFSI, 1.6, 1.6 FSI, 1.6 TDI, 1.8 TFSI, 1.8 TFSI quattro, 1.9 TDI, 2.0, 2.0 FSI, 2.0 TDI, 2.0 TDI 16V, 2.0 TDI 16V quattro, 2.0 TDI quattro, 2.0 TFSI, 2.0 TFSI quattro, 3.2 V6 quattro 09/04 - 66 -184 kW	47-128347	30-50	30-50	disconnect DCC; outside diameter strut 50 mm; Conditions see certificates VA: mark: G02; axle load to: 1210 kg HA: axle load to: 1100 kg
B14	1.2 TSI, 1.4 TFSI, 1.6, 1.6 FSI, 1.6 TDI, 1.8 TFSI, 1.8 TFSI quattro, 1.9 TDI, 2.0, 2.0 FSI, 2.0 TDI, 2.0 TDI 16V, 2.0 TDI 16V quattro, 2.0 TDI quattro, 2.0 TFSI, 2.0 TFSI quattro, 3.2 V6 quattro 09/04 - 66 -184 kW	47-127708	30-50	30-50	Øa: 55 mm; disconnect DCC; Conditions see certificates VA: axle load to: 1210 kg HA: axle load to: 1100 kg
B14	RS3 quattro, S3 quattro 06/08 - 188 -250 kW	47-127708	20-30	20-30	Øa: 55 mm; disconnect DCC; Conditions see certificates VA: axle load to: 1210 kg HA: axle load to: 1100 kg
B16 PSS10	1.2 TSI, 1.4 TFSI, 1.6, 1.6 FSI, 1.6 TDI, 1.8 TFSI, 1.8 TFSI quattro, 1.9 TDI, 2.0, 2.0 FSI, 2.0 TDI, 2.0 TDI 16V, 2.0 TDI 16V quattro, 2.0 TDI quattro, 2.0 TFSI, 2.0 TFSI quattro, 3.2 V6 quattro 09/04 - 66 -184 kW	48-135238	30-50	30-50	disconnect DCC; outside diameter strut 50 mm; Conditions see certificates VA: mark: G02; axle load to: 1210 kg HA: axle load to: 1100 kg
B16 PSS10	1.2 TSI, 1.4 TFSI, 1.6, 1.6 FSI, 1.6 TDI, 1.8 TFSI, 1.8 TFSI quattro, 1.9 TDI, 2.0, 2.0 FSI, 2.0 TDI, 2.0 TDI 16V, 2.0 TDI 16V quattro, 2.0 TDI quattro, 2.0 TFSI, 2.0 TFSI quattro, 3.2 V6 quattro 09/04 - 66 -184 kW	48-135245	30-50	30-50	Øa: 55 mm; disconnect DCC; Conditions see certificates VA: mark: G07,G08; axle load to: 1210 kg HA: axle load to: 1100 kg
B16 PSS10	RS3 quattro, S3 quattro 06/08 - 188 -250 kW	48-135245	20-30	10-30	Øa: 55 mm; disconnect DCC; Conditions see certificates VA: mark: G07,G08; axle load to: 1210 kg HA: axle load to: 1100 kg
B16 RC	1.2 TSI, 1.4 TFSI, 1.6, 1.6 FSI, 1.6 TDI, 1.8 TFSI, 1.8 TFSI quattro, 1.9 TDI, 2.0, 2.0 FSI, 2.0 TDI, 2.0 TDI 16V, 2.0 TDI 16V quattro, 2.0 TDI quattro, 2.0 TFSI, 2.0 TFSI quattro, 3.2 V6 quattro 09/04 - 66 -184 kW	49-196849 14-230615	40-50	30-50	Øa: 55 mm; mark: G07, G08, G09, G11; disconnect DCC; Conditions see certificates VA: axle load to: 1140 kg HA: axle load to: 1040 kg
B16 RC	RS3 quattro, S3 quattro 06/08 - 188 -250 kW	49-196849 14-230615	20-30	10-30	Øa: 55 mm; mark: G07, G08, G09, G11; disconnect DCC; Conditions see certificates VA: axle load to: 1140 kg HA: axle load to: 1040 kg
B16 BCS	2.0 TDI, 2.0 TDI quattro, 2.0 TFSI, 2.0 TFSI quattro, 3.2 V6 quattro, RS3 quattro, S3 quattro 09/04 - 125 -250 kW	48-215909	20-30	10-30	Øa: 55 mm; disconnect DCC; Conditions see certificates VA: axle load to: 1210 kg HA: axle load to: 1100 kg
AUDI A3 Convertible					
B12 PK	1.6 TDI, 1.8 TFSI, 1.9 TDI, 2.0 TDI, 2.0 TFSI 04/08 - 77 -147 kW	46-192431	25	25	mark: G07, G08; disconnect DCC; outside diameter strut 55 mm; Conditions see certificates; With General Certification (ABE) VA: axle load to: 1155 kg HA: axle load to: 985 kg
B14	1.2 TSI, 1.4 TFSI, 1.6, 1.6 TDI, 1.8 TFSI, 1.9 TDI, 2.0 TDI, 2.0 TFSI 04/08 - 75 -147 kW	47-127708	40-50	30-50	Øa: 55 mm; disconnect DCC; Conditions see certificates VA: axle load to: 1210 kg HA: axle load to: 1100 kg
B16 PSS10	1.2 TSI, 1.4 TFSI, 1.6, 1.6 TDI, 1.8 TFSI, 1.9 TDI, 2.0 TDI, 2.0 TFSI 04/08 - 75 -147 kW	48-135245	40-50	30-50	Øa: 55 mm; disconnect DCC; Conditions see certificates VA: axle load to: 1210 kg HA: axle load to: 1100 kg
B16 RC	1.2 TSI, 1.4 TFSI, 1.6, 1.6 TDI, 1.8 TFSI, 1.9 TDI, 2.0 TDI, 2.0 TFSI 04/08 - 75 -147 kW	49-196849 14-230615	40-50	30-50	Øa: 55 mm; mark: G07, G08, G09, G11; disconnect DCC; Conditions see certificates VA: axle load to: 1140 kg HA: axle load to: 1040 kg





   					
AUDI					
AUDI A3 (8V1)					
B14	1.2 TFSI, 1.4 TFSI, 1.6 TDI, 1.8 TFSI, 2.0 TDI 12/12 - 77 -135 kW	47-229945	30-45	25-45	Øa: 50 mm; mark: G01, G02, 0N1; disconnect DCC; Conditions see certificates; rigid axle VA: axle load to: 1070 kg HA: axle load to: 1065 kg
B14	1.2 TFSI, 1.4 TFSI, 1.6 TDI, 1.8 TFSI, 1.8 TFSI quattro, 2.0 TDI, 2.0 TDI quattro, S3 quattro 11/12 - 77 -221 kW	47-229969	30-45	25-45	Øa: 50 mm; mark: G01, G02, 0N4; disconnect DCC; Conditions see certificates; multilink axle VA: axle load to: 1070 kg HA: axle load to: 1065 kg
B14	1.2 TFSI, 1.4 TFSI, 1.6 TDI, 1.8 TFSI, 1.8 TFSI quattro, 2.0 TDI, 2.0 TDI quattro, S3 quattro 11/12 - 77 -221 kW	47-229976	30-45	25-45	Øa: 55 mm; mark: G03, G04, G05; mark: G06, G07, 0N4; disconnect DCC; Conditions see certificates; multilink axle VA: axle load to: 1070 kg HA: axle load to: 1065 kg
B16 PSS10	1.2 TFSI, 1.4 TFSI, 1.6 TDI, 1.8 TFSI, 1.8 TFSI quattro, 2.0 TDI, 2.0 TDI quattro, S3 quattro 11/12 - 77 -221 kW	48-230056	30-45	30-50	Øa: 50 mm; mark: G01, G02, 0N4; disconnect DCC; Conditions see certificates; multilink axle VA: axle load to: 1070 kg HA: axle load to: 1065 kg
B16 PSS10	1.2 TFSI, 1.4 TFSI, 1.6 TDI, 1.8 TFSI, 1.8 TFSI quattro, 2.0 TDI, 2.0 TDI quattro, S3 quattro 11/12 - 77 -221 kW	48-230063	30-45	25-45	Øa: 55 mm; mark: G03, G04, G05; mark: G06, G07, 0N4; disconnect DCC; Conditions see certificates; multilink axle VA: axle load to: 1070 kg HA: axle load to: 1065 kg
B16 RC	1.2 TFSI, 1.4 TFSI, 1.6 TDI, 1.8 TFSI, 1.8 TFSI quattro, 2.0 TDI, 2.0 TDI quattro, S3 quattro 11/12 - 77 -221 kW	14-230615 49-231892	30-45	25-45	Øa: 55 mm; mark: G03, G04, G05; mark: G06, G07, 0N4; disconnect DCC; Conditions see certificates; multilink axle VA: axle load to: 1070 kg HA: axle load to: 1065 kg
B16 BCS	1.8 TFSI, 1.8 TFSI quattro, S3 quattro 04/12 - 132 -221 kW	48-231848	10-30	10-30	Øa: 55 mm; mark: G03, G04, G05; mark: G06, G07, 0N4; disconnect DCC; multilink axle
AUDI A3 Sportback (8VA)					
B14	1.4 TFSI, 1.6 TDI, 1.8 TFSI, 2.0 TDI 09/12 - 77 -132 kW	47-229945	30-45	25-45	Øa: 50 mm; mark: G01, G02, 0N1; disconnect DCC; Conditions see certificates; rigid axle VA: axle load to: 1070 kg HA: axle load to: 1065 kg
B14	1.4 TFSI, 1.6 TDI, 1.8 TFSI, 2.0 TDI, 2.0 TDI quattro 09/12 - 77 -135 kW	47-229969	30-45	25-45	Øa: 50 mm; mark: G01, G02, 0N4; disconnect DCC; Conditions see certificates; multilink axle VA: axle load to: 1070 kg HA: axle load to: 1065 kg
B14	1.4 TFSI, 1.6 TDI, 1.8 TFSI, 2.0 TDI, 2.0 TDI quattro 09/12 - 77 -135 kW	47-229976	30-45	25-45	Øa: 55 mm; mark: G03, G04, G05; mark: G06, G07, 0N4; disconnect DCC; Conditions see certificates; multilink axle VA: axle load to: 1070 kg HA: axle load to: 1065 kg
B16 PSS10	1.4 TFSI, 1.6 TDI, 1.8 TFSI, 2.0 TDI, 2.0 TDI quattro 09/12 - 77 -135 kW	48-230056	30-45	25-45	Øa: 50 mm; mark: G01, G02, 0N4; disconnect DCC; Conditions see certificates; multilink axle VA: axle load to: 1070 kg HA: axle load to: 1065 kg
B16 PSS10	1.4 TFSI, 1.6 TDI, 1.8 TFSI, 2.0 TDI, 2.0 TDI quattro 09/12 - 77 -135 kW	48-230063	30-45	25-45	Øa: 55 mm; mark: G03, G04, G05; mark: G06, G07, 0N4; disconnect DCC; Conditions see certificates; multilink axle VA: axle load to: 1070 kg HA: axle load to: 1065 kg
B16 RC	1.4 TFSI, 1.6 TDI, 1.8 TFSI, 2.0 TDI, 2.0 TDI quattro 09/12 - 77 -135 kW	14-230615 49-231892	30-45	25-45	Øa: 55 mm; mark: G03, G04, G05; mark: G06, G07, 0N4; disconnect DCC; Conditions see certificates; multilink axle VA: axle load to: 1070 kg HA: axle load to: 1065 kg
B16 BCS	2.0 TDI quattro 11/12 - 110 -135 kW	48-231848	10-30	10-30	Øa: 55 mm; mark: G03, G04, G05; mark: G06, G07, 0N4; disconnect DCC; Conditions see certificates; multilink axle
AUDI A4 (8D2, B5)					
B12 PK	1.6, 1.8 11/94 - 01/99 74 -95 kW	46-183194	30	30	-> CH.Nr.: 8D-X-200000; serie production spring seat must be used; Conditions see certificates VA: axle load to: 995 kg HA: axle load to: 970 kg





					
AUDI					
AUDI A4 (8D2, B5)					
B12 PK	1.6, 1.8 02/99 - CH-Nr. 74 -125 kW	46-189066	30	30	CH.Nr.: 8D-X-200001-> 8D-1-030000; serie production spring seat must be used; Conditions see certificates VA: axle load to: 995 kg HA: axle load to: 970 kg
B12 PK	1.6, 1.8 07/00 - 11/00 75 -125 kW	46-189073	30	30	CH.Nr.: 8D-1-030001 ->; Conditions see certificates VA: axle load to: 995 kg HA: axle load to: 970 kg
B12 PK	1.8, 1.8 T, 1.9 TDI, 2.4, 2.6 01/95 - 01/99 55 -132 kW	46-183200	30	30	-> CH.Nr.: 8D-X-200000; serie production spring seat must be used; Conditions see certificates VA: axle load to: 1055 kg HA: axle load to: 970 kg
B12 PK	1.8, 1.8 T, 1.9 TDI, 2.4, 2.6 02/99 - CH-Nr. 55 -132 kW	46-189080	30	30	CH.Nr.: 8D-X-200001-> 8D-1-30000; serie production spring seat must be used; Conditions see certificates VA: axle load to: 1055 kg HA: axle load to: 970 kg
B12 PK	1.8, 1.8 T, 1.9 TDI, 2.4, 2.6 07/00 - 11/00 55 -132 kW	46-189097	30	30	CH.Nr.: 8D-1-030001 ->; Conditions see certificates VA: axle load to: 1055 kg HA: axle load to: 970 kg
B12 PK	1.8 quattro 01/95 - 06/00 85 -92 kW	46-183217	30	30	-> CH.Nr.: 8D-1-030000; Conditions see certificates VA: axle load to: 955 kg HA: axle load to: 970 kg
B12 PK	1.8 quattro CH-Nr. - 07/00 85 -92 kW	46-189103	30	30	CH.Nr.: 8D-1-030001 ->; Conditions see certificates VA: axle load to: 955 kg HA: axle load to: 970 kg
B12 PK	1.8 quattro, 1.8 T quattro, 1.9 TDI quattro, 2.4 quattro, 2.6 quattro 01/95 - 06/00 81 -132 kW	46-183224	30	30	-> CH.Nr.: 8D-1-030000; Conditions see certificates VA: axle load to: 1055 kg HA: axle load to: 1080 kg
B12 PK	1.8 quattro, 1.8 T quattro, 1.9 TDI quattro, 2.4 quattro, 2.6 quattro 07/00 - 11/00 81 -132 kW	46-189110	30	30	CH.Nr.: 8D-1-030001 ->; Conditions see certificates VA: axle load to: 1055 kg HA: axle load to: 1080 kg
B12 PK	1.8 T 01/95 - 01/99 110 -132 kW	46-183194	30	30	-> CH.Nr.: 8D-X-200000; manual transmission; serie production spring seat must be used; without AC; Conditions see certificates VA: axle load to: 995 kg HA: axle load to: 970 kg
B12 PK	1.8 T 02/99 - CH-Nr. 110 -132 kW	46-189066	30	30	CH.Nr.: 8D-X-200001-> 8D-1-030000; manual transmission; serie production spring seat must be used; without AC; Conditions see certificates VA: axle load to: 995 kg HA: axle load to: 970 kg
B12 PK	1.8 T quattro 01/95 - 06/00 110 -132 kW	46-183217	30	30	-> CH.Nr.: 8D-1-030000; manual transmission; without AC; Conditions see certificates VA: axle load to: 955 kg HA: axle load to: 970 kg
B12 PK	1.8 T quattro CH-Nr. - 07/00 110 -132 kW	46-189103	30	30	CH.Nr.: 8D-1-030001 ->; manual transmission; without AC; Conditions see certificates VA: axle load to: 955 kg HA: axle load to: 970 kg
B12 PK	1.8 T 07/00 - 11/00 132 kW	46-189073	30	30	CH.Nr.: 8D-1-030001 ->; manual transmission; without AC; Conditions see certificates VA: axle load to: 995 kg HA: axle load to: 970 kg
B12 PK	2.4, 2.6, 2.8 01/95 - 01/99 102 -142 kW	46-183279	30	30	-> CH.Nr.: 8D-X-200000; automatic transmission; Conditions see certificates VA: axle load to: 1150 kg HA: axle load to: 970 kg
B12 PK	2.4, 2.6, 2.8 02/99 - 06/00 110 -142 kW	46-189189	30	30	CH.Nr.: 8D-X-200001-> 8D-1-030000; Conditions see certificates VA: axle load to: 1150 kg HA: axle load to: 970 kg
B12 PK	2.4, 2.6, 2.8 07/00 - 11/00 110 -142 kW	46-189196	30	30	CH.Nr.: 8D-1-030001 ->; Conditions see certificates VA: axle load to: 1150 kg HA: axle load to: 970 kg
B12 PK	2.4 quattro, 2.6 quattro, 2.8 quattro 10/96 - 06/00 110 -142 kW	46-183286	30	30	-> CH.Nr.: 8D-1-030000; serie production spring seat must be used; Conditions see certificates VA: axle load to: 1150 kg HA: axle load to: 1080 kg
B12 PK	2.4 quattro, 2.6 quattro, 2.8 quattro CH-Nr. - 11/00 110 -142 kW	46-189202	30	30	CH.Nr.: 8D-1-030001 ->; CH.Nr.: 200007 ->; Conditions see certificates VA: axle load to: 1150 kg HA: axle load to: 1080 kg
B12 PK	2.8 09/95 - 01/99 128 -142 kW	46-183200	30	30	-> CH.Nr.: 8D-X-200000; manual transmission; serie production spring seat must be used; Conditions see certificates VA: axle load to: 1055 kg HA: axle load to: 970 kg





					
AUDI					
AUDI A4 (8D2, B5)					
B12 PK	2.8 quattro 01/95 - 06/00 128 -142 kW	46-183224	30	30	-> CH.Nr.: 8D-1-030000; manual transmission; Conditions see certificates VA: axle load to: 1055 kg HA: axle load to: 1080 kg
B12 PK	2.8 02/99 - CH-Nr. 142 kW	46-189080	30	30	CH.Nr.: 8D-X-200001-> 200006; manual transmission; serie production spring seat must be used; Conditions see certificates VA: axle load to: 1055 kg HA: axle load to: 970 kg
B12 PK	2.8 07/00 - 11/00 142 kW	46-189097	30	30	CH.Nr.: 8D-1-030001 ->; manual transmission; Conditions see certificates VA: axle load to: 1055 kg HA: axle load to: 970 kg
B12 PK	2.8 quattro 07/00 - 11/00 142 kW	46-189110	30	30	CH.Nr.: 8D-1-030001 ->; manual transmission; Conditions see certificates VA: axle load to: 1055 kg HA: axle load to: 1080 kg
B12 PK	2.5 TDI 09/97 - 01/99 110 kW	46-183279	30	30	-> CH.Nr.: 8D-X-200000; manual transmission; Conditions see certificates VA: axle load to: 1150 kg HA: axle load to: 970 kg
B12 PK	2.5 TDI 02/99 - 06/00 110 kW	46-189189	30	30	CH.Nr.: 8D-X-200001-> 8D-1-030000; manual transmission; Conditions see certificates VA: axle load to: 1150 kg HA: axle load to: 970 kg
B12 PK	2.5 TDI 07/00 - 11/00 110 kW	46-189196	30	30	CH.Nr.: 8D-1-030001 ->; manual transmission; Conditions see certificates VA: axle load to: 1150 kg HA: axle load to: 970 kg
B12 PK	2.5 TDI quattro 09/97 - 06/00 110 kW	46-183286	30	30	-> CH.Nr.: 8D-1-030000; manual transmission; serie production spring seat must be used; Conditions see certificates VA: axle load to: 1150 kg HA: axle load to: 1080 kg
B12 PK	2.5 TDI quattro CH-Nr. - 11/00 110 kW	46-189202	30	30	CH.Nr.: 8D-1-030001 ->; CH.Nr.: 200007 ->; manual transmission; Conditions see certificates VA: axle load to: 1150 kg HA: axle load to: 1080 kg
B12 SL	1.6, 1.8, 1.8 T, 1.9 TDI, 2.4 11/94 - 01/99 55 -132 kW	46-183361	45-50	35-40	-> CH.Nr.: 8D-X-200000; serie production spring seat must be used; Conditions see certificates VA: axle load to: 1070 kg HA: axle load to: 1010 kg
B12 SL	1.6, 1.8, 1.8 T, 1.9 TDI, 2.4, 2.6 02/99 - CH-Nr. 55 -132 kW	46-189257	45-50	35-40	CH.Nr.: 8D-X-200001-> 8D-1-030000; serie production spring seat must be used; Conditions see certificates VA: axle load to: 1070 kg HA: axle load to: 1010 kg
B12 SL	1.6, 1.8, 1.8 T, 1.9 TDI, 2.4, 2.6 07/00 - 11/00 55 -132 kW	46-189264	45-50	35-40	CH.Nr.: 8D-1-030001 ->; Conditions see certificates VA: axle load to: 1070 kg HA: axle load to: 1010 kg
B12 SL	2.8 09/95 - 01/99 128 -142 kW	46-183361	45-50	35-40	-> CH.Nr.: 8D-X-200000; manual transmission; serie production spring seat must be used; Conditions see certificates VA: axle load to: 1070 kg HA: axle load to: 1010 kg
B12 SL	2.8 02/99 - CH-Nr. 142 kW	46-189257	45-50	35-40	CH.Nr.: 8D-X-200001-> 8D-1-30000; manual transmission; serie production spring seat must be used; Conditions see certificates VA: axle load to: 1070 kg HA: axle load to: 1010 kg
B12 SL	2.8 07/00 - 11/00 142 kW	46-189264	45-50	35-40	CH.Nr.: 8D-1-030001 ->; manual transmission; Conditions see certificates VA: axle load to: 1070 kg HA: axle load to: 1010 kg
B16 PSS9	1.6, 1.8, 1.8 T, 1.9 TDI, 2.4, 2.5 TDI, 2.6, 2.8 11/94 - 11/00 55 -142 kW	48-086059	35-55	30-50	Conditions see certificates VA: axle load to: 1150 kg HA: axle load to: 1020 kg
B16 PSS9	1.8 quattro, 1.8 T quattro, 1.9 TDI quattro, 2.4 quattro, 2.5 TDI quattro, 2.6 quattro, 2.7 Bi Turbo quattro, 2.7 Turbo quattro, 2.8 quattro 01/95 - 11/00 81 -187 kW	48-086103	30-50	30-50	Conditions see certificates VA: axle load to: 1150 kg HA: without ride height adjustment; axle load to: 1140 kg
B16 PSS9	S4 quattro 09/97 - 11/00 195 kW	48-086165	15-35	10-30	Conditions see certificates VA: axle load to: 1150 kg HA: axle load to: 1140 kg





					
AUDI					
AUDI A4 Avant (8D5, B5)					
B12 PK	1.6, 1.8 01/96 - 01/99 74 -92 kW	46-183231	30	30	-> CH.Nr.: 8D-X-200000; serie production spring seat must be used; Conditions see certificates VA: axle load to: 995 kg HA: axle load to: 1045 kg
B12 PK	1.6, 1.8 02/99 - 06/00 74 -92 kW	46-189127	30	30	CH.Nr.: 8D-X-200001-> 8D-1-030000; serie production spring seat must be used; Conditions see certificates VA: axle load to: 995 kg HA: axle load to: 1045 kg
B12 PK	1.6, 1.8 07/00 - 09/01 75 -92 kW	46-189134	30	30	CH.Nr.: 8D-1-030001 ->; Conditions see certificates VA: axle load to: 995 kg HA: axle load to: 1045 kg
B12 PK	1.8, 1.8 T, 1.9 TDI, 2.4, 2.6 01/96 - 01/99 55 -132 kW	46-183248	30	30	CH.Nr.: 8D-X-200000 ->; serie production spring seat must be used; Conditions see certificates VA: axle load to: 1055 kg HA: axle load to: 1045 kg
B12 PK	1.8, 1.8 T, 1.9 TDI, 2.4, 2.6 02/99 - 06/00 55 -132 kW	46-189141	30	30	CH.Nr.: 8D-X-200001-> 8D-1-030000; serie production spring seat must be used; Conditions see certificates VA: axle load to: 1055 kg HA: axle load to: 1045 kg
B12 PK	1.8 quattro 03/98 - CH-Nr. 85 -92 kW	46-183255	30	30	CH.Nr.: 8D-W-006471-> 8D-1-030000; serie production spring seat must be used; Conditions see certificates VA: axle load to: 995 kg HA: axle load to: 1115 kg
B12 PK	1.8 quattro, 1.8 T quattro, 1.9 TDI quattro, 2.4 quattro, 2.6 quattro 03/98 - CH-Nr. 81 -132 kW	46-183262	30	30	CH.Nr.: 8D-W-006471-> 8D-1-030000; serie production spring seat must be used; Conditions see certificates VA: axle load to: 1055 kg HA: axle load to: 1115 kg
B12 PK	1.8 quattro 07/00 - 09/01 85 -92 kW	46-189165	30	30	CH.Nr.: 8D-1-030001 ->; Conditions see certificates VA: axle load to: 995 kg HA: axle load to: 1115 kg
B12 PK	1.8 quattro, 1.8 T quattro, 1.9 TDI quattro, 2.4 quattro, 2.6 quattro 07/00 - 09/01 81 -132 kW	46-189172	30	30	CH.Nr.: 8D-1-030001 ->; Conditions see certificates VA: axle load to: 1055 kg HA: axle load to: 1115 kg
B12 PK	1.8, 1.8 T, 1.9 TDI, 2.4, 2.6 07/00 - 09/01 55 -132 kW	46-189158	30	30	CH.Nr.: 8D-1-030001 ->; Conditions see certificates VA: axle load to: 1055 kg HA: axle load to: 1045 kg
B12 PK	1.8 T 02/99 - 06/00 110 -132 kW	46-189127	30	30	CH.Nr.: 8D-X-200001-> 8D-1-030000; manual transmission; serie production spring seat must be used; without AC; Conditions see certificates VA: axle load to: 995 kg HA: axle load to: 1045 kg
B12 PK	1.8 T 07/00 - 09/01 110 -132 kW	46-189134	30	30	CH.Nr.: 8D-1-030001 ->; manual transmission; without AC; Conditions see certificates VA: axle load to: 995 kg HA: axle load to: 1045 kg
B12 PK	1.8 T quattro 03/98 - CH-Nr. 110 -132 kW	46-183255	30	30	CH.Nr.: 8D-W-006471-> 8D-1-030000; manual transmission; serie production spring seat must be used; without AC; Conditions see certificates VA: axle load to: 995 kg HA: axle load to: 1115 kg
B12 PK	1.8 T quattro 07/00 - 09/01 110 -132 kW	46-189165	30	30	CH.Nr.: 8D-1-030001 ->; manual transmission; without AC; Conditions see certificates VA: axle load to: 995 kg HA: axle load to: 1115 kg
B12 PK	2.4, 2.6, 2.8 01/96 - 01/99 102 -142 kW	46-183293	30	30	CH.Nr.: 8D-X-200000 ->; serie production spring seat must be used; Conditions see certificates VA: axle load to: 1150 kg HA: axle load to: 1045 kg
B12 PK	2.4, 2.6, 2.8 02/99 - 06/00 110 -142 kW	46-189219	30	30	CH.Nr.: 8D-X-200001-> 8D-1-030000; serie production spring seat must be used; Conditions see certificates VA: axle load to: 1150 kg HA: axle load to: 1045 kg
B12 PK	2.4, 2.6, 2.8 07/00 - 09/01 110 -142 kW	46-189226	30	30	CH.Nr.: 8D-1-030001 ->; Conditions see certificates VA: axle load to: 1150 kg HA: axle load to: 1045 kg
B12 PK	2.4 quattro, 2.6 quattro, 2.8 quattro 07/00 - 09/01 110 -142 kW	46-189233	30	30	CH.Nr.: 8D-1-030001 ->; Conditions see certificates VA: axle load to: 1150 kg HA: axle load to: 1115 kg
B12 PK	2.4 quattro, 2.6 quattro, 2.8 quattro 03/98 - CH-Nr. 110 -142 kW	46-183309	30	30	CH.Nr.: 8D-W-006471-> 8D-1-030000; serie production spring seat must be used; Conditions see certificates VA: axle load to: 1150 kg HA: axle load to: 1115 kg





					
AUDI					
AUDI A4 Avant (8D5, B5)					
B12 PK	S4 quattro 09/97 - 09/01 195 kW	46-183316	20	20	serie production spring seat must be used; Conditions see certificates VA: axle load to: 1150 kg HA: axle load to: 1130 kg
B12 PK	2.8 01/96 - 01/99 128 -142 kW	46-183248	30	30	CH.Nr.: 8D-X-200000 ->; manual transmission; serie production spring seat must be used; Conditions see certificates VA: axle load to: 1055 kg HA: axle load to: 1045 kg
B12 PK	2.8 02/99 - 06/00 140 -142 kW	46-189141	30	30	CH.Nr.: 8D-X-200001-> 8D-1-030000; manual transmission; serie production spring seat must be used; Conditions see certificates VA: axle load to: 1055 kg HA: axle load to: 1045 kg
B12 PK	2.8 07/00 - 09/01 140 -142 kW	46-189158	30	30	CH.Nr.: 8D-1-030001 ->; manual transmission; Conditions see certificates VA: axle load to: 1055 kg HA: axle load to: 1045 kg
B12 PK	2.8 quattro 03/98 - CH-Nr. 142 kW	46-183262	30	30	CH.Nr.: 8D-1-030000-> 8D-W-006471; manual transmission; serie production spring seat must be used; Conditions see certificates VA: axle load to: 1055 kg HA: axle load to: 1115 kg
B12 PK	2.8 quattro 07/00 - 09/01 142 kW	46-189172	30	30	CH.Nr.: 8D-1-030001 ->; manual transmission; Conditions see certificates VA: axle load to: 1055 kg HA: axle load to: 1115 kg
B12 PK	2.5 TDI 01/96 - 01/99 110 kW	46-183293	30	30	CH.Nr.: 8D-X-200000 ->; manual transmission; serie production spring seat must be used; Conditions see certificates VA: axle load to: 1150 kg HA: axle load to: 1045 kg
B12 PK	2.5 TDI 02/99 - 06/00 110 kW	46-189219	30	30	CH.Nr.: 8D-X-200001-> 8D-1-030000; manual transmission; serie production spring seat must be used; Conditions see certificates VA: axle load to: 1150 kg HA: axle load to: 1045 kg
B12 PK	2.5 TDI 07/00 - 09/01 110 kW	46-189226	30	30	CH.Nr.: 8D-1-030001 ->; manual transmission; Conditions see certificates VA: axle load to: 1150 kg HA: axle load to: 1045 kg
B12 PK	2.5 TDI quattro 03/98 - CH-Nr. 110 kW	46-183309	30	30	CH.Nr.: 8D-W-006471-> 8D-1-030000; manual transmission; serie production spring seat must be used; Conditions see certificates VA: axle load to: 1150 kg HA: axle load to: 1115 kg
B12 PK	2.5 TDI quattro 07/00 - 09/01 110 kW	46-189233	30	30	CH.Nr.: 8D-1-030001 ->; manual transmission; Conditions see certificates VA: axle load to: 1150 kg HA: axle load to: 1115 kg
B12 SL	1.6, 1.8, 1.8 T, 1.9 TDI, 2.4, 2.6, 2.8 01/96 - 01/99 55 -142 kW	46-183361	45-50	35-40	-> CH.Nr.: 8D-X-200000; serie production spring seat must be used; Conditions see certificates VA: axle load to: 1070 kg HA: axle load to: 1010 kg
B12 SL	1.6, 1.8, 1.8 T, 1.9 TDI, 2.4, 2.6 02/99 - 06/00 55 -132 kW	46-189257	45-50	35-40	CH.Nr.: 8D-X-200001-> 8D-1-030000; serie production spring seat must be used; Conditions see certificates VA: axle load to: 1070 kg HA: axle load to: 1010 kg
B12 SL	1.6, 1.8, 1.8 T, 1.9 TDI, 2.4, 2.6 07/00 - CH-Nr. 55 -132 kW	46-189264	45-50	35-40	-> CH.Nr.: 8D-1-030001; Conditions see certificates VA: axle load to: 1070 kg HA: axle load to: 1010 kg
B12 SL	2.8 02/99 - 06/00 140 -142 kW	46-189257	45-50	35-40	CH.Nr.: 8D-X-200001-> 8D-1-030000; manual transmission; serie production spring seat must be used; Conditions see certificates VA: axle load to: 1070 kg HA: axle load to: 1010 kg
B12 SL	2.8 07/00 - CH-Nr. 140 -142 kW	46-189264	45-50	35-40	-> CH.Nr.: 8D-1-030001; manual transmission; Conditions see certificates VA: axle load to: 1070 kg HA: axle load to: 1010 kg
B16 PSS9	1.6, 1.8, 1.8 T, 1.9 TDI, 2.4, 2.5 TDI, 2.6, 2.8 11/94 - 09/01 55 -142 kW	48-086059	35-55	30-50	Conditions see certificates VA: axle load to: 1150 kg HA: axle load to: 1020 kg
B16 PSS9	1.8 quattro, 1.8 T quattro, 1.9 TDI quattro, 2.4 quattro, 2.5 TDI quattro, 2.6 quattro, 2.8 quattro 07/95 - 09/01 81 -142 kW	48-086103	30-50	30-50	without ride height adjustment; Conditions see certificates VA: axle load to: 1150 kg HA: axle load to: 1140 kg
B16 PSS9	RS4 quattro, S4 quattro 09/97 - 09/01 195 -280 kW	48-086165	15-35	10-30	Conditions see certificates VA: axle load to: 1150 kg HA: axle load to: 1140 kg





					
AUDI					
AUDI A4 (8E2, B6)					
B12 PK	1.6, 1.8 T, 2.0, 2.0 FSI 11/00 - 09/02 75 -125 kW	46-182968	30	30	-> CH.Nr.: 8E-2-400 000; Conditions see certificates VA: axle load to: 1090 kg HA: axle load to: 1035 kg
B12 PK	1.6, 1.8 T, 2.0, 2.0 FSI 10/02 - 12/04 75 -140 kW	46-188465	30	30	CH.Nr.: 8E-2-400001 ->; Conditions see certificates VA: axle load to: 1090 kg HA: axle load to: 1035 kg
B12 PK	1.8 T quattro 11/00 - 09/02 110 -125 kW	46-182999	30	30	-> CH.Nr.: 8E-2-400 000; Conditions see certificates VA: axle load to: 1090 kg HA: axle load to: 1135 kg
B12 PK	1.8 T quattro, 1.9 TDI quattro, 3.0 quattro 11/00 - 09/02 96 -162 kW	46-183002	30	30	-> CH.Nr.: 8E-2-400 000; Conditions see certificates VA: axle load to: 1165 kg HA: axle load to: 1135 kg
B12 PK	1.8 T quattro 10/02 - 12/04 120 -140 kW	46-188496	30	30	CH.Nr.: 8E-2-400001 ->; Conditions see certificates VA: axle load to: 1090 kg HA: axle load to: 1135 kg
B12 PK	1.8 T quattro, 1.9 TDI quattro, 3.0 quattro 10/02 - 12/04 96 -162 kW	46-188502	30	30	CH.Nr.: 8E-2-400001 ->; Conditions see certificates VA: axle load to: 1165 kg HA: axle load to: 1135 kg
B12 PK	1.9 TDI, 2.4, 3.0 11/00 - 09/02 74 -162 kW	46-182975	30	30	-> CH.Nr.: 8E-2-400 000; Conditions see certificates VA: axle load to: 1165 kg HA: axle load to: 1035 kg
B12 PK	1.9 TDI, 2.4, 3.0 10/02 - 12/04 74 -162 kW	46-188472	30	30	CH.Nr.: 8E-2-400001 ->; Conditions see certificates VA: axle load to: 1165 kg HA: axle load to: 1035 kg
B12 PK	2.5 TDI 08/01 - 09/02 114 -120 kW	46-183019	30	30	-> CH.Nr.: 8E-2-400 000; Conditions see certificates VA: axle load to: 1230 kg HA: axle load to: 1035 kg
B12 PK	2.5 TDI 10/02 - 12/04 120 kW	46-188519	30	30	CH.Nr.: 8E-2-400001 ->; Conditions see certificates VA: axle load to: 1230 kg HA: axle load to: 1035 kg
B12 PK	2.5 TDI quattro 11/00 - 09/02 132 kW	46-182982	30	30	-> CH.Nr.: 8E-2-400 000; Conditions see certificates VA: axle load to: 1230 kg HA: axle load to: 1135 kg
B12 PK	2.5 TDI quattro 10/02 - 12/04 132 kW	46-188489	30	30	CH.Nr.: 8E-2-400001 ->; Conditions see certificates VA: axle load to: 1230 kg HA: axle load to: 1135 kg
B12 SL	1.6, 1.8 T, 2.0, 2.0 FSI 11/00 - 09/02 75 -125 kW	46-183378	45-50	35-40	-> CH.Nr.: 8E-2-400 000; Conditions see certificates VA: axle load to: 1090 kg HA: axle load to: 1035 kg
B12 SL	1.6, 1.8 T, 2.0, 2.0 FSI 10/02 - 12/04 75 -140 kW	46-188588	45-50	35-40	CH.Nr.: 8E-2-400001 ->; Conditions see certificates VA: axle load to: 1090 kg HA: axle load to: 1035 kg
B12 SL	1.9 TDI, 2.4, 3.0 11/00 - 09/02 74 -162 kW	46-183385	45-50	35-40	-> CH.Nr.: 8E-2-400 000; Conditions see certificates VA: axle load to: 1140 kg HA: axle load to: 1035 kg
B12 SL	1.9 TDI, 2.4, 3.0 10/02 - 12/04 74 -162 kW	46-188595	45-50	35-40	CH.Nr.: 8E-2-400001 ->; Conditions see certificates VA: axle load to: 1140 kg HA: axle load to: 1035 kg
B14	1.6, 1.8 T, 1.8 T quattro, 1.9 TDI, 1.9 TDI quattro, 2.0, 2.0 FSI, 2.4, 2.5 D, 2.5 TDI, 2.5 TDI quattro, 3.0, 3.0 quattro 10/00 - 12/04 74 -162 kW	47-169289	30-60	20-50	Conditions see certificates VA: axle load to: 1250 kg HA: axle load to: 1170 kg
B14	S4 quattro 03/03 - 12/04 253 kW	47-119444	10-30	10-30	Conditions see certificates VA: axle load to: 1250 kg HA: axle load to: 1170 kg
B16 PSS9	1.6, 1.8 T, 1.8 T quattro, 1.9 TDI, 1.9 TDI quattro, 2.0, 2.0 FSI, 2.4, 2.5 D, 2.5 TDI, 2.5 TDI quattro, 3.0, 3.0 quattro 10/00 - 12/04 74 -162 kW	48-169301	30-60	20-50	Conditions see certificates VA: axle load to: 1250 kg HA: axle load to: 1170 kg
B16 PSS9	S4 quattro 03/03 - 12/04 253 kW	48-105958	10-30	10-30	Conditions see certificates VA: axle load to: 1250 kg HA: axle load to: 1170 kg





					
AUDI					
AUDI A4 Avant (8E5, B6)					
B12 PK	1.6, 1.8 T, 2.0, 2.0 FSI 09/01 - 12/05 75 -140 kW	46-183026	30	30	-> CH.Nr.: 8E-5-400 000; Conditions see certificates VA: axle load to: 1090 kg HA: axle load to: 1130 kg
B12 PK	1.8 T quattro 09/01 - 12/05 110 -140 kW	46-183064	30	30	-> CH.Nr.: 8E-5-400 000; Conditions see certificates VA: axle load to: 1090 kg HA: axle load to: 1150 kg
B12 PK	1.8 T quattro, 1.9 TDI quattro, 3.0 quattro 04/01 - 12/05 96 -162 kW	46-183071	30	30	-> CH.Nr.: 8E-5-400 000; Conditions see certificates VA: axle load to: 1165 kg HA: axle load to: 1150 kg
B12 PK	1.8 T quattro CH-Nr. - 12/04 110 -140 kW	46-188564	30	30	CH.Nr.: 8E-5-400 001 ->; Conditions see certificates VA: axle load to: 1090 kg HA: axle load to: 1150 kg
B12 PK	1.8 T quattro, 1.9 TDI quattro, 3.0 quattro CH-Nr. - 12/04 96 -162 kW	46-188571	30	30	CH.Nr.: 8E-5-400 001 ->; Conditions see certificates VA: axle load to: 1165 kg HA: axle load to: 1150 kg
B12 PK	1.8 T, 2.0, 2.0 FSI CH-Nr. - 12/04 96 -140 kW	46-188526	30	30	CH.Nr.: 8E-5-400 001 ->; Conditions see certificates VA: axle load to: 1090 kg HA: axle load to: 1130 kg
B12 PK	1.9 TDI, 2.4, 3.0 09/01 - 12/05 74 -162 kW	46-183033	30	30	-> CH.Nr.: 8E-5-400 000; Conditions see certificates VA: axle load to: 1165 kg HA: axle load to: 1130 kg
B12 PK	1.9 TDI, 2.4, 3.0 CH-Nr. - 12/04 74 -162 kW	46-188533	30	30	CH.Nr.: 8E-5-400 001 ->; Conditions see certificates VA: axle load to: 1165 kg HA: axle load to: 1130 kg
B12 PK	2.5 TDi 10/00 - 12/05 114 -132 kW	46-183040	30	30	-> CH.Nr.: 8E-5-400 000; Conditions see certificates VA: axle load to: 1230 kg HA: axle load to: 1130 kg
B12 PK	2.5 TDi CH-Nr. - 12/04 114 -132 kW	46-188540	30	30	CH.Nr.: 8E-5-400 001 ->; Conditions see certificates VA: axle load to: 1230 kg HA: axle load to: 1130 kg
B12 PK	2.5 TDI quattro 09/01 - 12/05 132 kW	46-183057	30	30	-> CH.Nr.: 8E-5-400 000; Conditions see certificates VA: axle load to: 1230 kg HA: axle load to: 1150 kg
B12 PK	2.5 TDI quattro CH-Nr. - 12/04 132 kW	46-188557	30	30	CH.Nr.: 8E-5-400 001 ->; Conditions see certificates VA: axle load to: 1230 kg HA: axle load to: 1150 kg
B12 SL	1.6, 1.8 T, 2.0, 2.0 FSI 09/01 - 12/05 75 -140 kW	46-182401	45-50	35-40	-> CH.Nr.: 8E-5-400 000; Conditions see certificates VA: axle load to: 1090 kg HA: axle load to: 1090 kg
B12 SL	1.6, 1.8 T, 2.0, 2.0 FSI CH-Nr. - 12/04 75 -140 kW	46-188601	45-50	35-40	CH.Nr.: 8E-5-400 001 ->; Conditions see certificates VA: axle load to: 1090 kg HA: axle load to: 1090 kg
B12 SL	1.9 TDI, 2.4, 3.0 09/01 - 12/05 74 -162 kW	46-182418	45-50	35-40	-> CH.Nr.: 8E-5-400 000; Conditions see certificates VA: axle load to: 1140 kg HA: axle load to: 1090 kg
B12 SL	1.9 TDI, 2.4, 3.0 CH-Nr. - 12/04 74 -162 kW	46-188618	45-50	35-40	CH.Nr.: 8E-5-400 001 ->; Conditions see certificates VA: axle load to: 1140 kg HA: axle load to: 1090 kg
B14	1.6, 1.8 T, 1.8 T quattro, 1.9 TDI, 1.9 TDI quattro, 2.0, 2.0 FSI, 2.4, 2.5 TDi, 2.5 TDI quattro, 3.0, 3.0 quattro 04/01 - 12/04 74 -162 kW	47-169289	30-60	20-50	Conditions see certificates VA: axle load to: 1250 kg HA: axle load to: 1170 kg
B14	S4 quattro 03/03 - 12/04 253 kW	47-119444	10-30	10-30	Conditions see certificates VA: axle load to: 1250 kg HA: axle load to: 1170 kg
B16 PSS9	1.6, 1.8 T, 1.8 T quattro, 1.9 TDI, 1.9 TDI quattro, 2.0, 2.0 FSI, 2.4, 2.5 TDi, 2.5 TDI quattro, 3.0, 3.0 quattro 04/01 - 12/04 74 -162 kW	48-169301	30-60	20-50	Conditions see certificates VA: axle load to: 1250 kg HA: axle load to: 1170 kg
B16 PSS9	S4 quattro 03/03 - CH-Nr. 253 kW	48-105958	10-30	10-30	-> CH.Nr.: 8E-2-400 000; Conditions see certificates VA: axle load to: 1250 kg HA: axle load to: 1170 kg
AUDI A4 Convertible (8H7, 8HE)					
B12 PK	1.8 T, 2.0 TDI, 2.0 TFSI 01/07 - 03/09 100 -147 kW	46-188687	20	20	CH.Nr.: 8E-7-400 001 ->; Conditions see certificates VA: axle load to: 1150 kg HA: axle load to: 1100 kg





					
AUDI					
AUDI A4 Convertible (8H7, 8HE)					
B12 PK	1.8, 1.8 T, 2.0, 2.0 TFSI 07/02 - 12/06 96 -147 kW	46-189837	20	20	-> CH.Nr.: 8E-7-400 000; Conditions see certificates VA: axle load to: 1150 kg HA: axle load to: 1100 kg
B12 PK	2.4, 2.5 TDI, 2.7 TDI, 3.0, 3.2 FSI 04/02 - 12/06 120 -188 kW	46-189820	20	20	-> CH.Nr.: 8H-7-400 000; Conditions see certificates VA: axle load to: 1230 kg HA: axle load to: 1100 kg
B12 PK	2.7 TDI, 3.2 FSI 01/07 - 03/09 132 -188 kW	46-188670	20	20	CH.Nr.: 8E-7-400 001 ->; Conditions see certificates VA: axle load to: 1230 kg HA: axle load to: 1100 kg
B14	1.8, 1.8 T, 1.8 T quattro, 2.0, 2.0 TDI, 2.0 TFSI, 2.0 TFSi quattro, 2.4, 2.5 TDI, 2.7 TDI, 3.0, 3.0 quattro, 3.0 TDI quattro, 3.2 FSI, 3.2 FSI quattro 04/02 - 03/09 96 -188 kW	47-169289	30-60	20-50	Conditions see certificates VA: axle load to: 1250 kg HA: axle load to: 1170 kg
B14	S4 quattro 03/04 - 03/09 253 kW	47-119444	15-30	10-30	with standard chassis; Conditions see certificates VA: axle load to: 1250 kg HA: axle load to: 1170 kg
B14	RS4 quattro 06/06 - 03/09 309 kW	47-119444	10-25	10-30	disconnect DRC; Conditions see certificates VA: axle load to: 1250 kg HA: axle load to: 1170 kg
B16 PSS9	1.8, 1.8 T, 1.8 T quattro, 2.0, 2.0 TDI, 2.0 TFSI, 2.0 TFSi quattro, 2.4, 2.5 TDI, 2.7 TDI, 3.0, 3.0 quattro, 3.0 TDI quattro, 3.2 FSI, 3.2 FSI quattro 04/02 - 03/09 96 -188 kW	48-169301	30-60	20-50	Conditions see certificates VA: axle load to: 1250 kg HA: axle load to: 1170 kg
B16 PSS9	S4 quattro 03/04 - 03/09 253 kW	48-105958	15-30	10-30	Conditions see certificates VA: axle load to: 1250 kg HA: axle load to: 1170 kg
B16 PSS9	RS4 quattro 06/06 - 03/09 309 kW	48-105958	10-25	10-30	disconnect DRC; Conditions see certificates VA: axle load to: 1250 kg HA: axle load to: 1170 kg
AUDI A4 (8EC)					
B12 PK	1.6, 1.8 T, 2.0, 2.0 FSi, 2.0 GL, 2.0 TFSI 11/04 - 06/08 75 -162 kW	46-188465	30	30	Conditions see certificates VA: axle load to: 1090 kg HA: axle load to: 1035 kg
B12 PK	1.8 T quattro, 2.0 TFSI quattro 11/04 - 06/08 120 -162 kW	46-188496	30	30	Conditions see certificates VA: axle load to: 1090 kg HA: axle load to: 1130 kg
B12 PK	1.8 T quattro, 2.0 TDI quattro, 2.0 TFSI quattro, 3.0 quattro, 3.2 FSI quattro 11/04 - 06/08 103 -188 kW	46-188502	30	30	Conditions see certificates VA: axle load to: 1165 kg HA: axle load to: 1130 kg
B12 PK	1.9 TDI, 2.0 TDI, 2.0 TDI 16V, 2.0 TFSI, 3.0, 3.2 FSI 11/04 - 06/08 85 -188 kW	46-188472	30	30	Conditions see certificates VA: axle load to: 1165 kg HA: axle load to: 1035 kg
B12 PK	2.5 TDI, 2.7 TDI 11/04 - 06/08 120 -132 kW	46-188519	30	30	Conditions see certificates VA: axle load to: 1230 kg HA: axle load to: 1035 kg
B12 PK	3.0 TDI quattro 11/04 - 06/08 150 -171 kW	46-188489	30	30	Conditions see certificates VA: axle load to: 1230 kg HA: axle load to: 1130 kg
B12 SL	1.6, 1.8 T, 2.0, 2.0 FSi, 2.0 GL, 2.0 TFSI 11/04 - 06/08 75 -162 kW	46-188588	45-50	35-40	Conditions see certificates VA: axle load to: 1090 kg HA: axle load to: 1035 kg
B12 SL	1.9 TDI, 2.0 TDI, 2.0 TFSI, 3.0, 3.2 FSI 11/04 - 06/08 85 -188 kW	46-188595	45-50	35-40	Conditions see certificates VA: axle load to: 1140 kg HA: axle load to: 1035 kg
B14	1.6, 1.8 T, 1.8 T quattro, 1.9 TDI, 2.0, 2.0 FSi, 2.0 GL, 2.0 TDI, 2.0 TDI 16V, 2.0 TDI quattro, 2.0 TFSI, 2.0 TFSI quattro, 2.5 TDI, 2.7 TDI, 3.0, 3.0 quattro, 3.0 TDI quattro, 3.2 FSI, 3.2 FSI quattro 11/04 - 06/08 75 -188 kW	47-169289	30-60	20-50	Conditions see certificates VA: axle load to: 1250 kg HA: axle load to: 1170 kg





					
AUDI					
AUDI A4 (8EC)					
B14	S4 quattro 11/04 - 06/08 253 kW	47-119444	15-30	10-30	Conditions see certificates VA: axle load to: 1250 kg HA: axle load to: 1170 kg
B14	RS4 quattro 09/05 - 06/08 309 kW	47-119444	15-30	10-30	disconnect DRC; Conditions see certificates VA: axle load to: 1250 kg HA: axle load to: 1170 kg
B16 PSS9	1.6, 1.8 T, 1.8 T quattro, 1.9 TDI, 2.0, 2.0 FSi, 2.0 GL, 2.0 TDI, 2.0 TDI 16V, 2.0 TDI quattro, 2.0 TFSI, 2.0 TFSI quattro, 2.5 TDI, 2.7 TDI, 3.0, 3.0 quattro, 3.0 TDI quattro, 3.2 FSI, 3.2 FSI quattro 11/04 - 06/08 75 -188 kW	48-169301	30-60	20-50	Conditions see certificates VA: axle load to: 1250 kg HA: axle load to: 1170 kg
B16 PSS9	S4 quattro 11/04 - 06/08 253 kW	48-105958	15-30	10-30	Conditions see certificates VA: axle load to: 1250 kg HA: axle load to: 1170 kg
B16 PSS9	RS4 quattro 09/05 - 06/08 309 kW	48-105958	15-30	10-30	disconnect DRC; Conditions see certificates VA: axle load to: 1250 kg HA: axle load to: 1170 kg
AUDI A4 Avant (8ED)					
B12 PK	1.6, 1.8 T, 2.0, 2.0 FSi, 2.0 TFSI 11/04 - 06/08 75 -162 kW	46-188526	30	30	Conditions see certificates VA: axle load to: 1090 kg HA: axle load to: 1130 kg
B12 PK	1.8 T quattro, 2.0 TFSI quattro 11/04 - 06/08 120 -162 kW	46-188564	30	30	Conditions see certificates VA: axle load to: 1090 kg HA: axle load to: 1150 kg
B12 PK	1.8 T quattro, 2.0 TDI quattro, 2.0 TFSI quattro, 3.0 quattro, 3.2 FSI quattro 11/04 - 06/08 103 -188 kW	46-188571	30	30	Conditions see certificates VA: axle load to: 1165 kg HA: axle load to: 1150 kg
B12 PK	1.9 TDI, 2.0 TDI, 2.0 TDI 16V, 2.0 TFSI, 3.0, 3.2 FSI 11/04 - 06/08 85 -188 kW	46-188533	30	30	Conditions see certificates VA: axle load to: 1165 kg HA: axle load to: 1130 kg
B12 PK	2.5 TDI, 2.7 TDi 11/04 - 06/08 120 -132 kW	46-188540	30	30	Conditions see certificates VA: axle load to: 1230 kg HA: axle load to: 1130 kg
B12 PK	3.0 TDI quattro 11/04 - 06/08 150 -171 kW	46-188557	30	30	Conditions see certificates VA: axle load to: 1230 kg HA: axle load to: 1150 kg
B12 SL	1.6, 1.8 T, 2.0, 2.0 FSi, 2.0 TFSI 11/04 - 06/08 75 -162 kW	46-188601	45-50	35-40	Conditions see certificates VA: axle load to: 1090 kg HA: axle load to: 1090 kg
B12 SL	1.9 TDI, 2.0 TDI, 2.0 TDI 16V, 2.0 TFSI, 3.0, 3.2 FSI 11/04 - 06/08 85 -188 kW	46-188618	45-50	35-40	Conditions see certificates VA: axle load to: 1140 kg HA: axle load to: 1090 kg
B14	1.6, 1.8 T, 1.8 T quattro, 1.9 TDI, 2.0, 2.0 FSi, 2.0 TDI, 2.0 TDI 16V, 2.0 TDI quattro, 2.0 TFSI, 2.0 TFSI quattro, 2.5 TDI, 2.7 TDi, 3.0, 3.0 quattro, 3.0 TDI quattro, 3.2 FSI, 3.2 FSI quattro 11/04 - 06/08 75 -188 kW	47-169289	30-60	20-50	Conditions see certificates VA: axle load to: 1250 kg HA: axle load to: 1170 kg
B14	S4 quattro 11/04 - 06/08 253 kW	47-119444	10-25	10-30	Conditions see certificates VA: axle load to: 1250 kg HA: axle load to: 1170 kg
B14	RS4 quattro 09/05 - 06/08 309 kW	47-119444	10-25	10-25	disconnect DRC; Conditions see certificates VA: axle load to: 1250 kg HA: axle load to: 1170 kg
B16 PSS9	1.6, 1.8 T, 1.8 T quattro, 1.9 TDI, 2.0, 2.0 FSi, 2.0 TDI, 2.0 TDI 16V, 2.0 TDI quattro, 2.0 TFSI, 2.0 TFSI quattro, 2.5 TDI, 2.7 TDi, 3.0, 3.0 quattro, 3.0 TDI quattro, 3.2 FSI, 3.2 FSI quattro 11/04 - 06/08 75 -188 kW	48-169301	30-60	20-50	Conditions see certificates VA: axle load to: 1250 kg HA: axle load to: 1170 kg





					
AUDI					
AUDI A4 Avant (8ED)					
B16 PSS9	S4 quattro 11/04 - 06/08 253 kW	48-105958	10-25	10-30	Conditions see certificates VA: axle load to: 1250 kg HA: axle load to: 1170 kg
B16 PSS9	RS4 quattro 09/05 - 06/08 309 kW	48-105958	10-25	10-25	disconnect DRC; Conditions see certificates VA: axle load to: 1250 kg HA: axle load to: 1170 kg
AUDI A4 (8K2)					
B12 PK	1.8 TFSI, 1.8 TFSI quattro, 2.0 TDi, 2.0 TDi quattro, 2.0 TFSi, 2.0 TFSI flexible fuel, 2.0 TFSI flexible fuel quattro, 2.0 TFSI quattro, 3.0 TFSI quattro, 3.2 FSI, 3.2 FSI quattro 11/07 - 88 -200 kW	46-183323	35	30	with standard chassis; without lowered chassis; without electronic suspension control; Conditions see certificates; With General Certification (ABE) VA: axle load to: 1105 kg HA: without ride height adjustment; axle load to: 1160 kg
B12 PK	2.7 TDi, 3.0 TDi, 3.0 TDi quattro, 3.0 TFSI quattro, 3.2 FSI, 3.2 FSI quattro, S4 quattro 11/07 - 120 -245 kW	46-183330	35	30	with standard chassis; without lowered chassis; without electronic suspension control; Conditions see certificates; With General Certification (ABE) VA: axle load to: 1215 kg HA: without ride height adjustment; axle load to: 1160 kg
B12 SL	1.8 TFSI, 1.8 TFSI quattro, 2.0 TDi, 2.0 TDi quattro, 2.0 TFSi, 2.0 TFSI flexible fuel, 2.0 TFSI flexible fuel quattro, 2.0 TFSI quattro, 3.0 TFSI quattro, 3.2 FSI, 3.2 FSI quattro 11/07 - 88 -200 kW	46-183521	45	35	with standard chassis; without lowered chassis; without electronic suspension control; Conditions see certificates VA: axle load to: 1105 kg HA: without ride height adjustment; axle load to: 1155 kg
B16 PSS10	1.8 TFSI, 1.8 TFSI quattro, 2.0 TDi, 2.0 TDi quattro, 2.0 TFSi, 2.0 TFSI flexible fuel, 2.0 TFSI flexible fuel quattro, 2.0 TFSI quattro, 2.7 TDi, 3.0 TDi, 3.0 TDi quattro, 3.0 TFSI quattro, 3.2 FSI, 3.2 FSI quattro 11/07 - 88 -200 kW	48-147231	20-50	30-50	without electronic suspension control; Conditions see certificates VA: axle load to: 1245 kg HA: axle load to: 1225 kg
B16 PSS10	S4 quattro 11/08 - 245 kW	48-147231	10-30	10-20	without electronic suspension control; Conditions see certificates VA: axle load to: 1245 kg HA: axle load to: 1225 kg
B16 RC	1.8 TFSI, 1.8 TFSI quattro, 2.0 TDi, 2.0 TDi quattro, 2.0 TFSi, 2.0 TFSI flexible fuel, 2.0 TFSI flexible fuel quattro, 2.0 TFSI quattro, 2.7 TDi, 3.0 TDi, 3.0 TDi quattro, 3.0 TFSI quattro, 3.2 FSI, 3.2 FSI quattro 11/07 - 88 -200 kW	49-151282 14-230615	20-50	30-50	without electronic suspension control; Conditions see certificates VA: axle load to: 1245 kg HA: axle load to: 1225 kg
B16 RC	S4 quattro 11/08 - 245 kW	49-151282 14-230615	10-30	10-20	without electronic suspension control; Conditions see certificates VA: axle load to: 1245 kg HA: axle load to: 1225 kg
AUDI A4 Avant (8K5)					
B12 PK	1.8 FSi, 1.8 TFSI, 2.0 TDi, 2.0 TFSI, 2.0 TFSI flexible fuel 04/08 - 88 -155 kW	46-183323	35	30	with standard chassis; without lowered chassis; without electronic suspension control; Conditions see certificates; With General Certification (ABE) VA: axle load to: 1105 kg HA: without ride height adjustment; axle load to: 1160 kg
B12 PK	1.8 TFSI quattro, 2.0 TDi quattro, 2.0 TFSI flexible fuel quattro, 2.0 TFSI quattro, 3.0 TFSI quattro, 3.2 FSI quattro 04/08 - 105 -200 kW	46-183354	30	30	with standard chassis; without lowered chassis; without electronic suspension control; Conditions see certificates; With General Certification (ABE) VA: axle load to: 1105 kg HA: without ride height adjustment; axle load to: 1225 kg
B12 PK	2.7 TDi, 3.0 TDi, 3.2 FSI 04/08 - 120 -195 kW	46-183330	35	30	with standard chassis; without lowered chassis; without electronic suspension control; Conditions see certificates; With General Certification (ABE) VA: axle load to: 1215 kg HA: without ride height adjustment; axle load to: 1160 kg





   					
AUDI					
AUDI A4 Avant (8K5)					
B12 PK	3.0 TDI quattro, 3.0 TFSI quattro, 3.2 FSI quattro, S4 quattro 04/08 - 155 -245 kW	46-183347	30	30	with standard chassis; without lowered chassis; without electronic suspension control; Conditions see certificates; With General Certification (ABE) VA: axle load to: 1215 kg HA: without ride height adjustment; axle load to: 1225 kg
B12 SL	1.8 FSi, 1.8 TFSI, 2.0 TDI, 2.0 TFSI, 2.0 TFSI flexible fuel 04/08 - 88 -155 kW	46-183521	45	35	with standard chassis; without lowered chassis; without electronic suspension control; Conditions see certificates VA: axle load to: 1105 kg HA: without ride height adjustment; axle load to: 1155 kg
B16 PSS10	1.8 FSi, 1.8 TFSI, 1.8 TFSI quattro, 2.0 TDI, 2.0 TDI quattro, 2.0 TFSI, 2.0 TFSI flexible fuel, 2.0 TFSI flexible fuel quattro, 2.0 TFSI quattro, 2.7 TDi, 3.0 TDI, 3.0 TDI quattro, 3.0 TFSI quattro, 3.2 FSI, 3.2 FSI quattro 04/08 - 88 -200 kW	48-147231	20-50	30-50	without electronic suspension control; Conditions see certificates VA: axle load to: 1245 kg HA: axle load to: 1225 kg
B16 PSS10	S4 quattro 11/08 - 245 kW	48-147231	10-30	10-20	without electronic suspension control; Conditions see certificates VA: axle load to: 1245 kg HA: axle load to: 1225 kg
B16 RC	1.8 FSi, 1.8 TFSI, 1.8 TFSI quattro, 2.0 TDI, 2.0 TDI quattro, 2.0 TFSI, 2.0 TFSI flexible fuel, 2.0 TFSI flexible fuel quattro, 2.0 TFSI quattro, 2.7 TDi, 3.0 TDI, 3.0 TDI quattro, 3.0 TFSI quattro, 3.2 FSI, 3.2 FSI quattro 04/08 - 88 -200 kW	49-151282 14-230615	20-50	30-50	without electronic suspension control; Conditions see certificates VA: axle load to: 1245 kg HA: axle load to: 1225 kg
B16 RC	S4 quattro 11/08 - 245 kW	49-151282 14-230615	10-30	10-20	without electronic suspension control; Conditions see certificates VA: axle load to: 1245 kg HA: axle load to: 1225 kg
AUDI A5 (8T)					
B12 PK	1.8 TFSI, 2.0 TDI, 2.0 TDI quattro, 2.0 TFSI, 2.0 TFSI quattro, 3.2 FSI 06/07 - 118 -195 kW	46-189738	20-25	15-20	without electronic suspension control; Conditions see certificates VA: axle load to: 1120 kg HA: axle load to: 1095 kg
B12 PK	2.7 TDI, 3.0 TDI, 3.0 TDI quattro, 3.0 TFSI quattro, 3.2 FSI quattro, RS 5 quattro, S5 quattro 06/07 - 120 -331 kW	46-189721	25	20	without electronic suspension control; Conditions see certificates VA: axle load to: 1205 kg HA: axle load to: 1095 kg
B16 PSS10	1.8 TFSI, 2.0 TDI, 2.0 TDI quattro, 2.0 TFSI, 2.0 TFSI quattro, 2.7 TDI, 3.0 TDI, 3.0 TDI quattro, 3.0 TFSI quattro, 3.2 FSI, 3.2 FSI quattro 06/07 - 118 -200 kW	48-147231	20-50	30-50	without electronic suspension control; Conditions see certificates VA: axle load to: 1245 kg HA: axle load to: 1225 kg
B16 PSS10	RS 5 quattro, S5 quattro 06/07 - 245 -331 kW	48-147231	10-30	10-20	without electronic suspension control; Conditions see certificates VA: axle load to: 1215 kg HA: axle load to: 1215 kg
B16 RC	1.8 TFSI, 2.0 TDI, 2.0 TDI quattro, 2.0 TFSI, 2.0 TFSI quattro, 2.7 TDI, 3.0 TDI, 3.0 TDI quattro, 3.0 TFSI quattro, 3.2 FSI, 3.2 FSI quattro 06/07 - 118 -200 kW	49-151282 14-230615	20-50	30-50	without electronic suspension control; Conditions see certificates VA: axle load to: 1245 kg HA: axle load to: 1225 kg
B16 RC	RS 5 quattro, S5 quattro 06/07 - 245 -331 kW	49-151282 14-230615	10-30	10-20	without electronic suspension control; Conditions see certificates VA: axle load to: 1215 kg HA: axle load to: 1215 kg
AUDI A5 Sportback					
B12 PK	1.8 TFSI, 2.0 TDI, 2.0 TDI quattro, 2.0 TFSI, 2.0 TFSI quattro 09/09 - 100 -155 kW	46-189783	25	25	without electronic suspension control; Conditions see certificates VA: axle load to: 1120 kg HA: axle load to: 1155 kg





   					
AUDI					
AUDI A5 Sportback					
B12 PK	2.7 TDI, 3.0 TDI, 3.0 TDI quattro, 3.0 TFSI quattro, 3.2 FSI quattro 09/09 - 120 -245 kW	46-189790	25	25	without electronic suspension control; Conditions see certificates VA: axle load to: 1205 kg HA: axle load to: 1155 kg
B16 PSS10	1.8 TFSI, 2.0 TDI, 2.0 TDI quattro, 2.0 TFSI, 2.0 TFSI quattro, 2.7 TDI, 3.0 TDI, 3.0 TDI quattro, 3.0 TFSI quattro, 3.2 FSI quattro 09/09 - 100 -200 kW	48-147231	20-50	30-50	without electronic suspension control; Conditions see certificates VA: axle load to: 1245 kg HA: axle load to: 1225 kg
B16 PSS10	S5 quattro 01/10 - 245 kW	48-147231	10-30	10-20	without electronic suspension control; Conditions see certificates VA: axle load to: 1215 kg HA: axle load to: 1225 kg
B16 RC	1.8 TFSI, 2.0 TDI, 2.0 TDI quattro, 2.0 TFSI, 2.0 TFSI quattro, 2.7 TDI, 3.0 TDI, 3.0 TDI quattro, 3.0 TFSI quattro, 3.2 FSI quattro 09/09 - 100 -200 kW	49-151282 14-230615	20-50	30-50	without electronic suspension control; Conditions see certificates VA: axle load to: 1245 kg HA: axle load to: 1225 kg
B16 RC	S5 quattro 01/10 - 245 kW	49-151282 14-230615	10-30	10-30	without electronic suspension control; Conditions see certificates VA: axle load to: 1215 kg HA: axle load to: 1225 kg
AUDI A5 Convertible (8F)					
B12 PK	1.8 TFSI, 2.0 TDI, 2.0 TFSI 03/09 - 105 -155 kW	46-189745	20-25	15	without electronic suspension control; Conditions see certificates VA: axle load to: 1120 kg HA: axle load to: 1240 kg
B12 PK	2.0 TFSI quattro, 3.0 TFSI quattro, 3.2 FSI quattro 03/09 - 155 -200 kW	46-189769	20-25	20	without electronic suspension control; Conditions see certificates VA: axle load to: 1205 kg HA: axle load to: 1240 kg
B12 PK	2.7 TDI, 3.0 TDI, 3.2 FSI 03/09 - 120 -195 kW	46-189752	20-25	15	without electronic suspension control; Conditions see certificates VA: axle load to: 1205 kg HA: axle load to: 1240 kg
B12 PK	3.0 TDI quattro, S5 quattro 03/09 - 176 -245 kW	46-189776	25	15	without electronic suspension control; Conditions see certificates VA: axle load to: 1245 kg HA: axle load to: 1240 kg
B16 PSS10	1.8 TFSI, 2.0 TDI, 2.0 TDI quattro, 2.0 TFSI, 2.0 TFSI quattro, 2.7 TDI, 3.0 TDI, 3.0 TDI quattro, 3.0 TFSI quattro, 3.2 FSI, 3.2 FSI quattro 03/09 - 105 -200 kW	48-147231	20-50	30-50	without electronic suspension control; Conditions see certificates VA: axle load to: 1245 kg HA: axle load to: 1225 kg
B16 PSS10	S5 quattro 06/09 - 245 kW	48-147231	10-30	10-20	without electronic suspension control; Conditions see certificates VA: axle load to: 1245 kg HA: axle load to: 1225 kg
B16 RC	1.8 TFSI, 2.0 TDI, 2.0 TDI quattro, 2.0 TFSI, 2.0 TFSI quattro, 2.7 TDI, 3.0 TDI, 3.0 TDI quattro, 3.0 TFSI quattro, 3.2 FSI, 3.2 FSI quattro 03/09 - 105 -200 kW	49-151282 14-230615	20-50	30-50	without electronic suspension control; Conditions see certificates VA: axle load to: 1245 kg HA: axle load to: 1225 kg
B16 RC	S5 quattro 06/09 - 245 kW	49-151282 14-230615	10-30	10-20	without electronic suspension control; Conditions see certificates VA: axle load to: 1245 kg HA: axle load to: 1225 kg
AUDI A6 (4A, C4)					
B12 PK	2.3, 2.5 TDI, 2.6, 2.8 06/94 - 10/97 84 -142 kW	46-192356	35	30	without ride height adjustment; Conditions see certificates VA: axle load to: 1160 kg HA: axle load to: 1080 kg
B12 PK	2.3, 2.5 TDI, 2.6, 2.8 06/94 - 10/97 84 -142 kW	46-192394	35	30	automatic transmission; without ride height adjustment; Conditions see certificates VA: axle load to: 1160 kg HA: axle load to: 1080 kg
B12 PK	2.3 quattro, 2.5 TDI quattro, 2.6 quattro, 2.8 quattro 06/94 - 10/97 98 -142 kW	46-192363	35	30	without ride height adjustment; Conditions see certificates; thread: M12 VA: axle load to: 1240 kg HA: axle load to: 1200 kg





   					
AUDI					
AUDI A6 (4A, C4)					
B12 PK	2.3 quattro, 2.5 TDI quattro, 2.6 quattro, 2.8 quattro, S6 4.2 quattro, S6 Plus quattro, S6 Turbo quattro 06/94 - 10/97 98 -240 kW	46-192400	35	30	automatic transmission; without ride height adjustment; Conditions see certificates VA: axle load to: 1240 kg HA: axle load to: 1200 kg
AUDI A6 Avant (4A, C4)					
B12 PK	2.3, 2.5 TDI, 2.6, 2.8 06/94 - 12/97 84 -142 kW	46-192370	35	30	without ride height adjustment; Conditions see certificates VA: axle load to: 1160 kg HA: axle load to: 1080 kg
B12 PK	2.3, 2.5 TDI, 2.6, 2.8 06/94 - 12/97 84 -142 kW	46-192417	35	30	automatic transmission; without ride height adjustment; Conditions see certificates VA: axle load to: 1160 kg HA: axle load to: 1080 kg
B12 PK	2.3 quattro, 2.5 TDI quattro, 2.6 quattro, 2.8 quattro 06/94 - 12/97 98 -142 kW	46-192387	35	30	without ride height adjustment; Conditions see certificates; thread: M12 VA: axle load to: 1240 kg HA: axle load to: 1200 kg
B12 PK	2.3 quattro, 2.5 TDI quattro, 2.6 quattro, 2.8 quattro, S6 4.2 quattro, S6 Plus quattro, S6 Turbo quattro 06/94 - 12/97 98 -240 kW	46-192424	35	30	automatic transmission; without ride height adjustment; Conditions see certificates; thread: M12 VA: axle load to: 1240 kg HA: axle load to: 1200 kg
AUDI A6 (4B, C5)					
B12 PK	1.8, 1.8 T, 1.9 TDI 04/97 - 12/00 81 -132 kW	46-192196	30	30	-> CH.Nr.: 4B-Y-200000; serie production spring seat must be used; without ride height adjustment; Conditions see certificates VA: axle load to: 1150 kg HA: axle load to: 1090 kg
B12 PK	1.8, 1.8 T, 1.9 TDI 01/01 - 01/05 85 -132 kW	46-192202	30	30	CH.Nr.: 4B-1-000001 ->; serie production spring seat must be used; without ride height adjustment; Conditions see certificates VA: axle load to: 1150 kg HA: axle load to: 1090 kg
B12 PK	1.8 T quattro 12/98 - 12/00 110 -132 kW	46-192240	30	30	CH.Nr.: 4B-W-070001-> 4B-Y-200000; serie production spring seat must be used; without ride height adjustment; Conditions see certificates VA: axle load to: 1150 kg HA: axle load to: 1175 kg
B12 PK	1.8 T quattro 01/01 - 01/05 110 -132 kW	46-192233	30	30	CH.Nr.: 4B-1-000001 ->; serie production spring seat must be used; without ride height adjustment; Conditions see certificates VA: axle load to: 1150 kg HA: axle load to: 1175 kg
B12 PK	2.4, 2.5 TDI, 2.7 T, 2.8 02/97 - 12/00 100 -169 kW	46-192219	30	30	-> CH.Nr.: 4B-Y-200000; serie production spring seat must be used; without ride height adjustment; Conditions see certificates VA: axle load to: 1230 kg HA: axle load to: 1090 kg
B12 PK	2.4, 2.5 TDI, 2.7, 2.7 T, 2.8, 3.0, 3.7 01/01 - 01/05 100 -191 kW	46-192226	30	30	CH.Nr.: 4B-1-000001 ->; serie production spring seat must be used; without ride height adjustment; Conditions see certificates VA: axle load to: 1230 kg HA: axle load to: 1090 kg
B12 PK	2.4 quattro, 2.5 TDI quattro, 2.7 T quattro, 2.8 quattro 12/98 - 12/00 110 -169 kW	46-192257	30	30	CH.Nr.: 4B-W-070001-> 4B-Y-200000; serie production spring seat must be used; without ride height adjustment; Conditions see certificates VA: axle load to: 1230 kg HA: axle load to: 1175 kg
B12 PK	2.4 quattro, 2.5 TDI quattro, 2.7 quattro, 2.7 T quattro, 2.8 quattro, 3.0 quattro 01/01 - 01/05 110 -195 kW	46-192264	30	30	CH.Nr.: 4B-1-000001 ->; serie production spring seat must be used; without ride height adjustment; Conditions see certificates VA: axle load to: 1230 kg HA: axle load to: 1175 kg
B14	1.8, 1.8 T, 1.9 TDI, 2.0, 2.4, 2.5 TDI, 2.7 T, 2.8, 3.0, 3.7 02/97 - 01/05 81 -191 kW	47-124806	35-55	35-55	without ride height adjustment; Conditions see certificates VA: axle load to: 1205 kg HA: axle load to: 1130 kg
B14	1.8 T quattro, 2.4 quattro, 2.5 TDI quattro, 2.7 quattro, 2.7 T quattro, 2.8 quattro, 3.0 quattro, 3.7 quattro, 4.2 quattro, S6 quattro 02/97 - 01/05 110 -250 kW	47-086937	25-45	20-40	Conditions see certificates VA: axle load to: 1260 kg HA: axle load to: 1200 kg
B14	RS6 07/02 - 01/05 331 kW	47-086937	25-45	20-40	disconnect DRC; Conditions see certificates VA: axle load to: 1260 kg HA: axle load to: 1200 kg





					
AUDI					
AUDI A6 (4B, C5)					
B16 PSS9	1.8, 1.8 T, 1.9 TDI, 2.0, 2.4, 2.5 TDI, 2.7 T, 2.8, 3.0, 3.7 02/97 - 01/05 81 -191 kW	48-088749	35-55	35-55	without ride height adjustment; Conditions see certificates VA: axle load to: 1205 kg HA: axle load to: 1130 kg
B16 PSS9	1.8 T quattro, 2.4 quattro, 2.5 TDI quattro, 2.7 quattro, 2.7 T quattro, 2.8 quattro, 3.0 quattro, 3.7 quattro, 4.2 quattro, S6 quattro 02/97 - 01/05 110 -250 kW	48-088688	25-45	10-40	Conditions see certificates VA: axle load to: 1260 kg HA: axle load to: 1200 kg
B16 PSS9	RS6 07/02 - 01/05 331 kW	48-088688	25-45	20-40	disconnect DRC; Conditions see certificates VA: axle load to: 1260 kg HA: axle load to: 1200 kg
AUDI A6 Avant (4B, C5)					
B12 PK	1.8, 1.8 T, 1.9 TDI 12/97 - 12/00 81 -132 kW	46-192271	30	30	-> CH.Nr.: 4B-Y-200000; serie production spring seat must be used; without ride height adjustment; Conditions see certificates VA: axle load to: 1150 kg HA: axle load to: 1130 kg
B12 PK	1.8, 1.8 T, 1.9 TDI, 2.0 01/01 - 01/05 81 -132 kW	46-192288	30	30	CH.Nr.: 4B-1-000001 ->; serie production spring seat must be used; without ride height adjustment; Conditions see certificates VA: axle load to: 1150 kg HA: axle load to: 1130 kg
B12 PK	1.8 T quattro 12/98 - 12/00 110 -132 kW	46-192318	30	30	CH.Nr.: 4B-W-070001-> 4B-Y-200000; serie production spring seat must be used; without ride height adjustment; Conditions see certificates VA: axle load to: 1150 kg HA: axle load to: 1230 kg
B12 PK	1.8 T quattro 01/01 - 01/05 110 -132 kW	46-192325	30	30	CH.Nr.: 4B-1-000001 ->; serie production spring seat must be used; without ride height adjustment; Conditions see certificates VA: axle load to: 1150 kg HA: axle load to: 1230 kg
B12 PK	2.4, 2.5 TDI, 2.7 T, 2.8 12/97 - 12/00 100 -169 kW	46-192295	30	30	-> CH.Nr.: 4B-Y-200000; serie production spring seat must be used; without ride height adjustment; Conditions see certificates VA: axle load to: 1230 kg HA: axle load to: 1130 kg
B12 PK	2.4, 2.5 TDI, 2.7 T, 2.8, 3.0 01/01 - 01/05 100 -169 kW	46-192301	30	30	CH.Nr.: 4B-1-000001 ->; serie production spring seat must be used; without ride height adjustment; Conditions see certificates VA: axle load to: 1230 kg HA: axle load to: 1130 kg
B12 PK	2.4 quattro, 2.5 TDI quattro, 2.7 T quattro, 2.8 quattro 12/98 - 12/00 110 -169 kW	46-192332	30	30	CH.Nr.: 4B-W-070001-> 4B-Y-200000; serie production spring seat must be used; without ride height adjustment; Conditions see certificates VA: axle load to: 1230 kg HA: axle load to: 1230 kg
B12 PK	2.4 quattro, 2.5 TDI quattro, 2.7 T quattro, 2.8 quattro, 3.0 quattro 01/01 - 01/05 110 -184 kW	46-192349	30	30	CH.Nr.: 4B-1-000001 ->; serie production spring seat must be used; without ride height adjustment; Conditions see certificates VA: axle load to: 1230 kg HA: axle load to: 1230 kg
B14	1.8, 1.8 T, 1.9 TDI, 2.0, 2.4, 2.5 TDI, 2.7 T, 2.8, 3.0, 3.7 12/97 - 01/05 81 -191 kW	47-124806	35-55	35-55	without ride height adjustment; Conditions see certificates VA: axle load to: 1205 kg HA: axle load to: 1130 kg
B14	1.8 T quattro, 2.4 quattro, 2.5 TDI quattro, 2.7 T quattro, 2.8 quattro, 3.0 quattro, 3.7 quattro, 4.2 quattro, S6 quattro 12/97 - 01/05 110 -250 kW	47-086937	25-45	20-40	without ride height adjustment; Conditions see certificates VA: axle load to: 1260 kg HA: axle load to: 1200 kg
B14	RS6, RS6 plus 07/02 - 01/05 331 -353 kW	47-086937	45	40	disconnect DRC; without ride height adjustment; Conditions see certificates VA: axle load to: 1260 kg HA: axle load to: 1200 kg
B16 PSS9	1.8, 1.8 T, 1.9 TDI, 2.0, 2.4, 2.5 TDI, 2.7 T, 2.8, 3.0, 3.7 12/97 - 01/05 81 -191 kW	48-088749	35-55	35-55	without ride height adjustment; Conditions see certificates VA: axle load to: 1205 kg HA: axle load to: 1130 kg
B16 PSS9	1.8 T quattro, 2.4 quattro, 2.5 TDI quattro, 2.7 T quattro, 2.8 quattro, 3.0 quattro, 3.7 quattro, 4.2 quattro, S6 quattro 12/97 - 01/05 110 -250 kW	48-088688	45	40	without sport chassis; without ride height adjustment; Conditions see certificates VA: axle load to: 1260 kg HA: axle load to: 1200 kg
B16 PSS9	RS6, RS6 plus 07/02 - 01/05 331 -353 kW	48-088688	45	40	disconnect DRC; without ride height adjustment; Conditions see certificates VA: axle load to: 1260 kg HA: axle load to: 1200 kg

									
AUDI									
AUDI A6 (4F2)									
B12 PK	2.4 quattro, 2.8 FSI quattro, 3.0 quattro, 3.0 TFSI quattro, 3.2 FSI quattro 05/04 - 03/11 130 -220 kW	46-189851	30	30	without ride height adjustment; Conditions see certificates; without pneumatic suspension VA: axle load to: 1215 kg HA: axle load to: 1240 kg				
B12 PK	2.0 TDI, 2.0 TFSI, 2.4, 2.8 FSI, 3.0, 3.2 FSI 05/04 - 03/11 89 -195 kW	46-189844	30	30	without ride height adjustment; Conditions see certificates; without pneumatic suspension VA: axle load to: 1215 kg HA: axle load to: 1130 kg				
B12 PK	2.7 TDI 11/04 - 03/11 120 -140 kW	46-189882	30	30	without ride height adjustment; Conditions see certificates; without pneumatic suspension VA: axle load to: 1350 kg HA: axle load to: 1130 kg				
B12 PK	2.7 TDI quattro, 3.0 TDI quattro, 3.0 TFSI quattro, 4.2 quattro 05/04 - 03/11 120 -246 kW	46-189875	30	30	without ride height adjustment; Conditions see certificates; without pneumatic suspension VA: axle load to: 1350 kg HA: axle load to: 1240 kg				
B14	RS6 quattro, S6 quattro 03/06 - 03/11 320 -426 kW	47-116573	20-40	20-40	disconnect DRC; without ride height adjustment; Conditions see certificates; without pneumatic suspension VA: axle load to: 1410 kg HA: axle load to: 1380 kg				
B14	2.0 TDI, 2.0 TFSI, 2.4, 2.4 quattro, 2.7 TDI, 2.7 TDI quattro, 2.8 FSI, 2.8 FSI quattro, 3.0, 3.0 quattro, 3.0 TDi PF, 3.0 TDI quattro, 3.0 TFSI quattro, 3.2 FSI, 3.2 FSI quattro, 4.2 FSI quattro, 4.2 quattro 05/04 - 03/11 89 -257 kW	47-116573	40-60	40-60	without ride height adjustment; Conditions see certificates; without pneumatic suspension VA: axle load to: 1410 kg HA: axle load to: 1380 kg				
B16 PSS9	RS6 quattro, S6 quattro 03/06 - 03/11 320 -426 kW	48-116541	20-40	20-40	disconnect DRC; without ride height adjustment; Conditions see certificates; without pneumatic suspension VA: axle load to: 1410 kg HA: axle load to: 1380 kg				
B16 PSS9	2.0 TDI, 2.0 TFSI, 2.4, 2.4 quattro, 2.7 TDI, 2.7 TDI quattro, 2.8 FSI, 2.8 FSI quattro, 3.0, 3.0 quattro, 3.0 TDi PF, 3.0 TDI quattro, 3.0 TFSI quattro, 3.2 FSI, 3.2 FSI quattro, 4.2 FSI quattro, 4.2 quattro 05/04 - 03/11 89 -257 kW	48-116541	40-60	40-60	without ride height adjustment; Conditions see certificates; without pneumatic suspension VA: axle load to: 1410 kg HA: axle load to: 1380 kg				
AUDI A6 Avant (4F5)									
B12 PK	2.4 quattro, 2.8 FSI quattro, 3.0 quattro, 3.2 FSI quattro 03/05 - 08/11 130 -188 kW	46-189912	30	30	without ride height adjustment; Conditions see certificates; without pneumatic suspension VA: axle load to: 1215 kg HA: axle load to: 1335 kg				
B12 PK	S6 quattro 03/06 - 08/11 320 kW	46-189936	20	10	without ride height adjustment; Conditions see certificates; without pneumatic suspension VA: axle load to: 1350 kg HA: axle load to: 1335 kg				
B12 PK	2.0 TDI, 2.0 TFSI, 2.4, 2.8 FSI, 3.0, 3.2 FSI 03/05 - 10/08 89 -188 kW	46-189899	30	30	without ride height adjustment; Conditions see certificates; without pneumatic suspension VA: axle load to: 1215 kg HA: axle load to: 1240 kg				
B12 PK	2.7 TDI, 3.0 TDi PF 03/05 - 08/11 120 -171 kW	46-189905	30	30	without ride height adjustment; Conditions see certificates; without pneumatic suspension VA: axle load to: 1350 kg HA: axle load to: 1240 kg				
B12 PK	2.7 TDI quattro, 3.0 TDI quattro, 3.0 TFSI quattro, 4.2 FSI quattro, 4.2 quattro 03/05 - 08/11 120 -257 kW	46-189929	30	30	without ride height adjustment; Conditions see certificates; without pneumatic suspension VA: axle load to: 1350 kg HA: axle load to: 1335 kg				
B14	S6 quattro 03/06 - 08/11 320 kW	47-116573	20-40	20-40	without ride height adjustment; Conditions see certificates; without pneumatic suspension VA: axle load to: 1410 kg HA: axle load to: 1380 kg				

									
AUDI									
AUDI A6 Avant (4F5)									
B14	2.0 TDI, 2.0 TFSI, 2.4, 2.4 quattro, 2.7 TDI, 2.7 TDI quattro, 2.8 FSI, 2.8 FSI quattro, 3.0, 3.0 quattro, 3.0 TDI PF, 3.0 TDI quattro, 3.0 TFSI quattro, 3.2 FSI, 3.2 FSI quattro, 4.2 FSI quattro, 4.2 quattro 03/05 - 08/11 89 -257 kW	47-116573	40-60	40-60	without ride height adjustment; Conditions see certificates; without pneumatic suspension VA: axle load to: 1410 kg HA: axle load to: 1380 kg				
B16 PSS9	S6 quattro 03/06 - 08/11 320 kW	48-116541	20-40	20-40	without ride height adjustment; Conditions see certificates; without pneumatic suspension VA: axle load to: 1410 kg HA: axle load to: 1380 kg				
B16 PSS9	2.0 TDI, 2.0 TFSI, 2.4, 2.4 quattro, 2.7 TDI, 2.7 TDI quattro, 2.8 FSI, 2.8 FSI quattro, 3.0, 3.0 quattro, 3.0 TDI PF, 3.0 TDI quattro, 3.0 TFSI quattro, 3.2 FSI, 3.2 FSI quattro, 4.2 FSI quattro, 4.2 quattro 03/05 - 08/11 89 -257 kW	48-116541	40-60	40-60	without ride height adjustment; Conditions see certificates; without pneumatic suspension VA: axle load to: 1410 kg HA: axle load to: 1380 kg				
AUDI A6 (4G2)									
B16 PSS10	S6 quattro 02/12 - 309 kW	48-221832	15-35	15-35	Conditions see certificates; without pneumatic suspension				
B16 PSS10	2.0 TDI, 2.0 TFSI, 2.0 TFSI hybrid, 2.8 FSI, 2.8 FSI quattro, 3.0 TDI, 3.0 TDI quattro, 3.0 TFSI quattro 03/11 - 100 -230 kW	48-221832	30-50	30-50	Conditions see certificates				
AUDI A6 Avant (4G5)									
B16 PSS10	S6 quattro 02/12 - 309 kW	48-221832	15-35	15-35	Conditions see certificates; without pneumatic suspension				
B16 PSS10	2.0 TDI, 2.0 TFSI, 2.8 FSI, 2.8 FSI quattro, 3.0 TDI, 3.0 TDI quattro, 3.0 TFSI quattro 11/11 - 100 -230 kW	48-221832	30-50	30-50	Conditions see certificates; without pneumatic suspension				
AUDI A7 Sportback									
B16 PSS10	2.8 FSI, 2.8 FSI quattro, 3.0 TDI, 3.0 TDI quattro, 3.0 TFSI quattro 01/11 - 150 -230 kW	48-221832	30-50	30-50	Conditions see certificates; without pneumatic suspension				
B16 PSS10	S7 quattro 02/12 - 309 kW	48-221832	15-35	15-35	Conditions see certificates; without pneumatic suspension				
AUDI A8 (4D2, 4D8)									
B12 PK	3.7, 3.7 quattro, 4.2 quattro 03/94 - 04/00 169 -228 kW	46-193810	25	25	-> CH.Nr.: 4D-Y-020000; without ride height adjustment; Conditions see certificates VA: axle load to: 1255 kg HA: axle load to: 1230 kg				
B12 PK	3.7, 3.7 quattro, 4.2 quattro 05/00 - 09/02 191 -228 kW	46-193834	25	25	CH.Nr.: 4D-1-000 001 ->; without ride height adjustment; Conditions see certificates VA: axle load to: 1255 kg HA: axle load to: 1230 kg				
B12 PK	2.5 TDI, 2.5 TDI quattro, 2.8, 2.8 quattro 04/96 - 04/00 110 -142 kW	46-193827	25	25	-> CH.Nr.: 4D-Y-020000; without ride height adjustment; Conditions see certificates VA: axle load to: 1255 kg HA: axle load to: 1230 kg				
B12 PK	2.5 TDI, 2.5 TDI quattro, 2.8, 2.8 quattro 05/00 - 09/02 132 -142 kW	46-193841	25	25	CH.Nr.: 4D-1-000 001 ->; without ride height adjustment; Conditions see certificates VA: axle load to: 1255 kg HA: axle load to: 1230 kg				





   					
AUDI					
AUDI Q5 (8R)					
B12 PK	2.0 TDI, 2.0 TDI FWD, 2.0 TDI quattro, 2.0 TFSI, 2.0 TFSI quattro, 3.2 FSI 11/08 - 100 -199 kW	46-188083	30	25	without electronic suspension control; without ride height adjustment; Conditions see certificates VA: axle load to: 1235 kg HA: axle load to: 1345 kg
B12 PK	3.0 TDI, 3.0 TDI quattro, 3.0 TFSI quattro, SQ5 quattro 11/08 - 155 -230 kW	46-188090	30	25	without electronic suspension control; without ride height adjustment; Conditions see certificates VA: axle load to: 1315 kg HA: axle load to: 1345 kg
AUDI R8					
B16 BCS	4.2 FSI quattro, 4.2 quattro, 5.2 FSI quattro 04/09 - 309 -412 kW	48-153690	10-25	20-35	without electronic suspension control; Conditions see certificates VA: axle load to: 940 kg HA: axle load to: 1095 kg
AUDI R8 Spyder					
B16 CSC	4.2 FSI quattro, 5.2 FSI quattro 02/10 - 316 -386 kW	48-153690	10-25	20-35	without electronic suspension control; Conditions see certificates VA: axle load to: 940 kg HA: axle load to: 1095 kg
AUDI TT (8N3)					
B12 PK	1.8 T 10/98 - 06/06 110 -140 kW	46-189592	25	25	Conditions see certificates VA: axle load to: 980 kg HA: axle load to: 760 kg
B12 PK	1.8 T quattro 10/98 - 06/06 132 -176 kW	46-189608	25	25	Conditions see certificates VA: axle load to: 1050 kg HA: axle load to: 920 kg
B14	1.8 T 10/98 - 06/06 110 -140 kW	47-080478	30-50	30-50	Conditions see certificates VA: axle load to: 1040 kg HA: axle load to: 825 kg
B14	1.8 T quattro, 3.2 VR6 quattro 10/98 - 06/06 132 -184 kW	47-080416	30-50	30-50	Conditions see certificates VA: axle load to: 1110 kg HA: axle load to: 920 kg
B16 PSS9	1.8 T 10/98 - 06/06 110 -140 kW	48-080484	30-50	30-50	Conditions see certificates VA: axle load to: 1040 kg HA: axle load to: 825 kg
B16 PSS9	1.8 T quattro, 3.2 VR6 quattro 10/98 - 06/06 132 -184 kW	48-080422	30-50	30-50	Conditions see certificates VA: max. load: 1110 kg HA: max. load: 920 kg
AUDI TT Roadster (8N9)					
B12 PK	1.8 T 10/99 - 06/06 110 -140 kW	46-189578	25	25	Conditions see certificates VA: axle load to: 1040 kg HA: axle load to: 820 kg
B12 PK	1.8 T quattro 10/99 - 06/06 132 -165 kW	46-189608	25	25	Conditions see certificates VA: axle load to: 1050 kg HA: axle load to: 920 kg
B14	1.8 T 10/99 - 06/06 110 -140 kW	47-080478	30-50	30-50	Conditions see certificates VA: axle load to: 1040 kg HA: axle load to: 825 kg
B14	1.8 T quattro, 3.2 VR6 quattro 10/99 - 06/06 132 -184 kW	47-080416	30-50	30-50	Conditions see certificates VA: axle load to: 1110 kg HA: axle load to: 920 kg
B16 PSS9	1.8 T 10/99 - 06/06 110 -140 kW	48-080484	30-50	30-50	Conditions see certificates VA: axle load to: 1040 kg HA: axle load to: 825 kg
B16 PSS9	1.8 T quattro, 3.2 VR6 quattro 10/99 - 06/06 132 -184 kW	48-080422	30-50	30-50	Conditions see certificates VA: axle load to: 1110 kg HA: axle load to: 920 kg
AUDI TT (8J3)					
B12 PK	1.8 TFSI, 2.0 TFSI 08/06 - 118 -155 kW	46-189615	25	20	without Magnetic Ride; Conditions see certificates VA: axle load to: 1005 kg HA: axle load to: 785 kg
B12 PK	3.2 V6 quattro 08/06 - 06/10 184 kW	46-189622	25	20	without Magnetic Ride; Conditions see certificates VA: axle load to: 1040 kg HA: axle load to: 885 kg

   					
AUDI					
AUDI TT (8J3)					
B12 PK	2.0 TDI quattro, 2.0 TFSI quattro 05/08 - 125 -200 kW	46-189653	25	20	without Magnetic Ride; Conditions see certificates VA: axle load to: 1005 kg HA: axle load to: 885 kg
B14	1.8 TFSI, 2.0 quattro, 2.0 TDI quattro, 2.0 TFSI, 2.0 TFSI quattro, 2.5 TFSI quattro, 3.2 V6 quattro 08/06 - 118 -265 kW	47-138896	20-40	20-40	without Magnetic Ride; Conditions see certificates VA: axle load to: 1040 kg HA: axle load to: 1040 kg
B16 PSS10	1.8 TFSI, 2.0 quattro, 2.0 TDI quattro, 2.0 TFSI, 2.0 TFSI quattro, 2.5 TFSI quattro, 3.2 V6 quattro 08/06 - 118 -265 kW	48-138864	20-40	20-40	without Magnetic Ride; Conditions see certificates VA: axle load to: 1040 kg HA: axle load to: 1040 kg
B16 BCS	1.8 TFSI, 2.0 quattro, 2.0 TDI quattro, 2.0 TFSI, 2.0 TFSI quattro, 2.5 TFSI quattro, 3.2 V6 quattro 08/06 - 118 -265 kW	48-231954	10-30	10-30	Conditions see certificates
AUDI TT Roadster (8J9)					
B12 PK	1.8 TFSI 06/08 - 118 kW	46-189639	25	20	without Magnetic Ride; Conditions see certificates VA: axle load to: 1005 kg HA: axle load to: 785 kg
B12 PK	2.0 quattro, 2.0 TDI quattro, 2.0 TFSI quattro 05/08 - 125 -200 kW	46-189653	25	20	without Magnetic Ride; Conditions see certificates VA: axle load to: 1005 kg HA: axle load to: 885 kg
B12 PK	3.2 V6 quattro 03/07 - 06/10 184 kW	46-189646	25	20	without Magnetic Ride; Conditions see certificates VA: axle load to: 1040 kg HA: axle load to: 885 kg
B14	1.8 TFSI, 2.0 quattro, 2.0 TDI quattro, 2.0 TFSI, 2.0 TFSI quattro, 2.5 TFSI quattro, 3.2 V6 quattro 03/07 - 118 -250 kW	47-138896	30-50	30-50	without Magnetic Ride; Conditions see certificates VA: axle load to: 1040 kg HA: axle load to: 1040 kg
B16 PSS10	1.8 TFSI, 2.0 quattro, 2.0 TDI quattro, 2.0 TFSI, 2.0 TFSI quattro, 2.5 TFSI quattro, 3.2 V6 quattro 03/07 - 118 -250 kW	48-138864	30-50	30-50	without Magnetic Ride; Conditions see certificates VA: axle load to: 1040 kg HA: axle load to: 1040 kg
B16 BCS	1.8 TFSI, 2.0 quattro, 2.0 TDI quattro, 2.0 TFSI, 2.0 TFSI quattro, 2.5 TFSI quattro, 3.2 V6 quattro 03/07 - 118 -265 kW	48-231954	10-30	10-30	Conditions see certificates
AUDI CABRIOLET (8G7, B4)					
B12 PK	1.8, 1.9 TDI, 2.0 16V, 2.0 E, 2.3 E 05/91 - 08/00 66 -103 kW	46-189806	20	20	outside diameter strut 50 mm; Conditions see certificates VA: axle load to: 1100 kg HA: axle load to: 870 kg
B12 PK	2.6, 2.8 11/92 - 08/00 102 -128 kW	46-189813	20	20	outside diameter strut 50 mm; Conditions see certificates VA: axle load to: 1100 kg HA: axle load to: 870 kg
AUDI 100 (4A, C4)					
B12 PK	2.3 E quattro, 2.6 E quattro, 2.6 quattro, 2.8 E quattro, S4 Turbo quattro 12/90 - 07/94 98 -169 kW	46-192363	35	30	without ride height adjustment; Conditions see certificates; thread: M12 VA: axle load to: 1240 kg HA: axle load to: 1200 kg
B12 PK	2.3 E quattro, 2.6 E quattro, 2.6 quattro, 2.8 E quattro, S4 Turbo quattro 12/90 - 07/94 98 -169 kW	46-192400	35	30	automatic transmission; without ride height adjustment; Conditions see certificates VA: axle load to: 1240 kg HA: axle load to: 1200 kg
AUDI-FAW					
AUDI-FAW A4 Saloon (B7)					
B12 PK	1.8 TURBO, 2.0 TURBO 07/05 - 09/08 120 -147 kW	46-188465	30	30	Conditions see certificates VA: axle load to: 1090 kg HA: axle load to: 1035 kg

   					
AUDI-FAW					
AUDI-FAW A4 Saloon (B7)					
B12 PK	2.0 TURBO, 2.0 07/05 - 09/08 132 -147 kW	46-188472	30	30	Conditions see certificates VA: axle load to: 1165 kg HA: axle load to: 1035 kg
B12 PK	3.0 quattro 07/05 - 09/08 160 kW	46-188489	30	30	Conditions see certificates VA: axle load to: 1230 kg HA: axle load to: 1130 kg
B12 SL	1.8 TURBO, 2.0 TURBO 07/05 - 09/08 120 -147 kW	46-188588	45-50	35-40	Conditions see certificates VA: axle load to: 1090 kg HA: axle load to: 1035 kg
B12 SL	2.0 TURBO, 2.0 07/05 - 09/08 132 -147 kW	46-188595	45-50	35-40	Conditions see certificates VA: axle load to: 1140 kg HA: axle load to: 1035 kg
B14	1.8 TURBO, 2.0 TURBO, 3.0 quattro, 2.0 07/05 - 09/08 120 -160 kW	47-169289	30-60	20-50	Conditions see certificates VA: axle load to: 1250 kg HA: axle load to: 1170 kg
B16 PSS9	1.8 TURBO, 2.0 TURBO, 3.0 quattro, 2.0 07/05 - 09/08 120 -160 kW	48-169301	30-60	20-50	Conditions see certificates VA: axle load to: 1250 kg HA: axle load to: 1170 kg

AUDI-FAW A4L Saloon (B8)					
B12 PK	2.0 12/07 - 09/08 132 kW	46-188465	30	30	Conditions see certificates VA: axle load to: 1090 kg HA: axle load to: 1035 kg
B12 PK	2.0, 3.2, L 1.8 11/08 - 118 -195 kW	46-183323	35	30	with standard chassis; without lowered chassis; without electronic suspension control; Conditions see certificates; With General Certification (ABE) VA: axle load to: 1105 kg HA: without ride height adjustment; axle load to: 1160 kg
B12 SL	2.0 12/07 - 09/08 132 kW	46-188588	45-50	35-40	Conditions see certificates VA: axle load to: 1090 kg HA: axle load to: 1035 kg
B12 SL	2.0, 3.2, L 1.8 11/08 - 118 -195 kW	46-183521	45	35	with standard chassis; without lowered chassis; without electronic suspension control; Conditions see certificates VA: axle load to: 1105 kg HA: without ride height adjustment; axle load to: 1155 kg
B16 PSS10	2.0, 3.2, L 1.8 11/08 - 118 -195 kW	48-147231	20-50	30-50	without electronic suspension control; Conditions see certificates VA: axle load to: 1245 kg HA: axle load to: 1225 kg
B16 RC	2.0, 3.2, L 1.8 11/08 - 118 -195 kW	49-151282 14-230615	20-50	30-50	without electronic suspension control; Conditions see certificates VA: axle load to: 1245 kg HA: axle load to: 1225 kg

AUDI-FAW A6 Saloon (C5)					
B12 PK	1.8 TURBO 01/00 - 12/00 110 kW	46-192196	30	30	-> CH.Nr.: 4B-Y-200000; serie production spring seat must be used; without ride height adjustment; Conditions see certificates VA: axle load to: 1150 kg HA: axle load to: 1090 kg
B12 PK	1.8 TURBO 01/01 - 12/05 110 kW	46-192202	30	30	CH.Nr.: 4B-1-000001 ->; serie production spring seat must be used; without ride height adjustment; Conditions see certificates VA: axle load to: 1150 kg HA: axle load to: 1090 kg
B12 PK	2.4, 2.8 09/99 - 12/00 121 -140 kW	46-192219	30	30	-> CH.Nr.: 4B-Y-200000; serie production spring seat must be used; without ride height adjustment; Conditions see certificates VA: axle load to: 1230 kg HA: axle load to: 1090 kg
B12 PK	2.4, 2.5 D 01/01 - 12/05 121 -132 kW	46-192226	30	30	CH.Nr.: 4B-1-000001 ->; serie production spring seat must be used; without ride height adjustment; Conditions see certificates VA: axle load to: 1230 kg HA: axle load to: 1090 kg
B14	1.8 TURBO, 2.4, 2.5 D, 2.8 09/99 - 12/05 110 -140 kW	47-124806	35-55	35-55	without ride height adjustment; Conditions see certificates VA: axle load to: 1205 kg HA: axle load to: 1130 kg
B16 PSS9	1.8 TURBO, 2.4, 2.5 D, 2.8 09/99 - 12/05 110 -140 kW	48-088749	35-55	35-55	without ride height adjustment; Conditions see certificates VA: axle load to: 1205 kg HA: axle load to: 1130 kg

									
AUDI-FAW									
AUDI-FAW A6L Saloon (C6)									
B12 PK	2.8 quattro, 3.2 TURBO quattro, 4.2 TURBO quattro, L 3.0 quattro 01/09 - 162-253 kW	46-189851	30	30	without ride height adjustment; Conditions see certificates; without pneumatic suspension VA: axle load to: 1215 kg HA: axle load to: 1240 kg				





AUDI-FAW Q5 Closed Off-Road Vehicle									
B12 PK	2.0 03/10 - 155 kW	46-188083	30	25	without electronic suspension control; without ride height adjustment; Conditions see certificates VA: axle load to: 1235 kg HA: axle load to: 1345 kg				





BMW									
BMW 1 (E81, E87)									





B12 PK	116 i, 116i, 118 i, 118i, 120 i, 120i, 2.0 09/06 - 09/12 85 -125 kW	46-180483	30	25	Conditions see certificates VA: axle load to: 875 kg HA: without ride height adjustment; axle load to: 1060 kg				
B12 PK	116d, 118 d, 118d, 120d, 123d, 130i 09/06 - 09/12 85 -195 kW	46-180490	30	25	Conditions see certificates VA: axle load to: 920 kg HA: without ride height adjustment; axle load to: 1060 kg				
B12 SL	116 i, 116i, 118 i, 118i, 120 i, 120i, 2.0 09/06 - 09/12 85 -125 kW	46-180506	45-50	35	Conditions see certificates; With General Certification (ABE) VA: axle load to: 895 kg HA: without ride height adjustment; axle load to: 1060 kg				
B12 SL	116d, 118 d, 118d, 120d, 123d, 130i 09/06 - 09/12 85 -195 kW	46-180513	45-50	35	Conditions see certificates; With General Certification (ABE) VA: axle load to: 920 kg HA: without ride height adjustment; axle load to: 1060 kg				
B14	116 i, 116d, 116i, 118 d, 118 i, 118d, 118i, 120 i, 120d, 120i, 123d, 130i, 2.0 09/06 - 09/12 85 -195 kW	47-120471	30-50	30-50	Conditions see certificates VA: axle load to: 1020 kg HA: axle load to: 1035 kg				
B16 PSS10	116 i, 116d, 116i, 118 d, 118 i, 118d, 118i, 120 i, 120d, 120i, 123d, 130i, 2.0 09/06 - 09/12 85 -195 kW	48-131636	30-50	30-50	Conditions see certificates VA: axle load to: 1020 kg HA: axle load to: 1200 kg				
B16 PSS10	116 i, 116d, 116i, 118 d, 118 i, 118d, 118i, 120 i, 120d, 120i, 123d, 130i, 2.0 09/06 - 09/12 85 -195 kW	48-195232	20-40	20-40	Conditions see certificates VA: axle load to: 1020 kg HA: axle load to: 1200 kg				
B16 RC	116 i, 116d, 116i, 118 d, 118 i, 118d, 118i, 120 i, 120d, 120i, 123d, 130i, 2.0 09/06 - 09/12 85 -195 kW	49-131543 14-230615	30-50	30-50	Conditions see certificates VA: axle load to: 1020 kg HA: axle load to: 1200 kg				





BMW 1 (E87)									
--------------------	--	--	--	--	--	--	--	--	--





B12 PK	116 i, 118 i, 120 i 11/03 - 09/12 85 -125 kW	46-180483	30	25	Conditions see certificates VA: axle load to: 875 kg HA: without ride height adjustment; axle load to: 1060 kg				
B12 PK	116 d, 118 d, 120 d, 123 d, 130 i 03/05 - 09/12 85 -195 kW	46-180490	30	25	Conditions see certificates VA: axle load to: 920 kg HA: without ride height adjustment; axle load to: 1060 kg				
B12 SL	116 i, 118 i, 120 i 11/03 - 09/12 85 -125 kW	46-180506	45-50	35	Conditions see certificates; With General Certification (ABE) VA: axle load to: 895 kg HA: without ride height adjustment; axle load to: 1060 kg				
B12 SL	116 d, 118 d, 120 d, 123 d, 130 i 03/05 - 09/12 85 -195 kW	46-180513	45-50	35	Conditions see certificates; With General Certification (ABE) VA: axle load to: 920 kg HA: without ride height adjustment; axle load to: 1060 kg				
B14	116 d, 116 i, 118 d, 118 i, 120 d, 120 i, 123 d, 130 i 03/05 - 09/12 85 -195 kW	47-120471	30-50	30-50	Conditions see certificates VA: axle load to: 1020 kg HA: axle load to: 1035 kg				
B16 PSS10	116 d, 116 i, 118 d, 118 i, 120 d, 120 i, 123 d, 130 i 03/05 - 09/12 85 -195 kW	48-131636	30-50	30-50	Conditions see certificates VA: axle load to: 1020 kg HA: axle load to: 1200 kg				





					
BMW					
BMW 1 (E87)					
B16 PSS10	116 d, 116 i, 118 d, 118 i, 120 d, 120 i, 123 d, 130 i 03/05 - 09/12 85 -195 kW	48-195232	20-40	20-40	Conditions see certificates VA: axle load to: 1020 kg HA: axle load to: 1200 kg
B16 RC	116 d, 116 i, 118 d, 118 i, 120 d, 120 i, 123 d, 130 i 03/05 - 09/12 85 -195 kW	49-131543 14-230615	30-50	30-50	Conditions see certificates VA: axle load to: 1020 kg HA: axle load to: 1200 kg
BMW 1 Coupe (E82)					
B12 PK	118d, 120d, 123d, 125i, 135i 10/07 - 100 -225 kW	46-180537	30-35	30-35	Conditions see certificates VA: axle load to: 945 kg HA: without ride height adjustment; axle load to: 1030 kg
B14	118d, 120d, 120i, 123d, 125i, 135i 10/07 - 100 -225 kW	47-120471	30-50	30-50	Conditions see certificates VA: axle load to: 1020 kg HA: axle load to: 1035 kg
B16 PSS10	3.0 M 04/11 - 06/12 250 kW	48-145701	10-35	20-35	without electronic suspension control; without EDC; Conditions see certificates VA: axle load to: 1060 kg HA: axle load to: 1270 kg
B16 PSS10	118d, 120d, 120i, 123d, 125i, 135i 10/07 - 100 -225 kW	48-131636	30-50	30-50	Conditions see certificates VA: axle load to: 1020 kg HA: axle load to: 1200 kg
B16 PSS10	118d, 120d, 120i, 123d, 125i, 135i 10/07 - 100 -225 kW	48-195232	20-40	20-40	Conditions see certificates VA: axle load to: 1020 kg HA: axle load to: 1200 kg
B16 RC	118d, 120d, 120i, 123d, 125i, 135i 10/07 - 100 -225 kW	49-131543 14-230615	30-50	30-50	Conditions see certificates VA: axle load to: 1020 kg HA: axle load to: 1200 kg
B16 BCS	3.0 M 04/11 - 06/12 250 kW	48-223539	10-35	20-35	Conditions see certificates VA: axle load to: 1020 kg HA: axle load to: 1190 kg
BMW 1 Convertible (E88)					
B12 PK	118d, 118i, 120d, 120i, 123d, 125i 03/08 - 100 -160 kW	46-180520	30	30	Conditions see certificates VA: axle load to: 945 kg HA: without ride height adjustment; axle load to: 1120 kg
B14	118d, 118i, 120d, 120i, 123d, 125i, 135i 03/08 - 100 -225 kW	47-120471	30-50	30-50	Conditions see certificates VA: axle load to: 1020 kg HA: axle load to: 1035 kg
B16 PSS10	118d, 118i, 120d, 120i, 123d, 125i, 135i 03/08 - 100 -225 kW	48-131636	30-50	30-50	Conditions see certificates VA: axle load to: 1020 kg HA: axle load to: 1200 kg
B16 PSS10	118d, 118i, 120d, 120i, 123d, 125i, 135i 03/08 - 100 -225 kW	48-195232	20-40	20-40	Conditions see certificates VA: axle load to: 1020 kg HA: axle load to: 1200 kg
B16 RC	118d, 118i, 120d, 120i, 123d, 125i, 135i 03/08 - 100 -225 kW	49-131543 14-230615	30-50	30-50	Conditions see certificates VA: axle load to: 1020 kg HA: axle load to: 1200 kg
BMW 1 (F20)					
B12 PK	114 i, 114d, 116d, 116i, 118d, 118i, 120d, 125d, 125i 08/11 - 70 -160 kW	46-223609	25	30	without electronic suspension control; Conditions see certificates; With General Certification (ABE) VA: axle load to: 905 kg HA: axle load to: 1110 kg
B12 PK	114 i, 114d, 116d, 116i, 118d, 118i, 120d, 125d, 125i 08/11 - 70 -160 kW	46-223609	25	30	with electronic suspension control; disconnect EDC; Conditions see certificates; With General Certification (ABE); Only in connection with 1x 3130679221 VA: axle load to: 905 kg HA: axle load to: 1110 kg
B12 PK	125i, M 135 i 08/11 - 160 -235 kW	46-237552	25	30	without electronic suspension control; Conditions see certificates VA: axle load to: 960 kg HA: axle load to: 1110 kg
B12 PK	M 135 i xDrive 02/12 - 235 kW	46-237545	15	15	without electronic suspension control; Conditions see certificates VA: axle load to: 1010 kg HA: axle load to: 1110 kg
B12 PK	120 d xDrive 02/12 - 135 kW	46-237538	25	30	without electronic suspension control; Conditions see certificates; With General Certification (ABE) VA: axle load to: 960 kg HA: axle load to: 1110 kg





					
BMW					
BMW 1 (F20)					
B12 SL	114 i, 114d, 116d, 116i, 118d, 118i, 120d, 125d, 125i 08/11 - 70 -160 kW	46-237569	40	40	without electronic suspension control; Conditions see certificates VA: axle load to: 905 kg HA: axle load to: 1090 kg
B14	114 i, 114d, 116d, 116i, 118d, 118i, 120d, 125d, 125i, M 135 i 08/11 - 70 -235 kW	47-217522	30-50	30-50	without electronic suspension control; Conditions see certificates VA: axle load to: 1020 kg HA: axle load to: 1235 kg
B14	114 i, 114d, 116d, 116i, 118d, 118i, 120d, 125d, 125i, M 135 i 08/11 - 70 -235 kW	47-217522	30-50	30-50	with electronic suspension control; disconnect EDC; Conditions see certificates; Only in connection with 1x 3130679221 VA: axle load to: 1020 kg HA: axle load to: 1235 kg
B14	120 d xDrive, M 135 i xDrive 02/12 - 135 -235 kW	47-207233	30-50	30-50	without electronic suspension control; Conditions see certificates VA: axle load to: 1020 kg HA: axle load to: 1120 kg
B16 PSS10	114 i, 114d, 116d, 116i, 118d, 118i, 120d, 125d, 125i, M 135 i 08/11 - 70 -235 kW	48-217170	30-50	30-50	without electronic suspension control; Conditions see certificates VA: axle load to: 1020 kg HA: axle load to: 1235 kg
B16 PSS10	114 i, 114d, 116d, 116i, 118d, 118i, 120d, 125d, 125i, M 135 i 08/11 - 70 -235 kW	48-217170	30-50	30-50	with electronic suspension control; disconnect EDC; Conditions see certificates; Only in connection with 1x 313067921 VA: axle load to: 1020 kg HA: axle load to: 1235 kg
B16 PSS10	114 i, 114d, 116d, 116i, 118d, 118i, 120d, 125d, 125i, M 135 i 08/11 - 70 -235 kW	48-229012	10-30	10-30	mark: Komfort; without electronic suspension control; Conditions see certificates VA: axle load to: 1020 kg HA: axle load to: 1235 kg
B16 PSS10	114 i, 114d, 116d, 116i, 118d, 118i, 120d, 125d, 125i, M 135 i 08/11 - 70 -235 kW	48-229012	10-30	10-30	mark: Komfort; with electronic suspension control; disconnect EDC; Conditions see certificates; Only in connection with 1x 313067921 VA: axle load to: 1020 kg HA: axle load to: 1235 kg
B16 PSS10	120 d xDrive, M 135 i xDrive 02/12 - 135 -235 kW	48-207287	30-50	30-50	without electronic suspension control; Conditions see certificates VA: axle load to: 1020 kg HA: axle load to: 1120 kg
B16 RC	114 i, 114d, 116d, 116i, 118d, 118i, 120d, 125d, 125i, M 135 i 08/11 - 70 -235 kW	49-224658 14-230615	30-50	30-50	without electronic suspension control; Conditions see certificates VA: axle load to: 1020 kg HA: axle load to: 1235 kg
B16 RC	114 i, 114d, 116d, 116i, 118d, 118i, 120d, 125d, 125i, M 135 i 08/11 - 70 -235 kW	49-224658 14-230615	30-50	30-50	with electronic suspension control; disconnect EDC; Conditions see certificates; Only in connection with 1x 3130679221 VA: axle load to: 1020 kg HA: axle load to: 1235 kg
B16 RC	120 d xDrive, M 135 i xDrive 02/12 - 135 -235 kW	14-230615 49-207323	30-50	30-50	without electronic suspension control; Conditions see certificates VA: axle load to: 1020 kg HA: axle load to: 1235 kg
BMW 1 (F21)					
B12 PK	125 i, M 135 i 12/11 - 160 -235 kW	46-237552	15	15	without electronic suspension control; Conditions see certificates VA: axle load to: 1010 kg HA: axle load to: 1110 kg
B12 PK	M 135 i xDrive 02/12 - 235 kW	46-237545	15	15	Conditions see certificates VA: axle load to: 1010 kg HA: axle load to: 1110 kg
B12 PK	114 d, 114 i, 116 d, 116 i, 118 d, 118 i, 120 d, 125 d, 125 i 12/11 - 70 -160 kW	46-223609	25	30	without electronic suspension control; Conditions see certificates; With General Certification (ABE) VA: axle load to: 905 kg HA: axle load to: 1110 kg
B12 PK	114 d, 114 i, 116 d, 116 i, 118 d, 118 i, 120 d, 125 d, 125 i 12/11 - 70 -160 kW	46-223609	25	30	with electronic suspension control; disconnect EDC; Conditions see certificates; Only in connection with 1x 3130679221 VA: axle load to: 905 kg HA: axle load to: 1110 kg
B12 PK	120 d xDrive 02/12 - 135 kW	46-237538	25	30	without electronic suspension control; Conditions see certificates; With General Certification (ABE) VA: axle load to: 960 kg HA: axle load to: 1110 kg
B12 SL	114 d, 114 i, 116 d, 116 i, 118 d, 118 i, 120 d, 125 d, 125 i 12/11 - 70 -160 kW	46-237569	40	40	without electronic suspension control; Conditions see certificates VA: axle load to: 905 kg HA: axle load to: 1090 kg
B14	114 d, 114 i, 116 d, 116 i, 118 d, 118 i, 120 d, 125 d, 125 i, M 135 i 12/11 - 70 -235 kW	47-217522	30-50	30-50	without electronic suspension control; Conditions see certificates VA: axle load to: 1020 kg HA: axle load to: 1235 kg





					
BMW					
BMW 1 (F21)					
B14	114 d, 114 i, 116 d, 116 i, 118 d, 118 i, 120 d, 125 d, 125 i, M 135 i 12/11 - 70 -235 kW	47-217522	30-50	30-50	with electronic suspension control; disconnect EDC; Conditions see certificates; Only in connection with 1x 3130679221 VA: axle load to: 1020 kg HA: axle load to: 1235 kg
B14	120 d xDrive, M 135 i xDrive 02/12 - 135 -235 kW	47-207233	30-50	30-50	without electronic suspension control; Conditions see certificates VA: axle load to: 1020 kg HA: axle load to: 1120 kg
B16 PSS10	114 d, 114 i, 116 d, 116 i, 118 d, 118 i, 120 d, 125 d, 125 i, M 135 i 12/11 - 70 -235 kW	48-217170	30-50	30-50	without electronic suspension control; Conditions see certificates VA: axle load to: 1020 kg HA: axle load to: 1235 kg
B16 PSS10	114 d, 114 i, 116 d, 116 i, 118 d, 118 i, 120 d, 125 d, 125 i, M 135 i 12/11 - 70 -235 kW	48-217170	30-50	30-50	with electronic suspension control; disconnect EDC; Conditions see certificates; Only in connection with 1x 313067921 VA: axle load to: 1020 kg HA: axle load to: 1235 kg
B16 PSS10	114 d, 114 i, 116 d, 116 i, 118 d, 118 i, 120 d, 125 d, 125 i, M 135 i 12/11 - 70 -235 kW	48-229012	10-30	10-30	mark: Komfort; without electronic suspension control; Conditions see certificates VA: axle load to: 1020 kg HA: axle load to: 1235 kg
B16 PSS10	114 d, 114 i, 116 d, 116 i, 118 d, 118 i, 120 d, 125 d, 125 i, M 135 i 12/11 - 70 -235 kW	48-229012	10-30	10-30	mark: Komfort; with electronic suspension control; disconnect EDC; Conditions see certificates; Only in connection with 1x 313067921 VA: axle load to: 1020 kg HA: axle load to: 1235 kg
B16 PSS10	120 d xDrive, M 135 i xDrive 02/12 - 135 -235 kW	48-207287	30-50	30-50	without electronic suspension control; Conditions see certificates VA: axle load to: 1020 kg HA: axle load to: 1120 kg
B16 RC	114 d, 114 i, 116 d, 116 i, 118 d, 118 i, 120 d, 125 d, 125 i, M 135 i 12/11 - 70 -235 kW	49-224658 14-230615	30-50	30-50	without electronic suspension control; Conditions see certificates VA: axle load to: 1020 kg HA: axle load to: 1235 kg
B16 RC	114 d, 114 i, 116 d, 116 i, 118 d, 118 i, 120 d, 125 d, 125 i, M 135 i 12/11 - 70 -235 kW	49-224658 14-230615	30-50	30-50	with electronic suspension control; disconnect EDC; Conditions see certificates; Only in connection with 1x 31306792211 VA: axle load to: 1020 kg HA: axle load to: 1235 kg
B16 RC	120 d xDrive, M 135 i xDrive 02/12 - 135 -235 kW	14-230615 49-207323	30-50	30-50	without electronic suspension control; Conditions see certificates VA: axle load to: 1020 kg HA: axle load to: 1235 kg
BMW 3 (E30)					
B12 PK	316 i, 316 i 1.8, 318 i, 318 is 09/82 - 08/91 73 -100 kW	46-180803	30-40	30	outside diameter strut 45 mm; Conditions see certificates VA: axle load to: 805 kg HA: axle load to: 905 kg
B12 PK	316 i, 316 i 1.8, 318 i, 318 is 09/82 - 08/91 73 -100 kW	46-000118	30-40	30	outside diameter strut 51 mm; Conditions see certificates VA: axle load to: 805 kg HA: axle load to: 905 kg
B12 PK	320 i, 323 i 09/82 - 08/86 92 -110 kW	46-180797	30-40	30	outside diameter strut 45 mm; Conditions see certificates VA: axle load to: 825 kg HA: axle load to: 905 kg
B12 PK	320 i, 323 i, 325 e 2.7, 325 i 09/82 - 11/89 90 -126 kW	46-000101	30-40	30	outside diameter strut 51 mm; Conditions see certificates VA: axle load to: 825 kg HA: axle load to: 905 kg
B12 PK	320 i 09/82 - 06/90 92 -110 kW	46-180834	30-40	30	outside diameter strut 45 mm; Conditions see certificates VA: axle load to: 865 kg HA: axle load to: 945 kg
B12 PK	320 i, 323 i, 324 d, 324 td, 325 e 2.7, 325 i 09/82 - 11/89 63 -126 kW	46-000163	30-40	30	outside diameter strut 51 mm; Conditions see certificates VA: axle load to: 865 kg HA: axle load to: 905 kg
BMW 3 Convertible (E30)					
B12 PK	318 i, 318i 06/88 - 10/93 83 -103 kW	46-180827	30	30	outside diameter strut 45 mm; Conditions see certificates VA: axle load to: 790 kg HA: axle load to: 945 kg
B12 PK	318 i, 318i 06/88 - 10/93 83 -103 kW	46-000156	30	30	outside diameter strut 51 mm; Conditions see certificates VA: axle load to: 790 kg HA: axle load to: 945 kg
B12 PK	320 i, 325 i 12/85 - 10/93 93 -126 kW	46-180810	30-40	30	outside diameter strut 45 mm; Conditions see certificates VA: axle load to: 865 kg HA: axle load to: 945 kg
B12 PK	320 i, 325 i 12/85 - 10/93 93 -126 kW	46-000132	30-40	30	outside diameter strut 51 mm; Conditions see certificates VA: axle load to: 865 kg HA: axle load to: 945 kg

					
BMW					
BMW 3 (E36)					
B10	316 i, 318 i, 318 is, 318 tds 06/92 - 02/98 66 -103 kW	46-113047	60	40	Conditions see certificates
B10	320 i, 323 i 2.5, 325 i, 325 td, 325 tds, 328 i 06/92 - 02/98 85 -142 kW	46-113054	60	40	Conditions see certificates
B12 PK	316 i, 318 i 09/90 - 05/92 73 -83 kW	46-180933	30	30	Conditions see certificates; With General Certification (ABE) VA: axle load to: 830 kg HA: axle load to: 1070 kg
B12 PK	316 i, 318 i, 318 is 06/92 - 02/98 73 -103 kW	46-000736	30	30	Conditions see certificates; With General Certification (ABE) VA: axle load to: 830 kg HA: axle load to: 1070 kg
B12 PK	320 i, 325 i, 325 td 09/90 - 05/92 85 -141 kW	46-180940	30	30	Conditions see certificates; With General Certification (ABE) VA: axle load to: 890 kg HA: axle load to: 1070 kg
B12 PK	M3 3.0 08/94 - 09/95 210 kW	46-188427	25	15	Conditions see certificates VA: axle load to: 910 kg; Ø: 116 mm; spring HA: axle load to: 1090 kg
B12 PK	M3 3.2 09/95 - 02/98 236 kW	46-000781	25	15	Conditions see certificates VA: axle load to: 920 kg; Ø: 106 mm; spring HA: axle load to: 1130 kg
B12 PK	318 tds, 320 i, 323 i 2.5, 325 i, 325 td, 325 tds, 328 i 06/92 - 02/98 66 -142 kW	46-180957	30	30	Conditions see certificates; With General Certification (ABE) VA: axle load to: 900 kg HA: axle load to: 1070 kg
B12 SL	316 i, 318 i 09/90 - 05/92 73 -83 kW	46-181022	45-50	30	manual transmission; Conditions see certificates VA: axle load to: 830 kg HA: axle load to: 1070 kg
B12 SL	316 i, 318 i, 318 is 06/92 - 02/98 73 -103 kW	46-000750	45-50	30	manual transmission; Conditions see certificates VA: axle load to: 830 kg HA: axle load to: 1070 kg
B12 SL	320 i, 325 i, 325 td 09/90 - 05/92 85 -141 kW	46-181039	45-50	30	Conditions see certificates VA: axle load to: 900 kg HA: axle load to: 1070 kg
B12 SL	318 tds, 320 i, 323 i 2.5, 325 i, 325 td, 325 tds, 328 i 06/92 - 02/98 66 -142 kW	46-000767	45-50	30	Conditions see certificates VA: axle load to: 900 kg HA: axle load to: 1070 kg
B14	316 i, 318 i, 318 is, 318 tds, 320 i, 323 i 2.5, 325 i, 325 td, 325 tds, 328 i 06/92 - 02/98 66 -142 kW	47-124813	35-55	20-40	Conditions see certificates VA: axle load to: 930 kg HA: axle load to: 1130 kg
B14	316 i, 318 i, 320 i, 325 i, 325 td 11/91 - 05/92 73 -141 kW	47-124813	35-55	20-40	Conditions see certificates; Only in connection with 2 x 12-116829 VA: axle load to: 930 kg HA: axle load to: 1130 kg
B16 PSS9	316 i, 318 i, 320 i, 325 i, 325 td 11/91 - 05/92 73 -141 kW	48-080347	35-55	20-40	Spacers required for several wheel/tyre combinations; Conditions see certificates VA: Only in connection with 2 x AFS-B682
B16 PSS9	316 i, 318 i, 318 is, 318 tds, 320 i, 323 i 2.5, 325 i, 325 td, 325 tds, 328 i 06/92 - 02/98 66 -142 kW	48-080347	35-55	20-40	Spacers required for several wheel/tyre combinations; Conditions see certificates VA: axle load to: 930 kg HA: axle load to: 1130 kg
B16 PSS9	316 i, 320 i, 325 i, 325 td 09/90 - 05/92 73 -141 kW	48-080347	35-55	20-40	Spacers required for several wheel/tyre combinations; Conditions see certificates VA: Only in connection with 2x AFS-B682; axle load to: 930 kg HA: axle load to: 1130 kg
B16 PSS9	M3 3.0, M3 3.2 08/94 - 02/98 210 -236 kW	48-088459	55	40	Conditions see certificates VA: axle load to: 930 kg HA: axle load to: 1130 kg
B16 PSS9	M3 3.0 08/94 - 09/95 210 kW	48-115766	40	40	mark: Club-Sport; Conditions see certificates; Ø: 116 mm; spring VA: axle load to: 930 kg HA: axle load to: 1130 kg
B16 PSS9	M3 3.2 09/95 - 02/98 236 kW	48-115674	40	40	mark: Club-Sport; Conditions see certificates; Ø: 106 mm; spring VA: axle load to: 930 kg HA: axle load to: 1130 kg

					
BMW					
BMW 3 (E36)					
B16 BCS	M3 3.0, M3 3.2 08/94 - 02/98 210 -236 kW	48-215855	35-40	35-40	Conditions see certificates VA: axle load to: 930 kg HA: axle load to: 1130 kg
BMW 3 Compact (E36)					
B12 PK	316 i, 318 ti 03/94 - 08/00 75 -103 kW	46-180988	30	30	Conditions see certificates; With General Certification (ABE) VA: axle load to: 830 kg HA: axle load to: 970 kg
B12 PK	318 tds, 323 ti 01/95 - 08/00 66 -125 kW	46-181008	30	30	Conditions see certificates; With General Certification (ABE) VA: axle load to: 900 kg HA: axle load to: 970 kg
B12 SL	316 i, 318 ti 03/94 - 08/00 75 -103 kW	46-181077	45-50	30	manual transmission; Conditions see certificates VA: axle load to: 830 kg HA: axle load to: 970 kg
B12 SL	318 tds, 323 ti 01/95 - 08/00 66 -125 kW	46-181084	45-50	30	Conditions see certificates VA: axle load to: 900 kg HA: axle load to: 970 kg
B16 PSS9	316 g, 316 i, 318 tds, 318 ti, 323 ti 07/95 - 08/00 66 -125 kW	48-080408	30-50	20-40	Spacers required for several wheel/tyre combinations; Conditions see certificates
BMW 3 Coupe (E36)					
B10	316 i, 318 is 06/92 - 04/99 75 -103 kW	46-113047	60	40	Conditions see certificates
B10	320 i, 323 i 2.5, 325 i, 328 i 06/92 - 04/99 110 -142 kW	46-113054	60	40	Conditions see certificates
B12 PK	316 i, 318 is 06/92 - 04/99 75 -103 kW	46-000736	30	15	Conditions see certificates; With General Certification (ABE) VA: axle load to: 830 kg HA: axle load to: 1070 kg
B12 PK	318 is 03/92 - 05/92 103 kW	46-180933	30	15	Conditions see certificates; With General Certification (ABE) VA: axle load to: 830 kg HA: axle load to: 1070 kg
B12 PK	320 i, 323 i 2.5, 325 i, 328 i 06/92 - 04/99 110 -142 kW	46-180957	30	15	Conditions see certificates; With General Certification (ABE) VA: axle load to: 900 kg HA: axle load to: 1070 kg
B12 PK	M3 3.0 10/92 - 10/95 210 -217 kW	46-188427	25	15	Conditions see certificates VA: axle load to: 910 kg; Ø: 116 mm; spring HA: axle load to: 1090 kg
B12 PK	M3 3.2 10/95 - 04/99 236 kW	46-000781	25	15	Conditions see certificates VA: axle load to: 920 kg; Ø: 106 mm; spring HA: axle load to: 1130 kg
B12 SL	316 i, 318 is 06/92 - 04/99 75 -103 kW	46-000750	45	15	manual transmission; Conditions see certificates VA: axle load to: 830 kg HA: axle load to: 1070 kg
B12 SL	318 is 03/92 - 05/92 103 kW	46-181022	45	30	manual transmission; Conditions see certificates VA: axle load to: 830 kg HA: axle load to: 1070 kg
B12 SL	320 i, 325 i 03/92 - 05/92 110 -141 kW	46-181039	45	15	Conditions see certificates VA: axle load to: 900 kg HA: axle load to: 1070 kg
B12 SL	320 i, 323 i 2.5, 325 i, 328 i 06/92 - 04/99 110 -142 kW	46-000767	45	15	Conditions see certificates VA: axle load to: 900 kg HA: axle load to: 1070 kg
B14	316 i, 318 is, 320 i, 323 i 2.5, 325 i, 328 i 06/92 - 04/99 75 -142 kW	47-124813	35-55	20-40	Conditions see certificates VA: axle load to: 930 kg HA: axle load to: 1130 kg
B14	318 is, 325 i 03/92 - 05/92 103 -141 kW	47-124813	35-55	20-40	Conditions see certificates; Only in connection with 2 x AFS-B682
B16 PSS9	316 i, 318 is, 320 i, 323 i 2.5, 325 i, 328 i 06/92 - 04/99 75 -142 kW	48-080347	35-55	20-40	Spacers required for several wheel/tyre combinations; Conditions see certificates VA: axle load to: 930 kg HA: axle load to: 1130 kg
B16 PSS9	318 is, 320 i, 325 i 03/92 - 05/92 103 -141 kW	48-080347	35-55	20-40	Spacers required for several wheel/tyre combinations; Conditions see certificates; Only in connection with 2 x AFS-B682

					
BMW					
BMW 3 Coupe (E36)					
B16 PSS9	M3 3.0, M3 3.2 10/92 - 04/99 210 -236 kW	48-088459	45-55	20-40	Spacers required for several wheel/tyre combinations; Conditions see certificates
B16 PSS9	M3 3.0 10/92 - 10/95 210 -217 kW	48-115766	30-40	30-40	mark: Club-Sport; Spacers required for several wheel/tyre combinations; Conditions see certificates; Øi: 116 mm; spring VA: axle load to: 930 kg HA: axle load to: 1130 kg
B16 PSS9	M3 3.2 10/95 - 04/99 236 kW	48-115674	30-40	30-40	mark: Club-Sport; Spacers required for several wheel/tyre combinations; Conditions see certificates; Øi: 106 mm; spring VA: axle load to: 930 kg HA: axle load to: 1130 kg
B16 BCS	M3 3.0, M3 3.2 10/92 - 04/99 210 -236 kW	48-215855	35-40	35-40	Conditions see certificates VA: axle load to: 930 kg HA: axle load to: 1130 kg
BMW 3 Convertible (E36)					
B12 PK	318 i 01/94 - 04/99 85 kW	46-180971	30	30	Conditions see certificates; With General Certification (ABE) VA: axle load to: 830 kg HA: axle load to: 1115 kg
B12 PK	320 i, 323 i 2.5, 325 i, 328 i 03/93 - 04/99 110 -142 kW	46-180964	30	30	Conditions see certificates; With General Certification (ABE) VA: axle load to: 900 kg HA: axle load to: 1115 kg
B12 PK	M3 3.0 01/94 - 10/95 210 kW	46-188427	25	15	Conditions see certificates VA: axle load to: 910 kg; Øi: 116 mm; spring HA: axle load to: 1090 kg
B12 PK	M3 3.2 10/95 - 04/99 236 kW	46-000781	25	15	Conditions see certificates VA: axle load to: 920 kg; Øi: 106 mm; spring HA: axle load to: 1130 kg
B12 SL	318 i 01/94 - 04/99 85 kW	46-181053	45-50	30	manual transmission; Conditions see certificates VA: axle load to: 830 kg HA: axle load to: 1070 kg
B12 SL	320 i, 323 i 2.5, 325 i, 328 i 03/93 - 04/99 110 -142 kW	46-181060	45-50	30	Conditions see certificates VA: axle load to: 900 kg HA: axle load to: 1070 kg
B14	318 i, 320 i, 323 i 2.5, 325 i, 328 i 03/93 - 04/99 85 -142 kW	47-124813	35-55	25-40	Conditions see certificates VA: axle load to: 930 kg HA: axle load to: 1130 kg
B16 PSS9	318 i, 320 i, 323 i 2.5, 325 i, 328 i 03/93 - 04/99 85 -142 kW	48-080347	35-55	20-40	Spacers required for several wheel/tyre combinations; Conditions see certificates VA: axle load to: 930 kg HA: axle load to: 1130 kg
B16 PSS9	M3 3.0, M3 3.2 01/94 - 04/99 210 -236 kW	48-088459	35-55	20-40	Conditions see certificates
B16 PSS9	M3 3.0 01/94 - 10/95 210 kW	48-115766	30-40	30-40	mark: Club-Sport; Conditions see certificates; Øi: 116 mm; spring VA: axle load to: 930 kg HA: axle load to: 1130 kg
B16 PSS9	M3 3.2 10/95 - 04/99 236 kW	48-115674	30-40	30-40	mark: Club-Sport; Conditions see certificates; Øi: 106 mm; spring VA: axle load to: 930 kg HA: axle load to: 1130 kg
BMW 3 Touring (E36)					
B12 PK	316 i, 318 i 07/95 - 10/99 75 -85 kW	46-181015	30	30	Conditions see certificates; With General Certification (ABE); Self-levelling inactive after modification VA: axle load to: 830 kg HA: axle load to: 1115 kg
B12 PK	318 tds, 320 i, 323 i 2.5, 325 tds, 328 i 01/95 - 10/99 66 -142 kW	46-180995	30	30	Conditions see certificates; With General Certification (ABE) VA: axle load to: 900 kg HA: axle load to: 1115 kg
B12 SL	316 i, 318 i 07/95 - 10/99 75 -85 kW	46-181091	45-30	30	manual transmission; Conditions see certificates; Self-levelling inactive after modification VA: axle load to: 830 kg HA: axle load to: 1115 kg
B12 SL	318 tds, 320 i, 323 i 2.5, 325 tds, 328 i 01/95 - 10/99 66 -142 kW	46-181046	45-30	30	Conditions see certificates VA: axle load to: 900 kg HA: axle load to: 1115 kg
B14	316 i, 318 i, 318 tds, 320 i, 323 i 2.5, 325 tds, 328 i 01/95 - 10/99 66 -142 kW	47-124813	35-55	25-45	Conditions see certificates; Self-levelling inactive after modification VA: axle load to: 930 kg HA: axle load to: 1130 kg

					
BMW					
BMW 3 Touring (E36)					
B16 PSS9	316 i, 318 i, 318 tds, 320 i, 323 i 2.5, 325 tds, 328 i 01/95 - 10/99 66 -142 kW	48-080347	35-55	20-40	Spacers required for several wheel/tyre combinations; Conditions see certificates; Self-levelling inactive after modification VA: axle load to: 930 kg HA: axle load to: 1130 kg
BMW 3 (E46)					
B12 PK	316 i, 318 i 02/98 - 02/05 77 -105 kW	46-180001	30	20-25	Conditions see certificates VA: axle load to: 895 kg HA: without ride height adjustment; axle load to: 1190 kg
B12 PK	325 xi, 330 xi 06/00 - 02/05 141 -170 kW	46-180032	30	20-25	serie production spring seat must be used; Conditions see certificates VA: axle load to: 1010 kg HA: without ride height adjustment; axle load to: 1250 kg
B12 PK	318 d, 320 d, 320 i, 323 i, 325 i, 328 i, 330 i 06/00 - 02/05 85 -170 kW	46-180018	30	20-25	Conditions see certificates VA: axle load to: 970 kg HA: without ride height adjustment; axle load to: 1190 kg
B12 PK	330 d 10/99 - 02/05 135 -150 kW	46-180025	30	20-25	Conditions see certificates VA: axle load to: 1030 kg HA: without ride height adjustment; axle load to: 1190 kg
B12 PK	330 xd 06/00 - 02/05 135 -150 kW	46-180049	30	20-25	serie production spring seat must be used; Conditions see certificates VA: axle load to: 1065 kg HA: without ride height adjustment; axle load to: 1250 kg
B12 SL	316 i, 318 i 02/98 - 02/05 77 -105 kW	46-180131	45-50	20-25	Conditions see certificates VA: axle load to: 895 kg HA: without ride height adjustment; axle load to: 1045 kg
B12 SL	330 i 06/00 - 02/05 170 kW	46-180117	45-50	20-25	manual transmission; Conditions see certificates VA: axle load to: 935 kg HA: without ride height adjustment; axle load to: 1190 kg
B12 SL	318 d, 320 d, 320 i, 323 i, 325 i, 328 i 02/98 - 02/05 85 -142 kW	46-180117	45-50	20-25	Conditions see certificates VA: axle load to: 935 kg HA: without ride height adjustment; axle load to: 1190 kg
B14	316 i, 318 d, 318 i, 320 d, 320 i, 323 i, 325 i, 328 i, 330 d, 330 i 10/99 - 04/05 77 -170 kW	47-126848	35-50	25-40	Conditions see certificates VA: axle load to: 1030 kg HA: axle load to: 1190 kg
B16 PSS10	316 i, 318 d, 318 i, 320 d, 320 i, 323 i, 325 i, 328 i, 330 d, 330 i 10/99 - 04/05 77 -170 kW	48-126380	35-50	25-40	Conditions see certificates VA: axle load to: 1030 kg HA: axle load to: 1190 kg
B16 RC	316 i, 318 d, 318 i, 320 d, 320 i, 323 i, 325 i, 328 i, 330 d, 330 i 10/99 - 04/05 77 -170 kW	49-135121 14-230615	35-50	25-40	Conditions see certificates VA: axle load to: 1030 kg HA: axle load to: 1190 kg
BMW 3 Compact (E46)					
B12 PK	1.6 Ti, 316 ti, 318 ti 09/01 - 02/05 77 -105 kW	46-180070	25	15	Conditions see certificates VA: axle load to: 895 kg HA: without ride height adjustment; axle load to: 1045 kg
B12 PK	2.0 TD, 318 td, 320 td, 325 ti 06/01 - 02/05 85 -141 kW	46-180087	25	15	Conditions see certificates VA: axle load to: 970 kg HA: without ride height adjustment; axle load to: 1045 kg
B12 SL	1.6 Ti, 316 ti, 318 ti 09/01 - 02/05 77 -105 kW	46-180100	30-35	15	Conditions see certificates VA: axle load to: 895 kg HA: without ride height adjustment; axle load to: 1190 kg
B12 SL	325 ti 06/01 - 02/05 141 kW	46-180124	30-35	15	manual transmission; Conditions see certificates VA: axle load to: 935 kg HA: without ride height adjustment; axle load to: 1190 kg
B12 SL	2.0 TD, 318 td, 320 td 09/01 - 02/05 85 -110 kW	46-180124	30-35	15	Conditions see certificates VA: axle load to: 935 kg HA: without ride height adjustment; axle load to: 1190 kg
B16 PSS9	1.6 Ti, 2.0 TD, 316 ti, 318 td, 318 ti, 320 td, 325 ti 06/01 - 02/05 77 -141 kW	48-088435	35	20	Conditions see certificates VA: axle load to: 1000 kg HA: axle load to: 1060 kg

					
BMW					
BMW 3 Coupe (E46)					
B12 PK	316 Ci, 318 Ci 11/99 - 77 -110 kW	46-180001	25	10	Conditions see certificates VA: axle load to: 895 kg HA: without ride height adjustment; axle load to: 1190 kg
B12 PK	M3 3.2 06/00 - 252 kW	46-000613	20	10	Conditions see certificates; Only in connection with 31 32 1 139 423 (2x) VA: axle load to: 990 kg HA: axle load to: 1170 kg
B12 PK	320 Cd, 320 Ci, 323 Ci, 325 Ci, 328 Ci, 330 ci 06/00 - 110 -170 kW	46-180018	25	10	Conditions see certificates VA: axle load to: 970 kg HA: without ride height adjustment; axle load to: 1190 kg
B12 PK	330 Cd 03/03 - 150 kW	46-180025	25	10	Conditions see certificates VA: axle load to: 1030 kg HA: without ride height adjustment; axle load to: 1190 kg
B12 SL	316 Ci, 318 Ci 09/01 - 85 -110 kW	46-180131	30-35	15	Conditions see certificates VA: axle load to: 895 kg HA: without ride height adjustment; axle load to: 1045 kg
B12 SL	320 Ci, 323 Ci, 325 Ci, 328 Ci 04/99 - 110 -142 kW	46-180117	30-35	15	Conditions see certificates VA: axle load to: 935 kg HA: without ride height adjustment; axle load to: 1190 kg
B12 SL	330 ci 06/00 - 170 kW	46-180117	30-35	15	manual transmission; Conditions see certificates VA: axle load to: 935 kg HA: without ride height adjustment; axle load to: 1190 kg
B14	316 Ci, 318 Ci, 320 Cd, 320 Ci, 323 Ci, 325 Ci, 328 Ci, 330 Cd, 330 ci 04/99 - 77 -170 kW	47-126848	35-50	25-40	Conditions see certificates VA: axle load to: 1030 kg HA: axle load to: 1190 kg
B16 PSS10	316 Ci, 318 Ci, 320 Cd, 320 Ci, 323 Ci, 325 Ci, 328 Ci, 330 Cd, 330 ci 04/99 - 77 -170 kW	48-126380	30-50	20-40	Conditions see certificates VA: axle load to: 1030 kg HA: axle load to: 1190 kg
B16 PSS10	M3 3.2, M3 CSL 06/00 - 252 -265 kW	48-126687	15-35	20-35	Conditions see certificates; Only in connection with 31 32 1 139 423 (2x) VA: axle load to: 990 kg HA: axle load to: 1170 kg
B16 RC	316 Ci, 318 Ci, 320 Cd, 320 Ci, 323 Ci, 325 Ci, 328 Ci, 330 Cd, 330 ci 04/99 - 77 -170 kW	49-135121 14-230615	35-50	25-40	Conditions see certificates VA: axle load to: 1030 kg HA: axle load to: 1190 kg
B16 BCS	M3 3.2, M3 CSL 06/00 - 252 -265 kW	48-213660	35-40	35-40	Conditions see certificates VA: axle load to: 990 kg HA: axle load to: 1170 kg
BMW 3 Convertible (E46)					
B12 PK	318 Ci 09/01 - 105 -110 kW	46-180001	30	15-20	Conditions see certificates VA: axle load to: 895 kg HA: without ride height adjustment; axle load to: 1190 kg
B12 PK	M3 3.2 04/01 - 252 kW	46-000613	20	10	Conditions see certificates; Only in connection with 31 32 1 139 423 (2x) VA: axle load to: 990 kg HA: axle load to: 1170 kg
B12 PK	320 Cd, 320 Ci, 323 Ci, 325 Ci, 330 Ci 06/00 - 110 -170 kW	46-180018	40	20-25	Conditions see certificates VA: axle load to: 970 kg HA: without ride height adjustment; axle load to: 1190 kg
B12 PK	330 Cd 08/05 - 150 kW	46-180025	30	20-25	Conditions see certificates VA: axle load to: 1030 kg HA: without ride height adjustment; axle load to: 1190 kg
B14	318 Ci, 320 Cd, 320 Ci, 323 Ci, 325 Ci, 330 Cd, 330 Ci 06/00 - 105 -170 kW	47-126848	35-50	25-40	Conditions see certificates VA: axle load to: 1030 kg HA: axle load to: 1190 kg
B16 PSS10	318 Ci, 320 Cd, 320 Ci, 323 Ci, 325 Ci, 330 Cd, 330 Ci 06/00 - 105 -170 kW	48-126380	35-50	25-40	Conditions see certificates VA: axle load to: 1030 kg HA: axle load to: 1190 kg
B16 PSS10	M3 3.2 04/01 - 252 kW	48-126687	15-35	20-35	Conditions see certificates; Only in connection with 31 32 1 139 423 (2x) VA: axle load to: 990 kg HA: axle load to: 1170 kg

				
--	---	---	---	---

BMW
BMW 3 Convertible (E46)





B16 RC	318 Ci, 320 Cd, 320 Ci, 323 Ci, 325 Ci, 330 Cd, 330 Ci 06/00 - 105-170 kW	49-135121 14-230615	35-50	25-40	Conditions see certificates VA: axle load to: 1030 kg HA: axle load to: 1190 kg
---------------	---	--------------------------------	-------	-------	---





BMW 3 Touring (E46)





B12 PK	316 i, 318 i 09/01 - 02/05 85-105 kW	46-180001	30	20-25	Conditions see certificates VA: axle load to: 895 kg HA: without ride height adjustment; axle load to: 1190 kg
B12 PK	325 xi, 330 xi 06/00 - 02/05 141-170 kW	46-180056	30	20-25	serie production spring seat must be used; Conditions see certificates VA: axle load to: 1010 kg HA: axle load to: 1250 kg
B12 PK	318 d, 320 d, 320 i, 325 i, 328 i, 330 i 06/00 - 02/05 85-170 kW	46-180018	30	20-25	Conditions see certificates VA: axle load to: 970 kg HA: without ride height adjustment; axle load to: 1190 kg
B12 PK	330 d 10/99 - 02/05 135-150 kW	46-180025	30	20-25	Conditions see certificates VA: axle load to: 1030 kg HA: without ride height adjustment; axle load to: 1190 kg
B12 SL	316 i, 318 i 09/01 - 02/05 85-105 kW	46-180094	45-50	30	Conditions see certificates VA: axle load to: 895 kg HA: without ride height adjustment; axle load to: 1190 kg
B12 SL	318 d, 320 d, 320 i, 325 i, 328 i, 330 i 06/00 - 02/05 85-170 kW	46-180117	45-50	30	Conditions see certificates VA: axle load to: 935 kg HA: without ride height adjustment; axle load to: 1190 kg
B14	316 i, 318 d, 318 i, 320 d, 320 i, 325 i, 328 i, 330 d, 330 i 06/00 - 02/05 85-170 kW	47-126848	35-50	25-40	Conditions see certificates VA: axle load to: 1030 kg HA: axle load to: 1190 kg
B16 PSS10	316 i, 318 d, 318 i, 320 d, 320 i, 325 i, 328 i, 330 d, 330 i 06/00 - 02/05 85-170 kW	48-126380	35-50	25-40	Conditions see certificates VA: axle load to: 1030 kg HA: axle load to: 1190 kg
B16 RC	316 i, 318 d, 318 i, 320 d, 320 i, 325 i, 328 i, 330 d, 330 i 06/00 - 02/05 85-170 kW	49-135121 14-230615	35-50	25-40	Conditions see certificates VA: axle load to: 1030 kg HA: axle load to: 1190 kg





BMW 3 (E90)





B12 PK	318 i, 318i, 320 si, 320i 03/07 - 12/11 95-127 kW	46-180544	30	25	Conditions see certificates; With General Certification (ABE) VA: axle load to: 935 kg HA: without ride height adjustment; axle load to: 1085 kg
B12 PK	2.5, 3.0, 316d, 318d, 320d, 323 i, 325i, 330i 01/05 - 12/11 85-200 kW	46-180551	30	25	Conditions see certificates; With General Certification (ABE) VA: axle load to: 1045 kg HA: without ride height adjustment; axle load to: 1135 kg
B12 PK	3.0, 325d, 330d, 335d, 335i 09/06 - 12/11 145-225 kW	46-180568	20	0	Conditions see certificates; With General Certification (ABE) VA: axle load to: 1090 kg HA: without ride height adjustment; axle load to: 1135 kg
B12 PK	M3 03/07 - 12/11 309 kW	46-180698	20	15	without electronic suspension control; without EDC; Conditions see certificates VA: axle load to: 1060 kg HA: without ride height adjustment; axle load to: 1190 kg
B12 PK	M3 03/07 - 12/11 309 kW	50-174546 46-180698	20	15	with electronic suspension control; with EDC; Conditions see certificates VA: axle load to: 1060 kg HA: without ride height adjustment; axle load to: 1190 kg
B12 PK	320d xDrive, 320xd, 325i xDrive, 325xi, 330i xDrive, 330xi 09/07 - 12/11 120-200 kW	46-180605	30	15-20	Conditions see certificates; With General Certification (ABE) VA: axle load to: 1045 kg HA: without ride height adjustment; axle load to: 1200 kg
B12 PK	330d xDrive, 330xd 09/05 - 12/11 170-180 kW	46-180612	30	15-20	Conditions see certificates; With General Certification (ABE) VA: axle load to: 1090 kg HA: without ride height adjustment; axle load to: 1200 kg
B12 SL	318 i, 318i, 320 si, 320i 03/07 - 12/11 95-127 kW	46-180711	45-50	35	Conditions see certificates; With General Certification (ABE) VA: axle load to: 935 kg HA: without ride height adjustment; axle load to: 1085 kg
B12 SL	2.5, 3.0, 316d, 318d, 320d, 323 i, 325i, 330i 01/05 - 12/11 85-200 kW	46-180728	45-50	35	Conditions see certificates; With General Certification (ABE) VA: axle load to: 955 kg HA: without ride height adjustment; axle load to: 1135 kg





					
BMW					
BMW 3 (E90)					
B14	2.5, 3.0, 316d, 316i, 318 i, 318d, 318i, 320 si, 320d, 320i, 323 i, 325d, 325i, 330d, 330i, 335d, 335i 01/05 - 12/11 85 -225 kW	47-120471	30-50	30-50	Conditions see certificates VA: axle load to: 1020 kg HA: axle load to: 1200 kg
B16 PSS10	2.5, 3.0, 316d, 316i, 318 i, 318d, 318i, 320 si, 320d, 320i, 323 i, 325d, 325i, 330d, 330i, 335d, 335i 01/05 - 12/11 85 -225 kW	48-131636	30-50	30-50	Conditions see certificates VA: axle load to: 1020 kg HA: axle load to: 1200 kg
B16 PSS10	2.5, 3.0, 316d, 316i, 318 i, 318d, 318i, 320 si, 320d, 320i, 323 i, 325d, 325i, 330d, 330i, 335d, 335i 01/05 - 12/11 85 -225 kW	48-195232	20-40	20-40	Conditions see certificates VA: axle load to: 1020 kg HA: axle load to: 1200 kg
B16 PSS10	M3 03/07 - 12/11 309 kW	48-145701	10-35	20-35	without electronic suspension control; without EDC; Conditions see certificates VA: axle load to: 1060 kg HA: axle load to: 1270 kg
B16 PSS10	M3 03/07 - 12/11 309 kW	48-145701 50-174546	10-35	20-35	with electronic suspension control; with EDC; Conditions see certificates VA: axle load to: 1060 kg HA: axle load to: 1270 kg
B16 RC	2.5, 3.0, 316d, 316i, 318 i, 318d, 318i, 320 si, 320d, 320i, 323 i, 325d, 325i, 330d, 330i, 335d, 335i 01/05 - 12/11 85 -225 kW	49-131543 14-230615	30-50	30-50	Conditions see certificates VA: axle load to: 1020 kg HA: axle load to: 1200 kg
B16 DTC	M3 03/07 - 12/11 309 kW	49-237108	10-35	10-35	with electronic suspension control; with EDC; Conditions see certificates VA: axle load to: 1070 kg HA: axle load to: 1270 kg
B16 BCS	M3 03/07 - 12/11 309 kW	48-223539	15-30	15-30	without electronic suspension control; without EDC; Conditions see certificates VA: axle load to: 1020 kg HA: axle load to: 1190 kg
BMW 3 Touring (E91)					
B12 PK	316i, 318i, 320 i, 320i 09/05 - 90 -125 kW	46-180575	30	25	Conditions see certificates; With General Certification (ABE) VA: axle load to: 935 kg HA: without ride height adjustment; axle load to: 1135 kg
B12 PK	2.5, 316d, 318d, 320d, 325i, 330i 09/05 - 85 -200 kW	46-180582	30	25	Conditions see certificates; With General Certification (ABE) VA: axle load to: 1045 kg HA: without ride height adjustment; axle load to: 1200 kg
B12 PK	2.0 320d xDrive, 320d xDrive, 320xd, 325i xDrive, 325xi, 330i xDrive, 330xi 09/07 - 120 -200 kW	46-180629	30	25	Conditions see certificates; With General Certification (ABE) VA: axle load to: 1045 kg HA: without ride height adjustment; axle load to: 1200 kg
B12 PK	325d, 330d, 335d, 335i 09/05 - 145 -225 kW	46-180599	30	25	Conditions see certificates; With General Certification (ABE) VA: axle load to: 1090 kg HA: without ride height adjustment; axle load to: 1200 kg
B12 PK	330xd, 335i xDrive, 335xi 09/05 - 170 -225 kW	46-180636	30	25	Conditions see certificates; With General Certification (ABE) VA: axle load to: 1090 kg HA: without ride height adjustment; axle load to: 1200 kg
B12 SL	316i, 318i, 320 i, 320i 09/05 - 90 -125 kW	46-180735	45-50	35	Conditions see certificates; With General Certification (ABE) VA: axle load to: 935 kg HA: without ride height adjustment; axle load to: 1135 kg
B12 SL	2.5, 316d, 318d, 320d, 325i, 330i, 335i 09/05 - 85 -225 kW	46-180742	45-50	35	Conditions see certificates; With General Certification (ABE) VA: axle load to: 955 kg HA: without ride height adjustment; axle load to: 1175 kg
B14	2.5, 316d, 316i, 318d, 318i, 320 i, 320d, 320i, 325d, 325i, 330d, 330i, 335d, 335i 09/05 - 85 -225 kW	47-120471	30-50	30-50	Conditions see certificates VA: axle load to: 1020 kg HA: axle load to: 1200 kg
B16 PSS10	2.5, 316d, 316i, 318d, 318i, 320 i, 320d, 320i, 325d, 325i, 330d, 330i, 335d, 335i 09/05 - 85 -225 kW	48-131636	30-50	30-50	Conditions see certificates VA: axle load to: 1020 kg HA: axle load to: 1200 kg





   					
BMW					
BMW 3 Touring (E91)					
B16 PSS10	2.5, 316d, 316i, 318d, 318i, 320 i, 320d, 320i, 325d, 325i, 330d, 330i, 335d, 335i 09/05 - 85 -225 kW	48-195232	20-40	20-40	Conditions see certificates VA: axle load to: 1020 kg HA: axle load to: 1200 kg
B16 RC	2.5, 316d, 316i, 318d, 318i, 320 i, 320d, 320i, 325d, 325i, 330d, 330i, 335d, 335i 09/05 - 85 -225 kW	49-131543 14-230615	30-50	30-50	Conditions see certificates VA: axle load to: 1020 kg HA: axle load to: 1200 kg
BMW 3 Coupe (E92)					
B12 PK	2.0, 2.5, 3.0, 316 i, 318i, 320 i, 320d, 320i, 325i, 330i 09/06 - 90 -200 kW	46-180643	35	25	Conditions see certificates VA: axle load to: 930 kg HA: without ride height adjustment; axle load to: 1090 kg
B12 PK	M3 03/07 - 309 kW	46-180698	20	15	without electronic suspension control; without EDC; Conditions see certificates VA: axle load to: 1060 kg HA: without ride height adjustment; axle load to: 1190 kg
B12 PK	M3 03/07 - 309 kW	50-174546 46-180698	20	15	with electronic suspension control; with EDC; Conditions see certificates VA: axle load to: 1060 kg HA: without ride height adjustment; axle load to: 1190 kg
B12 PK	325d, 330d, 335d, 335i 09/06 - 145 -225 kW	46-180650	35	25	Conditions see certificates VA: axle load to: 990 kg HA: without ride height adjustment; axle load to: 1090 kg
B14	2.0, 2.5, 3.0, 316 i, 318i, 320 i, 320d, 320i, 325d, 325i, 330d, 330i, 335d, 335i 09/06 - 90 -225 kW	47-120471	30-50	30-50	Conditions see certificates VA: axle load to: 1020 kg HA: axle load to: 1200 kg
B16 PSS10	2.0, 2.5, 3.0, 316 i, 318i, 320 i, 320d, 320i, 325d, 325i, 330d, 330i, 335d, 335i 09/06 - 90 -225 kW	48-131636	30-50	30-50	Conditions see certificates VA: axle load to: 1020 kg HA: axle load to: 1200 kg
B16 PSS10	2.0, 2.5, 3.0, 316 i, 318i, 320 i, 320d, 320i, 325d, 325i, 330d, 330i, 335d, 335i 09/06 - 90 -225 kW	48-195232	20-40	20-40	Conditions see certificates VA: axle load to: 1020 kg HA: axle load to: 1200 kg
B16 PSS10	M3, M3 GTS 03/07 - 309 -331 kW	48-145701	10-35	20-35	without electronic suspension control; without EDC; Conditions see certificates VA: axle load to: 1060 kg HA: axle load to: 1270 kg
B16 PSS10	M3, M3 GTS 03/07 - 309 -331 kW	48-145701 50-174546	10-35	20-35	with electronic suspension control; with EDC; Conditions see certificates VA: axle load to: 1060 kg HA: axle load to: 1270 kg
B16 RC	2.0, 2.5, 3.0, 316 i, 318i, 320 i, 320d, 320i, 325d, 325i, 330d, 330i, 335d, 335i 09/06 - 90 -225 kW	49-131543 14-230615	30-50	30-50	Conditions see certificates VA: axle load to: 1020 kg HA: axle load to: 1200 kg
B16 DTC	M3, M3 GTS 03/07 - 309 -331 kW	49-237108	10-35	10-35	with electronic suspension control; with EDC; Conditions see certificates VA: axle load to: 1070 kg HA: axle load to: 1270 kg
B16 BCS	M3, M3 GTS 03/07 - 309 -331 kW	48-223539	15-30	15-30	without electronic suspension control; without EDC; Conditions see certificates VA: axle load to: 1020 kg HA: axle load to: 1190 kg
B16 BCS	M3, M3 GTS 03/07 - 309 -331 kW	50-174546 48-223539	15-30	15-30	with electronic suspension control; with EDC; Conditions see certificates VA: axle load to: 1020 kg HA: axle load to: 1190 kg
BMW 3 Convertible (E93)					
B12 PK	1.9, 318i, 320d, 320i 03/07 - 105 -135 kW	46-180667	30	10-15	Conditions see certificates VA: axle load to: 930 kg HA: without ride height adjustment; axle load to: 1200 kg





					
BMW					
BMW 3 Convertible (E93)					
B12 PK	2.5, 3.0, 325i, 330i, 335i 03/07 - 130 -225 kW	46-180674	30	10-15	Conditions see certificates VA: axle load to: 990 kg HA: without ride height adjustment; axle load to: 1200 kg
B12 PK	325d, 330d 03/07 - 145 -180 kW	46-180681	30	10-15	Conditions see certificates VA: axle load to: 1085 kg HA: without ride height adjustment; axle load to: 1200 kg
B14	1.9, 2.5, 3.0, 318i, 320d, 320i, 325d, 325i, 330d, 330i, 335i 03/07 - 105 -225 kW	47-120471	30-50	30-50	Conditions see certificates VA: axle load to: 1020 kg HA: axle load to: 1200 kg
B16 PSS10	1.9, 2.5, 3.0, 318i, 320d, 320i, 325d, 325i, 330d, 330i, 335i 03/07 - 105 -225 kW	48-131636	30-50	30-50	Conditions see certificates VA: axle load to: 1020 kg HA: axle load to: 1200 kg
B16 PSS10	1.9, 2.5, 3.0, 318i, 320d, 320i, 325d, 325i, 330d, 330i, 335i 03/07 - 105 -225 kW	48-195232	20-40	20-40	Conditions see certificates VA: axle load to: 1020 kg HA: axle load to: 1200 kg
B16 PSS10	M3 03/07 - 309 kW	48-145701	10-35	20-35	without electronic suspension control; without EDC; Conditions see certificates VA: axle load to: 1060 kg HA: axle load to: 1270 kg
B16 PSS10	M3 03/07 - 309 kW	48-145701 50-174546	10-35	20-35	with electronic suspension control; with EDC; Conditions see certificates VA: axle load to: 1060 kg HA: axle load to: 1270 kg
B16 RC	1.9, 2.5, 3.0, 318i, 320d, 320i, 325d, 325i, 330d, 330i, 335i 03/07 - 105 -225 kW	49-131543 14-230615	30-50	30-50	Conditions see certificates VA: axle load to: 1020 kg HA: axle load to: 1200 kg
B16 DTC	M3 03/07 - 309 kW	49-237108	10-35	10-35	with electronic suspension control; with EDC; Conditions see certificates VA: axle load to: 1070 kg HA: axle load to: 1270 kg
BMW 3 (F30)					
B12 PK	316 i, 316d, 318d, 320d, 320i, 328i 10/11 - 85 -180 kW	46-223661	25-30	25	without electronic suspension control; Conditions see certificates; With General Certification (ABE) VA: axle load to: 965 kg HA: axle load to: 1170 kg
B12 PK	316 i, 316d, 318d, 320d, 320i, 328i 10/11 - 85 -180 kW	46-223661	25-30	25	with electronic suspension control; disconnect EDC; Conditions see certificates; With General Certification (ABE); Only in connection with 1x 31306792211 VA: axle load to: 965 kg HA: axle load to: 1170 kg
B12 PK	335i 10/11 - 225 kW	46-223678	25-30	25	without electronic suspension control; without ride height adjustment; Conditions see certificates; With General Certification (ABE) VA: axle load to: 990 kg HA: axle load to: 1160 kg
B12 PK	335i 10/11 - 225 kW	46-223678	25-30	25	with electronic suspension control; disconnect EDC; without ride height adjustment; Conditions see certificates; With General Certification (ABE); Only in connection with 31306792211 VA: axle load to: 990 kg HA: axle load to: 1160 kg
B12 PK	ActiveHybrid 01/12 - 225 -250 kW	46-237576	35	25	without electronic suspension control; Conditions see certificates VA: axle load to: 1030 kg HA: axle load to: 1265 kg
B12 SL	316 i, 316d, 318d, 320d, 320i, 328i 10/11 - 85 -180 kW	46-226617	40	40	without electronic suspension control; Conditions see certificates VA: axle load to: 950 kg HA: axle load to: 116 kg
B14	316 i, 316d, 318d, 320d, 320i, 328i, 335i, ActiveHybrid 01/12 - 85 -250 kW	47-217522	30-50	30-50	without electronic suspension control; Conditions see certificates VA: axle load to: 1020 kg HA: axle load to: 1235 kg
B14	316 i, 316d, 318d, 320d, 320i, 328i, 335i, ActiveHybrid 01/12 - 85 -250 kW	47-217522	30-50	30-50	with electronic suspension control; disconnect EDC; Conditions see certificates; Only in connection with 1x 31306792211 VA: axle load to: 1020 kg HA: axle load to: 1235 kg
B14	320 d xDrive, 320 i xDrive, 328 i xDrive, 335 i xDrive 10/11 - 135 -225 kW	47-207233	30-50	30-50	without electronic suspension control; Conditions see certificates VA: axle load to: 1020 kg HA: axle load to: 1120 kg





					
BMW					
BMW 3 (F30)					
B16 PSS10	316 i, 316d, 318d, 320d, 320i, 328i, 335i, ActiveHybrid 01/12 - 85 -250 kW	48-217170	30-50	30-50	without electronic suspension control; Conditions see certificates VA: axle load to: 1020 kg HA: axle load to: 1235 kg
B16 PSS10	316 i, 316d, 318d, 320d, 320i, 328i, 335i, ActiveHybrid 01/12 - 85 -250 kW	48-217170	30-50	30-50	with electronic suspension control; disconnect EDC; Conditions see certificates; Only in connection with 1x 31306792211 VA: axle load to: 1020 kg HA: axle load to: 1235 kg
B16 PSS10	316 i, 316d, 318d, 320d, 320i, 328i, 335i, ActiveHybrid 01/12 - 85 -250 kW	48-229012	10-30	10-30	mark: Komfort; without electronic suspension control; Conditions see certificates VA: axle load to: 1020 kg HA: axle load to: 1235 kg
B16 PSS10	316 i, 316d, 318d, 320d, 320i, 328i, 335i, ActiveHybrid 01/12 - 85 -250 kW	48-229012	10-30	10-30	mark: Komfort; with electronic suspension control; disconnect EDC; Conditions see certificates; Only in connection with 1x 313067921 VA: axle load to: 1020 kg HA: axle load to: 1235 kg
B16 PSS10	320 d xDrive, 320 i xDrive, 328 i xDrive, 335 i xDrive 10/11 - 135 -225 kW	48-207287	30-50	30-50	without electronic suspension control; Conditions see certificates VA: axle load to: 1020 kg HA: axle load to: 1120 kg
B16 RC	316 i, 316d, 318d, 320d, 320i, 328i, 335i, ActiveHybrid 01/12 - 85 -250 kW	49-224658 14-230615	30-50	30-50	without electronic suspension control; Conditions see certificates VA: axle load to: 1020 kg HA: axle load to: 1235 kg
B16 RC	316 i, 316d, 318d, 320d, 320i, 328i, 335i, ActiveHybrid 01/12 - 85 -250 kW	49-224658 14-230615	30-50	30-50	with electronic suspension control; disconnect EDC; Conditions see certificates; Only in connection with 1x 31306792211 VA: axle load to: 1020 kg HA: axle load to: 1235 kg
B16 RC	320 d xDrive, 320 i xDrive, 328 i xDrive, 335 i xDrive 10/11 - 135 -225 kW	14-230615 49-207323	30-50	30-50	without electronic suspension control; Conditions see certificates VA: axle load to: 1020 kg HA: axle load to: 1235 kg
BMW 3 Touring (F31)					
B12 PK	316 d, 318 d, 320 d, 320 i, 328 i 06/12 - 85 -180 kW	46-229793	25-30	25	without electronic suspension control; Conditions see certificates; With General Certification (ABE) VA: axle load to: 965 kg HA: axle load to: 1265 kg
B12 PK	330 d 06/12 - 190 kW	46-229809	25-30	25	without electronic suspension control; Conditions see certificates; With General Certification (ABE) VA: axle load to: 990 kg HA: axle load to: 1265 kg
B12 SL	316 d, 318 d, 320 d, 320 i, 328 i 06/12 - 85 -180 kW	46-237583	40	35	without electronic suspension control; Conditions see certificates VA: axle load to: 950 kg HA: axle load to: 1265 kg
B14	316 d, 318 d, 320 d, 320 i, 328 i, 330 d 06/12 - 85 -190 kW	47-217522	30-50	30-50	without electronic suspension control; Conditions see certificates VA: axle load to: 1020 kg HA: axle load to: 1235 kg
B14	316 d, 318 d, 320 d, 320 i, 328 i, 330 d 06/12 - 85 -190 kW	47-217522	30-50	30-50	with electronic suspension control; disconnect EDC; Conditions see certificates; Only in connection with 1x 31306792211 VA: axle load to: 1020 kg HA: axle load to: 1235 kg
B16 PSS10	316 d, 318 d, 320 d, 320 i, 328 i, 330 d 06/12 - 85 -190 kW	48-217170	30-50	30-50	without electronic suspension control; Conditions see certificates VA: axle load to: 1020 kg HA: axle load to: 1235 kg
B16 PSS10	316 d, 318 d, 320 d, 320 i, 328 i, 330 d 06/12 - 85 -190 kW	48-217170	30-50	30-50	with electronic suspension control; disconnect EDC; Conditions see certificates; Only in connection with 1x 31306792211 VA: axle load to: 1020 kg HA: axle load to: 1235 kg
B16 PSS10	316 d, 318 d, 320 d, 320 i, 328 i, 330 d 06/12 - 85 -190 kW	48-229012	10-30	10-30	mark: Komfort; without electronic suspension control; Conditions see certificates VA: axle load to: 1020 kg HA: axle load to: 1235 kg
B16 PSS10	316 d, 318 d, 320 d, 320 i, 328 i, 330 d 06/12 - 85 -190 kW	48-229012	10-30	10-30	mark: Komfort; with electronic suspension control; disconnect EDC; Conditions see certificates; Only in connection with 1x 313067921 VA: axle load to: 1020 kg HA: axle load to: 1235 kg
B16 RC	316 d, 318 d, 320 d, 320 i, 328 i, 330 d 06/12 - 85 -190 kW	49-224658 14-230615	30-50	30-50	without electronic suspension control; Conditions see certificates VA: axle load to: 1020 kg HA: axle load to: 1235 kg

					
BMW					
BMW 3 Touring (F31)					
B16 RC	316 d, 318 d, 320 d, 320 i, 328 i, 330 d 06/12 - 85 -190 kW	49-224658 14-230615	30-50	30-50	with electronic suspension control; disconnect EDC; Conditions see certificates; Only in connection with 1x 31306792211 VA: axle load to: 1020 kg HA: axle load to: 1235 kg
BMW 3 GRAN TURISMO (F34)					
B12 PK	335 i 03/13 - 225 kW	46-229809	25-30	25	without electronic suspension control; Conditions see certificates; With General Certification (ABE) VA: axle load to: 990 kg HA: axle load to: 1265 kg
B12 PK	318 d, 320 d, 320 i, 328 i 03/13 - 105 -180 kW	46-229793	25-30	25	without electronic suspension control; Conditions see certificates; With General Certification (ABE) VA: axle load to: 965 kg HA: axle load to: 1265 kg
B12 SL	318 d, 320 d, 320 i, 328 i 03/13 - 105 -180 kW	46-237583	40-50	35-40	without electronic suspension control; Conditions see certificates VA: axle load to: 950 kg HA: axle load to: 1265 kg
B14	318 d, 320 d, 320 i, 328 i, 335 i 03/13 - 105 -225 kW	47-217522	30-50	30-50	without electronic suspension control; Conditions see certificates VA: axle load to: 1020 kg HA: axle load to: 1235 kg
B14	318 d, 320 d, 320 i, 328 i, 335 i 03/13 - 105 -225 kW	47-217522	30-50	30-50	with electronic suspension control; disconnect EDC; Conditions see certificates; Only in connection with 1x 31306792211 VA: axle load to: 1020 kg HA: axle load to: 1235 kg
B16 PSS10	318 d, 320 d, 320 i, 328 i, 335 i 03/13 - 105 -225 kW	48-217170	30-50	30-50	without electronic suspension control; Conditions see certificates VA: axle load to: 1020 kg HA: axle load to: 1235 kg
B16 PSS10	318 d, 320 d, 320 i, 328 i, 335 i 03/13 - 105 -225 kW	48-217170	30-50	30-50	with electronic suspension control; disconnect EDC; Conditions see certificates; Only in connection with 1x 31306792211 VA: axle load to: 1020 kg HA: axle load to: 1235 kg
B16 PSS10	318 d, 320 d, 320 i, 328 i, 335 i 03/13 - 105 -225 kW	48-229012	10-30	10-30	mark: Komfort; without electronic suspension control; Conditions see certificates VA: axle load to: 1020 kg HA: axle load to: 1235 kg
B16 PSS10	318 d, 320 d, 320 i, 328 i, 335 i 03/13 - 105 -225 kW	48-229012	10-30	10-30	mark: Komfort; with electronic suspension control; disconnect EDC; Conditions see certificates; Only in connection with 1x 313067921 VA: axle load to: 1020 kg HA: axle load to: 1235 kg
BMW 5 (E34)					
B12 PK	518 i, 520 i, 520 i 24V 01/88 - 09/95 83 -110 kW	46-190925	25-35	20-30	without ride height adjustment; Conditions see certificates; With General Certification (ABE) VA: axle load to: 970 kg HA: axle load to: 1300 kg
B12 PK	525 i, 525 i 24V 01/88 - 07/90 125 -141 kW	46-190901	25-35	20-30	without ride height adjustment; Conditions see certificates; With General Certification (ABE) VA: axle load to: 970 kg HA: axle load to: 1300 kg
B12 PK	525 i, 525 i 24V 08/90 - 09/92 125 -141 kW	46-190918	25-35	20-30	without ride height adjustment; Conditions see certificates; With General Certification (ABE) VA: axle load to: 970 kg HA: axle load to: 1300 kg
B12 PK	525 i 24V 10/92 - 09/95 141 kW	46-190925	25-35	20-30	without ride height adjustment; Conditions see certificates; With General Certification (ABE) VA: axle load to: 970 kg HA: axle load to: 1300 kg
B12 PK	524 td, 530 i, 535 i 01/88 - 07/90 85 -155 kW	46-190871	25-35	20-30	without ride height adjustment; Conditions see certificates; With General Certification (ABE) VA: axle load to: 1060 kg HA: axle load to: 1300 kg
B12 PK	524 td, 525 tds, 530 i, 535 i CH-Nr. - CH-Nr. 85 -155 kW	46-190888	25-35	20-30	CH.Nr.: 199008-> 199209; without ride height adjustment; Conditions see certificates; With General Certification (ABE) VA: axle load to: 1060 kg HA: axle load to: 1300 kg
B12 PK	524 td, 525 td, 525 tds CH-Nr. - 09/95 85 -105 kW	46-190895	25-35	20-30	CH.Nr.: 199210 ->; without ride height adjustment; Conditions see certificates; With General Certification (ABE) VA: axle load to: 1060 kg HA: axle load to: 1300 kg
B12 SL	518 i, 520 i, 520 i 24V 01/88 - 09/95 83 -110 kW	46-190956	45-50	30	without ride height adjustment; Conditions see certificates VA: axle load to: 975 kg HA: axle load to: 1300 kg

					
BMW					
BMW 5 (E34)					
B12 SL	525 i 24V, 525 tds 08/90 - 09/92 105 -141 kW	46-190949	45-50	30	without ride height adjustment; Conditions see certificates VA: axle load to: 975 kg HA: axle load to: 1300 kg
B12 SL	525 i 24V, 525 td, 525 tds 10/92 - 09/95 85 -141 kW	46-190956	45-50	30	without ride height adjustment; Conditions see certificates VA: axle load to: 975 kg HA: axle load to: 1300 kg
B12 SL	524 td, 525 i, 525 i 24V, 530 i, 535 i 01/88 - 07/90 85 -155 kW	46-190932	45-50	30	without ride height adjustment; Conditions see certificates VA: axle load to: 975 kg HA: axle load to: 1300 kg
B12 SL	524 td, 525 i, 530 i, 535 i 01/88 - 09/95 85 -155 kW	46-190949	45-50	30	without ride height adjustment; Conditions see certificates VA: axle load to: 975 kg HA: axle load to: 1300 kg
BMW 5 Touring (E34)					
B12 PK	518 i, 520 i, 525 i 11/91 - 01/97 83 -141 kW	46-190925	25-35	20-30	without ride height adjustment; Conditions see certificates; With General Certification (ABE) VA: axle load to: 970 kg HA: axle load to: 1300 kg
B12 PK	525 td, 525 tds, 530 i V8, 540 i 09/92 - 01/97 85 -210 kW	46-190888	25-35	20-30	without ride height adjustment; Conditions see certificates; With General Certification (ABE) VA: axle load to: 1060 kg HA: axle load to: 1300 kg
BMW 5 (E39)					
B12 PK	535 i, 540 i 04/96 - 06/03 173 -210 kW	46-180858	30	20-25	without electronic suspension control; without ride height adjustment; Conditions see certificates VA: axle load to: 1100 kg HA: axle load to: 1290 kg
B12 PK	520 d, 520 i, 523 i, 525 i, 525 td, 525 tds, 528 i, 530 i 11/95 - 06/03 85 -170 kW	46-180841	30	20-25	without electronic suspension control; without ride height adjustment; Conditions see certificates VA: axle load to: 1065 kg HA: axle load to: 1290 kg
B12 PK	525 d, 530 d 08/98 - 06/03 120 -142 kW	46-180865	30	20-25	without electronic suspension control; without ride height adjustment; Conditions see certificates VA: axle load to: 1100 kg HA: axle load to: 1290 kg
B12 SL	520 d, 520 i, 523 i, 525 i, 525 td, 525 tds, 528 i, 530 i 11/95 - 06/03 85 -170 kW	46-180926	45-50	30	without electronic suspension control; without ride height adjustment; Conditions see certificates VA: axle load to: 1040 kg HA: axle load to: 1170 kg
B14	535 i, 540 i 04/96 - 06/03 173 -210 kW	47-111264	25-50	20-50	with standard chassis; with M-technics; without electronic suspension control; Spacers required for several wheel/tyre combinations; without ride height adjustment; Conditions see certificates VA: axle load to: 1105 kg HA: axle load to: 1225 kg
B14	M5 09/98 - 06/03 230 -294 kW	47-111264	40-50	40-50	with standard chassis; without electronic suspension control; Spacers required for several wheel/tyre combinations; without ride height adjustment; Conditions see certificates VA: Only in connection with 33 53 1 091 924; axle load to: 1105 kg HA: axle load to: 1225 kg
B14	520 d, 520 i, 523 i, 525 d, 525 i, 525 td, 525 tds, 528 i, 530 d, 530 i 08/98 - 06/03 85 -170 kW	47-100763	35-50	20-50	without electronic suspension control; Spacers required for several wheel/tyre combinations; without ride height adjustment; Conditions see certificates VA: axle load to: 1105 kg HA: axle load to: 1225 kg
B16 PSS9	535 i, 540 i 04/96 - 06/03 173 -210 kW	48-104555	25-50	20-50	with standard chassis; with M-technics; without electronic suspension control; Spacers required for several wheel/tyre combinations; without ride height adjustment; Conditions see certificates VA: axle load to: 1105 kg HA: axle load to: 1225 kg
B16 PSS9	M5 09/98 - 06/03 230 -294 kW	48-104555	25-50	20-50	with standard chassis; without electronic suspension control; Spacers required for several wheel/tyre combinations; without ride height adjustment; Conditions see certificates VA: Only in connection with 33 53 1 091 924; axle load to: 1105 kg HA: axle load to: 1225 kg
B16 PSS9	520 d, 520 i, 523 i, 525 d, 525 i, 525 td, 525 tds, 528 i, 530 d, 530 i 08/98 - 06/03 85 -170 kW	48-104692	35-50	20-50	without electronic suspension control; Spacers required for several wheel/tyre combinations; without ride height adjustment; Conditions see certificates VA: axle load to: 1105 kg HA: axle load to: 1225 kg

					
BMW					
BMW 5 Touring (E39)					
B12 PK	540 i 01/97 - 05/04 210 kW	46-180902	30	25	without electronic suspension control; with ride height adjustment; Conditions see certificates; with air suspension VA: axle load to: 1100 kg HA: axle load to: 1390 kg
B12 PK	520 d, 520 i, 523 i, 525 i, 525 tds, 528 i, 530 i 01/97 - 05/04 100 -170 kW	46-180872	30	25	without electronic suspension control; without ride height adjustment; Conditions see certificates; without pneumatic suspension VA: axle load to: 1065 kg HA: axle load to: 1390 kg
B12 PK	520 d, 520 i, 523 i, 525 i, 525 tds, 528 i, 530 i 01/97 - 05/04 100 -170 kW	46-180896	30	25	without electronic suspension control; with ride height adjustment; Conditions see certificates; with air suspension VA: axle load to: 1065 kg HA: axle load to: 1390 kg
B12 PK	525 d, 530 d 08/98 - 05/04 120 -142 kW	46-180889	30	25-30	without electronic suspension control; without ride height adjustment; Conditions see certificates; without pneumatic suspension VA: axle load to: 1100 kg HA: axle load to: 1390 kg
B12 PK	525 d, 530 d 08/98 - 05/04 120 -142 kW	46-180919	30	25	without electronic suspension control; with ride height adjustment; Conditions see certificates; with air suspension VA: axle load to: 1100 kg HA: axle load to: 1390 kg
BMW 5 (E60)					
B12 PK	3.0, 540i, 545i, 550i 07/05 - 03/10 225 -270 kW	46-181121	30	30	without electronic suspension control; Conditions see certificates VA: axle load to: 1070 kg HA: without ride height adjustment; axle load to: 1275 kg
B12 PK	520d, 520i, 523i, 525i, 530i 07/05 - 03/10 110 -200 kW	46-181107	30	30	without electronic suspension control; Conditions see certificates VA: axle load to: 990 kg HA: without ride height adjustment; axle load to: 1245 kg
B12 PK	525d, 530d, 535d 09/04 - 03/10 120 -210 kW	46-181114	30	30	without electronic suspension control; Conditions see certificates VA: axle load to: 1070 kg HA: without ride height adjustment; axle load to: 1245 kg
B12 SL	3.0, 525d, 530d, 535d, 540i, 545i, 550i 07/05 - 03/10 120 -270 kW	46-181206	45-50	30	without electronic suspension control; Conditions see certificates VA: axle load to: 1070 kg HA: without ride height adjustment; axle load to: 1300 kg
B12 SL	520d, 520i, 523i, 525i, 530i 07/05 - 03/10 110 -200 kW	46-181190	45-50	30	without electronic suspension control; Conditions see certificates VA: axle load to: 990 kg HA: without ride height adjustment; axle load to: 1300 kg
B14	3.0, 520d, 520i, 523i, 525d, 525i, 530d, 530i, 535d, 540i, 545i, 550i 07/05 - 03/10 110 -270 kW	47-111165	30-50	30-50	without electronic suspension control; without ride height adjustment; Conditions see certificates VA: axle load to: 1070 kg HA: axle load to: 1300 kg
B16 PSS10	3.0, 520d, 520i, 523i, 525d, 525i, 530d, 530i, 535d, 540i, 545i, 550i 07/05 - 03/10 110 -270 kW	48-135498	30-50	30-50	without electronic suspension control; without ride height adjustment; Conditions see certificates VA: axle load to: 1070 kg HA: axle load to: 1300 kg
B16 RC	3.0, 520d, 520i, 523i, 525d, 525i, 530d, 530i, 535d, 540i, 545i, 550i 07/05 - 03/10 110 -270 kW	49-135169 14-230615	30-50	30-50	without electronic suspension control; without ride height adjustment; Conditions see certificates VA: axle load to: 1070 kg HA: axle load to: 1300 kg
BMW 5 Touring (E61)					
B12 PK	520d, 520i, 523i, 525i, 530i 07/05 - 110 -200 kW	46-181138	30	30	without electronic suspension control; Conditions see certificates VA: axle load to: 990 kg HA: axle load to: 1300 kg
B12 PK	525d, 530d, 535d, 545i, 550i 06/04 - 120 -270 kW	46-181145	30	30	without electronic suspension control; Conditions see certificates VA: axle load to: 1070 kg HA: axle load to: 1300 kg
BMW 5 (F10)					
B12 PK	550i 03/10 - 300 kW	46-195128	30	30	without electronic suspension control; without ride height adjustment; Conditions see certificates VA: axle load to: 1250 kg HA: axle load to: 1320 kg
B12 PK	520d, 520i, 523i, 528i 03/10 - 120 -190 kW	46-195104	30	30	without electronic suspension control; without ride height adjustment; Conditions see certificates VA: axle load to: 1070 kg HA: axle load to: 1310 kg

   					
BMW					
BMW 5 (F10)					
B12 PK	525d, 530d, 530i, 535d, 535i 03/10 - 150 -230 kW	46-195111	30	30	without electronic suspension control; without ride height adjustment; Conditions see certificates VA: axle load to: 1190 kg HA: axle load to: 1310 kg
B16 PSS10	520d, 520i, 523i, 525d, 528i, 530d, 530i, 535d, 535i, 550i 03/10 - 120 -300 kW	48-177580	10-30	10-30	without electronic suspension control; Conditions see certificates VA: axle load to: 1250 kg HA: axle load to: 1320 kg
BMW 5 Touring (F11)					
B12 PK	520d, 520i, 523i, 525d, 528i, 530i 09/10 - 135 -200 kW	46-195173	30	25	without electronic suspension control; with ride height adjustment; Conditions see certificates VA: axle load to: 1070 kg HA: axle load to: 1410 kg; with air suspension
B12 PK	525d, 530d, 535d, 535i 09/10 - 150 -230 kW	46-195180	30	25	without electronic suspension control; with ride height adjustment; Conditions see certificates VA: axle load to: 1200 kg HA: axle load to: 1410 kg; with air suspension
BMW 6 (E63)					
B12 PK	630i 09/04 - 190 -200 kW	46-181176	25	20	Conditions see certificates VA: axle load to: 980 kg HA: without ride height adjustment; axle load to: 1170 kg
B12 PK	635d, 645Ci, 650i 07/05 - 210 -270 kW	46-181152	30	25-30	Conditions see certificates VA: axle load to: 1070 kg HA: without ride height adjustment; axle load to: 1170 kg
B16 PSS9	630i, 635d, 645Ci, 650i 01/04 - 190 -270 kW	48-123952	30-50	30-50	with standard chassis; Conditions see certificates VA: axle load to: 1070 kg HA: axle load to: 1270 kg
B16 DTC	M6 09/05 - 373 kW	49-237276	10-30	10-30	with electronic suspension control; with EDC; Conditions see certificates
BMW 6 Convertible (E64)					
B12 PK	630i 09/04 - 190 -200 kW	46-181183	25	20	Conditions see certificates VA: axle load to: 1070 kg HA: without ride height adjustment; axle load to: 1270 kg
B12 PK	635d, 645Ci, 650i 07/05 - 210 -270 kW	46-181169	30	25-30	Conditions see certificates VA: axle load to: 1100 kg HA: without ride height adjustment; axle load to: 1270 kg
B16 PSS9	630i, 635d, 645Ci, 650i 04/04 - 190 -270 kW	48-123952	30-50	30-50	Conditions see certificates VA: axle load to: 1070 kg HA: axle load to: 1270 kg
B16 DTC	M6 07/06 - 373 kW	49-237276	10-30	10-30	with electronic suspension control; with EDC; Conditions see certificates
BMW 7 (E32)					
B12 PK	730 i,iL, 735 i,iL 03/88 - 07/90 138 -155 kW	46-189448	25-35	25-30	without electronic suspension control; Conditions see certificates; Self-levelling inactive after modification VA: axle load to: 1110 kg HA: axle load to: 1280 kg
B12 PK	730 i,iL, 730 i,iL V8, 735 i,iL 08/90 - 09/94 138 -160 kW	46-189455	25-35	25-30	without electronic suspension control; Conditions see certificates; Self-levelling inactive after modification VA: axle load to: 1110 kg HA: axle load to: 1280 kg
B12 PK	740 i,iL V8 08/90 - 09/94 210 kW	46-189462	30	25	without ride height adjustment; Conditions see certificates; Self-levelling inactive after modification VA: axle load to: 1110 kg HA: axle load to: 1280 kg
BMW 7 (E38)					
B12 PK	730 i,iL, 740 i,iL, 750 i,iL 10/94 - 11/01 155 -240 kW	46-189479	30	25	without EDC; without ride height adjustment; Conditions see certificates VA: axle load to: 1230 kg HA: axle load to: 1370 kg

					
BMW					
BMW 8 (E31)					
B12 PK	840 Ci, 840 i, 850 Ci, 850 CSI 04/93 - 12/99 210 -280 kW	46-188106	25	15-20	without electronic suspension control; Conditions see certificates VA: axle load to: 1150 kg HA: axle load to: 1200 kg
B12 PK	850 i,Ci 04/90 - 07/90 220 kW	46-188106	25	15-20	without electronic suspension control; Conditions see certificates; Only in connection with 31 33 1139 436 VA: axle load to: 1150 kg HA: axle load to: 1200 kg
B12 PK	850 i,Ci 07/90 - 10/94 220 kW	46-188106	25	15-20	without electronic suspension control; Conditions see certificates VA: axle load to: 1150 kg HA: axle load to: 1200 kg
BMW X1 (E84)					
B12 PK	sDrive18d, sDrive18i, sDrive20d, sDrive20i 03/09 - 100 -135 kW	46-189554	30	30	without ride height adjustment; Conditions see certificates VA: axle load to: 940 kg HA: axle load to: 1180 kg
B12 PK	xDrive 25 d, xDrive18d, xDrive20d, xDrive20i, xDrive23d, xDrive25i, xDrive28i 03/09 - 100 -190 kW	46-191465	30	30	without ride height adjustment; Conditions see certificates VA: axle load to: 1030 kg HA: axle load to: 1180 kg
BMW X3 (E83)					
B12 PK	2.0 d, 2.5 i, 2.5 si, 3.0 d, 3.0 i, 3.0 sd, 3.0 si, xDrive18d, xDrive20d, xDrive25i, xDrive30d, xDrive30i, xDrive35d 01/04 - 105 -210 kW	46-189547	30-40	30	Conditions see certificates; without pneumatic suspension VA: axle load to: 1177 kg HA: axle load to: 1285 kg
BMW X5 (E53)					
B12 PK	3.0 i 05/00 - 163 -170 kW	46-189523	30	30	Conditions see certificates; without pneumatic suspension VA: axle load to: 1230 kg HA: axle load to: 1630 kg
B12 PK	3.0 d, 3.0 d All-wheel Drive 05/01 - 135 -160 kW	46-189530	30	30	Conditions see certificates; without pneumatic suspension VA: axle load to: 1250 kg HA: axle load to: 1630 kg
BMW X5 (E70)					
B12 PK	3.0 d, 3.0 d All-wheel Drive, 3.0 sd, 3.0 si, xDrive30d, xDrive30i, xDrive35d, xDrive35i, xDrive40d 02/07 - 155 -225 kW	46-181220	30-40	25	without ride height adjustment; without 3rd seating row; Conditions see certificates VA: axle load to: 1400 kg HA: axle load to: 1755 kg
BMW X6 (E71)					
B12 PK	30d, 35d, 35i, 50i, xDrive30d, xDrive35d, xDrive35i, xDrive40d, xDrive50i 05/08 - 155 -300 kW	46-187987	20	20	without ride height adjustment; without 3rd seating row; Conditions see certificates VA: axle load to: 1365 kg HA: axle load to: 1520 kg
BMW Z3					
B12 PK	1.8, 1.9 10/95 - 03/99 85 -103 kW	46-189493	30	30	Conditions see certificates VA: axle load to: 755 kg HA: axle load to: 870 kg
B12 PK	2.0, 2.2, 2.8, 3.0 01/96 - 01/03 110 -170 kW	46-189509	30	30	Conditions see certificates VA: axle load to: 830 kg HA: axle load to: 870 kg
BMW Z3 Coupe					
B12 PK	2.8, 3.0 07/97 - 06/03 141 -170 kW	46-189516	30	30	Conditions see certificates VA: axle load to: 830 kg HA: axle load to: 870 kg
BMW Z4 (E85)					
B12 PK	2.2 i, 2.5 i, 2.5 si, 3.0 i, 3.0 si 02/03 - 125 -195 kW	46-181237	30	30	Conditions see certificates VA: axle load to: 790 kg HA: without ride height adjustment; axle load to: 860 kg
B12 PK	3.2 M 03/06 - 252 kW	46-000033	20	10	Conditions see certificates VA: axle load to: 855 kg HA: without ride height adjustment; axle load to: 935 kg

				
--	---	---	---	---

BMW
BMW Z4 (E85)

B16 PSS9	2.0 i, 2.2 i, 2.5 i, 2.5 si, 3.0 i, 3.0 si 02/03 - 110 -195 kW	48-104739	25-45	25-45	Conditions see certificates VA: axle load to: 790 kg HA: axle load to: 890 kg
B16 PSS10	3.2 M 03/06 - 252 kW	48-141635	10-30	10-30	Conditions see certificates VA: axle load to: 855 kg HA: axle load to: 935 kg

BMW Z4 Coupe

B12 PK	3.0 si 03/06 - 195 kW	46-181251	30	20	Conditions see certificates VA: axle load to: 790 kg HA: without ride height adjustment; axle load to: 890 kg
B12 PK	3.2 M 03/06 - 252 kW	46-000033	20	10	Conditions see certificates VA: axle load to: 855 kg HA: without ride height adjustment; axle load to: 935 kg
B16 PSS9	3.0 si 03/06 - 195 kW	48-104739	25-45	25-45	Conditions see certificates VA: axle load to: 790 kg HA: axle load to: 890 kg
B16 PSS10	3.2 M 03/06 - 252 kW	48-141635	10-30	10-30	Conditions see certificates VA: axle load to: 855 kg HA: axle load to: 935 kg

BMW Z4 (E89)

B12 PK	sDrive20i, sDrive23i, sDrive28i, sDrive30i 05/09 - 135 -190 kW	46-181268	25	15	without electronic suspension control; Conditions see certificates VA: axle load to: 800 kg HA: without ride height adjustment; axle load to: 975 kg
B12 PK	sDrive35i, sDrive35is 05/09 - 225 -250 kW	46-181275	20	20	without electronic suspension control; Conditions see certificates VA: axle load to: 870 kg HA: without ride height adjustment; axle load to: 1000 kg
B16 PSS10	sDrive20i, sDrive23i, sDrive28i, sDrive30i, sDrive35i, sDrive35is 09/10 - 135 -250 kW	48-169998	20-40	20-40	without electronic suspension control; not for: 2VF; Conditions see certificates

BRILLIANCE BMW
BRILLIANCE BMW 3 SERIES (E46)

B12 PK	2.0, 2.5 07/03 - 06/05 105 -141 kW	46-180018	30	20-25	Conditions see certificates VA: axle load to: 970 kg HA: axle load to: 1190 kg
B12 SL	2.0, 2.5 07/03 - 06/05 105 -141 kW	46-180117	45-50	20-25	Conditions see certificates VA: axle load to: 935 kg HA: axle load to: 1190 kg
B14	2.0, 2.5 07/03 - 06/05 105 -141 kW	47-126848	35-50	25-40	Conditions see certificates VA: axle load to: 1000 kg HA: axle load to: 1190 kg
B16 PSS10	2.0, 2.5 07/03 - 06/05 105 -141 kW	48-126380	25-40	35-50	Conditions see certificates VA: axle load to: 1000 kg HA: axle load to: 1190 kg
B16 RC	2.0, 2.5 07/03 - 06/05 105 -141 kW	49-135121 14-230615	35-50	25-40	Conditions see certificates VA: axle load to: 1000 kg HA: axle load to: 1190 kg

BRILLIANCE BMW 3 Series (E90)

B12 PK	2.0, 320i 12/07 - 09/12 100 -115 kW	46-180544	30	25	Conditions see certificates VA: axle load to: 935 kg HA: without ride height adjustment; axle load to: 1085 kg
B12 PK	2.5 06/05 - 09/12 160 kW	46-180551	30	25	Conditions see certificates VA: axle load to: 1045 kg HA: without ride height adjustment; axle load to: 1135 kg
B12 SL	2.0, 320i 12/07 - 09/12 100 -115 kW	46-180711	45-50	35	Conditions see certificates VA: axle load to: 935 kg HA: without ride height adjustment; axle load to: 1085 kg
B12 SL	2.5 06/05 - 09/12 160 kW	46-180728	45-50	35	Conditions see certificates VA: axle load to: 955 kg HA: without ride height adjustment; axle load to: 1135 kg

BRILLIANCE BMW
BRILLIANCE BMW 3 Series (E90)

B14	2.0, 2.5, 320i 06/05 - 09/12 100 -160 kW	47-120471	30-50	30-50	Conditions see certificates VA: axle load to: 1020 kg HA: axle load to: 1200 kg
B16 PSS10	2.0, 2.5, 320i 06/05 - 09/12 100 -160 kW	48-131636	30-50	30-50	Conditions see certificates VA: axle load to: 1020 kg HA: axle load to: 1200 kg
B16 RC	2.0, 2.5, 320i 06/05 - 09/12 100 -160 kW	49-131543 14-230615	30-50	30-50	Conditions see certificates VA: axle load to: 1020 kg HA: axle load to: 1200 kg

BRILLIANCE BMW 5 SERIES (E60)

B12 PK	2.2, 2.5, 3.0, 520i, 523Li, 525Li 10/03 - 04/10 115 -190 kW	46-181107	30	30	without electronic suspension control; Conditions see certificates VA: axle load to: 990 kg HA: without ride height adjustment; axle load to: 1245 kg
B14	2.2, 2.5, 3.0, 520i, 523Li, 525Li 10/03 - 04/10 115 -190 kW	47-111165	30-50	30-50	without electronic suspension control; without ride height adjustment; Conditions see certificates VA: axle load to: 1070 kg HA: axle load to: 1300 kg
B16 PSS10	2.2, 2.5, 3.0, 520i, 523Li, 525Li 10/03 - 04/10 115 -190 kW	48-135498	30-50	30-50	without electronic suspension control; without ride height adjustment; Conditions see certificates VA: axle load to: 1070 kg HA: axle load to: 1300 kg
B16 RC	2.2, 2.5, 3.0, 520i, 523Li, 525Li 10/03 - 04/10 115 -190 kW	49-135169 14-230615	30-50	30-50	without electronic suspension control; without ride height adjustment; Conditions see certificates VA: axle load to: 1070 kg HA: axle load to: 1300 kg

BRILLIANCE BMW 5 SERIES (F18)

B16 PSS10	520Li, 523Li, 528Li, 535Li 08/10 - 130 -225 kW	48-177580	30-50	30-50	Conditions see certificates
---------------------	---	------------------	-------	-------	-----------------------------

BRILLIANCE BMW X1 (E84)





B12 PK	5.5 V10, sDrive18i 03/12 - 110 -135 kW	46-189554	30	30	without ride height adjustment; Conditions see certificates VA: axle load to: 940 kg HA: axle load to: 1180 kg
B12 PK	xDrive20i, xDrive28i 03/12 - 135 -180 kW	46-191465	30	30	without ride height adjustment; Conditions see certificates VA: axle load to: 1030 kg HA: axle load to: 1180 kg

BUICK
BUICK SAIL Saloon

B14	1.6 07/02 - 68 kW	47-080713	30-50	20-40	Spacers required for several wheel/tyre combinations; Conditions see certificates VA: axle load to: 820 kg HA: axle load to: 700 kg
B16 PSS9	1.6 07/02 - 68 kW	48-080767	30-50	20-40	Spacers required for several wheel/tyre combinations; Conditions see certificates VA: axle load to: 820 kg HA: axle load to: 700 kg

BUICK SAIL Estate

B14	1.6 07/02 - 68 kW	47-080713	30-50	20-40	Spacers required for several wheel/tyre combinations; Conditions see certificates VA: axle load to: 820 kg HA: axle load to: 700 kg
B16 PSS9	1.6 07/02 - 68 kW	48-080767	30-50	20-40	Spacers required for several wheel/tyre combinations; Conditions see certificates VA: axle load to: 820 kg HA: axle load to: 700 kg

									
Buick SGM									
Buick SGM EXCELLE GT									
B12 PK	1.6, 1.6 T, 1.8 T 06/10 - 89 -135 kW	46-188755	30	30	without FlexRide; Conditions see certificates VA: axle load to: 995 kg HA: axle load to: 1020 kg				
B14	1.6, 1.6 T, 1.8 T 06/10 - 89 -135 kW	47-171725	30-50	30-50	without FlexRide; Conditions see certificates VA: axle load to: 1220 kg HA: axle load to: 1020 kg				
Buick SGM EXCELLE XT									
B12 PK	1.6, 1.6 T, 1.8 01/10 - 89 -135 kW	46-188755	30	30	without FlexRide; Conditions see certificates VA: axle load to: 995 kg HA: axle load to: 1020 kg				
B14	1.6, 1.6 T, 1.8 01/10 - 89 -135 kW	47-171725	30-50	30-50	without FlexRide; Conditions see certificates VA: axle load to: 1220 kg HA: axle load to: 1020 kg				
Buick SGM SAIL									
B14	1.6 06/01 - 02/05 68 kW	47-080713	30-50	20-40	Spacers required for several wheel/tyre combinations; Conditions see certificates VA: axle load to: 820 kg HA: axle load to: 700 kg				
B16 PSS9	1.6 06/01 - 02/05 68 kW	48-080767	30-50	20-40	Spacers required for several wheel/tyre combinations; Conditions see certificates VA: axle load to: 820 kg HA: axle load to: 700 kg				
Buick SGM SAIL Estate									
B14	1.6 06/01 - 02/05 68 kW	47-080713	30-50	20-40	Spacers required for several wheel/tyre combinations; Conditions see certificates VA: axle load to: 820 kg HA: axle load to: 700 kg				
B16 PSS9	1.6 06/01 - 02/05 68 kW	48-080767	30-50	20-40	Spacers required for several wheel/tyre combinations; Conditions see certificates VA: axle load to: 820 kg HA: axle load to: 700 kg				
CHEVROLET									
CHEVROLET ASTRA Hatchback									
B14	1.8, 2.0 DTi GLS, 2.0 GL, 2.0 GLS 09/98 - 74 -100 kW	47-087484	30-45	25-45	Conditions see certificates VA: axle load to: 885 kg				
CHEVROLET ASTRA Saloon									
B14	1.8, 2.0 DTi GLS, 2.0 GL, 2.0 GLS 03/99 - 74 -100 kW	47-087484	30-45	25-45	Conditions see certificates VA: axle load to: 885 kg				
CHEVROLET ASTRA Estate									
B12 PK	2.0 10/99 - 07/02 94 kW	46-188953	30	30	without ride height adjustment; Conditions see certificates VA: axle load to: 935 kg HA: axle load to: 885 kg				
B12 PK	2.0, 2.2 10/99 - 08/04 94 -108 kW	46-188977	30	30	without ride height adjustment; Conditions see certificates VA: axle load to: 1035 kg HA: axle load to: 885 kg				
B12 PK	2.0 08/02 - 07/05 100 kW	46-188953	30	30	without ride height adjustment; Conditions see certificates VA: axle load to: 935 kg HA: axle load to: 885 kg				
B12 PK	2.2 08/00 - 08/04 108 kW	46-188953	30	30	without ride height adjustment; Conditions see certificates VA: axle load to: 935 kg HA: axle load to: 885 kg				
CHEVROLET CAMARO									
B16 PSS10	3.6, 6.2 01/11 - 232 -318 kW	48-191845	0-30	0-30	for USA; Without roadworthy certificate				



CHEVROLET

CHEVROLET CAMARO

B16 PSS10	3.6, 6.2 CH-Nr. - 232 -318 kW	48-222983	30-60	30-60	CH.Nr.: xxxxxxxxAXxxxxxx ->; Conditions see certificates VA: axle load to: 1100 kg HA: axle load to: 1200 kg
--------------	---	------------------	-------	-------	--

CHEVROLET CAMARO Convertible

B16 PSS10	3.6, 6.2 01/11 - 232 -318 kW	48-222983	30-60	30-50	Conditions see certificates VA: axle load to: 1100 kg HA: axle load to: 1300 kg
--------------	--	------------------	-------	-------	---

CHEVROLET CORSA

B10	1.0, 1.4 GLS, 1.6 GLS, 1.6 GS, 1.7 D 03/94 - 07/02 44 -75 kW	46-111951	60	40	Conditions see certificates
-----	--	------------------	----	----	-----------------------------

B14	1.0, 1.4 GLS, 1.6 GLS, 1.6 GS, 1.7 D 03/94 - 07/02 44 -75 kW	47-080713	30-50	20-40	Spacers required for several wheel/tyre combinations; Conditions see certificates VA: axle load to: 820 kg HA: axle load to: 700 kg
-----	--	------------------	-------	-------	---

B16 PSS9	1.0, 1.4 GLS, 1.6 GLS, 1.6 GS, 1.7 D 03/94 - 07/02 44 -75 kW	48-080767	30-50	20-40	Spacers required for several wheel/tyre combinations; Conditions see certificates VA: axle load to: 820 kg HA: axle load to: 700 kg
-------------	--	------------------	-------	-------	---

CHEVROLET CORSA Hatchback

B14	1.0, 1.4 GLS, 1.6 GLS, 1.6 GS, 1.6 GSI, 1.7 D 03/94 - 07/02 37 -80 kW	47-080713	30-50	20-40	Spacers required for several wheel/tyre combinations; Conditions see certificates VA: axle load to: 820 kg HA: axle load to: 700 kg
-----	---	------------------	-------	-------	---

B16 PSS9	1.0, 1.4 GLS, 1.6 GLS, 1.6 GS, 1.6 GSI, 1.7 D 03/94 - 07/02 37 -80 kW	48-080767	30-50	20-40	Spacers required for several wheel/tyre combinations; Conditions see certificates VA: axle load to: 820 kg HA: axle load to: 700 kg
-------------	---	------------------	-------	-------	---

CHEVROLET CRUZE

B14	1.6, 1.6 T, 1.7 D, 1.8, 1.8 Flex, 1.8 LPG, 2.0 CDI 05/09 - 80 -135 kW	47-171725	30-50	20-40	Conditions see certificates VA: axle load to: 1220 kg HA: axle load to: 1020 kg
-----	---	------------------	-------	-------	---

CHEVROLET CRUZE Hatchback

B14	1.4, 1.6, 1.6 T, 1.7 D, 1.8, 1.8 LPG, 2.0 CDI 06/11 - 80 -135 kW	47-171725	30-50	20-40	Conditions see certificates VA: axle load to: 1220 kg HA: axle load to: 1020 kg
-----	--	------------------	-------	-------	---

CHEVROLET CRUZE Station Wagon (J308)

B14	1.4, 1.6, 1.6 T, 1.7 TD, 1.8, 2.0 TD 08/12 - 86 -135 kW	47-171725	30-50	30-50	Conditions see certificates VA: axle load to: 1220 kg HA: axle load to: 1020 kg
-----	---	------------------	-------	-------	---

SGM CHEVROLET

SGM CHEVROLET CRUZE

B14	1.6, 1.6 T, 1.8 04/09 - 86 -135 kW	47-171725	30-50	20-40	Conditions see certificates VA: axle load to: 1220 kg HA: axle load to: 1020 kg
-----	--	------------------	-------	-------	---

CHRYSLER

CHRYSLER CROSSFIRE

B12 PK	3.2 07/03 - 12/07 160 kW	46-000682	30	30	Conditions see certificates VA: axle load to: 845 kg HA: without ride height adjustment; axle load to: 820 kg
-----------	------------------------------------	------------------	----	----	---

B14	3.2, SRT-6 07/03 - 12/07 160 -246 kW	47-119536	15-35	10-30	Conditions see certificates VA: axle load to: 905 kg HA: axle load to: 850 kg
-----	--	------------------	-------	-------	---

					
--	--	---	---	---	---

CHRYSLER

CHRYSLER CROSSFIRE

B16 PSS9	3.2, SRT-6 07/03 - 12/07 160 -246 kW	48-119542	15-30	10-30	Conditions see certificates VA: axle load to: 905 kg HA: axle load to: 850 kg
--------------------	---	------------------	-------	-------	---

CHRYSLER CROSSFIRE Roadster

B12 PK	3.2 05/04 - 12/07 160 kW	46-000682	30	30	Conditions see certificates VA: axle load to: 845 kg HA: without ride height adjustment; axle load to: 820 kg
------------------	---------------------------------------	------------------	----	----	---

B14	3.2, SRT-6 05/04 - 12/07 160 -246 kW	47-119536	15-35	10-30	Conditions see certificates VA: axle load to: 905 kg HA: axle load to: 850 kg
------------	---	------------------	-------	-------	---

B16 PSS9	3.2, SRT-6 05/04 - 12/07 160 -246 kW	48-119542	15-30	10-30	Conditions see certificates VA: axle load to: 905 kg HA: axle load to: 850 kg
--------------------	---	------------------	-------	-------	---

CHRYSLER DELTA

B14	1.4, 1.4 16V, 1.6 D Multijet 08/11 - 88 -103 kW	47-158993	30-40	25-40	fixing hole pitches 58 mm; Conditions see certificates
------------	--	------------------	-------	-------	--

CITROËN

CITROËN AX (ZA-)

B12 PK	10, 10 E, 11, 11 CAT, 14, 14 D 07/86 - 12/97 30 -62 kW	46-189301	25-30		Conditions see certificates VA: axle load to: 605 kg HA: axle load to: 585 kg
------------------	---	------------------	-------	--	---

CITROËN C1 (PM_, PN_)

B12 PK	1.0, 1.4 HDi 06/05 - 40 -50 kW	46-206657	30	30	twin-tube; Conditions see certificates VA: axle load to: 695 kg HA: axle load to: 695 kg
------------------	---	------------------	----	----	--

CITROËN C2 (JM_)

B12 PK	1.1, 1.4, 1.4 16V, 1.4 HDi, 1.6, 1.6 VTS 09/03 - 44 -90 kW	46-189363	30	30	Conditions see certificates VA: axle load to: 850 kg HA: axle load to: 820 kg
------------------	---	------------------	----	----	---

B12 SL	1.1, 1.4, 1.4 16V, 1.4 HDi, 1.6, 1.6 HDi, 1.6 VTS 09/03 - 44 -90 kW	46-189370	45-50	30	Conditions see certificates VA: axle load to: 820 kg HA: axle load to: 735 kg
------------------	--	------------------	-------	----	---

B14	1.1, 1.4, 1.4 16V, 1.4 HDi, 1.6, 1.6 HDi, 1.6 VTS 09/03 - 44 -90 kW	47-168299	20-40	20-40	Conditions see certificates VA: axle load to: 850 kg HA: axle load to: 820 kg
------------	--	------------------	-------	-------	---

CITROËN C3 (FC_)

B12 PK	1.1 i, 1.4 16V, 1.4 16V HDi, 1.4 Bioflex, 1.4 Flex, 1.4 HDi, 1.4 i, 1.6 16V, 1.6 Bioflex 02/02 - 44 -83 kW	46-189363	30	30	Conditions see certificates VA: axle load to: 850 kg HA: axle load to: 820 kg
------------------	---	------------------	----	----	---

B12 SL	1.1 i, 1.4 16V, 1.4 16V HDi, 1.4 Bioflex, 1.4 Flex, 1.4 HDi, 1.4 i, 1.6 16V, 1.6 Bioflex 02/02 - 44 -83 kW	46-189370	45-50	30	Conditions see certificates VA: axle load to: 820 kg HA: axle load to: 735 kg
------------------	---	------------------	-------	----	---

B14	1.1 i, 1.4 16V, 1.4 16V HDi, 1.4 Bioflex, 1.4 Flex, 1.4 HDi, 1.4 i, 1.4 i Bivalent, 1.6 16V, 1.6 16V HDi, 1.6 Bioflex 02/02 - 44 -83 kW	47-168299	20-40	20-40	Conditions see certificates
------------	--	------------------	-------	-------	-----------------------------

CITROËN C3

B14	1.0 VTi 68, 1.1, 1.1 BiFuel, 1.2 VTi 82, 1.4, 1.4 16V, 1.4 Flex, 1.4 HDi, 1.6 16V, 1.6 Flex, 1.6 HDi, 1.6 HDi 115 11/09 - 44 -88 kW	47-175976	30-50	30-50	Øa: 47 mm; Conditions see certificates VA: axle load to: 850 kg HA: axle load to: 820 kg
------------	--	------------------	-------	-------	--



CITROËN

CITROËN C4 (LC_)

B12 PK	1.4 16V, 1.6 THP 140, 1.6 THP 150, 1.6 VTi 120 11/04 - 65 -110 kW	46-189332	30	25	Conditions see certificates VA: axle load to: 1010 kg HA: axle load to: 920 kg
B12 PK	1.6 16V, 1.6 16V Bio-Flex 11/04 - 80 kW	46-189332	30	25	manual transmission; Conditions see certificates VA: axle load to: 1010 kg HA: axle load to: 920 kg
B12 PK	1.6 16V, 1.6 16V Bio-Flex, 1.6 HDi, 1.6 THP 140, 1.6 THP 150, 1.6 VTi 120, 2.0 16V, 2.0 HDi 11/04 - 66 -130 kW	46-189349	30	25	Conditions see certificates VA: axle load to: 1120 kg HA: axle load to: 920 kg
B14	1.4 16V, 1.6 16V, 1.6 16V Bio-Flex, 1.6 HDi, 1.6 THP 140, 1.6 THP 150, 1.6 VTi 120, 2.0 16V, 2.0 HDi 11/04 - 65 -130 kW	47-100817	45-55	30-50	Conditions see certificates VA: axle load to: 1065 kg HA: axle load to: 1065 kg

CITROËN C4 Saloon

B12 PK	1.6 16V, 2.0 16V, 2.0 Flex 07/06 - 80 -103 kW	46-189332	30	25	Conditions see certificates VA: axle load to: 1010 kg HA: axle load to: 920 kg
B12 PK	1.6 HDi, 2.0 Flex, 2.0 HDi 07/06 - 80 -103 kW	46-189349	30	25	Conditions see certificates VA: axle load to: 1120 kg HA: axle load to: 920 kg
B14	1.6 16V, 1.6 HDi, 2.0 16V, 2.0 Flex, 2.0 HDi 07/06 - 80 -103 kW	47-100817	45-55	30-50	Conditions see certificates VA: axle load to: 1065 kg HA: axle load to: 1065 kg

CITROËN C4 Coupe (LA_)

B12 PK	1.4 16V, 1.6 THP 150, 1.6 VTi 120 11/04 - 65 -110 kW	46-189332	30	25	Conditions see certificates VA: axle load to: 1010 kg HA: axle load to: 920 kg
B12 PK	1.6 16V 11/04 - 80 kW	46-189332	30	25	manual transmission; Conditions see certificates VA: axle load to: 1010 kg HA: axle load to: 920 kg
B12 PK	1.6 16V, 1.6 HDi, 1.6 THP 150, 1.6 VTi 120, 2.0 16V, 2.0 HDi 11/04 - 66 -130 kW	46-189349	30	25	Conditions see certificates VA: axle load to: 1120 kg HA: axle load to: 920 kg
B14	1.4 16V, 1.6 16V, 1.6 HDi, 1.6 THP 150, 1.6 VTi 120, 2.0 16V, 2.0 HDi 11/04 - 65 -130 kW	47-100817	45-55	30-50	Conditions see certificates VA: axle load to: 1065 kg HA: axle load to: 1065 kg

CITROËN C5 (RD_)

B12 PK	2.0 HDi 02/08 - 100 -120 kW	46-206749	40	35	twin-tube; Conditions see certificates VA: axle load to: 1280 kg HA: axle load to: 1045 kg
-----------	---------------------------------------	------------------	----	----	--

CITROËN DS3





B14	1.2 VTi 82, 1.4 16V, 1.4 HDi 70, 1.4 VTi 95 LPG, 1.4 VTi 98, 1.6 16V, 1.6 HDi, 1.6 HDi 115, 1.6 THP 150 01/10 - 50 -115 kW	47-175976	30-50	5-15	Øa: 47 mm; Without roadworthy certificate
-----	--	------------------	-------	------	---

CITROËN DS3 Convertible

B14	1.2 VTi 82, 1.6 HDi 90, 1.6 THP 155, 1.6 VTi 120 01/13 - 60 -115 kW	47-175976	30-50	5-15	Øa: 47 mm; Without roadworthy certificate
-----	---	------------------	-------	------	---

CITROËN SAXO (S0, S1)

B12 PK	1.0 X, 1.1 X,SX, 1.4 VTS, 1.5 D, 1.6, 1.6 VTL,VTR, 1.6 VTR, 1.6 VTS 02/96 - 09/03 33 -88 kW	46-189318	30	25-30	Conditions see certificates VA: axle load to: 785 kg HA: axle load to: 700 kg
-----------	---	------------------	----	-------	---

   					
CITROËN					
CITROËN SAXO (S0, S1)					
B12 SL	1.0 X, 1.1 X,SX, 1.4 VTS, 1.5 D, 1.6, 1.6 VTL,VTR, 1.6 VTR, 1.6 VTS 02/96 - 09/03 33 -88 kW	46-189325	45-50	30	Conditions see certificates VA: axle load to: 785 kg HA: axle load to: 700 kg
CITROËN XSARA (N1)					
B12 PK	1.4 i, 1.5 D, 1.6 16V, 1.6 i, 1.8 D, 1.8 i, 1.8 i 16V, 1.8 i Aut., 1.8 TD, 1.8 VTS, 1.9 D, 1.9 SD, 1.9 TD, 2.0 16V, 2.0 HDi 90 04/97 - 09/00 42 -120 kW	46-189356	30	30	Conditions see certificates VA: axle load to: 950 kg HA: axle load to: 870 kg
CITROËN XSARA Break (N2)					
B12 PK	1.4 i, 1.5 D, 1.6 16V, 1.6 i, 1.8 D, 1.8 i, 1.8 i 16V, 1.8 i Aut., 1.9 D, 1.9 TD, 2.0 16V, 2.0 HDi 90 10/97 - 09/00 42 -100 kW	46-189356	30	30	Conditions see certificates VA: axle load to: 950 kg HA: axle load to: 870 kg
CITROËN XSARA Coupe (N0)					
B12 PK	1.4 i, 1.6 16V, 1.6 i, 1.8 i, 1.8 i 16V, 1.8 VTS, 1.9 D, 1.9 TD, 2.0, 2.0 16V, 2.0 HDi 90, 2.0 i 16V 02/98 - 09/00 50 -120 kW	46-189356	30	30	Conditions see certificates VA: axle load to: 950 kg HA: axle load to: 870 kg
DACIA					
DACIA DUSTER					
B12 PK	1.5 dCi, 1.6 16V, 1.6 16V Flexifuel 04/10 - 63 -79 kW	46-206671	30	30	twin-tube; front wheel drive; Conditions see certificates VA: axle load to: 940 kg HA: axle load to: 910 kg
B12 PK	1.5 dCi 4x4, 1.6 16V 4x4 06/10 - 66 -81 kW	46-206688	30	30	twin-tube; all-wheel drive; Conditions see certificates VA: axle load to: 940 kg HA: axle load to: 980 kg
DACIA LOGAN					
B12 PK	1.4, 1.5 dCi, 1.6, 1.6 16V, 1.6 MPI 85 09/04 - 48 -77 kW	46-189387	35	35	twin-tube; Conditions see certificates VA: axle load to: 930 kg HA: axle load to: 880 kg
DACIA SANDERO					
B12 PK	1.2 16V, 1.2 16V Bifuel, 1.4, 1.4 MPI LPG, 1.5 dCi, 1.6, 1.6 MPI 85 06/08 - 50 -65 kW	46-232823	30	30	twin-tube; Conditions see certificates VA: axle load to: 860 kg HA: axle load to: 880 kg
DAEWOO					
DAEWOO ESPERO (KLEJ)					
B12 PK	1.5, 1.5 16V, 1.8, 2.0 10/93 - 09/99 55 -81 kW	46-189400	30	30	Conditions see certificates VA: axle load to: 860 kg HA: axle load to: 890 kg
DAEWOO NEXIA (KLETN)					
B12 PK	1.5, 1.5 16V 02/95 - 08/97 44 -66 kW	46-189424	30	30	Conditions see certificates VA: axle load to: 760 kg HA: axle load to: 830 kg
B12 PK	1.5 16V 02/95 - 08/97 66 kW	46-189431	30	30	Conditions see certificates VA: axle load to: 830 kg HA: axle load to: 830 kg
DAEWOO NEXIA Saloon (KLETN)					
B12 PK	1.5, 1.5 16V 02/95 - 08/97 44 -66 kW	46-189424	30	30	Conditions see certificates VA: axle load to: 760 kg HA: axle load to: 830 kg



DAEWOO

DAEWOO NEXIA Saloon (KLETN)

B12 PK	1.5 16V 02/95 - 08/97 66 kW	46-189431	30	30	Conditions see certificates VA: axle load to: 830 kg HA: axle load to: 830 kg
-----------	---------------------------------------	------------------	----	----	---

DAEWOO NEXIA Saloon

B12 PK	1.5, 1.6 07/08 - 59 -80 kW	46-189424	30	30	Conditions see certificates VA: axle load to: 760 kg HA: axle load to: 830 kg
B12 PK	1.5, 1.6 07/08 - 59 -80 kW	46-189431	30	30	Conditions see certificates VA: axle load to: 830 kg HA: axle load to: 830 kg

FIAT

FIAT BARCHETTA (183)

B12 PK	1.8 16V 04/95 - 05/05 96 kW	46-192509	30	30	Conditions see certificates VA: axle load to: 850 kg HA: axle load to: 700 kg
-----------	---------------------------------------	------------------	----	----	---

FIAT BRAVO (198)

B12 PK	1.4, 1.4 16V, 1.4 T-Jet 04/07 - 66 -110 kW	46-192448	30	30	fixing hole pitches 58 mm; without ride height adjustment; Conditions see certificates VA: axle load to: 1000 kg HA: axle load to: 880 kg
B12 PK	1.6 D Multijet, 1.9 D Multijet 04/07 - 66 -110 kW	46-192455	30	30	fixing hole pitches 58 mm; without ride height adjustment; Conditions see certificates VA: axle load to: 1090 kg HA: axle load to: 880 kg
B12 SL	1.4, 1.4 16V, 1.4 T-Jet 04/07 - 66 -110 kW	46-192493	45-50	30	fixing hole pitches 58 mm; without ride height adjustment; Conditions see certificates VA: axle load to: 1000 kg HA: axle load to: 880 kg
B12 SL	1.6 D Multijet, 1.9 D Multijet 04/07 - 66 -110 kW	46-192486	45-50	30	fixing hole pitches 58 mm; without ride height adjustment; Conditions see certificates VA: axle load to: 1090 kg HA: axle load to: 880 kg
B14	1.4, 1.4 16V, 1.4 LPG, 1.4 T-Jet, 1.6 D Multijet, 1.8 16V, 1.9 D Multijet 11/06 - 66 -110 kW	47-158993	30-40	20-40	fixing hole pitches 58 mm; Conditions see certificates VA: axle load to: 1150 kg HA: axle load to: 950 kg

FIAT CROMA (194)

B12 PK	1.9 D Multijet, 2.2 16V 06/05 - 85 -110 kW	46-194152	30-35	25-30	Conditions see certificates VA: axle load to: 1150 kg HA: axle load to: 1120 kg
B12 PK	2.4 D Multijet 06/05 - 147 kW	46-194169	30-35	25-30	Conditions see certificates VA: axle load to: 1200 kg HA: axle load to: 1120 kg

FIAT PANDA (169)





B12 PK	1.1, 1.2, 1.2 Bi-Power, 1.2 LPG 09/03 - 40 -51 kW	46-206718	30	30	twin-tube; front wheel drive; Conditions see certificates VA: axle load to: 750 kg HA: axle load to: 680 kg
-----------	---	------------------	----	----	---

FIAT PANDA (312, 323)

B12 PK	0.9, 0.9 4x4, 0.9 CNG, 1.2, 3.2 02/12 - 48 -63 kW	46-206732	25	25	twin-tube; Conditions see certificates VA: axle load to: 770 kg HA: axle load to: 810 kg
-----------	---	------------------	----	----	--

FIAT PUNTO (188)

B12 PK	1.2 16V 80, 1.2 60, 1.2 Bifuel, 1.3 JTD 16V, 1.4 09/99 - 44 -70 kW	46-192523	25-30	25	Conditions see certificates VA: axle load to: 900 kg HA: axle load to: 870 kg
B12 PK	1.8 130 HGT, 1.9 DS 60, 1.9 JTD, 1.9 JTD 80 09/99 - 44 -96 kW	46-192530	25-30	25	Conditions see certificates VA: axle load to: 900 kg HA: axle load to: 870 kg

					
FIAT					
FIAT PUNTO (188)					
B12 SL	1.2 16V 80, 1.2 60, 1.2 Bifuel, 1.3 JTD 16V, 1.4, 1.8 130 HGT, 1.9 DS 60, 1.9 JTD, 1.9 JTD 80 09/99 - 44 -96 kW	46-192516	45-50	35-40	Conditions see certificates VA: axle load to: 900 kg HA: axle load to: 750 kg
FIAT GRANDE PUNTO (199)					
B12 PK	1.2, 1.4, 1.4 16V 10/05 - 48 -70 kW	46-188120	25-30	30	Conditions see certificates VA: axle load to: 950 kg HA: without ride height adjustment; axle load to: 950 kg
B12 PK	1.3 D Multijet, 1.4 16V, 1.4 Abarth, 1.4 T-Jet, 1.6 D Multijet, 1.9 D Multijet 10/05 - 51 -132 kW	46-188137	25-30	30	Conditions see certificates VA: axle load to: 1000 kg HA: without ride height adjustment; axle load to: 950 kg
B12 SL	1.2, 1.4, 1.4 16V, 1.4 T-Jet 10/05 - 48 -112 kW	46-188168	40-45	30	Conditions see certificates VA: axle load to: 950 kg HA: without ride height adjustment; axle load to: 950 kg
B12 SL	1.3 D Multijet, 1.4, 1.4 16V, 1.4 Abarth, 1.4 T-Jet, 1.6 D Multijet, 1.9 D Multijet 10/05 - 51 -132 kW	46-188175	40-45	30	Conditions see certificates VA: axle load to: 1000 kg HA: without ride height adjustment; axle load to: 950 kg
B14	1.2, 1.3 D Multijet, 1.4, 1.4 16V, 1.4 Abarth, 1.4 LPG, 1.4 Natural Power, 1.4 T-Jet, 1.6 16V, 1.6 D Multijet, 1.8, 1.8 16V, 1.9 D Multijet 10/05 - 48 -132 kW	47-164499	35-45	20-45	Conditions see certificates VA: axle load to: 1000 kg HA: axle load to: 850 kg
FIAT PUNTO EVO					
B12 PK	1.2, 1.4, 1.4 16V, 1.4 Abarth 07/09 - 02/12 48 -120 kW	46-188120	25-30	30	Conditions see certificates VA: axle load to: 950 kg HA: without ride height adjustment; axle load to: 950 kg
B12 PK	1.3 16V Multijet, 1.3 D Multijet, 1.6 D Multijet 07/08 - 02/12 51 -88 kW	46-188137	25-30	30	Conditions see certificates VA: axle load to: 1000 kg HA: without ride height adjustment; axle load to: 950 kg
B12 SL	1.2, 1.4, 1.4 16V, 1.4 Abarth 07/09 - 02/12 48 -120 kW	46-188168	40-45	30	Conditions see certificates VA: axle load to: 950 kg HA: without ride height adjustment; axle load to: 950 kg
B12 SL	1.3 16V Multijet, 1.3 D Multijet, 1.6 D Multijet 07/08 - 02/12 51 -88 kW	46-188175	40-45	30	Conditions see certificates VA: axle load to: 1000 kg HA: without ride height adjustment; axle load to: 950 kg
B14	1.2, 1.3 16V Multijet, 1.3 D Multijet, 1.4, 1.4 16V, 1.4 Abarth, 1.4 Natural Power, 1.6 D Multijet 07/09 - 02/12 48 -120 kW	47-164499	35-45	20-45	Conditions see certificates VA: axle load to: 1000 kg HA: axle load to: 850 kg
FIAT STILO (192)					
B12 PK	1.2 16V, 1.4 16V, 1.6 16V, 1.9 D Multijet, 1.9 JTD 10/01 - 11/06 59 -88 kW	46-190963	30	30	fixing hole pitches 58 mm; Conditions see certificates VA: axle load to: 1020 kg HA: axle load to: 940 kg
B12 PK	1.9 JTD 10/01 - 11/06 85 -100 kW	46-190987	30	30	fixing hole pitches 58 mm; Conditions see certificates VA: axle load to: 1030 kg HA: axle load to: 940 kg
B12 SL	1.2 16V, 1.4 16V, 1.6 16V, 1.8, 1.8 16V, 1.9 D Multijet, 1.9 JTD 10/01 - 11/06 59 -98 kW	46-191014	45-50	30	fixing hole pitches 58 mm; Conditions see certificates VA: axle load to: 1020 kg HA: axle load to: 940 kg
B12 SL	1.9 JTD 10/01 - 11/06 85 kW	46-191021	45-50	30	fixing hole pitches 58 mm; Conditions see certificates VA: axle load to: 1030 kg HA: axle load to: 940 kg
FIAT STILO Multi Wagon (192)					
B12 PK	1.4 16V, 1.6 16V, 1.8, 1.8 16V, 1.9 D, 1.9 D Multijet, 1.9 JTD 01/04 - 08/08 59 -110 kW	46-191045	30	30	fixing hole pitches 58 mm; Conditions see certificates VA: axle load to: 1020 kg HA: axle load to: 980 kg



FIAT

FIAT STILO Multi Wagon (192)

B12 PK	1.9 JTD 01/03 - 08/08 85 -103 kW	46-191052	30	30	fixing hole pitches 58 mm; Conditions see certificates VA: axle load to: 1030 kg HA: axle load to: 980 kg
-----------	--	------------------	----	----	---

FIAT 500

B12 PK	0.9, 1.2, 1.3 D Multijet, 1.4, 1.4 Abarth 08/08 - 48 -140 kW	46-229779	30	30	not for USA; mark: ZFA; Conditions see certificates VA: axle load to: 830 kg HA: axle load to: 640 kg
-----------	--	------------------	----	----	---

B12 SL	0.9, 1.2, 1.3 D Multijet, 1.4, 1.4 Abarth 08/08 - 48 -140 kW	46-229786	45-50	30	not for USA; Conditions see certificates VA: axle load to: 830 kg HA: axle load to: 640 kg
-----------	--	------------------	-------	----	--

B14	0.9, 1.2, 1.2 LPG, 1.3 D Multijet, 1.4, 1.4 Abarth 08/08 - 48 -140 kW	47-155770	20-40	20-40	not for USA; mark: ZFA; Conditions see certificates VA: axle load to: 830 kg HA: axle load to: 640 kg
-----	---	------------------	-------	-------	---

B14	0.9, 1.2, 1.2 LPG, 1.3 D Multijet, 1.4, 1.4 Abarth 08/08 - 48 -140 kW	47-228078		20-40	for USA; mark: 3C3; Without roadworthy certificate
-----	---	------------------	--	-------	--

FIAT 500 C

B12 PK	0.9, 1.2, 1.3 D Multijet, 1.4, 1.4 Abarth, 2.5 TDi 09/09 - 48 -118 kW	46-229779	30	30	not for USA; Conditions see certificates VA: axle load to: 830 kg HA: axle load to: 640 kg
-----------	---	------------------	----	----	--

B12 SL	1.3 D Multijet 09/09 - 55 -70 kW	46-229786	45-50	30	Conditions see certificates VA: axle load to: 830 kg HA: axle load to: 640 kg
-----------	--	------------------	-------	----	---

B14	0.9, 1.2, 1.3 D Multijet, 1.4, 1.4 Abarth, 2.5 TDi 09/09 - 48 -118 kW	47-155770	20-40	20-40	not for USA; mark: ZFA; Conditions see certificates VA: axle load to: 830 kg HA: axle load to: 640 kg
-----	---	------------------	-------	-------	---

B14	0.9, 1.2, 1.3 D Multijet, 1.4, 1.4 Abarth, 2.5 TDi 09/09 - 48 -118 kW	47-228078	20-40	20-40	for USA; mark: 3C3; Without roadworthy certificate
-----	---	------------------	-------	-------	--

FORD

FORD FIESTA V (JH_, JD_)

B12 PK	1.25 16V, 1.3, 1.4 16V 11/01 - 44 -59 kW	46-190116	35	30	Conditions see certificates; With General Certification (ABE) VA: axle load to: 820 kg HA: axle load to: 800 kg
-----------	--	------------------	----	----	---

B12 PK	1.4 TDCi, 1.6, 1.6 16V, 1.6 Flex, 1.6 TDCi, ST150 11/01 - 50 -110 kW	46-190123	35	30	Conditions see certificates; With General Certification (ABE) VA: axle load to: 860 kg HA: axle load to: 800 kg
-----------	--	------------------	----	----	---

FORD FIESTA VI

B14	1.0 Flex, 1.25, 1.4, 1.4 LPG, 1.4 TDCi, 1.5, 1.6, 1.6 Flex, 1.6 TDCi, 1.6 Ti 02/10 - 44 -99 kW	47-167490	25-40	20-40	Conditions see certificates VA: axle load to: 850 kg HA: axle load to: 785 kg
-----	--	------------------	-------	-------	---





FORD FOCUS (DAW, DBW)

B12 PK	1.4 16V, 1.6 16V 10/98 - 11/04 55 -74 kW	46-181336	30	30	Conditions see certificates; With General Certification (ABE) VA: axle load to: 855 kg HA: without ride height adjustment; axle load to: 905 kg
-----------	--	------------------	----	----	---

B12 PK	1.8 16V, 2.0 16V 10/98 - 11/04 85 -96 kW	46-181343	30	30	Conditions see certificates; With General Certification (ABE) VA: axle load to: 915 kg HA: without ride height adjustment; axle load to: 905 kg
-----------	--	------------------	----	----	---

B12 PK	ST170 03/02 - 11/04 127 kW	46-181343	20-25	30	Conditions see certificates; With General Certification (ABE) VA: axle load to: 915 kg HA: without ride height adjustment; axle load to: 905 kg
-----------	--------------------------------------	------------------	-------	----	---

B12 PK	1.8 DI / TDDi, 1.8 TDCi, 1.8 Turbo DI / TDDi 10/98 - 11/04 55 -85 kW	46-181374	30	30	Conditions see certificates; With General Certification (ABE) VA: axle load to: 965 kg HA: without ride height adjustment; axle load to: 905 kg
-----------	--	------------------	----	----	---

									
FORD									
FORD FOCUS (DAW, DBW)									
B16 PSS9	1.4 16V, 1.6 16V, 1.8 16V, 1.8 DI / TDDi, 1.8 TDCi, 1.8 Turbo DI / TDDi, 2.0 16V, ST170 10/98 - 11/04 55 -127 kW	48-080460	30-50	30-50	Spacers required for several wheel/tyre combinations; Conditions see certificates VA: axle load to: 965 kg HA: axle load to: 880 kg				
FORD FOCUS Saloon (DFW)									
B12 PK	1.4 16V, 1.6 16V 02/99 - 11/04 55 -74 kW	46-181336	30	30	Conditions see certificates; With General Certification (ABE) VA: axle load to: 855 kg HA: without ride height adjustment; axle load to: 905 kg				
B12 PK	1.8 16V, 2.0 16V 02/99 - 11/04 85 -96 kW	46-181343	30	30	Conditions see certificates; With General Certification (ABE) VA: axle load to: 915 kg HA: without ride height adjustment; axle load to: 905 kg				
B12 PK	1.8 TDCi, 1.8 Turbo DI / TDDi 02/99 - 11/04 66 -85 kW	46-181374	30	30	Conditions see certificates; With General Certification (ABE) VA: axle load to: 965 kg HA: without ride height adjustment; axle load to: 905 kg				
B16 PSS9	1.4 16V, 1.6 16V, 1.8 16V, 1.8 TDCi, 1.8 TDDi, 1.8 Turbo DI / TDDi, 2.0 16V 02/99 - 03/05 55 -96 kW	48-080460	30-50	30-50	Spacers required for several wheel/tyre combinations; Conditions see certificates VA: axle load to: 965 kg HA: axle load to: 880 kg				
FORD FOCUS Estate (DNW)									
B12 PK	1.4 16V, 1.6 16V, 1.6 16V Flexifuel 02/99 - 11/04 55 -75 kW	46-181350	30	30	Conditions see certificates; With General Certification (ABE) VA: axle load to: 855 kg HA: without ride height adjustment; axle load to: 1010 kg				
B12 PK	1.8 16V, 2.0 16V, ST170 02/99 - 11/04 85 -127 kW	46-181367	30	30	Conditions see certificates; With General Certification (ABE) VA: axle load to: 915 kg HA: without ride height adjustment; axle load to: 1010 kg				
B12 PK	1.8 DI / TDDi, 1.8 TDCi, 1.8 Turbo DI / TDDi 02/99 - 11/04 55 -85 kW	46-181381	30	30	Conditions see certificates; With General Certification (ABE) VA: axle load to: 965 kg HA: without ride height adjustment; axle load to: 1010 kg				
B16 PSS9	1.4 16V, 1.6 16V, 1.6 16V Flexifuel, 1.8 16V, 1.8 DI / TDDi, 1.8 TDCi, 1.8 Turbo DI / TDDi, 2.0 16V, ST170 02/99 - 11/04 55 -127 kW	48-080453	30-50	25-45	Conditions see certificates VA: axle load to: 965 kg HA: axle load to: 960 kg				
FORD FOCUS C-MAX									
B12 PK	1.6, 1.6 Ti, 1.8, 1.8 Flexifuel, 2.0 10/03 - 03/07 74 -107 kW	46-206770	30	30	Conditions see certificates; With General Certification (ABE) VA: axle load to: 990 kg HA: axle load to: 1065 kg				
B12 PK	1.6 TDCi, 1.8 TDCi, 2.0 TDCi 10/03 - 03/07 66 -100 kW	46-206787	30	30	Conditions see certificates; With General Certification (ABE) VA: axle load to: 1065 kg HA: axle load to: 1065 kg				
FORD C-MAX									
B12 PK	1.6, 1.8, 2.0 02/07 - 74 -107 kW	46-206770	30	30	Conditions see certificates; With General Certification (ABE) VA: axle load to: 990 kg HA: axle load to: 1065 kg				
B12 PK	1.6 TDCi, 1.8 TDCi, 2.0 TDCi 02/07 - 66 -100 kW	46-206787	30	30	Conditions see certificates; With General Certification (ABE) VA: axle load to: 1065 kg HA: axle load to: 1065 kg				
FORD FOCUS II (DA_)									
B12 PK	1.4, 1.6, 1.6 Flex, 1.6 Ti, 1.8 11/04 - 59 -92 kW	46-181282	30	30	Conditions see certificates; With General Certification (ABE) VA: axle load to: 1005 kg HA: without ride height adjustment; axle load to: 1015 kg				
B12 PK	2.5 ST 10/05 - 166 kW	46-181329	20	25	Conditions see certificates; With General Certification (ABE) VA: axle load to: 1050 kg HA: without ride height adjustment; axle load to: 915 kg				
B12 PK	1.6 TDCi, 1.8 TDCi, 2.0, 2.0 TDCi 11/04 - 66 -107 kW	46-181299	30	30	Conditions see certificates; With General Certification (ABE) VA: axle load to: 1070 kg HA: without ride height adjustment; axle load to: 1015 kg				
B14	1.4, 1.6, 1.6 Flex, 1.6 LPG, 1.6 TDCi, 1.6 Ti, 1.8, 1.8 Flexifuel, 1.8 Ghia Flexifuel, 1.8 TDCi, 2.0, 2.0 Flex, 2.0 LPG, 2.0 TDCi, 2.5 ST 11/04 - 59 -166 kW	47-121225	30-50	30-50	Conditions see certificates VA: axle load to: 1070 kg HA: axle load to: 1090 kg				



FORD

FORD FOCUS II (DA_)

B16 PSS9	1.4, 1.6, 1.6 Flex, 1.6 LPG, 1.6 TDCi, 1.6 Ti, 1.8, 1.8 Flexifuel, 1.8 Ghia Flexifuel, 1.8 TDCi, 2.0, 2.0 Flex, 2.0 LPG, 2.0 TDCi, 2.5 ST 11/04 - 59 -166 kW	48-121262	30-50	30-50	Conditions see certificates VA: axle load to: 1070 kg HA: axle load to: 1090 kg
-------------	---	-----------	-------	-------	---

FORD FOCUS II Saloon (DA_)

B12 PK	1.4, 1.6, 1.6 Flex, 1.6 Ti, 1.8 04/05 - 59 -92 kW	46-181282	30	30	Conditions see certificates; With General Certification (ABE) VA: axle load to: 1005 kg HA: without ride height adjustment; axle load to: 1015 kg
B12 PK	1.6 TDCi, 1.8 TDCi, 2.0, 2.0 TDCi, 400h 04/05 - 66 -107 kW	46-181299	30	30	Conditions see certificates; With General Certification (ABE) VA: axle load to: 1070 kg HA: without ride height adjustment; axle load to: 1015 kg
B14	1.4, 1.6, 1.6 Flex, 1.6 TDCi, 1.6 Ti, 1.8, 1.8 Flexifuel, 1.8 Ghia Flexifuel, 1.8 TDCi, 2.0, 2.0 Flex, 2.0 TDCi, 400h 04/05 - 59 -107 kW	47-121225	30-50	30-50	Conditions see certificates VA: axle load to: 1070 kg HA: axle load to: 1090 kg
B16 PSS9	1.4, 1.6, 1.6 Flex, 1.6 TDCi, 1.6 Ti, 1.8, 1.8 Flexifuel, 1.8 Ghia Flexifuel, 1.8 TDCi, 2.0, 2.0 Flex, 2.0 TDCi, 400h 04/05 - 59 -107 kW	48-121262	30-50	30-50	Conditions see certificates VA: axle load to: 1070 kg HA: axle load to: 1090 kg

FORD FOCUS II Turnier (DAW_)

B12 PK	1.4, 1.6, 1.6 Ti, 1.8 11/04 - 59 -92 kW	46-181305	30	30	Conditions see certificates; With General Certification (ABE) VA: axle load to: 1005 kg HA: without ride height adjustment; axle load to: 1090 kg
B12 PK	1.6 TDCi, 1.8 TDCi, 2.0, 2.0 TDCi 11/04 - 66 -107 kW	46-181312	30	30	Conditions see certificates; With General Certification (ABE) VA: axle load to: 1070 kg HA: without ride height adjustment; axle load to: 1090 kg

FORD FOCUS II Convertible

B12 PK	1.6, 2.0 10/06 - 74 -107 kW	46-187925	30	30	Conditions see certificates VA: axle load to: 990 kg HA: without ride height adjustment; axle load to: 1065 kg
B12 PK	2.0 TDCi 10/06 - 100 kW	46-187932	30	30	Conditions see certificates VA: axle load to: 1070 kg HA: without ride height adjustment; axle load to: 1065 kg

FORD FOCUS III





B12 PK	1.0 EcoBoost, 1.6, 1.6 EcoBoost, 1.6 Flexifuel, 1.6 Ti 08/11 - 63 -134 kW	46-229816	25	25	Conditions see certificates VA: axle load to: 985 kg HA: axle load to: 1025 kg
B12 PK	1.6 TDCi, 2.0 TDCi 04/11 - 70 -120 kW	46-229823	25	25	Conditions see certificates VA: axle load to: 1100 kg HA: axle load to: 1025 kg
B14	1.0 EcoBoost, 1.6, 1.6 EcoBoost, 1.6 Flexifuel, 1.6 LPG, 1.6 TDCi, 1.6 Ti, 2.0 TDCi 04/11 - 63 -134 kW	47-196568	35-50	30-50	Conditions see certificates VA: axle load to: 1100 kg HA: axle load to: 1025 kg
B14	2.0 ST 07/12 - 184 kW	47-232952	15-30	15-30	Conditions see certificates VA: axle load to: 1100 kg HA: axle load to: 1025 kg

FORD FOCUS III Saloon

B14	1.0 EcoBoost, 1.6, 1.6 EcoBoost, 1.6 Flexifuel, 1.6 TDCi, 1.6 Ti, 2.0 TDCi 04/11 - 63 -134 kW	47-196568	35-50	30-50	Conditions see certificates VA: axle load to: 1100 kg HA: axle load to: 1025 kg
-----	--	-----------	-------	-------	---

FORD GALAXY (WGR)

B12 PK	2.0 i, 2.3 16V 11/95 - 05/06 85 -107 kW	46-193872	30	30	Conditions see certificates VA: axle load to: 1240 kg HA: axle load to: 1355 kg
-----------	--	-----------	----	----	---

									
FORD									
FORD GALAXY (WGR)									
B12 PK	1.9 TDI, 2.8 i V6, 2.8 V6 03/95 - 05/06 66 -150 kW	46-193889	30	30	Conditions see certificates VA: axle load to: 1260 kg HA: axle load to: 1355 kg				
FORD GALAXY									
B12 PK	1.6 EcoBoost, 2.0, 2.0 Flexifuel, 2.0 SCTi 03/10 - 107 -149 kW	46-194336	30	25	Conditions see certificates VA: axle load to: 1300 kg HA: axle load to: 1405 kg				
B12 PK	1.6 TDCi, 1.8 TDCi, 2.0 TDCi, 2.2 TDCi, 2.3 07/07 - 74 -147 kW	46-194343	30	25	Conditions see certificates VA: axle load to: 1300 kg HA: axle load to: 1405 kg				
FORD KA									
B14	1.0, 1.0 Flex, 1.6, 1.6 Flex, 1.2, 1.3 TDCi 02/08 - 48 -75 kW	47-155770	20-40	20-40	Conditions see certificates VA: axle load to: 830 kg HA: axle load to: 640 kg				
FORD MONDEO III Estate (BWY)									
B12 PK	1.8 16V, 1.8 SCi, 2.0 16V 11/00 - 08/07 81 -107 kW	46-192608	40	30	Conditions see certificates; With General Certification (ABE) VA: axle load to: 1065 kg HA: without ride height adjustment; axle load to: 1140 kg				
B12 PK	1.8 16V, 1.8 SCi, 2.0 16V, 2.0 16V DI / TDDi, 2.0 16V TDDi / TDCi, 2.0 TDCi, 2.2 TDCi, 2.5 V6 24V, 3.0 V6 24V 11/00 - 08/07 66 -150 kW	46-192615	40	30	Conditions see certificates; With General Certification (ABE) VA: axle load to: 1200 kg HA: without ride height adjustment; axle load to: 1140 kg				
FORD MONDEO IV									
B12 PK	1.6 EcoBoost, 1.6 Ti, 2.0, 2.0 EcoBoost, 2.0 SCTi 03/10 - 81 -176 kW	46-192547	30	30	without ride height adjustment; Conditions see certificates VA: axle load to: 1100 kg HA: axle load to: 1115 kg				
B12 PK	1.8 TDCi, 2.0 TDCi, 2.2 TDCi, 2.3, 2.5 03/07 - 74 -162 kW	46-192554	30	30	without ride height adjustment; Conditions see certificates VA: axle load to: 1215 kg HA: axle load to: 1115 kg				
FORD MONDEO IV Saloon									
B12 PK	1.6 Ti, 2.0 03/07 - 81 -107 kW	46-192547	30	30	without ride height adjustment; Conditions see certificates VA: axle load to: 1100 kg HA: axle load to: 1115 kg				
B12 PK	1.8 TDCi, 2.0 TDCi, 2.2 TDCi, 2.3, 2.5 03/07 - 74 -162 kW	46-192554	30	30	without ride height adjustment; Conditions see certificates VA: axle load to: 1215 kg HA: axle load to: 1115 kg				
FORD MONDEO IV Turnier									
B12 PK	1.6 Ti, 2.0 03/07 - 81 -107 kW	46-192561	30	30	without ride height adjustment; Conditions see certificates VA: axle load to: 1100 kg HA: axle load to: 1220 kg				
B12 PK	1.8 TDCi, 2.0 TDCi, 2.2 TDCi, 2.3, 2.5 03/07 - 74 -162 kW	46-192578	30	30	without ride height adjustment; Conditions see certificates VA: axle load to: 1215 kg HA: axle load to: 1220 kg				
FORD S-MAX									
B12 PK	1.6 EcoBoost, 2.0, 2.0 EcoBoost, 2.0 Flexifuel, 2.0 SCTi 03/10 - 107 -176 kW	46-193957	30	30	Conditions see certificates VA: axle load to: 1300 kg HA: axle load to: 1405 kg				
B12 PK	1.6 TDCi, 1.8 TDCi, 2.0 TDCi, 2.2 TDCi, 2.3, 2.5 ST 05/06 - 74 -162 kW	46-193940	30	30	Conditions see certificates VA: axle load to: 1300 kg HA: axle load to: 1405 kg				
FORD STREET KA									
B12 PK	1.6 05/03 - 07/05 70 kW	46-206763	30	30	twin-tube; Conditions see certificates; With General Certification (ABE) VA: axle load to: 760 kg HA: axle load to: 610 kg				



CHANGAN FORD MAZDA

CHANGAN FORD MAZDA FIESTA

B14	1.3, 1.5 02/09 - 63 -76 kW	47-167490	25-40	20-40	Conditions see certificates VA: axle load to: 850 kg HA: axle load to: 765 kg
-----	--------------------------------------	------------------	-------	-------	---

CHANGAN FORD MAZDA FOCUS Hatchback (CD5)

B14	1.8, 2.0 08/06 - 12/11 91 -104 kW	47-121225	30-50	30-50	Conditions see certificates VA: axle load to: 1070 kg HA: axle load to: 1090 kg
-----	---	------------------	-------	-------	---

B16 PSS9	1.8, 2.0 08/06 - 12/11 91 -104 kW	48-121262	30-50	30-50	Conditions see certificates VA: axle load to: 1070 kg HA: axle load to: 1090 kg
-------------	---	------------------	-------	-------	---

CHANGAN FORD MAZDA FOCUS Saloon (CD4)

B14	1.8, 2.0 09/05 - 12/11 91 -104 kW	47-121225	30-50	30-50	Conditions see certificates VA: axle load to: 1070 kg HA: axle load to: 1090 kg
-----	---	------------------	-------	-------	---

B16 PSS9	1.8, 2.0 09/05 - 12/11 91 -104 kW	48-121262	30-50	30-50	Conditions see certificates VA: axle load to: 1070 kg HA: axle load to: 1090 kg
-------------	---	------------------	-------	-------	---

FORD USA

FORD USA MUSTANG

B12 PK	4.0 V6, 4.6 V8, 5.4 V8 12/04 - 12/09 157 -355 kW	46-198297	25	30	mark: Europa; Conditions see certificates VA: axle load to: 1070 kg HA: axle load to: 1116 kg
-----------	--	------------------	----	----	---

B12 PK	4.0 V6, 4.6 V8, 5.4 V8 01/10 - 157 -355 kW	46-229830	25	30	mark: Europa; Conditions see certificates VA: axle load to: 1070 kg HA: axle load to: 1116 kg
-----------	--	------------------	----	----	---

B12 PK	4.0 V6, 4.6 V8, 5.4 V8 12/04 - 12/09 157 -355 kW	46-228888	25	30	for USA; mark: USA; Conditions see certificates VA: axle load to: 1070 kg HA: axle load to: 1116 kg
-----------	--	------------------	----	----	---

B12 PK	5.0, 5.4 V8 03/10 - 307 -403 kW	46-229830	25	30	mark: Europa; Conditions see certificates VA: axle load to: 1070 kg HA: axle load to: 1116 kg
-----------	---	------------------	----	----	---

B12 PK	5.4 V8 01/10 - 355 kW		25	30	for USA; mark: USA; Conditions see certificates VA: axle load to: 1070 kg HA: axle load to: 1116 kg
-----------	---------------------------------	--	----	----	---

FORD USA MUSTANG Convertible

B12 PK	4.0 V6, 4.6 V8, 5.4 V8 12/05 - 12/09 157 -403 kW	46-198297	25	30	mark: Europa; Conditions see certificates VA: axle load to: 1070 kg HA: axle load to: 1116 kg
-----------	--	------------------	----	----	---

B12 PK	4.0 V6, 4.6 V8, 5.4 V8 01/10 - 157 -403 kW	46-229830	25	30	mark: Eurpoa; Conditions see certificates
-----------	--	------------------	----	----	---



B12 PK	4.0 V6, 4.6 V8, 5.4 V8 12/05 - 12/09 157 -403 kW	46-228888	25	30	mark: USA; Conditions see certificates VA: axle load to: 1070 kg HA: axle load to: 1116 kg
-----------	--	------------------	----	----	--

HOLDEN

HOLDEN ASTRA Hatchback (TR)

B10	1.6 CD, 1.8 i, 2.0 CDX 08/95 - 09/98 74 -100 kW	46-111920	60	40	manual transmission; Conditions see certificates VA: axle load to: 900 kg HA: axle load to: 800 kg
-----	---	------------------	----	----	--

B12 PK	1.6 CD, 1.8 i, 2.0 CDX 08/95 - 09/98 74 -100 kW	46-188861	30	30	Conditions see certificates VA: axle load to: 870 kg HA: axle load to: 800 kg
-----------	---	------------------	----	----	---

									
HOLDEN									
HOLDEN ASTRA Hatchback (TR)									
B12 SL	1.6 CD, 1.8 i, 2.0 CDX 08/95 - 09/98 74 -100 kW	46-188885	45-50	30	Conditions see certificates VA: axle load to: 900 kg HA: axle load to: 800 kg				
HOLDEN ASTRA Saloon (TR)									
B10	1.6 CD, 1.8 SRi 08/95 - 09/98 74 -85 kW	46-111920	60	40	manual transmission; Conditions see certificates VA: axle load to: 900 kg HA: axle load to: 800 kg				
B12 PK	1.6 CD, 1.8 SRi 08/95 - 09/98 74 -85 kW	46-188861	30	30	Conditions see certificates VA: axle load to: 870 kg HA: axle load to: 800 kg				
B12 SL	1.6 CD, 1.8 SRi 08/95 - 09/98 74 -85 kW	46-188885	45-50	30	Conditions see certificates VA: axle load to: 900 kg HA: axle load to: 800 kg				
HOLDEN ASTRA Hatchback (TS)									
B12 PK	1.8, 1.8 SRi, 2.0 i Turbo, 2.2 02/98 - 10/04 85 -147 kW	46-188946	30	30	Conditions see certificates VA: axle load to: 935 kg HA: axle load to: 820 kg				
B12 PK	1.8, 1.8 SRi, 2.0 i Turbo, 2.2 02/98 - 10/04 85 -147 kW	46-188960	30	30	Conditions see certificates VA: axle load to: 1035 kg HA: axle load to: 820 kg				
B12 SL	1.8, 1.8 SRi, 2.0 i Turbo, 2.2 02/98 - 10/04 85 -147 kW	46-188939	45-50	30	Conditions see certificates VA: axle load to: 965 kg HA: axle load to: 895 kg				
HOLDEN ASTRA Saloon (TS)									
B12 PK	1.8, 1.8 i 02/98 - 10/04 85 -92 kW	46-188946	30	30	Conditions see certificates VA: axle load to: 935 kg HA: axle load to: 820 kg				
B12 PK	1.8, 1.8 i 02/98 - 10/04 85 -92 kW	46-188960	30	30	Conditions see certificates VA: axle load to: 1035 kg HA: axle load to: 820 kg				
B12 SL	1.8, 1.8 i 02/98 - 10/04 85 -92 kW	46-188939	45-50	30	Conditions see certificates VA: axle load to: 965 kg HA: axle load to: 895 kg				
HOLDEN ASTRA Convertible (TS)									
B12 PK	1.8 i 06/02 - 12/06 108 kW	46-182128	30	30	disconnect ITS+; Conditions see certificates VA: axle load to: 970 kg HA: axle load to: 860 kg				
B12 PK	2.0 Turbo 06/02 - 07/04 147 kW	46-188908	30	30	Conditions see certificates VA: axle load to: 1015 kg HA: axle load to: 845 kg				
B12 SL	1.8 i 06/02 - 12/06 108 kW	46-182166	45-50	30	disconnect ITS+; Conditions see certificates VA: axle load to: 960 kg HA: axle load to: 860 kg				
B14	1.8 i 06/02 - 12/06 108 kW	47-121133	30-50	30-50	disconnect ITS+; Conditions see certificates VA: axle load to: 1060 kg HA: axle load to: 860 kg				
HOLDEN ASTRA (AH)									
B12 PK	1.8, 1.8 i 07/05 - 03/10 92 -103 kW	46-182128	30	30	disconnect ITS+; Conditions see certificates VA: axle load to: 970 kg HA: without ride height adjustment; axle load to: 860 kg				
B12 PK	1.9 CDTi, 2.0 Turbo, 2.2 i 07/05 - 03/10 88 -147 kW	46-182135	30	30	disconnect ITS+; Conditions see certificates VA: axle load to: 1075 kg HA: without ride height adjustment; axle load to: 860 kg				
B12 SL	1.8, 1.8 i 07/05 - 03/10 92 -103 kW	46-182166	45-50	30	disconnect ITS+; Conditions see certificates VA: axle load to: 960 kg HA: without ride height adjustment; axle load to: 860 kg				
B14	1.8, 1.8 i, 1.9 CDTi, 2.0 Turbo, 2.2 i 07/05 - 03/08 88 -147 kW	47-121133	30-50	30-50	disconnect ITS+; Conditions see certificates VA: axle load to: 1060 kg HA: axle load to: 860 kg				



HOLDEN

HOLDEN ASTRA Estate (AH)

B12 PK	1.8 i 07/05 - 03/10 92 -103 kW	46-182142	30-35	25-30	disconnect ITS+; Conditions see certificates VA: axle load to: 970 kg HA: without ride height adjustment; axle load to: 940 kg
B12 PK	1.9 CDTI 08/08 - 03/10 88 kW	46-182159	30-35	25-30	disconnect ITS+; Conditions see certificates VA: axle load to: 1075 kg HA: without ride height adjustment; axle load to: 940 kg
B12 SL	1.8 i 07/05 - 03/10 92 -103 kW	46-182180	40-45	35	disconnect ITS+; Conditions see certificates VA: axle load to: 960 kg HA: without ride height adjustment; axle load to: 940 kg

HOLDEN ASTRA Twintop (TS)

B12 PK	1.8, 1.8 i 07/05 - 03/10 92 -103 kW	46-182128	30	30	disconnect ITS+; Conditions see certificates VA: axle load to: 970 kg HA: axle load to: 860 kg
B12 PK	2.0 i Turbo, 2.2, 2.2 i 06/06 - 03/10 109 -147 kW	46-182135	30	30	disconnect ITS+; Conditions see certificates VA: axle load to: 1075 kg HA: axle load to: 860 kg
B12 SL	1.8, 1.8 i 07/05 - 03/10 92 -103 kW	46-182166	45-50	30	disconnect ITS+; Conditions see certificates VA: axle load to: 960 kg HA: axle load to: 860 kg
B12 SL	2.0 i Turbo, 2.2, 2.2 i 06/06 - 03/10 109 -147 kW	46-182173	45-50	30	disconnect ITS+; Conditions see certificates VA: axle load to: 1025 kg HA: axle load to: 860 kg
B14	1.8, 1.8 i, 2.0 i Turbo, 2.2, 2.2 i 07/05 - 03/10 92 -147 kW	47-121133	30-50	30-50	disconnect ITS+; Conditions see certificates VA: axle load to: 1060 kg HA: axle load to: 860 kg

HOLDEN ASTRA TWINTOP (AH)

B12 PK	1.9 TDCi 03/08 - 03/10 110 kW	46-188908	30	30	Conditions see certificates VA: axle load to: 1015 kg HA: axle load to: 845 kg
-----------	--	------------------	----	----	--

HOLDEN BARINA Hatchback (SB)





B10	1.2 i, 1.4 i, 1.6 i 04/94 - 08/98 33 -78 kW	46-111951	60	40	Conditions see certificates
B12 PK	1.2 i, 1.4 i, 1.6 i 04/94 - 08/98 33 -78 kW	46-189011	30	30	Conditions see certificates VA: axle load to: 790 kg HA: axle load to: 700 kg
B12 SL	1.2 i, 1.4 i, 1.6 i 04/94 - 08/98 33 -78 kW	46-189004	45-50	25	Conditions see certificates VA: axle load to: 790 kg HA: axle load to: 700 kg
B14	1.2 i, 1.4 i, 1.6 i 04/94 - 08/98 33 -78 kW	47-080713	30-50	20-40	Spacers required for several wheel/tyre combinations; Conditions see certificates VA: axle load to: 820 kg HA: axle load to: 700 kg
B16 PSS9	1.2 i, 1.4 i, 1.6 i 04/94 - 08/98 33 -78 kW	48-080767	30-50	20-40	Spacers required for several wheel/tyre combinations; Conditions see certificates VA: axle load to: 820 kg HA: axle load to: 700 kg

HOLDEN BARINA Hatchback (XC)

B12 PK	1.4, 1.4 i, 1.8 SRi 09/00 - 02/05 66 -92 kW	46-189059	30	30	Conditions see certificates; thread: M10 VA: axle load to: 940 kg HA: drum Brake; axle load to: 760 kg
B12 PK	1.4, 1.4 i, 1.8 SRi 09/00 - 02/05 66 -92 kW	46-189035	30	30	Conditions see certificates; thread: M14 VA: axle load to: 940 kg HA: disc Brake; axle load to: 760 kg
B14	1.4, 1.4 i, 1.8 SRi 09/00 - 02/05 66 -92 kW	47-167254	30-50	20-40	Conditions see certificates VA: axle load to: 900 kg HA: axle load to: 760 kg

HOLDEN CALIBRA (YE)

B12 PK	2.0 i Turbo 4x4 03/92 - 11/97 150 kW	46-192851	30	30	Conditions see certificates VA: axle load to: 885 kg HA: axle load to: 880 kg
-----------	---	------------------	----	----	---

									
HOLDEN									
HOLDEN CRUZE Saloon (JG)									
B14	1.4 i Turbo, 1.8, 2.0 Diesel, 2.0 DTFi 06/09 - 103 -120 kW	47-171725	30-50	20-40	Conditions see certificates VA: axle load to: 1220 kg HA: axle load to: 1020 kg				
HOLDEN CRUZE Hatchback (JG, JH)									
B14	1.4 i Turbo, 1.8 i, 2.0 DTFi 11/11 - 103 -120 kW	47-171725	30-50	20-40	Conditions see certificates VA: axle load to: 1220 kg HA: axle load to: 1020 kg				
HOLDEN ZAFIRA (TT)									
B12 PK	2.2 06/01 - 02/06 108 kW	46-194220	30	30	Conditions see certificates VA: axle load to: 1075 kg HA: axle load to: 1130 kg				
HONDA									
HONDA ACCORD IV Aerodeck (CB8, CB9)									
B14	2.0 i 16V 03/93 - 12/93 98 kW	47-087392	25-50	25-50	Conditions see certificates				
HONDA ACCORD V (CC7, CD)									
B14	2.0 i, 2.0 i S, 2.3 i SR 03/93 - 01/96 85 -116 kW	47-087392	20-50	20-50	Conditions see certificates				
HONDA ACCORD V Aerodeck (CE)									
B14	2.0 i LS 16V, 2.2 i ES 09/93 - 02/98 100 -110 kW	47-087392	20-50	20-50	Conditions see certificates				
HONDA ACCORD V Coupe (CD7, CD9)									
B14	2.0 09/93 - 12/97 100 kW	47-087392	50	50	Conditions see certificates				
HONDA ACCORD VI (CE, CF)									
B14	1.9 i, 2.0 i LS, 2.0 TDi, 2.2 i VTEC 02/96 - 10/98 77 -110 kW	47-087392	20-50	20-50	Conditions see certificates				
HONDA ACCORD VII (CG, CK)									
B12 PK	1.6 i, 1.6 LS, 1.8 i, 2.0 i, 2.0 Turbo DI, 2.2 Type-R 10/98 - 12/02 77 -156 kW	46-190130	30-35	30	Conditions see certificates; Vehicle Production Country: Great Britain VA: axle load to: 1040 kg HA: axle load to: 940 kg				
B16 PSS9	1.6 i, 1.6 LS, 1.8 i, 2.0 i, 2.0 Turbo DI, 2.2 Type-R, 2.3, 3.0 Vtec 10/98 - 06/03 77 -156 kW	48-088428	35-55	40-50	Conditions see certificates; Vehicle Production Country: Great Britain VA: axle load to: 1040 kg HA: axle load to: 940 kg				
HONDA ACCORD VII Hatchback (CH)									
B12 PK	1.6, 1.8 i, 2.0, 2.0 TDi, 2.3 12/99 - 12/02 77 -113 kW	46-190130	30-35	30	Conditions see certificates; Vehicle Production Country: Great Britain VA: axle load to: 1040 kg HA: axle load to: 940 kg				
B16 PSS9	1.8 i, 2.0, 2.0 TDi, 2.3 12/99 - 12/02 77 -113 kW	48-088428	35-55	40-50	Conditions see certificates; Vehicle Production Country: Great Britain VA: axle load to: 1040 kg HA: axle load to: 940 kg				
HONDA ACCORD VII Coupe (CG)									
B16 PSS9	3.0 V6 24V, 3.0 Vtec 02/98 - 06/03 147 -152 kW	48-088428	35-55	40-50	Conditions see certificates VA: axle load to: 1040 kg HA: axle load to: 940 kg				



HONDA

HONDA ACCORD VIII (CL_, CM_)

B12 PK	2.0 02/03 - 114 kW	46-190154	35-40	30	without xenon lights; Conditions see certificates VA: axle load to: 1050 kg HA: axle load to: 920 kg
B12 PK	2.2 i-CTDi, 2.4 02/03 - 103 -140 kW	46-190178	35-40	30	without xenon lights; Conditions see certificates VA: axle load to: 1100 kg HA: axle load to: 920 kg

HONDA CIVIC IV Hatchback (EG)

B12 PK	1.3 16V, 1.4 16V, 1.5 i 16V, 1.6, 1.6 16V Vtec, 1.6 si 16V, 1.6 Vtec, 1.6 VTi 16V 10/91 - 04/97 55 -118 kW	46-190208	30	30	Conditions see certificates; With General Certification (ABE) VA: axle load to: 835 kg HA: axle load to: 750 kg
-----------	--	------------------	----	----	---

HONDA CIVIC V Saloon (EG, EH)

B12 PK	1.3, 1.5, 1.5 i 16V, 1.6, 1.6 16V Vtec, 1.6 EX, 1.6 si 16V, 1.6 VTi 10/91 - 11/95 55 -118 kW	46-190208	30	30	Conditions see certificates; With General Certification (ABE) VA: axle load to: 835 kg HA: axle load to: 750 kg
-----------	--	------------------	----	----	---

HONDA CIVIC V Coupe (EJ)

B12 PK	1.5 i LSi, 1.6 i Vtec 01/94 - 03/96 74 -92 kW	46-190208	30	30	Conditions see certificates; With General Certification (ABE) VA: axle load to: 835 kg HA: axle load to: 750 kg
-----------	---	------------------	----	----	---

HONDA CIVIC VII Hatchback (EU, EP, ES)

B12 PK	1.6 i, 1.7 01/00 - 09/05 81 -92 kW	46-190215	30	30	Conditions see certificates; thread: M16 VA: axle load to: 855 kg HA: axle load to: 850 kg
B12 SL	1.4 i, 1.4 iS, 1.6 i, 1.7 01/00 - 09/05 55 -92 kW	46-190246	45-50	30	Conditions see certificates; thread: M16 VA: axle load to: 855 kg HA: axle load to: 850 kg
B14	1.6 i, 1.7, 1.7 CTDi, 2.0 i Sport 01/00 - 09/05 74 -118 kW	47-118768	40-50	35-50	Conditions see certificates VA: axle load to: 955 kg; thread: M16 HA: axle load to: 850 kg
B14	2.0 Type-R 09/01 - 09/05 147 kW	47-118768	20-35	15-35	Conditions see certificates VA: axle load to: 955 kg; thread: M16 HA: axle load to: 850 kg
B16 PSS9	1.6 i, 1.7, 1.7 CTDi, 2.0 i Sport 01/00 - 09/05 74 -118 kW	48-118804	40-50	35-50	Conditions see certificates VA: axle load to: 955 kg; thread: M16 HA: axle load to: 850 kg
B16 PSS9	2.0 Type-R 09/01 - 09/05 147 kW	48-118804	20-35	15-35	Conditions see certificates VA: axle load to: 955 kg; thread: M16 HA: axle load to: 850 kg

HONDA CIVIC VII Saloon (EU)

B12 PK	1.4, 1.6 12/00 - 09/05 66 -84 kW	46-190215	30	30	Conditions see certificates; thread: M16 VA: axle load to: 855 kg HA: axle load to: 850 kg
B12 SL	1.3 IMA, 1.4, 1.6 02/01 - 09/05 61 -84 kW	46-190246	45-50	30	Conditions see certificates; thread: M16 VA: axle load to: 855 kg HA: axle load to: 850 kg

HONDA CIVIC VII Coupe (EM2)

B12 SL	1.6 i, 1.7 i, 1.7 i VTEC 02/01 - 12/05 81 -92 kW	46-190246	45-50	30	Conditions see certificates; thread: M16 VA: axle load to: 855 kg HA: axle load to: 850 kg
-----------	--	------------------	-------	----	--

HONDA CIVIC VIII Hatchback (FN, FK)

B14	1.4, 1.6, 1.8, 2.0 09/05 - 61 -110 kW	47-171329	25-40	20-40	mark: FK/ FN; not for: Type R; Conditions see certificates VA: axle load to: 1085 kg HA: axle load to: 835 kg
-----	---	------------------	-------	-------	---

HONDA CIVIC VIII Saloon (FD)

B14	1.3, 1.6, 1.7, 1.8, 1.8 Flex, 2.0 09/05 - 70 -148 kW	47-171329	25-40	20-40	mark: FD1; not for: Type R FD2; Without roadworthy certificate VA: axle load to: 1085 kg HA: axle load to: 835 kg
-----	--	------------------	-------	-------	---

					
--	--	---	---	---	---

HONDA

HONDA CR-V III

B12 PK	2.0 i, 2.0 i-VTEC, 2.2 i-CTDi, 2.2 i-DTEC 01/07 - 103 -110 kW	46-206800	30	30	twin-tube; without xenon lights; Conditions see certificates VA: axle load to: 1170 kg HA: axle load to: 1055 kg
-----------	---	------------------	----	----	--

HONDA JAZZ III (GE)

B14	1.4, 1.4 HYBRID, 1.5 Flexfuel, 1.5 i 07/08 - 65 -88 kW	47-165854	0-30	0-30	Without roadworthy certificate
B14	1.4, 1.4 HYBRID, 1.5 Flexfuel, 1.5 i 07/08 - 65 -88 kW	47-172401	20-45	15-45	Without roadworthy certificate

HONDA S2000 (AP)

B14	2.0, 2.0 Vtec, 2.2 Vtec 03/99 - 170 -184 kW	47-080386	10-35	10-35	Conditions see certificates VA: axle load to: 710 kg HA: axle load to: 840 kg
B16 PSS9	2.0, 2.0 Vtec, 2.2 Vtec 03/99 - 170 -184 kW	48-088657	10-35	10-35	Conditions see certificates VA: axle load to: 710 kg HA: axle load to: 840 kg

HYUNDAI

HYUNDAI COUPE (GK)

B12 PK	2.0, 2.0 GLS, 2.7 V6 08/01 - 08/09 100 -123 kW	46-190284	30	30	Conditions see certificates VA: axle load to: 1015 kg HA: axle load to: 880 kg
B12 SL	2.0, 2.0 GLS, 2.7 V6 08/01 - 08/09 100 -123 kW	46-190291	45-50	30	Conditions see certificates VA: axle load to: 1000 kg HA: axle load to: 860 kg
B14	1.6 16V, 2.0, 2.0 GLS, 2.7 V6 08/01 - 08/09 77 -123 kW	47-107991	30-50	30-50	Conditions see certificates VA: axle load to: 1015 kg HA: axle load to: 880 kg
B16 PSS9	1.6 16V, 2.0, 2.0 GLS, 2.7 V6 08/01 - 08/09 77 -123 kW	48-108041	35-50	30-50	Conditions see certificates VA: axle load to: 1015 kg HA: axle load to: 880 kg

HYUNDAI GETZ (TB)

B12 PK	1.1, 1.3, 1.4, 1.5 GL, 1.6 09/02 - 06/09 46 -78 kW	46-206824	30	30	twin-tube; Conditions see certificates VA: axle load to: 860 kg HA: axle load to: 830 kg
B12 PK	1.5 CRDi, 1.5 CRDi GLS 03/03 - 06/09 60 -81 kW	46-206831	30	30	twin-tube; Conditions see certificates VA: axle load to: 900 kg HA: axle load to: 830 kg

HYUNDAI GENESIS Coupe

B14	2.0 T, 3.8 V6 01/10 - 157 -223 kW	47-193680	20-30	10-30	mark: BK; Conditions see certificates VA: axle load to: 1000 kg HA: axle load to: 1050 kg
-----	---	------------------	-------	-------	---

HYUNDAI SONATA V (NF)

B14	2.0 CRDi, 2.0 VVTi GLS, 2.4, 3.3 06/05 - 100 -184 kW	47-146631	30-50	30-50	Conditions see certificates VA: axle load to: 1200 kg HA: axle load to: 1070 kg
-----	--	------------------	-------	-------	---

HYUNDAI TIBURON Coupe

B14	1.6 CVVT, 2.0 CVVT, 2.7 01/06 - 78 -123 kW	47-107991	30-50	30-50	mark: GK; Conditions see certificates VA: axle load to: 1015 kg HA: axle load to: 880 kg
B16 PSS9	1.6 CVVT, 2.0 CVVT, 2.7 01/06 - 78 -123 kW	48-108041	35-50	30-50	mark: GK; Conditions see certificates VA: axle load to: 1015 kg HA: axle load to: 880 kg



INFINITI

INFINITI G Coupe

B16 PSS10	37 10/08 -	235 -243 kW	48-165815	50	30	Without roadworthy certificate
--------------	---------------	-------------	-----------	----	----	--------------------------------

INFINITI G Convertible

B16 PSS10	37 09/10 -	235 kW	48-165815	50	30	Without roadworthy certificate
--------------	---------------	--------	-----------	----	----	--------------------------------

JAGUAR

JAGUAR X-TYPE (CF1)

B12 PK	2.0 D, 2.0 V6, 2.2 D, 2.5 V6, 3.0 V6 06/01 - 11/09	96 -169 kW	46-194046	30-35	25-30	without CATS; front wheel drive; Conditions see certificates VA: axle load to: 1150 kg HA: axle load to: 1115 kg
-----------	---	------------	-----------	-------	-------	--

KIA

KIA CEE'D Hatchback (ED)

B12 PK	1.4, 1.4 CVVT, 1.6 12/06 -	66 -93 kW	46-206848	30	20	twin-tube; Conditions see certificates VA: axle load to: 1010 kg HA: axle load to: 940 kg
B12 PK	1.4, 1.4 CVVT, 1.6, 1.6 CVVT 12/06 -	66 -93 kW	46-206862	25	20	twin-tube; Conditions see certificates VA: axle load to: 1010 kg HA: axle load to: 940 kg
B12 PK	1.6 CRDi 115, 1.6 CRDi 128, 1.6 CRDi 90, 2.0, 2.0 CRDi 12/06 -	66 -105 kW	46-206886	25	20	twin-tube; Conditions see certificates VA: axle load to: 1090 kg HA: axle load to: 940 kg
B12 PK	1.6 CRDi 115, 1.6 CRDi 90, 2.0, 2.0 CRDi 12/06 -	66 -105 kW	46-206909	30-35	20	twin-tube; Conditions see certificates VA: axle load to: 1090 kg HA: axle load to: 940 kg

KIA CEE'D Estate (ED)

B12 PK	1.4, 1.4 CVVT, 1.6, 1.6 CVVT 11/09 -	66 -93 kW	46-206923	30	30	twin-tube; Conditions see certificates VA: axle load to: 1010 kg HA: axle load to: 1050 kg
B12 PK	1.4, 1.6, 1.6 CVVT 09/07 -	80 -93 kW	i.v.	30	20-25	twin-tube; Conditions see certificates VA: axle load to: 1010 kg HA: axle load to: 1050 kg
B12 PK	1.6 CRDi 115, 1.6 CRDi 128, 1.6 CRDi 90, 2.0, 2.0 CRDi 09/07 -	66 -105 kW	46-206947	25	20-25	twin-tube; Conditions see certificates VA: axle load to: 1090 kg HA: axle load to: 1050 kg
B12 PK	1.6 CRDi 115, 1.6 CRDi 90, 2.0, 2.0 CRDi 09/07 -	66 -105 kW	46-206954	30-35	20-25	twin-tube; Conditions see certificates VA: axle load to: 1090 kg HA: axle load to: 1050 kg

KIA PRO CEE'D (ED)

B12 PK	1.6, 2.0 02/08 -	90 -105 kW	46-206848	30	30	twin-tube; Conditions see certificates VA: axle load to: 1010 kg HA: axle load to: 940 kg
B12 PK	1.6, 1.6 CVVT, 2.0 02/08 -	90 -105 kW	46-206862	25	20	twin-tube; Conditions see certificates VA: axle load to: 1010 kg HA: axle load to: 940 kg
B12 PK	1.6 CRDi 115, 1.6 CRDi 128, 1.6 CRDi 90, 2.0 CRDi 02/08 -	66 -103 kW	46-206886	25	20	twin-tube; Conditions see certificates VA: axle load to: 1090 kg HA: axle load to: 940 kg
B12 PK	1.6 CRDi 115, 1.6 CRDi 90, 2.0 CRDi 02/08 -	66 -103 kW	46-206909	30-35	20	twin-tube; Conditions see certificates VA: axle load to: 1090 kg HA: axle load to: 940 kg

				
--	---	---	---	---

LANCIA

LANCIA DELTA III (844)

B14	1.4, 1.4 16V, 1.4 Bifuel, 1.6 D Multijet, 1.6 MULTIJET, 1.8 Di, 1.9 MULTIJET 08/08 - 77 -147 kW	47-158993	30-40	25-40	fixing hole pitches 58 mm; Conditions see certificates
-----	---	------------------	-------	-------	--

LAND ROVER

LAND ROVER RANGE ROVER EVOQUE

B14	2.0, 2.2, 2.2 SD4, 2.2 TD4 06/11 - 110 -177 kW	47-228146	30-50	30-50	without electronic suspension control; Conditions see certificates VA: axle load to: 1300 kg HA: axle load to: 1145 kg
-----	--	------------------	-------	-------	--

LEXUS

LEXUS GS (JZS160)

B14	300, 300 T3, 400, 430 12/97 - 03/05 161 -216 kW	47-083011	45	45	Without roadworthy certificate; without electronic suspension control; axle strut housing with external thread M52x1,5
-----	---	------------------	----	----	--

LEXUS LS (FE)

B14	430 10/00 - 08/06 207 kW	47-086401	35	35	Without roadworthy certificate; mark: UCF30
-----	------------------------------------	------------------	----	----	---

LOTUS

LOTUS ELISE

B16 PSS10	1.8, 1.8 111R, 1.8 111S, 1.8 GLX, 1.8, 1.8 16V, 1.8 265 E, 1.8 Cup 240 09/01 - 99 -197 kW	48-136723	0-10	0-20	mark: Toyota Engine; Conditions see certificates VA: axle load to: 485 kg HA: axle load to: 760 kg
--------------	---	------------------	------	------	--

MAHINDRA RENAULT

MAHINDRA RENAULT LOGAN

B12 PK	1.4, 1.5 D, 1.6 CNG 04/07 - 48 -63 kW	46-189387	35	35	Conditions see certificates VA: axle load to: 930 kg HA: axle load to: 880 kg
-----------	---	------------------	----	----	---

MAHINDRA RENAULT VERITO

B12 PK	1.4, 1.5 D 03/11 - 48 -56 kW	46-189387	35	35	Conditions see certificates VA: axle load to: 930 kg HA: axle load to: 880 kg
-----------	--	------------------	----	----	---

MARUTI SUZUKI

MARUTI SUZUKI SWIFT

B14	1.2, 1.3 01/04 - 63 -64 kW	47-167551	10-30	0-20	mark: EZ/ MZ; Conditions see certificates VA: axle load to: 830 kg HA: axle load to: 830 kg
B14	1.3 D 01/07 - 55 kW	47-167551	10-30	0-20	Conditions see certificates VA: axle load to: 830 kg HA: axle load to: 830 kg

MAZDA

MAZDA 2 (DE)

B14	1.3, 1.3 MZR, 1.4 MZR, 1.5, 1.5 MZR, 1.6 MZ-CD 10/07 - 50 -76 kW	47-167490	25-40	20-40	Conditions see certificates VA: axle load to: 850 kg HA: axle load to: 785 kg
-----	--	------------------	-------	-------	---



MAZDA

MAZDA 3 (BK)

B12 PK	1.4, 1.6, 2.0 10/03 - 06/09 59 -110 kW	46-190307	30	30	Conditions see certificates VA: axle load to: 955 kg HA: axle load to: 915 kg
B12 PK	2.3 DiSi Turbo MPS, 2.3 MPS, 2.3 MZR, 2.3 MZR Sport 10/03 - 06/09 115 -191 kW	46-190321	25	15	Conditions see certificates VA: axle load to: 1070 kg HA: axle load to: 915 kg
B12 PK	1.6 DI Turbo 06/04 - 06/09 80 kW	46-190314	30	30	Conditions see certificates VA: axle load to: 955 kg HA: axle load to: 915 kg
B14	1.4, 1.6, 1.6 DI Turbo, 2.0, 2.0 MZR-CD, 2.3 MZR 10/03 - 06/09 59 -115 kW	47-121225	25-40	20-40	Conditions see certificates VA: axle load to: 1100 kg HA: axle load to: 1090 kg
B14	2.3 DiSi Turbo MPS, 2.3 MPS, 2.3 MZR Sport 10/03 - 06/09 126 -191 kW	47-121225	10-25	5-25	Conditions see certificates VA: axle load to: 1100 kg HA: axle load to: 1090 kg
B16 PSS9	1.4, 1.6, 1.6 DI Turbo, 2.0, 2.0 MZR-CD, 2.3 MZR 10/03 - 06/09 59 -115 kW	48-121262	25-40	20-40	Conditions see certificates VA: axle load to: 1100 kg HA: axle load to: 1090 kg
B16 PSS9	2.3 DiSi Turbo MPS, 2.3 MPS, 2.3 MZR Sport 10/03 - 06/09 126 -191 kW	48-121262	10-25	5-25	Conditions see certificates VA: axle load to: 1100 kg HA: axle load to: 1090 kg

MAZDA 3 Saloon (BK)





B12 PK	1.6, 2.0 02/04 - 77 -110 kW	46-190307	30	30	Conditions see certificates VA: axle load to: 955 kg HA: axle load to: 915 kg
B12 PK	2.3 06/00 - 03/09 118 -126 kW	46-190321	25	15	Conditions see certificates VA: axle load to: 1070 kg HA: axle load to: 915 kg
B12 PK	1.6 DI Turbo 06/04 - 80 kW	46-190314	30	30	Conditions see certificates VA: axle load to: 955 kg HA: axle load to: 915 kg
B14	1.6, 1.6 DI Turbo, 2.0, 2.0 MZR-CD, 2.3 06/00 - 77 -126 kW	47-121225	30-50	30-50	Without roadworthy certificate VA: axle load to: 1100 kg HA: axle load to: 1090 kg
B16 PSS9	1.6, 1.6 DI Turbo, 2.0, 2.0 MZR-CD, 2.3 06/00 - 77 -126 kW	48-121262	30-50	30-50	Without roadworthy certificate VA: axle load to: 1100 kg HA: axle load to: 1090 kg

MAZDA 3 (BL)

B14	1.6 MZR, 1.6 MZR CD, 1.6 MZR-CD, 2.0 MZR, 2.0 MZR DISI, 2.2 MZR-CD 06/09 - 77 -136 kW	47-121225	25-40	20-40	Conditions see certificates VA: axle load to: 1135 kg HA: axle load to: 1090 kg
B14	2.3 MPS Turbo, 2.5 06/09 - 122 -191 kW	47-121225	10-25	5-25	Conditions see certificates VA: axle load to: 1135 kg HA: axle load to: 1090 kg
B16 PSS9	1.6 MZR, 1.6 MZR CD, 1.6 MZR-CD, 2.0 MZR, 2.0 MZR DISI, 2.2 MZR-CD 06/09 - 77 -136 kW	48-121262	25-40	25-40	Conditions see certificates VA: axle load to: 1135 kg HA: axle load to: 1090 kg
B16 PSS9	2.3 MPS Turbo, 2.5 06/09 - 122 -191 kW	48-121262	10-25	5-25	Conditions see certificates VA: axle load to: 1135 kg HA: axle load to: 1090 kg

MAZDA 3 Saloon (BL)

B14	1.6 MZR, 1.6 MZR CD, 2.0 MZR, 2.0 MZR DISI, 2.2 MZR-CD, 2.5 06/09 - 77 -136 kW	47-121225	25-40	20-40	Conditions see certificates VA: axle load to: 1135 kg HA: axle load to: 1090 kg
B16 PSS9	1.6 MZR, 1.6 MZR CD, 2.0 MZR, 2.0 MZR DISI, 2.2 MZR-CD, 2.5 06/09 - 77 -136 kW	48-121262	25-40	25-40	Conditions see certificates VA: axle load to: 1135 kg HA: axle load to: 1090 kg

					
MAZDA					
MAZDA 6 Hatchback (GG)					
B12 PK	1.8, 2.0, 2.3 08/02 - 02/05 88 -122 kW	46-192646	30	30	Conditions see certificates VA: axle load to: 1040 kg HA: axle load to: 1010 kg
B12 PK	2.0 DI 08/02 - 02/05 89 -100 kW	46-192660	30	30	Conditions see certificates VA: axle load to: 1095 kg HA: axle load to: 1010 kg

MAZDA 6 (GG)					
B12 PK	1.8, 2.0, 2.3 06/02 - 02/05 88 -122 kW	46-192646	30	30	Conditions see certificates VA: axle load to: 1040 kg HA: axle load to: 1010 kg
B12 PK	2.0 DI 06/02 - 02/05 89 -100 kW	46-192660	30	30	Conditions see certificates VA: axle load to: 1095 kg HA: axle load to: 1010 kg

MAZDA 6 Station Wagon (GY)					
B12 PK	1.8, 2.0, 2.3 08/02 - 02/05 88 -122 kW	46-192653	30	30	Conditions see certificates VA: axle load to: 1040 kg HA: axle load to: 1100 kg
B12 PK	2.0 DI 08/02 - 02/05 89 -100 kW	46-192677	30	30	Conditions see certificates VA: axle load to: 1095 kg HA: axle load to: 1100 kg

MAZDA MX-5 II (NB)					
B14	1.6 16V, 1.8, 1.8 16V, 1.9 16V, 1.9 i, 1.9 i Turbo 01/98 - 10/05 81 -157 kW	47-083004	40-20	35-15	Without roadworthy certificate
B16 PSS9	1.6 16V, 1.8, 1.8 16V, 1.9 16V, 1.9 i, 1.9 i Turbo 01/98 - 10/05 81 -157 kW	48-086097	35-50	35-45	Conditions see certificates VA: axle load to: 655 kg HA: axle load to: 665 kg

MAZDA MX-5 III (NC)					
B12 PK	1.8, 2.0 03/05 - 93 -118 kW	46-190345	30-35	30	Conditions see certificates VA: axle load to: 720 kg HA: axle load to: 720 kg
B14	1.8, 2.0 03/05 - 93 -118 kW	47-131811	30-50	30-50	Conditions see certificates VA: axle load to: 680 kg HA: axle load to: 705 kg
B16 PSS10	1.8, 2.0 03/05 - 93 -118 kW	48-131841	30-50	30-50	Conditions see certificates VA: axle load to: 680 kg HA: axle load to: 705 kg

MAZDA RX 8 (SE17)					
B12 PK	2.6, 2.6 Wankel 10/03 - 06/12 141 -177 kW	46-190338	25-30	25	Conditions see certificates VA: axle load to: 860 kg HA: axle load to: 1030 kg
B14	2.6, 2.6 Wankel 10/03 - 06/12 141 -177 kW	47-110267	30-50	30-50	Conditions see certificates VA: axle load to: 860 kg HA: axle load to: 1030 kg
B16 PSS9	2.6, 2.6 Wankel 10/03 - 06/12 141 -177 kW	48-110297	30-50	30-50	Conditions see certificates VA: axle load to: 860 kg HA: axle load to: 1030 kg

CHANGAN MAZDA					
CHANGAN MAZDA 3 Saloon					
B12 PK	1.6, 2.0 02/06 - 77 -110 kW	46-190307	30	30	Conditions see certificates VA: axle load to: 955 kg HA: axle load to: 915 kg
B14	1.6, 2.0 02/06 - 77 -110 kW	47-121225	25-40	20-40	Conditions see certificates VA: axle load to: 1100 kg HA: axle load to: 1090 kg
B16 PSS9	1.6, 2.0 02/06 - 77 -110 kW	48-121262	25-40	20-40	Conditions see certificates VA: axle load to: 1100 kg HA: axle load to: 1090 kg



CHANGAN MAZDA

CHANGAN MAZDA 3 Saloon

B14	1.6, 2.0 01/09 - 79 -110 kW	47-121225	25-40	20-40	Conditions see certificates VA: axle load to: 1135 kg HA: axle load to: 1090 kg
B16 PSS9	1.6, 2.0 01/09 - 79 -110 kW	48-121262	25-40	25-40	Conditions see certificates VA: axle load to: 1135 kg HA: axle load to: 1090 kg

CHANGAN MAZDA 3 Hatchback

B14	1.6, 2.0 09/11 - 79 -110 kW	47-121225	25-40	20-40	Conditions see certificates VA: axle load to: 1135 kg HA: axle load to: 1090 kg
B16 PSS9	1.6, 2.0 09/11 - 79 -110 kW	48-121262	25-40	25-40	Conditions see certificates VA: axle load to: 1135 kg HA: axle load to: 1090 kg

MERCEDES-BENZ

MERCEDES-BENZ A-CLASS (W168)

B12 PK	A 140, A 160, A 160 CDI, A 170 CDI, A 190, A 210 07/97 - 08/04 44 -103 kW	46-190383	20	20	Conditions see certificates; Short Wheelbase VA: axle load to: 810 kg HA: axle load to: 845 kg
-----------	---	------------------	----	----	--

MERCEDES-BENZ A-CLASS (W169)

B12 PK	A 150, A 170, A 200 09/04 - 06/12 70 -100 kW	46-182104	30	25	spring pads must be observed; without ride height adjustment; Conditions see certificates VA: axle load to: 885 kg HA: axle load to: 900 kg
B12 PK	A 160 CDI, A 180 CDI, A 200 CDI, A 200 TURBO 09/04 - 06/12 60 -142 kW	46-182098	30	25	spring pads must be observed; without ride height adjustment; Conditions see certificates VA: axle load to: 980 kg HA: axle load to: 900 kg

MERCEDES-BENZ A-CLASS (W176)

B14	A 180, A 180 CDI, A 200, A 200 CDI, A 220 CDI, A 250 06/12 - 80 -155 kW	47-231108	30-50	30-50	VA: axle load to: 1100 kg HA: axle load to: 945 kg
B16 PSS10	A 180, A 180 CDI, A 200, A 200 CDI, A 220 CDI, A 250 06/12 - 80 -155 kW	48-230971	30-50	30-50	VA: axle load to: 1100 kg HA: axle load to: 945 kg

MERCEDES-BENZ B-CLASS (W245)





B12 PK	B 150, B 170 03/05 - 11/11 70 -85 kW	46-182111	30	30	spring pads must be observed; without ride height adjustment; Conditions see certificates VA: axle load to: 950 kg HA: axle load to: 900 kg
B12 PK	B 180 CDI, B 200, B 200 CDI, B 200 TURBO 03/05 - 11/11 80 -142 kW	46-000637	30	30	spring pads must be observed; without ride height adjustment; Conditions see certificates VA: axle load to: 1005 kg HA: axle load to: 900 kg

MERCEDES-BENZ 190 (W201)

B12 PK	2.0, 2.3, D 2.0, D 2.5, E 1.8, E 2.0, E 2.3, E 2.3-16, E 2.5-16 10/82 - 08/93 53 -143 kW	46-181404	40	30-40	spring pads must be observed; without ride height adjustment; Conditions see certificates VA: axle load to: 880 kg HA: axle load to: 940 kg
-----------	--	------------------	----	-------	--

MERCEDES-BENZ C-CLASS (W202)

B12 PK	C 180, C 200, C 200 D, C 200 Kompressor, C 220, C 220 D, C 230 Kompressor 08/93 - 05/00 55 -142 kW	46-181701	30	30	spring pads must be observed; without ride height adjustment; Conditions see certificates; With General Certification (ABE) VA: axle load to: 970 kg HA: axle load to: 1030 kg
-----------	--	------------------	----	----	---

   					
MERCEDES-BENZ					
MERCEDES-BENZ C-CLASS (W202)					
B12 PK	C 180, C 200, C 200 CDI, C 200 Kompressor, C 220 CDI, C 220 D, C 230 08/93 - 05/00 70 -132 kW	46-181725	30	30	spring pads must be observed; without ride height adjustment; Conditions see certificates VA: axle load to: 990 kg HA: axle load to: 1070 kg
B12 PK	C 230 Kompressor, C 240, C 250 D, C 250 Turbo-D, C 280 05/93 - 05/00 83 -145 kW	46-181732	30	30	spring pads must be observed; without ride height adjustment; Conditions see certificates VA: axle load to: 1010 kg HA: axle load to: 1070 kg
B12 SL	C 180, C 200, C 200 CDI, C 200 D, C 200 Kompressor, C 220, C 220 D, C 230, C 230 Kompressor, C 240 08/93 - 05/00 55 -142 kW	46-181749	45-50	30-35	spring pads must be observed; without ride height adjustment; Conditions see certificates VA: axle load to: 1010 kg HA: axle load to: 1070 kg
MERCEDES-BENZ C-CLASS Estate (S202)					
B12 PK	C 180 T, C 200 T, C 200 T CDI, C 200 T D, C 200 T Kompressor, C 220 T CDI, C 220 T D, C 230 T 06/96 - 03/01 55 -141 kW	46-193902	30	30	without ride height adjustment; Conditions see certificates VA: axle load to: 990 kg HA: axle load to: 1070 kg
B12 PK	C 230 T Kompressor, C 240 T, C 250 T Turbo- D, C 280 T 06/96 - 03/01 110 -145 kW	46-193919	30	30	without ride height adjustment; Conditions see certificates VA: axle load to: 1010 kg HA: axle load to: 1070 kg
MERCEDES-BENZ C-CLASS (W203)					
B12 PK	C 180, C 180 Kompressor, C 200 CDI, C 200 CGI Kompressor, C 200 Kompressor, C 220 CDI, C 230, C 230 Kompressor 05/00 - 02/07 75 -150 kW	46-181800	30	30	spring pads must be observed; Spacers required for several wheel/tyre combinations; Conditions see certificates VA: axle load to: 1035 kg HA: without ride height adjustment; axle load to: 1170 kg
B12 PK	C 240, C 270 CDI, C 280, C 3.5, C 320, C 320 CDI, C 350 05/00 - 02/07 125 -200 kW	46-181817	30	30	spring pads must be observed; Spacers required for several wheel/tyre combinations; Conditions see certificates VA: axle load to: 1130 kg HA: without ride height adjustment; axle load to: 1170 kg
B14	C 180, C 180 Kompressor, C 200 CDI, C 200 CGI Kompressor, C 200 Kompressor, C 220 CDI, C 230, C 230 Kompressor, C 240, C 270 CDI, C 280, C 3.5, C 30 CDI AMG, C 32 AMG Kompressor, C 320, 05/00 - 02/07 75 -270 kW	47-100770	30-50	30-50	with standard chassis; Spacers required for several wheel/tyre combinations; without ride height adjustment; Conditions see certificates VA: axle load to: 1130 kg HA: axle load to: 1155 kg
B16 PSS9	C 180, C 180 Kompressor, C 200 CDI, C 200 CGI Kompressor, C 200 Kompressor, C 220 CDI, C 230, C 230 Kompressor, C 240, C 270 CDI, C 280, C 3.5, C 30 CDI AMG, C 32 AMG Kompressor, C 320, 05/00 - 02/07 75 -270 kW	48-088602	30-50	30-50	with standard chassis; Spacers required for several wheel/tyre combinations; without ride height adjustment; Conditions see certificates VA: axle load to: 1130 kg HA: axle load to: 1155 kg
MERCEDES-BENZ C-CLASS T-Model (S203)					
B12 PK	C 180, C 180 Kompressor, C 200 CDI, C 200 Kompressor, C 220 CDI, C 230, C 230 Kompressor 03/01 - 08/07 75 -150 kW	46-181824	30	30	without off-road suspension; spring pads must be observed; Spacers required for several wheel/tyre combinations; without ride height adjustment; Conditions see certificates VA: axle load to: 1015 kg HA: axle load to: 1170 kg
B12 PK	C 240, C 270 CDI, C 280, C 320, C 320 CDI, C 350 03/01 - 08/07 125 -200 kW	46-181831	30	30	without off-road suspension; spring pads must be observed; without ride height adjustment; Conditions see certificates VA: axle load to: 1090 kg HA: axle load to: 1170 kg
B14	C 180, C 180 Kompressor, C 200 CDI, C 200 CGI Kompressor, C 200 Kompressor, C 220 CDI, C 230, C 230 Kompressor, C 240, C 270 CDI, C 280, C 30 CDI AMG, C 32 AMG Kompressor, C 320, C 320 CDI, C 350, C 55 AMG 03/01 - 08/07 75 -270 kW	47-100770	30-50	30-50	Spacers required for several wheel/tyre combinations; without ride height adjustment; Conditions see certificates VA: axle load to: 1130 kg HA: axle load to: 1155 kg



MERCEDES-BENZ

MERCEDES-BENZ C-CLASS T-Model (S203)

B16 PSS9	C 180, C 180 Kompressor, C 200 CDI, C 200 CGI Kompressor, C 200 Kompressor, C 220 CDI, C 230, C 230 Kompressor, C 240, C 270 CDI, C 280, C 30 CDI AMG, C 32 AMG Kompressor, C 320, C 320 CDI, C 350, C 55 AMG 03/01 - 08/07 75 -270 kW	48-088602	50	50	Spacers required for several wheel/tyre combinations; without ride height adjustment; Conditions see certificates VA: axle load to: 1130 kg HA: axle load to: 1155 kg
-------------	---	-----------	----	----	---

MERCEDES-BENZ C-CLASS Coupe (CL203)





B12 PK	C 160 Kompressor, C 180, C 180 Kompressor, C 200 CGI Kompressor, C 200 Kompressor, C 230, C 230 Kompressor 03/01 - 05/08 90 -150 kW	46-190475	25-30	20-25	spring pads must be observed; Spacers required for several wheel/tyre combinations; without ride height adjustment; Conditions see certificates VA: axle load to: 1070 kg HA: axle load to: 1035 kg
B12 PK	C 200 CDI, C 220 CDI, C 320, C 350 09/02 - 05/08 90 -200 kW	46-190482	25-30	20-25	spring pads must be observed; Spacers required for several wheel/tyre combinations; without ride height adjustment; Conditions see certificates VA: axle load to: 1100 kg HA: axle load to: 1035 kg
B14	C 160 Kompressor, C 180, C 180 Kompressor, C 200 CDI, C 200 CGI Kompressor, C 200 Kompressor, C 220, C 220 CDI, C 230, C 230 Kompressor, C 30 CDI AMG, C 32 AMG Kompressor, C 320, C 350 03/01 - 05/08 90 -260 kW	47-100770	30-50	30-50	with standard chassis; Spacers required for several wheel/tyre combinations; without ride height adjustment; Conditions see certificates VA: axle load to: 1130 kg HA: axle load to: 1155 kg
B16 PSS9	C 160 Kompressor, C 180, C 180 Kompressor, C 200 CDI, C 200 CGI Kompressor, C 200 Kompressor, C 220, C 220 CDI, C 230, C 230 Kompressor, C 30 CDI AMG, C 32 AMG Kompressor, C 320, C 350 03/01 - 05/08 90 -260 kW	48-088602	30-50	30-50	with standard chassis; Spacers required for several wheel/tyre combinations; without ride height adjustment; Conditions see certificates VA: axle load to: 1130 kg HA: axle load to: 1155 kg

MERCEDES-BENZ CLC-CLASS





B12 PK	CLC 180 Kompressor, CLC 200 Kompressor, CLC 230 05/08 - 06/11 105 -150 kW	46-190475	25-30	20-25	without ride height adjustment; Conditions see certificates VA: axle load to: 1070 kg HA: axle load to: 1035 kg
B12 PK	CLC 200 CDI, CLC 220 CDI, CLC 350 05/08 - 06/11 90 -200 kW	46-190482	25-30	20-25	spring pads must be observed; Spacers required for several wheel/tyre combinations; without ride height adjustment; Conditions see certificates VA: axle load to: 1100 kg HA: axle load to: 1035 kg
B14	CLC 160, CLC 180 Kompressor, CLC 200 CDI, CLC 200 Kompressor, CLC 220 CDI, CLC 230, CLC 350 05/08 - 06/11 90 -200 kW	47-100770	30-50	30-50	with standard chassis; Spacers required for several wheel/tyre combinations; without ride height adjustment; Conditions see certificates VA: axle load to: 1130 kg HA: axle load to: 1155 kg
B16 PSS9	CLC 160, CLC 180 Kompressor, CLC 200 CDI, CLC 200 Kompressor, CLC 220 CDI, CLC 230, CLC 350 05/08 - 06/11 90 -200 kW	48-088602	30-50	30-50	with standard chassis; Spacers required for several wheel/tyre combinations; without ride height adjustment; Conditions see certificates VA: axle load to: 1130 kg HA: axle load to: 1155 kg





MERCEDES-BENZ C CLASS (W204)

B12 PK	C 180 CGI, C 180 Kompressor, C 200, C 200 CGI, C 200 Kompressor, C 230, C 250 CGI 01/07 - 115 -150 kW	46-180759	30	30	without electronic suspension control; spring pads must be observed; without ride height adjustment; Conditions see certificates VA: axle load to: 1150 kg HA: axle load to: 1200 kg
B12 PK	C 180 CDI, C 200 CDI, C 220 CDI, C 250 CDI, C 280, C 300, C 320 CDI, C 350, C 350 CDI, C 350 CGI 09/08 - 88 -225 kW	46-180766	30	30	without electronic suspension control; spring pads must be observed; without ride height adjustment; Conditions see certificates VA: axle load to: 1150 kg HA: axle load to: 1200 kg

					
MERCEDES-BENZ					
MERCEDES-BENZ C CLASS (W204)					
B14	C 180 CDI, C 180 CGI, C 180 Kompressor, C 200, C 200 CDI, C 200 CGI, C 200 Kompressor, C 220 CDI, C 230, C 250 CDI, C 250 CGI, C 280, C 300, C 320 CDI, C 350, C 350 CDI, C 350 CGI 09/08 - 88 -225 kW	47-141179	30-50	30-50	without electronic suspension control; Conditions see certificates VA: axle load to: 1110 kg HA: axle load to: 1225 kg
B16 PSS10	C 63 AMG 02/08 - 336 -358 kW	48-141147	20-40	20-40	mark: excl. Black Series; without electronic suspension control; without ride height adjustment; Conditions see certificates VA: axle load to: 1110 kg HA: axle load to: 1225 kg
B16 PSS10	C 180 CDI, C 180 CGI, C 180 Kompressor, C 200, C 200 CDI, C 200 CGI, C 200 Kompressor, C 220 CDI, C 230, C 250 CDI, C 250 CGI, C 280, C 300, C 320 CDI, C 350, C 350 CDI, C 350 CGI 09/08 - 88 -225 kW	48-141147	30-50	30-50	without electronic suspension control; Conditions see certificates VA: axle load to: 1110 kg HA: axle load to: 1225 kg
MERCEDES-BENZ C CLASS T-Model (S204)					
B12 PK	C 180 CGI, C 180 Kompressor, C 200 CGI, C 200 Kompressor, C 230, C 250 CGI 07/09 - 115 -150 kW	46-180773	30	30	without electronic suspension control; spring pads must be observed; without ride height adjustment; Conditions see certificates VA: axle load to: 1150 kg HA: axle load to: 1230 kg
B12 PK	C 180 CDI, C 200 CDI, C 220 CDI, C 280, C 300, C 320 CDI, C 350, C 350 CDI, C 350 CGI 10/09 - 88 -225 kW	46-180780	30	30	without electronic suspension control; spring pads must be observed; without ride height adjustment; Conditions see certificates VA: axle load to: 1150 kg HA: axle load to: 1230 kg
B14	C 180 CDI, C 180 CGI, C 180 Kompressor, C 200 CDI, C 200 CGI, C 200 Kompressor, C 220 CDI, C 230, C 250 CGI, C 280, C 300, C 320 CDI, C 350, C 350 CDI, C 350 CGI 10/09 - 88 -225 kW	47-141179	30-50	30-50	without electronic suspension control; Conditions see certificates VA: axle load to: 1110 kg HA: without ride height adjustment; axle load to: 1225 kg
B16 PSS10	C 63 AMG 02/08 - 336 -386 kW	48-141147	20-40	20-40	mark: excl. Black Series; without electronic suspension control; without ride height adjustment; Conditions see certificates VA: axle load to: 1110 kg HA: axle load to: 1225 kg
B16 PSS10	C 180 CDI, C 180 CGI, C 180 Kompressor, C 200 CDI, C 200 CGI, C 200 Kompressor, C 220 CDI, C 230, C 250 CGI, C 280, C 300, C 320 CDI, C 350, C 350 CDI, C 350 CGI 10/09 - 88 -225 kW	48-141147	30-50	30-50	without electronic suspension control; Conditions see certificates VA: axle load to: 1110 kg HA: without ride height adjustment; axle load to: 1225 kg
MERCEDES-BENZ C-CLASS Coupe (C204)					
B12 PK	C 180, C 200 CGI, C 250 06/11 - 115 -150 kW	46-180773	30	30	without electronic suspension control; spring pads must be observed; without ride height adjustment; Conditions see certificates VA: axle load to: 1150 kg HA: axle load to: 1230 kg
B12 PK	C 220 CDI, C 250 CDI, C 350 06/11 - 125 -225 kW	46-180780	30	30	without electronic suspension control; spring pads must be observed; without ride height adjustment; Conditions see certificates VA: axle load to: 1150 kg HA: axle load to: 1230 kg
B14	C 180, C 200 CGI, C 220 CDI, C 250, C 250 CDI, C 350 06/11 - 115 -225 kW	47-141179	30-50	30-50	without electronic suspension control; Conditions see certificates VA: axle load to: 1110 kg HA: axle load to: 1225 kg
B16 PSS10	C 180, C 200 CGI, C 220 CDI, C 250, C 250 CDI, C 350 06/11 - 115 -225 kW	48-141147	30-50	30-50	without electronic suspension control; Conditions see certificates VA: axle load to: 1110 kg HA: axle load to: 1225 kg
B16 PSS10	C 63 AMG 06/11 - 336 -380 kW	48-141147	20-40	20-40	mark: excl. Black Series; without electronic suspension control; without ride height adjustment; Conditions see certificates VA: axle load to: 1110 kg HA: axle load to: 1225 kg

M

					
MERCEDES-BENZ					
MERCEDES-BENZ CLA Coupe (C117)					
B14	CLA 180, CLA 200, CLA 220 CDI, CLA 250 01/13 - 90 -155 kW	47-231108	30-50	30-50	Conditions see certificates VA: axle load to: 1110 kg HA: axle load to: 945 kg
B16 PSS10	CLA 180, CLA 200, CLA 220 CDI, CLA 250 01/13 - 90 -155 kW	48-230971	30-50	30-50	
MERCEDES-BENZ CLK (C208)					
B12 PK	200, 200 Kompressor 06/97 - 06/02 100 -141 kW	46-181763	30	30	spring pads must be observed; without ride height adjustment; Conditions see certificates VA: axle load to: 990 kg HA: axle load to: 1070 kg
B12 PK	230 Kompressor, 320, 430 06/97 - 06/02 142 -205 kW	46-181770	30	30	spring pads must be observed; without ride height adjustment; Conditions see certificates VA: axle load to: 1010 kg HA: axle load to: 1070 kg
B12 SL	200, 200 Kompressor, 230 Kompressor, 320, 430 06/97 - 06/02 100 -205 kW	46-194695	45-50	30-35	spring pads must be observed; without ride height adjustment; Conditions see certificates VA: axle load to: 1010 kg HA: axle load to: 1070 kg
MERCEDES-BENZ CLK Convertible (A208)					
B12 PK	200, 200 Kompressor 03/98 - 03/02 100 -141 kW	46-181787	30	30	spring pads must be observed; without ride height adjustment; Conditions see certificates VA: axle load to: 990 kg HA: axle load to: 1070 kg
B12 PK	230 Kompressor, 320, 430 03/98 - 03/02 142 -205 kW	46-181794	30	30	spring pads must be observed; without ride height adjustment; Conditions see certificates VA: axle load to: 1010 kg HA: axle load to: 1070 kg
B12 SL	200, 200 Kompressor, 230 Kompressor, 320, 430 03/98 - 03/02 100 -205 kW	46-194695	45-50	30-35	spring pads must be observed; without ride height adjustment; Conditions see certificates VA: axle load to: 1010 kg HA: axle load to: 1070 kg
MERCEDES-BENZ CLK (C209)					
B12 PK	200 CGI, 200 Kompressor, 220 CDI 09/02 - 05/09 110 -135 kW	46-181800	30	30	without electronic suspension control; spring pads must be observed; Spacers required for several wheel/tyre combinations; Conditions see certificates VA: axle load to: 1035 kg HA: without ride height adjustment; axle load to: 1170 kg
B12 PK	240, 270 CDI, 280, 320, 320 CDI, 350, 500 06/02 - 05/09 125 -285 kW	46-181817	30	30	without electronic suspension control; spring pads must be observed; Spacers required for several wheel/tyre combinations; Conditions see certificates VA: axle load to: 1130 kg HA: without ride height adjustment; axle load to: 1170 kg
B14	200 CGI, 200 Kompressor, 220 CDI, 240, 270 CDI, 280, 320, 320 CDI, 350, 500, 55 AMG, 6.2, 63 AMG 09/02 - 05/09 110 -373 kW	47-100770	30-50	30-50	with sports suspension; Spacers required for several wheel/tyre combinations; without ride height adjustment; Conditions see certificates VA: axle load to: 1130 kg HA: axle load to: 1150 kg
B16 PSS9	200 CGI, 200 Kompressor, 220 CDI, 240, 270 CDI, 280, 320, 320 CDI, 350, 500, 55 AMG, 6.2, 63 AMG 09/02 - 05/09 110 -373 kW	48-088602	30-50	30-50	with standard chassis; Spacers required for several wheel/tyre combinations; without ride height adjustment; Conditions see certificates VA: axle load to: 1130 kg HA: axle load to: 1155 kg
MERCEDES-BENZ CLK Convertible (A209)					
B12 PK	200 CGI, 200 Kompressor 02/03 - 03/10 120 -135 kW	46-181800	30	30	without electronic suspension control; spring pads must be observed; Spacers required for several wheel/tyre combinations; Conditions see certificates VA: axle load to: 1035 kg HA: without ride height adjustment; axle load to: 1170 kg
B12 PK	240, 280, 320, 350, 500 02/03 - 03/10 125 -285 kW	46-181817	30	30	without electronic suspension control; spring pads must be observed; Spacers required for several wheel/tyre combinations; Conditions see certificates VA: axle load to: 1130 kg HA: without ride height adjustment; axle load to: 1170 kg
B14	200 CGI, 200 Kompressor, 240, 280, 320, 320 CDI, 350, 500, 55 AMG, 63 AMG 02/03 - 03/10 120 -354 kW	47-100770	30-50	30-50	with standard chassis; Spacers required for several wheel/tyre combinations; Conditions see certificates VA: axle load to: 1130 kg HA: axle load to: 1155 kg

									
MERCEDES-BENZ									
MERCEDES-BENZ CLK Convertible (A209)									
B16 PSS9	200 CGI, 200 Kompressor, 240, 280, 320, 320 CDI, 350, 500, 55 AMG, 63 AMG 02/03 - 03/10 120-354 kW	48-088602	30-50	30-50	with standard chassis; Spacers required for several wheel/tyre combinations; Conditions see certificates VA: axle load to: 1130 kg HA: axle load to: 1155 kg				
MERCEDES-BENZ CLS (C219)									
B12 PK	320 CDI, 350 10/04 - 12/10 165-215 kW	46-182081	30	25-30	spring pads must be observed; without Airmatic DC; Conditions see certificates VA: axle load to: 1135 kg HA: axle load to: 1190 kg				
B16 PSS9	280, 300, 320 CDI, 350, 350 CDI, 350 CGI, 500, CLS 55 AMG, CLS 550, CLS 63 AMG 04/06 - 165-378 kW	48-088763	30-50	30-50	without Airmatic DC; Conditions see certificates VA: axle load to: 1175 kg HA: axle load to: 1250 kg				
B16 RC	280, 300, 320 CDI, 350, 350 CDI, 350 CGI, 500, CLS 55 AMG, CLS 550, CLS 63 AMG 04/06 - 165-378 kW	49-132380 14-230615	30-50	30-50	without Airmatic DC; Conditions see certificates VA: axle load to: 1175 kg HA: axle load to: 1255 kg				
MERCEDES-BENZ CLS (C218)									
B16 PSS10	63 AMG 01/11 - 386-410 kW	48-197441	10-30	10-30	mark: 485+B00; without Airmatic DC; Conditions see certificates VA: axle load to: 1195 kg HA: axle load to: 1240 kg				
B16 PSS10	250 CDI, 350, 350 CDI, 500 02/11 - 150-300 kW	48-197441	30-50	30-50	without Airmatic DC; Conditions see certificates VA: axle load to: 1195 kg HA: axle load to: 1240 kg				
MERCEDES-BENZ E-CLASS (W210)									
B12 PK	E 200, E 200 CDI, E 200 D, E 200 Kompressor, E 220 CDI, E 220 D, E 230, E 250 D, E 250 Turbo-D, E 290 Turbo-D 06/95 - 06/99 55-137 kW	46-190413	35	30	-> CH.Nr.: A394035; spring pads must be observed; without ADS; without ride height adjustment; Conditions see certificates VA: axle load to: 1095 kg HA: axle load to: 1165 kg				
B12 PK	E 200, E 200 CDI, E 200 D, E 200 Kompressor, E 220 D, E 270 CDI 07/99 - 03/02 55-137 kW	46-190420	35	30	CH.Nr.: A394036 ->; spring pads must be observed; without ADS; without ride height adjustment; Conditions see certificates VA: axle load to: 1095 kg HA: axle load to: 1165 kg				
B12 PK	E 240, E 280, E 320, E 430 06/95 - 06/99 125-205 kW	46-190437	35	30	-> CH.Nr.: A394035; spring pads must be observed; without ADS; without ride height adjustment; Conditions see certificates VA: axle load to: 1095 kg HA: axle load to: 1165 kg				
B12 PK	E 240, E 280, E 320, E 430 07/99 - 03/02 125-205 kW	46-190444	35	30	CH.Nr.: A394036 ->; spring pads must be observed; without ADS; without ride height adjustment; Conditions see certificates VA: axle load to: 1095 kg HA: axle load to: 1165 kg				
B12 PK	E 220 CDI 07/99 - 03/02 105 kW	46-190420	35	30	CH.Nr.: A394035 ->; spring pads must be observed; without ADS; without ride height adjustment; Conditions see certificates VA: axle load to: 1095 kg HA: axle load to: 1165 kg				
MERCEDES-BENZ E-CLASS (W211)									
B12 PK	E 200 CDI, E 200 CGI, E 200 Kompressor, E 220 CDI, E 240, E 350 03/02 - 12/08 75-200 kW	46-181879	30-35	30	with standard chassis; spring pads must be observed; without Airmatic DC; without ride height adjustment; Conditions see certificates VA: axle load to: 1095 kg HA: axle load to: 1230 kg				
B12 PK	E 200 CDI, E 200 CGI, E 200 Kompressor, E 220 CDI, E 240, E 350 03/02 - 12/08 75-200 kW	46-181879	15-20	15	mark: Avantgarde, Elegance; spring pads must be observed; without Airmatic DC; without ride height adjustment; Conditions see certificates VA: axle load to: 1095 kg HA: axle load to: 1230 kg				
B12 PK	E 220 CDI, E 270 CDI, E 320, E 320 CDI 03/02 - 12/08 100-165 kW	46-181862	35-40	30	with standard chassis; spring pads must be observed; without Airmatic DC; without ride height adjustment; Conditions see certificates VA: axle load to: 1160 kg HA: axle load to: 1230 kg				
B12 PK	E 220 CDI, E 270 CDI, E 320, E 320 CDI 03/02 - 12/08 100-165 kW	46-181862	20-25	15	mark: Avantgarde, Elegance; spring pads must be observed; without Airmatic DC; without ride height adjustment; Conditions see certificates VA: axle load to: 1160 kg HA: axle load to: 1230 kg				



MERCEDES-BENZ

MERCEDES-BENZ E-CLASS (W211)

B16 PSS9	E 200 CDI, E 200 CGI, E 200 Kompressor, E 220 CDI, E 230, E 240, E 270 CDI, E 280, E 280 CDI, E 300 BLUETEC, E 320, E 320 CDI, E 350, E 350 CGI, E 400 CDI, E 420 CDI, E200 NGT 03/02 - 12/08 75 -231 kW	48-088763	30-50	30-50	without Airmatic DC; Conditions see certificates VA: axle load to: 1175 kg HA: axle load to: 1255 kg
B16 RC	E 200 CDI, E 200 CGI, E 200 Kompressor, E 220 CDI, E 230, E 240, E 270 CDI, E 280, E 280 CDI, E 300 BLUETEC, E 320, E 320 CDI, E 350, E 350 CGI, E 400 CDI, E 420 CDI, E200 NGT 03/02 - 12/08 75 -231 kW	49-132380 14-230615	30-50	30-50	without Airmatic DC; Conditions see certificates VA: axle load to: 1175 kg HA: axle load to: 1255 kg

MERCEDES-BENZ E-CLASS T-Model (S211)





B12 PK	E 200 T Kompressor, E 220 CDI, E 220 T CDI, E 230 T, E 240 T, E 350 T 03/03 - 07/09 100 -200 kW	46-190499	30-35	30	without Airmatic DC; Conditions see certificates VA: axle load to: 1095 kg HA: with ride height adjustment; axle load to: 1230 kg
B12 PK	E 220 T CDI, E 270 T CDI, E 280 T CDI, E 320 T, E 320 T CDI, E 350 T 03/03 - 07/09 110 -200 kW	46-190505	30-35	30	without Airmatic DC; Conditions see certificates VA: axle load to: 1160 kg HA: with ride height adjustment; axle load to: 1230 kg





MERCEDES-BENZ E-CLASS (W212)

B12 PK	E 200 CGI, E 250 CGI 01/09 - 135 -150 kW	46-182067	30	30	with standard chassis; spring pads must be observed; without Airmatic DC; without ride height adjustment; Conditions see certificates VA: axle load to: 1055 kg HA: axle load to: 1275 kg
B12 PK	E 200 CGI, E 250 CGI 01/09 - 135 -150 kW	46-182074	15	15	mark: Avantgarde; spring pads must be observed; without Airmatic DC; without ride height adjustment; Conditions see certificates VA: axle load to: 1200 kg HA: axle load to: 1275 kg
B12 PK	E 200 CDI, E 220 CDI, E 250 CDI, E 300, E 300 BlueEfficiency, E 300 CDI, E 350, E 350 BlueTEC, E 350 CDI, E 350 CGI, E350 01/09 - 100 -225 kW	46-182074	30	30	with standard chassis; spring pads must be observed; without Airmatic DC; without ride height adjustment; Conditions see certificates VA: axle load to: 1200 kg HA: axle load to: 1275 kg
B12 PK	E 200 CDI, E 220 CDI, E 250 CDI, E 300, E 300 BlueEfficiency, E 300 CDI, E 350, E 350 BlueTEC, E 350 CDI, E 350 CGI, E350 01/09 - 100 -225 kW	46-182074	15	15	mark: Avantgarde; spring pads must be observed; without Airmatic DC; without ride height adjustment; Conditions see certificates VA: axle load to: 1200 kg HA: axle load to: 1240 kg
B16 PSS10	E 200 CDI, E 200 CGI, E 200 NGT, E 220 CDI, E 250 CDI, E 250 CGI, E 300, E 300 BlueEfficiency, E 300 CDI, E 300 Hybrid, E 350, E 350 BlueTEC, E 350 CDI, E 350 CGI, E 500, E350 01/09 - 100 -300 kW	48-166560	30-55	30-50	with standard chassis; without Airmatic DC; Conditions see certificates

MERCEDES-BENZ E-CLASS Coupe (C207)

B12 PK	E 200 CGI, E 250 CGI 01/09 - 135 -150 kW	46-180759	30	30	without electronic suspension control; spring pads must be observed; without ride height adjustment; Conditions see certificates VA: axle load to: 1150 kg HA: axle load to: 1200 kg
B12 PK	E 220 CDI, E 250 CDI, E 300, E 350, E 350 CDI, E 350 CGI 01/09 - 125 -225 kW	46-180766	30	30	without electronic suspension control; spring pads must be observed; without ride height adjustment; Conditions see certificates VA: axle load to: 1150 kg HA: axle load to: 1200 kg
B14	E 200 CGI, E 220 CDI, E 250 CDI, E 250 CGI, E 300, E 350, E 350 CDI, E 350 CGI, E 500 01/09 - 125 -300 kW	47-141179	10-30	10-30	Conditions see certificates VA: axle load to: 1110 kg HA: axle load to: 1225 kg

   					
MERCEDES-BENZ					
MERCEDES-BENZ E-CLASS Coupe (C207)					
B16 PSS10	E 200 CGI, E 220 CDI, E 250 CDI, E 250 CGI, E 300, E 350, E 350 CDI, E 350 CGI, E 500 01/09 - 125 -300 kW	48-141147	10-30	10-30	Conditions see certificates VA: axle load to: 1110 kg HA: axle load to: 1225 kg
MERCEDES-BENZ E-CLASS Convertible (A207)					
B12 PK	E 200 CGI, E 250 CGI 01/10 - 135 -150 kW	46-180759	30	30	without electronic suspension control; spring pads must be observed; without ride height adjustment; Conditions see certificates VA: axle load to: 1150 kg HA: axle load to: 1200 kg
B12 PK	E 220 CDI, E 250 CDI, E 300, E 350, E 350 CDI, E 350 CGI 01/10 - 125 -225 kW	46-180766	30	30	without electronic suspension control; spring pads must be observed; without ride height adjustment; Conditions see certificates VA: axle load to: 1150 kg HA: axle load to: 1200 kg
B14	E 200 CGI, E 220 CDI, E 250 CDI, E 250 CGI, E 300, E 350, E 350 CDI, E 350 CGI, E 500 01/10 - 125 -300 kW	47-141179	10-30	10-30	Conditions see certificates VA: axle load to: 1110 kg HA: axle load to: 1225 kg
B16 PSS10	E 200 CGI, E 220 CDI, E 250 CDI, E 250 CGI, E 300, E 350, E 350 CDI, E 350 CGI, E 500 01/10 - 125 -300 kW	48-141147	10-30	10-30	Conditions see certificates VA: axle load to: 1110 kg HA: axle load to: 1225 kg
MERCEDES-BENZ S-CLASS (W126)					
B12 PK	260 SE, 280 S, 280 SE,SEL, 300 SE,SEL, 380 SE,SEL 12/79 - 06/91 115 -160 kW	46-181398	40-45	30-35	spring pads must be observed; without ride height adjustment; Conditions see certificates VA: axle load to: 1110 kg HA: axle load to: 1160 kg
MERCEDES-BENZ S-CLASS Coupe (C126)					
B12 PK	380 SEC 10/81 - 07/85 150 kW	46-181398	40-45	30-35	spring pads must be observed; without ride height adjustment; Conditions see certificates VA: axle load to: 1110 kg HA: axle load to: 1160 kg
MERCEDES-BENZ SL (R129)					
B12 PK	280, 320, 500 09/92 - 10/01 142 -235 kW	46-193926	30	30	without ADS; Conditions see certificates VA: axle load to: 1080 kg HA: axle load to: 1190 kg
B12 PK	300 SL, 300 SL-24, 500 SL 02/92 - 08/93 140 -240 kW	46-193926	30	30	CH.Nr.: F054768 ->; without ADS; Conditions see certificates VA: axle load to: 1080 kg HA: axle load to: 1190 kg
MERCEDES-BENZ SL (R231)					
B12 PK	350 02/12 - 225 kW	46-237156	25	25	without ABC; Conditions see certificates VA: axle load to: 1005 kg HA: axle load to: 1150 kg
B12 PK	500 01/12 - 320 kW	46-237156	25	25	without ABC; Conditions see certificates VA: axle load to: 1075 kg HA: axle load to: 1150 kg
B16 PSS10	350, 500, 63 AMG 01/12 - 225 -415 kW	49-237191	10-30	10-30	Conditions see certificates VA: axle load to: 1075 kg HA: axle load to: 1150 kg
MERCEDES-BENZ SLK (R170)					
B12 PK	200, 200 Kompressor, 230 Kompressor, 320 09/96 - 04/04 100 -160 kW	46-181756	30	30	spring pads must be observed; without ride height adjustment; Conditions see certificates VA: axle load to: 845 kg HA: axle load to: 820 kg
B14	200, 200 Kompressor, 230 Kompressor, 32 AMG Kompressor, 320 09/96 - 04/04 100 -260 kW	47-119536	35-55	35-55	Conditions see certificates VA: axle load to: 905 kg HA: axle load to: 850 kg
B16 PSS9	200, 200 Kompressor, 230 Kompressor, 32 AMG Kompressor, 320 09/96 - 04/04 100 -260 kW	48-119542	35-55	35-55	Conditions see certificates VA: axle load to: 905 kg HA: axle load to: 850 kg

   					
MERCEDES-BENZ					
MERCEDES-BENZ SLK (R171)					
B12 PK	200 Kompressor 03/04 - 02/11 120 -135 kW	46-182043	25	25	spring pads must be observed; without ride height adjustment; Conditions see certificates VA: axle load to: 840 kg HA: axle load to: 940 kg
B12 PK	280, 300, 350 06/04 - 02/11 170 -224 kW	46-182050	25	25	spring pads must be observed; without ride height adjustment; Conditions see certificates VA: axle load to: 910 kg HA: axle load to: 940 kg
B14	200 Kompressor, 280, 300, 350 03/04 - 02/11 120 -224 kW	47-116115	35-45	35-45	without AMG Sports Package; Conditions see certificates VA: axle load to: 910 kg HA: axle load to: 940 kg
B16 PSS9	200 Kompressor, 280, 300, 350 03/04 - 02/11 120 -224 kW	48-116077	35-45	35-45	without AMG Sports Package; Conditions see certificates VA: axle load to: 910 kg HA: axle load to: 940 kg





MERCEDES-BENZ M-CLASS (W164)					
B12 PK	ML 280 CDI 4-matic, ML 320 CDI 4-matic, ML 350 4-matic 07/05 - 140 -200 kW	46-193964	35	35	Conditions see certificates; with coil-spring suspension VA: axle load to: 1400 kg HA: axle load to: 1600 kg

MERCEDES-BENZ (BBDC)					
MERCEDES-BENZ (BBDC) C-CLASS					
B14	C 180 K, C 200 K, C 200 Turbo, C 230, C 260 Turbo, C 280, C 300 03/08 - 115 -180 kW	47-141179	30-50	30-50	without electronic suspension control; Conditions see certificates VA: axle load to: 1110 kg HA: axle load to: 1225 kg
B16 PSS10	C 180 K, C 200 K, C 200 Turbo, C 230, C 260 Turbo, C 280, C 300 03/08 - 115 -180 kW	48-141147	30-50	30-50	without electronic suspension control; Conditions see certificates VA: axle load to: 1110 kg HA: axle load to: 1225 kg

MERCEDES-BENZ (BBDC) E-CLASS (W211)					
B16 PSS9	1.8, 2.5, 3.0, 3.5 11/05 - 120 -200 kW	48-088763	30-50	30-50	without Airmatic DC; Conditions see certificates VA: axle load to: 1175 kg HA: axle load to: 1255 kg
B16 RC	1.8, 2.5, 3.0, 3.5 11/05 - 120 -200 kW	49-132380 14-230615	30-50	30-50	without Airmatic DC; Conditions see certificates VA: axle load to: 1175 kg HA: axle load to: 1255 kg

MERCEDES-BENZ (BBDC) E-CLASS (W212)					
B16 PSS10	E 200 L CGI, E 300 L 06/10 - 150 -180 kW	48-166560	30-55	30-50	with standard chassis; without Airmatic DC; Conditions see certificates

MINI					
MINI MINI (R50, R53)					
B12 PK	Cooper, One 03/02 - 11/06 66 -85 kW	46-180452	30	30	Conditions see certificates VA: axle load to: 890 kg HA: axle load to: 800 kg
B12 PK	Cooper S, One D 03/02 - 09/06 55 -125 kW	46-180452	30	30	mark: ex. JC Works GP; Conditions see certificates VA: axle load to: 890 kg HA: axle load to: 800 kg
B14	1.4, 1.6 GLX, Cooper S, One D, Works 03/02 - 11/06 55 -155 kW	47-126916	30-50	30-50	mark: R50,R53; mark: ex. JC Works GP; Conditions see certificates VA: axle load to: 890 kg HA: axle load to: 760 kg
B14	Cooper, One 06/01 - 02/02 66 -85 kW	47-126916	30-50	30-50	mark: R50, R53; Conditions see certificates; Only in connection with 31 30 6 769 741; Only in connection with 31 33 6 759 452; Only in connection with 31 33 0 146 229; Only in connection with 31 33 0 146 240; Only in connection with 31 33 0 146 241 VA: axle load to: 890 kg HA: axle load to: 760 kg

					
MINI					
MINI MINI (R50, R53)					
B14	Cooper, One 03/02 - 11/06 66 -85 kW	47-126916	30-50	30-50	mark: R50, R53; Conditions see certificates VA: axle load to: 890 kg HA: axle load to: 760 kg
B14	1.6, Cooper, Cooper D, Cooper S, Cooper SD, John Cooper Works, One, One D 03/06 - 06/11 55 -160 kW	47-139060	30-50	30-50	mark: R56; Conditions see certificates VA: axle load to: 905 kg HA: axle load to: 855 kg
B16 PSS10	1.4, 1.6 GLX, Cooper, Cooper S, One, One D, Works 03/03 - 11/06 55 -155 kW	48-136648	30-50	30-50	mark: R50,R53; mark: ex. JC Works GP; Conditions see certificates VA: axle load to: 890 kg
B16 PSS10	Cooper, One 06/01 - 02/02 66 -85 kW	48-136648	30-50	30-50	mark: R50, R53; additional original parts required; Conditions see certificates; Only in connection with 31 30 6 769 741; Only in connection with 31 33 6 759 452; Only in connection with 31 33 0 146 229; Only in connection with 31 33 0 146 240; Only in connection with 31 33 0 146 241 VA: axle load to: 890 kg
B16 PSS10	1.6, Cooper, Cooper D, Cooper S, Cooper SD, John Cooper Works, One, One D 03/06 - 06/11 55 -160 kW	48-153720	30-50	30-50	mark: R56; Conditions see certificates VA: axle load to: 905 kg HA: axle load to: 855 kg
MINI MINI Convertible (R52)					
B12 PK	Cooper, Cooper S, One 07/04 - 11/07 66 -125 kW	46-180452	30	30	Conditions see certificates VA: axle load to: 890 kg HA: axle load to: 800 kg
B14	Cooper, Cooper S, One, Works 07/04 - 11/07 66 -155 kW	47-126916	30-50	30-50	mark: R52; Conditions see certificates VA: axle load to: 890 kg HA: axle load to: 760 kg
B16 PSS10	Cooper, Cooper S, One, Works 07/04 - 11/07 66 -155 kW	48-136648	30-50	30-50	mark: R52; Conditions see certificates VA: axle load to: 890 kg HA: axle load to: 800 kg
MINI MINI (R56)					
B12 PK	Cooper, Cooper D, Cooper S, One, One D 06/09 - 06/11 55 -135 kW	46-180469	25-30	25-30	Conditions see certificates VA: axle load to: 905 kg HA: axle load to: 755 kg
B12 PK	Cooper, Cooper D, Cooper S, One, One D 07/11 - 55 -135 kW	46-180469	25-30	25-30	Conditions see certificates; Only in connection with 2x 33 50 6 778 572 VA: axle load to: 905 kg HA: axle load to: 755 kg
B12 PK	Cooper S 01/12 - 147 kW	46-180469	25-30	25-30	Conditions see certificates; Only in connection with 2x 33 50 6 778 572 VA: axle load to: 905 kg HA: axle load to: 755 kg
B14	Cooper, Cooper D, Cooper S, Cooper SD, John Cooper Works, One, One D 07/11 - 55 -155 kW	47-139060	30-50	30-50	mark: R56; Conditions see certificates; Only in connection with 2x 33 50 6 778 572 VA: axle load to: 905 kg HA: axle load to: 855 kg
B14	Cooper S 01/12 - 147 kW	47-139060	30-50	30-50	mark: R56; Conditions see certificates; Only in connection with 2x 33 50 6 778 572 VA: axle load to: 905 kg HA: axle load to: 855 kg
B16 PSS10	Cooper, Cooper D, Cooper S, Cooper SD, John Cooper Works, One, One D 07/11 - 55 -155 kW	48-153720	30-50	30-50	mark: R56; Conditions see certificates; Only in connection with 2x 33 50 6 778 572 VA: axle load to: 905 kg HA: axle load to: 855 kg
B16 PSS10	Cooper S 01/12 - 147 kW	48-153720	30-50	30-50	mark: R56; Conditions see certificates; Only in connection with 2x 33 50 6 778 572 VA: axle load to: 905 kg HA: axle load to: 855 kg
B16 PSS10	John Cooper Works GP 09/12 - 160 kW	48-153720	0-20	0-20	mark: R56; Conditions see certificates VA: axle load to: 905 kg HA: axle load to: 855 kg
MINI MINI Convertible (R57)					
B12 PK	1.6 Cooper, 1.6 Cooper S, Cooper, Cooper D, Cooper S, One 07/06 - 72 -147 kW	46-180476	30	20	Conditions see certificates; Only in connection with 2x 33 50 6 778 572 VA: axle load to: 905 kg HA: axle load to: 855 kg



MINI

MINI MINI Convertible (R57)

B14	1.6 Cooper, 1.6 Cooper S, Cooper, Cooper D, Cooper S, Cooper SD, John Cooper Works, One 03/08 - 06/11 72 -155 kW	47-139060	30-50	30-50	mark: R57; Conditions see certificates VA: axle load to: 890 kg HA: axle load to: 800 kg
B14	1.6 Cooper, 1.6 Cooper S, Cooper, Cooper D, Cooper S, Cooper SD, John Cooper Works, One 07/11 - 72 -155 kW	47-139060	30-50	30-50	mark: R57; Conditions see certificates; Only in connection with 2x 33 50 6 778 572 VA: axle load to: 890 kg HA: axle load to: 800 kg
B16 PSS10	1.6 Cooper, 1.6 Cooper S, Cooper, Cooper D, Cooper S, Cooper SD, John Cooper Works, One 03/08 - 06/11 72 -155 kW	48-153720	30-50	30-50	mark: R56; Conditions see certificates VA: axle load to: 905 kg HA: axle load to: 855 kg
B16 PSS10	1.6 Cooper, 1.6 Cooper S, Cooper, Cooper D, Cooper S, Cooper SD, John Cooper Works, One 07/11 - 72 -155 kW	48-153720	30-50	30-50	mark: R56; Conditions see certificates; Only in connection with 2x 33 50 778 572 VA: axle load to: 905 kg HA: axle load to: 855 kg

MINI MINI Roadster (R59)

B14	Cooper, Cooper S, Cooper SD, John Cooper Works 02/12 - 85 -155 kW	47-139060	30-50	30-50	Conditions see certificates; Only in connection with 2x 33 50 778 572 VA: axle load to: 905 kg HA: axle load to: 855 kg
B16 PSS10	Cooper, Cooper S, Cooper SD, John Cooper Works 02/12 - 85 -155 kW	48-153720	30-50	30-50	Conditions see certificates; Only in connection with 2x 33 50 778 572 VA: axle load to: 905 kg HA: axle load to: 855 kg

MINI MINI CLUBMAN (R55)





B12 PK	1.6, 1.6 D, Cooper, Cooper D, Cooper S, Cooper SD, One, One D 10/07 - 06/11 66 -147 kW	46-180476	30	20	Conditions see certificates VA: axle load to: 905 kg HA: without ride height adjustment; axle load to: 855 kg
B12 PK	1.6, 1.6 D, Cooper, Cooper D, Cooper S, Cooper SD, One, One D 07/11 - 66 -147 kW	46-180476	30	20	Conditions see certificates; Only in connection with 2x 33 50 6 778 572 VA: axle load to: 905 kg HA: without ride height adjustment; axle load to: 855 kg
B14	1.6, 1.6 D, Cooper, Cooper D, Cooper S, Cooper SD, John Cooper Works, One, One D 10/07 - 06/11 66 -155 kW	47-139060	30-50	30-50	Conditions see certificates VA: axle load to: 905 kg HA: axle load to: 855 kg
B14	1.6, 1.6 D, Cooper, Cooper D, Cooper S, Cooper SD, John Cooper Works, One, One D 07/11 - 66 -155 kW	47-139060	30-50	30-50	Conditions see certificates; Only in connection with 2x 33 50 778 572 VA: axle load to: 905 kg HA: axle load to: 855 kg
B16 PSS10	1.6, 1.6 D, Cooper, Cooper D, Cooper S, Cooper SD, John Cooper Works, One, One D 10/07 - 06/11 66 -155 kW	48-153720	30-50	30-50	Conditions see certificates VA: axle load to: 905 kg HA: axle load to: 855 kg
B16 PSS10	1.6, 1.6 D, Cooper, Cooper D, Cooper S, Cooper SD, John Cooper Works, One, One D 07/11 - 66 -155 kW	48-153720	30-50	30-50	Conditions see certificates; Only in connection with 2x 33 50 778 572 VA: axle load to: 905 kg HA: axle load to: 855 kg

MINI MINI CLUBVAN (R55)

B14	Cooper, Cooper D, One 12/12 - 72 -90 kW	47-139060	30-50	30-50	Conditions see certificates; Only in connection with 2x 33 50 778 572 VA: axle load to: 905 kg HA: axle load to: 855 kg
B16 PSS10	Cooper, Cooper D, One 12/12 - 72 -90 kW	48-153720	30-50	30-50	Conditions see certificates; Only in connection with 2x 33 50 778 572 VA: axle load to: 905 kg HA: axle load to: 855 kg

MINI MINI Coupe (R58)

B12 PK	Cooper, Cooper S, Cooper SD, John Cooper Works 09/11 - 85 -155 kW	46-180469	25-30	25-30	Conditions see certificates; Only in connection with 2x 33 50 6 778 572 VA: axle load to: 905 kg HA: axle load to: 755 kg
-----------	--	-----------	-------	-------	---

   					
MINI					
MINI MINI Coupe (R58)					
B14	Cooper, Cooper S, Cooper SD, John Cooper Works 09/11 - 85 -155 kW	47-139060	30-50	30-50	Conditions see certificates; Only in connection with 2x 33 50 778 572 VA: axle load to: 905 kg HA: axle load to: 855 kg
B16 PSS10	Cooper, Cooper S, Cooper SD, John Cooper Works 09/11 - 85 -155 kW	48-153720	30-50	30-50	Conditions see certificates; Only in connection with 2x 33 50 778 572 VA: axle load to: 905 kg HA: axle load to: 855 kg

MITSUBISHI					
MITSUBISHI COLT VI (Z_)					
B14	1.1, 1.3, 1.5, 1.5 CZT, 1.5 DI-D, 1.5 Turbo 08/04 - 09/08 50 -113 kW	47-168053	35-50	30-50	Conditions see certificates VA: axle load to: 880 kg HA: axle load to: 750 kg

MITSUBISHI LANCER VI (CK/P_A)					
B14	2.0 16V EVO VI / VII, 2.0 16V EVO IX, 2.0 16V EVO VIII, 2.0 4x4 08/96 - 195 -213 kW	47-118478	40-50	40-50	mark: EVO 7-9; mark: CT9; Conditions see certificates VA: axle load to: 1015 kg HA: axle load to: 900 kg
B16 PSS9	2.0 16V EVO VI / VII 01/00 - 08/03 206 kW	48-086424	40-50	40-50	mark: CT9A/CT0; mark: EVO 7; Conditions see certificates VA: axle load to: 1015 kg HA: axle load to: 900 kg

MITSUBISHI LANCER Saloon (CS_A)					
B16 PSS9	2.0 16V EVO IX, 2.0 16V EVO VIII, 2.0 4x4 08/05 - 195 -213 kW	48-086424	40-50	40-50	mark: EVO 7-9; mark: CT9; Conditions see certificates VA: axle load to: 1015 kg HA: axle load to: 900 kg

MITSUBISHI LANCER Saloon (CY/Z_A)					
B16 PSS10	2.0 EVO, 2.0 EVO X 06/08 - 217 -264 kW	48-227186	40-50	30-50	mark: EVO X; mark: CZ0; Conditions see certificates VA: axle load to: 1080 kg HA: axle load to: 1030 kg

MITSUBISHI LANCER SPORTBACK (CX_A)					
B16 PSS10	2.0 Ralliart 10/08 - 177 -184 kW	48-227186	40-50	30-50	mark: EVO X; Conditions see certificates VA: axle load to: 1080 kg HA: axle load to: 1030 kg

NISSAN					
NISSAN 350 Z (Z33)					
B12 PK	3.5 10/03 - 206 -230 kW	46-190529	30	30	Conditions see certificates VA: axle load to: 975 kg HA: axle load to: 975 kg
B14	3.5 10/03 - 206 -230 kW	47-101623	35-45	35-45	Conditions see certificates VA: axle load to: 975 kg HA: axle load to: 975 kg
B16 PSS10	3.5 10/03 - 206 -230 kW	48-146142	35-45	35-45	Conditions see certificates VA: axle load to: 975 kg HA: axle load to: 975 kg

NISSAN 350 Z Roadster (Z33)					
B12 PK	3.5 03/05 - 206 -230 kW	46-190529	30	30	Conditions see certificates VA: axle load to: 975 kg HA: axle load to: 975 kg
B14	3.5 03/05 - 206 -230 kW	47-101623	35-45	35-45	Conditions see certificates VA: axle load to: 975 kg HA: axle load to: 975 kg
B16 PSS10	3.5 03/05 - 206 -230 kW	48-146142	35-45	35-45	Conditions see certificates VA: axle load to: 975 kg HA: axle load to: 975 kg



NISSAN

NISSAN 370 Z (Z34)

B16 PSS10	3.7 06/09 - 241 -243 kW	48-165815	25-40	0-40	Conditions see certificates VA: axle load to: 980 kg HA: axle load to: 1000 kg
--------------	----------------------------	-----------	-------	------	--

NISSAN 370 Z Roadster (Z34)

B16 PSS10	3.7 01/10 - 241 -243 kW	48-165815	25-40	0-40	Conditions see certificates VA: axle load to: 980 kg HA: axle load to: 1000 kg
--------------	----------------------------	-----------	-------	------	--

NISSAN JUKE

B14	1.5 dCi, 1.6, 1.6 4x4, 1.6 DIG-T, 1.6 DIG-T 4x4 06/10 - 81 -147 kW	47-228214	30-50	30-50	Conditions see certificates VA: axle load to: 1010 kg HA: axle load to: 900 kg
-----	--	-----------	-------	-------	--

NISSAN MICRA (K12)

B12 PK	1.0 16V, 1.2 16V, 1.4 16V, 1.5 dCi 01/03 - 06/10 48 -65 kW	46-206961	30	30	twin-tube; Conditions see certificates VA: axle load to: 875 kg HA: axle load to: 800 kg
-----------	---	-----------	----	----	--

NISSAN SKYLINE Coupe (R33)

B16 PSS9	2.5 4x4, 2.6 Twin Turbo 4x4, 2.5 4x4 07/93 - 07/00 140 -206 kW	48-080750	40	40	Without roadworthy certificate; mark: R34
-------------	---	-----------	----	----	---

NISSAN SKYLINE Coupe (V35)

B16 PSS9	3.5 4x4 08/03 - 206 kW	48-080750	40	40	Without roadworthy certificate; mark: R34
-------------	---------------------------	-----------	----	----	---

OPEL

OPEL AGILA

B12 PK	1.0, 1.2 04/08 - 48 -69 kW	46-206978	30	30	twin-tube; rim: 15"; Conditions see certificates VA: axle load to: 835 kg HA: axle load to: 800 kg
-----------	-------------------------------	-----------	----	----	--

OPEL ASTRA F Hatchback (53_, 54_, 58_, 59_)





B10	1.4, 1.4 i, 1.4 i 16V, 1.4 Si, 1.6, 1.6 i, 1.6 i 16V, 1.6 Si, 1.7 D, 1.7 TD, 1.7 TDS, 1.8, 1.8 i, 1.8 i 16V, 2.0 GSI 16V, 2.0 i, 2.0 i 16V 09/91 - 01/98 42 -110 kW	46-111920	60	40	manual transmission; Conditions see certificates VA: axle load to: 900 kg HA: axle load to: 800 kg
-----	---	-----------	----	----	--

B12 PK	1.4, 1.4 i, 1.4 i 16V, 1.4 Si, 1.6, 1.6 i, 1.6 i 16V, 1.6 Si, 1.7 D, 1.7 TD, 1.7 TDS, 1.8, 1.8 i, 1.8 i 16V, 2.0 GSI 16V, 2.0 i, 2.0 i 16V 09/91 - 01/98 42 -110 kW	46-188861	30	30	Conditions see certificates VA: axle load to: 870 kg HA: axle load to: 800 kg
-----------	---	-----------	----	----	---

B12 SL	1.4, 1.4 i, 1.4 i 16V, 1.4 Si, 1.6, 1.6 i, 1.6 i 16V, 1.6 Si, 1.7 D, 1.7 TD, 1.7 TDS, 1.8, 1.8 i, 1.8 i 16V, 2.0 GSI 16V, 2.0 i, 2.0 i 16V 09/91 - 01/98 42 -110 kW	46-188885	45-50	30	Conditions see certificates VA: axle load to: 900 kg HA: axle load to: 800 kg
-----------	---	-----------	-------	----	---

OPEL ASTRA F (56_, 57_)

B10	1.4, 1.4 i, 1.4 i 16V, 1.4 Si, 1.6, 1.6 i, 1.6 i 16V, 1.6 Si, 1.7 D, 1.7 TD, 1.7 TDS, 1.8 i, 1.8 i 16V, 2.0 i, 2.0 i 16V 09/91 - 09/98 42 -100 kW	46-111920	60	40	manual transmission; Conditions see certificates VA: axle load to: 900 kg HA: axle load to: 800 kg
-----	---	-----------	----	----	--

   					
OPEL					
OPEL ASTRA F (56_, 57_)					
B12 PK	1.4, 1.4 i, 1.4 i 16V, 1.4 Si, 1.6, 1.6 i, 1.6 i 16V, 1.6 Si, 1.7 D, 1.7 TD, 1.7 TDS, 1.8 i, 1.8 i 16V, 2.0 i, 2.0 i 16V 09/91 - 09/98 42 -100 kW	46-188861	30	30	Conditions see certificates VA: axle load to: 870 kg HA: axle load to: 800 kg
B12 SL	1.4, 1.4 i, 1.4 i 16V, 1.4 Si, 1.6, 1.6 i, 1.6 i 16V, 1.6 Si, 1.7 D, 1.7 TD, 1.7 TDS, 1.8 i, 1.8 i 16V, 2.0 i, 2.0 i 16V 09/91 - 09/98 42 -100 kW	46-188885	45-50	30	Conditions see certificates VA: axle load to: 900 kg HA: axle load to: 800 kg
OPEL ASTRA F Estate (51_, 52_)					
B12 PK	1.4, 1.4 i, 1.4 i 16V, 1.4 Si, 1.6, 1.6 i, 1.6 i 16V, 1.6 Si, 1.7 D, 1.7 TD, 1.7 TDS, 1.8 i, 1.8 i 16V, 2.0 i, 2.0 i 16V 09/91 - 01/98 42 -110 kW	46-188878	30	30	Conditions see certificates VA: axle load to: 870 kg HA: axle load to: 860 kg
OPEL ASTRA F Convertible (53_B)					
B12 PK	1.4 i 16V, 1.4 Si, 1.6 i, 1.8 i 16V, 2.0 i 03/93 - 03/01 52 -85 kW	46-188861	30	30	Conditions see certificates VA: axle load to: 870 kg HA: axle load to: 800 kg
OPEL ASTRA F CLASSIC Hatchback					
B10	1.4 i, 1.6 i, 1.6 i 16V, 1.7 TD, 1.8 i, 2.0 Di, 2.0 DTI, 2.0 i 01/98 - 08/02 44 -118 kW	46-111920	60	40	manual transmission; Conditions see certificates VA: axle load to: 900 kg HA: axle load to: 800 kg
OPEL ASTRA F CLASSIC Saloon					
B10	1.4 i, 1.6 i, 1.6 i 16V 01/98 - 08/02 44 -74 kW	46-111920	60	40	manual transmission; Conditions see certificates VA: axle load to: 900 kg HA: axle load to: 800 kg
OPEL ASTRA G Hatchback (F48_, F08_)					
B12 PK	1.2 16V, 1.4, 1.4 16V, 1.6, 1.6 16V 02/98 - 01/05 48 -76 kW	46-188984	30	30	Conditions see certificates VA: axle load to: 845 kg HA: axle load to: 820 kg
B12 PK	1.4, 1.4 16V, 1.6, 1.6 16V, 1.7 CDTI, 1.7 DTI 16V, 1.7 TD, 1.8, 1.8 16V, 2.0 16V 02/98 - 12/09 50 -100 kW	46-188946	30	30	Conditions see certificates VA: axle load to: 935 kg HA: axle load to: 820 kg
B12 PK	1.7 CDTI, 1.7 DTI 16V, 1.7 TD, 1.8 16V, 2.0 16V, 2.0 DI, 2.0 DTI 16V, 2.2 16V, 2.2 DTI 09/02 - 01/05 50 -108 kW	46-188960	30	30	Conditions see certificates VA: axle load to: 1035 kg HA: axle load to: 820 kg
B12 SL	1.2 16V, 1.4, 1.4 16V, 1.6, 1.6 16V, 1.8, 1.8 16V, 2.0 16V, 2.2 16V 02/98 - 01/05 48 -108 kW	46-188939	45-50	30	Conditions see certificates VA: axle load to: 965 kg HA: axle load to: 895 kg
B14	1.0, 1.2 16V, 1.4, 1.4 16V, 1.6, 1.6 16V, 1.7 CDTI, 1.7 DTI 16V, 1.7 TD, 1.8, 1.8 16V, 2.0 16V, 2.0 16V OPC, 2.0 DI, 2.0 DTI 16V, 2.0 OPC, 2.2 16V, 2.2 DTI 09/02 - 01/05 44 -147 kW	47-087484	40-50	25-45	Conditions see certificates VA: axle load to: 1040 kg HA: axle load to: 885 kg
OPEL ASTRA G Saloon (F69_)					
B12 PK	1.2 16V, 1.4, 1.4 16V, 1.6, 1.6 16V 09/98 - 01/05 48 -76 kW	46-188984	30	30	Conditions see certificates VA: axle load to: 845 kg HA: axle load to: 820 kg
B12 PK	1.4, 1.4 16V, 1.6, 1.6 16V, 1.7 CDTI, 1.7 DTI 16V, 1.7 TD, 1.8, 1.8 16V, 2.0 16V 09/98 - 12/09 50 -100 kW	46-188946	30	30	Conditions see certificates VA: axle load to: 935 kg HA: axle load to: 820 kg



OPEL

OPEL ASTRA G Saloon (F69_)

B12 PK	1.7 CDTI, 1.7 DTI 16V, 1.7 TD, 1.8, 1.8 16V, 2.0 16V, 2.0 DI, 2.0 DTI 16V, 2.2 16V, 2.2 DTI 09/02 - 01/05 50 -108 kW	46-188960	30	30	Conditions see certificates VA: axle load to: 1035 kg HA: axle load to: 820 kg
B12 SL	1.2 16V, 1.4, 1.4 16V, 1.6, 1.6 16V, 1.8, 1.8 16V, 2.0 16V, 2.2 16V 09/98 - 01/05 48 -108 kW	46-188939	45-50	30	Conditions see certificates VA: axle load to: 965 kg HA: axle load to: 895 kg

OPEL ASTRA G Estate (F35_)

B12 PK	1.2 16V, 1.4, 1.4 16V, 1.6, 1.6 16V 02/98 - 07/04 48 -76 kW	46-188991	30	30	without ride height adjustment; Conditions see certificates VA: axle load to: 845 kg HA: axle load to: 885 kg
B12 PK	1.4, 1.4 16V, 1.6, 1.6 16V, 1.7 DTI 16V, 1.7 TD, 1.8 16V, 2.0 16V 02/98 - 12/09 50 -100 kW	46-188953	30	30	without ride height adjustment; Conditions see certificates VA: axle load to: 935 kg HA: axle load to: 885 kg
B12 PK	1.7 DTI 16V, 1.7 TD, 1.8 16V, 2.0 16V, 2.0 DI, 2.0 DTI 16V, 2.2 16V, 2.2 DTI 08/99 - 07/04 50 -108 kW	46-188977	30	30	without ride height adjustment; Conditions see certificates VA: axle load to: 1035 kg HA: axle load to: 885 kg

OPEL ASTRA G Coupe (F07_)

B12 PK	1.6 16V, 1.8 16V, 2.0 16V Turbo, 2.2 16V 03/00 - 05/05 74 -147 kW	46-188892	30	30	Conditions see certificates VA: axle load to: 1015 kg HA: axle load to: 780 kg
B12 PK	2.2 DTI 09/02 - 05/05 92 kW	46-188915	30	30	Conditions see certificates VA: axle load to: 1040 kg HA: axle load to: 780 kg

OPEL ASTRA G Convertible





B12 PK	1.6, 1.6 16V, 1.8 16V, 2.0 16V Turbo, 2.2 16V 03/01 - 10/05 74 -147 kW	46-188908	30	30	Conditions see certificates VA: axle load to: 1015 kg HA: axle load to: 845 kg
B12 PK	2.2 DTI 09/02 - 10/05 92 kW	46-188922	30	30	Conditions see certificates VA: axle load to: 1040 kg HA: axle load to: 845 kg

OPEL ASTRA H

B12 PK	1.4, 1.6, 1.8 03/04 - 55 -103 kW	46-182128	30	30	disconnect ITS+; Conditions see certificates VA: axle load to: 970 kg HA: without ride height adjustment; axle load to: 860 kg
B12 PK	1.3 CDTI, 1.6 Turbo, 1.7 CDTI, 1.9 CDTI, 1.9 CDTI 16V, 2.0 Turbo 03/05 - 59 -177 kW	46-182135	30	30	disconnect ITS+; Conditions see certificates VA: axle load to: 1075 kg HA: without ride height adjustment; axle load to: 860 kg
B12 SL	1.4, 1.6, 1.8 03/04 - 55 -103 kW	46-182166	45-50	30	disconnect ITS+; Conditions see certificates VA: axle load to: 960 kg HA: without ride height adjustment; axle load to: 860 kg
B12 SL	1.3 CDTI, 1.6 Turbo, 1.7 CDTI, 2.0 Turbo 03/05 - 59 -177 kW	46-182173	45-50	30	disconnect ITS+; Conditions see certificates VA: axle load to: 1025 kg HA: without ride height adjustment; axle load to: 860 kg
B14	1.2, 1.3 CDTI, 1.4, 1.4 LPG, 1.6, 1.6 Turbo, 1.7 CDTI, 1.8, 1.9 CDTI, 1.9 CDTI 16V, 2.0 Turbo 03/05 - 48 -177 kW	47-121133	30-50	30-50	disconnect ITS+; Conditions see certificates VA: axle load to: 1060 kg HA: axle load to: 860 kg

OPEL ASTRA H Saloon

B12 PK	1.6, 1.8 02/07 - 85 -103 kW	46-182128	30	30	disconnect ITS+; Conditions see certificates VA: axle load to: 970 kg HA: without ride height adjustment; axle load to: 860 kg
B12 PK	1.3 CDTi, 1.7 CDTi 02/07 - 66 -81 kW	46-182135	30	30	disconnect ITS+; Conditions see certificates VA: axle load to: 1075 kg HA: without ride height adjustment; axle load to: 860 kg
B12 SL	1.6, 1.8 02/07 - 85 -103 kW	46-182166	45-50	30	disconnect ITS+; Conditions see certificates VA: axle load to: 960 kg HA: without ride height adjustment; axle load to: 860 kg

									
OPEL									
OPEL ASTRA H Saloon									
B12 SL	1.3 CDTi, 1.7 CDTi 02/07 - 66 -81 kW	46-182173	45-50	30	disconnect ITS+; Conditions see certificates VA: axle load to: 1025 kg HA: without ride height adjustment; axle load to: 860 kg				
OPEL ASTRA H GTC									
B12 PK	1.4, 1.6, 1.8 03/05 - 55 -103 kW	46-182128	30	30	disconnect ITS+; Conditions see certificates VA: axle load to: 970 kg HA: axle load to: 860 kg				
B12 PK	1.3 CDTi, 1.6 Turbo, 1.7 CDTi, 1.9 CDTi, 1.9 CDTi 16V, 2.0 Turbo 03/05 - 59 -177 kW	46-182135	30	30	disconnect ITS+; Conditions see certificates VA: axle load to: 1075 kg HA: axle load to: 860 kg				
B12 SL	1.4, 1.6, 1.8 03/05 - 55 -103 kW	46-182166	45-50	30	disconnect ITS+; Conditions see certificates VA: axle load to: 960 kg HA: axle load to: 860 kg				
B12 SL	1.3 CDTi, 1.6 Turbo, 1.7 CDTi, 2.0 Turbo 03/05 - 59 -177 kW	46-182173	45-50	30	disconnect ITS+; Conditions see certificates VA: axle load to: 1025 kg HA: axle load to: 860 kg				
B14	1.2, 1.3 CDTi, 1.4, 1.6, 1.6 Turbo, 1.7 CDTi, 1.8, 1.9 CDTi, 1.9 CDTi 16V, 2.0 Turbo 08/05 - 48 -177 kW	47-121133	30-50	30-50	disconnect ITS+; Conditions see certificates VA: axle load to: 1060 kg HA: axle load to: 860 kg				
OPEL ASTRA H Estate									
B12 PK	1.4, 1.6, 1.8 08/04 - 55 -103 kW	46-182142	30-35	25-30	disconnect ITS+; Conditions see certificates VA: axle load to: 970 kg HA: without ride height adjustment; axle load to: 940 kg				
B12 PK	1.3 CDTi, 1.6 Turbo, 1.7 CDTi, 1.9 CDTi, 1.9 CDTi 16V, 2.0 Turbo 09/04 - 59 -147 kW	46-182159	30-35	25-30	disconnect ITS+; Conditions see certificates VA: axle load to: 1075 kg HA: without ride height adjustment; axle load to: 940 kg				
B12 SL	1.4, 1.6, 1.8 08/04 - 55 -103 kW	46-182180	40-45	35	disconnect ITS+; Conditions see certificates VA: axle load to: 960 kg HA: without ride height adjustment; axle load to: 940 kg				
B12 SL	1.6 Turbo, 1.7 CDTi, 2.0 Turbo 09/04 - 59 -147 kW	46-182197	40-45	35	disconnect ITS+; Conditions see certificates VA: axle load to: 1025 kg HA: without ride height adjustment; axle load to: 940 kg				
OPEL ASTRA H TwinTop									
B12 PK	1.6, 1.8 09/05 - 77 -103 kW	46-194022	30	30	disconnect ITS+; Conditions see certificates VA: axle load to: 1000 kg HA: axle load to: 955 kg				
B12 PK	1.6 Turbo, 1.9 CDTi, 2.0 Turbo 09/05 - 110 -147 kW	46-194039	30	30	Conditions see certificates VA: axle load to: 1070 kg HA: axle load to: 955 kg				
OPEL ASTRA H Van									
B12 PK	1.3 CDTi, 1.7 CDTi, 1.9 CDTi, 1.9 CDTi 16V 08/04 - 66 -110 kW	46-182159	30-35	25-30	disconnect ITS+; Conditions see certificates VA: axle load to: 1075 kg HA: without ride height adjustment; axle load to: 940 kg				
B12 PK	1.7 CDTi 03/04 - 74 -92 kW	46-182296	25	25	Conditions see certificates VA: axle load to: 1020 kg HA: without ride height adjustment; axle load to: 1010 kg				
OPEL ASTRA J									
B12 PK	1.4 ecoFLEX, 1.4 Turbo, 1.6, 1.6 SIDI 12/09 - 64 -125 kW	46-188755	30	30	without FlexRide; Conditions see certificates; With General Certification (ABE) VA: axle load to: 995 kg HA: axle load to: 1020 kg				
B12 PK	1.3 CDTi ecoFLEX, 1.6, 1.6 SIDI, 1.6 Turbo 12/09 - 70 -132 kW	46-188762	30	30	without FlexRide; Conditions see certificates; With General Certification (ABE) VA: axle load to: 1080 kg HA: axle load to: 1020 kg				
B12 PK	1.7 CDTi, 2.0 BiTurbo CDTi, 2.0 CDTi 12/09 - 74 -143 kW	46-188779	30	30	without FlexRide; Conditions see certificates; With General Certification (ABE) VA: axle load to: 1175 kg HA: axle load to: 1020 kg				



OPEL

OPEL ASTRA J

B14	1.3 CDTI ecoFLEX, 1.4 ecoFLEX, 1.4 LPG, 1.4 Turbo, 1.6, 1.6 SIDI, 1.6 Turbo, 1.7 CDTI, 2.0 BiTurbo CDTI, 2.0 CDTI 12/09 - 64 -143 kW	47-171725	30-50	30-50	without FlexRide; Conditions see certificates VA: axle load to: 1220 kg HA: axle load to: 1020 kg
-----	--	------------------	-------	-------	---

OPEL ASTRA J Saloon

B12 PK	1.4 06/12 - 74 kW	46-188755	30	30	without FlexRide; Conditions see certificates; With General Certification (ABE) VA: axle load to: 995 kg HA: axle load to: 1020 kg
B12 PK	1.3 CDTI, 1.4 Turbo, 1.6 SIDI, 1.6 Turbo 06/12 - 70 -132 kW	46-188755	30	30	without FlexRide; Conditions see certificates; With General Certification (ABE) VA: axle load to: 995 kg HA: axle load to: 1020 kg
B12 PK	1.7 CDTI 06/12 - 81 -96 kW	46-188779	30	30	without FlexRide; Conditions see certificates; With General Certification (ABE) VA: axle load to: 1175 kg HA: axle load to: 1020 kg
B14	1.3 CDTI, 1.4, 1.4 Turbo, 1.6 SIDI, 1.6 Turbo, 1.7 CDTI 06/12 - 70 -132 kW	47-171725	30-50	30-50	without FlexRide; Conditions see certificates VA: axle load to: 1220 kg HA: axle load to: 1020 kg

OPEL ASTRA GTC J

B14	1.4, 1.6, 1.6 SIDI, 1.7 CDTI, 1.8, 2.0, 2.0 BiTurbo CDTI 10/11 - 74 -143 kW	47-231207	20-40	20-40	without electronic suspension control; disconnect ITS+; Conditions see certificates
B14	2.0 04/12 - 206 kW	47-231207	10-25	10-25	without electronic suspension control; disconnect ITS+; Conditions see certificates

OPEL ASTRA Sports Tourer (J)





B14	1.3 CDTI, 1.4, 1.4 LPG, 1.4 Turbo, 1.6, 1.6 LPG, 1.6 SIDI, 1.6 Turbo, 1.7 CDTI, 2.0 BiTurbo CDTI, 2.0 CDTI 10/10 - 70 -143 kW	47-171725	30-50	30-50	without FlexRide; Conditions see certificates VA: axle load to: 1220 kg HA: axle load to: 1020 kg
-----	---	------------------	-------	-------	---





OPEL CALIBRA A (85_)

B12 PK	2.0 i, 2.0 i 16V, 2.0 i 16V 4x4, 2.0 i 4x4 06/90 - 07/97 85 -110 kW	46-192851	30	30	Conditions see certificates VA: axle load to: 885 kg HA: axle load to: 880 kg
B12 PK	2.0 i Turbo 4x4 03/92 - 07/97 150 kW	46-192868	25	25	Conditions see certificates VA: axle load to: 940 kg HA: axle load to: 880 kg

OPEL CORSA A Hatchback (93_, 94_, 98_, 99_)

B10	1.0, 1.2, 1.2 i, 1.2 N, 1.2 S, 1.3, 1.3 GL, 1.3 i, 1.3 S, 1.4 i, 1.4 S, 1.4 Si, 1.5 D, 1.5 TD, 1.6 GL, 1.6 GSI, 1.6 GSI CAT 09/82 - 03/93 33 -74 kW	46-111951	60	40	Conditions see certificates
B12 SL	1.0, 1.2, 1.2 i, 1.2 N, 1.2 S, 1.3, 1.3 GL, 1.3 i, 1.3 S, 1.4 i, 1.4 S, 1.4 Si 09/82 - 03/93 33 -60 kW	46-189004	45-50	30-35	Conditions see certificates VA: axle load to: 790 kg HA: axle load to: 700 kg
B14	1.0, 1.2, 1.2 i, 1.2 N, 1.2 S, 1.3, 1.3 GL, 1.3 i, 1.3 S, 1.4 i, 1.4 S, 1.4 Si, 1.5 D, 1.5 TD, 1.6 GL, 1.6 GSI, 1.6 GSI CAT 09/82 - 03/93 33 -74 kW	47-080713	30-50	20-40	Spacers required for several wheel/tyre combinations; Conditions see certificates VA: axle load to: 820 kg HA: axle load to: 700 kg
B16 PSS9	1.0, 1.2, 1.2 i, 1.2 N, 1.2 S, 1.3, 1.3 GL, 1.3 i, 1.3 S, 1.4 i, 1.4 S, 1.4 Si, 1.5 D, 1.5 TD, 1.6 GL, 1.6 GSI, 1.6 GSI CAT 09/82 - 03/93 33 -74 kW	48-080767	30-50	20-40	Spacers required for several wheel/tyre combinations; Conditions see certificates VA: axle load to: 820 kg HA: axle load to: 700 kg

   					
OPEL					
OPEL CORSA A TR (91_, 92_, 96_, 97_)					
B10	1.0, 1.2 i, 1.2 N, 1.2 S, 1.3, 1.3 GL, 1.3 S, 1.4 i, 1.4 S, 1.5 D, 1.5 TD 09/82 - 03/93 33 -55 kW	46-111951	55	50	Conditions see certificates VA: axle load to: 775 kg HA: axle load to: 670 kg
B12 SL	1.0, 1.2 i, 1.2 N, 1.2 S, 1.3, 1.3 GL, 1.3 S, 1.4 i, 1.4 S 09/82 - 03/93 33 -55 kW	46-189004	45-50	30-35	Conditions see certificates VA: axle load to: 790 kg HA: axle load to: 700 kg
B14	1.0, 1.2 i, 1.2 N, 1.2 S, 1.3, 1.3 GL, 1.3 S, 1.4 i, 1.4 S, 1.5 D, 1.5 TD 09/82 - 03/93 33 -55 kW	47-080713	30-50	20-40	Spacers required for several wheel/tyre combinations; Conditions see certificates VA: axle load to: 820 kg HA: axle load to: 700 kg
B16 PSS9	1.0, 1.2 i, 1.2 N, 1.2 S, 1.3, 1.3 GL, 1.3 S, 1.4 i, 1.4 S, 1.5 D, 1.5 TD 09/82 - 03/93 33 -55 kW	48-080767	30-50	20-40	Spacers required for several wheel/tyre combinations; Conditions see certificates VA: axle load to: 820 kg HA: axle load to: 700 kg
OPEL CORSA B (73_, 78_, 79_)					
B10	1.0 i 12V, 1.2 i, 1.2 i 16V, 1.3, 1.4, 1.4 i, 1.4 i 16V, 1.4 Si, 1.5 D, 1.5 TD, 1.6 GSI 16V, 1.6 i 16V, 1.7 D 02/96 - 12/02 33 -80 kW	46-111951	60	40	Conditions see certificates
B12 PK	1.0 i 12V, 1.2 i, 1.2 i 16V, 1.3, 1.4, 1.4 i, 1.4 i 16V, 1.4 Si, 1.6 GSI 16V, 1.6 i 16V 09/94 - 12/02 33 -80 kW	46-189011	30	30	Conditions see certificates VA: axle load to: 790 kg HA: axle load to: 700 kg
B12 SL	1.0 i 12V, 1.2 i, 1.2 i 16V, 1.3, 1.4, 1.4 i, 1.4 i 16V, 1.4 Si, 1.6 GSI 16V, 1.6 i 16V 09/94 - 12/02 33 -80 kW	46-189004	45-50	25	Conditions see certificates VA: axle load to: 790 kg HA: axle load to: 700 kg
B14	1.0 i 12V, 1.2 i, 1.2 i 16V, 1.3, 1.4, 1.4 i, 1.4 i 16V, 1.4 Si, 1.5 D, 1.5 TD, 1.6 GSI 16V, 1.6 i 16V, 1.7 D 02/96 - 12/02 33 -80 kW	47-080713	30-50	20-40	Spacers required for several wheel/tyre combinations; Conditions see certificates VA: axle load to: 820 kg HA: axle load to: 700 kg
B16 PSS9	1.0 i 12V, 1.2 i, 1.2 i 16V, 1.3, 1.4, 1.4 i, 1.4 i 16V, 1.4 Si, 1.5 D, 1.5 TD, 1.6 GSI 16V, 1.6 i 16V, 1.7 D 02/96 - 12/02 33 -80 kW	48-080767	30-50	20-40	Spacers required for several wheel/tyre combinations; Conditions see certificates VA: axle load to: 820 kg HA: axle load to: 700 kg
OPEL CORSA CLASSIC Saloon					
B10	1.4 08/94 - 07/02 44 kW	46-111951	60	40	Conditions see certificates
B14	1.4 08/94 - 07/02 44 kW	47-080713	30-50	20-40	Spacers required for several wheel/tyre combinations; Conditions see certificates VA: axle load to: 820 kg HA: axle load to: 700 kg
B16 PSS9	1.4 08/94 - 07/02 44 kW	48-080767	30-50	20-40	Spacers required for several wheel/tyre combinations; Conditions see certificates VA: axle load to: 820 kg HA: axle load to: 700 kg
OPEL CORSA C (F08, F68)					
B12 PK	1.0, 1.2, 1.2 Twinport, 1.4, 1.4 Twinport 09/00 - 43 -66 kW	46-189042	30	30	Conditions see certificates; thread: M10 VA: axle load to: 820 kg HA: axle load to: 760 kg
B12 PK	1.0, 1.2, 1.2 Twinport, 1.4, 1.4 Twinport 09/00 - 44 -66 kW	46-189028	30	30	Conditions see certificates; thread: M14 VA: axle load to: 820 kg HA: axle load to: 760 kg
B12 PK	1.3 CDTI, 1.7 CDTI, 1.7 DI, 1.7 DTI, 1.8 09/00 - 48 -92 kW	46-189059	30	30	Conditions see certificates; thread: M10 VA: axle load to: 940 kg HA: drum Brake; axle load to: 760 kg

									
OPEL									
OPEL CORSA C (F08, F68)									
B12 PK	1.3 CDTI, 1.7 CDTI, 1.7 DI, 1.7 DTI, 1.8 09/00 - 48 -92 kW	46-189035	30	30	Conditions see certificates; thread: M14 VA: axle load to: 940 kg HA: disc Brake; axle load to: 760 kg				
B14	1.0, 1.2, 1.2 Twinport, 1.3 CDTI, 1.4, 1.4 Twinport, 1.6, 1.7 CDTI, 1.7 DI, 1.7 DTI, 1.8 09/00 - 43 -92 kW	47-167254	30-50	20-40	Conditions see certificates VA: axle load to: 900 kg HA: axle load to: 760 kg				
OPEL CORSA D									
B12 PK	1.0, 1.2, 1.4, 1.4 ecoFLEX 07/06 - 44 -88 kW	46-188144	30	30	Conditions see certificates VA: axle load to: 885 kg HA: without ride height adjustment; axle load to: 845 kg				
B12 PK	1.2, 1.3 CDTI, 1.4, 1.4 ecoFLEX, 1.6 T, 1.6 Turbo, 1.7 CDTI 07/06 - 55 -132 kW	46-188151	30	30	with standard chassis; Conditions see certificates VA: axle load to: 1000 kg HA: axle load to: 845 kg				
B12 PK	1.6 T, 1.6 Turbo 02/07 - 110 -141 kW	46-188151	15	15	with sports suspension; Conditions see certificates VA: axle load to: 1000 kg HA: axle load to: 845 kg				
B14	1.0, 1.2, 1.2 ecoFLEX, 1.2 LPG, 1.3 CDTI, 1.4, 1.4 ecoFLEX, 1.4 LPG, 1.7 CDTI 07/06 - 44 -96 kW	47-164499	35-45	30-45	VA: Conditions see certificates; axle load to: 1000 kg HA: axle load to: 850 kg				
B14	1.6 T, 1.6 Turbo 02/07 - 110 -141 kW	47-164499	20-30	15-30	VA: Conditions see certificates; axle load to: 1000 kg HA: axle load to: 850 kg				
B14	1.6 Turbo 06/11 - 155 kW	47-164499	0-10	0-10	VA: Conditions see certificates; axle load to: 1000 kg HA: axle load to: 850 kg				
OPEL CORSA D Van									
B12 PK	1.0, 1.2 07/06 - 44 -63 kW	46-188144	30	30	Conditions see certificates VA: axle load to: 885 kg HA: without ride height adjustment; axle load to: 845 kg				
B12 PK	1.3 CDTI 07/06 - 55 -70 kW	46-188151	30	30	Conditions see certificates VA: axle load to: 1000 kg HA: without ride height adjustment; axle load to: 845 kg				
B14	1.0, 1.2, 1.3 CDTI 07/06 - 44 -70 kW	47-164499	35-45	30-45	VA: Conditions see certificates; axle load to: 1000 kg HA: axle load to: 850 kg				
OPEL INSIGNIA									
B12 PK	1.4, 1.6, 1.8 07/08 - 85 -103 kW	46-188786	30	30	without FlexRide; without ride height adjustment; Conditions see certificates VA: axle load to: 1030 kg HA: axle load to: 1160 kg				
B12 PK	1.6 Turbo, 2.0 Biturbo CDTI, 2.0 CDTI, 2.0 E85 Turbo, 2.0 Turbo 07/08 - 81 -162 kW	46-188793	30	30	without FlexRide; without ride height adjustment; Conditions see certificates VA: axle load to: 1175 kg HA: axle load to: 1160 kg				
OPEL INSIGNIA Saloon									
B12 PK	1.6, 1.8 07/08 - 85 -103 kW	46-188786	30	30	without FlexRide; without ride height adjustment; Conditions see certificates VA: axle load to: 1030 kg HA: axle load to: 1160 kg				
B12 PK	1.6 Turbo, 2.0 Biturbo CDTI, 2.0 CDTI, 2.0 Turbo, 2.0 Turbo E85 07/08 - 81 -162 kW	46-188793	30	30	without FlexRide; without ride height adjustment; Conditions see certificates VA: axle load to: 1175 kg HA: axle load to: 1160 kg				
OPEL INSIGNIA Sports Tourer									
B12 PK	1.6, 1.8 07/08 - 85 -103 kW	46-188823	30	30	without FlexRide; without ride height adjustment; Conditions see certificates VA: axle load to: 1030 kg HA: axle load to: 1265 kg				
B12 PK	1.6 Turbo, 2.0 Biturbo CDTI, 2.0 CDTI, 2.0 E85 Turbo, 2.0 Turbo 07/08 - 81 -162 kW	46-188830	30	30	without FlexRide; without ride height adjustment; Conditions see certificates VA: axle load to: 1175 kg HA: axle load to: 1265 kg				

					
--	--	---	---	---	---

OPEL

OPEL INSIGNIA Sports Tourer

B12 PK	2.0 Turbo 4x4 07/08 - 162 -184 kW	46-188847	30	30	without FlexRide; without ride height adjustment; Conditions see certificates VA: axle load to: 1175 kg HA: axle load to: 1355 kg
B12 PK	2.0 Biturbo CDTI 4x4, 2.0 CDTI 4x4, 2.0 Turbo 4x4, 2.8 V6 Turbo 07/08 - 118 -191 kW	46-188854	30	30	without FlexRide; without ride height adjustment; Conditions see certificates VA: axle load to: 1240 kg HA: axle load to: 1355 kg

OPEL MERIVA B

B12 PK	1.3 CDTI, 1.4, 1.4 ecoFlex 06/10 - 55 -103 kW	46-206985	20-25	20-25	twin-tube; Conditions see certificates VA: axle load to: 1060 kg HA: axle load to: 1010 kg
B12 PK	1.7 CDTI 06/10 - 74 -96 kW	46-207005	20-25	20-25	twin-tube; Conditions see certificates VA: axle load to: 1145 kg HA: axle load to: 1010 kg

OPEL OMEGA B (25_, 26_, 27_)

B12 PK	2.0, 2.0 16V, 2.2 16V 03/94 - 07/03 85 -106 kW	46-192806	30	30	without ride height adjustment; Conditions see certificates VA: axle load to: 990 kg HA: axle load to: 1155 kg
B12 PK	2.0 DTI 16V, 2.2 DTI 16V, 2.5 DTI, 2.5 TD, 2.5 V6, 2.6 V6, 3.0 V6, 3.2 V6 04/94 - 07/03 74 -160 kW	46-192813	30	30	without ride height adjustment; Conditions see certificates VA: axle load to: 1080 kg HA: axle load to: 1155 kg

OPEL OMEGA B Estate (21_, 22_, 23_)

B12 PK	2.0, 2.0 16V, 2.2 16V 03/94 - 07/03 85 -106 kW	46-192820	30	30	without ride height adjustment; Conditions see certificates VA: axle load to: 990 kg HA: axle load to: 1290 kg
B12 PK	2.0 DTI 16V, 2.2 DTI 16V, 2.5 DTI, 2.5 TD, 2.5 V6, 2.6 V6, 3.0 V6, 3.2 V6 04/94 - 07/03 74 -160 kW	46-192837	30	30	without ride height adjustment; Conditions see certificates VA: axle load to: 1080 kg HA: axle load to: 1290 kg

OPEL SIGNUM





B12 PK	1.8, 2.2 direct 10/04 - 90 -114 kW	46-190604	30	30	CH.Nr.: 51000001 ->; disconnect ITS+; Conditions see certificates VA: axle load to: 1060 kg HA: without ride height adjustment; axle load to: 1215 kg
B12 PK	1.8, 2.2 direct 05/03 - 09/04 90 -114 kW	46-190574	30	30	-> CH.Nr.: 41999999; disconnect ITS+; Conditions see certificates VA: axle load to: 1060 kg HA: without ride height adjustment; axle load to: 1215 kg
B12 PK	1.9 CDTI, 2.0 DTI, 2.0 Turbo, 2.2 DTI, 2.8, 2.8 V6 Turbo, 3.2 V6 10/04 - 74 -206 kW	46-190611	30	30	CH.Nr.: 51000001 ->; disconnect ITS+; Conditions see certificates VA: axle load to: 1135 kg HA: without ride height adjustment; axle load to: 1215 kg
B12 PK	1.9 CDTI, 2.8, 2.8 V6 Turbo, 3.0 V6 CDTI, 3.2 V6 10/04 - 74 -206 kW	46-190628	30	30	CH.Nr.: 51000001 ->; disconnect ITS+; Conditions see certificates VA: axle load to: 1230 kg HA: axle load to: 1215 kg
B12 PK	1.9 CDTI, 2.0 DTI, 2.0 Turbo, 2.2 DTI, 3.2 V6 05/03 - 09/04 74 -155 kW	46-190581	30	30	-> CH.Nr.: 41999999; disconnect ITS+; Conditions see certificates VA: axle load to: 1135 kg HA: without ride height adjustment; axle load to: 1215 kg
B12 PK	1.9 CDTI, 3.0 V6 CDTI 05/03 - 09/04 88 -130 kW	46-190598	30	30	-> CH.Nr.: 41999999; disconnect ITS+; Conditions see certificates VA: axle load to: 1230 kg HA: without ride height adjustment; axle load to: 1215 kg

OPEL SPEEDSTER

B16 PSS10	2.0, 2.0 Turbo, 2.2 09/00 - 108 -162 kW	48-136723	0-10	0-20	Conditions see certificates VA: axle load to: 485 kg HA: axle load to: 760 kg
--------------	---	------------------	------	------	---

OPEL TIGRA (95_)

B14	1.4 16V, 1.6 16V 07/94 - 12/00 63 -78 kW	47-080713	30-50	20-40	Conditions see certificates VA: axle load to: 820 kg HA: axle load to: 700 kg
B16 PSS9	1.4 16V, 1.6 16V 07/94 - 12/00 63 -78 kW	48-080767	30-50	20-40	Conditions see certificates VA: axle load to: 820 kg HA: axle load to: 700 kg

   					
OPEL					
OPEL TIGRA TwinTop					
B12 PK	1.4, 1.8 06/04 - 66 -92 kW	46-194183	30	30	Conditions see certificates VA: axle load to: 865 kg HA: axle load to: 680 kg; thread: M14
B12 PK	1.4, 1.8 06/04 - 66 -92 kW	46-194190	30	30	Conditions see certificates VA: axle load to: 865 kg HA: axle load to: 680 kg; thread: M10
B14	1.3 CDTI, 1.4, 1.8 06/04 - 51 -92 kW	47-167254	30-50	20-40	Conditions see certificates VA: axle load to: 895 kg HA: axle load to: 680 kg





OPEL VECTRA A Hatchback (88_, 89_)					
B12 PK	1.4 S, 1.6, 1.6 i, 1.6 i CAT, 1.6 S, 1.7 D, 1.7 TD, 1.8 i, 1.8 i CAT, 1.8 S, 2.0, 2.0 i, 2.0 i 16V, 2.0 i 16V CAT, 2.0 i CAT, 2.0 i GT 04/88 - 11/95 42 -110 kW	46-192721	30	30	Conditions see certificates VA: axle load to: 915 kg HA: axle load to: 830 kg
B12 PK	2.5 V6 02/93 - 11/95 125 kW	46-192738	35	35	Conditions see certificates VA: axle load to: 975 kg HA: axle load to: 830 kg

OPEL VECTRA A (86_, 87_)					
B12 PK	1.4 S, 1.6, 1.6 i, 1.7 D, 1.7 TD, 1.8 i CAT, 1.8 S, 2.0, 2.0 i, 2.0 i 16V, 2.0 i CAT 09/88 - 11/95 42 -100 kW	46-192721	30	30	Conditions see certificates VA: axle load to: 915 kg HA: axle load to: 830 kg
B12 PK	2.5 V6 02/93 - 11/95 125 kW	46-192738	35	35	Conditions see certificates VA: axle load to: 975 kg HA: axle load to: 830 kg

OPEL VECTRA B Hatchback (38_)					
B12 PK	1.6 i, 1.6 i 16V, 1.7 TD, 1.8 i 16V, 2.0 i, 2.0 i 16V, 2.2 i 16V, 2.5 i V6 10/95 - 07/03 55 -125 kW	46-192745	35	35	Conditions see certificates VA: axle load to: 975 kg HA: without ride height adjustment; axle load to: 945 kg
B12 PK	1.6 i, 1.6 i 16V 10/95 - 07/03 55 -74 kW	46-192783	30	30	Conditions see certificates VA: axle load to: 870 kg HA: without ride height adjustment; axle load to: 945 kg
B12 PK	2.0 DI 16V, 2.0 DTI 16V, 2.0 i, 2.0 i 16V, 2.2 DTI 16V, 2.5 i V6, 2.6 i V6 10/95 - 07/03 60 -125 kW	46-192752	35	35	Conditions see certificates VA: axle load to: 1055 kg HA: without ride height adjustment; axle load to: 945 kg

OPEL VECTRA B (36_)					
B12 PK	1.6 GL, 1.6 i, 1.6 i 16V, 1.7 TD, 1.8 i 16V, 2.0 i, 2.0 i 16V, 2.2 i 16V, 2.5 i V6 09/95 - 09/00 55 -125 kW	46-192745	35	35	Conditions see certificates VA: axle load to: 975 kg HA: without ride height adjustment; axle load to: 945 kg
B12 PK	1.6 GL, 1.6 i, 1.6 i 16V 09/95 - 04/02 55 -74 kW	46-192783	30	30	Conditions see certificates VA: axle load to: 870 kg HA: without ride height adjustment; axle load to: 945 kg
B12 PK	2.0 DI 16V, 2.0 DTI 16V, 2.0 i, 2.0 i 16V, 2.2 DTI 16V, 2.5 i V6, 2.6 i V6 10/95 - 04/02 60 -125 kW	46-192752	35	35	Conditions see certificates VA: axle load to: 1055 kg HA: without ride height adjustment; axle load to: 945 kg

OPEL VECTRA B Estate (31_)					
B12 PK	1.6 i, 1.6 i 16V 11/96 - 07/02 55 -74 kW	46-192790	30	30	Conditions see certificates VA: axle load to: 870 kg HA: without ride height adjustment; axle load to: 1025 kg
B12 PK	1.6 i, 1.6 i 16V, 1.7 TD, 1.8 i 16V, 2.0 i, 2.0 i 16V, 2.2 i 16V, 2.5 i V6 11/96 - 09/00 55 -125 kW	46-192769	30	30	Conditions see certificates VA: axle load to: 975 kg HA: without ride height adjustment; axle load to: 1025 kg
B12 PK	2.0 DI 16V, 2.0 DTI 16V, 2.0 i, 2.0 i 16V, 2.2 DTI 16V, 2.2 i 16V, 2.5 i V6, 2.6 i V6 11/96 - 07/03 60 -125 kW	46-192776	30	30	Conditions see certificates VA: axle load to: 1055 kg HA: without ride height adjustment; axle load to: 1025 kg

									
OPEL									
OPEL VECTRA C GTS									
B12 PK	1.6, 1.8, 1.8 16V 10/04 - 74 -103 kW	46-194077	30	30	CH.Nr.: 51000001 ->; disconnect ITS+; Conditions see certificates VA: axle load to: 965 kg HA: axle load to: 1035 kg				
B12 PK	1.8 16V 08/02 - 09/04 81 -90 kW	46-190550	30	30	-> CH.Nr.: 41999999; without IDS+ suspension; Conditions see certificates VA: axle load to: 965 kg HA: axle load to: 1035 kg				
B12 PK	1.8 16V, 1.9 CDTI, 2.0 16V Turbo, 2.2 16V, 2.2 direct, 2.2 DTI 16V, 3.2 V6 08/02 - 09/04 81 -155 kW	46-190536	30	30	-> CH.Nr.: 41999999; disconnect ITS+; Conditions see certificates VA: axle load to: 1060 kg HA: axle load to: 1035 kg				
B12 PK	1.8, 1.8 16V, 1.9 CDTI, 2.0 16V Turbo, 2.2 16V, 2.2 direct, 2.2 DTI 16V, 3.2 V6 10/04 - 74 -155 kW	46-194060	30	30	CH.Nr.: 51000001 ->; disconnect ITS+; Conditions see certificates VA: axle load to: 1060 kg HA: axle load to: 1035 kg				
B12 PK	1.9 CDTI, 2.0 16V Turbo, 2.0 DTI 16V, 2.2 DTI 16V, 3.2 V6 10/04 - 74 -155 kW	46-194008	30	30	CH.Nr.: 51000001 ->; disconnect ITS+; Conditions see certificates VA: axle load to: 1135 kg HA: axle load to: 1035 kg				
B12 PK	1.9 CDTI, 2.0 16V Turbo, 2.0 DTI 16V, 2.2 DTI 16V, 3.2 V6 08/02 - 09/04 74 -155 kW	46-190543	30	30	-> CH.Nr.: 41999999; disconnect ITS+; Conditions see certificates VA: axle load to: 1135 kg HA: axle load to: 1035 kg				
B12 PK	3.0 CDTI 06/03 - 09/04 130 kW	46-190567	30	30	-> CH.Nr.: 41999999; without IDS+ suspension; Conditions see certificates VA: axle load to: 1230 kg HA: axle load to: 1035 kg				
B12 PK	3.0 CDTI 10/04 - 130 -135 kW	46-194008	30	30	CH.Nr.: 51000001 ->; without IDS+ suspension; Conditions see certificates VA: axle load to: 1230 kg HA: axle load to: 1035 kg				

OPEL VECTRA C					
B12 PK	1.6 16V, 1.8, 1.8 16V, 1.9 CDTI, 2.0 16V Turbo, 2.0 DTI 16V, 2.2 16V, 2.2 direct, 2.2 DTI 16V, 3.2 V6 08/02 - 09/04 74 -155 kW	46-190536	30	30	-> CH.Nr.: 48999999; disconnect ITS+; Conditions see certificates VA: axle load to: 1060 kg HA: axle load to: 1035 kg
B12 PK	1.6 16V, 1.8, 1.8 16V 04/02 - 09/04 74 -90 kW	46-190550	30	30	-> CH.Nr.: 48999999; disconnect ITS+; Conditions see certificates VA: axle load to: 965 kg HA: axle load to: 1035 kg
B12 PK	1.6, 1.6 16V, 1.8, 1.8 16V 10/04 - 74 -103 kW	46-194077	30	30	CH.Nr.: 51000001 ->; disconnect ITS+; Conditions see certificates VA: axle load to: 965 kg HA: axle load to: 1035 kg
B12 PK	1.8, 1.8 16V, 1.9 CDTI, 2.0 16V Turbo, 2.0 DTI 16V, 2.2 16V, 2.2 direct, 2.2 DTI 16V, 3.2 V6 10/04 - 74 -155 kW	46-194060	30	30	CH.Nr.: 51000001 ->; disconnect ITS+; Conditions see certificates VA: axle load to: 1060 kg HA: axle load to: 1035 kg
B12 PK	1.9 CDTI, 2.0 16V Turbo, 2.0 DTI 16V, 2.2 DTI 16V, 3.2 V6 10/04 - 74 -155 kW	46-194008	30	30	CH.Nr.: 51000001 ->; disconnect ITS+; Conditions see certificates VA: axle load to: 1135 kg HA: axle load to: 1035 kg
B12 PK	1.9 CDTI, 2.0 16V Turbo, 2.0 DTI 16V, 2.2 DTI 16V, 3.2 V6 08/02 - 09/04 74 -155 kW	46-190543	30	30	-> CH.Nr.: 48999999; disconnect ITS+; Conditions see certificates VA: axle load to: 1135 kg HA: axle load to: 1035 kg
B12 PK	3.0 CDTI 06/03 - 09/04 130 kW	46-190567	30	30	-> CH.Nr.: 48999999; disconnect ITS+; Conditions see certificates VA: axle load to: 1230 kg HA: axle load to: 1035 kg
B12 PK	3.0 CDTI 10/04 - 130 -135 kW	46-194084	30	30	CH.Nr.: 51000001 ->; disconnect ITS+; Conditions see certificates VA: axle load to: 1230 kg HA: axle load to: 1035 kg

OPEL VECTRA C Estate					
B12 PK	1.6 16V, 1.8, 1.9 CDTI, 2.0 Turbo, 2.2 direct, 3.2 V6 10/03 - 09/04 74 -155 kW	46-190574	30	30	-> CH.Nr.: 41999999; disconnect ITS+; Conditions see certificates VA: axle load to: 1060 kg HA: axle load to: 1215 kg
B12 PK	1.6, 1.6 16V, 1.8, 1.9 CDTI, 2.0 DTI, 2.0 Turbo, 2.2 direct, 2.2 DTI, 3.2 V6 10/04 - 74 -155 kW	46-190604	30	30	CH.Nr.: 51000001 ->; disconnect ITS+; Conditions see certificates VA: axle load to: 1060 kg HA: axle load to: 1215 kg



OPEL

OPEL VECTRA C Estate

B12 PK	1.9 CDTI, 2.0 DTI, 2.0 Turbo, 2.2 DTI, 3.2 V6 10/04 - 74 -155 kW	46-190611	30	30	CH.Nr.: 51000001 ->; disconnect ITS+; Conditions see certificates VA: axle load to: 1135 kg HA: axle load to: 1215 kg
B12 PK	1.9 CDTI, 2.0 DTI, 2.0 Turbo, 2.2 DTI, 3.2 V6 10/03 - 09/04 74 -155 kW	46-190581	30	30	-> CH.Nr.: 41999999; disconnect ITS+; Conditions see certificates VA: axle load to: 1135 kg HA: axle load to: 1215 kg
B12 PK	3.0 V6 CDTI 10/03 - 09/04 130 kW	46-190598	30	30	-> CH.Nr.: 41999999; disconnect ITS+; Conditions see certificates VA: axle load to: 1230 kg HA: axle load to: 1215 kg
B12 PK	3.0 V6 CDTI 10/04 - 130 -135 kW	46-190628	30	30	CH.Nr.: 51000001 ->; disconnect ITS+; Conditions see certificates VA: axle load to: 1230 kg HA: axle load to: 1215 kg

OPEL ZAFIRA (F75_)

B12 PK	1.6, 1.6 16V, 1.8, 1.8 16V, 2.0 DI 16V, 2.0 DTI 16V, 2.2 16V, 2.2 DTI 16V 01/02 - 06/05 60 -108 kW	46-194220	30	30	Conditions see certificates VA: axle load to: 1075 kg HA: axle load to: 1130 kg
-----------	--	------------------	----	----	---

OPEL ZAFIRA

B12 PK	1.6, 1.8 07/05 - 62 -103 kW	46-194237	30	30-35	without IDS+ suspension; without electronic suspension control; Conditions see certificates VA: axle load to: 1030 kg HA: axle load to: 1230 kg
B12 PK	1.7 CDTI, 1.9 CDTI, 2.0, 2.2 07/05 - 74 -177 kW	46-194244	30	30-35	without IDS+ suspension; without electronic suspension control; Conditions see certificates VA: axle load to: 1155 kg HA: axle load to: 1230 kg

OPEL ZAFIRA Van

B12 PK	1.8 07/05 - 103 kW	46-194237	30	30-35	without IDS+ suspension; without electronic suspension control; Conditions see certificates VA: axle load to: 1030 kg HA: axle load to: 1230 kg
B12 PK	1.7 CDTI 01/08 - 81 kW	46-194244	30	30-35	without IDS+ suspension; without electronic suspension control; Conditions see certificates VA: axle load to: 1155 kg HA: axle load to: 1230 kg

PEUGEOT

PEUGEOT 106 I (1A, 1C)





B12 PK	1.0, 1.4, 1.4 D, 1.5 D 08/91 - 04/96 33 -69 kW	46-192899	30-40	30	Conditions see certificates VA: axle load to: 650 kg HA: axle load to: 640 kg
B12 PK	1.1, 1.3, 1.4, 1.6 08/91 - 04/96 44 -76 kW	46-192882	25-35	30	Conditions see certificates VA: axle load to: 640 kg HA: axle load to: 620 kg
B12 SL	1.0, 1.1, 1.3, 1.4, 1.4 D, 1.5 D, 1.6 08/91 - 04/96 33 -76 kW	46-192875	45-50	30	Conditions see certificates VA: axle load to: 785 kg

PEUGEOT 106 II (1)

B12 PK	1.0 i, 1.1, 1.1 i, 1.4 i, 1.5 D, 1.6 i, 1.6 S16 05/96 - 33 -87 kW	46-192899	20	20	Conditions see certificates VA: axle load to: 640 kg HA: axle load to: 640 kg
B12 SL	1.0 i, 1.1, 1.1 i, 1.4 i, 1.5 D, 1.6 i, 1.6 S16 05/96 - 33 -87 kW	46-192875	45-50	30	Conditions see certificates VA: axle load to: 785 kg HA: axle load to: 640 kg

PEUGEOT 107

B12 PK	1.0, 1.4 HDi 06/05 - 40 -50 kW	46-207043	30-35	25-30	twin-tube; Conditions see certificates VA: axle load to: 695 kg HA: axle load to: 695 kg
-----------	--	------------------	-------	-------	--

									
PEUGEOT									
PEUGEOT 206 Hatchback (2A/C)									
B12 PK	1.1, 1.1 i, 1.4 16V, 1.4 Flex, 1.4 i 08/98 - 40 -65 kW	46-182203	30	30	without ride height adjustment; Conditions see certificates VA: axle load to: 890 kg HA: axle load to: 730 kg				
B12 PK	1.6 16V, 1.6 Flex, 1.6 i 09/98 - 65 -81 kW	46-182210	30	30	without ride height adjustment; Conditions see certificates HA: axle load to: 730 kg				
B12 PK	2.0 RC 07/03 - 130 kW	46-182241	20-25	20-25	without ride height adjustment; Conditions see certificates VA: axle load to: 850 kg HA: axle load to: 730 kg				
B12 PK	1.4 HDi, 1.4 HDi eco 70, 2.0 S16 10/00 - 50 -100 kW	46-182227	25	25	without ride height adjustment; Conditions see certificates HA: axle load to: 780 kg				
B12 PK	1.6 HDi FAP 110, 1.9 D, 2.0 HDI 90 12/99 - 51 -80 kW	46-182234	30	30	without ride height adjustment; Conditions see certificates VA: axle load to: 890 kg HA: axle load to: 730 kg				
B12 SL	1.1, 1.1 i, 1.4 16V, 1.4 Flex, 1.4 HDi, 1.4 HDi eco 70, 1.4 i, 1.6 16V, 1.6 Flex, 1.6 i, 1.9 D, 2.0 HDI 90, 2.0 RC, 2.0 S16 08/98 - 40 -130 kW	46-182258	45-50	30	without ride height adjustment; Conditions see certificates VA: axle load to: 890 kg HA: axle load to: 730 kg				
B14	1.0, 1.1, 1.1 i, 1.4 16V, 1.4 Flex, 1.4 HDi, 1.4 HDi eco 70, 1.4 i, 1.4 LPG, 1.6 16V, 1.6 Flex, 1.6 HDi FAP 110, 1.6 i, 1.9 D, 2.0 HDI 90, 2.0 RC, 2.0 S16 10/00 - 40 -130 kW	47-087569	35-45	0-25	Conditions see certificates VA: axle load to: 890 kg HA: axle load to: 790 kg				
PEUGEOT 206 Saloon									
B12 PK	1.4 03/07 - 55 kW	46-182203	30	30	without ride height adjustment; Conditions see certificates VA: axle load to: 890 kg HA: axle load to: 730 kg				
B12 PK	1.6 16V 03/07 - 80 kW	46-182210	30	30	without ride height adjustment; Conditions see certificates VA: axle load to: 890 kg HA: axle load to: 730 kg				
B14	1.4, 1.6 16V 03/07 - 55 -80 kW	47-087569	35-45	0-25	Conditions see certificates VA: axle load to: 890 kg HA: axle load to: 790 kg				
PEUGEOT 206 SW (2E/K)									
B12 PK	1.1, 1.4, 1.4 16V 07/02 - 44 -65 kW	46-182203	30	30	without ride height adjustment; Conditions see certificates VA: axle load to: 890 kg HA: axle load to: 730 kg				
B12 PK	1.6 16V 07/02 - 80 kW	46-182210	30	30	without ride height adjustment; Conditions see certificates VA: axle load to: 890 kg HA: axle load to: 730 kg				
B12 PK	1.4 HDi, 2.0 16V 07/02 - 50 -100 kW	46-182227	30	30	without ride height adjustment; Conditions see certificates				
B12 PK	1.6 HDi FAP 110, 2.0 HDi 07/02 - 66 -80 kW	46-182234	30	30	without ride height adjustment; Conditions see certificates VA: axle load to: 890 kg HA: axle load to: 730 kg				
B12 SL	1.1, 1.4, 1.4 16V, 1.4 HDi, 1.6 16V, 1.6 HDi FAP 110, 2.0 16V, 2.0 HDi 07/02 - 44 -100 kW	46-182258	30	30	without ride height adjustment; Conditions see certificates VA: axle load to: 890 kg HA: axle load to: 730 kg				
B14	1.1, 1.4, 1.4 16V, 1.4 HDi, 1.6 16V, 1.6 LPG, 2.0 16V, 2.0 HDi 07/02 - 44 -100 kW	47-087569	35-45	0-25	Conditions see certificates VA: axle load to: 890 kg HA: axle load to: 790 kg				
PEUGEOT 206 CC (2D)									
B12 PK	1.6 16V, 2.0 S16 09/00 - 80 -100 kW	46-182227	30	30	Conditions see certificates VA: axle load to: 890 kg HA: axle load to: 780 kg				
B12 SL	1.6 16V, 2.0 S16 09/00 - 80 -100 kW	46-182258	45-50	30	Conditions see certificates VA: axle load to: 890 kg HA: axle load to: 780 kg				



PEUGEOT

PEUGEOT 206 CC (2D)

B14	1.6 16V, 1.6 HDi FAP 110, 2.0 S16 09/00 - 80 -100 kW	47-087569	35-45	0-25	Conditions see certificates VA: axle load to: 890 kg HA: axle load to: 780 kg
-----	--	------------------	-------	------	---

PEUGEOT 206+ (T3E)

B12 PK	1.1, 1.4 HDi eco 70, 1.4 i 01/09 - 44 -55 kW	46-182210	20-25	10-15	without ride height adjustment; Conditions see certificates VA: axle load to: 890 kg HA: axle load to: 730 kg
B14	1.1, 1.4 HDi eco 70, 1.4 i 01/09 - 44 -55 kW	47-087569	35-45	0-25	Conditions see certificates VA: axle load to: 890 kg HA: axle load to: 790 kg

PEUGEOT 207 (WA_, WC_)

B12 PK	1.4, 1.4 16V, 1.4 Bioflex, 1.6 16V, 1.6 16V Turbo, 1.6 Flex 02/06 - 53 -115 kW	46-194275	30	30	outside diameter strut 47 mm; Conditions see certificates VA: axle load to: 1000 kg HA: axle load to: 900 kg
B12 PK	1.4, 1.4 16V, 1.4 Bioflex, 1.6 16V, 1.6 16V Turbo, 1.6 Flex 02/06 - 53 -115 kW	46-194282	30	30	outside diameter strut 51 mm; Conditions see certificates VA: axle load to: 1000 kg HA: axle load to: 900 kg
B12 PK	1.4 HDi, 1.6 HDi 02/06 - 50 -82 kW	46-194299	30	30	outside diameter strut 47 mm; Conditions see certificates VA: axle load to: 1050 kg HA: axle load to: 900 kg
B12 PK	1.4 HDi, 1.6 HDi 02/06 - 50 -82 kW	46-194305	30	30	outside diameter strut 51 mm; Conditions see certificates VA: axle load to: 1050 kg HA: axle load to: 900 kg

PEUGEOT 207 CC (WD_)

B12 PK	1.6 16V, 1.6 16V Turbo, 1.6 HDi 02/07 - 80 -115 kW	46-194305	30	30	outside diameter strut 51 mm; Conditions see certificates VA: axle load to: 1050 kg HA: axle load to: 900 kg
-----------	--	------------------	----	----	--

PEUGEOT 208

B14	1.0, 1.2, 1.4, 1.4 HDi, 1.6, 1.6 HDi 03/12 - 50 -115 kW	47-225176	25-45	25-45	Øa: 47 mm; Conditions see certificates VA: axle load to: 1000 kg HA: axle load to: 900 kg
B14	1.0, 1.2, 1.4, 1.4 HDi, 1.6, 1.6 HDi 03/12 - 50 -115 kW	47-225183	25-45	25-45	Øa: 51 mm; Conditions see certificates VA: axle load to: 1000 kg HA: axle load to: 900 kg
B14	1.6 GTI 08/12 - 147 kW	47-225183	15-35	15-35	Øa: 51 mm; Conditions see certificates VA: axle load to: 1000 kg HA: axle load to: 900 kg

PEUGEOT 306 Hatchback (7A, 7C, N3, N5)





B12 PK	1.1, 1.4, 1.6 05/93 - 05/01 44 -72 kW	46-194312	30	30	Conditions see certificates VA: axle load to: 950 kg HA: axle load to: 820 kg
B12 PK	1.8, 1.8 16V, 1.8 D, 1.9 D, 1.9 DT, 2.0 16V, 2.0 HDi 90, 2.0 S16, 2.0 XSi 05/93 - 05/01 43 -120 kW	46-194329	30	30	Conditions see certificates VA: axle load to: 950 kg HA: axle load to: 820 kg

PEUGEOT 306 (7B, N3, N5)

B12 PK	1.1, 1.4, 1.4 SL, 1.6, 1.6 SR 04/93 - 05/01 44 -72 kW	46-194312	30	30	Conditions see certificates VA: axle load to: 950 kg HA: axle load to: 820 kg
B12 PK	1.8, 1.8 16V, 1.8 D, 1.8 ST, 1.9 D, 1.9 SLD, 1.9 SRDT, 1.9 STD, 2.0, 2.0 HDi 90, 2.0 S16, 2.0 ST 07/94 - 05/01 44 -112 kW	46-194329	30	30	Conditions see certificates VA: axle load to: 950 kg HA: axle load to: 820 kg

PEUGEOT 306 Break (7E, N3, N5)

B12 PK	1.4, 1.6 03/97 - 04/02 55 -72 kW	46-194312	30	30	Conditions see certificates VA: axle load to: 950 kg HA: axle load to: 820 kg
-----------	--	------------------	----	----	---

									
PEUGEOT									
PEUGEOT 306 Break (7E, N3, N5)									
B12 PK	1.8, 1.8 16V, 1.8 XA, 1.9 D, 1.9 TD, 2.0, 2.0 HDi 90 02/97 - 04/02 44 -97 kW	46-194329	30	30	Conditions see certificates VA: axle load to: 950 kg HA: axle load to: 820 kg				
PEUGEOT 306 Convertible (7D, N3, N5)									
B12 PK	1.6, 1.8, 1.8 16V, 2.0, 2.0 16V 03/94 - 04/02 65 -97 kW	46-194329	30	30	Conditions see certificates VA: axle load to: 950 kg HA: axle load to: 820 kg				
PEUGEOT 307 (3A/C)									
B12 PK	1.4, 1.4 16V, 1.6, 1.6 BioFlex, 2.0, 2.0 16V 08/00 - 55 -130 kW	46-190635	30	30	Conditions see certificates VA: axle load to: 1050 kg HA: axle load to: 900 kg				
B12 PK	1.4 HDi, 1.6 HDi, 2.0 HDi 110 FAP, 2.0 HDi 135, 2.0 HDi 90 08/00 - 50 -100 kW	46-190642	30	30	Conditions see certificates VA: axle load to: 1100 kg HA: axle load to: 900 kg				
B12 SL	1.4, 1.4 16V, 1.4 HDi, 1.6, 1.6 BioFlex, 1.6 HDi, 1.6 HDi 110, 2.0, 2.0 16V, 2.0 HDi 110 FAP, 2.0 HDi 135, 2.0 HDi 90 08/00 - 50 -130 kW	46-190659	40-50	30	Conditions see certificates VA: axle load to: 1020 kg HA: axle load to: 900 kg				
B14	1.4, 1.4 16V, 1.4 HDi, 1.6, 1.6 BioFlex, 1.6 HDi, 1.6 HDi 110, 2.0, 2.0 16V, 2.0 HDi 110 FAP, 2.0 HDi 135, 2.0 HDi 90 08/00 - 50 -130 kW	47-100817	45-55	30-50	Conditions see certificates VA: axle load to: 1065 kg HA: axle load to: 1065 kg				
PEUGEOT 307 Break (3E)									
B14	1.4, 1.4 16V, 1.4 HDi, 1.6 16V, 1.6 BioFlex, 1.6 HDi, 1.6 HDi 110 FAP, 2.0, 2.0 16V, 2.0 HDi 110, 2.0 HDi 135 FAP, 2.0 HDi 90 03/02 - 50 -130 kW	47-100817	45-55	30-50	Conditions see certificates VA: axle load to: 1065 kg HA: axle load to: 1065 kg				
PEUGEOT 307 SW (3H)									
B14	1.4, 1.4 16V, 1.6 16V, 1.6 BioFlex, 1.6 D, 1.6 HDi 110, 2.0 16V, 2.0 HDi 110, 2.0 HDi 135, 2.0 HDi 90 03/02 - 55 -103 kW	47-100817	45-55	30-50	Conditions see certificates VA: axle load to: 1065 kg HA: axle load to: 1065 kg				
PEUGEOT 307 CC (3B)									
B14	1.6 16V, 2.0 16V, 2.0 HDi 135 FAP 10/03 - 80 -130 kW	47-100817	45-55	30-50	Conditions see certificates VA: axle load to: 1065 kg HA: axle load to: 1065 kg				
PEUGEOT 308 (4A_, 4C_)									
B14	1.4 16V, 1.6 16V, 1.6 BioFlex, 1.6 GTi, 1.6 HDi, 2.0 HDi 09/07 - 66 -147 kW	47-100817	40-50	35-50	Conditions see certificates VA: axle load to: 1065 kg HA: axle load to: 1065 kg				
PEUGEOT 308 CC									
B14	1.6 16V, 1.6 HDi, 2.0 D 04/09 - 82 -110 kW	47-100817	40-50	35-50	Conditions see certificates VA: axle load to: 1065 kg HA: axle load to: 1065 kg				
PEUGEOT 1007 (KM_)									
B12 PK	1.4, 1.4 16V, 1.4 HDi, 1.6 16V 04/05 - 50 -80 kW	46-207036	30	30	Conditions see certificates VA: axle load to: 920 kg HA: axle load to: 825 kg				
PEUGEOT RCZ									
B14	1.6 16V, 2.0 HDi 03/10 - 115 -147 kW	47-235106	20-40	20-40	Conditions see certificates				



PORSCHE

PORSCHE 911 (964)

B16 PSS10	3.3 Turbo, 3.6 Carrera, 3.6 Carrera 4 01/91 - 09/93 184 -235 kW	48-132633	20-40	20-40	CH.Nr.: 96MS4_01468 ->; CH.Nr.: 96MS4_10519 ->; mark: Coupe; Conditions see certificates VA: axle load to: 780 kg HA: axle load to: 1150 kg
B16 PSS10	3.3 Turbo S, 3.6 Turbo 06/91 - 09/93 261 -265 kW	48-132633	20-40	20-40	Conditions see certificates VA: axle load to: 780 kg HA: axle load to: 1150 kg
B16 PSS10	3.6 Carrera, 3.6 Carrera 4 12/88 - 12/90 184 kW	48-132626	20-40	20-40	-> CH.Nr.: 96MS4_01467; -> CH.Nr.: 96MS4_10518; mark: Coupe; Conditions see certificates VA: axle load to: 780 kg HA: axle load to: 1150 kg
B16 PSS10	3.6 Carrera, 3.6 Carrera 4 12/88 - 12/90 184 kW	48-132626	20-40	20-40	-> CH.Nr.: 96MS4_30299; -> CH.Nr.: 96MS4_40240; mark: Targa; Conditions see certificates VA: axle load to: 780 kg HA: axle load to: 1150 kg
B16 PSS10	3.6 Carrera, 3.6 Carrera 4 01/91 - 09/93 184 kW	48-132633	20-40	20-40	CH.Nr.: 96MS4_30300 ->; CH.Nr.: 96MS4_40241 ->; mark: Targa; Conditions see certificates VA: axle load to: 780 kg HA: axle load to: 1150 kg
B16 PSS10	3.6 Carrera RS 06/91 - 09/93 191 kW	48-137539	20-40	20-40	mark: Walter Röhrl; Conditions see certificates

PORSCHE 911 Convertible (964)

B16 PSS10	3.6 Carrera, 3.6 Carrera 4 05/89 - 12/90 184 kW	48-132626	20-40	20-40	-> CH.Nr.: 96MS4_50777; -> CH.Nr.: 96MS4_60466; mark: Cabrio; Conditions see certificates VA: axle load to: 780 kg HA: axle load to: 1150 kg
B16 PSS10	3.6 Carrera, 3.6 Carrera 4 05/89 - 12/90 184 kW	48-132626	20-40	20-40	-> CH.Nr.: 96MS4_30299; -> CH.Nr.: 96MS4_40240; mark: Targa; Conditions see certificates VA: axle load to: 780 kg HA: axle load to: 1150 kg
B16 PSS10	3.6 Carrera, 3.6 Carrera 4 01/91 - 05/94 184 kW	48-132633	20-40	20-40	CH.Nr.: 96MS4_50778 ->; CH.Nr.: 96MS4_60467 ->; mark: Cabrio; Conditions see certificates VA: axle load to: 780 kg HA: axle load to: 1150 kg
B16 PSS10	3.6 Carrera, 3.6 Carrera 4 01/91 - 05/94 184 kW	48-132633	20-40	20-40	CH.Nr.: 96MS4_30300 ->; CH.Nr.: 96MS4_40241 ->; mark: Targa; Conditions see certificates VA: axle load to: 780 kg HA: axle load to: 1150 kg

PORSCHE 911 (993)

B12 PK	3.6 Carrera, 3.6 Carrera 4, 3.8 Carrera, 3.8 Carrera 4 10/93 - 09/97 200 -210 kW	46-193605	30	30	serie production spring seat must be used; Conditions see certificates VA: axle load to: 760 kg HA: axle load to: 1080 kg
B16 PSS10	3.6 Carrera, 3.6 Carrera 4, 3.6 Turbo 4, 3.6 Turbo GT2, 3.6 Turbo GT2 4, 3.8 Carrera, 3.8 Carrera 4 10/93 - 09/97 200 -331 kW	48-132688	15-35	10-20	Conditions see certificates VA: axle load to: 760 kg HA: axle load to: 1150 kg

PORSCHE 911 Targa (993)

B12 PK	3.6 Carrera, 3.7 Carrera 08/95 - 09/97 210 -221 kW	46-193605	30	30	mark: M 033, ex. M30 Turbo; Conditions see certificates VA: axle load to: 760 kg HA: axle load to: 1080 kg
B16 PSS10	3.6 Carrera, 3.7 Carrera 08/95 - 09/97 210 -221 kW	48-132688	15-35	10-20	Conditions see certificates VA: axle load to: 760 kg HA: axle load to: 1150 kg

PORSCHE 911 Convertible (993)

B12 PK	3.6 Carrera, 3.6 Carrera 4, 3.8 Carrera, 3.8 Carrera 4 07/94 - 09/97 200 -210 kW	46-193605	30	30	mark: M 033, ex. M30 Turbo; Conditions see certificates VA: axle load to: 760 kg HA: axle load to: 1080 kg
-----------	--	------------------	----	----	--

					
--	--	---	---	---	---

PORSCHE

PORSCHE 911 Convertible (993)

B16 PSS10	3.6 Carrera, 3.6 Carrera 4, 3.8 Carrera, 3.8 Carrera 4 07/94 - 09/97 200 -210 kW	48-132688	15-35	10-20	Conditions see certificates VA: axle load to: 760 kg HA: axle load to: 1150 kg
--------------	--	------------------	-------	-------	--

PORSCHE 911 (996)

B16 PSS10	3.4 Carrera, 3.6 Carrera, 3.6 Carrera S, 3.6 S 09/97 - 08/05 221 -331 kW	48-135344	15-35	10-30	Conditions see certificates VA: axle load to: 780 kg HA: axle load to: 1180 kg
B16 PSS10	3.4 Carrera 4, 3.6 Carrera 4, 3.6 Carrera 4S 09/97 - 08/05 221 -254 kW	48-135351	25-35	15-20	Conditions see certificates VA: axle load to: 825 kg HA: axle load to: 1250 kg
B16 PSS10	3.6 Turbo 4, 3.6 Turbo 4S 06/00 - 08/05 309 -331 kW	48-135368	25-35	15-20	Conditions see certificates VA: axle load to: 825 kg HA: axle load to: 1250 kg

PORSCHE 911 Convertible (996)

B16 PSS10	3.4 Carrera, 3.6 Carrera, 3.6 Carrera S, 3.6 S 02/98 - 08/05 221 -331 kW	48-135344	15-35	10-30	Conditions see certificates VA: axle load to: 780 kg HA: axle load to: 1180 kg
B16 PSS10	3.4 Carrera 4, 3.6 Carrera 4, 3.6 Carrera 4S 02/98 - 08/05 221 -254 kW	48-135351	25-35	15-20	Conditions see certificates VA: axle load to: 825 kg HA: axle load to: 1250 kg
B16 PSS10	3.6 Turbo 4, 3.6 Turbo 4S 10/03 - 08/05 309 -331 kW	48-135368	25-35	15-20	Conditions see certificates VA: axle load to: 825 kg HA: axle load to: 1250 kg

PORSCHE 911 Targa (996)

B16 PSS10	3.6 12/01 - 08/05 235 kW	48-135344	25-35	15-20	Conditions see certificates VA: axle load to: 780 kg HA: axle load to: 1180 kg
--------------	------------------------------------	------------------	-------	-------	--

PORSCHE 911 (997)

B14	3.6 Carrera, 3.8 Carrera GTS, 3.8 Carrera S 07/04 - 239 -300 kW	47-114609	15-35	15-35	without PASM; Conditions see certificates VA: axle load to: 775 kg HA: axle load to: 1180 kg
B16 PSS9	3.6 Carrera, 3.8 Carrera GTS, 3.8 Carrera S 07/04 - 239 -300 kW	48-115575	15-35	15-35	without PASM; Conditions see certificates VA: axle load to: 775 kg HA: axle load to: 1180 kg
B16 PSS10	3.6 Carrera 4, 3.8 Carrera 4GTS, 3.8 Carrera 4S, 3.8 Carrera S S4 07/04 - 239 -300 kW	48-135887	25-35	15-35	without electronic suspension control; without PASM; Conditions see certificates
B16 PSS10	3.6 Carrera 4, 3.8 Carrera 4GTS, 3.8 Carrera 4S, 3.8 Carrera S S4 07/04 - 239 -300 kW	48-136013	15-35	15-35	mark: Club Sport; without electronic suspension control; without PASM; Conditions see certificates
B16 PSS10	3.6 Turbo, 3.8 Turbo, 3.8 Turbo S 03/06 - 353 -390 kW	48-136013	15-35	15-35	without electronic suspension control; without PASM; Conditions see certificates
B16 PSS10	3.6 Turbo, 3.8 Turbo, 3.8 Turbo S 03/06 - 353 -390 kW	48-135887	25-35	15-35	mark: Komfort; without electronic suspension control; without PASM; Conditions see certificates
B16 PSS10	3.6 GT 2, 3.6 GT 3, 3.6 GT2 RS, 3.8 GT3, 3.8 GT3 RS, 4.0 GT3 RS 03/06 - 305 -456 kW	48-145459	10-30	10-30	disconnect PASM; with PASM; Conditions see certificates VA: axle load to: 675 kg HA: axle load to: 1105 kg
B16 DTC	3.6 Carrera, 3.8 Carrera GTS, 3.8 Carrera S 07/04 - 239 -300 kW	49-115604	15-35	15-35	with PASM; Conditions see certificates VA: axle load to: 775 kg HA: axle load to: 1180 kg
B16 DTC	3.6 Carrera 4, 3.8 Carrera 4GTS, 3.8 Carrera 4S, 3.8 Carrera S S4 07/04 - 239 -300 kW	49-135817	25-35	15-35	with electronic suspension control; with PASM; Conditions see certificates
B16 DTC	3.6 Carrera 4, 3.8 Carrera 4GTS, 3.8 Carrera 4S, 3.8 Carrera S S4 07/04 - 239 -300 kW	49-135985	15-35	15-35	mark: Club Sport; with electronic suspension control; with PASM; Conditions see certificates



PORSCHE

PORSCHE 911 (997)

B16 DTC	3.6 Turbo, 3.8 Turbo, 3.8 Turbo S 03/06 - 353 -390 kW	49-135985	15-35	15-35	with electronic suspension control; with PASM; Conditions see certificates
B16 DTC	3.6 Turbo, 3.8 Turbo, 3.8 Turbo S 03/06 - 353 -390 kW	49-135817	25-35	15-35	mark: Komfort; with electronic suspension control; with PASM; Conditions see certificates
B16 DTC	3.6 GT 2, 3.6 GT 3, 3.6 GT2 RS, 3.8 GT3, 3.8 GT3 RS, 4.0 GT3 RS 03/06 - 305 -456 kW	49-145489	10-30	10-30	with PASM; Conditions see certificates VA: axle load to: 675 kg HA: axle load to: 1105 kg
B16 BCS	3.6 GT 2, 3.6 GT 3, 3.6 GT2 RS, 3.8 GT3, 3.8 GT3 RS, 4.0 GT3 RS 03/06 - 305 -456 kW	48-218412	10-30	10-30	Conditions see certificates VA: axle load to: 675 kg HA: axle load to: 1105 kg

PORSCHE 911 Convertible (997)

B14	3.6 Carrera, 3.8 Carrera GTS, 3.8 Carrera S 04/05 - 239 -300 kW	47-114609	15-35	15-35	without PASM; Conditions see certificates VA: axle load to: 775 kg HA: axle load to: 1220 kg
B16 PSS9	3.6 Carrera, 3.8 Carrera GTS, 3.8 Carrera S 04/05 - 239 -300 kW	48-115575	15-35	15-35	without PASM; Conditions see certificates VA: axle load to: 775 kg HA: axle load to: 1220 kg
B16 PSS10	3.6 Carrera 4, 3.6 Turbo, 3.8 Carrera 4GTS, 3.8 Carrera 4S, 3.8 Carrera S S4, 3.8 Turbo, 3.8 Turbo S 04/05 - 239 -390 kW	48-135887	25-35	15-35	without electronic suspension control; without PASM; Conditions see certificates
B16 PSS10	3.6 Carrera 4, 3.6 Turbo, 3.8 Carrera 4GTS, 3.8 Carrera 4S, 3.8 Turbo, 3.8 Turbo S 04/05 - 239 -390 kW	48-136013	15-35	15-35	mark: Club Sport; without electronic suspension control; without PASM; Conditions see certificates
B16 PSS10	3.8 Carrera 4S, 3.8 Carrera S S4 04/05 - 261 -280 kW	48-136013	20-30	10-30	mark: Club Sport; without electronic suspension control; without PASM; Conditions see certificates
B16 DTC	3.6 Carrera, 3.8 Carrera GTS, 3.8 Carrera S 04/05 - 239 -300 kW	49-115604	15-35	15-35	with PASM; Conditions see certificates VA: axle load to: 775 kg HA: axle load to: 1220 kg
B16 DTC	3.6 Carrera 4, 3.6 Turbo, 3.8 Carrera 4GTS, 3.8 Carrera 4S, 3.8 Carrera S S4, 3.8 Turbo, 3.8 Turbo S 04/05 - 239 -390 kW	49-135817	25-35	15-35	with electronic suspension control; with PASM
B16 DTC	3.6 Carrera 4, 3.6 Turbo, 3.8 Carrera 4GTS, 3.8 Carrera 4S, 3.8 Carrera S S4, 3.8 Turbo, 3.8 Turbo S 04/05 - 239 -390 kW	49-135985	15-35	15-35	mark: Club Sport; with electronic suspension control; with PASM; Conditions see certificates

PORSCHE 911 Targa (997)

B16 PSS10	3.6 Carrera 4, 3.8 Carrera 4S 07/06 - 239 -283 kW	48-135887	25-35	15-35	without electronic suspension control; without PASM; Conditions see certificates
B16 PSS10	3.6 Carrera 4, 3.8 Carrera 4S 07/06 - 239 -283 kW	48-136013	15-35	15-35	mark: Club Sport; without electronic suspension control; without PASM; Conditions see certificates
B16 DTC	3.6 Carrera 4, 3.8 Carrera 4S 07/06 - 239 -283 kW	49-135985	15-35	15-35	mark: Club Sport; with electronic suspension control; with PASM; Conditions see certificates
B16 DTC	3.6 Carrera 4, 3.8 Carrera 4S 07/06 - 239 -283 kW	49-135817	25-35	15-35	with electronic suspension control; with PASM; Conditions see certificates

PORSCHE 911 (991)

B16 PSS10	3.4 Carrera, 3.4 Carrera 4, 3.8 Carrera 4S, 3.8 Carrera S 12/11 - 257 -316 kW	48-216036	20-40	20-40	without electronic suspension control; without PASM; Conditions see certificates VA: axle load to: 775 kg HA: axle load to: 1180 kg
B16 DTC	3.4 Carrera, 3.4 Carrera 4, 3.8 Carrera 4S, 3.8 Carrera S 12/11 - 257 -316 kW	49-216042	20-40	20-40	with electronic suspension control; with PASM; without active stabilizer; Conditions see certificates VA: axle load to: 775 kg HA: axle load to: 1180 kg

PORSCHE					
PORSCHE 911 (991)					
B16 DTC	3.4 Carrera, 3.4 Carrera 4, 3.8 Carrera 4S, 3.8 Carrera S 12/11 - 257 -316 kW	49-216042 11-223900	20-40	20-40	mark: I031; I352; with electronic suspension control; with PASM; with active stabilizer; Conditions see certificates; Only in connection with 1x 11-223900 VA: axle load to: 775 kg HA: axle load to: 1180 kg
PORSCHE 911 Convertible (991)					
B16 PSS10	3.4 Carrera, 3.8 Carrera S 03/12 - 257 -294 kW	48-216036	20-40	20-40	without electronic suspension control; without PASM; Conditions see certificates VA: axle load to: 775 kg HA: axle load to: 1180 kg
B16 DTC	3.4 Carrera, 3.8 Carrera S 03/12 - 257 -294 kW	49-216042	20-40	20-40	with electronic suspension control; with PASM; Conditions see certificates VA: axle load to: 775 kg HA: axle load to: 1180 kg
B16 DTC	3.4 Carrera, 3.8 Carrera S 03/12 - 257 -294 kW	49-216042 11-223900	20-40	20-40	mark: I031; I352; with electronic suspension control; with PASM; with active stabilizer; Conditions see certificates; Only in connection with 1x 11-223900 VA: axle load to: 775 kg HA: axle load to: 1180 kg
PORSCHE BOXSTER (986)					
B12 PK	2.5, 2.7 09/96 - 12/04 150 -168 kW	46-193803	25	25	Conditions see certificates VA: axle load to: 775 kg HA: axle load to: 940 kg
B16 PSS9	2.5, 2.7, S 3.2, S 3.2 09/96 - 12/04 150 -196 kW	48-088473	15-35	10-30	Spacers required for several wheel/tyre combinations; Conditions see certificates VA: axle load to: 775 kg HA: axle load to: 920 kg
PORSCHE BOXSTER (987)					
B12 PK	2.7, 2.9, S 3.2, S 3.4, Spyder 3.4 11/04 - 176 -235 kW	46-190673	30	30	without PASM; Conditions see certificates VA: axle load to: 785 kg HA: axle load to: 940 kg
B16 PSS9	2.7, 2.9, S 3.2, S 3.4, Spyder 3.4 11/04 - 176 -235 kW	48-121897	25-45	25-45	without PASM; Conditions see certificates VA: axle load to: 775 kg HA: axle load to: 940 kg
B16 DTC	2.7, 2.9, S 3.2, S 3.4, Spyder 3.4 11/04 - 176 -235 kW	49-122046	25-45	25-45	with PASM; Conditions see certificates VA: axle load to: 775 kg HA: axle load to: 940 kg
PORSCHE BOXSTER					
B16 PSS10	2.7, S 3.4 04/12 - 195 -232 kW	48-223867	10-30	10-30	without electronic suspension control; without PASM; Conditions see certificates VA: axle load to: 785 kg HA: axle load to: 930 kg
B16 DTC	2.7, S 3.4 04/12 - 195 -232 kW	49-223873	0-20	10-25	with electronic suspension control; with PASM; Conditions see certificates VA: axle load to: 785 kg HA: axle load to: 930 kg
PORSCHE CAYENNE (955)					
B12 PK	3.2, 3.2 S4, S 4.5 09/02 - 01/07 177 -250 kW	46-187918	35	35	without ride height adjustment; Conditions see certificates; without pneumatic suspension VA: axle load to: 1460 kg HA: axle load to: 1680 kg
PORSCHE CAYMAN					
B12 PK	2.7, 2.9, S 3.4 Sport, S 3.4 11/05 - 180 -235 kW	46-190697	30	30	without PASM; Conditions see certificates VA: axle load to: 785 kg HA: axle load to: 940 kg
B16 PSS9	2.7, 2.9, R 3.4, S 3.4 Sport, S 3.4 11/05 - 180 -243 kW	48-121897	25-45	25-45	without PASM; Conditions see certificates VA: axle load to: 775 kg HA: axle load to: 940 kg
B16 DTC	2.7, 2.9, R 3.4, S 3.4 Sport, S 3.4 11/05 - 180 -243 kW	49-122046	25-45	25-45	with PASM; Conditions see certificates VA: axle load to: 775 kg HA: axle load to: 940 kg



PORSCHE

PORSCHE CAYMAN

B16 PSS10	2.7, S 3.4 03/12 - 202 -239 kW	48-223867	10-30	10-30	without electronic suspension control; without PASM; Conditions see certificates
B16 DTC	2.7, S 3.4 03/12 - 202 -239 kW	49-223873	0-20	10-25	with electronic suspension control; with PASM; Conditions see certificates

RENAULT

RENAULT CLIO II (BB0/1/2_, CB0/1/2_)

B14	2.0 16V Sport 02/00 - 12/02 124 kW	47-087750	25-30	25-30	fixing hole pitches 54 mm; Conditions see certificates VA: axle load to: 860 kg HA: axle load to: 820 kg
------------	--	------------------	-------	-------	--

RENAULT CLIO III (BR0/1, CR0/1)

B14	1.2 16V, 1.2 16V Hi-Flex, 1.2 SL, 1.4 16V, 1.5 D, 1.5 dCi, 1.6 16V, 1.6 Hi-Flex, 2.0 16V 05/05 - 03/09 47 -102 kW	47-128705	40-55	40-55	Conditions see certificates VA: axle load to: 950 kg HA: axle load to: 880 kg
B14	2.0 16V Sport 02/06 - 145 -148 kW		20-40	20-40	mark: 192; Conditions see certificates

RENAULT CLIO IV

B14	0.9 TCe 90, 1.2 16V, 1.2 TCe 120, 1.5 dCi 75, 1.5 dCi 90 03/03 - 54 -88 kW	47-233942	30-50	30-50	Conditions see certificates
------------	--	------------------	-------	-------	-----------------------------

RENAULT MEGANE III Coupe (DZ0/1_)

B12 PK	2.0 R.S. 11/08 - 195 kW	46-237927	25	25	with standard chassis; Conditions see certificates VA: axle load to: 1102 kg HA: axle load to: 855 kg
B14	2.0, 2.0 R.S., 2.0 TCe 11/08 - 132 -195 kW	47-237308	10-30	10-30	Conditions see certificates

RENAULT TWINGO (C06_)

B12 PK	1.2 03/93 - 08/00 40 -44 kW	46-207050	30	30	Conditions see certificates VA: axle load to: 700 kg HA: axle load to: 690 kg
B12 PK	1.2, 1.2 16V 09/00 - 40 -55 kW	i.v.	30	30	Conditions see certificates VA: axle load to: 700 kg HA: axle load to: 690 kg





RENAULT TWINGO (CN0_)

B12 PK	1.2, 1.2 16V, 1.2 TCe 100, 1.2 Turbo 03/07 - 43 -75 kW	46-207074	25	25	For vehicles without stabilizer; automatic transmission; twin-tube; Conditions see certificates VA: axle load to: 870 kg HA: axle load to: 710 kg
B12 PK	1.2, 1.2 16V, 1.2 TCe 100, 1.2 Turbo 03/07 - 43 -75 kW	46-207081	25	25	For vehicles without stabilizer; manual transmission; twin-tube; Conditions see certificates VA: axle load to: 810 kg HA: axle load to: 710 kg
B14	1.2, 1.2 16V, 1.2 TCe 100, 1.2 Turbo, 1.5 dCi, 1.5 dCi 75, 1.5 dCi 90 03/07 - 43 -75 kW	47-172586	15-45	25-45	For vehicles without stabilizer; Conditions see certificates VA: axle load to: 810 kg HA: axle load to: 710 kg

SAAB

SAAB 9-5 (YS3E)

B12 PK	2.0 t, 2.3 t, 2.3 Turbo, 3.0 TiD, 3.0 V6t 09/01 - 110 -184 kW	46-194381	30	30	CH.Nr.: YS3ES55CD2 ->; Conditions see certificates VA: axle load to: 1175 kg HA: axle load to: 1050 kg
------------------	---	------------------	----	----	--





   					
SAAB					
SAAB 9-5 (YS3E)					
B12 PK	2.0, 2.0 t, 2.0 Turbo SE, 2.3 t, 2.3 Turbo, 3.0 TiD, 3.0 V6t 01/98 - 08/01 110 -169 kW	46-194374	30	30	-> CH.Nr.: YS3ES55CD1; Conditions see certificates VA: axle load to: 1175 kg HA: axle load to: 1050 kg
B12 PK	1.9 TiD, 2.0, 2.0 T, 2.0 t BioPower, 2.2 TiD, 2.3, 2.3 t BioPower, 2.3 Turbo 11/05 - 88 -224 kW	46-194381	30	30	Conditions see certificates VA: axle load to: 1175 kg HA: axle load to: 1050 kg

SAAB 9-5 Estate (YS3E)					
B12 PK	2.0 t, 2.3 t, 2.3 Turbo, 3.0 TiD, 3.0 V6t 10/98 - 08/01 110 -169 kW	46-194398	30	30	-> CH.Nr.: YS3ES55CD1; Conditions see certificates VA: axle load to: 1175 kg HA: axle load to: 1125 kg
B12 PK	2.0 t, 2.3, 2.3 t, 2.3 t BioPower, 2.3 Turbo, 3.0 TiD, 3.0 V6t 09/01 - 125 -224 kW	46-194404	30	30	CH.Nr.: YS3ES55CD2 ->; Conditions see certificates VA: axle load to: 1175 kg HA: axle load to: 1125 kg
B12 PK	1.9 TiD, 2.2 TiD, 2.3 Turbo 09/01 - 88 -184 kW	46-194404	30	30	Conditions see certificates VA: axle load to: 1175 kg HA: axle load to: 1125 kg

SEAT					
SEAT ALHAMBRA (7V8, 7V9)					
B12 PK	1.8 T 20V, 2.0 i 04/96 - 03/10 85 -110 kW	46-193858	30	20-25	Conditions see certificates VA: axle load to: 1240 kg HA: axle load to: 1355 kg
B12 PK	1.9 TDI, 2.0 TDI, 2.8 V6 04/96 - 03/10 66 -150 kW	46-193865	30	20-25	Conditions see certificates VA: axle load to: 1260 kg HA: axle load to: 1355 kg

SEAT ALTEA (5P1)					
B12 PK	1.4 TSI, 1.6 03/04 - 75 -92 kW	46-182487	30	30	outside diameter strut 50 mm; Conditions see certificates VA: axle load to: 1022 kg HA: without ride height adjustment; axle load to: 998 kg
B12 PK	1.4 TSI, 1.6, 2.0 FSI 05/04 - 75 -110 kW	46-000187	30	30	outside diameter strut 55 mm; Conditions see certificates VA: axle load to: 1022 kg HA: without ride height adjustment; axle load to: 998 kg
B12 PK	1.8 TFSI, 1.9 TDI, 2.0 FSI, 2.0 TDI, 2.0 TDI 16V, 2.0 TFSI 04/06 - 66 -147 kW	46-182494	30	30	outside diameter strut 50 mm; Conditions see certificates VA: axle load to: 1120 kg HA: without ride height adjustment; axle load to: 998 kg
B12 PK	1.8 TFSI, 1.9 TDI, 2.0 FSI, 2.0 TDI, 2.0 TDI 16V, 2.0 TFSI 04/06 - 66 -147 kW	46-000194	30	30	outside diameter strut 55 mm; Conditions see certificates VA: axle load to: 1120 kg HA: without ride height adjustment; axle load to: 998 kg
B12 PK	2.0 FSI 05/04 - 03/09 110 kW	46-182487	30	30	outside diameter strut 50 mm; Conditions see certificates VA: axle load to: 1022 kg HA: without ride height adjustment; axle load to: 998 kg
B14	1.2 TSI, 1.4 16V, 1.4 TSI, 1.6, 1.6 LPG, 1.6 TDI, 1.8 TFSI, 1.9 TDI, 2.0 FSI, 2.0 TDI, 2.0 TDI 16V, 2.0 TFSI 04/06 - 63 -147 kW	47-128347	30-50	30-50	Spacers required for several wheel/tyre combinations; outside diameter strut 50 mm; Conditions see certificates VA: axle load to: 1210 kg HA: axle load to: 1095 kg
B14	1.2 TSI, 1.4 16V, 1.4 TSI, 1.6, 1.6 LPG, 1.6 TDI, 1.8 TFSI, 1.9 TDI, 2.0 FSI, 2.0 TDI, 2.0 TDI 16V, 2.0 TFSI 04/06 - 63 -147 kW	47-127708	30-50	30-50	Øa: 55 mm; Spacers required for several wheel/tyre combinations; Conditions see certificates VA: axle load to: 1210 kg HA: axle load to: 1095 kg
B16 PSS10	1.2 TSI, 1.4 16V, 1.4 TSI, 1.6, 1.6 LPG, 1.6 TDI, 1.8 TFSI, 1.9 TDI, 2.0 FSI, 2.0 TDI, 2.0 TDI 16V, 2.0 TFSI 04/06 - 63 -147 kW	48-135238	30-50	30-50	outside diameter strut 50 mm; Conditions see certificates VA: mark: G02; axle load to: 1210 kg HA: axle load to: 1095 kg
B16 PSS10	1.2 TSI, 1.4 16V, 1.4 TSI, 1.6, 1.6 LPG, 1.6 TDI, 1.9 TDI, 2.0 FSI, 2.0 TDI, 2.0 TDI 16V, 2.0 TFSI 04/06 - 63 -147 kW	48-135245	30-50	30-50	Øa: 55 mm; Conditions see certificates VA: mark: G07,G08; axle load to: 1210 kg HA: axle load to: 1095 kg





S

					
SEAT					
SEAT ALTEA (5P1)					
B16 RC	1.2 TSI, 1.4 16V, 1.4 TSI, 1.6, 1.6 LPG, 1.6 TDI, 1.8 TFSI, 1.9 TDI, 2.0 FSI, 2.0 TDI, 2.0 TDI 16V, 2.0 TFSI 04/06 - 63 -147 kW	49-196849 14-230615	30-50	30-50	Øa: 55 mm; mark: G07, G08, G09, G11; not for: Freetrack; Conditions see certificates VA: axle load to: 1140 kg HA: axle load to: 1040 kg

SEAT ALTEA XL (5P5, 5P8)					
B12 PK	1.4 TSI, 1.6, 2.0 FSI 10/06 - 75 -110 kW	46-182500	30	30	outside diameter strut 55 mm; Conditions see certificates VA: axle load to: 1022 kg HA: without ride height adjustment; axle load to: 1050 kg
B12 PK	1.8 TFSI, 1.9 TDI, 2.0 FSI, 2.0 TDI, 2.0 TDI 16V 10/06 - 66 -125 kW	46-182517	30	30	outside diameter strut 55 mm; Conditions see certificates VA: axle load to: 1120 kg HA: without ride height adjustment; axle load to: 1050 kg
B14	1.2 TSI, 1.4, 1.4 TSI, 1.6, 1.6 LPG, 1.6 Multifuel, 1.6 TDI, 1.8 TFSI, 1.9 TDI, 2.0 FSI, 2.0 TDI, 2.0 TDI 16V, 2.0 TDI 4WD, 2.0 TFSI 4WD, 2.0 TFSI 4x4 05/09 - 63 -155 kW	47-128347	30-50	30-50	Spacers required for several wheel/tyre combinations; outside diameter strut 50 mm; Conditions see certificates VA: axle load to: 1210 kg HA: axle load to: 1095 kg
B14	1.2 TSI, 1.4, 1.4 TSI, 1.6, 1.6 LPG, 1.6 Multifuel, 1.6 TDI, 1.8 TFSI, 1.9 TDI, 2.0 FSI, 2.0 TDI, 2.0 TDI 16V, 2.0 TDI 4WD, 2.0 TFSI 4WD, 2.0 TFSI 4x4 05/09 - 63 -155 kW	47-127708	30-50	30-50	Øa: 55 mm; Spacers required for several wheel/tyre combinations; Conditions see certificates VA: axle load to: 1210 kg HA: axle load to: 1095 kg
B16 PSS10	1.2 TSI, 1.4, 1.4 TSI, 1.6, 1.6 LPG, 1.6 Multifuel, 1.6 TDI, 1.8 TFSI, 1.9 TDI, 2.0 FSI, 2.0 TDI, 2.0 TDI 16V, 2.0 TDI 4WD, 2.0 TFSI 4WD, 2.0 TFSI 4x4 05/09 - 63 -155 kW	48-135238	30-50	30-50	outside diameter strut 50 mm; Conditions see certificates VA: mark: G02; axle load to: 1210 kg HA: axle load to: 1095 kg
B16 PSS10	1.2 TSI, 1.4, 1.4 TSI, 1.6, 1.6 LPG, 1.6 Multifuel, 1.6 TDI, 1.8 TFSI, 1.9 TDI, 2.0 FSI, 2.0 TDI, 2.0 TDI 16V, 2.0 TDI 4WD, 2.0 TFSI 4WD, 2.0 TFSI 4x4 05/09 - 63 -155 kW	48-135245	30-50	30-50	Øa: 55 mm; Conditions see certificates VA: mark: G07,G08; axle load to: 1210 kg HA: axle load to: 1095 kg

SEAT AROSA (6H)					
B10	1.0, 1.4, 1.4 16V, 1.4 TDI, 1.7 SDI 08/97 - 06/04 37 -74 kW	46-112019	60	40	Conditions see certificates VA: axle load to: 790 kg
B10	1.0, 1.4, 1.4 16V, 1.4 TDI, 1.7 SDI 08/97 - 06/04 37 -74 kW	46-112002	60	40	Conditions see certificates VA: axle load from: 791 kg
B12 PK	1.0, 1.4, 1.4 16V, 1.4 TDI, 1.7 SDI 08/97 - 06/04 37 -74 kW	46-193896	30	20-25	Conditions see certificates VA: axle load to: 810 kg HA: axle load to: 690 kg

SEAT CORDOBA (6K2/C2)					
B10	1.0 CL, 1.0 i, 1.3, 1.4, 1.4 i, 1.4 i 16V, 1.6 i, 1.8 i, 1.8 i 16V, 2.0 i 02/93 - 06/99 33 -95 kW	46-111975	60	40	Conditions see certificates
B14	1.0 CL, 1.0 i, 1.3, 1.4, 1.4 i, 1.4 i 16V, 1.6 i, 1.7 SDI, 1.8 i, 1.8 i 16V, 1.9 D, 1.9 SDI, 1.9 TD, 1.9 TDI, 2.0 i, 2.0 i 16V 02/93 - 06/99 33 -110 kW	47-080720	30-50	30-50	Conditions see certificates VA: axle load to: 850 kg HA: axle load to: 780 kg
B16 PSS9	1.0 CL, 1.0 i, 1.3, 1.4, 1.4 i, 1.4 i 16V, 1.6 i, 1.7 SDI, 1.8 i, 1.8 i 16V, 1.9 D, 1.9 SDI, 1.9 TD, 1.9 TDI, 2.0 i, 2.0 i 16V 02/93 - 06/99 33 -110 kW	48-080736	30-50	30-50	Conditions see certificates VA: axle load to: 870 kg HA: axle load to: 780 kg

					
SEAT					
SEAT CORDOBA Vario (6K5)					
B14	1.4, 1.4 i, 1.6 i, 1.7 SDI, 1.9 SDI, 1.9 TDI 07/97 - 06/99 40 -81 kW	47-080720	30-50	30-50	Conditions see certificates VA: axle load to: 870 kg HA: axle load to: 780 kg
B16 PSS9	1.4, 1.4 i, 1.6 i, 1.7 SDI, 1.9 SDI, 1.9 TDI 07/97 - 06/99 40 -81 kW	48-080736	30-50	30-50	Conditions see certificates VA: axle load to: 870 kg HA: axle load to: 780 kg
SEAT CORDOBA Hatchback (6K2)					
B14	1.0, 1.0 16V, 1.4, 1.4 16V, 1.6, 1.8 T 20V Cupra, 1.9 SDI, 1.9 TDI 06/99 - 10/02 37 -115 kW	47-081888	30-50	30-50	Conditions see certificates VA: axle load to: 900 kg HA: axle load to: 780 kg
B16 PSS9	1.0, 1.0 16V, 1.4, 1.4 16V, 1.6, 1.8 T 20V Cupra, 1.9 SDI, 1.9 TDI 06/99 - 10/02 37 -115 kW	48-081894	30-50	30-50	Conditions see certificates VA: axle load to: 900 kg HA: axle load to: 780 kg
SEAT CORDOBA Vario (6K5)					
B14	1.4, 1.4 16V, 1.6, 1.9 SDI, 1.9 TDI 06/99 - 12/02 44 -81 kW	47-081888	30-50	30-50	Conditions see certificates VA: axle load to: 900 kg HA: axle load to: 780 kg
B16 PSS9	1.4, 1.4 16V, 1.6, 1.9 SDI, 1.9 TDI 06/99 - 12/02 44 -81 kW	48-081894	30-50	30-50	Conditions see certificates VA: axle load to: 900 kg HA: axle load to: 780 kg
SEAT CORDOBA (6L2)					
B14	1.2, 1.2 12V, 1.4 16V, 1.4 TDI, 1.6, 1.6 16V, 1.9 SDI, 1.9 TDI, 2.0 09/02 - 11/09 47 -96 kW	47-146914	30-50	30-45	Conditions see certificates VA: axle load to: 960 kg HA: axle load to: 835 kg
B16 PSS9	1.2, 1.2 12V, 1.4 16V, 1.4 TDI, 1.6, 1.6 16V, 1.9 SDI, 1.9 TDI, 2.0 09/02 - 11/09 47 -96 kW	48-146852	30-50	30-45	Conditions see certificates VA: axle load to: 960 kg HA: axle load to: 835 kg
SEAT EXEO (3R2)					
B12 PK	1.6, 1.8 T, 1.8 TSI, 2.0 TFSI 12/08 - 75 -155 kW	46-182388	30-35	25-30	without ride height adjustment; Conditions see certificates VA: axle load to: 1090 kg HA: axle load to: 1130 kg
B12 PK	2.0 TDI, 2.0 TFSI 12/08 - 88 -155 kW	46-182395	30-35	25-30	without ride height adjustment; Conditions see certificates VA: axle load to: 1165 kg HA: axle load to: 1130 kg
B12 SL	1.6, 1.8 T, 1.8 TSI, 2.0 TFSI 12/08 - 75 -155 kW	46-188601	45	30	without ride height adjustment; Conditions see certificates VA: axle load to: 1090 kg HA: axle load to: 1135 kg
B12 SL	2.0 TDI, 2.0 TFSI 12/08 - 88 -155 kW	46-188618	45	30	without ride height adjustment; Conditions see certificates VA: axle load to: 1140 kg HA: axle load to: 1135 kg
B14	1.6, 1.8 T, 1.8 TSI, 2.0 TDI, 2.0 TFSI 02/09 - 75 -155 kW	47-169289	30-60	20-50	Conditions see certificates VA: axle load to: 1250 kg HA: axle load to: 1170 kg
B16 PSS9	1.6, 1.8 T, 1.8 TSI, 2.0 TDI, 2.0 TFSI 02/09 - 75 -155 kW	48-169301	30-60	20-50	Conditions see certificates VA: axle load to: 1250 kg HA: axle load to: 1170 kg
SEAT EXEO ST (3R5)					
B12 PK	1.6, 1.8 T, 1.8 TSI, 2.0 TFSI 06/09 - 75 -155 kW	46-182388	30	30	without ride height adjustment; Conditions see certificates VA: axle load to: 1090 kg HA: axle load to: 1130 kg
B12 PK	2.0 TDI, 2.0 TFSI 06/09 - 88 -155 kW	46-182395	30	30	without ride height adjustment; Conditions see certificates VA: axle load to: 1165 kg HA: axle load to: 1130 kg
B12 SL	1.6, 1.8 T, 1.8 TSI, 2.0 TFSI 06/09 - 75 -155 kW	46-188601	45	40	without ride height adjustment; Conditions see certificates VA: axle load to: 1090 kg HA: axle load to: 1135 kg



SEAT

SEAT EXEO ST (3R5)

B12 SL	2.0 TDI, 2.0 TFSI 06/09 - 88 -155 kW	46-188618	45	40	without ride height adjustment; Conditions see certificates VA: axle load to: 1140 kg HA: axle load to: 1135 kg
B14	1.6, 1.8 T, 1.8 TSI, 2.0 TDI, 2.0 TFSI 05/09 - 75 -155 kW	47-169289	30-60	20-50	Conditions see certificates VA: axle load to: 1250 kg HA: axle load to: 1170 kg
B16 PSS9	1.6, 1.8 T, 1.8 TSI, 2.0 TDI, 2.0 TFSI 05/09 - 75 -155 kW	48-169301	30-60	20-50	Conditions see certificates VA: axle load to: 1250 kg HA: axle load to: 1170 kg

SEAT IBIZA II (6K1)

B10	1.0, 1.0 i, 1.3 i, 1.4, 1.4 i, 1.4 i 16V, 1.6 i, 1.8 i, 1.8 i 16V, 2.0 i 03/93 - 08/99 33 -95 kW	46-111975	60	40	Conditions see certificates
B14	1.0, 1.0 i, 1.3 i, 1.4, 1.4 i, 1.4 i 16V, 1.6 i, 1.8 i, 1.8 i 16V, 1.9 D, 1.9 SDI, 1.9 TD, 1.9 TDI, 2.0 i, 2.0 i 16V 03/93 - 08/99 33 -110 kW	47-080720	30-50	30-50	Conditions see certificates VA: axle load to: 850 kg HA: axle load to: 780 kg
B16 PSS9	1.0, 1.0 i, 1.3 i, 1.4, 1.4 i, 1.4 i 16V, 1.6 i, 1.8 i, 1.8 i 16V, 1.9 D, 1.9 SDI, 1.9 TD, 1.9 TDI, 2.0 i, 2.0 i 16V 03/93 - 08/99 33 -110 kW	48-080736	30-50	30-50	Conditions see certificates VA: axle load to: 850 kg HA: axle load to: 780 kg

SEAT IBIZA III (6K1)





B12 PK	1.8 T 20V Cupra, 1.9 SDI, 1.9 TDI 08/99 - 02/02 50 -115 kW	46-182470	25	20-25	Conditions see certificates VA: axle load to: 900 kg HA: axle load to: 810 kg
B14	1.0, 1.0 16V, 1.4, 1.4 16V, 1.6, 1.8 T 20V Cupra, 1.9 SDI, 1.9 TDI 08/99 - 02/02 37 -115 kW	47-081888	30-50	30-50	Conditions see certificates VA: axle load to: 900 kg HA: axle load to: 780 kg
B16 PSS9	1.0, 1.0 16V, 1.4, 1.4 16V, 1.6, 1.8 T 20V Cupra, 1.9 SDI, 1.9 TDI 08/99 - 02/02 37 -115 kW	48-081894	30-50	30-50	Conditions see certificates VA: axle load to: 900 kg HA: axle load to: 780 kg

SEAT IBIZA IV (6L1)

B12 PK	1.2, 1.2 12V, 1.4 16V, 1.6, 1.6 16V 11/06 - 11/09 44 -77 kW	46-182449	30	20-25	Conditions see certificates VA: axle load to: 860 kg HA: axle load to: 860 kg
B12 PK	1.4 TDI, 1.8 T FR, 1.9 SDI, 1.9 TDI 02/02 - 11/09 47 -110 kW	46-182456	30	20-25	Conditions see certificates VA: axle load to: 960 kg HA: axle load to: 860 kg
B14	1.2, 1.2 12V, 1.4 16V, 1.4 TDI, 1.6, 1.6 16V, 1.8 T Cupra R, 1.8 T FR, 1.9 SDI, 1.9 TDI, 1.9 TDI Cupra R, 2.0 04/02 - 11/09 44 -132 kW	47-146914	30-50	30-45	Conditions see certificates VA: axle load to: 960 kg HA: axle load to: 835 kg
B16 PSS9	1.2, 1.2 12V, 1.4 16V, 1.4 TDI, 1.6, 1.6 16V, 1.8 T Cupra R, 1.8 T FR, 1.9 SDI, 1.9 TDI, 1.9 TDI Cupra R, 2.0 04/02 - 11/09 44 -132 kW	48-146852	30-50	30-45	Conditions see certificates VA: axle load to: 960 kg HA: axle load to: 835 kg

SEAT IBIZA V (6J5)

B12 PK	1.2, 1.2 TDI, 1.2 TSI, 1.4, 1.4 TDI, 1.4 TSI, 1.6, 1.6 TDI 05/09 - 44 -110 kW	46-182425	25	25	Conditions see certificates VA: axle load to: 860 kg HA: without ride height adjustment; axle load to: 820 kg
B12 PK	1.2 TDI, 1.2 TSI, 1.4 TDI, 1.4 TSI, 1.6, 1.6 TDI, 1.9 TDI, 2.0 10/08 - 55 -110 kW	46-182432	25	25	Conditions see certificates VA: axle load to: 940 kg HA: without ride height adjustment; axle load to: 820 kg

   					
SEAT					
SEAT IBIZA V (6J5)					
B14	1.2, 1.2 TDI, 1.2 TSI, 1.4, 1.4 TDI, 1.4 TSI, 1.6, 1.6 LPG, 1.6 TDI, 1.9 TDI, 2.0, 2.0 TDI 10/08 - 44 -110 kW	47-168091	35-50	30-45	Conditions see certificates VA: axle load to: 950 kg HA: axle load to: 820 kg
B16 PSS9	1.2, 1.2 TDI, 1.2 TSI, 1.4, 1.4 TDI, 1.4 TSI, 1.6, 1.6 LPG, 1.6 TDI, 1.9 TDI, 2.0, 2.0 TDI 10/08 - 44 -110 kW	48-168229	35-50	30-45	Conditions see certificates VA: axle load to: 950 kg HA: axle load to: 820 kg
SEAT IBIZA V SPORTCOUPE (6J1)					
B12 PK	1.2, 1.2 TDI, 1.2 TSI, 1.4, 1.4 TDI, 1.4 TSI, 1.6, 1.6 TDI 05/09 - 44 -132 kW	46-182425	25	25	Conditions see certificates VA: axle load to: 860 kg HA: without ride height adjustment; axle load to: 820 kg
B12 PK	1.2 TDI, 1.2 TSI, 1.4 TDI, 1.4 TSI, 1.6, 1.6 TDI, 1.9 TDI, 2.0 10/08 - 55 -132 kW	46-182432	25	25	Conditions see certificates VA: axle load to: 940 kg HA: without ride height adjustment; axle load to: 820 kg
B14	1.2, 1.2 TDI, 1.2 TSI, 1.4, 1.4 TDI, 1.4 TSI, 1.6, 1.6 LPG, 1.6 TDI, 1.9 TDI, 2.0, 2.0 TDI 10/08 - 44 -132 kW	47-168091	35-50	30-45	Conditions see certificates VA: axle load to: 950 kg HA: axle load to: 820 kg
B16 PSS9	1.2, 1.2 TDI, 1.2 TSI, 1.4, 1.4 TDI, 1.4 TSI, 1.6, 1.6 LPG, 1.6 TDI, 1.9 TDI, 2.0, 2.0 TDI 10/08 - 44 -132 kW	48-168229	35-50	30-45	Conditions see certificates VA: axle load to: 950 kg HA: axle load to: 820 kg
SEAT IBIZA V ST (6J8)					
B12 PK	1.2, 1.2 TDI, 1.2 TSI, 1.4, 1.4 TSI, 1.6, 1.6 TDI 03/10 - 44 -110 kW	46-182425	25	25	Conditions see certificates VA: axle load to: 860 kg HA: without ride height adjustment; axle load to: 820 kg
B12 PK	1.2, 1.2 TDI, 1.2 TSI, 1.4, 1.4 TSI, 1.6, 1.6 TDI 03/10 - 44 -110 kW	46-182432	25	25	Conditions see certificates VA: axle load to: 940 kg HA: without ride height adjustment; axle load to: 820 kg
B14	1.2, 1.2 TDI, 1.2 TSI, 1.4, 1.4 TSI, 1.6, 1.6 TDI 03/10 - 44 -110 kW	47-168091	35-50	30-45	Conditions see certificates VA: axle load to: 950 kg HA: axle load to: 820 kg
B16 PSS9	1.2, 1.2 TDI, 1.2 TSI, 1.4, 1.4 TSI, 1.6, 1.6 TDI 03/10 - 44 -110 kW	48-168229	35-50	30-45	Conditions see certificates VA: axle load to: 950 kg HA: axle load to: 820 kg
SEAT LEON (1M1)					
B10	1.4 16V, 1.6, 1.6 16 V, 1.8 20V, 1.8 20V T, 1.9 SDI, 1.9 TDI, 2.3 VR5, 2.8 11/99 - 06/06 50 -150 kW	46-111890	50	40	Conditions see certificates VA: axle load to: 980 kg
B10	1.4 16V, 1.6, 1.6 16 V, 1.8 20V, 1.8 20V T, 1.9 SDI, 1.9 TDI, 2.3 VR5, 2.8 11/99 - 06/06 50 -150 kW	46-111906	50	40	Conditions see certificates VA: axle load from: 981 kg
B12 PK	1.4 16V, 1.6, 1.6 16 V 11/99 - 06/06 55 -77 kW	46-182319	30	20-25	Conditions see certificates VA: axle load to: 910 kg HA: without ride height adjustment; axle load to: 985 kg
B12 PK	1.8 20V, 1.8 20V T, 1.9 SDI, 1.9 TDI 11/99 - 06/06 50 -132 kW	46-182326	30	20-25	Conditions see certificates VA: axle load to: 982 kg HA: without ride height adjustment; axle load to: 985 kg
B12 PK	1.8 T Cupra R 02/02 - 06/06 154 -165 kW	46-187994	30	20-25	Conditions see certificates VA: axle load to: 982 kg HA: without ride height adjustment; axle load to: 985 kg
B12 PK	1.9 SDI, 1.9 TDI 11/99 - 06/06 50 -110 kW	46-182333	30	20-25	Conditions see certificates VA: axle load to: 1005 kg HA: without ride height adjustment; axle load to: 985 kg







SEAT

SEAT LEON (1M1)

B12 PK	1.9 TDI Syncro, 2.8 Cupra 4 02/01 - 06/06 110 -150 kW	46-182302	20-25	20	Conditions see certificates VA: axle load to: 1050 kg HA: without ride height adjustment; axle load to: 1070 kg
B12 SL	1.4 16V, 1.6, 1.6 16 V 11/99 - 06/06 55 -77 kW	46-180254	45-50	30	Conditions see certificates VA: axle load to: 950 kg HA: without ride height adjustment; axle load to: 1000 kg
B12 SL	1.8 20V, 1.8 20V T, 1.9 SDI, 1.9 TDI 11/99 - 06/06 50 -132 kW	46-180261	45-50	30	Conditions see certificates VA: axle load to: 1000 kg HA: without ride height adjustment; axle load to: 1000 kg
B12 SL	1.8 T Cupra R 02/02 - 06/06 154 -165 kW	46-180278	25-30	10	Conditions see certificates VA: axle load to: 1000 kg HA: without ride height adjustment; axle load to: 1000 kg
B14	1.4 16V, 1.6, 1.6 16 V, 1.8 20V, 1.8 20V T, 1.9 SDI, 1.9 TDI, 2.3 VR5, 2.8 11/99 - 06/06 50 -150 kW	47-124851	25-45	20-40	Spacers required for several wheel/tyre combinations; Conditions see certificates VA: axle load to: 1060 kg HA: axle load to: 1010 kg
B14	1.8 20V T 4, 1.8 Turbo 4x4, 1.9 TDI Syncro, 2.8 Cupra 4 11/99 - 06/06 110 -154 kW	47-080416	30-50	30-50	Conditions see certificates VA: axle load to: 1110 kg HA: axle load to: 1080 kg
B14	1.8 T Cupra R 02/02 - 06/06 154 -165 kW	47-080478	10-30	25-55	Conditions see certificates VA: axle load to: 1040 kg HA: axle load to: 825 kg
B16 PSS9	1.4 16V, 1.6, 1.6 16 V, 1.8 20V, 1.8 20V T, 1.9 SDI, 1.9 TDI, 2.3 VR5, 2.8 11/99 - 06/06 50 -150 kW	48-080651	25-45	20-40	Conditions see certificates VA: axle load to: 1060 kg HA: axle load to: 1010 kg
B16 PSS9	1.8 20V T 4, 1.8 Turbo 4x4, 1.9 TDI Syncro, 2.8 Cupra 4 11/99 - 06/06 110 -154 kW	48-080422	30-50	30-50	Conditions see certificates VA: axle load to: 1110 kg HA: axle load to: 1080 kg
B16 PSS9	1.8 T Cupra R 02/02 - 06/06 154 -165 kW	48-080484	10-30	25-55	Conditions see certificates VA: axle load to: 1040 kg HA: axle load to: 825 kg

SEAT LEON (1P1)

B12 PK	1.2 TSI, 1.4 16V, 1.4 TSI, 1.6, 1.6 MultiFuel, 2.0 FSI 07/05 - 63 -110 kW	46-000217	30	30	outside diameter strut 50 mm; Conditions see certificates VA: axle load to: 1022 kg HA: axle load to: 965 kg
B12 PK	1.4 16V, 1.4 TSI, 1.6, 1.6 MultiFuel, 2.0 FSI 07/05 - 63 -110 kW	46-182364	30	30	outside diameter strut 55 mm; Conditions see certificates VA: axle load to: 1022 kg HA: axle load to: 965 kg
B12 PK	2.0 FSI 07/05 - 05/10 110 kW	46-000200	30	30	Øa: 50 mm; automatic transmission; Conditions see certificates VA: axle load to: 1120 kg HA: axle load to: 965 kg
B12 PK	2.0 FSI 07/05 - 05/10 110 kW	46-182371	30	30	Øa: 55 mm; automatic transmission; Conditions see certificates VA: axle load to: 1120 kg HA: axle load to: 965 kg
B12 PK	1.6 TDI, 1.8 TSI, 1.9 TDI, 2.0 TDI, 2.0 TDI 16V, 2.0 TFSI 11/06 - 66 -177 kW	46-000200	30	30	Øa: 50 mm; Conditions see certificates VA: axle load to: 1120 kg HA: axle load to: 965 kg
B12 PK	1.6 TDI, 1.8 TSI, 1.9 TDI, 2.0 TDI, 2.0 TDI 16V, 2.0 TFSI 11/06 - 66 -177 kW	46-182371	30	30	Øa: 55 mm; Conditions see certificates VA: axle load to: 1120 kg HA: axle load to: 965 kg
B12 SL	1.2 TSI, 1.4 16V, 1.4 TSI, 1.6, 1.6 MultiFuel, 1.6 TDI, 1.8 TSI, 2.0 FSI 07/05 - 63 -118 kW	46-182340	45-50	35	Øa: 50 mm; Conditions see certificates; With General Certification (ABE) VA: axle load to: 1040 kg HA: axle load to: 930 kg
B12 SL	1.4 16V, 1.4 TSI, 1.6, 1.6 MultiFuel, 1.6 TDI, 1.8 TSI, 2.0 FSI 07/05 - 63 -118 kW	46-000224	45-50	35	Øa: 55 mm; Conditions see certificates; With General Certification (ABE) VA: axle load to: 1040 kg HA: axle load to: 930 kg
B12 SL	2.0 FSI 07/05 - 05/10 110 kW	46-182357	45-50	35	Øa: 50 mm; automatic transmission; Conditions see certificates; With General Certification (ABE) VA: axle load to: 1130 kg HA: without ride height adjustment; axle load to: 930 kg

					
SEAT					
SEAT LEON (1P1)					
B12 SL	2.0 FSI 07/05 - 05/10 110 kW	46-000262	45-50	35	Øa: 55 mm; automatic transmission; Conditions see certificates; With General Certification (ABE) VA: axle load to: 1130 kg HA: without ride height adjustment; axle load to: 930 kg
B12 SL	2.0 TFSI 09/09 - 195 kW	46-000262	20	30	Øa: 55 mm; Conditions see certificates; With General Certification (ABE) VA: axle load to: 1130 kg HA: without ride height adjustment; axle load to: 930 kg
B12 SL	1.6 TDI, 1.8 TSI, 1.9 TDI, 2.0 TDI, 2.0 TDI 16V, 2.0 TFSI 11/06 - 66 -177 kW	46-182357	45-50	35	Øa: 50 mm; Conditions see certificates; With General Certification (ABE) VA: axle load to: 1130 kg HA: without ride height adjustment; axle load to: 930 kg
B12 SL	1.6 TDI, 1.8 TSI, 1.9 TDI, 2.0 TDI, 2.0 TDI 16V, 2.0 TFSI 11/06 - 66 -177 kW	46-000262	45-50	35	Øa: 55 mm; Conditions see certificates; With General Certification (ABE) VA: axle load to: 1130 kg HA: without ride height adjustment; axle load to: 930 kg
B14	1.2 TSI, 1.4 16V, 1.4 TSI, 1.6, 1.6 LPG, 1.6 MultiFuel, 1.6 TDI, 1.8 TSI, 1.9 TDI, 2.0 FSI, 2.0 TDI, 2.0 TDI 16V, 2.0 TFSI 11/06 - 63 -177 kW	47-128347	30-40	20-40	outside diameter strut 50 mm; Conditions see certificates VA: axle load to: 1210 kg HA: axle load to: 1095 kg
B14	1.2 TSI, 1.4 16V, 1.4 TSI, 1.6, 1.6 LPG, 1.6 MultiFuel, 1.6 TDI, 1.8 TSI, 1.9 TDI, 2.0 FSI, 2.0 TDI, 2.0 TDI 16V, 2.0 TFSI 11/06 - 63 -177 kW	47-127708	30-40	20-40	Øa: 55 mm; Conditions see certificates VA: axle load to: 1210 kg HA: axle load to: 1095 kg
B14	2.0 TFSI 09/09 - 195 kW	47-127708	20-30	10-30	Øa: 55 mm; Conditions see certificates VA: axle load to: 1210 kg HA: axle load to: 1095 kg
B16 PSS10	1.2 TSI, 1.4 16V, 1.4 TSI, 1.6, 1.6 LPG, 1.6 MultiFuel, 1.6 TDI, 1.8 TSI, 1.9 TDI, 2.0 FSI, 2.0 TDI, 2.0 TDI 16V, 2.0 TFSI 11/06 - 63 -177 kW	48-135238	30-40	20-40	outside diameter strut 50 mm; Conditions see certificates VA: axle load to: 1210 kg HA: axle load to: 1095 kg
B16 PSS10	1.2 TSI, 1.4 16V, 1.4 TSI, 1.6, 1.6 LPG, 1.6 MultiFuel, 1.6 TDI, 1.8 TSI, 1.9 TDI, 2.0 FSI, 2.0 TDI, 2.0 TDI 16V, 2.0 TFSI 11/06 - 63 -177 kW	48-135245	30-40	20-40	Øa: 55 mm; Conditions see certificates VA: axle load to: 1210 kg HA: axle load to: 1095 kg
B16 PSS10	2.0 TFSI 09/09 - 195 kW	48-135245	20-30	10-30	Øa: 55 mm; Conditions see certificates VA: axle load to: 1210 kg HA: axle load to: 1095 kg
B16 RC	1.2 TSI, 1.4 16V, 1.4 TSI, 1.6, 1.6 LPG, 1.6 MultiFuel, 1.6 TDI, 1.8 TSI, 1.9 TDI, 2.0 FSI, 2.0 TDI, 2.0 TDI 16V, 2.0 TFSI 09/09 - 63 -195 kW	49-196849 14-230615	20-30	10-30	Øa: 55 mm; mark: G07, G08, G09, G11; without electronic suspension control; Conditions see certificates VA: axle load to: 1140 kg HA: axle load to: 1040 kg
B16 BCS	2.0 TDI, 2.0 TFSI 05/05 - 125 -195 kW	48-215909	10-20	10-30	Øa: 55 mm; Conditions see certificates VA: axle load to: 1210 kg HA: axle load to: 1095 kg
SEAT LEON (5F_)					
B14	1.2 TSI, 1.4 TSI, 1.6 TDI, 1.8 TFSI, 2.0 TDI 09/12 - 63 -135 kW	47-229945	30-50	30-50	Øa: 50 mm; mark: G01, G02, 0N1; Conditions see certificates; rigid axle
B14	1.2 TSI, 1.4 TSI, 1.6 TDI, 1.8 TFSI, 2.0 TDI 09/12 - 63 -135 kW	47-229969	30-50	30-50	Øa: 50 mm; mark: G01, G02, 0N4; Conditions see certificates; multilink axle
B14	1.2 TSI, 1.4 TSI, 1.6 TDI, 1.8 TFSI, 2.0 TDI 09/12 - 63 -135 kW	47-229976	30-50	30-50	Øa: 55 mm; mark: G03, G04, G05; mark: G06, G07, 0N4; Conditions see certificates; multilink axle
B16 PSS10	1.2 TSI, 1.4 TSI, 1.6 TDI, 1.8 TFSI, 2.0 TDI 09/12 - 63 -135 kW	48-230056	30-50	30-50	Øa: 50 mm; mark: G01, G02, 0N4; Conditions see certificates; multilink axle
B16 PSS10	1.2 TSI, 1.4 TSI, 1.6 TDI, 1.8 TFSI, 2.0 TDI 09/12 - 63 -135 kW	48-230063	30-50	30-50	Øa: 55 mm; mark: G03, G04, G05; mark: G06, G07, 0N4; Conditions see certificates; multilink axle



SEAT

SEAT LEON (5F_)





B16 RC	1.2 TSI, 1.4 TSI, 1.6 TDI, 1.8 TFSI, 2.0 TDI 09/12 - 63 -135 kW	49-231892	30-50	30-50	Øa: 55 mm; mark: G03, G04, G05; mark: G06, G07, 0N4; disconnect DCC; Conditions see certificates; multilink axle
-----------	---	-----------	-------	-------	--

SEAT TOLEDO II (1M2)

B10	1.4 16V, 1.6, 1.6 16V, 1.8 20V, 1.8 20VT, 1.9 SDI, 1.9 TDi, 2.3 V5, 2.3 V5 20V 04/99 - 05/06 50 -132 kW	46-111890	50	40	Conditions see certificates VA: axle load to: 980 kg
B10	1.4 16V, 1.6, 1.6 16V, 1.8 20V, 1.8 20VT, 1.9 SDI, 1.9 TDi, 2.3 V5, 2.3 V5 20V 04/99 - 05/06 50 -132 kW	46-111906	50	40	Conditions see certificates VA: axle load from: 981 kg
B12 PK	1.4 16V, 1.6, 1.6 16V 04/99 - 05/06 55 -77 kW	46-188007	30	20-25	Conditions see certificates VA: axle load to: 910 kg HA: without ride height adjustment; axle load to: 1000 kg
B12 PK	1.8 20V, 1.8 20VT, 1.9 SDI, 1.9 TDi 04/99 - 05/06 50 -132 kW	46-188014	30	20-25	Conditions see certificates VA: axle load to: 982 kg HA: without ride height adjustment; axle load to: 1000 kg
B12 PK	1.9 TDi, 2.3 V5, 2.3 V5 20V 05/01 - 05/06 66 -125 kW	46-188021	30	20-25	Conditions see certificates VA: axle load to: 1005 kg HA: without ride height adjustment; axle load to: 1000 kg
B12 SL	1.4 16V, 1.6, 1.6 16V, 1.8 20V, 1.8 20VT, 1.9 SDI, 1.9 TDi 04/99 - 05/06 50 -132 kW	46-180285	45-50	30	Conditions see certificates VA: axle load to: 950 kg HA: without ride height adjustment; axle load to: 1000 kg
B12 SL	1.9 SDI, 1.9 TDi, 2.3 V5, 2.3 V5 20V 04/99 - 05/06 50 -125 kW	46-180292	45-50	30	Conditions see certificates VA: axle load to: 1000 kg HA: without ride height adjustment; axle load to: 1000 kg
B14	1.4 16V, 1.6, 1.6 16V, 1.8 20V, 1.8 20VT, 1.9 SDI, 1.9 TDi, 2.3 V5, 2.3 V5 20V 04/99 - 05/06 50 -132 kW	47-124851	20-45	20-40	Spacers required for several wheel/tyre combinations; Conditions see certificates VA: axle load to: 1060 kg HA: axle load to: 1010 kg
B16 PSS9	1.4 16V, 1.6, 1.6 16V, 1.8 20V, 1.8 20VT, 1.9 SDI, 1.9 TDi, 2.3 V5, 2.3 V5 20V 04/99 - 05/06 50 -132 kW	48-080651	25-45	20-40	Spacers required for several wheel/tyre combinations; Conditions see certificates VA: axle load to: 1060 kg HA: axle load to: 1010 kg

SEAT TOLEDO III (5P2)

B12 PK	1.6, 2.0 FSI 10/04 - 05/09 75 -110 kW	46-194749	30	30	outside diameter strut 50 mm; Conditions see certificates VA: axle load to: 1022 kg HA: axle load to: 1050 kg
B12 PK	1.6, 2.0 FSI 10/04 - 05/09 75 -110 kW	46-194756	30	30	outside diameter strut 55 mm; Conditions see certificates VA: axle load to: 1022 kg HA: axle load to: 1050 kg
B12 PK	1.8 TFSI, 1.9 TDi, 2.0 TDi, 2.0 TFSI 11/05 - 05/09 77 -147 kW	46-194763	30	30	outside diameter strut 50 mm; Conditions see certificates VA: axle load to: 1120 kg HA: axle load to: 1050 kg
B12 PK	1.8 TFSI, 1.9 TDi, 2.0 TDi, 2.0 TFSI 11/05 - 05/09 77 -147 kW	46-194770	30	30	outside diameter strut 55 mm; Conditions see certificates VA: axle load to: 1120 kg HA: axle load to: 1050 kg
B12 PK	2.0 FSI 10/04 - 05/09 110 kW	46-194763	30	30	automatic transmission; outside diameter strut 50 mm; Conditions see certificates VA: axle load to: 1120 kg HA: axle load to: 1050 kg
B12 PK	2.0 FSI 10/04 - 05/09 110 kW	46-194770	30	30	automatic transmission; outside diameter strut 55 mm; Conditions see certificates VA: axle load to: 1120 kg HA: axle load to: 1050 kg
B14	1.6, 1.8 TFSI, 1.9 TDi, 2.0 FSI, 2.0 TDi, 2.0 TFSI 04/04 - 05/09 75 -147 kW	47-128347	30-50	30-50	outside diameter strut 50 mm; Conditions see certificates VA: axle load to: 1210 kg HA: axle load to: 1095 kg
B14	1.6, 1.8 TFSI, 1.9 TDi, 2.0 FSI, 2.0 TDi, 2.0 TFSI 04/04 - 05/09 75 -147 kW	47-127708	30-50	30-50	Øa: 55 mm; Conditions see certificates VA: axle load to: 1210 kg HA: axle load to: 1095 kg
B16 PSS10	1.6, 1.8 TFSI, 1.9 TDi, 2.0 FSI, 2.0 TDi, 2.0 TFSI 04/04 - 05/09 75 -147 kW	48-135238	30-50	30-50	outside diameter strut 50 mm; Conditions see certificates VA: axle load to: 1210 kg HA: axle load to: 1095 kg

					
SEAT					
SEAT TOLEDO III (5P2)					
B16 PSS10	1.6, 1.8 TFSI, 1.9 TDI, 2.0 FSI, 2.0 TDI, 2.0 TFSI 04/04 - 05/09 75 -147 kW	48-135245	30-50	30-50	Øa: 55 mm; Conditions see certificates VA: axle load to: 1210 kg HA: axle load to: 1095 kg
B16 RC	1.6, 1.8 TFSI, 1.9 TDI, 2.0 FSI, 2.0 TDI, 2.0 TFSI 04/04 - 05/09 75 -147 kW	49-196849 14-230615	30-50	30-50	Øa: 55 mm; mark: G07, G08, G09, G11; Conditions see certificates VA: axle load to: 1140 kg HA: axle load to: 1040 kg

SKODA					
SKODA FABIA (6Y2)					
B12 PK	1.0, 1.2, 1.4, 1.4 16V 08/99 - 03/08 37 -74 kW	46-182623	30	30	Conditions see certificates VA: axle load to: 920 kg HA: without ride height adjustment; axle load to: 840 kg
B12 PK	1.4 TDI, 1.9 SDI, 1.9 TDI, 2.0 12/99 - 03/08 47 -85 kW	46-182630	30	30	Conditions see certificates VA: axle load to: 960 kg HA: without ride height adjustment; axle load to: 840 kg
B12 PK	1.9 TDI RS 06/03 - 03/08 96 kW	46-182647	25	25	Conditions see certificates VA: axle load to: 960 kg HA: without ride height adjustment; axle load to: 840 kg
B14	1.0, 1.2, 1.4, 1.4 16V, 1.4 TDI, 1.9 SDI, 1.9 TDI, 1.9 TDI RS, 2.0 08/99 - 03/08 37 -96 kW	47-146914	30-50	30-45	Conditions see certificates VA: axle load to: 960 kg HA: axle load to: 835 kg
B16 PSS9	1.0, 1.2, 1.4, 1.4 16V, 1.4 TDI, 1.9 SDI, 1.9 TDI, 1.9 TDI RS, 2.0 08/99 - 03/08 37 -96 kW	48-146852	30-50	30-45	Conditions see certificates VA: axle load to: 960 kg HA: axle load to: 835 kg

SKODA FABIA Saloon (6Y3)					
B12 PK	1.2, 1.4, 1.4 16V 12/99 - 12/07 40 -74 kW	46-182609	30	30	Conditions see certificates VA: axle load to: 900 kg HA: without ride height adjustment; axle load to: 875 kg
B12 PK	1.4 TDI, 1.9 SDI, 1.9 TDI, 2.0 12/99 - 12/07 47 -85 kW	46-182616	30	30	Conditions see certificates VA: axle load to: 900 kg HA: without ride height adjustment; axle load to: 875 kg
B14	1.0, 1.2, 1.4, 1.4 16V, 1.4 TDI, 1.9 SDI, 1.9 TDI, 2.0 12/99 - 12/07 37 -85 kW	47-146914	30-50	30-45	Conditions see certificates VA: axle load to: 960 kg HA: axle load to: 835 kg
B16 PSS9	1.0, 1.2, 1.4, 1.4 16V, 1.4 TDI, 1.9 SDI, 1.9 TDI, 2.0 12/99 - 12/07 37 -85 kW	48-146852	30-50	30-45	Conditions see certificates VA: axle load to: 960 kg HA: axle load to: 835 kg

SKODA FABIA Combi (6Y5)					
B12 PK	1.2, 1.4, 1.4 16V 04/00 - 12/07 40 -74 kW	46-182609	30	30	Conditions see certificates VA: axle load to: 900 kg HA: without ride height adjustment; axle load to: 875 kg
B12 PK	1.4 TDI, 1.9 SDI, 1.9 TDI, 2.0 04/00 - 12/07 47 -85 kW	46-182616	30	30	Conditions see certificates VA: axle load to: 900 kg HA: without ride height adjustment; axle load to: 875 kg
B14	1.0, 1.2, 1.4, 1.4 16V, 1.4 TDI, 1.9 SDI, 1.9 TDI, 2.0 04/00 - 12/07 37 -85 kW	47-146914	30-50	30-45	Conditions see certificates VA: axle load to: 960 kg HA: axle load to: 835 kg
B16 PSS9	1.0, 1.2, 1.4, 1.4 16V, 1.4 TDI, 1.9 SDI, 1.9 TDI, 2.0 04/00 - 12/07 37 -85 kW	48-146852	30-50	30-45	Conditions see certificates VA: axle load to: 960 kg HA: axle load to: 835 kg

SKODA FABIA					
B12 PK	1.2, 1.2 16V, 1.2 TSI, 1.4, 1.4 TDI, 1.6, 1.6 TDI 12/06 - 44 -77 kW	46-182678	30	30	Conditions see certificates VA: axle load to: 920 kg HA: axle load to: 840 kg



SKODA

SKODA FABIA

B12 PK	1.4 TDI, 1.6 TDI, 1.9 TDI 01/07 - 51 -77 kW	46-182692	30	30	Conditions see certificates VA: axle load to: 960 kg HA: axle load to: 840 kg
-----------	---	------------------	----	----	---

SKODA FABIA Combi

B12 PK	1.2, 1.2 16V, 1.2 TSI, 1.4, 1.6 10/07 - 44 -77 kW	46-182708	30	20	Conditions see certificates VA: axle load to: 920 kg HA: axle load to: 840 kg
B12 PK	1.2 TDI, 1.4 TDI, 1.6, 1.6 TDI, 1.9 TDI 10/07 - 51 -77 kW	46-182715	30	20	Conditions see certificates VA: axle load to: 960 kg HA: axle load to: 840 kg

SKODA OCTAVIA (1U2)





B10	1.4, 1.4 16V, 1.6, 1.8, 1.8 T, 1.9 SDI, 1.9 TDI, 2.0 08/97 - 05/07 44 -110 kW	46-111890	50	40	Conditions see certificates VA: axle load to: 980 kg
B10	1.4, 1.4 16V, 1.6, 1.8, 1.8 T, 1.9 SDI, 1.9 TDI, 2.0 08/97 - 05/07 44 -110 kW	46-111906	50	40	Conditions see certificates VA: axle load from: 981 kg
B12 PK	1.4, 1.4 16V, 1.6, 1.9 SDI 06/97 - 12/03 44 -75 kW	46-182524	30	30	Conditions see certificates VA: axle load to: 1000 kg HA: without ride height adjustment; axle load to: 1000 kg
B12 PK	1.8, 1.8 T, 1.9 TDI 09/96 - 09/04 66 -110 kW	46-182531	30	30	Conditions see certificates VA: axle load to: 1000 kg HA: without ride height adjustment; axle load to: 1000 kg
B12 PK	2.0 04/99 - 05/07 85 kW	46-182531	30	30	automatic transmission; Conditions see certificates VA: axle load to: 1000 kg HA: without ride height adjustment; axle load to: 1000 kg
B12 PK	2.0 04/99 - 05/07 85 kW	46-182524	30	30	manual transmission; Conditions see certificates VA: axle load to: 1000 kg HA: without ride height adjustment; axle load to: 1000 kg
B12 SL	1.4, 1.4 16V, 1.6, 1.8, 1.8 T, 1.9 SDI, 1.9 TDI, 2.0 08/97 - 05/07 44 -110 kW	46-180230	45-50	30	Conditions see certificates VA: axle load to: 950 kg HA: axle load to: 1000 kg
B12 SL	1.4, 1.4 16V, 1.6, 1.8, 1.8 T, 1.9 SDI, 1.9 TDI, 2.0 08/97 - 05/07 44 -110 kW	46-180247	45-50	30	Conditions see certificates VA: axle load to: 1000 kg HA: axle load to: 1000 kg

SKODA OCTAVIA Combi (1U5)

B10	1.4 16V, 1.6, 1.8 20V, 1.8 T, 1.9 SDI, 1.9 TDI, 2.0 04/99 - 12/10 50 -110 kW	46-111944	50	40	Conditions see certificates VA: axle load to: 980 kg HA: axle load to: 1020 kg
B10	1.4 16V, 1.6, 1.8 20V, 1.8 T, 1.9 SDI, 1.9 TDI, 2.0 04/99 - 12/10 50 -110 kW	46-111937	50	40	Conditions see certificates VA: axle load to: 1020 kg; axle load from: 981 kg
B12 PK	1.4 16V, 1.6, 1.9 SDI 07/98 - 12/10 50 -75 kW	46-182548	30	30	Conditions see certificates VA: axle load to: 1020 kg HA: without ride height adjustment; axle load to: 1020 kg
B12 PK	1.8 20V, 1.8 T, 1.9 TDI 07/98 - 09/04 66 -110 kW	46-182555	30	30	Conditions see certificates VA: axle load to: 1020 kg HA: without ride height adjustment; axle load to: 1020 kg
B12 PK	2.0, 2.0 4x4 04/99 - 12/10 85 -88 kW	46-182548	30	30	manual transmission; Conditions see certificates VA: axle load to: 1000 kg HA: without ride height adjustment; axle load to: 1020 kg
B12 PK	2.0, 2.0 4x4 04/99 - 12/10 85 -88 kW	46-182555	30	30	automatic transmission; Conditions see certificates VA: axle load to: 1000 kg HA: without ride height adjustment; axle load to: 1020 kg

SKODA OCTAVIA (1Z3)

B12 PK	1.2 TSI, 1.4, 1.4 TSI, 1.6, 1.6 FSI 02/04 - 55 -90 kW	46-182562	30	30	outside diameter strut 50 mm; Conditions see certificates; With General Certification (ABE) VA: axle load to: 1050 kg HA: axle load to: 1100 kg
-----------	---	------------------	----	----	---

   					
SKODA					
SKODA OCTAVIA (1Z3)					
B12 PK	1.2 TSI, 1.4, 1.4 TSI, 1.6, 1.6 FSI 02/04 - 55 -90 kW	46-000279	30	30	outside diameter strut 55 mm; Conditions see certificates; With General Certification (ABE) VA: axle load to: 1050 kg HA: axle load to: 1100 kg
B12 PK	1.2 TSI, 1.6 TDI, 1.8 TSI, 1.9 TDI, 2.0 FSI, 2.0 RS, 2.0 TDI, 2.0 TDI 16V 02/04 - 77 -147 kW	46-182579	30	30	outside diameter strut 50 mm; Conditions see certificates; With General Certification (ABE) VA: axle load to: 1100 kg HA: axle load to: 1100 kg
B12 PK	1.2 TSI, 1.6 TDI, 1.8 TSI, 1.9 TDI, 2.0 FSI, 2.0 RS, 2.0 TDI, 2.0 TDI 16V 02/04 - 77 -147 kW	46-000286	30	30	outside diameter strut 55 mm; Conditions see certificates; With General Certification (ABE) VA: axle load to: 1100 kg HA: axle load to: 1100 kg
B14	1.2 TSI, 1.4, 1.4 TSI, 1.6, 1.6 FSI, 1.6 GreenLine, 1.6 LPG, 1.6 TDI, 1.8 TSI, 1.9 TDI, 2.0 FSI, 2.0 TDI, 2.0 TDI 16V 02/04 - 55 -125 kW	47-128347	30-50	30-50	outside diameter strut 50 mm; Conditions see certificates VA: axle load to: 1210 kg HA: axle load to: 1250 kg
B14	1.2 TSI, 1.4, 1.4 TSI, 1.6, 1.6 FSI, 1.6 GreenLine, 1.6 LPG, 1.6 TDI, 1.8 TSI, 1.9 TDI, 2.0 FSI, 2.0 TDI, 2.0 TDI 16V 02/04 - 55 -125 kW	47-127708	30-50	30-50	Øa: 55 mm; Conditions see certificates VA: axle load to: 1210 kg HA: axle load to: 1250 kg
B14	2.0 RS 10/05 - 147 kW	47-127708	20-30	10-30	Øa: 55 mm; Conditions see certificates VA: axle load to: 1200 kg HA: axle load to: 1240 kg
B16 PSS10	1.2 TSI, 1.4, 1.4 TSI, 1.6, 1.6 FSI, 1.6 GreenLine, 1.6 LPG, 1.6 TDI, 1.8 TSI, 1.9 TDI, 2.0 FSI, 2.0 TDI, 2.0 TDI 16V 02/04 - 55 -125 kW	48-135238	30-50	30-50	outside diameter strut 50 mm; Conditions see certificates VA: axle load to: 1210 kg HA: axle load to: 1250 kg
B16 PSS10	1.2 TSI, 1.4, 1.4 TSI, 1.6, 1.6 FSI, 1.6 GreenLine, 1.6 LPG, 1.6 TDI, 1.8 TSI, 1.9 TDI, 2.0 FSI, 2.0 TDI, 2.0 TDI 16V 02/04 - 55 -125 kW	48-135245	30-50	30-50	Øa: 55 mm; Conditions see certificates VA: axle load to: 1210 kg HA: axle load to: 1250 kg
B16 PSS10	2.0 RS 10/05 - 147 kW	48-135245	20-30	10-30	Øa: 55 mm; Conditions see certificates VA: axle load to: 1210 kg HA: axle load to: 1250 kg
B16 RC	1.2 TSI, 1.4, 1.4 TSI, 1.6, 1.6 FSI, 1.6 GreenLine, 1.6 LPG, 1.6 TDI, 1.8 TSI, 1.9 TDI, 2.0 FSI, 2.0 RS, 2.0 TDI, 2.0 TDI 16V 02/04 - 55 -147 kW	49-196849 14-230615	30-50	30-50	Øa: 55 mm; mark: G07, G08, G09, G11; Conditions see certificates VA: axle load to: 1155 kg HA: axle load to: 1140 kg
B16 BCS	2.0 RS, 2.0 TDI 10/05 - 125 -147 kW	48-215909	10-20	10-30	Øa: 55 mm; Conditions see certificates VA: axle load to: 1210 kg HA: axle load to: 1095 kg

SKODA OCTAVIA Combi (1Z5)					
B12 PK	1.2 TSI, 1.4, 1.4 TSI, 1.6, 1.6 FSI, 1.8 TSI 06/07 - 55 -118 kW	46-182586	30	30	outside diameter strut 50 mm; Conditions see certificates; With General Certification (ABE) VA: axle load to: 1050 kg HA: axle load to: 1150 kg
B12 PK	1.2 TSI, 1.4, 1.4 TSI, 1.6, 1.6 FSI, 1.8 TSI 06/07 - 55 -118 kW	46-000293	30	30	outside diameter strut 55 mm; Conditions see certificates; With General Certification (ABE) VA: axle load to: 1050 kg HA: axle load to: 1150 kg
B12 PK	1.2 TSI, 1.6 TDI, 1.9 TDI, 2.0 FSI, 2.0 RS, 2.0 TDI, 2.0 TDI 16V 02/04 - 77 -147 kW	46-182593	30	30	outside diameter strut 50 mm; Conditions see certificates; With General Certification (ABE) VA: axle load to: 1100 kg HA: axle load to: 1150 kg
B12 PK	1.2 TSI, 1.6 TDI, 1.9 TDI, 2.0 FSI, 2.0 RS, 2.0 TDI, 2.0 TDI 16V 02/04 - 77 -147 kW	46-000354	30	30	outside diameter strut 55 mm; Conditions see certificates; With General Certification (ABE) VA: axle load to: 1100 kg HA: axle load to: 1150 kg
B14	1.2 TSI, 1.4, 1.4 TSI, 1.6, 1.6 FSI, 1.6 GreenLine, 1.6 LPG, 1.6 TDI, 1.6 TDI 4x4, 1.8 TSI, 1.8 TSI 4x4, 1.9 TDI, 1.9 TDI 4x4, 2.0 FSI, 2.0 FSI 4x4, 2.0 TDI, 2.0 TDI 16V, 2.0 TDI 16V 4x4, 2.0 TDI 4x4 07/06 - 55 -125 kW	47-128347	30-50	30-50	outside diameter strut 50 mm; Conditions see certificates VA: axle load to: 1210 kg HA: axle load to: 1250 kg







SKODA





SKODA OCTAVIA Combi (1Z5)

B14	1.2 TSI, 1.4, 1.4 TSI, 1.6, 1.6 FSI, 1.6 GreenLine, 1.6 LPG, 1.6 TDI, 1.6 TDI 4x4, 1.8 TSI, 1.8 TSI 4x4, 1.9 TDI, 1.9 TDI 4x4, 2.0 FSI, 2.0 FSI 4x4, 2.0 TDI, 2.0 TDI 16V, 2.0 TDI 16V 4x4, 2.0 TDI 4x4 07/06 - 55 -125 kW	47-127708	30-50	30-50	Øa: 55 mm; Conditions see certificates VA: axle load to: 1210 kg HA: axle load to: 1250 kg
B14	2.0 RS 10/05 - 147 kW	47-127708	20-30	10-30	Øa: 55 mm; Conditions see certificates VA: axle load to: 1200 kg HA: axle load to: 1240 kg
B16 PSS10	1.2 TSI, 1.4, 1.4 TSI, 1.6, 1.6 FSI, 1.6 GreenLine, 1.6 LPG, 1.6 TDI, 1.6 TDI 4x4, 1.8 TSI, 1.8 TSI 4x4, 1.9 TDI, 1.9 TDI 4x4, 2.0 FSI, 2.0 FSI 4x4, 2.0 TDI, 2.0 TDI 16V, 2.0 TDI 16V 4x4, 2.0 TDI 4x4 07/06 - 55 -125 kW	48-135238	30-50	30-50	outside diameter strut 50 mm; Conditions see certificates VA: axle load to: 1210 kg HA: without ride height adjustment; axle load to: 1250 kg
B16 PSS10	1.2 TSI, 1.4, 1.4 TSI, 1.6, 1.6 FSI, 1.6 GreenLine, 1.6 LPG, 1.6 TDI, 1.6 TDI 4x4, 1.8 TSI, 1.8 TSI 4x4, 1.9 TDI, 1.9 TDI 4x4, 2.0 FSI, 2.0 FSI 4x4, 2.0 TDI, 2.0 TDI 16V, 2.0 TDI 16V 4x4, 2.0 TDI 4x4 07/06 - 55 -125 kW	48-135245	30-50	30-50	Øa: 55 mm; Conditions see certificates VA: axle load to: 1210 kg HA: axle load to: 1250 kg
B16 PSS10	2.0 RS 10/05 - 147 kW	48-135245	20-30	10-30	Øa: 55 mm; Conditions see certificates VA: axle load to: 1210 kg HA: axle load to: 1250 kg
B16 RC	1.2 TSI, 1.4, 1.4 TSI, 1.6, 1.6 FSI, 1.6 GreenLine, 1.6 LPG, 1.6 TDI, 1.6 TDI 4x4, 1.8 TSI, 1.8 TSI 4x4, 1.9 TDI, 1.9 TDI 4x4, 2.0 FSI, 2.0 FSI 4x4, 2.0 RS, 2.0 TDI, 2.0 TDI 16V, 2.0 TDI 16V 4x4, 2.0 TDI 4x4 07/06 - 55 -147 kW	49-196849 14-230615	30-50	30-50	Øa: 55 mm; mark: G07, G08, G09, G11; Conditions see certificates VA: axle load to: 1155 kg HA: axle load to: 1140 kg
B16 BCS	2.0 RS, 2.0 TDI 10/05 - 125 -147 kW	48-215909	10-20	10-30	Øa: 55 mm; Conditions see certificates VA: axle load to: 1210 kg HA: axle load to: 1095 kg

SKODA OCTAVIA (5E3)

B14	1.2 TSI, 1.4 TSI, 1.6 TDI, 1.8 TSI, 2.0 TDI 11/12 - 63 -132 kW	47-229945	30-50	30-50	Øa: 50 mm; mark: G01, 0N1; disconnect DCC; Conditions see certificates; rigid axle
B14	1.2 TSI, 1.4 TSI, 1.6 TDI, 1.8 TSI, 2.0 TDI 11/12 - 63 -132 kW	47-229969	30-50	30-50	Øa: 50 mm; mark: G01, 0N4; disconnect DCC; Conditions see certificates; multilink axle
B14	1.2 TSI, 1.4 TSI, 1.6 TDI, 1.8 TSI, 2.0 TDI 11/12 - 63 -132 kW	47-229976	30-50	30-50	Øa: 55 mm; mark: G02, 0N4; disconnect DCC; Conditions see certificates; multilink axle
B16 PSS10	1.2 TSI, 1.4 TSI, 1.6 TDI, 1.8 TSI, 2.0 TDI 11/12 - 63 -132 kW	48-230056	30-50	30-50	Øa: 50 mm; mark: G01, 0N4; disconnect DCC; Conditions see certificates; multilink axle
B16 PSS10	1.2 TSI, 1.4 TSI, 1.6 TDI, 1.8 TSI, 2.0 TDI 11/12 - 63 -132 kW	48-230063	30-50	30-50	Øa: 55 mm; mark: G02, 0N4; disconnect DCC; Conditions see certificates; multilink axle
B16 RC	1.2 TSI, 1.4 TSI, 1.6 TDI, 1.8 TSI, 2.0 TDI 11/12 - 63 -132 kW	14-230615 49-231892	30-50	30-50	Øa: 55 mm; mark: G02, 0N4; disconnect DCC; Conditions see certificates; multilink axle
B16 BCS	1.8 TSI, 2.0 TDI 11/12 - 110 -132 kW	48-231848	10-30	10-30	Øa: 55 mm; mark: G02, 0N4; disconnect DCC; multilink axle

					
SKODA					
SKODA OCTAVIA Combi (5E5)					
B14	1.2 TSI, 1.4 TSI, 1.6 TDI, 1.8 TSI, 2.0 TDI 11/12 - 63 -132 kW	47-229945	30-50	30-50	Øa: 50 mm; mark: G01, 0N1; disconnect DCC; Conditions see certificates; rigid axle
B14	1.2 TSI, 1.4 TSI, 1.6 TDI, 1.8 TSI, 2.0 TDI 11/12 - 63 -132 kW	47-229969	30-50	30-50	Øa: 50 mm; mark: G01, 0N4; disconnect DCC; Conditions see certificates; multilink axle
B14	1.2 TSI, 1.4 TSI, 1.6 TDI, 1.8 TSI, 2.0 TDI 11/12 - 63 -132 kW	47-229976	30-50	30-50	Øa: 55 mm; mark: G02, 0N4; disconnect DCC; Conditions see certificates; multilink axle
B16 PSS10	1.2 TSI, 1.4 TSI, 1.6 TDI, 1.8 TSI, 2.0 TDI 11/12 - 63 -132 kW	48-230056	30-50	30-50	Øa: 50 mm; mark: G01, 0N4; disconnect DCC; Conditions see certificates; multilink axle
B16 PSS10	1.2 TSI, 1.4 TSI, 1.6 TDI, 1.8 TSI, 2.0 TDI 11/12 - 63 -132 kW	48-230063	30-50	30-50	Øa: 55 mm; mark: G02, 0N4; disconnect DCC; Conditions see certificates; multilink axle
B16 RC	1.2 TSI, 1.4 TSI, 1.6 TDI, 1.8 TSI, 2.0 TDI 11/12 - 63 -132 kW	14-230615 49-231892	30-50	30-50	Øa: 55 mm; mark: G02, 0N4; disconnect DCC; Conditions see certificates; multilink axle
B16 BCS	1.8 TSI, 2.0 TDI 11/12 - 110 -132 kW	48-231848	10-30	10-30	Øa: 55 mm; mark: G02, 0N4; disconnect DCC; multilink axle
SKODA SUPERB (3U4)					
B12 PK	1.8 T, 1.9 TDI, 2.0 12/01 - 03/08 74 -110 kW	46-182654	30	30	Conditions see certificates VA: axle load to: 1160 kg HA: without ride height adjustment; axle load to: 1090 kg
B12 PK	2.5 TDI, 2.8 V6 12/01 - 03/08 114 -142 kW	46-182661	30	30	Conditions see certificates VA: axle load to: 1230 kg HA: without ride height adjustment; axle load to: 1090 kg
B14	1.8 T, 1.9 TDI, 2.0, 2.0 TDI, 2.5 TDI, 2.8 V6 12/01 - 03/08 74 -142 kW	47-124806	35-55	35-55	Conditions see certificates VA: axle load to: 1230 kg HA: axle load to: 1200 kg
B16 PSS9	1.8 T, 1.9 TDI, 2.0, 2.0 TDI, 2.5 TDI, 2.8 V6 12/01 - 03/08 74 -142 kW	48-088749	35-55	35-55	Conditions see certificates VA: axle load to: 1230 kg HA: axle load to: 1200 kg
SKODA SUPERB (3T4)					
B12 PK	1.4 TSI, 1.6 TDI, 1.8 TSI, 1.9 TDI, 2.0 TDI, 2.0 TDI 16V, 2.0 TSI 03/08 - 77 -147 kW	46-182685	30	30	outside diameter strut 55 mm; Conditions see certificates; With General Certification (ABE) VA: axle load to: 1210 kg HA: without ride height adjustment; axle load to: 1250 kg
B14	1.4 TSI, 1.6 TDI, 1.8 TSI, 1.8 TSI 4x4, 1.9 TDI, 2.0 TDI, 2.0 TDI 16V, 2.0 TDI 16V 4x4, 2.0 TDI 4x4, 2.0 TSI, 3.6 4x4, 3.6 FSI 4x4 03/08 - 77 -191 kW	47-127708	30-50	30-50	Øa: 55 mm; Conditions see certificates VA: axle load to: 1210 kg HA: axle load to: 1250 kg
B16 PSS10	1.4 TSI, 1.6 TDI, 1.8 TSI, 1.8 TSI 4x4, 1.9 TDI, 2.0 TDI, 2.0 TDI 16V, 2.0 TDI 16V 4x4, 2.0 TDI 4x4, 2.0 TSI, 3.6 4x4, 3.6 FSI 4x4 03/08 - 77 -191 kW	48-135245	30-50	30-50	Øa: 55 mm; Conditions see certificates VA: axle load to: 1210 kg HA: axle load to: 1250 kg
B16 RC	1.4 TSI, 1.6 TDI, 1.8 TSI, 1.8 TSI 4x4, 1.9 TDI, 2.0 TDI, 2.0 TDI 16V, 2.0 TDI 16V 4x4, 2.0 TDI 4x4, 2.0 TSI, 3.6 4x4, 3.6 FSI 4x4 03/08 - 77 -191 kW	49-196849 14-230615	30-50	30-50	Øa: 55 mm; mark: G07, G08, G09, G11; Conditions see certificates VA: axle load to: 1140 kg HA: axle load to: 1040 kg
B16 BCS	3.6 4x4, 3.6 FSI 4x4 11/08 - 191 kW	48-215909	10-20	10-30	Øa: 55 mm; Conditions see certificates VA: axle load to: 1210 kg HA: axle load to: 1095 kg

   					
SKODA					
SKODA SUPERB Estate (3T5)					
B12 PK	1.4 TSI, 1.6 TDI, 1.8 TSI, 1.9 TDI, 2.0 TDI, 2.0 TSI 10/09 - 77 -147 kW	46-182685	30	30	outside diameter strut 55 mm; Conditions see certificates; With General Certification (ABE) VA: axle load to: 1210 kg HA: without ride height adjustment; axle load to: 1250 kg
B14	1.4 TSI, 1.6 TDI, 1.8 TSI, 1.8 TSI 4x4, 1.9 TDI, 2.0 TDI, 2.0 TDI 16V 4x4, 2.0 TDI 4x4, 2.0 TSI, 3.6 V6 4x4 10/09 - 77 -191 kW	47-127708	30-50	30-50	Øa: 55 mm; Conditions see certificates VA: axle load to: 1210 kg HA: axle load to: 1250 kg
B16 PSS10	1.4 TSI, 1.6 TDI, 1.8 TSI, 1.8 TSI 4x4, 1.9 TDI, 2.0 TDI, 2.0 TDI 16V 4x4, 2.0 TDI 4x4, 2.0 TSI, 3.6 V6 4x4 10/09 - 77 -191 kW	48-135245	30-50	30-50	Øa: 55 mm; Conditions see certificates VA: axle load to: 1210 kg HA: axle load to: 1250 kg
B16 BCS	3.6 V6 4x4 10/09 - 191 kW	48-215909	10-20	10-30	Øa: 55 mm; Conditions see certificates VA: axle load to: 1210 kg HA: axle load to: 1095 kg

SVW SKODA

SVW SKODA OCTAVIA

B12 PK	1.4 TSi, 1.6, 1.8, 2.0, 2.0 TSI 06/07 - 77 -147 kW	46-182562	30	30	outside diameter strut 50 mm; Conditions see certificates; With General Certification (ABE) VA: axle load to: 1050 kg HA: axle load to: 1100 kg
B12 PK	1.4 TSi, 1.6, 1.8, 2.0, 2.0 TSI 06/07 - 77 -147 kW	46-000279	30	30	outside diameter strut 55 mm; Conditions see certificates; With General Certification (ABE) VA: axle load to: 1050 kg HA: axle load to: 1100 kg
B14	1.4 TSi, 1.6, 1.8, 2.0, 2.0 TSI 06/07 - 77 -147 kW	47-128347	30-50	30-50	outside diameter strut 50 mm; Conditions see certificates VA: axle load to: 1210 kg HA: axle load to: 1250 kg
B14	1.4 TSi, 1.6, 1.8, 2.0, 2.0 TSI 06/07 - 77 -147 kW	47-127708	30-50	30-50	Øa: 55 mm; Conditions see certificates VA: axle load to: 1210 kg HA: axle load to: 1250 kg
B16 PSS10	1.4 TSi, 1.6, 1.8, 2.0, 2.0 TSI 06/07 - 77 -147 kW	48-135238	30-50	30-50	outside diameter strut 50 mm; Conditions see certificates VA: axle load to: 1210 kg HA: axle load to: 1250 kg
B16 PSS10	1.4 TSi, 1.6, 1.8, 2.0, 2.0 TSI 06/07 - 77 -147 kW	48-135245	30-50	30-50	Øa: 55 mm; Conditions see certificates VA: axle load to: 1210 kg HA: axle load to: 1250 kg
B16 RC	1.4 TSi, 1.6, 1.8, 2.0, 2.0 TSI 06/07 - 77 -147 kW	49-196849 14-230615	30-50	30-50	Øa: 55 mm; mark: G07, G08, G09, G11; Conditions see certificates VA: axle load to: 1155 kg HA: axle load to: 1140 kg





SMART





SMART CABRIO

B12 PK	0.6 03/00 - 01/04 40 -45 kW	46-207098		25	twin-tube; Conditions see certificates VA: axle load to: 427 kg; with leaf-spring suspension HA: axle load to: 610 kg; with coil-spring suspension
B12 PK	0.6, 0.7, 0.8 CDI 03/00 - 01/04 30 -55 kW	46-207104	25	25	twin-tube; serie production spring seat must be used; Conditions see certificates; with coil-spring suspension VA: axle load to: 430 kg HA: axle load to: 610 kg
B14	0.6, 0.7, 0.8 CDI 03/00 - 01/04 30 -55 kW	47-107632	10-30	10-30	Spacers required for several wheel/tyre combinations; Conditions see certificates; with coil-spring suspension VA: axle load to: 465 kg HA: axle load to: 610 kg

SMART CITY-COUPÉ (MC01)

B12 PK	0.6, 0.8 CDI 07/98 - 01/04 30 -40 kW	46-207098		25	twin-tube; Conditions see certificates VA: axle load to: 427 kg; with leaf-spring suspension HA: axle load to: 610 kg; with coil-spring suspension
B12 PK	0.6, 0.7, 0.8 CDI, 0.7, 0.8 CDI, 0.7, 0.8 CDI 07/98 - 01/07 30 -55 kW	46-207104	25	25	twin-tube; serie production spring seat must be used; Conditions see certificates; with coil-spring suspension VA: axle load to: 430 kg HA: axle load to: 610 kg

					
SMART					
SMART CITY-COUPÉ (MC01)					
B14	0.6, 0.7 07/98 - 01/04 33 -55 kW	47-107632	10-30	10-30	Spacers required for several wheel/tyre combinations; Conditions see certificates VA: axle load to: 430 kg; with coil-spring suspension HA: axle load to: 610 kg
B14	0.8 CDI 03/01 - 01/04 30 kW	47-107632	10-30	10-30	Spacers required for several wheel/tyre combinations; Conditions see certificates VA: axle load to: 430 kg; with coil-spring suspension HA: axle load from: 610 kg
SMART CROSSBLADE					
B14	0.6 06/02 - 12/03 52 kW	47-107632	10-30	10-30	Spacers required for several wheel/tyre combinations; Conditions see certificates VA: axle load to: 465 kg HA: axle load to: 610 kg
SMART ROADSTER					
B12 PK	0.7 04/03 - 11/05 45 -60 kW	46-207135	25	25	twin-tube; serie production spring seat must be used; Conditions see certificates VA: axle load to: 465 kg HA: axle load to: 610 kg
B14	0.7, 0.7 Brabus 04/03 - 11/05 45 -74 kW	47-107632	10-30	10-30	Spacers required for several wheel/tyre combinations; Conditions see certificates VA: axle load to: 465 kg HA: axle load to: 610 kg
SMART ROADSTER Coupe					
B12 PK	0.7 04/03 - 11/05 45 -60 kW	46-207135	25	25	twin-tube; serie production spring seat must be used; Conditions see certificates VA: axle load to: 465 kg HA: axle load to: 610 kg
B14	0.7, 0.7 Brabus 04/03 - 11/05 45 -74 kW	47-107632	10-30	10-30	Spacers required for several wheel/tyre combinations; Conditions see certificates VA: axle load to: 465 kg HA: axle load to: 610 kg
SMART FORTWO Coupe					
B14	0.7, 0.8 CDI 01/04 - 01/07 30 -55 kW	47-107632	10-30	10-30	Spacers required for several wheel/tyre combinations; Conditions see certificates; axle load to: 430 kg; with coil-spring suspension
SMART FORTWO cabrio					
B14	0.7, 0.8 CDI 01/04 - 01/07 30 -55 kW	47-107632	10-30	10-30	Spacers required for several wheel/tyre combinations; Conditions see certificates; axle load to: 465 kg; with coil-spring suspension
SMART FORTWO Coupe					
B12 PK	0.8 CDI, 1.0, 1.0 Turbo 01/07 - 33 -88 kW	46-207159	20	20	serie production spring seat must be used; Conditions see certificates VA: axle load to: 440 kg HA: axle load to: 660 kg
B14	0.8 CDI, 1.0, 1.0 Turbo 01/07 - 33 -88 kW	47-165403	10-20	10-30	Conditions see certificates VA: axle load to: 440 kg HA: axle load to: 660 kg
SMART FORTWO Cabrio					
B12 PK	0.8 CDI, 1.0, 1.0 Turbo 01/07 - 33 -62 kW	46-207159	20	20	serie production spring seat must be used; Conditions see certificates VA: axle load to: 440 kg HA: axle load to: 660 kg
B14	0.8 CDI, 1.0, 1.0 Brabus, 1.0 Turbo 01/07 - 33 -88 kW	47-165403	10-20	10-30	Conditions see certificates VA: axle load to: 440 kg HA: axle load to: 660 kg

					
SUBARU					
SUBARU BRZ					
B14	2.0 06/12 - 147 kW	47-228337	10-30	10-30	Conditions see certificates VA: axle load to: 876 kg HA: axle load to: 943 kg
B16 PSS10	2.0 06/12 - 147 kW	48-228299	10-30	10-30	Conditions see certificates VA: axle load to: 876 kg HA: axle load to: 943 kg
SUBARU IMPREZA Saloon (GC)					
B16 PSS9	1.5, 1.6 i, 1.6 i 4WD, 1.8, 1.8 i 4WD, 2.0, 2.0 AWD, 2.0 i 4WD, 2.0 Turbo GT 4WD, 2.2 GX AWD 03/94 - 09/00 66 -206 kW	48-086035	50	35	Without roadworthy certificate
SUBARU IMPREZA Estate (GF)					
B16 PSS9	1.5 L, 1.6, 1.6 i, 1.6 i 4WD, 1.8, 1.8 i 4WD, 2.0, 2.0 16V, 2.0 4WD, 2.0 i Turbo 4WD, 2.0 Turbo GT 4WD, 2.2 GX AWD 11/95 - 12/00 66 -160 kW	48-086035	50	35	Without roadworthy certificate
SUBARU IMPREZA Saloon (GD, GG)					
B14	1.5, 1.5 LX, 1.6, 2.0, 2.0 All-wheel Drive, 2.0 R, 2.0 WRX STi, 2.0 WRX Turbo, 2.2 GX, 2.4 WRX, 2.4 WRX ST1, 2.5 All-wheel Drive, 2.5 AWD 03/01 - CH-Nr. 70 -235 kW	47-101791	25-45	20-40	-> CH.Nr.: XXXXXXXX4XXXXXXX; fixing hole pitches at the front 65 mm; Conditions see certificates VA: axle load to: 1030 kg HA: axle load to: 920 kg
B14	1.5, 1.5 AWD, 1.5 LX, 1.6, 2.0, 2.0 All-wheel Drive, 2.0 AWD, 2.0 R, 2.0 WRX STi, 2.0 WRX Turbo, 2.2 GX, 2.4 WRX, 2.4 WRX ST1, 2.5 All-wheel Drive, 2.5 AWD CH-Nr. - 70 -235 kW	47-124226	20-40	30-40	CH.Nr.: XXXXXXXX5XXXXXXX ->; fixing hole pitches at the front 75 mm; Conditions see certificates
B16 PSS9	1.5, 1.5 LX, 1.6, 2.0, 2.0 All-wheel Drive, 2.0 R, 2.0 WRX STi, 2.0 WRX Turbo, 2.2 GX, 2.4 WRX, 2.4 WRX ST1, 2.5 All-wheel Drive, 2.5 AWD 03/01 - CH-Nr. 70 -235 kW	48-086202	25-45	25-45	-> CH.Nr.: XXXXXXXX4XXXXXXX; fixing hole pitches at the front 65 mm
B16 PSS9	1.5, 1.5 LX, 1.6, 2.0, 2.0 All-wheel Drive, 2.0 R, 2.0 WRX STi, 2.0 WRX Turbo, 2.2 GX, 2.4 WRX, 2.4 WRX ST1, 2.5 All-wheel Drive, 2.5 AWD 03/01 - CH-Nr. 70 -235 kW	48-103398	25-45	20-40	-> CH.Nr.: XXXXXXXX4XXXXXXX; fixing hole pitches at the front 65 mm; Conditions see certificates VA: axle load to: 1030 kg HA: axle load to: 920 kg
B16 PSS9	1.5, 1.5 AWD, 1.5 LX, 1.6, 2.0, 2.0 All-wheel Drive, 2.0 AWD, 2.0 R, 2.0 WRX STi, 2.0 WRX Turbo, 2.2 GX, 2.4 WRX, 2.4 WRX ST1, 2.5 All-wheel Drive, 2.5 AWD CH-Nr. - 70 -235 kW	48-123525	20-40	30-40	CH.Nr.: XXXXXXXX5XXXXXXX ->; fixing hole pitches at the front 75 mm; Conditions see certificates
B16 PSS9	2.0 All-wheel Drive, 2.0 AWD, 2.0 WRX STi, 2.0 WRX Turbo, 2.4 WRX, 2.4 WRX ST1, 2.5 All-wheel Drive, 2.5 AWD 03/01 - 112 -235 kW	48-101288	25-45	20-40	for USA; Without roadworthy certificate
SUBARU IMPREZA Hatchback					
B14	2.0 All-wheel Drive, 2.5 All-wheel Drive, 2.5 WRX 12/02 - CH-Nr. 92 -195 kW	47-101791	25-45	20-40	-> CH.Nr.: XXXXXXXX4XXXXXXX; fixing hole pitches at the front 65 mm; Conditions see certificates VA: axle load to: 1030 kg HA: axle load to: 920 kg
B14	2.0 All-wheel Drive, 2.5 All-wheel Drive, 2.5 WRX CH-Nr. - 92 -195 kW	47-124226	25-45	20-40	CH.Nr.: XXXXXXXX5XXXXXXX ->; fixing hole pitches at the front 75 mm; Conditions see certificates VA: axle load to: 1030 kg HA: axle load to: 960 kg

				
--	---	---	---	---

SUBARU

SUBARU IMPREZA Hatchback

B16 PSS9	2.0 All-wheel Drive, 2.5 All-wheel Drive, 2.5 WRX 12/02 - CH-Nr. 92 -195 kW	48-086202	25-45	20-40	-> CH.Nr.: XXXXXXXX4XXXXXX; fixing hole pitches at the front 65 mm
B16 PSS9	2.0 All-wheel Drive, 2.5 All-wheel Drive, 2.5 WRX 12/02 - CH-Nr. 92 -195 kW	48-103398	25-45	20-40	-> CH.Nr.: XXXXXXXX4XXXXXX; fixing hole pitches at the front 65 mm; Conditions see certificates VA: axle load to: 1030 kg HA: axle load to: 920 kg
B16 PSS9	2.0 All-wheel Drive, 2.5 All-wheel Drive, 2.5 WRX CH-Nr. - 92 -195 kW	48-123525	25-45	20-40	CH.Nr.: XXXXXXXX5XXXXXX ->; fixing hole pitches at the front 75 mm; Conditions see certificates VA: axle load to: 1030 kg HA: axle load to: 960 kg

SUBARU IMPREZA Estate (GD, GG)

B14	1.5, 1.6, 2.0, 2.0 R, 2.0 Turbo, 2.0 WRX Turbo 12/02 - CH-Nr. 70 -165 kW	47-101791	25-45	20-40	-> CH.Nr.: XXXXXXXX4XXXXXX; fixing hole pitches at the front 65 mm; Conditions see certificates VA: axle load to: 1030 kg HA: axle load to: 920 kg
B14	1.5, 1.5 AWD, 1.6, 2.0, 2.0 AWD, 2.0 R, 2.0 Turbo, 2.0 WRX STi AWD, 2.0 WRX Turbo, 2.2 GX, 2.4 WRX, 2.5 AWD CH-Nr. - 70 -221 kW	47-124226	25-45	20-40	CH.Nr.: XXXXXXXX5XXXXXX ->; fixing hole pitches at the front 75 mm; Conditions see certificates VA: axle load to: 1030 kg HA: axle load to: 960 kg
B16 PSS9	1.5, 1.6, 2.0, 2.0 R, 2.0 Turbo, 2.0 WRX Turbo 12/02 - CH-Nr. 70 -165 kW	48-086202	25-45	20-40	-> CH.Nr.: XXXXXXXX4XXXXXX; fixing hole pitches at the front 65 mm
B16 PSS9	1.5, 1.6, 2.0, 2.0 R, 2.0 Turbo, 2.0 WRX Turbo, 2.2 GX 06/01 - CH-Nr. 70 -165 kW	48-103398	25-45	20-40	-> CH.Nr.: XXXXXXXX4XXXXXX; fixing hole pitches at the front 65 mm; Conditions see certificates VA: axle load to: 1030 kg HA: axle load to: 920 kg
B16 PSS9	1.5, 1.5 AWD, 1.6, 2.0, 2.0 AWD, 2.0 R, 2.0 Turbo, 2.0 WRX STi AWD, 2.0 WRX Turbo, 2.2 GX, 2.4 WRX, 2.5 AWD CH-Nr. - CH-Nr. 70 -221 kW	48-123525	25-45	20-40	CH.Nr.: XXXXXXXX5XXXXXX-> XXXXXXXX7XXX; fixing hole pitches at the front 75 mm; Conditions see certificates VA: axle load to: 1030 kg HA: axle load to: 960 kg

SUBARU IMPREZA Hatchback

B16 PSS10	1.5 All-wheel Drive, 2.5 All-wheel Drive, 2.5 STi CS400, WRX STi 01/08 - 79 -294 kW	48-155830	20-40	20-40	mark: G3; mark: STi; Conditions see certificates VA: axle load to: 1050 kg HA: axle load to: 1040 kg
--------------	---	-----------	-------	-------	--

SUBARU IMPREZA Saloon (GR)

B16 PSS10	2.5 WRX STi AWD 01/11 - 221 kW	48-155830	20-40	20-40	mark: G3; mark: STi; Conditions see certificates VA: axle load to: 1050 kg HA: axle load to: 1040 kg
--------------	--	-----------	-------	-------	--

SUZUKI

SUZUKI SPLASH

B12 PK	1.0, 1.2 01/08 - 48 -63 kW	46-206978	30	30	twin-tube; rim: 15"; Conditions see certificates VA: axle load to: 835 kg HA: axle load to: 800 kg
-----------	--------------------------------------	-----------	----	----	--

SUZUKI SWIFT III (SG)

B14	1.3, 1.3 DDiS, 1.5, 1.6 02/05 - 51 -92 kW	47-167551	10-30	0-20	Conditions see certificates VA: axle load to: 830 kg HA: axle load to: 830 kg
-----	---	-----------	-------	------	---

SUZUKI SWIFT IV

B14	1.2, 1.3 DDiS, 1.4, 1.6 10/10 - 55 -100 kW	47-218871	0-35	0-35	Conditions see certificates VA: axle load to: 820 kg HA: axle load to: 800 kg
-----	--	-----------	------	------	---



CHANGAN SUZUKI

CHANGAN SUZUKI SWIFT

B14	1.3, 1.5 05/05 - 63 -76 kW	47-167551	10-30	0-20	Conditions see certificates VA: axle load to: 830 kg HA: axle load to: 830 kg
-----	--------------------------------------	------------------	-------	------	---

TOYOTA

TOYOTA AYGO (B10)

B12 PK	1.0, 1.4 HDi 07/05 - 40 -50 kW	46-207166	30	30	twin-tube; Conditions see certificates VA: axle load to: 695 kg HA: axle load to: 695 kg
-----------	--	------------------	----	----	--

TOYOTA COROLLA (_E12U_, _E12J_)

B12 PK	1.4 VVT-i, 1.6 VVT-i, 1.8, 1.8 VVTL-i TS 01/02 - 02/07 71 -141 kW	46-182265	30	30	not for Taiwan; without ride height adjustment; Conditions see certificates VA: axle load to: 1000 kg HA: axle load to: 970 kg
B12 PK	1.4 D, 2.0 D-4D 05/03 - 02/07 66 -85 kW	46-182272	30	30	not for Taiwan; without ride height adjustment; Conditions see certificates VA: axle load to: 1000 kg HA: axle load to: 970 kg
B16 PSS9	1.4 D, 1.4 VVT-i, 1.6 VVT-i, 1.8, 1.8 VVTL-i TS, 2.0 D-4D 05/03 - 02/07 66 -165 kW	48-088756	25-45	25-45	not for Taiwan; Conditions see certificates VA: axle load to: 1000 kg HA: axle load to: 970 kg

TOYOTA COROLLA Estate (_E12J_, _E12T_)

B12 PK	1.4 VVT-i, 1.6 VVT-i, 1.8 01/02 - 02/07 71 -100 kW	46-182265	30	30	without ride height adjustment; Conditions see certificates VA: axle load to: 1000 kg HA: axle load to: 970 kg
B12 PK	1.4 D, 2.0 D-4D 04/04 - 02/07 66 -85 kW	46-182272	30	30	without ride height adjustment; Conditions see certificates VA: axle load to: 1000 kg HA: axle load to: 970 kg
B16 PSS9	1.4 D, 1.4 VVT-i, 1.6 VVT-i, 1.8, 2.0 D-4D 04/04 - 02/07 66 -100 kW	48-088756	25-45	25-50	Conditions see certificates VA: axle load to: 1000 kg HA: axle load to: 970 kg

TOYOTA COROLLA Saloon (_E12J_, _E12T_)





B12 PK	1.4 VVT-i, 1.6 VVT-i, 1.8 11/01 - 07/07 71 -100 kW	46-182265	30	30	without ride height adjustment; Conditions see certificates VA: axle load to: 1000 kg HA: axle load to: 970 kg
B12 PK	1.4 D, 1.4 D-4D, 2.0 D4d, 2.0 D-4D 08/02 - 07/07 55 -85 kW	46-182272	30	30	without ride height adjustment; Conditions see certificates VA: axle load to: 1000 kg HA: axle load to: 970 kg
B16 PSS9	1.4 D, 1.4 D-4D, 1.4 VVT-i, 1.5, 1.5 RC, 1.6, 1.6 VVT-i, 1.8, 2.0 D4d, 2.0 D-4D, 2.2 D4d 08/02 - 55 -130 kW	48-088756	25-45	25-45	Conditions see certificates VA: axle load to: 1000 kg HA: axle load to: 970 kg

TOYOTA COROLLA Verso (_E12J_)

B12 PK	1.4 VVT-i, 1.6 VVT-i, 1.8 VVT-i 01/02 - 12/03 71 -99 kW	46-182265	30	30	without ride height adjustment; Conditions see certificates VA: axle load to: 1000 kg HA: axle load to: 970 kg
B12 PK	2.0 D-4D 01/02 - 12/03 66 kW	46-182272	30	30	without ride height adjustment; Conditions see certificates VA: axle load to: 1000 kg HA: axle load to: 970 kg
B16 PSS9	1.4 VVT-i, 1.6 VVT-i, 1.8 VVT-i, 2.0 D-4D 01/02 - 12/03 66 -99 kW	48-088756	25-45	25-45	Conditions see certificates VA: axle load to: 1000 kg HA: axle load to: 970 kg

TOYOTA GT 86 Coupe (_ZN6_)

B14	2.0 GT 03/12 - 147 kW	47-228337	10-30	10-30	Conditions see certificates VA: axle load to: 876 kg HA: axle load to: 943 kg
B16 PSS10	2.0 GT 03/12 - 147 kW	48-228299	10-30	10-30	Conditions see certificates VA: axle load to: 876 kg HA: axle load to: 943 kg

   					
TOYOTA					
TOYOTA YARIS (_P9_)					
B12 PK	1.0 VVT-i, 1.3 VVT-i, 1.33 VVT-i 11/05 - 51 -74 kW	46-207173	25	25	twin-tube; Conditions see certificates VA: axle load to: 895 kg HA: axle load to: 905 kg
B12 PK	D-4D 01/06 - 66 kW	46-207180	25	25	twin-tube; Conditions see certificates VA: axle load to: 895 kg HA: axle load to: 905 kg
B14	1.0 GPL, 1.0 VVT-i, 1.3 VVT-i, 1.33 VVT-i, 1.5, 1.8 VVTi, D-4D 11/05 - 51 -98 kW	47-188044	45-55	35-55	mark: XP9; XP9F; Conditions see certificates VA: axle load to: 895 kg HA: axle load to: 825 kg

GUANGZHOU TOYOTA					
GUANGZHOU TOYOTA YARIS					
B14	1.3, 1.6 09/10 - 63 -87 kW	47-188044	45-55	35-55	Without roadworthy certificate

VAUXHALL					
VAUXHALL AGILA					
B12 PK	1.0, 1.0 i, 1.2, 1.2 i 16V 01/08 - 48 -69 kW	46-206978	30	30	twin-tube; rim: 15"; Conditions see certificates VA: axle load to: 835 kg HA: axle load to: 800 kg

VAUXHALL ASTRA Mk III					
B10	1.4 i, 1.4 i 16V, 1.6 i, 1.6 i 16V, 1.7 D, 1.7 TD, 1.8 i, 1.8 i 16V, 2.0 i, 2.0 i 16V 03/92 - 09/98 42 -100 kW	46-111920	60	40	Conditions see certificates VA: axle load to: 900 kg HA: axle load to: 800 kg
B12 PK	1.4 i, 1.4 i 16V, 1.6 i, 1.6 i 16V, 1.7 D, 1.7 TD, 1.8 i, 1.8 i 16V, 2.0 i, 2.0 i 16V 03/92 - 09/98 42 -100 kW	46-188861	30	30	Conditions see certificates VA: axle load to: 870 kg HA: axle load to: 800 kg
B12 SL	1.4 i, 1.4 i 16V, 1.6 i, 1.6 i 16V, 1.7 D, 1.7 TD, 1.8 i, 1.8 i 16V, 2.0 i, 2.0 i 16V 03/92 - 09/98 42 -100 kW	46-188885	45-50	30	Conditions see certificates VA: axle load to: 900 kg HA: axle load to: 800 kg

VAUXHALL ASTRA Mk III Hatchback					
B10	1.4 i, 1.4 i 16V, 1.4 S, 1.6 i, 1.6 i 16V, 1.7 D, 1.7 TD, 1.8 i, 1.8 i 16V, 2.0 i, 2.0 i 16V 09/91 - 02/98 42 -110 kW	46-111920	60	40	Conditions see certificates VA: axle load to: 900 kg HA: axle load to: 800 kg
B12 PK	1.4 i, 1.4 i 16V, 1.4 S, 1.6 i, 1.6 i 16V, 1.7 D, 1.7 TD, 1.8 i, 1.8 i 16V, 2.0 i, 2.0 i 16V 09/91 - 02/98 42 -110 kW	46-188861	30	30	Conditions see certificates VA: axle load to: 870 kg HA: axle load to: 800 kg
B12 SL	1.4 i, 1.4 i 16V, 1.4 S, 1.6 i, 1.6 i 16V, 1.7 D, 1.7 TD, 1.8 i, 1.8 i 16V, 2.0 i, 2.0 i 16V 09/91 - 02/98 42 -110 kW	46-188885	45-50	30	Conditions see certificates VA: axle load to: 900 kg HA: axle load to: 800 kg

VAUXHALL ASTRA Mk III Estate					
B12 PK	1.4 i, 1.4 i 16V, 1.4 S, 1.6 i, 1.6 i 16V, 1.6 Si, 1.7 D, 1.7 TD, 1.8 i, 1.8 i 16V, 2.0 i, 2.0 i 16V 03/91 - 02/98 42 -100 kW	46-188878	30	30	Conditions see certificates VA: axle load to: 870 kg HA: axle load to: 860 kg



VAUXHALL

VAUXHALL ASTRA Mk III Convertible

B12 PK	1.4 i, 1.4 i 16V, 1.6, 1.6 i, 1.8, 1.8 16V, 2.0 i 03/93 - 03/01 52 -92 kW	46-188861	30	30	Conditions see certificates VA: axle load to: 870 kg HA: axle load to: 800 kg
-----------	---	-----------	----	----	---

VAUXHALL ASTRAVAN Mk III

B12 PK	1.4 i, 1.6 i, 1.7 D, 1.7 TD 01/91 - 08/98 44 -55 kW	46-188878	30	30	Conditions see certificates VA: axle load to: 870 kg HA: axle load to: 860 kg
-----------	--	-----------	----	----	---

VAUXHALL ASTRA Mk IV

B12 PK	1.2 16V, 1.4, 1.4 16V, 1.6, 1.6 16V 05/98 - 05/05 44 -74 kW	46-188984	30	30	Conditions see certificates VA: axle load to: 845 kg HA: axle load to: 820 kg
-----------	--	-----------	----	----	---

B12 PK	1.4, 1.4 16V, 1.6, 1.6 16V, 1.7 CDTI 16V, 1.7 DTI 16V, 1.7 TD, 1.8 16V, 1.8 16V Dualfuel, 2.0 16V 02/98 - 05/05 44 -100 kW	46-188946	30	30	Conditions see certificates VA: axle load to: 935 kg HA: axle load to: 820 kg
-----------	---	-----------	----	----	---

B12 PK	2.0 DI, 2.0 DTI 16V, 2.2 16V 02/98 - 05/05 60 -108 kW	46-188960	30	30	Conditions see certificates VA: axle load to: 1035 kg HA: axle load to: 820 kg
-----------	--	-----------	----	----	--

B12 SL	1.2 16V, 1.4, 1.4 16V, 1.6, 1.6 16V, 1.8 16V, 1.8 16V Dualfuel, 2.0 16V, 2.2 16V 02/98 - 05/05 44 -108 kW	46-188939	45-50	30	Conditions see certificates VA: axle load to: 965 kg HA: axle load to: 895 kg
-----------	--	-----------	-------	----	---

B14	1.2 16V, 1.4, 1.4 16V, 1.6, 1.6 16V, 1.6 Dualfuel, 1.7 CDTI 16V, 1.7 DTI 16V, 1.7 TD, 1.8 16V, 1.8 16V Dualfuel, 2.0 16V, 2.0 DI, 2.0 DTI 16V, 2.2 16V 02/98 - 05/05 44 -108 kW	47-087484	40-60	25-45	Conditions see certificates VA: axle load to: 1034 kg HA: axle load to: 820 kg
-----	---	-----------	-------	-------	--

VAUXHALL ASTRA Mk IV Hatchback

B12 PK	1.2 16V, 1.4, 1.4 16V, 1.6, 1.6 16V 02/98 - 05/05 44 -74 kW	46-188984	30	30	Conditions see certificates VA: axle load to: 845 kg HA: axle load to: 820 kg
-----------	--	-----------	----	----	---

B12 PK	1.4, 1.4 16V, 1.6, 1.6 16V, 1.7 CDTI 16V, 1.7 DTI 16V, 1.7 TD, 1.8 16V, 1.8 16V Dualfuel, 1.9, 2.0 16V 02/98 - 05/05 44 -118 kW	46-188946	30	30	Conditions see certificates VA: axle load to: 935 kg HA: axle load to: 820 kg
-----------	--	-----------	----	----	---

B12 PK	1.7 CDTI 16V, 1.7 DTI 16V, 1.7 TD, 1.8 16V, 1.8 16V Dualfuel, 1.9, 2.0 16V, 2.0 DI, 2.0 DTI 16V, 2.0 SRI Turbo, 2.2 16V 03/01 - 05/05 50 -141 kW	46-188960	30	30	Conditions see certificates VA: axle load to: 1035 kg HA: axle load to: 820 kg
-----------	---	-----------	----	----	--





B12 SL	1.2 16V, 1.4, 1.4 16V, 1.6, 1.6 16V, 1.7 CDTI 16V, 1.7 DTI 16V, 1.7 TD, 1.8 16V, 1.8 16V Dualfuel, 1.9, 2.0 16V, 2.0 DI, 2.0 DTI 16V, 2.0 SRI Turbo, 2.2 16V 02/98 - 05/05 44 -141 kW	46-188939	45-50	30	Conditions see certificates VA: axle load to: 965 kg HA: axle load to: 895 kg
-----------	--	-----------	-------	----	---

B14	1.2 16V, 1.4, 1.4 16V, 1.6, 1.6 16V, 1.6 Dualfuel, 1.7 CDTI 16V, 1.7 DTI 16V, 1.7 TD, 1.8 16V, 1.8 16V Dualfuel, 1.9, 2.0 16V, 2.0 DI, 2.0 DTI 16V, 2.0 SRI Turbo, 2.2 16V 02/98 - 05/05 44 -141 kW	47-087484	40-60	25-45	Conditions see certificates VA: axle load to: 1034 kg HA: axle load to: 820 kg
-----	--	-----------	-------	-------	--

VAUXHALL ASTRA Mk IV Estate

B12 PK	1.2 16V, 1.4 16V, 1.6, 1.6 16V 02/98 - 04/04 48 -74 kW	46-188991	30	30	without ride height adjustment; Conditions see certificates VA: axle load to: 845 kg HA: axle load to: 885 kg
-----------	---	-----------	----	----	---

B12 PK	1.4 16V, 1.6, 1.6 16V, 1.7 DTI 16V, 1.8 16V, 2.0 16V 02/98 - 05/05 55 -100 kW	46-188953	30	30	without ride height adjustment; Conditions see certificates VA: axle load to: 935 kg HA: axle load to: 885 kg
-----------	---	-----------	----	----	---

									
VAUXHALL									
VAUXHALL ASTRA Mk IV Estate									
B12 PK	1.7 CDTI 16V, 1.7 DTI 16V, 1.7 TD, 1.8 16V, 2.0 16V, 2.0 DI, 2.0 DTI 16V, 2.2 16V 03/01 - 05/05 50 -108 kW	46-188977	30	30	without ride height adjustment; Conditions see certificates VA: axle load to: 1035 kg HA: axle load to: 885 kg				
VAUXHALL ASTRA Mk IV Coupe									
B12 PK	1.8 16V, 1.9, 2.0 16V Turbo 03/00 - 08/05 85 -147 kW	46-188892	30	30	Conditions see certificates VA: axle load to: 1015 kg HA: axle load to: 780 kg				
VAUXHALL ASTRA MK IV Convertible									
B12 PK	1.6 16V, 1.8 16V, 1.9, 2.0 Turbo 03/01 - 07/06 74 -147 kW	46-188908	30	30	Conditions see certificates VA: axle load to: 1015 kg HA: axle load to: 845 kg				
VAUXHALL ASTRAVAN MK IV									
B12 PK	1.6 i 08/98 - 08/06 55 -62 kW	46-188991	30	30	without ride height adjustment; Conditions see certificates VA: axle load to: 845 kg HA: axle load to: 885 kg				
B12 PK	1.7 CDTI, 1.7 DTI, 1.7 TD, 2.0 DI, 2.0 DTI 08/98 - 08/06 50 -74 kW	46-188953	30	30	without ride height adjustment; Conditions see certificates VA: axle load to: 935 kg HA: axle load to: 885 kg				
VAUXHALL ASTRA MK V Sport Hatch									
B12 PK	1.4, 1.4 16V, 1.6, 1.6 i 16V, 1.8 02/05 - 11/10 55 -132 kW	46-182128	30	30	disconnect ITS+; Conditions see certificates VA: axle load to: 970 kg HA: without ride height adjustment; axle load to: 860 kg				
B12 PK	1.3 CDTi, 1.7 CDTi, 1.7 CDTi 16V, 1.9 CDTi, 2.0 Turbo 02/05 - 11/10 66 -125 kW	46-182135	30	30	disconnect ITS+; Conditions see certificates VA: axle load to: 1075 kg HA: without ride height adjustment; axle load to: 860 kg				
B12 SL	1.4, 1.4 16V, 1.6, 1.6 i 16V, 1.8 02/05 - 11/10 55 -132 kW	46-182166	45-50	30	disconnect ITS+; Conditions see certificates VA: axle load to: 960 kg HA: without ride height adjustment; axle load to: 860 kg				
B12 SL	1.3 CDTi, 1.7 CDTi, 1.7 CDTi 16V, 2.0 Turbo 02/05 - 11/10 66 -125 kW	46-182173	45-50	30	disconnect ITS+; Conditions see certificates VA: axle load to: 1025 kg HA: without ride height adjustment; axle load to: 860 kg				
B14	1.3 CDTi, 1.4, 1.4 16V, 1.6, 1.6 i 16V, 1.7 CDTi, 1.7 CDTi 16V, 1.8, 1.9 CDTi, 2.0 Turbo, VX Racing Edition 02/05 - 11/10 55 -176 kW	47-121133	30-50	30-50	disconnect ITS+; Conditions see certificates VA: axle load to: 1060 kg HA: axle load to: 860 kg				
VAUXHALL ASTRA MK V Hatchback									
B12 PK	1.4, 1.6, 1.8 01/04 - 05/09 66 -103 kW	46-182128	30	30	disconnect ITS+; Conditions see certificates VA: axle load to: 970 kg HA: without ride height adjustment; axle load to: 860 kg				
B12 PK	1.3 CDTi, 1.7 CDTi, 1.7 TD, 1.9 CDTi, 1.9 CDTi 16V, 2.0 Turbo 01/04 - 05/09 59 -177 kW	46-182135	30	30	disconnect ITS+; Conditions see certificates VA: axle load to: 1075 kg HA: without ride height adjustment; axle load to: 860 kg				
B12 SL	1.3 CDTi, 1.4, 1.6, 1.7 CDTi, 1.7 TD, 1.8, 2.0 Turbo 01/04 - 05/09 59 -177 kW	46-182166	45-50	30	disconnect ITS+; Conditions see certificates VA: axle load to: 960 kg HA: without ride height adjustment; axle load to: 860 kg				
B14	1.3 CDTi, 1.4, 1.6, 1.7 CDTi, 1.7 TD, 1.8, 1.9 CDTi, 1.9 CDTi 16V, 2.0 Turbo 01/04 - 05/09 59 -177 kW	47-121133	30-50	30-50	disconnect ITS+; Conditions see certificates				
VAUXHALL ASTRA MK V Estate									
B12 PK	1.4, 1.6, 1.8 08/04 - 03/09 66 -132 kW	46-182142	30-35	25-30	disconnect ITS+; Conditions see certificates VA: axle load to: 970 kg HA: without ride height adjustment; axle load to: 940 kg				
B12 PK	1.3 CDTi, 1.7 CDTi, 1.7 TD, 1.9 CDTi, 1.9 CDTi 16V, 2.0 Turbo 08/04 - 10/10 66 -147 kW	46-182159	30-35	25-30	disconnect ITS+; Conditions see certificates VA: axle load to: 1075 kg HA: without ride height adjustment; axle load to: 940 kg				



VAUXHALL

VAUXHALL ASTRA MK V Estate

B12 SL	1.3 CDTi, 1.4, 1.6, 1.7 CDTi, 1.7 TD, 1.8, 2.0 Turbo 08/04 - 10/10 66 -147 kW	46-182197	40-45	35	disconnect ITS+; Conditions see certificates VA: axle load to: 1025 kg HA: without ride height adjustment; axle load to: 940 kg
-----------	--	-----------	-------	----	---

VAUXHALL ASTRAVAN MK V

B12 PK	1.4 i 16V, 1.6 03/05 - 66 -76 kW	46-182142	30-35	25-30	disconnect ITS+; Conditions see certificates VA: axle load to: 970 kg HA: without ride height adjustment; axle load to: 940 kg
B12 PK	1.3 CDTi 16V, 1.7 CDTi, 1.7 CDTi 16V, 1.9 CDTi, 1.9 CDTi 16V 03/05 - 59 -110 kW	46-182159	30-35	25-30	disconnect ITS+; Conditions see certificates VA: axle load to: 1075 kg HA: without ride height adjustment; axle load to: 940 kg
B12 SL	1.6 03/05 - 76 kW	46-182197	40-45	35	disconnect ITS+; Conditions see certificates VA: axle load to: 1025 kg HA: without ride height adjustment; axle load to: 940 kg
B12 SL	1.3 CDTi 16V, 1.4 i 16V, 1.7 CDTi, 1.7 CDTi 16V 03/05 - 59 -74 kW	46-182197	40-45	35	disconnect ITS+; Conditions see certificates VA: axle load to: 1025 kg HA: without ride height adjustment; axle load to: 940 kg

VAUXHALL ASTRA MK VI

B12 PK	1.6 i 16v Turbo, 1.6 SIDI 12/09 - 125 -132 kW	46-188762	30	30	without FlexRide; Conditions see certificates VA: axle load to: 1080 kg HA: axle load to: 1020 kg
B12 PK	1.3 CDTi 16V, 1.4 i 16v VVT, 1.4 i 16v VVT Turbo, 1.4 Turbo, 1.6 i 16v Turbo, 1.6 i 16v VVT, 1.6 SIDI 12/09 - 64 -132 kW	46-188755	30	30	without FlexRide; Conditions see certificates VA: axle load to: 995 kg HA: axle load to: 1020 kg
B12 PK	1.7 CDTi, 2.0 BiTurbo CDTi, 2.0 CDTi 12/09 - 74 -143 kW	46-188779	30	30	without FlexRide; Conditions see certificates VA: axle load to: 1155 kg HA: axle load to: 1020 kg
B14	1.3 CDTi 16V, 1.4 i 16v VVT, 1.4 i 16v VVT Turbo, 1.4 Turbo, 1.6 i 16v Turbo, 1.6 i 16v VVT, 1.6 SIDI, 1.7 CDTi, 2.0 BiTurbo CDTi, 2.0 CDTi 12/09 - 64 -143 kW	47-171725	30-50	30-50	without FlexRide; Conditions see certificates VA: axle load to: 1220 kg HA: axle load to: 1020 kg

VAUXHALL ASTRA Mk VI (J) Sports Tourer

B14	1.3 CDTi 16V, 1.4 i 16V, 1.4 Turbo, 1.6 i 16V, 1.6 SIDI, 1.6 Turbo, 1.7 CDTi, 1.7 CDTi 16V, 2.0 BiTurbo CDTi, 2.0 CDTi, 2.0 CDTi 16V 12/09 - 70 -143 kW	47-171725	30-50	30-50	without FlexRide; Conditions see certificates VA: axle load to: 1220 kg HA: axle load to: 1020 kg
-----	--	-----------	-------	-------	---

VAUXHALL ASTRA GTC Mk VI (J)





B14	1.4, 1.6, 1.6 SIDI, 1.7 CDTi, 2.0 BiTurbo CDTi, 2.0 CDTi 10/11 - 74 -143 kW	47-231207	20-40	20-40	without electronic suspension control; disconnect ITS+; Conditions see certificates
B14	2.0 VXR 04/12 - 206 kW	47-231207	10-25	10-25	without electronic suspension control; disconnect ITS+; Conditions see certificates





VAUXHALL CALIBRA





B12 PK	2.0 i, 2.0 i 16V, 2.0 i 16V 4x4 06/90 - 07/97 85 -110 kW	46-192851	30	30	Conditions see certificates VA: axle load to: 885 kg HA: axle load to: 880 kg
B12 PK	2.0 i 4x4 06/90 - 07/97 85 kW	46-192851	30	30	Conditions see certificates VA: axle load to: 885 kg HA: axle load to: 880 kg

VAUXHALL CORSA

B10	1.0 i 12V, 1.2 i, 1.2 i 16V, 1.4 i, 1.4 i 16V, 1.4 i S, 1.5 D, 1.5 TD, 1.6 GSI 16V, 1.6 i 16V, 1.7 D 02/96 - 09/00 33 -80 kW	46-111951	55	50	Conditions see certificates VA: axle load to: 840 kg HA: axle load to: 700 kg
-----	---	-----------	----	----	---

   					
VAUXHALL					
VAUXHALL CORSA					
B12 PK	1.0 i 12V, 1.2 i, 1.2 i 16V, 1.4 i, 1.4 i 16V, 1.4 i S, 1.6 GSI 16V, 1.6 i 16V 09/94 - 09/00 33 -80 kW	46-189011	30	30	Conditions see certificates VA: axle load to: 790 kg HA: axle load to: 700 kg
B12 SL	1.0 i 12V, 1.2 i, 1.2 i 16V, 1.4 i, 1.4 i 16V, 1.4 i S, 1.6 GSI 16V, 1.6 i 16V 09/94 - 09/00 33 -80 kW	46-189004	45-50	25	Conditions see certificates VA: axle load to: 790 kg HA: axle load to: 700 kg
B14	1.0 i 12V, 1.2 i, 1.2 i 16V, 1.4 i, 1.4 i 16V, 1.4 i S, 1.5 D, 1.5 TD, 1.6 GSI 16V, 1.6 i 16V, 1.7 D 02/96 - 09/00 33 -80 kW	47-080713	30-50	30-50	Conditions see certificates VA: axle load to: 820 kg HA: axle load to: 700 kg
B16 PSS9	1.0 i 12V, 1.2 i, 1.2 i 16V, 1.4 i, 1.4 i 16V, 1.4 i S, 1.5 D, 1.5 TD, 1.6 GSI 16V, 1.6 i 16V, 1.7 D 02/96 - 09/00 33 -80 kW	48-080767	30-50	30-50	Conditions see certificates VA: axle load to: 820 kg HA: axle load to: 700 kg
VAUXHALL CORSAVAN					
B10	1.4 i, 1.5 D, 1.7 D 01/94 - 09/00 37 -44 kW	46-111951	55	50	Conditions see certificates VA: axle load to: 840 kg HA: axle load to: 700 kg
B12 PK	1.4 i 01/94 - 09/00 44 kW	46-189011	30	30	Conditions see certificates VA: axle load to: 790 kg HA: axle load to: 700 kg
B12 SL	1.4 i 01/94 - 09/00 44 kW	46-189004	45-50	25	Conditions see certificates VA: axle load to: 790 kg HA: axle load to: 700 kg
B14	1.4 i, 1.5 D, 1.7 D 01/94 - 09/00 37 -44 kW	47-080713	30-50	30-50	Conditions see certificates VA: axle load to: 820 kg HA: axle load to: 700 kg
B16 PSS9	1.4 i, 1.5 D, 1.7 D 01/94 - 09/00 37 -44 kW	48-080767	30-50	30-50	Conditions see certificates VA: axle load to: 820 kg HA: axle load to: 700 kg
VAUXHALL CORSA Mk II					
B12 PK	1.0 12V, 1.2 16V, 1.4 16V, 1.4 Twinport, 1.7 CDTI 16V, 1.7 DI 16V, 1.7 DTI 16V, 1.8 16V 08/00 - 09/06 43 -92 kW	46-189059	30	30	Conditions see certificates; thread: M10 VA: axle load to: 940 kg HA: drum Brake; axle load to: 760 kg
B12 PK	1.0 12V, 1.2 16V, 1.4 16V, 1.4 Twinport 09/00 - 10/06 43 -66 kW	46-189028	30	30	Conditions see certificates; thread: M14 VA: axle load to: 820 kg HA: disc Brake; axle load to: 760 kg
B12 PK	1.3 CDTI 16V, 1.7 CDTI 16V, 1.7 DI 16V, 1.7 DTI 16V, 1.8 16V 08/00 - 09/06 48 -92 kW	46-189035	30	30	Conditions see certificates; thread: M14 VA: axle load to: 940 kg HA: disc Brake; axle load to: 760 kg
B14	1.0 12V, 1.2 16V, 1.2 16V Dualfuel, 1.3 CDTI 16V, 1.4 16V, 1.4 Twinport, 1.7 CDTI 16V, 1.7 DI 16V, 1.7 DTI 16V, 1.8 16V 08/00 - 09/06 43 -92 kW	47-167254	30-50	20-40	Conditions see certificates VA: axle load to: 900 kg HA: axle load to: 760 kg
VAUXHALL CORSAVAN MK II					
B12 PK	1.2 16V, 1.3 CDTI 16V, 1.4, 1.7 DI 16V, 1.7 DTI 16V 09/00 - 06/06 48 -66 kW	46-189059	30	30	Conditions see certificates; thread: M10 VA: axle load to: 940 kg HA: drum Brake; axle load to: 760 kg
B12 PK	1.2 16V, 1.3 CDTI 16V, 1.4, 1.7 DI 16V, 1.7 DTI 16V 09/00 - 06/06 48 -66 kW	46-189035	30	30	Conditions see certificates; thread: M14 VA: axle load to: 940 kg HA: disc Brake; axle load to: 760 kg
B14	1.2 16V, 1.2 16V Dualfuel, 1.3 CDTI 16V, 1.4, 1.7 DI 16V, 1.7 DTI 16V 09/00 - 06/06 48 -66 kW	47-167254	30-50	20-40	Conditions see certificates VA: axle load to: 900 kg HA: axle load to: 760 kg

   					
VAUXHALL					
VAUXHALL CORSA MK III					
B12 PK	1.0, 1.0 i 12V, 1.2, 1.2 i 16V, 1.4, 1.4 16V 07/06 - 44 -74 kW	46-188144	30	30	Conditions see certificates VA: axle load to: 885 kg HA: without ride height adjustment; axle load to: 845 kg
B12 PK	1.3 CDTI, 1.6 SRi, 1.6 Turbo, 1.7 CDTI, 1.7 CDTI 16V 11/06 - 55 -141 kW	46-188151	30	30	Conditions see certificates VA: axle load to: 1000 kg HA: without ride height adjustment; axle load to: 845 kg
B14	1.0, 1.0 i 12V, 1.2, 1.2 i 16V, 1.3 CDTI, 1.4, 1.4 16V, 1.6 SRi, 1.6 Turbo, 1.7 CDTI, 1.7 CDTI 16V 07/06 - 44 -141 kW	47-164499	35-45	30-45	VA: Conditions see certificates; axle load to: 1000 kg HA: axle load to: 850 kg
VAUXHALL CORSAVAN MK III					
B12 PK	1.2 i 16V 01/10 - 51 kW	46-188144	30	30	Conditions see certificates VA: axle load to: 885 kg HA: without ride height adjustment; axle load to: 845 kg
B12 PK	1.3 CDTI, 1.3 CDTI 16V 07/06 - 55 -70 kW	46-188151	30	30	Conditions see certificates VA: axle load to: 1000 kg HA: without ride height adjustment; axle load to: 845 kg
B14	1.2 i 16V, 1.3 CDTI, 1.3 CDTI 16V 07/06 - 51 -70 kW	47-164499	35-45	30-45	VA: Conditions see certificates; axle load to: 1000 kg HA: axle load to: 850 kg
VAUXHALL INSIGNIA					
B12 PK	1.4, 1.6, 1.6 Turbo, 2.0 Biturbo CDTI, 2.0 CDTI, 2.0 CDTI 16V 4x4, 2.0 CDTI 4x4, 2.0 Turbo, 2.0 Turbo 4x4, 2.8 i V6 24V, 2.8 V6 Turbo 07/08 - 81 -239 kW	46-188793	30	30	without FlexRide; without ride height adjustment; Conditions see certificates VA: axle load to: 1160 kg HA: axle load to: 1160 kg
B12 PK	1.8 07/08 - 103 kW	46-188786	30	30	without FlexRide; without ride height adjustment; Conditions see certificates VA: axle load to: 1030 kg HA: axle load to: 1160 kg
VAUXHALL INSIGNIA Saloon					
B12 PK	1.4, 1.6, 1.8 07/08 - 85 -103 kW	46-188786	30	30	without FlexRide; Conditions see certificates VA: axle load to: 1030 kg HA: axle load to: 1160 kg
B12 PK	1.6 Turbo, 2.0 Biturbo CDTI, 2.0 CDTI, 2.0 Turbo 07/08 - 81 -162 kW	46-188793	30	30	without FlexRide; without ride height adjustment; Conditions see certificates VA: axle load to: 1160 kg HA: axle load to: 1160 kg
VAUXHALL INSIGNIA SPORTS TOURER					
B12 PK	1.4, 1.6, 1.6 Turbo, 2.0 Biturbo CDTI, 2.0 CDTI, 2.0 Turbo 07/08 - 81 -162 kW	46-188830	30	30	without FlexRide; without ride height adjustment; Conditions see certificates VA: axle load to: 1160 kg HA: axle load to: 1265 kg
B12 PK	1.8 07/08 - 103 kW	46-188823	30	30	without FlexRide; Conditions see certificates VA: axle load to: 1030 kg HA: axle load to: 1265 kg
B12 PK	2.0 Turbo 4x4 07/08 - 162 kW	46-188847	30	30	without FlexRide; without ride height adjustment; Conditions see certificates VA: axle load to: 1160 kg HA: axle load to: 1355 kg
B12 PK	2.0 Biturbo CDTI 4x4, 2.0 CDTI 16V 4x4, 2.0 CDTI 4x4, 2.0 Turbo 4x4, 2.8 i V6 24V, 2.8 V6 Turbo 08/08 - 118 -239 kW	46-188854	30	30	without FlexRide; without ride height adjustment; Conditions see certificates VA: axle load to: 1240 kg HA: axle load to: 1265 kg
VAUXHALL MERIVA MK II					
B12 PK	1.3 CDTI 16V, 1.4 16V, 1.4 16V Turbo 06/10 - 55 -103 kW	46-206985	20-25	20-25	twin-tube; Conditions see certificates VA: axle load to: 1060 kg HA: axle load to: 1010 kg

					
VAUXHALL					
VAUXHALL MERIVA MK II					
B12 PK	1.7 CDTi, 1.7 CDTi 16V 06/10 - 74 -96 kW	46-207005	20-25	20-25	twin-tube; Conditions see certificates VA: axle load to: 1145 kg HA: axle load to: 1010 kg
VAUXHALL NOVA					
B10	1.0, 1.2 N, 1.2 S, 1.3 i, 1.3 S, 1.4, 1.4 S, 1.5 D, 1.5 TD 09/82 - 02/93 33 -60 kW	46-111951	55	50	Conditions see certificates VA: axle load to: 775 kg HA: axle load to: 670 kg
B14	1.0, 1.2 N, 1.2 S, 1.3 i, 1.3 S, 1.4, 1.4 S, 1.5 D, 1.5 TD 09/82 - 02/93 33 -60 kW	47-080713	30-50	20-40	Conditions see certificates VA: axle load to: 820 kg HA: axle load to: 700 kg
B16 PSS9	1.0, 1.2 N, 1.2 S, 1.3 i, 1.3 S, 1.4, 1.4 S, 1.5 D, 1.5 TD 09/82 - 02/93 33 -60 kW	48-080767	30-50	20-40	Conditions see certificates VA: axle load to: 820 kg HA: axle load to: 700 kg
VAUXHALL NOVA Hatchback					
B10	1.0, 1.2 i, 1.2 i CAT, 1.2 N, 1.2 S, 1.3 i, 1.3 i CAT, 1.3 S, 1.4 i, 1.4 i S, 1.4 S, 1.5 D, 1.5 TD, 1.6, 1.6 GSi, 1.6 GSi CAT 05/83 - 03/93 33 -74 kW	46-111951	55	55	Conditions see certificates VA: axle load to: 775 kg HA: axle load to: 670 kg
B14	1.0, 1.2 i, 1.2 i CAT, 1.2 N, 1.2 S, 1.3 i, 1.3 i CAT, 1.3 S, 1.4 i, 1.4 i S, 1.4 S, 1.5 D, 1.5 TD, 1.6, 1.6 GSi, 1.6 GSi CAT 05/83 - 03/93 33 -74 kW	47-080713	30-50	20-40	Conditions see certificates VA: axle load to: 820 kg HA: axle load to: 700 kg
B16 PSS9	1.0, 1.2 i, 1.2 i CAT, 1.2 N, 1.2 S, 1.3 i, 1.3 i CAT, 1.3 S, 1.4 i, 1.4 i S, 1.4 S, 1.5 D, 1.5 TD, 1.6, 1.6 GSi, 1.6 GSi CAT 05/83 - 03/93 33 -74 kW	48-080767	30-50	20-40	Conditions see certificates VA: axle load to: 820 kg HA: axle load to: 700 kg
VAUXHALL OMEGA					
B12 PK	2.0, 2.0 16V, 2.2 16V 01/94 - 06/03 85 -106 kW	46-192806	30	30	without ride height adjustment; Conditions see certificates VA: axle load to: 990 kg HA: axle load to: 1155 kg
B12 PK	2.0 DTI 16V, 2.2 DTI 16V, 2.5 DTI 24V, 2.5 TD, 2.5 V6, 2.6 V6, 3.0 V6, 3.2 V6 04/94 - 07/03 74 -160 kW	46-192813	30	30	without ride height adjustment; Conditions see certificates VA: axle load to: 1080 kg HA: axle load to: 1155 kg
VAUXHALL OMEGA Estate					
B12 PK	2.0, 2.0 16V, 2.2 16V 02/94 - 06/03 85 -106 kW	46-192820	30	30	without ride height adjustment; Conditions see certificates VA: axle load to: 990 kg HA: axle load to: 1290 kg
B12 PK	2.0 DTI 16V, 2.2 DTI 16V, 2.5 DTI 24V, 2.5 TD, 2.5 V6, 2.6 V6, 3.0 V6, 3.2 V6 07/94 - 03/04 74 -160 kW	46-192837	30	30	without ride height adjustment; Conditions see certificates VA: axle load to: 1080 kg HA: axle load to: 1290 kg
VAUXHALL SIGNUM					
B12 PK	1.8, 1.9 CDTi, 1.9 CDTi 16V, 2.0 DTI, 2.0 i Turbo, 2.2 DTI, 2.2 i 05/03 - 09/04 74 -129 kW	46-190574	30	30	-> CH.Nr.: 41999999; without electronic suspension control; Conditions see certificates VA: axle load to: 1060 kg HA: axle load to: 1215 kg
B12 PK	1.8, 1.9 CDTi, 1.9 CDTi 16V, 2.0 DTI, 2.0 i Turbo, 2.2 DTI, 2.2 i 10/04 - 05/08 74 -129 kW	46-190604	30	30	CH.Nr.: 51000001 ->; without electronic suspension control; Conditions see certificates VA: axle load to: 1060 kg HA: axle load to: 1215 kg
B12 PK	1.9 CDTi, 1.9 CDTi 16V, 2.0 DTI, 2.2 DTI, 3.2 V6 05/03 - 09/04 74 -155 kW	46-190581	30	30	-> CH.Nr.: 41999999; without electronic suspension control; Conditions see certificates VA: axle load to: 1135 kg HA: axle load to: 1215 kg



VAUXHALL

VAUXHALL SIGNUM

B12 PK	1.9 CDTI, 1.9 CDTI 16V, 2.0 DTI, 2.2 DTI, 3.2 V6 10/04 - 05/08 74 -155 kW	46-190611	30	30	CH.Nr.: 51000001 ->; without electronic suspension control; Conditions see certificates VA: axle load to: 1135 kg HA: axle load to: 1215 kg
B12 PK	3.0 V6 CDTI 04/02 - CH-Nr. 135 kW	46-190598	30	30	-> CH.Nr.: 41999999; without electronic suspension control; Conditions see certificates VA: axle load to: 1230 kg HA: axle load to: 1215 kg
B12 PK	3.0 V6 CDTI 10/04 - 05/08 135 kW	46-190628	30	30	CH.Nr.: 51000001 ->; without electronic suspension control; Conditions see certificates VA: axle load to: 1230 kg HA: axle load to: 1215 kg

VAUXHALL SPEEDSTER (VX220)

B16 PSS10	2.0 10/03 - 09/06 162 kW	48-136723	0-10	0-20	Conditions see certificates VA: axle load to: 485 kg HA: axle load to: 760 kg
--------------	------------------------------------	------------------	------	------	---

VAUXHALL TIGRA

B14	1.4 16V, 1.6 16V 07/94 - 12/00 66 -78 kW	47-080713	30-50	30-50	Conditions see certificates
B16 PSS9	1.4 16V, 1.6 16V 07/94 - 12/00 66 -78 kW	48-080767	30-50	30-50	Conditions see certificates

VAUXHALL TIGRA TwinTop

B14	1.3 CDTI, 1.4, 1.8 06/04 - 08/09 51 -92 kW	47-167254	30-50	20-40	Conditions see certificates VA: axle load to: 895 kg HA: axle load to: 680 kg
-----	--	------------------	-------	-------	---

VAUXHALL VECTRA





B12 PK	1.6 i, 1.6 i 16V 08/95 - 10/01 55 -74 kW	46-192745	35	35	Conditions see certificates VA: axle load to: 975 kg HA: without ride height adjustment; axle load to: 945 kg
B12 PK	1.6 i, 1.6 i 16V, 1.8 i 16V, 2.0 i 16V, 2.2 i 16V, 2.5 i V6 08/95 - 03/02 55 -125 kW	46-192783	30	30	Conditions see certificates VA: axle load to: 870 kg HA: without ride height adjustment; axle load to: 945 kg
B12 PK	2.0 Di 16V, 2.0 DTi 16V, 2.0 i 16V, 2.2 DTi 16V, 2.2 i 16V, 2.5 i V6, 2.6 i V6 08/95 - 03/02 60 -125 kW	46-192752	35	35	Conditions see certificates VA: axle load to: 1055 kg HA: without ride height adjustment; axle load to: 945 kg

VAUXHALL VECTRA Hatchback

B12 PK	1.6 i, 1.6 i 16V 08/95 - 10/01 55 -74 kW	46-192745	35	35	Conditions see certificates VA: axle load to: 975 kg HA: without ride height adjustment; axle load to: 945 kg
B12 PK	1.6 i, 1.6 i 16V, 1.7 TD, 1.8 i 16V, 2.0 i 16V, 2.2 i 16V, 2.5 i V6 08/95 - 07/03 55 -125 kW	46-192783	30	30	Conditions see certificates VA: axle load to: 870 kg HA: without ride height adjustment; axle load to: 945 kg
B12 PK	2.0 Di 16V, 2.0 DTi 16V, 2.0 i 16V, 2.2 DTi 16V, 2.2 i 16V, 2.5 i V6, 2.6 i V6 08/95 - 07/03 60 -125 kW	46-192752	35	35	Conditions see certificates VA: axle load to: 1055 kg HA: without ride height adjustment; axle load to: 945 kg

VAUXHALL VECTRA Estate

B12 PK	1.6 i, 1.6 i 16V 11/96 - 03/02 55 -74 kW	46-192783	30	30	Conditions see certificates VA: axle load to: 870 kg HA: without ride height adjustment; axle load to: 1025 kg
B12 PK	1.6 i, 1.6 i 16V, 1.8 i 16V, 2.0 i 16V, 2.2 i 16V, 2.5 i V6 08/95 - 03/02 55 -125 kW	46-192769	30	30	Conditions see certificates VA: axle load to: 975 kg HA: without ride height adjustment; axle load to: 1025 kg

					
VAUXHALL					
VAUXHALL VECTRA Estate					
B12 PK	2.0 DI 16V, 2.0 DTI 16V, 2.0 i 16V, 2.2 DTI 16V, 2.2 i 16V, 2.5 i V6, 2.6 i V6 08/95 - 03/02 60 -125 kW	46-192776	30	30	Conditions see certificates VA: axle load to: 1055 kg HA: without ride height adjustment; axle load to: 1025 kg

VAUXHALL VECTRA Mk II GTS					
B12 PK	1.6 16V, 1.8 16V, 1.8 16V Dualfuel 08/02 - 09/04 74 -90 kW	46-190550	30	30	-> CH.Nr.: 41999999; without IDS+ suspension; Conditions see certificates VA: axle load to: 965 kg HA: axle load to: 1035 kg
B12 PK	1.6, 1.8, 1.8 16V, 1.9 CDTI, 1.9 CDTI 16V, 2.0 16V Turbo, 2.0 DTI 16V, 2.2 16V, 2.2 direct, 2.2 DTI 16V, 3.2 V6 10/04 - 07/08 74 -155 kW	46-194060	30	30	CH.Nr.: 51000001 ->; without IDS+ suspension; Conditions see certificates VA: axle load to: 1060 kg HA: axle load to: 1035 kg
B12 PK	1.6, 1.6 16V, 1.8, 1.8 16V 10/04 - 07/08 74 -103 kW	46-194077	30	30	CH.Nr.: 51000001 ->; without IDS+ suspension; Conditions see certificates VA: axle load to: 965 kg HA: axle load to: 1035 kg
B12 PK	1.8 16V, 1.8 16V Dualfuel, 1.9 CDTI, 1.9 CDTI 16V, 2.0 16V Turbo, 2.0 DTI 16V, 2.2 16V, 2.2 direct, 2.2 DTI 16V, 3.2 V6 08/02 - 09/04 74 -155 kW	46-190536	30	30	-> CH.Nr.: 41999999; without IDS+ suspension; Conditions see certificates VA: axle load to: 1060 kg HA: axle load to: 1035 kg
B12 PK	1.9 CDTI, 1.9 CDTI 16V, 2.0 16V Turbo, 2.0 DTI 16V, 2.2 16V, 2.2 direct, 2.2 DTI 16V, 3.2 V6 10/04 - 07/08 74 -155 kW	46-194008	30	30	CH.Nr.: 51000001 ->; without IDS+ suspension; Conditions see certificates VA: axle load to: 1135 kg HA: axle load to: 1035 kg
B12 PK	1.9 CDTI, 1.9 CDTI 16V, 2.0 16V Turbo, 2.0 DTI 16V, 2.2 16V, 2.2 direct, 2.2 DTI 16V, 3.2 V6 08/02 - 09/04 74 -155 kW	46-190543	30	30	-> CH.Nr.: 41999999; without IDS+ suspension; Conditions see certificates VA: axle load to: 1135 kg HA: axle load to: 1035 kg
B12 PK	3.0 V6 CDTI 06/03 - 09/04 130 kW	46-190567	30	30	-> CH.Nr.: 41999999; without IDS+ suspension; Conditions see certificates VA: axle load to: 1230 kg HA: axle load to: 1035 kg
B12 PK	3.0 CDTi 08/05 - CH-Nr. 135 kW	46-190567	30	30	-> CH.Nr.: 41999999; without IDS+ suspension; Conditions see certificates VA: axle load to: 1230 kg HA: axle load to: 1035 kg
B12 PK	3.0 CDTi 10/04 - 07/08 135 kW	46-194084	30	30	CH.Nr.: 51000001 ->; without IDS+ suspension; Conditions see certificates VA: axle load to: 1135 kg HA: axle load to: 1035 kg

VAUXHALL VECTRA Mk II					
B12 PK	1.6 16V, 1.8, 1.8 16V, 1.8 16V Dualfuel 04/02 - 09/04 74 -90 kW	46-190550	30	30	-> CH.Nr.: 48999999; without IDS+ suspension; Conditions see certificates VA: axle load to: 965 kg HA: axle load to: 1035 kg
B12 PK	1.6, 1.6 16V, 1.8, 1.8 16V 10/04 - 07/08 74 -103 kW	46-194077	30	30	CH.Nr.: 51000001 ->; without IDS+ suspension; Conditions see certificates VA: axle load to: 965 kg HA: axle load to: 1035 kg
B12 PK	1.8, 1.8 16V Dualfuel, 1.9 CDTI, 1.9 CDTI 16V, 2.0 16V Turbo, 2.0 DTI 16V, 2.2 16V, 2.2 direct, 2.2 DTI 16V, 3.2 V6 01/02 - 09/04 74 -155 kW	46-190536	30	30	-> CH.Nr.: 48999999; without IDS+ suspension; Conditions see certificates VA: axle load to: 1060 kg HA: axle load to: 1035 kg
B12 PK	1.8, 1.8 16V, 1.9 CDTI, 1.9 CDTI 16V, 2.0 16V Turbo, 2.0 DTI 16V, 2.2 16V, 2.2 direct, 2.2 DTI 16V, 3.2 V6 10/04 - 10/08 74 -155 kW	46-194060	30	30	CH.Nr.: 51000001 ->; without IDS+ suspension; Conditions see certificates VA: axle load to: 1060 kg HA: axle load to: 1035 kg
B12 PK	1.9 CDTI, 1.9 CDTI 16V, 2.0 DTI 16V, 2.2 DTI 16V, 3.2 V6 10/04 - 10/08 74 -155 kW	46-194008	30	30	CH.Nr.: 51000001 ->; without IDS+ suspension; Conditions see certificates VA: axle load to: 1135 kg HA: axle load to: 1035 kg



VAUXHALL

VAUXHALL VECTRA Mk II

B12 PK	1.9 CDTI, 1.9 CDTI 16V, 2.0 16V Turbo, 2.0 DTI 16V, 2.2 16V, 2.2 DTI 16V, 3.2 V6 01/02 - 09/04 74 -155 kW	46-190543	30	30	-> CH.Nr.: 48999999; without IDS+ suspension; Conditions see certificates VA: axle load to: 1135 kg HA: axle load to: 1035 kg
B12 PK	3.0 V6 CDTI 06/03 - 09/04 130 kW	46-190567	30	30	-> CH.Nr.: 48999999; without IDS+ suspension; Conditions see certificates VA: axle load to: 1230 kg HA: axle load to: 1035 kg
B12 PK	3.0 CDTI CH-Nr. - 07/08 135 kW	46-190567	30	30	CH.Nr.: 48999999 ->; without IDS+ suspension; Conditions see certificates VA: axle load to: 1230 kg HA: axle load to: 1035 kg
B12 PK	3.0 CDTI 10/04 - 07/08 135 kW	46-194084	30	30	CH.Nr.: 51000001 ->; without IDS+ suspension; Conditions see certificates VA: axle load to: 1230 kg HA: axle load to: 1035 kg

VAUXHALL VECTRA Mk II Estate

B12 PK	1.6 16V, 1.8 16V, 1.9 CDTI, 1.9 CDTI 16V, 2.0 16V Turbo, 2.0 DTI 16V, 2.2 direct, 2.2 DTI 16V, 3.2 V6 10/03 - 09/04 74 -155 kW	46-190574	30	30	-> CH.Nr.: 41999999; without IDS+ suspension; Conditions see certificates VA: axle load to: 1060 kg HA: without ride height adjustment; axle load to: 1215 kg
B12 PK	1.6 16V, 1.8, 1.8 16V, 1.9 CDTI, 1.9 CDTI 16V, 2.0 16V Turbo, 2.0 DTI 16V, 2.2 direct, 2.2 DTI 16V, 3.2 V6 10/04 - 07/08 74 -155 kW	46-190604	30	30	CH.Nr.: 51000001 ->; without IDS+ suspension; Conditions see certificates VA: axle load to: 1060 kg HA: without ride height adjustment; axle load to: 1215 kg
B12 PK	1.9 CDTI, 1.9 CDTI 16V, 2.0 16V Turbo, 2.0 DTI 16V, 2.2 direct, 2.2 DTI 16V, 3.2 V6 10/04 - 07/08 74 -155 kW	46-190611	30	30	CH.Nr.: 51000001 ->; without IDS+ suspension; Conditions see certificates VA: axle load to: 1135 kg HA: without ride height adjustment; axle load to: 1215 kg
B12 PK	1.9 CDTI, 1.9 CDTI 16V, 2.0 16V Turbo, 2.0 DTI 16V, 2.2 direct, 2.2 DTI 16V, 3.2 V6 10/03 - 09/04 74 -155 kW	46-190581	30	30	-> CH.Nr.: 41999999; without IDS+ suspension; Conditions see certificates VA: axle load to: 1135 kg HA: without ride height adjustment; axle load to: 1215 kg
B12 PK	3.0 V6 CDTI 10/03 - 09/04 130 kW	46-190598	30	30	-> CH.Nr.: 41999999; without IDS+ suspension; Conditions see certificates VA: axle load to: 1230 kg HA: without ride height adjustment; axle load to: 1215 kg
B12 PK	3.0 CDTI, 3.0 V6 CDTI 10/04 - 07/08 130 -135 kW	46-190628	30	30	CH.Nr.: 51000001 ->; without IDS+ suspension; Conditions see certificates VA: axle load to: 1230 kg HA: without ride height adjustment; axle load to: 1215 kg

VAUXHALL VX220





B16 PSS10	2.0 i Turbo, 2.2 i 09/00 - 07/05 108 -147 kW	48-136723	0-10	0-20	Conditions see certificates VA: axle load to: 485 kg HA: axle load to: 760 kg
--------------	--	------------------	------	------	---





VAUXHALL ZAFIRA

B12 PK	1.6 16V, 1.8 16V, 2.0 DI 16V, 2.0 DTI 16V, 2.2 16V, 2.2 D 11/98 - 08/05 60 -108 kW	46-194220	30	30	Conditions see certificates VA: axle load to: 1075 kg HA: axle load to: 1130 kg
-----------	--	------------------	----	----	---

VAUXHALL ZAFIRA Mk II

B12 PK	1.6, 1.8 04/05 - 77 -103 kW	46-194237	30	30-35	without IDS+ suspension; without electronic suspension control; Conditions see certificates VA: axle load to: 1030 kg HA: axle load to: 1230 kg
B12 PK	1.7 CDTI, 1.7 TD, 1.9 CDTI, 2.0, 2.2 07/05 - 74 -176 kW	46-194244	30	30-35	without IDS+ suspension; without electronic suspension control; Conditions see certificates VA: axle load to: 1155 kg HA: axle load to: 1230 kg

   					
VOLVO					
VOLVO C30					
B12 PK	1.6, 1.6 D, 1.6 D2, 1.8, 1.8 FlexFuel, 2.0, 2.0 FlexFuel 10/06 - 74 -107 kW	46-194367	30	30	Conditions see certificates VA: axle load to: 1020 kg HA: axle load to: 900 kg
B12 PK	2.0 D, 2.4 D5, 2.4 i, D3, D4, D5, T5 10/06 - 100 -169 kW	46-194350	30	30	Conditions see certificates VA: axle load to: 1140 kg HA: axle load to: 900 kg
B14	1.6, 1.6 D, 1.6 D2, 1.8, 1.8 FlexFuel, 2.0, 2.0 D, 2.0 FlexFuel, 2.4 D5, 2.4 i, D3, D4, D5, T5 10/06 - 74 -169 kW	47-121225	15-30	10-20	Conditions see certificates VA: axle load to: 1100 kg HA: axle load to: 1090 kg
B16 PSS9	1.6, 1.6 D, 1.6 D2, 1.8, 1.8 FlexFuel, 2.0, 2.0 D, 2.0 FlexFuel, 2.4 D5, 2.4 i, D3, D4, D5, T5 10/06 - 74 -169 kW	48-121262	15-30	10-20	Conditions see certificates VA: axle load to: 1100 kg HA: axle load to: 1090 kg
VOLVO S40 II (MS)					
B12 PK	1.6, 1.6 D, 1.6 D2, 1.8, 1.8 FlexFuel, 2.0, 2.0 F 04/04 - 74 -107 kW	46-182296	25	25	Conditions see certificates VA: axle load to: 1020 kg HA: without ride height adjustment; axle load to: 1010 kg
B12 PK	2.0 D, 2.0 D4, 2.4, 2.4 D5, D3, D4, T5 01/04 - 96 -169 kW	46-182289	25	25	Conditions see certificates VA: axle load to: 1140 kg HA: without ride height adjustment; axle load to: 1010 kg
B14	1.6, 1.6 D, 1.6 D2, 1.8, 1.8 FlexFuel, 2.0, 2.0 D, 2.0 D4, 2.0 F, 2.4, 2.4 D5, D3, D4, T5 01/04 - 74 -169 kW	47-121225	35-50	35-50	Conditions see certificates VA: axle load to: 1100 kg HA: axle load to: 1090 kg
B16 PSS9	1.6, 1.6 D, 1.6 D2, 1.8, 1.8 FlexFuel, 2.0, 2.0 D, 2.0 D4, 2.0 F, 2.4, 2.4 D5, D3, D4, T5 01/04 - 74 -169 kW	48-121262	35-50	35-50	Conditions see certificates VA: axle load to: 1100 kg HA: axle load to: 1090 kg
VOLVO V50 (MW)					
B12 PK	1.6, 1.6 D, 1.8, 1.8 FlexFuel, 2.0, 2.0 FlexFuel, D2 04/04 - 74 -107 kW	46-182296	25	25	Conditions see certificates VA: axle load to: 1020 kg HA: without ride height adjustment; axle load to: 1010 kg
B12 PK	2.0 D, 2.4, 2.4 D5, 2.4 Tdi, D3, D4, T5 04/04 - 100 -169 kW	46-182289	25	25	Conditions see certificates VA: axle load to: 1140 kg HA: without ride height adjustment; axle load to: 1010 kg
B14	1.6, 1.6 D, 1.8, 1.8 FlexFuel, 2.0, 2.0 D, 2.0 FlexFuel, 2.4, 2.4 D5, 2.4 Tdi, D2, D3, D4, T5 04/04 - 74 -169 kW	47-121225	20-40	20-40	Conditions see certificates VA: axle load to: 1100 kg HA: axle load to: 1090 kg
B16 PSS9	1.6, 1.6 D, 1.8, 1.8 FlexFuel, 2.0, 2.0 D, 2.0 FlexFuel, 2.4, 2.4 D5, 2.4 Tdi, D2, D3, D4, T5 04/04 - 74 -169 kW	48-121262	20-40	20-40	Conditions see certificates VA: axle load to: 1100 kg HA: axle load to: 1090 kg
VOLVO S60					
B12 PK	2.0 T, 2.3 T5, 2.4, 2.4 T, 2.4 T5, T5 11/00 - 04/10 103 -195 kW	46-190727	30	30	without ride height adjustment; Conditions see certificates VA: axle load to: 1110 kg HA: axle load to: 1120 kg
B12 PK	2.4 D, 2.4 D5, 2.5 T 02/04 - 04/10 90 -154 kW	46-190734	30	30	without ride height adjustment; Conditions see certificates VA: axle load to: 1110 kg HA: axle load to: 1120 kg
VOLVO V70 II Estate (P80_)					
B12 PK	2.0 T, 2.3 T5, 2.4, 2.4 T, 2.4 T5 03/00 - 08/07 103 -191 kW	46-190703	30	30	without ride height adjustment; Conditions see certificates VA: axle load to: 1100 kg HA: axle load to: 1170 kg
B12 PK	2.4 D, 2.4 D5, 2.5 T, 2.5 TDI 03/00 - 08/07 93 -154 kW	46-190710	30	30	without ride height adjustment; Conditions see certificates VA: axle load to: 1120 kg HA: axle load to: 1170 kg





					
VOLVO					
VOLVO S80 II					
B12 PK	2.4 D, 2.4 D5, 2.5 T, 2.5 T FlexFuel, 3.2, D5 03/06 - 120 -179 kW	46-190741	30	30	without ride height adjustment; Conditions see certificates VA: axle load to: 1270 kg HA: axle load to: 1210 kg

CHANGAN VOLVO					
CHANGAN VOLVO S40 (MS)					
B14	2.0, 2.4, 2.5 06/06 - 107 -162 kW	47-121225	35-50	35-50	Conditions see certificates VA: axle load to: 1100 kg HA: axle load to: 1090 kg
B16 PSS9	2.0, 2.4, 2.5 06/06 - 107 -162 kW	48-121262	35-50	35-50	Conditions see certificates VA: axle load to: 1100 kg HA: axle load to: 1090 kg

VW					
VW BEETLE					
B14	1.2 TSI, 1.4 TSI, 1.6 TDI, 2.0 TDI, 2.0 TSI, 2.5 04/11 - 77 -147 kW	47-158283	20-30	10-30	Øa: 55 mm; Conditions see certificates VA: axle load to: 1110 kg HA: multilink axle; axle load to: 870 kg
B16 PSS10	1.2 TSI, 1.4 TSI, 1.6 TDI, 2.0 TDI, 2.0 TSI, 2.5 04/11 - 77 -147 kW	48-158176	20-30	10-30	Øa: 55 mm; Conditions see certificates VA: axle load to: 1110 kg HA: multilink axle; axle load to: 870 kg
B16 RC	1.2 TSI, 1.4 TSI, 1.6 TDI, 2.0 TDI, 2.0 TSI, 2.5 04/11 - 77 -147 kW	49-196849 14-230615	20-40	20-40	Øa: 55 mm; mark: G07, G08, G09, G11; disconnect DCC; Conditions see certificates; multilink axle VA: axle load to: 1140 kg HA: axle load to: 1040 kg

VW BEETLE Convertible					
B14	1.2 TSI, 1.4 TSI, 1.6 TDI, 2.0 TDI, 2.0 TSI 12/12 - 77 -147 kW	47-158283	20-30	10-30	Øa: 55 mm; Conditions see certificates VA: axle load to: 1110 kg HA: multilink axle; axle load to: 870 kg
B16 PSS10	1.2 TSI, 1.4 TSI, 1.6 TDI, 2.0 TDI, 2.0 TSI 12/12 - 77 -147 kW	48-158176	20-30	10-30	Øa: 55 mm; Conditions see certificates VA: axle load to: 1110 kg HA: multilink axle; axle load to: 870 kg
B16 RC	1.2 TSI, 1.4 TSI, 1.6 TDI, 2.0 TDI, 2.0 TSI 12/12 - 77 -147 kW	49-196849 14-230615	20-40	20-40	Øa: 55 mm; mark: G07, G08, G09, G11; disconnect DCC; Conditions see certificates; multilink axle VA: axle load to: 1140 kg HA: axle load to: 1040 kg

VW BORA (1J2)					
B10	1.4 16V, 1.6, 1.6 16V, 1.6 FSI, 1.8, 1.8 T, 1.9 SDI, 1.9 TDI, 2.0, 2.3 V5 10/98 - 05/05 50 -132 kW	46-111890	55	40	Conditions see certificates VA: axle load to: 980 kg
B10	1.4 16V, 1.6, 1.6 16V, 1.6 FSI, 1.8, 1.8 T, 1.9 SDI, 1.9 TDI, 2.0, 2.3 V5 10/98 - 05/05 50 -132 kW	46-111906	55	40	Conditions see certificates VA: axle load from: 981 kg
B12 PK	1.4 16V, 1.6, 1.6 16V, 1.6 FSI 10/98 - 05/05 55 -81 kW	46-180360	30	30	Conditions see certificates VA: axle load to: 930 kg HA: without ride height adjustment; axle load to: 960 kg
B12 PK	1.8, 1.9 SDI, 2.0 10/98 - 05/05 50 -92 kW	46-180377	30	30	Conditions see certificates VA: axle load to: 970 kg HA: without ride height adjustment; axle load to: 960 kg
B12 PK	1.8 4motion, 1.9 TDI 4motion, 2.0 4motion 02/99 - 05/05 66 -110 kW	46-180193	30	30	Conditions see certificates VA: axle load to: 1030 kg HA: without ride height adjustment; axle load to: 1120 kg
B12 PK	1.8 T 05/00 - 05/05 110 -132 kW	46-180384	30	30	Conditions see certificates VA: axle load to: 1000 kg HA: without ride height adjustment; axle load to: 960 kg

					
VW					
VW BORA (1J2)					
B12 PK	1.9 TDI 10/98 - 06/01 66 -81 kW	46-180377	30	30	manual transmission; Conditions see certificates VA: axle load to: 970 kg HA: without ride height adjustment; axle load to: 960 kg
B12 PK	1.9 TDI 10/98 - 06/01 66 -81 kW	46-180384	30	30	automatic transmission; Conditions see certificates VA: axle load to: 1000 kg HA: without ride height adjustment; axle load to: 960 kg
B12 PK	1.9 TDI 4motion, 2.3 V5 4motion, 2.8 V6 4motion 12/98 - 05/05 66 -150 kW	46-180209	30	30	Conditions see certificates VA: axle load to: 1050 kg HA: without ride height adjustment; axle load to: 1120 kg
B12 PK	1.9 TDI, 2.3 V5 10/98 - 05/05 74 -110 kW	46-180384	30	30	manual transmission; Conditions see certificates VA: axle load to: 1000 kg HA: without ride height adjustment; axle load to: 960 kg
B12 PK	1.9 TDI, 2.3 V5 10/98 - 05/05 74 -110 kW	46-180391	30	30	automatic transmission; Conditions see certificates VA: axle load to: 1050 kg HA: without ride height adjustment; axle load to: 960 kg
B12 PK	1.9 TDI, 2.3 V5 10/00 - 05/05 96 -125 kW	46-180391	30	30	manual transmission; Conditions see certificates VA: axle load to: 1050 kg HA: without ride height adjustment; axle load to: 960 kg
B12 SL	1.4 16V, 1.6, 1.6 16V, 1.6 FSI, 1.8, 1.8 T, 1.9 SDI, 1.9 TDI, 2.0 10/98 - 05/05 50 -132 kW	46-180308	45-50	30-35	Conditions see certificates VA: axle load to: 950 kg HA: without ride height adjustment; axle load to: 1000 kg
B12 SL	1.8, 1.8 T, 1.9 TDI, 2.0, 2.3 V5 10/98 - 05/05 66 -132 kW	46-180315	45-50	30-35	Conditions see certificates VA: axle load to: 1000 kg HA: without ride height adjustment; axle load to: 1000 kg
B14	1.4 16V, 1.6, 1.6 16V, 1.6 FSI, 1.8, 1.8 T, 1.9 SDI, 1.9 TDI, 2.0, 2.3 V5, 2.8 VR6 11/98 - 07/05 50 -147 kW	47-124851	25-45	20-40	Spacers required for several wheel/tyre combinations; Conditions see certificates VA: axle load to: 1060 kg HA: axle load to: 1010 kg
B14	1.8 4motion, 1.9 TDI 4motion, 2.0 4motion, 2.3 V5 4motion, 2.8 V6 4motion 12/98 - 05/05 66 -150 kW	47-080416	30-50	30-50	Spacers required for several wheel/tyre combinations; Conditions see certificates VA: axle load to: 1110 kg HA: axle load to: 1080 kg
B16 PSS9	1.4 16V, 1.6, 1.6 16V, 1.6 FSI, 1.8, 1.8 T, 1.9 SDI, 1.9 TDI, 2.0, 2.3 V5, 2.8 VR6 11/98 - 07/05 50 -147 kW	48-080651	25-45	25-45	Spacers required for several wheel/tyre combinations; Conditions see certificates VA: axle load to: 1060 kg HA: axle load to: 1010 kg
B16 PSS9	1.8 4motion, 1.9 TDI 4motion, 2.0 4motion, 2.3 V5 4motion, 2.8 V6 4motion 12/98 - 05/05 66 -150 kW	48-080422	30-50	30-50	Spacers required for several wheel/tyre combinations; Conditions see certificates VA: axle load to: 1110 kg HA: axle load to: 1080 kg
VW BORA Estate (1J6)					
B10	1.4 16V, 1.6, 1.6 16V, 1.6 FSI, 1.8 T, 1.9 TDI, 2.0, 2.3 V5, 2.8 VR6 03/00 - 05/05 55 -150 kW	46-111944	55	40	Conditions see certificates VA: axle load to: 980 kg
B10	1.4 16V, 1.6, 1.6 16V, 1.6 FSI, 1.8 T, 1.9 TDI, 2.0, 2.3 V5, 2.8 VR6 03/00 - 05/05 55 -150 kW	46-111937	55	40	Conditions see certificates VA: axle load to: 1020 kg; axle load from: 981 kg
B12 PK	1.4 16V, 1.6, 1.6 16V, 1.6 FSI 02/00 - 05/05 55 -81 kW	46-180407	30	30	Conditions see certificates VA: axle load to: 930 kg HA: without ride height adjustment; axle load to: 1020 kg
B12 PK	1.8 4motion, 1.9 TDI 4motion, 2.0 4motion 05/99 - 05/05 74 -110 kW	46-180193	30	30	Conditions see certificates VA: axle load to: 1030 kg HA: without ride height adjustment; axle load to: 1120 kg
B12 PK	1.8 T 05/00 - 05/05 110 -132 kW	46-180421	30	30	Conditions see certificates VA: axle load to: 1000 kg HA: without ride height adjustment; axle load to: 1020 kg
B12 PK	2.0 05/99 - 05/05 85 kW	46-180414	30	30	Conditions see certificates VA: axle load to: 970 kg HA: without ride height adjustment; axle load to: 1020 kg
B12 PK	1.9 TDI 05/99 - 05/05 66 -81 kW	46-180421	30	30	automatic transmission; Conditions see certificates VA: axle load to: 1000 kg HA: without ride height adjustment; axle load to: 1020 kg
B12 PK	1.9 TDI 05/99 - 05/05 66 -81 kW	46-180414	30	30	manual transmission; Conditions see certificates VA: axle load to: 970 kg HA: without ride height adjustment; axle load to: 1020 kg



VW

VW BORA Estate (1J6)

B12 PK	1.9 TDI, 2.3 V5 05/99 - 05/05 74 -110 kW	46-180438	30	30	automatic transmission; Conditions see certificates VA: axle load to: 1050 kg HA: without ride height adjustment; axle load to: 1020 kg
B12 PK	1.9 TDI, 2.3 V5 05/99 - 05/05 74 -110 kW	46-180421	30	30	manual transmission; Conditions see certificates VA: axle load to: 1000 kg HA: without ride height adjustment; axle load to: 1020 kg
B12 PK	1.9 TDI 4motion, 2.3 V5 4motion, 2.8 V6 4motion 05/99 - 05/05 74 -150 kW	46-180209	30	30	Conditions see certificates VA: axle load to: 1050 kg HA: without ride height adjustment; axle load to: 1120 kg
B12 PK	1.9 TDI, 2.3 V5 10/00 - 05/05 96 -125 kW	46-180438	30	30	manual transmission; Conditions see certificates VA: axle load to: 1050 kg HA: without ride height adjustment; axle load to: 1020 kg

VW CORRADO (53I)

B12 PK	1.8 16V, 1.8 G60, 2.0 i, 2.0 i 16V, 2.9 VR6 09/88 - 12/95 85 -140 kW	46-190093	25-30	25	for vehicles with "Basisachse" only; Conditions see certificates VA: axle load to: 950 kg HA: axle load to: 710 kg
B12 PK	1.8 16V, 1.8 G60, 2.0 i, 2.0 i 16V, 2.9 VR6 09/88 - 12/95 85 -140 kW	46-190109	25-30	25	for vehicles with "Plusachse" only; Conditions see certificates VA: axle load to: 950 kg HA: axle load to: 710 kg
B14	1.8 16V, 1.8 G60, 2.0 i, 2.0 i 16V, 2.9 VR6 09/88 - 12/95 85 -140 kW	47-124844	30-50	0-10	Spacers required for several wheel/tyre combinations; Conditions see certificates VA: axle load to: 950 kg HA: axle load to: 710 kg
B16 PSS9	1.8 16V, 1.8 G60, 2.0 i, 2.0 i 16V, 2.9 VR6 09/88 - 12/95 85 -140 kW	48-080569	30-50	0-10	Spacers required for several wheel/tyre combinations; Conditions see certificates VA: axle load to: 950 kg HA: axle load to: 710 kg

VW EOS (1F7)





B12 PK	1.4 TSI, 1.6 FSI 06/06 - 85 -118 kW	46-184351	25	25	Conditions see certificates VA: axle load to: 1010 kg HA: without ride height adjustment; axle load to: 1000 kg
B12 PK	1.4 TSI, 2.0 FSI, 2.0 TDI, 2.0 TDI 16V, 2.0 TFSI, 2.0 TSI 03/06 - 90 -155 kW	46-184368	25	25	Conditions see certificates VA: axle load to: 1080 kg HA: without ride height adjustment; axle load to: 1000 kg
B12 PK	3.6 V6 05/09 - 191 kW	46-184375	25	25	Conditions see certificates VA: axle load to: 1130 kg HA: without ride height adjustment; axle load to: 1000 kg
B12 PK	2.0 TDI, 2.0 TDI 16V, 2.0 TFSI, 3.2 V6 06/06 - 100 -184 kW	46-184375	25	25	with DSG; Conditions see certificates VA: axle load to: 1130 kg HA: without ride height adjustment; axle load to: 1000 kg
B14	1.4 TSI, 1.6 FSI, 2.0 FSI, 2.0 TDI, 2.0 TDI 16V, 2.0 TFSI, 2.0 TSI, 3.2 V6, 3.6 V6 06/06 - 85 -191 kW	47-140868	30-50	30-50	Conditions see certificates VA: axle load to: 1190 kg HA: axle load to: 1060 kg
B16 PSS9	1.4 TSI, 1.6 FSI, 2.0 FSI, 2.0 TDI, 2.0 TDI 16V, 2.0 TFSI, 2.0 TSI, 3.2 V6, 3.6 V6 06/06 - 85 -191 kW	48-139137	30-50	30-50	Conditions see certificates VA: axle load to: 1190 kg HA: axle load to: 1060 kg

VW FOX (5Z1)

B12 PK	1.2, 1.4, 1.4 TDI 04/05 - 40 -55 kW	46-207197	30	30	Conditions see certificates VA: axle load to: 870 kg HA: axle load to: 800 kg
-----------	---	------------------	----	----	---

VW GOLF I (17)

B12 PK	1.1, 1.3, 1.5, 1.5 D, 1.6, 1.6 D, 1.6 GTI, 1.6 TD, 1.6 TD CL, 1.8 GTI 04/74 - 12/83 37 -82 kW	46-189868	30-40	30-35	for bolted struts only; Conditions see certificates VA: axle load to: 785 kg HA: axle load to: 630 kg
-----------	---	------------------	-------	-------	---





					
VW					
VW GOLF I Cabriolet (155)					
B12 PK	1.5, 1.6, 1.8 01/79 - 12/89 51 -82 kW	46-189943	30-40	30-35	for bolted struts only; Conditions see certificates VA: axle load to: 785 kg HA: axle load to: 630 kg
VW GOLF II (19E, 1G1)					
B12 PK	1.0, 1.3, 1.3 CAT, 1.6, 1.6 G, 1.8, 1.8 GTI, 1.8 GTI CAT, 1.8 GTI G60, 1.8 i CAT 08/83 - 10/91 33 -118 kW	46-189950	30-40	30-35	Conditions see certificates VA: axle load to: 840 kg HA: axle load to: 740 kg
B12 PK	1.6 D, 1.6 TD, 1.6 TD CL, 1.8 GTI 16V 08/83 - 10/91 37 -102 kW	46-189967	20	20	Conditions see certificates VA: axle load to: 840 kg HA: axle load to: 740 kg
B14	1.0, 1.3, 1.3 CAT, 1.6, 1.6 D, 1.6 G, 1.6 TD, 1.6 TD CL, 1.8, 1.8 GTI, 1.8 GTI 16V, 1.8 GTI CAT, 1.8 GTI G60, 1.8 i CAT, 2.0 08/83 - 07/92 33 -118 kW	47-124844	35-50	10-30	Conditions see certificates VA: axle load to: 840 kg HA: axle load to: 740 kg
B16 PSS9	1.0, 1.3, 1.3 CAT, 1.6, 1.6 D, 1.6 G, 1.6 TD, 1.6 TD CL, 1.8, 1.8 GTI, 1.8 GTI 16V, 1.8 GTI CAT, 1.8 GTI G60, 1.8 i CAT, 2.0 08/83 - 07/92 33 -118 kW	48-080569	30-50	10-30	Conditions see certificates VA: axle load to: 840 kg HA: axle load to: 740 kg
VW GOLF III (1H1)					
B10	1.0, 1.3 CL, 1.4, 1.6, 1.8 11/91 - 07/98 37 -74 kW	46-112279	60	40	for vehicles with "Basisachse" only; Conditions see certificates VA: Only in connection with 1H0 412 341
B10	1.9 D, 1.9 SDI, 1.9 TD,GTD, 1.9 TDI 11/91 - 08/97 47 -81 kW	46-113221	60	40	for vehicles with "Basisachse" only; Conditions see certificates VA: Only in connection with 1H0 412 341
B12 PK	1.4, 1.6, 1.8, 1.9 D, 1.9 TD,GTD, 1.9 TDI, 2.0, 2.0 GTI 16V, 2.8 VR6 10/91 - 08/94 40 -128 kW	46-189981	30	30	for vehicles with "Basisachse" only; Conditions see certificates VA: axle load to: 980 kg HA: axle load to: 840 kg
B12 PK	1.4, 1.6, 1.8, 1.9 D, 1.9 SDI, 1.9 TD,GTD, 1.9 TDI, 1.9 TDI Syncro, 2.0, 2.0 GL, 2.0 GTI 16V, 2.8 VR6 09/94 - 09/97 40 -128 kW	46-190000	30	30	for vehicles with "Plusachse" only; Conditions see certificates VA: axle load to: 980 kg HA: axle load to: 840 kg
B12 SL	1.4, 1.6, 1.8, 1.9 D, 1.9 SDI, 1.9 TD,GTD, 1.9 TDI, 2.0, 2.0 GL, 2.0 GTI 16V, 2.8 VR6 09/94 - 09/97 40 -128 kW	46-190024	45-50	30-35	for vehicles with "Plusachse" only; Conditions see certificates VA: axle load to: 950 kg HA: axle load to: 840 kg
B12 SL	1.8, 1.9 D, 1.9 TD,GTD, 1.9 TDI, 2.0, 2.0 GTI 16V, 2.8 VR6 11/91 - 08/94 48 -128 kW	46-190017	45-50	30-35	for vehicles with "Basisachse" only; Conditions see certificates VA: axle load to: 950 kg HA: axle load to: 840 kg
B14	1.0, 1.3 CL, 1.4, 1.6, 1.8, 1.9 D, 1.9 SDI, 1.9 TD,GTD, 1.9 TDI, 2.0, 2.0 GL, 2.0 GTI 16V, 2.8 VR6 01/92 - 09/97 37 -128 kW	47-124844	30-50	10-30	Spacers required for several wheel/tyre combinations; Conditions see certificates VA: axle load to: 980 kg HA: axle load to: 840 kg
B16 PSS9	1.0, 1.3 CL, 1.4, 1.6, 1.8, 1.9 D, 1.9 SDI, 1.9 TD,GTD, 1.9 TDI, 2.0, 2.0 GL, 2.0 GTI 16V, 2.8 VR6 01/92 - 09/97 37 -128 kW	48-080569	30-50	10-30	Spacers required for several wheel/tyre combinations; Conditions see certificates VA: axle load to: 980 kg HA: axle load to: 840 kg
VW GOLF III Variant (1H5)					
B12 PK	1.4, 1.6, 1.8, 1.9 D, 1.9 SDI, 1.9 TD, 1.9 TDI, 2.0, 2.9 VR6 07/93 - 04/99 40 -140 kW	46-190086	30	30	for vehicles with "Basisachse" only; Conditions see certificates VA: axle load to: 980 kg HA: axle load to: 925 kg
B12 PK	1.4, 1.6, 1.8, 1.9 D, 1.9 SDI, 1.9 TD, 1.9 TDI, 2.0, 2.9 VR6 07/93 - 04/99 40 -140 kW	46-190079	30	30	for vehicles with "Plusachse" only; Conditions see certificates VA: axle load to: 980 kg HA: axle load to: 925 kg

VW
VW GOLF III Cabriolet (1E7)





B10	1.6, 1.8, 1.9 TDI, 2.0 07/93 - 05/98 55 -85 kW	46-112255	60	40	for vehicles with "Basisachse" only; Conditions see certificates VA: Only in connection with 1H0 412 341
B12 PK	1.6, 1.8, 1.9 TDI, 2.0 07/93 - 05/98 55 -85 kW	46-190062	30	30	for vehicles with "Plusachse" only; Conditions see certificates VA: axle load to: 980 kg HA: axle load to: 840 kg
B12 PK	1.8, 2.0 07/93 - 08/94 55 -85 kW	46-193285	30	30	for vehicles with "Basisachse" only; Conditions see certificates VA: axle load to: 980 kg HA: axle load to: 840 kg
B14	1.6, 1.8, 1.9 TDI, 2.0 07/93 - 05/98 55 -85 kW	47-124844	30-50	10-30	Spacers required for several wheel/tyre combinations; Conditions see certificates VA: axle load to: 980 kg HA: axle load to: 840 kg
B16 PSS9	1.6, 1.8, 1.9 TDI, 2.0 07/93 - 05/98 55 -85 kW	48-080569	30-50	10-30	Conditions see certificates VA: axle load to: 980 kg HA: axle load to: 840 kg

VW GOLF IV (1J1)





B10	1.4 16V, 1.6, 1.6 16V, 1.6 D, 1.6 FSI, 1.8, 1.8 T, 1.8 T GTI, 1.9 SDI, 1.9 TD, 1.9 TDI, 2.0, 2.3 V5 08/97 - 06/05 40 -132 kW	46-111890	55	40	Conditions see certificates VA: axle load to: 980 kg
B10	1.4 16V, 1.6, 1.6 16V, 1.6 D, 1.6 FSI, 1.8, 1.8 T, 1.8 T GTI, 1.9 SDI, 1.9 TD, 1.9 TDI, 2.0, 2.3 V5 08/97 - 06/05 40 -132 kW	46-111906	55	40	Conditions see certificates VA: axle load from: 981 kg
B12 PK	1.4 16V, 1.6, 1.6 16V, 1.6 FSI 08/97 - 06/05 55 -81 kW	46-180353	30	30	Conditions see certificates VA: axle load to: 930 kg HA: without ride height adjustment; axle load to: 925 kg
B12 PK	1.8, 1.9 SDI, 2.0 08/97 - 05/04 50 -92 kW	46-180346	30	30	Conditions see certificates VA: axle load to: 970 kg HA: without ride height adjustment; axle load to: 925 kg
B12 PK	1.8 4motion, 1.9 TDI 4motion, 2.0 4motion 05/98 - 06/05 66 -110 kW	46-180193	30	30	Conditions see certificates VA: axle load to: 1030 kg HA: without ride height adjustment; axle load to: 1120 kg
B12 PK	1.8 T 08/97 - 06/05 110 kW	46-180339	30	30	Conditions see certificates VA: axle load to: 1000 kg HA: without ride height adjustment; axle load to: 925 kg
B12 PK	1.8 T GTI 08/01 - 06/05 132 kW	46-180339	10	10	Conditions see certificates VA: axle load to: 1000 kg HA: without ride height adjustment; axle load to: 925 kg
B12 PK	1.9 TD, 1.9 TDI 08/97 - 05/04 55 -81 kW	46-180346	30	30	manual transmission; Conditions see certificates VA: axle load to: 970 kg HA: without ride height adjustment; axle load to: 925 kg
B12 PK	1.9 TDI 08/97 - 05/04 66 -81 kW	46-180339	30	30	automatic transmission; Conditions see certificates VA: axle load to: 1000 kg HA: without ride height adjustment; axle load to: 925 kg
B12 PK	1.9 TDI 4motion, 2.3 V5 4motion, 2.8 V6 4motion 07/98 - 06/05 66 -150 kW	46-180209	30	30	Conditions see certificates VA: axle load to: 1050 kg HA: without ride height adjustment; axle load to: 1120 kg
B12 PK	1.9 TDI, 2.3 V5 08/97 - 06/05 74 -110 kW	46-180339	30	30	manual transmission; Conditions see certificates VA: axle load to: 1000 kg HA: without ride height adjustment; axle load to: 925 kg
B12 PK	1.9 TDI, 2.3 V5 08/97 - 06/05 74 -110 kW	46-180322	30	30	automatic transmission; Conditions see certificates VA: axle load to: 1050 kg HA: without ride height adjustment; axle load to: 925 kg
B12 PK	1.9 TDI, 2.3 V5 10/00 - 06/05 96 -125 kW	46-180322	30	30	manual transmission; Conditions see certificates VA: axle load to: 1050 kg HA: without ride height adjustment; axle load to: 925 kg
B12 SL	1.0 GX, 1.4 16V, 1.6, 1.6 16V, 1.6 D, 1.6 FSI, 1.8, 1.8 T, 1.9 SDI, 1.9 TD, 1.9 TDI, 2.0 08/97 - 05/04 40 -110 kW	46-180308	45-50	30-35	Conditions see certificates VA: axle load to: 950 kg HA: without ride height adjustment; axle load to: 1000 kg
B12 SL	1.8, 1.8 T, 1.9 TD, 1.9 TDI, 2.0, 2.3 V5 08/97 - 06/05 55 -125 kW	46-180315	45-50	30-35	Conditions see certificates VA: axle load to: 1000 kg HA: without ride height adjustment; axle load to: 1000 kg





					
VW					
VW GOLF IV (1J1)					
B12 SL	1.8 T GTI 08/01 - 06/05 132 kW	46-180308	25-30	10-15	Conditions see certificates VA: axle load to: 950 kg HA: without ride height adjustment; axle load to: 1000 kg
B12 SL	1.8 T GTI 08/01 - 06/05 132 kW	46-180315	25-30	10-15	Conditions see certificates VA: axle load to: 1000 kg HA: without ride height adjustment; axle load to: 1000 kg
B14	1.0 GX, 1.4 16V, 1.6, 1.6 16V, 1.6 D, 1.6 FSI, 1.8, 1.8 T, 1.8 T GTI, 1.9 SDI, 1.9 TD, 1.9 TDI, 2.0, 2.3 V5 08/97 - 06/05 40 -132 kW	47-124851	25-45	20-40	Spacers required for several wheel/tyre combinations; Conditions see certificates VA: axle load to: 1060 kg HA: axle load to: 1010 kg
B14	1.8 4motion, 1.9 TDI 4motion, 2.0 4motion, 2.3 V5 4motion, 2.8 V6 4motion, 3.2 R32 4motion 05/98 - 06/05 66 -177 kW	47-080416	30-50	30-50	Spacers required for several wheel/tyre combinations; Conditions see certificates VA: axle load to: 1110 kg HA: axle load to: 1080 kg
B16 PSS9	1.0 GX, 1.4 16V, 1.6, 1.6 16V, 1.6 D, 1.6 FSI, 1.8, 1.8 T, 1.8 T GTI, 1.9 SDI, 1.9 TD, 1.9 TDI, 2.0, 2.3 V5 08/97 - 06/05 40 -132 kW	48-080651	25-45	20-40	Spacers required for several wheel/tyre combinations; Conditions see certificates VA: axle load to: 1060 kg HA: axle load to: 1010 kg
B16 PSS9	1.8 4motion, 1.9 TDI 4motion, 2.0 4motion, 2.3 V5 4motion, 2.8 V6 4motion, 3.2 R32 4motion 05/98 - 06/05 66 -177 kW	48-080422	30-50	30-50	Spacers required for several wheel/tyre combinations; Conditions see certificates VA: axle load to: 1110 kg HA: axle load to: 1080 kg





VW GOLF IV Variant (1J5)					
B10	1.4 16V, 1.6, 1.6 16V, 1.6 FSI, 1.8 T, 1.9 SDI, 1.9 TDI, 1.9 TDi GTi, 2.0, 2.3 V5 05/99 - 06/06 50 -125 kW	46-111944	55	40	Conditions see certificates VA: axle load to: 980 kg
B10	1.4 16V, 1.6, 1.6 16V, 1.6 FSI, 1.8 T, 1.9 SDI, 1.9 TDI, 1.9 TDi GTi, 2.0, 2.3 V5 05/99 - 06/06 50 -125 kW	46-111937	55	40	Conditions see certificates VA: axle load to: 1020 kg; axle load from: 981 kg
B12 PK	1.4 16V, 1.6, 1.6 16V, 1.6 FSI 05/99 - 06/06 55 -85 kW	46-180407	30	30	Conditions see certificates VA: axle load to: 930 kg HA: without ride height adjustment; axle load to: 1020 kg
B12 PK	1.8 4motion, 1.9 TDI 4motion, 2.0 4motion 05/99 - 06/06 66 -96 kW	46-180193	30	30	Conditions see certificates VA: axle load to: 1030 kg HA: without ride height adjustment; axle load to: 1120 kg
B12 PK	1.8 T 05/00 - 06/06 110 kW	46-180421	30	30	Conditions see certificates VA: axle load to: 1000 kg HA: without ride height adjustment; axle load to: 1020 kg
B12 PK	1.9 SDI, 2.0 05/99 - 06/06 50 -85 kW	46-180414	30	30	Conditions see certificates VA: axle load to: 970 kg HA: without ride height adjustment; axle load to: 1020 kg
B12 PK	1.9 TDI 05/99 - 05/06 66 -81 kW	46-180414	30	30	manual transmission; Conditions see certificates VA: axle load to: 970 kg HA: without ride height adjustment; axle load to: 1020 kg
B12 PK	1.9 TDI 05/99 - 05/06 66 -81 kW	46-180421	30	30	automatic transmission; Conditions see certificates VA: axle load to: 1000 kg HA: without ride height adjustment; axle load to: 1020 kg
B12 PK	1.9 TDI 4motion, 2.3 V5 4motion, 2.8 V6 4motion 05/99 - 06/06 66 -150 kW	46-180209	30	30	Conditions see certificates VA: axle load to: 1050 kg HA: without ride height adjustment; axle load to: 1120 kg
B12 PK	1.9 TDI, 2.3 V5 05/99 - 06/06 74 -110 kW	46-180421	30	30	manual transmission; Conditions see certificates VA: axle load to: 1000 kg HA: without ride height adjustment; axle load to: 1020 kg
B12 PK	1.9 TDI, 2.3 V5 05/99 - 06/06 74 -110 kW	46-180438	30	30	automatic transmission; Conditions see certificates VA: axle load to: 1050 kg HA: without ride height adjustment; axle load to: 1020 kg
B12 PK	1.9 TDI, 2.3 V5 10/00 - 06/06 96 -125 kW	46-180438	30	30	manual transmission; Conditions see certificates VA: axle load to: 1050 kg HA: without ride height adjustment; axle load to: 1020 kg
B12 PK	1.9 TDi GTi 06/01 - 06/06 110 kW	46-180438	10	10	manual transmission; Conditions see certificates VA: axle load to: 1050 kg HA: without ride height adjustment; axle load to: 1020 kg

   					
VW					
VW GOLF IV Cabriolet (1E7)					
B10	1.6, 1.8, 1.9 TDI, 2.0 06/98 - 06/02 55 -85 kW	46-112255	60	40	for vehicles with "Basisachse" only; Conditions see certificates VA: Only in connection with 1H0 412 341
B12 PK	1.6, 1.8, 1.9 TDI, 2.0 06/98 - 06/02 55 -85 kW	46-190062	30	30	for vehicles with "Plusachse" only; Conditions see certificates VA: axle load to: 980 kg HA: axle load to: 840 kg
B14	1.6, 1.8, 1.9 TDI, 2.0 06/98 - 06/02 55 -85 kW	47-124844	30-50	10-30	Spacers required for several wheel/tyre combinations; Conditions see certificates VA: axle load to: 980 kg HA: axle load to: 840 kg
B16 PSS9	1.6, 1.8, 1.9 TDI, 2.0 06/98 - 06/02 55 -85 kW	48-080569	30-50	10-30	Conditions see certificates VA: axle load to: 950 kg HA: axle load to: 820 kg

VW GOLF V (1K1)					
B12 PK	1.4 16V, 1.4 FSi, 1.6, 1.6 FSi, 1.6 MultiFuel 10/03 - 11/08 55 -85 kW	46-184047	30	30	mark: G02; outside diameter strut 50 mm; Conditions see certificates; With General Certification (ABE) VA: axle load to: 1010 kg HA: axle load to: 1010 kg
B12 PK	1.4 16V, 1.4 FSi, 1.6, 1.6 FSi, 1.6 MultiFuel 10/03 - 11/08 55 -85 kW	46-194855	30	30	mark: G07, G08, G09, G11; outside diameter strut 55 mm; Conditions see certificates; With General Certification (ABE) VA: axle load to: 1010 kg HA: axle load to: 1010 kg
B12 PK	1.4 TSI, 1.6, 1.6 MultiFuel, 1.8, 1.9 SDi, 1.9 TDI, 2.0, 2.0 FSi 01/04 - 11/08 47 -125 kW	46-184115	30	30	mark: G02; outside diameter strut 50 mm; Conditions see certificates; With General Certification (ABE) VA: axle load to: 1080 kg HA: axle load to: 1010 kg
B12 PK	1.4 TSI, 1.6, 1.6 MultiFuel, 1.8, 1.9 SDi, 1.9 TDI, 2.0, 2.0 FSi 01/04 - 11/08 47 -125 kW	46-194862	30	30	mark: G07, G08, G09, G11; outside diameter strut 55 mm; Conditions see certificates; With General Certification (ABE) VA: axle load to: 1080 kg HA: axle load to: 1010 kg
B12 PK	1.6 FSi 10/03 - 11/08 74 -85 kW	46-184115	30	30	mark: G02; automatic transmission; outside diameter strut 50 mm; Conditions see certificates; With General Certification (ABE) VA: axle load to: 1080 kg HA: axle load to: 1010 kg
B12 PK	1.6 FSi 10/03 - 11/08 74 -85 kW	46-194862	30	30	mark: G07, G08, G09, G11; automatic transmission; outside diameter strut 55 mm; Conditions see certificates; With General Certification (ABE) VA: axle load to: 1080 kg HA: axle load to: 1010 kg
B12 PK	1.9 TDI 4motion, 2.0 FSi 4motion, 2.0 TDI 16V 4motion, 2.0 TDI 4motion 08/04 - 11/08 77 -110 kW	46-184474	30	30	mark: G02; outside diameter strut 50 mm; Conditions see certificates; With General Certification (ABE) VA: axle load to: 1110 kg HA: axle load to: 980 kg
B12 PK	1.9 TDI 4motion, 2.0 FSi 4motion, 2.0 TDI 16V 4motion, 2.0 TDI 4motion 08/04 - 11/08 77 -110 kW	46-194961	30	30	mark: G07, G08, G09, G11; outside diameter strut 55 mm; Conditions see certificates; With General Certification (ABE) VA: axle load to: 1110 kg HA: axle load to: 980 kg
B12 PK	1.9 SDi, 1.9 TDI 10/03 - 11/08 47 -77 kW	46-184153	30	30	mark: G02; automatic transmission; outside diameter strut 50 mm; Conditions see certificates; With General Certification (ABE) VA: axle load to: 1150 kg HA: axle load to: 1010 kg
B12 PK	1.9 SDi, 1.9 TDI 10/03 - 11/08 47 -77 kW	46-194879	30	30	mark: G07; G08; G09; G11; automatic transmission; outside diameter strut 55 mm; Conditions see certificates; With General Certification (ABE) VA: axle load to: 1150 kg HA: axle load to: 1010 kg
B12 PK	2.0 GTD, 2.0 SDi, 2.0 TDI, 2.0 TDI 16V 10/03 - 11/08 55 -125 kW	46-184153	30	30	mark: G02; outside diameter strut 50 mm; Conditions see certificates; With General Certification (ABE) VA: axle load to: 1150 kg HA: axle load to: 1010 kg
B12 PK	2.0 GTD, 2.0 SDi, 2.0 TDI, 2.0 TDI 16V 10/03 - 11/08 55 -125 kW	46-194879	30	30	mark: G07; G08; G09; G11; outside diameter strut 55 mm; Conditions see certificates; With General Certification (ABE) VA: axle load to: 1150 kg HA: axle load to: 1010 kg
B12 SL	1.4 16V, 1.4 TSI, 1.6, 1.6 FSi, 1.6 MultiFuel, 1.8, 2.0, 2.0 FSi 10/03 - 11/08 55 -125 kW	46-230904	45-50	30-35	mark: G02; outside diameter strut 50 mm; Conditions see certificates; With General Certification (ABE) VA: axle load to: 1040 kg HA: axle load to: 930 kg

					
VW					
VW GOLF V (1K1)					
B12 SL	1.4 16V, 1.4 FSi, 1.4 TSI, 1.6, 1.6 FSi, 1.6 MultiFuel, 1.8, 2.0, 2.0 FSi 10/03 - 11/08 55 -125 kW	46-194909	45-50	30-35	mark: G07, G08,G09,G011; outside diameter strut 55 mm; Conditions see certificates; With General Certification (ABE) VA: axle load to: 1040 kg HA: axle load to: 930 kg
B12 SL	1.4 TSI, 1.8 GTi, 1.8 Turbo, 2.0 GTI 09/06 - 12/08 90 -169 kW	46-230911	20-25	20	mark: G02; mark: GT, GTI; outside diameter strut 50 mm; Conditions see certificates; With General Certification (ABE) VA: axle load to: 1040 kg HA: axle load to: 930 kg
B12 SL	1.4 TSI, 1.8 GTi, 1.8 Turbo, 2.0 GTI 09/06 - 12/08 90 -169 kW	46-194909	20-25	20	mark: G07, G08,G09,G011; mark: GT,GTI; outside diameter strut 55 mm; Conditions see certificates; With General Certification (ABE) VA: axle load to: 1040 kg HA: axle load to: 930 kg
B12 SL	1.9 SDi, 1.9 TDI, 2.0 GTD, 2.0 GTI, 2.0 SDi, 2.0 TDI, 2.0 TDI 16V 10/03 - 12/08 47 -169 kW	46-194916	20-25	20	mark: G07,G08,G09,G011; mark: GT,GTI; outside diameter strut 55 mm; Conditions see certificates; With General Certification (ABE) VA: axle load to: 1130 kg HA: axle load to: 930 kg
B14	1.0, 1.0 Touring, 1.4 16V, 1.4 FSi, 1.4 TSI, 1.6, 1.6 FSi, 1.6 MultiFuel, 1.8, 1.9 SDi, 1.9 TDI, 1.9 TDI 4motion, 2.0, 2.0 FSi, 2.0 FSi 4motion, 2.0 GTD, 2.0 SDi, 2.0 TDI, 2.0 TDI 16V, 2.0 TDI 16V 4motion, 2.0 TDI 4motion 08/04 - 11/08 47 -125 kW	47-128347	30-50	30-50	mark: G02; outside diameter strut 50 mm; Conditions see certificates VA: axle load to: 1210 kg HA: axle load to: 1100 kg
B14	1.0, 1.0 Touring, 1.4 16V, 1.4 FSi, 1.4 TSI, 1.6, 1.6 FSi, 1.6 MultiFuel, 1.8, 1.9 SDi, 1.9 TDI, 1.9 TDI 4motion, 2.0, 2.0 FSi, 2.0 FSi 4motion, 2.0 GTD, 2.0 SDi, 2.0 TDI, 2.0 TDI 16V, 2.0 TDI 16V 4motion, 2.0 TDI 4motion 08/04 - 11/08 47 -125 kW	47-127708	30-50	30-50	Øa: 55 mm; mark: G07, G08, G09, G11; Conditions see certificates VA: axle load to: 1210 kg HA: axle load to: 1100 kg
B14	1.8 GTi, 1.8 Turbo, 2.0 GTI, 2.5 FSi VR5, 3.2, 3.2 R32 4motion 11/05 - 12/08 110 -184 kW	47-127708	20-30	10-30	Øa: 55 mm; Conditions see certificates VA: axle load to: 1210 kg HA: axle load to: 1100 kg
B16 PSS10	1.0, 1.0 Touring, 1.4 16V, 1.4 FSi, 1.4 TSI, 1.6, 1.6 FSi, 1.6 MultiFuel, 1.8, 1.9 SDi, 1.9 TDI, 1.9 TDI 4motion, 2.0, 2.0 FSi, 2.0 FSi 4motion, 2.0 GTD, 2.0 SDi, 2.0 TDI, 2.0 TDI 16V, 2.0 TDI 16V 4motion, 2.0 TDI 4motion 08/04 - 11/08 47 -125 kW	48-135238	30-50	30-50	mark: G02; outside diameter strut 50 mm; Conditions see certificates VA: axle load to: 1210 kg HA: axle load to: 1100 kg
B16 PSS10	1.0, 1.0 Touring, 1.4 16V, 1.4 FSi, 1.4 TSI, 1.6, 1.6 FSi, 1.6 MultiFuel, 1.8, 1.9 SDi, 1.9 TDI, 1.9 TDI 4motion, 2.0, 2.0 FSi, 2.0 FSi 4motion, 2.0 GTD, 2.0 SDi, 2.0 TDI, 2.0 TDI 16V, 2.0 TDI 16V 4motion, 2.0 TDI 4motion 08/04 - 11/08 47 -125 kW	48-135245	30-50	30-50	Øa: 55 mm; mark: G07, G08, G09, G11; Conditions see certificates VA: axle load to: 1210 kg HA: axle load to: 1100 kg
B16 PSS10	1.8 GTi, 1.8 Turbo, 2.0 GTI, 2.5 FSi VR5, 3.2, 3.2 R32 4motion 11/05 - 12/08 110 -184 kW	48-135245	20-30	10-30	Øa: 55 mm; Conditions see certificates VA: axle load to: 1210 kg HA: axle load to: 1100 kg
B16 RC	1.0, 1.0 Touring, 1.4 16V, 1.4 FSi, 1.4 TSI, 1.6, 1.6 FSi, 1.6 MultiFuel, 1.8, 1.9 SDi, 1.9 TDI, 1.9 TDI 4motion, 2.0, 2.0 FSi, 2.0 FSi 4motion, 2.0 GTD, 2.0 SDi, 2.0 TDI, 2.0 TDI 16V, 2.0 TDI 16V 4motion, 2.0 TDI 4motion 08/04 - 11/08 47 -125 kW	49-196849 14-230615	20-40	20-40	Øa: 55 mm; mark: G07, G08, G09, G11; disconnect DCC; Conditions see certificates VA: axle load to: 1140 kg HA: axle load to: 1040 kg
B16 RC	1.8 GTi, 1.8 Turbo, 2.0 GTI, 2.5 FSi VR5, 3.2, 3.2 R32 4motion 11/05 - 12/08 110 -184 kW	49-196849 14-230615	10-30	10-30	Øa: 55 mm; mark: G07, G08, G09, G11; disconnect DCC; Conditions see certificates VA: axle load to: 1140 kg HA: axle load to: 1040 kg
B16 BCS	1.8 GTi, 1.8 Turbo, 2.0 GTD, 2.0 GTI, 3.2, 3.2 R32 4motion 11/05 - 12/08 110 -184 kW	48-215909	30-40	20-40	Øa: 55 mm; Conditions see certificates VA: axle load to: 1210 kg HA: axle load to: 1100 kg

					
VW					
VW GOLF V Variant (1K5)					
B12 PK	1.4 TSI, 1.9 TDI 06/07 - 77 -125 kW	46-184191	30	30	mark: G02; outside diameter strut 50 mm; Conditions see certificates; With General Certification (ABE) VA: axle load to: 1080 kg HA: axle load to: 1010 kg
B12 PK	1.4 TSI, 1.9 TDI 06/07 - 77 -125 kW	46-194985	30	30	mark: G07,G08; outside diameter strut 55 mm; Conditions see certificates; With General Certification (ABE) VA: axle load to: 1080 kg HA: axle load to: 1010 kg
B12 PK	1.6 06/07 - 75 kW	46-184184	30	30	mark: G02; outside diameter strut 50 mm; Conditions see certificates; With General Certification (ABE) VA: axle load to: 1010 kg HA: axle load to: 1010 kg
B12 PK	1.6 06/07 - 75 kW	46-184191	30	30	mark: G02; automatic transmission; outside diameter strut 50 mm; Conditions see certificates; With General Certification (ABE) VA: axle load to: 1080 kg HA: axle load to: 1010 kg
B12 PK	1.6 06/07 - 75 kW	46-194978	30	30	mark: G07,G08; outside diameter strut 55 mm; Conditions see certificates; With General Certification (ABE) VA: axle load to: 1010 kg HA: axle load to: 1010 kg
B12 PK	1.6 06/07 - 75 kW	46-194985	30	30	mark: G07,G08; automatic transmission; outside diameter strut 55 mm; Conditions see certificates; With General Certification (ABE) VA: axle load to: 1080 kg HA: axle load to: 1010 kg
B12 PK	1.9 TDI 06/07 - 77 kW	46-184214	30	30	mark: G02; outside diameter strut 50 mm; with DSG; Conditions see certificates; With General Certification (ABE) VA: axle load to: 1150 kg HA: axle load to: 1010 kg
B12 PK	1.9 TDI 06/07 - 77 kW	46-194992	30	30	mark: G07,G08; outside diameter strut 55 mm; with DSG; Conditions see certificates; With General Certification (ABE) VA: axle load to: 1150 kg HA: axle load to: 1010 kg
B12 PK	2.0 TDI, 2.0 TDI 16V 06/07 - 100 -103 kW	46-184214	30	30	mark: G02; outside diameter strut 50 mm; Conditions see certificates; With General Certification (ABE) VA: axle load to: 1150 kg HA: axle load to: 1010 kg
B12 PK	2.0 TDI, 2.0 TDI 16V 06/07 - 100 -103 kW	46-194992	30	30	mark: G07,G08; outside diameter strut 55 mm; Conditions see certificates; With General Certification (ABE) VA: axle load to: 1150 kg HA: axle load to: 1010 kg
B14	1.4, 1.4 TSI, 1.6, 1.6 MultiFuel, 1.9 TDI, 1.9 TDI 4motion, 2.0, 2.0 TDI, 2.0 TDI 16V, 2.0 TDI 4motion 06/07 - 59 -147 kW	47-128347	35-50	30-50	mark: G02; outside diameter strut 50 mm; Conditions see certificates VA: axle load to: 1210 kg HA: axle load to: 1100 kg
B14	1.4, 1.4 TSI, 1.6, 1.6 MultiFuel, 1.9 TDI, 1.9 TDI 4motion, 2.0, 2.0 TDI, 2.0 TDI 16V, 2.0 TDI 4motion 06/07 - 59 -147 kW	47-127708	35-40	30-50	Øa: 55 mm; mark: G07,G08; Conditions see certificates VA: axle load to: 1210 kg HA: axle load to: 1100 kg
B16 PSS10	1.4, 1.4 TSI, 1.6, 1.6 MultiFuel, 1.9 TDI, 1.9 TDI 4motion, 2.0, 2.0 TDI, 2.0 TDI 16V, 2.0 TDI 4motion 06/07 - 59 -147 kW	48-135238	30-50	30-50	mark: G02; outside diameter strut 50 mm; Conditions see certificates VA: axle load to: 1210 kg HA: axle load to: 1100 kg
B16 PSS10	1.4, 1.4 TSI, 1.6, 1.6 MultiFuel, 1.9 TDI, 1.9 TDI 4motion, 2.0, 2.0 TDI, 2.0 TDI 16V, 2.0 TDI 4motion 06/07 - 59 -147 kW	48-135245	35-50	30-50	Øa: 55 mm; mark: G07,G08; Conditions see certificates VA: axle load to: 1210 kg HA: axle load to: 1100 kg
B16 RC	1.4, 1.4 TSI, 1.6, 1.6 MultiFuel, 1.9 TDI, 1.9 TDI 4motion, 2.0, 2.0 TDI, 2.0 TDI 16V, 2.0 TDI 4motion 06/07 - 59 -147 kW	49-196849 14-230615	20-40	20-40	Øa: 55 mm; mark: G07, G08, G09, G11; disconnect DCC; Conditions see certificates VA: axle load to: 1140 kg HA: axle load to: 1040 kg
VW GOLF VI (5K1)					
B12 PK	1.2 TSI, 1.4, 1.4 TSI, 1.6, 1.6 TDI, 1.8 TSI, 2.0 TDI 04/09 - 05/13 59 -125 kW	46-187949	30	30	mark: G07, G08, G09, G11; disconnect DCC; outside diameter strut 55 mm; Conditions see certificates; With General Certification (ABE) VA: axle load to: 1010 kg HA: without ride height adjustment; axle load to: 940 kg





					
VW					
VW GOLF VI (5K1)					
B12 PK	1.2 TSI, 1.4, 1.4 TSI, 1.6, 1.6 TDI, 1.8 TSI, 2.0 TDI 04/09 - 05/13 59 -125 kW	46-184481	30	30	mark: G02; disconnect DCC; outside diameter strut 50 mm; Conditions see certificates; With General Certification (ABE) VA: axle load to: 1010 kg HA: without ride height adjustment; axle load to: 940 kg
B12 PK	1.4 TSI, 1.6 TDI, 1.8 TSI, 2.0 TDI 10/08 - 05/13 66 -125 kW	46-184498	30	30	mark: G02; disconnect DCC; outside diameter strut 50 mm; Conditions see certificates; With General Certification (ABE) VA: axle load to: 1120 kg HA: without ride height adjustment; axle load to: 940 kg
B12 PK	1.4 TSI, 1.6 TDI, 1.8 TSI, 2.0 TDI 10/08 - 05/13 66 -125 kW	46-187956	30	30	mark: G07, G08, G09, G11; disconnect DCC; outside diameter strut 55 mm; Conditions see certificates; With General Certification (ABE) VA: axle load to: 1120 kg HA: without ride height adjustment; axle load to: 940 kg
B12 SL	1.2 TSI, 1.4, 1.4 TSI, 1.6, 1.6 TDI 02/09 - 11/12 59 -118 kW	46-183767	45-50	30-35	mark: G02; disconnect DCC; outside diameter strut 50 mm; Conditions see certificates; With General Certification (ABE) VA: axle load to: 1040 kg HA: without ride height adjustment; axle load to: 930 kg
B12 SL	1.2 TSI, 1.4, 1.4 TSI, 1.6, 1.6 TDI 02/09 - 11/12 59 -118 kW	46-188076	45-50	30-35	mark: G07, G08, G09, G11; disconnect DCC; outside diameter strut 55 mm; Conditions see certificates; With General Certification (ABE) VA: axle load to: 1040 kg HA: without ride height adjustment; axle load to: 930 kg
B12 SL	1.4 TSI, 1.8 TSI, 2.0, 2.0 TDI, 2.0 TSI 10/08 - 05/13 81 -173 kW	46-183774	45-50	30-35	mark: G02; disconnect DCC; outside diameter strut 50 mm; Conditions see certificates; With General Certification (ABE) VA: axle load to: 1130 kg HA: without ride height adjustment; axle load to: 930 kg
B12 SL	1.4 TSI, 1.8 TSI, 2.0, 2.0 TDI, 2.0 TSI 10/08 - 05/13 81 -173 kW	46-188069	45-50	30-35	mark: G07, G08, G09, G11; disconnect DCC; outside diameter strut 55 mm; Conditions see certificates; With General Certification (ABE) VA: axle load to: 1130 kg HA: without ride height adjustment; axle load to: 930 kg
B14	1.2 TSI, 1.4, 1.4 TSI, 1.6, 1.6 BiFuel, 1.6 MultiFuel, 1.6 TDI, 1.8 TSI, 2.0, 2.0 TDI, 2.0 TDI 4motion, 2.0 TSI 04/09 - 05/13 59 -173 kW	47-158276	20-40	20-40	mark: G02; disconnect DCC; outside diameter strut 50 mm; Conditions see certificates VA: axle load to: 1140 kg HA: axle load to: 1040 kg
B14	1.2 TSI, 1.4, 1.4 TSI, 1.6, 1.6 BiFuel, 1.6 MultiFuel, 1.6 TDI, 1.8 TSI, 2.0, 2.0 TDI, 2.0 TDI 4motion, 2.0 TSI 04/09 - 05/13 59 -173 kW	47-158283	20-40	20-40	Øa: 55 mm; mark: G07, G08, G09, G11; disconnect DCC; Conditions see certificates VA: axle load to: 1140 kg HA: axle load to: 1040 kg
B14	2.0 R 4motion 11/09 - 11/13 188 -199 kW	47-158283	10-30	10-30	Øa: 55 mm; mark: G07, G08, G09, G11; disconnect DCC; Conditions see certificates VA: axle load to: 1140 kg HA: axle load to: 1040 kg
B16 PSS10	1.2 TSI, 1.4, 1.4 TSI, 1.6, 1.6 BiFuel, 1.6 MultiFuel, 1.6 TDI, 1.8 TSI, 2.0, 2.0 TDI, 2.0 TDI 4motion, 2.0 TSI 04/09 - 05/13 59 -173 kW	48-156745	20-40	20-40	mark: G02; disconnect DCC; outside diameter strut 50 mm; Conditions see certificates VA: axle load to: 1140 kg HA: axle load to: 1040 kg
B16 PSS10	1.2 TSI, 1.4, 1.4 TSI, 1.6, 1.6 BiFuel, 1.6 MultiFuel, 1.6 TDI, 1.8 TSI, 2.0, 2.0 TDI, 2.0 TDI 4motion, 2.0 TSI 04/09 - 05/13 59 -173 kW	48-158176	20-40	20-40	Øa: 55 mm; mark: G07, G08, G09, G11; disconnect DCC; Conditions see certificates VA: axle load to: 1140 kg HA: axle load to: 1040 kg
B16 PSS10	2.0 R 4motion 11/09 - 11/13 188 -199 kW	48-158176	10-30	10-30	Øa: 55 mm; mark: G07, G08, G09, G11; disconnect DCC; Conditions see certificates VA: axle load to: 1140 kg HA: axle load to: 1040 kg
B16 RC	1.2 TSI, 1.4, 1.4 TSI, 1.6, 1.6 BiFuel, 1.6 MultiFuel, 1.6 TDI, 1.8 TSI, 2.0, 2.0 TDI, 2.0 TDI 4motion, 2.0 TSI 04/09 - 05/13 59 -173 kW	49-196849 14-230615	20-40	20-40	Øa: 55 mm; mark: G07, G08, G09, G11; disconnect DCC; Conditions see certificates VA: axle load to: 1140 kg HA: axle load to: 1040 kg
B16 RC	2.0 R 4motion 11/09 - 11/13 188 -199 kW	49-196849 14-230615	10-30	10-30	Øa: 55 mm; mark: G07, G08, G09, G11; disconnect DCC; Conditions see certificates VA: axle load to: 1140 kg HA: axle load to: 1040 kg
B16 BCS	2.0, 2.0 TDI, 2.0 TSI 04/09 - 11/13 125 -173 kW	48-215909	30-40	20-40	Øa: 55 mm; disconnect DCC; Conditions see certificates VA: axle load to: 1140 kg HA: axle load to: 1040 kg
B16 BCS	2.0 R 4motion 11/09 - 11/13 188 -199 kW	48-215909	20-30	10-30	Øa: 55 mm; disconnect DCC; Conditions see certificates VA: axle load to: 1140 kg HA: axle load to: 1040 kg

VW
VW GOLF VI Variant (AJ5)

B12 PK	1.2 TSI, 1.4, 1.4 TSI, 1.6, 1.6 MultiFuel, 1.6 TDI 07/09 - 59 -118 kW	46-187963	25-30	30	mark: G07, G08, G09, G11; without electronic suspension control; outside diameter strut 55 mm; Conditions see certificates; With General Certification (ABE) VA: axle load to: 1010 kg HA: without ride height adjustment; axle load to: 1000 kg
B12 PK	1.2 TSI, 1.4, 1.4 TSI, 1.6, 1.6 MultiFuel, 1.6 TDI 07/09 - 59 -118 kW	46-184504	25-30	30	mark: G02; without electronic suspension control; outside diameter strut 50 mm; Conditions see certificates; With General Certification (ABE) VA: axle load to: 1010 kg HA: without ride height adjustment; axle load to: 1000 kg
B12 PK	1.4 TSI, 1.6 TDI, 2.0 TDI 07/09 - 66 -118 kW	46-187970	25-30	30	mark: G07, G08, G09, G11; without electronic suspension control; outside diameter strut 55 mm; Conditions see certificates; With General Certification (ABE) VA: axle load to: 1120 kg HA: without ride height adjustment; axle load to: 1000 kg
B12 PK	1.4 TSI, 1.6 TDI, 2.0 TDI 07/09 - 66 -118 kW	46-184511	25-30	30	mark: G02; without electronic suspension control; outside diameter strut 50 mm; Conditions see certificates; With General Certification (ABE) VA: axle load to: 1120 kg HA: without ride height adjustment; axle load to: 1000 kg
B14	1.2 TSI, 1.4, 1.4 TSI, 1.6, 1.6 MultiFuel, 1.6 TDI, 1.6 TDI 4motion, 2.0 TDI 07/09 - 59 -118 kW	47-128347	35-50	30-50	mark: G02; without electronic suspension control; outside diameter strut 50 mm; Conditions see certificates VA: axle load to: 1210 kg HA: axle load to: 1100 kg
B14	1.2 TSI, 1.4, 1.4 TSI, 1.6, 1.6 MultiFuel, 1.6 TDI, 1.6 TDI 4motion, 2.0 TDI 07/09 - 59 -118 kW	47-127708	30-50	30-50	Øa: 55 mm; mark: G07, G08, G09, G11; without electronic suspension control; Conditions see certificates VA: axle load to: 1210 kg HA: axle load to: 1100 kg
B16 PSS10	1.2 TSI, 1.4, 1.4 TSI, 1.6, 1.6 MultiFuel, 1.6 TDI, 1.6 TDI 4motion, 2.0 TDI 07/09 - 59 -118 kW	48-135238	30-50	30-50	mark: G02; without electronic suspension control; outside diameter strut 50 mm; Conditions see certificates VA: axle load to: 1210 kg HA: axle load to: 1100 kg
B16 PSS10	1.2 TSI, 1.4, 1.4 TSI, 1.6, 1.6 MultiFuel, 1.6 TDI, 1.6 TDI 4motion, 2.0 TDI 07/09 - 59 -118 kW	48-135245	30-50	30-50	Øa: 55 mm; mark: G07, G08, G09, G11; without electronic suspension control; Conditions see certificates VA: axle load to: 1210 kg HA: axle load to: 1100 kg
B16 RC	1.2 TSI, 1.4, 1.4 TSI, 1.6, 1.6 MultiFuel, 1.6 TDI, 1.6 TDI 4motion, 2.0 TDI 07/09 - 59 -118 kW	49-196849 14-230615	10-30	10-30	Øa: 55 mm; mark: G07, G08, G09, G11; disconnect DCC; Conditions see certificates VA: axle load to: 1140 kg HA: axle load to: 1040 kg





VW GOLF VI Convertible





B12 PK	1.2 TSI 03/11 - 77 kW	46-184504	25	20	mark: G02; without electronic suspension control; outside diameter strut 50 mm; Conditions see certificates; With General Certification (ABE) VA: axle load to: 1010 kg HA: without ride height adjustment; axle load to: 1000 kg
B12 PK	1.2 TSI 03/11 - 77 kW	46-187963	25	20	mark: G07, G08; disconnect DCC; outside diameter strut 55 mm; Conditions see certificates; With General Certification (ABE) VA: axle load to: 1010 kg HA: axle load to: 1000 kg
B12 PK	1.4 TSI, 1.6 TDI, 2.0 TDI, 2.0 TSI 03/11 - 77 -155 kW	46-187970	25	20	mark: G07, G08, G09, G11; without electronic suspension control; outside diameter strut 55 mm; Conditions see certificates; With General Certification (ABE) VA: axle load to: 1120 kg HA: without ride height adjustment; axle load to: 1000 kg
B12 PK	1.4 TSI, 1.6 TDI, 2.0 TDI, 2.0 TSI 03/11 - 77 -155 kW	46-184511	25	20	mark: G02; without electronic suspension control; outside diameter strut 50 mm; Conditions see certificates; With General Certification (ABE) VA: axle load to: 1130 kg HA: without ride height adjustment; axle load to: 1000 kg
B12 SL	1.2 TSI, 1.4 TSI, 1.6 TDI, 2.0 TDI, 2.0 TSI 03/11 - 77 -155 kW	46-183446	45-50	35-40	mark: G02; outside diameter strut 50 mm; Conditions see certificates; With General Certification (ABE) VA: axle load to: 1130 kg HA: axle load to: 1005 kg
B12 SL	1.2 TSI, 1.4 TSI, 1.6 TDI, 2.0 TDI, 2.0 TSI 03/11 - 77 -155 kW	46-194688	35	30	mark: G07, G08; outside diameter strut 55 mm; Conditions see certificates; With General Certification (ABE) VA: axle load to: 1130 kg HA: axle load to: 1005 kg
B14	1.2 TSI, 1.4 TSI, 1.6 TDI, 2.0 TDI, 2.0 TSI 03/11 - 77 -155 kW	47-127708	40-50	30-50	Øa: 55 mm; disconnect DCC; Conditions see certificates VA: axle load to: 1210 kg HA: axle load to: 1100 kg





					
VW					
VW GOLF VI Convertible					
B16 PSS10	1.2 TSI, 1.4 TSI, 1.6 TDI, 2.0 TDI, 2.0 TSI 03/11 - 77 -155 kW	48-135245	40-50	30-50	Øa: 55 mm; disconnect DCC; Conditions see certificates VA: axle load to: 1210 kg HA: axle load to: 1100 kg
B16 RC	1.2 TSI, 1.4 TSI, 1.6 TDI, 2.0 TDI, 2.0 TSI 03/11 - 77 -155 kW	49-196849 14-230615	10-30	10-30	Øa: 55 mm; mark: G07, G08, G09, G11; disconnect DCC; Conditions see certificates VA: axle load to: 1140 kg HA: axle load to: 1040 kg
VW GOLF VII					
B14	1.2 TSI, 1.4 TSI, 1.4 TSI E85-100, 1.6 TDI, 2.0 TDI 11/12 - 63 -110 kW	47-229945	30-50	30-50	Øa: 50 mm; mark: G01, 0N1; disconnect DCC; Conditions see certificates; rigid axle
B14	1.2 TSI, 1.4 TSI, 1.4 TSI E85-100, 1.6 TDI, 1.6 TDI 4motion, 2.0 TDI, 2.0 TDI 4motion 11/12 - 63 -110 kW	47-229969	30-50	30-50	Øa: 50 mm; mark: G01, 0N4; disconnect DCC; Conditions see certificates; multilink axle
B14	1.2 TSI, 1.4 TSI, 1.4 TSI E85-100, 1.6 TDI, 1.6 TDI 4motion, 2.0 TDI, 2.0 TDI 4motion 11/12 - 63 -110 kW	47-229976	30-50	30-50	Øa: 55 mm; mark: G02, 0N4; disconnect DCC; Conditions see certificates; multilink axle
B16 PSS10	1.2 TSI, 1.4 TSI, 1.4 TSI E85-100, 1.6 TDI, 1.6 TDI 4motion, 2.0 TDI, 2.0 TDI 4motion 11/12 - 63 -110 kW	48-230056	30-50	30-50	Øa: 50 mm; mark: G01, 0N4; disconnect DCC; Conditions see certificates; multilink axle
B16 PSS10	1.2 TSI, 1.4 TSI, 1.4 TSI E85-100, 1.6 TDI, 1.6 TDI 4motion, 2.0 TDI, 2.0 TDI 4motion 11/12 - 63 -110 kW	48-230063	30-50	30-50	Øa: 55 mm; mark: G02, 0N4; disconnect DCC; Conditions see certificates; multilink axle
B16 RC	1.2 TSI, 1.4 TSI, 1.4 TSI E85-100, 1.6 TDI, 1.6 TDI 4motion, 2.0 TDI, 2.0 TDI 4motion 11/12 - 63 -110 kW	14-230615 49-231892	30-50	30-50	Øa: 55 mm; mark: G02, 0N4; disconnect DCC; Conditions see certificates; multilink axle
B16 BCS	1.2 TSI, 1.4 TSI, 1.4 TSI E85-100, 1.6 TDI, 1.6 TDI 4motion, 2.0 TDI, 2.0 TDI 4motion 11/12 - 63 -110 kW	48-231848	10-30	10-30	Øa: 55 mm; mark: G02, 0N4; disconnect DCC; multilink axle
VW GOLF PLUS (5M1, 521)					
B12 PK	1.2 TSI, 1.4 16V, 1.4 FSI, 1.6, 1.6 FSI 01/05 - 55 -85 kW	46-184320	30	30	mark: G02; outside diameter strut 50 mm; Conditions see certificates; With General Certification (ABE) VA: axle load to: 1010 kg HA: axle load to: 1010 kg
B12 PK	1.2 TSI 11/09 - 63 -77 kW	46-184337	30	30	mark: G02; outside diameter strut 50 mm; with DSG; Conditions see certificates; With General Certification (ABE) VA: axle load to: 1080 kg HA: axle load to: 1010 kg
B12 PK	1.2 TSI, 1.4 16V, 1.4 FSI, 1.6, 1.6 FSI 01/05 - 55 -85 kW	46-194787	30	30	mark: G07, G08; outside diameter strut 55 mm; Conditions see certificates; With General Certification (ABE) VA: axle load to: 1010 kg HA: axle load to: 1010 kg
B12 PK	1.2 TSI 11/09 - 63 -77 kW	46-194794	30	30	mark: G07, G08; outside diameter strut 55 mm; with DSG; Conditions see certificates; With General Certification (ABE) VA: axle load to: 1080 kg HA: axle load to: 1010 kg
B12 PK	1.4 TSI, 1.9 TDI, 2.0 FSI 05/05 - 66 -125 kW	46-184337	30	30	mark: G02; outside diameter strut 50 mm; Conditions see certificates; With General Certification (ABE) VA: axle load to: 1080 kg HA: axle load to: 1010 kg
B12 PK	1.4 TSI, 1.9 TDI, 2.0 FSI 05/05 - 66 -125 kW	46-194794	30	30	mark: G07, G08; outside diameter strut 55 mm; Conditions see certificates; With General Certification (ABE) VA: axle load to: 1080 kg HA: axle load to: 1010 kg
B12 PK	1.6, 1.6 FSI 01/05 - 67 -85 kW	46-184337	30	30	mark: G02; automatic transmission; outside diameter strut 50 mm; Conditions see certificates; With General Certification (ABE) VA: axle load to: 1080 kg HA: axle load to: 1010 kg
B12 PK	1.6, 1.6 FSI 01/05 - 67 -85 kW	46-194794	30	30	mark: G07, G08; automatic transmission; outside diameter strut 55 mm; Conditions see certificates; With General Certification (ABE) VA: axle load to: 1080 kg HA: axle load to: 1010 kg





VW
VW GOLF PLUS (5M1, 521)





B12 PK	1.6 TDI, 2.0 TDI 12/05 - 66 -103 kW	46-184344	30	30	mark: G02; outside diameter strut 50 mm; Conditions see certificates; With General Certification (ABE) VA: axle load to: 1150 kg HA: axle load to: 1010 kg
B12 PK	1.6 TDI, 2.0 TDI 12/05 - 66 -103 kW	46-194800	30	30	mark: G07, G08; outside diameter strut 55 mm; Conditions see certificates; With General Certification (ABE) VA: axle load to: 1150 kg HA: axle load to: 1010 kg
B12 PK	1.9 TDI 01/05 - 01/09 66 -77 kW	46-184344	30	30	mark: G02; outside diameter strut 50 mm; with DSG; Conditions see certificates; With General Certification (ABE) VA: axle load to: 1150 kg HA: axle load to: 1010 kg
B12 PK	1.9 TDI 01/05 - 01/09 66 -77 kW	46-194800	30	30	mark: G07, G08; outside diameter strut 55 mm; with DSG; Conditions see certificates; With General Certification (ABE) VA: axle load to: 1150 kg HA: axle load to: 1010 kg
B12 SL	1.2 TSI, 1.4 16V, 1.4 FSI, 1.4 TSI, 1.6, 1.6 FSI, 2.0 TDI 12/05 - 55 -125 kW	46-183781	45-50	45-50	mark: G02; outside diameter strut 50 mm; Conditions see certificates; With General Certification (ABE) VA: axle load to: 1040 kg HA: axle load to: 1010 kg
B12 SL	1.2 TSI, 1.4 16V, 1.4 FSI, 1.4 TSI, 1.6, 1.6 FSI 01/05 - 55 -125 kW	46-194817	45-50	45-50	mark: G07,08; outside diameter strut 55 mm; Conditions see certificates; With General Certification (ABE) VA: axle load to: 1040 kg HA: axle load to: 1010 kg
B12 SL	1.4 TSI 05/06 - 90 -125 kW	46-183798	45-50	45-50	mark: G02; outside diameter strut 50 mm; with DSG; Conditions see certificates; With General Certification (ABE) VA: axle load to: 1130 kg HA: axle load to: 1010 kg
B12 SL	1.4 TSI 05/06 - 90 -125 kW	46-194824	45-50	45-50	mark: G07,08; outside diameter strut 55 mm; with DSG; Conditions see certificates; With General Certification (ABE) VA: axle load to: 1130 kg HA: axle load to: 1010 kg
B12 SL	1.6, 1.6 TDI, 1.9 TDI, 2.0 FSI, 2.0 TDI 05/05 - 66 -110 kW	46-183798	45-50	45-50	mark: G02; outside diameter strut 50 mm; Conditions see certificates; With General Certification (ABE) VA: axle load to: 1130 kg HA: axle load to: 1010 kg
B12 SL	1.6, 1.6 TDI, 1.9 TDI, 2.0 FSI, 2.0 TDI 05/05 - 66 -110 kW	46-194824	45-50	45-50	mark: G07,08; outside diameter strut 55 mm; Conditions see certificates; With General Certification (ABE) VA: axle load to: 1130 kg HA: axle load to: 1010 kg
B12 SL	1.6 FSI 01/05 - 05/08 85 kW	46-183798	45-50	45-50	mark: G02; automatic transmission; outside diameter strut 50 mm; Conditions see certificates; With General Certification (ABE) VA: axle load to: 1130 kg HA: axle load to: 1010 kg
B12 SL	1.6 FSI 01/05 - 05/08 85 kW	46-194824	45-50	45-50	mark: G07,08; automatic transmission; outside diameter strut 55 mm; Conditions see certificates; With General Certification (ABE) VA: axle load to: 1130 kg HA: axle load to: 1010 kg
B14	1.0, 1.0 GLS, 1.2 TSI, 1.4 16V, 1.4 FSI, 1.4 TSI, 1.6, 1.6 FSI, 1.6 Multifuel, 1.6 TDI, 1.8, 1.8 Hybrid, 1.9 SDi, 1.9 TDI, 2.0 FSI, 2.0 TDI, 2.0 TDI 16V 01/05 - 47 -125 kW	47-128347	30-50	30-50	mark: G02; outside diameter strut 50 mm; Conditions see certificates VA: mark: G02; axle load to: 1210 kg HA: axle load to: 1100 kg
B14	1.0, 1.0 GLS, 1.2 TSI, 1.4 16V, 1.4 FSI, 1.4 TSI, 1.6, 1.6 FSI, 1.6 Multifuel, 1.6 TDI, 1.8, 1.8 Hybrid, 1.9 SDi, 1.9 TDI, 2.0 FSI, 2.0 TDI, 2.0 TDI 16V 01/05 - 47 -125 kW	47-127708	30-50	30-50	Øa: 55 mm; mark: G07, G08; Conditions see certificates VA: mark: G07; axle load to: 1210 kg HA: axle load to: 1100 kg
B16 PSS10	1.0, 1.0 GLS, 1.2 TSI, 1.4 16V, 1.4 FSI, 1.4 TSI, 1.6, 1.6 FSI, 1.6 Multifuel, 1.6 TDI, 1.8, 1.8 Hybrid, 1.9 SDi, 1.9 TDI, 2.0 FSI, 2.0 TDI, 2.0 TDI 16V 01/05 - 47 -125 kW	48-135238	30-50	30-50	mark: G02; outside diameter strut 50 mm; Conditions see certificates VA: mark: G02; axle load to: 1210 kg HA: axle load to: 1100 kg
B16 PSS10	1.0, 1.0 GLS, 1.2 TSI, 1.4 16V, 1.4 FSI, 1.4 TSI, 1.6, 1.6 FSI, 1.6 Multifuel, 1.6 TDI, 1.8, 1.8 Hybrid, 1.9 SDi, 1.9 TDI, 2.0 FSI, 2.0 TDI, 2.0 TDI 16V 01/05 - 47 -125 kW	48-135245	30-50	30-50	Øa: 55 mm; mark: G07, G08; Conditions see certificates VA: mark: G07; axle load to: 1210 kg HA: axle load to: 1100 kg

					
VW					
VW GOLF PLUS (5M1, 521)					
B16 RC	1.0, 1.0 GLS, 1.2 TSI, 1.4 16V, 1.4 FSI, 1.4 TSI, 1.6, 1.6 FSI, 1.6 Multifuel, 1.6 TDI, 1.8, 1.8 Hybrid, 1.9 SDi, 1.9 TDI, 2.0 FSI, 2.0 TDI, 2.0 TDI 16V 01/05 - 47 -125 kW	49-196849 14-230615	20-40	20-40	Øa: 55 mm; mark: G07, G08, G09, G11; disconect DCC; Conditions see certificates VA: axle load to: 1140 kg HA: axle load to: 1040 kg
VW JETTA I (16)					
B12 PK	1.1, 1.3, 1.5, 1.5 D, 1.6, 1.6 D, 1.6 GLI, 1.6 TD, 1.8 08/78 - 02/84 37 -82 kW	46-189868	30-40	30-35	for bolted struts only; Conditions see certificates VA: axle load to: 785 kg HA: axle load to: 630 kg
VW JETTA II (19E, 1G2)					
B12 PK	1.3, 1.3 CAT, 1.6, 1.8, 1.8 16V, 1.8 CAT 01/84 - 10/91 40 -102 kW	46-189950	30-40	30-35	Conditions see certificates VA: axle load to: 840 kg HA: axle load to: 740 kg
B12 PK	1.6 D, 1.6 TD 01/84 - 10/91 40 -59 kW	46-189967	20	20	Conditions see certificates VA: axle load to: 840 kg HA: axle load to: 740 kg
B14	1.3, 1.3 CAT, 1.6, 1.6 D, 1.6 TD, 1.8, 1.8 16V, 1.8 CAT, 2.0 01/84 - 07/92 40 -102 kW	47-124844	30-50	20-40	Spacers required for several wheel/tyre combinations; Conditions see certificates VA: axle load to: 840 kg HA: axle load to: 740 kg
B16 PSS9	1.3, 1.3 CAT, 1.6, 1.6 D, 1.6 TD, 1.8, 1.8 16V, 1.8 CAT, 2.0 01/84 - 07/92 40 -102 kW	48-080569	30-50	20-30	Spacers required for several wheel/tyre combinations; Conditions see certificates VA: axle load to: 840 kg HA: axle load to: 740 kg
VW JETTA III (1K2)					
B12 PK	1.4 TSI, 1.9 TDI, 2.0, 2.0 FSI, 2.0 TFSI 10/05 - 10/10 77 -147 kW	46-184290	30	30	outside diameter strut 55 mm; Conditions see certificates; With General Certification (ABE) VA: axle load to: 1080 kg HA: axle load to: 1010 kg
B12 PK	1.6, 1.6 FSI, 1.6 MultiFuel, 2.0 08/05 - 10/10 75 -85 kW	46-184269	30	30	outside diameter strut 55 mm; Conditions see certificates; With General Certification (ABE) VA: axle load to: 1010 kg HA: axle load to: 1010 kg
B12 PK	1.6, 1.6 FSI, 1.6 TDI, 2.0 08/05 - 10/10 66 -85 kW	46-184290	30	30	automatic transmission; outside diameter strut 55 mm; Conditions see certificates; With General Certification (ABE) VA: axle load to: 1080 kg HA: axle load to: 1010 kg
B12 PK	1.9 TDI 08/05 - 10/10 77 kW	46-184313	30	30	outside diameter strut 55 mm; with DSG; Conditions see certificates; With General Certification (ABE) VA: axle load to: 1150 kg HA: axle load to: 1010 kg
B12 PK	2.0 TDI 10/06 - 10/10 81 -125 kW	46-184313	30	30	outside diameter strut 55 mm; Conditions see certificates; With General Certification (ABE) VA: axle load to: 1150 kg HA: axle load to: 1010 kg
B12 SL	1.4 TSI, 1.6, 1.6 FSI, 1.9 TDI, 2.0, 2.0 FSI, 2.0 TFSI 10/05 - 10/10 75 -147 kW	46-183804	45-50	45-50	outside diameter strut 55 mm; Conditions see certificates; With General Certification (ABE) VA: axle load to: 1040 kg HA: axle load to: 1005 kg
B12 SL	1.9 TDI, 2.0 TDI, 2.0 TDI 16V, 2.0 TFSI 08/05 - 10/10 77 -147 kW	46-183811	45-50	30-35	outside diameter strut 55 mm; Conditions see certificates; With General Certification (ABE) VA: axle load to: 1130 kg HA: axle load to: 1005 kg
B14	1.4 TSI, 1.6, 1.6 FSI, 1.6 MultiFuel, 1.6 TDI, 1.9 TDI, 2.0, 2.0 FSI, 2.0 TDI, 2.0 TDI 16V, 2.0 TFSI, 2.5, 2.5 FSI, 2.8 VR6 01/06 - 10/10 66 -147 kW	47-128347	30-50	30-50	mark: G02; outside diameter strut 50 mm; Conditions see certificates VA: axle load to: 1210 kg HA: axle load to: 1100 kg
B14	1.4 TSI, 1.6, 1.6 FSI, 1.6 MultiFuel, 1.6 TDI, 1.9 TDI, 2.0, 2.0 FSI, 2.0 TDI, 2.0 TDI 16V, 2.0 TFSI, 2.5, 2.5 FSI, 2.8 VR6 01/06 - 10/10 66 -147 kW	47-127708	30-50	30-50	Øa: 55 mm; Conditions see certificates VA: axle load to: 1210 kg HA: axle load to: 1100 kg

					
VW					
VW JETTA III (1K2)					
B16 PSS10	1.4 TSI, 1.6, 1.6 FSI, 1.6 MultiFuel, 1.6 TDI, 1.9 TDI, 2.0, 2.0 FSI, 2.0 TDI, 2.0 TDI 16V, 2.0 TFSI, 2.5, 2.5 FSI, 2.8 VR6 01/06 - 10/10 66 -147 kW	48-135238	30-50	30-50	mark: G02; outside diameter strut 50 mm; Conditions see certificates VA: axle load to: 1210 kg HA: axle load to: 1100 kg
B16 PSS10	1.4 TSI, 1.6, 1.6 FSI, 1.6 MultiFuel, 1.6 TDI, 1.9 TDI, 2.0, 2.0 FSI, 2.0 TDI, 2.0 TDI 16V, 2.0 TFSI, 2.5, 2.5 FSI, 2.8 VR6 01/06 - 10/10 66 -147 kW	48-135245	30-50	30-50	Øa: 55 mm; Conditions see certificates VA: mark: G07, G08; axle load to: 1210 kg HA: axle load to: 1100 kg
B16 RC	1.4 TSI, 1.6, 1.6 FSI, 1.6 MultiFuel, 1.6 TDI, 1.9 TDI, 2.0, 2.0 FSI, 2.0 TDI, 2.0 TDI 16V, 2.0 TFSI, 2.5, 2.5 FSI, 2.8 VR6 01/06 - 10/10 66 -147 kW	49-196849 14-230615	20-40	20-40	Øa: 55 mm; mark: G07, G08, G09, G11; disconnect DCC; Conditions see certificates VA: axle load to: 1140 kg HA: axle load to: 1040 kg
B16 BCS	2.0 FSI, 2.0 TDI, 2.0 TFSI, 2.5, 2.5 FSI, 2.8 VR6 08/05 - 10/10 110 -147 kW	48-215909	30-40	20-40	Øa: 55 mm; Conditions see certificates VA: axle load to: 1210 kg HA: axle load to: 1095 kg
VW JETTA IV (162)					
B14	1.2 TSI, 1.4 TSI, 1.4 TSI Hybrid, 1.6, 1.6 TDI, 2.0, 2.0 TDI, 2.0 TSI, 2.5 FSI 04/10 - 77 -155 kW	47-128347	30-50	30-50	mark: G46, G57, G10; disconnect DCC; outside diameter strut 50 mm; Conditions see certificates VA: axle load to: 1210 kg HA: axle load to: 1100 kg
B14	1.2 TSI, 1.4 TSI, 1.4 TSI Hybrid, 1.6, 1.6 TDI, 2.0, 2.0 TDI, 2.0 TSI, 2.5 FSI 04/10 - 77 -155 kW	47-127708	30-50	30-50	Øa: 55 mm; mark: G47, G57; disconnect DCC; Conditions see certificates VA: axle load to: 1210 kg HA: axle load to: 1100 kg
B16 PSS10	1.2 TSI, 1.4 TSI, 1.4 TSI Hybrid, 1.6, 1.6 TDI, 2.0, 2.0 TDI, 2.0 TSI, 2.5 FSI 04/10 - 77 -155 kW	48-135238	30-50	30-50	mark: G46, G57, G10; disconnect DCC; outside diameter strut 50 mm; Conditions see certificates VA: axle load to: 1210 kg HA: axle load to: 1100 kg
B16 PSS10	1.2 TSI, 1.4 TSI, 1.4 TSI Hybrid, 1.6, 1.6 TDI, 2.0, 2.0 TDI, 2.0 TSI, 2.5 FSI 04/10 - 77 -155 kW	48-135245	30-50	30-50	Øa: 55 mm; mark: G47, G57; disconnect DCC; Conditions see certificates VA: mark: G07, G08; axle load to: 1210 kg HA: axle load to: 1100 kg
B16 RC	1.2 TSI, 1.4 TSI, 1.4 TSI Hybrid, 1.6, 1.6 TDI, 2.0, 2.0 TDI, 2.0 TSI, 2.5 FSI 04/10 - 77 -155 kW	49-196849 14-230615	20-40	20-40	Øa: 55 mm; mark: G07, G08, G09, G11; disconnect DCC; Conditions see certificates VA: axle load to: 1140 kg HA: axle load to: 1040 kg
B16 BCS	2.0 TDI, 2.0 TSI, 2.5 FSI 04/10 - 103 -155 kW	48-215909	30-40	20-40	Øa: 55 mm; disconnect DCC; Conditions see certificates VA: axle load to: 1210 kg HA: axle load to: 1095 kg
VW LUPO (6X1, 6E1)					
B10	1.0, 1.4, 1.4 16V, 1.4 FSI, 1.4 TDI, 1.7 SDI 09/98 - 07/05 37 -77 kW	46-112019	60	40	Conditions see certificates VA: axle load to: 790 kg
B10	1.0, 1.4, 1.4 16V, 1.4 FSI, 1.4 TDI, 1.7 SDI 09/98 - 07/05 37 -77 kW	46-112002	60	40	Conditions see certificates VA: axle load from: 791 kg
B12 PK	1.0, 1.4, 1.4 16V, 1.4 FSI, 1.4 TDI, 1.6 GTI, 1.7 SDI 09/98 - 07/05 37 -92 kW	46-190833	30	30	Conditions see certificates VA: axle load to: 820 kg HA: axle load to: 690 kg
VW NEW BEETLE (9C1, 1C1)					
B12 PK	1.4, 1.6, 1.8 T, 1.9 TDI, 2.0 01/98 - 55 -132 kW	46-000378	30	30	Conditions see certificates VA: axle load to: 1010 kg HA: axle load to: 850 kg
B12 PK	1.8 T, 1.9 TDI, 2.3 V5 01/98 - 66 -132 kW	46-000361	30	30	Conditions see certificates VA: axle load to: 1050 kg HA: axle load to: 850 kg

					
VW					
VW NEW BEETLE (9C1, 1C1)					
B14	1.4, 1.6, 1.8 T, 1.9 TDI, 2.0, 2.3 V5, 2.5 Turbo 10/00 - 55 -132 kW	47-124851	25-45	20-40	Spacers required for several wheel/tyre combinations; Conditions see certificates VA: axle load to: 1060 kg HA: axle load to: 1010 kg
B14	RSI 3.2 04/00 - 05/01 165 kW	47-080416	10-30	10-30	Conditions see certificates VA: axle load to: 1110 kg HA: axle load to: 1080 kg
B16 PSS9	1.4, 1.6, 1.8 T, 1.9 TDI, 2.0, 2.3 V5, 2.5 Turbo 10/00 - 55 -132 kW	48-080651	25-45	20-40	Spacers required for several wheel/tyre combinations; Conditions see certificates VA: axle load to: 1060 kg HA: axle load to: 1010 kg
B16 PSS9	RSI 3.2 04/00 - 05/01 165 kW	48-080422	10-30	10-30	Conditions see certificates VA: axle load to: 1110 kg HA: axle load to: 1080 kg
VW NEW BEETLE Convertible (1Y7)					
B12 PK	1.4, 1.6, 1.9 TDI, 2.0 09/02 - 10/10 55 -85 kW	46-184023	25	25	Conditions see certificates VA: axle load to: 1010 kg HA: axle load to: 870 kg
B12 PK	1.8 T, 1.9 TDI, 2.0 09/02 - 10/10 74 -110 kW	46-184030	25	25	Conditions see certificates VA: axle load to: 1050 kg HA: axle load to: 870 kg
B14	1.4, 1.6, 1.8 T, 1.9 TDI, 2.0, 2.5 Turbo 09/02 - 10/10 55 -110 kW	47-124851	25-45	20-40	Spacers required for several wheel/tyre combinations; Conditions see certificates VA: axle load to: 1060 kg HA: axle load to: 1010 kg
B16 PSS9	1.4, 1.6, 1.8 T, 1.9 TDI, 2.0, 2.5 Turbo 09/02 - 10/10 55 -110 kW	48-080651	25-45	20-40	Spacers required for several wheel/tyre combinations; Conditions see certificates VA: axle load to: 1060 kg HA: axle load to: 1010 kg
VW PASSAT (3B2)					
B12 PK	1.6, 1.8, 1.8 T 10/96 - 11/00 74 -110 kW	46-188694	30	30	-> CH.Nr.: 3B_YE121221; Conditions see certificates VA: axle load to: 1020 kg HA: axle load to: 1010 kg
B12 PK	1.8, 1.8 T, 1.9 TDI, 2.3 VR5 10/96 - 11/00 66 -110 kW	46-188700	30	30	-> CH.Nr.: 3B_YE121221; Conditions see certificates VA: axle load to: 1090 kg HA: axle load to: 1010 kg
B12 PK	2.5 TDI 07/98 - 11/00 110 kW	46-188717	30	30	-> CH.Nr.: 3B_YE121221; Conditions see certificates VA: axle load to: 1190 kg HA: axle load to: 1010 kg
B14	1.6, 1.8, 1.8 T, 1.9 TDI, 2.0, 2.3 VR5, 2.5 TDI, 2.8 Syncro, 2.8 V6 08/96 - 11/00 66 -143 kW	47-124806	35-55	35-55	Conditions see certificates VA: axle load to: 1230 kg HA: axle load to: 1200 kg
B14	1.8 Syncro/4motion, 1.8 T Syncro, 1.9 TDI 4motion, 1.9 TDI Syncro/4motion, 2.0 4motion, 2.3 VR5 Syncro/4motion, 2.5 TDI Syncro/4motion, 2.8 Syncro, 2.8 V6 4motion, 2.8 V6 Syncro/4motion 10/96 - 11/00 81 -142 kW	47-086937	25-45	20-40	Conditions see certificates VA: axle load to: 1260 kg HA: axle load to: 1200 kg
B16 PSS9	1.6, 1.8, 1.8 T, 1.9 TDI, 2.0, 2.3 VR5, 2.5 TDI, 2.8 Syncro, 2.8 V6 08/96 - 11/00 66 -143 kW	48-088749	35-55	35-55	Conditions see certificates VA: axle load to: 1230 kg HA: axle load to: 1200 kg
B16 PSS9	1.8 Syncro/4motion, 1.8 T Syncro, 1.9 TDI 4motion, 1.9 TDI Syncro/4motion, 2.0 4motion, 2.3 VR5 Syncro/4motion, 2.5 TDI Syncro/4motion, 2.8 Syncro, 2.8 V6 4motion, 2.8 V6 Syncro/4motion 10/96 - 11/00 81 -142 kW	48-088688	25-45	20-40	Conditions see certificates VA: axle load to: 1260 kg HA: axle load to: 1200 kg
VW PASSAT Variant (3B5)					
B12 PK	1.6, 1.8, 1.8 T 06/97 - CH-Nr. 74 -110 kW	46-183958	30	30	-> CH.Nr.: 200011; -> CH.Nr.: 3B-YE121222; without off-road suspension; serie production spring seat must be used; Conditions see certificates VA: axle load to: 1020 kg HA: without ride height adjustment; axle load to: 1080 kg

					
VW					
VW PASSAT Variant (3B5)					
B12 PK	1.8, 1.8 T, 1.9 TDI, 2.3 VR5 06/97 - 11/00 66 -110 kW	46-183965	30	30	-> CH.Nr.: 3B-YE121222; without off-road suspension; serie production spring seat must be used; Conditions see certificates VA: axle load to: 1090 kg; axle load from: 1021 kg HA: without ride height adjustment; axle load to: 1080 kg
B12 PK	1.8 Syncro/4motion, 1.9 TDI 4motion, 1.9 TDI Syncro/4motion, 2.0 4motion, 2.3 VR5 Syncro/4motion 12/99 - 11/00 81 -110 kW	46-183972	30	30	CH.Nr.: 3B-YE121222 ->; without off-road suspension; Conditions see certificates VA: axle load to: 1090 kg HA: without ride height adjustment; axle load to: 1190 kg
B12 PK	2.8 V6 4motion, 2.8 V6 Syncro/4motion 12/99 - 11/00 140 -142 kW	46-183989	30	30	CH.Nr.: 3B-YE121222 ->; without off-road suspension; Conditions see certificates VA: axle load to: 1140 kg HA: without ride height adjustment; axle load to: 1190 kg
B12 PK	2.5 TDI 07/98 - 11/00 110 kW	46-183996	30	30	-> CH.Nr.: 3B-YE121222; without off-road suspension; serie production spring seat must be used; Conditions see certificates VA: axle load to: 1190 kg HA: without ride height adjustment; axle load to: 1080 kg
B12 PK	2.5 TDI Syncro/4motion 12/99 - 11/00 110 kW	46-183941	30	30	CH.Nr.: 3B-YE121222 ->; without off-road suspension; Conditions see certificates VA: axle load to: 1200 kg HA: without ride height adjustment; axle load to: 1190 kg
B14	1.6, 1.8, 1.8 T, 1.9 TDI, 2.0, 2.3 VR5, 2.5 TDI, 2.8 V6 06/97 - 11/00 66 -142 kW	47-124806	35-55	35-55	Conditions see certificates VA: axle load to: 1230 kg HA: axle load to: 1200 kg
B14	1.8 Syncro/4motion, 1.9 TDI 4motion, 1.9 TDI Syncro/4motion, 2.0 4motion, 2.3 VR5 Syncro/4motion, 2.5 TDI Syncro/4motion, 2.8 V6 4motion, 2.8 V6 Syncro/4motion 06/97 - 11/00 81 -142 kW	47-086937	20-45	20-40	Conditions see certificates VA: axle load to: 1260 kg HA: axle load to: 1200 kg
B16 PSS9	1.6, 1.8, 1.8 T, 1.9 TDI, 2.0, 2.3 VR5, 2.5 TDI, 2.8 V6 06/97 - 11/00 66 -142 kW	48-088749	35-55	35-55	with standard chassis; Conditions see certificates VA: axle load to: 1230 kg HA: axle load to: 1200 kg
B16 PSS9	1.8 Syncro/4motion, 1.9 TDI 4motion, 1.9 TDI Syncro/4motion, 2.0 4motion, 2.3 VR5 Syncro/4motion, 2.5 TDI Syncro/4motion, 2.8 V6 4motion, 2.8 V6 Syncro/4motion 06/97 - 11/00 81 -142 kW	48-088688	20-45	20-40	Conditions see certificates VA: axle load to: 1260 kg HA: axle load to: 1200 kg
VW PASSAT (3B3)					
B12 PK	1.6, 1.8, 1.8 T, 1.8 T 20V, 2.0 12/00 - 05/05 75 -125 kW	46-000439	30	30	CH.Nr.: 3B-YE121 222 ->; without off-road suspension; Conditions see certificates VA: axle load to: 1070 kg HA: without ride height adjustment; axle load to: 1070 kg
B12 PK	1.8, 1.8 T, 1.8 T 20V, 1.9 TDI, 2.0 TDI, 2.3 V5, 2.8 12/00 - 05/05 74 -142 kW	46-000446	30	30	CH.Nr.: 3B-YE121 222 ->; without off-road suspension; Conditions see certificates VA: axle load to: 1175 kg HA: without ride height adjustment; axle load to: 1070 kg
B12 PK	2.3 V5, 2.5 TDI, 2.8 12/00 - 05/05 110 -142 kW	46-000453	30	30	CH.Nr.: 3B-YE121 222 ->; without off-road suspension; Conditions see certificates VA: axle load to: 1250 kg HA: without ride height adjustment; axle load to: 1070 kg
B14	1.6, 1.8, 1.8 T, 1.8 T 20V, 1.9 TDI, 2.0, 2.0 TDI, 2.3 V5, 2.5 TDI, 2.8 11/00 - 05/05 74 -142 kW	47-124806	35-55	35-55	Conditions see certificates VA: axle load to: 1230 kg HA: axle load to: 1200 kg
B14	1.8 4motion, 1.9 TDI 4motion, 2.0 4motion, 2.3 V5 4motion, 2.5 TDI 4motion, 2.8 4motion, 4.0 W8 4motion 11/00 - 05/05 85 -202 kW	47-086937	20-45	20-40	without off-road suspension; Conditions see certificates VA: axle load to: 1260 kg HA: axle load to: 1200 kg
B16 PSS9	1.6, 1.8, 1.8 T, 1.8 T 20V, 1.9 TDI, 2.0, 2.0 TDI, 2.3 V5, 2.5 TDI, 2.8 11/00 - 05/05 74 -142 kW	48-088749	35-55	35-55	without off-road suspension; Conditions see certificates VA: axle load to: 1230 kg HA: axle load to: 1200 kg

					
VW					
VW PASSAT (3B3)					
B16 PSS9	1.8 4motion, 1.9 TDI 4motion, 2.0 4motion, 2.3 V5 4motion, 2.5 TDI 4motion, 2.8 4motion, 4.0 W8 4motion 11/00 - 05/05 85 -202 kW	48-088688	25-45	20-40	without off-road suspension; Conditions see certificates VA: axle load to: 1260 kg HA: axle load to: 1200 kg

VW PASSAT Variant (3B6)					
B12 PK	1.6, 1.8 T, 1.8 T 20V, 2.0 CH-Nr. - 08/05 75 -125 kW	46-000491	30	30	CH.Nr.: 3B_YE121 222 ->; Conditions see certificates VA: axle load to: 1070 kg HA: without ride height adjustment; axle load to: 1200 kg
B12 PK	1.8 T, 1.8 T 20V, 1.9 TDI, 2.0 TDI, 2.3 VR5 CH-Nr. - 08/05 74 -125 kW	46-000507	30	30	CH.Nr.: 3B_YE121 222 ->; Conditions see certificates VA: axle load to: 1175 kg HA: without ride height adjustment; axle load to: 1200 kg
B12 PK	2.3 VR5, 2.5 TDI CH-Nr. - 05/05 110 -125 kW	46-000514	30	30	CH.Nr.: 3B_YE121 222 ->; Conditions see certificates VA: axle load to: 1250 kg HA: without ride height adjustment; axle load to: 1200 kg
B12 PK	2.8 4motion CH-Nr. - 05/05 142 kW	46-183989	30	30	CH.Nr.: 3B_YE121 222 ->; Conditions see certificates VA: axle load to: 1140 kg HA: without ride height adjustment; axle load to: 1190 kg
B12 PK	1.9 TDI 4motion, 2.0 4motion, 2.3 VR5 4motion CH-Nr. - 05/05 85 -125 kW	46-183972	30	30	CH.Nr.: 3B_YE121 222 ->; Conditions see certificates VA: axle load to: 1090 kg HA: without ride height adjustment; axle load to: 1190 kg
B12 PK	2.5 TDI 4motion 11/00 - 05/05 110 -132 kW	46-183941	30	30	Conditions see certificates VA: axle load to: 1200 kg HA: without ride height adjustment; axle load to: 1190 kg
B14	1.6, 1.8 T, 1.8 T 20V, 1.9 TDI, 2.0, 2.0 TDI, 2.3 VR5, 2.5 TDI 11/00 - 08/05 74 -125 kW	47-124806	35-55	35-55	Conditions see certificates VA: axle load to: 1230 kg HA: axle load to: 1200 kg
B14	1.8 4motion, 1.9 TDI 4motion, 2.0 4motion, 2.3 VR5 4motion, 2.5 TDI 4motion, 2.8 4motion, 4.0 W8 4motion 11/00 - 05/05 85 -202 kW	47-086937	25-45	20-40	without off-road suspension; Conditions see certificates VA: axle load to: 1260 kg HA: axle load to: 1200 kg
B16 PSS9	1.6, 1.8 T, 1.8 T 20V, 1.9 TDI, 2.0, 2.0 TDI, 2.3 VR5, 2.5 TDI 11/00 - 08/05 74 -125 kW	48-088749	35-55	35-55	without off-road suspension; Conditions see certificates VA: axle load to: 1230 kg HA: axle load to: 1200 kg
B16 PSS9	1.8 4motion, 1.9 TDI 4motion, 2.0 4motion, 2.3 VR5 4motion, 2.5 TDI 4motion, 2.8 4motion, 4.0 W8 4motion 11/00 - 05/05 85 -202 kW	48-088688	25-45	20-40	without off-road suspension; Conditions see certificates VA: axle load to: 1260 kg HA: axle load to: 1200 kg

VW PASSAT (3C2)					
B12 PK	1.4 TSI, 1.4 TSI EcoFuel, 1.6, 1.6 FSI, 2.0 FSI, 2.0 TFSI 07/05 - 07/10 75 -147 kW	46-184405	30	30	without electronic suspension control; outside diameter strut 55 mm; Conditions see certificates; With General Certification (ABE) VA: axle load to: 1070 kg HA: without ride height adjustment; axle load to: 1130 kg
B12 PK	1.4 TSI, 1.4 TSI EcoFuel, 1.6, 1.6 TDI, 1.8 TSI, 1.9 TDI, 2.0 FSI, 2.0 TDI, 2.0 TDI 16V, 2.0 TFSI 07/05 - 75 -147 kW	46-184412	30	30	without electronic suspension control; outside diameter strut 55 mm; Conditions see certificates; With General Certification (ABE) VA: axle load to: 1180 kg HA: without ride height adjustment; axle load to: 1130 kg
B12 PK	2.0 FSI 4motion, 2.0 TDI 16V 4motion, 2.0 TDI 4motion, 3.2 FSI 4motion, 3.6 FSI 4motion 03/05 - 103 -206 kW	46-184443	30	30	without electronic suspension control; outside diameter strut 55 mm; Conditions see certificates; With General Certification (ABE) VA: axle load to: 1180 kg HA: without ride height adjustment; axle load to: 1230 kg
B14	1.4 TSI, 1.4 TSI EcoFuel, 1.6, 1.6 FSI, 1.6 TDI, 1.8 TSI, 1.9 TDI, 2.0 BlueTDI, 2.0 FSI, 2.0 FSI 4motion, 2.0 TDI, 2.0 TDI 16V, 2.0 TDI 16V 4motion, 2.0 TDI 4motion, 2.0 TFSI, 3.2 FSI 4motion, 3.6 FSI 4motion, 3.6 R36 4motion 04/07 - 75 -220 kW	47-127708	30-50	30-50	Øa: 55 mm; Conditions see certificates VA: axle load to: 1210 kg HA: axle load to: 1250 kg

VW
VW PASSAT (3C2)

B16 PSS10	1.4 TSI, 1.4 TSI EcoFuel, 1.6, 1.6 FSI, 1.6 TDI, 1.8 TSI, 1.9 TDI, 2.0 BlueTDI, 2.0 FSI, 2.0 FSI 4motion, 2.0 TDI, 2.0 TDI 16V, 2.0 TDI 16V 4motion, 2.0 TDI 4motion, 2.0 TFSI, 3.2 FSI 4motion, 3.6 FSI 4motion, 3.6 R36 4motion 04/07 - 75 -220 kW	48-135245	30-50	30-50	Øa: 55 mm; Conditions see certificates VA: axle load to: 1210 kg HA: axle load to: 1250 kg
B16 RC	1.4 TSI, 1.4 TSI EcoFuel, 1.6, 1.6 FSI, 1.6 TDI, 1.8 TSI, 1.9 TDI, 2.0 BlueTDI, 2.0 FSI, 2.0 FSI 4motion, 2.0 TDI, 2.0 TDI 16V, 2.0 TDI 16V 4motion, 2.0 TDI 4motion, 2.0 TFSI, 3.2 FSI 4motion, 3.6 FSI 4motion, 3.6 R36 4motion 04/07 - 75 -220 kW	49-196849 14-230615	20-40	20-40	Øa: 55 mm; mark: G07, G08, G09, G11; disconnect DCC; Without roadworthy certificate VA: axle load to: 1140 kg HA: axle load to: 1040 kg

VW PASSAT Variant (3C5)





B12 PK	1.4 TSI, 1.4 TSI EcoFuel, 1.6, 1.6 FSI, 1.8 TSI, 2.0 FSI, 2.0 TFSI 08/05 - 10/11 75 -147 kW	46-184429	30	30	without electronic suspension control; outside diameter strut 55 mm; Conditions see certificates; With General Certification (ABE) VA: axle load to: 1070 kg HA: without ride height adjustment; axle load to: 1130 kg
B12 PK	1.4 TSI, 1.4 TSI EcoFuel, 1.6, 1.6 FSI, 1.6 TDI, 1.8 TSI, 1.9 TDI, 2.0 BlueTDI, 2.0 FSI, 2.0 TDI, 2.0 TDI 16V, 2.0 TFSI 08/05 - 75 -147 kW	46-184436	30	30	without electronic suspension control; outside diameter strut 55 mm; Conditions see certificates; With General Certification (ABE) VA: axle load to: 1180 kg HA: without ride height adjustment; axle load to: 1130 kg
B12 PK	2.0 FSI 4motion, 2.0 TDI 16V 4motion, 2.0 TDI 4motion, 3.2 FSI 4motion 08/05 - 103 -184 kW	46-184443	30	30	without electronic suspension control; outside diameter strut 55 mm; Conditions see certificates; With General Certification (ABE) VA: axle load to: 1180 kg HA: without ride height adjustment; axle load to: 1230 kg
B14	1.4 TSI, 1.4 TSI EcoFuel, 1.6, 1.6 FSI, 1.6 TDI, 1.8 TSI, 1.9 TDI, 2.0 BlueTDI, 2.0 FSI, 2.0 TDI, 2.0 TDI 16V, 2.0 TFSI 08/05 - 75 -147 kW	47-127708	30-50	30-50	Øa: 55 mm; Conditions see certificates VA: axle load to: 1210 kg HA: axle load to: 1250 kg
B16 PSS10	1.4 TSI, 1.4 TSI EcoFuel, 1.6, 1.6 FSI, 1.6 TDI, 1.8 TSI, 1.9 TDI, 2.0 BlueTDI, 2.0 FSI, 2.0 TDI, 2.0 TDI 16V, 2.0 TFSI 08/05 - 75 -147 kW	48-135245	30-50	30-50	Øa: 55 mm; Conditions see certificates VA: axle load to: 1210 kg HA: axle load to: 1250 kg
B16 RC	1.4 TSI, 1.4 TSI EcoFuel, 1.6, 1.6 FSI, 1.6 TDI, 1.8 TSI, 1.9 TDI, 2.0 BlueTDI, 2.0 FSI, 2.0 TDI, 2.0 TDI 16V, 2.0 TFSI 08/05 - 75 -147 kW	49-196849 14-230615	20-40	20-40	Øa: 55 mm; mark: G07, G08, G09, G11; disconnect DCC; Without roadworthy certificate VA: axle load to: 1140 kg HA: axle load to: 1040 kg





VW PASSAT CC





B12 PK	2.0 TDI 4motion, 3.6 4motion, 3.6 FSI 4motion 06/08 - 103 -220 kW	46-184399	25	25	without electronic suspension control; outside diameter strut 55 mm; Conditions see certificates; With General Certification (ABE) VA: axle load to: 1170 kg HA: without ride height adjustment; axle load to: 1100 kg
B14	1.4 TSI MultiFuel, 1.8 TSI, 2.0 BlueTDI, 2.0 TDI, 2.0 TSI, 3.6 FSI 06/08 - 100 -206 kW	47-127708	30-50	30-50	Øa: 55 mm; disconnect DCC; Conditions see certificates VA: axle load to: 1210 kg HA: axle load to: 1250 kg
B16 PSS10	1.4 TSI MultiFuel, 1.8 TSI, 2.0 BlueTDI, 2.0 TDI, 2.0 TSI, 3.6 FSI 06/08 - 100 -206 kW	48-135245	30-50	30-50	Øa: 55 mm; disconnect DCC; Conditions see certificates VA: axle load to: 1210 kg HA: axle load to: 1250 kg
B16 RC	1.4 TSI MultiFuel, 1.8 TSI, 2.0 BlueTDI, 2.0 TDI, 2.0 TSI, 3.6 FSI 06/08 - 100 -206 kW	49-196849 14-230615	20-40	20-40	Øa: 55 mm; mark: G07, G08, G09, G11; disconnect DCC; Without roadworthy certificate VA: axle load to: 1140 kg HA: axle load to: 1040 kg

VW PASSAT (362)

B12 PK	1.4 TSI, 1.4 TSI EcoFuel, 1.4 TSI MultiFuel 08/10 - 90 -118 kW	46-184405	30	30	without electronic suspension control; outside diameter strut 55 mm; Conditions see certificates; With General Certification (ABE) VA: axle load to: 1070 kg HA: without ride height adjustment; axle load to: 1130 kg
------------------	--	------------------	----	----	--

					
VW					
VW PASSAT (362)					
B12 PK	1.4 TSI, 1.6 TDI, 1.8 TSI, 2.0 TDI, 2.0 TSI 08/10 - 77 -155 kW	46-184412	30	30	without electronic suspension control; outside diameter strut 55 mm; Conditions see certificates; With General Certification (ABE) VA: axle load to: 1180 kg HA: without ride height adjustment; axle load to: 1130 kg
B12 PK	2.0 TDI 4motion, 3.6 FSI 4motion 08/10 - 103 -220 kW	46-184443	30	30	without electronic suspension control; outside diameter strut 55 mm; Conditions see certificates; With General Certification (ABE) VA: axle load to: 1180 kg HA: without ride height adjustment; axle load to: 1230 kg
B14	1.4 TSI, 1.4 TSI EcoFuel, 1.4 TSI MultiFuel, 1.6 TDI, 1.8 TSI, 2.0 TDI, 2.0 TDI 4motion, 2.0 TSI, 3.6 FSI 4motion 08/10 - 77 -220 kW	47-127708	30-50	30-50	Øa: 55 mm; disconnect DCC; Conditions see certificates VA: axle load to: 1210 kg HA: axle load to: 1240 kg
B16 PSS10	1.4 TSI, 1.4 TSI EcoFuel, 1.4 TSI MultiFuel, 1.6 TDI, 1.8 TSI, 2.0 TDI, 2.0 TDI 4motion, 2.0 TSI, 3.6 FSI 4motion 08/10 - 77 -220 kW	48-135245	30-50	30-50	Øa: 55 mm; disconnect DCC; Conditions see certificates VA: axle load to: 1210 kg HA: axle load to: 1250 kg
B16 RC	1.4 TSI, 1.4 TSI EcoFuel, 1.4 TSI MultiFuel, 1.6 TDI, 1.8 TSI, 2.0 TDI, 2.0 TDI 4motion, 2.0 TSI, 3.6 FSI 4motion 08/10 - 77 -220 kW	49-196849 14-230615	20-40	20-40	Øa: 55 mm; mark: G07, G08, G09, G11; disconnect DCC; Conditions see certificates VA: axle load to: 1140 kg HA: axle load to: 1040 kg
VW PASSAT Variant (365)					
B12 PK	1.4 TSI, 1.4 TSI EcoFuel, 1.4 TSI MultiFuel 08/10 - 90 -118 kW	46-184429	30	30	without electronic suspension control; outside diameter strut 55 mm; Conditions see certificates VA: axle load to: 1070 kg HA: without ride height adjustment; axle load to: 1130 kg
B12 PK	1.4 TSI, 1.4 TSI EcoFuel, 1.4 TSI MultiFuel, 1.6 TDI, 1.8 TSI, 2.0 TDI, 2.0 TSI 08/10 - 77 -155 kW	46-184436	30	30	without electronic suspension control; outside diameter strut 55 mm; Conditions see certificates; With General Certification (ABE) VA: axle load to: 1180 kg HA: without ride height adjustment; axle load to: 1130 kg
B12 PK	2.0 TDI 4motion, 3.6 FSI 4motion, 2.0 TSI 4motion 08/10 - 103 -220 kW	46-184443	30	30	without electronic suspension control; outside diameter strut 55 mm; Conditions see certificates; With General Certification (ABE) VA: axle load to: 1180 kg HA: without ride height adjustment; axle load to: 1230 kg
B14	1.4 TSI, 1.4 TSI EcoFuel, 1.4 TSI MultiFuel, 1.6 TDI, 1.8 TSI, 2.0 TDI, 2.0 TSI 08/10 - 77 -155 kW	47-127708	30-50	30-50	Øa: 55 mm; disconnect DCC; Conditions see certificates VA: axle load to: 1210 kg HA: axle load to: 1240 kg
B16 PSS10	1.4 TSI, 1.4 TSI EcoFuel, 1.4 TSI MultiFuel, 1.6 TDI, 1.8 TSI, 2.0 TDI, 2.0 TSI 08/10 - 77 -155 kW	48-135245	30-50	30-50	Øa: 55 mm; disconnect DCC; Conditions see certificates VA: axle load to: 1210 kg HA: axle load to: 1250 kg
B16 RC	1.4 TSI, 1.4 TSI EcoFuel, 1.4 TSI MultiFuel, 1.6 TDI, 1.8 TSI, 2.0 TDI, 2.0 TSI 08/10 - 77 -155 kW	49-196849 14-230615	20-40	20-40	Øa: 55 mm; mark: G07, G08, G09, G11; disconnect DCC; Without roadworthy certificate VA: axle load to: 1140 kg HA: axle load to: 1040 kg
VW CC (358)					
B14	1.4 TSI, 1.8 TSI, 2.0 TDI, 2.0 TDI 4motion, 2.0 TSI, 3.6 FSI 4motion 11/11 - 100 -220 kW	47-127708	30-50	30-50	Øa: 55 mm; disconnect DCC; Conditions see certificates VA: axle load to: 1210 kg HA: axle load to: 1250 kg
B16 PSS10	1.4 TSI, 1.8 TSI, 2.0 TDI, 2.0 TDI 4motion, 2.0 TSI, 3.6 FSI 4motion 11/11 - 100 -220 kW	48-135245	30-50	30-50	Øa: 55 mm; disconnect DCC; Conditions see certificates VA: axle load to: 1210 kg HA: axle load to: 1250 kg
B16 RC	1.4 TSI, 1.8 TSI, 2.0 TDI, 2.0 TDI 4motion, 2.0 TSI 11/11 - 100 -155 kW	49-196849 14-230615	20-40	20-40	Øa: 55 mm; mark: G07, G08, G09, G11; disconnect DCC; Without roadworthy certificate VA: axle load to: 1140 kg HA: axle load to: 1040 kg
VW POLO (86C, 80)					
B12 PK	0.9, 1.0, 1.0 CAT, 1.1, 1.3, 1.3 CAT, 1.3 D, 1.4 D 10/81 - 09/94 29 -56 kW	46-192189	30-40	30-35	Conditions see certificates VA: axle load to: 640 kg HA: axle load to: 630 kg

									
VW									
VW POLO CLASSIC (86C, 80)									
B12 PK	1.0, 1.3, 1.3 CAT, 1.3 D, 1.4 D 01/85 - 09/94 29 -40 kW	46-192189	30-40	30-35	Conditions see certificates VA: axle load to: 640 kg HA: axle load to: 630 kg				
VW POLO Coupe (86C, 80)									
B12 PK	1.0, 1.0 CAT, 1.1, 1.3, 1.3 CAT, 1.3 D, 1.3 G40, 1.4 D 10/81 - 09/94 29 -85 kW	46-192189	30-40	30-35	Conditions see certificates VA: axle load to: 640 kg HA: axle load to: 630 kg				
VW POLO (6N1)									
B10	100 1.4 16V, 120 1.6 16V GTI 04/96 - 10/99 74 -88 kW	46-111999	40	20	Conditions see certificates				
B10	1.7 SDI, 45 1.0, 50 1.0, 55 1.3, 55 1.4, 60 1.4, 60 1.7 SDI, 64 1.9 D, 64 1.9 SDI, 75 1.6 10/94 - 10/99 33 -55 kW	46-111999	60	40	Conditions see certificates				
B12 PK	1.7 SDI, 100 1.4 16V, 120 1.6 16V GTI, 45 1.0, 50 1.0, 55 1.3, 55 1.4, 60 1.4, 60 1.7 SDI, 64 1.9 D, 64 1.9 SDI, 75 1.6 10/94 - 10/99 33 -88 kW	46-190789	30	30	Conditions see certificates VA: axle load to: 820 kg HA: axle load to: 750 kg				
B12 SL	1.7 SDI, 100 1.4 16V, 120 1.6 16V GTI, 45 1.0, 50 1.0, 55 1.3, 55 1.4, 60 1.4, 60 1.7 SDI, 64 1.9 D, 64 1.9 SDI, 75 1.6 10/94 - 10/99 33 -88 kW	46-190765	45-50	30-35	Conditions see certificates VA: axle load to: 800 kg HA: axle load to: 750 kg				
B14	1.7 SDI, 100 1.4 16V, 120 1.6 16V GTI, 45 1.0, 50 1.0, 55 1.3, 55 1.4, 60 1.4, 60 1.7 SDI, 64 1.9 D, 64 1.9 SDI, 75 1.6 10/94 - 10/99 33 -88 kW	47-080720	30-50	20-40	Conditions see certificates VA: axle load to: 870 kg HA: axle load to: 780 kg				
B16 PSS9	1.7 SDI, 100 1.4 16V, 120 1.6 16V GTI, 45 1.0, 50 1.0, 55 1.3, 55 1.4, 60 1.4, 60 1.7 SDI, 64 1.9 D, 64 1.9 SDI, 75 1.6 10/94 - 10/99 33 -88 kW	48-080736	30-50	20-40	Conditions see certificates VA: axle load to: 870 kg HA: axle load to: 780 kg				
VW POLO CLASSIC (6KV2)									
B12 PK	1.4, 1.6 L, 1.8 GDI LS, 1.8 LE, 1.8 SEi Limited, 100 1.6, 2.0, 54 1.4, 60 1.4, 75 1.4 16V, 75 1.6, 90 1.8 11/95 - 07/05 40 -85 kW	46-190819	30	30	Conditions see certificates VA: axle load to: 865 kg HA: axle load to: 790 kg				
B12 PK	1.9 D, 110 1.9 TDI, 57 1.7 SDI, 64 1.9 D, 64 1.9 SDI, 68 1.9 SDI, 90 1.9 TDI 12/95 - 09/01 42 -81 kW	46-190840	30	30	Conditions see certificates VA: axle load to: 900 kg HA: axle load to: 790 kg				
VW POLO (6N2)									
B12 PK	1.0, 1.2, 1.4, 1.4 16V 10/99 - 10/01 37 -74 kW	46-190802	30	30	Conditions see certificates VA: axle load to: 800 kg HA: axle load to: 780 kg				
B12 PK	1.4, 1.4 16V, 1.4 TDI, 1.6 16V GTI, 1.7 SDI, 1.9 D, 1.9 SDI 10/99 - 09/01 40 -92 kW	46-190796	30	30	Conditions see certificates VA: axle load to: 850 kg HA: axle load to: 780 kg				
B12 SL	1.0, 1.2, 1.4, 1.4 16V, 1.6 16V GTI 10/99 - 10/01 37 -92 kW	46-190772	45-50	30-35	manual transmission; Conditions see certificates VA: axle load to: 830 kg HA: axle load to: 780 kg				
B14	1.0, 1.2, 1.4, 1.4 16V, 1.4 TDI, 1.6 16V GTI, 1.7 SDI, 1.9 D, 1.9 SDI 10/99 - 10/01 37 -92 kW	47-081888	30-50	20-40	Conditions see certificates VA: axle load to: 900 kg HA: axle load to: 780 kg				
B16 PSS9	1.0, 1.2, 1.4, 1.4 16V, 1.4 TDI, 1.6 16V GTI, 1.7 SDI, 1.9 D, 1.9 SDI 10/99 - 10/01 37 -92 kW	48-081894	30-50	20-40	Conditions see certificates VA: axle load to: 900 kg HA: axle load to: 780 kg				

									
VW									
VW POLO (9N_)									
B12 PK	1.2, 1.4 16V, 1.4 FSI, 1.6 16V, 1.6 Sportline, 1.6 Total Flex 10/01 - 04/09 40 -77 kW	46-183927	30	30	mark: G29,G30; manual transmission; Conditions see certificates VA: axle load to: 870 kg HA: axle load to: 840 kg				
B12 PK	1.8 GTI, 1.8 GTi Cup Edition 09/05 - 11/09 110 -132 kW	46-183934	20	20	mark: G29,G30; Conditions see certificates VA: axle load to: 960 kg HA: axle load to: 840 kg				
B12 PK	1.4 TDI, 1.9 SDI, 1.9 TDI 11/03 - 11/09 47 -96 kW	46-183934	30	30	mark: G29,G30; Conditions see certificates VA: axle load to: 960 kg HA: axle load to: 840 kg				
B12 SL	1.2, 1.4 16V, 1.4 FSI, 1.6 16V, 1.6 Sportline, 1.6 Total Flex 10/01 - 04/09 40 -77 kW	46-183736	45-50	30-35	mark: G29,G30; manual transmission; Conditions see certificates VA: axle load to: 870 kg HA: axle load to: 800 kg				
B14	1.2, 1.4, 1.4 16V, 1.4 FSI, 1.4 TDI, 1.6 16V, 1.6 Sportline, 1.6 Total Flex, 1.9 SDI, 1.9 TDI, 2.0 10/01 - 11/09 40 -96 kW	47-146914	30-50	30-45	with standard chassis; Conditions see certificates VA: axle load to: 960 kg HA: axle load to: 835 kg				
B14	1.2, 1.4, 1.4 16V, 1.4 FSI, 1.4 TDI, 1.6 16V, 1.6 Sportline, 1.6 Total Flex, 1.8 GTI, 1.8 GTi Cup Edition, 1.9 SDI, 1.9 TDI, 2.0 10/01 - 11/09 40 -132 kW	47-146914	15-35	15-30	with sports suspension; Conditions see certificates VA: axle load to: 960 kg HA: axle load to: 835 kg				
B14	1.2, 1.4, 1.4 16V, 1.4 FSI, 1.4 TDI, 1.6 16V, 1.6 Sportline, 1.6 Total Flex, 1.9 SDI, 1.9 TDI, 2.0 10/01 - 11/09 40 -96 kW	47-146914	45-65	45-60	mark: Cross, Fun; with off-road suspension; Conditions see certificates VA: axle load to: 960 kg HA: axle load to: 835 kg				
B16 PSS9	1.2, 1.4, 1.4 16V, 1.4 FSI, 1.4 TDI, 1.6 16V, 1.6 Sportline, 1.6 Total Flex, 1.9 SDI, 1.9 TDI, 2.0 10/01 - 11/09 40 -96 kW	48-146852	30-50	30-45	with standard chassis; Conditions see certificates VA: axle load to: 960 kg HA: axle load to: 835 kg				
B16 PSS9	1.2, 1.4, 1.4 16V, 1.4 FSI, 1.4 TDI, 1.6 16V, 1.6 Sportline, 1.6 Total Flex, 1.8 GTI, 1.8 GTi Cup Edition, 1.9 SDI, 1.9 TDI, 2.0 10/01 - 11/09 40 -132 kW	48-146852	15-35	15-30	with sports suspension; Conditions see certificates VA: axle load to: 960 kg HA: axle load to: 835 kg				
B16 PSS9	1.2, 1.4, 1.4 16V, 1.4 FSI, 1.4 TDI, 1.6 16V, 1.6 Sportline, 1.6 Total Flex, 1.9 SDI, 1.9 TDI, 2.0 10/01 - 11/09 40 -96 kW	48-146852	45-65	45-60	mark: Cross; Fun; with off-road suspension; Conditions see certificates VA: axle load to: 960 kg HA: axle load to: 835 kg				
VW POLO Saloon									
B12 PK	1.4 07/03 - 55 -74 kW	46-183927	30	30	manual transmission; Conditions see certificates VA: axle load to: 870 kg HA: axle load to: 840 kg				
B12 PK	1.4 TDI, 1.9 SDI 09/02 - 47 -55 kW	46-183934	30	30	Conditions see certificates VA: axle load to: 960 kg HA: axle load to: 840 kg				
B14	1.0, 1.4, 1.4 TDI, 1.6, 1.9 SDI, 1.9 TDI, 2.0 09/02 - 47 -85 kW	47-146914	30-50	30-45	Conditions see certificates VA: axle load to: 960 kg HA: axle load to: 900 kg				
B16 PSS9	1.0, 1.4, 1.4 TDI, 1.6, 1.9 SDI, 1.9 TDI, 2.0 09/02 - 47 -85 kW	48-146852	30-50	30-45	Conditions see certificates VA: axle load to: 960 kg HA: axle load to: 835 kg				
VW POLO (6R_)									
B12 PK	1.2, 1.4, 1.4 BiFuel, 1.4 TSI, 1.6, 1.6 BiFuel 06/09 - 44 -103 kW	46-184450	25	30	Conditions see certificates VA: axle load to: 860 kg HA: axle load to: 820 kg				
B12 PK	1.2 TSI 06/09 - 63 -77 kW	46-184450	25	30	manual transmission; Conditions see certificates VA: axle load to: 860 kg HA: axle load to: 820 kg				

VW
VW POLO (6R_)

B12 PK	1.2 TSI 06/09 - 63 -77 kW	46-184467	25	30	automatic transmission; Conditions see certificates VA: axle load to: 940 kg HA: axle load to: 820 kg
B12 PK	1.4 GTI 05/10 - 132 kW	46-184467	15	20	Conditions see certificates VA: axle load to: 940 kg HA: axle load to: 820 kg
B12 PK	1.2 TDI, 1.6 BiFuel, 1.6 TDI 06/09 - 55 -77 kW	46-184467	25	30	Conditions see certificates VA: axle load to: 940 kg HA: axle load to: 820 kg
B14	1.2, 1.2 TDI, 1.2 TSI, 1.4, 1.4 BiFuel, 1.4 TSI, 1.6, 1.6 BiFuel, 1.6 TDI, 2.0 R WRC 06/09 - 44 -162 kW	47-168091	35-50	30-45	Conditions see certificates VA: axle load to: 960 kg HA: axle load to: 800 kg
B14	1.4 GTI 05/10 - 132 kW	47-168091	20-35	15-30	Conditions see certificates VA: axle load to: 960 kg HA: axle load to: 800 kg
B16 PSS9	1.2, 1.2 TDI, 1.2 TSI, 1.4, 1.4 BiFuel, 1.4 TSI, 1.6, 1.6 BiFuel, 1.6 TDI, 2.0 R WRC 06/09 - 44 -162 kW	48-168229	35-50	30-45	Conditions see certificates VA: axle load to: 960 kg HA: axle load to: 800 kg
B16 PSS9	1.4 GTI 05/10 - 132 kW	48-168229	20-35	15-30	Conditions see certificates VA: axle load to: 960 kg HA: axle load to: 800 kg

VW SCIROCCO (53)





B12 PK	1.3, 1.5, 1.6 06/76 - 07/80 44 -81 kW	46-189868	30-40	30	for bolted struts only; Conditions see certificates VA: axle load to: 785 kg HA: axle load to: 630 kg
-----------	---	------------------	-------	----	---





VW SCIROCCO (53B)

B12 PK	1.3, 1.5, 1.6, 1.8, 1.8 16V 08/80 - 07/89 44 -102 kW	46-189868	30-40	30	for bolted struts only; Conditions see certificates VA: axle load to: 785 kg HA: axle load to: 630 kg
-----------	--	------------------	-------	----	---

VW SCIROCCO (137)

B12 PK	1.4 TSI, 2.0 TDI, 2.0 TSI 05/08 - 90 -155 kW	46-184382	25-30	20	disconnect DCC; outside diameter strut 55 mm; Conditions see certificates VA: axle load to: 1050 kg HA: axle load to: 770 kg
B12 PK	2.0 R 11/09 - 188 -195 kW	46-184382	15	10	disconnect DCC; outside diameter strut 55 mm; Conditions see certificates VA: axle load to: 1050 kg HA: axle load to: 770 kg
B14	1.4 TSI, 2.0 TDI, 2.0 TSI 05/08 - 90 -155 kW	47-158283	20-40	20-40	Øa: 55 mm; disconnect DCC; Conditions see certificates VA: axle load to: 1110 kg HA: axle load to: 800 kg
B14	2.0 R 11/09 - 188 -195 kW	47-158283	10-30	10-30	Øa: 55 mm; disconnect DCC; Conditions see certificates VA: axle load to: 1110 kg HA: axle load to: 800 kg
B16 PSS10	1.4 TSI, 2.0 TDI, 2.0 TSI 05/08 - 90 -155 kW	48-158176	20-40	20-40	Øa: 55 mm; disconnect DCC; Conditions see certificates VA: axle load to: 1110 kg HA: axle load to: 800 kg
B16 PSS10	2.0 R 11/09 - 188 -195 kW	48-158176	10-30	10-30	Øa: 55 mm; disconnect DCC; Conditions see certificates VA: axle load to: 1110 kg HA: axle load to: 800 kg
B16 RC	1.4 TSI, 2.0 TDI, 2.0 TSI 05/08 - 90 -155 kW	49-196849 14-230615	20-40	20-40	Øa: 55 mm; mark: G07, G08, G09, G11; disconnect DCC; Conditions see certificates VA: axle load to: 1110 kg HA: axle load to: 1040 kg
B16 RC	2.0 R 11/09 - 188 -195 kW	49-196849 14-230615	10-30	10-30	Øa: 55 mm; mark: G07, G08, G09, G11; disconnect DCC; Conditions see certificates VA: axle load to: 1140 kg HA: axle load to: 1040 kg
B16 BCS	2.0 R 11/09 - 188 -195 kW	48-215909	20-30	10-30	Øa: 55 mm; disconnect DCC; Conditions see certificates VA: axle load to: 1140 kg HA: axle load to: 1040 kg

					
VW					
VW SCIROCCO (137)					
B16 BCS	2.0 TDI, 2.0 TSI 05/08 - 125 -155 kW	48-215909	30-40	20-40	Øa: 55 mm; disconnect DCC; Conditions see certificates VA: axle load to: 1140 kg HA: axle load to: 1040 kg
VW SHARAN (7M8, 7M9, 7M6)					
B12 PK	1.8 T 20V, 2.0, 2.0 CL 09/95 - 03/10 85 -110 kW	46-192172	30	30	Conditions see certificates VA: axle load to: 1240 kg HA: axle load to: 1355 kg
B12 PK	1.9 TDI, 2.0 TDI, 2.8 V6 24V, 2.8 VR6 09/95 - 03/10 66 -150 kW	46-192165	30	30	Conditions see certificates VA: axle load to: 1260 kg HA: axle load to: 1355 kg
VW TOUAREG (7LA, 7L6, 7L7)					
B12 PK	2.5 R5 TDI, 3.0 TDI, 3.0 V6 TDI, 3.2 V6, 3.6 V6 FSI, 4.2 V8, 4.2 V8 FSI 12/02 - CH-Nr. 128 -257 kW	46-187901	30	30	-> CH.Nr.: 7L-9-045000; without ride height adjustment; Conditions see certificates; without pneumatic suspension VA: axle load to: 1510 kg HA: axle load to: 1670 kg
VW TOURAN (1T1, 1T2, 1T3)					
B12 PK	1.9 TDI 08/03 - 05/10 66 -77 kW	46-184009	30	30	manual transmission; Conditions see certificates VA: axle load to: 1160 kg HA: without ride height adjustment; axle load to: 1190 kg
B12 PK	1.9 TDI 08/03 - 05/10 66 -77 kW	46-184016	30	30	automatic transmission; Conditions see certificates VA: axle load to: 1200 kg HA: without ride height adjustment; axle load to: 1190 kg
B12 PK	2.0 TDI, 2.0 TDI 16V, 2.0 TDI 02/03 - 81 -125 kW	46-184016	30	30	Conditions see certificates VA: axle load to: 1200 kg HA: without ride height adjustment; axle load to: 1190 kg
B14	1.4 Fsi, 1.4 TSI, 1.4 TSI EcoFuel, 1.6, 1.6 FSI, 1.6 TDI, 1.9 TDI, 2.0 EcoFuel, 2.0 FSI, 2.0 TDI, 2.0 TDI 16V, 1.2 TSI, 1.4 TSI, 1.6 TDI, 2.0 TDI 08/03 - 66 -125 kW	47-127708	30-50	30-50	Øa: 55 mm; without electronic suspension control; Conditions see certificates VA: axle load to: 1210 kg HA: axle load to: 1250 kg
B16 PSS10	1.4 Fsi, 1.4 TSI, 1.4 TSI EcoFuel, 1.6, 1.6 FSI, 1.6 TDI, 1.9 TDI, 2.0 EcoFuel, 2.0 FSI, 2.0 TDI, 2.0 TDI 16V, 1.2 TSI, 1.4 TSI, 1.6 TDI, 2.0 TDI 08/03 - 66 -125 kW	48-135245	30-50	30-50	Øa: 55 mm; without electronic suspension control; Conditions see certificates VA: axle load to: 1210 kg HA: axle load to: 1250 kg
B16 RC	1.4 Fsi, 1.4 TSI, 1.4 TSI EcoFuel, 1.6, 1.6 FSI, 1.6 TDI, 1.9 TDI, 2.0 EcoFuel, 2.0 FSI, 2.0 TDI, 2.0 TDI 16V, 1.2 TSI, 1.4 TSI, 1.6 TDI, 2.0 TDI 08/03 - 66 -125 kW	49-196849 14-230615	20-40	20-40	Øa: 55 mm; mark: G07, G08, G09, G11; disconnect DCC; Conditions see certificates VA: axle load to: 1140 kg HA: axle load to: 1040 kg
VW VENTO (1H2)					
B10	1.4, 1.6, 1.8 11/91 - 09/98 40 -74 kW	46-112279	60	40	for vehicles with "Basisachse" only; Conditions see certificates VA: Only in connection with 1H0 412 341
B10	1.9 D, 1.9 SDI, 1.9 TD, 1.9 TDI 11/91 - 09/98 47 -81 kW	46-113221	60	40	for vehicles with "Basisachse" only; Conditions see certificates VA: Only in connection with 1H0 412 341
B12 PK	1.4, 1.6, 1.8, 1.9 D, 1.9 TD, 1.9 TDI, 2.0, 2.0 GL, 2.8 VR6 11/91 - 08/94 40 -128 kW	46-189981	30	30	for vehicles with "Basisachse" only; Conditions see certificates VA: axle load to: 980 kg HA: axle load to: 840 kg
B12 PK	1.4, 1.6, 1.8, 1.9 D, 1.9 TD, 1.9 TDI, 2.0, 2.0 GL, 2.8 VR6 CH-Nr. - 09/98 40 -128 kW	46-190000	30	30	CH.Nr.: 199409 ->; for vehicles with "Plusachse" only; Conditions see certificates VA: axle load to: 980 kg HA: axle load to: 840 kg
B12 SL	1.4, 1.6, 1.8, 1.9 D, 1.9 SDI, 1.9 TD, 1.9 TDI, 2.0, 2.0 GL, 2.8 VR6 11/91 - 09/98 40 -128 kW	46-190017	45-50	30-35	for vehicles with "Basisachse" only; Conditions see certificates VA: axle load to: 950 kg HA: axle load to: 840 kg
B12 SL	1.4, 1.6, 1.8, 1.9 D, 1.9 SDI, 1.9 TD, 1.9 TDI, 2.0, 2.0 GL, 2.8 VR6 11/91 - 09/98 40 -128 kW	46-190024	45-50	30-35	for vehicles with "Plusachse" only; Conditions see certificates VA: axle load to: 950 kg HA: axle load to: 840 kg

									
VW									
VW VENTO (1H2)									
B14	1.4, 1.6, 1.8, 1.9 D, 1.9 SDI, 1.9 TD, 1.9 TDI, 2.0, 2.0 GL, 2.8 VR6 11/91 - 09/98 40 -128 kW	47-124844	30-50	10-30	Spacers required for several wheel/tyre combinations; Conditions see certificates VA: axle load to: 980 kg HA: axle load to: 840 kg				
B16 PSS9	1.4, 1.6, 1.8, 1.9 D, 1.9 SDI, 1.9 TD, 1.9 TDI, 2.0, 2.0 GL, 2.8 VR6 11/91 - 09/98 40 -128 kW	48-080569	30-50	10-30	Spacers required for several wheel/tyre combinations; Conditions see certificates VA: axle load to: 980 kg HA: axle load to: 840 kg				
VW KOMBI Bus (T2)									
B12 PK	1.9 07/92 - 07/00 68 kW	46-192134	40-45	45	Conditions see certificates VA: axle load to: 1600 kg HA: axle load to: 1490 kg				
VW KOMBI Box (T2)									
B12 PK	1.8, 1.9 07/92 - 07/00 62 -68 kW	46-192134	40-45	45	Conditions see certificates VA: axle load to: 1600 kg HA: axle load to: 1490 kg				
VW TRANSPORTER IV Bus (70XB, 70XC, 7DB, 7DW)									
B12 PK	1.8, 1.9 D, 1.9 TD, 2.0, 2.4 D, 2.4 D Syncro, 2.5, 2.5 Syncro, 2.5 TDI, 2.5 TDI Syncro, 2.8 Syncro, 2.8 V6, 2.8 VR 6 11/90 - 04/00 44 -150 kW	46-192134	40-45	45	Conditions see certificates VA: axle load to: 1600 kg HA: axle load to: 1490 kg				
VW TRANSPORTER IV Box (70XA)									
B12 PK	1.9 D, 1.9 TD, 2.0, 2.4 D, 2.4 D Syncro, 2.5, 2.5 Syncro, 2.5 TDI, 2.5 TDI Syncro, 2.8 VR6 07/90 - 04/03 45 -150 kW	46-192134	40-45	45	Conditions see certificates VA: axle load to: 1600 kg HA: axle load to: 1490 kg				
VW TRANSPORTER IV Flatbed / Chassis (70XD)									
B12 PK	1.8, 1.9 D, 1.9 TD, 2.0, 2.4 D, 2.4 D Syncro, 2.5, 2.5 Syncro, 2.5 TDI, 2.5 TDI Syncro, 2.8, 2.8 VR6 11/90 - 04/03 45 -150 kW	46-192134	40-45	45	Conditions see certificates VA: axle load to: 1600 kg HA: axle load to: 1490 kg				
VW MULTIVAN V (7HM, 7HF, 7HN, 7EF, 7EM, 7EN)									
B12 PK	1.9 TDI, 2.0, 2.0 BiTDI, 2.0 BiTDI 4motion, 2.0 TDI, 2.0 TDI 4motion, 2.0 TSI, 2.0 TSI 4motion 11/03 - 62 -150 kW	46-192141	30	30	not for: 1BH; Conditions see certificates VA: axle load to: 1550 kg HA: axle load to: 1720 kg				
B12 PK	2.0 BiTDI, 2.0 BiTDI 4motion, 2.0 TDI, 2.0 TDI 4motion, 2.5 TDI, 2.5 TDI 4motion, 3.2 4motion, 3.2 V6, 3.2 V6 4motion 07/04 - 62 -173 kW	46-192158	30	30	not for: 1BH; Conditions see certificates VA: axle load to: 1710 kg HA: axle load to: 1720 kg				
VW TRANSPORTER V Bus (7HB, 7HJ, 7EB, 7EJ)									
B12 PK	1.9 TDI, 2.0, 2.0 BiTDI 4motion, 2.0 TDI, 2.0 TDI 4motion, 2.0 TSI, 2.0 TSI 4motion 11/03 - 62 -150 kW	46-192141	30	30	not for: 1BH; Conditions see certificates VA: axle load to: 1550 kg HA: axle load to: 1720 kg				
B12 PK	2.0 BiTDI 4motion, 2.0 TDI, 2.0 TDI 4motion, 2.0 TSI 4motion, 2.5 TDI, 2.5 TDI 4motion, 3.2 4motion, 3.2 V6 02/04 - 62 -173 kW	46-192158	30	30	not for: 1BH; Conditions see certificates VA: axle load to: 1710 kg HA: axle load to: 1720 kg				
VW TRANSPORTER V Box (7HA, 7HH, 7EA, 7EH)									
B12 PK	1.9 TDI, 2.0, 2.0 BiTDI, 2.0 BiTDI 4motion, 2.0 TDI, 2.0 TDI 4motion, 2.0 TSI, 2.0 TSI 4motion 11/03 - 62 -150 kW	46-192141	30	30	not for: 1BH; Conditions see certificates VA: axle load to: 1550 kg HA: axle load to: 1720 kg				

				
--	---	---	---	---

VW

VW TRANSPORTER V Box (7HA, 7HH, 7EA, 7EH)

B12 PK	2.0 BiTDI, 2.0 BiTDI 4motion, 2.0 TDI, 2.0 TDI 4motion, 2.5 TDI, 2.5 TDI 4motion, 3.2 4motion, 3.2 V6 02/04 - 62 -173 kW	46-192158	30	30	not for: 1BH; Conditions see certificates VA: axle load to: 1710 kg HA: axle load to: 1720 kg
-----------	--	------------------	----	----	---

VW TRANSPORTER V Flatbed / Chassis (7JD, 7JE, 7JL, 7JY, 7JZ)

B12 PK	1.9 TDI, 2.0, 2.0 TDI, 2.0 TDI 4motion 11/03 - 62 -103 kW	46-192141	30	30	not for: 1BH; Conditions see certificates VA: axle load to: 1550 kg HA: axle load to: 1720 kg
B12 PK	2.0 BiTDI, 2.0 BiTDI 4motion, 2.0 TDI, 2.0 TDI 4motion, 2.5 TDI, 2.5 TDI 4motion, 3.2 4motion, 3.2 V6 08/03 - 62 -173 kW	46-192158	30	30	not for: 1BH; Conditions see certificates VA: axle load to: 1710 kg HA: axle load to: 1720 kg

SVW

SVW TOURAN MPV

B14	1.4 T, 1.8, 2.0 11/04 - 85 -110 kW	47-127708	30-50	30-50	Øa: 55 mm; without electronic suspension control; Conditions see certificates VA: axle load to: 1210 kg HA: axle load to: 1250 kg
B16 PSS10	1.4 T, 1.8, 2.0 11/04 - 85 -110 kW	48-135245	30-50	30-50	Øa: 55 mm; without electronic suspension control; Conditions see certificates VA: axle load to: 1210 kg HA: axle load to: 1250 kg
B16 RC	1.4 T, 1.8, 2.0 11/04 - 85 -110 kW	49-196849 14-230615	20-40	20-40	Øa: 55 mm; mark: G07, G08, G09, G11; disconnect DCC; Conditions see certificates VA: axle load to: 1140 kg HA: axle load to: 1040 kg



Old order number – New order number

Old	New	Page	Old	New	Page	Old	New	Page	Old	New	Page	Old	New	Page
ACO-H454	50-174546	37	GM5-8874	48-088749	146	GM5-D549	48-135498	48	HE5-A077	47-100770	72	HE5-C770	47-127708	153
ACO-H454	50-174546	38	GM5-8874	48-088749	147	GM5-D588	48-135887	97	HE5-A077	47-100770	74	HE5-C770	47-127708	155
ACO-H454	50-174546	39	GM5-8875	48-088756	118	GM5-D588	48-135887	98	HE5-A081	47-100817	52	HE5-C834	47-128347	6
ACO-H454	50-174546	40	GM5-8876	48-088763	75	GM5-D601	48-136013	97	HE5-A081	47-100817	95	HE5-C834	47-128347	8
GA5-B560	49-115604	97	GM5-8876	48-088763	76	GM5-D601	48-136013	98	HE5-A162	47-101623	81	HE5-C834	47-128347	101
GA5-B560	49-115604	98	GM5-8876	48-088763	78	GM5-D664	48-136648	79	HE5-A179	47-101791	116	HE5-C834	47-128347	102
GA5-C204	49-122046	99	GM5-A072	48-100724	1	GM5-D672	48-136723	67	HE5-A179	47-101791	117	HE5-C834	47-128347	107
GA5-D154	49-131543	4	GM5-A072	48-100724	2	GM5-D672	48-136723	89	HE5-A763	47-107632	114	HE5-C834	47-128347	108
GA5-D154	49-131543	28	GM5-A072	48-100724	3	GM5-D672	48-136723	126	HE5-A763	47-107632	115	HE5-C834	47-128347	111
GA5-D154	49-131543	29	GM5-A128	48-101288	116	GM5-D672	48-136723	126	HE5-A799	47-107991	65	HE5-C834	47-128347	114
GA5-D154	49-131543	38	GM5-A339	48-103398	116	GM5-D753	48-137539	96	HE5-B026	47-110267	69	HE5-C834	47-128347	137
GA5-D154	49-131543	39	GM5-A339	48-103398	117	GM5-D886	48-138864	26	HE5-B116	47-111165	44	HE5-C834	47-128347	138
GA5-D154	49-131543	40	GM5-A455	48-104555	43	GM5-D913	48-139137	132	HE5-B116	47-111165	48	HE5-C834	47-128347	140
GA5-D154	49-131543	48	GM5-A469	48-104692	43	GM5-D924	48-139243	2	HE5-B126	47-111264	43	HE5-C834	47-128347	142
GA5-D238	49-132380	75	GM5-A473	48-104739	47	GM5-D924	48-139243	43	HE5-B460	47-114609	97	HE5-C834	47-128347	143
GA5-D238	49-132380	76	GM5-A595	48-105958	17	GM5-E114	48-141147	73	HE5-B460	47-114609	98	HE5-C834	47-128347	144
GA5-D238	49-132380	78	GM5-A595	48-105958	15	GM5-E114	48-141147	77	HE5-B611	47-116115	78	HE5-C870	47-128705	100
GA5-D512	49-135121	35	GM5-A595	48-105958	16	GM5-E114	48-141147	78	HE5-B657	47-116573	23	HE5-D181	47-131811	69
GA5-D512	49-135121	36	GM5-A595	48-105958	17	GM5-E163	48-141635	47	HE5-B657	47-116573	24	HE5-D889	47-138896	26
GA5-D512	49-135121	37	GM5-A595	48-105958	18	GM5-E545	48-145459	97	HE5-B847	47-118478	81	HE5-D906	47-139060	79
GA5-D512	49-135121	47	GM5-A804	48-108041	65	GM5-E570	48-145701	29	HE5-B876	47-118768	64	HE5-D906	47-139060	80
GA5-D516	49-135169	44	GM5-B029	48-110297	69	GM5-E570	48-145701	38	HE5-B921	47-119215	1	HE5-D906	47-139060	81
GA5-D516	49-135169	48	GM5-B557	48-115575	97	GM5-E570	48-145701	39	HE5-B921	47-119215	2	HE5-D927	47-139275	2
GA5-D581	49-135817	97	GM5-B557	48-115575	98	GM5-E570	48-145701	40	HE5-B921	47-119215	3	HE5-D927	47-139275	3
GA5-D581	49-135817	98	GM5-B567	48-115674	32	GM5-E614	48-146142	81	HE5-B944	47-119444	14	HE5-E086	47-140868	132
GA5-D598	49-135985	97	GM5-B567	48-115674	34	GM5-E685	48-146852	103	HE5-B944	47-119444	15	HE5-E117	47-141179	73
GA5-D598	49-135985	98	GM5-B576	48-115766	32	GM5-E685	48-146852	104	HE5-B944	47-119444	16	HE5-E117	47-141179	76
GA5-E548	49-145489	98	GM5-B576	48-115766	34	GM5-E685	48-146852	109	HE5-B944	47-119444	17	HE5-E117	47-141179	77
GA5-F128	49-151282	18	GM5-B607	48-116077	78	GM5-E685	48-146852	151	HE5-B953	47-119536	50	HE5-E117	47-141179	78
GA5-F128	49-151282	19	GM5-B654	48-116541	23	GM5-E723	48-147231	18	HE5-B953	47-119536	51	HE5-E663	47-146631	65
GA5-F128	49-151282	20	GM5-B654	48-116541	24	GM5-E723	48-147231	19	HE5-B953	47-119536	77	HE5-E691	47-146914	103
GA5-F128	49-151282	27	GM5-B880	48-118804	64	GM5-E723	48-147231	20	HE5-C047	47-120471	3	HE5-E691	47-146914	104
GM5-8034	48-080347	32	GM5-B954	48-119542	51	GM5-E723	48-147231	27	HE5-C047	47-120471	28	HE5-E691	47-146914	109
GM5-8034	48-080347	33	GM5-B954	48-119542	77	GM5-F372	48-153720	79	HE5-C047	47-120471	29	HE5-E691	47-146914	151
GM5-8034	48-080347	34	GM5-C126	48-121262	58	GM5-F372	48-153720	80	HE5-C047	47-120471	38	HE5-F577	47-155770	56
GM5-8034	48-080347	35	GM5-C126	48-121262	60	GM5-F372	48-153720	81	HE5-C047	47-120471	39	HE5-F577	47-155770	59
GM5-8040	48-080408	33	GM5-C126	48-121262	68	GM5-F583	48-155830	117	HE5-C047	47-120471	40	HE5-F827	47-158276	139
GM5-8042	48-080422	5	GM5-C126	48-121262	69	GM5-F674	48-156745	139	HE5-C047	47-120471	48	HE5-F828	47-158283	130
GM5-8042	48-080422	25	GM5-C126	48-121262	70	GM5-F817	48-158176	130	HE5-C113	47-121133	61	HE5-F828	47-158283	139
GM5-8042	48-080422	106	GM5-C126	48-121262	129	GM5-F817	48-158176	139	HE5-C113	47-121133	62	HE5-F828	47-158283	152
GM5-8042	48-080422	131	GM5-C126	48-121262	130	GM5-F817	48-158176	152	HE5-C113	47-121133	84	HE5-F899	47-158993	51
GM5-8042	48-080422	135	GM5-C189	48-121897	99	GM5-G581	48-165815	66	HE5-C113	47-121133	85	HE5-F899	47-158993	54
GM5-8042	48-080422	145	GM5-C352	48-123525	116	GM5-G581	48-165815	82	HE5-C113	47-121133	121	HE5-F899	47-158993	67
GM5-8045	48-080453	57	GM5-C352	48-123525	117	GM5-G656	48-166560	76	HE5-C122	47-121225	57	HE5-G449	47-164499	3
GM5-8046	48-080460	57	GM5-C395	48-123952	45	GM5-G656	48-166560	78	HE5-C122	47-121225	58	HE5-G449	47-164499	55
GM5-8048	48-080484	25	GM5-C638	48-126380	35	GM5-G822	48-168229	4	HE5-C122	47-121225	60	HE5-G449	47-164499	88
GM5-8048	48-080484	106	GM5-C638	48-126380	36	GM5-G822	48-168229	105	HE5-C122	47-121225	68	HE5-G449	47-164499	124
GM5-8065	48-080651	5	GM5-C638	48-126380	37	GM5-G822	48-168229	152	HE5-C122	47-121225	69	HE5-G540	47-165403	115
GM5-8065	48-080651	106	GM5-C638	48-126380	47	GM5-G930	48-169301	14	HE5-C122	47-121225	70	HE5-G585	47-165854	65
GM5-8065	48-080651	108	GM5-C668	48-126687	36	GM5-G930	48-169301	15	HE5-C122	47-121225	129	HE5-G725	47-167254	62
GM5-8065	48-080651	131	GM5-D163	48-131636	3	GM5-G930	48-169301	16	HE5-C122	47-121225	130	HE5-G725	47-167254	88
GM5-8065	48-080651	135	GM5-D163	48-131636	28	GM5-G930	48-169301	17	HE5-C422	47-124226	116	HE5-G725	47-167254	90
GM5-8065	48-080651	145	GM5-D163	48-131636	29	GM5-G930	48-169301	27	HE5-C422	47-124226	117	HE5-G725	47-167254	123
GM5-8073	48-080736	102	GM5-D163	48-131636	38	GM5-G930	48-169301	103	HE5-C480	47-124806	21	HE5-G725	47-167254	126
GM5-8073	48-080736	103	GM5-D163	48-131636	39	GM5-G930	48-169301	104	HE5-C480	47-124806	22	HE5-G749	47-167490	56
GM5-8073	48-080736	104	GM5-D163	48-131636	40	GM5-G999	48-169998	47	HE5-C480	47-124806	27	HE5-G749	47-167490	60
GM5-8073	48-080736	150	GM5-D163	48-131636	48	GM5-H758	48-177580	45	HE5-C480	47-124806	113	HE5-G749	47-167490	67
GM5-8075	48-080750	82	GM5-D184	48-131841	69	GM5-H758	48-177580	48	HE5-C480	47-124806	145	HE5-G755	47-167551	67
GM5-8076	48-080767	48	GM5-D262	48-132626	96	GR5-F369	48-153690	25	HE5-C480	47-124806	146	HE5-G755	47-167551	117
GM5-8076	48-080767	49	GM5-D263	48-132633	96	HE5-8038	47-080386	65	HE5-C480	47-124806	147	HE5-G755	47-167551	118
GM5-8076	48-080767	50	GM5-D268	48-132688	96	HE5-8041	47-080416	5	HE5-C481	47-124813	32	HE5-G805	47-168059	81
GM5-8076	48-080767	62	GM5-D268	48-132688	97	HE5-8041	47-080416	25	HE5-C481	47-124813	33	HE5-G809	47-168091	4
GM5-8076	48-080767	86	GM5-D523	48-135238	6	HE5-8041	47-080416	106	HE5-C481	47-124813	34	HE5-G809	47-168091	105
GM5-8076	48-080767	87	GM5-D523	48-135238	8	HE5-8041	47-080416	131	HE5-C484	47-124844	132	HE5-G809	47-168091	152
GM5-8076	48-080767	89	GM5-D523	48-135238	101	HE5-8041	47-080416	135	HE5-C484	47-124844	133	HE5-G829	47-169289	51
GM5-8076	48-080767	123	GM5-D523	48-135238	102	HE5-8041	47-080416	145	HE5-C484	47-124844	134	HE5-G928	47-169289	14
GM5-8076	48-080767	125	GM5-D523	48-135238	107	HE5-8047	47-080478	25	HE5-C484	47-124844	136	HE5-G928	47-169289	15
GM5-8076	48-080767	126	GM5-D523	48-135238	108	HE5-8047	47-080478	106	HE5-C484	47-124844	143	HE5-G928	47-169289	16
GM5-8189	48-081894	103	GM5-D523	48-135238	111	HE5-8071	47-080713	48	HE5-C484	47-124844	154	HE5-G928	47-169289	17
GM5-8189	48-081894	104	GM5-D523	48-135238	112	HE5-8071	47-080713	49	HE5-C485	47-124851	4	HE5-G928	47-169289	27
GM5-8189	48-081894	150	GM5-D523	48-135238	114	HE5-8071	47-080713	50	HE5-C485	47-124851	106	HE5-G928	47-169289	103
GM5-8603	48-086035	116	GM5-D523	48-135238	137	HE5-8071	47-080713	62	HE5-C485	47-124851	108	HE5-G928	47-169289	104
GM5-8605	48-086059	11	GM5-D523	48-135238	138	HE5-8071	47-080713	86	HE5-C485	47-124851				



Old order number – New order number

Old	New	Page	Old	New	Page	Old	New	Page	Old	New	Page	Old	New	Page
SN5-B190	46-111906	134												
SN5-B192	46-111920	60												
SN5-B192	46-111920	61												
SN5-B192	46-111920	82												
SN5-B192	46-111920	83												
SN5-B192	46-111920	119												
SN5-B193	46-111937	110												
SN5-B193	46-111937	131												
SN5-B193	46-111937	135												
SN5-B194	46-111944	110												
SN5-B194	46-111944	131												
SN5-B194	46-111944	135												
SN5-B195	46-111951	50												
SN5-B195	46-111951	62												
SN5-B195	46-111951	86												
SN5-B195	46-111951	87												
SN5-B195	46-111951	122												
SN5-B195	46-111951	123												
SN5-B195	46-111951	125												
SN5-B197	46-111975	102												
SN5-B197	46-111975	104												
SN5-B199	46-111999	150												
SN5-B200	46-112002	102												
SN5-B200	46-112002	144												
SN5-B201	46-112019	102												
SN5-B201	46-112019	144												
SN5-B225	46-112255	134												
SN5-B225	46-112255	136												
SN5-B227	46-112279	133												
SN5-B227	46-112279	153												
SN5-B304	46-113047	32												
SN5-B304	46-113047	33												
SN5-B305	46-113054	32												
SN5-B305	46-113054	33												
SN5-B322	46-113221	133												
SN5-B322	46-113221	153												
SS0-8300	47-083004	69												
SS0-8301	47-083011	67												



New order number – Old order number

New	Old	Page	New	Old	Page	New	Old	Page	New	Old	Page	New	Old	Page
11-223900		99	46-111906	SN5-B190	130	46-180407		135	46-181220		46	46-182388		103
14-230615		4	46-111906	SN5-B190	134	46-180414		131	46-181237		46	46-182395		103
14-230615		6	46-111920	SN5-B192	60	46-180414		135	46-181251		47	46-182401		15
14-230615		8	46-111920	SN5-B192	61	46-180421		131	46-181268		47	46-182418		15
14-230615		9	46-111920	SN5-B192	82	46-180421		132	46-181275		47	46-182425		104
14-230615		18	46-111920	SN5-B192	83	46-180421		135	46-181282		57	46-182425		105
14-230615		19	46-111920	SN5-B192	119	46-180438		132	46-181282		58	46-182432		104
14-230615		20	46-111937	SN5-B193	110	46-180438		135	46-181299		57	46-182432		105
14-230615		27	46-111937	SN5-B193	131	46-180452		78	46-181299		58	46-182449		104
14-230615		28	46-111937	SN5-B193	135	46-180452		79	46-181305		58	46-182456		104
14-230615		29	46-111944	SN5-B194	110	46-180469		79	46-181312		58	46-182470		104
14-230615		30	46-111944	SN5-B194	131	46-180469		80	46-181329		57	46-182487		101
14-230615		31	46-111944	SN5-B194	135	46-180476		79	46-181336		56	46-182494		101
14-230615		35	46-111951	SN5-B195	50	46-180476		80	46-181336		57	46-182500		102
14-230615		36	46-111951	SN5-B195	62	46-180483		28	46-181343		56	46-182517		102
14-230615		37	46-111951	SN5-B195	86	46-180490		28	46-181343		57	46-182524		110
14-230615		38	46-111951	SN5-B195	87	46-180506		28	46-181350		57	46-182531		110
14-230615		39	46-111951	SN5-B195	122	46-180513		28	46-181367		57	46-182548		110
14-230615		40	46-111951	SN5-B195	123	46-180520		29	46-181374		56	46-182555		110
14-230615		41	46-111951	SN5-B195	125	46-180537		29	46-181374		57	46-182562		110
14-230615		42	46-111975	SN5-B197	102	46-180544		37	46-181381		57	46-182562		114
14-230615		44	46-111975	SN5-B197	104	46-180544		47	46-181398		77	46-182579		111
14-230615		47	46-111999	SN5-B199	150	46-180551		37	46-181404		70	46-182586		111
14-230615		48	46-112002	SN5-B200	102	46-180551		47	46-181701		70	46-182593		111
14-230615		75	46-112002	SN5-B200	144	46-180568		37	46-181725		71	46-182609		109
14-230615		76	46-112019	SN5-B201	102	46-180575		38	46-181732		71	46-182616		109
14-230615		78	46-112019	SN5-B201	144	46-180582		38	46-181749		71	46-182623		109
14-230615		102	46-112255	SN5-B225	134	46-180599		38	46-181756		77	46-182630		109
14-230615		107	46-112255	SN5-B225	136	46-180605		37	46-181763		74	46-182647		109
14-230615		109	46-112279	SN5-B227	133	46-180612		37	46-181770		74	46-182654		113
14-230615		111	46-112279	SN5-B227	153	46-180629		38	46-181787		74	46-182661		113
14-230615		112	46-113047	SN5-B304	32	46-180636		38	46-181794		74	46-182678		109
14-230615		113	46-113047	SN5-B304	33	46-180643		39	46-181800		71	46-182685		113
14-230615		114	46-113054	SN5-B305	32	46-180650		39	46-181800		71	46-182685		114
14-230615		130	46-113054	SN5-B305	33	46-180667		39	46-181817		74	46-182692		110
14-230615		137	46-113221	SN5-B322	133	46-180674		40	46-181817		74	46-182708		110
14-230615		138	46-113221	SN5-B322	153	46-180681		40	46-181824		71	46-182715		110
14-230615		139	46-180001		35	46-180698		37	46-181831		71	46-182739		1
14-230615		140	46-180001		36	46-180698		39	46-181862		75	46-182753		1
14-230615		141	46-180001		37	46-180711		37	46-181879		75	46-182760		2
14-230615		143	46-180018		35	46-180711		47	46-182043		78	46-182777		2
14-230615		144	46-180018		36	46-180728		37	46-182050		78	46-182784		2
14-230615		148	46-180018		37	46-180728		47	46-182067		76	46-182791		2
14-230615		149	46-180018		47	46-180735		38	46-182074		76	46-182807		2
14-230615		152	46-180025		35	46-180742		38	46-182081		75	46-182814		2
14-230615		153	46-180025		36	46-180759		72	46-182098		70	46-182852		1
14-230615		155	46-180025		37	46-180759		76	46-182104		70	46-182883		1
46-000033		46	46-180032		35	46-180759		77	46-182111		70	46-182890		3
46-000033		47	46-180049		35	46-180766		72	46-182128		61	46-182906		3
46-000040		3	46-180056		37	46-180766		76	46-182128		62	46-182920		1
46-000064		2	46-180070		35	46-180766		77	46-182128		84	46-182937		1
46-000071		2	46-180087		35	46-180773		73	46-182128		85	46-182968		14
46-000095		3	46-180094		37	46-180780		73	46-182128		121	46-182975		14
46-000101		31	46-180100		35	46-180797		31	46-182135		61	46-182982		14
46-000118		31	46-180117		35	46-180803		31	46-182135		62	46-182999		14
46-000132		31	46-180117		36	46-180810		31	46-182135		84	46-183002		14
46-000156		31	46-180117		37	46-180827		31	46-182135		85	46-183019		14
46-000163		31	46-180117		47	46-180834		31	46-182135		121	46-183026		15
46-000187		101	46-180124		35	46-180841		43	46-182142		62	46-183033		15
46-000194		101	46-180131		35	46-180858		43	46-182142		85	46-183040		15
46-000200		106	46-180131		36	46-180865		43	46-182142		121	46-183057		15
46-000217		106	46-180148		4	46-180872		44	46-182142		122	46-183064		15
46-000224		106	46-180155		4	46-180889		44	46-182159		62	46-183071		15
46-000262		107	46-180162		4	46-180896		44	46-182159		85	46-183088		5
46-000279		111	46-180179		4	46-180902		44	46-182159		121	46-183095		5
46-000279		114	46-180186		4	46-180919		44	46-182159		122	46-183101		5
46-000286		111	46-180193		130	46-180926		43	46-182166		61	46-183118		5
46-000293		111	46-180193		131	46-180933		32	46-182166		62	46-183125		5
46-000354		111	46-180193		134	46-180933		33	46-182166		84	46-183132		7
46-000361		144	46-180193		135	46-180940		32	46-182166		85	46-183156		7
46-000378		144	46-180209		131	46-180957		32	46-182166		121	46-183163		7
46-000439		146	46-180209		132	46-180957		33	46-182173		62	46-183170		7
46-000446		146	46-180209		134	46-180964		34	46-182173		84	46-183187		7
46-000453		146	46-180209		135	46-180971		34	46-182173		85	46-183194		9
46-000491		147	46-180216		4	46-180988		33	46-182173		121	46-183194		10
46-000507		147	46-180223		4	46-180995		34	46-182180		62	46-183200		10
46-000514		147	46-180230		110	46-181008		33	46-182180		85	46-183217		10
46-000613		36	46-180247		110	46-181015		34	46-182197		85	46-183224		10
46-000637		70	46-180254		106	46-181022		32	46-182197		122	46-183224		11
46-000682		50	46-180261		106	46-181022		33	46-182203		93	46-183231		12
46-000682		51	46-180278		106	46-181039		32	46-182210		93	46-183248		12
46-000736		32	46-180285		108	46-181039		33	46-182210		94	46-183248		13
46-000736		33	46-180292		108	46-181046		34	46-182227		93	46-183255		12
46-000750		32	46-180308		131	46-181053		34	46-182234		93	46-183262		12
46-000750		33	46-180308		134	46-181060		34	46-182241		93	46-183262		13
46-000767		32	46-180308		135	46-181077		33	46-182258		93	46-183279		10
46-000767		33	46-180315		131	46-181084		33	46-182265		118	46-183279		11
46-000781		32	46-180315		134	46-181091		34	46-182272		118	46-183286		10
46-000781		33	46-180315		135	46-181107		44	46-182289		129	46-183286		11
46-000781		34	46-180322		134	46-181107		48	46-182296		85	46-183293		12
46-111890	SN5-B189	4	46-180339		134	46-181114		44	46-182296		129			



New order number – Old order number

New	Old	Page	New	Old	Page	New	Old	Page	New	Old	Page	New	Old	Page
46-183361		13	46-188465		14	46-188960		83	46-189769		20	46-190635		95
46-183378		14	46-188465		16	46-188960		84	46-189776		20	46-190642		95
46-183385		14	46-188465		26	46-188960		120	46-189783		20	46-190659		95
46-183408		5	46-188465		27	46-188977		49	46-189790		19	46-190673		99
46-183422		6	46-188472		14	46-188977		84	46-189806		26	46-190697		99
46-183439		7	46-188472		16	46-188977		121	46-189813		26	46-190703		129
46-183446		7	46-188472		27	46-188984		83	46-189820		16	46-190710		129
46-183446		140	46-188489		14	46-188984		120	46-189837		16	46-190727		129
46-183521		18	46-188489		16	46-188991		84	46-189844		23	46-190734		129
46-183521		19	46-188489		27	46-188991		120	46-189851		23	46-190741		130
46-183521		27	46-188496		14	46-188991		121	46-189851		28	46-190765		150
46-183736		151	46-188496		16	46-189004		62	46-189868		132	46-190772		150
46-183767		139	46-188502		14	46-189004		86	46-189868		143	46-190789		150
46-183774		139	46-188502		16	46-189004		87	46-189868		152	46-190796		150
46-183781		142	46-188519		14	46-189004		123	46-189875		23	46-190802		150
46-183798		142	46-188519		16	46-189011		62	46-189882		23	46-190819		150
46-183804		143	46-188526		15	46-189011		87	46-189899		23	46-190833		144
46-183811		143	46-188526		17	46-189011		123	46-189905		23	46-190840		150
46-183927		151	46-188533		15	46-189028		87	46-189912		23	46-190871		42
46-183934		151	46-188533		17	46-189028		123	46-189929		23	46-190888		42
46-183941		146	46-188540		15	46-189035		62	46-189936		23	46-190888		43
46-183941		147	46-188540		17	46-189035		88	46-189943		133	46-190895		42
46-183958		145	46-188557		15	46-189035		123	46-189950		133	46-190901		42
46-183965		146	46-188557		17	46-189042		87	46-189950		143	46-190918		42
46-183972		146	46-188564		15	46-189059		62	46-189967		133	46-190925		42
46-183972		147	46-188564		17	46-189059		87	46-189967		143	46-190925		43
46-183989		146	46-188571		15	46-189059		123	46-189981		133	46-190932		43
46-183989		147	46-188571		17	46-189066		10	46-189981		153	46-190949		43
46-183996		146	46-188588		14	46-189073		10	46-190000		133	46-190956		42
46-184009		153	46-188588		16	46-189080		10	46-190000		153	46-190956		43
46-184016		153	46-188588		27	46-189080		11	46-190017		133	46-190963		55
46-184023		145	46-188595		14	46-189097		10	46-190017		153	46-190987		55
46-184030		145	46-188595		16	46-189097		11	46-190024		133	46-191014		55
46-184047		136	46-188595		27	46-189103		10	46-190024		153	46-191021		55
46-184115		136	46-188601		15	46-189110		10	46-190062		134	46-191045		55
46-184153		136	46-188601		17	46-189110		11	46-190062		136	46-191052		56
46-184184		138	46-188601		103	46-189127		12	46-190079		133	46-191465		46
46-184191		138	46-188618		15	46-189134		12	46-190086		133	46-191465		48
46-184214		138	46-188618		17	46-189141		12	46-190093		132	46-191465		48
46-184269		143	46-188618		103	46-189141		13	46-190109		132	46-192134		154
46-184290		143	46-188618		104	46-189158		12	46-190116		56	46-192141		155
46-184313		143	46-188670		16	46-189158		13	46-190123		56	46-192158		154
46-184320		141	46-188687		15	46-189165		12	46-190130		63	46-192158		155
46-184337		141	46-188694		145	46-189172		12	46-190154		64	46-192165		153
46-184344		142	46-188700		145	46-189172		13	46-190178		64	46-192172		153
46-184351		132	46-188717		145	46-189189		10	46-190208		64	46-192189		149
46-184368		132	46-188755		49	46-189189		11	46-190215		64	46-192189		150
46-184375		132	46-188755		85	46-189196		10	46-190246		64	46-192196		21
46-184382		152	46-188755		86	46-189196		11	46-190284		65	46-192196		27
46-184399		148	46-188755		122	46-189202		10	46-190291		65	46-192202		21
46-184405		147	46-188762		85	46-189202		11	46-190307		68	46-192202		27
46-184405		148	46-188762		122	46-189219		12	46-190307		69	46-192219		21
46-184412		147	46-188779		85	46-189219		13	46-190314		68	46-192219		27
46-184412		149	46-188779		86	46-189226		12	46-190321		68	46-192226		21
46-184429		148	46-188779		122	46-189226		13	46-190338		69	46-192226		27
46-184429		149	46-188786		88	46-189233		12	46-190345		69	46-192233		21
46-184436		148	46-188786		124	46-189233		13	46-190383		70	46-192240		21
46-184436		149	46-188793		88	46-189257		11	46-190413		75	46-192257		21
46-184443		147	46-188793		124	46-189257		13	46-190420		75	46-192264		21
46-184443		148	46-188823		88	46-189264		11	46-190437		75	46-192271		22
46-184443		149	46-188823		124	46-189264		13	46-190444		75	46-192288		22
46-184450		151	46-188830		88	46-189301		51	46-190475		72	46-192295		22
46-184467		152	46-188830		124	46-189318		52	46-190482		72	46-192301		22
46-184474		136	46-188847		89	46-189325		53	46-190499		76	46-192318		22
46-184481		139	46-188847		124	46-189332		52	46-190505		76	46-192325		22
46-184498		139	46-188854		89	46-189349		52	46-190529		81	46-192332		22
46-184504		140	46-188854		124	46-189356		53	46-190536		91	46-192349		22
46-184511		140	46-188861		60	46-189363		51	46-190536		92	46-192356		20
46-187901		153	46-188861		61	46-189370		51	46-190543		127	46-192363		20
46-187918		99	46-188861		82	46-189387		53	46-190543		127	46-192363		26
46-187925		58	46-188861		83	46-189387		67	46-190543		128	46-192370		21
46-187932		58	46-188861		119	46-189400		53	46-190550		91	46-192387		21
46-187949		138	46-188861		120	46-189424		53	46-190550		127	46-192394		20
46-187956		139	46-188878		83	46-189424		54	46-190567		91	46-192400		21
46-187963		140	46-188878		119	46-189431		53	46-190567		127	46-192400		26
46-187970		140	46-188878		120	46-189431		54	46-190567		128	46-192417		21
46-187987		46	46-188885		61	46-189448		45	46-190574		89	46-192424		21
46-187994		105	46-188885		82	46-189455		45	46-190574		91	46-192431		8
46-188007		108	46-188885		83	46-189462		45	46-190574		125	46-192448		54
46-188014		108	46-188885		119	46-189479		45	46-190574		128	46-192455		54
46-188021		108	46-188892		84	46-189493		46	46-190581		89	46-192466		54
46-188069		139	46-188892		121	46-189509		46	46-190581		92	46-192493		54
46-188076		139	46-188908		61	46-189516		46	46-190581		125	46-192509		54
46-188083		25	46-188908		62	46-189523		46	46-190581		128	46-192516		55
46-188083		28	46-188908		84	46-189530		46	46-190598		89	46-192523		54
46-188090		25	46-188908		121	46-189547		46	46-190598		92	46-192530		54
46-188106		46	46-188915		84	46-189554		46	46-190598		126	46-192547		59
46-188120		55	46-188922		84	46-189554		48	46-190598		128	46-192554		59
46-188137		55	46-188939		61	46-189578		25	46-190604		89	46-192561		59
46-188144		88	46-188939		83	46-189592		25	46-190604		91	46-192578		59
46-188144		124	46-188939		84	46-189608		25	46-190604		125	46-192608		59
46-188151		88	46-188939		120	46-189615		25	46-190604		128	46-192615		59
46-188151		124	46-188946											



New order number – Old order number

New	Old	Page	New	Old	Page	New	Old	Page	New	Old	Page	New	Old	Page
46-192752		90	46-194794		141	47-080416	HE5-8041	145	47-124844	HE5-C484	132	47-168091	HE5-G809	152
46-192752		126	46-194800		142	47-080478	HE5-8047	25	47-124844	HE5-C484	133	47-168299	HE5-G829	51
46-192769		90	46-194817		142	47-080478	HE5-8047	106	47-124844	HE5-C484	134	47-169289	HE5-G928	14
46-192769		126	46-194824		142	47-080713	HE5-8071	48	47-124844	HE5-C484	136	47-169289	HE5-G928	15
46-192776		90	46-194855		136	47-080713	HE5-8071	49	47-124844	HE5-C484	143	47-169289	HE5-G928	16
46-192776		127	46-194862		136	47-080713	HE5-8071	50	47-124844	HE5-C484	154	47-169289	HE5-G928	17
46-192783		90	46-194879		136	47-080713	HE5-8071	62	47-124851	HE5-C485	4	47-169289	HE5-G928	27
46-192783		126	46-194909		137	47-080713	HE5-8071	86	47-124851	HE5-C485	106	47-169289	HE5-G928	103
46-192790		90	46-194916		137	47-080713	HE5-8071	87	47-124851	HE5-C485	108	47-169289	HE5-G928	104
46-192806		89	46-194961		136	47-080713	HE5-8071	89	47-124851	HE5-C485	131	47-171329	HE5-H132	64
46-192806		125	46-194978		138	47-080713	HE5-8071	123	47-124851	HE5-C485	135	47-171725	HE5-H172	49
46-192813		89	46-194985		138	47-080713	HE5-8071	125	47-124851	HE5-C485	145	47-171725	HE5-H172	50
46-192813		125	46-194992		138	47-080713	HE5-8071	126	47-126848	HE5-C684	35	47-171725	HE5-H172	63
46-192820		89	46-195104		44	47-080720	HE5-8072	102	47-126848	HE5-C684	36	47-171725	HE5-H172	86
46-192820		125	46-195111		45	47-080720	HE5-8072	103	47-126848	HE5-C684	37	47-171725	HE5-H172	122
46-192837		89	46-195128		44	47-080720	HE5-8072	104	47-126848	HE5-C684	47	47-172401	HE5-H240	65
46-192837		125	46-195173		45	47-080720	HE5-8072	150	47-126916	HE5-C691	78	47-172586	HE5-H258	100
46-192851		62	46-195180		45	47-081888	HE5-8188	103	47-126916	HE5-C691	79	47-172586	HE5-H597	51
46-192851		86	46-195197		4	47-081888	HE5-8188	104	47-127708	HE5-C770	6	47-175976	HE5-H597	52
46-192851		122	46-195203		4	47-081888	HE5-8188	150	47-127708	HE5-C770	8	47-188044	HE5-H416	119
46-192868		86	46-198297		60	47-083004	SS0-8300	69	47-127708	HE5-C770	101	47-193680		65
46-192875		92	46-206657		51	47-083011	SS0-8301	67	47-127708	HE5-C770	102	47-196568		58
46-192882		92	46-206671		53	47-086401	HE5-8640	67	47-127708	HE5-C770	107	47-207233		30
46-192899		92	46-206688		53	47-086937	HE5-8693	21	47-127708	HE5-C770	108	47-207233		31
46-193285		134	46-206718		54	47-086937	HE5-8693	22	47-127708	HE5-C770	111	47-207233		40
46-193605		96	46-206732		54	47-086937	HE5-8693	145	47-127708	HE5-C770	112	47-217522		30
46-193803		99	46-206749		52	47-086937	HE5-8693	146	47-127708	HE5-C770	113	47-217522		31
46-193810		24	46-206763		59	47-086937	HE5-8693	147	47-127708	HE5-C770	114	47-217522		40
46-193827		24	46-206770		57	47-087392	HE5-8739	63	47-127708	HE5-C770	137	47-217522		41
46-193834		24	46-206787		57	47-087484	HE5-8748	49	47-127708	HE5-C770	138	47-217522		42
46-193841		24	46-206800		65	47-087484	HE5-8748	83	47-127708	HE5-C770	140	47-218871		117
46-193858		101	46-206824		65	47-087484	HE5-8748	120	47-127708	HE5-C770	142	47-225176		94
46-193865		101	46-206831		65	47-087569	HE5-8756	93	47-127708	HE5-C770	143	47-225183		94
46-193872		58	46-206848		66	47-087569	HE5-8756	94	47-127708	HE5-C770	144	47-228078		56
46-193889		59	46-206862		66	47-087750	HE5-8775	100	47-127708	HE5-C770	147	47-228146		67
46-193896		102	46-206886		66	47-100763	HE5-A076	43	47-127708	HE5-C770	148	47-228214		82
46-193902		71	46-206909		66	47-100770	HE5-A077	71	47-127708	HE5-C770	149	47-228337		116
46-193919		71	46-206923		66	47-100770	HE5-A077	72	47-127708	HE5-C770	153	47-228337		118
46-193926		77	46-206930		66	47-100770	HE5-A077	74	47-127708	HE5-C770	155	47-229945		9
46-193940		59	46-206947		66	47-100817	HE5-A081	52	47-128347	HE5-C834	6	47-229945		107
46-193957		59	46-206954		66	47-100817	HE5-A081	95	47-128347	HE5-C834	8	47-229945		112
46-193964		78	46-206961		82	47-101623	HE5-A162	81	47-128347	HE5-C834	101	47-229945		113
46-194008		91	46-206978		82	47-101791	HE5-A179	116	47-128347	HE5-C834	102	47-229945		141
46-194008		127	46-206978		117	47-101791	HE5-A179	117	47-128347	HE5-C834	107	47-229969		9
46-194022		85	46-206978		119	47-107632	HE5-A763	114	47-128347	HE5-C834	108	47-229969		107
46-194039		85	46-206985		89	47-107632	HE5-A763	115	47-128347	HE5-C834	111	47-229969		112
46-194046		66	46-206985		124	47-107991	HE5-A799	65	47-128347	HE5-C834	114	47-229969		113
46-194060		91	46-207005		89	47-110267	HE5-B026	69	47-128347	HE5-C834	137	47-229969		141
46-194060		127	46-207005		125	47-111165	HE5-B116	44	47-128347	HE5-C834	138	47-229976		9
46-194077		91	46-207036		95	47-111165	HE5-B116	48	47-128347	HE5-C834	140	47-229976		107
46-194077		127	46-207043		92	47-111264	HE5-B126	43	47-128347	HE5-C834	142	47-229976		112
46-194084		91	46-207050		100	47-114609	HE5-B460	97	47-128347	HE5-C834	143	47-229976		113
46-194084		127	46-207067		100	47-114609	HE5-B460	98	47-128347	HE5-C834	144	47-229976		141
46-194084		128	46-207074		100	47-116115	HE5-B611	78	47-128705	HE5-C870	100	47-231108		70
46-194152		54	46-207081		100	47-116573	HE5-B657	23	47-131811	HE5-D181	69	47-231108		74
46-194169		54	46-207098		114	47-116573	HE5-B657	24	47-138896	HE5-D889	26	47-231207		86
46-194183		90	46-207104		114	47-118478	HE5-B847	81	47-139060	HE5-D906	79	47-231207		122
46-194190		90	46-207135		115	47-118768	HE5-B876	64	47-139060	HE5-D906	80	47-232952		58
46-194220		63	46-207159		115	47-119215	HE5-B921	1	47-139060	HE5-D906	81	47-233942		100
46-194220		92	46-207166		118	47-119215	HE5-B921	2	47-139275	HE5-D927	2	47-235106		95
46-194220		128	46-207173		119	47-119215	HE5-B921	3	47-139275	HE5-D927	3	47-237308		100
46-194237		92	46-207180		119	47-119444	HE5-B944	14	47-140868	HE5-E086	132	48-080347	GM5-8034	32
46-194237		128	46-207197		132	47-119444	HE5-B944	15	47-141179	HE5-E117	73	48-080347	GM5-8034	33
46-194244		92	46-223500		3	47-119444	HE5-B944	16	47-141179	HE5-E117	76	48-080347	GM5-8034	34
46-194244		128	46-223609		29	47-119444	HE5-B944	17	47-141179	HE5-E117	77	48-080347	GM5-8034	35
46-194275		94	46-223609		30	47-119536	HE5-B953	50	47-141179	HE5-E117	78	48-080408	GM5-8040	33
46-194282		94	46-223661		40	47-119536	HE5-B953	51	47-146631	HE5-E663	65	48-080422	GM5-8042	5
46-194299		94	46-223678		40	47-119536	HE5-B953	77	47-146914	HE5-E691	103	48-080422	GM5-8042	25
46-194305		94	46-226617		40	47-120471	HE5-C047	3	47-146914	HE5-E691	104	48-080422	GM5-8042	106
46-194312		94	46-228888		60	47-120471	HE5-C047	28	47-146914	HE5-E691	109	48-080422	GM5-8042	131
46-194329		94	46-229779		56	47-120471	HE5-C047	29	47-146914	HE5-E691	151	48-080422	GM5-8042	135
46-194329		95	46-229786		56	47-120471	HE5-C047	38	47-155770	HE5-F577	56	48-080422	GM5-8042	145
46-194336		59	46-229793		41	47-120471	HE5-C047	39	47-155770	HE5-F577	59	48-080453	GM5-8045	57
46-194343		59	46-229793		42	47-120471	HE5-C047	40	47-158276	HE5-F827	139	48-080460	GM5-8046	57
46-194350		129	46-229809		41	47-120471	HE5-C047	48	47-158283	HE5-F828	130	48-080484	GM5-8048	25
46-194367		129	46-229809		42	47-121133	HE5-C113	61	47-158283	HE5-F828	139	48-080484	GM5-8048	106
46-194374		101	46-229816		58	47-121133	HE5-C113	62	47-158283	HE5-F828	152	48-080569	SO3-8056	132
46-194381		100	46-229823		58	47-121133	HE5-C113	84	47-158993	HE5-F899	51	48-080569	SO3-8056	133
46-194381		101	46-229830		60	47-121133	HE5-C113	85	47-158993	HE5-F899	54	48-080569	SO3-8056	134
46-194398		101	46-230904		136	47-121133	HE5-C113	121	47-158993	HE5-F899	67	48-080569	SO3-8056	136
46-194404		101	46-230911		137	47-121225	HE5-C122	57	47-164499	HE5-G449	3	48-080569	SO3-8056</	



New order number – Old order number

New	Old	Page	New	Old	Page	New	Old	Page	New	Old	Page	New	Old	Page
48-080767	GM5-8076	123	48-135238	GM5-D523	102	48-195232		40	49-196849		141			
48-080767	GM5-8076	125	48-135238	GM5-D523	107	48-197441		75	49-196849		143			
48-080767	GM5-8076	126	48-135238	GM5-D523	108	48-207287		30	49-196849		144			
48-081894	GM5-8189	103	48-135238	GM5-D523	111	48-207287		31	49-196849		148			
48-081894	GM5-8189	104	48-135238	GM5-D523	112	48-207287		41	49-196849		149			
48-081894	GM5-8189	150	48-135238	GM5-D523	114	48-213660		36	49-196849		152			
48-086035	GM5-8603	116	48-135238	GM5-D523	137	48-215855		33	49-196849		153			
48-086059	GM5-8605	11	48-135238	GM5-D523	138	48-215855		34	49-196849		155			
48-086059	GM5-8605	13	48-135238	GM5-D523	140	48-215909		6	49-207323		30			
48-086097	GM5-8609	69	48-135238	GM5-D523	142	48-215909		8	49-207323		31			
48-086103	GM5-8610	11	48-135238	GM5-D523	144	48-215909		107	49-207323		41			
48-086103	GM5-8610	13	48-135245	GM5-D524	6	48-215909		111	49-216042		98			
48-086165	GM5-8616	11	48-135245	GM5-D524	8	48-215909		112	49-216042		99			
48-086165	GM5-8616	13	48-135245	GM5-D524	101	48-215909		113	49-223873		99			
48-086202	GM5-8620	116	48-135245	GM5-D524	102	48-215909		114	49-223873		100			
48-086202	GM5-8620	117	48-135245	GM5-D524	107	48-215909		137	49-224658		30			
48-086424	GM5-8642	81	48-135245	GM5-D524	109	48-215909		139	49-224658		31			
48-088428	GM5-8842	63	48-135245	GM5-D524	111	48-215909		144	49-224658		41			
48-088435	GM5-8843	35	48-135245	GM5-D524	112	48-215909		152	49-224658		42			
48-088459	GM5-8845	32	48-135245	GM5-D524	113	48-215909		153	49-231892		9			
48-088459	GM5-8845	34	48-135245	GM5-D524	114	48-216036		98	49-231892		108			
48-088473	GM5-8847	99	48-135245	GM5-D524	137	48-216036		99	49-231892		112			
48-088602	GM5-8860	71	48-135245	GM5-D524	138	48-217170		30	49-231892		113			
48-088602	GM5-8860	72	48-135245	GM5-D524	140	48-217170		31	49-231892		141			
48-088602	GM5-8860	74	48-135245	GM5-D524	141	48-217170		41	49-237108		38			
48-088602	GM5-8860	75	48-135245	GM5-D524	142	48-217170		42	49-237108		39			
48-088657	GM5-8865	65	48-135245	GM5-D524	144	48-218412		98	49-237108		40			
48-088688	GM5-8868	22	48-135245	GM5-D524	148	48-221832		24	49-237191		77			
48-088688	GM5-8868	145	48-135245	GM5-D524	149	48-222983		50	49-237276		45			
48-088688	GM5-8868	146	48-135245	GM5-D524	153	48-223539		29	50-174546	ACO-H454	37			
48-088688	GM5-8868	147	48-135245	GM5-D524	155	48-223539		38	50-174546	ACO-H454	38			
48-088749	GM5-8874	22	48-135344	GM5-D534	97	48-223539		39	50-174546	ACO-H454	39			
48-088749	GM5-8874	27	48-135351	GM5-D535	97	48-223867		99	50-174546	ACO-H454	40			
48-088749	GM5-8874	113	48-135368	GM5-D536	97	48-223867		100						
48-088749	GM5-8874	145	48-135498	GM5-D549	44	48-227186		81						
48-088749	GM5-8874	146	48-135498	GM5-D549	48	48-228299		116						
48-088749	GM5-8874	147	48-135887	GM5-D588	97	48-228299		118						
48-088756	GM5-8875	118	48-135887	GM5-D588	98	48-229012		30						
48-088763	GM5-8876	75	48-136013	GM5-D601	97	48-229012		31						
48-088763	GM5-8876	76	48-136013	GM5-D601	98	48-229012		41						
48-088763	GM5-8876	78	48-136648	GM5-D664	79	48-229012		42						
48-100724	GM5-A072	1	48-136723	GM5-D672	67	48-230056		9						
48-100724	GM5-A072	2	48-136723	GM5-D672	89	48-230056		107						
48-100724	GM5-A072	3	48-136723	GM5-D672	126	48-230056		112						
48-101288	GM5-A128	116	48-136723	GM5-D672	128	48-230056		113						
48-103398	GM5-A339	116	48-137539	GM5-D753	96	48-230056		141						
48-103398	GM5-A339	117	48-138864	GM5-D886	26	48-230063		9						
48-104555	GM5-A455	43	48-139137	GM5-D913	132	48-230063		107						
48-104692	GM5-A469	43	48-139243	GM5-D924	2	48-230063		112						
48-104739	GM5-A473	47	48-139243	GM5-D924	3	48-230063		113						
48-105958	GM5-A595	14	48-141147	GM5-E114	73	48-230063		141						
48-105958	GM5-A595	15	48-141147	GM5-E114	77	48-230971		70						
48-105958	GM5-A595	16	48-141147	GM5-E114	78	48-230971		74						
48-105958	GM5-A595	17	48-141635	GM5-E163	47	48-231848		9						
48-105958	GM5-A595	18	48-145459	GM5-E545	97	48-231848		112						
48-108041	GM5-A804	65	48-145701	GM5-E570	29	48-231848		113						
48-110297	GM5-B029	69	48-145701	GM5-E570	38	48-231848		141						
48-115575	GM5-B557	97	48-145701	GM5-E570	39	48-231954		26						
48-115575	GM5-B557	98	48-145701	GM5-E570	40	49-115604	GA5-B560	97						
48-115674	GM5-B567	32	48-146142	GM5-E614	81	49-115604	GA5-B560	98						
48-115674	GM5-B567	34	48-146852	GM5-E685	103	49-122046	GA5-C204	99						
48-115766	GM5-B576	32	48-146852	GM5-E685	104	49-131543	GA5-D154	4						
48-115766	GM5-B576	34	48-146852	GM5-E685	109	49-131543	GA5-D154	28						
48-116077	GM5-B607	78	48-146852	GM5-E685	151	49-131543	GA5-D154	29						
48-116541	GM5-B654	23	48-147231	GM5-E723	18	49-131543	GA5-D154	38						
48-116541	GM5-B654	24	48-147231	GM5-E723	19	49-131543	GA5-D154	39						
48-118804	GM5-B880	64	48-147231	GM5-E723	20	49-131543	GA5-D154	40						
48-119542	GM5-B954	51	48-147231	GM5-E723	27	49-131543	GA5-D154	48						
48-119542	GM5-B954	77	48-153690	GR5-F369	25	49-132380	GA5-D238	75						
48-121262	GM5-C126	58	48-153720	GM5-F372	79	49-132380	GA5-D238	76						
48-121262	GM5-C126	60	48-153720	GM5-F372	80	49-132380	GA5-D238	78						
48-121262	GM5-C126	68	48-153720	GM5-F372	81	49-135121	GA5-D512	35						
48-121262	GM5-C126	69	48-155830	GM5-F583	117	49-135121	GA5-D512	36						
48-121262	GM5-C126	70	48-156745	GM5-F674	139	49-135121	GA5-D512	37						
48-121262	GM5-C126	129	48-158176	GM5-F817	130	49-135121	GA5-D512	47						
48-121262	GM5-C126	130	48-158176	GM5-F817	139	49-135169	GA5-D516	44						
48-121897	GM5-C189	99	48-158176	GM5-F817	152	49-135169	GA5-D516	48						
48-123525	GM5-C352	116	48-165815	GM5-G581	66	49-135817	GA5-D581	97						
48-123525	GM5-C352	117	48-165815	GM5-G581	82	49-135817	GA5-D581	98						
48-123952	GM5-C395	45	48-166560	GM5-G656	76	49-135985	GA5-D598	97						
48-126380	GM5-C638	35	48-166560	GM5-G656	78	49-135985	GA5-D598	98						
48-126380	GM5-C638	36	48-168229	GM5-G822	4	49-145489	GA5-E548	98						
48-126380	GM5-C638	37	48-168229	GM5-G822	105	49-151282	GA5-F128	18						
48-126380	GM5-C638	47	48-168229	GM5-G822	152	49-151282	GA5-F128	19						
48-126687	GM5-C668	36	48-169301	GM5-G930	14	49-151282	GA5-F128	20						
48-131636	GM5-D163	3	48-169301	GM5-G930	15	49-151282	GA5-F128	27						
48-131636	GM5-D163	28	48-169301	GM5-G930	16	49-196849		6						
48-131636	GM5-D163	29	48-169301	GM5-G930	17	49-196849		8						
48-131636	GM5-D163	38	48-169301	GM5-G930	27	49-196849		102						
48-131636	GM5-D163	39	48-169301	GM5-G930	103	49-196849		107						
48-131636	GM5-D163	40	48-169301	GM5-G930	104	49-196849		109						
48-131636	GM5-D163	48	48-169998	GM5-G999	47	49-196849		111						
48-131841	GM5-D184	69	48-177580	GM5-H758	45	49-196849		112						
48-132626	GM5-D262	96	48-177580	GM5-H758	48	49-196849		113						
48-132633	GM5-D263	96	48-191845		49	49-196849		114						
48-132688	GM5-D268	96	48-195232		3	49-196849		130						
48-132688	GM5-D268	97	48-195232	</										

Professional accessories. Tangible quality down to the last detail.



The professionals know that you can only do a perfect job if you've got the perfect tools. Which is why right down to the last tiny detail we make sure the quality is something that will even impress the professionals. Starting with service parts specifically designed to suit our suspension systems, such as bump stops and support bearings. And it doesn't stop at C-wrenches for threaded chassis either. With these you can even adjust the chassis height quickly and easily with the units in situ.



Size 68-75
Order no. EWK-9923

Size 80-90
Order no. EWK-9924

BILSTEIN-Turbo-Ordering

Click an additional time and finish faster.

Turbo-Ordering Turbo-Ordering Turbo-Ordering

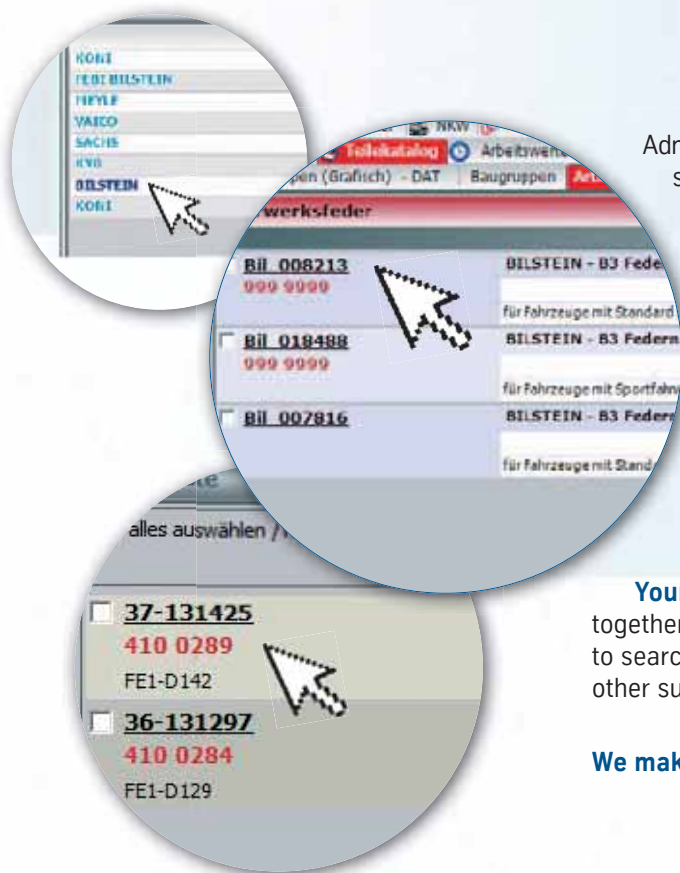

Admittedly, you have to click an extra time in the wholesale ordering system before you see BILSTEIN products with their price and availability. This is because we ask you first to click on the desired product category, for example: BILSTEIN B3 Spring, BILSTEIN B4 or BILSTEIN B6 Sport and so on.

Click on the BILSTEIN number of the product category ...

... and the system will clearly show you the products fitting your specifications, this of course including the availability and price. Simply select one and you're finished.

Your advantage: At BILSTEIN you see immediately what belongs together. **You do not have to scroll through** a whole list of products to search for different parts for one type of vehicle, as is the case with other suppliers.

We make short work of your order.

In addition, all current reports on our products can be accessed on the Internet at <http://katalog.bilstein.de> in PDF format.

1. After you access the katalog.bilstein.de pages, enter the number of the product in question in the "product search" field.
2. The product found will subsequently be shown. Click on the product number again.
3. You can open the desired document by clicking on the "report" link (see picture on the left)

Adobe Acrobat Reader® has to be installed for this.



Notes and explanations.

In cases of doubt please contact your local BILSTEIN dealer or our sales department before conversion.

BILSTEIN shock absorbers must always be replaced in pairs. The conversion requires special tools and expert knowledge. Therefore, converting your vehicle to BILSTEIN must be carried out by a specialist workshop. Use a chassis hoist for the fitting so that the raised vehicle cannot slip. If a chassis hoist is not available, you must ensure that the vehicle is blocked against any movement when it is raised. Under no circumstances should any work be completed underneath the vehicle if it is not adequately secured. Otherwise, there is a risk of extremely serious head injuries and contusions.

The application must be in accordance with the BILSTEIN type list, otherwise the proper function of the BILSTEIN gas pressure shock absorber is no longer guaranteed. The same goes for clamping a shock absorber in a vice or any similar tool.

Under no circumstances may this BILSTEIN gas pressure shock absorber be modified in any way, otherwise all warranty claims and the type homologation will be rendered invalid. The oil fill in a BILSTEIN gas pressure shock absorber is pretensioned with gas.

Opening or heating the shock absorber in contravention of this instruction can result in severe injuries to the hands and face. Do not use impact drivers for unscrewing and tightening the nuts, otherwise the fastening thread will be irreparably damaged.

Self-locking nuts are only allowed to be used once! Suspension springs are pretensioned! For safety reasons, the suspension spring must be pretensioned with the help of an appropriate spring tensioning device. The top mount is only to be removed when the spring is preloaded sufficiently so it can be moved by hand. Severe injuries to the head or upper body may occur if these warnings are disregarded.

All fixing mounts for struts must be tightened before the vehicle is let down to the ground. Ensure that the bump stop and dust cover are correctly and properly fastened.

Re-use any original equipment parts only if they are in good condition, otherwise replace them with new ones. Never remove the thin film of oil on the piston rod and seal. After the conversion, check and/or adjust the track and camber and, if necessary, the brake power control (load-dependent) and ABS sensors according to the manufacturer's data. Also check and adjust the headlight setting if necessary.

Observe the rules specified in the type list when disposing of old parts. If you have any questions about this, please contact our sales department or, for Germany only, PARTSLIFE Recycling System GmbH.

Company PARTSLIFE Recycling System GmbH & Co.KG,
Heinrich-Hertz-Str. 9, 63225 Langen
Tel. +49 (0)6103 / 20106-0, Fax: -19
www.partslife.de
info@partslife.de

General information BILSTEIN B10 – B16

It is essential to observe the instructions in the expert report and in the installation instructions for chassis before installation. When chassis have a parts report, correct installation of the parts must be confirmed by an expert (TÜV, DEKRA, motor vehicle expert). The specified lowering dimension depends on the engine and equipment of the vehicle, and cannot be guaranteed. The specified lowering data result from the parts report. In the case of threaded suspension systems, the lowest permitted spring collar position must be set for acceptance in accordance with section 19 of the German Road Traffic Regulations. Spring collar positions outside the standard adjustment range must be presented for repeat acceptance by the official body (e.g. TÜV) in accordance with section 21 of the German Road Traffic Regulations. The report must be used as the basis for checking whether, and for which, wheel/tyre combinations it is necessary to have spacer discs.

Special tools are not supplied!

Size 30 cartridge spanner order no.: MS 08/7 Size 36 cartridge spanner order no.: MS 08/6 Profi-Hakenschlüssel: EWK-9923, EWK-9924

Registering a complaint

The document for registering the complaint can be downloaded from our website at www.bilstein.com

Ordering instructions

All orders are accepted subject to our delivery and payment terms. All information is subject to change without prior notice.

Reproduction, in whole or in part, is not permitted without consent.

Disposal of used parts BILSTEIN gas pressure shock absorbers

BILSTEIN mono-tube and twin-tube shock absorbers should not simply be thrown away. According to accident prevention and environment regulations, it is absolutely essential to depressurise the shock absorber and properly dispose of its content and its individual parts (danger of explosion when heating over 200 °C). Safety glasses according to DIN standard 58211 part 2 – as used when grinding – are to be worn in accordance with the following disposal procedures.

Disposal:

Illustrations 1-3:

BILSTEIN mono-tube gas pressure shock absorbers with a piston rod diameter of 8-14 mm (remove mounting parts, protective tube or dirt shield) are to be fixed on a suitable base, e.g. in a prism and centre marked at the 3 points to be drilled according to drawing no. 1. First of all, holes are to be drilled in the shock absorber close to the shock absorber base (c) with a 5 mm drill bit so that the hydrogen gas (pressure up to 25 bar) can escape. Two holes are now to be drilled at distance (d) in order to enable oil drainage. Proceed in the same manner when dismantling BILSTEIN mono-tube struts according to drawing no. 2. First of all remove the outer tube. Saw off the tube above the mount (a) (fixture, axle stub, clip) but not the piston rod. Remove burrs from the separated parts. Remove tube by pulling it over the chrome-plated tube. Proceed in the same manner with BILSTEIN cartridge inserts according to drawing no. 3. First of all remove outer tube. Grip the tube at point (b), turn (stud pointing downwards) and knock heavily against a hard base until the tube falls out of the tube bottom. Remove tube by pulling it over the chromeplated tube. The details listed in the drawings are to be strictly adhered to.

Illustration 4:

BILSTEIN twin-tube gas pressure shock absorbers with a piston rod diameter of 20-24 mm (remove mounting parts, protective tube and dirt shield) are to be fixed on a suitable base, e.g. in a prism and centre marked at the 2 points to be drilled according to drawing no. 4. First of all drill a hole in the shock absorber close to the piston rod seal with a 5 mm drill bit so that the hydrogen gas can escape (e), then drill a 15 mm deep hole at the point stated (f) (80 mm from bottom of the tube with the piston rod in the extended position) in order to enable oil drainage. By repeated movement of the piston rod the oil is pumped out of the damper tube and collected in an appropriate container. The shock absorber oil, free from PCB and PCT, is to be disposed of in accordance with national waste disposal laws (same regulations apply to motor oil). After the shock absorbers have been depressurised and the oil drained off, shock absorber struts, cartridge inserts and their individual parts – still partly covered with oil and grease – must also be disposed of in accordance with the national waste disposal law. This information has been provided in good faith, subject to the applicable regulations. We cannot accept liability for each individual circumstance. If in doubt, please contact the Sales Consulting department of ThyssenKrupp Bilstein GmbH or the

Company PARTSLIFE Recycling System GmbH & Co. KG
Heinrich-Hertz-Str. 9, 63225 Langen
Tel. +49 (0)6103/20106-0, Fax: -19
www.partslife.de
info@partslife.de

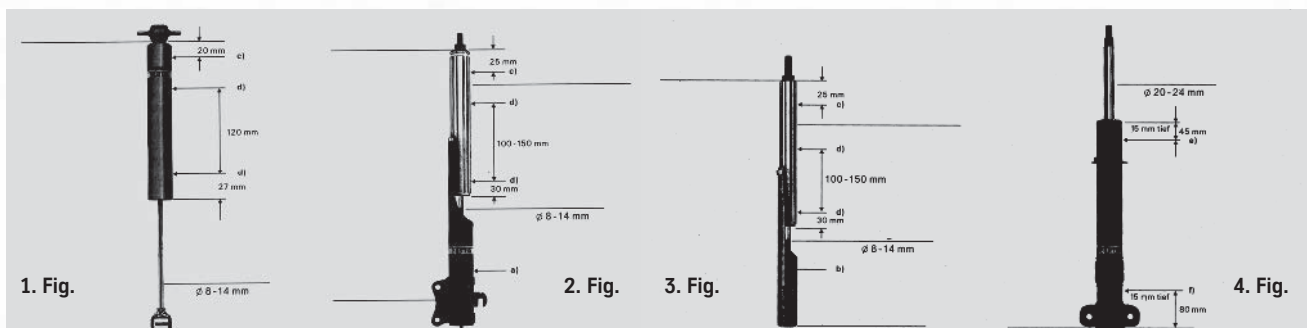

12.2013 · W-800554 · Subject to technical modifications, misprints and errors excepted.

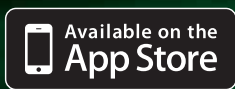

Find us on Facebook
www.facebook.com/bilstein.de

ThyssenKrupp Bilstein GmbH

Milsper Straße 214, D-58256 Ennepetal
Postfach 1151, D-58240 Ennepetal

☎ +49 (0)2333 791-0

☎ +49 (0)2333 791-4400

✉ info@bilstein.de

www.bilstein.com

