



BRAKE CATALOGUE



**2012
2013**



TecDoc
CERTIFIED DATA SUPPLIER

Oltre che sui cataloghi cartacei dei prodotti aftermarket di Ashika, è possibile trovare i prodotti Ashika anche in TecDoc, leader europeo nella produzione di catalogazione elettronica.

Ashika è "Fornitore di dati certificato" per TecDoc. Vale a dire che tutti i dati di Ashika presenti in TecDoc godono di ottima qualità, sono stati controllati e verificati da TecDoc, e supportati dagli specialisti di Ashika. I pezzi possono essere facilmente reperiti cliccando sul relativo veicolo e sul gruppo di prodotti. Quando vengono visualizzate le parti Ashika corrette, l'utente può visionare anche informazioni aggiuntive (ad es. dimensioni, caratteristiche o immagini).

Beside the paper catalogues of the Ashika Aftermarket products, Ashika products can also be found in TecDoc, European leader of electronic cataloguing.

Ashika is a "certified Data Supplier" to TecDoc. This means that all Ashika data in TecDoc is of the highest quality, controlled and checked by TecDoc, and maintained by Japanparts' own specialists. Parts can easily be found just by clicking on the proper vehicle and product-group. When the correct Ashika part(s) is/are displayed, also additional information can be viewed (i.e. dimensions, remarks or pictures).





PRODUCTS RANGE - PRODUKTE IM SORTIMENT	
GAMME DE PRODUITS - GAMA DE PRODUCTOS	
PRODOTTI IN GAMMA	
REPLACED CODES - ERSETZTE CODES	
CODES REMPLACÉS - CÓDIGOS SUBSTITUIDOS	
CODICI SOSTITUITI	
NEW CODES - NEUE CODES	
NOUVEAUX CODES - NUEVOS CODIGOS	
NUOVI CODICI	
NEW LINES BRAKE CABLES BREMSZUG	
CÂBLES DE FREIN- CABLE DE FRENO	
NUOVA LINEA CAVI FRENO	
	Pag.
EUROPE Crossover	1
EUROPE Vehicle	2
AIXAM	8
ASIA MOTORS	9
BEDFORD	10
CADILLAC	11
CHATENET	12
CHEVROLET	13
CHRYSLER	15
DAEWOO	19
DAIHATSU	24
DODGE	32
DR	33
GASOLONE	34
GONOW	35
GREAT WALL	36
HONDA	37
HUMMER	55
HYUNDAI	56
INFINITI	74
ISUZU	75
ISUZU COMMERCIAL	79
JEEP	80
KIA	84
LADA	93
LAND ROVER	94
LEXUS	100
LIGIER	102
LOTUS	103
MAHINDRA	104
MARUTI	105
MAZDA	106
MINI	130
MITSUBISHI COMMERCIAL	157
NISSAN	158
NISSAN COMMERCIAL	191
PIAGGIO	192
PONTIAC	193
PROTON	194
SHUANGHUAN AUTO	196
SMART	197
SSANGYONG	199

	Pag.
SUBARU	202
SUZUKI	214
TATA (TELCO)	224
TOYOTA	226
VOLKSWAGEN	274
PICTURES BRAKE DISC FRONT	
ABBILDUNGEN BREMSSCHEIBEN VORN	
FIGURAS DISCOS DE FRENO DELANTEROS	
ILLUSTRAT. DISQUES DE FREIN AVANT	
IMMAGINI DISCHI FRENO ANTERIORI	275
PICTURES BRAKE DISC REAR	
ABBILDUNGEN BREMSSCHEIBEN HINTEN	
FIGURAS DISCOS DE FRENO POSTERIORES	
ILLUSTRAT. DISQUES DE FREIN ARRIÈRE	
IMMAGINI DISCHI FRENO POSTERIORI	330
PICTURES BRAKE SHOES	
ABBILDUNGEN BREMSBACKEN	
FIGURAS MÂCHOIRES DE FREIN	
ILLUSTRAT. ZAPATAS DE FRENO	
IMMAGINI GANASCE FRENO	357
PICTURES BRAKE DRUMS	
ABBILDUNGEN BREMSTROMMEL	
FIGURAS TAMBORES DE FRENO	
ILLUSTRAT. TAMBOURS DE FREIN	
IMMAGINI TAMBURI FRENO	387
PICTURES REAR WHEEL CYLINDERS	
ABBILDUNGEN RADBREMSZYLINDER	
FIGURAS BOMBINES DE FRENO	
ILLUSTRAT. CYLINDRES DE FREIN	
IMMAGINI CILINDRETTI FRENO	400
PICTURES BRAKE PADS FRONT	
ABBILDUNGEN BREMSKLÖTZE VORN	
FIGURAS PASTILLAS DE FRENO DELANTORES	
ILLUSTRAT. PLAQUETTES DE FREI AVANT	
IMMAGINI PASTIGLIE FRENO ANTERIORI	439
PICTURES BRAKE PADS REAR	
ABBILDUNGEN BREMSKLÖTZE HINTEN	
FIGURAS PASTILLAS DE FRENO POSTERIORES	
ILLUSTRAT. PLAQUETTES DE FREI ARRIÈRE	
IMMAGINI PASTIGLIE FRENO POSTERIORI	861
CROSS REFERENCE LIST	
VERGLEICHSLISTE	
LISTA DE REFERENCIAS CRUZADES	
LISTE DE COMPARAISON	
LISTA DI COMPARAZIONE	1021

BIANCA

FILTRI/FILTERS/FILTRES FILTER/FILTROS/FILTROS		
	10	FILTRI OLIO - OIL FILTERS - FILTRES À HUILE - ÖLFILTER - FILTROS DO ÓLEO - FILTROS DE ACEITE
	20	FILTRI ARIA - AIR FILTERS - FILTRES À AIR - LUFTFILTER - FILTROS DE AR - FILTROS DE AIRE
	21	FILTRI ABITACOLO - CABIN FILTERS - FILTRES D'HABITACLE - POLLENFILTER - FILTROS DE HANBITÁCULO - FILTROS DEPURACIÓN
	30	FILTRI CARBURANTE - FUEL FILTERS - FILTRES À CARBURANT - KRAFTSTOFFFILTER - FILTROS DE COMBUSTÍVEL - FILTROS DE CARBURANTE
	10-ECO	FILTRI OLIO ECO - ECO OIL FILTERS - FILTRES À HUILE ECO - ÖLFILTER ECO - ECO FILTROS DO ÓLEO - ECO FILTROS DE ACEITE
	30-ECO	FILTRI CARBURANTE ECO - ECO FUEL FILTERS - FILTRES À CARBURANT ECO - KRAFTSTOFFFILTER ECO - ECO FILTROS DE COMBUSTÍVEL - ECO FILTROS DE CARBURANTE
	74	KIT FILTRI PER TAGLIANDO - SERVICE FILTER KIT - KIT FILTRES ENTRETIEN - FILTER SERVICE SATZ - KIT DE FILTROS DA REVISÃO - KIT FILTROS PARA REVISIÓN
	10-GAS	FILTRO DEPURAZIONE GPL - GPL PURIFICATION FILTER - FILTRE PURIFICATION GPL - REINIGUNGSFILTER GPL - FILTRO DE GÁS PARA A FILTRAGEM DO GPL - GAS FILTRO DEPURACIÓN GPL
	99	SUPPORTO FILTRO - FILTER SUPPORT - FILTRE D'APPUI - FILTRE HALTERUNG - SUPORTE DO FILTRO - SOPORTE FILTRI

FRENANTE/BRAKES/BREMS FREINAGE/TRAVÕES/ FRENOS		
	67	CILINDRETTI FRENO SX - REAR WHEEL CYLINDER LEFT - CYLINDRE DE ROUE GAUCHE - RADBREM-SZYLINDER, LINKS - CILINDRO DE TRAVÃO DE TRÁS ESQUERDO - CILINDROS DE FRENO SX
	68	POMPE FRENO - BRAKE MASTER CYLINDERS - MAÎTRE CYLINDRES - HAUPTBREMSZYLINDER - BOMBAS DOS TRAVÕES - BOMBAS DE FRENO
	69	TUBI FRENO - BRAKE HOSES - FLÉXIBLES DE FREIN - BREMSCHLÄUCHE - TUBOS DOS TRAVÕES - TUBOS DE FRENO
	KFR	KIT FRENO (2 dischi+1 past. ant.) - BRAKE KIT (2 discs+1 pads front) - KIT DE FREINS - (2 disques+1 plaquettes avant) - BREMSSENSATZ (2 Scheiben+1 Klötze vorne) - KIT DOS TRAVÕES (2 discos+1 jogo de pastilhas da frente) - KIT DE FRENO (2 discos+1 past. ant.)
	KRR	KIT FRENO (2 dischi+1 past. post.) - BRAKE KIT (2 discs+1 pads rear) - KIT DE FREINS - (2 disques+1 plaquettes arrière) - BREMSSENSATZ (2 Scheiben+1 Klötze hinten) - KIT DOS TRAVÕES (2 discos+1 jogo de pastilhas de trás) - Kit de freno (2 discos+1 past. ant.)
	114	KIT RIPARAZIONE POMPA FRENO - REPAIR KIT, BRAKE MASTER CYLINDER - KIT DE RÉPARATION, MAÎTRE CYLINDRE DE FREIN - REPARATURSATZ, HAUPTBREMSZYLINDER - KIT REPARAÇÃO DA BOMBA DOS TRAVÕES - KIT REPARACIÓN BOMBA DE FRENO
	120	KIT RIPARAZIONE PINZA FRENO - BRAKE CALIPERS REPAIR KIT - KIT DE REPARATION ETRIERES DE FREIN - REPARATURSATZ BREMSSEL - KIT REPARAÇÃO PINÇA TRAVÃO - KIT REPARACIÓN PINZA DE FRENO

NEW

FULL RANGE

FRENANTE/BRAKES/BREMS FREINAGE/TRAVÕES/ FRENOS		
	50	PASTIGLIE FRENO ANT. - BRAKE PADS FRONT - PLAQUETTES DE FREIN AVANT - BREMSKLÖTZE VORNE - PASTILHAS DOS TRAVÕES DA FRENTE - PASTILLAS DE FRENO ANT.
	51	PASTIGLIE FRENO POST. - BRAKE PADS REAR - PLAQUETTES DE FREIN ARRIÈRE - BREMSKLÖTZE HINTEN - PASTILHAS DOS TRAVÕES DE TRÁS - PASTILLAS DE FRENO POST.
	60	DISCHI FRENO ANT. - BRAKE DISCS FRONT - DISQUES DE FREIN AVANT - BREMSSCHEIBEN VORNE - DISCOS DOS TRAVÕES DA FRENTE - DISCOS DE FRENO ANT.
	61	DISCHI FRENO POST. - BRAKE DISCS REAR - DISQUES DE FREIN ARRIÈRE - BREMSSCHEIBEN HINTEN - DISCOS DOS TRAVÕES DE TRÁS - DISCOS DE FRENO POST.
	55	GANASCE FRENO - BRAKE SHOES - MACHOIRES DE FREIN - BREMSBACKEN - MAXILAS DE TRAVÃO - ZAPATAS DE FRENO
	56	TAMBURI FRENO - BRAKE DRUMS - TAMBOURS DE FREIN - BREMSSTROMMEL - TAMBORES DOS TRAVÕES - TAMBORES DE FRENO
	65	CILINDRETTI FRENO DX - REAR WHEEL CYLINDER RIGHT - CYLINDRE DE ROUE DROIT - RADBREM-SZYLINDER, RECHTS - CILINDRO DE TRAVÃO DE TRÁS DIREITO - CILINDROS DE FRENO DX

FRIZIONI/CLUTCH/KUPPLUNG EMBRAYAGE/ EMBRAIAGEM / EMBRAGUE		
	80	DISCHI FRIZIONE - CLUTCH DISCS - DISQUES D'EMBRAYAGE - KUPPLUNGSSCHEIBEN - DISCO DE EMBRAIAGEM - DISCO DE EMBRAGUE
	70	SPINGIDISCO FRIZIONE - CLUTCH COVER - MÉCANISME D'EMBRAYAGE - DRUCKPLATTEN KUPPLUNG - PRATO DE PRESSÃO DA EMBRAIAGEM - PRENSA DE EMBRAGUE
	90	CUSCINETTI FRIZIONE - CLUTCH BEARINGS - BUTÉES D'EMBRAYAGE - KUPPLUNGS-AUSRÜCKLAGER - ROLAMENTO DE EMBRAIAGEM - COJINETES DE EMBRAGUE
	92	KIT FRIZIONE - CLUTCH KITS - KIT EMBRAYAGES - KUPPLUNGSSÄTZE - KIT EMBRAIAGEM - KIT EMBRAGUE
	91	VOLANI - FLYWHEELS - VOLANTS - SCHWUNGRÄDER - VOLANTES BI-MASSA - VOLANTES
	98	KIT FRIZIONE COMPLETO DI VOLANO - CLUTCH KIT WITH FLYWHEEL - KIT EMBRAYAGE AVEC VOLANT - KUPPLUNGSKIT MIT SCHWUNGRA - KIT DE EMBRAIAGEM COM VOLANTE - KIT EMBRAGUE COMPLETO CON VOLANTE DE INERCIA
	54	BULLONE, PORTA CORONA DENTATA VOLANO - BOLT, FLYWHEEL RING GEAR CARRIER - VIS BOULON AU SUPPORT DU PIGNON POUR VOLANT D'INERTIE - SCHRAUBE, ZAHNKRANZTRÄGER - SCHWUNGRAD - PARAFUSO PORTA VOLANTE - PERNO, SOPORTE CORONA - DENTADA, VOLANTE

NOVITÀ

GAMMA COMPLETA

NEW
FULL RANGE
NOVITÀ
GAMMA COMPLETA
FRIZIONI/CLUTCH/KUPPLUNG
EMBRAYAGE/ EMBRAIAGEM / EMBRAGUE

	95	POMPE FRIZIONE - CLUTCH MASTER CYLINDERS - CYLINDRE ÉMETTEUR - KUPPLUNGS-HAUPTZYLINDER - BOMBAS EMBRAIAGEM - BOMBA EMBRAGUE
	85	CILINDRETTI FRIZIONE - CLUTCH SLAVE CYLINDERS - CYLINDRE RÉCEPTEUR - KUPPLUNGS-NEHMERZYLINDER - BOMBA SECUNDÁRIA DA EMBRAIAGEM - CILINDROS EMBRAGUE
	123	KIT RIPARAZIONE POMPA FRIZIONE - REPAIR KIT, CLUTCH MASTER CYLINDER - KIT D'ASSEMBLAGE, CYLINDRE ÉMETTEUR D'EMBRAYAGE - REPARATURSATZ, KUPPLUNGSGEBERZYLINDER - KIT DE REPARAÇÃO DA BOMBA DE EMBRAIAGEM PRINCIPAL - KIT REPARACIÓN BOMBA DE EMBRAGUE
	124	KIT RIPARAZIONE CILINDRETTO FRIZIONE REPAIR KIT, CLUTCH SLAVE CYLINDER - KIT D'ASSEMBLAGE, CYLINDRE - RÉCEPTEUR D'EMBRAYAGE - REPARATURSATZ, KUPPLUNGSNEHMERZYLINDER - KIT DE REPARAÇÃO DA BOMBA DE EMBRAIAGEM SECUNDÁRIA - KIT REPARACIÓN CILINDRO EMBRAGUE

DISTRIBUZIONE / DISTRIBUTION / VERTEILUNG
DISTRIBUTION/ DISTRIBUIÇÃO /DISTRIBUCIÓN

	45	CUSCINETTI TENDICINGHIA - TIMING BELT TENSIONERS - GALET TENDEUR - SPANNROLLEN - TENSORES DA CORREIA DE DISTRIBUIÇÃO - COJINETES DE TENSOR DE CORREA
	40	CINGHIE DISTRIBUZIONE - TIMING BELTS COURROIES DE DISTRIBUTION - ZAHNRIEMEN - CORREIA DE DISTRIBUIÇÃO - CORREAS DE DISTRIBUCIÓN
	41	CATENE DISTRIBUZIONE - TIMING CHAINS CHAINES DE DISTRIBUTION - STEUERKETTEN - CORRENTES DE DISTRIBUIÇÃO CADENAS DE DISTRIBUCIÓN
	KCK	KIT DISTRIBUZIONE CATENA - TIMING CHAIN KIT - KIT CHAINES DE DISTRIBUTION - STEUERKETTENSATZ - KIT DA CORRENTE DE DISTRIBUIÇÃO - KIT DISTRIBUCIÓN DE CADENA
	94	CINGHIA SERVIZI - FAN BELTS - COURROIE KEILRIEMEN - CORREIA DE VENTONHA - CORREA DE SERVICIOS
	109	CINGHIA SERVIZI MITSUBOSHI - FAN BELT MITSUBOSHI - COURROIE MITSUBOSHI - KEILRIEMEN MITSUBOSHI - CORREIA DE VENTONHA MITSUBOSHI CORREA DE SERVICIOS MITSUBOSHI
	96	CINGHIE SERVIZI SCANALATE FAN BELTS COURROIES - KEILRIIPPENRIEMEN CORREIA DE VENTONHA - CORREA DE SERVICIOS
	112	CINGHIA SERVIZI SCANALATA MITSUBOSHI - FAN BELT MITSUBOSHI - COURROIES MITSUBOSHI KEILRIIPPENRIEMEN MITSUBOSHI - CORREIA DE VENTONHA MITSUBOSHI - CORREA DE SERVICIOS MITSUBOSHI
	KCT	KIT CINGHIA E TENDICINGHIA - TIMING BELT KIT - KIT DE DISTRIBUTION - ZAHNRIEMENSATZ - KIT DE DISTRIBUIÇÃO DE CORREIA - KIT CORREA Y TENSOR DE CORREA

RAFFREDDAMENTO/COOLING/ABKÜHLUNG
REFROIDISSEMENT/ARREFECIMENTO/REFRIGERACIÓN

	35	POMPE ACQUA - WATER PUMPS - POMPES À EAU - WASSERPUMPEN - BOMBAS DA ÁGUA - BOMBAS DE AGUA
	SKC KCT+35	SUPERKIT DISTRIBUZIONE - TIMING SUPERKIT - ZAHNRIEMEN-SUPERSATZ - SUPERKIT DE DISTRIBUTION - SUPERKIT DE DISTRIBUCIÓN - SUPERKIT DE DISTRIBUIÇÃO
	36	GIUNTI VISCOSI - VISCOUS COUPLINGS - VISCO COUPLEUR - VISCO-KUPPLUNGEN - JUNTAS VISCOSAS - JUNTAS VISCOSAS
	38	VALVOLE TERMOSTATICHE - THERMOSTATS - THERMOSTATES - THERMOSTATE TERMOSTATOS - VÁLVULAS TERMOSTÁTICAS

RAFFREDDAMENTO/COOLING/ABKÜHLUNG
REFROIDISSEMENT/ARREFECIMENTO/REFRIGERACIÓN

	22	VALVOLA TERMOSTATICA TAMA - THERMOSTATE TAMA (made in japan) - VANNE THERMOSTATIQUE TAMA - THERMOSTATVENTIL TAMA - TERMOSTATOS TAMA - VÁLVULA TERMOSTÁTICA TAMA (MADE IN JAPAN)
	33	TAPPI RADIATORE - RADIATOR CAPS - BOUCHONS RADIATEURS - KÜHLER VERSCHLUSS KAPPE TAMPÕES DE RADIADOR - TAPONES RADIADOR











GIUNTI E CUFFIE / JOINTS AND BOOTS / KUPPLUNGEN UND
ACHSMANSCHETTEN / COUPLEUR, SOUFFLET DE CARDAN /
JUNTAS DE TRANSMISSÃO E FOLAS / JUNTAS Y FUELLES















	62	GIUNTI OMOCINETICI LATO RUOTA - COSTANT VELOCITY JOINTS - JOINT HOMOCINÉTIQUE - ANTRIEBSWELLEN - JUNTAS HOMOCINÉTICAS LATO RODA - JUNTAS HOMOCINÉTICAS DE LATO DE RUEDA
	63	KIT CUFFIA - BOOT KITS - SOUFFLET DE CARDAN - ACHSMANSCHETTEN - KIT DE FOLAS - KIT DE FUELLES
	66	CROCIERE - UNIVERSAL JOINTS - CROISILLONS DE TRANS - UNIVERSAL GELENKE CRUZETAS DE CARDAN - CRUCETAS

SOSPENSIONI / SUSPENSIONS
LENKUNGS UND-AUFHÄNGUNGSTEILE
SUSPENSION / SUSPENSÃO/ SUSPENSIÓN

	MA	AMMORTIZZATORI - SHOCK ABSORBERS AMORTISSEURS - STOSSDÄMPFER AMORTECEDORES - AMORTIGUADOR
	MR	KIT AMMORTIZZATORI SANKEI ROKI SHOCK ABSORBERS KIT SANKEI ROKI KIT AMORTISSEURS SANKEI ROKI - STOSSDÄMPFER KIT SANKEI ROKI - KIT DE AMORTECEDORES SANKEI ROKI - KIT DE AMORTIGUADOR SANKEI ROKI
	63-0A	CUFFIE AMMORTIZZATORI UNIVERSALI - UNIVERSAL BUMP RUBBER KIT - SOUFFLET DE CARDAN UNIVERSALE DÄMPFERKAPPEN KITS DE FOLAS UNIVERSAIS DOS AMORTECEDORES - FUELLES AMORTIGUADORES UNIVERSALES
	44	KIT CUSCINETTI RUOTA - WHEELBEARING KITS - KIT DE ROULEMENTS DE ROUES RADLAGERSÄTZE - JOGOS DE ROLAMENTOS DAS RODAS - KIT COJINETES DE RUEDA
	GOM	GOMMINI - RUBBERS - SILENT BLOCS MOTORAUFHÄNGUNG - BORRACHAS - TAPONES DE GOMA
	72	TRAPEZIO - SUSPENSION TRIANGLE TRIANGLE DE SUSPENSION - TRAPEZ - TRIÂNGULO DA SUSPENSÃO - TRAPECIO
	71 102	BRACCIO OSCILLANTE - SUSPENSION ARMS - BRAS OSCILLANTS - SCHWENKARME - BRAÇOS DA SUSPENSÃO - BRAZO OSCILANTE
	59	LEVE RINVIO STERZO - STEERING RELAY LEVIERS DE RENVOI DE LA DIRECTION - LENKRADHEBEL - PENDURAL DA BARRA DE DIRECÇÃO - LEVAS DE REENVÍO DE LA DIRECCIÓN
	53	TESTINE SOSPENSIONE - BALL JOINT - ROTULE (POUR SUSPENSION ET DIRECTION) - AUFHÄNGEKÖPFE - ROTULA DA SUSPENSÃO - CABEZALES DE SUSPENSÓN
	105	BARRE ACCOPPIAMENTO - COUPLING BARS - BARRES D'ACCOUPEMENT - PLEUELSTANGEN - BARRAS DA DIRECÇÃO BARRAS DE ACOPLAMIENTO
	111	TESTA BARRA D'ACCOPIAMENTO - TIE-ROD END - ROTULE DE BARRE DE CONNEXION - SPURSTANGENKOPF - TERMINAL DA DIRECÇÃO - CABEZA DE BARRA DE ACOPLAMIENTO
	26	BRACCIO OSCILLANTE, SOSPENSIONE RUOTA - TRACK CONTROL ARM - BRAS DE LIAISON, SUSPENSION DE ROUE - LENKER, RADAUFHÄNGUNG - BRAÇO DE SUSPENSÃO - BRAZO OSCILANTE, SUSPENSIÓN DE RUEDA

SOSPENSIONI / SUSPENSIONS LENKUNGS UND-AUFHÄNGUNGSTEILE SUSPENSION / SUSPENSÃO/ SUSPENSIÓN	
	52 LEVE RINVIO STERZO - STEERING RELAY LEVIERS DE RENVOI DE LA DIRECTION - LENKRADHEBEL - BRAÇO DO PENDURAL DA DIRECÇÃO - LEVAS DE REENVÍO DE LA DIRECCIÓN
	103 GIUNTO ASSIALE, ASTA TRASVERSALE AXIAL ROD, TIE ROD - ROTULE DE DIRECTION INTÉRIEURE, BARRE DE CONNEXION - AXIALGELENK, SPURSTANGE - RÓTULA DA DIRECÇÃO INTERIOR - JUNTA AXIAL, ASTA TRANSVERSAL
	106 STABILIZZATORE, CHASSIS - STABILIZER, CHASSIS - STABILISATEUR, CHASSIS - STABILISATOR, FAHRWERK - ESTABILIZADOR, CHASSI - ESTABILIZADOR, CHASSIS
	27 BARRA D'ACCOPIAMENTO - TIE ROD, STEERING BARRE DE CONNEXION SPURSTANGE - VERBINDUNGSTANGE - BARRA DE JUNÇÃO - BARRA DE ACOPLAMIENTO
	76 GIUNTO ASSIALE, ASTA TRASVERSALE AXIAL ROD, TIE ROD - ROTULE DE DIRECTION INTÉRIEURE, BARRE DE CONNEXION AXIALGELENK, SPURSTANGE - JUNTA AXIAL, FERRO TRANSVERSAL - JUNTA AXIAL, ASTA TRANSVERSAL
	73 GIUNTO DI SUPPORTO/GUIDA - SUPPORT/STEERING LINK - ROTULE DE SUSPENSION TRAG/FÜHRUNGSGELENK - RÓTULA DA SUSPENSÃO - JUNTA DE SOPORTE /GUÍA

IMPIANTO ELETTRICO / ELECTRICAL PARTS ELEKTRISCHE TEILE / ÉLECTRIQUE PARTS MATERIAL ELÉCTRICO/ PARTES ELECTRICAS	
	002 ALTERNATORI - ALTERNATORS - ALTERNATEURS - LICHTMASCHINEN - ALTERNADORES - ALTERNADORES
	003 MOTORINI AVVIAMENTO - STARTERS - DÉMARREURS - ANLASSER - MOTORES DE ARRANQUE - ARRANCADOR
	64 BULBI ELETTRIVENTOLA - TEMP. SENSORS - CAPTEUR DE TEMPÉRATURE - VENTILKUGELN - SENSORES DE TEMPERATURA - SENSOR TEMPERATURA
	121 CALOTTE SPINTEROGENO - DISTRIBUTOR CAPS - TÊTE D'ALLUMEUR - VERTEILEKAPPEN - TAMPAS DO DISTRIBUIDOR - TAPA DISTRIBUIDOR
	01 CANDELETTE - GLOW PLUGS - BOUGIES DE PRÉ-CHAUFFAGE - GLUHKERZEN - VELAS DE INCANDESCÊNCIA - BUJIAS
	DENSO CANDELE - SPARK PLUGS - BOUGIES D'ALLUMAGE - KERZEN - DENSO VELAS - DENSO BUJÍAS
	HKT CANDELETTE HKT - HKT GLOW PLUGS BOUGIES DE PRÉCHAUFFAGE HKT - GLUHKERZEN HKT - VELAS DE INCANDESCÊNCIA HKT - CANDELILLAS HKT
	DENSO CANDELETTE DENSO - DENSO GLOW PLUGS - BOUGIES DE PRÉCHAUFFAGE DENSO - GLUHKERZEN DENSO - VELAS DE INCANDESCÊNCIA DENSO - CANDELILLAS DENSO
	43 SONDE LAMBDA - OXIGEN SENSORS SONDE LAMBDA - LAMBDA SÖNDE SONDAS LAMBDA - SENSOR OXIGEN
	DENSO SONDE LAMBDA DENSO - OXIGEN SENSORS DENSO SONDE LAMBDA DENSO - LAMBDA SÖNDE DENSO - SONDAS LAMBDA DENSO - SONDAS LAMBDA
	05 POMPE BENZINA - FUEL PUMP - POMPE A CARBURANT - BENZINPUMPEN - BOMBAS GASOLINA - BOMBAS DE GASOLINA

IMPIANTO ELETTRICO / ELECTRICAL PARTS ELEKTRISCHE TEILE / ÉLECTRIQUE PARTS MATERIAL ELÉCTRICO/ PARTES ELECTRICAS	
	77 REGOLATORI - REGULATORS - REGULATEUR DE TENSION - SPANNUNGSREGLER - REGULADORES - REGULADORES
	97 SPAZZOLE ACCENSIONE - ROTOR ARMS ROTORS D'ALLUMEURS - VERTEILERFINGER - ROTORES - ROTOR DEL DISTRIBUIDOR
	SA-X SPAZZOLE TERGICRISTALLO - WIPER BLADES - BALAIS ESSUIE GLACES - WISCHERBLÄTTER - ESCOVAS LIMPA VIDROS - ESCOBILLAS
	SA-F SPAZZOLE TERGICRISTALLO UNIVERSALI - UNIVERSAL WIPER BLADES - BALAIS ESSUIE GLACES UNIVERSELLES - UNIVERSALE WISCHERBLÄTTER - ESCOVAS LIMPA VIDROS UNIVERSAIS - ESCOBILLAS LIMPIAPARRABRISAS UNIVERSALES
	SA-RE60C SA-RE70C REFILL UNIVERSALI PER SPAZZOLE NORMALI/FLAT - UNIVERSAL REFILL FOR NORMAL WIPER BLADES/FLAT WIPER BLADES - REFILL UNIVERSEL POUR BALAIS ESSUIE GLACE NORMALES ET BALAIS "FLAT" UNIVERSAL REFILL FUER NORMALE - WISCHERBLÄTTER UND FUER FLAT WISCHERBLÄTTER - RECARGAS UNIVERSAIS PARA ESCOVAS FLAT NORMAIS - RECAMBIOS UNIVERSALES PARA ESCOBILLAS NORMALES
	SA-RE70VL SA-RE75BH REFILL UNIVERSALI PER SPAZZOLE NORMALI/FLAT VALEO (70CM)/BOSCH (75CM) UNIVERSAL REFILL FOR NORMAL WIPER BLADES AND FOR BOSCH AND VALEO FLAT WIPER BLADES - REFILL UNIVERSEL POUR BALAIS ESSUIE GLACE NORMALES ET BALAIS "FLAT" BOSCH ET VALEO - UNIVERSAL REFILL FUER NORMALE WISCHERBLÄTTER UND FUER BOSCH UND VALEO FLAT WISCHERBLÄTTER - RECARGAS UNIVERSAIS PARA ESCOVAS NORMAIS/FLAT VALEO (70CM)/BOSCH (75CM) - RECAMBIOS UNIVERSALES PARA ESCOBILLAS NORMALES/FLAT VALEO (70CM) / BOSCH (75CM)
	78 KIT CAVI ACCENSIONE - ELECTRIC-CABLE IGNITION KIT - KIT CÂBLES D'ALLUMAGE - ZÜNDKABEL SET - JOGO DE FIOS DE VELA KIT CABLES DE ENCENDIDO
	13 BOBINA DI ACCENSIONE - COIL, IGNITION BOBINE D'ALLUMAGE - ZÜNDSPULE - BOBINA DE IGNIÇÃO - BOBINA DE ENCENDIDO
	06 CONDENSATORE - CONDENSER, IGNITION CONDENSEUR, SYSTÈME D'ALLUMAGE - KONDENSATOR, ZÜNDANLAGE - CONDENSADOR - CONDENSADOR
	06 KIT CONTATTI ACCENSIONE - CONTACT BREAKER - DISTRIBUTOR JEU DE CONTACTS, - DISTRIBUTEUR D'ALLUMAGE - KONTAKTSATZ, ZÜNDVERTEILER - JOGO DE PLATINADOS - KIT CONTACTOS DE ENCENDIDO
	07 08 09 GRUPPO UNIVERSALE KOITO - INSERT, HEADLIGHT KOITO - BLOC-OPTIQUE DE PHARE KOITO - SCHEINWERFEREINSATZ, HAUPTSCHNITZERWERFER KOITO - ÓPTICA KOITO - GRUPO UNIVERSAL KOITO
	00 INTERRUTTORE STOP - INTERRUPTEUR DES FEUX DE FREINS - BRAKE LIGHT SWITCH - BREMSLICHTSCHALTER - INTERRUPTOR STOP - INTERRUPTOR DE LUCES DE FRENO
	12 INTERRUTTORE TEMPERATURA, VENTOLA RADIATORE - TEMPERATURE SWITCH, RADIATOR FAN - INTERRUPTEUR DE TEMPÉRATURE, VENTILATEUR DE RADIATEUR TEMPERATURSCHALTER, KÜHLERLÜFTER - INTERRUPTOR TEMPERATURA, VENTOINHA RADIADOR - INTERRUPTOR TEMPERATURA, VENTILADOR RADIADOR
	11 PRESSOSTATO OLIO - OIL PRESSURE SWITCH SWITCH DE PRESSION D'HUILE ÖLDRUCKSCHALTER - INTERRUPTOR DA PRESSÃO DO ÓLEO - INTERRUPTOR PRESIÓN DE ACEITE

NEW

FULL RANGE

NOVITÀ

GAMMA COMPLETA

NEW
FULL RANGE

NOVITÀ
GAMMA COMPLETA

IMPIANTO ELETTRICO / ELECTRICAL PARTS ELEKTRISCHE TEILE / ÉLECTRIQUE PARTS MATERIAL ELÉCTRICO/ PARTES ELECTRICAS		
	06	SPINTEROGENO - DISTRIBUTOR - DISTRIBUTEUR - VERTEILER - DISTRIBUIDOR - DISTRIBUIDOR
	02	SENSORE MASSA ARIA - MASS SENSOR - CAPTEUR DE MASSE - SENSORENMESSEUR SENSOR MASSA AR - SENSOR MASA DE AIRE
	75	CORPO FARFALLATO ELETTRICO - THROTTLE HOUSING - BOÏTIER DE PAPILLON DROSSELKLAPPENSTUTZEN - CORPO DE MARIPOSA ELÉCTRICO - CUERPO DE MARIPOSA ELÉCTRICO
		SENSORE TEMPERATURA ARIA ASPIRATA - SENDER UNIT, INTAKE AIR TEMPERATURE CAPTEUR, TEMPÉRATURE DE L'AIR D'ADMISSION - SENSOR, ANSAUGLUFTTEMPERATUR SENSOR DA TEMPERATURA DO AR DE ADMISSÃO - SENSOR DE TEMPERATURA DE AIRE ASPIRADO

MOTORE / ENGINE / MOTOR MOTEUR / MOTOR / MOTOR		
	16	ALBERI A CAMME - CAMSHAFTS - ARBRES A CAMES - NOCKENWELLEN - ÁRVORES DE CAMES - ÁRBOLES DE LEVAS
	18	ALBERI MOTORE - CRANKSHAFTS - VILEBREQUINS - KURBELWELLEN - CABBOTAS ÁRBOLES DE MOTOR
	122	PULEGGIA ALBERO MOTORE - CRANK SHAFT PULLEYS - POULIE DE VILEBREQUIN - MOTOR-WELLE ROLLE - POLIA DA CABBOTA - POLEA DEL EJE MOTOR
	47	GUARNIZIONI COPERCHIO VALVOLE - VALVES COVER GASKETS - JOINT DE COUVRE CULBUTEUR - DICHTUNGEN DES KLAPPENDECKELS - JUNTAS DA CABBÇA - TAPA DE CULATA DE CILINDRO
	46	GUARNIZIONI TESTATA - HEAD GASKETS - JOINTS DE CULASSES - ZYLINDERKÖPFE DICHTURG - JOGO DE JUNTAS DA CABBÇA - JUNTAS DE CULATA
	48	KIT GUARNIZIONI TESTATA - HEAD GASKETS SET - KIT JOINTS DE CULASSES ZYLINDERKOPFDICHTUNGSSATZE - KIT GUARNIÇÕES CABBÇA - KIT JUNTAS DE CULATA
	39	KIT PISTONI - PISTONS KIT - KIT PISTONS KOLBEN REP. SÄTZE - JOGO DE PISTÕES KIT PISTONES
	49	KIT GUARNIZIONI MOTORE - FULL SET GASKET - KIT POCHETTE JOINT MOTEUR MOTOR DICHTUNGSSATZE - JOGO DE JUNTAS COMPLETO - KIT JUNTAS DE MOTOR
	15	VALVOLE - ENGINE VALVES - SOUPAPES - VENTILE - VALVÚLAS - VÁLVULAS
		TESTATE - CYLINDER HEADS - CULASSES - ZILINDERKÖPFE - CABBÇAS - CULATA DEL CILINDRO
		COLLETTORE DI ASPIRAZIONE - INDUCTION MANIFOLD - COLLECTEUR D'ADMISSION - ANSAUGKOLLEKTOR - COLECTOR DE ADMISSÃO - COLECTOR DE ASPIRACIÓN
	23	BIELLE - CONNECTING RODS - BIELLE - PLEUEL - BIELAS - BIELAS
	05	BOCCOLA BIELLA - PISTON PIN BUSHINGS BAGUES TÊTE DE BIELLE - KOLBEN-PLEUEL-BUCHSE - CASQUILHOS DE BIELA CASQUILLO DE BIELA
	34	FASCIA ELASTICA - PISTON RING - SEGMENT DE PISTON - KOLBENRING - SEGMENTO - AROS DEL PISTÓN
	86	BRONZINA BANCO - MAIN BEARINGS - COUSSINETS DE PALIER - HAUPTLAGER BRONZES DE APOIO - COJINETE DE BANCADA

MOTORE / ENGINE / MOTOR MOTEUR / MOTOR / MOTOR		
	82	BRONZINA DI BIELLA - BIG END BEARINGS COUSSINET DE BIELLE - PLEUELLAGER - BRONZES DE BIELA - COJINETE DE BIELA
	19	KIT CANNE CILINDRO MOTORE - CYLINDER LINER KITS - KIT CHEMISES - LAUFBUCHSENSÄTZE - JOGOS DE CAMISAS - KIT BARRAS DE CILINDRO DE MOTOR
	17	BILANCIERI VALVOLE - BALANCES VALVES - VALVES D'ÉQUILIBRES BALANÇEN VENTILE - MARTELOS - BALANÇINES DE LAS VÁLVULAS
	83	BRONZINA ALBERO A CAMME - CAMSHAFT BEARINGS - COUSSINETS ARBRE À CAMES NOCKENWELLENLAGER - BRONZES DA ÁRVORE DE CAMES - COJINETE DE ÁRBOL DE LEVAS
	79	RASAMENTI - THRUST WASHERS - CALES LATÉRALE - ANLAUFSCHLEIBE - ANILHAS DE FOLGA DA CABBOTA - ENRASES
	115	BULLONI TESTATA - CYLINDER HEAD BOLT BOULON DE CULASSE DE CILINDRE - ZYLINDERKOPFSCHRAUBE - PERNOS DA CABBÇA - PERNOS DE CABBZAL
		VALVOLA RICIRCOLO GAS DI SCARICO EXHAUST GAS RECIRCULATION VALVE VANNE EGR - EGR VENTIL - AGR VENTIL - VALVÚLA DE RECICLO DO GÁS DE ESCAPE VÁLVULA DE RECIRCULACIÓN DE GAS DE DESCARGA
		POMPA OLIO - OIL PUMP - POMPE À HUILE ÖLPUMPE - BOMBA ÓLEO - BOMBA DE ACEITE
		INIETTORE - INJECTOR - INJECTEUR - INJEKTOREN - INJECTOR - INYECTOR
		MOTORE COMPLETO - COMPLETE ENGINE MOTEUR COMPLET - MOTOR KOMPLETT MOTOR COMPLETO - MOTOR COMPLETO
		TURBINA - TURBOCHARGER - TURBOCOMPRESSEUR - TURBOLADER - TURBO - TURBINA

URETHANE CUSHION

CODE MA-A	CODE MA-B	CODE MA-C	CODE MA-D	CODE MA-E	CODE MA-F

NEW "CON SOLO 6 CODICI, GAMMA COMPLETA!!!"

PULITORE GAS IMPIANTI LPG/GPL
CODE XX-GAS

NEW
www.ashika.eu



SUBST. BY

REPLACES CODES
ERSETZE CODES
CODES REMPLACES
CODIGOS SUBSTITUIDOS
CODICI SOSTITUITI

Code Article Codice Articolo	Sostituito da Replaced by
67-01-113	67-01-161
67-01-197	67-01-199
67-01-198	67-01-171
67-02-202	67-02-215
67-02-205	67-02-213
67-02-214	67-02-208
67-02-222	67-02-212
67-02-242	67-02-216
67-02-245	67-02-215
67-02-247	67-02-212
67-02-248	67-02-249
67-02-256	67-02-294
67-02-257	67-02-212
67-02-258	67-02-219
67-02-276	67-02-278
67-02-277	67-02-279
67-02-296	67-02-294
67-02-297	67-02-219
67-02-298	67-02-220
67-02-299	67-02-219
67-03-308	67-03-368
67-03-314	67-03-368
67-03-372	67-03-365
67-04-401	67-04-403
67-04-402	67-04-403
67-05-510	67-05-500
67-05-511	67-05-501
67-05-520	67-05-534
67-05-521	67-05-535
67-05-591	67-05-589
67-05-592	67-05-590
67-06-605	67-02-208
67-07-710	67-07-704
67-08-825	67-08-824
67-08-826	67-08-824
67-08-897	67-01-116
67-08-898	67-01-195
67-09-900	67-09-901
67-H0-000	67-H0-008
67-H0-003	67-05-589
67-H0-004	67-05-590

Code Article Codice Articolo	Sostituito da Replaced by
67-H0-009	67-05-589
67-H0-010	67-05-590
67-H0-012	67-H0-014
67-K0-003	67-K0-000
67-K0-011	67-K0-012
67-K0-018	67-K0-000
60-00-058	60-05-586
60-01-130	60-01-132
60-01-141	60-01-199
60-01-147	60-00-015
60-01-156	60-01-158
60-01-184	60-01-197
60-01-186	60-01-187
60-01-192	60-01-197
60-01-193	60-01-185
60-01-195	60-01-108
60-02-200	60-02-202
60-02-209	60-02-270
60-02-231	60-02-286
60-02-238	60-02-270
60-02-256	60-02-255
60-02-260	60-02-252
60-02-273	60-02-244
60-02-290	60-02-282
60-03-308	60-05-508
60-03-328	60-03-324
60-03-331	60-03-332
60-03-339	60-03-330
60-03-343	60-03-349
60-04-408	61-04-408
60-04-497	60-04-423
60-05-503	60-05-522
60-05-504	61-05-504
60-05-519	60-05-523
60-05-528	60-05-530
60-05-531	60-05-598
60-05-584	60-05-516
60-05-585	60-05-599
60-05-590	60-05-592
60-05-594	60-05-524
60-05-596	60-05-520

Code Article Codice Articolo	Sostituito da Replaced by
60-05-597	60-05-521
60-06-606	60-06-609
60-06-616	60-06-607
60-06-698	60-06-603
60-07-799	60-07-702
60-08-803	60-08-807
60-08-810	60-08-811
60-09-901	60-09-997
60-09-902	60-09-903
60-09-905	60-09-903
60-09-908	60-09-997
60-0H-000	60-0H-002
60-0H-001	60-00-057
60-0H-006	60-05-587
60-0K-000	60-03-398
60-0K-001	60-05-587
60-0W-000	60-0W-001
60-0W-002	60-09-910
60-0W-003	60-0W-005
60-0W-006	60-09-910
61-01-105	61-01-116
61-01-196	61-01-155
61-02-292	61-02-216
61-03-398	61-03-308
61-04-403	61-04-402
61-04-445	61-04-495
61-04-499	61-04-402
61-05-507	61-05-506
61-05-522	61-05-511
61-06-601	61-06-602
61-09-901	60-09-997
61-09-908	61-09-997
61-09-991	61-09-993
61-09-998	61-09-995
61-0H-000	61-05-596
61-0K-001	60-0K-002
61-0K-K09	61-0H-001
55-00-005	55-00-003
55-01-131	55-01-132
55-01-135	55-01-129
55-01-139	55-01-134

SUBST. BY



Code Article Codice Articolo	Sostituito da Replaced by
55-01-192	55-01-138
55-01-198	55-01-101
55-02-203	55-06-601
55-02-207	55-02-205
55-02-208	55-06-601
55-02-213	55-02-206
55-02-218	55-06-601
55-02-222	55-02-237
55-02-238	55-02-206
55-02-241	55-02-237
55-02-244	55-02-201
55-02-245	55-02-234
55-02-246	55-02-239
55-02-295	55-02-239
55-02-296	55-02-233
55-02-298	55-02-234
55-03-308	55-03-303
55-03-310	55-03-303
55-03-331	55-03-313
55-03-387	55-03-395
55-03-389	55-03-305
55-03-390	55-03-332
55-03-392	55-03-305
55-04-495	55-04-409
55-04-497	55-04-410
55-04-498	55-04-499
55-05-506	55-05-583
55-05-530	55-05-586
55-05-531	55-05-526
55-05-589	55-05-501
55-05-590	55-05-526
55-05-591	55-05-587
55-05-593	55-05-587
55-05-594	55-05-586
55-05-597	55-05-585
55-05-598	55-05-592
55-05-599	55-H0-013
55-06-608	55-08-813
55-06-609	55-06-602
55-06-612	55-08-811
55-06-613	55-06-604

Code Article Codice Articolo	Sostituito da Replaced by
55-07-708	55-07-797
55-08-803	55-08-805
55-08-816	55-08-818
55-08-819	55-08-818
55-08-889	55-08-899
55-08-890	55-08-813
55-08-891	55-08-899
55-08-892	55-08-899
55-08-893	55-08-899
55-08-895	55-08-811
55-08-896	55-08-808
55-09-905	55-09-991
55-09-992	55-09-991
55-09-993	55-01-194
55-09-994	55-09-991
55-09-997	55-09-999
55-09-998	55-03-395
55-H0-000	55-H0-001
55-H0-004	55-H0-002
55-H0-009	55-H0-007
55-H0-014	55-05-592
55-H0-017	55-K0-008
55-K0-002	55-00-097
55-K0-003	55-H0-003
55-K0-006	55-K0-000
55-K0-009	55-K0-000
55-K0-010	55-K0-001
55-W0-000	55-W0-001
KFR375	KFRW03
50-00-005	50-00-003
50-00-053	50-00-059
50-00-091	50-00-090
50-00-095	50-00-099
50-01-104	50-01-112
50-01-106	50-01-105
50-01-107	50-01-108
50-01-125	50-00-010
50-01-126	51-01-101
50-01-131	50-01-134
50-01-133	50-01-195
50-01-136	51-01-136

Code Article Codice Articolo	Sostituito da Replaced by
50-01-138	50-01-134
50-01-139	50-01-137
50-01-145	50-01-134
50-01-148	50-01-197
50-01-177	51-01-137
50-01-181	50-01-179
50-01-182	50-01-134
50-01-183	50-01-143
50-01-184	50-01-103
50-01-185	50-01-101
50-01-186	50-01-135
50-01-187	50-01-147
50-01-189	50-01-143
50-01-190	50-00-015
50-01-198	50-01-191
50-01-199	50-08-806
50-02-208	50-02-228
50-02-215	50-02-203
50-02-227	51-02-207
50-02-234	50-01-116
50-02-240	50-02-247
50-02-241	50-02-202
50-02-246	50-02-231
50-02-248	50-02-286
50-02-251	50-02-237
50-02-252	50-02-237
50-02-253	50-02-224
50-02-257	50-02-235
50-02-260	50-02-245
50-02-261	50-02-264
50-02-262	50-02-235
50-02-266	50-02-285
50-02-288	50-02-292
50-02-289	50-02-264
50-02-290	50-02-264
50-02-296	50-02-293
50-02-297	50-03-330
50-02-298	50-02-255
50-02-299	50-02-258
50-03-306	50-03-307
50-03-321	50-04-490



SUBST. BY

REPLACES CODES
ERSETZE CODES
CODES REMPLACES
CODIGOS SUBSTITUIDOS
CODICI SOSTITUITI

Code Article Codice Articolo	Sostituito da Replaced by
50-03-324	50-05-502
50-03-327	50-03-301
50-03-333	50-03-326
50-03-334	50-06-601
50-03-338	50-05-590
50-03-345	50-03-332
50-03-374	50-03-341
50-03-375	50-W0-003
50-03-379	50-03-398
50-03-381	50-04-413
50-03-385	50-03-399
50-03-386	50-03-342
50-03-387	50-03-341
50-03-388	50-03-383
50-03-389	50-W0-003
50-03-391	50-K0-002
50-03-393	50-03-384
50-03-394	50-03-329
50-03-395	50-03-383
50-03-396	50-05-509
50-04-408	50-04-412
50-04-418	50-04-424
50-04-419	50-04-414
50-04-420	50-03-339
50-04-422	50-04-426
50-04-440	50-04-426
50-04-441	50-04-493
50-04-453	50-04-427
50-04-496	50-04-430
50-04-497	50-04-432
50-04-498	50-04-432
50-04-499	50-04-432
50-05-500	50-05-593
50-05-521	50-05-525
50-05-523	50-05-528
50-05-532	50-05-528
50-05-562	51-05-502
50-05-584	50-05-586
50-05-587	50-05-530
50-05-588	50-05-592
50-05-589	50-05-528

Code Article Codice Articolo	Sostituito da Replaced by
50-05-591	50-05-590
50-05-594	50-03-339
50-05-596	50-05-528
50-05-598	50-05-530
50-06-611	50-03-343
50-07-700	50-01-101
50-07-704	50-07-799
50-07-730	50-07-708
50-08-808	50-08-899
50-08-811	50-08-897
50-08-812	50-08-893
50-08-814	50-08-813
50-08-817	51-06-601
50-08-887	50-08-805
50-08-888	50-08-899
50-08-889	50-08-899
50-08-890	50-08-899
50-08-891	50-08-805
50-08-892	50-08-816
50-08-895	50-W0-000
50-09-903	50-09-999
50-09-906	50-03-390
50-09-995	50-03-320
50-09-996	50-K0-014
50-A0-000	50-05-502
50-H0-003	50-H0-005
50-H0-004	50-05-590
50-H0-007	50-H0-002
50-H0-009	50-03-339
50-0H-H16	50-0S-S01
50-K0-003	50-00-057
50-K0-004	50-00-057
50-K0-006	50-05-583
50-K0-007	50-K0-017
50-K0-015	50-H0-010
50-0K-K16	50-H0-010
50-0K-K21	50-K0-005
50-0S-S03	50-H0-005
50-W0-001	50-W0-002
50-0W-W11	50-W0-005
51-00-002	51-05-508

Code Article Codice Articolo	Sostituito da Replaced by
51-00-017	51-00-016
51-00-018	51-00-016
51-01-126	51-01-123
51-01-195	51-01-129
51-01-198	51-01-196
51-01-199	51-01-127
51-02-201	51-02-210
51-02-205	51-02-213
51-02-208	51-02-213
51-02-209	51-02-213
51-02-215	51-02-259
51-02-255	51-02-204
51-02-296	51-02-294
51-02-297	51-02-210
51-02-298	51-02-210
51-02-299	51-02-213
51-03-314	50-03-314
51-03-340	51-03-303
51-03-341	51-03-303
51-03-384	51-03-391
51-03-389	51-03-305
51-03-390	51-03-307
51-03-392	51-03-307
51-03-393	51-03-391
51-03-394	51-03-391
51-03-395	51-03-391
51-03-396	51-03-391
51-03-397	51-03-305
51-04-408	51-04-405
51-04-409	51-04-405
51-04-425	51-04-404
51-04-495	51-04-405
51-04-497	51-04-405
51-04-498	51-04-405
51-05-503	51-05-594
51-05-596	51-05-504
51-05-597	51-05-504
51-06-699	51-03-303
51-09-903	51-09-999
51-09-995	51-09-994
51-0A-A01	50-02-286



NEW ITEMS

NEW CODES
NEUE CODES
NOUVEAUX CODES
NUEVOS CODIGOS
NUOVI CODICI

JAPANPARTS CODE	OEM	APPLICATIONS / APPLICAZIONI
BRAKE PADS FRONT\BREMSSKLÖTZE VORN\PASTILLAS DE FRENO DELANTEROS\PASTIGLIE FRENO ANTERIORI		
50-01-118	41060-CA090	NISSAN MURANO 3.5 4x4 -INFINITI FX 45
50-01-127	D10601JY00	NISSAN TIIDA (SC11X) 1.8 - NISSAN TIIDA (SC11X) 1.5 dCi
50-01-128	D1060-JX50B	NISSAN NV200 1.6 16V - NISSAN EVALIA 1.5 dCi
50-01-146	D1060JL00E	NISSAN 370 Z 3.7
50-01-150	410606N091	NISSAN ALMERA II (N16) 1.5 - NISSAN ALMERA II (N16) 2.2 dCi
50-02-276	04465-05260	TOYOTA AVENSIS 2.2 D - TOYOTA VERSO 2.2 D-CAT
50-02-277	0446533440	TOYOTA CAMRY (_V30) 2.4 VVTi Hybrid
50-08-819	55810-80J51	INFINITI I30 3.0 -SUZUKI SX4 1.5 - FIAT SEDICI 1.6 16V 4x4
50-08-820	55810-57K00	SUZUKI SWIFT III (SG) 1.5 - SUZUKI SWIFT III (SG) 1.3 4x4
50-09-913	05142555AA	CHRYSLER 300 C 3.5 - CHRYSLER 300 C 3.0 V6 CRD
50-09-914	8-98079104-0	ISUZU D-MAX 2.5 DiTD 4x4 - ISUZU D-MAX 3.0 D 4x
50-0H-H15	58101-2DA50	HYUNDAI ELANTRA (XD) 1.6 - HYUNDAI ELANTRA (XD) 2.0
50-0H-H17	58101-1KA00	HYUNDAI ix20 1.4 - HYUNDAI ix20 1.6
50-0K-K22	58101-1PA00	KIA VENGA 1.6 CRDi - KIA VENGA 1.4 16V
50-0K-K23	58101-1YA30	KIA PICANTO (TA) 1.0
50-0K-K24	58101-1WA05	KIA RIO 1.2 - KIA RIO 1.4 CRDi
50-0L-L00	LR004936	LAND ROVER FREELANDER 2 2.2 TD4 - RANGE ROVER EVOQUE 2.2 SD4
50-0L-L01	LR019618	LAND ROVER DISCOVERY III 4.4 - RANGE ROVER SPORT 4.4
50-0L-L02	SFP000260	LAND ROVER DEFENDER (LD) 2.5 Td5 4WD - LAND ROVER 90/110 2.5 D 4x4
50-0L-L03	SFP000020	LAND ROVER FREELANDER (LN) 2.5 V6 -LAND ROVER RANGE ROVER III (LM) 4.4
50-0L-L04	STC9187	LAND ROVER DISCOVERY I 2.0 16 V - LAND ROVER 88/109 3.5
50-0L-L05	SFC500080	LAND ROVER RANGE ROVER III (LM) 3.0 TD 6
50-0L-L06	SFP500070	LAND ROVER RANGE ROVER III (LM) 4.2 - DISCOVERY III 3.0 TD
50-0L-L07	LR015578	LAND ROVER RANGE ROVER III (LM) 3.6 TD 8 - DISCOVERY IV (LA) 3.0 TD
50-0W-W12	13301207	CHEVROLET CRUZE (J3000) 1.6 - OPEL ASTRA J 1.6
50-0W-W13	13301234	CHEVROLET CRUZE 2.0 CDI - CHEVROLET ORLANDO 2.0 D
50-0W-W14	96682858	CHEVROLET SPARK 1.0 - CHEVROLET SPARK 1.2
BRAKE DISC FRONT\BREMSSCHEIBEN VORN\DISCOS DE FRENO DELANTEROS\DISCHI FRENO ANTERIORI		
60-00-017	271942103701	TATA SAFARI 2.2 TDiC -TATA XENON 2.2 DiCOR
60-01-142	40206-00QAA	NISSAN KUBISTAR 1.2 - NISSAN KUBISTAR 1.5 dCi 70
60-01-152	40206-CA010	NISSAN MURANO 3.5 4x4 - INFINITI FX 35
60-01-154	40206-1KA3A	NISSAN Juke 1.5 dCi - NISSAN Juke 1.6
60-01-155	40206-1HA0A	NISSAN MICRA (K13) 1.2
60-01-160	40206-3LG0A	NISSAN EVALIA 1.6 - NISSAN NV200 1.5 dci
60-01-161	40206-MB600	NISSAN CABSTAR 35.13 - NISSAN Comm. CABSTAR E 110.45
60-02-2015	43512-05090	TOYOTA AVENSIS 2.2 D - TOYOTA VERSO 2.2 D-4D
60-02-2016	43512-0F030	TOYOTA AVENSIS 1.8 - TOYOTA VERSO 1.6
60-02-2017	43512-52120	TOYOTA YARIS 1.8 VVTi - TOYOTA YARIS 1.0 VVT-i
60-02-2018	43512-12670	TOYOTA AURIS 1.4 D-4D - TOYOTA AURIS 1.6
60-02-2019	43512-60140	TOYOTA LAND CRUISER (_J7_) 4.2 TD (HZJ7__V)
60-02-2020	43512-06090	TOYOTA CAMRY (_V30) 3.5 VVTi XLE - TOYOTA CAMRY 2.4 VVTi Hybrid



JAPANPARTS CODE	OEM	APPLICATIONS / APPLICAZIONI
BRAKE DISC FRONT\BREMSSCHEIBEN VORN\DISCOS DE FRENO DELANTEROS\DISCHI FRENO ANTERIORI		
60-02-2021	43512-35080	TOYOTA HILUX Pick-up (_N_) 2.0
60-02-2023	42512-26160	TOYOTA HIACE IV 2.4 (RCH12_, RCH22_) - HIACE IV (_H1_, _H2_) 2.7
60-02-2024	43512-35280	TOYOTA 4 RUNNER (_N130) 2.7 i 4x4 - TOYOTA 4 RUNNER (_N130) 3.4 i 4x4
60-02-2025	43512-22260	LEXUS GS 300 - LEXUS GS 450 h
60-02-2026	43516-22010	LEXUS GS 300 - LEXUS GS 450 h
60-02-2027	43512-47030	TOYOTA PRIUS 1.5
60-03-355	UH7433251	MAZDA B-SERIE (UN) 2.5 D 4WD - MAZDA B-SERIE (UN) 2.5 D
60-03-356	DB0Y-33-251	MAZDA 121 II (DB) 1.3 16V
60-03-357	UG 52 33 25X	MAZDA B-SERIE (UF) 2.5 D 4WD
60-04-425	45251-SAA-G50	HONDA JAZZ (GD) 1.2 - HONDA JAZZ (GD) 1.4
60-04-428	45251-SDC-A00	HONDA ACCORD VIII 2.4 (CL9) - HONDA ACCORD VIII Tourer 2.4 Vtec E
60-04-431	45251-S9A-E50	HONDA CR-V II 2.0 - HONDA CR-V II 2.2 CTDi
60-04-433	45251-S6M-A10	HONDA CIVIC VI Hatchback 2.0 Type-R - HONDA INTEGRA 2.0
60-05-543	4615A115	MITSUBISHI LANCER SPORTBACK 1.5 - MITSUBISHI LANCER 2.0 DI-D
60-05-544	MR 307375	MITSUBISHI LANCER VI (CK/P_A) 2.0 16V EVO VI / VII (CP9A)
60-05-545	MR334998	MITSUBISHI ECLIPSE II (D3_) 2400 GS 16V
60-07-713	26300FE070	SUBARU IMPREZA 2.5 4 ruote motrici
60-08-824	55211-76J00-000	SUZUKI JIMNY (FJ) 1.3 16V 4x4 - SUZUKI JIMNY (FJ) 1.5 DDiS 4x4
60-08-825	55211-76J11-000	SUZUKI JIMNY (FJ) 1.3 16V 4x4 - SUZUKI JIMNY (FJ) 1.5 DDiS 4x4
60-0H-H15	51712-2L500	HYUNDAI i30 1.4 - HYUNDAI i30 2.0 CRDi
60-0H-H17	51712-2T100	HYUNDAI i40 1.6 Gdi - HYUNDAI i40 1.7 CRDi
60-0H-H24	51712-4H500	HYUNDAI H-1 2.5 CRDi - HYUNDAI H-1/H-200 2.5 CRDi
60-0K-K13	0K71E-33251	KIA K2700 2.7 D - ASIA MOTORS HI-TOPIC (AM 725) 2.7 D
60-0K-K22	0K63B-33-251A	KIA K2700 2.7 D
60-0L-L00	SDB101070	LAND ROVER FREELANDER (LN) 2.5 V6 - FREELANDER (LN) 2.0 DI
60-0L-L01	SDB000380	LAND ROVER DISCOVERY II (LJ, LT) 2.5 Td5 - DISCOVERY II (LJ, LT) 4.0 V8
60-0L-L02	SDB000622	LAND ROVER RANGE ROVER III (LM) 4.2 - DISCOVERY III 5.0 V8
60-0L-L03	SDB500192	LAND ROVER RANGE ROVER III (LM) 4.2 - RANGE ROVER SPORT 3.0 TD
60-0L-L04	SDB000602	LAND ROVER DISCOVERY III 2.7 TD - RANGE ROVER SPORT 2.7 TDVM
60-0L-L05	LR000470	LAND ROVER FREELANDER 2 3.2
60-0L-L06	SDB500182	LAND ROVER RANGE ROVER III (LM) 4.4 - RANGE ROVER III (LM) 3.0 TD 6
60-0L-L07	NTC8780	LAND ROVER RANGE ROVER II (LP) 4.0 - RANGE ROVER II (LP) 2.5 D
60-0L-L08	SDB000614	LAND ROVER DISCOVERY III 4.4 - RANGE ROVER SPORT 4.4
60-0L-L09	FTC902	LAND ROVER DISCOVERY I 2.5 TDI - DEFENDER (LD) 2.5 4x4
60-0L-L10	SDB100830	LAND ROVER FREELANDER (LN) 2.5 V6 - FREELANDER (LN) 2.0 DI
60-0L-L11	SDB000201	LAND ROVER RANGE ROVER III (LM) 4.4 - RANGE ROVER III (LM) 3.6 TD 8
60-0L-L12	FRC7329	LAND ROVER DISCOVERY II (LJ, LT) 2.0 16 V - RANGE ROVER I 3.5
60-0L-L13	LR000571	LAND ROVER FREELANDER 2 2.2 TD4 - RANGE ROVER EVOQUE 2.0 Si4
60-0S-S04	41441-08130	SSANGYONG REXTON 3.2
60-0S-S05	41441-08000	SSANGYONG REXTON 3.2
60-0S-S06	4144134000	SSANGYONG KORANDO 2.0 e-Xdi - KORANDO 2.0 e-XDi 4x4



NEW ITEMS

NEW CODES
NEUE CODES
NOUVEAUX CODES
NUEVOS CODIGOS
NUOVI CODICI

JAPANPARTS CODE	OEM	APPLICATIONS / APPLICAZIONI
BRAKE DISC FRONT\BREMSSCHEIBEN VORN\DISCOS DE FRENO DELANTEROS\DISCHI FRENO ANTERIORI		
60-0W-W15	13502045	CHEVROLET CRUZE 2.0 CDI - OPEL ASTRA J 1.6 Turbo
60-0W-W16	13502052	CHEVROLET CRUZE 2.0 CDI - CHEVROLET ORLANDO 2.0 D
BRAKE PADS REAR\BREMSSKLÖTZE HINTEN\PASTILLAS DE FRENO POSTERIORES\PASTIGLIE FRENO POSTERIORI		
51-00-007	25814674	CADILLAC CTS 2.8 - CADILLAC CTS 3.6 AWD
51-00-009	182043	AIXAM 400 0.5 - AIXAM A.741 0.4 D
51-01-100	D4060MB40A	NISSAN ATLEON 3.0 (120.35 - 120.56) - NISSAN CABSTAR 35.13
51-01-101	D4060-MA000	NISSAN CABSTAR 45.13 - NISSAN CABSTAR 35.13
51-02-223	04466-05040	TOYOTA AVENSIS 1.8 - TOYOTA AVENSIS 2.2 D-CAT
51-02-224	04466-0F010	TOYOTA VERSO 1.6 - TOYOTA VERSO 2.2 D-CAT
51-02-225	04466-0D010	TOYOTA YARIS 1.3 VVT-i - TOYOTA YARIS 1.4 D-4D
51-0H-H01	58302-3ZA10	HYUNDAI i40 1.6 Gdi - HYUNDAI i40 1.7 CRDi
51-0K-K11	58302-2MA90	KIA SORENTO 2.4 16V - KIA SORENTO 2.0 CRDi 4WD
51-0K-K12	58302-1PA30	KIA VENGA 1.6 CRDi - KIA VENGA 1.4 16V
51-0L-L00	SFP500210	LAND ROVER RANGE ROVER III (LM) 4.2
51-0L-L01	LR019627	LAND ROVER RANGE ROVER III (LM) 3.0 TD 6 - DISCOVERY III 5.0 V8
51-0L-L02	SFP100490	LAND ROVER RANGE ROVER II (LP) 4.0 - DISCOVERY II (LJ, LT) 2.5 Td5
51-0L-L03	LR003657	LAND ROVER FREELANDER 2 2.2 TD4
51-0L-L04	SFP000270	LAND ROVER RANGE ROVER I 3.5 - DISCOVERY I 2.0 16 V
51-0L-L05	LR027129	LAND ROVER RANGE ROVER EVOQUE 2.2 TD4
51-0W-W05	13300867	CHEVROLET CRUZE 2.0 CDI - CHEVROLET ORLANDO 1.8
BRAKE DISC REAR\BREMSSCHEIBEN HINTEN\DISCOS DE FRENO POSTERIORES\DISCHI FRENO POSTERIORI		
61-01-104	43207-9X100	NISSAN ATLEON 3.0 (120.35 - 120.56)
61-01-106	43206-CA000	NISSAN MURANO 3.5 4x4 - INFINITI FX 37
61-01-107	43206-MB600	NISSAN CABSTAR 35.15
61-02-239	42431-52150	TOYOTA URBAN CRUISER 1.3 VVT-i - TOYOTA URBAN CRUISER 1.4 D-4D
61-02-240	42431-05070	TOYOTA AVENSIS 1.8 - TOYOTA AVENSIS 2.2 D-CAT
61-02-241	42431-12310	TOYOTA PRIUS 1.8 HSD -TOYOTA VERSO-S 1.4 D
61-02-242	42431-05050	TOYOTA AVENSIS Station wagon (T25) 2.2 D-CAT
61-02-243	42431-12260	TOYOTA AURIS 1.6 - TOYOTA AURIS 2.2 D
61-02-244	42431-05040	TOYOTA AVENSIS (_T22_) 1.6 VVT-i
61-02-245	42431-0F020	TOYOTA VERSO 1.6 - TOYOTA VERSO 2.2 D-CAT
61-02-246	42431-30290	LEXUS IS 250 (GSE20)
61-02-247	42431-33130	TOYOTA CAMRY (_V30) 3.5 VVTi XLE - TOYOTA CAMRY 2.4 VVTi Hybrid
61-02-248	42431-12190	TOYOTA COROLLA Liftback (_E11_) 1.4 (ZZE111_)
61-02-249	42431-33080	LEXUS RX (XU1) 3.0 2WD - LEXUS RX (XU1) 300 V6
61-02-250	42431-51010	TOYOTA CROWN (_S1_) 2.2 D (LS110_)
61-02-251	42043-19065	TOYOTA PASEO (EL54) 1.5 16V
61-03-329	L232-26-251B	MAZDA CX-7 2.2 MZR-CD
61-04-419	42510-ST7-R00	HONDA INTEGRA (DC2) 1.8 Type-R - HONDA LEGEND III (KA9) 3.5 i 24V
61-04-420	42510-SZ3-000	HONDA LEGEND III (KA9) 3.5 i 24V
61-05-516	4615A037	MITSUBISHI PAJERO IV (V80) 3.2 DI-D (V88W, V98W)



JAPANPARTS CODE	OEM	APPLICATIONS / APPLICAZIONI
BRAKE DISC REAR\BREMSSCHEIBEN HINTEN\DISCOS DE FRENO POSTERIORES\DISCHI FRENO POSTERIORI		
61-05-517	MN116332	mitsubishi LANCER SPORTBACK 1.5 - LANCER SPORTBACK 2.0 DI-D
61-06-604	42403-87709	DAIHATSU CHARADE IV Tre volumi (G203) 1.5
61-07-709	26700-FE050	SUBARU IMPREZA (GD, GG) 2.5 WRX- IMPREZA (GD, GG) 2.0 AWD
61-0H-H08	58411-3N020	HYUNDAI GENESIS COUPE 2.0 Turbo Sport
61-0H-H09	58411-3Z100	HYUNDAI i40 1.6 Gdi - HYUNDAI i40 1.7 CRDi
61-0H-H10	58411-3Z700	HYUNDAI i40 1.6 Gdi - HYUNDAI i40 1.7 CRDi
61-0H-H11	58411-4H300	HYUNDAI H-1 2.5 CRDi
61-0K-K15	58411-2K300	KIA SOUL 1.6 - KIA SOUL 1.6 CRDi
61-0K-K16	58411-2P000	KIA SORENTO 2.4 16V - KIA SORENTO 2.0 CRDi
61-0K-K17	58411-1P300	KIA VENGA 1.6 CRDi - HYUNDAI ix20 1.6
61-0K-K18	58411-0U300	KIA RIO 1.2 - KIA RIO 1.4 CRDi
61-0L-L00	SDB000635	LAND ROVER DISCOVERY III 2.7 TD
61-0L-L01	SDB000644	LAND ROVER DISCOVERY III 4.4
61-0L-L02	LR017804	LAND ROVER RANGE ROVER III (LM) 3.0 TD 6
61-0L-L03	LR001018	LAND ROVER FREELANDER 2 2.2 TD4 4x4
61-0L-L04	SDB000211	LAND ROVER RANGE ROVER III (LM) 4.2
61-0L-L05	LR017953	LAND ROVER DISCOVERY II (LJ, LT) 2.0 16 V
61-0L-L06	LR001019	LAND ROVER FREELANDER 2 3.2
61-0L-L07	SDB000470	LAND ROVER DISCOVERY II (LJ, LT) 2.5 Td5
61-0L-L08	SDB000330	LAND ROVER DEFENDER Station Wagon (LD) 2.5 Td5 4WD
61-0L-L09	LR027123	LAND ROVER RANGE ROVER EVOQUE 2.2 TD4
61-0S-S03	4840134100	SSANGYONG KORANDO 2.0 e-XDi 4x4
61-0S-S04	48401-34000	SSANGYONG KORANDO 2.0 e-XDi
61-0W-W06	13502136	CHEVROLET CRUZE 2.0 CDI - OPEL ASTRA J 2.0 CDTI
61-0W-W07	13502139	CHEVROLET CRUZE 2.0 CDI - CHEVROLET ORLANDO 1.8
BRAKE SHOES\BREMSBACKEN\MÂCHOIRES DE FREIN\GANASCE FRENO		
55-00-007	720060023	DR DR1 1.3 Ecopower - DR2 1.3
55-00-008	181028L	LIGIER NOVA 500 - AIXAM 500 0.5 D
55-00-009	181028L	LIGIER NOVA 500 - AIXAM 500 0.5 D
55-01-115	44060-8H725	NISSAN X-TRAIL (T30) 2.0 4x4 - NISSAN X-TRAIL (T30) 2.0
55-01-116	D4060-JX00A	NISSAN EVALIA 1.6 - NISSAN NV200 1.5 dci
55-01-117	D4060-1HD3B	NISSAN MICRA (K13) 1.2
55-02-228	46540-42020	TOYOTA RAV 4 III 2.2 D-4D - TOYOTA RAV 4 III 2.0
55-02-229	04495-36070	TOYOTA DYNA 200 - 3.7 D
55-02-230	46550-60070	TOYOTA LAND CRUISER (_J4_) 3.6 D (HJ45_V)
55-02-231	0449505040	TOYOTA COROLLA (_E12U_) 1.8 VVTL-i TS
55-02-232	0449502070	TOYOTA COROLLA (_E12U_) 2.0 D-4D
55-02-235	46540-60050	TOYOTA LAND CRUISER 100 (_J10_) 4.7
55-04-407	04431S1AE60	HONDA ACCORD VII (CG) 1.6 i
55-05-511	MN186120	SMART FORFOUR 1.1 (454.030) - MITSUBISHI COLT VI 1.3
55-05-515	4800A001	MITSUBISHI OUTLANDER 2.0 DI-D - SUBARU IMPREZA 1.5



NEW ITEMS

NEW CODES
NEUE CODES
NOUVEAUX CODES
NUEVOS CODIGOS
NUOVI CODICI

JAPANPARTS CODE	OEM	APPLICATIONS / APPLICAZIONI
BRAKE SHOES\BREMSBACKEN\MÂCHOIRES DE FREIN\GANASCE FRENO		
55-05-516	58305-29A00	HYUNDAI LANTRA I (J-1) 1.6 i.e. 16V - HYUNDAI COUPE (RD) 2.0 16V
55-06-618	04495-97203-000	DAIHATSU SIRION (M1) 1.0 i 4WD
55-06-619	04495-87215	DAIHATSU MOVE (L6, L9) 1.0 i - DAIHATSU CUORE V (L5) 0.8
55-06-620	04495-87508-000	DAIHATSU GRAN MOVE (G3) 1.6 16V (G301) - PIAGGIO PORTER 1.0
55-09-911	04882576	CHRYSLER VOYAGER III (RG) 2.4 - CHRYSLER VOYAGER III (RG) 3.3 AWD
55-09-912	8973682530	ISUZU D-MAX 2.5 D - ISUZU D-MAX 3.0 DiTD
55-09-913	5018209AA	CHRYSLER PT CRUISER 2.0 -CHRYSLER PT CRUISER 2.2 CRD
55-09-914	4238827	CHRYSLER NEON II 2.0 16V - CHRYSLER LE BARON 3.0 i V6
55-09-915	05066036AA	CHRYSLER SEBRING (JR) 2.0 - CHRYSLER PT CRUISER GT 2.4
55-0H-H10	58350-H1A40	HYUNDAI TERRACAN (HP) 2.5 TD - HYUNDAI TERRACAN (HP) 2.9 CRDi
55-0H-H11	58305-47A00	HYUNDAI H-1 2.5 CRDi
55-0H-H12	58350-1CA00	HYUNDAI GETZ (TB) 1.6 - HYUNDAI GETZ (TB) 1.5 CRDi
55-0K-K21	58350-1HA00	KIA CEE'D 1.4 - HYUNDAI i30 1.4 -KIA PRO CEE'D 1.6
55-0K-K22	583503FA00	KIA OPIRUS 3.5 - KIA OPIRUS 3.8 V6
55-0L-L00	SFS500010	LAND ROVER DISCOVERY III 4.4
55-0L-L02	GBS753	LAND ROVER 88/109 2.3 (LR 88 OL, LR 109 OL)
55-0L-L03	GBS728	LAND ROVER 88/109 2.3 (LR 88 OL, LR 109 OL)
55-0L-L04	SFS000060	LAND ROVER FREELANDER (LN) 1.8 i 16V
55-0L-L05	SFS000030	LAND ROVER FREELANDER (LN) 2.5 V6
55-0L-L06	GBS655	LAND ROVER DISCOVERY II (LJ, LT) 2.0 16 V -RANGE ROVER I 3.5
55-0L-L07	ICW100030	LAND ROVER DISCOVERY II (LJ, LT) 2.5 Td5 - RANGE ROVER II (LP) 4.6
55-0L-L08	SFS500012	LAND ROVER DISCOVERY III 4.4 - DISCOVERY IV (LA) 3.0 TD
55-0L-L09	SFS000050	LAND ROVER RANGE ROVER III (LM) 4.4
55-0S-S02	583052PA10	KIA SORENTO 2.2 CRDi
55-0S-S03	4833A34000	SSANGYONG KORANDO 2.0 e-XDi
55-0W-W05	96625871	CHEVROLET CAPTIVA 2.4 - CHEVROLET CAPTIVA 2.0 D 4WD
BRAKE DRUMS\BREMSTROMMEL\TAMBORES DE FRENO\TAMBURI FRENO		
56-00-001	720060022	DR DR1 1.3 Ecopower
56-01-107	4320637G10	NISSAN PICK UP/KING CAB (D21) 2.5 D
56-01-109	43206-0F001	NISSAN TERRANO II (R20) 2.7 D - NISSAN TERRANO II (R20) 2.7 TDi 4WD
56-01-111	432064Z801	NISSAN ALMERA II (N16) 1.5 - NISSAN ALMERA II (N16) 2.2 dCi
56-01-112	43200-00Q0C	NISSAN KUBISTAR 1.2 - NISSAN KUBISTAR 1.5 dCi 85
56-01-113	43206-08G11	NISSAN VANETTE (C22) 2.0 D - NISSAN PICK UP NAVARA (D22) 2.4 i
56-01-114	43206-15G11	NISSAN PICK UP/KING CAB (D21) 2.4 i 4WD
56-01-115	43206-1HA0A	NISSAN MICRA (K13) 1.2
56-01-116	43202-08M02	NISSAN SUNNY II (N13) 1.0 - NISSAN SUNNY II (N13) 1.6 i
56-01-117	432069C000	NISSAN SERENA (C23M) 2.3 D -NISSAN VANETTE CARGO (HC 23) 2.0 D
56-02-204	42431-26181	TOYOTA HIACE IV Wagon (_H1_, _H2_) 2.5 D-4D
56-02-211	42431-02100	TOYOTA COROLLA (_E12U_) 2.0 D-4D
56-02-212	42431-0D010	TOYOTA YARIS (_CP10) 1.0 16V (SCP10_)
56-02-213	42431-47010	TOYOTA PRIUS (NHW11_) 1.5

NEW LINE CAVI FRENO\BRAKE CABLES



ASHIKA CODE	OEM	APPLICATIONS / APPLICAZIONI
131-01-100	36530-4F100	NISSAN MICRA (K11) 1.0 i 16V
131-01-101	36530-00QAC	NISSAN PRIMASTAR Autobus 2.0
131-01-102	36531-00QAC	NISSAN PRIMASTAR Autobus 2.0
131-01-103	3640227000	NISSAN PRIMERA (P11) 2.0 TD
131-01-104	36530-BM700	NISSAN ALMERA II Hatchback (N16) 1.5
131-01-105	1102456	NISSAN PRIMERA (P11) 1.6 16V
131-01-106	1954195	NISSAN TERRANO II (R20) 2.7 TD 4WD
131-01-107	1954197	NISSAN TERRANO II (R20) 2.7 TD 4WD
131-01-108	36531-2F200	NISSAN PRIMERA Traveller (WP11) 1.8 16V
131-01-109	36531-AV600	NISSAN PRIMERA (P12) 1.8
131-01-110	36531-0M810	NISSAN ALMERA I (N15) 1.6
131-01-111	36531-71J10	NISSAN PRIMERA Hatchback (P10) 2.0
131-01-112	36530-71J10	NISSAN PRIMERA Hatchback (P10) 2.0
131-02-200	46420-12390	TOYOTA COROLLA Compact (_E11_) 1.4 (ZZE111_)
131-02-201	46420-10150	TOYOTA STARLET (_P8_) 1.5 D (NP80_)
131-02-202	46420-18030	TOYOTA STARLET (EP91) 1.3
131-02-203	46430-05020	TOYOTA AVENSIS Liftback (_T22_) 2.0 D-4D (CDT220_)
131-02-204	46420-05020	TOYOTA AVENSIS Liftback (_T22_) 2.0 D-4D (CDT220_)
131-02-205	46420-02030	TOYOTA COROLLA Compact (_E11_) 1.4 (ZZE111_)
131-02-206	46430-52010	TOYOTA YARIS (_CP10) 1.0 16V (SCP10_)
131-02-207	46430-20600	TOYOTA AVENSIS Liftback (_T22_) 2.0 D-4D (CDT220_)
131-02-208	46430-05030	TOYOTA AVENSIS Tre volumi (T25) 1.8
131-02-209	46420-52010	TOYOTA YARIS (_CP10) 1.0 16V (SCP10_)
131-02-210	46430-05010	TOYOTA CARINA E Tre volumi (_T19_) 2.0 TD (CT190_)
131-02-211	46420-02090	TOYOTA COROLLA (_E12U_) 1.4 VVT-i
131-02-212	46430-02090	TOYOTA COROLLA (_E12U_) 1.4 VVT-i
131-02-213	46420-05010	TOYOTA CARINA E Tre volumi (_T19_) 2.0 TD (CT190_)
131-02-214	46430-42070	TOYOTA RAV 4 II (XA2) 1.8 VVTi
131-02-215	46420-33100	TOYOTA CAMRY (_V30) 2.4 VVT-i
131-02-216	46430-33100	TOYOTA CAMRY (_V30) 2.4 VVT-i
131-02-217	46420-42070	TOYOTA RAV 4 II (XA2) 1.8 VVTi
131-02-218	46420-05030	TOYOTA AVENSIS Tre volumi (T25) 1.8
131-02-219	46430-02030	TOYOTA COROLLA Compact (_E11_) 1.4 (ZZE111_)
131-02-220	46420-12490	TOYOTA COROLLA Station Wagon (_E12J_) 1.4 VVT-i
131-02-221	46430-12400	TOYOTA COROLLA Station Wagon (_E12J_) 1.4 VVT-i
131-02-222	46420-20480	TOYOTA AVENSIS Liftback (_T22_) 2.0 D-4D (CDT220_)
131-02-223	46420-05030	TOYOTA AVENSIS Tre volumi (T25) 1.8
131-02-224	46420-52080	TOYOTA YARIS (_CP10) 1.0 16V (SCP10_)
131-02-225	46430-52080	TOYOTA YARIS (_CP10) 1.0 16V (SCP10_)
131-02-226	46430-20520	TOYOTA CELICA Cabriolet (_T20_) 2.0 GTi
131-02-227	46430-05020	TOYOTA AVENSIS Liftback (_T22_) 2.0 D-4D (CDT220_)
131-02-228	46420-20520	TOYOTA AVENSIS Liftback (_T22_) 1.6 VVT-i



NEW LINE CAVI FRENO\BRAKE CABLES

NEW CODES
NEUE CODES
NOUVEAUX CODES
NUEVOS CODIGOS
NUOVI CODICI

ASHIKA CODE	OEM	APPLICATIONS / APPLICAZIONI
131-02-229	46430-20580	TOYOTA CELICA (ZZT23_) 1.8 16V VT-i (ZZT230_)
131-03-300	GA5R-44-410A	MAZDA 626 IV (GE) 2.0 D
131-03-301	GA5R-44-420B	MAZDA 626 IV (GE) 2.0 D
131-03-302	BC1D-44-410B	MAZDA 323 V S (BA) 1.6
131-03-303	BC1D-44-420A	MAZDA 323 V S (BA) 1.8
131-03-304	GE4T-44-410B	MAZDA 626 V Hatchback (GF) 1.8
131-03-305	GE4T-44-420B	MAZDA 626 V Hatchback (GF) 1.8
131-03-306	B25D-44-410B	MAZDA 323 VI S (BJ) 1.9 16V
131-03-307	BP4K-44-410J	MAZDA 3 1.6
131-03-308	BP4K-44-420H	MAZDA 3 1.6
131-03-309	G72144150	MAZDA 323 VI S (BJ) 1.9 16V
131-03-310	D001-44-150J	KIA PRIDE (DA) 1.1 i
131-04-400	47560-SR4-931	HONDA CIVIC V Fastback (MB) 1.6 VTi
131-04-401	47510-SR4-931	HONDA CIVIC V Fastback (MB) 1.6 VTi
131-04-402	47560-S1A-E03	HONDA ACCORD VII (CG) 1.8 i
131-04-403	47510-S1A-E03	HONDA ACCORD VII (CG) 1.8 i
131-04-404	47560-S4N-013	HONDA HR-V (GH) 1.6 16V 4WD
131-04-405	47560-SN7-952	HONDA ACCORD V (CC7) 2.0 i
131-04-406	47510-SN7-952	HONDA ACCORD V (CC7) 2.0 i
131-04-407	47510-S04-A01	HONDA ODYSSEY 2.3
131-04-408	47560-S04-A02	HONDA CIVIC V (EJ9, EK3/4) 1.4
131-05-500	MB 858045	MITSUBISHI GALANT VI (EA_) 2.4 GDI
131-05-501	MB 858044	MITSUBISHI GALANT VI (EA_) 2.4 GDI
131-05-502	MR510573	MITSUBISHI SPACE WAGON (N5_W) 2.4 GDI
131-05-503	MR 475555	MITSUBISHI SPACE STAR (DG0) 1.3 16V
131-05-504	MB 950336	MITSUBISHI LANCER VI (CK/P_A) 1.6 16V (CK4A)
131-06-600	6420-87606-000	DAIHATSU FEROZA Soft Top (F300) 1.6 16V
131-08-800	4504100000	SUZUKI SAMURAI (SJ) 1.9 TD
131-08-801	54402-M79G00	SUZUKI ALTO IV (FF) 1.1
131-08-802	54410-60A20	SUZUKI VITARA Cabrio (ET, TA) 1.6 (TA)
131-08-803	54400-70F00	SUZUKI ALTO III (EF) 1.0
131-08-804	54402-64G00	SUZUKI BALENO 2 volumi /Coda spiovente (EG) 1.3
131-08-805	54410-81A00	SUZUKI JIMNY (FJ) 1.3 16V
131-08-806		SUZUKI BALENO Station wagon (EG) 1.6 i 16V
131-08-807	54420-81A00	SUZUKI JIMNY (FJ) 1.3 16V
131-08-808	54410-65D10	SUZUKI GRAND VITARA (FT, GT) 2.5 V6 24V (FT)
131-08-809	54401M79G00	SUZUKI ALTO IV (FF) 1.1
131-08-810	54420-65D10	SUZUKI GRAND VITARA (FT, GT) 2.5 V6 24V (FT)
131-09-900	4509633	CHRYSLER NEON (PL) 1.8 16V
131-0H-H00	59760-17010	HYUNDAI MATRIX (FC) 1.6
131-0H-H01	59770-17010	HYUNDAI MATRIX (FC) 1.6
131-0H-H02	59770-02010	HYUNDAI ATOS PRIME (MX) 1.0 i















NEW LINE CAVI FRENO\BRAKE CABLES



ASHIKA CODE	OEM	APPLICATIONS / APPLICAZIONI
131-0H-H03	59760-27301	HYUNDAI COUPE (RD) 1.6 16V
131-0H-H04	59760-2D310	HYUNDAI ELANTRA (XD) 1.6
131-0H-H05	59770-2C300	HYUNDAI COUPE (GK) 2.0
131-0H-H06	59760-25200	HYUNDAI ACCENT (LC) 1.3
131-0H-H07	59770-25200	HYUNDAI ACCENT (LC) 1.3
131-0H-H08	59760-2C300	HYUNDAI COUPE (GK) 2.0
131-0H-H09	59760-22100	HYUNDAI ACCENT (LC) 1.3
131-0H-H10	59760-22100	HYUNDAI ACCENT (LC) 1.3
131-0H-H11	59770-22100	HYUNDAI ACCENT (LC) 1.3
131-0H-H12	59760-2D310	HYUNDAI ELANTRA (XD) 1.6
131-0H-H13	59770-2D310	HYUNDAI ELANTRA (XD) 1.6
131-0H-H14	59760-02010	HYUNDAI ATOS PRIME (MX) 1.0 i
131-0K-K00	0K205-44-420J	KIA CARENS I (FC) 1.8
131-0K-K01	0K2A-244-410E	KIA CARENS I (FC) 1.8
131-0K-K02	0K56B-44-150	KIA CARNIVAL II 2.5 V6
131-0K-K03	0K56B-44-420	KIA CARNIVAL II 2.5 V6
131-0K-K04	0K56B-44-410	KIA CARNIVAL II 2.5 V6
131-0K-K05	0K30A-44-420H	KIA RIO 1.5
131-0K-K06	0K30A-44-410H	KIA RIO Station wagon (DC) 1.3
131-0K-K07	0K2A-244-410E	KIA CARENS I (FC) 1.8
131-0K-K08	59770-07310	KIA PICANTO 1.1
131-0K-K09	KK153-44-150	KIA PRIDE (DA) 1.3 i
131-0K-K10	0K2A1-44-420D	KIA SHUMA II (FB) 1.6
131-0K-K11	59760-07310	KIA PICANTO 1.1
131-0W-W00	96243462	DAEWOO NUBIRA (KLAJ) 1.6 16V
131-0W-W01	96243463	DAEWOO NUBIRA (KLAJ) 1.6 16V
131-0W-W02	96245829	DAEWOO LANOS Tre volumi (KLAT) 1.6 16V
131-0W-W03	96230545	DAEWOO LANOS Tre volumi (KLAT) 1.6 16V
131-0W-W04	96590791	DAEWOO MATIZ (KLYA) 0.8



EUROPE Crossover

	KW			
DACIA DUSTER <i>i</i> <i>i</i>				
1.5 dCi	63	04.10 →	 60-00-013	NO ABS Imp. LUCAS
1.5 dCi	79	06.10 →		
1.5 dCi	66	10.10 →		
1.6 16V	77	04.10 →		
1.6 16V 4x4	77	06.10 →		
FIAT SEDICI <i>i</i> <i>i</i>				
1.6 16V 4x4	79	06.06 →	 60-08-801	Imp. TRW
1.9 D Multijet	88	06.06 →	 60-08-819	Made in Japan Imp. HITACHI
			 60-08-820	
				 65-08-817  67-08-846
OPEL ANTARA <i>i</i> <i>i</i>				
2.0 CDTI		03.07 →	 60-0W-W10	 61-0W-W04
2.0 CDTI		05.06 →	 60-0W-W12	 61-0W-W05
2.0 CDTI FWD		09.08 →		 65-0W-W06
2.4		05.06 →		
2.4 FWD		09.08 →		
3.2 V6		03.07 →		Parking Brake/Freno staz.

EUROPE Vehicle



	KW			
CITROEN C1				
1.0	50	06.05 →	50-02-217	55-02-212
1.4 HDi	40	06.05 →	60-02-269	56-02-203
				67-02-207
OPEL ASTRA F (56_, 57_)				
1.7 D	42	03.92 → 09.92	50-03-390	55-03-395
1.7 D	44	07.92 → 09.98	60-09-910	56-W0-000
1.7 TD	50	11.94 → 09.98		67-W0-000
1.7 TDS	60	03.92 → 09.98		67-W0-001
OPEL ASTRA F Hatchback (53_, 54_, 58_, 5)				
1.7 D	44	07.92 → 01.98	50-03-390	55-03-395
1.7 D	42	12.91 → 09.92	60-09-910	56-W0-000
1.7 TD	50	11.94 → 01.98		67-W0-000
1.7 TDS	60	12.91 → 01.98		67-W0-001
OPEL ASTRA F Station wagon (51_, 52_)				
1.7 D	44	07.92 → 01.98	50-03-390	55-03-395
1.7 D	42	12.91 → 09.92	60-09-910	56-W0-000
1.7 TD	50	11.94 → 01.98		67-W0-000
1.7 TDS	60	12.91 → 01.98		67-W0-001
OPEL ASTRA J				
1.3 CDTI ecoFLEX	70	12.09 →	50-0W-W12 50-0W-W13	51-0W-W05
1.4 ecoFLEX	64	12.09 →	50-0W-W12	51-0W-W05
1.4 ecoFLEX	74	12.09 →	50-0W-W13	61-0W-W06
1.4 Turbo	103	12.09 →	60-0W-W15	61-0W-W07
1.6	85	12.09 →	60-0W-W16	
1.6 Turbo	132	12.09 →	50-0W-W13	51-0W-W05
1.7 CDTI	92	12.09 →	60-0W-W15	61-0W-W06
1.7 CDTI	81	12.09 →	60-0W-W16	61-0W-W07
2.0 CDTI	118	12.09 →		
OPEL ASTRA Sports Tourer (J)				
1.3 CDTI	70	10.10 →	50-0W-W12	51-0W-W05
1.4	74	10.10 →	50-0W-W13	61-0W-W06
1.4 Turbo	103	10.10 →	60-0W-W15	61-0W-W07
1.6	85	10.10 →	60-0W-W16	
1.4 Turbo	88	10.10 →	50-0W-W12	51-0W-W05
			50-0W-W13	61-0W-W07
			60-0W-W16	
1.6 Turbo	132	10.10 →	50-0W-W13	51-0W-W05
1.7 CDTI	92	10.10 →	60-0W-W15	61-0W-W06
1.7 CDTI	81	10.10 →	60-0W-W16	61-0W-W07
2.0 CDTI	118	10.10 →		



























































EUROPE Vehicle

	KW			
OPEL CAMPO (TF_) <i>i</i> <i>i</i>				
2.6 D (TFR64)	56	08.91 → 06.94	60-09-904	Imp. AKEBONO
2.6 D 4x4 (TFS64)	56	08.91 → 06.94	60-09-909	
2.6 DTI	74	12.01 →		
2.6 TD (TFR64)	56	07.94 →		61-09-900
2.6 TD 4x4 (TFS64)	56	07.94 →		65-09-904
				66-09-902
				67-09-901
OPEL CORSA B (73_, 78_, 79_, F35_) <i>i</i> <i>i</i>				
1.6 D	37	03.93 → 09.00	60-03-390	
1.6 TD	49	03.93 → 09.00	60-09-904	55-09-996
1.7 D	44	02.96 → 09.00	60-09-911	67-W0-001
OPEL CORSA B Furgonato/Box (73_) <i>i</i> <i>i</i>				
1.7 D	44	08.99 → 09.00	60-03-390	
			60-09-904	55-09-996
			60-09-911	67-W0-001
OPEL FRONTERA A (5_MWL4) <i>i</i> <i>i</i>				
2.3 TD (6JMWL4)	74	03.92 → 10.98	60-09-904	Imp. AKEBONO
			60-09-909	55-09-991
				67-09-901
OPEL KADETT E (39_, 49_) <i>i</i> <i>i</i>				
1.6 TD	53	07.88 → 08.91	60-03-390	
			60-09-904	55-09-999
			60-09-911	56-W0-000
				67-W0-000
OPEL KADETT E Hatchback (33_, 34_, 43_) <i>i</i> <i>i</i>				
1.6 TD	53	07.88 → 08.91	60-03-390	
			60-09-904	55-09-999
			60-09-911	56-W0-000
				67-W0-000
OPEL KADETT E Station wagon (35_, 36_, 45_, 46_) <i>i</i> <i>i</i>				
1.6 TD	53	07.88 → 08.91	60-03-390	
			60-09-904	55-09-999
			60-09-911	56-W0-000
				67-W0-000
OPEL MONTEREY A (UBS_) <i>i</i> <i>i</i>				
3.1 TD (UBS69_)	84	09.91 → 07.98	60-09-904	→12.95
3.2 (UBS25_)	130	06.92 → 07.98	60-09-999	Imp. AKEBONO
				01.96→
			60-09-997	Imp. SUMITOMO
				61-09-900
				61-09-997
OPEL VECTRA A (86_, 87_) <i>i</i> <i>i</i>				
1.7 D	44	07.92 → 11.95	60-03-390	
1.7 D	42	10.88 → 09.92	60-09-910	55-09-999
1.7 TD	60	03.90 → 11.95		56-W0-000
				67-W0-001
OPEL VECTRA A Hatchback (88_, 89_) <i>i</i> <i>i</i>				













































EUROPE Vehicle



	KW			
OPEL VECTRA A Hatchback (88_, 89_) <i>i</i> <i>i</i>				
1.7 D	44	07.92 → 11.95	 50-03-390	 55-09-999
1.7 D	42	09.88 → 09.92	 60-09-910	 56-W0-000
1.7 TD	60	03.90 → 11.95		 67-W0-001
OPEL VECTRA B (36_) <i>i</i> <i>i</i>				
1.7 TD	60	10.95 → 12.98	 50-03-390	 55-09-999
			 60-09-910	 67-W0-001
OPEL VECTRA B Hatchback (38_) <i>i</i> <i>i</i>				
1.7 TD	60	10.95 → 12.98	 50-03-390	 55-09-999
			 60-09-910	 67-W0-001
PEUGEOT 107 <i>i</i> <i>i</i>				
1.0	50	06.05 →	 50-02-217	 55-02-212
1.4 HDi	40	06.05 →	 60-02-269	 56-02-203
				 67-02-207
ROVER 200 (RF) <i>i</i> <i>i</i>				
211	44	01.98 → 03.00	 50-04-429	 55-04-410
214 i	55	11.95 → 03.00	 60-04-411	 67-H0-013
214 Si	76	11.95 → 03.00		 67-H0-014
216 Si	82	11.95 → 03.00	 50-04-427	 51-04-404
218 K Vi	107	11.95 → 03.00		 61-04-402
220 D/SD	63	11.95 → 03.00	 50-04-430	 55-04-410
220 SDi	77	11.95 → 03.00	 60-04-498	 67-H0-013
				 67-H0-014
ROVER 200 (XH) <i>i</i> <i>i</i>				
213 S	54	09.85 → 09.89	 50-04-429	 55-04-403
			 60-04-411	 65-04-400 Right/Destra
216	61	03.85 → 09.89	 50-04-430	 51-04-404
216 Vitesse	75	03.85 → 09.89	 60-04-498	 61-04-498
				 55-04-403 03.85→ →04.89
				 67-04-450
				 67-04-451
ROVER 200 Coupe (XW) <i>i</i> <i>i</i>				
216	90	10.92 → 06.99	 50-04-427	 51-04-404 →12.96
				 61-04-498 →12.96
			 50-04-430	 55-04-410
			 60-04-498	
				01.97→ Imp. LUCAS →12.96 →12.96
220 GSi	100	05.94 → 06.99	 50-04-427	 51-04-404
220 Turbo	147	10.92 → 06.99	 50-04-430	 61-04-498
			 60-04-498	
				Imp. LUCAS























































EUROPE Vehicle

	KW					
ROVER 200 Hatchback (XW)						
218 D	52	09.91 → 10.95	 50-04-427	Imp. LUCAS	 51-04-404	
218 TD	65	09.91 → 10.95	 60-04-498		 61-04-498	
220 GTi	100	01.93 → 10.95			 55-04-410	
220 GTi	103	09.91 → 10.95			 67-04-410	
220 Turbo	147	01.93 → 10.95				
214	55	09.93 → 10.95	 50-04-429		 55-04-410	
214 GSi/Si	70	01.90 → 10.95	 60-04-411		 67-04-410	
214 GSi/Si	76	12.92 → 10.95				
214 Si/Gsi	66	10.89 → 10.95				
216 GSi	82	10.89 → 10.95	 50-04-430		 51-04-404	
216 GSi	85	10.89 → 10.95	 60-04-498		 61-04-498	
216 GTi	90	09.90 → 10.95			 55-04-410	
216 GTi	96	09.90 → 10.95			 67-04-410	
ROVER 25 (RF)						
1.1 16V	55	01.04 →	 50-04-427	Imp. LUCAS	 51-04-404	
1.4 16V	76	10.99 →	 60-04-498		 61-04-402	
1.4 16V	62	10.99 →			 55-04-410	
1.6 16V	80	10.99 →				
1.8 16V	107	02.00 →				
1.8 16V	85	10.99 →				
2.0 iDT	74	10.99 →				
ROVER 400 (RT)						
414 Si	76	05.95 → 03.00	 50-04-427	Imp. LUCAS	 51-04-404	
			 60-04-498		 61-04-498	
					 55-04-410	
416 Si	83	05.95 → 03.00	 50-04-427	01.97→	 51-04-404	→12.96
416 Si	82	05.95 → 03.00		Imp. LUCAS	 61-04-498	→12.96
420 D	63	11.95 → 03.00	 50-04-430	→12.96	 55-04-410	→12.96
420 Di	77	05.95 → 03.00	 60-04-498	→12.96		
420 Si Lux	100	12.95 → 03.00				
ROVER 400 (XW)						
414	70	01.93 → 04.95	 50-04-430		 51-04-404	
414 GSI/SI	66	04.90 → 04.95	 60-04-498		 61-04-498	
414 GSI/SI Cat.	76	01.93 → 04.95			 55-04-410	
416 GSI	82	04.90 → 04.95				
416 GSI/GSE	85	04.90 → 04.95				
416 GTI	90	04.90 → 04.95				
416 GTI/GTE	96	04.90 → 04.95				
418 D	49	09.91 → 04.95				
418 TD	65	09.91 → 04.95				
420 GSI/SLI/GTI/Vite	100	01.93 → 04.95	 50-04-430		 51-04-404	
420 GTI/GSI/Vitesse	103	02.92 → 04.95	 60-04-498		 61-04-498	
420 Turbo	147	01.93 → 04.95				
ROVER 400 Hatchback (RT)						

































EUROPE Vehicle





































	KW					
ROVER 400 Hatchback (RT)						
414 Si	76	05.95 → 03.00	 50-04-427	01.97→	 51-04-404	
416 Si	82	05.95 → 03.00		Imp. LUCAS	 61-04-498	
416 Si	83	06.95 → 03.00	 50-04-430	→12.96	 55-04-410	
			 60-04-498			
420 D	63	11.95 → 03.00	 50-04-427	Imp. LUCAS	 51-04-404	
			 60-04-498		 61-04-498	
					 55-04-410	
420 Di	77	05.95 → 03.00	 50-04-427	Imp. LUCAS	 51-04-404	
420 Si Lux	100	12.95 → 03.00	 60-04-498		 61-04-498	
ROVER 400 Tourer (XW)						
1.6 i	90	05.94 → 11.98	 50-04-427	Imp. LUCAS	 51-04-404	
1.6 i	82	05.94 → 11.98	 60-04-498		 61-04-498	
1.8 i	107	06.96 → 11.98			 55-04-410	
1.8 TD	65	09.93 → 11.98				
2.0 i	100	05.94 → 11.98				
ROVER 45 (RT)						
1.4	76	02.00 →	 50-04-427	Imp. LUCAS	 51-04-404	
1.6	80	02.00 →	 60-04-426		 61-04-402	
1.8	86	02.00 →			 55-04-410	
2.0 iDT	74	02.00 →				
2.0 V6	110	02.00 →				
ROVER 45 Tre volumi/Saloon (RT)						
1.4	76	02.00 →	 50-04-427	Imp. LUCAS	 51-04-404	
1.6	80	02.00 →	 60-04-426		 61-04-402	
1.8	86	02.00 →			 55-04-410	
2.0 iDT	74	02.00 →				
2.0 V6	110	02.00 →				
ROVER 800						
820 16V Turbo (RS)	132	01.92 → 02.99	 50-04-427	Imp. LUCAS	 61-04-406	
820 I/SI (RS)	100	01.92 → 02.99	 60-04-421			
825 D/SD (XS)	87	01.90 → 02.99				
825 Si Lux (RS)	129	04.96 → 02.99				
825 SI/Sterling (XS)	127	01.87 → 12.91				
825 SI/Sterling (XS)	123	10.86 → 10.88				
827 SI/Sterling (XS)	130	02.88 → 12.91	 50-04-426		 51-04-405	
827 SI/Sterling (XS)	124	02.88 → 02.99	 60-04-421		 61-04-406	
Cat.						
825 SI/Sterling (XS)	110	10.86 → 12.91	 50-04-427	Imp. LUCAS	 51-04-406	
Cat.			 60-04-421		 61-04-406	
ROVER 800 Coupe						
827 24V (RS)	124	08.92 → 02.99	 50-04-426		 51-04-405	
			 60-04-421		 61-04-406	
825 SD	87	09.93 → 02.99	 50-04-427	Imp. LUCAS	 51-04-406	
825 Si (RS)	129	04.96 → 02.99	 60-04-421		 61-04-406	

















EUROPE Vehicle

























	KW			
ROVER 800 Hatchback <i>i</i> <i>i</i>				
827 24V I/SI (RS) Cat.	124	01.92 → 02.99	 50-04-426  60-04-421	 51-04-405  61-04-406
827 Vitesse (XS) Cat.	124	10.88 → 12.91		
827 Vitesse/SLI	130	10.88 → 12.91		
820 16V Turbo (RS)	132	01.92 → 02.99	 50-04-427  60-04-421	 51-04-406  61-04-406
825 D/SD (XS)	87	01.92 → 02.99		
820 I/SI (XS)	100	01.93 → 02.99	 50-04-427  60-04-418	 51-04-406  61-04-406
ROVER CABRIOLET (XW) <i>i</i> <i>i</i>				
214 1.4	66	01.92 → 11.99	 50-04-427  60-04-498	 51-04-404  61-04-498
214 1.4	70	04.90 → 09.92		
214 1.4i 16V	76	01.93 → 11.99		
216 1.6i	90	01.92 → 11.99		 55-04-410
216 1.6i 16V	82	01.96 → 11.99		
ROVER CITYROVER <i>i</i> <i>i</i>				
1.4	62	01.04 →	 50-04-404  60-00-080	 51-04-404  61-04-402
ROVER COUPE <i>i</i> <i>i</i>				
1.6 16 V	82	03.96 → 11.99	 50-04-427  60-04-498	 51-04-404  61-04-402
1.8 16 V	107	03.96 → 11.99		
ROVER STREETWISE <i>i</i> <i>i</i>				
1.4	76	08.03 →	 50-04-427  60-04-498	 51-04-404  61-04-402
1.4	62	08.03 →		
2.0 TD	74	08.03 →		

	KW				
400 <i>i</i> <i>i</i>					
0.6	4	01.00 →	 60-00-021  60-00-023  60-00-024	 61-00-009  66-00-008  66-00-009	01.06→
500 <i>i</i> <i>i</i>					
0.6 D	10	12.97 →	 60-00-021  60-00-023  60-00-024	 61-00-009  66-00-008  66-00-009	01.06→
A.721 <i>i</i> <i>i</i>					
0.4 D	4	01.05 →	 60-00-021  60-00-023  60-00-024	 61-00-009  66-00-008  66-00-009	01.06→
A.741 <i>i</i> <i>i</i>					
0.4 D	4	01.05 →	 60-00-021  60-00-023  60-00-024	 61-00-009  66-00-008  66-00-009	01.06→
A.751 <i>i</i> <i>i</i>					
0.6 D	10	01.05 →	 60-00-021  60-00-023  60-00-024	 61-00-009  66-00-008  66-00-009	01.06→



















ASIA MOTORS

	KW			
HI-TOPIC (AM 725) i				
2.7 D Trazione posteriore	55	06.93 →	 50-0K-018  60-0K-K13	 55-03-391  56-0K-K03
ROCSTA i				
1.8 i 4x4	57	06.93 →	 50-05-502 Imp. AKEBONO	 55-03-313  55-03-325  67-03-325
2.2 D	45	07.93 → 12.98	 50-05-502 Imp. AKEBONO	 55-03-313
2.2 D 4x4	45	06.93 →		 67-03-325

	KW			
MIDI Autobus i				
1.8	63	09.84 → 05.88	 50-09-902  60-09-903	 55-09-901  56-09-902  67-09-901
2.0	60	09.84 → 08.92		 56-09-902
MIDI Furgonato/Box i				
1.8	63	09.84 → 05.88	 50-09-902  60-09-903	 55-09-901
2.0	62	06.88 → 08.92		 56-09-902
2.0 4WD	62	06.88 → 08.92		 67-09-901
2.0 D	42	08.84 → 05.88		
2.0 D 4WD		06.88 →		
2.0 TD 4WD		06.88 →		
2.2 D	45	06.88 → 08.92		
2.2 D 4WD	45	06.88 → 08.92		
RASCAL Autobus i				
1.0	34	07.86 → 06.90	 50-04-404  60-08-801	Imp. SUMITOMO  55-08-809  67-08-816  67-08-817
				Left/Sinistra Right/Destra
RASCAL Furgonato/Box i				
1.0	34	07.86 → 06.90	 50-04-404  60-08-801	Imp. SUMITOMO  55-08-809  67-08-816  67-08-817
				Left/Sinistra Right/Destra









CADILLAC

	KW			
BLS				
1.9 D	110	04.06 →	 50-00-011	 51-00-005
1.9 D	132	12.07 →	 60-00-009	 61-00-006
2.0 T	154	04.06 →	 60-00-011	 61-00-007
2.0 T	129	04.06 →		
2.8 T	188	04.06 →		
CTS				
2.8	158	03.05 →	 50-00-014	 51-00-006
3.6	189	03.05 →	 60-00-014	 61-00-009
2.8	155	01.08 →	 50-00-014	 51-00-007
3.6	229	01.08 →		
3.6 AWD	229	01.08 →		

CHATENET



	KW			
CH 26				
0.5			 60-00-025	<i>i</i>
CH 30				
0.5			 60-00-025	<i>i</i>



















































CHEVROLET

	KW			
AVEO				
1.2	53	03.06 →	50-W0-007	55-W0-003
1.2	62	04.08 →	60-0W-010	56-W0-007
1.4	74	01.08 →		
1.4	69	03.06 →		
CAMARO 92				
3.4 V6	119	12.92 → 07.98	50-00-098	
5.7 V8	205	12.92 → 07.98		
CAMARO 98				
3.8 V6	142	07.98 →	50-00-098	
5.7	212	07.98 →		
CAMARO 98 Cabriolet				
3.8 V6	142	07.98 →	50-00-098	
CAPTIVA				
2.0 D	110	09.07 →	50-0W-W10	51-0W-W04
2.0 D 4WD	110	10.06 →	60-0W-W12	61-0W-W05
2.4	100	06.06 →		55-0W-W05
2.4 4WD	100	06.06 →		Parking Brake/Freno staz.
3.2 4WD	169	06.06 →		
2.2 D	135	12.10 →	50-0W-W10	51-0W-W04
2.2 D	120	12.10 →	60-0W-W12	61-0W-W05
				55-0W-W05 Parking Brake/Freno staz.
CRUZE				
2.0 CDI	90	05.09 →	50-0W-W13	51-0W-W05
			60-0W-W15 Rim Size/Diam Cerchio:15	61-0W-W06 Rim Size/Diam Cerchio:15
			60-0W-W16 Rim Size/Diam Cerchio:16	61-0W-W07 Rim Size/Diam Cerchio:16
CRUZE (J3000)				
1.6	83	05.09 →	50-0W-W12 Rim Size/Diam Cerchio:15	51-0W-W05 Rim Size/Diam Cerchio:15
			60-0W-W15 Rim Size/Diam Cerchio:15	61-0W-W06 Rim Size/Diam Cerchio:15
			60-0W-W16 Rim Size/Diam Cerchio:16	61-0W-W07 Rim Size/Diam Cerchio:16
1.8	104	05.09 →	60-0W-W15 Rim Size/Diam Cerchio:15	61-0W-W06 Rim Size/Diam Cerchio:15
2.0 CDI	110	05.09 →	60-0W-W16 Rim Size/Diam Cerchio:16	61-0W-W07 Rim Size/Diam Cerchio:16
EPICA				
2.0	98	01.05 → 12.06	50-0W-W09	51-0W-W03
2.0	105	06.06 →	60-0W-W11	61-0W-W04
2.0 D	110	01.07 →		
2.5	115	06.06 →		
EVANDA				
2.0	96	03.05 →	50-W0-005	51-0W-W01
			60-0W-009	61-0W-W02
KALOS				





































CHEVROLET

























































	KW			
KALOS				
1.2	53	03.05 →	 50-W0-007	 55-W0-003
1.4	61	03.05 →	 60-0W-010	 56-W0-006
1.4 16V	69	03.05 →		 56-W0-007
				 67-W0-006
NO ABS con/with ABS				
KALOS Tre volumi/Saloon				
1.4 16V	69	03.05 →	 50-W0-007	 55-W0-003
			 60-0W-010	 56-W0-006
				 56-W0-007
				 67-W0-006
NO ABS con/with ABS				
LACETTI				
1.4 16V	70	03.05 →	 50-W0-005	 51-0W-W02
1.6	80	03.05 →	 60-0W-009	 61-0W-W03
1.8	90	03.05 →		
1.8	89	08.05 →		
2.0 D	89	01.07 →	 50-W0-003	 51-0W-W02
			 60-0W-009	 61-0W-W03
MATIZ				
0.8	38	03.05 →	 50-W0-004	 55-W0-001
1.0	47	03.05 →	 60-0W-004	 56-W0-002
1.0	49	03.05 →		 67-W0-002
NO ABS con/with ABS				
NUBIRA Station wagon				
1.6	80	03.05 →	 50-W0-005	 51-0W-W02
1.8	90	03.05 →	 60-0W-009	 61-0W-W03
1.8	89	08.05 →		
2.0 D	89	01.07 →		
NO ABS con/with ABS				
NUBIRA Tre volumi/Saloon				
1.6	80	03.05 →	 50-W0-005	 51-0W-W02
1.8	90	03.05 →	 60-0W-009	 61-0W-W03
2.0 D		01.05 →		
NO ABS con/with ABS				
ORLANDO				
1.8	104	12.10 →	 50-0W-W13	 51-0W-W05
2.0 D	96	12.10 →	 60-0W-W16	 61-0W-W07
2.0 D	120	12.10 →		Rim Size/Diam Cerchio:16
NO ABS con/with ABS				
REZZO				
1.6	77	03.05 →	 50-W0-005	 55-W0-002
1.6	79	08.05 →	 60-0W-009	 56-W0-003
2.0	89	03.05 →		
2.0	90	08.05 →		
NO ABS con/with ABS				
SPARK				
1.0	50	02.10 →	 50-0W-W14	 55-W0-003
1.2	60	02.10 →	 60-0W-010	 56-0W-W04























CHRYSLER

























	KW				
300 C					
2.7	142	09.04 →	 50-09-911  60-09-914	 51-09-902  61-09-903	
3.0 CRD	160	09.05 →	 50-09-911  50-09-913  60-09-914	Imp. BOSCH	
3.0 V6 CRD	155	11.10 →			 51-09-902  61-09-903
3.5	183	09.04 →			
5.7	250	09.04 →			
300 C Touring					
3.0 CRD	160	09.05 →	 50-09-911  50-09-913  60-09-914	Imp. BOSCH	
3.5	183	09.04 →			 51-09-902  61-09-903
3.5 AWD	183	09.04 →			
5.7	250	09.04 →			
300 M (LR)					
2.7 V6 24V	150	08.00 → 09.04	 50-00-099	 51-00-016	
2.7 V6 24V	149	11.98 → 08.00			
3.5 V6 24V	187	07.98 → 08.00			
3.5 V6 24V	185	08.00 → 09.04			
GS DAYTONA SHELBY Coupe					
2.2 i Turbo	130	10.87 → 10.92	 50-00-060		
2.5 i Turbo	110	01.89 → 10.92			
LE BARON					
2.2 i	69	09.86 → 12.94	 50-00-060	 55-09-914	
2.2 i Turbo	130	09.86 → 01.91			
2.5 i	75	09.86 → 12.94			
2.5 i Turbo	112	01.89 → 12.94			
3.0 i V6	105	01.90 → 12.94			
LE BARON Cabriolet					
2.2 i Turbo	130	09.86 → 12.90	 50-00-060	 55-09-914	
2.2 i Turbo	109	09.86 → 12.90			
2.5 i	75	09.86 → 12.93			
2.5 i Turbo	112	01.89 → 12.93			
3.0 i V6	105	01.90 → 12.96			
NEON (PL)					
1.8 16V	85	09.97 → 08.99	 50-00-099  60-09-995	 51-00-016  61-09-990  55-09-914	
2.0 16V	109	04.96 → 08.99			
2.0 16V	98	05.94 → 08.99			
2.0 16V	107	06.94 → 08.99			
NEON II					
1.6	85	11.01 →	 50-00-099  60-00-001	 51-00-016  61-09-994  55-09-914	
2.0 16V	98	08.99 →			
2.0 16V R/T	110	10.01 →			
PT CRUISER					
2.0	104	06.00 →	 50-00-094  60-09-994	 51-00-016  61-09-994  55-09-913  55-09-915	
2.0	100	10.04 →			
2.2 CRD	89	03.02 →			
2.2 CRD	110	08.05 →			
				NO ABS Parking Brake/Freno staz.	

	KW			
PT CRUISER <i>i</i> <i>i</i>				
2.4	110	06.00 →	 50-00-094	 51-00-016
2.4	105	08.05 →	 60-09-994	 61-09-994
GT 2.4	164	08.03 →		 55-09-915
				Parking Brake\Freno staz.
1.6	85	11.01 →	 50-00-094	 51-00-016
			 60-09-994	 61-09-994
				 55-09-913
				NO ABS
PT CRUISER Cabriolet <i>i</i> <i>i</i>				
2.4	105	03.04 →	 50-00-094	 51-00-016
2.4 GT	164	03.04 →	 60-09-994	 61-09-994
				 55-09-915
				Parking Brake\Freno staz.
SARATOGA <i>i</i> <i>i</i>				
2.5	72	10.89 → 09.91	 50-00-060	 55-H0-005
3.0	105	09.89 → 12.95		
SEBRING <i>i</i> <i>i</i>				
2.0 CRD	103	07.07 →	 50-00-004	 51-05-505
			 60-00-003	 61-09-904
SEBRING (JR) <i>i</i> <i>i</i>				
2.0	104	04.01 →	 50-00-092	 51-00-016
2.4	112	04.01 →	 60-09-996	 61-09-990
2.7 V6 24V	149	04.01 →		 55-09-915
				Parking Brake\Freno staz.
SEBRING Cabriolet (JR) <i>i</i> <i>i</i>				
2.0	104	04.01 →	 50-00-092	 51-00-016
2.4	112	04.01 →	 60-09-996	 61-09-990
2.7 V6 24V	149	04.01 →		 55-09-915
				Parking Brake\Freno staz.
STRATUS (JA) <i>i</i> <i>i</i>				
2.0 LE	96	12.95 → 04.01	 50-00-093	 51-00-016
2.5 LX V6	120	12.95 → 04.01	 60-09-993	 61-09-990
2.5 V6	125	12.95 →	 60-09-996	→12.98 01.99→
2.4 16 V	103	12.95 → 04.01	 50-00-093	 51-00-016
2.4 16V	112	12.95 →	 60-09-993	 61-09-994
2.0 16V	98	12.95 →	 50-00-093	 51-00-016
			 60-09-993	 61-09-990
STRATUS Cabriolet (JX) <i>i</i> <i>i</i>				
2.0 LE	96	06.96 → 04.01	 50-00-093	 51-00-016
2.5 LX	120	04.96 → 04.01	 60-09-993	 61-09-990
			 60-09-996	→12.98 01.99→
VISION <i>i</i> <i>i</i>				
3.5 TSi	155	09.93 →	 50-00-099	



CHRYSLER

	KW					
VOYAGER I (ES)						
2.6 i	72	08.84 → 09.95	 60-00-066	Rim Size\Diam Cerchio:14	 65-00-066	
2.6 i	74	08.90 → 09.95	 60-00-060	10.90→	 67-00-096	
3.0 i	108	08.84 → 09.95	 60-00-096	Rim Size\Diam Cerchio:15	 67-00-097	
3.3 i	110	08.90 → 09.95	 60-00-066	Rim Size\Diam Cerchio:14	 65-00-066	
3.3 i	120	08.90 → 09.95	 60-00-060	10.90→	 67-00-096	
3.3 i AWD	110	08.90 → 09.95	 60-00-096	Rim Size\Diam Cerchio:15	 67-00-097	
3.3 i AWD	120	08.90 → 09.95	 60-00-099			
2.6 TD	87	01.92 → 09.95	 60-00-066	Rim Size\Diam Cerchio:14	 65-00-066	
			 60-00-060	10.90→	 67-00-096	
			 60-00-096	Rim Size\Diam Cerchio:15	 67-00-097	
			 60-00-099	14"		
2.6 D		01.88 → 12.92	 60-00-066	Rim Size\Diam Cerchio:14	 65-00-066	
			 60-00-096		 67-00-097	
			 60-00-099			
VOYAGER II (GS)						
2.0 i	98	01.95 → 03.01	 60-00-099		 61-09-994	01.99→
2.4 i	111	01.95 → 03.01	 60-00-096		 61-09-993	01.99→
					 65-00-097	→12.98
					 66-09-901	Rim Size\Diam Cerchio:15
					 67-00-097	→12.98
3.0	112	01.95 → 03.01	 60-00-099		 61-09-994	
3.3 i	116	01.95 → 03.01	 60-00-096		 61-09-993	
					 65-00-097	
					 66-09-901	Rim Size\Diam Cerchio:15
					 67-00-097	
3.8 i AWD	131	01.95 → 03.01	 60-00-096	con/with ABS	 61-09-994	
3.8 i AWD	122	01.95 → 03.01	 60-09-992		 61-09-993	
					 65-00-097	
					 66-09-901	Rim Size\Diam Cerchio:15
					 67-00-097	
2.6 TD	85	01.95 → 03.01	 60-00-099		 61-09-994	01.96→
			 60-00-096		 61-09-993	
					 65-00-097	
					 66-09-901	Rim Size\Diam Cerchio:15
					 67-00-096	
					 67-00-097	→12.98























































	KW			
VOYAGER II (GS) i				
2.6 TDiC AWD	85	10.95 → 03.01	 60-00-096  60-00-096	 61-09-993  61-09-993  66-00-097  66-09-901
VOYAGER III (RG) i				
2.4	108	02.00 →	 60-00-096  60-09-992	 61-09-993  61-09-993  66-09-911
2.6 CRD	105	02.00 →		
3.3	128	02.00 →		
3.3 AWD	128	02.00 →		
3.8	160	02.00 →		
3.8 AWD	160	02.00 →	con/with ABS	Parking Brake/Freno staz.
2.8 CRD	110	06.04 →	 60-00-002  60-00-002	 61-09-993  61-09-993  66-09-911
VOYAGER IV i				
2.8 CRD	120	10.07 →	 60-09-910  60-09-915	 61-09-906  61-09-906



































	KW			
ARANOS <i>i</i> <i>i</i>				
1.6	66	01.95 → 11.97	60-03-376	66-03-396 NO ABS
2.0	77	01.95 → 11.97	60-0W-006	66-W0-000
1.8	70	01.95 → 11.97	60-0W-006	66-03-396 NO ABS 66-W0-000
ESPERO (KLEJ) <i>i</i> <i>i</i>				
1.6	55	10.97 → 09.99	60-03-376	66-03-396 NO ABS
1.6 16V	66	02.95 → 06.99	60-0W-006	66-W0-000
1.6 16V	65	10.93 → 09.94		67-W0-001
1.8	70	02.95 → 06.99	60-03-376	66-03-396 NO ABS
1.8	66	02.95 → 09.99	60-W0-003 60-0W-006	66-W0-000 67-W0-001
2.0	77	02.95 → 06.99	60-W0-003 60-0W-006	66-03-396 NO ABS 66-W0-000 67-W0-001
2.0	74	10.91 → 09.93	60-W0-002	66-03-396 NO ABS
2.0	81	10.93 → 09.94	60-0W-006	66-W0-000 67-W0-001
EVANDA (KLAL) <i>i</i> <i>i</i>				
2.0	96	08.02 →	60-W0-006 60-0W-009	61-0W-W01 61-0W-W02
FSO Truck Pick Up <i>i</i> <i>i</i>				
1.9 D		01.84 →	60-W0-006	66-01-194 Imp. LUCAS
KALOS (KLAS) <i>i</i> <i>i</i>				
1.2	53	04.03 →	60-W0-007	66-W0-003
1.4	61	09.02 →	60-0W-010	66-W0-006 NO ABS
1.4 16V	69	04.03 →		66-W0-007 con/with ABS 67-W0-006
KORANDO (KJ) <i>i</i> <i>i</i>				
2.3	105	01.99 →	60-09-997	61-09-997 con/with ABS
2.9 D	72	01.99 →	60-0S-000 con/with ABS	61-0S-099
2.9 TD	88	01.99 →		66-0S-S01 Parking Brake/Freno staz.
3.2	156	01.99 →		66-H0-001
KORANDO Cabrio (KJ) <i>i</i> <i>i</i>				
2.9 D	72	02.99 →	60-09-997 60-0S-000 con/with ABS	61-09-997 con/with ABS 61-0S-000 con/with ABS 61-0S-099 66-0S-S01 Parking Brake/Freno staz. 66-H0-001

























































	KW			
KORANDO Cabrio (KJ)				
2.3	105	02.99 →	50-09-997	51-09-997
2.9 TD	88	02.99 →	60-0S-000	61-0S-099
			con/with ABS	con/with ABS
				55-0S-S01
				55-H0-001
				Parking Brake/Freno staz.
2.0 16V	94	02.99 →	50-09-997	51-09-997
			60-0S-000	61-0S-099
			con/with ABS	con/with ABS
				55-0S-S01
				Parking Brake/Freno staz.
LACETTI (KLAN)				
1.4	70	02.04 →	50-W0-005	51-0W-W02
1.6	80	02.04 →	60-0W-009	61-0W-W03
1.8	90	02.04 →		55-0W-W04
LANOS (KLAT)				
1.4	55	05.97 →	50-03-390	55-03-395
1.5	63	05.97 →	60-09-910	56-W0-000
				56-W0-001
				67-W0-000
				NO ABS
1.6 16V	78	05.97 →	50-03-376	55-03-395
			50-W0-003	56-W0-000
			60-0W-005	56-W0-001
				67-W0-001
				NO ABS
				NO ABS
LANOS Tre volumi/Saloon (KLAT)				
1.4	55	05.97 →	50-03-390	55-03-395
1.5	63	05.97 →	60-09-910	56-W0-000
				56-W0-001
				67-W0-000
				NO ABS
1.6 16V	78	05.97 →	50-03-376	55-03-395
			50-W0-003	56-W0-000
			60-0W-005	56-W0-001
				67-W0-001
				NO ABS
				NO ABS
LEGANZA (KLAV)				
1.8 CD	70	06.97 → 07.03	50-W0-005	51-03-398
2.0 16V	98	06.97 → 12.02	60-0W-007	61-0W-001
2.0 16V	93	07.00 →	60-0W-008	
2.2 16V	100	04.99 → 12.02		
LUBLIN II				
2.4 D (3352)	52	04.97 →	50-0W-008	
2.4 TD (3354)	66	04.97 →	60-0W-014	
LUBLIN II Furgonato/Box				
2.4 D (3302)	52	04.97 →	50-0W-008	
2.4 TD (3304)	66	04.97 →	60-0W-014	
2.8 TD		04.97 →		

	KW			
MATIZ (KLYA)				
0.8	38	09.98 →	50-W0-004	55-W0-001
1.0	47	01.03 →	60-0W-004	56-W0-002
				67-W0-002
MUSSO (FJ)				
2.3	103	01.99 →	50-09-997	51-09-997
2.9 TD	88	01.99 →	60-0S-000	61-0S-000
3.2	162	01.99 →	con/with ABS	55-0S-S01
				55-H0-001
2.2 TD	74	09.99 →	50-09-997	51-09-997
2.9 D	73	01.99 → 09.99	60-0S-000	61-0S-099
			con/with ABS	55-0S-S01
				55-H0-001
NEXIA (KLETN)				
1.5	55	02.95 → 08.97	50-03-390	55-03-395
1.5	52	02.95 → 08.97	60-09-910	56-W0-000
1.5	44	08.96 → 08.97		67-W0-000
1.5 16V	66	02.95 → 08.97	50-03-376	55-03-395
			60-0W-005	56-W0-000
				67-W0-001
NEXIA Tre volumi/Saloon (KLETN)				
1.5	55	02.95 → 08.97	50-03-390	55-03-395
1.5	52	02.95 → 08.97	60-09-910	56-W0-000
1.5	44	08.96 → 08.97		67-W0-000
1.5 16V	66	02.95 → 08.97	50-03-376	55-03-395
			60-0W-005	56-W0-000
				67-W0-001
NUBIRA (KLAJ)				
1.6 16V	78	05.97 →	50-W0-003	51-03-398
2.0 16V	98	05.97 →	60-0W-001	61-0W-000
			→12.98	con/with ABS
			01.99→	55-03-395
				56-W0-000
				67-W0-003
NUBIRA Tre volumi/Saloon (KLAJ)				
1.6 16V	78	05.97 →	50-W0-003	51-03-398
2.0 16V	98	05.97 →	60-0W-001	61-0W-000
			→12.98	con/with ABS
			01.99→	55-03-395
				56-W0-000
				67-W0-003

	KW			
NUBIRA Tre volumi/Saloon (KLAJ) i				
1.6 16V	76	07.00 →	 50-W0-003  60-0W-001	 51-03-398  61-0W-000 con/with ABS  55-03-395 NO ABS  56-W0-000  67-W0-003
2.0 16V	93	12.00 →	 50-W0-003  60-0W-013	 51-03-398  61-0W-000 con/with ABS  55-03-395 NO ABS  56-W0-000  67-W0-003
NUBIRA Tre volumi/Saloon (KLAN) i				
1.6 1.8	80 90	07.03 → 07.03 →	 50-W0-003  60-0W-001	 51-03-398  61-0W-000 con/with ABS  61-0W-W03  55-03-395 NO ABS  56-W0-000  67-W0-003
NUBIRA Wagon (KLAJ) i				
1.6 16V 2.0 16V	78 98	05.97 → 05.97 →	 50-W0-003  60-0W-001  60-0W-013	 51-03-398  61-0W-000 con/with ABS  55-03-395 NO ABS  56-W0-000  67-W0-003
1.6 16V 1.6 16V	66 76	06.97 → 12.00 →	 50-W0-002  50-W0-003  60-0W-001  60-0W-013	 51-03-398  61-0W-000 con/with ABS  55-03-395 NO ABS  56-W0-000  67-W0-003
2.0 16V	93	12.00 →	 50-W0-003  60-0W-013	 51-03-398  61-0W-000 con/with ABS  55-03-395 NO ABS  56-W0-000  67-W0-003
NUBIRA Wagon (KLAN) i				
1.6	80	07.03 →	 50-W0-003  60-0W-001	 51-0W-W02  61-0W-W03









	KW				
NUBIRA Wagon (KLAN) <i>i</i> <i>i</i>					
1.8	90	07.03 →	 50-W0-003  60-0W-001	 51-03-398  61-0W-000  61-0W-W03  55-03-395  56-W0-000  67-W0-003	con/with ABS NO ABS
REXTON <i>i</i> <i>i</i>					
3.2 V6	162	04.02 →	 50-0S-S02	 51-09-997	con/with ABS
2.9 TD	88	04.02 →	 50-0S-S02  60-0S-S01	 51-0S-S01  61-0S-099	
TACUMA (KLAU) <i>i</i> <i>i</i>					
1.8	72	09.00 →	 50-W0-005  60-0W-009	 55-W0-002  56-W0-003  67-W0-005	
1.8	67	09.00 →			
1.8	74	09.00 →			
1.8	66	09.00 →			
1.6	77	09.00 →	 50-W0-003  60-0W-009	 55-W0-002  56-W0-003  67-W0-005	
2.0	94	09.00 →			
2.0	89	09.01 →			
1.6 SX	66	08.01 → 12.04	 50-W0-003		
TICO (KLY3) <i>i</i> <i>i</i>					
0.8	38	01.96 → 12.00	 50-W0-000  60-08-800	 55-W0-001	
0.8	35	02.95 → 12.00			































































	KW			
APPLAUSE I (A101, A111)				
1.6 16V (A101)	77	06.89 → 07.97	 50-06-606	 51-06-601
1.6 16V (A101)	66	06.89 → 07.97	 60-06-603	 61-06-602
1.6 16V 4WD (A111)	77	06.89 → 07.97		 55-08-811
				 65-06-615
				 67-06-615
				Left\Sinistra Right\Destra
APPLAUSE II				
1.6 16V	73	07.97 →	 50-06-606	 61-06-602
			 60-06-603	 55-08-811
				 65-06-615
				 67-06-615
				Left\Sinistra Right\Destra
CHARADE I (G10)				
1.0	38	02.81 → 02.83	 50-06-600	 55-06-604
1.0	37	10.77 → 02.81	 60-06-600	 67-06-600
			Imp. SUMITOMO	Right\Destra
CHARADE II (G11, G30)				
1.0 (G11)	38	10.83 → 03.87	 50-06-602	 55-06-603
1.0 D (G30)	27	10.83 → 03.87	 60-06-602	 67-06-606
1.0 TD (G30)	34	02.85 → 03.87		
1.0 Turbo (G11)	50	10.83 → 03.87		
CHARADE III (G100, G101, G102)				
1.0 (G100)	38	03.87 → 12.92	 50-06-697	 55-06-611
1.0 Turbo (G100)	50	03.87 → 10.90	 60-06-604	 56-06-603
				 65-06-609
				 67-06-609
				Left\Sinistra Right\Destra
1.0 D (G101)	27	03.87 → 12.92	 50-06-606	 55-06-611
1.0 TD (G101)	35	03.87 → 12.92	 60-06-604	 56-06-603
				 67-06-606
1.0 (G100)	41	04.89 → 12.92	 50-06-606	 55-06-611
1.0 (G100)	40	11.90 → 12.92	 60-06-604	 56-06-603
1.3 i (G102)	66	06.88 → 12.92		 65-06-609
				 67-06-609
				Left\Sinistra Right\Destra
1.0 GTi (G100)	74	03.87 → 12.92	 50-06-606	 51-06-600
			 60-06-603	 61-06-600
				 55-06-611
				 65-06-609
1.3 i 4WD (G102)	66	06.88 → 01.93	 50-06-606	 55-06-611
			 60-06-604	 65-06-609
				 67-06-609
				Left\Sinistra Right\Destra
1.3	56	09.88 → 01.92	 50-06-606	 55-06-611
			 60-06-604	
CHARADE III Tre volumi/Saloon (G102)				

































































	KW			
CHARADE III Tre volumi/Saloon (G102)				
1.3	66	11.90 → 02.93	50-06-606 60-06-604	55-06-611 56-06-603 65-06-609 67-06-609
				Left\Sinistra Right\Destra
CHARADE IV (G200, G202)				
1.3 16V	62	01.93 → 11.99	50-06-699 60-06-603 60-06-604	55-06-611 56-06-603 65-06-609
1.5 16V	66	01.97 → 11.99	50-06-699 60-06-603	55-06-611 65-06-609
1.6 GTi	77	03.93 → 11.99		
1.3	44	09.96 → 11.99	50-06-699 60-06-603	55-06-611 56-06-603 65-06-609
1.3 16V	55	05.96 → 11.99		
1.0	38	09.94 → 03.96	50-06-699 60-06-604	55-06-611 56-06-603 65-06-609
1.5 HG	55	06.94 → 03.96	50-06-699	
CHARADE IV Tre volumi/Saloon (G203)				
1.5 16V	66	08.94 →	50-06-699 60-06-603	51-03-303 61-06-604 55-06-611 65-06-609 67-06-609
				Left\Sinistra Right\Destra
1.5	55	10.94 →	50-06-699 60-06-603	51-03-303 61-06-603 61-06-604 55-06-611 65-06-609 67-06-609
				Left\Sinistra Right\Destra
CHARMANT (A)				
1.3 (A35)	48	11.81 → 07.87	50-02-287 50-03-310 60-02-212 60-02-247	55-02-206 67-02-206
			09.83→ →08.83	
1.6 (A60)	60	05.86 → 07.87	50-02-287 60-02-247	55-06-601 67-02-208
1.6 (A60)	61	08.83 → 07.87		
1.6 (A60)	57	09.85 → 07.87		
1.6 (A45)	55	12.81 → 09.84	50-03-310 60-02-228	55-06-601 67-02-208
COPEN				

























































	KW				
COPEN <i>i</i> <i>i</i>					
0.7 1.3	50 64	09.03 → 03.06 →	 50-08-809  60-06-618	 55-06-617  67-08-840	con/with ABS
CUORE <i>i</i> <i>i</i>					
1.0	51	04.07 →	 50-08-809  60-06-614	 55-06-615  67-06-630  67-06-631	Right/Destra Left/Sinistra
CUORE I (L55, L60) <i>i</i> <i>i</i>					
0.5 (L55)	20	10.80 → 09.85	 50-06-604  60-06-612	 55-06-604  65-06-600  67-06-600	
0.6 (L60)	22	08.82 → 09.85	 50-06-604  60-06-611	 55-06-604  65-06-600  67-06-600	
CUORE II (L80, L81) <i>i</i> <i>i</i>					
0.8 (L80)	32	09.85 → 06.90	 50-06-605  60-06-609  60-06-619	 55-06-615  67-06-611	
0.8 (L80)	29	11.89 → 12.90			
0.8 4WD (L81)	32	09.86 → 10.88	 50-06-605  60-06-609	 67-06-611	
CUORE III (L201) <i>i</i> <i>i</i>					
0.8	30	10.90 → 12.94	 50-06-610  60-06-619	 67-06-611	
CUORE IV (L501) <i>i</i> <i>i</i>					
0.8	32	01.95 → 11.96	 50-06-605  60-06-609  60-06-619	 55-06-619  67-06-632	→10.95
CUORE V (L5) <i>i</i> <i>i</i>					
0.8	31	11.96 → 10.98	 50-06-605  60-06-609  60-06-619	 55-06-619  67-06-611	
CUORE VI <i>i</i> <i>i</i>					
1.0 i (L701)	41	10.98 → 05.03	 50-06-608  60-06-613	 55-06-617  56-06-600  65-06-608	con/with ABS
1.0	40	11.98 → 09.00		 55-06-619	
CUORE VII <i>i</i> <i>i</i>					



	KW			
CUORE VII <i>i</i> <i>i</i>				
1.0	43	05.03 →	 50-06-609  60-06-614	 55-06-615  56-06-600  67-06-601
FEROZA Hard Top (F300) <i>i</i> <i>i</i>				
1.6 16V	63	10.88 →	 50-06-607	 55-06-607
1.6 i 16V	70	10.88 →	 50-06-698  60-06-601  60-06-607	 56-06-602  65-06-616 Left/Sinistra  67-06-616 Right/Destra
FEROZA Soft Top (F300) <i>i</i> <i>i</i>				
1.6 16V	63	10.88 →	 50-06-607	 55-06-607
1.6 i 16V	70	10.88 →	 50-06-698  60-06-601  60-06-607	 56-06-602  65-06-616 Left/Sinistra  67-06-616 Right/Destra
GRAN MOVE (G3) <i>i</i> <i>i</i>				
1.5 16V (G303)	66	10.96 → 07.98	 50-06-699	 51-03-303
1.6 16V (G301)	67	05.98 →	 60-06-603	 61-06-603  55-06-620
HIJET I Autobus <i>i</i> <i>i</i>				
1.0	33	06.86 → 12.89	 50-06-605  60-06-605  60-06-609	 55-06-604  65-06-608 Left/Sinistra  67-06-608 Right/Destra
0.8	29	06.86 → 12.89	 50-06-605  60-06-609	 55-06-605  55-06-606  65-06-608 Left/Sinistra  67-06-608
HIJET I Furgonato/Box <i>i</i> <i>i</i>				
0.8	29	06.86 → 12.89	 50-06-605  60-06-609	 55-06-605  55-06-606  65-06-608 Left/Sinistra  67-06-608
1.0	33	06.86 → 12.89	 50-06-605  60-06-605  60-06-609	 55-06-604  65-06-608 Left/Sinistra  67-06-608 Right/Destra
1.0 4x4	33	07.86 → 10.90	 50-06-605	 55-06-604
HIJET II Autobus (S85) <i>i</i> <i>i</i>				
1.0 i	35	07.94 → 05.98	 50-06-605  60-06-605  60-06-609	 55-06-604  65-06-607 Left/Sinistra  67-06-607 Right/Destra
HIJET II Furgonato/Box (S85) <i>i</i> <i>i</i>				

	KW			
HIJET II Furgonato/Box (S85) <i>i</i> <i>i</i>				
1.2 D	26	05.95 → 03.98	 50-06-605  60-06-605  60-06-609	 55-06-604  67-05-569
1.0 i	35	07.94 → 05.98	 50-06-605  60-06-605  60-06-609	 55-06-604  65-06-607 Left/Sinistra  67-06-607 Right/Destra
1.0	33	12.92 → 05.98	 50-06-605  60-06-605  60-06-609	 55-06-604
1.3 i 16V	48	05.98 →		 65-06-608 Left/Sinistra
1.4 D	28	03.98 →		 67-06-608 Right/Destra
MATERIA <i>i</i> <i>i</i>				
1.3	67	10.06 →	 50-03-343  60-06-617	 55-06-610
1.5	76	10.06 →		 67-06-630 Right/Destra  67-06-631 Left/Sinistra
MOVE (L6, L9) <i>i</i> <i>i</i>				
0.8	31	10.96 →	 50-06-603  60-06-615	 55-06-619  67-06-632
1.0 i	41	10.98 →	 50-06-615  60-06-614	 55-06-611  55-06-617 con/with ABS  55-06-619 →09.99  56-06-600  67-06-632 NO ABS
ROCKY Hard Top (F7, F8) <i>i</i> <i>i</i>				
2.0	65	02.85 → 04.93	 50-06-601  50-06-698 03.85→  60-06-601 →10.89  60-06-607 →12.88	 55-06-607  56-06-602  65-06-614 Left/Sinistra  65-06-616 →09.89  65-06-616 Left/Sinistra  67-06-614 10.89→  67-06-614 →09.89  67-06-616 Right/Destra  67-06-616 10.89→  67-06-616 Right/Destra
2.8 D	54	02.85 →	 50-06-607  50-06-698  60-06-601  60-06-607	 55-06-607
2.8 TD	67	12.87 → 04.93		 56-06-602  65-06-614 Left/Sinistra  65-06-616 Left/Sinistra  67-06-614 01.90→  67-06-614 Right/Destra  67-06-616 01.90→  67-06-616 Right/Destra





































	KW			
ROCKY Hard Top (F7, F8)				
2.8 TD	72	05.93 →	 50-06-607	 55-06-607
2.8 TD	75	09.91 →	 60-06-601	 56-06-602
			 60-06-607	 65-06-616
				 67-06-616
				Left\Sinistra Right\Destra
2.2		01.92 → 12.93	 50-06-601	 55-06-607
			 60-06-601	 56-06-602
				 65-06-616
				 67-06-616
				Left\Sinistra Right\Destra
2.2 4x4	67	09.91 → 04.93		 56-06-602
ROCKY Soft Top (F7, F8)				
2.0	65	02.85 → 04.93	 50-06-601	 55-06-607
			 50-06-698	 56-06-602
			 60-06-601	 65-06-614
				 65-06-616
				 67-06-614
				 67-06-616
			12.88→ →10.89	Left\Sinistra →09.89 Left\Sinistra 10.89→ →10.89 Right\Destra 10.89→ Right\Destra
2.8 D	54	02.85 →	 50-06-601	 55-06-607
2.8 TD	67	12.87 → 04.93	 50-06-698	 56-06-602
			 60-06-601	 65-06-614
			 60-06-607	 65-06-616
				 67-06-614
				 67-06-616
				Left\Sinistra Left\Sinistra 01.90→ Right\Destra 01.90→ Right\Destra
2.8 TD	75	09.91 →	 50-06-607	 55-06-607
			 50-06-698	 56-06-602
			 60-06-601	 65-06-616
			 60-06-607	 67-06-616
				Left\Sinistra Right\Destra
2.2 4x4	67	09.91 → 04.93	 50-06-601	 55-06-607
			 60-06-601	 56-06-602
				 65-06-616
				 67-06-616
				Left\Sinistra Right\Destra
SIRION				
1.0	51	01.05 →	 50-08-809	 55-06-610
1.5	76	03.08 →	 60-06-614	 67-06-630
				 67-06-631
				Right\Destra Left\Sinistra

















	KW			
SIRION				
1.3	64	01.05 →	50-08-809	55-06-610
1.3	67	03.08 →	60-06-614	67-06-630
1.3 4WD	67	03.08 →	60-06-618	67-06-631
				Right/Destra Left/Sinistra
SIRION (M1)				
1.0 i	43	09.00 → 01.05	50-06-615	55-06-617
1.0 i (M100)	41	04.98 → 09.00	60-06-614	55-06-618
				65-06-608 67-06-618
				con/with ABS Imp. SUMITOMO
1.0 i 4WD	41	04.99 → 09.00	50-06-615	55-06-618
1.0 i 4WD	43	09.00 → 01.05	60-06-614	67-06-618
				Imp. SUMITOMO
0.7 Turbo 4WD	88	09.98 → 01.05	50-06-615	
1.3 Sport	75	08.00 → 01.05	50-06-615	55-06-617
			60-06-614	67-06-618
				con/with ABS
1.3 Sport 4WD	75	08.00 → 01.05	50-06-615	67-06-618
			60-06-614	
1.0	40	04.98 → 10.00	50-06-615	55-06-617
1.3 DVVT 16V	75	02.01 → 04.05	60-06-614	
SPARCAR/BUS WIDE Autobus				
0.8	29	09.83 → 05.86	50-06-605	55-06-602
			60-06-609	55-06-604
				55-06-605
				55-06-606
				65-06-607
				67-06-600
				67-06-607
				Left/Sinistra Right/Destra Right/Destra
1.0	33	09.83 → 05.86	50-06-605	55-06-605
			60-06-609	55-06-606
				65-06-607
				67-06-607
TAFT				
1.6 D 4x4 (F20, F25)	49	09.76 → 02.85	50-06-601	55-06-600
2.5 D 4x4 (F50, F55)	45	08.78 → 08.82	60-06-601	56-06-602
2.8 D 4x4 (F60, F65)	51	08.82 → 02.85		65-06-612
				67-06-612
			10.81→ 10.81→	10.81→ 10.81→ 10.81→ Right/Destra
				Left/Sinistra
TERIOS				
1.5	77	11.05 →	50-05-528	55-02-297
			60-06-610	55-06-601
			60-06-620	67-02-209



	KW			
TERIOS (J1) i				
1.3	63	09.01 → 10.05	50-05-528	55-02-297
1.3 4WD	63	10.00 → 10.05	60-06-610	56-06-601
1.3 4WD	61	10.97 → 10.00		
1.3 DVVT FWD	63	10.02 → 10.05	50-05-528	55-02-297
1.3 DVVT Turbo 4WD	103	10.02 → 10.05	60-06-620	56-06-601
1.5 4WD	77	05.06 →		67-02-209
TREVIS i				
1.0	43	06.06 →	50-06-609	55-06-616
			50-06-612	67-06-632
			60-06-613	
			60-06-614	
WILDCAT/ROCKY (F70) i				
2.8 D	54	02.85 → 03.87	50-06-601	55-06-607
			50-06-698	56-06-602
			60-06-601	65-06-614
			60-06-607	67-06-614
				03.85→
				Left/Sinistra
				Right/Destra
2.8 TD	65	09.85 → 04.87	50-06-601	55-06-607
			60-06-601	56-06-602
			60-06-607	65-06-614
				67-06-614
				Left/Sinistra
				Right/Destra
WILDCAT/ROCKY (F75) i				
2.8 D	54	02.85 → 03.87	50-06-601	55-06-607
			50-06-698	56-06-602
			60-06-601	65-06-614
			60-06-607	67-06-614
				Left/Sinistra
				Right/Destra
2.8 TD	65	09.85 → 04.87	50-06-601	55-06-607
			60-06-601	56-06-602
			60-06-607	65-06-614
				67-06-614
				Left/Sinistra
				Right/Destra
YRV (M2) i				
1.0	43	02.01 →	50-06-615	55-06-617
1.3	64	02.01 →	60-06-614	67-06-618
1.3 GTti	95	07.02 →		
1.3 4WD	64	02.01 →	50-06-615	67-06-618
			60-06-614	
				con/with ABS











	KW			
AVENGER i				
2.0	115	06.07 →	 50-09-912	 51-05-505
2.4	129	06.07 →	 60-00-003	 61-09-904
2.0 CRD	103	06.07 →	 50-09-912	 51-05-505
			 60-00-003	 61-09-904
CALIBER i				
1.8	110	06.06 →	 50-09-912	 51-05-508
2.0	115	06.06 →	 60-00-003	 61-00-002
2.0 CRD	103	06.06 →		 55-09-909 Parking Brake\Freno staz.
JOURNEY i				
2.0 CRD	103	06.08 →	 50-09-910	 51-09-905
			 60-09-915	 61-09-906
				 55-09-909 Parking Brake\Freno staz.
2.4	125	01.09 →	 50-09-910	 51-05-508
			 50-09-912	 51-09-905
			 60-00-003	 61-09-904
				 55-09-909 Parking Brake\Freno staz.
NITRO i				
2.8 CRD	130	06.07 →	 50-09-910	 51-09-901 Imp. GIRLING
2.8 CRD 4WD	130	06.07 →	 60-00-012	 61-00-008
3.7 V6 4WD	151	06.07 →		 55-09-910 Parking Brake\Freno staz.
4.0 V6	191	07.07 →		



	KW			
DR1 <i>i</i> <i>i</i>				
1.3 Ecopower	61	10.09 →	 50-08-813  60-00-020	 55-00-007  56-00-001
DR2 <i>i</i> <i>i</i>				
1.3		06.10 →	 50-08-813  60-00-020	 55-00-007
DR5 <i>i</i> <i>i</i>				
1.6 1.9 D	75 88	06.07 → 06.07 →	 50-00-020  50-00-022  60-00-019  60-00-027	 51-02-256  61-02-221













GASOLONE



	KW			
GASOLONE				
35 2.5 D	59		 60-00-019  60-00-018	 55-00-001
35D11S	81	10.07 →	 60-00-016  60-00-018	 55-00-001
FD29	65	10.07 →		















GONOW

































































	KW			
TROY <i>i</i> <i>i</i>				
1.9 TD 4X4	81	05.06 →	 50-05-585	 51-0H-H03
2.0 16V	93	05.06 →	 60-05-599	 61-0H-005
VICTORY <i>i</i> <i>i</i>				
1.9 TD 4X4	81	05.06 →	 50-05-585	 51-0H-H03
2.0 16V	93	05.06 →	 60-05-599	 61-0H-005

GREAT WALL





























































































































	KW			
HOVER <i>i</i> <i>i</i>				
CUV 2.4	93	01.07 →	 50-00-006  60-00-004	 51-09-999  61-00-003
STEED <i>i</i> <i>i</i>				
2.4	93	01.10 →	 50-00-006  60-00-004	 51-09-999  61-00-003

	KW			
ACCORD I (SJ, SY) i				
1.6 L/EX (SY)	59	01.78 → 09.83	50-04-406	61-04-408 55-04-400 67-04-400
ACCORD I Hatchback (SJ, SY) i				
1.6 L/EX (SJ, SY)	59	01.79 → 09.83	50-04-406	61-04-408 55-04-400 67-04-400
ACCORD II (AC, AD) i				
1.6 EX (AC)	65	09.83 → 10.85	50-04-402 60-04-416	55-04-499 67-04-407
1.8 EX (AD)	74	09.83 → 10.85	50-03-339 60-04-416	51-04-401 61-04-400 55-04-499 67-04-407
1.8 12V		01.85 → 01.87	50-04-423 60-04-416	51-04-404 61-04-400 67-04-407
ACCORD II Hatchback (AC, AD) i				
1.6 EX (AC)	65	09.83 → 10.85	50-03-339 60-04-416	51-04-401 61-04-409 55-04-499 67-04-407
1.8 EX (AD)	74	09.83 → 10.85	50-03-339 60-04-416	51-04-401 61-04-400 55-04-499 67-04-407
ACCORD III (CA4, CA5) i				
1.6 L (CA4)	65	11.85 → 12.89	50-04-424 60-04-416	01.86→ 55-04-499 56-04-403 67-04-452
2.0 EX (CA5)	76	11.85 → 12.89	50-04-423	01.86→ 51-04-404
2.0 EX (CA5)	75	11.85 → 12.89	60-04-416	61-04-402 55-04-499 56-04-403 67-04-452
2.0 EX (CA5)	78	11.85 → 05.89	50-04-423 50-04-426 60-04-416 60-04-418	51-04-404 61-04-402 55-04-499 56-04-403 67-04-452

	KW			
ACCORD III (CA4, CA5)				
2.0 EXi (CA5)	85	01.86 → 12.89	 50-04-426  60-04-418	 51-04-402  61-04-402  55-04-499  56-04-403
2.0 EXi (CA5)	90	11.85 → 12.87	 50-04-424  60-04-416	 51-04-402  61-04-402  55-04-499  56-04-403  67-04-452
2.0 i 16V (CA5)	98	10.87 → 12.89	 50-04-426  60-04-418	 51-04-402  61-04-402  55-04-499
2.0 i 16V (CA5)	101	01.87 → 12.87	 50-04-426  60-04-416  60-04-418	 51-04-402  61-04-402  55-04-499  56-04-403
ACCORD III Aerodeck (CA5)				
2.0 EX	75	10.87 → 12.89	 50-04-423  60-04-416	 55-04-499  56-04-403  67-04-452
2.0 EX (CA5)	78	11.85 → 05.89	 50-04-423  50-04-426  60-04-416 →12.88  60-04-418	 51-04-402  61-04-402  55-04-499  56-04-403  67-04-452
2.0 EXi (CA5)	85	10.87 → 12.89	 50-04-426  60-04-418	 51-04-402  61-04-402  55-04-499  56-04-403  67-04-452
2.0 EXi (CA5)	90	11.85 → 12.87	 50-04-424  60-04-418	 51-04-402  61-04-402  55-04-499  56-04-403  67-04-452
2.0 EX (CA5)	76	10.87 → 12.89	 50-04-424  50-04-426  60-04-418	 51-04-402  61-04-402  55-04-499  56-04-403  67-04-452



	KW			
ACCORD III Aerodeck (CA5) i				
1.6 L (CA4)	65	11.85 → 12.89	 50-04-424  60-04-416	 55-04-499  56-04-403  67-04-407
ACCORD IV (CB3, CB7) i				
2.0 16V (CB3)	66	01.90 → 03.93	 50-04-493  60-04-423	Imp. AKEBONO  51-04-405  61-04-407  55-04-411  65-04-403  67-04-457
2.0 i 16V (CB3)	98	01.90 → 03.93		
2.0 16V (CB3)	81	01.90 → 03.93	 50-04-493  60-04-423	01.92→ Imp. AKEBONO 01.92→  51-04-405  61-04-404  61-04-407  55-04-411  65-04-403  67-04-457
2.2 i 16V (CB7)	110	01.90 → 03.93	 50-04-423  50-04-492  60-04-424	 51-04-402  61-04-407  55-04-411  65-04-403  67-04-457
2.2 i 16V Automatic (CB7)	108	01.90 → 03.93		
ACCORD IV Aerodeck (CB8, CC) i				
2.2 i 16V (CB8)	110	01.91 → 12.93	 50-04-432  60-04-401	 51-04-405  61-04-407  65-04-403  67-04-457
2.2 i 16V (CB8)	108	01.91 → 12.93		
2.0 i 16V (CC9)	98	03.93 → 12.93	 50-04-493  60-04-401  60-04-423  60-04-424	Imp. AKEBONO  51-04-405  61-04-407  65-04-401  67-04-459
ACCORD IV Coupe (CC1) i				
2.0 i 16V	98	01.92 → 09.93	 50-04-493  60-04-423	Imp. AKEBONO  51-04-405  61-04-407  55-04-411  65-04-403  67-04-457
ACCORD IX i				
2.0	115	07.08 →	 50-04-407  60-04-412	 51-04-410  61-04-415
2.2 i-DTEC	110	07.08 →		
2.4	148	07.08 →	 50-04-409  60-04-417	 51-04-445  61-04-416

	KW			
ACCORD Station wagon <i>i</i> <i>i</i>				
2.0	115	07.08 →	 50-04-407	 51-04-410
2.2 i-DTEC	110	07.08 →	 60-04-412	 61-04-415
ACCORD V (CC7) <i>i</i> <i>i</i>				
2.0 i	85	03.93 → 01.96	 50-04-432	 51-04-405
2.0 i S	96	03.93 → 01.96	 50-04-493  60-04-423  60-04-424	Imp. AKEBONO  61-04-407
2.3 i SR	116	03.93 → 01.96	 50-04-432  50-04-493  60-04-424	Imp. AKEBONO  51-04-405  61-04-407
ACCORD V Aerodeck (CE) <i>i</i> <i>i</i>				
2.0 i LS 16V (CE2)	100	09.93 → 02.98	 50-04-432  50-04-493  60-04-401  60-04-424	Imp. AKEBONO  51-04-405  61-04-407
2.2 i ES (CE1)	110	09.93 → 02.98	 50-04-432  60-04-401	 51-04-405  61-04-407
ACCORD V Coupe (CD7, CD9) <i>i</i> <i>i</i>				
2.0 (DC9)	100	09.93 → 12.97	 50-04-432	 51-04-405
2.2 i ES	110	09.93 → 02.98	 60-04-401	 61-04-407
ACCORD VI (CE, CF) <i>i</i> <i>i</i>				
1.9 i (CE7)	85	02.96 → 10.98	 50-04-432	 51-04-405
2.0 i LS (CE8)	96	02.96 → 10.98	 60-04-423	 61-04-407
2.2 i VTEC (CE9)	110	02.96 → 10.98	 50-04-432  60-04-424	 51-04-405  61-04-407
2.0 TDi (CF1)	77	04.96 → 10.98	 50-04-493  60-04-423	Imp. AKEBONO  51-04-405  61-04-407
ACCORD VII (CG) <i>i</i> <i>i</i>				
1.8 i	100	10.98 → 12.02	 50-01-176	 51-04-407
2.0 i	108	10.98 → 01.01	 60-04-404	 61-04-414
2.0 Turbo DI	77	02.99 → 12.02		
2.3	113	01.01 → 12.02		
2.2 Type-R	156	02.99 → 12.02	 50-01-176  50-04-432  60-04-490	 51-04-407  61-04-414  61-04-494
1.6 i	85	10.98 → 12.02	 50-01-176  60-04-404	 51-04-407  61-04-414  55-04-407
2.4 Vtec E	118	02.03 → 09.05	 60-04-428	
ACCORD VII Aerodeck <i>i</i> <i>i</i>				

































	KW			
ACCORD VII Aerodeck <i>i</i> <i>i</i>				
2.3 16 V	118	02.98 →	50-01-176 60-04-404	51-04-407 61-04-414
ACCORD VII Coupe (CG) <i>i</i> <i>i</i>				
2.0 i 16V	108	02.98 → 06.03	50-01-176 60-04-404	51-04-407 61-04-414
3.0 V6 24V	147	02.98 → 06.03		
ACCORD VII Hatchback (CH) <i>i</i> <i>i</i>				
1.8 i (CH6)	100	12.99 → 12.02	50-01-176 60-04-404	51-04-407 61-04-414
2.0 (CH7)	108	12.99 → 12.02		
2.0 TDi	77	12.99 → 10.00		
2.3 (CL4)	113	11.00 → 12.02		
ACCORD VIII <i>i</i> <i>i</i>				
2.0 (CL7)	114	02.03 →	50-04-452 60-04-403	51-04-407 61-04-443
2.0 4 ruote motrici (CL8)	114	02.03 →		
2.2 i-CTDi	103	01.04 →	60-04-420	Rim Size\Diam Cerchio:15
2.4 (CL9)	140	02.03 →	50-04-452 60-04-403 60-04-420 60-04-428	Rim Size\Diam Cerchio:16 Rim Size\Diam Cerchio:15
2.4	113	09.06 →	60-04-428	
ACCORD VIII Tourer <i>i</i> <i>i</i>				
2.0 (CM1)	114	04.03 →	50-04-452 60-04-403 60-04-420	51-04-405 61-04-442
2.2 i-CTDi	103	01.04 →		Rim Size\Diam Cerchio:16 Rim Size\Diam Cerchio:15
2.4 (CM2)	140	04.03 →	50-04-452 60-04-403 60-04-420 60-04-428	51-04-405 61-04-442
				Rim Size\Diam Cerchio:16 Rim Size\Diam Cerchio:15
ACTY TN <i>i</i> <i>i</i>				
0.6	23	08.79 → 06.86	50-04-417 60-04-413	55-04-400
BALLADE EW2 EW3 <i>i</i> <i>i</i>				
1.5 16V		01.83 → 12.89	50-04-413 60-04-411	55-04-403 67-04-453 67-04-454
			01.86→ Imp. SUMITOMO 01.86→	01.86→ 01.86→ Left\Sinistra 01.86→ Right\Destra
CITY Tre volumi/Saloon <i>i</i> <i>i</i>				
1.5 Vtec	65	08.00 → 09.03	50-04-425 60-04-491	

	KW					
CIVIC I (SL)						
1300 L	33	09.80 → 09.83	50-04-404 50-04-406 60-04-402 60-04-406	Imp. SUMITOMO Imp. SUMITOMO	55-04-402 65-04-400 67-04-403	
1300 L	44	09.80 → 09.83	50-04-404 60-04-410	Imp. SUMITOMO Imp. SUMITOMO	55-04-402 67-04-450 67-04-451	Right\Destra Left\Sinistra
1300 S	52	10.79 → 12.84	50-04-413 60-04-410	01.82→ Imp. SUMITOMO 01.82→ Imp. SUMITOMO	55-04-402 67-04-403 67-04-454	Left\Sinistra Right\Destra
CIVIC I Hatchback (SB, SS)						
1200 (SB1)	40	07.72 → 02.77	50-04-400 60-04-400		55-04-400 67-04-400	
1200 (SB2)	40	03.77 → 12.80				
1200 (SB2)	44	09.77 → 12.80				
1300 L (SS)	44	09.79 → 09.83	50-04-404 60-04-410	Imp. SUMITOMO Imp. SUMITOMO	55-04-402 67-04-450 67-04-451	Right\Destra Left\Sinistra
CIVIC I Wagon (WC)						
1300	44	09.79 → 09.83	50-04-406 60-04-410	Imp. SUMITOMO	55-04-402 67-04-450 67-04-451	Right\Destra Left\Sinistra
CIVIC II						
1.2	40	01.85 → 10.87	50-04-413 60-04-411	Imp. SUMITOMO	55-04-496 65-04-400	
1.3	52	10.83 → 10.87	50-04-413 60-04-410 60-04-411	Imp. SUMITOMO Imp. SUMITOMO	55-04-403 65-04-400	
1.5 GL	63	10.83 → 10.87	50-04-413 60-04-411	Imp. SUMITOMO	55-04-409 65-04-400 67-04-403	Right\Destra Left\Sinistra
1.5 GT	74	01.85 → 10.87	50-04-413	Imp. SUMITOMO	55-04-403	
1.5 GTI	66	03.86 → 10.87	60-04-413		65-04-400 67-04-403	
CIVIC II Hatchback (AL, AJ, AG, AH)						
1.2 (AL)	40	01.84 → 10.87	50-04-413 60-04-411	Imp. SUMITOMO	55-04-496 65-04-400	
1.3 (AG)	52	10.83 → 10.87	50-04-413 50-04-414 60-04-410 60-04-411	Imp. SUMITOMO Imp. AKEBONO Imp. SUMITOMO	55-04-403 65-04-400	

	KW			
CIVIC II Hatchback (AL, AJ, AG, AH)				
1.6 GL (AH)	63	10.83 → 10.87	60-04-413 60-04-411	Imp. SUMITOMO 55-04-403 65-04-400 Right\Destra 67-04-403 Left\Sinistra
1.6 GT (AH)	74	01.85 → 10.87	60-04-413 60-04-413	Imp. SUMITOMO 55-04-403 65-04-400 Right\Destra 67-04-403 Left\Sinistra
1.6 GTI (AH)	66	03.86 → 10.87		
CIVIC III Hatchback (EC, ED, EE)				
1.4 L (EC9)	66	10.87 → 12.89	60-04-414 60-04-413	Imp. AKEBONO 55-04-409 65-04-400 Right\Destra 67-04-403 Left\Sinistra
1.6 i 16V (ED7)	80	10.87 → 09.91	60-04-423 60-04-413	51-04-404 61-04-402 55-04-404 65-04-401 67-04-459
1.3 (EC8)	55	10.87 → 12.89	60-04-414 60-04-411	Imp. AKEBONO 55-04-403 65-04-403 67-04-456
1.3 16 V (EC8) Cat.	55	09.89 → 09.91		
1.6 i 16V (ED6)	69	10.88 → 09.91	60-04-414 60-04-419	Imp. AKEBONO 51-04-404 61-04-498 55-04-403 65-04-403 67-04-456
1.6 i 16V (ED7)	81	10.87 → 09.91	60-04-423 60-04-413	51-04-404 61-04-402 55-04-404 65-04-401 67-04-456
1.6 i 16V Vtec (EE9)	110	10.89 → 09.91	60-04-426 60-04-426	51-04-404 61-04-402 55-04-404 65-04-401 67-04-459
1.6 i 16V	96	09.87 → 09.91	60-04-423 60-04-413 60-04-419	51-04-404 01.90→ 61-04-402 55-04-404 65-04-403 67-04-456
1.6 i 16V	66	10.88 → 09.91	60-04-414 60-04-419	Imp. AKEBONO 55-04-403 65-04-403 67-04-456

	KW			
CIVIC III Tre volumi/Saloon (ED)				
1.4 L (ED2)	66	10.87 → 12.89	 50-04-414 60-04-413	Imp. AKEBONO 55-04-409 65-04-400 67-04-403
1.6 i 16V	96	09.87 → 09.91	 50-04-423 60-04-413	 55-04-404 65-04-403 67-04-456
1.6 i 16V (ED4)	80	11.87 → 09.91		
1.6 i 16V 4x4	80	10.89 → 09.91		
1.5 i 16V	66	10.87 → 09.91	 50-04-414 60-04-419	Imp. AKEBONO 55-04-403 65-04-403 67-04-456
1.5 i 16V (ED3)	69	10.87 → 09.91		
1.6 i 16V (ED4)	81	10.87 → 09.91	 50-04-423 60-04-413 60-04-426	 55-04-404 65-04-403 67-04-456
1.3	55	10.87 → 12.89	 50-04-414 60-04-411	Imp. AKEBONO 55-04-403 65-04-403 67-04-456
CIVIC IV (EG, EH)				
1.5 i 16V (EG8)	69	10.91 → 11.95	 50-04-425 50-04-435 60-04-499	Imp. AKEBONO 51-04-404 61-04-402 55-04-403 55-04-412 56-04-403 65-04-403 67-04-456
1.6 16V Vtec (EH9)	92	10.91 → 11.95	 50-04-435 60-04-426 60-04-499	Imp. AKEBONO 51-04-404 61-04-402 61-04-409 56-04-403
1.6 VTi (EG9)	118	10.91 → 11.95	 50-04-435 60-04-423 60-04-426 60-04-499	Imp. AKEBONO 51-04-404 61-04-402
CIVIC IV Coupe (EJ)				
1.6 i Vtec	118	01.94 → 11.95	 50-04-435 60-04-426	Imp. AKEBONO 55-04-494 56-04-403 65-04-403 67-04-456
1.6 i Vtec (EJ1)	92	01.94 → 03.96		
1.5 i LSi (EJ2)	74	01.94 → 11.95	 50-04-435 60-04-499	Imp. AKEBONO 55-04-494 56-04-403 65-04-403 67-04-456
1.6 i (EJ6)	77	01.94 → 11.95		



	KW			
CIVIC IV Fastback (MA, MB)				
1.6 i (MB1)	83	09.94 → 01.97	 50-04-427	Imp. LUCAS
1.6 i Vtec (MB1)	93	09.94 → 01.97	 60-04-426	
1.4 i (MA8)	66	09.94 → 01.97	 50-04-427	01.95→
1.4 i (MA8)	55	09.95 → 01.97		Imp. LUCAS
1.5 i Vtec-E (MA9)	66	09.94 → 01.97	 60-04-426	
CIVIC IV Hatchback (EG)				
1.3 16V (EG3)	55	10.91 → 11.95	 50-04-414	Imp. AKEBONO
			 60-04-411	
			 60-04-413	
1.5 i 16V (EG4)	69	10.91 → 11.95	 50-04-425	Imp. AKEBONO
			 50-04-435	
			 60-04-499	
1.6 16V Vtec (EG5)	92	10.91 → 11.95	 50-04-435	Imp. AKEBONO
			 60-04-426	
			 60-04-499	
1.6 VTi 16V (EG6)	118	10.91 → 11.95	 50-04-435	Imp. AKEBONO
			 60-04-423	
			 60-04-426	
			 60-04-499	
1.5 i 16V	66	10.91 → 11.95	 50-04-435	Imp. AKEBONO
			 60-04-499	
CIVIC Shuttle I (AN, AR)				
1.5 (AN)	63	10.83 → 10.87	 50-04-416	
			 60-04-411	
1.5 4WD (AR)	63	01.85 → 10.87	 50-04-413	Imp. SUMITOMO
			 60-04-411	
CIVIC Shuttle II (EE)				
1.6 16V 4WD D16Z2		01.90 →	 50-04-423	
1.6 i 16V 4WD (EE4)	81	01.88 → 02.95	 60-04-419	
1.6 i 16V 4WD (EE4)	80	01.88 → 12.89		
1.4 i 16V (EE1)	66	01.88 → 12.92	 50-04-423	
1.5 i 16V (EE2)	69	01.88 → 11.91	 50-04-442	
			 60-04-419	

	KW			
CIVIC Shuttle II (EE) i i				
1.6 4x4	85	01.88 → 12.92	50-04-423 60-04-419	55-04-409 67-04-455
CIVIC V (EJ9, EK3/4) i i				
1.4 i (EJ9)	66	11.95 → 02.01	50-04-435 60-04-426 60-04-499	Imp. AKEBONO 55-04-410 56-04-403 65-04-403 67-04-456
1.5 i (EK3)	84	11.95 → 02.01	50-04-435 60-04-423	Imp. AKEBONO 51-04-404 61-04-402 55-04-499 56-04-403 65-04-403 67-04-456
1.6 VTi (EK4)	118	11.95 → 02.01	50-04-435 60-04-423 60-04-426	Imp. AKEBONO 51-04-404 61-04-402
1.6 i Vtec	92	11.95 → 02.01	50-04-435 60-04-423 60-04-426	Imp. AKEBONO 51-04-404 61-04-402 56-04-403
CIVIC V Coupe (EJ6, EJ8) i i				
1.6 i	77	03.96 → 03.00	50-04-435 60-04-426	Imp. AKEBONO 55-04-499 56-04-403
1.6 i Vtec	92	03.96 → 03.00		
1.6 i Vtec	118	04.99 → 12.00		
1.6	77	05.96 → 04.99		56-04-403
CIVIC V Fastback (MB) i i				
1.4 16V (MB2)	66	01.97 → 02.01	50-04-414 50-04-423 50-04-427 60-04-413	Imp. AKEBONO Imp. LUCAS 61-04-495 55-04-410 56-04-403 65-04-400 67-04-403
1.4 16V (MB2)	55	01.97 → 02.01		Right\Destra Left\Sinistra
1.5 16V (MB3)	84	01.97 → 02.01	50-04-425 60-04-426	51-04-404 61-04-402 61-04-495 55-04-410 56-04-403 65-04-403 67-04-456
1.6 16V (MB4)	85	01.97 → 02.01	50-04-427 60-04-426	Imp. LUCAS 51-04-404 61-04-402 61-04-495



















































	KW			
CIVIC V Fastback (MB) <i>i</i> <i>i</i>				
1.8 16V (MB6)	124	01.97 → 02.01	50-04-432 60-04-423	51-04-405 61-04-407
2.0 i TD (MB7)	63	01.97 → 02.01	50-04-427 60-04-426	11.98→ Imp. LUCAS 51-04-404 61-04-402 55-04-410
1.6 VTi	118	01.97 → 02.01	50-04-435 60-04-423 60-04-426	Imp. AKEBONO 51-04-404 61-04-402
CIVIC VI <i>i</i> <i>i</i>				
1.7	85	02.01 → 09.05	50-04-489 60-04-492	01.02→ 01.02→ 51-04-405 61-04-495
1.3 IMA	61	01.04 → 09.05	50-04-427	Imp. LUCAS 51-04-405
1.6	81	02.01 → 09.05	50-04-435	Imp. AKEBONO 61-04-495
1.6	84	09.05 → 09.05	60-04-426	
1.4 (ES4)	66	02.01 → 09.05	50-04-435 60-04-426	Imp. AKEBONO 55-04-411 56-04-415 67-04-403 67-04-436
				Right\Destra Left\Sinistra
CIVIC VI Aerodeck (MB,MC) <i>i</i> <i>i</i>				
1.4 16V (MB8)	66	04.98 → 02.01	50-04-427	Imp. LUCAS 51-04-404 61-04-495 55-04-410 56-04-402 65-04-403 67-04-456
1.4 16V (MB8)	55	04.98 → 02.01	60-04-426	Right\Destra Left\Sinistra
1.5 16V (MB9)	84	04.98 → 02.01	50-04-427 60-04-426	Imp. LUCAS 51-04-405 61-04-402 55-04-410 56-04-402 65-04-403 67-04-456
1.6 16V (MC1)	85	04.98 → 02.01	50-04-427 60-04-426	Imp. LUCAS 51-04-404 61-04-402 61-04-495
1.8 16V (MC2)	124	04.98 → 02.01	50-04-432 60-04-426	51-04-405 61-04-407 56-04-403
2.0 i D (MC3)	77	04.98 → 02.01	50-04-427 60-04-426	Imp. LUCAS 51-04-404 61-04-402
CIVIC VI Coupe (EM) <i>i</i> <i>i</i>				



























































	KW					
CIVIC VI Coupe (EM) i						
1.6 i	81	02.01 → 12.05	50-04-427 50-04-435 60-04-426	01.03→ Imp. LUCAS →12.02 Imp. AKEBONO	51-04-405 61-04-495	
1.7 i 1.7 i VTEC	88 92	05.01 → 12.05 05.01 → 12.05	50-04-435 60-04-426	Imp. AKEBONO	51-04-405 61-04-495	
CIVIC VI Hatchback (EJ,EK) i						
1.4 i (EJ9)	55	11.95 → 02.01	50-04-435 60-04-499	Imp. AKEBONO	61-04-402 55-04-410 65-04-403 67-04-456	Right\Destra Left\Sinistra
1.4 i S (EJ9)	66	11.95 → 02.01	50-04-435 60-04-499	Imp. AKEBONO	55-04-410 56-04-403 65-04-403 67-04-456	
1.6 i (EK1)	84	11.95 → 02.01	50-04-435 60-04-426	Imp. AKEBONO	51-04-404 55-04-412 56-04-403	
1.5 i (EK3)	84	11.95 → 02.01	50-04-435 60-04-423	Imp. AKEBONO	51-04-404 61-04-402 55-04-499 56-04-403 65-04-403 67-04-456	
1.6 VTi (EK4)	118	11.95 → 02.01	50-04-435 60-04-423 60-04-426	Imp. AKEBONO	51-04-404 61-04-402	
CIVIC VI Hatchback (EU_, EP_) i						
1.4 i 1.4 iS (EP1)	55 66	02.01 → 09.05 02.01 → 09.05	50-04-435 60-04-426	Imp. AKEBONO	55-04-411 56-04-415 67-04-403 67-04-436	Right\Destra Left\Sinistra
1.6 i	81	02.01 → 09.05	50-04-427 50-04-435 60-04-426	01.03→ Imp. LUCAS →12.02 Imp. AKEBONO	51-04-405 61-04-495	
2.0 Type-R	147	09.01 → 09.05	50-04-490 60-04-433		51-04-405 61-04-446	

	KW			
CIVIC VI Hatchback (EU_, EP_) <i>i</i> <i>i</i>				
1.7 CTDi	74	01.02 → 09.05	50-04-489 60-04-434 60-04-492	01.05→ 51-04-405 61-04-446 61-04-495
2.0 i Sport	118	01.04 → 09.05	50-04-491 60-04-494	51-04-405 61-04-446
CIVIC VII <i>i</i> <i>i</i>				
1.3	70	01.06 →	60-0K-005	51-04-405 61-04-412
1.4	61	01.06 →	50-04-403	51-04-403
1.8	103	01.06 →	60-04-407	61-04-412
2.2 CTDi	103	01.06 →		
1.8	103	09.05 →	50-04-491 60-04-494	51-04-405 61-04-412
CIVIC VII Hatchback <i>i</i> <i>i</i>				
Type R	148	09.06 →	50-04-490	51-04-403 61-04-412
1.4	73	10.08 →	50-04-403	51-04-403 61-04-412
CONCERTO (HW) <i>i</i> <i>i</i>				
1.5 i 16V	66	08.89 → 03.95	50-04-427 60-02-252	08.91→ →12.94 Imp. LUCAS 51-04-404 61-04-402 55-04-410 56-04-402 67-04-410
1.6 i 16V	90	08.89 → 03.95	50-04-427	Imp. LUCAS 51-04-404
1.6 i 16V	82	08.89 → 03.95	60-04-498	61-04-402
1.4	66	08.89 → 10.91	50-04-427	01.90→ →07.91 Imp. LUCAS 55-04-410 56-04-402 67-04-410
1.4	61	10.89 → 10.92	60-02-252 60-04-498	
1.6 16V	78	08.89 → 03.95	50-04-427 60-02-252	Imp. LUCAS 51-04-404 61-04-402
1.8 TD	65	08.94 → 10.96	50-04-427	Imp. LUCAS 61-04-402
1.8 TD	58	08.94 → 10.96	60-04-498	55-04-410
CONCERTO Tre volumi/Saloon <i>i</i> <i>i</i>				
1.4	66	08.89 → 10.91	50-04-427	Imp. LUCAS 55-04-410
1.4	61	10.89 → 10.92	60-02-252 60-04-498	56-04-402 67-04-410

















































	KW			
CONCERTO Tre volumi/Saloon <i>i</i> <i>i</i>				
1.6 i 16V	66	08.89 → 05.95	60-04-427 60-02-252	08.91→ →12.94 Imp. LUCAS 61-04-404 61-04-402 66-04-410 66-04-402 67-04-410
1.6 i 16V	90	08.89 → 03.95	60-04-427 60-04-498	Imp. LUCAS 61-04-404 61-04-402
1.6 16V	78	08.89 → 03.95	60-04-427 60-02-252	Imp. LUCAS 61-04-404 61-04-402
CR-V I (RD) <i>i</i> <i>i</i>				
2.0 16V (RD1, RD3)	108	01.99 → 02.02	60-04-432 60-04-496	66-04-411 66-04-400 67-04-460 67-04-461
2.0 16V (RD1, RD3)	94	10.95 → 01.99		Left/Sinistra Right/Destra
CR-V II <i>i</i> <i>i</i>				
2.0	110	07.02 → 09.06	60-04-401 60-04-431 60-04-494 60-0K-007	61-04-406 61-04-441 66-04-406
				Parking Brake/Freno staz.
2.2 CTDi	103	02.05 → 09.06	60-04-401 60-04-403 60-04-431	61-04-446 61-04-444 66-04-406
				Parking Brake/Freno staz.
2.0 i-VTEC	110	01.07 →	60-04-406 60-04-406	61-04-400 61-04-444
2.2 i-CTDi	103	01.07 →		
CRX I (AF, AS) <i>i</i> <i>i</i>				
1.6 i (AF)	74	10.83 → 11.86	60-04-413 60-04-414 60-04-411 60-04-413	Imp. SUMITOMO Imp. AKEBONO 66-04-403 66-04-400 67-04-403
				Right/Destra Left/Sinistra
1.6 i 16V (AS)	92	03.86 → 10.87	60-04-424 60-04-413	66-04-403 66-04-400 67-04-403
				Right/Destra Left/Sinistra
1.3	52	10.83 → 10.87	60-04-413	Imp. SUMITOMO
CRX II (ED, EE) <i>i</i> <i>i</i>				
1.6 i 16V (ED9)	96	10.87 → 12.89	60-04-423 60-04-424 60-04-419	61-04-404 61-04-402
1.6 i 16V (ED9)	91	10.87 → 02.92	60-04-423 60-04-419	61-04-404 61-04-402



	KW			
CRX II (ED, EE)				
1.6 i 16V Vtec (EE8)	110	10.89 → 02.92	 50-04-426  60-04-426	 51-04-404  61-04-402
1.6 i 16V	79	10.87 → 05.88	 60-04-419	 51-04-404  61-04-402
CRX III (EH, EG)				
1.6 ESi (EH6)	92	03.92 → 12.98	 50-04-435  60-04-426	Imp. AKEBONO  51-04-404  61-04-409  55-04-412  65-04-403  67-04-456
				Right\Destra Left\Sinistra
1.6 i VTi (EG2)	118	03.92 → 12.98	 50-04-435  60-04-426	Imp. AKEBONO  51-04-404  61-04-402  55-04-412  65-04-403  67-04-456
				Right\Destra Left\Sinistra
FR-V				
2.2 i CTDi	103	07.05 →	 50-04-491  60-04-432	 51-04-405  61-04-496  55-04-408
				Parking Brake\Freno staz.
1.7	92	02.05 →	 50-04-491	 51-04-405
1.8	103	01.07 →	 60-04-494	 61-04-496
2.0	110	02.05 →		 55-04-408
				Parking Brake\Freno staz.
HR-V (GH)				
1.6 16V	77	03.99 →	 50-04-432	 55-04-410
1.6 16V 4WD	77	03.99 →	 60-04-496	 56-04-400
1.6 16V 4WD	91	10.99 →		 65-04-403  67-04-456
INSIGHT				
1.3	65	04.09 →	 50-04-410  60-04-426	 51-04-405  61-04-418
INSIGHT (ZE)				
1.0	56	04.00 → 12.06	 50-04-411  60-04-413	 56-04-404
INTEGRA				
2.0	118	02.02 →	 50-04-432  60-04-433	 51-04-405
INTEGRA (DA_)				



	KW				
INTEGRA (DA_) i					
1.6	63	10.85 → 08.89	 60-04-424  60-04-413  60-04-419	 61-04-402  61-04-498  66-04-409  66-04-400  67-04-403	Right\Destra Left\Sinistra
1.6	88	03.86 → 08.89	 60-04-424  60-04-419	 61-04-402  61-04-498	
INTEGRA (DC2) i					
1.8 Type-R	140	11.97 → 10.01	 60-04-432  60-04-496	 61-04-404  61-04-406  61-04-419	→10.00
JAZZ i					
1.2	66	07.08 →	 60-04-410	 61-04-404	
1.4	73	07.08 →	 60-04-426	 61-04-417	
JAZZ (AA) i					
45 1.2	33	02.84 → 10.86	 60-04-417	 66-04-402	
66 1.2	40	09.84 → 10.86	 60-04-416	 67-04-403  67-04-464	
66 1.2	41	10.83 → 10.86	 60-04-417  60-04-416	 66-04-404  67-04-403  67-04-464	Left\Sinistra Right\Destra
JAZZ (GD) i					
1.2	57	03.02 →	 60-04-426	 61-04-404	
1.4	61	03.02 →	 60-04-426  60-04-491	 61-04-409  66-04-493  67-04-436	01.05→
LEGEND I (HS, KA) i					
2.6 i (HS)	110	01.86 → 12.87	 60-04-428	 61-04-406	
2.6 i (HS)	127	02.87 → 06.88	 60-04-422	 61-04-406	
2.7 i 24V (KA4)	124	01.88 → 12.90	 60-04-426  60-04-421	 61-04-406  61-04-406	
LEGEND I Coupe (KA3) i					
2.7 i 24V	124	10.87 → 12.90	 60-04-426  60-04-421	 61-04-406  61-04-406	
LEGEND II (KA7) i					
3.2 i 24V	151	01.91 → 02.96	 60-04-432  60-04-429	 61-04-406  61-04-411	
LEGEND II Coupe (KA8) i					

	KW			
LEGEND II Coupe (KA8) i				
3.2 i 24V	151	01.91 → 02.96	50-04-432 60-04-429	51-04-405 61-04-411
LEGEND III (KA9) i				
3.5 i 24V	151	02.96 →	50-04-432 60-04-490	51-04-405 61-04-411 61-04-419 61-04-420
LOGO (GA3) i				
1.3	48	03.99 → 03.02	50-04-425 60-04-493	55-04-410 56-04-403
NSX Cabriolet (NA) i				
3.0 24V Vtec	201	03.95 → 09.05	50-04-432 60-04-429	51-04-499 61-04-402
3.0 24V Vtec Automatic	188	03.95 → 09.05		
3.2 24V Vtec	206	01.97 → 09.05		
NSX Coupe (NA) i				
3.0 24V Vtec (NA1)	201	06.90 → 09.05	50-04-432 60-04-429	51-04-499 61-04-402
3.0 24V Vtec Automatic (NA1)	188	06.90 → 09.05		
3.2 24V Vtec (NA2)	206	01.97 → 09.05		
PRELUDE I Coupe (SN) i				
1.6	59	11.78 → 10.82	50-04-412 60-04-409 60-04-410	51-04-401 61-04-401 55-04-406 67-04-406
PRELUDE II (AB) i				
1.8 EX	77	11.83 → 04.87	50-04-414 60-04-414	51-04-401 61-04-400 61-04-401
1.8 EX	74	11.85 → 04.87		
PRELUDE III (BA) i				
2.0 EX (BA4)	80	04.87 → 01.92	50-04-423 60-04-418	51-04-404 61-04-402
2.0 i EX 16V	101	04.86 → 12.87	50-04-421 60-04-418	51-04-402 61-04-400
2.0 i EX 16V (BA2)	101	04.86 → 12.87		
2.0 i EX 16V (BA4)	103	04.90 → 01.92	50-04-426 60-04-418	51-04-404 61-04-402
2.0 i EX 16V (BA4) Cat.	101	04.87 → 01.92		

	KW			
PRELUDE III (BA) <i>i</i> <i>i</i>				
2.0 (BA4)	84	08.87 → 01.92	 50-04-423  50-04-426  60-04-418	 51-04-404  61-04-402
2.0 i EX 16V	110	10.87 → 12.90	 50-04-426  60-04-416	 51-04-404  61-04-402
PRELUDE IV (BB) <i>i</i> <i>i</i>				
2.0 i 16V (BB3)	98	02.92 → 09.96	 50-04-493  60-04-430	Imp. AKEBONO  51-04-405  61-04-404
2.3 i 16V (BB2)	118	02.92 → 09.96	 50-04-432  60-04-427	 51-04-405  61-04-404
2.2 i 16V Vtec (BB1)	136	02.93 → 09.96	 50-04-432  60-04-430	 51-04-405  61-04-404
PRELUDE V (BB) <i>i</i> <i>i</i>				
2.0 16V (BB9)	98	10.96 → 10.00	 50-04-493  60-04-430	Imp. AKEBONO  51-04-405  61-04-413
2.2 16V	147	10.96 → 10.00	 50-04-432	 51-04-405
2.2 16V (BB6, BB8)	136	10.96 → 10.00	 60-04-427	 61-04-410
QUINTET (SU) <i>i</i> <i>i</i>				
1.6 EX	59	02.80 → 12.84	 50-04-412  60-04-410	Imp. SUMITOMO  55-04-402  67-04-450  67-04-451
S2000 (AP) <i>i</i> <i>i</i>				
2.0	177	06.99 →	 50-04-490  60-04-495	01.02→ 01.02→  51-04-405  61-04-497
SHUTTLE (RA) <i>i</i> <i>i</i>				
2.2 16V	110	10.94 → 02.98	 50-04-432	 51-04-405
2.3 16V	110	10.97 → 06.02	 60-04-496	 61-04-411
STREAM (RN) <i>i</i> <i>i</i>				
1.7 16V	92	05.01 →	 50-04-491	 51-04-405
2.0 16V	115	05.01 →	 60-04-494	 61-04-496  55-04-408
Parking Brake\Freno staz.				











































































































HUMMER

	KW			
HUMMER H2 <i>i</i> <i>i</i>				
6.0 4 ruote motrici	232	09.02 → 09.04	 50-00-009  60-00-008	 51-00-004  61-00-005  55-00-004 Parking Brake\Freno staz.
HUMMER H2 SUT <i>i</i> <i>i</i>				
6.0	237	09.04 →	 50-00-009  60-00-008	 51-00-004  61-00-005  55-00-004 Parking Brake\Freno staz.
HUMMER H3 <i>i</i> <i>i</i>				
3.5	162	04.05 →	 50-00-008  60-00-007	 51-00-003  61-00-004  55-00-006 Parking Brake\Freno staz.
3.7 4 ruote motrici	180	09.06 →	 50-00-008  60-00-007	 51-00-003  61-00-004

	KW					
ACCENT (LC) i						
1.3	61	01.00 →	60-03-339 60-0H-016	66-H0-013 66-H0-013 67-H0-013 67-H0-014	Left\Sinistra Right\Destra	
1.3	63	01.00 →				
1.3	55	01.00 →				
1.3	62	08.02 →				
1.5	66	01.00 →				
1.5	75	09.00 →				
1.5 CRDi	60	04.02 →				
1.6	77	12.02 →				
ACCENT (MC) i						
1.4 GL	71	11.05 →	60-0K-K12 60-0K-K18	Imp. MANDO	61-0K-K09 61-0H-001 66-0K-K18 67-K0-008	Parking Brake\Freno staz.
1.5 CRDi GLS	81	11.05 →				
1.6 GLS	82	11.05 →	60-0K-K12 60-0K-K18	Imp. MANDO	61-0K-K09 61-0H-001 66-0K-K18	Parking Brake\Freno staz.
ACCENT Tre volumi/Saloon (LC) i						
1.3	63	01.00 →	60-03-339 60-0H-016		66-H0-013 66-H0-013 67-H0-013 67-H0-014	Left\Sinistra Right\Destra
1.3	55	01.00 →				
1.5	66	01.00 →				
1.5 CRDi	60	01.02 →				
1.6	77	12.02 →				
ACCENT Tre volumi/Saloon (MC) i						
1.4 GL	71	11.05 →	60-0K-K12 60-0K-K18	Imp. MANDO	61-0K-K09 61-0H-001 66-0K-K18 67-K0-008	Parking Brake\Freno staz.
1.5 CRDi GLS	81	11.05 →				
1.6 GLS	82	11.05 →	60-0K-K12 60-0K-K18	Imp. MANDO	61-0K-K09 61-0H-001 66-0K-K18	Parking Brake\Freno staz.
ACCENT/EXCEL (X-3) i						
1.3	55	10.94 → 01.00	60-03-339 60-00-067		66-06-696 66-0H-H16 66-H0-001 67-06-689 67-06-690	06.96→ →05.96 Left\Sinistra Right\Destra
1.3	44	10.94 → 01.00				
1.3 i 12V	62	10.94 → 01.00				
1.5 i 12V	65	10.94 → 01.00				
1.5 i 16V	73	12.95 → 01.00				
1.3	40	09.95 → 05.98			66-0H-H16 06.96→	
ACCENT/EXCEL Tre volumi/Saloon (X-3) i						

























































	KW			
ACCENT/EXCEL Tre volumi/Saloon (X-3)				
1.3	55	10.94 → 01.00	 60-03-339	 66-06-696
1.3	44	10.94 → 01.00	 60-00-057	 66-0H-H16
1.3 i 12V	62	10.94 → 01.00		 66-H0-001
1.6 i 12V	65	10.94 → 01.00		 67-06-689
1.6 i 16V	73	10.95 → 01.00		 67-06-690
				06.96→ Left\Sinistra Right\Destra
ATOS (MX)				
1.0 i	40	02.98 → 03.02	 60-06-683	 66-06-684
			 60-06-687	 66-H0-016
				 67-H0-001
				 67-H0-002
				Left\Sinistra Right\Destra
1.0 i	43	03.01 →	 60-H0-008	 66-06-684
			 60-0H-007	 66-H0-016
				 67-H0-001
				 67-H0-002
				Left\Sinistra Right\Destra
1.1	46	03.04 →	 60-H0-008	 66-06-684
			 60-0H-007	 66-H0-016
ATOS PRIME (MX)				
1.0 i	40	08.99 →	 60-06-683	 66-06-684
			 60-06-687	 66-H0-016
			 60-0H-007	 67-H0-001
				 67-H0-002
				Left\Sinistra Right\Destra
1.0 i	43	03.01 →	 60-H0-008	 66-06-684
			 60-0H-007	 66-H0-016
				 67-H0-001
				 67-H0-002
				01.02→ 01.02→ Left\Sinistra Right\Destra
1.1	43	06.03 →	 60-06-683	 66-06-684
1.1	46	09.05 →	 60-H0-008	 66-0H-012
			 60-0H-007	 67-H0-001
				 67-H0-002
				Left\Sinistra Right\Destra
COUPE				
1.6	77	02.06 →	 60-H0-010	 61-06-696
2.0	105	02.06 →	 60-0H-012	 61-0H-004
2.7 V6	121	02.06 →		
COUPE (GK)				
1.6 16V	77	03.02 →	 60-H0-010	 61-06-696
1.6 16V	79	03.02 →	 60-0H-012	 61-0H-004
2.0	102	03.02 →		
2.0 GLS	105	02.03 →		
2.7 V6	123	03.02 →		

	KW				
COUPE (RD)					
2.0 16V	102	08.96 → 04.02	 50-05-590  50-0S-S02  60-05-586  60-0H-018	 51-05-595  61-05-596  55-05-516  56-H0-004  67-05-589  67-05-590	 Left\Sinistra Right\Destra
1.6 16V	85	03.98 → 04.02	 50-05-590  60-05-586  60-0H-018	 51-05-595  61-05-596  55-05-516  56-H0-004  67-05-589  67-05-590	 01.99→ Left\Sinistra Right\Destra
1.6 i 16V	84	12.96 → 04.02	 50-05-590  60-05-586	 51-05-595  61-05-596  55-05-516  56-H0-004  67-05-589  67-05-590	 Left\Sinistra Right\Destra
2.0 16V	99	03.01 → 04.02	 50-05-590  60-0H-018	 51-05-595  61-05-596  55-05-516  56-H0-004	
ELANTRA (XD)					
1.6	79	06.00 →	 50-05-590  50-0H-H15  50-H0-013  60-0H-008	 51-05-595  61-05-596  55-05-592  55-H0-007  56-H0-004  56-H0-011  67-H0-011  67-H0-013  67-H0-014	 →08.01 09.01→ →08.01 09.01→ →08.01 Left\Sinistra 09.01→ Left\Sinistra Right\Destra
2.0	104	06.00 →			
2.0	102	06.00 →			

	KW			
ELANTRA (XD)				
1.8	97	06.00 →	50-0H-H15 50-H0-013 60-0H-008	51-05-595 61-05-596 55-05-592 →08.01 55-H0-007 09.01→ 56-H0-004 67-H0-011 →08.01 67-H0-013 Left\Sinistra 67-H0-013 09.01→ 67-H0-013 Left\Sinistra 67-H0-014 Right\Destra
1.6 2.0 2.0 CRDi	77 105 83	05.03 → 10.03 → 04.01 →	50-0H-H15 50-H0-013 60-0H-008	51-05-595 61-05-596 55-H0-007 56-H0-011 67-H0-013 Left\Sinistra 67-H0-014 Right\Destra
1.6	82	09.03 →	50-H0-013 60-0H-008	51-05-595 61-05-596 55-H0-007 56-H0-011 67-H0-013 Left\Sinistra 67-H0-014 Right\Destra
1.8	98	11.02 →	50-H0-013 60-0H-008	51-05-595 61-05-596 55-05-592 09.01→ 55-H0-007 56-H0-004 67-H0-011 Left\Sinistra 67-H0-013 09.01→ 67-H0-013 Left\Sinistra 67-H0-014 Right\Destra
CRDi	85	02.06 →	50-H0-010	51-0H-H04
ELANTRA Tre volumi/Saloon (XD)				

























































	KW			
ELANTRA Tre volumi/Saloon (XD)				
1.6 2.0 2.0	79 104 102	06.00 → 06.00 → 06.00 →	 	
			09.01→	→08.01 09.01→ →08.01 09.01→ →08.01 Left\Sinistra 09.01→ Left\Sinistra Right\Destra
1.8	97	06.00 →	 	
				→08.01 09.01→ →08.01 Left\Sinistra 09.01→ Left\Sinistra Right\Destra
1.6 2.0 2.0 CRDi	77 105 83	05.03 → 10.03 → 04.01 →	 	
				Left\Sinistra Right\Destra
1.6 CRDi	85	02.06 →		
GALLOPER I				
2.5 TD 2.5 TD intercooler	62 70	08.91 → 07.98 08.91 → 07.98	 	
			Imp. SUMITOMO	Rear Axle\Assale posteriore Right\Destra
3.0 V6	104	08.91 → 07.98	 	
			Imp. SUMITOMO	
GALLOPER II (JK-01)				
3.0 V6	104	08.98 →	 	
			Imp. SUMITOMO	

	KW				
GALLOPER II (JK-01)					
2.6 TD	65	08.98 →	60-H0-001 60-0H-002 60-0H-H20	66-H0-002 66-H0-000 66-H0-007 67-H0-006	
2.6 TD intercooler	73	08.98 →			con/with ABS Colonnette da 22 mm NO ABS Colonnette da 32 mm
2.6 TCi D	77	08.98 →	60-H0-001 60-0H-002 60-0H-H20	66-H0-002 66-H0-007 67-H0-006	
			con/with ABS Colonnette da 22 mm NO ABS Colonnette da 32 mm	Rear AxleAssale posteriore	
GENESIS COUPE					
2.0 Turbo Sport	157	12.10 →	60-0H-H14	61-0K-K11 61-0H-H08	
GETZ (TB)					
1.5 CRDi	60	03.03 →	60-03-339 60-0H-010 60-0H-011	61-0H-H04 61-0H-001 66-H0-006 66-H0-008 67-H0-001 67-H0-002	
			NO ABS con/with ABS	LeftSinistra RightDestra	
1.6	77	09.02 →	60-03-339 60-0H-010 60-0H-011	61-0H-H04 61-0H-001 66-0H-H12 66-H0-006 66-H0-006 66-H0-008 66-H0-009 67-H0-001 67-H0-002	
			con/with ABS	con/with ABS Parking BrakeFreno staz. NO ABS con/with ABS NO ABS con/with ABS LeftSinistra RightDestra	
1.1	46	09.02 →	60-03-339 60-0H-010 60-0H-011	61-0H-H04 61-0H-001 66-H0-006 66-H0-006 66-H0-008 66-H0-009 67-H0-001 67-H0-002	
1.1	49	09.05 →			NO ABS con/with ABS
1.3	60	09.02 →			

	KW			
GETZ (TB)				
1.3	63	09.03 →	 50-03-339  60-0H-011 con/with ABS	 51-0H-H04  61-0H-001  55-H0-006  56-H0-008  56-H0-009  67-H0-001  67-H0-002 NO ABS con/with ABS Left\Sinistra Right\Destra
1.4	71	08.05 →	 50-03-339  60-0H-010  60-0H-011 con/with ABS	 51-0H-H04  61-0H-001  55-H0-006  56-H0-009 con/with ABS
1.5 CRDi	65	08.05 →	 50-03-339  60-0H-010  60-0H-011 NO ABS con/with ABS	 51-0H-H04  61-0H-001  55-0H-H12  55-H0-006  56-H0-008  67-H0-001  67-H0-002 con/with ABS Parking Brake\Freno staz. Left\Sinistra Right\Destra
1.5 CRDi GLS	81	08.05 →	 50-03-339  60-0H-011 con/with ABS	 51-0H-H04  61-0H-001  55-0H-H12  55-H0-006  56-H0-009 con/with ABS Parking Brake\Freno staz. con/with ABS
1.6	78	08.05 →	 50-03-339  60-0H-010	 51-0H-H04  61-0H-001  55-0H-H12  56-H0-009 con/with ABS Parking Brake\Freno staz. con/with ABS
GRANDEUR				
3.3	173	04.05 →		 51-0H-H04
2.2 CRDi	110	06.06 →	 50-H0-010	 51-0H-H04
2.2 CRDi	114	06.06 →		
H-1				
2.5 D	73	06.00 → 10.05		 67-0H-H17  67-0H-H18
2.5 CRDi	125	02.08 →	 50-0K-019  60-0H-H24	 51-0K-K07  61-0H-H11
2.5 CRDi	103	12.02 →	 50-0K-019	 55-0H-H11





















	KW			
H-1/H-200 Furgonato/Box				
2.6 TD	59	03.00 → 09.00	60-H0-002 60-0H-003	66-H0-002 66-H0-003 67-H0-007 67-H0-008 Left\Sinistra Right\Destra
2.4	82	03.00 →	60-H0-002 60-0H-003	66-H0-002 66-H0-003
2.6 TD 2.6 TD	73 74	03.00 → 10.01 →	60-H0-002 60-H0-006 60-0H-003 60-0H-H14	→09.02 10.02→ →08.04 09.04→ 66-H0-002 66-H0-003 67-H0-007 67-H0-008 Left\Sinistra Right\Destra
2.6 CRDi	103	08.03 →	60-H0-006 60-0H-003 60-0H-H14	→08.04 09.04→ 66-H0-002 66-H0-003 67-H0-007 67-H0-008 Left\Sinistra Right\Destra
2.6 CRDi	81	01.07 →	60-0K-019 60-0H-H24	61-0K-K07 61-0H-H11
H-1/H-200/SATELLITE Autobus				
2.6 TD	73	10.99 → 11.01	60-H0-002 60-0H-003	66-H0-002 66-H0-003 67-06-697 67-H0-007 67-H0-008 Left\Sinistra Right\Destra
2.4 2.4 4WD	82 82	10.97 → 10.97 →	60-H0-002 60-0H-003 60-0H-H14	66-H0-002 66-H0-003 67-H0-007 67-H0-008 Left\Sinistra Right\Destra
2.6 D 2.6 TD 2.6 TD	57 59 74	10.97 → 10.97 → 11.01 →	60-H0-002 60-0H-003	66-H0-002 66-H0-003 67-H0-007 67-H0-008 Left\Sinistra Right\Destra
2.6 CRDi 2.6 CRDi 4WD	103 103	12.02 → 12.02 →	60-0K-019 60-0H-003	
2.6 CRDi	81	06.06 →	60-0K-019 60-0H-003	61-0K-K07
H100 Autobus (P)				
2.6 D	57	12.94 → 03.00	60-06-696 60-06-691	66-0H-H16 66-H0-001 66-H0-002 67-06-676 67-06-677 Left\Sinistra Right\Destra

	KW				
H100 Autobus (P)					
2.4	84	01.97 → 03.00	 50-05-595  60-05-591	 55-H0-001  56-H0-002  67-05-576  67-05-577	Left/Sinistra Right/Destra
2.4 2.5 D	90 55	07.93 → 03.00 07.93 → 12.94	 50-05-585  60-05-591	 55-H0-001  56-H0-002  67-05-576  67-05-577	Left/Sinistra Right/Destra
2.5 TD	59	07.93 → 03.00	 50-05-585  60-05-591	 55-0H-H15  55-H0-001  56-H0-002  67-05-576  67-05-577	Left/Sinistra Right/Destra
H100 Furgonato/Box					
2.5 D	57	12.94 → 03.00	 50-05-595  60-05-591	 55-0H-H15  55-H0-001  56-H0-002  67-0H-H15  67-0H-H16	
2.5 D	55	07.93 → 12.94	 50-05-585  60-05-591	 55-H0-001  56-H0-002  67-0H-H15  67-0H-H16	
H100 TRUCK					
2.5 D	57	07.93 → 12.97	 50-05-595	 55-0K-004	
2.5 D	59	05.96 → 12.97	 50-05-595  60-05-591	 55-H0-001	
HIGHWAY VAN					
2.0 16V 2.7 V6 24V	100 125	03.00 → 03.00 →	 50-H0-005  60-0H-005	 51-0H-H04	
i10					
1.1 1.1 1.2	49 48 57	01.08 → 12.07 → 11.08 →	 50-0K-010  60-0K-010	 51-0K-004  61-0K-002	
1.1 CRDi	55	01.08 →	 50-0K-010  60-0K-K20	 51-0K-004  61-0K-002	
i20					
1.2	57	04.09 →	 50-0H-H12  50-0K-K12  60-0K-K18	NO ABS Imp. MANDO	 51-0K-K09  61-0H-001





















	KW			
i20				
1.4	74	04.09 →	50-0K-K12	Imp. MANDO
1.4 CRDi	55	04.09 →	60-0K-K18	
1.6 CRDi	85	04.09 →	60-0K-K18	
1.2	57	09.08 →	50-0H-H12	NO ABS
			50-0K-K12	Imp. MANDO
			60-0K-K18	
1.4	74	09.08 →	50-0K-K12	Imp. MANDO
1.6 CRDi	85	09.08 →	60-0K-K18	
1.6	93	09.08 →	60-0K-K18	
i30				
1.4	77	10.07 →	50-H0-006	
1.4	80	10.07 →	60-0H-012	Rim Size\Diam Cerchio:15
1.6	90	10.07 →	60-0H-H15	Rim Size\Diam Cerchio:16
1.6 CRDi	85	10.07 →		
1.6 CRDi	66	10.07 →		Parking Brake\Freno staz.
2.0	105	10.07 →	50-K0-009	
2.0 CRDi	103	10.07 →	60-0H-H15	
i30 CW Station wagon				
1.6	93	02.08 →	50-H0-006	
1.6 CRDi	66	02.08 →	60-0H-012	Rim Size\Diam Cerchio:15
			60-0H-H15	Rim Size\Diam Cerchio:16
1.6	90	02.08 →	50-K0-009	
1.6	85	02.08 →	60-0H-H15	Rim Size\Diam Cerchio:16
i40				
1.6 GDi	99	06.11 →	50-0K-K20	
1.7 CRDi	100	06.11 →	60-0H-H17	Rim Size\Diam Cerchio:17
1.7 CRDi	85	06.11 →	60-0H-H23	Rim Size\Diam Cerchio:16
2.0 GDi	130	06.11 →		
ix20				
1.4	66	11.10 →	50-0H-H17	
1.4 CRDi	57	11.10 →	60-0H-012	
1.6	92	11.10 →		
ix35				
2.0	120	03.10 →	50-0K-K20	
2.0 CRDi	100	03.10 →	60-0H-H23	
2.0 CRDi	135	03.10 →		All-wheel Drive\4 ruote motrici
				Front Wheel Drive\Trazione anteriore
1.7 CRDi	85	03.10 →	50-0K-K20	
			60-0H-H23	





























































	KW				
ix55 i					
3.0 V6 CRDi	176	09.08 →	 50-0K-K20  60-0H-H19	 51-0K-K07  61-0H-001	
LANTRA I (J-1) i					
1.5 i.e.	63	10.90 → 11.95	 50-03-339  60-00-056  60-05-586	 51-05-595  61-05-596  55-05-516  56-H0-004  67-05-589  67-05-590	
1.6 i.e. 16V	84	10.90 → 11.95	 50-03-339  50-05-590  60-05-586	 51-05-595  61-05-596  55-05-516  56-H0-004  67-05-589  67-05-590	
1.6 i.e. 16V	78	10.90 → 11.95			→09.93
1.8 i.e. 16V	93	10.90 → 11.95	 50-05-590  60-05-586	 51-05-595  61-05-596  55-05-516  56-H0-004  67-05-589  67-05-590	
LANTRA II (J-2) i					
1.6 16V	84	11.95 → 09.00	 50-05-590  60-05-586  60-0H-018	 51-05-595  61-05-596  55-05-516  56-H0-004  67-05-589  67-05-590	
1.6 i	66	11.95 → 09.00			→05.98
2.0 16V	102	08.96 → 09.00			06.98→
1.8 16V	94	11.95 → 09.00	 50-05-590  60-05-586	 51-05-595  61-05-596  55-05-516  56-H0-004  67-05-589  67-05-590	
1.5 12V	65	12.96 → 09.00	 50-05-590  50-05-595  60-00-056  60-05-586	 51-05-595  61-05-596  55-05-516  56-H0-004  67-05-589  67-05-590	

	KW				
LANTRA II (J-2) i					
1.9 D	50	03.98 → 09.00	50-05-590	51-05-595 61-05-596 55-05-516 56-H0-004 67-05-589 67-05-590	Left\Sinistra Right\Destra
LANTRA II Wagon (J2) i					
1.6 16V	84	02.96 →	50-05-590	51-05-595 61-05-596 55-05-516 56-H0-004 67-05-589 67-05-590	Left\Sinistra Right\Destra
1.6 i	66	02.96 →	60-05-586 →05.98 60-0H-018 06.98→		
2.0 16V	102	12.96 →			
1.5 12V	65	04.97 →	50-05-590	51-05-595 61-05-596 55-05-516 56-H0-004 67-05-589 67-05-590	Left\Sinistra Right\Destra
1.8 16V	94	02.96 →	60-05-586		
1.9 D	50	03.98 →	50-05-590	51-05-595 55-05-516 56-H0-004 67-05-589 67-05-590	
MATRIX (FC) i					
1.5 CRDi	60	10.01 →	50-05-590 →03.02	51-0H-H04 61-0K-003 55-05-592 56-H0-011 67-H0-013 67-H0-014	Left\Sinistra Right\Destra
1.6	76	06.01 →	50-H0-013 04.02→		
1.8	90	06.01 →	60-0H-008		
1.5 CRDi	75	12.04 →	50-H0-013 60-0H-008	51-0H-H04 61-0K-003 55-05-592 56-H0-011 67-H0-013 67-H0-014	06.06→ con/with ABS Left\Sinistra Right\Destra
PONY i					
1.5	53	10.85 → 09.89	50-03-310 60-05-508	55-05-512 67-05-532	

	KW			
PONY i i				
1.3	50	10.85 → 09.89	50-03-310 60-00-057 60-05-508	55-05-512 67-05-532
1.2 1.4	40 50	06.74 → 08.77 →	50-03-310 60-05-508	01.79→ 01.79→ 55-05-512 67-05-502 67-05-503 01.79→ Right/Destra 01.79→ Left/Sinistra
PONY (X-2) i i				
1.3 1.3	49 43	10.89 → 01.95 10.89 → 01.95	50-03-339 60-00-057	55-H0-013 67-05-574 67-05-575
1.5 1.5 i 1.5 i	53 61 62	10.89 → 01.95 10.89 → 01.95 10.89 → 01.95	50-03-310 50-03-339 60-00-057	→12.90 01.91→ 55-05-512 55-H0-013 67-05-532 67-05-572 67-05-573 →12.90 01.91→ →12.90 01.91→ Left/Sinistra 01.91→ Right/Destra
PONY Tre volumi/Saloon i i				
1.3	50	10.85 → 09.89	50-03-310 60-00-057 60-05-508	55-05-512 67-05-532
1.5	53	10.85 → 09.89	50-03-310 60-05-508	55-05-512 67-05-532
PONY Wagon i i				
1.2 1.4	40 50	02.78 → 02.78 →	50-03-310 60-05-508	55-05-512 67-05-502 67-05-503 Right/Destra Left/Sinistra
PONY/EXCEL Tre volumi/Saloon (X-2) i i				
1.5 1.5 i 1.5 i	53 61 62	01.90 → 01.95 01.90 → 01.95 01.90 → 01.95	50-03-339 60-00-057	55-H0-013 67-05-572 67-05-573 Left/Sinistra Right/Destra
1.3	49	01.90 → 01.95	50-03-339 60-00-057	55-H0-013 67-05-574 67-05-575
S COUPE (SLC) i i				

























	KW					
S COUPE (SLC) <i>i</i> <i>i</i>						
1.6 i	62	02.90 → 05.96	 60-03-337  60-03-339  60-06-586	02.92→ →07.92 →01.91	 55-06-596  55-H0-013  67-06-599	→01.91 02.92→ →07.92
1.6 i	65	04.92 → 05.96	 60-03-339  60-00-057  60-06-586		 55-06-596  55-H0-013  67-06-599	
1.6 i Turbo	85	04.91 → 05.96	 60-03-339  60-00-057		 55-H0-013  67-06-599	
SANTA FÉ <i>i</i> <i>i</i>						
2.2 CRDi	102	03.06 →	 60-0H-H14  60-0H-H19		 51-0H-H08  61-0H-H06	
2.2 CRDi	114	03.06 →				
2.2 CRDi 4x4	102	03.06 →				
2.2 CRDi GLS	110	03.06 →				
2.2 CRDi GLS 4x4	110	03.06 →				
2.7 V6 GLS	139	03.06 →				
2.7 V6 GLS 4x4	139	03.06 →				
2.7	125	03.06 →	 60-0H-H14  60-0H-H19		 51-0H-H08  61-0H-H06  55-H0-007	
2.7 4x4	125	03.06 →				
SANTA FE' (SM) <i>i</i> <i>i</i>						
2.0	99	08.01 →	 60-H0-005  60-0H-009  60-0H-H21	Rim Size\Diam Cerchio:15 Rim Size\Diam Cerchio:16	 51-0H-H04  61-0H-003  55-0H-H08	NO ABS
2.0 CRDi	83	08.01 →				
2.0 CRDi 4x4	83	04.01 →				
2.0 CRDi 4x4	92	08.03 →				
2.4 16V	100	02.01 →				
2.4 16V	107	02.01 →				
2.4 16V 4x4	100	02.01 →				
2.4 16V 4x4	107	02.01 →				
2.7 V6 4x4	127	02.01 →				
2.2 CRDi	110	10.05 →				
2.2 CRDi 4x4	110	10.05 →				
2.7	139	10.05 →				
2.7 4x4	139	10.05 →				
SANTAMO <i>i</i> <i>i</i>						
2.0 16V	102	05.99 →	 60-06-530  60-06-530		 51-0H-H02  61-0H-002  55-H0-001  55-H0-003	
2.0 16V 4x4	102	05.99 →				
SONATA I (Y-2) <i>i</i> <i>i</i>						

	KW			
SONATA I (Y-2)				
2.0 i	80	01.91 → 10.93	 50-05-590	 51-03-399
2.0 i 16V	96	01.91 → 10.93	 60-00-060	 61-05-509
				 55-05-585
				 67-05-589
				 67-05-590
				Imp. BENDIX
				Left\Sinistra
				Right\Destra
3.0 i V6	107	01.91 → 10.93	 50-05-590	 51-03-399
			 60-00-060	 61-05-509
				 67-05-571
1.8 i	70	09.88 → 10.93	 50-01-144	 51-03-399
			 50-05-590	 61-05-509
			 60-00-060	 55-05-585
				 67-05-589
				 67-05-590
				Imp. BENDIX
				Left\Sinistra
				Right\Destra
2.4 i	83	09.88 → 08.91	 50-01-144	 51-03-399
			 50-05-590	 61-05-509
			 60-00-060	 55-01-134
				 55-05-585
				 67-05-589
				 67-05-590
				Imp. BENDIX
				Left\Sinistra
				Right\Destra
2.0 i	74	09.88 → 08.91	 50-01-144	 51-03-399
			 60-00-060	 61-05-509
				 55-05-585
				 67-05-589
				 67-05-590
				Imp. BENDIX
				Left\Sinistra
				Right\Destra
SONATA II (Y-3)				
2.0 i	77	06.94 → 08.96	 50-05-590	 51-03-399
			 60-00-060	 61-05-509
				 55-05-585
				 67-05-589
				 67-05-590
				Imp. BENDIX
				Left\Sinistra
				Right\Destra
2.0 i 16V	102	05.93 → 06.98	 50-05-590	 51-03-399
			 60-00-060	 61-05-509
				 67-05-589
				 67-05-590
				Left\Sinistra
				Right\Destra
3.0 i V6	107	05.93 → 06.98	 50-01-144	 51-03-399
			 50-05-590	 61-05-509
			 60-00-060	 61-05-596
				 55-05-585
				Imp. BENDIX

	KW			
SONATA II (Y-3) i i				
2.0 i	70	08.96 → 06.98	50-01-144	51-03-399
2.0 i 16V	92	06.96 → 06.98	60-00-060	61-05-596
				55-05-585 Imp. BENDIX
				67-05-589 Left\Sinistra
				67-05-590 Right\Destra
1.8 i	72	05.93 → 06.98	50-05-590	51-05-598
			60-00-060	55-05-585 Imp. BENDIX
				67-05-589 Left\Sinistra
				67-05-590 Right\Destra
SONATA III (EF) i i				
2.5 V6 24V	118	06.98 → 10.01	50-05-590	51-0H-H04
			60-00-060	61-0K-003
			60-0K-014	56-H0-014
2.0 16V	100	06.98 → 10.01	50-05-590	51-0H-H04
			60-00-060	55-K0-008
			60-0H-018	56-H0-014
			60-0K-014	67-05-598
				67-05-599 Right\Destra
2.4 16V	105	03.98 → 10.01	50-05-590	51-0H-H04
			60-00-060	56-H0-014
SONATA IV/ SONICA i i				
2.0	96	10.01 → 11.04	50-05-590	51-03-399
2.7 V6	127	10.01 → 11.04	60-0K-015	61-0K-003
2.7 V6	129	11.02 → 11.04		55-K0-008
				56-H0-014
				67-05-589 Left\Sinistra
				67-05-590 Right\Destra
SONATA V i i				
2.4	119	01.05 →	50-05-590	51-0H-H04
3.3	171	01.05 →	60-0H-012	61-0K-K10
3.3	173	06.05 →		
2.0 CRDi	100	02.06 →	50-H0-010	51-0H-H04
2.0 CRDi	103	02.06 →	60-0H-H23	61-0H-H07
2.0 CRDi	110	03.09 →		
2.2 CRDi GLS	110	02.06 →	50-H0-010	51-0H-H04
			60-0H-012	61-0H-H07
			60-0H-H23	61-0K-K10
SONICA i i				
2.0 CRDi	103	05.06 →	50-H0-010	51-0H-H04
2.4	119	05.06 →	60-0H-H23	61-0K-K10
NQR 70	107	09.98 →		
STAREX (H1) i i				











































	KW			
STAREX (H1)				
2.4	82	06.97 →	50-H0-002	55-H0-002
2.4 4WD	82	02.98 →	60-05-583 60-0H-003	56-H0-003
2.5 TD	59	06.97 →	50-H0-002	55-H0-002
2.5 TD 4WD	59	02.98 →	60-0H-003	56-H0-003
STELLAR				
1.6	56	10.83 → 12.91	50-03-339 50-03-378 60-00-062	55-03-303 67-05-573
1.4	50	10.83 → 08.86	50-03-377 →02.85 50-03-378 03.85→ 60-00-062	55-03-303 67-05-573
2.0 (4G63B)	61	01.86 → 12.89	50-03-339 60-00-062	55-03-303 67-05-573
TERRACAN (HP)				
2.5 TD	74	12.01 →	50-H0-006	51-0H-H03
2.9 CRDi	110	12.01 →	60-0H-013	61-0H-005
3.5 i V6 4WD	147	12.01 →		55-0H-H10 Parking Brake/Freno staz.
3.5 i V6 4WD	143	12.01 →		
2.9 CRDi	120	11.03 →	50-0S-S01 60-0H-H22	51-0H-H03 61-0H-005 55-0H-H10 Parking Brake/Freno staz.
TRAJET (FO)				
2.0	100	03.00 →	50-H0-005	51-0H-H04
2.0 CRDi	83	04.01 →	60-0H-009	61-0H-003
2.7 V6	127	09.00 →		55-05-585 NO ABS Imp. BENDIX 55-H0-007 con/with ABS 56-H0-005 67-H0-021 Left/Sinistra 67-H0-022 Right/Destra
2.0	103	01.04 →	50-H0-005 60-0H-009	51-0H-H04 61-0H-003 55-H0-007 56-H0-005 67-H0-021 Left/Sinistra 67-H0-022 Right/Destra
2.0	104	11.03 →	50-H0-005 60-0H-009	51-0H-H04 61-0H-003 55-H0-007 56-H0-005

	KW			
TUCSON (JM)				
2.0	104	08.04 →	50-H0-010	51-0H-H04 →03.10
2.0 4 ruote motrici	104	08.04 →	60-0H-012	51-0K-K09 04.10→
2.0 CRDi	103	01.06 →	60-0H-H23 →03.10	61-0H-003 →03.10
2.0 CRDi	100	01.06 →		Rim Size/Diam Cerchio: 15
2.0 CRDi 4 ruote motrici	103	01.06 →		61-0K-K10 →03.10
2.0 CRDi 4 ruote motrici	100	01.06 →		Rim Size/Diam Cerchio: 14
2.7 4 ruote motrici	129	08.04 →		
2.0 CRDi	83	08.04 →	50-H0-010	51-0H-H04 →03.10
2.0 CRDi 4 ruote motrici	83	08.04 →	60-0H-012	51-0K-K09 04.10→
				61-0H-003 →03.10
				Rim Size/Diam Cerchio: 15
				61-0K-K10 →03.10
				Rim Size/Diam Cerchio: 14
2.0 CRDi	88	01.07 →		51-0K-K09 04.10→
2.0 CRDi 4 ruote motrici	88	01.07 →		
VELOSTER				
1.6 GDi	103	01.11 →	50-0H-H18	51-0H-H09
			60-0H-H25	61-0H-H12
XG				
25	120	12.98 →	50-H0-005	51-0H-H04
30/300	138	12.98 →		61-0K-K10
350	145	04.03 →		

	KW				
FX i					
35	206	01.03 →	 60-01-118  60-01-152	Imp. TOKICO  61-01-154  61-01-106  66-01-114	Parking Brake\Freno staz.
37 45	235 232	10.08 → 01.03 →	 60-01-118	Imp. TOKICO  61-01-154  61-01-106  66-01-114	Parking Brake\Freno staz.
I30 i					
3.0	142	01.97 →	 60-01-120  60-08-819  60-01-158	Imp. HITACHI  61-01-127  61-01-101	Imp. BENDIX
QX4 i					
3.3	125	01.97 →	 60-01-154  60-01-145	 66-01-196  67-01-190	



























































	KW				
CAMPO (KB)					
2.2 (TFS)	66	01.89 → 12.90	60-09-904 60-09-909	Imp. AKEBONO	66-09-904 67-09-901
2.2 D (TFR62 / TFS62)	39	08.88 →			
2.3 (TFR16)	68	08.88 →			
2.3 4WD (TFS16)	68	08.88 →			
2.6 D (TFR64)		08.88 →			
2.6 D (TFS64)		01.93 → 12.99			
Pick-Up					
2.6 D (KBD27)	55	01.83 → 12.90			
2.6 D 4WD (KBD47)	55	01.83 → 12.90			
2.0 (KB23)	52	01.83 → 03.88	60-09-901 60-09-900		66-09-904 67-09-901
2.0 (KB28)	58	06.85 → 12.88			
2.0 4WD (KB43, KB48)	52	01.83 → 03.88			
2.0 4WD (KB48)	58	06.85 → 12.88			
2.2 D (KBD27)	39	04.86 → 12.90	60-09-900 60-09-901 60-09-900 60-09-903		66-09-904 67-09-901
2.2 D (KBD27)	45	01.83 → 12.91			
2.2 D 4WD (KBD42, KBD47)	39	01.83 → 12.90			
2.0 (KB21, KB27)	48	04.77 → 12.82	60-09-900 60-09-900		
2.0 4WD (KB41, KB45)	48	04.77 → 12.82			
2.0 D (KBD23, KBD28)	36	08.78 → 12.82			
2.0 D 4WD (KBD42, KBD46)	36	04.77 → 12.82			
D-MAX					
2.4 4x4	94	05.02 →	60-09-908 60-09-921		
3.6 V6 24V 4x4	147	05.02 →			
2.6 D 4x4	74	05.02 →	60-09-908 60-09-920 60-09-921	Front Wheel Drive/Trazione anteriore	66-09-900 66-09-903 67-09-906
3.0 DiTD 4x4	96	05.02 →			
2.6 DiTD 4x4	100	01.07 →	60-09-908 60-09-914 60-09-921		66-09-900 66-09-903
3.0 D 4x4	120	01.07 →			
2.6 D	74	10.02 →	60-09-908 60-09-920 60-09-921	Front Wheel Drive/Trazione anteriore	66-09-912 66-09-900 67-09-906
3.0 DiTD	96	10.02 →			
2.6 DiTD	100	10.06 →	60-09-908 60-09-921		66-09-912 66-09-900
GEMINI					

	KW			
GEMINI <i>i</i> <i>i</i>				
1.6	73	01.90 → 12.93	 60-09-901	
1.6	97	01.90 → 12.93	 60-09-999	
1.6	132	01.90 → 12.93		
1.7 TD	65	01.90 → 12.93		
1.8	105	01.90 → 12.93		
GEMINI (JT) <i>i</i> <i>i</i>				
1.6 D	37	02.88 → 12.90	 60-09-901  60-09-909	 67-09-998
1.6 TD	49	02.88 → 12.90	 60-09-901  60-09-909	
1.6 GTI 16V	84	08.88 → 12.90	 60-09-901  60-09-999	
1.6	52	02.88 → 12.90	 60-09-901  60-09-999	 67-09-998
GEMINI Tre volumi/Saloon <i>i</i> <i>i</i>				
1.6	73	01.90 → 12.93	 60-09-901	
1.6	132	01.90 → 12.93	 60-09-999	
1.6	97	01.90 → 12.93		
1.7 TD	65	01.90 → 12.93		
1.8	105	01.90 → 12.93		
GEMINI Tre volumi/Saloon (JT) <i>i</i> <i>i</i>				
1.6 D	37	02.88 → 12.90	 60-09-901	
1.6 TD	49	02.88 → 12.90	 60-09-909	
1.6	52	02.88 → 12.90	 60-09-901  60-09-999	
IMPULSE <i>i</i> <i>i</i>				
1.6	120	01.90 → 12.93	 60-09-999	
1.6	71	01.90 → 12.93		
MIDI Autobus (94000, 98000) <i>i</i> <i>i</i>				
2.0 (98000)	61	01.89 →	 60-09-902	→08.92
2.2 D (98000)	45	01.89 →	 60-09-903  60-09-906	
				 66-09-901 →08.92  66-09-902  66-09-997  67-09-997
2.0 4WD (94000)	61	01.89 →	 60-09-902	→08.92
2.2 D 4WD (94000)	45	01.89 →	 60-09-903	
				 66-09-901  66-09-902  66-09-997  67-09-997
2.0 TD (98000)	51	01.89 →	 60-09-902  60-09-903  60-09-906	
				 66-09-901 →08.92  66-09-902  67-09-901











































































	KW			
MIDI Autobus (94000, 98000) <i>i</i> <i>i</i>				
2.4 D (98000)	56	01.94 →	50-09-902	55-09-901 56-09-902 65-09-997 67-09-997
MIDI Furgonato/Box (98000N) <i>i</i> <i>i</i>				
2.0	61	06.88 →	50-09-902	55-09-901
2.2 D	45	01.89 →	60-09-903	56-09-902
2.2 D 4WD	45	09.88 →	60-09-906	65-09-997 67-09-997
2.0 4WD	61	09.88 →	50-09-902 60-09-903	55-09-901 56-09-902 65-09-997 67-09-997
2.4 TD	56	02.94 →	50-09-902	55-09-901 56-09-902 65-09-997 67-09-997
MIDI Van (94000, 98000) <i>i</i> <i>i</i>				
1.8	56	01.83 → 12.90	50-09-902	55-09-901
2.0 (98000)	61	01.89 →	60-09-903	56-09-902
2.0 4WD (94000)	61	01.89 →		65-09-997
2.0 D 4WD 4FC1		06.88 →		67-09-997
2.2 D (98000)	45	01.89 →		
2.2 D 4WD (94000)	45	01.89 →		
2.4 TD (98000)	56	01.94 →		
2.0 TD (98000)	51	01.89 →	50-09-902 60-09-903	55-09-901 56-09-902 67-09-901
PIAZZA <i>i</i> <i>i</i>				
2.0 Turbo	104	06.85 → 12.90	50-09-998 60-09-999	51-03-301 →02.89 51-09-996
TROOPER <i>i</i> <i>i</i>				
3.0 DTI	118	04.00 →	50-09-999	51-09-999
3.5 V6 24V	158	04.00 →	60-09-997	61-09-997
TROOPER (UB) <i>i</i> <i>i</i>				
3.1 TD	84	08.91 → 07.98	50-09-999	51-09-999
3.2	130	08.91 → 07.98	60-09-997	61-09-997 55-09-903
TROOPER (UBS) <i>i</i> <i>i</i>				

	KW			
TROOPER (UBS) i				
2.8 TD (UBS66)	71	10.87 → 12.91	 60-09-904	Imp. AKEBONO
2.8 TD (UBS66)	78	10.88 → 12.91	 60-09-909	
				 61-09-900  61-09-900  66-09-904  66-09-902  67-09-901
2.2 D 4x4	39	05.84 → 12.89	 60-09-901	
			 60-09-903	
			 60-09-909	 66-09-904  66-09-902  67-09-901
TROOPER Fuoristrada aperto\Open Off-Road i				
3.0 DTI	118	04.00 →	 60-09-999	Imp. SUMITOMO
3.6 V6 24V	158	04.00 →	 60-09-997	NO ABS
				 61-09-999  61-09-997  66-09-903
				NO ABS Parking Brake\Freno staz.
TROOPER Fuoristrada aperto\Open Off-Road (UB) i				
3.1 TD	84	08.91 → 07.98	 60-09-999	Imp. SUMITOMO
3.2	130	08.91 → 07.98	 60-09-997	
				 61-09-999  61-09-997  66-09-903
				Parking Brake\Freno staz.
TROOPER Fuoristrada aperto\Open Off-Road (UBS) i				
2.3 (UBS16)	66	11.85 → 12.91	 60-09-904	Imp. AKEBONO
2.6 i (UBS17)	85	10.87 → 12.91	 60-09-909	
				 61-09-900  61-09-900  66-09-904  66-09-902  67-09-901
2.2 TD (UBS62)	53	03.84 → 12.91	 60-09-901	
			 60-09-903	
			 60-09-909	 61-09-900  61-09-900  66-09-904  66-09-902  67-09-901
2.2 (UBS13)	58	01.83 → 12.85	 60-09-900	
				 66-09-904  67-09-901
2.2 D (UBS62)	45	01.83 → 12.83	 60-09-900	
			 60-09-900	
			 60-09-909	 66-09-904  67-09-901
2.2 D 4x4	39	05.84 → 07.89	 60-09-904	Imp. AKEBONO
			 60-09-903	
				 61-09-900  61-09-900  66-09-904  66-09-902  67-09-901





































ISUZU Comm.

	KW			
N-Serie				
2.0 CRDi	103	05.06 →	 50-09-916	
2.4	119	05.06 →		
NQR 70	107	09.98 →		
NKR69S, NPR69M, NPR69L	61	01.98 → 12.01	 50-09-909	
NQR75L, NQR75P, NQR75T	140	10.06 →	 50-09-916	
NKR85EA, NPR85G, NPR85L	110	10.06 →	 50-09-916	
NPR85L	110	10.06 →	 60-09-912	
NPR85L, NPR85P	110	10.06 →		

	KW			
CHEROKEE (KJ)				
<i>i</i>				
2.4	108	09.01 →	 50-09-994	 51-09-904
2.8 CRD	110	11.02 →	 60-09-991	 61-09-905
2.8 CRD	120	11.04 →		 55-09-906
3.7 V6	150	08.03 →		
3.7 V6	155	09.01 →		
2.5 CRD	105	09.01 →	 50-09-994	 51-09-904
			 60-09-991	 61-09-905
				 55-00-099
				 55-09-906
				 67-00-005
<i>i</i>				
CHEROKEE (XJ)				
<i>i</i>				
2.5 i 4x4	90	12.91 →	 50-00-057	 55-00-056
			 50-00-059	 56-00-098
			 60-00-059	 67-09-996
			 60-00-097	
			con/with ABS	
			NO ABS	
			NO ABS	
			con/with ABS	
4.0 i	136	01.88 →	 50-00-057	 51-09-998
4.0 i	127	07.98 →	 60-00-097	 55-00-056
4.0 i	135	12.91 →		 56-00-098
2.1 TD	64	10.84 →	 50-00-057	 55-00-022
			 50-00-059	 55-00-056
			 60-00-059	 56-00-098
			 60-00-097	 56-00-099
			con/with ABS	 67-00-098
				 67-00-099
				01.87→
				→12.87
				→12.87
				01.87→
				Right\Destra
				Left\Sinistra
2.5 TD	85	01.88 →	 50-00-059	 55-00-056
			 60-00-097	 56-00-098
			con/with ABS	
4.0 i	131	01.95 →	 50-00-057	 51-09-992
			 60-00-097	 55-00-056
			con/with ABS	 56-00-098
2.1 D 4x4	59	10.86 → 09.92	 50-00-057	 55-00-056
2.5	89	10.90 → 09.96	 60-00-097	 56-00-098
2.5	89	10.95 →		
2.5 Tdi 4x4	85	10.96 → 09.01		
2.5 i	87	11.96 →	 50-00-057	 55-00-056
			 50-00-059	 56-00-098
			 60-00-059	 67-09-996
			 60-00-097	
			con/with ABS	
4.0 i	135	02.99 →	 50-00-057	 51-09-992
			 60-00-097	 51-09-998
			con/with ABS	 55-00-056
				 56-00-098

	KW					
CHEROKEE (XJ) i i						
2.1 TD	59	06.89 → 03.92	50-00-057 50-00-059 60-00-059 60-00-097	01.91→ →12.91 →12.91 01.91→ con/with ABS	55-00-022 56-00-099 67-00-098 67-00-099	Right/Destra Left/Sinistra
2.5 SE	87	10.96 → 09.99	50-00-057 60-00-093		55-00-056 56-00-098	
CJ5 - CJ8 i i						
2.0	63	01.83 → 12.87	50-00-059		55-00-022	
2.1 D	44	01.83 → 12.87				
2.4 D	44	01.83 → 12.87				
2.5	65	01.80 → 12.83				
2.5	78	01.84 → 12.87				
3.7	110	01.66 → 12.71				
3.8	74	01.72 → 12.78				
4.2	76	01.72 → 12.87				
5.0	89	01.73 → 12.81				
CJ7/CJ6 RENEGADE LAREDO i i						
2.4 D 4WD C240		01.79 →	50-00-054 50-00-055 50-00-059	→12.80 01.80→ →12.83	55-00-022 67-09-999	
COMMANDER i i						
3.0 CRD	160	04.06 →	50-00-018		51-00-001	
3.7 V6	157	09.05 →	60-00-061		61-00-001	
4.7 V8	170	09.05 →			55-09-908	Parking Brake/Freno staz.
5.7 V8	240	09.05 →				
COMPASS i i						
2.0 CRD 4x4	103	09.06 →	50-00-004		51-05-508	
2.4 4x4	125	09.06 →	60-00-003		61-00-002 55-09-909	Parking Brake/Freno staz.
2.2 D	120	04.11 →	50-09-912 60-00-003		51-05-505 61-09-904	
GRAND CHEROKEE I (Z) i i						
4.0 i (Z)	130	10.95 → 04.99	50-00-057		51-00-019	
4.0 i (ZJ)	135	09.91 → 04.99	60-00-097	con/with ABS	51-09-998	
4.0 i (ZJ)	132	09.91 → 04.99			61-09-995	
5.2 (Z)	156	10.95 → 04.99				
5.2 i (ZJ)	155	01.92 → 04.99				
5.2 i (ZJ)	158	09.92 → 04.99				
2.5 TD (Z)	85	10.95 → 04.99	50-00-057		51-00-019	
5.9 i	177	08.97 → 04.99	60-00-097	con/with ABS	61-09-995	
GRAND CHEROKEE II (WJ, WG) i i						

	KW					
GRAND CHEROKEE II (WJ, WG)						
4.0 4x4	140	04.99 →	 50-00-090  50-00-097  60-00-094	10.02→ →09.02	 51-09-992  51-09-998  61-09-992  55-09-907	Parking Brake\Freno staz.
2.7 CRD 4x4	120	10.01 →	 50-00-090		 51-09-992	
4.7 V8	162	04.99 → 08.00	 50-00-097		 61-09-992	
4.7 V8	164	08.00 →	 60-00-094		 55-09-907	Parking Brake\Freno staz.
4.7 V8	190	10.01 →				
3.1 TD	103	04.99 →	 50-00-097  60-00-094		 51-09-992  61-09-992  55-09-907	Parking Brake\Freno staz.
4.7 V8 4x4	167	06.03 →	 50-00-090  60-00-094		 51-09-992  61-09-992  55-09-907	Parking Brake\Freno staz.
GRAND CHEROKEE III						
4.7 V8	170	06.05 →	 50-00-090  60-00-061		 51-09-992  61-00-001  55-09-908	Parking Brake\Freno staz.
5.7 V8	240	06.05 →	 50-00-018  60-00-061		 51-00-001  55-09-908	Parking Brake\Freno staz.
3.0 CRD	160	06.05 →	 50-00-018  60-00-061		 51-00-001  61-00-001  55-09-908	Parking Brake\Freno staz.
GRAND CHEROKEE IV (WL)						
3.0 CRD V6	177	01.11 →	 50-09-915		 51-09-906  61-09-907	Rim Size\Diam Cerchio:18
3.0 CRD V6	140	01.11 →				
3.6 V6	210	11.10 →				
5.7 V8	259	11.10 →				
PATRIOT						
2.0 CRD	103	01.08 →	 50-09-912		 51-05-508  61-00-002  61-09-904  55-09-909	NO ABS con/with ABS Parking Brake\Freno staz.
2.4	125	01.08 →	 60-00-003			
WRANGLER I						
2.5	76	01.88 → 12.91	 50-00-057  60-00-097	con/with ABS	 55-00-022  67-09-996	
2.5	89	12.91 → 08.96	 50-00-057	01.93→	 55-00-022	01.93→
4.0	131	12.91 → 08.96	 60-00-097	01.93→ con/with ABS	 67-09-996	01.93→
4.2	84	08.86 → 08.89	 50-00-057		 55-00-022	
WRANGLER II (TJ)						

	KW			
WRANGLER II (TJ)				
2.5	87	08.96 →	60-00-067	56-00-022
4.0	124	06.98 →	60-00-097	56-09-906
4.0	130	08.96 →	con/with ABS	56-00-098
				67-09-996
2.4	105	11.02 →	60-00-067	56-00-066
			60-00-069	56-09-906
			60-00-097	56-00-098
			con/with ABS	67-00-001
4.0 Rubicon	128	08.03 →	60-00-067	56-00-066
			60-00-069	56-09-906
				56-00-098
				67-00-001
3.8	153	02.06 →	60-00-067	61-09-901
			60-00-097	61-09-904
			60-01-110	61-09-902
			con/with ABS	56-00-066
				56-09-910
WRANGLER III (JK)				
2.8 CRD	130	04.07 →	60-09-910	61-09-901
			60-09-913	61-09-902
				56-09-910
				Imp. GIRLING
				Parking Brake\Freno staz.

	KW			
BESTA Furgonato/Box <i>i</i> <i>i</i>				
2.2 D	48	02.96 →	50-03-325 50-03-398 60-03-326	55-03-325 56-0K-K03
CARENS I (FC) <i>i</i> <i>i</i>				
1.8	81	11.00 → 07.02	50-K0-017 60-03-396	51-0K-K00 61-0K-000 55-K0-000 56-K0-000 67-K0-000
CARENS II <i>i</i> <i>i</i>				
1.6 1.8 2.0 CRDi	77 93 83	07.02 → 07.02 → 07.02 →	50-K0-009 60-0K-006	51-0K-K00 61-0K-008 55-K0-000 56-K0-004 67-K0-009
2.0 CVVT	102	08.04 →	50-K0-009 60-0K-006	51-0K-K00 61-0K-008 55-K0-000 56-K0-004
CARENS III <i>i</i> <i>i</i>				
2.0 CRDi 2.0 CVVT	103 106	09.06 → 09.06 →	50-0K-K20 60-0H-012	51-0K-K10 61-0K-K13
CARNIVAL (UP) <i>i</i> <i>i</i>				
2.5 V6 2.9 TD	121 93	08.99 → 10.01 08.99 → 10.01	50-00-057 →04.00 50-K0-005 05.00→ 60-0K-002 →04.00 60-0K-003 05.00→	55-00-097 56-K0-001 67-K0-001
CARNIVAL II <i>i</i> <i>i</i>				
2.5 V6 2.9 CRDi	110 106	10.01 → 10.01 →	50-0K-K13 01.04→ 50-K0-005 →12.03 60-0K-003 →11.03 60-0K-K11 12.03→	55-0K-K14 01.03→ 55-K0-001 56-K0-006 67-0K-K10 Left/Sinistra 67-K0-012 Right/Destra
3.5	143	07.02 →	50-K0-005 60-0K-003 60-0K-K11	55-0K-K14 56-K0-001
2.7 V6 2.9 CRDi	139 136	06.06 → 06.06 →	50-0K-019 60-0K-K21	51-0K-K07 61-0K-K11 55-0K-K19 Parking Brake/Freno staz.



















































	KW			
CEE'D i i				
1.4	80	12.06 →	60-K0-009	61-0K-K09
1.6	90	12.06 →	60-0H-012	61-0K-K14
1.6 CRDi 116	85	12.06 →		66-0K-K21
1.6 CRDi 90	66	12.06 →		
2.0	105	12.06 →		
2.0 CRDi	103	09.07 →		
CEE'D Station wagon i i				
1.4	80	09.07 →	60-K0-009	61-0K-K09
1.6	90	09.07 →	60-0H-012	61-0K-K14
1.6 CRDi 116	85	09.07 →		66-0K-K21
1.6 CRDi 90	66	09.07 →		
2.0	105	09.07 →		
2.0 CRDi	103	09.07 →		
CERATO i i				
1.6 CRDi	75	07.05 →	60-0K-K11	61-06-696
1.6	77	07.04 →	60-0K-K17	61-0K-K07
1.6 CRDi	85	06.05 →		
2.0	105	04.04 →		
2.0 CRDi	83	04.04 →		
CERATO Tre volumi/Saloon i i				
1.6 CRDi	75	07.05 →	60-0K-K11	61-06-696
1.6	77	04.04 →	60-0K-K17	61-0K-K07
1.6 CRDi	85	06.05 →		
2.0	105	04.04 →		
2.0 CRDi	83	04.04 →		
CLARUS (K9A) i i				
1.8 i 16V	85	07.96 →	60-K0-002	61-0K-K00
2.0 i 16V	98	07.96 →	60-K0-017	61-0K-000
			60-03-396	66-K0-000
				66-K0-000
				67-K0-000
CLARUS Station wagon (GC) i i				
1.8 i 16V	85	05.98 →	60-K0-017	61-0K-K00
2.0 i 16V	98	05.98 →	60-03-396	61-0K-000
				66-K0-000
				66-K0-000
				67-K0-000
JOICE i i				
2.0	102	02.00 →	60-06-690	61-0H-H02
			60-K0-002	61-0H-002
			60-0K-K19	66-00-097
2.0	88	09.01 →	60-00-067	61-0H-H02
			60-03-396	61-0H-002
				66-00-097

	KW			
K2500				
2.5 D	69	01.03 →	50-0K-018 60-0K-004	55-0K-004 07.04→ 56-0K-014 07.04→ 56-0K-K16 67-0K-019 →04.04 Right\Destra 67-0K-K17 05.04→ 67-0K-K20 05.04→ 67-K0-006 →04.04 Left\Sinistra 67-K0-007 Right\Destra 67-K0-015 Left\Sinistra
K2700				
2.7 D	59	10.99 →	50-0K-018 60-0K-004 08.01→ →07.04 60-0K-K13 →12.99 60-0K-K22 08.04→	55-0K-004 56-0K-K16
MAGENTIS				
2.0	106	11.05 →	50-H0-010 60-0H-012	51-0H-H04 61-0K-K10
2.0 CRDi	103	04.06 →		
2.7	138	11.05 →		
MAGENTIS (GD)				
2.0	100	05.01 →	50-H0-010 09.02→ 50-K0-014 →09.02 60-0K-014 60-0K-015 NO ABS	51-0H-H04 61-0K-003 55-K0-008 56-H0-014 67-K0-013 Left\Sinistra 67-K0-014 Right\Destra
2.5 V6	124	05.01 →		
OPIRUS				
3.5	149	09.03 →	50-H0-010	51-0H-H04 55-0K-K22 Parking Brake\Freno staz.
3.8 V6	196	10.06 →		51-0H-H04 55-0K-K22 Parking Brake\Freno staz.
PICANTO				
1.0	46	02.08 →	50-0K-010 60-0K-010	51-0K-004 61-0K-002 con/with ABS 55-0K-K15 NO ABS 67-0K-K16 NO ABS
1.0	45	09.05 →		
1.1	48	04.04 →		

	KW			
PICANTO				
1.1 CRDi	55	02.08 →	50-0K-010	51-0K-004
1.1 CRDi	55	11.05 →	60-0K-K20	61-0K-002 55-0K-K15 67-0K-K16
				NO ABS NO ABS
1.1	48	02.08 →	50-0K-010 60-0K-010	51-0K-004 61-0K-002 55-0K-K15
PICANTO (TA)				
1.0	51	05.11 →	50-0K-K23 60-0K-010	51-0K-K09 61-0K-002 56-0K-K15
PREGIO (TB)				
2.7 D	60	10.97 →	50-K0-001 60-0K-007	55-03-325 56-0K-K03 67-0K-019 67-K0-006
				Right\Destra Left\Sinistra
2.5 Tci D	69	09.02 →	50-K0-005 60-0K-007	55-K0-013 56-0K-K03 67-0K-019 67-K0-006
				Right\Destra Left\Sinistra
PRIDE (DA)				
1.1 i	38	01.91 →	50-03-332	55-03-330
1.3 16V	53	01.90 →	60-03-338	67-K0-004
1.3 16V	44	01.90 →		
1.3 16V	47	10.96 →		
1.3 i	51	01.90 →		
PRIDE Station wagon				
1.3	47	08.99 →	50-03-332 60-03-338	55-03-330 67-K0-004
PRO CEE'D				
1.4	80	02.08 →	50-K0-009	51-0K-K09
1.6	93	02.08 →	60-0H-012	61-0K-K14
1.6 CRDi 115	85	02.08 →		55-0K-K21
1.6 CRDi 90	66	02.08 →		
2.0	105	02.08 →		
2.0 CRDi	103	02.08 →		
				Parking Brake\Freno staz.
RETONA (CE)				
2.0 16V	94	05.00 →	50-K0-000	55-03-396
2.0 TD	61	06.99 →	60-0K-009	
RIO				

	KW			
RIO				
1.3 1.6	55 72	09.00 → 02.05 09.00 → 02.05	60-03-341 60-K0-017 60-0K-008 60-0K-016	→06.02 07.02→ →06.02 07.02→
				56-K0-007 →06.02 56-K0-011 07.02→ 56-K0-010 →06.02 NO ABS 56-K0-011 07.02→ NO ABS 56-K0-012 →06.02 con/with ABS 56-K0-013 07.02→ con/with ABS 67-03-373 →06.02 67-K0-008 07.02→
1.3	60	08.02 → 02.05	60-03-341 60-K0-017 60-0K-008 60-0K-016	07.02→ 07.02→
				56-0K-K18 Parking Brake/Freno staz. 56-K0-007 56-K0-011 07.02→ 56-K0-010 NO ABS 56-K0-011 07.02→ NO ABS 56-K0-012 con/with ABS 56-K0-013 07.02→ con/with ABS 67-03-373 67-K0-008 07.02→
1.2	63	09.11 →	60-0K-K24 60-0K-K18	
1.1 CRDi	55	09.11 →	60-0K-K24	
1.4 CRDi	66	09.11 →	60-0K-K24	
RIO II				
1.4 16V 1.5 CRDi 1.6 16V	71 81 82	03.05 → 03.05 → 03.05 →	60-0K-K12 60-0K-K18	Imp. MANDO
				61-0K-K09 61-0H-001 56-0K-K18 Parking Brake/Freno staz.
RIO II Tre volumi/Saloon				
1.4 16V 1.5 CRDi 1.6 16V	71 81 82	03.05 → 03.05 → 03.05 →	60-0K-K12 60-0K-K18	Imp. MANDO
				61-0K-K09 61-0H-001 56-0K-K18 Parking Brake/Freno staz.
RIO Station wagon (DC)				









	KW			
RIO Station wagon (DC) i i				
1.3	60	08.00 → 02.05	60-03-341 →06.02	56-K0-007 →06.02
1.3	55	08.00 → 02.05	60-K0-017 07.02→	56-K0-011 07.02→
1.5	72	08.00 → 02.05	60-0K-008 →06.02	56-K0-010 →06.02
			60-0K-016 07.02→	NO ABS
				56-K0-011 07.02→
				NO ABS
				56-K0-012 →06.02
				con/with ABS
				56-K0-013 07.02→
				con/with ABS
				67-03-373 →06.02
				67-K0-008 07.02→
1.5	71	09.02 → 02.05	60-K0-017	56-K0-011
			60-0K-016	NO ABS
				56-K0-011 con/with ABS
				56-K0-013 con/with ABS
				67-K0-008
SEPHIA (FA) i i				
1.6 i 16V	59	02.96 →	60-03-398	61-0K-K01
1.6 i	59	01.95 →	60-03-398	61-0K-004
1.8 i 16V	82	01.95 →		56-03-398 →04.97
				56-K0-006 →04.97
				56-K0-009 05.97→
				67-K0-000
1.6 16V	65	01.99 →	60-03-398	61-0K-K00
			60-0K-012	61-0K-006
				56-K0-012
				56-K0-009
				67-03-373
1.8 16V	82	01.99 →	60-03-398	61-0K-K01
			60-03-398	61-0K-004
SEPHIA Tre volumi/Saloon (FA) i i				
1.6 i	59	09.93 →	60-03-398	61-0K-K01
1.8 i 16V	82	01.95 →	60-03-398	61-0K-004
				56-03-398 →05.97
				56-K0-006 →04.97
				56-K0-009 05.97→
				67-K0-000

	KW			
SEPHIA Tre volumi/Saloon (FA) <i>i</i> <i>i</i>				
1.6 i 16V	59	02.96 → 10.97	 60-03-398  60-03-398	 61-0K-K01  61-0K-004  66-03-398  66-K0-006  67-K0-000
SHUMA (FB) <i>i</i> <i>i</i>				
1.6 i 16V	65	10.97 → 03.01	 60-K0-002  60-03-398	 61-0K-K00  61-0K-006  66-03-398  66-K0-009  67-K0-000
1.8 i 16V	81	10.97 → 03.01		
SHUMA II (FB) <i>i</i> <i>i</i>				
1.6	75	05.01 → 08.04	 60-03-398  60-0K-012	 61-0K-K00  61-0K-006  66-K0-012  66-K0-009  67-03-373
1.8	84	04.03 → 08.04		
SHUMA II Tre volumi/Saloon (FB) <i>i</i> <i>i</i>				
1.6	75	05.01 → 05.04	 60-03-398  60-0K-012	 61-0K-K00  61-0K-006  66-K0-012  66-K0-009  67-03-373
SHUMA Tre volumi/Saloon (FB) <i>i</i> <i>i</i>				
1.6 i 16V	65	10.97 → 10.01	 60-K0-002  60-03-398	 61-0K-K00  61-0K-006  66-03-398  66-K0-009  67-K0-000
1.6	59	03.96 → 12.98	 60-03-398  60-03-398	 61-0K-K00  61-0K-006  66-03-398  66-K0-009  67-K0-000
SORENTO <i>i</i> <i>i</i>				
2.0 CRDi	110	11.10 →	 60-0H-H14  60-0H-H19	 61-0K-K11  61-0K-K16  66-0S-S02
2.0 CRDi 4WD	110	11.10 →		
2.2 CRDi	145	11.09 →		
2.4 16V	129	11.09 →		
SORENTO (JC) <i>i</i> <i>i</i>				















Parking Brake/Freno staz.



	KW			
SORENTO (JC)				
2.4	102	08.02 →	60-K0-008	61-0K-K03
2.6 CRDi	103	08.02 →	60-0K-005	61-0K-005
3.5 V6	143	08.02 →		65-0K-K17
3.3 V6	177	12.06 →	60-K0-008	61-0K-K03
			60-0K-005	61-0K-005
				65-0K-K20
2.6 CRDi	125	12.06 →	60-K0-008	61-0K-K03
			60-0K-005	61-0K-K12
				65-0K-K20
SOUL				
1.6	93	02.09 →	60-H0-010	61-0K-K06
1.6 CRDi	93	02.09 →	60-0H-012	61-0K-K16
				65-0K-K16
SPORTAGE				
2.0 16V	104	09.04 →	60-0K-K20	61-0H-H04
2.0 16V 4WD	104	09.04 →	60-H0-010	61-0K-K09
2.0 CRDi 4WD	83	09.04 →	60-0H-012	61-0H-003
2.7 V6 4WD	129	09.04 →	60-0H-H23	
2.0 CRDi 4WD	103	01.06 →	60-0K-K20	61-0H-H03
			60-H0-010	61-0K-K09
			60-0H-012	61-0H-003
			60-0H-H23	
2.0 CRDi	83	02.05 →	60-0K-K20	61-0H-H04
			60-H0-010	61-0K-K09
			60-0H-012	61-0K-K10
1.7 CRDi	85	02.11 →	60-0K-K20	61-0K-K09
2.0 16V CRDi VGT	100	10.10 →	60-0H-H23	61-0K-K14
2.0 16V CVVT	120	10.10 →		
SPORTAGE (K00)				
2.0 CRDi	103	01.06 →	60-03-392	65-03-342
2.0 i 16V 4WD	94	04.94 → 08.03	60-0K-009	66-K0-008
2.0 i 4WD	70	04.94 → 08.99		67-K0-005
2.0	87	10.00 → 08.03	60-K0-000	65-03-396
2.0 4WD	87	10.00 → 08.03	60-0K-009	66-K0-002
2.0 i 16V	94	10.99 → 08.03		67-K0-002
2.0 TD 4WD	61	10.97 → 08.03		
2.2 D 4x4	52	08.94 → 04.99	60-K0-000	65-03-342
			60-0K-009	65-03-396
				66-K0-002
				66-K0-008
				67-K0-002
VENGA				

























































	KW			
VENGA				
1.4 16V	66	02.10 →	 50-0K-K22	 51-0K-K12
1.4 CRDi	66	02.10 →	 60-0H-012	 61-0K-K17
1.6 16V	92	02.10 →		
1.6 CRDi	94	02.10 →		



	KW			
NADESCHDA (2120) <i>i</i> <i>i</i>				
1.7	60	12.97 →	 50-00-000	 55-00-000
1.7 i	59	12.97 →	 60-00-070	 67-00-000
1.8	60	12.97 →		
1.8 i	67	12.97 →		
NIVA (2121) <i>i</i> <i>i</i>				
1600	54	01.87 → 03.95	 50-00-000	 55-00-000
1600	56	04.80 → 12.87	 60-00-070	 67-00-000
1600	56	12.76 → 05.87		
1700 i	59	06.96 →		
1700 i 4x4	60	10.00 →		
1900 Diesel	47	01.93 →		
1900 Diesel	55	01.99 →	 50-00-000	
			 60-00-070	



























































LAND ROVER



























































	KW			
88/109 i				
2.3 (LR 88 OL, LR 109 OL)	51	09.63 → 12.86	 50-0L-L04	 55-0L-L02
2.3 D (LR 88 DL, LR 109 DL)	46	09.63 → 12.86	 60-0L-L12	 55-0L-L03
				 56-0L-L02
3.5	68	01.80 → 12.83	 50-0L-L04	 55-0L-L02
			 60-0L-L12	 55-0L-L03
				 56-0L-L01
				 56-0L-L02
88/109 Hardtop i				
2.3 (LR 88 OP, LR 109 OP)	51	09.63 → 12.86	 50-0L-L04	 55-0L-L02
2.3 D (LR 88 DP, LR 109 DP)	46	09.63 → 12.86	 60-0L-L12	 55-0L-L03
				 56-0L-L02
				11.71→ →05.84
90/110 i				
3.5 V8	100	09.83 → 07.90	 50-0L-L02	 55-0L-L03
			 50-0L-L04	 55-0L-L06
			 60-0L-L12	 56-0L-L02
			06.84→ →12.85	07.89→
2.5	62	09.85 → 07.90	 50-0L-L02	 55-0L-L03
			 60-0L-L12	 55-0L-L06
				 56-0L-L02
				07.89→
2.5 TD	63	09.86 → 07.90	 50-0L-L02	 55-0L-L02
			 60-0L-L12	 55-0L-L03
				 55-0L-L06
				 56-0L-L02
				07.89→
2.5 D 4x4	51	09.86 → 08.88	 50-0L-L02	 56-0L-L02
			 60-0L-L12	
DEFENDER (LD) i				
2.5 90 TDI	83	09.90 →	 50-0L-L02	 51-0L-L04
2.5 Td5 4WD	90	06.98 →	 60-0L-L09	 61-0L-L05
			 60-0L-L12	 61-0L-L08
				 55-0L-L06
				 55-0L-L07
				VIN-> (V)XA159807
				Parking Brake\Freno staz.
DEFENDER Pick-up i				
2.5 Td5 4WD	90	06.98 →	 50-0L-L02	 51-0L-L04
			 60-0L-L09	 61-0L-L05
			 60-0L-L12	 61-0L-L08
			VIN-> LA930456	 55-0L-L06
				 55-0L-L07
				 56-0L-L02
				VIN-> (V)XA159807
				Parking Brake\Freno staz.



























































LAND ROVER

	KW			
DEFENDER Station Wagon (LD)				
2.6 90,110 TDI 2.6 Td6 4WD	83 90	09.90 → 12.98 06.98 →	 60-0L-L02  60-0L-L09  60-0L-L12	 61-0L-L04  61-0L-L06  61-0L-L08  66-0L-L06  66-0L-L07
				VIN-> (V)XA159807 Parking Brake\Freno staz.
3.9 V8	136	11.98 →	 60-0L-L02  60-0L-L12	 61-0L-L02  61-0L-L08  66-0L-L06  66-0L-L07
				VIN-> (V)XA159807 →12.01 Parking Brake\Freno staz.
2.6 4x4	61	09.90 → 12.94	 60-0L-L02  60-0L-L09  60-0L-L12	 61-0L-L06
3.5 4x4	86	09.90 → 08.93	 60-0L-L02  60-0L-L09  60-0L-L12	 61-0L-L04  61-0L-L06  66-0L-L07
				Parking Brake\Freno staz.
DISCOVERY I				
2.6 TDI 3.9 V8	83 134	09.89 → 06.94 09.93 → 06.94	 60-0L-L04  60-0L-L09  60-0L-L12	 61-0L-L04  61-0L-L06  66-0L-L06  66-0L-L07
				Parking Brake\Freno staz.
3.6 (SALLJG)	113	09.89 → 06.94	 60-0L-L04  60-0L-L09  60-0L-L12	 61-0L-L04  61-0L-L06  66-0L-L06
2.0 16 V	99	09.93 → 06.94	 60-0L-L04  60-0L-L09	 61-0L-L04  61-0L-L06  66-0L-L06  66-0L-L07
				Parking Brake\Freno staz.
DISCOVERY II (LJ, LT)				
2.0 16 V 2.6 TDI 2.6 TDI 3.9 V8	99 83 90 134	06.94 → 08.96 → 10.95 → 06.94 → 11.98	 60-0L-L09  60-0L-L12	 61-0L-L04  61-0L-L06  66-0L-L06  66-0L-L07
				Parking Brake\Freno staz.
2.6 Td6	102	01.99 →	 60-0L-L01	 61-0L-L02  61-0L-L07  66-0L-L07
				Parking Brake\Freno staz.
4.0 V8	136	11.98 →	 60-0L-L01  60-0L-L12	→06.04  61-0L-L02  61-0L-L04  61-0L-L06  61-0L-L07  66-0L-L07
				Parking Brake\Freno staz.

	KW				
DISCOVERY III					
4.4	220	10.04 →	 50-0L-L01  60-0L-L08	 51-0L-L01  61-0L-L01  55-0L-L00  55-0L-L08	Parking Brake\Freno staz. 01.07→ Parking Brake\Freno staz.
2.7 TD	140	10.04 →	 50-0L-L01  60-0L-L04	 51-0L-L01  61-0L-L00  55-0L-L00  55-0L-L08	Parking Brake\Freno staz. 01.07→ Parking Brake\Freno staz.
4.0 4x4	161	02.05 →	 50-0L-L01	 51-0L-L01	
3.0 TD	180	09.09 →	 50-0L-L06  50-0L-L08  60-0L-L02	 51-0L-L01  61-0L-L01  55-0L-L08	Parking Brake\Freno staz.
5.0 V8	375	09.09 →	 60-0L-L02	 51-0L-L01  61-0L-L01  55-0L-L08	Parking Brake\Freno staz.
DISCOVERY IV (LA)					
2.7 TD	140	09.09 →	 50-0L-L01  60-0L-L04	 51-0L-L01  61-0L-L00  55-0L-L08	Parking Brake\Freno staz.
3.0 TD	155	05.10 →	 50-0L-L07  60-0L-L02	 51-0L-L01  61-0L-L01  55-0L-L08	Parking Brake\Freno staz.
FREELANDER (LN)					
1.8 i 16V	88	02.98 → 11.00	 50-04-427	 55-0L-L04	
2.0 DI	72	02.98 → 11.00	 50-0L-L03  60-0L-L00  60-0L-L10	 56-0L-L00	Imp. LUCAS VIN-> (V)1A000001 VIN (V)YA999999->
1.8 16V	86	11.00 →	 50-04-427	 55-0L-L05	VIN YA999999 ->
2.0 Td4	82	11.00 →		 56-0L-L00	Imp. LUCAS
2.0 Td4	80	11.01 →	 50-0L-L03	 56-0L-L00	VIN-> (V)1A000001
2.5 V6	130	11.00 →	 60-0L-L00  60-0L-L10		VIN (V)YA999999->
FREELANDER 2					
2.2 TD4	112	01.07 →	 50-0L-L00	 51-0L-L03	
2.2 TD4	118	10.06 →	 60-0L-L13	 61-0L-L03	
2.2 TD4 4x4	115	10.06 →		 55-0L-L01	Parking Brake\Freno staz.



































































LAND ROVER

	KW			
FREELANDER 2 <i>i</i> <i>i</i>				
3.2	171	10.06 →	 50-0L-L00  60-0L-L05	 51-0L-L03  61-0L-L06  55-0L-L01 Parking Brake\Freno staz.
FREELANDER Soft Top <i>i</i> <i>i</i>				
1.8 i 16V	88	02.98 →	 50-04-427	Imp. LUCAS VIN-> (V)1A000001
2.0 DI	72	02.98 →	 50-0L-L03  60-0L-L00  60-0L-L10 VIN (V)YA999999->	 55-0L-L04 →10.00  55-0L-L05 11.00→  56-0L-L00
RANGE ROVER EVOQUE <i>i</i> <i>i</i>				
2.0 Si4	177	06.11 →	 50-0L-L00	 51-0L-L05
2.2 SD4	140	06.11 →	 60-0L-L13	 61-0L-L09
2.2 TD4	110	06.11 →		
RANGE ROVER I <i>i</i> <i>i</i>				
2.4 Diesel	78	04.86 → 12.90	 50-0L-L04	 51-0L-L04
2.5 TD 4x4	89	10.89 → 04.94	 60-0L-L09	 61-0L-L05
3.5	107	01.87 → 09.90	 60-0L-L12	 55-0L-L06 10.85→
3.5 Vogue	93	08.81 → 09.90		
3.5 Vogue	120	10.85 → 09.90		
3.9 Cat.	127	11.88 → 07.94		
3.9 Vogue SEI	134	11.88 → 07.94	 50-0L-L04  60-0L-L09  60-0L-L12	 51-0L-L04  61-0L-L05  61-0L-L07  55-0L-L07 Parking Brake\Freno staz.
4.3 Vogue LSE	149	09.92 → 07.94	 50-0L-L04  60-0L-L09	 51-0L-L04  61-0L-L05  55-0L-L06
3.5	97	07.70 → 08.81	 50-0L-L04  60-0L-L12	 51-0L-L04  61-0L-L05  55-0L-L06
2.4 TD 4x4	89	10.89 → 02.92	 60-0L-L12	 61-0L-L05
2.5 TDi 4x4	83	09.91 → 04.94	 60-0L-L09	 61-0L-L05
3.5 4x4	96	10.85 → 08.91	 50-0L-L04  60-0L-L09  60-0L-L12	 51-0L-L04  61-0L-L05
RANGE ROVER II (LP) <i>i</i> <i>i</i>				
2.5 D	83	08.94 → 03.02	 60-0L-L07	 51-0L-L02  61-0L-L07  55-0L-L06 →04.96  55-0L-L07 Parking Brake\Freno staz.















LAND ROVER

























































	KW			
RANGE ROVER II (LP)				
2.6 D	100	07.94 → 03.02	 60-0L-L07	 61-0L-L02
3.9	140	07.94 → 03.02	 60-0L-L09	 61-0L-L05
				 61-0L-L07
				 65-0L-L07
4.0	136	06.98 → 03.02	 60-0L-L07	 61-0L-L02
4.6	160	06.98 → 03.02		 61-0L-L07
4.6	165	07.94 → 03.02		 65-0L-L07
RANGE ROVER III (LM)				
3.0 TD 6	130	03.02 →	 60-0L-L03	 61-0L-L00
4.4	210	03.02 →	 60-0L-L06	 61-0L-L01
4.4	225	05.05 →	 60-0L-L06	 61-0L-L02
			 60-0L-L11	 61-0L-L04
				 61-0L-L07
				 65-0L-L09
4.2	291	05.05 →	 60-0L-L06	 61-0L-L00
			 60-0L-L06	 61-0L-L01
			 60-0L-L02	 61-0L-L02
			 60-0L-L03	 61-0L-L04
			 60-0L-L06	
			 60-0L-L11	 61-0L-L07
				 65-0L-L09
3.6 TD 8	200	04.06 →	 60-0L-L06	 61-0L-L00
			 60-0L-L07	 61-0L-L01
			 60-0L-L03	 61-0L-L02
			 60-0L-L11	 61-0L-L04
				 61-0L-L07
				 65-0L-L09
RANGE ROVER SPORT				
4.2	287	02.05 →	 60-0L-L06	 61-0L-L01
			 60-0L-L02	 61-0L-L01
				 65-0L-L08
4.4	220	02.05 →	 60-0L-L01	 61-0L-L01
			 60-0L-L02	 61-0L-L01
			 60-0L-L08	 65-0L-L08
2.7 TDVM	140	02.05 →	 60-0L-L01	 61-0L-L01
			 60-0L-L06	 61-0L-L00
			 60-0L-L02	
			 60-0L-L04	 65-0L-L08

































































LAND ROVER

	KW			
RANGE ROVER SPORT				
3.6 TD 8	200	04.06 →	 50-0L-L06  60-0L-L02	 51-0L-L01  61-0L-L01  55-0L-L00 Parking Brake\Freno staz.
3.0 TD	180	09.09 →	 50-0L-L08  60-0L-L03	 51-0L-L01  61-0L-L02  55-0L-L09 Parking Brake\Freno staz.







	KW			
CT i				
200h	73	03.11 →	 50-02-219  60-02-277	 51-02-214  61-02-241
ES (F1, F2) i				
250	118	12.89 → 09.91	 50-02-265	 51-02-213
300	138	09.91 → 12.97	 60-02-275	 61-02-225
GS i				
300	183	04.05 →	 50-02-222	 51-02-217
430	208	04.05 →	 60-02-2025	 55-02-226
450 h	218	02.06 →	 60-02-2026	Parking Brake\Freno staz.
460	255	05.08 →		
3.0	170	04.05 →	 50-02-222  60-02-2025  60-02-2026	 51-02-217
GS (JZS147) i				
300	156	03.93 → 08.97	 50-02-265  50-02-294  60-02-286	04.93→ →03.93  51-02-206  51-02-212  61-02-259  55-02-223
				04.93→ →03.93 Parking Brake\Freno staz.
GS (JZS160) i				
300	161	10.00 → 03.05	 50-02-207	 51-02-260
300 T3	163	08.97 → 10.00	 60-02-286	 55-02-223
400	216	12.97 → 11.00		Parking Brake\Freno staz.
430	208	11.00 → 03.05		
IS i				
250 (GSE20)	153	10.05 →	 50-02-223  60-02-2007	 51-02-217  61-02-233  61-02-246  55-02-226
				07.06→ Parking Brake\Freno staz.
220 d (ALE20)	130	10.05 →	 50-02-223  60-02-2007	 51-02-217  61-02-233  61-02-246
				07.06→
IS (GXE10) i				
200	114	04.99 →	 50-02-207	 51-02-260
300	157	09.01 →	 60-02-286	 61-02-229  55-02-223
				Parking Brake\Freno staz.
IS SportCross i				
300	157	10.01 →	 50-02-207  50-03-300  60-02-286	 51-02-260  61-02-229  55-02-223
				Parking Brake\Freno staz.



	KW			
IS SportCross <i>i</i> <i>i</i>				
200	114	10.02 →	 50-02-207  60-02-286	 51-02-260  61-02-229  55-02-223 Parking Brake\Freno staz.
LS (FE) <i>i</i> <i>i</i>				
430	207	10.00 →	 50-02-274  60-02-292	 51-02-222  61-02-259
LS (UCF10) <i>i</i> <i>i</i>				
400	180	12.89 → 12.94	 50-02-265 →08.92  50-02-295 09.92→  60-02-283 →08.92  60-02-286	 51-02-265 →08.92  51-02-295 09.92→  61-02-216 →08.92  61-02-259 09.92→
LS (UCF20) <i>i</i> <i>i</i>				
400	209	09.97 →	 50-02-265	 51-02-212
400	203	09.98 →	 60-02-292	 61-02-216
400	194	12.94 → 08.97		 55-02-223 Parking Brake\Freno staz.
RX <i>i</i> <i>i</i>				
300	150	05.03 →	 50-02-209	 51-02-211
350	203	02.06 →	 60-02-225	 61-02-228
400h	155	09.04 →		
400h	155	09.04 →		
400h FWD	155	09.05 →		
RX (XU1) <i>i</i> <i>i</i>				
3.0 2WD	148	07.00 → 03.03	 50-02-209 08.01→  50-02-273 →07.01	 51-02-213  61-02-249
300 V6	148	10.00 → 05.03	 50-02-209 08.01→  50-02-273 →07.01  60-02-249	 51-02-213  61-02-249
SC <i>i</i> <i>i</i>				
430	210	08.01 →	 50-02-207  60-02-286	 51-02-260  61-02-229  55-02-223 Parking Brake\Freno staz.







	KW			
AMBRA <i>i</i> <i>i</i>				
0.6	14	12.96 →	 60-00-021  60-00-022	 55-00-008  55-00-009
BE UP <i>i</i> <i>i</i>				
0.6	14	08.02 →	 60-00-021  60-00-022	 55-00-008  55-00-009
NOVA <i>i</i> <i>i</i>				
400	5	08.02 →	 60-00-021  60-00-022	 51-00-008  55-00-008  55-00-009
500	4	08.02 →		
650	14	08.02 →		
X-TOO <i>i</i> <i>i</i>				
			 60-00-022	



	KW			
ELAN				
1.6 i 16V	97	09.89 → 11.95	 50-09-905	<i>i</i>
1.6 i 16V Turbo	123	09.89 → 11.95	 60-09-909	<i>i</i>
1.6 i 16V Turbo	115	09.91 → 11.95		











MAHINDRA



	KW			
GOA i i				
2.6 TD	79	01.07 →	 60-00-007  60-00-006	 66-02-216









































MARUTI

	KW				
800 <i>i</i> <i>i</i>					
0.8	26	01.91 →	 50-04-404  60-08-801	Imp. SUMITOMO	 55-08-808  67-08-800 UpperSuperiore  67-08-801 LowerInferiore  67-08-810









































































	KW			
1000 <i>i</i> <i>i</i>				
1.0	33	01.75 → 01.77	 50-03-304  60-03-304	 55-03-302  67-03-368
121 I (DA) <i>i</i> <i>i</i>				
1.1	42	10.87 → 10.90	 50-03-332	 55-03-330
1.3	40	04.89 → 10.90	 60-03-338	 67-03-399
1.3	44	10.87 → 11.90		
1.4 16V (DA1)	71	11.87 → 12.94		
121 II (DB) <i>i</i> <i>i</i>				
1.3 16V	53	11.90 → 03.96	 50-03-341	 55-03-330
1.3 16V	39	11.90 → 03.96	 60-03-342  60-03-356	 67-03-399
			01.91→	
121 III (JASM, JBSM) <i>i</i> <i>i</i>				
1.3	44	03.96 →	 50-03-332	 55-03-394
1.3	37	03.96 →		 56-03-301  67-03-399
1.25	55	03.96 →	 50-03-383	 55-03-394  56-03-301  67-03-399
1.8 D	44	03.96 →	 50-03-398	 55-03-394  56-03-301  67-03-399
				01.98→
1.3i 16V CABRIO (JJA)		03.96 →	 50-03-332	 55-03-394  56-03-301
1300 <i>i</i> <i>i</i>				
1.3	44	01.75 → 01.77	 50-03-304  60-03-304	 55-03-302  67-03-368
2 <i>i</i> <i>i</i>				
1.25	55	04.03 →	 50-03-302	 55-03-307
1.4	59	04.03 →	 60-03-307	 67-03-318
1.4 CD	50	04.03 →		
1.6	74	04.03 →		
1.3	55	10.07 →	 50-03-343	 55-03-314
1.3	63	10.07 →	 60-03-325	
1.4 MZR-CD	50	01.08 →		
1.5	76	10.07 →		
1.6 MZ-CD	66	10.08 →	 50-03-343  60-03-307	 55-03-314
3 <i>i</i> <i>i</i>				
1.4	59	02.04 →	 50-03-300	 51-01-138
1.4	62	10.03 →	 60-03-311	 61-03-321
1.6	77	10.03 →		
1.6 DI Turbo	80	06.04 →		

	KW			
3				
2.0	110	10.03 →	50-03-300 60-03-309	51-01-138 61-03-317
2.3 MPS	191	12.06 →	50-03-300 60-03-309	51-00-005 61-03-317
2.0 MZR-CD	105	12.06 →	50-03-300 60-03-309	51-01-138
1.6 MZR	77	06.09 →	50-03-300	51-00-005
1.6 MZR-CD	80	06.09 →	60-03-311	61-03-321
2.0 MZR	110	06.09 →	50-03-300	51-00-005
2.2 MZR-CD	110	06.09 →	60-03-309	61-03-317
3 Tre volumi/Saloon				
1.6	77	02.04 →	50-03-300	51-01-138
1.6 DI Turbo	80	06.04 →	60-03-311	61-03-321
2.0	110	02.04 →	50-03-300	51-01-138
2.0 MZR-CD	105	12.06 →	60-03-309	61-03-317
323 F IV (BG)				
1.6	62	09.89 → 06.91	50-03-341	51-06-601
1.6 16V	65	03.91 → 10.94	60-03-342 60-03-344	61-03-312 55-03-388 05.91→ 55-03-397 →04.91 56-03-300 05.91→ 56-03-302 →04.91 67-03-368
1.8 16V	76	08.89 → 07.94	50-03-341	51-03-391
1.8 16V	103	09.89 → 03.93	60-03-349	61-03-399 55-03-388 55-03-397 56-03-300 05.91→ 56-03-302 →04.91
1.8 16V GT	94	08.89 → 07.94	50-03-342 60-03-349	51-03-391 61-03-308 55-03-388 55-03-397 56-03-300 05.91→ 56-03-302 →04.91





























































	KW			
323 F IV (BG) i i				
1.8 4WD	76	01.91 → 04.94	 50-03-341  60-03-349	 51-03-391  61-03-308  55-03-388  55-03-397  56-03-300  56-03-302
				05.91→ →04.91 05.91→ →04.91
323 F V (BA) i i				
2.0 24V	106	08.94 → 09.98	 50-03-342  60-03-349	 51-03-391  61-03-399  67-03-398
1.5 16V	65	07.94 → 09.98	 50-03-341  60-03-344	 51-03-391  61-03-399  55-03-397  56-03-300  67-03-398
1.8 16V	84	08.94 → 09.98	 50-03-342  60-03-349	 51-03-391  61-03-399  55-03-397  56-03-300  67-03-398
323 F VI (BJ) i i				
1.4 16V	54	09.98 → 01.01	 50-03-311  60-03-344	 51-03-302  61-03-322  55-03-397  56-03-300  67-03-398
1.4	53	01.01 → 05.04	 50-03-311  60-03-344	 51-03-302  61-03-322  55-03-397  56-03-300
1.5 16V	65	09.98 → 01.01		
1.9 16V	84	09.98 → 01.01	 50-03-399  60-03-320	 51-03-302  61-03-322
2.0	96	01.01 → 05.04		
2.0 TD	74	01.01 → 05.04		
2.0 D	52	09.98 → 05.04	 50-03-399  60-03-320	 51-03-302  61-03-322  55-03-397  56-03-300  67-03-398

























































	KW			
323 F VI (BJ)				
2.0 TD	66	09.98 → 01.01	50-03-399 60-03-320	51-03-302 61-03-322 55-03-397 67-03-398
1.6	70	01.01 → 05.04	50-03-399	51-03-302
1.6	72	01.01 → 05.04	60-03-320	61-03-322 55-03-397 56-03-300
323 I (FA)				
1.0	33	06.77 → 05.80	50-03-314 60-03-312	55-03-302 67-03-368
1.3	44	01.77 → 05.80	50-03-314 60-03-312	55-03-302 67-03-310
1.4	51	05.78 → 05.80	50-03-314 60-03-312	55-03-302 67-03-310 67-03-368
				Left/Sinistra Right/Destra
323 I Station Wagon (FA)				
1.3	44	05.78 → 05.86	50-03-314	55-03-302
1.4	51	05.78 → 08.82	60-03-312	67-03-310 67-03-368
				Left/Sinistra Right/Destra
1.5	52	04.82 → 05.86	50-03-316 60-03-314	55-03-316 67-03-312
323 II (BD)				
1.1	40	11.80 → 10.85	50-03-316	55-03-316
1.3	44	09.81 → 10.85	60-03-314	67-03-312
1.3	50	11.80 → 10.89		
1.5	65	03.82 → 09.86		
1.5	55	05.81 → 12.85		
1.5	59	11.80 → 07.85		
323 II Hatchback (BD)				
1.1	40	11.80 → 10.85	50-03-316	55-03-316
1.3	44	11.80 → 10.85	60-03-314	67-03-312
1.3	50	11.80 → 10.89		
1.5	65	03.82 → 12.85		
1.5	55	05.81 → 07.85		
1.5	63	11.80 → 12.83		
323 III (BF)				
1.3	44	08.85 → 05.89	50-03-326 60-03-335	55-03-327 67-03-313 67-03-371
			07.87→	→12.87 01.87→

	KW			
323 III (BF)				
1.6	55	08.85 → 05.89	 60-03-341  60-03-336	 66-03-327  66-03-328  67-03-313  67-03-371
1.6	54	09.87 → 10.89	 60-03-341	 66-03-327
1.6 i	70	08.85 → 05.89	 60-03-336	 67-03-371
1.6 GT	77	01.86 → 12.88	 60-03-326	 61-03-303
1.6 GT	63	11.86 → 10.89	 60-03-336	 61-03-304  67-03-371
1.7 D	42	01.87 → 05.89	 60-03-326	 66-03-327
1.7 D	40	09.86 → 05.89	 60-03-336	 67-03-371
1.6 i Turbo	85	08.85 → 05.89	 60-03-341  60-03-336	 67-03-371
1.6 GT Turbo	103	10.85 → 11.91	 60-03-326  60-03-336	 61-03-303  61-03-304
1.1	40	08.85 → 04.90	 60-03-326  60-03-336	 66-03-327  67-03-313
1.4	44	04.87 → 07.89	 60-03-326  60-03-336	 66-03-327
323 III Hatchback (BF)				
1.1	40	09.85 → 10.89	 60-03-326	 66-03-327
1.3	44	09.85 → 12.87	 60-03-336	 67-03-313
1.3 i	49	09.85 → 08.89		
1.6	55	08.85 → 05.89	 60-03-341  60-03-336	 66-03-327  67-03-313
1.6	54	09.87 → 10.89	 60-03-341	 66-03-327
1.6 i	70	08.85 → 05.89	 60-03-336	 67-03-371
1.6 i Turbo	85	08.85 → 05.89		
1.6 GT	77	08.85 → 12.88	 60-03-326	 61-03-303
1.6 GT	63	09.87 → 10.89	 60-03-336	 61-03-304  67-03-371
1.4	44	09.87 → 10.89	 60-03-326	 66-03-327
1.7 D	42	01.87 → 05.89	 60-03-336	 67-03-371
1.7 D	40	04.86 → 05.89		
1.6 GT Turbo 4WD (BF2)	110	08.87 → 10.89	 60-03-326	 61-03-303
1.6 GT Turbo 4WD (BF2)	103	10.87 → 11.91	 60-03-336	 61-03-303
1.6 GT Turbo (BF1)	103	10.85 → 11.91	 60-03-326  60-03-336	 61-03-303  61-03-304
1.6	54	09.87 → 10.89	 60-03-326  60-03-336	 61-03-303  61-03-304  66-03-327  67-03-313

	KW			
323 III Station Wagon (BW)				
			<i>i</i>	<i>i</i>
1.6	54	01.87 → 05.89	60-03-326 60-03-336	66-03-328 67-03-371
1.6	55	05.86 → 05.89		
1.6	63	09.86 → 10.95		
1.7 D	40	11.86 → 08.87	60-03-326 60-03-336	66-03-327 67-03-371
1.7 D	42	11.86 → 10.89	60-03-326 60-03-336 60-03-342	66-03-328 67-03-371
1.7 D	41	10.89 → 03.93	60-03-326 60-03-341 60-03-336	66-03-388 67-03-368
			→07.91 08.91→	09.91→
1.6 4x4	63	05.90 → 03.93	60-03-326 60-03-336	61-03-303
1.6	54	09.87 → 10.89	60-03-326 60-03-336	67-03-371
1.3	44	07.86 → 04.90	60-03-326 60-03-336	66-03-327 67-03-313
323 IV C (BG)				
			<i>i</i>	<i>i</i>
1.3	49	09.89 → 07.94	60-03-341 60-03-342	66-03-388 66-03-397 66-03-300 66-03-302 67-03-368
1.3 16V	54	09.89 → 07.94		05.91→ →04.91
1.6	62	09.89 → 06.91	60-03-341 60-03-342 60-03-344	66-03-388 66-03-397 66-03-300 66-03-302 67-03-368
				05.91→ →04.91
1.6 16V	65	03.91 → 10.94	60-03-341 60-03-342 60-03-344	61-06-601 61-03-312 66-03-388 66-03-397 66-03-300 66-03-302 67-03-368
				05.91→ →04.91
1.8 16V GT	94	09.89 → 03.93	60-03-342 60-03-349	61-03-391 61-03-308 66-03-388 66-03-397 66-03-300 66-03-302
				05.91→ →04.91

	KW				
323 IV C (BG)					
1.7 D	41	08.89 → 07.94	 50-03-341  60-03-342	 51-03-302  61-03-308  55-03-388  55-03-397  56-03-300  56-03-302  67-03-368	05.91→ →04.91
1.8 16V 4WD	76	11.91 → 12.93	 50-03-342	 51-03-391	
1.8 16V Turbo 4WD	136	01.93 → 07.94	 60-03-349	 61-03-308	
1.8 16V Turbo 4WD	120	09.90 → 12.92			
1.8 16V	103	09.89 → 03.93	 50-03-341  60-03-349	 51-06-601  61-03-308  55-03-388  55-03-397  56-03-300  56-03-302	05.91→ →04.91
1.9 16V 2WD/4WD		01.90 →	 50-03-342  60-03-349	 51-03-302  61-03-308  67-03-368	
323 IV S (BG)					
1.3	49	09.89 → 06.91	 50-03-341	 55-03-388	
1.7 D	41	08.89 → 07.94	 60-03-342	 55-03-397  56-03-300  56-03-302  67-03-368	05.91→ →04.91
1.3 16V	54	04.91 → 07.94	 50-03-341  60-03-342	 55-03-388  56-03-300  67-03-368	05.91→
1.6	62	09.89 → 06.91	 50-03-341  60-03-342  60-03-344	 55-03-388  55-03-397  56-03-300  56-03-302  67-03-368	05.91→ →04.91
1.6 16V	65	08.89 → 10.94	 50-03-341  60-03-342  60-03-344	 51-06-601  61-03-302  55-03-388  55-03-397  56-03-300  56-03-302  67-03-368	01.91→ 05.91→ →04.91

	KW				
323 IV S (BG) i					
1.8 16V	76	08.89 → 07.94	50-03-341 60-03-342	51-06-601 61-03-308 55-03-388 55-03-397 56-03-300 56-03-302 67-03-368	05.91→ →04.91
1.8 16V 4WD	76	09.91 → 07.94	50-03-342 60-03-349	51-03-391 61-03-308	
1.8 16V Turbo 4WD	120	01.91 → 07.94			
1.8 16V GT	94	06.89 → 07.94	50-03-342 60-03-349	51-03-391 61-03-308 55-03-388 55-03-397 56-03-300 56-03-302	05.91→ →04.91
323 V C (BA) i					
1.3 16V	54	08.94 → 09.98	50-03-341 60-03-342	51-03-391 61-03-399 55-03-397 56-03-300 67-03-398	
1.5 16V	65	08.94 → 09.98	50-03-341 60-03-344	51-03-391 61-03-399 55-03-397 56-03-300 67-03-398	11.96→ →10.97
1.8 16V	84	08.94 → 09.98	50-03-342 60-03-349	51-03-391 61-03-399 55-03-397 56-03-300 67-03-398	
323 V P (BA) i					
1.3 16V	54	10.96 →	50-03-341 60-03-342	55-03-397 56-03-300 67-03-398	
1.5 16V	65	10.96 →	50-03-341 60-03-344	51-03-391 55-03-397 56-03-300 67-03-398	11.96→ →10.97



	KW			
323 V P (BA) i				
2.0 D	52	10.96 →	 50-03-399  60-03-349	 61-03-399  55-03-397  56-03-300  67-03-398
323 V S (BA) i				
1.3 16V	54	08.94 → 09.98	 50-03-341  60-03-342	 55-03-397  56-03-300  67-03-398
1.6 TD	60	05.94 → 09.98		
1.5 16V	65	08.94 → 09.98	 50-03-341  60-03-344	 51-03-391 11.96→ →10.97  61-03-399  55-03-397  56-03-300  67-03-398
1.8 16V	84	08.94 → 09.98	 50-03-342  60-03-349	 55-03-397  56-03-300  67-03-398
2.0 D	52	10.96 → 09.98	 50-03-399  60-03-349	 55-03-397  56-03-300  67-03-398
323 VI P (BJ) i				
1.4 16V	54	09.98 →	 50-03-311	 55-03-397
1.5 16V	65	09.98 →	 60-03-342	 56-03-300
323 VI S (BJ) i				
1.4	53	01.01 → 05.04	 50-03-311	 51-03-302
1.4 16V	54	09.98 → 01.01	 60-03-344	 61-03-322
1.5 16V	65	09.98 → 01.01		 55-03-397  56-03-300
2.0 D	52	09.98 → 05.04	 50-03-399	 51-03-302
2.0 TD	66	09.98 → 05.04	 60-03-320	 61-03-322  55-03-397  56-03-300  67-03-398
1.6	70	01.01 → 05.04	 50-03-399	 51-03-302
1.6	72	01.01 → 05.04	 60-03-320	 61-03-322
1.9 16V	84	09.98 → 05.04		 55-03-397
2.0	96	01.01 → 05.04		 56-03-300
5 i				



























































	KW			
5				
1.8	85	03.05 →	50-03-300	51-01-138
2.0	107	03.05 →	60-03-309	61-03-317
2.0 CD	107	03.05 →		Rim Size\Diam Cerchio:15
2.0 CD	81	03.05 →	60-03-311	61-03-323
2.0 CD	105	06.05 →		Rim Size\Diam Cerchio:16
1.6 CD	85	12.10 →	50-03-300	51-00-005
1.8	85	12.10 →	60-03-309	61-03-323
6				
1.8 MRZ	88	08.07 →	50-03-346	51-03-302
2.0	108	04.08 →	60-03-353	61-03-316
2.0 CD	103	04.08 →		
2.0 MRZ	108	08.07 →		
2.0 MRZ-CD	103	08.07 →		
2.2 CD	120	04.08 →		
2.2 MRZ-CD	120	01.09 →		
2.2 MRZ-CD	136	01.09 →		
2.5	125	04.08 →		
2.5 MRZ	125	08.07 →		
2.2 MRZ-CD	92	01.09 →	50-03-305	51-03-302
			60-03-353	61-03-316
6 (GG)				
1.8	88	08.02 →	50-03-305	51-03-302
2.0	104	06.02 →	50-03-307	61-03-316
2.0 DI	100	06.02 →	60-03-305	
2.0 DI	89	08.02 →		
2.3	122	06.02 →		
2.0	108	03.05 →	50-03-305	51-03-302
2.0 DI	105	06.05 →	60-03-305	61-03-316
2.3	191	12.05 →	50-03-344	51-03-312
			60-03-351	61-03-328
6 Hatchback (GG)				
1.8	88	08.02 →	50-03-305	51-03-302
2.0	108	03.05 →	50-03-307	61-03-316
2.0	104	08.02 →	60-03-305	
2.0 DI	105	06.05 →		
2.0 DI	89	08.02 →		
2.0 DI	100	08.02 →		
2.3	122	08.02 →	50-03-307	51-03-302
			60-03-305	61-03-316
6 Hatchback (GH)				
2.0 MRZ-CD	103	08.07 →	50-03-346	51-03-302
2.2 MRZ-CD	136	01.09 →	60-03-353	61-03-316
2.2 MRZ-CD	120	01.09 →		
2.2 MRZ-CD	92	01.09 →		
6 Station Wagon (GY)				

	KW			
6 Station Wagon (GY) i				
1.8	88	08.02 →	50-03-305	51-03-302
2.0	108	03.05 →	50-03-307	61-03-316
2.0	104	08.02 →	60-03-305	
2.0 DI	89	08.02 →		
2.0 DI	100	08.02 →		
2.3	122	08.02 →	50-03-307	51-03-302
2.3 AWD	119	11.02 →	60-03-305	61-03-316
2.0 DI	105	06.05 →	50-03-305	51-03-302
			60-03-305	61-03-316
6 WAGON i				
1.8	88	04.08 →	50-03-346	51-03-302
2.0	108	04.08 →	60-03-353	61-03-316
2.0 CD	103	04.08 →		
2.2 MRZ-CD	92	01.09 →		
2.2 MRZ-CD	120	01.09 →		
2.5	125	04.08 →		
2.2 MRZ-CD	136	01.09 →	50-03-346	51-03-302
			60-03-352	61-03-316
616 i				
1.6	55	06.73 → 02.78	50-03-308	55-03-303
			60-03-306	67-03-355
626 I (CB) i				
1.6	55	05.79 → 05.82	50-03-319	55-03-303
2.0	66	05.79 → 05.82	60-03-316	67-03-354 →12.79 Left\Sinistra
				67-03-355 →12.79 Right\Destra
				67-03-356 01.80→ Left\Sinistra
				67-03-357 01.80→ Right\Destra
626 II (GC) i				
1.6	59	11.82 → 06.87	50-03-301 Imp. AKEBONO	55-03-305
			60-03-301 →08.84	67-03-303
			60-03-330 09.84→	
2.0	74	03.83 → 09.87	50-03-301 Imp. AKEBONO	51-03-300
			50-03-330 Imp. SUMITOMO	61-03-305
			60-03-303 →11.84	55-03-305
			60-03-334 12.84→	67-03-303

	KW					
626 II (GC) i i						
2.0	88	01.86 → 09.87	50-03-301	Imp. AKEBONO	51-03-300	
2.0	68	11.86 → 09.87	50-03-330	Imp. SUMITOMO	61-03-305	
			60-03-334		55-03-305	
					67-03-303	
2.0 D	46	01.83 → 06.87	50-03-301	Imp. AKEBONO	55-03-305	
			60-03-330		67-03-303	
626 II Hatchback (GC) i i						
1.6	55	03.83 → 09.87	50-03-301	Imp. AKEBONO	55-03-305	
1.6	59	03.83 → 09.87	60-03-301	→08.84	67-03-303	
			60-03-330	09.84→		
2.0	74	03.83 → 09.87	50-03-301	Imp. AKEBONO	51-03-300	
			50-03-330	Imp. SUMITOMO	61-03-305	
			60-03-303	→11.84	55-03-305	
			60-03-334	12.84→	67-03-303	
2.0	68	01.85 → 09.87	50-03-301	Imp. AKEBONO	51-03-300	
2.0	88	01.86 → 09.87	60-03-334		61-03-305	
					55-03-305	
					67-03-303	
2.0 D	46	03.84 → 06.87	50-03-301	Imp. AKEBONO	55-03-305	
			60-03-330		67-03-303	
626 III (GD) i i						
2.0	66	09.87 → 10.90	50-03-331		51-03-306	
2.0 16V	109	07.87 → 09.89	60-03-340		61-03-309	
2.0 16V	103	11.87 → 05.92			55-03-329	
					67-03-368	
2.2 12V	85	11.87 → 07.91	50-03-380		51-03-302	
			60-03-340		61-03-318	
					55-03-329	
					67-03-368	
2.0 D	44	07.87 → 07.91	50-03-330	Imp. SUMITOMO	51-03-305	
			50-03-331		61-03-309	
			60-03-341		55-03-329	
					67-03-368	
1.8	65	11.87 → 05.92	50-03-331		61-03-302	
			60-03-341		61-03-309	
					55-03-329	
					67-03-368	

	KW			
626 III (GD) i i				
2.0 12V	79	09.87 → 05.92	  50-03-331 60-03-340	     51-03-306 61-03-302 61-03-309 55-03-329 67-03-368
1.6	60	06.87 → 05.92	  50-03-331 60-03-341	  55-03-329 67-03-368
626 III Coupe (GD) i i				
2.0	66	09.87 → 10.90	  50-03-331 60-03-340	    51-03-306 61-03-309 55-03-329 67-03-368
2.0 12V	79	09.87 → 12.88		
2.0 16V	109	06.87 → 09.89	  50-03-331 60-03-340	     51-03-306 61-03-302 61-03-309 55-03-329 67-03-368
2.0 16V	103	12.87 → 10.90		
2.2 12V	85	04.88 → 12.91	  50-03-380 60-03-340	    51-03-302 61-03-318 55-03-329 67-03-368
1.8	65	09.87 → 08.91	  50-03-331 60-03-341	     51-03-306 61-03-302 61-03-309 55-03-329 67-03-368
1.6	60	06.87 → 05.92	  50-03-331 60-03-341	  55-03-329 67-03-368
626 III Hatchback (GD) i i				
2.0	66	09.87 → 10.90	  50-03-331 60-03-340	    51-03-306 61-03-309 55-03-329 67-03-368
2.0 12V	79	11.87 → 05.92		
2.0 16V	109	06.87 → 08.89		
2.0 16V	103	11.87 → 10.90		
2.2 12V	85	06.88 → 04.92	  50-03-380 60-03-340	    51-03-302 61-03-318 55-03-329 67-03-368

















































	KW			
626 III Hatchback (GD) i				
2.0 D	44	07.87 → 07.91	50-03-330 50-03-331 60-03-341	Imp. SUMITOMO 51-03-305 61-03-309 55-03-329 67-03-368
1.6	60	06.87 → 05.92	50-03-331 60-03-341	55-03-329 67-03-368
1.8	65	11.87 → 05.92	50-03-331 60-03-341	51-03-306 61-03-302 61-03-309 55-03-329 67-03-368
1.8	69	11.87 → 05.92	50-03-331 60-03-341	51-03-306 61-03-302 61-03-309 55-03-329 67-03-368
2.2 12V 4WD	85	11.87 → 07.90	50-03-331 60-03-340	51-03-302 61-03-318 55-03-329 67-03-368
626 III Station Wagon (GV) i				
2.0	66	10.88 → 09.97	50-03-330 50-03-331 60-03-340	Imp. SUMITOMO 51-03-306 61-03-313 55-03-329
2.2 12V	85	03.89 → 11.96	50-03-380 60-03-340	51-03-302 61-03-318
2.0 D	60	11.94 → 09.97	50-03-399 60-03-340 60-03-348	51-03-307 61-03-313 61-03-314
2.0 D Complex	55	05.93 → 11.96	50-03-399 60-03-340 60-03-348	51-03-307 61-03-313 61-03-314
1.8	65	01.88 → 03.92	50-03-331 60-03-341	51-03-306 61-03-309 55-03-329 67-03-368
2.0 12V	81	09.87 → 01.90	50-03-330 50-03-331 60-03-340	Imp. SUMITOMO 51-03-306 61-03-309 61-03-313 67-03-368
2.0 16V	103	01.88 → 03.92	50-03-330 50-03-331 60-03-340	Imp. SUMITOMO 51-03-306 61-03-309 61-03-313 67-03-368
2.2 12V 4WD	85	05.91 → 11.92	50-03-331 60-03-340	51-03-302 61-03-318
2.0 D	44	09.88 → 07.91	50-03-330 50-03-331 60-03-341	Imp. SUMITOMO 51-03-305 61-03-313 55-03-329 67-03-368

	KW			
626 III Station Wagon (GV) i i				
2.0 i	110	11.94 → 09.97	 50-03-399  60-03-348	 51-03-307  61-03-314  67-02-293
626 IV (GE) i i				
1.8 i	77	01.92 → 04.97	 50-03-399  60-03-348	 51-03-307  61-03-314  67-03-368
1.8 i	66	08.94 → 04.97		
2.0 i	85	01.92 → 04.97		
2.0 D GLX Complex	55	10.92 → 04.97	 50-03-399  60-03-340  60-03-348	 51-03-307  61-03-313  61-03-314
2.0 i 4WD	85	04.92 → 04.97	 50-03-399  60-03-348	 51-03-307  61-03-314  61-03-315  67-03-368
2.0 D	56	05.94 → 06.97	 50-03-399  60-03-348	 51-03-307  61-03-314
626 IV Hatchback (GE) i i				
1.8	77	08.91 → 04.97	 50-03-399  60-03-348	 51-03-307  61-03-314  67-03-368
1.8	66	08.94 → 04.97		
2.0 i	85	08.91 → 04.97		
2.0 i 4WD	85	04.92 → 04.97		 67-03-368
2.5 24V	120	08.94 → 04.97		
2.5 24V	121	01.92 → 04.97	 50-03-399  60-03-348	 51-03-307  61-03-314
2.0 D GLX Complex	55	01.93 → 04.97	 50-03-399  60-03-340  60-03-348	 51-03-307  61-03-313  61-03-314
626 V (GF) i i				
1.8	66	05.97 → 12.99	 50-03-399  60-03-348	 51-03-302  61-03-314  55-03-309
1.8	74	12.99 → 10.02	 50-03-318  60-03-348	 51-03-302  61-03-314  55-03-309
2.0	100	04.98 → 10.02		
2.0	85	05.97 → 10.02		
2.0 DITD	66	04.98 → 10.02		
2.0 TD	81	10.00 → 10.02		
2.0 Turbo DI	74	04.98 → 10.02		
626 V Hatchback (GF) i i				
1.8	66	05.97 → 12.99	 50-03-399  60-03-348	 51-03-302  61-03-314  55-03-309

	KW			
626 V Hatchback (GF) i				
1.8	74	12.99 → 10.02	50-03-318 60-03-348	51-03-302 61-03-314 55-03-309
2.0	85	05.97 → 10.02		
2.0 DITD	66	04.98 → 10.02		
2.0 H.P.	100	02.98 → 10.02		
2.0 Turbo DI	74	04.98 → 10.02		
2.0 TD	81	10.00 → 10.02	50-03-318 60-03-348	51-03-302 61-03-315 55-03-309
626 V Station Wagon (GW) i				
1.8	66	02.98 → 01.00	50-03-399 60-03-348	51-03-302 61-03-314 55-03-309
1.8	74	01.00 → 10.02	50-03-318 60-03-348	51-03-302 61-03-314 55-03-309
2.0	85	02.98 → 10.02		
2.0 H.P.	100	02.98 → 10.02		
2.0 TD	81	10.00 → 10.02		
2.0 Turbo DI	74	04.98 → 10.02		
2.0 DITD	66	09.99 → 10.02	50-03-318 60-03-348	51-03-302 61-03-316 55-03-309
818 Station wagon i				
1.3	44	01.74 → 10.78	50-03-310 60-03-306	67-03-302
1.6	55	01.77 → 10.78	50-02-210 60-03-306	
929 I (LA) i				
2.0	66	05.79 → 07.86	50-03-301 50-03-303 60-03-324	01.82→ Imp. AKEBONO 01.82→ 01.82→ 51-03-300 61-03-300 55-03-303 67-03-362 67-03-363
				01.82→ 01.82→ Left\Sinistra 01.82→ Right\Destra
1.8	66	01.74 → 12.81		67-03-358 67-03-359 Left\Sinistra Right\Destra
929 II (HB) i				
2.0	66	05.82 → 03.84	50-03-301 50-03-303 60-03-324	Imp. AKEBONO 51-03-300 61-03-300 55-03-303 67-03-362 67-03-363
				Left\Sinistra Right\Destra

	KW			
929 II (HB) i				
2.0	74	03.84 → 07.87	50-03-320	51-03-300
2.0 i GLX	88	10.84 → 07.87	60-03-324	61-03-300
				55-03-303
				67-03-362
				67-03-363
				Left\Sinistra
				Right\Destra
929 II Coupe (HB) i				
2.0	66	05.82 → 03.84	50-03-301	Imp. AKEBONO
			50-03-303	51-03-300
			60-03-324	61-03-300
				55-03-303
				67-03-362
				67-03-363
				Left\Sinistra
				Right\Destra
2.0	74	03.84 → 07.87	50-03-320	51-03-300
2.0 i	88	10.84 → 07.87	60-03-324	61-03-300
				55-03-303
				67-03-362
				67-03-363
				Left\Sinistra
				Right\Destra
929 II Station Wagon (HV) i				
2.0	66	01.83 → 12.87	50-03-301	Imp. AKEBONO
			50-03-303	51-03-300
			60-03-324	61-03-300
				55-03-303
				67-03-362
				67-03-363
				Left\Sinistra
				Right\Destra
929 III (HC) i				
2.2 12V	85	01.88 → 04.89	50-03-330	Imp. SUMITOMO
			50-03-397	51-03-305
			60-03-332	61-03-310
				55-03-303
				67-03-362
				67-03-363
				Left\Sinistra
				Right\Destra
2.2 i	100	05.87 → 12.88	50-03-330	Imp. SUMITOMO
			50-03-397	51-03-305
			60-03-332	61-03-310
				67-03-362
				67-03-363
				Left\Sinistra
				Right\Destra
3.0	125	01.88 → 12.89	50-03-330	Imp. SUMITOMO
3.0	123	01.90 → 06.91	50-03-397	51-03-305
3.0	140	06.87 → 06.91	60-03-332	61-03-310
2.0	85	06.87 → 12.88	50-03-320	51-03-300
			50-03-397	61-03-300
			60-03-324	55-03-303
				67-03-362
				67-03-363
				Left\Sinistra
				Right\Destra

	KW				
929 III (HC) <i>i</i> <i>i</i>					
2.2 12V	94	04.89 → 06.91	50-03-330 50-03-397 60-03-332	Imp. SUMITOMO 01.91→ 51-03-305 61-03-310 55-03-303	
B-SERIE (PE) <i>i</i> <i>i</i>					
1.6	55	02.77 → 09.78		67-03-366	
B-SERIE (UD) <i>i</i> <i>i</i>					
1.8	62	10.81 → 08.85	50-06-601	55-03-313	
B-SERIE (UF) <i>i</i> <i>i</i>					
2.5 D 4WD	57	09.98 → 06.99	50-03-382 60-03-326 60-03-355 60-03-357	55-03-393 67-03-396 67-03-397	Right\Destra Left\Sinistra
2.5 D 4WD	63	02.96 → 06.99	50-03-382 60-03-326 60-03-357	55-03-393	
2.0	65	01.85 → 03.96	50-06-601 60-03-326	55-03-333 56-0K-K03	Right\Destra Left\Sinistra
2.0	62	01.85 → 12.91		67-03-396 67-03-397	
2.2	68	08.91 → 12.96	50-06-601 60-03-326	55-03-333	
2.2 D	47	01.85 → 03.96	50-06-601 60-03-326	55-03-333 67-03-365	
2.6 4WD	73	01.87 → 10.90	60-03-326	55-03-333 56-0K-K03 67-03-396 67-03-397	Right\Destra Left\Sinistra
2.6 12V 4WD	90	01.90 → 06.99	50-03-312 60-03-326	55-03-333 56-0K-K03 67-03-396 67-03-397	Right\Destra Left\Sinistra
2.5 D	63	02.96 → 06.99	50-03-312 50-03-382 60-03-326	55-03-393 67-03-396 67-03-397	Right\Destra Left\Sinistra
1.6	60	01.85 → 03.96	50-06-601	56-0K-K03	
2.2	62	03.85 → 10.91		67-03-365	
B-SERIE (UN) <i>i</i> <i>i</i>					

	KW				
B-SERIE (UN)					
2.6 D 4WD	57	06.99 →	 60-03-323  60-03-373  60-03-323  60-03-366	 66-03-311  67-03-307	
2.6 D 4WD 2.6 TD 4WD	62 80	12.02 → 06.99 →	 60-03-323  60-03-323  60-03-366	 66-03-311  67-03-307	
2.2 8V 4WD 2.6 12V 4WD	68 90	06.99 → 06.99 →	 60-03-373  60-03-366	 67-03-307	
2.6 D 2.6 D	57 62	06.99 → 12.02 →	 60-03-373  60-03-318  60-03-366	 66-03-311  67-03-307	
2.6 D	61	11.99 → 12.01	 60-03-373		
BT-50					
2.6 CD 4WD	105	12.06 →	 60-03-323  60-03-373  60-03-318  60-03-323	<p>Front Wheel Drive/Trazione anteriore</p>  66-03-311  66-03-312	<p>Front Wheel Drive/Trazione anteriore</p>
CX-7					
2.3 MZR DISI Turbo	190	10.07 →	 60-03-336  60-03-347  60-03-362	<p>Per cambio automatico</p>  61-03-309  61-03-327	<p>Cambio manuale di velocità</p>
2.2 MZR-CD	127	09.09 →	 60-03-336  60-03-347  60-03-362	<p>Per cambio automatico</p>  61-03-309  61-03-329	<p>Cambio manuale di velocità</p>
DEMIO (DW)					
1.3 16V 1.3 16V 1.6 16V	53 46 55	08.98 → 04.00 08.98 → 04.00 →	 60-03-341  60-03-344	 66-03-399  66-03-300  67-03-379	
E 1600					
1.6	51	08.80 → 06.84	 60-06-502  60-03-326	Imp. AKEBONO	
E 1800					
1.8 (VC)		11.80 →		 67-03-364  67-03-366	<p>01.84→ Left/Sinistra</p> <p>01.84→ Right/Destra</p>
E 2000,2200 Autobus (SR1)					























	KW			
E 2000,2200 Autabus (SR1) i				
2.0	63	11.84 → 02.88	50-03-325	55-03-325
2.2 D	46	01.84 → 02.88	60-03-326 60-03-345	67-03-364 67-03-365 Left\Sinistra Right\Destra
2.0 4WD	60	10.88 → 09.89	50-03-325 60-03-326	55-03-325 67-03-364 67-03-365 Left\Sinistra Right\Destra
E 2000,2200 Furgonato/Box (SR2) i				
2.2 D	46	05.85 → 02.88	50-03-325 60-03-326 60-03-345	55-03-325 67-03-364 67-03-365 Left\Sinistra Right\Destra
2.0	60	03.91 → 05.94	50-03-325 60-03-326 60-03-345	55-03-325 56-0K-K03 67-03-364 67-03-365 Left\Sinistra Right\Destra
2.0	70	06.94 →	50-03-325 60-03-326	55-03-325 56-0K-K03 67-03-364 67-03-365 67-03-394 67-03-395 Left\Sinistra Right\Destra 01.95→ →12.98 01.95→ →12.98
2.2 D 4WD	47	03.91 →	50-03-325 60-03-399	55-03-325 56-0K-K03 67-03-369
2.2 D	47	03.91 →	50-03-325 60-03-326	55-03-325 56-0K-K03 67-03-369
2.0	63	05.85 → 04.89	50-03-325 60-03-326	55-03-325 67-03-364 67-03-365 Left\Sinistra Right\Destra
2.2 D	52	02.97 → 08.02	50-03-325	55-03-334
2.2 D 4WD	52	02.97 →	60-03-346	55-03-391 56-0K-K03 67-03-315 →08.99
2.0	65	01.88 → 07.91		67-03-365
2.0 4x4	63	11.87 → 09.89	50-03-325 60-03-326	55-03-325 56-0K-K03 67-03-365





























































	KW			
E 2000,2200 Furgonato/Box (SR2) i				
2.0 4x4	65	01.88 → 07.91		56-0K-K03 67-03-365
MPV I (LV) i				
2.5 TD	85	05.96 → 09.99	50-03-384	51-03-305
3.0 i V6	113	03.95 → 09.99	60-03-384	61-03-324
3.0 i V6	109	05.96 → 09.99		55-03-315 Parking Brake\Freno staz.
MPV II (LW) i				
2.0	90	09.99 → 08.00	50-03-384	51-03-305
2.5 V6	125	09.99 → 03.02	60-03-313 60-03-354	61-03-324 55-03-300 55-03-315 67-03-306 Parking Brake\Freno staz.
2.0	88	08.00 → 07.02	50-03-384 60-03-313 60-03-354	51-03-305 61-03-324 55-03-315 67-03-306 Parking Brake\Freno staz.
2.0 DI	100	07.02 →	50-03-384	51-03-305
2.3	104	07.02 →	60-03-313	61-03-324
3.0 V6	147	03.02 →		55-03-300 55-03-315 67-03-306 Parking Brake\Freno staz.
MX-3 (EC) i				
1.6 i	79	01.94 →	50-03-342	51-03-303
1.6 i	65	07.91 →	60-03-349	61-03-308 55-03-397 56-03-300 67-03-398
1.8 i V6	98	01.92 → 01.94	50-03-342 60-03-349	51-03-303 61-03-308 55-03-397 56-03-300 67-03-368
1.8 i V6	95	01.94 →	50-03-342 60-03-349	51-03-303 61-03-308 55-03-397 56-03-300
MX-5 I (NA) i				

	KW				
MX-5 I (NA)					
1.6	85	05.90 → 01.94	50-03-340 60-03-342 60-03-358	→08.93 NO ABS con/with ABS	
				51-03-303 51-06-601 61-03-308 61-03-312	NO ABS con/with ABS NO ABS
1.8	96	02.94 → 04.98	50-03-383 60-03-358	con/with ABS	
				51-03-303 51-03-391 61-03-308	NO ABS con/with ABS con/with ABS
1.6	66	01.95 → 04.98	50-03-383 60-03-342		
				51-03-303 51-03-391 61-03-308 61-03-312	NO ABS con/with ABS con/with ABS NO ABS
MX-5 II (NB)					
1.6 16V	81	05.98 → 10.05	50-03-383 60-03-358	con/with ABS	
				51-03-391 61-03-308 61-03-325	
1.8 16V	103	05.98 → 10.05	60-03-358	con/with ABS	
				51-06-601 61-03-308	
1.9 16V	102	11.00 → 10.05	50-03-317	→01.02	
1.9 16V	107	11.00 → 10.05	50-03-383 60-03-315	→12.01	
				51-03-345 51-03-391 61-03-325	01.02→
1.8	103	01.98 → 07.02	50-03-317 50-03-383 60-03-315 60-03-358	con/with ABS	
				51-03-345 51-03-391 61-03-325	
MX-5 III (NC)					
1.8	93	03.05 →	50-03-335		
2.0	118	03.05 →	60-03-319		
				51-03-311 61-03-316	
MX-6 (GE6)					
2.0	85	02.92 →	50-03-399		
2.5 24V	121	02.92 →	60-03-348		
2.5 i 24V	120	08.94 →			
				51-03-307 61-03-314 67-03-368	
PREMACY (CP)					
1.8	74	07.99 →	50-03-399		
1.9	84	07.99 →	60-03-348		
2.0 TD	66	10.99 → 07.00			
				51-03-302 61-03-314 55-03-309	
2.0 TD	74	07.00 →	50-03-399 60-03-348		
				51-03-302 61-03-314 61-03-316 55-03-309	

























































	KW			
PREMACY (CP) i i				
2.0	96	11.01 →	50-03-318 60-03-348	51-03-302 61-03-314 61-03-316 55-03-309
RX 7 I (SA) i i				
Wankel	77	05.79 → 05.81	50-03-308 60-03-302	51-03-301 55-03-303 67-03-352 67-03-353
				Left/Sinistra Right/Destra
Wankel	85	01.81 → 03.84	50-03-328 60-03-302	51-03-301 61-03-301
Wankel	83	03.84 → 03.86	50-03-328 60-03-329	51-03-302 61-03-307
				Imp. AKEBONO
RX 7 II (FC) i i				
Turbo	133	06.87 → 11.89	50-03-329	51-03-302
Wankel	110	11.85 → 04.89	60-03-333	61-03-306
Turbo	147	03.89 → 12.91	50-05-502 60-03-333	Imp. AKEBONO 51-03-302 61-03-306
RX 7 III (FD) i i				
Wankel Twin Turbo	176	07.92 →	50-03-329 60-03-350	51-03-302 61-03-319
RX 8 i i				
2.6	170	10.03 →	50-03-313	51-03-304
Wankel	141	10.03 →		
TRIBUTE (EP) i i				
2.0	91	03.00 →	50-03-315	55-03-309
2.0 4WD	91	03.00 →		67-03-305
3.0 V6 24V 4WD	145	03.00 →	50-03-322 60-03-395	
			Disc brakes on the rear axle\Freni a disco ad assale post.	
			Drum brakes on the rear axle\Freni a tamburo ad assale post.	
			Drum brakes on the rear axle\Freni a tamburo ad assale post.	
2.3 AWD	110	04.04 →	50-03-315	51-03-310
3.0 V6 AWD	149	04.04 →	50-03-322 60-03-317	61-03-365
			Disc brakes on the rear axle\Freni a disco ad assale post.	
			Drum brakes on the rear axle\Freni a tamburo ad assale post.	
XEDOS 6 (CA) i i				





































































	KW			
XEDOS 6 (CA) <i>i</i> <i>i</i>				
1.6 16V	79	06.94 →	 50-03-399	 51-03-307
1.6 16V	83	08.92 → 05.94	 60-03-348	 61-03-314
2.0 V6	106	01.92 → 05.94		
2.0 V6	103	06.94 →		
XEDOS 9 (TA) <i>i</i> <i>i</i>				
2.5 24V	123	07.93 → 07.00	 50-03-382	 51-03-305
			 60-03-313	 61-03-326
			 60-03-354	
2.0 24V	105	08.93 → 01.00	 50-03-382	 51-03-307
2.3 24V	155	02.95 → 01.00	 60-03-313	 61-03-326
			 60-03-354	
2.5 V6	120	07.00 →	 50-03-382	 51-03-305
			 60-03-313	 61-03-326



























































	KW			
3000 GT (Z16A) <i>i</i> <i>i</i>				
3.0 i 24V 4x4	210	06.92 → 08.99	 50-05-597  60-05-595	 51-05-594  61-05-512
ASX <i>i</i> <i>i</i>				
1.6	86	08.10 →	 50-05-501	 51-05-505
1.8 DI-D	110	08.10 →	 60-00-003	 61-09-904
CARISMA (DA_) <i>i</i> <i>i</i>				
1.6	70	12.98 → 06.06	 50-05-592	 51-05-504
1.8 16V	103	07.95 → 06.06	 60-05-522	 55-05-586
				 56-05-502
				 67-05-595
				NO ABS
1.6	66	07.95 → 06.06	 50-05-592	 51-05-504
			 60-05-522	 61-05-511
			 60-05-532	 61-05-514
			 60-05-540	 55-05-586
				 56-05-502
				 56-05-507
				 67-05-595
				NO ABS →05.99
1.8	85	07.95 → 06.06	 50-05-592	 51-05-504
			 60-05-522	 61-05-511
				 55-05-586
				 56-05-502
				 67-05-595
				NO ABS
1.9 TD	66	10.96 → 09.00	 50-05-592	 51-05-504
			 60-05-522	 61-05-511
			 60-05-532	 55-05-586
				 56-05-502
				 56-05-507
				 67-05-595
				NO ABS →02.99
1.6	73	05.97 → 06.06	 50-05-592	 51-05-504
			 60-05-522	 55-05-586
				 56-05-502
				 56-05-507
				 67-05-595
				NO ABS →05.99
1.8 16V GDI	92	09.97 → 06.06	 50-05-593	 51-05-504
			 60-05-522	 51-05-507
			 60-05-540	 61-05-511
				 55-05-586
				 56-05-502
				 67-05-595
				NO ABS Imp. LUCAS



	KW			
CARISMA (DA_) i i				
1.6	76	09.00 → 06.06	 50-05-516	 51-05-507
1.8 GDI	90	10.00 → 06.06	 60-05-540	 61-05-511
1.9 DI-D	85	09.00 → 06.06		 55-05-500
1.9 DI-D	75	09.00 → 06.06		 56-05-502
				 67-05-514
CARISMA Tre volumi/Saloon (DA_) i i				
1.9 TD	66	10.96 → 09.00	 50-05-592	 51-05-504
			 60-05-522	 61-05-511
			 60-05-532	 55-05-586
				 56-05-502
				 56-05-507
				 67-05-595
1.6	73	05.97 → 06.06	 50-05-592	 51-05-504
1.6	66	09.96 → 06.06	 60-05-522	 61-05-511
				 55-05-586
				 56-05-502
				 56-05-507
				 67-05-595
1.6	70	12.98 → 06.06	 50-05-592	 51-05-504
1.8	85	09.96 → 06.06	 60-05-522	 61-05-511
				 55-05-586
				 56-05-502
				 67-05-595
1.8 16V GDI	92	09.97 → 06.06	 50-05-593	 51-05-504
			 60-05-522	 51-05-507
			 60-05-540	 61-05-511
				 55-05-586
				 56-05-502
				 67-05-595
1.6	76	09.00 → 06.06	 50-05-516	 51-05-507
1.8 GDI	90	10.00 → 06.06	 60-05-540	 61-05-511
1.9 DI-D	85	09.00 → 06.06		 55-05-500
1.9 DI-D	75	09.00 → 06.06		 56-05-502
				 67-05-514
CELESTE (A7_) i i				
1.6 ST (A73)	54	01.77 → 06.81	 50-03-310	 55-05-512
2.0 GSR (A78)	71	01.77 → 06.81	 60-05-500	 67-05-502
2.0 GSR (A78)	77	01.79 → 06.81		 67-05-503
2.0 GSR (A78)	66	10.75 → 06.81		
COLT CZC Cabriolet i i				

	KW			
COLT CZC Cabriolet				
1.6	80	05.06 →	 60-06-593  60-0M-M01	 61-06-507  61-0M-M00 Imp. LUCAS
1.6 Turbo	110	05.06 →	 60-06-516  60-0M-M01	 61-06-507  61-0M-M00 Imp. LUCAS
COLT I (A16_A)				
1.2 GL (A161A)	40	12.78 → 01.84	 60-03-310	 66-06-508
1.4 GLX,GT (A162A)	51	05.79 → 01.84	 60-06-508	 67-06-531
1.4 Turbo (A162A)	77	09.81 → 01.84	 60-06-526  60-06-509	 66-06-508  67-06-531
COLT II (C1_A)				
1.2 EL,GL (C16A)	40	02.84 → 09.86	 60-06-524	 66-06-526
1.2 EL,GL (C16A)	44	09.86 → 04.88	 60-06-510	 66-06-506
1.3 EL,GL (C11A)	49	06.86 → 04.88		 67-06-532
1.6 GLX (C12A)	55	09.84 → 04.88		
1.6 GLX (C12A)	51	09.85 → 04.88		
1.6 Turbo ECi (C13A)	92	02.84 → 04.88	 60-06-526	 66-06-526
1.6 Turbo ECi (C13A)	77	07.86 → 04.88	 60-06-509	 66-06-506  67-06-532
1.8 GL Diesel (C14A)	43	02.84 → 09.86		
1.8 GL Diesel (C14A)	44	09.86 → 04.88		
COLT III (C6_A)				
1.3 (C61A)	51	04.88 → 05.92	 60-06-528	 66-06-587
1.3 GL	44	04.88 → 12.90	 60-06-509	 66-06-506  67-06-579
1.8 Diesel GLX (C64A)	44	04.88 → 05.92	 60-06-528  60-06-524	 66-06-587  66-06-506  67-06-596 01.91→
1.3 12V (C61A)	55	04.88 → 05.92	 60-06-528  60-06-509  60-06-593	 66-06-587  66-06-506  67-06-579
1.6 GLXi (C62A)	62	04.88 → 05.92	 60-06-524  60-06-510  60-06-593	 66-06-526  66-06-506  67-06-532
1.6 (C62A) Cat.	66	07.90 → 05.92	 60-06-528  60-06-509  60-06-524  60-06-593	 66-06-526  66-06-506  67-06-579
1.6 GTi 16V (C63A)	91	04.88 → 05.90	 60-06-526  60-06-523	 61-06-500  61-06-508
1.8 GTi 16V (C68A) Cat.	100	06.90 → 05.92	 60-06-530  60-06-524	 61-06-500  61-06-508

	KW				
COLT IV (CA_A) i i					
1.3 GLi 12V (CA1A)	55	04.92 → 04.96	50-05-528 60-05-509 60-05-532 60-05-538	55-05-587 56-05-505 67-05-579	
1.6 GLXi 16V (CA4A)	83	04.92 → 04.96	50-05-528 60-05-532	51-05-504 61-05-514 55-05-586 56-05-505 56-05-507 67-05-539	
1.8 GTi 16V (CA5A)	103	04.92 → 04.96	50-05-530 60-05-533	51-05-504 61-05-514	
1.6	66	02.94 → 04.96	50-05-528 60-05-532	55-05-586 56-05-505 56-05-507 67-05-539	
COLT LANCER (A7_) i i					
1.2	40	01.78 → 09.79	50-02-210 60-05-500	55-05-512 67-05-502	
1.4	50	01.78 → 09.79			
1.6	60	01.78 → 09.79			
COLT LANCER Station Wagon (A7_K) i i					
1.4	50	01.78 → 09.79	50-02-210 60-05-500	55-05-512 67-05-502	
COLT V (CJ_A) i i					
1300 GL, GLX (CJ1A)	55	05.96 → 09.00	50-05-528 60-05-532	55-05-500 56-05-506 56-05-507 67-05-579	→08.00
1600 GLX (CJ4A)	66	05.96 → 09.00	50-05-528 60-05-532	55-05-586 56-05-506 56-05-507 67-05-539 67-05-579	→08.00 con/with ABS con/with ABS
1500 (CJ2A)	69	11.95 → 07.05	50-05-528 60-05-532	55-05-586 56-05-506 67-05-539	

	KW				
COLT V (CJ_A) i					
1300 1600	60 76	09.00 → 07.05 09.00 → 07.05	 50-05-525  60-05-532	 55-05-586  55-05-587  56-05-506  56-05-507  67-05-539  67-05-579	→12.04 con/with ABS NO ABS
COLT VI i					
1.1 1.3 1.5 DI-D 1.5 DI-D	55 70 70 50	10.04 → 06.04 → 08.04 → 08.04 →	 50-05-593  60-0M-M01	 51-05-507  61-0M-M00  55-05-511  67-05-525	Imp. LUCAS
1.5	80	06.04 →	 50-05-593  60-0M-M01	 51-05-507  61-0M-M00  55-05-511	Imp. LUCAS
1.5 CZT	110	03.05 →	 50-05-593  60-0M-M01	 51-05-507  61-0M-M00	Imp. LUCAS
CORDIA (A21_A) i					
1.6 GSL (A212A)	55	10.82 → 12.86	 50-05-522  60-05-510	 55-05-514  67-05-532	
1.6 Turbo (A212A) 1.6 Turbo (A212A)	85 84	07.83 → 05.85 10.82 → 05.85	 50-05-525  60-05-509	 55-05-514  67-05-532	
1.8 GSL (A215A)	66	10.86 → 12.86	 50-05-522  60-05-510	 55-05-514  67-05-502	
1.8 Turbo ECi (A213A)	100	10.84 → 12.86	 50-05-525  60-05-523	 55-05-527  67-05-536	
ECLIPSE I (D2_A) i					
2.0 i 16V (D22A)	110	04.91 → 11.95	 50-05-530  60-05-598	 51-05-594  61-05-597	
2.0 i 16V 4x4	110	04.91 → 11.95	 50-05-599  60-05-529	 51-05-500  61-05-597	
ECLIPSE II (D3_) i					
2000 GS 16V	107	12.95 → 04.99	 50-05-530  60-05-545  60-05-592	 51-05-594  61-05-597	
2000 GT 16V 2400 GS 16V	157 105	12.95 → 04.99 09.98 → 04.99	 50-05-530  60-05-545	 51-05-594	
GALANT I (A12_) i					

	KW			
GALANT I (A12_) i				
1.6	55	01.77 → 08.80	50-03-310	55-05-512
2.0	72	01.79 → 08.80	60-05-500	67-05-502
2.0 GLX	63	01.77 → 08.80		67-05-503
GALANT I Station Wagon (A12_V) i				
1.6 GL (A121V)	55	01.79 → 08.80	50-03-310 60-05-500	55-05-512 67-05-502 67-05-503
2.0 GLX (A123V)	72	01.79 → 08.80	50-05-502 60-05-502	Imp. AKEBONO 55-05-512 67-05-502 67-05-503
GALANT II (A16_) i				
1.6 GLX (A161A)	55	09.80 → 05.84	50-05-508 60-05-506	55-05-504 67-05-500 67-05-501
2.0 GLS (A163)	75	09.80 → 05.84	50-05-520 60-05-502	51-05-502 61-05-500 55-05-502 67-05-500 67-05-501
2.0 Turbo ECi (A164)	125	05.82 → 05.84	50-05-520 60-05-513	51-05-502 61-05-504
2.3 Turbo-D (A167)	62	09.80 → 05.84	50-05-502 60-05-502	Imp. AKEBONO 55-05-504 67-05-500 67-05-501
GALANT II Station Wagon (A16_V) i				
1.6 GLX (A161V)	55	09.80 → 05.84	50-05-508 60-05-506	55-05-504 67-05-500 67-05-501
2.0 GLX (A163V)	75	09.80 → 06.83	50-05-502 60-05-502	Imp. AKEBONO 51-05-502 61-05-500
2.3 Turbo-D (A167V)	62	07.83 → 05.84	50-05-502 60-05-502	Imp. AKEBONO 55-05-504 67-05-500 67-05-501
GALANT III (E1_A) i				
1.6 GLX (E11A)	55	06.84 → 12.87	50-05-525 60-05-509	12.84→ 51-05-500 55-05-527 67-05-536

	KW			
--	----	--	--	--

GALANT III (E1_A) i

2.0 GLS (E16A)	75	06.84 → 12.87	60-05-525		61-05-500	
2.0 GLS (E16A)	66	06.86 → 12.87	60-05-517		61-05-506	
2.0 Turbo ECi (E16A)	110	06.84 → 05.85				
2.4 GLS (E16A)	82	07.85 → 12.87				
1.8 Turbo-D (E14A)	60	06.84 → 12.87	60-05-525		61-05-500	
			60-05-517		66-05-527	
					67-05-538	Left/Sinistra































































GALANT IV (E3_A) i

1.8 Turbo-D (E34A)	55	11.88 → 10.92	60-05-525	→12.89	66-05-527	→12.89
			60-05-530	01.90→	66-05-586	01.90→
			60-05-517	→12.89	67-05-536	→12.89
			60-05-522	01.90→	67-05-539	01.90→
1.8 (E32A)	66	11.88 → 10.92	60-05-525	→05.90	66-05-586	
			60-05-530	06.90→	67-05-539	
			60-05-517			
			60-05-522			
2.0 4x4 (E38A, E39A)	80	04.89 → 10.92	60-05-525		61-05-500	
			60-05-530		61-05-508	
			60-05-517	→05.90		
			60-05-522	06.90→		
2.0 GTI 16V (E33A)	107	11.88 → 10.92	60-05-530	06.90→	61-05-500	
2.0 GTI 16V (E33A)	106	11.88 → 10.92	60-05-522	→06.90	61-05-508	
2.0 (E33A)	80	04.89 → 10.92	60-05-525	→05.90	61-05-500	
			60-05-517	→05.90	61-05-508	
2.0 GTI 16V 4x4 (E39A)	106	07.89 → 12.92	60-05-525	06.90→	61-05-500	
			60-05-599	→05.90	61-05-508	
			60-05-517	→05.90		
			60-05-522	→06.90		
1.6	55	01.88 → 10.92	60-05-525		67-05-536	
			60-05-527	Imp. SUMITOMO		
			60-05-509			

GALANT IV Tre volumi/Saloon (E3_A) i



























































1.8 (E32A)	66	11.87 → 10.92	60-05-525	→05.90	66-05-586	
1.8 (E32A)	63	11.87 → 08.90	60-05-530	06.90→	67-05-539	
			60-05-517			
			60-05-522			
2.0 GTi 16V	107	11.88 → 10.92	60-05-530	06.90→	61-05-500	
2.0 GTi 16V (E33A)	106	11.87 → 10.92	60-05-522	→06.90	61-05-508	
2.0 GTI 16V 4x4 Cat.	110	09.91 → 10.92				































































	KW			
GALANT IV Tre volumi/Saloon (E3_A) i i				
2.0 GTi 16V 4x4	106	06.88 → 10.92	50-05-525 →05.90 50-05-599 06.90→ 60-05-517 →05.90 60-05-522 →06.90	51-05-500 61-05-508
1.8 Turbo-D (E34A)	55	12.87 → 10.92	50-05-525 →12.89 50-05-530 01.90→ 60-05-517 →12.89 60-05-522 01.90→	55-05-527 →12.89 55-05-586 01.90→ 67-05-536 →12.89 67-05-539 01.90→
2.0 (E33A)	80	11.87 → 10.92	50-05-525	51-05-500
2.0 4x4 (E38A)	80	12.88 → 10.92	60-05-517	61-05-508
GALANT V (E5_A, E7_A, E8_A) i i				
2.0 GLSTD (E57A)	66	11.92 → 08.96	50-05-530 60-05-530	51-05-594 61-05-510 56-05-501
1.8 (E52A)	85	02.94 → 08.96	50-05-530	55-05-586
1.8 GLSI (E52A)	93	11.92 → 08.96	60-05-530	56-05-501 67-05-569
2.0 GLSI (E55A)	101	11.92 → 08.96	50-05-530	51-05-594
2.0 GLSI 4x4 (E75A)	101	11.92 → 08.96	60-05-530	61-05-510
2.0 V6-24 (E54A)	110	11.92 → 08.96		
2.5 V6-24 4x4 (E88A)	125	11.92 → 08.96	50-05-599 60-05-535	51-05-594
GALANT V Tre volumi/Saloon (E5_A, E7_A, E8_A) i i				
2.0 GLSTD (E57A)	66	11.92 → 08.96	50-05-530 60-05-530	51-05-594 61-05-510 55-05-586 56-05-501
1.8 (E52A)	85	02.94 → 08.96	50-05-530	51-05-594
1.8 GLSI (E52A)	93	11.92 → 08.96	60-05-530	61-05-510 55-05-586 56-05-501 67-05-569
2.0 GLSI (E55A)	101	11.92 → 08.96	50-05-530	51-05-594
2.0 GLSI 4x4 (E75A)	101	11.92 → 08.96	60-05-530	61-05-510
2.0 V6-24 (E54A)	110	11.92 → 08.96		
2.5 V6-24 4x4 (E88A)	125	11.92 → 08.96	50-05-599 60-05-535	51-05-594
GALANT VI (EA_) i i				
2.0 (EA2A)	100	09.96 → 09.00	50-05-501 60-05-527 60-05-535	51-05-594 61-05-510
			Rim Size/Diam Cerchio:15	

	KW			
GALANT VI (EA_)				
2.6 V6 24V (EA6A)	120	09.96 → 09.00	 60-05-530  60-05-527  60-05-530  60-05-536	 61-05-594  61-05-510
2.0 TDI (EA6A)	66	09.96 → 10.04	 60-05-530  60-05-530  60-05-536	 61-05-594  61-05-510  56-05-586  56-05-501  67-05-569
2.4 GDI	110	02.99 → 09.00	 60-05-501  60-05-527  60-05-530  60-05-536	 61-05-594  61-05-510
2.0	98	09.00 → 10.04	 60-05-501  60-05-527	 61-05-594  61-05-510
2.4 GDI	106	09.00 → 10.04		
2.6 V6 24V	118	09.00 → 10.04		
GALANT VI Station wagon (EA_)				
2.0 (EA2W)	100	09.96 → 09.00	 60-05-530  60-05-530  60-05-536	 61-05-594  61-05-510
2.6 V6 24V (EA6W)	120	09.96 → 09.00	 60-03-339  60-05-530  60-05-527  60-05-530  60-05-536	 61-05-594  61-05-510
2.0 TDI (EA6W)	66	09.96 → 10.03	 60-05-530  60-05-530  60-05-536	 61-05-594  56-05-586  56-05-501
2.4 GDI	110	02.99 → 09.00	 60-05-501  60-05-527  60-05-530  60-05-536	 61-05-594
2.0	98	09.00 → 10.03	 60-05-501  60-05-527	 61-05-594  61-05-510
2.4 GDI	106	09.00 → 10.03		
2.6 V6 24V	118	09.00 → 10.03		
GRANDIS				
2.0 DI-D	100	09.05 →	 60-05-509  60-05-542	 61-05-505  61-05-520
2.4	121	04.04 →		
L 200				
2.6 DiD [RWD]	100	11.05 →	 60-05-504  60-05-534	 56-05-510  56-05-511
L 200 (K__T)				



































































MITSUBISHI

	KW				
L 200 (K__T)					
2.6 TD 4WD (K34T)	64	11.92 → 08.96	 60-06-686  60-06-520  60-06-599	 66-06-501  66-06-500  67-06-537  67-06-538	Imp. SUMITOMO Right\Destra Left\Sinistra
2.6 D (K14T)	51	11.86 → 08.96	 60-06-527  60-06-589	 66-06-501  66-06-500  67-06-593  67-06-594	Imp. SUMITOMO Right\Destra Left\Sinistra
2.6 D 4WD (K24T)	51	12.87 → 05.93	 60-06-527  60-06-520	 66-06-501  66-06-500  66-06-508  67-06-537  67-06-538	Imp. SUMITOMO Imp. SUMITOMO Right\Destra Left\Sinistra
2.0 (K62T)	90	06.96 →	 60-06-516  60-06-541	 66-06-528  66-06-500  67-06-526  67-06-528  67-06-593  67-06-594	02.00→ 02.00→
2.4 4x4 (K76T)	97	06.96 →	 60-06-516  60-06-599	 66-06-583  66-06-500  66-06-508  67-06-526  67-06-528  67-06-593  67-06-594	02.97→ 02.00→ 02.00→ Right\Destra Left\Sinistra
2.6 D (K64T)	55	06.96 →	 60-06-516  60-06-541	 66-06-583  66-06-500  67-06-526  67-06-528  67-06-593  67-06-594	02.00→ 02.00→ Right\Destra Left\Sinistra
2.6 TD 4x4 (K74T)	73	06.96 →	 60-06-586  60-06-599	 66-06-583  66-06-500  66-06-508  67-06-526  67-06-528  67-06-593  67-06-594	→01.97 02.97→ 02.00→ 02.00→ Right\Destra Left\Sinistra



























































	KW					
L 200 (K__T)						
2.6 4WD (K33T)	76	11.89 → 05.95	 50-05-527  60-05-520	Imp. SUMITOMO Imp. SUMITOMO	 55-05-501  56-05-500  56-05-508  67-05-593  67-05-594	Right/Destra Left/Sinistra
2.5 TD 4WD (K74T) 2.5 TD 4x4	85 74	09.01 → 11.01 →	 50-05-515  50-05-582  60-05-599	01.03→	 55-05-583  56-05-508  67-05-526  67-05-528  67-05-593  67-05-594	Right/Destra Left/Sinistra
2.5 TD 4WD	98	08.03 →	 50-05-582  60-05-599		 55-05-583  56-05-508  67-05-526  67-05-528  67-05-594	
2.0 4G63		01.87 →	 50-05-527  60-05-520  60-05-589	Imp. SUMITOMO All-wheel Drive/4 ruote motrici Imp. SUMITOMO	 55-05-501  56-05-500  67-05-501  67-05-537  67-05-538  67-05-594	Right/Destra Right/Destra Left/Sinistra Left/Sinistra
1.6 K11 (AG32)		03.80 →			 67-05-593  67-05-594	Right/Destra Left/Sinistra
2.5 DI-D	100	11.05 →	 50-05-504  60-05-534		 55-05-510  56-05-511	
2.0	75	11.86 → 08.96	 50-05-527	Imp. SUMITOMO	 55-05-501  56-05-500	
2.0 4x4	75	11.86 → 05.92	 50-05-527  60-05-520	Imp. SUMITOMO Imp. SUMITOMO	 55-05-501  56-05-508	
L 300 (L03_P)						
1.6 (L062P)	51	04.83 → 04.94	 50-05-502  50-05-506  60-05-512	Imp. AKEBONO 11.86→ Imp. AKEBONO	 55-05-501  56-05-500  67-05-534  67-05-535	
2.5 D (L039P)	51	11.86 → 04.94	 50-05-502  60-05-512	Imp. AKEBONO Imp. AKEBONO	 55-05-501  56-05-500  67-05-534  67-05-535	Left/Sinistra Right/Destra
L 300 (P1_T)						



	KW					
L 300 (P1_T)						
2.0 (P13T)	85	07.94 →	50-05-585 60-05-583 60-05-589	55-05-528 56-05-500 67-05-537 67-05-538	Right\Destra Left\Sinistra	
2.5 D (P15T)	64	11.94 →	50-05-585 60-05-520	Imp. SUMITOMO 55-05-528 56-05-500 67-05-534 67-05-535	Left\Sinistra Right\Destra	
L 300 Autobus (LO3_P/G, L0_2P)						
1.6 (L032P, L062P)	48	09.81 → 10.86	50-05-502 50-05-527 60-05-512 60-05-518	Imp. AKEBONO Imp. SUMITOMO Imp. AKEBONO SUMITOMO	55-05-501 56-05-500 67-05-534 67-05-535	Left\Sinistra Right\Destra
1.6 (L032P, L062P)	51	11.84 → 02.87	50-05-502 50-05-506 50-05-527 60-05-512 60-05-518	Imp. AKEBONO →10.86 Imp. SUMITOMO Imp. AKEBONO SUMITOMO	55-05-501 56-05-500 67-05-534 67-05-535	Left\Sinistra Right\Destra
1.8 4x4 (L035G)	60	08.84 → 02.87	50-05-502 50-05-527 60-05-501 60-05-512 60-05-518 60-05-520	Imp. AKEBONO Imp. SUMITOMO 01.86→ Imp. AKEBONO →01.86 Imp. AKEBONO →01.86 SUMITOMO 01.86→ Imp. SUMITOMO	55-05-501 56-05-500 67-05-534 67-05-535	Left\Sinistra Right\Destra
2.0 4x4 (L037G)	65	11.86 → 02.87	50-05-527 60-05-520	Imp. SUMITOMO Imp. SUMITOMO	55-05-528 56-05-500 67-05-534 67-05-535	Left\Sinistra Right\Destra
2.3 D (L038P)	50	04.83 → 10.86	50-05-502 60-05-512 60-05-518	Imp. AKEBONO Imp. AKEBONO	55-05-501 56-05-500 67-05-534 67-05-535	Left\Sinistra Right\Destra
L 300 Autobus (P0_W, P1_W, P2_W)						
1.6 (P02V, P12V)	51	11.86 →	50-05-502 50-05-527 60-05-501 60-05-520	Imp. AKEBONO Imp. SUMITOMO Imp. AKEBONO Imp. SUMITOMO	55-05-501 56-05-500 67-05-534 67-05-535	Left\Sinistra Right\Destra













































































	KW				
L 300 Autobus (P0_W, P1_W, P2_W)					
2.0 4WD (P23V, P23W)	65	12.86 →	 50-05-527	Imp. SUMITOMO	
2.0 4WD (P23W)	66	11.86 →	 60-05-520	Imp. SUMITOMO	
				 55-05-528  56-05-500  67-05-534  67-05-535	Left\Sinistra Right\Destra
2.0 (P03W)	64	11.86 →	 50-05-527	Imp. SUMITOMO	
			 60-05-518		
				 55-05-501  56-05-500  67-05-534  67-05-535	Right\Destra
2.4 4WD (P24W, P24V)	80	11.86 → 12.90	 50-05-527	Imp. SUMITOMO	
2.4 4WD (P24W, P24V)	82	11.90 →	 60-05-520	Imp. SUMITOMO	
				 55-05-528  56-05-500  67-05-534  67-05-535	
2.5 D (P05W, P05V, P15V)	51	11.86 →	 50-05-527	Imp. SUMITOMO	
			 60-05-520	Imp. SUMITOMO	
			 60-05-589		
				 55-05-528  56-05-500  67-05-534  67-05-535	Left\Sinistra Right\Destra
2.5 TD 4WD (P25W, P25V)	64	11.88 →	 50-05-527	Imp. SUMITOMO	
			 60-05-520	Imp. SUMITOMO	
				 55-05-501  55-05-528  56-05-500  67-05-534  67-05-535	Left\Sinistra Right\Destra
2.0 (P03W, P03V, P13V)	66	11.86 →	 50-05-527	Imp. SUMITOMO	
2.4 (P04W, P14V, P04V)	82	11.90 →	 60-05-518		
				 55-05-501  56-05-500  67-05-534  67-05-535	Left\Sinistra Right\Destra
2.0 (P00W)	83	07.96 →	 50-05-585		
			 60-05-518		
			 60-05-589		
				 55-05-528  56-05-500  67-05-537  67-05-538	Right\Destra Left\Sinistra
L 300 Furgonato/Box (L03_P)					
1.6 (L032P, L062P)	48	05.80 → 10.86	 50-05-502	Imp. AKEBONO	
			 50-05-527	Imp. SUMITOMO	
			 60-05-512	Imp. AKEBONO	
			 60-05-518	SUMITOMO	
				 55-05-501  56-05-500  67-05-534  67-05-535	Left\Sinistra Right\Destra
2.3 D (L038P, L068P)	50	09.83 → 10.86	 50-05-502	Imp. AKEBONO	
			 60-05-512	Imp. AKEBONO	
			 60-05-518		
				 55-05-501  56-05-500  67-05-534  67-05-535	Left\Sinistra Right\Destra
L 300 Furgonato/Box (P0_W, P1_W)					







































































	KW				
L 300 Furgonato/Box (P0_W, P1_W) i					
1.6 (P12V, P02V)	51	11.86 → 05.94	 50-05-527  60-05-589	Imp. SUMITOMO  55-05-501  56-05-500  67-05-534  67-05-535	Left\Sinistra Right\Destra
2.5 D (P05V, P05W, P15V)	51	11.86 →	 50-05-527  60-05-520  60-05-589	Imp. SUMITOMO Imp. SUMITOMO  55-05-528  56-05-500  67-05-534  67-05-535	Left\Sinistra Right\Destra
2.0 (P03V, P13V)	64	11.86 →	 50-05-527  60-05-518	Imp. SUMITOMO  55-05-501  56-05-500  67-05-534  67-05-535	Left\Sinistra Right\Destra
1.4 G33B		04.86 →		 67-05-508  67-05-509	Right\Destra Left\Sinistra
2.4	82	11.86 → 08.97	 50-05-527  60-05-518	Imp. SUMITOMO  55-05-501	
L 400 Autobus (PAOV) i					
2500 TD	64	06.96 →	 50-05-585  50-05-599  60-05-583	 51-05-599  61-05-598  55-05-583  67-05-537  67-05-593	PB5V
L 400 Furgonato/Box (PAOV) i					
2500 TD	64	09.96 →	 50-05-585  50-05-599  60-05-583	 51-05-599  61-05-598  55-05-583  67-05-537  67-05-593	PB5V
2500 TD 4x4	64	09.96 →	 50-05-585  50-05-599  60-05-583	 51-05-599  61-05-598  55-05-583  56-05-508  67-05-537  67-05-593	PB5V
2.0	85	06.96 → 03.01	 50-05-585  60-05-583	 55-05-528  56-05-500  67-05-537  67-05-593	PB3V

































































	KW			
L 400 Furgonato/Box (PAOV)				
2.4 16V i	97	01.95 → 10.98	50-05-599 60-05-583	55-05-528 56-05-500 67-05-537 67-05-593
				PB4V
LANCER F II (A17_)				
1.2 GLX (A171)	40	03.83 → 01.84	50-03-310 60-05-508	55-05-508 56-05-505 67-05-531
1.4 GLX (A172)	51	03.83 → 01.84		
1.4 Turbo	77	03.83 → 01.84		
LANCER I (A17_)				
1.2 (A171)	40	01.80 → 12.81	50-05-508 60-05-506	55-05-514 67-05-500 67-05-501
				Right/Destra Left/Sinistra
1.4 GLX (A172)	50	09.79 → 02.83	50-05-508 60-05-506	55-05-504 67-05-502 67-05-503
				Right/Destra Left/Sinistra
1.6 (A174)	60	09.79 → 02.83	50-05-508 60-05-506	51-05-501 61-05-502 55-05-502 67-05-500 67-05-501
				Right/Destra Left/Sinistra
1.6 (A174)	62	01.81 → 02.83	50-05-508 60-05-506	51-05-501 61-05-502 55-05-502
2.0 Turbo ECi (A176)	125	03.81 → 02.83	50-05-520 60-05-513	51-05-502 61-05-504
LANCER III (C1_A, C6_A)				
1.2 (C65A)	44	08.86 → 04.88	50-05-524 60-05-510	55-05-526 56-05-505 67-05-532
1.2 GL (C15AS)	40	01.84 → 10.86		
1.5 GLX (C12AS)	51	06.85 → 04.88		
1.5 GLX (C12AS)	55	11.83 → 04.88		
1.8 Diesel (C14AS)	43	01.84 → 09.86	50-05-524 50-05-525 60-05-509	55-05-526 56-05-505 67-05-579
1.8 Diesel (C14AS)	44	09.86 → 04.88	50-05-525 60-05-509	55-05-527 56-05-505 67-05-533
LANCER III Station Wagon (C1_V, C3_V)				
1.5 (C12V)	55	09.85 → 12.87	50-05-524 60-05-510	55-05-526 67-05-532
1.5 (C12V)	51	09.85 → 08.89		





























































	KW			
LANCER III Station Wagon (C1_V, C3_V)				
1.8 4x4 (C37V)	66	01.87 → 12.87	 50-05-525	 55-05-514
1.8 4x4 (C37V)	61	01.87 → 08.89	 60-05-509	 67-05-500
1.8 D (C14V)	43	09.85 → 09.86	 50-05-524	 55-05-526
			 50-05-525	 67-05-579
			 60-05-509	
1.8 D (C14V)	44	08.86 → 06.92	 50-05-525	 55-05-526
			 50-05-528	 55-05-527
			 60-05-509	 67-05-533
			 60-05-524	 67-05-579
			→12.89	01.90→
			01.90→	→12.89
			→12.89	→12.89
			01.90→	01.90→
1.5 (C12V)	61	09.88 → 12.90	 50-05-524	 55-05-526
			 60-05-510	 67-05-533
1.5 12V (C12V)	66	09.90 → 12.91	 50-05-528	 55-05-587
			 60-05-509	 67-05-532
			 60-05-593	
1.8 4x4 (C37V)	63	03.89 → 12.90	 50-05-525	 55-05-514
			 60-05-509	 67-05-533
1.8 4x4 (C37V)	69	08.90 → 06.92	 50-05-528	 55-05-514
			 60-05-509	 67-05-500
LANCER IV (C6_A, C7_A)				
1.8 D (C64A)	44	04.88 → 05.92	 50-05-525	 55-05-526
			 50-05-528	 55-05-527
			 60-05-509	 56-05-505
			 60-05-524	 67-05-533
			→12.89	→12.89
			01.90→	→12.89
			→12.89	→12.89
			01.90→	01.90→
1.3 12V (C61A)	55	06.92 → 05.94	 50-05-528	 55-05-587
			 60-05-524	 56-05-505
			 60-05-593	 67-05-579
1.5 12V (C62A)	66	05.89 → 05.92	 50-05-528	 55-05-587
			 60-05-509	 56-05-505
			 60-05-593	 67-05-532
1.6 16V (C66A)	83	06.92 → 05.94	 50-05-528	 51-05-504
			 60-05-524	 61-05-514
			 60-05-525	 55-05-586
				 55-05-587
				 56-05-505
				 67-05-539
1.8 4x4 (C77A)	71	09.89 → 06.92	 50-05-528	 55-05-527
			 60-05-524	 56-05-505
				 67-05-579
1.8 GTi 16V (C69A)	103	06.92 → 12.93	 50-05-530	 51-05-504
			 60-05-533	 61-05-514

	KW			
LANCER IV (C6_A, C7_A)				
1.8 GTi 16V (C68A)	100	11.89 → 05.92	 50-05-530  60-05-524	 51-05-500  61-05-508
1.5	62	06.88 → 05.92	 50-05-524 →05.90  50-05-528 06.90→  60-05-509 →05.90  60-05-510 →05.90  60-05-593 →06.90	 55-05-526 →05.90  55-05-587 06.90→  56-05-505  67-05-532 06.90→  67-05-533 →05.90
LANCER IV Tre volumi/Saloon (C6_A)				
1.3 (C61A)	44	04.88 → 05.92	 50-05-524 →05.90  50-05-525 →05.90  50-05-528 06.90→  60-05-510 →05.90  60-05-524 06.90→  60-05-593 06.90→	 55-05-526 →05.90  55-05-587 06.90→  56-05-505  67-05-532 →05.90  67-05-579 06.90→
1.3 (C61A)	51	08.88 → 05.92		
1.8 GLX Diesel (C64A)	44	04.88 → 05.92	 50-05-525 →12.89  50-05-528 01.90→  60-05-509 →12.89  60-05-524 01.90→	 55-05-526 01.90→  55-05-527 →12.89  56-05-505  67-05-533 →12.89  67-05-579 01.90→
1.3 12V (C61A)	55	01.91 → 06.92	 50-05-528  60-05-524  60-05-593	 55-05-587  56-05-505  67-05-579
1.5 (C62A)	62	04.88 → 05.92	 50-05-524 →05.90  50-05-528 06.90→  60-05-509 06.90→  60-05-510 →05.90  60-05-593 06.90→	 55-05-526 →05.90  55-05-587 06.90→  56-05-505  67-05-532 06.90→  67-05-533 →05.90
1.5 12V (C62A)	66	05.89 → 05.92	 50-05-528  60-05-509  60-05-593	 55-05-587  56-05-505  67-05-532
1.3 GL	50	05.88 → 06.90	 50-05-524  60-05-509  60-05-510	 55-05-526
LANCER SPORTBACK				
1.5	80	06.08 →	 50-05-501	 51-05-508
1.8	105	06.08 →	 60-05-543	 61-05-517
2.0 DI-D	103	06.08 →		
LANCER Station wagon				



	KW			
LANCER Station wagon i				
1.6	72	09.03 →	 50-05-501  50-05-503  60-05-527	 51-05-508  61-05-510  61-05-521  55-05-507 Parking Brake\Freno staz.
2.0	99	09.03 →	 50-05-501  60-05-537	 51-05-508  61-05-521  55-05-507 Parking Brake\Freno staz.
LANCER Tre volumi/Saloon i				
1.3	60	09.03 →	 50-05-501  60-05-527	 51-05-508  61-05-510  55-05-507 Parking Brake\Freno staz.
1.6	72	09.03 →	 50-05-501  50-05-503  60-05-527	 51-05-508  61-05-510  61-05-521  55-05-507 Parking Brake\Freno staz.
2.0	99	12.03 →	 50-05-501  60-05-537	 51-05-508  61-05-521  55-05-507 Parking Brake\Freno staz.
1.5	80	06.08 →	 50-05-501	 51-05-508
2.0 DI-D	103	01.08 →	 60-05-543	 61-05-517
2.0 EVO	217	06.08 →	 50-05-599  60-05-526	 51-05-505  61-05-501
LANCER V (CB/D_A) i				
2.0 Diesel (CB8A)	50	06.92 →	 50-05-528  60-05-532	 61-05-514  55-05-586  56-05-502  56-05-507  67-05-539 NO ABS →04.96
1.3 (CB1A)	55	06.92 →	 50-05-528  60-05-532  60-05-538	 51-05-504  61-05-514  55-05-587  67-05-579
1.6 16V (CB4A)	83	06.92 →	 50-05-528  60-05-524  60-05-525	 51-05-504  61-05-514  55-05-586  55-05-587  56-05-502  56-05-507  67-05-539 NO ABS →04.96

	KW				
LANCER V (CB/D_A) i i					
1.6	66	02.94 →	 50-05-528  60-05-532	 51-05-504  55-05-586  56-05-502  56-05-507  67-05-539	NO ABS →04.96
1.6 16V 4WD (CD4A)	83	06.92 →	 50-05-528  60-05-532	 51-05-504  55-05-586  56-05-501  67-05-539	
1.8 16V (CB5A)	103	06.92 → 12.93	 50-05-530	 51-05-504	
LANCER V Station Wagon (CB_W, CD_W) i i					
1.6 16V (CB4W)	83	12.92 → 10.03	 50-05-528  60-05-524  60-05-525  60-05-532	 51-05-504  61-05-514  55-05-586  55-05-587  56-05-502  56-05-507  67-05-539	NO ABS →09.96
2.0 D (CB8W)	50	12.92 → 10.03	 50-05-528  60-05-532	 55-05-586  56-05-502  56-05-507  67-05-539	NO ABS →04.96
1.6 16V 4WD (CD4W)	83	12.92 → 10.03	 50-05-528  60-05-532	 51-05-504	
LANCER VI (CK/P_A) i i					
1.3 12V (CK1A)	55	12.95 → 08.03	 50-05-528  60-05-532	 55-05-586  56-05-507  67-05-539	05.96→ →07.01
1.5 16V (CK2A)	69	12.95 → 08.03	 50-05-528  60-05-532		
1.6 16V (CK4A)	66	12.95 → 08.03	 50-05-528  60-05-532	 55-05-587  56-05-507  67-05-539	05.96→ →07.01
2.0 16V EVO VI / VII (CP9A)	206	01.99 → 08.03	 50-05-510  60-05-544	 51-05-506  61-05-523	
2.0 16V EVO VIII	195	03.04 →	 50-05-599  60-05-544	 51-05-508  61-05-521	



	KW			
LANCER VI (CK/P_A) <i>i</i> <i>i</i>				
2.0 16V EVO IX	206	01.06 →	50-05-599 60-05-537	51-05-508 61-05-521
OUTLANDER <i>i</i> <i>i</i>				
2.0	100	05.03 →	50-05-599	51-05-508
2.0 4WD	177	05.03 →	60-05-526	61-05-503
2.0 4WD	100	05.03 →		
2.0 4WD	93	05.03 →		
2.0 Turbo 4WD	148	04.04 →		
2.4 4WD	102	05.03 →		
2.4 4WD	119	05.03 →		
2.4 4WD	118	11.03 →		
2.0 DI-D	103	02.07 →	50-05-599 60-05-526	51-05-505 61-05-501 55-05-515
				Parking Brake\Freno staz.
2.2 DI-D	115	08.07 →	50-05-599	51-05-505
2.4 Mivec	125	09.07 →	60-05-526	61-05-501 55-05-515
				Parking Brake\Freno staz.
2.4	125	11.06 →		55-05-515
				Parking Brake\Freno staz.
PAJERO CLASSIC (V2_W) <i>i</i> <i>i</i>				
2.5 TD	85	07.02 →	50-05-599 60-05-505	51-05-592 61-05-598 55-05-501 55-05-513
				Parking Brake\Freno staz.
3.2 DI-D	118	05.05 →	50-05-509 60-05-516	51-05-505 55-05-501 55-05-513
				→08.06 Parking Brake\Freno staz.
PAJERO I (L04_G, L14_G) <i>i</i> <i>i</i>				
2.5 TD (L044G, L049G)	64	01.90 → 12.91	50-05-527	55-05-501
2.5 TD (L044G, L049G)	70	11.89 → 11.90	60-05-520	56-05-500 67-05-537 67-05-538
				Right\Destra Left\Sinistra
3.0 V6 (L141G, L146G)	104	11.88 → 11.90	50-05-527 60-05-520 60-05-521	55-05-501 56-05-500 67-05-537 67-05-538
			Imp. SUMITOMO Imp. SUMITOMO Imp. SUMITOMO	Right\Destra Left\Sinistra
2.0 4WD		01.82 →	50-05-502 60-05-520	55-05-501 56-05-500
			Imp. AKEBONO Imp. SUMITOMO	
PAJERO I aperto\Open Off-Road (L04_G) <i>i</i> <i>i</i>				

	KW			
--	----	--	--	--

PAJERO I aperto\Open Off-Road (L04_G)































































2.6 TD (L044G, L049G)	62	05.86 → 10.89	60-06-502	→05.87	66-06-501	Left\Sinistra Right\Destra
2.6 (L042G, L047G)	76	01.83 → 11.90	60-06-527	06.87→ Imp. SUMITOMO	66-06-500	
			60-06-501	→05.87 Imp. AKEBONO	67-06-534	
			60-06-520	Imp. SUMITOMO	67-06-536	
2.3 TD (L043G, L048G)	62	12.82 → 04.86	60-06-502	Imp. AKEBONO	66-06-501	Left\Sinistra Right\Destra
			60-06-501	Imp. AKEBONO	66-06-500	
			60-06-514		67-06-534	
2.6 TD (L044G, L049G)	70	11.89 → 11.90	60-06-527	Imp. SUMITOMO	66-06-501	Right\Destra Left\Sinistra
			60-06-520	Imp. SUMITOMO	66-06-500	
					67-06-537	
					67-06-538	

























































PAJERO II (V2_W, V4_W)

2.4	82	04.91 → 04.00	60-06-599		61-06-599	
2.6 TD (V24C, V24W)	73	12.90 → 04.00	60-06-599		61-06-598	
2.8 TD (V46W)	92	06.94 → 04.00			66-06-501	
3.0 V6 (V23W, V43W, V23C)	110	12.90 → 12.95	60-06-599		61-06-599	Right\Destra Left\Sinistra
			60-06-599		61-06-598	
					66-06-501	
					66-06-500	
					67-06-537	
3.6 V6 24V (V26W, V46W)	153	06.94 → 04.00	60-06-599		61-06-599	
			60-06-539		61-06-598	
3.0 V6 24V	133	06.94 → 05.97	60-06-599		61-06-599	
3.0 V6 24V	130	06.97 → 04.00	60-06-599		61-06-598	
					66-06-501	
					66-06-500	
3.6 V6 24V	143	07.97 → 04.00	60-06-599	11.98→	61-06-599	11.98→
			60-06-539		61-06-598	11.98→
			60-06-599	11.98→		

































































PAJERO II aperto\Open Off-Road (V2_W, V4_W)



	KW			
PAJERO II aperto/Open Off-Road (V2_W, V4_W) <i>i</i> <i>i</i>				
2.4	82	04.91 → 04.00	 60-06-699	 61-06-699
2.6 TD (V24C, V24W)	73	12.90 → 04.00	 60-06-699	 61-06-698
				 66-06-501
				 66-06-500
3.0 V6 (V23W, v43W, V23C)	110	12.90 → 12.95	 60-06-699	 61-06-699
			 60-06-699	 61-06-698
				 66-06-501
				 66-06-500
				 67-06-637 Right\Destra
				 67-06-638 Left\Sinistra
3.0 V6 24V	133	06.94 → 04.00	 60-06-699	 61-06-699
			 60-06-699	 61-06-698
1.8 GDI	96	06.98 → 04.00	 60-06-699	 61-06-699
			 60-06-699	 61-06-698
				 66-06-506
				 66-06-510
PAJERO III (V60) <i>i</i> <i>i</i>				
3.2 DI-D (V68W, V78W)	121	04.00 → 10.01	 60-06-609	 61-06-606
3.2 DI-D (V68W, V78W)	118	10.01 →	 60-06-616	 61-06-616
3.6 V6 GDI (V66W, V76W)	149	04.00 →		 66-06-513 Parking Brake\Freno staz.
2.6 TDi (V64W, V74W)	85	09.01 →	 60-06-609	 61-06-606
			 60-06-616	 61-06-698
				 66-06-513 Parking Brake\Freno staz.
2.6 TDi (V64W, V74W)	73	04.00 →	 60-06-609	 61-06-699
			 60-06-616	 61-06-616
				 66-06-513 Parking Brake\Freno staz.
PAJERO IV (V80) <i>i</i> <i>i</i>				
3.2 DI-D (V88W, V98W)	118	02.07 →	 60-02-206	 61-02-210
3.2 DI-D (V88W, V98W)	125	02.07 →	 60-06-609	 61-06-606
			 60-06-616	 61-06-616
			 60-06-636	 61-06-616
3.8 V6 (V87W, V97W)	184	02.07 →	 60-02-206	 61-02-210
			 60-06-609	 61-06-606
			 60-06-616	 61-06-616
				 61-06-616
PAJERO PININ (H6_W, H7_W) <i>i</i> <i>i</i>				
1.8 GDI (H66W)	88	10.99 →	 60-06-606	 61-06-694
2.0 GDI (H67W, H77W)	95	10.00 →	 60-06-607	 61-06-603
				 66-06-606

































































	KW			
PAJERO PININ (H6_W, H7_W) <i>i</i> <i>i</i>				
1.8	84	11.01 →	 50-05-505  60-05-507	 51-05-594  61-05-503  55-05-505  56-05-510
PAJERO SPORT (K90) <i>i</i> <i>i</i>				
3.0 V6	130	11.98 →	 50-05-599  60-05-505	 51-05-592  61-05-598  55-05-583  56-05-508  67-05-593  67-05-594
2.5 TD	73	11.98 →	 50-05-585  50-05-599  60-05-505  60-05-599	 51-05-592  51-05-599  61-05-598  55-05-503
2.5 TD	85	07.02 →	 50-05-599  60-05-505	 51-05-592  61-05-598
2.5 TD	98	08.03 →		
3.0 V6	123	03.03 →	 50-05-585  50-05-599  60-05-505	 51-05-592  61-05-598  56-05-508
3.0 V6	125	06.00 →		
SANTAMO <i>i</i> <i>i</i>				
2.0 16V	102	05.99 →	 50-05-530  60-05-522	 51-05-594  61-05-510
2.0 16V 4x4	102	05.99 →		
SAPORO I (A12_) <i>i</i> <i>i</i>				
1.6 SL, GL (A121)	55	04.78 → 07.80	 50-02-210  60-05-500	 55-05-502  67-05-502  67-05-503
2.0 (A123)	79	01.79 → 07.80	 50-05-502  60-05-502	 51-05-502  61-05-500  55-05-502  67-05-502  67-05-503
2.0 (A123)	72	04.78 → 07.80		
2.0 (A123)	66	04.78 → 07.80		
SAPORO II (A16_A) <i>i</i> <i>i</i>				
1.6 GLX (A161A)	55	08.80 → 09.84	 50-05-508  60-05-506	 55-05-504  67-05-500  67-05-501

































	KW				
SAPPORO II (A16_A) i					
2.0 GSL (A164A)	75	08.80 → 08.83	 50-05-502  60-05-502	Imp. AKEBONO  51-05-502  61-05-500  55-05-504  67-05-500  67-05-501	Right\Destra Left\Sinistra
2.0 GSR (A164A)	82	08.80 → 09.84	 50-05-502  60-05-513	Imp. AKEBONO  51-05-502  61-05-500  55-05-504  67-05-500  67-05-501	Right\Destra Left\Sinistra
2.0 Turbo ECi (A164)	125	08.82 → 08.83	 50-05-502  60-05-513	Imp. AKEBONO  51-05-502  61-05-504	
SAPPORO III (E16A) i					
2.4 (E16A)	91	06.87 → 08.90	 50-05-529  60-05-522	 51-05-594  61-05-599	
SIGMA (F16A) i					
3.0 V6 (F16A)	151	12.90 → 07.96	 50-05-599  60-05-529	 51-05-594  61-05-513	
3.0 V6 (F16A)	130	12.90 → 07.96			
SIGMA Station Wagon (F07W) i					
3.0 (V6)	125	01.93 → 07.96	 50-05-599  60-05-529	 51-05-599  61-05-595	
SPACE GEAR (PA/B/D_V/W) i					
2.0 16V (PA3V/W, PB3V)	85	05.95 → 05.00	 50-05-585  60-05-583	 55-05-501  67-05-593	
2.0 16V (PA3V/W, PB3V)	83	08.96 → 05.00			
2.4 i (PA4W)	97	05.95 → 05.00	 50-05-585  50-05-599  60-05-583	 51-05-599  61-05-598  55-05-501  67-05-537	
2.4 i 4x4 (PD4V/W)	97	05.95 → 05.00	 50-05-585  50-05-599  60-05-583	 51-05-599  61-05-598  55-05-501	
2.5 TD (PA5V/W, PB5V)	73	05.95 → 05.00	 50-05-585	 51-05-599	
2.5 TD (PA5V/W, PB5V)	64	05.95 → 05.00	 50-05-599  60-05-583	 61-05-598  55-05-501  67-05-537  67-05-593	
2.5 TD 4x4 (PD5V/W)	73	05.95 → 05.00	 50-05-585  50-05-599  60-05-583	 51-05-599  61-05-598  55-05-501	

	KW			
SPACE RUNNER (N1_W, N2_W)				
1.8 (N11W)	90	10.91 → 08.99	50-05-529	51-05-594
1.8 4x4 (N21W)	90	10.91 → 08.99	50-05-530	61-05-510
			60-05-522	55-05-586
			60-05-530	56-05-509
				67-05-596
				Made in USA
2.0 TD (N18W)	60	10.92 → 08.99	50-05-530	51-05-594
			60-05-522	61-05-510
				55-05-586
				56-05-509
1.8 (N11W)	85	06.96 → 08.99	60-05-522	51-05-594
			60-05-530	61-05-510
				55-05-586
				56-05-509
1.8 4x4 (N21W)	85	06.96 → 08.99	50-05-529	51-05-594
			50-05-530	61-05-510
			60-05-522	55-05-586
			60-05-530	
2.0 16V	98	06.97 → 08.99	50-05-530	51-05-594
			60-05-530	61-05-510
				56-05-509
SPACE RUNNER (N50)				
2.0	100	08.99 →	50-05-599	51-05-594
2.4 GDI	110	08.99 →	60-05-537	61-05-521
SPACE STAR (DG0)				
1.3 16V	63	06.98 →	50-05-593	55-05-500
1.3 16V	60	09.00 →	60-05-522	56-05-502
1.3 16V	61	12.98 →		67-05-514
				01.99→
				01.99→
				NO ABS
1.6 16V	72	01.01 →	50-05-593	51-05-507
1.8 GDI	90	06.98 →	60-05-522	61-05-511
1.8 GDI	87	06.98 →		55-05-500
1.8 GDI	82	10.02 →		56-05-502
1.9 DI-D	75	02.01 →		67-05-514
1.9 DI-D	85	10.02 →		
				Imp. LUCAS
				NO ABS
SPACE WAGON (D0_V/W)				
1.8 GLX (D05V, D05W)	66	01.84 → 12.88	50-05-525	55-05-527
1.8 TD (D09W)	55	06.86 → 04.91	60-05-509	67-05-533
2.0 GLX (D04W)	62	06.86 → 05.88	50-05-525	55-05-527
2.0 GLXi (D04W)	74	06.88 → 04.91	60-05-509	67-05-533
			60-05-517	





	KW			
SPACE WAGON (D0_V/W) <i>i</i> <i>i</i>				
2.0 4x4 (D08W)	75	03.85 → 04.91	 50-05-525	 55-05-529
2.0 GLX 4x4 (D08W)	62	06.86 → 05.88	 60-05-509	 67-05-533
2.0 GLXi 4x4 (D08W)	74	06.88 → 04.91	 60-05-517	
1.8 4x4 (D05V, D05W)	66	10.87 → 08.88	 50-05-525	 55-05-529
			 60-05-509	
SPACE WAGON (N3_W, N4_W) <i>i</i> <i>i</i>				
1.8 TD (N35W)	55	10.91 → 10.98	 50-05-530	 51-05-594
2.0 TD (N38W)	60	10.92 → 10.98	 60-05-522	 61-05-510
2.4 i (N34W)	85	10.91 → 05.96		 55-05-527
				 67-05-532
1.8 (N31W)	90	10.91 → 10.98	 50-05-530	 51-05-594
1.8 4x4 (N41W)	90	10.91 → 10.98	 60-05-522	 61-05-510
			 60-05-530	 55-05-527
			→12.92 01.93→	 67-05-532
2.0 (N33W)	98	10.92 → 10.98	 50-05-528	 51-05-594
			 50-05-530	 61-05-510
			 60-05-530	 55-05-527
				 67-05-532
2.0 4x4 (N43W)	98	10.92 → 10.98	 50-05-530	 51-05-594
			 60-05-530	 61-05-510
				 55-05-529
2.4 i AWD (N34W)	85	10.91 → 05.96	 50-05-530	 51-05-594
2.4 i	102	10.92 → 10.98	 50-05-530	 51-05-594
			 60-05-522	 61-05-510
				 55-05-588
SPACE WAGON (N5_W) <i>i</i> <i>i</i>				
2.4 GDI	110	10.98 →	 50-05-599	 51-05-510
			 60-05-529	 61-05-523
				 55-05-505
				 56-05-510
2.4 GDI 4x4	110	10.98 →	 50-05-599	 61-05-523
			 60-05-529	
2.0 GDI	98	04.02 →	 50-05-599	 51-05-510
2.4 GDI	108	09.00 →	 60-05-529	 61-05-523
2.4 GDI 4x4	108	09.00 →		 55-05-507
				Parking Brake/Freno staz.
STARION (A18_A) <i>i</i> <i>i</i>				
2.0 Turbo ECi (A183A)	132	05.85 → 08.87	 50-05-520	 51-05-502
2.0 Turbo ECi (A183A)	125	06.82 → 12.85	 60-05-513	 61-05-504
			 60-05-515	 61-05-505
				Imp. SUMITOMO

	KW				
STARION (A18_A) i					
2.6 Turbo ECI (A187A)	114	09.87 → 06.90	 50-05-520  60-05-515	 51-05-502  61-05-504  61-05-505	Imp. SUMITOMO
TREDIA (A21_) i					
1.4 GLX (A211)	51	10.82 → 08.85	 50-05-522  60-05-510	 55-05-514  67-05-536	
GLS 1.6 (A212)	55	09.82 → 10.87	 50-05-522  50-05-525  60-05-509  60-05-510	 55-05-514  67-05-536	
1.6 Turbo (A212)	85	09.82 → 07.84	 50-05-522	 55-05-514	
1.6 Turbo (A212)	84	09.82 → 05.85	 60-05-509	 67-05-536	
1.8 GLS (A215)	66	08.84 → 07.86	 50-05-525  60-05-517	 55-05-514  67-05-502	
1.8 Turbo	100	08.84 → 07.86	 50-05-525  60-05-523	 55-05-514  67-05-536	



































































MITSUBISHI Comm.































































	KW			
Canter				
Canter 35	92	09.01 →	 60-05-507	Imp. SUMITOMO
Canter 65	92	09.01 →	 60-05-514	
Canter 75	115	01.94 → 12.97	 60-05-586	Imp. SUMITOMO
Canter 35	85	07.98 →	 60-05-507	Imp. SUMITOMO
Canter 35	69	08.96 → 12.99	 60-05-514	
Canter 75	100	10.97 →	 60-05-514	
Canter 60	105	09.01 →	 60-05-514	
Canter 75	105	09.01 →	 60-05-514	
Canter 60	86	07.86 →	 60-05-514	
Canter 60	86	07.86 →	 60-05-586	Imp. SUMITOMO
Canter 60	100	08.96 →	 60-05-514	
Canter 60	100	08.96 →	 60-05-586	Imp. SUMITOMO
				 67-05-588
				 67-05-588
				 67-05-588
				 66-05-580
				 66-05-581
				 55-05-517 NO ABS
				 67-05-588

	KW					
100 NX (B13) i i						
1.6 1.6 SR	66 75	03.90 → 10.94 09.93 → 10.94	 50-01-149  60-01-139	 51-01-127  61-01-130  55-01-142  56-01-106  67-01-191	Imp. BENDIX NO ABS	
2.0 GTI	105	03.91 → 10.94	 50-01-197  60-01-185	Imp. SUMITOMO  51-01-127  61-01-126  67-01-191	Imp. BENDIX Imp. BENDIX	
2.0	110	10.90 → 10.94	 50-01-197  60-01-185	Imp. SUMITOMO  51-01-127  61-01-126	Imp. BENDIX Imp. BENDIX	
200 SX (S13) i i						
1.8 Turbo	124	07.88 → 11.93	 50-01-142  50-01-143  60-00-015  60-01-108  60-01-196	09.89→ →08.91 09.91→ 09.91→ 09.91→	 51-01-124  51-01-196  61-01-121  67-01-150	09.91→
2.0 i 16V	103	07.88 → 11.93	 50-01-142  50-01-143  60-01-151	09.89→ →08.91 09.91→	 67-01-150	
200 SX (S14) i i						
2.0 i 16V Turbo	147	10.93 → 12.99	 50-01-147  60-01-194		 51-01-196  61-01-123  67-01-150	
2.0 i 16V	118	10.93 → 12.99	 50-01-188  60-01-194		 51-01-122  67-01-150	
2.4 i	115	10.93 →	 50-01-188			
280 ZX,ZXT (HGS130) i i						
2.8	103	10.78 → 06.83	 50-01-116  60-01-112		 51-01-120  51-01-121  61-01-111	
2.8 2.8	147 108	01.83 → 02.84 02.80 → 09.82	 50-01-116  60-01-112		 51-01-121  61-01-111	
2.8	110	01.82 → 02.84	 50-01-134  60-01-112		 51-01-121  61-01-115	
300 ZX (Z31) i i						

	KW			
300 ZX (Z31) <i>i</i> <i>i</i>				
3.0	125	01.84 → 12.87	50-01-195 60-01-137	51-01-121 61-01-112 →02.87 61-01-113 61-01-117
3.0 Turbo	149	05.87 → 10.90	50-01-140 60-01-137 60-01-149	51-01-121 61-01-113 61-01-117
3.0 Turbo	168	04.84 → 10.90	50-01-195 60-01-137 60-01-153	51-01-194 61-01-113 61-01-117
300 ZX (Z32) <i>i</i> <i>i</i>				
3.0 Twin Turbo	197	05.90 → 09.95	50-01-147	51-01-129
3.0 Twin Turbo	208	05.90 → 09.95	60-01-194	61-01-199
350 Z <i>i</i> <i>i</i>				
3.5	221	04.06 →	50-01-113	51-01-119
3.5	221	04.06 →		
3.5	230	09.05 →		
3.5	206	10.03 →		
350 Z Roadster <i>i</i> <i>i</i>				
3.5	206	03.05 →	50-01-113	51-01-119
370 Z <i>i</i> <i>i</i>				
3.7	243	06.09 →	50-01-146	
ALMERA I (N15) <i>i</i> <i>i</i>				
1.4	64	09.95 → 07.00	50-01-191	51-01-196
1.4 GX,LX	55	09.95 → 07.00	60-01-111 07.97→ con/with ABS 60-01-135 02.98→ NO ABS 60-01-136 →01.98 NO ABS	61-01-126 Imp. BENDIX 61-01-130 55-01-142 56-01-106 67-01-107
1.6	73	09.95 → 07.00	50-01-191	51-01-196
1.6 SLX	66	09.95 → 07.00	60-01-111 07.97→ con/with ABS 60-01-135 02.98→ NO ABS	61-01-126 Imp. BENDIX 61-01-130 55-01-142 56-01-106 67-01-107
2.0 D	55	11.95 → 07.00		
ALMERA I Hatchback (N15) <i>i</i> <i>i</i>				

	KW					
ALMERA I Hatchback (N15)						
1.4 1.4 S,GX,LX	64 55	09.95 → 03.00 09.95 → 03.00	 50-01-191  60-01-111  60-01-135  60-01-136	07.97→ con/with ABS 02.98→ NO ABS →01.98 NO ABS	 51-01-196  61-01-126  61-01-130  55-01-142  56-01-106  67-01-107	Imp. BENDIX
1.6 1.6 SR,SLX 2.0 D	73 66 55	09.95 → 03.00 09.95 → 03.00 11.95 → 03.00	 50-01-191  60-01-111  60-01-135	07.97→ con/with ABS 02.98→ NO ABS	 51-01-196  61-01-126  61-01-130  55-01-142  56-01-106  67-01-107	Imp. BENDIX
2.0 GTi	105	07.96 → 03.00	 50-01-191  50-01-197  60-01-135  60-01-185	Imp. SUMITOMO 02.98→ NO ABS	 51-01-127  51-01-196  61-01-126  56-01-106	Imp. BENDIX Imp. BENDIX
ALMERA II (N16)						
1.5 1.5	77 66	03.01 → 07.00 →	 50-00-015  50-01-179  60-01-108	Imp. LUCAS	 51-00-015  61-00-015  55-01-191  56-01-111	Imp. LUCAS Imp. LUCAS NO ABS →11.06 NO ABS
2.2 Di	81	07.00 →	 50-01-179  60-01-108	Imp. LUCAS	 51-00-015  61-00-015  55-01-191  56-01-111	Imp. LUCAS Imp. LUCAS NO ABS NO ABS
1.8	84	07.00 →	 50-00-015  50-01-179  60-01-108	Imp. LUCAS	 51-00-015  61-00-015  55-01-191	Imp. LUCAS Imp. LUCAS NO ABS
1.5	72	10.02 →	 50-00-015  50-01-150  50-01-179  60-01-108	Imp. AKEBONO Imp. LUCAS	 51-00-015  61-00-015  55-01-191  56-01-111	Imp. LUCAS Imp. LUCAS NO ABS →11.06 NO ABS
1.8	85	10.02 →	 50-00-015  50-01-150  50-01-179  60-01-108	Imp. AKEBONO Imp. LUCAS	 51-00-015  61-00-015  55-01-191	Imp. LUCAS Imp. LUCAS NO ABS



































	KW			
ALMERA II (N16)				
1.6 dCi	60	01.03 →	60-01-150 Imp. AKEBONO	51-00-015 Imp. LUCAS
2.2 dCi	100	09.03 →	60-01-179 Imp. LUCAS 60-01-108	61-00-015 Imp. LUCAS 55-01-191 NO ABS →11.06 NO ABS
2.2 dCi	82	09.03 →	60-01-150 Imp. AKEBONO 60-01-179 Imp. LUCAS 60-01-108	51-00-015 Imp. LUCAS 61-00-015 Imp. LUCAS 55-01-191 NO ABS
ALMERA II Hatchback (N16)				
1.6	66	03.00 →	60-00-015 60-01-179 Imp. LUCAS 60-01-108	51-00-015 Imp. LUCAS 61-00-015 Imp. LUCAS 55-01-191 NO ABS →11.06 NO ABS
1.8	84	01.00 →	60-00-015 60-01-179 Imp. LUCAS 60-01-108	51-00-015 Imp. LUCAS 61-00-015 Imp. LUCAS 55-01-191 NO ABS
1.6 dCi 2.2 Di	60 81	01.03 → 03.00 →	60-01-179 Imp. LUCAS 60-01-108	51-00-015 Imp. LUCAS 61-00-015 Imp. LUCAS 55-01-191 NO ABS 56-01-111 NO ABS
1.6 1.8	72 85	10.02 → 10.02 →	60-00-015 60-01-150 Imp. AKEBONO 60-01-179 Imp. LUCAS 60-01-108	51-00-015 Imp. LUCAS 61-00-015 Imp. LUCAS 55-01-191 NO ABS →11.06 NO ABS
2.2 dCi	82	09.03 →	60-01-150 Imp. AKEBONO 60-01-179 Imp. LUCAS 60-01-108	51-00-015 Imp. LUCAS 61-00-015 Imp. LUCAS 55-01-191 NO ABS
2.2 dCi	100	09.03 →	60-01-150 Imp. AKEBONO 60-01-179 Imp. LUCAS 60-01-108	51-00-015 Imp. LUCAS 61-00-015 Imp. LUCAS 55-01-191 NO ABS 56-01-111 NO ABS
ALMERA TINO (V10)				
1.8 1.8 2.0 2.2 dCi 2.2 dCi 2.2 Di	84 85 100 82 100 84	08.00 → 12.02 → 08.00 → 09.03 → 09.03 → 08.00 →	60-01-176 60-01-158	51-00-015 Imp. LUCAS 61-01-156
ATLEON				

	KW				
ATLEON i i					
3.0 (120.36 - 120.66)	88	09.00 →	 60-01-122  60-01-196  60-01-106  60-01-117  60-01-190	06.04→ Imp. BENDIX 06.04→ →05.04	 61-01-100  61-01-104  66-01-110  67-01-116
BLUEBIRD (910) i i					
1.8	65	01.80 → 12.83	 60-01-106  60-01-106	 66-01-106  66-01-101  67-01-106	
2.0 D	44	01.80 → 12.83			
2.0 i	80	01.82 → 12.83	 60-01-106  60-01-106	 61-01-121  61-01-111  66-01-106  66-01-101  67-01-106	
2.0 TD	57	01.83 → 09.83	 60-01-106	 66-01-106  66-01-101	
1.6	60	01.80 → 11.83	 60-01-102  60-01-111  60-01-106	Imp. AKEBONO  66-01-106  66-01-101  67-01-171	
BLUEBIRD (B610) i i					
1.8	65	07.74 → 11.79	 60-01-102  60-01-102	 66-01-106  66-01-101	
BLUEBIRD (T72 , T12) i i					
1.6	61	03.86 → 06.90	 60-01-111  60-01-127	Imp. AKEBONO  66-01-134  67-01-171	
2.0 (T12)	75	12.85 → 12.87			
2.0 i (HLT72, T12)	77	12.85 → 12.90	 60-01-196  60-01-127	 66-01-134  67-01-110	
1.8 i 16V (RLT72)	95	02.89 → 12.90	 60-01-196  60-01-127	 61-01-121  61-01-124  66-01-134  67-01-171	
2.0 D (SLT72, T12)	49	03.86 → 12.90	 60-01-111  60-01-196  60-01-127	Imp. AKEBONO  66-01-134  67-01-110  67-01-171	
2.0 i	85	09.88 → 09.90	 60-01-196  60-01-127	 66-01-106  66-01-134  67-01-110	

	KW			
BLUEBIRD (T72 , T12)				
1.8 Turbo	99	12.85 → 05.90	50-01-111 50-01-195 60-01-127	Imp. AKEBONO 51-01-121 51-01-123 61-01-124 55-01-134 67-01-171
1.6	66	12.85 → 02.90	50-01-195 60-01-127	55-01-134
2.0 LX	66	12.85 → 02.90		
BLUEBIRD (U11)				
1.8	66	11.83 → 06.88	50-01-111 60-01-127	Imp. AKEBONO 55-01-106 67-01-171
2.0 i	77	04.84 → 01.88		
2.0 D	43	04.84 → 01.88	50-01-111 60-01-127	Imp. AKEBONO 55-01-106 67-01-171
1.8 Turbo	99	04.84 → 05.90	50-01-111 60-01-127	Imp. AKEBONO 51-01-121 61-01-124 55-01-106 67-01-171
1.6	66	12.85 → 02.90		67-01-193
BLUEBIRD Coupe (910)				
1.8	66	01.80 → 05.84	50-01-105 50-01-141 60-01-106	55-01-106 56-01-101 67-01-106
1.9 i	80	01.82 → 05.84	50-01-105 60-01-106	55-01-106 56-01-101
BLUEBIRD Hatchback (T72, T12)				
1.8 i 16V (FRLT72)	95	02.89 → 12.90	50-01-195 60-01-127	51-01-121 61-01-124 55-01-134 67-01-171
1.6	61	03.86 → 06.90	50-01-111 60-01-127	Imp. AKEBONO 55-01-134 67-01-171
1.6	66	03.86 → 06.91		
2.0 (T12)	75	12.85 → 12.87		
2.0 i	85	09.88 → 09.90	50-01-195 60-01-127	55-01-134 67-01-110
2.0 i (FHLT72, T12)	77	12.85 → 12.90		
2.0 D (FSLT72, T12)	49	03.86 → 12.90	50-01-111 50-01-195 60-01-127	Imp. AKEBONO 55-01-134 67-01-110 67-01-171

	KW			
BLUEBIRD Hatchback (T72, T12)				
1.8 Turbo	99	12.85 → 05.90	 	Imp. AKEBONO
BLUEBIRD Station Wagon (WU11)				
2.0	75	04.86 → 09.90	 	Imp. AKEBONO
2.0 D	43	04.84 → 01.88	 	Imp. AKEBONO
2.0 i	77	04.84 → 12.90		
2.0 D	49	03.86 → 12.90	 	Imp. AKEBONO
2.0 i	85	09.88 → 09.90		
BLUEBIRD Traveller (W910)				
1.8	65	01.80 → 05.84	 	
2.0 D	44	01.80 → 05.84	 	
CHERRY (E10)				
1.0	33	09.70 → 09.78	 	
CHERRY (N12)				
1.3	44	05.82 → 10.86	 	
1.5	55	11.83 → 10.86		
1.7 D	40	10.82 → 12.86	 	
1.0	37	05.82 → 05.86	 	Imp. AKEBONO
1.5 Turbo	77	01.83 → 12.85	 	→05.84 06.84→ 06.84→ →05.84 06.84→
1.6	51	05.84 → 07.86	 	
CHERRY Coupe (N10)				

	KW			
CHERRY Coupe (N10) <i>i</i> <i>i</i>				
1.2	38	08.78 → 07.81	50-01-100 60-01-100	55-01-112 67-01-100 67-01-101
1.3	44	08.81 → 09.82	50-01-100 60-01-100	55-01-112 67-01-100
1.4	59	08.80 → 07.81	50-01-100 60-01-101	55-01-112 67-01-100
CHERRY Hatchback (N10) <i>i</i> <i>i</i>				
1.2	38	08.78 → 07.81	50-01-100 60-01-100	55-01-112 67-01-100 67-01-101
1.0 1.3	32 44	08.78 → 07.81 08.81 → 09.82	50-01-100 60-01-100	55-01-112 67-01-100
1.4 i.e. 1.5	59 51	08.80 → 07.81 08.81 → 12.82	50-01-100 60-01-101	55-01-112 67-01-100
CHERRY Traveller (VN10) <i>i</i> <i>i</i>				
1.2	38	10.78 → 07.81	50-01-100 60-01-100	55-01-112 67-01-100 67-01-101
1.3	44	09.81 → 12.83	50-01-100 60-01-100	55-01-112 67-01-100
1.4	59	08.80 → 07.81	50-01-100 60-01-101	55-01-112 67-01-100
CUBE (Z12) <i>i</i> <i>i</i>				
1.5 dCi 1.6 16V	78 81	03.10 → 03.10 →	50-01-143 60-01-159	51-01-154 55-01-141
1.5 dCi	81	03.10 →	60-01-159	Parking Brake\Freno staz.
DATSUN 100 A (E10, BLF10) <i>i</i> <i>i</i>				
1.0 (E10) F-II 1.0 (BLF10)	33 33	12.74 → 06.78 12.75 → 08.80	50-01-100 60-01-116	55-01-112
DATSUN 100 A Station wagon (WBLF10) <i>i</i> <i>i</i>				
F-II 1.0 (WBLF10)	33	12.75 → 08.80	50-01-100 60-01-116	55-01-112
DATSUN 120 <i>i</i> <i>i</i>				
A F-II 1.2 (LF10) Y 1.2 (B210) Y 1.2 (LB210)	38 38 38	12.75 → 07.80 09.74 → 07.80 06.76 → 07.80	50-01-100 60-01-102	55-01-100
DATSUN 120 Y Coupe (KB 210) <i>i</i> <i>i</i>				

	KW			
DATSUN 120 Y Coupe (KB 210) <i>i</i> <i>i</i>				
1.2 (KB210)	38	04.62 → 07.80	 50-01-100	 55-01-100
A F-II 1.2 (KLF10)	38	12.75 → 08.80	 60-01-102	
DATSUN 140 Y Station wagon (HLB310) <i>i</i> <i>i</i>				
1.4	49	02.79 → 06.83	 50-01-112	 55-01-100
			 60-01-102	
DATSUN/VIOLET 140 J <i>i</i> <i>i</i>				
1.4	48	01.73 → 05.77	 50-01-102	
			 60-01-102	
DATSUN/VIOLET 160 J (710, A10) <i>i</i> <i>i</i>				
1.6	61	01.73 → 02.82	 50-01-112	 55-01-106
1.6 i.e. (A10)	65	01.78 → 02.82	 60-01-102	 56-01-101
1.6 (710)	53	01.73 → 01.78	 50-01-102	 55-01-106
			 60-01-102	 56-01-101
ECO T100 <i>i</i> <i>i</i>				
			 50-01-109	 51-01-109
			 60-01-197	
EVALIA <i>i</i> <i>i</i>				
1.6	81	01.11 →	 50-01-128	 55-01-116
			 60-01-160	
1.5 dCI	81	01.11 →	 50-01-128	
1.5 dCI	66	01.11 →		
INTERSTAR <i>i</i> <i>i</i>				
dCi 100	73	02.04 →	 50-01-151	 51-01-102
dCi 120	84	08.03 →		
dCi 120	88	08.06 →		
dCi 140	100	11.03 →		
dCi 150	107	08.06 →		
INTERSTAR Autobus <i>i</i> <i>i</i>				
dCi 100	73	11.03 →	 50-01-151	 51-01-102
dCi 120	84	07.02 →	 60-01-120	 61-01-102
dCi 120	88	09.06 →		
dCi 140	100	11.03 →		
dCi 150	107	09.06 →		
dCi 80	60	07.02 →		
dCI 90	66	07.02 →		
dCi 100	74	04.06 →	 50-01-151	 51-01-102
INTERSTAR Furgonato/Box <i>i</i> <i>i</i>				

	KW			
INTERSTAR Furgonato/Box <i>i</i> <i>i</i>				
dCi 100	73	11.03 →	60-01-151	61-01-102
dCi 120	88	07.02 →	60-01-120	61-01-102
dCi 120	84	07.02 →		
dCi 140	100	11.03 →		
dCi 160	107	09.06 →		
dCi 80	60	07.02 →		
dCi 90	66	07.02 →		
dCi 100	74	04.06 →	60-01-151	61-01-102
Juke <i>i</i> <i>i</i>				
1.6 dCi	81	10.10 →	60-01-143	61-01-164
1.6	86	10.10 →	60-01-164	61-01-120
				65-01-141 Parking Brake/Freno staz.
KUBISTAR <i>i</i> <i>i</i>				
1.2	44	08.03 →	60-01-114	65-01-106
1.2 16V	55	04.06 →	60-01-142	66-01-112
1.6 dCi	48	08.03 →		67-01-114
1.6 dCi	60	08.03 →		
1.6 dCi 70	50	04.06 →		
1.6 dCi 86	62	04.06 →		
1.6 16V	70	08.03 →		
L35.09/L70.90 EBRO <i>i</i> <i>i</i>				
4.0 D			60-01-180 60-01-196 60-01-190	65-01-110 67-08-896
			Imp. BENDIX	
LAUREL (HLC230) <i>i</i> <i>i</i>				
2.0	71	03.77 → 05.83	60-01-108	65-01-106
2.4	83	12.77 → 05.83	60-01-104	66-01-101
				67-01-108
LAUREL (JC31) <i>i</i> <i>i</i>				
2.0	71	01.81 → 01.84	60-01-106	65-01-106
2.0 D	44	04.81 → 10.84	60-01-141	66-01-101
2.4	83	01.81 → 01.84	60-01-133	67-01-110
2.4	88	09.83 → 12.85		
2.8 D	62	01.81 → 10.85	60-01-196 60-01-133	65-01-106 66-01-101 67-01-110
LAUREL (JC32) <i>i</i> <i>i</i>				
2.4	94	01.85 → 12.87	60-01-196	65-01-134
2.8 D	62	01.85 → 12.87	60-01-133	66-01-101
2.8 D	66	01.85 → 12.89		67-01-110
3.0i 16V VG30E	112	01.85 → 12.90	60-01-196 60-01-133	61-01-124







































































	KW			
LEAF <i>i</i> <i>i</i>				
Electric	80	11.10 →		51-01-154 61-01-158
MAXIMA (J30) <i>i</i> <i>i</i>				
3.0 i	125	10.88 → 06.94	50-01-143 50-01-192 60-01-140	→10.91 11.91→ Imp. SUMITOMO 51-01-121 61-01-123
MAXIMA QX (A32) <i>i</i> <i>i</i>				
2.0	103	02.95 → 08.00	50-01-143 50-01-192 60-01-140	→08.97 08.97→ Imp. SUMITOMO 51-01-124 61-01-101
3.0	142	01.95 → 08.00	50-01-143 50-01-192 60-01-140	→08.97 08.97→ Imp. SUMITOMO 51-01-127 61-01-101 Imp. BENDIX
2.5 V6 24V	140	02.95 → 08.00	50-01-192 60-01-140	Imp. SUMITOMO 51-01-127 61-01-101 Imp. BENDIX
MAXIMA QX (A33) <i>i</i> <i>i</i>				
2.0 V6 24V	103	03.00 →	50-01-120	61-01-101
2.5 V6 24V	154	03.00 →	60-01-158	
3.0 V6 24V	147	03.00 →		
MAXIMA Station Wagon <i>i</i> <i>i</i>				
2.0 QX	103	10.97 →	50-01-192 60-01-140	Imp. SUMITOMO 51-01-124 51-01-127 61-01-101 Imp. BENDIX
2.5 V6 24V	140	10.97 →	50-01-143 50-01-192 60-01-140	Imp. SUMITOMO 61-01-101
3.0 QX	142	10.97 →	50-01-192 60-01-140	Imp. SUMITOMO 51-01-124 61-01-101
MICRA (K10) <i>i</i> <i>i</i>				
1.0	37	12.82 → 12.89	50-01-103	55-01-103
1.0	40	12.82 → 05.89	60-01-122 60-01-148	56-01-119 67-01-107 12.88→
1.0	43	12.82 → 05.91	50-01-103	55-01-103
1.2	40	07.86 → 07.92	60-01-122 60-01-148 60-01-150 60-01-189	→10.88 →10.88 11.88→ 11.88→ 56-01-119 67-01-107 12.88→

	KW			
MICRA (K11)				
1.0 i 16V	40	08.92 → 09.00	60-00-012 60-01-198	61-01-197 61-01-198 66-01-197 66-01-106 67-01-188
1.0 i 16V	44	09.00 → 02.03		Imp. SUMITOMO
1.3 i 16V	55	08.92 → 09.00		
1.5 D	42	02.98 → 02.03		NO ABS
1.4 i 16V	60	09.00 → 02.03	60-00-012 60-01-113 60-01-198	con/with ABS NO ABS
				Imp. SUMITOMO NO ABS
MICRA (K12)				
1.0 16V	48	01.03 →	60-00-013 60-00-013	Imp. LUCAS
1.2 16V	59	01.03 →		66-01-104 67-01-126
1.2 16V	48	01.03 →		
1.4 16V	65	01.03 →		
1.5 dCi	48	01.03 →		
1.5 dCi	60	09.03 →		
160 SR	81	05.05 →		
1.5 dCi	50	06.05 →	60-00-013 60-00-013	Imp. LUCAS
1.5 dCi	63	06.05 →		66-01-104
MICRA (K13)				
1.2	59	05.10 →	60-08-800 60-01-156	66-01-117 66-01-116
MICRA C+C				
1.4 16V	65	08.05 →	60-00-013 60-00-013	Imp. LUCAS
1.6 160 SR	81	08.05 →		66-01-104 67-01-126
MURANO				
3.5 4x4	172	03.05 →	60-01-116 60-01-118 60-01-152	Imp. SUMITOMO Imp. TOKICO
				61-01-154 61-01-106 66-01-114
				Parking Brake\Freno staz.
2.5 dCi	140	10.10 →	60-01-116 60-01-152	Imp. SUMITOMO
				61-01-154 61-01-106 66-01-114
				Parking Brake\Freno staz.
NAVARA				
2.5 dCi	106	07.05 →	60-01-116	Rim Size\Diam Cerchio:17 Imp. SUMITOMO
2.5 dCi 4WD	126	10.06 →	60-01-121 60-01-109 60-01-116	Rim Size\Diam Cerchio:16 Rim Size\Diam Cerchio:17 Rim Size\Diam Cerchio:16
				61-01-130 61-01-100 66-01-108 66-01-113 66-01-120 67-01-118
				Parking Brake\Freno staz.

	KW					
NAVARA						
2.5 dCi 4WD	128	07.05 →	60-01-115 60-01-121 60-01-109 60-01-116	Rim Size\Diam Cerchio:17 Imp. SUMITOMO Rim Size\Diam Cerchio:16 Rim Size\Diam Cerchio:17 Rim Size\Diam Cerchio:16	61-01-130 61-01-100 66-01-108 66-01-113 67-01-118	Parking Brake\Freno staz.
NOTE						
1.4	65	03.06 →	60-00-013 60-00-013	Imp. LUCAS	66-00-013 66-01-104 67-01-125	
1.6 dCi	63	03.06 →				
1.6 dCi	50	03.06 →				
1.6	81	03.06 →				
NV200 Autobus						
1.6 dci	63	02.10 →	60-01-128 60-01-160		66-01-116	
1.6 16V	81	07.10 →				
NV200 Furgonato/Box						
1.6 dci	63	02.10 →	60-01-128 60-01-160		66-01-116	
1.6 16V	81	02.10 →				
PATHFINDER						
2.5 dCi 4WD	128	03.05 →	60-01-115 60-01-121 60-01-109 60-01-116	Imp. SUMITOMO	61-01-130 61-01-100 66-01-108 67-01-118	Parking Brake\Freno staz.
4.0 4WD	198	09.05 →				
2.5 dCi 4WD	126	10.06 →	60-01-115 60-01-121 60-01-109	Imp. SUMITOMO	61-01-130 61-01-100 66-01-108 67-01-118	Parking Brake\Freno staz.
PATHFINDER (R50)						
2.7 TD 4WD	96	09.97 → 12.04	60-01-164 60-01-146		66-01-196 66-01-103	
3.2 TD 4WD	110	09.97 → 12.04				
3.3 V6 4WD	110	03.98 → 10.00				
3.3 V6 4WD	125	09.97 → 12.04				
3.6 V6 4WD	162	11.00 → 12.04				
PATROL GR I (Y60)						
2.8 TD (Y60A)	85	09.88 → 06.97	60-01-134 60-01-126		61-01-136 61-01-116 66-01-111 66-01-140 67-01-196	Parking Brake\Freno staz.
4.2 D (Y60GR)	85	11.88 → 06.97	60-01-134 60-01-126	01.93→ 01.93→	61-01-116 66-01-140 67-01-196	01.93→ 01.93→



	KW			
PATROL GR I (Y60) <i>i</i> <i>i</i>				
4.2 Cat.	121	11.88 → 06.97	50-01-134 60-01-126	51-01-136 61-01-116 55-01-140 67-01-196
PATROL GR II (Y61) <i>i</i> <i>i</i>				
4.5 i	147	06.97 →	50-01-178	51-01-137
2.8 TD	95	06.97 → 05.00	50-01-178	51-01-137
3.0 DTi	116	05.00 →	60-01-103	61-01-116
3.0 DTi	118	05.00 →		55-01-111 Parking Brake/Freno staz.
4.2 TD	107	06.97 →	50-01-178 60-01-103	51-01-137 61-01-116
2.8 TDiC	96	10.97 → 02.00		55-01-111 Parking Brake/Freno staz.
3.2 D	70	05.98 → 06.01		
4.2 TDi	125	03.00 → 08.02		
PATROL Hardtop (K160) <i>i</i> <i>i</i>				
2.8 (K160)	89	07.80 → 08.88	50-01-134	55-01-132
2.8 (K160)	88	07.80 → 08.88	60-01-126	56-01-100
3.2 TD (K160)	81	07.83 → 08.88		67-01-172
3.3 D (K160)	70	11.79 → 08.88	50-01-134 60-01-126	01.82→ 55-01-132 55-01-133 01.82→ Made in Japan →12.85 56-01-100 01.85→ 67-01-172 01.82→
PATROL Hardtop (K260) <i>i</i> <i>i</i>				
2.8 TD	85	05.86 → 06.90	50-01-134	55-01-132
3.2 D	81	08.88 → 06.90	60-01-126	56-01-100 67-01-196
2.8	88	05.86 → 06.90	50-01-134 60-01-126	55-01-132 67-01-172
PATROL Station Wagon (W160) <i>i</i> <i>i</i>				
2.8 (W160)	88	07.80 → 08.88	50-01-134	55-01-132
3.2 TD (W160)	81	07.83 → 08.88	60-01-126	56-01-100 67-01-172
3.3 D (W160)	70	11.79 → 08.88	50-01-134 60-01-126	01.82→ 55-01-132 55-01-133 01.82→ Made in Japan →12.85 56-01-100 67-01-172 01.82→

























































	KW			
PATROL Station Wagon (W260) i i				
2.8 TD	85	06.89 → 11.95	 50-01-134  60-01-126	 51-01-136  61-01-116  55-01-132  56-01-100  67-01-196
3.2 D	81	08.88 → 06.90	 50-01-134  60-01-126	 55-01-132  56-01-100  67-01-196
PICK UP/KING CAB (720) i i				
1.8	59	01.83 → 03.86	 50-01-111  60-01-131	 55-01-129  67-01-168
2.2 4WD	71	04.83 → 03.86	 50-01-111  60-01-132	 55-01-129  67-01-168
2.3 D	51	04.83 → 03.86	 50-01-111  60-01-129	 55-01-129  67-01-168
2.5 D 4WD	53	04.83 → 03.86	 50-01-111  60-01-132	 55-01-129
2.2 D	47	01.82 → 01.84	 50-01-111  60-01-153	 55-01-129  67-01-168
PICK UP/KING CAB (D21) i i				
2.4 i 4WD	74	03.86 → 04.92	 50-01-111  60-01-131  60-01-132	 55-01-137  56-01-107  56-01-114  67-01-168
2.4 i 12V	91	04.92 → 02.98	 50-01-111  60-01-143  60-01-144	 55-01-137  56-01-107  67-01-173
2.4 i 12V 4WD	93	04.92 → 02.98	 50-01-137  60-01-143  60-01-144	 55-01-137  56-01-107  67-01-173
3.0 i V6 4WD	109	09.90 → 02.98	 50-01-137  60-01-144	 55-01-196  56-01-107
2.7 D 4WD	73	08.87 → 02.98	 50-01-111  60-01-144	 56-01-107  56-01-114
2.5 D 4WD	61	03.96 → 02.98	 50-01-111  60-01-144	 55-01-138  56-01-107
2.5 D	61	03.96 → 02.98	 50-01-111  60-01-131  60-01-144	 55-01-138  56-01-107

























































	KW				
PICK UP/KING CAB (D21)					
2.6 D 4WD	59	08.87 → 02.98	60-01-111 60-01-131 60-01-132 60-01-144	Imp. AKEBONO 09.92→ →08.92 09.92→	56-01-136 56-01-107 56-01-114 →10.88 67-01-176 →08.92 67-01-190 09.92→
2.6 D 4WD	55	03.86 → 08.91	60-01-111 60-01-132	Imp. AKEBONO	56-01-138 56-01-107 56-01-114 08.89→ 67-01-176
2.6 D	59	09.94 → 08.96	60-01-111 60-01-131 60-01-144	Imp. AKEBONO	56-01-136 56-01-107 67-01-190
2.0	64	09.85 → 07.88	60-01-111 60-01-131	Imp. AKEBONO	56-01-129 56-01-107 67-01-168
2.3 D	51	09.85 → 08.88			
2.0	66	09.88 → 08.91	60-01-111 60-01-131	Imp. AKEBONO	56-01-138 56-01-107 67-01-173
2.6 D 4WD	53	09.85 → 08.88	60-01-111 60-01-132	Imp. AKEBONO	56-01-107 67-01-176
2.6 D	55	09.87 → 02.98	60-01-111 60-01-131 60-01-144	Imp. AKEBONO	56-01-138 56-01-107 67-01-176
2.7 D 4WD	58	09.87 → 08.91			56-01-107
PICK UP/KING CAB/NAVARA (D22)					
2.4 i 4WD	88	02.98 →	60-01-137 60-01-144		56-01-196 56-01-103 67-01-173
2.6 D	61	02.98 →	60-01-137 60-01-143		56-01-138 56-01-103 56-01-113 →10.01 67-01-173
2.6 TD 4WD	76	05.98 →	60-01-137 60-01-144		56-01-196 56-01-103 67-01-183
2.4 i	88	02.98 →	60-01-137 60-01-144		56-01-113 →10.01 67-01-173
2.6 D 4WD	61	02.98 →	60-01-137 60-01-143		56-01-138 56-01-113 67-01-173

	KW			
PICK UP/KING CAB/NAVARA (D22)				
2.4 i 4WD	98	03.02 →	60-01-130	55-01-196
2.6 Di 4WD	98	03.02 →	60-01-145	56-01-103 67-01-183
3.2 D 4WD	76	12.98 →	60-01-137 60-01-144	55-01-196 56-01-103
2.6 Di	98	03.02 →	60-01-130 60-01-145	55-01-196 56-01-103 56-01-113 →01.04 67-01-183
PIXO				
1.0	50	06.09 →	60-08-809 60-08-822	55-08-825
PRAIRIE (M10, NM10)				
1.6 S (M10)	55	01.84 → 12.87	60-01-105	55-01-104
1.8 SGL (M10)	66	05.85 → 10.87	60-01-141	67-01-109
1.8 SGL (M10)	65	07.83 → 12.85	60-01-125	
2.0 4x4 (NM10)	68	06.86 → 09.88	60-01-111 60-01-196	Imp. AKEBONO 55-01-134 56-01-101 67-01-176
PRAIRIE PRO (M11)				
2.0 i	72	10.88 → 04.92	60-01-142 60-01-196 60-01-125 60-01-127	55-01-134 56-01-101 67-01-171
2.4 i	98	04.92 → 07.94	60-01-194 60-00-016	55-01-193 67-01-180
2.0 i 4x4	72	10.88 → 12.92	60-01-142 60-01-196 60-00-016	55-01-134 56-01-101 67-01-110
2.4 i 4x4	98	04.92 → 07.94	60-01-142 60-00-016	55-01-193 67-01-180
PRIMASTAR Autobus				
2.0	88	03.01 →	60-01-109	51-01-109
dCi 100	74	03.01 →	60-01-134	61-01-103
dCi 120	84	09.06 →		
dCi 140	99	07.03 →		
dCi 80	60	03.01 →		
PRIMASTAR Furgonato/Box				

	KW			
PRIMASTAR Furgonato/Box				
2.0	88	02.03 →	50-01-109	51-01-109
dCi 100	74	09.02 →	60-01-134	61-01-103
dCi 120	84	09.06 →		
dCi 140	99	07.03 →		
dCi 80	60	09.02 →		
PRIMERA (P10)				
1.6	66	06.90 → 01.96	50-00-010	51-00-015
1.6	71	06.90 → 01.96	50-00-015	Imp. BENDIX
2.0 D	55	01.91 → 01.96	60-00-010	Imp. BENDIX
			60-00-015	61-00-015
				08.93→
				Imp. LUCAS
				08.93→
				Imp. LUCAS
				55-00-010
				56-01-108
				→05.93
				65-01-199
				67-01-199
2.0 16V	85	06.90 → 01.96	50-00-015	51-00-015
2.0 i	92	01.95 → 06.96	60-00-015	61-00-015
				Imp. LUCAS
				Imp. LUCAS
				55-00-010
				56-01-108
				→05.93
2.0 GT	110	06.90 → 01.96	50-00-015	51-00-015
			60-00-015	61-00-015
				Imp. LUCAS
				Imp. LUCAS
				56-01-108
				→05.93
2.0 16V 4x4	85	04.91 → 06.96	50-00-010	51-00-015
			50-00-015	61-00-015
			60-00-015	55-00-010
				56-01-108
				→05.93
1.6	75	06.93 → 01.96	50-00-010	51-00-015
			50-00-015	61-00-015
			60-00-010	55-00-010
				56-01-108
				Imp. LUCAS
				Imp. LUCAS
2.0	105	06.90 → 04.93	50-00-015	51-00-015
			60-00-015	61-00-015
				Imp. LUCAS
				Imp. LUCAS
PRIMERA (P11)				
1.6 16V	73	09.96 → 10.00	50-00-015	51-00-015
			60-00-015	61-00-015
				Imp. LUCAS
				Imp. LUCAS
				55-01-199
				Imp. BENDIX
				56-01-102
				67-01-161









	KW				
PRIMERA (P11)					
1.6 16V	66	09.96 → 12.01	 50-00-015  60-00-015  60-01-196	 51-00-015  61-00-015  55-01-199  56-01-102  67-01-161	Imp. LUCAS Imp. LUCAS Imp. BENDX
2.0 16V 2.0 16V	85 96	09.96 → 12.01 09.96 → 12.01	 50-01-179  60-00-015	Imp. LUCAS  51-00-015  61-00-015  55-01-199  56-01-102	Imp. LUCAS Imp. LUCAS Imp. BENDX
2.0 16V	110	09.96 → 12.01	 50-01-179  60-00-015  60-01-108	Imp. LUCAS  51-00-015  61-00-015  61-01-155  55-01-199  56-01-102	Imp. LUCAS Imp. LUCAS Imp. BENDX
2.0 TD	66	09.96 → 12.01	 50-01-179  60-00-015	 51-00-015  61-00-015  61-01-155  55-01-199  56-01-102  67-01-161	Imp. LUCAS Imp. LUCAS Imp. BENDX
1.8 16V	84	08.99 → 12.01	 50-01-179  60-01-108	 51-00-015  61-00-015  61-01-155  55-01-199  56-01-102  67-01-161	Imp. LUCAS Imp. LUCAS Imp. BENDX
2.0 16V	103	08.99 → 12.01	 50-00-015  60-00-015	 51-00-015  61-00-015  61-01-155  55-01-199  56-01-102	Imp. LUCAS Imp. LUCAS Imp. BENDX
1.6 16V	78	06.96 → 12.01	 50-01-179  60-00-015	 51-00-015  61-00-015  55-01-199  56-01-102  67-01-161	Imp. LUCAS Imp. LUCAS Imp. BENDX
PRIMERA (P12)					

	KW			
PRIMERA (P12) i i				
1.6	80	01.02 →	50-01-176 60-01-158	51-01-138 61-01-156
1.6	78	03.02 →		
1.8	85	03.02 →		
1.9 dCi	88	04.03 →		
1.9 dCi	85	08.02 →		
2.0	103	03.02 →		
2.2 dCi	102	04.03 →		
2.2 Di	93	03.02 →		
PRIMERA Hatchback (P10) i i				
1.6	66	06.90 → 01.96	50-00-010 50-00-015 60-00-010 60-00-015	Imp. BENDIX Imp. BENDIX 51-00-015 61-00-015 55-00-010 56-01-108 65-01-199 67-01-199
1.6	75	06.93 → 01.96		08.93→ Imp. LUCAS
2.0 D	55	01.91 → 01.96		08.93→ Imp. LUCAS
2.0 16V	85	06.90 → 01.96	50-00-015 60-00-015	Imp. LUCAS Imp. LUCAS
2.0 i	92	01.95 → 06.96		55-00-010 56-01-108 →05.93
1.6	71	06.90 → 06.93	50-00-010 60-00-010 60-00-015	Imp. BENDIX Imp. BENDIX 51-00-015 61-00-015 55-00-010 56-01-108 →05.93 65-01-199 67-01-199
2.0 16V 4x4	85	04.91 → 06.96	50-00-010 50-00-015 60-00-015	→05.93 Imp. BENDIX 51-00-015 61-00-015 55-00-010 56-01-108 →05.93
2.0	110	06.90 → 01.96	50-00-015 60-00-015	51-00-015 61-00-015 Imp. LUCAS Imp. LUCAS 55-00-010 56-01-108 →05.93 67-01-199
2.0	105	06.90 → 04.93	50-00-015 60-00-015	51-00-015 61-00-015 Imp. LUCAS Imp. LUCAS
PRIMERA Hatchback (P11) i i				













































	KW			
PRIMERA Hatchback (P11)				
1.6 16V	66	09.96 → 07.02	 50-00-015	 51-00-015 Imp. LUCAS
1.6 16V	73	09.96 → 07.02	 60-00-015	 61-00-015 Imp. LUCAS
			 60-01-108	 61-01-155
				 55-01-199 Imp. BENDX
				 56-01-102
				 67-01-161
2.0 16V	110	09.96 → 07.02	 50-01-179 Imp. LUCAS	 51-00-015 Imp. LUCAS
2.0 16V	96	09.96 → 07.02	 60-00-015	 61-00-015 Imp. LUCAS
			 60-01-108	 61-01-155
				 55-01-199 Imp. BENDX
				 56-01-102
2.0 16V	85	09.96 → 07.02	 50-01-179 Imp. LUCAS	 51-00-015 Imp. LUCAS
			 60-00-015	 61-00-015 Imp. LUCAS
				 55-01-199 Imp. BENDX
				 56-01-102
2.0 TD	66	09.96 → 07.02	 50-01-179 Imp. LUCAS	 51-00-015 Imp. LUCAS
			 60-00-015	 61-00-015 Imp. LUCAS
				 61-01-155
				 55-01-199 Imp. BENDX
				 56-01-102
				 67-01-161
1.8 16V	84	08.99 → 07.02	 50-01-179 Imp. LUCAS	 51-00-015 Imp. LUCAS
			 60-01-108	 61-00-015 Imp. LUCAS
				 61-01-155
				 55-01-199 Imp. BENDX
				 56-01-102
				 67-01-161
2.0 16V	103	08.99 → 07.02	 50-01-179 Imp. LUCAS	 51-00-015 Imp. LUCAS
			 60-00-015	 61-00-015 Imp. LUCAS
				 56-01-102
1.6 16V	78	09.00 → 07.02	 50-01-179 Imp. LUCAS	 51-00-015 Imp. LUCAS
			 60-00-015	 61-00-015 Imp. LUCAS
				 55-01-199 Imp. BENDX
				 56-01-102
				 67-01-161
PRIMERA Hatchback (P12)				



	KW				
PRIMERA Hatchback (P12) i i					
1.6	78	07.02 →	50-01-176	51-01-138	
1.6	80	07.02 →	60-01-158	61-01-156	
1.8	85	07.02 →			
1.9 dCi	88	04.03 →			
1.9 dCi	85	08.02 →			
2.0	103	07.02 →			
2.2 dCi	102	04.03 →			
2.2 Di	93	07.02 →			
PRIMERA Station wagon (WP12) i i					
1.8	85	03.02 →	50-01-176	51-01-138	
1.9 dCi	88	04.03 →	60-01-158	61-01-156	
1.9 dCi	85	08.02 →			
2.0	103	03.02 →			
2.2 dCi	102	04.03 →			
2.2 Di	93	03.02 →			
PRIMERA Traveller (W10) i i					
1.6 i	66	07.90 → 03.98	50-01-142 60-00-015	51-01-124 51-01-197 61-00-016 55-00-010 56-01-101 65-01-199 67-01-199	→03.93 04.93→ Imp. SUMITOMO
2.0 i	85	07.90 → 03.98	50-00-015 60-00-015	51-01-197 61-00-016 55-00-010 67-01-171	Imp. SUMITOMO
2.0 D	55	07.90 → 12.95	50-00-010 50-00-015 60-00-010 60-00-015	→05.93 Imp. BENDIX Imp. BENDIX	Imp. LUCAS Imp. LUCAS
1.6 i	75	03.94 → 03.98	50-01-142 60-00-015	51-01-197 61-00-016 55-00-010 56-01-101 65-01-199 67-01-171	Imp. SUMITOMO
PRIMERA Traveller (WP11) i i					



































































	KW			
PRIMERA Traveller (WP11)				
1.6 16V	73	04.98 → 12.01	 50-01-179	Imp. LUCAS
1.6 16V	66	04.98 → 12.01	 60-00-015	
				 51-00-015 Imp. LUCAS
				 61-00-015 Imp. LUCAS
				 55-01-199 Imp. BENDX
				 56-01-102
				 67-01-161
2.0 16V	96	04.98 → 12.01	 50-01-179	Imp. LUCAS
2.0 16V	85	04.98 → 12.01	 60-00-015	
2.0 16V	103	08.99 → 12.01		
				 51-00-015 Imp. LUCAS
				 61-00-015 Imp. LUCAS
				 55-01-199 Imp. BENDX
				 56-01-102
2.0 TD	66	04.98 → 12.01	 50-01-179	Imp. LUCAS
			 60-01-108	
				 51-01-127 Imp. BENDIX
				 61-01-155
				 67-01-161
1.8 16V	84	08.99 → 12.01	 50-01-179	Imp. LUCAS
			 60-01-108	
				 51-00-015 Imp. LUCAS
				 61-00-015 Imp. LUCAS
				 61-01-155
				 55-01-199 Imp. BENDX
				 56-01-102
				 67-01-161
Q-BIC (Y10)				
1.6 16V (GA16DS)	66	01.94 →	 50-01-193	
1.7 D (CD17)	40	01.94 →	 60-01-139	
				 55-01-101
				 67-01-171
QASHQAI				
1.5 dCi	78	02.07 →	 50-01-115	PER QASHQAI + 2
			 50-01-123	Imp. SUMITOMO
			 60-01-157	
				 51-01-154
				 61-01-120
				 61-01-158
				 55-01-141 Parking Brake/Freno staz.
1.6	84	02.07 →	 50-01-123	
2.0	103	02.07 →	 60-01-157	
2.0 4 ruote motrici	103	02.07 →		
2.0 dCi	110	02.07 →		
2.0 dCi 4 ruote motrici	110	02.07 →		
				 51-01-154
				 61-01-120
				 61-01-158
				 55-01-141 Parking Brake/Freno staz.
1.5 dCi	76	07.08 →	 50-01-115	PER QASHQAI + 2
			 50-01-123	Imp. SUMITOMO
			 60-01-157	
				 51-01-154
				 61-01-120
				 55-01-141 Parking Brake/Freno staz.
1.6 dCi	96	11.11 →	 50-01-123	
			 60-01-157	
				 51-01-154
				 61-01-120
				 55-01-141 Parking Brake/Freno staz.
SERENA (C23M)				



























































	KW			
SERENA (C23M)				
2.0 16V	93	11.92 →	 50-00-017	Imp. LUCAS
2.3 D	55	01.95 →	 60-01-183	
			 60-01-191	
1.6 16V	71	02.93 →	 50-00-017	Imp. LUCAS
2.0 D	49	11.92 →	 50-01-111	Imp. AKEBONO
			 60-01-183	
			 60-01-191	
SILVIA (HS13)				
1.8i / 2.0i (S13/S14) CA18T-SR20DET			 50-01-188	
				 51-01-122
SILVIA (S110)				
1.8	68	01.79 → 05.83	 50-01-108	
			 60-01-104	
				 51-01-194
				 61-01-111
SILVIA (S12)				
2.0 GP	107	04.84 → 09.88	 50-01-111	09.85→ Imp. AKEBONO
			 50-01-195	
			 60-01-128	
1.8	90	07.86 → 04.88	 50-01-111	Imp. AKEBONO
			 60-01-128	
				 51-01-194
				 61-01-114
SKYLINE				
2.6 i Turbo 6 cyl. (GT-R Twin)		01.92 →	 50-01-129	
				 51-05-506
STANZA (T11)				
1.6	60	08.81 → 12.85	 50-01-105	
1.8 SGL	66	03.83 → 12.85	 50-01-141	
			 60-01-121	
				 55-01-100
				 67-01-109
STANZA Hatchback (T11)				
1.6	60	08.81 → 12.85	 50-01-105	
1.8	65	08.81 → 12.85	 50-01-141	
1.8	66	08.81 → 12.85	 60-01-121	
				 55-01-100
				 67-01-109
SUNNY (140Y, 150Y)				
1.4 (HBL310)	48	01.70 → 02.82	 50-01-112	
1.4 (HBL310)	49	06.79 → 02.82	 60-01-102	
1.5 (HBL310)	51	06.79 → 02.82		
				 55-01-100
				 67-01-171
SUNNY Furgonato/Box (Y10)				
1.6 i 16V	66	10.92 → 03.00	 50-01-193	
1.7 D	40	11.90 → 03.00	 60-01-139	
				 55-01-134
				 67-01-180
SUNNY I (B11)				





























































	KW			
SUNNY I (B11)				
1.3	44	03.82 → 09.87	60-01-101	55-01-101
1.6	55	03.82 → 10.86	60-01-119	67-01-169
1.7 D	40	03.82 → 10.86	60-01-106 60-01-141 60-01-125	55-01-101 67-01-169
1.2 (A12) B110-B210		01.70 →		67-01-162 01.73→ Left\Sinistra 67-01-164 01.73→ Right\Destra 67-01-169 →01.73
1.2 (A12) B310		02.78 →		67-01-171
1.6 SLX 4x4	62	07.86 → 10.88	60-01-101 60-01-139	55-01-101 56-01-116
1.6	51	05.84 → 02.86	60-01-101 60-01-119	55-01-101
SUNNY I Coupe (B11)				
1.3	44	04.82 → 09.86	60-01-101	55-01-101
1.6	55	03.82 → 10.86	60-01-119	67-01-169
SUNNY I Traveller (B11)				
1.3	44	08.82 → 08.90	60-01-101	55-01-101
1.6	55	03.82 → 10.86	60-01-119	67-01-169
1.7 D	40	03.82 → 10.86	60-01-106 60-01-141 60-01-125	55-01-101 67-01-169
SUNNY II (N13)				
1.0	37	07.86 → 09.90	60-01-101	55-01-101
1.3	44	07.86 → 10.91	60-01-138	56-01-116
1.4 LX	55	10.88 → 08.91		67-01-169
1.6	52	06.86 → 10.88		
1.6 i 12V	66	10.88 → 06.91		
1.6	62	06.86 → 10.88	60-01-101	55-01-101
1.6 i	54	06.86 → 10.90	60-01-138	56-01-116 67-01-107
1.6 i 4x4 (A)	54	06.86 → 10.90	60-01-135	55-01-101
1.7 D	40	06.86 → 05.89	60-01-139	56-01-116 67-01-169
1.6 GTI 16V	81	02.87 → 10.88	60-01-135 60-01-139	Imp. AKEBONO 51-01-125 61-01-136
1.6	88	02.87 → 10.88	60-01-135 60-01-139	Imp. AKEBONO 51-01-125



	KW			
SUNNY II (N13) i i				
1.6 4x4	66	07.86 → 10.88	 50-01-101  60-01-139	 55-01-101  56-01-116
SUNNY II Coupe (B12) i i				
1.6	62	06.86 → 10.88	 50-01-101	 55-01-101
1.6 i	54	06.86 → 05.89	 60-01-138  60-01-139	 56-01-116  67-01-180
1.6 i 12V	66	10.88 → 06.91	 50-01-101  60-01-139	 55-01-101  56-01-116  67-01-169
1.6 GTI 16V	81	05.87 → 05.89	 50-01-135  60-01-138  60-01-139	Imp. AKEBONO  51-01-125  61-01-136  55-01-101  56-01-116
1.8 GTI 16V	92	01.89 → 06.91	 50-01-135  60-01-146	Imp. AKEBONO  51-01-125  61-01-136
1.5	52	06.86 → 10.88	 50-01-101  60-01-138	 55-01-101  56-01-116  67-01-169
SUNNY II Hatchback (N13) i i				
1.6	62	06.86 → 10.88	 50-01-101	 55-01-101
1.6 i	54	06.86 → 10.90	 60-01-138	 56-01-116
1.6 i 12V	66	06.86 → 10.90		 67-01-107
1.6 GTI 16V	81	06.87 → 05.89	 50-01-135  60-01-139	Imp. AKEBONO  51-01-125  61-01-136
1.8 GTI 16V	92	01.89 → 06.91	 50-01-135  60-01-146	Imp. AKEBONO  51-01-125  61-01-136
1.7 D	40	06.86 → 01.91	 50-01-135  60-01-139	Imp. AKEBONO  55-01-101  56-01-116  67-01-169
1.3	44	06.86 → 10.88	 50-01-101	 55-01-101
1.4 LX	55	01.89 → 08.91	 60-01-138	 56-01-116
1.5	52	06.86 → 10.88		 67-01-169
1.6	88	02.87 → 10.88	 60-01-139	 51-01-125  61-01-136
SUNNY II Traveller (B12) i i				
1.6	62	06.86 → 10.88	 50-01-135	Imp. AKEBONO  55-01-101
1.6 i	54	08.86 → 05.89	 60-01-139	 56-01-116
1.6 i 12V 4x4	66	10.88 → 08.90		 67-01-180
1.6 i 4x4 (A)	54	06.86 → 05.89		

	KW			
SUNNY II Traveller (B12) i				
1.6 i 12V 1.7 D	66 40	10.88 → 06.91 01.86 → 06.91	 50-01-135  60-01-139	Imp. AKEBONO  55-01-101  56-01-116  67-01-169
1.5	52	06.86 → 10.88	 50-01-101  60-01-138	 55-01-101  56-01-116  67-01-169
SUNNY III (N14) i				
2.0 D	55	10.90 → 05.95	 50-01-149  60-01-139	 51-01-196  61-01-130  55-01-142  56-01-106  67-01-107 Left\Sinistra  67-01-176 Left\Sinistra  67-01-179 Right\Destra  67-01-191 Right\Destra
1.4 i 1.4 i 16V	55 64	10.90 → 05.95 10.90 → 06.95	 50-01-149  60-01-139	 51-01-133 con/with ABS  51-01-196  61-01-130  55-01-101  56-01-106  67-01-107
1.6 i 1.6 i 16V 1.6 i 16V 4WD	66 75 66	10.90 → 05.95 10.92 → 05.95 10.90 → 05.95	 50-01-149  60-01-139	 51-01-196  61-01-130  55-01-142  56-01-106  67-01-107
1.4	60	10.90 → 06.95	 50-01-197  60-01-139	Imp. SUMITOMO  51-01-133  61-01-130  55-01-142  56-01-106
SUNNY III Hatchback (N14) i				
1.4 i 1.4 i 16V	55 64	10.90 → 05.95 10.90 → 05.95	 50-01-149  60-01-139	 51-01-133 con/with ABS  51-01-196  61-01-130  55-01-101  56-01-106  67-01-107
2.0 GTI 16V	105	10.90 → 05.95	 50-01-197  60-01-185	Imp. SUMITOMO  51-01-197 Imp. SUMITOMO  61-01-126 Imp. BENDIX

	KW			
SUNNY III Hatchback (N14)				
2.0 D	55	10.90 → 05.95	50-01-149 60-01-139	51-01-196 61-01-130 55-01-142 56-01-106 67-01-107 Left/Sinistra 67-01-176 Left/Sinistra 67-01-179 Right/Destra 67-01-191 Right/Destra
2.0 GTI-R 4x4	162	10.90 → 05.95	50-00-010 50-01-197 60-01-185	Imp. BENDIX Imp. SUMITOMO 51-01-127 Imp. BENDIX 51-01-197 Imp. SUMITOMO 61-01-126 Imp. BENDIX 61-01-131 Imp. SUMITOMO
1.6 i	66	10.90 → 05.95	50-01-149 60-01-139	51-01-196 61-01-130 55-01-142 56-01-106 67-01-107
1.6 i 16V	75	10.92 → 05.95		
1.6 i 16V 4x4	75	10.92 → 05.95		
1.5	51	10.90 → 05.95	50-01-149	56-01-106
1.4	60	10.90 → 06.95	50-01-197 60-01-139	Imp. SUMITOMO 51-01-133 61-01-130 55-01-142 56-01-106
SUNNY III Liftback (N14)				
2.0 D	55	10.90 → 05.95	50-01-149 60-01-139	51-01-196 61-01-130 55-01-142 56-01-106 67-01-107 Left/Sinistra 67-01-176 Left/Sinistra 67-01-179 Right/Destra 67-01-191 Right/Destra
1.4 i	55	10.90 → 05.95	50-01-149 60-01-139	51-01-133 con/with ABS 51-01-196 61-01-130 55-01-101 56-01-106 67-01-107
1.4 i 16V	64	10.90 → 06.95		















	KW			
SUNNY III Liftback (N14)				
1.6 i	66	10.90 → 05.95	 50-01-149  60-01-139	 51-01-196  61-01-130  55-01-142  56-01-106  67-01-107
1.6 i 16V	75	10.92 → 05.95	 50-01-149  60-01-139	 51-01-196  61-01-130  55-01-142  56-01-106  67-01-171
2.0 i 16V	105	10.90 → 05.95	 50-01-197  60-01-185	Imp. SUMITOMO  51-01-197  61-01-126  56-01-106 Imp. SUMITOMO Imp. BENDIX
SUNNY III Traveller (Y10)				
1.6 i	66	06.91 → 03.00	 50-01-193  60-01-139	 55-01-134  56-01-106  67-01-180
1.6 i 16V 4x4	75	10.92 → 03.00	 50-01-193  60-01-139	
2.0 D	55	06.91 → 03.00	 50-01-193  60-01-139	 55-01-134  56-01-106  67-01-181
1.6 16V 4x4	66	11.90 → 05.95	 50-01-193  60-01-139	 61-01-130  67-01-180
SUNNY Traveller (140Y, 150Y)				
1.4 (HBL310)	48	06.79 → 02.82	 50-01-112  60-01-102	 55-01-100  67-01-102
1.5 (HBL310)	51	06.79 → 02.82		
TERRANO I (WD21)				
2.4 i 4WD	76	10.87 → 02.93	 50-01-137  60-01-144	 55-01-138  56-01-113  67-01-173
2.7 TD 4WD	73	02.89 → 02.96	 50-01-137  60-01-144	 51-01-128  61-01-119  55-01-138  56-01-113 →10.93  67-01-173
3.0 i 4WD	109	01.90 → 12.95	 50-01-137  60-01-144	 51-01-128  61-01-119  55-01-138  67-01-173

	KW			
TERRANO II (R20)				
2.7 TD 4WD	74	02.93 → 01.02	50-00-017 60-01-144	Imp. LUCAS 55-01-109 55-01-195 56-01-109 67-01-111 67-01-186
				10.99→ →09.99 →12.97 10.99→ →09.99
2.4 i 12V 4WD	91	02.93 → 06.96	50-00-017 60-01-144	Imp. LUCAS 55-01-195 56-01-109 67-01-187
2.4 4WD	87	05.96 →	50-00-017 60-01-144	Imp. LUCAS 55-01-195 56-01-109 67-01-111
2.4 4WD	85	05.96 → 01.02		
2.7 TDi 4WD	92	05.96 →	50-00-017 60-01-144	Imp. LUCAS 55-01-195 56-01-109 67-01-111 67-01-186 67-01-187
				→12.97 01.98→
3.0 Di 4WD	113	05.02 →	50-00-017 60-01-144	Imp. LUCAS NO ABS 55-01-109 56-01-109 67-01-111
2.7 D		02.93 → 01.02	50-00-017	Imp. LUCAS 55-01-195 56-01-109
				→12.97
TIIDA Hatchback				
1.6	81	05.04 → 02.07	50-00-013 60-00-013	Imp. LUCAS 51-01-154 55-00-013 56-01-104 67-01-125
TIIDA Hatchback (C11X)				
1.5 dCi	78	09.07 →	50-01-127 60-00-013	51-01-154 55-00-013 56-01-104
1.6	81	09.07 →	50-00-013 50-01-127 60-00-013	Imp. LUCAS 51-01-154 55-00-013 56-01-104 67-01-117 67-01-125
1.8	93	09.07 →		
TIIDA Tre volumi/Saloon (SC11X)				
1.5 dCi	78	09.07 →	50-01-127 60-00-013	51-01-154 55-00-013 56-01-104

	KW			
TIIDA Tre volumi/Saloon (SC11X)				
1.6	81	09.07 →	50-00-013	Imp. LUCAS
1.8	93	09.07 →	50-01-127	51-01-154
			60-00-013	55-00-013
				56-01-104
				67-01-117
				67-01-125
				09.09→
TRADE				
3.0 D	63	04.93 → 10.98	50-01-196	Imp. BENDIX
			60-01-197	55-01-194
				67-08-896
2.8 D	59	12.86 → 06.94	50-01-195	Imp. BENDIX
			50-01-196	55-01-138
			60-01-197	55-01-194
				67-01-116
				67-01-195
				67-08-896
				Made in Spain
				01.91→
				Imp. LUCAS
TRADE Furgonato/Box				
2.0 D	44	11.86 → 03.93	50-01-196	Imp. BENDIX
			60-01-197	55-01-138
				67-01-116
URVAN Autobus (E23)				
2.0 (E23B)	64	12.82 → 11.88	50-01-116	
			60-01-123	55-01-129
				56-01-113
				67-01-178
2.3 D (E23B)	51	04.85 → 11.88	50-01-116	
			60-01-123	55-01-129
				56-01-113
				67-01-168
URVAN Autobus (E24)				
2.4 i	74	05.89 → 09.93	50-01-137	
			60-01-143	55-01-138
				56-01-113
				67-01-178
2.5 D	59	05.89 → 10.96	50-01-137	
			60-01-143	55-01-134
				56-01-113
				67-01-178
URVAN Furgonato/Box (E23)				
2.0	55	07.81 → 11.82	50-01-116	
2.2 D	47	07.81 → 11.82	60-01-123	55-01-129
				67-01-170
2.3 D	50	11.82 → 05.87	50-01-116	
			60-01-123	55-01-129
				67-01-168
URVAN Furgonato/Box (E24)				

























	KW			
URVAN Furgonato/Box (E24) i				
2.0	64	05.87 → 05.97	50-01-137	55-01-138
2.3 D	51	01.88 → 05.97	60-01-143 60-01-199	56-01-113 67-01-178
2.5 D	59	12.88 → 05.97	50-01-137 60-01-143	55-01-134 56-01-113 67-01-178 01.89→
2.7 TD	58	10.94 → 04.97		55-01-138
VANETTE Autobus (C22) i				
2.4 i (SLC22)	77	10.86 → 12.95	50-01-137	55-01-138
2.4 i (SLC22)	74	10.86 → 12.95	60-01-199	56-01-101 67-01-179
2.0 D (ULC22)	49	10.86 → 12.95	50-01-195	55-01-134
2.0 D (ULC22)	47	10.86 → 12.95	60-01-106 →12.87 60-01-199	55-01-138 →12.87 56-01-101 67-01-110 →12.87 67-01-171 01.87→
1.5	51	10.86 → 12.95	50-01-137 60-01-199	51-01-136 55-01-134 56-01-101 67-01-171
2.0	66	07.87 → 08.94	50-01-195 60-01-199	55-01-106
VANETTE Autobus (KC120) i				
1.5	51	01.83 → 12.87	50-01-105 60-01-124	55-01-106 56-01-101 67-01-176
2.0 D (LD20)	49	01.81 → 12.87	50-01-195 01.86→ 60-01-106 01.86→	55-01-138 01.86→ 67-01-110 01.86→
VANETTE CARGO Autobus (HC 23) i				
2.0 D	49	01.96 →	50-00-017 Imp. LUCAS	55-01-195
2.3 D	55	01.96 →	60-01-191	56-01-117 67-01-187
1.6 i	72	01.96 →	50-01-195 60-01-191	55-01-195 56-01-117 67-01-187
VANETTE CARGO Furgonato/Box (HC 23) i				
1.6 i	71	01.95 →	50-01-195 60-01-191	55-01-195 56-01-117 67-01-187

	KW			
VANETTE CARGO Furgonato/Box (HC 23)				
2.0 D	49	01.95 →	 50-00-017  60-01-191	Imp. LUCAS  55-01-195  56-01-117
2.3 D	55	01.95 →	 50-00-017  60-01-183  60-01-191	Imp. LUCAS  55-01-195  56-01-117  67-01-187
VANETTE Furgonato/Box (C22)				
2.0 D	49	07.91 → 01.95	 50-01-111  50-01-137  50-01-195  60-01-124  60-01-199	01.90→ Imp. AKEBONO Made in Spain →07.91 Made in Spain 08.91→ →07.91 08.91→
				 51-01-136  55-01-106  55-01-137  56-01-101  56-01-113  67-01-171  67-01-179
1.5	51	10.86 → 12.95	 50-01-137  60-01-199	 51-01-136  55-01-134  55-01-138  56-01-113  67-01-171
X-TRAIL (T30)				
2.0	103	07.01 →	 50-01-154  60-01-158	 51-01-154  61-01-158  55-01-115
2.0 4x4	103	07.01 →		
2.2 dCi	84	10.04 →		
2.2 dCi	100	12.03 →		
2.2 dCi 4x4	100	12.03 →		
2.2 Di 4x4	84	07.01 →		
2.5 4x4	121	01.03 →		
2.0 4x4	110	09.01 →	 60-01-158	 51-01-154  61-01-158  55-01-115
2.5 4x4	132	11.02 →		
X-TRAIL (T31)				
2.0	104	06.07 →	 50-01-123  60-01-157	 51-01-154  61-01-158  55-01-141
2.0 dCi	127	06.07 →		
2.0 dCi	110	06.07 →		
2.5	124	06.07 →		











NISSAN Comm.































































	KW			
ATLEON <i>i</i> <i>i</i>				
120.35	88	09.00 →		61-01-104
120.66	88	09.00 →		
CABSTAR <i>i</i> <i>i</i>				
28.11	81	10.06 →	60-01-117 60-01-106 Versione 45 Q 60-01-161 Versione 35 Q	61-01-100 Versione 45 Q 61-01-101 Versione 35 Q Imp. BREMBO 65-01-109
35.13	96	10.06 →	60-01-117 60-01-106 Versione 45 Q 60-01-161 Versione 35 Q	61-01-100 Versione 45 Q 61-01-101 Versione 35 Q Imp. BREMBO 61-01-107 65-01-109 67-01-119 Imp. BOSCH
35.15	101	10.06 →		
45.13	96	10.06 →	60-01-117 60-01-106 Versione 45 Q 60-01-161 Versione 35 Q	61-01-100 Versione 45 Q 61-01-101 Versione 35 Q Imp. BREMBO 65-01-109 67-01-119 Imp. BOSCH
45.15	110	10.06 →	60-01-117 60-01-106 Versione 45 Q 60-01-161 Versione 35 Q	61-01-100 Versione 45 Q 65-01-109 67-01-119 Imp. BOSCH
CABSTAR E <i>i</i> <i>i</i>				
110.35	78	10.98 → 10.06	60-01-110 Imp. BOSCH 60-01-196 Imp. BENDIX 60-01-106 Versione 45 Q 60-01-161 Versione 35 Q	65-01-110 65-01-194 →08.01 Imp. LUCAS
110.45	78	10.98 → 10.06		
120.35	88	10.98 → 10.06		
120.45	88	10.98 → 10.06		
75.28	55	10.98 → 10.06	60-01-110 Imp. BOSCH 60-01-196 Imp. BENDIX 60-01-110 08.01→ 60-01-190 60-01-197 →08.01	65-01-194 →08.01 Imp. LUCAS 67-01-119 08.01→ Imp. BOSCH 67-08-896 Imp. LUCAS
90.32	66	10.98 → 10.06		
TRADE <i>i</i> <i>i</i>				
3,0	63	01.94 → 12.98		67-01-194

	KW			
M500 <i>i</i> <i>i</i>				
0.5 D	4	01.04 →	 50-00-021	
PORTER <i>i</i> <i>i</i>				
1.0	33	02.93 → 06.94	 50-06-605  60-06-696  60-06-697	 55-06-620  55-06-699  67-06-699 Imp. LOCKHEED
1.0	35	07.94 → 07.02	 50-06-605	 55-06-699 Imp. LOCKHEED
1.0	35	07.94 →	 60-06-696	 67-06-699
1.2 D	26	05.95 →	 60-06-697	
1.3 i 16V	48	05.98 →		
1.3 i 16V 4x4	48	05.98 →		
1.4 D	28	04.98 →		
PORTER Furgonato/Box <i>i</i> <i>i</i>				
1.0	33	05.95 → 05.98	 50-06-605	 55-06-699 Imp. LOCKHEED
1.2 D	26	05.95 →	 60-06-696	 67-06-699
1.3 i 16V	48	05.98 →	 60-06-697	
1.3 i 16V 4x4	48	05.98 →		
1.4 D	28	04.98 →		
VESPACAR <i>i</i> <i>i</i>				
0.2	8	01.71 →	 50-06-605	
0.4 D	11	08.93 →		































PONTIAC

	KW			
TRANS SPORT '89				
3.1	90	07.89 → 03.97	 50-00-098	
3.8	127	07.89 → 03.97	 60-00-098	
3.8	123	07.89 → 03.97		
3.8	112	07.89 → 03.97		
33.1	104	07.89 → 03.97		
2.3	108	01.93 → 03.97	 50-00-098	 55-00-098
2.3	101	01.93 → 03.97	 60-00-098	

	KW			
AEROBACK/ISWARA Hatchback <i>i</i> <i>i</i>				
1.5	66	01.91 → 11.96	 60-06-528	 61-06-504
PERSONA 300 <i>i</i> <i>i</i>				
313i	55	03.96 →	 60-06-528  60-06-538	 66-06-587  66-06-506  67-06-579
316 GLi/GLSi	66	03.96 →	 60-06-528	 66-06-587
316 GLSi	64	09.96 →	 60-06-532	 66-06-506  67-06-579
316	70	03.96 →	 60-06-530	 61-06-504
316 GLXi	83	03.96 →	 60-06-532	 61-06-514
318 16V GTI	99	03.96 →	 60-06-530  60-06-533	 61-06-504  61-06-514
PERSONA 400 <i>i</i> <i>i</i>				
413	55	01.94 →	 60-06-528  60-06-538	 66-06-587  66-06-506  67-06-579
416 GLi/GLSi	66	01.94 →	 60-06-528	 66-06-587
420 GLS D	48	05.96 →	 60-06-532	 66-06-506
420 TD	60	09.96 →		 67-06-579
416 GLXi	83	01.94 →	 60-06-530	 61-06-504
418	85	05.96 →	 60-06-533	 61-06-514
PERSONA 400 Hatchback <i>i</i> <i>i</i>				
413 GLSi	55	01.94 →	 60-06-528  60-06-538	 66-06-587  66-06-506  67-06-579
416 GLi/GLSi	66	01.94 →	 60-06-528	 66-06-587
420 D	60	09.96 →	 60-06-532	 66-06-506
420 GLS D	48	05.96 →		 67-06-579
416 GLXi	83	01.94 →	 60-06-530	 61-06-504
416 i	70	12.95 →	 60-06-533	 61-06-514
418 GLXi	85	05.96 →		
SATRIA <i>i</i> <i>i</i>				
1.5	64	07.00 →	 60-06-528  60-06-532	 66-06-587  66-06-506  67-06-579
WIRA <i>i</i> <i>i</i>				
1.5	64	08.00 →	 60-06-528  60-06-532	 66-06-587  66-06-506  67-06-579









PROTON











































	KW			
WIRA i				
1.3	55	08.00 →	 50-05-528  60-05-538	 55-05-587  56-05-506  67-05-579
1.6	70	08.00 → 02.02	 50-05-530	 51-05-504
1.3 1.5	57 67	10.05 → 10.05 →	 50-05-524  50-05-528  60-05-510	 51-05-504  55-05-508  55-05-587  56-05-505
WIRA Hatchback i				
1.3	55	08.00 →	 50-05-528  60-05-538	 55-05-587  56-05-506  67-05-579
1.5	64	08.00 →	 50-05-528  60-05-532	 55-05-587  56-05-506  67-05-579

SHUANGHUAN AUTO

























































	KW			
CEO <i>i</i> <i>i</i>				
2.4 16V Bi-Fuel	93	06.10 →	 50-05-585	 51-0S-S02

	KW			
CABRIO i i				
0.6	52	06.02 → 01.04	50-0M-000 60-0M-000	55-M0-000 56-0M-M00 67-M0-000 Right\Destra 67-M0-001 Right\Destra 67-M0-002 Left\Sinistra 67-M0-003 Left\Sinistra
0.6 (S1OLA1)	40	03.00 → 01.04		
0.6 (S1OLD2)	45	01.01 → 01.04		
0.7	45	01.03 → 01.04		
0.7	55	01.03 → 01.04		
0.8 CDI (S1OLC1)	30	03.01 → 01.04		
CITY-COUPÉ (MC01) i i				
0.6	45	01.01 → 01.04	50-0M-000 60-0M-000	55-M0-000 56-0M-M00 67-M0-000 Right\Destra 67-M0-001 Right\Destra 67-M0-002 Left\Sinistra 67-M0-003 Left\Sinistra
0.6	52	06.02 → 01.04		
0.6 (S1CLA1)	40	07.98 → 01.04		
0.6 (S1CLB1)	33	07.98 → 01.04		
0.7	45	01.03 → 01.04		
0.7	37	01.03 → 01.04		
0.7	55	01.03 → 01.04		
0.8 CDI (S1CLC1)	30	11.99 → 01.04		
CROSSBLADE i i				
0.6	52	06.02 →	50-0M-000 60-0M-000	55-M0-000 56-0M-M00 67-M0-000 Right\Destra 67-M0-001 Right\Destra 67-M0-002 Left\Sinistra 67-M0-003 Left\Sinistra
FORFOUR i i				
1.1 (454.030)	55	01.04 →	50-05-593 60-0M-M01	51-05-507 Imp. LUCAS 61-0M-M00 55-05-511 67-05-525
1.3 (454.031)	70	01.04 →		
1.5 CDI (454.000)	50	09.04 →		
1.5 (454.032)	80	01.04 →	50-05-593 60-0M-M01	51-05-507 Imp. LUCAS 61-0M-M00
1.5 BRABUS (454.034)	130	05.05 →		
1.5 CDI (454.001)	70	09.04 →		
1.1	47	02.05 →		55-05-511
1.5	90	01.04 →	50-05-593 60-0M-M01	51-05-507 Imp. LUCAS 61-0M-M00 55-05-511
FORTWO cabrio i i				
0.7 (450.432)	45	01.04 →	50-0M-000 60-0M-000	55-M0-000 56-0M-M00 67-M0-000 Right\Destra 67-M0-001 Right\Destra 67-M0-002 Left\Sinistra 67-M0-003 Left\Sinistra
0.7 (450.433)	55	01.04 →		
0.8 CDI (450.400)	30	01.04 →		

	KW			
FORTWO Cabrio i				
0.8 CDi (461.400)	33	01.07 →	 50-0M-000	 55-M0-000
1.0 (461.431)	52	01.07 →	 60-0M-000	 56-0M-M00
1.0 Brabus (461.433)	72	01.08 →		 67-0M-M04
1.0 Turbo (461.432)	62	01.07 →		 67-0M-M06
FORTWO Coupe i				
0.7 (460.330)	37	01.04 →	 50-0M-000	 55-M0-000
0.7 (460.332)	45	01.04 →	 60-0M-000	 56-0M-M00
0.7 (460.333)	55	01.04 →		 67-M0-000 Right\Destra
0.8 CDI (460.300)	30	01.04 →		 67-M0-001 Right\Destra
				 67-M0-002 Left\Sinistra
				 67-M0-003 Left\Sinistra
FORTWO Coupé i				
0.8 CDi (461.300)	33	01.07 →	 50-0M-000	 55-M0-000
1.0 (461.330)	45	01.07 →	 60-0M-000	 56-0M-M00
1.0 (461.331)	52	01.07 →		 67-0M-M04
1.0 Brabus (461.333)	72	01.08 →		 67-0M-M06
1.0 Turbo (461.332)	62	01.07 →		
0.8 CDi	40	08.09 →		 56-0M-M00
ROADSTER i				
0.7 (462.432)	45	04.03 →	 50-0M-000	 55-M0-000
0.7 (462.434)	60	04.03 →	 60-0M-000	 56-0M-M00
0.7 Brabus (462.437)	74	12.03 →		 67-M0-000 Right\Destra
				 67-M0-001 Right\Destra
				 67-M0-002 Left\Sinistra
				 67-M0-003 Left\Sinistra
ROADSTER Coupe i				
0.7 (462.334)	60	04.03 →	 50-0M-000	 55-M0-000
0.7 Brabus (462.337)	74	12.03 →	 60-0M-000	 56-0M-M00
				 67-M0-000 Right\Destra
				 67-M0-001 Right\Destra
				 67-M0-002 Left\Sinistra
				 67-M0-003 Left\Sinistra
0.7 (462.332)	45	06.03 →		 56-0M-M00



	KW			
ACTYON				
200 Xdi 4WD	104	10.06 →	50-H0-005 60-0S-S03	51-0S-S01 51-0S-S02 61-0S-S02 55-0S-S01 Parking Brake/Freno staz.
2.3 4x4	110	11.06 →	50-H0-005 60-0S-S03 con/with ABS	51-0S-S01 61-0S-S02 55-0S-S01 Parking Brake/Freno staz.
KORANDO				
2.0 e-XDi	129	11.10 →	50-0H-H14 60-0S-S06	51-0K-K06 61-0S-S04 55-0S-S03 Parking Brake/Freno staz.
2.0 e-XDi 4x4	129	11.10 →	50-0H-H14 60-0S-S06	51-0K-K06 61-0S-S03 55-0S-S02 Parking Brake/Freno staz.
KORANDO (K4)				
2.2 D	50	12.88 → 12.96	50-09-997 60-0S-000 09.93→ 09.93→ con/with ABS	51-09-997 61-0S-099 55-H0-001 con/with ABS
KORANDO (KJ)				
2.3	105	01.99 →	50-09-997 60-0S-000 con/with ABS	51-09-997 61-0S-000 55-H0-001 con/with ABS con/with ABS
2.3	103	05.97 →		
2.9 D	73	06.97 → 10.00		
2.9 D (KJ)	72	12.96 →		
2.9 TD	88	04.98 →		
3.2	156	01.99 →		
3.2	162	06.97 →		
3.2 (KJ)	154	12.96 →		
2.3 D (KJ)	58	12.96 →	50-09-901 50-09-997 60-0S-000 con/with ABS	51-09-997 61-0S-000 55-S0-099 con/with ABS con/with ABS
2.0	94	05.97 →	50-09-997 60-0S-000 01.01→ 01.01→ con/with ABS	51-09-997 61-0S-000 55-H0-001 67-S0-099 01.01→ con/with ABS 01.01→ con/with ABS
KORANDO Cabrio (KJ)				
2.3	105	02.99 →	50-09-997 60-0S-000 con/with ABS	51-09-997 61-0S-000 55-H0-001 con/with ABS con/with ABS Drum brakes on the rear axle/Freni a tamburo ad assale post.
2.3	103	11.97 →		
2.9 TD	88	04.98 →		
3.2	156	01.99 →		
3.2	162	06.97 →		

	KW				
KORANDO Cabrio (KJ) <i>i</i> <i>i</i>					
2.9 D	72	11.97 →	 50-09-997  60-0S-000	 51-09-997  61-0S-000  61-0S-099  55-H0-001	con/with ABS con/with ABS Drum brakes on the rear axle Freni a tamburo ad assale post.
KYRON <i>i</i> <i>i</i>					
2.0 Xdi	104	05.05 →	 50-H0-005  60-0S-S03	 51-0S-S01  61-0S-S01  61-0S-S02	
2.0 Xdi 4x4	104	05.05 →			
2.7 Xdi	121	05.05 →	 50-H0-005  60-0S-S03	 51-0S-S01  61-0S-S02  55-H0-001	
MUSSO (FJ) <i>i</i> <i>i</i>					
2.0	93	10.96 →	 50-09-997  60-0S-000	 51-09-997  61-0S-000  55-H0-001	con/with ABS con/with ABS
2.3	103	10.96 →			
3.2	162	06.96 →			
2.3 D	59	10.95 →	 50-09-997	 51-09-997	con/with ABS
2.9 D	73	03.96 →	 50-K0-014  60-0S-000	 61-0S-000  55-H0-001	con/with ABS con/with ABS
2.9 TD	88	04.98 →			
2.3	110	04.03 →	 50-09-997  60-0S-000	 51-0S-S01  61-0S-099  55-H0-001	
MUSSO SPORTS <i>i</i> <i>i</i>					
2.9 D	88	08.04 →	 50-09-997  60-0S-000	 51-09-997  61-0S-000  55-H0-001	con/with ABS con/with ABS
REXTON <i>i</i> <i>i</i>					
2.9 TD	88	04.02 →	 50-0S-S02  60-0S-S01	 51-0S-S01  61-0S-099  55-0S-S01	Parking Brake Freno staz.
3.2	162	04.02 →	 50-0S-S02  60-0S-S01  60-0S-S04  60-0S-S05	01.04→ →12.03	04.06→ Parking Brake Freno staz.
2.7 Xdi	120	08.04 →	 50-0S-S02  50-H0-005  60-0S-S01  60-0S-S03	→02.06 →02.06 →03.06 02.06→	→02.06 03.06→ →03.06 04.06→ 04.06→



























































SSANGYONG





































































	KW			
--	----	--	--	--

RODIUS *i* *i*

































































2.7 Xdi	120	05.05 →	50-0S-S01	51-0S-S02
2.7 Xdi 4WD	120	05.05 →	60-0S-S02	61-0S-S01

	KW			
1800 XT COUPE (XT)				
			<i>i</i>	<i>i</i>
Turbo 4WD	96	01.87 → 12.90	 50-07-703	 51-07-700
Turbo 4WD	88	01.88 → 12.90	 60-07-703	 61-07-700
Turbo 4WD	100	11.84 → 12.90		
E WAGON (E12)				
			<i>i</i>	<i>i</i>
1.2 i (EF12)	40	05.94 →	 50-07-795	 55-08-808
E10 (KJ5)				
			<i>i</i>	<i>i</i>
1.0 (EF10)	37	01.88 → 07.93	 60-07-701  60-07-702	 51-07-700  55-07-707
E12 (KA)				
			<i>i</i>	<i>i</i>
1.2 (EF12)		05.88 → 02.96	 60-07-701  60-07-702	 51-07-700
E12 (KJ8)				
			<i>i</i>	<i>i</i>
1.2 (EF12)	49	01.88 → 07.93	 60-07-701  60-07-702	 51-07-700  55-07-799
FORESTER				
			<i>i</i>	<i>i</i>
2.0	110	01.08 →	 50-07-706  60-07-711	 51-07-704  61-07-708
FORESTER (SF)				
			<i>i</i>	<i>i</i>
2.0	90	08.97 → 09.02	 50-07-708  60-07-711	 51-07-701  51-07-702  61-07-701  55-07-798  56-07-700  67-07-712
				Imp. SUMITOMO Imp. AKEBONO NO ABS
2.0 S Turbo	130	04.01 → 09.02	 50-07-796	 51-07-701
2.0 S Turbo	125	06.98 → 04.01	 60-07-711	 51-07-702  61-07-701
				Imp. SUMITOMO Imp. AKEBONO
2.0	92	06.98 → 09.02	 50-07-796  60-07-711	 51-07-701  51-07-702  61-07-701  55-07-798  56-07-700
				Imp. SUMITOMO Imp. AKEBONO NO ABS
FORESTER (SG)				
			<i>i</i>	<i>i</i>
2.0	92	09.02 →	 50-07-706  60-07-711	 55-07-798  56-07-700  67-07-712
				NO ABS
2.0 S Turbo	130	09.02 →	 50-07-706  60-07-711  60-07-725	 51-07-703  61-07-701  67-07-712







































































	KW			
FORESTER (SG)				
2.5	155	12.03 →	60-07-706 60-07-711	61-07-703 61-07-701
2.0 X	116	09.05 →	60-07-706 60-07-711	66-07-798 66-07-700
2.5 XT	169	09.05 →	60-07-706 60-07-711	61-07-702 61-07-701
FORESTER (SH)				
2.0	110	01.08 →	60-07-706	61-07-704
2.0 D	108	09.08 →	60-07-711	61-07-708 66-06-616
IMPREZA				
2.0R	110	08.07 →	60-07-706 60-07-711	61-07-704 61-07-708
1.5	79	02.08 →	60-07-706	61-07-704
1.5 4 ruote motrici	79	02.08 →	60-07-706	61-07-708 66-06-616
2.0	110	02.08 →	60-07-706	61-07-704
2.0 4 ruote motrici	110	01.08 →	60-07-711	61-07-708 66-06-616
2.5	221	02.08 →	60-07-706	61-07-704 66-06-616
2.5 4 ruote motrici	221	01.08 →	60-07-713	66-06-616
2.5 4 ruote motrici	169	01.08 →	60-07-706 60-07-713	61-07-704 66-06-616
2.0 D 4 ruote motrici	110	01.09 →	60-07-706 60-07-726	61-07-704 61-07-706 66-06-616
IMPREZA (GC)				
1.6 i 4WD	66	08.92 → 12.00	60-07-706 60-07-711 60-07-706 60-07-706	61-07-701 61-07-702 61-07-701 66-07-798 66-07-700 67-07-706
1.8 i 4WD	76	08.92 → 12.00	60-07-706 60-07-706 60-07-706	61-07-701 61-07-702 61-07-701 66-07-710 66-07-700 67-07-713

	KW				
IMPREZA (GC)					
2.0 Turbo GT 4WD	155	03.94 → 12.00	 50-07-708  60-07-711  60-07-725	 51-07-701  51-07-702  61-07-701  61-07-702  55-07-798	Imp. SUMITOMO Imp. AKEBONO
2.0 i 4WD	85	10.95 → 12.00	 50-07-708  50-07-711  60-07-705  60-07-706	 51-07-701  51-07-702  61-07-701  55-07-798  56-07-700	Imp. SUMITOMO Imp. AKEBONO NO ABS
1.6 i	66	08.92 → 12.00	 50-07-705  50-07-711  60-07-705  60-07-706	 51-07-701  51-07-702  61-07-701  55-07-798  56-07-700  67-07-703	Imp. SUMITOMO Imp. AKEBONO NO ABS
1.6 i	70	06.98 → 12.00	 50-01-147  50-07-711  60-07-706	 51-01-129  61-07-701  55-07-798  56-07-700  67-07-703	NO ABS
2.0 i 4WD	92	06.98 → 12.00	 50-01-147  50-07-711  60-07-706	 51-01-129  61-07-701  55-07-798  56-07-700  67-07-712	NO ABS
2.0 Turbo GT 4WD	160	06.98 → 12.00	 50-01-147  60-07-706	 51-01-129  61-07-701	
1.6 i 4WD	70	06.98 → 12.00	 50-07-705  50-07-711  60-07-706	 51-07-701  51-07-702  61-07-701  55-07-798  56-07-700  67-07-703	Imp. SUMITOMO Imp. AKEBONO NO ABS
IMPREZA (GD, GG)					
1.6 AWD	70	12.00 →	 50-01-147  50-07-711  60-07-706	 55-07-798  67-07-703	
2.0	92	12.00 →	 50-01-147  60-07-706	 51-07-703  61-07-701	























































	KW			
IMPREZA (GD, GG)				
2.0 WRX Turbo	160	12.00 →	50-01-147 60-07-725	51-07-703 61-07-705 55-07-710 Parking Brake/Freno staz.
2.0 WRX STi	195	11.01 →	50-01-147 60-07-725	51-01-129 61-07-705
2.0 WRX Turbo	165	12.02 →	50-07-706 60-07-711	51-07-703 61-07-705 55-07-710 67-07-713 Parking Brake/Freno staz.
2.0 WRX STi	235	02.04 →	50-07-706 60-07-711	61-07-705 55-07-710 67-07-713 Parking Brake/Freno staz.
2.0 R	118	09.05 →	50-01-188 60-07-711	51-07-703 61-07-701
2.5 WRX	169	09.05 →	50-01-188 50-07-706 60-07-725	51-07-703 61-07-705 61-07-709
2.5 WRX STi	206	09.05 →	50-07-706 60-07-725	51-07-703 61-07-709 55-07-710 Parking Brake/Freno staz.
2.0 AWD	206	10.05 →		61-07-709
2.5 AWD	221	10.05 →	50-07-706 60-07-713	51-07-704
IMPREZA Coupe (GFC)				
2.0 4WD	85	12.95 → 12.00	50-07-708 50-07-711 60-07-705 60-07-706	51-07-701 51-07-702 61-07-701 55-07-709 56-07-700 Imp. SUMITOMO Imp. AKEBONO NO ABS
1.6	66	12.96 → 12.00	50-07-705 50-07-711 60-07-705 60-07-706	51-07-701 51-07-702 61-07-701 55-07-798 67-07-703 Imp. SUMITOMO Imp. AKEBONO
1.6 4WD	66	12.96 → 12.00	50-07-705 50-07-711 60-07-705 60-07-706	51-07-701 51-07-702 61-07-701 55-07-798 56-07-700 67-07-705 Imp. SUMITOMO Imp. AKEBONO

	KW				
IMPREZA Coupe (GFC) i					
2.0 Turbo 4WD	155	12.96 → 12.00	 50-07-796  60-07-711	 51-07-701  51-07-702  61-07-701	Imp. SUMITOMO Imp. AKEBONO
IMPREZA Station wagon (GD, GG) i					
1.6	70	12.00 →	 50-01-147  50-07-711  60-07-706	 51-01-129  55-07-798	
2.0	92	12.00 →	 50-01-147  60-07-725	 51-01-129  61-07-701	
2.0 Turbo	160	12.00 →	 50-01-147  60-07-725	 51-01-129  61-07-705  55-07-710	Parking Brake/Freno staz.
2.0 WRX Turbo	165	12.02 →	 50-07-706  60-07-711	 51-07-703  61-07-705  55-07-710  67-07-713	Parking Brake/Freno staz.
2.0 R	118	09.05 →	 50-01-188  60-07-711	 51-07-703  61-07-701	
2.5 WRX	169	09.05 →	 50-07-706  60-07-725	 51-07-703  61-07-705	
IMPREZA Station wagon (GF) i					
1.6 i 4WD	66	08.92 → 12.00	 50-07-705  50-07-711  60-07-705  60-07-706	 51-07-701  51-07-702  61-07-701  55-07-798  56-07-700  67-07-705	Imp. SUMITOMO Imp. AKEBONO NO ABS
1.8 i 4WD	76	08.92 → 12.00	 50-07-705  50-07-711  60-07-705  60-07-706	 51-07-701  51-07-702  61-07-701  55-07-710  56-07-700  67-07-713	Imp. SUMITOMO Imp. AKEBONO Parking Brake/Freno staz. NO ABS
2.0 i Turbo 4WD	155	03.94 → 12.00	 50-07-708  60-07-711	 51-07-701  51-07-702  61-07-701  55-07-798  67-07-712	Imp. SUMITOMO Imp. AKEBONO

































	KW				
IMPREZA Station wagon (GF)					
1.6 i	70	06.98 → 12.00	50-07-705 50-07-711 60-07-705 60-07-706	51-07-701 51-07-702 61-07-701 55-07-798 56-07-700 67-07-712	Imp. SUMITOMO Imp. AKEBONO NO ABS
2.0 16V AWD	92	06.98 → 12.00	50-01-147 60-07-706	51-01-129 61-07-701 55-07-798 56-07-700	NO ABS
2.0 Turbo GT 4WD	160	06.98 → 12.00	50-01-147 60-07-706	51-01-129 61-07-701	
1.6 i 4WD	70	06.98 → 12.00	50-07-705 50-07-706 50-07-711 60-07-705 60-07-706	51-07-701 61-07-701 55-07-798 56-07-700 67-07-712	Imp. SUMITOMO NO ABS
2.0 4WD	85	12.95 → 12.00	50-07-708 50-07-711 60-07-705 60-07-706	51-07-701 51-07-702 61-07-701 55-07-798 56-07-700 67-07-712	Imp. SUMITOMO Imp. AKEBONO NO ABS
JUSTY I (KAD)					
1000	40	11.84 → 06.89	50-01-101	55-08-808	
1000 4WD (KAD-A)	37	05.87 → 11.94	50-07-702	67-07-707	Imp. AKEBONO
1000 4WD (KAD-A)	40	11.84 → 12.90	60-07-701 60-07-702		
1000	37	05.87 → 10.95	50-07-707 60-07-702	55-08-808 67-07-707	
1200	49	05.87 → 10.95	50-07-702	55-08-808	Imp. AKEBONO
1200 4WD	50	10.86 → 12.90	50-07-710	67-07-707	
1200 4WD (KAD-A)	49	05.87 → 05.91	60-07-702 60-07-709		
1200 4WD	55	10.90 → 12.94	50-07-707 60-07-709	55-08-808 67-07-707	
JUSTY II (JMA, MS)					
1.3 4x4	63	04.01 → 11.03	50-08-805	55-08-811	Imp. SUMITOMO
1.3 GX 4x4	50	10.95 → 11.03	60-08-806	67-08-832 67-08-837	Right\Destra Left\Sinistra
JUSTY III (G3X)					

	KW			
JUSTY III (G3X) i				
1.3	69	09.03 →	 60-08-885	 66-08-821
1.6	73	09.03 →	 60-08-817	 67-08-840
JUSTY IV i				
1.0	51	01.07 →	 60-08-809	 66-06-610
			 60-06-614	 67-06-630
			 60-06-618	 67-06-631
			Rim Size\Diam Cerchio:13	
			Rim Size\Diam Cerchio:14	
LEGACY I (BC) i				
1800 4WD	76	01.89 → 09.91	 60-07-706	 61-07-701
			 60-07-706	 61-07-701
				 66-07-709
				 67-07-706
				Imp. SUMITOMO
2000 4WD	85	08.91 → 07.94	 60-07-706	 61-07-701
			 60-07-706	 61-07-701
				 66-07-798
				Imp. SUMITOMO
2200 4WD	100	01.89 → 07.94	 60-07-706	 61-07-701
			 60-07-706	 61-07-701
				Imp. SUMITOMO
2000 Turbo 4WD	147	05.92 → 07.94	 60-07-708	 61-07-701
			 60-07-711	 61-07-702
				Imp. SUMITOMO
1800	76	01.89 → 12.93	 60-07-706	 61-07-701
			 60-07-706	 61-07-701
			 60-07-706	 66-07-798
				 67-07-703
				Imp. SUMITOMO
1.6i 16V		02.89 →	 60-07-706	 66-07-798
			 60-07-706	 67-07-703
				Imp. SUMITOMO
LEGACY I Station wagon (BJF) i				
1800 4WD	76	01.89 → 07.94	 60-07-706	 61-07-701
			 60-07-706	 61-07-701
				 66-07-798
				 67-07-703
				Imp. SUMITOMO
2000 4WD	85	09.91 → 07.94	 60-07-706	 61-07-701
			 60-07-706	 61-07-701
				 61-07-702
				 66-07-798
				Imp. SUMITOMO
2000 Turbo Super 4WD	147	05.92 → 07.94	 60-07-708	 61-07-701
			 60-07-711	 61-07-702
				Imp. SUMITOMO
2000	85	09.91 → 12.93	 60-07-706	 61-07-701
2200 Super 4WD	100	01.89 → 07.94	 60-07-706	 61-07-701
				Imp. SUMITOMO
1800	76	01.89 → 07.94	 60-07-706	 61-07-701
			 60-07-706	 66-07-798
			 60-07-706	 67-07-703
				Imp. SUMITOMO

	KW			
LEGACY II (BD, BG)				
2.0 i	85	09.94 → 03.99	50-07-708	51-07-701
2.0 i 4WD	85	09.94 → 03.99	50-07-711 60-07-706	61-07-701 55-07-798 56-07-700
				Imp. SUMITOMO NO ABS
2.2 i 4WD	96	06.96 → 03.99	50-07-705	51-07-701
2.2 i 4WD	94	09.94 → 03.99	50-07-711 60-07-706	61-07-701 55-07-798 56-07-700
				Imp. SUMITOMO NO ABS
2.5 i 4WD	110	06.96 → 03.99	50-07-711 50-07-796 60-07-711	51-07-701 61-07-702 55-07-798 56-07-700
				Imp. SUMITOMO NO ABS
LEGACY II Station wagon (BD, BG)				
2.0 i	85	09.94 → 11.98	50-07-708	51-07-701
2.0 i 4WD	85	09.94 → 11.98	50-07-711 60-07-706	61-07-701 55-07-798 56-07-700
				Imp. SUMITOMO NO ABS
2.2 i 4WD	96	06.96 → 11.98	50-07-705	51-07-701
2.2 i 4WD	94	09.94 → 11.98	50-07-711 60-07-706	61-07-701 55-07-798 56-07-700
				Imp. SUMITOMO NO ABS
2.5 i 4WD	110	06.96 → 11.98	50-07-711 50-07-796 60-07-711	51-07-701 61-07-702 55-07-798
				Imp. SUMITOMO
LEGACY III (BE, BH)				
2.0	92	04.99 → 08.03	50-07-711 50-07-796 60-07-706 60-07-711	51-07-701 51-07-702 61-07-707
				→07.00 Imp. SUMITOMO 08.00→ →08.03 Imp. AKEBONO
2.5	115	10.98 → 08.03	50-07-796 60-07-711	51-07-701 51-07-702 61-07-707
				→07.00 Imp. SUMITOMO 08.00→ →08.03 Imp. AKEBONO
3.0 H6 AWD	154	08.00 → 08.03	50-07-796 60-07-725	51-07-702 61-07-707
				Imp. AKEBONO
LEGACY III Station wagon (BE, BH)				









































	KW			
LEGACY III Station wagon (BE, BH)				
2.5	115	12.98 → 08.03	 60-07-796  60-07-711	 61-07-701 →07.00 Imp. SUMITOMO  61-07-702 08.00→ →08.03 Imp. AKEBONO  61-07-707
2.0	92	12.98 → 08.03	 60-07-711  60-07-796  60-07-706  60-07-711	 61-07-701 Imp. SUMITOMO  61-07-707
3.0 H6 AWD	154	08.00 → 08.03	 60-07-796  60-07-725	 61-07-702 Imp. AKEBONO  61-07-707
LEGACY IV				
2.0	101	09.03 →	 60-07-706	 61-07-704
2.5	121	09.03 →	 60-07-711	 61-07-706
3.0	180	09.03 →		 65-07-711 Parking Brake/Freno staz.
2.0 D	110	06.08 →	 60-07-706  60-07-725	 61-07-704  61-07-706  65-07-711 Parking Brake/Freno staz.
2.0	121	06.05 →		 65-07-711 Parking Brake/Freno staz.
2.0	140	06.05 →		
2.0	110	09.07 →		
2.5	127	09.07 →		
LEGACY V				
2.0 D	110	09.09 →	 60-07-706	 61-07-704
2.5 i	123	09.09 →	 60-07-725	 61-07-708
2.0 i	110	09.09 →	 60-07-706  60-07-711	 61-07-704  61-07-708
LEONE I (AB)				
1800 4WD	60	09.80 → 10.84	 60-07-701	 65-07-701
1800 4WD	59	09.80 → 10.84	 60-07-700	 67-07-700
1800 FWD		01.79 → 12.84	 60-07-704	
1300	45	03.79 → 10.84	 60-07-701  60-07-700  60-07-704	 65-07-701  67-07-702
1600	63	03.79 → 10.84	 60-07-701  60-07-700  60-07-704	 65-07-701  67-07-700  67-07-702
LEONE I Hatchback				

	KW			
LEONE I Hatchback i i				
1800 4WD	59	09.80 → 10.84	50-07-701 60-07-700 60-07-704	55-07-701 67-07-700
1600 1800 Turismo 4WD	63 60	03.79 → 10.84 09.80 → 10.84	50-07-701 60-07-700 60-07-704	55-07-701 67-07-700 67-07-702
1300	45	03.79 → 10.84	50-07-701 60-07-700 60-07-704	55-07-701 67-07-702
LEONE I Station wagon i i				
1600 4WD 1800 4WD (AM)	52 59	03.79 → 10.84 09.80 → 10.84	50-07-701 60-07-700 60-07-704	55-07-701 67-07-700
1600 1800 Super 4WD (AM, AJ)	63 60	03.79 → 10.84 09.80 → 10.84	50-07-701 60-07-700 60-07-704	55-07-701 67-07-700 67-07-702
1300	45	03.79 → 10.84	50-07-701 60-07-700 60-07-704	55-07-701 67-07-702
LEONE II i i				
1.8 1800 4WD 1800 4WD 1800 4WD 1800 4WD Cat.	77 72 88 66 70	06.85 → 07.86 01.88 → 12.90 01.88 → 12.90 11.84 → 12.90 07.86 → 09.91	50-07-703 60-07-703	51-07-700 61-07-700 55-07-704 67-07-704
1800 Turbo 4WD	96	03.89 → 12.90	50-07-703 60-07-703	51-07-700 61-07-700 55-07-705
1800 Turbo 4WD	100	11.84 → 12.90	50-07-703 60-07-703	51-07-700 61-07-700
1300	48	11.84 → 09.91	50-07-703 60-07-703	51-07-700 61-07-700 55-07-704 67-07-711
1600	55	11.84 → 09.91	50-07-703 60-07-703	51-07-700 61-07-700 55-07-701 67-07-704
1.6 1.8 1.8 GL	52 66 59	06.85 → 07.90 06.85 → 07.87 08.86 → 07.89		51-07-700 61-07-700

























































	KW			
LEONE II <i>i</i> <i>i</i>				
1.8 Turbo AWD	100	06.85 → 07.86		 51-07-700  61-07-700  55-07-705
LEONE II Station wagon <i>i</i> <i>i</i>				
1800 4WD	88	01.88 → 12.90	 50-07-703	 55-07-704
1800 4WD	66	11.84 → 12.90	 60-07-703	 67-07-704
1800 4WD	72	12.86 → 07.91		
1800 Super 4WD Cat.	70	07.86 → 02.92		
1800 Super 4WD	96	03.89 → 12.90	 50-07-703  60-07-703	 51-07-700  61-07-700  55-07-705  67-07-704
1800 Super Turbo 4WD	100	11.84 → 12.90	 50-07-703  60-07-703	 51-07-700  61-07-700  55-07-704
LIBERO Autobus (E10, E12) <i>i</i> <i>i</i>				
1.0 4WD (E10, KJ6)	37	01.83 → 12.87	 50-01-101  60-07-702	 55-07-707  67-07-709
1.2 4WD (E12, KJ8)	38	08.86 → 02.00	 50-01-101  50-07-707  60-07-701  60-07-702  60-07-709	→12.88 01.89→ →12.88 →12.88 01.89→  55-07-707  67-07-709
1.2 i 4WD (E12, FA)	40	08.91 → 02.00	 50-07-707  60-07-709	 55-07-707  67-07-709
MV (AS_) <i>i</i> <i>i</i>				
1.6	52	06.78 → 04.81	 50-07-702	Imp. AKEBONO
1.8	60	05.81 → 08.86	 50-07-701  60-07-700  60-07-704	
OUTBACK <i>i</i> <i>i</i>				
2.5 3.0	121 180	11.03 → 11.03 →	 50-07-706  60-07-725	 51-07-704  61-07-705  55-07-711
2.0 D	110	09.08 →	 50-07-706  60-07-725	 51-07-704  61-07-706  55-07-711
2.0 D 2.5 i	110 123	09.09 → 09.09 →	 50-07-706  60-07-725	 51-07-704  61-07-708



	KW			
OUTBACK <i>i</i> <i>i</i>				
3.6 R	191	09.09 →	50-07-709	61-07-708
OUTBACK (BE, BH) <i>i</i> <i>i</i>				
3.0 H6	154	10.00 → 08.03	50-07-796 60-07-725	51-07-701 61-07-705 Imp. SUMITOMO
2.5	115	10.00 → 08.03	50-07-796 60-07-711	51-07-701 61-07-707 Imp. SUMITOMO
REX II/ MINI JUMBO <i>i</i> <i>i</i>				
550	23	08.81 → 06.87	50-01-101	55-07-700
550 4WD	23	08.83 → 06.87	60-07-707	
550 Turbo	30	07.84 → 06.87		
700	27	08.82 → 06.89	50-01-101 60-07-701	55-07-707 67-07-706 01.86→ 01.86→
REX III/ MINI JUMBO/ M80-70 <i>i</i> <i>i</i>				
0.5	28	06.89 → 07.90	50-01-101	55-07-797
0.5 4WD	28	06.89 → 07.90	60-07-707	67-07-706
0.5 Kompressor	45	06.89 → 07.90		
0.8	31	06.89 → 03.92	50-07-799 60-07-707	55-07-797 67-07-798
0.7	35	07.90 → 03.92	50-01-101	55-07-797
0.7 4WD	35	07.90 → 03.92	60-07-707	67-07-799
0.7 Kompressor 4WD	47	07.90 → 02.92		FrontAnteriore
SVX (CX) <i>i</i> <i>i</i>				
3.3 i 24V 4WD (CXW)	169	09.92 → 09.94	50-01-137	51-07-701
3.3 i 24V 4WD (CXW)	162	09.94 → 12.97	60-07-710	61-07-703 Imp. SUMITOMO
TREZIA <i>i</i> <i>i</i>				
1.3i	73	01.11 →	50-02-269	51-02-214
1.4 D	66	01.11 →	60-02-2014	61-02-241
TRIBECA (B9) <i>i</i> <i>i</i>				
3.0	184	01.05 →	50-07-709 60-07-712	51-07-705 61-07-704 55-07-702 Parking Brake/Freno staz.
VIVIO <i>i</i> <i>i</i>				
660 4WD	32	03.92 → 10.95	50-07-798	55-07-797 67-07-798

	KW			
ALTO I (SS80) <i>i</i> <i>i</i>				
0.8 (SS80F, SS80G)	29	06.82 → 12.85	 50-04-404  60-08-800	Imp. SUMITOMO  55-08-802  67-08-808
ALTO II (EC) <i>i</i> <i>i</i>				
0.8 (SB308/CA)	29	01.86 → 11.93	 50-04-404  60-08-801	Imp. SUMITOMO  55-08-808  67-08-810 →12.87  67-08-813 01.88→ →08.92
ALTO III (EF) <i>i</i> <i>i</i>				
1.0	43	01.00 →	 50-08-805	Imp. SUMITOMO  55-08-808
1.0	39	09.94 → 06.02	 60-08-806	 56-08-815
ALTO IV (FF) <i>i</i> <i>i</i>				
1.1	46	06.02 →	 50-08-825	 55-08-822
			 60-08-812	 67-08-841
ALTO V (GF) <i>i</i> <i>i</i>				
1.0	50	01.09 →	 50-08-809	 55-08-825
			 60-08-822	
BALENO (EG) <i>i</i> <i>i</i>				
1.3	52	09.96 → 05.02	 50-08-816	→12.98  55-08-811
1.3 i 16V	63	07.95 → 05.02	 60-08-814	 56-08-811
1.6 i 16V	72	07.95 → 05.02		 67-08-832 Right/Destra
1.6 i 16V 4x4	72	07.95 → 05.02		 67-08-837 Left/Sinistra
1.8 GT	89	03.96 → 05.02	 50-08-816	 51-06-601
			 60-08-891	 61-08-800
				 55-08-811
1.9 TD	55	04.98 → 05.02	 50-08-816	 51-06-601
			 60-08-891	 61-08-800
BALENO Hatchback (EG) <i>i</i> <i>i</i>				
1.3	52	09.96 → 05.02	 50-08-816	→12.98  55-08-811
1.3 i 16V	63	07.95 → 05.02	 60-08-814	 56-08-811
1.6 i 16V	72	07.95 → 05.02		 67-08-832 Right/Destra
1.6 i 16V 4x4	72	07.95 → 05.02		 67-08-837 Left/Sinistra
1.8 GT	89	03.96 → 05.02	 50-08-816	 51-06-601
1.9 TD	55	04.98 → 05.02	 60-08-891	 61-08-800
BALENO Station wagon (EG) <i>i</i> <i>i</i>				
1.6 i 16V	72	08.96 → 05.02	 50-08-816	 55-08-811
1.6 i 16V 4x4	72	08.96 → 05.02	 60-08-814	 56-08-811
				 67-08-832 Right/Destra
				 67-08-837 Left/Sinistra



	KW			
BALENO Station wagon (EG)				
1.8 i 16V	89	08.96 → 05.02	 50-08-816  60-08-891	 51-06-601  61-08-800  56-08-811
1.3 16V	63	03.97 → 05.02	 50-08-815  50-08-816  60-08-814	01.99→ →12.98  55-08-811  56-08-811  67-08-832  67-08-837
1.9 TD	55	04.98 → 05.02	 50-08-816  60-08-891	 51-06-601  61-08-800
CAPPUCINO				
0.7	47	02.92 → 08.95	 50-08-805  60-08-806	Imp. SUMITOMO
CARRY Furgonato/Box (FD)				
1.3	58	03.99 →	 50-08-809	 55-04-411  56-08-813  67-04-457  67-08-842
1.3 16 V	58	03.00 →	 50-08-809	 55-04-411  56-08-813
0.8 (DA21) F8A	29	01.86 →	 50-04-404  60-08-801	Imp. SUMITOMO  55-08-809  67-08-816  67-08-817
CARRY Furgonato/Box (ST90V)				
0.8	27	11.80 → 10.85	 50-04-404  60-08-801	Imp. SUMITOMO  55-08-809  65-08-803  67-08-802  67-08-817
GRAND VITARA				
1.6 4 ruote motrici	78	04.05 →	 50-08-802	 55-08-824
2.0 4 ruote motrici	103	10.05 →	 50-08-807  60-08-821	 67-08-823  67-08-824
1.9 DDiS	95	10.05 →	 50-08-802  50-08-807  60-08-821	 55-08-818  55-08-824  67-08-823  67-08-824
3.2 4 ruote motrici	171	01.09 →	 50-08-802  60-08-821	
GRAND VITARA (FT, GT)				

























































	KW			
GRAND VITARA (FT, GT)				
1.6	69	03.98 →	60-08-893	65-08-818
2.0	94	03.98 →	60-08-809	66-08-806
2.5 V6 24V (FT)	106	04.98 →		67-08-823 67-08-824
				Left\Sinistra Right\Destra
2.0 TD Intercooler	64	03.98 →	60-08-893 60-08-811	65-08-818 66-08-806 67-08-823 67-08-824
				Left\Sinistra Right\Destra
2.0 HDI 110	80	07.01 →	60-08-893 60-08-811 60-08-819	65-08-818 66-08-812 67-08-823 67-08-824
			→07.05 08.05→	Left\Sinistra Right\Destra
2.7 XL-7	127	09.01 →	60-08-893 60-08-809	65-08-818 66-08-812 67-08-823 67-08-824
				Left\Sinistra Right\Destra
2.7 XL-7	135	04.03 →	60-08-893 60-08-809 60-08-819	65-08-818 66-08-812 67-08-823 67-08-824
			08.05→	Left\Sinistra Right\Destra
2.5 V6 24V	116	04.01 →	60-08-893 60-08-809 60-08-819	65-08-818 67-08-823 67-08-824
			→07.05 08.05→	Left\Sinistra Right\Destra
IGNIS (FH)				
1.3	61	10.00 → 09.03	60-08-809 60-08-890	65-08-808 67-08-841
1.3 4WD	61	10.00 → 09.03	60-08-809 60-08-890	65-08-822 67-08-841
IGNIS II				
1.3	69	09.03 →	60-08-886	65-08-821
1.3 DDiS	51	09.03 →	60-08-817	67-08-840
1.6	73	09.03 →		
1.6 4x4	73	09.03 →		
1.6 Sport	80	12.03 →		
JIMNY (FJ)				
1.3 16V	60	02.01 →	60-08-803	65-04-411
1.3 16V	59	09.98 →	60-08-807	67-04-467
1.3 16V 4WD	60	02.01 →		67-08-842
1.3 16V 4WD	59	09.98 →		
1.6 DDiS 4WD	48	12.03 →	60-08-803 60-08-808	65-04-411 67-04-467 67-08-842
			Imp. SUMITOMO	Left\Sinistra Right\Destra



	KW			
JIMNY (FJ)				
1.3 16V 4x4	63	08.05 →	50-08-803 60-08-824 60-08-825	55-04-411
1.5 DDiS 4x4	63	08.05 →	50-08-897 60-08-807 60-08-808 60-08-824 60-08-825	55-04-411 67-04-457 67-08-842
1.3 4x4	63	09.98 → 08.00	50-08-803 60-08-807	55-04-411
LIANA (ER)				
1.3	66	03.02 →	50-08-810 60-08-891	55-08-811 56-08-811
1.4 DDiS	66	03.05 →		
1.6	76	03.02 →		
1.6	78	04.02 →		
1.6 4WD	76	03.02 →		
1.6 4WD	78	04.02 →		
LJ 80				
0.8	29	01.80 → 01.84	50-08-803 60-08-814	55-08-800 65-08-802 65-08-806 65-08-807 67-08-802 67-08-806 67-08-807
SAMURAI (S-J)				
1.0 (SJ 410)	33	11.88 →	50-08-803 50-08-806 50-08-898 60-08-807	55-08-810 55-08-899 56-08-802 65-08-811 67-08-811
1.3 (SJ 413)	51	11.88 →	50-08-898 50-08-899 60-08-807	55-08-810 55-08-899 56-08-800 56-08-801 67-08-899

	KW			
SAMURAI (SJ)				
1.3 (SJ 413)	47	11.88 →	50-08-898	55-08-805
1.3 (SJ 413)	44	11.88 →	50-08-899 60-08-807	55-08-810 55-08-899 56-08-800 56-08-801 67-08-899
				→12.95 Parking Brake/Freno staz. Made in Japan Made in Spain →08.90 09.90→
1.9 TD	46	11.98 →	50-08-803 50-08-806 50-08-898 60-08-807	55-08-810 55-08-899 56-08-802 67-08-894
			Imp. LUCAS	Made in Japan Made in Spain
SANTANA				
1.0 (SJ410) F10A		01.84 →	50-08-803 50-08-806 50-08-898 60-08-807	55-08-804 →09.85 55-08-806 09.85→ 56-08-801 09.85→ 56-08-802 65-08-811 65-08-812 67-08-811 →07.85 67-08-812 08.85→
			Imp. LUCAS	
1.3 (SJ413)		01.85 →	50-08-898	55-08-899 Lower clean screw 56-08-802
			50-08-899 60-08-807	65-08-812 67-08-804 67-08-894 UPPER CLEAN SCREW 67-08-899 LOWER CLEAN SCREW
			08.92→ Imp. LUCAS →08.00	
1.0 (SJ410) F10A MADE IN SPAIN		04.82 →03.88	50-08-899 60-08-807	55-08-899 56-08-802 65-08-812 67-08-812 Left/Sinistra 67-08-894 UPPER CLEAN SCREW 67-08-899 LOWER CLEAN SCREW
SIDEKICK				

	KW			
SIDEKICK i				
1.6 (JLX - JS - JX)	59	04.89 → 04.96	50-08-806 50-08-897 60-08-807 60-08-808	55-08-898 65-08-815 67-08-820 67-08-821 67-08-822
			Imp. SUMITOMO	01.91→ →12.95 →12.90 Right\Destra →12.90 Left\Sinistra 01.91→ →12.95 Left\Sinistra
SJ 410 i				
1.0	33	09.81 → 12.88	50-08-803 50-08-806 60-08-807	55-08-801 55-08-805 56-08-802 65-08-800 65-08-801 65-08-802 65-08-812 67-08-800 67-08-801 67-08-802 67-08-812
			01.85→ 01.85→	01.85→ 01.85→ Parking Brake\Freno staz. →12.87 01.85→ Right\Destra Right\Destra 01.85→ Left\Sinistra Left\Sinistra Left\Sinistra 01.85→
SJ 413 i				
1.3	44	08.86 → 08.90	50-08-803 50-08-806 50-08-898 60-08-807	55-08-801 56-08-801 65-08-812 67-08-804
			Imp. LUCAS	
1.3	47	09.84 → 12.88	50-08-803 50-08-806 60-08-807	55-08-801 56-08-802 65-08-812 67-08-804
SPLASH i				
1.0	48	01.08 →	50-08-800 60-08-815	55-08-815
1.2	63	01.08 →		
1.3 CDTI	55	01.08 →		
SUPER CARRY Autobus (ED) i				
1.0	30	09.94 → 03.99	50-04-404 60-08-801	55-08-809 67-08-816 67-08-817
			Imp. SUMITOMO	Left\Sinistra Right\Destra

	KW					
SUPERCARRY Pick-Up , Van (SK410) i						
1.0 (F10A)	33	01.86 →	 50-04-404  50-08-886  60-08-801	→12.94 Imp. SUMITOMO 01.95→	 55-08-809  67-08-816  67-08-817	Left\Sinistra Right\Destra
SWIFT Cabriolet (SF413) i						
1.3 (SF413, AK35)	50	09.91 → 10.96	 50-01-135  60-08-804	Imp. AKEBONO	 51-08-800  61-08-800  55-08-813  67-08-819	
SWIFT I (AA) i						
1.0 (SA310, AA41/43)	37	10.83 → 03.89	 50-08-804  50-08-896  60-08-801  60-08-806	→12.86 01.87→ 01.87→	 55-08-807  55-08-813  67-08-818	→12.86 01.87→
1.0 Turbo (SA310)	52	02.85 → 12.89	 50-08-804  60-08-801		 55-08-807  55-08-813	→12.86 01.87→
1.3 GTi/GXi (SA413, AA33)	74	08.86 → 03.89	 50-08-805  60-08-804	Imp. SUMITOMO	 55-08-813  67-08-818	
1.3 (SA413, AA51)	50	10.84 → 03.89	 50-08-804  60-08-801		 55-08-813  67-08-818	
1.3 (SA413, AA51/53)	54	10.84 → 03.89				
1.3 (SA413, AA53)	47	08.86 → 03.89				
SWIFT II (AH, AJ) i						
1.3 (SF413, AH35, MA)	50	03.89 → 05.01	 50-08-805  50-08-818  60-08-806	Imp. SUMITOMO	 55-08-811  55-08-813  56-08-810  67-08-818  67-08-832  67-08-837	→01.95 04.92→ Right\Destra 04.92→ Left\Sinistra
1.3 (SF413, AH35)	52	03.89 → 12.91	 50-08-805  60-08-806	Imp. SUMITOMO	 55-08-813  56-08-810  67-08-818	
1.6 (SF416, AH14)	70	11.89 → 12.91	 50-01-135  50-08-805  60-08-805	Imp. AKEBONO	 55-08-811  56-08-810  67-08-820  67-08-821	Rear Axle Left\Assale posterior Rear Axle Right\Assale posterio
1.6 4WD (SF416, AJ14)	70	11.89 → 12.91		Imp. SUMITOMO		
1.6 i (SF416, AH14)	68	01.90 → 05.01				
1.6 i 4WD (SF416, AJ14)	68	01.90 → 05.01				
SWIFT II Hatchback (EA, MA) i						

	KW			
SWIFT IV i				
1.2	66	10.10 →	50-03-343	51-08-801
1.2	69	10.10 →	60-08-826	61-08-801
1.2 4x4	69	10.10 →		
1.2 4x4	66	10.10 →		
1.3 DDiS	55	10.10 →		
SX4 i				
1.5	73	06.06 →	50-08-801	55-08-817
1.6 DDiS	66	04.07 →	50-08-819	67-08-846
1.6 VVT	79	06.06 →		
1.9 DDiS	88	06.06 →		
2.0 DDiS	99	07.09 →	60-08-820	
2.0 DDiS 4x4	99	07.09 →		
VITARA (ET, TA) i				
1.6 (ET)	60	07.88 → 12.91	50-08-806	55-08-812
1.6 (TA)	59	07.88 → 03.98	60-08-807	55-08-814 01.91→
			60-08-808	56-08-803 Left\Sinistra
				67-08-820 Right\Destra
				67-08-821
1.6 16V (ET)	71	07.90 → 03.98	50-08-806	55-08-812
			60-08-807	55-08-898 01.92→
			60-08-808	56-08-803 Left\Sinistra
				67-08-829 Right\Destra
				67-08-830
2.0 TD (ET)	52	12.94 → 03.98	50-08-893	55-08-894 03.95→
2.0 TD Intercooler (ET)	64	12.95 → 03.98	60-08-816	56-08-816
2.0 V6 24V (ET)	100	12.94 → 03.98		67-08-829 Left\Sinistra
				67-08-830 Right\Destra
2.0 16V (ET)	97	12.96 → 03.98	50-08-893 05.97→	55-08-894
			60-08-807	56-08-816
				67-08-829 Left\Sinistra
				67-08-830 Right\Destra
1.9 D (ET)	50	01.95 → 03.98	50-08-893	55-08-894
			60-08-808	56-08-816
				67-08-899
2.5 V6 24V (FT)	118	12.95 → 03.98	50-08-893	
1.9 D (ET)	55	08.96 → 03.98	50-08-893	55-08-894
			60-08-808	67-08-899
VITARA Cabrio (ET, TA) i				

	KW			
VITARA Cabrio (ET, TA)				
1.6 (TA)	59	07.88 → 01.95	50-08-806 60-08-808	55-08-812 55-08-814 56-08-803 67-08-820 67-08-821
			Imp. SUMITOMO	01.91→ LeftSinistra RightDestra
1.6 16V (ET)	71	07.90 → 03.99	50-08-806 50-08-897 60-08-808	55-08-812 55-08-897 55-08-898 67-08-829 67-08-830
			Imp. SUMITOMO	01.92→ LeftSinistra RightDestra
2.0 16V (ET)	97	12.96 → 03.99	50-08-893 60-08-807	55-08-894 56-08-816 67-08-829 67-08-830
				LeftSinistra RightDestra
1.9 D (ET)	50	01.95 → 03.98	50-08-893	55-08-894
1.9 D (ET)	55	08.96 → 03.99	60-08-808	56-08-816 67-08-899
			Imp. SUMITOMO	
WAGON R+ (EM)				
1.0	48	02.98 → 05.00	50-08-813	55-07-797
1.2	51	02.98 → 05.00	60-08-812	55-08-820
1.2 4WD	51	02.98 → 05.00		56-08-808 56-08-814 67-07-799
				→01.00 →01.00
1.2	59	06.04 →	50-08-885 60-08-817	55-08-821
WAGON R+ (MM)				
1.3	56	05.00 →	50-08-885 60-08-817 60-08-818	55-08-822 56-08-817 67-08-840
1.3 4WD	56	10.01 →	50-08-885 60-08-818	55-08-822 56-08-817 67-08-840
1.3	69	09.03 →	50-08-885	55-08-821
1.3 DDiS	51	09.03 →	60-08-817	56-08-817 67-08-840
1.3	65	08.01 →		56-08-817
X-90 (EL)				
1.6 i 16V	71	09.95 →	50-08-806	55-08-830
1.6 i 16V 4x4	71	09.95 →	60-08-807	67-08-829 67-08-830
				LeftSinistra RightDestra









TATA (TELCO)



	KW			
2000 D <i>i</i> <i>i</i>				
2.0 D			50-00-003	55-00-003 67-00-003
2000 TD <i>i</i> <i>i</i>				
2.0 TD			50-00-003	55-00-003 67-00-003
INDICA <i>i</i> <i>i</i>				
1.4 D 1.4 i	39 55	10.98 → 10.98 →	50-00-080 50-08-805 60-00-080 60-00-081	con/with ABS NO ABS Imp. SUMITOMO con/with ABS NO ABS
				55-08-811 67-00-002 67-00-004
				Left\Sinistra Right\Destra
1.4 TD	52	07.03 →	50-00-080 50-08-805 60-00-081	con/with ABS NO ABS Imp. SUMITOMO NO ABS
				67-00-002 67-00-004
				Left\Sinistra Right\Destra
INDIGO <i>i</i> <i>i</i>				
1.4 1.4 D	62 46	01.03 → 01.03 →	50-00-080 50-08-805 60-00-080 60-00-081	con/with ABS NO ABS Imp. SUMITOMO NO ABS
				55-08-811 67-00-002 67-00-004
				Left\Sinistra Right\Destra
INDIGO MARINA <i>i</i> <i>i</i>				
1.4 1.4 D	62 46	01.03 → 01.03 →	50-00-080 50-08-805 60-00-080 60-00-081	con/with ABS NO ABS Imp. SUMITOMO NO ABS
				55-08-811 67-00-002 67-00-004
				Left\Sinistra Right\Destra
SAFARI <i>i</i> <i>i</i>				
1.9 D	66	04.00 →	50-00-003 60-00-005	55-00-003 67-00-003
2.0 16V	101	06.99 →	50-00-003 60-00-016	55-00-003
2.0 TD 4X4 (403.001)		02.01 →	50-00-001 50-00-003 60-00-005	01.04→ →12.03 55-00-003 56-00-005 67-00-003
2.2 TDiC 2.2 TDiC 4 ruote motrici	103 103	07.06 → 07.06 →	50-00-001 60-00-017	
XENON <i>i</i> <i>i</i>				





















































TATA (TELCO)

	KW			
XENON i				
2.2 DiCOR	103	01.09 →	 50-00-001	 55-00-003
2.2 DiCOR 4x4	103	01.09 →	 60-00-016	
			 60-00-017	
			All-wheel Drive4 ruote motrici	

	KW					
1000 / COPAIN (KP30_) <i>i</i> <i>i</i>						
1.0	33	04.69 →	50-01-124 50-06-600 60-02-202	Imp. BENDIX Imp. SUMITOMO	55-02-206	
1000 Furgonato/Box (KP36V_) <i>i</i> <i>i</i>						
1.0	33	04.69 →	50-01-124 50-06-600 60-02-202	Imp. BENDIX Imp. SUMITOMO	55-02-206	
4 RUNNER <i>i</i> <i>i</i>						
3.0 Turbo-D	92	11.95 →	50-02-254 60-02-287	Imp. SUMITOMO	55-02-227 56-02-221 67-02-212	Parking Brake/Freno staz.
4 RUNNER (_N130) <i>i</i> <i>i</i>						
3.0 Turbo-D (KZN 130)	92	10.93 → 03.96	50-02-254 60-02-287	Imp. SUMITOMO	55-02-239 56-02-221 67-02-212	
3.0 V6 (VZN 130)	105	07.90 → 11.95	50-02-254 50-02-291 60-02-271 60-02-287	10.93→ Imp. SUMITOMO →12.93 10.93→ →12.93	55-02-239 56-02-221 67-02-212	
2.4 (RN61)	82	08.87 → 03.96	50-02-254 50-02-291 60-02-271 60-02-287	→12.90 Imp. SUMITOMO 01.91→	55-02-239 56-02-221 67-02-290	01.90→
2.7 i 4x4 3.4 i 4x4	112 136	11.95 → 03.96 11.95 → 03.96	50-02-254 60-02-2024 60-02-205	Imp. SUMITOMO Rim Size/Diam Cerchio:16	55-02-239 56-02-221	
2.4 TD (LN130)	66	01.90 → 01.93	50-02-254 60-02-271	Imp. SUMITOMO	55-02-239 56-02-221 67-05-527	
2.4 TD 4x4	66	08.89 → 11.95	50-02-254 60-02-271 60-02-287	Imp. SUMITOMO	55-02-239	
AURIS <i>i</i> <i>i</i>						
1.4 D-4D	66	03.07 →	50-02-250 60-02-2018 60-02-229	Made in Japan	51-02-214 51-02-220 61-02-234 61-02-243	Made in Japan Made in Great Britain Made in Great Britain Made in Japan





























































	KW			
AURIS				
1.33 Dual-VVTi	74	05.09 →	 50-02-250	 51-02-214 Made in Japan
1.4 VVTi	71	03.07 →	 50-02-269 Made in Japan	 51-02-220 Made in Great Britain
1.6	97	05.09 →	 60-02-2018 Made in Japan	 61-02-234 Made in Great Britain
1.6 VVTi	91	03.07 →	 60-02-229	 61-02-243 Made in Japan
2.0 D-4D	93	03.07 →	 50-02-244	 51-02-214 Made in Japan
2.2 D	130	03.07 →	 60-02-2018 Made in Japan	 51-02-220 Made in Great Britain
			 60-02-264	 61-02-234 Made in Great Britain
				 61-02-243 Made in Japan
AVENSIS				
1.6	97	02.09 →	 50-02-244	 51-02-223
1.6 VVT-i	97	05.09 →	 60-02-2016	 61-02-240
1.8	108	02.09 →		
2.0 D	93	02.09 →		
2.2 D	130	02.09 →	 50-02-276	 51-02-223
2.2 D-CAT	130	05.09 →	 60-02-2015	 61-02-240
AVENSIS (T25)				
1.6 VVT-i	81	04.03 →	 50-02-206	 51-02-200
1.8	95	04.03 →	 60-02-211	 61-02-214
2.0	108	04.03 →		 55-02-231 Parking Brake\Freno staz.
2.4	125	09.03 →		
2.4	120	10.03 →		
2.0 D-4D	93	03.06 →	 50-02-206	 51-02-200
2.0 D-4D	85	04.03 →	 60-02-235	 61-02-214
				 55-02-231 Parking Brake\Freno staz.
2.2 D-4D	110	10.05 →	 50-02-206	 51-02-200
2.2 D-CAT	130	07.05 →	 60-02-235	 61-02-242
				 55-02-231 Parking Brake\Freno staz.
AVENSIS (_T22_)				
1.6 (AT220_)	81	09.97 → 10.00	 50-02-282	 61-02-236 →07.01
1.6 (AT220_)	74	09.97 → 10.00	 60-02-279 Drum brakes on the rear axle\Freni a tamburo ad assale post.	 55-02-216
1.8 (AT221_)	81	09.97 → 10.00		 56-02-202
2.0 (ST220_)	94	09.97 → 10.00		 67-02-201 Right\Destra
				 67-02-203 Left\Sinistra
2.0 TD (CT220_)	66	09.97 → 02.03	 50-02-282	 51-02-213
			 60-02-279 Drum brakes on the rear axle\Freni a tamburo ad assale post.	 61-02-236 →07.01
				 61-02-244 08.01→
				 55-02-216
				 56-02-202
				 67-02-201 Right\Destra
				 67-02-203 Left\Sinistra

	KW					
AVENSIS (_T22_)						
2.0 D-4D (GDT220_)	81	10.99 → 02.03	 50-02-263  50-02-282  60-02-279	<p>Disc brakes on the rear axle\Freni a disco ad assale post. →06.01</p> <p>Drum brakes on the rear axle\Freni a tamburo ad assale post.</p> <p>Drum brakes on the rear axle\Freni a tamburo ad assale post.</p>	 51-02-219  61-02-236  61-02-244  55-02-216  56-02-202  67-02-201  67-02-203	<p>→07.01</p> <p>08.01→</p> <p>Right\Destra</p> <p>Left\Sinistra</p>
1.6 VVT-i 1.8 VVT-i	81 95	10.00 → 02.03 10.00 → 02.03	 50-02-221  50-02-282  60-02-279	<p>Drum brakes on the rear axle\Freni a tamburo ad assale post.</p>	 51-02-213  61-02-236  61-02-244  55-02-216  56-02-202  67-02-201  67-02-203	<p>→07.01</p> <p>08.01→</p> <p>Right\Destra</p> <p>Left\Sinistra</p>
2.0 VVT-i	110	10.00 → 02.03	 50-02-221  50-02-282  60-02-279	<p>→06.01</p> <p>Drum brakes on the rear axle\Freni a tamburo ad assale post.</p>	 51-02-213  51-02-219  61-02-236  61-02-244  55-02-216  56-02-202  67-02-201  67-02-203	<p>→06.01</p> <p>07.01→</p> <p>→07.01</p> <p>08.01→</p> <p>Left\Sinistra</p> <p>Right\Destra</p>
AVENSIS Liftback (_T22_)						
1.6 (AT220_) 1.6 (AT220_) 1.8 (AT221_) 2.0 (ST220_)	81 74 81 94	09.97 → 10.00 09.97 → 10.00 09.97 → 10.00 09.97 → 10.00	 50-02-282  60-02-279	<p>Drum brakes on the rear axle\Freni a tamburo ad assale post.</p>	 61-02-236  55-02-216  56-02-202  67-02-201  67-02-203	<p>→07.01</p> <p>Right\Destra</p> <p>Left\Sinistra</p>
2.0 TD (CT220_)	66	09.97 → 02.03	 50-02-282  60-02-279	<p>Drum brakes on the rear axle\Freni a tamburo ad assale post.</p>	 51-02-213  61-02-236  61-02-244  55-02-216  56-02-202  67-02-201  67-02-203	<p>→07.01</p> <p>08.01→</p> <p>Right\Destra</p> <p>Left\Sinistra</p>

	KW					
AVENSIS Liftback (_T22_)						
2.0 D-4D (GDT220_)	81	10.99 → 02.03	50-02-221 50-02-263 50-02-282 60-02-279	07.01→ →02.03 Disc brakes on the rear axle\Freni a disco ad assale post. →06.01 Drum brakes on the rear axle\Freni a tamburo ad assale post. Drum brakes on the rear axle\Freni a tamburo ad assale post.	51-02-219 61-02-236 61-02-244 55-02-216 56-02-202 67-02-201 67-02-203	→07.01 08.01→ Right\Destra Left\Sinistra
1.6 VVT-i	81	10.00 → 02.03	50-02-221 50-02-282 60-02-279	Drum brakes on the rear axle\Freni a tamburo ad assale post.	51-02-213 61-02-236 61-02-244 55-02-216 56-02-202 67-02-201 67-02-203	→07.01 08.01→ Right\Destra Left\Sinistra
1.8 VVT-i	95	10.00 → 02.03	50-02-221 50-02-282 60-02-279	07.01→ →02.03 →06.01 Drum brakes on the rear axle\Freni a tamburo ad assale post.	61-02-236 61-02-244 55-02-216 56-02-202 67-02-201 67-02-203	→07.01 08.01→ Right\Destra Left\Sinistra
2.0 VVT-i	110	10.00 → 02.03	50-02-221 50-02-282 60-02-279	07.01→ →02.03 →06.01 Drum brakes on the rear axle\Freni a tamburo ad assale post.	51-02-213 51-02-219 61-02-236 61-02-244 55-02-216 56-02-202 67-02-201 67-02-203	→06.01 07.01→ →07.01 08.01→ Right\Destra Left\Sinistra
AVENSIS Station wagon (T25)						
1.6 VVT-i	81	04.03 →	50-02-206		51-02-200	
1.8	95	04.03 →	60-02-211		61-02-214	
2.0	108	04.03 →			55-02-231	Parking Brake\Freno staz.
2.4	125	09.03 →				
2.4	120	10.03 →				
2.0 D-4D	93	03.06 →	50-02-206		51-02-200	
2.0 D-4D	85	04.03 →	60-02-235		61-02-214 55-02-231	Parking Brake\Freno staz.

































































	KW			
AVENSIS Station wagon (T25) i				
2.2 D-4D	110	10.05 →	50-02-206	51-02-200
2.2 D-CAT	130	07.05 →	60-02-235	61-02-242
				55-02-231 Parking Brake\Freno staz.
AVENSIS Station wagon (T27) i				
2.2 D	130	02.09 →	50-02-276	51-02-223
			60-02-2015	61-02-240
AVENSIS Station Wagon (_T22_) i				
1.6 (AT220_)	81	09.97 → 10.00	50-02-282	61-02-236 →07.01
1.6 (AT220_)	74	09.97 → 10.00	60-02-279	55-02-216
1.8 (AT221_)	81	09.97 → 10.00	Drum brakes on the rear axle\Freni a tamburo ad assale post.	56-02-202
2.0 (ST220_)	94	09.97 → 10.00		67-02-201 Right\Destra
				67-02-203 Left\Sinistra
2.0 TD (CT220_)	66	09.97 → 02.03	50-02-282	51-02-213
			60-02-279	61-02-236 →07.01
			Drum brakes on the rear axle\Freni a tamburo ad assale post.	61-02-244 08.01→
				55-02-216
				56-02-202
				67-02-201 Right\Destra
				67-02-203 Left\Sinistra
2.0 D-4D (CDT220_)	81	10.99 → 02.03	50-02-263	51-02-219
			50-02-282	61-02-236 →07.01
			Disc brakes on the rear axle\Freni a disco ad assale post.	61-02-244 08.01→
			→06.01	55-02-216
			Drum brakes on the rear axle\Freni a tamburo ad assale post.	56-02-202
			60-02-279	67-02-201 Right\Destra
			Drum brakes on the rear axle\Freni a tamburo ad assale post.	67-02-203 Left\Sinistra
1.6 VVT-i	81	10.00 → 02.03	50-02-282	61-02-236 →07.01
			60-02-279	61-02-244 08.01→
			Drum brakes on the rear axle\Freni a tamburo ad assale post.	55-02-216
				56-02-202
				67-02-201 Right\Destra
				67-02-203 Left\Sinistra
2.0 VVT-i	110	10.00 → 02.03	50-02-221	51-02-213 →06.01
			50-02-282	51-02-219 07.01→
			60-02-279	61-02-236 →07.01
			Drum brakes on the rear axle\Freni a tamburo ad assale post.	61-02-244 08.01→
				55-02-216
				56-02-202
				67-02-201 Right\Destra
				67-02-203 Left\Sinistra

































































	KW			
AVENSIS Station Wagon (_T22_)				
1.8 VVT-i	95	10.00 → 02.03	 50-02-221  50-02-282  60-02-279	07.01→ →02.03 →06.01 Drum brakes on the rear axle\Freni a tamburo ad assale post.
				 61-02-236 →07.01  61-02-244 08.01→  55-02-216  56-02-202  67-02-201 Right\Destra  67-02-203 Left\Sinistra
1.9 D	61	10.97 → 05.98		 61-02-236 →07.01
AVENSIS Tre volumi/Saloon (T25)				
1.6 VVT-i	81	04.03 →	 50-02-206  60-02-211	
1.8	95	04.03 →		 51-02-200  61-02-214  55-02-231 Parking Brake\Freno staz.
2.0	108	04.03 →		
2.4	125	09.03 →		
2.4	120	10.03 →		
2.0 D-4D	93	03.06 →	 50-02-206  60-02-235	
2.0 D-4D	85	04.03 →		 51-02-200  61-02-214  55-02-231 Parking Brake\Freno staz.
2.2 D-4D	110	10.05 →	 50-02-206  60-02-235	
2.2 D-CAT	130	07.05 →		 51-02-200  61-02-242  55-02-231 Parking Brake\Freno staz.
AVENSIS Tre volumi/Saloon (T27)				
2.0	112	02.09 →	 50-02-244  60-02-2016	
				 51-02-223  61-02-240
2.2 D	110	02.09 →	 50-02-276  60-02-2015	
				 51-02-223  61-02-240
AVENSIS VERSO				
2.0 D-4D	85	08.01 →	 50-02-213	
2.0 VVT-i	110	08.01 →	 50-02-221  60-02-2002  60-02-213	
				 51-02-219  61-02-258  55-02-223 Parking Brake\Freno staz.
AYGO				
1.0	50	07.05 →	 50-02-217	
1.4 HDi	40	07.05 →	 60-02-269	
				 55-02-212  56-02-203  67-02-207
CAMRY				
2.4 VVTi Hybrid	105	01.06 →	 50-02-277  60-02-2020	
2.4 VVTi LE	116	01.06 →		 51-02-218  61-02-247
CAMRY (_V1_)				
2.2 (SXV10)	100	06.91 → 08.96	 50-02-264  60-02-275  60-02-291	
				 51-02-213  61-02-225  61-02-226

	KW					
CAMRY (_V1_) i						
3.0 (VCV10)	138	06.91 → 08.96	50-02-264 50-02-265 60-02-275	51-02-213 61-02-225 61-02-226		
CAMRY (_V20) i						
3.0 24V (MCV20_)	140	08.96 → 11.01	50-02-213 60-02-2002 60-02-275	51-02-213 61-02-225		
2.2 (SXV20_)	96	08.96 → 11.01	50-02-264 60-02-275 60-02-291	51-02-213 61-02-225 55-06-601		
2.2	93	11.00 → 11.01	50-02-264 60-02-275	51-02-213 61-02-225		
3.0 V6	135	08.96 → 11.01	50-02-213 60-02-275	51-02-213 61-02-225		
CAMRY (_V2_) i						
2.0 (SV21_, SV25_)	94	11.86 → 05.91	50-02-237 50-02-249 60-02-252 60-02-258	Imp. SUMITOMO	51-02-213 61-02-202 61-02-205 55-02-240 67-02-219 67-02-220	Left\Sinistra Right\Destra
2.0 GLi 16V (SV21_, SV25_)	89	11.86 → 05.91			50-02-237 60-02-258 60-02-263	51-02-213 61-02-202 55-02-240 67-02-219 67-02-220
2.5 V6 GXI (VZV21_)	118	02.88 → 05.91	50-02-237 60-02-258 60-02-263		51-02-213 61-02-202 55-02-240 67-02-219 67-02-220	Left\Sinistra Right\Destra
2.0 Turbo-D (CV20_)	62	11.86 → 05.91	50-02-237 60-02-252 60-02-258		55-02-234 67-02-219 67-02-220	→12.88 Left\Sinistra →12.88 Right\Destra
2.0 Turbo-D (CV20_)	63	11.88 → 05.91	50-02-237 60-02-252		55-02-234 67-02-219 67-02-220	Left\Sinistra Right\Destra
1.8 i (SV20_)	66	10.86 → 08.88	50-02-235 60-02-252		55-02-234 67-02-219 67-02-220	Left\Sinistra Right\Destra
2.0 4x4 2.0 GLi 4x4	94 88	08.88 → 05.91 10.87 → 07.88	50-02-249 60-02-258	Imp. SUMITOMO	51-02-213 61-02-205	
CAMRY (_V30) i						

	KW			
CAMRY (_V30) i i				
2.4 VVT-i	112	11.01 →	50-02-218 60-02-2000 60-02-2001	51-02-216 61-02-226
3.0 V6	137	11.01 →	50-02-218 60-02-2000 60-02-2001	51-02-259 61-02-226
2.4 VVTi Hybrid	105	01.06 →	50-02-277	51-02-218
2.4 VVTi LE	116	01.06 →		
3.5 VVTi XLE	197	01.06 →	50-02-277 60-02-2020	51-02-218 61-02-247
CAMRY Liftback (V1) i i				
1.8	66	02.83 → 10.86	50-02-235 60-02-236	55-02-234 67-02-219 67-02-220 Left\Sinistra Right\Destra
1.8 Turbo-D	54	10.84 → 01.88	50-02-235 50-02-237 60-02-236	→12.85 55-02-234 67-02-219 67-02-220 Left\Sinistra Right\Destra
2.0	73	04.86 → 01.88	50-02-235 60-02-236	55-02-240 67-02-219 67-02-220 Left\Sinistra Right\Destra
CAMRY Station Wagon (_V10) i i				
2.2 (SXV10)	100	03.92 → 07.96	50-02-264 60-02-275 60-02-291	51-02-213 61-02-225 61-02-226
3.0 (VCV10)	138	03.92 → 07.96	50-02-264 50-02-265 60-02-275	51-02-213 61-02-225 61-02-226
CAMRY Station Wagon (_V2_) i i				
2.0 (SV21_)	94	11.86 → 05.91	50-02-237	51-02-213
2.0 GLi 16V (SV21_)	89	11.86 → 05.91	50-02-249 60-02-252 60-02-258	61-02-202 61-02-205 55-02-234 67-02-219 67-02-220 Imp. SUMITOMO 08.88→ →07.88 Left\Sinistra Right\Destra
2.0 Turbo-D (CV20_)	62	11.86 → 05.91	50-02-237 60-02-252 60-02-258	55-02-234 67-02-219 67-02-220 Left\Sinistra Right\Destra
2.0 Turbo-D (CV20_)	63	11.88 → 05.91	50-02-237 60-02-252	55-02-240 67-02-219 67-02-220 Left\Sinistra Right\Destra

	KW			
CAMRY Station Wagon (_V2_) i				
2.6 (VZV21_)	118	01.90 → 05.91	 60-02-237  60-02-258  60-02-263	 61-02-213  61-02-202
1.8 (SV20_)	66	11.86 → 08.88	 60-02-237  60-02-252	 66-02-234  67-02-219 LeftSinistra  67-02-220 RightDestra
CAMRY Tre volumi/Saloon (V1) i				
1.8	66	02.83 → 10.86	 60-02-236	 66-02-234
2.0 GLI	79	03.83 → 10.86	 60-02-236	 67-02-219 LeftSinistra  67-02-220 RightDestra
2.0	73	04.86 → 01.88	 60-02-236  60-02-236	 66-02-240  67-02-219 LeftSinistra  67-02-220 RightDestra
1.8 Turbo-D	54	11.83 → 01.88	 60-02-236 →12.85  60-02-237  60-02-236	 66-02-234  67-02-219 LeftSinistra  67-02-220 RightDestra
2.0 GLi 4x4	88	10.87 → 07.88	 60-02-249 Imp. SUMITOMO  60-02-258	 61-02-213  61-02-206  67-02-294
CARINA (TA1_) i				
1.6	55	02.76 → 03.78	 60-02-228	 66-06-601
1.6	63	10.75 → 03.78	 60-02-210	 67-02-213
1.6 (TA12)	58	05.73 → 03.78		
CARINA (TA4L, TA6_L) i				
1.6 (TA4L, TA60L)	55	01.78 → 09.83	 60-02-228	 66-06-601
1.8	57	01.78 → 05.83	 60-02-210	 67-02-213
1.8 D	48	04.82 → 09.83		
1.8	63	01.82 → 02.87	 60-02-228  60-02-223	 66-06-601  67-02-213
1.8 XE	62	08.81 → 09.83	 60-02-223	 66-06-601
CARINA E (_T19_) i				
1.6 (AT190)	73	12.93 → 09.97	 60-02-264	 66-02-234
1.6 (AT190)	85	12.93 → 09.97	 60-02-262	 66-02-208
1.6 GLI (AT190)	79	04.92 → 09.97	 60-02-277	 67-02-219 LeftSinistra  67-02-220 RightDestra
2.0 GLI (ST191)	98	04.92 → 09.97	 60-02-264  60-02-216	 61-02-213  61-02-202  66-02-234  66-02-208  67-02-294 RightDestra  67-02-296 LeftSinistra

	KW			
CARINA E (_T19_)				
2.0 GTi (ST191)	116	04.92 → 02.94	50-02-235 60-02-215 60-02-294	51-02-213 61-02-224 55-02-234 56-02-208 67-02-219 67-02-220
				Left\Sinistra Right\Destra
2.0 GTi 16V (ST191_)	129	03.94 → 09.97	50-02-235 60-02-294	51-02-213 61-02-224 67-02-219 67-02-220
				Left\Sinistra Right\Destra
1.8 (AT191)	79	01.95 → 09.97	50-02-264 60-02-281	55-02-234 56-02-208 67-02-294 67-02-295
				Left\Sinistra Right\Destra
2.0 D (CT190)	54	04.92 → 01.96	50-02-264 60-02-215 60-02-281	55-02-234 56-02-208 67-02-294 67-02-295
				Right\Destra Left\Sinistra
2.0 i (ST191)	93	12.93 → 09.97	50-02-264 60-02-215	51-02-213 61-02-224 67-02-294 67-02-295
				Right\Destra Left\Sinistra
2.0 TD (CT190)	61	01.96 → 09.97	50-02-264 60-02-215	55-02-220 56-02-208 67-02-224 67-02-225
				Right\Destra Left\Sinistra
1.6 16V	78	10.95 → 09.97	50-02-264 60-02-281	55-02-234 56-02-208 67-02-219 67-02-220
				Rear Axle Left\Assale posterior Rear Axle Right\Assale posterio
1.8 GL	92	10.94 → 09.97	50-02-264 60-02-281	55-02-234 56-02-208
CARINA E Sportswagon (_T19_)				
1.6 GLI (AT190_)	79	01.93 → 09.97	50-02-263	55-02-234
1.6 i (AT190_)	73	02.95 → 09.97	50-02-264 60-02-215 60-02-277	56-02-208 67-02-219 67-02-220
				Left\Sinistra Right\Destra
2.0 D (CT190_)	54	01.93 → 01.96	50-02-264	55-02-234
2.0 GLI (ST191_)	98	01.93 → 09.97	60-02-215	56-02-208 67-02-294 67-02-295
				Right\Destra Left\Sinistra

	KW			
CARINA E Sportswagon (_T19_) i i				
1.8 i (AT191_)	79	02.95 → 09.97	 50-02-264  60-02-281	 55-02-234  56-02-208  67-02-294  67-02-295 Left/Sinistra Right/Destra
2.0 i (ST191_)	93	05.95 → 09.97	 50-02-264  60-02-215	 67-02-294  67-02-295 Right/Destra Left/Sinistra
2.0 TD (CT190_)	61	01.96 → 09.97	 50-02-264  60-02-215	 55-02-220  56-02-208  67-02-224  67-02-225 Right/Destra Left/Sinistra
1.8 GL	92	10.94 → 09.97	 50-02-264  60-02-281	 55-02-201  56-02-208
CARINA E Tre volumi/Saloon (_T19_) i i				
1.6 (AT190)	79	01.93 → 09.97	 50-02-264  60-02-252  60-02-277  60-02-281	 55-02-234  56-02-208  67-02-219  67-02-220 Left/Sinistra Right/Destra
1.6 GLI (AT190)	79	04.92 → 09.97	 50-02-264  60-02-252  60-02-277	 55-02-234  56-02-208  67-02-219  67-02-220 Left/Sinistra Right/Destra
2.0 (ST191)	98	01.93 → 09.97	 50-02-264  60-02-215	 55-02-234  56-02-208  67-02-294  67-02-295 Right/Destra Left/Sinistra
2.0 GLI (ST191)	98	04.92 → 09.97	 50-02-264  60-02-215	 51-02-213  61-02-202  55-02-234  56-02-208  67-02-294  67-02-295 Right/Destra Left/Sinistra
2.0 GTi 16V (ST191_)	129	03.94 → 09.97	 50-02-235  60-02-294	 51-02-213  61-02-224  67-02-219  67-02-220 Left/Sinistra Right/Destra
1.6 (AT190)	73	01.95 → 09.97	 50-02-264  60-02-281	 55-02-234  56-02-208
1.6 (AT190)	78	10.95 → 09.97		
1.6 16V (AT190_)	85	12.94 → 09.97		

























































	KW			
CARINA E Tre volumi/Saloon (_T19_)				
1.8 i 16V (AT191)	79	01.95 → 09.97	50-02-264 60-02-281	55-02-234 56-02-208 67-02-294 67-02-295 Left\Sinistra Right\Destra
2.0 D (CT190)	54	08.92 → 01.96	50-02-264 60-02-215 60-02-281	55-02-234 56-02-208 67-02-294 67-02-295 Right\Destra Left\Sinistra
2.0 i (ST191)	93	12.92 → 09.97	50-02-264 60-02-215	67-02-294 67-02-295 Right\Destra Left\Sinistra
2.0 TD (CT190_)	61	01.96 → 09.97	50-02-264 60-02-215	55-02-220 56-02-208 67-02-224 67-02-225 Right\Destra Left\Sinistra
2.0 GTi (ST191_)	116	04.92 → 02.94	50-02-235 60-02-215 60-02-294	51-02-213 61-02-224 55-02-234 56-02-208 67-02-219 67-02-220 Left\Sinistra Right\Destra
1.8	85	04.92 → 09.97	50-02-264	55-02-201
1.8 GL	92	10.94 → 09.97	60-02-281	56-02-208
CARINA II (_T15_)				
1.6 (AT151)	62	10.83 → 11.87	50-02-235	55-02-201
1.6 (AT151)	55	10.83 → 11.87	60-02-246	67-02-219 67-02-220 Left\Sinistra Right\Destra
1.6 (AT151)	63	10.86 → 11.87	50-02-235 60-02-246	55-02-201 67-02-216 67-02-243 Left\Sinistra Right\Destra
1.8 GLI (ST150)	74	10.83 → 11.87	50-02-235	55-02-234
2.0 D	50	02.84 → 05.88	60-02-246	67-02-216
2.0 D (CT150)	51	12.85 → 11.87		67-02-219 67-02-220 Left\Sinistra Left\Sinistra Right\Destra
CARINA II (_T17_)				
1.6 (AT171)	75	12.87 → 03.92	50-02-235	55-02-234
1.6 (AT171)	66	12.87 → 11.89	60-02-259	56-02-218
1.6 (AT171)	72	12.87 → 03.92		67-02-216 67-02-219 67-02-220 Left\Sinistra Left\Sinistra Right\Destra





















































	KW			
CARINA II (_T17_)				
2.0 GLI (ST171)	89	12.87 → 03.92	50-02-237 60-02-252	51-02-213 61-02-202 56-02-218 67-02-216 LeftSinistra 67-02-219 LeftSinistra 67-02-220 RightDestra
2.0 D	54	03.88 → 06.93	50-02-235 60-02-259	55-02-234 56-02-218 67-02-219 LeftSinistra 67-02-220 RightDestra
2.0 GLi	94	12.87 → 03.92	50-02-249 60-02-252	Imp. SUMITOMO 51-02-213 61-02-202 67-02-220
CARINA II Station Wagon (_T17_)				
1.6 (AT171)	75	12.87 → 03.92	50-02-235 60-02-259	55-02-234 56-02-218 67-02-216 LeftSinistra 67-02-219 LeftSinistra 67-02-220 RightDestra
1.6 (AT171)	66	12.87 → 12.89		
1.6 (AT171)	72	12.87 → 03.92		
2.0 D (CT170)	54	12.87 → 01.92	50-02-235 60-02-259	55-02-234 56-02-218 67-02-219 LeftSinistra 67-02-220 RightDestra
2.0	89	12.87 → 04.92	50-02-237 60-02-252	51-02-213 61-02-202 55-02-234 56-02-218 67-02-216 LeftSinistra 67-02-219 LeftSinistra 67-02-220 RightDestra
2.0 GLi	94	12.87 → 03.92	50-02-249 60-02-252	Imp. SUMITOMO 51-02-213 61-02-202 67-02-220
CARINA II Tre volumi/Saloon (_T15_)				
1.6 (AT151)	55	10.83 → 11.87	50-02-235 60-02-246	55-02-234 56-02-218 67-02-219 LeftSinistra 67-02-220 RightDestra
1.6 (AT151)	62	10.83 → 11.87	50-02-235 60-02-246	55-02-234 67-02-219 LeftSinistra 67-02-220 RightDestra

	KW			
CARINA II Tre volumi/Saloon (_T15_) i				
1.8 GLI (ST150)	74	10.83 → 11.87	50-02-235	55-02-234
2.0 D	50	02.84 → 05.88	60-02-246	56-02-218
				67-02-216 Left\Sinistra
				67-02-219 Left\Sinistra
				67-02-220 Right\Destra
CARINA II Tre volumi/Saloon (_T17_) i				
1.6 (AT171)	75	12.87 → 03.92	50-02-235	55-02-234
1.6 (AT171)	66	12.87 → 08.90	60-02-259	56-02-218
1.6 (AT171)	72	12.87 → 03.92		67-02-216 Left\Sinistra
				67-02-219 Left\Sinistra
				67-02-220 Right\Destra
2.0 GLI (ST171)	89	12.87 → 03.92	50-02-237	51-02-213
			60-02-252	61-02-202
				56-02-218
				67-02-216 Left\Sinistra
				67-02-219 Left\Sinistra
				67-02-220 Right\Destra
2.0 D	54	03.88 → 06.93	50-02-235	55-02-234
			60-02-259	56-02-218
				67-02-219 Left\Sinistra
				67-02-220 Right\Destra
2.0	94	12.87 → 03.92	50-02-249	51-02-213
			60-02-252	61-02-202
			Imp. SUMITOMO	67-02-220
CARINA Station Wagon (TA4K, TA6K) i				
1.6 (TA4K)	54	03.81 → 01.82	50-02-228	55-06-601
1.6 (TA4K, TA60LG)	55	04.78 → 09.83	60-02-210	67-02-213
1.8	57	08.82 → 12.82		
1.8 D	48	04.82 → 09.83		
CELICA (ST16_) i				
2.0	110	01.87 → 08.90	50-02-235	55-02-204
			60-02-203	56-02-208
				67-02-294
1.6	63	04.86 → 02.90	50-02-235	55-02-234
			60-02-246	67-02-219 Left\Sinistra
				67-02-220 Right\Destra
1.6 GT 16V	91	04.86 → 08.89	50-02-235	55-02-234
			60-02-246	56-02-218
				67-02-219 Left\Sinistra
				67-02-220 Right\Destra
CELICA (TA2) i				





















































	KW			
CELICA (TA2) i				
1.6 GT (TA2, TA22)	79	12.74 → 03.78	50-02-228 60-02-210	55-06-601 67-02-213
1.6 LT (TA2)	55	02.76 → 03.78		
1.6 LT (TA22)	58	05.73 → 03.78		
1.6 ST (TA2, TA22)	63	05.73 → 03.78		
2.0	63	10.75 → 07.77		
CELICA (TA60, RA40, RA6_) i				
1.6 ST (TA60)	63	08.77 → 08.85	50-02-293 60-02-214	55-06-601 67-02-213
1.6 ST (TA60)	66	02.79 → 08.83	50-02-293	55-06-601
2.0 GT (RA63)	90	02.78 → 08.83	60-02-214	67-02-208
2.0 XT (RA40)	65	01.80 → 12.82		
2.0 XT (RA40)	66	02.79 → 07.85		
2.0 XT (RA61)	77	02.82 → 08.85	50-02-235 50-02-293 60-02-214 60-02-226	55-06-601 67-02-208
				Left/Sinistra
CELICA (ZZT23_) i				
1.8 16V TS (ZZT231_)	141	11.99 →	50-02-203 60-02-203	51-02-203 61-02-210
1.8 16V VT-i (ZZT230_)	105	11.99 →		
CELICA (_T20_) i				
1.8 i 16V (AT200/ST)	85	11.93 → 11.99	50-02-264 60-02-203 60-02-282	51-02-213 61-02-202
2.0 i 16V (ST202/GT)	129	11.93 → 11.99	50-02-265 60-02-211	51-02-213 61-02-202
			04.94→	04.94→
2.0 i Turbo 4WD (ST205)	178	02.94 → 11.99	50-02-293 60-02-289	51-02-294 61-02-202
2.0 i 16V	125	04.96 → 11.99	50-02-265 60-02-270	51-02-213 61-02-202
			Imp. AKEBONO	
CELICA Cabriolet (_T16_) i				
2.0 GT (ST162)	110	10.86 → 08.90	50-02-235	51-02-213
2.0 GT (ST162)	103	10.86 → 08.90	50-02-237 50-02-247 60-02-248 60-02-282	61-02-202 67-02-294
			NO ABS 12.88→ →11.88 Imp. AKEBONO	
CELICA Cabriolet (_T18_) i				
2.0 GTi (ST182)	115	05.91 → 01.94	50-02-237 60-02-262 60-02-263 60-02-282	51-02-213 61-02-202































































	KW			
CELICA Cabriolet (_T20_) <i>i</i> <i>i</i>				
2.0 i 16V	125	04.96 → 11.99	 50-02-265  60-02-282	 51-02-213  61-02-202
CELICA Coupe (RA6) <i>i</i> <i>i</i>				
2.0	77	01.82 → 10.86	 50-02-231  60-02-226	 55-06-601  67-02-208 Left/Sinistra
2.0	88	01.82 → 10.86	 50-02-231  60-02-214	 55-06-601  67-02-208
1.6	91	12.83 → 10.86	 60-02-226	 67-02-219
CELICA Coupe (T16F) <i>i</i> <i>i</i>				
2.0 Turbo 4x4	136	03.88 → 08.90	 50-02-249  60-02-282	Imp. SUMITOMO  51-02-213  61-02-205
2.0	103	08.87 → 08.89	 50-02-235  50-02-249  60-02-248  60-02-282	NO ABS Imp. SUMITOMO  51-02-213  61-02-202
CELICA Coupe (TA4C, TA60) <i>i</i> <i>i</i>				
1.6 GT (TA4C)	80	04.78 → 02.82	 50-02-293  60-02-214	 55-06-601  67-02-213
1.6 LT (TA4C)	55	02.79 → 07.83		
1.6 ST (TA60)	66	02.79 → 08.83		
1.6 ST (TA4C, TA60)	63	08.77 → 08.85	 50-02-293  60-02-210  60-02-214	 55-06-601  67-02-213
1.6 GT (TA4C)	81	04.80 → 02.82	 60-02-214	 55-06-601  67-02-213
CELICA Coupe (_T18_) <i>i</i> <i>i</i>				
1.6 STI (AT180)	77	10.89 → 01.94	 50-02-235  60-02-252  60-02-298	08.91→ →07.91  55-02-201  56-02-218  67-02-219  67-02-294 Right/Destra Left/Sinistra
2.0 GTi (ST182)	115	10.89 → 01.94	 50-02-237  60-02-262  60-02-263  60-02-282	 51-02-213  61-02-202
2.0 Turbo 4WD (ST185)	153	10.89 → 01.94	 50-02-237	 51-02-213
2.0 Turbo 4WD (ST185)	150	10.89 → 01.94	 60-02-263	 61-02-208
CELICA Hatchback (T16) <i>i</i> <i>i</i>				

	KW			
CELICA Hatchback (T16)				
1.6	63	04.86 → 02.90	 50-02-235	 55-02-234
1.6 GT	85	08.87 → 08.89	 60-02-246	 56-02-218
1.6 GT 16V	91	09.85 → 08.89		 67-02-219
				 67-02-220
				Left\Sinistra
				Right\Destra
2.0 GT	110	08.85 → 08.89	 50-02-235	 51-02-213
2.0 GT	103	09.85 → 08.89	 50-02-237	 61-02-202
			 50-02-247	 67-02-294
			 60-02-248	
			 60-02-282	
			NO ABS	
			12.88→	
			→11.88	
			Imp. AKEBONO	
CELICA SUPRA (MA61)				
2.8 i	125	05.82 → 10.86	 50-02-235	 51-02-261
			 60-02-227	 61-02-206
COROLLA (KE)				
1.2 (KE20, KE25)	43	10.72 → 06.77	 50-02-210	 55-02-206
1.2 (KE20, KE25, KE30)	40	08.74 → 12.80	 60-02-206	 67-02-208
			 60-02-218	
COROLLA (_E10_)				
1.3 12V (EE100_)	53	07.92 → 04.97	 50-02-264	 55-02-294
1.3 XLI (EE101_)	55	09.95 → 04.97	 60-02-233	 56-02-207
1.3 XLI 16V (EE101)	65	07.92 → 09.95		 67-02-294
1.6 Si (AE101_)	84	09.95 → 04.97		 67-02-295
2.0 D (CE100_)	53	07.92 → 04.97		
				Left\Sinistra
				Right\Destra
COROLLA (_E11_)				
1.4 (EE111_)	63	04.97 → 02.00	 50-02-264	 51-02-213
			 60-02-233	 61-02-235
				 61-02-248
				 55-02-234
				 56-02-207
				 67-02-294
				 67-02-295
				Made in Great Britain
1.6 (AE111_)	81	04.97 → 02.00	 50-02-264	 51-02-213
1.6 Aut. (AE111_)	79	04.97 → 02.00	 50-02-281	 61-02-235
			 60-02-233	 61-02-248
				 55-02-201
				 56-02-207
				 67-02-294
				 67-02-295
				Left\Sinistra
				Right\Destra

	KW			
COROLLA (_E11_)				
2.0 D (CE110_)	53	04.97 → 02.00	50-02-264 60-02-233	51-02-213 61-02-235 61-02-248 55-02-201 56-02-207 67-02-219 67-02-220
				Made in Great Britain Left\Sinistra Right\Destra
1.4 16V (ZZE111_)	71	02.00 → 01.02	50-02-201 50-02-216 60-02-207	51-02-213 61-02-235 61-02-248 55-02-201 56-02-207 67-02-294 67-02-295
			con/with ABS	Made in Great Britain
1.6 16V (ZZE112_)	81	02.00 → 01.02	50-02-201 50-02-216 60-02-2022 60-02-207	51-02-213 61-02-235 61-02-248 55-02-201 56-02-207 67-02-294 67-02-295
			con/with ABS →08.00 10.01→	Made in Great Britain
1.9 D (WZE110_)	51	02.00 → 01.02	50-02-264 60-02-233	51-02-213 61-02-235 61-02-248 55-02-294 56-02-207 67-02-295
				Made in Great Britain
2.0 D-4D	66	09.00 → 01.02	50-02-201 50-02-216 60-02-201	51-02-213 61-02-235 61-02-248 55-02-201 56-02-207
			con/with ABS 10.01→ CDE120R	Made in Great Britain
1.3 16V	63	01.97 → 12.00	50-02-264 60-02-233	51-02-213 61-02-235 61-02-248 55-02-201 56-02-207 67-02-294 67-02-295
				Made in Great Britain Left\Sinistra Right\Destra
COROLLA (_E12U_)				

	KW			
COROLLA (_E12U_)				
1.4 VVT-i	71	01.02 →	 50-02-211  60-02-207	 51-02-257  61-02-217
1.6 VVT-i 1.8 VVTL-i TS	81 141	01.02 → 01.02 →	 50-02-211  60-02-207	 51-02-257  61-02-217  55-02-231 →05.04 Parking Brake\Freno staz.  55-02-232 06.04→ Parking Brake\Freno staz.
2.0 D-4D 2.0 D-4D	81 66	01.02 → 01.02 →	 50-02-211  60-02-201	 51-02-257  61-02-215  55-02-232 Parking Brake\Freno staz.
2.0 D-4D	85	05.03 →	 50-02-211  60-02-201	 51-02-257  61-02-215  55-02-232 Parking Brake\Freno staz.  56-02-211
1.4 D	66	07.04 →	 50-02-211  60-02-201	 51-02-257  61-02-217
1.8 VVTL-i TS	165	02.05 →	 50-02-203  60-02-207	 51-02-257  61-02-217  55-02-231 Parking Brake\Freno staz.
COROLLA (_E7_)				
1.3 (KE70) 1.3 (KE70) 1.6 (TE71)	48 44 55	02.82 → 06.83 09.79 → 06.83 10.82 → 09.83	 50-03-310  60-02-228	 55-06-601  67-02-206
1.8 D (CE70)	43	01.83 → 09.83	 50-02-235  60-02-239  60-02-288	 55-02-294  67-02-216 Left\Sinistra  67-02-217 Right\Destra
COROLLA (_E8_)				
1.3 (AE80)	51	06.83 → 10.84	 50-02-235  60-02-239	 55-02-234  67-02-219 Left\Sinistra  67-02-220 Right\Destra
1.3 (AE80/EE80)	55	10.84 → 08.87	 50-02-235  60-02-239	 55-02-234  67-02-216 01.85→ Left\Sinistra EE80  67-02-217 01.85→ Right\Destra EE80

































































	KW			
COROLLA (_E8_) <i>i</i> <i>i</i>				
1.6	54	12.85 → 05.88	50-02-235	51-02-213
1.6 (AE82)	62	06.83 → 08.87	60-02-243	61-02-201
1.6 (AE82)	53	08.85 → 08.87		55-02-234
				67-02-216 Left\Sinistra
				67-02-217 Right\Destra
1.8 D	43	06.83 → 05.88	50-02-235	55-02-294
			60-02-239	56-02-218
			60-02-288	67-02-216 Left\Sinistra
				67-02-217 Right\Destra
1.8 D	47	07.85 → 05.88	50-02-235	55-02-294
			60-02-239	67-02-216 Left\Sinistra
			60-02-288	67-02-217 Right\Destra
COROLLA (_E9_) <i>i</i> <i>i</i>				
1.6 (AE92)	66	08.87 → 12.89	50-02-235	55-02-294
			60-02-265	56-02-218
			60-02-288	67-02-216 Left\Sinistra
				67-02-217 Right\Destra
1.3 i (EE90)	55	08.87 → 12.92	50-02-235	55-02-294
			60-02-265	56-02-218
				67-02-216 Left\Sinistra
				67-02-217 Right\Destra
1.6 i	77	11.89 → 06.93	50-02-235	55-02-294
1.8 D	47	07.87 → 06.93	60-02-239	56-02-218
1.8 D	49	11.89 → 06.93	60-02-288	67-02-216 Left\Sinistra
				67-02-217 Right\Destra
1.6 i 4WD	77	10.87 → 08.90	50-02-235	
1.6 GL 4x4	70	10.87 → 08.90	50-02-235	55-02-299
			60-02-266	
COROLLA Combi (KE) <i>i</i> <i>i</i>				
1.2 (KE36)	40	07.75 → 01.80	50-02-210	55-02-206
			60-02-218	67-02-208
COROLLA Compact (_E10_) <i>i</i> <i>i</i>				
1.3 12V (EE100_)	53	07.92 → 05.95	50-02-264	55-02-294
1.3 XLI (EE101_)	55	09.95 → 04.97	60-02-233	56-02-207
1.3 XLI 16V (EE101)	65	07.92 → 09.95		67-02-294 Left\Sinistra
1.6 Si (AE101_)	84	07.92 → 04.97		67-02-295 Right\Destra
2.0 D (CE100_)	53	07.92 → 04.97		
1.8 GT (AE102_)	86	11.92 → 05.95	50-02-264	55-02-201
			60-02-233	56-02-207
COROLLA Compact (_E11_) <i>i</i> <i>i</i>				

	KW					
COROLLA Compact (_E11_)						
1.4 (EE111_)	63	04.97 → 02.00	 50-02-264  60-02-233	 51-02-213  61-02-235  61-02-248  55-02-234  56-02-207  67-02-294  67-02-295	<p>Made in Great Britain</p> <p>Left\Sinistra Right\Destra</p>	
1.6 (AE111_)	81	04.97 → 02.00	 50-02-264	 51-02-213	<p>Made in Great Britain</p> <p>Left\Sinistra Right\Destra</p>	
1.6 Aut. (AE111_)	79	04.97 → 02.00	 50-02-281  60-02-233	 61-02-235  61-02-248  55-02-201  56-02-207  67-02-294  67-02-295		
2.0 D (CE110_)	53	04.97 → 02.00	 50-02-264  60-02-233	 51-02-213  61-02-235  61-02-248  55-02-201  56-02-207  67-02-219  67-02-220	<p>Made in Great Britain</p> <p>Left\Sinistra Right\Destra</p>	
1.4 (ZZE111_)	71	02.00 → 01.02	 50-02-211  60-02-223	 51-02-213  61-02-235  61-02-248  55-02-220  56-02-207  67-02-294  67-02-295	<p>Made in Great Britain</p> <p>Left\Sinistra Right\Destra</p>	
1.6 (ZZE112_)	81	02.00 → 01.02	 50-02-201  50-02-216  60-02-2022  60-02-207	<p>con/with ABS →08.00 10.01→</p>	 51-02-213  61-02-235  61-02-248  55-02-201  56-02-207  67-02-294  67-02-295	<p>Made in Great Britain</p> <p>Left\Sinistra Right\Destra</p>
2.0 D-4D	66	09.00 → 01.02	 50-02-201  50-02-216  60-02-201	<p>con/with ABS 10.01→ CDE120R</p>	 51-02-213  61-02-235  61-02-248  55-02-201  56-02-207	<p>Made in Great Britain</p>





































































	KW				
COROLLA Compact (_E11_) <i>i</i> <i>i</i>					
1.9 D (WZE110_)	51	02.00 → 01.02	50-02-264 60-02-233	51-02-213 61-02-235 61-02-248 55-02-294 56-02-207 67-02-294 67-02-295	
				Made in Great Britain Left\Sinistra Right\Destra	
COROLLA Compact (_E9_) <i>i</i> <i>i</i>					
1.6 GTi (AE92)	85	08.87 → 04.92	50-02-235 50-02-258 60-02-265 60-02-266 60-02-288	51-02-213 61-02-201 55-02-294 56-02-218 67-02-216 67-02-217	
				Left\Sinistra Right\Destra	
1.6 (AE92)	66	08.87 → 04.92	50-02-235 60-02-265 60-02-288	55-02-294 56-02-218 67-02-216 67-02-217	
1.6 (AE92)	77	08.89 → 04.92			Left\Sinistra Right\Destra
1.8 D (CE90)	47	08.87 → 04.92	50-02-235 60-02-239 60-02-288	55-02-294 56-02-218 67-02-216 67-02-217	
1.8 D (CE90)	49	08.89 → 04.92			Left\Sinistra Right\Destra
1.3 (EE90)	55	08.87 → 12.89	50-02-235 60-02-265	55-02-294 56-02-218 67-02-216 67-02-217	
1.3 i (EE90)	55	06.89 → 04.92			Left\Sinistra Right\Destra
COROLLA Coupe (AE86) <i>i</i> <i>i</i>					
1.6 16V	85	12.85 → 04.87	50-02-229 50-02-287 60-02-240	51-02-207 61-02-200 55-06-601 67-02-219 67-02-220	
1.6 GT 16V (AE86)	91	08.83 → 07.87			Left\Sinistra
1.6 SR 16V	57	05.83 → 04.87			Right\Destra
COROLLA Coupe (KE) <i>i</i> <i>i</i>					
1.2 (KE35)	40	07.75 → 01.80	50-02-210 60-02-218	55-02-206 67-02-208	
COROLLA FX Compact (E8B) <i>i</i> <i>i</i>					

	KW			
COROLLA FX Compact (E8B) i i				
1.6 1.6 GT 16V	55 89	08.84 → 08.87 08.85 → 08.87	50-02-235 60-02-243	51-02-213 61-02-201 55-02-234 56-02-218 67-02-216 67-02-217 Left/Sinistra Right/Destra
1.3 1.8 D	55 43	08.85 → 08.87 01.85 → 05.88	50-02-235 60-02-239	55-02-234 56-02-218 67-02-216 67-02-217 Left/Sinistra Right/Destra
1.8 D	47	08.85 → 08.87	50-02-235 50-02-294 60-02-239 60-02-288	55-02-234 56-02-218 67-02-216 67-02-217 Left/Sinistra Right/Destra
1.6	54	01.87 → 09.87	50-02-235 60-02-243	61-02-201 55-02-234 56-02-218 67-02-216 67-02-217 Left/Sinistra Right/Destra
1.3	60	10.84 → 04.87	50-02-235 60-02-239	55-02-234 56-02-218 67-02-220
COROLLA Hatchback (KE, TE) i i				
1.2 1.6 1.6	40 54 62	09.76 → 01.80 09.76 → 01.80 09.76 → 01.80	50-02-210 60-02-218	55-02-206 67-02-208
COROLLA Hatchback (_E7_) i i				
1.3 (KE70)	44	09.79 → 01.82	50-03-310 60-02-228	55-02-206 67-02-206
1.3 (KE70)	48	02.82 → 05.83	50-03-310 60-02-212	55-02-206 67-02-206
1.6 (TE71) 1.6 (TE71) 1.6 (TE71) 1.6 GT (TE71) 1.8 (TE72)	55 54 63 81 57	09.79 → 05.83 09.79 → 05.83 09.79 → 05.83 05.80 → 09.83 09.79 → 05.82	50-03-310 60-02-228	55-06-601 67-02-206
1.8 D (CE70)	48	01.83 → 09.83	50-02-235 60-02-239 60-02-288	55-02-294 67-02-216 67-02-217 Left/Sinistra Right/Destra
COROLLA Liftback (_E10_) i i				



























































	KW			
COROLLA Liftback (_E10_) i i				
1.3 12V (EE100_)	53	07.92 → 05.95	50-02-264 60-02-233	55-02-294 56-02-207 67-02-294 67-02-295 Left\Sinistra Right\Destra
1.3 XLI (EE101_)	65	07.92 → 04.97		
1.6 GLI (AE101_)	84	07.92 → 04.97		
2.0 D (CE100_)	53	07.92 → 04.97		
1.8 GT (AE102_)	86	11.92 → 05.95	50-02-264 60-02-233	61-02-235 55-02-201 56-02-207
COROLLA Liftback (_E11_) i i				
1.6 (AE111_)	81	04.97 → 02.00	50-02-264	51-02-213
1.6 Aut. (AE111_)	79	04.97 → 02.00	50-02-281 60-02-233	61-02-235 61-02-248 55-02-201 56-02-207 67-02-294 67-02-295 Made in Great Britain Left\Sinistra Right\Destra
1.4 (EE111_)	63	04.97 → 02.00	50-02-264 60-02-233	51-02-213 61-02-235 61-02-248 55-02-234 56-02-207 67-02-294 67-02-295 Made in Great Britain Left\Sinistra Right\Destra
2.0 D (CE110)	53	04.97 → 02.00	50-02-264 60-02-233	51-02-213 61-02-235 61-02-248 55-02-201 56-02-207 67-02-219 67-02-220 Made in Great Britain Left\Sinistra Right\Destra
1.4 (ZZE111_)	71	02.00 → 01.02	50-02-211 60-02-207	51-02-213 61-02-235 61-02-248 55-02-201 56-02-207 67-02-294 67-02-295 Made in Great Britain Left\Sinistra Right\Destra

	KW					
COROLLA Liftback (_E11_)						
1.6 (ZZE112_)	81	02.00 → 01.02	 50-02-201  50-02-216  60-02-2022  60-02-207	con/with ABS →08.00	 51-02-213  61-02-235  61-02-248  55-02-201  56-02-207  67-02-294  67-02-295	Made in Great Britain Left\Sinistra Right\Destra
2.0 D-4D	66	09.00 → 01.02	 50-02-201  50-02-216  60-02-201	con/with ABS 10.01→ CDE120R	 51-02-213  61-02-235  61-02-248  55-02-201  56-02-207	Made in Great Britain
1.9 D (WZE110_)	51	02.00 → 01.02	 50-02-264  60-02-233		 51-02-213  61-02-235  61-02-248  55-02-294  56-02-207  67-02-294  67-02-295	Made in Great Britain Left\Sinistra Right\Destra
COROLLA Liftback (_E8_)						
1.3 (AE80)	51	06.83 → 09.84	 50-02-235  60-02-239		 55-02-234  56-02-218  67-02-219  67-02-220	Left\Sinistra Right\Destra
1.3 (EE80)	55	01.85 → 08.87	 50-02-235  60-02-239		 55-02-234  56-02-218  67-02-216  67-02-217	Left\Sinistra Right\Destra
1.6	63	07.85 → 05.88	 50-02-235  60-02-243		 51-02-213	Left\Sinistra Right\Destra
1.6 (AE82)	62	06.83 → 08.87			 61-02-201	
1.6 (AE82)	54	08.85 → 08.87			 55-02-234  56-02-218  67-02-216  67-02-217	
1.8 D	43	06.83 → 05.88	 50-02-235  60-02-239  60-02-288		 55-02-294	Left\Sinistra Right\Destra
1.8 D (CE80)	47	06.83 → 08.87			 56-02-218  67-02-216  67-02-217	
1.3	60	08.83 → 04.87	 50-02-235  60-02-239		 55-02-234  56-02-218  67-02-220	



























































	KW			
COROLLA Liftback (_E9_)				
1.6	70	08.87 → 04.92	50-02-235	55-02-294
1.6 (AE92)	66	08.87 → 04.92	60-02-265	56-02-218
1.6 (AE92)	77	08.89 → 04.92	60-02-288	67-02-216 67-02-217
				Left\Sinistra Right\Destra
1.8 D (CE90)	47	08.87 → 04.92	50-02-235	55-02-294
1.8 D (CE90)	49	08.89 → 04.92	60-02-239	56-02-218
			60-02-288	67-02-216 67-02-217
				Left\Sinistra Right\Destra
1.3 i (EE90)	55	08.87 → 04.92	50-02-235	55-02-294
			60-02-265	56-02-218
				67-02-216 67-02-217
				Left\Sinistra Right\Destra
1.6 GTI	92	07.87 → 06.93	50-02-235	51-02-213
			60-02-265	61-02-201
			60-02-266	55-02-299
			60-02-288	56-02-218
				67-02-216 67-02-217
				Left\Sinistra Right\Destra
1.3	60	05.87 → 04.92		56-02-218
COROLLA MPV / Space Wagon				
2.2 D-4D	100	10.05 →	50-02-206	51-02-200
			60-02-264	61-02-231
COROLLA Station Wagon (_E12J_)				
1.4 VVT-i	71	01.02 →	50-02-211	51-02-257
1.6 VVT-i	81	01.02 →	60-02-207	61-02-217
				55-02-231
				Parking Brake\Freno staz.
2.0 D-4D	66	01.02 →	50-02-211	51-02-203
			60-02-219	61-02-218
				55-02-231
				Parking Brake\Freno staz.
2.0 D-4D	85	04.04 →	50-02-211	51-02-257
			60-02-219	61-02-218
1.4 D	66	07.04 →	50-02-211	51-02-257
			60-02-201	61-02-217
				55-02-232
				Parking Brake\Freno staz.
COROLLA Station Wagon (_E7_)				
1.3 (KE70)	44	12.79 → 01.82	60-02-212	55-02-206
				67-02-206
1.3 (KE70)	48	02.82 → 08.87	50-02-287	55-02-206
			60-02-212	67-02-206

	KW				
COROLLA Station Wagon (_E7_) i					
1.8 D (CE70)	44	05.83 → 08.87	 50-02-235  60-02-239  60-02-288	 55-02-294  56-02-218  67-02-216  67-02-217	Left\Sinistra Right\Destra
COROLLA Station Wagon (_E9_) i					
1.6 XLI 4x4 (AE95)	77	08.88 → 06.92	 50-02-235  60-02-265	 55-02-299  67-02-215	
1.3 (EE90)	55	12.87 → 12.89	 50-02-235  60-02-265	 55-02-294  56-02-218  67-02-216  67-02-217	Left\Sinistra Right\Destra
1.3 i (EE90)	55	06.89 → 06.92			
1.8 D (CE90)	49	08.89 → 06.92	 50-02-235  60-02-239  60-02-288	 55-02-294  56-02-218  67-02-216  67-02-217	Left\Sinistra Right\Destra
1.8 D (CE90)	47	12.87 → 06.92			
1.6 XLI	77	11.89 → 06.92	 50-02-235  60-02-265	 55-02-299  56-02-218  67-02-215	
1.6 (AE92)	66	02.88 → 05.92	 50-02-235  60-02-265  60-02-288	 55-02-294  56-02-218  67-02-216  67-02-217	Left\Sinistra Right\Destra
1.6 (AE92)	70	12.87 → 04.92			
COROLLA Tre volumi/Saloon (_E12_) i					
1.4 VVT-i	71	08.02 →	 50-02-211  60-02-207	 51-02-257  61-02-217  55-02-231  55-02-232	Parking Brake\Freno staz. Parking Brake\Freno staz.
1.6 VVT-i	81	08.02 →	 50-02-211  60-02-207  60-02-208	 51-02-257  61-02-217  55-02-231  55-02-232	Parking Brake\Freno staz. Parking Brake\Freno staz.
2.0 D-4D	66	08.02 →	 50-02-211  60-02-201	 51-02-257  61-02-215  55-02-232	Parking Brake\Freno staz.
1.4 D	66	07.04 →	 50-02-211  60-02-201	 51-02-257  61-02-217  55-02-231	Parking Brake\Freno staz.
2.0 D4d	85	06.04 →	 50-02-211  60-02-201	 51-02-257  61-02-218  55-02-232	Parking Brake\Freno staz.



























































	KW			
COROLLA Verso <i>i</i> <i>i</i>				
1.6	81	04.04 →	50-02-206 60-02-264	51-02-200 61-02-231
1.8	95	04.04 →		
2.0 D-4D	85	04.04 →		
2.2 D-4D	130	10.05 →		
COROLLA Verso (_E12J_) <i>i</i> <i>i</i>				
1.4 VVT-i	71	01.02 → 05.04	50-02-211 60-02-207	51-02-257 61-02-217 55-02-231 Parking Brake\Freno staz.
1.6 VVT-i	81	01.02 → 05.04	50-02-203 60-02-208	51-02-203 61-02-218 55-02-231 Parking Brake\Freno staz.
1.8 VVT-i	99	01.02 → 05.04	50-02-212 60-02-219	51-02-203 61-02-218 55-02-231 Parking Brake\Freno staz.
2.0 D-4D	66	01.02 → 05.04		
COROLLA Wagon (_E10_) <i>i</i> <i>i</i>				
1.3 12V (EE100_)	53	07.92 → 05.95	50-02-264	55-02-294
1.3 XLI (EE101_)	55	09.95 → 04.97	60-02-233	56-02-207
1.3 XLI 16V (EE101_)	65	07.92 → 09.95		67-02-294 Left\Sinistra
1.6 Si (AE101_)	84	07.92 → 04.97		67-02-295 Right\Destra
2.0 D (CE100_)	53	07.92 → 04.97		
1.8 16V 4WD (AE103_)	81	09.95 → 04.97	50-02-235 60-02-233	55-02-294 56-02-207 67-02-294 Left\Sinistra 67-02-295 Right\Destra
COROLLA Wagon (_E11_) <i>i</i> <i>i</i>				
1.4 (EE111_)	63	04.97 → 02.00	50-02-264 60-02-233	51-02-213 61-02-235 61-02-248 Made in Great Britain 55-02-234 56-02-207 67-02-294 Left\Sinistra 67-02-295 Right\Destra
1.6 (AE111_)	81	04.97 → 02.00	50-02-264	51-02-213
1.6 Aut. (AE111_)	79	04.97 → 02.00	50-02-281 60-02-233	61-02-235 61-02-248 Made in Great Britain 55-02-201 56-02-207 67-02-294 Left\Sinistra 67-02-295 Right\Destra

	KW					
COROLLA Wagon (_E11_) i i						
1.8 AWD (AE116_)	81	04.97 → 01.02	 60-02-264  60-02-281  60-02-233	 61-02-213  61-02-236  61-02-248  55-02-294  56-02-207  67-02-216  67-02-217	Made in Great Britain LeftSinistra RightDestra	
2.0 D (CE110_)	53	04.97 → 02.00	 60-02-264  60-02-233	 61-02-213  61-02-236  61-02-248  55-02-201  56-02-207  67-02-219  67-02-220	Made in Great Britain LeftSinistra RightDestra	
1.4 16V (ZZE111_)	71	02.00 → 01.02	 60-02-212  60-02-208	 61-02-213  61-02-236  61-02-248  55-02-201  56-02-207  67-02-294  67-02-296	Made in Great Britain LeftSinistra RightDestra	
1.6 16V (ZZE112_)	81	02.00 → 01.02	 60-02-201  60-02-216  60-02-208	con/with ABS	 61-02-213  61-02-236  61-02-248  55-02-201  56-02-207  67-02-294  67-02-296	Made in Great Britain LeftSinistra RightDestra
1.9 D (WZE110_)	51	02.00 → 01.02	 60-02-264  60-02-233		 61-02-213  61-02-236  61-02-248  55-02-294  56-02-207  67-02-216  67-02-217	Made in Great Britain LeftSinistra RightDestra
2.0 D-4D	66	09.00 → 01.02	 60-02-201  60-02-216  60-02-219	con/with ABS 10.01→	 61-02-213  61-02-236  61-02-248  55-02-207	Made in Great Britain
CORONA (RX, RT) i i						















































	KW			
CORONA (RX, RT)				
1.8 (TT1)	63	06.79 → 01.81	50-02-228 60-02-216	55-06-601 67-02-208
2.0 (RT104)	65	01.76 → 05.79		
2.0 Mark II (RX12)	65	12.75 → 10.77		
2.0 Mark II (RX22)	65	12.75 → 10.77		
CORONA Hatchback				
1.8	79	02.92 → 09.97	50-02-264 60-02-233	61-02-235
CORONA Hatchback (TT)				
1.8	63	06.79 → 07.81	50-02-228 60-02-216	55-06-601 67-02-208
CORONA Station wagon				
1.8	79	02.92 → 09.97	50-02-264 60-02-233	51-02-207 61-02-235
CORONA Station wagon (RT118)				
2.0	65	09.75 → 05.79	50-02-228 60-02-216	55-06-601 67-02-208
CORONA Tre volumi/Saloon				
1.8	79	02.92 → 09.97	50-02-264 60-02-233	51-02-207 61-02-235
CRESSIDA (RX3_)				
2.0 (RX30)	66	07.77 → 07.81	50-01-108 60-02-216	55-06-601 67-02-208
CRESSIDA (_X6_)				
2.0 (RX60)	77	05.81 → 03.85	50-02-232 60-02-267	51-02-202 61-02-206 55-06-601 67-02-208
2.0 GLI	80	11.82 → 12.84	50-02-232 60-02-267	51-02-202 61-02-211 55-06-601 67-02-208
2.2 D (LX60)	49	09.80 → 07.84	50-02-232 60-02-267	51-02-202 55-06-601 67-02-208
2.4 TD	66	05.85 → 09.88	50-05-502 60-02-242	Imp. AKEBONO 51-02-261 61-02-206 55-06-601 67-02-290

	KW			
CRESSIDA (_X6_) <i>i</i> <i>i</i>				
2.0	125	10.88 → 09.91	 50-05-502  60-02-242	Imp. AKEBONO  51-02-261  61-02-206  67-02-291
2.4 D	63	08.84 →	 50-05-502  60-02-242	Imp. AKEBONO  51-02-261  61-02-206
2.8	106	05.85 → 09.88	 50-02-242	 61-02-206  61-02-211
2.0 GLi	110	08.82 → 09.92	 50-02-242  60-02-267	 51-02-202  61-02-206  55-06-601
CRESSIDA Station Wagon (RX3_) <i>i</i> <i>i</i>				
2.0 (RX35)	66	12.77 → 03.81	 50-01-108  60-02-216	 55-06-601  67-02-208
CRESSIDA Station Wagon (X6K) <i>i</i> <i>i</i>				
2.0	77	02.81 → 03.85	 50-02-232	 51-02-202
2.2 D	49	06.81 → 03.85	 60-02-267	 55-06-601  67-02-208
CRESSIDA Tre volumi/Saloon <i>i</i> <i>i</i>				
2.8	125	05.85 → 09.88	 50-02-242	 61-02-206
CROWN (_S1_) <i>i</i> <i>i</i>				
2.8 i Super Saloon (S12)	125	02.84 → 03.85	 50-01-116	 51-02-206
2.8 SI (MS112)	107	04.80 → 07.83	 60-02-220	 61-02-250  55-02-237  67-02-221
2.2 D (LS110_)	53	04.80 → 07.83	 50-01-116  60-02-220	 61-02-250  55-02-237  67-02-212
CROWN Station Wagon (_S1_) <i>i</i> <i>i</i>				
2.8 (MS1K)	107	09.80 → 09.83	 50-01-116  60-02-220	 51-02-206  61-02-250  55-02-237  67-02-221
DYNA <i>i</i> <i>i</i>				
2.0	79	09.84 → 08.87	 50-02-267	 55-02-224
2.4 D	55	09.84 → 08.87	 50-02-285	 55-02-224  67-02-212
2.5 D4d	75	08.01 →	 50-02-286  60-02-2028	 55-02-239  56-02-221

	KW			
DYNA <i>i</i> <i>i</i>				
2.5 D4d	65	08.01 →	60-02-286 60-02-2028	
3.0 D4d	80	09.06 →	60-02-286 60-02-2028	55-02-239
DYNA 100 (2Y) <i>i</i> <i>i</i>				
2.4 D (LH80-LH81)	69	08.87 → 04.95	60-02-247 60-02-270	Imp. AKEBONO Imp. AKEBONO
				55-02-233 08.87→ →08.88 55-02-237 67-02-212 09.88→ 67-02-249 09.88→ 67-02-261 08.87→ →08.88
DYNA 100 (2Y) <i>i</i> <i>i</i>				
1.8 (Y81)	58	10.80 → 04.95	60-02-247 60-02-270	Imp. AKEBONO Imp. AKEBONO
				55-02-233 08.87→ →08.88 55-02-237 67-02-212 09.88→ 67-02-249 09.88→ 67-02-261 →08.88
DYNA 160 (3L / 5L) <i>i</i> <i>i</i>				
2.8 D (LY211 / LY212)		05.95 → 11.97	60-02-286	
2.0	79	08.85 → 08.88	60-02-286	55-02-224
DYNA 200 (Diesel) <i>i</i> <i>i</i>				
3.4 D (BU79/89)		10.92 → 05.95	60-02-283	55-06-601
3.7 D		08.88 → 09.92	60-02-224 →09.91 60-02-283 10.91→	55-06-601
HIACE I Furgonato/Box (_H_) <i>i</i> <i>i</i>				
2.0 (RH25-32)	65	07.77 → 03.83	60-02-224 60-02-222	55-02-233 55-02-210 67-02-215
2.2 D (LH20-30)	46	01.79 → 03.83	60-02-224 60-02-222	55-02-233 55-02-210 67-02-212

	KW			
HIACE I Furgonato/Box (_H_) i				
1.6 (RH20-30)	49	02.77 → 03.83	 50-02-224  60-02-222	 55-02-233  56-02-210 →08.85  65-02-240  65-02-241  67-02-215  67-02-240  67-02-241
HIACE I Wagon (_H_) i				
1.6	49	01.79 → 12.84	 50-02-224  60-02-222	 55-02-233  56-02-210 →08.85  65-02-240  65-02-241  67-02-212  67-02-240  67-02-241
2.2 D	49	01.80 → 12.80		 56-02-210
HIACE II Furgonato/Box (H5_) i				
1.8	58	03.83 → 11.89	 50-02-247  60-02-270	 55-02-233  56-02-210 →08.85  67-02-251
2.0	65	01.84 → 11.89	Imp. AKEBONO	
2.2 D	49	03.83 → 11.89	Imp. AKEBONO	
2.4 D	55	05.84 → 11.89		
HIACE II Wagon (H5_) i				
1.8 (H5G)	58	03.83 → 11.89	 50-02-247  60-02-270	 55-02-233  56-02-210  67-02-251
2.0 (H5G)	65	01.85 → 08.89	Imp. AKEBONO	
2.2 D (H5G)	49	03.83 → 11.89		
2.4 D (H5G)	55	08.84 → 08.89		
2.4 D 4WD (H5F)	54	01.87 → 01.88	 50-02-267  60-02-270	 55-02-239  56-02-221  67-02-251
2.0 4x4	65	08.87 → 07.89		 56-02-210
HIACE III Furgonato/Box (_H10_) i				
2.4 4WD	88	08.89 → 08.95	 50-02-224  60-02-2013  60-02-268	 55-02-239  56-02-221  67-02-251
2.4 D 4WD	55	08.89 → 08.95	08.93→	
2.4 Diesel	55	02.90 → 08.95		
2.0	74	02.90 → 08.95	 50-02-214  60-02-2013  60-02-268	 55-02-233  56-02-210  56-02-220  67-02-251
2.4	88	08.89 → 08.95	 50-02-286  60-02-2013  60-02-268	 56-02-220  56-02-221  67-02-251 08.93→

	KW			
HIACE III Furgonato/Box (_H10_) <i>i</i> <i>i</i>				
2.8 D	61	08.89 → 08.95	60-02-2013 60-02-268	56-02-220
2.4 D	57	09.89 → 08.95		56-02-220
HIACE III Wagon (_H10_) <i>i</i> <i>i</i>				
2.0 (RZH102)	74	08.89 → 08.95	50-02-214 60-02-2013 60-02-268	55-02-233 56-02-220 67-02-251
2.4 D (LH102)	55	08.89 → 08.95	50-02-214 60-02-2013 60-02-268 60-02-270	55-02-239 55-02-242 56-02-220 56-02-221 67-02-212
2.4 (RZH103)	88	08.89 → 08.95	50-02-286 60-02-2013 60-02-268	55-02-239 55-02-242 56-02-220 56-02-221 67-02-251
2.4 D	57	10.93 → 08.95	50-02-286 60-02-2013 60-02-268	55-02-233 67-02-251
2.4 4WD	88	08.89 → 08.95	50-02-286 60-02-2013 60-02-268	55-02-239 67-02-251
2.4 D 4WD	55	08.89 → 08.95	50-02-286 60-02-2013 60-02-293	55-02-239 55-02-242 56-02-220 56-02-221 67-02-251
2.8 D	61	08.89 → 08.95		56-02-220
HIACE IV Furgonato/Box (_H1_, _H2_) <i>i</i> <i>i</i>				
2.4 (RCH12_, RCH22_)	85	08.95 → 04.98	50-02-286 60-02-2023	55-02-242 56-02-204
2.4 4WD (RCH18_, RCH28_)	85	08.95 → 04.98		
2.4 TD (LXH12_, LXH22_)	66	08.95 →		
2.7 (RCH13_, RCH23_)	105	04.98 →		
2.4 D (LXH12_, LXH22_)	58	08.95 →	50-02-286 60-02-2023	55-02-242 56-02-204 67-02-251



































































	KW			
HIACE IV Furgonato/Box (_H1_, _H2_) <i>i</i> <i>i</i>				
2.4 TD 4WD (LXH18_, LXH28_) 2.7 4WD (RCH19_, RCH29_)	66 105	08.95 → 04.98 →	 50-02-286	 55-02-242  56-02-204
2.5 D-4D 2.5 D-4D	75 65	11.01 → 11.01 →	 50-02-286  60-02-2000  60-02-2002  60-02-2023	09.04→ →08.04  55-02-242  56-02-204
2.5 D-4D 4WD	75	11.01 →	 50-02-286  60-02-2002	 55-02-242  56-02-204
2.5 D4d 2.5 D4d 2.5 D4d 4x4 2.5 D4d 4x4	70 86 65 86	09.06 → 09.06 → 08.01 →08.06 09.06 →		 55-02-242
2.8 D	61	08.95 →08.00		 56-02-220
HIACE IV Wagon (_H1_, _H2_) <i>i</i> <i>i</i>				
2.4 D	58	08.95 →	 50-02-286  60-02-2023	 55-02-242  56-02-204  67-02-251
2.4 (RCH12_, RCH22_) 2.4 D 2.4 TD (LXH12_, LXH22_) 2.5 D-4D 2.5 D-4D 2.7 (RCH13_, RCH23_)	85 55 66 70 86 105	08.95 →04.98 07.99 → 08.95 → 08.06 → 08.06 → 04.98 →11.01	 50-02-286  60-02-2023	 55-02-242  56-02-204
2.4 4WD (RCH18_) 2.4 TD 4WD (H18/28) 2.7 4WD (RCH19_)	85 66 105	08.95 →04.98 08.95 → 04.98 →	 50-02-286	 55-02-242  56-02-204
2.5 D-4D 2.5 D-4D 2.7	75 65 106	11.01 → 11.01 → 11.01 →	 50-02-286  60-02-2000  60-02-2002  60-02-2023	09.04→ →08.04  55-02-242  56-02-204
2.4	85	11.96 →09.06	 60-02-2023	 55-02-242  56-02-204
2.5 D4d 4x4	75	08.01 →08.06		 55-02-242
2.8 D	61	08.95 →08.00		 56-02-220
HILUX Fuoristrada chiuso <i>i</i> <i>i</i>				
2.4 TD 4x4	66	08.97 →07.01	 50-02-226  60-02-271	 55-02-239  56-02-221
HILUX Pick-up <i>i</i> <i>i</i>				































































	KW			
HILUX Pick-up				
2.6 D	88	12.07 →	60-02-225 60-02-226 60-02-243 60-02-2008 60-02-2009	56-02-217 56-02-219
2.6 D 4x4	88	12.07 →	60-02-225 60-02-226 60-02-2008	56-02-217 56-02-219
2.6 D 4x4 3.0 D 4x4	75 126	08.05 → 12.07 →	60-02-226 60-02-2008	56-02-217 56-02-219
2.6 D4d	75	06.06 →	60-02-243 60-02-2009	56-02-217 67-02-211 EXTRA CAB
HILUX Pick-up (_N_)				
2.4 D	59	01.92 →	60-02-236 60-02-270 Imp. AKEBONO	56-02-233 56-02-210 67-02-290
2.4 i 4WD 2.4 i 4WD	84 84	06.89 → 06.89 →	60-02-264 60-02-271 Imp. SUMITOMO	56-02-239 56-02-221 67-02-290
2.4 D 4WD	58	01.94 →	60-02-264 Imp. SUMITOMO	56-02-233 56-02-210 67-02-290
2.0	65	01.84 → 12.86	60-02-236 60-02-2021 60-02-249	56-02-233 56-02-210 67-02-289
2.2 4WD (YN106_, YN110_)	69	01.87 → 12.89	60-02-236 60-02-249	56-02-233 56-02-210 67-02-289
2.4 i 4WD 2.4 TD 4WD 2.6 D-4D 4WD	103 66 75	08.97 → 08.98 → 01.02 11.01 →	60-02-264 60-02-271 Imp. SUMITOMO	56-02-239 56-02-221 67-02-290
1.8 (YN86_, YN90_)	61	08.88 → 07.94	60-02-247 Imp. AKEBONO 60-02-266 Imp. SUMITOMO 60-02-270 Imp. AKEBONO	56-02-233 56-02-210 67-02-212
2.4 D	58	03.95 →	60-02-247 Imp. AKEBONO 60-02-264 Imp. SUMITOMO 60-02-270 Imp. AKEBONO 60-02-271 SUMITOMO	56-02-239 56-02-221 67-02-290
2.4 D	61	08.88 →	60-02-264 Imp. SUMITOMO 60-02-270 Imp. AKEBONO	56-02-233 56-02-210 67-02-290

	KW					
HILUX Pick-up (_N_)						
2.4 D 4WD	61	08.88 →	50-02-254 60-02-270 60-02-271	Imp. SUMITOMO Imp. AKEBONO	55-02-233 67-02-290	
2.4 D	55	07.98 → 01.02	50-02-254 60-02-270	Imp. SUMITOMO Imp. AKEBONO	55-02-233 56-02-210	
2.5 D-4D	65	11.01 →	50-02-214 60-02-270	Imp. AKEBONO	55-02-219	
2.2 D	49	08.83 → 08.84	50-02-254 50-02-255 60-02-271	Imp. SUMITOMO Imp. SUMITOMO	55-02-233 56-02-210 67-02-290	
1.6	48	08.78 → 08.88	50-02-224 60-02-222		55-02-233 56-02-210 67-02-212 67-02-249	01.84→
2.2 D 2WD/ 4WD		01.79 → 12.95			67-02-212 67-02-215 67-02-249	01.84→
2.0 4WD	65	08.85 → 07.88			56-02-210 67-02-213	
2.4 D AWD	55	01.84 → 08.88	50-02-236		55-02-233 56-02-210	
1.8	58	08.83 → 07.88			56-02-221	
iQ						
1.0	50	01.09 →	50-02-275		51-02-214 61-02-232 55-02-204 67-02-278 67-02-279	Right/Destra NO ABS Left/Sinistra NO ABS
1.33	72	01.09 →	60-02-2012			
1.4 D-4D	66	01.09 →				
LAND CRUISER (J12)						
3.0 D-4D (KDJ120)	120	01.03 →	50-02-205		51-02-210 61-02-209	
3.0 D-4D (KDJ120)	127	01.07 →	60-02-2003			
3.0 D-4D (KDJ120)	122	08.04 →				
4.0 (GRJ12)	183	01.03 →				
LAND CRUISER (_J4_)						
4.2 (FJ40_V, FJ43_V, FJ45_V, FJ55_V)	89	01.75 → 04.86	50-02-236 60-02-234		55-02-205	
3.6 D (HJ45_V)	66	04.79 → 07.80	50-02-236 60-02-234		55-02-230	Parking Brake/Freno staz.

	KW			
LAND CRUISER (_J4_) i				
3.4 D (BJ42_V, BJ46_V, BJ46_) 4.0 D (HJ47_V)	66 76	08.80 → 10.84 08.80 → 10.84	60-02-236 60-02-234	56-02-206 67-02-218
3.0 D (BJ40_V, BJ43_)	59	02.74 → 10.84	60-02-236 60-02-234	56-02-210 56-02-211 67-02-281 Left lower\Sinistra inf. 67-02-282 Left upper\Sx sup. 67-02-283 Left lower\Sx inf. 67-02-284 Front Right upperAnt. Dx sup. 67-02-285 Front LeftAnt. Sx 67-02-286 Front LeftAnt. Sx 67-02-287 Front RightAnt. Dx 67-02-288 Front RightAnt. Dx
LAND CRUISER (_J6_) i				
4.0 Diesel (HJ60) 4.0 Diesel (HJ60) 4.0 Diesel (HJ60_V) 4.0 Turbo-D (HJ61_V)	74 76 77 100	01.82 → 12.85 01.85 → 12.87 10.81 → 01.88 10.85 → 12.89	60-02-236 60-02-234	56-02-206 67-02-218
4.0 (FJ62_G) 4.2 (FJ60_V)	115 88	08.87 → 12.89 10.81 → 01.88	60-02-236 60-02-234	56-02-206 67-02-218
3.4 Diesel (BJ60_V)	66	10.81 → 08.87	60-02-236 60-02-234	56-02-206 67-02-287 Front RightAnt. Dx 67-02-288 Front RightAnt. Dx
4.0 (FJ62_V)	101	11.84 → 08.87	60-02-236 60-02-234	56-02-206
LAND CRUISER (_J7_) i				
2.4 (RJ70_, RJ73_) 2.4 (RJ70_, RJ73_)	81 77	11.84 → 05.93 11.84 → 05.93	60-02-236 60-02-254 60-02-256 60-02-234 60-02-249	09.88→ →12.89 01.90→ Imp. SUMITOMO 01.90→ 01.90→ 61-02-210 01.90→ 61-02-209 01.90→ 56-02-230 Parking Brake\Freno staz. 56-02-237 56-02-200 67-02-261
2.4 D (LJ70_)	53	11.84 → 10.85	60-02-236 60-02-249	61-02-210 61-02-209 56-02-230 Parking Brake\Freno staz. 56-02-237 56-02-200 67-02-261























































	KW					
LAND CRUISER (_J7_)						
2.4 TD (LJ70_, LJ73_)	63	10.85 → 05.90	 50-02-256  60-02-249	01.88→ 01.88→	 51-02-210  61-02-209  55-02-230  55-02-237  56-02-200  67-02-251	Parking Brake\Freno staz. 01.88→ 01.88→ 01.88→
2.4 TD (LJ70)	66	01.90 → 05.93	 50-02-254  50-02-256  60-02-234  60-02-249	Imp. SUMITOMO	 51-02-210  61-02-209  55-02-230  55-02-237  56-02-201  67-02-250	Parking Brake\Freno staz.
3.0 TD (KZJ70_, KZJ73_, KZJ77_)	92	05.93 → 05.96	 50-02-254  60-02-234	Imp. SUMITOMO	 51-02-210  61-02-209  55-02-230  55-02-237  56-02-221  67-02-218	Parking Brake\Freno staz.
3.4 D (BJ70_V, BJ73_)	70	11.84 → 12.96	 50-02-236  60-02-234		 51-02-210  61-02-209  55-02-205  55-02-230  67-02-218	Parking Brake\Freno staz.
3.4 TD (BJ71_V)	91	10.85 → 08.86				
2.4 (RJ70_V, RJ73_V)	84	12.88 → 12.96	 50-02-236  50-02-254  50-02-256  50-02-292  60-02-234  60-02-249	→12.89 01.90→ Imp. SUMITOMO →05.93 01.90→ →05.93 06.93→ 01.90→ →05.93	 51-02-210  61-02-209  55-02-230  55-02-237  56-02-201  67-02-251	01.90→ 01.90→ Parking Brake\Freno staz.
4.2 TD (HZJ7__V)	96	01.90 →	 50-02-254  60-02-2005  60-02-2019	Imp. SUMITOMO 08.99→	 51-02-210  61-02-212  55-02-205  55-02-230  67-02-218	Parking Brake\Freno staz.
3.5 D	85	01.90 → 12.93	 50-02-254  60-02-234	Imp. SUMITOMO	 51-02-210  55-02-205  67-02-218	
3.5 D 4x4	85	01.90 → 08.92	 50-02-236  60-02-234		 51-02-210  55-02-205	

	KW			
LAND CRUISER 100 (_J10_) i i				
4.2 TD (HDJ100_)	150	01.98 →	50-02-268	51-02-259
4.7	175	02.02 →	60-02-224	61-02-223
4.7 (UZJ100_)	173	01.98 →		55-02-235
Parking Brake/Freno staz.				
LAND CRUISER 80 (_J8_) i i				
4.2 TD (HDJ80)	123	01.90 → 12.97	50-02-255	51-02-210
4.2 TD (HDJ80)	118	10.92 → 12.97	60-02-2005	61-02-212
			60-02-272	55-02-205
				67-02-218
4.2 TD 24V (HDJ80_)	125	03.95 → 12.97	50-02-255	51-02-210
			60-02-2005	61-02-212
				55-02-205
				67-02-218
4.5 24V (FZJ80_)	151	08.92 → 12.97	50-02-254	51-02-210
			50-02-292	61-02-209
			60-02-234	
4.0 (FJ80_)	115	01.90 → 08.92	50-02-292	51-02-210
			60-02-272	61-02-219
				55-02-205
				67-02-250
4.2 D (HZJ80_)	99	01.90 → 12.97	50-02-254	51-02-210
			60-02-2005	61-02-212
				61-02-219
				55-02-205
				67-02-218
LAND CRUISER 90 (_J9_) i i				
3.0 D-4D	120	10.00 →	50-02-292	51-02-210
3.4 i 24V (VZJ90_, VZJ95_)	131	04.96 →	60-02-205	61-02-209
3.0 TD (KZJ90_, KZJ95_)	92	04.96 →	50-02-256	51-02-210
			60-02-205	61-02-209
LAND CRUISER Hardtop (_J7_) i i				
2.4 TD (LJ77)	66	07.90 → 05.96	50-02-254	51-02-210
			→05.93	→05.93
			Imp. SUMITOMO	61-02-209
			50-02-256	→05.93
			60-02-234	55-02-230
			60-02-249	55-02-237
			→05.93	56-02-201
			→05.93	67-02-251
				→05.93
Parking Brake/Freno staz.				

	KW			
LAND CRUISER Hardtop (_J7_) <i>i</i> <i>i</i>				
3.0 TD	92	05.93 → 05.96	 50-02-254  60-02-234	Imp. SUMITOMO  51-02-210  61-02-209  55-02-239  56-02-221  67-02-218
LAND CRUISER Pick-up (_J4_) <i>i</i> <i>i</i>				
4.2 (FJ45_P)	89	01.75 → 04.86	 50-02-236  60-02-234	 55-02-211
3.6 D (HJ45_P)	66	01.75 → 07.80	 50-02-236  60-02-234	 55-02-211  67-02-218
3.4 D (BJ45_P)	66	08.80 → 10.84	 50-02-236	 55-02-205
4.0 D (HJ47_P)	76	08.80 → 10.84	 60-02-234	 67-02-218
LAND CRUISER V8 <i>i</i> <i>i</i>				
4.5 D V8	210	01.08 →	 50-02-272	 51-02-221
4.7 V8	212	01.08 →	 60-02-2011	 61-02-237  55-02-225
Parking Brake\Freno staz.				
LITEACE Autobus (CM30_G, KM30_G) <i>i</i> <i>i</i>				
1.5 (KM30LG)	51	10.85 → 08.89	 50-02-239  50-02-242  60-02-245	VIN-> 003986  55-06-601  67-02-208
1.5 (KM30LG)	52	07.89 → 01.92	 50-02-239  60-02-245	 55-06-601  67-02-208
2.0 D (CM30LG)	53	08.88 → 01.92	 50-02-239  60-02-245	 55-02-239  67-02-208
LITEACE Autobus (_R2_LG) <i>i</i> <i>i</i>				
1.5 (KR21LG)	52	01.92 → 01.95	 50-02-239	 55-02-237
2.0 D (CR21LG)	53	01.92 → 05.94	 60-02-245	 67-02-212
2.2 (YR22LG)	72	01.92 → 01.95	 50-02-239  60-02-245	 55-02-237
LITEACE Furgonato/Box (CM3_V, KM3_V) <i>i</i> <i>i</i>				
1.5 (KM31_V, KM36_V)	51	05.86 → 09.91	 50-02-239  50-02-242  60-02-245	VIN-> 0039896  55-06-601  67-02-208
1.8 D (CM35_V)	46	10.85 → 08.88	 50-02-239  60-02-245  60-02-254	 55-02-239  67-02-208
2.0 D (CM36_V)	53	08.88 → 01.92	 50-02-239  60-02-245	 55-02-239  67-02-208
LITEACE Furgonato/Box (M2_V) <i>i</i> <i>i</i>				



	KW			
LITEACE Furgonato/Box (M2_V) <i>i</i> <i>i</i>				
1.3	42	10.79 → 10.86	50-02-233 60-02-254	55-06-601 67-02-213
LITEACE Furgonato/Box (_R2_V) <i>i</i> <i>i</i>				
1.5 (KR27_V)	52	01.92 → 01.95	50-02-239	55-02-237
2.0 D (CR27_V)	51	01.92 → 05.94	60-02-245	67-02-212
2.2 (YR29LV)	72	01.92 → 01.95	50-02-239 60-02-245	55-02-237
LITEACE Wagon (M2_G) <i>i</i> <i>i</i>				
1.3	43	10.79 → 09.85	50-02-233	55-06-601
1.8 D	41	10.82 → 09.85	60-02-254	67-02-213
MODELL F Autobus (_R2_, 31) <i>i</i> <i>i</i>				
1.8 De Luxe (YR20)	58	11.82 → 08.84	50-02-242	55-02-237
2.0 (YR21_G)	66	08.88 → 01.90	60-02-237	67-02-208
2.0 Super (YR21)	65	08.84 → 08.88	50-02-242 60-02-237 60-02-245	55-02-237 67-02-208
2.2 (YR22LG, YR31LG)	72	08.87 → 01.90	50-02-242 60-02-251	55-02-237 67-02-208
MR 2 (_W1_) <i>i</i> <i>i</i>				
1.6 16V (AW11)	91	11.84 → 06.90	50-02-235	51-02-204
1.6 16V (AW11)	85	11.84 → 06.90	60-02-243 60-02-250	61-02-203 61-02-204
MR 2 (_W2_) <i>i</i> <i>i</i>				
2.0 16V	129	12.89 → 05.00	50-02-258	51-02-204
2.0 16V	125	12.89 → 05.00	50-02-263	51-02-213
2.0 16V (SW20)	115	12.89 → 05.00	60-02-217 60-02-299	61-02-213 61-02-227
MR 2 (_W3_) <i>i</i> <i>i</i>				
1.8 16V VT-i (ZZW30)	103	04.00 →	50-02-203 60-02-230	51-02-204 61-02-220
PASEO (EL54) <i>i</i> <i>i</i>				
1.5 16V	66	08.95 → 07.99	50-02-235 60-02-221	61-02-251 55-02-236 67-02-216 67-02-217
PICNIC (_XM10) <i>i</i> <i>i</i>				

	KW			
PICNIC (_XM10) <i>i</i> <i>i</i>				
2.0	90	01.01 → 12.01	 50-02-264	 55-02-297
2.0 16V (SXM10_)	94	05.96 → 12.01	 60-02-291	 56-02-205
2.2 D (CMX10_)	66	08.97 → 12.01		 67-02-212
				 67-02-292 con/with ABS
PREVIA (ACR3_) <i>i</i> <i>i</i>				
2.0 D-4D	85	03.01 →	 50-02-270 →03.03	 51-02-258
2.4 16V	115	08.00 →	 50-02-271	 61-02-258
			 60-02-2000 04.03→	 55-02-223
			 60-02-275 →03.03	Parking Brake\Freno staz.
PREVIA (TCR1_, 2_) <i>i</i> <i>i</i>				
2.4	97	05.90 → 08.00	 50-02-231	 51-02-262
			 50-02-235	 61-02-207
			 60-02-296	 55-02-223
			 60-02-297	 55-02-237
				 67-02-221
2.4 4WD	97	05.90 → 08.00	 50-02-239	 51-02-262
			 50-02-259	 61-02-207
			 60-02-280	 55-02-223
				 55-02-237
				 67-02-221
PRIUS <i>i</i> <i>i</i>				
1.5	57	08.03 →	 50-02-203	 51-02-203
			 60-02-2027	 61-02-210
1.8 HSD	100	02.09 →	 50-02-219	 51-02-214
			 60-02-277	 61-02-241
PRIUS (NHW11_) <i>i</i> <i>i</i>				
1.5	53	05.00 → 01.04	 50-02-203	 51-02-203
			 60-02-276	 61-02-218
				 55-02-231
				 56-02-213
				Parking Brake\Freno staz.
PRIUS (ZVW30) <i>i</i> <i>i</i>				
1.8	73	01.09 →	 50-02-219	 51-02-214
			 60-02-277	 61-02-241
RAV 4 I Cabrio/ FUNCRUISER (SXA1_) <i>i</i> <i>i</i>				
2.0 16V	94	12.97 → 06.00	 50-02-264	 55-06-601
			 60-02-274	
RAV 4 II <i>i</i> <i>i</i>				















































	KW			
RAV 4 II <i>i</i> <i>i</i>				
2.4		08.03 →	50-02-280 60-02-229	51-02-256 61-02-221 55-02-214 67-02-209 NO ABS
RAV 4 II (XA2) <i>i</i> <i>i</i>				
1.8 VVTi	92	02.01 →	50-02-280 60-02-229	51-02-256 61-02-221 55-02-214 55-02-223 56-02-214 67-02-209 NO ABS Parking Brake\Freno staz.
2.0 D-4D 4WD	85	09.01 →		
2.0 VVTi 4WD	110	06.00 →		
RAV 4 III <i>i</i> <i>i</i>				
2.0 VVT-i	112	03.06 →	50-02-230 60-02-2006	51-02-218 61-02-230 55-02-228 Parking Brake\Freno staz.
2.2 D-4D	100	03.06 →		
2.2 D-4D	110	12.08 →		
2.2 D-CAT	130	03.06 →	50-02-269 60-02-2010	51-02-218 61-02-230 55-02-228 Parking Brake\Freno staz.
2.0	116	12.08 →	50-02-230 60-02-2010	51-02-218 61-02-230 55-02-228 Parking Brake\Freno staz.
STARLET (EP91) <i>i</i> <i>i</i>				
1.3	55	04.96 → 03.99	50-02-235 50-02-284 60-02-255 60-02-261	55-02-236 67-02-216 67-02-217 Left\Sinistra Right\Destra
STARLET (KP6_) <i>i</i> <i>i</i>				
1.0 (KP60)	33	02.78 → 09.84	50-02-202 60-02-202	55-02-200 67-02-215
1.2 S (KP62)	39	10.78 → 08.82		
1.3 S (KP61)	48	08.82 → 09.84		
STARLET (_P7_) <i>i</i> <i>i</i>				
1.0 (EP70L)	40	10.84 → 12.89	50-02-202 50-02-239 60-02-241	→12.87 01.88→ 55-02-236 67-02-216 67-02-217 Left\Sinistra Right\Destra
1.3 (EP71L)	55	10.84 → 12.89	50-02-235 60-02-244	55-02-236 67-02-216 67-02-217 Left\Sinistra Right\Destra
1.5 D (NP70L)	40	12.86 → 12.89	50-02-284 60-02-241	55-02-236 67-02-216 67-02-217 Left\Sinistra Right\Destra



















	KW				
STARLET (_P8_)					
1.3 12V (EP81) Cat.	55	12.89 → 03.96	50-02-235 50-02-284 60-02-255 60-02-261	55-02-236 67-02-216 67-02-217	Left\Sinistra Right\Destra
1.5 D (NP80_)	40	12.89 → 03.96	50-02-284 60-02-261	55-02-236 67-02-216 67-02-217	Left\Sinistra Right\Destra
1.0 (EP80_)	40	12.89 → 12.92	50-02-235 50-02-284 60-02-255	55-02-236 67-02-216 67-02-217	Left\Sinistra Right\Destra
1.3 12V (EP81_)	55	12.89 → 12.92			
STARLET 1000 (KP)					
1.0	33	11.74 → 08.78	50-06-600 60-02-202	55-02-200	Imp. SUMITOMO
STARLET Station wagon (KP6_)					
1.0 (KP60)	33	02.78 → 09.84	50-02-202 60-02-202	55-02-200	
1.2	41	02.78 → 09.82		67-02-215	
SUPRA (JZA80)					
3.0 i Bi-Turbo	243	05.93 → 08.98	50-02-293	51-02-294 61-02-259 55-02-223	Parking Brake\Freno staz.
SUPRA (MA70)					
3.0	140	01.86 → 08.90	50-02-245 60-02-253	51-02-206 61-02-207	
3.0 24V	150	01.86 → 08.88			
3.0 Turbo	173	09.87 → 04.93	50-02-245 60-02-253 60-02-295	51-02-206 61-02-207	
3.0 Turbo	175	08.88 → 05.93			
TERCEL (AL2_)					
1.5 4WD	52	10.82 → 01.88	50-02-235 60-02-232	55-02-200	
1.5 4WD (AL25)	50	05.86 → 01.88		56-02-209 67-02-215	
TERCEL (_L1_, _L2_)					
1.3 (AL20, AL11)	48	03.79 → 01.88	50-02-235 60-02-204 60-02-232	55-02-200 67-02-215	→04.82 05.82→
1.45 (AL21)	52	08.83 → 05.85	50-02-235 60-02-232	55-02-200 67-02-215	
URBAN CRUISER					
1.3 VVT-i	74	05.09 →	50-02-269	51-02-214	
1.4 D-4D	66	05.09 →	60-02-2014	61-02-239	















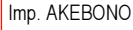







	KW				
VERSO i i					
1.6	97	04.09 →	50-02-244	51-02-224	
1.8	108	04.09 →	60-02-2016	61-02-245	
2.0 D-4D	93	04.09 →			
2.2 D-4D	110	04.09 →	50-02-276	51-02-224	
2.2 D-CAT	130	04.09 →	60-02-2015	61-02-245	
VERSO-S i i					
1.3 VVT-i	73	01.11 →	50-02-269	51-02-214	
1.4 D	66	01.11 →	60-02-2014	61-02-241	
YARIS i i					
1.0 VVT-i	51	01.06 →	50-02-219	51-02-214	Made in Japan
				61-02-232	Made in Japan
				61-02-238	Made in France
				55-02-204	Made in Japan
				55-02-221	Made in France
		56-02-215	Made in Japan		
		56-02-216	Made in France		
		67-02-210			
1.3 VVT-i D-4D	64 66	01.06 → 01.06 →	50-02-219	51-02-214	Made in Japan
				51-02-225	Made in France
				61-02-232	Made in Japan
				61-02-238	Made in France
				55-02-204	Made in Japan
		55-02-221	Made in France		
		56-02-215	Made in Japan		
		56-02-216	Made in France		
		67-02-210			
1.8 VVTi	98	01.07 →	50-02-220	51-02-214	Made in Japan
				61-02-232	Made in Japan
				61-02-238	Made in France
		55-02-221			
		56-02-215	Made in Japan		
		56-02-216	Made in France		
1.33 VVT-i	74	03.09 →	50-02-238	51-02-225	Made in France
			60-02-284	61-02-238	
				55-02-221	
		56-02-216			
1.0 VVT-i 1.3 VVT-i 1.4 D-4D	51 73 66	10.11 → 10.11 → 10.11 →	50-02-238	51-02-225	con/with ABS
			60-02-284	61-02-238	
				55-02-221	
		56-02-216			

	KW			
YARIS (_CP10)				
1.0 16V (SCP10_) 1.3 16V (NCP10_) 1.4 D-4D	50 63 55	04.99 → 11.99 → 12.01 →	 50-02-203 01.01→ Made in France con/with ABS  50-02-204 01.01→ Made in France NO ABS →03.03  50-02-281  60-02-221  60-02-278 Drum brakes on the rear axle\Freni a tamburo ad assale post. Made in Japan	 51-02-203  61-02-222  55-02-204  56-02-206  56-02-212  67-02-278  67-02-279 →03.03 04.03→ Right\Destra Left\Sinistra
1.5 VVT-i TS	78	04.01 →	 50-02-203 con/with ABS Made in France  50-02-204 NO ABS Made in France  50-02-281  60-02-221  60-02-278 Drum brakes on the rear axle\Freni a tamburo ad assale post. Made in Japan	 51-02-203  61-02-222
1.0 16V 1.3	48 64	03.03 → 04.02 →	 50-02-203 con/with ABS Made in France  50-02-204 NO ABS Made in France  60-02-221  60-02-278 Drum brakes on the rear axle\Freni a tamburo ad assale post. Made in Japan	 51-02-203  61-02-222  55-02-212  56-02-212  67-02-278  67-02-279 Right\Destra Left\Sinistra
1.5 TS (NCP13)	77	01.03 →	 50-02-203 con/with ABS Made in France  50-02-204 NO ABS Made in France  60-02-221  60-02-278 Drum brakes on the rear axle\Freni a tamburo ad assale post. Made in Japan	 51-02-203  61-02-222  55-02-212
1.5 VVT-i TS	110	03.03 → 07.05	 50-02-203  60-02-221	 51-02-203  61-02-222
YARIS VERSO (NC/LP2_)				



	KW			
YARIS VERSO (NC/LP2_)				
1.3 (NCP22)	62	01.03 →	 50-02-203	 51-02-203
1.3 (NCP22)	63	11.99 →	 60-02-221	 61-02-222
1.4 D-4D (NLP22)	55	12.01 →		 55-02-204
				 56-02-206 →03.03
				 56-02-212 04.03→
				 67-02-274
				 67-02-275
1.5 (NCP21)	78	03.00 →	 50-02-203	 51-02-203
1.5 (NCP21)	77	05.03 →	 60-02-221	 61-02-222
				 55-02-204
				 56-02-206

	KW			
TARO				
1.8	61	04.89 → 09.94	 50-02-247	
2.4 D	61	06.89 → 03.97	 60-02-270	
2.4 D	58	07.94 → 03.97		 55-02-205
2.4 D	59	09.91 → 07.94		 55-02-233
2.4 D 4x4	61	04.89 → 03.97		 56-02-210
2.4 D 4x4	58	07.94 → 03.97		 56-02-221
				 67-02-249
2.2	69	06.89 → 07.94	 50-02-247	
2.4 i 4x4	84	06.89 → 03.97	 60-02-271	
				 55-02-205
				 55-02-233
				 56-02-210
				 56-02-221
				 67-02-249

60-00-001	
	Pitch Circle Ø/Foro int.-Ø [mm]
	61
	Height/Altezza [mm]
	38,3
	Diam./Diam. [mm]
256,8	
Thickness/Spessore - Min [mm]	
22/20	
No. of Bores/N° fori	
5	
CHRYSLER	Ventilato/Vented

60-00-006	
	Pitch Circle Ø/Foro int.-Ø [mm]
	95
	Height/Altezza [mm]
	31
	Diam./Diam. [mm]
298	
Thickness/Spessore - Min [mm]	
24/22	
No. of Bores/N° fori	
5	
MAHINDRA	Ventilato/Vented

60-00-002	
	Pitch Circle Ø/Foro int.-Ø [mm]
	73,3
	Height/Altezza [mm]
	38,4
	Diam./Diam. [mm]
280,6	
Thickness/Spessore - Min [mm]	
28/26	
No. of Bores/N° fori	
5	
CHRYSLER	Ventilato/Vented

60-00-007	
	Pitch Circle Ø/Foro int.-Ø [mm]
	101
	Height/Altezza [mm]
	73
	Diam./Diam. [mm]
315	
Thickness/Spessore - Min [mm]	
28/26	
No. of Bores/N° fori	
6	
HUMMER	Ventilato/Vented

60-00-003	
	Pitch Circle Ø/Foro int.-Ø [mm]
	69
	Height/Altezza [mm]
	46
	Diam./Diam. [mm]
294	
Thickness/Spessore - Min [mm]	
26/24	
No. of Bores/N° fori	
5	
JEEP - DODGE - CHRYSLER - MITSUBISHI	Ventilato/Vented

60-00-008	
	Pitch Circle Ø/Foro int.-Ø [mm]
	118
	Height/Altezza [mm]
	90
	Diam./Diam. [mm]
325	
Thickness/Spessore - Min [mm]	
38/36	
No. of Bores/N° fori	
8	
HUMMER	Ventilato/Vented

60-00-004	
	Pitch Circle Ø/Foro int.-Ø [mm]
	88
	Height/Altezza [mm]
	37
	Diam./Diam. [mm]
280	
Thickness/Spessore - Min [mm]	
26/24	
No. of Bores/N° fori	
6	
GREAT WALL	Ventilato/Vented

60-00-009	
	Pitch Circle Ø/Foro int.-Ø [mm]
	70
	Height/Altezza [mm]
	47
	Diam./Diam. [mm]
302	
Thickness/Spessore - Min [mm]	
28/26	
No. of Bores/N° fori	
5	
CADILLAC	Ventilato/Vented

60-00-005	
	Pitch Circle Ø/Foro int.-Ø [mm]
	104
	Height/Altezza [mm]
	79
	Diam./Diam. [mm]
270,6	
Thickness/Spessore - Min [mm]	
21/19	
No. of Bores/N° fori	
5	
TATA (TELCO)	Ventilato/Vented

60-00-010	
	Pitch Circle Ø/Foro int.-Ø [mm]
	68
	Height/Altezza [mm]
	49,6
	Diam./Diam. [mm]
241,4	
Thickness/Spessore - Min [mm]	
20,1/18	
No. of Bores/N° fori	
4	
NISSAN	Ventilato/Vented

60-00-011	
	Pitch Circle Ø/Foro int.-Ø [mm]
	70
	Height/Altezza [mm]
	44
	Diam./Diam. [mm]
	285
Thickness/Spessore - Min [mm]	
25/23	
No. of Bores/N° fori	
5	
CADILLAC	Ventilato/Vented

60-00-016	
	Pitch Circle Ø/Foro int.-Ø [mm]
	85
	Height/Altezza [mm]
	71
	Diam./Diam. [mm]
	281
Thickness/Spessore - Min [mm]	
21/19	
No. of Bores/N° fori	
5	
TATA (TELCO)	Ventilato/Vented

60-00-012	
	Pitch Circle Ø/Foro int.-Ø [mm]
	72
	Height/Altezza [mm]
	65
	Diam./Diam. [mm]
	302
Thickness/Spessore - Min [mm]	
28/26	
No. of Bores/N° fori	
5	
DODGE	Ventilato/Vented

60-00-017	
	Pitch Circle Ø/Foro int.-Ø [mm]
	104
	Height/Altezza [mm]
	81
	Diam./Diam. [mm]
	281
Thickness/Spessore - Min [mm]	
21/19	
No. of Bores/N° fori	
5	
TATA (TELCO)	Ventilato/Vented

60-00-013	
	Pitch Circle Ø/Foro int.-Ø [mm]
	61
	Height/Altezza [mm]
	44,4
	Diam./Diam. [mm]
	259,6
Thickness/Spessore - Min [mm]	
22/20	
No. of Bores/N° fori	
4	
NISSAN	Ventilato/Vented

60-00-018	
	Pitch Circle Ø/Foro int.-Ø [mm]
	115
	Height/Altezza [mm]
	169
	Diam./Diam. [mm]
	262
Thickness/Spessore - Min [mm]	
14/12	
No. of Bores/N° fori	
6	
GASOLONE	Non Ventilato/Not Vented

60-00-014	
	Pitch Circle Ø/Foro int.-Ø [mm]
	71
	Height/Altezza [mm]
	54
	Diam./Diam. [mm]
	303
Thickness/Spessore - Min [mm]	
32/30	
No. of Bores/N° fori	
5	
CADILLAC	Ventilato/Vented

60-00-019	
	Pitch Circle Ø/Foro int.-Ø [mm]
	62
	Height/Altezza [mm]
	50
	Diam./Diam. [mm]
	265
Thickness/Spessore - Min [mm]	
25/23	
No. of Bores/N° fori	
5	
DR	Ventilato/Vented

60-00-015	
	Pitch Circle Ø/Foro int.-Ø [mm]
	68
	Height/Altezza [mm]
	49,5
	Diam./Diam. [mm]
	256,9
Thickness/Spessore - Min [mm]	
22/20	
No. of Bores/N° fori	
4	
NISSAN	Ventilato/Vented

60-00-020	
	Pitch Circle Ø/Foro int.-Ø [mm]
	60
	Height/Altezza [mm]
	45
	Diam./Diam. [mm]
	257
Thickness/Spessore - Min [mm]	
17/15	
No. of Bores/N° fori	
4	
DR	Ventilato/Vented

60-00-022	
	Pitch Circle Ø/Foro int.-Ø [mm]
	74
	Height/Altezza [mm]
	27
	Diam./Diam. [mm]
	209
Thickness/Spessore - Min [mm]	
5,5/3,5	
No. of Bores/N° fori	
4	
LIGIER	Non Ventilato/Not Vented

60-00-056	
	Pitch Circle Ø/Foro int.-Ø [mm]
	86
	Height/Altezza [mm]
	37
	Diam./Diam. [mm]
	241,6
Thickness/Spessore - Min [mm]	
19/16	
No. of Bores/N° fori	
4	
HYUNDAI	Ventilato/Vented

60-00-023	
	Pitch Circle Ø/Foro int.-Ø [mm]
	74
	Height/Altezza [mm]
	40
	Diam./Diam. [mm]
	209
Thickness/Spessore - Min [mm]	
5,5/3,5	
No. of Bores/N° fori	
4	
AIXAM	Non Ventilato/Not Vented

60-00-057	
	Pitch Circle Ø/Foro int.-Ø [mm]
	86
	Height/Altezza [mm]
	41
	Diam./Diam. [mm]
	241,5
Thickness/Spessore - Min [mm]	
19/17,5	
No. of Bores/N° fori	
4	
HYUNDAI	Ventilato/Vented

60-00-024	
	Pitch Circle Ø/Foro int.-Ø [mm]
	74
	Height/Altezza [mm]
	40
	Diam./Diam. [mm]
	171
Thickness/Spessore - Min [mm]	
5,5/3,5	
No. of Bores/N° fori	
4	
AIXAM	Non Ventilato/Not Vented

60-00-059	
	Pitch Circle Ø/Foro int.-Ø [mm]
	72
	Height/Altezza [mm]
	77
	Diam./Diam. [mm]
	279,5
Thickness/Spessore - Min [mm]	
22,4/21	
No. of Bores/N° fori	
5	
JEEP	Ventilato/Vented

60-00-025	
	Pitch Circle Ø/Foro int.-Ø [mm]
	74
	Height/Altezza [mm]
	35
	Diam./Diam. [mm]
	209
Thickness/Spessore - Min [mm]	
5,5/3,5	
No. of Bores/N° fori	
4	
CHATENET	Non Ventilato/Not Vented

60-00-060	
	Pitch Circle Ø/Foro int.-Ø [mm]
	69
	Height/Altezza [mm]
	45,4
	Diam./Diam. [mm]
	256,9
Thickness/Spessore - Min [mm]	
22/20	
No. of Bores/N° fori	
4	
HYUNDAI	Ventilato/Vented

60-00-027	
	Pitch Circle Ø/Foro int.-Ø [mm]
	62
	Height/Altezza [mm]
	49,5
	Diam./Diam. [mm]
	300
Thickness/Spessore - Min [mm]	
25/23	
No. of Bores/N° fori	
5	
DR	Ventilato/Vented

60-00-061	
	Pitch Circle Ø/Foro int.-Ø [mm]
	72
	Height/Altezza [mm]
	53,2
	Diam./Diam. [mm]
	327,5
Thickness/Spessore - Min [mm]	
30/28	
No. of Bores/N° fori	
5	
JEEP	Ventilato/Vented

60-00-062	
	Pitch Circle Ø/Foro int.-Ø [mm]
	68,4
	Height/Altezza [mm]
	27,2
	Diam./Diam. [mm]
	247,1
Thickness/Spessore - Min [mm]	
12,8/11	
No. of Bores/N° fori	
4	
HYUNDAI	Non Ventilato/Not Vented

60-00-094	
	Pitch Circle Ø/Foro int.-Ø [mm]
	72
	Height/Altezza [mm]
	63,8
	Diam./Diam. [mm]
	304,7
Thickness/Spessore - Min [mm]	
26/24	
No. of Bores/N° fori	
5	
JEEP	Ventilato/Vented

60-00-070	
	Pitch Circle Ø/Foro int.-Ø [mm]
	108
	Height/Altezza [mm]
	50,5
	Diam./Diam. [mm]
	271
Thickness/Spessore - Min [mm]	
11/9,8	
No. of Bores/N° fori	
5	
LADA	Non Ventilato/Not Vented

60-00-095	
	Pitch Circle Ø/Foro int.-Ø [mm]
	73,5
	Height/Altezza [mm]
	38,4
	Diam./Diam. [mm]
	282
Thickness/Spessore - Min [mm]	
24/22	
No. of Bores/N° fori	
5	
CHRYSLER	Ventilato/Vented

60-00-080	
	Pitch Circle Ø/Foro int.-Ø [mm]
	66
	Height/Altezza [mm]
	40,7
	Diam./Diam. [mm]
	231
Thickness/Spessore - Min [mm]	
20/18,5	
No. of Bores/N° fori	
4	
ROVER - TATA (TELCO)	Ventilato/Vented

60-00-096	
	Pitch Circle Ø/Foro int.-Ø [mm]
	73
	Height/Altezza [mm]
	38,4
	Diam./Diam. [mm]
	281,8
Thickness/Spessore - Min [mm]	
24/22	
No. of Bores/N° fori	
5	
CHRYSLER	Ventilato/Vented

60-00-081	
	Pitch Circle Ø/Foro int.-Ø [mm]
	66
	Height/Altezza [mm]
	40
	Diam./Diam. [mm]
	231
Thickness/Spessore - Min [mm]	
17/15	
No. of Bores/N° fori	
4	
TATA (TELCO)	Ventilato/Vented

60-00-097	
	Pitch Circle Ø/Foro int.-Ø [mm]
	72
	Height/Altezza [mm]
	81,7
	Diam./Diam. [mm]
	279,8
Thickness/Spessore - Min [mm]	
24/22	
No. of Bores/N° fori	
5	
JEEP	Ventilato/Vented

60-00-093	
	Pitch Circle Ø/Foro int.-Ø [mm]
	72
	Height/Altezza [mm]
	78
	Diam./Diam. [mm]
	281
Thickness/Spessore - Min [mm]	
25/23	
No. of Bores/N° fori	
5	
JEEP	Ventilato/Vented

60-00-098	
	Pitch Circle Ø/Foro int.-Ø [mm]
	70,8
	Height/Altezza [mm]
	52,4
	Diam./Diam. [mm]
	277
Thickness/Spessore - Min [mm]	
32,2/30	
No. of Bores/N° fori	
5	
PONTIAC	Ventilato/Vented



60-00-099	
	Pitch Circle Ø/Foro int.-Ø [mm]
	61
	Height/Altezza [mm]
	38,3
	Diam./Diam. [mm]
	259
Thickness/Spessore - Min [mm]	
24/22	
No. of Bores/N° fori	
5	
CHRYSLER	Ventilato/Vented

60-01-104	
	Pitch Circle Ø/Foro int.-Ø [mm]
	73
	Height/Altezza [mm]
	48
	Diam./Diam. [mm]
	253,6
Thickness/Spessore - Min [mm]	
12,5/11,5	
No. of Bores/N° fori	
4	
NISSAN	Non Ventilato/Not Vented

60-01-100	
	Pitch Circle Ø/Foro int.-Ø [mm]
	64
	Height/Altezza [mm]
	40
	Diam./Diam. [mm]
	238,7
Thickness/Spessore - Min [mm]	
9,5/8,6	
No. of Bores/N° fori	
4	
NISSAN	Non Ventilato/Not Vented

60-01-105	
	Pitch Circle Ø/Foro int.-Ø [mm]
	96
	Height/Altezza [mm]
	53
	Diam./Diam. [mm]
	290
Thickness/Spessore - Min [mm]	
26/24	
No. of Bores/N° fori	
6	
NISSAN	Ventilato/Vented

60-01-101	
	Pitch Circle Ø/Foro int.-Ø [mm]
	64
	Height/Altezza [mm]
	38,5
	Diam./Diam. [mm]
	238,4
Thickness/Spessore - Min [mm]	
9,6/8,6	
No. of Bores/N° fori	
4	
NISSAN	Non Ventilato/Not Vented

60-01-106	
	Pitch Circle Ø/Foro int.-Ø [mm]
	73
	Height/Altezza [mm]
	22,4
	Diam./Diam. [mm]
	249,4
Thickness/Spessore - Min [mm]	
18/16,5	
No. of Bores/N° fori	
4	
NISSAN	Ventilato/Vented

60-01-102	
	Pitch Circle Ø/Foro int.-Ø [mm]
	73
	Height/Altezza [mm]
	35,8
	Diam./Diam. [mm]
	244,1
Thickness/Spessore - Min [mm]	
10/8,5	
No. of Bores/N° fori	
4	
NISSAN	Non Ventilato/Not Vented

60-01-107	
	Pitch Circle Ø/Foro int.-Ø [mm]
	81
	Height/Altezza [mm]
	44,5
	Diam./Diam. [mm]
	270,9
Thickness/Spessore - Min [mm]	
12,5/11	
No. of Bores/N° fori	
4	
NISSAN	Non Ventilato/Not Vented

60-01-103	
	Pitch Circle Ø/Foro int.-Ø [mm]
	109
	Height/Altezza [mm]
	47,3
	Diam./Diam. [mm]
	305,3
Thickness/Spessore - Min [mm]	
32/30	
No. of Bores/N° fori	
6	
NISSAN	Ventilato/Vented

60-01-108	
	Pitch Circle Ø/Foro int.-Ø [mm]
	68
	Height/Altezza [mm]
	49,8
	Diam./Diam. [mm]
	279,8
Thickness/Spessore - Min [mm]	
22/20	
No. of Bores/N° fori	
4	
NISSAN	Ventilato/Vented

60-01-109	
	Pitch Circle Ø/Foro int.-Ø [mm]
	68
	Height/Altezza [mm]
	38,5
	Diam./Diam. [mm]
	319,4
Thickness/Spessore - Min [mm]	
28/26	
No. of Bores/N° fori	
6	
Ventilato/Vented	
NISSAN	

60-01-114	
Image Not Available	Pitch Circle Ø/Foro int.-Ø [mm]
	64
	Height/Altezza [mm]
	40
	Diam./Diam. [mm]
	200
Thickness/Spessore - Min [mm]	
10/8,5	
Non Ventilato/Not Vented	

60-01-110	
	Pitch Circle Ø/Foro int.-Ø [mm]
	96
	Height/Altezza [mm]
	50
	Diam./Diam. [mm]
	276
Thickness/Spessore - Min [mm]	
24/22	
No. of Bores/N° fori	
5	
Ventilato/Vented	
NISSAN - JEEP	

60-01-115	
	Pitch Circle Ø/Foro int.-Ø [mm]
	68
	Height/Altezza [mm]
	38
	Diam./Diam. [mm]
	296
Thickness/Spessore - Min [mm]	
28/26	
No. of Bores/N° fori	
6	
Ventilato/Vented	
NISSAN	

60-01-111	
	Pitch Circle Ø/Foro int.-Ø [mm]
	61
	Height/Altezza [mm]
	45,5
	Diam./Diam. [mm]
	251,5
Thickness/Spessore - Min [mm]	
20/19	
No. of Bores/N° fori	
4	
Ventilato/Vented	
NISSAN	

60-01-116	
	Pitch Circle Ø/Foro int.-Ø [mm]
	64
	Height/Altezza [mm]
	40
	Diam./Diam. [mm]
	218,5
Thickness/Spessore - Min [mm]	
9,5/8,5	
No. of Bores/N° fori	
4	
Non Ventilato/Not Vented	
NISSAN	

60-01-112	
	Pitch Circle Ø/Foro int.-Ø [mm]
	81
	Height/Altezza [mm]
	29
	Diam./Diam. [mm]
	250,7
Thickness/Spessore - Min [mm]	
20/18	
No. of Bores/N° fori	
4	
Ventilato/Vented	
NISSAN	

60-01-117	
	Pitch Circle Ø/Foro int.-Ø [mm]
	96
	Height/Altezza [mm]
	51
	Diam./Diam. [mm]
	282
Thickness/Spessore - Min [mm]	
24,3/22	
No. of Bores/N° fori	
6	
Ventilato/Vented	
NISSAN	

60-01-113	
	Pitch Circle Ø/Foro int.-Ø [mm]
	59
	Height/Altezza [mm]
	47
	Diam./Diam. [mm]
	238
Thickness/Spessore - Min [mm]	
18/16	
No. of Holes/N° fori	
4	
Ventilato/Vented	
NISSAN	

60-01-118	
	Pitch Circle Ø/Foro int.-Ø [mm]
	70
	Height/Altezza [mm]
	36
	Diam./Diam. [mm]
	210,8
Thickness/Spessore - Min [mm]	
9,6/8,5	
No. of Bores/N° fori	
4	
Non Ventilato/Not Vented	

60-01-119	
	Pitch Circle Ø/Foro int.-Ø [mm]
	76
	Height/Altezza [mm]
	35
	Diam./Diam. [mm]
239,3	
Thickness/Spessore - Min [mm]	
12/11	
No. of Bores/N° fori	
4	
NISSAN	Non Ventilato/Not Vented

60-01-124	
	Pitch Circle Ø/Foro int.-Ø [mm]
	73
	Height/Altezza [mm]
	22
	Diam./Diam. [mm]
231,9	
Thickness/Spessore - Min [mm]	
18/16	
No. of Bores/N° fori	
4	
NISSAN	Ventilato/Vented

60-01-120	
	Pitch Circle Ø/Foro int.-Ø [mm]
	90
	Height/Altezza [mm]
	79
	Diam./Diam. [mm]
305	
Thickness/Spessore - Min [mm]	
28/26	
No. of Bores/N° fori	
5	
NISSAN	Ventilato/Vented

60-01-125	
	Pitch Circle Ø/Foro int.-Ø [mm]
	76
	Height/Altezza [mm]
	36,8
	Diam./Diam. [mm]
231,5	
Thickness/Spessore - Min [mm]	
18/16	
No. of Bores/N° fori	
4	
NISSAN	Ventilato/Vented

60-01-121	
	Pitch Circle Ø/Foro int.-Ø [mm]
	79
	Height/Altezza [mm]
	31,5
	Diam./Diam. [mm]
232	
Thickness/Spessore - Min [mm]	
18/16	
No. of Bores/N° fori	
4	
NISSAN	Ventilato/Vented

60-01-126	
	Pitch Circle Ø/Foro int.-Ø [mm]
	104
	Height/Altezza [mm]
	29,3
	Diam./Diam. [mm]
294,4	
Thickness/Spessore - Min [mm]	
20/18	
No. of Bores/N° fori	
6	
NISSAN	Ventilato/Vented

60-01-122	
	Pitch Circle Ø/Foro int.-Ø [mm]
	59
	Height/Altezza [mm]
	43,2
	Diam./Diam. [mm]
213	
Thickness/Spessore - Min [mm]	
12/11	
No. of Bores/N° fori	
4	
NISSAN	Non Ventilato/Not Vented

60-01-127	
	Pitch Circle Ø/Foro int.-Ø [mm]
	68
	Height/Altezza [mm]
	50
	Diam./Diam. [mm]
249,6	
Thickness/Spessore - Min [mm]	
22/20	
No. of Bores/N° fori	
4	
NISSAN	Ventilato/Vented

60-01-123	
	Pitch Circle Ø/Foro int.-Ø [mm]
	81
	Height/Altezza [mm]
	29
	Diam./Diam. [mm]
251,4	
Thickness/Spessore - Min [mm]	
20/18	
No. of Bores/N° fori	
6	
NISSAN	Ventilato/Vented

60-01-128	
	Pitch Circle Ø/Foro int.-Ø [mm]
	81
	Height/Altezza [mm]
	35,7
	Diam./Diam. [mm]
273,7	
Thickness/Spessore - Min [mm]	
22/20	
No. of Bores/N° fori	
4	
NISSAN	Ventilato/Vented

60-01-129	
	Pitch Circle Ø/Foro int.-Ø [mm]
	81
	Height/Altezza [mm]
	30,3
	Diam./Diam. [mm]
	249,6
Thickness/Spessore - Min [mm]	
22/20	
No. of Bores/N° fori	
6	
NISSAN	Ventilato/Vented

60-01-135	
	Pitch Circle Ø/Foro int.-Ø [mm]
	61
	Height/Altezza [mm]
	46
	Diam./Diam. [mm]
	247
Thickness/Spessore - Min [mm]	
18/16	
No. of Bores/N° fori	
4	
NISSAN	Ventilato/Vented

60-01-131	
	Pitch Circle Ø/Foro int.-Ø [mm]
	81
	Height/Altezza [mm]
	37
	Diam./Diam. [mm]
	249,2
Thickness/Spessore - Min [mm]	
21,9/20	
No. of Bores/N° fori	
6	
NISSAN	Ventilato/Vented

60-01-136	
	Pitch Circle Ø/Foro int.-Ø [mm]
	61
	Height/Altezza [mm]
	46
	Diam./Diam. [mm]
	232
Thickness/Spessore - Min [mm]	
18/16	
No. of Bores/N° fori	
4	
NISSAN	Ventilato/Vented

60-01-132	
	Pitch Circle Ø/Foro int.-Ø [mm]
	100
	Height/Altezza [mm]
	39,2
	Diam./Diam. [mm]
	266,7
Thickness/Spessore - Min [mm]	
22/20	
No. of Bores/N° fori	
6	
NISSAN	Ventilato/Vented

60-01-137	
	Pitch Circle Ø/Foro int.-Ø [mm]
	77
	Height/Altezza [mm]
	35,8
	Diam./Diam. [mm]
	273,3
Thickness/Spessore - Min [mm]	
22/20	
No. of Bores/N° fori	
5	
NISSAN	Ventilato/Vented

60-01-133	
	Pitch Circle Ø/Foro int.-Ø [mm]
	45
	Height/Altezza [mm]
	94,3
	Diam./Diam. [mm]
	249,8
Thickness/Spessore - Min [mm]	
22,3/20	
No. of Bores/N° fori	
4	
NISSAN	Ventilato/Vented

60-01-138	
	Pitch Circle Ø/Foro int.-Ø [mm]
	61
	Height/Altezza [mm]
	45,5
	Diam./Diam. [mm]
	239,7
Thickness/Spessore - Min [mm]	
12/11	
No. of Bores/N° fori	
4	
NISSAN	Non Ventilato/Not Vented

60-01-134	
	Pitch Circle Ø/Foro int.-Ø [mm]
	72
	Height/Altezza [mm]
	51
	Diam./Diam. [mm]
	305
Thickness/Spessore - Min [mm]	
28/26	
No. of Bores/N° fori	
5	
NISSAN	Ventilato/Vented

60-01-139	
	Pitch Circle Ø/Foro int.-Ø [mm]
	61
	Height/Altezza [mm]
	45,5
	Diam./Diam. [mm]
	240
Thickness/Spessore - Min [mm]	
18/16	
No. of Bores/N° fori	
4	
NISSAN	Ventilato/Vented

60-01-140	
	Pitch Circle Ø/Foro int.-Ø [mm]
	68
	Height/Altezza [mm]
	49,7
	Diam./Diam. [mm]
	279,5
Thickness/Spessore - Min [mm]	
22/20	
No. of Bores/N° fori	
5	
NISSAN	Ventilato/Vented

60-01-146	
	Pitch Circle Ø/Foro int.-Ø [mm]
	61
	Height/Altezza [mm]
	45
	Diam./Diam. [mm]
	254
Thickness/Spessore - Min [mm]	
20/18	
No. of Holes/N° fori	
4	
NISSAN	Ventilato/Vented

60-01-142	
	Pitch Circle Ø/Foro int.-Ø [mm]
	61
	Height/Altezza [mm]
	41,5
	Diam./Diam. [mm]
	258,5
Thickness/Spessore - Min [mm]	
21/19	
No. of Holes/N° fori	
4	
NISSAN	Ventilato/Vented

60-01-148	
	Pitch Circle Ø/Foro int.-Ø [mm]
	59
	Height/Altezza [mm]
	46,5
	Diam./Diam. [mm]
	213,9
Thickness/Spessore - Min [mm]	
15/13	
No. of Bores/N° fori	
4	
NISSAN	Ventilato/Vented

60-01-143	
	Pitch Circle Ø/Foro int.-Ø [mm]
	81
	Height/Altezza [mm]
	37
	Diam./Diam. [mm]
	259,3
Thickness/Spessore - Min [mm]	
26/24	
No. of Bores/N° fori	
6	
NISSAN	Ventilato/Vented

60-01-149	
	Pitch Circle Ø/Foro int.-Ø [mm]
	68
	Height/Altezza [mm]
	57,3
	Diam./Diam. [mm]
	279,9
Thickness/Spessore - Min [mm]	
26/24	
No. of Bores/N° fori	
5	
NISSAN	Ventilato/Vented

60-01-144	
	Pitch Circle Ø/Foro int.-Ø [mm]
	100
	Height/Altezza [mm]
	39,2
	Diam./Diam. [mm]
	276,3
Thickness/Spessore - Min [mm]	
26/24	
No. of Bores/N° fori	
6	
NISSAN	Ventilato/Vented

60-01-150	
	Pitch Circle Ø/Foro int.-Ø [mm]
	61
	Height/Altezza [mm]
	46,5
	Diam./Diam. [mm]
	212
Thickness/Spessore - Min [mm]	
15/13	
No. of Bores/N° fori	
4	
NISSAN	Ventilato/Vented

60-01-145	
	Pitch Circle Ø/Foro int.-Ø [mm]
	100
	Height/Altezza [mm]
	38,5
	Diam./Diam. [mm]
	299,8
Thickness/Spessore - Min [mm]	
28/26	
No. of Bores/N° fori	
6	
NISSAN - INFINITI	Ventilato/Vented

60-01-151	
	Pitch Circle Ø/Foro int.-Ø [mm]
	68
	Height/Altezza [mm]
	49,7
	Diam./Diam. [mm]
	250
Thickness/Spessore - Min [mm]	
20/18	
No. of Bores/N° fori	
4	
NISSAN	Ventilato/Vented

60-01-152	
	Pitch Circle Ø/Foro int.-Ø [mm]
	68
	Height/Altezza [mm]
	50
	Diam./Diam. [mm]
	320
Thickness/Spessore - Min [mm]	
28/26	
No. of Bores/N° fori	
5	
INFINITI - NISSAN	Ventilato/Vented

60-01-158	
	Pitch Circle Ø/Foro int.-Ø [mm]
	68
	Height/Altezza [mm]
	49,7
	Diam./Diam. [mm]
	279,2
Thickness/Spessore - Min [mm]	
28/26	
No. of Bores/N° fori	
5	
NISSAN - INFINITI	Ventilato/Vented

60-01-153	
	Pitch Circle Ø/Foro int.-Ø [mm]
	81
	Height/Altezza [mm]
	44,4
	Diam./Diam. [mm]
	271,3
Thickness/Spessore - Min [mm]	
12,6/11,5	
No. of Bores/N° fori	
6	
NISSAN	Non Ventilato/Not Vented

60-01-159	
Image Not Available	Pitch Circle Ø/Foro int.-Ø [mm]
	68
	Height/Altezza [mm]
	44
	Diam./Diam. [mm]
	280
Thickness/Spessore - Min [mm]	
24/22	
No. of Bores/N° fori	
4	
NISSAN	Ventilato/Vented

60-01-154	
	Pitch Circle Ø/Foro int.-Ø [mm]
	68
	Height/Altezza [mm]
	44
	Diam./Diam. [mm]
	280
Thickness/Spessore - Min [mm]	
24/22	
No. of Bores/N° fori	
5	
NISSAN	Ventilato/Vented

60-01-160	
	Pitch Circle Ø/Foro int.-Ø [mm]
	68
	Height/Altezza [mm]
	54
	Diam./Diam. [mm]
	257
Thickness/Spessore - Min [mm]	
26/24	
No. of Bores/N° fori	
4	
NISSAN	Ventilato/Vented

60-01-155	
	Pitch Circle Ø/Foro int.-Ø [mm]
	61
	Height/Altezza [mm]
	44,5
	Diam./Diam. [mm]
	260
Thickness/Spessore - Min [mm]	
22/20	
No. of Bores/N° fori	
4	
NISSAN	Ventilato/Vented

60-01-161	
	Pitch Circle Ø/Foro int.-Ø [mm]
	94
	Height/Altezza [mm]
	45,5
	Diam./Diam. [mm]
	276
Thickness/Spessore - Min [mm]	
28/26	
No. of Bores/N° fori	
5	
NISSAN	Ventilato/Vented

60-01-157	
	Pitch Circle Ø/Foro int.-Ø [mm]
	68
	Height/Altezza [mm]
	44
	Diam./Diam. [mm]
	296
Thickness/Spessore - Min [mm]	
26/24	
No. of Holes/N° fori	
5	
NISSAN	Ventilato/Vented

60-01-183	
	Pitch Circle Ø/Foro int.-Ø [mm]
	68
	Height/Altezza [mm]
	50,5
	Diam./Diam. [mm]
	249,8
Thickness/Spessore - Min [mm]	
22/20	
No. of Bores/N° fori	
5	
NISSAN	Ventilato/Vented



60-01-185	
	Pitch Circle Ø/Foro int.-Ø [mm]
	61,3
	Height/Altezza [mm]
	45,5
	Diam./Diam. [mm]
255,4	
Thickness/Spessore - Min [mm]	
26,1/24	
No. of Bores/N° fori	
4	
NISSAN	Ventilato/Vented

60-01-191	
	Pitch Circle Ø/Foro int.-Ø [mm]
	68
	Height/Altezza [mm]
	52,3
	Diam./Diam. [mm]
256,6	
Thickness/Spessore - Min [mm]	
26/24	
No. of Bores/N° fori	
5	
NISSAN	Ventilato/Vented

60-01-187	
	Pitch Circle Ø/Foro int.-Ø [mm]
	68
	Height/Altezza [mm]
	50,5
	Diam./Diam. [mm]
273,9	
Thickness/Spessore - Min [mm]	
22/20	
No. of Bores/N° fori	
4	
NISSAN	Ventilato/Vented

60-01-194	
	Pitch Circle Ø/Foro int.-Ø [mm]
	68
	Height/Altezza [mm]
	54
	Diam./Diam. [mm]
280	
Thickness/Spessore - Min [mm]	
30/28	
No. of Bores/N° fori	
5	
NISSAN	Ventilato/Vented

60-01-188	
	Pitch Circle Ø/Foro int.-Ø [mm]
	81
	Height/Altezza [mm]
	29,5
	Diam./Diam. [mm]
261	
Thickness/Spessore - Min [mm]	
20/18	
No. of Bores/N° fori	
6	
NISSAN	Ventilato/Vented

60-01-196	
	Pitch Circle Ø/Foro int.-Ø [mm]
	68
	Height/Altezza [mm]
	49,3
	Diam./Diam. [mm]
256,8	
Thickness/Spessore - Min [mm]	
22/20	
No. of Bores/N° fori	
4	
NISSAN	Ventilato/Vented

60-01-189	
	Pitch Circle Ø/Foro int.-Ø [mm]
	61
	Height/Altezza [mm]
	46,5
	Diam./Diam. [mm]
213,4	
Thickness/Spessore - Min [mm]	
12/11	
No. of Bores/N° fori	
4	
NISSAN	Non Ventilato/Not Vented

60-01-197	
	Pitch Circle Ø/Foro int.-Ø [mm]
	96
	Height/Altezza [mm]
	53
	Diam./Diam. [mm]
263	
Thickness/Spessore - Min [mm]	
24/22,4	
No. of Bores/N° fori	
5	
NISSAN	Ventilato/Vented

60-01-190	
	Pitch Circle Ø/Foro int.-Ø [mm]
	96
	Height/Altezza [mm]
	53,5
	Diam./Diam. [mm]
262,9	
Thickness/Spessore - Min [mm]	
24/22,4	
No. of Bores/N° fori	
6	
NISSAN	Ventilato/Vented

60-01-198	
	Pitch Circle Ø/Foro int.-Ø [mm]
	59
	Height/Altezza [mm]
	45,8
	Diam./Diam. [mm]
233,6	
Thickness/Spessore - Min [mm]	
12/10	
No. of Bores/N° fori	
4	
NISSAN	Non Ventilato/Not Vented

60-01-199	
	Pitch Circle Ø/Foro int.-Ø [mm]
	73
	Height/Altezza [mm]
	30
	Diam./Diam. [mm]
249,9	
Thickness/Spessore - Min [mm]	
22/20	
No. of Bores/N° fori	
4	
NISSAN	Ventilato/Vented

60-02-2005	
	Pitch Circle Ø/Foro int.-Ø [mm]
	105
	Height/Altezza [mm]
	58,6
	Diam./Diam. [mm]
310,8	
Thickness/Spessore - Min [mm]	
32/30	
No. of Bores/N° fori	
6	
TOYOTA	Ventilato/Vented

60-02-2000	
	Pitch Circle Ø/Foro int.-Ø [mm]
	62
	Height/Altezza [mm]
	49,6
	Diam./Diam. [mm]
295,6	
Thickness/Spessore - Min [mm]	
28/26	
No. of Bores/N° fori	
5	
TOYOTA	Ventilato/Vented

60-02-2006	
	Pitch Circle Ø/Foro int.-Ø [mm]
	62
	Height/Altezza [mm]
	50
	Diam./Diam. [mm]
296	
Thickness/Spessore - Min [mm]	
28/26	
No. of Holes/N° fori	
5	
TOYOTA	Ventilato/Vented

60-02-2001	
	Pitch Circle Ø/Foro int.-Ø [mm]
	62
	Height/Altezza [mm]
	49,6
	Diam./Diam. [mm]
295,7	
Thickness/Spessore - Min [mm]	
28/26	
No. of Bores/N° fori	
5	
TOYOTA	Ventilato/Vented

60-02-2007	
	Pitch Circle Ø/Foro int.-Ø [mm]
	62
	Height/Altezza [mm]
	50
	Diam./Diam. [mm]
296	
Thickness/Spessore - Min [mm]	
28/26	
No. of Bores/N° fori	
5	
LEXUS	Ventilato/Vented

60-02-2002	
	Pitch Circle Ø/Foro int.-Ø [mm]
	62
	Height/Altezza [mm]
	49,5
	Diam./Diam. [mm]
274,5	
Thickness/Spessore - Min [mm]	
28/26	
No. of Bores/N° fori	
5	
TOYOTA	Ventilato/Vented

60-02-2008	
	Pitch Circle Ø/Foro int.-Ø [mm]
	108
	Height/Altezza [mm]
	68
	Diam./Diam. [mm]
297	
Thickness/Spessore - Min [mm]	
25/23,5	
No. of Bores/N° fori	
6	
TOYOTA	Ventilato/Vented

60-02-2003	
	Pitch Circle Ø/Foro int.-Ø [mm]
	108
	Height/Altezza [mm]
	67,8
	Diam./Diam. [mm]
337,4	
Thickness/Spessore - Min [mm]	
28/26	
No. of Bores/N° fori	
6	
TOYOTA	Ventilato/Vented

60-02-2009	
	Pitch Circle Ø/Foro int.-Ø [mm]
	62
	Height/Altezza [mm]
	59
	Diam./Diam. [mm]
257	
Thickness/Spessore - Min [mm]	
28/26	
No. of Bores/N° fori	
5	
TOYOTA	Ventilato/Vented



60-02-201	
	Pitch Circle Ø/Foro int.-Ø [mm]
	55
	Height/Altezza [mm]
	49,3
	Diam./Diam. [mm]
274,6	
Thickness/Spessore - Min [mm]	
25/23	
No. of Bores/N° fori	
4	
TOYOTA	Ventilato/Vented

60-02-2014	
	Pitch Circle Ø/Foro int.-Ø [mm]
	55
	Height/Altezza [mm]
	47
	Diam./Diam. [mm]
275	
Thickness/Spessore - Min [mm]	
22/20	
No. of Bores/N° fori	
5	
TOYOTA - SUBARU	Ventilato/Vented

60-02-2010	
	Pitch Circle Ø/Foro int.-Ø [mm]
	62
	Height/Altezza [mm]
	47
	Diam./Diam. [mm]
275	
Thickness/Spessore - Min [mm]	
25/23	
No. of Bores/N° fori	
5	
TOYOTA	Ventilato/Vented

60-02-2015	
	Pitch Circle Ø/Foro int.-Ø [mm]
	62
	Height/Altezza [mm]
	50
	Diam./Diam. [mm]
320	
Thickness/Spessore - Min [mm]	
26/24	
No. of Bores/N° fori	
5	
TOYOTA	Ventilato/Vented

60-02-2011	
	Pitch Circle Ø/Foro int.-Ø [mm]
	112
	Height/Altezza [mm]
	84
	Diam./Diam. [mm]
340	
Thickness/Spessore - Min [mm]	
32/30	
No. of Bores/N° fori	
5	
TOYOTA	Ventilato/Vented

60-02-2016	
	Pitch Circle Ø/Foro int.-Ø [mm]
	62
	Height/Altezza [mm]
	50
	Diam./Diam. [mm]
295	
Thickness/Spessore - Min [mm]	
26/24	
No. of Bores/N° fori	
5	
TOYOTA	Ventilato/Vented

60-02-2012	
	Pitch Circle Ø/Foro int.-Ø [mm]
	55
	Height/Altezza [mm]
	47
	Diam./Diam. [mm]
255	
Thickness/Spessore - Min [mm]	
20/18	
No. of Bores/N° fori	
4	
TOYOTA	Ventilato/Vented

60-02-2017	
	Pitch Circle Ø/Foro int.-Ø [mm]
	55
	Height/Altezza [mm]
	46,5
	Diam./Diam. [mm]
255	
Thickness/Spessore - Min [mm]	
22/20	
No. of Bores/N° fori	
4	
TOYOTA	Ventilato/Vented

60-02-2013	
	Pitch Circle Ø/Foro int.-Ø [mm]
	84
	Height/Altezza [mm]
	46
	Diam./Diam. [mm]
285	
Thickness/Spessore - Min [mm]	
28/26	
No. of Bores/N° fori	
5	
TOYOTA	Ventilato/Vented

60-02-2018	
	Pitch Circle Ø/Foro int.-Ø [mm]
	62
	Height/Altezza [mm]
	47
	Diam./Diam. [mm]
275	
Thickness/Spessore - Min [mm]	
22/20	
No. of Bores/N° fori	
5	
TOYOTA	Ventilato/Vented

60-02-2019	
	Pitch Circle Ø/Foro int.-Ø [mm]
	115
	Height/Altezza [mm]
	64
	Diam./Diam. [mm]
	322
Thickness/Spessore - Min [mm]	
32/30	
No. of Bores/N° fori	
5	
TOYOTA	Ventilato/Vented

60-02-2023	
	Inner Diam./Diam. int. [mm]
	83,5
	Height/Altezza [mm]
	45,5
	Diam./Diam. [mm]
	285
Thickness/Spessore - Min [mm]	
28/26	
	Ventilato/Vented
TOYOTA	

60-02-202	
	Pitch Circle Ø/Foro int.-Ø [mm]
	64
	Height/Altezza [mm]
	31
	Diam./Diam. [mm]
	226
Thickness/Spessore - Min [mm]	
10/9	
No. of Holes/N° fori	
4	
TOYOTA	Non Ventilato/Not Vented

60-02-2024	
	Pitch Circle Ø/Foro int.-Ø [mm]
	108
	Height/Altezza [mm]
	70
	Diam./Diam. [mm]
	297
Thickness/Spessore - Min [mm]	
22/21	
No. of Bores/N° fori	
6	
TOYOTA	Ventilato/Vented

60-02-2020	
	Inner Diam./Diam. int. [mm]
	62
	Height/Altezza [mm]
	50
	Diam./Diam. [mm]
	296
Thickness/Spessore - Min [mm]	
28/26	
No. of Bores/N° fori	
5	
TOYOTA	Ventilato/Vented

60-02-2025	
	Pitch Circle Ø/Foro int.-Ø [mm]
	62
	Height/Altezza [mm]
	54
	Diam./Diam. [mm]
	334
Thickness/Spessore - Min [mm]	
30/28	
No. of Bores/N° fori	
5	
LEXUS	Ventilato/Vented

60-02-2021	
	Pitch Circle Ø/Foro int.-Ø [mm]
	84
	Height/Altezza [mm]
	46
	Diam./Diam. [mm]
	248
Brake Disc Thickness/Spessore disco freno [mm]	
22	
No. of Bores/N° fori	
5	
TOYOTA	Ventilato/Vented

60-02-2026	
	Pitch Circle Ø/Foro int.-Ø [mm]
	63
	Height/Altezza [mm]
	51
	Diam./Diam. [mm]
	334
Thickness/Spessore - Min [mm]	
30/28	
No. of Bores/N° fori	
5	
LEXUS	Ventilato/Vented

60-02-2022	
Image Not Available	Pitch Circle Ø/Foro int.-Ø [mm]
	54
	Height/Altezza [mm]
	48
	Diam./Diam. [mm]
	238
Thickness/Spessore - Min [mm]	
18/16	
No. of Bores/N° fori	
4	
TOYOTA	Ventilato/Vented

60-02-2027	
	Pitch Circle Ø/Foro int.-Ø [mm]
	55
	Height/Altezza [mm]
	50
	Diam./Diam. [mm]
	255
Thickness/Spessore - Min [mm]	
22/20	
No. of Bores/N° fori	
5	
TOYOTA	Ventilato/Vented



60-02-2028	
Image Not Available	Pitch Circle Ø/Foro int.-Ø [mm]
	100
	Height/Altezza [mm]
	49
	Diam./Diam. [mm]
	287
Thickness/Spessore - Min [mm]	
28/26	
No. of Bores/N° fori	
6	
TOYOTA	Ventilato/Vented

60-02-206	
	Pitch Circle Ø/Foro int.-Ø [mm]
	64
	Height/Altezza [mm]
	36
	Diam./Diam. [mm]
	200
Thickness/Spessore - Min [mm]	
10/9	
Non Ventilato/Not Vented	
TOYOTA	

60-02-2029	
Image Not Available	Pitch Circle Ø/Foro int.-Ø [mm]
	108
	Height/Altezza [mm]
	68,5
	Diam./Diam. [mm]
	338
Thickness/Spessore - Min [mm]	
32/29	
No. of Bores/N° fori	
6	
TOYOTA	Ventilato/Vented

60-02-207	
	Pitch Circle Ø/Foro int.-Ø [mm]
	55
	Height/Altezza [mm]
	49
	Diam./Diam. [mm]
	255
Thickness/Spessore - Min [mm]	
25/23	
No. of Bores/N° fori	
4	
TOYOTA	Ventilato/Vented

60-02-203	
	Pitch Circle Ø/Foro int.-Ø [mm]
	55
	Height/Altezza [mm]
	49,7
	Diam./Diam. [mm]
	254,6
Thickness/Spessore - Min [mm]	
25/23	
No. of Bores/N° fori	
5	
TOYOTA	Ventilato/Vented

60-02-208	
	Pitch Circle Ø/Foro int.-Ø [mm]
	55
	Height/Altezza [mm]
	49,7
	Diam./Diam. [mm]
	254,8
Thickness/Spessore - Min [mm]	
25,2/23	
No. of Bores/N° fori	
4	
TOYOTA	Ventilato/Vented

60-02-204	
	Pitch Circle Ø/Foro int.-Ø [mm]
	76
	Height/Altezza [mm]
	30
	Diam./Diam. [mm]
	225
Thickness/Spessore - Min [mm]	
10/9	
No. of Bores/N° fori	
4	
TOYOTA	Non Ventilato/Not Vented

60-02-210	
	Pitch Circle Ø/Foro int.-Ø [mm]
	64
	Height/Altezza [mm]
	17,5
	Diam./Diam. [mm]
	227,6
Thickness/Spessore - Min [mm]	
10/9	
No. of Bores/N° fori	
4	
TOYOTA	Non Ventilato/Not Vented

60-02-205	
	Pitch Circle Ø/Foro int.-Ø [mm]
	108
	Height/Altezza [mm]
	71
	Diam./Diam. [mm]
	318,4
Thickness/Spessore - Min [mm]	
22/20	
No. of Bores/N° fori	
6	
TOYOTA	Ventilato/Vented

60-02-211	
	Pitch Circle Ø/Foro int.-Ø [mm]
	55
	Height/Altezza [mm]
	50
	Diam./Diam. [mm]
	276,9
Thickness/Spessore - Min [mm]	
26/24	
No. of Bores/N° fori	
5	
TOYOTA	Ventilato/Vented

60-02-212	
	Pitch Circle Ø/Foro int.-Ø [mm]
	64
	Height/Altezza [mm]
	32
	Diam./Diam. [mm]
	228,4
Thickness/Spessore - Min [mm]	
12,5/11,5	
No. of Bores/N° fori	
4	
TOYOTA - DAIHATSU	Non Ventilato/Not Vented

60-02-217	
	Pitch Circle Ø/Foro int.-Ø [mm]
	62
	Height/Altezza [mm]
	47,4
	Diam./Diam. [mm]
	274,7
Thickness/Spessore - Min [mm]	
30/28	
No. of Bores/N° fori	
5	
TOYOTA	Ventilato/Vented

60-02-213	
	Pitch Circle Ø/Foro int.-Ø [mm]
	62
	Height/Altezza [mm]
	49,3
	Diam./Diam. [mm]
	274
Thickness/Spessore - Min [mm]	
28/26	
No. of Bores/N° fori	
5	
TOYOTA	Ventilato/Vented

60-02-218	
	Pitch Circle Ø/Foro int.-Ø [mm]
	64
	Height/Altezza [mm]
	30,3
	Diam./Diam. [mm]
	217,6
Thickness/Spessore - Min [mm]	
10/9	
No. of Bores/N° fori	
4	
TOYOTA	Non Ventilato/Not Vented

60-02-214	
	Pitch Circle Ø/Foro int.-Ø [mm]
	73
	Height/Altezza [mm]
	16
	Diam./Diam. [mm]
	254
Thickness/Spessore - Min [mm]	
12,6/11,5	
No. of Bores/N° fori	
4	
TOYOTA	Non Ventilato/Not Vented

60-02-219	
	Pitch Circle Ø/Foro int.-Ø [mm]
	55
	Height/Altezza [mm]
	49,6
	Diam./Diam. [mm]
	274,9
Thickness/Spessore - Min [mm]	
25/23	
No. of Bores/N° fori	
4	
TOYOTA	Ventilato/Vented

60-02-215	
	Pitch Circle Ø/Foro int.-Ø [mm]
	55
	Height/Altezza [mm]
	49,6
	Diam./Diam. [mm]
	255
Thickness/Spessore - Min [mm]	
28/26	
No. of Bores/N° fori	
5	
TOYOTA	Ventilato/Vented

60-02-220	
	Pitch Circle Ø/Foro int.-Ø [mm]
	76
	Height/Altezza [mm]
	26,5
	Diam./Diam. [mm]
	251,6
Thickness/Spessore - Min [mm]	
20/19	
No. of Bores/N° fori	
5	
TOYOTA	Ventilato/Vented

60-02-216	
	Pitch Circle Ø/Foro int.-Ø [mm]
	76
	Height/Altezza [mm]
	42
	Diam./Diam. [mm]
	265,6
Thickness/Spessore - Min [mm]	
12,6/11	
No. of Bores/N° fori	
4	
TOYOTA	Non Ventilato/Not Vented

60-02-221	
	Pitch Circle Ø/Foro int.-Ø [mm]
	55
	Height/Altezza [mm]
	43,3
	Diam./Diam. [mm]
	254,7
Thickness/Spessore - Min [mm]	
20/18	
No. of Bores/N° fori	
4	
TOYOTA	Ventilato/Vented

60-02-222	
	Pitch Circle Ø/Foro int.-Ø [mm]
	79
	Height/Altezza [mm]
	26
	Diam./Diam. [mm]
251,8	
Thickness/Spessore - Min [mm]	
20/18,7	
No. of Bores/N° fori	
5	
TOYOTA	Ventilato/Vented

60-02-227	
	Pitch Circle Ø/Foro int.-Ø [mm]
	76
	Height/Altezza [mm]
	26,6
	Diam./Diam. [mm]
257,7	
Thickness/Spessore - Min [mm]	
20,2/18,5	
No. of Bores/N° fori	
4	
TOYOTA	Ventilato/Vented

60-02-223	
	Pitch Circle Ø/Foro int.-Ø [mm]
	64
	Height/Altezza [mm]
	21,2
	Diam./Diam. [mm]
233,6	
Thickness/Spessore - Min [mm]	
12,5/11,5	
No. of Bores/N° fori	
4	
TOYOTA	Non Ventilato/Not Vented

60-02-228	
	Pitch Circle Ø/Foro int.-Ø [mm]
	64
	Height/Altezza [mm]
	23
	Diam./Diam. [mm]
229	
Thickness/Spessore - Min [mm]	
12,5/11	
No. of Bores/N° fori	
4	
TOYOTA - DAIHATSU	Non Ventilato/Not Vented

60-02-224	
	Pitch Circle Ø/Foro int.-Ø [mm]
	115
	Height/Altezza [mm]
	70
	Diam./Diam. [mm]
312,5	
Thickness/Spessore - Min [mm]	
32/30	
No. of Bores/N° fori	
5	
TOYOTA	Ventilato/Vented

60-02-229	
	Pitch Circle Ø/Foro int.-Ø [mm]
	62
	Height/Altezza [mm]
	49,6
	Diam./Diam. [mm]
274,9	
Thickness/Spessore - Min [mm]	
25/23	
No. of Bores/N° fori	
5	
TOYOTA	Ventilato/Vented

60-02-225	
	Pitch Circle Ø/Foro int.-Ø [mm]
	62
	Height/Altezza [mm]
	49,6
	Diam./Diam. [mm]
318,5	
Thickness/Spessore - Min [mm]	
28/26	
No. of Bores/N° fori	
5	
LEXUS	Ventilato/Vented

60-02-230	
	Pitch Circle Ø/Foro int.-Ø [mm]
	55
	Height/Altezza [mm]
	43,2
	Diam./Diam. [mm]
254,8	
Thickness/Spessore - Min [mm]	
20/18,5	
No. of Bores/N° fori	
4	
TOYOTA	Ventilato/Vented

60-02-226	
	Pitch Circle Ø/Foro int.-Ø [mm]
	76
	Height/Altezza [mm]
	26,3
	Diam./Diam. [mm]
258,4	
Thickness/Spessore - Min [mm]	
20/19	
No. of Bores/N° fori	
4	
TOYOTA	Ventilato/Vented

60-02-232	
	Pitch Circle Ø/Foro int.-Ø [mm]
	54
	Height/Altezza [mm]
	39,5
	Diam./Diam. [mm]
242,2	
Thickness/Spessore - Min [mm]	
11,1/10	
No. of Bores/N° fori	
4	
TOYOTA	Non Ventilato/Not Vented

60-02-233	
	Pitch Circle Ø/Foro int.-Ø [mm]
	55
	Height/Altezza [mm]
	48
	Diam./Diam. [mm]
	254
Thickness/Spessore - Min [mm]	
22/20	
No. of Bores/N° fori	
4	
TOYOTA	Ventilato/Vented

60-02-239	
	Pitch Circle Ø/Foro int.-Ø [mm]
	54
	Height/Altezza [mm]
	47,5
	Diam./Diam. [mm]
	242,8
Thickness/Spessore - Min [mm]	
13,6/12,5	
No. of Bores/N° fori	
4	
TOYOTA	Non Ventilato/Not Vented

60-02-234	
	Pitch Circle Ø/Foro int.-Ø [mm]
	100
	Height/Altezza [mm]
	48,4
	Diam./Diam. [mm]
	301,4
Thickness/Spessore - Min [mm]	
20/19	
No. of Bores/N° fori	
6	
TOYOTA	Ventilato/Vented

60-02-240	
	Pitch Circle Ø/Foro int.-Ø [mm]
	64
	Height/Altezza [mm]
	38
	Diam./Diam. [mm]
	232,9
Thickness/Spessore - Min [mm]	
17,8/17	
No. of Bores/N° fori	
4	
TOYOTA	Ventilato/Vented

60-02-235	
	Pitch Circle Ø/Foro int.-Ø [mm]
	55
	Height/Altezza [mm]
	49,7
	Diam./Diam. [mm]
	294,7
Thickness/Spessore - Min [mm]	
26/24	
No. of Bores/N° fori	
5	
TOYOTA	Ventilato/Vented

60-02-241	
	Pitch Circle Ø/Foro int.-Ø [mm]
	54
	Height/Altezza [mm]
	41,7
	Diam./Diam. [mm]
	225,3
Thickness/Spessore - Min [mm]	
11/9,5	
No. of Bores/N° fori	
4	
TOYOTA	Non Ventilato/Not Vented

60-02-236	
	Pitch Circle Ø/Foro int.-Ø [mm]
	54
	Height/Altezza [mm]
	46
	Diam./Diam. [mm]
	242,6
Thickness/Spessore - Min [mm]	
22/21	
No. of Bores/N° fori	
5	
TOYOTA	Ventilato/Vented

60-02-242	
	Pitch Circle Ø/Foro int.-Ø [mm]
	76
	Height/Altezza [mm]
	40,5
	Diam./Diam. [mm]
	248
Thickness/Spessore - Min [mm]	
22/20,5	
No. of Bores/N° fori	
4	
TOYOTA	Ventilato/Vented

60-02-237	
	Pitch Circle Ø/Foro int.-Ø [mm]
	74
	Height/Altezza [mm]
	44
	Diam./Diam. [mm]
	254,8
Thickness/Spessore - Min [mm]	
20/19	
No. of Bores/N° fori	
4	
TOYOTA	Ventilato/Vented

60-02-243	
	Pitch Circle Ø/Foro int.-Ø [mm]
	54
	Height/Altezza [mm]
	47,7
	Diam./Diam. [mm]
	242,4
Thickness/Spessore - Min [mm]	
18/17	
No. of Bores/N° fori	
4	
TOYOTA	Ventilato/Vented

60-02-244	
	Pitch Circle Ø/Foro int.-Ø [mm]
	54
	Height/Altezza [mm]
	42
	Diam./Diam. [mm]
	225,5
Thickness/Spessore - Min [mm]	
16/15	
No. of Bores/N° fori	
4	
TOYOTA	Ventilato/Vented

60-02-249	
	Pitch Circle Ø/Foro int.-Ø [mm]
	100
	Height/Altezza [mm]
	48,4
	Diam./Diam. [mm]
	301,8
Thickness/Spessore - Min [mm]	
12,7/11,5	
No. of Bores/N° fori	
6	
TOYOTA - LEXUS	Non Ventilato/Not Vented

60-02-245	
	Pitch Circle Ø/Foro int.-Ø [mm]
	74
	Height/Altezza [mm]
	42
	Diam./Diam. [mm]
	254,6
Thickness/Spessore - Min [mm]	
20/19	
No. of Bores/N° fori	
4	
TOYOTA	Ventilato/Vented

60-02-250	
	Pitch Circle Ø/Foro int.-Ø [mm]
	54
	Height/Altezza [mm]
	47
	Diam./Diam. [mm]
	258
Thickness/Spessore - Min [mm]	
22/21	
No. of Holes/N° fori	
4	
TOYOTA	Ventilato/Vented

60-02-246	
	Pitch Circle Ø/Foro int.-Ø [mm]
	54
	Height/Altezza [mm]
	48
	Diam./Diam. [mm]
	242,7
Thickness/Spessore - Min [mm]	
22/21	
No. of Bores/N° fori	
4	
TOYOTA	Ventilato/Vented

60-02-251	
	Pitch Circle Ø/Foro int.-Ø [mm]
	95
	Height/Altezza [mm]
	45,3
	Diam./Diam. [mm]
	262
Thickness/Spessore - Min [mm]	
25/24	
No. of Bores/N° fori	
5	
TOYOTA	Ventilato/Vented

60-02-247	
	Pitch Circle Ø/Foro int.-Ø [mm]
	64
	Height/Altezza [mm]
	38,4
	Diam./Diam. [mm]
	233,5
Thickness/Spessore - Min [mm]	
12,5/11,5	
No. of Bores/N° fori	
4	
DAIHATSU	Non Ventilato/Not Vented

60-02-252	
	Pitch Circle Ø/Foro int.-Ø [mm]
	54
	Height/Altezza [mm]
	47,3
	Diam./Diam. [mm]
	254,8
Thickness/Spessore - Min [mm]	
22/21	
No. of Bores/N° fori	
5	
HONDA - TOYOTA	Ventilato/Vented

60-02-248	
	Pitch Circle Ø/Foro int.-Ø [mm]
	54
	Height/Altezza [mm]
	48
	Diam./Diam. [mm]
	257,6
Thickness/Spessore - Min [mm]	
22/21	
No. of Bores/N° fori	
5	
TOYOTA	Ventilato/Vented

60-02-253	
	Pitch Circle Ø/Foro int.-Ø [mm]
	60
	Diam./Diam. [mm]
	302
	Height/Altezza [mm]
	54
Thickness/Spessore - Min [mm]	
22/20	
No. of Bores/N° fori	
5	
TOYOTA	Ventilato/Vented

60-02-254	
	Pitch Circle Ø/Foro int.-Ø [mm]
	74
	Height/Altezza [mm]
	43,7
	Diam./Diam. [mm]
	229,5
Thickness/Spessore - Min [mm]	
20/19	
No. of Bores/N° fori	
4	
TOYOTA	Ventilato/Vented

60-02-261	
	Pitch Circle Ø/Foro int.-Ø [mm]
	55
	Height/Altezza [mm]
	43,5
	Diam./Diam. [mm]
	229
Thickness/Spessore - Min [mm]	
16/15	
No. of Bores/N° fori	
4	
TOYOTA	Ventilato/Vented

60-02-255	
	Pitch Circle Ø/Foro int.-Ø [mm]
	55
	Height/Altezza [mm]
	43,4
	Diam./Diam. [mm]
	237,8
Thickness/Spessore - Min [mm]	
18/17	
No. of Bores/N° fori	
4	
TOYOTA	Ventilato/Vented

60-02-262	
	Pitch Circle Ø/Foro int.-Ø [mm]
	54
	Height/Altezza [mm]
	46,5
	Diam./Diam. [mm]
	255
Thickness/Spessore - Min [mm]	
22/21	
No. of Bores/N° fori	
5	
TOYOTA	Ventilato/Vented

60-02-257	
	Pitch Circle Ø/Foro int.-Ø [mm]
	100
	Height/Altezza [mm]
	48
	Diam./Diam. [mm]
	301
Thickness/Spessore - Min [mm]	
13/10,5	
No. of Bores/N° fori	
6	
TOYOTA	Non Ventilato/Not Vented

60-02-263	
	Pitch Circle Ø/Foro int.-Ø [mm]
	54
	Height/Altezza [mm]
	46,8
	Diam./Diam. [mm]
	276,3
Thickness/Spessore - Min [mm]	
25/23	
No. of Bores/N° fori	
5	
TOYOTA	Ventilato/Vented

60-02-258	
	Pitch Circle Ø/Foro int.-Ø [mm]
	54
	Height/Altezza [mm]
	48,3
	Diam./Diam. [mm]
	254,6
Thickness/Spessore - Min [mm]	
25/24	
No. of Bores/N° fori	
5	
TOYOTA	Ventilato/Vented

60-02-264	
	Pitch Circle Ø/Foro int.-Ø [mm]
	62
	Height/Altezza [mm]
	49,5
	Diam./Diam. [mm]
	294,7
Thickness/Spessore - Min [mm]	
26/24	
No. of Bores/N° fori	
5	
TOYOTA	Ventilato/Vented

60-02-259	
	Pitch Circle Ø/Foro int.-Ø [mm]
	54
	Height/Altezza [mm]
	48
	Diam./Diam. [mm]
	238
Thickness/Spessore - Min [mm]	
22/21	
No. of Bores/N° fori	
4	
TOYOTA	Ventilato/Vented

60-02-265	
	Pitch Circle Ø/Foro int.-Ø [mm]
	54
	Height/Altezza [mm]
	48
	Diam./Diam. [mm]
	238
Thickness/Spessore - Min [mm]	
12/11	
No. of Bores/N° fori	
4	
TOYOTA	Non Ventilato/Not Vented

60-02-266	
	Pitch Circle Ø/Foro int.-Ø [mm]
	54
	Height/Altezza [mm]
	48,4
	Diam./Diam. [mm]
	238
Thickness/Spessore - Min [mm]	
18/17	
No. of Bores/N° fori	
4	
TOYOTA	Ventilato/Vented

60-02-271	
	Pitch Circle Ø/Foro int.-Ø [mm]
	100
	Height/Altezza [mm]
	64
	Diam./Diam. [mm]
	288,8
Thickness/Spessore - Min [mm]	
20/18	
No. of Bores/N° fori	
6	
TOYOTA - VW	Ventilato/Vented

60-02-267	
	Pitch Circle Ø/Foro int.-Ø [mm]
	76
	Height/Altezza [mm]
	28,3
	Diam./Diam. [mm]
	248,8
Thickness/Spessore - Min [mm]	
22/21	
No. of Bores/N° fori	
4	
TOYOTA	Ventilato/Vented

60-02-272	
	Pitch Circle Ø/Foro int.-Ø [mm]
	105
	Height/Altezza [mm]
	58,5
	Diam./Diam. [mm]
	285,5
Thickness/Spessore - Min [mm]	
25/23	
No. of Bores/N° fori	
6	
TOYOTA	Ventilato/Vented

60-02-268	
	Pitch Circle Ø/Foro int.-Ø [mm]
	84
	Height/Altezza [mm]
	46,3
	Diam./Diam. [mm]
	256,7
Thickness/Spessore - Min [mm]	
25/23	
No. of Bores/N° fori	
5	
TOYOTA	Ventilato/Vented

60-02-274	
	Pitch Circle Ø/Foro int.-Ø [mm]
	62
	Height/Altezza [mm]
	47
	Diam./Diam. [mm]
	301,9
Thickness/Spessore - Min [mm]	
18/16	
No. of Bores/N° fori	
5	
TOYOTA	Ventilato/Vented

60-02-269	
	Pitch Circle Ø/Foro int.-Ø [mm]
	55
	Height/Altezza [mm]
	35,5
	Diam./Diam. [mm]
	246,9
Thickness/Spessore - Min [mm]	
20/18	
No. of Bores/N° fori	
4	
TOYOTA - PEUGEOT - CITROEN	Ventilato/Vented

60-02-275	
	Pitch Circle Ø/Foro int.-Ø [mm]
	62
	Height/Altezza [mm]
	49,7
	Diam./Diam. [mm]
	274,9
Thickness/Spessore - Min [mm]	
28/26	
No. of Bores/N° fori	
5	
LEXUS - TOYOTA	Ventilato/Vented

60-02-270	
	Pitch Circle Ø/Foro int.-Ø [mm]
	84
	Height/Altezza [mm]
	47,4
	Diam./Diam. [mm]
	257,3
Thickness/Spessore - Min [mm]	
25/24	
No. of Bores/N° fori	
5	
TOYOTA - VW	Ventilato/Vented

60-02-276	
	Pitch Circle Ø/Foro int.-Ø [mm]
	55
	Height/Altezza [mm]
	49,7
	Diam./Diam. [mm]
	254,7
Thickness/Spessore - Min [mm]	
25/23	
No. of Bores/N° fori	
4	
TOYOTA	Ventilato/Vented

60-02-277	
	Pitch Circle Ø/Foro int.-Ø [mm]
	55
	Height/Altezza [mm]
	49,6
	Diam./Diam. [mm]
	254,8
Thickness/Spessore - Min [mm]	
25/23	
No. of Bores/N° fori	
5	
TOYOTA - LEXUS	Ventilato/Vented

60-02-282	
	Pitch Circle Ø/Foro int.-Ø [mm]
	54
	Height/Altezza [mm]
	46,4
	Diam./Diam. [mm]
	254,8
Thickness/Spessore - Min [mm]	
25/23	
No. of Bores/N° fori	
5	
TOYOTA	Ventilato/Vented

60-02-278	
	Pitch Circle Ø/Foro int.-Ø [mm]
	55
	Height/Altezza [mm]
	43,7
	Diam./Diam. [mm]
	235
Thickness/Spessore - Min [mm]	
18/17	
No. of Bores/N° fori	
4	
TOYOTA	Ventilato/Vented

60-02-283	
	Pitch Circle Ø/Foro int.-Ø [mm]
	60
	Height/Altezza [mm]
	51,4
	Diam./Diam. [mm]
	274,5
Thickness/Spessore - Min [mm]	
28/26	
No. of Bores/N° fori	
5	
LEXUS	Ventilato/Vented

60-02-279	
	Pitch Circle Ø/Foro int.-Ø [mm]
	55
	Height/Altezza [mm]
	49,4
	Diam./Diam. [mm]
	260,2
Thickness/Spessore - Min [mm]	
25/23	
No. of Bores/N° fori	
5	
TOYOTA	Ventilato/Vented

60-02-284	
	Pitch Circle Ø/Foro int.-Ø [mm]
	55
	Height/Altezza [mm]
	48
	Diam./Diam. [mm]
	258
Thickness/Spessore - Min [mm]	
22/20	
No. of Bores/N° fori	
4	
TOYOTA	Ventilato/Vented

60-02-280	
	Pitch Circle Ø/Foro int.-Ø [mm]
	62
	Height/Altezza [mm]
	53
	Diam./Diam. [mm]
	254,2
Thickness/Spessore - Min [mm]	
25,2/24	
No. of Bores/N° fori	
5	
TOYOTA	Ventilato/Vented

60-02-286	
	Pitch Circle Ø/Foro int.-Ø [mm]
	62
	Height/Altezza [mm]
	51,3
	Diam./Diam. [mm]
	296
Thickness/Spessore - Min [mm]	
31,9/30	
No. of Bores/N° fori	
5	
LEXUS	Ventilato/Vented

60-02-281	
	Pitch Circle Ø/Foro int.-Ø [mm]
	55
	Height/Altezza [mm]
	49,6
	Diam./Diam. [mm]
	254,5
Thickness/Spessore - Min [mm]	
28/26	
No. of Bores/N° fori	
5	
TOYOTA	Ventilato/Vented

60-02-287	
	Pitch Circle Ø/Foro int.-Ø [mm]
	100
	Height/Altezza [mm]
	66
	Diam./Diam. [mm]
	290
Thickness/Spessore - Min [mm]	
25/23	
No. of Bores/N° fori	
6	
TOYOTA	Ventilato/Vented

60-02-288	
	Pitch Circle Ø/Foro int.-Ø [mm]
	54
	Height/Altezza [mm]
	47
	Diam./Diam. [mm]
	255
Thickness/Spessore - Min [mm]	
22/20	
No. of Bores/N° fori	
4	
TOYOTA	Ventilato/Vented

60-02-294	
	Pitch Circle Ø/Foro int.-Ø [mm]
	54
	Height/Altezza [mm]
	48,6
	Diam./Diam. [mm]
	274,6
Thickness/Spessore - Min [mm]	
25/24	
No. of Bores/N° fori	
5	
TOYOTA	Ventilato/Vented

60-02-289	
	Pitch Circle Ø/Foro int.-Ø [mm]
	55
	Height/Altezza [mm]
	58
	Diam./Diam. [mm]
	314,8
Thickness/Spessore - Min [mm]	
32/30	
No. of Bores/N° fori	
5	
TOYOTA	Ventilato/Vented

60-02-295	
	Pitch Circle Ø/Foro int.-Ø [mm]
	60
	Height/Altezza [mm]
	54
	Diam./Diam. [mm]
	301,5
Thickness/Spessore - Min [mm]	
22/21	
No. of Bores/N° fori	
5	
TOYOTA	Ventilato/Vented

60-02-291	
	Pitch Circle Ø/Foro int.-Ø [mm]
	62
	Height/Altezza [mm]
	49,4
	Diam./Diam. [mm]
	255
Thickness/Spessore - Min [mm]	
28/26	
No. of Bores/N° fori	
5	
TOYOTA	Ventilato/Vented

60-02-296	
	Pitch Circle Ø/Foro int.-Ø [mm]
	62
	Height/Altezza [mm]
	53
	Diam./Diam. [mm]
	278,8
Thickness/Spessore - Min [mm]	
22/20	
No. of Bores/N° fori	
5	
TOYOTA	Ventilato/Vented

60-02-292	
	Pitch Circle Ø/Foro int.-Ø [mm]
	60
	Height/Altezza [mm]
	48,5
	Diam./Diam. [mm]
	274,1
Thickness/Spessore - Min [mm]	
25/24	
No. of Bores/N° fori	
5	
LEXUS	Ventilato/Vented

60-02-297	
	Pitch Circle Ø/Foro int.-Ø [mm]
	62
	Height/Altezza [mm]
	53
	Diam./Diam. [mm]
	270,6
Thickness/Spessore - Min [mm]	
25/23	
No. of Bores/N° fori	
5	
TOYOTA	Ventilato/Vented

60-02-293	
	Pitch Circle Ø/Foro int.-Ø [mm]
	100
	Height/Altezza [mm]
	51
	Diam./Diam. [mm]
	287
Thickness/Spessore - Min [mm]	
22/21	
No. of Bores/N° fori	
6	
TOYOTA	Ventilato/Vented

60-02-298	
	Pitch Circle Ø/Foro int.-Ø [mm]
	54
	Height/Altezza [mm]
	46,5
	Diam./Diam. [mm]
	238
Thickness/Spessore - Min [mm]	
22/20	
No. of Bores/N° fori	
4	
TOYOTA	Ventilato/Vented

60-02-299	
	Pitch Circle Ø/Foro int.-Ø [mm]
	62
	Height/Altezza [mm]
	47,8
	Diam./Diam. [mm]
	257,8
Thickness/Spessore - Min [mm]	
25/24	
No. of Bores/N° fori	
5	
TOYOTA	Ventilato/Vented

60-03-305	
	Pitch Circle Ø/Foro int.-Ø [mm]
	72
	Height/Altezza [mm]
	48,8
	Diam./Diam. [mm]
	282,3
Thickness/Spessore - Min [mm]	
25/23	
No. of Bores/N° fori	
5	
MAZDA	Ventilato/Vented

60-03-301	
	Pitch Circle Ø/Foro int.-Ø [mm]
	75
	Height/Altezza [mm]
	34,8
	Diam./Diam. [mm]
	229
Thickness/Spessore - Min [mm]	
14/12,5	
No. of Bores/N° fori	
4	
MAZDA	Non Ventilato/Not Vented

60-03-306	
	Pitch Circle Ø/Foro int.-Ø [mm]
	72
	Height/Altezza [mm]
	34,6
	Diam./Diam. [mm]
	229,7
Thickness/Spessore - Min [mm]	
12/10,5	
No. of Bores/N° fori	
4	
MAZDA	Non Ventilato/Not Vented

60-03-302	
	Pitch Circle Ø/Foro int.-Ø [mm]
	40,5
	Height/Altezza [mm]
	100,8
	Diam./Diam. [mm]
	227
Thickness/Spessore - Min [mm]	
17,8/17	
No. of Bores/N° fori	
4	
MAZDA	Ventilato/Vented

60-03-307	
	Pitch Circle Ø/Foro int.-Ø [mm]
	63,5
	Height/Altezza [mm]
	43,7
	Diam./Diam. [mm]
	257,7
Thickness/Spessore - Min [mm]	
22/20	
No. of Bores/N° fori	
4	
MAZDA	Ventilato/Vented

60-03-303	
	Pitch Circle Ø/Foro int.-Ø [mm]
	75
	Height/Altezza [mm]
	35
	Diam./Diam. [mm]
	248,8
Thickness/Spessore - Min [mm]	
13,8/12,5	
No. of Bores/N° fori	
4	
MAZDA	Non Ventilato/Not Vented

60-03-309	
	Pitch Circle Ø/Foro int.-Ø [mm]
	72
	Height/Altezza [mm]
	49
	Diam./Diam. [mm]
	299,4
Thickness/Spessore - Min [mm]	
25/23	
No. of Holes/N° fori	
5	
MAZDA	Ventilato/Vented

60-03-304	
	Pitch Circle Ø/Foro int.-Ø [mm]
	46
	Height/Altezza [mm]
	67
	Diam./Diam. [mm]
	221,8
Thickness/Spessore - Min [mm]	
10/8,5	
No. of Bores/N° fori	
4	
MAZDA	Non Ventilato/Not Vented

60-03-311	
	Pitch Circle Ø/Foro int.-Ø [mm]
	72
	Height/Altezza [mm]
	49
	Diam./Diam. [mm]
	277,8
Thickness/Spessore - Min [mm]	
25/23	
No. of Bores/N° fori	
5	
MAZDA	Ventilato/Vented



60-03-312	
	Pitch Circle Ø/Foro int.-Ø [mm]
	40,3
	Height/Altezza [mm]
	95,7
	Diam./Diam. [mm]
	229
Thickness/Spessore - Min [mm]	
13/12	
No. of Bores/N° fori	
4	
MAZDA	Non Ventilato/Not Vented

60-03-317	
	Pitch Circle Ø/Foro int.-Ø [mm]
	72
	Height/Altezza [mm]
	47,4
	Diam./Diam. [mm]
	302,7
Thickness/Spessore - Min [mm]	
26/24	
No. of Bores/N° fori	
5	
MAZDA	Ventilato/Vented

60-03-313	
	Pitch Circle Ø/Foro int.-Ø [mm]
	72
	Height/Altezza [mm]
	51,2
	Diam./Diam. [mm]
	295,6
Thickness/Spessore - Min [mm]	
28/26	
No. of Bores/N° fori	
5	
MAZDA	Ventilato/Vented

60-03-318	
	Pitch Circle Ø/Foro int.-Ø [mm]
	86
	Height/Altezza [mm]
	24,2
	Diam./Diam. [mm]
	255,6
Thickness/Spessore - Min [mm]	
24/22	
No. of Bores/N° fori	
6	
MAZDA	Ventilato/Vented

60-03-314	
	Pitch Circle Ø/Foro int.-Ø [mm]
	75
	Height/Altezza [mm]
	31,6
	Diam./Diam. [mm]
	226,8
Thickness/Spessore - Min [mm]	
11/10	
No. of Bores/N° fori	
4	
MAZDA	Non Ventilato/Not Vented

60-03-319	
	Pitch Circle Ø/Foro int.-Ø [mm]
	72
	Height/Altezza [mm]
	45
	Diam./Diam. [mm]
	289,5
Thickness/Spessore - Min [mm]	
22/20,5	
No. of Holes/N° fori	
5	
MAZDA	Ventilato/Vented

60-03-315	
	Pitch Circle Ø/Foro int.-Ø [mm]
	55
	Height/Altezza [mm]
	46,3
	Diam./Diam. [mm]
	269,5
Thickness/Spessore - Min [mm]	
22/20	
No. of Bores/N° fori	
4	
MAZDA	Ventilato/Vented

60-03-320	
	Pitch Circle Ø/Foro int.-Ø [mm]
	55
	Height/Altezza [mm]
	47,2
	Diam./Diam. [mm]
	256,2
Thickness/Spessore - Min [mm]	
24/22	
No. of Bores/N° fori	
4	
MAZDA	Ventilato/Vented

60-03-316	
	Pitch Circle Ø/Foro int.-Ø [mm]
	46
	Height/Altezza [mm]
	95,8
	Diam./Diam. [mm]
	231
Thickness/Spessore - Min [mm]	
13/12	
No. of Bores/N° fori	
4	
MAZDA	Non Ventilato/Not Vented

60-03-323	
	Pitch Circle Ø/Foro int.-Ø [mm]
	98
	Height/Altezza [mm]
	71
	Diam./Diam. [mm]
	289
Thickness/Spessore - Min [mm]	
28/26	
No. of Bores/N° fori	
6	
MAZDA - FORD	Ventilato/Vented

60-03-324	
	Pitch Circle Ø/Foro int.-Ø [mm]
	48
	Height/Altezza [mm]
	69,5
	Diam./Diam. [mm]
245,3	
Thickness/Spessore - Min [mm]	
20/18	
No. of Holes/N° fori	
4	
MAZDA	Ventilato/Vented

60-03-330	
	Pitch Circle Ø/Foro int.-Ø [mm]
	75
	Height/Altezza [mm]
	35
	Diam./Diam. [mm]
228,8	
Thickness/Spessore - Min [mm]	
20/18,5	
No. of Bores/N° fori	
4	
MAZDA	Ventilato/Vented

60-03-325	
	Pitch Circle Ø/Foro int.-Ø [mm]
	55
	Height/Altezza [mm]
	45
	Diam./Diam. [mm]
258	
Thickness/Spessore - Min [mm]	
23/21	
No. of Bores/N° fori	
4	
MAZDA	Ventilato/Vented

60-03-332	
	Pitch Circle Ø/Foro int.-Ø [mm]
	53
	Height/Altezza [mm]
	72,8
	Diam./Diam. [mm]
254,7	
Thickness/Spessore - Min [mm]	
22,2/20	
No. of Bores/N° fori	
5	
MAZDA	Ventilato/Vented

60-03-326	
	Pitch Circle Ø/Foro int.-Ø [mm]
	86
	Height/Altezza [mm]
	20,5
	Diam./Diam. [mm]
255,6	
Thickness/Spessore - Min [mm]	
20/18	
No. of Bores/N° fori	
6	
MAZDA - KIA	Ventilato/Vented

60-03-333	
	Pitch Circle Ø/Foro int.-Ø [mm]
	77
	Height/Altezza [mm]
	65,3
	Diam./Diam. [mm]
276	
Thickness/Spessore - Min [mm]	
22/20	
No. of Bores/N° fori	
5	
MAZDA	Ventilato/Vented

60-03-327	
	Pitch Circle Ø/Foro int.-Ø [mm]
	45,8
	Height/Altezza [mm]
	96,5
	Diam./Diam. [mm]
249,8	
Thickness/Spessore - Min [mm]	
18/16	
No. of Bores/N° fori	
4	
MAZDA	Ventilato/Vented

60-03-334	
	Pitch Circle Ø/Foro int.-Ø [mm]
	75
	Height/Altezza [mm]
	34,7
	Diam./Diam. [mm]
249,2	
Thickness/Spessore - Min [mm]	
20/18,5	
No. of Bores/N° fori	
4	
MAZDA	Ventilato/Vented

60-03-329	
	Pitch Circle Ø/Foro int.-Ø [mm]
	48
	Height/Altezza [mm]
	90,5
	Diam./Diam. [mm]
249,7	
Thickness/Spessore - Min [mm]	
22/20	
No. of Bores/N° fori	
4	
MAZDA	Ventilato/Vented

60-03-335	
	Pitch Circle Ø/Foro int.-Ø [mm]
	75
	Height/Altezza [mm]
	31,2
	Diam./Diam. [mm]
237,5	
Thickness/Spessore - Min [mm]	
18/16	
No. of Bores/N° fori	
4	
MAZDA	Ventilato/Vented



60-03-336	
	Pitch Circle Ø/Foro int.-Ø [mm]
	70
	Height/Altezza [mm]
	31
	Diam./Diam. [mm]
	259,7
Thickness/Spessore - Min [mm]	
18/16	
No. of Bores/N° fori	
4	
MAZDA	Ventilato/Vented

60-03-342	
	Pitch Circle Ø/Foro int.-Ø [mm]
	55
	Height/Altezza [mm]
	45,4
	Diam./Diam. [mm]
	234
Thickness/Spessore - Min [mm]	
18/16	
No. of Bores/N° fori	
4	
MAZDA	Ventilato/Vented

60-03-337	
	Pitch Circle Ø/Foro int.-Ø [mm]
	51,7
	Height/Altezza [mm]
	71,6
	Diam./Diam. [mm]
	264,6
Thickness/Spessore - Min [mm]	
10,1/8,5	
No. of Bores/N° fori	
4	
	Non Ventilato/Not Vented

60-03-344	
	Pitch Circle Ø/Foro int.-Ø [mm]
	55
	Height/Altezza [mm]
	45,5
	Diam./Diam. [mm]
	234,7
Thickness/Spessore - Min [mm]	
22/20	
No. of Bores/N° fori	
4	
MAZDA	Ventilato/Vented

60-03-338	
	Pitch Circle Ø/Foro int.-Ø [mm]
	75
	Height/Altezza [mm]
	37,2
	Diam./Diam. [mm]
	218,2
Thickness/Spessore - Min [mm]	
13/11,5	
No. of Bores/N° fori	
4	
MAZDA - KIA	Non Ventilato/Not Vented

60-03-345	
	Pitch Circle Ø/Foro int.-Ø [mm]
	85
	Height/Altezza [mm]
	33
	Diam./Diam. [mm]
	274,5
Thickness/Spessore - Min [mm]	
20/19	
No. of Bores/N° fori	
4	
MAZDA	Ventilato/Vented

60-03-340	
	Pitch Circle Ø/Foro int.-Ø [mm]
	64
	Height/Altezza [mm]
	47
	Diam./Diam. [mm]
	263,2
Thickness/Spessore - Min [mm]	
24/22	
No. of Bores/N° fori	
5	
MAZDA	Ventilato/Vented

60-03-346	
	Pitch Circle Ø/Foro int.-Ø [mm]
	86
	Height/Altezza [mm]
	20,3
	Diam./Diam. [mm]
	267,8
Thickness/Spessore - Min [mm]	
20/18	
No. of Bores/N° fori	
6	
MAZDA	Ventilato/Vented

60-03-341	
	Pitch Circle Ø/Foro int.-Ø [mm]
	75
	Height/Altezza [mm]
	37,7
	Diam./Diam. [mm]
	241,4
Thickness/Spessore - Min [mm]	
20/18	
No. of Bores/N° fori	
4	
MAZDA	Ventilato/Vented

60-03-347	
	Pitch Circle Ø/Foro int.-Ø [mm]
	72
	Height/Altezza [mm]
	50
	Diam./Diam. [mm]
	296
Thickness/Spessore - Min [mm]	
28/26	
No. of Bores/N° fori	
5	
MAZDA	Ventilato/Vented

60-03-348	
	Pitch Circle Ø/Foro int.-Ø [mm]
	72
	Height/Altezza [mm]
	48,8
	Diam./Diam. [mm]
	257
Thickness/Spessore - Min [mm]	
24/22	
No. of Bores/N° fori	
5	
MAZDA	Ventilato/Vented

60-03-353	
	Pitch Circle Ø/Foro int.-Ø [mm]
	72
	Height/Altezza [mm]
	49
	Diam./Diam. [mm]
	299
Thickness/Spessore - Min [mm]	
25/23	
No. of Bores/N° fori	
5	
MAZDA	Ventilato/Vented

60-03-349	
	Pitch Circle Ø/Foro int.-Ø [mm]
	55
	Height/Altezza [mm]
	45,4
	Diam./Diam. [mm]
	256,8
Thickness/Spessore - Min [mm]	
22/20	
No. of Bores/N° fori	
4	
MAZDA	Ventilato/Vented

60-03-354	
	Pitch Circle Ø/Foro int.-Ø [mm]
	72
	Height/Altezza [mm]
	51,5
	Diam./Diam. [mm]
	274
Thickness/Spessore - Min [mm]	
28/26	
No. of Bores/N° fori	
5	
MAZDA	Ventilato/Vented

60-03-350	
	Pitch Circle Ø/Foro int.-Ø [mm]
	72
	Height/Altezza [mm]
	67,5
	Diam./Diam. [mm]
	293,8
Thickness/Spessore - Min [mm]	
22/20	
No. of Bores/N° fori	
5	
MAZDA	Ventilato/Vented

60-03-355	
	Inner Diam./Diam. int. [mm]
	93
	Height/Altezza [mm]
	24
	Diam./Diam. [mm]
	274
Thickness/Spessore - Min [mm]	
24/22	
No. of Bores/N° fori	
6	
MAZDA	Ventilato/Vented

60-03-351	
	Pitch Circle Ø/Foro int.-Ø [mm]
	72
	Height/Altezza [mm]
	48
	Diam./Diam. [mm]
	320
Thickness/Spessore - Min [mm]	
25/23	
No. of Bores/N° fori	
5	
MAZDA	Ventilato/Vented

60-03-356	
	Pitch Circle Ø/Foro int.-Ø [mm]
	55
	Height/Altezza [mm]
	45
	Diam./Diam. [mm]
	235
Thickness/Spessore - Min [mm]	
12/10	
No. of Bores/N° fori	
4	
MAZDA	Non Ventilato/Not Vented

60-03-352	
	Pitch Circle Ø/Foro int.-Ø [mm]
	72
	Height/Altezza [mm]
	51
	Diam./Diam. [mm]
	320
Thickness/Spessore - Min [mm]	
28/26	
No. of Bores/N° fori	
5	
MAZDA	Ventilato/Vented

60-03-357	
	Pitch Circle Ø/Foro int.-Ø [mm]
	93
	Height/Altezza [mm]
	28
	Diam./Diam. [mm]
	274
Thickness/Spessore - Min [mm]	
28/26	
No. of Bores/N° fori	
5	
MAZDA	Ventilato/Vented

60-03-358	
Image Not Available	Pitch Circle Ø/Foro int.-Ø [mm]
	55
	Height/Altezza [mm]
	45
	Diam./Diam. [mm]
255	
Thickness/Spessore - Min [mm]	
20/18	
No. of Bores/N° fori	
4	
MAZDA	Ventilato/Vented

60-03-398	
	Pitch Circle Ø/Foro int.-Ø [mm]
	57
	Height/Altezza [mm]
	42,8
	Diam./Diam. [mm]
240,8	
Thickness/Spessore - Min [mm]	
20/18	
No. of Bores/N° fori	
4	
KIA	Ventilato/Vented

60-03-384	
	Pitch Circle Ø/Foro int.-Ø [mm]
	72
	Height/Altezza [mm]
	58,3
	Diam./Diam. [mm]
275,7	
Thickness/Spessore - Min [mm]	
28/26	
No. of Bores/N° fori	
5	
MAZDA	Ventilato/Vented

60-03-399	
	Pitch Circle Ø/Foro int.-Ø [mm]
	93
	Height/Altezza [mm]
	23
	Diam./Diam. [mm]
256	
Thickness/Spessore - Min [mm]	
20/18	
No. of Bores/N° fori	
6	
MAZDA	Ventilato/Vented

60-03-395	
	Pitch Circle Ø/Foro int.-Ø [mm]
	72
	Height/Altezza [mm]
	47,7
	Diam./Diam. [mm]
277,8	
Thickness/Spessore - Min [mm]	
24/22	
No. of Bores/N° fori	
5	
MAZDA	Ventilato/Vented

60-04-400	
	Pitch Circle Ø/Foro int.-Ø [mm]
	92
	Height/Altezza [mm]
	44
	Diam./Diam. [mm]
226,5	
Thickness/Spessore - Min [mm]	
9,6/9	
No. of Holes/N° fori	
4	
HONDA	Non Ventilato/Not Vented

60-03-396	
	Pitch Circle Ø/Foro int.-Ø [mm]
	72
	Height/Altezza [mm]
	48,5
	Diam./Diam. [mm]
257,6	
Thickness/Spessore - Min [mm]	
24/22	
No. of Bores/N° fori	
4	
KIA	Ventilato/Vented

60-04-401	
	Pitch Circle Ø/Foro int.-Ø [mm]
	92
	Height/Altezza [mm]
	35
	Diam./Diam. [mm]
281,2	
Thickness/Spessore - Min [mm]	
25/23	
No. of Bores/N° fori	
4	
HONDA	Ventilato/Vented

60-03-397	
	Pitch Circle Ø/Foro int.-Ø [mm]
	96,5
	Height/Altezza [mm]
	51,6
	Diam./Diam. [mm]
284,3	
Thickness/Spessore - Min [mm]	
24/22	
No. of Bores/N° fori	
5	
MAZDA	Ventilato/Vented

60-04-402	
	Pitch Circle Ø/Foro int.-Ø [mm]
	61
	Height/Altezza [mm]
	49,8
	Diam./Diam. [mm]
214,6	
Thickness/Spessore - Min [mm]	
11/9	
No. of Bores/N° fori	
4	
TRIUMPH - HONDA	Non Ventilato/Not Vented

60-04-403	
	Pitch Circle Ø/Foro int.-Ø [mm]
	64
	Height/Altezza [mm]
	47,5
	Diam./Diam. [mm]
	299,6
Thickness/Spessore - Min [mm]	
25/23	
No. of Bores/N° fori	
5	
HONDA	Ventilato/Vented

60-04-409	
	Pitch Circle Ø/Foro int.-Ø [mm]
	61
	Height/Altezza [mm]
	49,9
	Diam./Diam. [mm]
	230,9
Thickness/Spessore - Min [mm]	
17/15	
No. of Bores/N° fori	
4	
HONDA	Ventilato/Vented

60-04-404	
	Pitch Circle Ø/Foro int.-Ø [mm]
	64,5
	Height/Altezza [mm]
	47
	Diam./Diam. [mm]
	280,5
Thickness/Spessore - Min [mm]	
25/23	
No. of Bores/N° fori	
4	
HONDA	Ventilato/Vented

60-04-410	
	Pitch Circle Ø/Foro int.-Ø [mm]
	61
	Height/Altezza [mm]
	49,2
	Diam./Diam. [mm]
	230,7
Thickness/Spessore - Min [mm]	
12/10,5	
No. of Bores/N° fori	
4	
HONDA	Non Ventilato/Not Vented

60-04-405	
	Pitch Circle Ø/Foro int.-Ø [mm]
	64
	Height/Altezza [mm]
	47,5
	Diam./Diam. [mm]
	293
Thickness/Spessore - Min [mm]	
28/26,5	
No. of Bores/N° fori	
5	
HONDA	Ventilato/Vented

60-04-411	
	Pitch Circle Ø/Foro int.-Ø [mm]
	61
	Height/Altezza [mm]
	44,2
	Diam./Diam. [mm]
	230,5
Thickness/Spessore - Min [mm]	
12/10	
No. of Bores/N° fori	
4	
ROVER - HONDA	Non Ventilato/Not Vented

60-04-406	
	Pitch Circle Ø/Foro int.-Ø [mm]
	61
	Height/Altezza [mm]
	49,8
	Diam./Diam. [mm]
	230,5
Thickness/Spessore - Min [mm]	
12/10	
No. of Bores/N° fori	
4	
HONDA	Non Ventilato/Not Vented

60-04-412	
	Pitch Circle Ø/Foro int.-Ø [mm]
	64
	Height/Altezza [mm]
	48
	Diam./Diam. [mm]
	296
Thickness/Spessore - Min [mm]	
25/23	
No. of Bores/N° fori	
5	
HONDA	Ventilato/Vented

60-04-407	
	Pitch Circle Ø/Foro int.-Ø [mm]
	64,3
	Height/Altezza [mm]
	47,7
	Diam./Diam. [mm]
	281,5
Thickness/Spessore - Min [mm]	
23/21	
No. of Bores/N° fori	
5	
HONDA	Ventilato/Vented

60-04-413	
	Pitch Circle Ø/Foro int.-Ø [mm]
	61
	Height/Altezza [mm]
	44,4
	Diam./Diam. [mm]
	230,7
Thickness/Spessore - Min [mm]	
17/15	
No. of Bores/N° fori	
4	
HONDA	Ventilato/Vented



60-04-414	
	Pitch Circle Ø/Foro int.-Ø [mm]
	61
	Height/Altezza [mm]
	49,5
	Diam./Diam. [mm]
	231
Thickness/Spessore - Min [mm]	
19/17	
No. of Bores/N° fori	
4	
Ventilato/Vented	
HONDA	

60-04-419	
	Pitch Circle Ø/Foro int.-Ø [mm]
	61
	Height/Altezza [mm]
	44,4
	Diam./Diam. [mm]
	241,4
Thickness/Spessore - Min [mm]	
19/17	
No. of Bores/N° fori	
4	
Ventilato/Vented	
HONDA	

60-04-415	
	Pitch Circle Ø/Foro int.-Ø [mm]
	61
	Height/Altezza [mm]
	40
	Diam./Diam. [mm]
	212,6
Thickness/Spessore - Min [mm]	
10,3/8	
No. of Bores/N° fori	
4	
Non Ventilato/Not Vented	
HONDA	

60-04-420	
	Pitch Circle Ø/Foro int.-Ø [mm]
	64
	Height/Altezza [mm]
	47
	Thickness/Spessore - Min [mm]
	25/23
No. of Bores/N° fori	
5	
Ventilato/Vented	
Diam./Diam. [mm]	
280	
HONDA	

60-04-416	
	Pitch Circle Ø/Foro int.-Ø [mm]
	61
	Height/Altezza [mm]
	50
	Diam./Diam. [mm]
	241,5
Thickness/Spessore - Min [mm]	
19/17	
No. of Bores/N° fori	
4	
Ventilato/Vented	
HONDA	

60-04-421	
	Pitch Circle Ø/Foro int.-Ø [mm]
	64
	Height/Altezza [mm]
	51,5
	Diam./Diam. [mm]
	281
Thickness/Spessore - Min [mm]	
21/18	
No. of Bores/N° fori	
4	
Ventilato/Vented	
ROVER - HONDA	

60-04-417	
	Pitch Circle Ø/Foro int.-Ø [mm]
	64
	Height/Altezza [mm]
	49
	Diam./Diam. [mm]
	320
Thickness/Spessore - Min [mm]	
32/30	
No. of Bores/N° fori	
5	
Ventilato/Vented	
HONDA	

60-04-422	
	Pitch Circle Ø/Foro int.-Ø [mm]
	64
	Height/Altezza [mm]
	51,6
	Diam./Diam. [mm]
	284,7
Thickness/Spessore - Min [mm]	
21/19	
No. of Bores/N° fori	
4	
Ventilato/Vented	
HONDA	

60-04-418	
	Pitch Circle Ø/Foro int.-Ø [mm]
	64
	Height/Altezza [mm]
	51,4
	Diam./Diam. [mm]
	261
Thickness/Spessore - Min [mm]	
21,2/19	
No. of Bores/N° fori	
4	
Ventilato/Vented	
ROVER - HONDA	

60-04-423	
	Pitch Circle Ø/Foro int.-Ø [mm]
	92
	Height/Altezza [mm]
	34,2
	Diam./Diam. [mm]
	259,7
Thickness/Spessore - Min [mm]	
23/21	
No. of Bores/N° fori	
4	
Ventilato/Vented	
HONDA	

60-04-424	
	Pitch Circle Ø/Foro int.-Ø [mm]
	92
	Height/Altezza [mm]
	34,4
	Diam./Diam. [mm]
	281,6
Thickness/Spessore - Min [mm]	
23/21	
No. of Bores/N° fori	
4	
HONDA	Ventilato/Vented

60-04-429	
	Pitch Circle Ø/Foro int.-Ø [mm]
	70
	Height/Altezza [mm]
	47,5
	Diam./Diam. [mm]
	282
Thickness/Spessore - Min [mm]	
28/26	
No. of Bores/N° fori	
5	
HONDA	Ventilato/Vented

60-04-425	
	Pitch Circle Ø/Foro int.-Ø [mm]
	64
	Height/Altezza [mm]
	40
	Diam./Diam. [mm]
	258
Thickness/Spessore - Min [mm]	
21/19	
No. of Bores/N° fori	
4	
HONDA	Ventilato/Vented

60-04-430	
	Pitch Circle Ø/Foro int.-Ø [mm]
	64
	Height/Altezza [mm]
	47,5
	Diam./Diam. [mm]
	259,7
Thickness/Spessore - Min [mm]	
23/21	
No. of Bores/N° fori	
4	
HONDA	Ventilato/Vented

60-04-426	
	Pitch Circle Ø/Foro int.-Ø [mm]
	64
	Height/Altezza [mm]
	45
	Diam./Diam. [mm]
	261,7
Thickness/Spessore - Min [mm]	
21/19	
No. of Bores/N° fori	
4	
HONDA - ROVER	Ventilato/Vented

60-04-431	
	Pitch Circle Ø/Foro int.-Ø [mm]
	64
	Height/Altezza [mm]
	47
	Diam./Diam. [mm]
	300
Thickness/Spessore - Min [mm]	
25/23	
No. of Bores/N° fori	
5	
HONDA	Ventilato/Vented

60-04-427	
	Pitch Circle Ø/Foro int.-Ø [mm]
	64
	Height/Altezza [mm]
	47,5
	Diam./Diam. [mm]
	281,4
Thickness/Spessore - Min [mm]	
23/21	
No. of Bores/N° fori	
4	
HONDA	Ventilato/Vented

60-04-432	
	Pitch Circle Ø/Foro int.-Ø [mm]
	64
	Height/Altezza [mm]
	47,4
	Diam./Diam. [mm]
	281,3
Thickness/Spessore - Min [mm]	
25/23	
No. of Bores/N° fori	
5	
HONDA	Ventilato/Vented

60-04-428	
	Pitch Circle Ø/Foro int.-Ø [mm]
	64
	Height/Altezza [mm]
	47,5
	Diam./Diam. [mm]
	282
Thickness/Spessore - Min [mm]	
23/21	
No. of Bores/N° fori	
5	
HONDA	Ventilato/Vented

60-04-433	
	Pitch Circle Ø/Foro int.-Ø [mm]
	65
	Height/Altezza [mm]
	47
	Diam./Diam. [mm]
	298
Thickness/Spessore - Min [mm]	
25/23	
No. of Bores/N° fori	
5	
HONDA	Ventilato/Vented



60-04-434	
	Pitch Circle Ø/Foro int.-Ø [mm]
	64,2
	Height/Altezza [mm]
	47,3
	Diam./Diam. [mm]
	259,5
Thickness/Spessore - Min [mm]	
23/21	
No. of Bores/N° fori	
5	
HONDA	Ventilato/Vented

60-04-494	
	Pitch Circle Ø/Foro int.-Ø [mm]
	64
	Height/Altezza [mm]
	47,5
	Diam./Diam. [mm]
	282
Thickness/Spessore - Min [mm]	
23/21	
No. of Bores/N° fori	
5	
HONDA	Ventilato/Vented

60-04-490	
	Pitch Circle Ø/Foro int.-Ø [mm]
	70
	Height/Altezza [mm]
	47,4
	Diam./Diam. [mm]
	299,3
Thickness/Spessore - Min [mm]	
28,2/26,5	
No. of Bores/N° fori	
5	
HONDA	Ventilato/Vented

60-04-495	
	Pitch Circle Ø/Foro int.-Ø [mm]
	70,2
	Height/Altezza [mm]
	40,5
	Diam./Diam. [mm]
	299,6
Thickness/Spessore - Min [mm]	
25/23	
No. of Bores/N° fori	
5	
HONDA	Ventilato/Vented

60-04-491	
	Pitch Circle Ø/Foro int.-Ø [mm]
	61
	Height/Altezza [mm]
	39,5
	Diam./Diam. [mm]
	239,3
Thickness/Spessore - Min [mm]	
21/19	
No. of Bores/N° fori	
4	
HONDA	Ventilato/Vented

60-04-496	
	Pitch Circle Ø/Foro int.-Ø [mm]
	70
	Height/Altezza [mm]
	47
	Diam./Diam. [mm]
	281,7
Thickness/Spessore - Min [mm]	
23/21	
No. of Bores/N° fori	
5	
HONDA	Ventilato/Vented

60-04-492	
	Pitch Circle Ø/Foro int.-Ø [mm]
	63,9
	Height/Altezza [mm]
	45
	Diam./Diam. [mm]
	260
Thickness/Spessore - Min [mm]	
23/21	
No. of Bores/N° fori	
4	
HONDA	Ventilato/Vented

60-04-498	
	Pitch Circle Ø/Foro int.-Ø [mm]
	64
	Height/Altezza [mm]
	47,9
	Diam./Diam. [mm]
	261,9
Thickness/Spessore - Min [mm]	
22/20	
No. of Bores/N° fori	
4	
ROVER - HONDA	Ventilato/Vented

60-04-493	
	Pitch Circle Ø/Foro int.-Ø [mm]
	61
	Height/Altezza [mm]
	39
	Diam./Diam. [mm]
	239,6
Thickness/Spessore - Min [mm]	
21/19,5	
No. of Bores/N° fori	
4	
HONDA	Ventilato/Vented

60-04-499	
	Pitch Circle Ø/Foro int.-Ø [mm]
	61
	Height/Altezza [mm]
	45,4
	Diam./Diam. [mm]
	240
Thickness/Spessore - Min [mm]	
21/19	
No. of Bores/N° fori	
4	
HONDA	Ventilato/Vented

60-05-500	
	Pitch Circle Ø/Foro int.-Ø [mm]
	67
	Height/Altezza [mm]
	30
	Diam./Diam. [mm]
228,4	
Thickness/Spessore - Min [mm]	
13/11,4	
No. of Bores/N° fori	
4	
Non Ventilato/Not Vented	
MITSUBISHI	

60-05-507	
	Pitch Circle Ø/Foro int.-Ø [mm]
	69
	Height/Altezza [mm]
	39
	Diam./Diam. [mm]
285	
Thickness/Spessore - Min [mm]	
22/20,4	
No. of Bores/N° fori	
5	
Ventilato/Vented	
MITSUBISHI	

60-05-501	
	Pitch Circle Ø/Foro int.-Ø [mm]
	87
	Height/Altezza [mm]
	45
	Diam./Diam. [mm]
254,4	
Thickness/Spessore - Min [mm]	
20/18,4	
No. of Bores/N° fori	
6	
Ventilato/Vented	
MITSUBISHI	

60-05-508	
	Pitch Circle Ø/Foro int.-Ø [mm]
	86
	Height/Altezza [mm]
	39,9
	Diam./Diam. [mm]
225	
Thickness/Spessore - Min [mm]	
13/11,4	
No. of Bores/N° fori	
4	
Non Ventilato/Not Vented	
MITSUBISHI - HYUNDAI	

60-05-502	
	Pitch Circle Ø/Foro int.-Ø [mm]
	80
	Height/Altezza [mm]
	27,5
	Diam./Diam. [mm]
255,5	
Thickness/Spessore - Min [mm]	
12,6/11	
No. of Holes/N° fori	
4	
Non Ventilato/Not Vented	
MITSUBISHI	

60-05-509	
	Pitch Circle Ø/Foro int.-Ø [mm]
	86
	Height/Altezza [mm]
	34,6
	Diam./Diam. [mm]
241,8	
Thickness/Spessore - Min [mm]	
18/16,4	
No. of Bores/N° fori	
4	
Ventilato/Vented	
MITSUBISHI	

60-05-505	
	Pitch Circle Ø/Foro int.-Ø [mm]
	87
	Height/Altezza [mm]
	45,5
	Diam./Diam. [mm]
313,8	
Thickness/Spessore - Min [mm]	
24/22,4	
No. of Bores/N° fori	
6	
Ventilato/Vented	
MITSUBISHI	

60-05-510	
	Pitch Circle Ø/Foro int.-Ø [mm]
	86
	Height/Altezza [mm]
	34
	Diam./Diam. [mm]
242,4	
Thickness/Spessore - Min [mm]	
13/11,4	
No. of Bores/N° fori	
4	
Non Ventilato/Not Vented	
PROTON - MITSUBISHI	

60-05-506	
	Pitch Circle Ø/Foro int.-Ø [mm]
	67
	Height/Altezza [mm]
	27
	Diam./Diam. [mm]
231,8	
Thickness/Spessore - Min [mm]	
13/11,4	
No. of Bores/N° fori	
4	
Non Ventilato/Not Vented	
MITSUBISHI	

60-05-512	
	Pitch Circle Ø/Foro int.-Ø [mm]
	84
	Height/Altezza [mm]
	33,8
	Diam./Diam. [mm]
254,6	
Thickness/Spessore - Min [mm]	
20,2/18	
No. of Bores/N° fori	
5	
Ventilato/Vented	
MITSUBISHI	



60-05-513	
	Pitch Circle Ø/Foro int.-Ø [mm]
	80
	Height/Altezza [mm]
	35,8
	Diam./Diam. [mm]
	255,7
Thickness/Spessore - Min [mm]	
24/22	
No. of Bores/N° fori	
4	
MITSUBISHI	Ventilato/Vented

60-05-518	
	Pitch Circle Ø/Foro int.-Ø [mm]
	84
	Height/Altezza [mm]
	33,5
	Diam./Diam. [mm]
	257,2
Thickness/Spessore - Min [mm]	
22/20,4	
No. of Bores/N° fori	
5	
MITSUBISHI	Ventilato/Vented

60-05-514	
	Pitch Circle Ø/Foro int.-Ø [mm]
	87
	Height/Altezza [mm]
	45
	Diam./Diam. [mm]
	275,8
Thickness/Spessore - Min [mm]	
20/18,4	
No. of Bores/N° fori	
6	
MITSUBISHI	Ventilato/Vented

60-05-520	
	Pitch Circle Ø/Foro int.-Ø [mm]
	87
	Height/Altezza [mm]
	45
	Diam./Diam. [mm]
	276,3
Thickness/Spessore - Min [mm]	
22/20	
No. of Bores/N° fori	
6	
HYUNDAI - MITSUBISHI	Ventilato/Vented

60-05-515	
	Pitch Circle Ø/Foro int.-Ø [mm]
	76
	Height/Altezza [mm]
	66,4
	Diam./Diam. [mm]
	275,2
Thickness/Spessore - Min [mm]	
24/22	
No. of Bores/N° fori	
5	
MITSUBISHI	Ventilato/Vented

60-05-521	
	Pitch Circle Ø/Foro int.-Ø [mm]
	87
	Height/Altezza [mm]
	45,5
	Diam./Diam. [mm]
	258
Thickness/Spessore - Min [mm]	
22/20,4	
No. of Bores/N° fori	
6	
MITSUBISHI	Ventilato/Vented

60-05-516	
	Pitch Circle Ø/Foro int.-Ø [mm]
	94
	Height/Altezza [mm]
	46,6
	Diam./Diam. [mm]
	289,9
Thickness/Spessore - Min [mm]	
26/24	
No. of Bores/N° fori	
6	
MITSUBISHI	Ventilato/Vented

60-05-522	
	Pitch Circle Ø/Foro int.-Ø [mm]
	69
	Height/Altezza [mm]
	45,5
	Diam./Diam. [mm]
	255,6
Thickness/Spessore - Min [mm]	
24/22,4	
No. of Bores/N° fori	
4	
MITSUBISHI	Ventilato/Vented

60-05-517	
	Pitch Circle Ø/Foro int.-Ø [mm]
	69
	Height/Altezza [mm]
	45,5
	Diam./Diam. [mm]
	266
Thickness/Spessore - Min [mm]	
24/22,4	
No. of Bores/N° fori	
4	
MITSUBISHI	Ventilato/Vented

60-05-523	
	Pitch Circle Ø/Foro int.-Ø [mm]
	86
	Height/Altezza [mm]
	33,8
	Diam./Diam. [mm]
	266
Thickness/Spessore - Min [mm]	
24,2/23	
No. of Bores/N° fori	
4	
MITSUBISHI	Ventilato/Vented

60-05-524	
	Pitch Circle Ø/Foro int.-Ø [mm]
	86
	Height/Altezza [mm]
	34
	Diam./Diam. [mm]
235,7	
Thickness/Spessore - Min [mm]	
18/16,4	
No. of Bores/N° fori	
4	
MITSUBISHI	Ventilato/Vented

60-05-530	
	Pitch Circle Ø/Foro int.-Ø [mm]
	69
	Height/Altezza [mm]
	45,5
	Diam./Diam. [mm]
255,8	
Thickness/Spessore - Min [mm]	
24/22,4	
No. of Bores/N° fori	
4	
MITSUBISHI - HYUNDAI	Ventilato/Vented

60-05-525	
	Pitch Circle Ø/Foro int.-Ø [mm]
	86
	Height/Altezza [mm]
	34
	Diam./Diam. [mm]
255,8	
Thickness/Spessore - Min [mm]	
24/22	
No. of Bores/N° fori	
4	
MITSUBISHI	Ventilato/Vented

60-05-532	
	Pitch Circle Ø/Foro int.-Ø [mm]
	64
	Height/Altezza [mm]
	45,4
	Diam./Diam. [mm]
235,6	
Thickness/Spessore - Min [mm]	
18/16,4	
No. of Bores/N° fori	
4	
PROTON - MITSUBISHI	Ventilato/Vented

60-05-526	
	Pitch Circle Ø/Foro int.-Ø [mm]
	69
	Height/Altezza [mm]
	46
	Diam./Diam. [mm]
293,7	
Thickness/Spessore - Min [mm]	
24/22,4	
No. of Bores/N° fori	
5	
MITSUBISHI	Ventilato/Vented

60-05-533	
	Pitch Circle Ø/Foro int.-Ø [mm]
	64
	Height/Altezza [mm]
	45,5
	Diam./Diam. [mm]
255,8	
Thickness/Spessore - Min [mm]	
24/22,4	
No. of Bores/N° fori	
4	
MITSUBISHI - PROTON	Ventilato/Vented

60-05-527	
	Pitch Circle Ø/Foro int.-Ø [mm]
	69
	Height/Altezza [mm]
	46
	Diam./Diam. [mm]
275,6	
Thickness/Spessore - Min [mm]	
26/24	
No. of Bores/N° fori	
4	
MITSUBISHI	Ventilato/Vented

60-05-534	
	Pitch Circle Ø/Foro int.-Ø [mm]
	93,5
	Height/Altezza [mm]
	46,5
	Diam./Diam. [mm]
294,2	
Thickness/Spessore - Min [mm]	
28/26	
No. of Holes/N° fori	
6	
MITSUBISHI	Ventilato/Vented

60-05-529	
	Pitch Circle Ø/Foro int.-Ø [mm]
	69
	Height/Altezza [mm]
	45,8
	Diam./Diam. [mm]
275,3	
Thickness/Spessore - Min [mm]	
24/22,4	
No. of Bores/N° fori	
5	
MITSUBISHI	Ventilato/Vented

60-05-535	
	Pitch Circle Ø/Foro int.-Ø [mm]
	69
	Height/Altezza [mm]
	46
	Diam./Diam. [mm]
276	
Thickness/Spessore - Min [mm]	
24/22	
No. of Bores/N° fori	
6	
MITSUBISHI	Ventilato/Vented



60-05-536	
	Pitch Circle Ø/Foro int.-Ø [mm]
	94
	Height/Altezza [mm]
	57
	Diam./Diam. [mm]
	332
Thickness/Spessore - Min [mm]	
28/26	
No. of Bores/N° fori	
6	
VENTILATED	Ventilato/Vented

60-05-541	
	Pitch Circle Ø/Foro int.-Ø [mm]
	87
	Height/Altezza [mm]
	39,3
	Diam./Diam. [mm]
	254
Thickness/Spessore - Min [mm]	
24/22	
No. of Bores/N° fori	
6	
VENTILATED	Ventilato/Vented

60-05-537	
	Pitch Circle Ø/Foro int.-Ø [mm]
	69
	Height/Altezza [mm]
	46
	Diam./Diam. [mm]
	276
Thickness/Spessore - Min [mm]	
26/24	
No. of Bores/N° fori	
5	
VENTILATED	Ventilato/Vented

60-05-542	
	Pitch Circle Ø/Foro int.-Ø [mm]
	69
	Height/Altezza [mm]
	46
	Diam./Diam. [mm]
	289,7
Thickness/Spessore - Min [mm]	
26/24	
No. of Bores/N° fori	
5	
VENTILATED	Ventilato/Vented

60-05-538	
	Pitch Circle Ø/Foro int.-Ø [mm]
	64
	Height/Altezza [mm]
	45,3
	Diam./Diam. [mm]
	233,7
Thickness/Spessore - Min [mm]	
13/11,4	
No. of Bores/N° fori	
4	
NON VENTILATED	Non Ventilato/Not Vented

60-05-543	
	Pitch Circle Ø/Foro int.-Ø [mm]
	69
	Height/Altezza [mm]
	46
	Diam./Diam. [mm]
	276
Thickness/Spessore - Min [mm]	
26/24	
No. of Bores/N° fori	
5	
VENTILATED	Ventilato/Vented

60-05-539	
	Pitch Circle Ø/Foro int.-Ø [mm]
	87
	Height/Altezza [mm]
	47
	Diam./Diam. [mm]
	276
Thickness/Spessore - Min [mm]	
27/25	
No. of Bores/N° fori	
6	
VENTILATED	Ventilato/Vented

60-05-544	
	Pitch Circle Ø/Foro int.-Ø [mm]
	70
	Height/Altezza [mm]
	46
	Diam./Diam. [mm]
	275
Thickness/Spessore - Min [mm]	
24/22	
No. of Bores/N° fori	
5	
VENTILATED	Ventilato/Vented

60-05-540	
	Pitch Circle Ø/Foro int.-Ø [mm]
	69
	Height/Altezza [mm]
	46
	Diam./Diam. [mm]
	280,7
Thickness/Spessore - Min [mm]	
24/22	
No. of Bores/N° fori	
4	
VENTILATED	Ventilato/Vented

60-05-545	
	Inner Diam./Diam. int. [mm]
	68,5
	Height/Altezza [mm]
	46
	Diam./Diam. [mm]
	268
Thickness/Spessore - Min [mm]	
26/24	
No. of Bores/N° fori	
5	
VENTILATED	Ventilato/Vented

60-05-583	
	Pitch Circle Ø/Foro int.-Ø [mm]
	87
	Height/Altezza [mm]
	39,5
	Diam./Diam. [mm]
	254
Thickness/Spessore - Min [mm]	
24/22	
No. of Bores/N° fori	
5	
VENTILATED	Ventilato/Vented
mitsubishi - hyundai	

60-05-591	
	Pitch Circle Ø/Foro int.-Ø [mm]
	84
	Height/Altezza [mm]
	29,4
	Diam./Diam. [mm]
	253
Thickness/Spessore - Min [mm]	
20/18	
No. of Bores/N° fori	
5	
VENTILATED	Ventilato/Vented
hyundai	

60-05-586	
	Pitch Circle Ø/Foro int.-Ø [mm]
	86
	Height/Altezza [mm]
	34,4
	Diam./Diam. [mm]
	256,3
Thickness/Spessore - Min [mm]	
22/20	
No. of Bores/N° fori	
4	
VENTILATED	Ventilato/Vented
hyundai	

60-05-592	
	Pitch Circle Ø/Foro int.-Ø [mm]
	69
	Height/Altezza [mm]
	45,5
	Diam./Diam. [mm]
	255,6
Thickness/Spessore - Min [mm]	
24/22,4	
No. of Bores/N° fori	
5	
VENTILATED	Ventilato/Vented
mitsubishi	

60-05-587	
	Pitch Circle Ø/Foro int.-Ø [mm]
	67
	Height/Altezza [mm]
	44
	Diam./Diam. [mm]
	230
Thickness/Spessore - Min [mm]	
11/9,4	
No. of Bores/N° fori	
4	
Non Ventilated	Non Ventilato/Not Vented
hyundai	

60-05-593	
	Pitch Circle Ø/Foro int.-Ø [mm]
	86
	Height/Altezza [mm]
	33,6
	Diam./Diam. [mm]
	233,6
Thickness/Spessore - Min [mm]	
13/11,5	
No. of Bores/N° fori	
4	
Non Ventilated	Non Ventilato/Not Vented
mitsubishi	

60-05-588	
	Pitch Circle Ø/Foro int.-Ø [mm]
	84
	Height/Altezza [mm]
	33,5
	Diam./Diam. [mm]
	254,7
Thickness/Spessore - Min [mm]	
20/18,4	
No. of Bores/N° fori	
6	
Non Ventilated	Non Ventilato/Not Vented
Non Ventilated/Not Vented	

60-05-595	
	Pitch Circle Ø/Foro int.-Ø [mm]
	69
	Height/Altezza [mm]
	45,5
	Diam./Diam. [mm]
	295,5
Thickness/Spessore - Min [mm]	
30/28,4	
No. of Bores/N° fori	
5	
VENTILATED	Ventilato/Vented
mitsubishi	

60-05-589	
	Pitch Circle Ø/Foro int.-Ø [mm]
	84
	Height/Altezza [mm]
	33,8
	Diam./Diam. [mm]
	258
Thickness/Spessore - Min [mm]	
22/20,4	
No. of Bores/N° fori	
6	
VENTILATED	Ventilato/Vented
mitsubishi	

60-05-598	
	Pitch Circle Ø/Foro int.-Ø [mm]
	69
	Height/Altezza [mm]
	45,3
	Diam./Diam. [mm]
	254,8
Thickness/Spessore - Min [mm]	
24/22,4	
No. of Bores/N° fori	
5	
VENTILATED	Ventilato/Vented
mitsubishi	



60-05-599	
	Pitch Circle Ø/Foro int.-Ø [mm]
	87
	Height/Altezza [mm]
	45,5
	Diam./Diam. [mm]
	275,8
Thickness/Spessore - Min [mm]	
24/22,4	
No. of Bores/N° fori	
6	
GONOW - MITSUBISHI	Ventilato/Vented

60-06-604	
	Pitch Circle Ø/Foro int.-Ø [mm]
	56
	Height/Altezza [mm]
	47,3
	Diam./Diam. [mm]
	233
Thickness/Spessore - Min [mm]	
11/10	
No. of Bores/N° fori	
4	
DAIHATSU	Non Ventilato/Not Vented

60-06-600	
	Pitch Circle Ø/Foro int.-Ø [mm]
	47
	Height/Altezza [mm]
	38,8
	Diam./Diam. [mm]
	207,3
Thickness/Spessore - Min [mm]	
10/9	
No. of Bores/N° fori	
4	
DAIHATSU	Non Ventilato/Not Vented

60-06-605	
	Pitch Circle Ø/Foro int.-Ø [mm]
	70
	Height/Altezza [mm]
	35
	Diam./Diam. [mm]
	212
Thickness/Spessore - Min [mm]	
10/8,6	
No. of Bores/N° fori	
4	
DAIHATSU	Non Ventilato/Not Vented

60-06-601	
	Pitch Circle Ø/Foro int.-Ø [mm]
	96
	Height/Altezza [mm]
	29,9
	Diam./Diam. [mm]
	276,3
Thickness/Spessore - Min [mm]	
12,4/11,5	
No. of Bores/N° fori	
5	
DAIHATSU	Non Ventilato/Not Vented

60-06-607	
	Pitch Circle Ø/Foro int.-Ø [mm]
	96
	Height/Altezza [mm]
	33
	Diam./Diam. [mm]
	276,8
Thickness/Spessore - Min [mm]	
18/17	
No. of Bores/N° fori	
5	
DAIHATSU	Ventilato/Vented

60-06-602	
	Pitch Circle Ø/Foro int.-Ø [mm]
	47
	Height/Altezza [mm]
	28
	Diam./Diam. [mm]
	208
Thickness/Spessore - Min [mm]	
11/10	
No. of Holes/N° fori	
4	
DAIHATSU	Non Ventilato/Not Vented

60-06-608	
	Pitch Circle Ø/Foro int.-Ø [mm]
	70
	Height/Altezza [mm]
	36,5
	Diam./Diam. [mm]
	210
Thickness/Spessore - Min [mm]	
10/9	
No. of Bores/N° fori	
4	
DAIHATSU	Non Ventilato/Not Vented

60-06-603	
	Pitch Circle Ø/Foro int.-Ø [mm]
	56
	Height/Altezza [mm]
	47,2
	Diam./Diam. [mm]
	233,5
Thickness/Spessore - Min [mm]	
18/17	
No. of Bores/N° fori	
4	
DAIHATSU	Ventilato/Vented

60-06-609	
	Pitch Circle Ø/Foro int.-Ø [mm]
	70
	Height/Altezza [mm]
	35
	Diam./Diam. [mm]
	211
Thickness/Spessore - Min [mm]	
10/9	
No. of Holes/N° fori	
4	
DAIHATSU	Non Ventilato/Not Vented

60-06-610	
	Pitch Circle Ø/Foro int.-Ø [mm]
	66,5
	Height/Altezza [mm]
	38
	Diam./Diam. [mm]
	273
Thickness/Spessore - Min [mm]	
16,2/15	
No. of Bores/N° fori	
5	
Non Ventilato/Not Vented	
DAIHATSU	

60-06-615	
	Pitch Circle Ø/Foro int.-Ø [mm]
	70
	Height/Altezza [mm]
	37,3
	Diam./Diam. [mm]
	233,8
Thickness/Spessore - Min [mm]	
16/14,5	
No. of Bores/N° fori	
4	
Ventilato/Vented	
DAIHATSU	

60-06-611	
	Pitch Circle Ø/Foro int.-Ø [mm]
	70
	Height/Altezza [mm]
	33
	Diam./Diam. [mm]
	179
Thickness/Spessore - Min [mm]	
10/8	
No. of Bores/N° fori	
4	
Non Ventilato/Not Vented	
DAIHATSU	

60-06-617	
	Pitch Circle Ø/Foro int.-Ø [mm]
	55
	Height/Altezza [mm]
	42
	Diam./Diam. [mm]
	254
Thickness/Spessore - Min [mm]	
22/20,5	
No. of Holes/N° fori	
4	
Ventilato/Vented	
DAIHATSU	

60-06-612	
	Pitch Circle Ø/Foro int.-Ø [mm]
	79
	Height/Altezza [mm]
	24
	Diam./Diam. [mm]
	209,6
Thickness/Spessore - Min [mm]	
10/9	
No. of Bores/N° fori	
4	
Non Ventilato/Not Vented	
DAIHATSU	

60-06-618	
	Pitch Circle Ø/Foro int.-Ø [mm]
	55
	Height/Altezza [mm]
	43
	Diam./Diam. [mm]
	246
Thickness/Spessore - Min [mm]	
17/15	
No. of Bores/N° fori	
4	
Ventilato/Vented	
DAIHATSU - SUBARU	

60-06-613	
	Pitch Circle Ø/Foro int.-Ø [mm]
	55
	Height/Altezza [mm]
	41,3
	Diam./Diam. [mm]
	210,8
Thickness/Spessore - Min [mm]	
11/9,5	
No. of Bores/N° fori	
4	
Non Ventilato/Not Vented	
DAIHATSU	

60-06-619	
	Pitch Circle Ø/Foro int.-Ø [mm]
	70
	Height/Altezza [mm]
	42
	Diam./Diam. [mm]
	211
Thickness/Spessore - Min [mm]	
16/14	
No. of Bores/N° fori	
4	
Ventilato/Vented	
DAIHATSU	

60-06-614	
	Pitch Circle Ø/Foro int.-Ø [mm]
	55
	Height/Altezza [mm]
	41
	Diam./Diam. [mm]
	233,6
Thickness/Spessore - Min [mm]	
16/14	
No. of Bores/N° fori	
4	
Ventilato/Vented	
SUBARU - DAIHATSU	

60-06-620	
	Pitch Circle Ø/Foro int.-Ø [mm]
	66,5
	Height/Altezza [mm]
	38
	Diam./Diam. [mm]
	287
Thickness/Spessore - Min [mm]	
22/20	
No. of Bores/N° fori	
5	
Ventilato/Vented	
DAIHATSU	

60-06-696	
	Pitch Circle Ø/Foro int.-Ø [mm]
	70
	Height/Altezza [mm]
	37
	Diam./Diam. [mm]
	210
Thickness/Spessore - Min [mm]	
16/14,5	
No. of Bores/N° fori	
4	
PIAGGIO	Non Ventilato/Not Vented

60-07-702	
	Pitch Circle Ø/Foro int.-Ø [mm]
	65
	Height/Altezza [mm]
	36,7
	Diam./Diam. [mm]
	211,8
Thickness/Spessore - Min [mm]	
18/16	
No. of Bores/N° fori	
4	
SUBARU	Ventilato/Vented

60-06-697	
	Pitch Circle Ø/Foro int.-Ø [mm]
	70
	Height/Altezza [mm]
	36,7
	Diam./Diam. [mm]
	208
Thickness/Spessore - Min [mm]	
15,3/14	
No. of Bores/N° fori	
4	
PIAGGIO	Ventilato/Vented

60-07-703	
	Pitch Circle Ø/Foro int.-Ø [mm]
	70
	Height/Altezza [mm]
	44,2
	Diam./Diam. [mm]
	242
Thickness/Spessore - Min [mm]	
18,2/16	
No. of Bores/N° fori	
4	
SUBARU	Ventilato/Vented

60-06-699	
	Pitch Circle Ø/Foro int.-Ø [mm]
	55
	Height/Altezza [mm]
	62,2
	Diam./Diam. [mm]
	213
Thickness/Spessore - Min [mm]	
9,5/8,6	
No. of Bores/N° fori	
4	
INNOCENTI	Non Ventilato/Not Vented

60-07-704	
	Pitch Circle Ø/Foro int.-Ø [mm]
	70
	Height/Altezza [mm]
	52,3
	Diam./Diam. [mm]
	229,8
Thickness/Spessore - Min [mm]	
18/16	
No. of Bores/N° fori	
4	
SUBARU	Ventilato/Vented

60-07-700	
	Pitch Circle Ø/Foro int.-Ø [mm]
	70
	Height/Altezza [mm]
	51,7
	Diam./Diam. [mm]
	229,3
Thickness/Spessore - Min [mm]	
12,4/10	
No. of Bores/N° fori	
4	
SUBARU	Non Ventilato/Not Vented

60-07-705	
	Pitch Circle Ø/Foro int.-Ø [mm]
	58
	Height/Altezza [mm]
	53,3
	Diam./Diam. [mm]
	242
Thickness/Spessore - Min [mm]	
18,2/16	
No. of Bores/N° fori	
5	
SUBARU	Ventilato/Vented

60-07-701	
	Pitch Circle Ø/Foro int.-Ø [mm]
	65
	Height/Altezza [mm]
	28,5
	Diam./Diam. [mm]
	212
Thickness/Spessore - Min [mm]	
10/8,5	
No. of Bores/N° fori	
4	
SUBARU	Non Ventilato/Not Vented

60-07-706	
	Pitch Circle Ø/Foro int.-Ø [mm]
	58
	Height/Altezza [mm]
	57,4
	Diam./Diam. [mm]
	259,9
Thickness/Spessore - Min [mm]	
24/22	
No. of Bores/N° fori	
5	
SUBARU	Ventilato/Vented

60-07-707	
	Pitch Circle Ø/Foro int.-Ø [mm]
	65
	Height/Altezza [mm]
	18
	Diam./Diam. [mm]
	212
Thickness/Spessore - Min [mm]	
9/8	
No. of Bores/N° fori	
4	
SUBARU	Non Ventilato/Not Vented

60-07-713	
	Pitch Circle Ø/Foro int.-Ø [mm]
	58
	Height/Altezza [mm]
	53
	Diam./Diam. [mm]
	326
Thickness/Spessore - Min [mm]	
30/28	
No. of Bores/N° fori	
5	
SUBARU	Ventilato/Vented

60-07-709	
	Pitch Circle Ø/Foro int.-Ø [mm]
	65
	Height/Altezza [mm]
	36,4
	Diam./Diam. [mm]
	239,7
Thickness/Spessore - Min [mm]	
18,2/17	
No. of Bores/N° fori	
4	
SUBARU	Ventilato/Vented

60-07-725	
	Pitch Circle Ø/Foro int.-Ø [mm]
	58
	Height/Altezza [mm]
	57
	Diam./Diam. [mm]
	293
Thickness/Spessore - Min [mm]	
24/22	
No. of Bores/N° fori	
5	
SUBARU	Ventilato/Vented

60-07-710	
	Pitch Circle Ø/Foro int.-Ø [mm]
	58
	Height/Altezza [mm]
	57,3
	Diam./Diam. [mm]
	301,5
Thickness/Spessore - Min [mm]	
28/26	
No. of Bores/N° fori	
5	
SUBARU	Ventilato/Vented

60-08-800	
	Pitch Circle Ø/Foro int.-Ø [mm]
	86
	Height/Altezza [mm]
	33
	Diam./Diam. [mm]
	213
Thickness/Spessore - Min [mm]	
11/10	
No. of Bores/N° fori	
4	
SUZUKI - DAEWOO	Non Ventilato/Not Vented

60-07-711	
	Pitch Circle Ø/Foro int.-Ø [mm]
	58
	Height/Altezza [mm]
	57
	Diam./Diam. [mm]
	276,5
Thickness/Spessore - Min [mm]	
24/22	
No. of Bores/N° fori	
5	
SUBARU	Ventilato/Vented

60-08-801	
	Pitch Circle Ø/Foro int.-Ø [mm]
	86
	Height/Altezza [mm]
	33
	Diam./Diam. [mm]
	214,8
Thickness/Spessore - Min [mm]	
10/9	
No. of Bores/N° fori	
4	
BEDFORD - SUZUKI - MARUTI	Non Ventilato/Not Vented

60-07-712	
	Pitch Circle Ø/Foro int.-Ø [mm]
	58
	Height/Altezza [mm]
	57
	Diam./Diam. [mm]
	316
Thickness/Spessore - Min [mm]	
30,5/28,5	
No. of Bores/N° fori	
5	
SUBARU	Ventilato/Vented

60-08-802	
	Pitch Circle Ø/Foro int.-Ø [mm]
	62
	Height/Altezza [mm]
	29
	Diam./Diam. [mm]
	207,1
Thickness/Spessore - Min [mm]	
10/9	
No. of Bores/N° fori	
4	
BEDFORD - SUZUKI - MARUTI	Non Ventilato/Not Vented



60-08-804	
	Pitch Circle Ø/Foro int.-Ø [mm]
	64
	Height/Altezza [mm]
	52,5
	Diam./Diam. [mm]
	230,6
Thickness/Spessore - Min [mm]	
17/15,6	
No. of Bores/N° fori	
4	
SUZUKI	Ventilato/Vented

60-08-809	
	Pitch Circle Ø/Foro int.-Ø [mm]
	108
	Height/Altezza [mm]
	29,6
	Diam./Diam. [mm]
	286,6
Thickness/Spessore - Min [mm]	
17/15	
No. of Bores/N° fori	
5	
SUZUKI	Ventilato/Vented

60-08-805	
	Pitch Circle Ø/Foro int.-Ø [mm]
	64
	Height/Altezza [mm]
	47
	Diam./Diam. [mm]
	249,8
Thickness/Spessore - Min [mm]	
18,6/16,5	
No. of Bores/N° fori	
4	
SUZUKI	Ventilato/Vented

60-08-811	
	Pitch Circle Ø/Foro int.-Ø [mm]
	108
	Height/Altezza [mm]
	29,3
	Diam./Diam. [mm]
	309,6
Thickness/Spessore - Min [mm]	
22/20	
No. of Bores/N° fori	
5	
SUZUKI	Ventilato/Vented

60-08-806	
	Pitch Circle Ø/Foro int.-Ø [mm]
	64
	Height/Altezza [mm]
	50,2
	Diam./Diam. [mm]
	231
Thickness/Spessore - Min [mm]	
17/15	
No. of Bores/N° fori	
4	
SUZUKI - SUBARU	Ventilato/Vented

60-08-812	
	Pitch Circle Ø/Foro int.-Ø [mm]
	60
	Height/Altezza [mm]
	49,3
	Diam./Diam. [mm]
	231,2
Thickness/Spessore - Min [mm]	
17/15	
No. of Bores/N° fori	
4	
SUZUKI	Ventilato/Vented

60-08-807	
	Pitch Circle Ø/Foro int.-Ø [mm]
	107
	Height/Altezza [mm]
	46,5
	Diam./Diam. [mm]
	290
Thickness/Spessore - Min [mm]	
10/8	
No. of Bores/N° fori	
5	
SUZUKI	Non Ventilato/Not Vented

60-08-814	
	Pitch Circle Ø/Foro int.-Ø [mm]
	60
	Height/Altezza [mm]
	50
	Diam./Diam. [mm]
	234,5
Thickness/Spessore - Min [mm]	
20/18,5	
No. of Bores/N° fori	
4	
SUZUKI	Ventilato/Vented

60-08-808	
	Pitch Circle Ø/Foro int.-Ø [mm]
	107
	Height/Altezza [mm]
	46,3
	Diam./Diam. [mm]
	286,6
Thickness/Spessore - Min [mm]	
17/15	
No. of Bores/N° fori	
5	
SUZUKI	Ventilato/Vented

60-08-815	
	Pitch Circle Ø/Foro int.-Ø [mm]
	60
	Height/Altezza [mm]
	40,2
	Diam./Diam. [mm]
	251,3
Thickness/Spessore - Min [mm]	
20/18,5	
No. of Bores/N° fori	
4	
SUZUKI	Ventilato/Vented

60-08-816	
	Pitch Circle Ø/Foro int.-Ø [mm]
	107
	Height/Altezza [mm]
	46,2
	Diam./Diam. [mm]
309,8	
Thickness/Spessore - Min [mm]	
22/20	
No. of Bores/N° fori	
5	
SUZUKI	Ventilato/Vented

60-08-821	
	Pitch Circle Ø/Foro int.-Ø [mm]
	62
	Height/Altezza [mm]
	49
	Diam./Diam. [mm]
294	
Thickness/Spessore - Min [mm]	
25/23	
No. of Bores/N° fori	
5	
SUZUKI	Ventilato/Vented

60-08-817	
	Pitch Circle Ø/Foro int.-Ø [mm]
	60
	Height/Altezza [mm]
	49,5
	Diam./Diam. [mm]
252,4	
Thickness/Spessore - Min [mm]	
17/15,5	
No. of Bores/N° fori	
4	
SUZUKI - SUBARU	Ventilato/Vented

60-08-822	
	Pitch Circle Ø/Foro int.-Ø [mm]
	60
	Height/Altezza [mm]
	52
	Diam./Diam. [mm]
231	
Thickness/Spessore - Min [mm]	
20/18	
No. of Bores/N° fori	
4	
NISSAN - SUZUKI	Ventilato/Vented

60-08-818	
	Pitch Circle Ø/Foro int.-Ø [mm]
	60
	Height/Altezza [mm]
	44,5
	Diam./Diam. [mm]
246,5	
Thickness/Spessore - Min [mm]	
12/10,5	
No. of Bores/N° fori	
4	
SUZUKI	Non Ventilato/Not Vented

60-08-823	
	Pitch Circle Ø/Foro int.-Ø [mm]
	62
	Height/Altezza [mm]
	41
	Diam./Diam. [mm]
276	
Thickness/Spessore - Min [mm]	
20/18	
No. of Bores/N° fori	
5	
SUZUKI	Ventilato/Vented

60-08-819	
	Pitch Circle Ø/Foro int.-Ø [mm]
	108,3
	Height/Altezza [mm]
	29,3
	Diam./Diam. [mm]
309,3	
Thickness/Spessore - Min [mm]	
22/20	
No. of Bores/N° fori	
5	
SUZUKI	Ventilato/Vented

60-08-824	
	Pitch Circle Ø/Foro int.-Ø [mm]
	108
	Height/Altezza [mm]
	47
	Diam./Diam. [mm]
290	
Thickness/Spessore - Min [mm]	
10/8	
No. of Bores/N° fori	
5	
SUZUKI	Non Ventilato/Not Vented

60-08-820	
	Pitch Circle Ø/Foro int.-Ø [mm]
	62,1
	Height/Altezza [mm]
	47
	Diam./Diam. [mm]
279	
Thickness/Spessore - Min [mm]	
22/20	
No. of Bores/N° fori	
5	
FIAT - SUZUKI	Ventilato/Vented

60-08-825	
	Pitch Circle Ø/Foro int.-Ø [mm]
	108
	Height/Altezza [mm]
	47
	Diam./Diam. [mm]
287	
Thickness/Spessore - Min [mm]	
17/15	
No. of Bores/N° fori	
5	
SUZUKI	Ventilato/Vented



60-08-826	
	Pitch Circle Ø/Foro int.-Ø [mm]
	60
	Height/Altezza [mm]
	40,5
	Diam./Diam. [mm]
256	
Thickness/Spessore - Min [mm]	
22/20	
	Ventilato/Vented
SUZUKI	

60-09-904	
	Pitch Circle Ø/Foro int.-Ø [mm]
	57
	Height/Altezza [mm]
	43,5
	Diam./Diam. [mm]
229,9	
Thickness/Spessore - Min [mm]	
18/16,6	
No. of Bores/N° fori	
4	
	Ventilato/Vented
OPEL	

60-08-890	
	Pitch Circle Ø/Foro int.-Ø [mm]
	60
	Height/Altezza [mm]
	49,7
	Diam./Diam. [mm]
256,6	
Thickness/Spessore - Min [mm]	
17/15	
No. of Bores/N° fori	
4	
	Ventilato/Vented
SUZUKI	

60-09-906	
	Pitch Circle Ø/Foro int.-Ø [mm]
	80
	Height/Altezza [mm]
	33,7
	Diam./Diam. [mm]
250,5	
Thickness/Spessore - Min [mm]	
18/16	
No. of Bores/N° fori	
6	
	Ventilato/Vented
ISUZU	

60-08-891	
	Pitch Circle Ø/Foro int.-Ø [mm]
	60
	Height/Altezza [mm]
	50
	Diam./Diam. [mm]
245,5	
Thickness/Spessore - Min [mm]	
20/18,5	
No. of Bores/N° fori	
4	
	Ventilato/Vented
SUZUKI	

60-09-909	
	Pitch Circle Ø/Foro int.-Ø [mm]
	88
	Height/Altezza [mm]
	36,4
	Diam./Diam. [mm]
256,8	
Thickness/Spessore - Min [mm]	
22/20	
No. of Bores/N° fori	
6	
	Ventilato/Vented
LOTUS - OPEL - ISUZU	

60-09-900	
	Pitch Circle Ø/Foro int.-Ø [mm]
	80
	Height/Altezza [mm]
	37,5
	Diam./Diam. [mm]
259	
Thickness/Spessore - Min [mm]	
12,5/11	
No. of Holes/N° fori	
6	
	Non Ventilato/Not Vented
ISUZU	

60-09-910	
	Pitch Circle Ø/Foro int.-Ø [mm]
	60
	Height/Altezza [mm]
	41,6
	Diam./Diam. [mm]
236	
Thickness/Spessore - Min [mm]	
20/17	
No. of Bores/N° fori	
4	
	Ventilato/Vented
DAEWOO - OPEL - VAUXHALL	

60-09-903	
	Pitch Circle Ø/Foro int.-Ø [mm]
	80
	Height/Altezza [mm]
	34
	Diam./Diam. [mm]
250,3	
Thickness/Spessore - Min [mm]	
18/16,6	
No. of Bores/N° fori	
6	
	Ventilato/Vented
BEDFORD - ISUZU	

60-09-911	
	Pitch Circle Ø/Foro int.-Ø [mm]
	60
	Height/Altezza [mm]
	41,4
	Diam./Diam. [mm]
235,5	
Thickness/Spessore - Min [mm]	
10/8	
No. of Bores/N° fori	
6	
	Non Ventilato/Not Vented
OPEL	

60-09-912	
	Pitch Circle Ø/Foro int.-Ø [mm]
	110
	Height/Altezza [mm]
	58
	Diam./Diam. [mm]
	293
Thickness/Spessore - Min [mm]	
40/38	
No. of Bores/N° fori	
12	
ISUZU	Ventilato/Vented

60-09-921	
	Pitch Circle Ø/Foro int.-Ø [mm]
	88
	Height/Altezza [mm]
	40,4
	Diam./Diam. [mm]
	279,9
Thickness/Spessore - Min [mm]	
27/25	
No. of Bores/N° fori	
6	
ISUZU	Ventilato/Vented

60-09-913	
	Pitch Circle Ø/Foro int.-Ø [mm]
	72
	Height/Altezza [mm]
	56
	Diam./Diam. [mm]
	302
Thickness/Spessore - Min [mm]	
28/26	
No. of Bores/N° fori	
5	
JEEP	Ventilato/Vented

60-09-991	
	Pitch Circle Ø/Foro int.-Ø [mm]
	72
	Height/Altezza [mm]
	65,2
	Diam./Diam. [mm]
	287,7
Thickness/Spessore - Min [mm]	
28/26	
No. of Bores/N° fori	
5	
JEEP	Ventilato/Vented

60-09-914	
	Pitch Circle Ø/Foro int.-Ø [mm]
	73
	Height/Altezza [mm]
	57
	Diam./Diam. [mm]
	345
Thickness/Spessore - Min [mm]	
28/26	
No. of Bores/N° fori	
5	
CHRYSLER	Ventilato/Vented

60-09-992	
	Pitch Circle Ø/Foro int.-Ø [mm]
	73,5
	Height/Altezza [mm]
	39,3
	Diam./Diam. [mm]
	301
Thickness/Spessore - Min [mm]	
28/26	
No. of Bores/N° fori	
5	
CHRYSLER	Ventilato/Vented

60-09-915	
	Pitch Circle Ø/Foro int.-Ø [mm]
	72,5
	Height/Altezza [mm]
	39
	Diam./Diam. [mm]
	302
Thickness/Spessore - Min [mm]	
28/26	
No. of Bores/N° fori	
5	
DODGE - CHRYSLER	Ventilato/Vented

60-09-993	
	Pitch Circle Ø/Foro int.-Ø [mm]
	61
	Height/Altezza [mm]
	32,6
	Diam./Diam. [mm]
	260
Thickness/Spessore - Min [mm]	
22,9/21,4	
No. of Bores/N° fori	
5	
CHRYSLER	Ventilato/Vented

60-09-920	
	Pitch Circle Ø/Foro int.-Ø [mm]
	88
	Height/Altezza [mm]
	40,3
	Diam./Diam. [mm]
	255,8
Thickness/Spessore - Min [mm]	
26/24	
No. of Bores/N° fori	
6	
ISUZU	Ventilato/Vented

60-09-994	
	Pitch Circle Ø/Foro int.-Ø [mm]
	61
	Height/Altezza [mm]
	39,8
	Diam./Diam. [mm]
	279,8
Thickness/Spessore - Min [mm]	
23/21,4	
No. of Bores/N° fori	
5	
CHRYSLER	Ventilato/Vented



60-09-995	
	Pitch Circle Ø/Foro int.-Ø [mm]
	61
	Height/Altezza [mm]
	38
	Diam./Diam. [mm]
	256,8
Thickness/Spessore - Min [mm]	
20,1/18,4	
No. of Bores/N° fori	
5	
CHRYSLER	Ventilato/Vented

60-0H-003	
	Pitch Circle Ø/Foro int.-Ø [mm]
	87
	Height/Altezza [mm]
	40,4
	Diam./Diam. [mm]
	254
Thickness/Spessore - Min [mm]	
24/22	
No. of Bores/N° fori	
5	
HYUNDAI	Ventilato/Vented

60-09-996	
	Pitch Circle Ø/Foro int.-Ø [mm]
	61
	Height/Altezza [mm]
	33
	Diam./Diam. [mm]
	280
Thickness/Spessore - Min [mm]	
23/21,4	
No. of Bores/N° fori	
5	
CHRYSLER	Ventilato/Vented

60-0H-005	
	Pitch Circle Ø/Foro int.-Ø [mm]
	63
	Height/Altezza [mm]
	51
	Diam./Diam. [mm]
	234
Thickness/Spessore - Min [mm]	
18/16	
No. of Bores/N° fori	
4	
HYUNDAI	Ventilato/Vented

60-09-997	
	Pitch Circle Ø/Foro int.-Ø [mm]
	88
	Height/Altezza [mm]
	36,3
	Diam./Diam. [mm]
	279,5
Thickness/Spessore - Min [mm]	
26/24,6	
No. of Bores/N° fori	
6	
ISUZU - OPEL	Ventilato/Vented

60-0H-007	
	Pitch Circle Ø/Foro int.-Ø [mm]
	62
	Height/Altezza [mm]
	51
	Diam./Diam. [mm]
	233,8
Thickness/Spessore - Min [mm]	
18/16	
No. of Bores/N° fori	
4	
HYUNDAI	Ventilato/Vented

60-09-999	
	Pitch Circle Ø/Foro int.-Ø [mm]
	57
	Height/Altezza [mm]
	42,2
	Diam./Diam. [mm]
	226,6
Thickness/Spessore - Min [mm]	
11/9,6	
No. of Bores/N° fori	
4	
ISUZU	Non Ventilato/Not Vented

60-0H-008	
	Pitch Circle Ø/Foro int.-Ø [mm]
	69
	Height/Altezza [mm]
	47
	Diam./Diam. [mm]
	256,9
Thickness/Spessore - Min [mm]	
24/22	
No. of Bores/N° fori	
4	
HYUNDAI	Ventilato/Vented

60-0H-002	
	Pitch Circle Ø/Foro int.-Ø [mm]
	87
	Height/Altezza [mm]
	45,4
	Diam./Diam. [mm]
	276
Thickness/Spessore - Min [mm]	
22/20,5	
No. of Bores/N° fori	
6	
HYUNDAI	Ventilato/Vented

60-0H-009	
	Pitch Circle Ø/Foro int.-Ø [mm]
	69
	Height/Altezza [mm]
	47
	Diam./Diam. [mm]
	275,8
Thickness/Spessore - Min [mm]	
26,1/24	
No. of Bores/N° fori	
5	
HYUNDAI	Ventilato/Vented

60-0H-010		
	Pitch Circle Ø/Foro int.-Ø [mm]	62
	Height/Altezza [mm]	48
	Diam./Diam. [mm]	241
	Thickness/Spessore - Min [mm]	18/16
	No. of Bores/N° fori	4
HYUNDAI	Ventilato/Vented	

60-0H-H15		
	Pitch Circle Ø/Foro int.-Ø [mm]	69
	Height/Altezza [mm]	48
	Diam./Diam. [mm]	300
	Thickness/Spessore - Min [mm]	28/26
	No. of Bores/N° fori	5
HYUNDAI	Ventilato/Vented	

60-0H-011		
	Pitch Circle Ø/Foro int.-Ø [mm]	62
	Height/Altezza [mm]	48,2
	Diam./Diam. [mm]	255,4
	Thickness/Spessore - Min [mm]	19/17
	No. of Bores/N° fori	4
HYUNDAI	Ventilato/Vented	

60-0H-016		
	Pitch Circle Ø/Foro int.-Ø [mm]	62
	Height/Altezza [mm]	52,4
	Diam./Diam. [mm]	240,8
	Thickness/Spessore - Min [mm]	19/17,5
	No. of Bores/N° fori	4
HYUNDAI	Ventilato/Vented	

60-0H-012		
	Pitch Circle Ø/Foro int.-Ø [mm]	69
	Height/Altezza [mm]	47,7
	Diam./Diam. [mm]	279,8
	Thickness/Spessore - Min [mm]	26/24
	No. of Bores/N° fori	5
KIA - HYUNDAI	Ventilato/Vented	

60-0H-H17		
	Pitch Circle Ø/Foro int.-Ø [mm]	69
	Height/Altezza [mm]	48
	Diam./Diam. [mm]	320
	Thickness/Spessore - Min [mm]	28/26
	No. of Bores/N° fori	5
HYUNDAI	Ventilato/Vented	

60-0H-013		
	Pitch Circle Ø/Foro int.-Ø [mm]	87
	Height/Altezza [mm]	43
	Diam./Diam. [mm]	280
	Thickness/Spessore - Min [mm]	27/25,4
	No. of Bores/N° fori	6
HYUNDAI	Ventilato/Vented	

60-0H-018		
	Pitch Circle Ø/Foro int.-Ø [mm]	69
	Height/Altezza [mm]	46
	Diam./Diam. [mm]	257
	Thickness/Spessore - Min [mm]	24/22
	No. of Bores/N° fori	4
HYUNDAI	Ventilato/Vented	

60-0H-H14		
	Pitch Circle Ø/Foro int.-Ø [mm]	87
	Height/Altezza [mm]	44,5
	Diam./Diam. [mm]	273,9
	Thickness/Spessore - Min [mm]	26/24
	No. of Bores/N° fori	5
HYUNDAI	Ventilato/Vented	

60-0H-H19		
	Pitch Circle Ø/Foro int.-Ø [mm]	69,2
	Height/Altezza [mm]	49
	Diam./Diam. [mm]	320,5
	Thickness/Spessore - Min [mm]	27,5/25,5
	No. of Bores/N° fori	5
KIA - HYUNDAI	Ventilato/Vented	



60-0H-H20	
	Pitch Circle Ø/Foro int.-Ø [mm]
	87
	Height/Altezza [mm]
	45,4
	Diam./Diam. [mm]
276	
Thickness/Spessore - Min [mm]	
22/20,5	
No. of Holes/N° fori	
6	
HYUNDAI	Ventilato/Vented

60-0K-002	
	Pitch Circle Ø/Foro int.-Ø [mm]
	72
	Height/Altezza [mm]
	47,7
	Diam./Diam. [mm]
274,3	
Thickness/Spessore - Min [mm]	
24/22	
No. of Bores/N° fori	
5	
KIA	Ventilato/Vented

60-0H-H21	
	Pitch Circle Ø/Foro int.-Ø [mm]
	69
	Height/Altezza [mm]
	46,5
	Diam./Diam. [mm]
294	
Thickness/Spessore - Min [mm]	
26/24	
No. of Bores/N° fori	
5	
HYUNDAI	Ventilato/Vented

60-0K-003	
	Pitch Circle Ø/Foro int.-Ø [mm]
	72
	Height/Altezza [mm]
	48,8
	Diam./Diam. [mm]
273	
Thickness/Spessore - Min [mm]	
26/24	
No. of Bores/N° fori	
5	
KIA	Ventilato/Vented

60-0H-H22	
	Pitch Circle Ø/Foro int.-Ø [mm]
	87
	Height/Altezza [mm]
	43
	Diam./Diam. [mm]
303	
Thickness/Spessore - Min [mm]	
28,3/26	
No. of Bores/N° fori	
6	
HYUNDAI	Ventilato/Vented

60-0K-004	
	Pitch Circle Ø/Foro int.-Ø [mm]
	86
	Height/Altezza [mm]
	24,2
	Diam./Diam. [mm]
260,6	
Thickness/Spessore - Min [mm]	
24,2/22	
No. of Bores/N° fori	
6	
KIA	Ventilato/Vented

60-0H-H23	
	Pitch Circle Ø/Foro int.-Ø [mm]
	69
	Height/Altezza [mm]
	47,5
	Diam./Diam. [mm]
300	
Thickness/Spessore - Min [mm]	
28/26	
No. of Bores/N° fori	
5	
KIA - HYUNDAI	Ventilato/Vented

60-0K-005	
	Pitch Circle Ø/Foro int.-Ø [mm]
	96,3
	Height/Altezza [mm]
	54,4
	Diam./Diam. [mm]
301,6	
Thickness/Spessore - Min [mm]	
28/26	
No. of Bores/N° fori	
5	
KIA - HONDA	Ventilato/Vented

60-0H-H24	
	Pitch Circle Ø/Foro int.-Ø [mm]
	96
	Height/Altezza [mm]
	53
	Diam./Diam. [mm]
300	
Thickness/Spessore - Min [mm]	
30/28	
No. of Bores/N° fori	
6	
HYUNDAI	Ventilato/Vented

60-0K-006	
	Pitch Circle Ø/Foro int.-Ø [mm]
	72
	Height/Altezza [mm]
	49
	Diam./Diam. [mm]
280	
Thickness/Spessore - Min [mm]	
26/24	
No. of Bores/N° fori	
4	
KIA	Ventilato/Vented

60-0K-007	
	Pitch Circle Ø/Foro int.-Ø [mm]
	87
	Height/Altezza [mm]
	56,5
	Diam./Diam. [mm]
	258,2
Thickness/Spessore - Min [mm]	
26/24	
No. of Bores/N° fori	
6	
HONDA - KIA	Ventilato/Vented

60-0K-012	
	Pitch Circle Ø/Foro int.-Ø [mm]
	57
	Height/Altezza [mm]
	48,8
	Diam./Diam. [mm]
	257,7
Thickness/Spessore - Min [mm]	
24/22	
No. of Bores/N° fori	
4	
KIA	Ventilato/Vented

60-0K-008	
	Pitch Circle Ø/Foro int.-Ø [mm]
	55
	Height/Altezza [mm]
	45,3
	Diam./Diam. [mm]
	234,3
Thickness/Spessore - Min [mm]	
22/20	
No. of Bores/N° fori	
4	
KIA	Ventilato/Vented

60-0K-K13	
	Pitch Circle Ø/Foro int.-Ø [mm]
	86
	Height/Altezza [mm]
	25
	Diam./Diam. [mm]
	255
Thickness/Spessore - Min [mm]	
24/22	
No. of Bores/N° fori	
6	
ASIA MOTORS - KIA	Ventilato/Vented

60-0K-009	
	Pitch Circle Ø/Foro int.-Ø [mm]
	96
	Height/Altezza [mm]
	51,2
	Diam./Diam. [mm]
	283,6
Thickness/Spessore - Min [mm]	
24/22	
No. of Bores/N° fori	
5	
KIA	Ventilato/Vented

60-0K-014	
	Pitch Circle Ø/Foro int.-Ø [mm]
	69
	Height/Altezza [mm]
	47,7
	Diam./Diam. [mm]
	256,5
Thickness/Spessore - Min [mm]	
24,5/22,5	
No. of Bores/N° fori	
4	
KIA - HYUNDAI	Ventilato/Vented

60-0K-010	
	Pitch Circle Ø/Foro int.-Ø [mm]
	62
	Height/Altezza [mm]
	49
	Diam./Diam. [mm]
	240,6
Thickness/Spessore - Min [mm]	
18/16	
No. of Bores/N° fori	
4	
KIA - HYUNDAI	Ventilato/Vented

60-0K-015	
	Pitch Circle Ø/Foro int.-Ø [mm]
	69
	Height/Altezza [mm]
	47,5
	Diam./Diam. [mm]
	279,7
Thickness/Spessore - Min [mm]	
26/24	
No. of Bores/N° fori	
4	
HYUNDAI - KIA	Ventilato/Vented

60-0K-K11	
	Pitch Circle Ø/Foro int.-Ø [mm]
	72
	Height/Altezza [mm]
	51
	Diam./Diam. [mm]
	273,7
Thickness/Spessore - Min [mm]	
28/26	
No. of Bores/N° fori	
5	
KIA	Ventilato/Vented

60-0K-016	
	Pitch Circle Ø/Foro int.-Ø [mm]
	55
	Height/Altezza [mm]
	51
	Diam./Diam. [mm]
	254
Thickness/Spessore - Min [mm]	
24/22	
No. of Bores/N° fori	
4	
KIA	Ventilato/Vented

60-0K-K17	
	Pitch Circle Ø/Foro int.-Ø [mm]
	69
	Height/Altezza [mm]
	47,8
	Diam./Diam. [mm]
	274,7
Thickness/Spessore - Min [mm]	
26/24	
No. of Bores/N° fori	
4	
KIA	Ventilato/Vented

60-0K-K22	
	Pitch Circle Ø/Foro int.-Ø [mm]
	93
	Height/Altezza [mm]
	25
	Diam./Diam. [mm]
	261
Thickness/Spessore - Min [mm]	
24/22	
No. of Bores/N° fori	
6	
KIA	Ventilato/Vented

60-0K-K18	
	Pitch Circle Ø/Foro int.-Ø [mm]
	62,3
	Height/Altezza [mm]
	46,9
	Diam./Diam. [mm]
	255,9
Thickness/Spessore - Min [mm]	
22/20	
No. of Bores/N° fori	
4	
HYUNDAI - KIA	Ventilato/Vented

60-0L-L00	
	Pitch Circle Ø/Foro int.-Ø [mm]
	66
	Height/Altezza [mm]
	52
	Diam./Diam. [mm]
	277
Thickness/Spessore - Min [mm]	
21/19	
No. of Bores/N° fori	
5	
LAND ROVER	Ventilato/Vented

60-0K-K19	
	Pitch Circle Ø/Foro int.-Ø [mm]
	69
	Height/Altezza [mm]
	45,4
	Diam./Diam. [mm]
	255,9
Thickness/Spessore - Min [mm]	
24/22	
No. of Bores/N° fori	
4	
KIA	Ventilato/Vented



60-0L-L01	
	Pitch Circle Ø/Foro int.-Ø [mm]
	70
	Height/Altezza [mm]
	92
	Diam./Diam. [mm]
	297
Thickness/Spessore - Min [mm]	
25/23	
No. of Bores/N° fori	
5	
LAND ROVER	Ventilato/Vented

60-0K-K20	
	Pitch Circle Ø/Foro int.-Ø [mm]
	62,5
	Height/Altezza [mm]
	49
	Diam./Diam. [mm]
	252
Thickness/Spessore - Min [mm]	
18/16	
No. of Holes/N° fori	
4	
KIA - HYUNDAI	Ventilato/Vented



60-0L-L02	
	Pitch Circle Ø/Foro int.-Ø [mm]
	79
	Height/Altezza [mm]
	63
	Diam./Diam. [mm]
	360
Thickness/Spessore - Min [mm]	
30/28	
No. of Bores/N° fori	
5	
LAND ROVER	Ventilato/Vented



60-0K-K21	
	Pitch Circle Ø/Foro int.-Ø [mm]
	96,5
	Height/Altezza [mm]
	54
	Diam./Diam. [mm]
	300
Thickness/Spessore - Min [mm]	
28/26	
No. of Bores/N° fori	
6	
KIA	Ventilato/Vented



60-0L-L03	
	Pitch Circle Ø/Foro int.-Ø [mm]
	79
	Height/Altezza [mm]
	82
	Diam./Diam. [mm]
	360
Thickness/Spessore - Min [mm]	
30/28	
No. of Bores/N° fori	
5	
LAND ROVER	Ventilato/Vented



60-0L-L04	
 	Pitch Circle Ø/Foro int.-Ø [mm]
	79
	Height/Altezza [mm]
	63
	Diam./Diam. [mm]
	317
Thickness/Spessore - Min [mm]	
30/28	
No. of Bores/N° fori	
5	
LAND ROVER	Ventilato/Vented

60-0L-L09	
 	Pitch Circle Ø/Foro int.-Ø [mm]
	101,5
	Height/Altezza [mm]
	71
	Diam./Diam. [mm]
	298
Thickness/Spessore - Min [mm]	
24/22	
No. of Bores/N° fori	
5	
LAND ROVER	Ventilato/Vented

60-0L-L05	
 	Pitch Circle Ø/Foro int.-Ø [mm]
	63,5
	Height/Altezza [mm]
	52,5
	Diam./Diam. [mm]
	315
Thickness/Spessore - Min [mm]	
28/26	
No. of Bores/N° fori	
5	
LAND ROVER	Ventilato/Vented

60-0L-L10	
 	Pitch Circle Ø/Foro int.-Ø [mm]
	66
	Height/Altezza [mm]
	51
	Diam./Diam. [mm]
	262
Thickness/Spessore - Min [mm]	
14/12	
No. of Bores/N° fori	
5	
LAND ROVER	Non Ventilato/Not Vented



60-0L-L06	
 	Pitch Circle Ø/Foro int.-Ø [mm]
	79
	Height/Altezza [mm]
	76
	Diam./Diam. [mm]
	344
Thickness/Spessore - Min [mm]	
30/28	
No. of Bores/N° fori	
5	
LAND ROVER	Ventilato/Vented

60-0L-L11	
 	Pitch Circle Ø/Foro int.-Ø [mm]
	79
	Height/Altezza [mm]
	76
	Diam./Diam. [mm]
	344
Thickness/Spessore - Min [mm]	
30/28	
No. of Bores/N° fori	
5	
LAND ROVER	Ventilato/Vented

60-0L-L07	
 	Pitch Circle Ø/Foro int.-Ø [mm]
	70
	Height/Altezza [mm]
	65
	Diam./Diam. [mm]
	297
Thickness/Spessore - Min [mm]	
25/23	
No. of Bores/N° fori	
5	
LAND ROVER	Ventilato/Vented

60-0L-L12	
 	Pitch Circle Ø/Foro int.-Ø [mm]
	101,5
	Height/Altezza [mm]
	70
	Diam./Diam. [mm]
	298,5
Thickness/Spessore - Min [mm]	
14/12	
No. of Bores/N° fori	
5	
LAND ROVER	Non Ventilato/Not Vented

60-0L-L08	
 	Pitch Circle Ø/Foro int.-Ø [mm]
	79
	Height/Altezza [mm]
	62
	Diam./Diam. [mm]
	337
Thickness/Spessore - Min [mm]	
30/28	
No. of Bores/N° fori	
5	
LAND ROVER	Ventilato/Vented

60-0L-L13	
 	Pitch Circle Ø/Foro int.-Ø [mm]
	63,5
	Height/Altezza [mm]
	52
	Diam./Diam. [mm]
	300
Thickness/Spessore - Min [mm]	
28/26	
No. of Bores/N° fori	
5	
LAND ROVER	Ventilato/Vented



60-0M-000	
	Pitch Circle Ø/Foro int.-Ø [mm]
	58
	Height/Altezza [mm]
	38,6
	Diam./Diam. [mm]
	279,9
Thickness/Spessore - Min [mm]	
9/7,5	
No. of Bores/N° fori	
3	
SMART	Non Ventilato/Not Vented

60-0S-S03	
	Pitch Circle Ø/Foro int.-Ø [mm]
	85
	Height/Altezza [mm]
	56,7
	Diam./Diam. [mm]
	293,8
Thickness/Spessore - Min [mm]	
28/26	
No. of Bores/N° fori	
5	
SSANGYONG	Ventilato/Vented

60-0M-M01	
	Pitch Circle Ø/Foro int.-Ø [mm]
	69
	Height/Altezza [mm]
	45,8
	Diam./Diam. [mm]
	255,6
Thickness/Spessore - Min [mm]	
23,9/22	
No. of Bores/N° fori	
4	
SMART - MITSUBISHI	Ventilato/Vented

60-0S-S04	
	Pitch Circle Ø/Foro int.-Ø [mm]
	96
	Height/Altezza [mm]
	56
	Diam./Diam. [mm]
	294
Thickness/Spessore - Min [mm]	
26/24	
No. of Bores/N° fori	
6	
SSANGYONG	Ventilato/Vented

60-0S-000	
	Pitch Circle Ø/Foro int.-Ø [mm]
	88
	Height/Altezza [mm]
	40,2
	Diam./Diam. [mm]
	277,6
Thickness/Spessore - Min [mm]	
24/22	
No. of Bores/N° fori	
6	
DAEWOO - SSANGYONG	Ventilato/Vented

60-0S-S05	
	Pitch Circle Ø/Foro int.-Ø [mm]
	96
	Height/Altezza [mm]
	55
	Diam./Diam. [mm]
	296
Thickness/Spessore - Min [mm]	
24/22	
No. of Bores/N° fori	
6	
SSANGYONG	Ventilato/Vented

60-0S-S01	
	Pitch Circle Ø/Foro int.-Ø [mm]
	88
	Height/Altezza [mm]
	33
	Diam./Diam. [mm]
	293,7
Thickness/Spessore - Min [mm]	
26/24	
No. of Bores/N° fori	
6	
DAEWOO - SSANGYONG	Ventilato/Vented

60-0S-S06	
	Pitch Circle Ø/Foro int.-Ø [mm]
	67
	Height/Altezza [mm]
	46
	Diam./Diam. [mm]
	298
Thickness/Spessore - Min [mm]	
26/24	
No. of Bores/N° fori	
5	
SSANGYONG	Ventilato/Vented

60-0S-S02	
	Pitch Circle Ø/Foro int.-Ø [mm]
	85
	Height/Altezza [mm]
	68
	Diam./Diam. [mm]
	299,6
Thickness/Spessore - Min [mm]	
28/26	
No. of Bores/N° fori	
5	
SSANGYONG	Ventilato/Vented

60-0W-001	
	Pitch Circle Ø/Foro int.-Ø [mm]
	60
	Height/Altezza [mm]
	47,3
	Diam./Diam. [mm]
	255,9
Thickness/Spessore - Min [mm]	
24/22	
No. of Bores/N° fori	
4	
DAEWOO	Ventilato/Vented

60-0W-004	
	Pitch Circle Ø/Foro int.-Ø [mm]
	86
	Height/Altezza [mm]
	35,7
	Diam./Diam. [mm]
235,9	
Thickness/Spessore - Min [mm]	
12,6/10	
No. of Bores/N° fori	
4	
CHEVROLET - DAEWOO	Non Ventilato/Not Vented

60-0W-010	
	Pitch Circle Ø/Foro int.-Ø [mm]
	59
	Height/Altezza [mm]
	41
	Diam./Diam. [mm]
235,4	
Thickness/Spessore - Min [mm]	
20/18	
No. of Bores/N° fori	
4	
DAEWOO - CHEVROLET	Ventilato/Vented

60-0W-005	
	Pitch Circle Ø/Foro int.-Ø [mm]
	60
	Height/Altezza [mm]
	41,2
	Diam./Diam. [mm]
255,8	
Thickness/Spessore - Min [mm]	
23,8/22	
No. of Bores/N° fori	
4	
DAEWOO	Ventilato/Vented

60-0W-W11	
	Pitch Circle Ø/Foro int.-Ø [mm]
	60
	Height/Altezza [mm]
	47,5
	Diam./Diam. [mm]
277,5	
Thickness/Spessore - Min [mm]	
24/22	
No. of Bores/N° fori	
4	
CHEVROLET	Ventilato/Vented

60-0W-007	
	Pitch Circle Ø/Foro int.-Ø [mm]
	60
	Height/Altezza [mm]
	47,3
	Diam./Diam. [mm]
255,9	
Thickness/Spessore - Min [mm]	
24/22	
No. of Bores/N° fori	
4	
DAEWOO	Ventilato/Vented

60-0W-W12	
	Pitch Circle Ø/Foro int.-Ø [mm]
	71
	Height/Altezza [mm]
	52
	Diam./Diam. [mm]
296	
Thickness/Spessore - Min [mm]	
29/27	
No. of Bores/N° fori	
5	
CHEVROLET	Ventilato/Vented



60-0W-008	
	Pitch Circle Ø/Foro int.-Ø [mm]
	60
	Height/Altezza [mm]
	47,4
	Diam./Diam. [mm]
255,7	
Thickness/Spessore - Min [mm]	
23,9/22	
No. of Bores/N° fori	
5	
DAEWOO	Ventilato/Vented

60-0W-013	
	Pitch Circle Ø/Foro int.-Ø [mm]
	60
	Height/Altezza [mm]
	47,4
	Diam./Diam. [mm]
255,9	
Thickness/Spessore - Min [mm]	
24/22	
No. of Bores/N° fori	
4	
DAEWOO	Ventilato/Vented

60-0W-009	
	Pitch Circle Ø/Foro int.-Ø [mm]
	60
	Height/Altezza [mm]
	47,2
	Diam./Diam. [mm]
255,5	
Thickness/Spessore - Min [mm]	
24,2/22	
No. of Bores/N° fori	
4	
CHEVROLET - DAEWOO	Ventilato/Vented

60-0W-014	
	Pitch Circle Ø/Foro int.-Ø [mm]
	110
	Height/Altezza [mm]
	61,3
	Diam./Diam. [mm]
279,4	
Thickness/Spessore - Min [mm]	
22,4/21	
No. of Bores/N° fori	
5	
DAEWOO	Ventilato/Vented



60-0W-W15	
  W15	Pitch Circle Ø/Foro int.-Ø [mm]
	60
	Height/Altezza [mm]
	46
	Diam./Diam. [mm]
	276
Thickness/Spessore - Min [mm]	
26/24	
No. of Bores/N° fori	
5	
Ventilato/Vented	
OPEL - CHEVROLET	

60-0W-W16	
  W16	Pitch Circle Ø/Foro int.-Ø [mm]
	71
	Height/Altezza [mm]
	46
	Diam./Diam. [mm]
	300
Thickness/Spessore - Min [mm]	
26/24	
No. of Bores/N° fori	
5	
Ventilato/Vented	
CHEVROLET - OPEL	

61-00-001	
	Pitch Circle Ø/Foro int.-Ø [mm]
	72
	Height/Altezza [mm]
	66,6
	Diam./Diam. [mm]
	319,5
Thickness/Spessore - Min [mm]	
14/13	
No. of Bores/N° fori	
5	
JEEP	Non Ventilato/Not Vented

61-00-006	
	Pitch Circle Ø/Foro int.-Ø [mm]
	65
	Height/Altezza [mm]
	42
	Diam./Diam. [mm]
	292
Thickness/Spessore - Min [mm]	
20/18	
No. of Bores/N° fori	
5	
CADILLAC	Ventilato/Vented

61-00-002	
	Pitch Circle Ø/Foro int.-Ø [mm]
	80
	Height/Altezza [mm]
	60,5
	Diam./Diam. [mm]
	262
Thickness/Spessore - Min [mm]	
10/9	
No. of Bores/N° fori	
5	
JEEP - DODGE	Non Ventilato/Not Vented

61-00-007	
	Pitch Circle Ø/Foro int.-Ø [mm]
	65
	Height/Altezza [mm]
	42
	Diam./Diam. [mm]
	278
Thickness/Spessore - Min [mm]	
12/10	
No. of Bores/N° fori	
5	
CADILLAC	Non Ventilato/Not Vented

61-00-003	
	Pitch Circle Ø/Foro int.-Ø [mm]
	101
	Height/Altezza [mm]
	81
	Diam./Diam. [mm]
	313
Thickness/Spessore - Min [mm]	
18/16	
No. of Bores/N° fori	
6	
GREAT WALL	Ventilato/Vented

61-00-008	
	Pitch Circle Ø/Foro int.-Ø [mm]
	72
	Height/Altezza [mm]
	77
	Diam./Diam. [mm]
	316
Thickness/Spessore - Min [mm]	
12/10	
No. of Bores/N° fori	
5	
DODGE	Non Ventilato/Not Vented

61-00-004	
	Pitch Circle Ø/Foro int.-Ø [mm]
	101
	Height/Altezza [mm]
	69
	Diam./Diam. [mm]
	312
Thickness/Spessore - Min [mm]	
12/10	
No. of Bores/N° fori	
6	
HUMMER	Non Ventilato/Not Vented

61-00-009	
	Pitch Circle Ø/Foro int.-Ø [mm]
	71
	Height/Altezza [mm]
	48
	Diam./Diam. [mm]
	298
Thickness/Spessore - Min [mm]	
26/24	
No. of Bores/N° fori	
5	
CADILLAC	Ventilato/Vented

61-00-005	
	Pitch Circle Ø/Foro int.-Ø [mm]
	118
	Height/Altezza [mm]
	87
	Diam./Diam. [mm]
	330
Thickness/Spessore - Min [mm]	
29/27	
No. of Bores/N° fori	
8	
HUMMER	Ventilato/Vented

61-00-015	
	Pitch Circle Ø/Foro int.-Ø [mm]
	68
	Height/Altezza [mm]
	45,4
	Diam./Diam. [mm]
	257,7
Thickness/Spessore - Min [mm]	
10/9	
No. of Bores/N° fori	
4	
NISSAN	Non Ventilato/Not Vented

61-00-016	
	Pitch Circle Ø/Foro int.-Ø [mm]
	68
	Height/Altezza [mm]
	45
	Diam./Diam. [mm]
257,6	
Thickness/Spessore - Min [mm]	
9/8	
No. of Bores/N° fori	
4	
NISSAN	Non Ventilato/Not Vented

61-01-104	
	Pitch Circle Ø/Foro int.-Ø [mm]
	110
	Height/Altezza [mm]
	75
	Diam./Diam. [mm]
290	
Thickness/Spessore - Min [mm]	
22/20	
No. of Bores/N° fori	
8	
NISSAN	Ventilato/Vented

61-01-100	
	Pitch Circle Ø/Foro int.-Ø [mm]
	68
	Height/Altezza [mm]
	63
	Diam./Diam. [mm]
307,4	
Thickness/Spessore - Min [mm]	
18/17	
No. of Bores/N° fori	
6	
NISSAN	Ventilato/Vented

61-01-106	
	Pitch Circle Ø/Foro int.-Ø [mm]
	68
	Height/Altezza [mm]
	62
	Diam./Diam. [mm]
308	
Thickness/Spessore - Min [mm]	
16/14	
No. of Bores/N° fori	
5	
NISSAN - INFINITI	Ventilato/Vented

61-01-101	
	Pitch Circle Ø/Foro int.-Ø [mm]
	68
	Height/Altezza [mm]
	44,7
	Diam./Diam. [mm]
277,8	
Thickness/Spessore - Min [mm]	
9/8	
No. of Bores/N° fori	
5	
NISSAN - INFINITI	Non Ventilato/Not Vented

61-01-107	
	Pitch Circle Ø/Foro int.-Ø [mm]
	108
	Height/Altezza [mm]
	62,5
	Diam./Diam. [mm]
280	
Thickness/Spessore - Min [mm]	
16/13	
No. of Bores/N° fori	
6	
NISSAN	Non Ventilato/Not Vented

61-01-102	
	Pitch Circle Ø/Foro int.-Ø [mm]
	90
	Height/Altezza [mm]
	68
	Diam./Diam. [mm]
305	
Thickness/Spessore - Min [mm]	
12/10	
No. of Bores/N° fori	
5	
NISSAN	Non Ventilato/Not Vented

61-01-111	
	Pitch Circle Ø/Foro int.-Ø [mm]
	68
	Height/Altezza [mm]
	47
	Diam./Diam. [mm]
257	
Thickness/Spessore - Min [mm]	
10/9	
No. of Bores/N° fori	
4	
NISSAN	Non Ventilato/Not Vented

61-01-103	
	Pitch Circle Ø/Foro int.-Ø [mm]
	64
	Height/Altezza [mm]
	104
	Diam./Diam. [mm]
280	
Thickness/Spessore - Min [mm]	
12/10	
No. of Bores/N° fori	
5	
NISSAN	Non Ventilato/Not Vented

61-01-112	
	Pitch Circle Ø/Foro int.-Ø [mm]
	68
	Height/Altezza [mm]
	47
	Diam./Diam. [mm]
289,4	
Thickness/Spessore - Min [mm]	
10/9	
No. of Bores/N° fori	
5	
NISSAN	Non Ventilato/Not Vented

61-01-113	
	Pitch Circle Ø/Foro int.-Ø [mm]
	68
	Height/Altezza [mm]
	57,4
	Diam./Diam. [mm]
281,6	
Thickness/Spessore - Min [mm]	
20/18	
No. of Bores/N° fori	
5	
NISSAN	Ventilato/Vented

61-01-118	
	Pitch Circle Ø/Foro int.-Ø [mm]
	68
	Height/Altezza [mm]
	47,3
	Diam./Diam. [mm]
303,5	
Thickness/Spessore - Min [mm]	
20/18	
No. of Bores/N° fori	
5	
NISSAN	Ventilato/Vented

61-01-114	
	Pitch Circle Ø/Foro int.-Ø [mm]
	68
	Height/Altezza [mm]
	47,5
	Diam./Diam. [mm]
290	
Thickness/Spessore - Min [mm]	
10/9	
No. of Bores/N° fori	
4	
NISSAN	Non Ventilato/Not Vented

61-01-119	
	Pitch Circle Ø/Foro int.-Ø [mm]
	105
	Height/Altezza [mm]
	69,9
	Diam./Diam. [mm]
285,9	
Thickness/Spessore - Min [mm]	
18/16	
No. of Bores/N° fori	
6	
NISSAN	Ventilato/Vented

61-01-115	
	Pitch Circle Ø/Foro int.-Ø [mm]
	68
	Height/Altezza [mm]
	47,3
	Diam./Diam. [mm]
289,5	
Thickness/Spessore - Min [mm]	
10/9	
No. of Bores/N° fori	
4	
NISSAN	Non Ventilato/Not Vented

61-01-120	
	Pitch Circle Ø/Foro int.-Ø [mm]
	68
	Height/Altezza [mm]
	62
	Diam./Diam. [mm]
292	
Thickness/Spessore - Min [mm]	
9/7	
No. of Bores/N° fori	
5	
NISSAN	Non Ventilato/Not Vented

61-01-116	
	Pitch Circle Ø/Foro int.-Ø [mm]
	111
	Height/Altezza [mm]
	80,3
	Diam./Diam. [mm]
316,4	
Thickness/Spessore - Min [mm]	
18/16	
No. of Bores/N° fori	
6	
NISSAN	Ventilato/Vented

61-01-121	
	Pitch Circle Ø/Foro int.-Ø [mm]
	68
	Height/Altezza [mm]
	64
	Diam./Diam. [mm]
265,8	
Thickness/Spessore - Min [mm]	
9,2/8	
No. of Bores/N° fori	
4	
NISSAN	Non Ventilato/Not Vented

61-01-117	
Image Not Available	Diam./Diam. [mm]
	290
	Brake Disc Thickness/Spessore disco freno [mm]
	10
No. of Holes/N° fori	
5	
NISSAN	Non Ventilato/Not Vented

61-01-123	
	Pitch Circle Ø/Foro int.-Ø [mm]
	68
	Height/Altezza [mm]
	45,4
	Diam./Diam. [mm]
257	
Thickness/Spessore - Min [mm]	
10/9	
No. of Bores/N° fori	
5	
NISSAN	Non Ventilato/Not Vented



61-01-124	
	Pitch Circle Ø/Foro int.-Ø [mm]
	46,2
	Height/Altezza [mm]
	73
	Diam./Diam. [mm]
	257
Thickness/Spessore - Min [mm]	
10,1/8	
No. of Bores/N° fori	4
Non Ventilato/Not Vented	
NISSAN	

61-01-155	
	Pitch Circle Ø/Foro int.-Ø [mm]
	68
	Height/Altezza [mm]
	45
	Diam./Diam. [mm]
	277,5
Thickness/Spessore - Min [mm]	
10,1/9	
No. of Bores/N° fori	4
Non Ventilato/Not Vented	
NISSAN	

61-01-126	
	Pitch Circle Ø/Foro int.-Ø [mm]
	68
	Height/Altezza [mm]
	45
	Diam./Diam. [mm]
	258
Thickness/Spessore - Min [mm]	
9/7	
No. of Bores/N° fori	4
Non Ventilato/Not Vented	
NISSAN	

61-01-156	
	Pitch Circle Ø/Foro int.-Ø [mm]
	68
	Height/Altezza [mm]
	45,3
	Diam./Diam. [mm]
	277,4
Thickness/Spessore - Min [mm]	
10/8,4	
No. of Bores/N° fori	5
Non Ventilato/Not Vented	
NISSAN	

61-01-130	
	Pitch Circle Ø/Foro int.-Ø [mm]
	68
	Height/Altezza [mm]
	40
	Diam./Diam. [mm]
	233,4
Thickness/Spessore - Min [mm]	
7/6	
No. of Bores/N° fori	4
Non Ventilato/Not Vented	
NISSAN	

61-01-158	
	Pitch Circle Ø/Foro int.-Ø [mm]
	68
	Height/Altezza [mm]
	62,3
	Diam./Diam. [mm]
	292,4
Thickness/Spessore - Min [mm]	
16/15	
No. of Bores/N° fori	5
Ventilato/Vented	
NISSAN	

61-01-131	
	Pitch Circle Ø/Foro int.-Ø [mm]
	68
	Height/Altezza [mm]
	33,4
	Diam./Diam. [mm]
	257,4
Thickness/Spessore - Min [mm]	
9/7	
No. of Bores/N° fori	4
Non Ventilato/Not Vented	
NISSAN	

61-01-197	
	Pitch Circle Ø/Foro int.-Ø [mm]
	46
	Height/Altezza [mm]
	74,3
	Diam./Diam. [mm]
	285
Thickness/Spessore - Min [mm]	
10/9	
No. of Bores/N° fori	4
Non Ventilato/Not Vented	
NISSAN	

61-01-136	
	Pitch Circle Ø/Foro int.-Ø [mm]
	52
	Height/Altezza [mm]
	81
	Diam./Diam. [mm]
	234
Thickness/Spessore - Min [mm]	
10,1/9	
No. of Bores/N° fori	4
Non Ventilato/Not Vented	
NISSAN	

61-01-198	
	Pitch Circle Ø/Foro int.-Ø [mm]
	61
	Height/Altezza [mm]
	41,1
	Diam./Diam. [mm]
	239,3
Thickness/Spessore - Min [mm]	
7,1/6	
No. of Bores/N° fori	4
Non Ventilato/Not Vented	
NISSAN	

61-01-199	
	Pitch Circle Ø/Foro int.-Ø [mm]
	68
	Height/Altezza [mm]
	64
	Diam./Diam. [mm]
	296,5
Thickness/Spessore - Min [mm]	
18/16	
No. of Bores/N° fori	
5	
NISSAN	Ventilato/Vented

61-02-204	
	Pitch Circle Ø/Foro int.-Ø [mm]
	54
	Height/Altezza [mm]
	40,4
	Diam./Diam. [mm]
	262,5
Thickness/Spessore - Min [mm]	
10/9	
No. of Bores/N° fori	
4	
TOYOTA	Non Ventilato/Not Vented

61-02-200	
	Pitch Circle Ø/Foro int.-Ø [mm]
	60
	Height/Altezza [mm]
	47,4
	Diam./Diam. [mm]
	230,5
Thickness/Spessore - Min [mm]	
10/9	
No. of Bores/N° fori	
4	
TOYOTA	Non Ventilato/Not Vented

61-02-205	
	Pitch Circle Ø/Foro int.-Ø [mm]
	54
	Height/Altezza [mm]
	60
	Diam./Diam. [mm]
	267,8
Thickness/Spessore - Min [mm]	
10/9	
No. of Bores/N° fori	
5	
TOYOTA	Non Ventilato/Not Vented

61-02-201	
	Pitch Circle Ø/Foro int.-Ø [mm]
	54
	Height/Altezza [mm]
	36,5
	Diam./Diam. [mm]
	241,9
Thickness/Spessore - Min [mm]	
9/8	
No. of Bores/N° fori	
4	
TOYOTA	Non Ventilato/Not Vented

61-02-206	
	Pitch Circle Ø/Foro int.-Ø [mm]
	60
	Height/Altezza [mm]
	60,7
	Diam./Diam. [mm]
	264,4
Thickness/Spessore - Min [mm]	
18/17	
No. of Bores/N° fori	
4	
TOYOTA	Ventilato/Vented

61-02-202	
	Pitch Circle Ø/Foro int.-Ø [mm]
	54
	Height/Altezza [mm]
	65
	Diam./Diam. [mm]
	268,7
Thickness/Spessore - Min [mm]	
10/9	
No. of Bores/N° fori	
5	
TOYOTA	Non Ventilato/Not Vented

61-02-207	
	Pitch Circle Ø/Foro int.-Ø [mm]
	60
	Height/Altezza [mm]
	68,4
	Diam./Diam. [mm]
	290,6
Thickness/Spessore - Min [mm]	
18/17	
No. of Bores/N° fori	
5	
TOYOTA	Ventilato/Vented

61-02-203	
	Pitch Circle Ø/Foro int.-Ø [mm]
	54
	Height/Altezza [mm]
	40,4
	Diam./Diam. [mm]
	240
Thickness/Spessore - Min [mm]	
10/9	
No. of Bores/N° fori	
4	
TOYOTA	Non Ventilato/Not Vented

61-02-208	
	Pitch Circle Ø/Foro int.-Ø [mm]
	54
	Height/Altezza [mm]
	59,6
	Diam./Diam. [mm]
	287,5
Thickness/Spessore - Min [mm]	
10/9	
No. of Bores/N° fori	
5	
TOYOTA	Non Ventilato/Not Vented

61-02-209	
	Pitch Circle Ø/Foro int.-Ø [mm]
	105,9
	Height/Altezza [mm]
	68,3
	Diam./Diam. [mm]
	311,8
Thickness/Spessore - Min [mm]	
18/16	
No. of Bores/N° fori	
6	
TOYOTA	Ventilato/Vented

61-02-214	
	Pitch Circle Ø/Foro int.-Ø [mm]
	55
	Height/Altezza [mm]
	56
	Diam./Diam. [mm]
	280
Thickness/Spessore - Min [mm]	
10/9	
No. of Bores/N° fori	
5	
TOYOTA	Non Ventilato/Not Vented

61-02-210	
	Pitch Circle Ø/Foro int.-Ø [mm]
	55
	Height/Altezza [mm]
	56
	Diam./Diam. [mm]
	268,8
Thickness/Spessore - Min [mm]	
9,1/8	
No. of Bores/N° fori	
5	
TOYOTA	Non Ventilato/Not Vented

61-02-215	
	Pitch Circle Ø/Foro int.-Ø [mm]
	55
	Height/Altezza [mm]
	56,3
	Diam./Diam. [mm]
	278
Thickness/Spessore - Min [mm]	
9/8	
No. of Bores/N° fori	
4	
TOYOTA	Non Ventilato/Not Vented

61-02-211	
	Pitch Circle Ø/Foro int.-Ø [mm]
	60
	Height/Altezza [mm]
	60,7
	Diam./Diam. [mm]
	260
Thickness/Spessore - Min [mm]	
18/17	
No. of Bores/N° fori	
4	
TOYOTA	Ventilato/Vented

61-02-216	
	Pitch Circle Ø/Foro int.-Ø [mm]
	60
	Height/Altezza [mm]
	68
	Diam./Diam. [mm]
	291,2
Thickness/Spessore - Min [mm]	
16,1/15	
No. of Bores/N° fori	
5	
LEXUS	Ventilato/Vented

61-02-212	
	Pitch Circle Ø/Foro int.-Ø [mm]
	106
	Height/Altezza [mm]
	102,7
	Diam./Diam. [mm]
	312
Thickness/Spessore - Min [mm]	
18/16	
No. of Bores/N° fori	
6	
TOYOTA	Ventilato/Vented

61-02-217	
	Pitch Circle Ø/Foro int.-Ø [mm]
	55
	Height/Altezza [mm]
	56
	Diam./Diam. [mm]
	257,5
Thickness/Spessore - Min [mm]	
9/8	
No. of Bores/N° fori	
4	
TOYOTA	Non Ventilato/Not Vented

61-02-213	
	Pitch Circle Ø/Foro int.-Ø [mm]
	62
	Height/Altezza [mm]
	46,5
	Diam./Diam. [mm]
	262,7
Thickness/Spessore - Min [mm]	
16/15	
No. of Bores/N° fori	
5	
TOYOTA	Ventilato/Vented

61-02-218	
	Pitch Circle Ø/Foro int.-Ø [mm]
	55
	Height/Altezza [mm]
	56
	Diam./Diam. [mm]
	268,5
Thickness/Spessore - Min [mm]	
9/8	
No. of Bores/N° fori	
4	
TOYOTA	Non Ventilato/Not Vented

61-02-219	
	Pitch Circle Ø/Foro int.-Ø [mm]
	105,7
	Height/Altezza [mm]
	102,8
	Diam./Diam. [mm]
	334,9
Thickness/Spessore - Min [mm]	
18/17	
No. of Bores/N° fori	
6	
TOYOTA	Ventilato/Vented

61-02-224	
	Pitch Circle Ø/Foro int.-Ø [mm]
	55
	Height/Altezza [mm]
	65
	Diam./Diam. [mm]
	268,7
Thickness/Spessore - Min [mm]	
10/9	
No. of Bores/N° fori	
5	
TOYOTA	Non Ventilato/Not Vented

61-02-220	
	Pitch Circle Ø/Foro int.-Ø [mm]
	55
	Height/Altezza [mm]
	41,5
	Diam./Diam. [mm]
	262,8
Thickness/Spessore - Min [mm]	
16/15	
No. of Bores/N° fori	
4	
TOYOTA	Ventilato/Vented

61-02-225	
	Pitch Circle Ø/Foro int.-Ø [mm]
	62
	Height/Altezza [mm]
	65
	Diam./Diam. [mm]
	269,2
Thickness/Spessore - Min [mm]	
10,2/9	
No. of Bores/N° fori	
5	
TOYOTA - LEXUS	Non Ventilato/Not Vented

61-02-221	
	Pitch Circle Ø/Foro int.-Ø [mm]
	62
	Height/Altezza [mm]
	62,5
	Diam./Diam. [mm]
	302,7
Thickness/Spessore - Min [mm]	
9/8	
No. of Bores/N° fori	
5	
TOYOTA - DR	Non Ventilato/Not Vented

61-02-226	
	Pitch Circle Ø/Foro int.-Ø [mm]
	62
	Height/Altezza [mm]
	65,6
	Diam./Diam. [mm]
	287,4
Thickness/Spessore - Min [mm]	
10/9	
No. of Bores/N° fori	
5	
TOYOTA	Non Ventilato/Not Vented

61-02-222	
	Pitch Circle Ø/Foro int.-Ø [mm]
	55
	Height/Altezza [mm]
	56
	Diam./Diam. [mm]
	268,1
Thickness/Spessore - Min [mm]	
9/8	
No. of Bores/N° fori	
4	
TOYOTA	Non Ventilato/Not Vented

61-02-227	
	Pitch Circle Ø/Foro int.-Ø [mm]
	62
	Height/Altezza [mm]
	46,8
	Diam./Diam. [mm]
	280,5
Thickness/Spessore - Min [mm]	
22/20	
No. of Bores/N° fori	
5	
TOYOTA	Ventilato/Vented

61-02-223	
	Pitch Circle Ø/Foro int.-Ø [mm]
	110
	Height/Altezza [mm]
	103
	Diam./Diam. [mm]
	329
Thickness/Spessore - Min [mm]	
18/17	
No. of Bores/N° fori	
5	
TOYOTA	Ventilato/Vented

61-02-228	
	Pitch Circle Ø/Foro int.-Ø [mm]
	62
	Height/Altezza [mm]
	69,7
	Diam./Diam. [mm]
	287,8
Thickness/Spessore - Min [mm]	
10/9	
No. of Bores/N° fori	
5	
LEXUS	Non Ventilato/Not Vented

61-02-229	
	Pitch Circle Ø/Foro int.-Ø [mm]
	62
	Height/Altezza [mm]
	63,7
	Diam./Diam. [mm]
	306,7
Thickness/Spessore - Min [mm]	
12/11	
No. of Bores/N° fori	
5	
LEXUS	Non Ventilato/Not Vented

61-02-234	
	Pitch Circle Ø/Foro int.-Ø [mm]
	62
	Height/Altezza [mm]
	37
	Diam./Diam. [mm]
	270
Thickness/Spessore - Min [mm]	
10/8	
No. of Holes/N° fori	
5	
TOYOTA	Non Ventilato/Not Vented

61-02-230	
	Pitch Circle Ø/Foro int.-Ø [mm]
	62
	Height/Altezza [mm]
	55
	Diam./Diam. [mm]
	281
Thickness/Spessore - Min [mm]	
12/10,5	
No. of Holes/N° fori	
5	
TOYOTA	Non Ventilato/Not Vented

61-02-235	
	Pitch Circle Ø 1/Foro int.-Ø 1 [mm]
	56
	Height/Altezza [mm]
	36
	Diam./Diam. [mm]
	265,5
Thickness/Spessore - Min [mm]	
9/8	
No. of Bores/N° fori	
4	
TOYOTA	Non Ventilato/Not Vented

61-02-231	
	Pitch Circle Ø/Foro int.-Ø [mm]
	62
	Height/Altezza [mm]
	57
	Diam./Diam. [mm]
	289,8
Thickness/Spessore - Min [mm]	
10/9	
No. of Bores/N° fori	
5	
TOYOTA	Non Ventilato/Not Vented

61-02-236	
	Pitch Circle Ø/Foro int.-Ø [mm]
	55
	Height/Altezza [mm]
	65
	Diam./Diam. [mm]
	288
Thickness/Spessore - Min [mm]	
10/8	
No. of Bores/N° fori	
5	
TOYOTA	Non Ventilato/Not Vented

61-02-232	
	Pitch Circle Ø/Foro int.-Ø [mm]
	55
	Height/Altezza [mm]
	32
	Diam./Diam. [mm]
	258
Thickness/Spessore - Min [mm]	
9/7,5	
No. of Bores/N° fori	
4	
TOYOTA	Non Ventilato/Not Vented

61-02-237	
	Pitch Circle Ø/Foro int.-Ø [mm]
	112
	Height/Altezza [mm]
	77
	Diam./Diam. [mm]
	345
Thickness/Spessore - Min [mm]	
18/16	
No. of Bores/N° fori	
5	
TOYOTA	Ventilato/Vented

61-02-233	
	Pitch Circle Ø/Foro int.-Ø [mm]
	62
	Height/Altezza [mm]
	62
	Diam./Diam. [mm]
	291
Thickness/Spessore - Min [mm]	
10/8,5	
No. of Bores/N° fori	
5	
LEXUS	Non Ventilato/Not Vented

61-02-238	
	Pitch Circle Ø/Foro int.-Ø [mm]
	55
	Height/Altezza [mm]
	27
	Diam./Diam. [mm]
	278
Thickness/Spessore - Min [mm]	
9/7	
No. of Bores/N° fori	
4	
TOYOTA	Non Ventilato/Not Vented

61-02-239	
	Pitch Circle Ø/Foro int.-Ø [mm]
	55
	Height/Altezza [mm]
	42
	Diam./Diam. [mm]
	259
Thickness/Spessore - Min [mm]	
9/7	
No. of Bores/N° fori	
5	
TOYOTA	Non Ventilato/Not Vented

61-02-244	
	Pitch Circle Ø/Foro int.-Ø [mm]
	55
	Height/Altezza [mm]
	62
	Diam./Diam. [mm]
	271
Thickness/Spessore - Min [mm]	
10/8	
No. of Bores/N° fori	
5	
TOYOTA	Non Ventilato/Not Vented

61-02-240	
	Pitch Circle Ø/Foro int.-Ø [mm]
	62
	Height/Altezza [mm]
	34
	Diam./Diam. [mm]
	290
Thickness/Spessore - Min [mm]	
11/9	
No. of Bores/N° fori	
5	
TOYOTA	Non Ventilato/Not Vented

61-02-245	
	Pitch Circle Ø/Foro int.-Ø [mm]
	62
	Height/Altezza [mm]
	59
	Diam./Diam. [mm]
	297
Thickness/Spessore - Min [mm]	
11/9	
No. of Bores/N° fori	
5	
TOYOTA	Non Ventilato/Not Vented

61-02-241	
	Pitch Circle Ø/Foro int.-Ø [mm]
	55
	Height/Altezza [mm]
	31
	Diam./Diam. [mm]
	259
Thickness/Spessore - Min [mm]	
9/7	
No. of Bores/N° fori	
5	
LEXUS - SUBARU - TOYOTA	Non Ventilato/Not Vented

61-02-246	
	Pitch Circle Ø/Foro int.-Ø [mm]
	62
	Height/Altezza [mm]
	68,7
	Diam./Diam. [mm]
	310
Thickness/Spessore - Min [mm]	
18/16	
No. of Bores/N° fori	
5	
LEXUS	Ventilato/Vented

61-02-242	
	Pitch Circle Ø/Foro int.-Ø [mm]
	59
	Height/Altezza [mm]
	62
	Diam./Diam. [mm]
	276,5
Thickness/Spessore [mm]	
8	
No. of Bores/N° fori	
5	
TOYOTA	Non Ventilato/Not Vented

61-02-247	
	Pitch Circle Ø/Foro int.-Ø [mm]
	62
	Height/Altezza [mm]
	66
	Diam./Diam. [mm]
	281
Thickness/Spessore - Min [mm]	
10/8,5	
No. of Bores/N° fori	
5	
TOYOTA	Non Ventilato/Not Vented

61-02-243	
	Pitch Circle Ø/Foro int.-Ø [mm]
	62
	Height/Altezza [mm]
	31
	Diam./Diam. [mm]
	259
Thickness/Spessore - Min [mm]	
9/7	
No. of Bores/N° fori	
5	
TOYOTA	Non Ventilato/Not Vented

61-02-248	
	Pitch Circle Ø/Foro int.-Ø [mm]
	55
	Height/Altezza [mm]
	60
	Diam./Diam. [mm]
	240
Thickness/Spessore - Min [mm]	
10/9	
No. of Bores/N° fori	
4	
TOYOTA	Non Ventilato/Not Vented

61-02-249	
 <p>NEW</p> <p>249</p> <p>LEXUS</p>	Pitch Circle Ø/Foro int.-Ø [mm]
	62
	Height/Altezza [mm]
	60
	Diam./Diam. [mm]
	288
Thickness/Spessore - Min [mm]	
10/9	
No. of Bores/N° fori	
5	
Non Ventilato/Not Vented	

61-03-300	
 <p>300</p> <p>MAZDA</p>	Pitch Circle Ø/Foro int.-Ø [mm]
	66
	Height/Altezza [mm]
	45,5
	Diam./Diam. [mm]
	253,8
Thickness/Spessore - Min [mm]	
10,1/9	
No. of Bores/N° fori	
4	
Non Ventilato/Not Vented	

61-02-250	
 <p>NEW</p> <p>250</p> <p>TOYOTA</p>	Pitch Circle Ø/Foro int.-Ø [mm]
	62
	Height/Altezza [mm]
	62
	Diam./Diam. [mm]
	291
Thickness/Spessore - Min [mm]	
10/9	
No. of Bores/N° fori	
5	
Non Ventilato/Not Vented	

61-03-301	
 <p>301</p> <p>MAZDA</p>	Pitch Circle Ø/Foro int.-Ø [mm]
	48
	Height/Altezza [mm]
	72,5
	Diam./Diam. [mm]
	235,4
Thickness/Spessore - Min [mm]	
10/9	
No. of Bores/N° fori	
4	
Non Ventilato/Not Vented	

61-02-251	
 <p>NEW</p> <p>251</p> <p>TOYOTA</p>	Pitch Circle Ø/Foro int.-Ø [mm]
	52
	Height/Altezza [mm]
	80
	Diam./Diam. [mm]
	240
Thickness/Spessore - Min [mm]	
9/8	
No. of Bores/N° fori	
4	
Non Ventilato/Not Vented	

61-03-302	
 <p>302</p> <p>MAZDA</p>	Pitch Circle Ø/Foro int.-Ø [mm]
	47,7
	Height/Altezza [mm]
	71,8
	Diam./Diam. [mm]
	258,8
Thickness/Spessore - Min [mm]	
10/9	
No. of Bores/N° fori	
5	
Non Ventilato/Not Vented	

61-02-258	
 <p>258</p> <p>TOYOTA</p>	Pitch Circle Ø/Foro int.-Ø [mm]
	62
	Height/Altezza [mm]
	69
	Diam./Diam. [mm]
	290,7
Thickness/Spessore - Min [mm]	
12/11	
No. of Bores/N° fori	
5	
Non Ventilato/Not Vented	

61-03-303	
 <p>303</p> <p>MAZDA</p>	Pitch Circle Ø/Foro int.-Ø [mm]
	75
	Height/Altezza [mm]
	30
	Diam./Diam. [mm]
	247
Thickness/Spessore - Min [mm]	
10/9	
No. of Bores/N° fori	
4	
Non Ventilato/Not Vented	

61-02-259	
 <p>259</p> <p>TOYOTA - LEXUS</p>	Pitch Circle Ø/Foro int.-Ø [mm]
	62
	Height/Altezza [mm]
	67,6
	Diam./Diam. [mm]
	306,6
Thickness/Spessore - Min [mm]	
16/15	
No. of Bores/N° fori	
5	
Ventilato/Vented	

61-03-304	
 <p>304</p> <p>MAZDA</p>	Pitch Circle Ø/Foro int.-Ø [mm]
	45,8
	Height/Altezza [mm]
	66,6
	Diam./Diam. [mm]
	221,7
Thickness/Spessore - Min [mm]	
10/8	
No. of Bores/N° fori	
4	
Non Ventilato/Not Vented	

61-03-305	
	Pitch Circle Ø/Foro int.-Ø [mm]
	46
	Height/Altezza [mm]
	72,6
	Diam./Diam. [mm]
	254
Thickness/Spessore - Min [mm]	
10/9	
No. of Bores/N° fori	
4	
MAZDA	Non Ventilato/Not Vented

61-03-310	
	Pitch Circle Ø/Foro int.-Ø [mm]
	68
	Height/Altezza [mm]
	56,5
	Diam./Diam. [mm]
	265,8
Thickness/Spessore - Min [mm]	
10/8	
No. of Bores/N° fori	
5	
MAZDA	Non Ventilato/Not Vented

61-03-306	
	Pitch Circle Ø/Foro int.-Ø [mm]
	66
	Height/Altezza [mm]
	53,5
	Diam./Diam. [mm]
	272,4
Thickness/Spessore - Min [mm]	
20/18	
No. of Bores/N° fori	
5	
MAZDA	Ventilato/Vented

61-03-312	
	Pitch Circle Ø/Foro int.-Ø [mm]
	55
	Height/Altezza [mm]
	35
	Diam./Diam. [mm]
	230,2
Thickness/Spessore - Min [mm]	
9/8	
No. of Bores/N° fori	
4	
MAZDA	Non Ventilato/Not Vented

61-03-307	
	Pitch Circle Ø/Foro int.-Ø [mm]
	66
	Height/Altezza [mm]
	63
	Diam./Diam. [mm]
	257
Thickness/Spessore - Min [mm]	
20/18	
No. of Bores/N° fori	
4	
MAZDA	Ventilato/Vented

61-03-313	
	Pitch Circle Ø/Foro int.-Ø [mm]
	47,7
	Height/Altezza [mm]
	74,4
	Diam./Diam. [mm]
	258,3
Thickness/Spessore - Min [mm]	
10,4/8	
No. of Bores/N° fori	
5	
MAZDA	Non Ventilato/Not Vented

61-03-308	
	Pitch Circle Ø/Foro int.-Ø [mm]
	55
	Height/Altezza [mm]
	35
	Diam./Diam. [mm]
	250
Thickness/Spessore - Min [mm]	
9/8	
No. of Bores/N° fori	
4	
MAZDA	Non Ventilato/Not Vented

61-03-314	
	Pitch Circle Ø/Foro int.-Ø [mm]
	72
	Height/Altezza [mm]
	40,3
	Diam./Diam. [mm]
	261
Thickness/Spessore - Min [mm]	
10/8	
No. of Bores/N° fori	
5	
MAZDA	Non Ventilato/Not Vented

61-03-309	
	Pitch Circle Ø/Foro int.-Ø [mm]
	48
	Height/Altezza [mm]
	73,5
	Diam./Diam. [mm]
	258,6
Thickness/Spessore - Min [mm]	
10/8	
No. of Bores/N° fori	
5	
MAZDA	Non Ventilato/Not Vented

61-03-315	
	Pitch Circle Ø/Foro int.-Ø [mm]
	72
	Height/Altezza [mm]
	40
	Diam./Diam. [mm]
	261
Thickness/Spessore - Min [mm]	
10/8	
No. of Bores/N° fori	
5	
MAZDA	Non Ventilato/Not Vented

61-03-316	
	Pitch Circle Ø/Foro int.-Ø [mm]
	72
	Height/Altezza [mm]
	40,3
	Diam./Diam. [mm]
	279,3
Thickness/Spessore - Min [mm]	
10/9	
No. of Bores/N° fori	
5	
MAZDA	Non Ventilato/Not Vented

61-03-322	
	Pitch Circle Ø/Foro int.-Ø [mm]
	55
	Height/Altezza [mm]
	41
	Diam./Diam. [mm]
	259
Thickness/Spessore - Min [mm]	
10/8,5	
No. of Bores/N° fori	
4	
MAZDA	Non Ventilato/Not Vented

61-03-317	
	Pitch Circle Ø/Foro int.-Ø [mm]
	72
	Height/Altezza [mm]
	41
	Diam./Diam. [mm]
	279,7
Thickness/Spessore - Min [mm]	
11/10	
No. of Bores/N° fori	
5	
MAZDA	Non Ventilato/Not Vented

61-03-323	
	Pitch Circle Ø/Foro int.-Ø [mm]
	72
	Height/Altezza [mm]
	41
	Diam./Diam. [mm]
	301,5
Thickness/Spessore - Min [mm]	
11/9	
No. of Bores/N° fori	
5	
MAZDA	Non Ventilato/Not Vented

61-03-318	
	Pitch Circle Ø/Foro int.-Ø [mm]
	66
	Height/Altezza [mm]
	53
	Diam./Diam. [mm]
	261
Thickness/Spessore - Min [mm]	
10/8	
No. of Bores/N° fori	
5	
MAZDA	Non Ventilato/Not Vented

61-03-324	
	Pitch Circle Ø/Foro int.-Ø [mm]
	72
	Height/Altezza [mm]
	57,5
	Diam./Diam. [mm]
	285,3
Thickness/Spessore - Min [mm]	
18/17	
No. of Bores/N° fori	
5	
MAZDA	Ventilato/Vented

61-03-319	
	Pitch Circle Ø/Foro int.-Ø [mm]
	72
	Height/Altezza [mm]
	45
	Diam./Diam. [mm]
	294
Thickness/Spessore - Min [mm]	
20,2/19	
No. of Bores/N° fori	
5	
MAZDA	Ventilato/Vented

61-03-325	
	Pitch Circle Ø/Foro int.-Ø [mm]
	55
	Height/Altezza [mm]
	35
	Diam./Diam. [mm]
	275,5
Thickness/Spessore - Min [mm]	
10/9	
No. of Bores/N° fori	
4	
MAZDA	Non Ventilato/Not Vented

61-03-321	
	Pitch Circle Ø/Foro int.-Ø [mm]
	72
	Height/Altezza [mm]
	41,3
	Diam./Diam. [mm]
	264,5
Thickness/Spessore - Min [mm]	
11/9	
No. of Bores/N° fori	
5	
MAZDA	Non Ventilato/Not Vented

61-03-326	
	Pitch Circle Ø/Foro int.-Ø [mm]
	72
	Height/Altezza [mm]
	57,2
	Diam./Diam. [mm]
	285,2
Thickness/Spessore - Min [mm]	
9,4/8	
No. of Bores/N° fori	
5	
MAZDA	Non Ventilato/Not Vented

61-03-327	
	Pitch Circle Ø/Foro int.-Ø [mm]
	72
	Height/Altezza [mm]
	57
	Diam./Diam. [mm]
	302
Thickness/Spessore - Min [mm]	
18/16	
No. of Bores/N° fori	
5	
MAZDA	Ventilato/Vented

61-04-400	
	Pitch Circle Ø/Foro int.-Ø [mm]
	46
	Height/Altezza [mm]
	72
	Diam./Diam. [mm]
	239
Thickness/Spessore - Min [mm]	
10/8	
No. of Bores/N° fori	
4	
HONDA	Non Ventilato/Not Vented

61-03-328	
	Pitch Circle Ø/Foro int.-Ø [mm]
	72
	Height/Altezza [mm]
	43
	Diam./Diam. [mm]
	314
Thickness/Spessore - Min [mm]	
11/9	
No. of Bores/N° fori	
5	
MAZDA	Non Ventilato/Not Vented

61-04-401	
	Pitch Circle Ø/Foro int.-Ø [mm]
	45
	Height/Altezza [mm]
	62
	Diam./Diam. [mm]
	239
Thickness/Spessore - Min [mm]	
10/9	
No. of Bores/N° fori	
4	
HONDA	Non Ventilato/Not Vented

61-03-329	
	Pitch Circle Ø/Foro int.-Ø [mm]
	72
	Height/Altezza [mm]
	57
	Diam./Diam. [mm]
	325
Thickness/Spessore - Min [mm]	
18/16	
No. of Bores/N° fori	
5	
MAZDA	Ventilato/Vented

61-04-402	
	Pitch Circle Ø/Foro int.-Ø [mm]
	61
	Height/Altezza [mm]
	48
	Diam./Diam. [mm]
	238
Thickness/Spessore - Min [mm]	
10/8	
No. of Bores/N° fori	
4	
HONDA - ROVER	Non Ventilato/Not Vented

61-03-365	
	Pitch Circle Ø/Foro int.-Ø [mm]
	72
	Height/Altezza [mm]
	56
	Diam./Diam. [mm]
	301,6
Thickness/Spessore - Min [mm]	
12/11	
No. of Bores/N° fori	
5	
MAZDA	Non Ventilato/Not Vented

61-04-404	
	Pitch Circle Ø/Foro int.-Ø [mm]
	64
	Height/Altezza [mm]
	43,3
	Diam./Diam. [mm]
	259,6
Thickness/Spessore - Min [mm]	
10/8	
No. of Bores/N° fori	
4	
HONDA	Non Ventilato/Not Vented

61-03-399	
	Pitch Circle Ø/Foro int.-Ø [mm]
	72
	Height/Altezza [mm]
	34,9
	Diam./Diam. [mm]
	250,4
Thickness/Spessore - Min [mm]	
9/8	
No. of Bores/N° fori	
5	
MAZDA	Non Ventilato/Not Vented

61-04-405	
	Pitch Circle Ø/Foro int.-Ø [mm]
	64
	Height/Altezza [mm]
	43,6
	Diam./Diam. [mm]
	260
Thickness/Spessore - Min [mm]	
10/8,5	
No. of Bores/N° fori	
4	
HONDA	Non Ventilato/Not Vented

61-04-406	
	Pitch Circle Ø/Foro int.-Ø [mm]
	64
	Height/Altezza [mm]
	53,7
	Diam./Diam. [mm]
259,9	
Thickness/Spessore - Min [mm]	
10/8	
No. of Bores/N° fori	
4	
HONDA - ROVER	Non Ventilato/Not Vented

61-04-411	
	Pitch Circle Ø/Foro int.-Ø [mm]
	69,4
	Height/Altezza [mm]
	61
	Diam./Diam. [mm]
281,6	
Thickness/Spessore - Min [mm]	
9/7,5	
No. of Bores/N° fori	
5	
HONDA	Non Ventilato/Not Vented

61-04-407	
	Pitch Circle Ø/Foro int.-Ø [mm]
	64
	Height/Altezza [mm]
	49,3
	Diam./Diam. [mm]
259,6	
Thickness/Spessore - Min [mm]	
10/8	
No. of Bores/N° fori	
4	
HONDA	Non Ventilato/Not Vented

61-04-412	
	Pitch Circle Ø/Foro int.-Ø [mm]
	64,2
	Height/Altezza [mm]
	42,1
	Diam./Diam. [mm]
260	
Thickness/Spessore - Min [mm]	
9/7,5	
No. of Bores/N° fori	
5	
HONDA	Non Ventilato/Not Vented

61-04-408	
	Pitch Circle Ø/Foro int.-Ø [mm]
	86
	Height/Altezza [mm]
	41,2
	Diam./Diam. [mm]
230,7	
Thickness/Spessore - Min [mm]	
12/10,5	
No. of Bores/N° fori	
4	
HONDA	Non Ventilato/Not Vented

61-04-413	
	Pitch Circle Ø/Foro int.-Ø [mm]
	64
	Height/Altezza [mm]
	43
	Diam./Diam. [mm]
260	
Thickness/Spessore - Min [mm]	
9/7	
No. of Bores/N° fori	
4	
HONDA	Non Ventilato/Not Vented

61-04-409	
	Pitch Circle Ø/Foro int.-Ø [mm]
	61
	Height/Altezza [mm]
	47,7
	Diam./Diam. [mm]
237,6	
Thickness/Spessore - Min [mm]	
9/8	
No. of Bores/N° fori	
4	
HONDA	Non Ventilato/Not Vented

61-04-414	
	Pitch Circle Ø/Foro int.-Ø [mm]
	64,5
	Height/Altezza [mm]
	64
	Diam./Diam. [mm]
259,5	
Thickness/Spessore - Min [mm]	
10/9	
No. of Bores/N° fori	
4	
HONDA	Non Ventilato/Not Vented

61-04-410	
	Pitch Circle Ø/Foro int.-Ø [mm]
	64
	Height/Altezza [mm]
	43,4
	Diam./Diam. [mm]
258,6	
Thickness/Spessore - Min [mm]	
10/8	
No. of Bores/N° fori	
4	
HONDA	Non Ventilato/Not Vented

61-04-415	
	Pitch Circle Ø/Foro int.-Ø [mm]
	64
	Height/Altezza [mm]
	49
	Diam./Diam. [mm]
282	
Thickness/Spessore - Min [mm]	
9/7	
No. of Bores/N° fori	
5	
HONDA	Non Ventilato/Not Vented

61-04-416	
	Pitch Circle Ø/Foro int.-Ø [mm]
	70
	Height/Altezza [mm]
	61
	Diam./Diam. [mm]
	305
Thickness/Spessore - Min [mm]	
9/7	
No. of Bores/N° fori	
5	
HONDA	Non Ventilato/Not Vented

61-04-441	
	Pitch Circle Ø/Foro int.-Ø [mm]
	64
	Height/Altezza [mm]
	58,7
	Diam./Diam. [mm]
	281,6
Thickness/Spessore - Min [mm]	
9/7,5	
No. of Bores/N° fori	
5	
HONDA	Non Ventilato/Not Vented

61-04-417	
	Pitch Circle Ø/Foro int.-Ø [mm]
	61
	Height/Altezza [mm]
	34
	Diam./Diam. [mm]
	239
Thickness/Spessore - Min [mm]	
9/7	
No. of Bores/N° fori	
4	
HONDA	Non Ventilato/Not Vented

61-04-442	
	Pitch Circle Ø/Foro int.-Ø [mm]
	64
	Height/Altezza [mm]
	61
	Diam./Diam. [mm]
	281,5
Thickness/Spessore - Min [mm]	
9/8	
No. of Bores/N° fori	
5	
HONDA	Non Ventilato/Not Vented

61-04-418	
	Pitch Circle Ø/Foro int.-Ø [mm]
	61
	Height/Altezza [mm]
	32
	Diam./Diam. [mm]
	260
Thickness/Spessore - Min [mm]	
9/7	
No. of Bores/N° fori	
4	
HONDA	Non Ventilato/Not Vented

61-04-443	
	Pitch Circle Ø/Foro int.-Ø [mm]
	64
	Height/Altezza [mm]
	49,2
	Diam./Diam. [mm]
	259,5
Thickness/Spessore - Min [mm]	
10/9	
No. of Bores/N° fori	
5	
HONDA	Non Ventilato/Not Vented

61-04-419	
	Pitch Circle Ø/Foro int.-Ø [mm]
	64
	Height/Altezza [mm]
	48,5
	Diam./Diam. [mm]
	260
Thickness/Spessore - Min [mm]	
9/7	
No. of Bores/N° fori	
5	
HONDA	Non Ventilato/Not Vented

61-04-444	
	Pitch Circle Ø/Foro int.-Ø [mm]
	64
	Height/Altezza [mm]
	61
	Diam./Diam. [mm]
	304,4
Thickness/Spessore - Min [mm]	
9/8	
No. of Bores/N° fori	
5	
HONDA	Non Ventilato/Not Vented

61-04-420	
	Pitch Circle Ø/Foro int.-Ø [mm]
	70
	Height/Altezza [mm]
	61
	Diam./Diam. [mm]
	281
Thickness/Spessore - Min [mm]	
12/10	
No. of Bores/N° fori	
5	
HONDA	Non Ventilato/Not Vented

61-04-446	
	Pitch Circle Ø/Foro int.-Ø [mm]
	64
	Height/Altezza [mm]
	49
	Diam./Diam. [mm]
	259,7
Thickness/Spessore - Min [mm]	
10/9	
No. of Bores/N° fori	
5	
HONDA	Non Ventilato/Not Vented



61-04-494	
	Pitch Circle Ø/Foro int.-Ø [mm]
	64
	Height/Altezza [mm]
	64,1
	Diam./Diam. [mm]
260	
Thickness/Spessore - Min [mm]	
10,1/9	
No. of Bores/N° fori	
5	
HONDA	Non Ventilato/Not Vented

61-05-500	
	Pitch Circle Ø/Foro int.-Ø [mm]
	89,7
	Height/Altezza [mm]
	48,2
	Diam./Diam. [mm]
246,5	
Thickness/Spessore - Min [mm]	
10/8,4	
No. of Bores/N° fori	
4	
mitsubishi	Non Ventilato/Not Vented

61-04-495	
	Pitch Circle Ø/Foro int.-Ø [mm]
	61
	Height/Altezza [mm]
	49
	Diam./Diam. [mm]
259,5	
Thickness/Spessore - Min [mm]	
10/8	
No. of Bores/N° fori	
4	
HONDA	Non Ventilato/Not Vented

61-05-501	
	Pitch Circle Ø/Foro int.-Ø [mm]
	80
	Height/Altezza [mm]
	59
	Diam./Diam. [mm]
302	
Thickness/Spessore - Min [mm]	
10/8,5	
No. of Bores/N° fori	
5	
mitsubishi	Non Ventilato/Not Vented

61-04-496	
	Pitch Circle Ø/Foro int.-Ø [mm]
	64
	Height/Altezza [mm]
	58,5
	Diam./Diam. [mm]
282	
Thickness/Spessore - Min [mm]	
12/10	
No. of Bores/N° fori	
5	
HONDA	Non Ventilato/Not Vented

61-05-502	
	Pitch Circle Ø/Foro int.-Ø [mm]
	90
	Height/Altezza [mm]
	48,2
	Diam./Diam. [mm]
230,9	
Thickness/Spessore - Min [mm]	
10/8,4	
No. of Bores/N° fori	
4	
mitsubishi	Non Ventilato/Not Vented

61-04-497	
	Pitch Circle Ø/Foro int.-Ø [mm]
	63,7
	Height/Altezza [mm]
	42,6
	Diam./Diam. [mm]
282	
Thickness/Spessore - Min [mm]	
12/10,5	
No. of Bores/N° fori	
5	
HONDA	Non Ventilato/Not Vented

61-05-503	
	Pitch Circle Ø/Foro int.-Ø [mm]
	89,8
	Height/Altezza [mm]
	60,5
	Diam./Diam. [mm]
262	
Thickness/Spessore - Min [mm]	
9,5/8	
No. of Bores/N° fori	
5	
mitsubishi	Non Ventilato/Not Vented

61-04-498	
	Pitch Circle Ø/Foro int.-Ø [mm]
	48
	Height/Altezza [mm]
	34
	Diam./Diam. [mm]
238,8	
Thickness/Spessore - Min [mm]	
10/8	
No. of Bores/N° fori	
4	
ROVER - HONDA	Non Ventilato/Not Vented

61-05-504	
Image Not Available	Pitch Circle Ø/Foro int.-Ø [mm]
	90
	Height/Altezza [mm]
	47
	Diam./Diam. [mm]
247	
Thickness/Spessore - Min [mm]	
18/16	
	Ventilato/Vented
mitsubishi	

61-05-505	
	Pitch Circle Ø/Foro int.-Ø [mm]
	90
	Height/Altezza [mm]
	47
	Diam./Diam. [mm]
266	
Thickness/Spessore - Min [mm]	
18/16	
No. of Bores/N° fori	
5	
VENTILATO/VENTED	
MITSUBISHI	

61-05-511	
	Pitch Circle Ø/Foro int.-Ø [mm]
	90
	Height/Altezza [mm]
	41
	Diam./Diam. [mm]
260	
Thickness/Spessore - Min [mm]	
10/8,5	
No. of Bores/N° fori	
4	
Non Ventilato/Not Vented	
MITSUBISHI	

61-05-506	
	Pitch Circle Ø/Foro int.-Ø [mm]
	51,4
	Height/Altezza [mm]
	72
	Diam./Diam. [mm]
265	
Thickness/Spessore - Min [mm]	
10/8,4	
No. of Bores/N° fori	
4	
Non Ventilato/Not Vented	
MITSUBISHI	

61-05-512	
	Pitch Circle Ø/Foro int.-Ø [mm]
	90
	Height/Altezza [mm]
	51,3
	Diam./Diam. [mm]
296,6	
Thickness/Spessore - Min [mm]	
20/18	
No. of Bores/N° fori	
5	
Ventilato/Vented	
MITSUBISHI	

61-05-508	
	Pitch Circle Ø/Foro int.-Ø [mm]
	90
	Height/Altezza [mm]
	49,9
	Diam./Diam. [mm]
265	
Thickness/Spessore - Min [mm]	
10/8,4	
No. of Bores/N° fori	
4	
Non Ventilato/Not Vented	
MITSUBISHI	

61-05-513	
	Pitch Circle Ø/Foro int.-Ø [mm]
	90
	Height/Altezza [mm]
	65,8
	Diam./Diam. [mm]
265,6	
Thickness/Spessore - Min [mm]	
18/16,4	
No. of Bores/N° fori	
5	
Ventilato/Vented	
MITSUBISHI	

61-05-509	
	Pitch Circle Ø/Foro int.-Ø [mm]
	90
	Height/Altezza [mm]
	46,4
	Diam./Diam. [mm]
262,3	
Thickness/Spessore - Min [mm]	
12/10	
No. of Bores/N° fori	
4	
Non Ventilato/Not Vented	
HYUNDAI	

61-05-514	
	Pitch Circle Ø/Foro int.-Ø [mm]
	64
	Height/Altezza [mm]
	42
	Diam./Diam. [mm]
260	
Thickness/Spessore - Min [mm]	
10/8,4	
No. of Bores/N° fori	
4	
Non Ventilato/Not Vented	
MITSUBISHI - PROTON	

61-05-510	
	Pitch Circle Ø/Foro int.-Ø [mm]
	90
	Height/Altezza [mm]
	60,4
	Diam./Diam. [mm]
261,9	
Thickness/Spessore - Min [mm]	
10/8,4	
No. of Bores/N° fori	
4	
Non Ventilato/Not Vented	
MITSUBISHI	

61-05-515	
	Pitch Circle Ø/Foro int.-Ø [mm]
	94
	Height/Altezza [mm]
	72,6
	Diam./Diam. [mm]
299,9	
Thickness/Spessore - Min [mm]	
22/20	
No. of Bores/N° fori	
6	
Ventilato/Vented	
MITSUBISHI	



61-05-516	
	Pitch Circle Ø/Foro int.-Ø [mm]
	94
	Height/Altezza [mm]
	74
	Diam./Diam. [mm]
	333
Thickness/Spessore - Min [mm]	
18/16	
No. of Bores/N° fori	
6	
Ventilato/Vented	
MITSUBISHI	

61-05-595	
	Pitch Circle Ø/Foro int.-Ø [mm]
	90
	Height/Altezza [mm]
	53,3
	Diam./Diam. [mm]
	284
Thickness/Spessore - Min [mm]	
20/18,4	
No. of Bores/N° fori	
5	
Ventilato/Vented	
MITSUBISHI	

61-05-517	
	Inner Diam./Diam. int. [mm]
	79,5
	Height/Altezza [mm]
	60
	Diam./Diam. [mm]
	262
Thickness/Spessore - Min [mm]	
10/8	
No. of Bores/N° fori	
5	
Non Ventilato/Not Vented	
MITSUBISHI	

61-05-596	
	Pitch Circle Ø/Foro int.-Ø [mm]
	76
	Height/Altezza [mm]
	40,5
	Diam./Diam. [mm]
	258
Thickness/Spessore - Min [mm]	
10/8,5	
No. of Bores/N° fori	
4	
Non Ventilato/Not Vented	
HYUNDAI	

61-05-520	
	Pitch Circle Ø/Foro int.-Ø [mm]
	69
	Height/Altezza [mm]
	60,6
	Diam./Diam. [mm]
	301,5
Thickness/Spessore - Min [mm]	
10/8,5	
No. of Bores/N° fori	
5	
Non Ventilato/Not Vented	
MITSUBISHI	

61-05-597	
	Pitch Circle Ø/Foro int.-Ø [mm]
	90
	Height/Altezza [mm]
	50
	Diam./Diam. [mm]
	263,8
Thickness/Spessore - Min [mm]	
10/8,4	
No. of Bores/N° fori	
5	
Non Ventilato/Not Vented	
MITSUBISHI	

61-05-521	
	Pitch Circle Ø/Foro int.-Ø [mm]
	90
	Height/Altezza [mm]
	60,5
	Diam./Diam. [mm]
	261,7
Thickness/Spessore - Min [mm]	
10/9	
No. of Bores/N° fori	
5	
Non Ventilato/Not Vented	
MITSUBISHI	

61-05-598	
	Pitch Circle Ø/Foro int.-Ø [mm]
	108
	Height/Altezza [mm]
	84,4
	Diam./Diam. [mm]
	314,7
Thickness/Spessore - Min [mm]	
18/16	
No. of Bores/N° fori	
6	
Non Ventilato/Not Vented	
MITSUBISHI	

61-05-523	
	Pitch Circle Ø/Foro int.-Ø [mm]
	90
	Height/Altezza [mm]
	60,5
	Diam./Diam. [mm]
	283,8
Thickness/Spessore - Min [mm]	
20/18,5	
No. of Bores/N° fori	
5	
Ventilato/Vented	
MITSUBISHI	

61-05-599	
	Pitch Circle Ø/Foro int.-Ø [mm]
	90
	Height/Altezza [mm]
	60,2
	Diam./Diam. [mm]
	265,8
Thickness/Spessore - Min [mm]	
18/16,4	
No. of Bores/N° fori	
4	
Ventilato/Vented	
MITSUBISHI	

61-06-600	
	Pitch Circle Ø/Foro int.-Ø [mm]
	47,8
	Height/Altezza [mm]
	72
	Diam./Diam. [mm]
	231
Thickness/Spessore - Min [mm]	
9/7,4	
No. of Bores/N° fori	
4	
DAIHATSU	Non Ventilato/Not Vented

61-07-701	
	Pitch Circle Ø/Foro int.-Ø [mm]
	58
	Height/Altezza [mm]
	67,7
	Diam./Diam. [mm]
	265,4
Thickness/Spessore - Min [mm]	
10/8,5	
No. of Bores/N° fori	
5	
SUBARU	Non Ventilato/Not Vented

61-06-602	
	Pitch Circle Ø/Foro int.-Ø [mm]
	56
	Height/Altezza [mm]
	40,5
	Diam./Diam. [mm]
	236
Thickness/Spessore - Min [mm]	
10/8,5	
No. of Bores/N° fori	
4	
DAIHATSU	Non Ventilato/Not Vented

61-07-702	
	Pitch Circle Ø/Foro int.-Ø [mm]
	58
	Height/Altezza [mm]
	67,6
	Diam./Diam. [mm]
	265
Thickness/Spessore - Min [mm]	
18,2/16	
No. of Bores/N° fori	
5	
SUBARU	Ventilato/Vented

61-06-603	
	Pitch Circle Ø/Foro int.-Ø [mm]
	56
	Height/Altezza [mm]
	37
	Diam./Diam. [mm]
	231
Thickness/Spessore - Min [mm]	
9,2/8	
No. of Bores/N° fori	
4	
DAIHATSU	Non Ventilato/Not Vented

61-07-703	
	Pitch Circle Ø/Foro int.-Ø [mm]
	58
	Height/Altezza [mm]
	67,4
	Diam./Diam. [mm]
	289,3
Thickness/Spessore - Min [mm]	
10/8,5	
No. of Bores/N° fori	
5	
SUBARU	Non Ventilato/Not Vented

61-06-604	
	Pitch Circle Ø/Foro int.-Ø [mm]
	36
	Height/Altezza [mm]
	72
	Diam./Diam. [mm]
	231
Thickness/Spessore - Min [mm]	
9/7	
No. of Bores/N° fori	
4	
DAIHATSU	Non Ventilato/Not Vented

61-07-704	
	Pitch Circle Ø/Foro int.-Ø [mm]
	58
	Height/Altezza [mm]
	68
	Diam./Diam. [mm]
	319,5
Thickness/Spessore - Min [mm]	
18/16	
No. of Bores/N° fori	
5	
SUBARU	Ventilato/Vented

61-07-700	
	Pitch Circle Ø/Foro int.-Ø [mm]
	80
	Height/Altezza [mm]
	42,5
	Diam./Diam. [mm]
	226
Thickness/Spessore - Min [mm]	
10/9	
No. of Bores/N° fori	
4	
SUBARU	Non Ventilato/Not Vented

61-07-705	
	Pitch Circle Ø/Foro int.-Ø [mm]
	58
	Height/Altezza [mm]
	68
	Diam./Diam. [mm]
	289,4
Thickness/Spessore - Min [mm]	
18/16,5	
No. of Bores/N° fori	
5	
SUBARU	Ventilato/Vented



61-07-706	
	Pitch Circle Ø/Foro int.-Ø [mm]
	58
	Height/Altezza [mm]
	67,5
	Diam./Diam. [mm]
	273,4
Thickness/Spessore - Min [mm]	
10/8,5	
No. of Bores/N° fori	
5	
Non Ventilato/Not Vented	
SUBARU	

61-08-801	
	Pitch Circle Ø/Foro int.-Ø [mm]
	62
	Height/Altezza [mm]
	43,5
	Diam./Diam. [mm]
	259
Thickness/Spessore - Min [mm]	
9/7	
No. of Holes/N° fori	
4	
Non Ventilato/Not Vented	
SUZUKI	

61-07-707	
	Pitch Circle Ø/Foro int.-Ø [mm]
	58
	Height/Altezza [mm]
	68
	Diam./Diam. [mm]
	290
Thickness/Spessore - Min [mm]	
10/8	
No. of Bores/N° fori	
5	
Non Ventilato/Not Vented	
SUBARU	

61-09-900	
	Pitch Circle Ø/Foro int.-Ø [mm]
	96,5
	Height/Altezza [mm]
	47,4
	Diam./Diam. [mm]
	265
Thickness/Spessore - Min [mm]	
11,9/10,6	
No. of Bores/N° fori	
6	
Non Ventilato/Not Vented	
ISUZU	

61-07-708	
	Pitch Circle Ø/Foro int.-Ø [mm]
	58
	Height/Altezza [mm]
	64
	Diam./Diam. [mm]
	286
Thickness/Spessore - Min [mm]	
10/8,5	
No. of Bores/N° fori	
5	
Non Ventilato/Not Vented	
SUBARU	

61-09-902	
	Pitch Circle Ø/Foro int.-Ø [mm]
	72
	Height/Altezza [mm]
	77
	Diam./Diam. [mm]
	316
Thickness/Spessore - Min [mm]	
12/10	
No. of Bores/N° fori	
5	
Non Ventilato/Not Vented	
JEEP	

61-07-709	
	Pitch Circle Ø/Foro int.-Ø [mm]
	58
	Height/Altezza [mm]
	68
	Diam./Diam. [mm]
	316
Thickness/Spessore - Min [mm]	
20/18	
No. of Bores/N° fori	
5	
Ventilato/Vented	
SUBARU	

61-09-903	
	Pitch Circle Ø/Foro int.-Ø [mm]
	73
	Height/Altezza [mm]
	69
	Diam./Diam. [mm]
	320
Thickness/Spessore - Min [mm]	
22/20	
No. of Bores/N° fori	
5	
Ventilato/Vented	
CHRYSLER	

61-08-800	
	Pitch Circle Ø/Foro int.-Ø [mm]
	64,2
	Height/Altezza [mm]
	35,3
	Diam./Diam. [mm]
	240
Thickness/Spessore - Min [mm]	
10/8	
No. of Bores/N° fori	
4	
Non Ventilato/Not Vented	
SUZUKI	

61-09-904	
	Pitch Circle Ø/Foro int.-Ø [mm]
	80
	Height/Altezza [mm]
	62
	Diam./Diam. [mm]
	302
Thickness/Spessore - Min [mm]	
10/8,5	
No. of Bores/N° fori	
5	
Non Ventilato/Not Vented	
DODGE - JEEP - CHRYSLER - MITSUBISHI	

61-09-905	
	Pitch Circle Ø/Foro int.-Ø [mm]
	72
	Height/Altezza [mm]
	60
	Diam./Diam. [mm]
	285
Thickness/Spessore - Min [mm]	
12/10	
No. of Bores/N° fori	
5	
JEEP	Non Ventilato/Not Vented

61-09-993	
	Pitch Circle Ø/Foro int.-Ø [mm]
	72
	Height/Altezza [mm]
	57
	Diam./Diam. [mm]
	289,7
Thickness/Spessore - Min [mm]	
12,5/11,3	
No. of Bores/N° fori	
5	
CHRYSLER	Non Ventilato/Not Vented

61-09-906	
	Pitch Circle Ø/Foro int.-Ø [mm]
	72
	Height/Altezza [mm]
	35
	Diam./Diam. [mm]
	305
Thickness/Spessore - Min [mm]	
12/10	
No. of Bores/N° fori	
5	
DODGE - CHRYSLER	Non Ventilato/Not Vented

61-09-994	
	Pitch Circle Ø/Foro int.-Ø [mm]
	57,6
	Height/Altezza [mm]
	53,6
	Diam./Diam. [mm]
	269,6
Thickness/Spessore - Min [mm]	
9,1/7,3	
No. of Bores/N° fori	
5	
CHRYSLER	Non Ventilato/Not Vented

61-09-907	
	Pitch Circle Ø/Foro int.-Ø [mm]
	72
	Height/Altezza [mm]
	64
	Diam./Diam. [mm]
	330
Thickness/Spessore - Min [mm]	
22/20	
No. of Bores/N° fori	
5	
JEEP	Ventilato/Vented

61-09-995	
	Pitch Circle Ø/Foro int.-Ø [mm]
	72
	Height/Altezza [mm]
	59,6
	Diam./Diam. [mm]
	284,4
Thickness/Spessore - Min [mm]	
11/9,5	
No. of Bores/N° fori	
5	
JEEP	Non Ventilato/Not Vented

61-09-990	
	Pitch Circle Ø/Foro int.-Ø [mm]
	57,5
	Height/Altezza [mm]
	53,5
	Diam./Diam. [mm]
	269,6
Thickness/Spessore - Min [mm]	
9/7,5	
No. of Bores/N° fori	
5	
CHRYSLER	Non Ventilato/Not Vented

61-09-997	
	Pitch Circle Ø/Foro int.-Ø [mm]
	101
	Height/Altezza [mm]
	80,3
	Diam./Diam. [mm]
	312,8
Thickness/Spessore - Min [mm]	
18/16,6	
No. of Bores/N° fori	
6	
ISUZU - OPEL	Ventilato/Vented

61-09-992	
	Pitch Circle Ø/Foro int.-Ø [mm]
	72
	Height/Altezza [mm]
	75,5
	Diam./Diam. [mm]
	305
Thickness/Spessore - Min [mm]	
10/9	
No. of Bores/N° fori	
5	
JEEP	Non Ventilato/Not Vented

61-0H-001	
	Pitch Circle Ø/Foro int.-Ø [mm]
	62,5
	Height/Altezza [mm]
	64
	Diam./Diam. [mm]
	261,8
Thickness/Spessore - Min [mm]	
10/8,5	
No. of Bores/N° fori	
4	
KIA - HYUNDAI	Non Ventilato/Not Vented

61-0H-002	
	Pitch Circle Ø/Foro int.-Ø [mm]
	90
	Height/Altezza [mm]
	60,3
	Diam./Diam. [mm]
	266
Thickness/Spessore - Min [mm]	
18/16	
No. of Bores/N° fori	
4	
HYUNDAI - KIA	Ventilato/Vented

61-0H-H07	
	Pitch Circle Ø/Foro int.-Ø [mm]
	76
	Height/Altezza [mm]
	55
	Diam./Diam. [mm]
	284
Thickness/Spessore - Min [mm]	
10/8	
No. of Holes/N° fori	
5	
HYUNDAI	Non Ventilato/Not Vented

61-0H-003	
	Pitch Circle Ø/Foro int.-Ø [mm]
	76
	Height/Altezza [mm]
	61,1
	Diam./Diam. [mm]
	284
Thickness/Spessore - Min [mm]	
10/8,4	
No. of Bores/N° fori	
5	
KIA - HYUNDAI	Non Ventilato/Not Vented

61-0H-H08	
	Pitch Circle Ø/Foro int.-Ø [mm]
	69
	Height/Altezza [mm]
	60
	Diam./Diam. [mm]
	314
Thickness/Spessore - Min [mm]	
20/18	
No. of Bores/N° fori	
5	
HYUNDAI	Ventilato/Vented

61-0H-004	
	Pitch Circle Ø/Foro int.-Ø [mm]
	76
	Height/Altezza [mm]
	45,5
	Diam./Diam. [mm]
	257,8
Thickness/Spessore - Min [mm]	
10/8,5	
No. of Bores/N° fori	
5	
HYUNDAI	Non Ventilato/Not Vented

61-0H-H09	
	Pitch Circle Ø/Foro int.-Ø [mm]
	76
	Height/Altezza [mm]
	25
	Diam./Diam. [mm]
	284
Thickness/Spessore - Min [mm]	
10/8	
No. of Bores/N° fori	
5	
HYUNDAI	Non Ventilato/Not Vented

61-0H-005	
	Pitch Circle Ø 1/Foro int.-Ø 1 [mm]
	108,5
	Height/Altezza [mm]
	87
	Diam./Diam. [mm]
	315
Thickness/Spessore - Min [mm]	
20/18	
No. of Bores/N° fori	
6	
GONOW - HYUNDAI	Ventilato/Vented

61-0H-H10	
	Pitch Circle Ø/Foro int.-Ø [mm]
	76
	Height/Altezza [mm]
	25
	Diam./Diam. [mm]
	300
Thickness/Spessore - Min [mm]	
10/8	
No. of Bores/N° fori	
5	
HYUNDAI	Non Ventilato/Not Vented

61-0H-H06	
	Pitch Circle Ø/Foro int.-Ø [mm]
	69
	Height/Altezza [mm]
	72
	Diam./Diam. [mm]
	302
Thickness/Spessore - Min [mm]	
11/9,5	
No. of Holes/N° fori	
5	
HYUNDAI	Non Ventilato/Not Vented

61-0H-H11	
	Pitch Circle Ø/Foro int.-Ø [mm]
	96
	Height/Altezza [mm]
	83
	Diam./Diam. [mm]
	324
Thickness/Spessore - Min [mm]	
18/16	
No. of Bores/N° fori	
6	
HYUNDAI	Ventilato/Vented

61-0H-H12	
Image Not Available	No. of Bores/N° fori
	5
HYUNDAI	

61-0K-005	
	Pitch Circle Ø/Foro int.-Ø [mm]
	96,2
	Height/Altezza [mm]
	88
	Diam./Diam. [mm]
	314,8
Thickness/Spessore - Min [mm]	
20/18	
No. of Bores/N° fori	
5	
KIA	
Ventilato/Vented	

61-0K-000	
	Pitch Circle Ø/Foro int.-Ø [mm]
	72
	Height/Altezza [mm]
	40,5
	Diam./Diam. [mm]
	260,5
Thickness/Spessore - Min [mm]	
10/8,5	
No. of Bores/N° fori	
4	
KIA	
Non Ventilato/Not Vented	

61-0K-006	
	Pitch Circle Ø/Foro int.-Ø [mm]
	57
	Height/Altezza [mm]
	40,3
	Diam./Diam. [mm]
	260,5
Thickness/Spessore - Min [mm]	
10/8	
No. of Bores/N° fori	
4	
KIA	
Non Ventilato/Not Vented	

61-0K-002	
	Pitch Circle Ø/Foro int.-Ø [mm]
	62,4
	Height/Altezza [mm]
	37,7
	Diam./Diam. [mm]
	234
Thickness/Spessore - Min [mm]	
10/8,5	
No. of Bores/N° fori	
4	
HYUNDAI - KIA	
Non Ventilato/Not Vented	

61-0K-K07	
	Pitch Circle Ø/Foro int.-Ø [mm]
	76
	Height/Altezza [mm]
	41,6
	Diam./Diam. [mm]
	257,8
Thickness/Spessore - Min [mm]	
10/8,5	
No. of Bores/N° fori	
4	
KIA	
Non Ventilato/Not Vented	

61-0K-003	
	Pitch Circle Ø/Foro int.-Ø [mm]
	76
	Height/Altezza [mm]
	61,2
	Diam./Diam. [mm]
	261,7
Thickness/Spessore - Min [mm]	
10/8,5	
No. of Bores/N° fori	
4	
KIA - HYUNDAI	
Non Ventilato/Not Vented	

61-0K-008	
	Pitch Circle Ø/Foro int.-Ø [mm]
	72
	Height/Altezza [mm]
	40,5
	Diam./Diam. [mm]
	260,7
Thickness/Spessore - Min [mm]	
10/8,5	
No. of Bores/N° fori	
4	
KIA	
Non Ventilato/Not Vented	

61-0K-004	
	Pitch Circle Ø/Foro int.-Ø [mm]
	57
	Height/Altezza [mm]
	61,3
	Diam./Diam. [mm]
	270
Thickness/Spessore - Min [mm]	
10/8,5	
No. of Bores/N° fori	
4	
KIA	
Non Ventilato/Not Vented	

61-0K-K10	
	Pitch Circle Ø/Foro int.-Ø [mm]
	76
	Height/Altezza [mm]
	61
	Diam./Diam. [mm]
	261,7
Thickness/Spessore - Min [mm]	
9,5/8,5	
No. of Bores/N° fori	
5	
KIA - HYUNDAI	
Non Ventilato/Not Vented	

61-0K-K11	
	Pitch Circle Ø/Foro int.-Ø [mm]
	96
	Height/Altezza [mm]
	70
	Diam./Diam. [mm]
	324
Thickness/Spessore - Min [mm]	
12/10	
No. of Bores/N° fori	
7	
KIA	Non Ventilato/Not Vented

61-0K-K16	
	Pitch Circle Ø/Foro int.-Ø [mm]
	69
	Height/Altezza [mm]
	72
	Diam./Diam. [mm]
	302
Thickness/Spessore - Min [mm]	
11/9	
No. of Bores/N° fori	
5	
KIA	Non Ventilato/Not Vented

61-0K-K12	
	Pitch Circle Ø/Foro int.-Ø [mm]
	96,2
	Height/Altezza [mm]
	79
	Diam./Diam. [mm]
	315
Thickness/Spessore - Min [mm]	
20/18	
No. of Bores/N° fori	
5	
KIA	Ventilato/Vented

61-0K-K17	
	Pitch Circle Ø/Foro int.-Ø [mm]
	76
	Height/Altezza [mm]
	41
	Diam./Diam. [mm]
	258
Thickness/Spessore - Min [mm]	
10/8	
No. of Bores/N° fori	
5	
HYUNDAI - KIA	Non Ventilato/Not Vented

61-0K-K13	
	Pitch Circle Ø/Foro int.-Ø [mm]
	76
	Height/Altezza [mm]
	61,5
	Diam./Diam. [mm]
	275
Thickness/Spessore - Min [mm]	
10/9	
No. of Bores/N° fori	
5	
KIA	Non Ventilato/Not Vented



61-0K-K18	
	Pitch Circle Ø/Foro int.-Ø [mm]
	62
	Height/Altezza [mm]
	44,5
	Diam./Diam. [mm]
	262
Thickness/Spessore - Min [mm]	
10/8	
No. of Bores/N° fori	
4	
KIA	Non Ventilato/Not Vented

61-0K-K14	
	Pitch Circle Ø/Foro int.-Ø [mm]
	76
	Height/Altezza [mm]
	61,5
	Diam./Diam. [mm]
	262
Thickness/Spessore - Min [mm]	
10/8	
No. of Bores/N° fori	
5	
HYUNDAI - KIA	Non Ventilato/Not Vented

61-0L-L00	
	Pitch Circle Ø/Foro int.-Ø [mm]
	79
	Height/Altezza [mm]
	60
	Diam./Diam. [mm]
	325
Thickness/Spessore - Min [mm]	
20/18	
No. of Bores/N° fori	
5	
LAND ROVER	Ventilato/Vented



61-0K-K15	
	Pitch Circle Ø/Foro int.-Ø [mm]
	76
	Height/Altezza [mm]
	64
	Diam./Diam. [mm]
	262
Thickness/Spessore - Min [mm]	
10/8	
No. of Bores/N° fori	
5	
KIA	Non Ventilato/Not Vented

61-0L-L01	
	Pitch Circle Ø/Foro int.-Ø [mm]
	79
	Height/Altezza [mm]
	60
	Diam./Diam. [mm]
	350
Thickness/Spessore - Min [mm]	
20/18	
No. of Bores/N° fori	
5	
LAND ROVER	Ventilato/Vented



61-0L-L02	
  L02 LAND ROVER	Pitch Circle Ø/Foro int.-Ø [mm]
	79
	Height/Altezza [mm]
	76
	Diam./Diam. [mm]
	354
Thickness/Spessore - Min [mm]	
20/18	
No. of Bores/N° fori	
5	
	Ventilato/Vented

61-0L-L07	
  L07 LAND ROVER	Pitch Circle Ø/Foro int.-Ø [mm]
	70
	Height/Altezza [mm]
	63
	Diam./Diam. [mm]
	304
Thickness/Spessore - Min [mm]	
13/11	
No. of Bores/N° fori	
5	
	Non Ventilato/Not Vented

61-0L-L03	
  L03 LAND ROVER	Pitch Circle Ø/Foro int.-Ø [mm]
	63,5
	Height/Altezza [mm]
	66
	Diam./Diam. [mm]
	302
Thickness/Spessore - Min [mm]	
12/10	
No. of Bores/N° fori	
5	
	Non Ventilato/Not Vented

61-0L-L08	
  L08 LAND ROVER	Pitch Circle Ø/Foro int.-Ø [mm]
	102
	Height/Altezza [mm]
	60
	Diam./Diam. [mm]
	298
Thickness/Spessore - Min [mm]	
14/12	
No. of Bores/N° fori	
5	
	Non Ventilato/Not Vented

61-0L-L04	
  L04 LAND ROVER	Pitch Circle Ø/Foro int.-Ø [mm]
	79
	Height/Altezza [mm]
	75
	Diam./Diam. [mm]
	354
Thickness/Spessore - Min [mm]	
12/10	
No. of Bores/N° fori	
5	
	Non Ventilato/Not Vented

61-0L-L09	
  L09 LAND ROVER	Pitch Circle Ø/Foro int.-Ø [mm]
	63
	Height/Altezza [mm]
	51
	Diam./Diam. [mm]
	302
Thickness/Spessore - Min [mm]	
11/9	
No. of Bores/N° fori	
5	
	Non Ventilato/Not Vented

61-0L-L05	
  L05 LAND ROVER	Pitch Circle Ø/Foro int.-Ø [mm]
	101,5
	Height/Altezza [mm]
	62
	Diam./Diam. [mm]
	290
Thickness/Spessore - Min [mm]	
12,5/10,5	
No. of Bores/N° fori	
5	
	Non Ventilato/Not Vented

61-0M-M00	
 L00 SMART - MITSUBISHI	Pitch Circle Ø/Foro int.-Ø [mm]
	69
	Height/Altezza [mm]
	38,8
	Diam./Diam. [mm]
	249,7
Thickness/Spessore - Min [mm]	
10/8,5	
No. of Bores/N° fori	
4	
	Non Ventilato/Not Vented

61-0L-L06	
  L06 LAND ROVER	Pitch Circle Ø/Foro int.-Ø [mm]
	63,5
	Height/Altezza [mm]
	61,2
	Diam./Diam. [mm]
	302
Thickness/Spessore - Min [mm]	
20/18	
No. of Bores/N° fori	
5	
	Ventilato/Vented

61-0S-000	
 L00 SSANGYONG - DAEWOO	Pitch Circle Ø/Foro int.-Ø [mm]
	105,2
	Height/Altezza [mm]
	67,9
	Diam./Diam. [mm]
	298,8
Thickness/Spessore - Min [mm]	
10,5/9	
No. of Bores/N° fori	
6	
	Non Ventilato/Not Vented

61-0S-S01	
	Pitch Circle Ø/Foro int.-Ø [mm]
	85
	Height/Altezza [mm]
	71
	Diam./Diam. [mm]
307	
Thickness/Spessore - Min [mm]	
20/18,5	
No. of Bores/N° fori	
5	
SSANGYONG	Ventilato/Vented

61-0W-000	
	Pitch Circle Ø/Foro int.-Ø [mm]
	57
	Height/Altezza [mm]
	65
	Diam./Diam. [mm]
258	
Thickness/Spessore - Min [mm]	
10,3/9	
No. of Bores/N° fori	
4	
DAEWOO	Non Ventilato/Not Vented

61-0S-S02	
	Pitch Circle Ø/Foro int.-Ø [mm]
	85
	Height/Altezza [mm]
	68
	Diam./Diam. [mm]
298,8	
Thickness/Spessore - Min [mm]	
10,2/9	
No. of Holes/N° fori	
5	
SSANGYONG	Non Ventilato/Not Vented

61-0W-001	
	Pitch Circle Ø/Foro int.-Ø [mm]
	57
	Height/Altezza [mm]
	65
	Diam./Diam. [mm]
258	
Thickness/Spessore - Min [mm]	
10,3/9	
No. of Bores/N° fori	
5	
DAEWOO	Non Ventilato/Not Vented

61-0S-S03	
	Pitch Circle Ø/Foro int.-Ø [mm]
	67
	Height/Altezza [mm]
	58
	Diam./Diam. [mm]
284	
Thickness/Spessore - Min [mm]	
10/8	
No. of Bores/N° fori	
5	
SSANGYONG	Non Ventilato/Not Vented

61-0W-W02	
	Pitch Circle Ø/Foro int.-Ø [mm]
	60
	Height/Altezza [mm]
	58,2
	Diam./Diam. [mm]
257,6	
Thickness/Spessore - Min [mm]	
12/10,5	
No. of Bores/N° fori	
4	
CHEVROLET - DAEWOO	Non Ventilato/Not Vented

61-0S-S04	
	Pitch Circle Ø/Foro int.-Ø [mm]
	67
	Height/Altezza [mm]
	63
	Diam./Diam. [mm]
262	
Thickness/Spessore - Min [mm]	
10/8	
No. of Bores/N° fori	
5	
SSANGYONG	Non Ventilato/Not Vented

61-0W-W03	
	Pitch Circle Ø/Foro int.-Ø [mm]
	60
	Height/Altezza [mm]
	57,4
	Diam./Diam. [mm]
257,5	
Thickness/Spessore - Min [mm]	
10,7/9	
No. of Bores/N° fori	
4	
DAEWOO - CHEVROLET	Non Ventilato/Not Vented



61-0S-099	
	Pitch Circle Ø/Foro int.-Ø [mm]
	105,5
	Height/Altezza [mm]
	67,8
	Diam./Diam. [mm]
299	
Thickness/Spessore - Min [mm]	
10,4/9	
No. of Bores/N° fori	
6	
SSANGYONG - DAEWOO	Non Ventilato/Not Vented

61-0W-W04	
	Pitch Circle Ø/Foro int.-Ø [mm]
	60
	Height/Altezza [mm]
	58,5
	Diam./Diam. [mm]
276	
Thickness/Spessore - Min [mm]	
12/10,5	
No. of Bores/N° fori	
4	
CHEVROLET	Ventilato/Vented



61-0W-W05

	Pitch Circle Ø/Foro int.-Ø [mm]	71
	Height/Altezza [mm]	72
	Diam./Diam. [mm]	303
	Thickness/Spessore - Min [mm]	20/18
	No. of Bores/N° fori	5
		Ventilato/Vented
CHEVROLET		

61-0W-W06

 	Pitch Circle Ø/Foro int.-Ø [mm]	60
	Height/Altezza [mm]	46
	Diam./Diam. [mm]	268
	Thickness/Spessore - Min [mm]	12/10
	No. of Bores/N° fori	5
		Non Ventilato/Not Vented
OPEL - CHEVROLET		

61-0W-W07

 	Pitch Circle Ø/Foro int.-Ø [mm]	71
	Height/Altezza [mm]	46
	Diam./Diam. [mm]	292
	Thickness/Spessore - Min [mm]	12/10
	No. of Bores/N° fori	5
		Non Ventilato/Not Vented
CHEVROLET - OPEL		

55-00-000	
	Diam./Diam. [mm] 250
	Width/Largh. [mm] 50,8
LADA	

55-00-007	
	Diam./Diam. [mm] 200
	Width/Largh. [mm] 32
DR	

55-00-001	
	Diam./Diam. [mm] 260
	Width/Largh. [mm] 89
GASOLONE	

55-00-008	
	Diam./Diam. [mm] 160
	Width/Largh. [mm] 41
AIXAM - LIGIER	

55-00-003	
	Diam./Diam. [mm] 280
	Width/Largh. [mm] 52,7
TATA (TELCO)	

55-00-009	
	Diam./Diam. [mm] 180
	Width/Largh. [mm] 32
AIXAM - LIGIER	

55-00-004	
	Diam./Diam. [mm] 205
	Width/Largh. [mm] 45
HUMMER	

55-00-010	
	Diam./Diam. [mm] 200
	Width/Largh. [mm] 39
NISSAN	

55-00-006	
	Diam./Diam. [mm] 210
	Width/Largh. [mm] 35
HUMMER	

55-00-013	
	Diam./Diam. [mm] 200
	Width/Largh. [mm] 38
NISSAN	

55-00-022	
	Diam./Diam. [mm]
	255
	Width/Largh. [mm]
	45,8
JEEP	



55-00-099	
	Diam./Diam. [mm]
	260
	Width/Largh. [mm]
	46
JEEP	

55-00-023	
	Diam./Diam. [mm]
	290
	Width/Largh. [mm]
	53,6

55-01-100	
	Diam./Diam. [mm]
	200
	Width/Largh. [mm]
	36
NISSAN	

55-00-056	
	Diam./Diam. [mm]
	230
	Width/Largh. [mm]
	65,3
JEEP - CHRYSLER	

55-01-101	
	Diam./Diam. [mm]
	180
	Width/Largh. [mm]
	36
NISSAN	

55-00-097	
	Diam./Diam. [mm]
	250
	Width/Largh. [mm]
	57,2
KIA - CHRYSLER - PLYMOUTH	

55-01-103	
	Diam./Diam. [mm]
	180
	Width/Largh. [mm]
	27,7
NISSAN	

55-00-098	
	Diam./Diam. [mm]
	220
	Width/Largh. [mm]
	46
PONTIAC	

55-01-104	
	Diam./Diam. [mm]
	200
	Width/Largh. [mm]
	35,3
NISSAN	

55-01-105	
	Diam./Diam. [mm] 210
	Width/Largh. [mm] 39
NISSAN	

55-01-110		
	Solo Ferodo	
	Diam./Diam. [mm]	310
	Width/Largh. [mm]	100
NISSAN		

55-01-106	
	Diam./Diam. [mm] 230
	Width/Largh. [mm] 41
NISSAN	

55-01-111	
	Diam./Diam. [mm] 200
	Width/Largh. [mm] 46
NISSAN	

55-01-107	
	Diam./Diam. [mm] 230
	Width/Largh. [mm] 40,4
NISSAN	

55-01-112	
	Diam./Diam. [mm] 180
	Width/Largh. [mm] 31,4
NISSAN	

55-01-108	
	Diam./Diam. [mm] 190
	Width/Largh. [mm] 26,6
NISSAN	

55-01-113	
	Diam./Diam. [mm] 300
	Width/Largh. [mm] 56,5
NISSAN	

55-01-109	
	Diam./Diam. [mm] 290
	Width/Largh. [mm] 65
NISSAN	

55-01-114	
	Diam./Diam. [mm] 190
	Width/Largh. [mm] 33
NISSAN - INFINITI	

55-01-115	
 <p>NEW</p> <p>X4</p> <p>115</p>	Diam./Diam. [mm] 170
	Width/Largh. [mm] 22
NISSAN	

55-01-128	
	Diam./Diam. [mm] 255
	Width/Largh. [mm] 46,3
NISSAN	

55-01-116	
 <p>NEW</p> <p>X2</p> <p>116</p>	Diam./Diam. [mm] 230
	Width/Largh. [mm] 37
NISSAN	

55-01-129	
	Diam./Diam. [mm] 255
	Width/Largh. [mm] 46,9
NISSAN	

55-01-117	
 <p>NEW</p> <p>M1 M2 M3 M4</p> <p>117</p>	Diam./Diam. [mm] 200
	Width/Largh. [mm] 39
NISSAN	

55-01-132	
	Diam./Diam. [mm] 270
	Width/Largh. [mm] 52,3
NISSAN	

55-01-124	
 <p>X2 T24 X2</p>	Diam./Diam. [mm] 205
	Width/Largh. [mm] 36
NISSAN	

55-01-133	
	Diam./Diam. [mm] 300
	Width/Largh. [mm] 76,7
NISSAN	

55-01-126	
	Diam./Diam. [mm] 230
	Width/Largh. [mm] 40,6
NISSAN	

55-01-134	
 <p>X2 T26 X2</p>	Diam./Diam. [mm] 230
	Width/Largh. [mm] 41
HYUNDAI - NISSAN	

55-01-136	
	Diam./Diam. [mm] 255
	Width/Largh. [mm] 61,6
NISSAN	

55-01-142	
	Diam./Diam. [mm] 180
	Width/Largh. [mm] 31
NISSAN	

55-01-137	
	Diam./Diam. [mm] 260
	Width/Largh. [mm] 51,8
NISSAN	

55-01-191	
	Diam./Diam. [mm] 200
	Width/Largh. [mm] 36,5
NISSAN	

55-01-138	
	Diam./Diam. [mm] 260
	Width/Largh. [mm] 51,3
NISSAN	

55-01-193	
	Diam./Diam. [mm] 260
	Width/Largh. [mm] 41
NISSAN	

55-01-140	
	Diam./Diam. [mm] 300
	Width/Largh. [mm] 62
NISSAN	

55-01-194	
	Diam./Diam. [mm] 255
	Width/Largh. [mm] 57,2
NISSAN - DAEWOO	

55-01-141	
	Diam./Diam. [mm] 170
	Width/Largh. [mm] 32
NISSAN	

55-01-195	
	Diam./Diam. [mm] 255
	Width/Largh. [mm] 57,3
NISSAN	

55-01-196	
	Diam./Diam. [mm] 295
	Width/Largh. [mm] 51,2
INFINITI - NISSAN	

55-02-202	
	Diam./Diam. [mm] 180
	Width/Largh. [mm] 33
TOYOTA	

55-01-197	
	Diam./Diam. [mm] 180
	Width/Largh. [mm] 27
NISSAN	

55-02-204	
	Diam./Diam. [mm] 200
	Width/Largh. [mm] 32,2
TOYOTA	

55-01-199	
	Diam./Diam. [mm] 225
	Width/Largh. [mm] 42
NISSAN	

55-02-205	
	Diam./Diam. [mm] 300
	Width/Largh. [mm] 62,2
TOYOTA - VW	

55-02-200	
	Diam./Diam. [mm] 200
	Width/Largh. [mm] 36,3
TOYOTA	

55-02-206	
	Diam./Diam. [mm] 200
	Width/Largh. [mm] 36,5
TOYOTA - DAIHATSU	

55-02-201	
	Diam./Diam. [mm] 200
	Width/Largh. [mm] 37
TOYOTA	

55-02-209	
	Diam./Diam. [mm] 180
	Width/Largh. [mm] 33
TOYOTA	

55-02-210	
	Diam./Diam. [mm] 300
	Width/Largh. [mm] 57,5
TOYOTA	

55-02-216	
	Diam./Diam. [mm] 230
	Width/Largh. [mm] 37
TOYOTA	

55-02-211	
	Diam./Diam. [mm] 295
	Width/Largh. [mm] 77,6
TOYOTA	

55-02-217	
	Diam./Diam. [mm] 295
	Width/Largh. [mm] 61,5
TOYOTA	

55-02-212	
	Diam./Diam. [mm] 200
	Width/Largh. [mm] 32
PEUGEOT - TOYOTA - CITROEN	

55-02-219	
	Diam./Diam. [mm] 260
	Width/Largh. [mm] 52
TOYOTA	

55-02-214	
	Diam./Diam. [mm] 230
	Width/Largh. [mm] 40
TOYOTA	

55-02-220	
	Diam./Diam. [mm] 200
	Width/Largh. [mm] 37
TOYOTA	

55-02-215	
	Diam./Diam. [mm] 300
	Width/Largh. [mm] 62
MAHINDRA	

55-02-221	
	Diam./Diam. [mm] 200
	Width/Largh. [mm] 38,5
TOYOTA	

55-02-223	
	Diam./Diam. [mm] 190
	Width/Largh. [mm] 45
LEXUS - TOYOTA	

55-02-228	
	Diam./Diam. [mm] 170
	Width/Largh. [mm] 32
TOYOTA	

55-02-224	
	Diam./Diam. [mm] 260
	Width/Largh. [mm] 57,2
TOYOTA	

55-02-229	
	Diam./Diam. [mm] 320
	Width/Largh. [mm] 87

55-02-225	
	Diam./Diam. [mm] 242
	Width/Largh. [mm] 35
TOYOTA	

55-02-230	
	Diam./Diam. [mm] 210
	Width/Largh. [mm] 46
TOYOTA	

55-02-226	
	Diam./Diam. [mm] 190
	Width/Largh. [mm] 26
LEXUS	

55-02-231	
	Diam./Diam. [mm] 170
	Width/Largh. [mm] 32
TOYOTA	

55-02-227	
	Diam./Diam. [mm] 300
	Width/Largh. [mm] 51
TOYOTA	

55-02-232	
	Diam./Diam. [mm] 170
	Width/Largh. [mm] 22,5
TOYOTA	



55-02-233	
	Diam./Diam. [mm] 255
	Width/Largh. [mm] 58,2
TOYOTA - VW	

55-02-239	
	Diam./Diam. [mm] 300
	Width/Largh. [mm] 51,4
TOYOTA	

55-02-234	
	Diam./Diam. [mm] 200
	Width/Largh. [mm] 37
TOYOTA	

55-02-240	
	Diam./Diam. [mm] 200
	Width/Largh. [mm] 37
TOYOTA	

55-02-235	
	Diam./Diam. [mm] 230
	Width/Largh. [mm] 45
TOYOTA	

55-02-242	
	Diam./Diam. [mm] 275
	Width/Largh. [mm] 57
TOYOTA	

55-02-236	
	Diam./Diam. [mm] 180
	Width/Largh. [mm] 27,3
TOYOTA	

55-02-247	
	Diam./Diam. [mm] 180
	Width/Largh. [mm] 27,6
TOYOTA	

55-02-237	
	Diam./Diam. [mm] 250
	Width/Largh. [mm] 51,6
TOYOTA	

55-02-294	
	Diam./Diam. [mm] 200
	Width/Largh. [mm] 37
TOYOTA	

55-02-297	
	Diam./Diam. [mm] 230
	Width/Largh. [mm] 41
DAIHATSU - TOYOTA	

55-03-303	
	Diam./Diam. [mm] 225
	Width/Largh. [mm] 43
MAZDA - HYUNDAI	

55-02-299	
	Diam./Diam. [mm] 200
	Width/Largh. [mm] 36,4
TOYOTA	

55-03-305	
	Diam./Diam. [mm] 200
	Width/Largh. [mm] 25,8
MAZDA	

55-03-300	
	Diam./Diam. [mm] 260
	Width/Largh. [mm] 51,6
MAZDA	

55-03-307	
	Diam./Diam. [mm] 200
	Width/Largh. [mm] 38
MAZDA	

55-03-301	
	Diam./Diam. [mm] 200
	Width/Largh. [mm] 32,9

55-03-309	
	Diam./Diam. [mm] 230
	Width/Largh. [mm] 43
MAZDA	

55-03-302	
	Diam./Diam. [mm] 200
	Width/Largh. [mm] 32,8
MAZDA	

55-03-311	
	Diam./Diam. [mm] 300
	Width/Largh. [mm] 56
FORD - MAZDA	

55-03-312	
	Diam./Diam. [mm] 280
	Width/Largh. [mm] 55
MAZDA	

55-03-324	
	Diam./Diam. [mm] 180
	Width/Largh. [mm] 46

55-03-313	
	Diam./Diam. [mm] 260
	Width/Largh. [mm] 45,8
MAZDA - ASIA MOTORS	

55-03-325	
	Diam./Diam. [mm] 260
	Width/Largh. [mm] 51
MAZDA - ASIA MOTORS - KIA	

55-03-314	
	Diam./Diam. [mm] 200
	Width/Largh. [mm] 32
MAZDA	

55-03-327	
	Diam./Diam. [mm] 200
	Width/Largh. [mm] 26
MAZDA	

55-03-315	
	Diam./Diam. [mm] 190
	Width/Largh. [mm] 32
MAZDA	

55-03-328	
	Diam./Diam. [mm] 225
	Width/Largh. [mm] 26
MAZDA	

55-03-316	
	Diam./Diam. [mm] 180
	Width/Largh. [mm] 31
MAZDA	

55-03-329	
	Diam./Diam. [mm] 230
	Width/Largh. [mm] 31,5
MAZDA	

55-03-330	
	Diam./Diam. [mm] 170
	Width/Largh. [mm] 26
MAZDA - KIA	

55-03-388	
	Diam./Diam. [mm] 200
	Width/Largh. [mm] 26
MAZDA	

55-03-332	
	Diam./Diam. [mm] 225
	Width/Largh. [mm] 42,7

55-03-391	
	Diam./Diam. [mm] 265
	Width/Largh. [mm] 51
ASIA MOTORS - MAZDA	

55-03-333	
	Diam./Diam. [mm] 260
	Width/Largh. [mm] 51,2
MAZDA	

55-03-393	
	Diam./Diam. [mm] 260
	Width/Largh. [mm] 51
MAZDA	

55-03-334	
	Diam./Diam. [mm] 220
	Width/Largh. [mm] 56
MAZDA	

55-03-394	
	Diam./Diam. [mm] 175
	Width/Largh. [mm] 31,2
MAZDA	

55-03-342	
	Diam./Diam. [mm] 250
	Width/Largh. [mm] 57,7
KIA	

55-03-395	
	Diam./Diam. [mm] 200
	Width/Largh. [mm] 46
OPEL - DAEWOO	



55-03-396	
	Diam./Diam. [mm] 260
	Width/Largh. [mm] 46
KIA	

55-04-402	
	Diam./Diam. [mm] 185
	Width/Largh. [mm] 26
TRIUMPH - HONDA	

55-03-397	
	Diam./Diam. [mm] 200
	Width/Largh. [mm] 35,5
MAZDA	

55-04-403	
	Diam./Diam. [mm] 180
	Width/Largh. [mm] 31
ROVER - HONDA	

55-03-398	
	Diam./Diam. [mm] 200
	Width/Largh. [mm] 36
KIA	

55-04-404	
	Diam./Diam. [mm] 180
	Width/Largh. [mm] 26,3
HONDA	

55-03-399	
	Diam./Diam. [mm] 180
	Width/Largh. [mm] 31
MAZDA	

55-04-405	
	Diam./Diam. [mm] 200
	Width/Largh. [mm] 35
HONDA	

55-04-400	
	Diam./Diam. [mm] 180
	Width/Largh. [mm] 36
HONDA	

55-04-406	
	Diam./Diam. [mm] 200
	Width/Largh. [mm] 26
HONDA	

55-04-407	
	Diam./Diam. [mm] 230
	Width/Largh. [mm] 42
HONDA	

55-04-412	
	Diam./Diam. [mm] 180
	Width/Largh. [mm] 30,2
HONDA	

55-04-408	
	Diam./Diam. [mm] 180
	Width/Largh. [mm] 30
HONDA	

55-04-493	
	Diam./Diam. [mm] 180
	Width/Largh. [mm] 31,8
HONDA	

55-04-409	
	Diam./Diam. [mm] 200
	Width/Largh. [mm] 31
HONDA	

55-04-494	
	Diam./Diam. [mm] 200
	Width/Largh. [mm] 36,2
HONDA	

55-04-410	
	Diam./Diam. [mm] 200
	Width/Largh. [mm] 38,6
ROVER - HONDA	

55-04-496	
	Diam./Diam. [mm] 180
	Width/Largh. [mm] 30
HONDA	

55-04-411	
	Diam./Diam. [mm] 220
	Width/Largh. [mm] 35
SUZUKI - HONDA	

55-04-499	
	Diam./Diam. [mm] 200
	Width/Largh. [mm] 36
HONDA	



55-05-500	
	Diam./Diam. [mm] 200
	Width/Largh. [mm] 38,5
MITSUBISHI	

55-05-505	
	Diam./Diam. [mm] 170
	Width/Largh. [mm] 31,8
MITSUBISHI	

55-05-501	
	Diam./Diam. [mm] 255
	Width/Largh. [mm] 52
MITSUBISHI	

55-05-507	
	Diam./Diam. [mm] 170
	Width/Largh. [mm] 31,6
MITSUBISHI	

55-05-502	
	Diam./Diam. [mm] 230
	Width/Largh. [mm] 41,2
MITSUBISHI	

55-05-508	
	Diam./Diam. [mm] 180
	Width/Largh. [mm] 37,2
PROTON - MITSUBISHI	

55-05-503	
	Diam./Diam. [mm] 200
	Width/Largh. [mm] 40
MITSUBISHI	

55-05-509	
	Diam./Diam. [mm] 280
	Width/Largh. [mm] 62
MITSUBISHI	

55-05-504	
	Diam./Diam. [mm] 230
	Width/Largh. [mm] 41,2
MITSUBISHI	

55-05-510	
	Diam./Diam. [mm] 300
	Width/Largh. [mm] 50
MITSUBISHI	

55-05-511	
	Diam./Diam. [mm] 210
	Width/Largh. [mm] 39
MITSUBISHI - SMART	

55-05-516	
	Diam./Diam. [mm] 203
	Width/Largh. [mm] 39
HYUNDAI	

55-05-512	
	Diam./Diam. [mm] 205
	Width/Largh. [mm] 36,8
HYUNDAI - MITSUBISHI	

55-05-517	
<p style="text-align: center;">Image Not Available</p>	Diam./Diam. [mm] 318
	Width/Largh. [mm] 110
MITSUBISHI	

55-05-513	
	Diam./Diam. [mm] 200
	Width/Largh. [mm] 34
MITSUBISHI	

55-05-520	
	Diam./Diam. [mm] 220
	Width/Largh. [mm] 46,7

55-05-514	
	Diam./Diam. [mm] 200
	Width/Largh. [mm] 37
MITSUBISHI	

55-05-526	
	Diam./Diam. [mm] 180
	Width/Largh. [mm] 36,5
MITSUBISHI	

55-05-515	
	Diam./Diam. [mm] 190
	Width/Largh. [mm] 32
MITSUBISHI - SUBARU	

55-05-527	
	Diam./Diam. [mm] 200
	Width/Largh. [mm] 36,6
MITSUBISHI	



55-05-528	
	Diam./Diam. [mm] 255
	Width/Largh. [mm] 51,6
MITSUBISHI	

55-05-586	
	Diam./Diam. [mm] 205
	Width/Largh. [mm] 36,5
MITSUBISHI	

55-05-529	
	Diam./Diam. [mm] 230
	Width/Largh. [mm] 41
MITSUBISHI	

55-05-587	
	Diam./Diam. [mm] 180
	Width/Largh. [mm] 36,6
PROTON - MITSUBISHI	

55-05-583	
	Diam./Diam. [mm] 270
	Width/Largh. [mm] 53,3
MITSUBISHI	

55-05-588	
	Diam./Diam. [mm] 230
	Width/Largh. [mm] 41,6
MITSUBISHI	

55-05-584	
	Diam./Diam. [mm] 180
	Width/Largh. [mm] 32,2
HYUNDAI	

55-05-592	
	Diam./Diam. [mm] 205
	Width/Largh. [mm] 38
HYUNDAI	

55-05-585	
	Diam./Diam. [mm] 230
	Width/Largh. [mm] 45
HYUNDAI	

55-05-595	
	Diam./Diam. [mm] 180
	Width/Largh. [mm] 32,5
HYUNDAI	

55-05-596	
	Diam./Diam. [mm] 180
	Width/Largh. [mm] 33,8
HYUNDAI	

55-06-604	
	Diam./Diam. [mm] 180
	Width/Largh. [mm] 36
INNOCENTI - DAIHATSU	

55-06-600	
	Diam./Diam. [mm] 255
	Width/Largh. [mm] 45,3
DAIHATSU	

55-06-605	
	Diam./Diam. [mm] 200
	Width/Largh. [mm] 41,5
DAIHATSU	

55-06-601	
	Diam./Diam. [mm] 230
	Width/Largh. [mm] 41
TOYOTA - DAIHATSU	

55-06-606	
	Diam./Diam. [mm] 180
	Width/Largh. [mm] 36,1
DAIHATSU	

55-06-602	
	Diam./Diam. [mm] 180
	Width/Largh. [mm] 36
INNOCENTI - DAIHATSU	

55-06-607	
	Diam./Diam. [mm] 255
	Width/Largh. [mm] 45
DAIHATSU	

55-06-603	
	Diam./Diam. [mm] 185
	Width/Largh. [mm] 33
DAIHATSU	

55-06-610	
	Width/Largh. [mm] 27,7
	Diam./Diam. [mm] 180
SUBARU - DAIHATSU	

55-06-611	
	Diam./Diam. [mm] 180
	Width/Largh. [mm] 27,5
DAIHATSU	

55-06-619	
	Diam./Diam. [mm] 170
	Width/Largh. [mm] 27,5
DAIHATSU	

55-06-615	
	Diam./Diam. [mm] 170
	Width/Largh. [mm] 26
DAIHATSU	

55-06-620	
	Diam./Diam. [mm] 200
	Width/Largh. [mm] 37,5
PIAGGIO - DAIHATSU	

55-06-616	
	Diam./Diam. [mm] 170
	Width/Largh. [mm] 28
DAIHATSU	

55-06-699	
	Diam./Diam. [mm] 200
	Width/Largh. [mm] 38
PIAGGIO	

55-06-617	
	Diam./Diam. [mm] 180
	Width/Largh. [mm] 38
DAIHATSU	

55-07-700	
	Diam./Diam. [mm] 170
	Width/Largh. [mm] 29,6
SUBARU	

55-06-618	
	Diam./Diam. [mm] 180
	Width/Largh. [mm] 35
DAIHATSU	

55-07-701	
	Diam./Diam. [mm] 180
	Width/Largh. [mm] 31
SUBARU	

55-07-702	
	Diam./Diam. [mm] 206
	Width/Largh. [mm] 40
SUBARU	

55-07-710	
	Diam./Diam. [mm] 175
	Width/Largh. [mm] 31,6
SUBARU	

55-07-704	
	Diam./Diam. [mm] 180
	Width/Largh. [mm] 31
SUBARU	

55-07-711	
	Diam./Diam. [mm] 175
	Width/Largh. [mm] 35,7
SUBARU	

55-07-705	
	Diam./Diam. [mm] 180
	Width/Largh. [mm] 30,5
SUBARU	

55-07-797	
	Diam./Diam. [mm] 180
	Width/Largh. [mm] 26
SUBARU - SUZUKI	

55-07-707	
	Diam./Diam. [mm] 180
	Width/Largh. [mm] 31,5
SUBARU	

55-07-798	
	Diam./Diam. [mm] 230
	Width/Largh. [mm] 36,7
SUBARU	

55-07-709	
	Diam./Diam. [mm] 230
	Width/Largh. [mm] 36,5
SUBARU	

55-07-799	
	Diam./Diam. [mm] 180
	Width/Largh. [mm] 32
SUBARU	



55-08-800	
	Diam./Diam. [mm] 210
	Width/Largh. [mm] 34,7
SUZUKI	

55-08-806	
	Diam./Diam. [mm] 220
	Width/Largh. [mm] 40
SUZUKI	

55-08-801	
	Diam./Diam. [mm] 220
	Width/Largh. [mm] 40
SUZUKI	

55-08-807	
	Diam./Diam. [mm] 180
	Width/Largh. [mm] 31,3
SUZUKI	

55-08-802	
	Diam./Diam. [mm] 180
	Width/Largh. [mm] 35
SUZUKI	

55-08-808	
	Diam./Diam. [mm] 180
	Width/Largh. [mm] 31
SUZUKI - SUBARU - MARUTI	

55-08-804	
	Diam./Diam. [mm] 220
	Width/Largh. [mm] 40
SUZUKI	

55-08-809	
	Diam./Diam. [mm] 220
	Width/Largh. [mm] 40
SUZUKI - BEDFORD	

55-08-805	
	Diam./Diam. [mm] 180
	Width/Largh. [mm] 30
SUZUKI	

55-08-810	
	Diam./Diam. [mm] 220
	Width/Largh. [mm] 40
SUZUKI	

55-08-811	
	Diam./Diam. [mm] 200
	Width/Largh. [mm] 31,2
TATA (TELCO) - DAIHATSU - SUZUKI - SUBARU	

55-08-817	
	Diam./Diam. [mm] 220
	Width/Largh. [mm] 35
FIAT - SUZUKI	

55-08-812	
	Diam./Diam. [mm] 220
	Width/Largh. [mm] 35
SUZUKI	

55-08-818	
	Diam./Diam. [mm] 220
	Width/Largh. [mm] 41,5
SUZUKI	

55-08-813	
	Diam./Diam. [mm] 180
	Width/Largh. [mm] 26,5
SUZUKI	

55-08-820	
	Diam./Diam. [mm] 180
	Width/Largh. [mm] 26
SUZUKI	

55-08-814	
	Diam./Diam. [mm] 220
	Width/Largh. [mm] 34,8
SUZUKI	

55-08-821	
	Diam./Diam. [mm] 200
	Width/Largh. [mm] 29,2
SUZUKI - SUBARU	

55-08-815	
	Diam./Diam. [mm] 200
	Width/Largh. [mm] 32,1
SUZUKI	

55-08-822	
	Diam./Diam. [mm] 180
	Width/Largh. [mm] 26
SUZUKI	



55-08-824	
	Diam./Diam. [mm] 250
	Width/Largh. [mm] 41
SUZUKI	

55-08-898	
	Diam./Diam. [mm] 255
	Width/Largh. [mm] 46,5
SUZUKI	

55-08-825	
	Diam./Diam. [mm] 180
	Width/Largh. [mm] 26
SUZUKI - NISSAN	

55-08-899	
	Diam./Diam. [mm] 225
	Width/Largh. [mm] 41,3
SUZUKI	

55-08-830	
	Diam./Diam. [mm] 255
	Width/Largh. [mm] 46,5
SUZUKI	

55-09-900	
	Diam./Diam. [mm] 300
	Width/Largh. [mm] 46
ISUZU	

55-08-894	
	Diam./Diam. [mm] 255
	Width/Largh. [mm] 46,6
SUZUKI	

55-09-901	
	Diam./Diam. [mm] 255
	Width/Largh. [mm] 51,5
BEDFORD - ISUZU	

55-08-897	
	Diam./Diam. [mm] 220
	Width/Largh. [mm] 35,5
SUZUKI	

55-09-902	
	solo ferodo
	Diam./Diam. [mm] 310
	Width/Largh. [mm] 75
	Thickness/Spessore [mm] 9,8
ISUZU	

55-09-903	
	Diam./Diam. [mm] 210
	Width/Largh. [mm] 31
ISUZU	

55-09-909	
	Diam./Diam. [mm] 170
	Width/Largh. [mm] 32
DODGE - JEEP	

55-09-904	
	Diam./Diam. [mm] 255
	Width/Largh. [mm] 51,6
ISUZU - OPEL	

55-09-910	
	Diam./Diam. [mm] 210
	Width/Largh. [mm] 32
JEEP - DODGE	

55-09-906	
	Diam./Diam. [mm] 185
	Width/Largh. [mm] 31
JEEP	

55-09-911	
	Diam./Diam. [mm] 180
	Width/Largh. [mm] 30,5
CHRYSLER	

55-09-907	
	Diam./Diam. [mm] 195
	Width/Largh. [mm] 30
JEEP	

55-09-912	
	Diam./Diam. [mm] 254
	Width/Largh. [mm] 52
ISUZU	

55-09-908	
	Diam./Diam. [mm] 200
	Width/Largh. [mm] 31
JEEP	

55-09-913	
	Diam./Diam. [mm] 220
	Width/Largh. [mm] 42
CHRYSLER	



55-09-914	
 <p>NEW x4 914</p>	Diam./Diam. [mm] 200
	Width/Largh. [mm] 34
CHRYSLER	

55-09-999	
	Diam./Diam. [mm] 200
	Width/Largh. [mm] 46
OPEL	

55-09-915	
 <p>NEW x4 915</p>	Diam./Diam. [mm] 170
	Width/Largh. [mm] 20
CHRYSLER	

55-H0-001	
	Diam./Diam. [mm] 255
	Width/Largh. [mm] 57,4
HYUNDAI - DAEWOO - SSANGYONG	

55-09-991	
	Diam./Diam. [mm] 255
	Width/Largh. [mm] 51,5
OPEL	

55-H0-002	
	Diam./Diam. [mm] 270
	Width/Largh. [mm] 53,8
HYUNDAI	

55-09-995	
	Diam./Diam. [mm] 180
	Width/Largh. [mm] 26,7

55-H0-003	
	Diam./Diam. [mm] 230
	Width/Largh. [mm] 45
HYUNDAI	

55-09-996	
	Diam./Diam. [mm] 200
	Width/Largh. [mm] 29
OPEL	

55-H0-005	
	Diam./Diam. [mm] 180
	Width/Largh. [mm] 31,4
CHRYSLER - HYUNDAI	

55-H0-006	
	Diam./Diam. [mm] 205
	Width/Largh. [mm] 31,5
HYUNDAI	

55-0H-H12	
	Diam./Diam. [mm] 170
	Width/Largh. [mm] 32
HYUNDAI	

55-H0-007	
	Diam./Diam. [mm] 190
	Width/Largh. [mm] 40
HYUNDAI	

55-H0-013	
	Diam./Diam. [mm] 180
	Width/Largh. [mm] 37
HYUNDAI	

55-0H-H08	
	Diam./Diam. [mm] 260
	Width/Largh. [mm] 56,1
HYUNDAI	

55-0H-H15	
	Diam./Diam. [mm] 220
	Width/Largh. [mm] 46
HYUNDAI	

55-0H-H10	
	Diam./Diam. [mm] 190
	Width/Largh. [mm] 40
HYUNDAI	

55-K0-000	
	Diam./Diam. [mm] 230
	Width/Largh. [mm] 32,3
KIA	

55-0H-H11	
	Diam./Diam. [mm] 220
	Width/Largh. [mm] 61
HYUNDAI	

55-K0-001	
	Diam./Diam. [mm] 255
	Width/Largh. [mm] 57
KIA	

55-0K-004	
	Diam./Diam. [mm] 220
	Width/Largh. [mm] 57
KIA - HYUNDAI	

55-K0-013	
	Diam./Diam. [mm] 260
	Width/Largh. [mm] 51
KIA	

55-K0-007	
	Diam./Diam. [mm] 200
	Width/Largh. [mm] 26
KIA	

55-0K-K14	
	Diam./Diam. [mm] 300
	Width/Largh. [mm] 53,4
KIA	

55-K0-008	
	Diam./Diam. [mm] 230
	Width/Largh. [mm] 44,7
HYUNDAI - KIA	

55-0K-K15	
	Diam./Diam. [mm] 180
	Width/Largh. [mm] 32
KIA	

55-K0-011	
	Diam./Diam. [mm] 200
	Width/Largh. [mm] 31
KIA	

55-0K-K16	
	Diam./Diam. [mm] 170
	Width/Largh. [mm] 32
KIA	

55-K0-012	
	Diam./Diam. [mm] 200
	Width/Largh. [mm] 36,2
KIA	

55-0K-K17	
	Diam./Diam. [mm] 190
	Width/Largh. [mm] 39,5
KIA	

55-0K-K18	
<p>K18</p>	Diam./Diam. [mm] 170
	Width/Largh. [mm] 32
HYUNDAI - KIA	

55-0L-L00	
<p>L00</p>	Diam./Diam. [mm] 210
	Width/Largh. [mm] 30
LAND ROVER	

55-0K-K19	
<p>K19</p>	Diam./Diam. [mm] 190
	Width/Largh. [mm] 31
KIA	

55-0L-L01	
<p>L01</p>	Diam./Diam. [mm] 190
	Width/Largh. [mm] 30
LAND ROVER	

55-0K-K20	
<p>K20</p>	Diam./Diam. [mm] 190
	Width/Largh. [mm] 32
KIA	

55-0L-L02	
<p>L02</p>	Diam./Diam. [mm] 290
	Width/Largh. [mm] 57
LAND ROVER	

55-0K-K21	
<p>K21</p>	Diam./Diam. [mm] 170
	Width/Largh. [mm] 27
HYUNDAI - KIA	

55-0L-L03	
<p>L03</p>	Diam./Diam. [mm] 270
	Width/Largh. [mm] 38
LAND ROVER	

55-0K-K22	
<p>K22</p>	Diam./Diam. [mm] 190
	Width/Largh. [mm] 40
KIA	

55-0L-L04	
<p>L04</p>	Diam./Diam. [mm] 254
	Width/Largh. [mm] 39
LAND ROVER	



55-0L-L05	
	Diam./Diam. [mm] 260
	Width/Largh. [mm] 45
LAND ROVER	

55-M0-000	
	Diam./Diam. [mm] 200
	Width/Largh. [mm] 32
SMART	

55-0L-L06	
	Diam./Diam. [mm] 260
	Width/Largh. [mm] 69,5
LAND ROVER	

55-0S-S01	
	Diam./Diam. [mm] 190
	Width/Largh. [mm] 25
DAEWOO - SSANGYONG	

55-0L-L07	
	Diam./Diam. [mm] 260
	Width/Largh. [mm] 70
LAND ROVER	

55-0S-S02	
	Diam./Diam. [mm] 190
	Width/Largh. [mm] 26
SSANGYONG - KIA	

55-0L-L08	
	Diam./Diam. [mm] 210
	Width/Largh. [mm] 30
LAND ROVER	

55-0S-S03	
	Diam./Diam. [mm] 170
	Width/Largh. [mm] 26
SSANGYONG	

55-0L-L09	
	Diam./Diam. [mm] 210
	Width/Largh. [mm] 30
LAND ROVER	

55-S0-099	
	Diam./Diam. [mm] 260
	Width/Largh. [mm] 57,5
SSANGYONG	

55-W0-001	
	Diam./Diam. [mm] 180
	Width/Largh. [mm] 31
CHEVROLET - DAEWOO	

55-W0-002	
	Diam./Diam. [mm] 230
	Width/Largh. [mm] 51,2
DAEWOO - CHEVROLET	

55-W0-003	
	Diam./Diam. [mm] 200
	Width/Largh. [mm] 36,3
DAEWOO - CHEVROLET	

55-0W-W04	
	Freno di stazionamento
	Diam./Diam. [mm] 170
	Width/Largh. [mm] 26,5
DAEWOO	

55-0W-W05	
	Diam./Diam. [mm] 180
	Width/Largh. [mm] 26
CHEVROLET	

56-00-001	
	Inner Diam./Diam. int. [mm]
	203
	Inner Height/Altezza int. [mm]
	43
	Hub Bore Ø/Foro mozzo-Ø [mm]
64	
No. of Bores/N° fori	
4	
DR	

56-01-101	
	Inner Diam./Diam. int. [mm]
	228,4
	Inner Height/Altezza int. [mm]
	51,7
	Hub Bore Ø/Foro mozzo-Ø [mm]
68	
No. of Bores/N° fori	
4	
NISSAN	

56-00-005	
	Inner Diam./Diam. int. [mm]
	281,5
	Inner Height/Altezza int. [mm]
	62
	Hub Bore Ø/Foro mozzo-Ø [mm]
110	
No. of Bores/N° fori	
5	
TATA (TELCO)	

56-01-102	
	Inner Height/Altezza int. [mm]
	52
	No. of Bores/N° fori
	4
	Inner Diam./Diam. int. [mm]
228,6	
Hub Bore Ø/Foro mozzo-Ø [mm]	
68	
NISSAN	

56-00-098	
	Inner Diam./Diam. int. [mm]
	228,2
	Inner Height/Altezza int. [mm]
	79,4
	Hub Bore Ø/Foro mozzo-Ø [mm]
72	
No. of Bores/N° fori	
5	
JEEP	

56-01-103	
	Inner Diam./Diam. int. [mm]
	295
	Inner Height/Altezza int. [mm]
	69,5
	Hub Bore Ø/Foro mozzo-Ø [mm]
100	
No. of Bores/N° fori	
6	
NISSAN	

56-00-099	
	Inner Diam./Diam. int. [mm]
	253,8
	Inner Height/Altezza int. [mm]
	64,3
	Hub Bore Ø/Foro mozzo-Ø [mm]
72,3	
No. of Bores/N° fori	
5	
JEEP	

56-01-104	
	Inner Diam./Diam. int. [mm]
	203,2
	Inner Height/Altezza int. [mm]
	50,5
	Hub Bore Ø/Foro mozzo-Ø [mm]
52	
No. of Bores/N° fori	
4	
NISSAN	

56-01-100	
	Inner Diam./Diam. int. [mm]
	269,9
	Inner Height/Altezza int. [mm]
	64,4
	Hub Bore Ø/Foro mozzo-Ø [mm]
102	
No. of Bores/N° fori	
6	
NISSAN	

56-01-105	
	Inner Diam./Diam. int. [mm]
	180
	Inner Height/Altezza int. [mm]
	31,5
	Hub Bore Ø/Foro mozzo-Ø [mm]
60	
No. of Bores/N° fori	
4	
NISSAN	

56-01-106	
	Inner Diam./Diam. int. [mm]
	180
	Inner Height/Altezza int. [mm]
	38
	Hub Bore Ø/Foro mozzo-Ø [mm]
68	
No. of Bores/N° fori	4
NISSAN	

56-01-112	
	Inner Diam./Diam. int. [mm]
	204
	Inner Height/Altezza int. [mm]
	47
	Hub Bore Ø/Foro mozzo-Ø [mm]
55	
No. of Bores/N° fori	4
NISSAN	

56-01-107	
	Inner Diam./Diam. int. [mm]
	295
	Inner Height/Altezza int. [mm]
	69
	Hub Bore Ø/Foro mozzo-Ø [mm]
100,5	
No. of Bores/N° fori	6
NISSAN	

56-01-113	
	Inner Diam./Diam. int. [mm]
	260
	Inner Height/Altezza int. [mm]
	62
	Hub Bore Ø/Foro mozzo-Ø [mm]
100	
No. of Bores/N° fori	6
NISSAN	

56-01-108	
	Inner Diam./Diam. int. [mm]
	203
	Inner Height/Altezza int. [mm]
	45
	Hub Bore Ø/Foro mozzo-Ø [mm]
68	
No. of Bores/N° fori	4
NISSAN	

56-01-114	
	Inner Diam./Diam. int. [mm]
	253,5
	Inner Height/Altezza int. [mm]
	57
	Hub Bore Ø/Foro mozzo-Ø [mm]
100	
No. of Bores/N° fori	6
NISSAN	

56-01-109	
	Inner Diam./Diam. int. [mm]
	254
	Inner Height/Altezza int. [mm]
	65
	Hub Bore Ø/Foro mozzo-Ø [mm]
100	
No. of Bores/N° fori	6
NISSAN	

56-01-115	
	Inner Height/Altezza int. [mm]
	40
	No. of Bores/N° fori
	4
	Inner Diam./Diam. int. [mm]
203	
Hub Bore Ø/Foro mozzo-Ø [mm]	55
NISSAN	

56-01-111	
	Inner Diam./Diam. int. [mm]
	203
	Inner Height/Altezza int. [mm]
	43
	Hub Bore Ø/Foro mozzo-Ø [mm]
68	
No. of Bores/N° fori	4
NISSAN	

56-01-116	
	Inner Diam./Diam. int. [mm]
	180
	Inner Height/Altezza int. [mm]
	41
	Hub Bore Ø/Foro mozzo-Ø [mm]
48	
No. of Bores/N° fori	4
NISSAN	

56-01-117	
	Inner Diam./Diam. int. [mm]
	254
	Inner Height/Altezza int. [mm]
	63
	Hub Bore Ø/Foro mozzo-Ø [mm]
68	
No. of Bores/N° fori	
5	
NISSAN	

56-02-202	
	Inner Diam./Diam. int. [mm]
	228,4
	Inner Height/Altezza int. [mm]
	57,2
	Hub Bore Ø/Foro mozzo-Ø [mm]
55	
No. of Bores/N° fori	
5	
TOYOTA	

56-01-119	
<p style="text-align: center;">Image Not Available</p>	Inner Height/Altezza int. [mm]
	32,5
	No. of Bores/N° fori
	4
	Inner Diam./Diam. int. [mm]
180	
Hub Bore Ø/Foro mozzo-Ø [mm]	
61	
NISSAN	

56-02-203	
	Inner Diam./Diam. int. [mm]
	199,9
	Inner Height/Altezza int. [mm]
	44
	Hub Bore Ø/Foro mozzo-Ø [mm]
55	
No. of Bores/N° fori	
4	
CITROEN - PEUGEOT - TOYOTA	

56-01-120	
<p style="text-align: center;">Image Not Available</p>	Inner Height/Altezza int. [mm]
	72,5
	No. of Bores/N° fori
	6
	Pitch Circle Ø/Foro int.-Ø [mm]
68	
Inner Diam./Diam. int. [mm]	
295	
NISSAN	

56-02-204	
	Inner Diam./Diam. int. [mm]
	270
	Inner Height/Altezza int. [mm]
	65
	Hub Bore Ø/Foro mozzo-Ø [mm]
69	
No. of Bores/N° fori	
6	
TOYOTA	

56-02-200	
	Inner Diam./Diam. int. [mm]
	253,8
	Inner Height/Altezza int. [mm]
	62,2
	Hub Bore Ø/Foro mozzo-Ø [mm]
91,1	
No. of Bores/N° fori	
6	
TOYOTA	

56-02-205	
	Inner Diam./Diam. int. [mm]
	228
	Inner Height/Altezza int. [mm]
	50
	Hub Bore Ø/Foro mozzo-Ø [mm]
62	
No. of Bores/N° fori	
5	
TOYOTA	

56-02-201	
	Inner Diam./Diam. int. [mm]
	254
	Inner Height/Altezza int. [mm]
	62
	Hub Bore Ø/Foro mozzo-Ø [mm]
106	
No. of Bores/N° fori	
6	
TOYOTA	

56-02-206	
	Inner Diam./Diam. int. [mm]
	200
	Inner Height/Altezza int. [mm]
	42
	Hub Bore Ø/Foro mozzo-Ø [mm]
55	
No. of Bores/N° fori	
4	
TOYOTA	

56-02-207	
	Inner Diam./Diam. int. [mm]
	200
	Inner Height/Altezza int. [mm]
	55
	Hub Bore Ø/Foro mozzo-Ø [mm]
55	
No. of Bores/N° fori	
4	
TOYOTA	

56-02-212	
	Inner Diam./Diam. int. [mm]
	200
	Inner Height/Altezza int. [mm]
	41
	Hub Bore Ø/Foro mozzo-Ø [mm]
55	
No. of Bores/N° fori	
4	
TOYOTA	

56-02-208	
	Inner Diam./Diam. int. [mm]
	200
	Inner Height/Altezza int. [mm]
	55
	Hub Bore Ø/Foro mozzo-Ø [mm]
55	
No. of Bores/N° fori	
5	
TOYOTA	

56-02-213	
	Inner Diam./Diam. int. [mm]
	200
	Inner Height/Altezza int. [mm]
	43,5
	Hub Bore Ø/Foro mozzo-Ø [mm]
55	
No. of Bores/N° fori	
4	
TOYOTA	

56-02-209	
	Inner Diam./Diam. int. [mm]
	200
	Inner Height/Altezza int. [mm]
	58,5
	Hub Bore Ø/Foro mozzo-Ø [mm]
54	
No. of Bores/N° fori	
4	
TOYOTA	

56-02-214	
	Inner Diam./Diam. int. [mm]
	228,5
	Inner Height/Altezza int. [mm]
	52
	Hub Bore Ø/Foro mozzo-Ø [mm]
62	
No. of Bores/N° fori	
5	
TOYOTA	



56-02-210	
	Inner Diam./Diam. int. [mm]
	254
	Inner Height/Altezza int. [mm]
	63,5
	Hub Bore Ø/Foro mozzo-Ø [mm]
67	
No. of Bores/N° fori	
5	
TOYOTA - VW	

56-02-215	
	Inner Diam./Diam. int. [mm]
	200
	Inner Height/Altezza int. [mm]
	42
	Hub Bore Ø/Foro mozzo-Ø [mm]
55	
No. of Bores/N° fori	
4	
TOYOTA	



56-02-211	
	Inner Diam./Diam. int. [mm]
	200
	Inner Height/Altezza int. [mm]
	41,5
	Hub Bore Ø/Foro mozzo-Ø [mm]
55	
No. of Bores/N° fori	
5	
TOYOTA	

56-02-216	
	Inner Diam./Diam. int. [mm]
	202
	Inner Height/Altezza int. [mm]
	43
	Hub Bore Ø/Foro mozzo-Ø [mm]
55	
No. of Bores/N° fori	
4	
TOYOTA	







56-02-218	
  <p>218</p>	Inner Diam./Diam. int. [mm]
	200
	Inner Height/Altezza int. [mm]
	55
	Hub Bore Ø/Foro mozzo-Ø [mm]
54	
No. of Bores/N° fori	
4	
TOYOTA	



56-03-301	
	Inner Diam./Diam. int. [mm]
	180
	Inner Height/Altezza int. [mm]
	44
	Hub Bore Ø/Foro mozzo-Ø [mm]
54	
No. of Bores/N° fori	
4	
MAZDA	

56-02-219	
  <p>219</p>	Inner Diam./Diam. int. [mm]
	295
	Inner Height/Altezza int. [mm]
	64
	Hub Bore Ø/Foro mozzo-Ø [mm]
108	
No. of Bores/N° fori	
6	
TOYOTA	

56-03-302	
  <p>302</p>	Inner Diam./Diam. int. [mm]
	200
	Inner Height/Altezza int. [mm]
	32
	Hub Bore Ø/Foro mozzo-Ø [mm]
55	
No. of Bores/N° fori	
4	
MAZDA	

56-02-220	
  <p>220</p>	Inner Diam./Diam. int. [mm]
	270
	Inner Height/Altezza int. [mm]
	63
	Hub Bore Ø/Foro mozzo-Ø [mm]
67	
No. of Bores/N° fori	
5	
TOYOTA	



56-04-400	
  <p>400</p>	Inner Diam./Diam. int. [mm]
	219,5
	Inner Height/Altezza int. [mm]
	44,5
	Hub Bore Ø/Foro mozzo-Ø [mm]
64	
No. of Bores/N° fori	
5	
HONDA	

56-02-221	
  <p>221</p>	Inner Diam./Diam. int. [mm]
	295
	Inner Height/Altezza int. [mm]
	66
	Hub Bore Ø/Foro mozzo-Ø [mm]
106	
No. of Bores/N° fori	
6	
VW - TOYOTA	

56-04-402	
  <p>402</p>	Inner Diam./Diam. int. [mm]
	203
	Inner Height/Altezza int. [mm]
	46
	Hub Bore Ø/Foro mozzo-Ø [mm]
61	
No. of Bores/N° fori	
4	
HONDA	

56-03-300	
 <p>300</p>	Inner Diam./Diam. int. [mm]
	200
	Inner Height/Altezza int. [mm]
	40
	Hub Bore Ø/Foro mozzo-Ø [mm]
55	
No. of Bores/N° fori	
4	
MAZDA	

56-04-403	
  <p>403</p>	Inner Diam./Diam. int. [mm]
	200
	Inner Height/Altezza int. [mm]
	42
	Hub Bore Ø/Foro mozzo-Ø [mm]
61	
No. of Bores/N° fori	
4	
HONDA	

56-04-404	
  <p>404</p>	Inner Diam./Diam. int. [mm]
	180
	Inner Height/Altezza int. [mm]
	38
	Hub Bore Ø/Foro mozzo-Ø [mm]
	61
	No. of Bores/N° fori
	4
HONDA	



56-05-505	
 <p>505</p>	Inner Diam./Diam. int. [mm]
	180
	Inner Height/Altezza int. [mm]
	39
	Hub Bore Ø/Foro mozzo-Ø [mm]
	57,5
	No. of Bores/N° fori
	4
PROTON - MITSUBISHI	

56-04-415	
	Inner Diam./Diam. int. [mm]
	219,8
	Inner Height/Altezza int. [mm]
	45
	Hub Bore Ø/Foro mozzo-Ø [mm]
	61
	No. of Bores/N° fori
	4
HONDA	

56-05-506	
 <p>506</p>	Inner Diam./Diam. int. [mm]
	180
	Inner Height/Altezza int. [mm]
	40,6
	Hub Bore Ø/Foro mozzo-Ø [mm]
	64
	No. of Bores/N° fori
	4
PROTON - MITSUBISHI	

56-05-500	
 <p>500</p>	Inner Diam./Diam. int. [mm]
	254
	Inner Height/Altezza int. [mm]
	56,5
	Hub Bore Ø/Foro mozzo-Ø [mm]
	93,3
	No. of Bores/N° fori
	6
MITSUBISHI	

56-05-507	
  <p>507</p>	Inner Diam./Diam. int. [mm]
	203
	Inner Height/Altezza int. [mm]
	42
	Hub Bore Ø/Foro mozzo-Ø [mm]
	64
	No. of Bores/N° fori
	4
MITSUBISHI	

56-05-501	
  <p>501</p>	Inner Diam./Diam. int. [mm]
	202,5
	Inner Height/Altezza int. [mm]
	42
	Hub Bore Ø/Foro mozzo-Ø [mm]
	90
	No. of Bores/N° fori
	4
MITSUBISHI	

56-05-508	
 <p>508</p>	Inner Diam./Diam. int. [mm]
	270
	Inner Height/Altezza int. [mm]
	73
	Hub Bore Ø/Foro mozzo-Ø [mm]
	108
	No. of Bores/N° fori
	6
MITSUBISHI	

56-05-502	
 <p>502</p>	Drum Diam./Diam. tamburo
	203
	Inner Diam./Diam. int. [mm]
	42
	Hub Bore Ø/Foro mozzo-Ø [mm]
	90
	No. of Bores/N° fori
	4
MITSUBISHI	



56-05-509	
  <p>509</p>	Inner Diam./Diam. int. [mm]
	203
	Inner Height/Altezza int. [mm]
	42
	Hub Bore Ø/Foro mozzo-Ø [mm]
	90
	No. of Bores/N° fori
	4
MITSUBISHI	





56-05-510	
  510 MITSUBISHI	Inner Diam./Diam. int. [mm]
	228
	Inner Height/Altezza int. [mm]
	38
	Hub Bore Ø/Foro mozzo-Ø [mm]
90	
No. of Bores/N° fori	5



56-06-603	
Image Not Available	Inner Height/Altezza int. [mm]
	36
	No. of Bores/N° fori
	4
	Inner Diam./Diam. int. [mm]
180	
Hub Bore Ø/Foro mozzo-Ø [mm]	100
DAIHATSU	

56-05-511	
  511 MITSUBISHI	Inner Diam./Diam. int. [mm]
	295
	Inner Height/Altezza int. [mm]
	74
	Hub Bore Ø/Foro mozzo-Ø [mm]
94	
No. of Bores/N° fori	6



56-07-700	
  700 SUBARU	Inner Diam./Diam. int. [mm]
	228
	Inner Height/Altezza int. [mm]
	43
	Hub Bore Ø/Foro mozzo-Ø [mm]
58	
No. of Bores/N° fori	5

56-06-600	
  600 DAIHATSU	Inner Diam./Diam. int. [mm]
	165
	Inner Height/Altezza int. [mm]
	34
	Hub Bore Ø/Foro mozzo-Ø [mm]
51,7	
No. of Bores/N° fori	4

56-08-800	
 SUZUKI	Inner Diam./Diam. int. [mm]
	180
	Inner Height/Altezza int. [mm]
	42,2
	Hub Bore Ø/Foro mozzo-Ø [mm]
47	
No. of Bores/N° fori	4

56-06-601	
  DAIHATSU	Inner Diam./Diam. int. [mm]
	228,5
	Inner Height/Altezza int. [mm]
	55
	Hub Bore Ø/Foro mozzo-Ø [mm]
66,5	
No. of Bores/N° fori	5

56-08-801	
 SUZUKI	Inner Diam./Diam. int. [mm]
	220
	Inner Height/Altezza int. [mm]
	48,6
	Hub Bore Ø/Foro mozzo-Ø [mm]
57	
No. of Bores/N° fori	5

56-06-602	
  602 DAIHATSU	Inner Diam./Diam. int. [mm]
	254
	Inner Height/Altezza int. [mm]
	51
	Hub Bore Ø/Foro mozzo-Ø [mm]
107	
No. of Bores/N° fori	5

56-08-802	
 SUZUKI	Inner Diam./Diam. int. [mm]
	228,7
	Inner Height/Altezza int. [mm]
	50
	Hub Bore Ø/Foro mozzo-Ø [mm]
57	
No. of Bores/N° fori	5

56-08-803	
	Inner Diam./Diam. int. [mm]
	219,8
	Inner Height/Altezza int. [mm]
	41,4
	Hub Bore Ø/Foro mozzo-Ø [mm]
50	
No. of Bores/N° fori	
5	
SUZUKI	

56-08-812	
	Inner Diam./Diam. int. [mm]
	254
	Inner Height/Altezza int. [mm]
	63
	Hub Bore Ø/Foro mozzo-Ø [mm]
108	
No. of Bores/N° fori	
5	
SUZUKI	

56-08-805	
	Inner Diam./Diam. int. [mm]
	220
	Inner Height/Altezza int. [mm]
	53
	Hub Bore Ø/Foro mozzo-Ø [mm]
108	
No. of Bores/N° fori	
5	
SUZUKI	

56-08-813	
	Inner Diam./Diam. int. [mm]
	220
	Inner Height/Altezza int. [mm]
	49
	Hub Bore Ø/Foro mozzo-Ø [mm]
58	
No. of Bores/N° fori	
4	
SUZUKI	

56-08-808	
	Inner Diam./Diam. int. [mm]
	180
	Inner Height/Altezza int. [mm]
	34
	Hub Bore Ø/Foro mozzo-Ø [mm]
47	
No. of Bores/N° fori	
4	
SUZUKI	

56-08-814	
	Inner Diam./Diam. int. [mm]
	180
	Inner Height/Altezza int. [mm]
	51
	Hub Bore Ø/Foro mozzo-Ø [mm]
47	
No. of Bores/N° fori	
4	
SUZUKI	

56-08-810	
	Inner Diam./Diam. int. [mm]
	180
	Inner Height/Altezza int. [mm]
	35,5
	Hub Bore Ø/Foro mozzo-Ø [mm]
47	
No. of Bores/N° fori	
4	
SUZUKI	

56-08-815	
	Inner Diam./Diam. int. [mm]
	180
	Inner Height/Altezza int. [mm]
	38
	No. of Bores/N° fori
4	
Hub Bore Ø/Foro mozzo-Ø [mm]	
47	
SUZUKI	

56-08-811	
	Inner Diam./Diam. int. [mm]
	200
	Inner Height/Altezza int. [mm]
	41
	Hub Bore Ø/Foro mozzo-Ø [mm]
58	
No. of Bores/N° fori	
4	
SUZUKI	

56-08-816	
<p>Image Not Available</p>	Inner Height/Altezza int. [mm]
	54
	No. of Holes/N° fori
	5
	Inner Diam./Diam. int. [mm]
254	
Hub Bore Ø/Foro mozzo-Ø [mm]	
100	
SUZUKI	



56-08-817		
 <p>NEW</p> <p>817</p> <p>SUZUKI</p>	Inner Diam./Diam. int. [mm]	180
	Inner Height/Altezza int. [mm]	34,5
	Hub Bore Ø/Foro mozzo-Ø [mm]	47
	No. of Bores/N° fori	4

56-H0-000		
 <p>HYUNDAI</p>	Inner Diam./Diam. int. [mm]	254
	Inner Height/Altezza int. [mm]	65,8
	Hub Bore Ø/Foro mozzo-Ø [mm]	93,5
	No. of Bores/N° fori	6

56-09-900		
 <p>NEW</p> <p>900</p> <p>ISUZU</p>	Inner Diam./Diam. int. [mm]	254
	Inner Height/Altezza int. [mm]	60
	Hub Bore Ø/Foro mozzo-Ø [mm]	101
	No. of Bores/N° fori	6

56-H0-001		
 <p>HYUNDAI</p>	Inner Diam./Diam. int. [mm]	179,9
	Inner Height/Altezza int. [mm]	38,5
	Hub Bore Ø/Foro mozzo-Ø [mm]	90
	No. of Bores/N° fori	4

56-09-901		
 <p>NEW</p> <p>901</p> <p>CHRYSLER</p>	Inner Diam./Diam. int. [mm]	250
	Inner Height/Altezza int. [mm]	69
	Hub Bore Ø/Foro mozzo-Ø [mm]	72
	No. of Bores/N° fori	5

56-H0-002		
 <p>HYUNDAI</p>	Inner Diam./Diam. int. [mm]	253,9
	Inner Height/Altezza int. [mm]	65,8
	Hub Bore Ø/Foro mozzo-Ø [mm]	75
	No. of Bores/N° fori	5

56-09-902		
 <p>OPEL - ISUZU - BEDFORD</p>	Inner Diam./Diam. int. [mm]	254
	Inner Height/Altezza int. [mm]	60
	Hub Bore Ø/Foro mozzo-Ø [mm]	96,5
	No. of Bores/N° fori	6

56-H0-003		
 <p>HYUNDAI</p>	Inner Diam./Diam. int. [mm]	269,8
	Inner Height/Altezza int. [mm]	70
	Hub Bore Ø/Foro mozzo-Ø [mm]	75
	No. of Bores/N° fori	5

56-09-903		
 <p>NEW</p> <p>903</p> <p>ISUZU</p>	Inner Diam./Diam. int. [mm]	295
	Inner Height/Altezza int. [mm]	58
	Hub Bore Ø/Foro mozzo-Ø [mm]	101
	No. of Bores/N° fori	6

56-H0-004		
 <p>HYUNDAI</p>	Inner Diam./Diam. int. [mm]	203
	Inner Height/Altezza int. [mm]	47,5
	Hub Bore Ø/Foro mozzo-Ø [mm]	76
	No. of Bores/N° fori	4

56-H0-005	
	Inner Diam./Diam. int. [mm]
	253,7
	Inner Height/Altezza int. [mm]
	63
	Hub Bore Ø/Foro mozzo-Ø [mm]
	76
	No. of Bores/N° fori
	5
HYUNDAI	

56-0H-012	
	Inner Diam./Diam. int. [mm]
	180
	Inner Height/Altezza int. [mm]
	36
	Hub Bore Ø/Foro mozzo-Ø [mm]
	62,4
	No. of Bores/N° fori
	4
HYUNDAI	

56-H0-007	
	Inner Diam./Diam. int. [mm]
	270
	Inner Height/Altezza int. [mm]
	69
	Hub Bore Ø/Foro mozzo-Ø [mm]
	93,5
	No. of Bores/N° fori
	6
HYUNDAI	

56-H0-013	
	Inner Diam./Diam. int. [mm]
	180
	Inner Height/Altezza int. [mm]
	44
	Hub Bore Ø/Foro mozzo-Ø [mm]
	62,5
	No. of Bores/N° fori
	4
HYUNDAI	

56-H0-008	
	Inner Diam./Diam. int. [mm]
	180
	Inner Height/Altezza int. [mm]
	38,3
	Hub Bore Ø/Foro mozzo-Ø [mm]
	62,5
	No. of Bores/N° fori
	4
HYUNDAI	

56-H0-014	
	Inner Diam./Diam. int. [mm]
	228,7
	Inner Height/Altezza int. [mm]
	56
	Hub Bore Ø/Foro mozzo-Ø [mm]
	76
	No. of Bores/N° fori
	4
KIA - HYUNDAI	

56-H0-009	
	Inner Diam./Diam. int. [mm]
	203
	Inner Height/Altezza int. [mm]
	38,7
	Hub Bore Ø/Foro mozzo-Ø [mm]
	62,5
	No. of Bores/N° fori
	4
HYUNDAI	

56-H0-015	
	Inner Diam./Diam. int. [mm]
	180
	Inner Height/Altezza int. [mm]
	37,7
	Hub Bore Ø/Foro mozzo-Ø [mm]
	51,7
	No. of Bores/N° fori
	4
HYUNDAI	

56-H0-011	
	Inner Diam./Diam. int. [mm]
	203
	Inner Height/Altezza int. [mm]
	44
	Hub Bore Ø/Foro mozzo-Ø [mm]
	76
	No. of Bores/N° fori
	4
HYUNDAI	

56-0H-H16	
	Inner Diam./Diam. int. [mm]
	180
	Inner Height/Altezza int. [mm]
	45
	Hub Bore Ø/Foro mozzo-Ø [mm]
	76
	No. of Bores/N° fori
	4
HYUNDAI	



56-K0-000	
	Inner Diam./Diam. int. [mm]
	228,4
	Inner Height/Altezza int. [mm]
	37,3
	Hub Bore Ø/Foro mozzo-Ø [mm]
72	
No. of Bores/N° fori	
4	
KIA	

56-K0-005	
	Inner Diam./Diam. int. [mm]
	199,9
	Inner Height/Altezza int. [mm]
	41,7
	Hub Bore Ø/Foro mozzo-Ø [mm]
57	
No. of Bores/N° fori	
4	
KIA	

56-K0-001	
	Inner Diam./Diam. int. [mm]
	250
	Inner Height/Altezza int. [mm]
	66,4
	Hub Bore Ø/Foro mozzo-Ø [mm]
71	
No. of Bores/N° fori	
5	
KIA	

56-K0-006	
	Inner Diam./Diam. int. [mm]
	254
	Inner Height/Altezza int. [mm]
	64,7
	Hub Bore Ø/Foro mozzo-Ø [mm]
71	
No. of Bores/N° fori	
5	
KIA	

56-K0-002	
	Inner Diam./Diam. int. [mm]
	260
	Inner Height/Altezza int. [mm]
	60,6
	Hub Bore Ø/Foro mozzo-Ø [mm]
42,9	
No. of Bores/N° fori	
5	
KIA	

56-K0-008	
	Inner Diam./Diam. int. [mm]
	250
	Inner Height/Altezza int. [mm]
	68
	Hub Bore Ø/Foro mozzo-Ø [mm]
43	
No. of Bores/N° fori	
5	
KIA	

56-0K-K03	
	Inner Diam./Diam. int. [mm]
	260
	Inner Height/Altezza int. [mm]
	64
	Hub Bore Ø/Foro mozzo-Ø [mm]
93	
No. of Bores/N° fori	
6	
MAZDA - KIA - ASIA MOTORS	

56-K0-009	
	Inner Diam./Diam. int. [mm]
	200
	Inner Height/Altezza int. [mm]
	41,8
	Hub Bore Ø/Foro mozzo-Ø [mm]
58,6	
No. of Bores/N° fori	
4	
KIA	

56-K0-004	
	Inner Diam./Diam. int. [mm]
	228,6
	Inner Height/Altezza int. [mm]
	36
	Hub Bore Ø/Foro mozzo-Ø [mm]
72	
No. of Bores/N° fori	
4	
KIA	

56-K0-010	
	Inner Diam./Diam. int. [mm]
	200
	Inner Height/Altezza int. [mm]
	31,2
	Hub Bore Ø/Foro mozzo-Ø [mm]
46	
No. of Bores/N° fori	
4	
KIA	

56-K0-011	
	Inner Diam./Diam. int. [mm]
	200
	Inner Height/Altezza int. [mm]
	34,2
	Hub Bore Ø/Foro mozzo-Ø [mm]
46	
No. of Bores/N° fori	
4	
KIA	

56-OK-K16	
	NEW
	Per ruote gemellate
	Inner Diam./Diam. int. [mm]
	218
	Inner Height/Altezza int. [mm]
	73
Pitch Circle Ø/Foro int.-Ø [mm]	
84	
No. of Bores/N° fori	
5	
KIA	

56-K0-012	
	Inner Diam./Diam. int. [mm]
	200
	Inner Height/Altezza int. [mm]
	31
	Hub Bore Ø/Foro mozzo-Ø [mm]
46	
No. of Bores/N° fori	
4	
KIA	

56-OL-L00	
	NEW
	Inner Diam./Diam. int. [mm]
	254
	Inner Height/Altezza int. [mm]
	48
Hub Bore Ø/Foro mozzo-Ø [mm]	
66	
No. of Bores/N° fori	
5	
LAND ROVER	

56-K0-013	
	Inner Diam./Diam. int. [mm]
	200
	Inner Height/Altezza int. [mm]
	34
	Hub Bore Ø/Foro mozzo-Ø [mm]
46	
No. of Bores/N° fori	
4	
KIA	

56-OL-L01	
	NEW
	Fitting Position/Lato montaggio
	Assale anteriore/Front Axle
	Inner Diam./Diam. int. [mm]
	279
	Inner Height/Altezza int. [mm]
81	
Hub Bore Ø/Foro mozzo-Ø [mm]	
114	
No. of Bores/N° fori	
5	
LAND ROVER	

56-OK-014	
	Inner Diam./Diam. int. [mm]
	220
	Inner Height/Altezza int. [mm]
	69,6
	Hub Bore Ø/Foro mozzo-Ø [mm]
126	
No. of Bores/N° fori	
5	
KIA	

56-OL-L02	
	NEW
	Inner Diam./Diam. int. [mm]
	279
	Inner Height/Altezza int. [mm]
	68
Pitch Circle Ø/Foro int.-Ø [mm]	
114	
No. of Bores/N° fori	
5	
LAND ROVER	

56-OK-K15	
	NEW
	Inner Diam./Diam. int. [mm]
	180
	Inner Height/Altezza int. [mm]
	33
Hub Bore Ø/Foro mozzo-Ø [mm]	
62	
No. of Bores/N° fori	
4	
KIA	

56-OM-M00	
	NEW
	Inner Diam./Diam. int. [mm]
	203
	Inner Height/Altezza int. [mm]
	38
Hub Bore Ø/Foro mozzo-Ø [mm]	
58	
No. of Bores/N° fori	
3	
SMART	



56-W0-000		
	Inner Diam./Diam. int. [mm]	200
	Inner Height/Altezza int. [mm]	54,2
	Hub Bore Ø/Foro mozzo-Ø [mm]	57
	No. of Bores/N° fori	4
	Per veicoli con ABS/For vehicles with ABS	
DAEWOO - OPEL		

56-W0-006		
	Inner Diam./Diam. int. [mm]	200
	Inner Height/Altezza int. [mm]	40
	Hub Bore Ø/Foro mozzo-Ø [mm]	52,5
	No. of Bores/N° fori	4
	CHEVROLET - DAEWOO	

56-W0-001		
	Inner Diam./Diam. int. [mm]	200
	Inner Height/Altezza int. [mm]	52,5
	Hub Bore Ø/Foro mozzo-Ø [mm]	39,7
	No. of Bores/N° fori	4
	DAEWOO	

56-W0-007		
	Inner Diam./Diam. int. [mm]	200
	Inner Height/Altezza int. [mm]	40,7
	Hub Bore Ø/Foro mozzo-Ø [mm]	52,5
	No. of Bores/N° fori	4
	DAEWOO - CHEVROLET	

56-W0-002		
	Inner Diam./Diam. int. [mm]	180
	Inner Height/Altezza int. [mm]	40
	Hub Bore Ø/Foro mozzo-Ø [mm]	47
	No. of Bores/N° fori	4
	DAEWOO - CHEVROLET	

56-W0-003		
	Inner Diam./Diam. int. [mm]	230
	Inner Height/Altezza int. [mm]	60,2
	Hub Bore Ø/Foro mozzo-Ø [mm]	57
	No. of Bores/N° fori	4
	CHEVROLET - DAEWOO	

56-0W-W04		
	Inner Diam./Diam. int. [mm]	200
	Inner Height/Altezza int. [mm]	40
	Hub Bore Ø/Foro mozzo-Ø [mm]	57
	No. of Bores/N° fori	4
	CHEVROLET	

67-00-000	
	Bore Ø 1/Alesaggio-Ø 1 [mm] 20,6
	Fitted Diam./Diam. montaggio [mm] 29,8
INNOCENTI - LADA	

67-00-005	
	Bore Ø 1/Alesaggio-Ø 1 [mm] 20,5
	Fitted Diam./Diam. montaggio [mm] 38
JEEP	

67-00-001	
	Bore Ø 1/Alesaggio-Ø 1 [mm] 19
	Fitted Diam./Diam. montaggio [mm] 30
JEEP	

67-00-095	
	Bore Ø 1/Alesaggio-Ø 1 [mm] 20,6
	Fitted Diam./Diam. montaggio [mm] 29,9
CHRYSLER	

67-00-002	
	Bore Ø 1/Alesaggio-Ø 1 [mm] 17,4
	Fitted Diam./Diam. montaggio [mm] 35,8
TATA (TELCO)	

67-00-096	
	Bore Ø 1/Alesaggio-Ø 1 [mm] 19
	Fitted Diam./Diam. montaggio [mm] 29,9
CHRYSLER	

67-00-003	
	Bore Ø 1/Alesaggio-Ø 1 [mm] 22,3
	Fitted Diam./Diam. montaggio [mm] 34
TATA (TELCO)	

67-00-097	
	Bore Ø 1/Alesaggio-Ø 1 [mm] 19
	Fitted Diam./Diam. montaggio [mm] 29,8
CHRYSLER	

67-00-004	
	Bore Ø 1/Alesaggio-Ø 1 [mm] 17,4
	Fitted Diam./Diam. montaggio [mm] 35,6
TATA (TELCO)	

67-00-098	
	Bore Ø 1/Alesaggio-Ø 1 [mm] 22,2
	Fitted Diam./Diam. montaggio [mm] 38
JEEP	



67-00-099	
	Bore Ø 1/Alesaggio-Ø 1 [mm] 22,1
	Fitted Diam./Diam. montaggio [mm] 37,8
JEEP	

67-01-106	
	Bore Ø 1/Alesaggio-Ø 1 [mm] 22,1
	Fitted Diam./Diam. montaggio [mm] 32,9
NISSAN	

67-01-100	
	Bore Ø 1/Alesaggio-Ø 1 [mm] 15,8
	Fitted Diam./Diam. montaggio [mm] 32,5
NISSAN	

67-01-107	
	Bore Ø 1/Alesaggio-Ø 1 [mm] 15,8
	Fitted Diam./Diam. montaggio [mm] 31,4
NISSAN	

67-01-101	
	Bore Ø 1/Alesaggio-Ø 1 [mm] 17,4
	Fitted Diam./Diam. montaggio [mm] 32,7
NISSAN	

67-01-108	
	Bore Ø 1/Alesaggio-Ø 1 [mm] 23,9
	Fitted Diam./Diam. montaggio [mm] 32,8
NISSAN	

67-01-102	
	Bore Ø 1/Alesaggio-Ø 1 [mm] 20,6
	Fitted Diam./Diam. montaggio [mm] 32,8
NISSAN	

67-01-109	
	Bore Ø 1/Alesaggio-Ø 1 [mm] 17,4
	Fitted Diam./Diam. montaggio [mm] 33
NISSAN	

67-01-104	
	Bore Ø 1/Alesaggio-Ø 1 [mm] 20,6
	Fitted Diam./Diam. montaggio [mm] 32,9
NISSAN	

67-01-110	
	Bore Ø 1/Alesaggio-Ø 1 [mm] 22,2
	Fitted Diam./Diam. montaggio [mm] 32,9
NISSAN	

67-01-111	
	Bore Ø 1/Alesaggio-Ø 1 [mm] 23,8
	Fitted Diam./Diam. montaggio [mm] 35,8
NISSAN	

67-01-118	
	Bore Ø 1/Alesaggio-Ø 1 [mm] 22
	Fitted Diam./Diam. montaggio [mm] 33
NISSAN	

67-01-114	
	Bore Ø 1/Alesaggio-Ø 1 [mm] 22
	Fitted Diam./Diam. montaggio [mm] 31,6
NISSAN	

67-01-119	
	Bore Ø 1/Alesaggio-Ø 1 [mm] 25,3
	Fitted Diam./Diam. montaggio [mm] 36
NISSAN	

67-01-115	
	Bore Ø 1/Alesaggio-Ø 1 [mm] 25,3
	Fitted Diam./Diam. montaggio [mm] 35
NISSAN	

67-01-125	
	Bore Ø 1/Alesaggio-Ø 1 [mm] 19
	Fitted Diam./Diam. montaggio [mm] 29,9
NISSAN	

67-01-116	
	Bore Ø 1/Alesaggio-Ø 1 [mm] 25,3
	Fitted Diam./Diam. montaggio [mm] 32,4
NISSAN	

67-01-150	
	Bore Ø 1/Alesaggio-Ø 1 [mm] 22
	Fitted Diam./Diam. montaggio [mm] 32,9
NISSAN	

67-01-117	
	Bore Ø 1/Alesaggio-Ø 1 [mm] 16
	Fitted Diam./Diam. montaggio [mm] 15,5
NISSAN	

67-01-155	
	Bore Ø 1/Alesaggio-Ø 1 [mm] 22,1
	Fitted Diam./Diam. montaggio [mm] 34
NISSAN	

67-01-161	
	Bore Ø 1/Alesaggio-Ø 1 [mm] 20,6
	Fitted Diam./Diam. montaggio [mm] 35,2
NISSAN	

67-01-169	
	Bore Ø 1/Alesaggio-Ø 1 [mm] 17,4
	Fitted Diam./Diam. montaggio [mm] 31,2
NISSAN	

65-08-807	
	Bore Ø 1 [mm]/Alesaggio-Ø 1 [mm] 25,3
	Fitted Diam./Diam. montaggio [mm] 30
SUZUKI	

67-01-170	
	Bore Ø 1/Alesaggio-Ø 1 [mm] 17,4
	Fitted Diam./Diam. montaggio [mm] 32,4
NISSAN	

67-01-164	
	
NISSAN	

67-01-171	
	Bore Ø 1/Alesaggio-Ø 1 [mm] 20,6
	Fitted Diam./Diam. montaggio [mm] 32,8
NISSAN	

67-01-166	
	Bore Ø 1/Alesaggio-Ø 1 [mm] 19
	Fitted Diam./Diam. montaggio [mm] 32
NISSAN	

67-01-172	
	Bore Ø 1/Alesaggio-Ø 1 [mm] 22,2
	Fitted Diam./Diam. montaggio [mm] 31,6
NISSAN	

67-01-168	
	Bore Ø 1/Alesaggio-Ø 1 [mm] 17,4
	Fitted Diam./Diam. montaggio [mm] 32
NISSAN	

67-01-173	
	Bore Ø 1/Alesaggio-Ø 1 [mm] 23,8
	Fitted Diam./Diam. montaggio [mm] 33
NISSAN	

67-01-174	
	Bore Ø 1/Alesaggio-Ø 1 [mm]
	20,6
	Fitted Diam./Diam. montaggio [mm]
	32,8
NISSAN	

67-01-180	
	Bore Ø 1/Alesaggio-Ø 1 [mm]
	17,8
	Fitted Diam./Diam. montaggio [mm]
	33
NISSAN	

67-01-175	
	Bore Ø 1/Alesaggio-Ø 1 [mm]
	15,8
	Fitted Diam./Diam. montaggio [mm]
	31,9
NISSAN	

67-01-181	
	Bore Ø 1/Alesaggio-Ø 1 [mm]
	17,4
	Fitted Diam./Diam. montaggio [mm]
	32,9
NISSAN	

67-01-176	
	Bore Ø 1/Alesaggio-Ø 1 [mm]
	19
	Fitted Diam./Diam. montaggio [mm]
	33
NISSAN	

67-01-182	
	Bore Ø/Alesaggio-Ø [mm]
	15,9

67-01-178	
	Bore Ø 1/Alesaggio-Ø 1 [mm]
	20,7
	Fitted Diam./Diam. montaggio [mm]
	32,9
NISSAN	

67-01-183	
	Bore Ø 1/Alesaggio-Ø 1 [mm]
	22,1
	Fitted Diam./Diam. montaggio [mm]
	32,8
NISSAN	

67-01-179	
	Bore Ø 1/Alesaggio-Ø 1 [mm]
	19
	Fitted Diam./Diam. montaggio [mm]
	33
NISSAN	

67-01-186	
	Bore Ø 1/Alesaggio-Ø 1 [mm]
	22
	Fitted Diam./Diam. montaggio [mm]
	35,5
NISSAN	



67-01-187	
	Bore Ø 1/Alesaggio-Ø 1 [mm] 23,8
	Fitted Diam./Diam. montaggio [mm] 35
NISSAN	

67-01-192	
	Bore Ø 1/Alesaggio-Ø 1 [mm] 15,8
	Fitted Diam./Diam. montaggio [mm] 31,5
NISSAN	

67-01-188	
	Bore Ø 1/Alesaggio-Ø 1 [mm] 17,4
	Fitted Diam./Diam. montaggio [mm] 31,6
NISSAN	

67-01-193	
	Bore Ø 1/Alesaggio-Ø 1 [mm] 19
	Fitted Diam./Diam. montaggio [mm] 32,9
NISSAN	

67-01-189	
	Bore Ø 1/Alesaggio-Ø 1 [mm] 19
	Fitted Diam./Diam. montaggio [mm] 31,9
NISSAN	

67-01-194	
	Bore Ø 1/Alesaggio-Ø 1 [mm] 28,5
	Fitted Diam./Diam. montaggio [mm] 31,7
NISSAN	

67-01-190	
	Bore Ø 1/Alesaggio-Ø 1 [mm] 20,6
	Fitted Diam./Diam. montaggio [mm] 32,6
INFINITI - NISSAN	

67-01-195	
	Bore Ø 1/Alesaggio-Ø 1 [mm] 25,4
	Fitted Diam./Diam. montaggio [mm] 35,9
NISSAN	

67-01-191	
	Bore Ø 1/Alesaggio-Ø 1 [mm] 15,8
	Fitted Diam./Diam. montaggio [mm] 31,5
NISSAN	

67-01-196	
	Bore Ø 1/Alesaggio-Ø 1 [mm] 25,4
	Fitted Diam./Diam. montaggio [mm] 32,7
NISSAN	

67-01-199	
	Bore Ø 1/Alesaggio-Ø 1 [mm] 20,6
	Fitted Diam./Diam. montaggio [mm] 35,2
NISSAN	

67-02-206	
	Bore Ø 1/Alesaggio-Ø 1 [mm] 20,6
	Fitted Diam./Diam. montaggio [mm] 25,6
TOYOTA - DAIHATSU	

67-02-200	
	Bore Ø 1/Alesaggio-Ø 1 [mm] 19
	Fitted Diam./Diam. montaggio [mm] 25,8

67-02-207	
	Bore Ø 1/Alesaggio-Ø 1 [mm] 17,4
	Fitted Diam./Diam. montaggio [mm] 16,8
CITROEN - PEUGEOT - TOYOTA	

67-02-201	
	Bore Ø 1/Alesaggio-Ø 1 [mm] 20,6
	Fitted Diam./Diam. montaggio [mm] 34,4
TOYOTA	

67-02-208	
	Bore Ø 1/Alesaggio-Ø 1 [mm] 20,6
	Fitted Diam./Diam. montaggio [mm] 30
TOYOTA - DAIHATSU	

67-02-203	
	Bore Ø 1/Alesaggio-Ø 1 [mm] 20,6
	Fitted Diam./Diam. montaggio [mm] 28,6
TOYOTA	

67-02-209	
	Bore Ø 1/Alesaggio-Ø 1 [mm] 19
	Fitted Diam./Diam. montaggio [mm] 30
DAIHATSU - TOYOTA	

67-02-204	
	Bore Ø 1/Alesaggio-Ø 1 [mm] 16
	Fitted Diam./Diam. montaggio [mm] 29,8

67-02-210	
	Bore Ø 1/Alesaggio-Ø 1 [mm] 20,5
	Fitted Diam./Diam. montaggio [mm] 24
TOYOTA	

67-02-211	
 <p>211</p>	Bore Ø 1/Alesaggio-Ø 1 [mm] 22
	Fitted Diam./Diam. montaggio [mm] 32
TOYOTA	

67-02-217	
 <p>.217</p>	Bore Ø 1/Alesaggio-Ø 1 [mm] 17,4
	Fitted Diam./Diam. montaggio [mm] 23,4
TOYOTA	

67-02-212	
 <p>.212</p>	Bore Ø 1/Alesaggio-Ø 1 [mm] 20,6
	Fitted Diam./Diam. montaggio [mm] 32,7
TOYOTA	

67-02-218	
 <p>.218</p>	Bore Ø 1/Alesaggio-Ø 1 [mm] 25,3
	Fitted Diam./Diam. montaggio [mm] 34,7
TOYOTA	

67-02-213	
 <p>.213</p>	Bore Ø 1/Alesaggio-Ø 1 [mm] 19
	Fitted Diam./Diam. montaggio [mm] 30
TOYOTA	

67-02-219	
 <p>.219</p>	Bore Ø 1/Alesaggio-Ø 1 [mm] 19
	Fitted Diam./Diam. montaggio [mm] 23,3
TOYOTA	

67-02-215	
 <p>215</p>	Bore Ø 1/Alesaggio-Ø 1 [mm] 19
	Fitted Diam./Diam. montaggio [mm] 26
TOYOTA	

67-02-220	
 <p>.220</p>	Bore Ø 1/Alesaggio-Ø 1 [mm] 19
	Fitted Diam./Diam. montaggio [mm] 23,3
TOYOTA	

67-02-216	
 <p>.216</p>	Bore Ø 1/Alesaggio-Ø 1 [mm] 17,4
	Fitted Diam./Diam. montaggio [mm] 23,3
TOYOTA	

67-02-221	
 <p>.221</p>	Bore Ø 1/Alesaggio-Ø 1 [mm] 20,6
	Fitted Diam./Diam. montaggio [mm] 34,6
TOYOTA	

67-02-223	
	Bore Ø 1/Alesaggio-Ø 1 [mm] 24
	Fitted Diam./Diam. montaggio [mm] 35
TOYOTA	

67-02-243	
	Bore Ø 1/Alesaggio-Ø 1 [mm] 17,5
	Fitted Diam./Diam. montaggio [mm] 23,5
TOYOTA	

67-02-224	
	Bore Ø 1/Alesaggio-Ø 1 [mm] 20,5
	Fitted Diam./Diam. montaggio [mm] 35
TOYOTA	

67-02-249	
	Bore Ø 1/Alesaggio-Ø 1 [mm] 22,1
	Fitted Diam./Diam. montaggio [mm] 32,9
VW - TOYOTA	

67-02-225	
	Bore Ø 1/Alesaggio-Ø 1 [mm] 20,5
	Fitted Diam./Diam. montaggio [mm] 35
TOYOTA	

67-02-250	
	Bore Ø 1/Alesaggio-Ø 1 [mm] 25,3
	Fitted Diam./Diam. montaggio [mm] 34,8
TOYOTA	

67-02-240	
	Bore Ø 1/Alesaggio-Ø 1 [mm] 28,5
	Fitted Diam./Diam. montaggio [mm] 34,6
TOYOTA	

67-02-251	
	Bore Ø 1/Alesaggio-Ø 1 [mm] 23,8
	Fitted Diam./Diam. montaggio [mm] 34,7
TOYOTA	

67-02-241	
	Bore Ø 1/Alesaggio-Ø 1 [mm] 28,5
	Fitted Diam./Diam. montaggio [mm] 34,6
TOYOTA	

67-02-259	
	Bore Ø 1/Alesaggio-Ø 1 [mm] 17,4
	Fitted Diam./Diam. montaggio [mm] 31,8
TOYOTA	

67-02-274	
	Bore Ø 1/Alesaggio-Ø 1 [mm] 19
	Fitted Diam./Diam. montaggio [mm] 23,9
TOYOTA	

67-02-281	
	Bore Ø 1/Alesaggio-Ø 1 [mm] 23,8
	Fitted Diam./Diam. montaggio [mm] 36,9
TOYOTA	

67-02-275	
	Bore Ø 1/Alesaggio-Ø 1 [mm] 19
	Fitted Diam./Diam. montaggio [mm] 23,9
TOYOTA	

67-02-282	
	Bore Ø 1/Alesaggio-Ø 1 [mm] 23,8
	Fitted Diam./Diam. montaggio [mm] 36,9
TOYOTA	

67-02-278	
	Bore Ø 1/Alesaggio-Ø 1 [mm] 17,4
	Fitted Diam./Diam. montaggio [mm] 23,8
TOYOTA	

67-02-283	
	Bore Ø 1/Alesaggio-Ø 1 [mm] 23,8
	Fitted Diam./Diam. montaggio [mm] 36,9
TOYOTA	

67-02-279	
	Bore Ø 1/Alesaggio-Ø 1 [mm] 17,4
	Fitted Diam./Diam. montaggio [mm] 23,8
TOYOTA	

67-02-284	
	Bore Ø 1/Alesaggio-Ø 1 [mm] 23,9
	Fitted Diam./Diam. montaggio [mm] 36,9
TOYOTA	

67-02-280	
	Bore Ø 1/Alesaggio-Ø 1 [mm] 28,5
	Fitted Diam./Diam. montaggio [mm] 34,8
TOYOTA	

67-02-285	
	Bore Ø 1/Alesaggio-Ø 1 [mm] 32
	Fitted Diam./Diam. montaggio [mm] 37
TOYOTA	

67-02-286	
	Bore Ø 1/Alesaggio-Ø 1 [mm] 31,7
	Fitted Diam./Diam. montaggio [mm] 36,9
TOYOTA	

67-02-291	
	Bore Ø 1/Alesaggio-Ø 1 [mm] 22,1
	Fitted Diam./Diam. montaggio [mm] 30,2
TOYOTA	

67-02-287	
	Bore Ø 1/Alesaggio-Ø 1 [mm] 31,8
	Fitted Diam./Diam. montaggio [mm] 36,9
TOYOTA	

67-02-292	
	Bore Ø 1/Alesaggio-Ø 1 [mm] 20,5
	Fitted Diam./Diam. montaggio [mm] 30
TOYOTA	

67-02-288	
	Bore Ø 1/Alesaggio-Ø 1 [mm] 31,8
	Fitted Diam./Diam. montaggio [mm] 36,9
TOYOTA	

67-02-293	
	Bore Ø 1/Alesaggio-Ø 1 [mm] 22,1
	Fitted Diam./Diam. montaggio [mm] 30,3
MAZDA	

67-02-289	
	Bore Ø 1/Alesaggio-Ø 1 [mm] 19
	Fitted Diam./Diam. montaggio [mm] 32,9
TOYOTA	

67-02-294	
	Bore Ø 1/Alesaggio-Ø 1 [mm] 19
	Fitted Diam./Diam. montaggio [mm] 23,7
TOYOTA	

67-02-290	
	Bore Ø 1/Alesaggio-Ø 1 [mm] 22,1
	Fitted Diam./Diam. montaggio [mm] 34,9
TOYOTA	

67-02-295	
	Bore Ø 1/Alesaggio-Ø 1 [mm] 19
	Fitted Diam./Diam. montaggio [mm] 23,8
TOYOTA	



67-03-300	
	Bore Ø 1/Alesaggio-Ø 1 [mm] 20,6
	Fitted Diam./Diam. montaggio [mm] 31,3
MAZDA	

67-03-306	
	Bore Ø 1/Alesaggio-Ø 1 [mm] 19
	Fitted Diam./Diam. montaggio [mm] 32
MAZDA	

67-03-301	
	Bore Ø 1/Alesaggio-Ø 1 [mm] 19
	Fitted Diam./Diam. montaggio [mm] 30
MAZDA	

67-03-307	
	Bore Ø 1/Alesaggio-Ø 1 [mm] 23,8
	Fitted Diam./Diam. montaggio [mm] 35
MAZDA	

67-03-302	
	Bore Ø 1/Alesaggio-Ø 1 [mm] 19
	Fitted Diam./Diam. montaggio [mm] 29,9
MAZDA	

67-03-310	
	Bore Ø 1/Alesaggio-Ø 1 [mm] 19
	Fitted Diam./Diam. montaggio [mm] 30,8
MAZDA	

67-03-303	
	Bore Ø 1/Alesaggio-Ø 1 [mm] 19
	Fitted Diam./Diam. montaggio [mm] 30
MAZDA	

67-03-312	
	Bore Ø 1/Alesaggio-Ø 1 [mm] 17,4
	Fitted Diam./Diam. montaggio [mm] 30
MAZDA	

67-03-305	
	Bore Ø 1/Alesaggio-Ø 1 [mm] 23,7
	Fitted Diam./Diam. montaggio [mm] 32,6
MAZDA	

67-03-313	
	Bore Ø 1/Alesaggio-Ø 1 [mm] 17,4
	Fitted Diam./Diam. montaggio [mm] 29,4
MAZDA	

67-03-315	
 <p>315</p>	Bore Ø 1/Alesaggio-Ø 1 [mm] 22
	Fitted Diam./Diam. montaggio [mm] 34
MAZDA	

67-03-352	
	Bore Ø 1/Alesaggio-Ø 1 [mm] 19
	Fitted Diam./Diam. montaggio [mm] 32
MAZDA	

67-03-318	
 <p>318</p>	Bore Ø 1/Alesaggio-Ø 1 [mm] 20,6
	Fitted Diam./Diam. montaggio [mm] 30
MAZDA	

67-03-353	
 <p>.353</p>	Bore Ø 1/Alesaggio-Ø 1 [mm] 19
	Fitted Diam./Diam. montaggio [mm] 30,3
MAZDA	

67-03-325	
 <p>.325</p>	Bore Ø 1/Alesaggio-Ø 1 [mm] 22,1
	Fitted Diam./Diam. montaggio [mm] 29,8
ASIA MOTORS	

67-03-354	
 <p>.354</p>	Bore Ø 1/Alesaggio-Ø 1 [mm] 20,6
	Fitted Diam./Diam. montaggio [mm] 31,6
MAZDA	

67-03-350	
 <p>.350</p>	Bore Ø 2/Alesaggio-Ø 2 [mm] 22,2
	Fitted Diam./Diam. montaggio [mm] 32

67-03-355	
 <p>.355</p>	Bore Ø 1/Alesaggio-Ø 1 [mm] 20,6
	Fitted Diam./Diam. montaggio [mm] 30,2
MAZDA	

67-03-351	
 <p>.351</p>	Bore Ø 1/Alesaggio-Ø 1 [mm] 22,2
	Fitted Diam./Diam. montaggio [mm] 32

67-03-356	
 <p>.356</p>	Bore Ø 1/Alesaggio-Ø 1 [mm] 20,6
	Fitted Diam./Diam. montaggio [mm] 31,7
MAZDA	

67-03-357	
	Bore Ø 1/Alesaggio-Ø 1 [mm] 20,6
	Fitted Diam./Diam. montaggio [mm] 32,2
MAZDA	

67-03-363	
	Bore Ø 1/Alesaggio-Ø 1 [mm] 22,1
	Fitted Diam./Diam. montaggio [mm] 30
MAZDA	

67-03-358	
	Bore Ø 1/Alesaggio-Ø 1 [mm] 17,4
	Fitted Diam./Diam. montaggio [mm] 32
MAZDA	

67-03-364	
	Bore Ø 1/Alesaggio-Ø 1 [mm] 17,4
	Fitted Diam./Diam. montaggio [mm] 31,3
MAZDA	

67-03-359	
	Bore Ø 1/Alesaggio-Ø 1 [mm] 17,4
	Fitted Diam./Diam. montaggio [mm] 32,1
MAZDA	

67-03-365	
	Bore Ø 1/Alesaggio-Ø 1 [mm] 17,4
	Fitted Diam./Diam. montaggio [mm] 31,4
MAZDA	

67-03-361	
	Diam./Diam. [mm] 19
MAZDA	

67-03-366	
	Bore Ø 1/Alesaggio-Ø 1 [mm] 25,3
	Fitted Diam./Diam. montaggio [mm] 30
MAZDA	

67-03-362	
	Bore Ø 1/Alesaggio-Ø 1 [mm] 22,2
	Fitted Diam./Diam. montaggio [mm] 30,4
MAZDA	

67-03-367	
	Bore Ø 1/Alesaggio-Ø 1 [mm] 25,4
	Fitted Diam./Diam. montaggio [mm] 30
MAZDA	

67-03-368	
	Bore Ø 1/Alesaggio-Ø 1 [mm] 17,4
	Fitted Diam./Diam. montaggio [mm] 30
MAZDA	

67-03-379	
	Bore Ø 1/Alesaggio-Ø 1 [mm] 17,4
	Fitted Diam./Diam. montaggio [mm] 28,2
MAZDA	

67-03-369	
	Bore Ø 1/Alesaggio-Ø 1 [mm] 17,5
	Fitted Diam./Diam. montaggio [mm] 30
MAZDA	

67-03-394	
	Bore Ø 1/Alesaggio-Ø 1 [mm] 19
	Fitted Diam./Diam. montaggio [mm] 30,8
MAZDA	

67-03-370	
	Bore Ø 1/Alesaggio-Ø 1 [mm] 17,4
	Fitted Diam./Diam. montaggio [mm] 30,3

67-03-395	
	Bore Ø 1/Alesaggio-Ø 1 [mm] 19
	Fitted Diam./Diam. montaggio [mm] 30,5
MAZDA	

67-03-371	
	Bore Ø 1/Alesaggio-Ø 1 [mm] 17,4
	Fitted Diam./Diam. montaggio [mm] 29,3
MAZDA	

67-03-396	
	Bore Ø 1/Alesaggio-Ø 1 [mm] 17,5
	Fitted Diam./Diam. montaggio [mm] 31,2
MAZDA	

67-03-373	
	Bore Ø 1/Alesaggio-Ø 1 [mm] 17,5
	Fitted Diam./Diam. montaggio [mm] 32,2
KIA	

67-03-397	
	Bore Ø 1/Alesaggio-Ø 1 [mm] 17,4
	Fitted Diam./Diam. montaggio [mm] 30
MAZDA	

67-03-398	
	Bore Ø 1/Alesaggio-Ø 1 [mm] 19
	Fitted Diam./Diam. montaggio [mm] 32
MAZDA	

67-04-406	
	Bore Ø 1/Alesaggio-Ø 1 [mm] 17,7
	Fitted Diam./Diam. montaggio [mm] 33,8
HONDA	

67-03-399	
	Bore Ø 1/Alesaggio-Ø 1 [mm] 15,8
	Fitted Diam./Diam. montaggio [mm] 29,6
MAZDA	

67-04-407	
	Bore Ø 1/Alesaggio-Ø 1 [mm] 19
	Fitted Diam./Diam. montaggio [mm] 32,3
HONDA	

67-04-400	
	Bore Ø 1/Alesaggio-Ø 1 [mm] 17,4
	Fitted Diam./Diam. montaggio [mm] 34,3
HONDA	

67-04-410	
	Bore Ø 1/Alesaggio-Ø 1 [mm] 19
	Fitted Diam./Diam. montaggio [mm] 37,5
HONDA - ROVER	

67-04-403	
	Bore Ø 1/Alesaggio-Ø 1 [mm] 19
	Fitted Diam./Diam. montaggio [mm] 34
HONDA - TRIUMPH	

67-04-435	
	Bore Ø 1/Alesaggio-Ø 1 [mm] 17,4
	Fitted Diam./Diam. montaggio [mm] 30,4
HONDA	

67-04-404	
	Bore Ø 1/Alesaggio-Ø 1 [mm] 19
	Fitted Diam./Diam. montaggio [mm] 34,2

67-04-436	
	Bore Ø 1/Alesaggio-Ø 1 [mm] 19
	Fitted Diam./Diam. montaggio [mm] 33,8
HONDA	

67-04-450	
	Bore Ø 1/Alesaggio-Ø 1 [mm] 17,4
	Fitted Diam./Diam. montaggio [mm] 33,3
ROVER - HONDA - TRIUMPH	

67-04-455	
	Bore Ø 1/Alesaggio-Ø 1 [mm] 19
	Fitted Diam./Diam. montaggio [mm] 32,2
HONDA	

67-04-451	
	Bore Ø 1/Alesaggio-Ø 1 [mm] 19
	Fitted Diam./Diam. montaggio [mm] 32
ROVER - HONDA	

67-04-456	
	Bore Ø 1/Alesaggio-Ø 1 [mm] 19
	Fitted Diam./Diam. montaggio [mm] 33,3
HONDA	

67-04-452	
	Bore Ø 1/Alesaggio-Ø 1 [mm] 20,6
	Fitted Diam./Diam. montaggio [mm] 32,4
HONDA	

67-04-457	
	Bore Ø 1/Alesaggio-Ø 1 [mm] 19
	Fitted Diam./Diam. montaggio [mm] 34,2
HONDA - SUZUKI	

67-04-453	
	Bore Ø 1/Alesaggio-Ø 1 [mm] 19
	Fitted Diam./Diam. montaggio [mm] 32,2
HONDA	

67-04-459	
	Bore Ø 1/Alesaggio-Ø 1 [mm] 19
	Fitted Diam./Diam. montaggio [mm] 34
HONDA	

67-04-454	
	Bore Ø 1/Alesaggio-Ø 1 [mm] 19
	Fitted Diam./Diam. montaggio [mm] 33,8
HONDA	

67-04-460	
	Bore Ø 1/Alesaggio-Ø 1 [mm] 20,6
	Fitted Diam./Diam. montaggio [mm] 33,7
HONDA	

67-04-461	
	Bore Ø 1/Alesaggio-Ø 1 [mm] 20,5
	Fitted Diam./Diam. montaggio [mm] 34
HONDA	

67-05-503	
	Bore Ø 1/Alesaggio-Ø 1 [mm] 19
	Fitted Diam./Diam. montaggio [mm] 30
HYUNDAI - MITSUBISHI	

67-04-499	
	Bore Ø 1/Alesaggio-Ø 1 [mm] 20,6
	Fitted Diam./Diam. montaggio [mm] 33,7

67-05-508	
	Bore Ø 1/Alesaggio-Ø 1 [mm] 17,4
	Fitted Diam./Diam. montaggio [mm] 29,9
MITSUBISHI	

67-05-500	
	Bore Ø 1/Alesaggio-Ø 1 [mm] 20,6
	Fitted Diam./Diam. montaggio [mm] 30
MITSUBISHI	

67-05-509	
	Bore Ø 1/Alesaggio-Ø 1 [mm] 17,4
	Fitted Diam./Diam. montaggio [mm] 30
MITSUBISHI	

67-05-501	
	Bore Ø 1/Alesaggio-Ø 1 [mm] 20,6
	Fitted Diam./Diam. montaggio [mm] 30,3
MITSUBISHI	

67-05-514	
	Bore Ø 1/Alesaggio-Ø 1 [mm] 19
	Fitted Diam./Diam. montaggio [mm] 31,4
MITSUBISHI	

67-05-502	
	Bore Ø 1/Alesaggio-Ø 1 [mm] 19
	Fitted Diam./Diam. montaggio [mm] 29,9
MITSUBISHI - HYUNDAI	

67-05-517	
	Bore Ø 1/Alesaggio-Ø 1 [mm] 17,4
	Fitted Diam./Diam. montaggio [mm] 29,8

67-05-525	
	Bore Ø/Alesaggio-Ø [mm] 19,05
	SMART - MITSUBISHI

67-05-532	
	Bore Ø 1/Alesaggio-Ø 1 [mm] 19
	Fitted Diam./Diam. montaggio [mm] 30,1
	HYUNDAI - MITSUBISHI

67-05-526	
 	Fitted Diam./Diam. montaggio [mm] 30
	Bore Ø 1/Alesaggio-Ø 1 [mm] 24
	MITSUBISHI

67-05-533	
	Bore Ø 1/Alesaggio-Ø 1 [mm] 20,6
	Fitted Diam./Diam. montaggio [mm] 30
	MITSUBISHI

67-05-527	
	Bore Ø 1/Alesaggio-Ø 1 [mm] 23,8
	Fitted Diam./Diam. montaggio [mm] 35
	TOYOTA

67-05-534	
	Bore Ø 1/Alesaggio-Ø 1 [mm] 20,5
	Fitted Diam./Diam. montaggio [mm] 30
	MITSUBISHI

67-05-528	
 	Fitted Diam./Diam. montaggio [mm] 30
	Bore Ø 1/Alesaggio-Ø 1 [mm] 24
	MITSUBISHI

67-05-535	
	Bore Ø 1/Alesaggio-Ø 1 [mm] 20,6
	Fitted Diam./Diam. montaggio [mm] 29,9
	MITSUBISHI

67-05-531	
	Bore Ø 1/Alesaggio-Ø 1 [mm] 19
	Fitted Diam./Diam. montaggio [mm] 30,1
	MITSUBISHI

67-05-536	
	Bore Ø 1/Alesaggio-Ø 1 [mm] 17,4
	Fitted Diam./Diam. montaggio [mm] 30
	MITSUBISHI

67-05-537	
	Bore Ø 1/Alesaggio-Ø 1 [mm] 22,2
	Fitted Diam./Diam. montaggio [mm] 30,3
MITSUBISHI	

67-05-572	
	Bore Ø 1/Alesaggio-Ø 1 [mm] 20,6
	Fitted Diam./Diam. montaggio [mm] 37,3
HYUNDAI	

67-05-538	
	Bore Ø 1/Alesaggio-Ø 1 [mm] 22
	Fitted Diam./Diam. montaggio [mm] 30
MITSUBISHI	

67-05-573	
	Bore Ø 1/Alesaggio-Ø 1 [mm] 20,6
	Fitted Diam./Diam. montaggio [mm] 37,9
HYUNDAI	

67-05-539	
	Bore Ø 1/Alesaggio-Ø 1 [mm] 17,4
	Fitted Diam./Diam. montaggio [mm] 15,5
MITSUBISHI	

67-05-574	
	Bore Ø 1/Alesaggio-Ø 1 [mm] 20,6
	Fitted Diam./Diam. montaggio [mm] 37,5
HYUNDAI	

67-05-569	
	Bore Ø 1/Alesaggio-Ø 1 [mm] 20,6
	Fitted Diam./Diam. montaggio [mm] 30,3
DAIHATSU - MITSUBISHI	

67-05-575	
	Bore Ø 1/Alesaggio-Ø 1 [mm] 19
	Fitted Diam./Diam. montaggio [mm] 37,6
HYUNDAI	

67-05-571	
	Bore Ø 1/Alesaggio-Ø 1 [mm] 20,6
	Fitted Diam./Diam. montaggio [mm] 37,5
HYUNDAI	

67-05-576	
	Bore Ø 1/Alesaggio-Ø 1 [mm] 19
	Fitted Diam./Diam. montaggio [mm] 37,6
HYUNDAI	

67-05-577	
	Bore Ø 1/Alesaggio-Ø 1 [mm] 19
	Fitted Diam./Diam. montaggio [mm] 37,7
HYUNDAI	

67-05-583	
	Bore Ø 1/Alesaggio-Ø 1 [mm] 28,6
	Fitted Diam./Diam. montaggio [mm] 31,9
MITSUBISHI	

67-05-579	
	Bore Ø 1/Alesaggio-Ø 1 [mm] 19
	Fitted Diam./Diam. montaggio [mm] 15,5
PROTON - MITSUBISHI	

67-05-584	
	Bore Ø 1/Alesaggio-Ø 1 [mm] 28,5
	Fitted Diam./Diam. montaggio [mm] 31,8
MITSUBISHI	

67-05-580	
	Bore Ø 1/Alesaggio-Ø 1 [mm] 28,6
	Fitted Diam./Diam. montaggio [mm] 31,9
MITSUBISHI	

67-05-585	
	Bore Ø 1/Alesaggio-Ø 1 [mm] 28,5
	Fitted Diam./Diam. montaggio [mm] 31,8
MITSUBISHI	

67-05-581	
	Bore Ø 1/Alesaggio-Ø 1 [mm] 28,5
	Fitted Diam./Diam. montaggio [mm] 32
MITSUBISHI	

67-05-586	
	Bore Ø 1/Alesaggio-Ø 1 [mm] 28,5
	Fitted Diam./Diam. montaggio [mm] 31,9
MITSUBISHI	

67-05-582	
	Bore Ø 1/Alesaggio-Ø 1 [mm] 28,5
	Fitted Diam./Diam. montaggio [mm] 32
MITSUBISHI	

67-05-587	
	Bore Ø 1/Alesaggio-Ø 1 [mm] 28,5
	Fitted Diam./Diam. montaggio [mm] 31,7
MITSUBISHI	



67-05-588	
	Bore Ø 1/Alesaggio-Ø 1 [mm] 22,1
	Fitted Diam./Diam. montaggio [mm] 31,9
MITSUBISHI	

67-05-595	
	Bore Ø 1/Alesaggio-Ø 1 [mm] 19
	Fitted Diam./Diam. montaggio [mm] 15,5
MITSUBISHI	

67-05-589	
	Bore Ø 1/Alesaggio-Ø 1 [mm] 19
	Fitted Diam./Diam. montaggio [mm] 38,2
HYUNDAI	

67-05-596	
	Bore Ø 1/Alesaggio-Ø 1 [mm] 19
	Fitted Diam./Diam. montaggio [mm] 30,1
MITSUBISHI	

67-05-590	
	Bore Ø 1/Alesaggio-Ø 1 [mm] 19
	Fitted Diam./Diam. montaggio [mm] 37,1
HYUNDAI	

67-05-597	
	Bore Ø 1/Alesaggio-Ø 1 [mm] 20,6
	Fitted Diam./Diam. montaggio [mm] 29,8
HYUNDAI	

67-05-593	
	Bore Ø 1/Alesaggio-Ø 1 [mm] 23,8
	Fitted Diam./Diam. montaggio [mm] 29,8
MITSUBISHI	

67-05-598	
	Bore Ø 1/Alesaggio-Ø 1 [mm] 20,6
	Fitted Diam./Diam. montaggio [mm] 32,4
HYUNDAI	

67-05-594	
	Bore Ø 1/Alesaggio-Ø 1 [mm] 23,7
	Fitted Diam./Diam. montaggio [mm] 29,9
MITSUBISHI	

67-05-599	
	Bore Ø 1/Alesaggio-Ø 1 [mm] 20,6
	Fitted Diam./Diam. montaggio [mm] 30
HYUNDAI	

67-06-600	
	Bore Ø 1/Alesaggio-Ø 1 [mm] 15,8
	Fitted Diam./Diam. montaggio [mm] 25
DAIHATSU	

67-06-607	
	Bore Ø 1/Alesaggio-Ø 1 [mm] 17,4
	Fitted Diam./Diam. montaggio [mm] 32,5
DAIHATSU	

67-06-601	
	Bore Ø 1/Alesaggio-Ø 1 [mm] 17,4
	Fitted Diam./Diam. montaggio [mm] 32,2
DAIHATSU	

67-06-608	
	Bore Ø 1/Alesaggio-Ø 1 [mm] 17,4
	Fitted Diam./Diam. montaggio [mm] 30,8
DAIHATSU	

67-06-602	
	Bore Ø 1/Alesaggio-Ø 1 [mm] 19
	Fitted Diam./Diam. montaggio [mm] 24,6
DAIHATSU	

67-06-609	
	Bore Ø 1/Alesaggio-Ø 1 [mm] 17,4
	Fitted Diam./Diam. montaggio [mm] 35,7
DAIHATSU	

67-06-603	
	Bore Ø 1/Alesaggio-Ø 1 [mm] 22,2
	Fitted Diam./Diam. montaggio [mm] 29,9
DAIHATSU	

67-06-611	
	Bore Ø 1/Alesaggio-Ø 1 [mm] 14,2
	Fitted Diam./Diam. montaggio [mm] 27,7
DAIHATSU	

67-06-606	
	Bore Ø 1/Alesaggio-Ø 1 [mm] 14,2
	Fitted Diam./Diam. montaggio [mm] 33,6
DAIHATSU	

67-06-612	
	Bore Ø 1/Alesaggio-Ø 1 [mm] 22,1
	Fitted Diam./Diam. montaggio [mm] 29,9
DAIHATSU	

67-06-613	
	Bore Ø 1/Alesaggio-Ø 1 [mm] 15,9
	Fitted Diam./Diam. montaggio [mm] 35,5
DAIHATSU	

67-06-630	
	Bore Ø 1/Alesaggio-Ø 1 [mm] 17,4
	Fitted Diam./Diam. montaggio [mm] 23,8
DAIHATSU - SUBARU	

67-06-614	
	Bore Ø 1/Alesaggio-Ø 1 [mm] 25,3
	Fitted Diam./Diam. montaggio [mm] 34,9
DAIHATSU	

67-06-631	
	Bore Ø 1/Alesaggio-Ø 1 [mm] 17,4
	Fitted Diam./Diam. montaggio [mm] 23,8
DAIHATSU - SUBARU	

67-06-615	
	Bore Ø 1/Alesaggio-Ø 1 [mm] 17,4
	Fitted Diam./Diam. montaggio [mm] 35
DAIHATSU	

67-06-632	
	Bore Ø 1/Alesaggio-Ø 1 [mm] 17,4
	Fitted Diam./Diam. montaggio [mm] 27,3
DAIHATSU	

67-06-616	
	Bore Ø 1/Alesaggio-Ø 1 [mm] 22,2
	Fitted Diam./Diam. montaggio [mm] 35
DAIHATSU	

67-06-699	
	Bore Ø 1/Alesaggio-Ø 1 [mm] 17,5
	Fitted Diam./Diam. montaggio [mm] 29,9
PIAGGIO	

67-06-618	
	Bore Ø 1/Alesaggio-Ø 1 [mm] 17,4
	Fitted Diam./Diam. montaggio [mm] 30,5
DAIHATSU	

67-07-700	
	Bore Ø 1/Alesaggio-Ø 1 [mm] 15,8
	Fitted Diam./Diam. montaggio [mm] 17
SUBARU	

67-07-702	
	Bore Ø 1/Alesaggio-Ø 1 [mm] 14,2
	Fitted Diam./Diam. montaggio [mm] 17,4
SUBARU	

67-07-707	
	Bore Ø 1/Alesaggio-Ø 1 [mm] 17,5
	Fitted Diam./Diam. montaggio [mm] 16,2
SUBARU	

67-07-703	
	Bore Ø 1/Alesaggio-Ø 1 [mm] 17,4
	Fitted Diam./Diam. montaggio [mm] 29,7
SUBARU	

67-07-708	
	Bore Ø/Alesaggio-Ø [mm] 14,3
SUBARU	

67-07-704	
	Bore Ø 1/Alesaggio-Ø 1 [mm] 17,4
	Fitted Diam./Diam. montaggio [mm] 17
SUBARU	

67-07-709	
	Bore Ø 1/Alesaggio-Ø 1 [mm] 17,5
	Fitted Diam./Diam. montaggio [mm] 28
SUBARU	

67-07-705	
	Bore Ø 1/Alesaggio-Ø 1 [mm] 19
	Fitted Diam./Diam. montaggio [mm] 29,9
SUBARU	

67-07-711	
	Bore Ø 1/Alesaggio-Ø 1 [mm] 19
	Fitted Diam./Diam. montaggio [mm] 17
SUBARU	

67-07-706	
	Bore Ø 1/Alesaggio-Ø 1 [mm] 17,5
	Fitted Diam./Diam. montaggio [mm] 16,6
SUBARU	

67-07-712	
	Bore Ø 1/Alesaggio-Ø 1 [mm] 19
	Fitted Diam./Diam. montaggio [mm] 30,5
SUBARU	

67-07-713	
	Bore Ø 1/Alesaggio-Ø 1 [mm] 17,4
	Fitted Diam./Diam. montaggio [mm] 30,4
SUBARU	

67-08-802	
	Bore Ø 1/Alesaggio-Ø 1 [mm] 22,2
	Fitted Diam./Diam. montaggio [mm] 29,1
SUZUKI	

67-07-798	
	Bore Ø 1/Alesaggio-Ø 1 [mm] 14,2
	Fitted Diam./Diam. montaggio [mm] 31
SUBARU	

67-08-803	
	Bore Ø 1/Alesaggio-Ø 1 [mm] 20,6
	Fitted Diam./Diam. montaggio [mm] 29,2

67-07-799	
	Bore Ø 1/Alesaggio-Ø 1 [mm] 15,5
	Fitted Diam./Diam. montaggio [mm] 30,8
SUZUKI - SUBARU	

67-08-804	
	Bore Ø 1/Alesaggio-Ø 1 [mm] 22,3
	Fitted Diam./Diam. montaggio [mm] 29,5
SUZUKI	

67-08-800	
	Bore Ø 1/Alesaggio-Ø 1 [mm] 25
	Fitted Diam./Diam. montaggio [mm] 34
MARUTI - SUZUKI	

67-08-806	
	Bore Ø 1/Alesaggio-Ø 1 [mm] 25,3
	Fitted Diam./Diam. montaggio [mm] 30,3
SUZUKI	

67-08-801	
	Bore Ø 1/Alesaggio-Ø 1 [mm] 25,3
	Fitted Diam./Diam. montaggio [mm] 32,1
SUZUKI - MARUTI	

67-08-807	
	Bore Ø 1/Alesaggio-Ø 1 [mm] 25,4
	Fitted Diam./Diam. montaggio [mm] 30
SUZUKI	

67-08-808	
	Bore Ø 1/Alesaggio-Ø 1 [mm] 15,8
	Fitted Diam./Diam. montaggio [mm] 29
SUZUKI	

67-08-813	
	Bore Ø 1/Alesaggio-Ø 1 [mm] 15,9
	Fitted Diam./Diam. montaggio [mm] 30,5
SUZUKI	

67-08-809	
	Bore Ø 1/Alesaggio-Ø 1 [mm] 15,8
	Fitted Diam./Diam. montaggio [mm] 29,3
SUZUKI	

67-08-814	
	Bore Ø 1/Alesaggio-Ø 1 [mm] 25,5
	Fitted Diam./Diam. montaggio [mm] 33
SUZUKI	

67-08-810	
	Bore Ø 1/Alesaggio-Ø 1 [mm] 15,8
	Fitted Diam./Diam. montaggio [mm] 29,6
SUZUKI - MARUTI	

67-08-815	
	Bore Ø 1/Alesaggio-Ø 1 [mm] 25,3
	Fitted Diam./Diam. montaggio [mm] 33,4
SUZUKI	

67-08-811	
	Bore Ø 1/Alesaggio-Ø 1 [mm] 22,1
	Fitted Diam./Diam. montaggio [mm] 29,4
SUZUKI	

67-08-816	
	Bore Ø 1/Alesaggio-Ø 1 [mm] 19
	Fitted Diam./Diam. montaggio [mm] 29,5
SUZUKI - BEDFORD	

67-08-812	
	Bore Ø 1/Alesaggio-Ø 1 [mm] 22,2
	Fitted Diam./Diam. montaggio [mm] 29,6
SUZUKI	

67-08-817	
	Bore Ø 1/Alesaggio-Ø 1 [mm] 19
	Fitted Diam./Diam. montaggio [mm] 29,6
SUZUKI - BEDFORD	



67-08-818	
 SUZUKI	Bore Ø 1/Alesaggio-Ø 1 [mm] 17,4
	Fitted Diam./Diam. montaggio [mm] 30,5

67-08-823	
 SUZUKI	Bore Ø 1/Alesaggio-Ø 1 [mm] 22,1
	Fitted Diam./Diam. montaggio [mm] 34

67-08-819	
 SUZUKI	Bore Ø 1/Alesaggio-Ø 1 [mm] 15,8
	Fitted Diam./Diam. montaggio [mm] 31,2

67-08-824	
 SUZUKI	Bore Ø 1/Alesaggio-Ø 1 [mm] 22,2
	Fitted Diam./Diam. montaggio [mm] 34,2

67-08-820	
 SUZUKI	Bore Ø 1/Alesaggio-Ø 1 [mm] 23,8
	Fitted Diam./Diam. montaggio [mm] 31,5

67-08-829	
 SUZUKI	Bore Ø 1/Alesaggio-Ø 1 [mm] 22
	Fitted Diam./Diam. montaggio [mm] 33

67-08-821	
 SUZUKI	Bore Ø 1/Alesaggio-Ø 1 [mm] 23,7
	Fitted Diam./Diam. montaggio [mm] 31,5

67-08-830	
 SUZUKI	Bore Ø 1/Alesaggio-Ø 1 [mm] 22
	Fitted Diam./Diam. montaggio [mm] 33

67-08-822	
 SUZUKI	Bore Ø 1/Alesaggio-Ø 1 [mm] 23,7
	Fitted Diam./Diam. montaggio [mm] 31,6

67-08-832	
 SUZUKI - SUBARU	Bore Ø 1/Alesaggio-Ø 1 [mm] 17,4
	Fitted Diam./Diam. montaggio [mm] 35,6

67-08-837	
	Bore Ø 1/Alesaggio-Ø 1 [mm] 17,4
	Fitted Diam./Diam. montaggio [mm] 35,6
SUBARU - SUZUKI	

67-08-892	
	Bore Ø 1/Alesaggio-Ø 1 [mm] 19
	Fitted Diam./Diam. montaggio [mm] 34,8

67-08-840	
	Bore Ø 1/Alesaggio-Ø 1 [mm] 15,8
	Fitted Diam./Diam. montaggio [mm] 15,8
SUBARU - SUZUKI - DAIHATSU	

67-08-893	
	Bore Ø 1/Alesaggio-Ø 1 [mm] 19
	Fitted Diam./Diam. montaggio [mm] 35,5

67-08-841	
	Bore Ø 1/Alesaggio-Ø 1 [mm] 15,8
	Fitted Diam./Diam. montaggio [mm] 31
SUZUKI	

67-08-894	
	Bore Ø 1/Alesaggio-Ø 1 [mm] 22
	Fitted Diam./Diam. montaggio [mm] 31,5
SUZUKI	

67-08-842	
	Bore Ø 1/Alesaggio-Ø 1 [mm] 19
	Fitted Diam./Diam. montaggio [mm] 34
SUZUKI	

67-08-895	
	Bore Ø 1/Alesaggio-Ø 1 [mm] 25,3
	Fitted Diam./Diam. montaggio [mm] 35,1
NISSAN	

67-08-846	
	Bore Ø 1/Alesaggio-Ø 1 [mm] 19
	Fitted Diam./Diam. montaggio [mm] 19,8
FIAT - SUZUKI	

67-08-896	
	Bore Ø 1/Alesaggio-Ø 1 [mm] 25,3
	Fitted Diam./Diam. montaggio [mm] 31,9
NISSAN	

67-08-899	
	Bore Ø 1/Alesaggio-Ø 1 [mm] 22
	Fitted Diam./Diam. montaggio [mm] 30,8
SUZUKI	

67-09-905	
	Bore Ø 1/Alesaggio-Ø 1 [mm] 25,4
	Fitted Diam./Diam. montaggio [mm] 33,8
ISUZU	

67-09-901	
	Bore Ø 1/Alesaggio-Ø 1 [mm] 25,4
	Fitted Diam./Diam. montaggio [mm] 33,9
OPEL - ISUZU - BEDFORD	

67-09-906	
	Bore Ø 1/Alesaggio-Ø 1 [mm] 23,8
	Fitted Diam./Diam. montaggio [mm] 35,8
ISUZU	

67-09-902	
	Bore Ø 1/Alesaggio-Ø 1 [mm] 25,3
	Fitted Diam./Diam. montaggio [mm] 33,9
ISUZU	

67-09-907	
	Bore Ø 1/Alesaggio-Ø 1 [mm] 14,3
	Fitted Diam./Diam. montaggio [mm] 28
ISUZU	

67-09-903	
	Bore Ø 1/Alesaggio-Ø 1 [mm] 25,3
	Fitted Diam./Diam. montaggio [mm] 33,9
ISUZU	

67-09-996	
	Bore Ø 1/Alesaggio-Ø 1 [mm] 20,5
	Fitted Diam./Diam. montaggio [mm] 29,8
JEEP	

67-09-904	
	Bore Ø 1/Alesaggio-Ø 1 [mm] 25,4
	Fitted Diam./Diam. montaggio [mm] 33,9
ISUZU	

67-09-997	
	Bore Ø 1/Alesaggio-Ø 1 [mm] 22,1
	Fitted Diam./Diam. montaggio [mm] 34,9
ISUZU	

67-09-998	
	Bore Ø 1/Alesaggio-Ø 1 [mm] 17,4
	Fitted Diam./Diam. montaggio [mm] 27,4
ISUZU	

67-H0-006	
	Bore Ø 1/Alesaggio-Ø 1 [mm] 22
	Fitted Diam./Diam. montaggio [mm] 37,5
HYUNDAI	

67-09-999	
	Bore Ø 1/Alesaggio-Ø 1 [mm] 22,1
	Fitted Diam./Diam. montaggio [mm] 31,8
JEEP	

67-H0-007	
	Bore Ø 1/Alesaggio-Ø 1 [mm] 22
	Fitted Diam./Diam. montaggio [mm] 37,7
HYUNDAI	

67-H0-001	
	Bore Ø 1/Alesaggio-Ø 1 [mm] 17,7
	Fitted Diam./Diam. montaggio [mm] 37,5
HYUNDAI	

67-H0-008	
	Bore Ø 1/Alesaggio-Ø 1 [mm] 22,2
	Fitted Diam./Diam. montaggio [mm] 37,5
HYUNDAI	

67-H0-002	
	Bore Ø 1/Alesaggio-Ø 1 [mm] 17,7
	Fitted Diam./Diam. montaggio [mm] 37,3
HYUNDAI	

67-H0-011	
	Bore Ø 1/Alesaggio-Ø 1 [mm] 19
	Fitted Diam./Diam. montaggio [mm] 37,6
HYUNDAI	

67-H0-005	
	Bore Ø 1/Alesaggio-Ø 1 [mm] 24
	Fitted Diam./Diam. montaggio [mm] 37,3
HYUNDAI	

67-H0-013	
	Bore Ø 1/Alesaggio-Ø 1 [mm] 19
	Fitted Diam./Diam. montaggio [mm] 37,6
HYUNDAI - ROVER	

67-H0-014	
	Bore Ø 1/Alesaggio-Ø 1 [mm] 19
	Fitted Diam./Diam. montaggio [mm] 37,4
HYUNDAI - ROVER	

67-H0-021	
	Bore Ø 1/Alesaggio-Ø 1 [mm] 20,5
	Fitted Diam./Diam. montaggio [mm] 37,1
HYUNDAI	

67-0H-H15	
	Bore Ø 1/Alesaggio-Ø 1 [mm] 17,5
	Fitted Diam./Diam. montaggio [mm] 29,5
HYUNDAI	

67-H0-022	
	Bore Ø 1/Alesaggio-Ø 1 [mm] 20,5
	Fitted Diam./Diam. montaggio [mm] 36,4
HYUNDAI	

67-0H-H16	
	Bore Ø 1/Alesaggio-Ø 1 [mm] 17,5
	Fitted Diam./Diam. montaggio [mm] 29,5
HYUNDAI	

67-K0-000	
	Bore Ø 1/Alesaggio-Ø 1 [mm] 19
	Fitted Diam./Diam. montaggio [mm] 30
KIA	

65-08-806	
	Bore Ø 1 [mm]/Alesaggio-Ø 1 [mm] 25,3
	Fitted Diam./Diam. montaggio [mm] 30
SUZUKI	

67-K0-001	
	Bore Ø 1/Alesaggio-Ø 1 [mm] 20
	Fitted Diam./Diam. montaggio [mm] 29,7
KIA	

65-08-803	
	Bore Ø 1 [mm]/Alesaggio-Ø 1 [mm] 20,6
	Fitted Diam./Diam. montaggio [mm] 29,1
SUZUKI	

67-K0-002	
	Bore Ø 1/Alesaggio-Ø 1 [mm] 20,5
	Fitted Diam./Diam. montaggio [mm] 31
KIA	

67-K0-004	
	Bore Ø 1/Alesaggio-Ø 1 [mm] 15,8
	Fitted Diam./Diam. montaggio [mm] 29,6
KIA	

67-K0-009	
	Bore Ø 1/Alesaggio-Ø 1 [mm] 20,6
	Fitted Diam./Diam. montaggio [mm] 30,5
KIA	

67-K0-005	
	Bore Ø 1/Alesaggio-Ø 1 [mm] 20,5
	Fitted Diam./Diam. montaggio [mm] 29,9
KIA	

67-0K-K10	
	Bore Ø 1/Alesaggio-Ø 1 [mm] 20,6
	Fitted Diam./Diam. montaggio [mm] 36,4
KIA	

67-K0-006	
	Bore Ø 1/Alesaggio-Ø 1 [mm] 19
	Fitted Diam./Diam. montaggio [mm] 31,2
KIA	

67-K0-012	
	Bore Ø 1/Alesaggio-Ø 1 [mm] 20,5
	Fitted Diam./Diam. montaggio [mm] 36,3
KIA	

67-K0-007	
	Bore Ø 1/Alesaggio-Ø 1 [mm] 20,6
	Fitted Diam./Diam. montaggio [mm] 30,8
KIA	

67-K0-013	
	Bore Ø 1/Alesaggio-Ø 1 [mm] 19
	Fitted Diam./Diam. montaggio [mm] 37,6
KIA	

67-K0-008	
	Bore Ø 1/Alesaggio-Ø 1 [mm] 17,4
	Fitted Diam./Diam. montaggio [mm] 31,3
HYUNDAI - KIA	

67-K0-014	
	Bore Ø 1/Alesaggio-Ø 1 [mm] 19
	Fitted Diam./Diam. montaggio [mm] 37,7
KIA	



67-K0-015	
 <p>K15</p>	Bore Ø 1/Alesaggio-Ø 1 [mm] 20,5
	Fitted Diam./Diam. montaggio [mm] 31,2
KIA	

67-M0-000	
 <p>J100</p>	Bore Ø 1/Alesaggio-Ø 1 [mm] 22
	Fitted Diam./Diam. montaggio [mm] 31,5
SMART	

67-0K-K16	
	Bore Ø 1/Alesaggio-Ø 1 [mm] 16
	Fitted Diam./Diam. montaggio [mm] 30
KIA	

67-M0-001	
 <p>J01</p>	Bore Ø 1/Alesaggio-Ø 1 [mm] 17,4
	Fitted Diam./Diam. montaggio [mm] 31,6
SMART	

67-0K-K17	
	Bore Ø 1/Alesaggio-Ø 1 [mm] 19
	Fitted Diam./Diam. montaggio [mm] 31
KIA	

67-M0-002	
 <p>J02</p>	Bore Ø 1/Alesaggio-Ø 1 [mm] 22
	Fitted Diam./Diam. montaggio [mm] 31,5
SMART	

67-0K-019	
 <p>K19</p>	Bore Ø 1/Alesaggio-Ø 1 [mm] 19
	Fitted Diam./Diam. montaggio [mm] 30,6
KIA	

67-M0-003	
 <p>J03</p>	Bore Ø 1/Alesaggio-Ø 1 [mm] 17,4
	Fitted Diam./Diam. montaggio [mm] 31,5
SMART	

67-0K-K20	
	Bore Ø 1/Alesaggio-Ø 1 [mm] 19
	Fitted Diam./Diam. montaggio [mm] 31
KIA	

67-0M-M04	
 <p>M04</p>	Bore Ø 1/Alesaggio-Ø 1 [mm] 20,5
	Fitted Diam./Diam. montaggio [mm] 32
SMART	

67-0M-M05	
 <p>M05</p>	Bore Ø 1/Alesaggio-Ø 1 [mm] 20,5
	Fitted Diam./Diam. montaggio [mm] 32
SMART	

67-W0-003	
 <p>.W03</p>	Bore Ø 1/Alesaggio-Ø 1 [mm] 20,5
	Fitted Diam./Diam. montaggio [mm] 27,8
DAEWOO	

67-S0-099	
 <p>.S99</p>	Bore Ø 1/Alesaggio-Ø 1 [mm] 22,2
	Fitted Diam./Diam. montaggio [mm] 36,4
SSANGYONG	

67-W0-005	
 <p>.W05</p>	Bore Ø 1/Alesaggio-Ø 1 [mm] 20,6
	Fitted Diam./Diam. montaggio [mm] 28
DAEWOO	

67-W0-000	
 <p>.W00</p>	Bore Ø 1/Alesaggio-Ø 1 [mm] 17,3
	Fitted Diam./Diam. montaggio [mm] 27,8
DAEWOO - OPEL	

67-W0-006	
 <p>.W06</p>	Bore Ø 1/Alesaggio-Ø 1 [mm] 19
	Fitted Diam./Diam. montaggio [mm] 28
CHEVROLET - DAEWOO	

67-W0-001	
 <p>.W01</p>	Bore Ø 1/Alesaggio-Ø 1 [mm] 19
	Fitted Diam./Diam. montaggio [mm] 27,8
OPEL - DAEWOO	

65-08-802	
 <p>802.</p>	Bore Ø 1 [mm]/Alesaggio-Ø 1 [mm] 22,2
	Fitted Diam./Diam. montaggio [mm] 29,9
SUZUKI	

67-W0-002	
 <p>.W02</p>	Bore Ø 1/Alesaggio-Ø 1 [mm] 17,4
	Fitted Diam./Diam. montaggio [mm] 29,9
CHEVROLET - DAEWOO	

65-08-801	
 <p>.801</p>	Bore Ø 1 [mm]/Alesaggio-Ø 1 [mm] 25,2
	Fitted Diam./Diam. montaggio [mm] 32,2
SUZUKI	



65-08-800	
	Bore Ø 1 [mm]/Alesaggio-Ø 1 [mm] 25,2
	Fitted Diam./Diam. montaggio [mm] 32
SUZUKI	

65-06-609	
	Bore Ø 1 [mm]/Alesaggio-Ø 1 [mm] 17,4
	Fitted Diam./Diam. montaggio [mm] 35,4
DAIHATSU	

65-06-616	
	Bore Ø 1 [mm]/Alesaggio-Ø 1 [mm] 22
	Fitted Diam./Diam. montaggio [mm] 34,6
DAIHATSU	

65-06-608	
	Bore Ø 1 [mm]/Alesaggio-Ø 1 [mm] 17,4
	Fitted Diam./Diam. montaggio [mm] 30,8
DAIHATSU	

65-06-615	
	Bore Ø 1 [mm]/Alesaggio-Ø 1 [mm] 17,3
	Fitted Diam./Diam. montaggio [mm] 34,9
DAIHATSU	

65-06-607	
	Bore Ø 1 [mm]/Alesaggio-Ø 1 [mm] 17,4
	Fitted Diam./Diam. montaggio [mm] 32,9
DAIHATSU	

65-06-614	
	Bore Ø 1 [mm]/Alesaggio-Ø 1 [mm] 25,2
	Fitted Diam./Diam. montaggio [mm] 34,7
DAIHATSU	

65-06-604	
	Bore Ø 1 [mm]/Alesaggio-Ø 1 [mm] 19
	Fitted Diam./Diam. montaggio [mm] 25
DAIHATSU	

65-06-612	
	Bore Ø 1 [mm]/Alesaggio-Ø 1 [mm] 22,1
	Fitted Diam./Diam. montaggio [mm] 30
DAIHATSU	

65-06-600	
	Bore Ø 1 [mm]/Alesaggio-Ø 1 [mm] 15,8
	Fitted Diam./Diam. montaggio [mm] 25
DAIHATSU	

65-05-582

	Bore Ø 1 [mm]/Alesaggio-Ø 1 [mm]	31,6
	Fitted Diam./Diam. montaggio [mm]	31,8
ROVER - HONDA		

65-04-400

	Fitted Diam./Diam. montaggio [mm]	32,3
	ROVER - HONDA	

65-05-581

	Bore Ø 1 [mm]/Alesaggio-Ø 1 [mm]	28,6
	Fitted Diam./Diam. montaggio [mm]	31,9
TOYOTA		

65-02-241

	Bore Ø 1 [mm]/Alesaggio-Ø 1 [mm]	28,5
	Fitted Diam./Diam. montaggio [mm]	30
TOYOTA		

65-05-580

	Bore Ø 1 [mm]/Alesaggio-Ø 1 [mm]	31,6
	Fitted Diam./Diam. montaggio [mm]	31,9
TOYOTA		

65-02-240

	Diam. [mm]/Diam. [mm]	28,5
	Bore Ø 1 [mm]/Alesaggio-Ø 1 [mm]	35
TOYOTA		

65-04-403

	Bore Ø 1 [mm]/Alesaggio-Ø 1 [mm]	19
	Fitted Diam./Diam. montaggio [mm]	34,5
HONDA		

65-01-199

	Bore Ø 1 [mm]/Alesaggio-Ø 1 [mm]	20,6
	Fitted Diam./Diam. montaggio [mm]	35,2
NISSAN		

65-04-401

	Bore Ø 1 [mm]/Alesaggio-Ø 1 [mm]	19
	Fitted Diam./Diam. montaggio [mm]	34,4
HONDA		

65-08-811

	Bore Ø 1 [mm]/Alesaggio-Ø 1 [mm]	22,1
	Fitted Diam./Diam. montaggio [mm]	29,3
SUZUKI		



65-08-812	
 812.	Bore Ø 1 [mm]/Alesaggio-Ø 1 [mm] 22,1
	Fitted Diam./Diam. montaggio [mm] 29,4
SUZUKI	

65-08-815	
 815.	Bore Ø 1 [mm]/Alesaggio-Ø 1 [mm] 23,7
	Fitted Diam./Diam. montaggio [mm] 31,6
SUZUKI	

65-09-997	
 997.	Bore Ø 1 [mm]/Alesaggio-Ø 1 [mm] 22,1
	Fitted Diam./Diam. montaggio [mm] 33,8
ISUZU	



PICTURES BRAKE PADS FRONT
ABBILDUNGEN BREMSKLÖTZE VORN
FIGURAS PASTILLAS DE FRENO DELANTORES
ILLUSTRATIONS PLAQUETTES DE FREI AVANT
IMMAGINI PASTIGLIE FRENO ANTERIORI

50-00-000				WVA
LADA	L	H	Th	
	126	45,1	15,5	20660

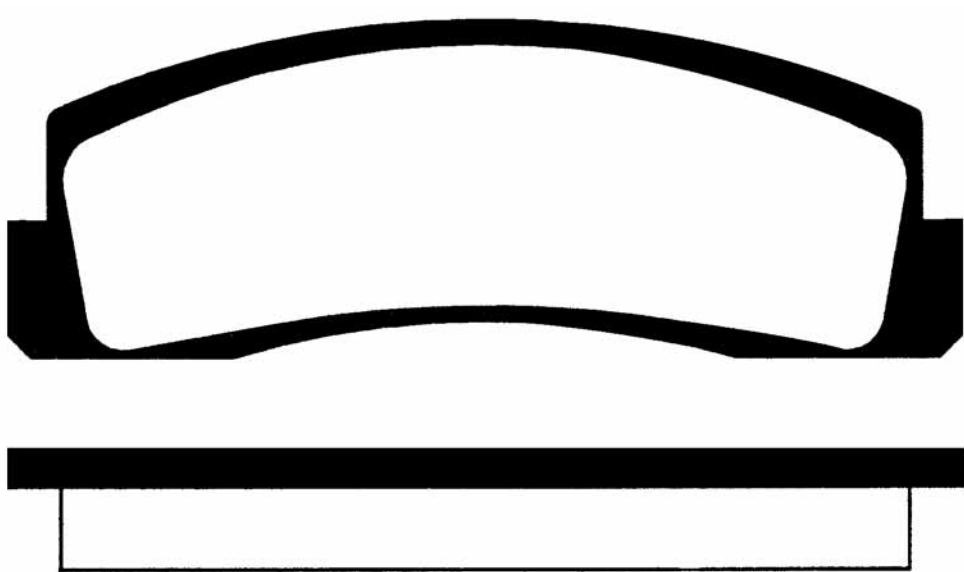

X4



50-00-001 TATA (TELCO)				WVA
	L 143,5	H 60	Th 18	21245

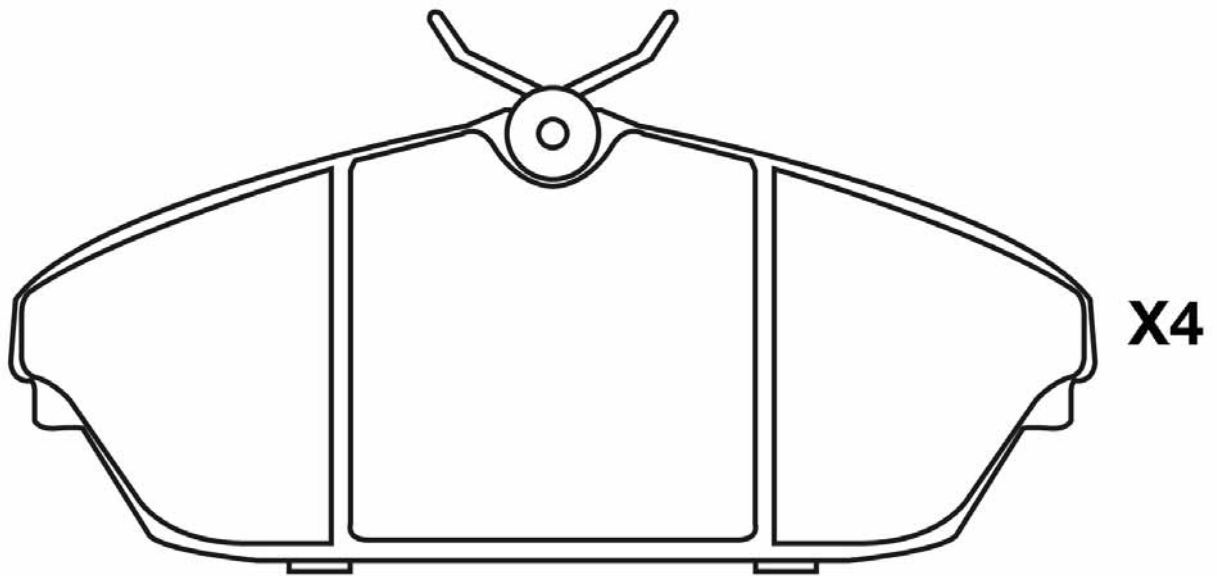



PICTURES BRAKE PADS FRONT
ABBILDUNGEN BREMSKLÖTZE VORN
FIGURAS PASTILLAS DE FRENO DELANTORES
ILLUSTRATIONS PLAQUETTES DE FREI AVANT
IMMAGINI PASTIGLIE FRENO ANTERIORI

50-00-002				WVA
	CHRYSLER	L	H	
	172,5	65,4	19	

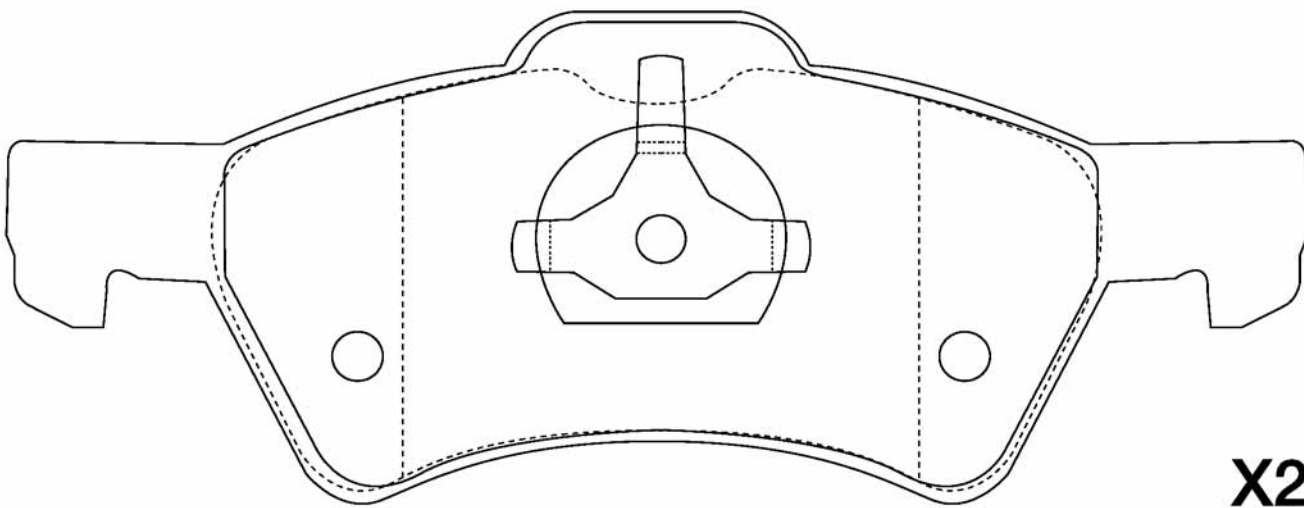
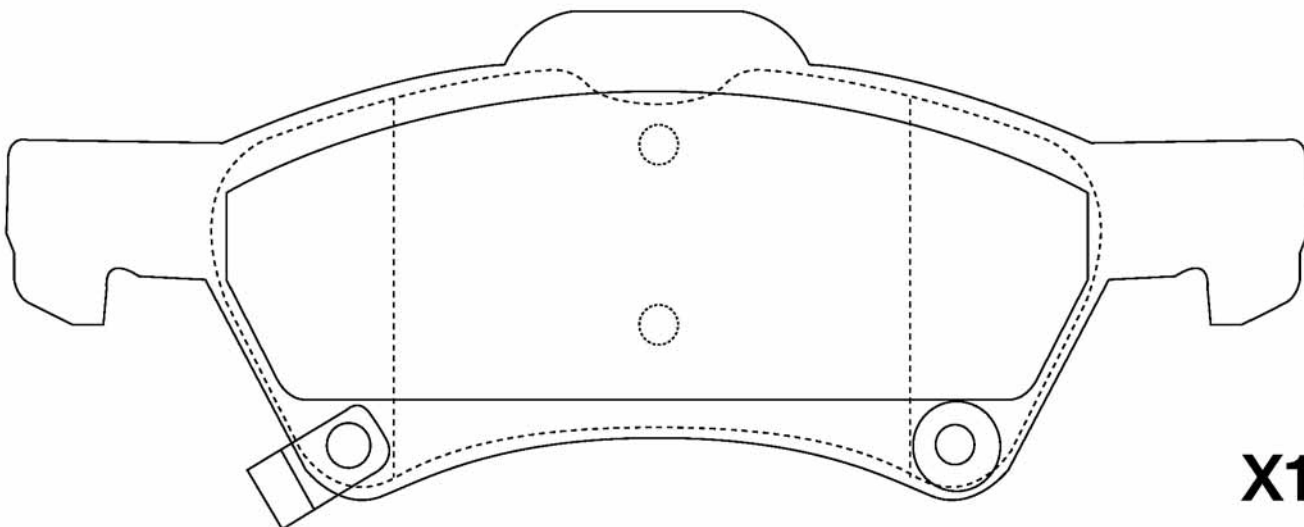
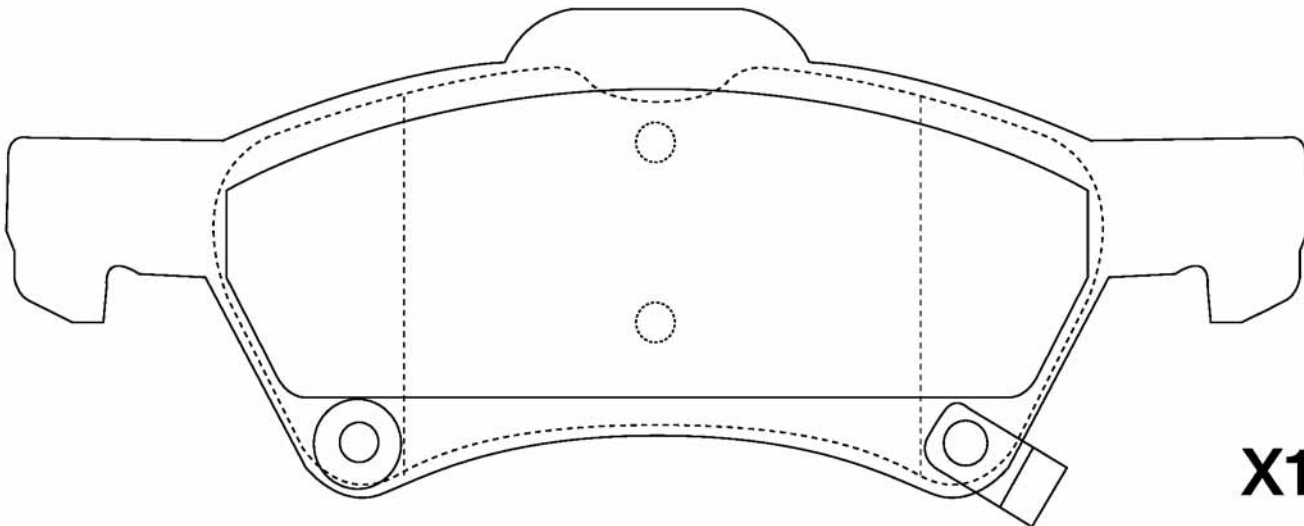



50-00-003				WVA
	TATA (TELCO)	L 129	H 68	Th 15,4

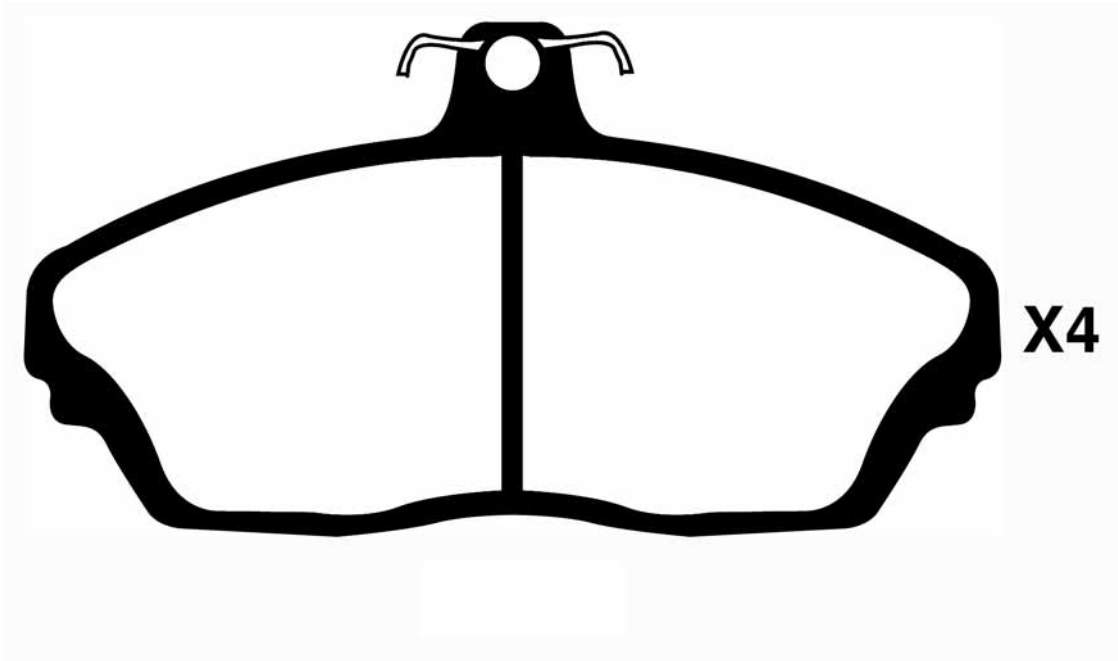



PICTURES BRAKE PADS FRONT
ABBILDUNGEN BREMSKLÖTZE VORN
FIGURAS PASTILLAS DE FRENO DELANTORES
ILLUSTRATIONS PLAQUETTES DE FREI AVANT
IMMAGINI PASTIGLIE FRENO ANTERIORI

50-00-004

CHRYSLER - JEEP

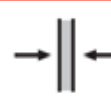
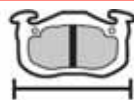

WVA

L

H

Th

145

55

16

23584

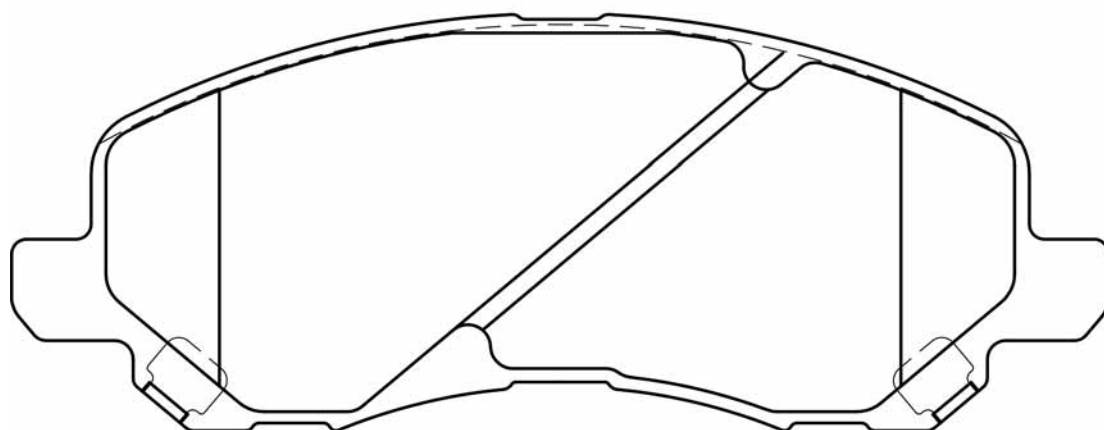



50-00-006

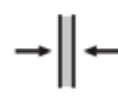
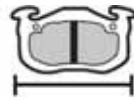

WVA

GREAT WALL

L

H

Th

167

54

17

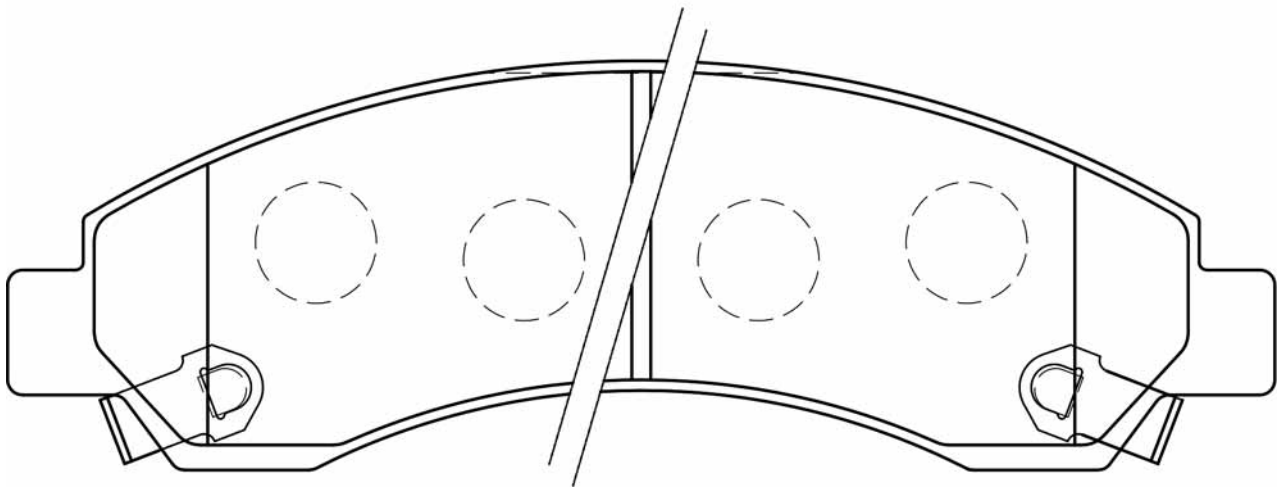



PICTURES BRAKE PADS FRONT
ABBILDUNGEN BREMSKLÖTZE VORN
FIGURAS PASTILLAS DE FRENO DELANTORES
ILLUSTRATIONS PLAQUETTES DE FREI AVANT
IMMAGINI PASTIGLIE FRENO ANTERIORI

50-00-007

MAHINDRA

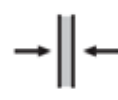
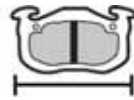

WVA

L

H

Th

144

66

18

25067

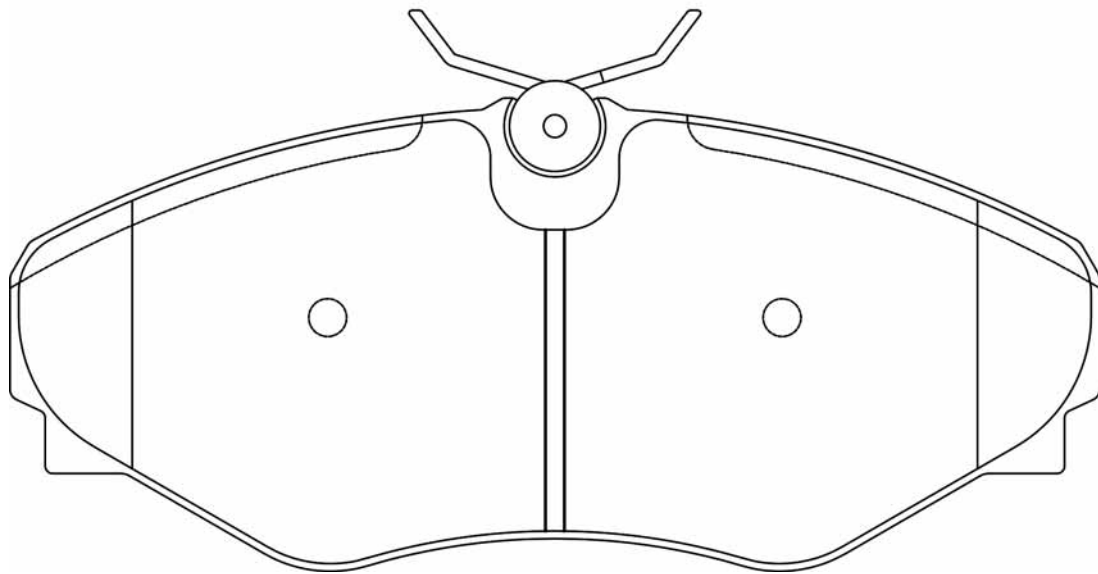



50-00-008				WVA
	HUMMER	L	H	
	134,5	75/76	17	

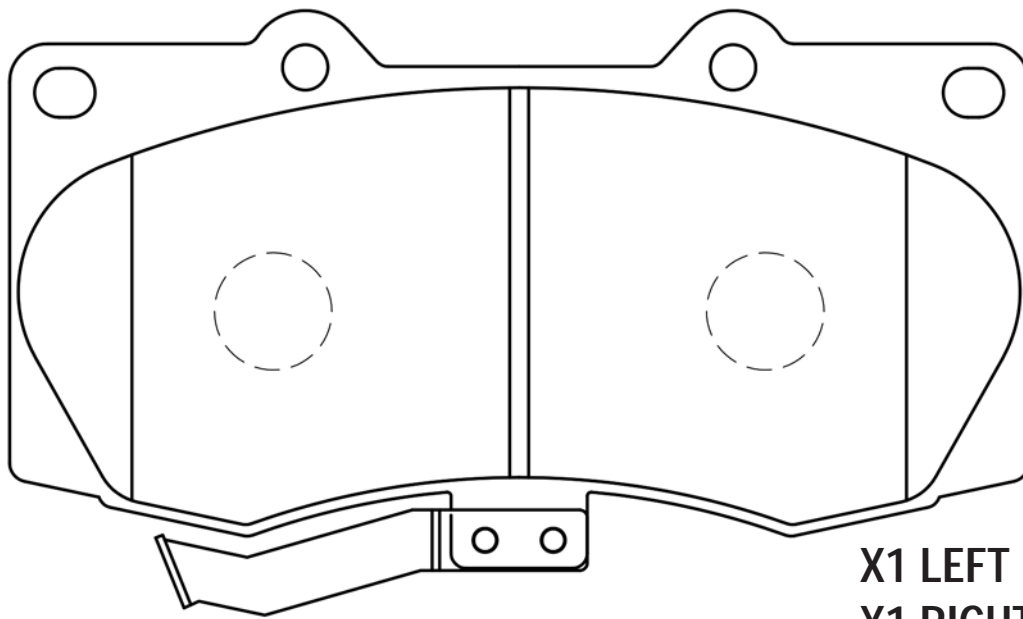

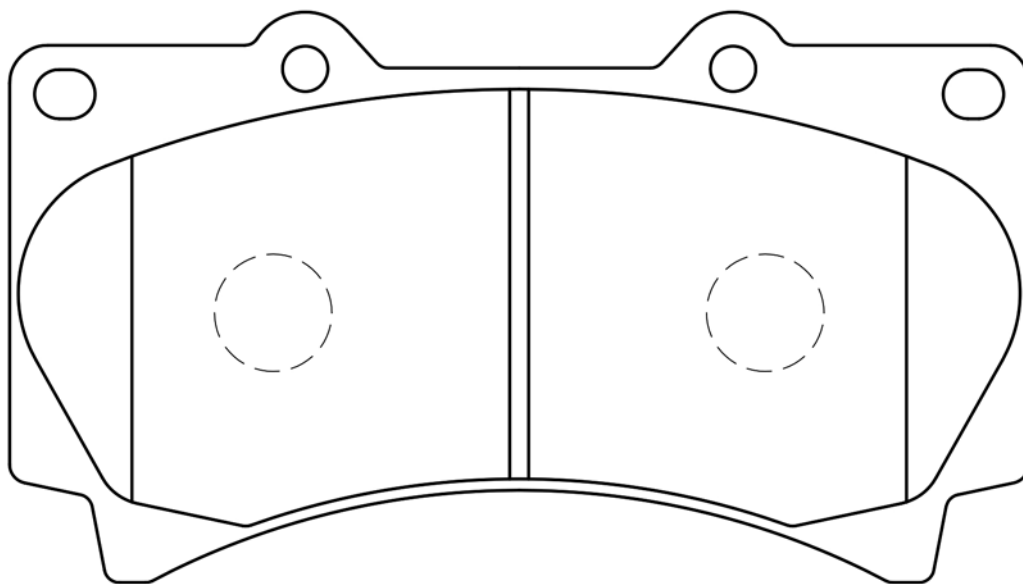

X1 LEFT
X1 RIGHT



X2

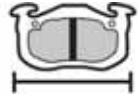

PICTURES BRAKE PADS FRONT
ABBILDUNGEN BREMSKLÖTZE VORN
FIGURAS PASTILLAS DE FRENO DELANTORES
ILLUSTRATIONS PLAQUETTES DE FREI AVANT
IMMAGINI PASTIGLIE FRENO ANTERIORI

50-00-009 HUMMER				WVA
	L	H	Th	
	216	70	20	

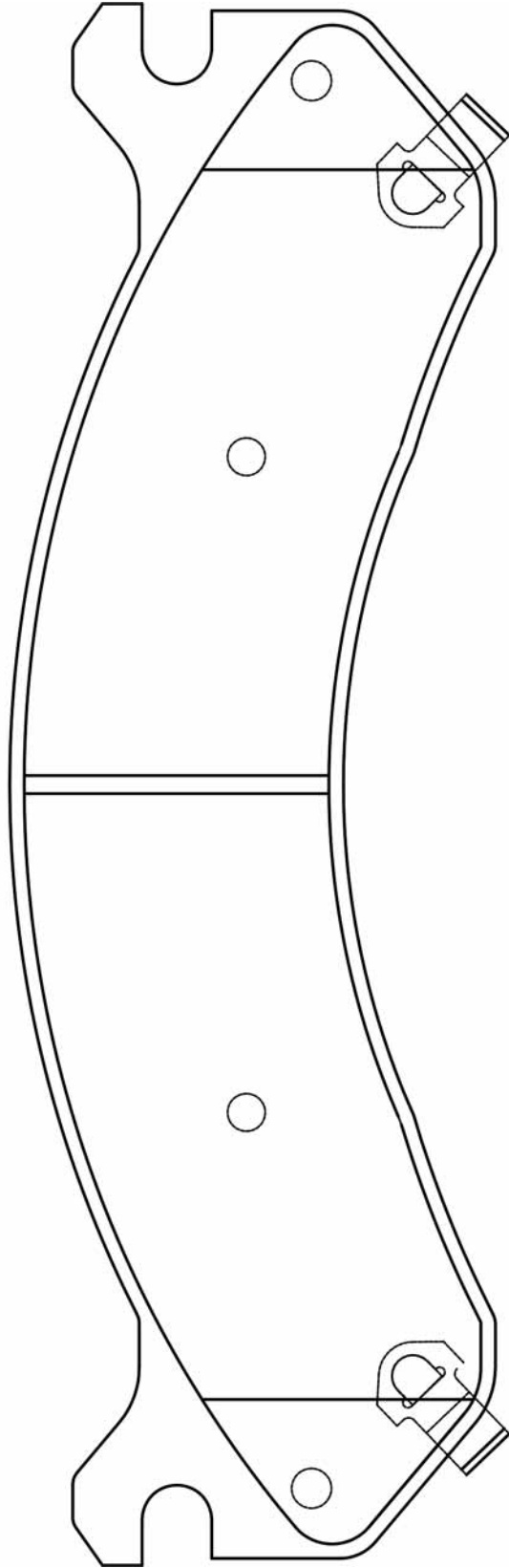



50-00-010				WVA
	NISSAN	L	H	Th
	128,2	50,3	15,5	21280

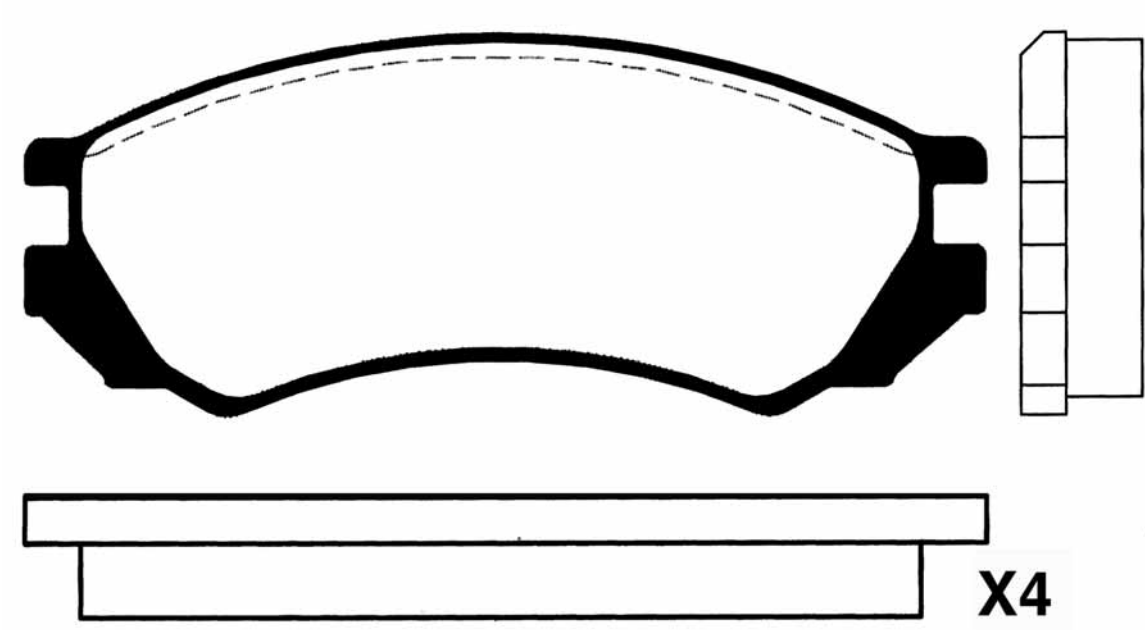



PICTURES BRAKE PADS FRONT
ABBILDUNGEN BREMSKLÖTZE VORN
FIGURAS PASTILLAS DE FRENO DELANTORES
ILLUSTRATIONS PLAQUETTES DE FREI AVANT
IMMAGINI PASTIGLIE FRENO ANTERIORI

50-00-011

CADILLAC



WVA

L

H

Th

156

70

20

23738

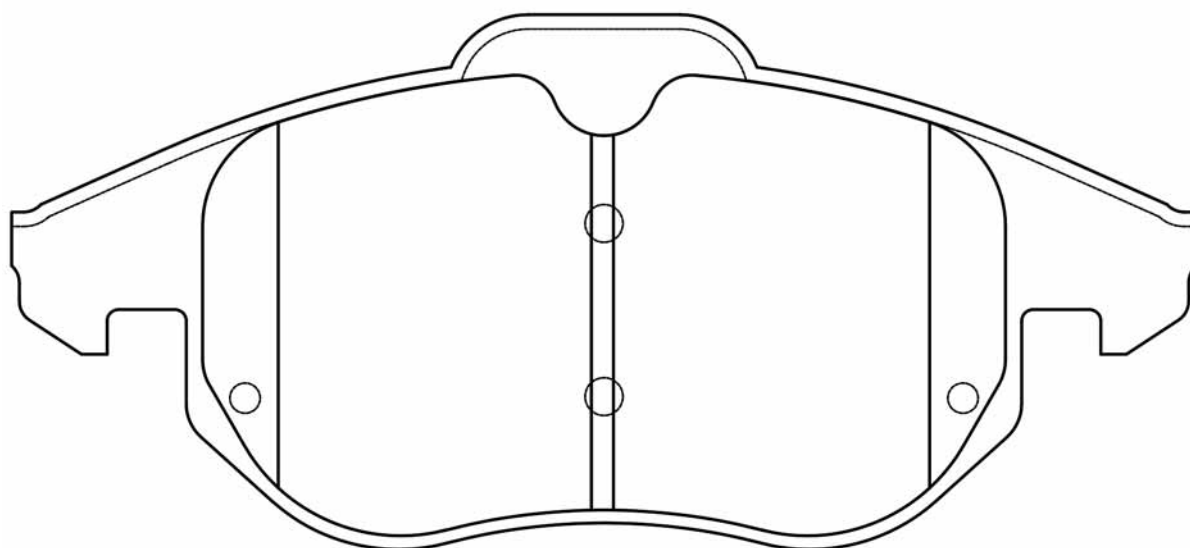
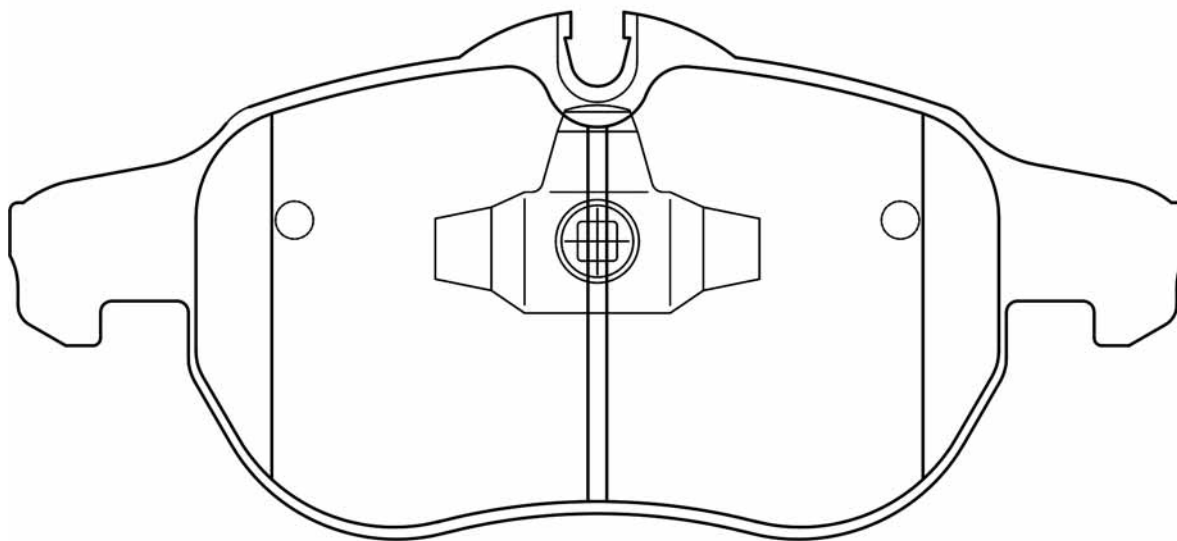



50-00-012				WVA
	NISSAN	L	H	Th
	120,7	44,5	14,4	21626

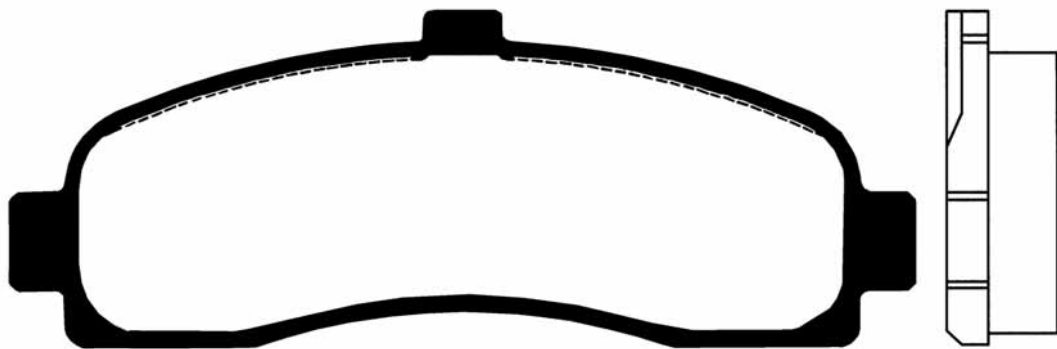

X4



PICTURES BRAKE PADS FRONT
ABBILDUNGEN BREMSKLÖTZE VORN
FIGURAS PASTILLAS DE FRENO DELANTORES
ILLUSTRATIONS PLAQUETTES DE FREI AVANT
IMMAGINI PASTIGLIE FRENO ANTERIORI

50-00-013				WVA
NISSAN - DACIA	L	H	Th	
	116,4	52,6	16,2	23973

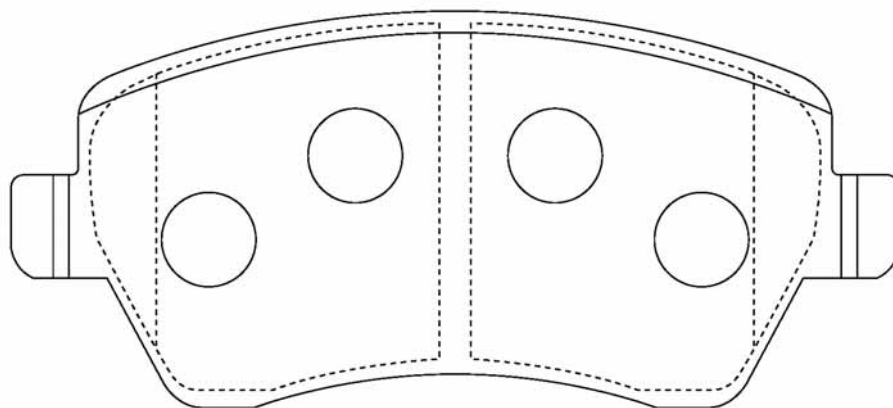

X4



50-00-014

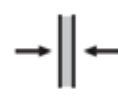
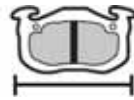

WVA

CADILLAC

L

H

Th

183

56

15,5

24303

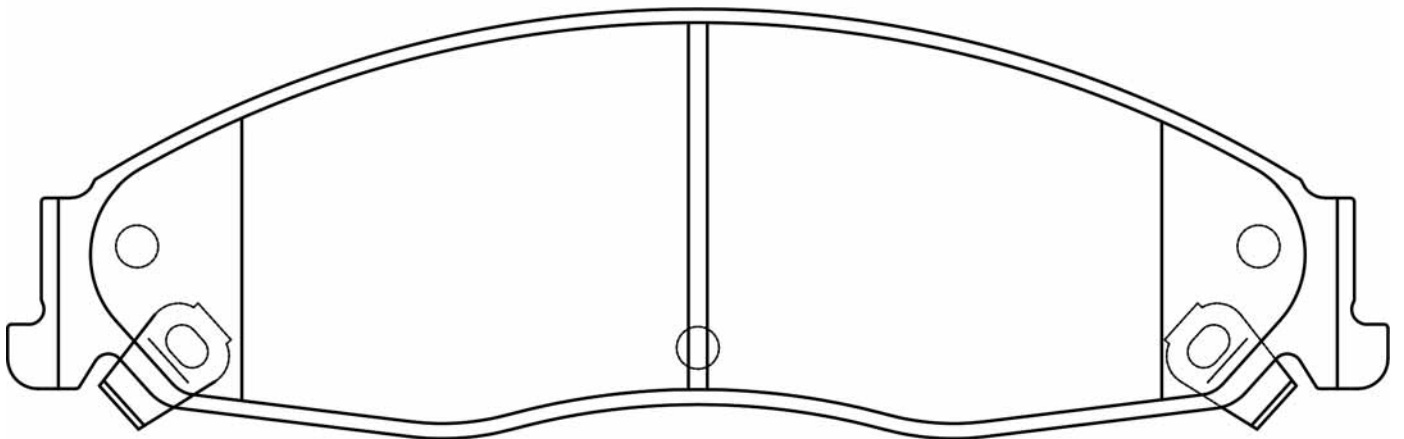



PICTURES BRAKE PADS FRONT
ABBILDUNGEN BREMSKLÖTZE VORN
FIGURAS PASTILLAS DE FRENO DELANTORES
ILLUSTRATIONS PLAQUETTES DE FREI AVANT
IMMAGINI PASTIGLIE FRENO ANTERIORI

50-00-015				WVA
NISSAN	L	H	Th	
	129,3	57,5	15,8	21546

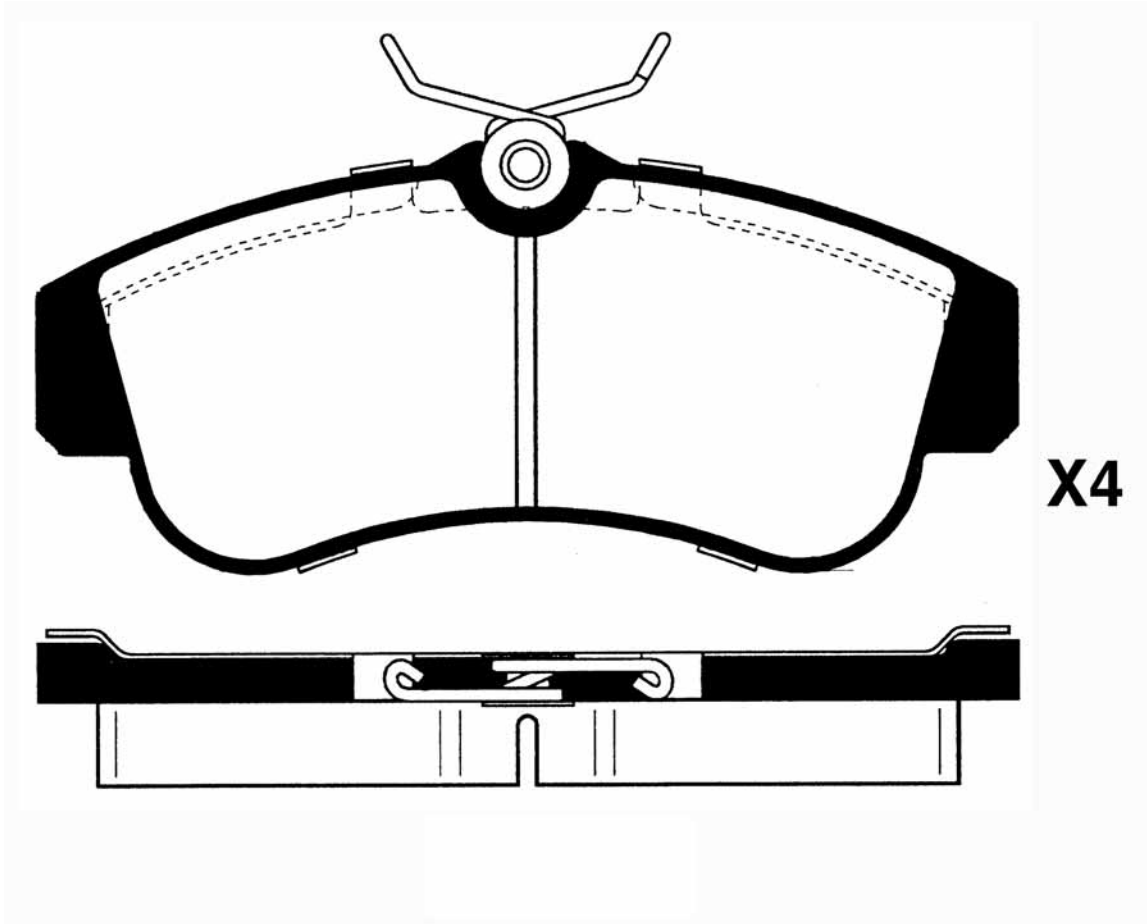



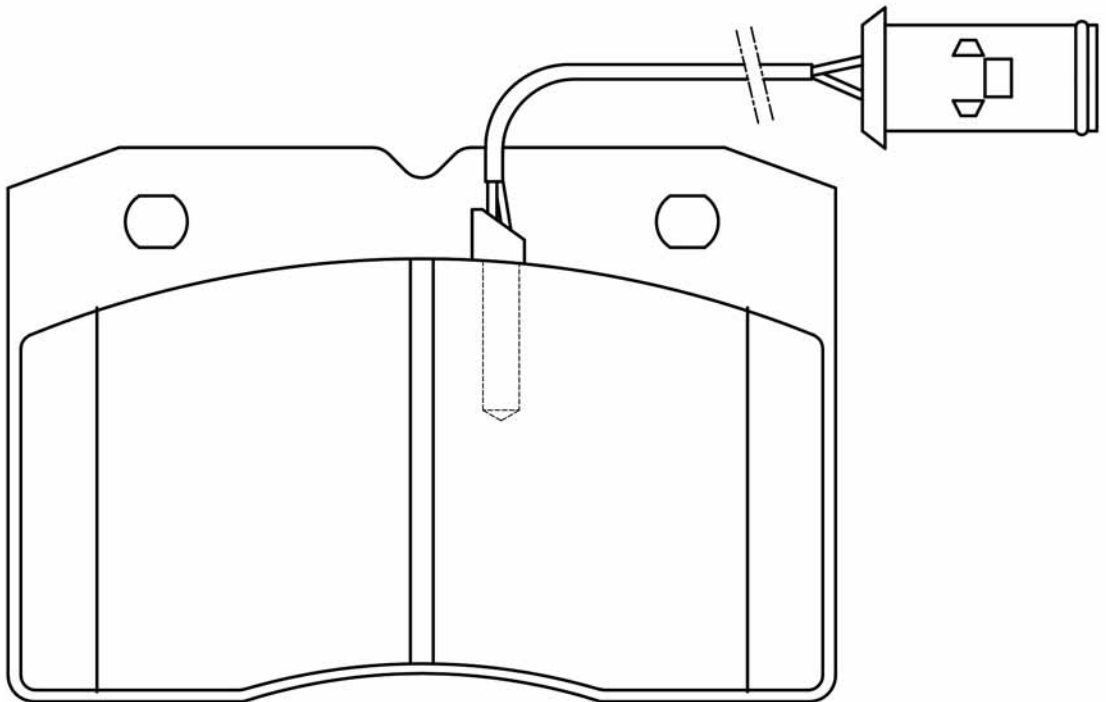
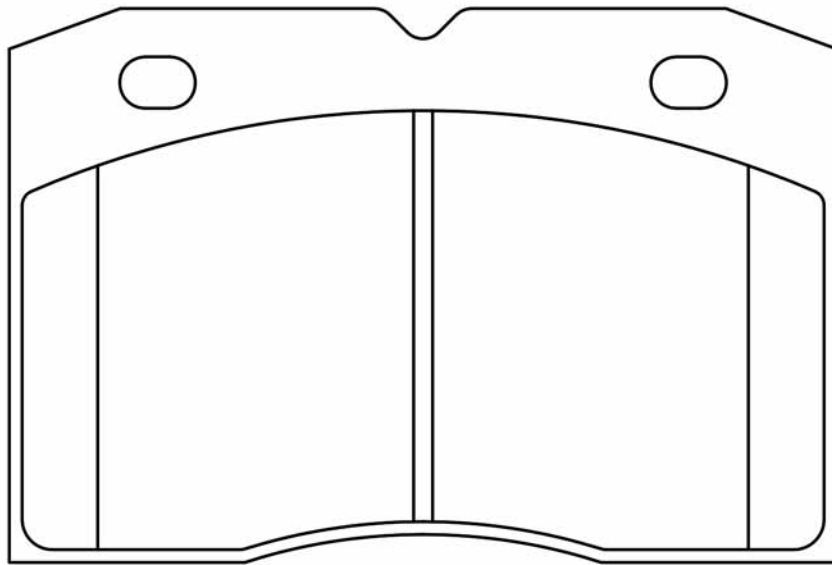

50-00-016 GASOLONE				WVA
	L 110	H 73	Th 18	



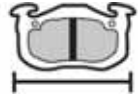

PICTURES BRAKE PADS FRONT
ABBILDUNGEN BREMSKLÖTZE VORN
FIGURAS PASTILLAS DE FRENO DELANTORES
ILLUSTRATIONS PLAQUETTES DE FREI AVANT
IMMAGINI PASTIGLIE FRENO ANTERIORI

50-00-017 NISSAN				WVA
	L	H	Th	
	145	55,9	15	21481

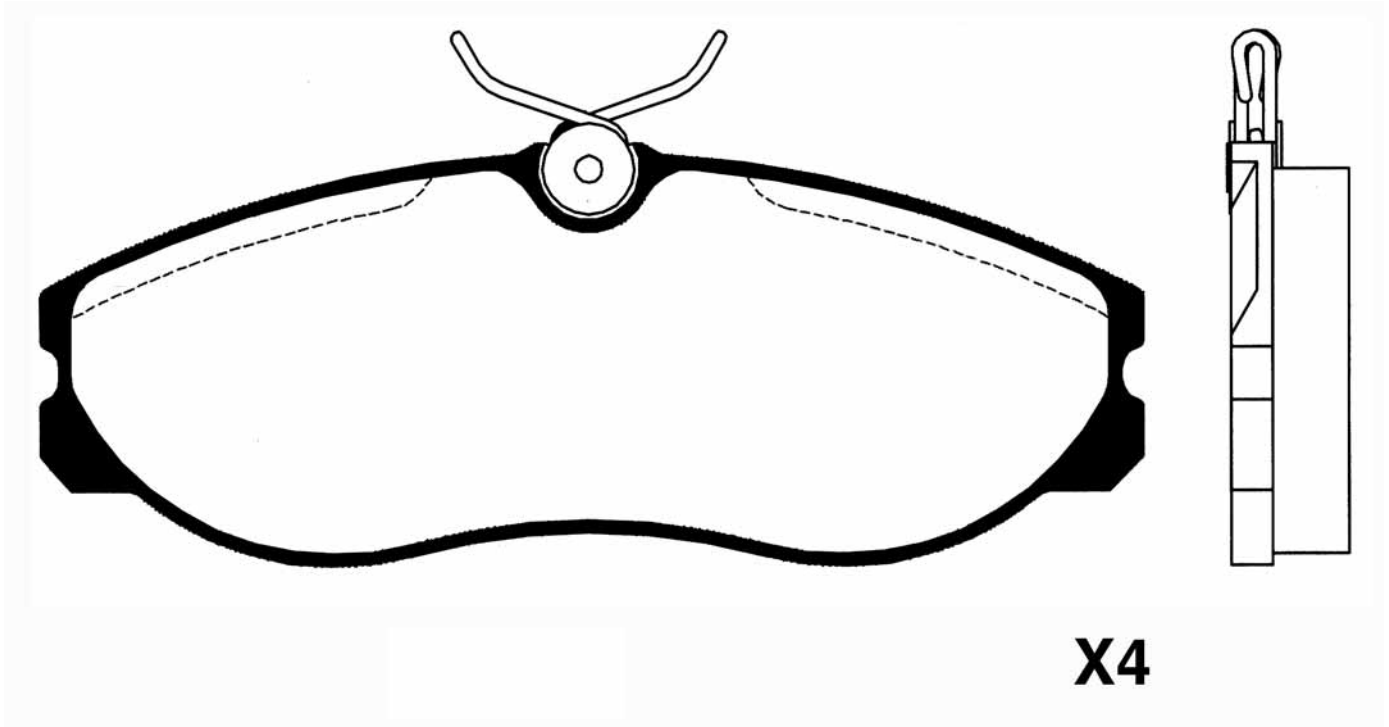



50-00-017P				WVA
	NISSAN	L	H	
	145	55,9	15	

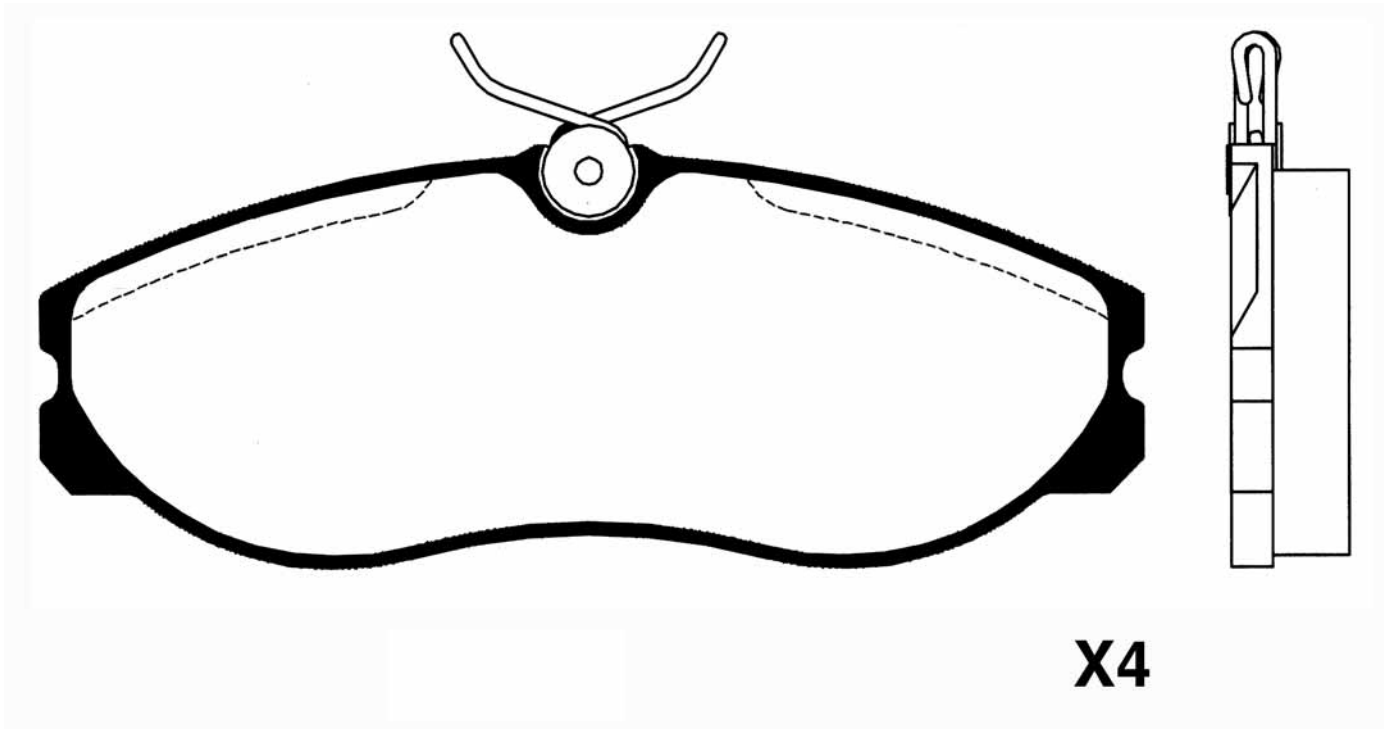



PICTURES BRAKE PADS FRONT
ABBILDUNGEN BREMSKLÖTZE VORN
FIGURAS PASTILLAS DE FRENO DELANTORES
ILLUSTRATIONS PLAQUETTES DE FREI AVANT
IMMAGINI PASTIGLIE FRENO ANTERIORI

50-00-018				WVA
JEEP	L	H	Th	
	176	57,2	19,1	

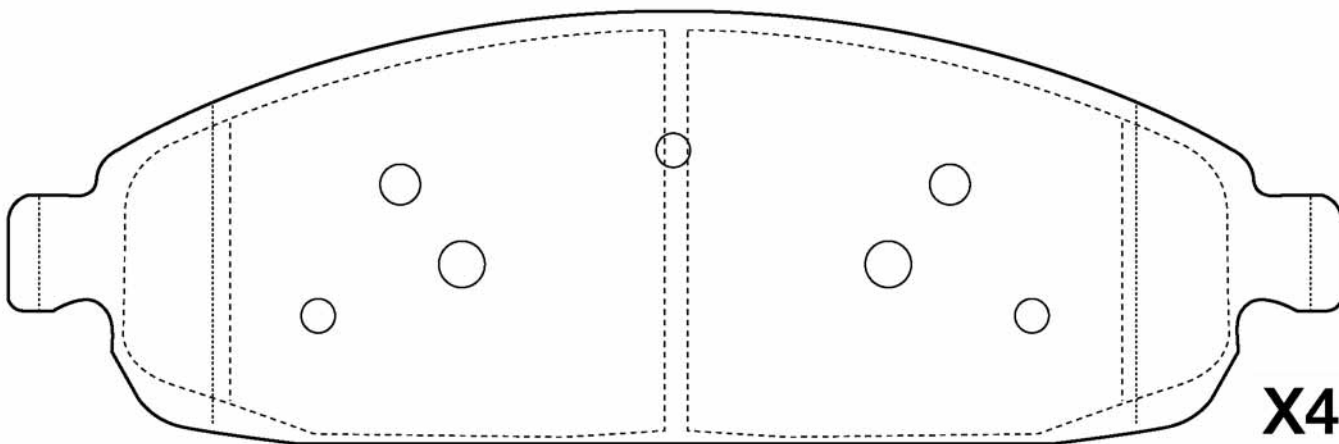



50-00-020				WVA
	DR	L	H	
	119	70	18	

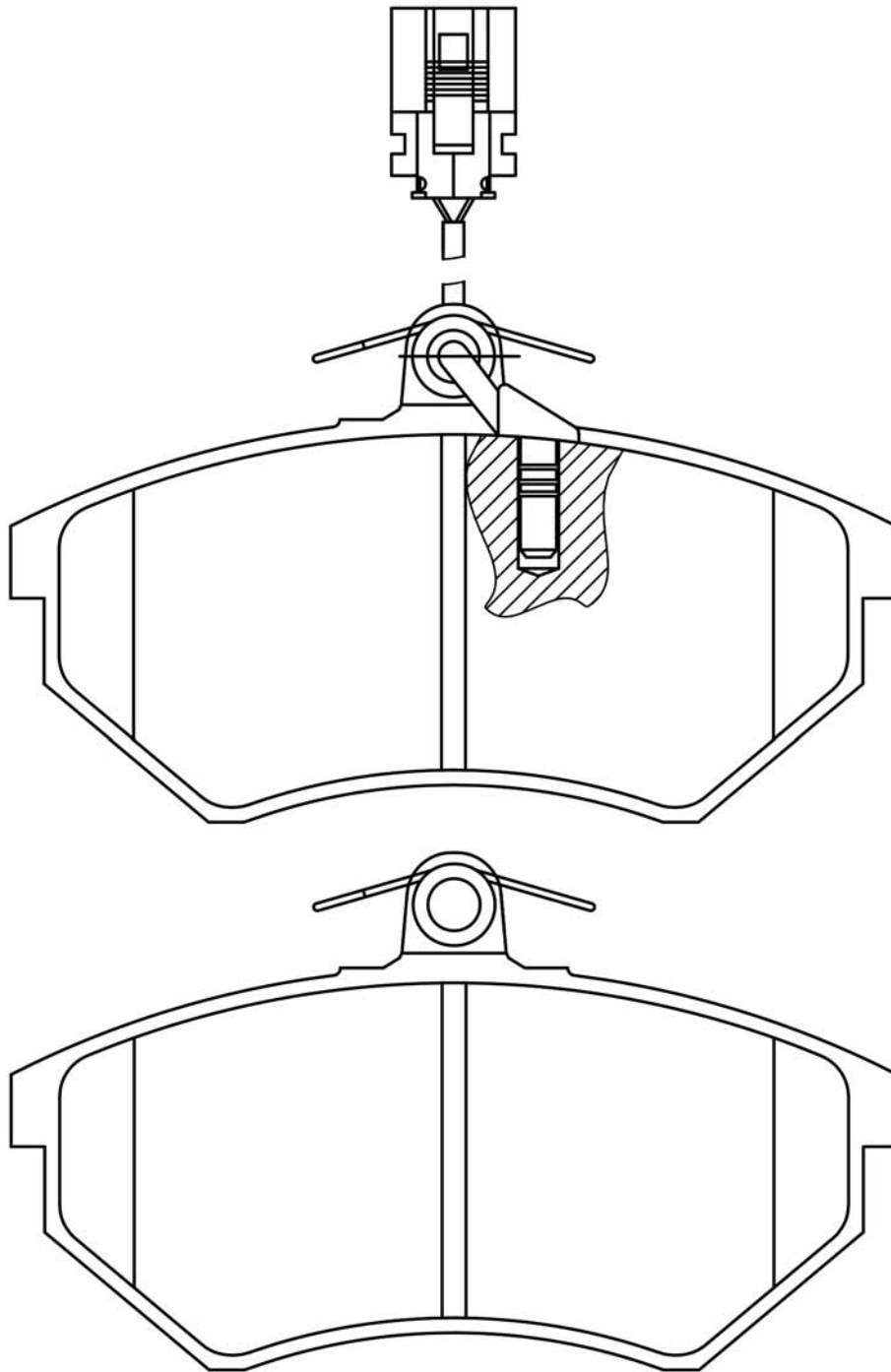



PICTURES BRAKE PADS FRONT
ABBILDUNGEN BREMSKLÖTZE VORN
FIGURAS PASTILLAS DE FRENO DELANTORES
ILLUSTRATIONS PLAQUETTES DE FREI AVANT
IMMAGINI PASTIGLIE FRENO ANTERIORI

50-00-021

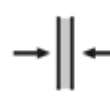

WVA

PIAGGIO - AIXAM - LIGIER

L

H

Th

90

42

10

24734

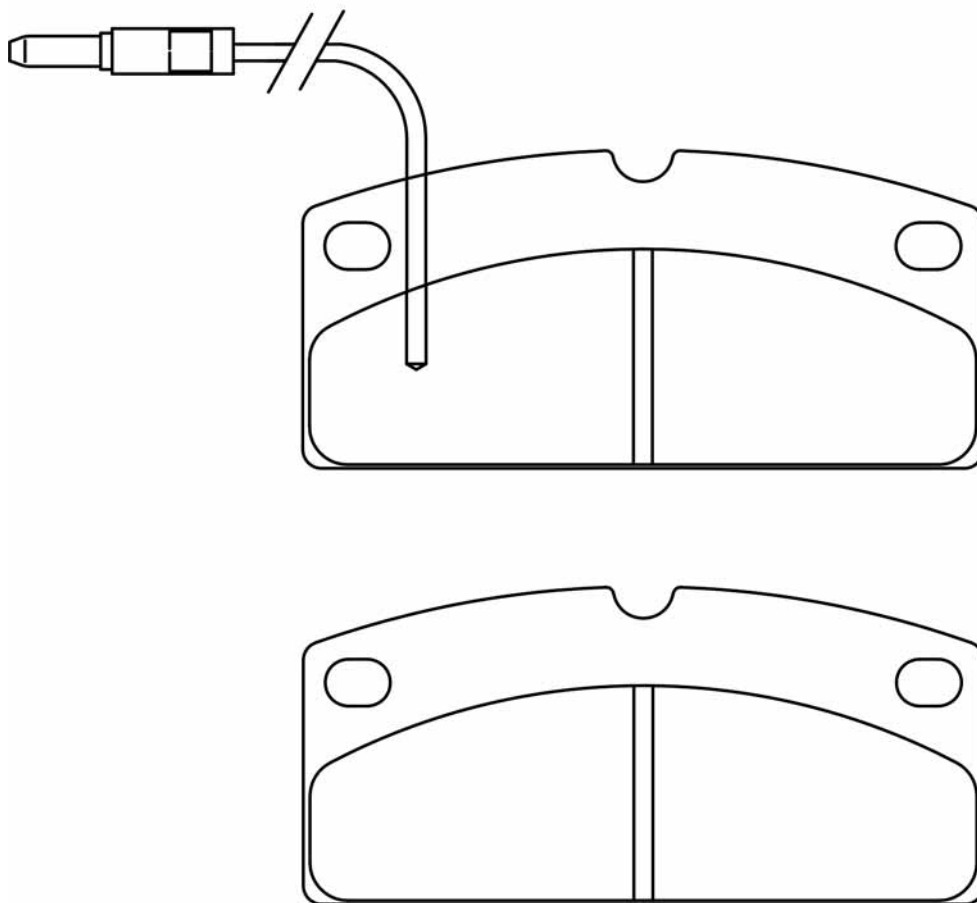



50-00-022				WVA
	DR	L	H	
	132	55	17	

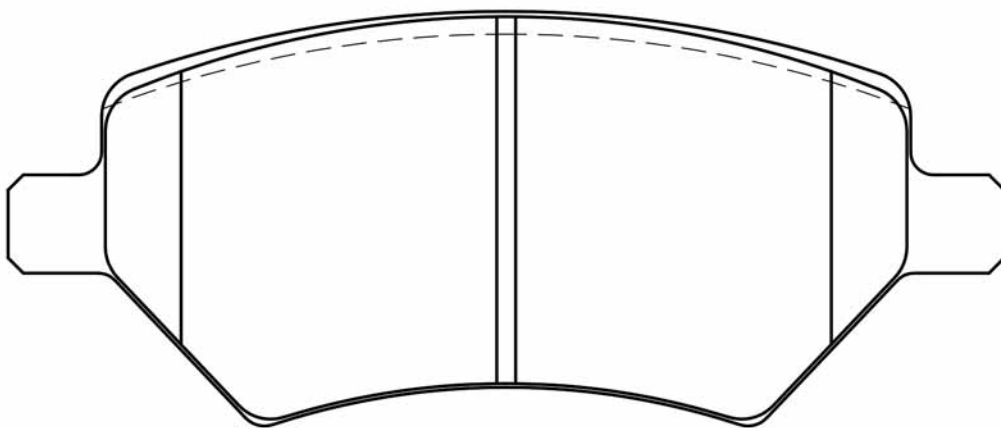
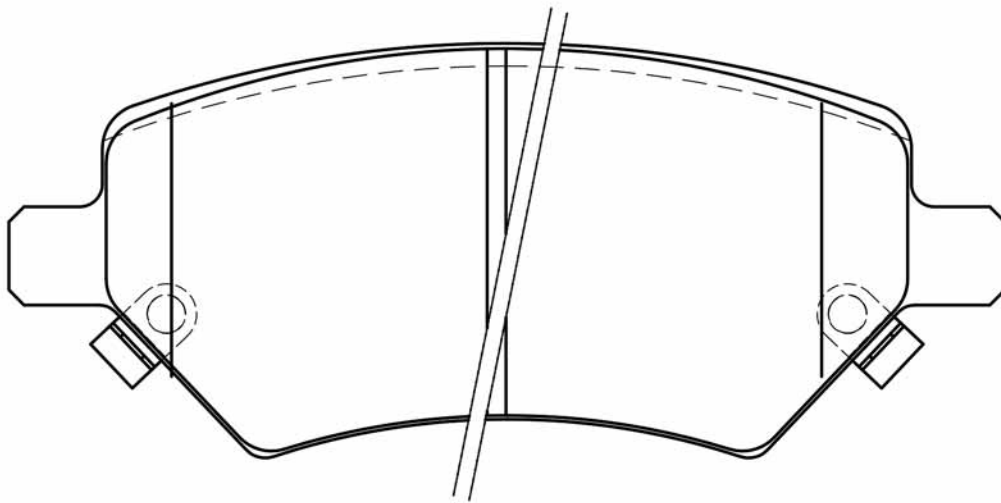



PICTURES BRAKE PADS FRONT
ABBILDUNGEN BREMSKLÖTZE VORN
FIGURAS PASTILLAS DE FRENO DELANTORES
ILLUSTRATIONS PLAQUETTES DE FREI AVANT
IMMAGINI PASTIGLIE FRENO ANTERIORI

50-00-054				WVA
JEEP	L	H	Th	
	157,8/148,5	57,4/54	14,7/15,2	

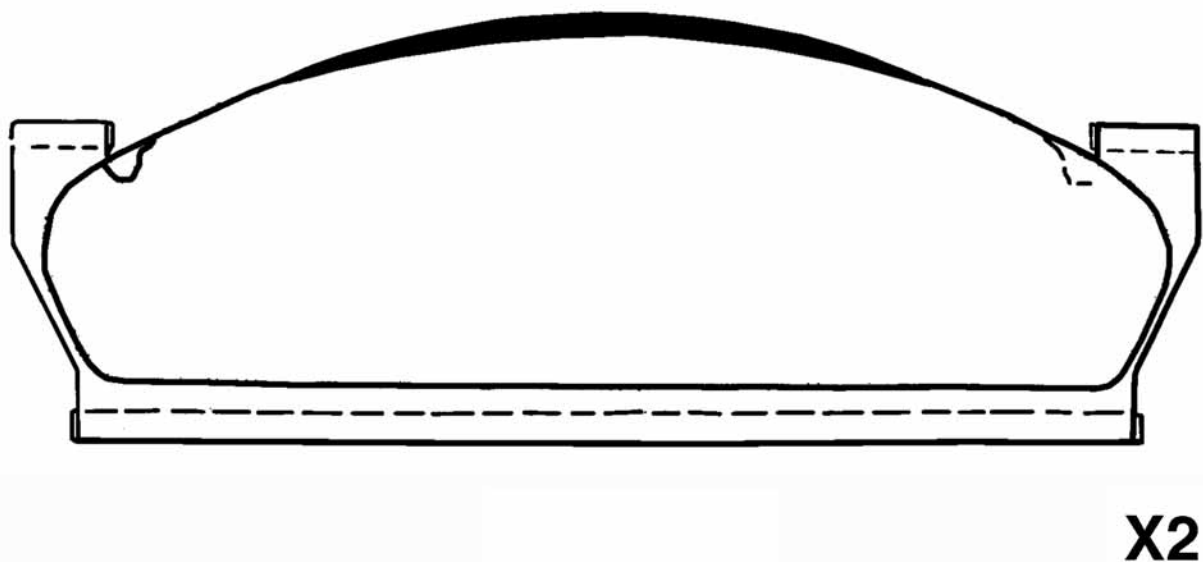
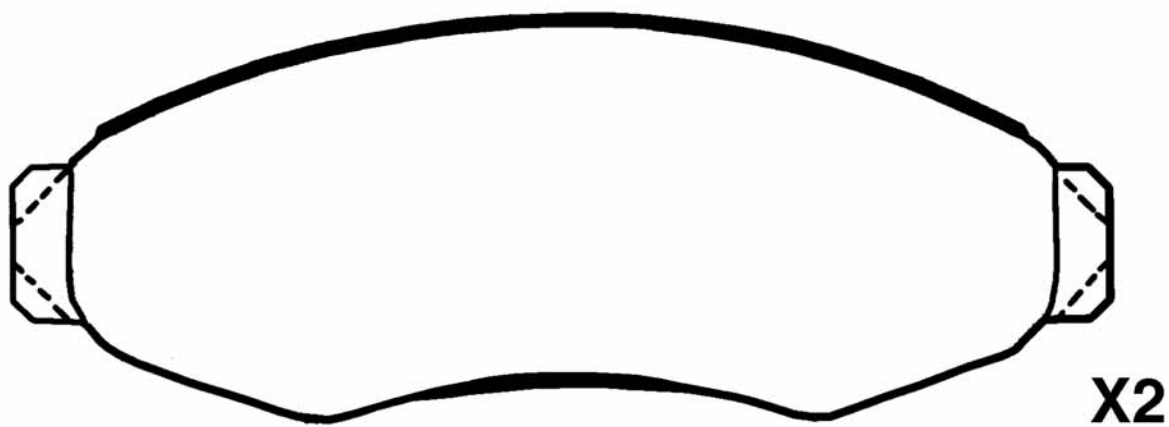



50-00-055

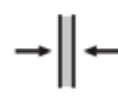
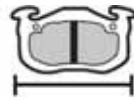

WVA

JEEP

L

H

Th

157,4/183,3

58,2/59,6

17,4/13,2

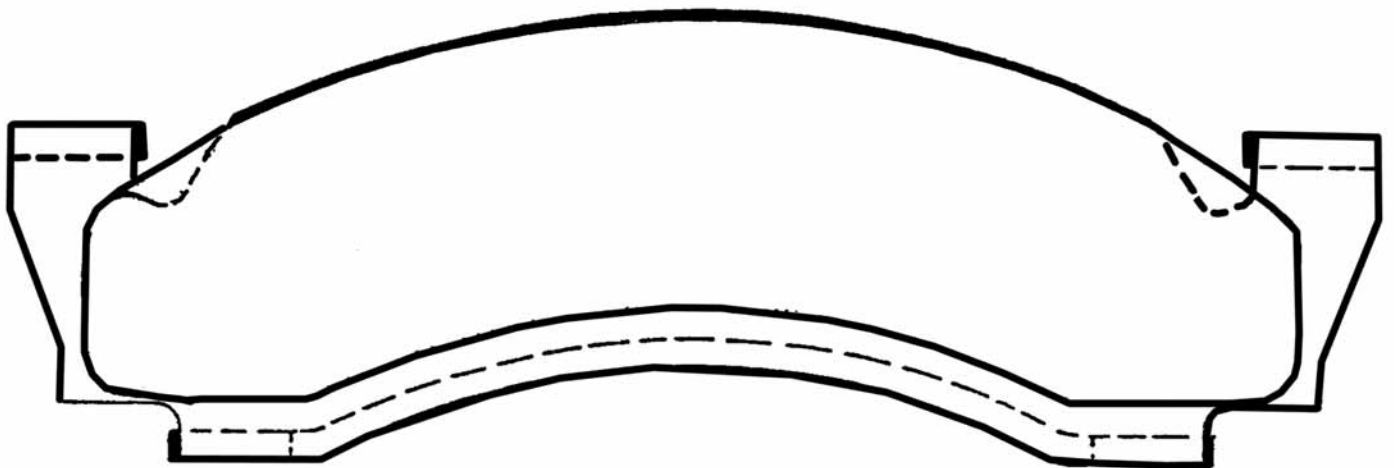

X2

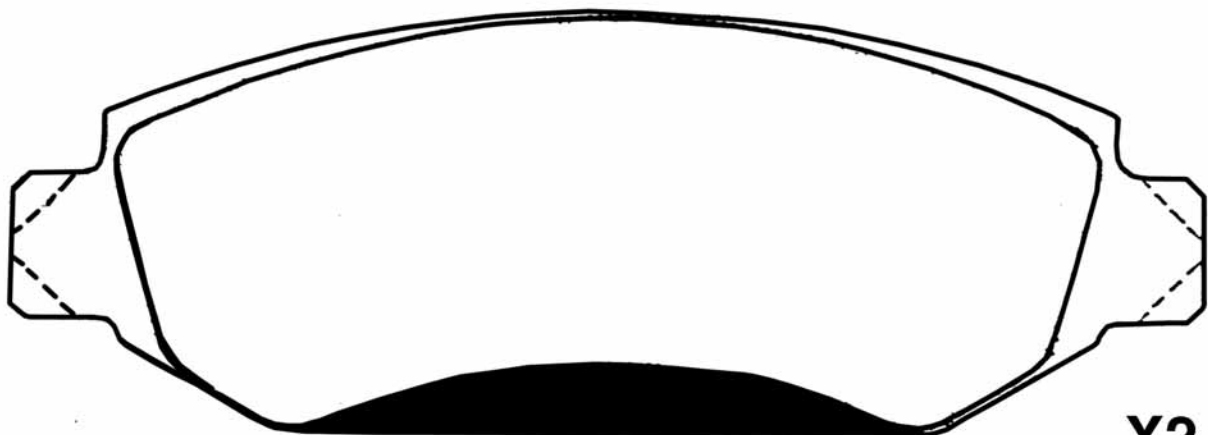

X2



PICTURES BRAKE PADS FRONT
ABBILDUNGEN BREMSKLÖTZE VORN
FIGURAS PASTILLAS DE FRENO DELANTORES
ILLUSTRATIONS PLAQUETTES DE FREI AVANT
IMMAGINI PASTIGLIE FRENO ANTERIORI

50-00-056				WVA
	CHRYSLER	L	H	Th
	173/165,4	64,8/54,5	16,3/17,9	21812

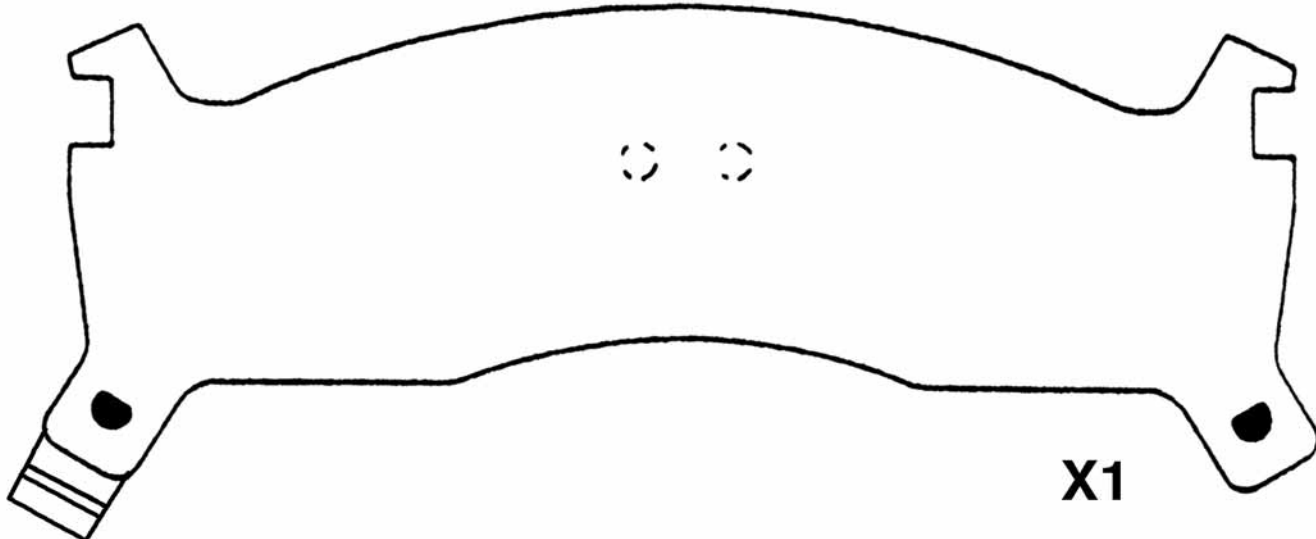
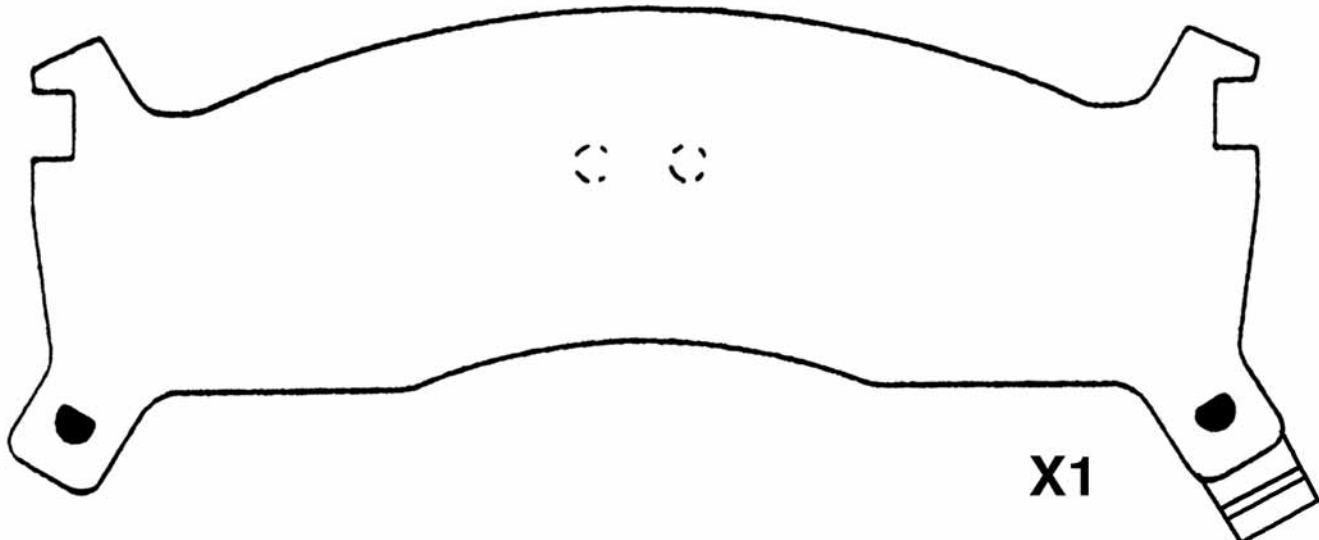
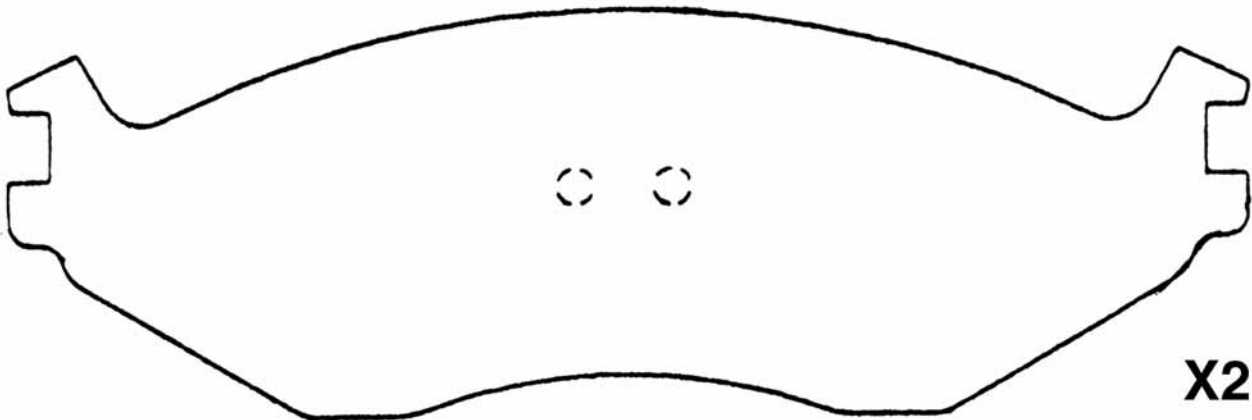



50-00-057				WVA
	JEEP - KIA	L 177	H 54	Th 16,3
				21823

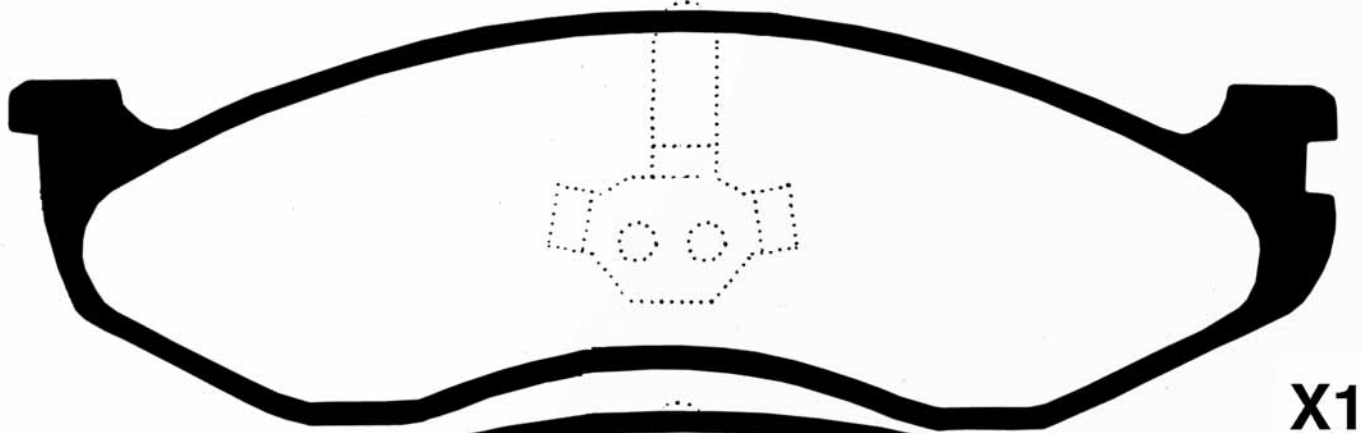

X1

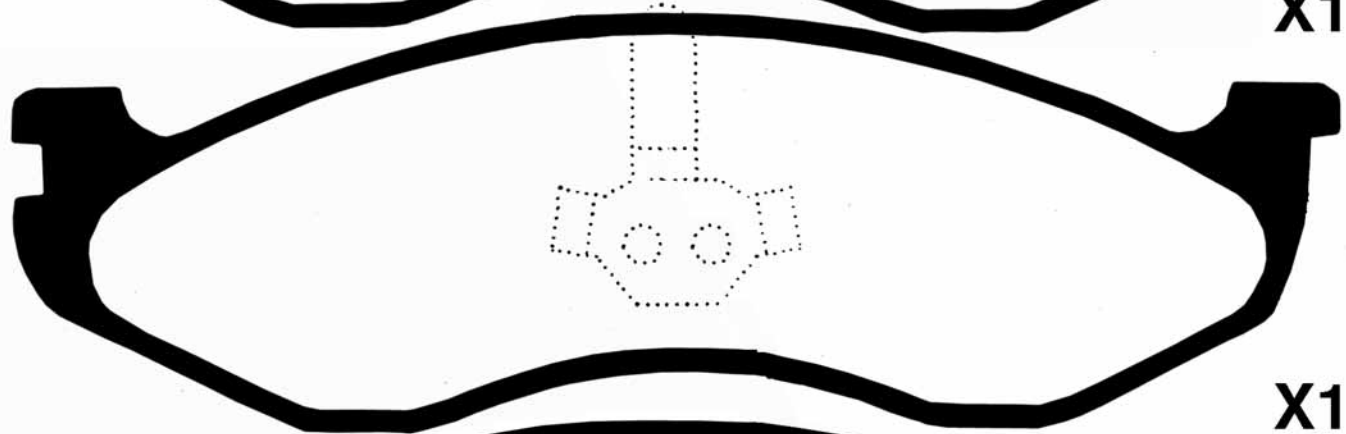

X1

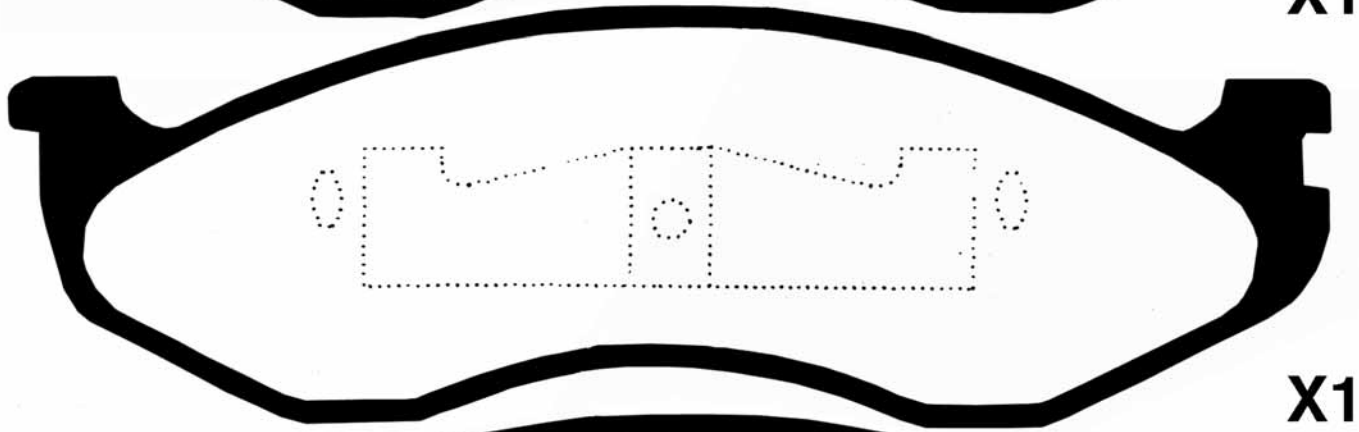

X1

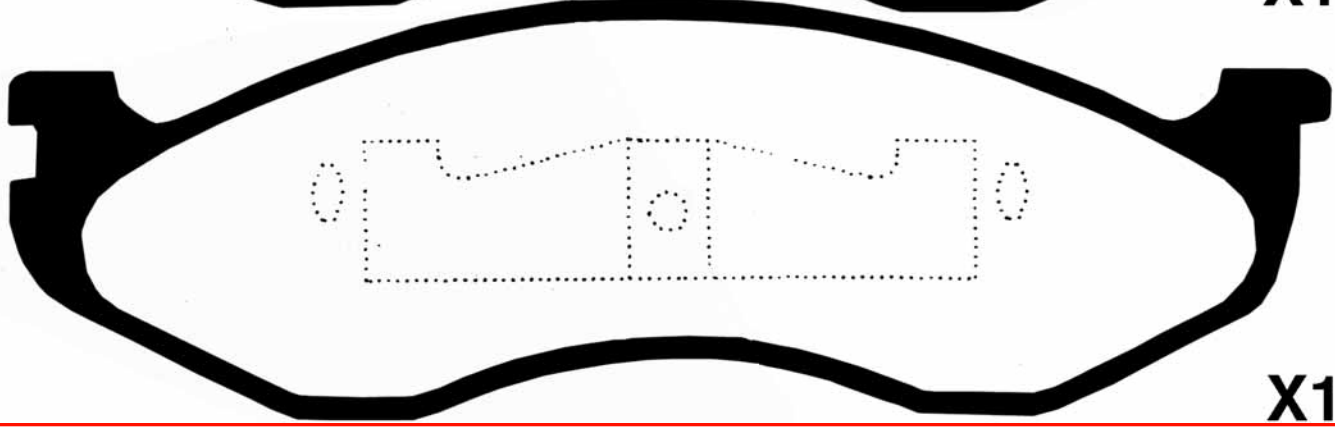

X1



PICTURES BRAKE PADS FRONT
ABBILDUNGEN BREMSKLÖTZE VORN
FIGURAS PASTILLAS DE FRENO DELANTORES
ILLUSTRATIONS PLAQUETTES DE FREI AVANT
IMMAGINI PASTIGLIE FRENO ANTERIORI

50-00-057P				WVA
	KIA - JEEP	L	H	
	177	54	16,3	

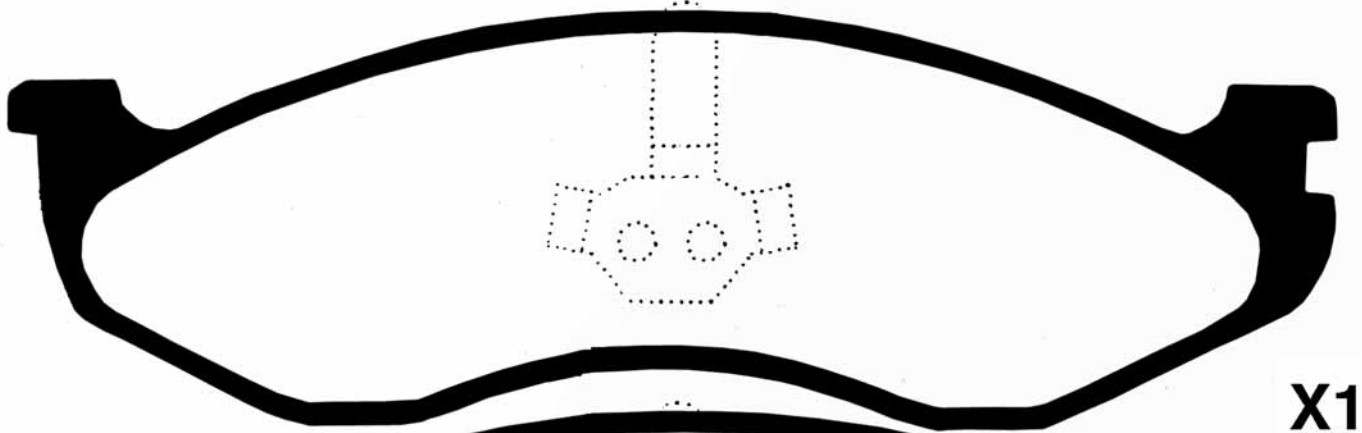

X1

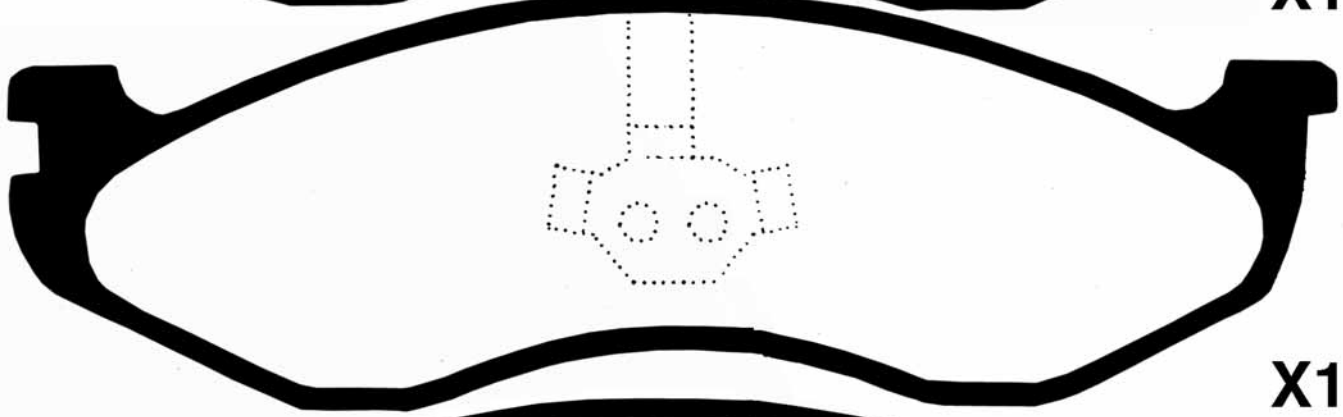

X1

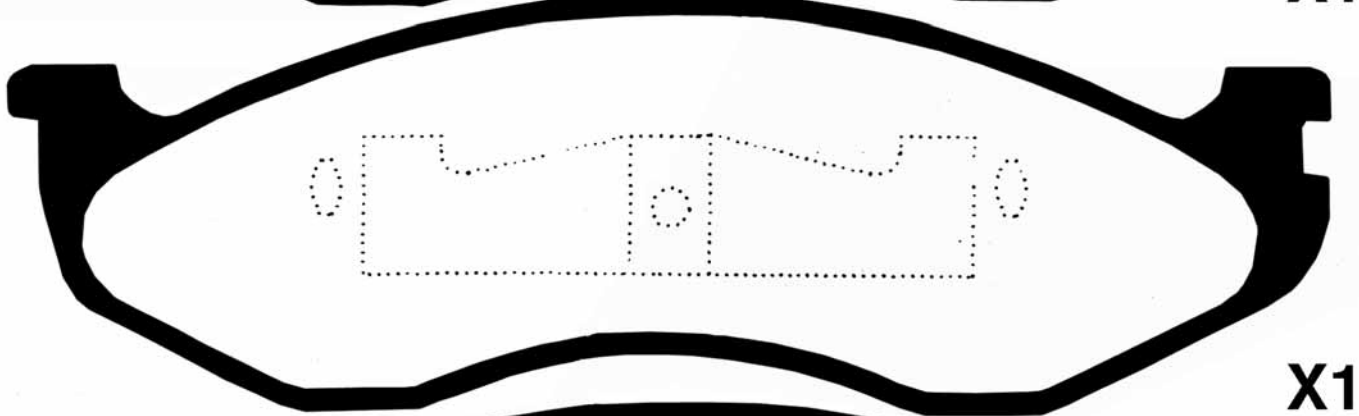

X1

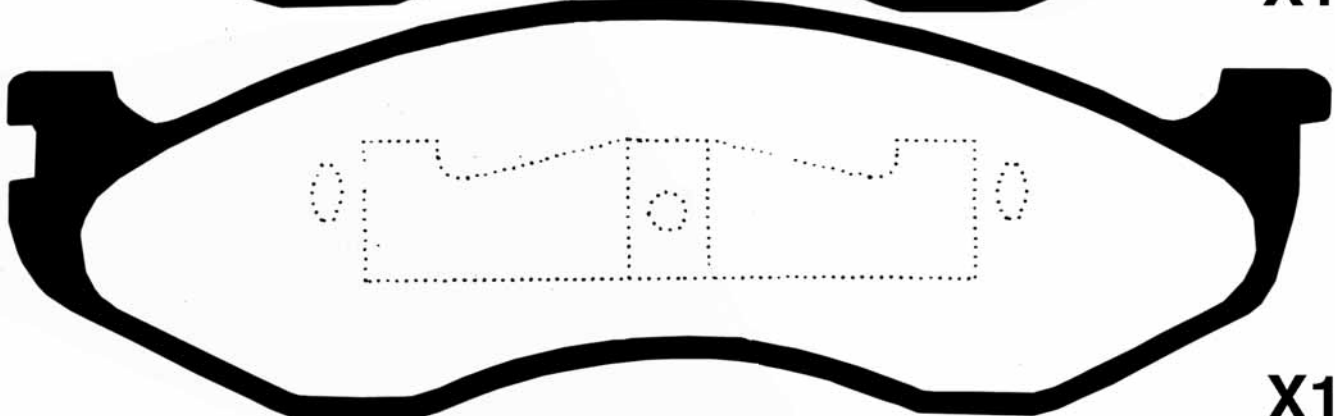

X1

PICTURES BRAKE PADS FRONT
 ABBILDUNGEN BREMSKLÖTZE VORN
 FIGURAS PASTILLAS DE FRENO DELANTORES
 ILLUSTRATIONS PLAQUETTES DE FREI AVANT
 IMMAGINI PASTIGLIE FRENO ANTERIORI



50-00-059				WVA
	JEEP	L	H	Th
	176,7	56,3	15,8	21820

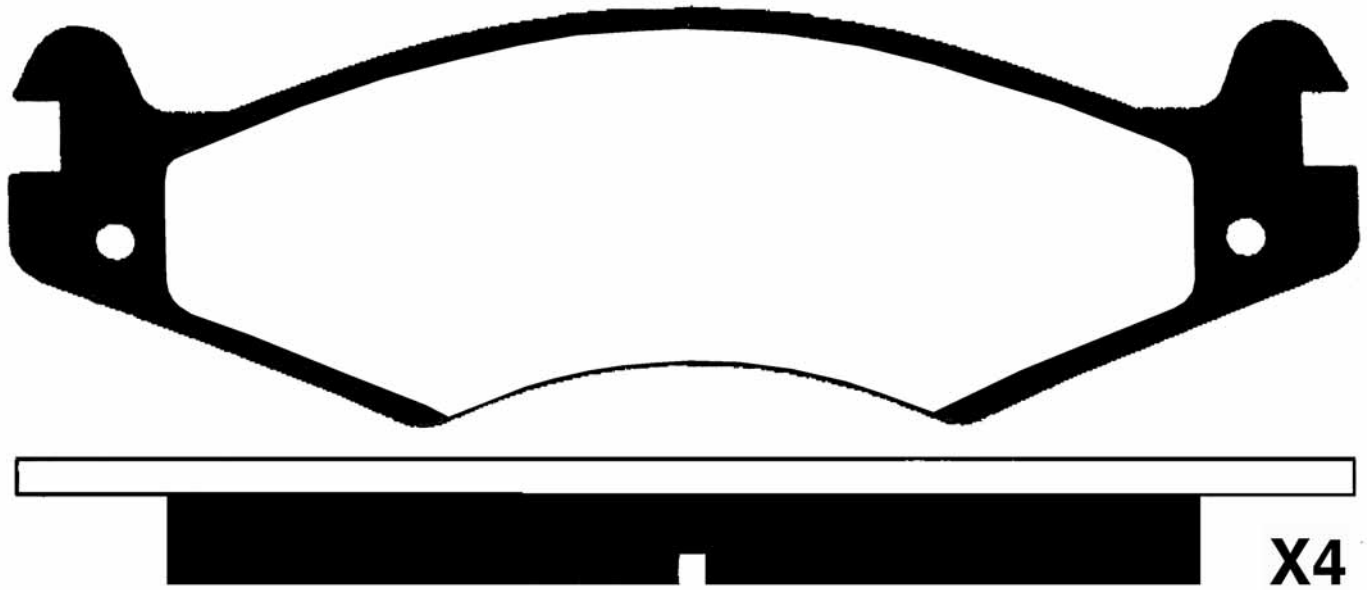



PICTURES BRAKE PADS FRONT
ABBILDUNGEN BREMSKLÖTZE VORN
FIGURAS PASTILLAS DE FRENO DELANTORES
ILLUSTRATIONS PLAQUETTES DE FREI AVANT
IMMAGINI PASTIGLIE FRENO ANTERIORI

50-00-060

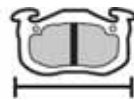

WVA

CHRYSLER

L

H

Th

165

62,2

16,2/18

21815

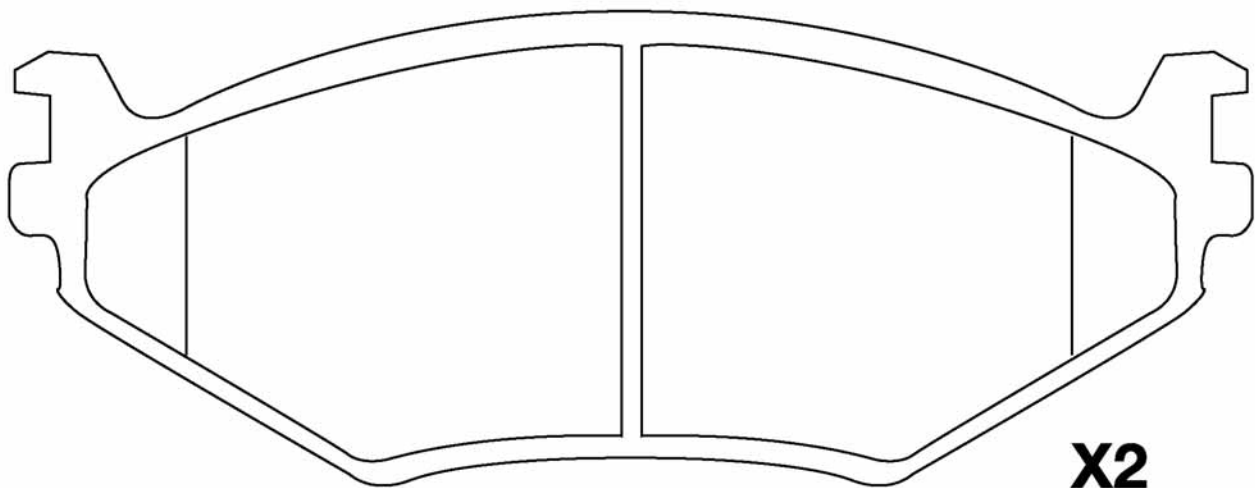
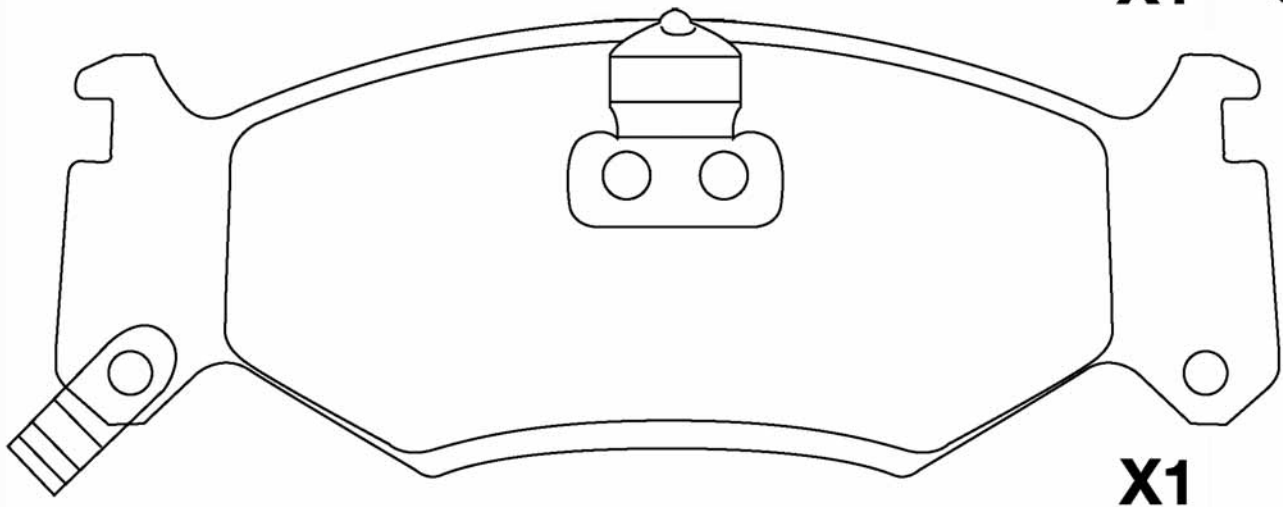
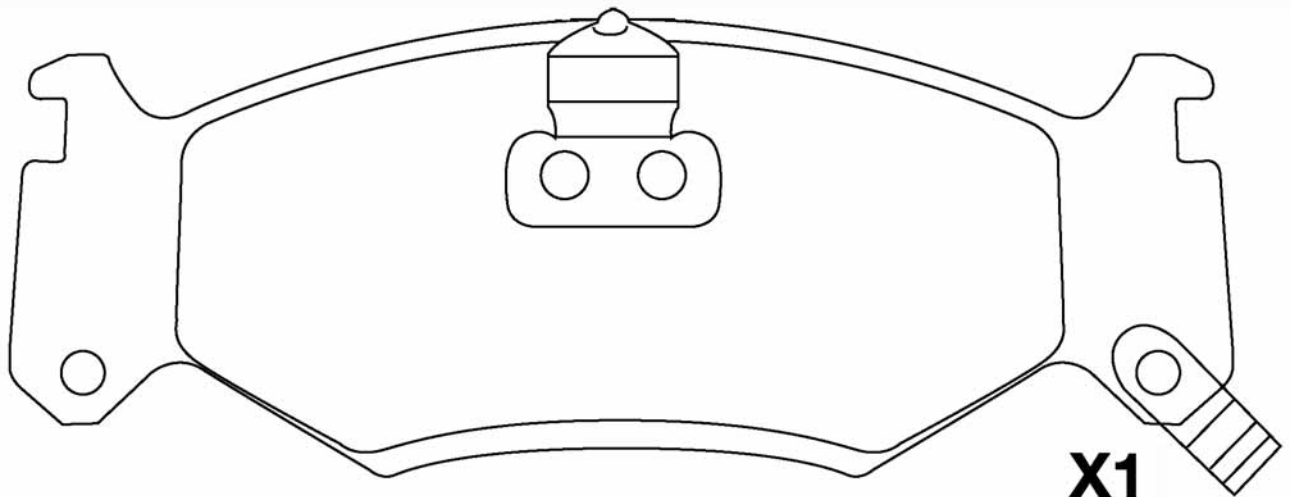



50-00-080				WVA
	TATA (TELCO)	L	H	Th
	121,4	45,4	16	24555

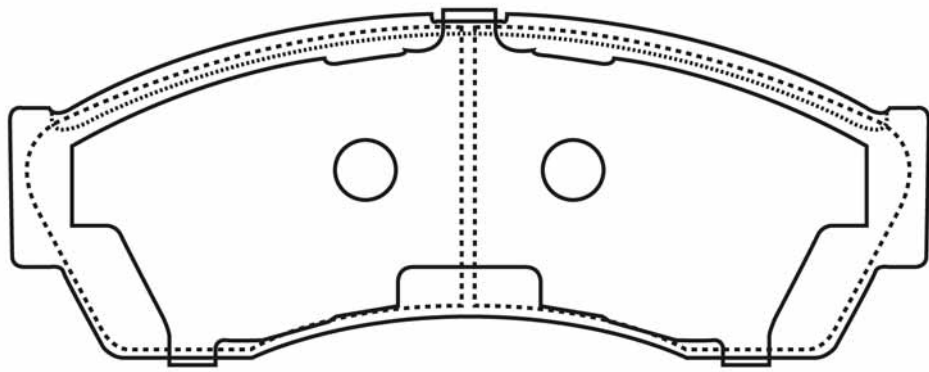

X4



PICTURES BRAKE PADS FRONT
ABBILDUNGEN BREMSKLÖTZE VORN
FIGURAS PASTILLAS DE FRENO DELANTORES
ILLUSTRATIONS PLAQUETTES DE FREI AVANT
IMMAGINI PASTIGLIE FRENO ANTERIORI

50-00-090				WVA
JEEP	L	H	Th	
	157,7	60	19	

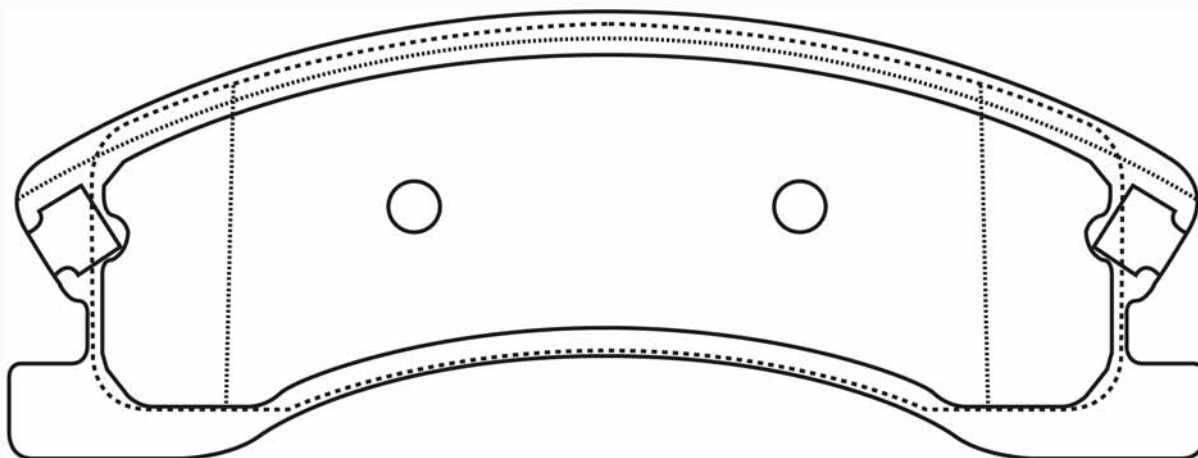

X4



50-00-092

CHRYSLER

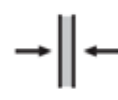
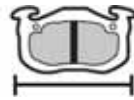

WVA

L

155,5

H

61

Th

19,4

23951

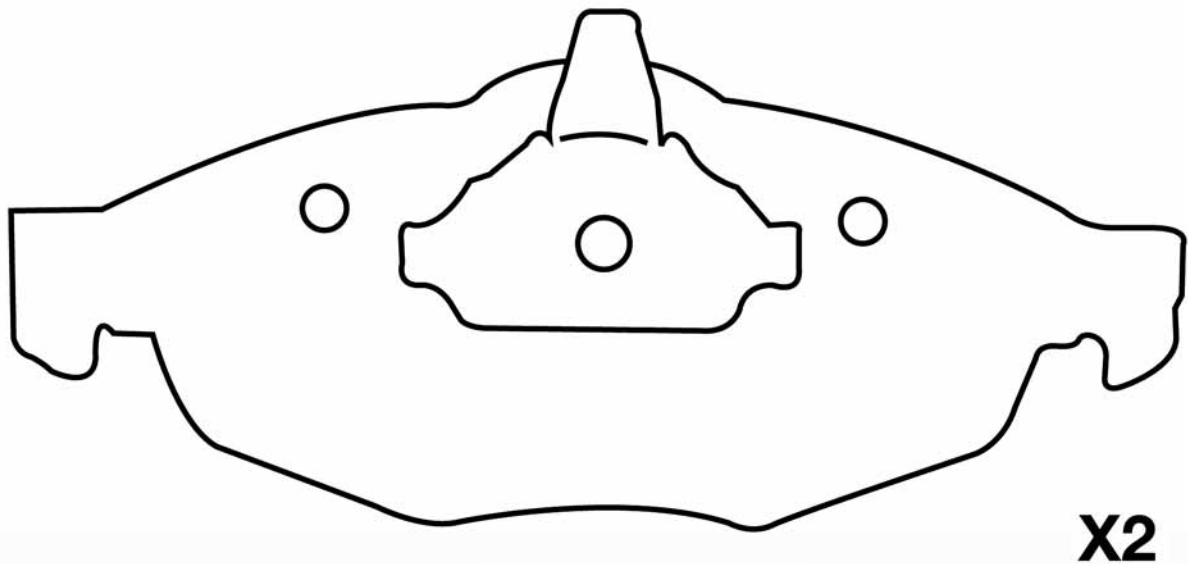
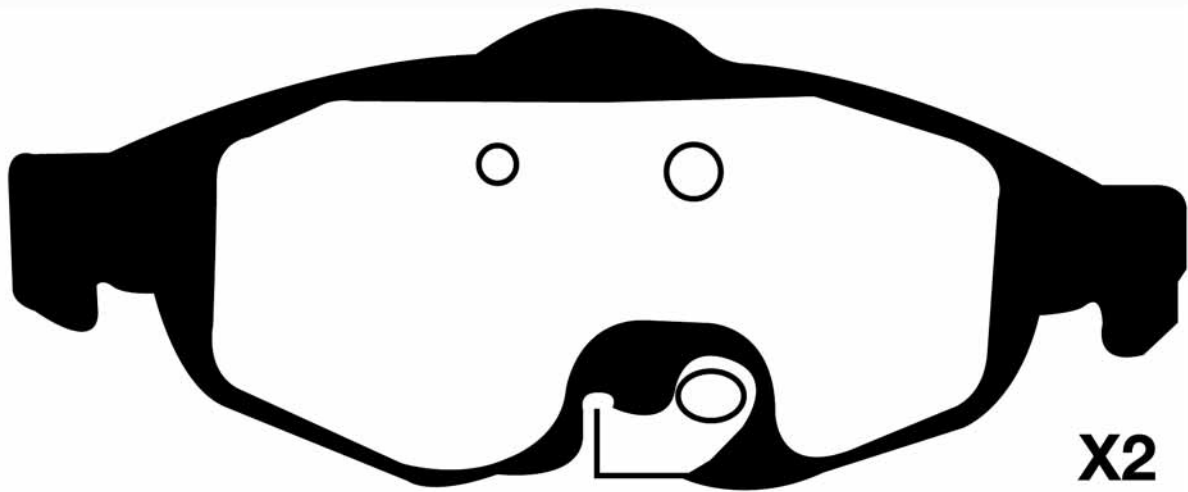



PICTURES BRAKE PADS FRONT
ABBILDUNGEN BREMSKLÖTZE VORN
FIGURAS PASTILLAS DE FRENO DELANTORES
ILLUSTRATIONS PLAQUETTES DE FREI AVANT
IMMAGINI PASTIGLIE FRENO ANTERIORI

50-00-093				WVA
	CHRYSLER	L	H	
	176,7	46,7	15,9	23318

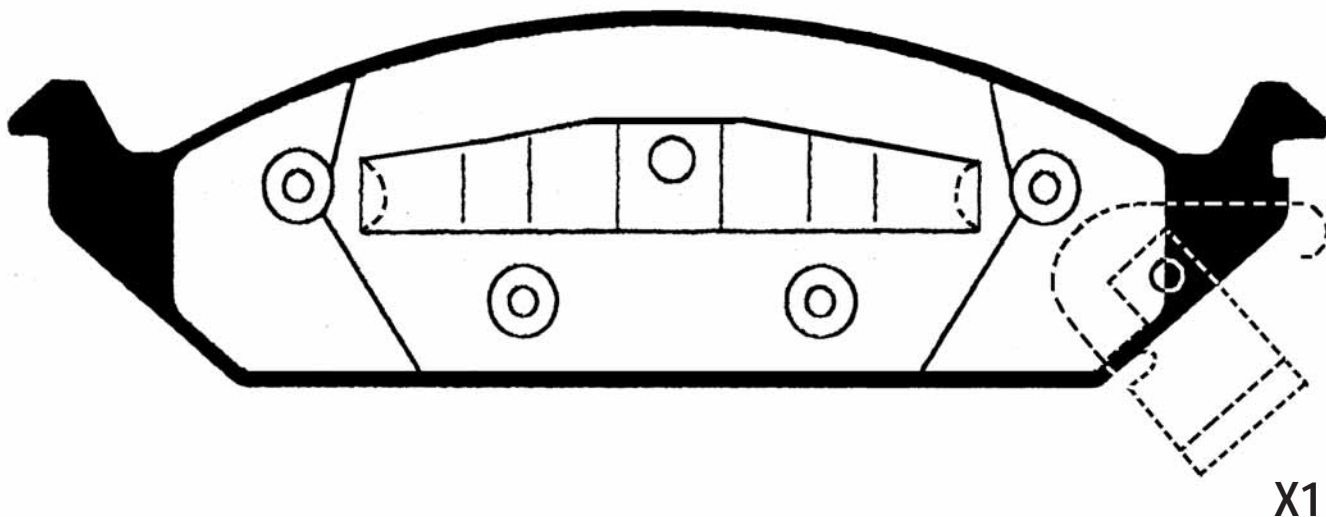
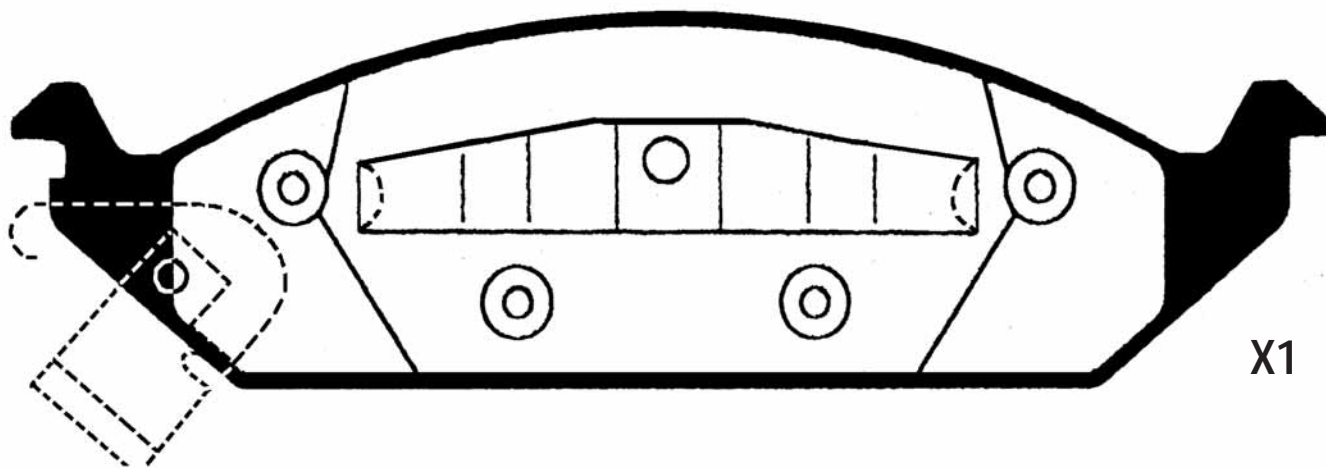
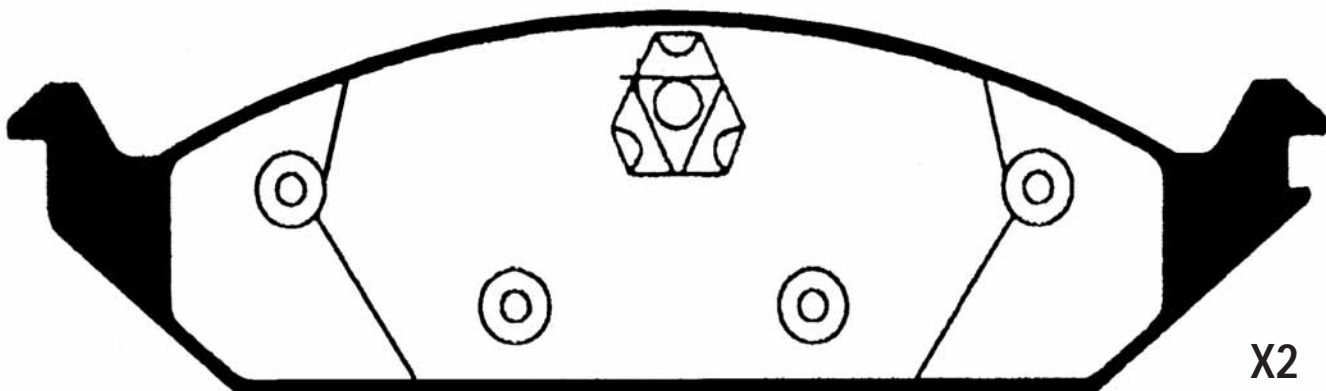



50-00-094				WVA
	CHRYSLER	L	H	Th
	124,4	65,3	18,5	23532

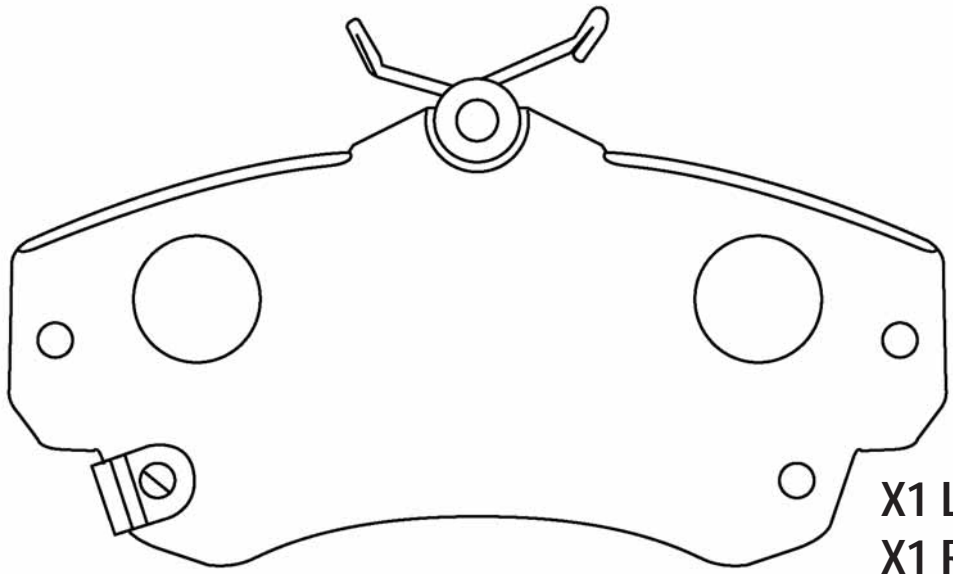

X1 LEFT
X1 RIGHT

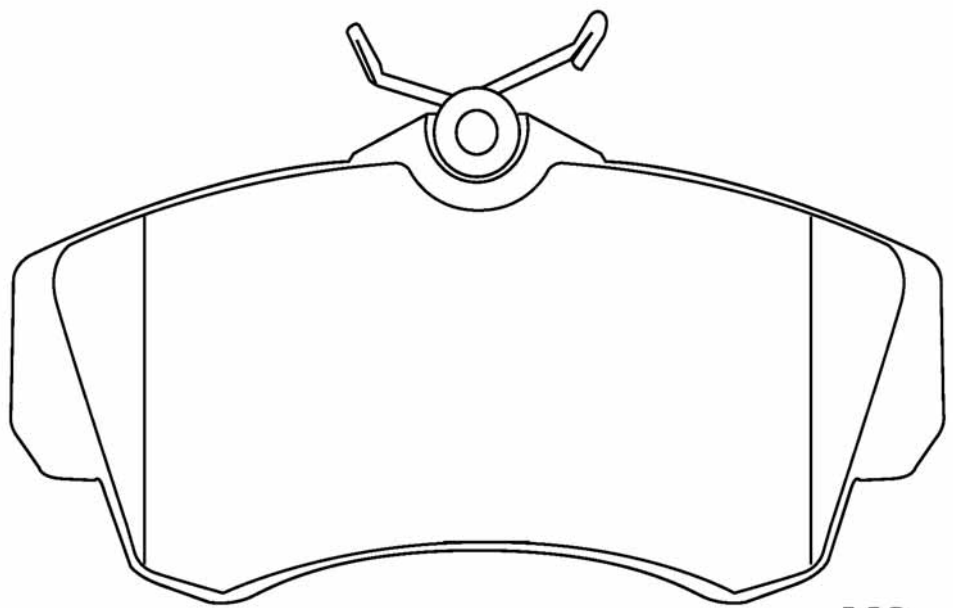

X2



PICTURES BRAKE PADS FRONT
ABBILDUNGEN BREMSKLÖTZE VORN
FIGURAS PASTILLAS DE FRENO DELANTORES
ILLUSTRATIONS PLAQUETTES DE FREI AVANT
IMMAGINI PASTIGLIE FRENO ANTERIORI

50-00-096				WVA
CHRYSLER	L	H	Th	
	172,5	72,5	18,8	

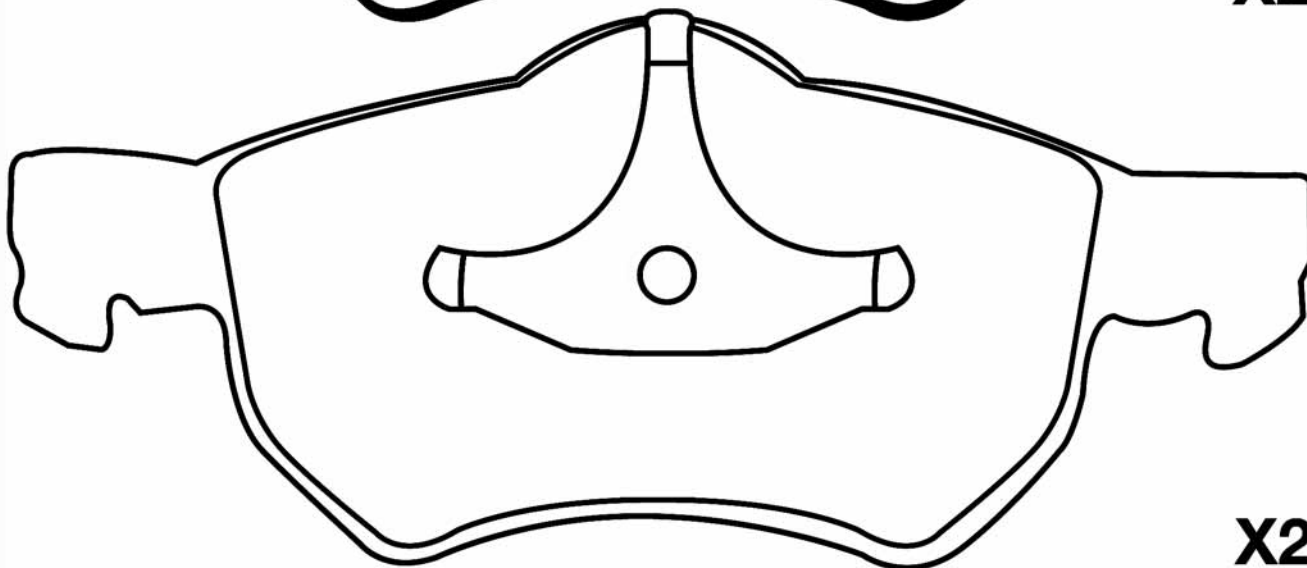
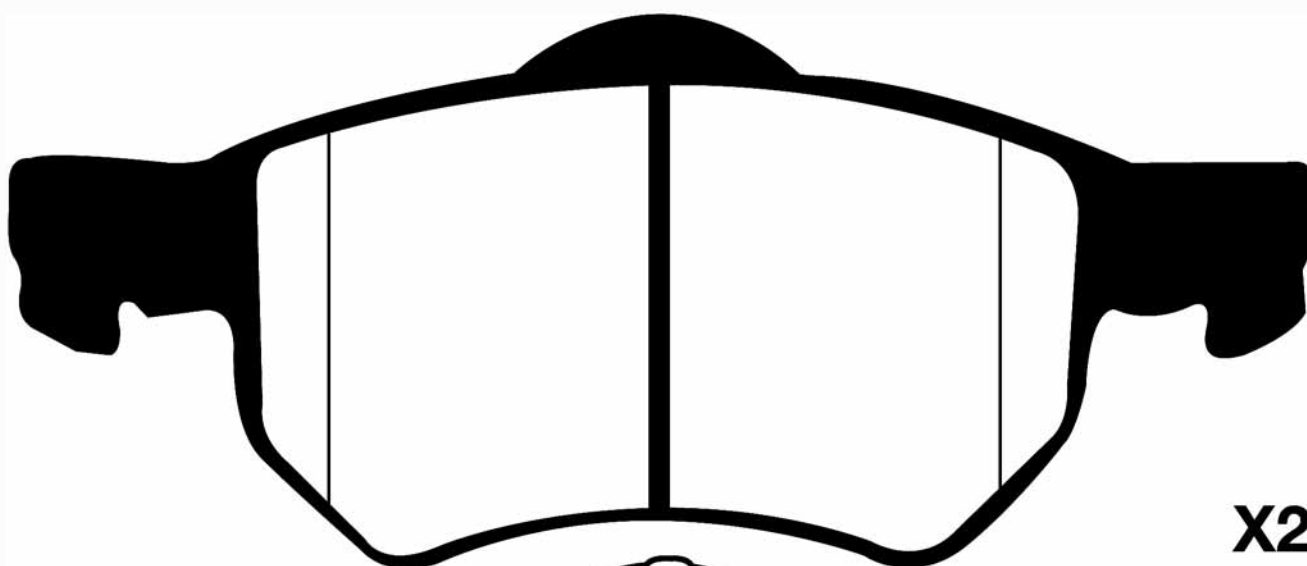



50-00-096P				WVA
CHRYSLER	L	H	Th	
	172,5	72,5	18,8	

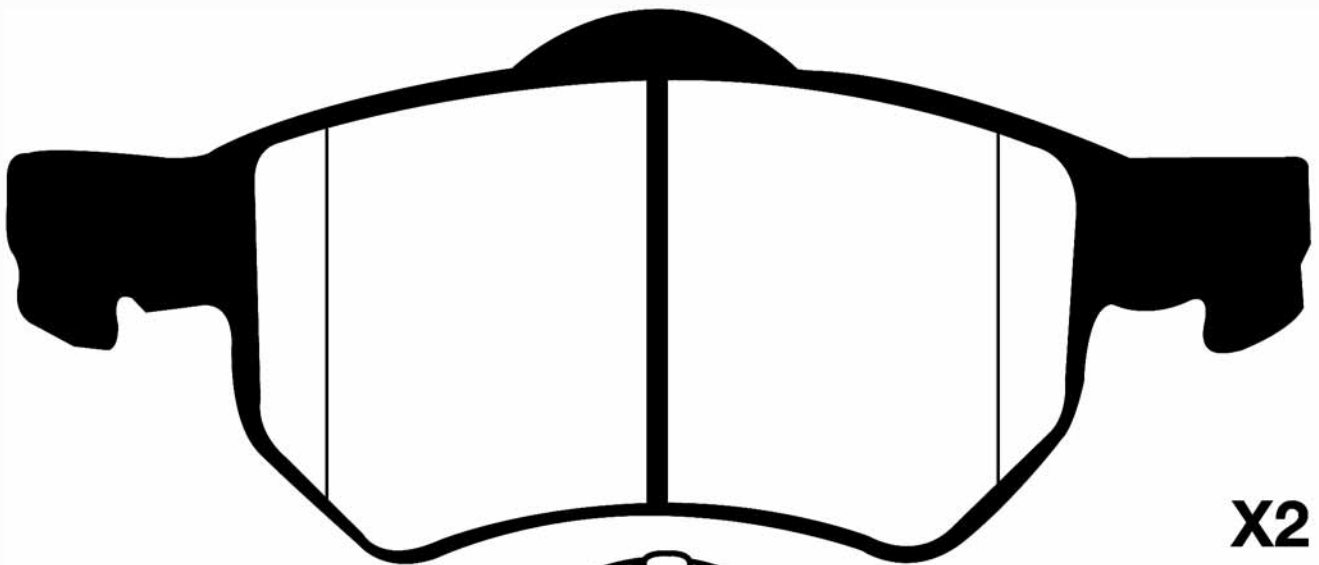

X2

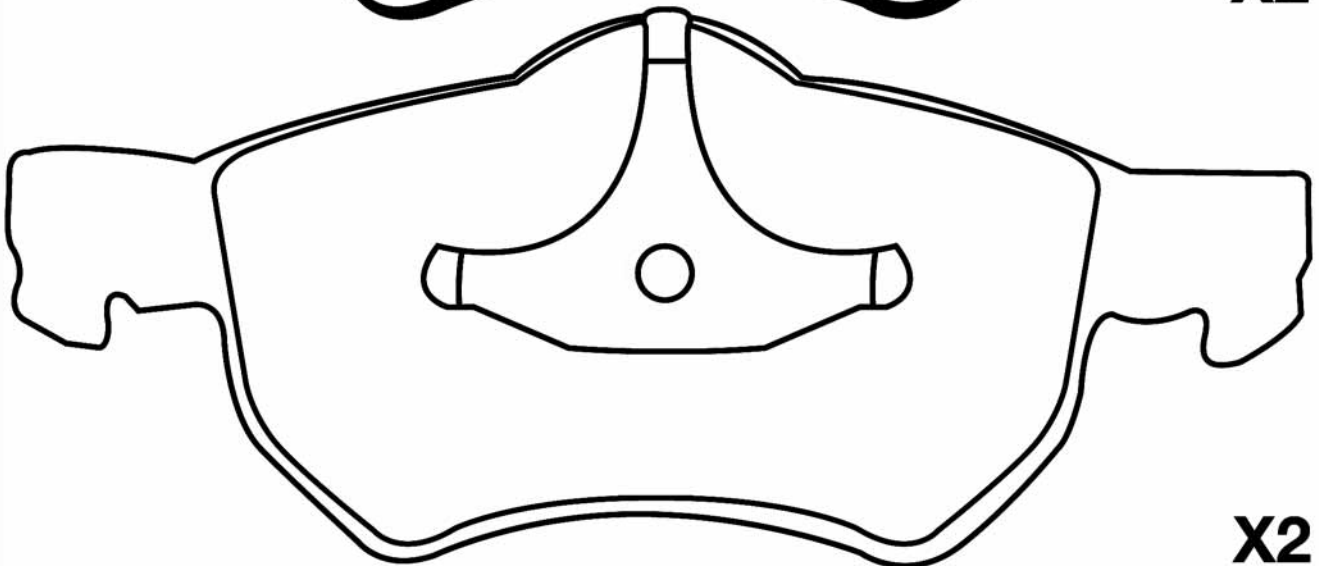

X2



PICTURES BRAKE PADS FRONT
ABBILDUNGEN BREMSKLÖTZE VORN
FIGURAS PASTILLAS DE FRENO DELANTORES
ILLUSTRATIONS PLAQUETTES DE FREI AVANT
IMMAGINI PASTIGLIE FRENO ANTERIORI

50-00-097

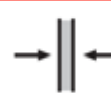

WVA

JEEP

L

H

Th

194,7/192,6

55,5

18,2

23631

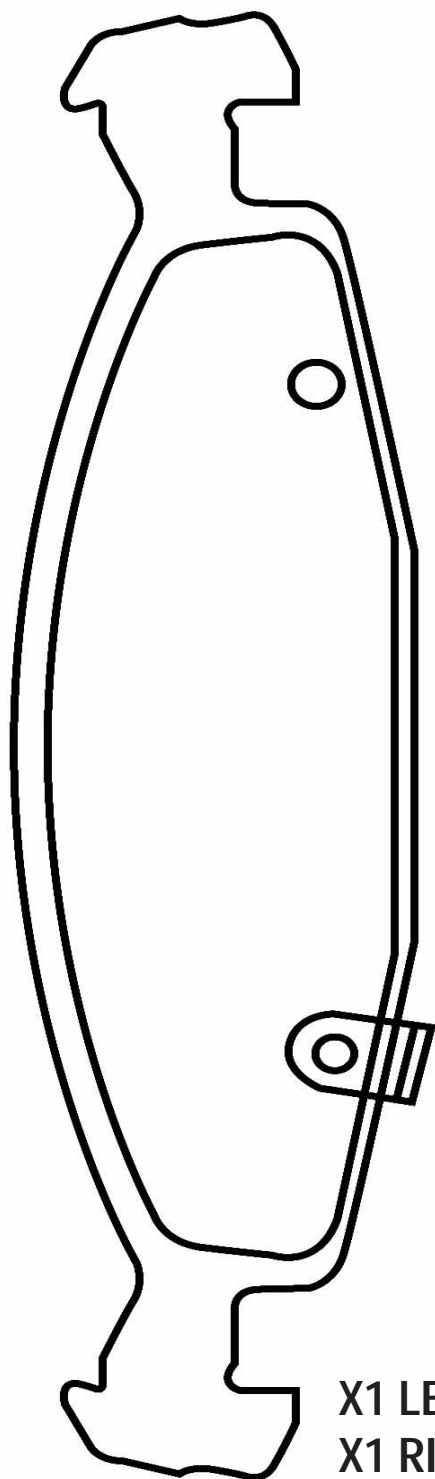

X1 LEFT
X1 RIGHT

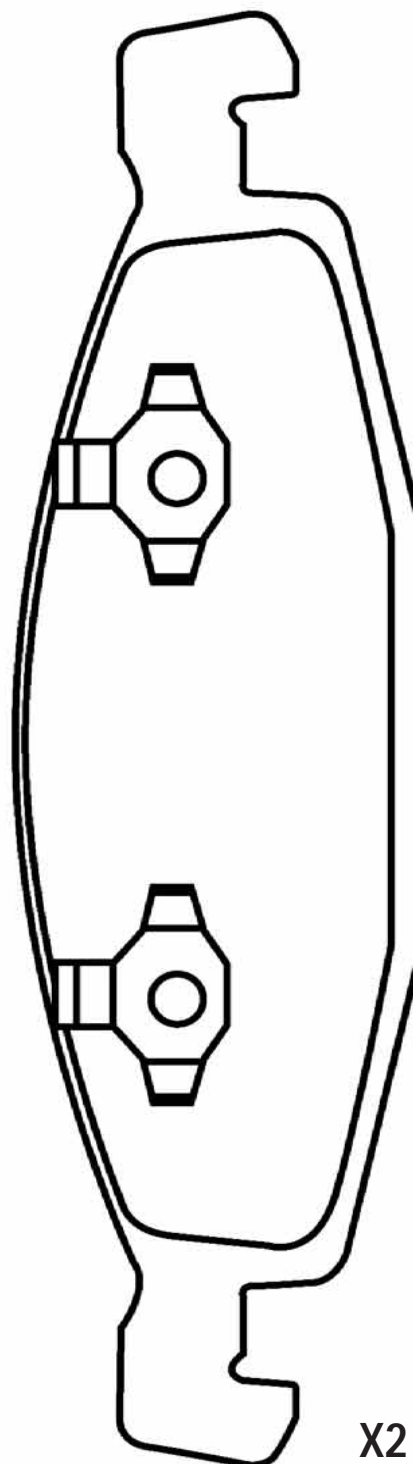

X2



50-00-098				WVA
	PONTIAC - CHEVROLET	L	H	
	147,6/212,5	65/67,5	17,2/16	

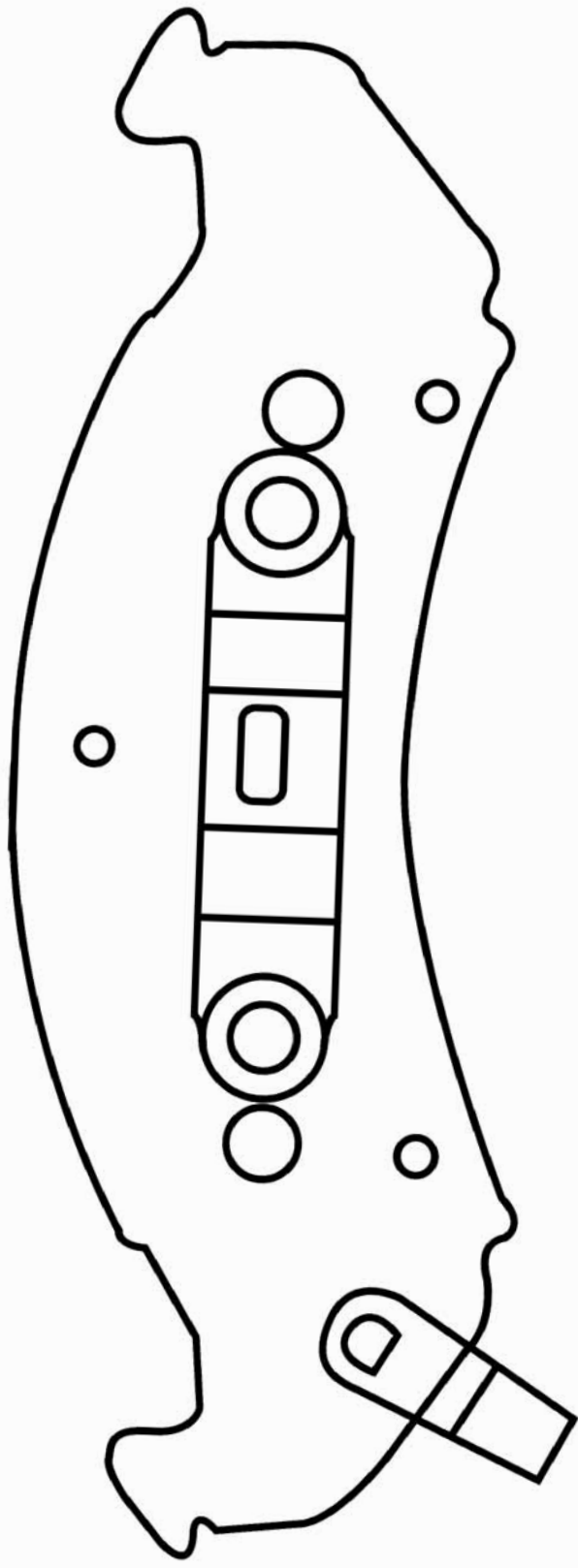

X1 LEFT
 X1 RIGHT

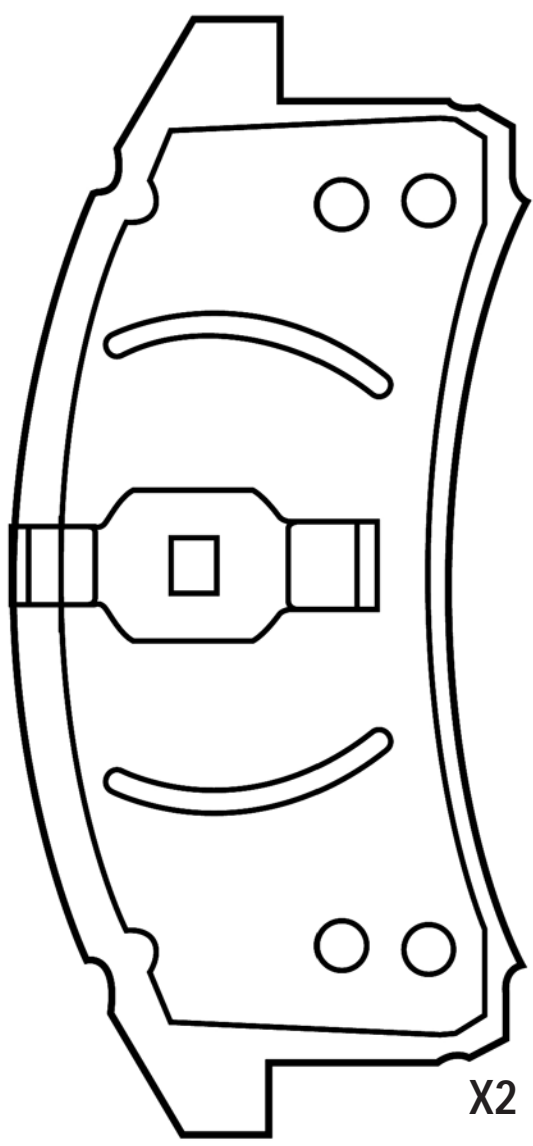

X2



PICTURES BRAKE PADS FRONT
ABBILDUNGEN BREMSKLÖTZE VORN
FIGURAS PASTILLAS DE FRENO DELANTORES
ILLUSTRATIONS PLAQUETTES DE FREI AVANT
IMMAGINI PASTIGLIE FRENO ANTERIORI

50-00-099				WVA
CHRYSLER	L	H	Th	
	164	55	17	24593

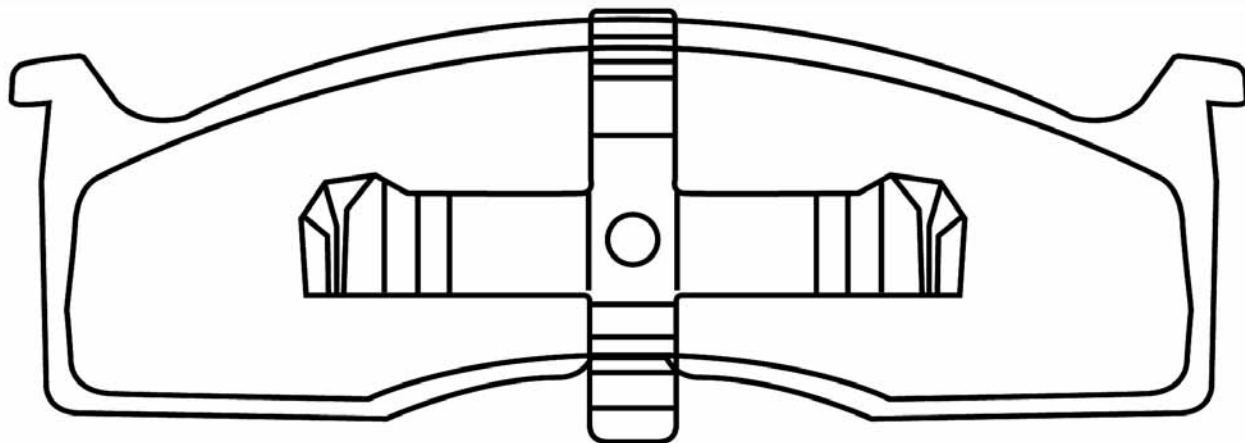

X2

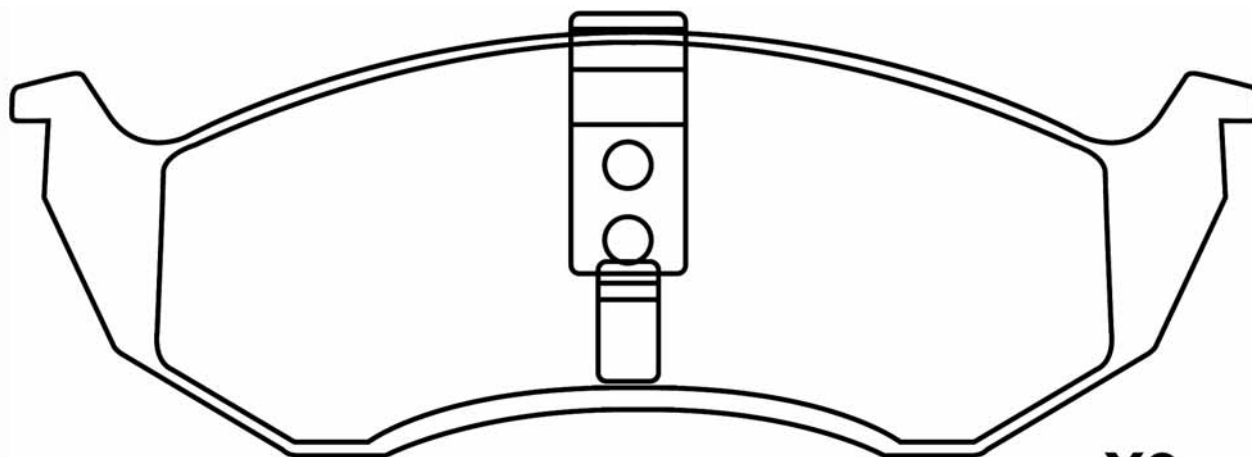

X2



50-00-099P				WVA
	CHRYSLER	L 164	H 55	

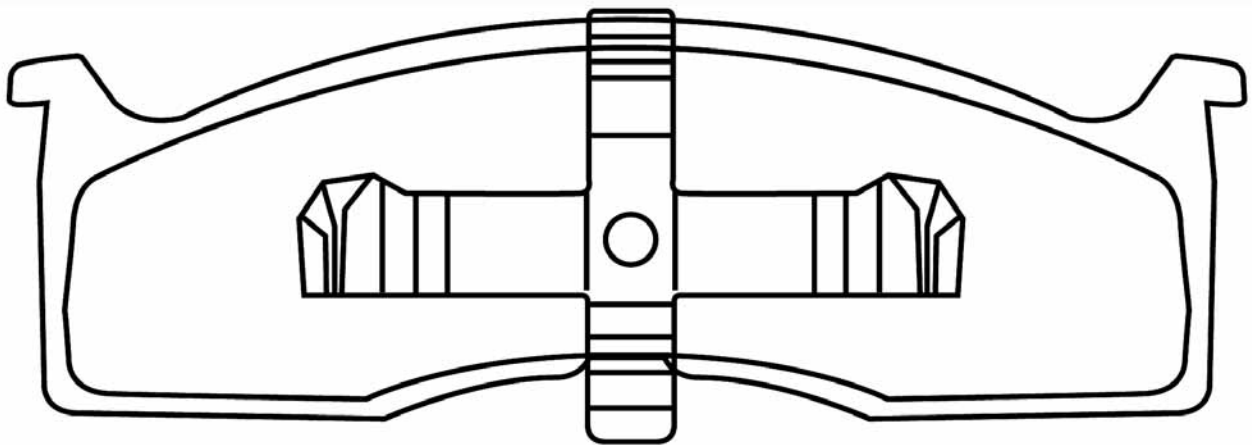

X2

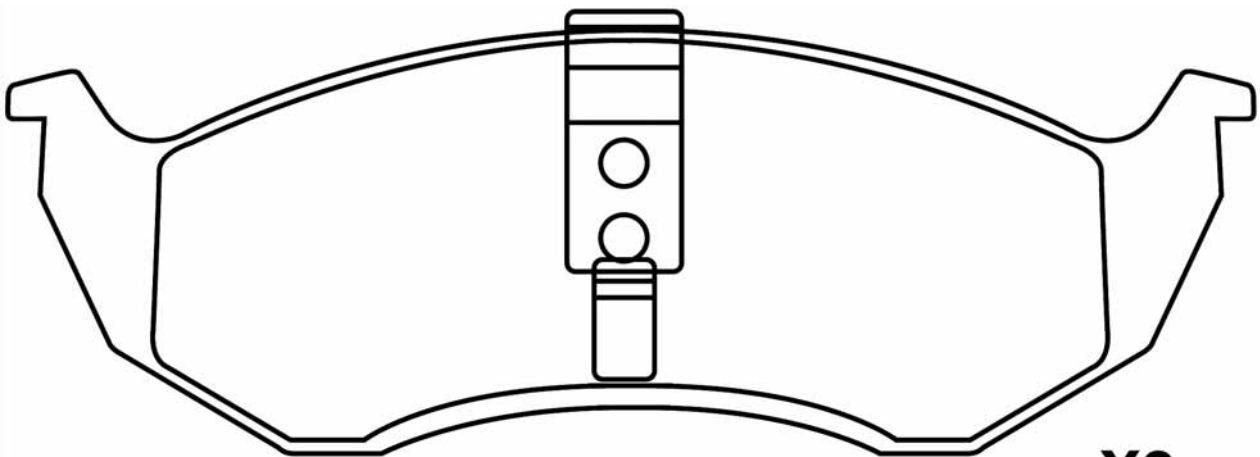

X2



PICTURES BRAKE PADS FRONT
ABBILDUNGEN BREMSKLÖTZE VORN
FIGURAS PASTILLAS DE FRENO DELANTORES
ILLUSTRATIONS PLAQUETTES DE FREI AVANT
IMMAGINI PASTIGLIE FRENO ANTERIORI

50-01-100				WVA
NISSAN	L	H	Th	
	58	55,2	13,8	20128

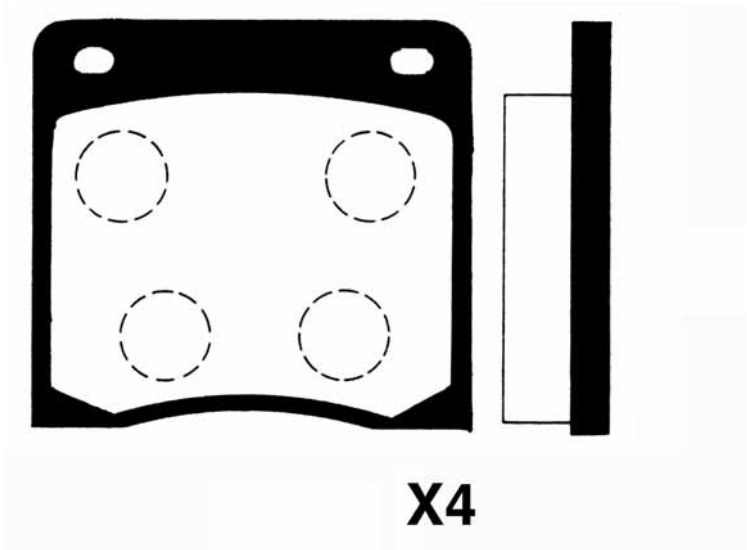



50-01-101				WVA
	SUBARU - NISSAN	L 108,8	H 40,4	Th 15,3
				20958

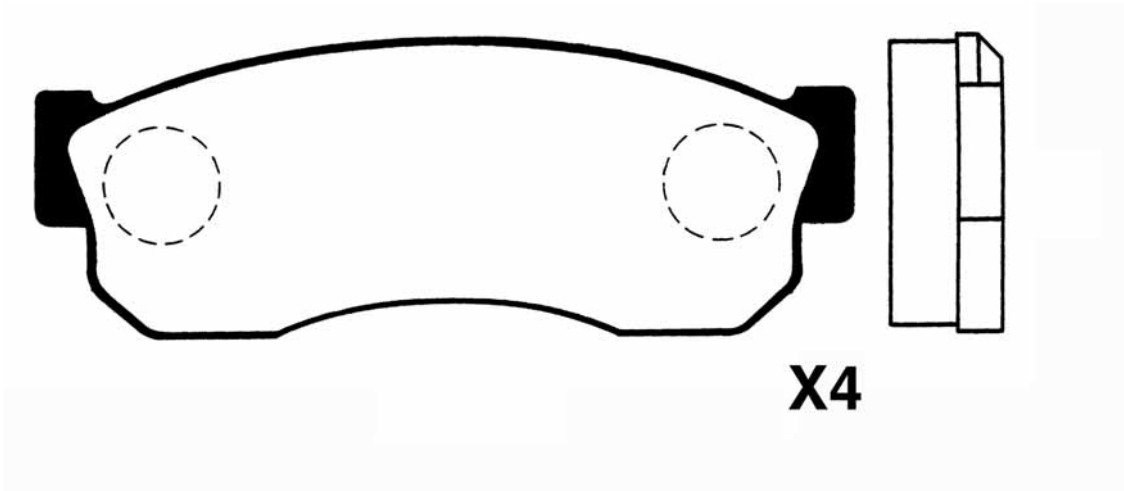



PICTURES BRAKE PADS FRONT
ABBILDUNGEN BREMSKLÖTZE VORN
FIGURAS PASTILLAS DE FRENO DELANTORES
ILLUSTRATIONS PLAQUETTES DE FREI AVANT
IMMAGINI PASTIGLIE FRENO ANTERIORI

50-01-102				WVA
NISSAN	L	H	Th	
	90,2	54,4	16,8	20218

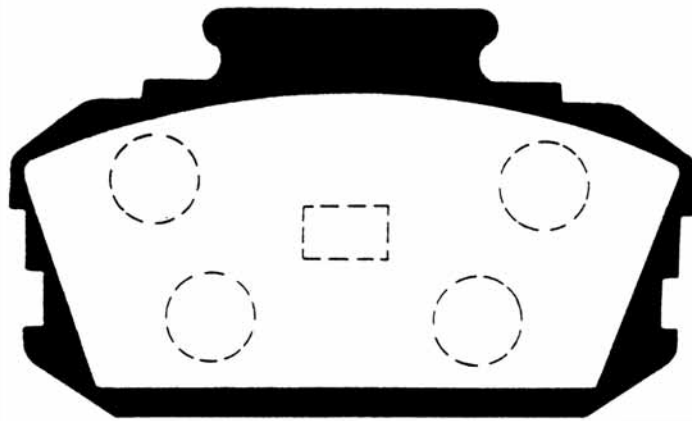

X2

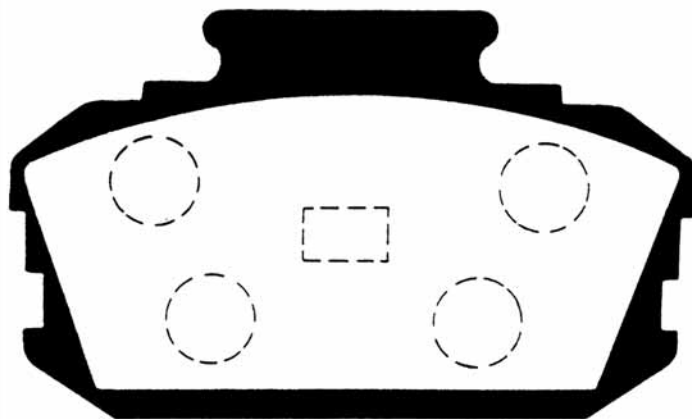
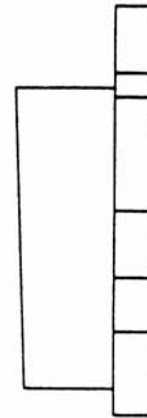

X2

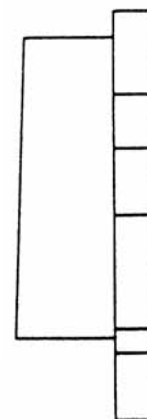



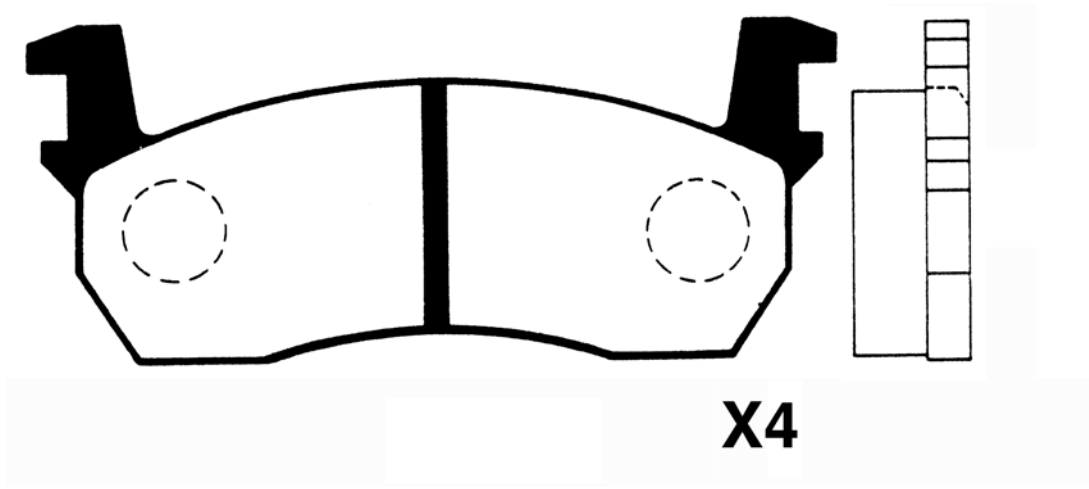

50-01-103				WVA
	NISSAN	L	H	Th
	108	45,5	15,2	20957





PICTURES BRAKE PADS FRONT
ABBILDUNGEN BREMSKLÖTZE VORN
FIGURAS PASTILLAS DE FRENO DELANTORES
ILLUSTRATIONS PLAQUETTES DE FREI AVANT
IMMAGINI PASTIGLIE FRENO ANTERIORI

50-01-105				WVA
NISSAN	L	H	Th	
	111,7	46,5	14	20718

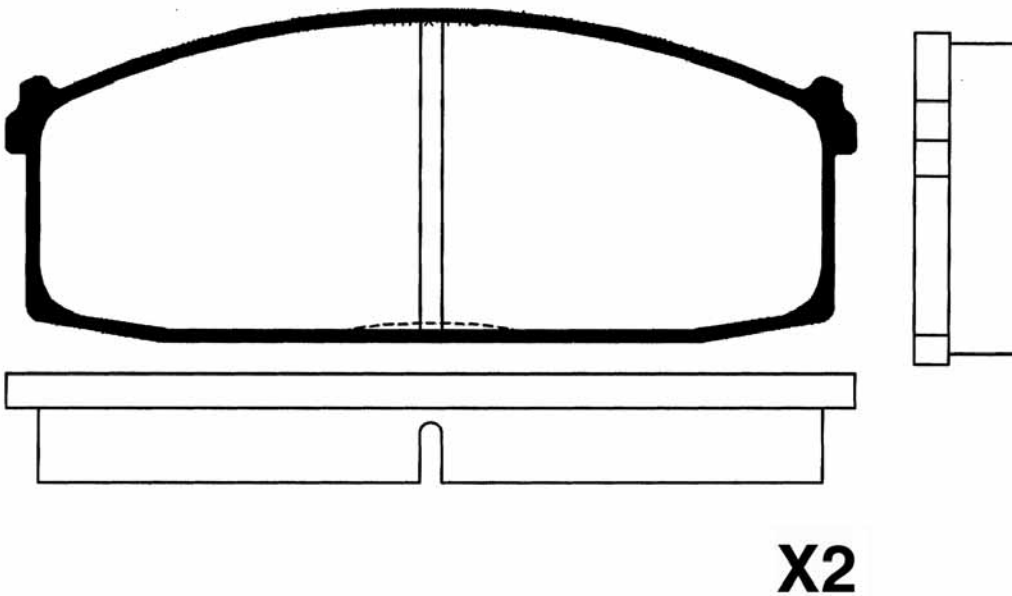
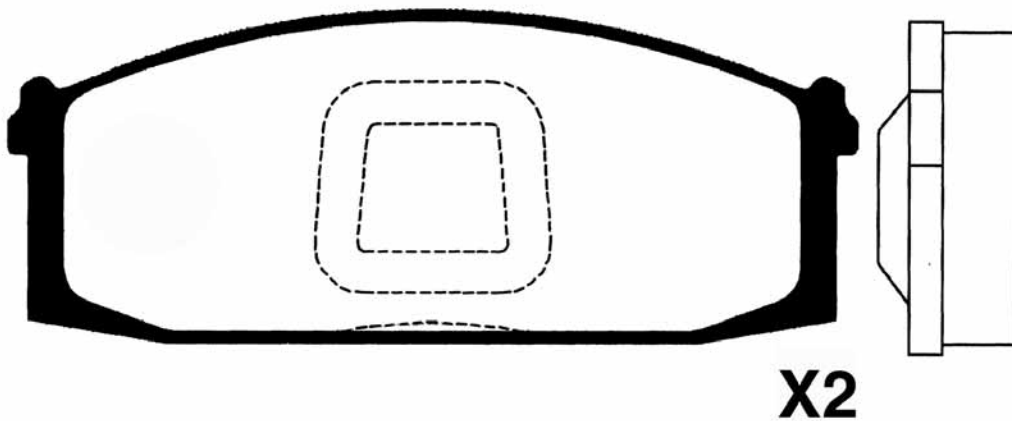



50-01-108				WVA
	NISSAN - TOYOTA	L 78	H 69,2	Th 13,9
				20289

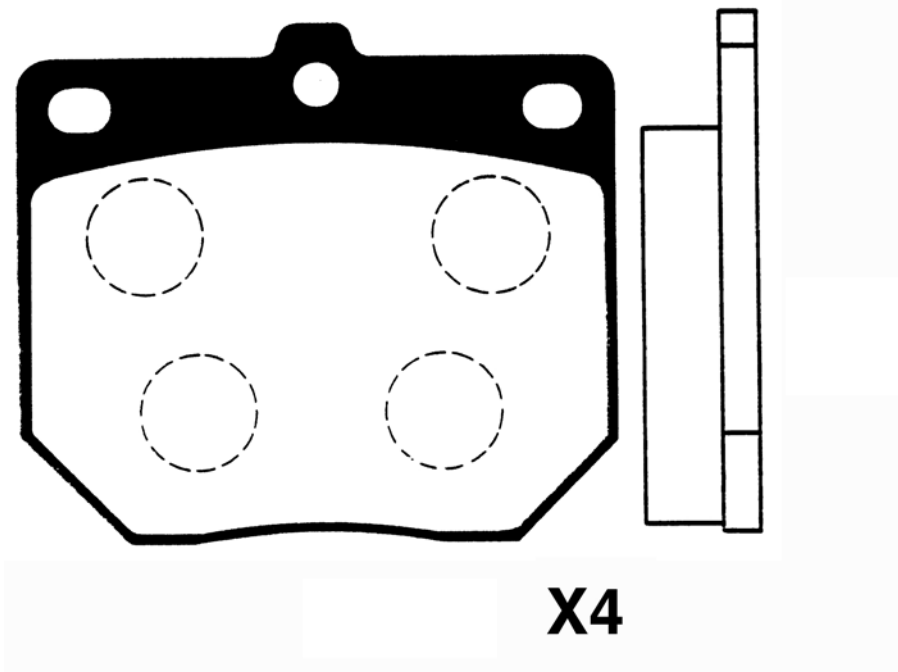



PICTURES BRAKE PADS FRONT
ABBILDUNGEN BREMSKLÖTZE VORN
FIGURAS PASTILLAS DE FRENO DELANTORES
ILLUSTRATIONS PLAQUETTES DE FREI AVANT
IMMAGINI PASTIGLIE FRENO ANTERIORI

50-01-109				WVA
NISSAN	L	H	Th	
	145	62,2	17,4	23099

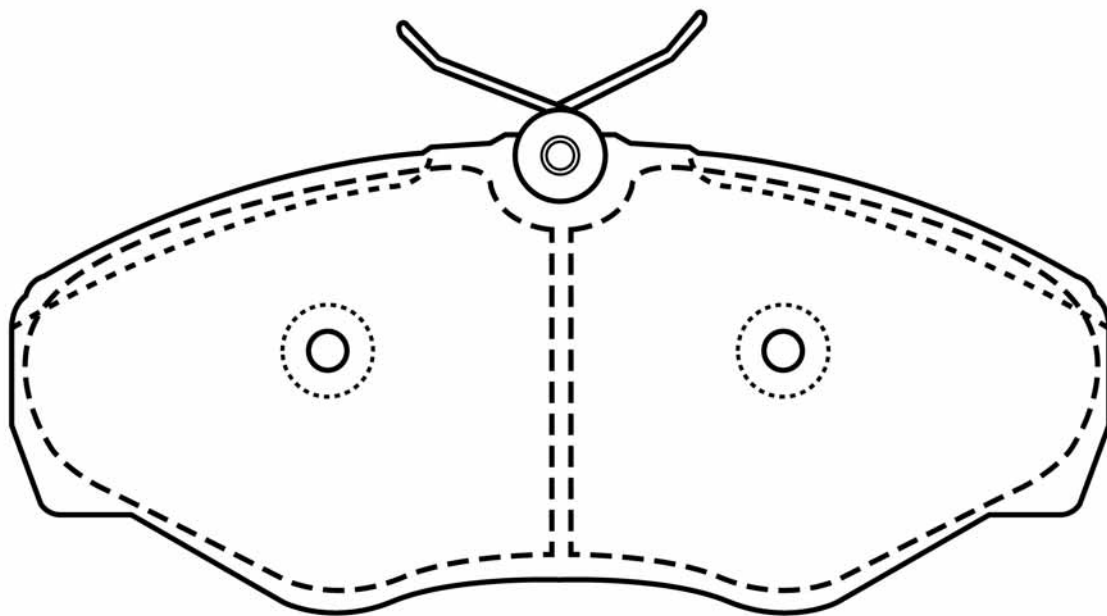

X4



50-01-110				WVA
	NISSAN	L	H	
	168,8	64,2	18,3	

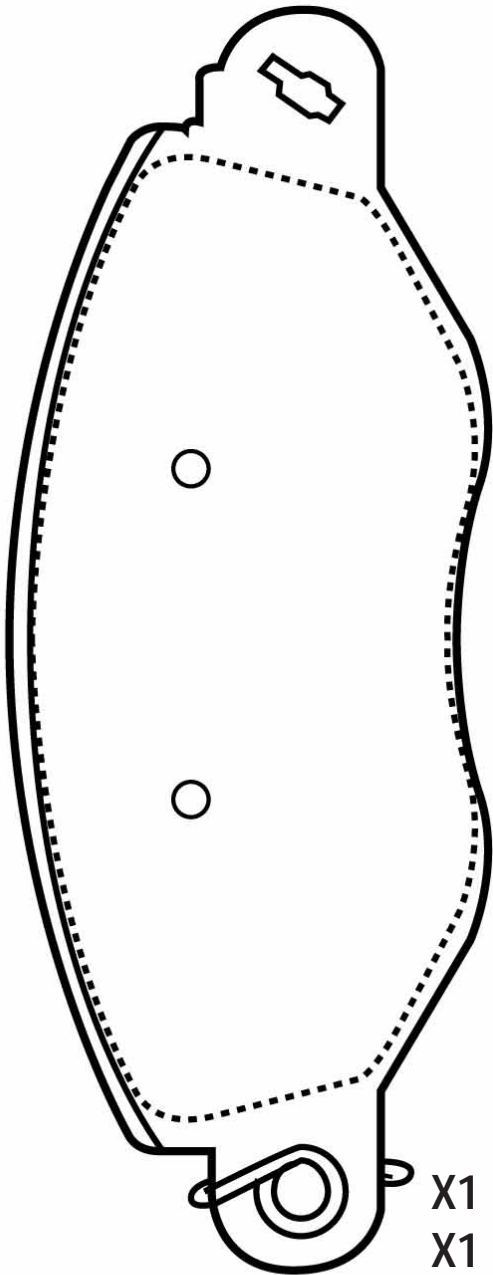

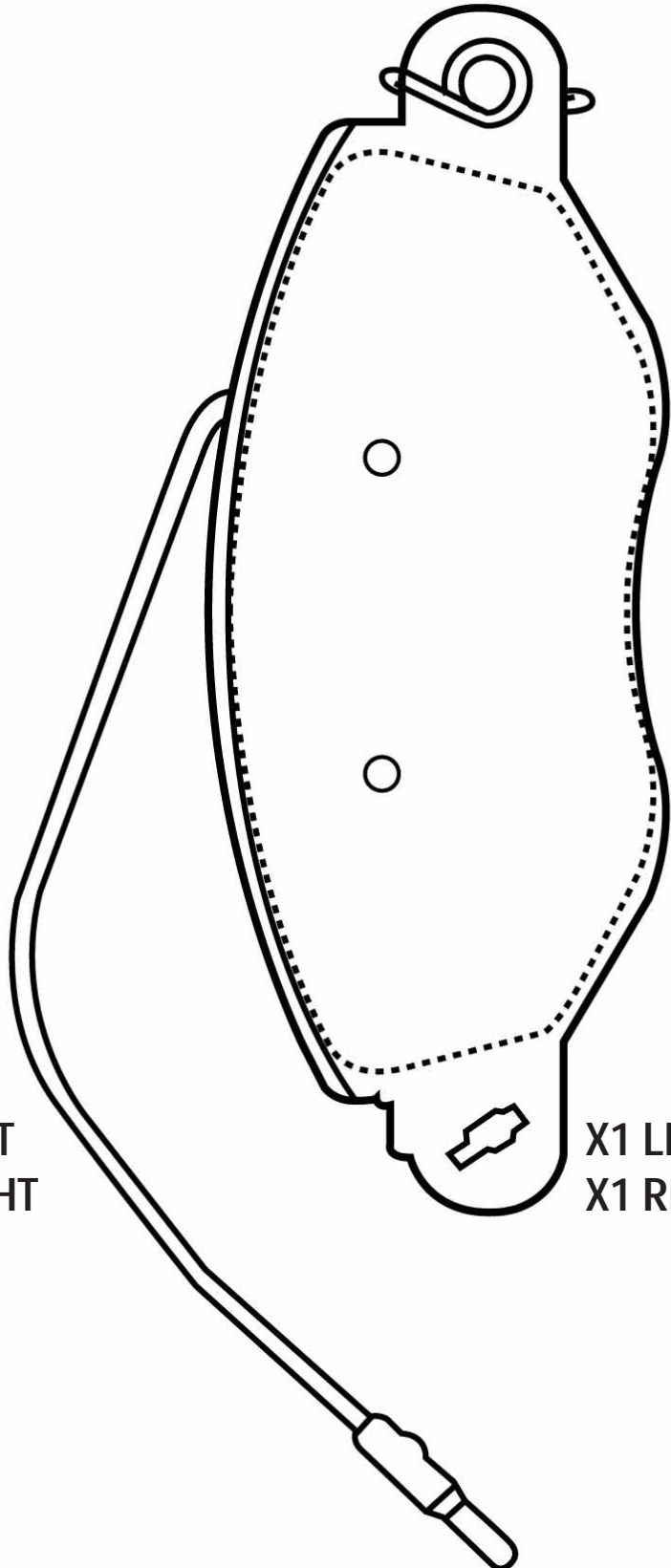

X1 LEFT
X1 RIGHT



X1 LEFT
X1 RIGHT



PICTURES BRAKE PADS FRONT
ABBILDUNGEN BREMSKLÖTZE VORN
FIGURAS PASTILLAS DE FRENO DELANTORES
ILLUSTRATIONS PLAQUETTES DE FREI AVANT
IMMAGINI PASTIGLIE FRENO ANTERIORI

50-01-111				WVA
NISSAN	L	H	Th	
	130	49,5	16	21099

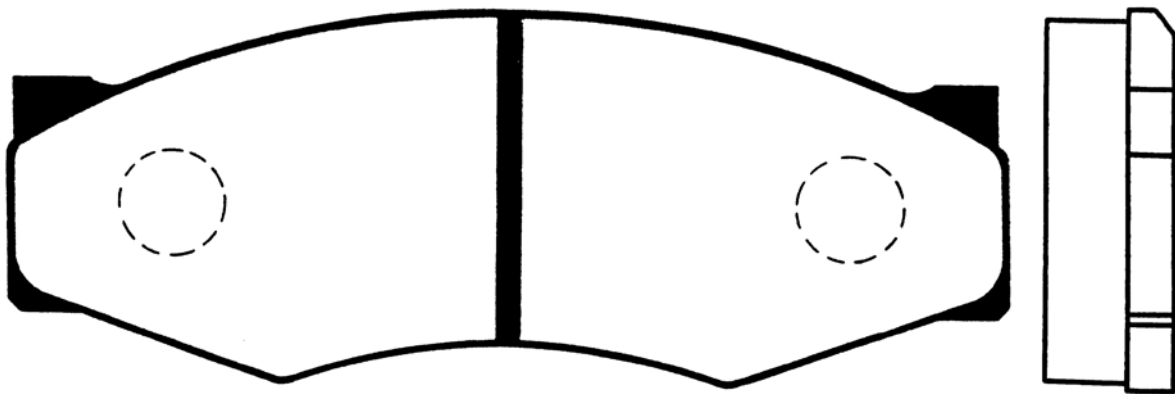

X4



50-01-111P				WVA
	NISSAN	L 130	H 49,5	

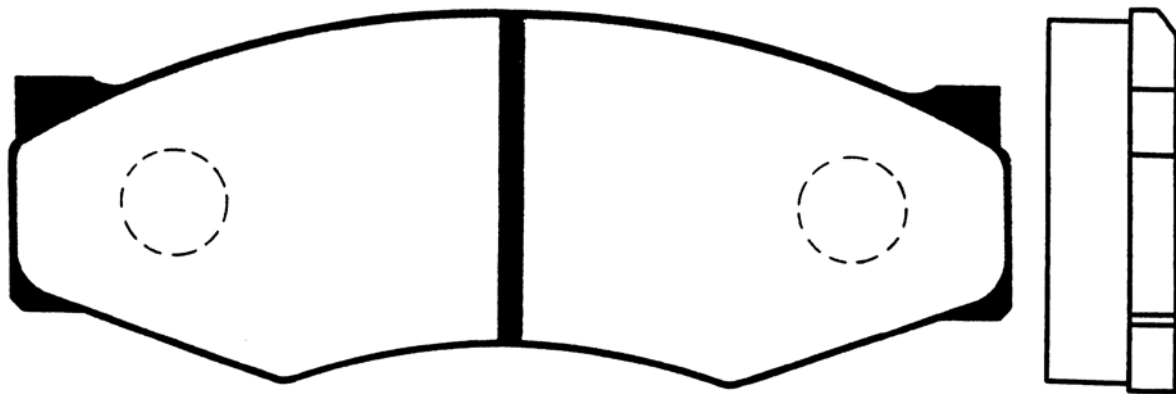

X4



PICTURES BRAKE PADS FRONT
ABBILDUNGEN BREMSKLÖTZE VORN
FIGURAS PASTILLAS DE FRENO DELANTORES
ILLUSTRATIONS PLAQUETTES DE FREI AVANT
IMMAGINI PASTIGLIE FRENO ANTERIORI

50-01-112 NISSAN				WVA
	L 63,4	H 56,6	Th 14	20391

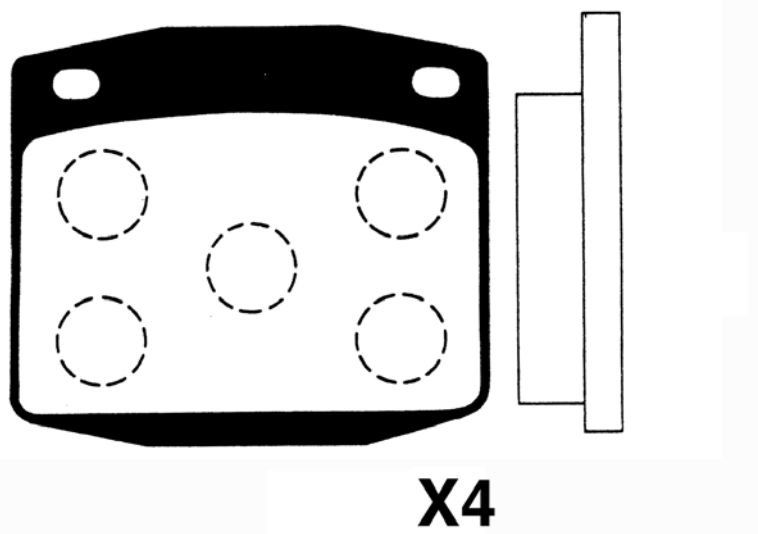



50-01-113				WVA
	NISSAN	L	H	
	119,7	73,6	15,2	23142

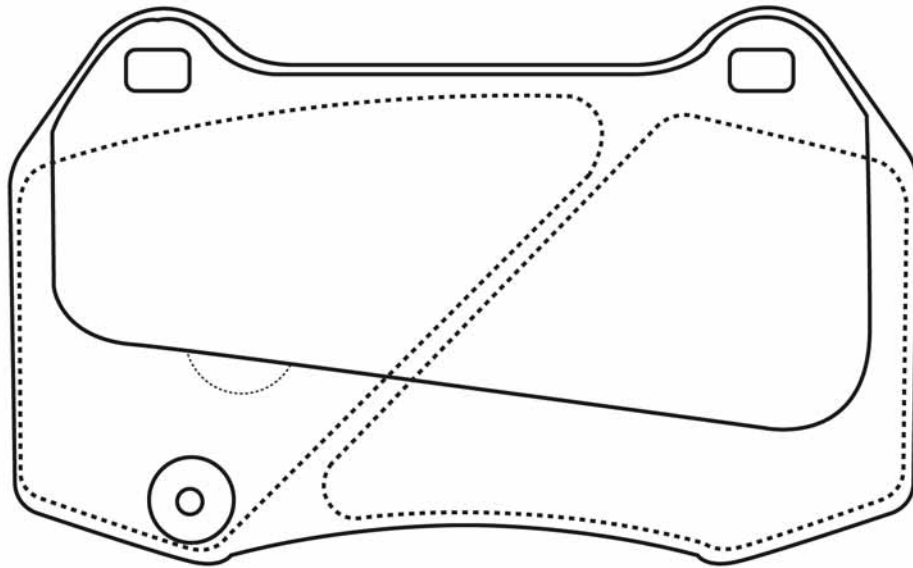

X2

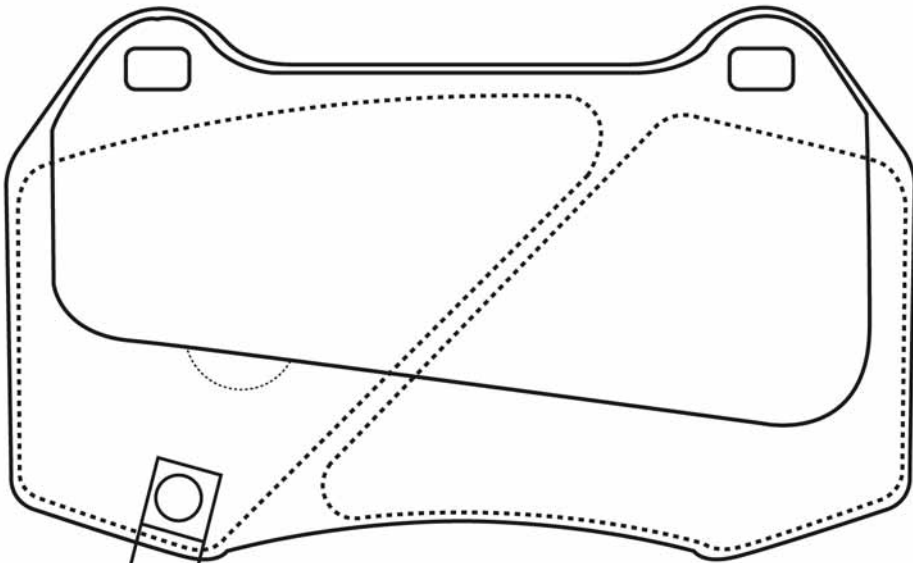

X2



PICTURES BRAKE PADS FRONT
ABBILDUNGEN BREMSKLÖTZE VORN
FIGURAS PASTILLAS DE FRENO DELANTORES
ILLUSTRATIONS PLAQUETTES DE FREI AVANT
IMMAGINI PASTIGLIE FRENO ANTERIORI

50-01-114



WVA

NISSAN

L

H

Th

131

47

17,9

21980

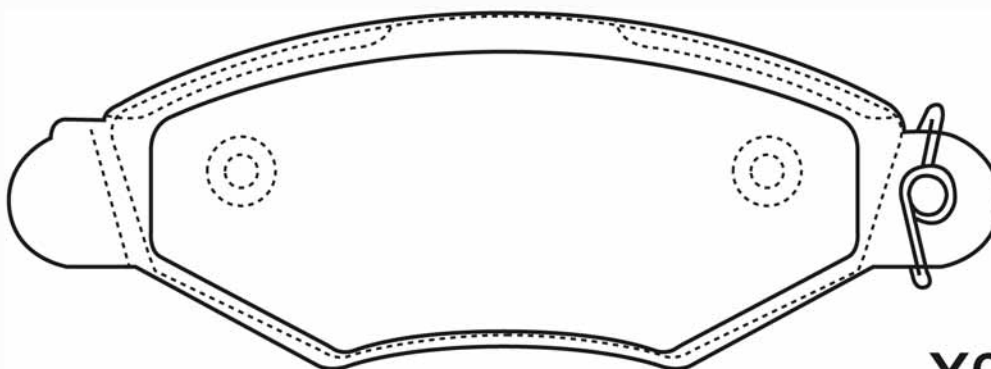

X2

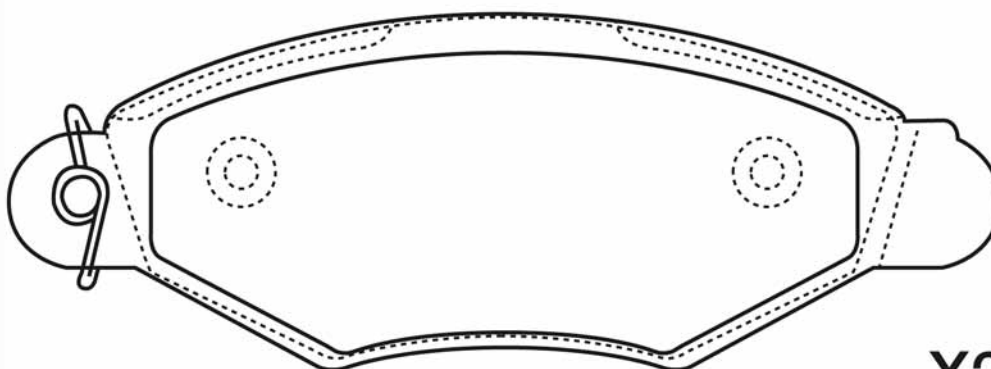

X2



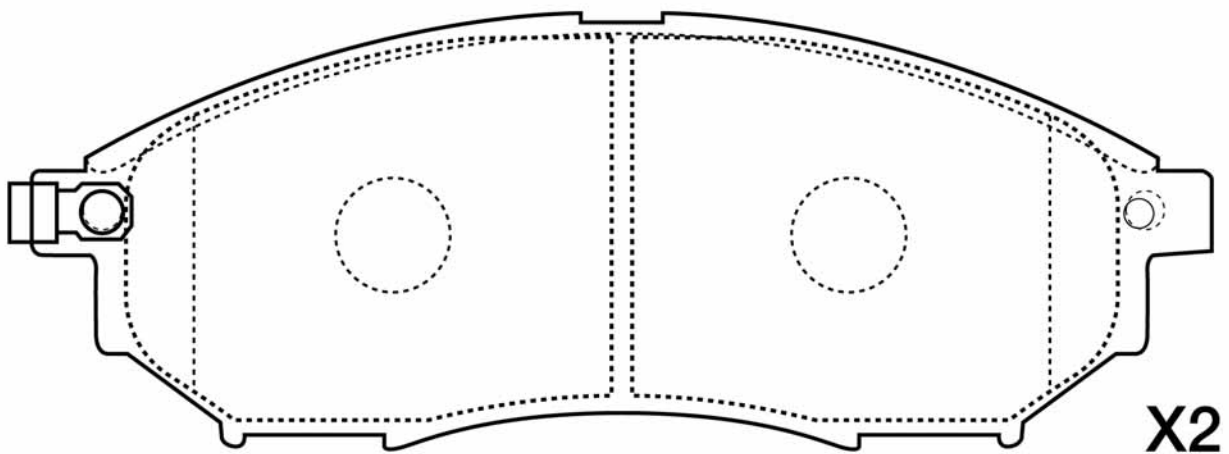
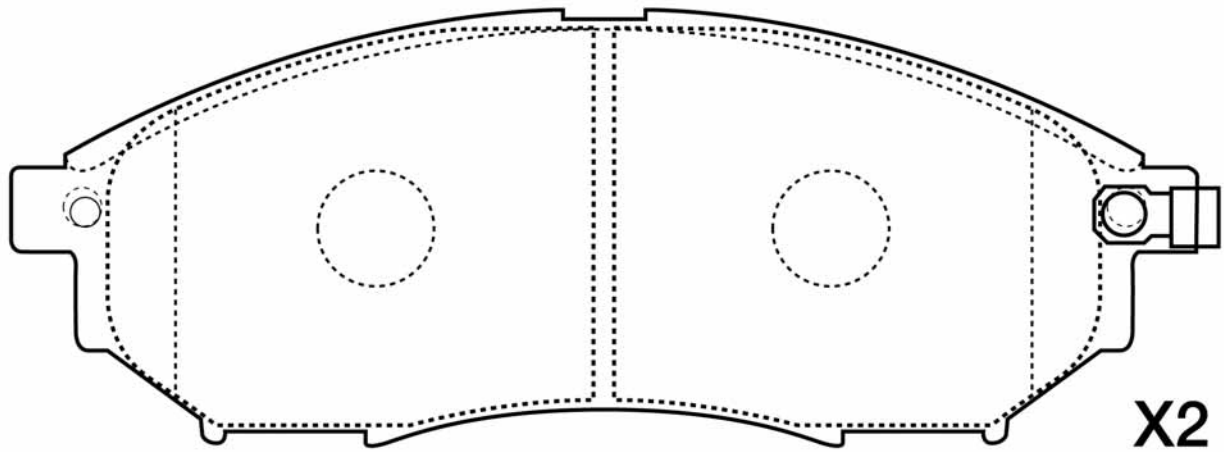

50-01-115				WVA
	NISSAN	L	H	Th
	159	58	16	23698





PICTURES BRAKE PADS FRONT
ABBILDUNGEN BREMSKLÖTZE VORN
FIGURAS PASTILLAS DE FRENO DELANTORES
ILLUSTRATIONS PLAQUETTES DE FREI AVANT
IMMAGINI PASTIGLIE FRENO ANTERIORI

50-01-116				WVA
TOYOTA - NISSAN	L	H	Th	
	130	51	14,4	20628

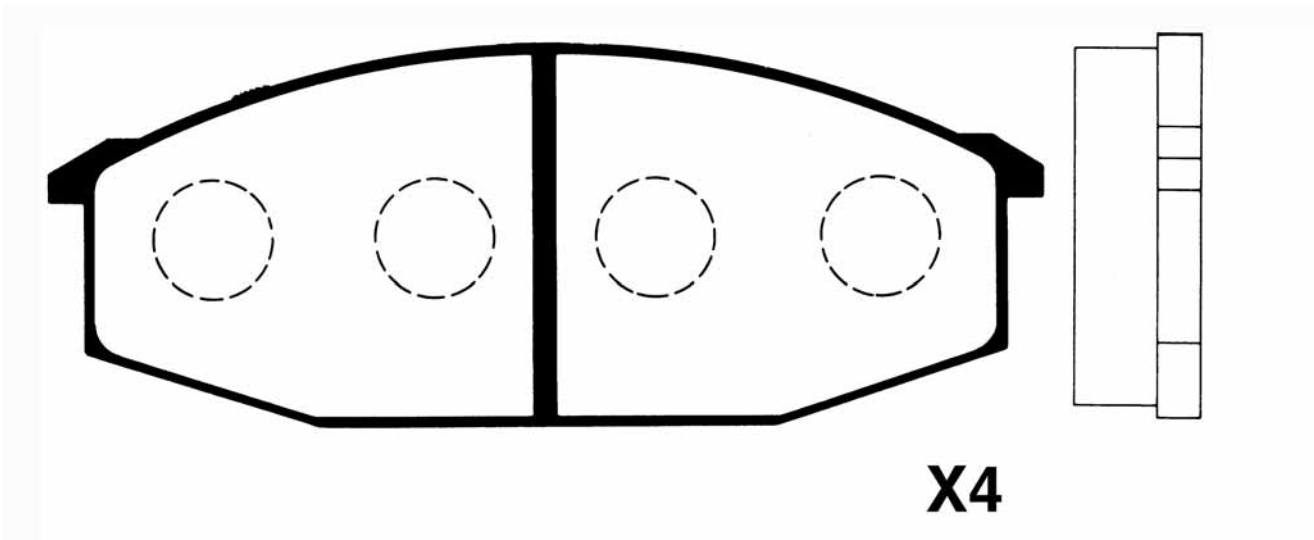



50-01-117				WVA
	NISSAN	L	H	Th
	163	67	21	29229

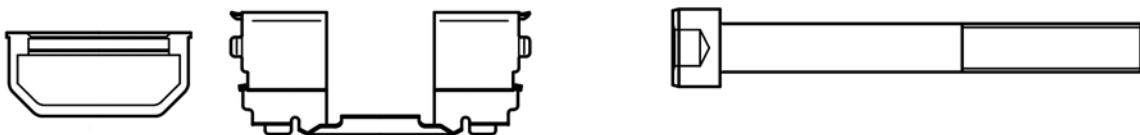
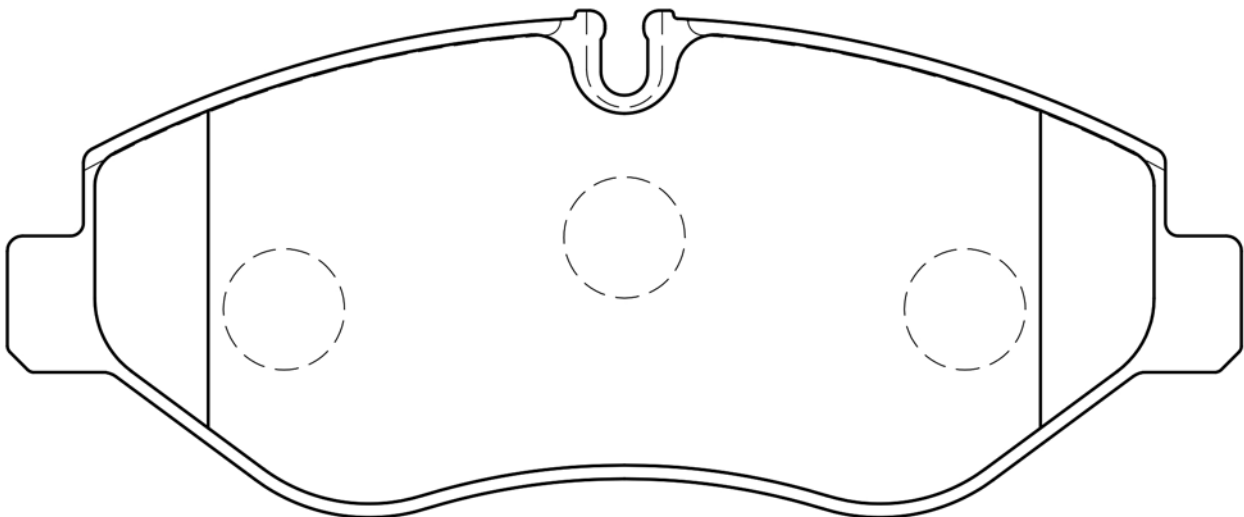
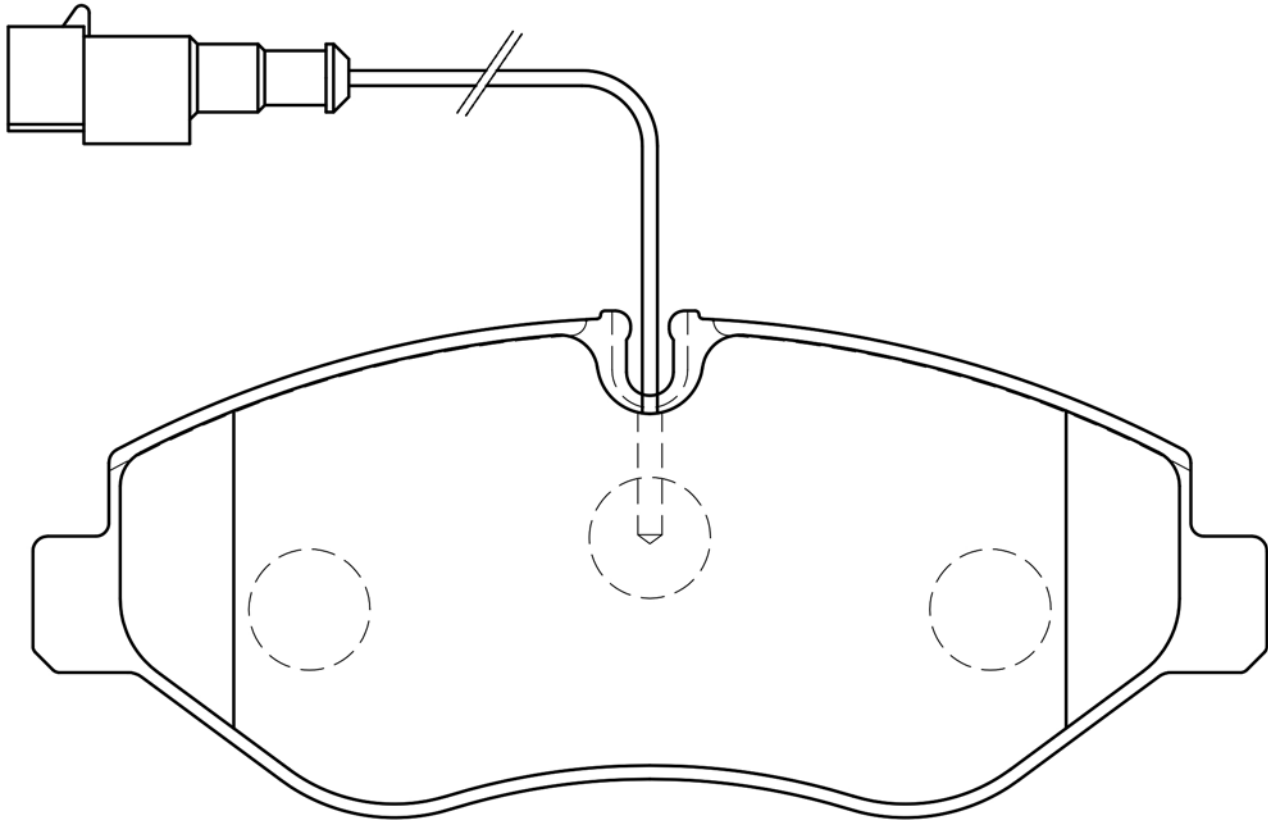



PICTURES BRAKE PADS FRONT
ABBILDUNGEN BREMSKLÖTZE VORN
FIGURAS PASTILLAS DE FRENO DELANTORES
ILLUSTRATIONS PLAQUETTES DE FREI AVANT
IMMAGINI PASTIGLIE FRENO ANTERIORI

50-01-118

NISSAN - INFINITI

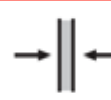

WVA

L

H

Th

135,5

66

16

24056

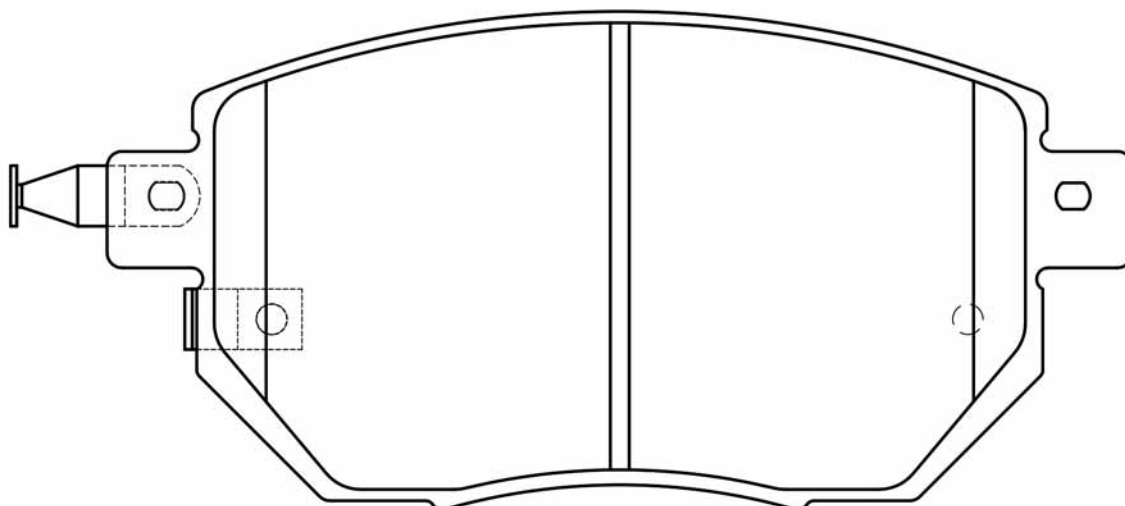
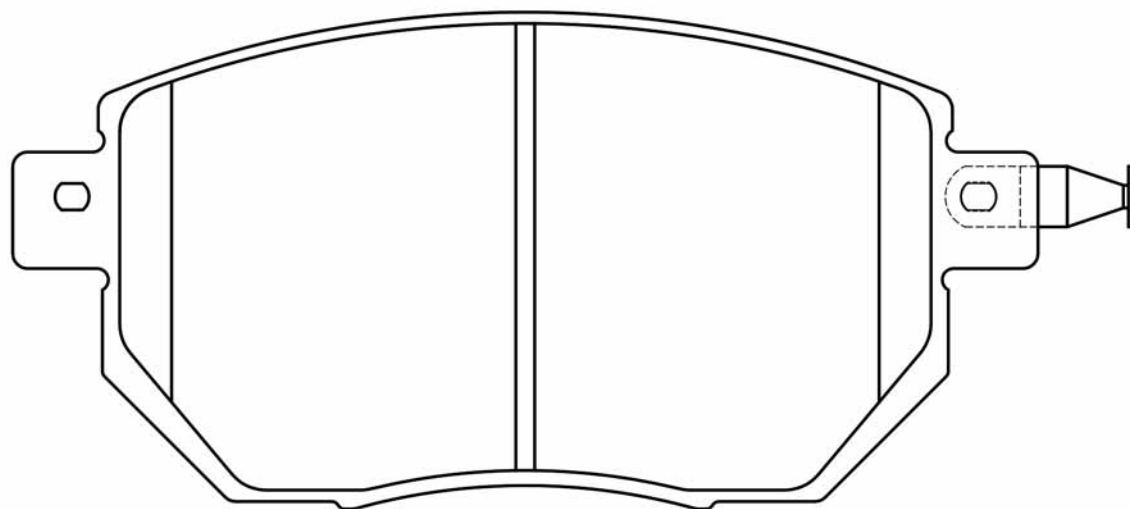
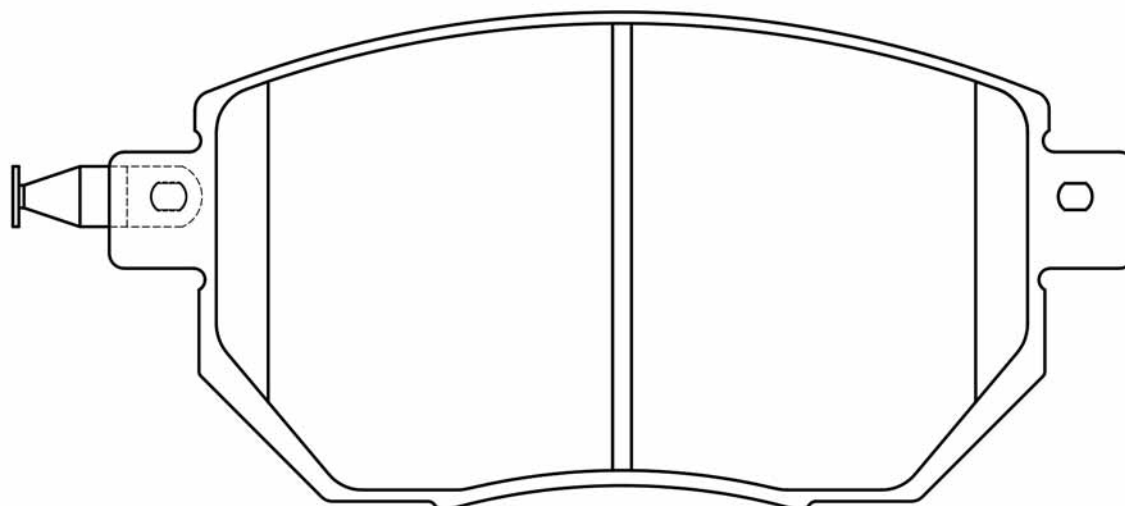



50-01-120				WVA
	NISSAN - INFINITI	L	H	
	139,3	59,2	14,9	23184

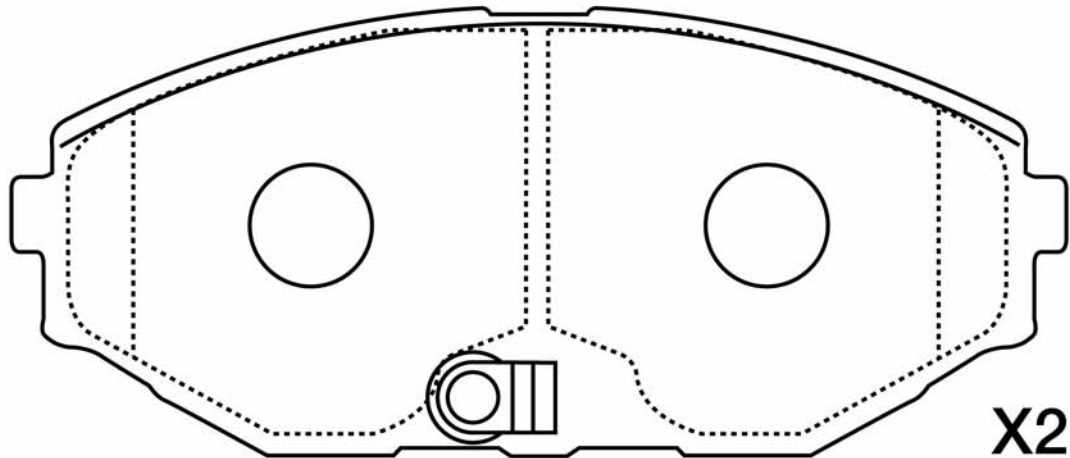
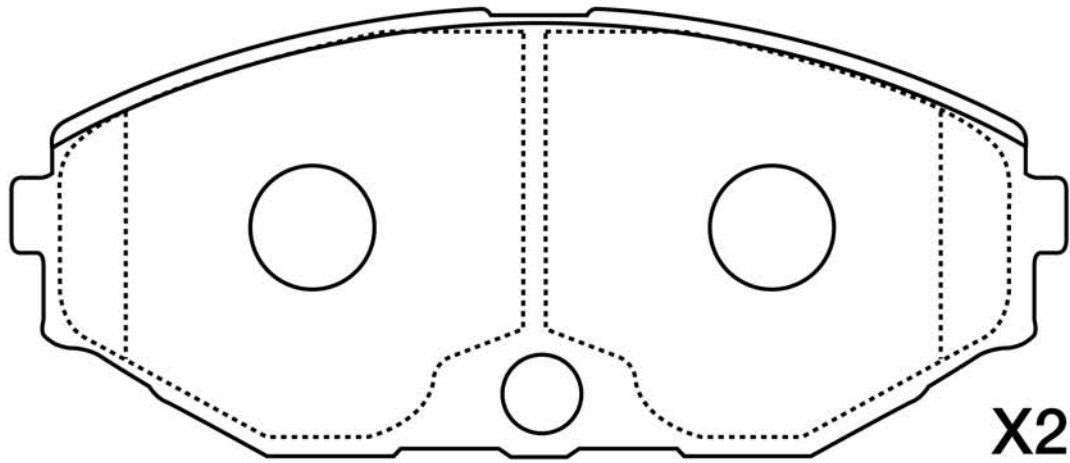



PICTURES BRAKE PADS FRONT
ABBILDUNGEN BREMSKLÖTZE VORN
FIGURAS PASTILLAS DE FRENO DELANTORES
ILLUSTRATIONS PLAQUETTES DE FREI AVANT
IMMAGINI PASTIGLIE FRENO ANTERIORI

50-01-121				WVA
NISSAN	L	H	Th	
	163,7	54,2	16,6	24227

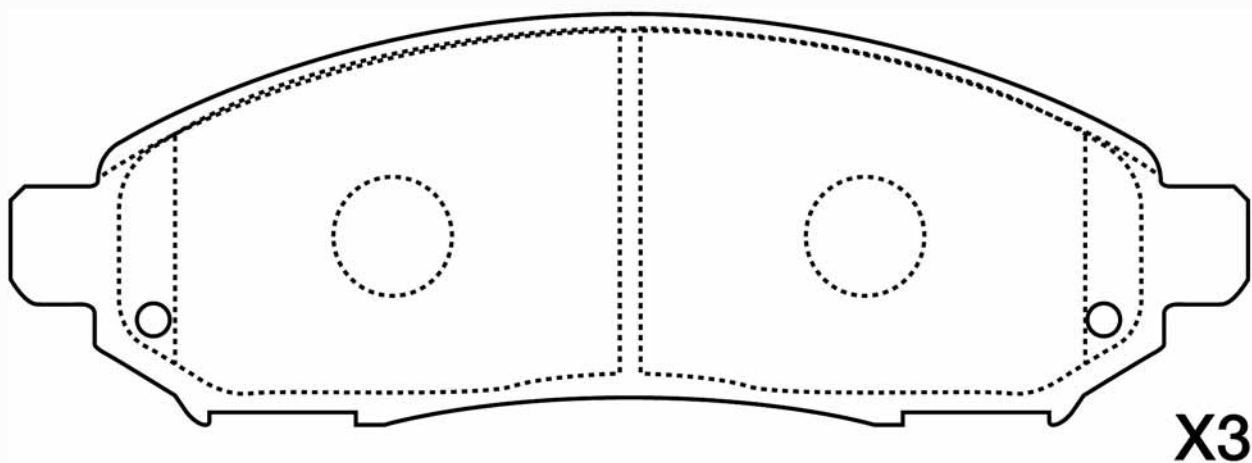

X3

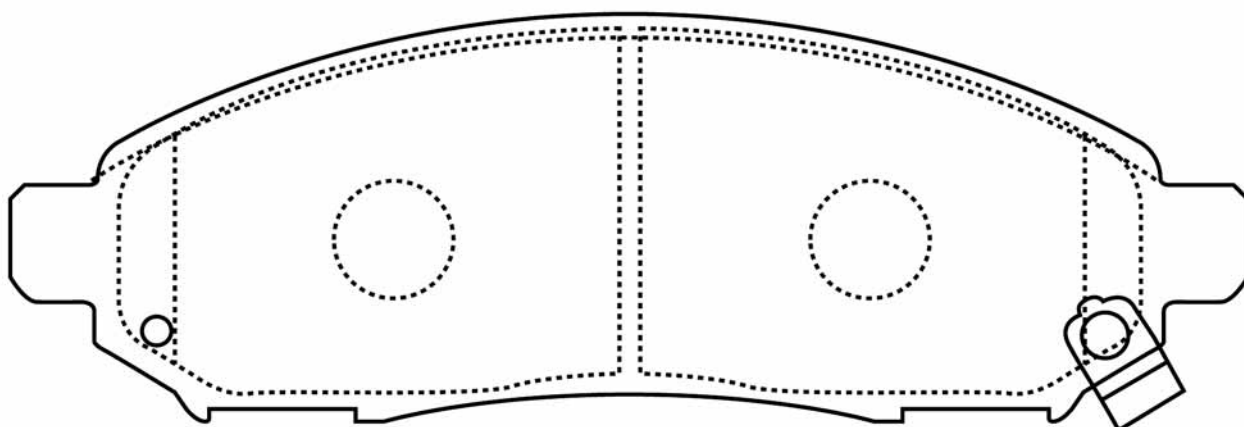

X1



50-01-122

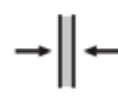
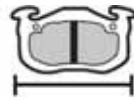

WVA

NISSAN

L

H

Th

165

68

20

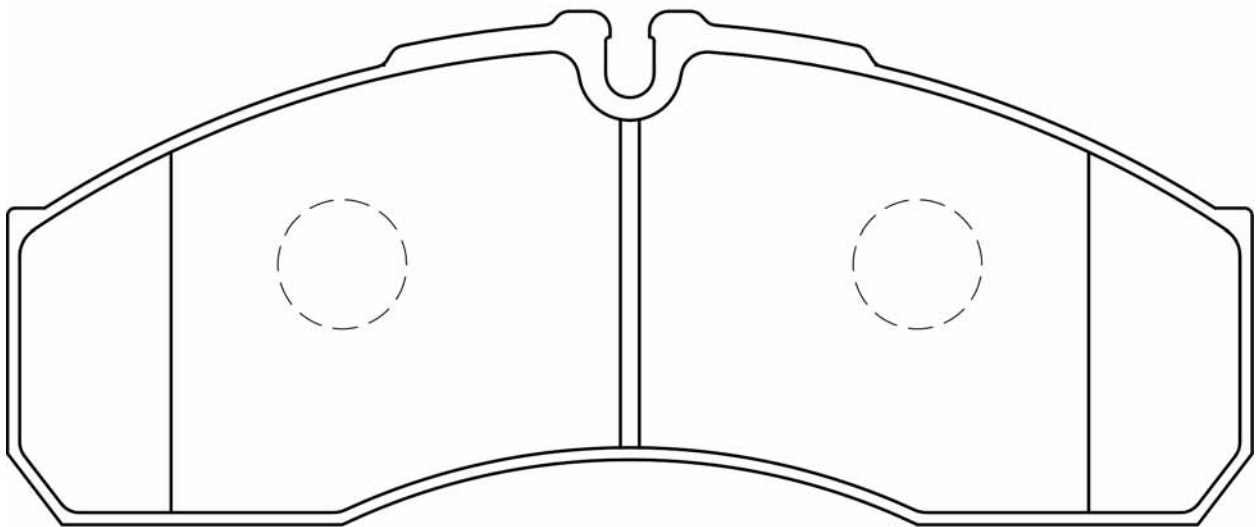



PICTURES BRAKE PADS FRONT
ABBILDUNGEN BREMSKLÖTZE VORN
FIGURAS PASTILLAS DE FRENO DELANTORES
ILLUSTRATIONS PLAQUETTES DE FREI AVANT
IMMAGINI PASTIGLIE FRENO ANTERIORI

50-01-123

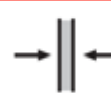

WVA

NISSAN

L

H

Th

142

59

17

24632

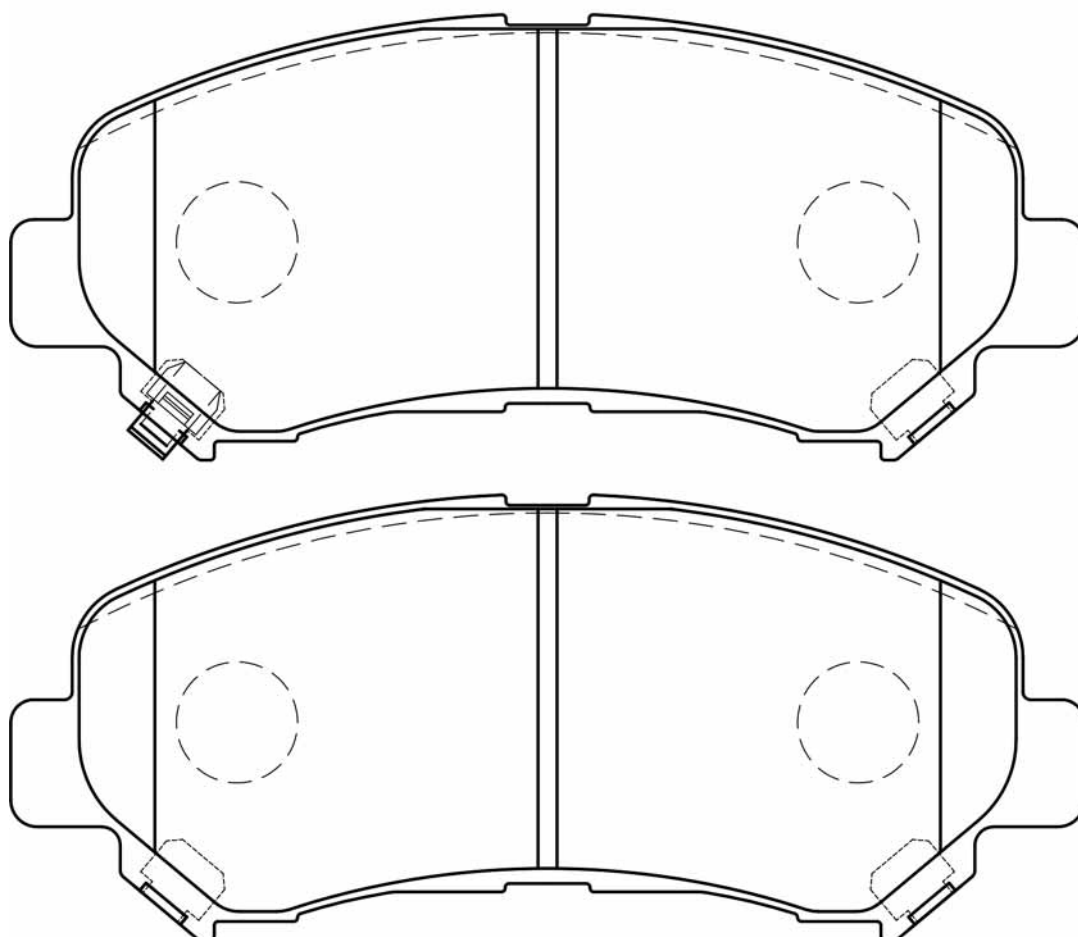



50-01-124				WVA
	TOYOTA	L	H	Th
	109	38,8	13,5	20074

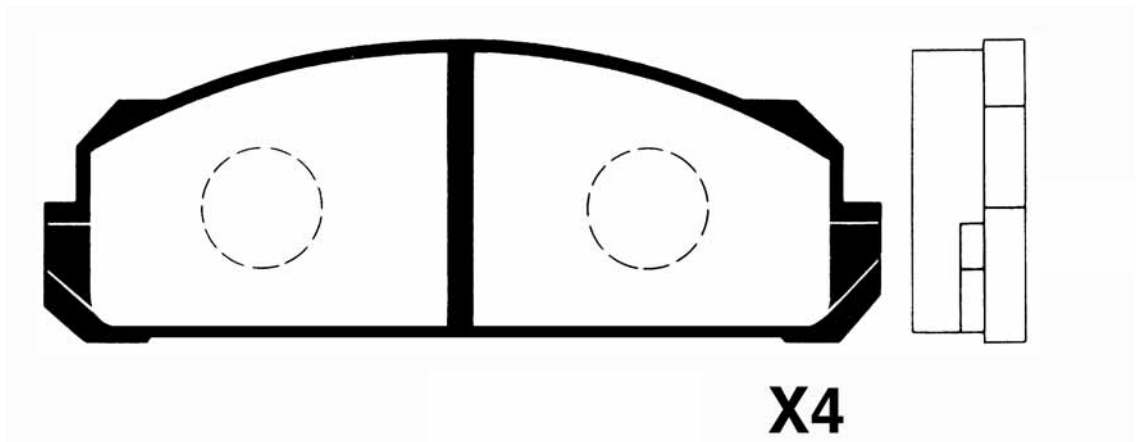



PICTURES BRAKE PADS FRONT
ABBILDUNGEN BREMSKLÖTZE VORN
FIGURAS PASTILLAS DE FRENO DELANTORES
ILLUSTRATIONS PLAQUETTES DE FREI AVANT
IMMAGINI PASTIGLIE FRENO ANTERIORI

50-01-127

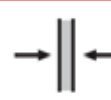
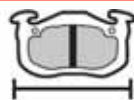

WVA

NISSAN

L

H

Th

144

48

14

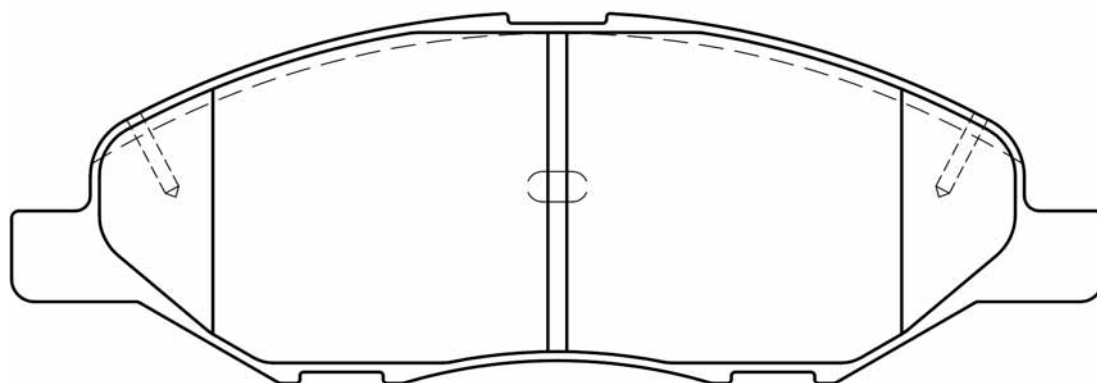
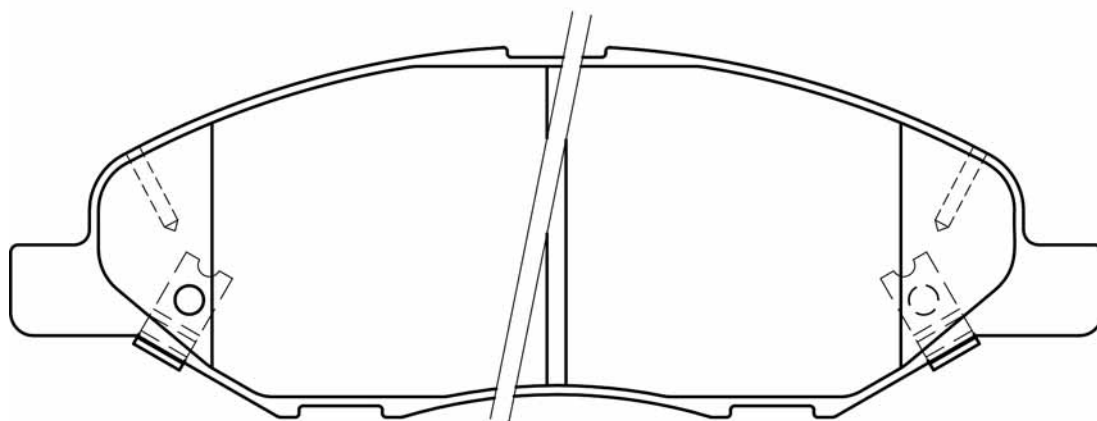



50-01-128				WVA
	NISSAN	L 156	H 51	Th 17
				25087

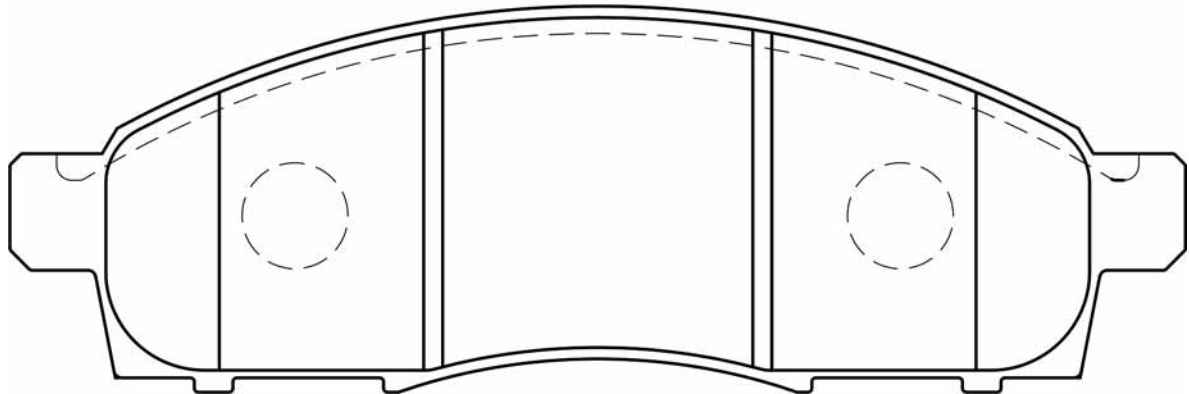
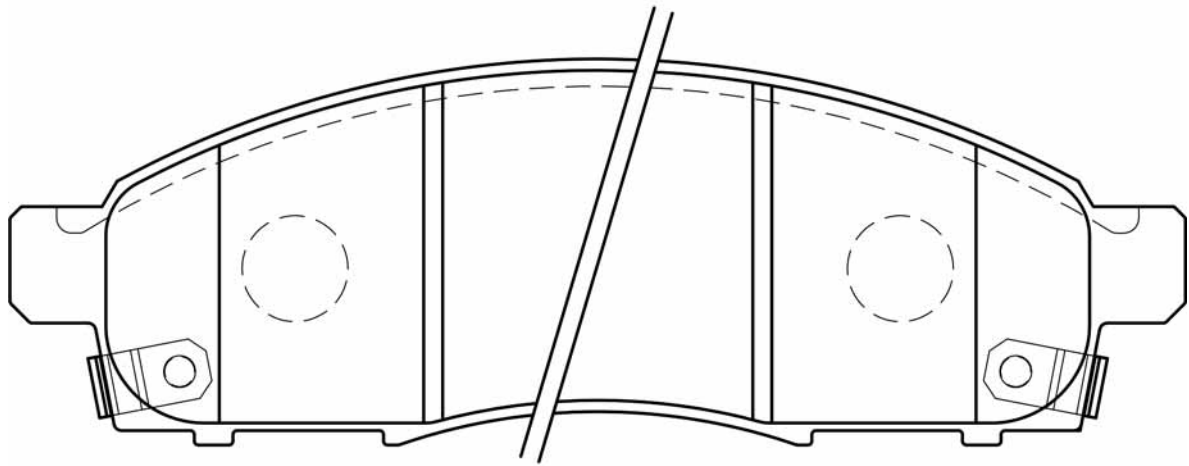



PICTURES BRAKE PADS FRONT
ABBILDUNGEN BREMSKLÖTZE VORN
FIGURAS PASTILLAS DE FRENO DELANTORES
ILLUSTRATIONS PLAQUETTES DE FREI AVANT
IMMAGINI PASTIGLIE FRENO ANTERIORI

50-01-129				WVA
NISSAN	L	H	Th	
	119,5	73,5	16,4	

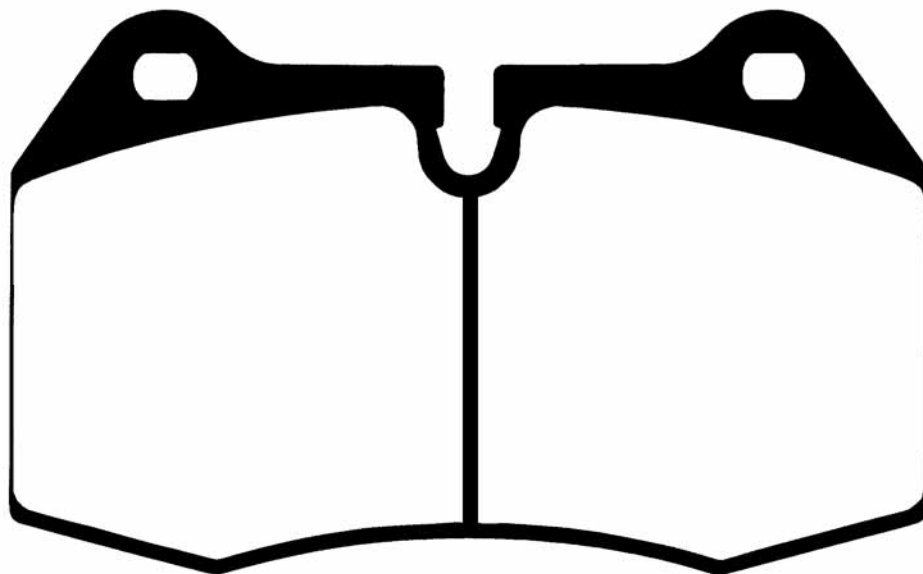

X4



50-01-130				WVA
	NISSAN	L	H	Th
	164,2	57	16,6	23970

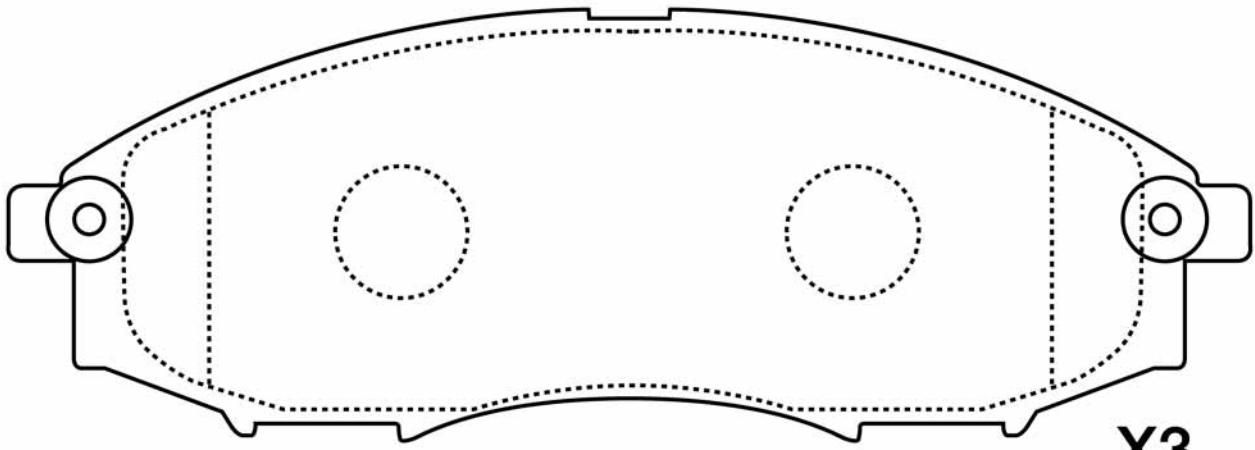

X3

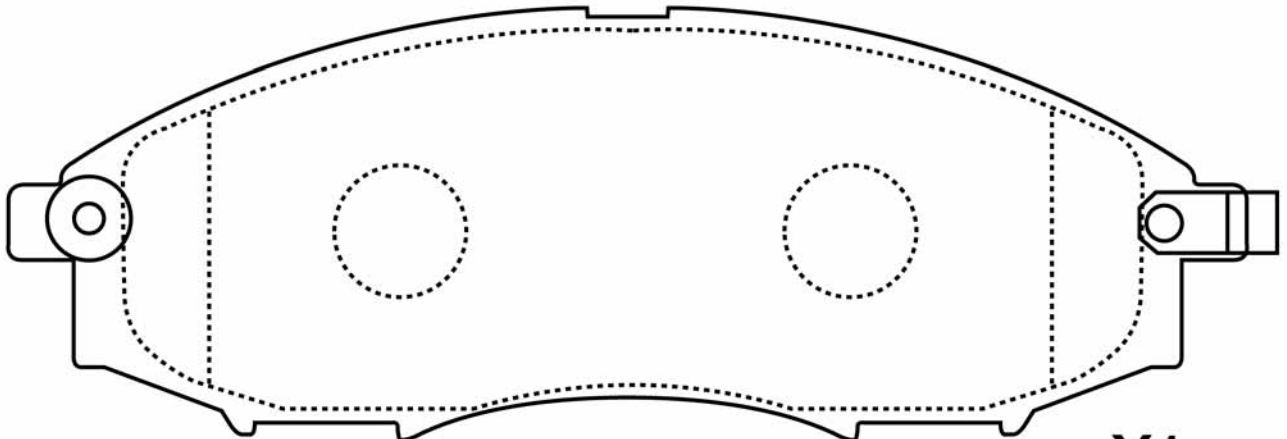

X1



PICTURES BRAKE PADS FRONT
ABBILDUNGEN BREMSKLÖTZE VORN
FIGURAS PASTILLAS DE FRENO DELANTORES
ILLUSTRATIONS PLAQUETTES DE FREI AVANT
IMMAGINI PASTIGLIE FRENO ANTERIORI

50-01-132				WVA
	NISSAN	L	H	Th
	142,5/142	60,3/53,6	16	20628

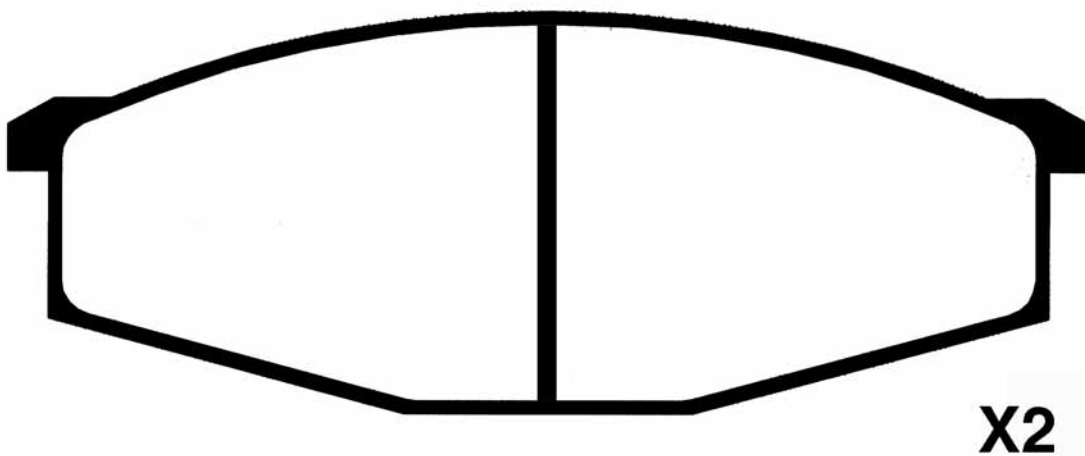
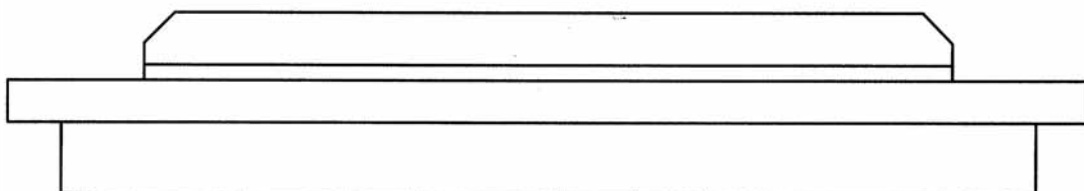
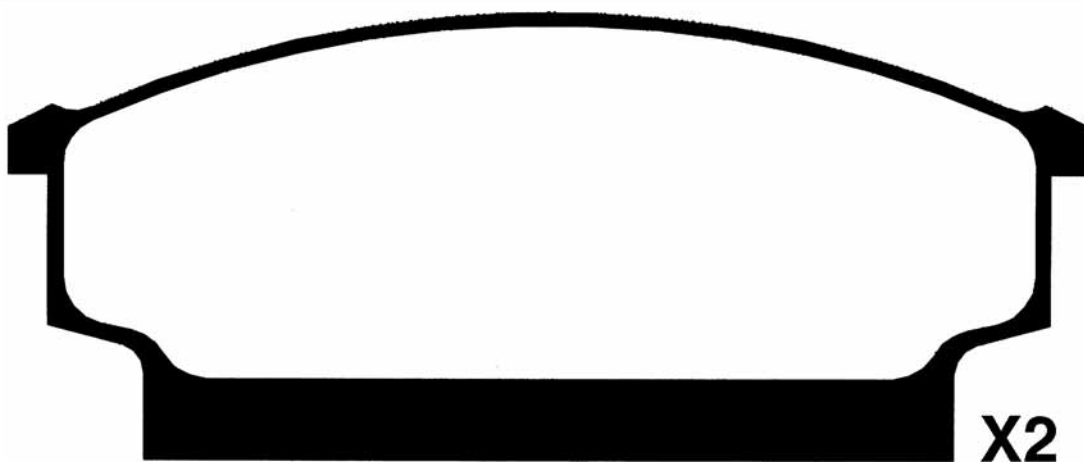



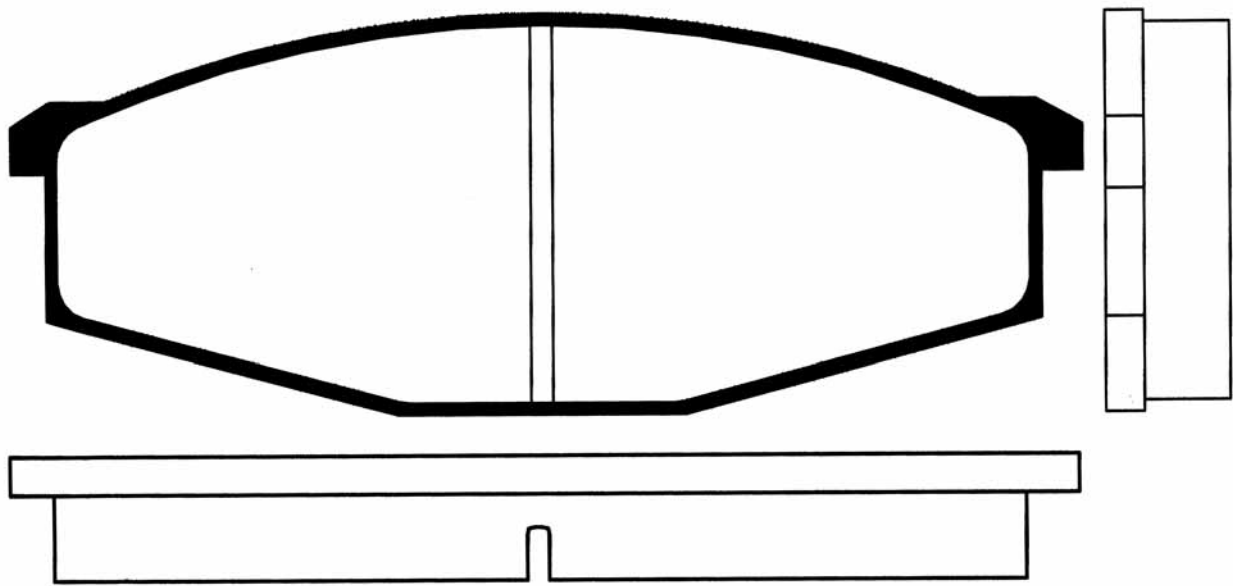

50-01-134				WVA
	NISSAN	L	H	Th
	142	53,3	15,9	20972



X4

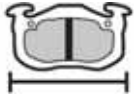

PICTURES BRAKE PADS FRONT
ABBILDUNGEN BREMSKLÖTZE VORN
FIGURAS PASTILLAS DE FRENO DELANTORES
ILLUSTRATIONS PLAQUETTES DE FREI AVANT
IMMAGINI PASTIGLIE FRENO ANTERIORI

50-01-134P				WVA
NISSAN	L	H	Th	
	142	53,3	15,9	

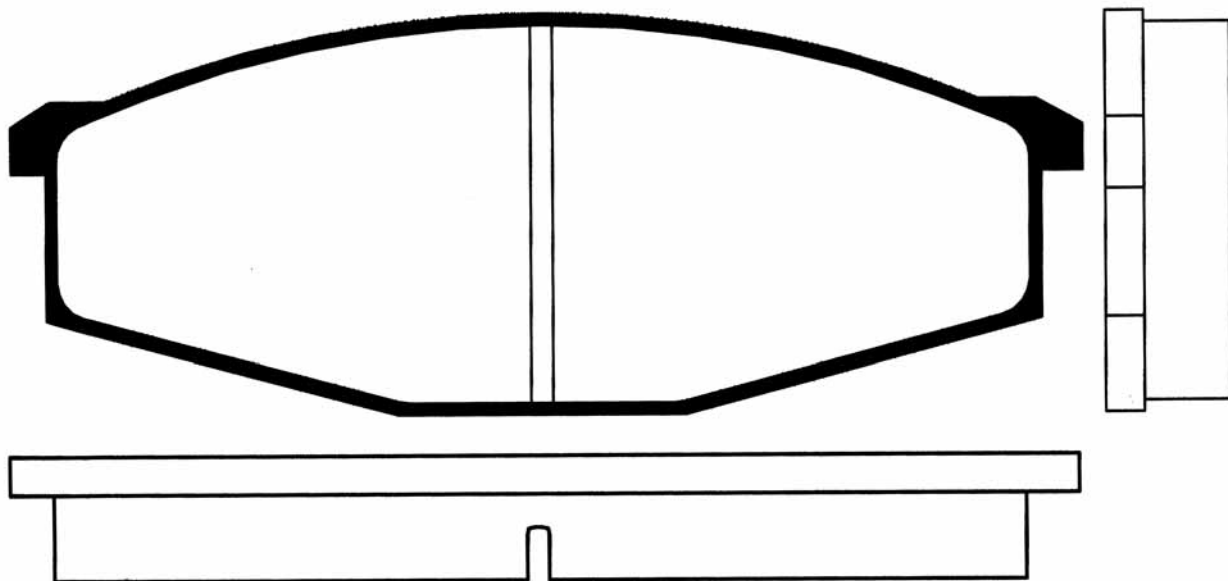

X4



50-01-135				WVA
	SUZUKI - NISSAN	L	H	
	115	47,5	15,4	21345

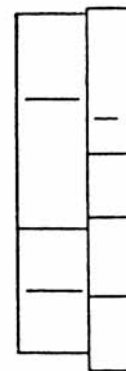
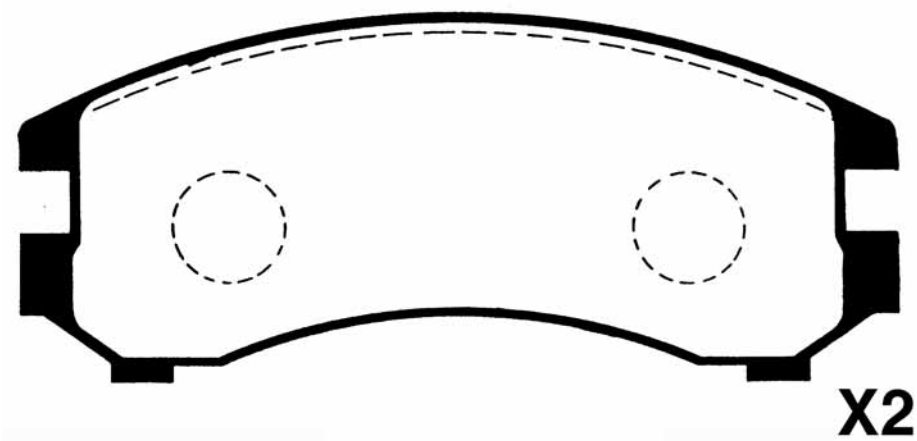
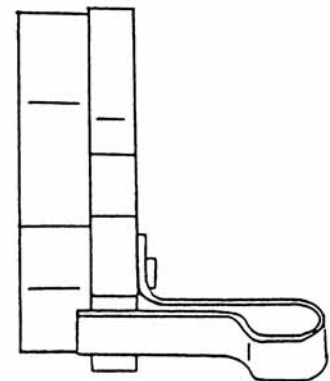
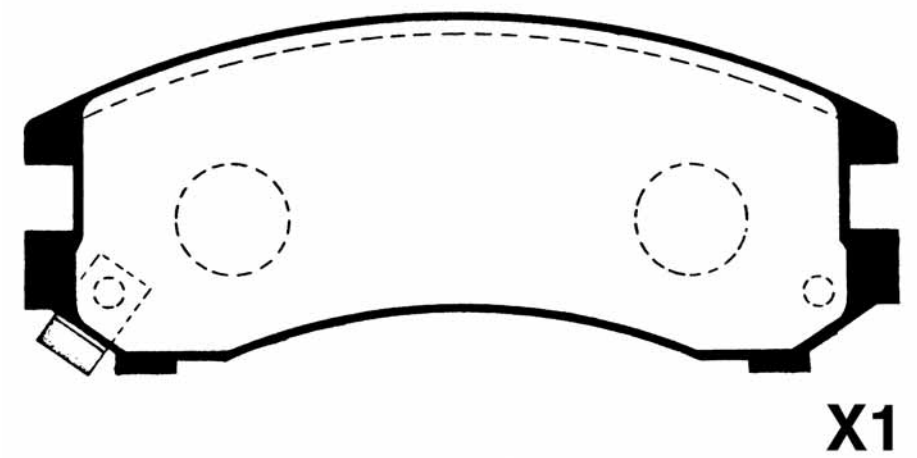
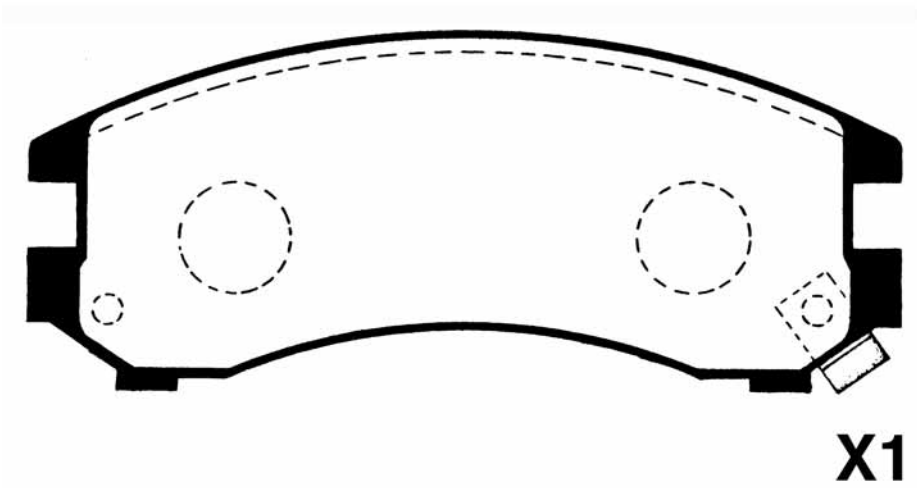



PICTURES BRAKE PADS FRONT
ABBILDUNGEN BREMSKLÖTZE VORN
FIGURAS PASTILLAS DE FRENO DELANTORES
ILLUSTRATIONS PLAQUETTES DE FREI AVANT
IMMAGINI PASTIGLIE FRENO ANTERIORI

50-01-137 SUBARU - NISSAN				WVA
	L	H	Th	
	161	49,6	16,3	21349

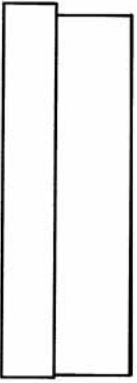
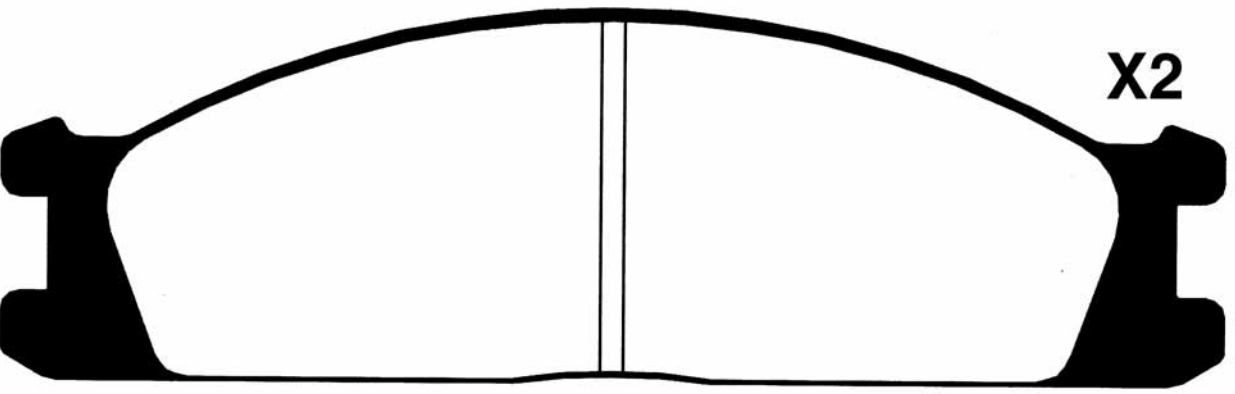
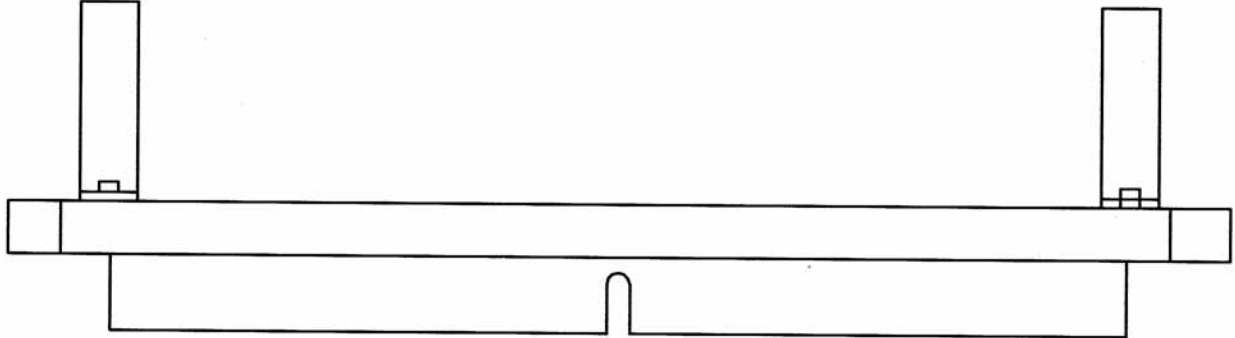
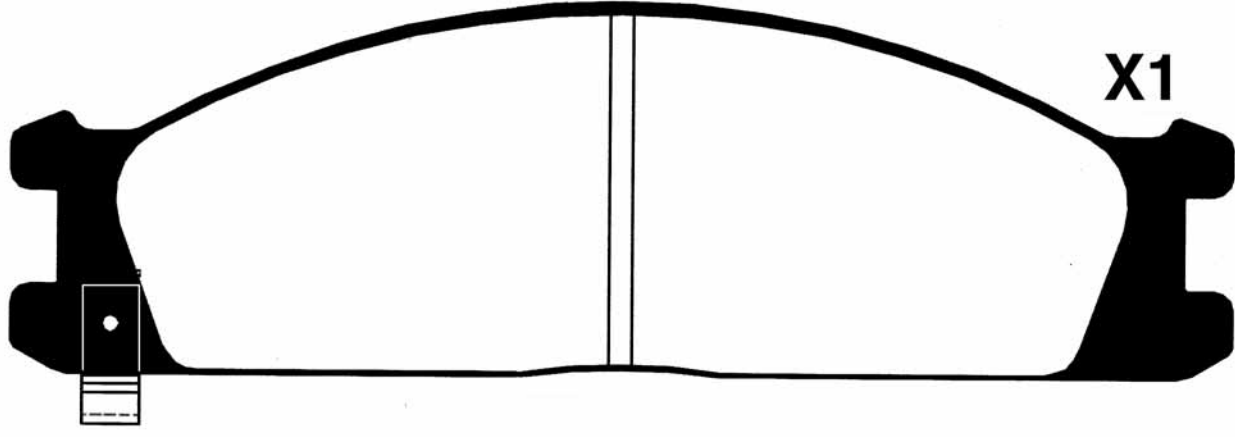
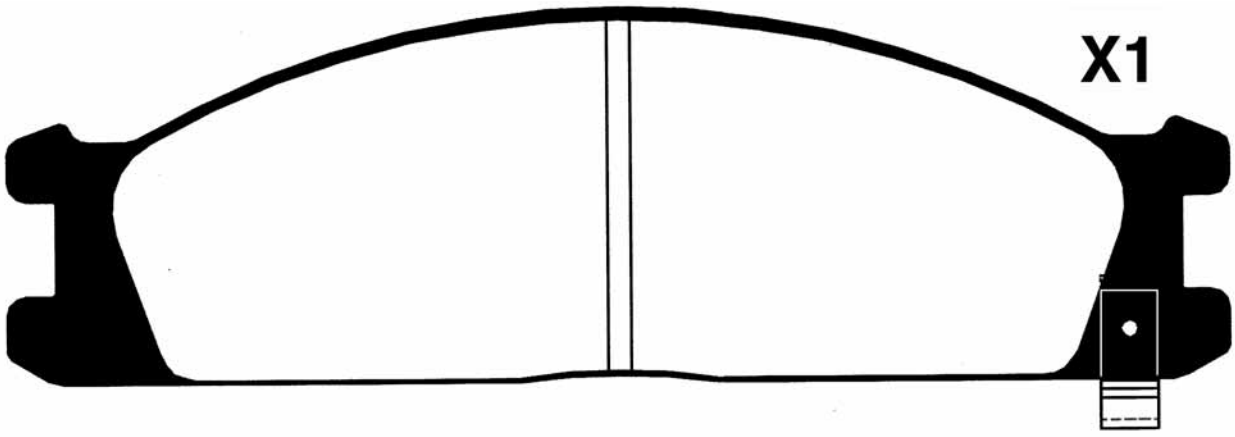



50-01-140				WVA
	NISSAN	L 136,8	H 59,6	

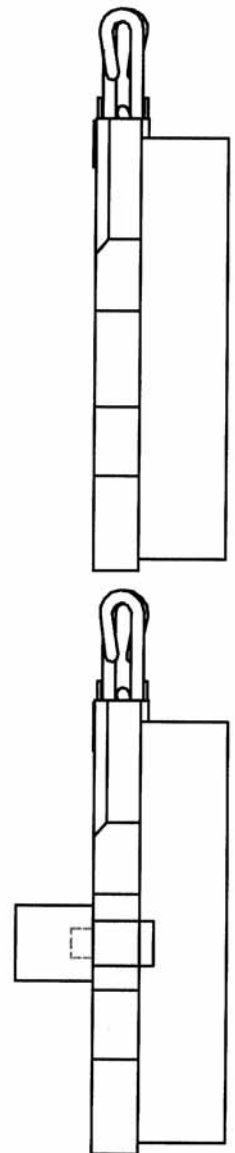
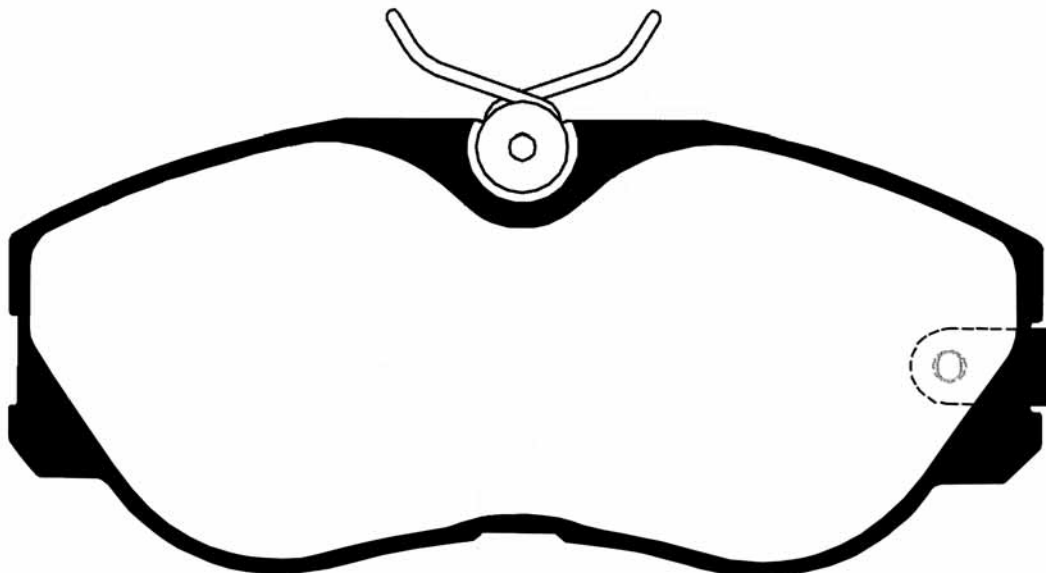
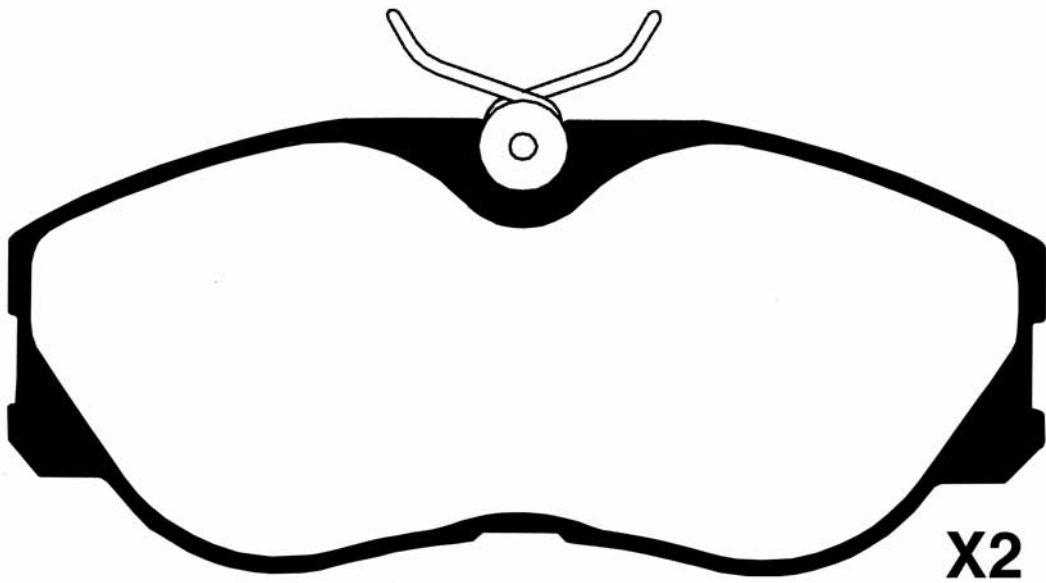



PICTURES BRAKE PADS FRONT
ABBILDUNGEN BREMSKLÖTZE VORN
FIGURAS PASTILLAS DE FRENO DELANTORES
ILLUSTRATIONS PLAQUETTES DE FREI AVANT
IMMAGINI PASTIGLIE FRENO ANTERIORI

50-01-141				WVA
	NISSAN	L	H	
	111,8	44	14,4	21118

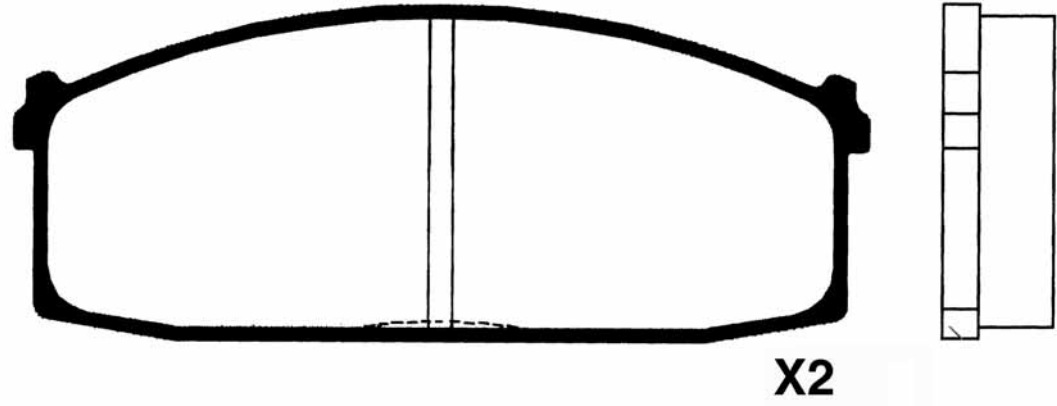
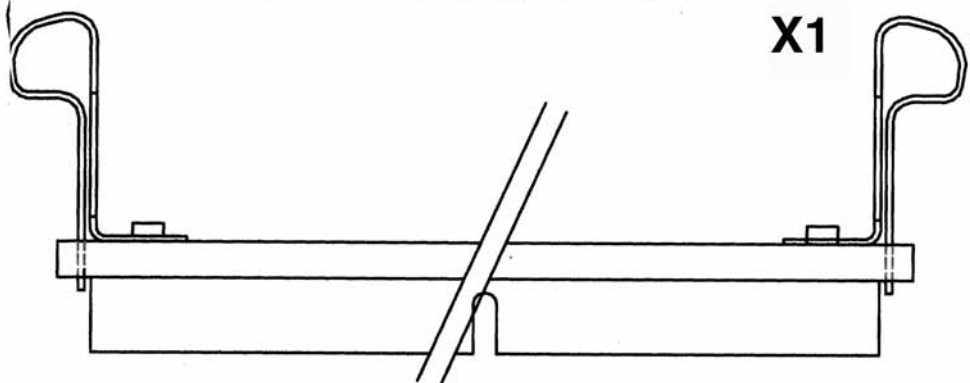
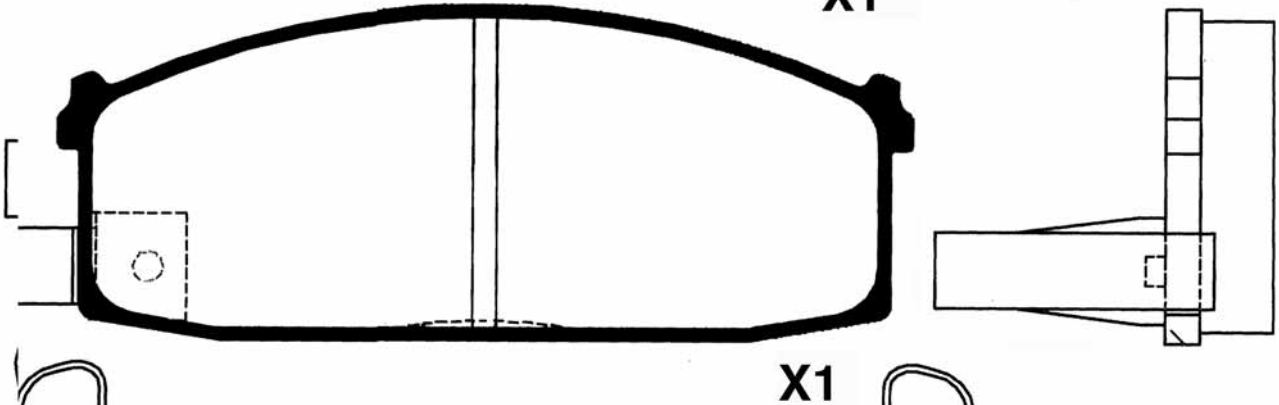
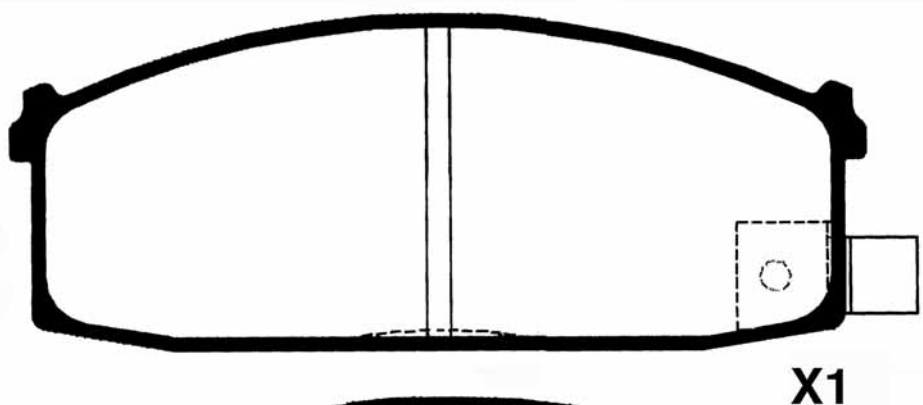



50-01-142				WVA
	NISSAN	L 137	H 54	Th 16,5
				21526

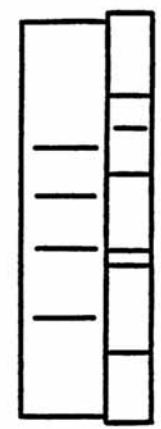
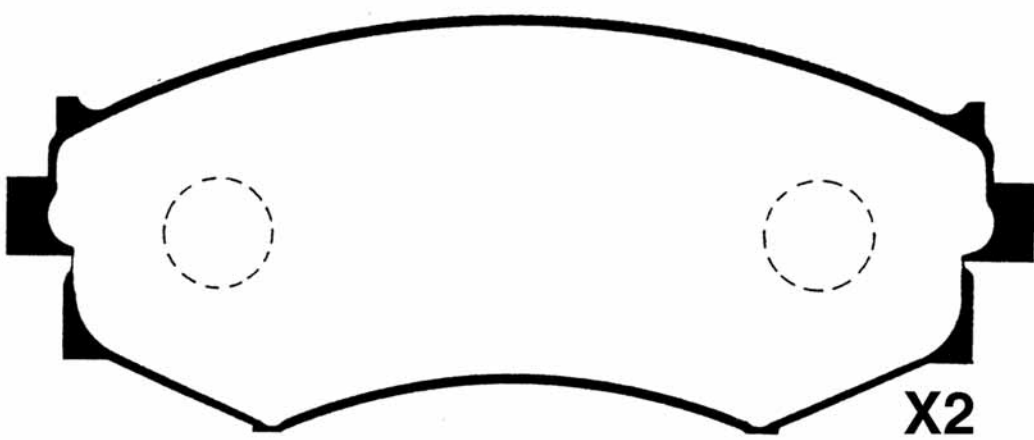
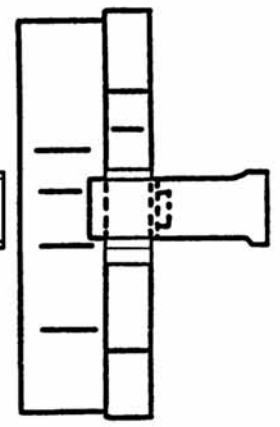
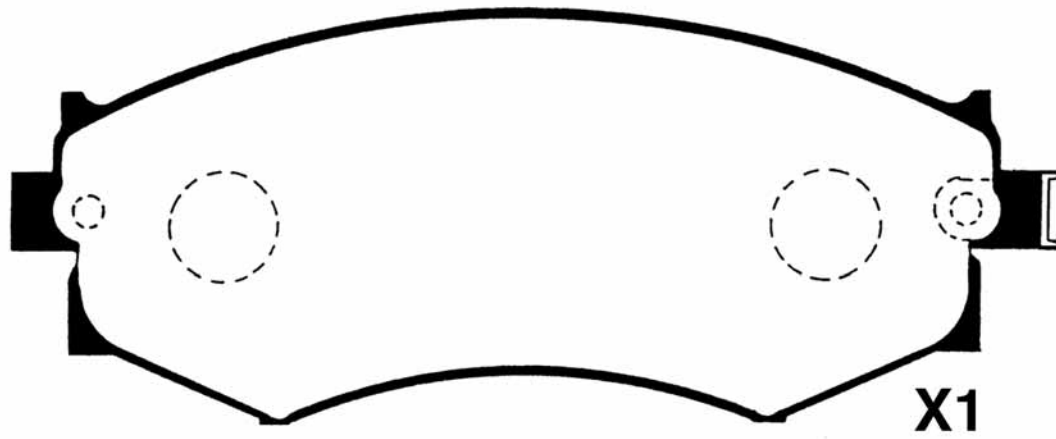
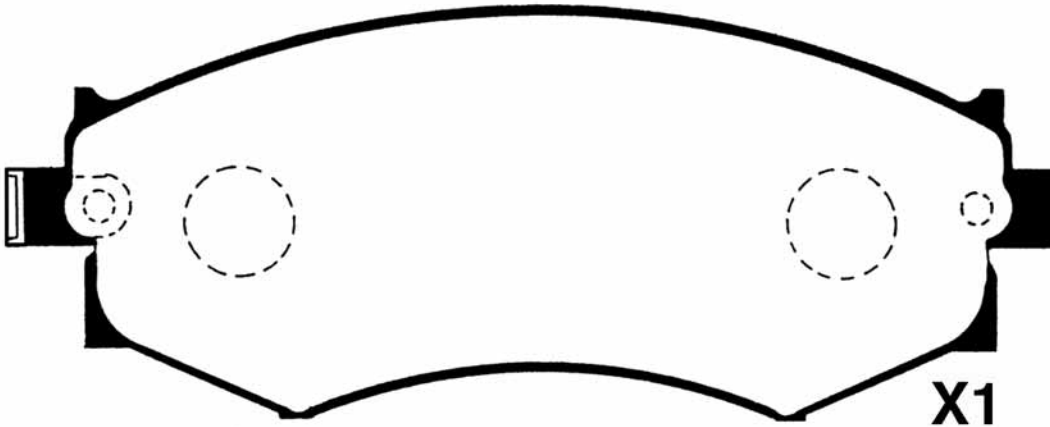



PICTURES BRAKE PADS FRONT
ABBILDUNGEN BREMSKLÖTZE VORN
FIGURAS PASTILLAS DE FRENO DELANTORES
ILLUSTRATIONS PLAQUETTES DE FREI AVANT
IMMAGINI PASTIGLIE FRENO ANTERIORI

50-01-143				WVA
	NISSAN	L	H	
	137	53	17	21562

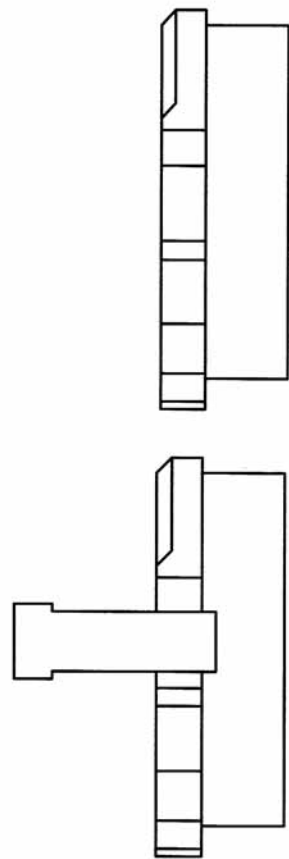
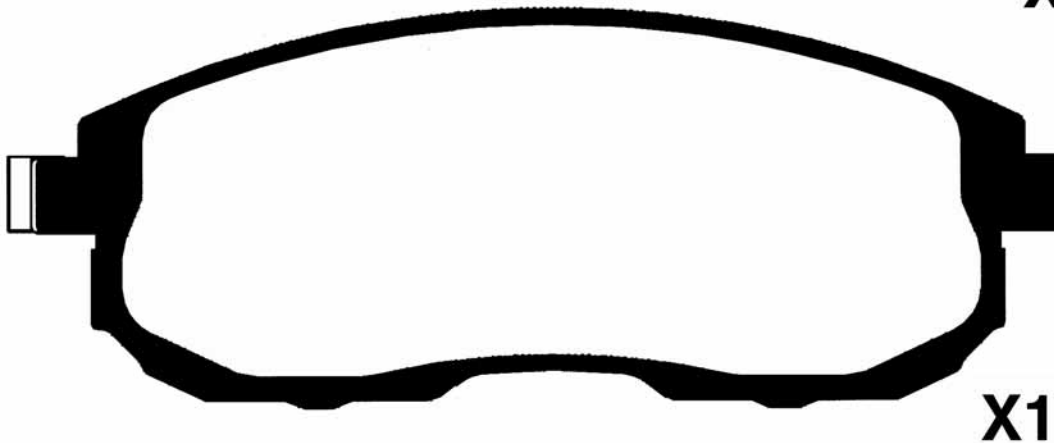
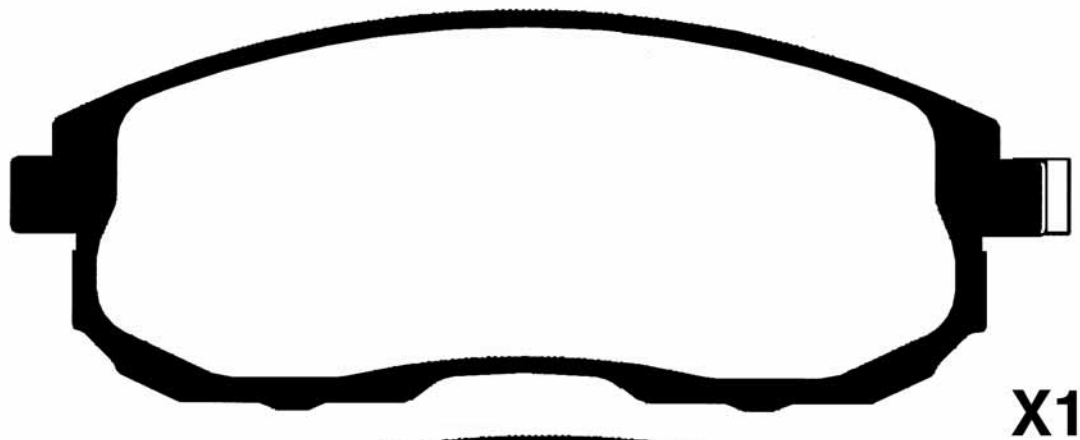
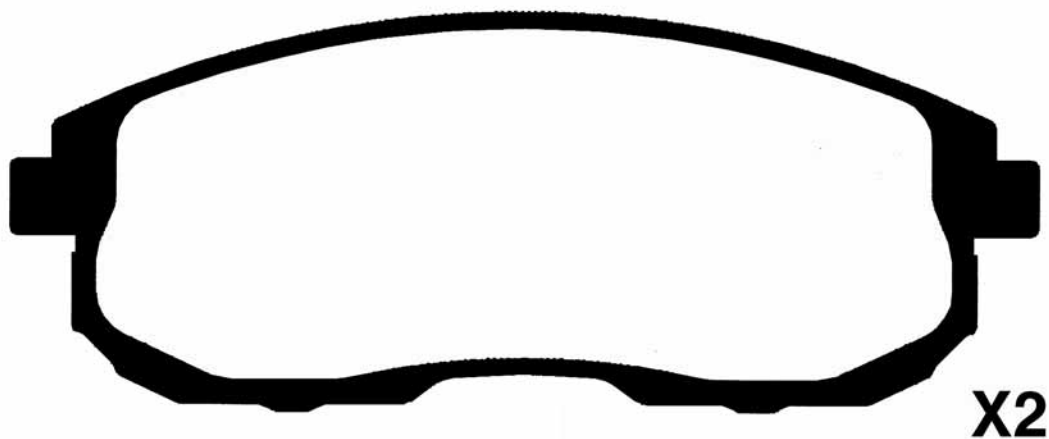



50-01-144				WVA
	HYUNDAI	L	H	Th
	137,4	54,4	16,2	21527

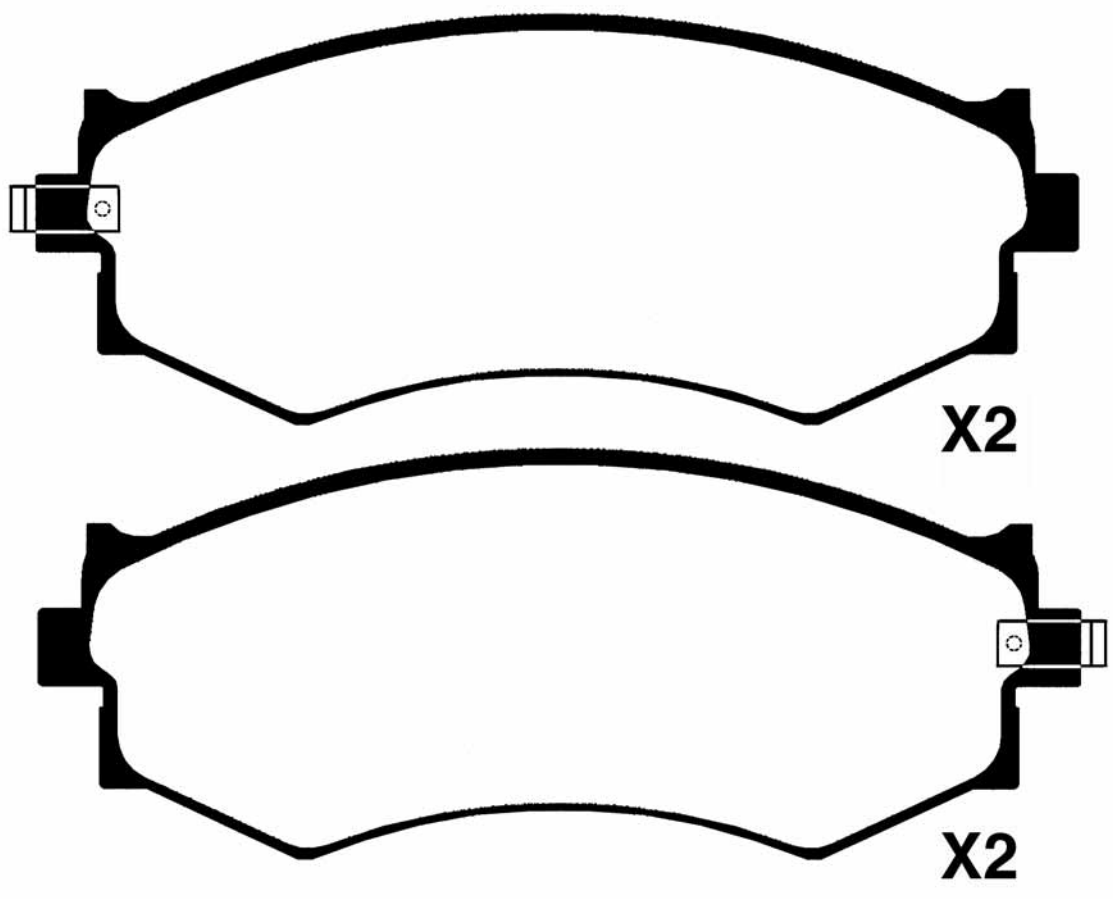



PICTURES BRAKE PADS FRONT
ABBILDUNGEN BREMSKLÖTZE VORN
FIGURAS PASTILLAS DE FRENO DELANTORES
ILLUSTRATIONS PLAQUETTES DE FREI AVANT
IMMAGINI PASTIGLIE FRENO ANTERIORI

50-01-146

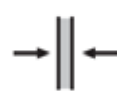

WVA

NISSAN

L

H

Th

127

76

16

24920

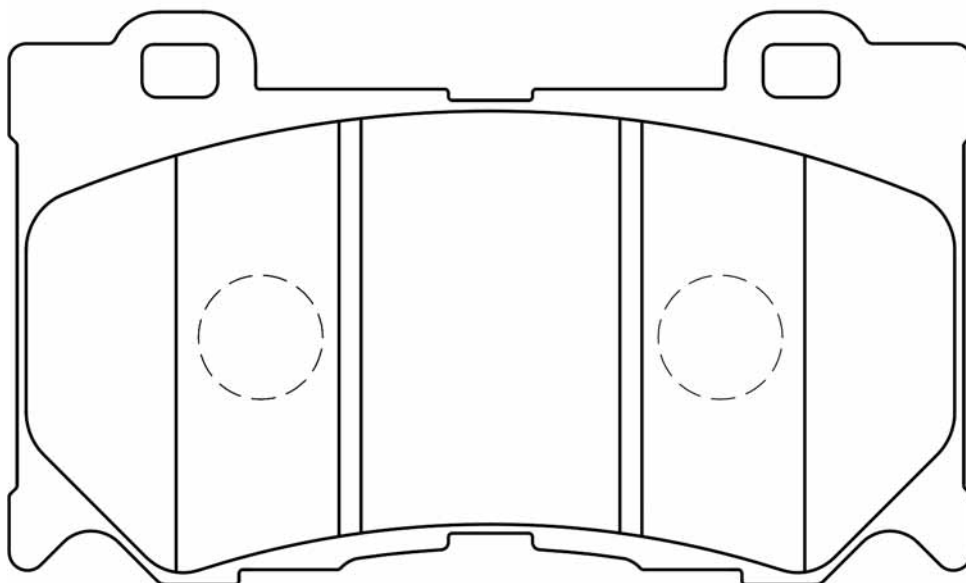
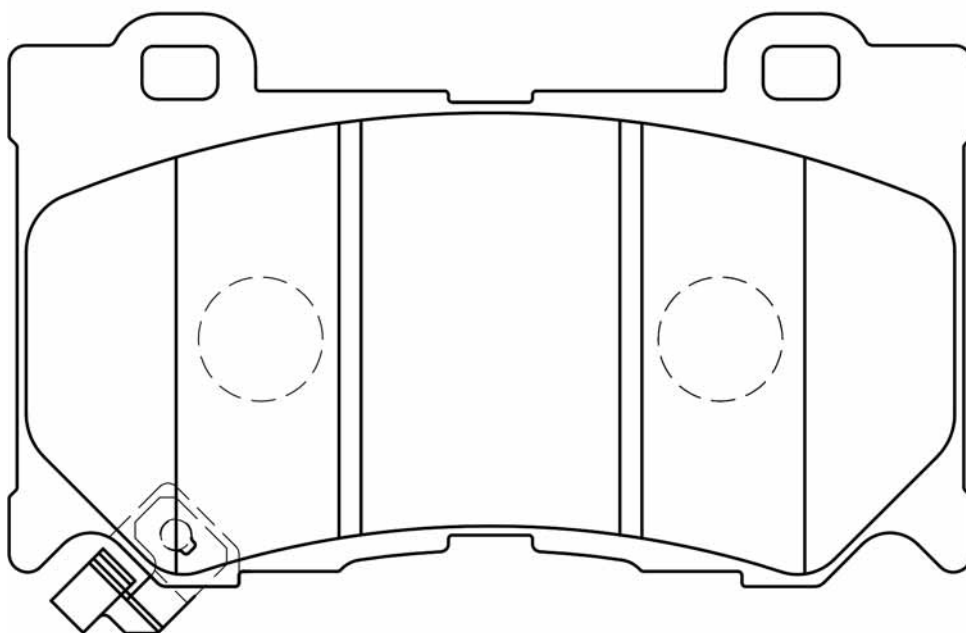



50-01-147				WVA
	SUBARU - NISSAN	L	H	Th
	119,5	61,9/71,3	14,3	21308

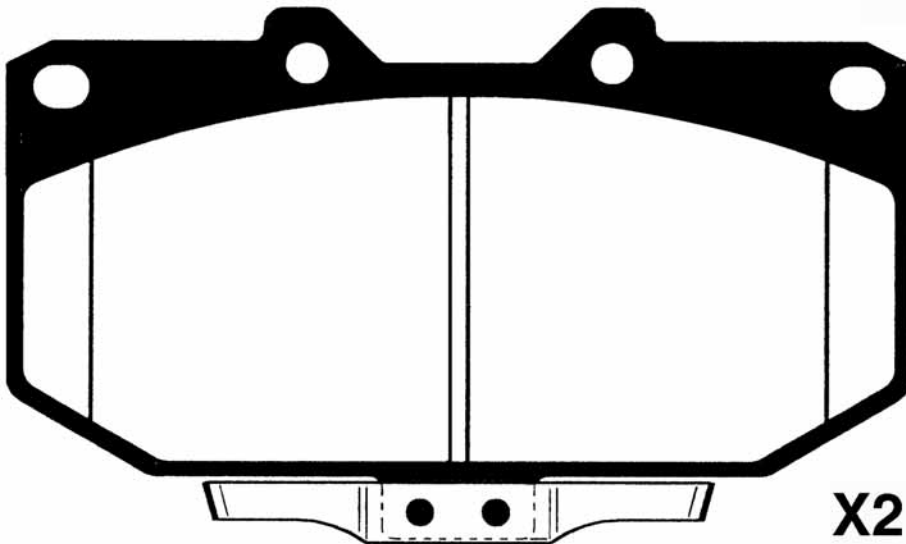
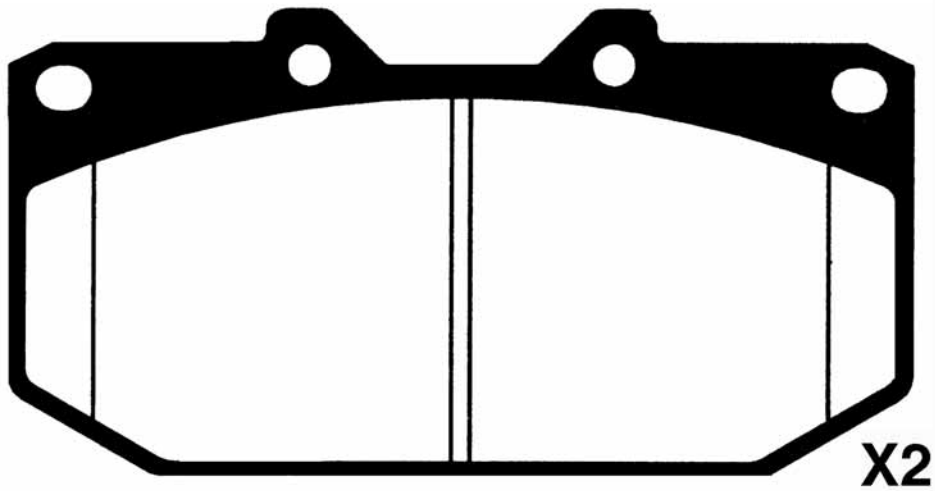



PICTURES BRAKE PADS FRONT
ABBILDUNGEN BREMSKLÖTZE VORN
FIGURAS PASTILLAS DE FRENO DELANTORES
ILLUSTRATIONS PLAQUETTES DE FREI AVANT
IMMAGINI PASTIGLIE FRENO ANTERIORI

50-01-149				WVA
NISSAN	L	H	Th	
	108,7	48	15,8	21659

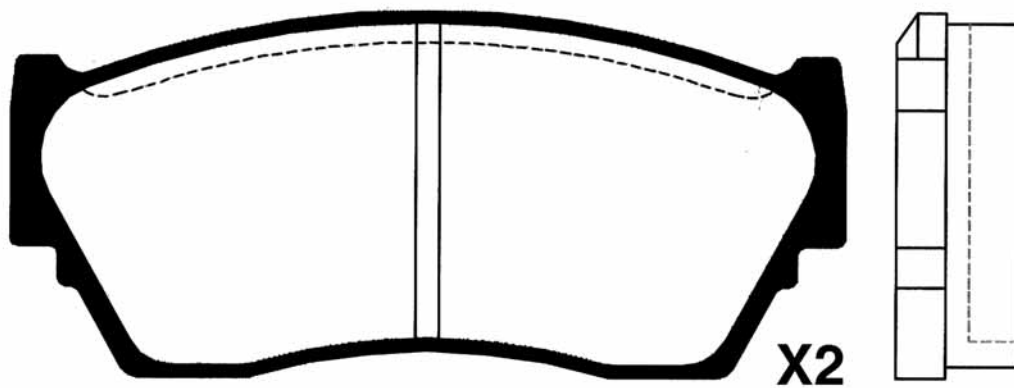
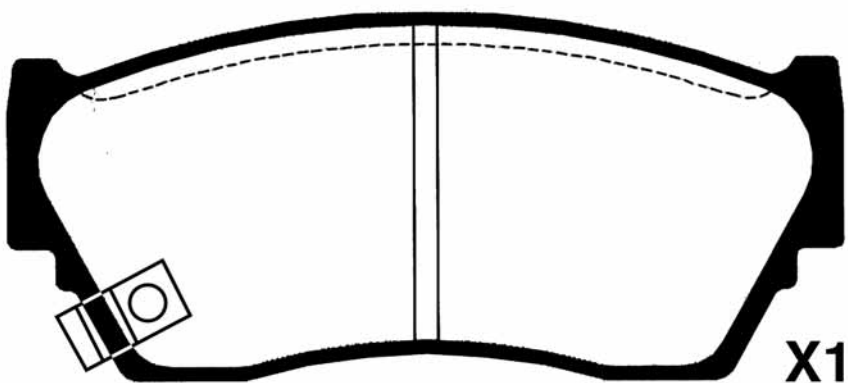
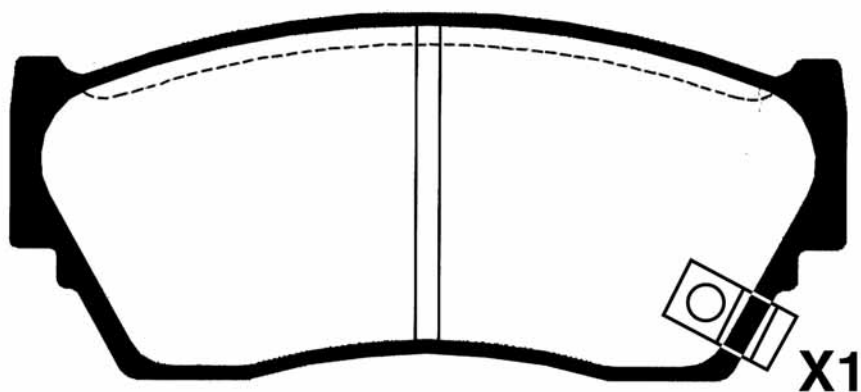



50-01-150				WVA
	NISSAN	L	H	
	135	48	16,5	24647

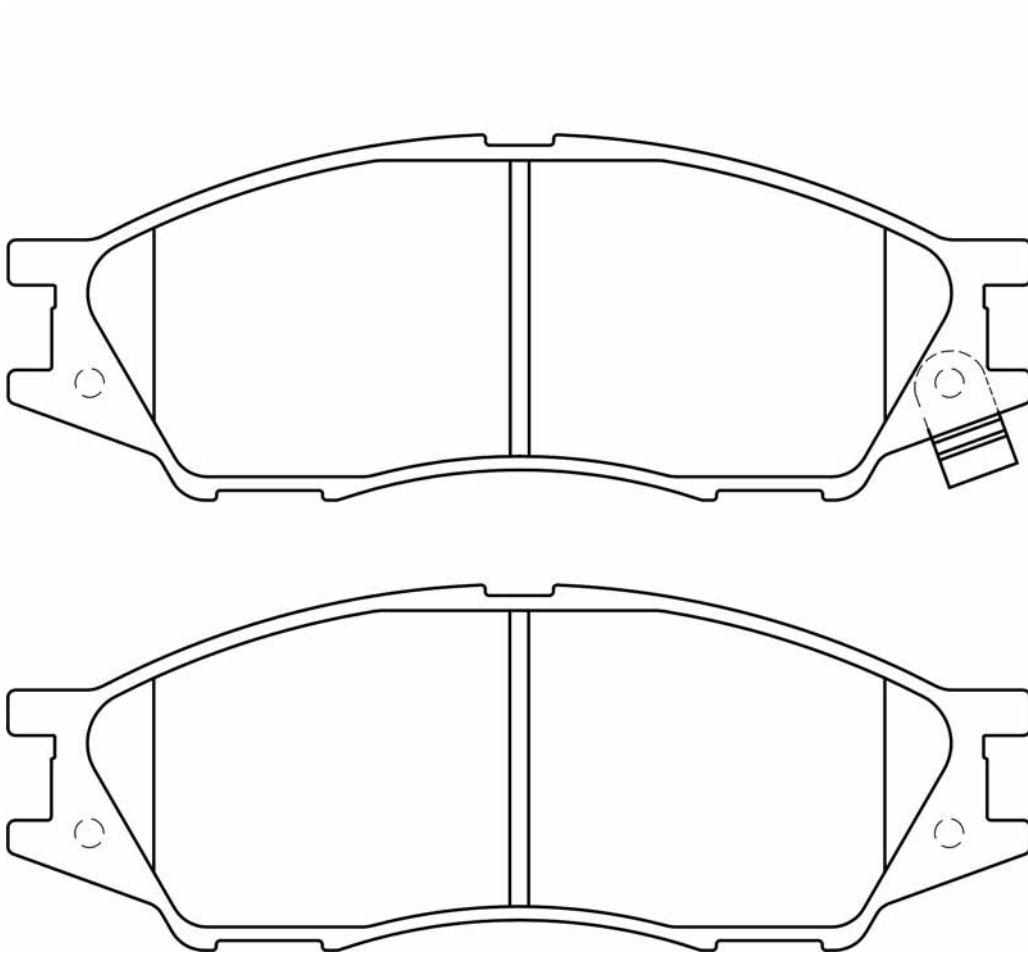



PICTURES BRAKE PADS FRONT
ABBILDUNGEN BREMSKLÖTZE VORN
FIGURAS PASTILLAS DE FRENO DELANTORES
ILLUSTRATIONS PLAQUETTES DE FREI AVANT
IMMAGINI PASTIGLIE FRENO ANTERIORI

50-01-154				WVA
NISSAN - INFINITI	L	H	Th	
	158,7	56	16	

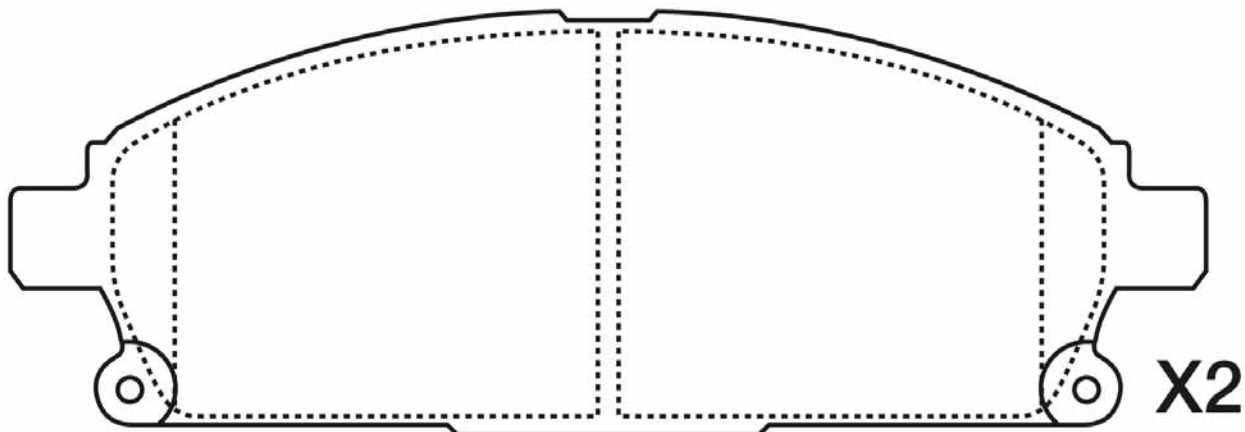
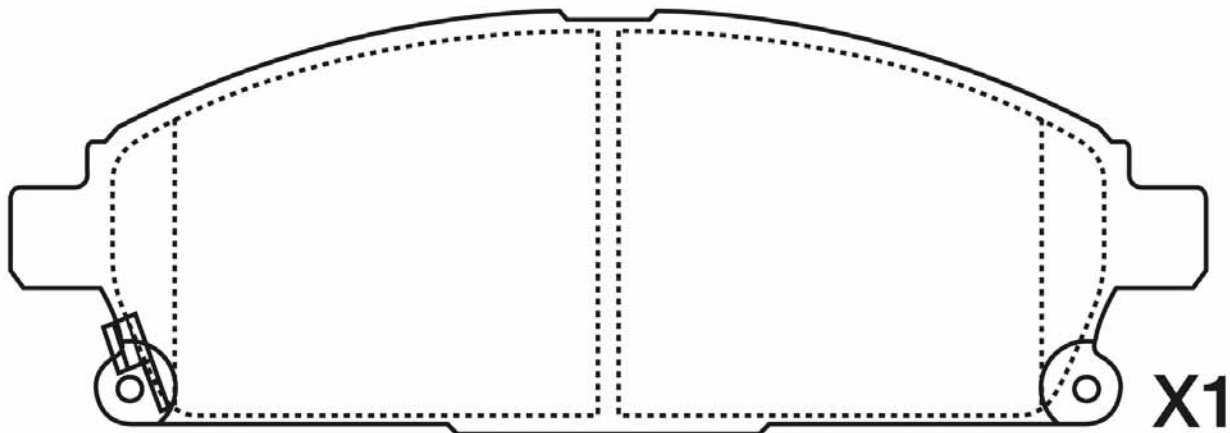
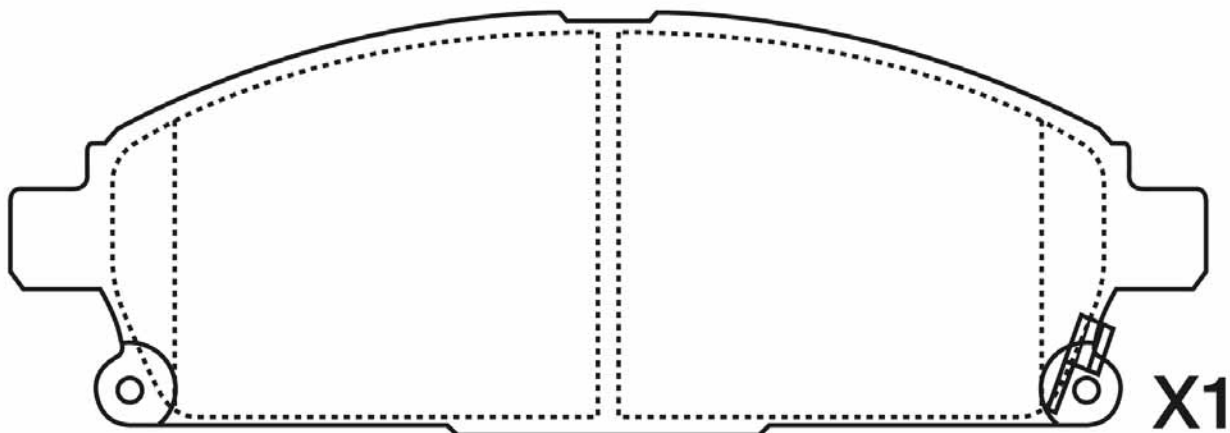



50-01-176					WVA
HONDA - NISSAN	L	H	Th		
	131,5	58,9	15,9		23095

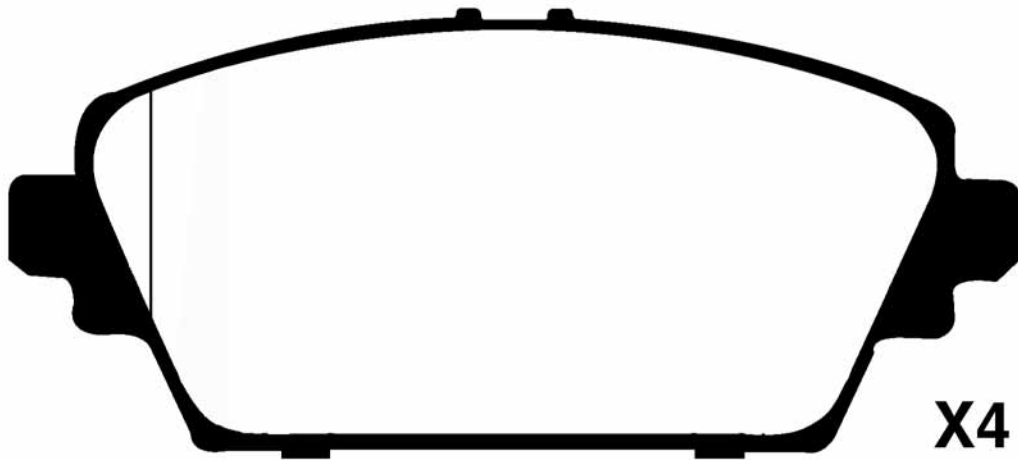



PICTURES BRAKE PADS FRONT
ABBILDUNGEN BREMSKLÖTZE VORN
FIGURAS PASTILLAS DE FRENO DELANTORES
ILLUSTRATIONS PLAQUETTES DE FREI AVANT
IMMAGINI PASTIGLIE FRENO ANTERIORI

50-01-178 NISSAN				WVA
	L	H	Th	
	166	61,2	18,4	23611

X1 LEFT
X1 RIGHT

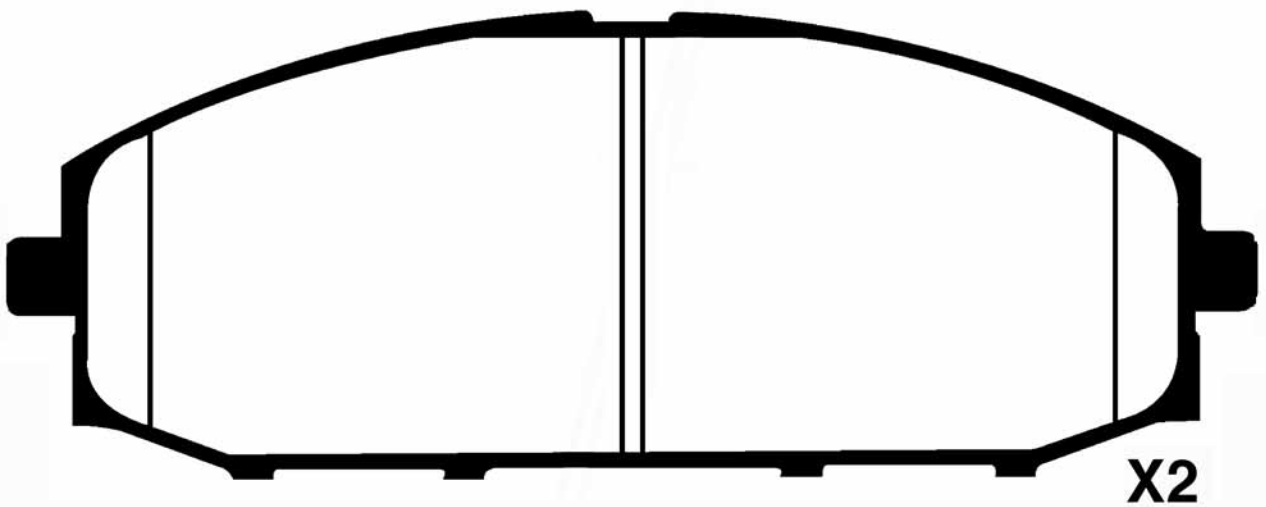
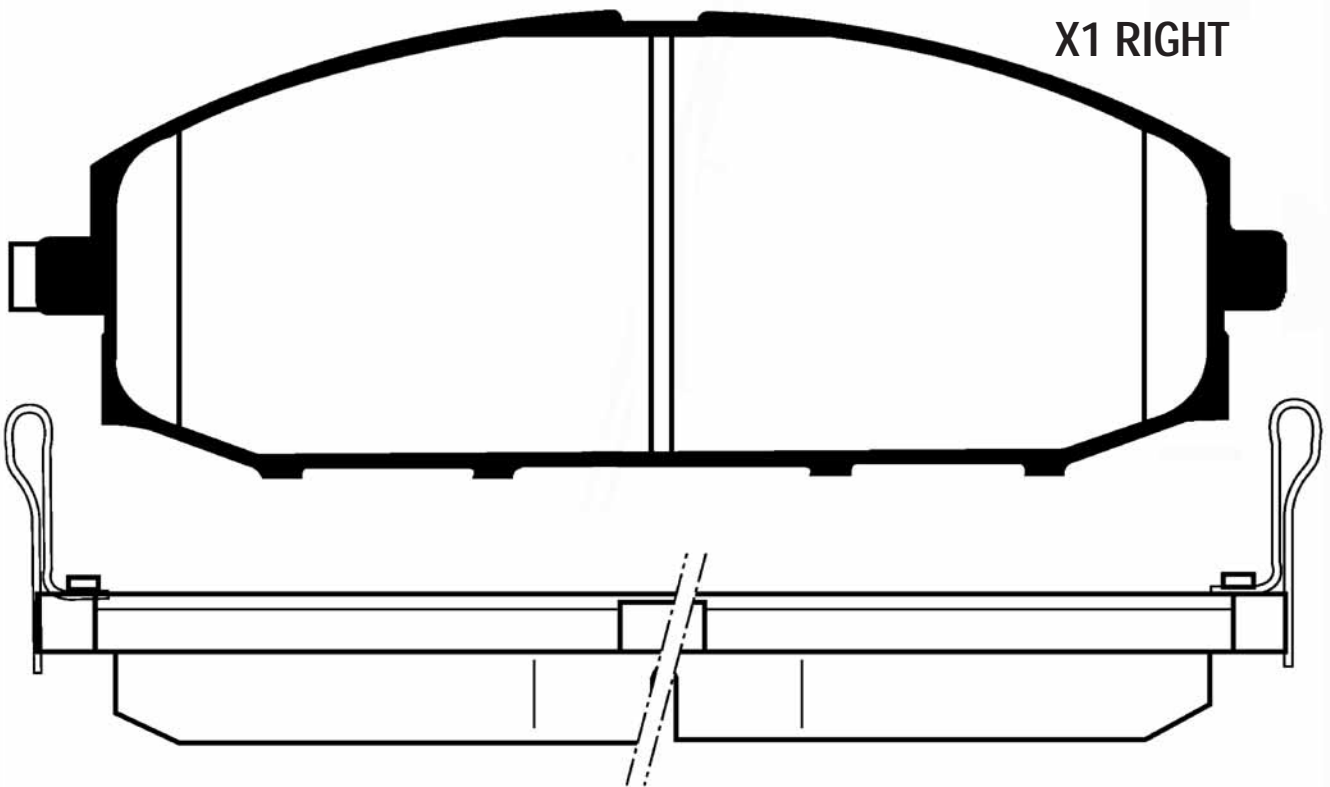



50-01-179				WVA
	NISSAN	L	H	
	124	57,2	16	23093

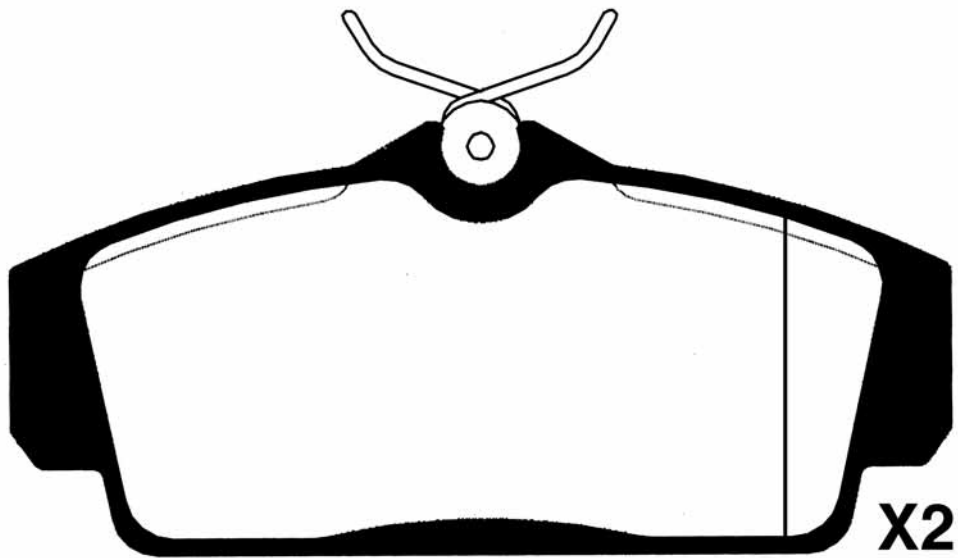
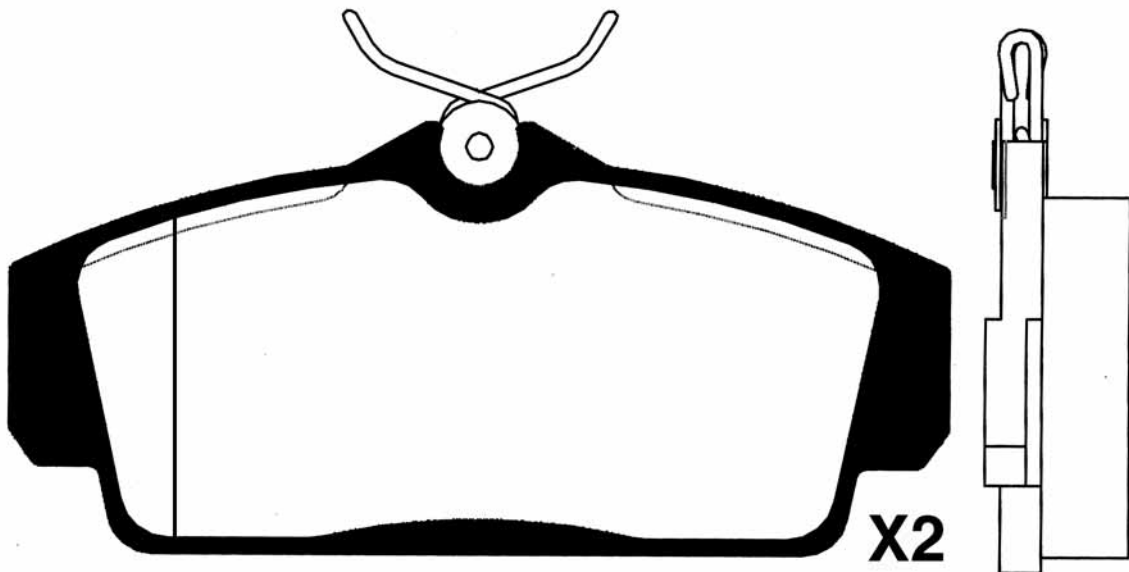



PICTURES BRAKE PADS FRONT
ABBILDUNGEN BREMSKLÖTZE VORN
FIGURAS PASTILLAS DE FRENO DELANTORES
ILLUSTRATIONS PLAQUETTES DE FREI AVANT
IMMAGINI PASTIGLIE FRENO ANTERIORI

50-01-180				WVA
	NISSAN	L	H	
	175,5	78	21,2	

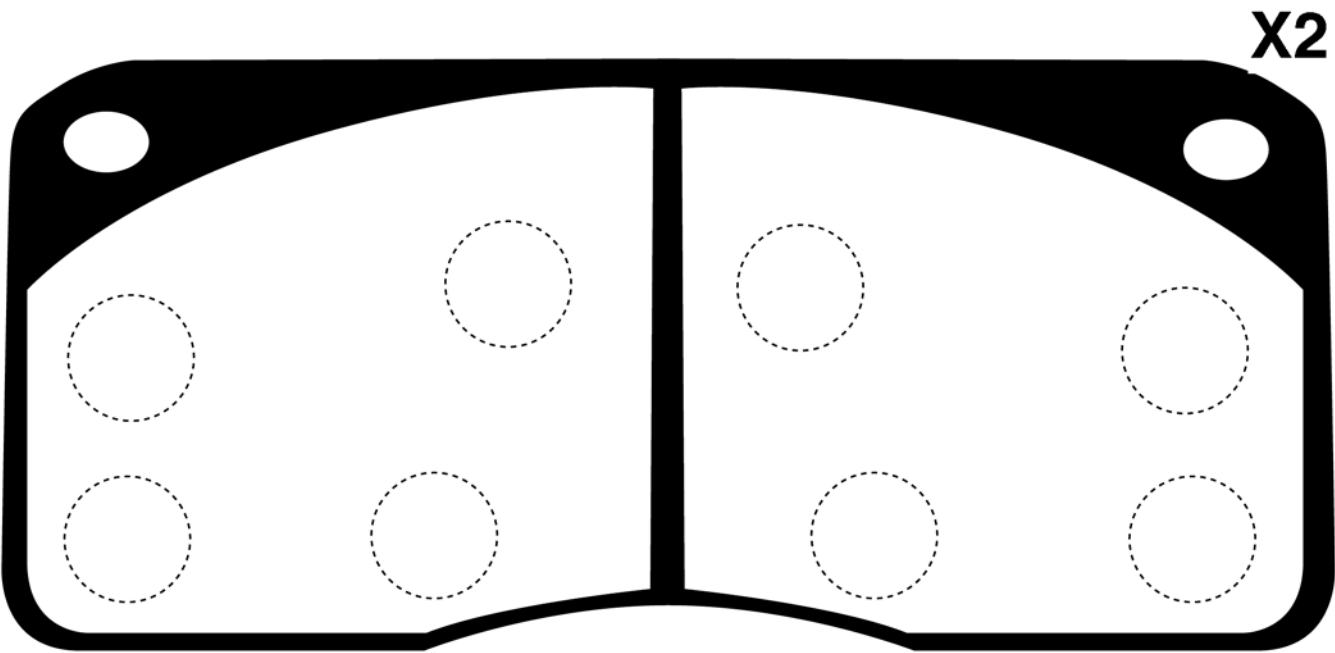
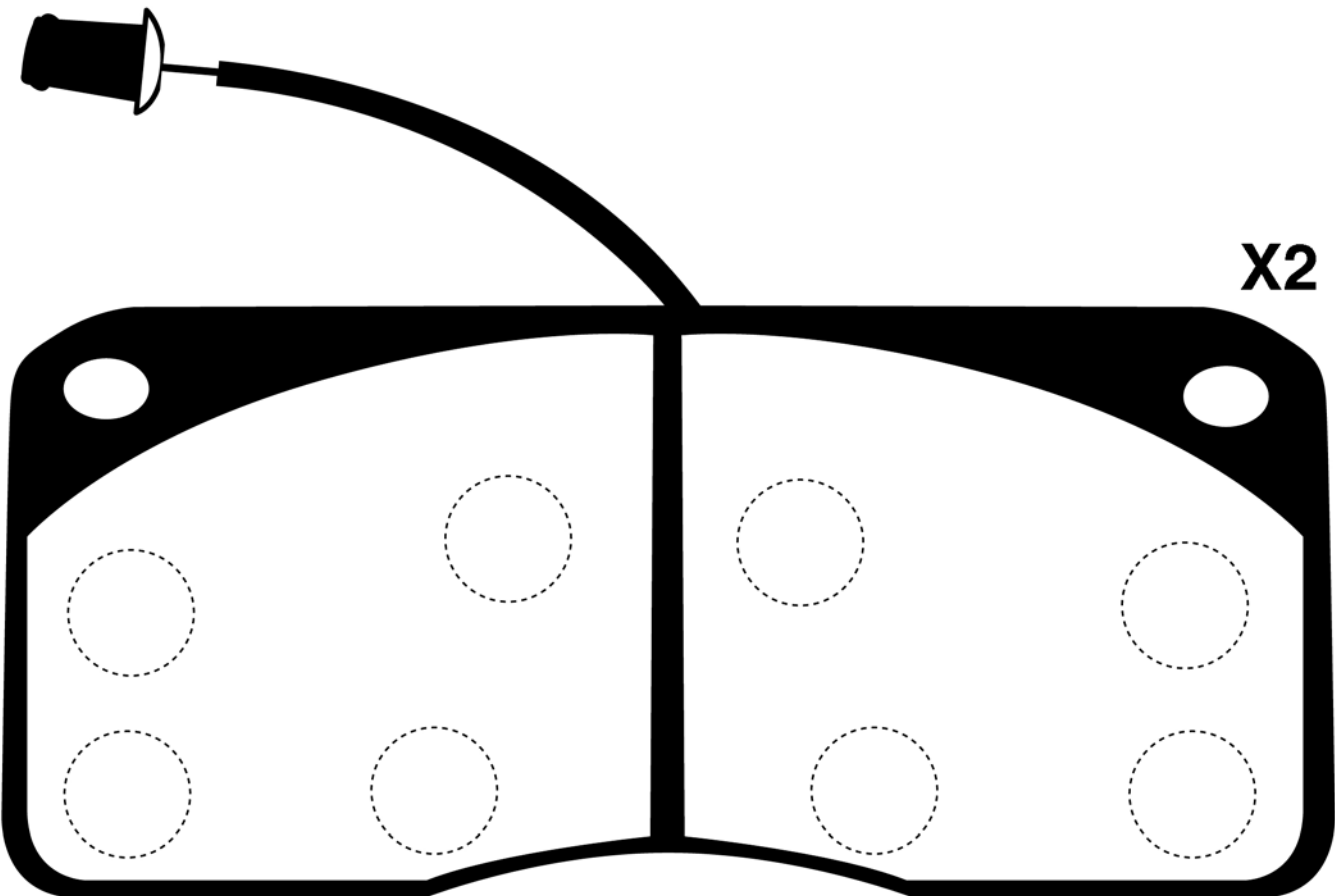



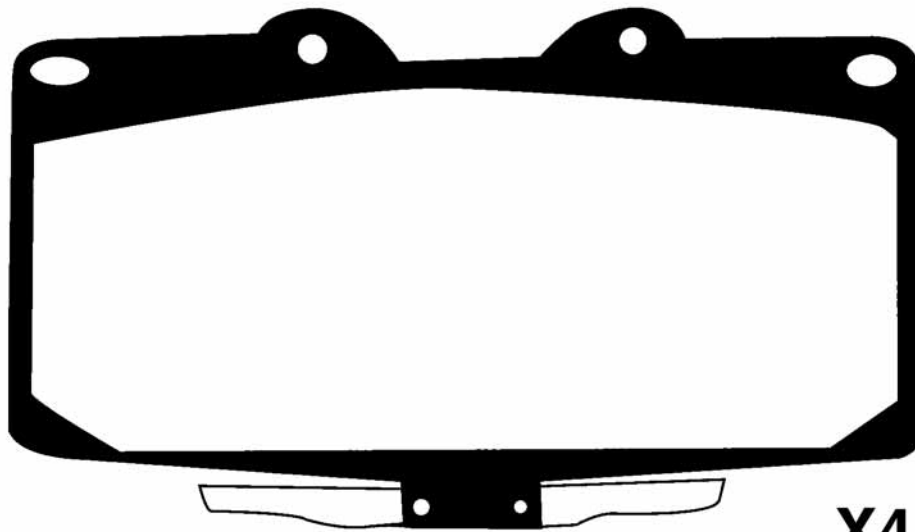

50-01-188				WVA
	L	H	Th	
SUBARU - NISSAN	119	69,7	14	21854



X4

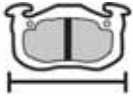

PICTURES BRAKE PADS FRONT
ABBILDUNGEN BREMSKLÖTZE VORN
FIGURAS PASTILLAS DE FRENO DELANTORES
ILLUSTRATIONS PLAQUETTES DE FREI AVANT
IMMAGINI PASTIGLIE FRENO ANTERIORI

50-01-191				WVA
	NISSAN	L	H	
	107,9	48	16	23004

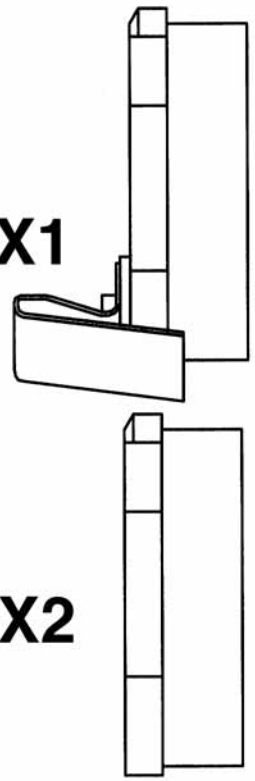
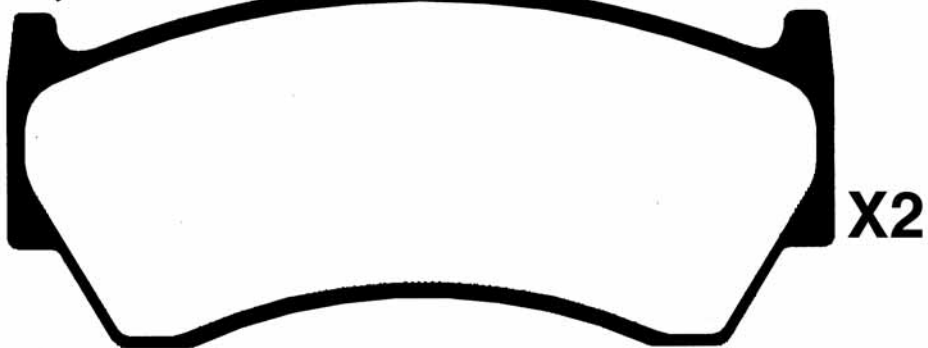
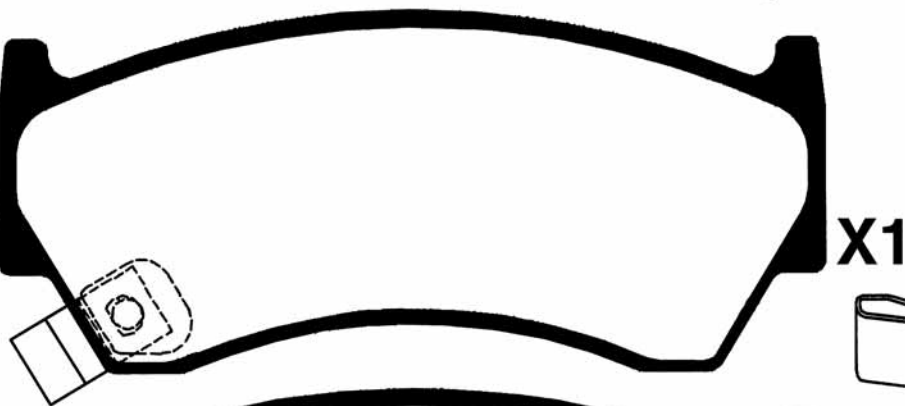
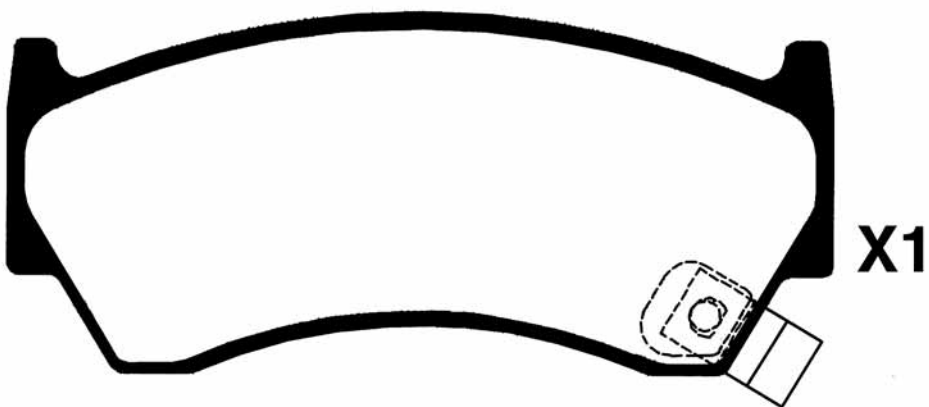



50-01-192				WVA
	NISSAN	L 151	H 48,4	Th 16 23317

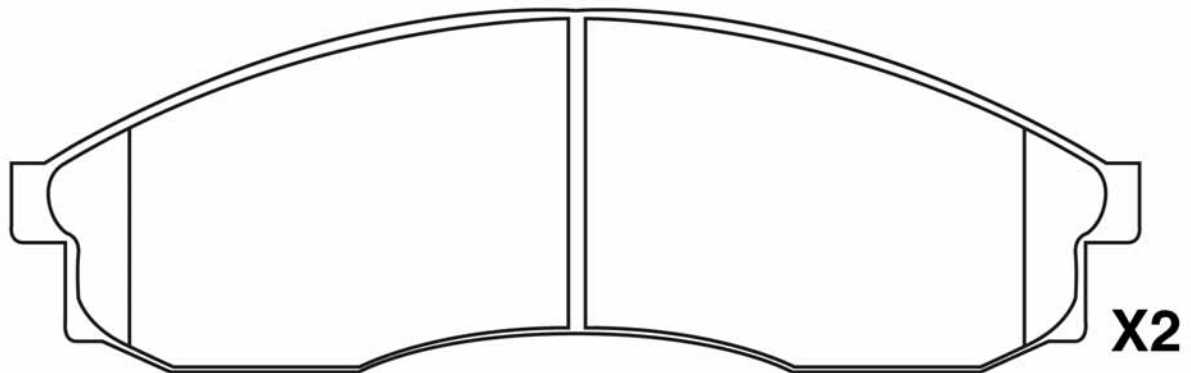
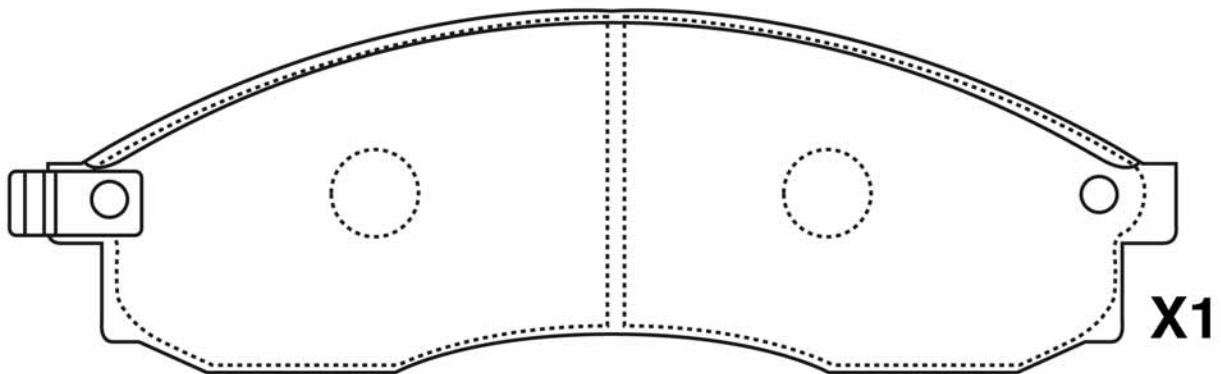
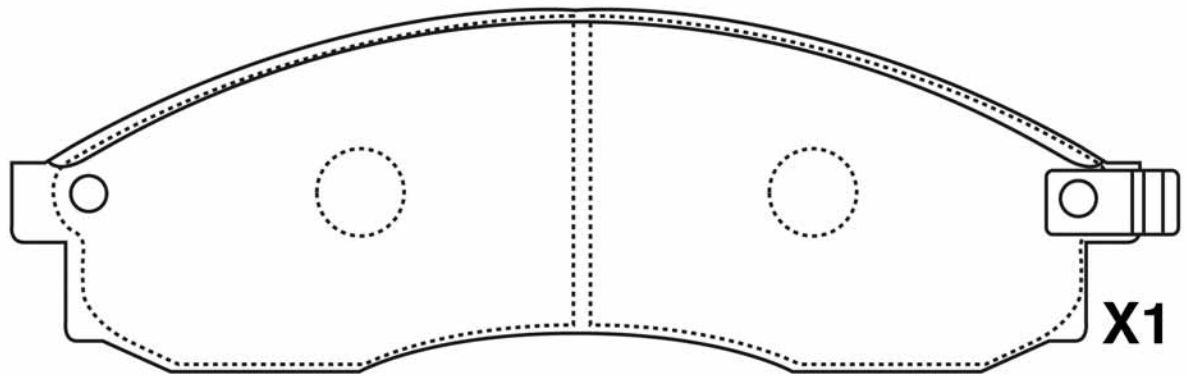



PICTURES BRAKE PADS FRONT
ABBILDUNGEN BREMSKLÖTZE VORN
FIGURAS PASTILLAS DE FRENO DELANTORES
ILLUSTRATIONS PLAQUETTES DE FREI AVANT
IMMAGINI PASTIGLIE FRENO ANTERIORI

50-01-193				WVA
NISSAN	L	H	Th	
	115	51,6	15,6	

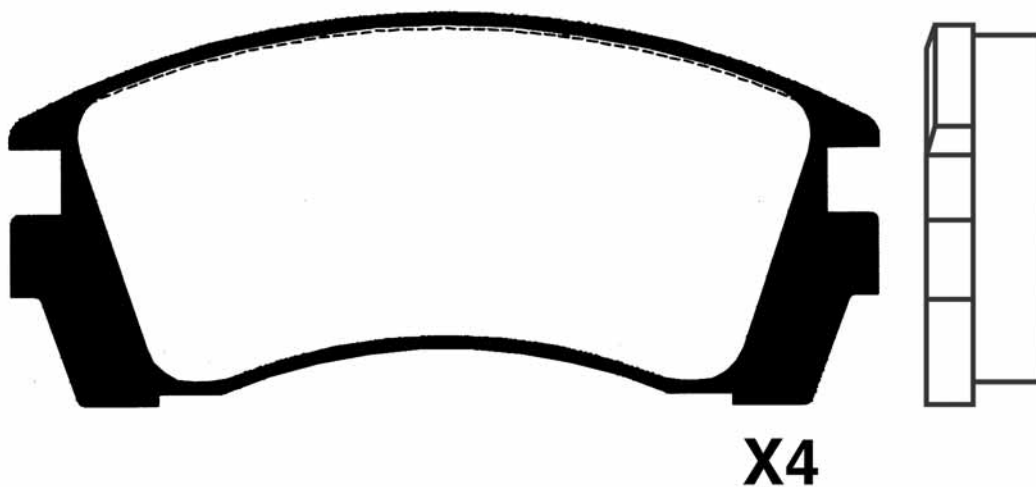



50-01-194				WVA
	NISSAN	L	H	Th
	137	54,4	15,5	21727

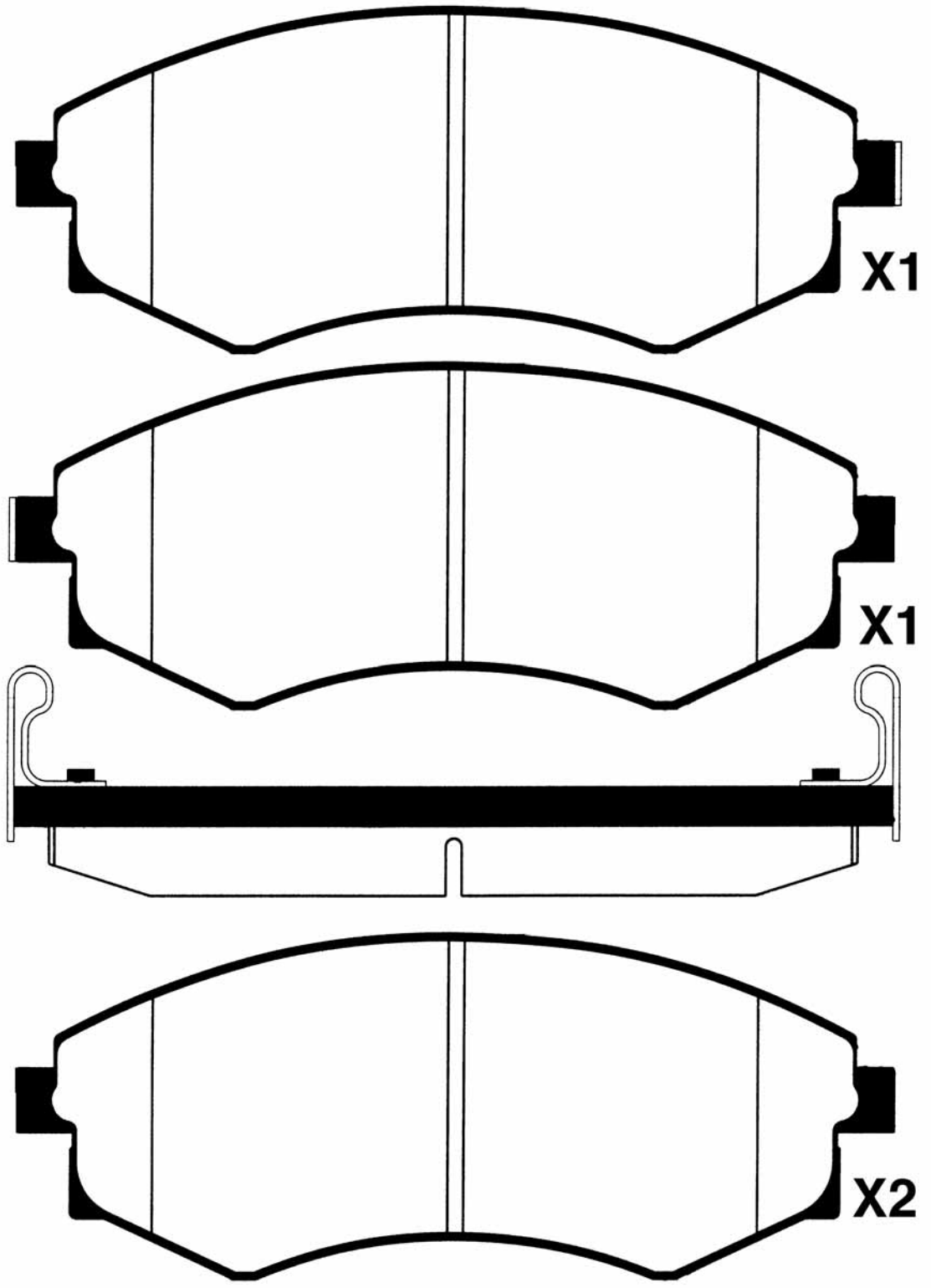



PICTURES BRAKE PADS FRONT
ABBILDUNGEN BREMSKLÖTZE VORN
FIGURAS PASTILLAS DE FRENO DELANTORES
ILLUSTRATIONS PLAQUETTES DE FREI AVANT
IMMAGINI PASTIGLIE FRENO ANTERIORI

50-01-195 NISSAN				WVA
	L 130	H 49,5	Th 16,4	21119

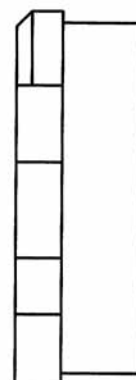
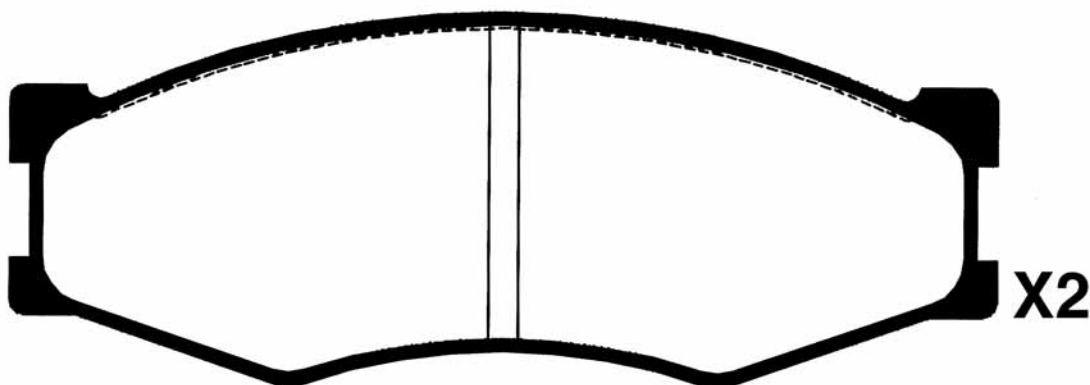
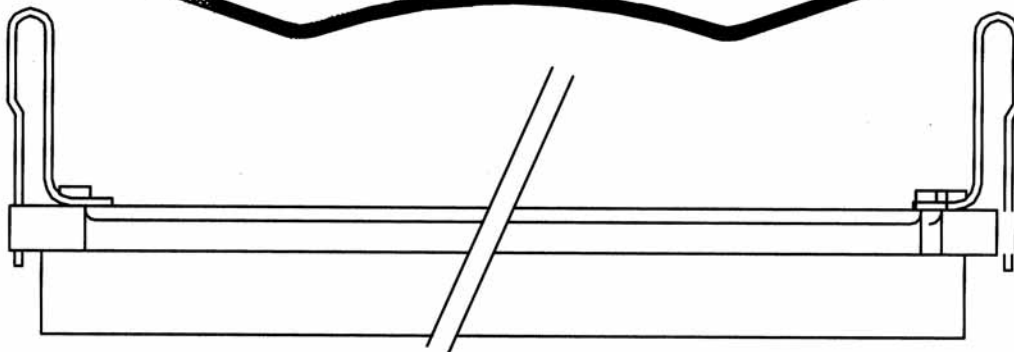
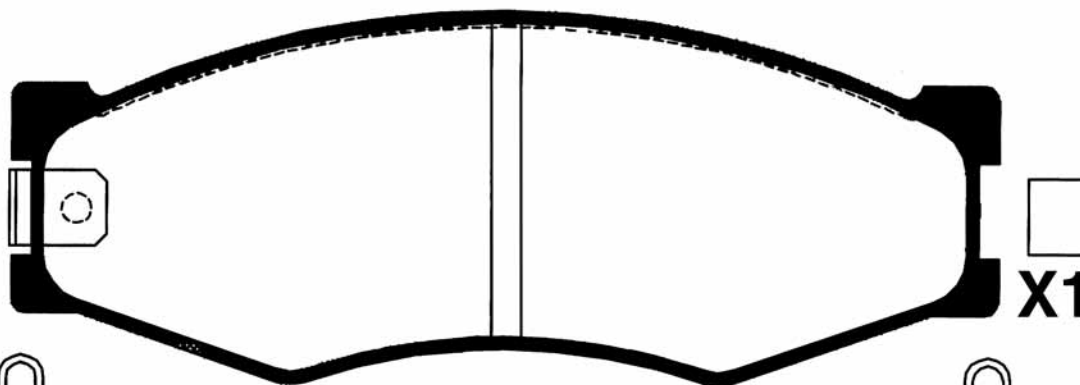
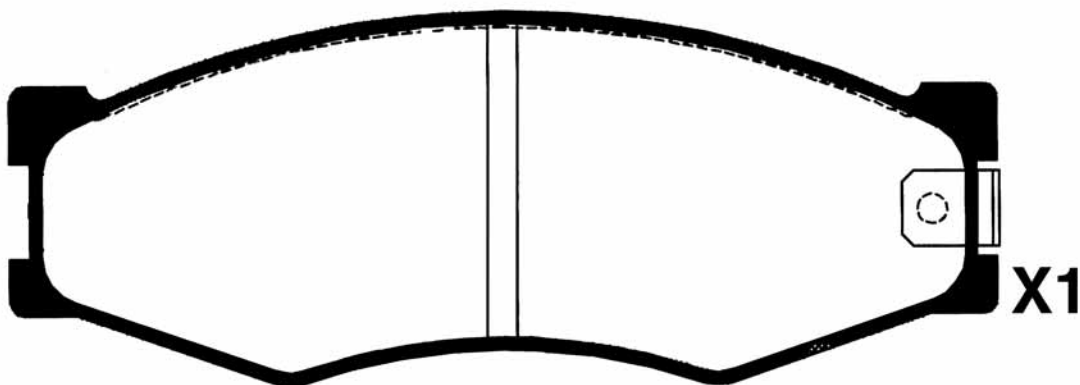



50-01-196				WVA
	NISSAN	L	H	Th
	166,3	62	16,3	29984

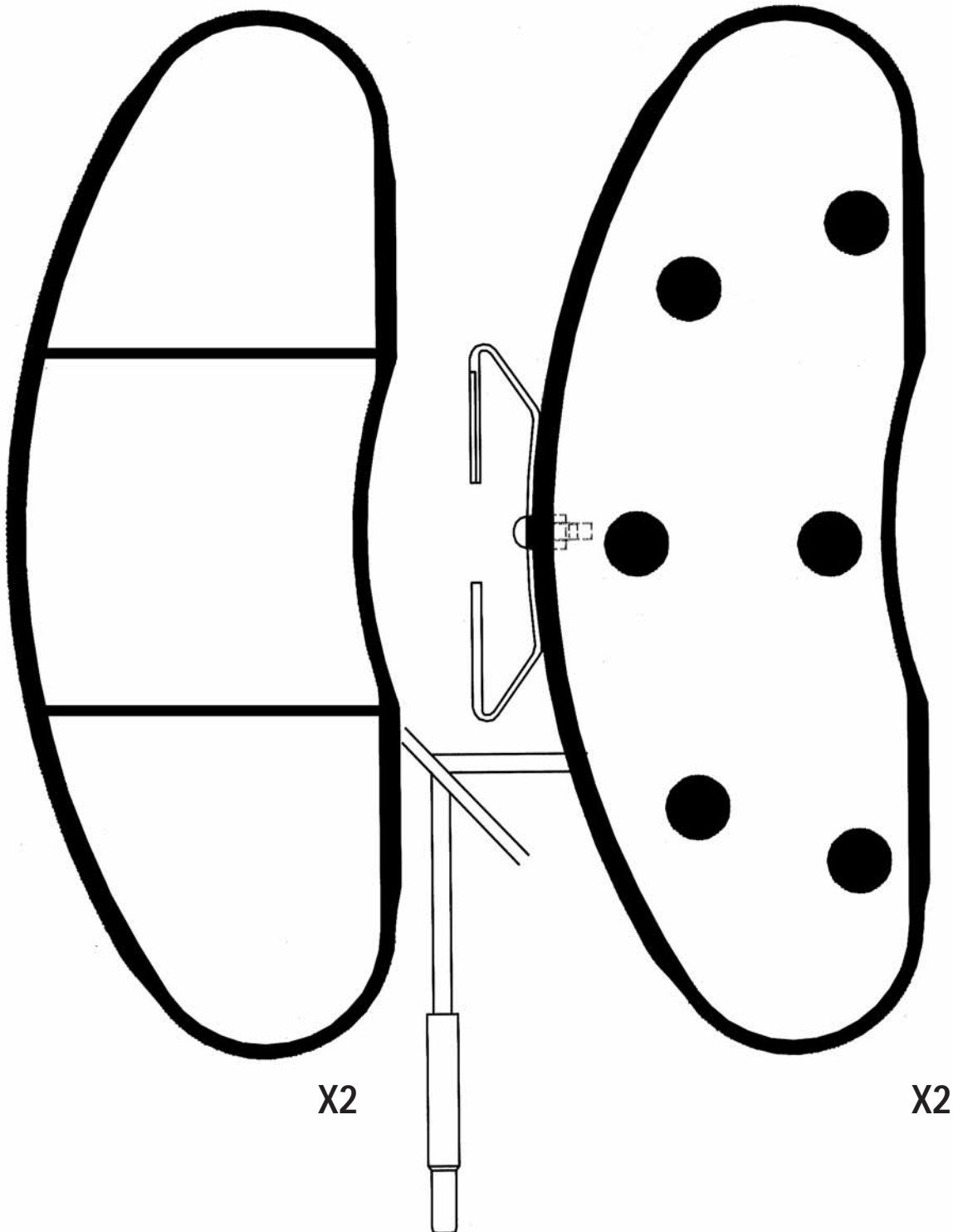



PICTURES BRAKE PADS FRONT
ABBILDUNGEN BREMSKLÖTZE VORN
FIGURAS PASTILLAS DE FRENO DELANTORES
ILLUSTRATIONS PLAQUETTES DE FREI AVANT
IMMAGINI PASTIGLIE FRENO ANTERIORI

50-01-196P				WVA
NISSAN	L	H	Th	
	166,3	62	16,3	

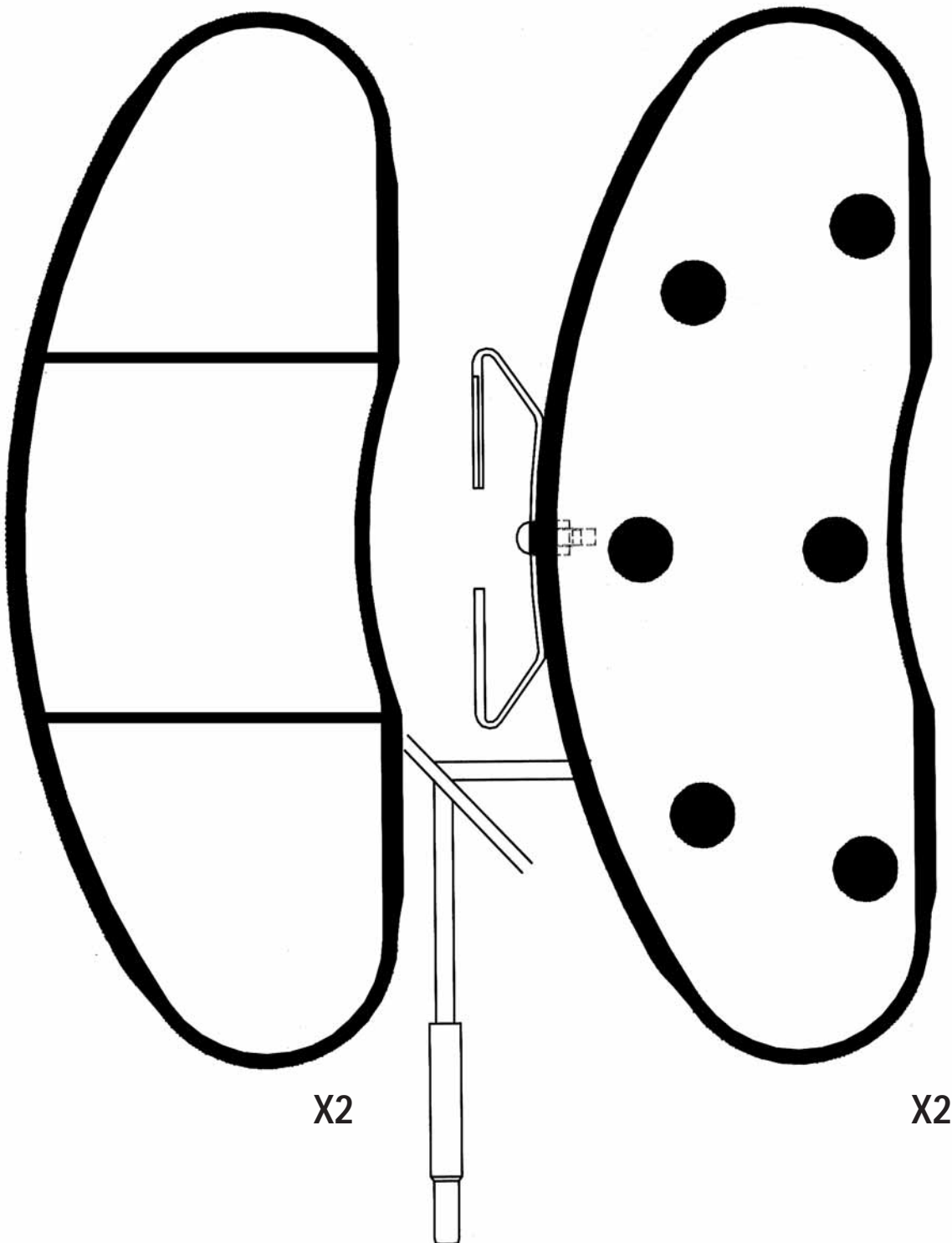



50-01-197				WVA
	NISSAN	L	H	Th
	127,7	51,4	14,7	21280

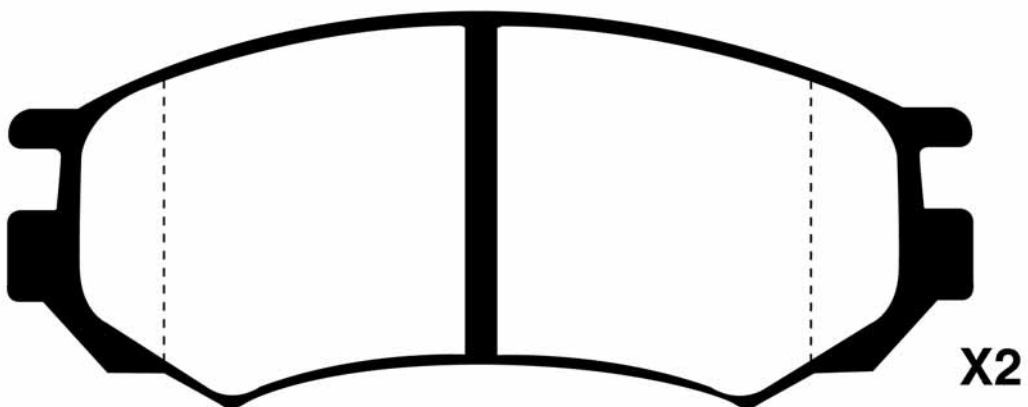
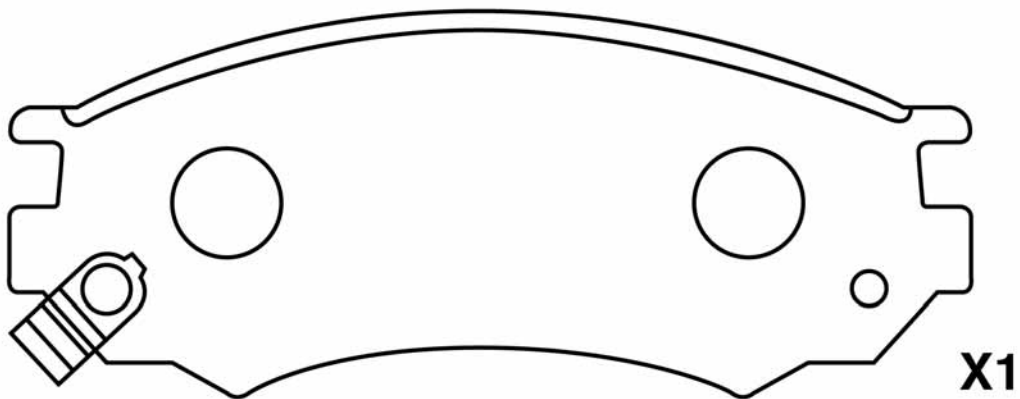
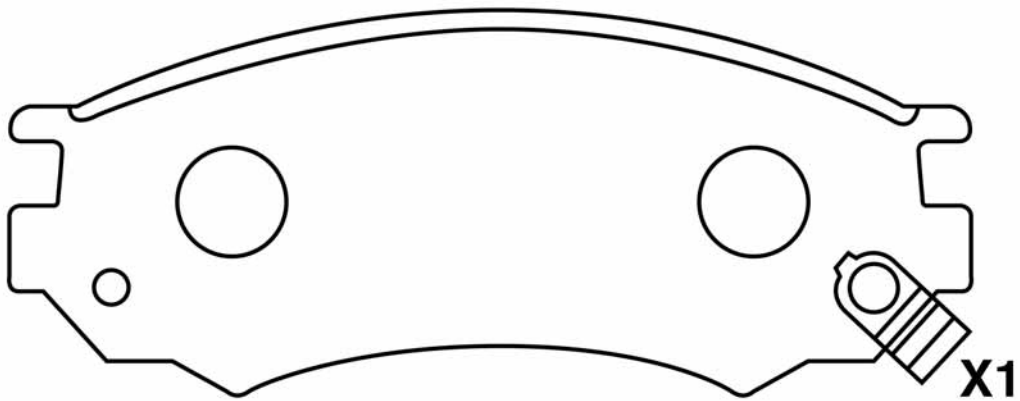



PICTURES BRAKE PADS FRONT
ABBILDUNGEN BREMSKLÖTZE VORN
FIGURAS PASTILLAS DE FRENO DELANTORES
ILLUSTRATIONS PLAQUETTES DE FREI AVANT
IMMAGINI PASTIGLIE FRENO ANTERIORI

50-02-201				WVA
TOYOTA	L	H	Th	
	131,6	52,6	17,5	23088

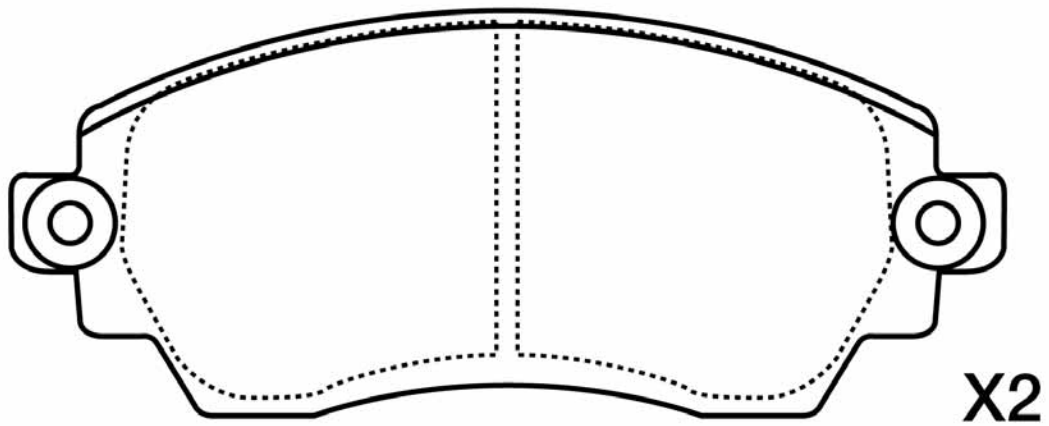
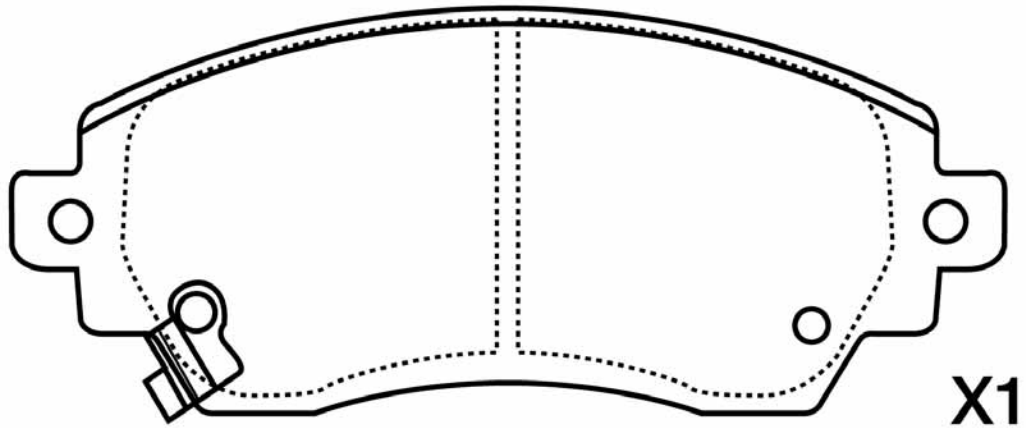
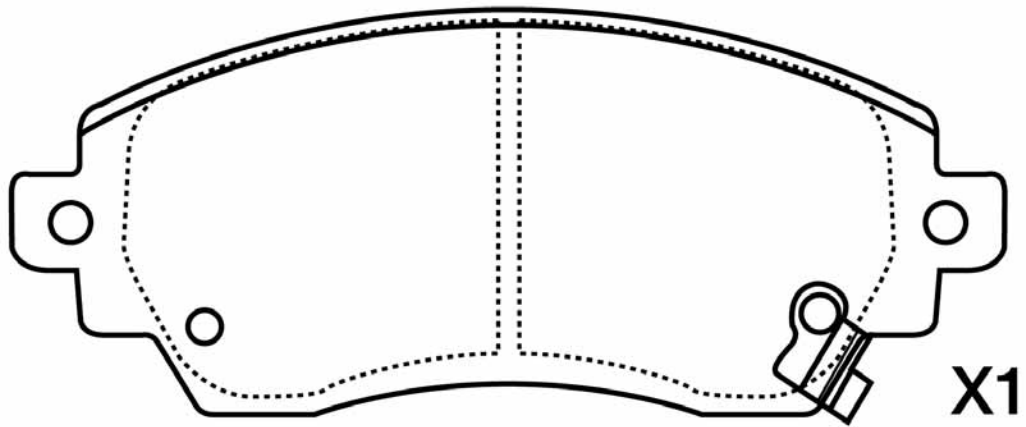



50-02-202				WVA
	TOYOTA	L	H	Th
	97,5/132	44/48,4	13,2	20605

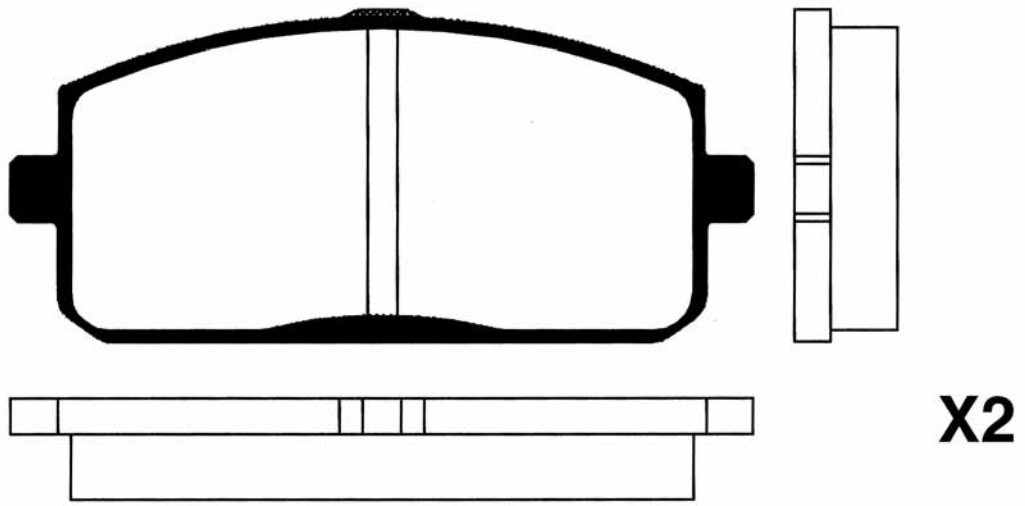
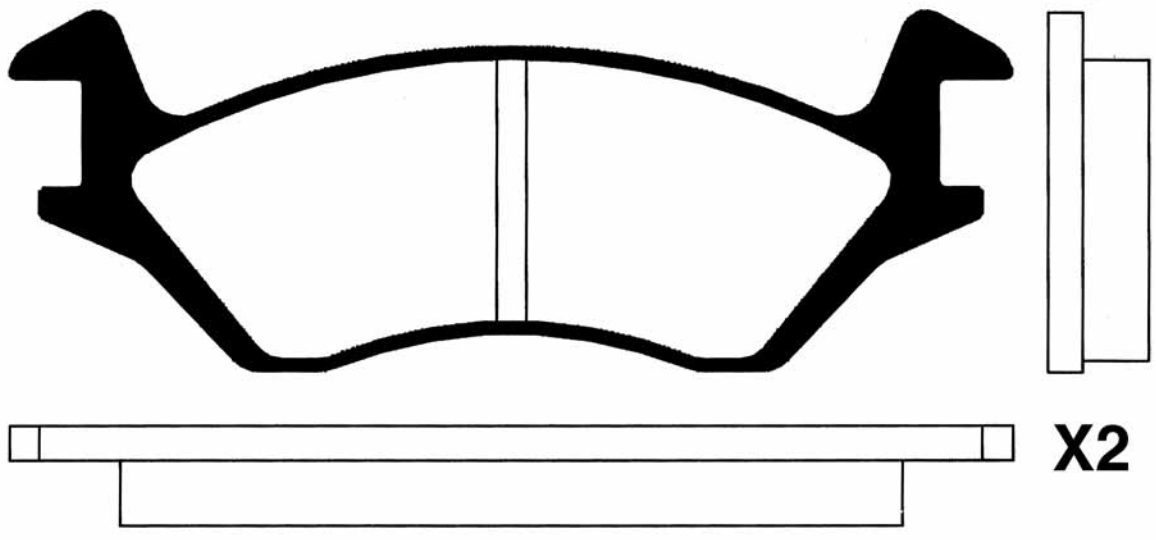



PICTURES BRAKE PADS FRONT
ABBILDUNGEN BREMSKLÖTZE VORN
FIGURAS PASTILLAS DE FRENO DELANTORES
ILLUSTRATIONS PLAQUETTES DE FREI AVANT
IMMAGINI PASTIGLIE FRENO ANTERIORI

50-02-203

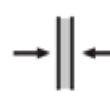

WVA

TOYOTA

L

H

Th

116,4

51,2

16,4

23510

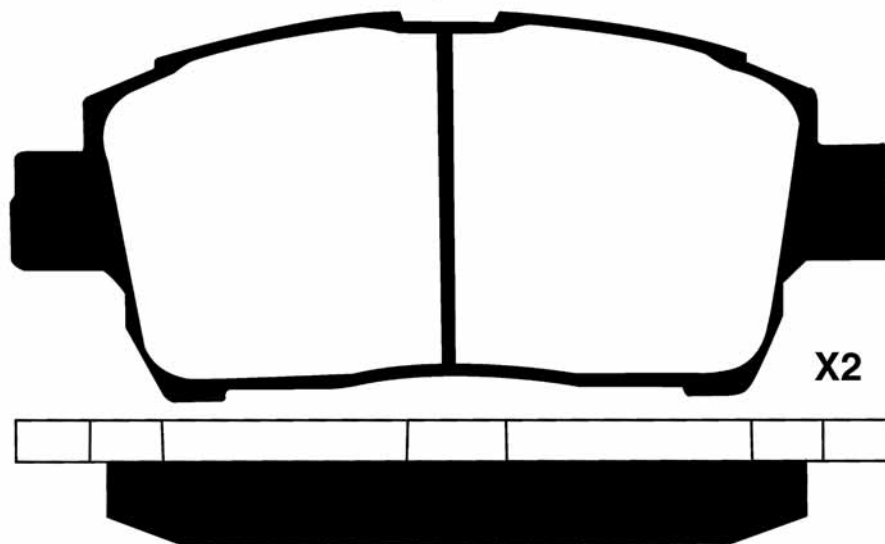
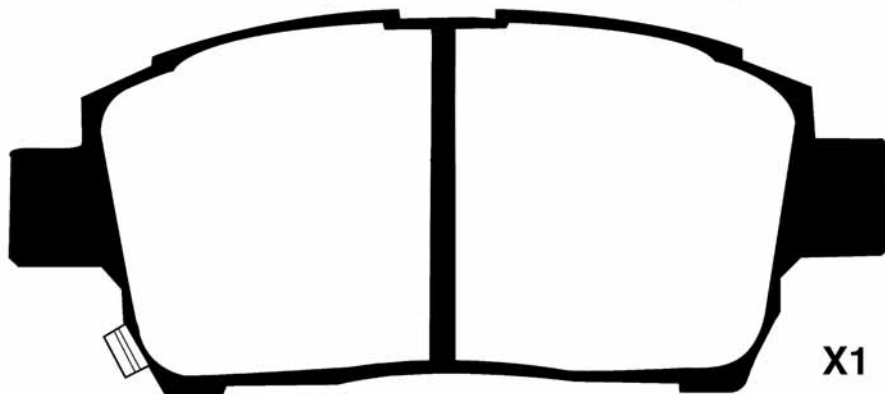
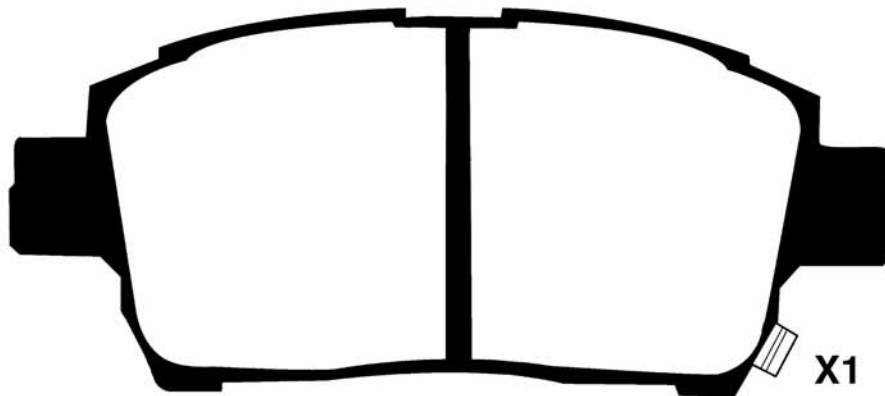



50-02-204				WVA
	TOYOTA	L	H	
	130,9	45/51,6	16,5	23340

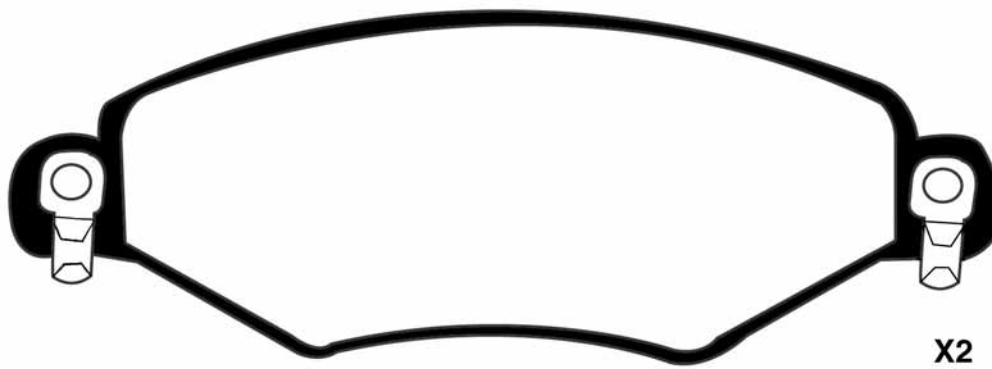
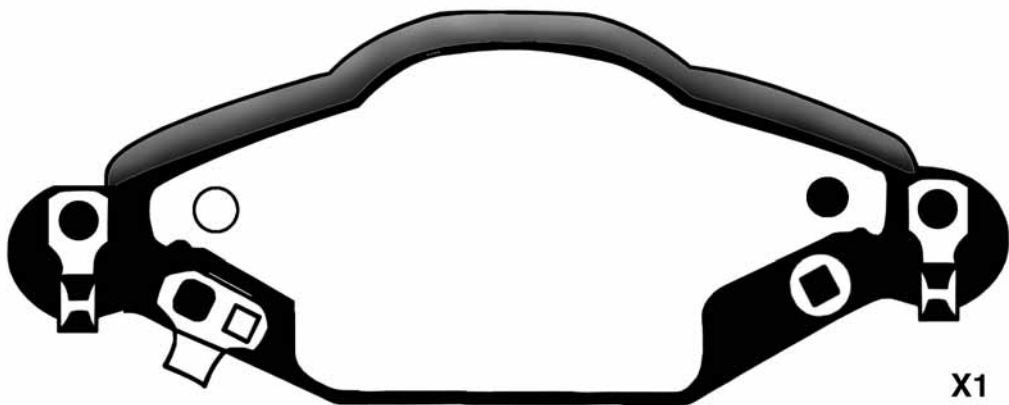
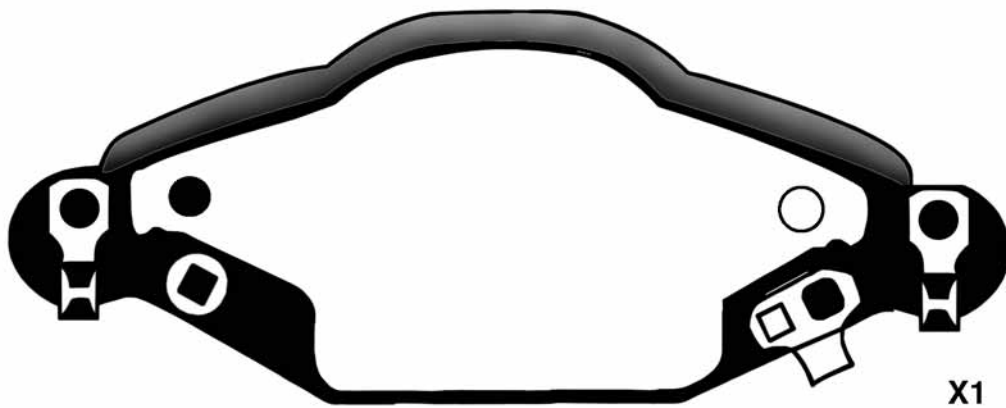



PICTURES BRAKE PADS FRONT
ABBILDUNGEN BREMSKLÖTZE VORN
FIGURAS PASTILLAS DE FRENO DELANTORES
ILLUSTRATIONS PLAQUETTES DE FREI AVANT
IMMAGINI PASTIGLIE FRENO ANTERIORI

50-02-205

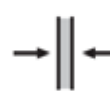

WVA

TOYOTA - MITSUBISHI

L

H

Th

134,6

77,1

17

24024

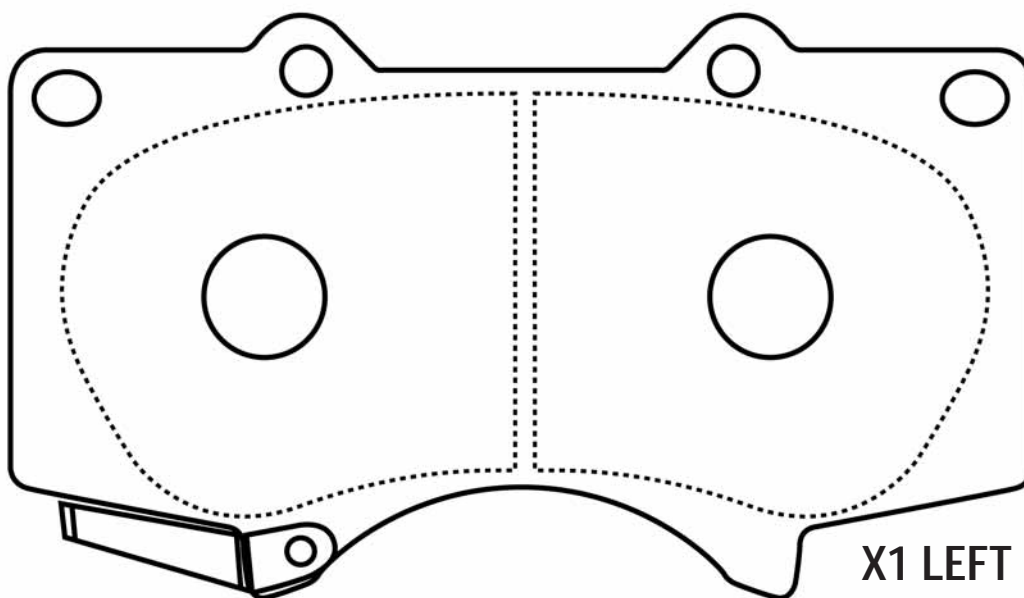

X1 LEFT
X1 RIGHT

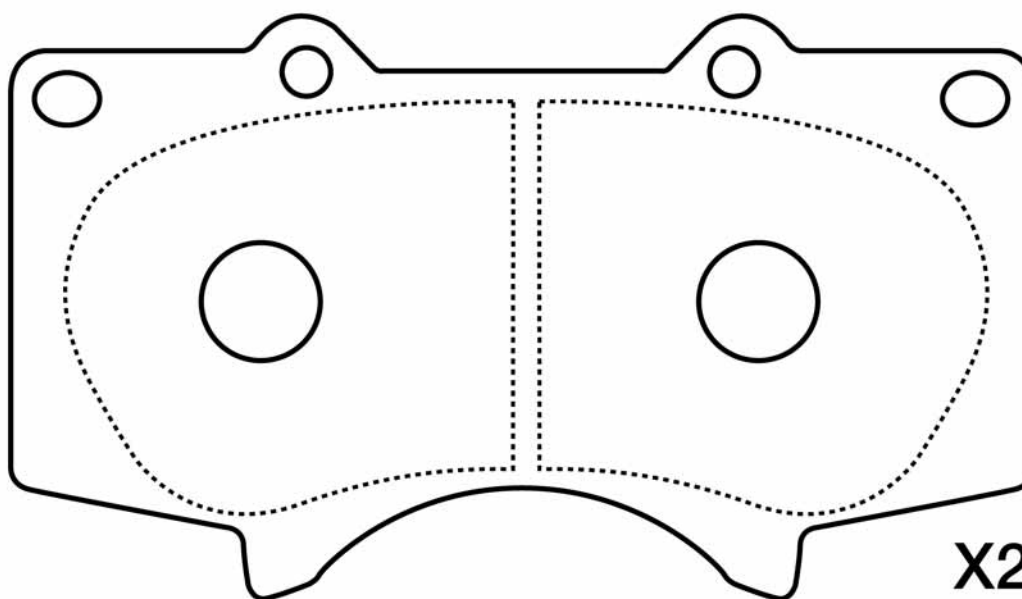

X2



50-02-206				WVA
	TOYOTA	L	H	
	151	63,1	18,7	23768

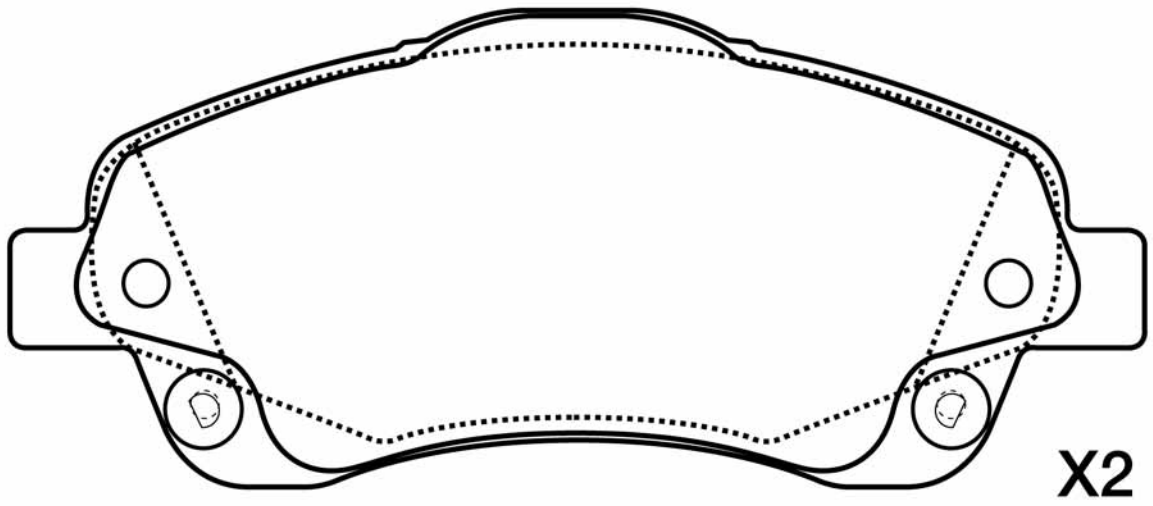
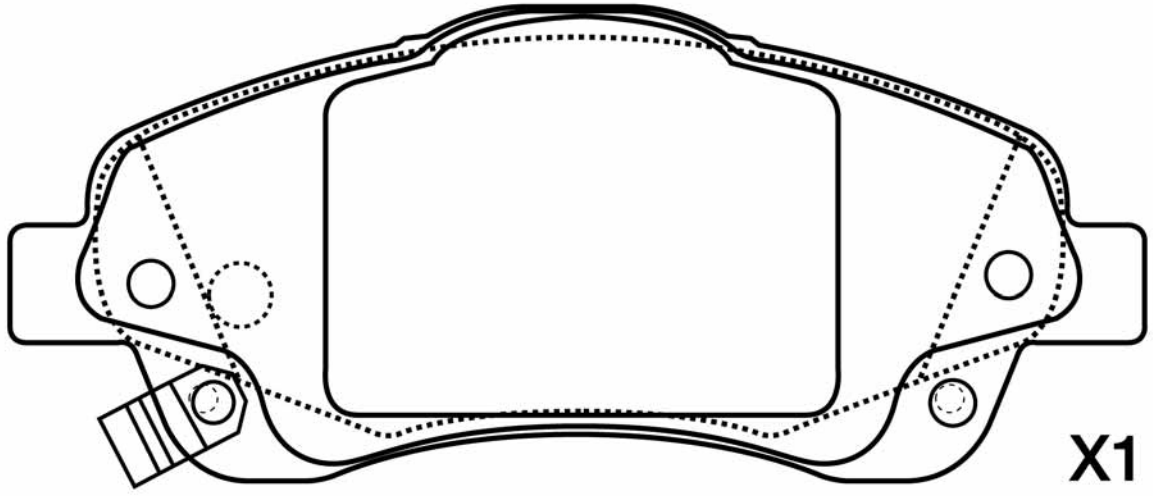
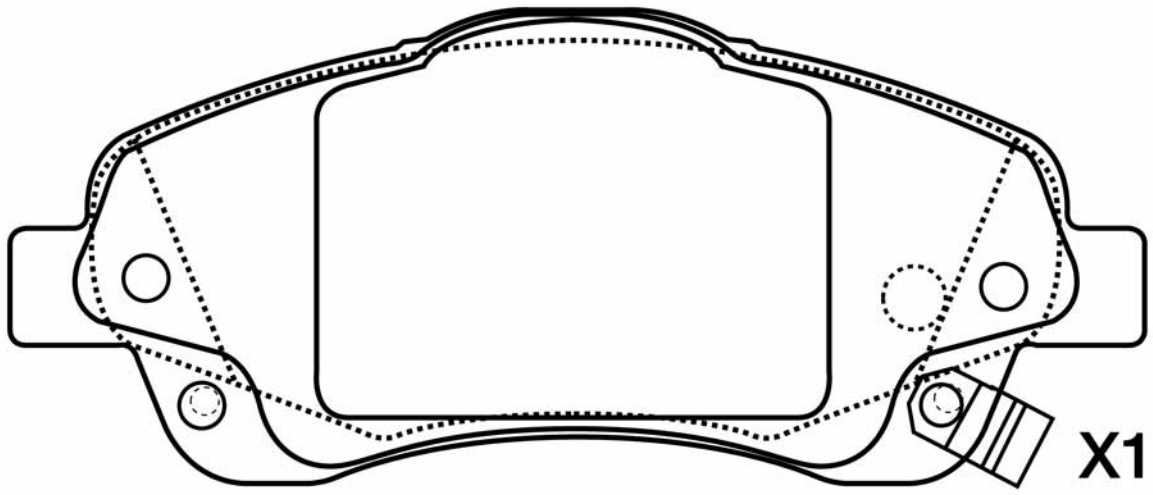



PICTURES BRAKE PADS FRONT
ABBILDUNGEN BREMSKLÖTZE VORN
FIGURAS PASTILLAS DE FRENO DELANTORES
ILLUSTRATIONS PLAQUETTES DE FREI AVANT
IMMAGINI PASTIGLIE FRENO ANTERIORI

50-02-207				WVA
	LEXUS	L	H	Th
	144	63,7	17	21490

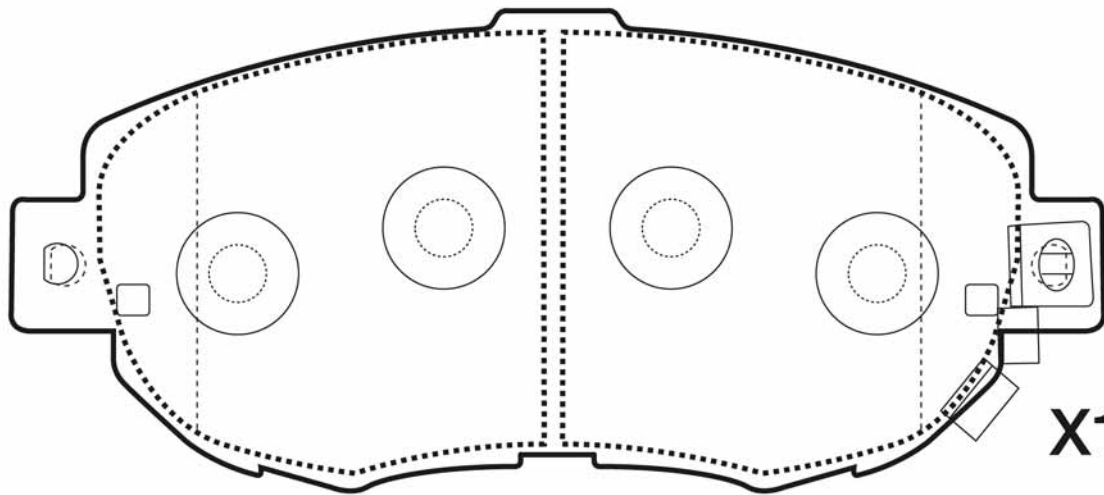
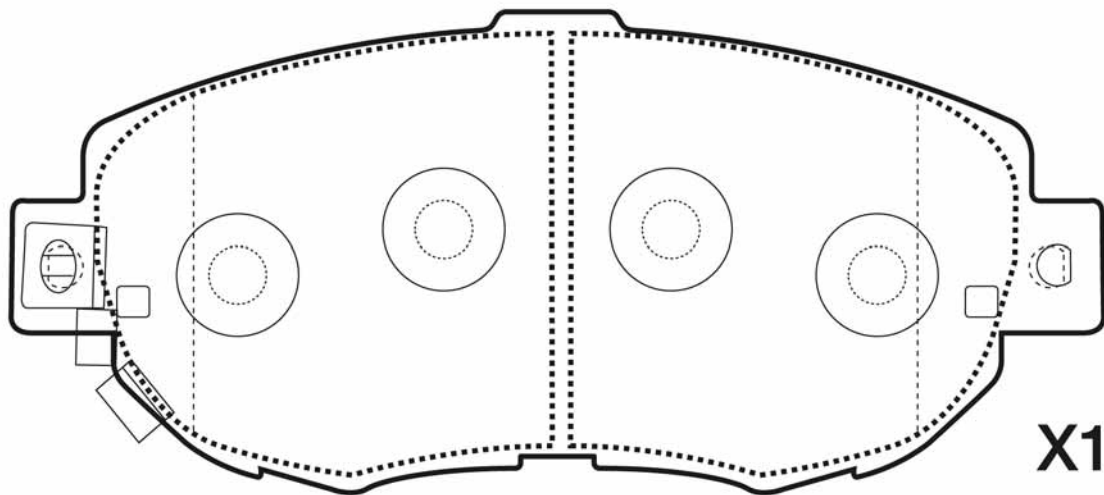
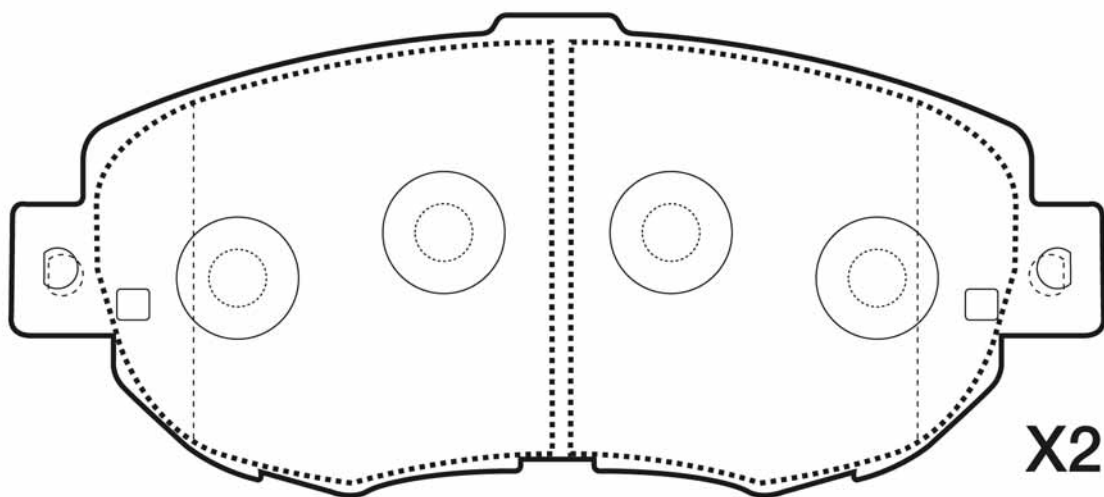

PICTURES BRAKE PADS FRONT
ABBILDUNGEN BREMSKLÖTZE VORN
FIGURAS PASTILLAS DE FRENO DELANTORES
ILLUSTRATIONS PLAQUETTES DE FREI AVANT
IMMAGINI PASTIGLIE FRENO ANTERIORI



50-02-209

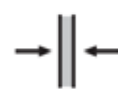
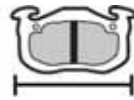

WVA

LEXUS

L

H

Th

140,8

59,3

16,8

23734

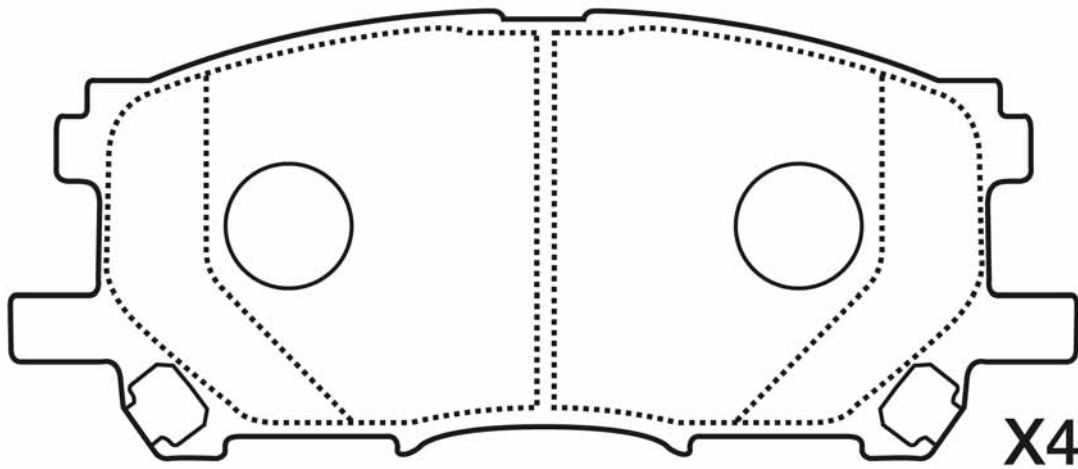



PICTURES BRAKE PADS FRONT
ABBILDUNGEN BREMSKLÖTZE VORN
FIGURAS PASTILLAS DE FRENO DELANTORES
ILLUSTRATIONS PLAQUETTES DE FREI AVANT
IMMAGINI PASTIGLIE FRENO ANTERIORI

50-02-210				WVA
MAZDA - TOYOTA - MITSUBISHI	L	H	Th	
	78,7	55,7	13,8	20302

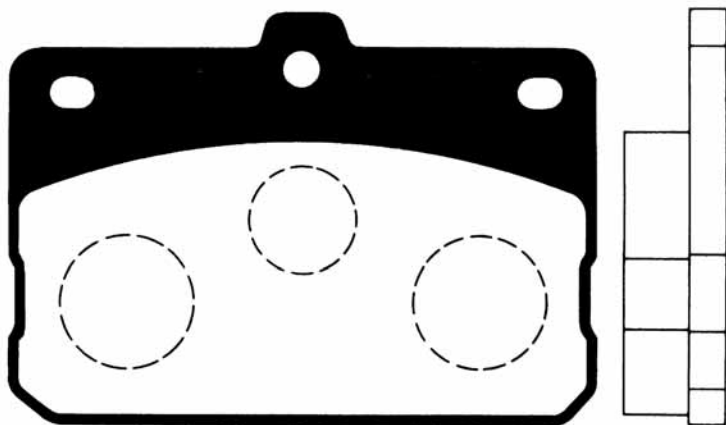

X4



50-02-211				WVA
	TOYOTA	L	H	
	131,4	57,2	16,4	23766

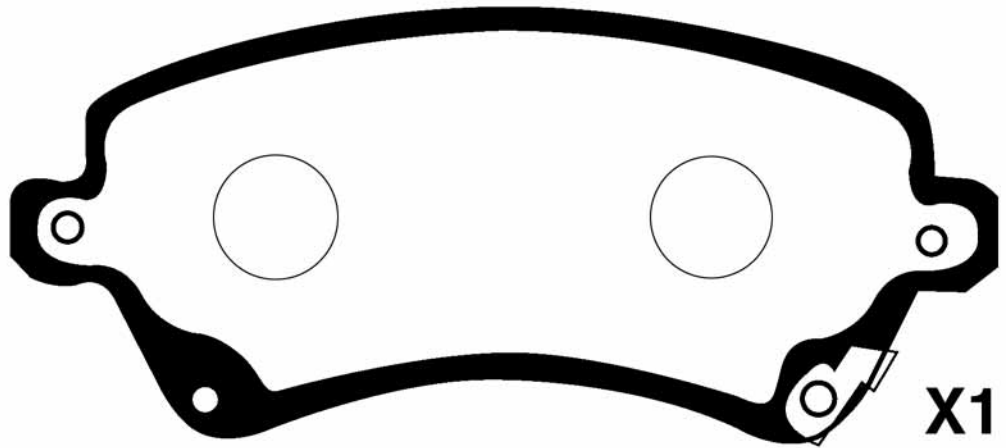
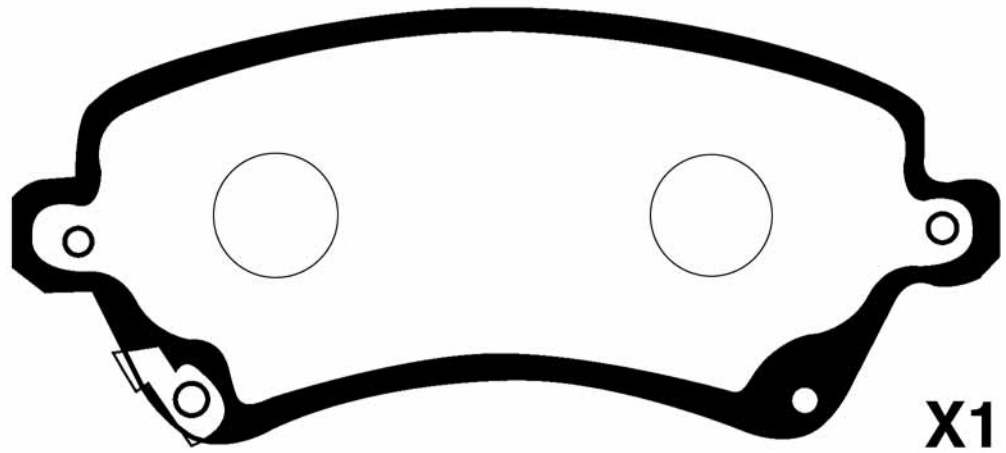
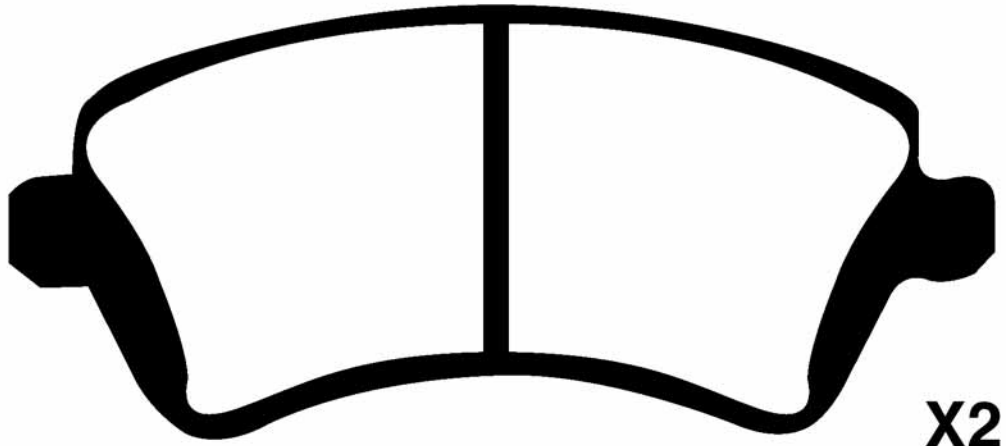



PICTURES BRAKE PADS FRONT
ABBILDUNGEN BREMSKLÖTZE VORN
FIGURAS PASTILLAS DE FRENO DELANTORES
ILLUSTRATIONS PLAQUETTES DE FREI AVANT
IMMAGINI PASTIGLIE FRENO ANTERIORI

50-02-212				WVA
TOYOTA	L	H	Th	
	117,5	58,6	16,7	23864

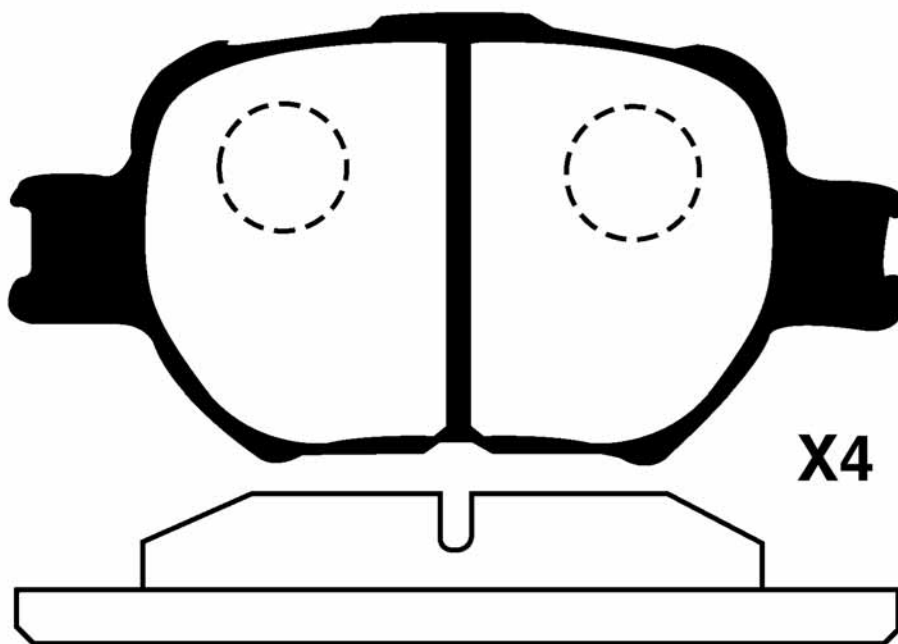



50-02-213

TOYOTA

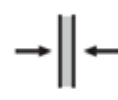
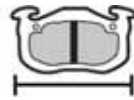

WVA

L

123

H

59,6

Th

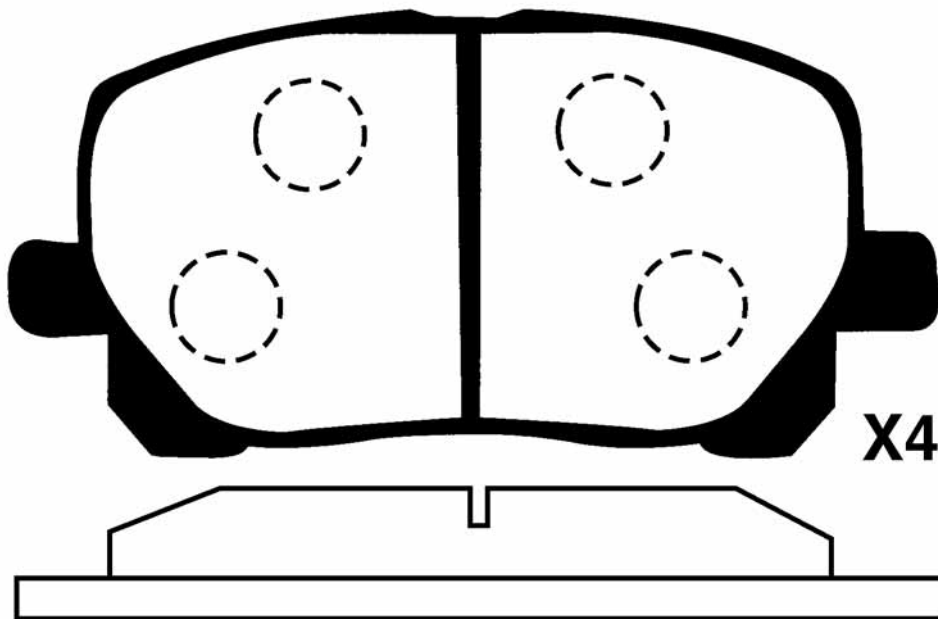

16

23836





PICTURES BRAKE PADS FRONT
ABBILDUNGEN BREMSKLÖTZE VORN
FIGURAS PASTILLAS DE FRENO DELANTORES
ILLUSTRATIONS PLAQUETTES DE FREI AVANT
IMMAGINI PASTIGLIE FRENO ANTERIORI

50-02-214				WVA
TOYOTA	L	H	Th	
	140	55	14,7	21689

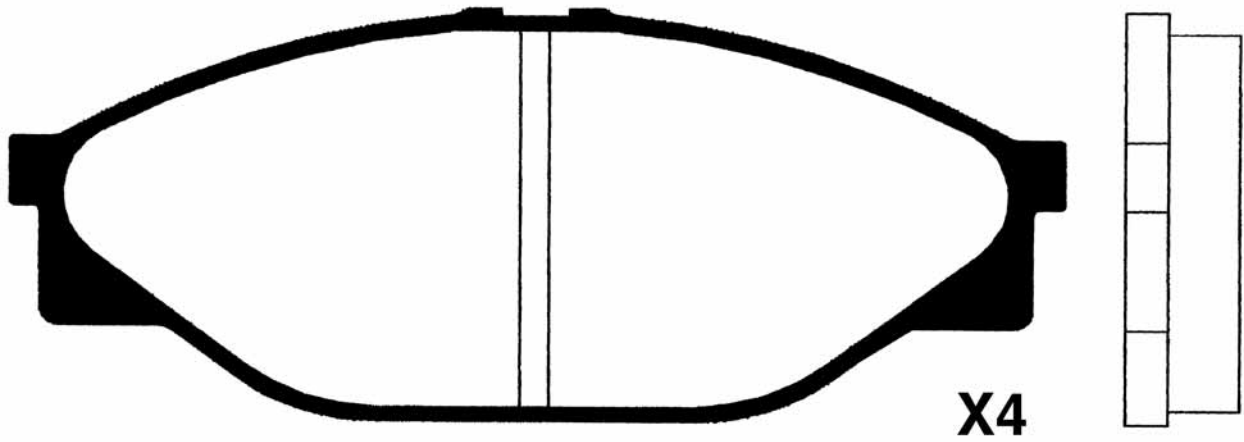



50-02-216				WVA
	TOYOTA	L	H	Th
	117,2	55	15,7	23294

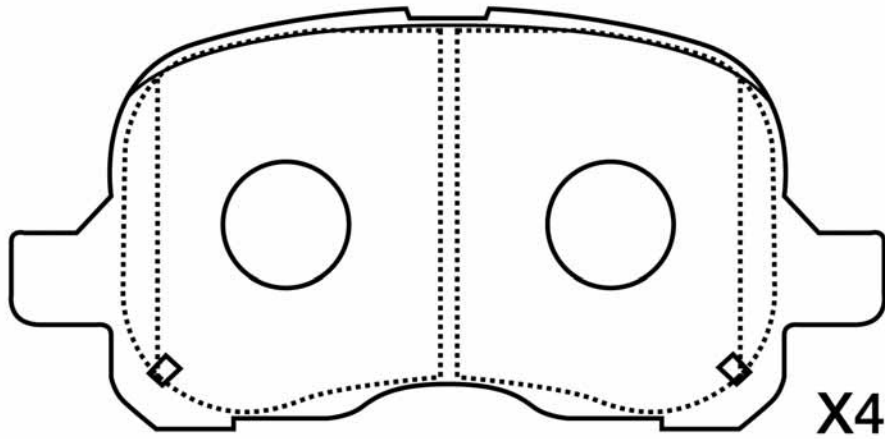



PICTURES BRAKE PADS FRONT
ABBILDUNGEN BREMSKLÖTZE VORN
FIGURAS PASTILLAS DE FRENO DELANTORES
ILLUSTRATIONS PLAQUETTES DE FREI AVANT
IMMAGINI PASTIGLIE FRENO ANTERIORI

50-02-217				WVA
CITROEN - TOYOTA - PEUGEOT	L	H	Th	
	123	47	17,4	23959

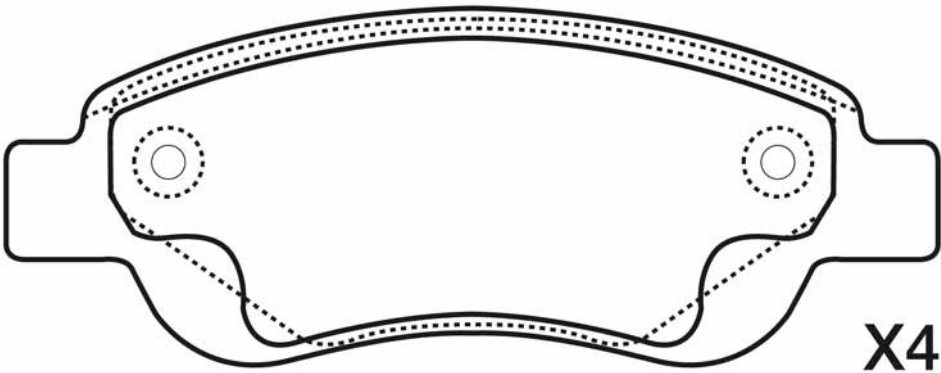



50-02-218

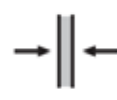
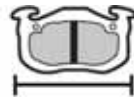

WVA

TOYOTA

L

H

Th

131,6

58,3

17,3

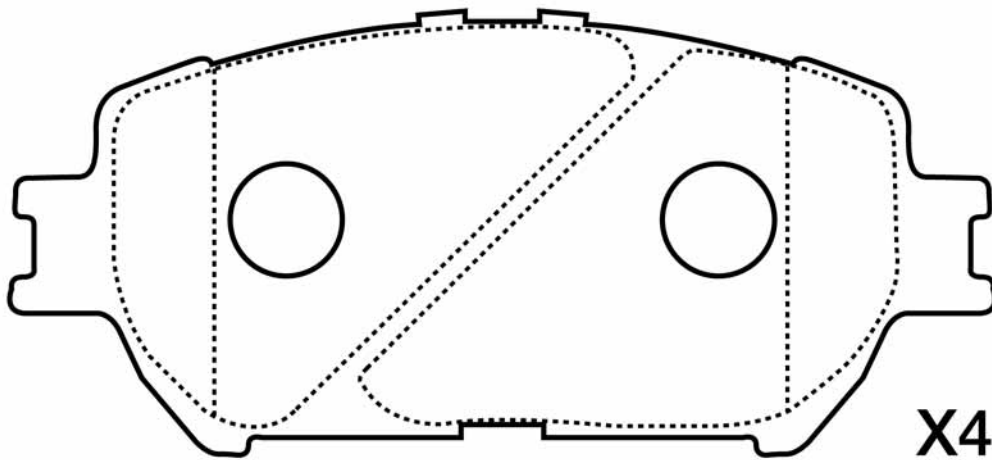



PICTURES BRAKE PADS FRONT
ABBILDUNGEN BREMSKLÖTZE VORN
FIGURAS PASTILLAS DE FRENO DELANTORES
ILLUSTRATIONS PLAQUETTES DE FREI AVANT
IMMAGINI PASTIGLIE FRENO ANTERIORI

50-02-219				WVA
TOYOTA - LEXUS	L	H	Th	
	123	48	17	24451

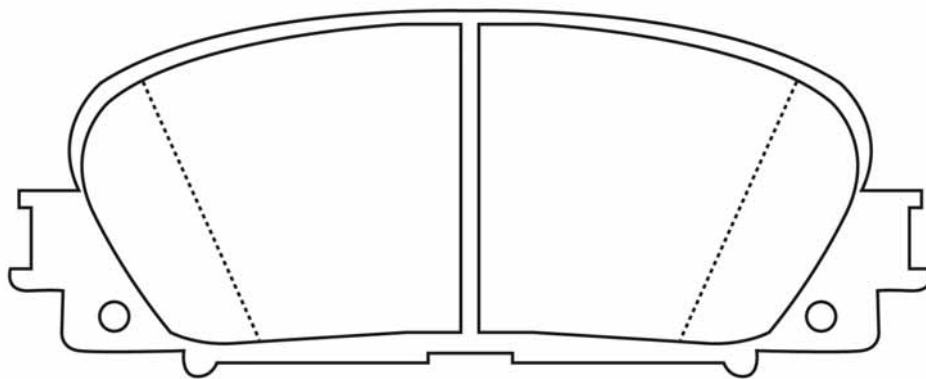

X4



50-02-220				WVA
TOYOTA	L	H	Th	
	122,5	54,5	17,2	24708

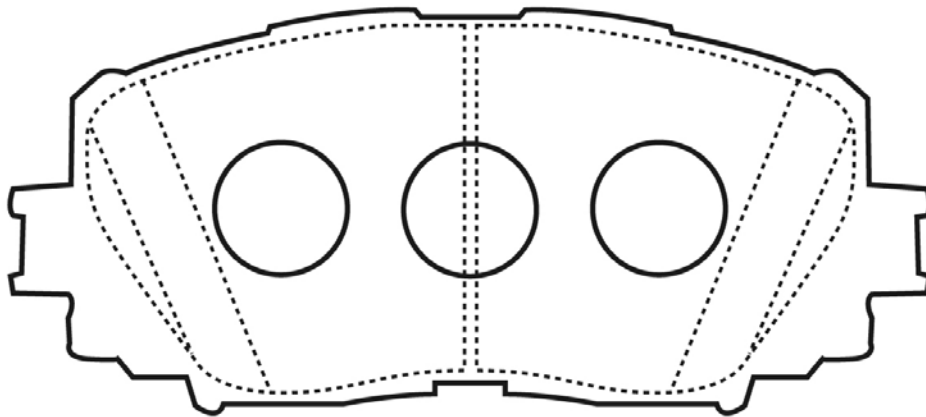

X4



PICTURES BRAKE PADS FRONT
ABBILDUNGEN BREMSKLÖTZE VORN
FIGURAS PASTILLAS DE FRENO DELANTORES
ILLUSTRATIONS PLAQUETTES DE FREI AVANT
IMMAGINI PASTIGLIE FRENO ANTERIORI

50-02-221

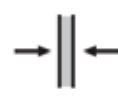
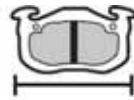

WVA

TOYOTA

L

H

Th

156

69

18

23996

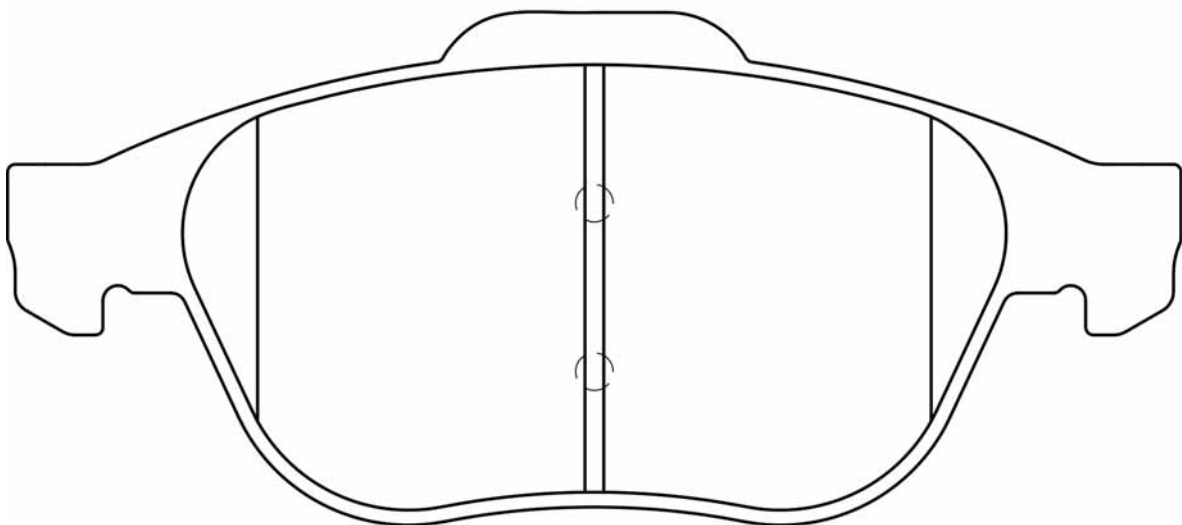
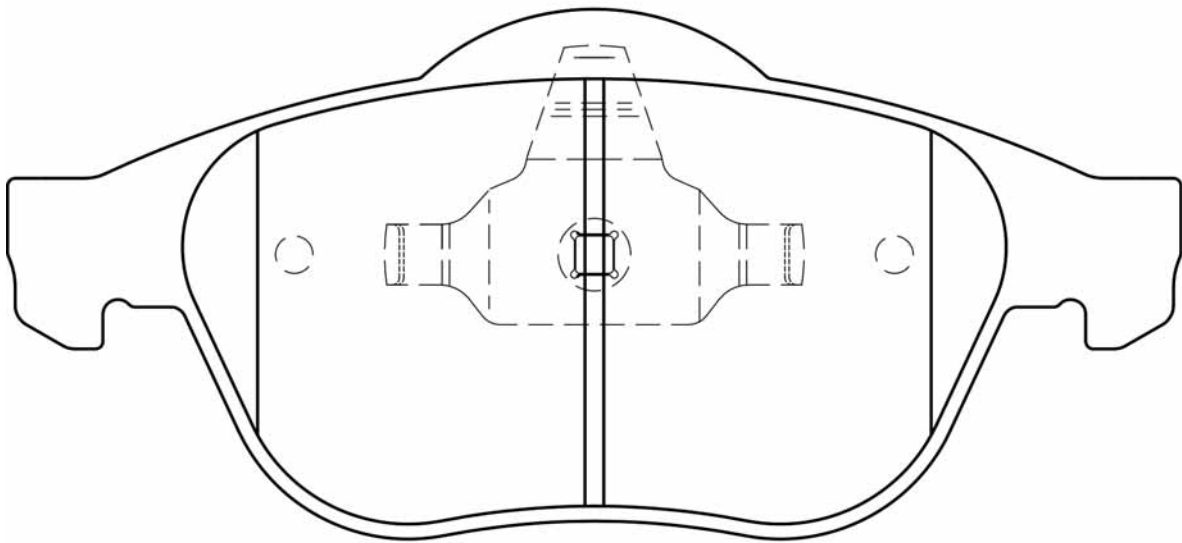



50-02-222

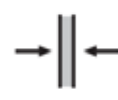
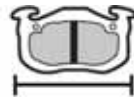

WVA

LEXUS

L

H

Th

118

78

17

20325

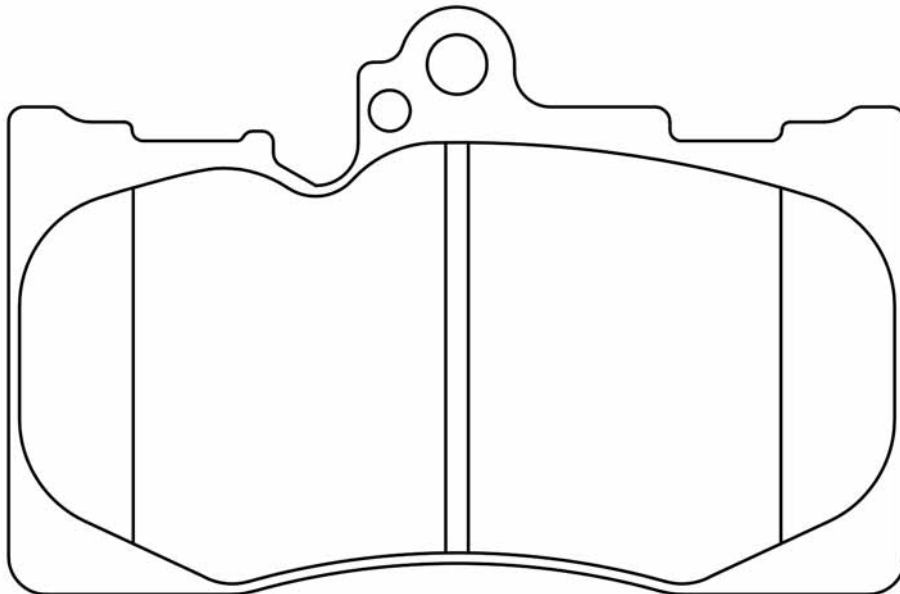
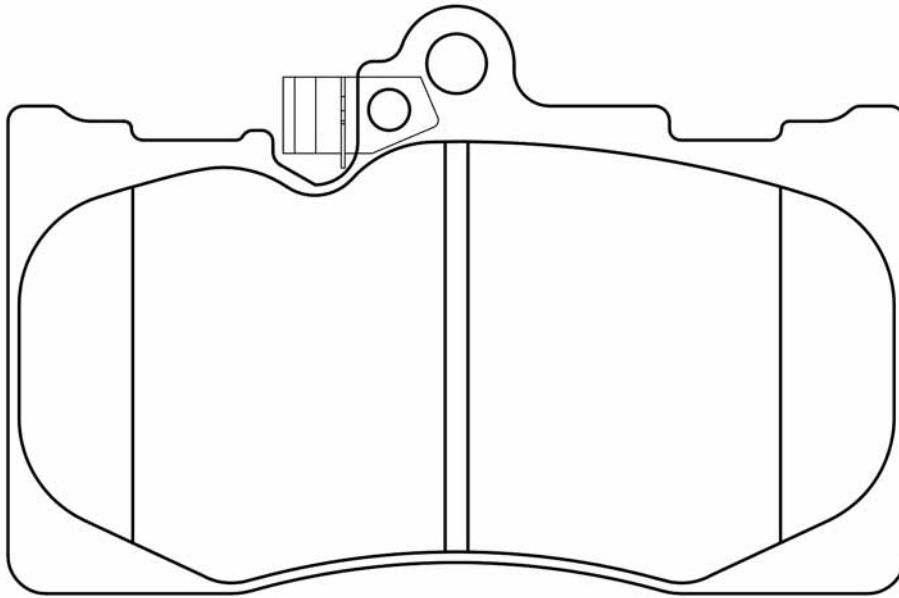



PICTURES BRAKE PADS FRONT
ABBILDUNGEN BREMSKLÖTZE VORN
FIGURAS PASTILLAS DE FRENO DELANTORES
ILLUSTRATIONS PLAQUETTES DE FREI AVANT
IMMAGINI PASTIGLIE FRENO ANTERIORI

50-02-223				WVA
LEXUS	L	H	Th	
	154	59	17,7	23983

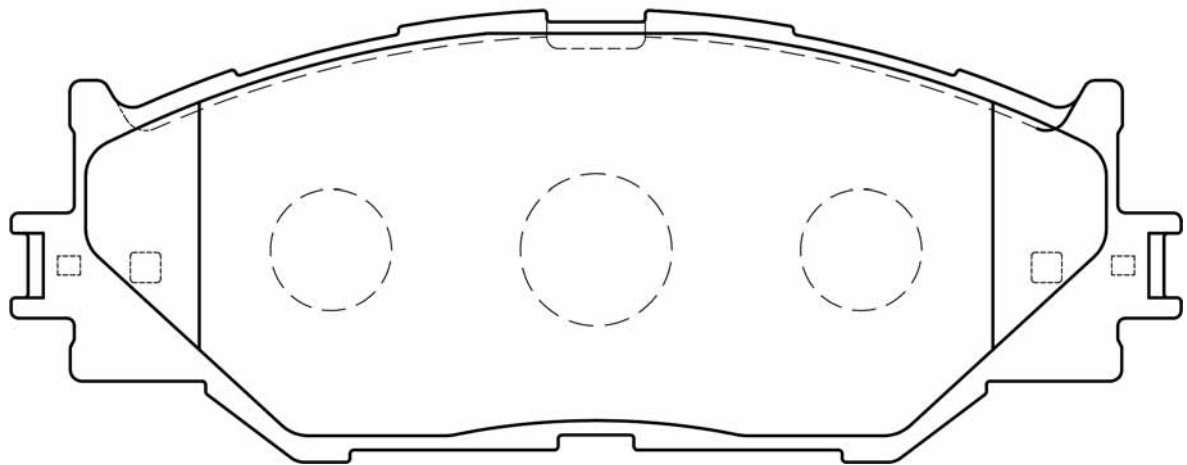



50-02-224				WVA
	TOYOTA	L	H	Th
	120,3/132	51	14,7	20729

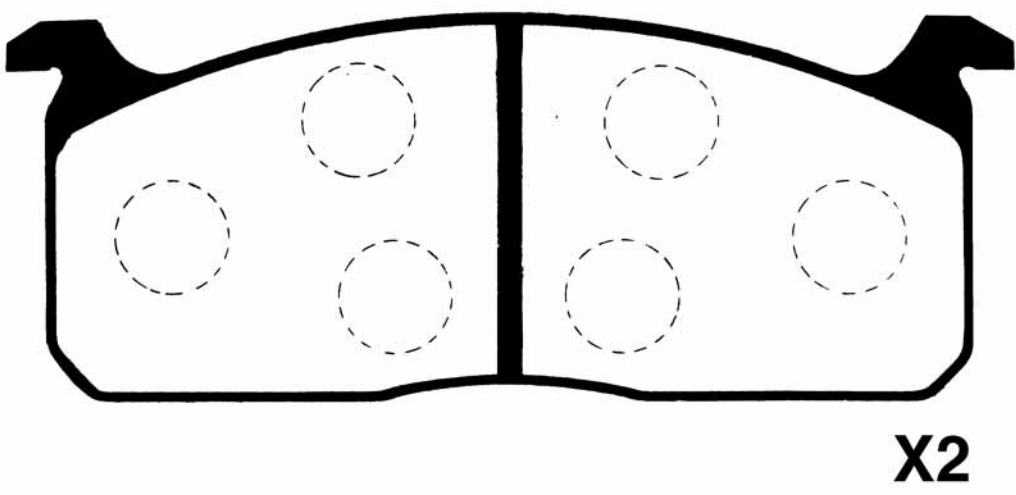
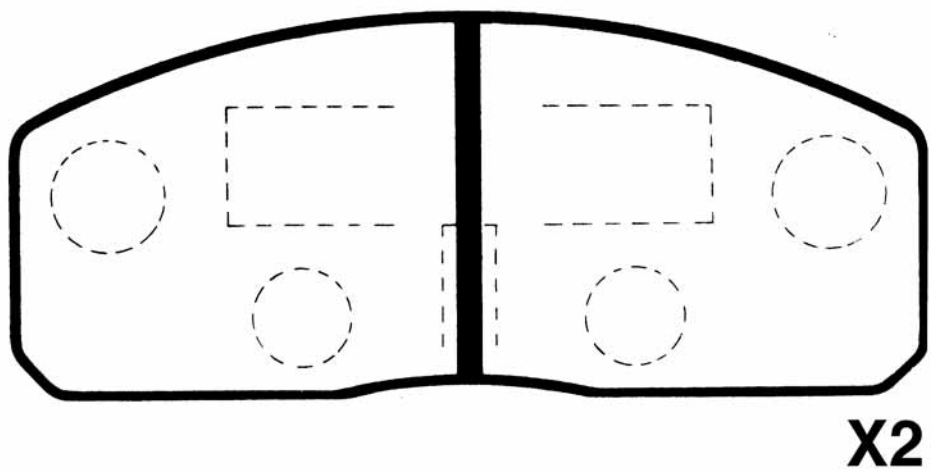



PICTURES BRAKE PADS FRONT
ABBILDUNGEN BREMSKLÖTZE VORN
FIGURAS PASTILLAS DE FRENO DELANTORES
ILLUSTRATIONS PLAQUETTES DE FREI AVANT
IMMAGINI PASTIGLIE FRENO ANTERIORI

50-02-225				WVA
TOYOTA	L	H	Th	
	147	53	16,3	24523

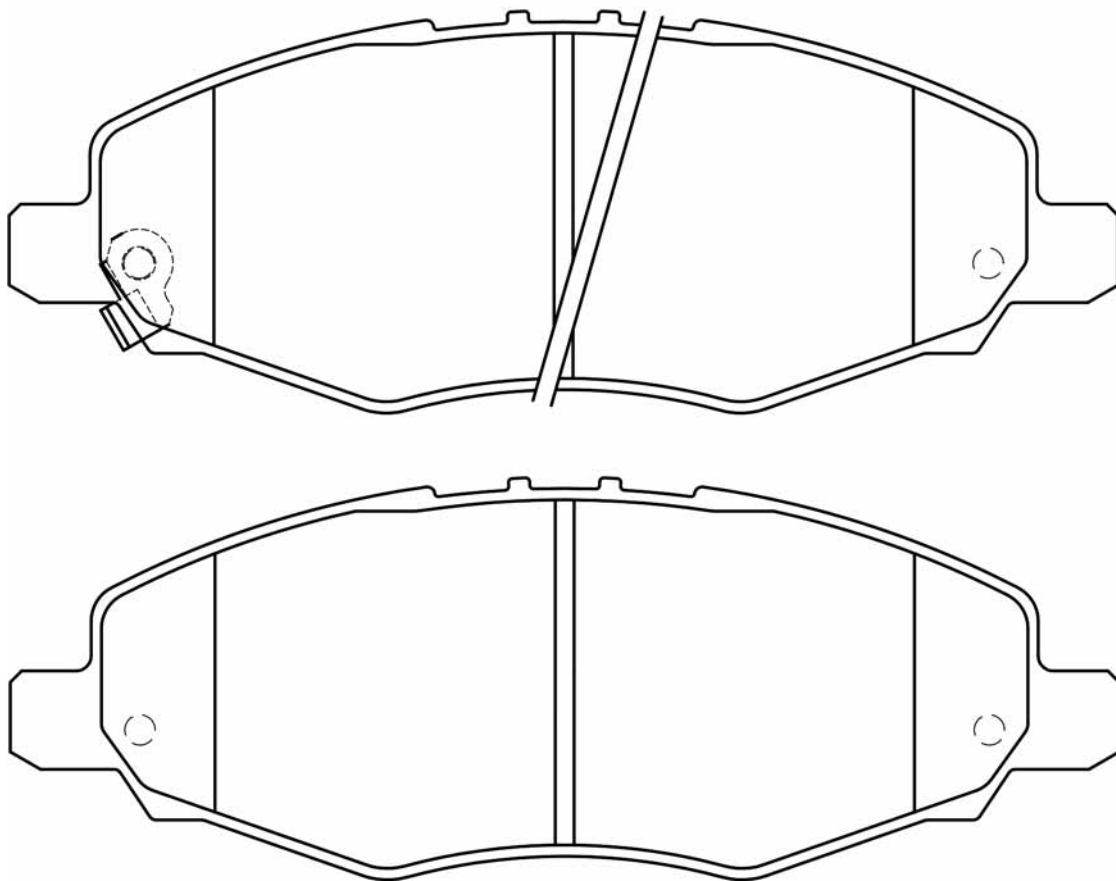



50-02-226

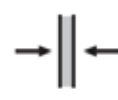
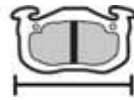

WVA

TOYOTA

L

H

Th

119,5

68

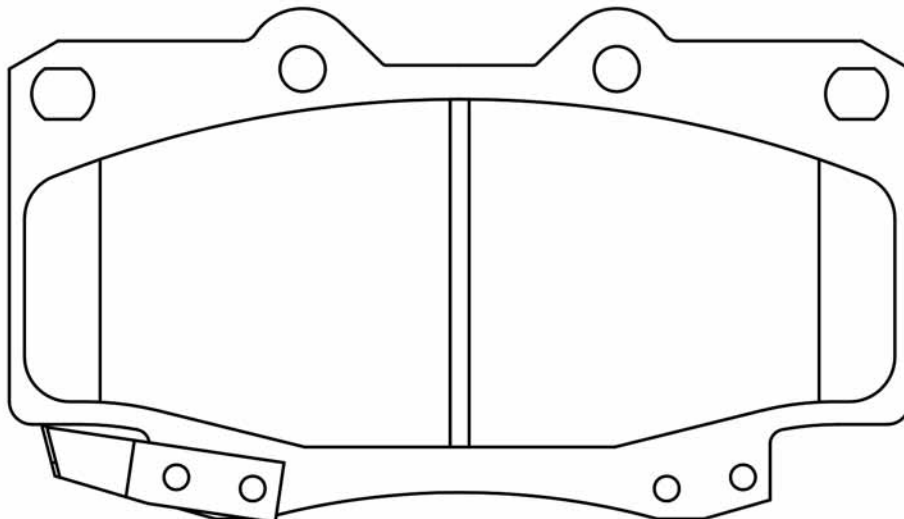
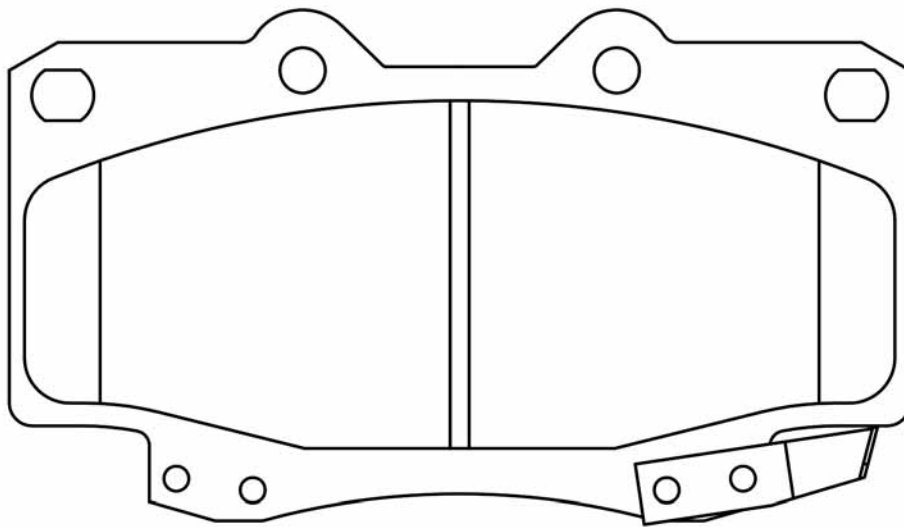

17

21680





PICTURES BRAKE PADS FRONT
ABBILDUNGEN BREMSKLÖTZE VORN
FIGURAS PASTILLAS DE FRENO DELANTORES
ILLUSTRATIONS PLAQUETTES DE FREI AVANT
IMMAGINI PASTIGLIE FRENO ANTERIORI

50-02-228				WVA
TOYOTA	L	H	Th	
	109	46	13,4	20599

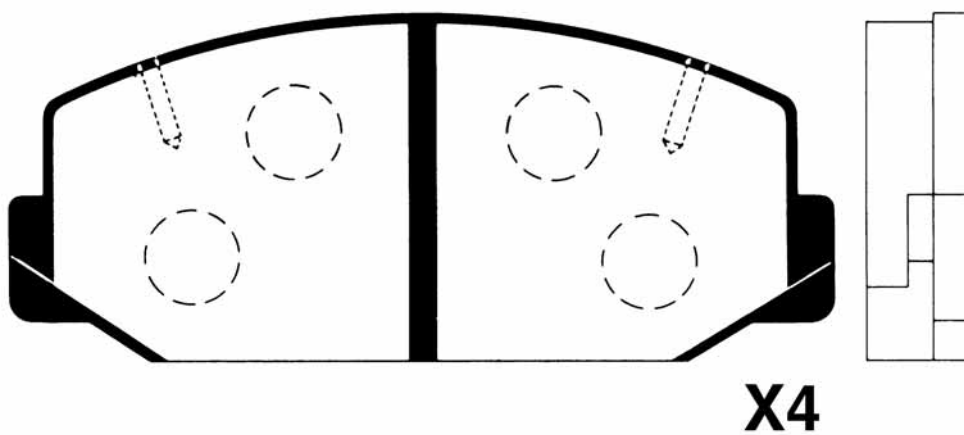



50-02-229

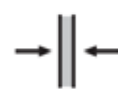
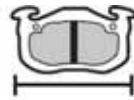

WVA

TOYOTA

L

H

Th

107/109

52/49

14,5

20856

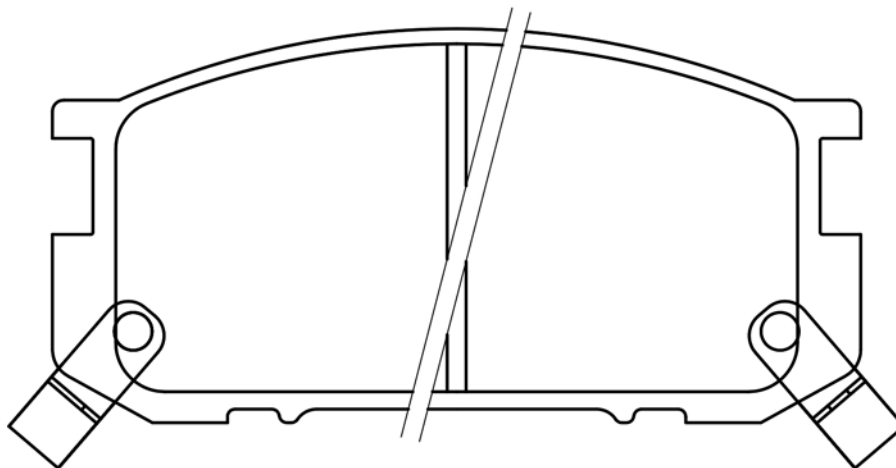
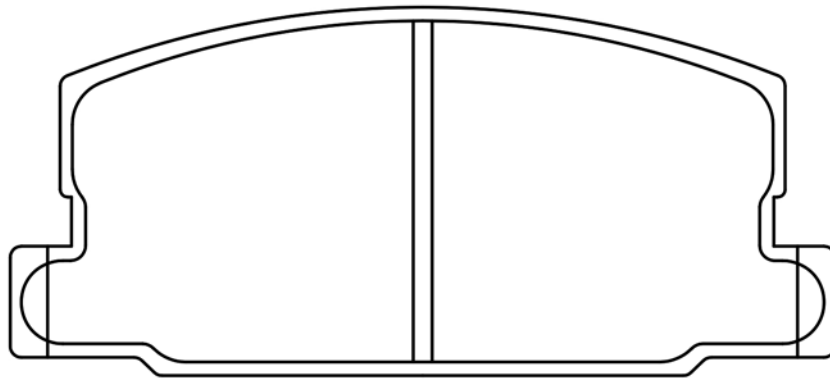



PICTURES BRAKE PADS FRONT
ABBILDUNGEN BREMSKLÖTZE VORN
FIGURAS PASTILLAS DE FRENO DELANTORES
ILLUSTRATIONS PLAQUETTES DE FREI AVANT
IMMAGINI PASTIGLIE FRENO ANTERIORI

50-02-230				WVA
TOYOTA	L	H	Th	
	146	57	17,8	

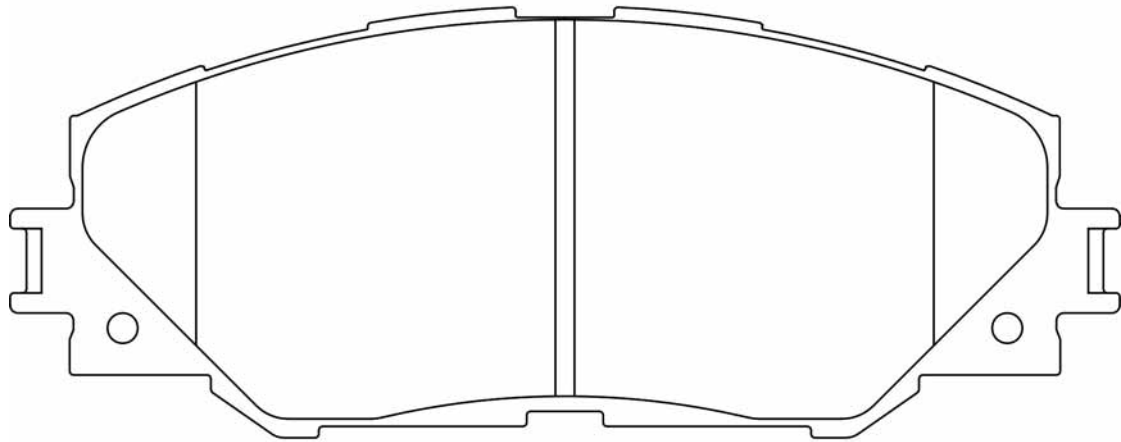



50-02-231				WVA
	TOYOTA	L	H	
	126,7/128,4	52,1/55	15,7	21250

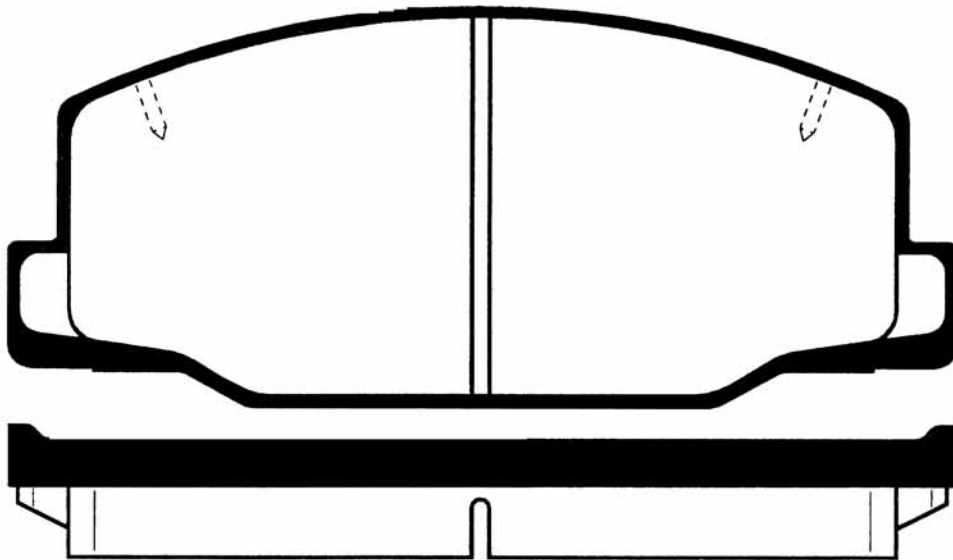

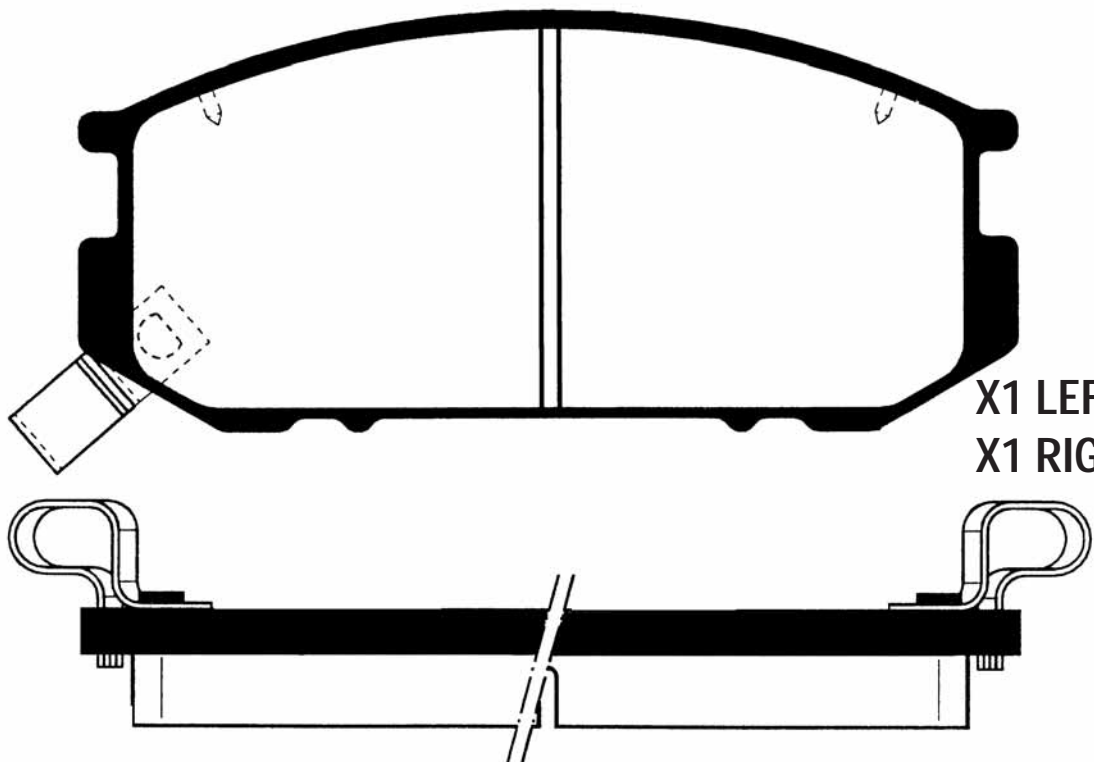

X2



X1 LEFT
 X1 RIGHT

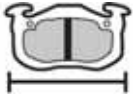

PICTURES BRAKE PADS FRONT
ABBILDUNGEN BREMSKLÖTZE VORN
FIGURAS PASTILLAS DE FRENO DELANTORES
ILLUSTRATIONS PLAQUETTES DE FREI AVANT
IMMAGINI PASTIGLIE FRENO ANTERIORI

50-02-232				WVA
TOYOTA	L	H	Th	
	116,3	51,2	14,5	21042

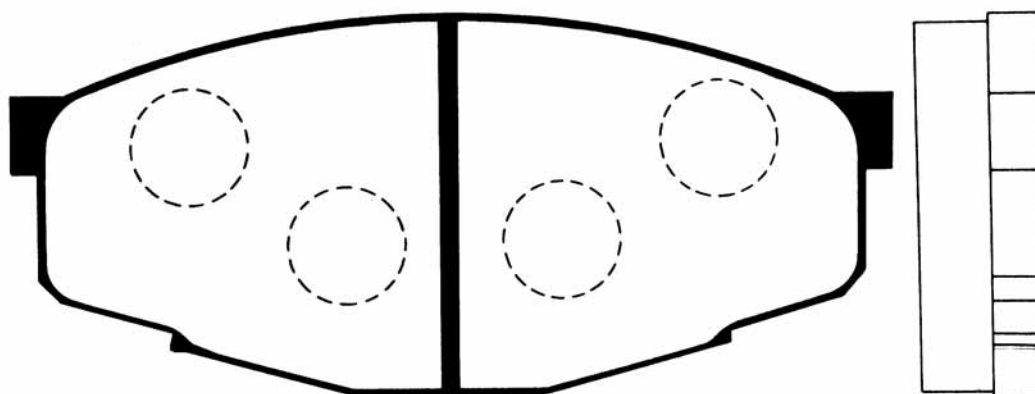

X4



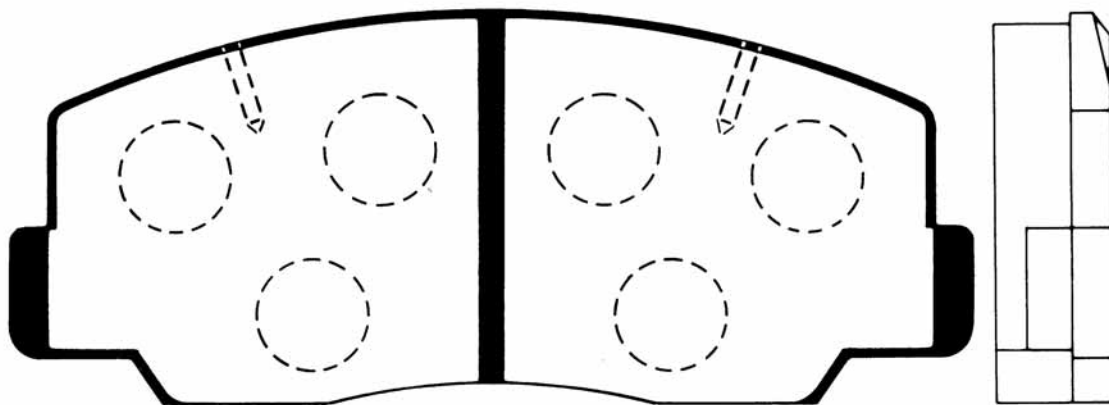

50-02-233				WVA
	TOYOTA	L 127,8	H 52,3	Th 15,5



X4

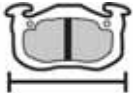

PICTURES BRAKE PADS FRONT
ABBILDUNGEN BREMSKLÖTZE VORN
FIGURAS PASTILLAS DE FRENO DELANTORES
ILLUSTRATIONS PLAQUETTES DE FREI AVANT
IMMAGINI PASTIGLIE FRENO ANTERIORI

50-02-235				WVA
TOYOTA	L	H	Th	
	119,7	47,5	14,8	20870

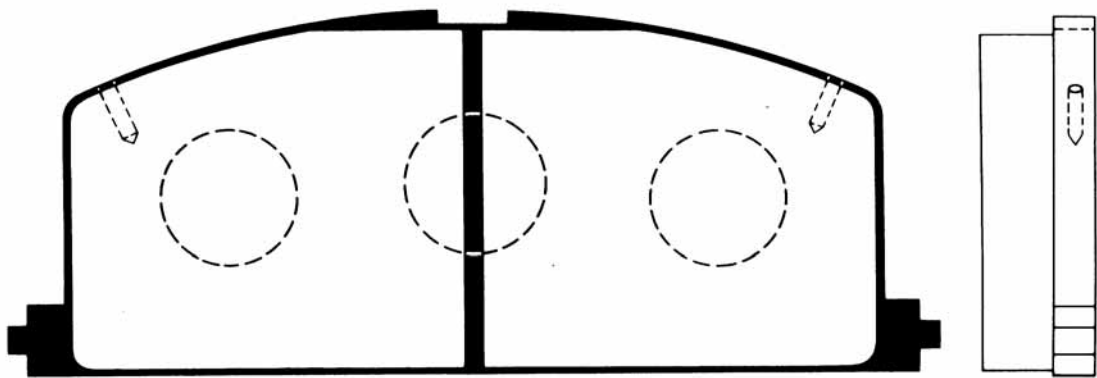

X4



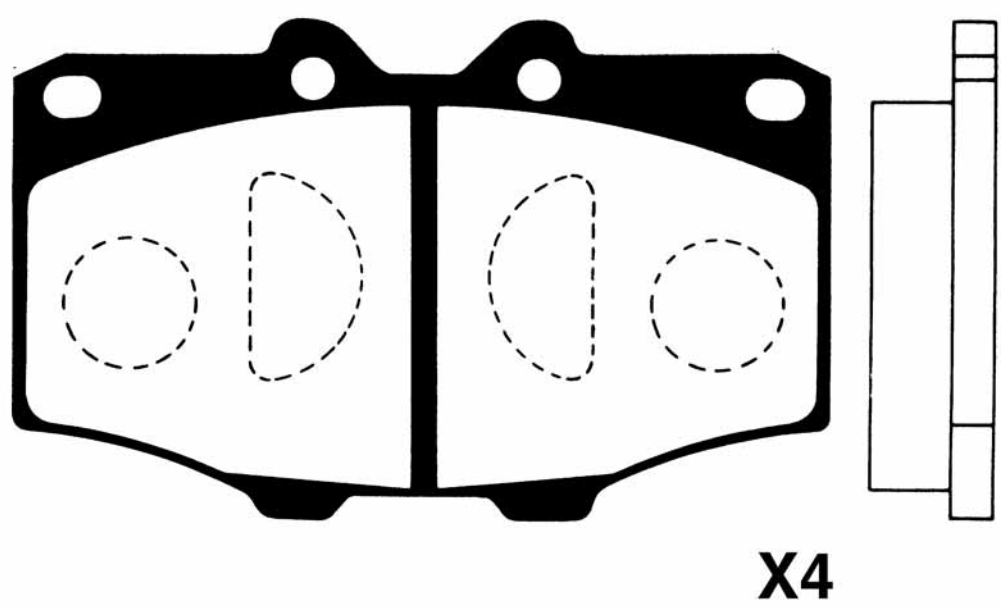

50-02-236				WVA
	TOYOTA	L	H	Th
	107,5	66	15	20852





PICTURES BRAKE PADS FRONT
ABBILDUNGEN BREMSKLÖTZE VORN
FIGURAS PASTILLAS DE FRENO DELANTORES
ILLUSTRATIONS PLAQUETTES DE FREI AVANT
IMMAGINI PASTIGLIE FRENO ANTERIORI

50-02-236P				WVA
TOYOTA	L	H	Th	
	107,5	66	15	

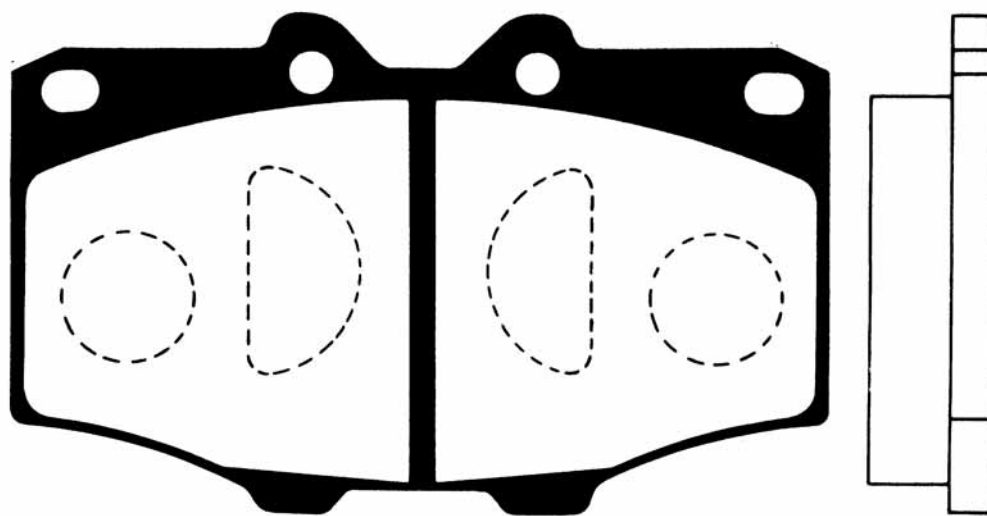

X4



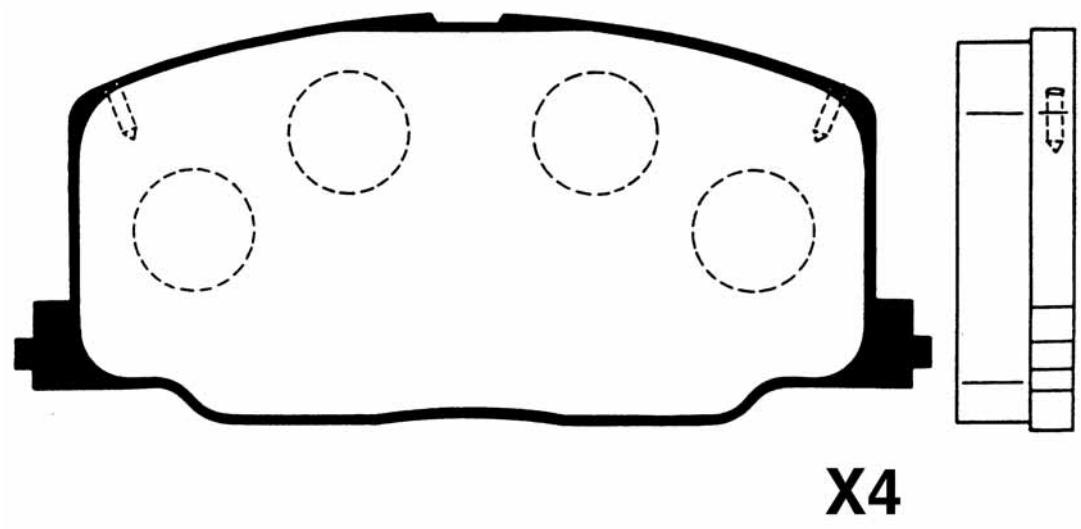

50-02-237				WVA	
	TOYOTA	L	H	Th	21372
	119,7	54,1	14,7		



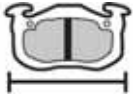

PICTURES BRAKE PADS FRONT
ABBILDUNGEN BREMSKLÖTZE VORN
FIGURAS PASTILLAS DE FRENO DELANTORES
ILLUSTRATIONS PLAQUETTES DE FREI AVANT
IMMAGINI PASTIGLIE FRENO ANTERIORI

50-02-238 TOYOTA				WVA
	L	H	Th	
	150/152	61/58	18	24022

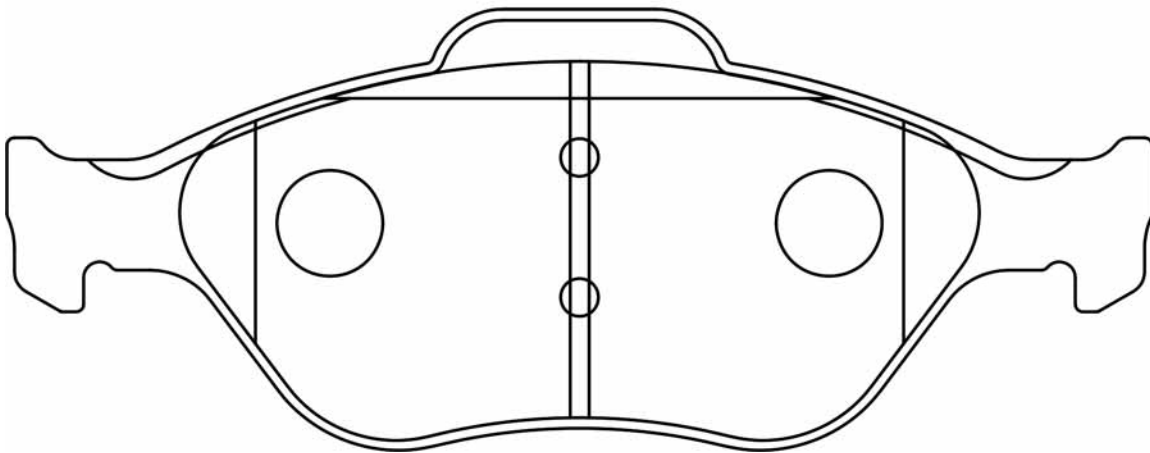
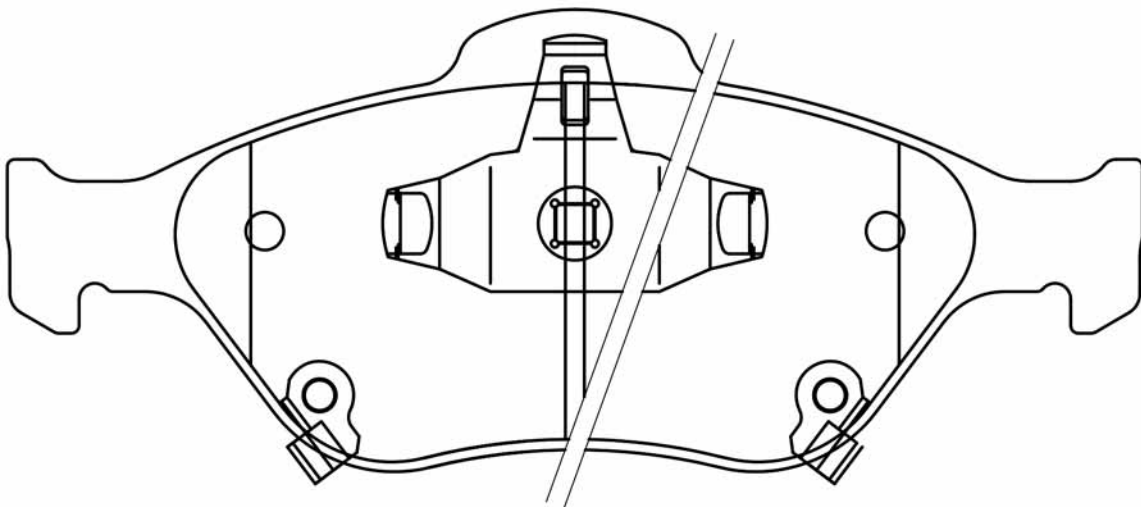



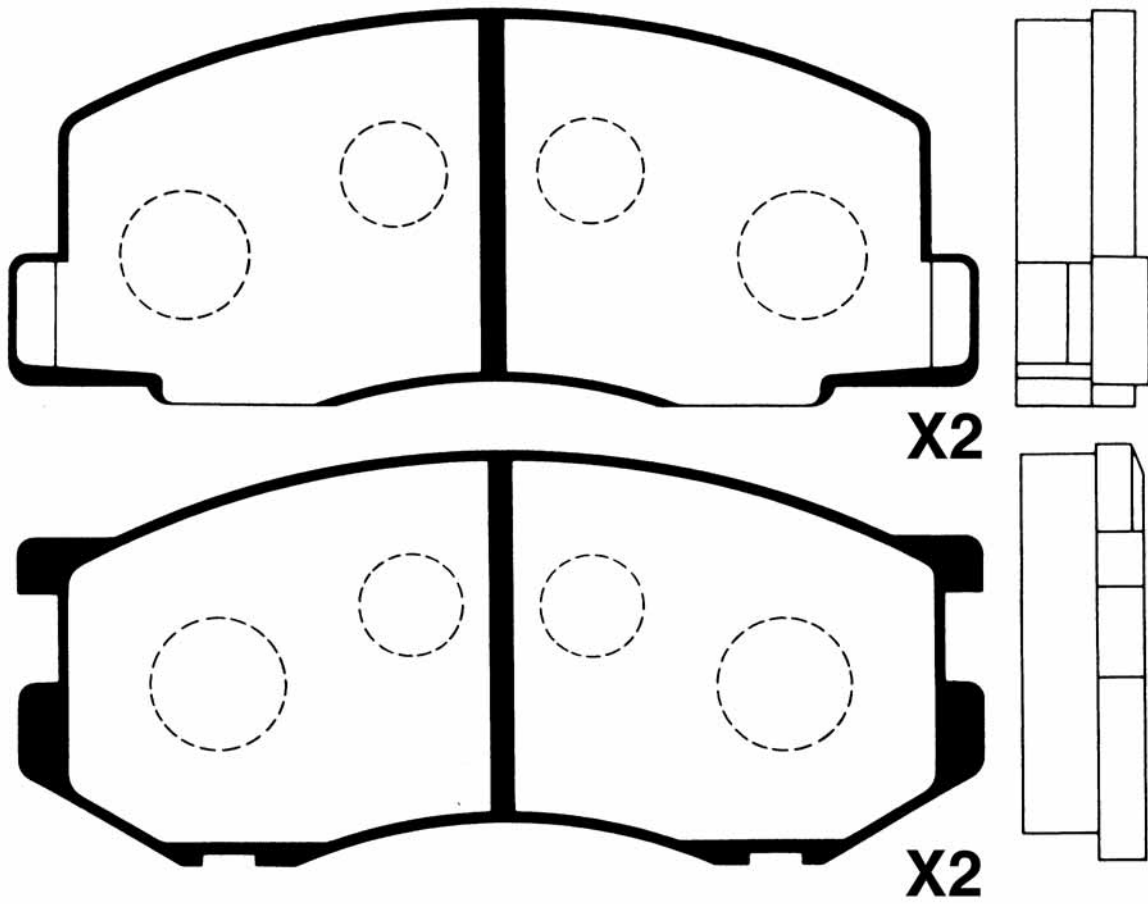

50-02-239				WVA
	TOYOTA	L	H	
	127/128,5	55/52	15	21836





PICTURES BRAKE PADS FRONT
ABBILDUNGEN BREMSKLÖTZE VORN
FIGURAS PASTILLAS DE FRENO DELANTORES
ILLUSTRATIONS PLAQUETTES DE FREI AVANT
IMMAGINI PASTIGLIE FRENO ANTERIORI

50-02-242				WVA
TOYOTA	L	H	Th	
	128,5/137,3	52,3/55,2	14,9	

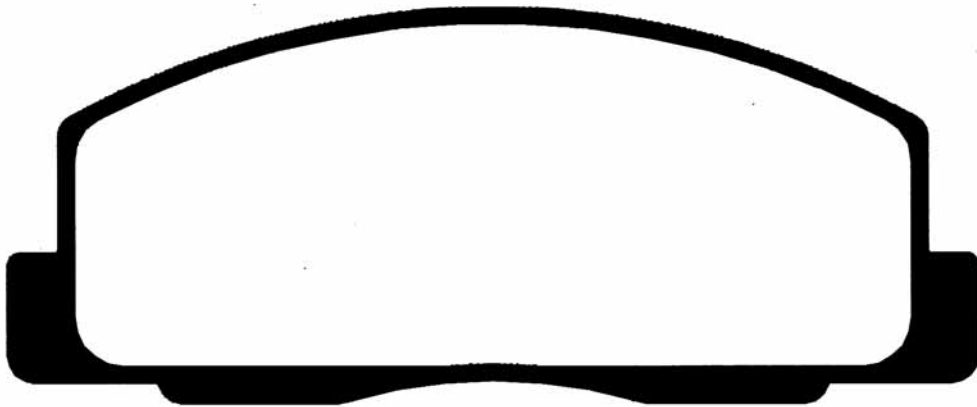

X2

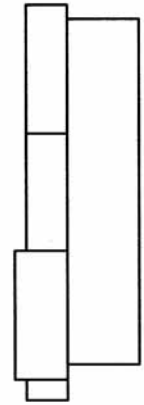

X2

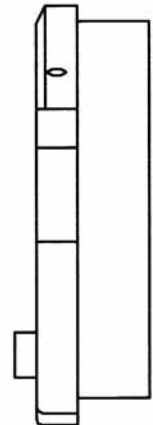

PICTURES BRAKE PADS FRONT
ABBILDUNGEN BREMSKLÖTZE VORN
FIGURAS PASTILLAS DE FRENO DELANTORES
ILLUSTRATIONS PLAQUETTES DE FREI AVANT
IMMAGINI PASTIGLIE FRENO ANTERIORI



50-02-243

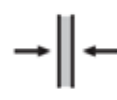
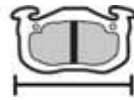

WVA

TOYOTA

L

H

Th

140

52

15,5

24567

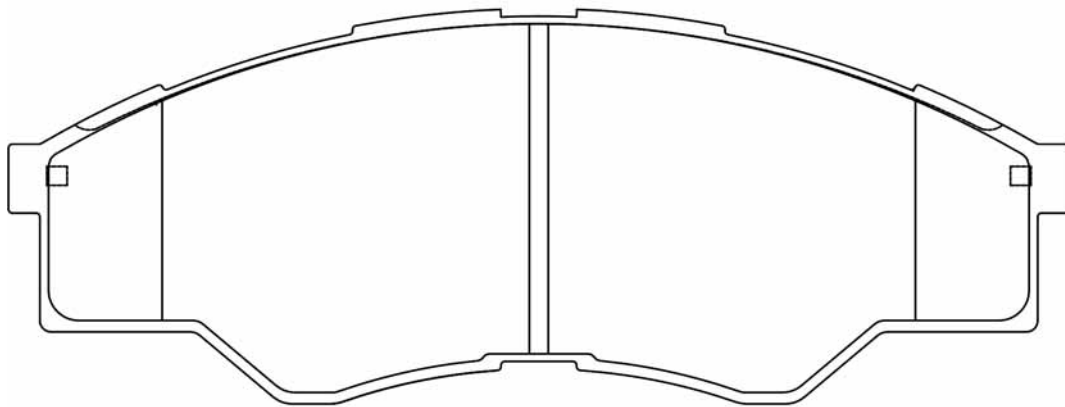



PICTURES BRAKE PADS FRONT
ABBILDUNGEN BREMSKLÖTZE VORN
FIGURAS PASTILLAS DE FRENO DELANTORES
ILLUSTRATIONS PLAQUETTES DE FREI AVANT
IMMAGINI PASTIGLIE FRENO ANTERIORI

50-02-244				WVA
TOYOTA	L	H	Th	
	151	65/63	19	24204

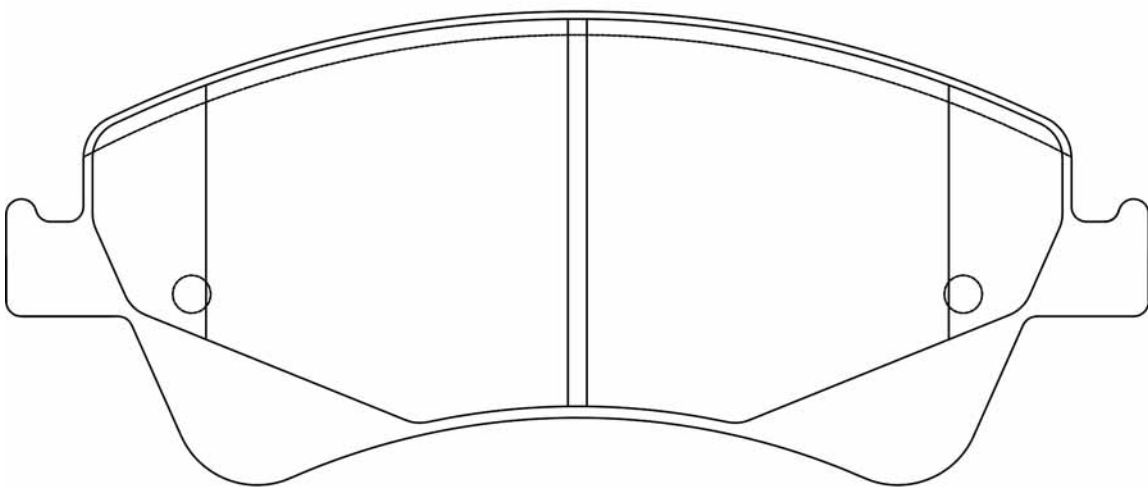
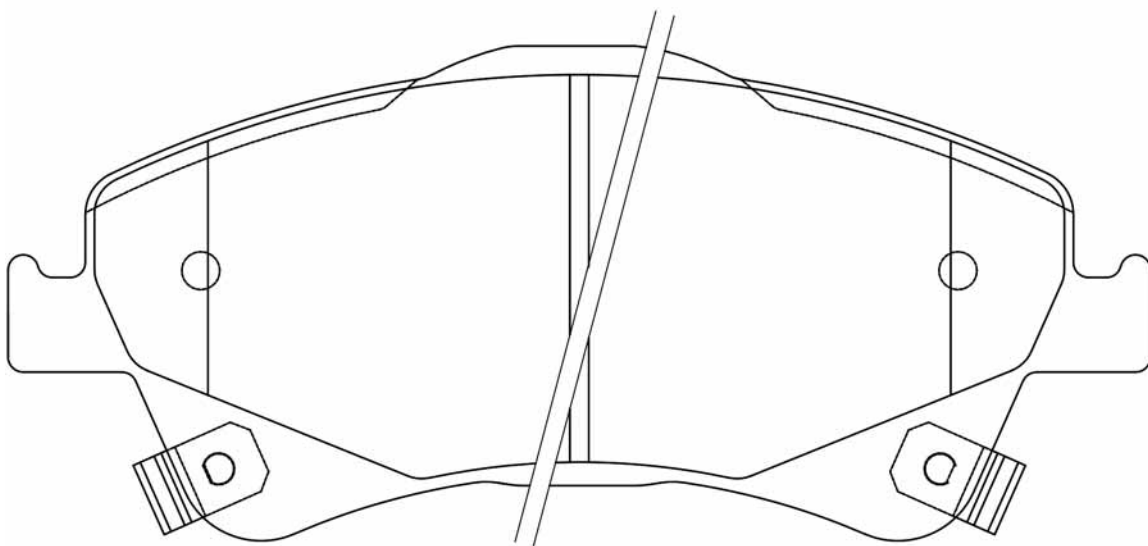



50-02-245				WVA
	TOYOTA	L	H	
	125,4	55,9	15,1	21376

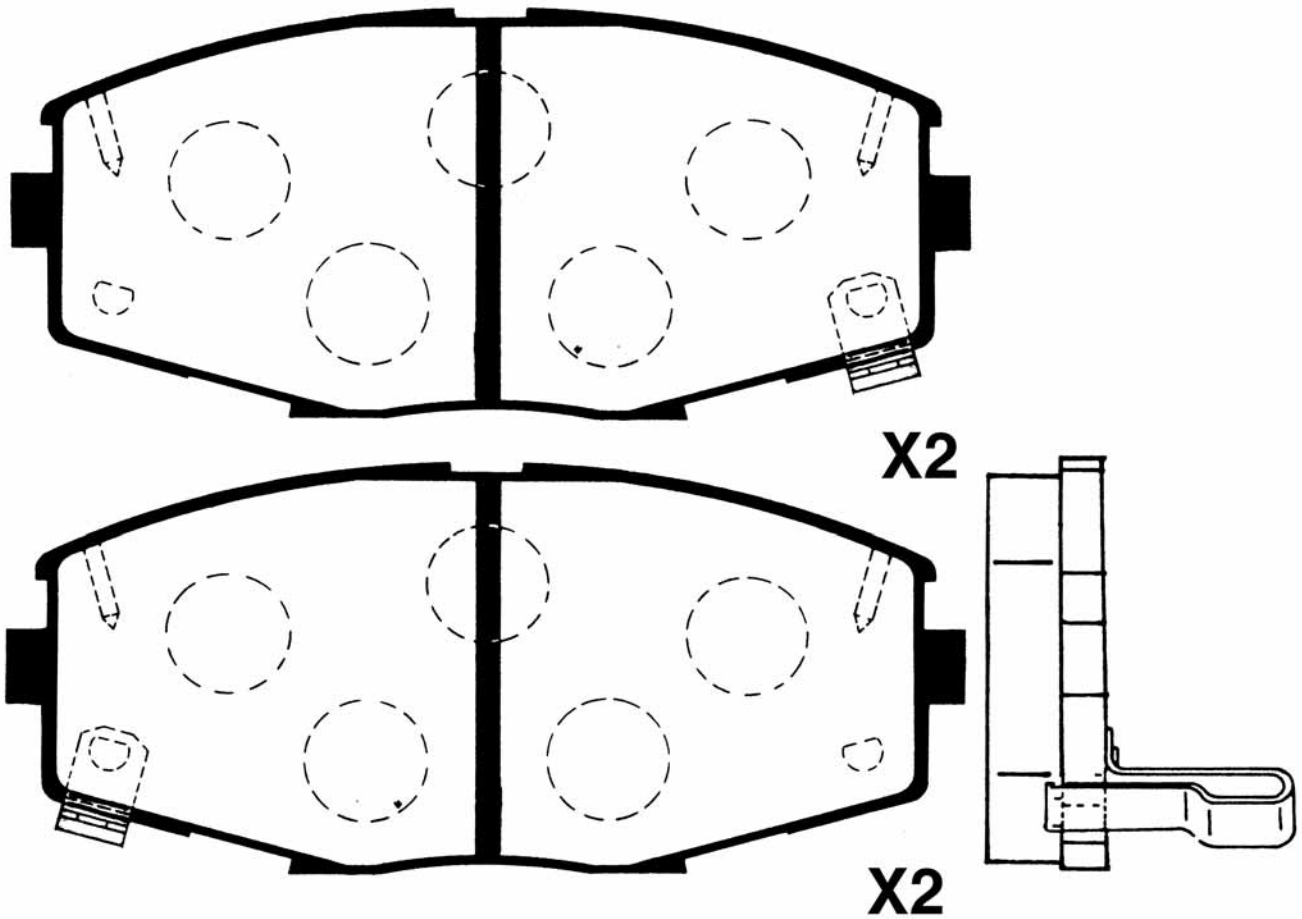



PICTURES BRAKE PADS FRONT
ABBILDUNGEN BREMSKLÖTZE VORN
FIGURAS PASTILLAS DE FRENO DELANTORES
ILLUSTRATIONS PLAQUETTES DE FREI AVANT
IMMAGINI PASTIGLIE FRENO ANTERIORI

50-02-247 VW - TOYOTA				WVA
	L 142,7	H 55,8	Th 15	21158

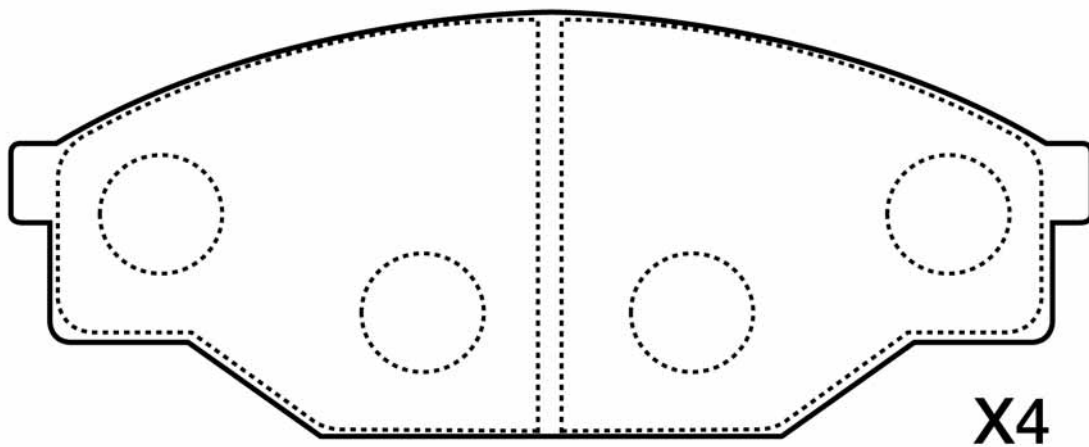



50-02-249				WVA
	TOYOTA	L	H	Th
	128	52,8	15,4	21764

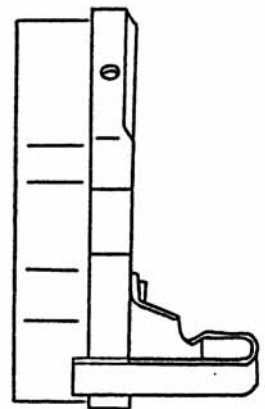
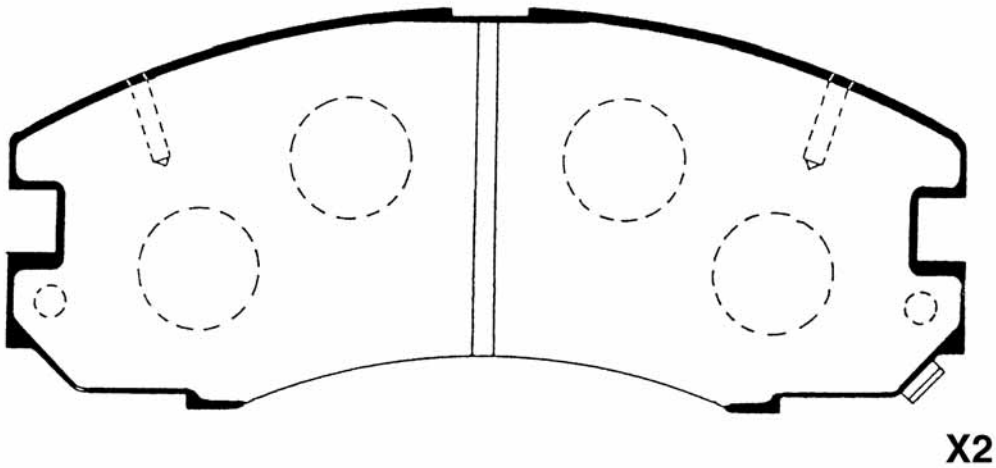
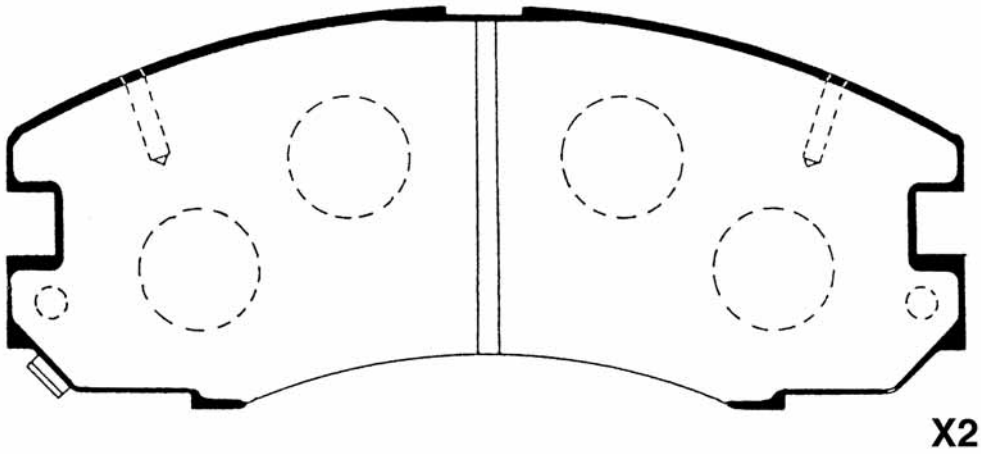



PICTURES BRAKE PADS FRONT
ABBILDUNGEN BREMSKLÖTZE VORN
FIGURAS PASTILLAS DE FRENO DELANTORES
ILLUSTRATIONS PLAQUETTES DE FREI AVANT
IMMAGINI PASTIGLIE FRENO ANTERIORI

50-02-250

TOYOTA

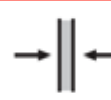

WVA

L

137

H

62/58

Th

19

24122

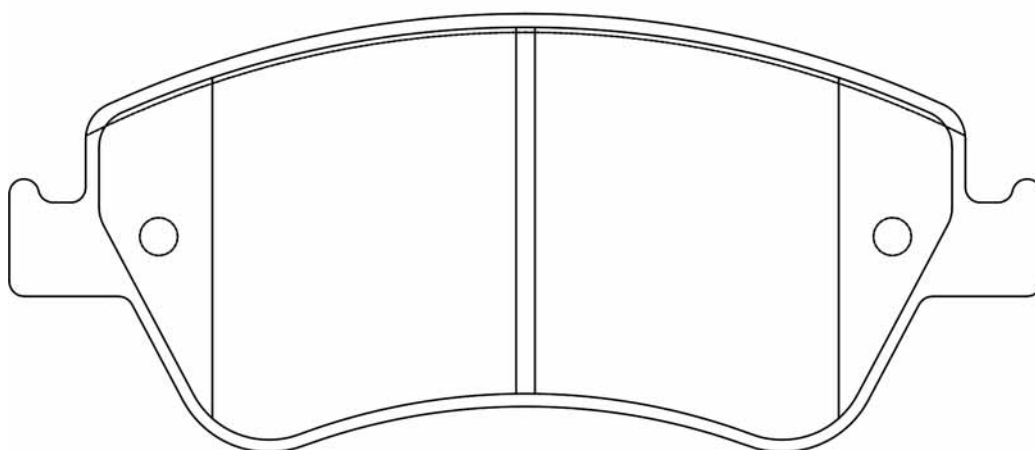
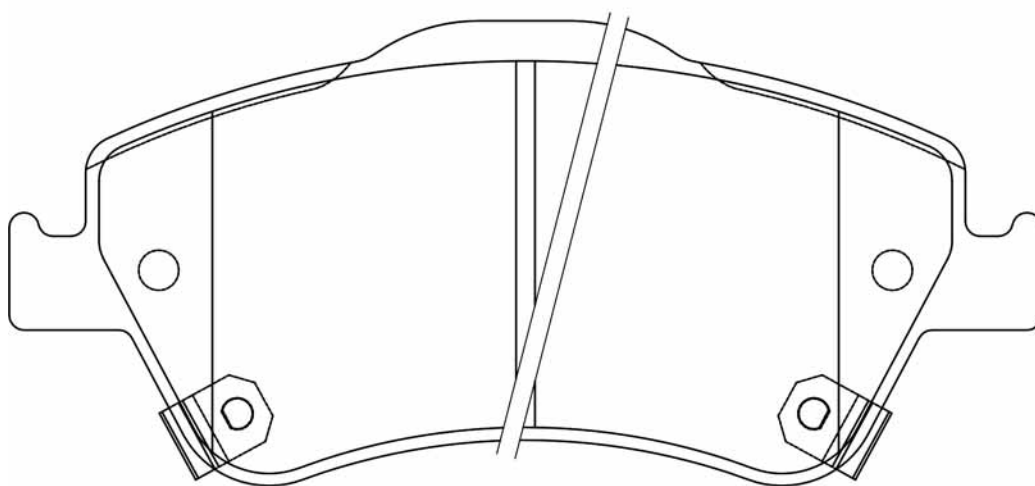



50-02-254				WVA
	TOYOTA	L	H	
	119,5	73,7/68	14,7	21679

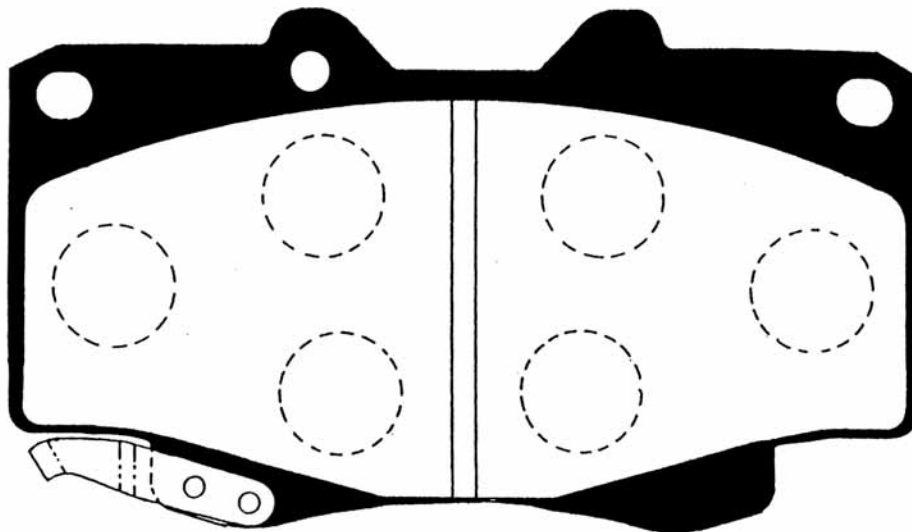

X1 LEFT
 X1 RIGHT

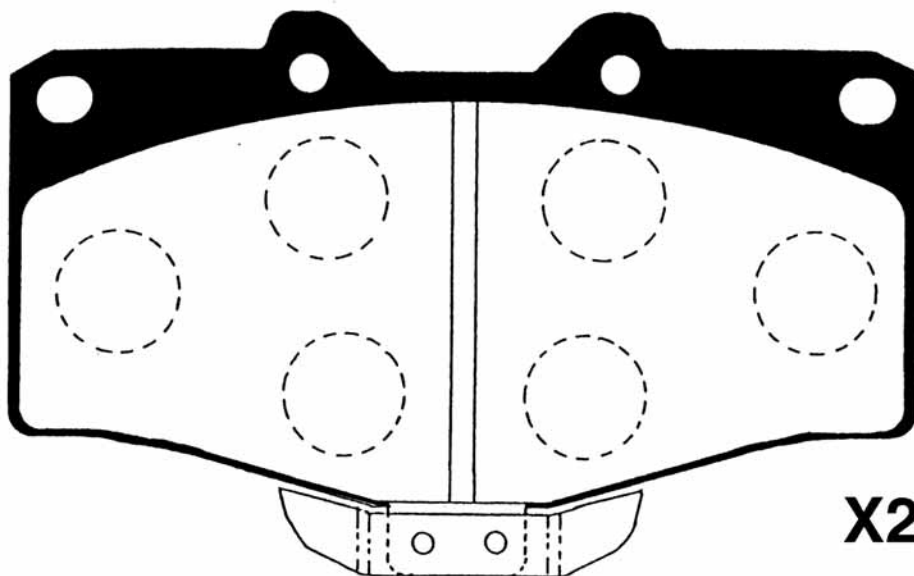

X2



PICTURES BRAKE PADS FRONT
ABBILDUNGEN BREMSKLÖTZE VORN
FIGURAS PASTILLAS DE FRENO DELANTORES
ILLUSTRATIONS PLAQUETTES DE FREI AVANT
IMMAGINI PASTIGLIE FRENO ANTERIORI

50-02-254P TOYOTA				WVA
	L	H	Th	
	119,5	73,7/68	14,7	

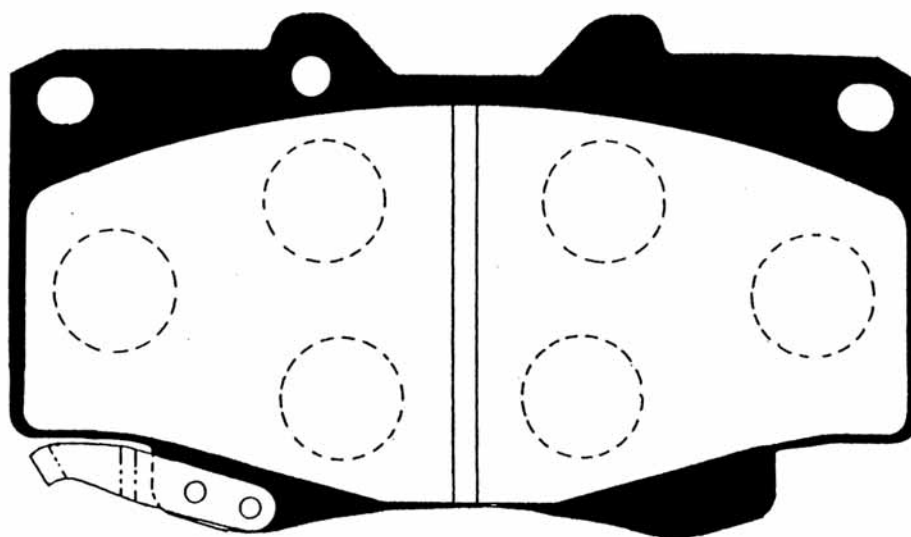

X1 LEFT
X1 RIGHT

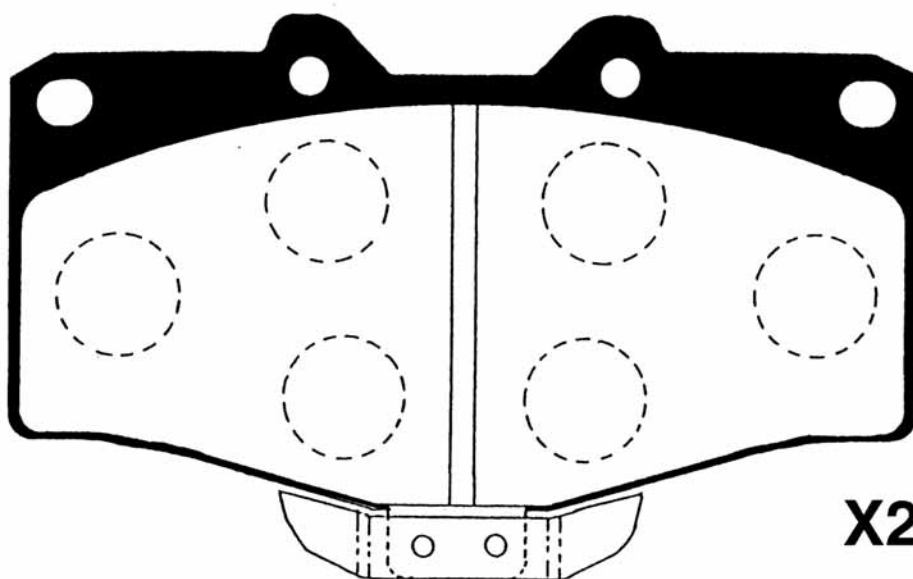

X2



50-02-255				WVA
	TOYOTA	L	H	
	119,4	73,7/65	14,6	

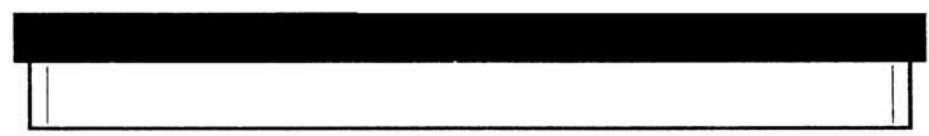
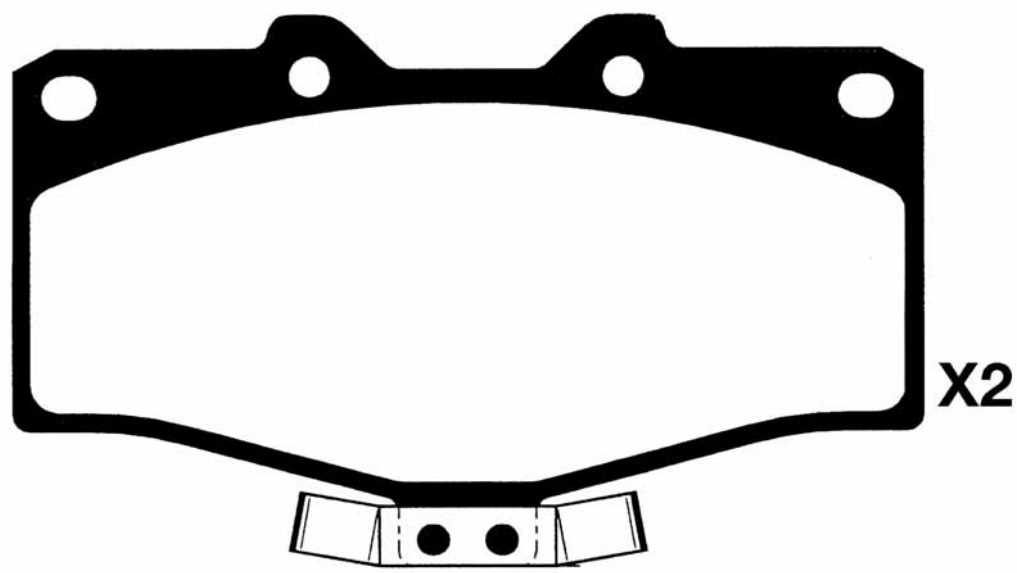
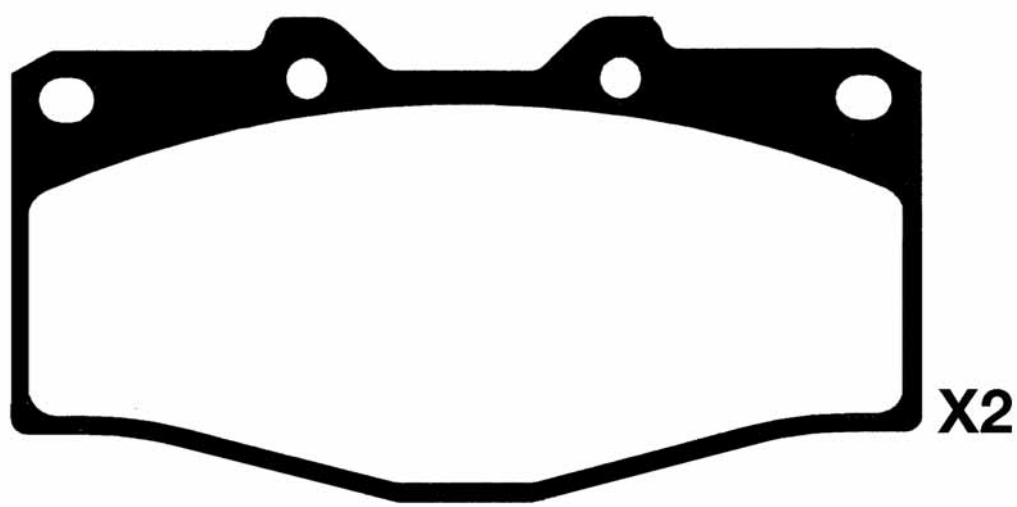



PICTURES BRAKE PADS FRONT
ABBILDUNGEN BREMSKLÖTZE VORN
FIGURAS PASTILLAS DE FRENO DELANTORES
ILLUSTRATIONS PLAQUETTES DE FREI AVANT
IMMAGINI PASTIGLIE FRENO ANTERIORI

50-02-256 TOYOTA				WVA
	L 107,2	H 70/74,7	Th 14,9	21779

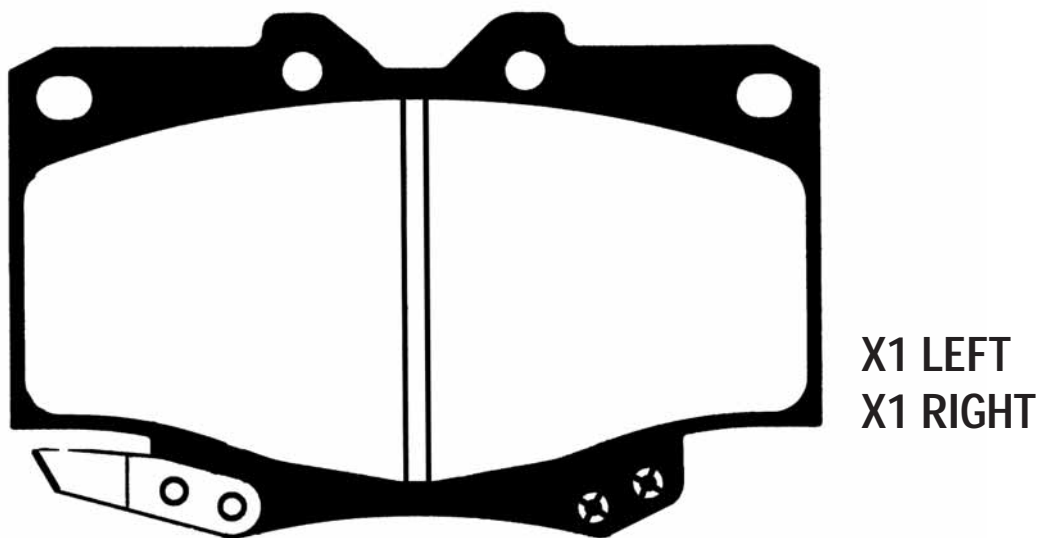
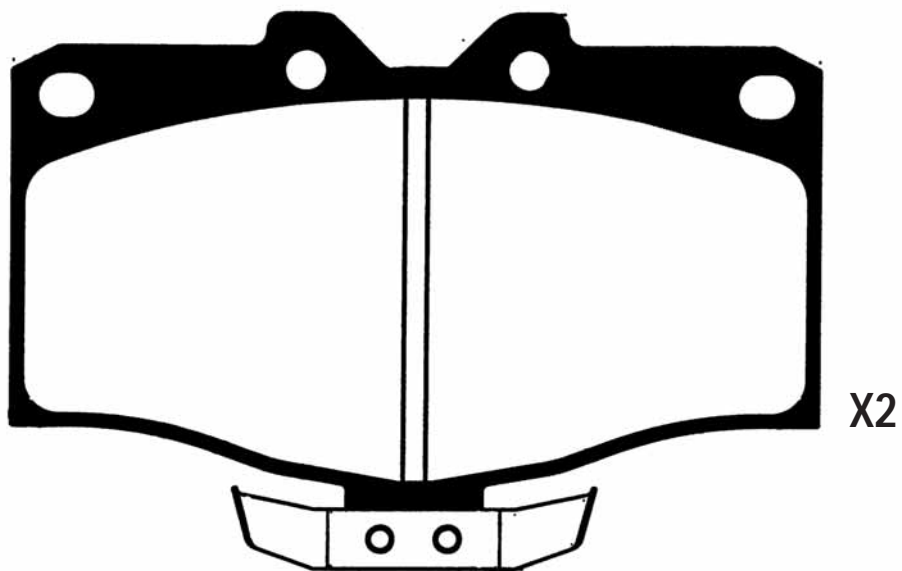



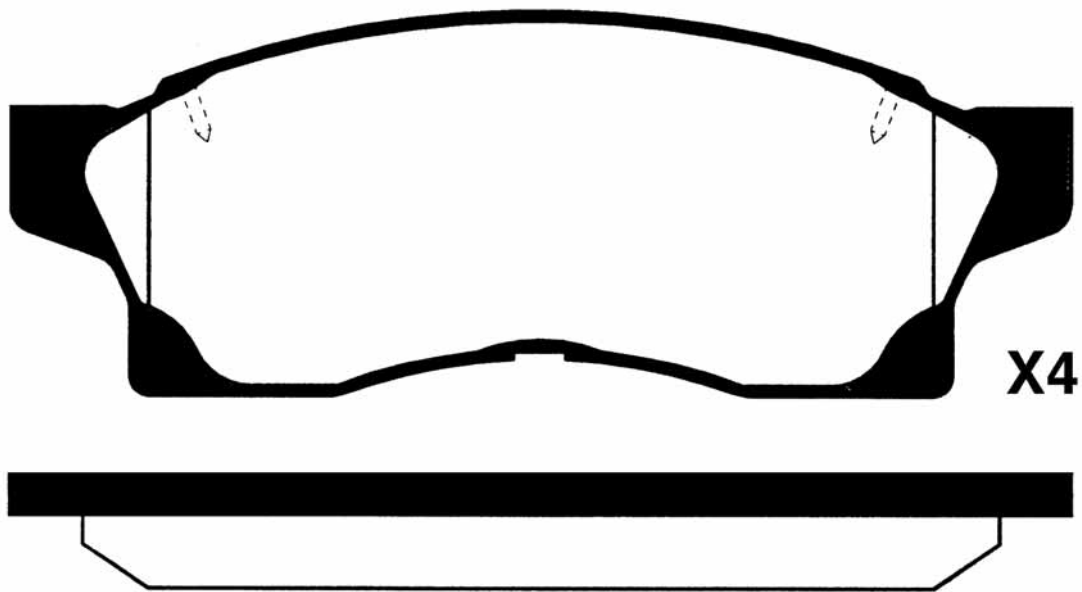

50-02-258				WVA
	TOYOTA	L	H	Th
	140,4	51,9	15,5	21762





PICTURES BRAKE PADS FRONT
ABBILDUNGEN BREMSKLÖTZE VORN
FIGURAS PASTILLAS DE FRENO DELANTORES
ILLUSTRATIONS PLAQUETTES DE FREI AVANT
IMMAGINI PASTIGLIE FRENO ANTERIORI

50-02-259				WVA
TOYOTA	L	H	Th	
	99,1	39	14,5	20722

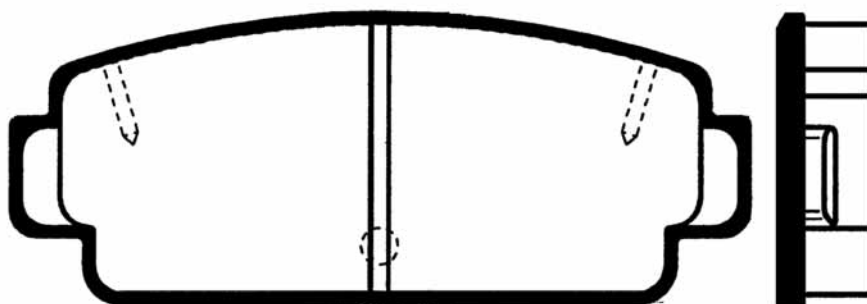

X4



50-02-263				WVA
	TOYOTA	L	H	Th
	141	55,8	16,4	21961

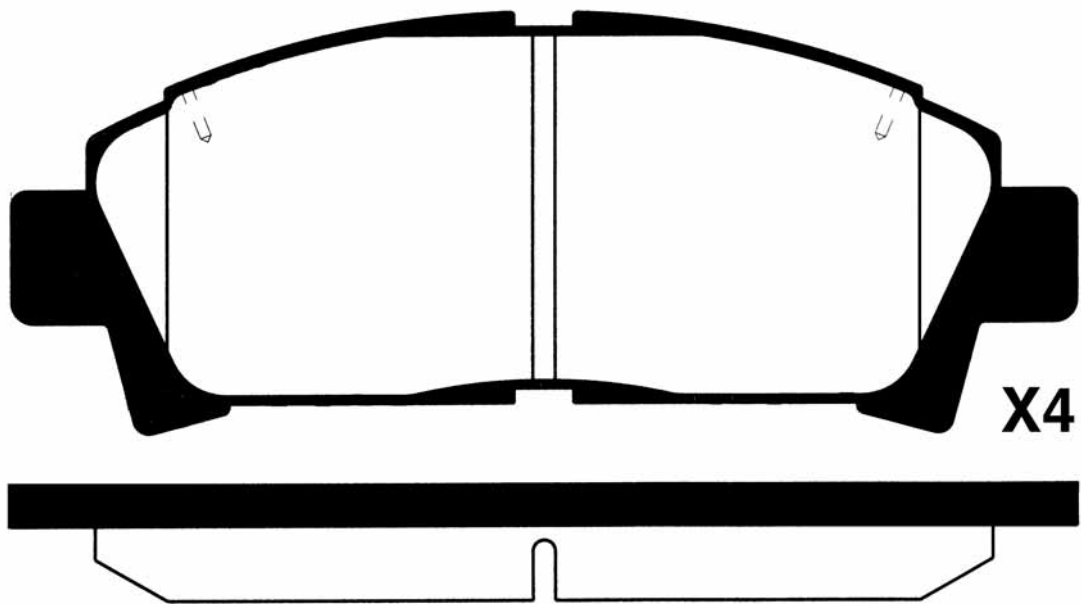



PICTURES BRAKE PADS FRONT
ABBILDUNGEN BREMSKLÖTZE VORN
FIGURAS PASTILLAS DE FRENO DELANTORES
ILLUSTRATIONS PLAQUETTES DE FREI AVANT
IMMAGINI PASTIGLIE FRENO ANTERIORI

50-02-264				WVA
TOYOTA	L	H	Th	
	133	52,7	17,4	21601

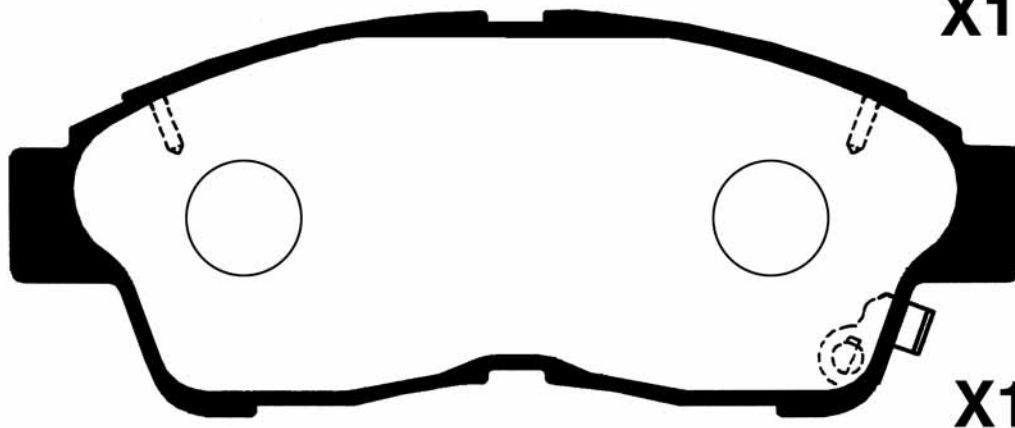
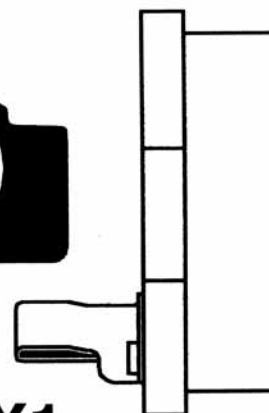
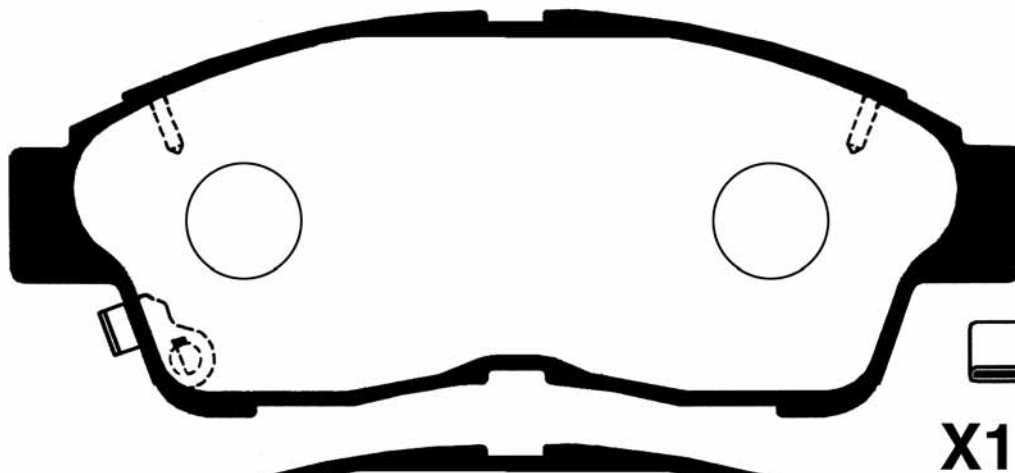
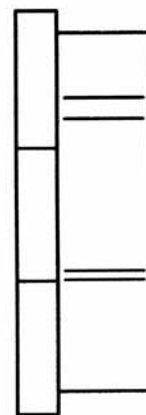
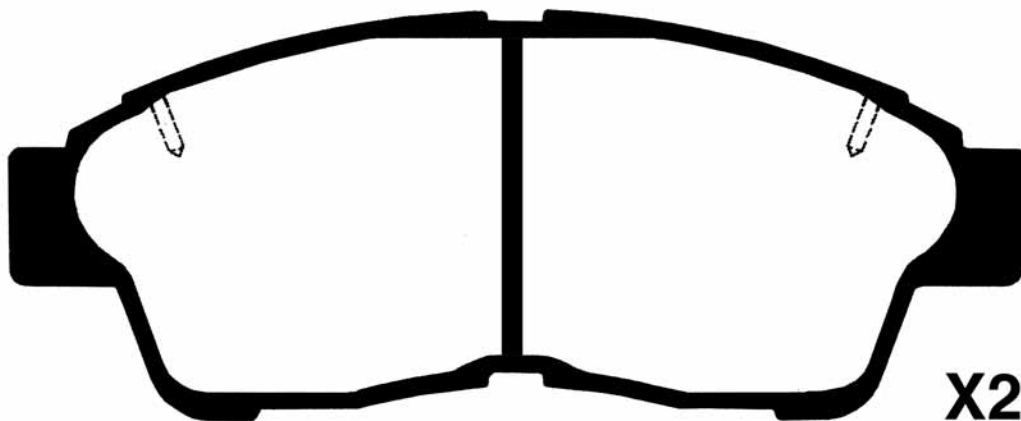



50-02-265 TOYOTA - LEXUS				WVA
	L 141	H 62,2	Th 16,8	

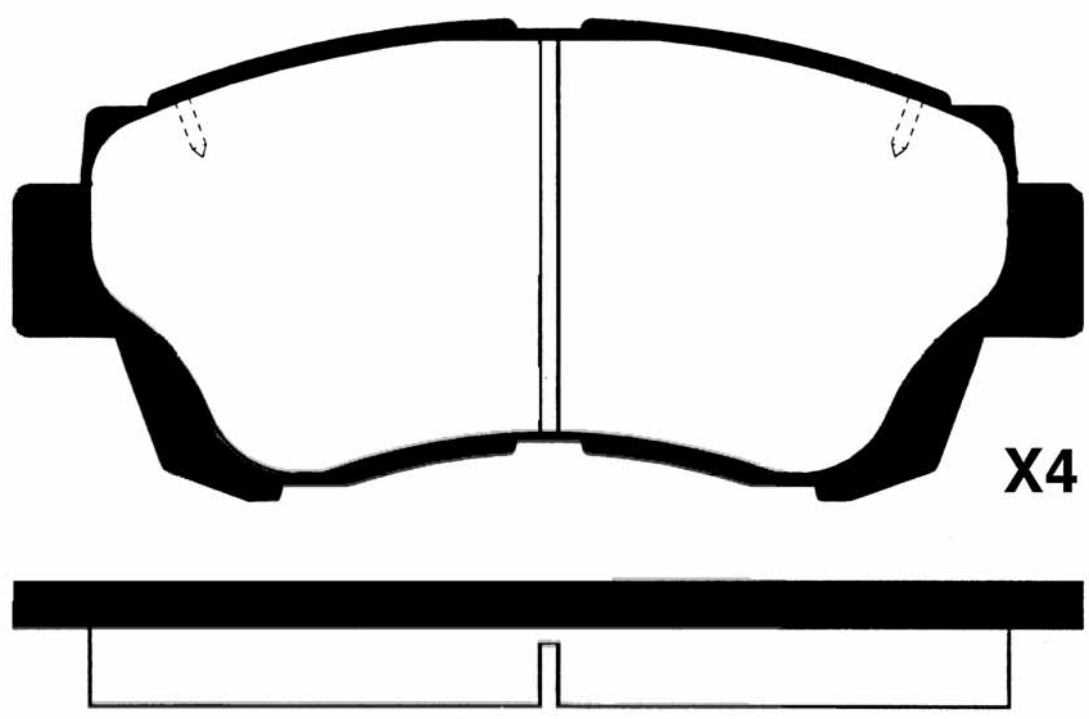



PICTURES BRAKE PADS FRONT
ABBILDUNGEN BREMSKLÖTZE VORN
FIGURAS PASTILLAS DE FRENO DELANTORES
ILLUSTRATIONS PLAQUETTES DE FREI AVANT
IMMAGINI PASTIGLIE FRENO ANTERIORI

50-02-267				WVA
TOYOTA	L	H	Th	
	144	52,6	15,3	21783

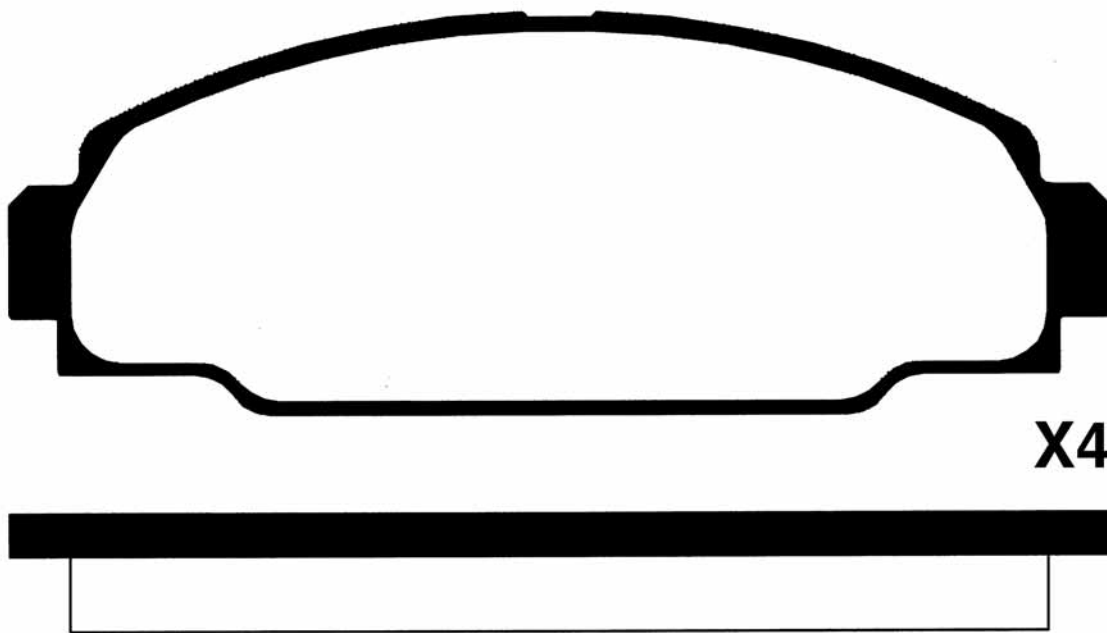



50-02-268				WVA
	TOYOTA	L	H	
	119	78,4	17,3	

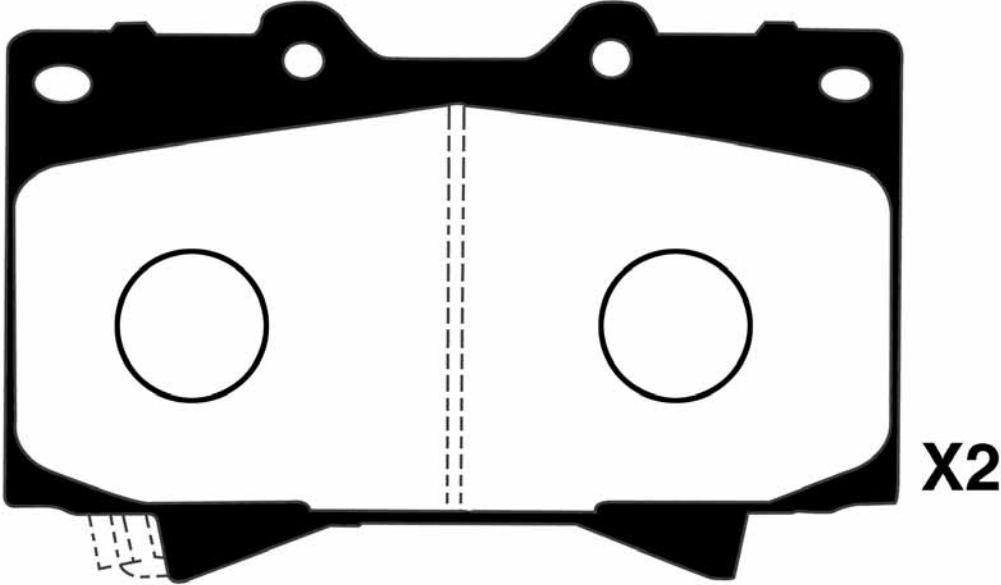
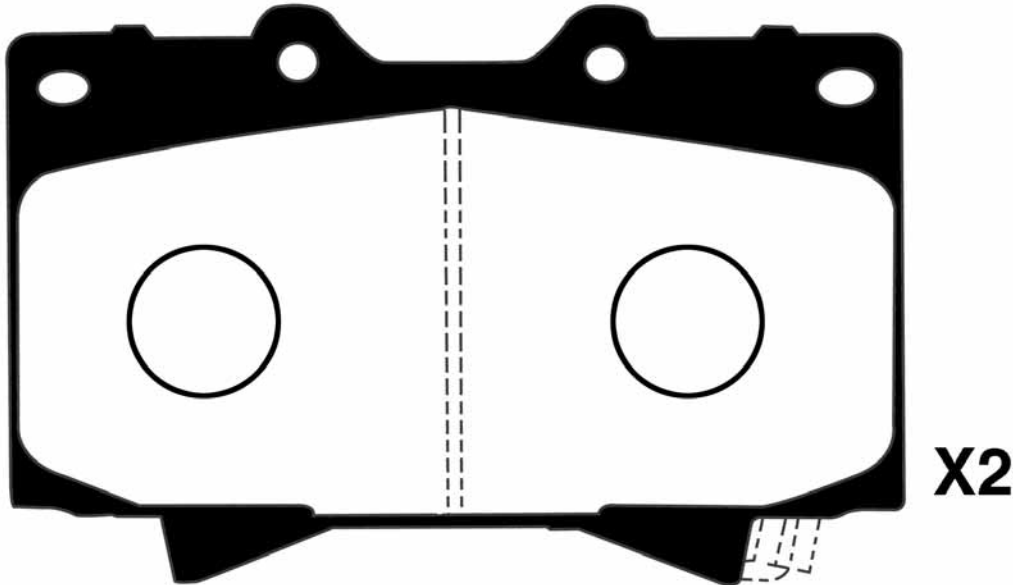



PICTURES BRAKE PADS FRONT
ABBILDUNGEN BREMSKLÖTZE VORN
FIGURAS PASTILLAS DE FRENO DELANTORES
ILLUSTRATIONS PLAQUETTES DE FREI AVANT
IMMAGINI PASTIGLIE FRENO ANTERIORI

50-02-269				WVA
TOYOTA - SUBARU	L	H	Th	
	139	56	17,5	24336

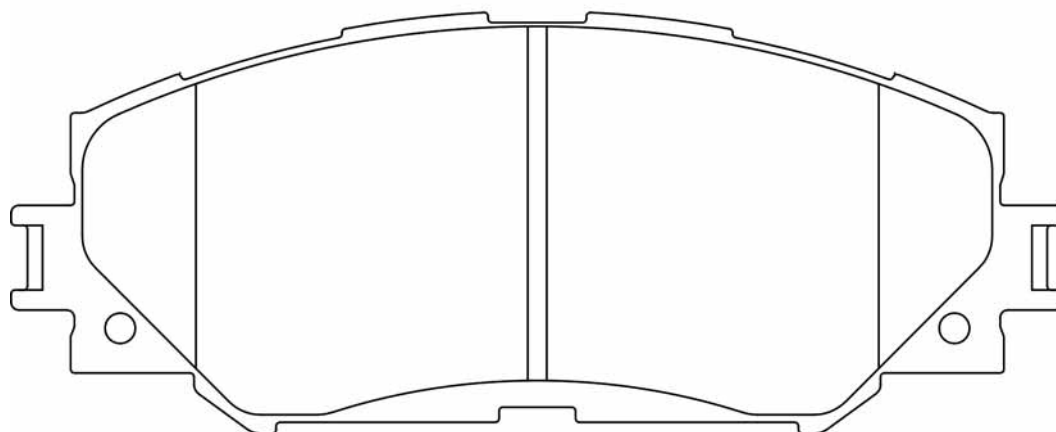



50-02-270				WVA
	TOYOTA	L	H	Th
	116,8	59,6	17	23513

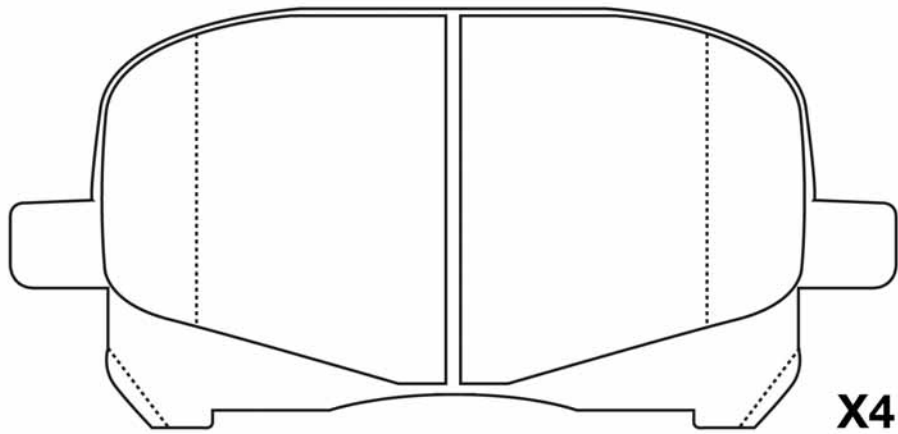

X4



PICTURES BRAKE PADS FRONT
ABBILDUNGEN BREMSKLÖTZE VORN
FIGURAS PASTILLAS DE FRENO DELANTORES
ILLUSTRATIONS PLAQUETTES DE FREI AVANT
IMMAGINI PASTIGLIE FRENO ANTERIORI

50-02-271				WVA
TOYOTA	L	H	Th	
	125,6	59,5	16,6	23759

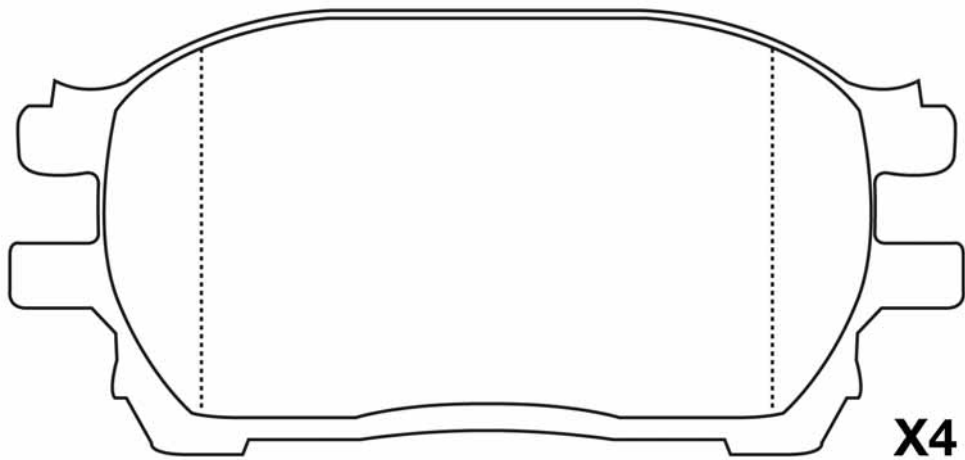



50-02-272

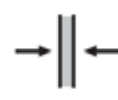
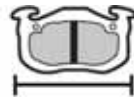

WVA

TOYOTA

L

H

Th

144

84

18

24386

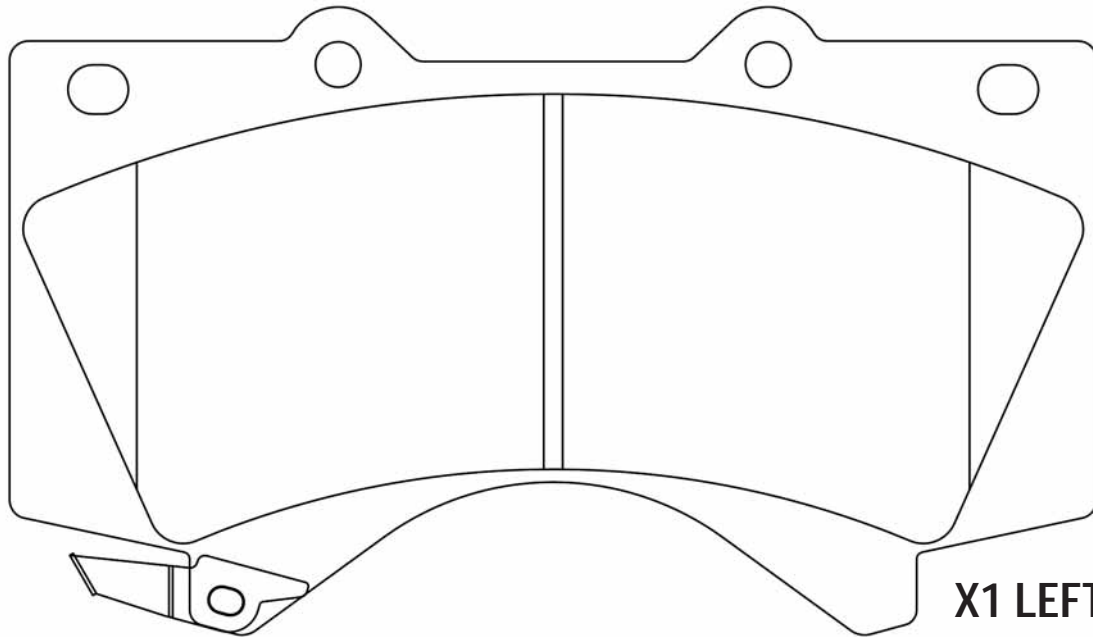

**X1 LEFT
X1 RIGHT**

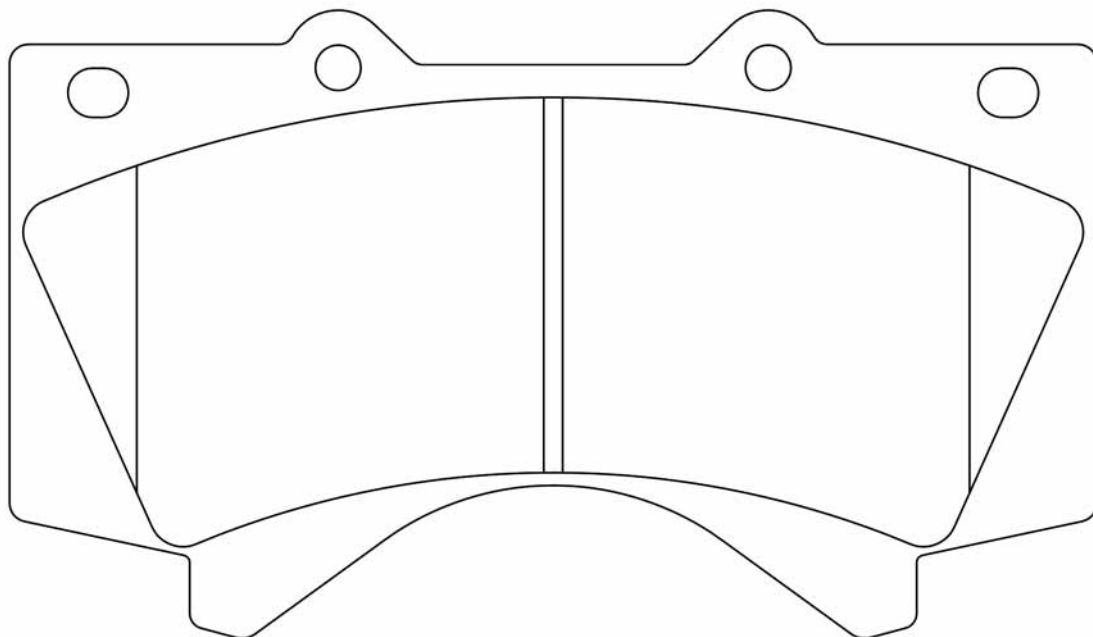



PICTURES BRAKE PADS FRONT
ABBILDUNGEN BREMSKLÖTZE VORN
FIGURAS PASTILLAS DE FRENO DELANTORES
ILLUSTRATIONS PLAQUETTES DE FREI AVANT
IMMAGINI PASTIGLIE FRENO ANTERIORI

50-02-273		WVA		
LEXUS	L	H	Th	
	139	59,5	16,5	23331

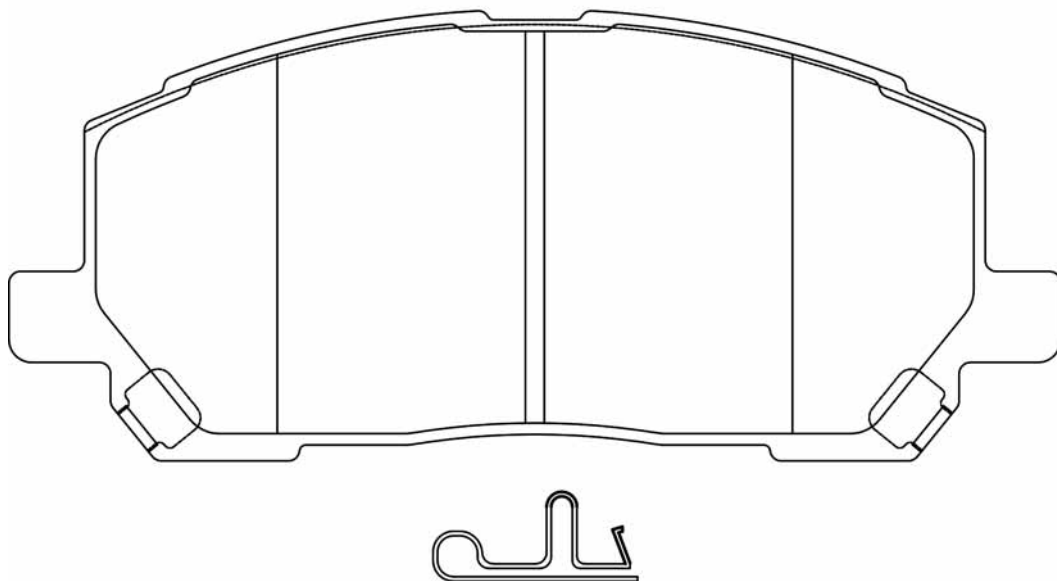



50-02-274

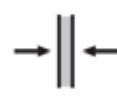
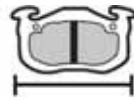

WVA

LEXUS

L

H

Th

119

77

16

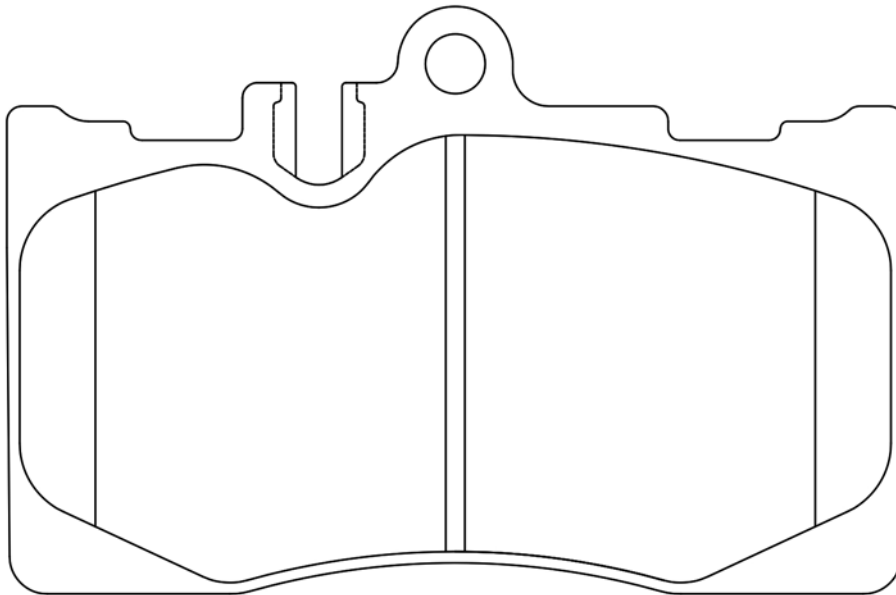



PICTURES BRAKE PADS FRONT
ABBILDUNGEN BREMSKLÖTZE VORN
FIGURAS PASTILLAS DE FRENO DELANTORES
ILLUSTRATIONS PLAQUETTES DE FREI AVANT
IMMAGINI PASTIGLIE FRENO ANTERIORI

50-02-275



WVA

TOYOTA

L

H

Th

117

54/51,6

17

24778

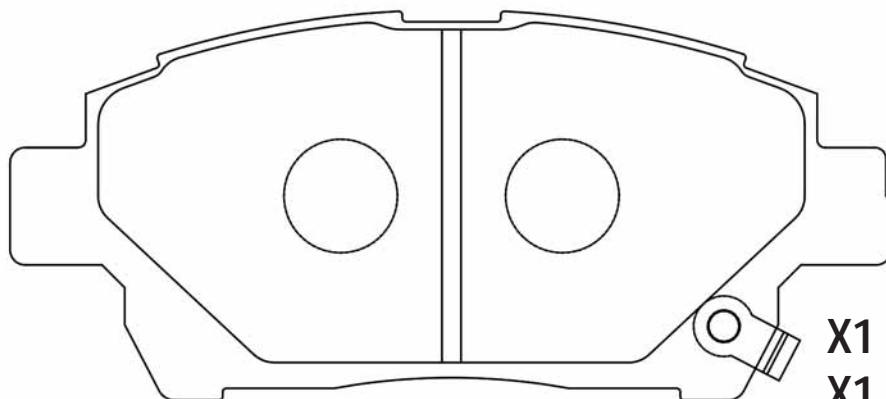

**X1 LEFT
X1 RIGHT**

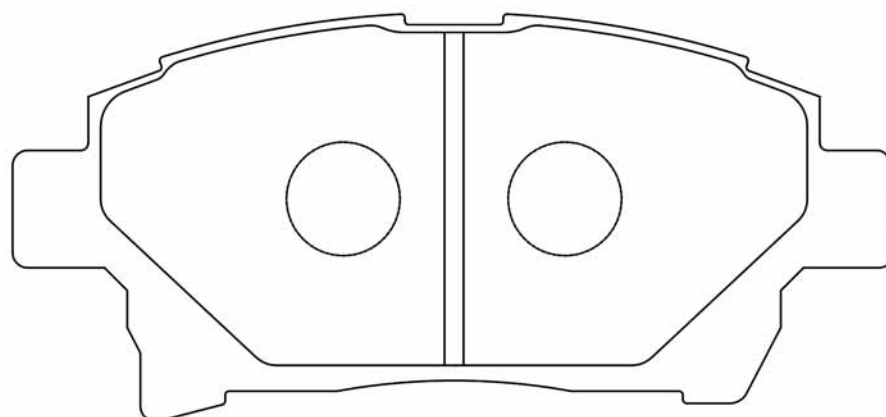
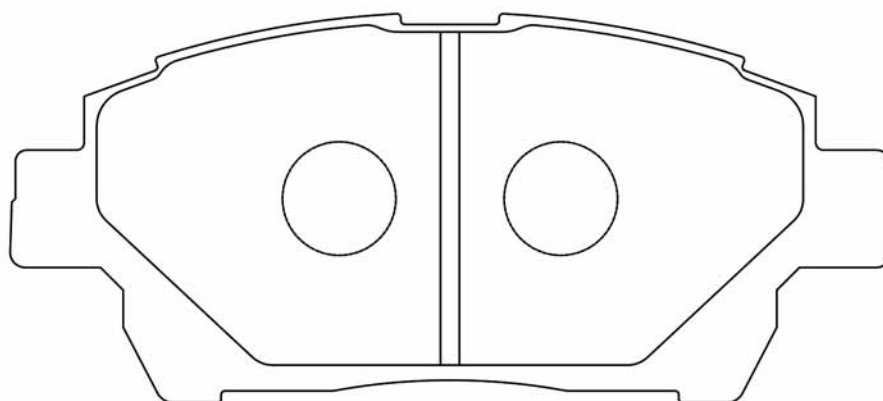

PICTURES BRAKE PADS FRONT
ABBILDUNGEN BREMSKLÖTZE VORN
FIGURAS PASTILLAS DE FRENO DELANTORES
ILLUSTRATIONS PLAQUETTES DE FREI AVANT
IMMAGINI PASTIGLIE FRENO ANTERIORI



50-02-276

TOYOTA

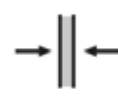
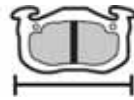

WVA

L

H

Th

151

61

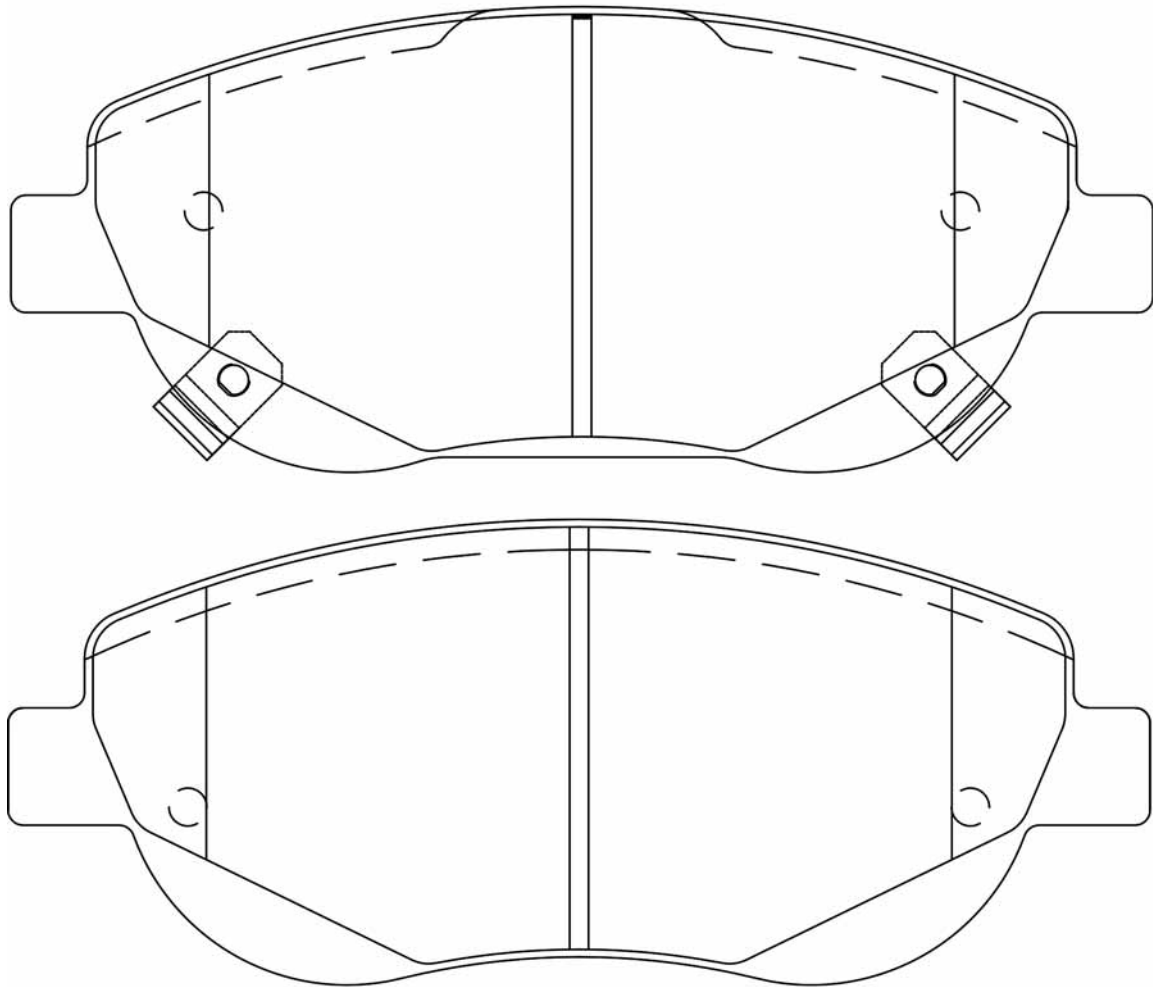

19

24946



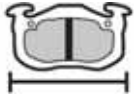

PICTURES BRAKE PADS FRONT
ABBILDUNGEN BREMSKLÖTZE VORN
FIGURAS PASTILLAS DE FRENO DELANTORES
ILLUSTRATIONS PLAQUETTES DE FREI AVANT
IMMAGINI PASTIGLIE FRENO ANTERIORI

50-02-277				WVA
TOYOTA	L	H	Th	
	157,7	57	17,6	24350

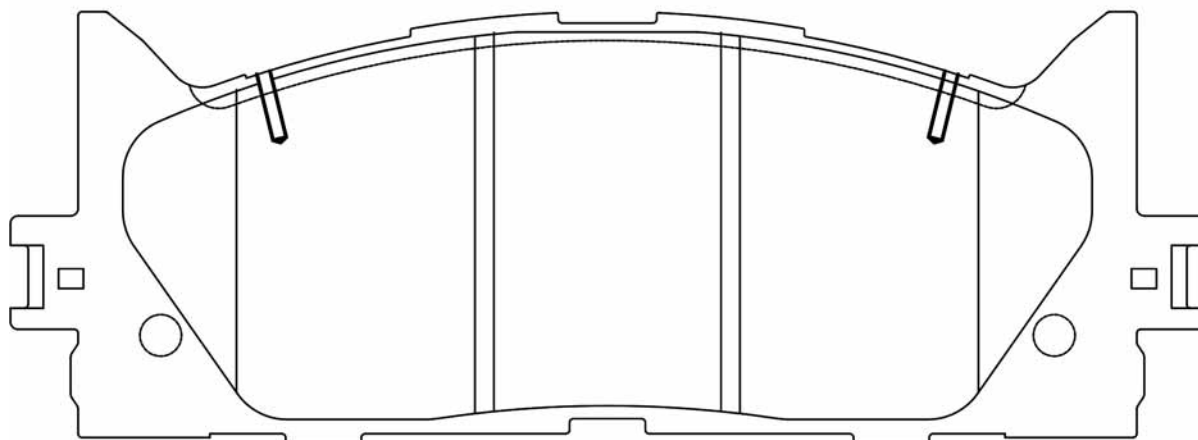



50-02-280				WVA
TOYOTA	L	H	Th	
	123	60,4	17	23585

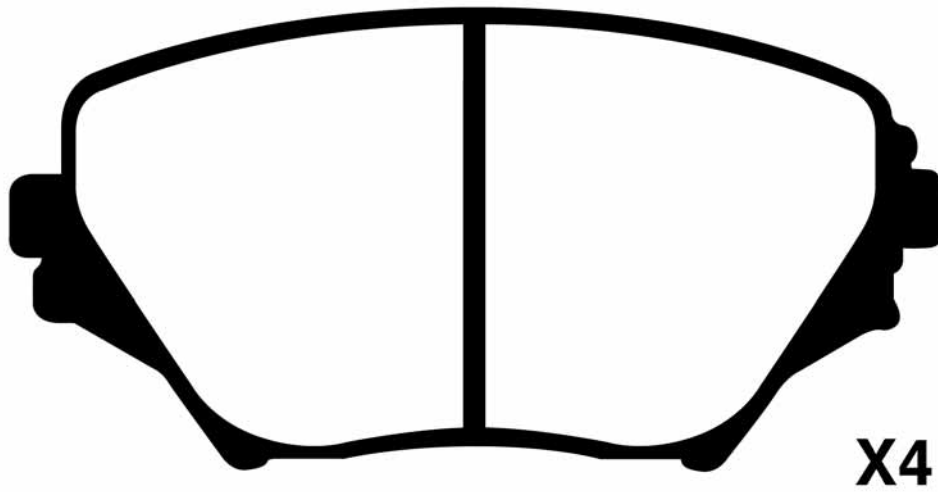

X4



PICTURES BRAKE PADS FRONT
ABBILDUNGEN BREMSKLÖTZE VORN
FIGURAS PASTILLAS DE FRENO DELANTORES
ILLUSTRATIONS PLAQUETTES DE FREI AVANT
IMMAGINI PASTIGLIE FRENO ANTERIORI

50-02-281 TOYOTA				WVA
	L	H	Th	
	112,5	46,5	16	23349

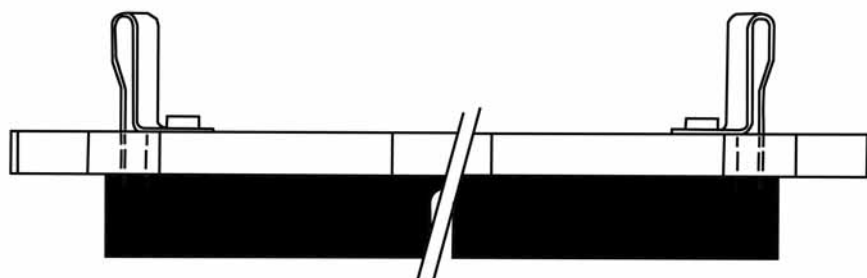
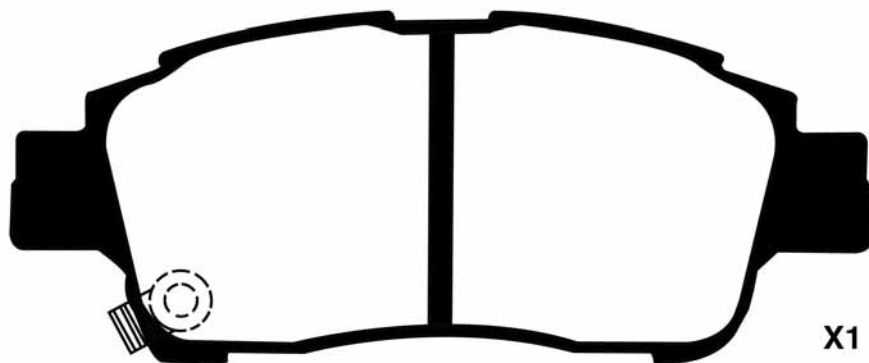
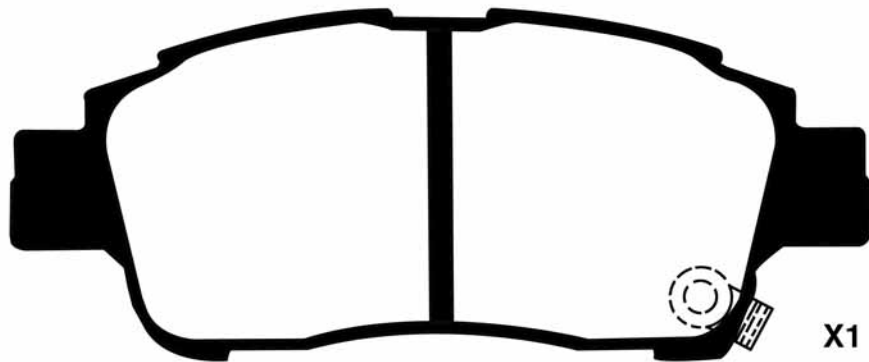
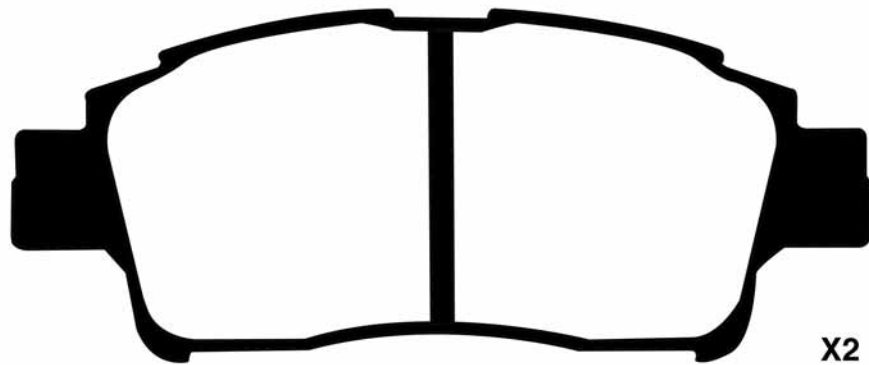



50-02-282				WVA
	TOYOTA	L	H	Th
	156,1	54,7	16,8	21976

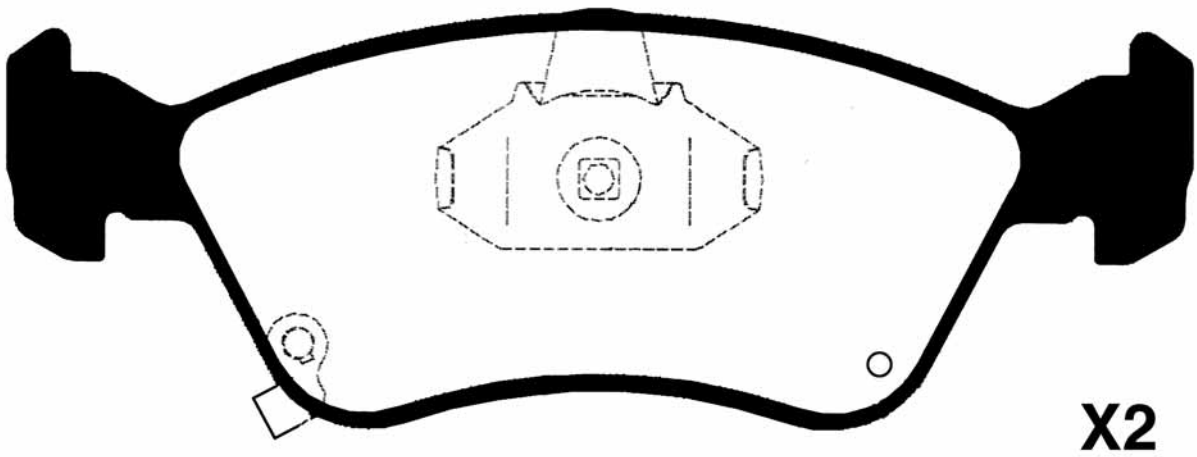
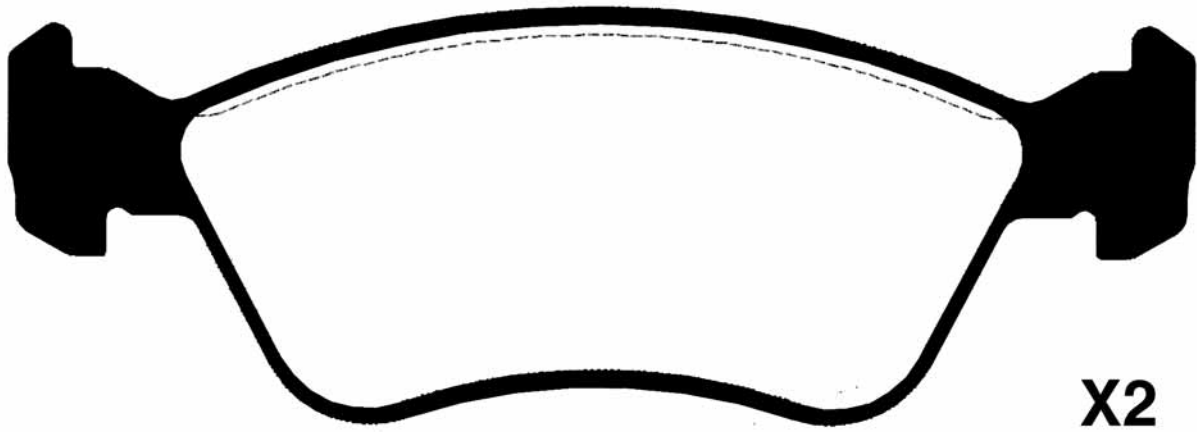



PICTURES BRAKE PADS FRONT
ABBILDUNGEN BREMSKLÖTZE VORN
FIGURAS PASTILLAS DE FRENO DELANTORES
ILLUSTRATIONS PLAQUETTES DE FREI AVANT
IMMAGINI PASTIGLIE FRENO ANTERIORI

50-02-283				WVA
TOYOTA	L	H	Th	
	166,5	63,3	17,6	

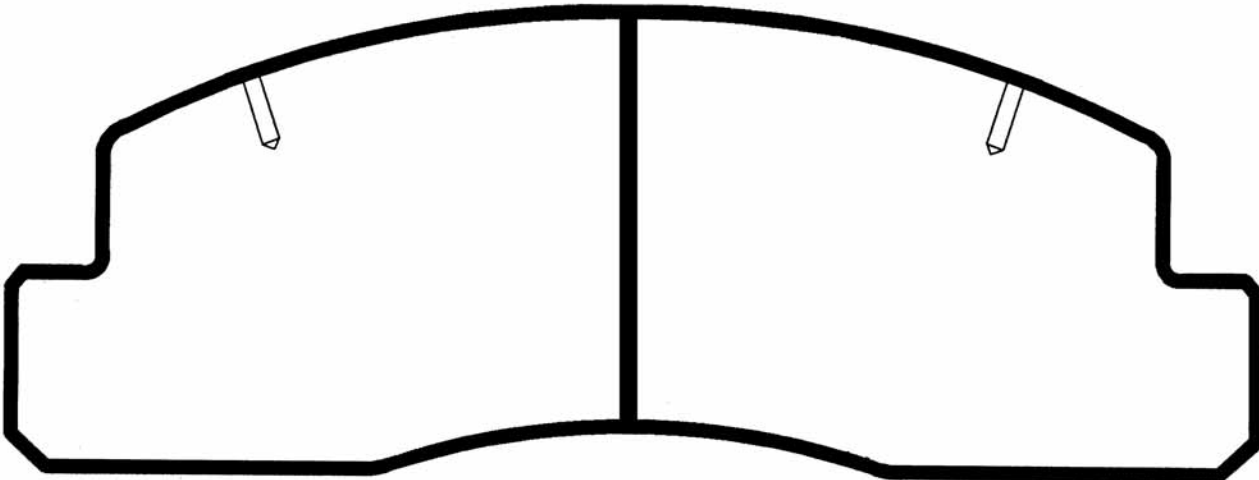

X4



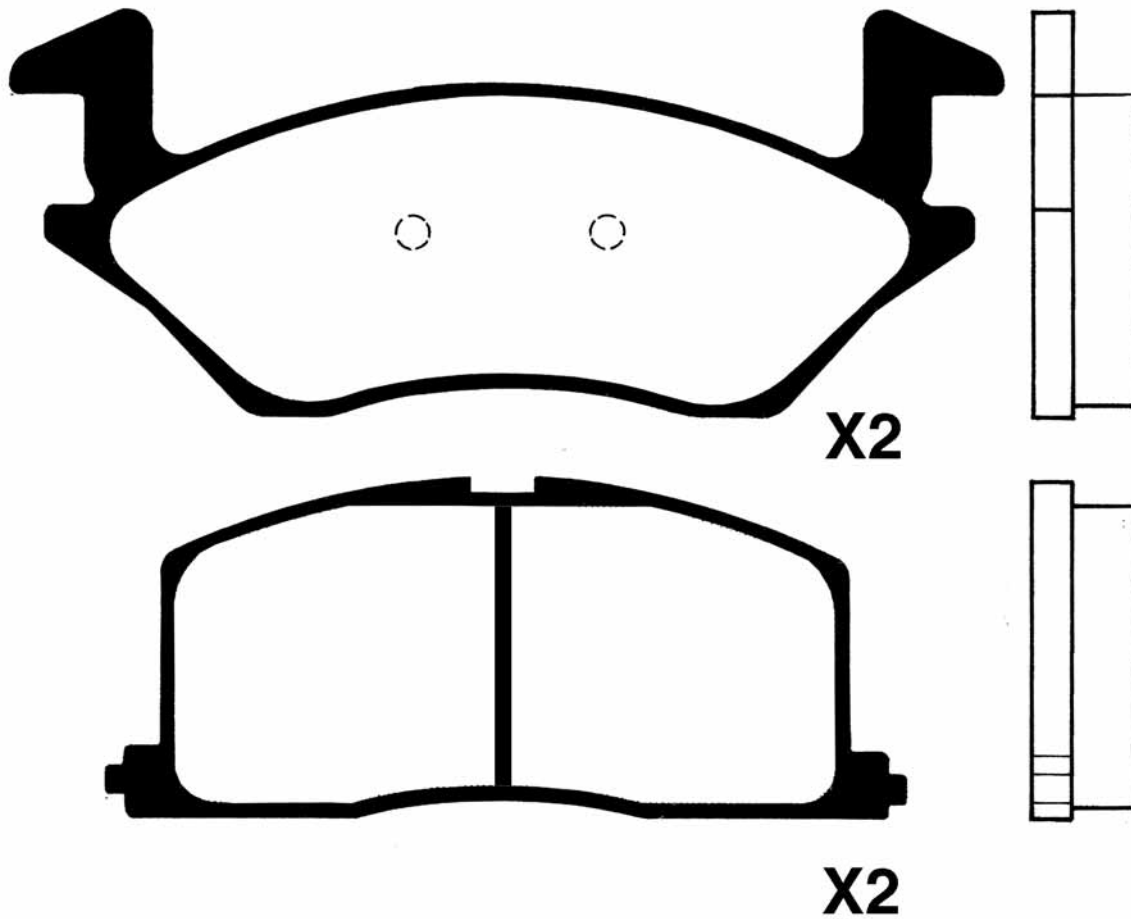

50-02-284				WVA
	TOYOTA	L	H	Th
	106,2/132,2	46/54,7	12,7	21949





PICTURES BRAKE PADS FRONT
ABBILDUNGEN BREMSKLÖTZE VORN
FIGURAS PASTILLAS DE FRENO DELANTORES
ILLUSTRATIONS PLAQUETTES DE FREI AVANT
IMMAGINI PASTIGLIE FRENO ANTERIORI

50-02-285				WVA
TOYOTA	L	H	Th	
	144,4	56,9	15,3	21855

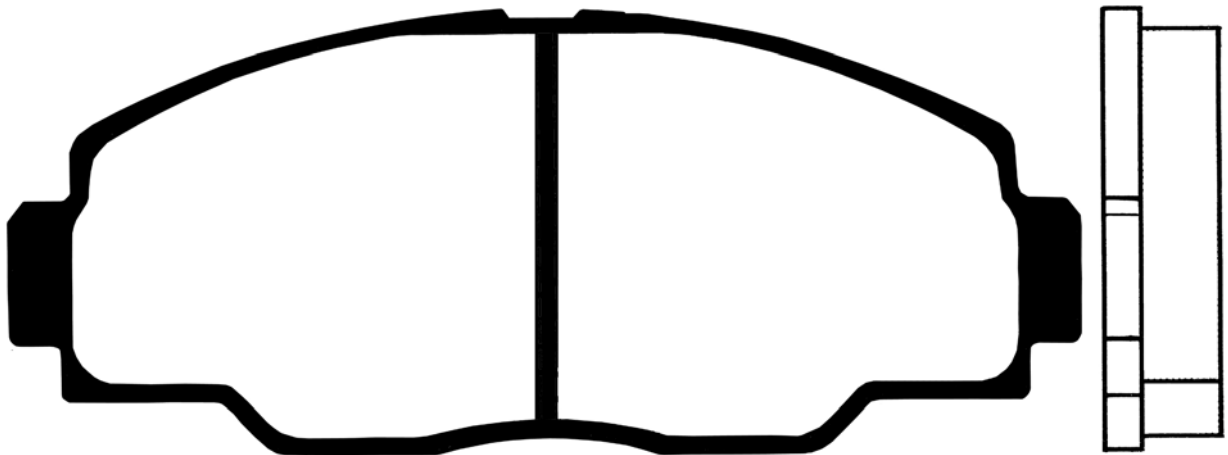

X4



50-02-286				WVA
	TOYOTA	L	H	Th
	145,5	56,7	15,2	21468

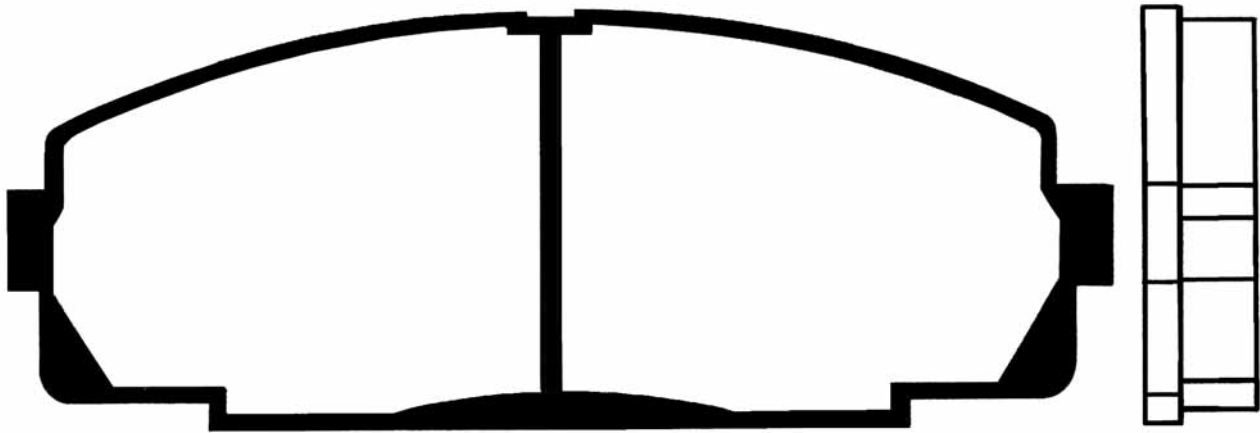

X4



PICTURES BRAKE PADS FRONT
ABBILDUNGEN BREMSKLÖTZE VORN
FIGURAS PASTILLAS DE FRENO DELANTORES
ILLUSTRATIONS PLAQUETTES DE FREI AVANT
IMMAGINI PASTIGLIE FRENO ANTERIORI

50-02-287				WVA
TOYOTA - DAIHATSU	L	H	Th	
	109/107	47/49	13	20867

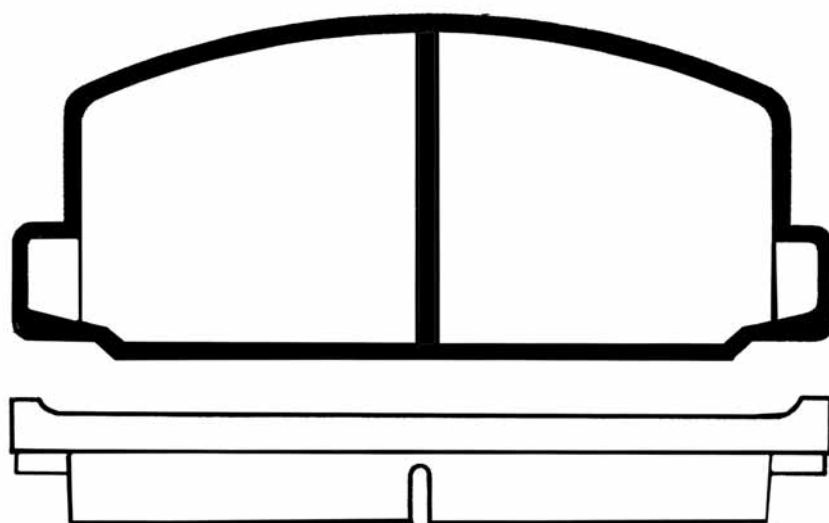

X4



50-02-291				WVA
	TOYOTA	L	H	
	119	72/76,9	15	

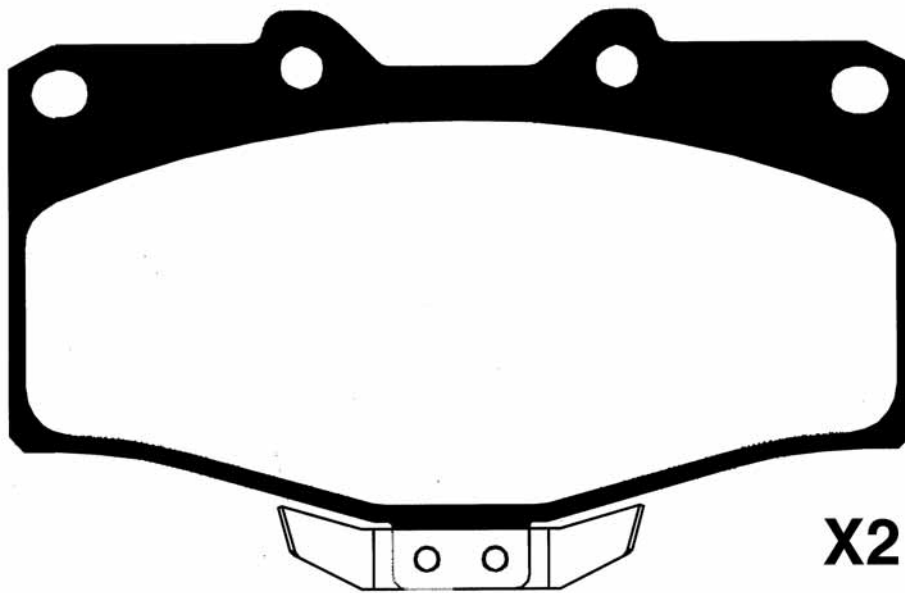

X2



X1



PICTURES BRAKE PADS FRONT
ABBILDUNGEN BREMSKLÖTZE VORN
FIGURAS PASTILLAS DE FRENO DELANTORES
ILLUSTRATIONS PLAQUETTES DE FREI AVANT
IMMAGINI PASTIGLIE FRENO ANTERIORI

50-02-292				WVA
TOYOTA	L	H	Th	
	119,4	72	14,4	21776

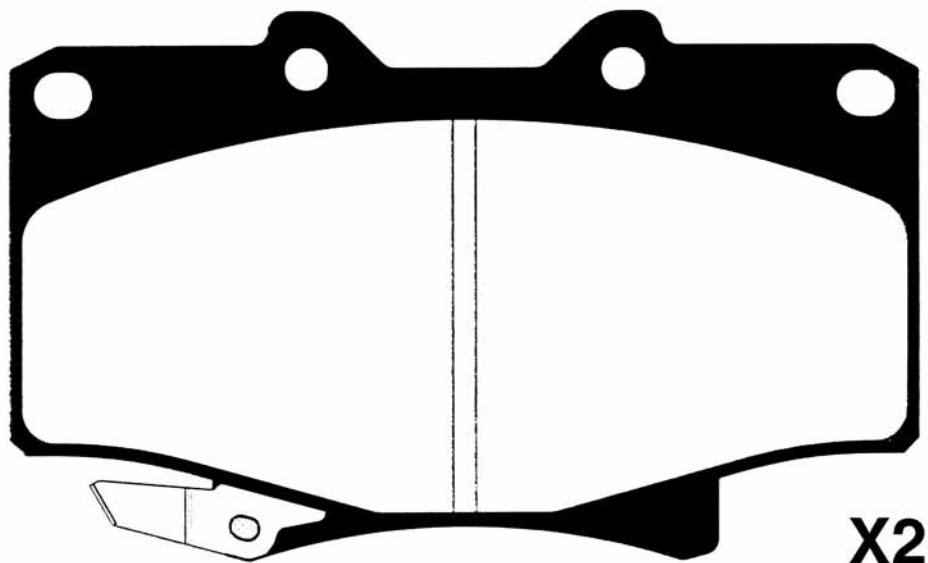

X2

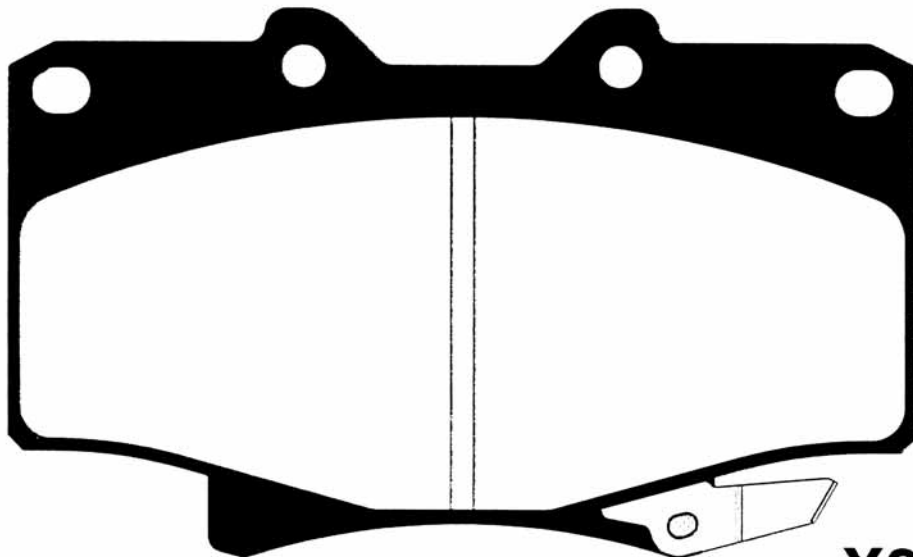

X2



50-02-293				WVA
	TOYOTA	L	H	Th
	119	81,8	16,9	21957

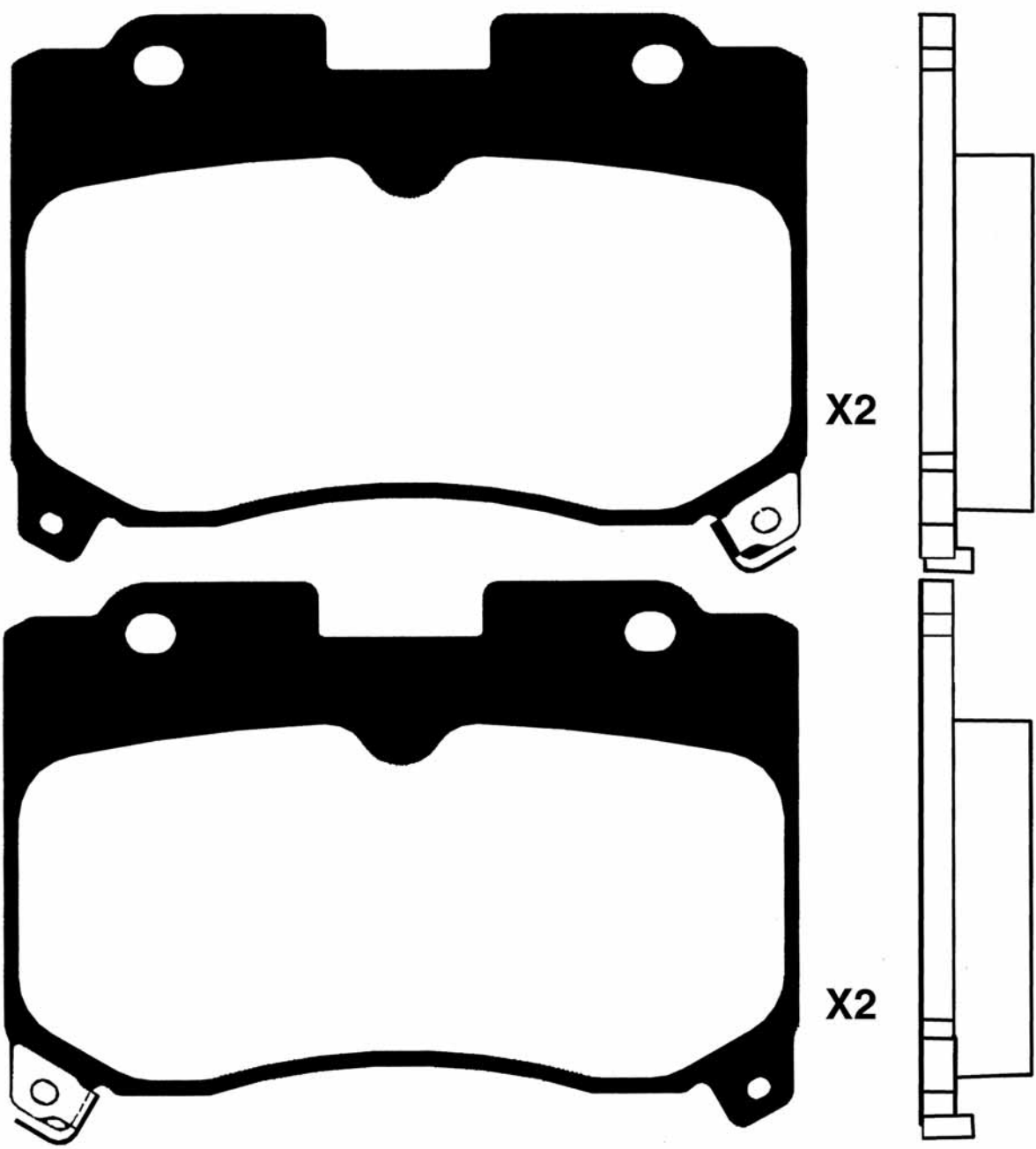



PICTURES BRAKE PADS FRONT
ABBILDUNGEN BREMSKLÖTZE VORN
FIGURAS PASTILLAS DE FRENO DELANTORES
ILLUSTRATIONS PLAQUETTES DE FREI AVANT
IMMAGINI PASTIGLIE FRENO ANTERIORI

50-02-294 LEXUS - TOYOTA				WVA
	L 144	H 68,3	Th 16,8	

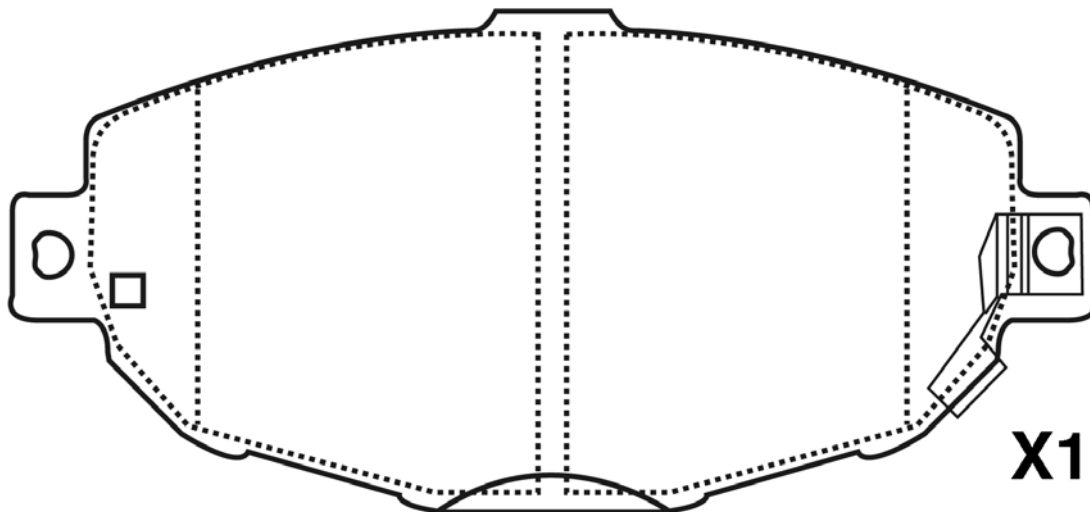

X1

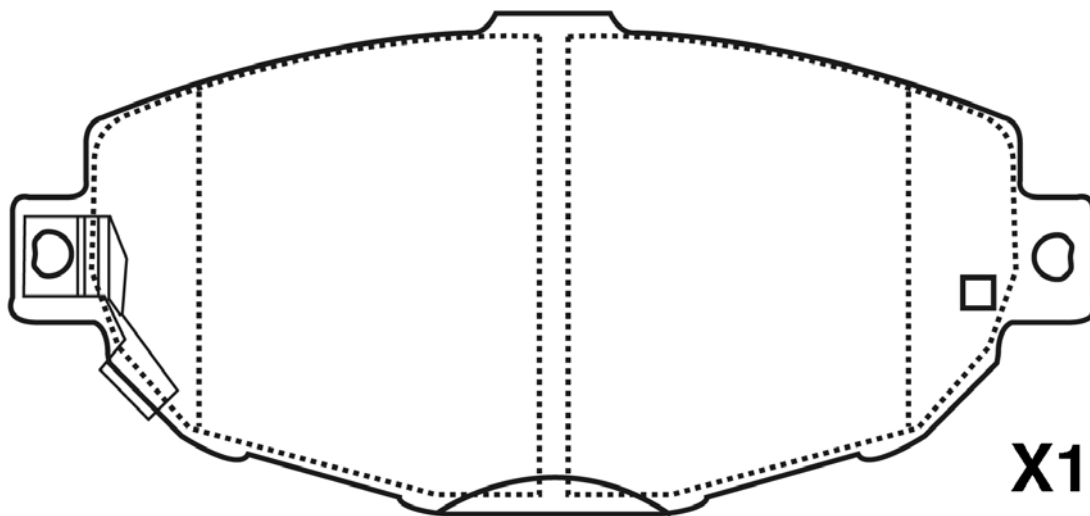

X1

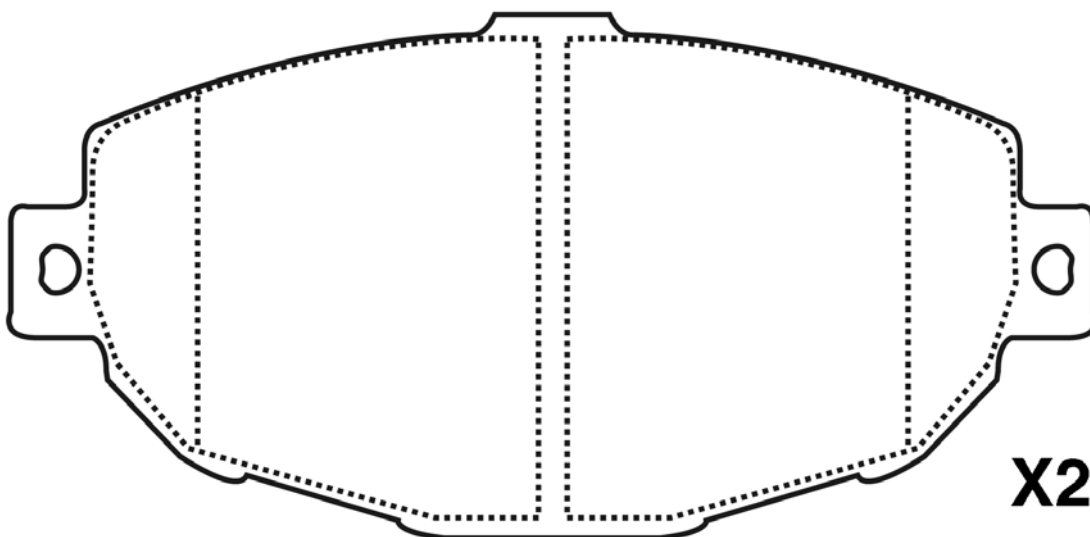

X2



50-02-295				WVA
	LEXUS	L	H	Th
	144	64	16,8	21490

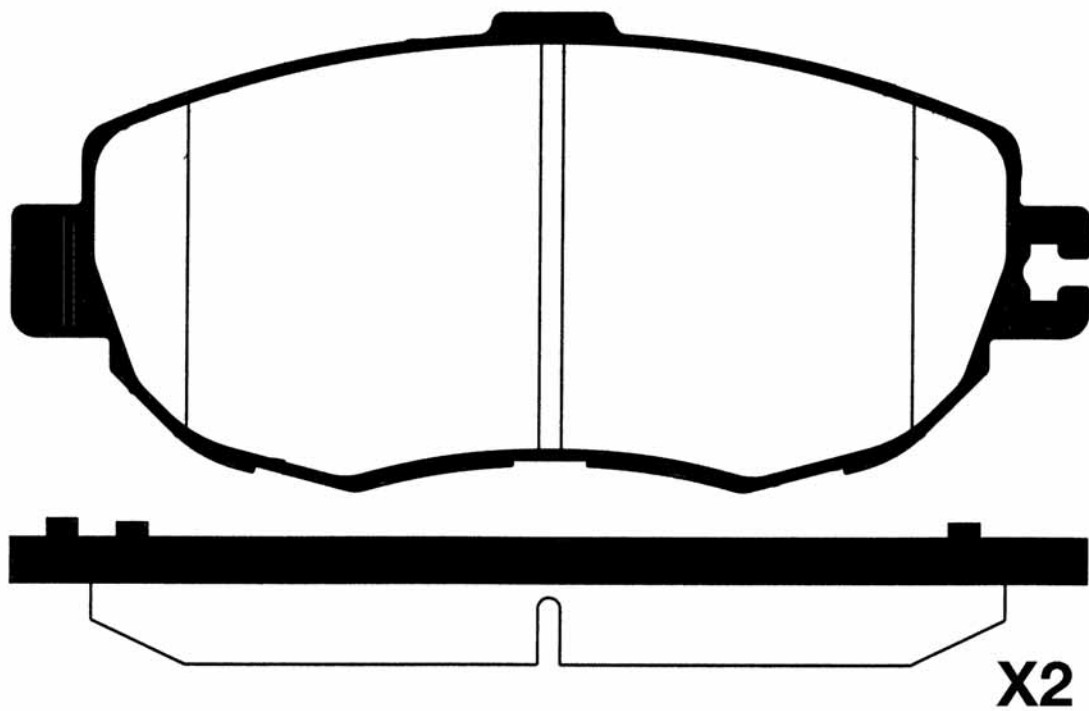
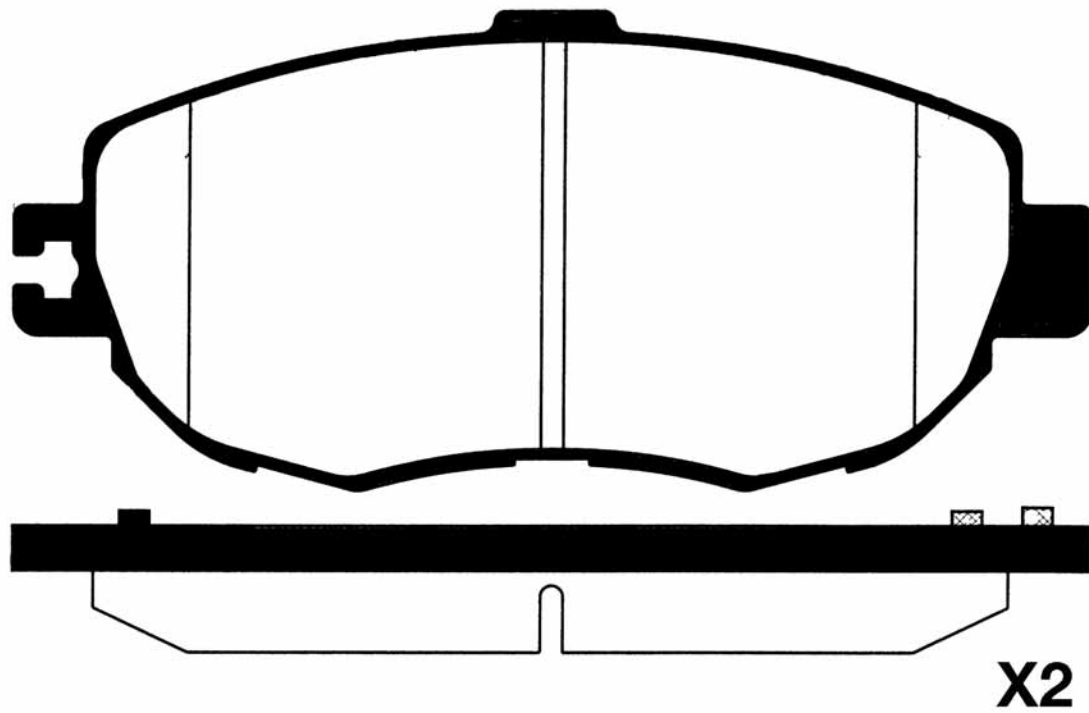



PICTURES BRAKE PADS FRONT
ABBILDUNGEN BREMSKLÖTZE VORN
FIGURAS PASTILLAS DE FRENO DELANTORES
ILLUSTRATIONS PLAQUETTES DE FREI AVANT
IMMAGINI PASTIGLIE FRENO ANTERIORI

50-03-300

LEXUS - MAZDA

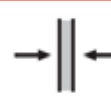

WVA

L

H

Th

156

67/62,5

17

23723

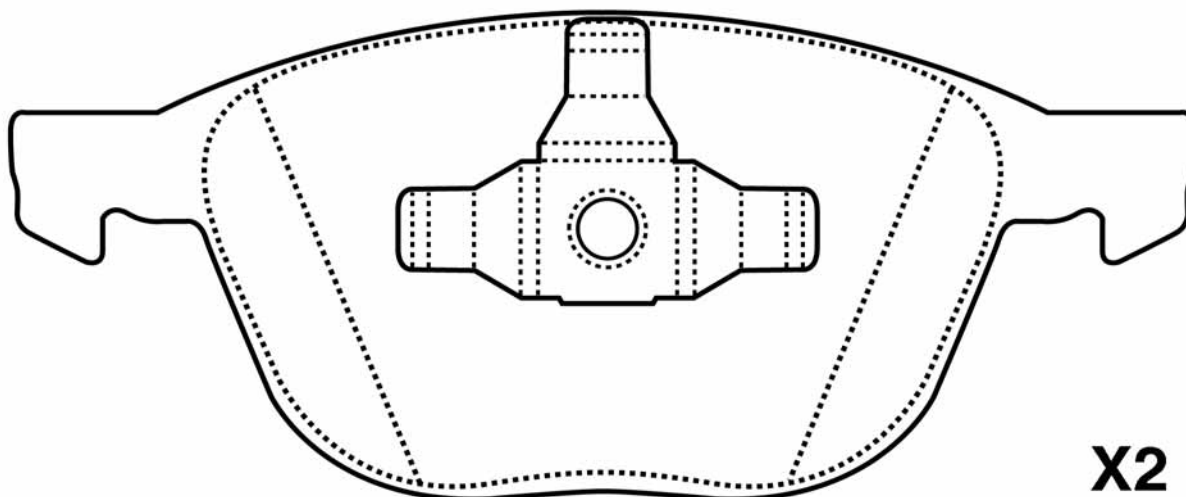
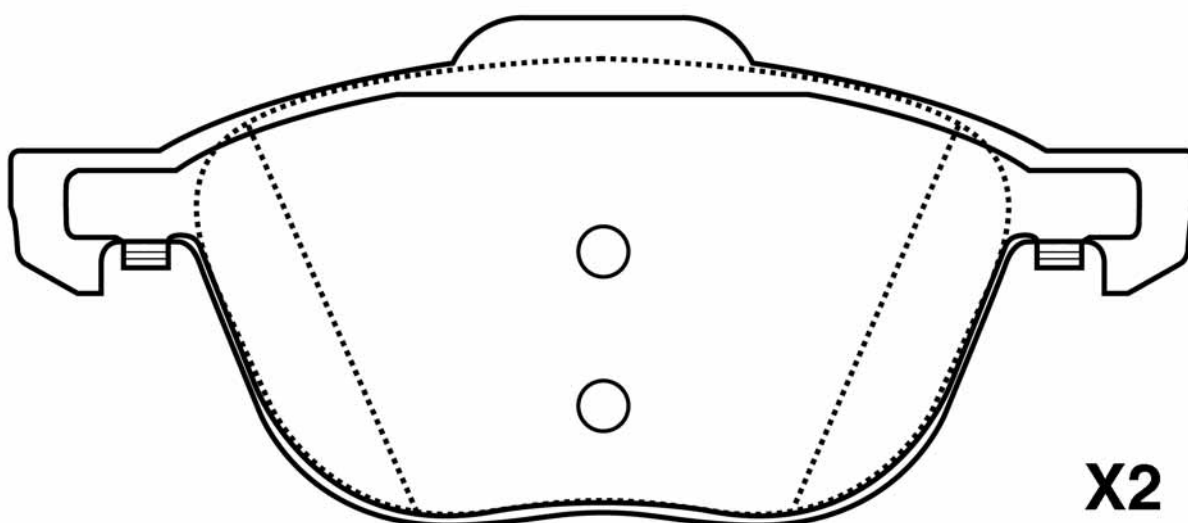



50-03-301				WVA
	MAZDA	L	H	
	129,7	60,9	14,9	21168

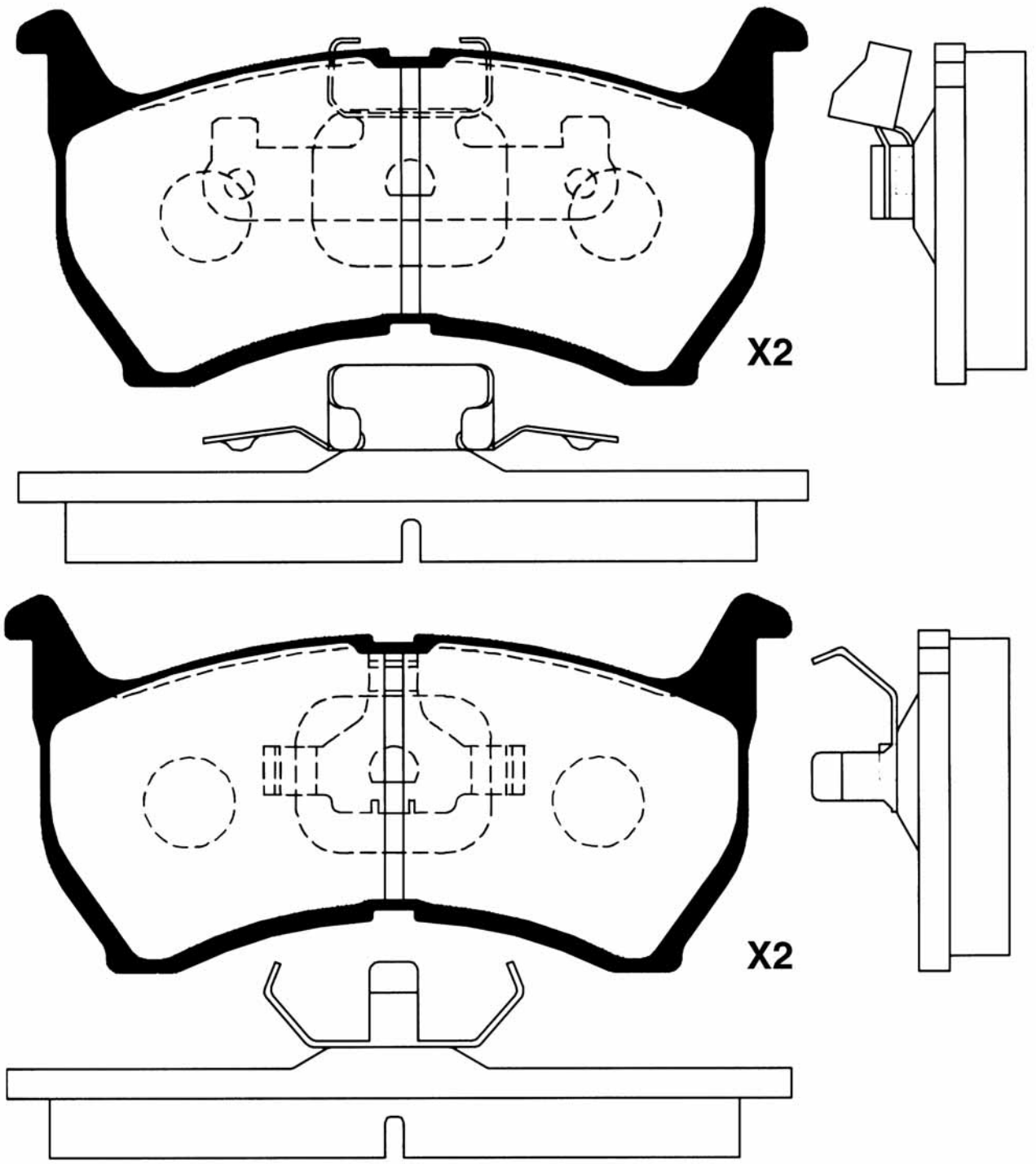



PICTURES BRAKE PADS FRONT
ABBILDUNGEN BREMSKLÖTZE VORN
FIGURAS PASTILLAS DE FRENO DELANTORES
ILLUSTRATIONS PLAQUETTES DE FREI AVANT
IMMAGINI PASTIGLIE FRENO ANTERIORI

50-03-302				WVA
MAZDA	L	H	Th	
	151,1/150,3	58,4/61,4	17,4	

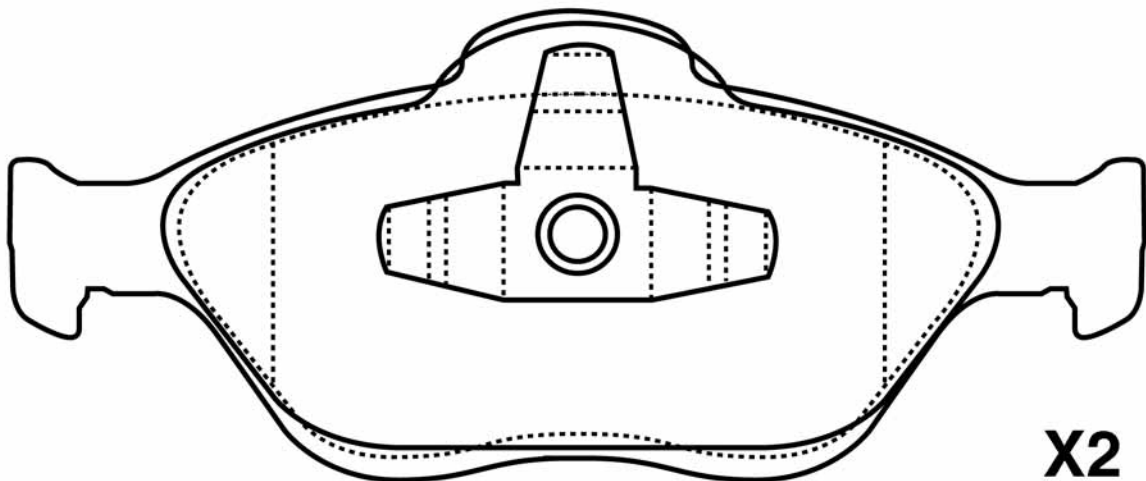
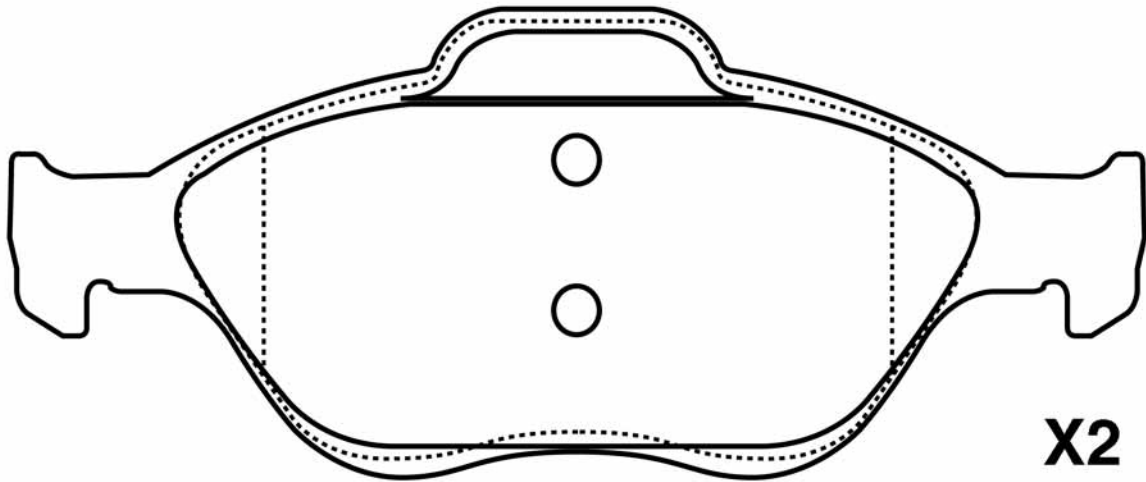



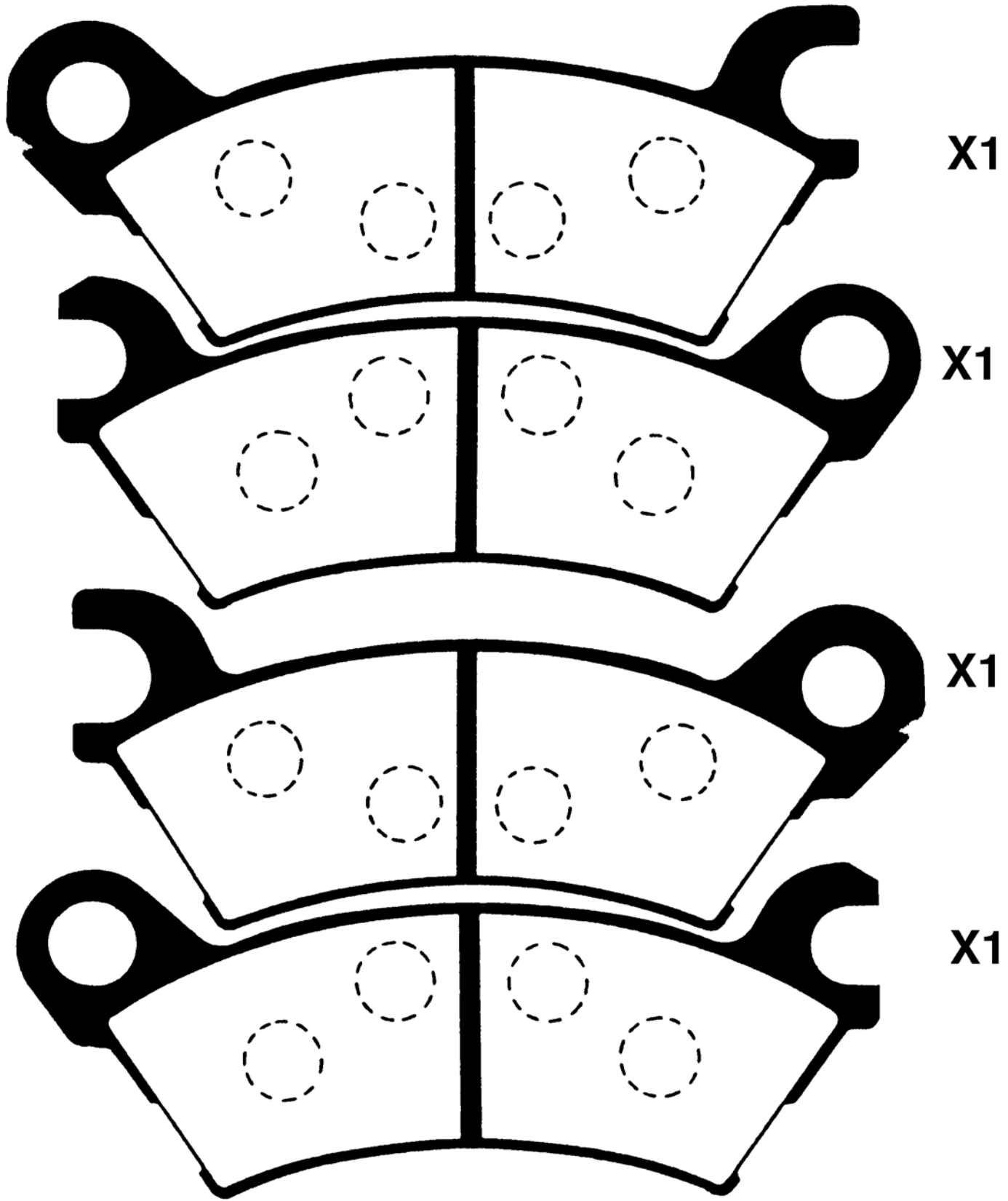

50-03-303				WVA
	MAZDA	L	H	Th
	156,2	62	14,8	21037





PICTURES BRAKE PADS FRONT
ABBILDUNGEN BREMSKLÖTZE VORN
FIGURAS PASTILLAS DE FRENO DELANTORES
ILLUSTRATIONS PLAQUETTES DE FREI AVANT
IMMAGINI PASTIGLIE FRENO ANTERIORI

50-03-304				WVA
MAZDA	L	H	Th	
	63	67,7	14	20251

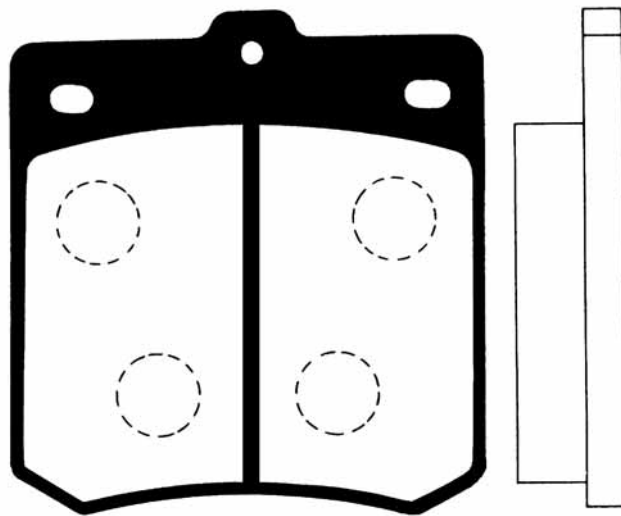

X4



50-03-305				WVA
	MAZDA	L	H	Th
	131,5	56,2	17,2	24246

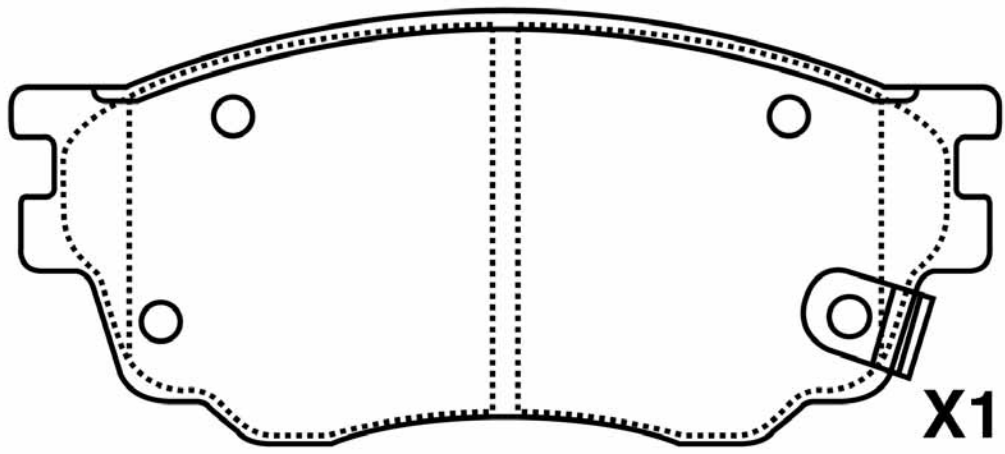
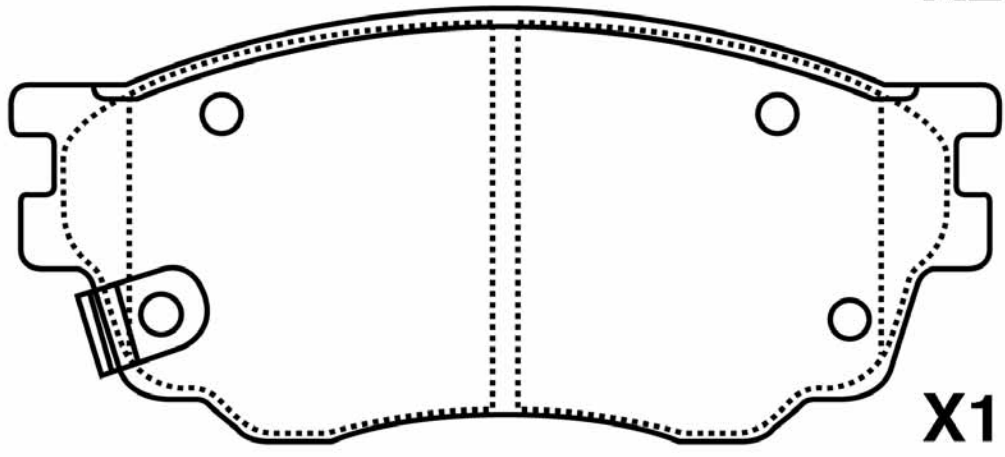
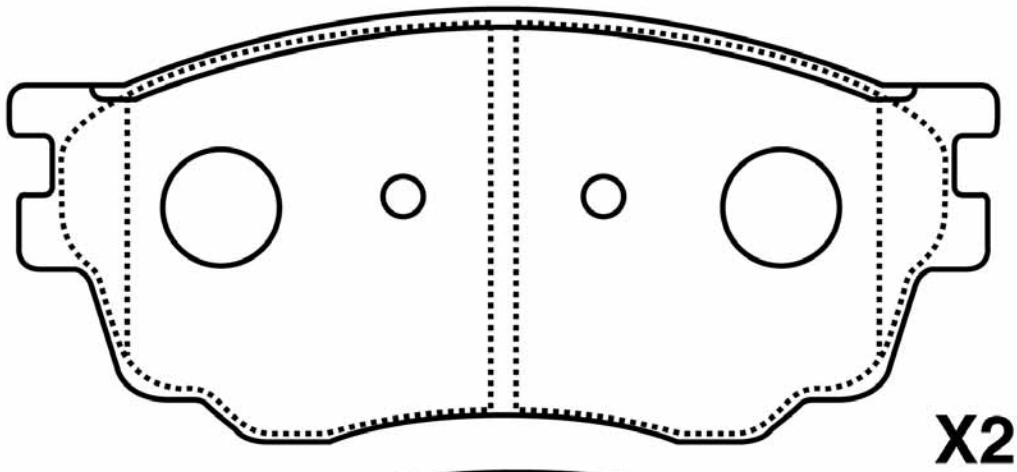



PICTURES BRAKE PADS FRONT
ABBILDUNGEN BREMSKLÖTZE VORN
FIGURAS PASTILLAS DE FRENO DELANTORES
ILLUSTRATIONS PLAQUETTES DE FREI AVANT
IMMAGINI PASTIGLIE FRENO ANTERIORI

50-03-307				WVA
MAZDA	L	H	Th	
	132,6	60,3	17,8	24046

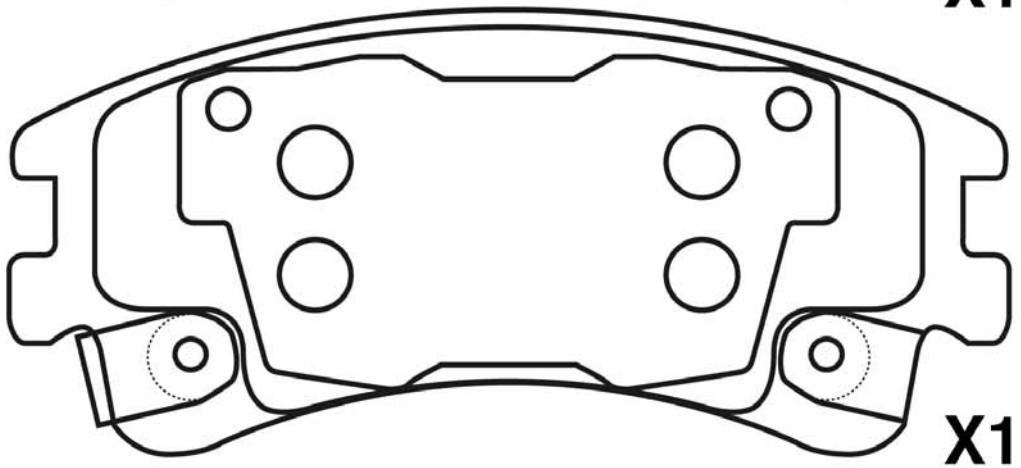
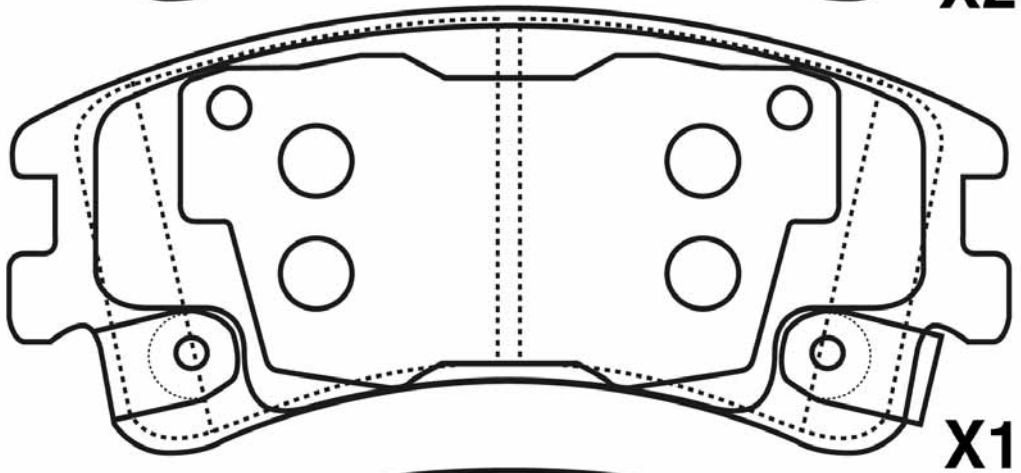
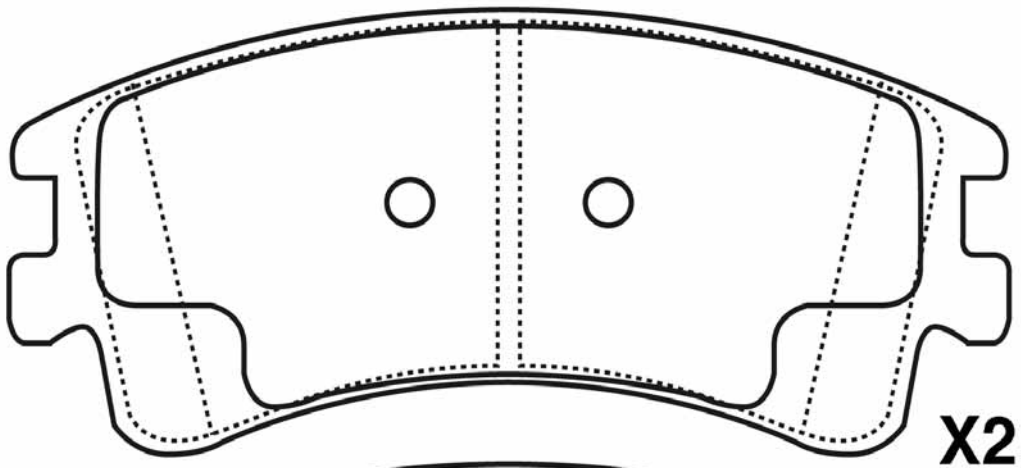



50-03-308				WVA
	MAZDA	L	H	Th
	108,7	51,4	13,8	20312

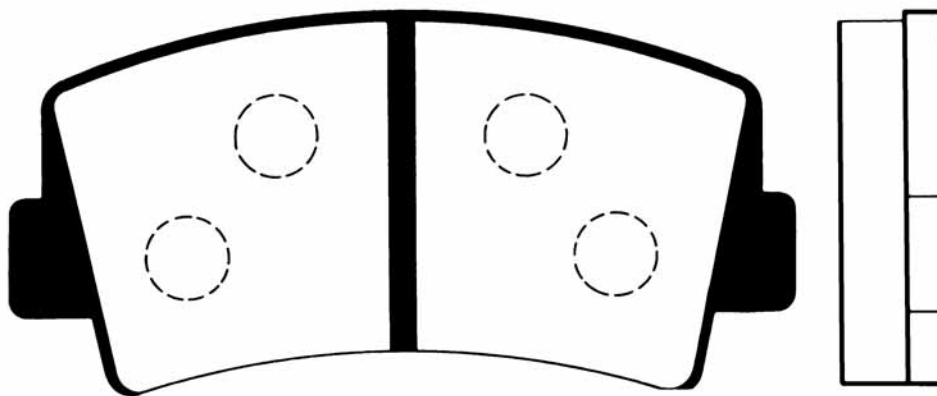

X4



PICTURES BRAKE PADS FRONT
ABBILDUNGEN BREMSKLÖTZE VORN
FIGURAS PASTILLAS DE FRENO DELANTORES
ILLUSTRATIONS PLAQUETTES DE FREI AVANT
IMMAGINI PASTIGLIE FRENO ANTERIORI

50-03-310				WVA
DAIHATSU - HYUNDAI - MITSUBISHI - TOYOTA -	L	H	Th	
	79	60,3	13,9	20519

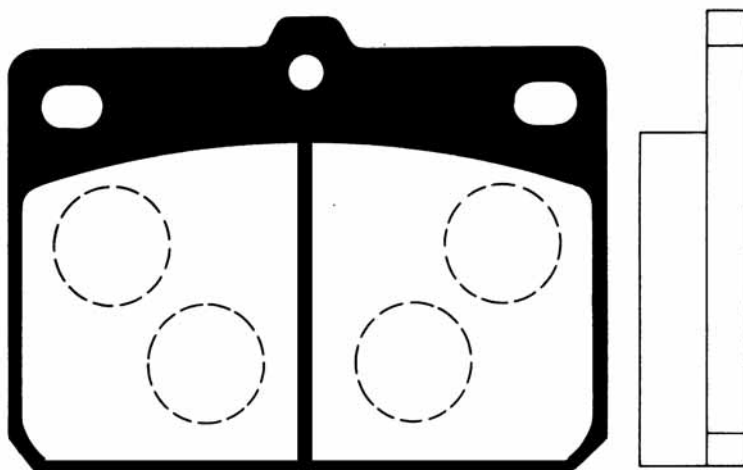

X4



50-03-311

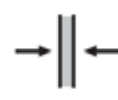
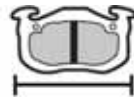

WVA

MAZDA

L

H

Th

123

52,3

15,2

23490

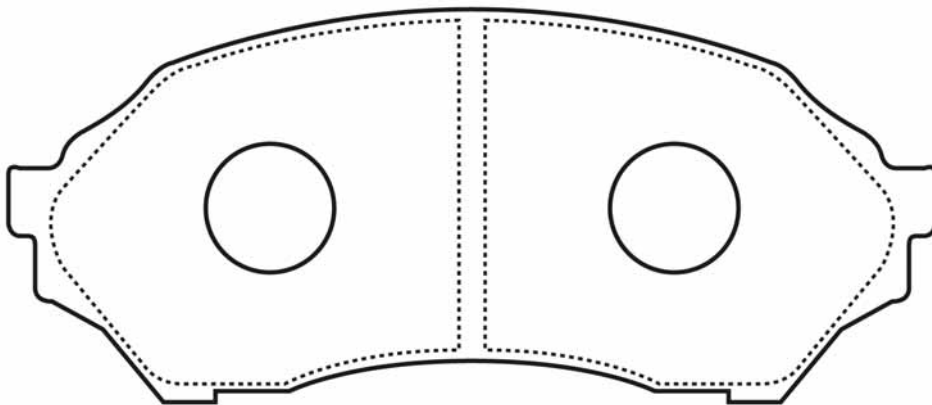

X4



PICTURES BRAKE PADS FRONT
ABBILDUNGEN BREMSKLÖTZE VORN
FIGURAS PASTILLAS DE FRENO DELANTORES
ILLUSTRATIONS PLAQUETTES DE FREI AVANT
IMMAGINI PASTIGLIE FRENO ANTERIORI

50-03-312

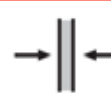

WVA

MAZDA

L

H

Th

143

55

15,7

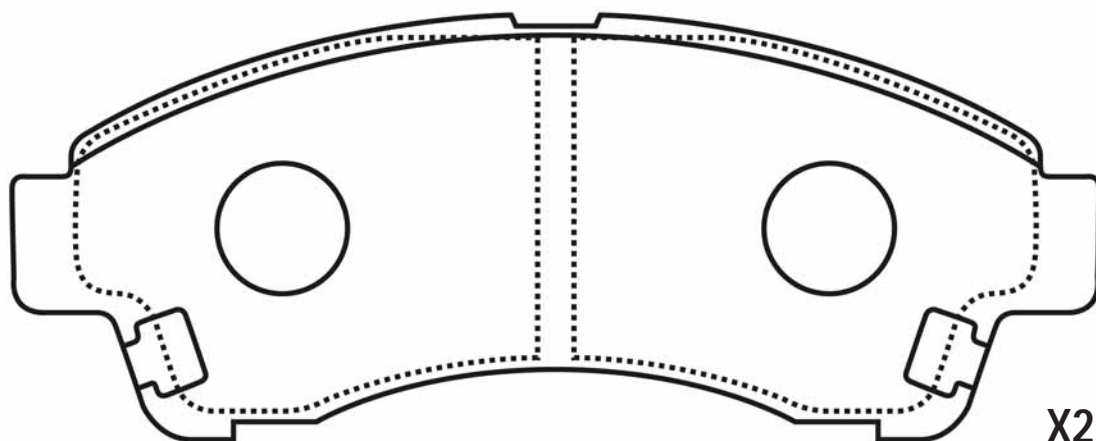

X2

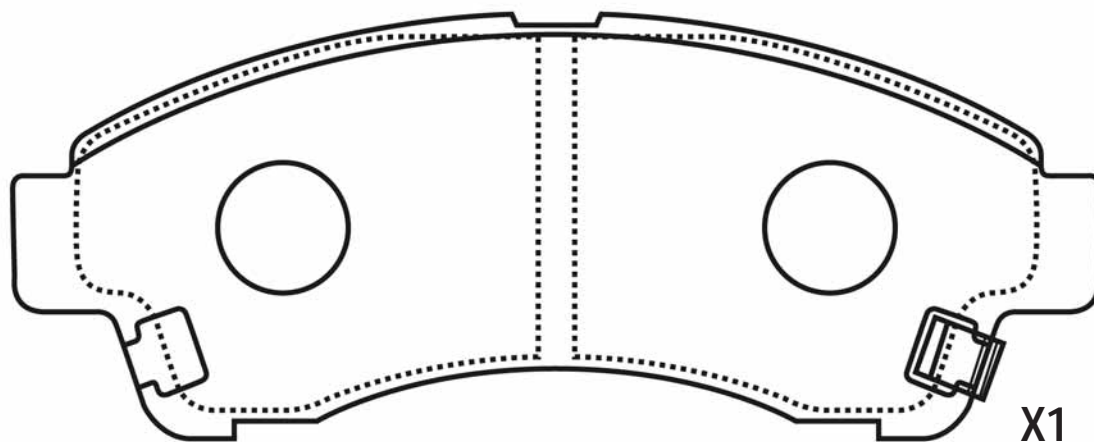

X1

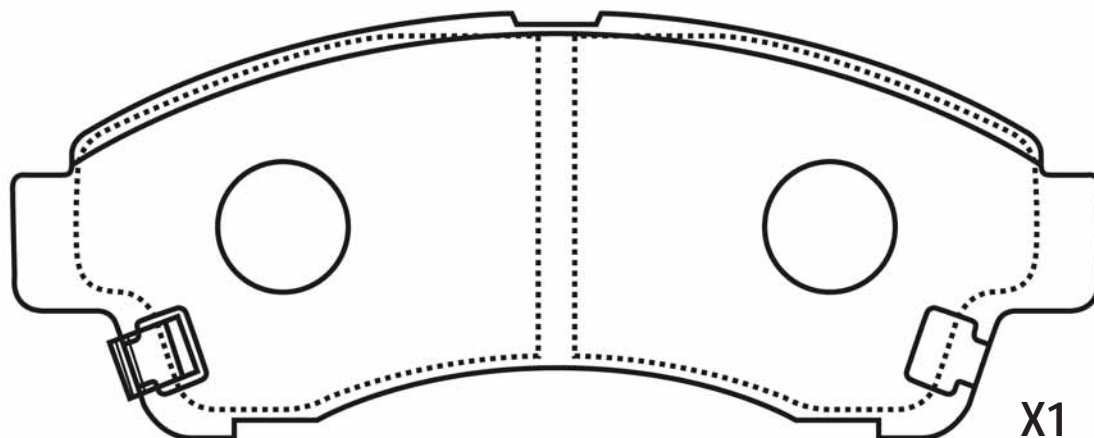

X1



50-03-313

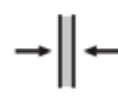
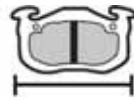

WVA

MAZDA

L

H

Th

138

62

15,7

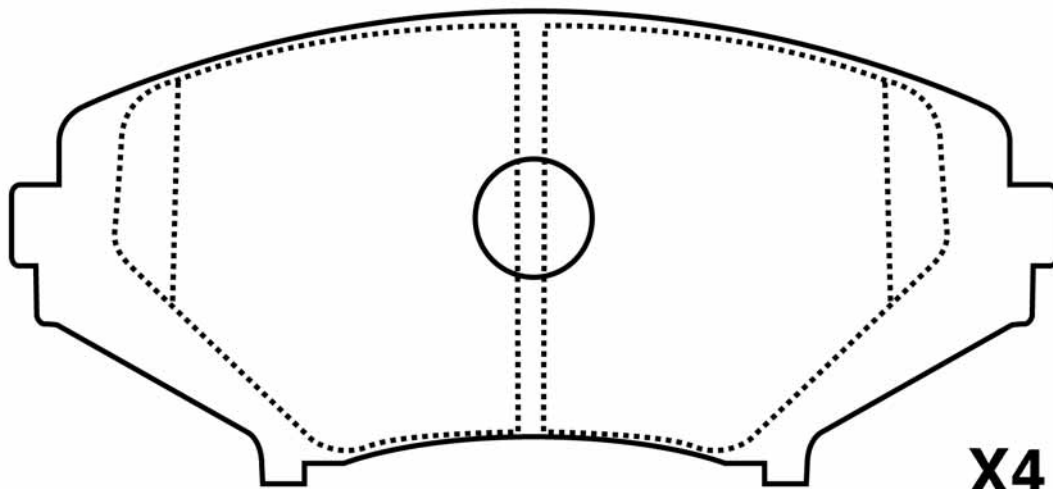

24042



X4

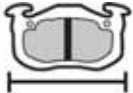

PICTURES BRAKE PADS FRONT
ABBILDUNGEN BREMSKLÖTZE VORN
FIGURAS PASTILLAS DE FRENO DELANTORES
ILLUSTRATIONS PLAQUETTES DE FREI AVANT
IMMAGINI PASTIGLIE FRENO ANTERIORI

50-03-314				WVA
MAZDA	L	H	Th	
	108	38,7	13,4	20564

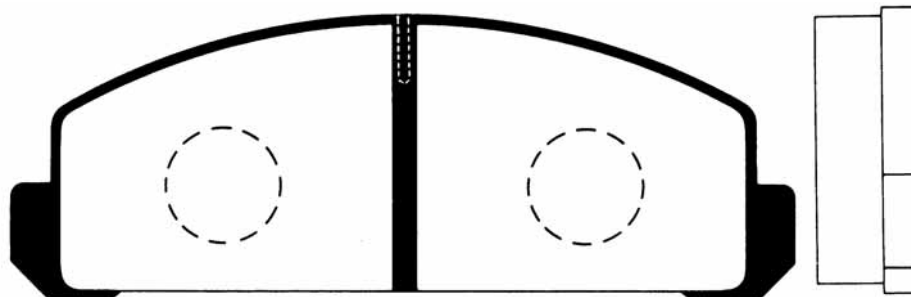

X4



50-03-315				WVA
	MAZDA	L	H	Th
	172,5	67,3	15,9	25093

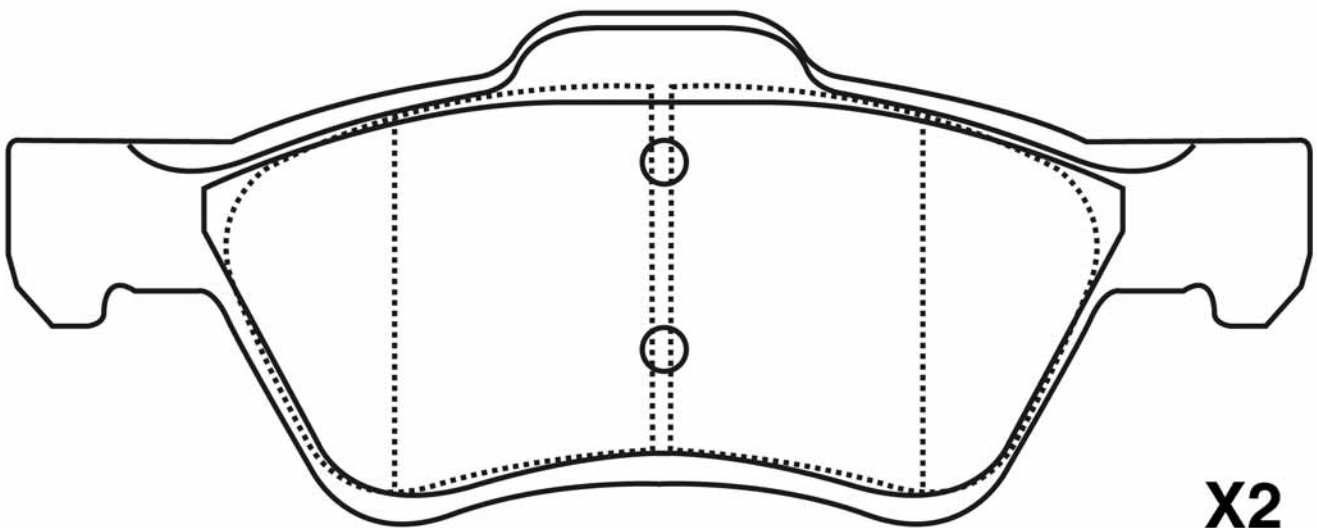

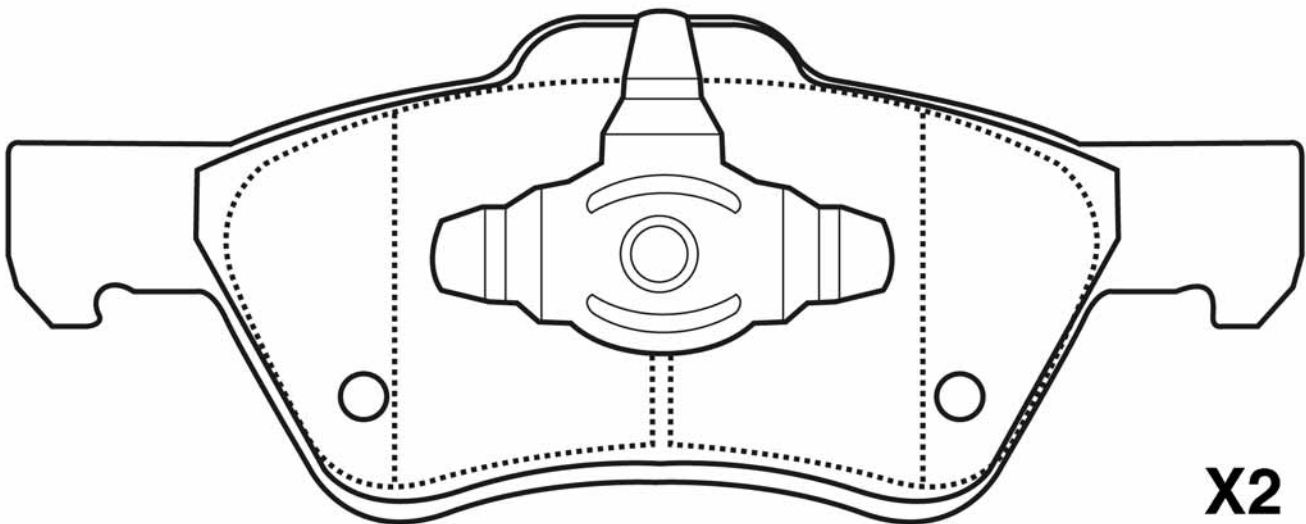

X2



X2



PICTURES BRAKE PADS FRONT
ABBILDUNGEN BREMSKLÖTZE VORN
FIGURAS PASTILLAS DE FRENO DELANTORES
ILLUSTRATIONS PLAQUETTES DE FREI AVANT
IMMAGINI PASTIGLIE FRENO ANTERIORI

50-03-316				WVA
MAZDA	L	H	Th	
	95	45,5	14	20760

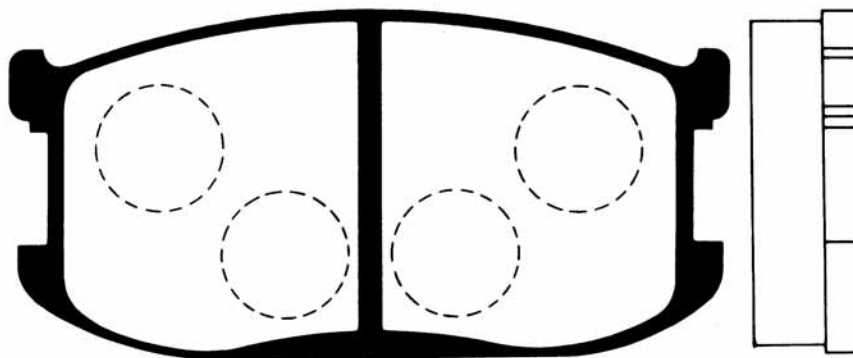

X4



50-03-317

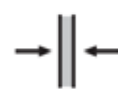
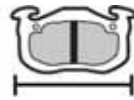

WVA

MAZDA

L

H

Th

123

58,5

14,3

23863

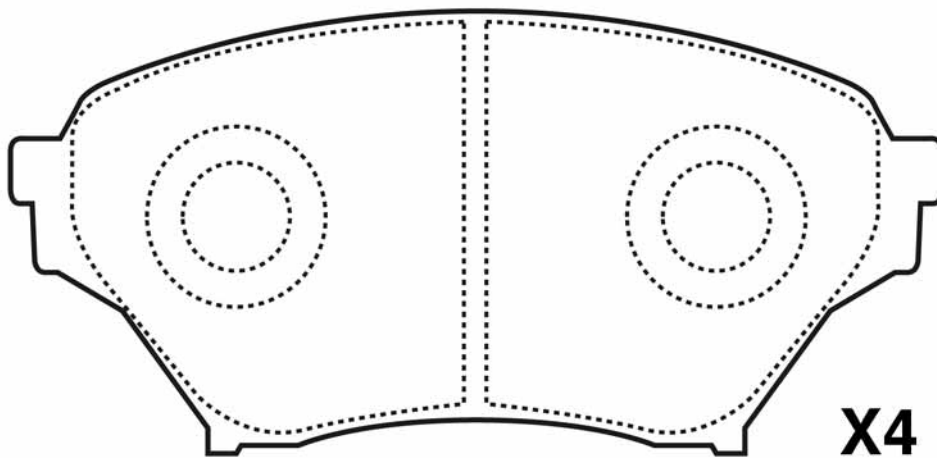



PICTURES BRAKE PADS FRONT
ABBILDUNGEN BREMSKLÖTZE VORN
FIGURAS PASTILLAS DE FRENO DELANTORES
ILLUSTRATIONS PLAQUETTES DE FREI AVANT
IMMAGINI PASTIGLIE FRENO ANTERIORI

50-03-318				WVA
	MAZDA	L	H	Th
	131,5	56	16	23777

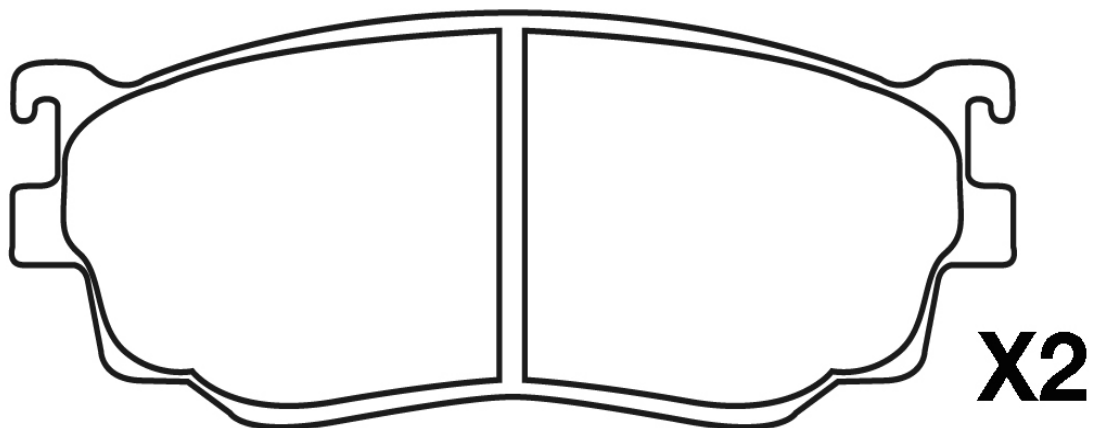
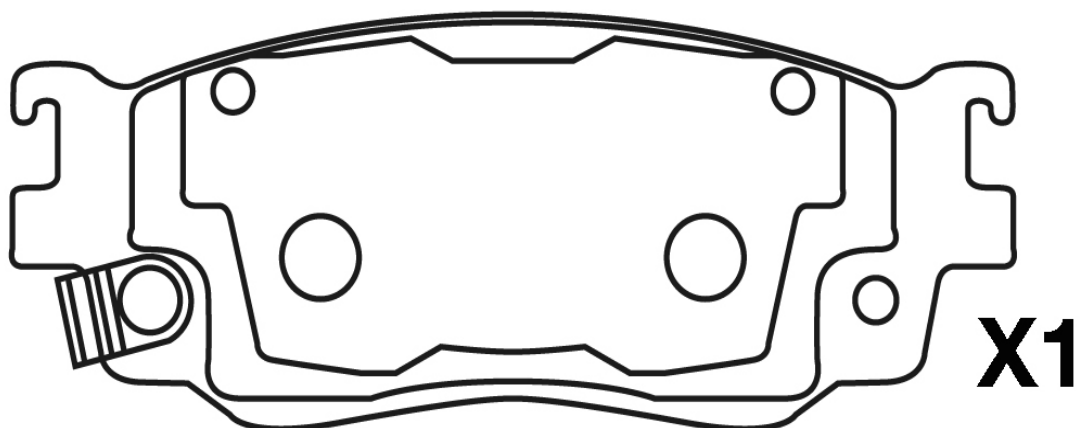
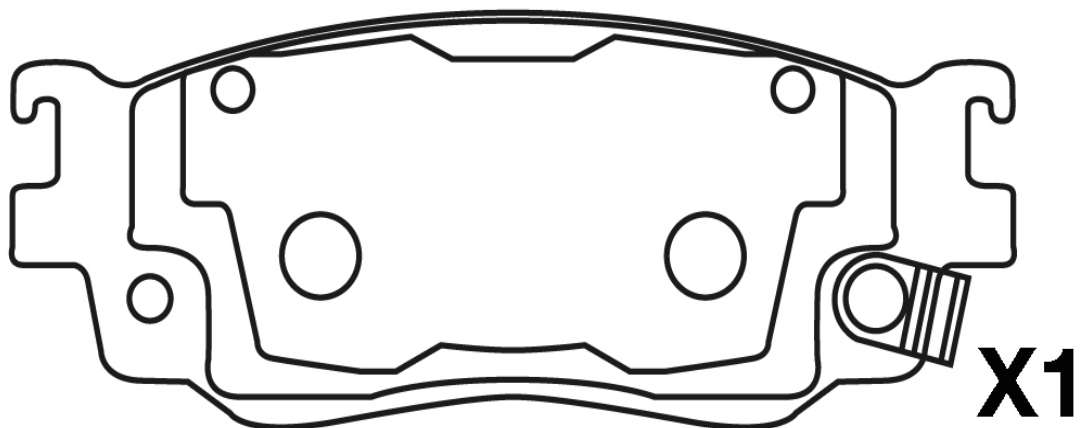



50-03-319				WVA
	MAZDA	L	H	Th
	106,4	46	14,3	20685

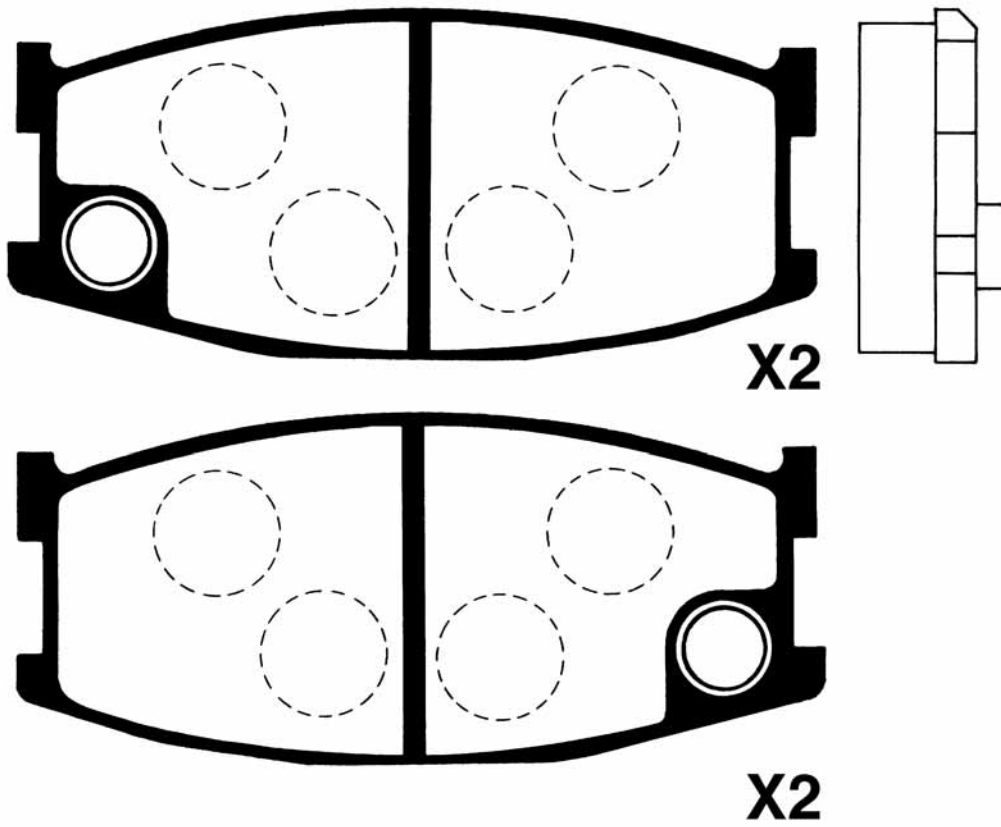



PICTURES BRAKE PADS FRONT
ABBILDUNGEN BREMSKLÖTZE VORN
FIGURAS PASTILLAS DE FRENO DELANTORES
ILLUSTRATIONS PLAQUETTES DE FREI AVANT
IMMAGINI PASTIGLIE FRENO ANTERIORI

50-03-320				WVA
MAZDA	L	H	Th	
	128,3	45,3	15,8	20539

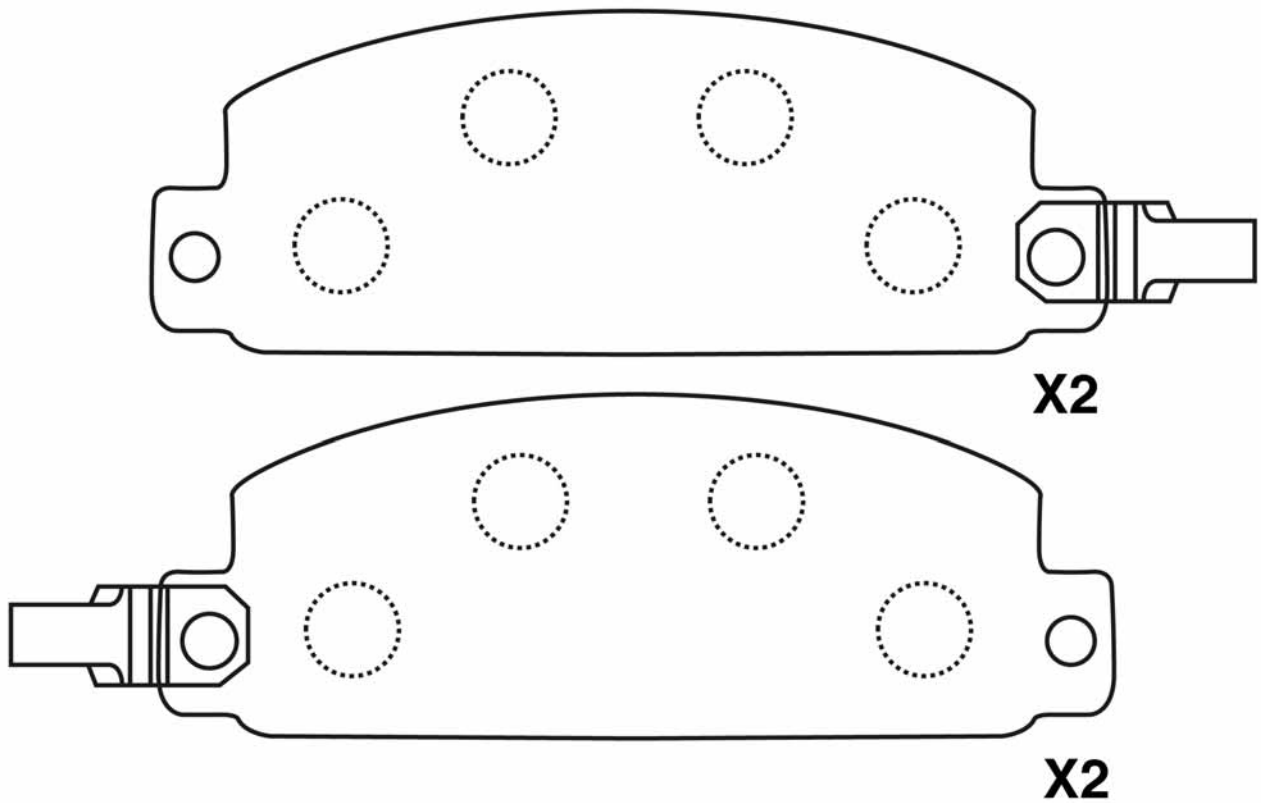



50-03-322				WVA
	MAZDA	L	H	
	156	66,3	17,9	23787

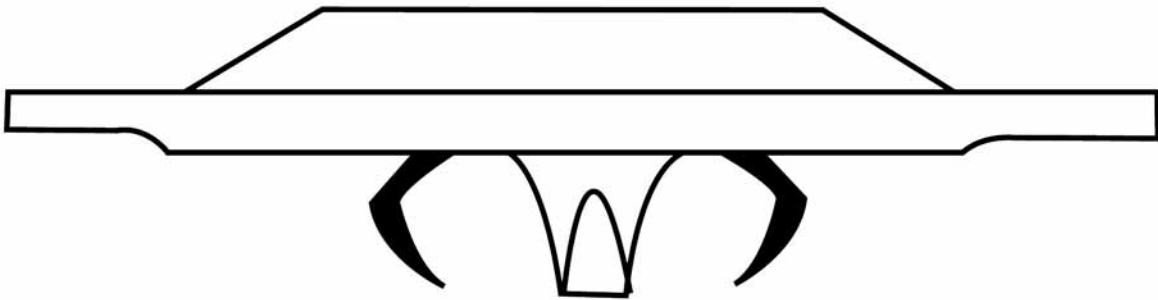
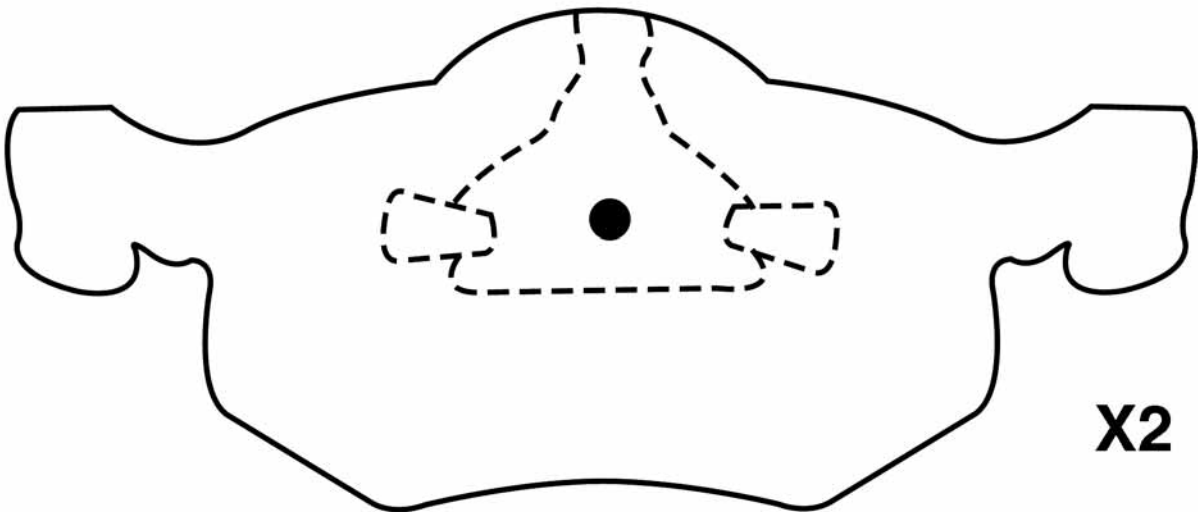
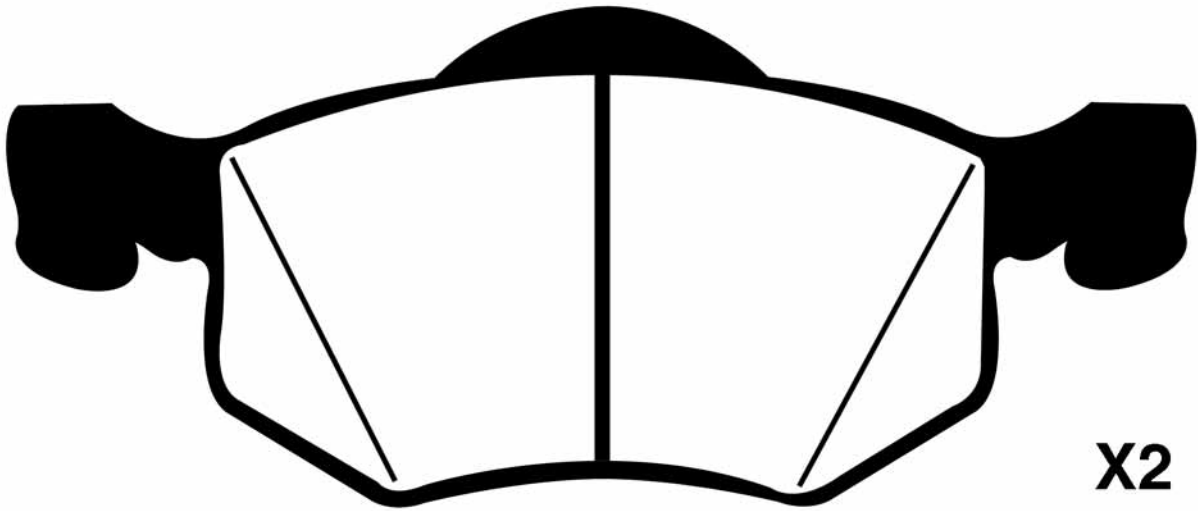



PICTURES BRAKE PADS FRONT
ABBILDUNGEN BREMSKLÖTZE VORN
FIGURAS PASTILLAS DE FRENO DELANTORES
ILLUSTRATIONS PLAQUETTES DE FREI AVANT
IMMAGINI PASTIGLIE FRENO ANTERIORI

50-03-323

MAZDA - FORD

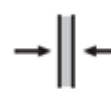
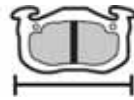

WVA

L

H

Th

145

58

16

24353

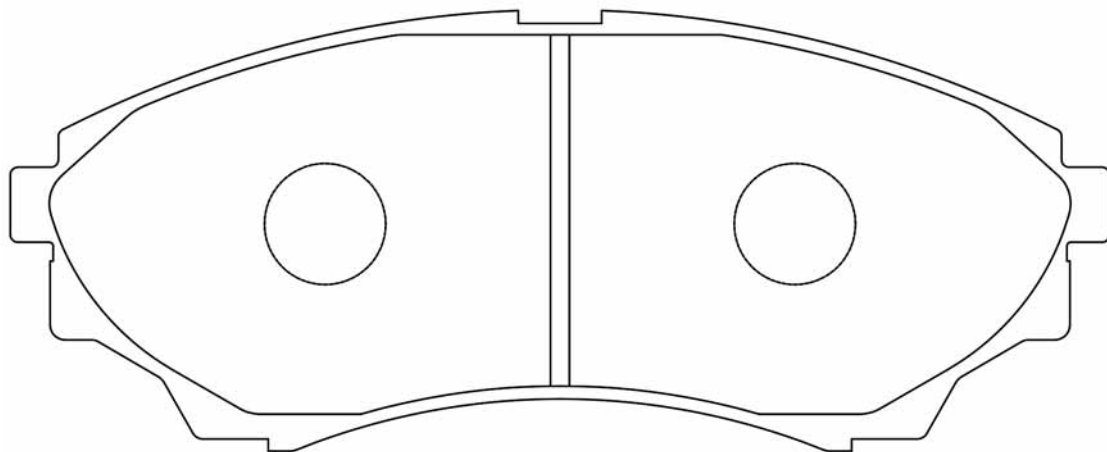
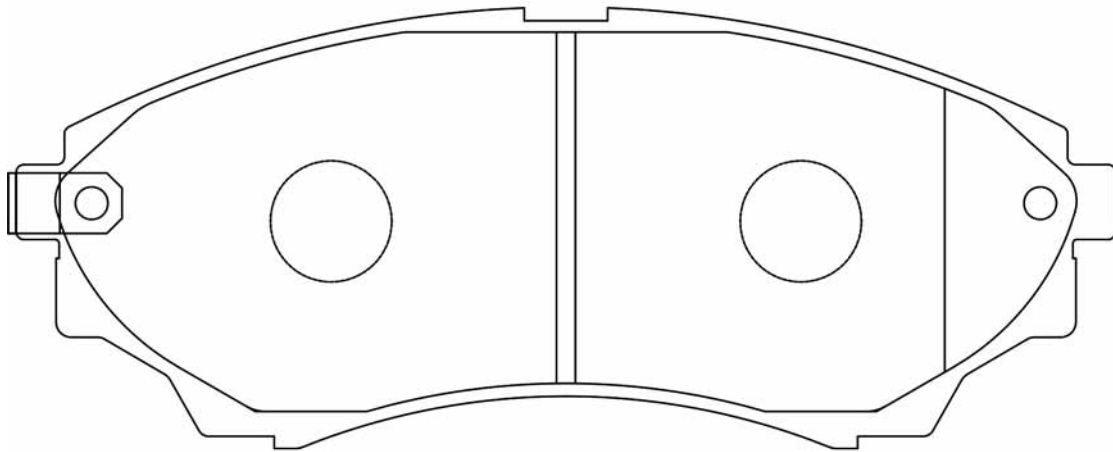



50-03-325				WVA
	KIA - FORD - MAZDA	L 133	H 52,3	Th 15
				20191

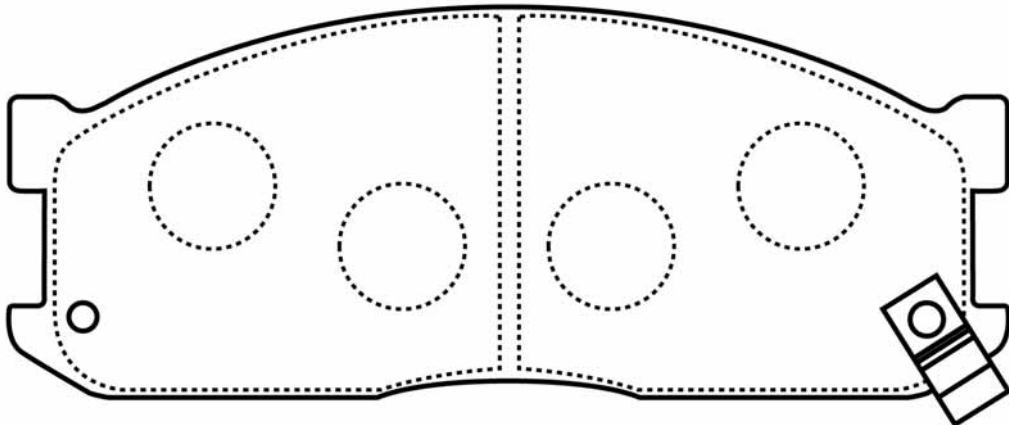

X1

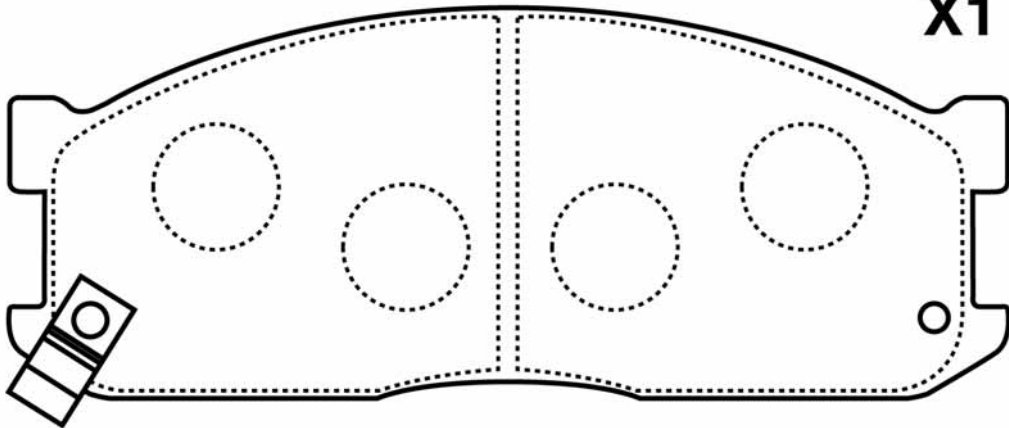

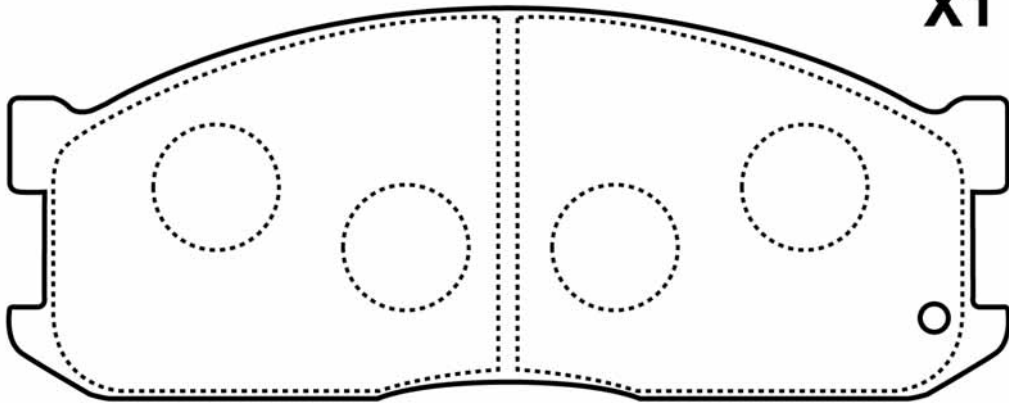

X1



X2



PICTURES BRAKE PADS FRONT
ABBILDUNGEN BREMSKLÖTZE VORN
FIGURAS PASTILLAS DE FRENO DELANTORES
ILLUSTRATIONS PLAQUETTES DE FREI AVANT
IMMAGINI PASTIGLIE FRENO ANTERIORI

50-03-326				WVA
	MAZDA	L	H	
	92	64,4	14	20039

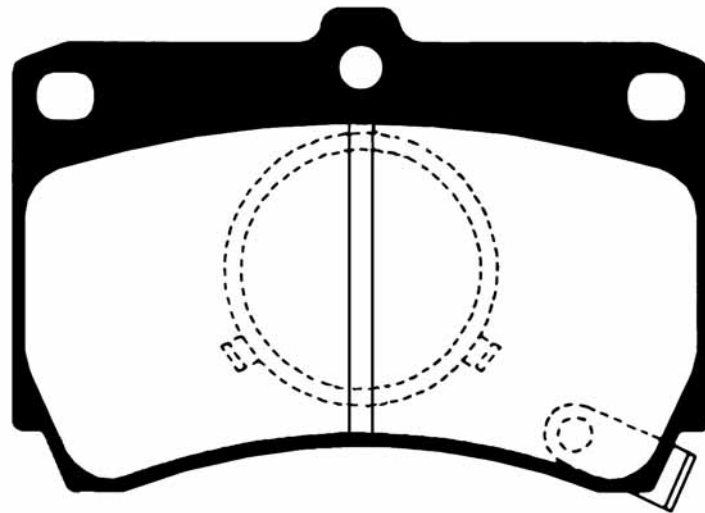

X1 LEFT
X1 RIGHT

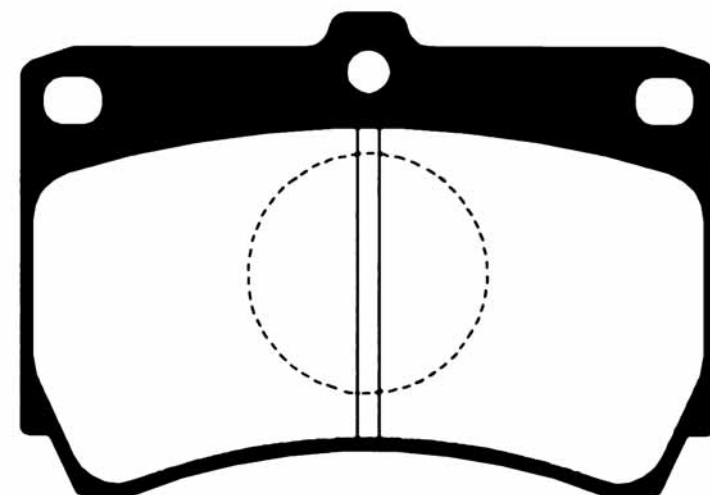
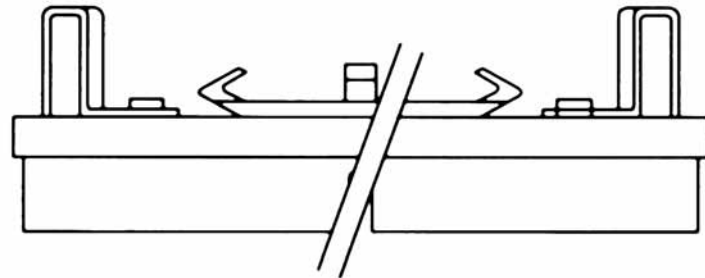

X2

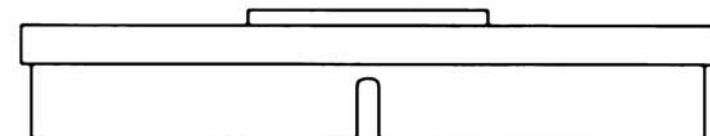



50-03-328				WVA
	MAZDA	L	H	Th
	128	45	13,8	20539

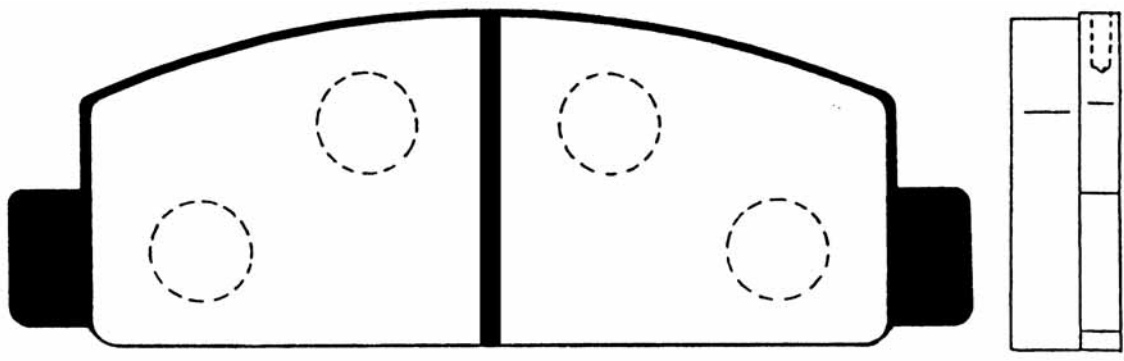

X4



PICTURES BRAKE PADS FRONT
ABBILDUNGEN BREMSKLÖTZE VORN
FIGURAS PASTILLAS DE FRENO DELANTORES
ILLUSTRATIONS PLAQUETTES DE FREI AVANT
IMMAGINI PASTIGLIE FRENO ANTERIORI

50-03-329				WVA
MAZDA	L	H	Th	
	106,6	77,2/67,4	14,5	20878

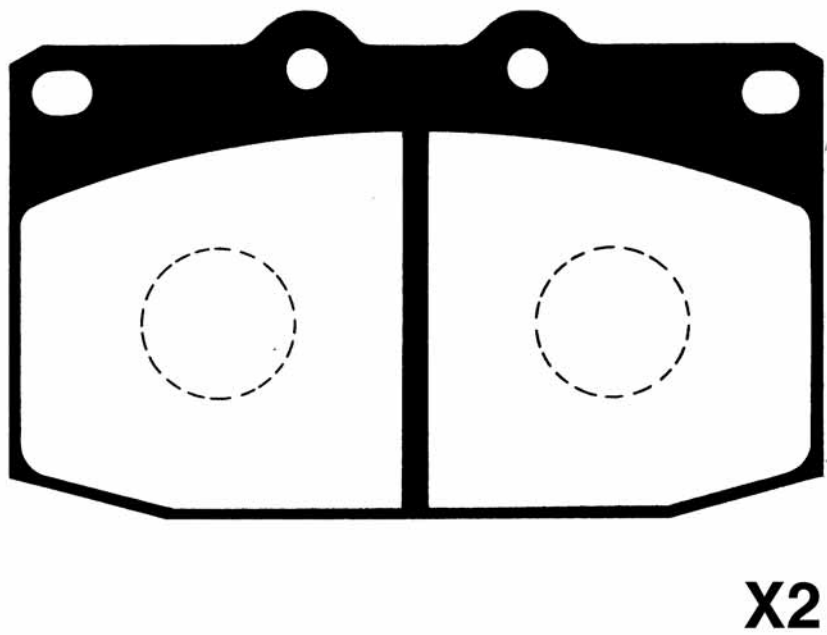
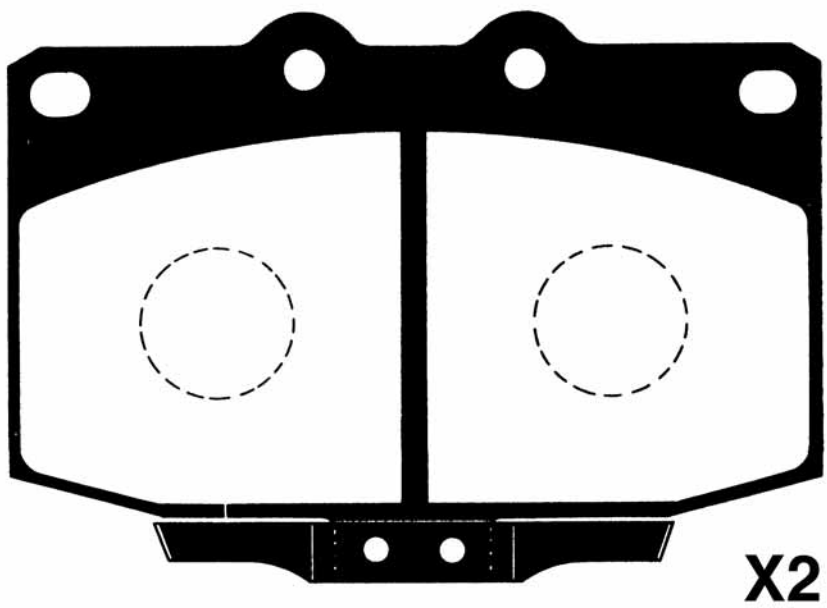



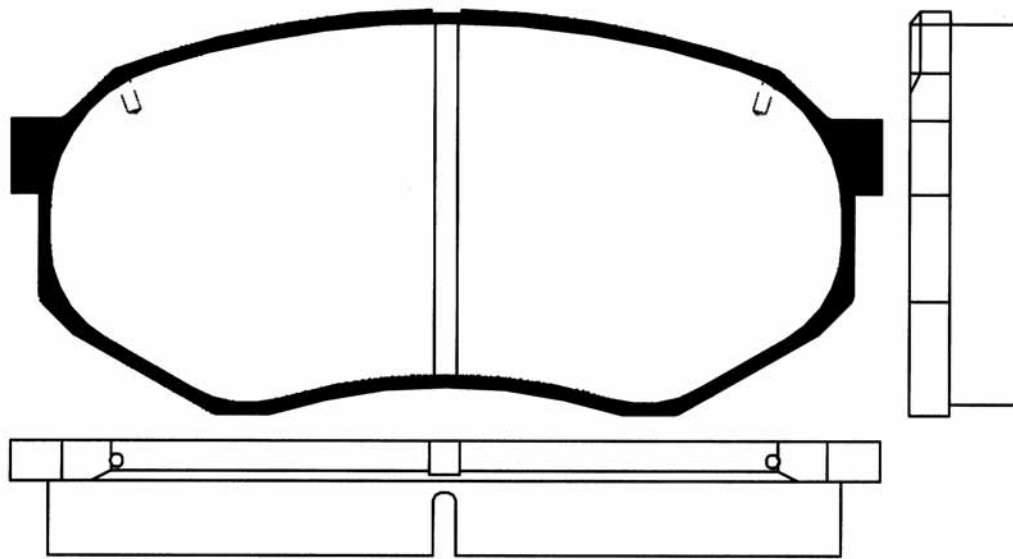

50-03-330				WVA
	MAZDA	L	H	
	116	53,7	14,8	21537



X4



PICTURES BRAKE PADS FRONT
ABBILDUNGEN BREMSKLÖTZE VORN
FIGURAS PASTILLAS DE FRENO DELANTORES
ILLUSTRATIONS PLAQUETTES DE FREI AVANT
IMMAGINI PASTIGLIE FRENO ANTERIORI

50-03-331				WVA
MAZDA	L	H	Th	
	130,4	52,7	14,4	21379

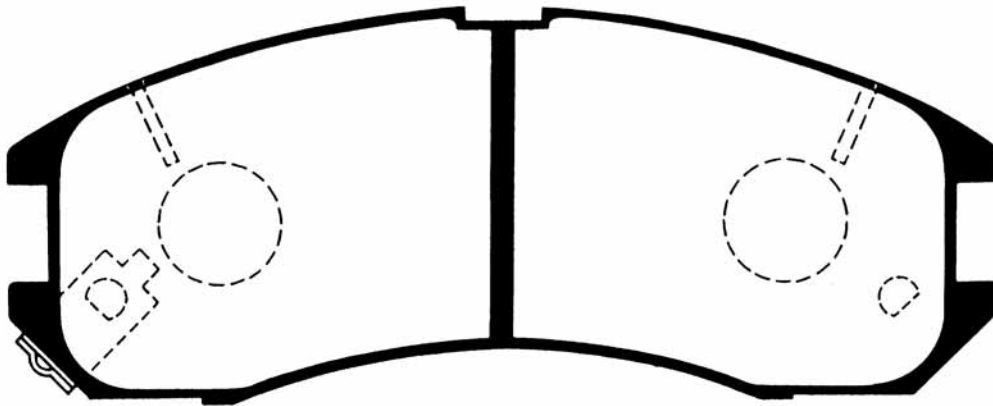

X1

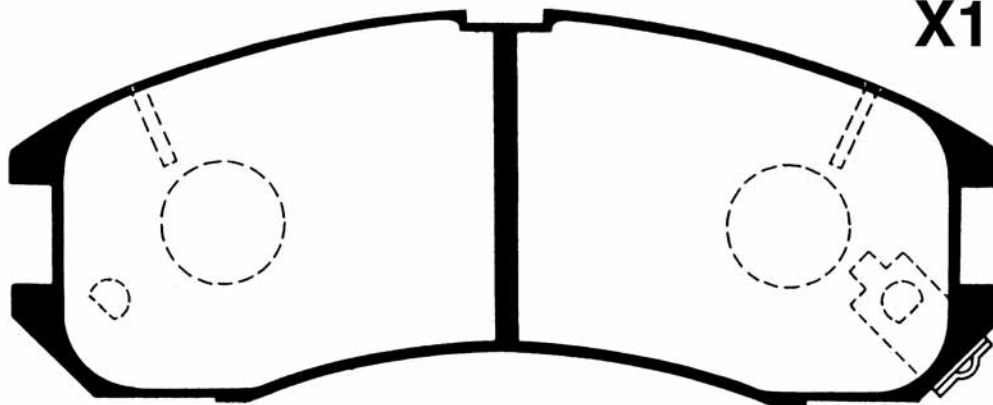

X1

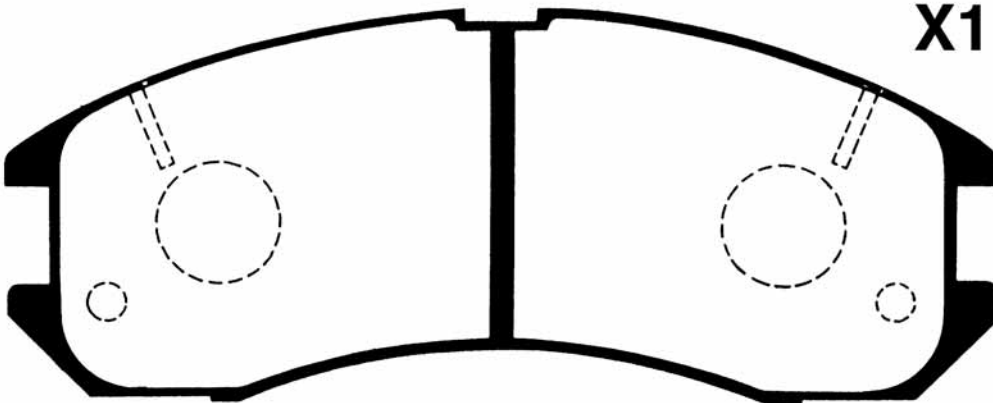

X2

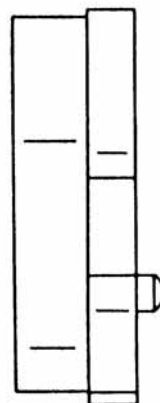
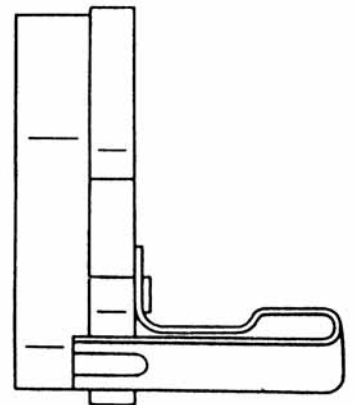



50-03-332				WVA
	KIA - MAZDA	L 78,7	H 63	
				21355

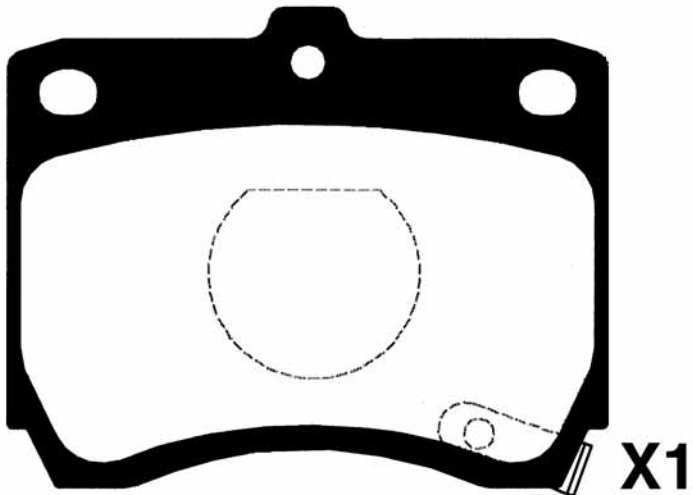
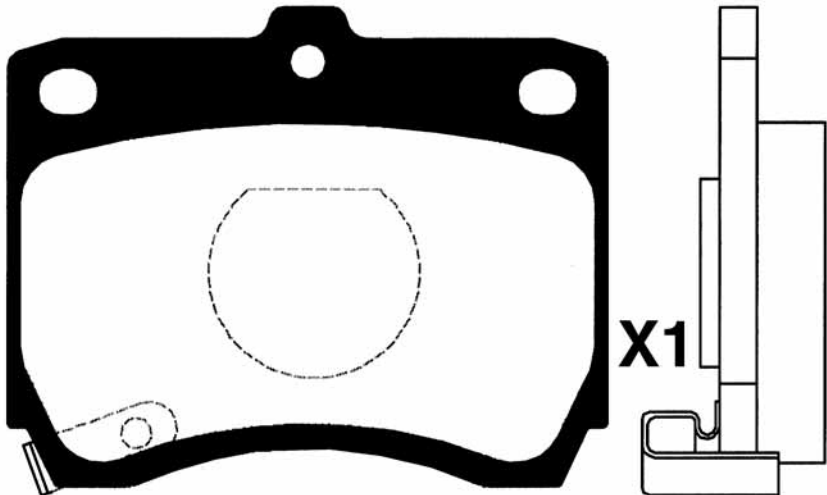
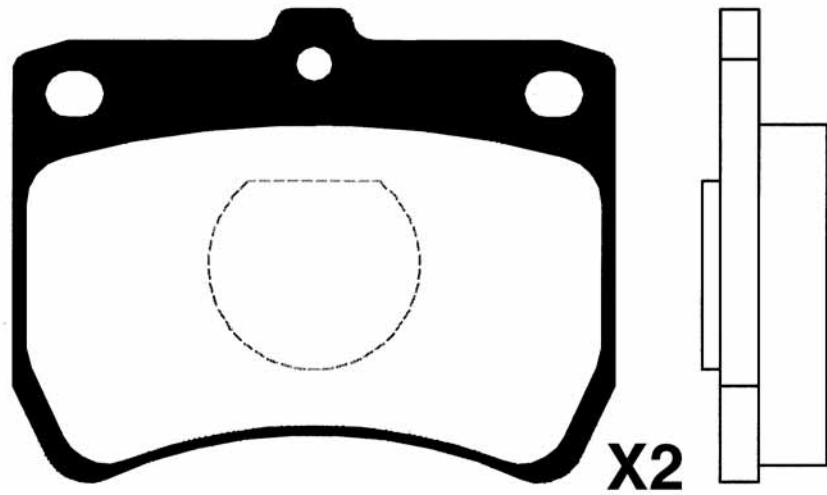



PICTURES BRAKE PADS FRONT
ABBILDUNGEN BREMSKLÖTZE VORN
FIGURAS PASTILLAS DE FRENO DELANTORES
ILLUSTRATIONS PLAQUETTES DE FREI AVANT
IMMAGINI PASTIGLIE FRENO ANTERIORI

50-03-335		WVA		
MAZDA	L	H	Th	
	123	58,5	14,3	

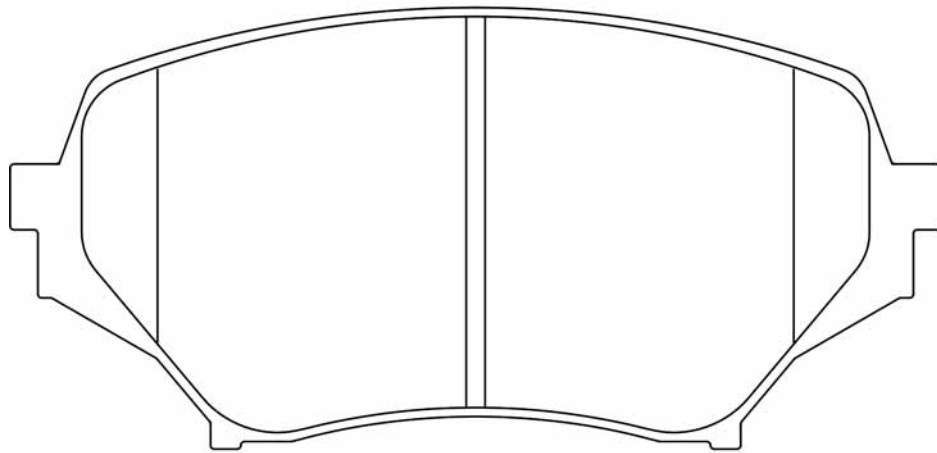

PICTURES BRAKE PADS FRONT
ABBILDUNGEN BREMSKLÖTZE VORN
FIGURAS PASTILLAS DE FRENO DELANTORES
ILLUSTRATIONS PLAQUETTES DE FREI AVANT
IMMAGINI PASTIGLIE FRENO ANTERIORI



50-03-336

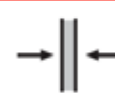

WVA

MAZDA

L

H

Th

139

57

17,3

24544

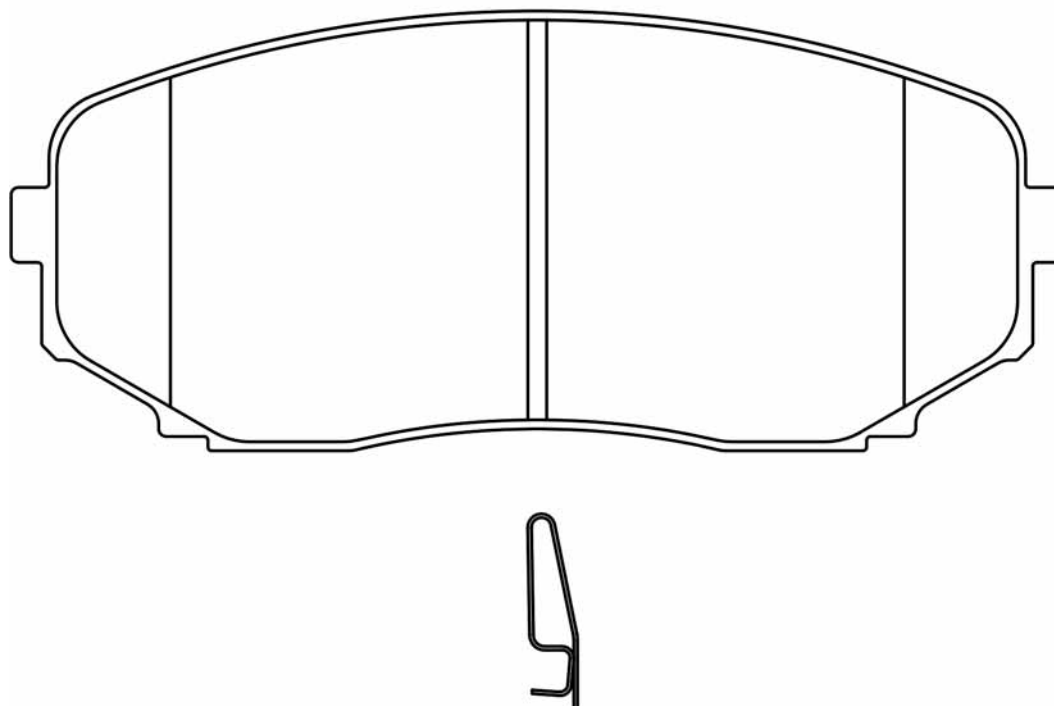



PICTURES BRAKE PADS FRONT
ABBILDUNGEN BREMSKLÖTZE VORN
FIGURAS PASTILLAS DE FRENO DELANTORES
ILLUSTRATIONS PLAQUETTES DE FREI AVANT
IMMAGINI PASTIGLIE FRENO ANTERIORI

50-03-337				WVA
	HYUNDAI	L	H	
	155	54	15,3	21529

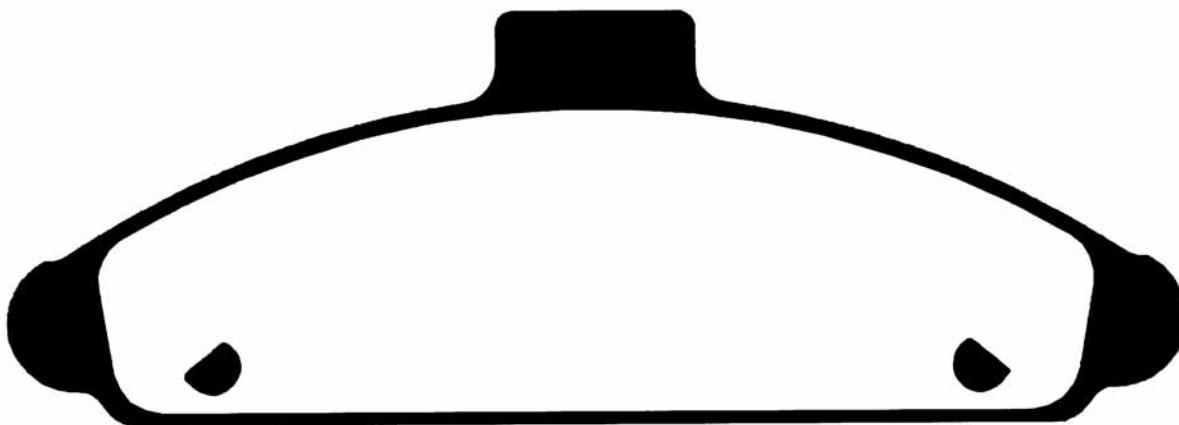

X2

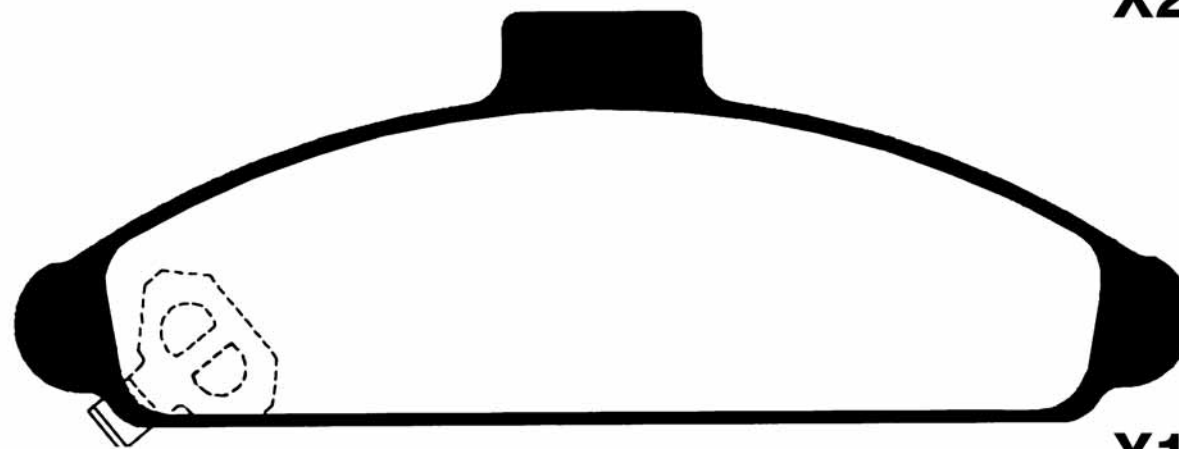
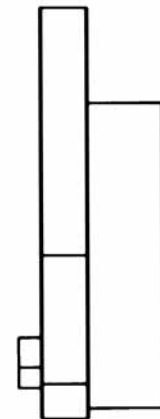

X1

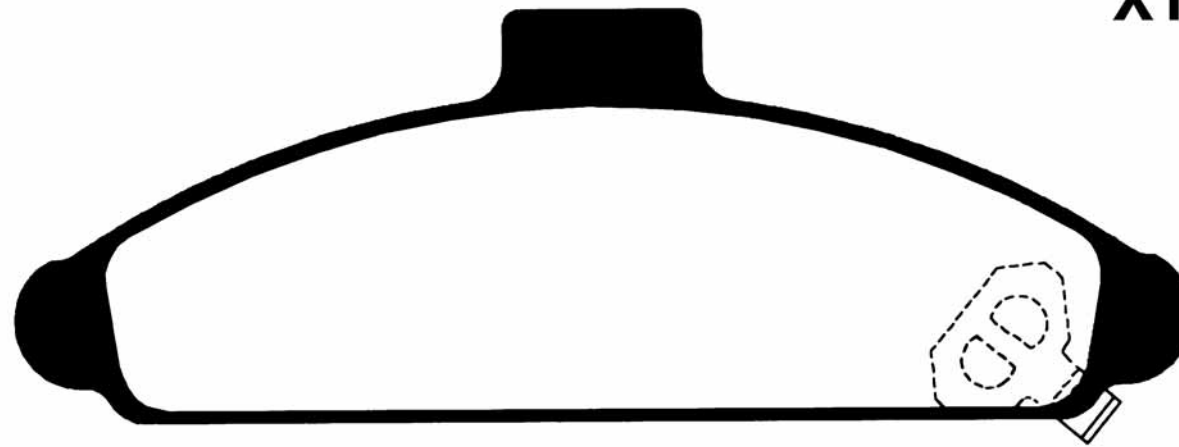
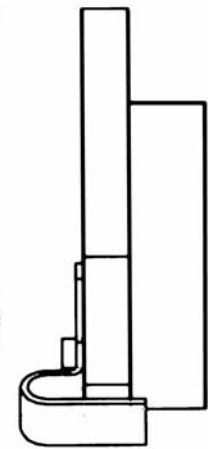

X1



50-03-339				WVA
	HONDA - HYUNDAI - MITSUBISHI	L	H	Th
	127	48,7	15	

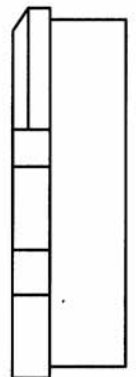
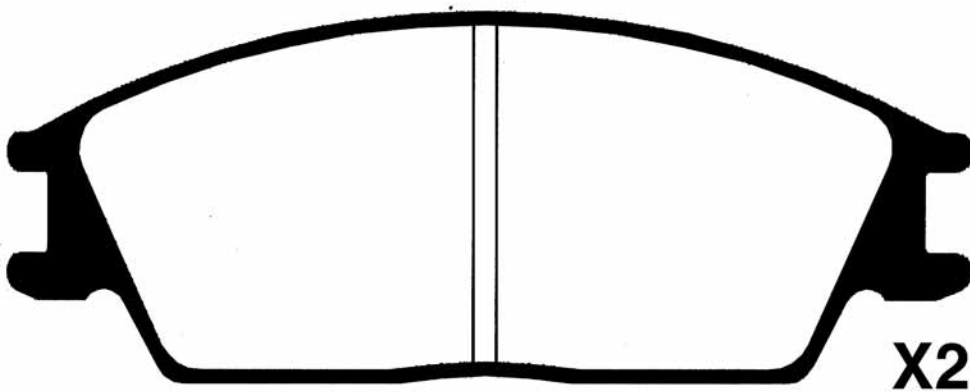
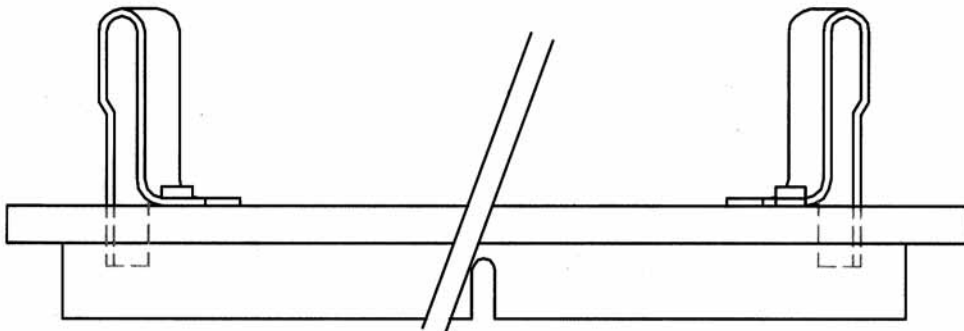
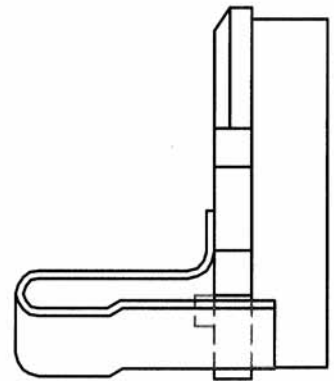
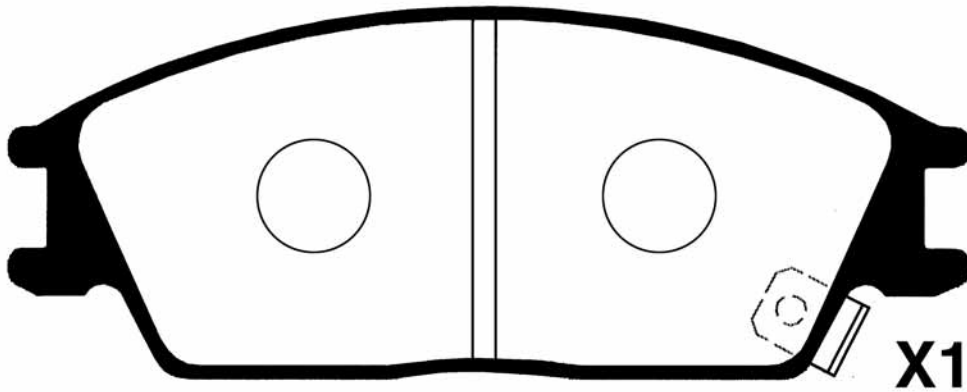
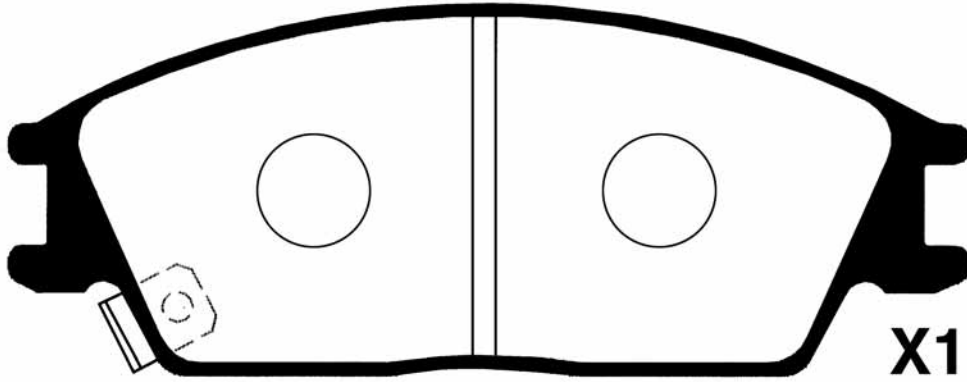



PICTURES BRAKE PADS FRONT
ABBILDUNGEN BREMSKLÖTZE VORN
FIGURAS PASTILLAS DE FRENO DELANTORES
ILLUSTRATIONS PLAQUETTES DE FREI AVANT
IMMAGINI PASTIGLIE FRENO ANTERIORI

50-03-340				WVA
MAZDA	L	H	Th	
	110,3	46,2	13,9	21552

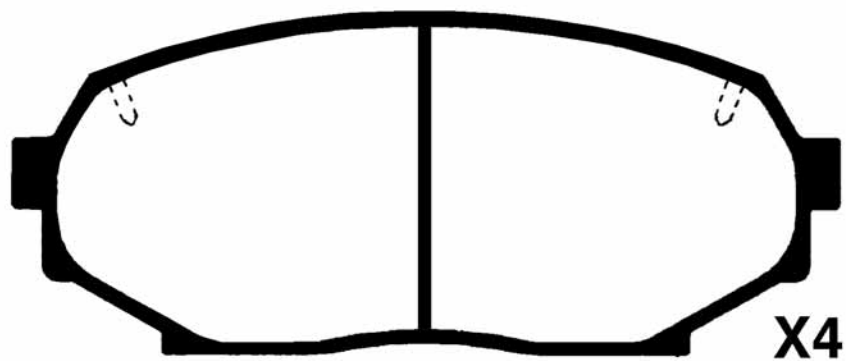



50-03-341				WVA
	MAZDA - KIA	L	H	
	91,6	64,6	14	21655

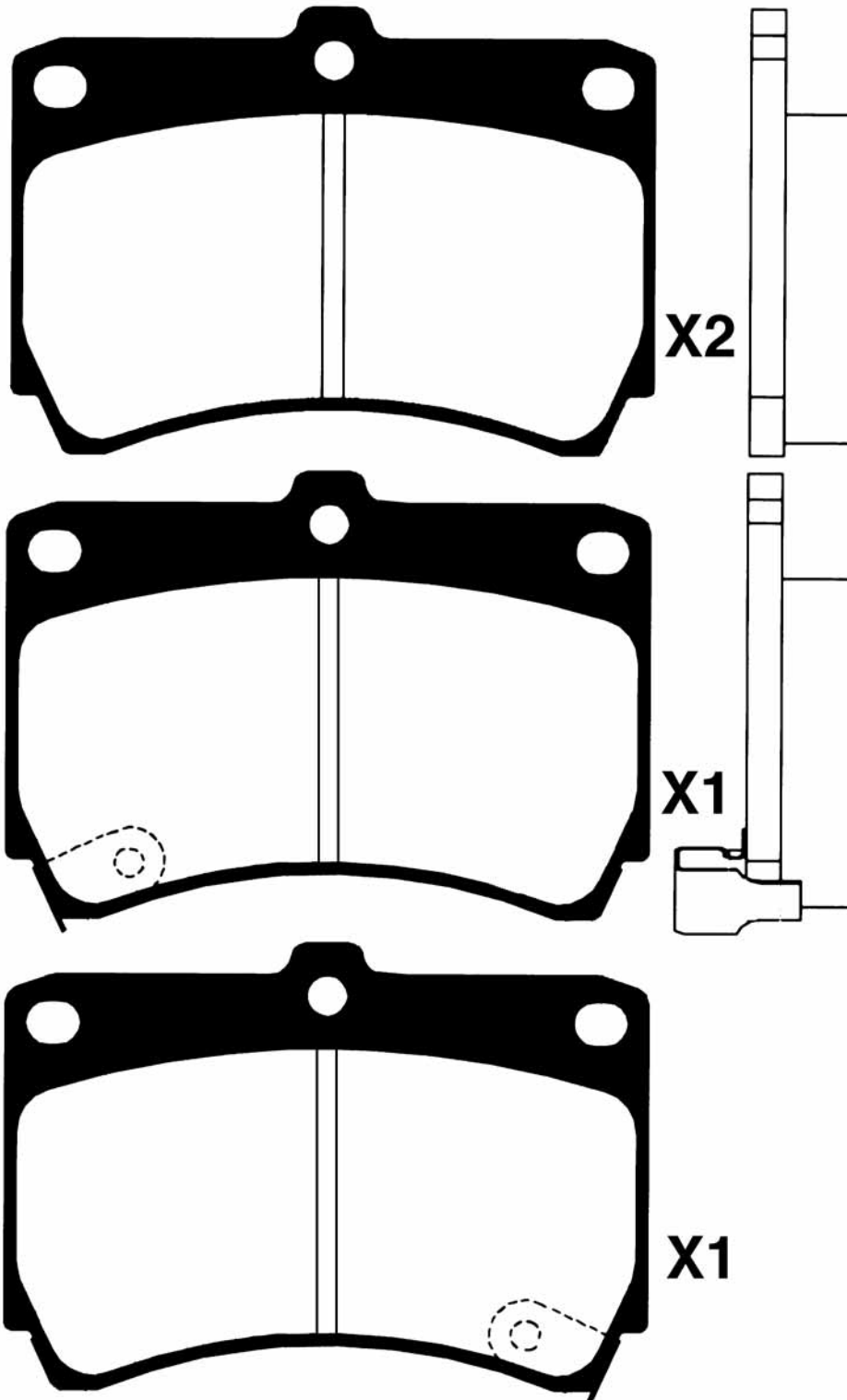



PICTURES BRAKE PADS FRONT
ABBILDUNGEN BREMSKLÖTZE VORN
FIGURAS PASTILLAS DE FRENO DELANTORES
ILLUSTRATIONS PLAQUETTES DE FREI AVANT
IMMAGINI PASTIGLIE FRENO ANTERIORI

50-03-342				WVA
MAZDA	L	H	Th	
	91,7	71,5	14,8	21541

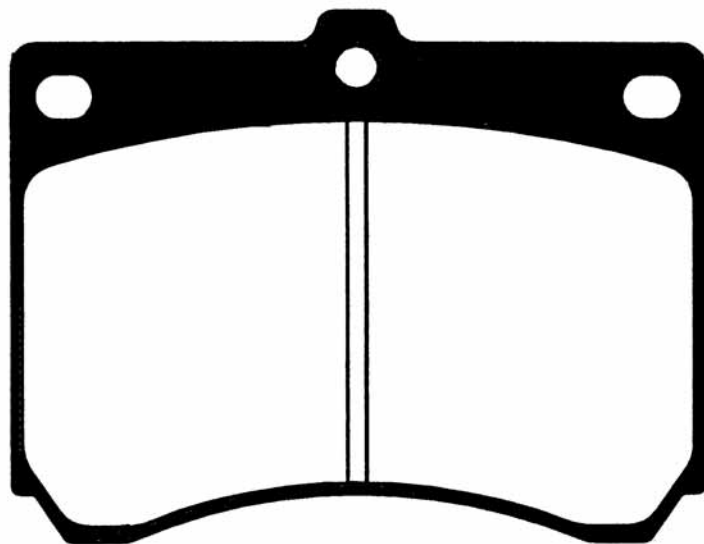

X2

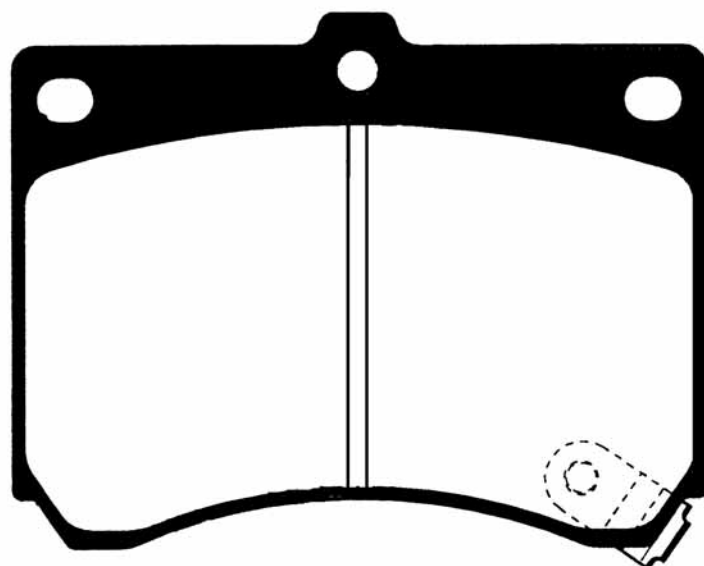

**X1 LEFT
X1 RIGHT**



PICTURES BRAKE PADS FRONT
ABBILDUNGEN BREMSKLÖTZE VORN
FIGURAS PASTILLAS DE FRENO DELANTORES
ILLUSTRATIONS PLAQUETTES DE FREI AVANT
IMMAGINI PASTIGLIE FRENO ANTERIORI



50-03-343

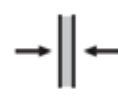
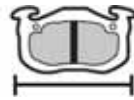

WVA

**MAZDA - SUZUKI - FORD -
DAIHATSU**

L

H

Th

126

52

16,5

24283

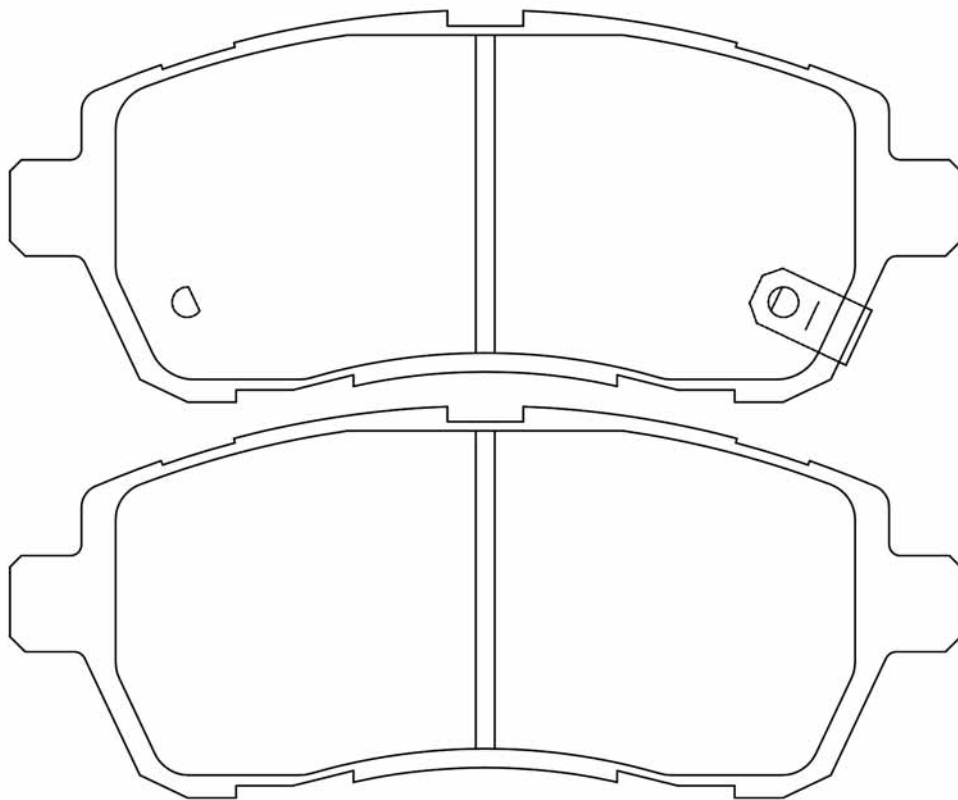



PICTURES BRAKE PADS FRONT
ABBILDUNGEN BREMSKLÖTZE VORN
FIGURAS PASTILLAS DE FRENO DELANTORES
ILLUSTRATIONS PLAQUETTES DE FREI AVANT
IMMAGINI PASTIGLIE FRENO ANTERIORI

50-03-344

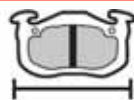

WVA

MAZDA

L

H

Th

155

74

19

24002

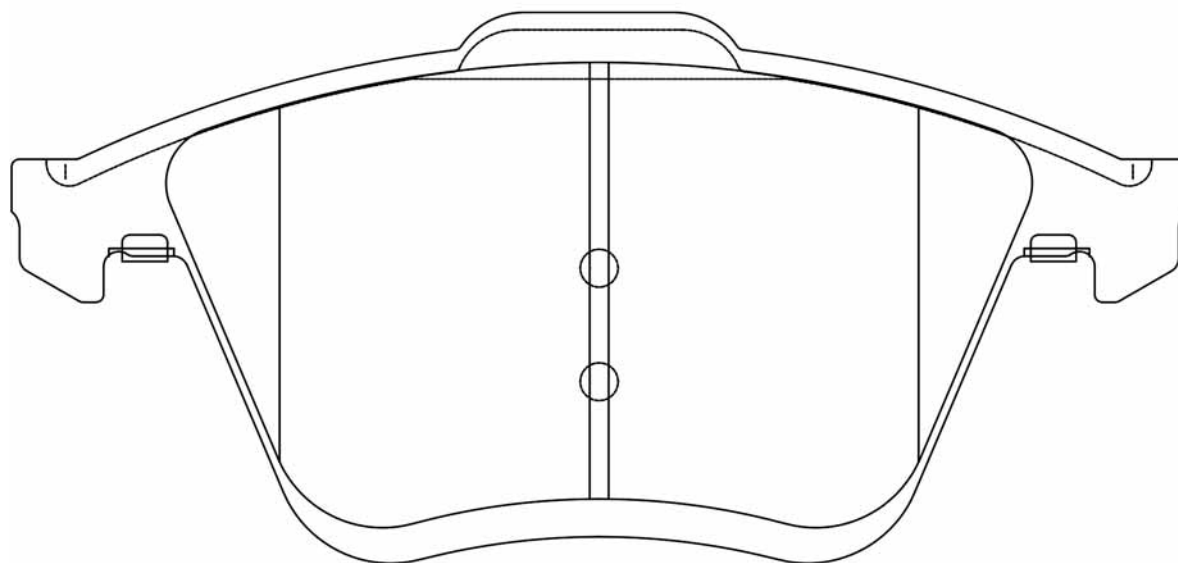
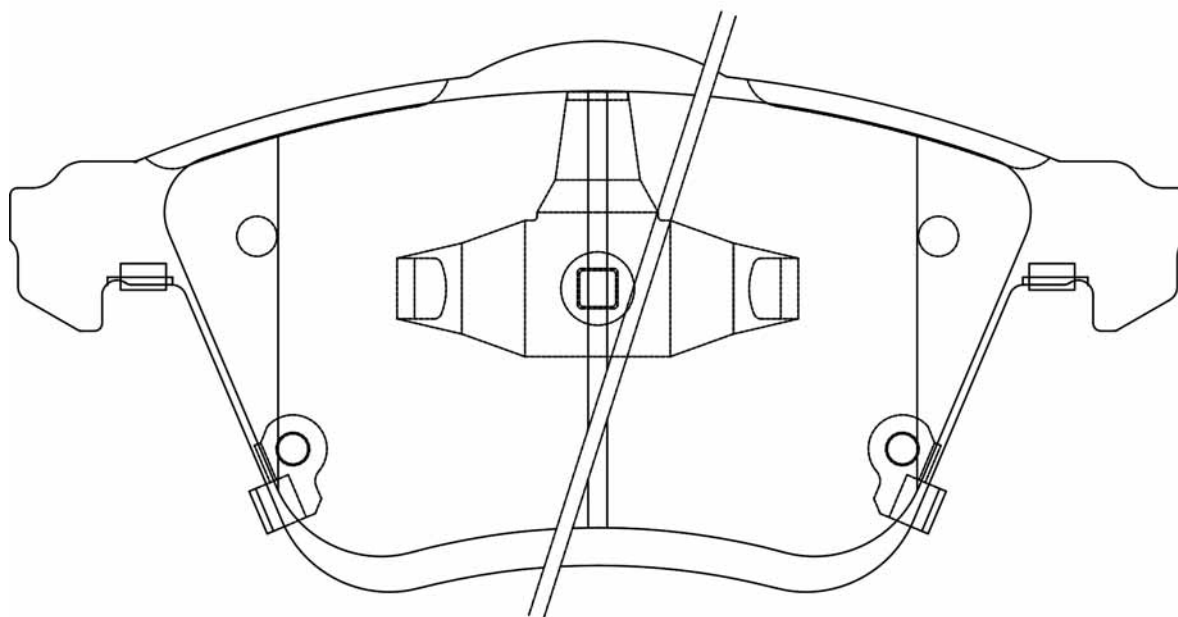

PICTURES BRAKE PADS FRONT
ABBILDUNGEN BREMSKLÖTZE VORN
FIGURAS PASTILLAS DE FRENO DELANTORES
ILLUSTRATIONS PLAQUETTES DE FREI AVANT
IMMAGINI PASTIGLIE FRENO ANTERIORI



50-03-346

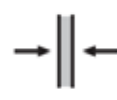
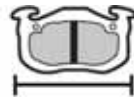

WVA

MAZDA

L

H

Th

137

60

17,5

24582

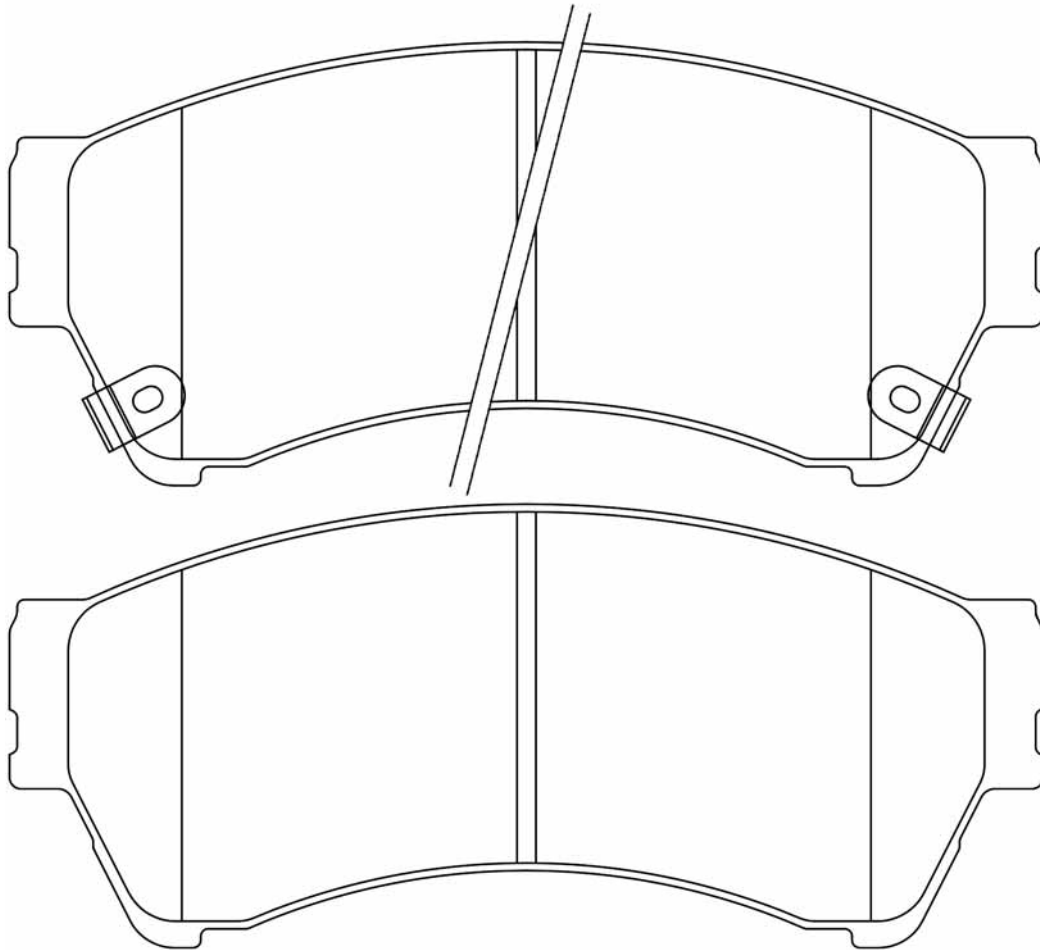



PICTURES BRAKE PADS FRONT
ABBILDUNGEN BREMSKLÖTZE VORN
FIGURAS PASTILLAS DE FRENO DELANTORES
ILLUSTRATIONS PLAQUETTES DE FREI AVANT
IMMAGINI PASTIGLIE FRENO ANTERIORI

50-03-373				WVA
	MAZDA	L	H	
	151,6	61,8	16,5	23540

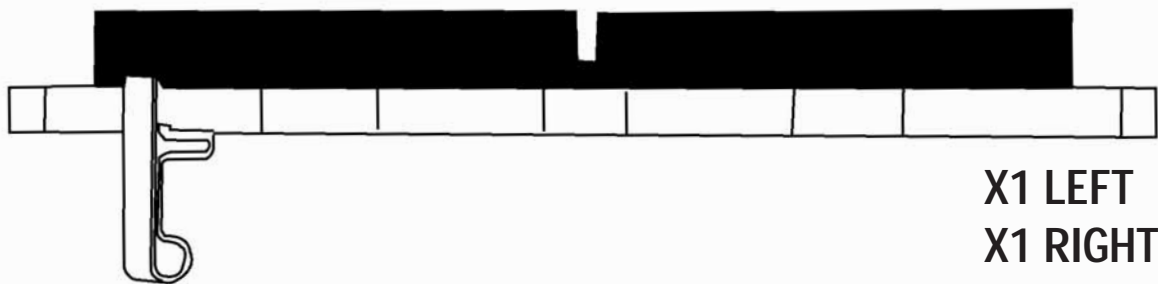
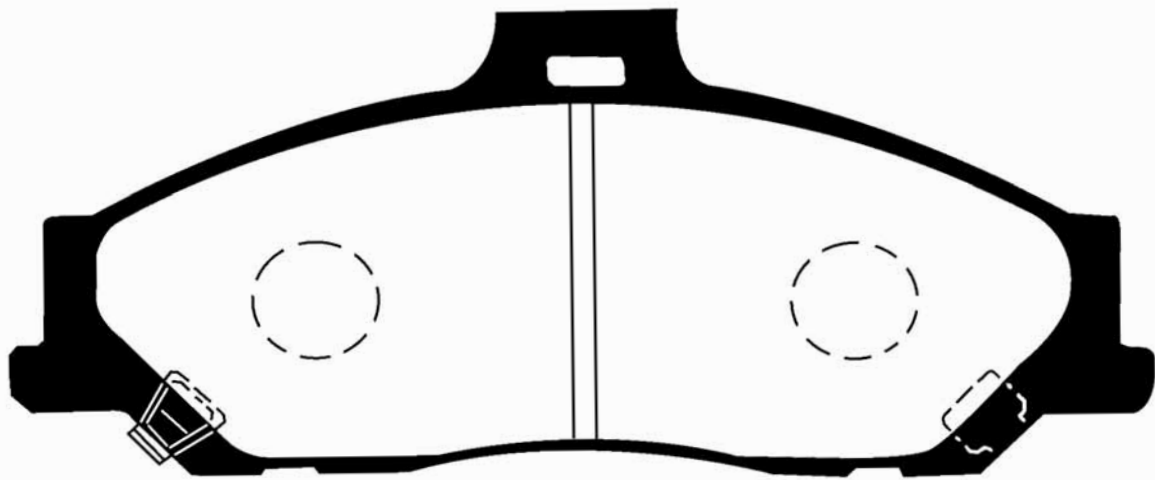
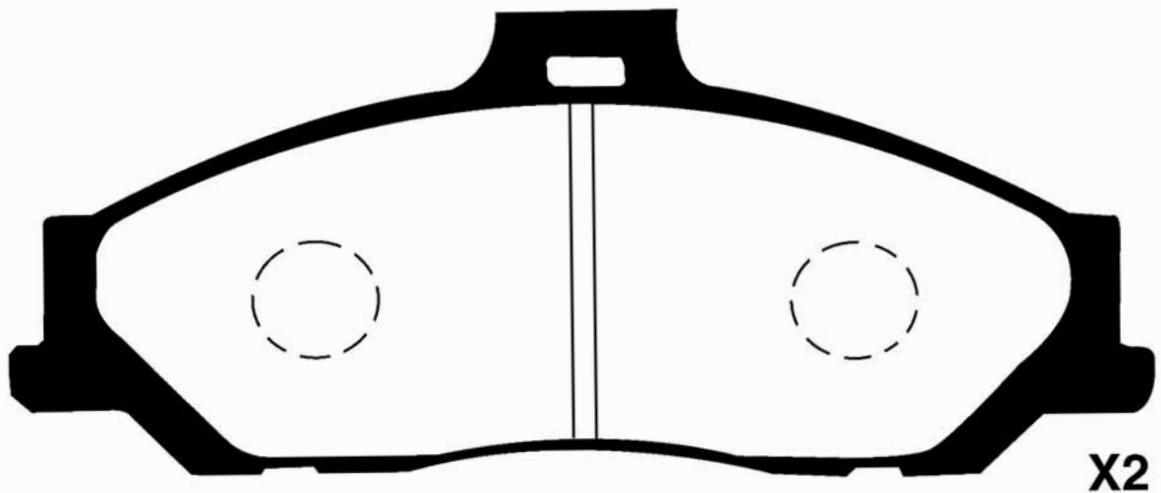



50-03-376				WVA
	DAEWOO	L	H	Th
	156,6	53	17,7	21862

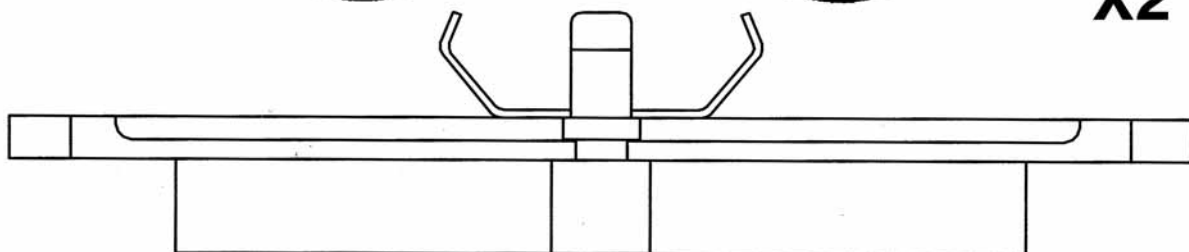
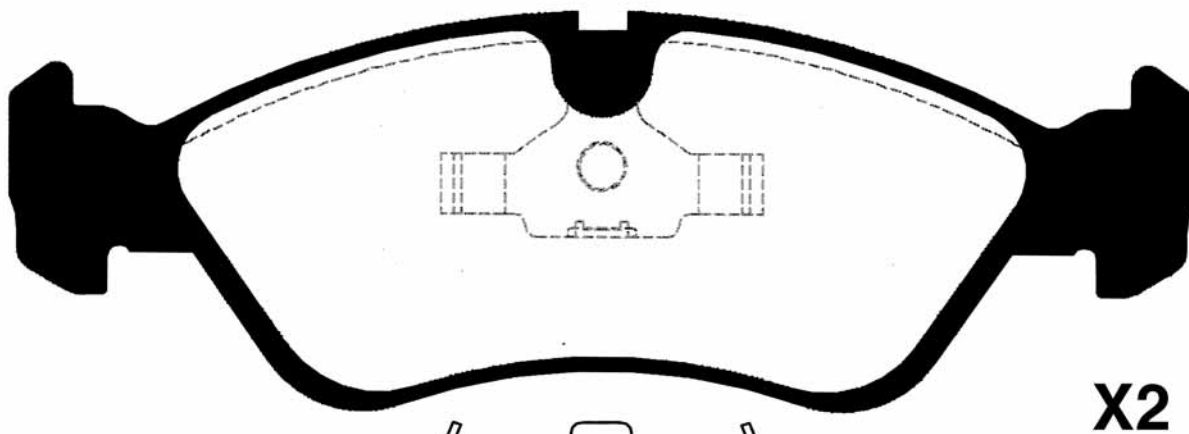
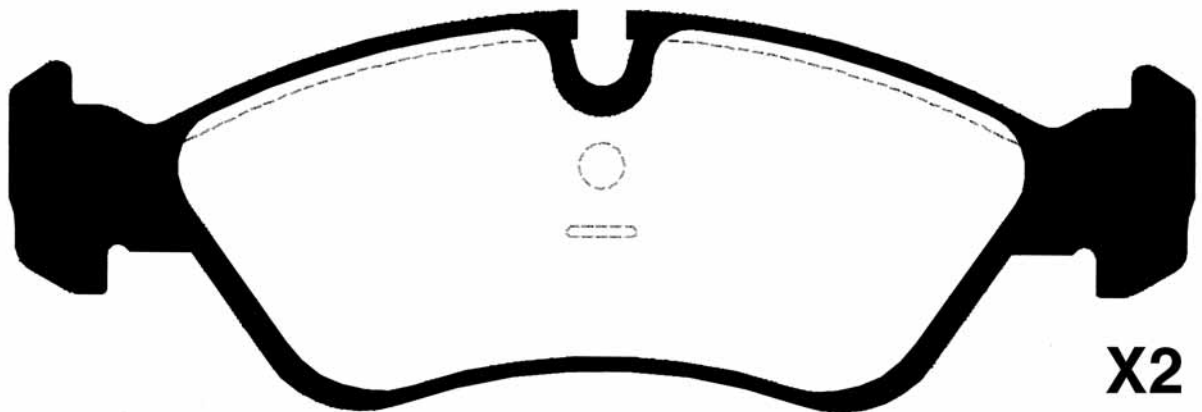



PICTURES BRAKE PADS FRONT
ABBILDUNGEN BREMSKLÖTZE VORN
FIGURAS PASTILLAS DE FRENO DELANTORES
ILLUSTRATIONS PLAQUETTES DE FREI AVANT
IMMAGINI PASTIGLIE FRENO ANTERIORI

50-03-377				WVA
HYUNDAI	L	H	Th	
	78,2	66,4	15	

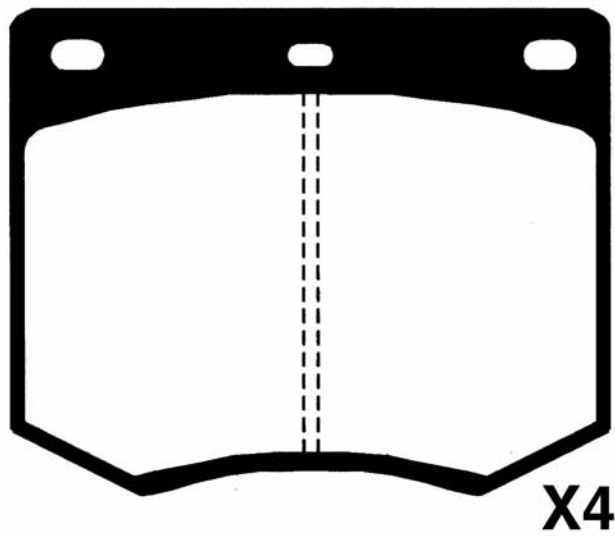



50-03-378				WVA	
	HYUNDAI	L	H	Th	20491
	78,2	66,6	15		

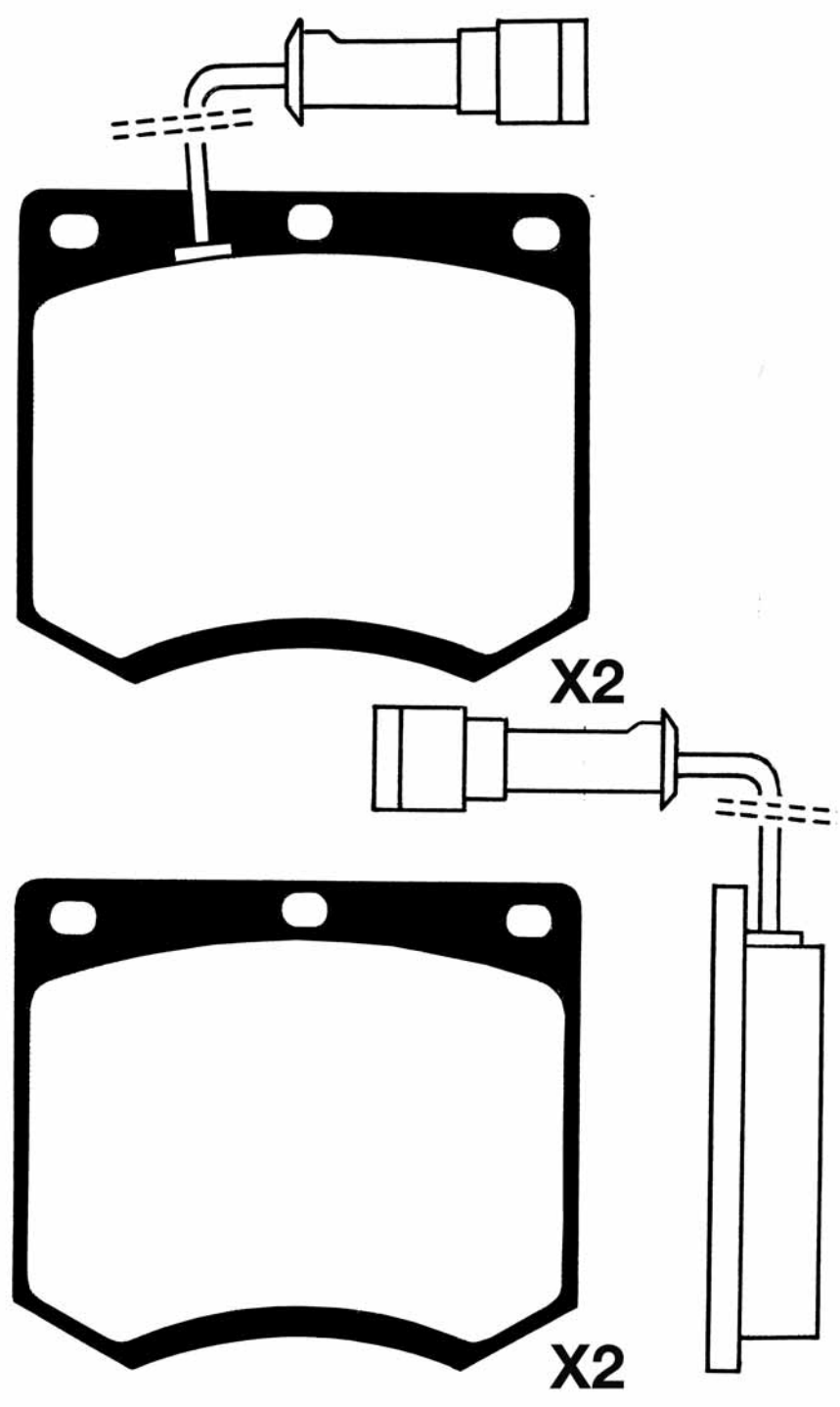



PICTURES BRAKE PADS FRONT
ABBILDUNGEN BREMSKLÖTZE VORN
FIGURAS PASTILLAS DE FRENO DELANTORES
ILLUSTRATIONS PLAQUETTES DE FREI AVANT
IMMAGINI PASTIGLIE FRENO ANTERIORI

50-03-380				WVA
MAZDA	L	H	Th	
	133,2	56,4	15,2	21731

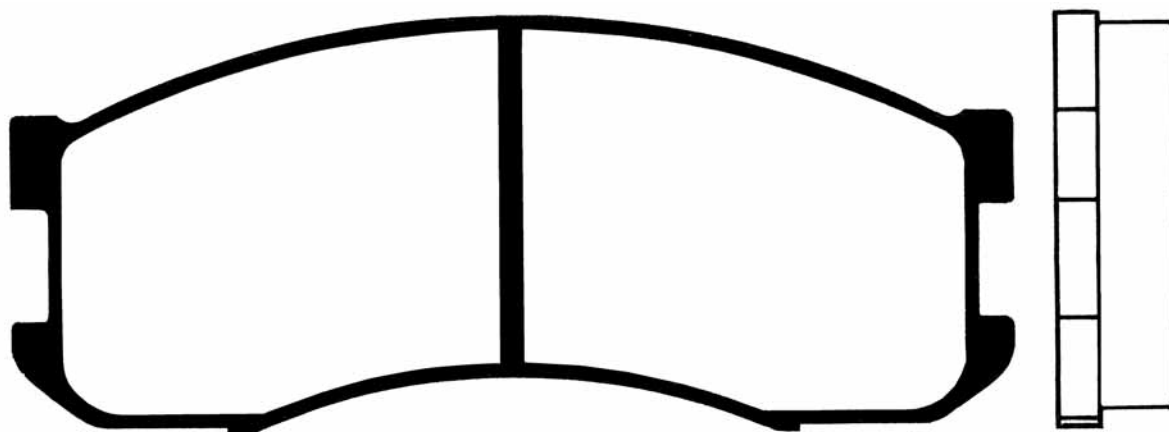

X2

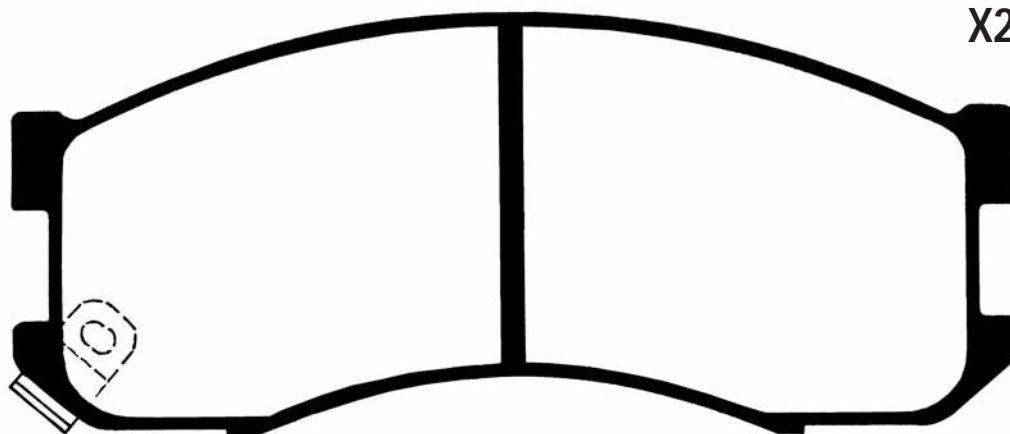

X1

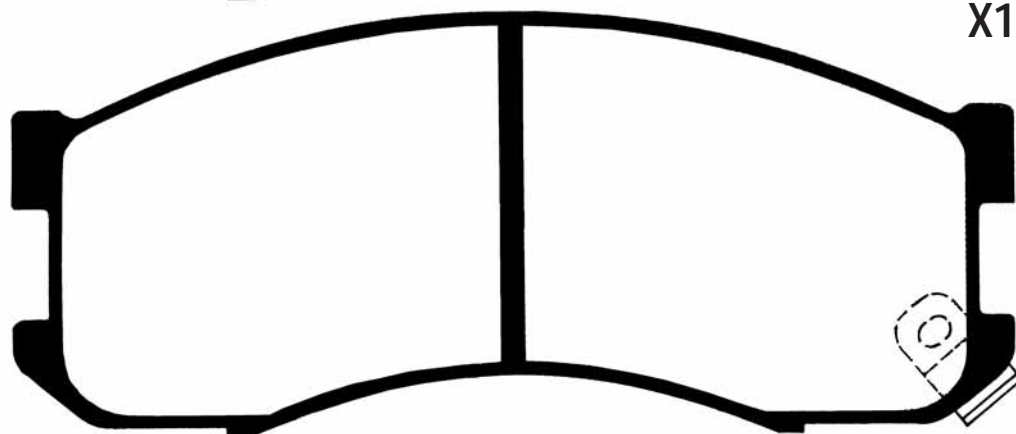

X1



50-03-382

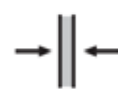
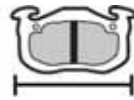

WVA

MAZDA

L

H

Th

142,3

60

15,2

21571

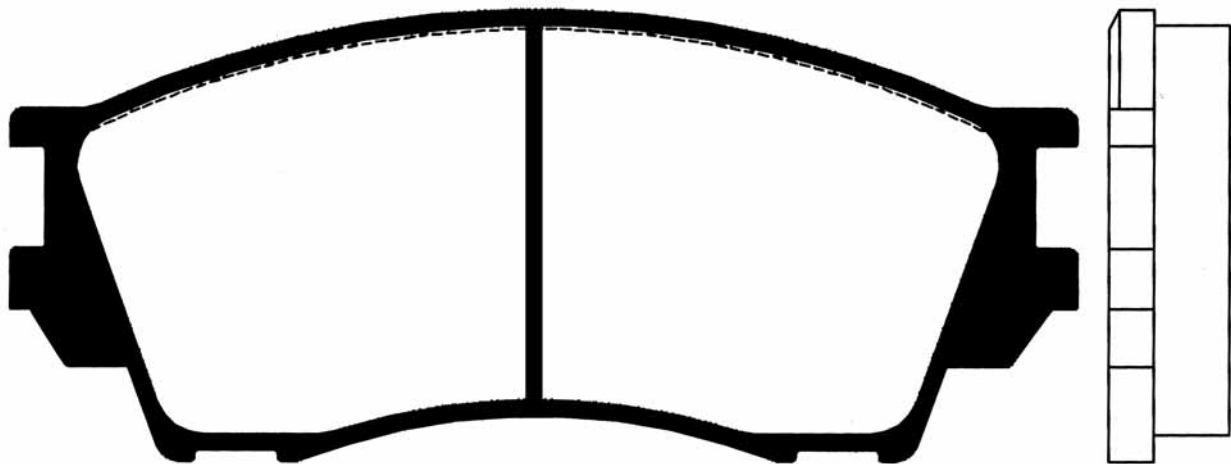

X4



PICTURES BRAKE PADS FRONT
ABBILDUNGEN BREMSKLÖTZE VORN
FIGURAS PASTILLAS DE FRENO DELANTORES
ILLUSTRATIONS PLAQUETTES DE FREI AVANT
IMMAGINI PASTIGLIE FRENO ANTERIORI

50-03-383				WVA
MAZDA	L	H	Th	
	110,2	57,5	14	23354

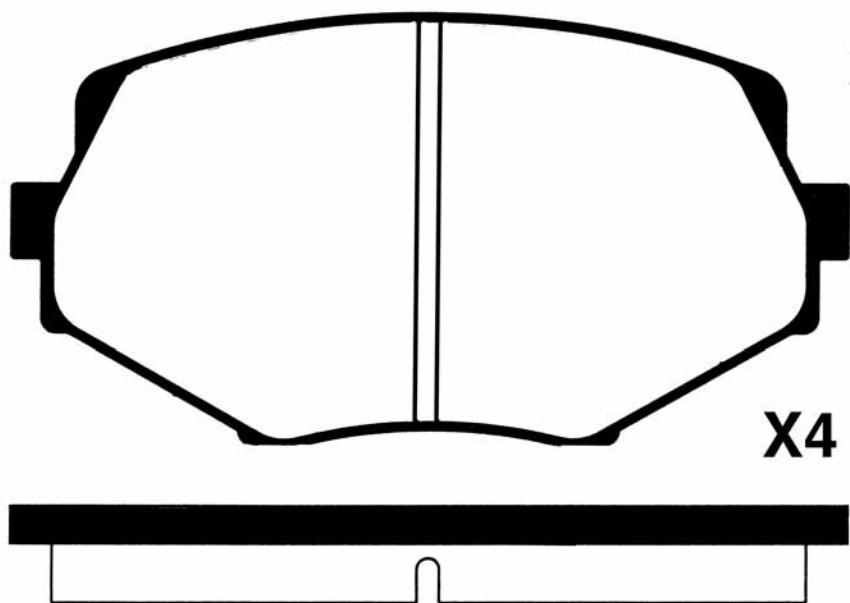



50-03-384

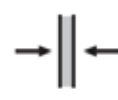
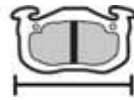

WVA

MAZDA

L

H

Th

139

60,7

15,3

23515

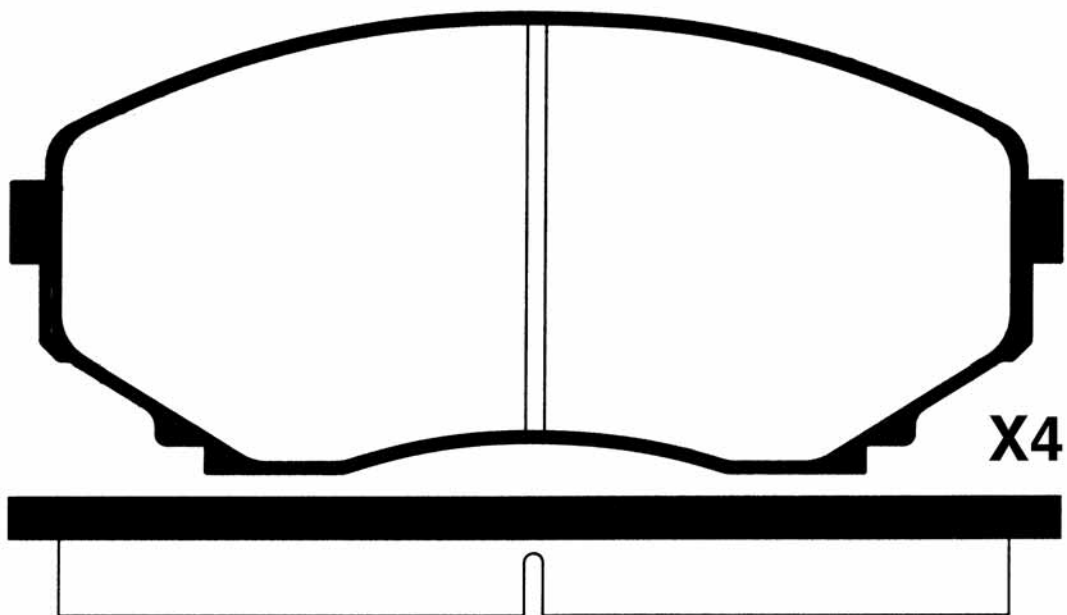



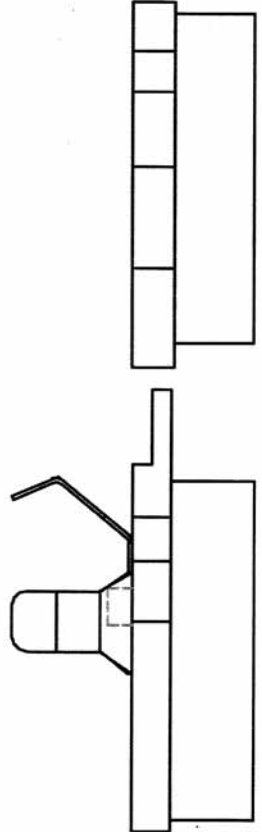
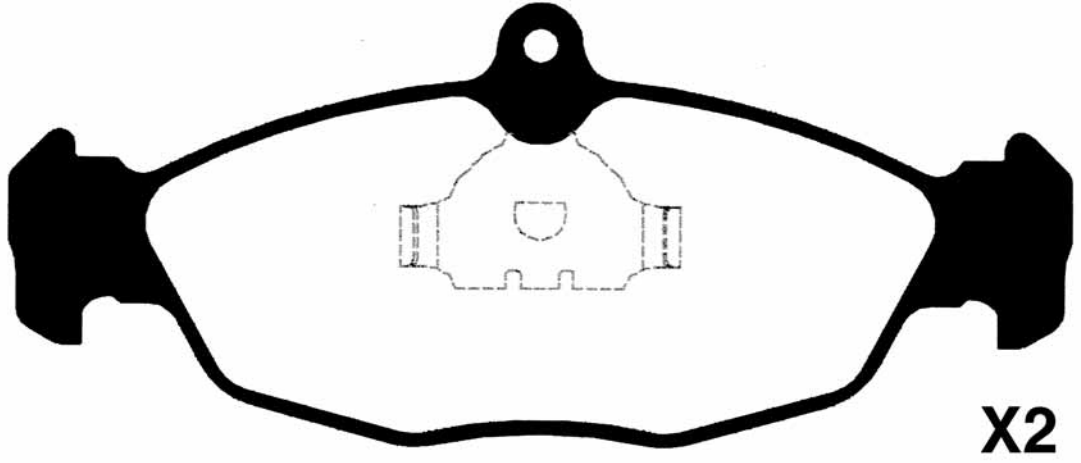
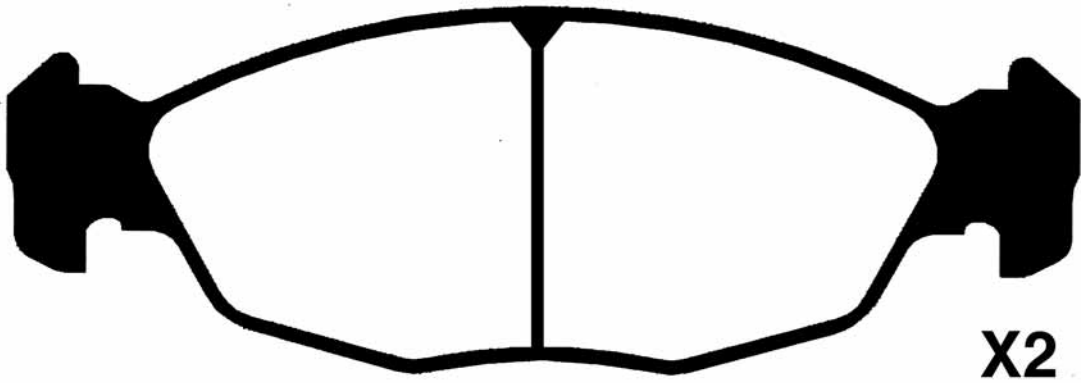

PICTURES BRAKE PADS FRONT
ABBILDUNGEN BREMSKLÖTZE VORN
FIGURAS PASTILLAS DE FRENO DELANTORES
ILLUSTRATIONS PLAQUETTES DE FREI AVANT
IMMAGINI PASTIGLIE FRENO ANTERIORI

50-03-390				WVA
	VAUXHALL - OPEL - DAEWOO	L	H	
	140/141,5	58,8/48	16,4	20547



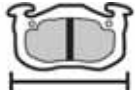

50-03-392	  			WVA
	KIA	L	H	Th
	165,3/171,8	49,2/65,7	17,1/15	21785

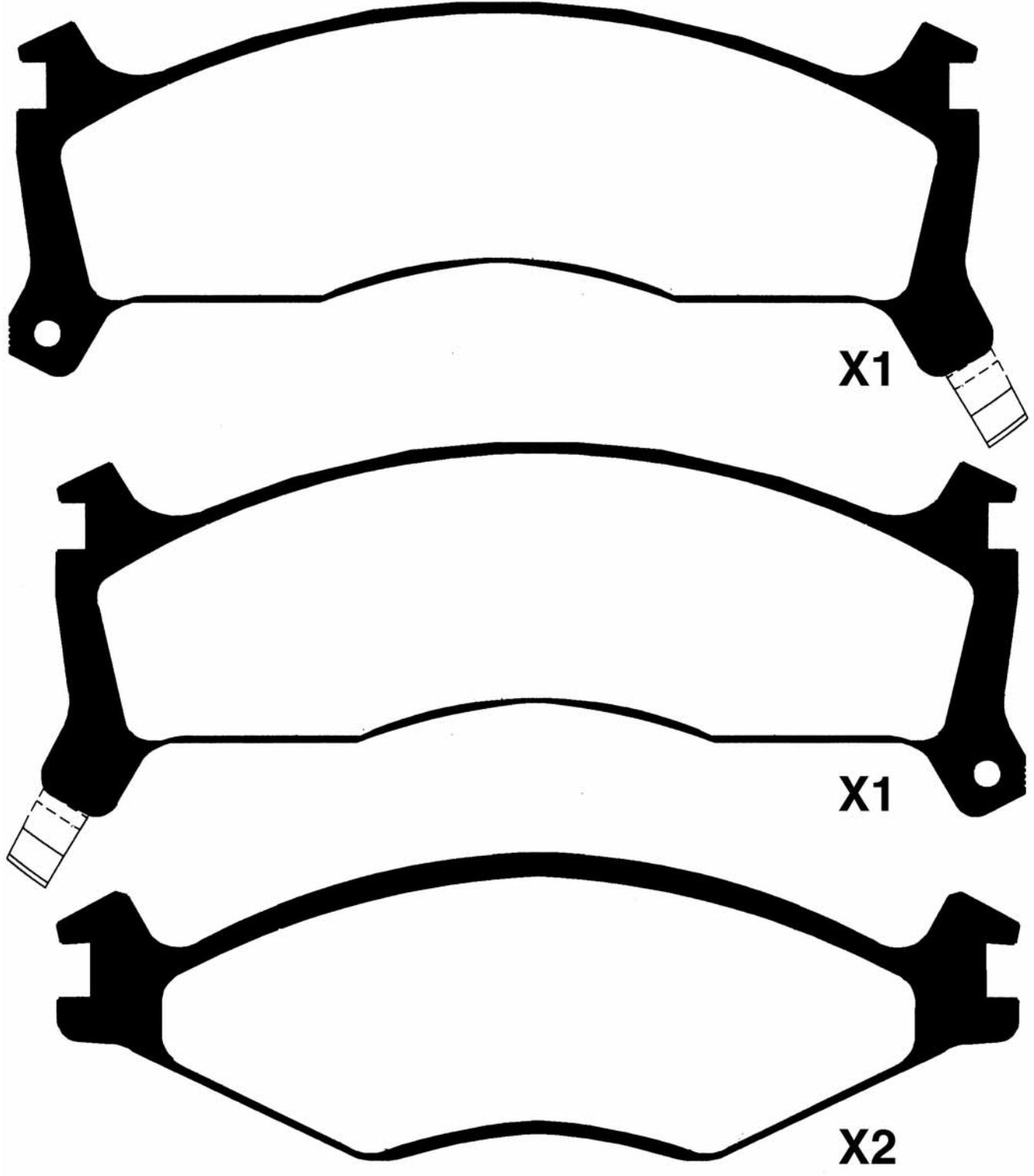



PICTURES BRAKE PADS FRONT
ABBILDUNGEN BREMSKLÖTZE VORN
FIGURAS PASTILLAS DE FRENO DELANTORES
ILLUSTRATIONS PLAQUETTES DE FREI AVANT
IMMAGINI PASTIGLIE FRENO ANTERIORI

50-03-397				WVA
MAZDA	L	H	Th	
	138	53,5	15,4	

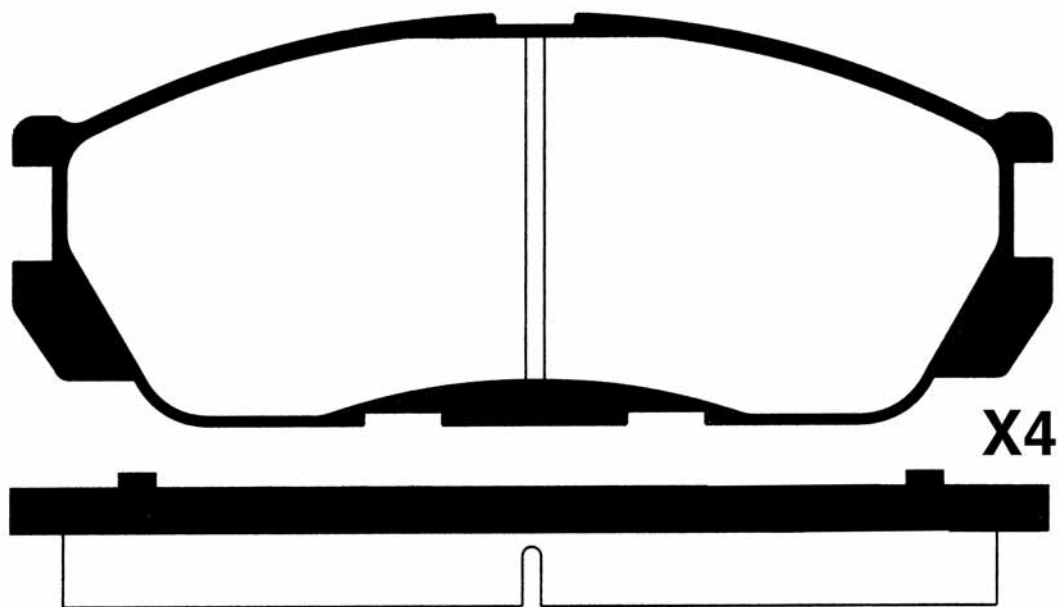



50-03-398				WVA
	MAZDA - KIA	L	H	
	151,4	48,7	17,3	23267

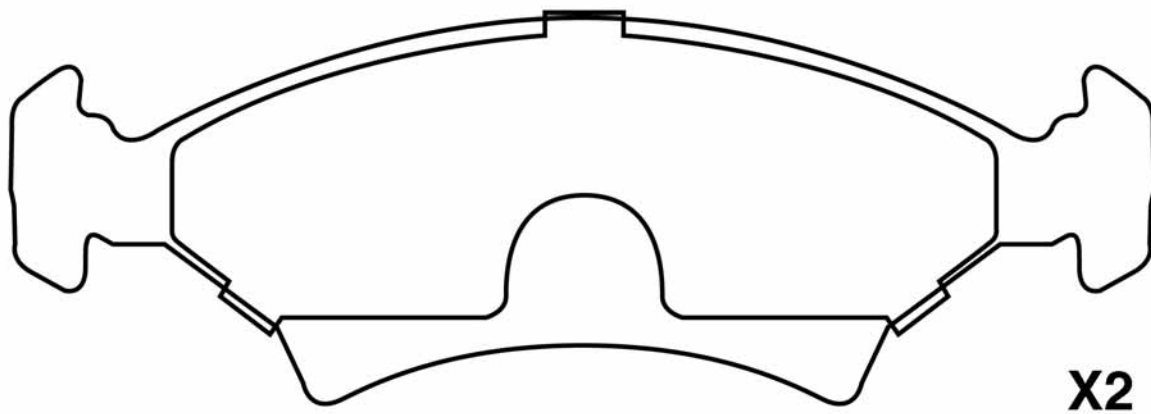
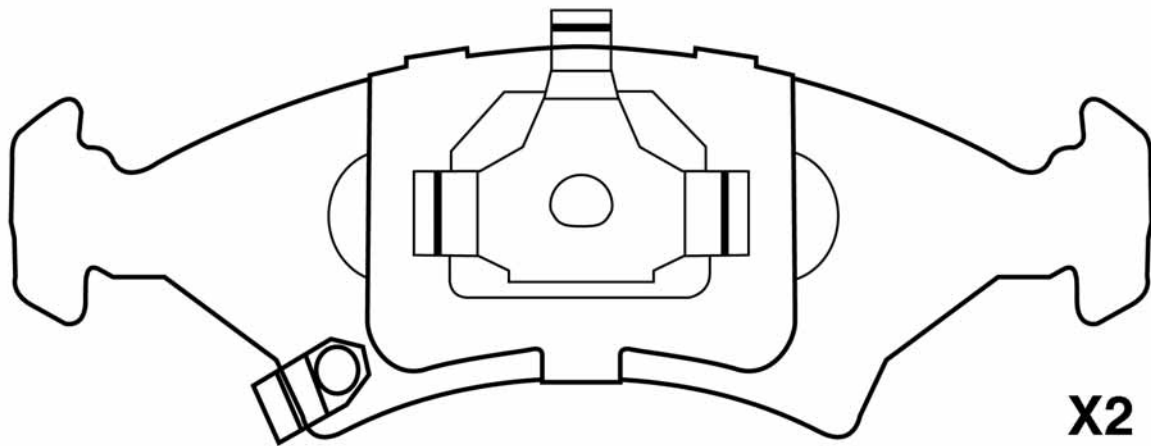



PICTURES BRAKE PADS FRONT
ABBILDUNGEN BREMSKLÖTZE VORN
FIGURAS PASTILLAS DE FRENO DELANTORES
ILLUSTRATIONS PLAQUETTES DE FREI AVANT
IMMAGINI PASTIGLIE FRENO ANTERIORI

50-03-399

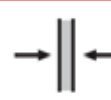
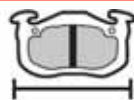

WVA

MAZDA

L

H

Th

131,5

52

15,8

21755

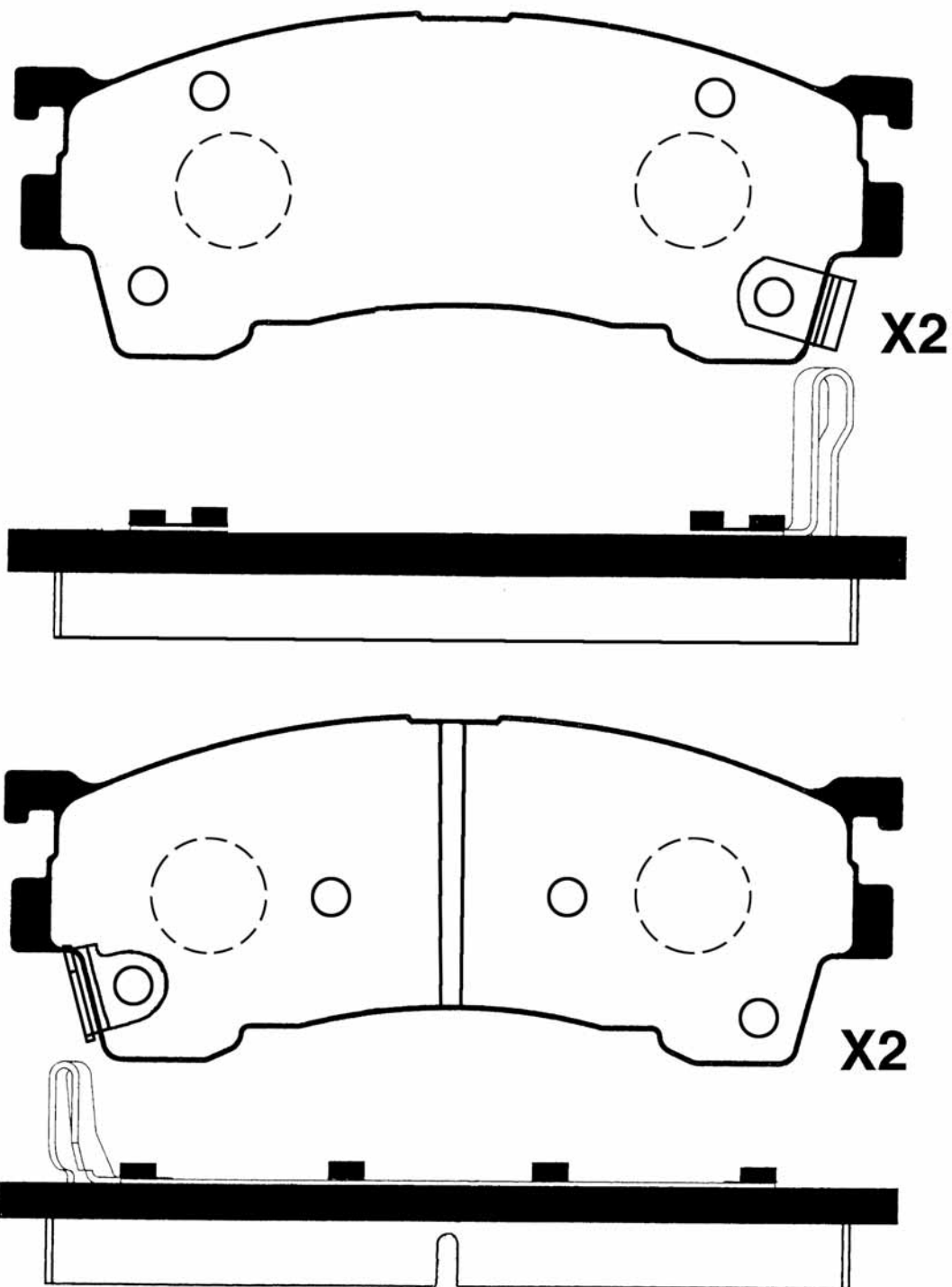



50-04-400				WVA
HONDA	L	H	Th	
	63,6	52,5	14	20485

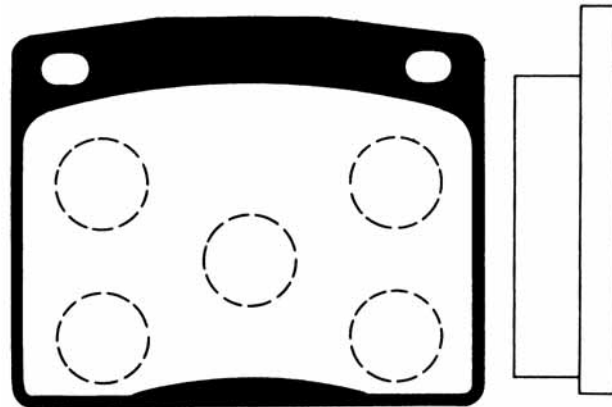

X4



PICTURES BRAKE PADS FRONT
ABBILDUNGEN BREMSKLÖTZE VORN
FIGURAS PASTILLAS DE FRENO DELANTORES
ILLUSTRATIONS PLAQUETTES DE FREI AVANT
IMMAGINI PASTIGLIE FRENO ANTERIORI

50-04-401				WVA
HONDA	L	H	Th	
	142,1	58	16,7	23868

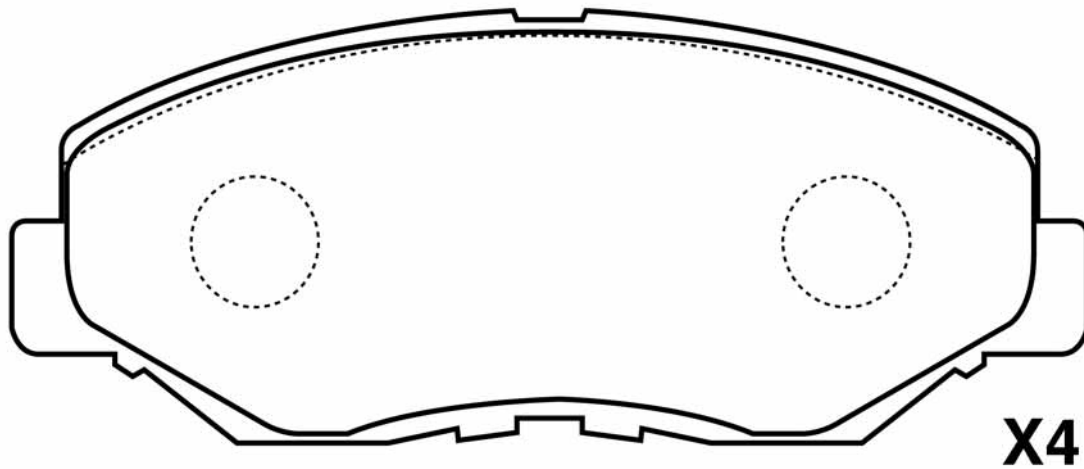



50-04-402				WVA
	HONDA	L	H	Th
	57,8	52,7	14,6	20529

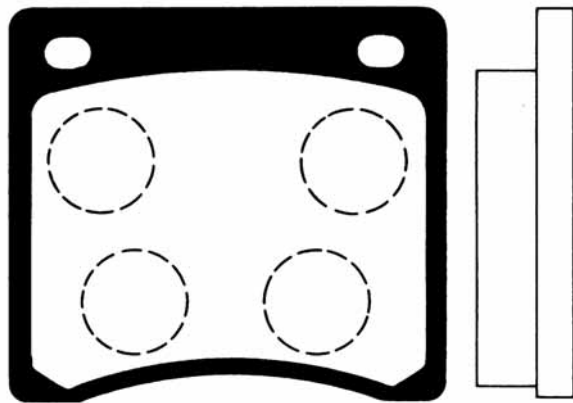

X4



PICTURES BRAKE PADS FRONT
ABBILDUNGEN BREMSKLÖTZE VORN
FIGURAS PASTILLAS DE FRENO DELANTORES
ILLUSTRATIONS PLAQUETTES DE FREI AVANT
IMMAGINI PASTIGLIE FRENO ANTERIORI

50-04-403

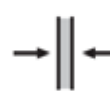

WVA

HONDA

L

H

Th

131,2

55

17,5

24087

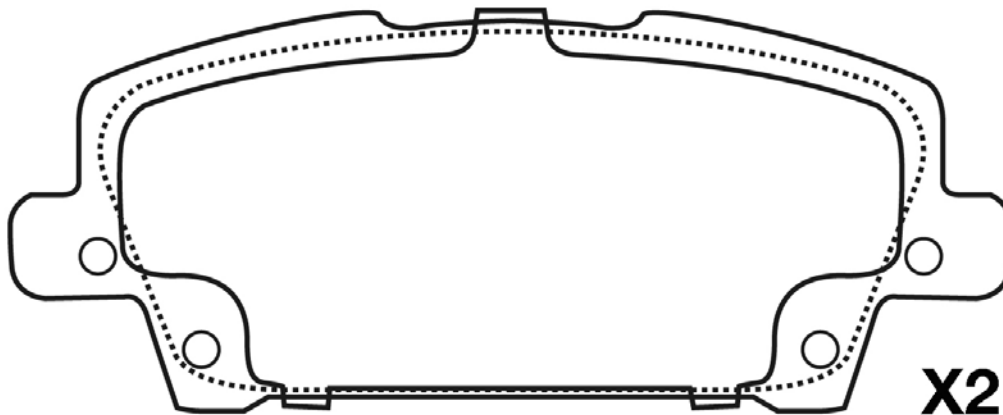
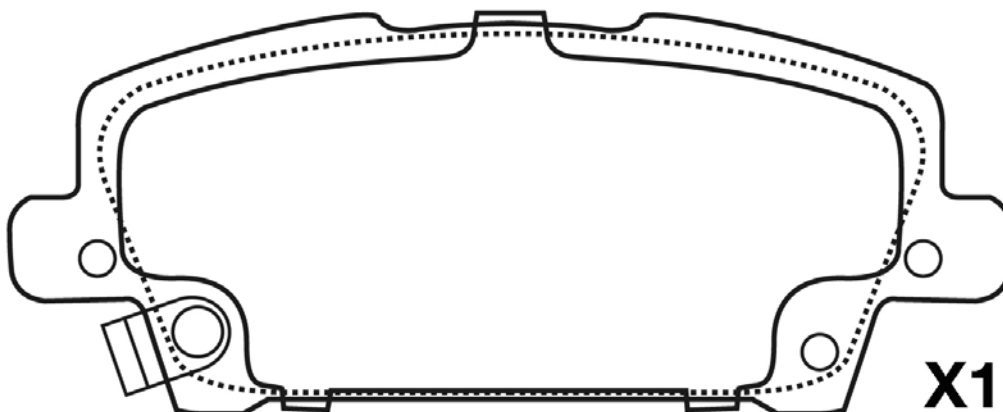
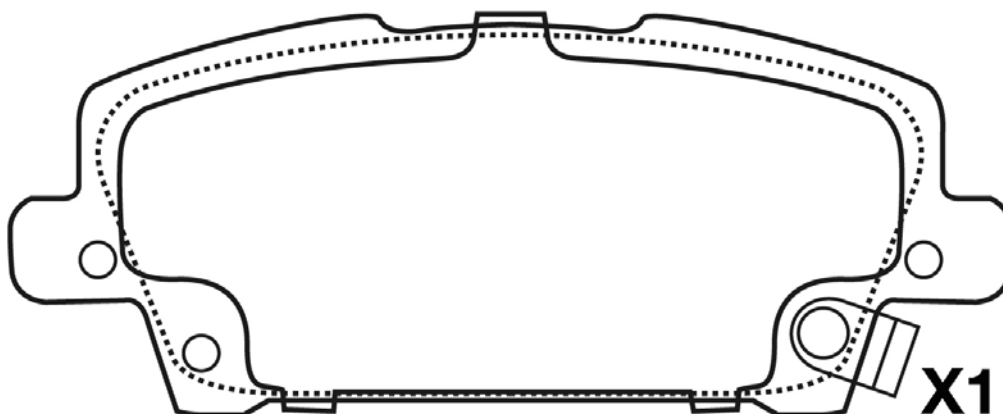



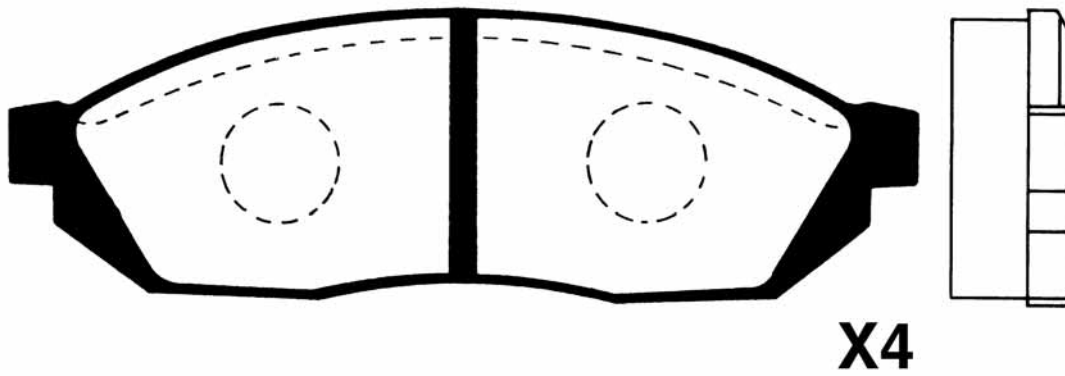

50-04-404 MARUTI - HONDA - BEDFORD - TRIUMPH -				WVA 20731
	L 119,4	H 38,3	Th 14,9	





PICTURES BRAKE PADS FRONT
ABBILDUNGEN BREMSKLÖTZE VORN
FIGURAS PASTILLAS DE FRENO DELANTORES
ILLUSTRATIONS PLAQUETTES DE FREI AVANT
IMMAGINI PASTIGLIE FRENO ANTERIORI

50-04-405				WVA
HONDA	L	H	Th	
	151	61/57	19	24638

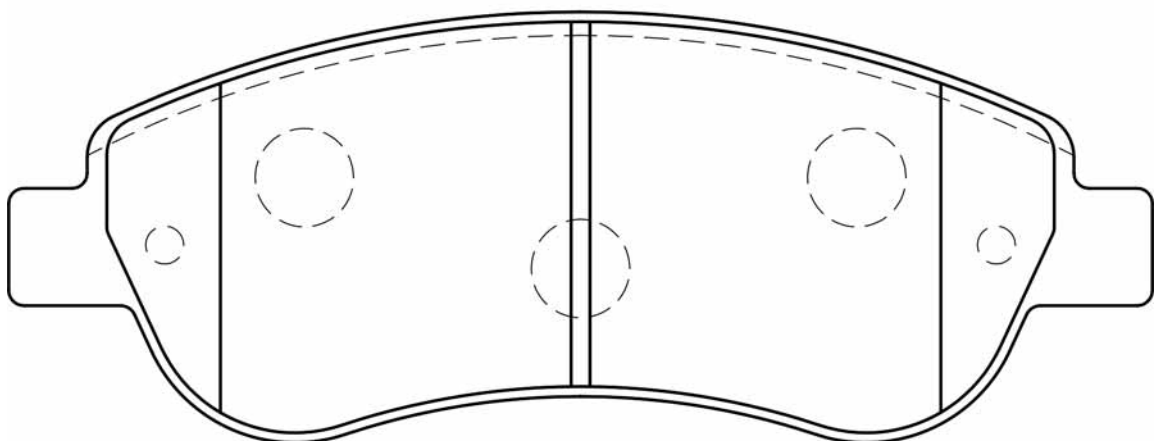
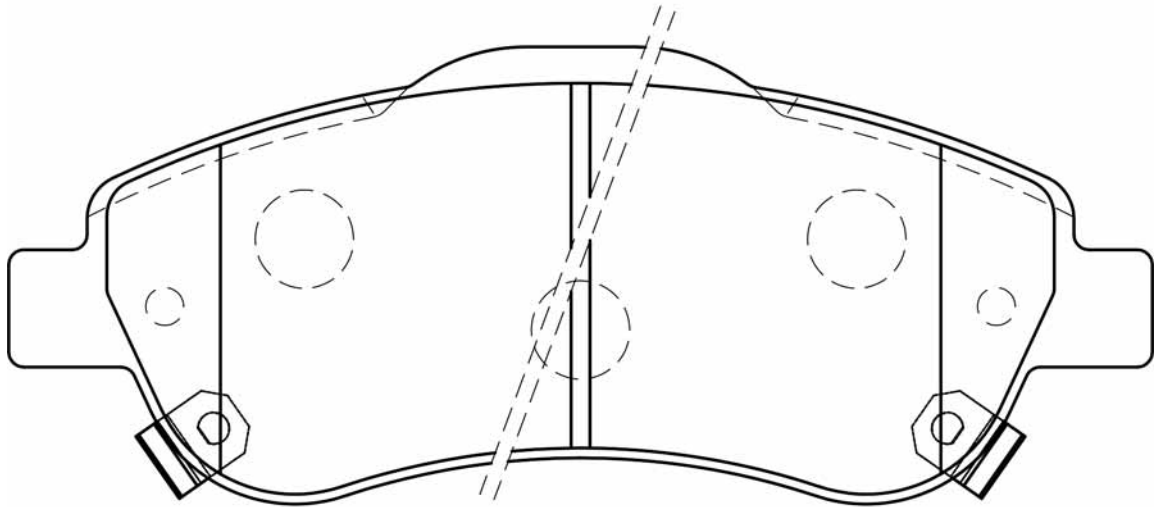



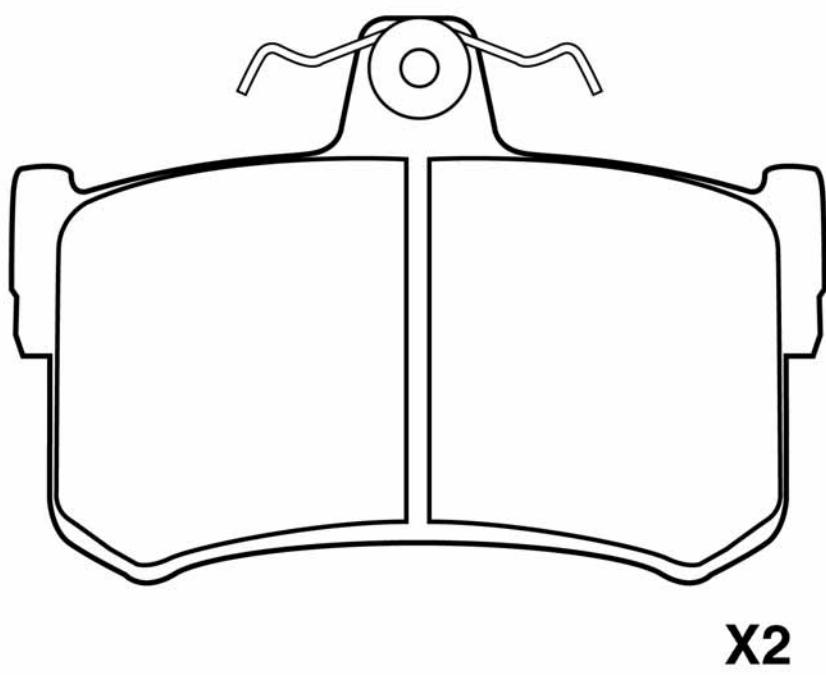
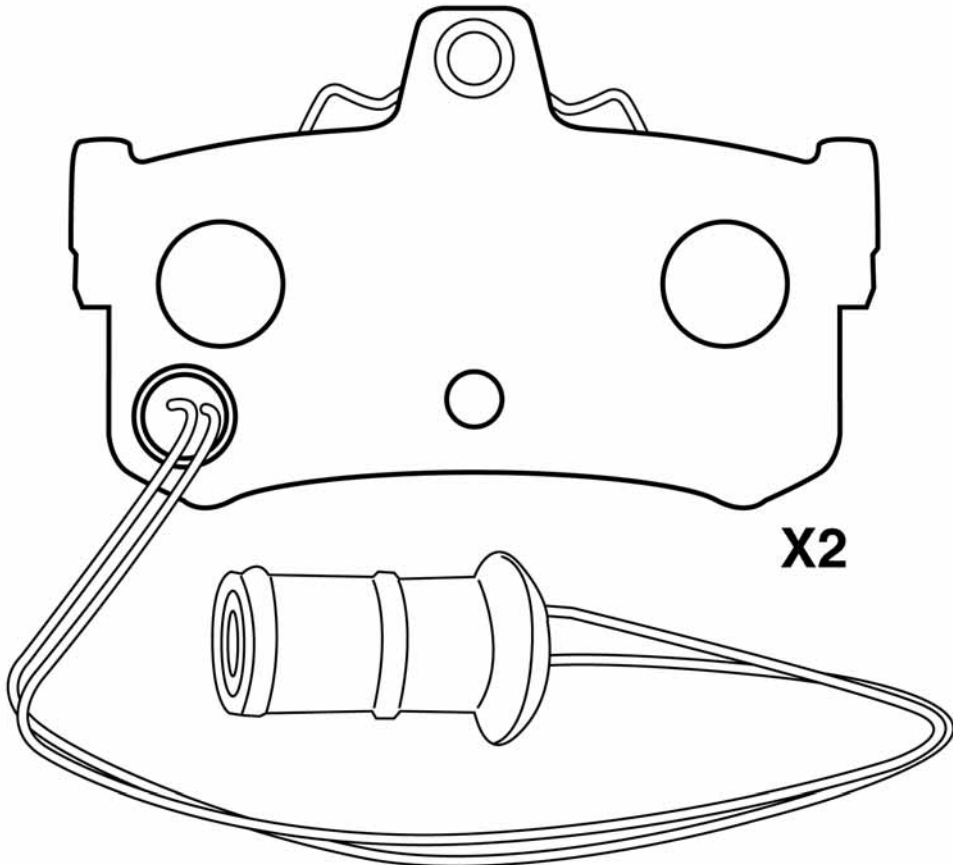

50-04-406				WVA
	HONDA	L 108	H 45,5	Th 14
				20535





PICTURES BRAKE PADS FRONT
ABBILDUNGEN BREMSKLÖTZE VORN
FIGURAS PASTILLAS DE FRENO DELANTORES
ILLUSTRATIONS PLAQUETTES DE FREI AVANT
IMMAGINI PASTIGLIE FRENO ANTERIORI

50-04-407				WVA
	HONDA	L	H	
	155	64/55	18	24796

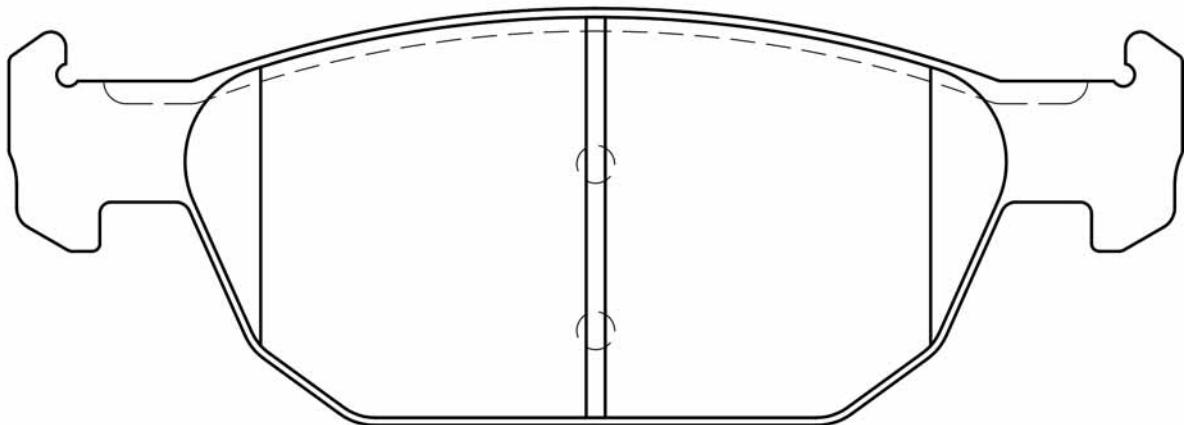
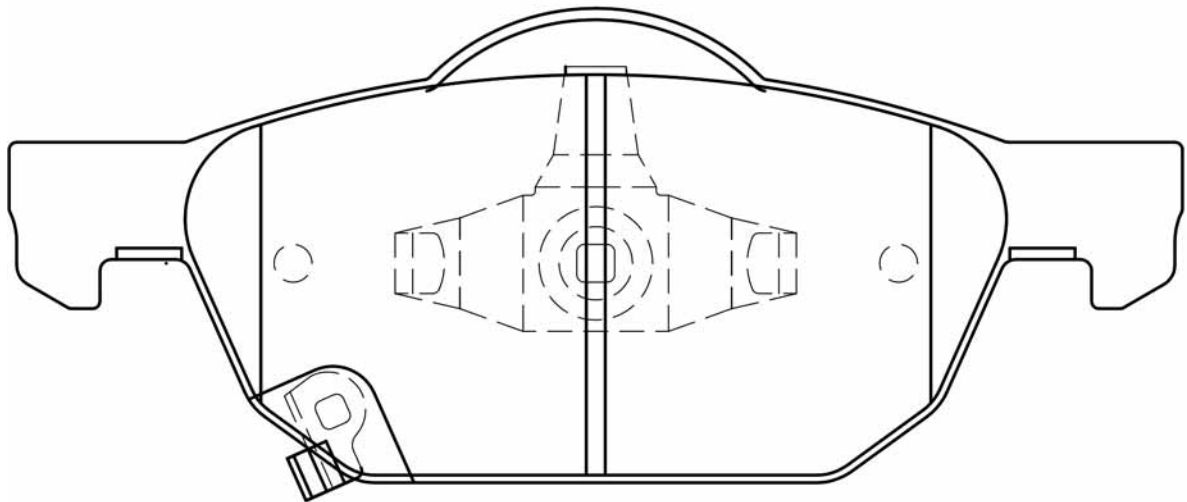
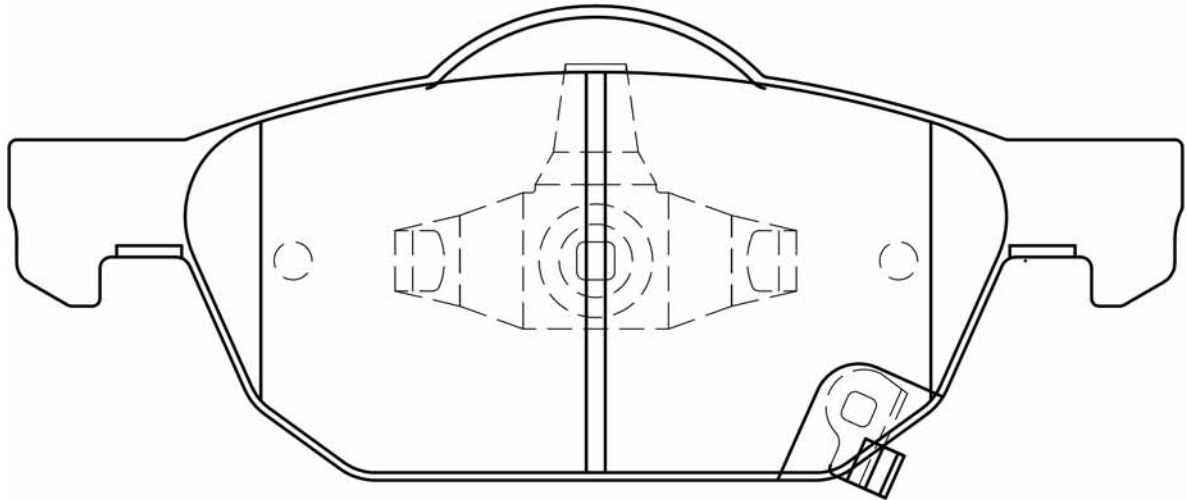



50-04-409

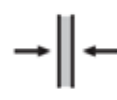
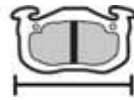

WVA

HONDA

L

H

Th

152

63

17

24766

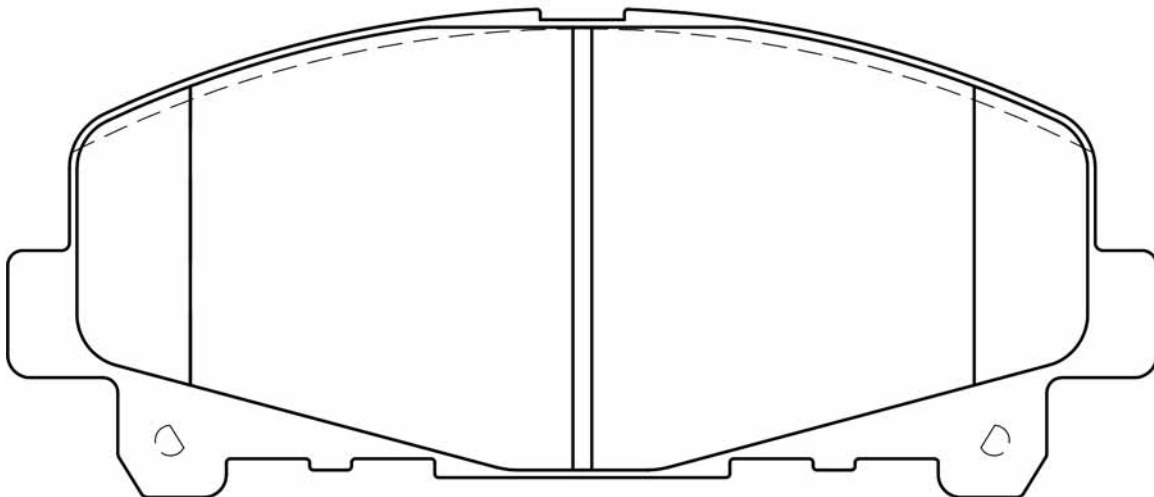
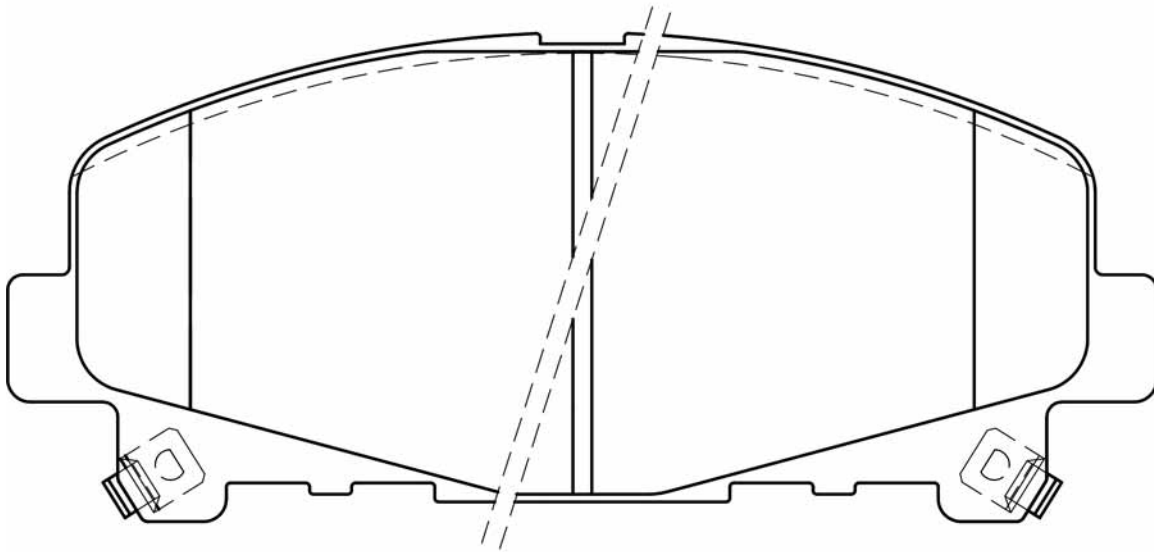



PICTURES BRAKE PADS FRONT
ABBILDUNGEN BREMSKLÖTZE VORN
FIGURAS PASTILLAS DE FRENO DELANTORES
ILLUSTRATIONS PLAQUETTES DE FREI AVANT
IMMAGINI PASTIGLIE FRENO ANTERIORI

50-04-410



WVA

HONDA

L

H

Th

136,5

56

16

24979

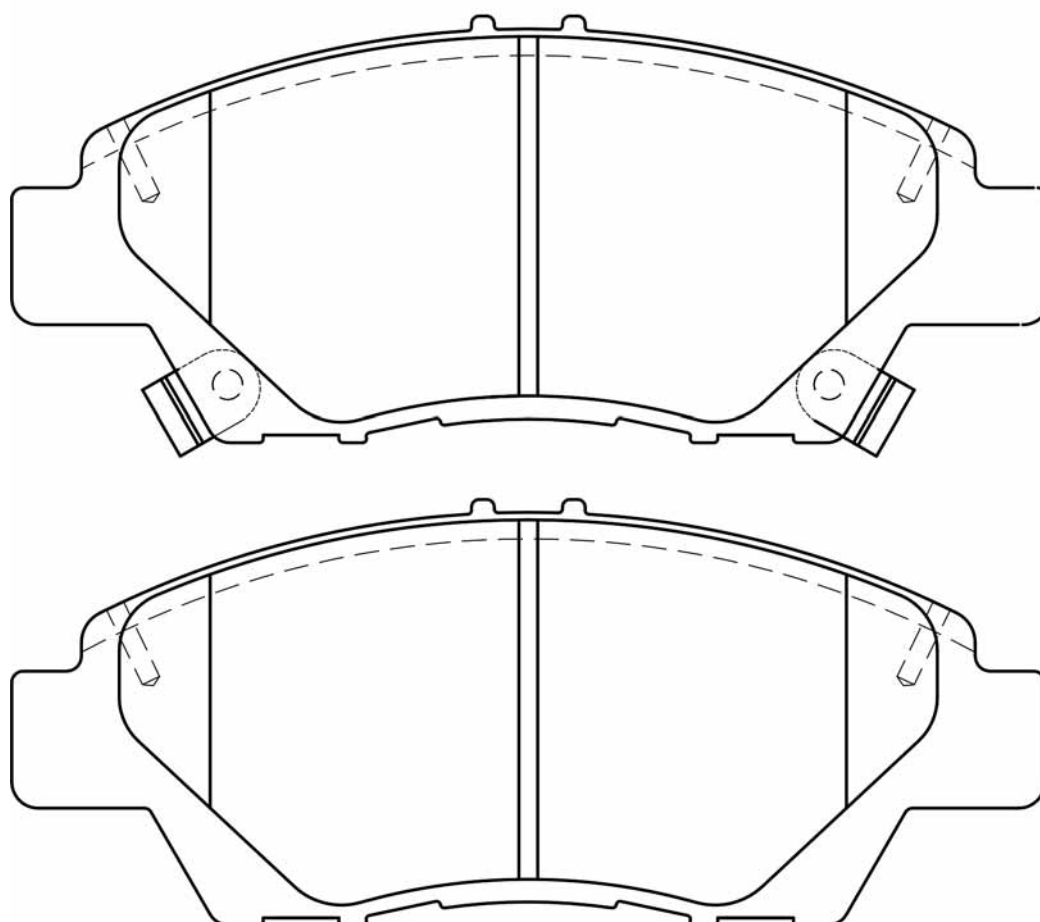



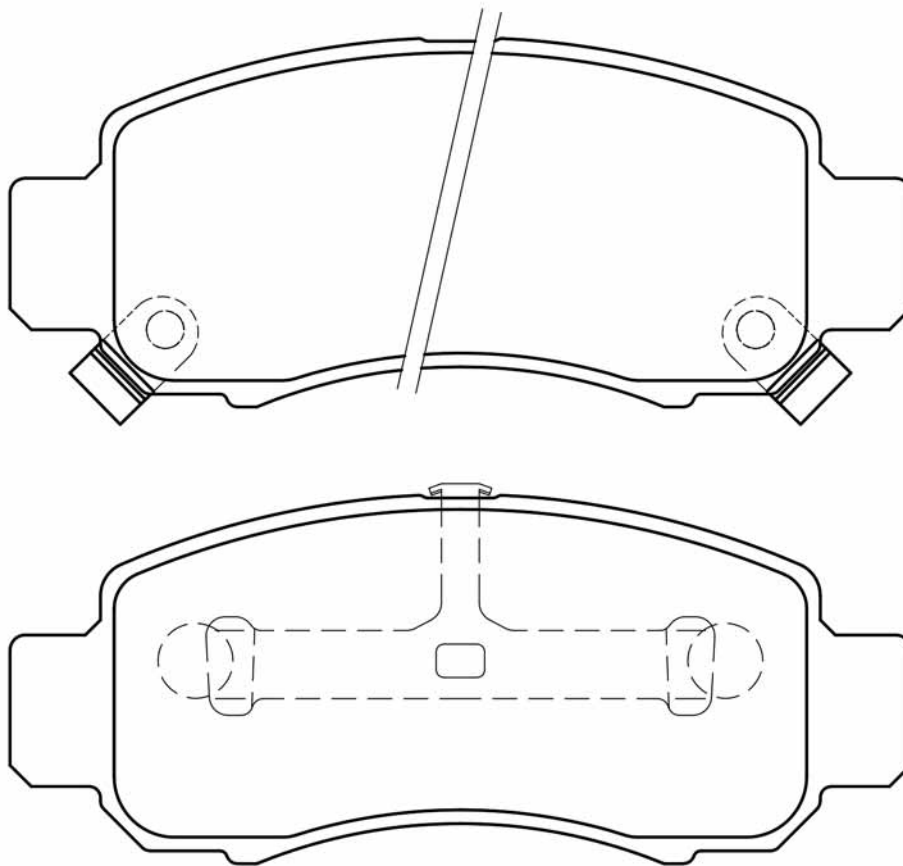

50-04-411 HONDA				WVA
	L 119	H 48,8	Th 13,3	23616



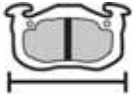

PICTURES BRAKE PADS FRONT
ABBILDUNGEN BREMSKLÖTZE VORN
FIGURAS PASTILLAS DE FRENO DELANTORES
ILLUSTRATIONS PLAQUETTES DE FREI AVANT
IMMAGINI PASTIGLIE FRENO ANTERIORI

50-04-412				WVA
HONDA	L	H	Th	
	111,3	47,3	15,4	20735

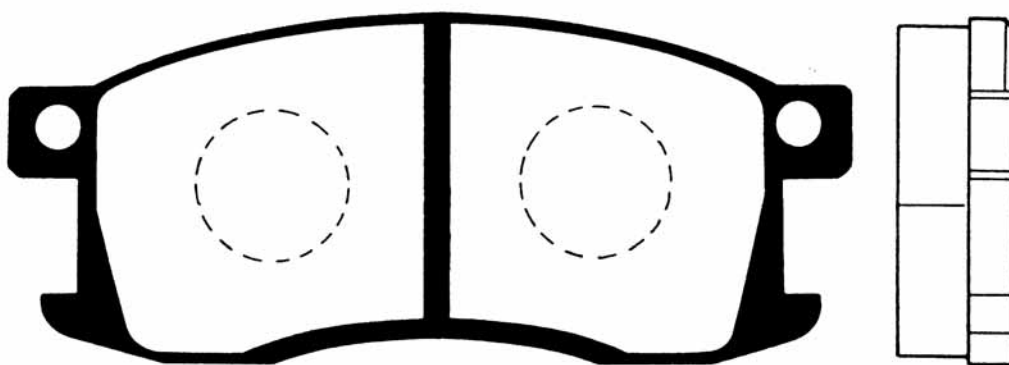

X4



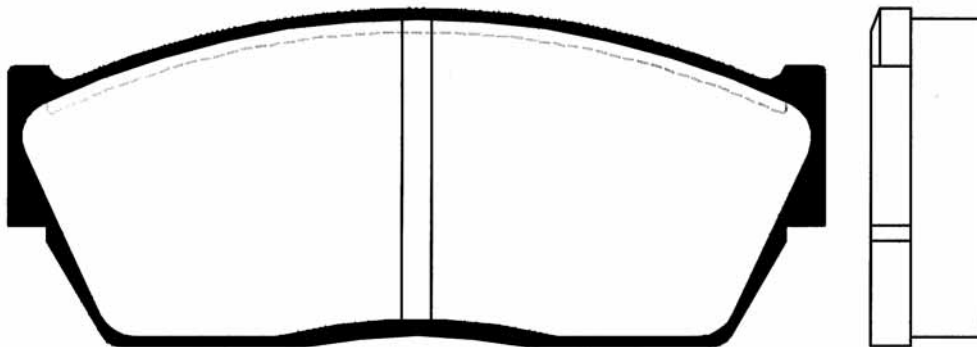

50-04-413				WVA
	HONDA	L	H	Th
	107,5	44,9	14,6	20895



X4

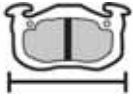

PICTURES BRAKE PADS FRONT
ABBILDUNGEN BREMSKLÖTZE VORN
FIGURAS PASTILLAS DE FRENO DELANTORES
ILLUSTRATIONS PLAQUETTES DE FREI AVANT
IMMAGINI PASTIGLIE FRENO ANTERIORI

50-04-414				WVA
HONDA	L	H	Th	
	116	46	14,4	20959

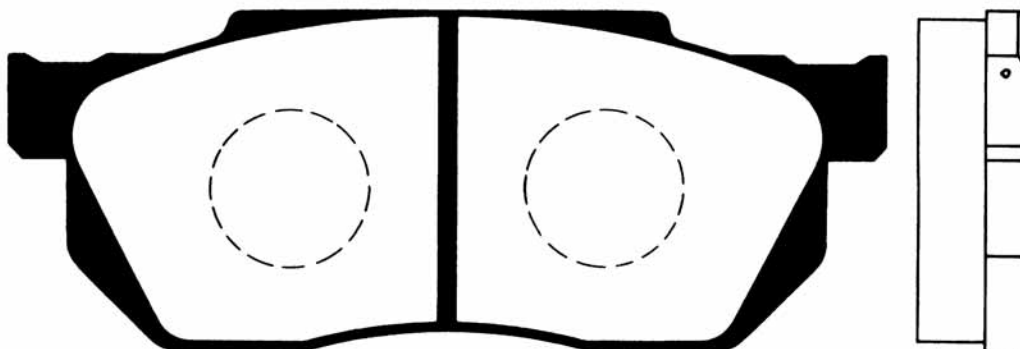

X4



50-04-416				WVA
	HONDA	L	H	Th
	111,5	47,3	14,9	21367

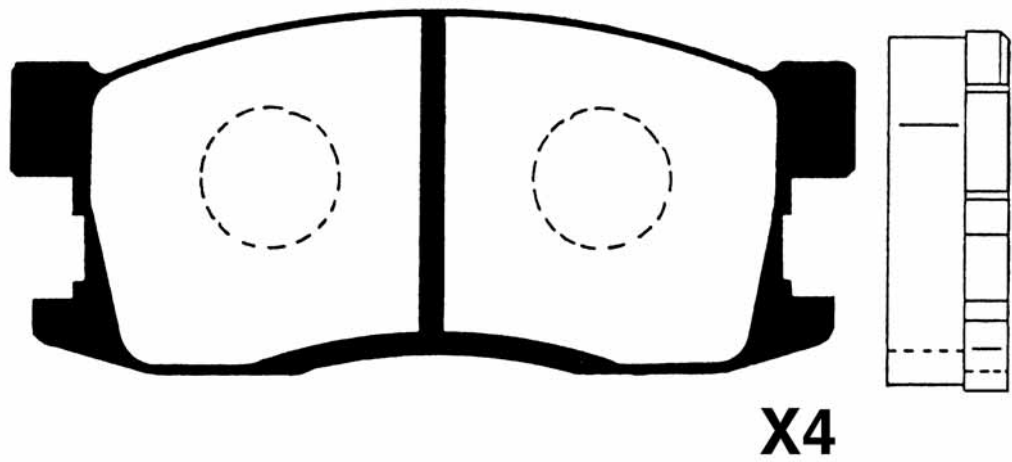



PICTURES BRAKE PADS FRONT
ABBILDUNGEN BREMSKLÖTZE VORN
FIGURAS PASTILLAS DE FRENO DELANTORES
ILLUSTRATIONS PLAQUETTES DE FREI AVANT
IMMAGINI PASTIGLIE FRENO ANTERIORI

50-04-417				WVA
HONDA	L	H	Th	
	104,4	40,8	14,9	21312

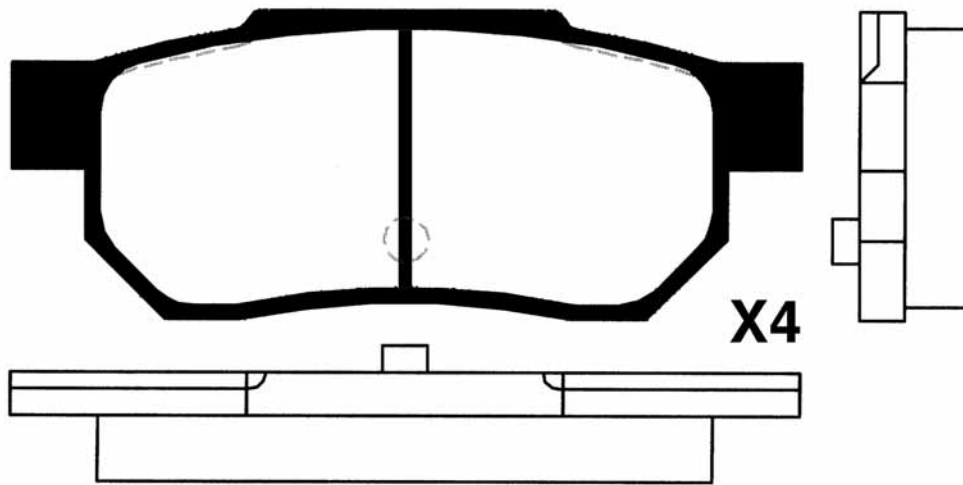



50-04-421				WVA
	HONDA	L	H	Th
	127,4	53,4	17,1	21446

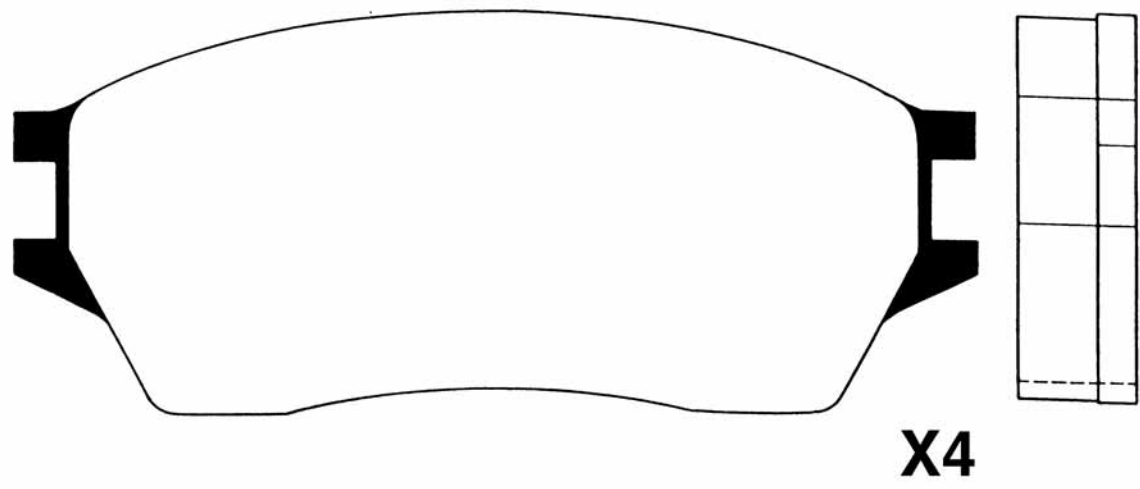



PICTURES BRAKE PADS FRONT
ABBILDUNGEN BREMSKLÖTZE VORN
FIGURAS PASTILLAS DE FRENO DELANTORES
ILLUSTRATIONS PLAQUETTES DE FREI AVANT
IMMAGINI PASTIGLIE FRENO ANTERIORI

50-04-423				WVA
	HONDA	L	H	
	132	49,2	15	21323

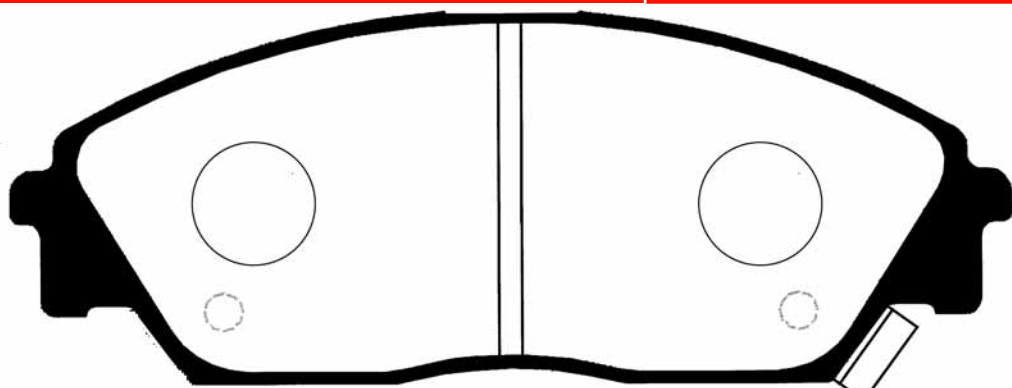

X1

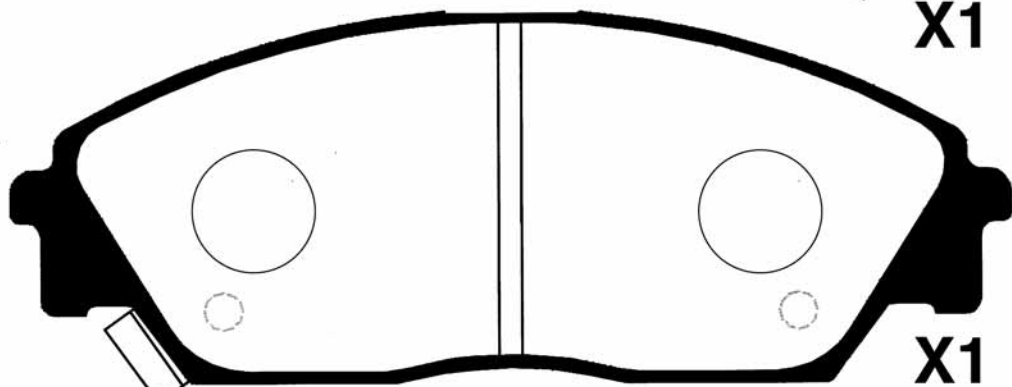

X1

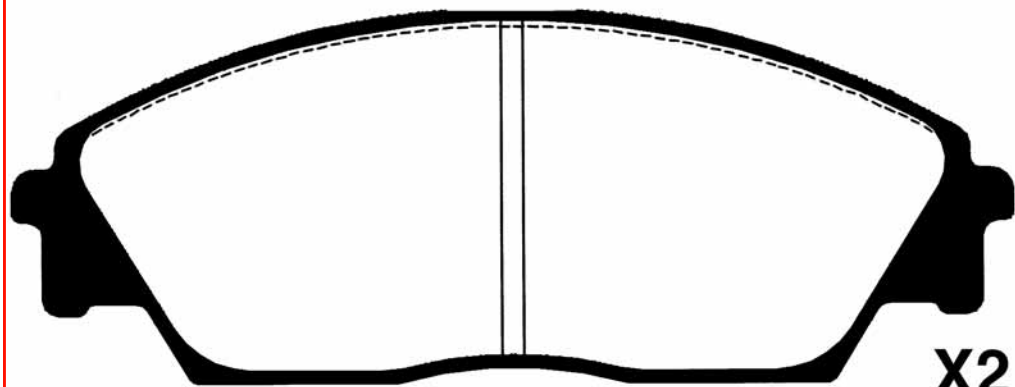
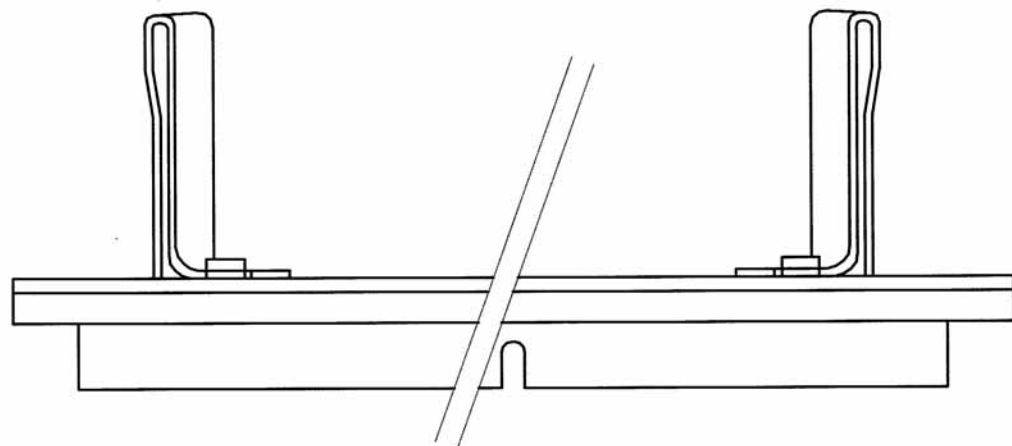
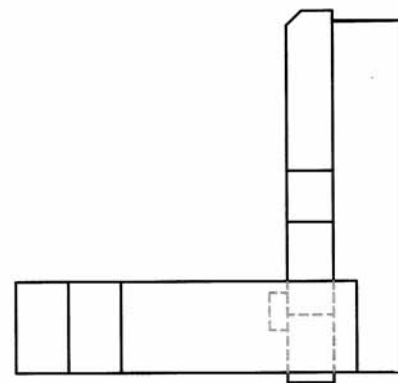

X2

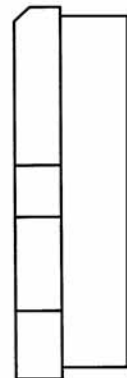



50-04-424				WVA	
	HONDA	L	H	Th	20108
	128	48,3	14,4		

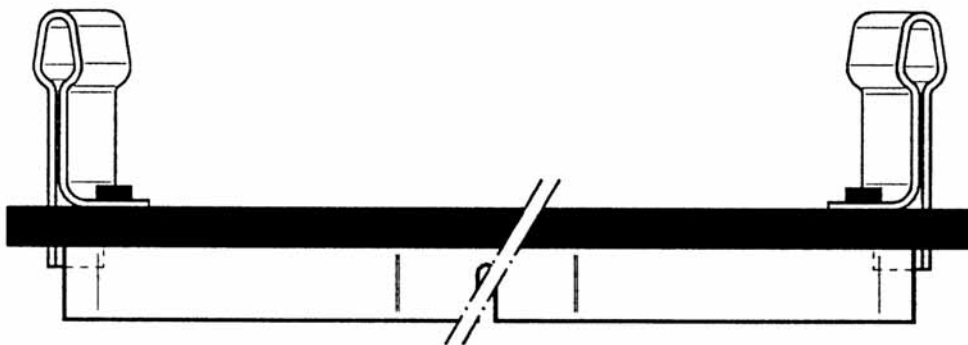
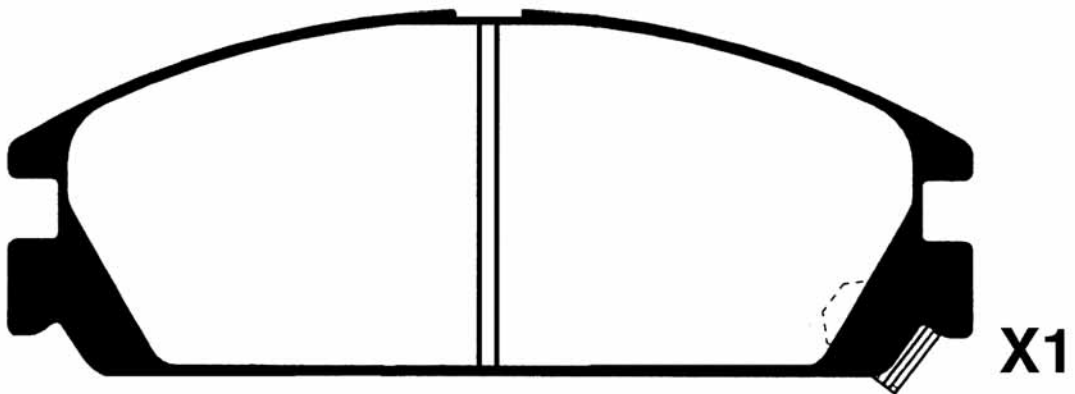
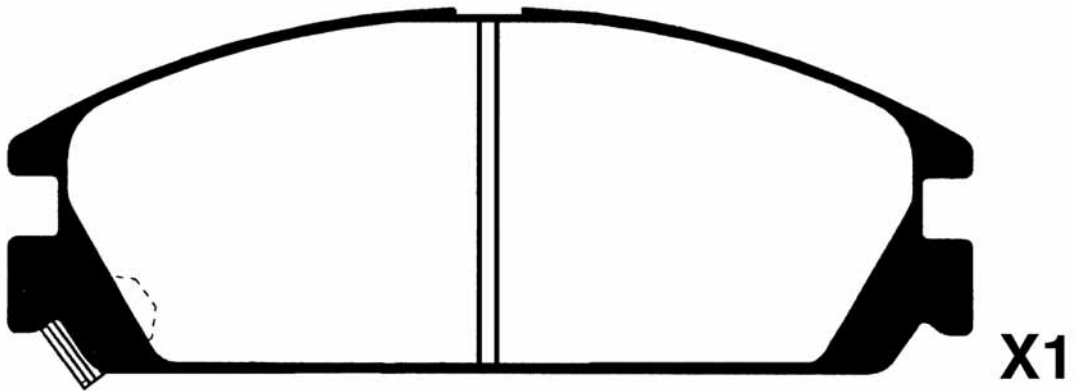
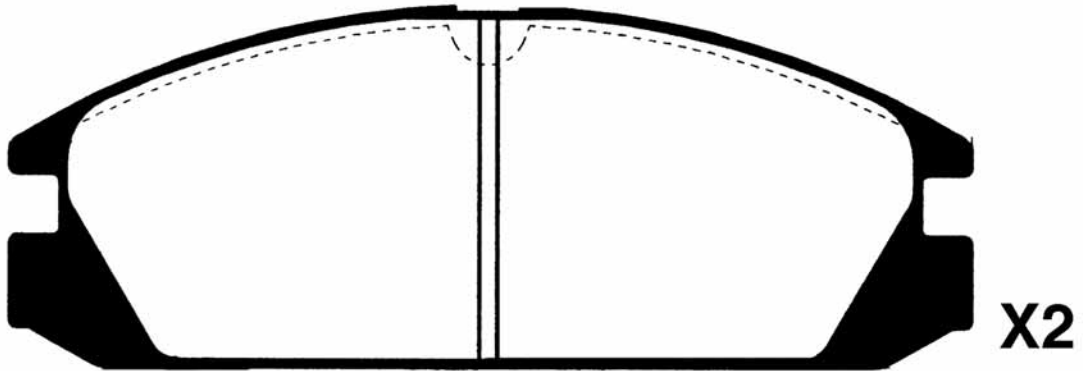



PICTURES BRAKE PADS FRONT
ABBILDUNGEN BREMSKLÖTZE VORN
FIGURAS PASTILLAS DE FRENO DELANTORES
ILLUSTRATIONS PLAQUETTES DE FREI AVANT
IMMAGINI PASTIGLIE FRENO ANTERIORI

50-04-425				WVA
HONDA	L	H	Th	
	131,7	55,3	14,4	21699

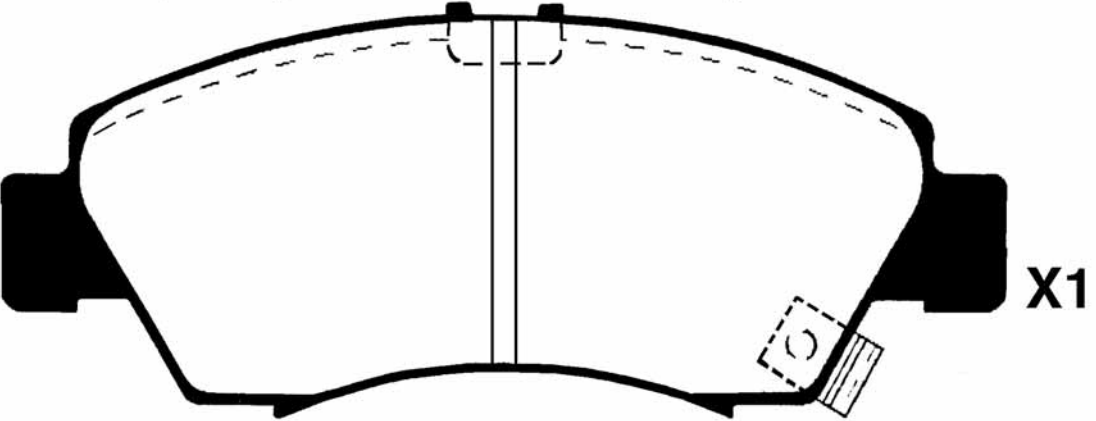
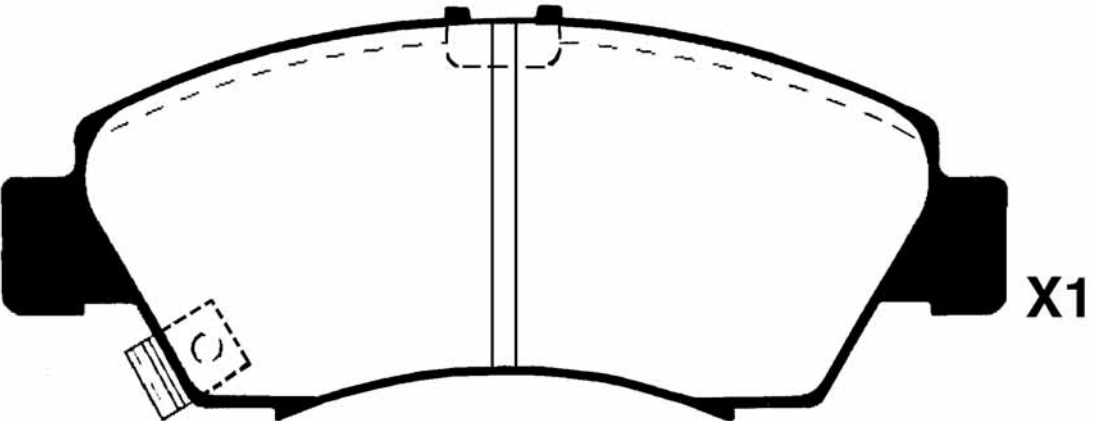
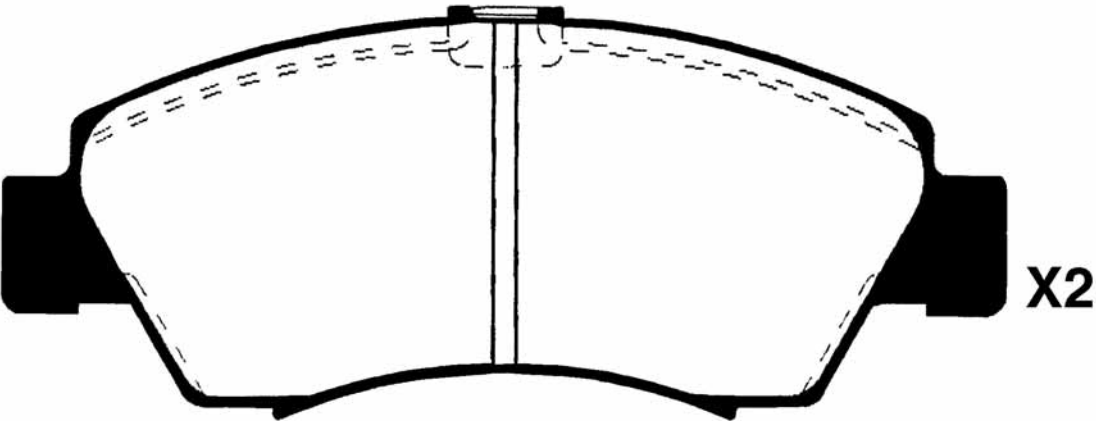



50-04-426				WVA
	HONDA - ROVER	L	H	Th
	129,1	53,3	17	21447

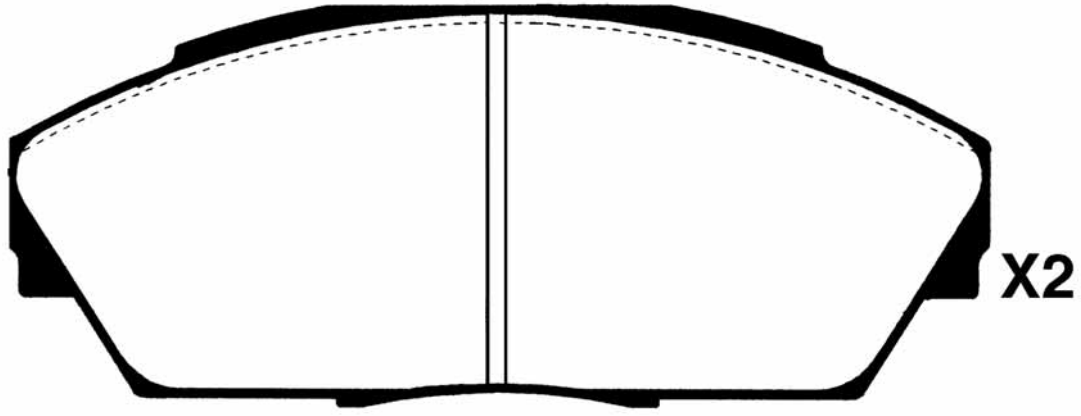
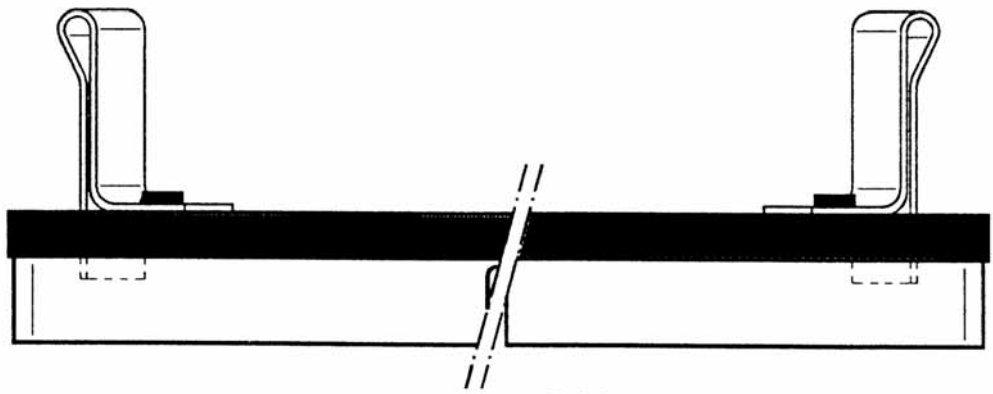
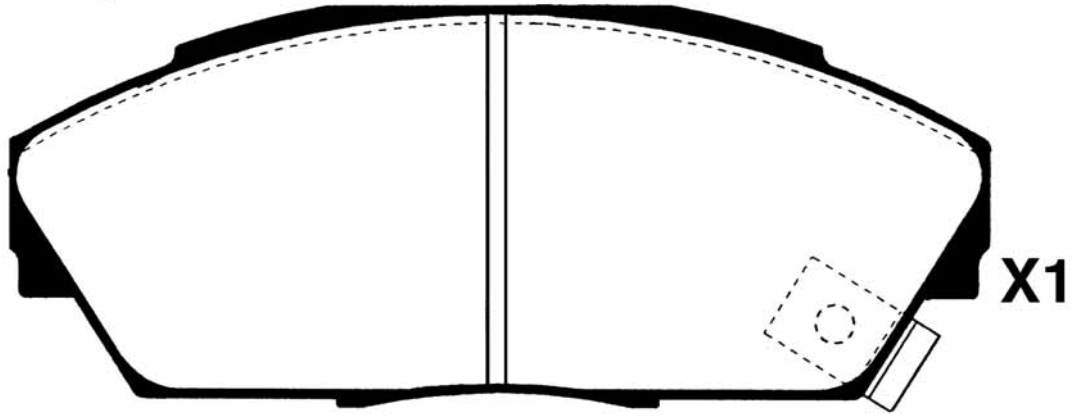
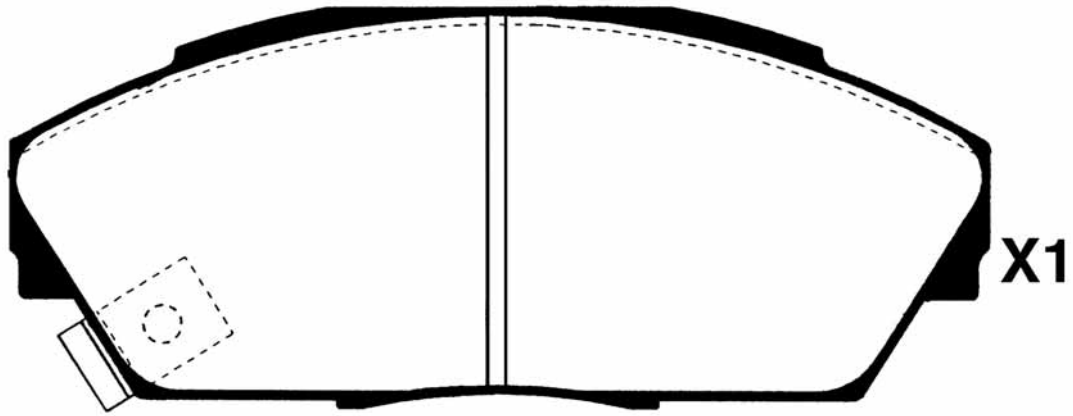



PICTURES BRAKE PADS FRONT
ABBILDUNGEN BREMSKLÖTZE VORN
FIGURAS PASTILLAS DE FRENO DELANTORES
ILLUSTRATIONS PLAQUETTES DE FREI AVANT
IMMAGINI PASTIGLIE FRENO ANTERIORI

50-04-427



WVA

**HONDA - LAND ROVER -
ROVER**

L

129,4

H

68,6

Th

17,6

21517

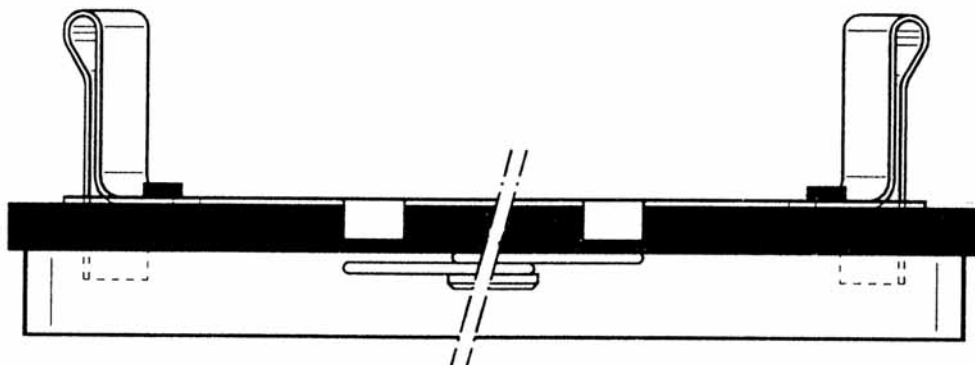
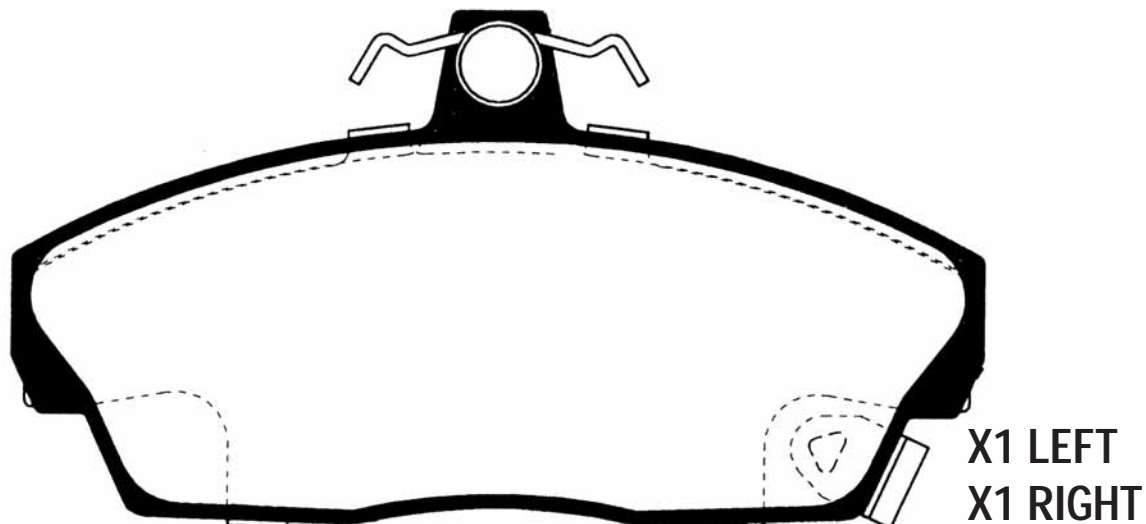
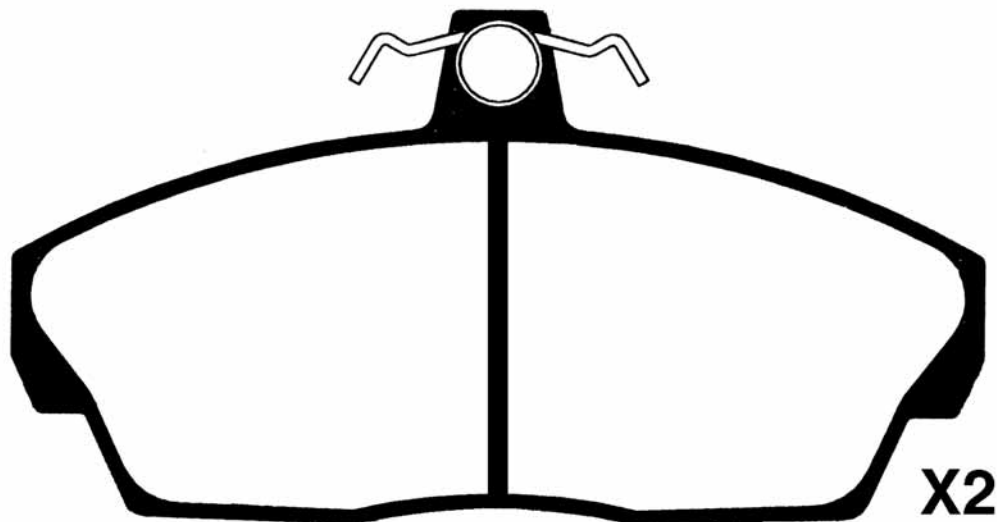



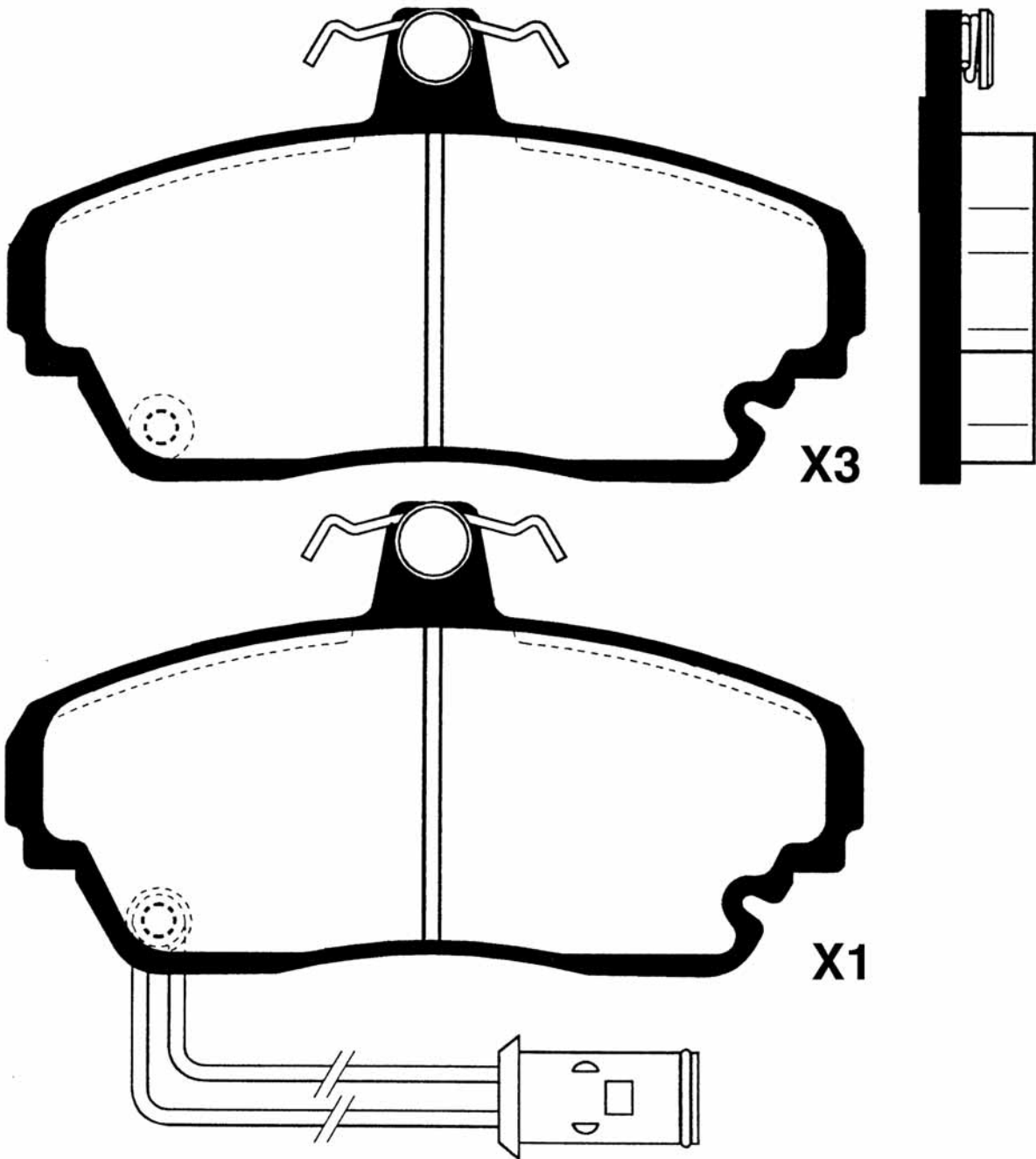

50-04-428				WVA
	HONDA	L 130	H 72,3	Th 17,5 21245





PICTURES BRAKE PADS FRONT
ABBILDUNGEN BREMSKLÖTZE VORN
FIGURAS PASTILLAS DE FRENO DELANTORES
ILLUSTRATIONS PLAQUETTES DE FREI AVANT
IMMAGINI PASTIGLIE FRENO ANTERIORI

50-04-429				WVA
ROVER	L	H	Th	
	107,6	45	14,8	23197

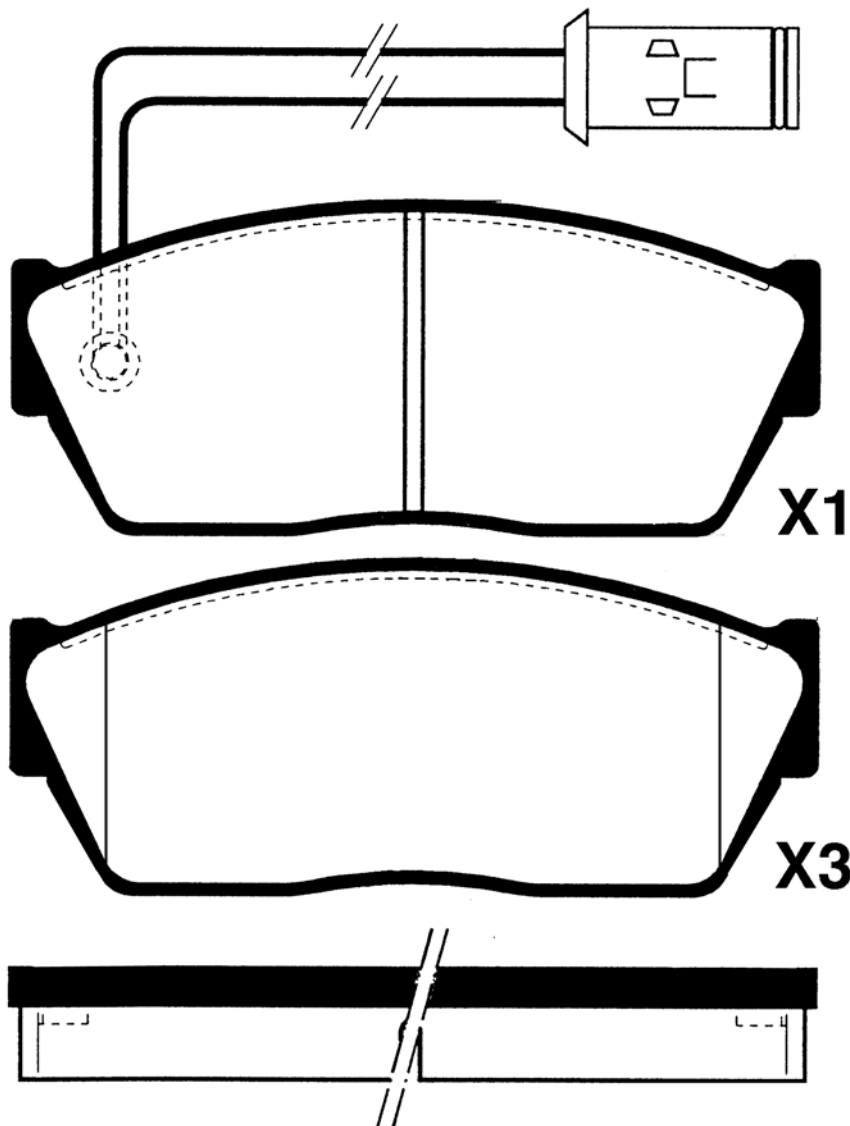



50-04-430				WVA
	ROVER	L	H	Th
	117,8	65,5	17	21520

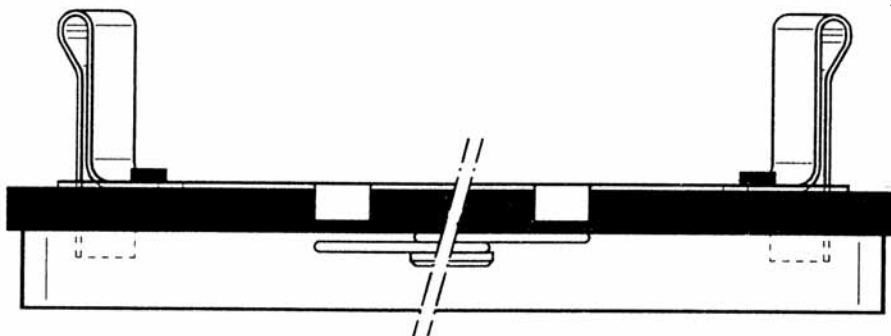
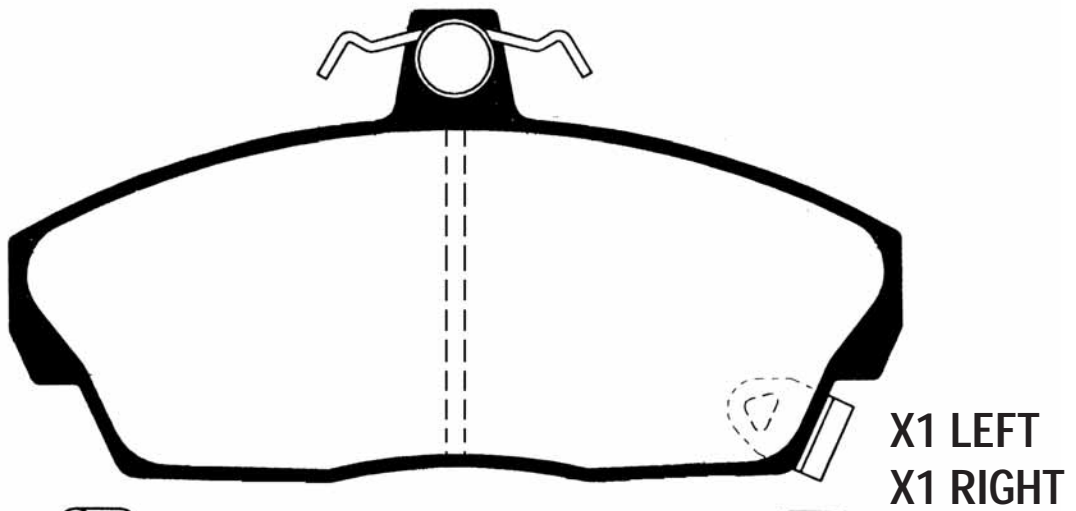
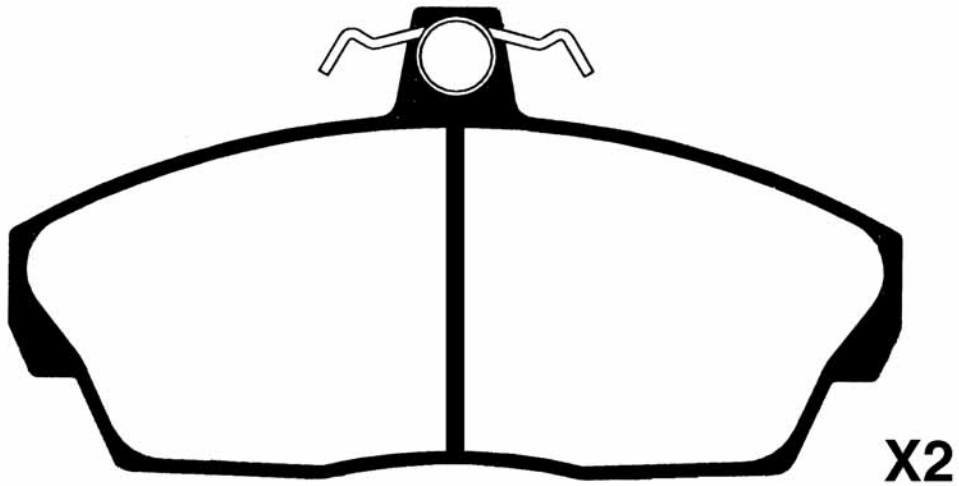



PICTURES BRAKE PADS FRONT
ABBILDUNGEN BREMSKLÖTZE VORN
FIGURAS PASTILLAS DE FRENO DELANTORES
ILLUSTRATIONS PLAQUETTES DE FREI AVANT
IMMAGINI PASTIGLIE FRENO ANTERIORI

50-04-432				WVA
HONDA	L	H	Th	
	149	58	16,9	21651

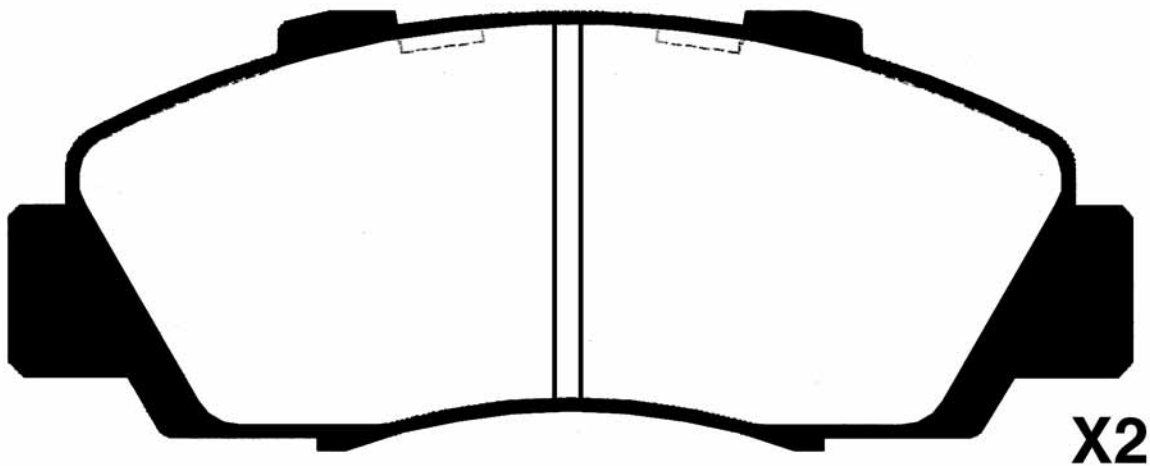
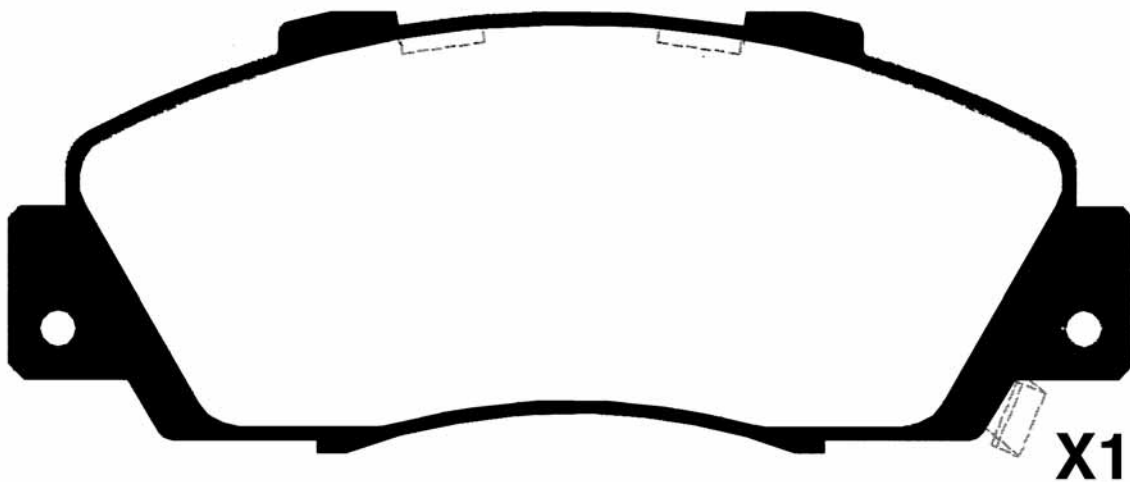
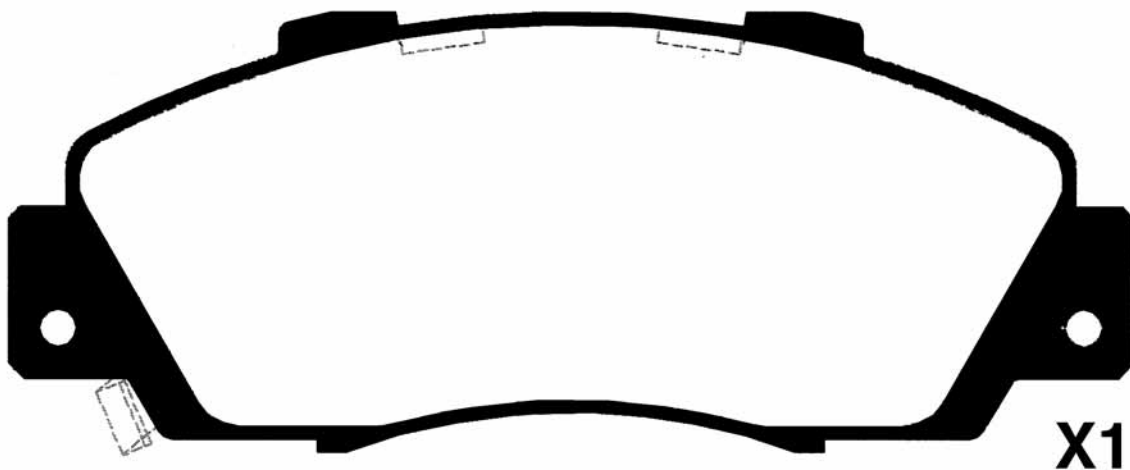



50-04-435				WVA
	HONDA	L	H	
	136,7	58,3	16	21694

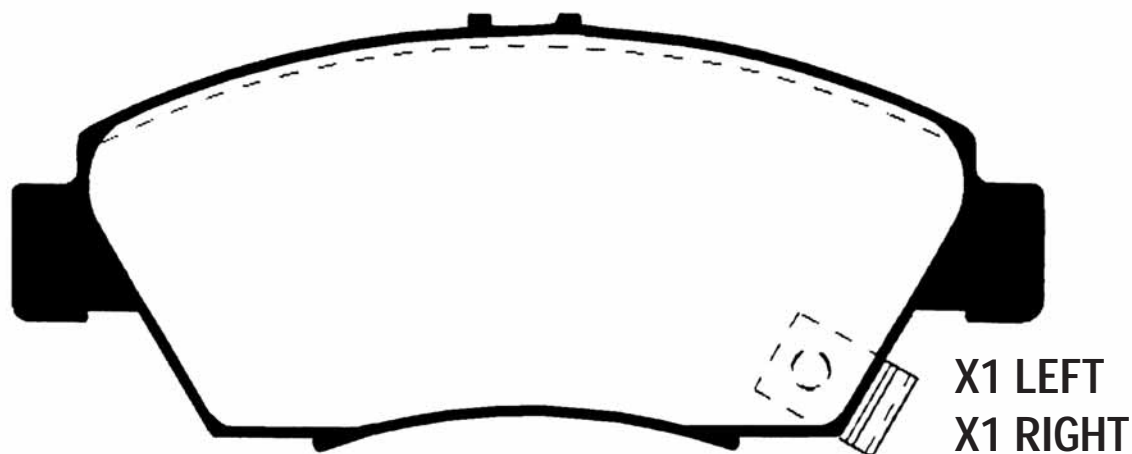
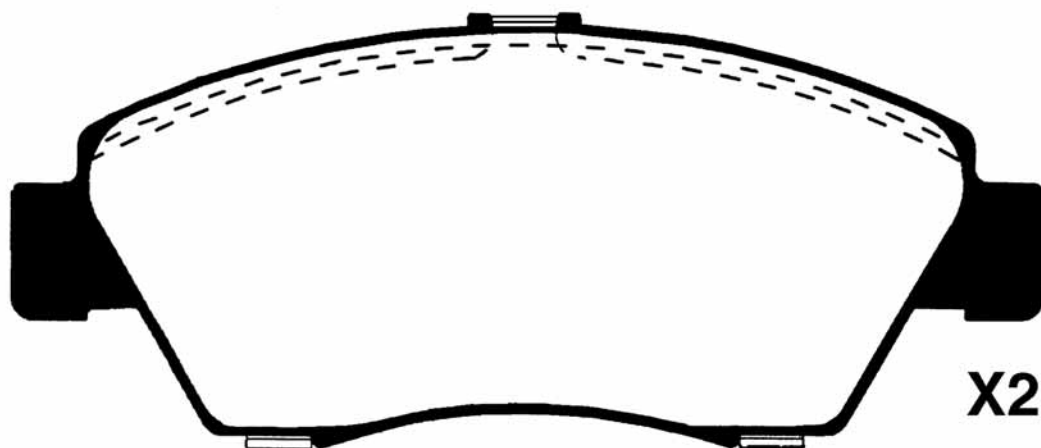



PICTURES BRAKE PADS FRONT
ABBILDUNGEN BREMSKLÖTZE VORN
FIGURAS PASTILLAS DE FRENO DELANTORES
ILLUSTRATIONS PLAQUETTES DE FREI AVANT
IMMAGINI PASTIGLIE FRENO ANTERIORI

50-04-442				WVA
HONDA	L	H	Th	
	127,7	48,4	14,2	21330

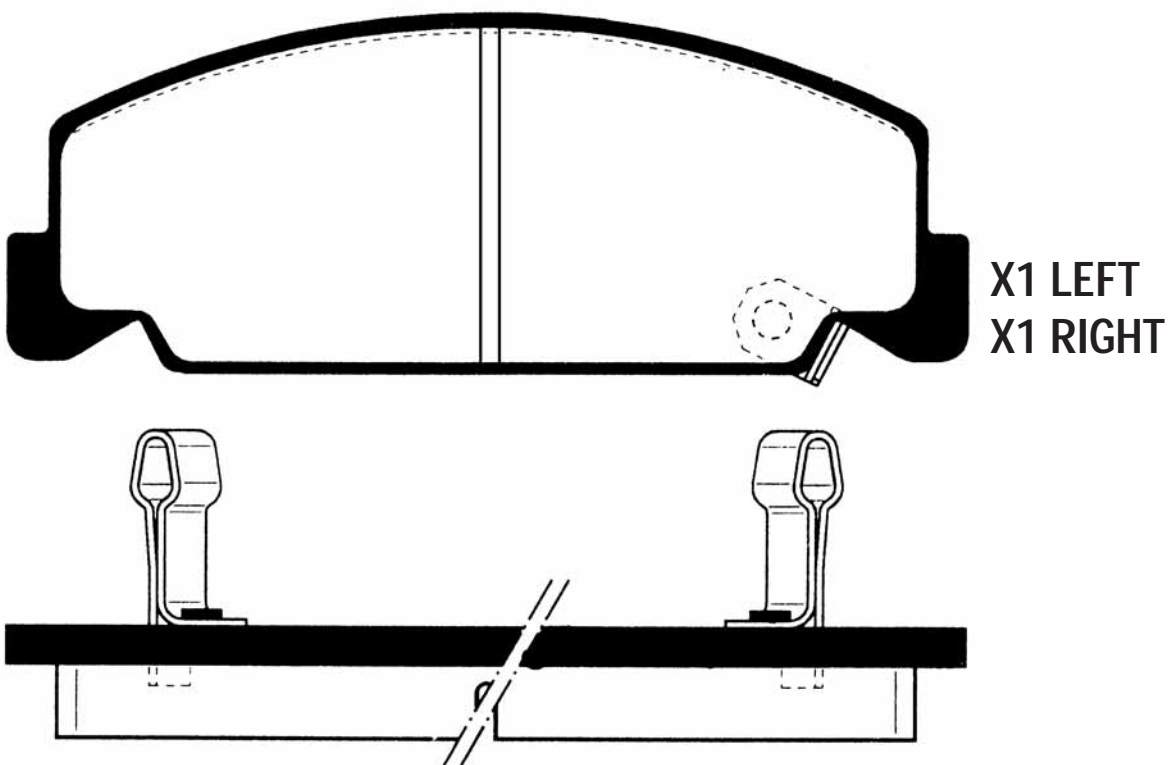
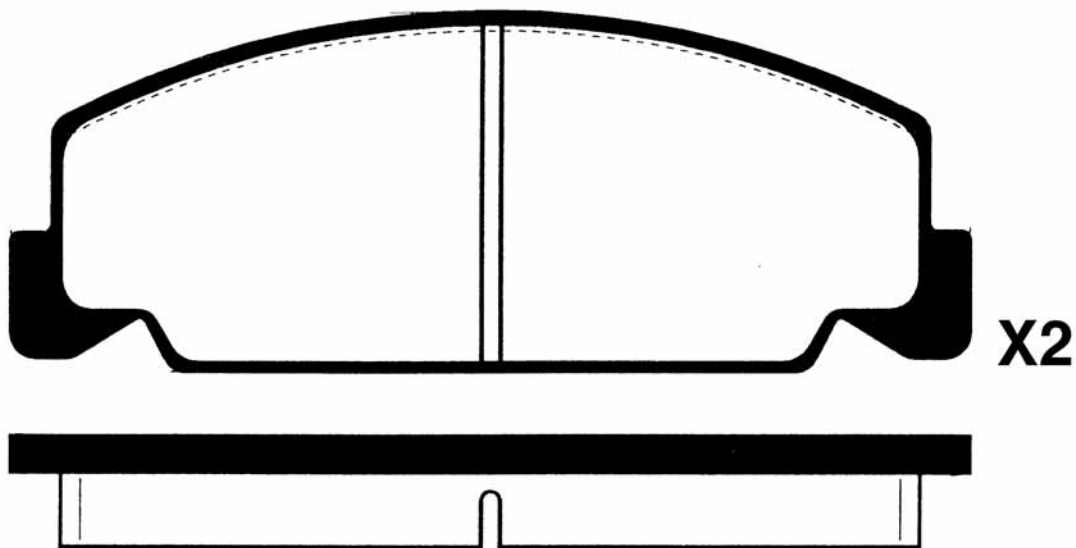



50-04-452				WVA
	HONDA	L	H	
	155,3	68,4/64,8	17,1	23720

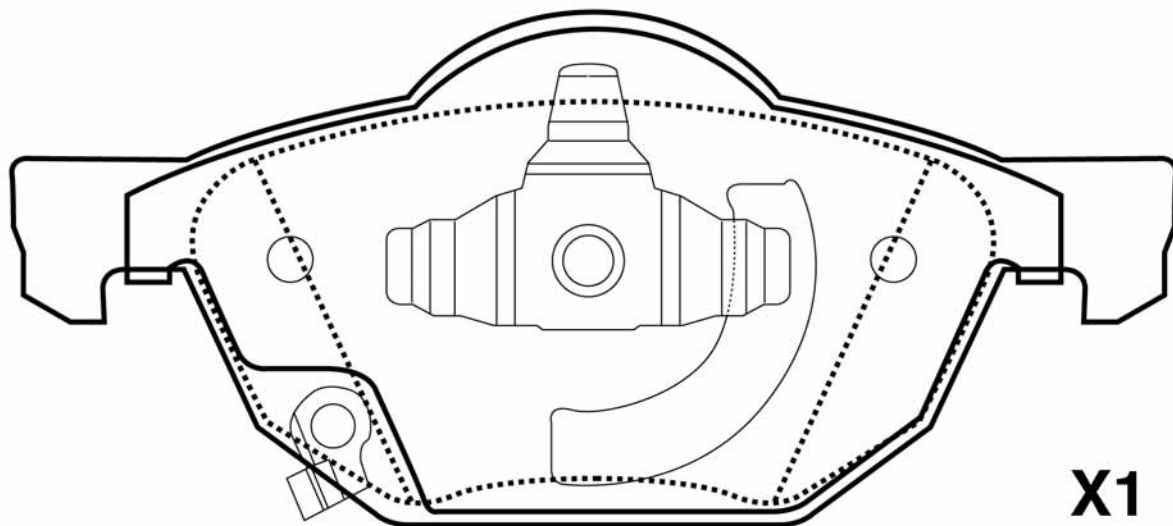
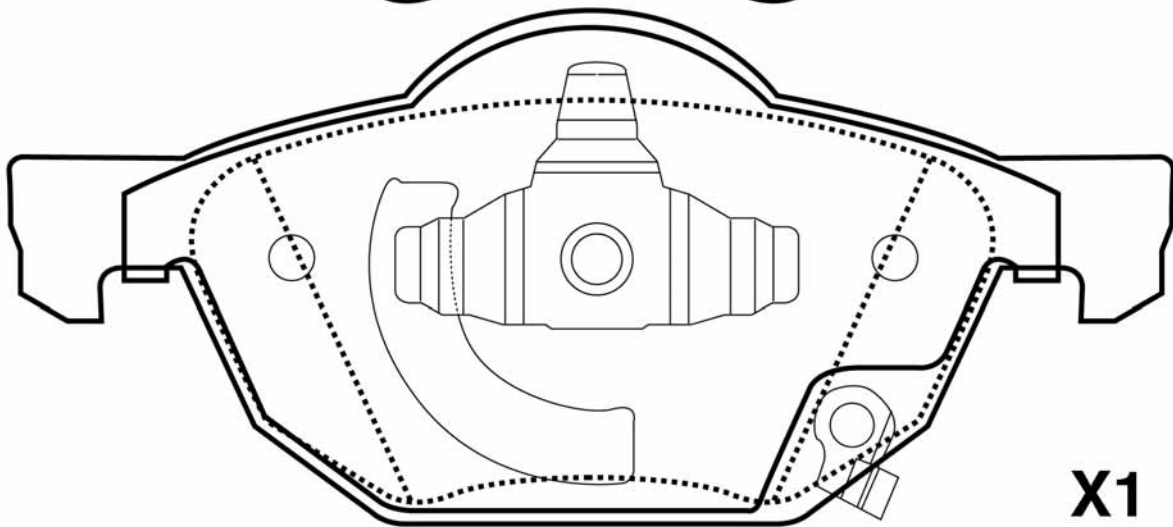
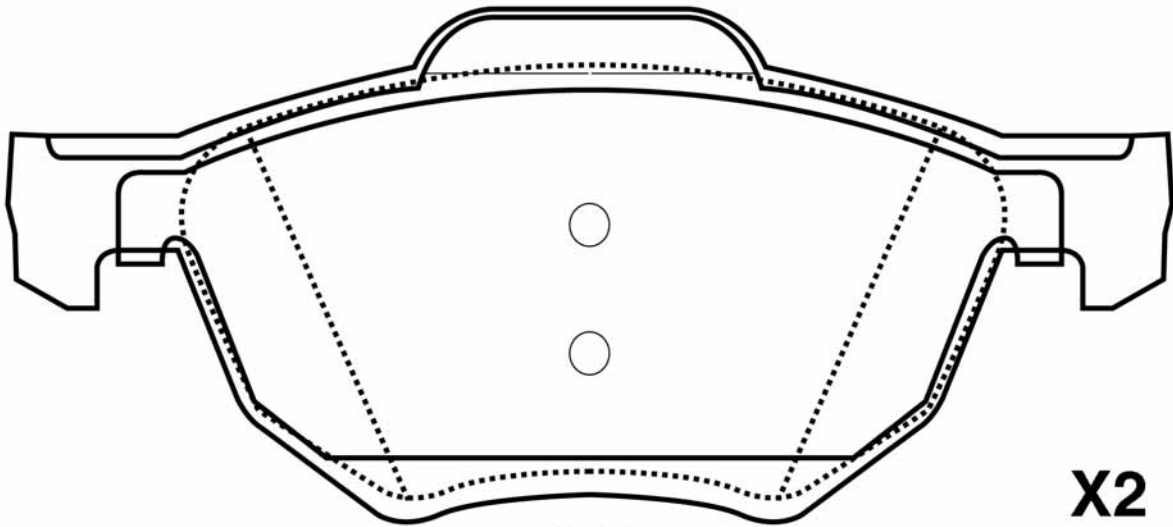



PICTURES BRAKE PADS FRONT
ABBILDUNGEN BREMSKLÖTZE VORN
FIGURAS PASTILLAS DE FRENO DELANTORES
ILLUSTRATIONS PLAQUETTES DE FREI AVANT
IMMAGINI PASTIGLIE FRENO ANTERIORI

50-04-489

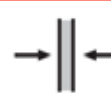

WVA

HONDA

L

H

Th

132

49,3

16,5

23096

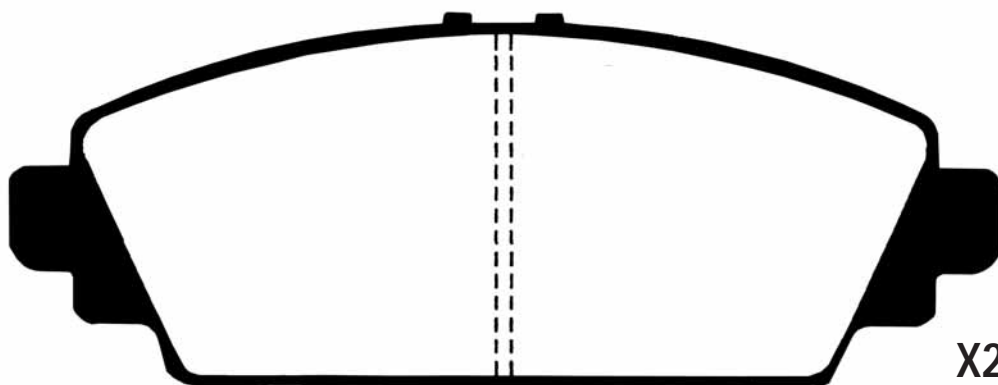
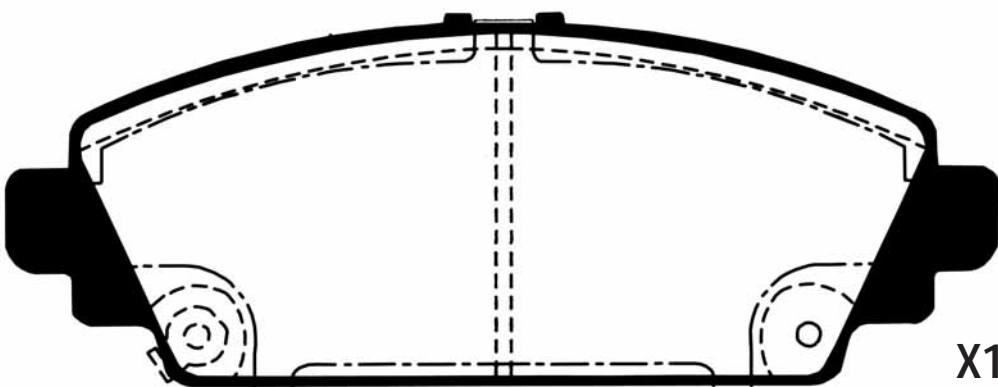
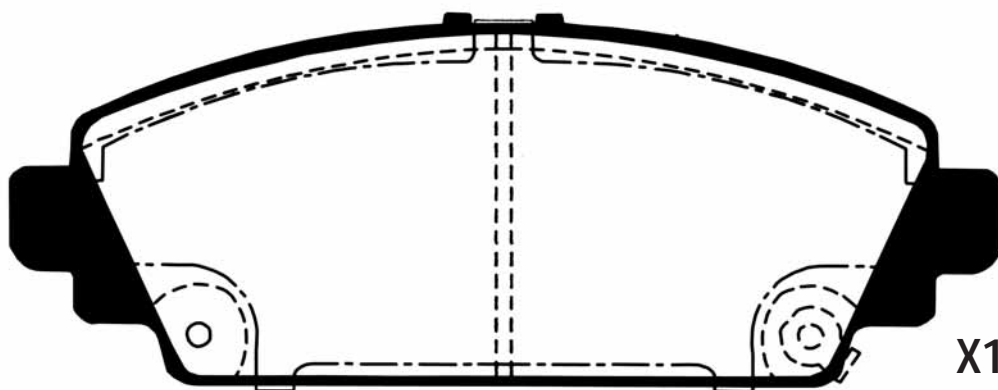



50-04-490				WVA
	HONDA	L	H	
	135	52,2	15,6	23178

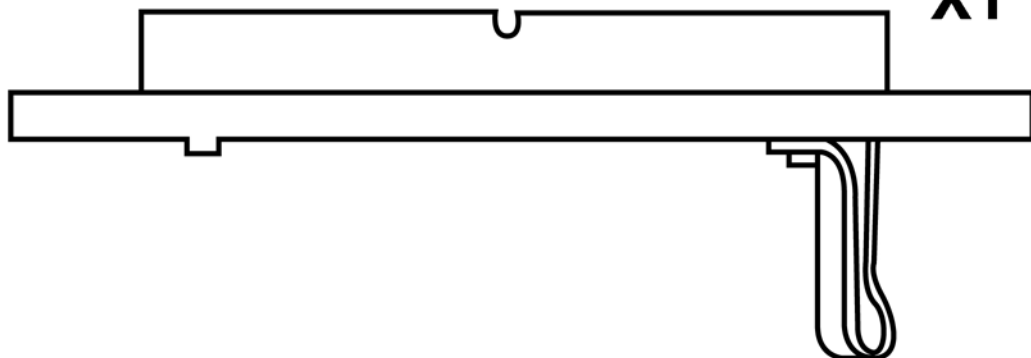
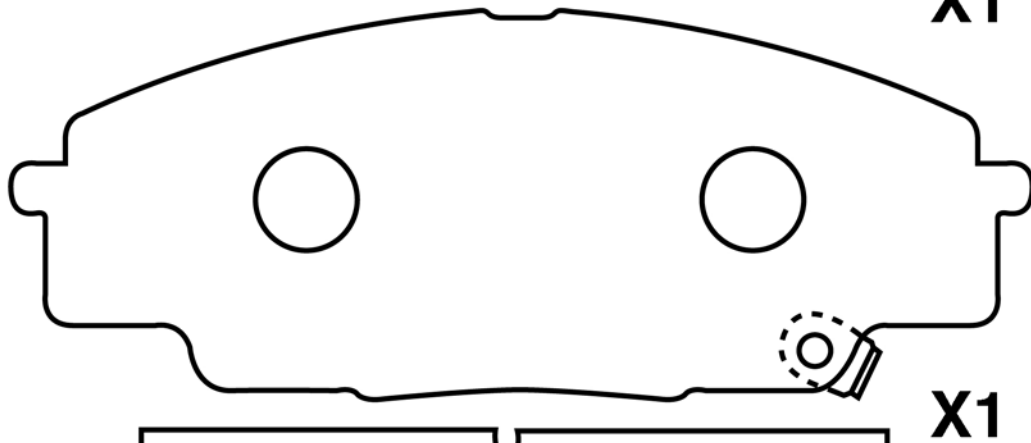
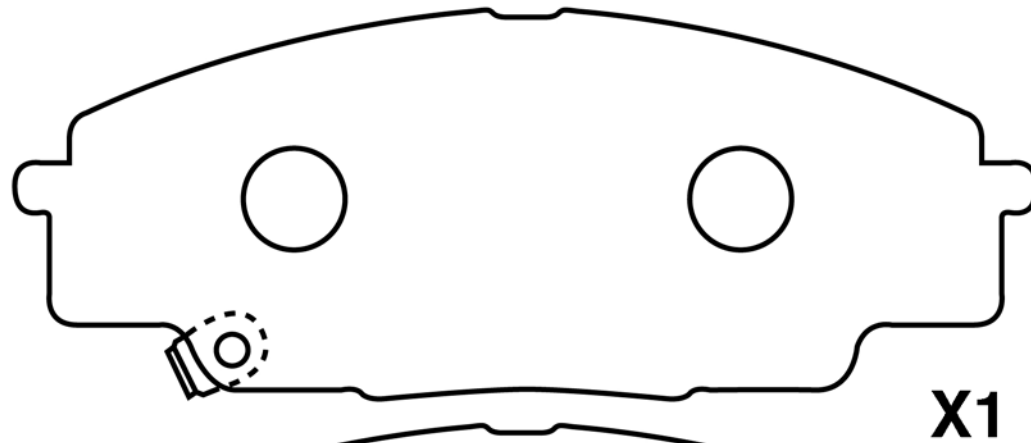
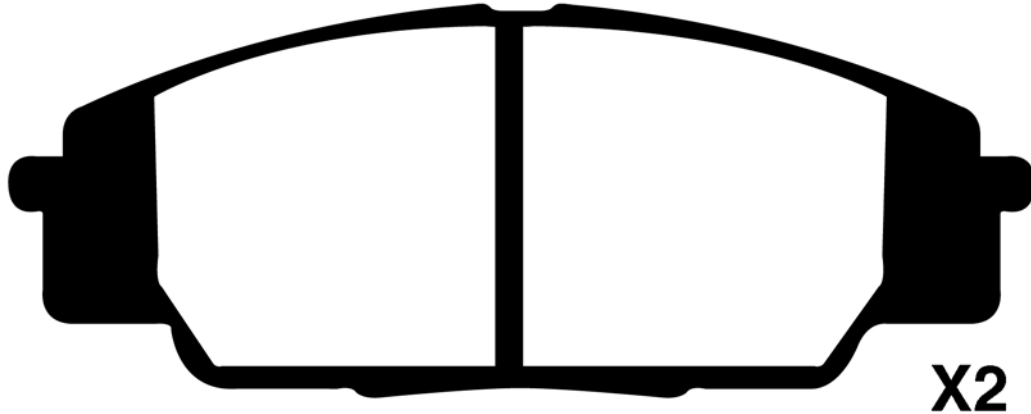



PICTURES BRAKE PADS FRONT
ABBILDUNGEN BREMSKLÖTZE VORN
FIGURAS PASTILLAS DE FRENO DELANTORES
ILLUSTRATIONS PLAQUETTES DE FREI AVANT
IMMAGINI PASTIGLIE FRENO ANTERIORI

50-04-491				WVA
HONDA	L	H	Th	
	148,6	59,7	16,3	23729

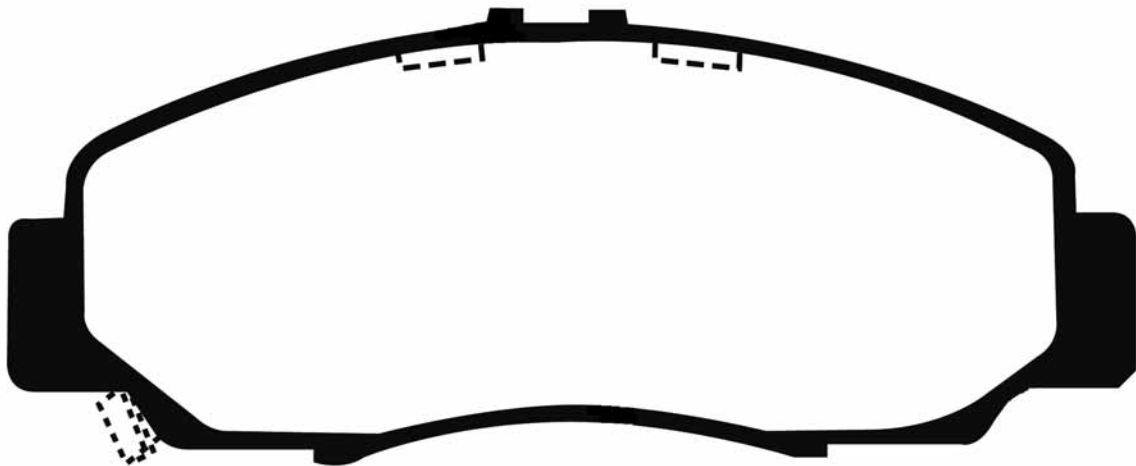

X1

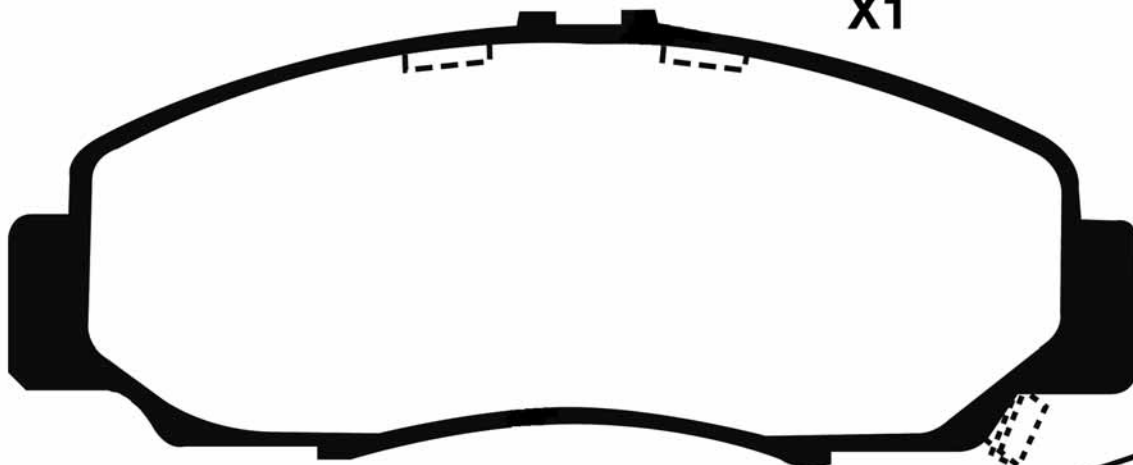

X1

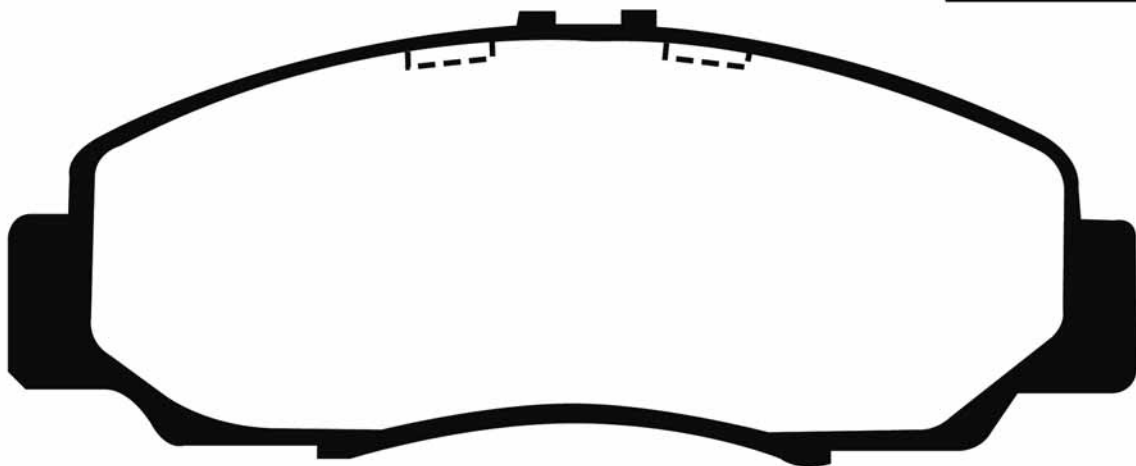
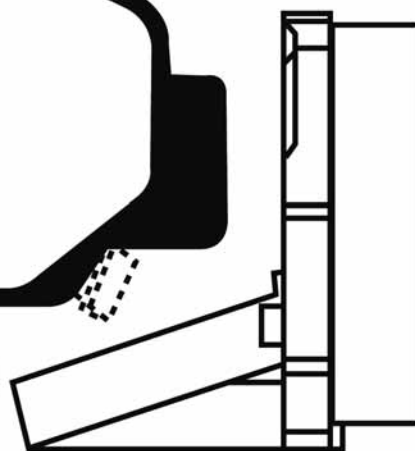

X2

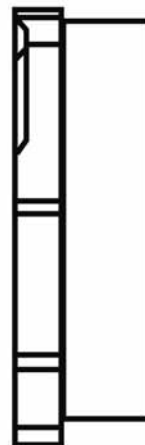



50-04-492				WVA
	HONDA	L	H	
	141,2	54,6	17,7	21702

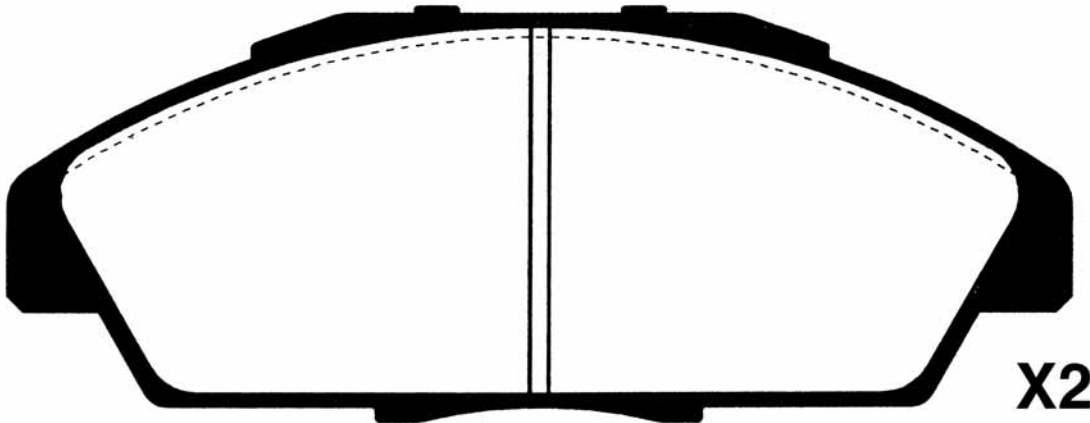
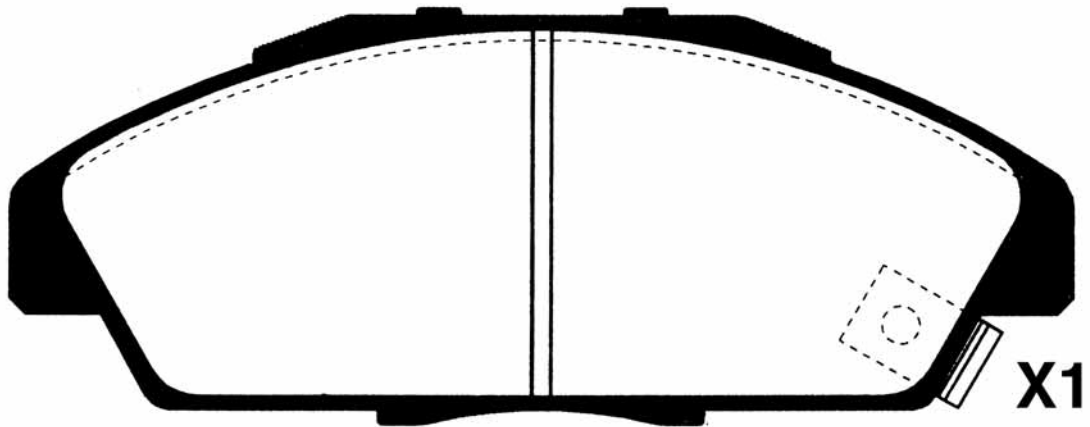
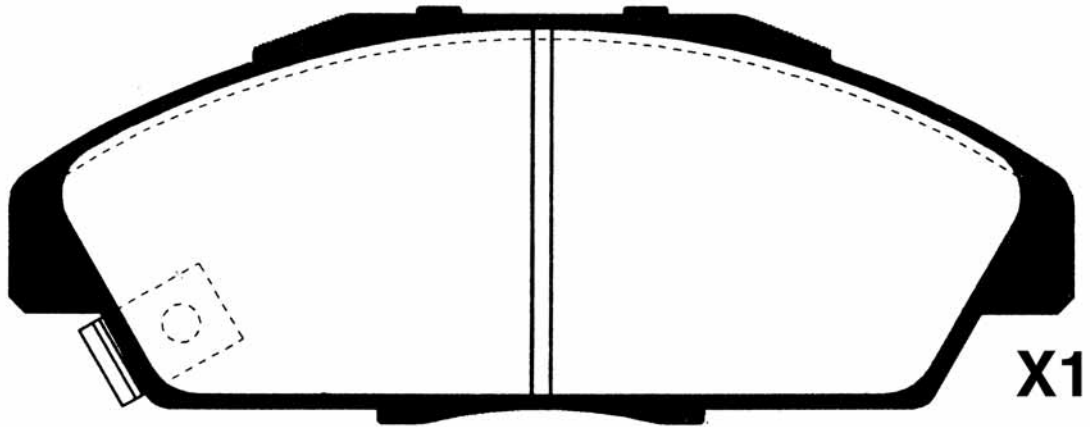



PICTURES BRAKE PADS FRONT
ABBILDUNGEN BREMSKLÖTZE VORN
FIGURAS PASTILLAS DE FRENO DELANTORES
ILLUSTRATIONS PLAQUETTES DE FREI AVANT
IMMAGINI PASTIGLIE FRENO ANTERIORI

50-04-493

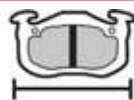

WVA

HONDA

L

H

Th

137,5

52,7

18

21499

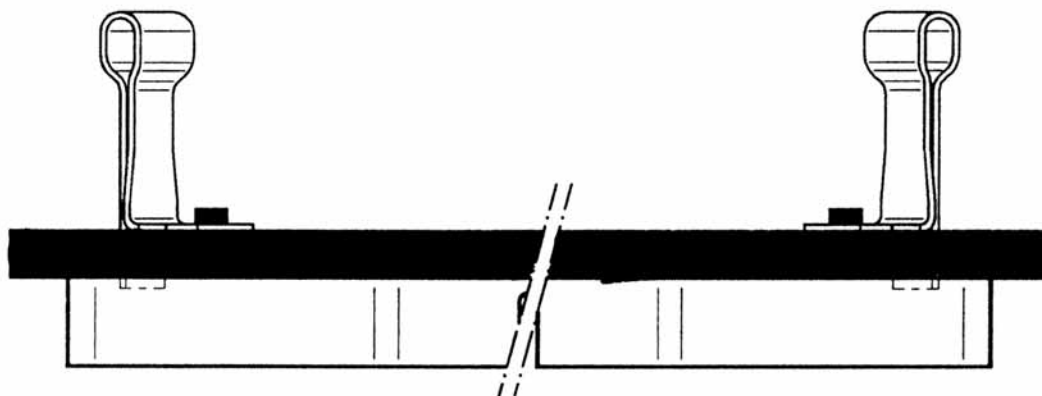
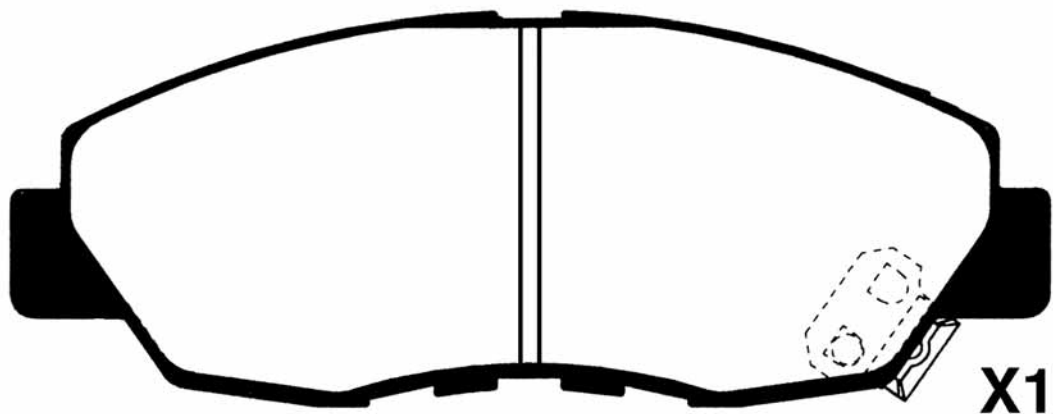
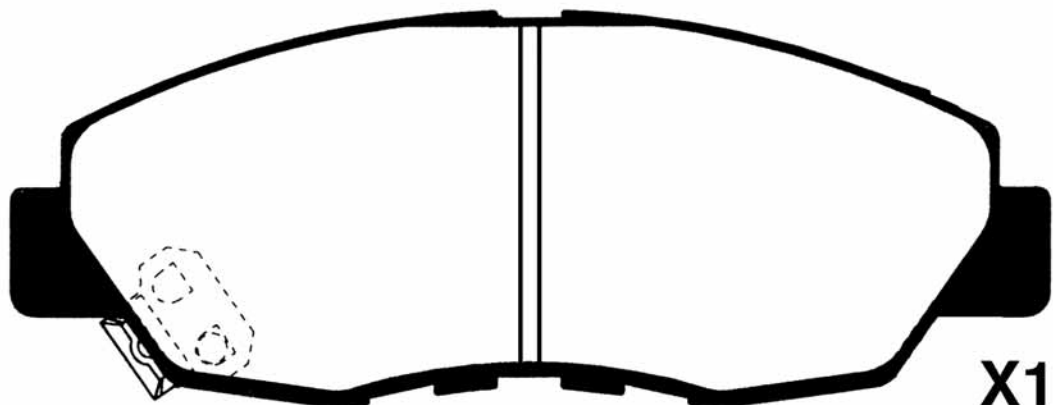
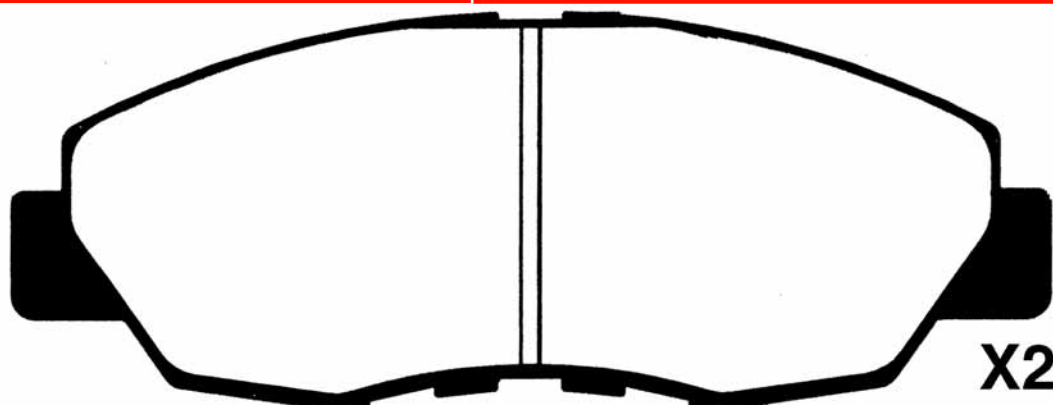



50-05-501				WVA
	MITSUBISHI	L 145	H 55	Th 15,9
				23584

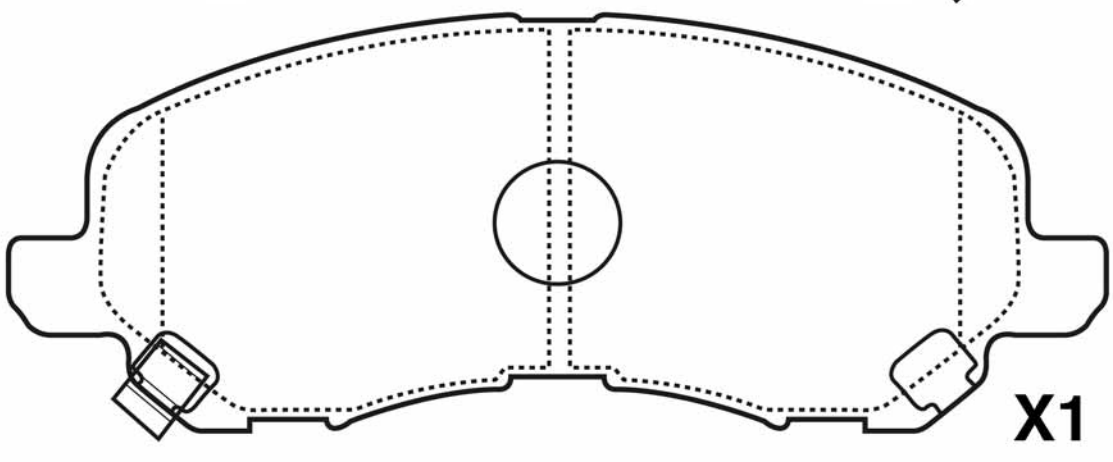
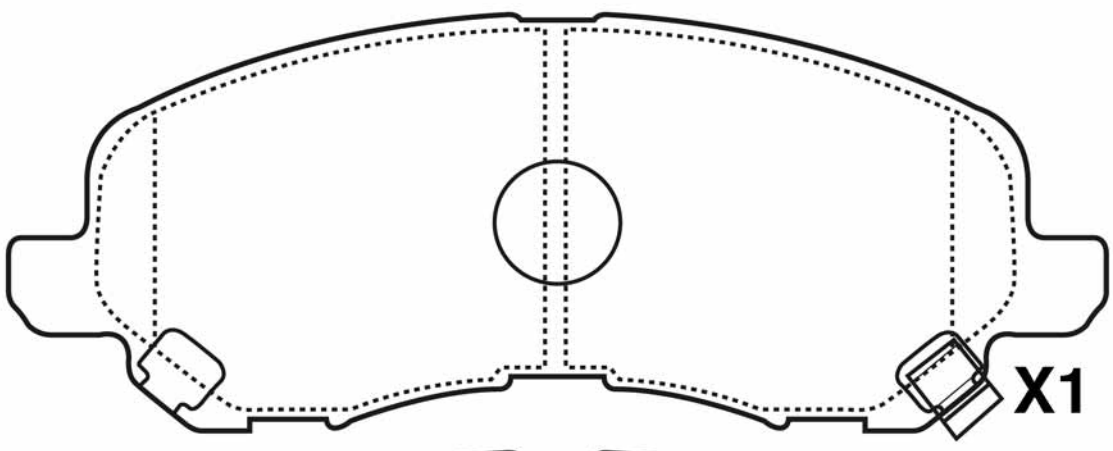
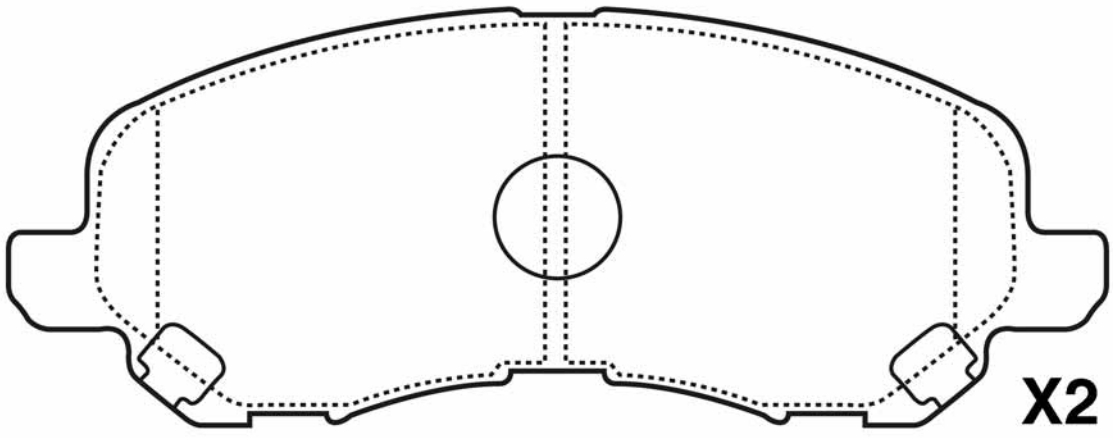



PICTURES BRAKE PADS FRONT
ABBILDUNGEN BREMSKLÖTZE VORN
FIGURAS PASTILLAS DE FRENO DELANTORES
ILLUSTRATIONS PLAQUETTES DE FREI AVANT
IMMAGINI PASTIGLIE FRENO ANTERIORI

50-05-502		WVA		
MAZDA - MITSUBISHI - TOYOTA - ASIA MOTORS	L 128	H 56,7	Th 15,5	20047

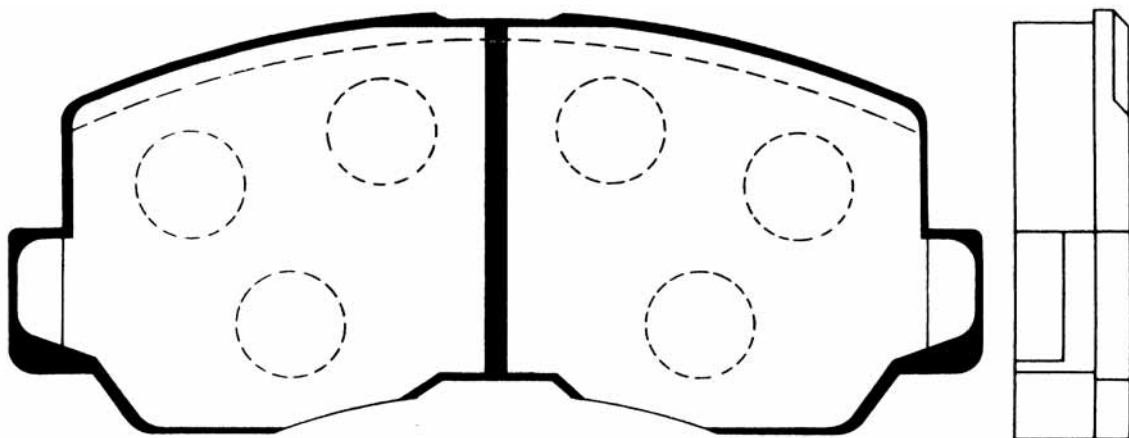

X4



50-05-503

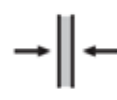
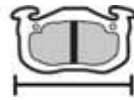

WVA

MITSUBISHI

L

H

Th

114,1

56,5

14,8

24291

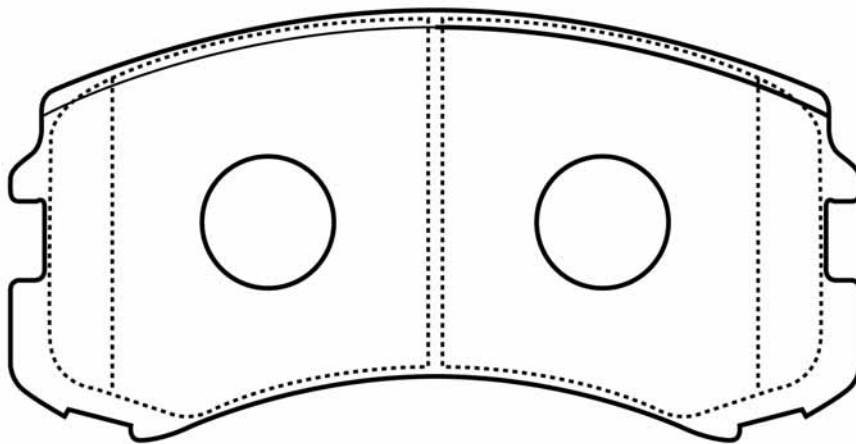

X4



PICTURES BRAKE PADS FRONT
ABBILDUNGEN BREMSKLÖTZE VORN
FIGURAS PASTILLAS DE FRENO DELANTORES
ILLUSTRATIONS PLAQUETTES DE FREI AVANT
IMMAGINI PASTIGLIE FRENO ANTERIORI

50-05-504

MITSUBISHI

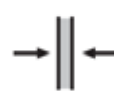

WVA

L

H

Th

155

51,2

15,5

24529

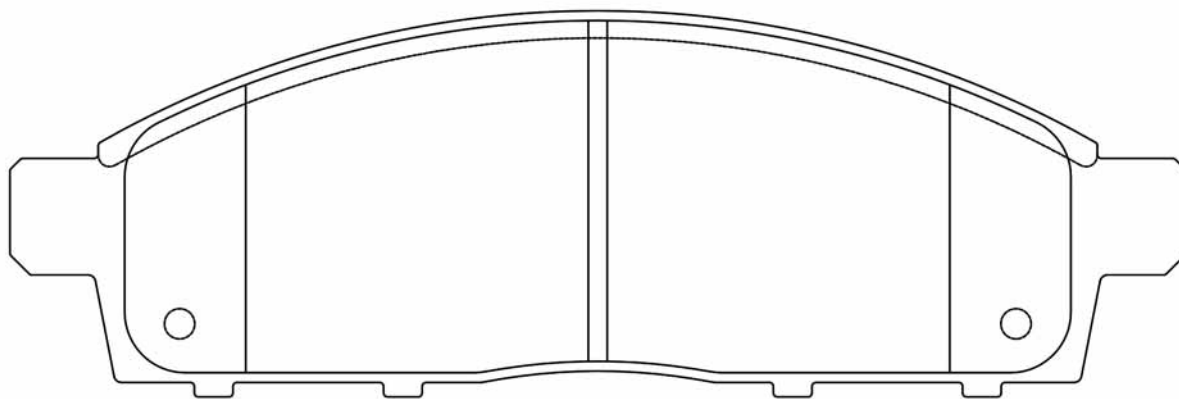
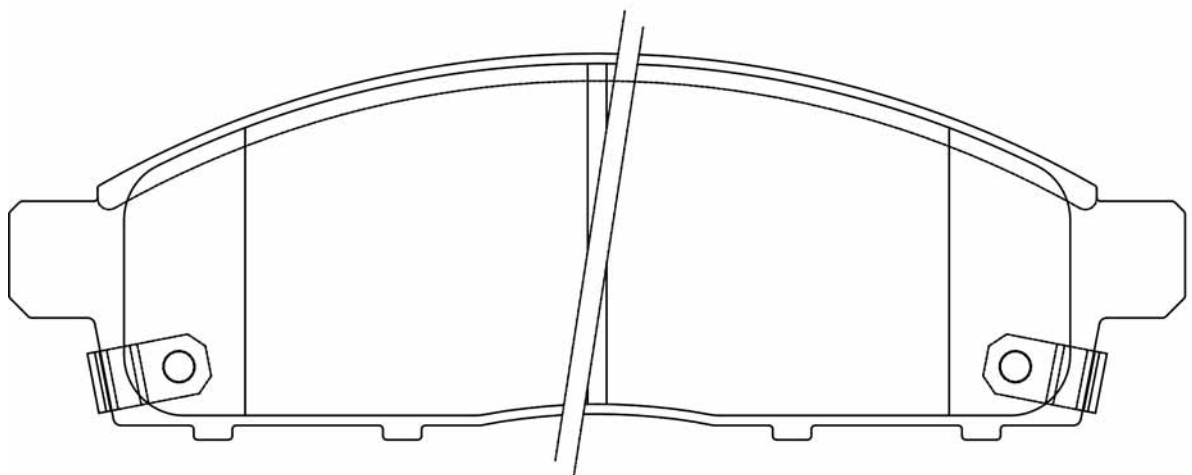



50-05-505

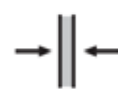
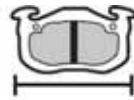

WVA

MITSUBISHI

L

H

Th

123,1

48,2

15,4

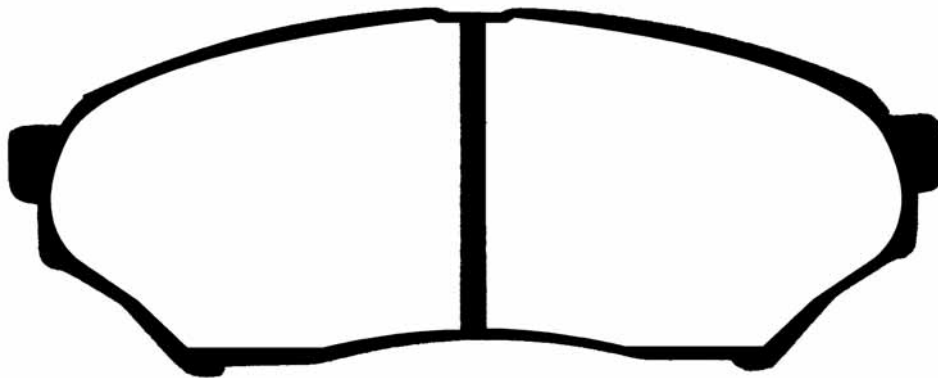

23487



X4

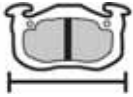

PICTURES BRAKE PADS FRONT
ABBILDUNGEN BREMSKLÖTZE VORN
FIGURAS PASTILLAS DE FRENO DELANTORES
ILLUSTRATIONS PLAQUETTES DE FREI AVANT
IMMAGINI PASTIGLIE FRENO ANTERIORI

50-05-506 MITSUBISHI				WVA
	L	H	Th	
	135	48,8	16	20851

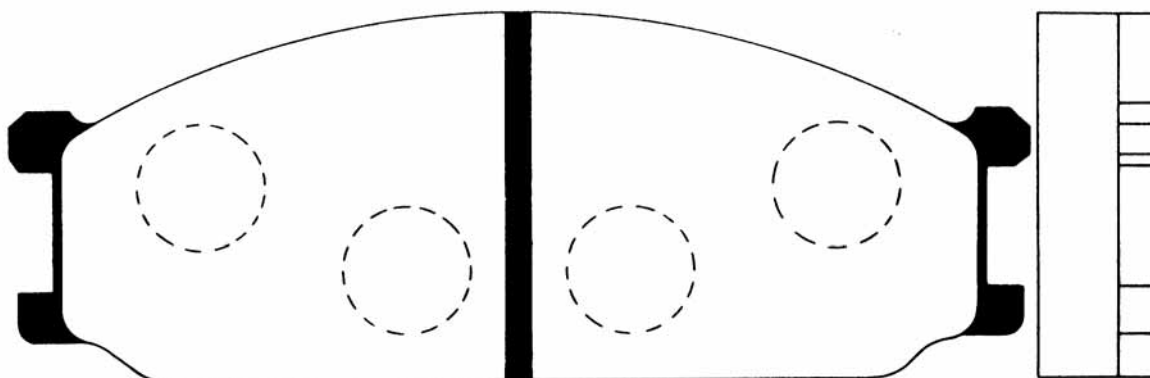

X4



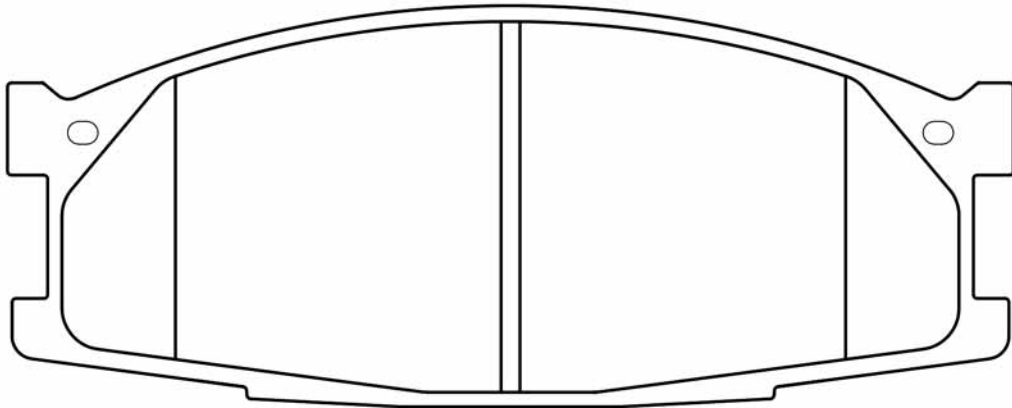
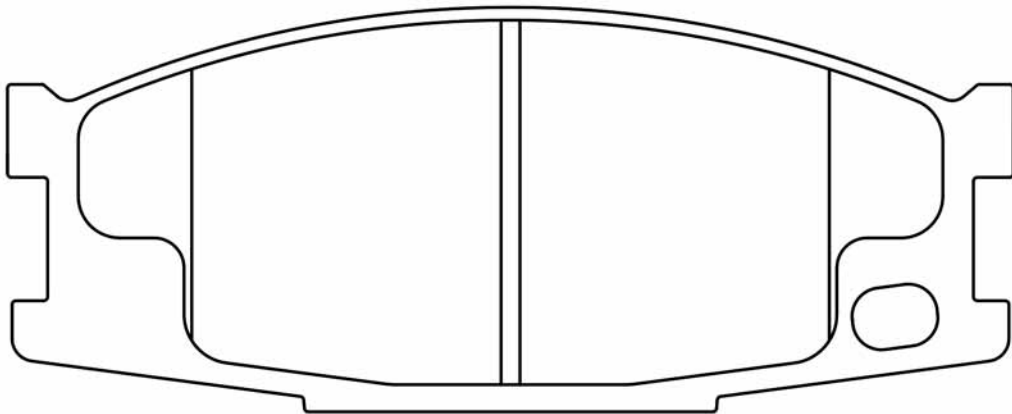
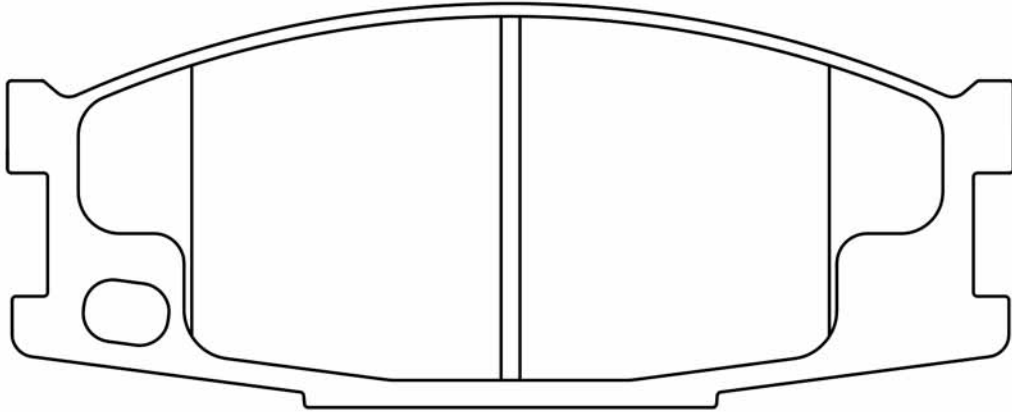

50-05-507				WVA
	MITSUBISHI	L	H	
	133	54	18	23501



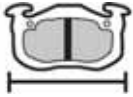

PICTURES BRAKE PADS FRONT
ABBILDUNGEN BREMSKLÖTZE VORN
FIGURAS PASTILLAS DE FRENO DELANTORES
ILLUSTRATIONS PLAQUETTES DE FREI AVANT
IMMAGINI PASTIGLIE FRENO ANTERIORI

50-05-508				WVA
MITSUBISHI	L	H	Th	
	109	48	15	20724

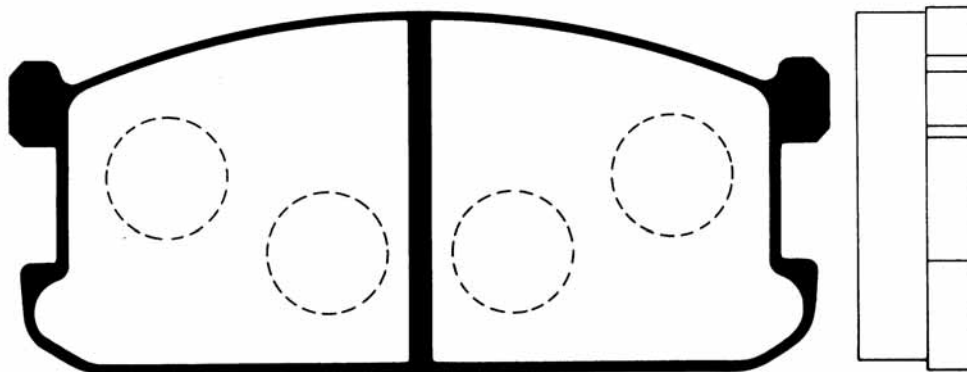

X4



50-05-509				WVA
	MITSUBISHI	L	H	Th
	139,2	58	15,6	23488

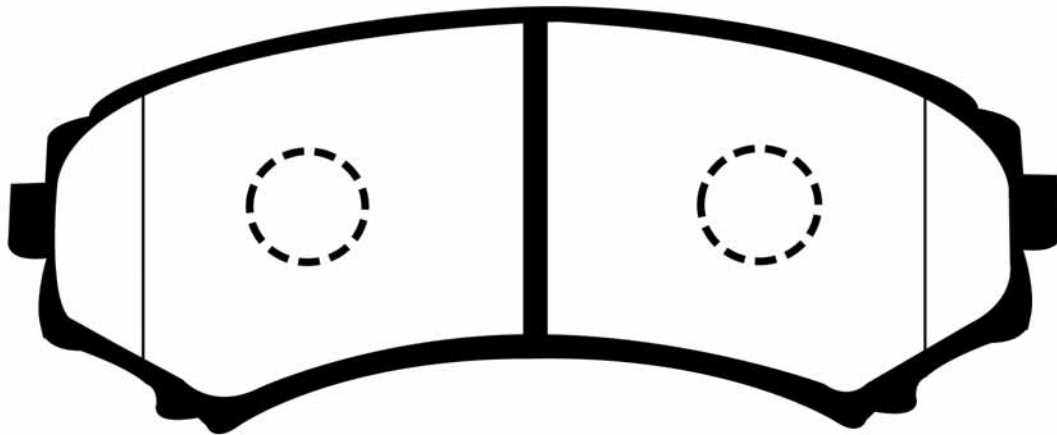

X4



PICTURES BRAKE PADS FRONT
ABBILDUNGEN BREMSKLÖTZE VORN
FIGURAS PASTILLAS DE FRENO DELANTORES
ILLUSTRATIONS PLAQUETTES DE FREI AVANT
IMMAGINI PASTIGLIE FRENO ANTERIORI

50-05-509P				WVA
MITSUBISHI	L	H	Th	
	139,2	58	15,6	

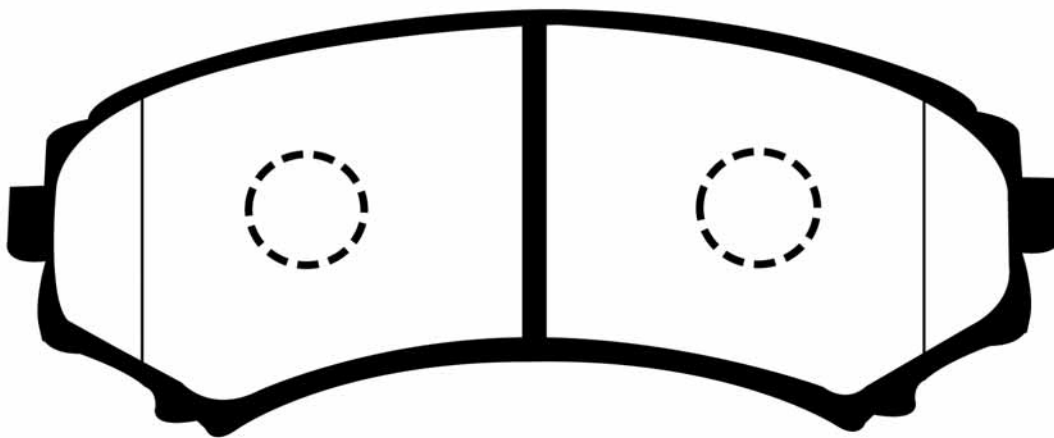

X4



50-05-510

MITSUBISHI

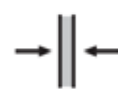
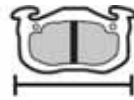

WVA

L

131,7

H

77,2

Th

14,7

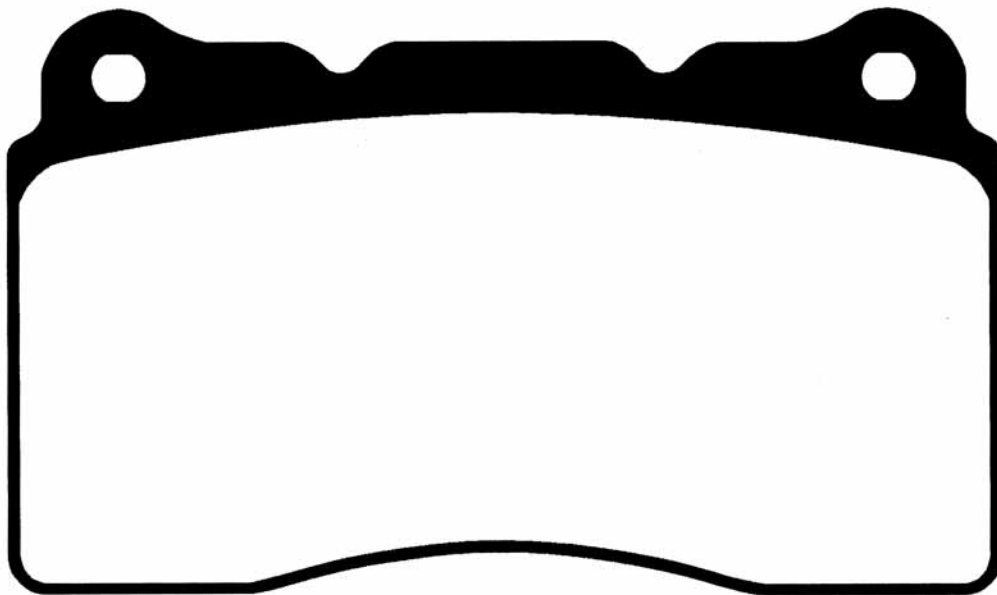

X4



PICTURES BRAKE PADS FRONT
ABBILDUNGEN BREMSKLÖTZE VORN
FIGURAS PASTILLAS DE FRENO DELANTORES
ILLUSTRATIONS PLAQUETTES DE FREI AVANT
IMMAGINI PASTIGLIE FRENO ANTERIORI

50-05-514

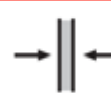

WVA

MITSUBISHI

L

H

Th

125,2

60

19,4

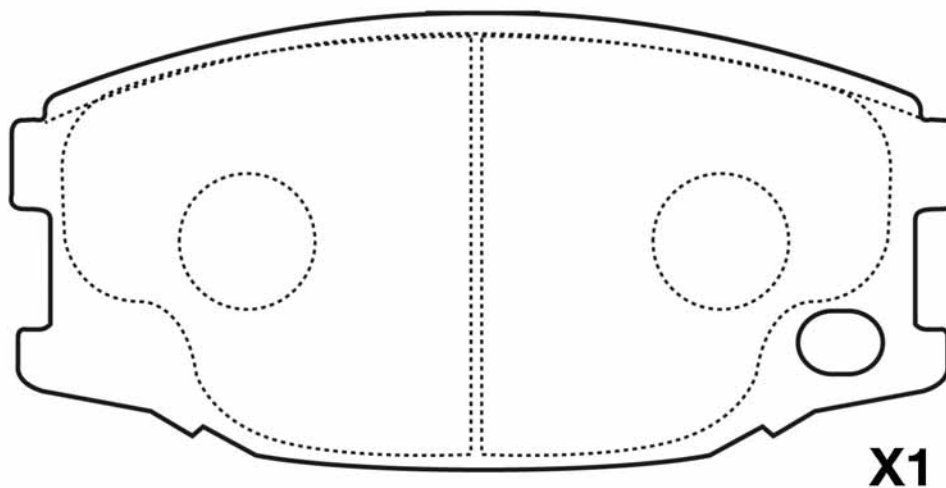
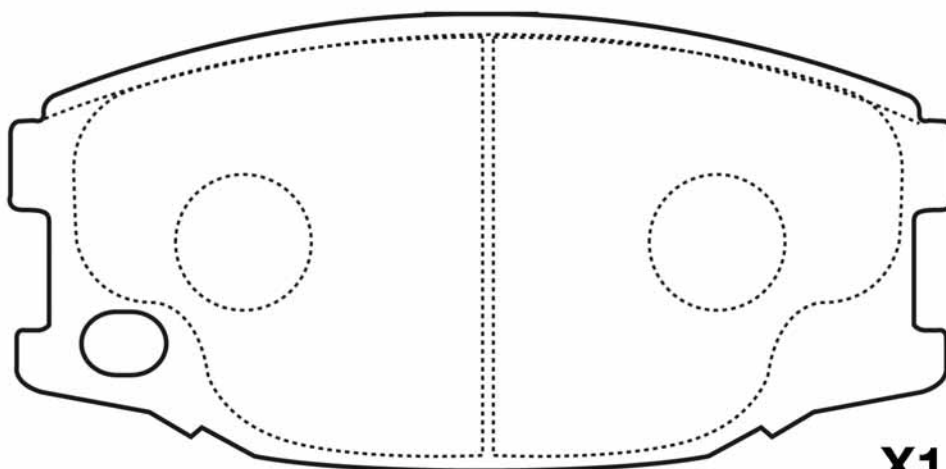
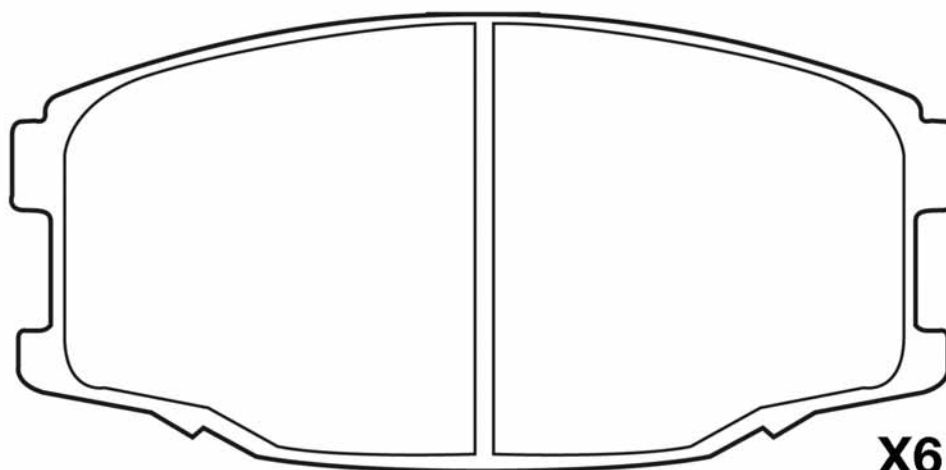



50-05-515				WVA
	MITSUBISHI	L	H	Th
	151,2	56,5	14,9	23879

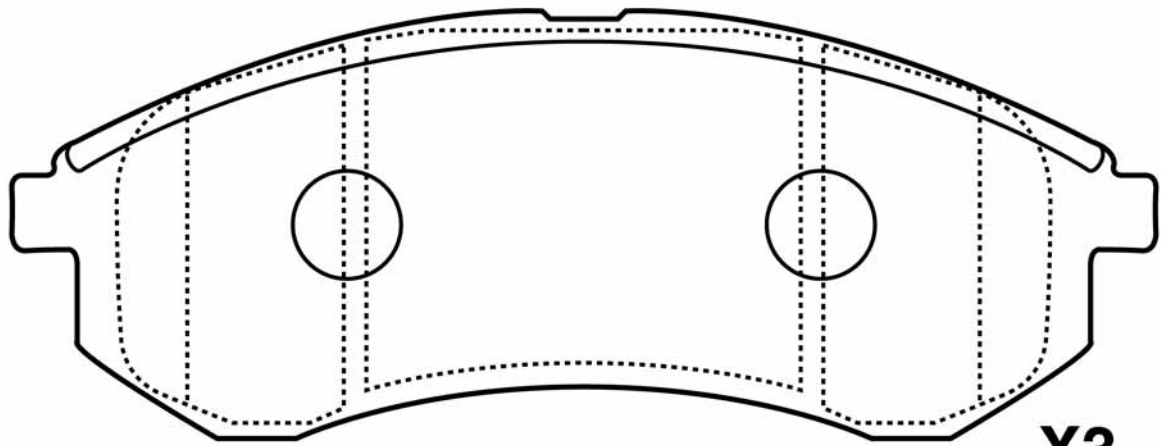

X3

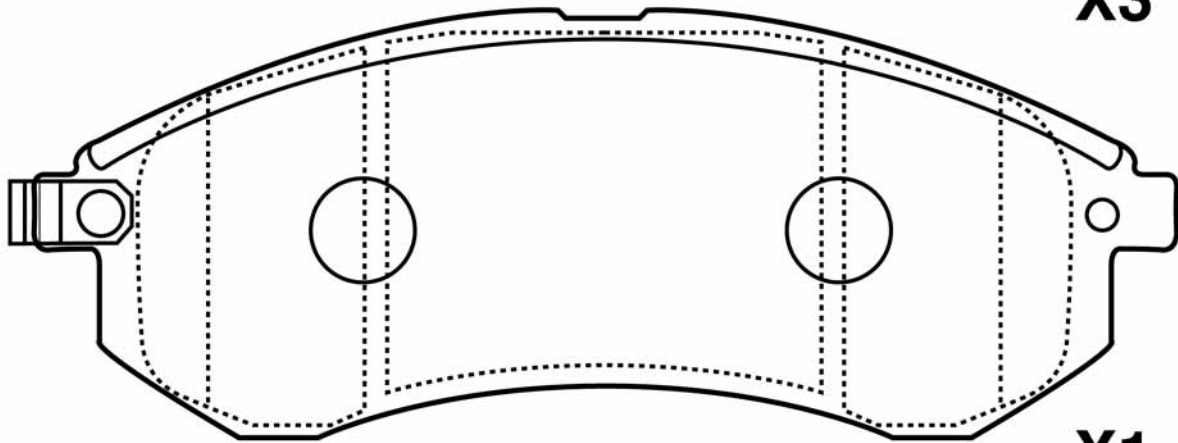

X1



PICTURES BRAKE PADS FRONT
ABBILDUNGEN BREMSKLÖTZE VORN
FIGURAS PASTILLAS DE FRENO DELANTORES
ILLUSTRATIONS PLAQUETTES DE FREI AVANT
IMMAGINI PASTIGLIE FRENO ANTERIORI

50-05-516

MITSUBISHI

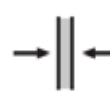

WVA

L

H

Th

130

77,3

17

21983

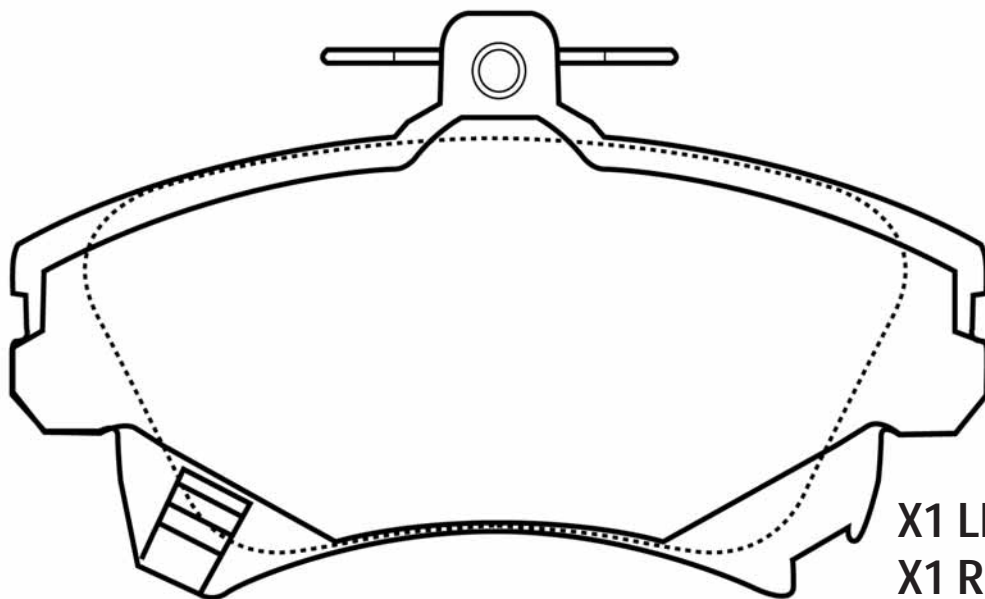

X1 LEFT
X1 RIGHT

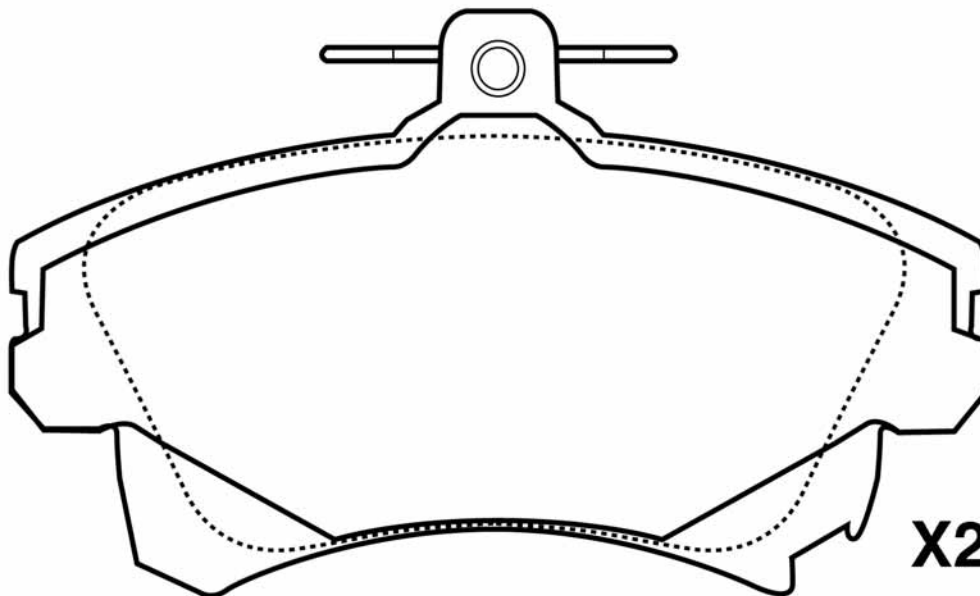

X2



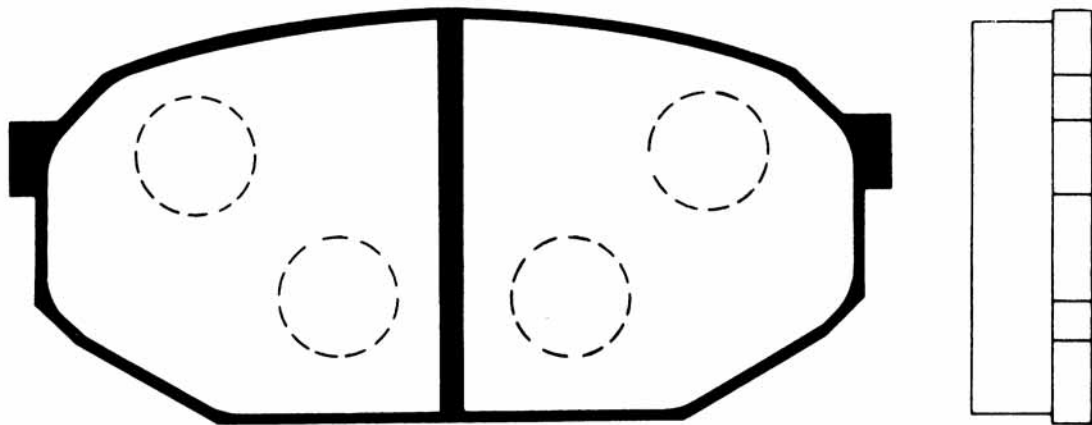

50-05-520				WVA
	MITSUBISHI	L	H	Th
	116,6	54,5	14,8	20892



X4

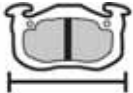

PICTURES BRAKE PADS FRONT
ABBILDUNGEN BREMSKLÖTZE VORN
FIGURAS PASTILLAS DE FRENO DELANTORES
ILLUSTRATIONS PLAQUETTES DE FREI AVANT
IMMAGINI PASTIGLIE FRENO ANTERIORI

50-05-522				WVA
MITSUBISHI	L	H	Th	
	108	50	14,7	20956

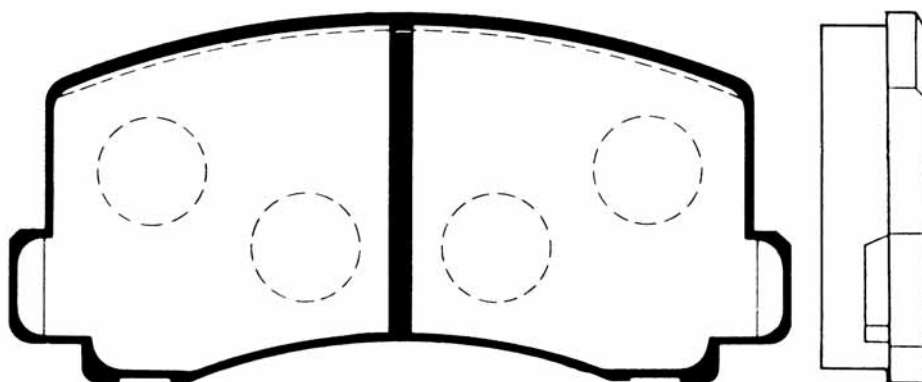

X4



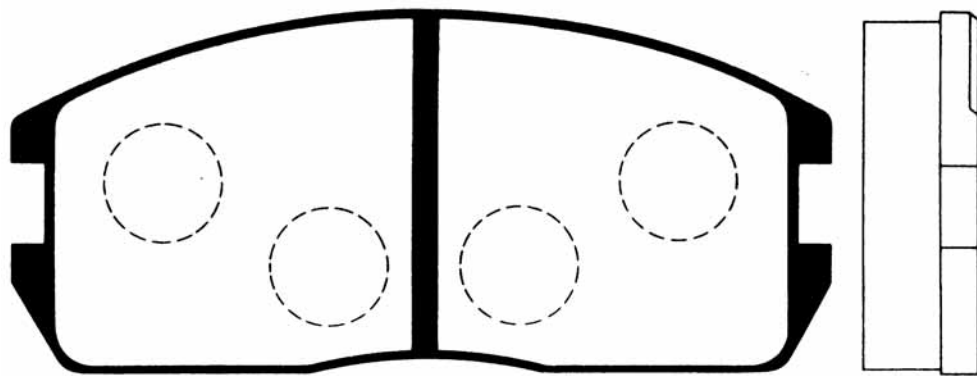

50-05-524				WVA
	MITSUBISHI - PROTON	L	H	Th
	108,3	47,9	14,4	21126



X4



PICTURES BRAKE PADS FRONT
ABBILDUNGEN BREMSKLÖTZE VORN
FIGURAS PASTILLAS DE FRENO DELANTORES
ILLUSTRATIONS PLAQUETTES DE FREI AVANT
IMMAGINI PASTIGLIE FRENO ANTERIORI

50-05-525				WVA
MITSUBISHI	L	H	Th	
	128	52,7	14,9	20955

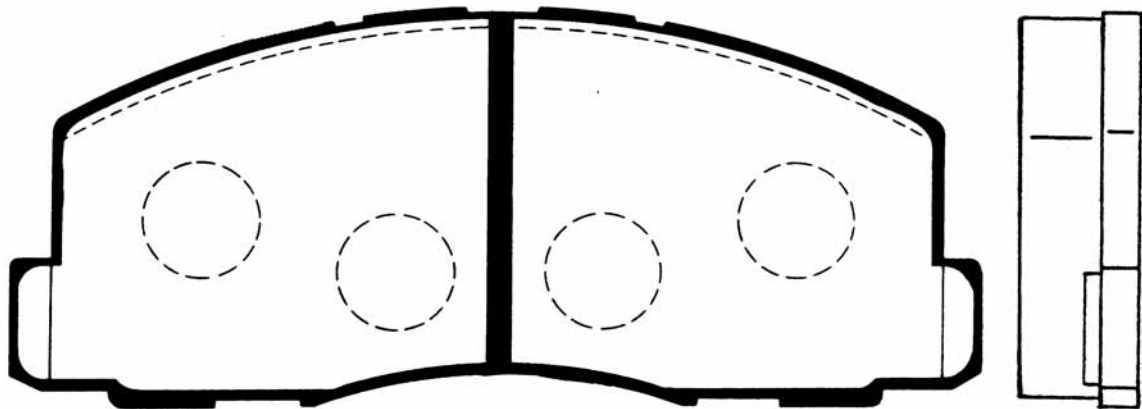

X4



50-05-527 MITSUBISHI				WVA
	L 128	H 57	Th 16,5	21373

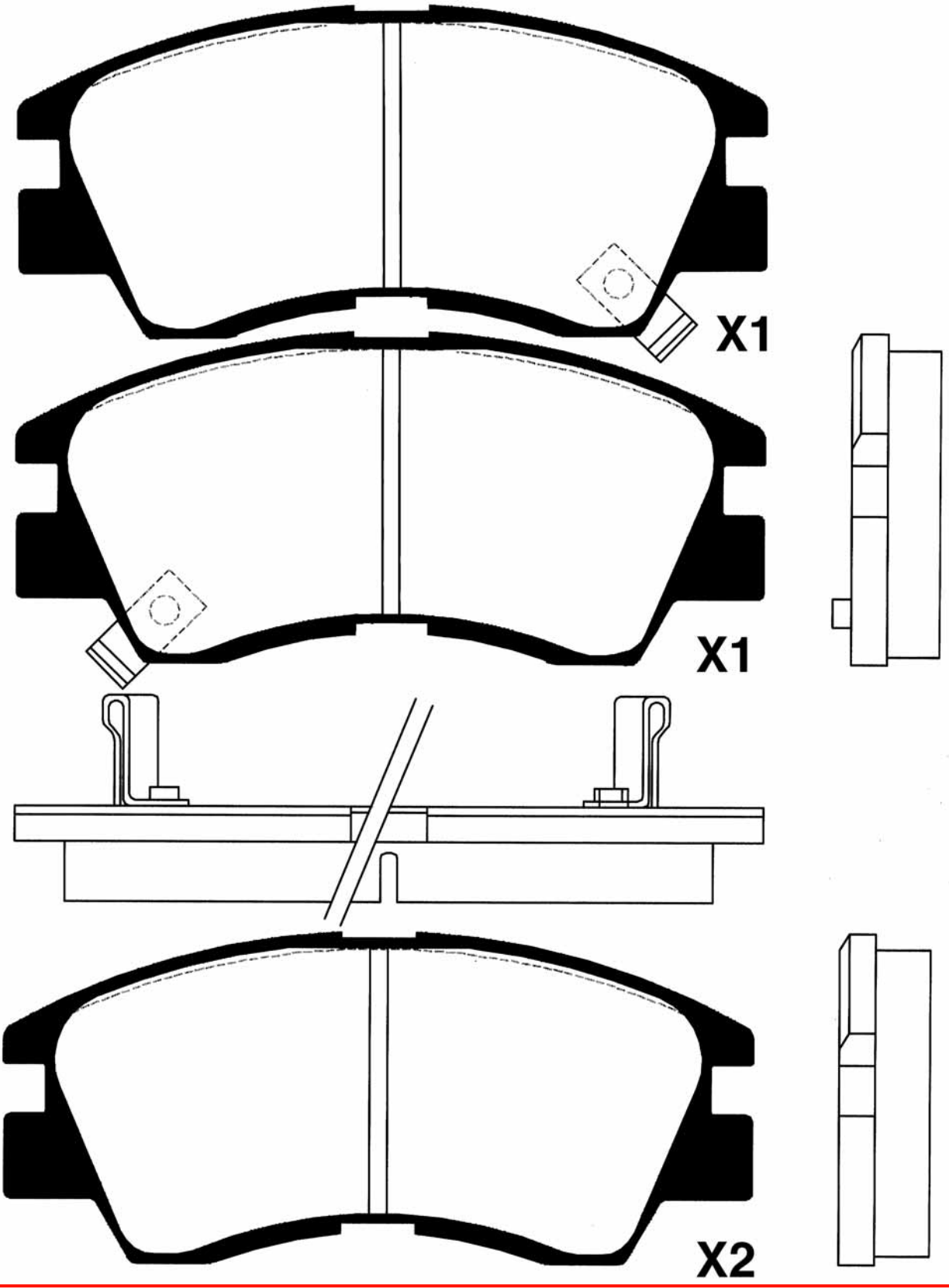



PICTURES BRAKE PADS FRONT
ABBILDUNGEN BREMSKLÖTZE VORN
FIGURAS PASTILLAS DE FRENO DELANTORES
ILLUSTRATIONS PLAQUETTES DE FREI AVANT
IMMAGINI PASTIGLIE FRENO ANTERIORI

50-05-527P

MITSUBISHI

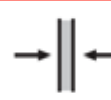
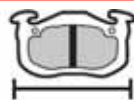

WVA

L

H

Th

128

57

16,5

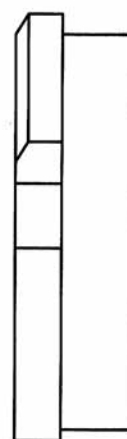
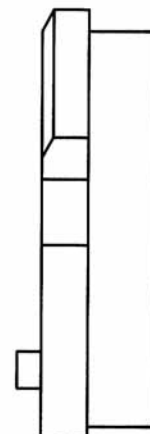
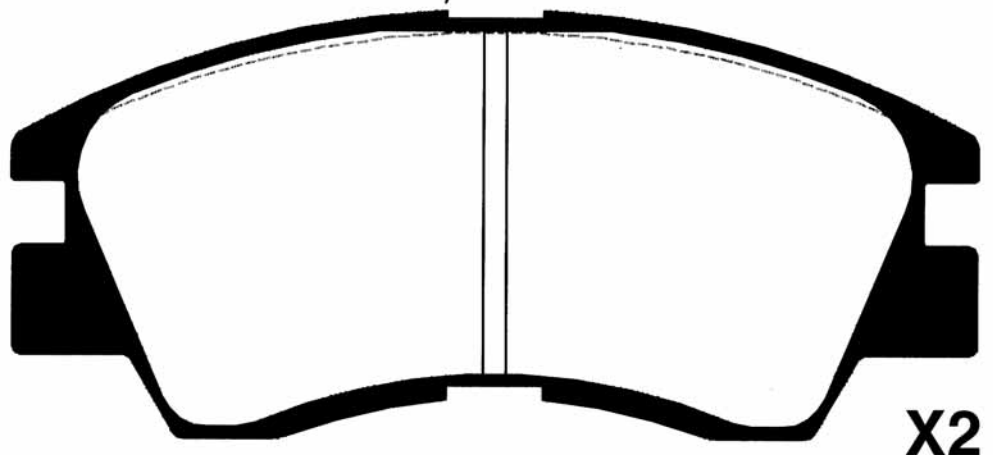
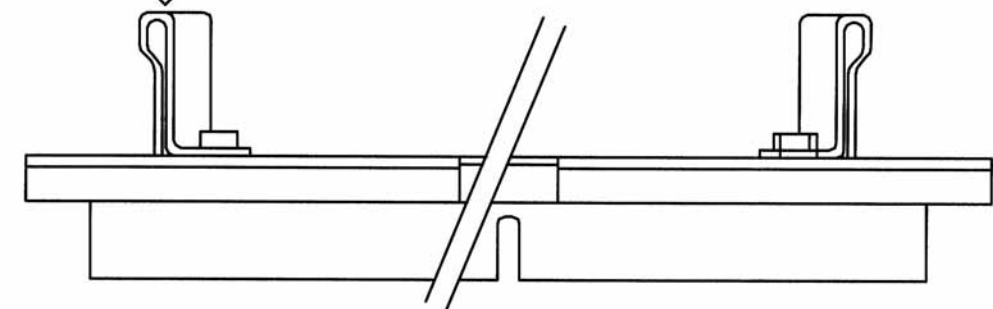
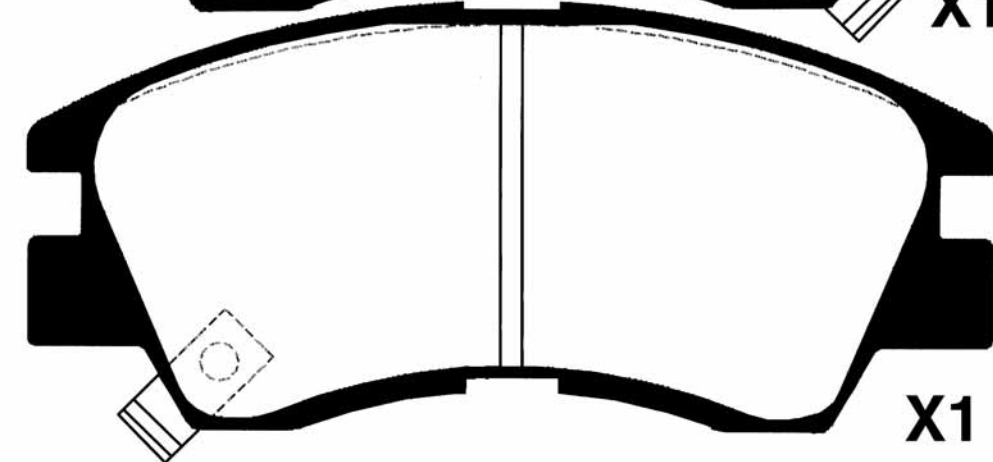
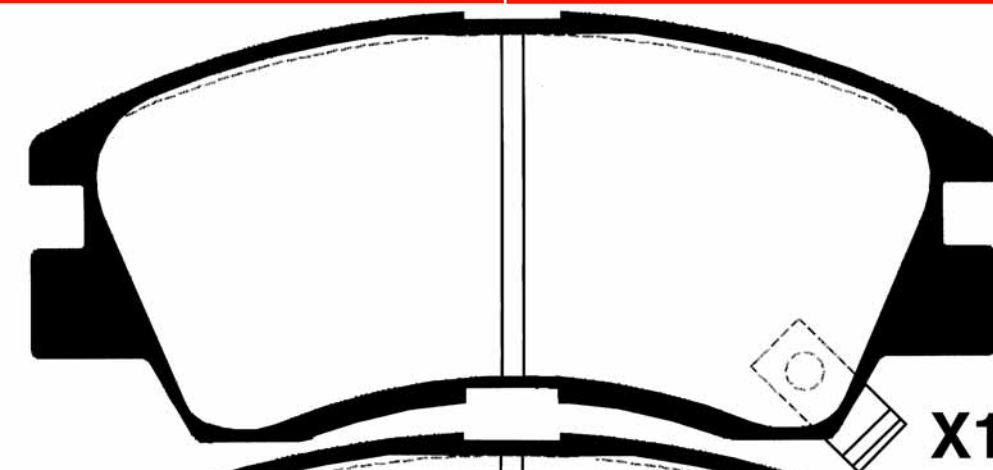



50-05-528				WVA
	L	H	Th	
MITSUBISHI - PROTON - DAIHATSU	114,2	50,3	14,4	21650

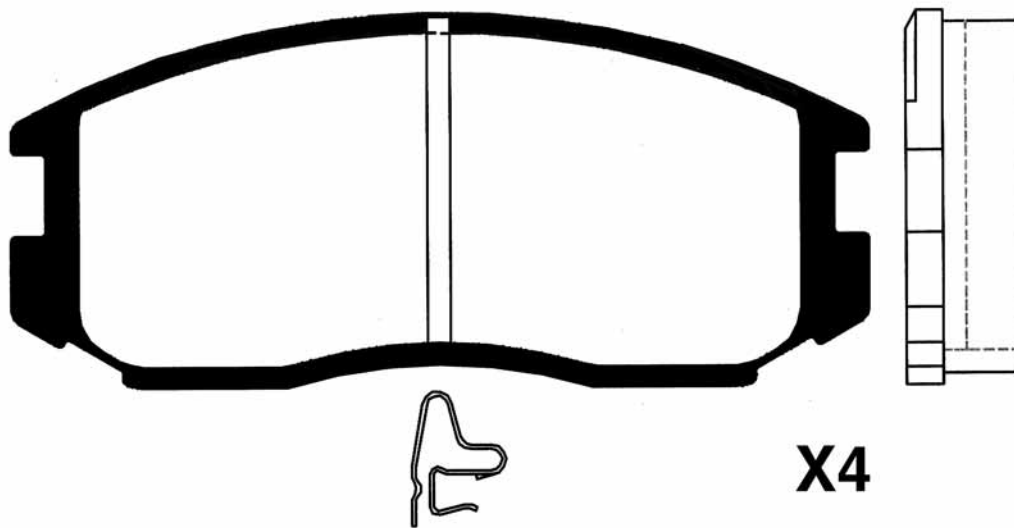



PICTURES BRAKE PADS FRONT
ABBILDUNGEN BREMSKLÖTZE VORN
FIGURAS PASTILLAS DE FRENO DELANTORES
ILLUSTRATIONS PLAQUETTES DE FREI AVANT
IMMAGINI PASTIGLIE FRENO ANTERIORI

50-05-529				WVA
MITSUBISHI	L	H	Th	
	127,7	52	16,5	21747

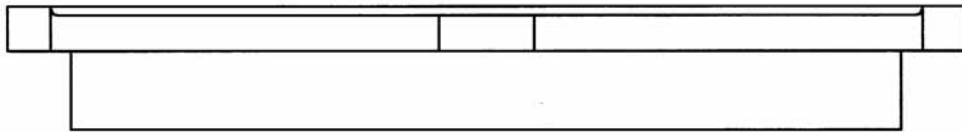
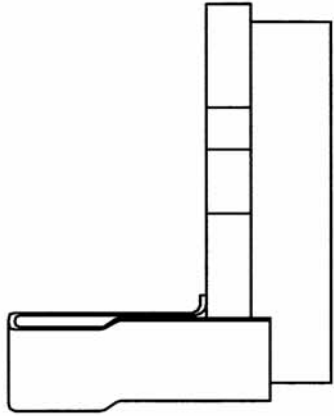
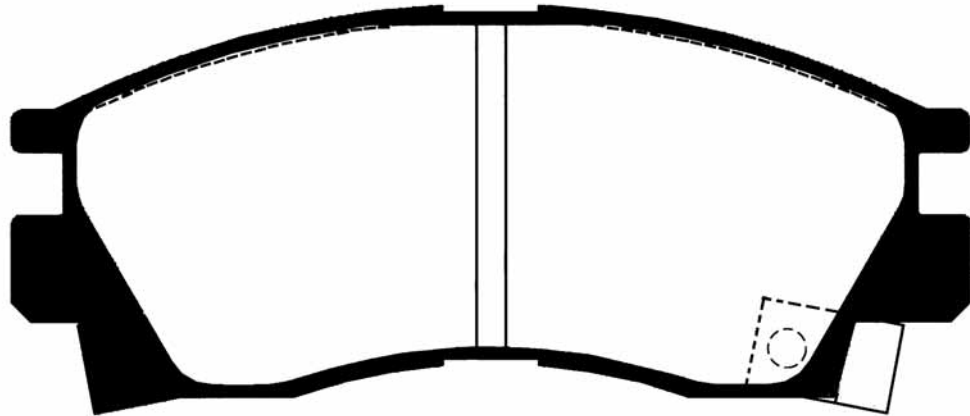
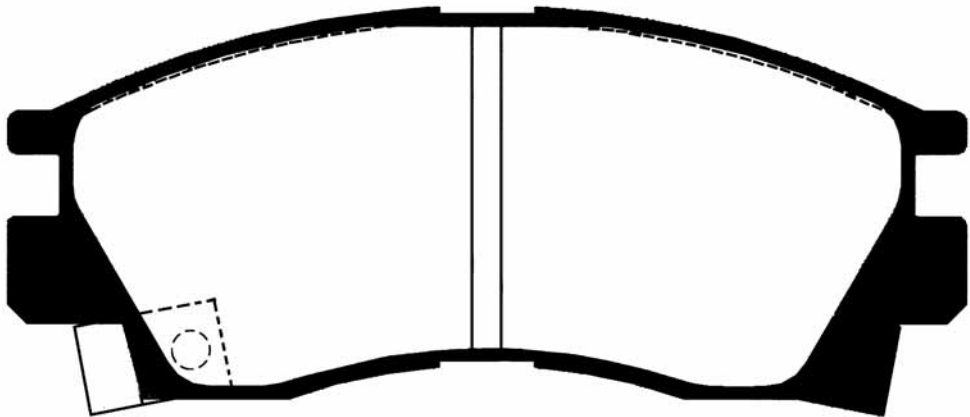



50-05-530				WVA
	PROTON - HYUNDAI - MITSUBISHI	L 127,8	H 52	
				21647

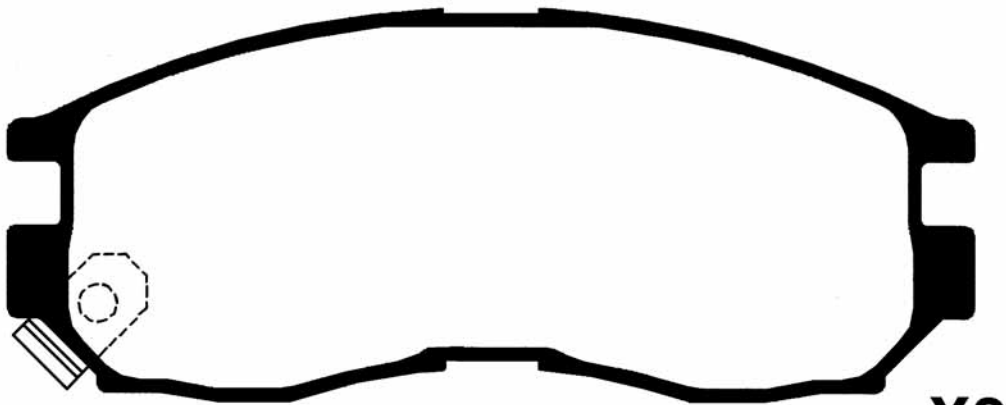

X2

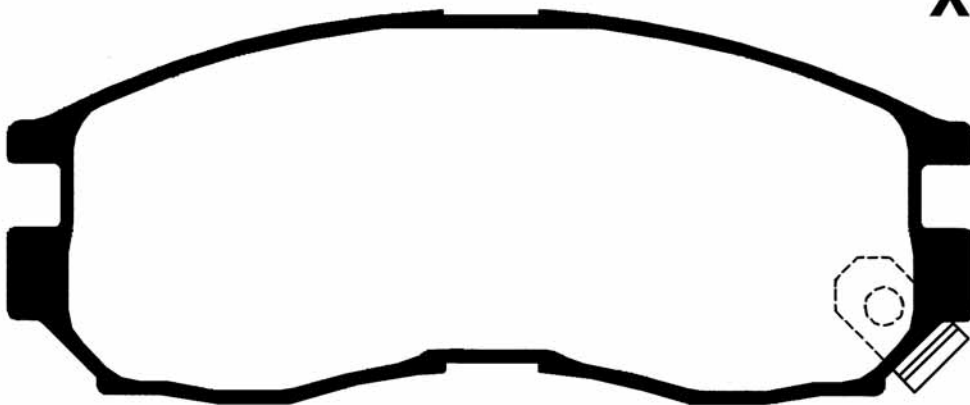

X2

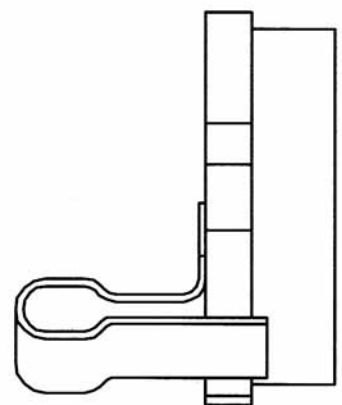



PICTURES BRAKE PADS FRONT
ABBILDUNGEN BREMSKLÖTZE VORN
FIGURAS PASTILLAS DE FRENO DELANTORES
ILLUSTRATIONS PLAQUETTES DE FREI AVANT
IMMAGINI PASTIGLIE FRENO ANTERIORI

50-05-582

MITSUBISHI

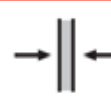
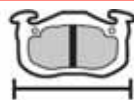

WVA

L

H

Th

151

51,6

16,9

23086

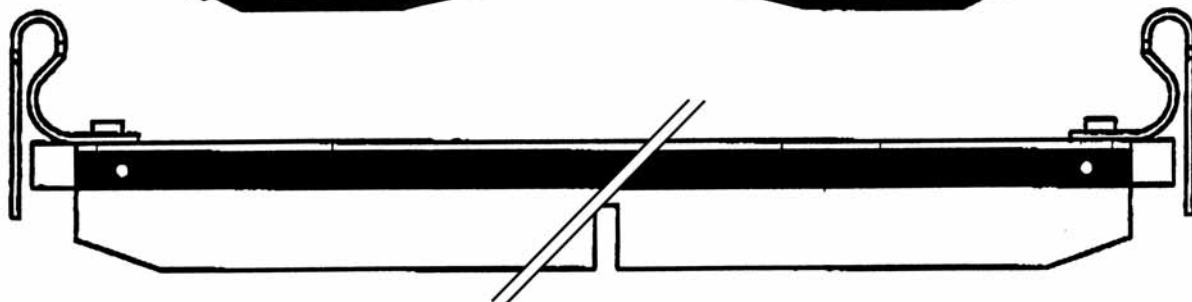
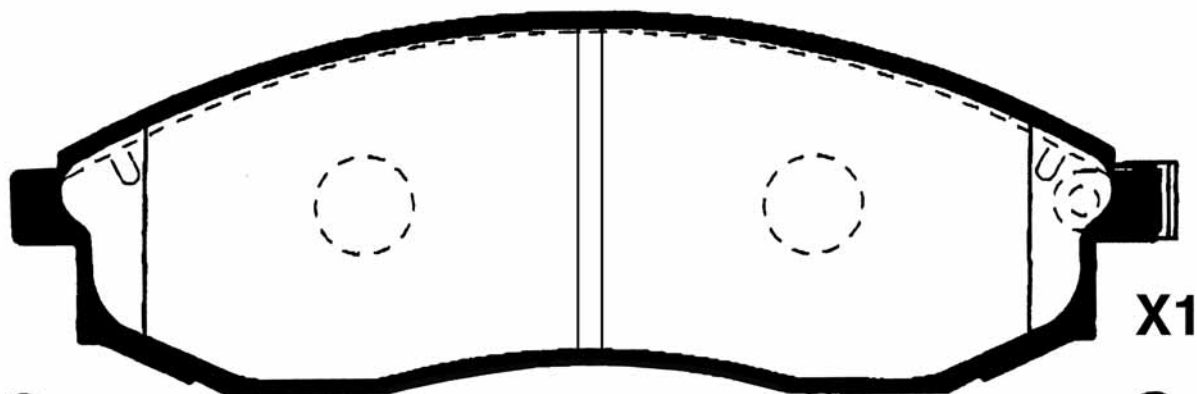
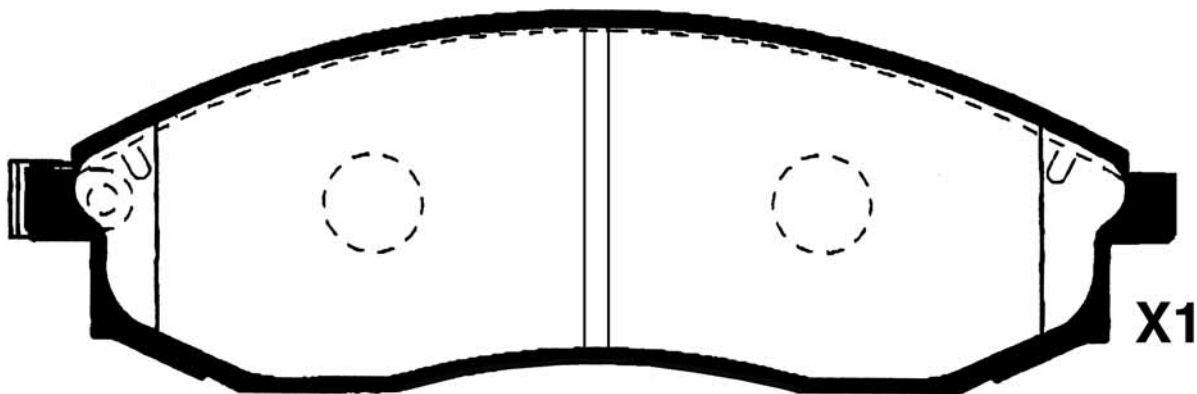
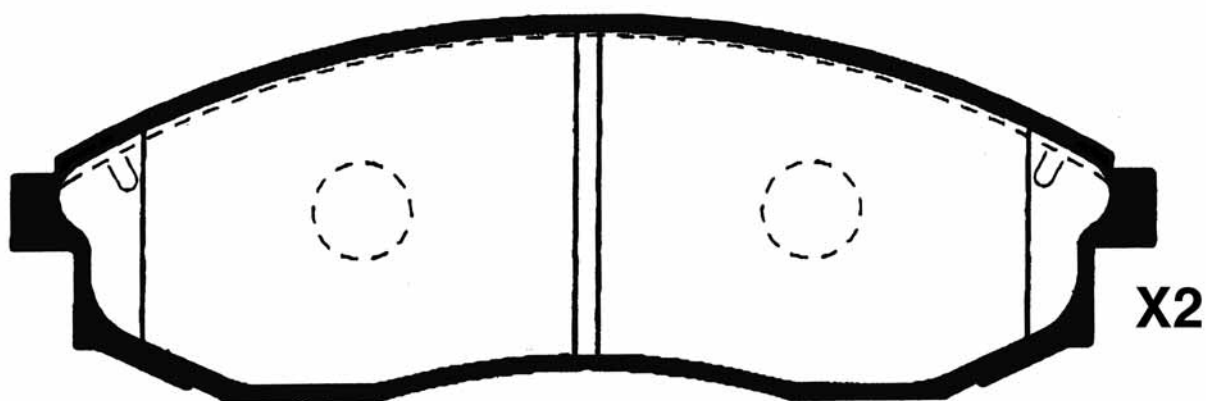



50-05-583				WVA
	HYUNDAI	L 105	H 41,6	Th 15,8
				23239

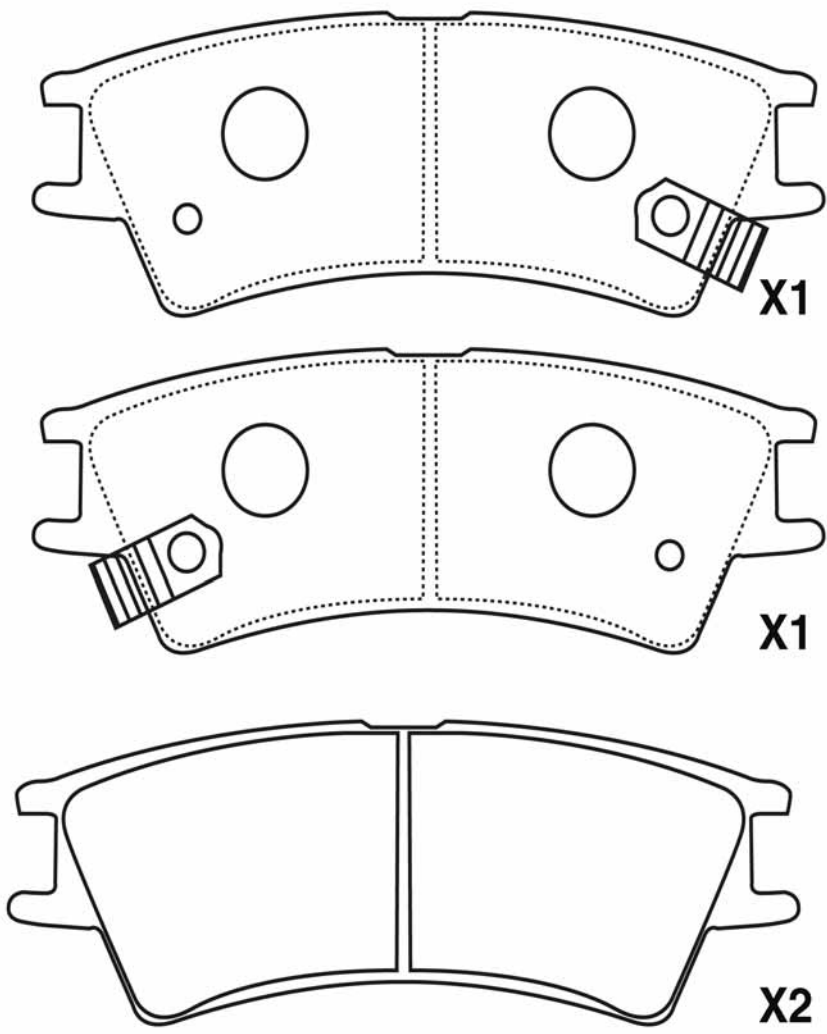



PICTURES BRAKE PADS FRONT
ABBILDUNGEN BREMSKLÖTZE VORN
FIGURAS PASTILLAS DE FRENO DELANTORES
ILLUSTRATIONS PLAQUETTES DE FREI AVANT
IMMAGINI PASTIGLIE FRENO ANTERIORI

50-05-585				WVA
	SHUANGHUAN AUTO - HYUNDAI - MITSUBISHI -	L	H	
	138	55,5	15,6	23290

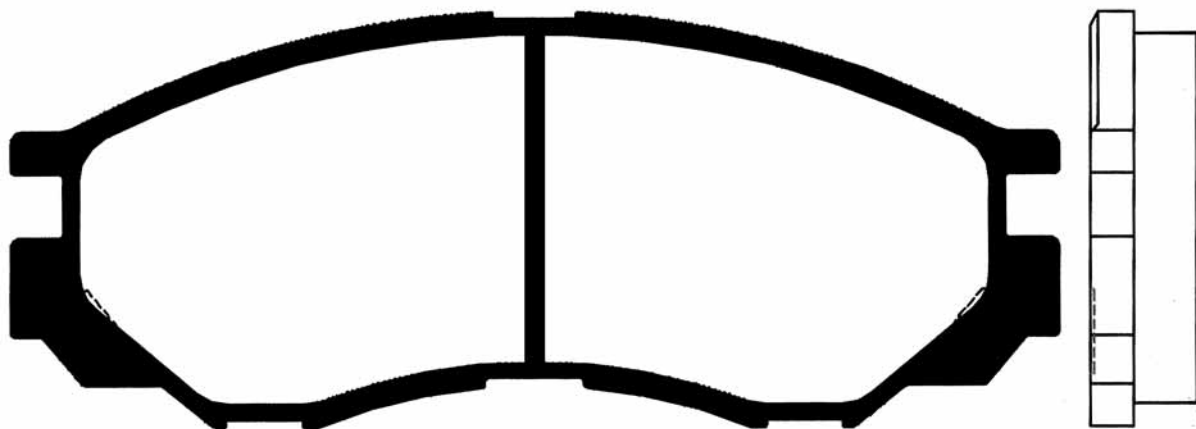

X4



50-05-585P				WVA
	L	H	Th	
MITSUBISHI - SHUANGHUAN AUTO -	138	55,5	15,6	

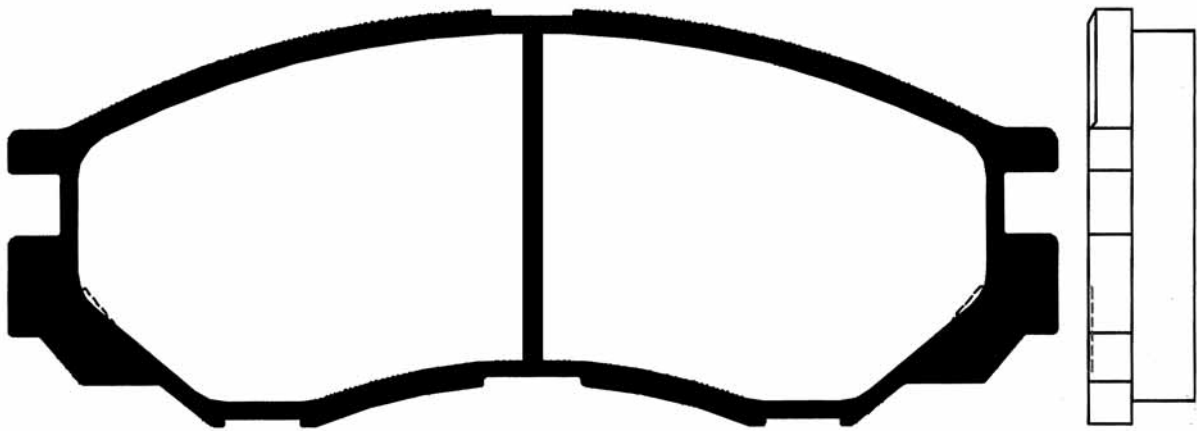

X4



PICTURES BRAKE PADS FRONT
ABBILDUNGEN BREMSKLÖTZE VORN
FIGURAS PASTILLAS DE FRENO DELANTORES
ILLUSTRATIONS PLAQUETTES DE FREI AVANT
IMMAGINI PASTIGLIE FRENO ANTERIORI

50-05-586				WVA
MITSUBISHI	L	H	Th	
	133	53	17,3	

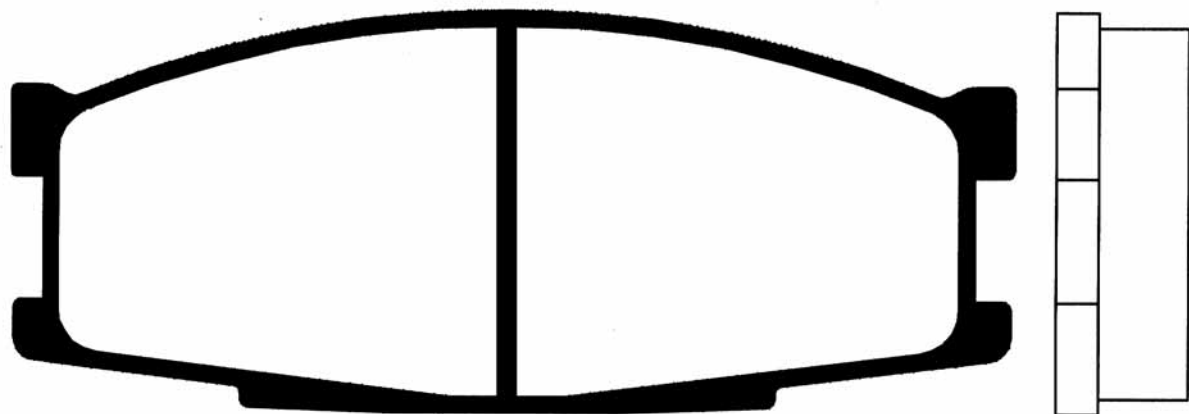

X4



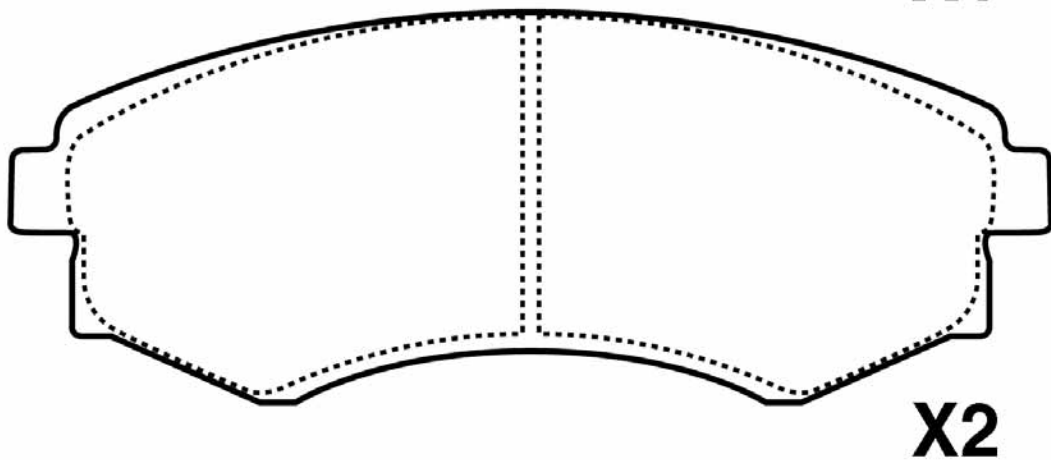
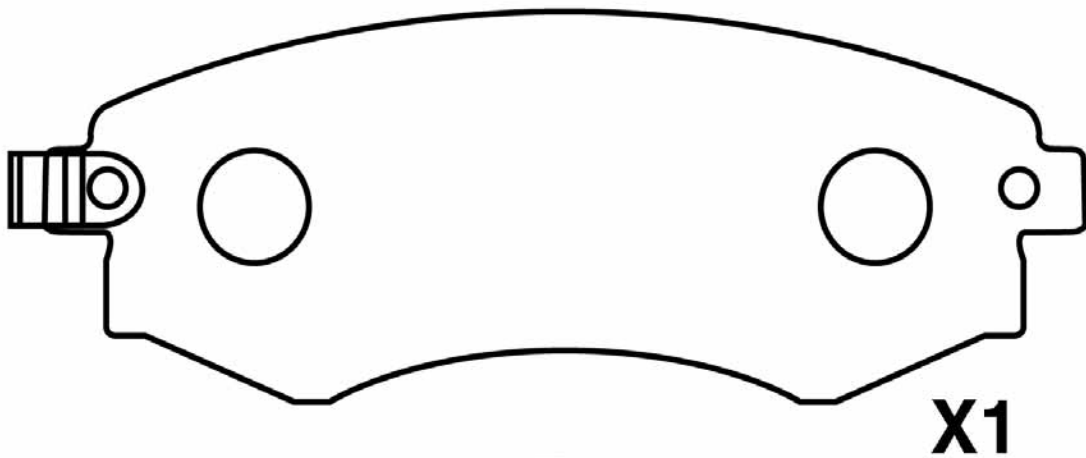
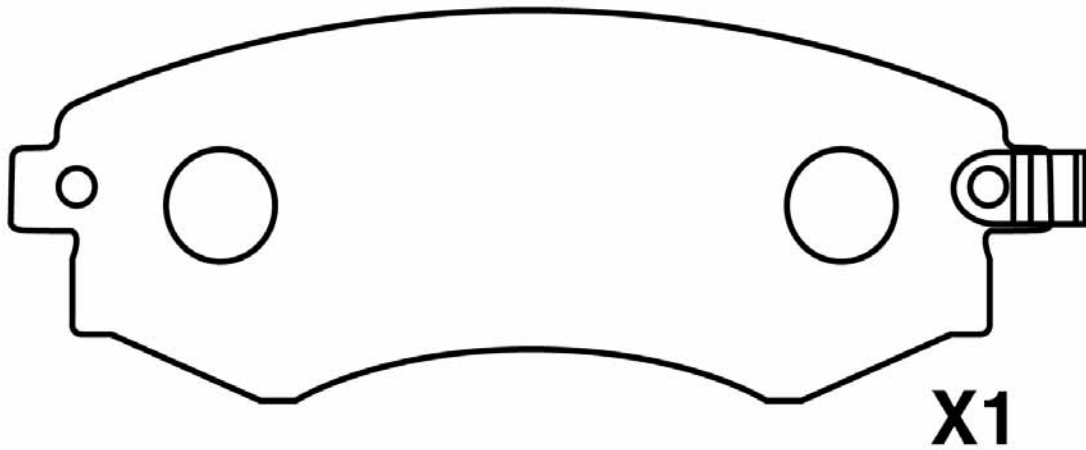

50-05-590				WVA
	HYUNDAI - KIA	L 136,4	H 54	Th 17 21727





PICTURES BRAKE PADS FRONT
ABBILDUNGEN BREMSKLÖTZE VORN
FIGURAS PASTILLAS DE FRENO DELANTORES
ILLUSTRATIONS PLAQUETTES DE FREI AVANT
IMMAGINI PASTIGLIE FRENO ANTERIORI

50-05-592				WVA
MITSUBISHI	L	H	Th	
	119,4	68,6	14,9	23080

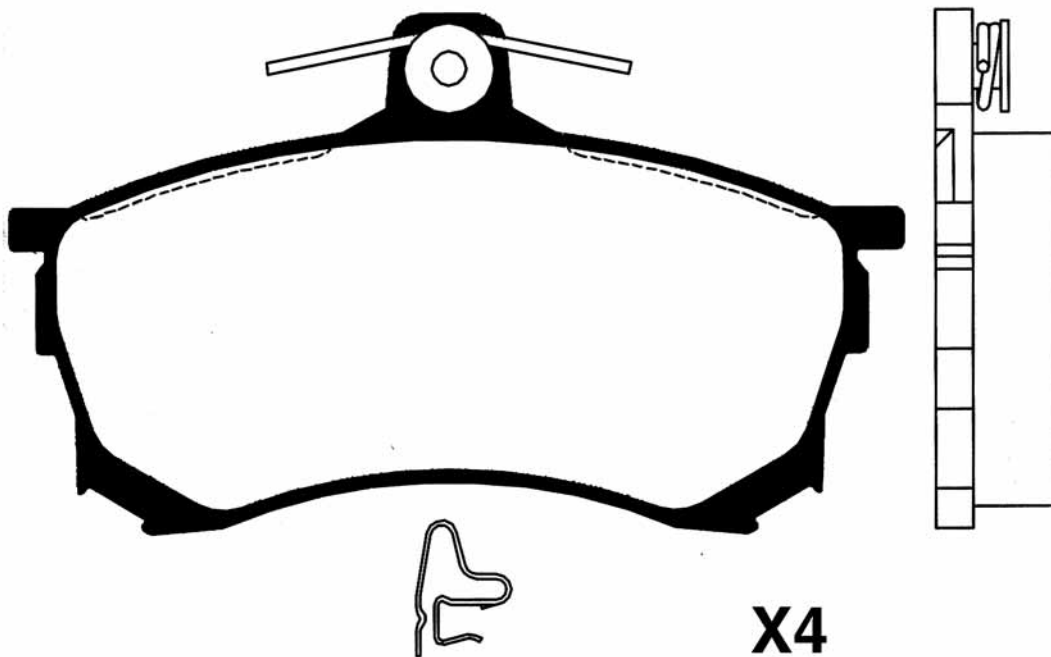



50-05-593				WVA
	SMART - MITSUBISHI	L 130	H 73	Th 14,6
				21920

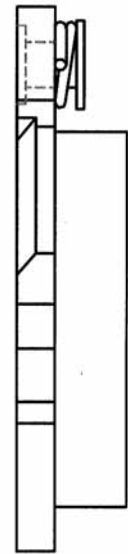
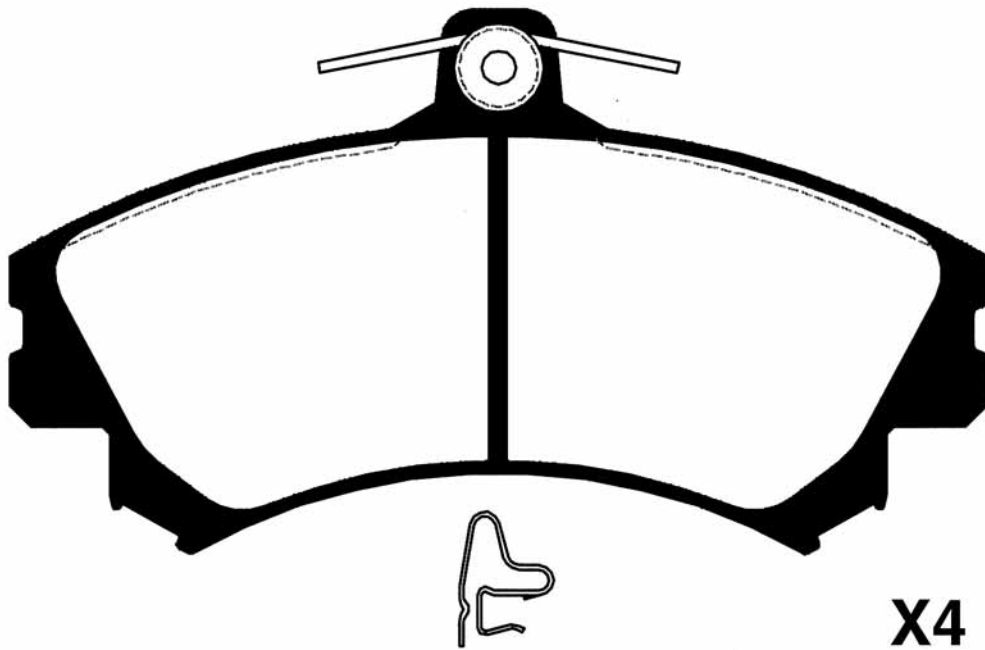



PICTURES BRAKE PADS FRONT
ABBILDUNGEN BREMSKLÖTZE VORN
FIGURAS PASTILLAS DE FRENO DELANTORES
ILLUSTRATIONS PLAQUETTES DE FREI AVANT
IMMAGINI PASTIGLIE FRENO ANTERIORI

50-05-595

HYUNDAI

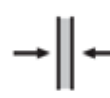

WVA

L

130

H

73,3

Th

17,8

23083

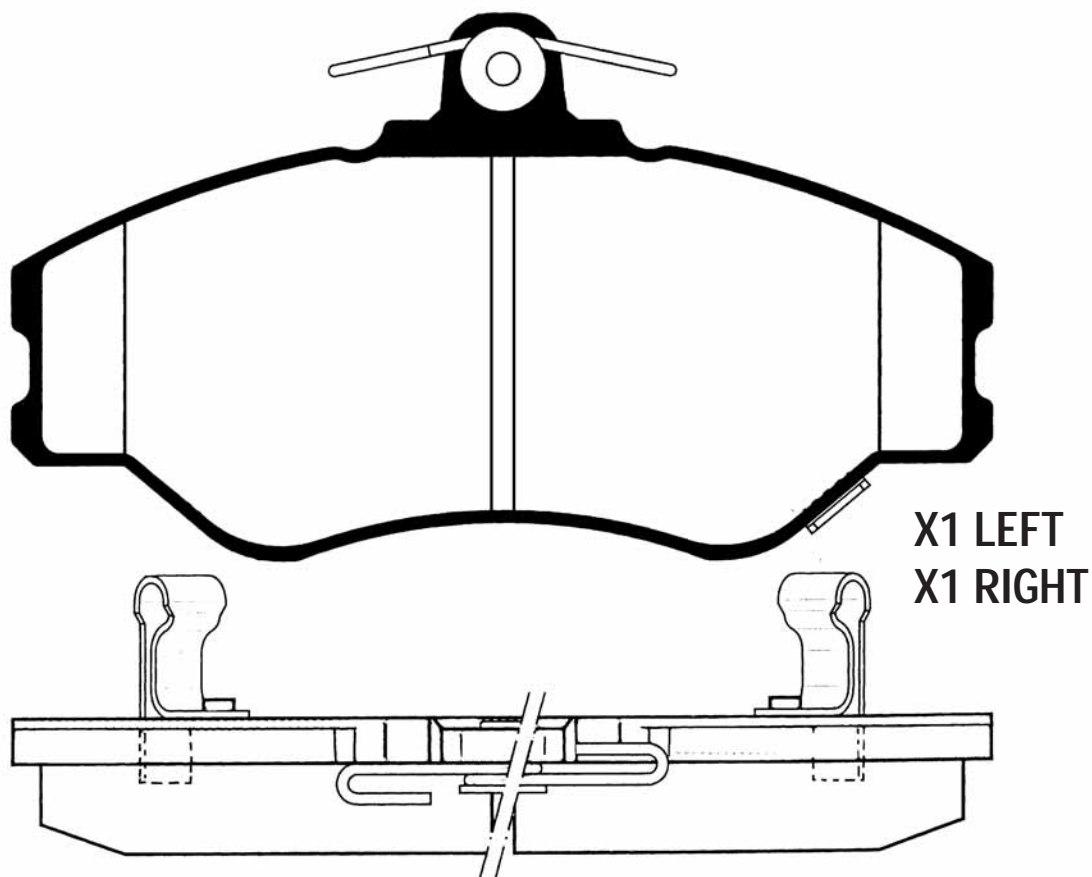
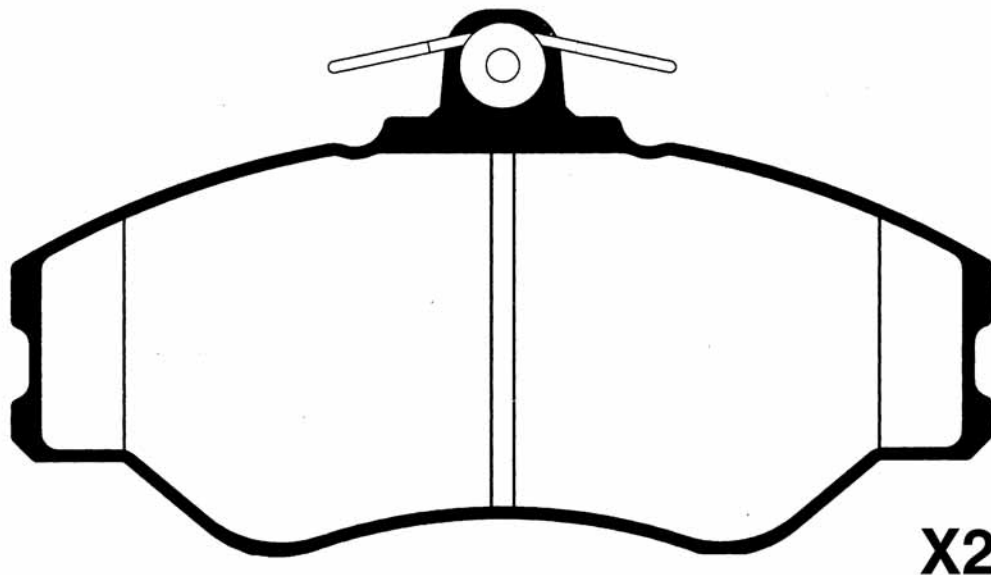



50-05-597				WVA
	MITSUBISHI	L 119,3	H 65,1/74,9	

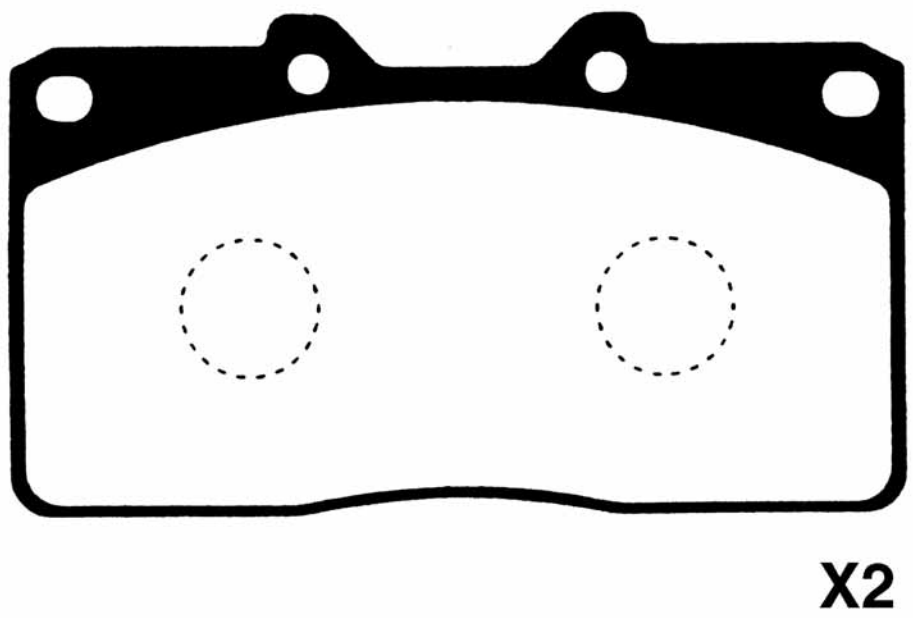
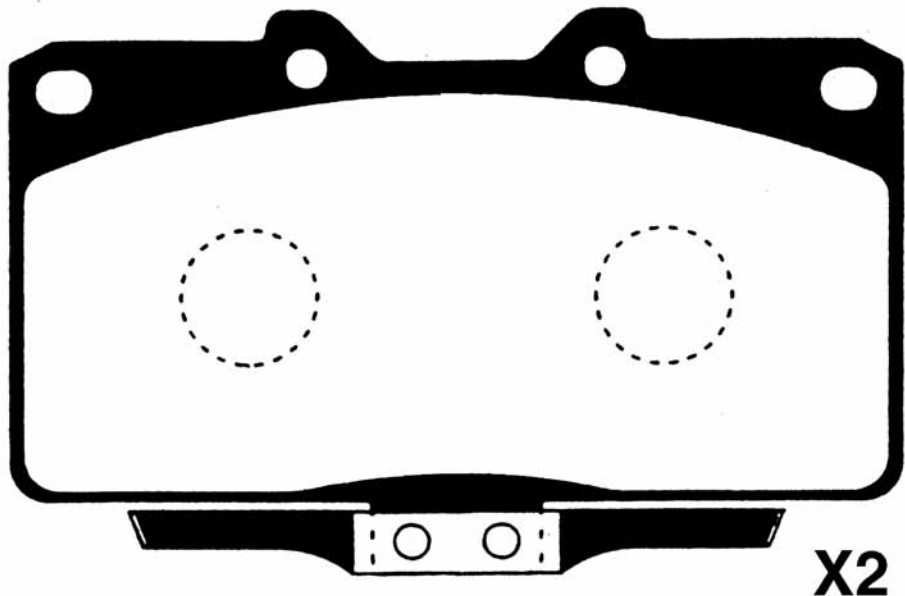



PICTURES BRAKE PADS FRONT
ABBILDUNGEN BREMSKLÖTZE VORN
FIGURAS PASTILLAS DE FRENO DELANTORES
ILLUSTRATIONS PLAQUETTES DE FREI AVANT
IMMAGINI PASTIGLIE FRENO ANTERIORI

50-05-599 MITSUBISHI				WVA
	L 150	H 59	Th 15,8	21769

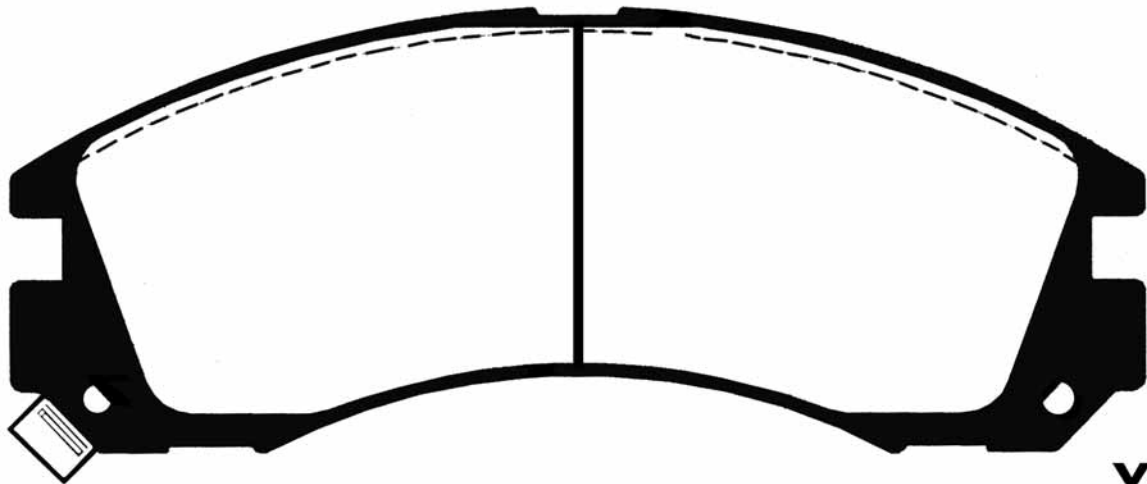

X1

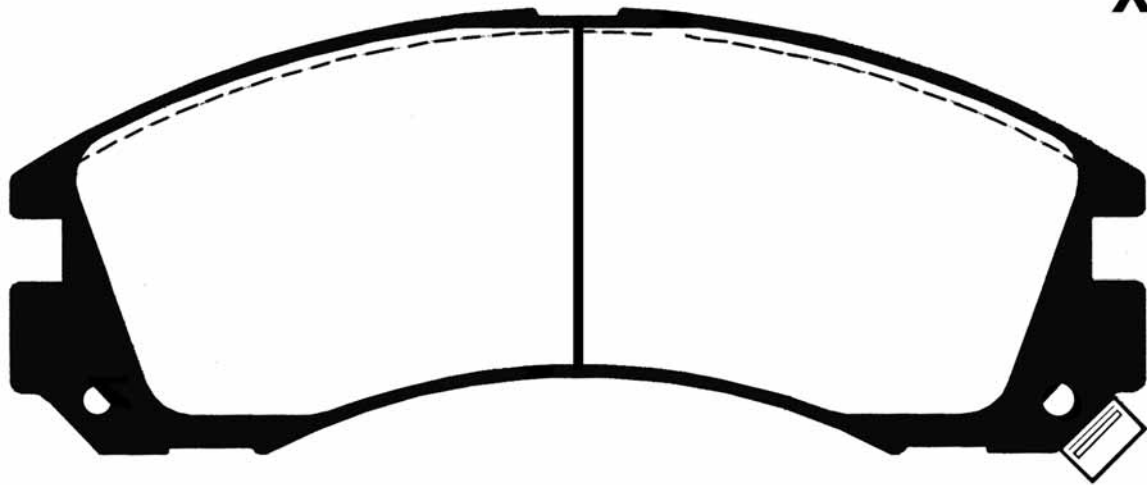

X1

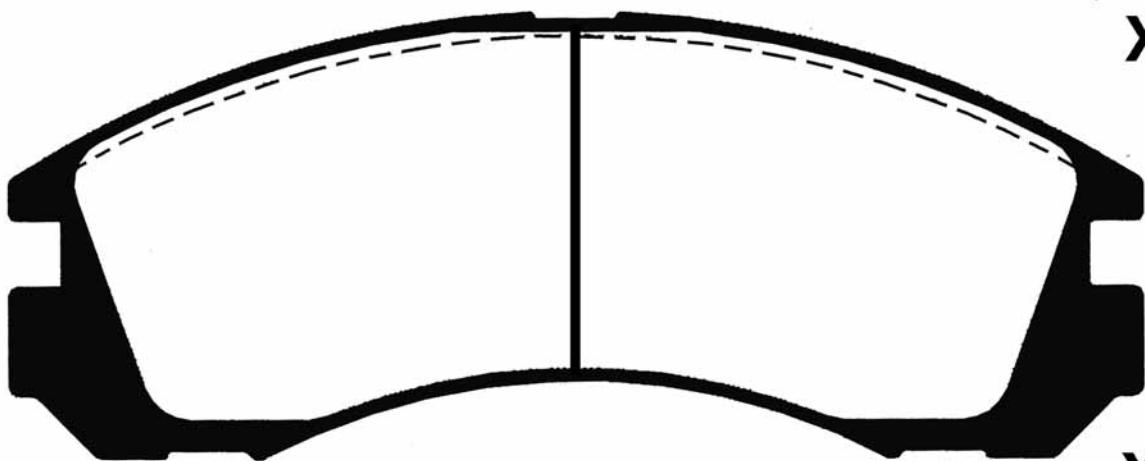

X2



50-05-599P				WVA
	MITSUBISHI	L 150	H 59	

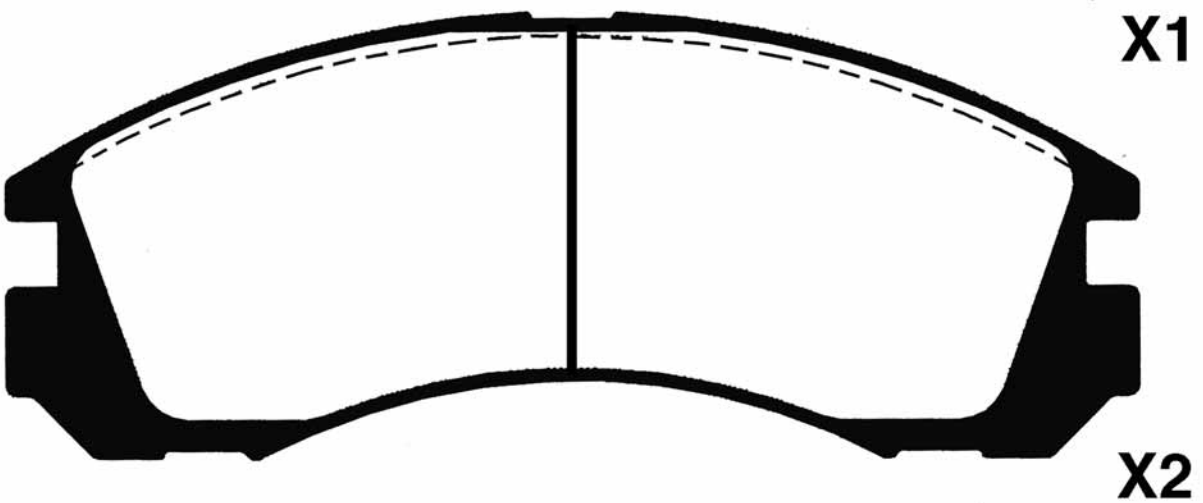
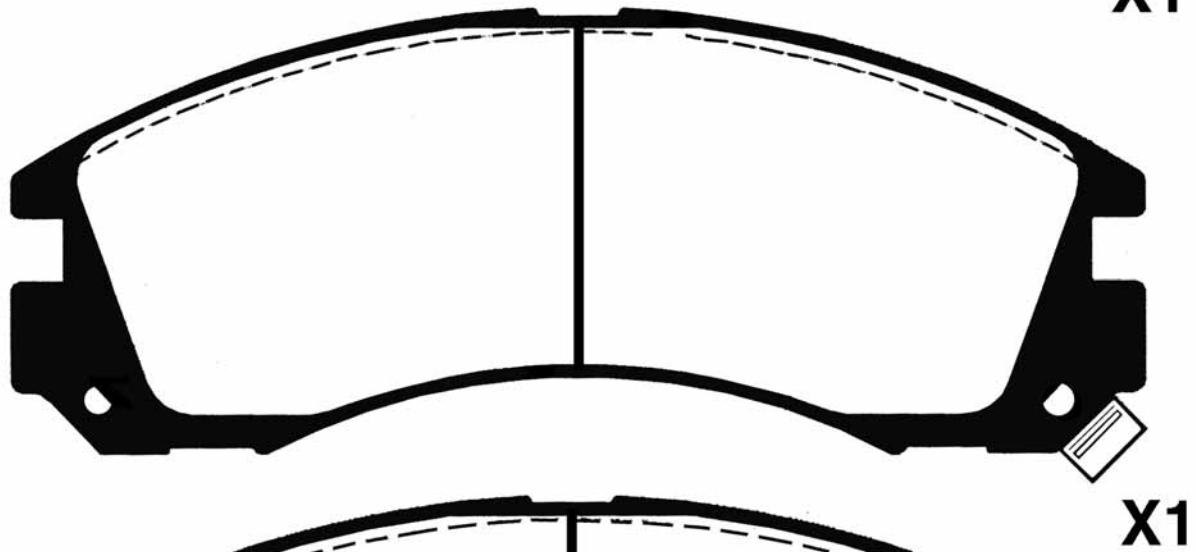
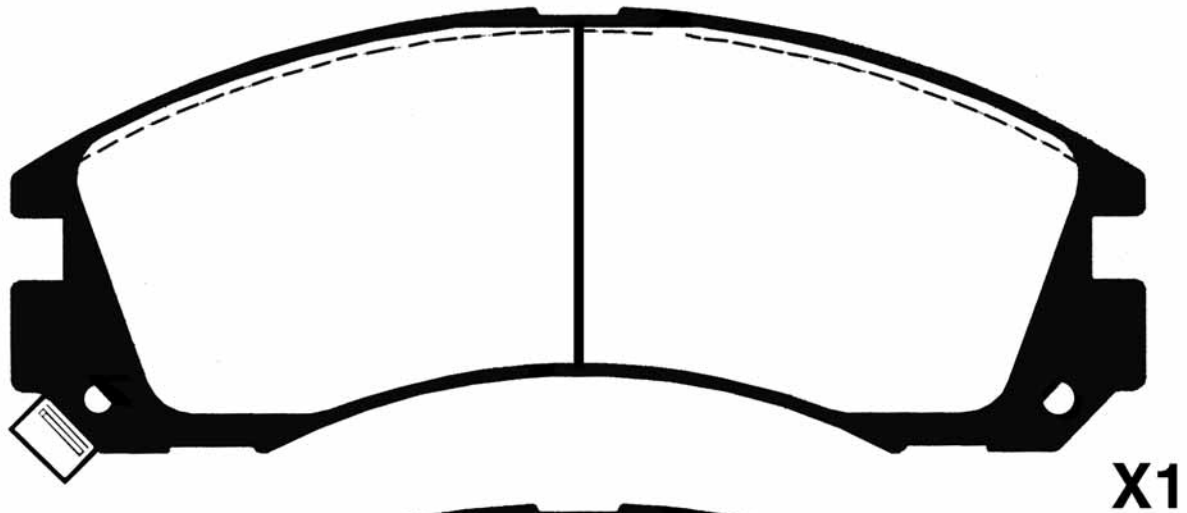



PICTURES BRAKE PADS FRONT
ABBILDUNGEN BREMSKLÖTZE VORN
FIGURAS PASTILLAS DE FRENO DELANTORES
ILLUSTRATIONS PLAQUETTES DE FREI AVANT
IMMAGINI PASTIGLIE FRENO ANTERIORI

50-06-600				WVA
DAIHATSU - TOYOTA	L	H	Th	
	78	62,8	13	20560

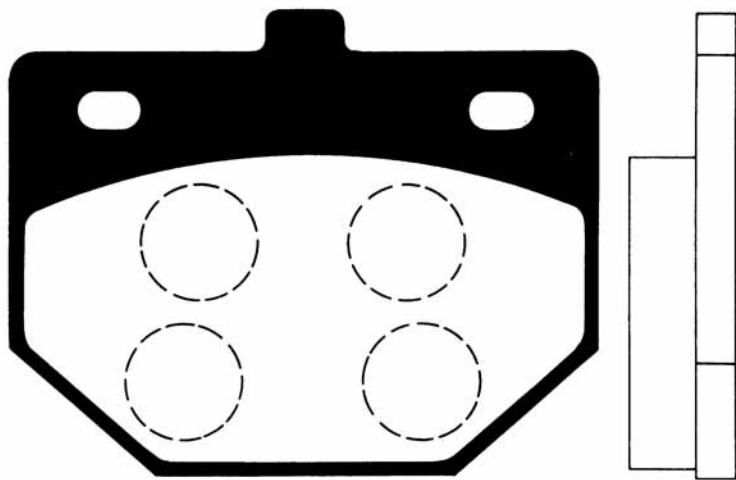

X4



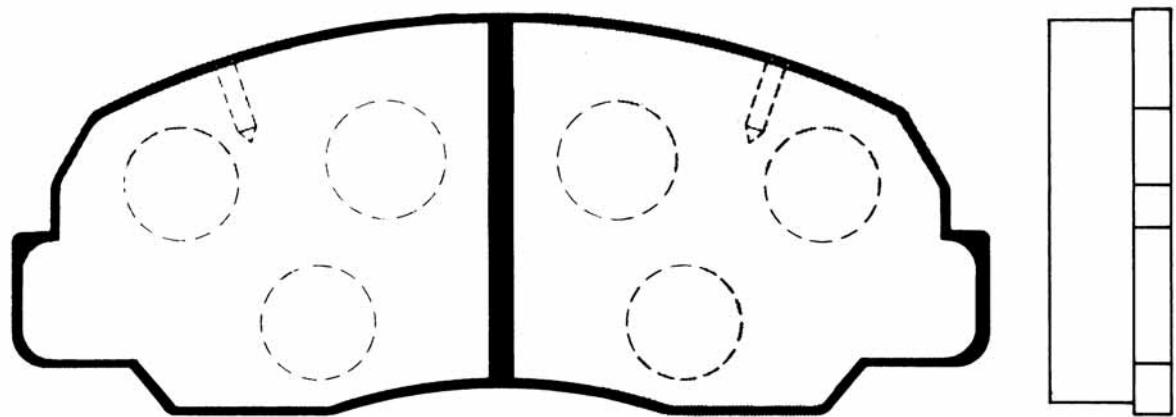

50-06-601				WVA
	MAZDA - DAIHATSU	L	H	Th
	128	52,6	13,4	21243



X4



PICTURES BRAKE PADS FRONT
ABBILDUNGEN BREMSKLÖTZE VORN
FIGURAS PASTILLAS DE FRENO DELANTORES
ILLUSTRATIONS PLAQUETTES DE FREI AVANT
IMMAGINI PASTIGLIE FRENO ANTERIORI

50-06-602				WVA
DAIHATSU	L	H	Th	
	124	43,8	13,3	21159

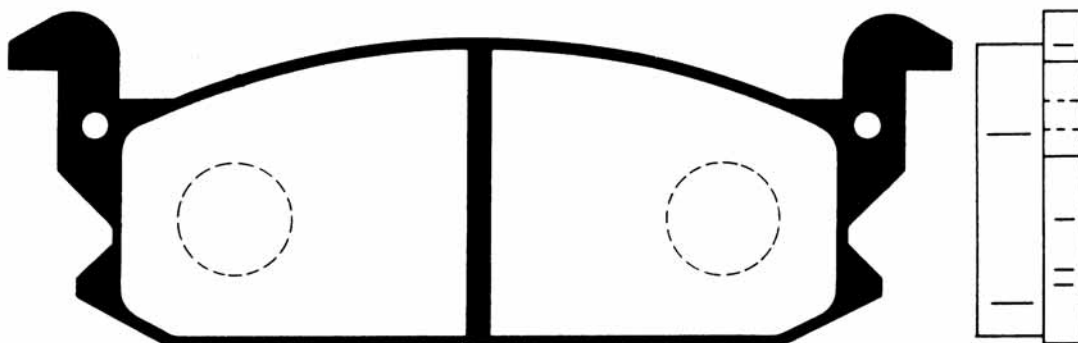

X4



50-06-603

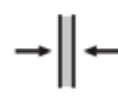
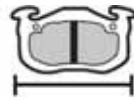

WVA

DAIHATSU

L

H

Th

104,3

45

13,7

23783

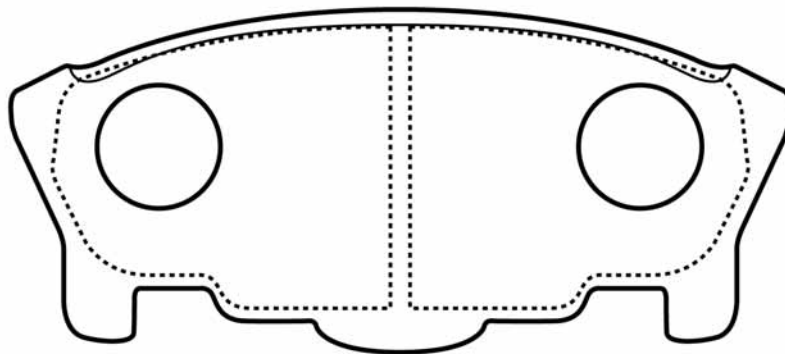

X4



PICTURES BRAKE PADS FRONT
ABBILDUNGEN BREMSKLÖTZE VORN
FIGURAS PASTILLAS DE FRENO DELANTORES
ILLUSTRATIONS PLAQUETTES DE FREI AVANT
IMMAGINI PASTIGLIE FRENO ANTERIORI

50-06-604				WVA
DAIHATSU	L	H	Th	
	94,8	34,2	13,9	

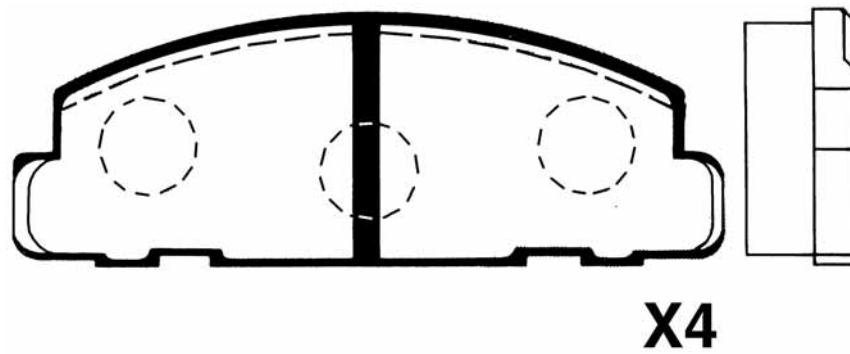



50-06-605				WVA
	DAIHATSU - PIAGGIO	L	H	Th
	78,7	63,9	13	20780

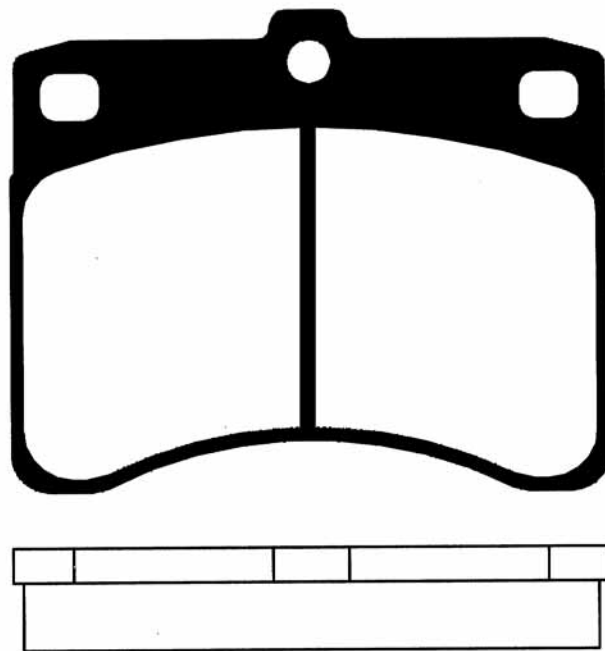

X4



PICTURES BRAKE PADS FRONT
ABBILDUNGEN BREMSKLÖTZE VORN
FIGURAS PASTILLAS DE FRENO DELANTORES
ILLUSTRATIONS PLAQUETTES DE FREI AVANT
IMMAGINI PASTIGLIE FRENO ANTERIORI

50-06-606 DAIHATSU				WVA
	L	H	Th	
	102,5	47,2	13,5	21340

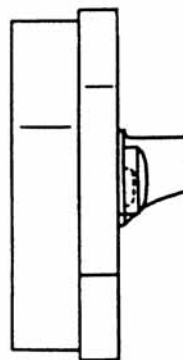
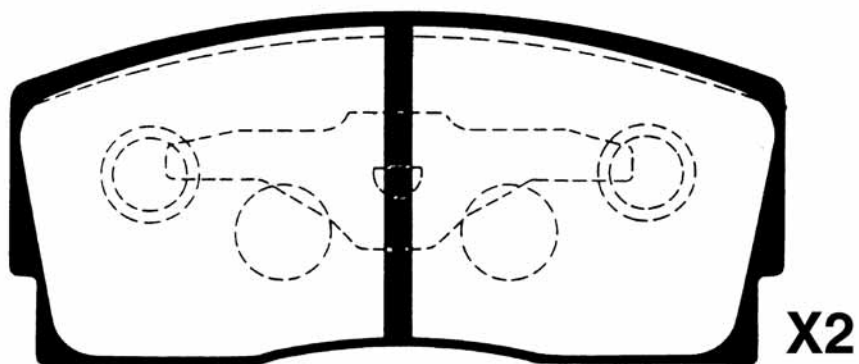
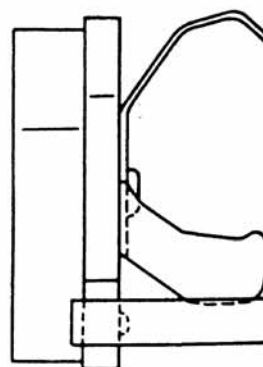
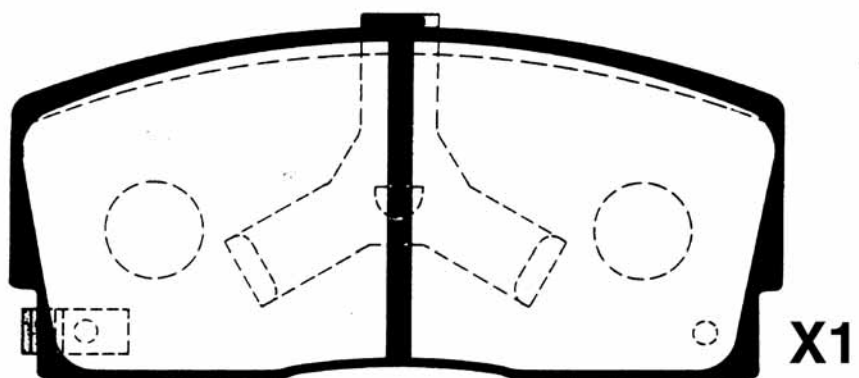
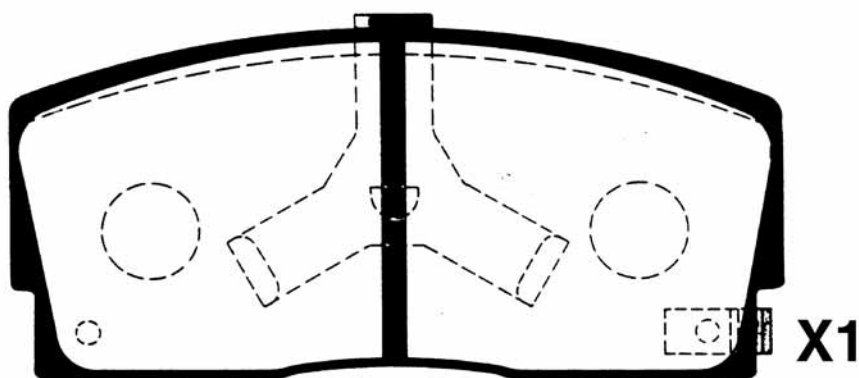



50-06-607

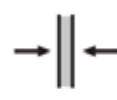
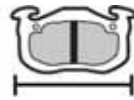

WVA

DAIHATSU

L

H

Th

127,8

52,2

13,8

21712

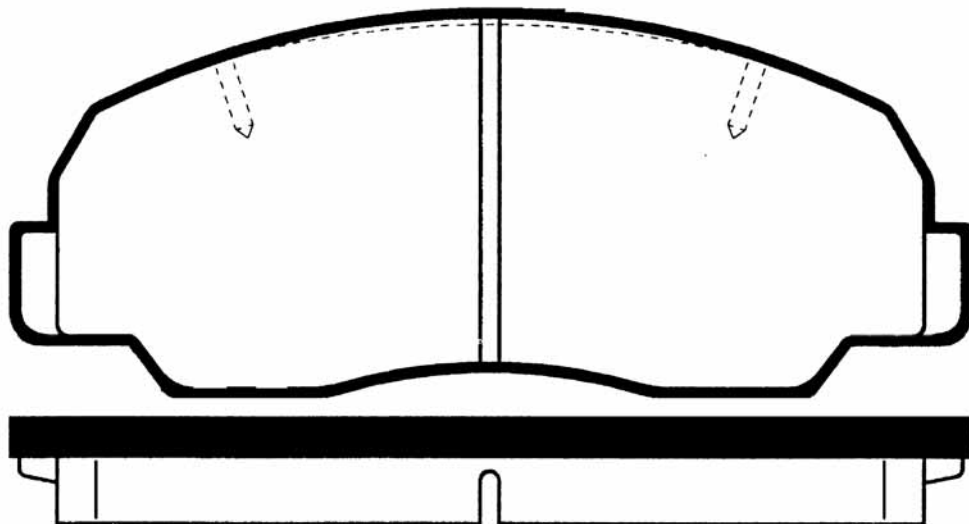

X4



PICTURES BRAKE PADS FRONT
ABBILDUNGEN BREMSKLÖTZE VORN
FIGURAS PASTILLAS DE FRENO DELANTORES
ILLUSTRATIONS PLAQUETTES DE FREI AVANT
IMMAGINI PASTIGLIE FRENO ANTERIORI

50-06-608 DAIHATSU				WVA
	L 79	H 58	Th 14,4	23495

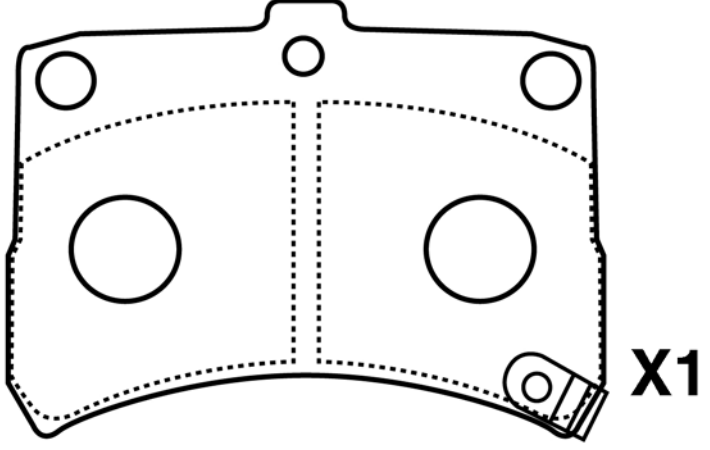
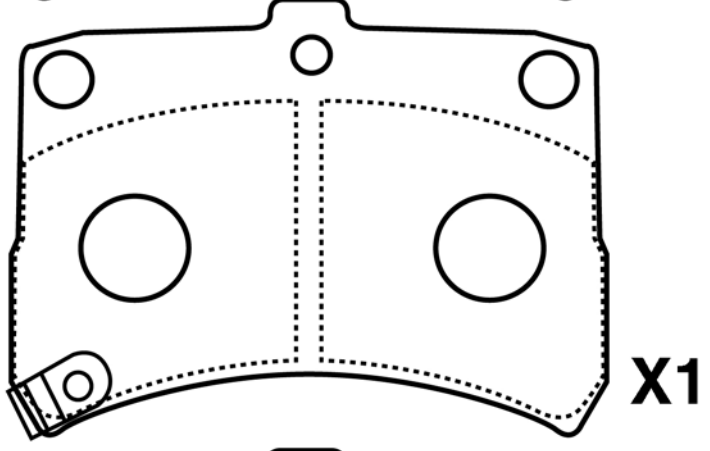
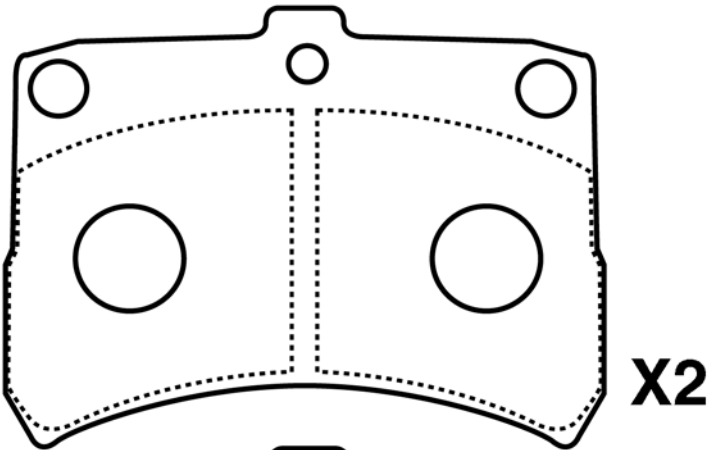



50-06-609				WVA
	DAIHATSU	L	H	Th
	92/122,2	44,1	15,3	24229

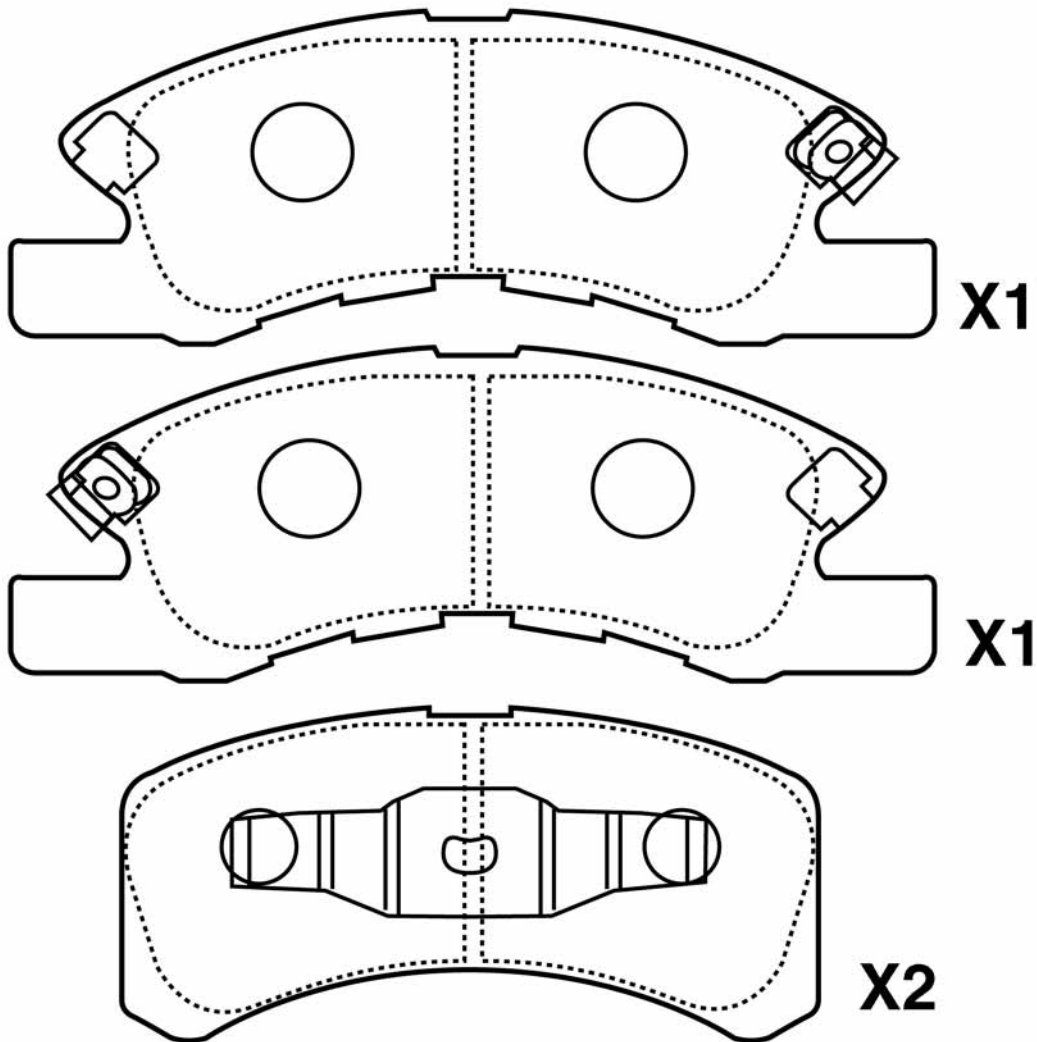



PICTURES BRAKE PADS FRONT
ABBILDUNGEN BREMSKLÖTZE VORN
FIGURAS PASTILLAS DE FRENO DELANTORES
ILLUSTRATIONS PLAQUETTES DE FREI AVANT
IMMAGINI PASTIGLIE FRENO ANTERIORI

50-06-610				WVA
DAIHATSU	L	H	Th	
	89	49,2	13,9	21969

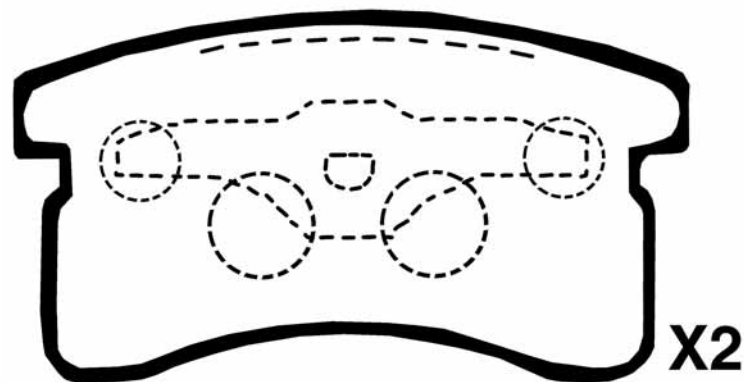
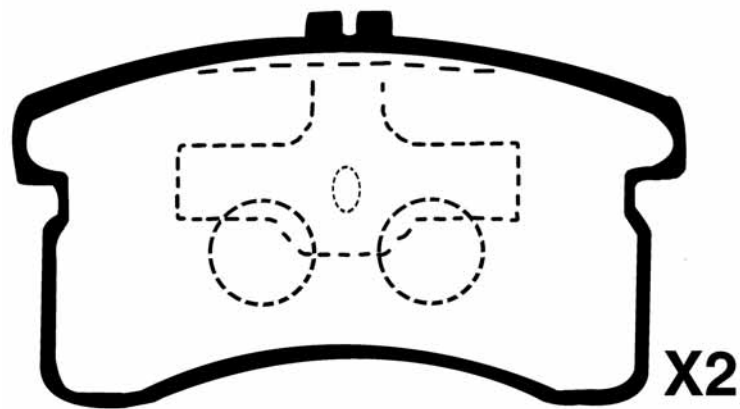

PICTURES BRAKE PADS FRONT
ABBILDUNGEN BREMSKLÖTZE VORN
FIGURAS PASTILLAS DE FRENO DELANTORES
ILLUSTRATIONS PLAQUETTES DE FREI AVANT
IMMAGINI PASTIGLIE FRENO ANTERIORI



50-06-612

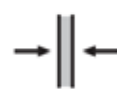
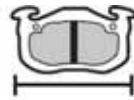

WVA

DAIHATSU

L

H

Th

109

46

15

23507

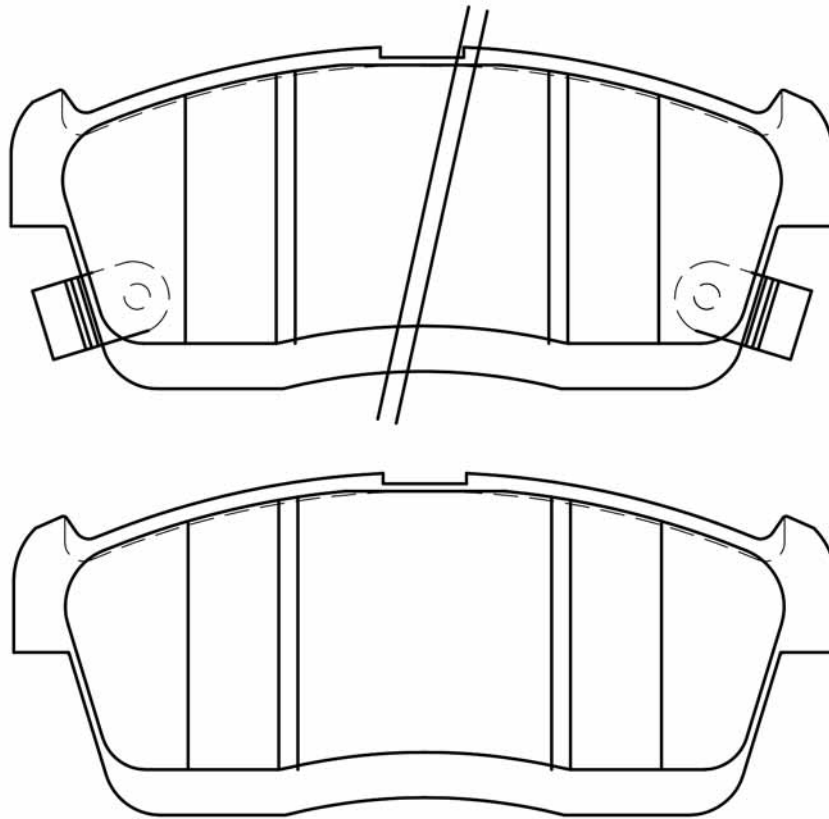



PICTURES BRAKE PADS FRONT
ABBILDUNGEN BREMSKLÖTZE VORN
FIGURAS PASTILLAS DE FRENO DELANTORES
ILLUSTRATIONS PLAQUETTES DE FREI AVANT
IMMAGINI PASTIGLIE FRENO ANTERIORI

50-06-615 DAIHATSU				WVA
	L	H	Th	
	95,2/115,5	49,7	15,3	23497

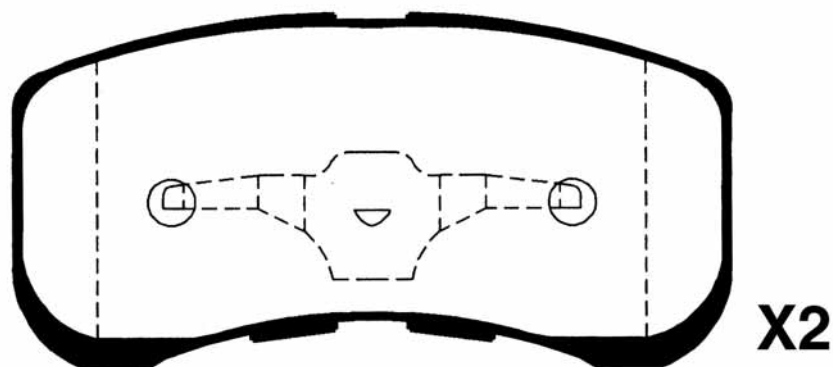
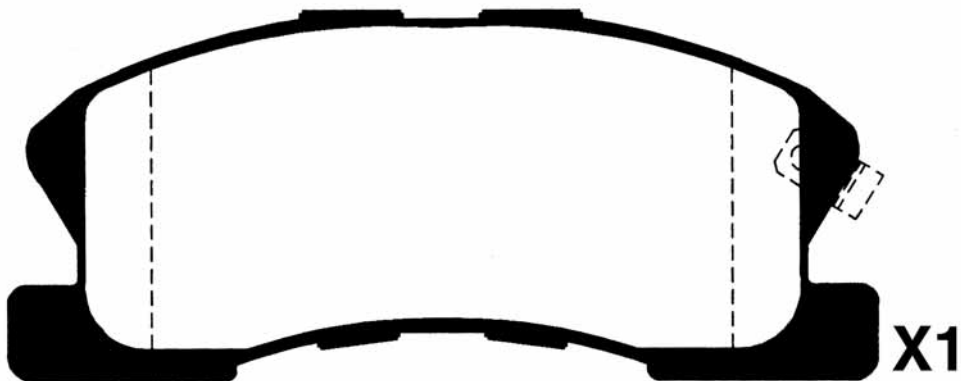
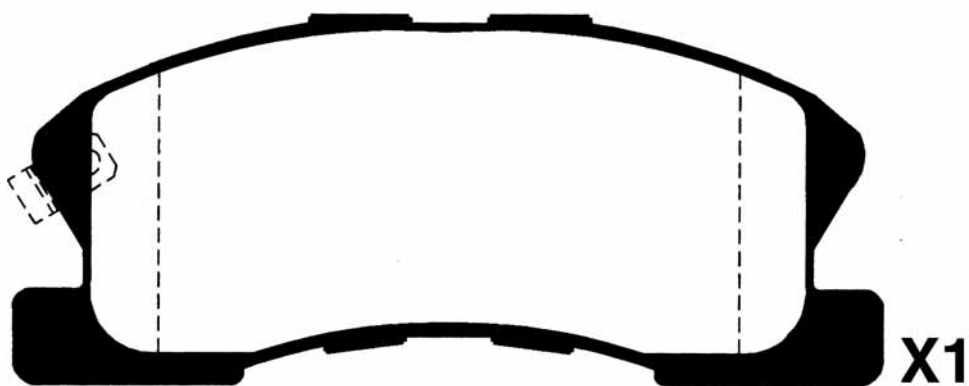



50-06-697

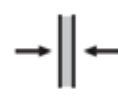
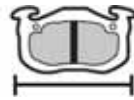

WVA

DAIHATSU

L

102,7/107,5

H

42

Th

15

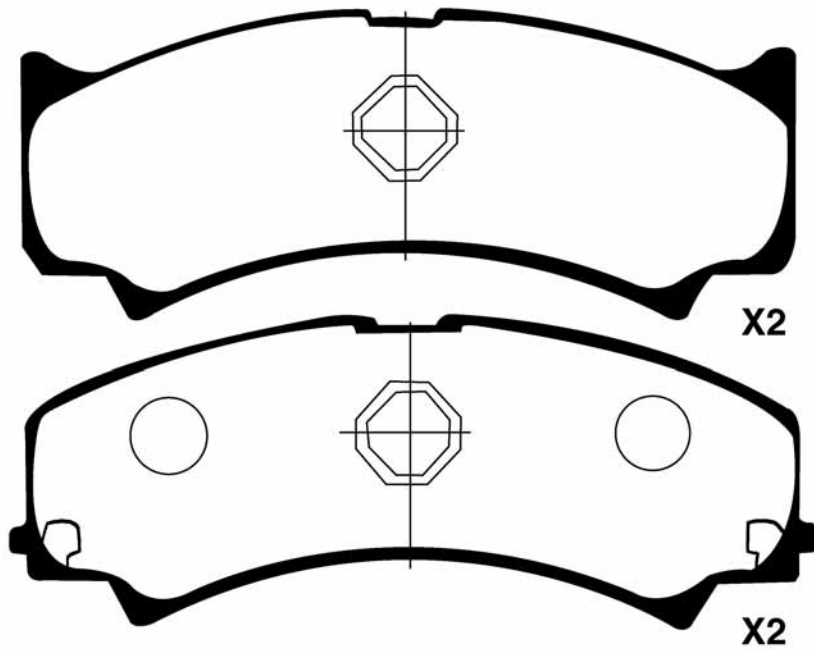



PICTURES BRAKE PADS FRONT
ABBILDUNGEN BREMSKLÖTZE VORN
FIGURAS PASTILLAS DE FRENO DELANTORES
ILLUSTRATIONS PLAQUETTES DE FREI AVANT
IMMAGINI PASTIGLIE FRENO ANTERIORI

50-06-698				WVA
DAIHATSU	L	H	Th	
	128	52,8	14	21967

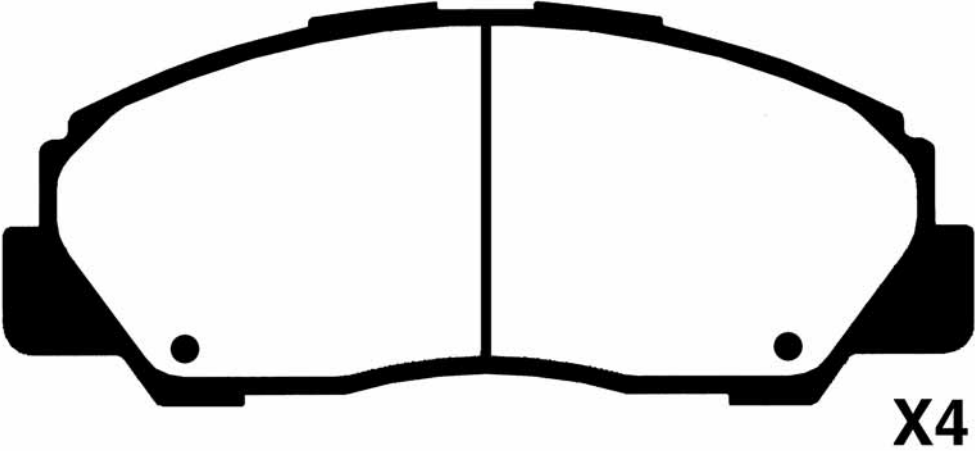



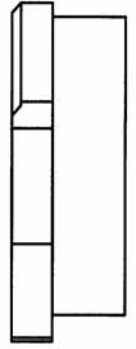
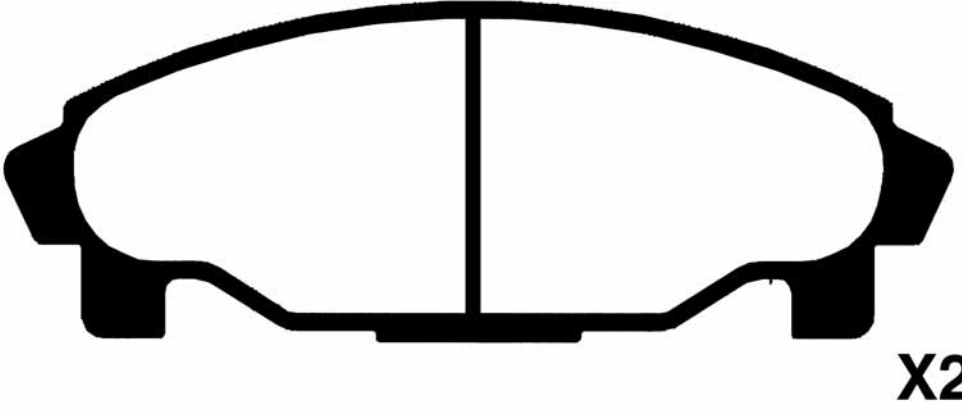
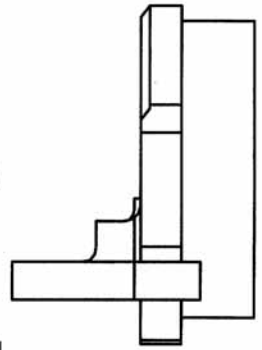
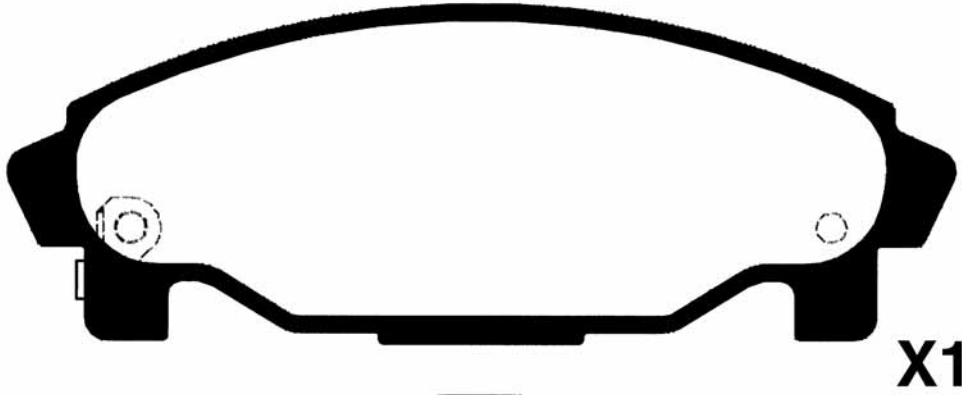
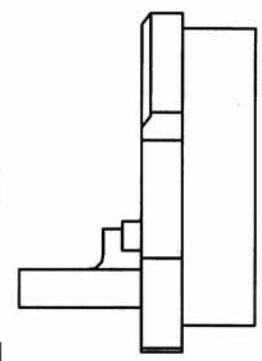
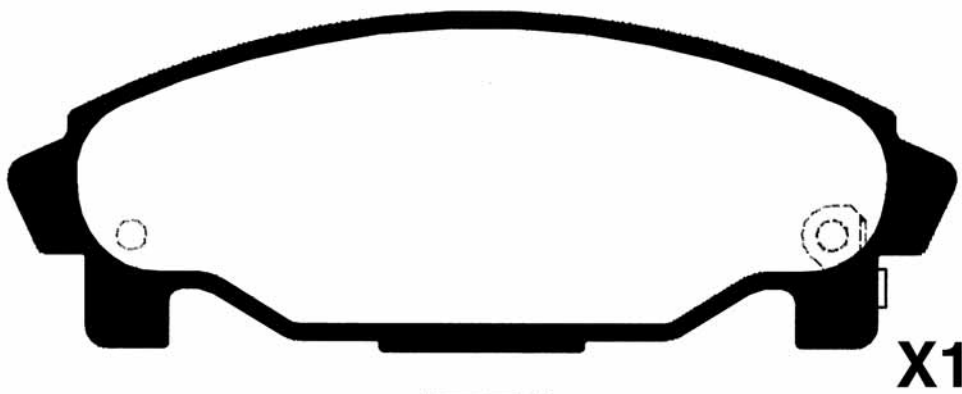

50-06-699				WVA
	DAIHATSU	L	H	Th
	125,6	45,5	14,9	21953



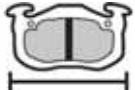

PICTURES BRAKE PADS FRONT
ABBILDUNGEN BREMSKLÖTZE VORN
FIGURAS PASTILLAS DE FRENO DELANTORES
ILLUSTRATIONS PLAQUETTES DE FREI AVANT
IMMAGINI PASTIGLIE FRENO ANTERIORI

50-07-701				WVA
SUBARU	L	H	Th	
	109/107	47/49	14	20767

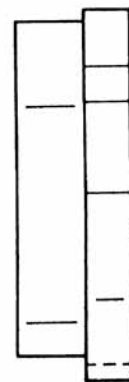
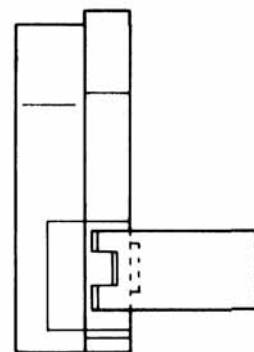
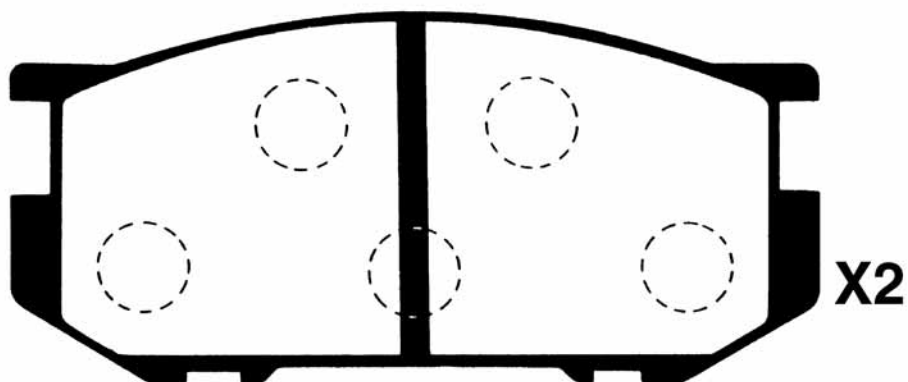
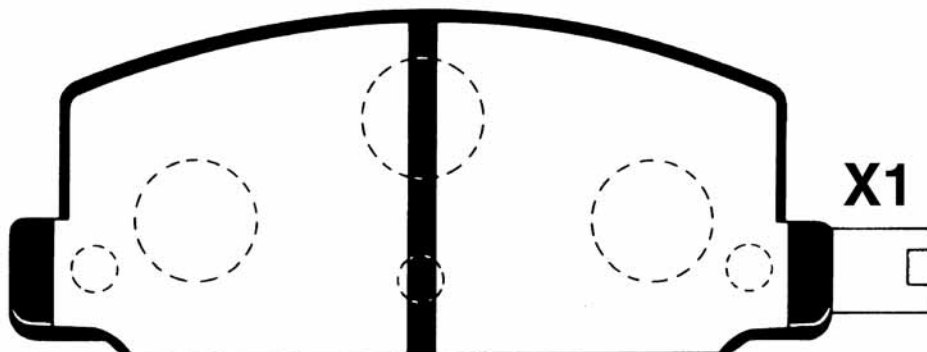
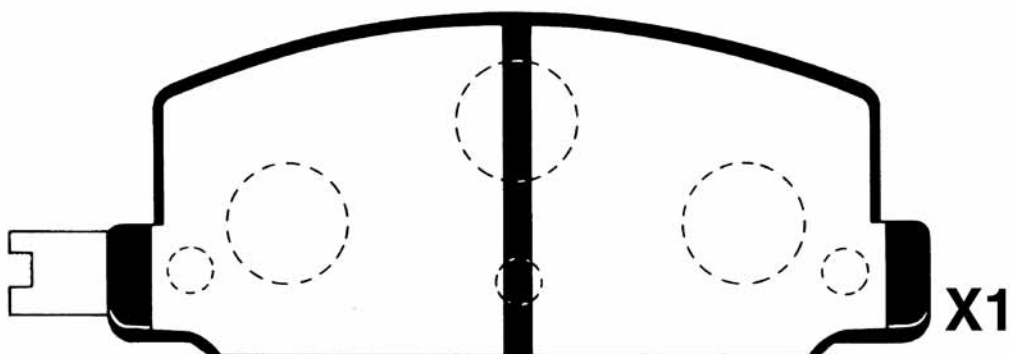



50-07-702				WVA
	L	H	Th	
SUBARU	108,6	45,8	13,9	20563

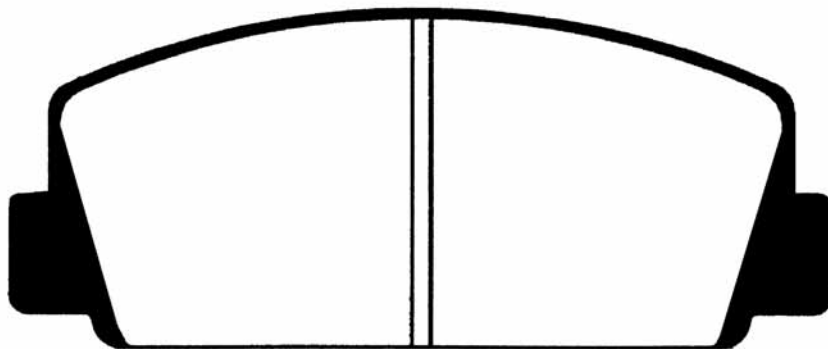

X4



PICTURES BRAKE PADS FRONT
ABBILDUNGEN BREMSKLÖTZE VORN
FIGURAS PASTILLAS DE FRENO DELANTORES
ILLUSTRATIONS PLAQUETTES DE FREI AVANT
IMMAGINI PASTIGLIE FRENO ANTERIORI

50-07-703



WVA

SUBARU

L

H

Th

127

54,6

16,6

20113

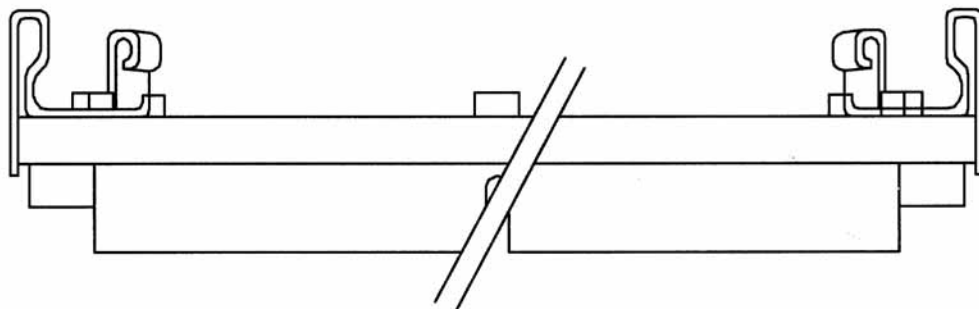
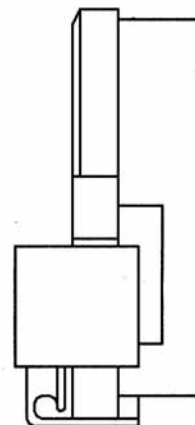
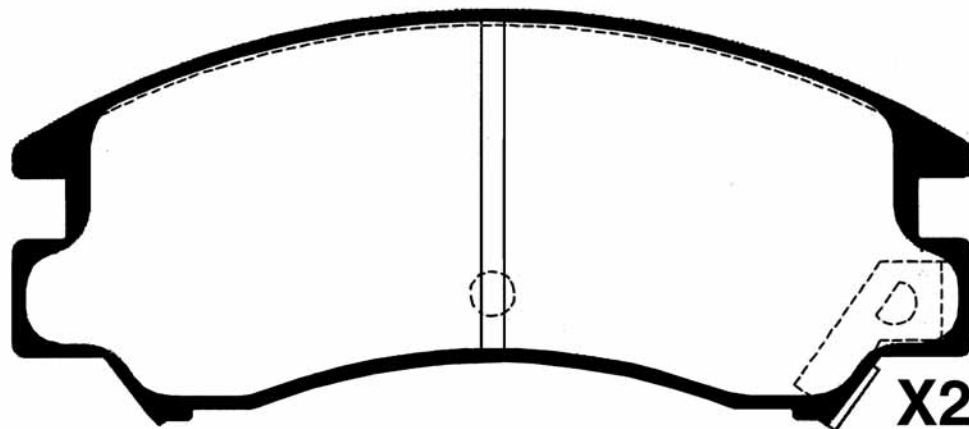
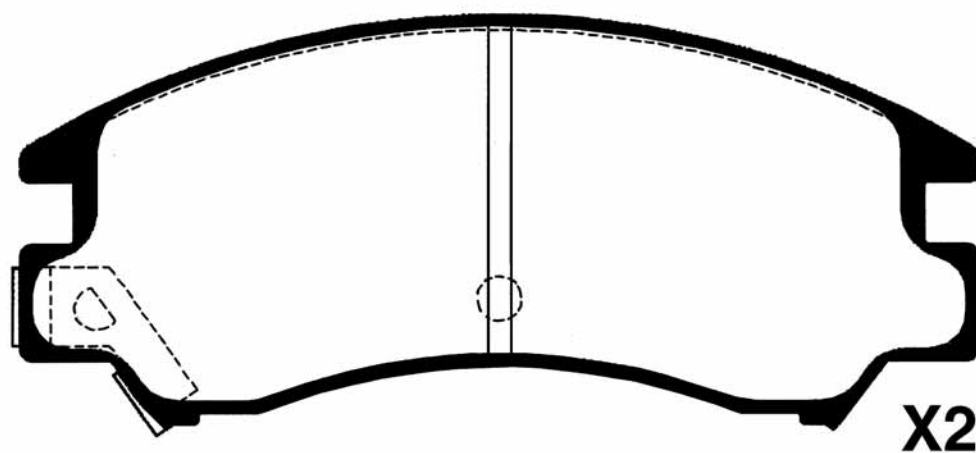



50-07-705				WVA
	SUBARU	L	H	Th
	128	54,7	16,6	21496

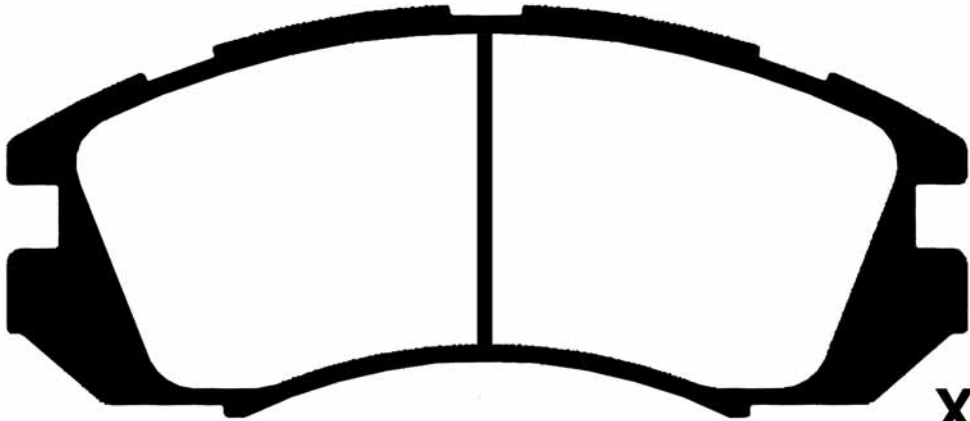

X2

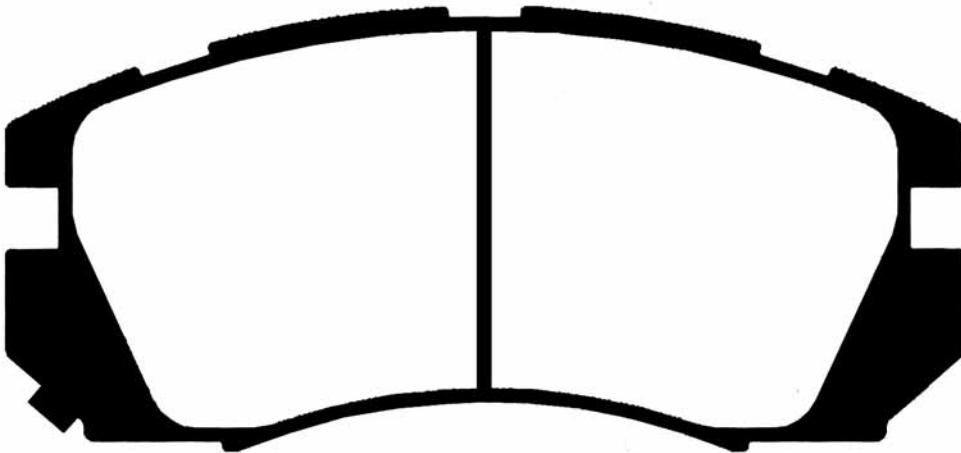
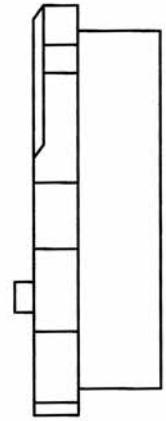

X1

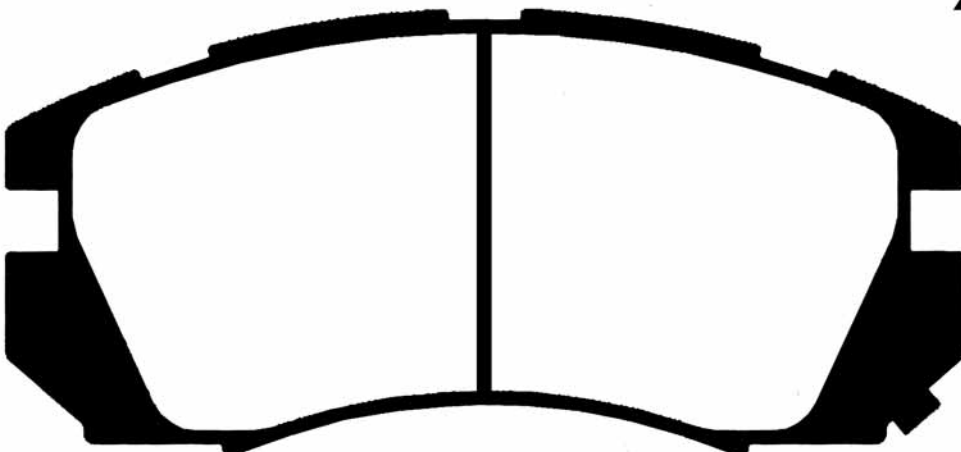
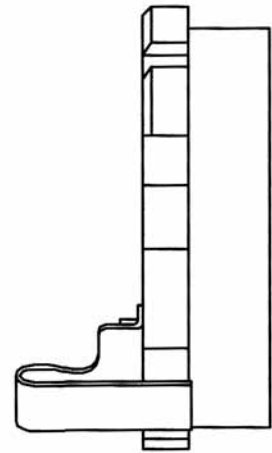

X1



PICTURES BRAKE PADS FRONT
ABBILDUNGEN BREMSKLÖTZE VORN
FIGURAS PASTILLAS DE FRENO DELANTORES
ILLUSTRATIONS PLAQUETTES DE FREI AVANT
IMMAGINI PASTIGLIE FRENO ANTERIORI

50-07-706

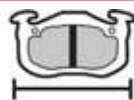

WVA

SUBARU

L

H

Th

137

57,5

18

23865

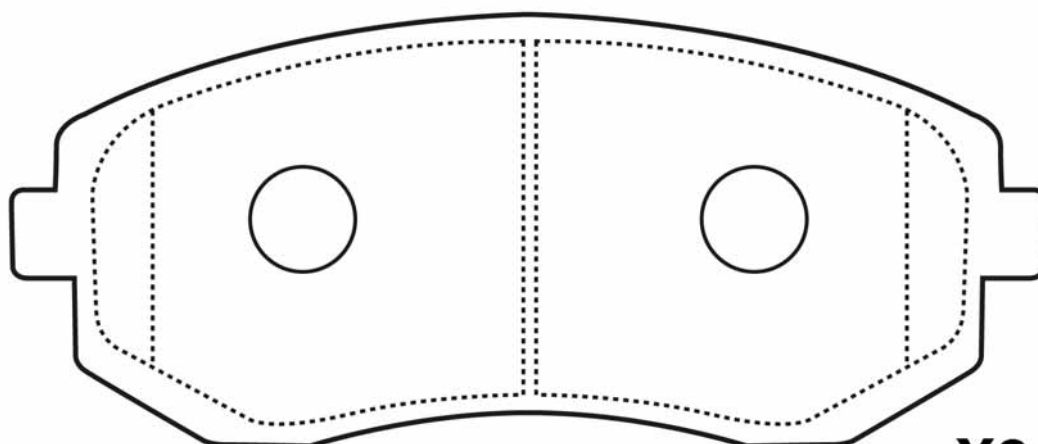

X2

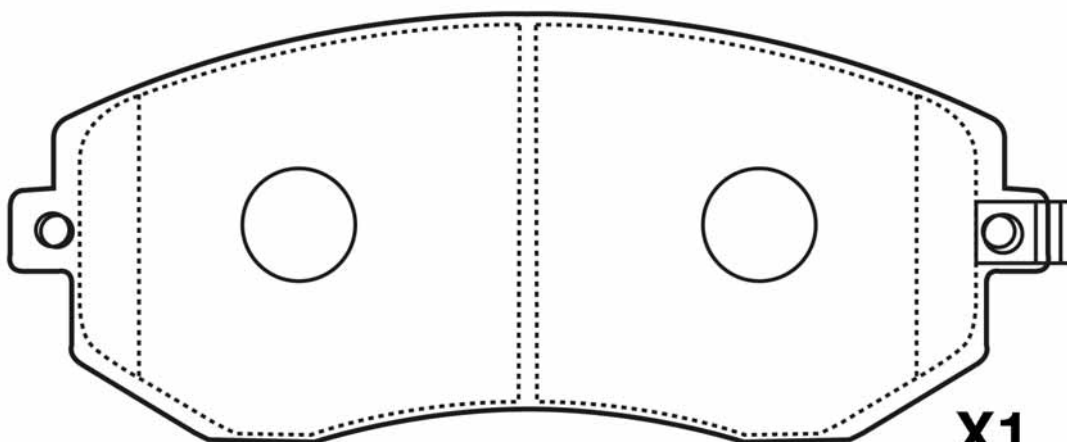

X1

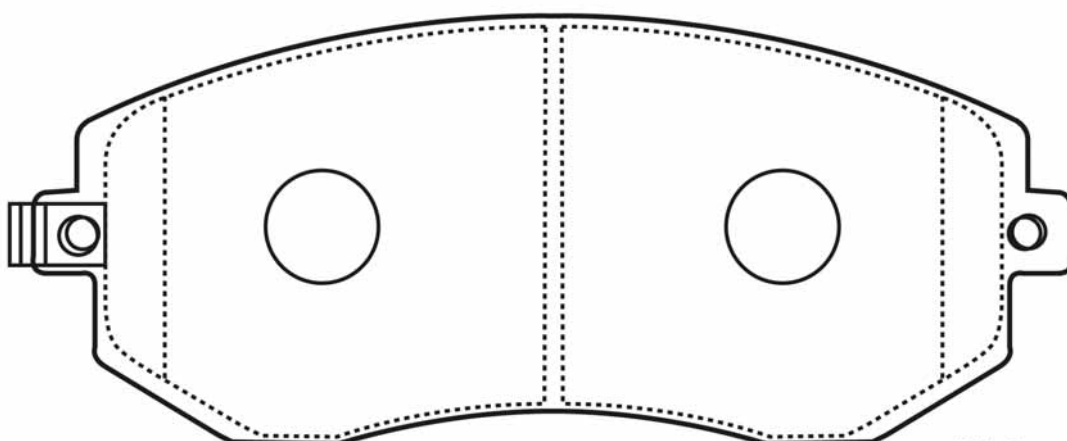

X1



50-07-707				WVA
	SUBARU	L	H	
	108,7	49,6	14,8	21549

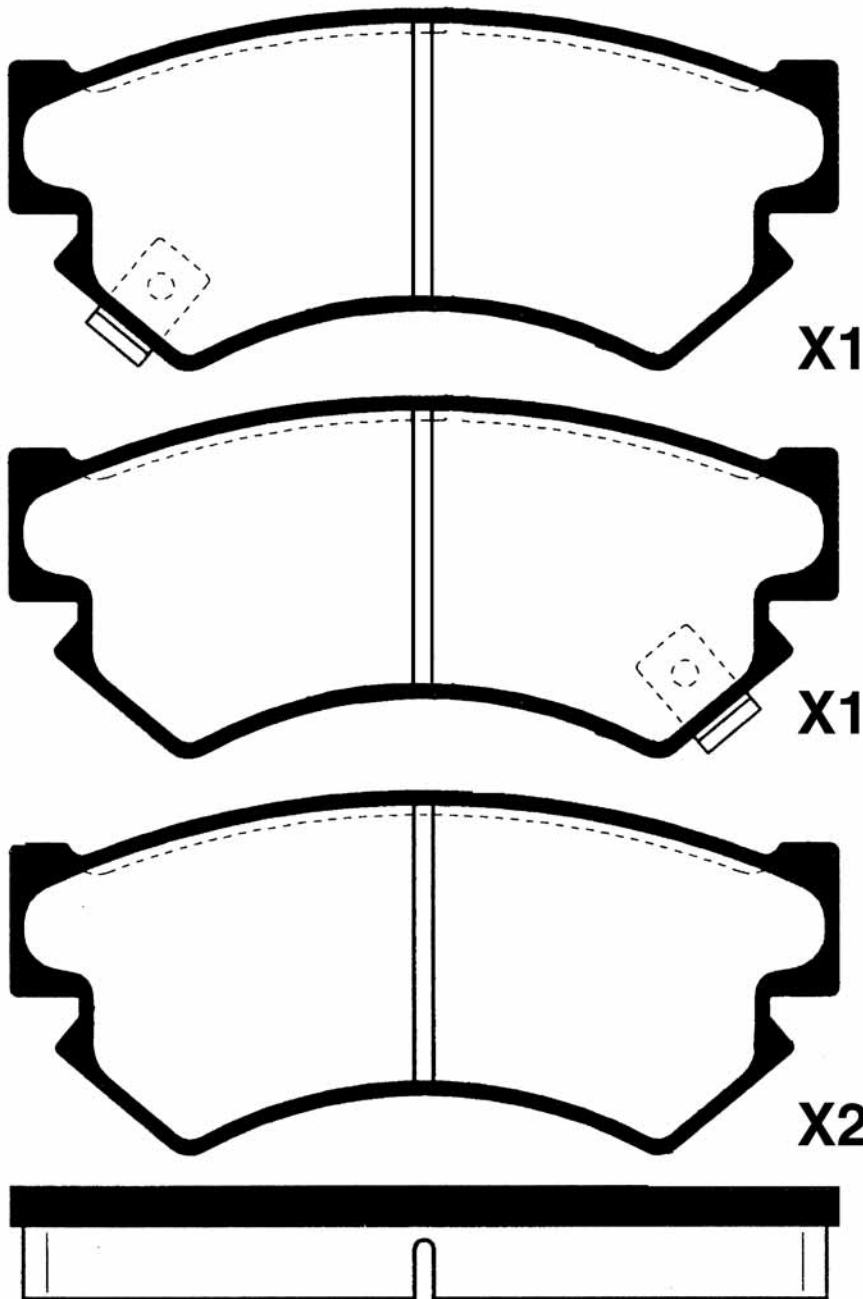



PICTURES BRAKE PADS FRONT
ABBILDUNGEN BREMSKLÖTZE VORN
FIGURAS PASTILLAS DE FRENO DELANTORES
ILLUSTRATIONS PLAQUETTES DE FREI AVANT
IMMAGINI PASTIGLIE FRENO ANTERIORI

50-07-708				WVA
SUBARU	L	H	Th	
	127,7	59	16,8	21482

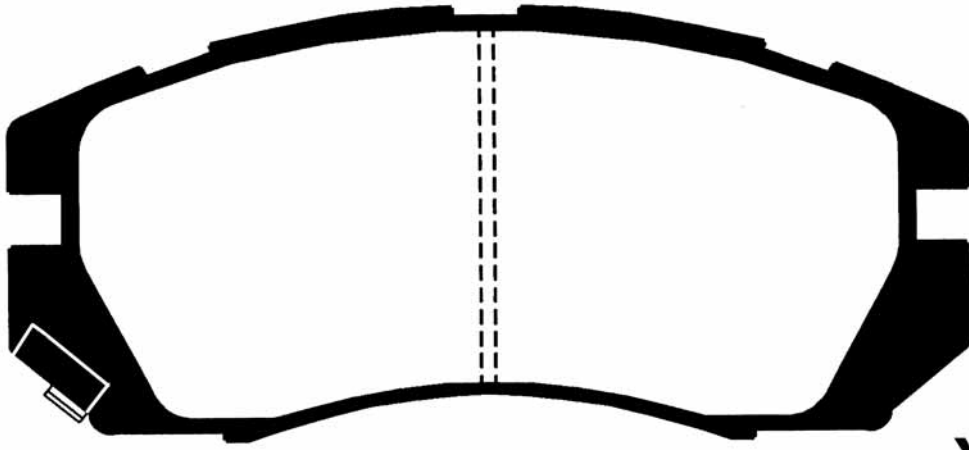

X1

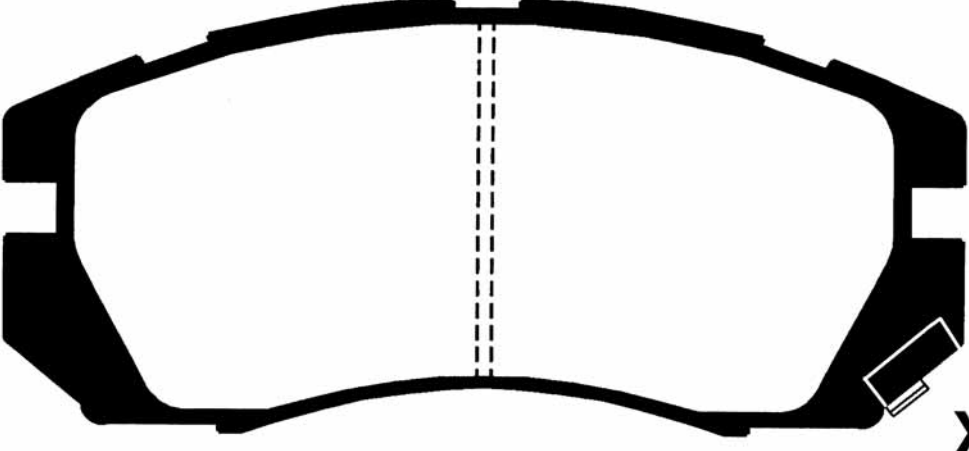

X1

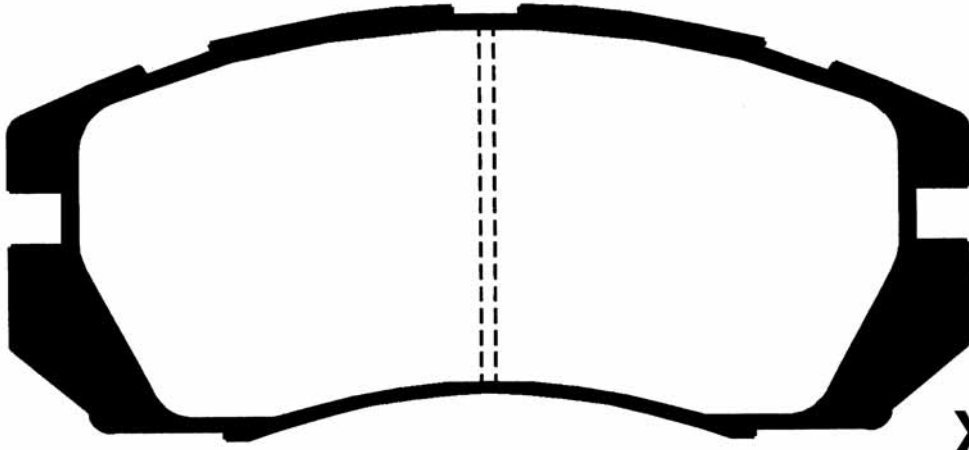

X2



50-07-709				WVA
	L	H	Th	
SUBARU	157	63,5	17	

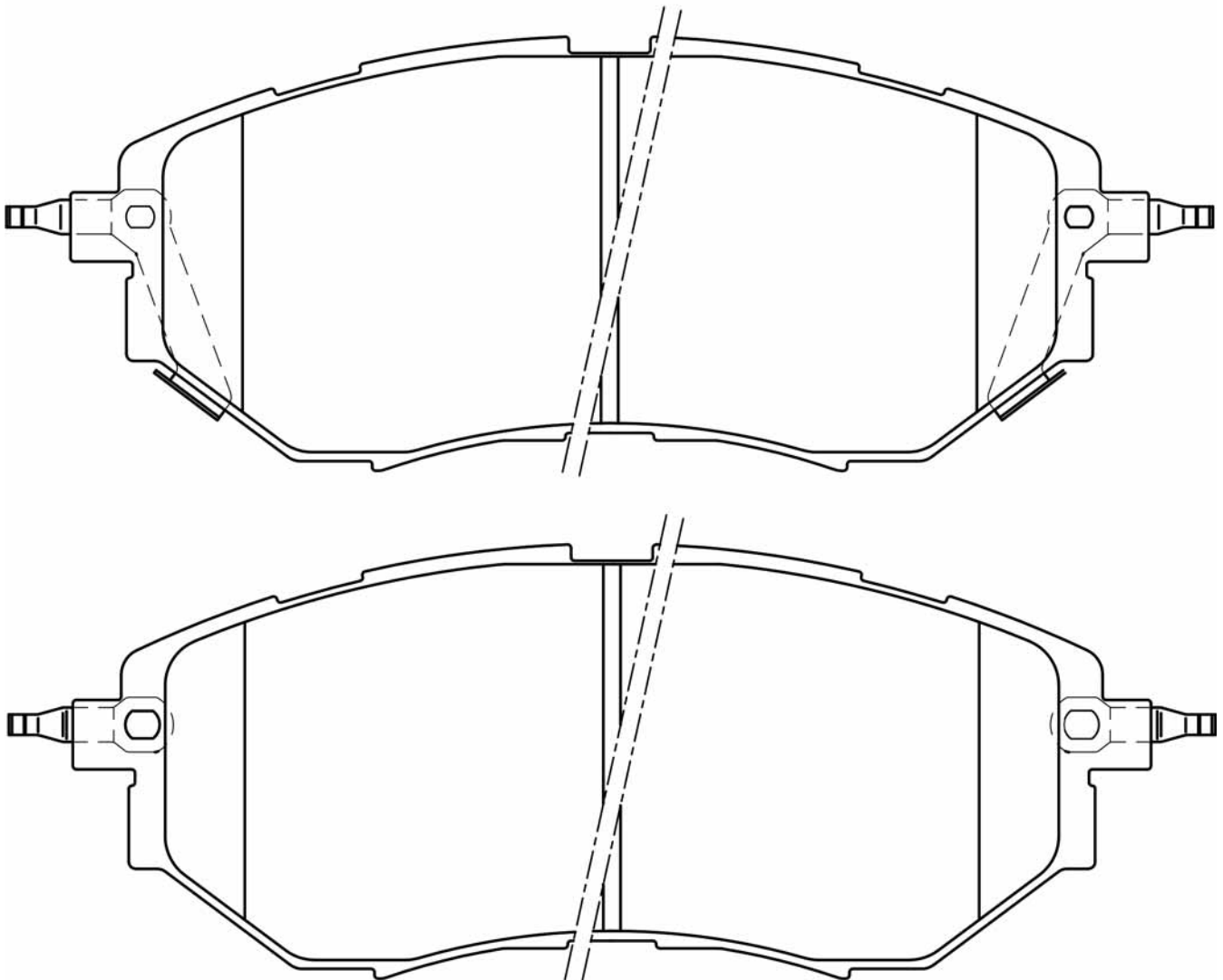



PICTURES BRAKE PADS FRONT
ABBILDUNGEN BREMSKLÖTZE VORN
FIGURAS PASTILLAS DE FRENO DELANTORES
ILLUSTRATIONS PLAQUETTES DE FREI AVANT
IMMAGINI PASTIGLIE FRENO ANTERIORI

50-07-710				WVA
SUBARU	L	H	Th	
	127,5	49,7	15,2	21709

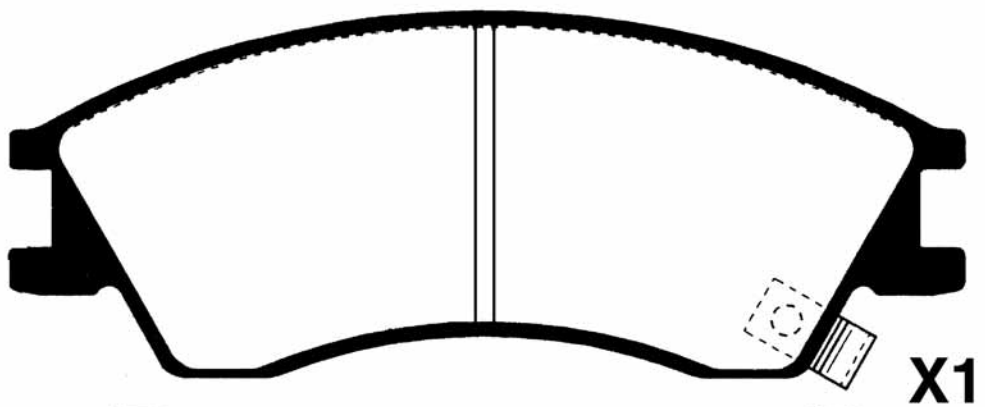
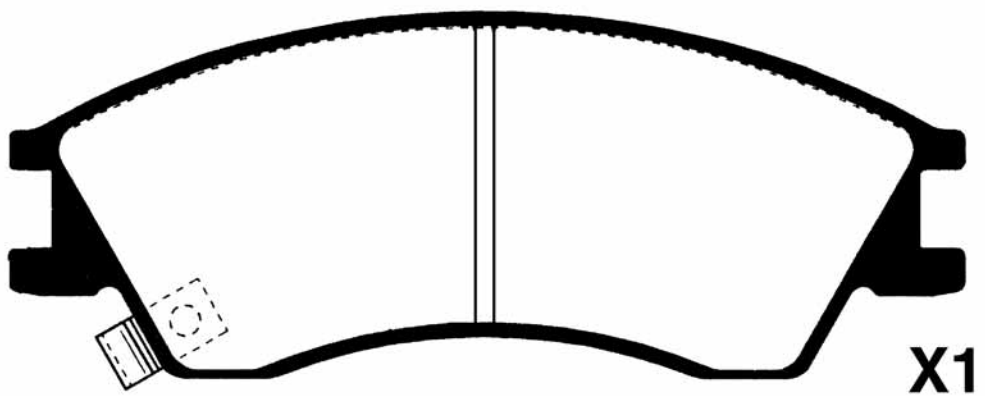
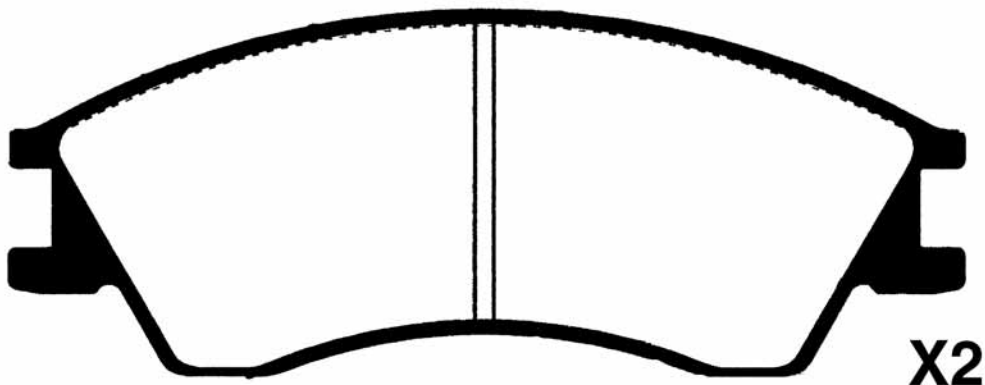

PICTURES BRAKE PADS FRONT
ABBILDUNGEN BREMSKLÖTZE VORN
FIGURAS PASTILLAS DE FRENO DELANTORES
ILLUSTRATIONS PLAQUETTES DE FREI AVANT
IMMAGINI PASTIGLIE FRENO ANTERIORI



50-07-711

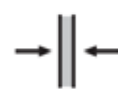
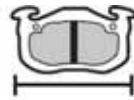

WVA

SUBARU

L

H

Th

138

54

17

23780

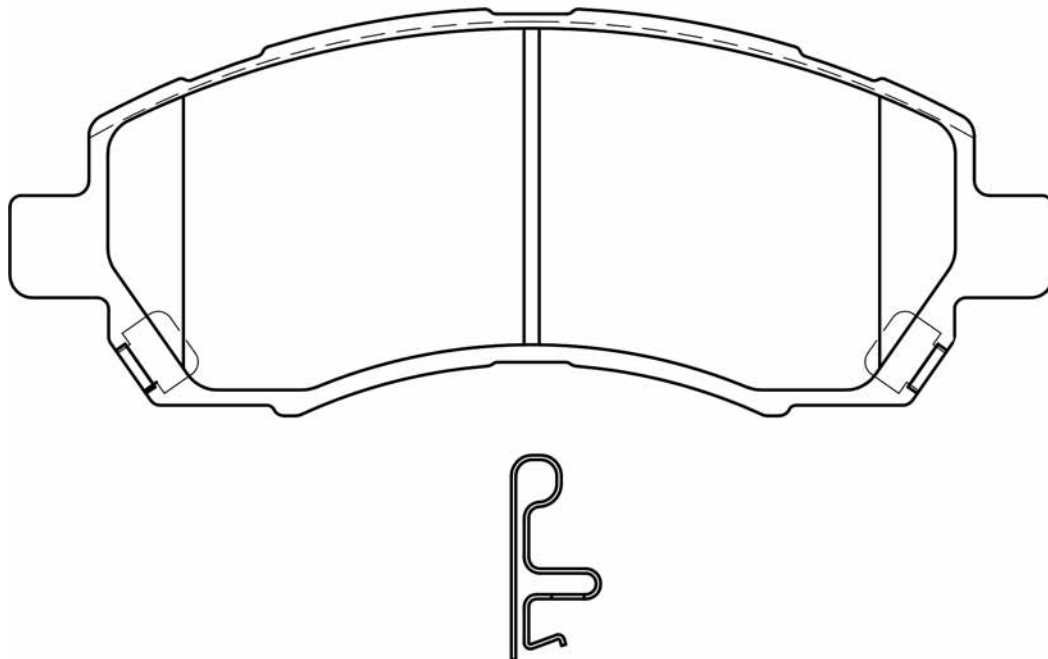



PICTURES BRAKE PADS FRONT
ABBILDUNGEN BREMSKLÖTZE VORN
FIGURAS PASTILLAS DE FRENO DELANTORES
ILLUSTRATIONS PLAQUETTES DE FREI AVANT
IMMAGINI PASTIGLIE FRENO ANTERIORI

50-07-795				WVA
SUBARU	L	H	Th	
	117,5	53,2	14,8	

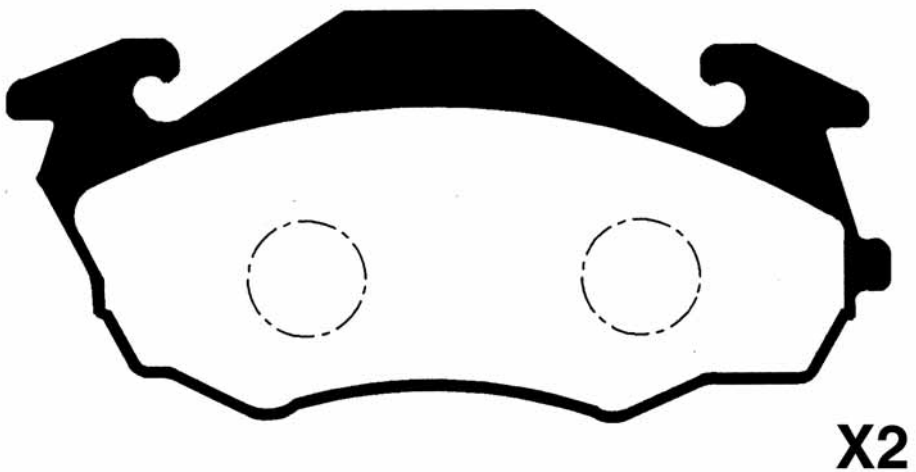
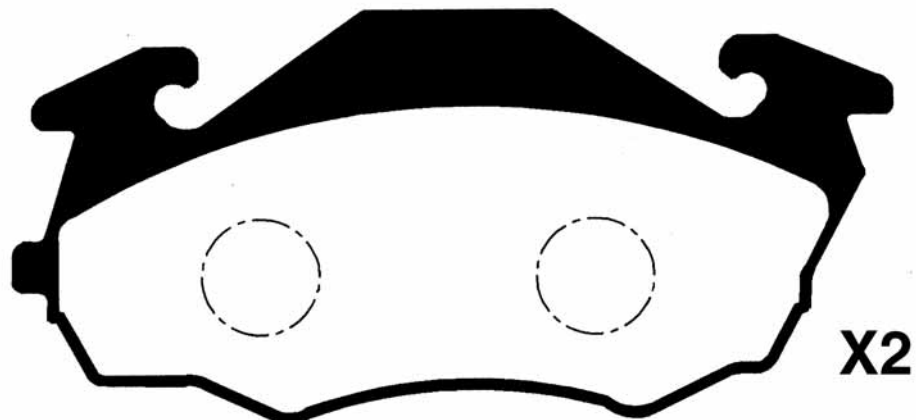



50-07-796				WVA
	L	H	Th	
SUBARU	138	60	16	21915

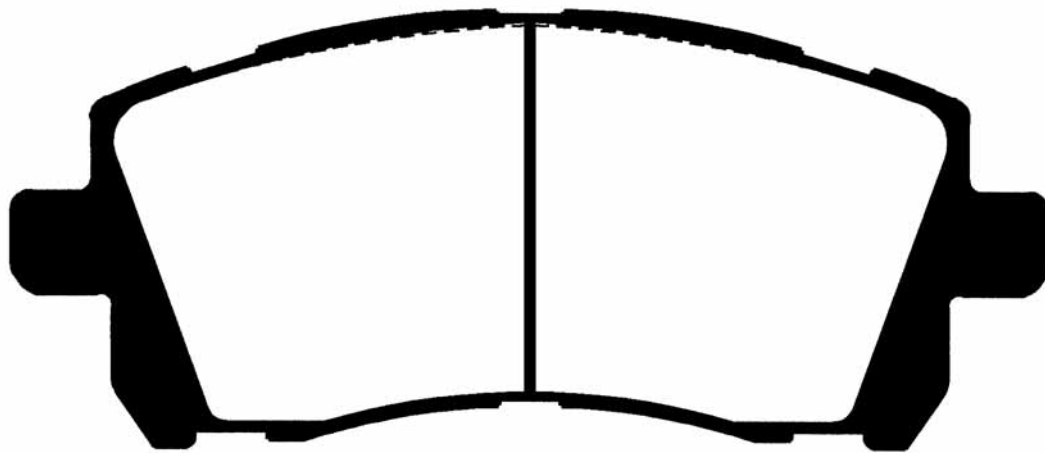

X4



PICTURES BRAKE PADS FRONT
ABBILDUNGEN BREMSKLÖTZE VORN
FIGURAS PASTILLAS DE FRENO DELANTORES
ILLUSTRATIONS PLAQUETTES DE FREI AVANT
IMMAGINI PASTIGLIE FRENO ANTERIORI

50-07-797

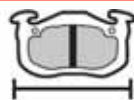

WVA

L

H

Th

108,7/106,6

46,2/53

14,6

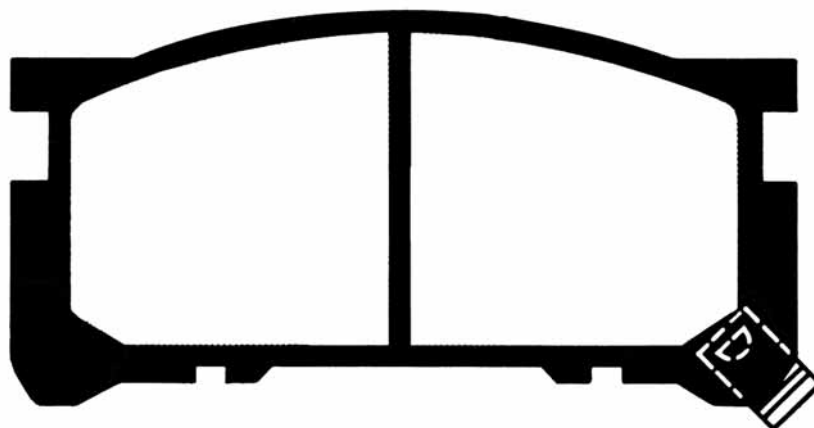

X1 LEFT
X1 RIGHT

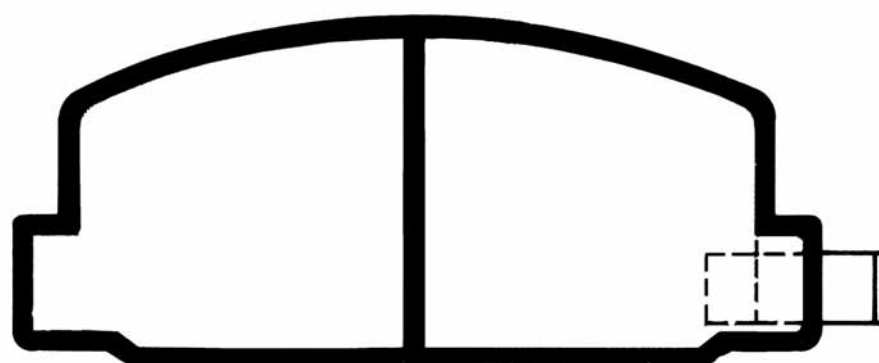
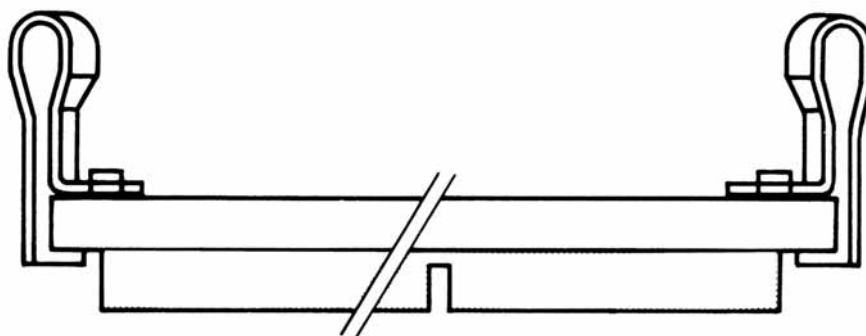

X1 LEFT
X1 RIGHT

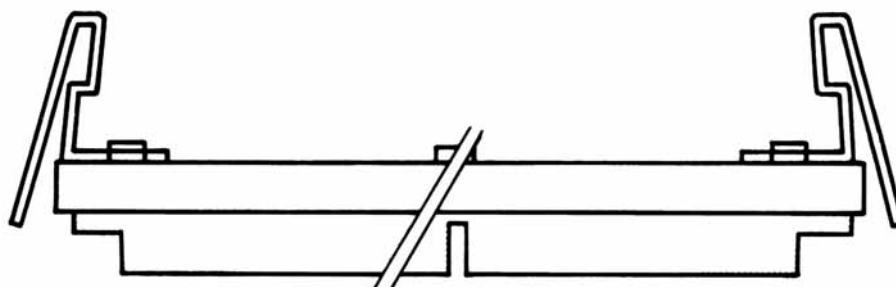



50-07-798				WVA
	98/112	39,6/39	14	
SUBARU	L	H	Th	
	98/112	39,6/39	14	23379

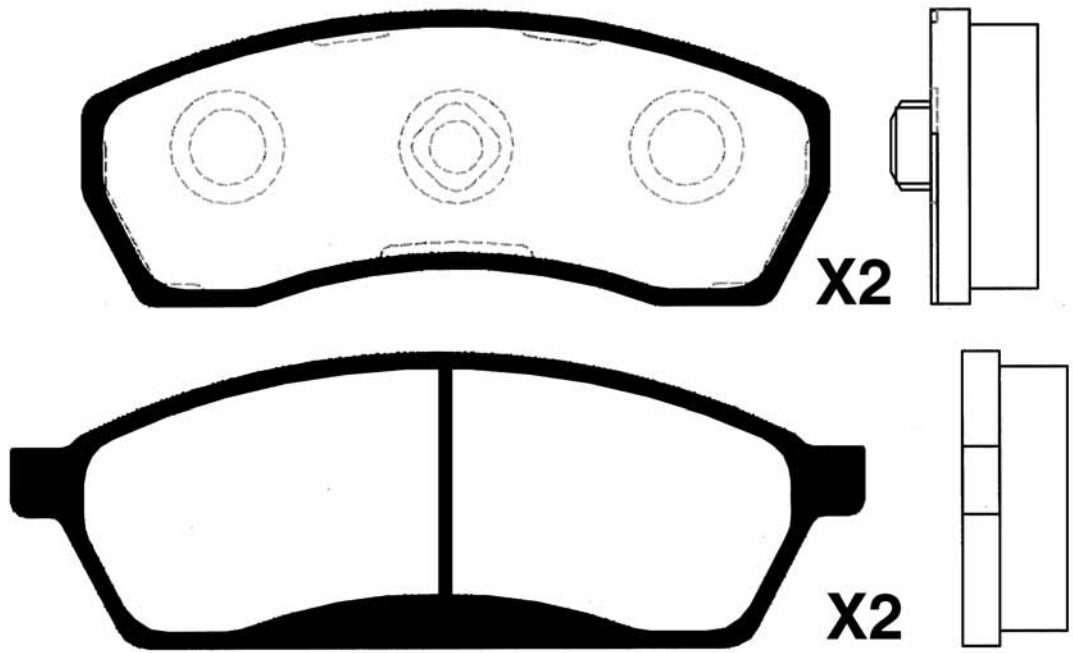



PICTURES BRAKE PADS FRONT
ABBILDUNGEN BREMSKLÖTZE VORN
FIGURAS PASTILLAS DE FRENO DELANTORES
ILLUSTRATIONS PLAQUETTES DE FREI AVANT
IMMAGINI PASTIGLIE FRENO ANTERIORI

50-07-799				WVA
SUBARU	L	H	Th	
	103	39	13,6	21542

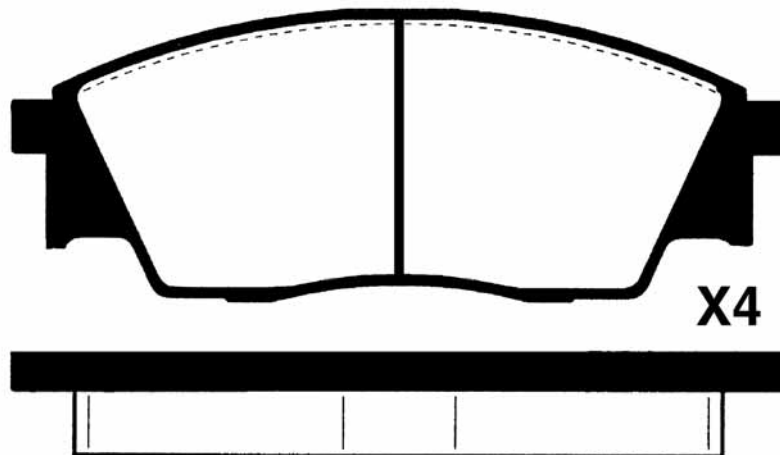



50-08-800				WVA
	SUZUKI - NISSAN	L	H	Th
	116,3	52,5	16,8	24403

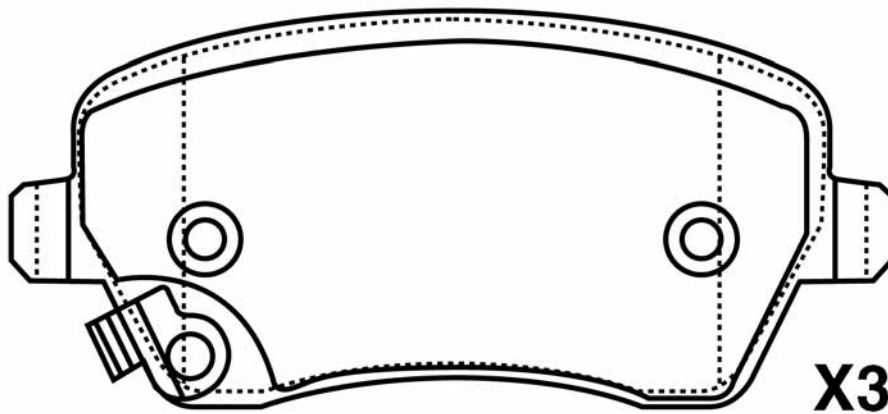



PICTURES BRAKE PADS FRONT
ABBILDUNGEN BREMSKLÖTZE VORN
FIGURAS PASTILLAS DE FRENO DELANTORES
ILLUSTRATIONS PLAQUETTES DE FREI AVANT
IMMAGINI PASTIGLIE FRENO ANTERIORI

50-08-801				WVA
FIAT - SUZUKI	L	H	Th	
	131,2	57	16	24391

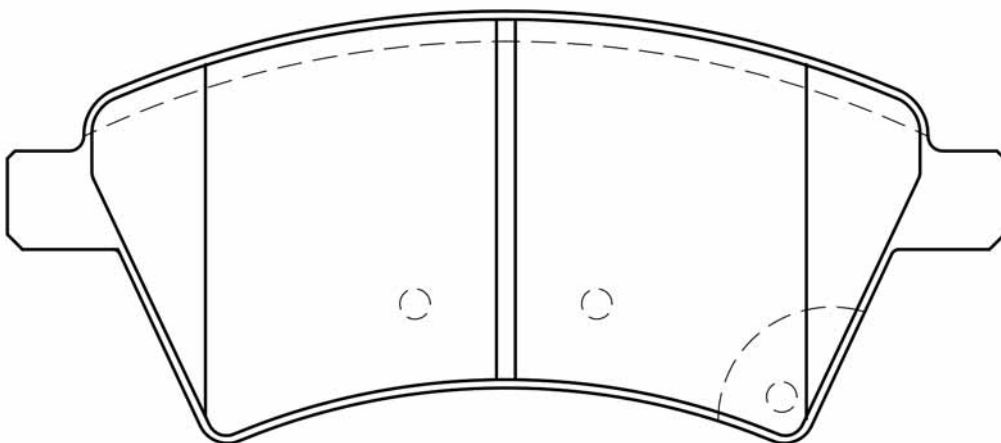
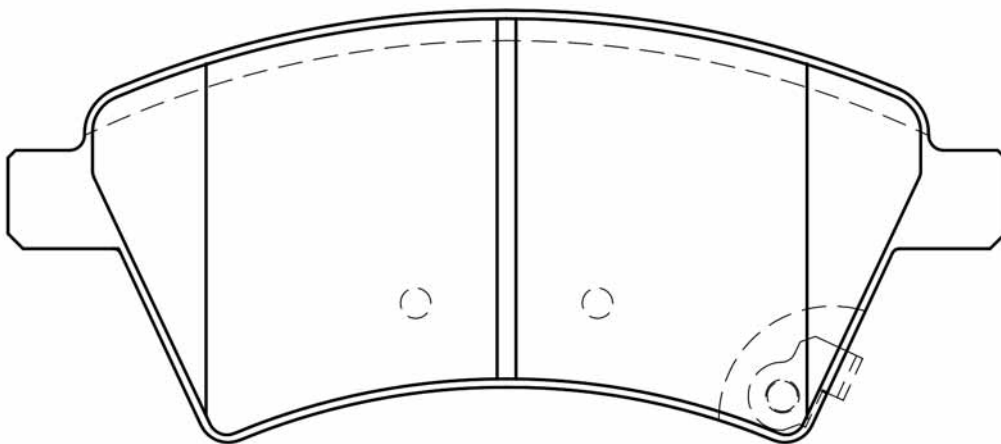

PICTURES BRAKE PADS FRONT
ABBILDUNGEN BREMSKLÖTZE VORN
FIGURAS PASTILLAS DE FRENO DELANTORES
ILLUSTRATIONS PLAQUETTES DE FREI AVANT
IMMAGINI PASTIGLIE FRENO ANTERIORI



50-08-802

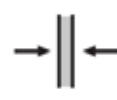
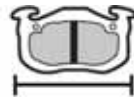

WVA

SUZUKI

L

H

Th

138

54,5

16,2

24346

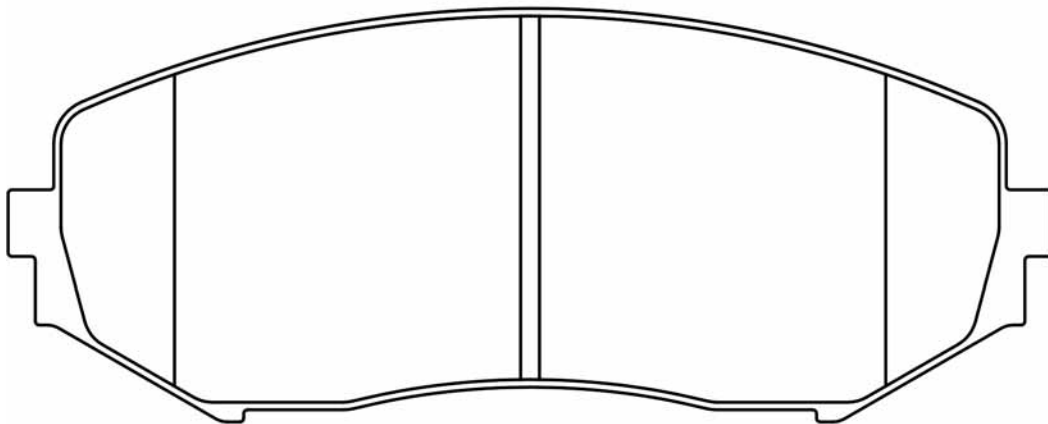



PICTURES BRAKE PADS FRONT
ABBILDUNGEN BREMSKLÖTZE VORN
FIGURAS PASTILLAS DE FRENO DELANTORES
ILLUSTRATIONS PLAQUETTES DE FREI AVANT
IMMAGINI PASTIGLIE FRENO ANTERIORI

50-08-803				WVA
SUZUKI	L	H	Th	
	110,4	41,5	14,8	21142

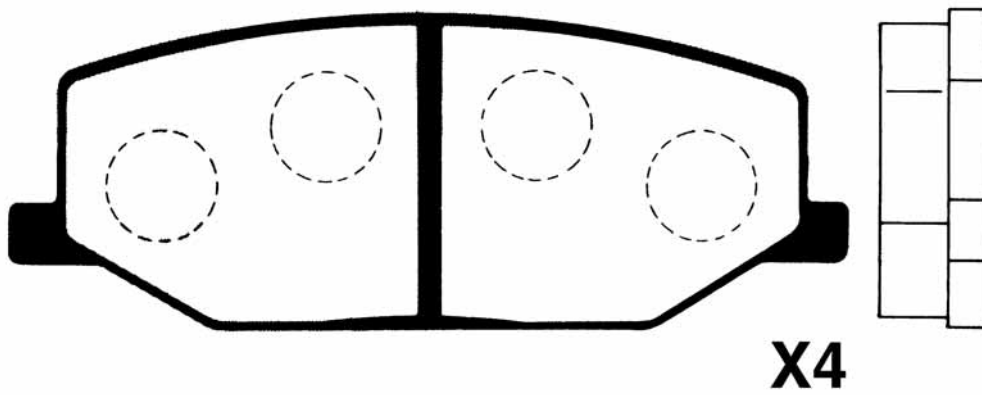



50-08-803P				WVA
	SUZUKI	L	H	
	110,4	41,5	14,8	

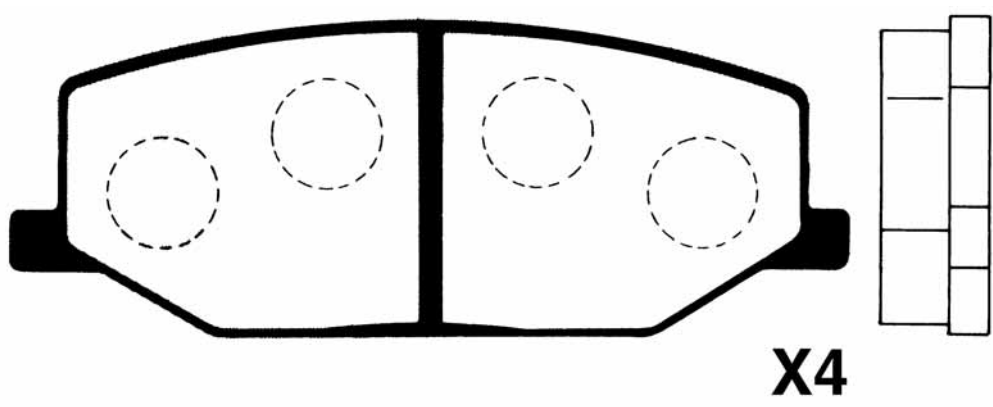



PICTURES BRAKE PADS FRONT
ABBILDUNGEN BREMSKLÖTZE VORN
FIGURAS PASTILLAS DE FRENO DELANTORES
ILLUSTRATIONS PLAQUETTES DE FREI AVANT
IMMAGINI PASTIGLIE FRENO ANTERIORI

50-08-804				WVA
SUZUKI	L	H	Th	
	123	42	14,8	21252

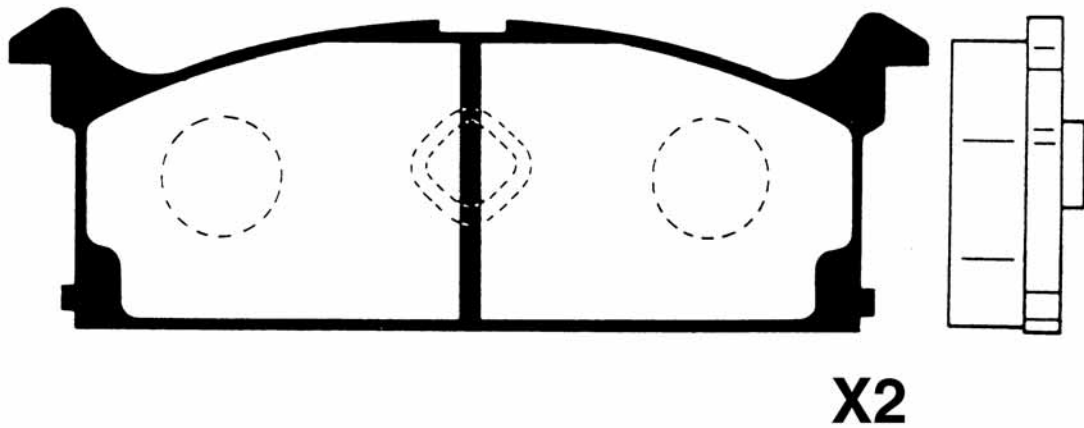
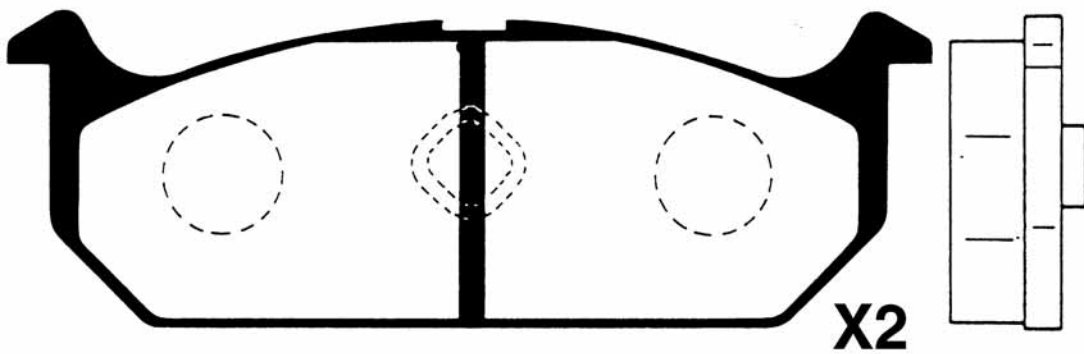



50-08-805				WVA
	SUBARU - SUZUKI - TATA (TELCO)	L	H	Th
	107,5	45	14,7	

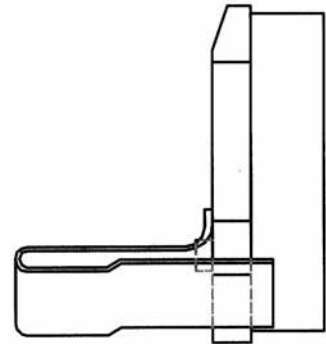
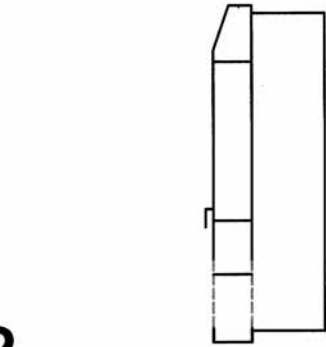
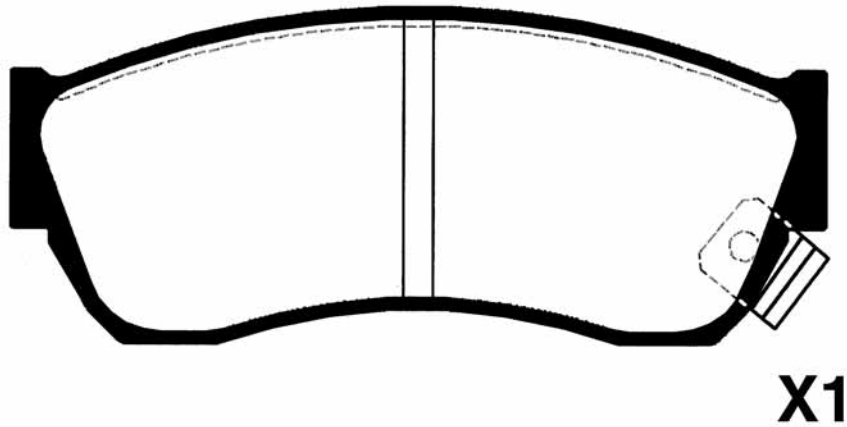
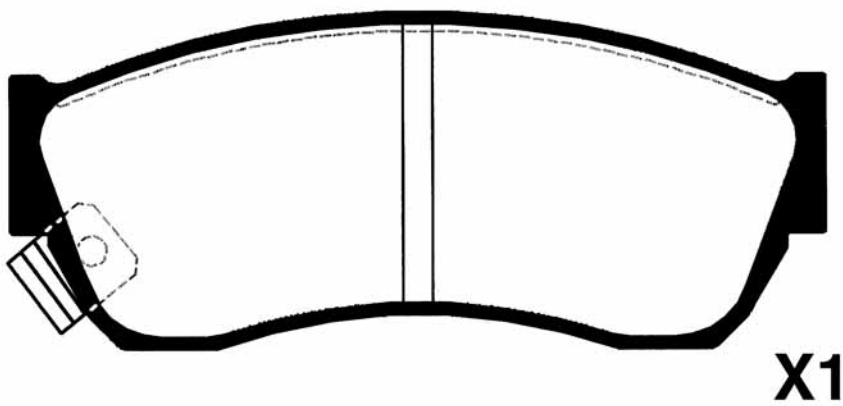
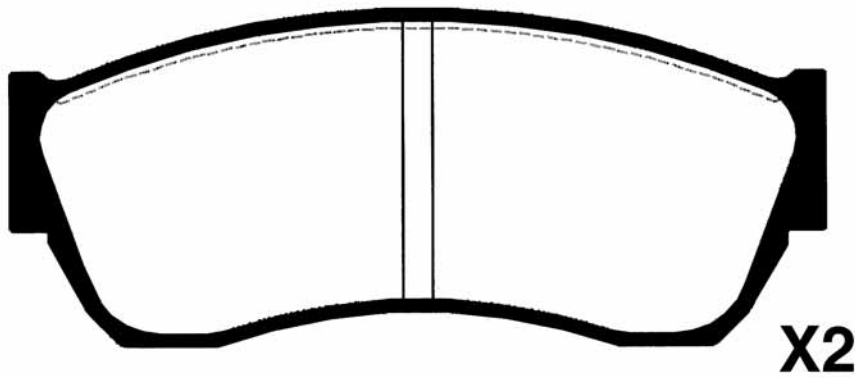



PICTURES BRAKE PADS FRONT
ABBILDUNGEN BREMSKLÖTZE VORN
FIGURAS PASTILLAS DE FRENO DELANTORES
ILLUSTRATIONS PLAQUETTES DE FREI AVANT
IMMAGINI PASTIGLIE FRENO ANTERIORI

50-08-806				WVA
	SUZUKI	L	H	
	103,7	43,7	14,5	21502

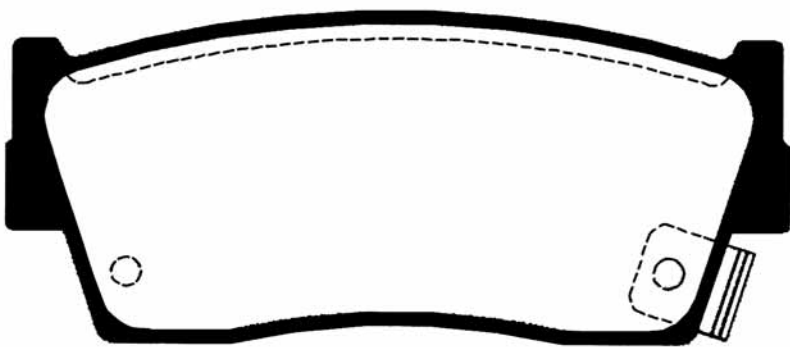
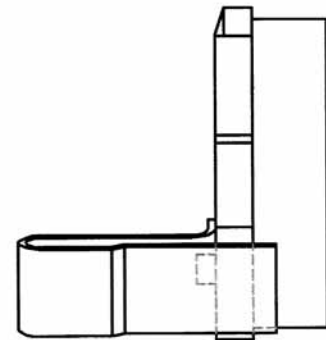
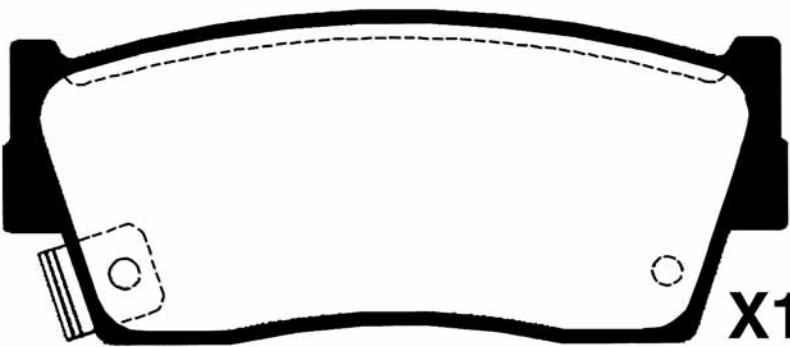
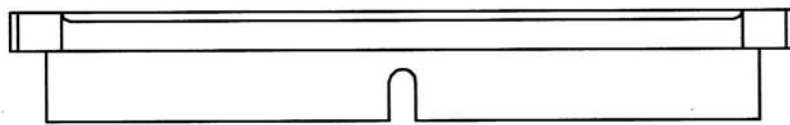
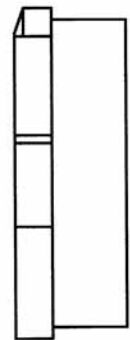
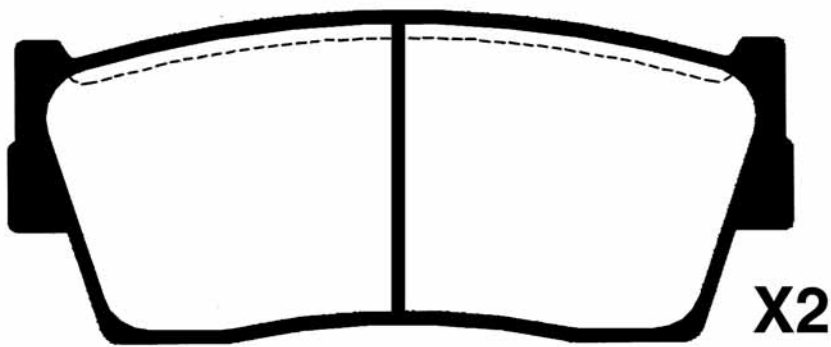



50-08-806P				WVA
	SUZUKI	L 103,7	H 43,7	

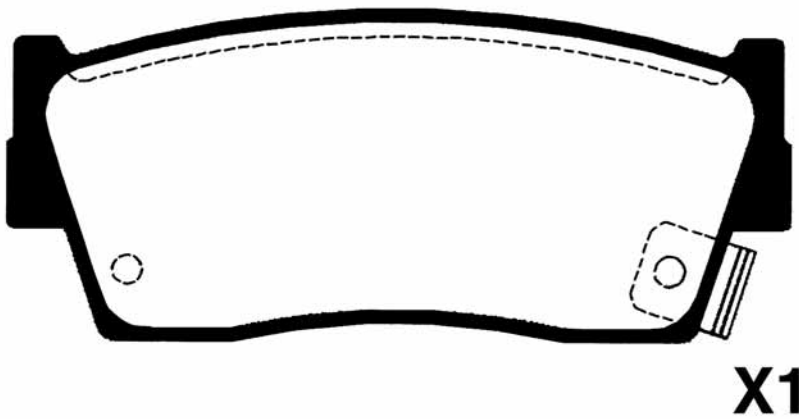
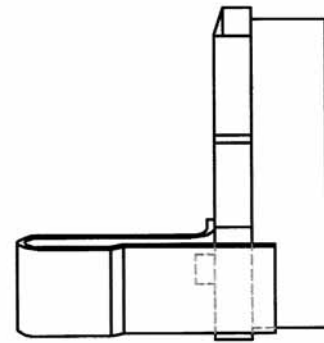
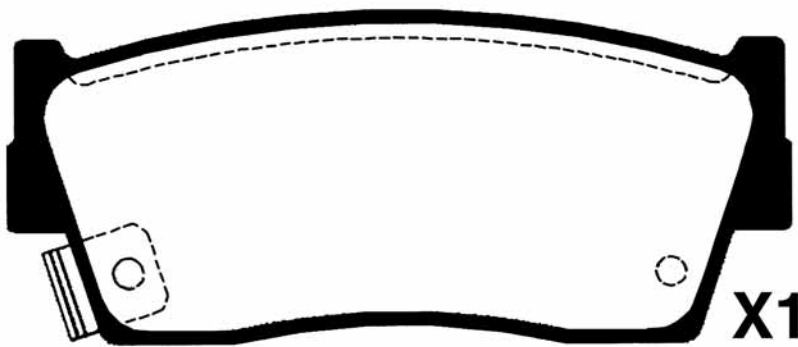
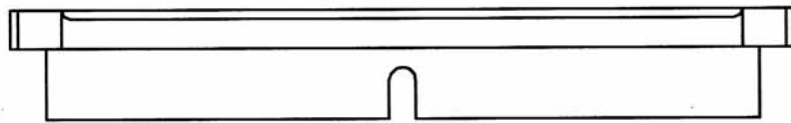
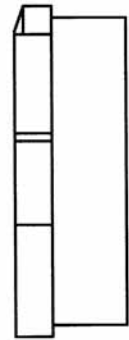
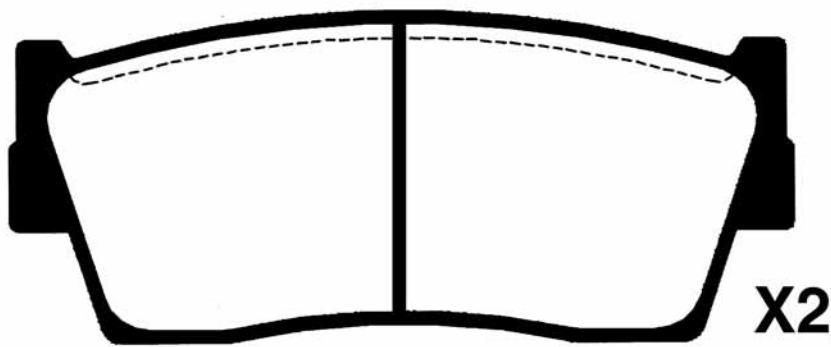



PICTURES BRAKE PADS FRONT
ABBILDUNGEN BREMSKLÖTZE VORN
FIGURAS PASTILLAS DE FRENO DELANTORES
ILLUSTRATIONS PLAQUETTES DE FREI AVANT
IMMAGINI PASTIGLIE FRENO ANTERIORI

50-08-807

SUZUKI

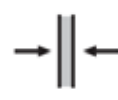
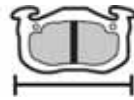

WVA

L

H

Th

123

56

15

24301

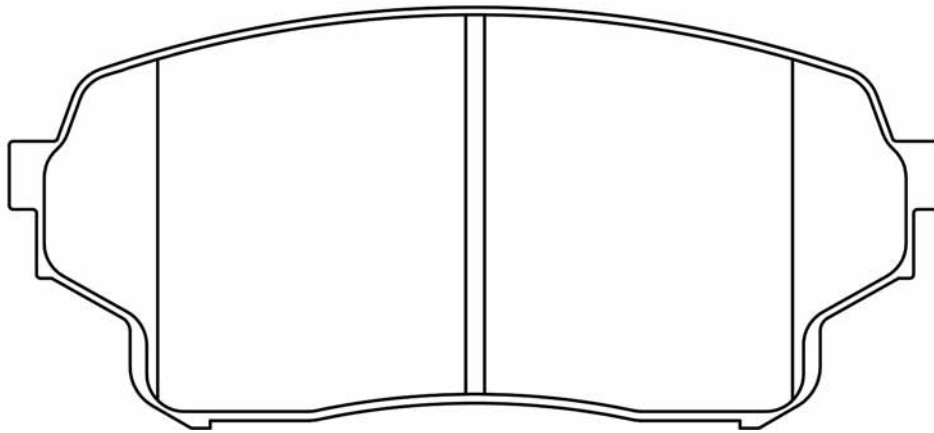



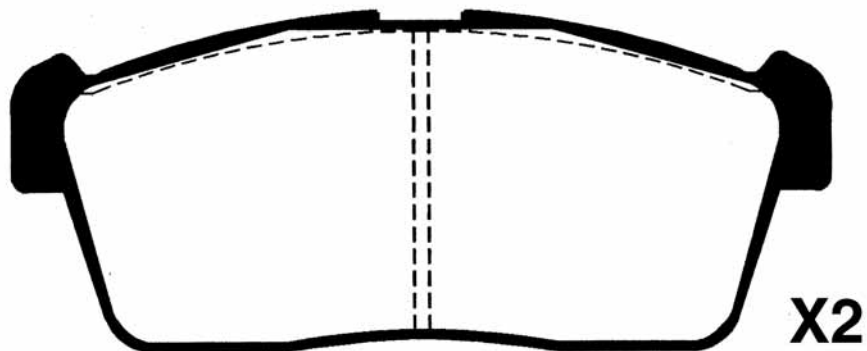
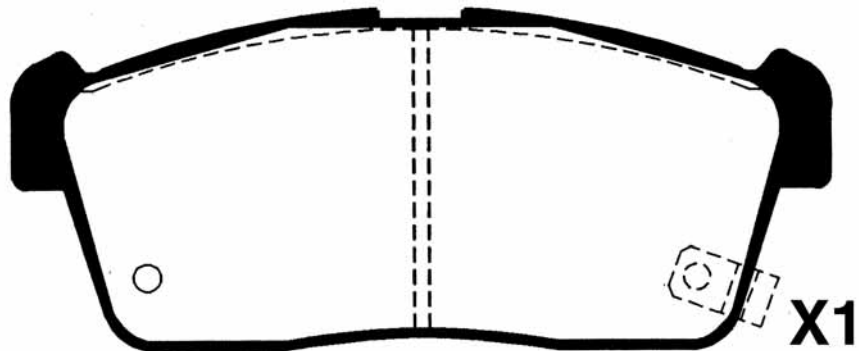
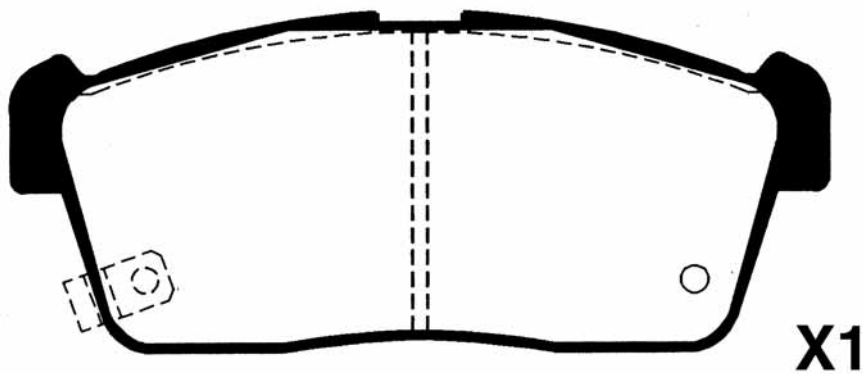

50-08-809				WVA
	NISSAN - DAIHATSU - SUBARU - SUZUKI	L 108,6	H 45,6	Th 14,4 23509





PICTURES BRAKE PADS FRONT
ABBILDUNGEN BREMSKLÖTZE VORN
FIGURAS PASTILLAS DE FRENO DELANTORES
ILLUSTRATIONS PLAQUETTES DE FREI AVANT
IMMAGINI PASTIGLIE FRENO ANTERIORI

50-08-810				WVA
SUZUKI	L	H	Th	
	136,5	53,7	15,7	23817

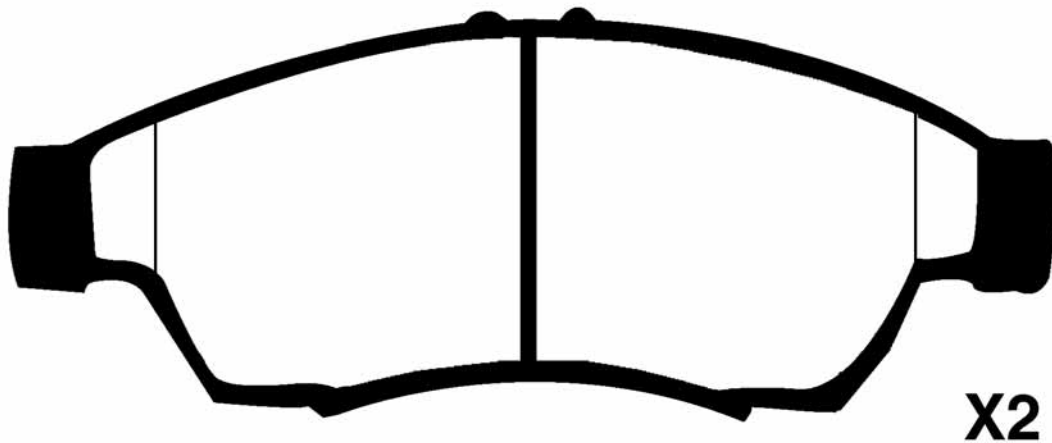
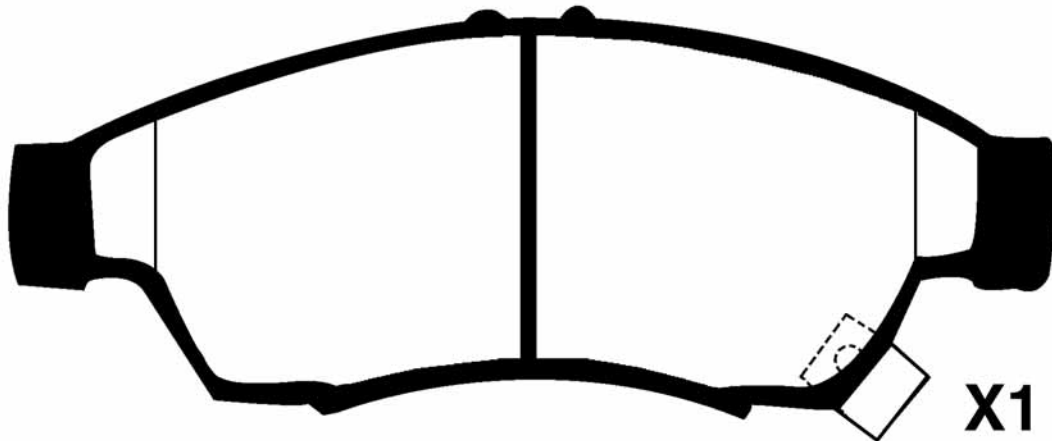



50-08-813				WVA
	SUZUKI - DR	L	H	
	106,4	49,8	14,8	23662

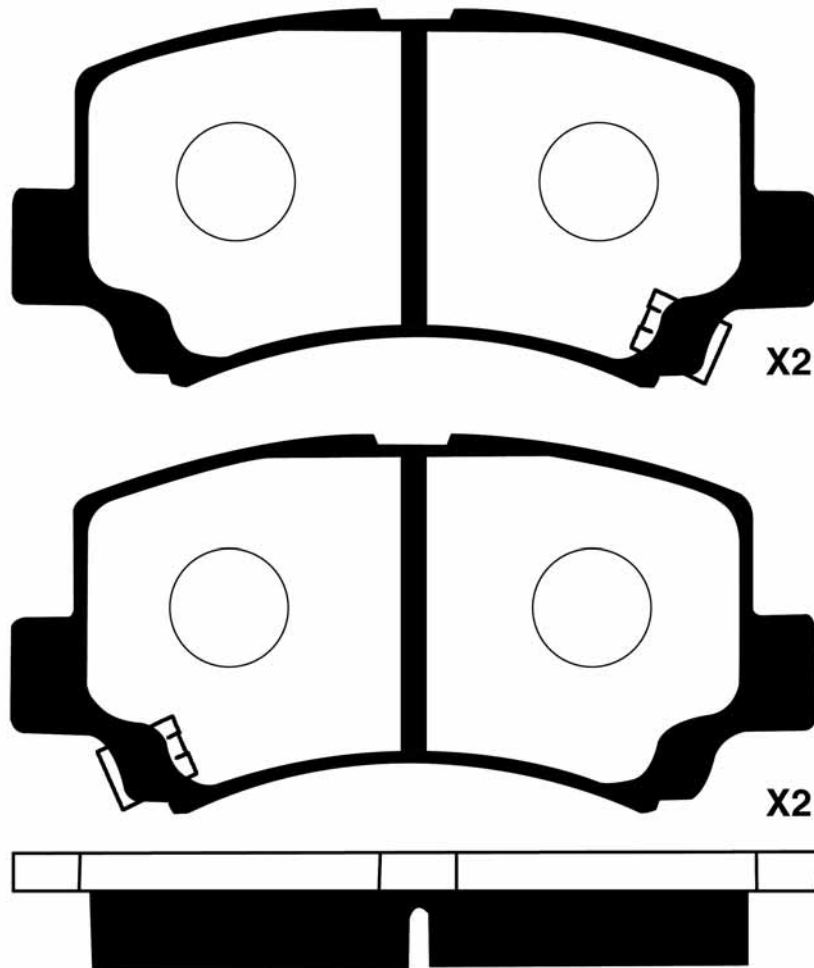



PICTURES BRAKE PADS FRONT
ABBILDUNGEN BREMSKLÖTZE VORN
FIGURAS PASTILLAS DE FRENO DELANTORES
ILLUSTRATIONS PLAQUETTES DE FREI AVANT
IMMAGINI PASTIGLIE FRENO ANTERIORI

50-08-815 SUZUKI				WVA
	L 108,7	H 50	Th 14,7	23795

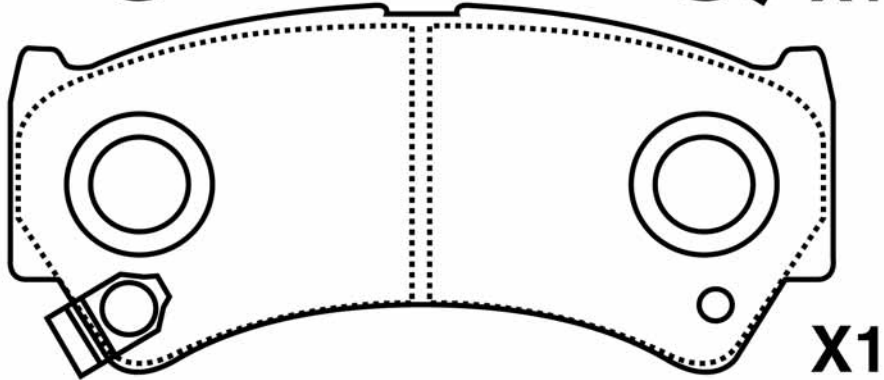
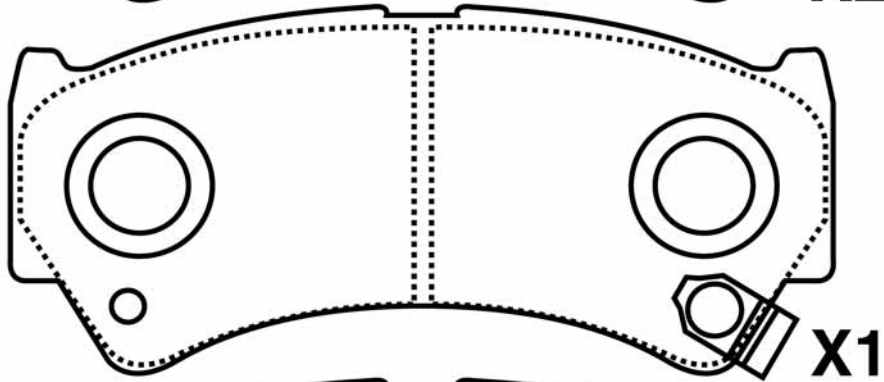
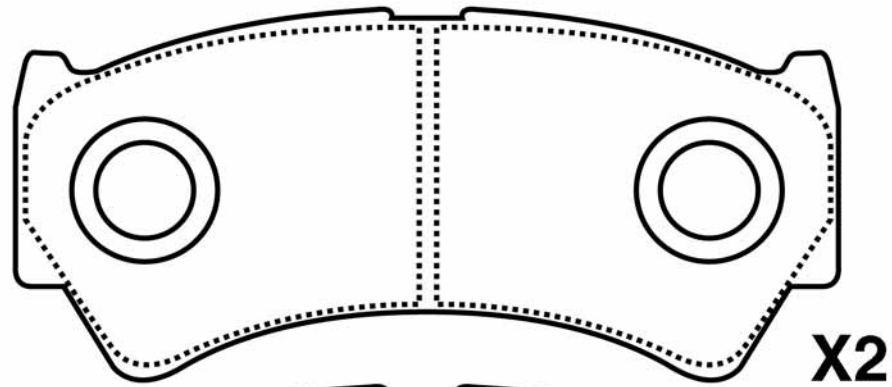



50-08-816				WVA
	SUZUKI	L	H	Th
	111,5	48,5	14,7	23400

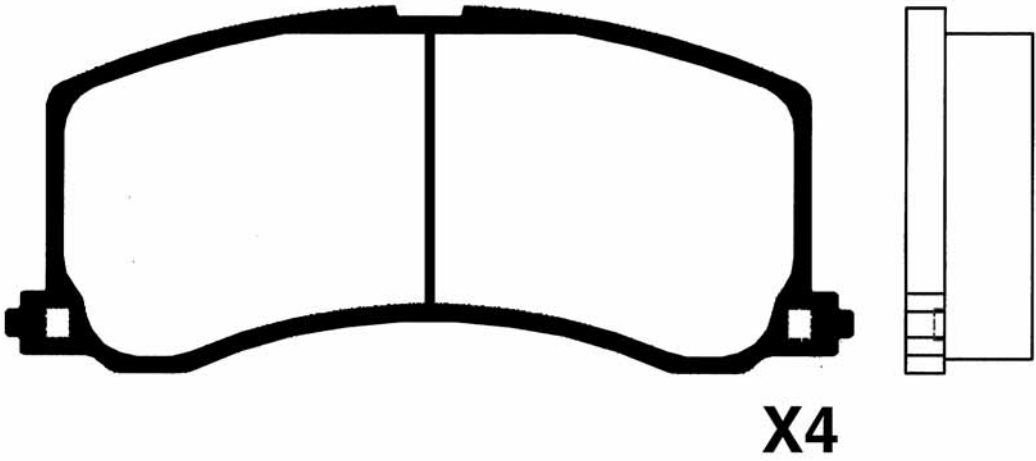



PICTURES BRAKE PADS FRONT
ABBILDUNGEN BREMSKLÖTZE VORN
FIGURAS PASTILLAS DE FRENO DELANTORES
ILLUSTRATIONS PLAQUETTES DE FREI AVANT
IMMAGINI PASTIGLIE FRENO ANTERIORI

50-08-818				WVA
	SUZUKI	L	H	
	131,2	45	14	23296

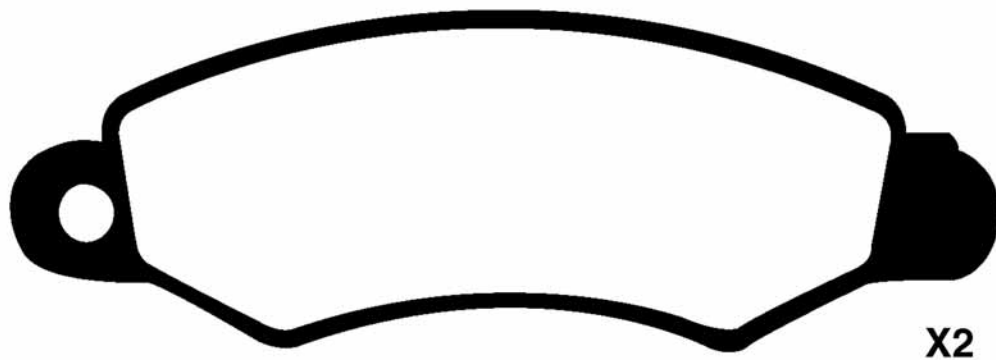
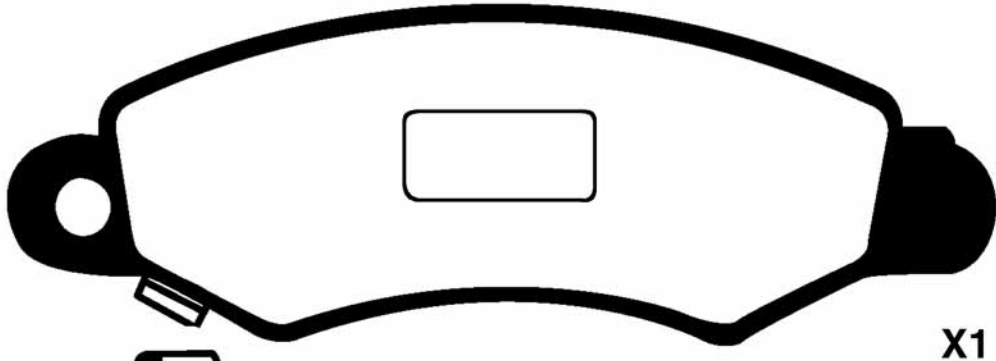
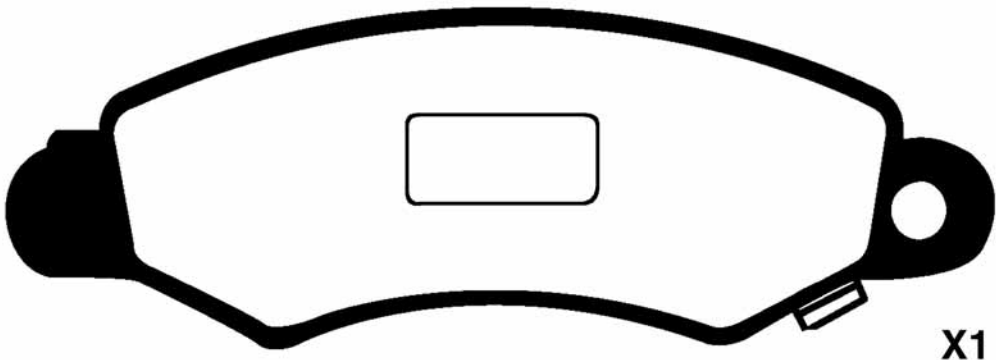

PICTURES BRAKE PADS FRONT
 ABBILDUNGEN BREMSKLÖTZE VORN
 FIGURAS PASTILLAS DE FRENO DELANTORES
 ILLUSTRATIONS PLAQUETTES DE FREI AVANT
 IMMAGINI PASTIGLIE FRENO ANTERIORI



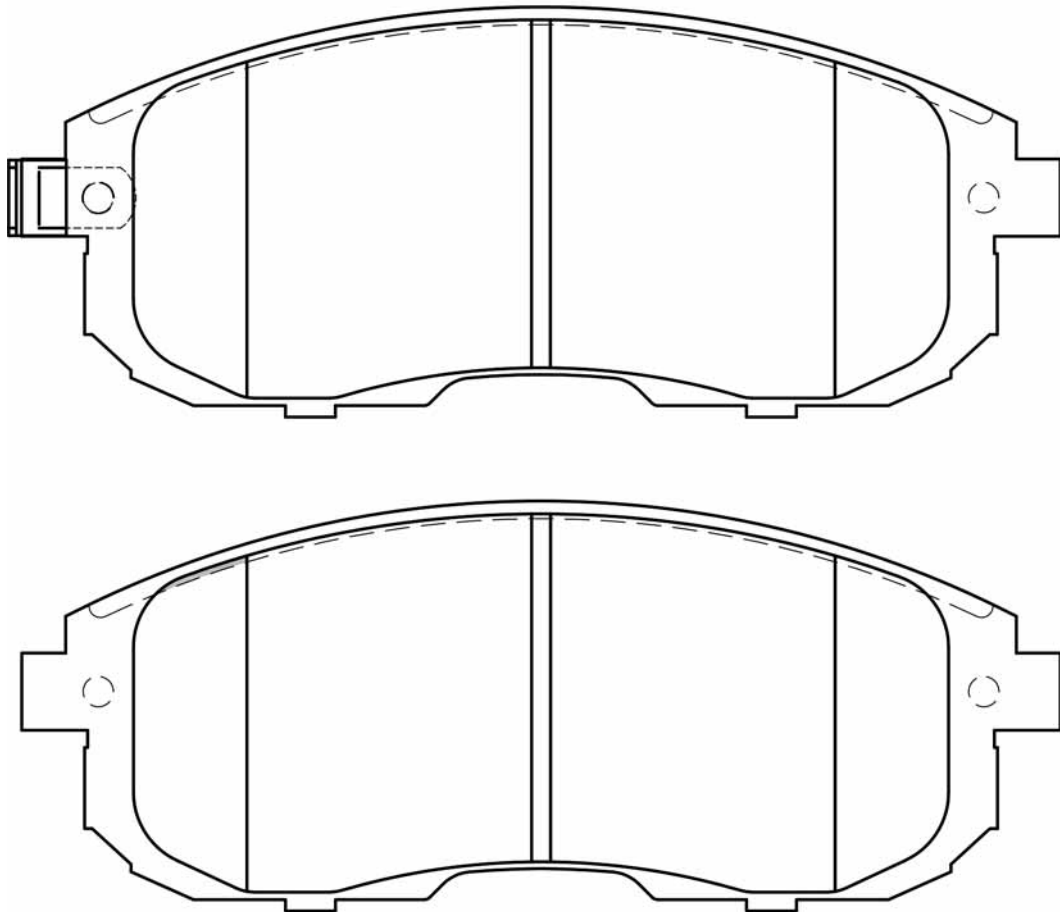

50-08-819				WVA
	FIAT - INFINITI - SUZUKI	L 137	H 54	Th 16
				24280



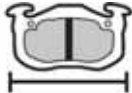

PICTURES BRAKE PADS FRONT
ABBILDUNGEN BREMSKLÖTZE VORN
FIGURAS PASTILLAS DE FRENO DELANTORES
ILLUSTRATIONS PLAQUETTES DE FREI AVANT
IMMAGINI PASTIGLIE FRENO ANTERIORI

50-08-820				WVA
SUZUKI	L	H	Th	
	108	46,5	15	

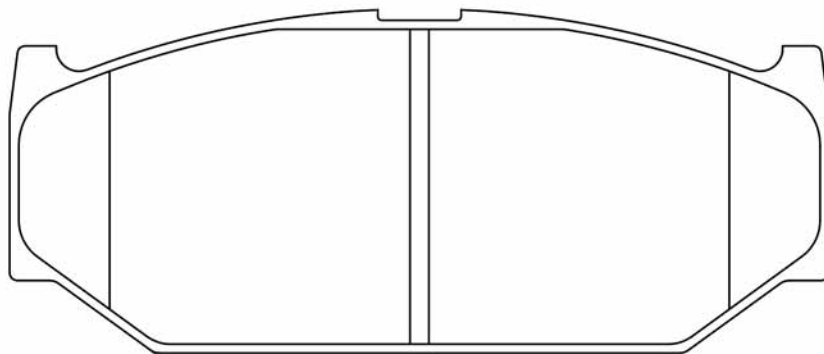
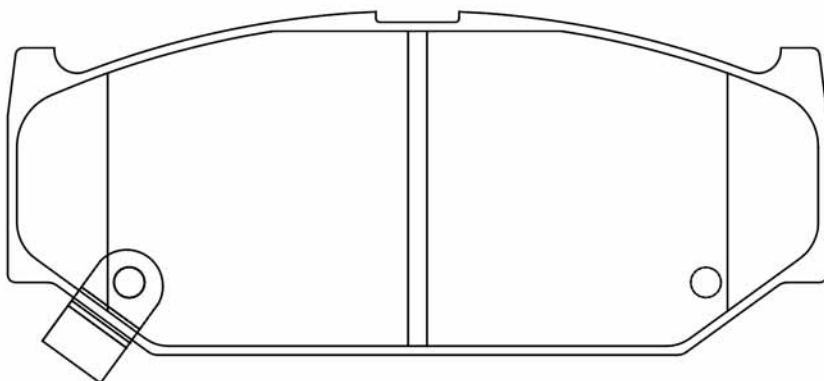
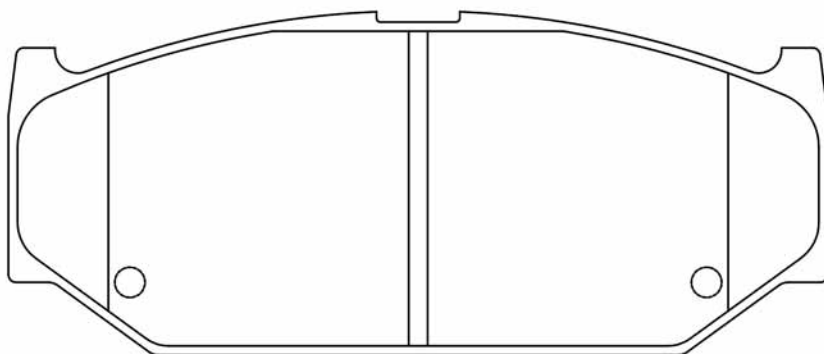



50-08-825

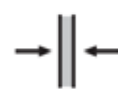
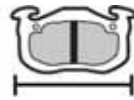

WVA

SUZUKI

L

108,7

H

42

Th

14,7

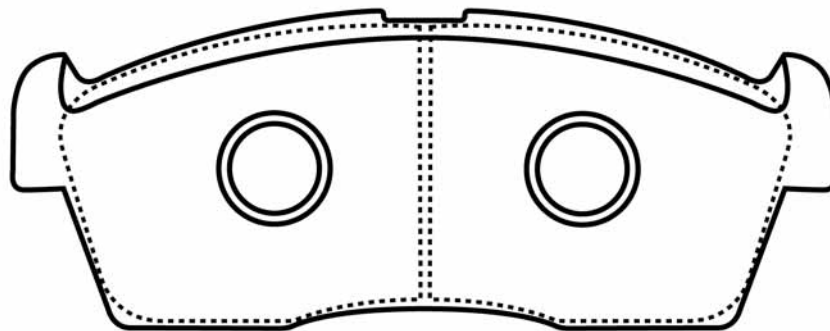

X4



PICTURES BRAKE PADS FRONT
ABBILDUNGEN BREMSKLÖTZE VORN
FIGURAS PASTILLAS DE FRENO DELANTORES
ILLUSTRATIONS PLAQUETTES DE FREI AVANT
IMMAGINI PASTIGLIE FRENO ANTERIORI

50-08-885 SUBARU - SUZUKI				WVA
	L	H	Th	23253

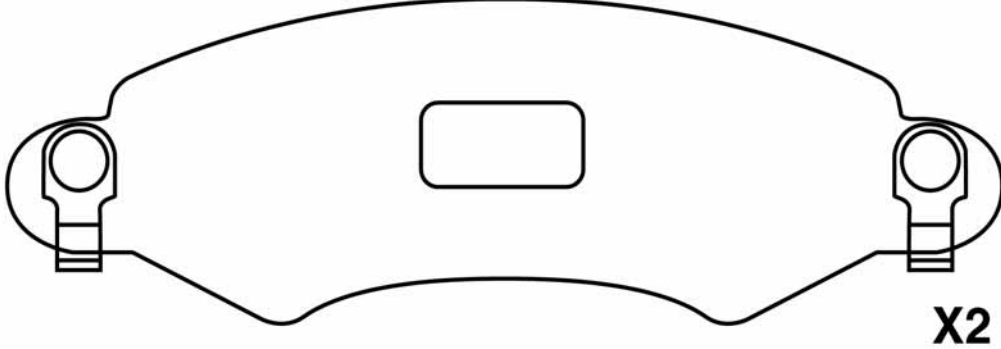
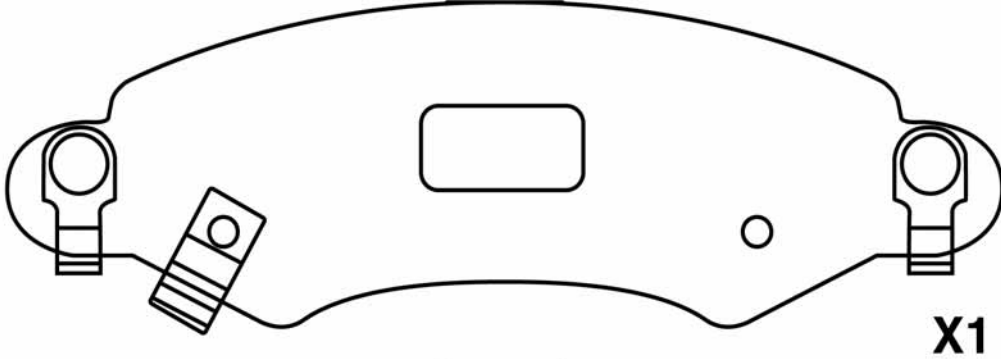
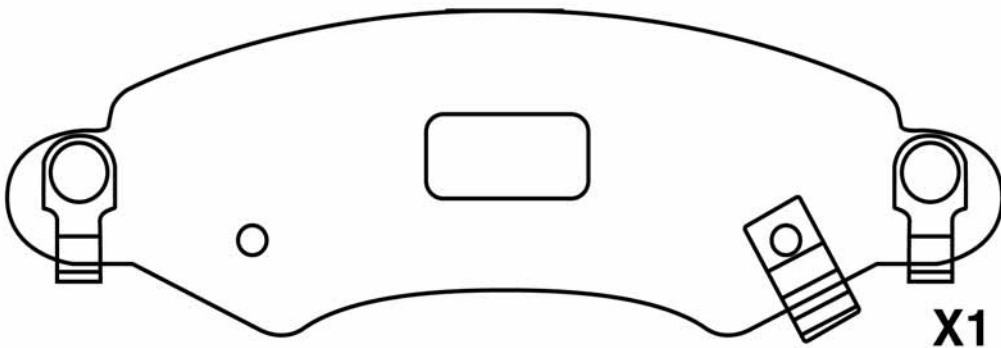



50-08-886 SUZUKI				WVA
	L 102/88,3	H 40	Th 14,4/15	

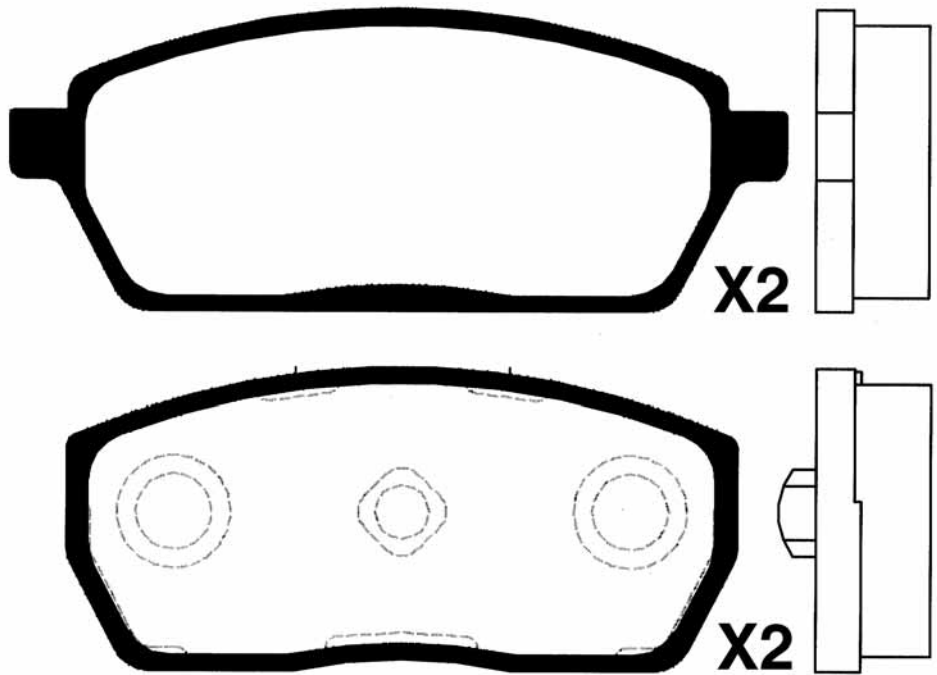



PICTURES BRAKE PADS FRONT
ABBILDUNGEN BREMSKLÖTZE VORN
FIGURAS PASTILLAS DE FRENO DELANTORES
ILLUSTRATIONS PLAQUETTES DE FREI AVANT
IMMAGINI PASTIGLIE FRENO ANTERIORI

50-08-893				WVA
SUZUKI	L	H	Th	
	110,2	55,5	14	

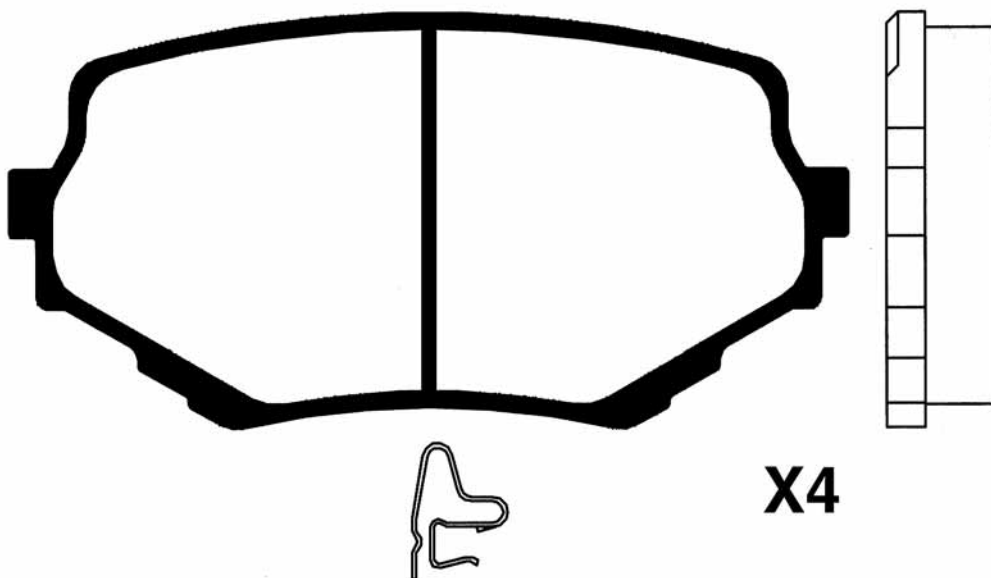



50-08-894

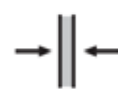
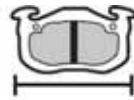

WVA

L

H

Th

99,9

44,6

14,6

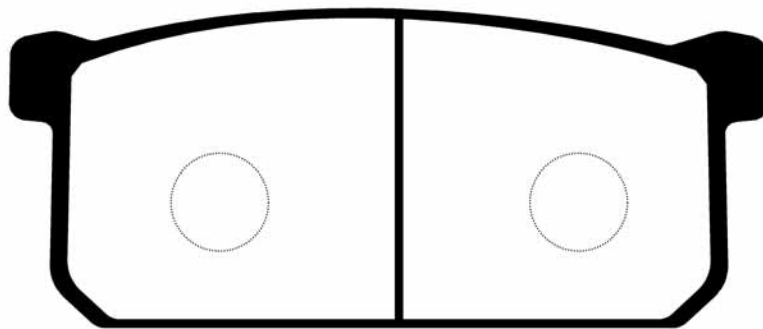



PICTURES BRAKE PADS FRONT
ABBILDUNGEN BREMSKLÖTZE VORN
FIGURAS PASTILLAS DE FRENO DELANTORES
ILLUSTRATIONS PLAQUETTES DE FREI AVANT
IMMAGINI PASTIGLIE FRENO ANTERIORI

50-08-896				WVA
SUZUKI	L	H	Th	
	109,6	44,2	13,4	

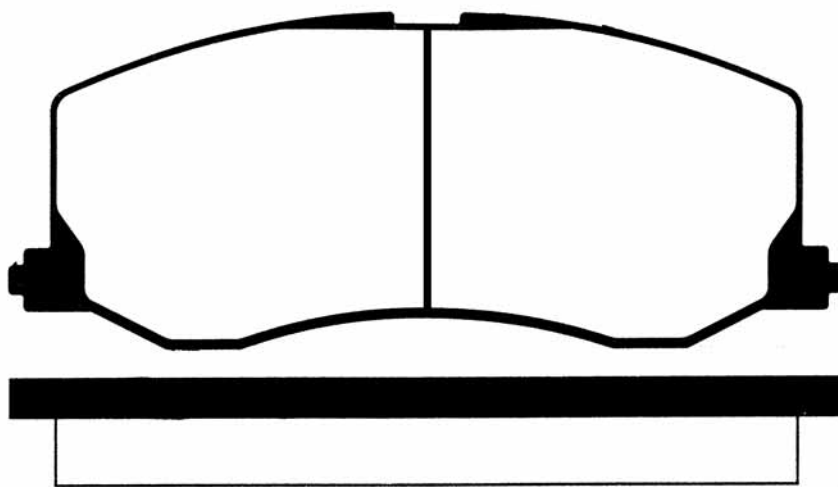

X4



50-08-897				WVA
	SUZUKI	L	H	Th
	116,5	45,5	15	21907

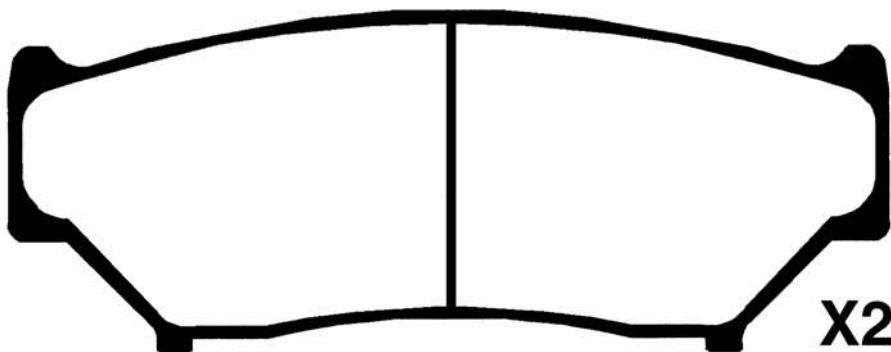
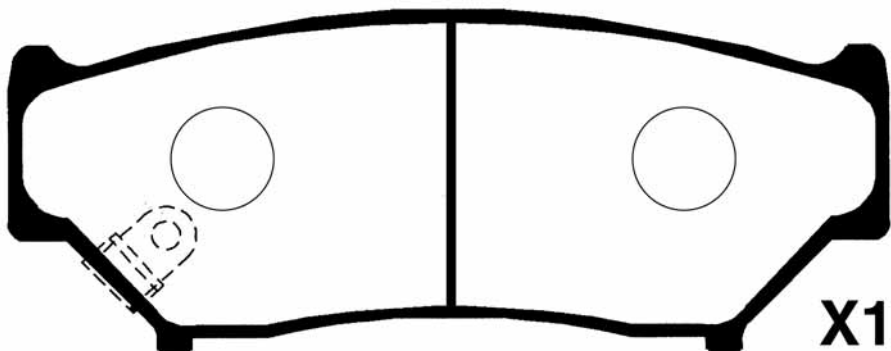
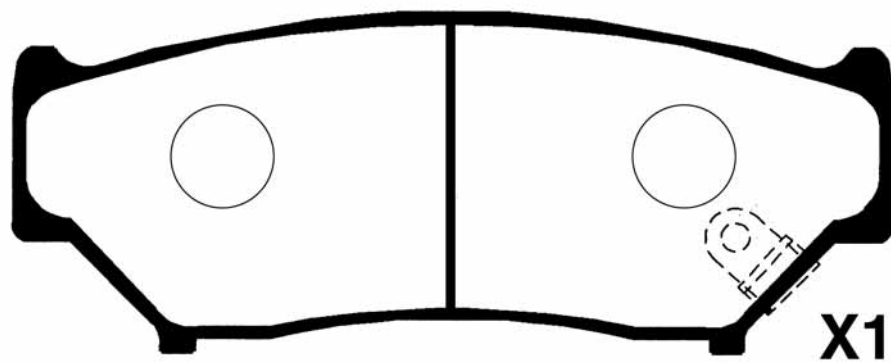



PICTURES BRAKE PADS FRONT
ABBILDUNGEN BREMSKLÖTZE VORN
FIGURAS PASTILLAS DE FRENO DELANTORES
ILLUSTRATIONS PLAQUETTES DE FREI AVANT
IMMAGINI PASTIGLIE FRENO ANTERIORI

50-08-898

SUZUKI

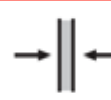

WVA

L

131,5

H

45,3

Th

14,8

21337

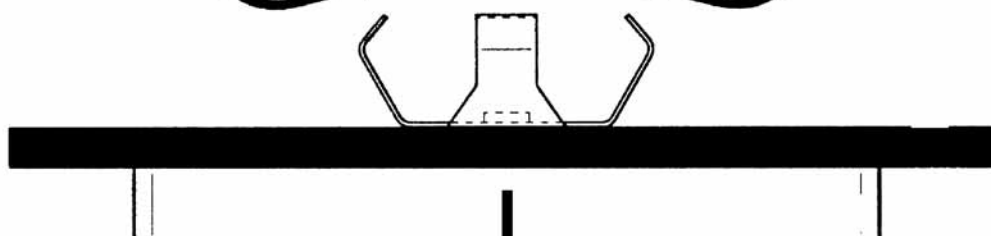
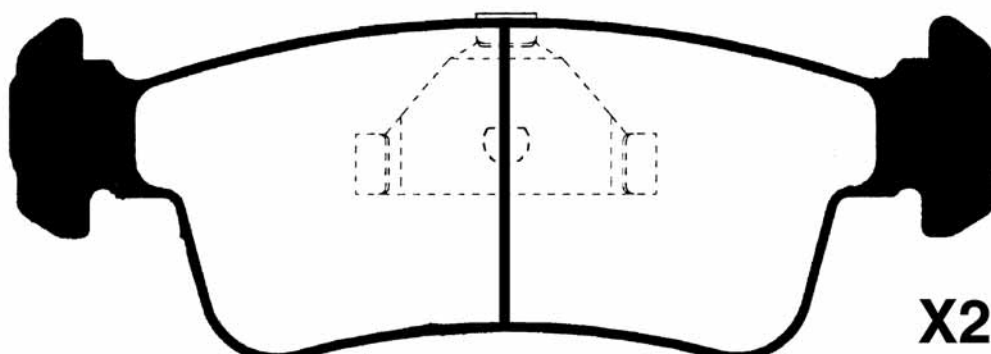
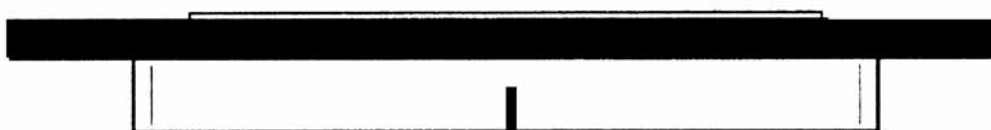
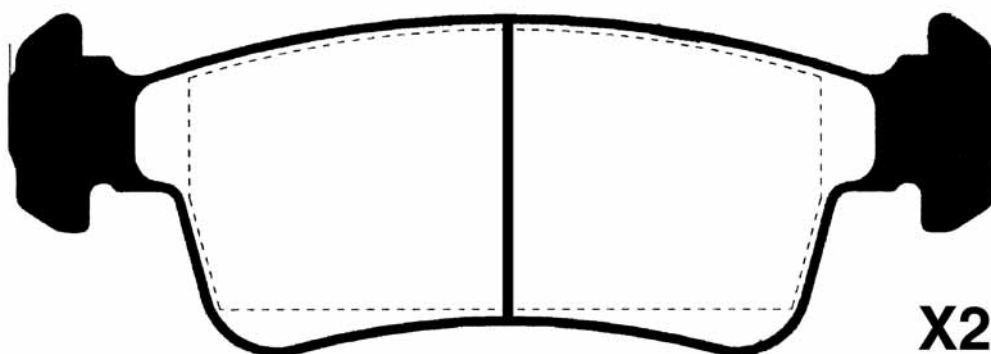



50-08-899				WVA
	SUZUKI	L 99	H 61,4	

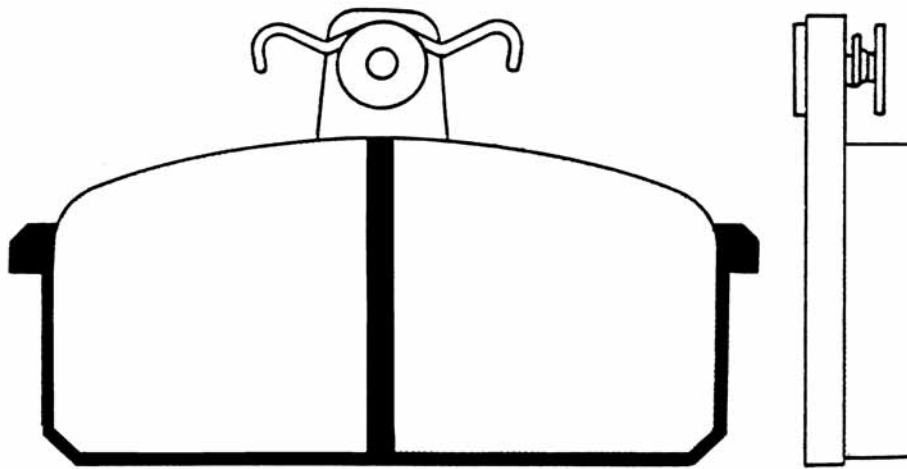

X4



PICTURES BRAKE PADS FRONT
ABBILDUNGEN BREMSKLÖTZE VORN
FIGURAS PASTILLAS DE FRENO DELANTORES
ILLUSTRATIONS PLAQUETTES DE FREI AVANT
IMMAGINI PASTIGLIE FRENO ANTERIORI

50-09-900				WVA
ISUZU	L	H	Th	
	110,6/115,7	49,7	15	21255

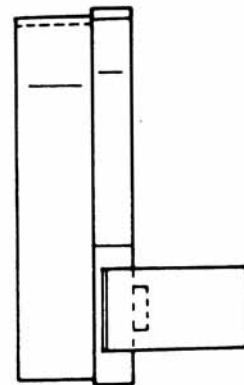
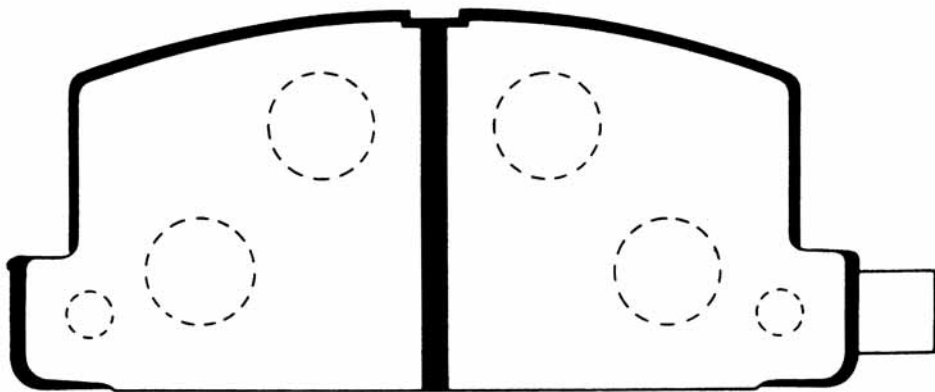

X1 LEFT
X1 RIGHT

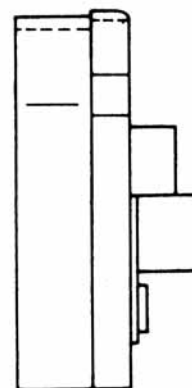
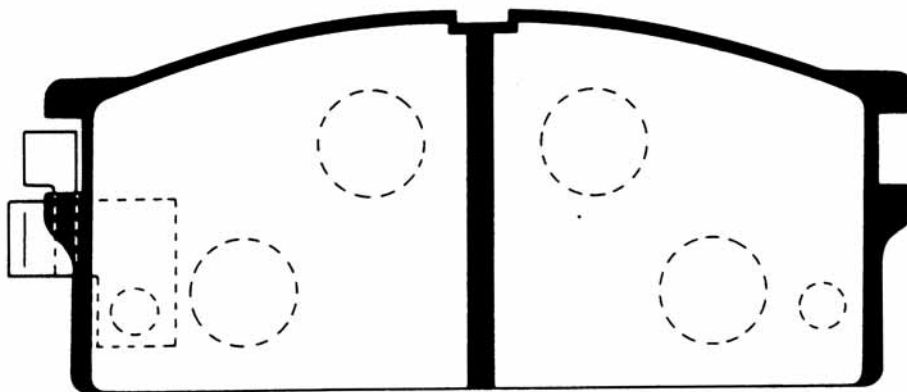

X1 LEFT
X1 RIGHT



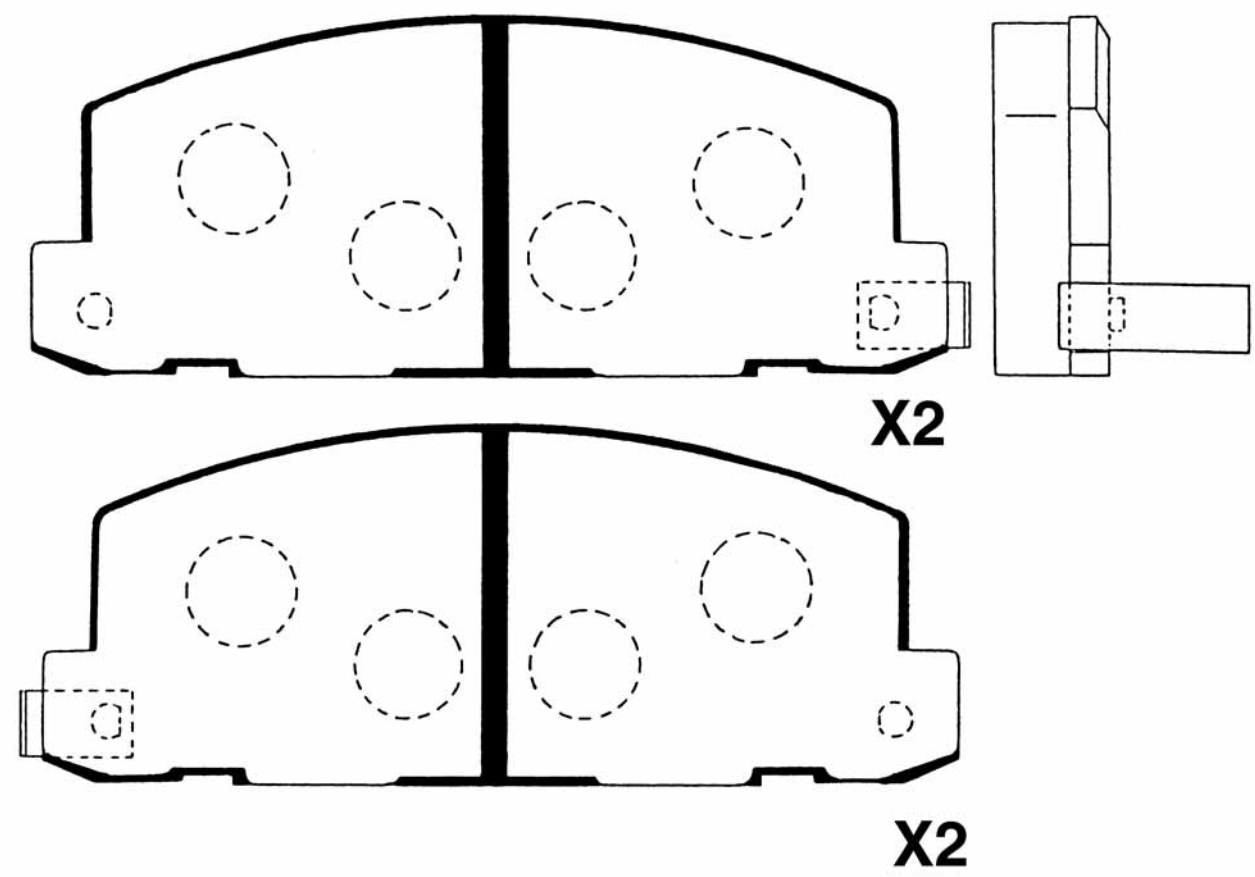

50-09-901				WVA
	SSANGYONG - ISUZU	L	H	Th
	120,6	48,1	15,8	20881





PICTURES BRAKE PADS FRONT
ABBILDUNGEN BREMSKLÖTZE VORN
FIGURAS PASTILLAS DE FRENO DELANTORES
ILLUSTRATIONS PLAQUETTES DE FREI AVANT
IMMAGINI PASTIGLIE FRENO ANTERIORI

50-09-902				WVA
BEDFORD - ISUZU	L	H	Th	
	133,4	47,5	15	21115

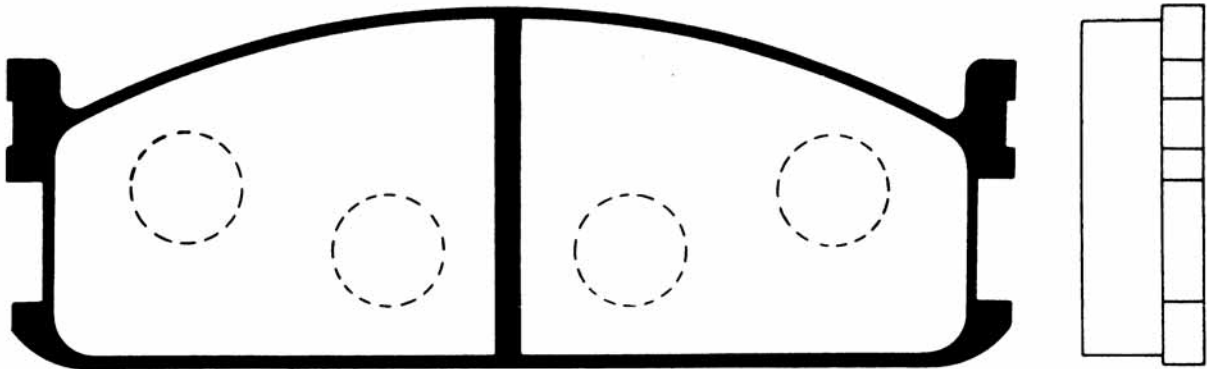

X4



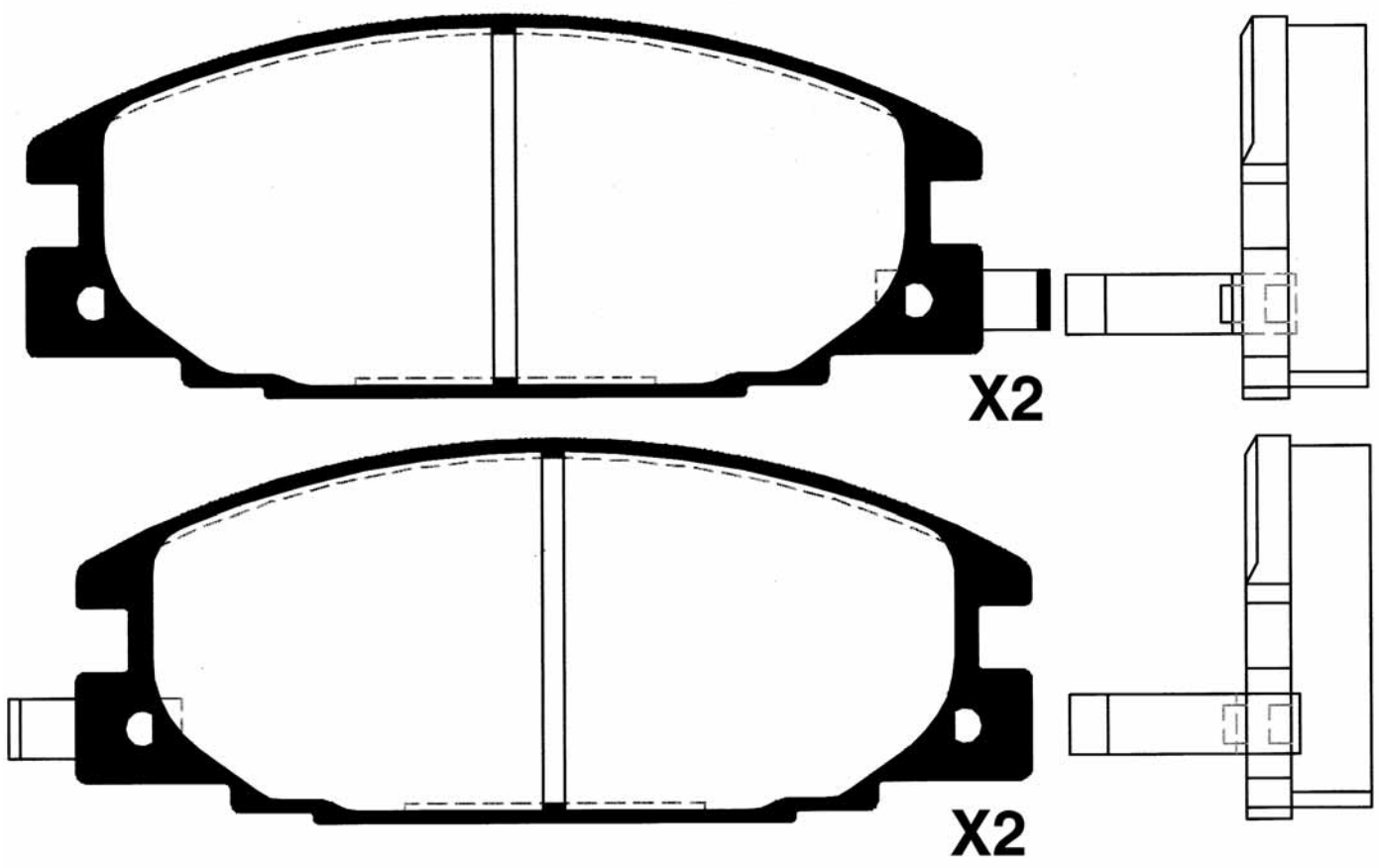

50-09-904				WVA
	OPEL - ISUZU	L	H	
	127	51,4	15,4	21467





PICTURES BRAKE PADS FRONT
ABBILDUNGEN BREMSKLÖTZE VORN
FIGURAS PASTILLAS DE FRENO DELANTORES
ILLUSTRATIONS PLAQUETTES DE FREI AVANT
IMMAGINI PASTIGLIE FRENO ANTERIORI

50-09-905				WVA
LOTUS	L	H	Th	
	111,5	46,2	12,2	

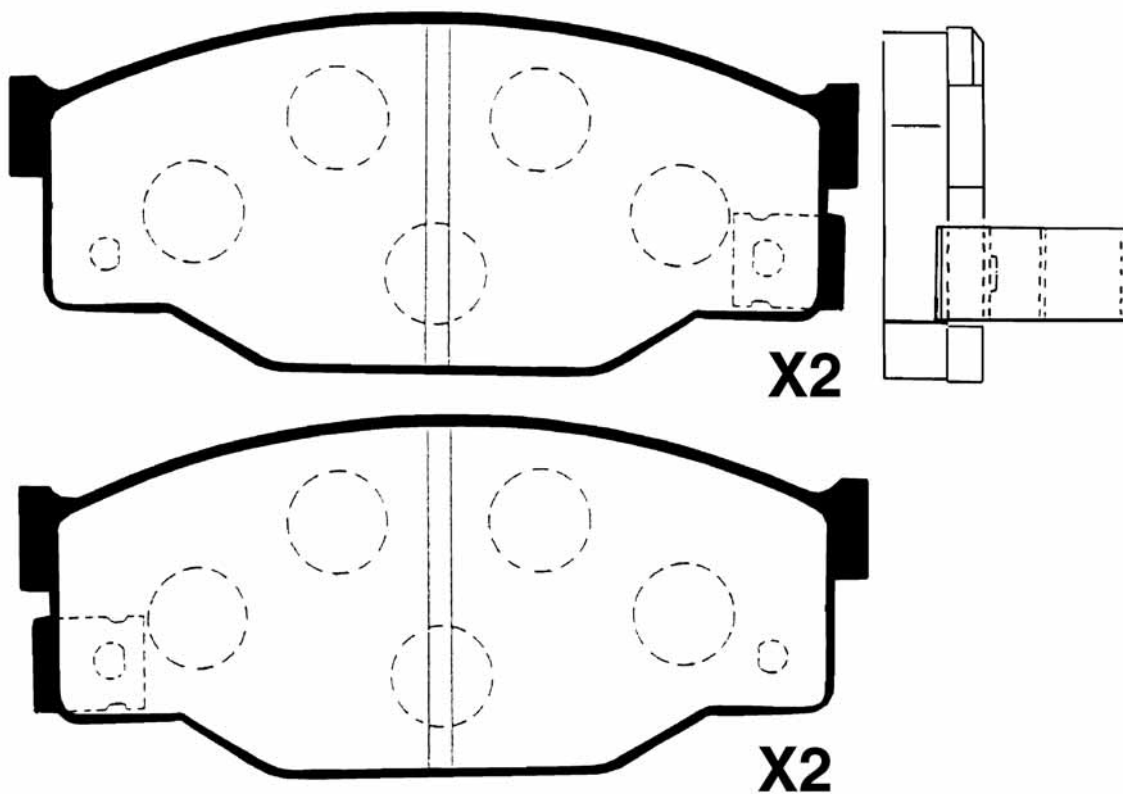



50-09-907				WVA
	ISUZU	L	H	
	183,2/238,2	69,8/93,4	21,7	

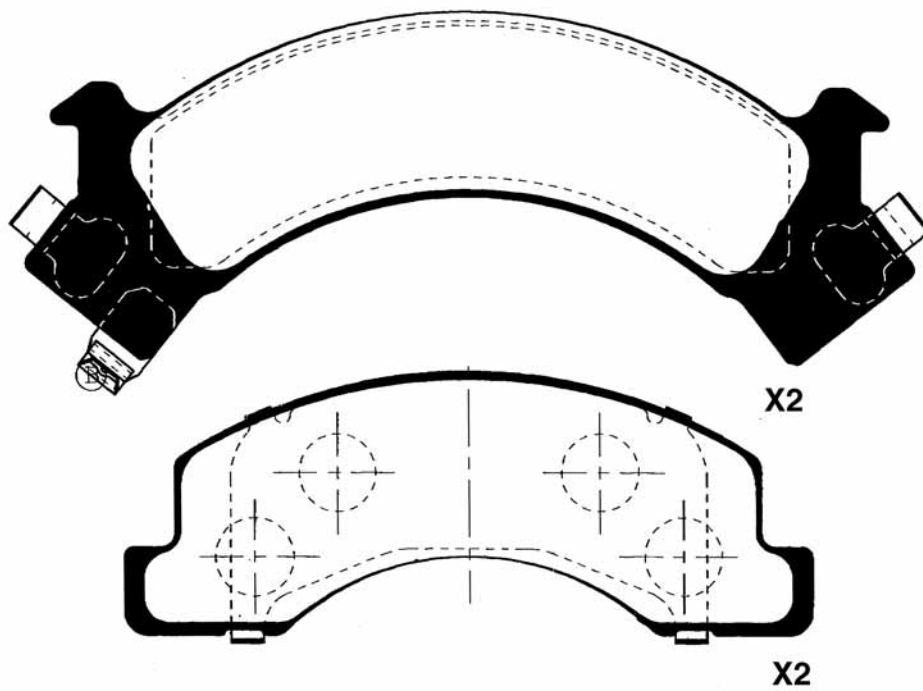

in scala 1:2



PICTURES BRAKE PADS FRONT
ABBILDUNGEN BREMSKLÖTZE VORN
FIGURAS PASTILLAS DE FRENO DELANTORES
ILLUSTRATIONS PLAQUETTES DE FREI AVANT
IMMAGINI PASTIGLIE FRENO ANTERIORI

50-09-908				WVA
ISUZU	L	H	Th	
	167,5	54,5	16,9	24370

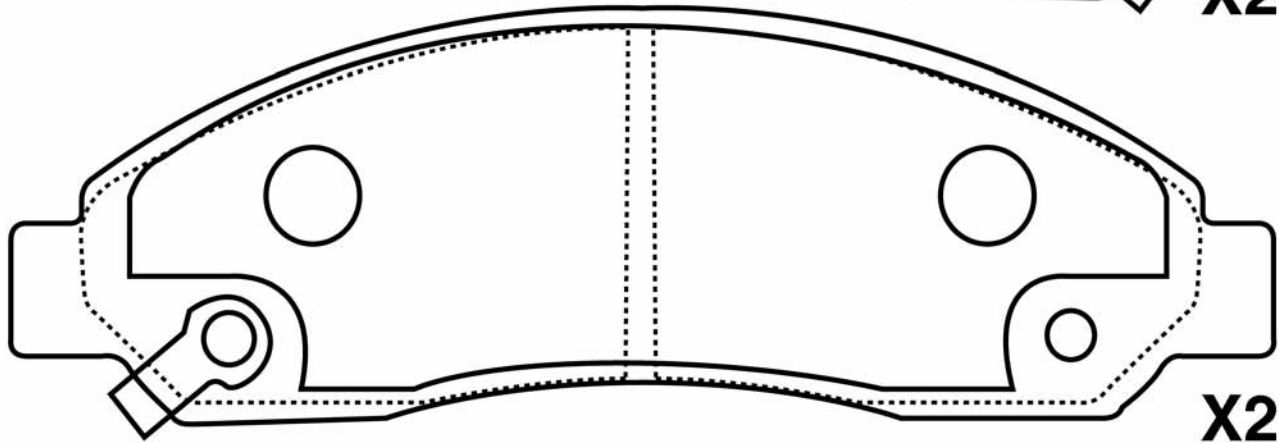
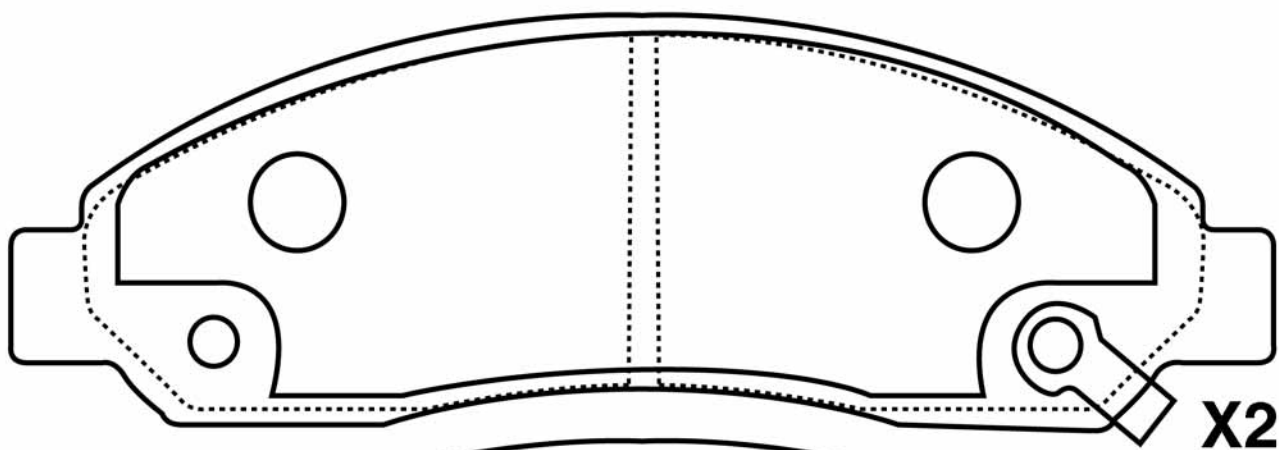



50-09-909

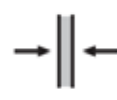
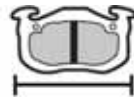

WVA

ISUZU

L

206,2

H

75

Th

20

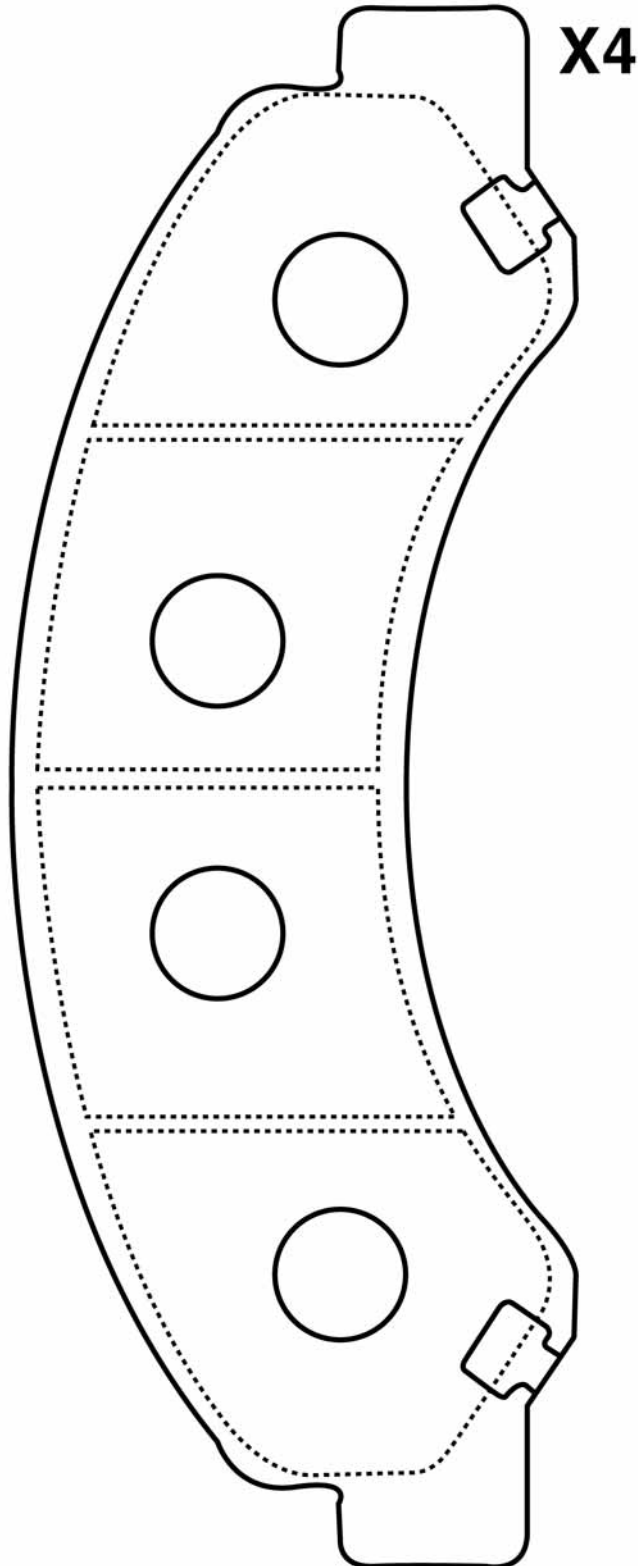



PICTURES BRAKE PADS FRONT
ABBILDUNGEN BREMSKLÖTZE VORN
FIGURAS PASTILLAS DE FRENO DELANTORES
ILLUSTRATIONS PLAQUETTES DE FREI AVANT
IMMAGINI PASTIGLIE FRENO ANTERIORI

50-09-910				WVA
DODGE - CHRYSLER - JEEP	L	H	Th	
	146	64	18	24604

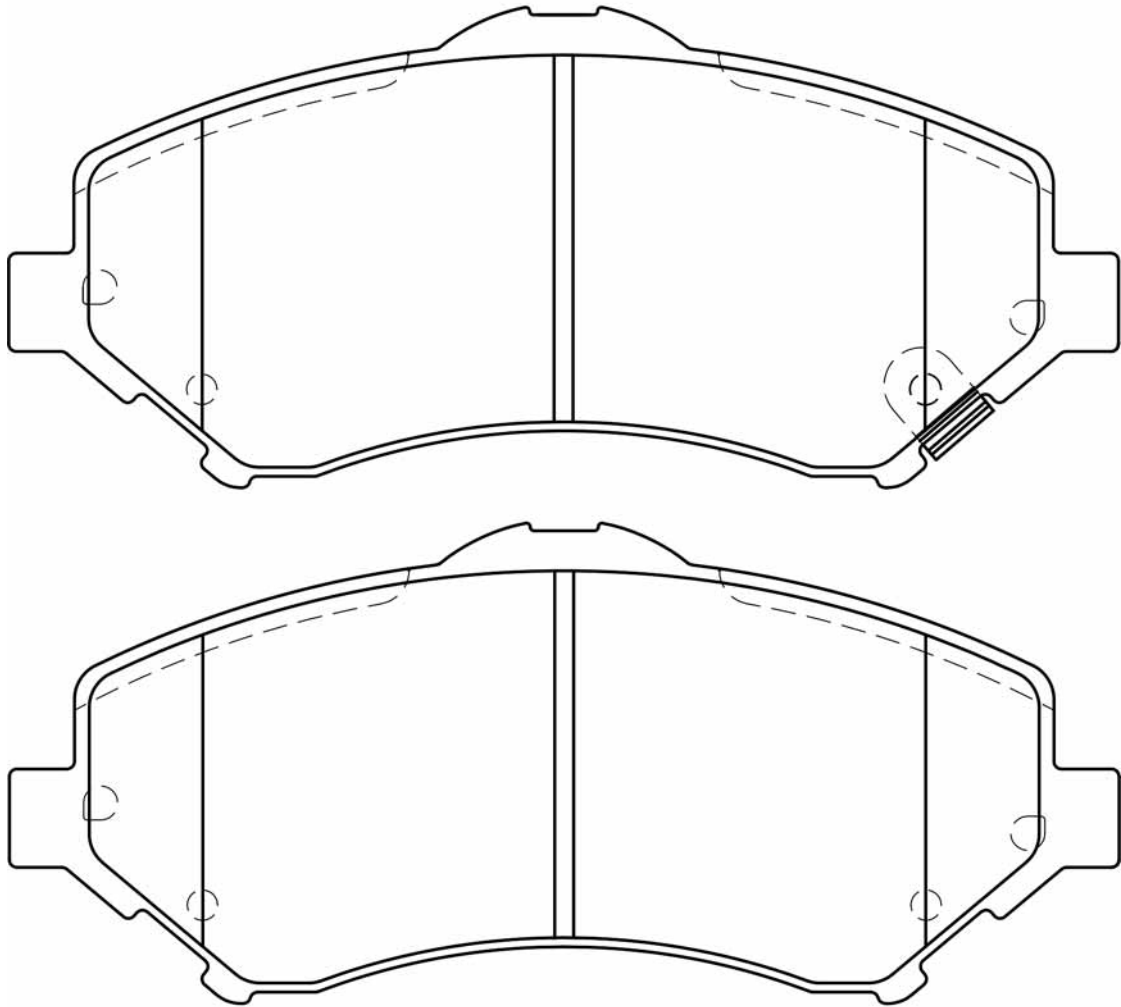



50-09-911

CHRYSLER

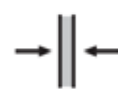
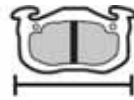

WVA

L

183,5

H

57

Th

18

24164

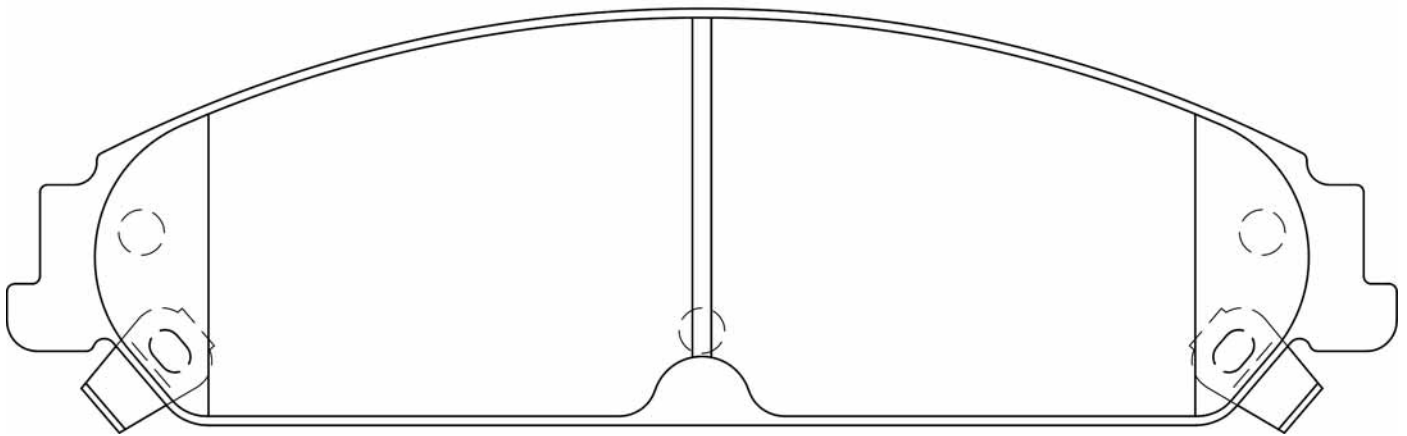



PICTURES BRAKE PADS FRONT
ABBILDUNGEN BREMSKLÖTZE VORN
FIGURAS PASTILLAS DE FRENO DELANTORES
ILLUSTRATIONS PLAQUETTES DE FREI AVANT
IMMAGINI PASTIGLIE FRENO ANTERIORI

50-09-912

DODGE - JEEP

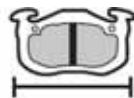

WVA

L

145

H

55

Th

17

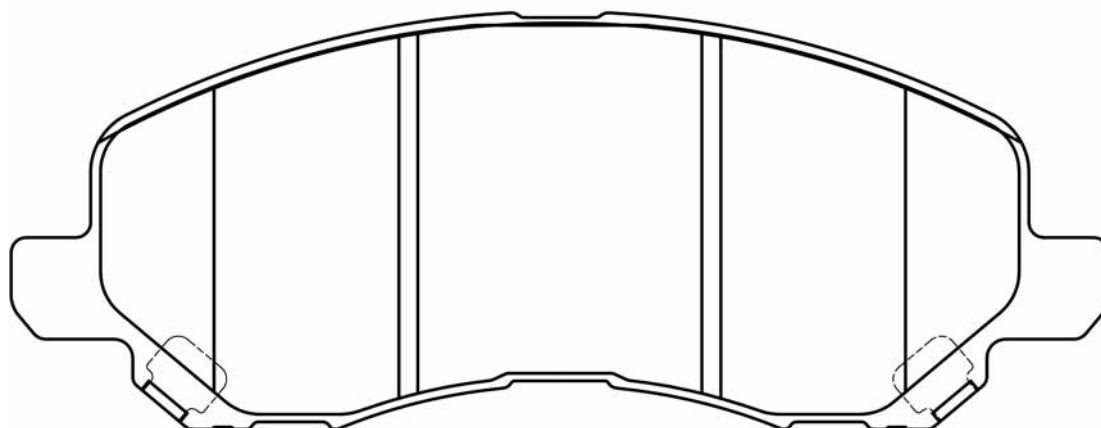

PICTURES BRAKE PADS FRONT
ABBILDUNGEN BREMSKLÖTZE VORN
FIGURAS PASTILLAS DE FRENO DELANTORES
ILLUSTRATIONS PLAQUETTES DE FREI AVANT
IMMAGINI PASTIGLIE FRENO ANTERIORI



50-09-913

CHRYSLER

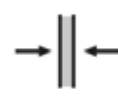
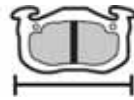

WVA

L

151

H

56

Th

19

24166

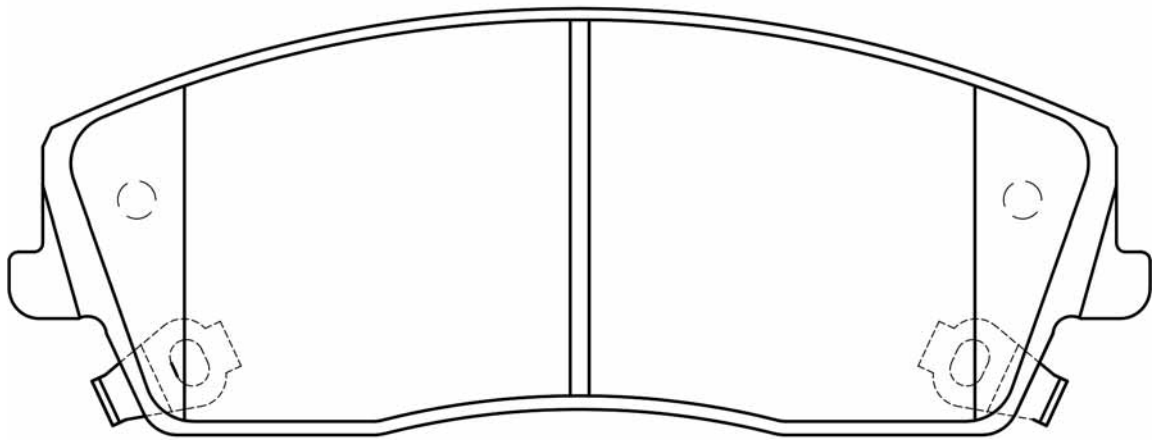



PICTURES BRAKE PADS FRONT
ABBILDUNGEN BREMSKLÖTZE VORN
FIGURAS PASTILLAS DE FRENO DELANTORES
ILLUSTRATIONS PLAQUETTES DE FREI AVANT
IMMAGINI PASTIGLIE FRENO ANTERIORI

50-09-914				WVA
ISUZU	L	H	Th	
	152	60	16	

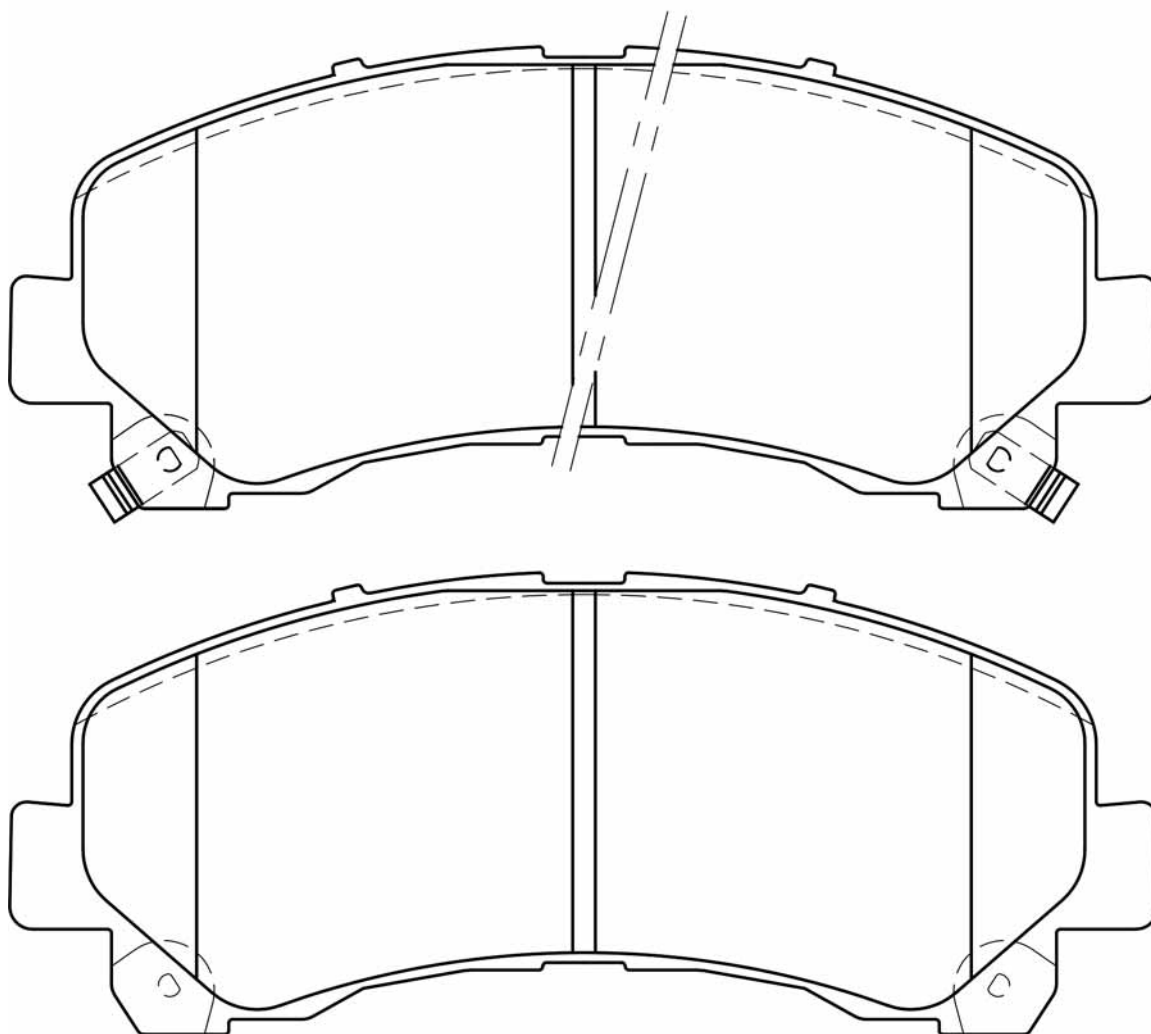



50-09-915				WVA
	JEEP	L 193	H 64	

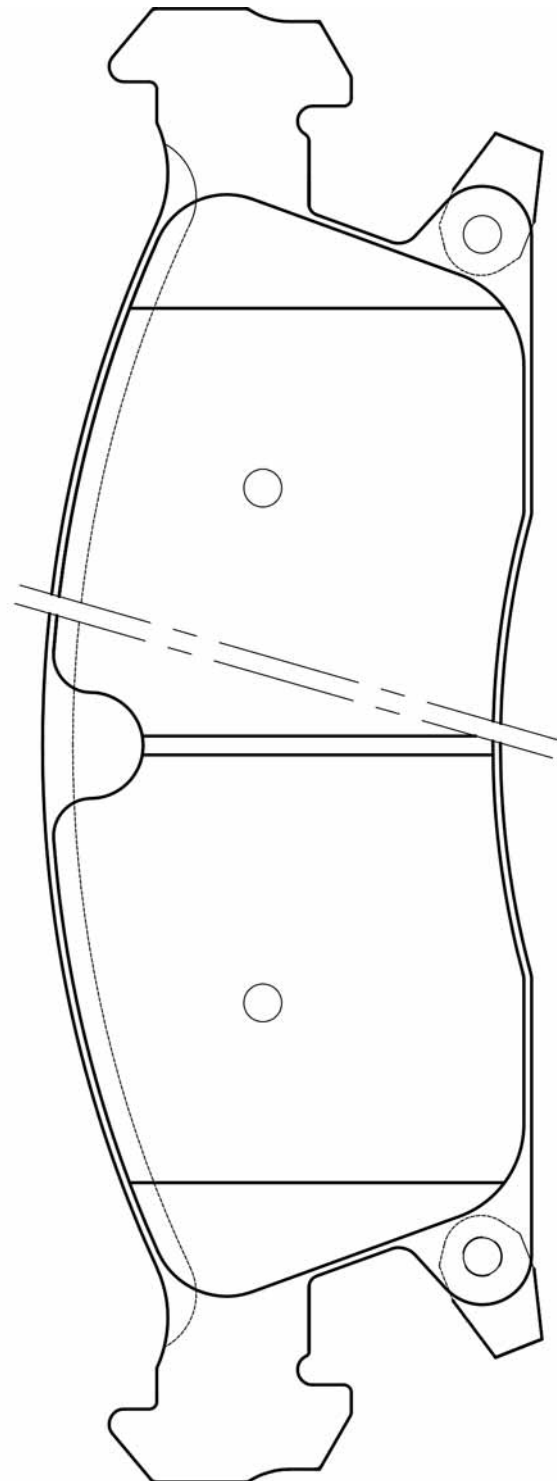
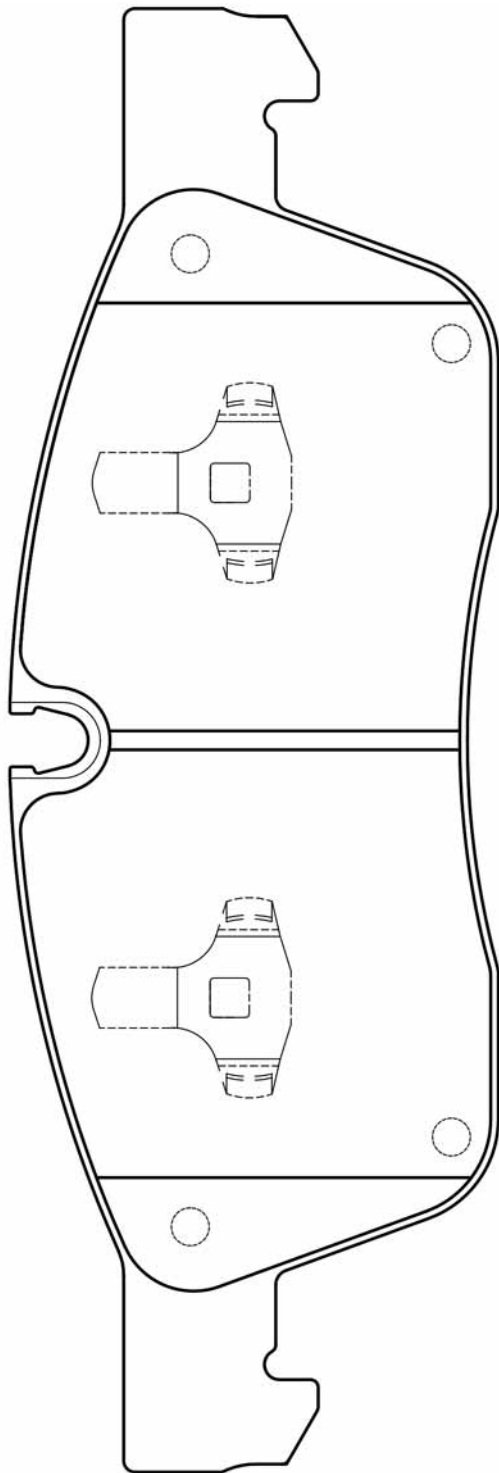



PICTURES BRAKE PADS FRONT
ABBILDUNGEN BREMSKLÖTZE VORN
FIGURAS PASTILLAS DE FRENO DELANTORES
ILLUSTRATIONS PLAQUETTES DE FREI AVANT
IMMAGINI PASTIGLIE FRENO ANTERIORI

50-09-994				WVA
JEEP	L	H	Th	
	147	59,9	17	23638

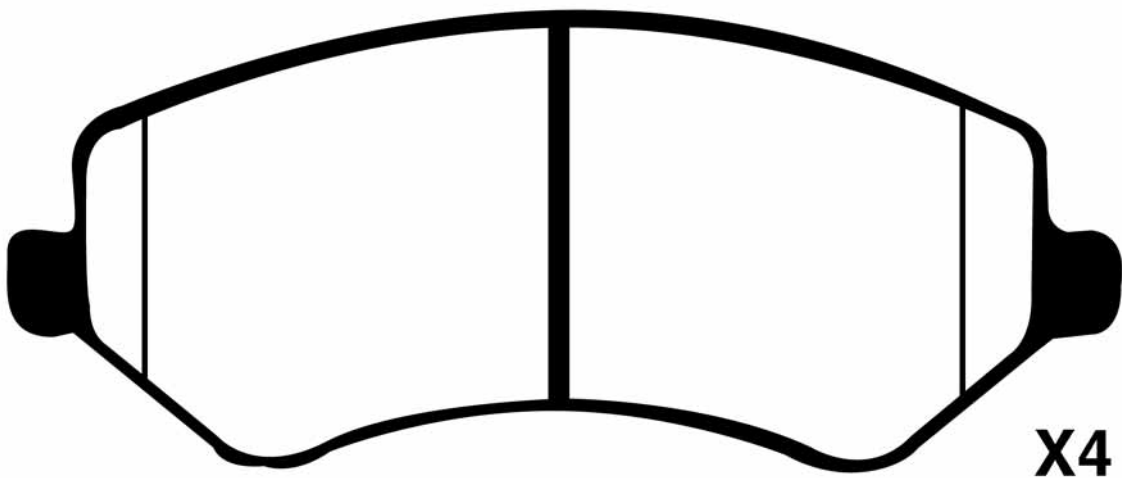



50-09-997				WVA
	SSANGYONG - DAEWOO	L	H	Th
	169,5/169	50,6/60,2	16	23230

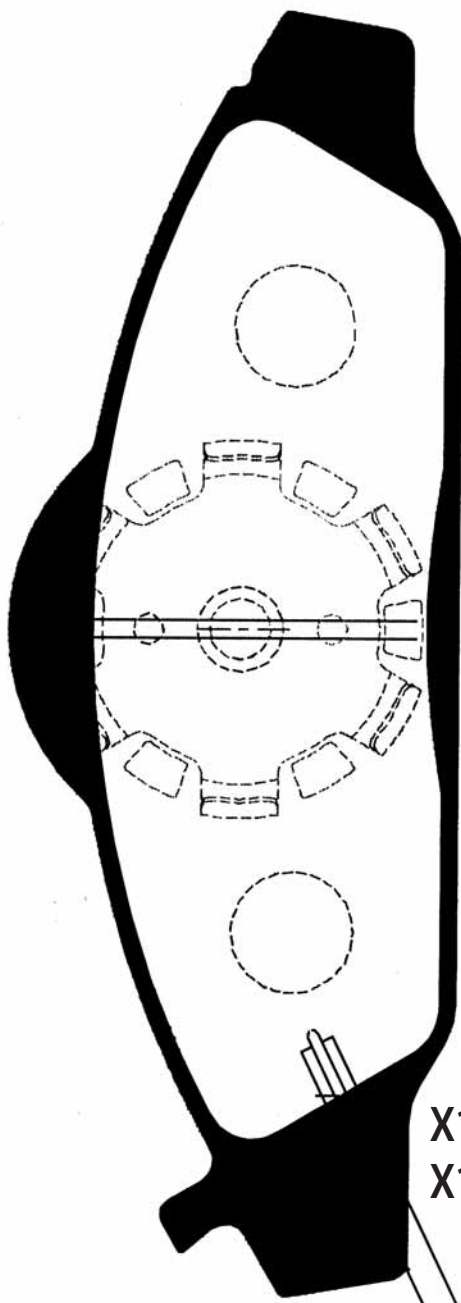

X1 LEFT
X1 RIGHT

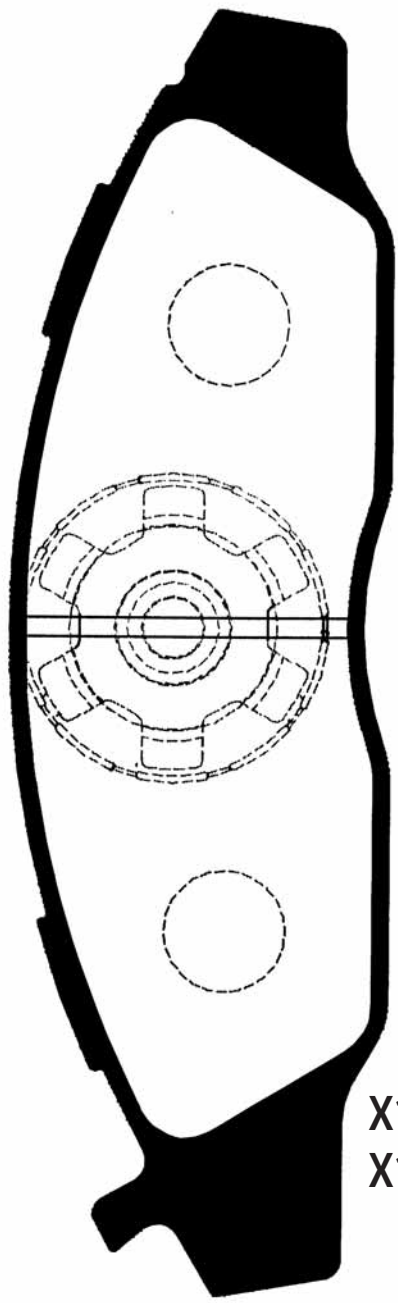

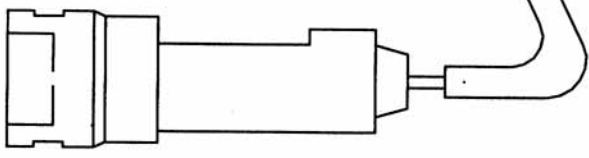

X1 LEFT
X1 RIGHT





PICTURES BRAKE PADS FRONT
ABBILDUNGEN BREMSKLÖTZE VORN
FIGURAS PASTILLAS DE FRENO DELANTORES
ILLUSTRATIONS PLAQUETTES DE FREI AVANT
IMMAGINI PASTIGLIE FRENO ANTERIORI

50-09-998				WVA
ISUZU	L	H	Th	
	95,3	45,4	14,3	

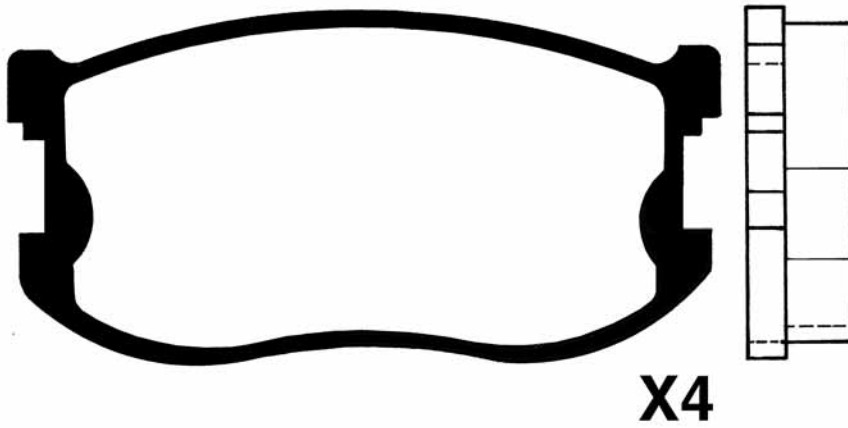



50-09-999 ISUZU - OPEL				WVA
	L 137,8	H 58,3	Th 16	

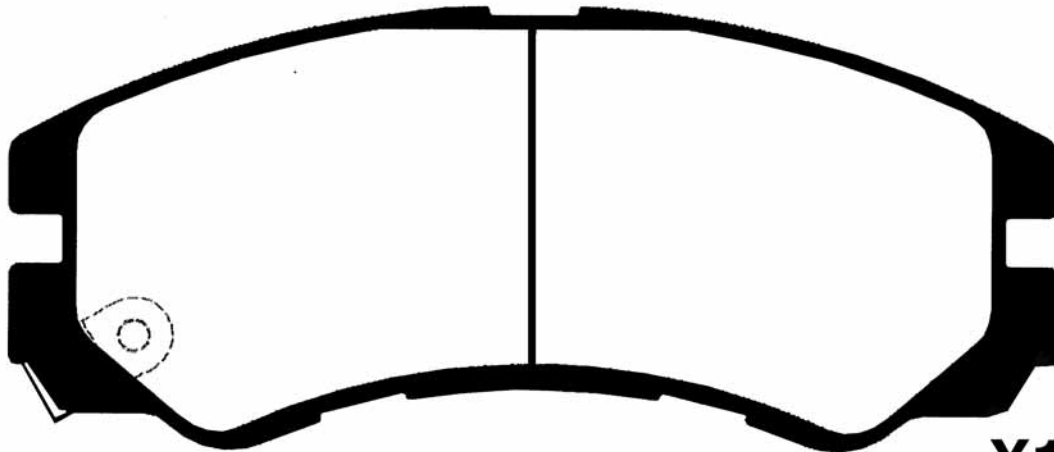

X1

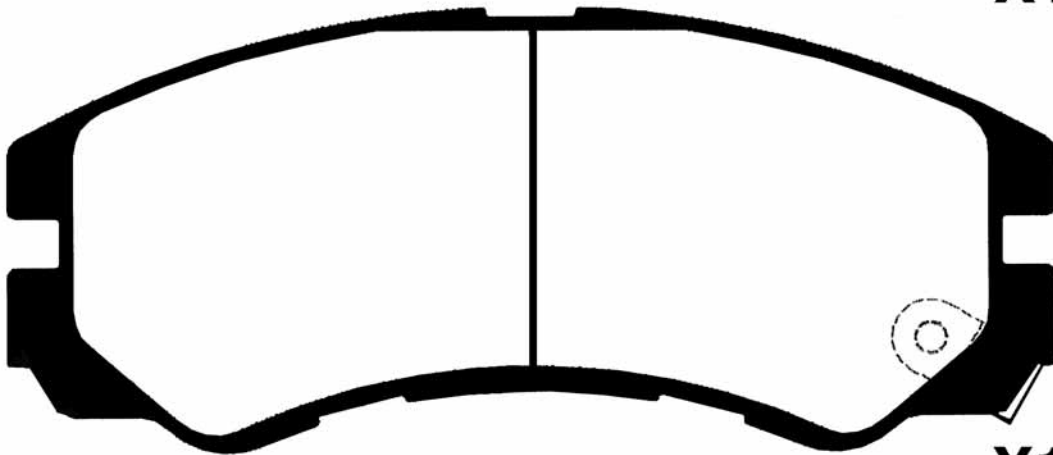

X1

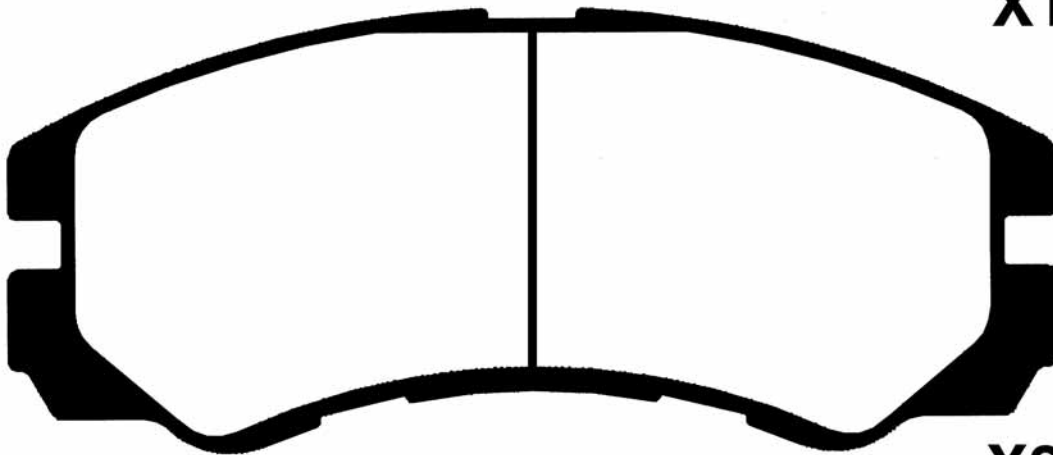

X2

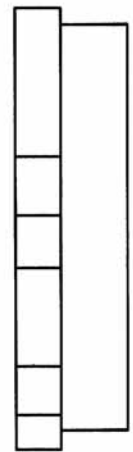
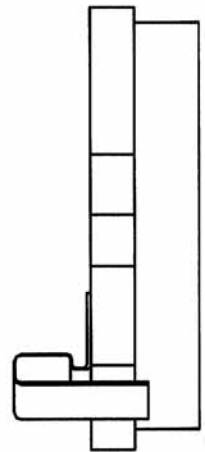



PICTURES BRAKE PADS FRONT
ABBILDUNGEN BREMSKLÖTZE VORN
FIGURAS PASTILLAS DE FRENO DELANTORES
ILLUSTRATIONS PLAQUETTES DE FREI AVANT
IMMAGINI PASTIGLIE FRENO ANTERIORI

50-H0-001				WVA
	HYUNDAI	L	H	Th
	137,2	51,7	17	21727

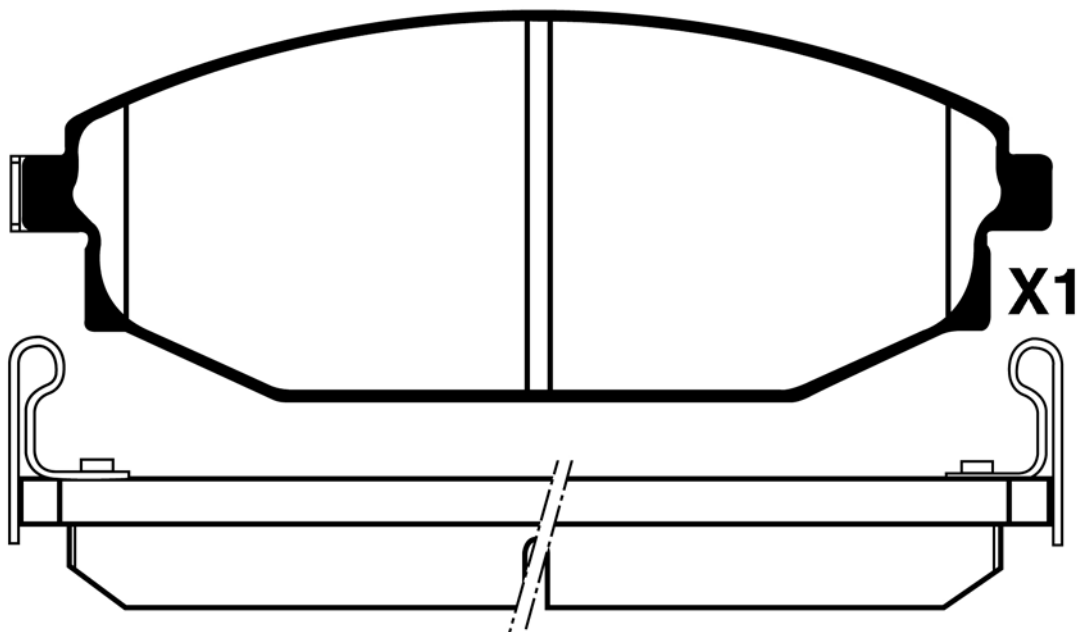
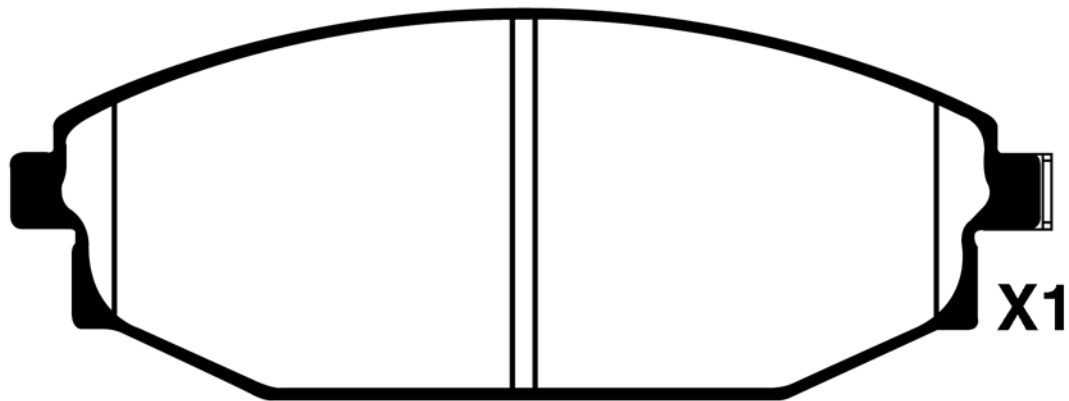
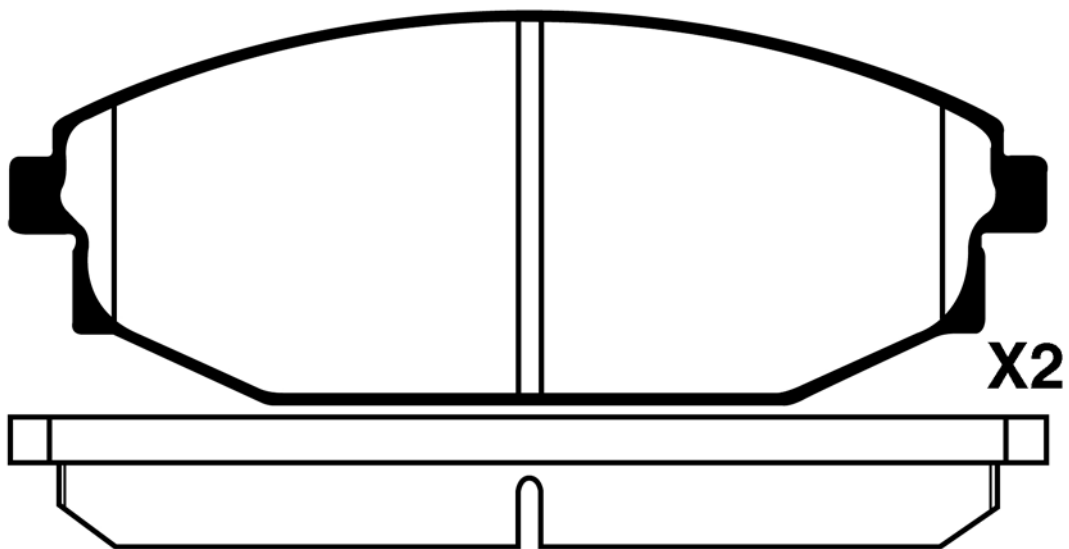



50-H0-001P				WVA
	HYUNDAI	L	H	
	137,2	51,7	17	

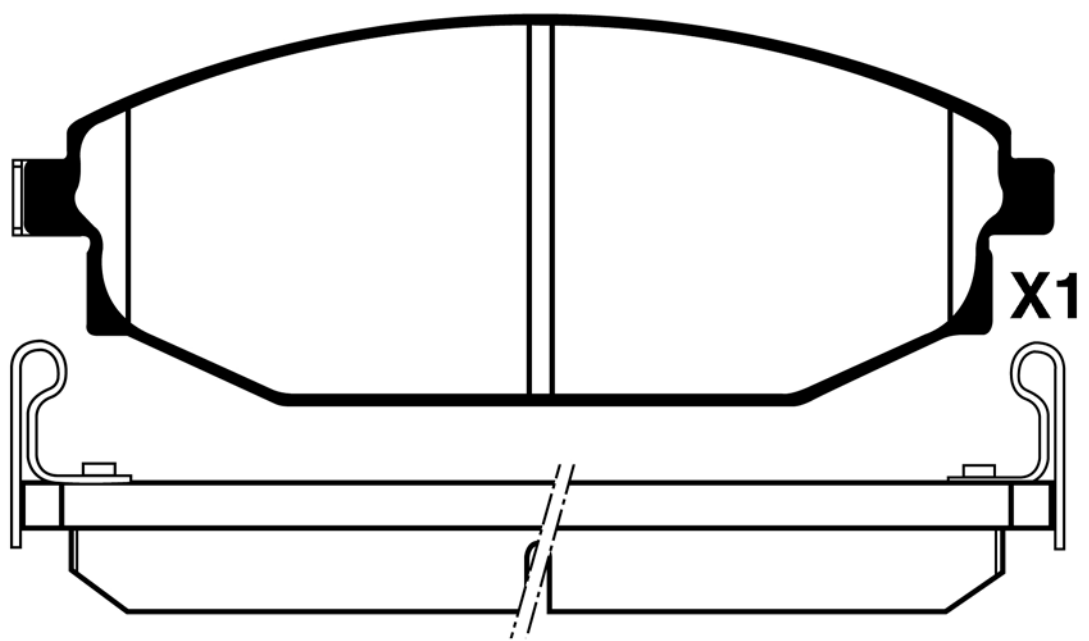
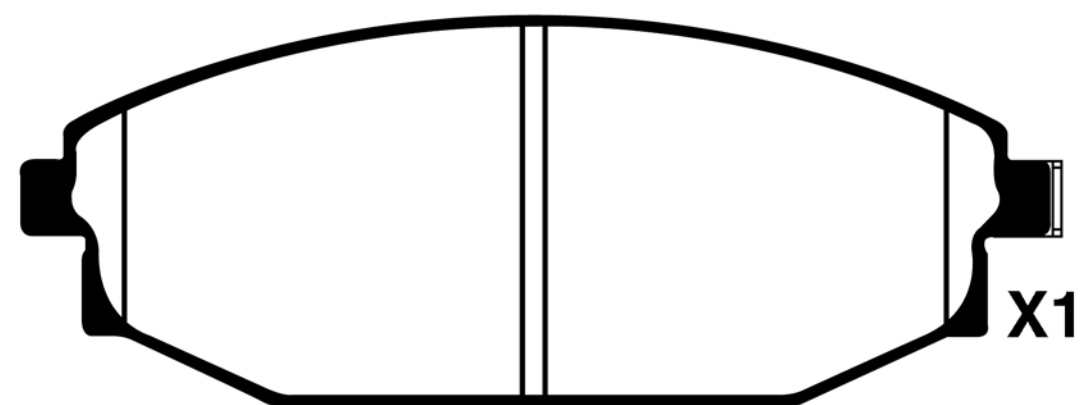
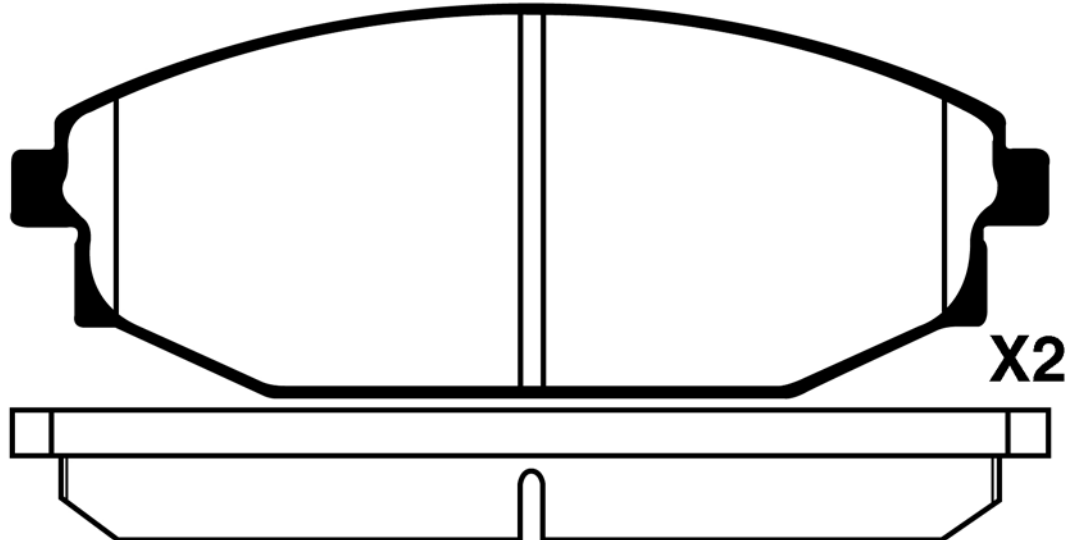



PICTURES BRAKE PADS FRONT
ABBILDUNGEN BREMSKLÖTZE VORN
FIGURAS PASTILLAS DE FRENO DELANTORES
ILLUSTRATIONS PLAQUETTES DE FREI AVANT
IMMAGINI PASTIGLIE FRENO ANTERIORI

50-H0-002				WVA
	HYUNDAI	L	H	Th
	147	53,8	15,9	23536

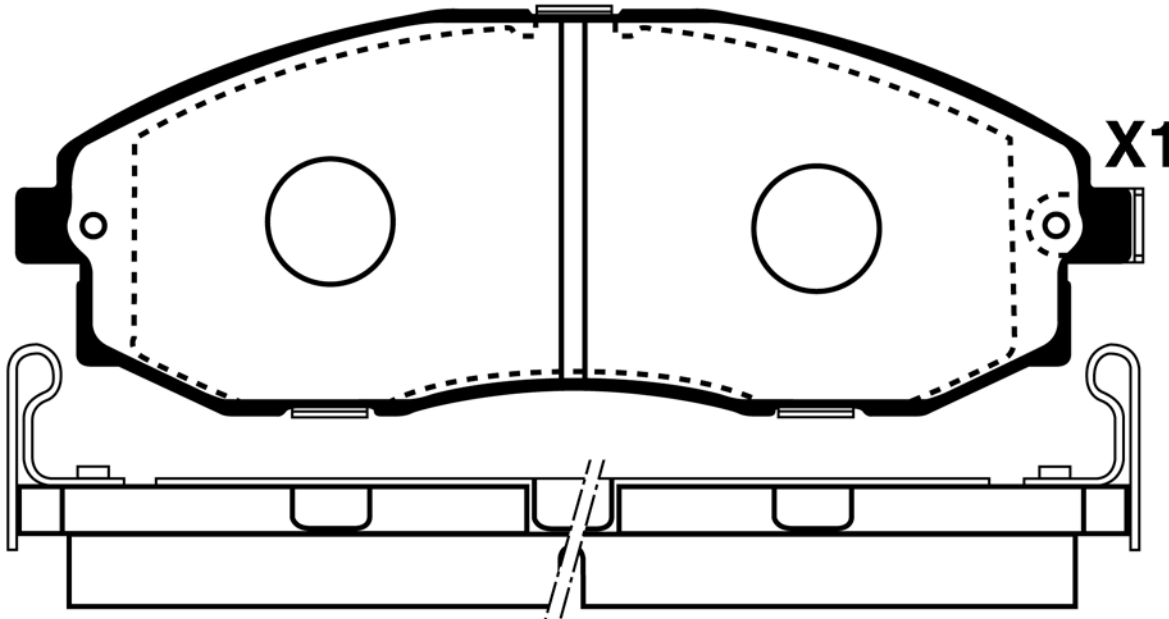
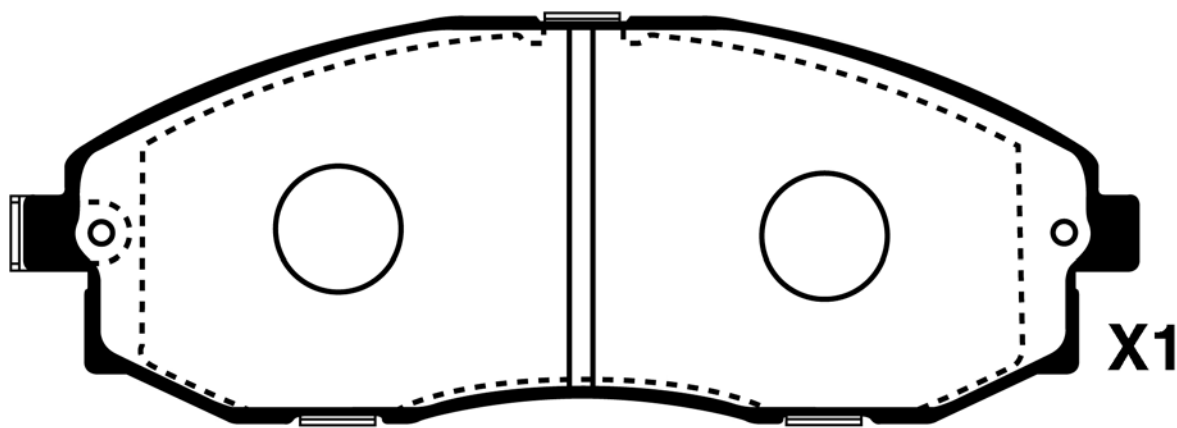
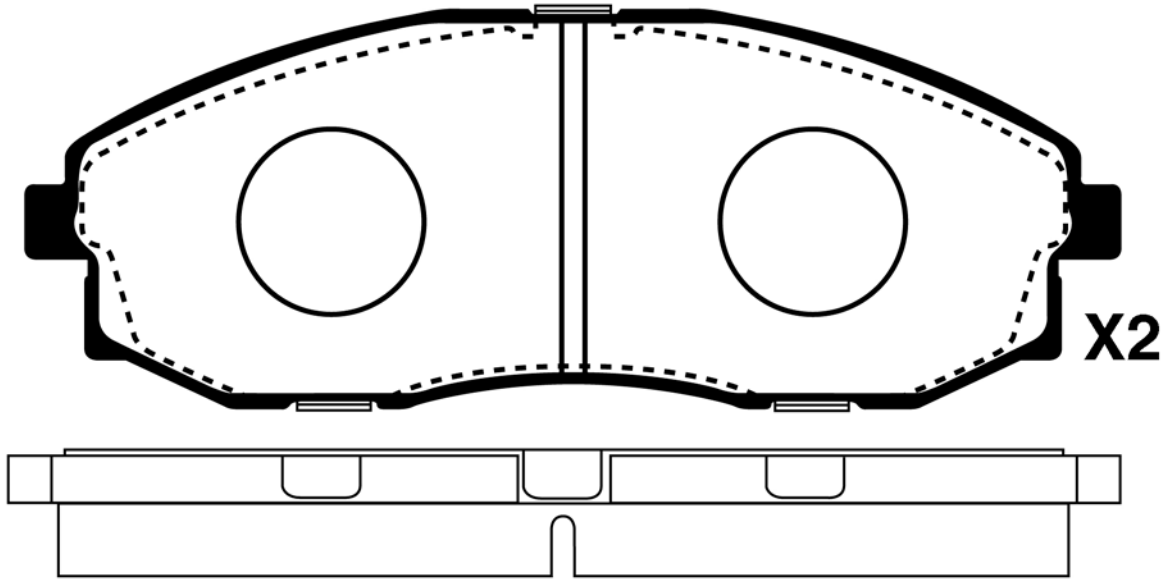



50-H0-005				WVA
	SSANGYONG - HYUNDAI	L	H	Th
	149,1	58,7	16	23571

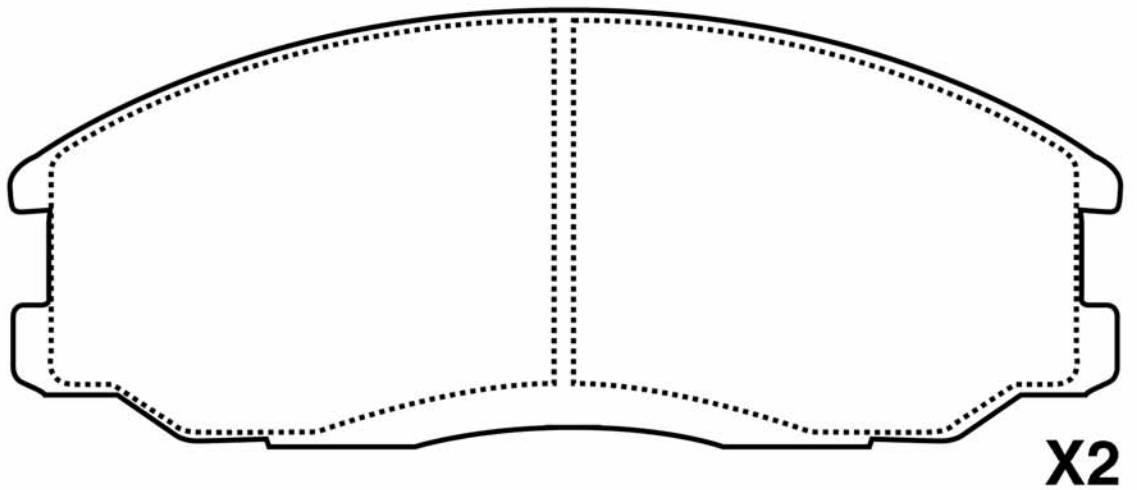
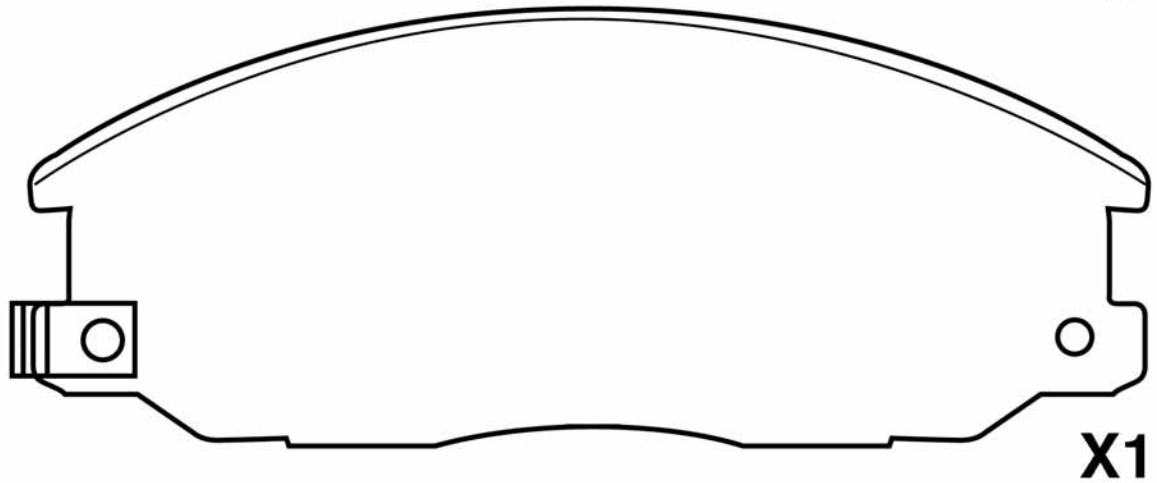
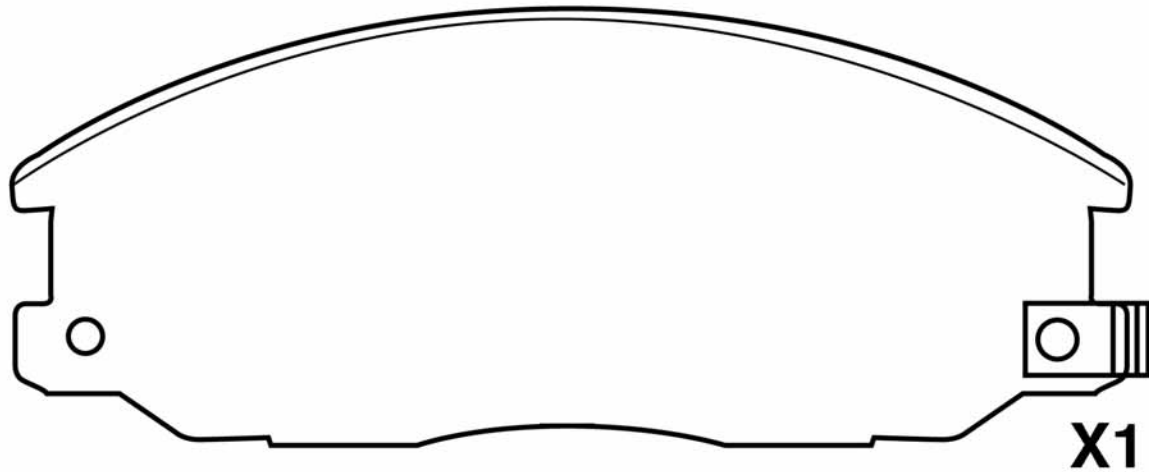



PICTURES BRAKE PADS FRONT
ABBILDUNGEN BREMSKLÖTZE VORN
FIGURAS PASTILLAS DE FRENO DELANTORES
ILLUSTRATIONS PLAQUETTES DE FREI AVANT
IMMAGINI PASTIGLIE FRENO ANTERIORI

50-H0-006				WVA
HYUNDAI	L	H	Th	
	149,1	57,9	16,7	24059

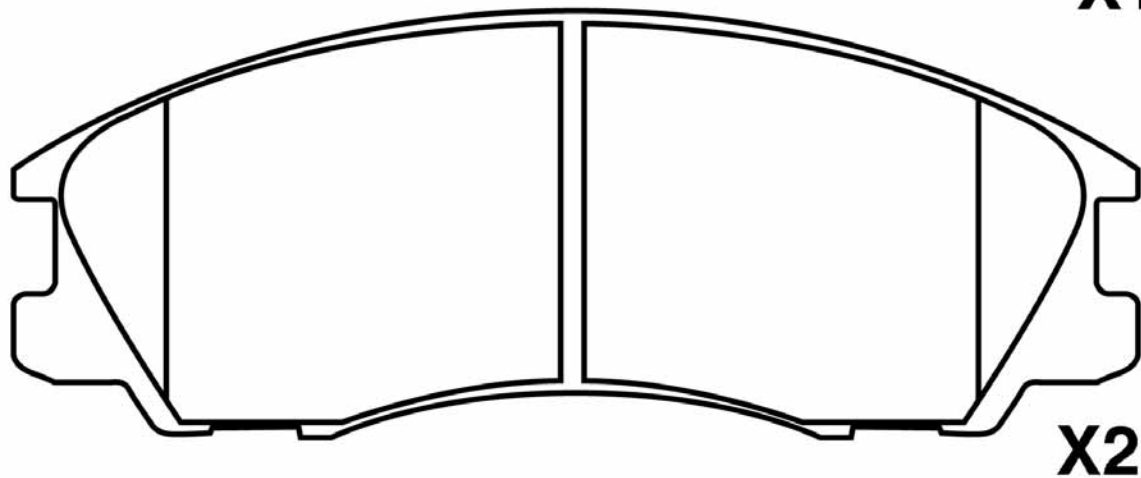
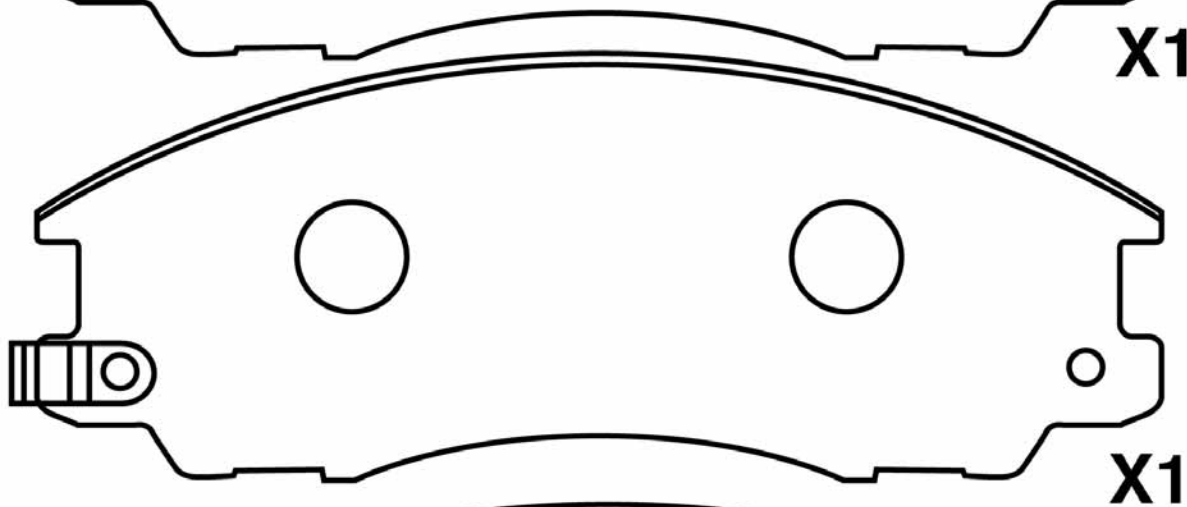
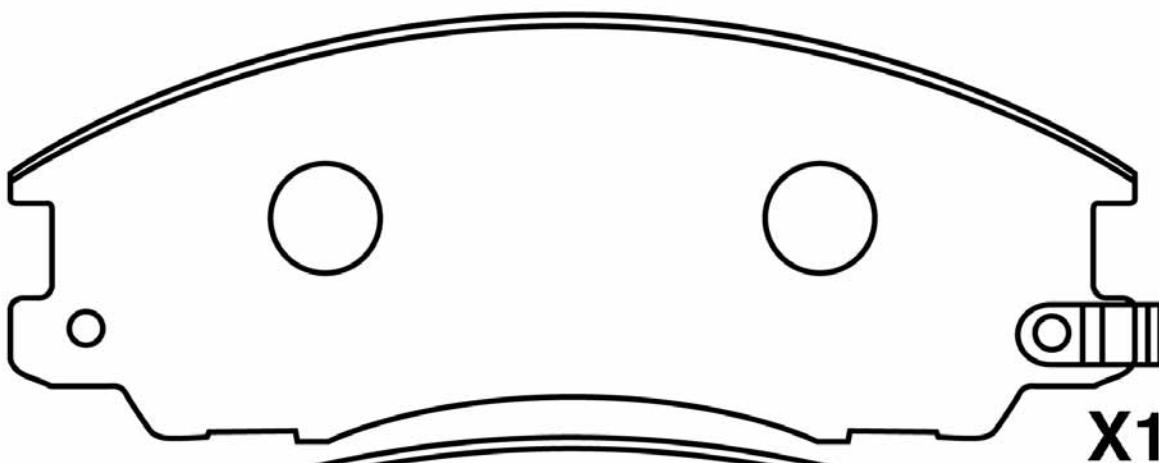



50-H0-008				WVA
	HYUNDAI	L	H	Th
	104,6	47	16,7	24277

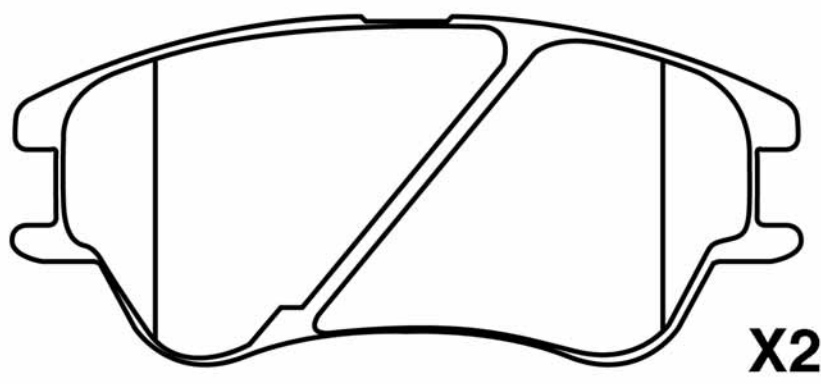
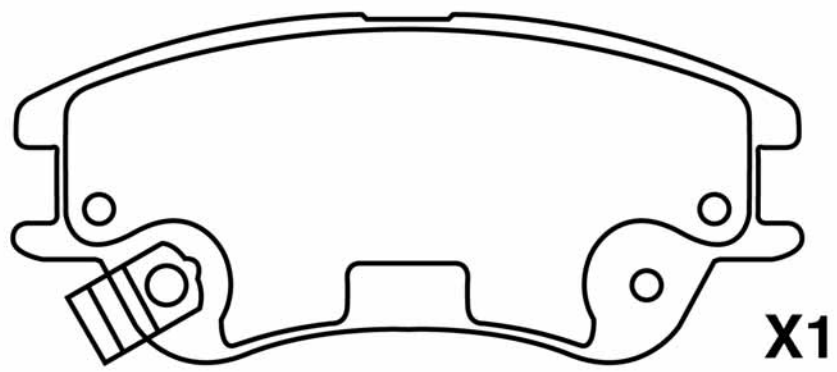
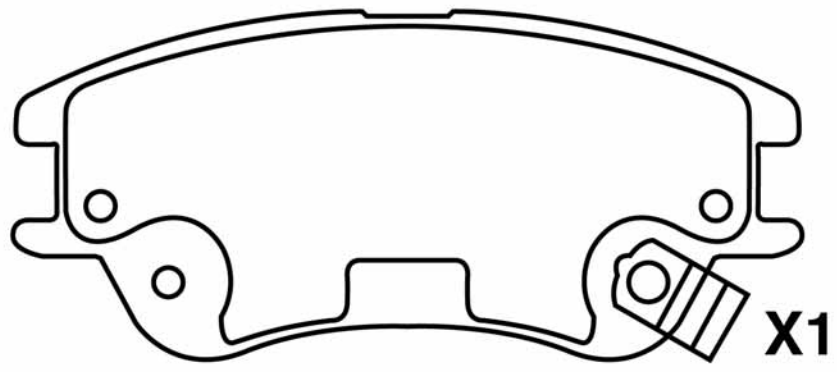



PICTURES BRAKE PADS FRONT
ABBILDUNGEN BREMSKLÖTZE VORN
FIGURAS PASTILLAS DE FRENO DELANTORES
ILLUSTRATIONS PLAQUETTES DE FREI AVANT
IMMAGINI PASTIGLIE FRENO ANTERIORI

50-H0-010

HYUNDAI - KIA

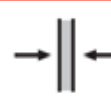
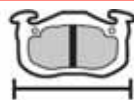

WVA

L

131,5

H

59,9

Th

17,3

24375

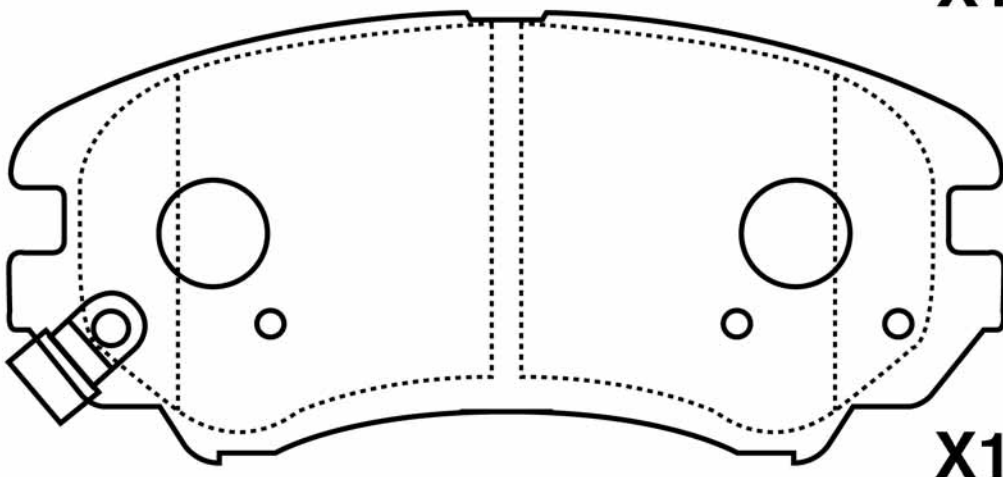
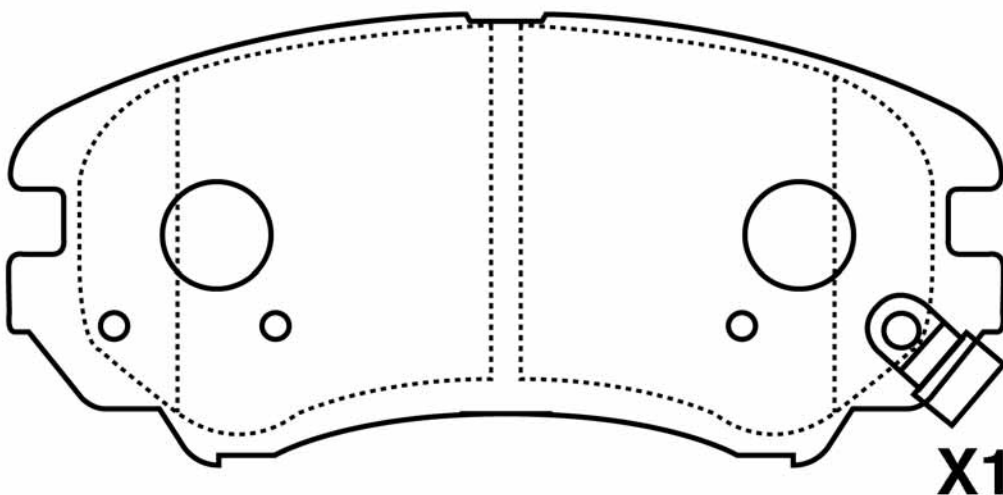
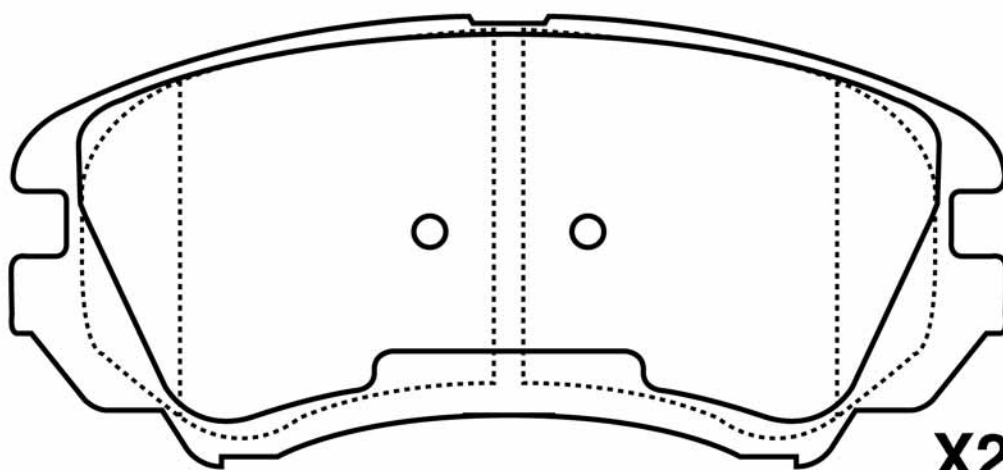



50-0H-H12				WVA
	HYUNDAI	L	H	Th
	116,3	49	16,5	24910

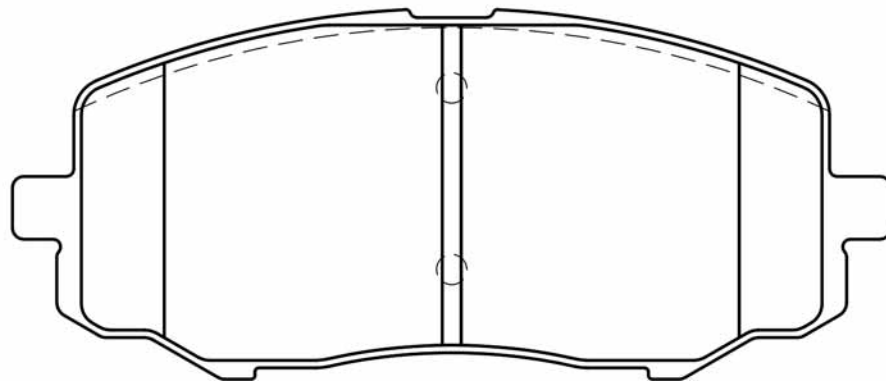
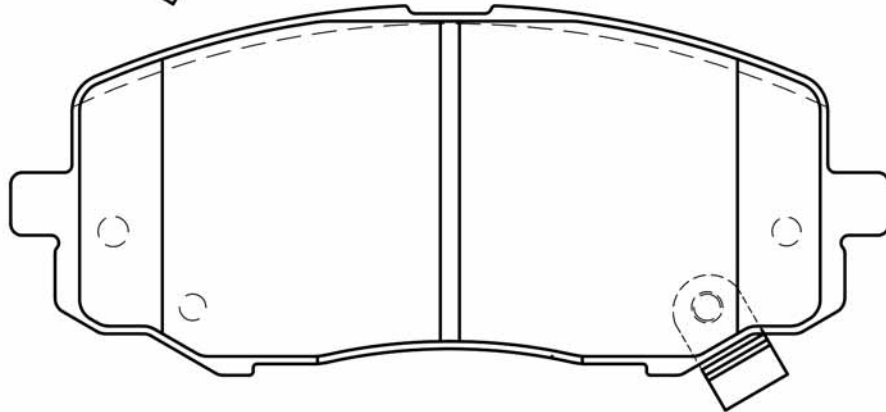
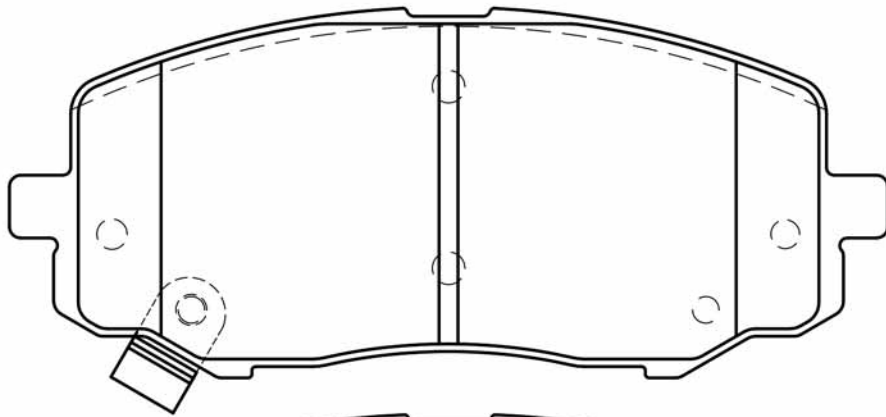



PICTURES BRAKE PADS FRONT
ABBILDUNGEN BREMSKLÖTZE VORN
FIGURAS PASTILLAS DE FRENO DELANTORES
ILLUSTRATIONS PLAQUETTES DE FREI AVANT
IMMAGINI PASTIGLIE FRENO ANTERIORI

50-H0-013				WVA
	HYUNDAI	L	H	Th
	137	63,4	16,9	24031

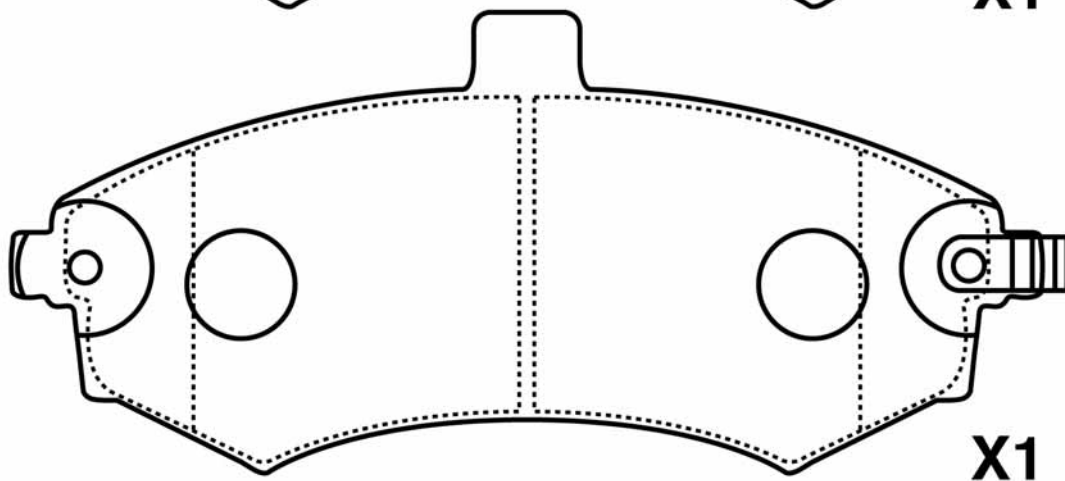
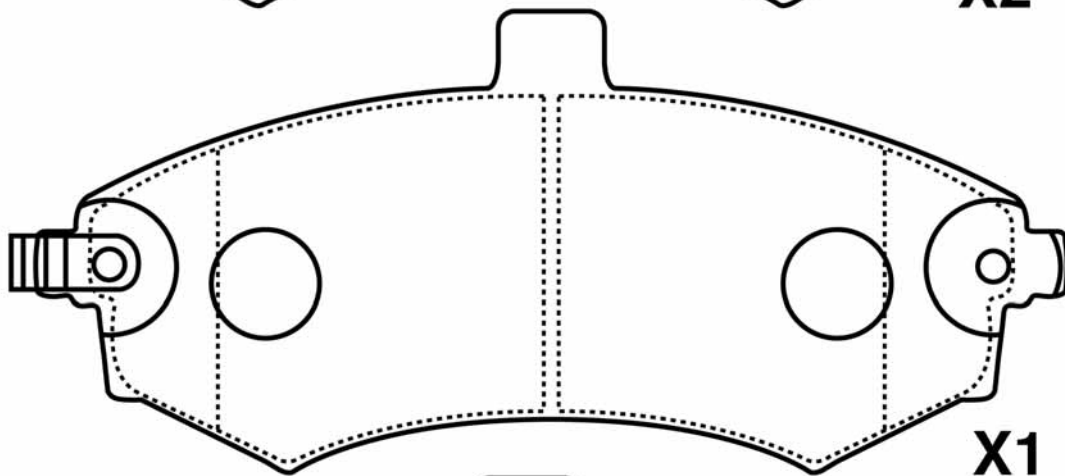
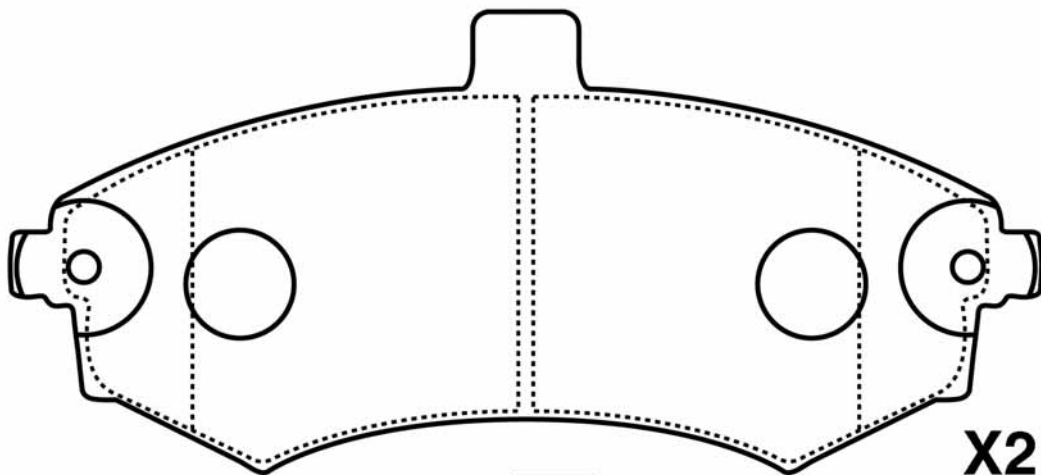



50-0H-H14 HYUNDAI - SSANGYONG - KIA				WVA 24351
	L 156,2	H 61	Th 17	

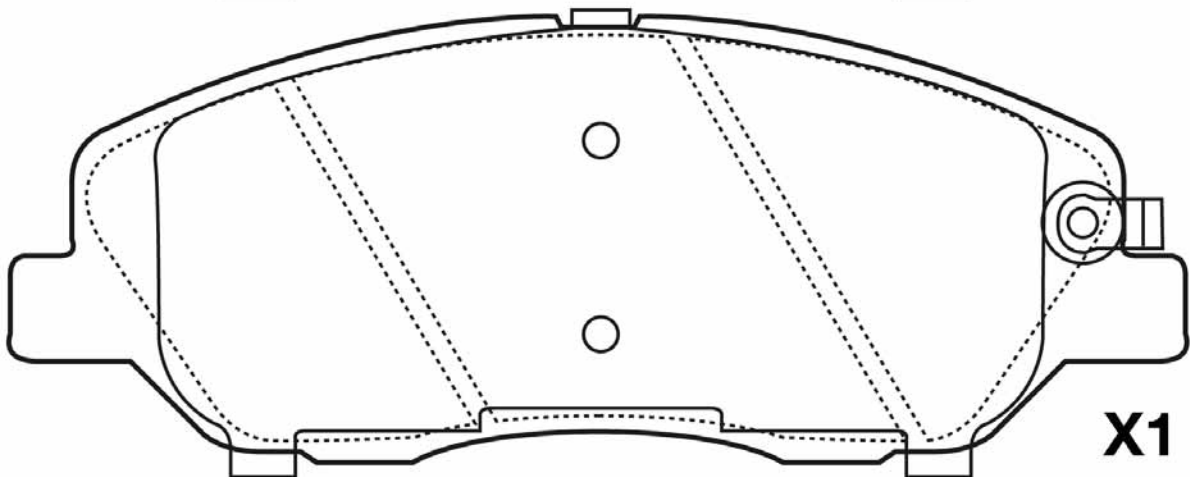
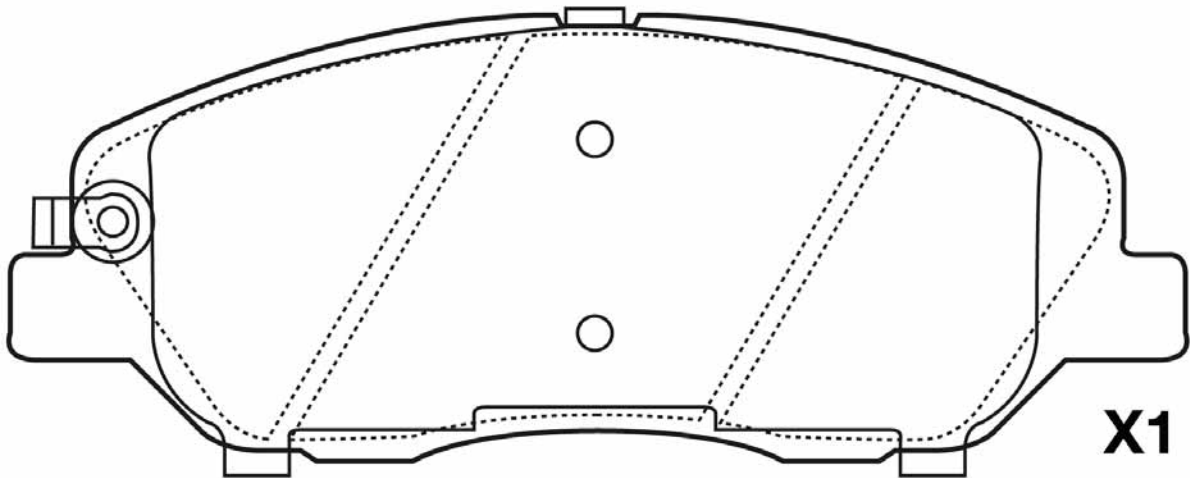
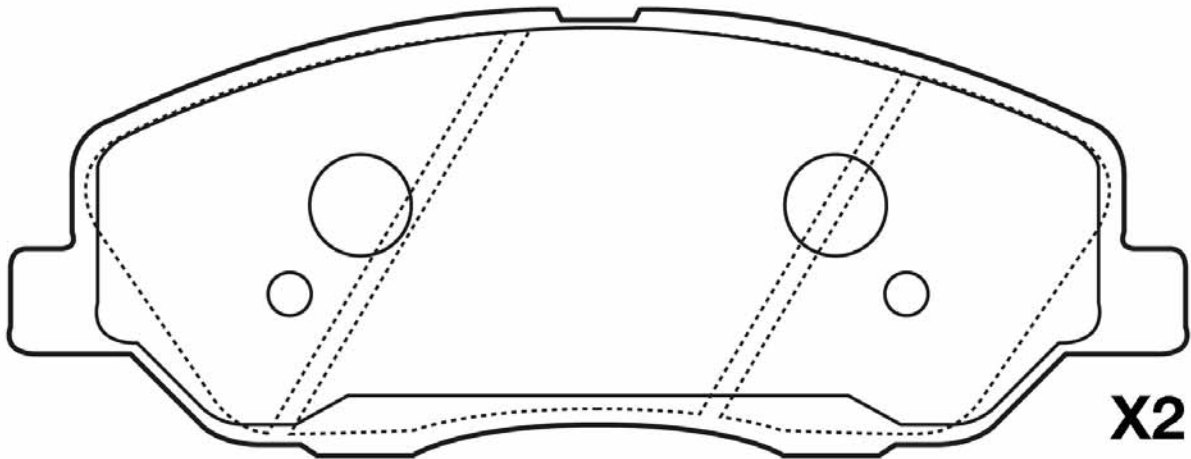



PICTURES BRAKE PADS FRONT
ABBILDUNGEN BREMSKLÖTZE VORN
FIGURAS PASTILLAS DE FRENO DELANTORES
ILLUSTRATIONS PLAQUETTES DE FREI AVANT
IMMAGINI PASTIGLIE FRENO ANTERIORI

50-0H-H15

HYUNDAI

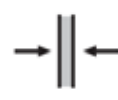
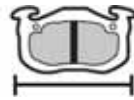

WVA

L

131

H

70

Th

17

24369

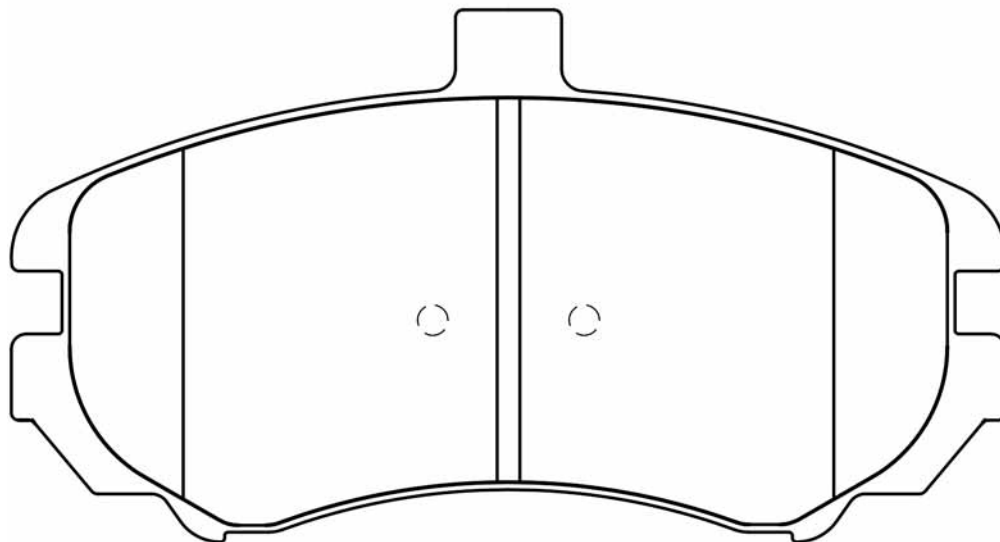
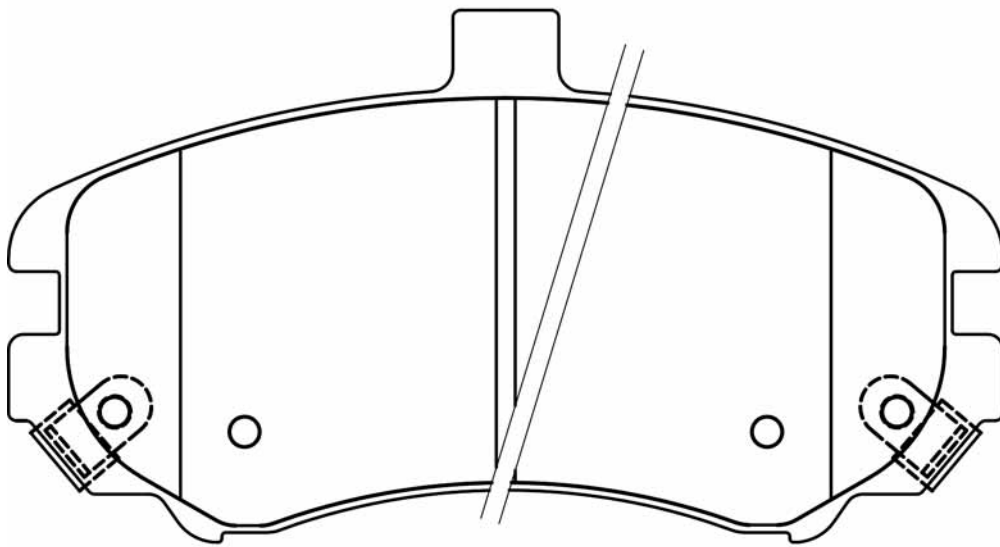



50-0H-H17

HYUNDAI

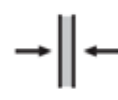
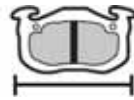

WVA

L

130

H

56

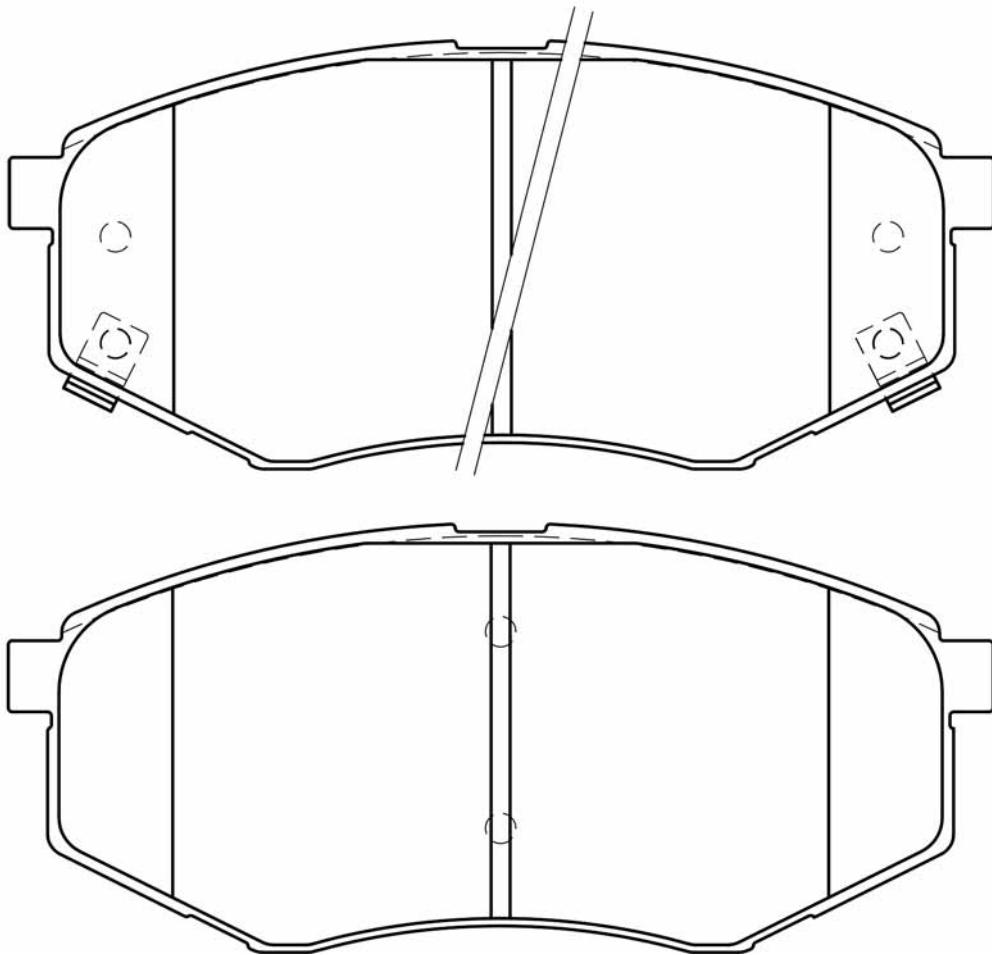

Th

18



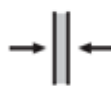

PICTURES BRAKE PADS FRONT
ABBILDUNGEN BREMSKLÖTZE VORN
FIGURAS PASTILLAS DE FRENO DELANTORES
ILLUSTRATIONS PLAQUETTES DE FREI AVANT
IMMAGINI PASTIGLIE FRENO ANTERIORI

50-K0-000				WVA
KIA	L	H	Th	
	149,3	53,5	16,7	23442

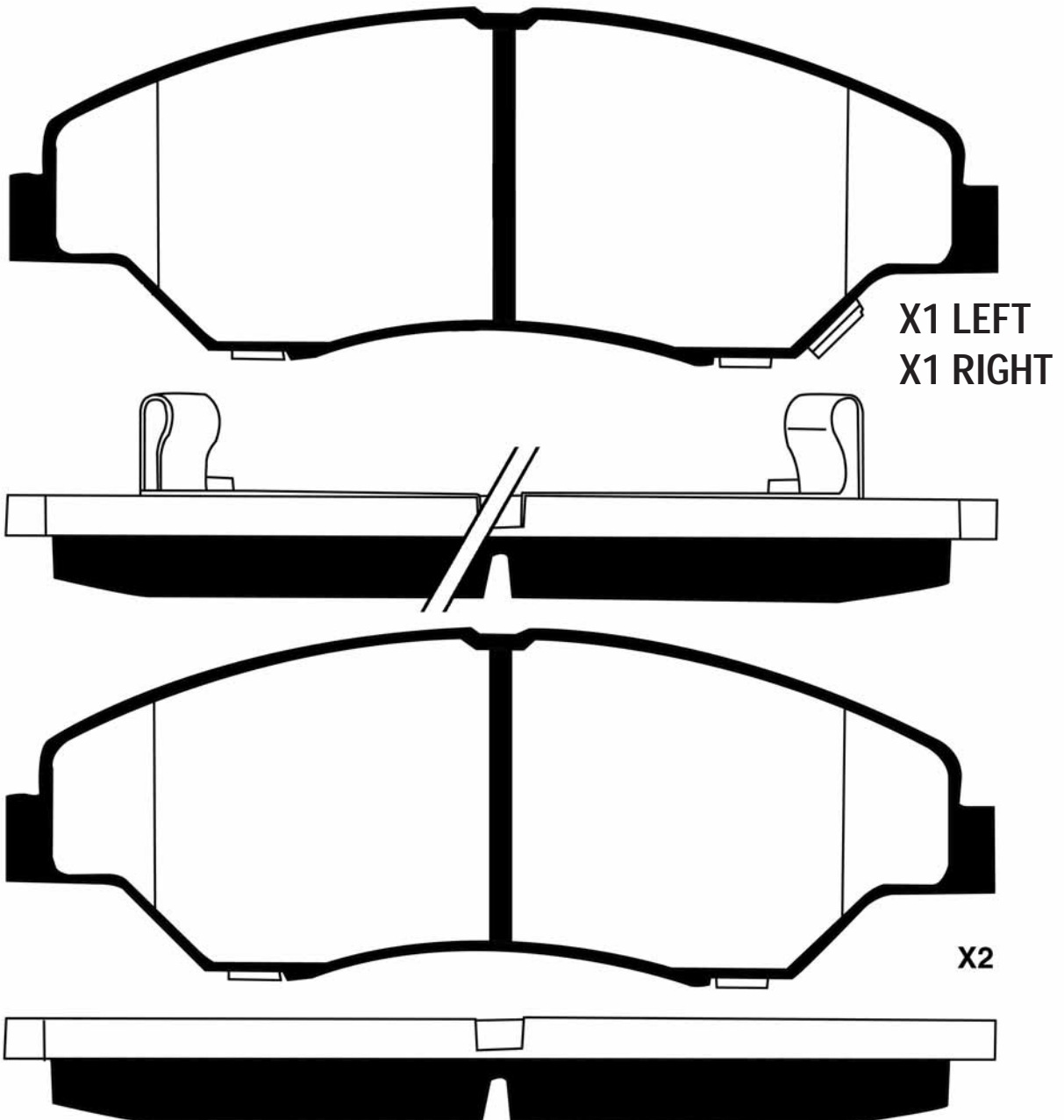



50-K0-001				WVA
	KIA	L	H	
	153,7	57,9	16	23484

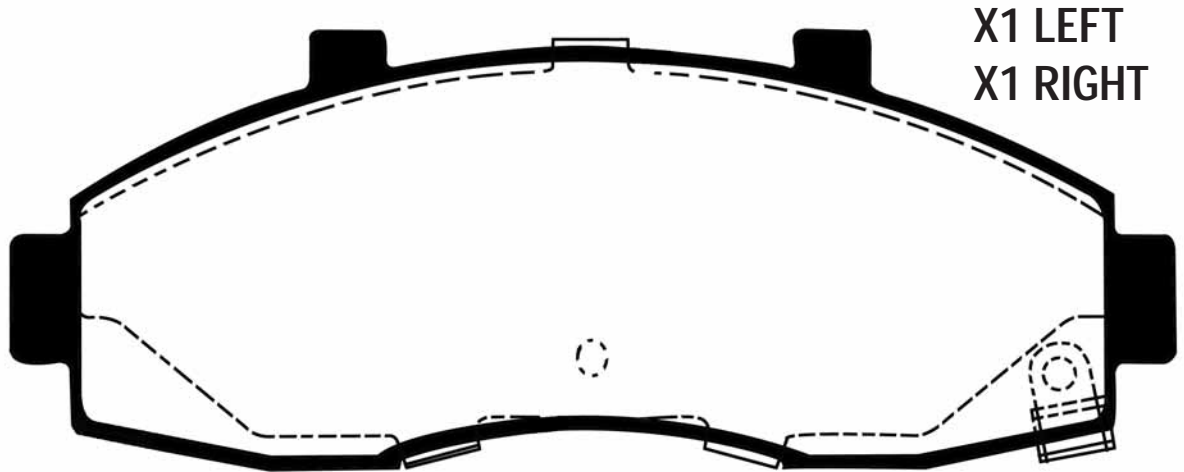

X1 LEFT
 X1 RIGHT

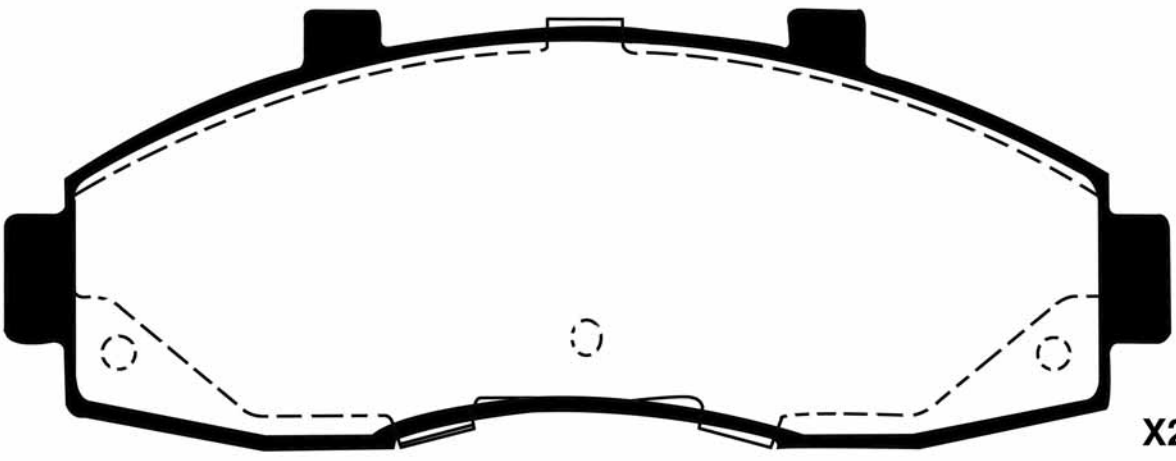
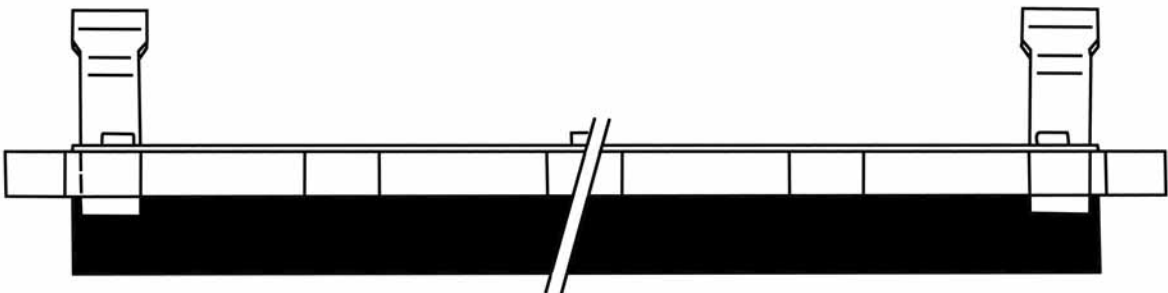

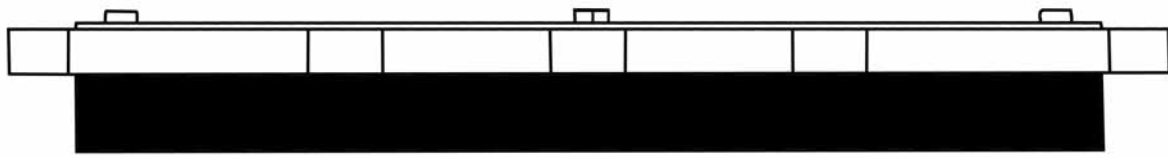

X2



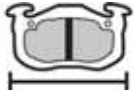

PICTURES BRAKE PADS FRONT
ABBILDUNGEN BREMSKLÖTZE VORN
FIGURAS PASTILLAS DE FRENO DELANTORES
ILLUSTRATIONS PLAQUETTES DE FREI AVANT
IMMAGINI PASTIGLIE FRENO ANTERIORI

50-K0-002				WVA
KIA	L	H	Th	
	151,2	52,1	17,5	23267

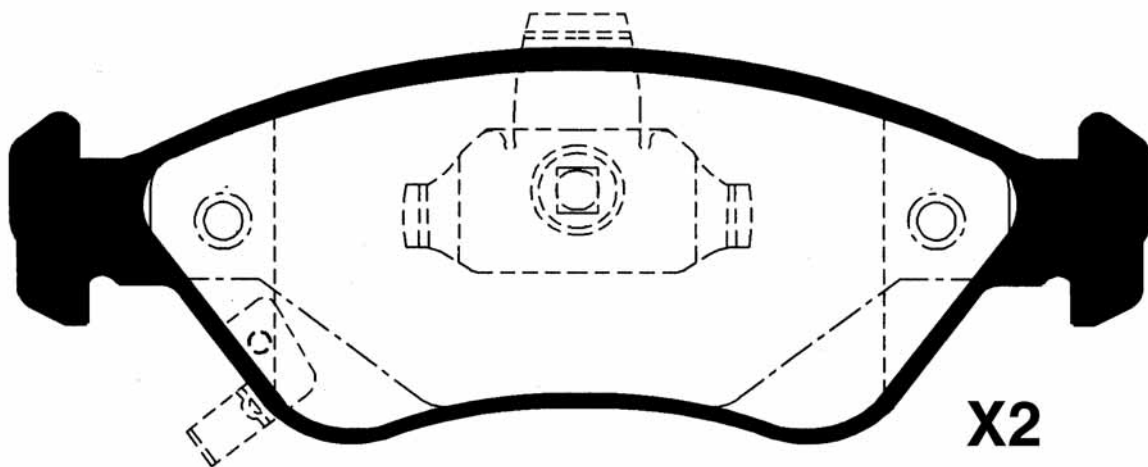
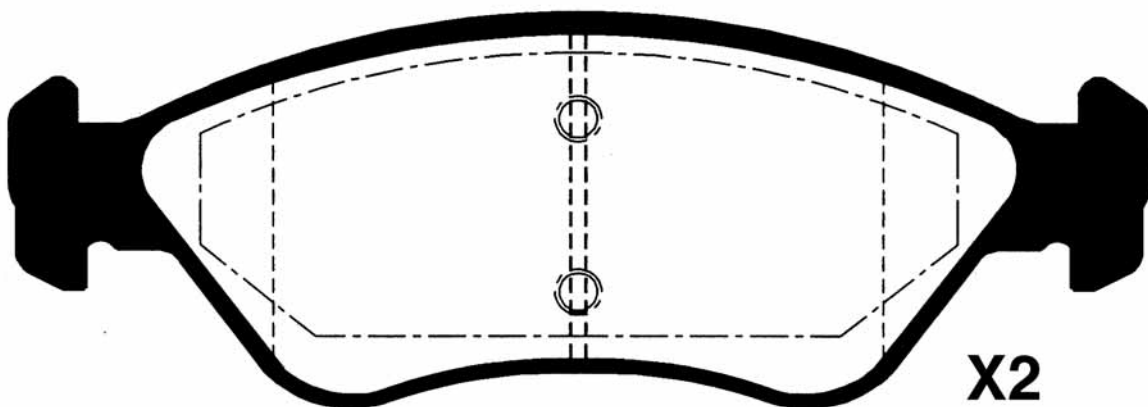



50-K0-005				WVA
	KIA	L	H	Th
	154,5	56,8	16,6	23649

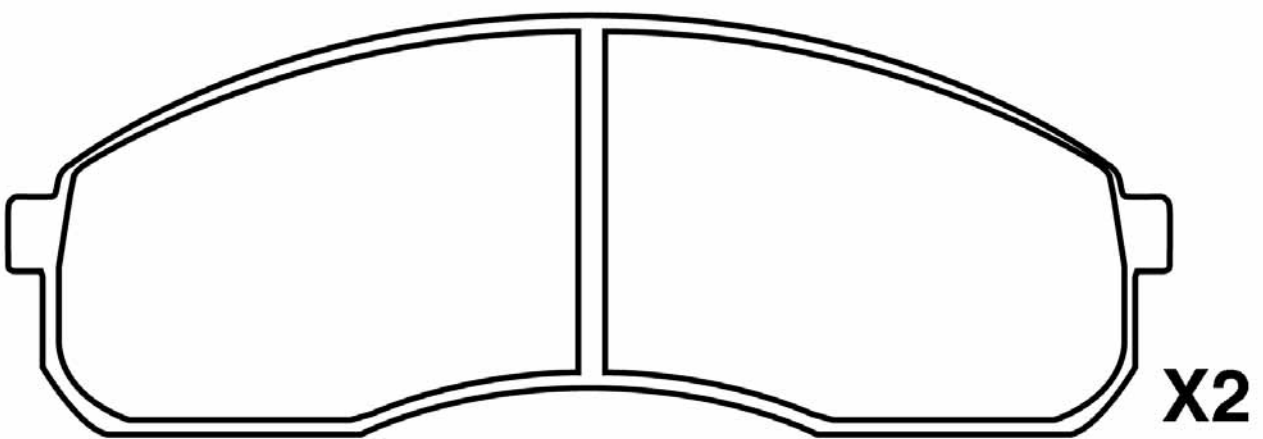
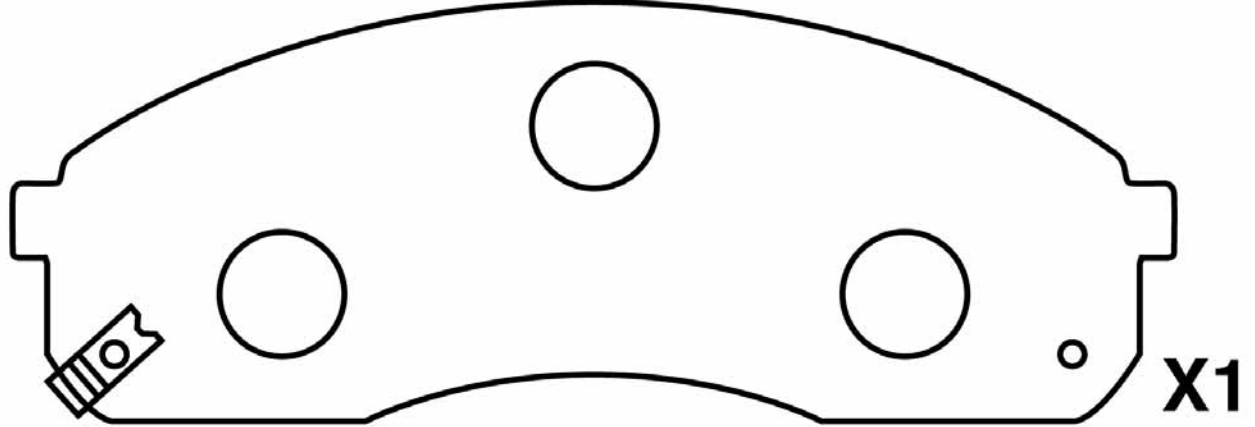
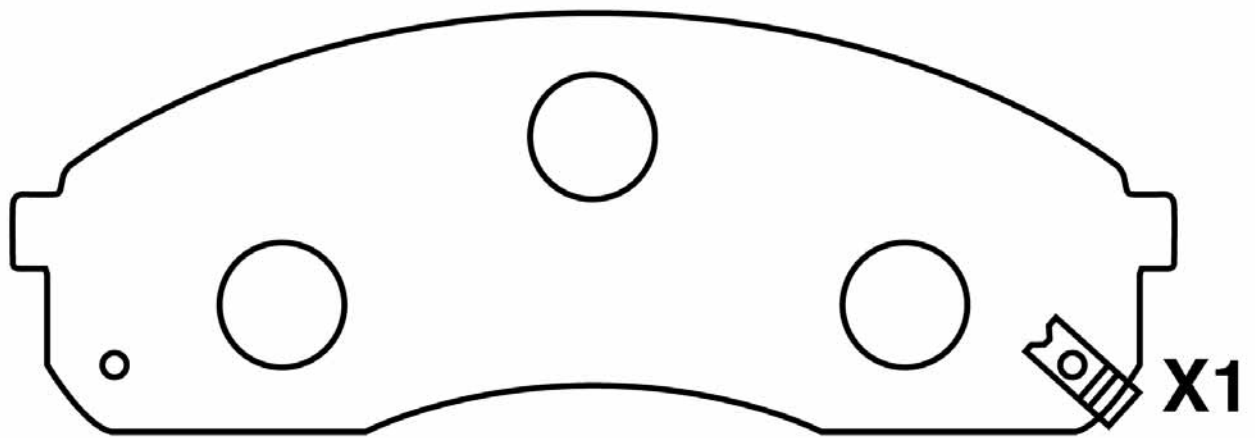



PICTURES BRAKE PADS FRONT
ABBILDUNGEN BREMSKLÖTZE VORN
FIGURAS PASTILLAS DE FRENO DELANTORES
ILLUSTRATIONS PLAQUETTES DE FREI AVANT
IMMAGINI PASTIGLIE FRENO ANTERIORI

50-K0-005P				WVA
KIA	L	H	Th	
	154,5	56,8	16,6	

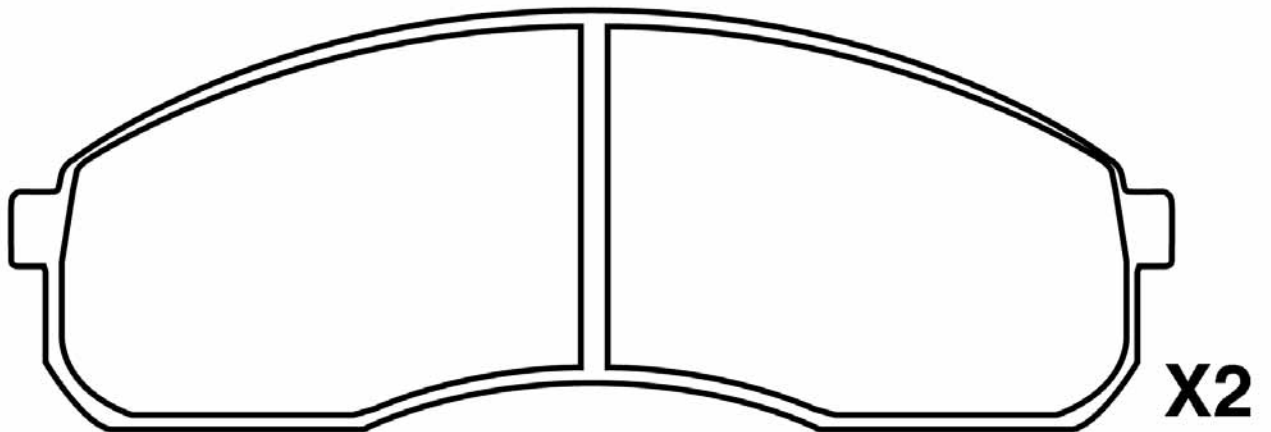
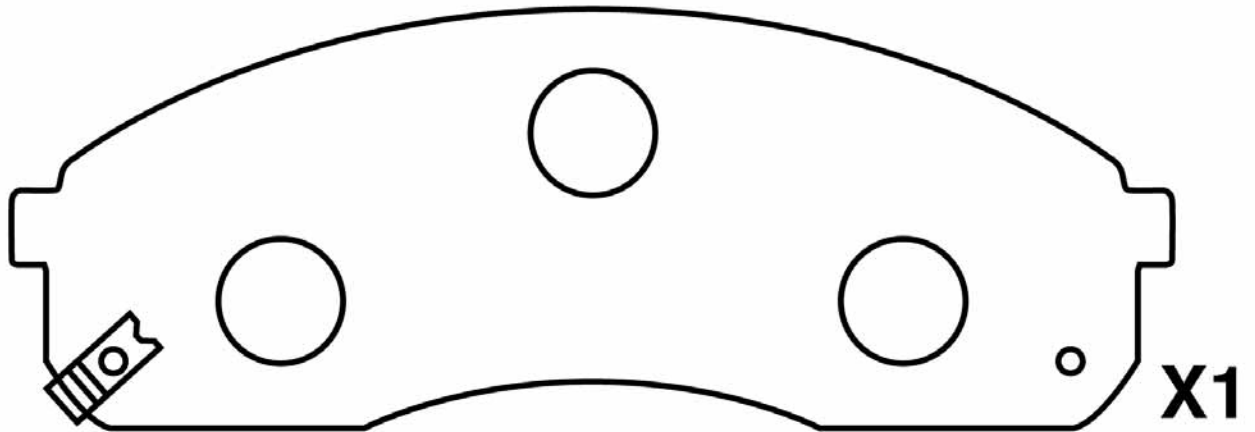
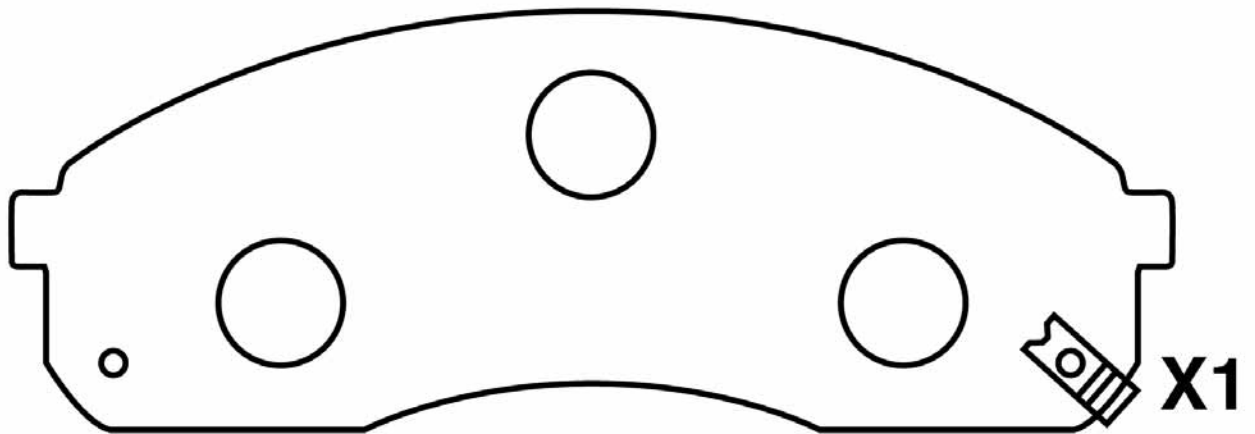



50-K0-008				WVA
	KIA	L 155	H 60	Th 17 24092

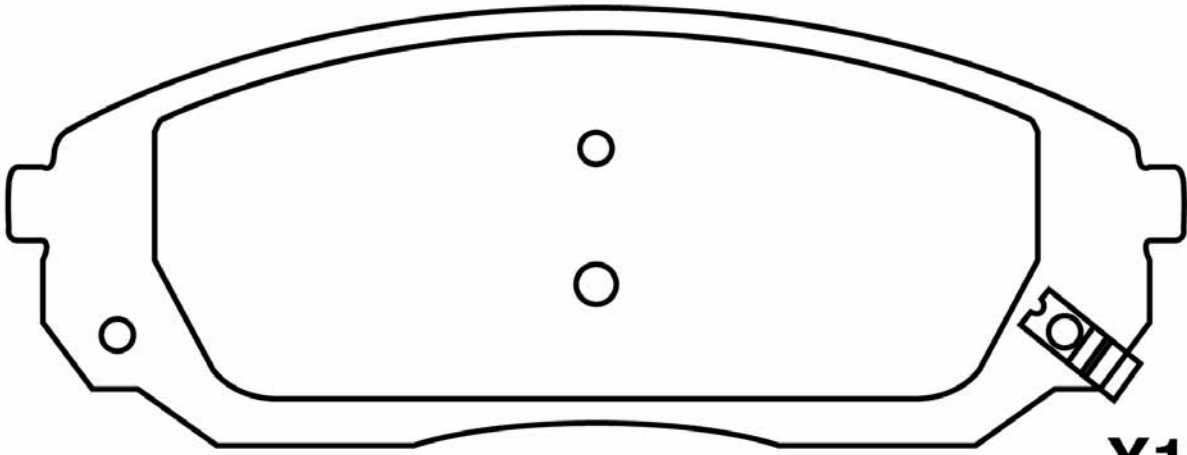

X1

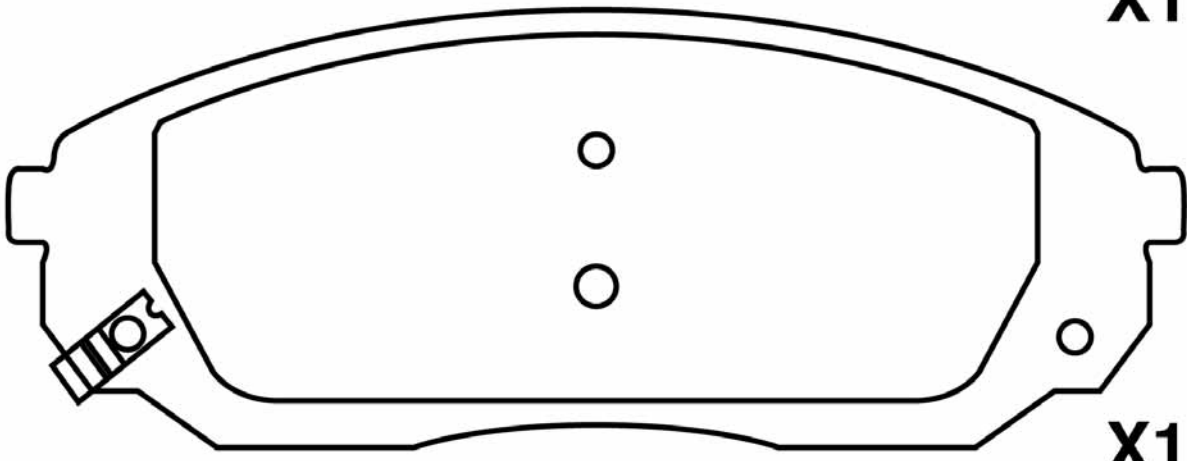

X1

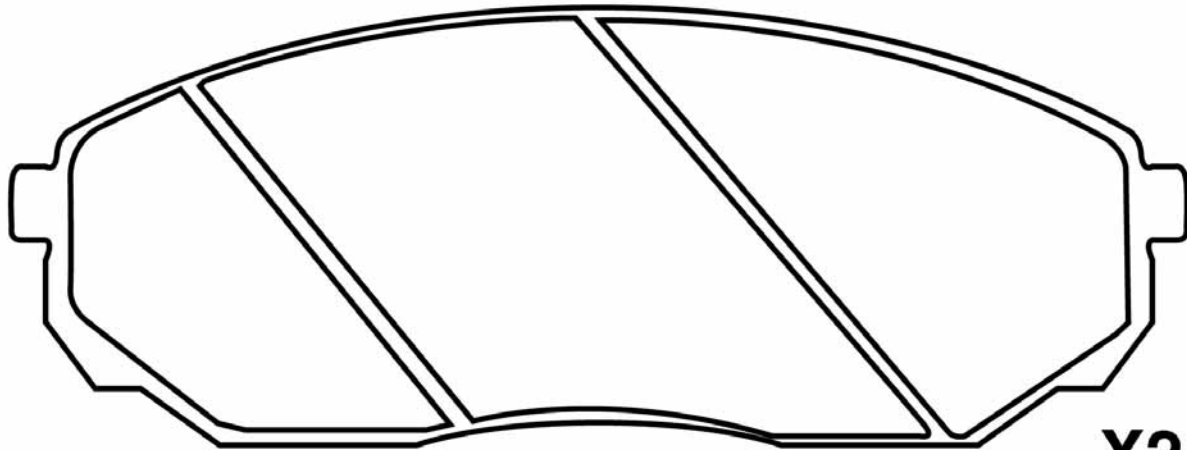

X2



PICTURES BRAKE PADS FRONT
ABBILDUNGEN BREMSKLÖTZE VORN
FIGURAS PASTILLAS DE FRENO DELANTORES
ILLUSTRATIONS PLAQUETTES DE FREI AVANT
IMMAGINI PASTIGLIE FRENO ANTERIORI

50-K0-009 HYUNDAI - KIA				WVA
	L	H	Th	
	130	58,1	16,7	23966

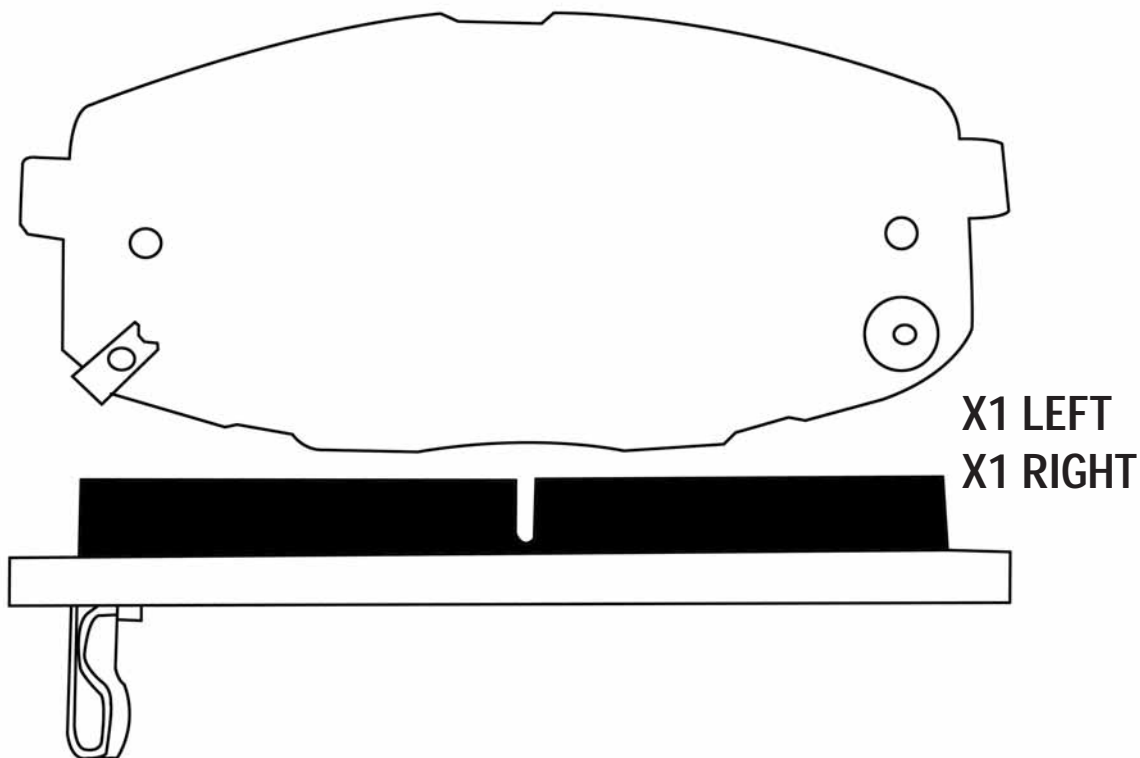
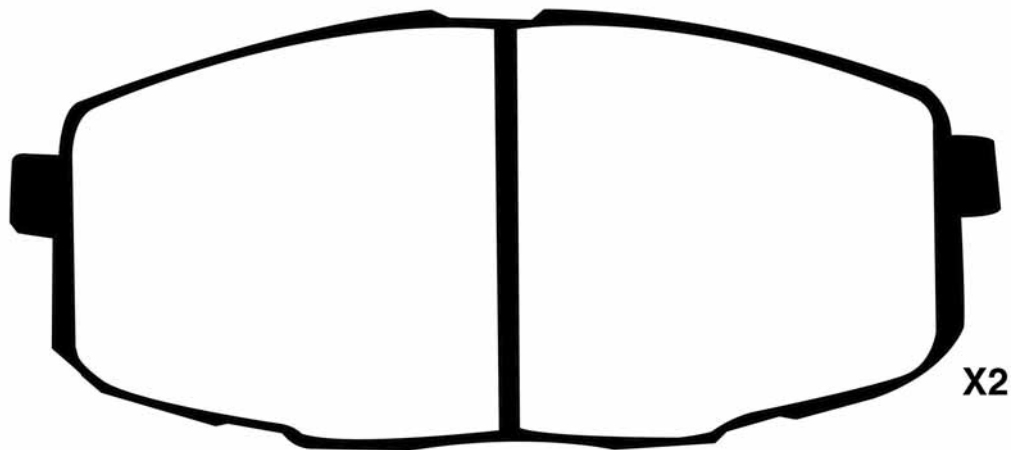



50-0K-010				WVA
	KIA - HYUNDAI	L	H	Th
	116,2	47,8	15,8	24275

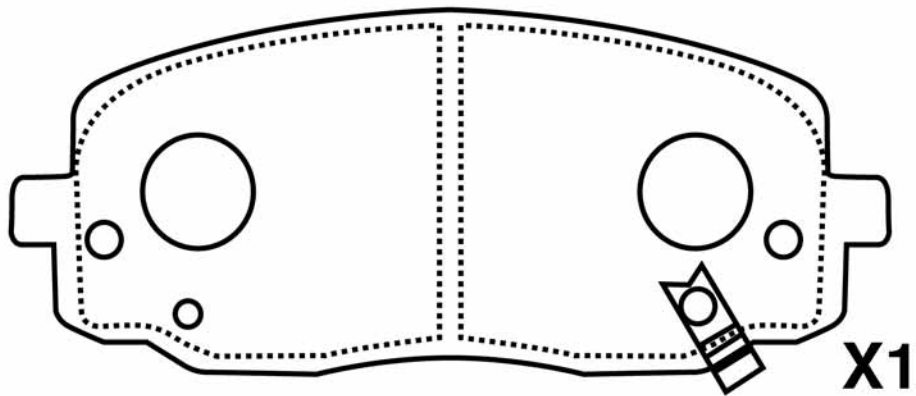
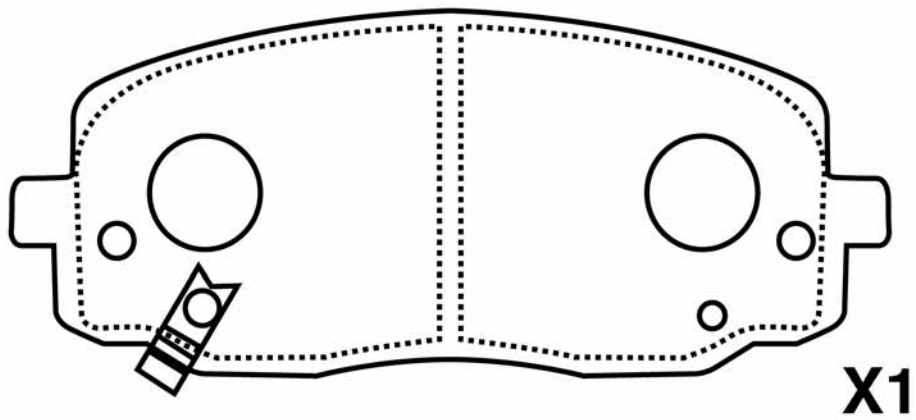
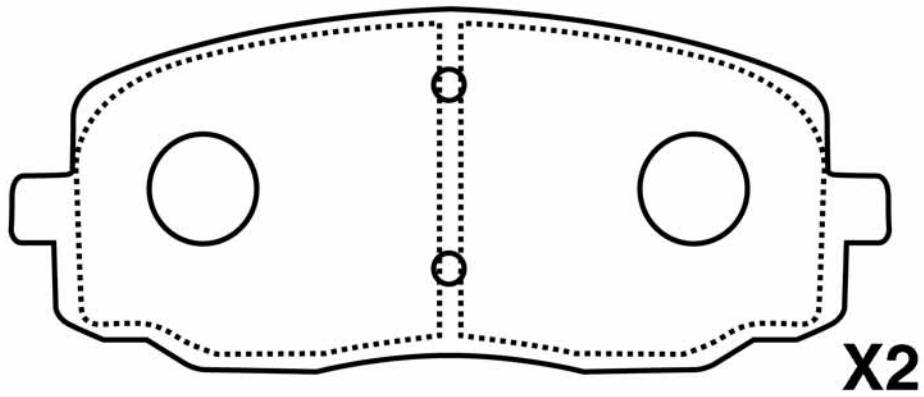



PICTURES BRAKE PADS FRONT
ABBILDUNGEN BREMSKLÖTZE VORN
FIGURAS PASTILLAS DE FRENO DELANTORES
ILLUSTRATIONS PLAQUETTES DE FREI AVANT
IMMAGINI PASTIGLIE FRENO ANTERIORI

50-0K-K11

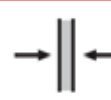
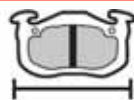

WVA

KIA

L

H

Th

165

59

17,4

24218

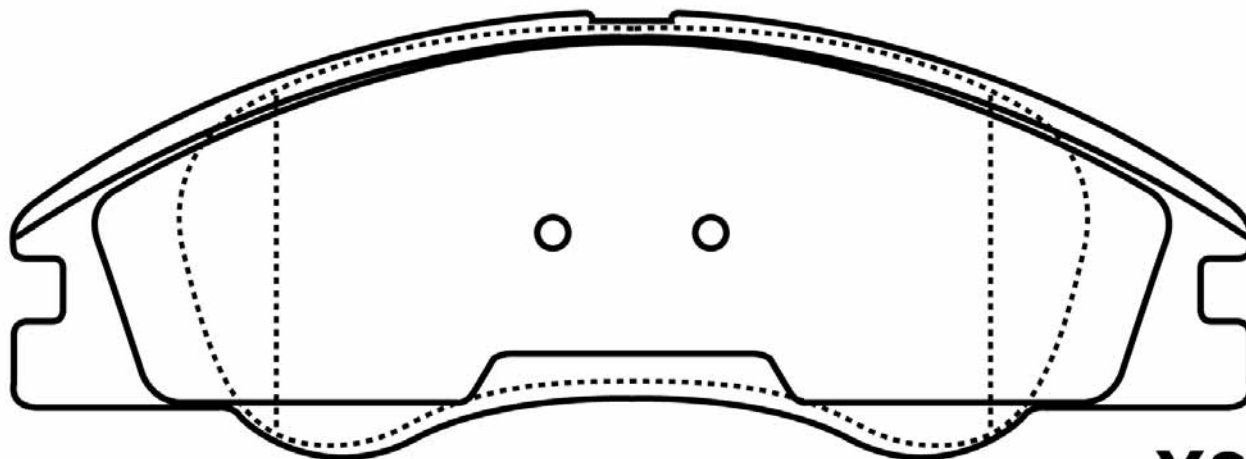

X2

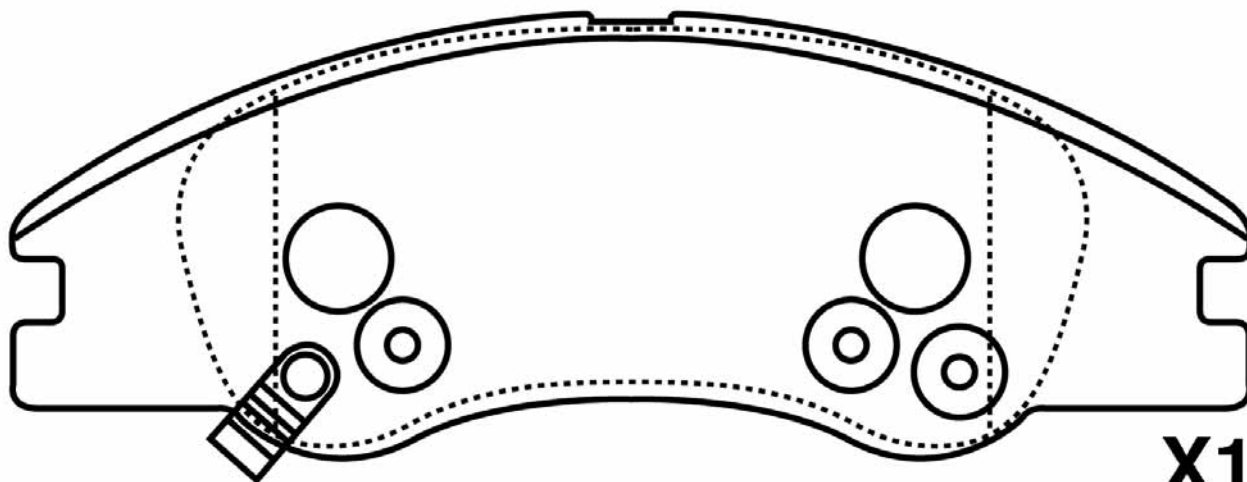

X1

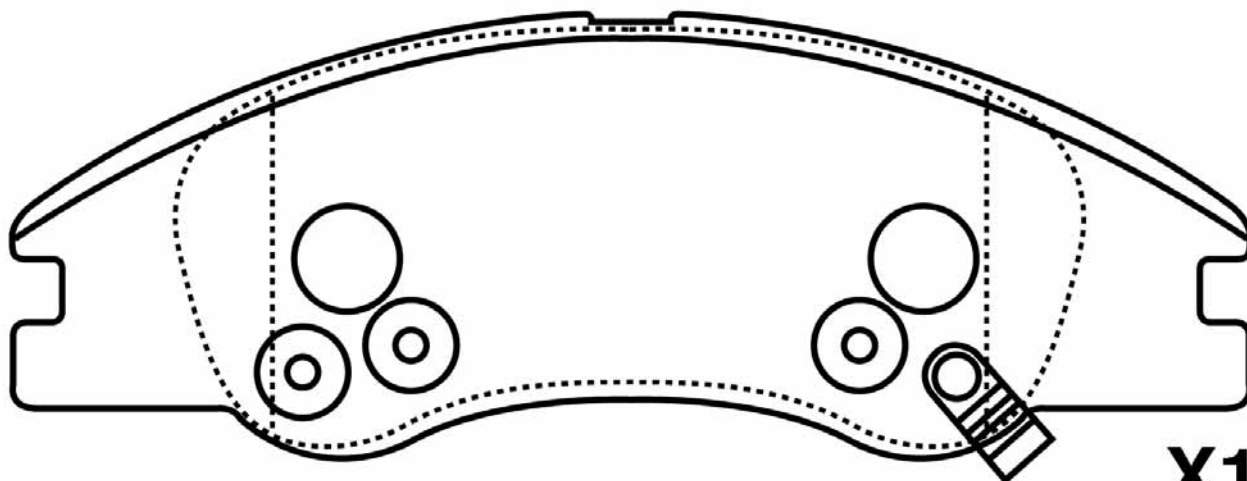

X1



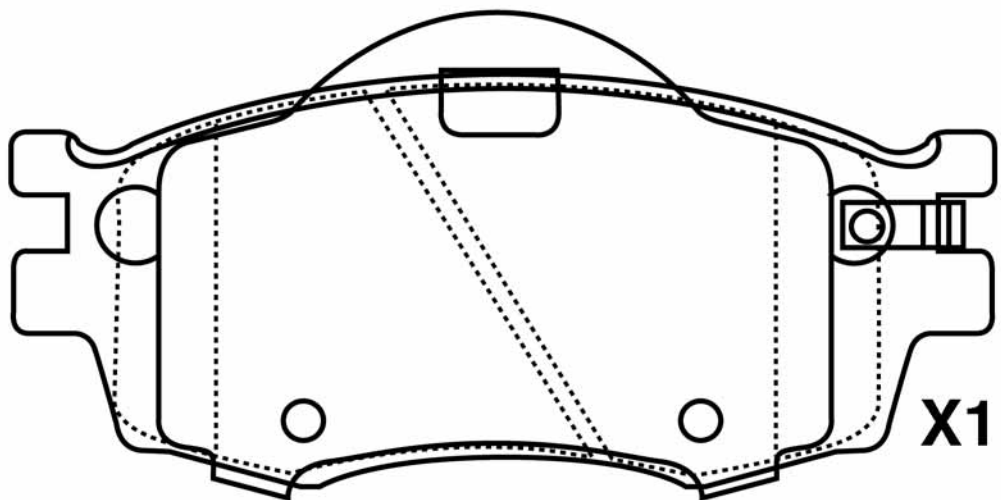
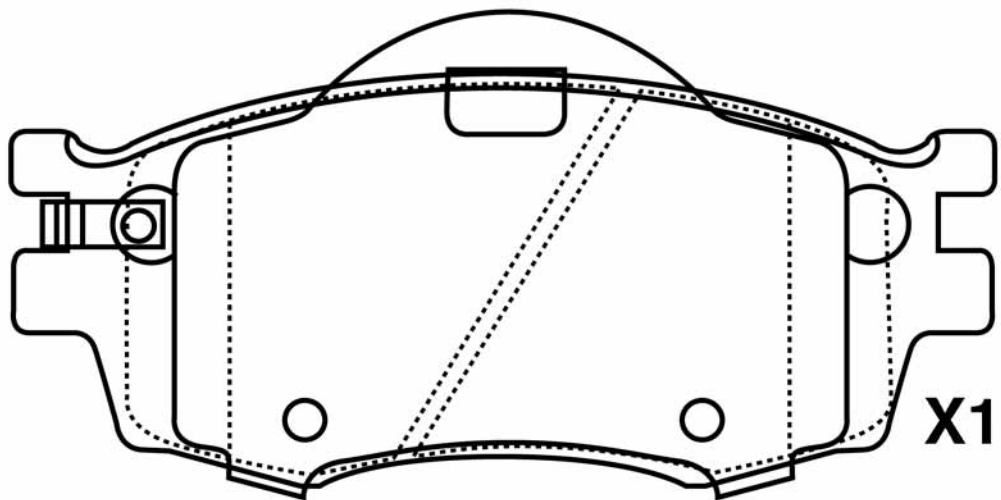
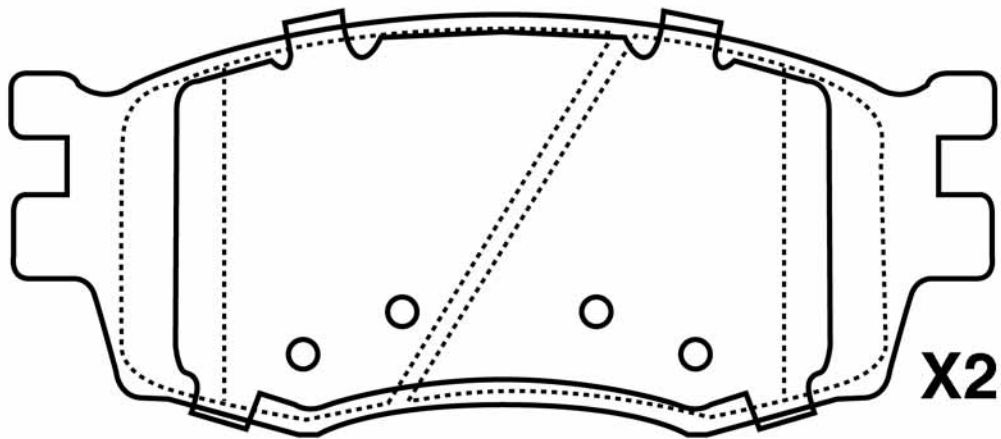

50-0K-K12				WVA
	L	H	Th	
KIA - HYUNDAI	130	56	17,7	24317





PICTURES BRAKE PADS FRONT
ABBILDUNGEN BREMSKLÖTZE VORN
FIGURAS PASTILLAS DE FRENO DELANTORES
ILLUSTRATIONS PLAQUETTES DE FREI AVANT
IMMAGINI PASTIGLIE FRENO ANTERIORI

50-0K-K13				WVA
KIA	L	H	Th	
	154,5	56,8	16,6	

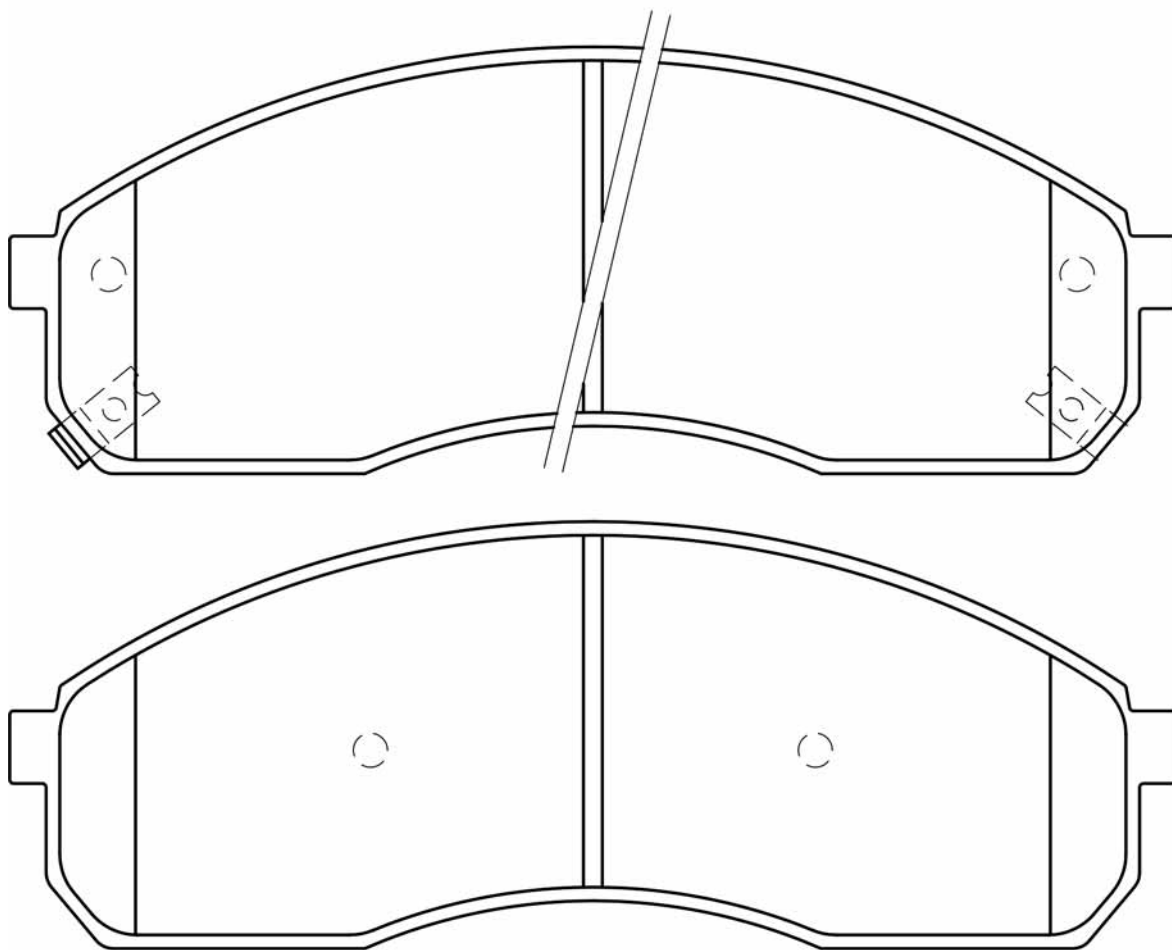



50-K0-014 KIA - HYUNDAI - SSANGYONG				WVA
	L 137	H 54	Th 17,2	21725

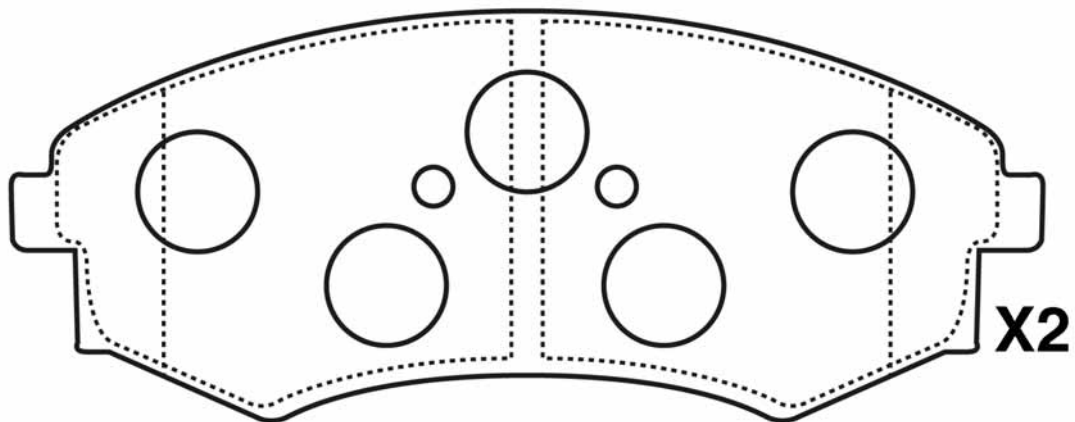
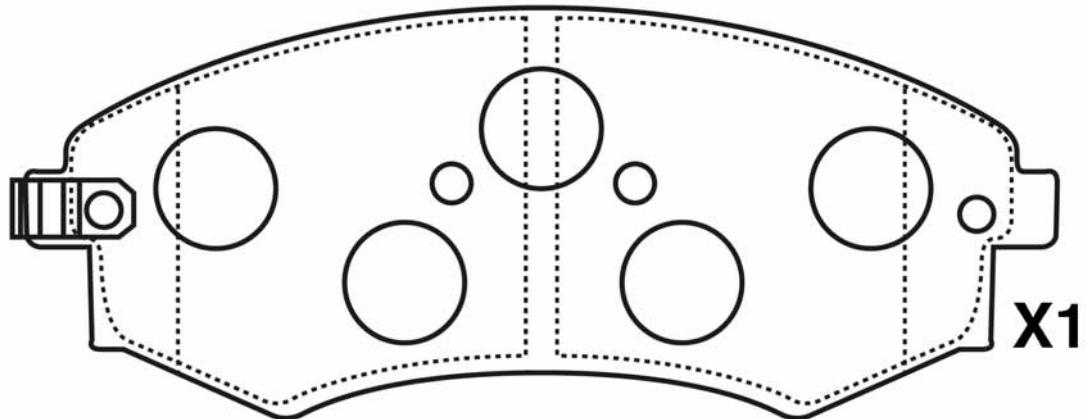
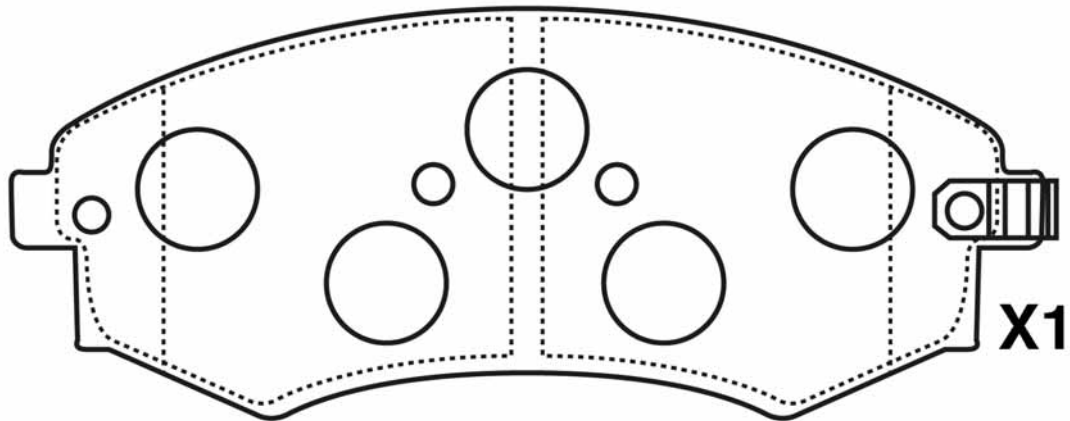



PICTURES BRAKE PADS FRONT
ABBILDUNGEN BREMSKLÖTZE VORN
FIGURAS PASTILLAS DE FRENO DELANTORES
ILLUSTRATIONS PLAQUETTES DE FREI AVANT
IMMAGINI PASTIGLIE FRENO ANTERIORI

50-K0-017				WVA
	KIA	L	H	Th
	129	52	17	

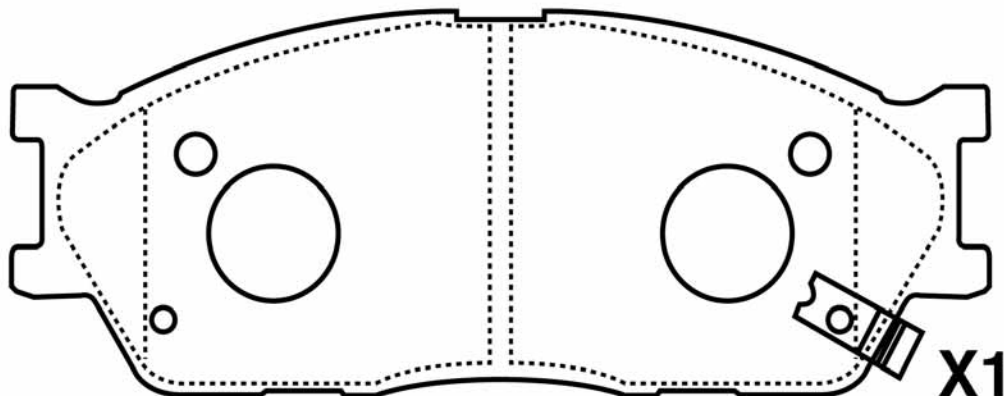
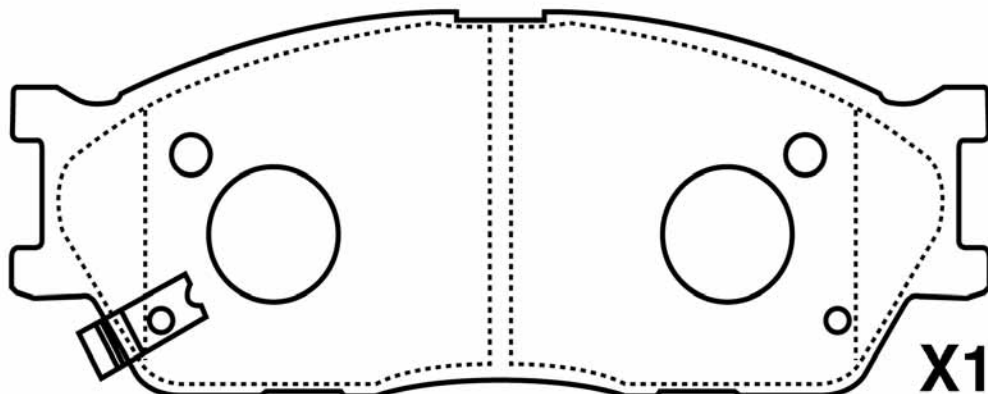
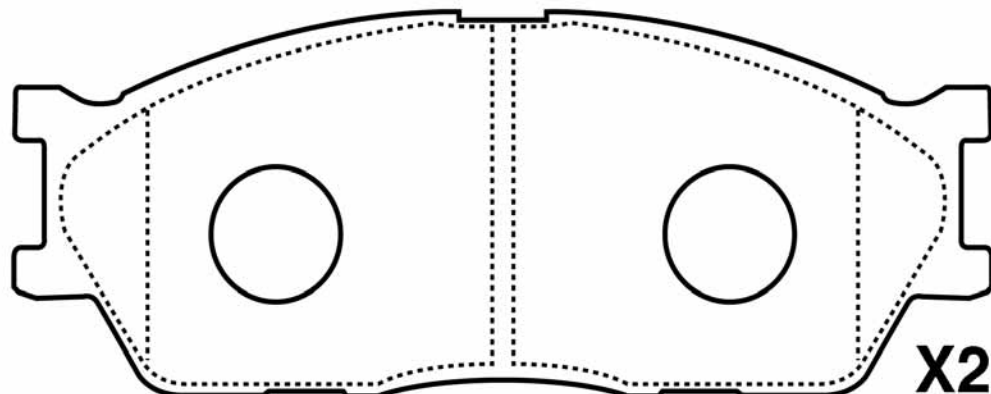



50-0K-018				WVA
	ASIA MOTORS - KIA	L	H	
	153,8	63,7	15,5	

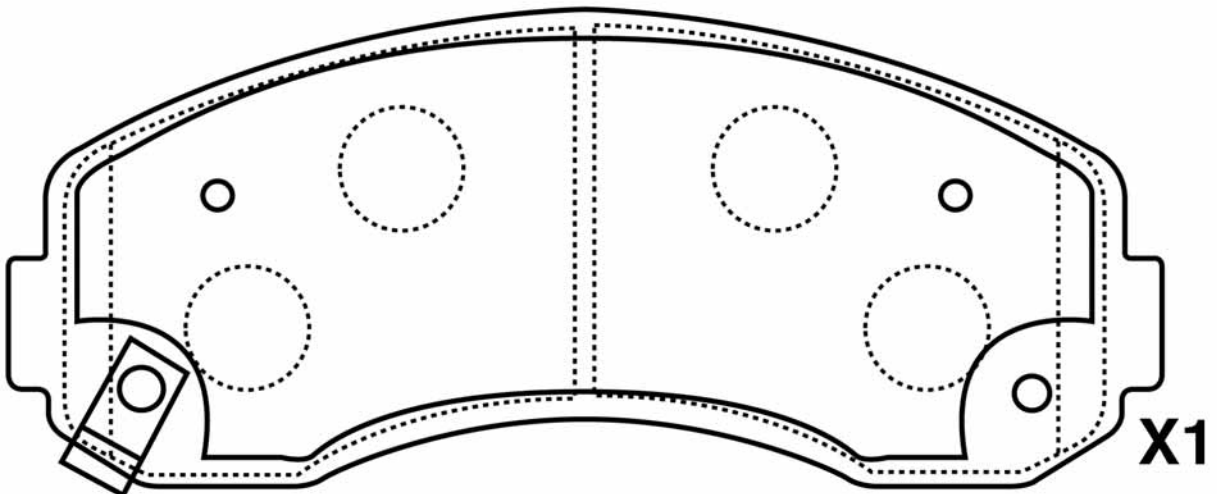
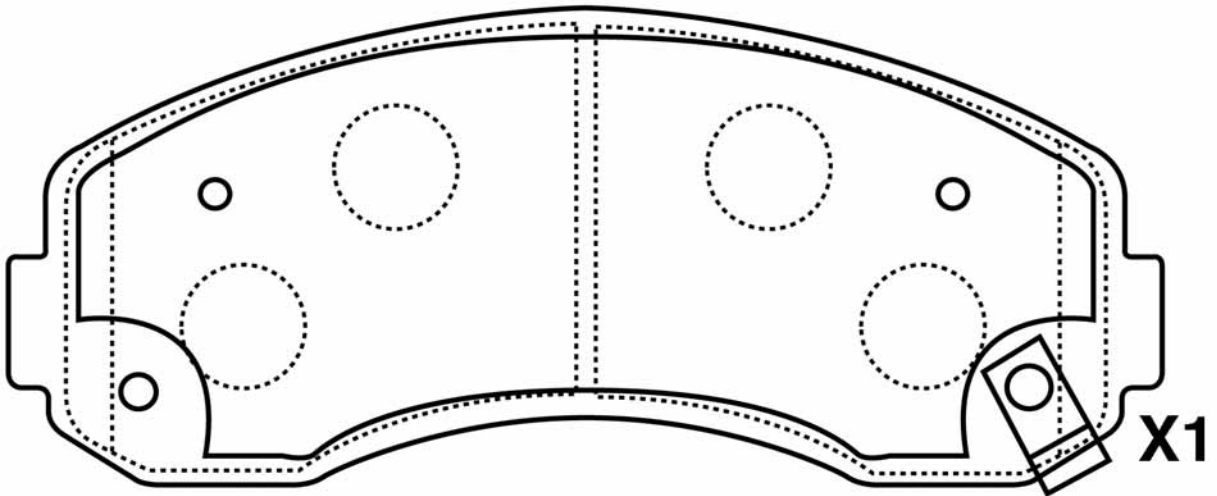
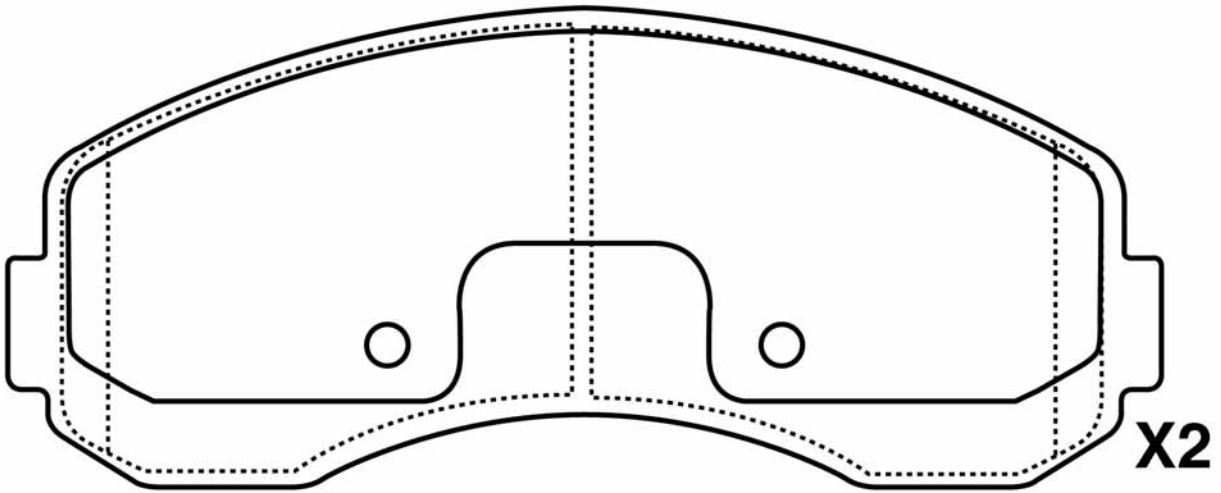



PICTURES BRAKE PADS FRONT
ABBILDUNGEN BREMSKLÖTZE VORN
FIGURAS PASTILLAS DE FRENO DELANTORES
ILLUSTRATIONS PLAQUETTES DE FREI AVANT
IMMAGINI PASTIGLIE FRENO ANTERIORI

50-0K-019

HYUNDAI - KIA

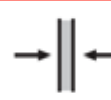

WVA

L

164,8

H

63,5

Th

17,5

24597

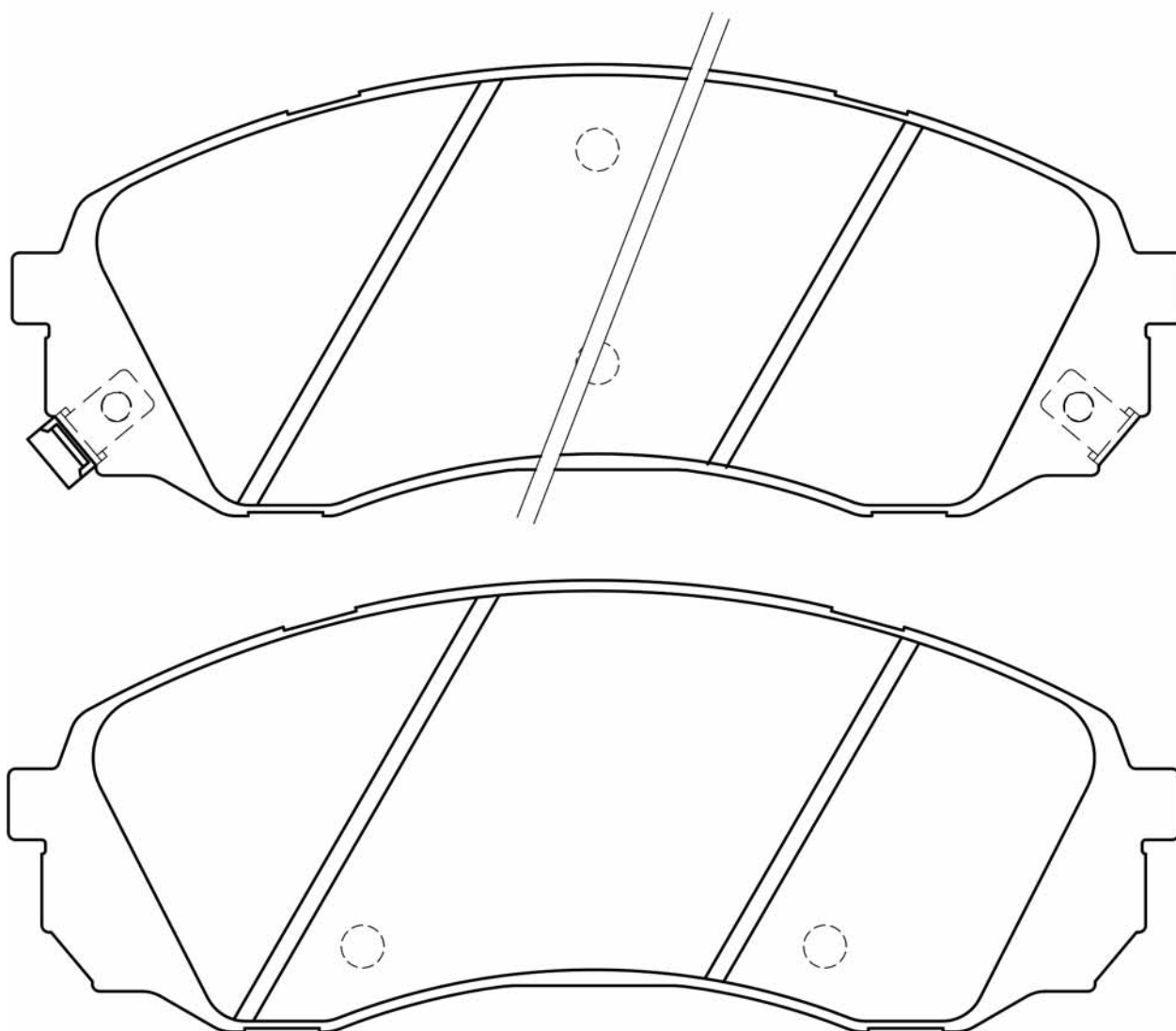



50-0K-K20				WVA
	L	H	Th	
KIA - HYUNDAI	137,8	60	16,8	24501

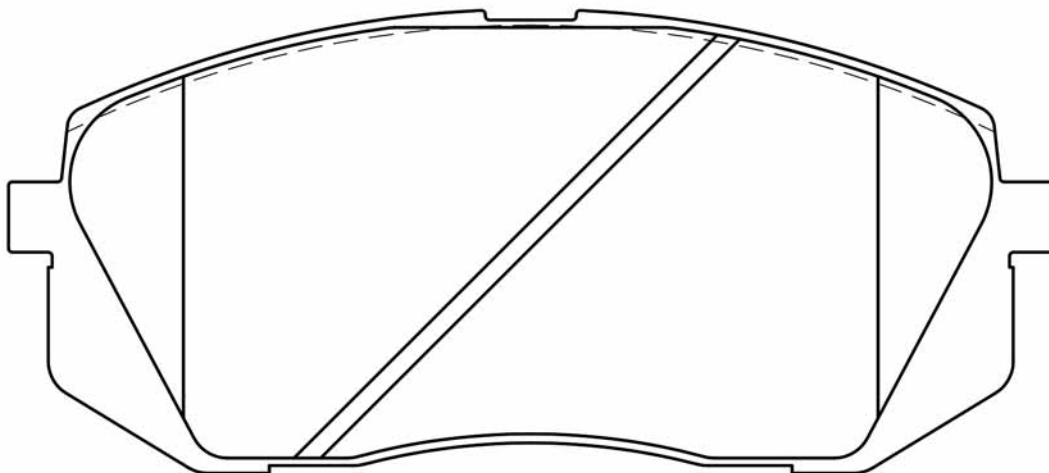
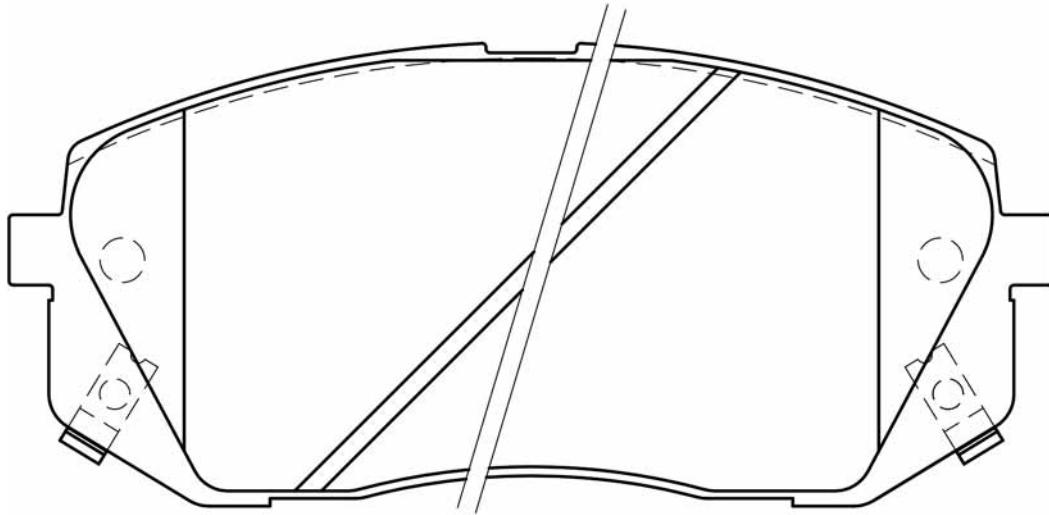



PICTURES BRAKE PADS FRONT
ABBILDUNGEN BREMSKLÖTZE VORN
FIGURAS PASTILLAS DE FRENO DELANTORES
ILLUSTRATIONS PLAQUETTES DE FREI AVANT
IMMAGINI PASTIGLIE FRENO ANTERIORI

50-0K-K22				WVA
KIA	L	H	Th	
	132	61	19	25184

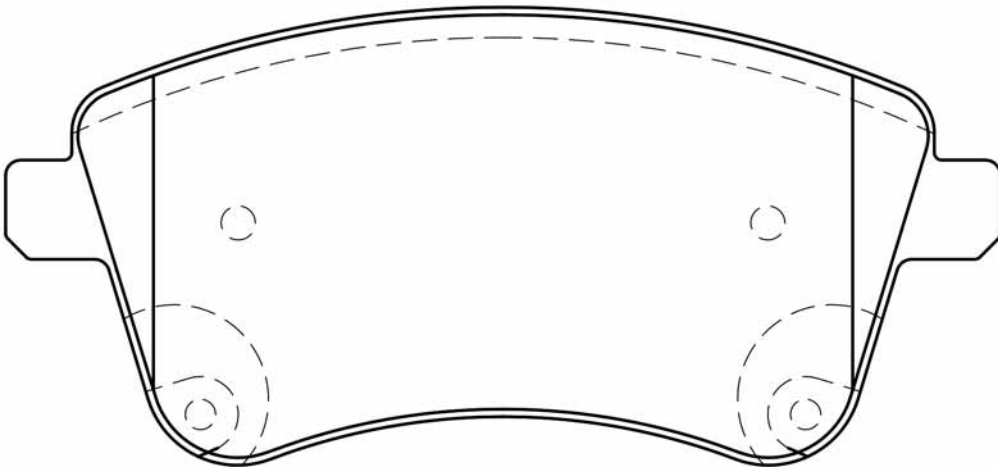
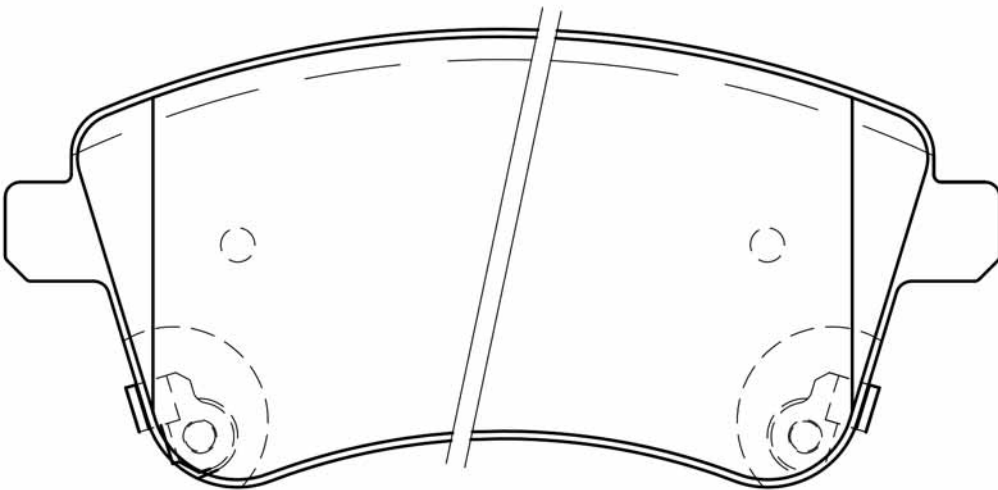



50-0K-K23				WVA
	KIA	L	H	
	110	47	17	

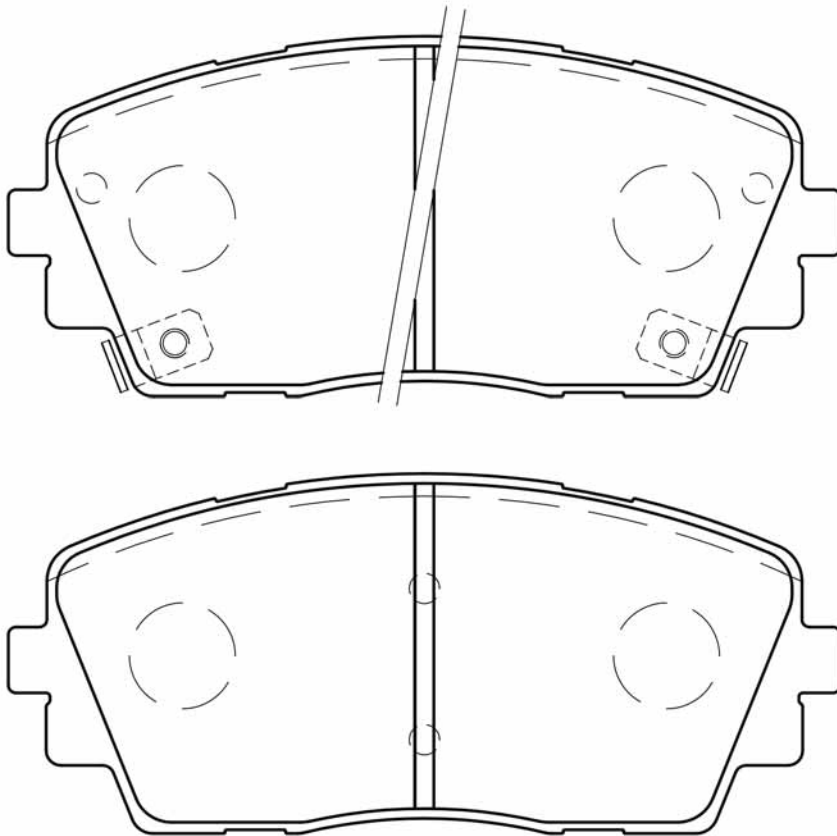



PICTURES BRAKE PADS FRONT
ABBILDUNGEN BREMSKLÖTZE VORN
FIGURAS PASTILLAS DE FRENO DELANTORES
ILLUSTRATIONS PLAQUETTES DE FREI AVANT
IMMAGINI PASTIGLIE FRENO ANTERIORI

50-0K-K24				WVA
KIA	L	H	Th	
	133	58	18	

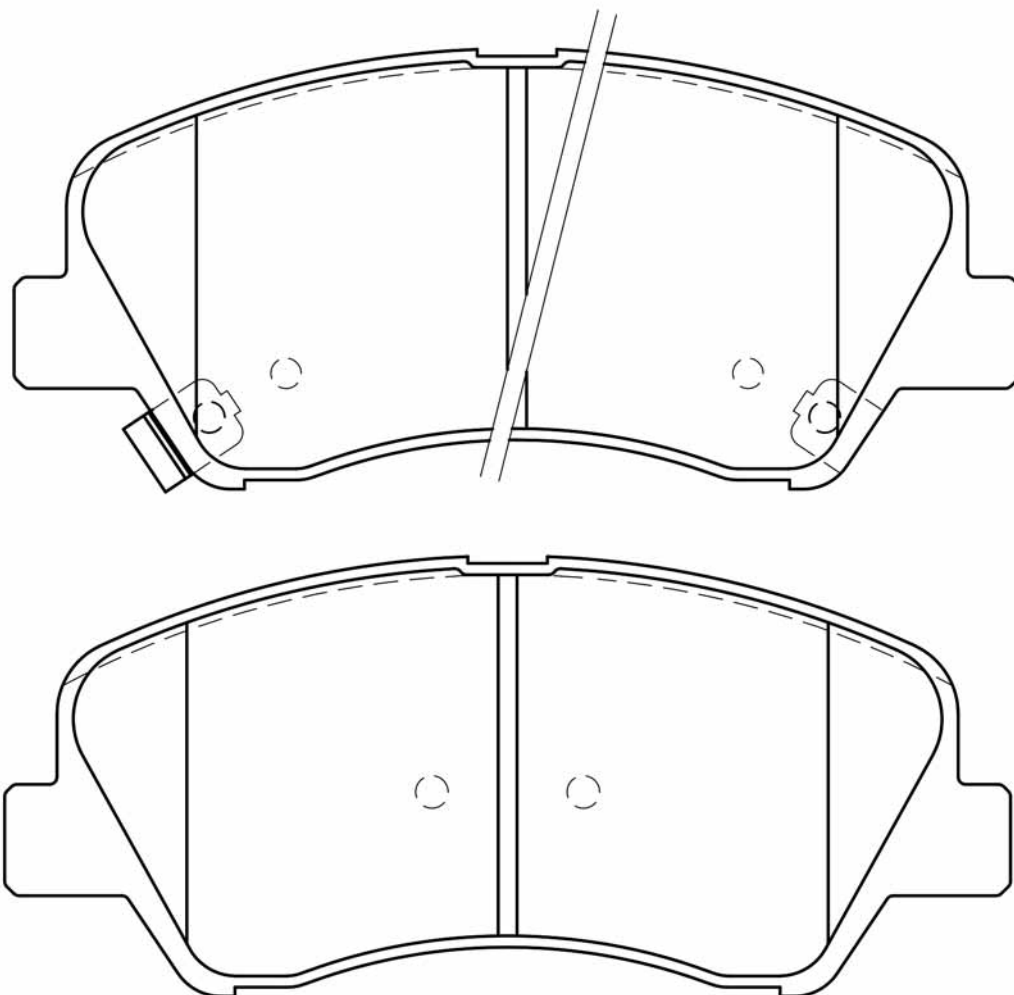



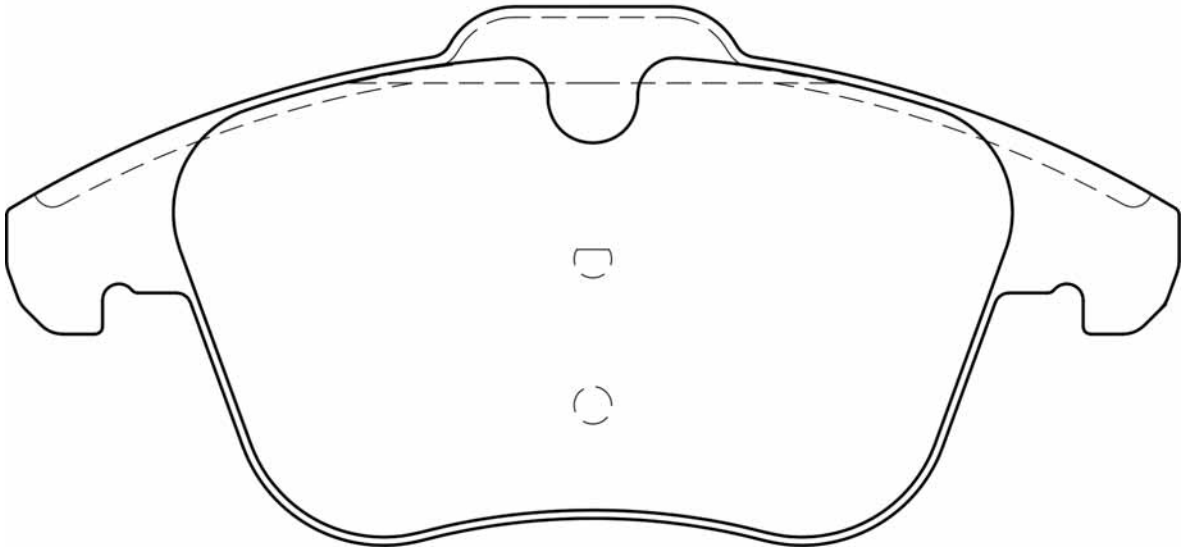
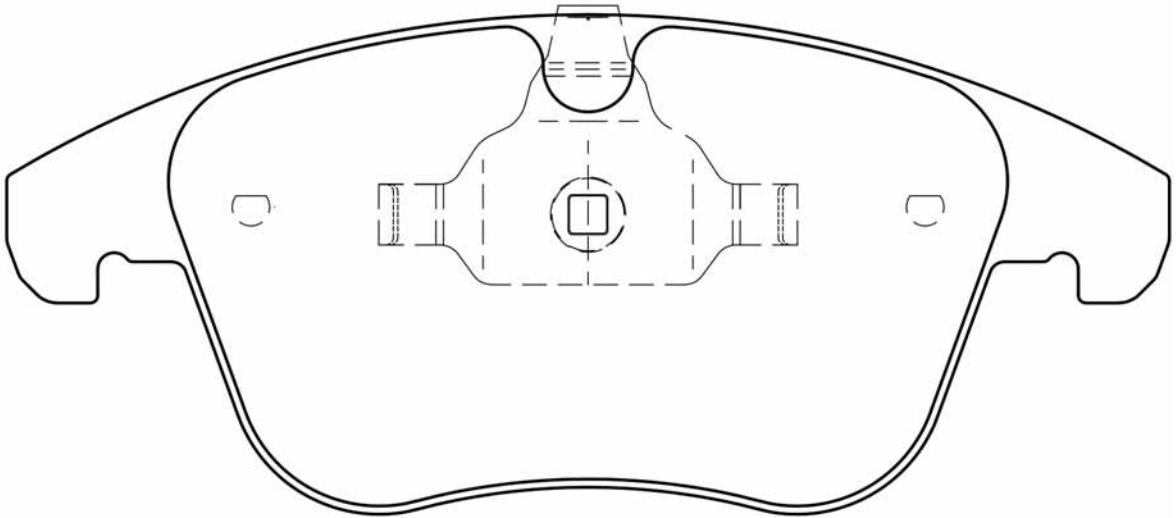

50-0L-L00				WVA
	LAND ROVER	L	H	
	155/156,5	72/66,5	20	24123



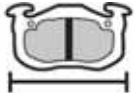

PICTURES BRAKE PADS FRONT
ABBILDUNGEN BREMSKLÖTZE VORN
FIGURAS PASTILLAS DE FRENO DELANTORES
ILLUSTRATIONS PLAQUETTES DE FREI AVANT
IMMAGINI PASTIGLIE FRENO ANTERIORI

50-0L-L01				WVA
LAND ROVER	L	H	Th	
	163	58	18	24191

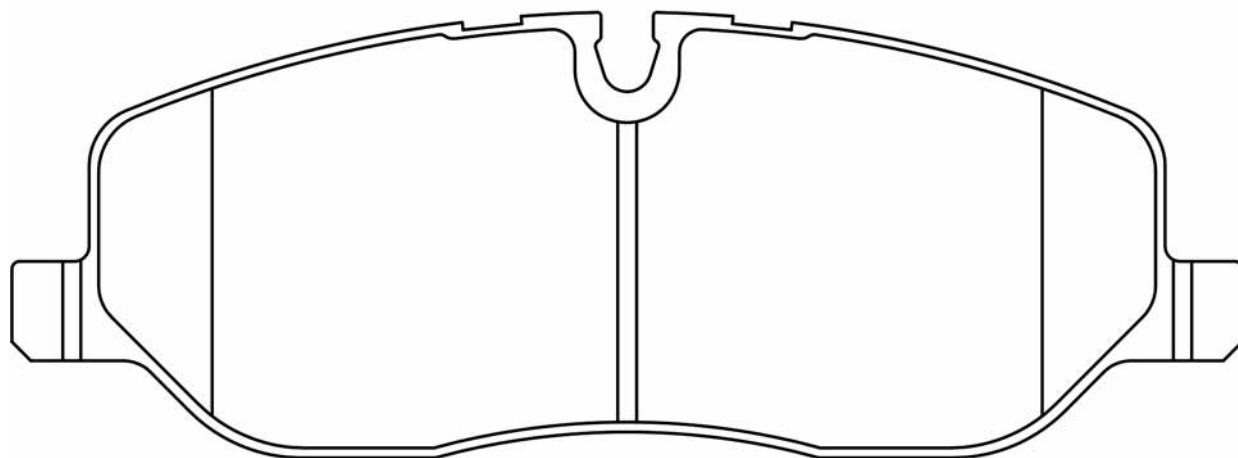



50-0L-L02				WVA
	LAND ROVER	L	H	
	126,5	69	18	21519

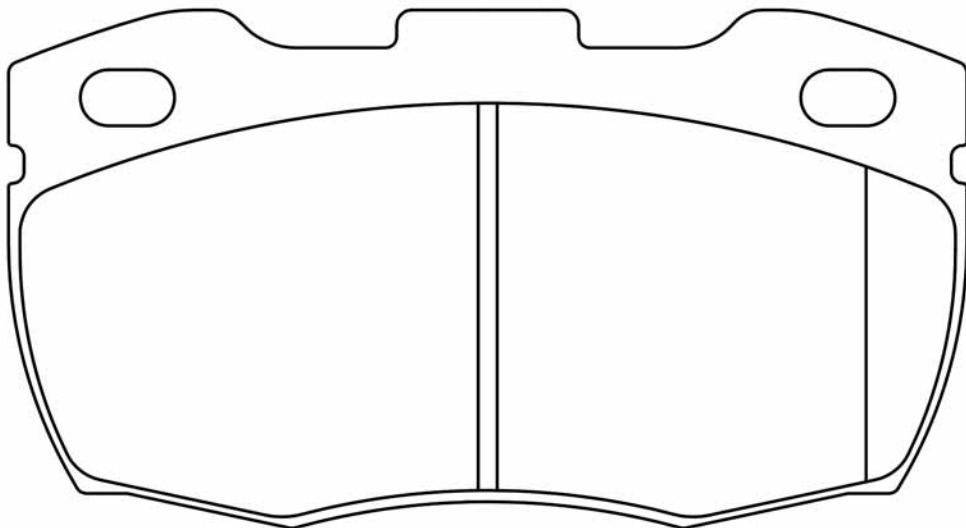
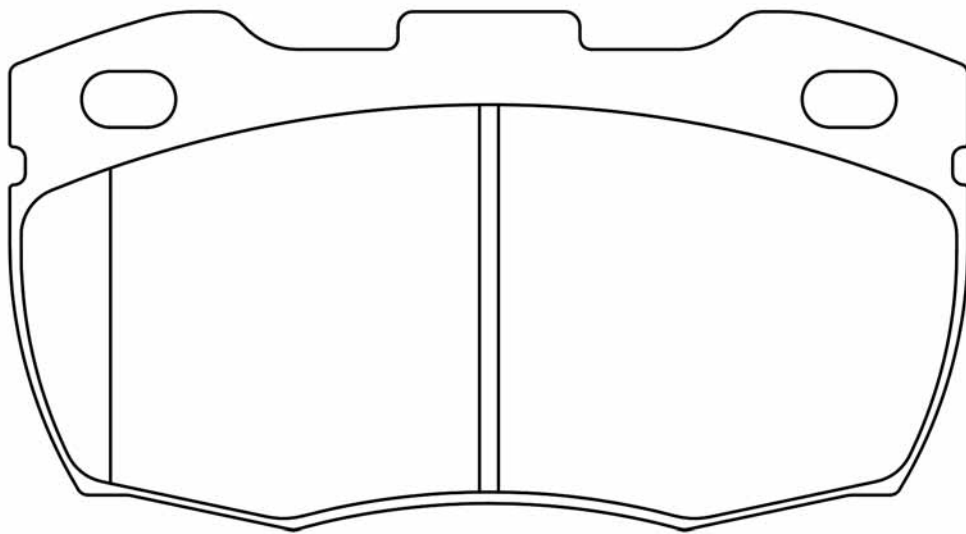



PICTURES BRAKE PADS FRONT
ABBILDUNGEN BREMSKLÖTZE VORN
FIGURAS PASTILLAS DE FRENO DELANTORES
ILLUSTRATIONS PLAQUETTES DE FREI AVANT
IMMAGINI PASTIGLIE FRENO ANTERIORI

50-0L-L03				WVA
LAND ROVER	L	H	Th	
	131,5	62	18,3	23615

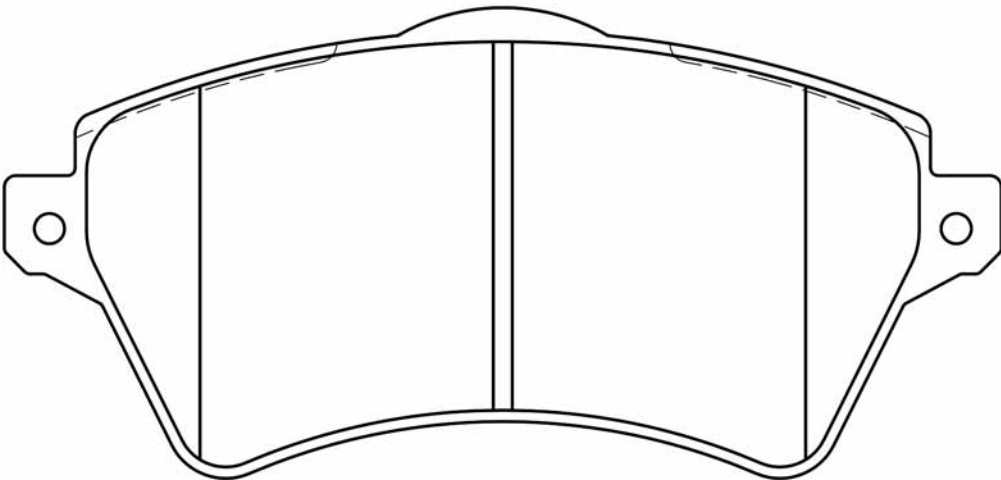



50-0L-L04				WVA
	LAND ROVER	L	H	
	105	75	19	21160

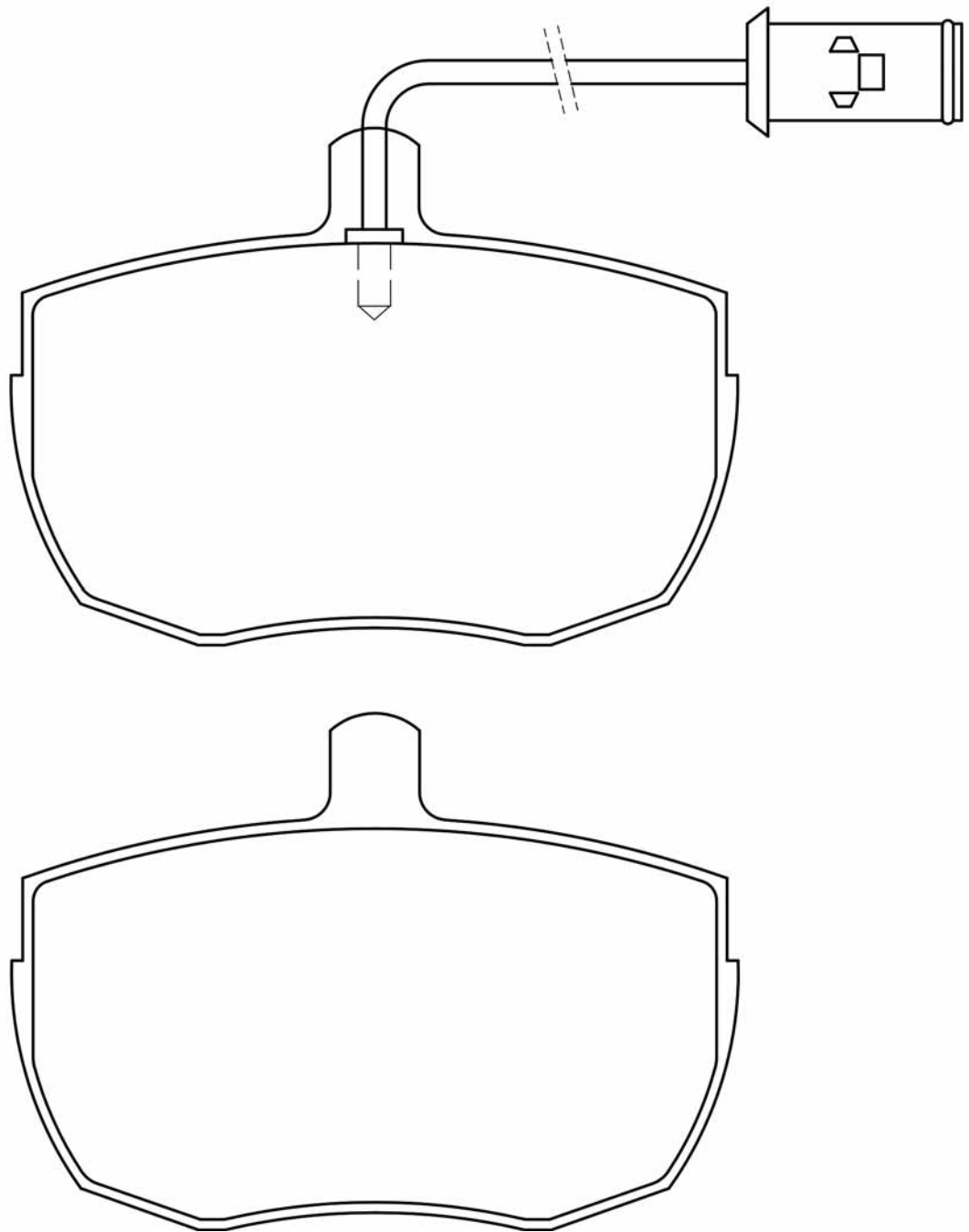



PICTURES BRAKE PADS FRONT
ABBILDUNGEN BREMSKLÖTZE VORN
FIGURAS PASTILLAS DE FRENO DELANTORES
ILLUSTRATIONS PLAQUETTES DE FREI AVANT
IMMAGINI PASTIGLIE FRENO ANTERIORI

50-0L-L05 LAND ROVER				WVA
	L	H	Th	
	156,5	73,5	19	23397

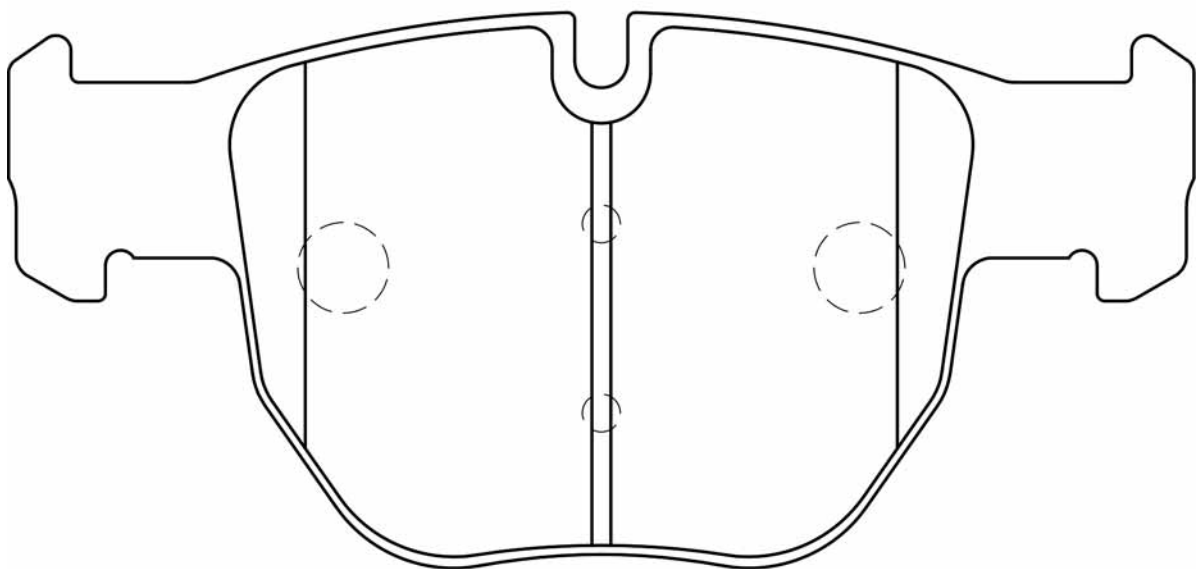
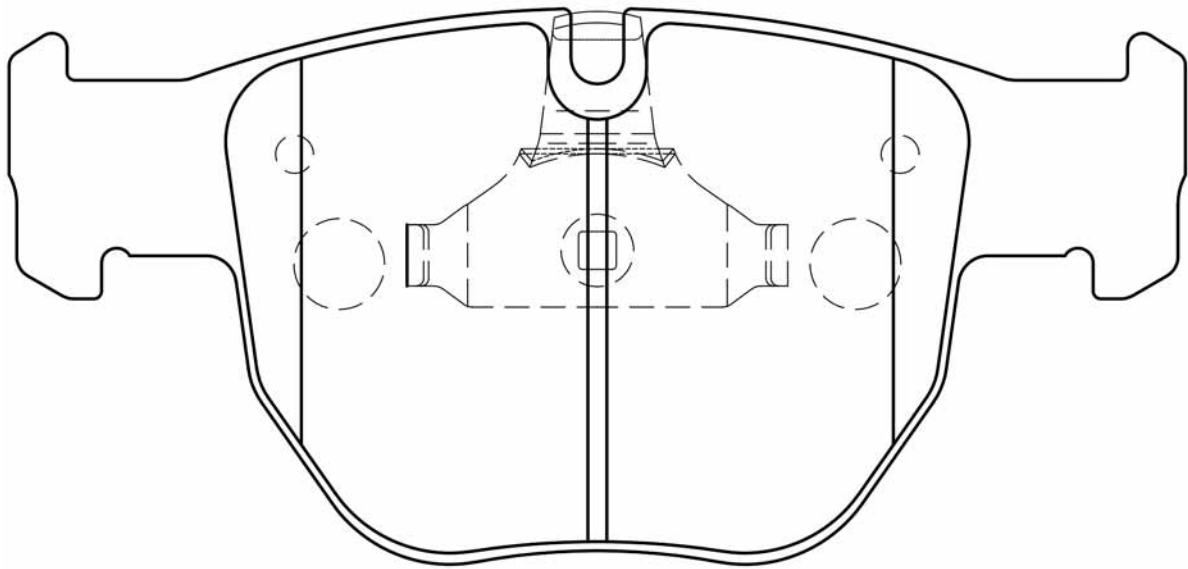



50-0L-L06

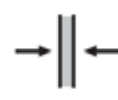
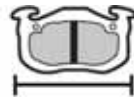

WVA

LAND ROVER

L

H

Th

132

77,5

17,5

20217

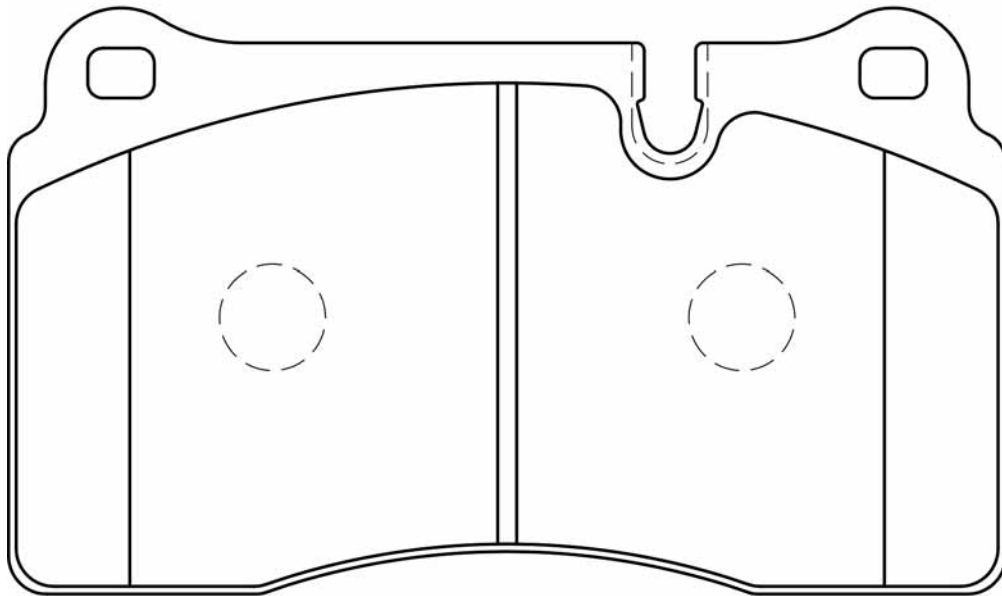



PICTURES BRAKE PADS FRONT
ABBILDUNGEN BREMSKLÖTZE VORN
FIGURAS PASTILLAS DE FRENO DELANTORES
ILLUSTRATIONS PLAQUETTES DE FREI AVANT
IMMAGINI PASTIGLIE FRENO ANTERIORI

50-0L-L07

LAND ROVER

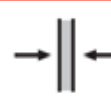
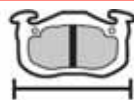

WVA

L

192,5

H

72

Th

17,8

25021

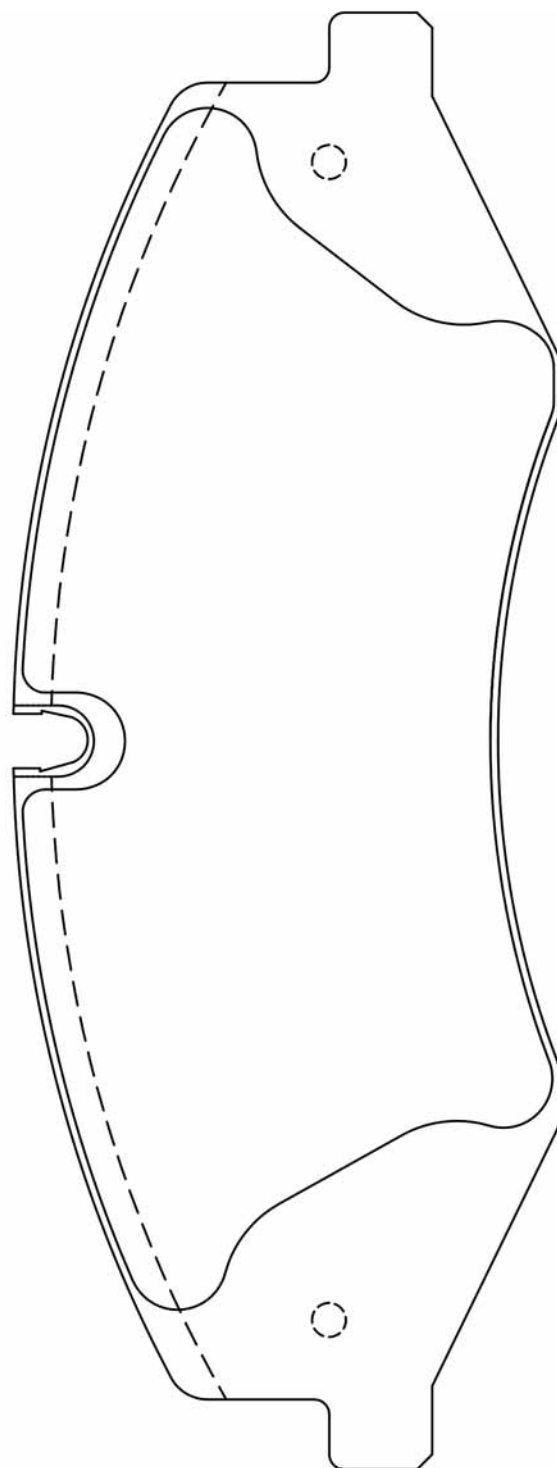
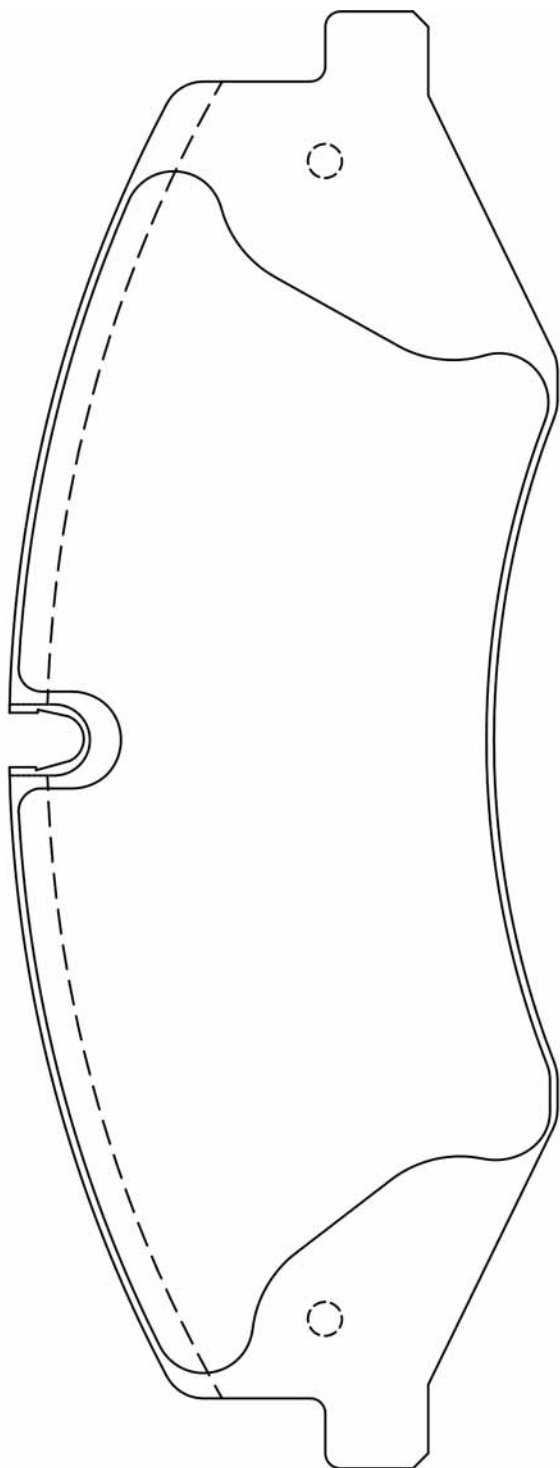



50-0L-L08

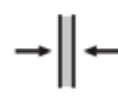
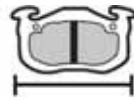

WVA

LAND ROVER

L

H

Th

190

95,5

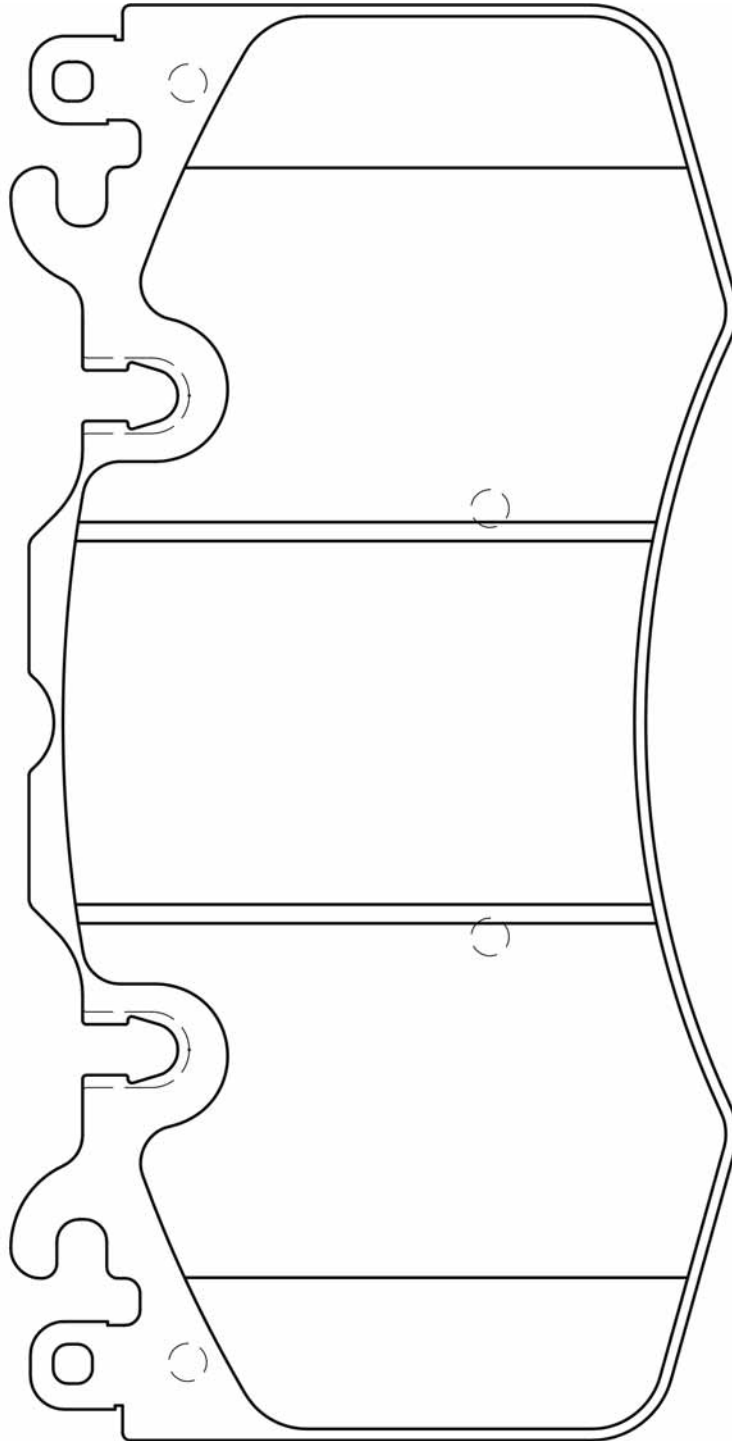

17,5

24659



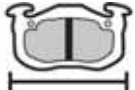

PICTURES BRAKE PADS FRONT
ABBILDUNGEN BREMSKLÖTZE VORN
FIGURAS PASTILLAS DE FRENO DELANTORES
ILLUSTRATIONS PLAQUETTES DE FREI AVANT
IMMAGINI PASTIGLIE FRENO ANTERIORI

50-0M-000				WVA
SMART	L	H	Th	
	90,2	70	14,9	21999

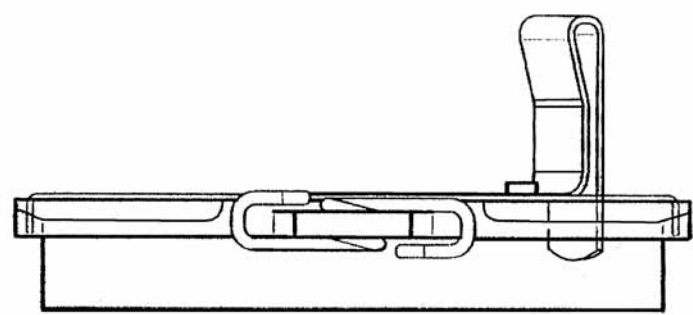
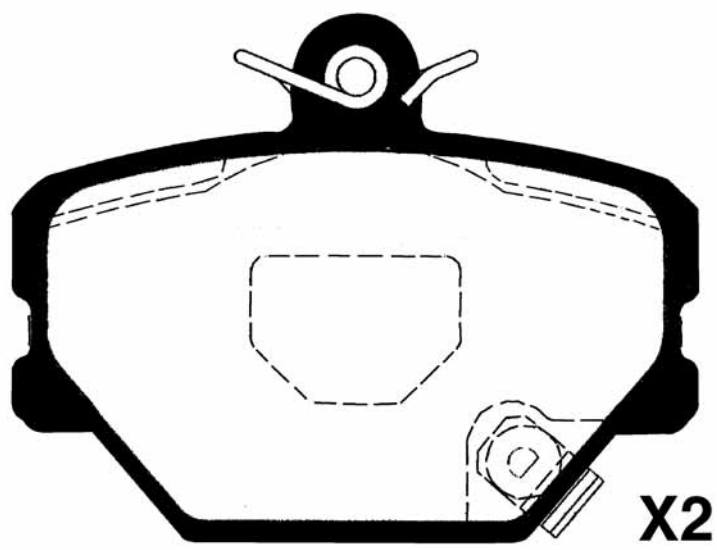
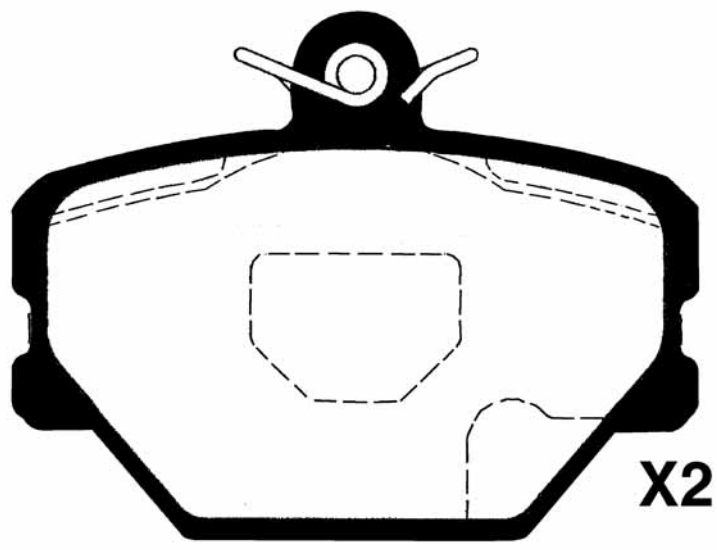



50-0S-S01				WVA
	SSANGYONG - HYUNDAI	L	H	
	149	60,9	17	23726

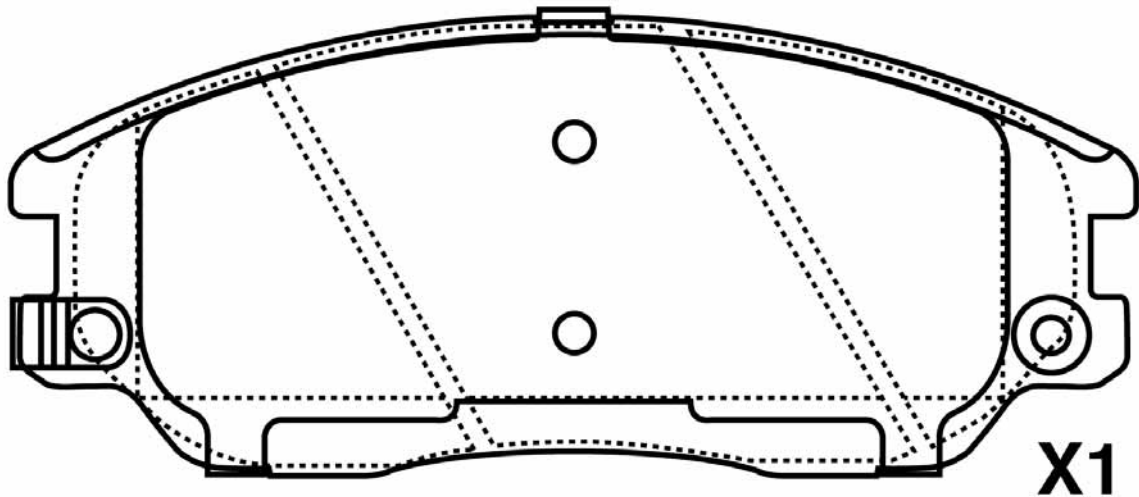
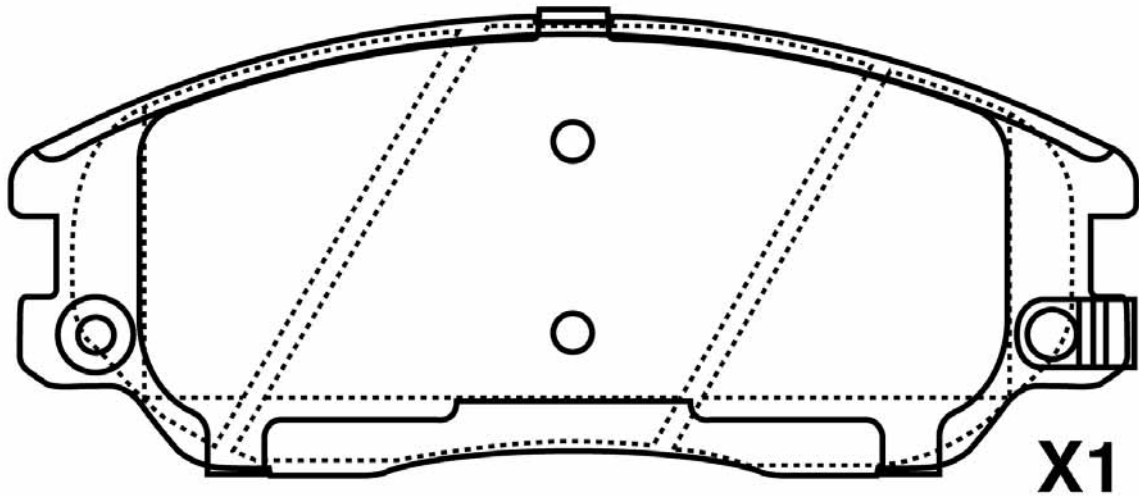
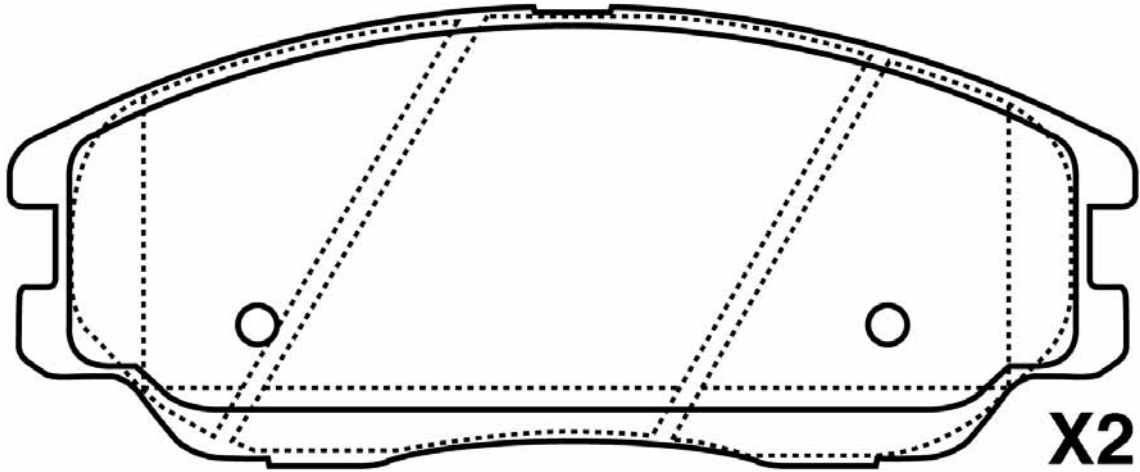



PICTURES BRAKE PADS FRONT
ABBILDUNGEN BREMSKLÖTZE VORN
FIGURAS PASTILLAS DE FRENO DELANTORES
ILLUSTRATIONS PLAQUETTES DE FREI AVANT
IMMAGINI PASTIGLIE FRENO ANTERIORI

50-0S-S02 SSANGYONG - HYUNDAI - DAEWOO				WVA
	L 137,3	H 54,5	Th 16	

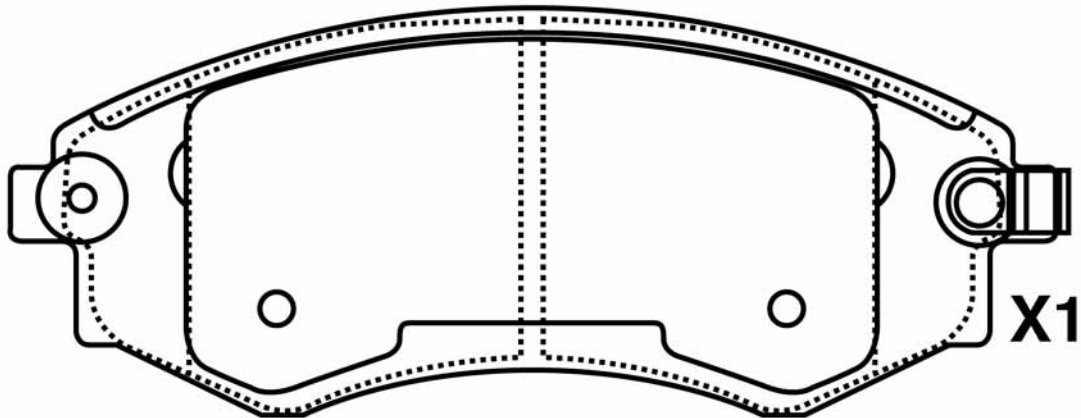
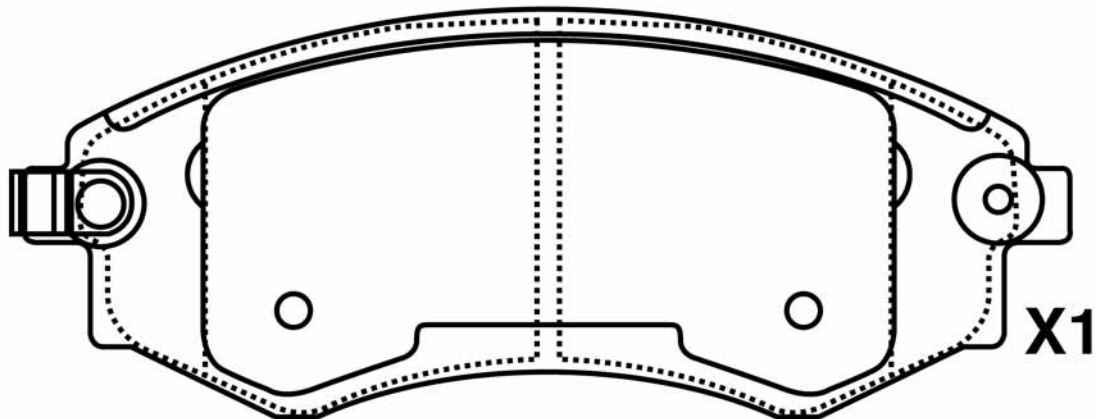
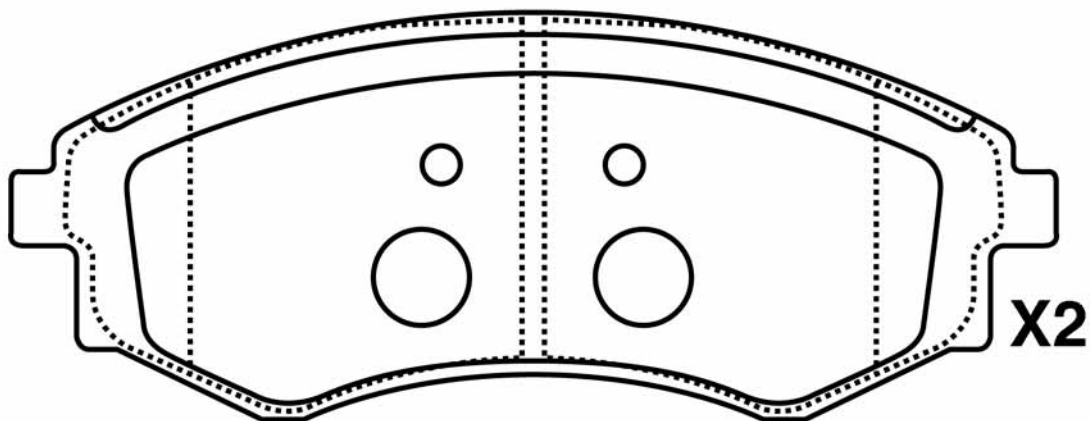



50-W0-000				WVA
DAEWOO	L	H	Th	
	108,5	39	13,3	23061

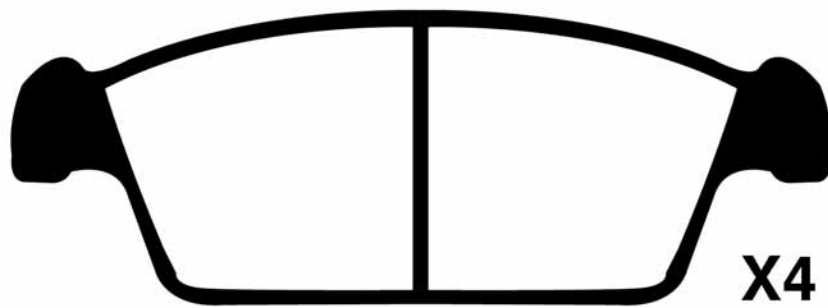



PICTURES BRAKE PADS FRONT
ABBILDUNGEN BREMSKLÖTZE VORN
FIGURAS PASTILLAS DE FRENO DELANTORES
ILLUSTRATIONS PLAQUETTES DE FREI AVANT
IMMAGINI PASTIGLIE FRENO ANTERIORI

50-W0-002				WVA
DAEWOO	L	H	Th	
	100,2	59	15,9	

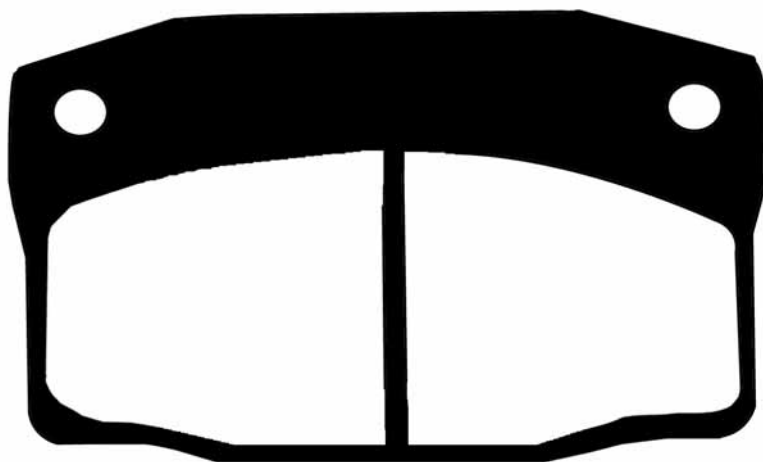

X4



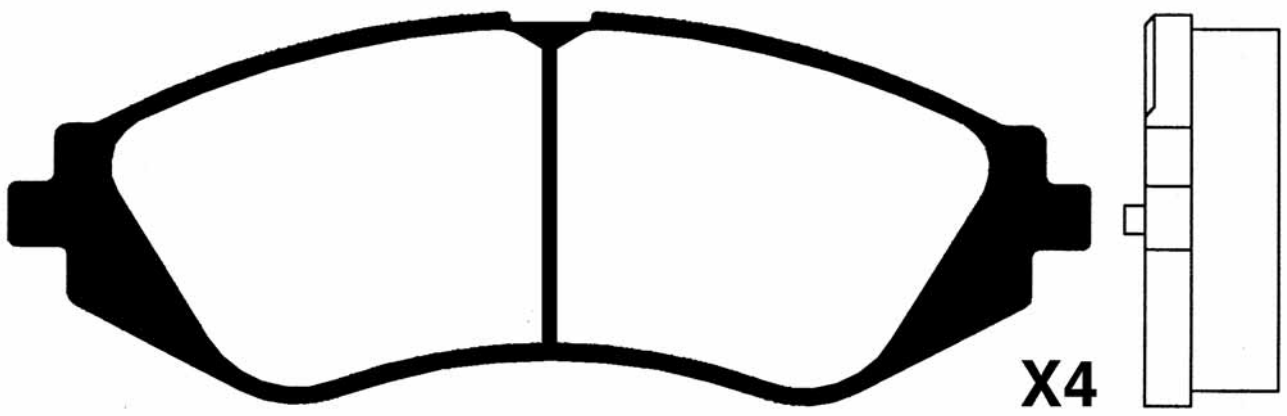

50-W0-003				WVA
	CHEVROLET - DAEWOO	L 142,6	H 50,8	
				23235





PICTURES BRAKE PADS FRONT
ABBILDUNGEN BREMSKLÖTZE VORN
FIGURAS PASTILLAS DE FRENO DELANTORES
ILLUSTRATIONS PLAQUETTES DE FREI AVANT
IMMAGINI PASTIGLIE FRENO ANTERIORI

50-W0-004				WVA
DAEWOO - CHEVROLET	L	H	Th	
	126,8	48	15,9	23241

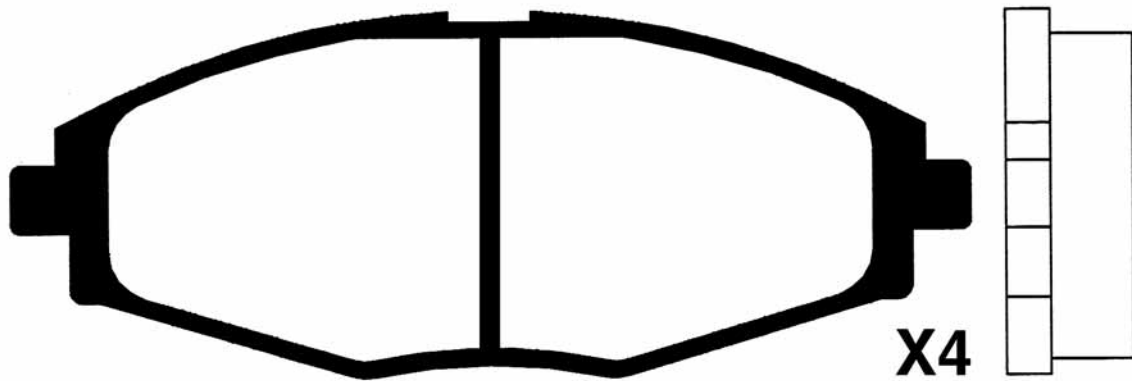



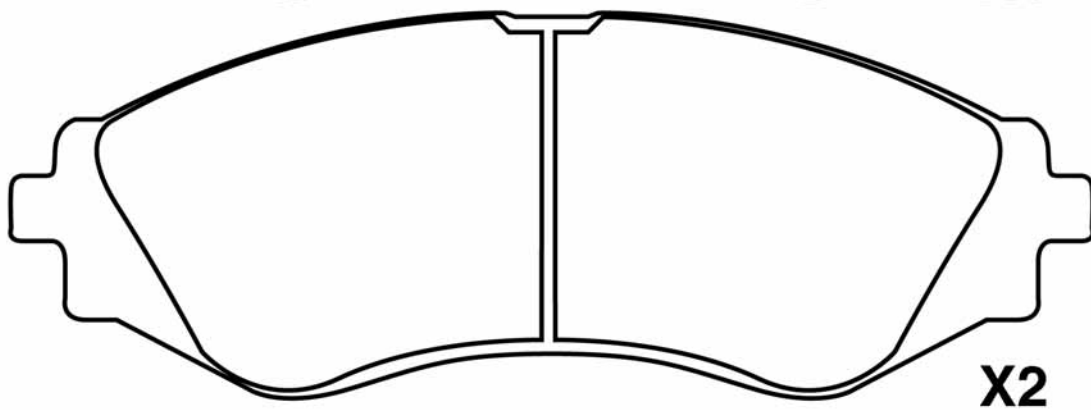
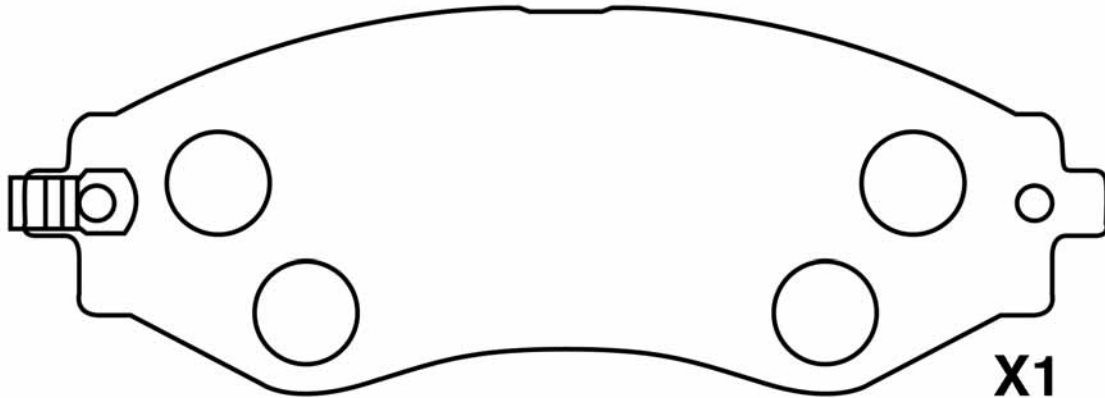
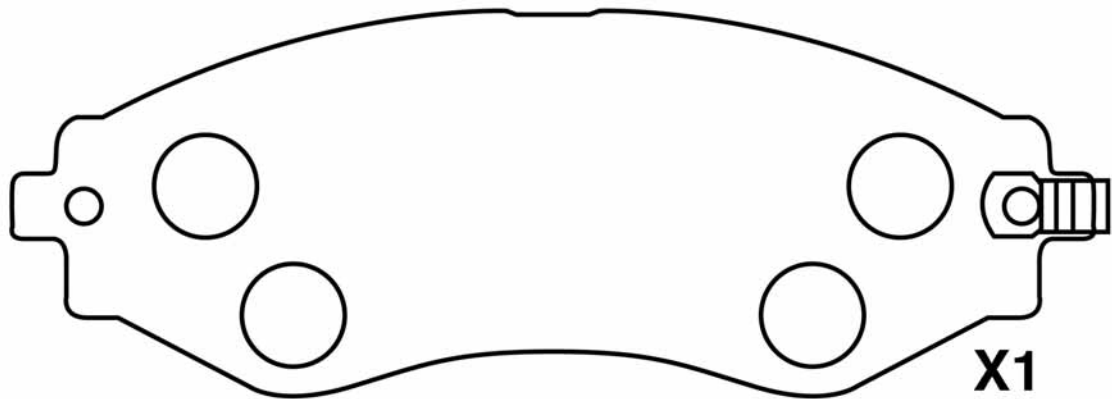

50-W0-005				WVA
	CHEVROLET - DAEWOO	L 143,2	H 51,5	



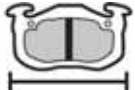

PICTURES BRAKE PADS FRONT
ABBILDUNGEN BREMSKLÖTZE VORN
FIGURAS PASTILLAS DE FRENO DELANTORES
ILLUSTRATIONS PLAQUETTES DE FREI AVANT
IMMAGINI PASTIGLIE FRENO ANTERIORI

50-W0-006				WVA
DAEWOO	L	H	Th	
	89,7	63,3	16,4	

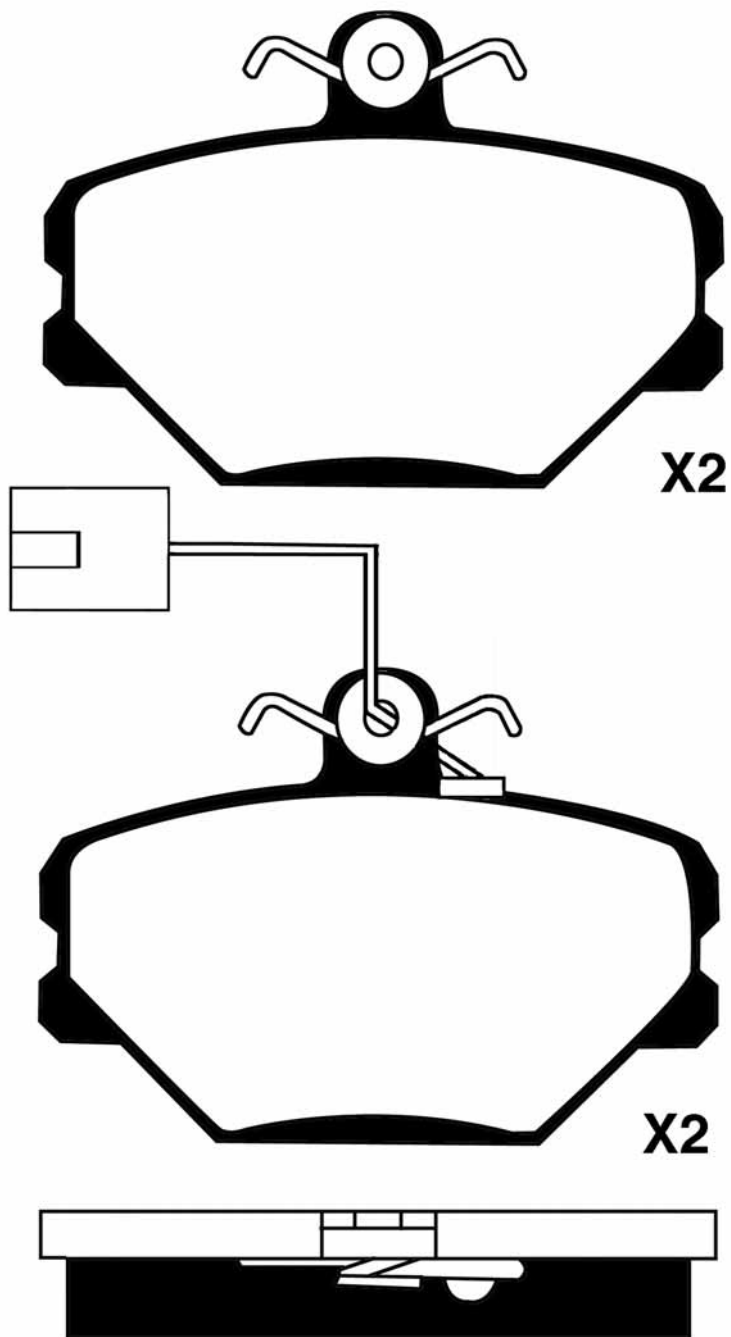



50-W0-007				WVA
	CHEVROLET - DAEWOO	L	H	Th
	132,9	49	16,9	23974

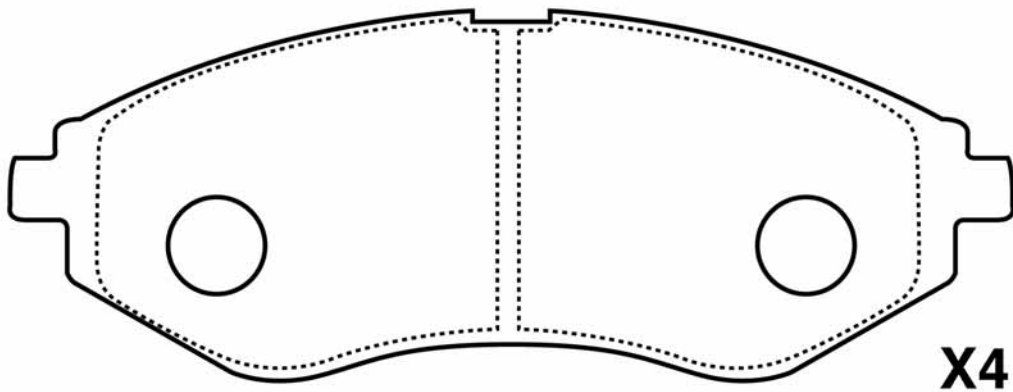



PICTURES BRAKE PADS FRONT
ABBILDUNGEN BREMSKLÖTZE VORN
FIGURAS PASTILLAS DE FRENO DELANTORES
ILLUSTRATIONS PLAQUETTES DE FREI AVANT
IMMAGINI PASTIGLIE FRENO ANTERIORI

50-0W-008				WVA
DAEWOO	L	H	Th	
	130	55,8	18,2	21388

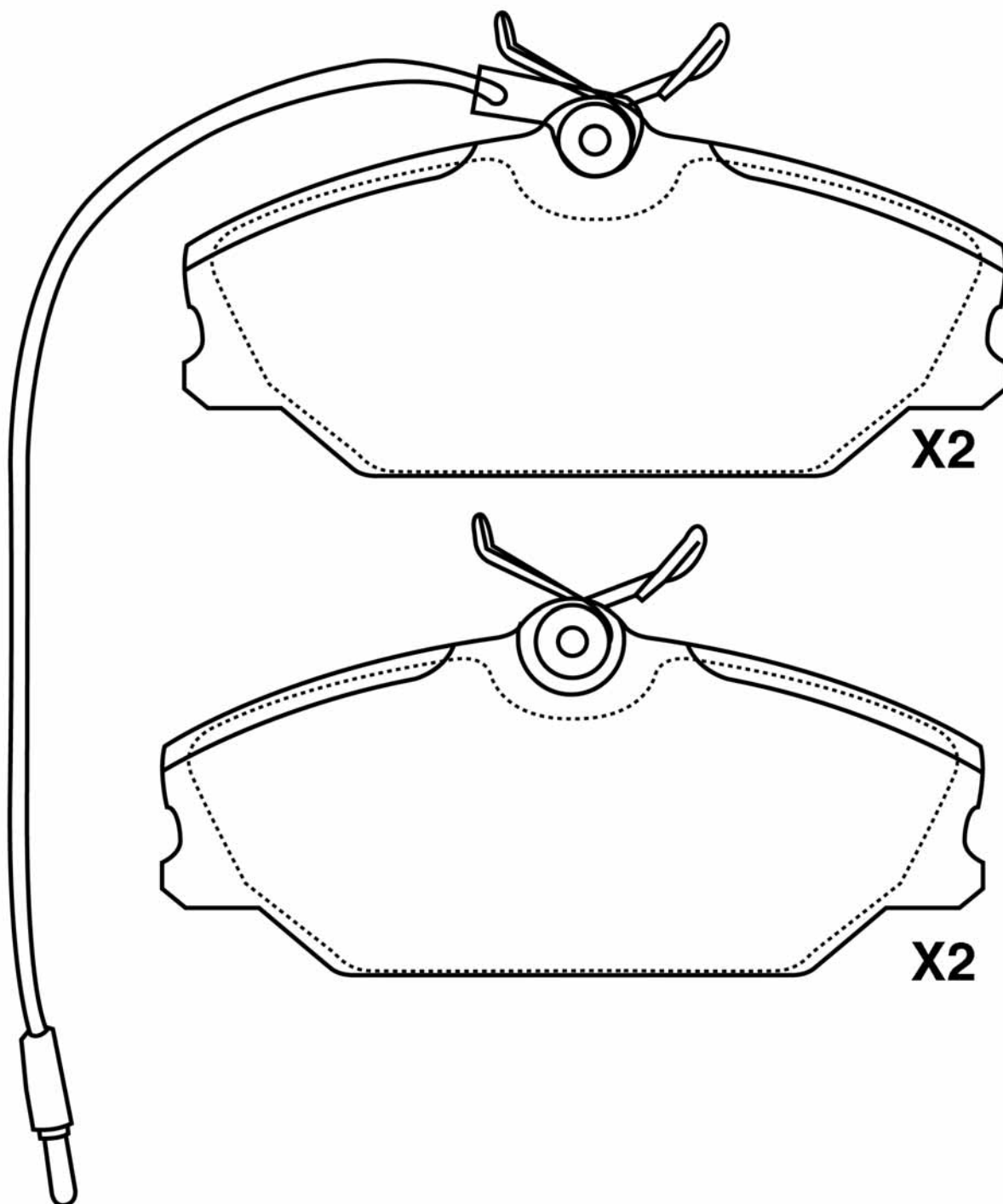



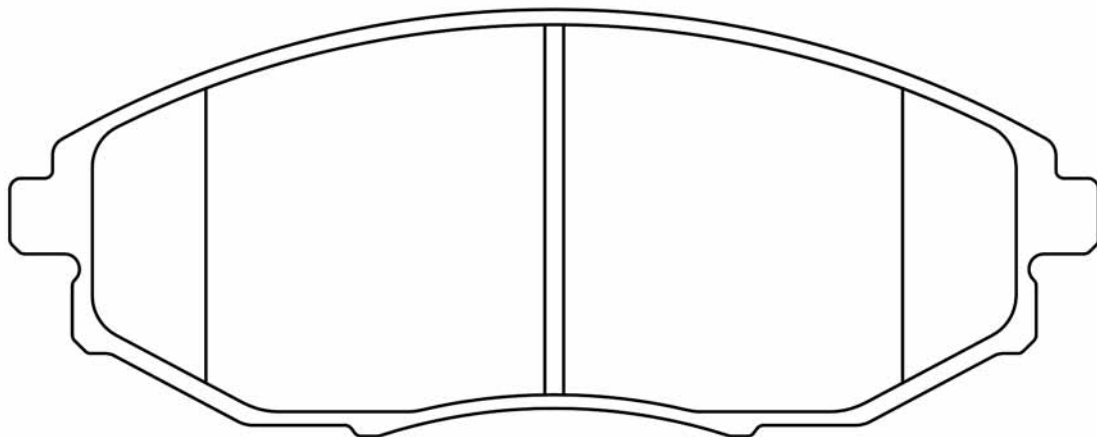
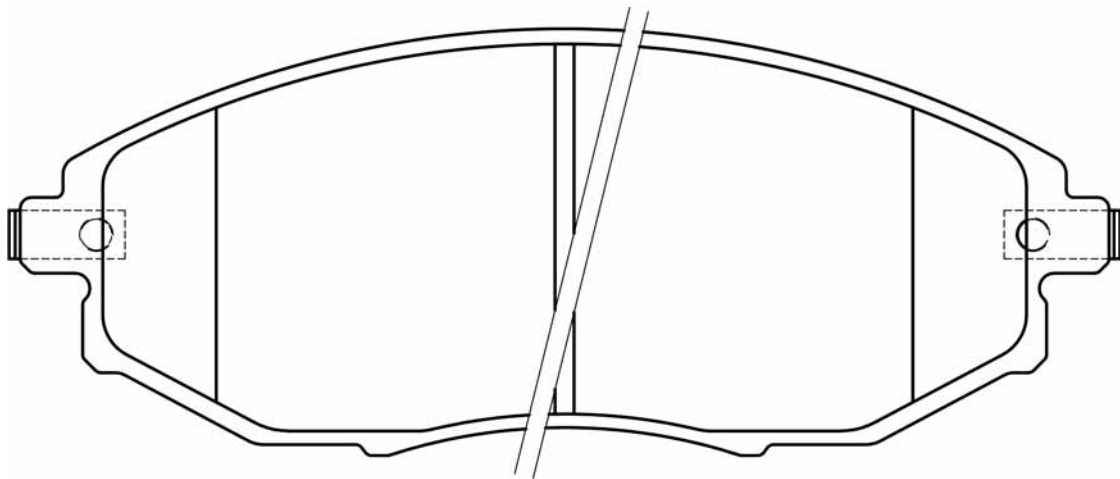

50-0W-W09				WVA
	CHEVROLET	L 144	H 56	
				24864



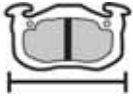

PICTURES BRAKE PADS FRONT
ABBILDUNGEN BREMSKLÖTZE VORN
FIGURAS PASTILLAS DE FRENO DELANTORES
ILLUSTRATIONS PLAQUETTES DE FREI AVANT
IMMAGINI PASTIGLIE FRENO ANTERIORI

50-0W-W10				WVA
CHEVROLET	L	H	Th	
	148,5	62	17	24510

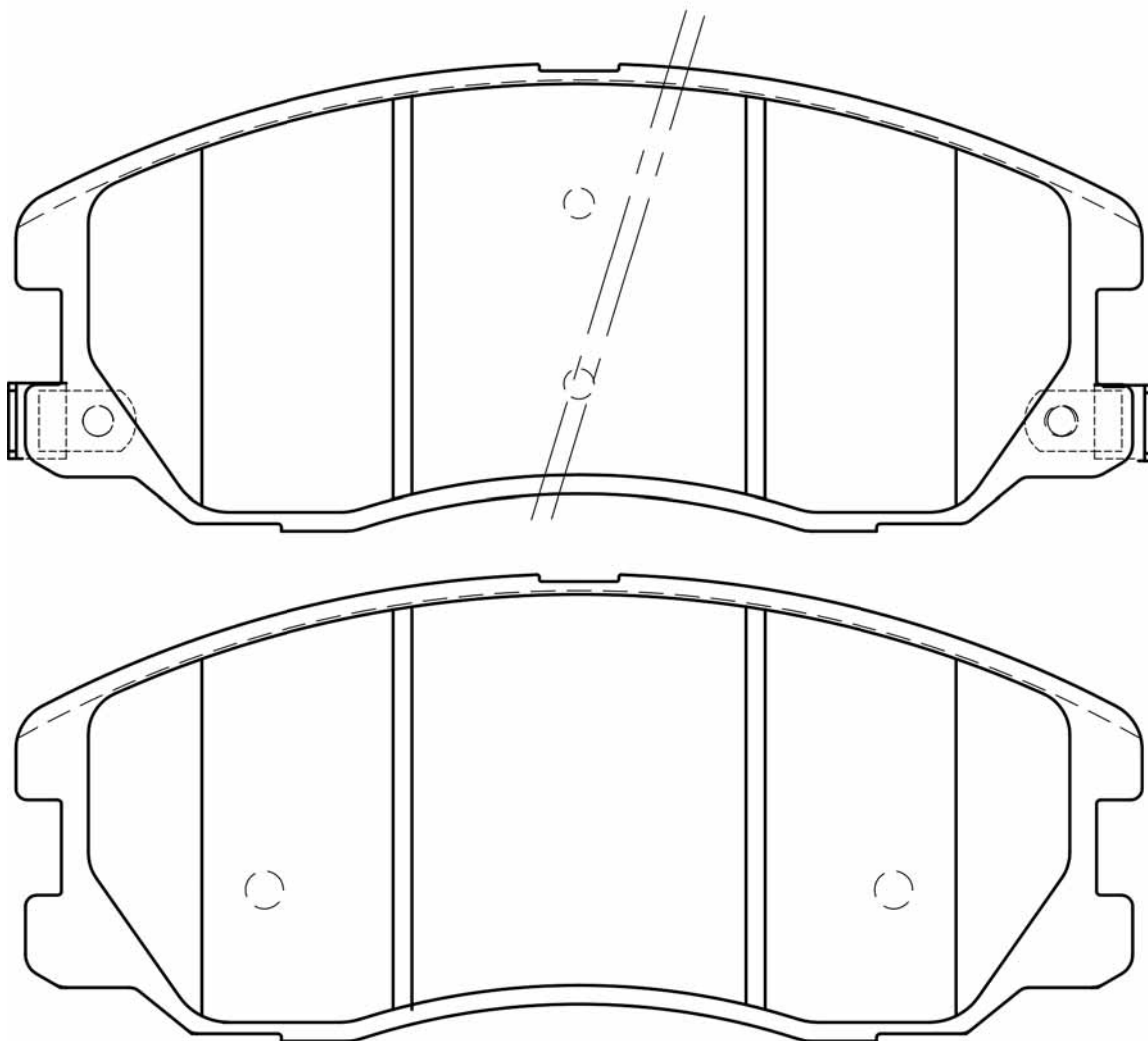



50-0W-W12				WVA
	OPEL - CHEVROLET	L	H	
	148	61	19	25031

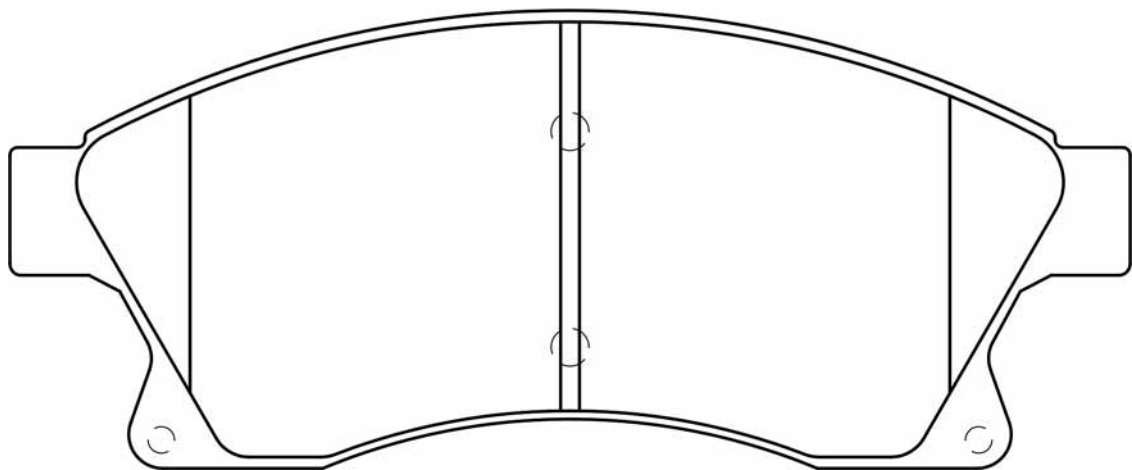
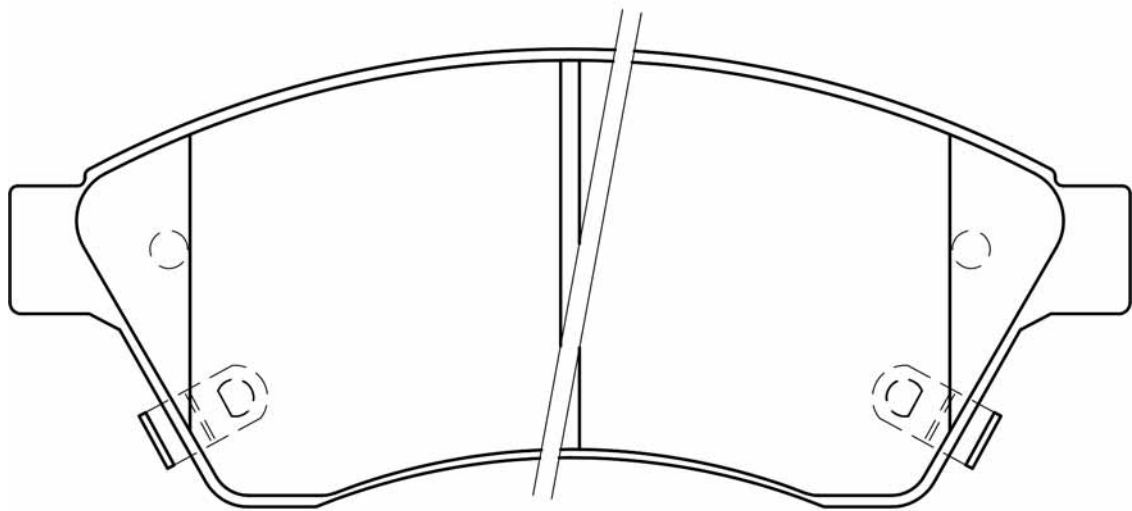



PICTURES BRAKE PADS FRONT
ABBILDUNGEN BREMSKLÖTZE VORN
FIGURAS PASTILLAS DE FRENO DELANTORES
ILLUSTRATIONS PLAQUETTES DE FREI AVANT
IMMAGINI PASTIGLIE FRENO ANTERIORI

50-0W-W13

OPEL - CHEVROLET

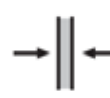

WVA

L

H

Th

148

62

19

25034

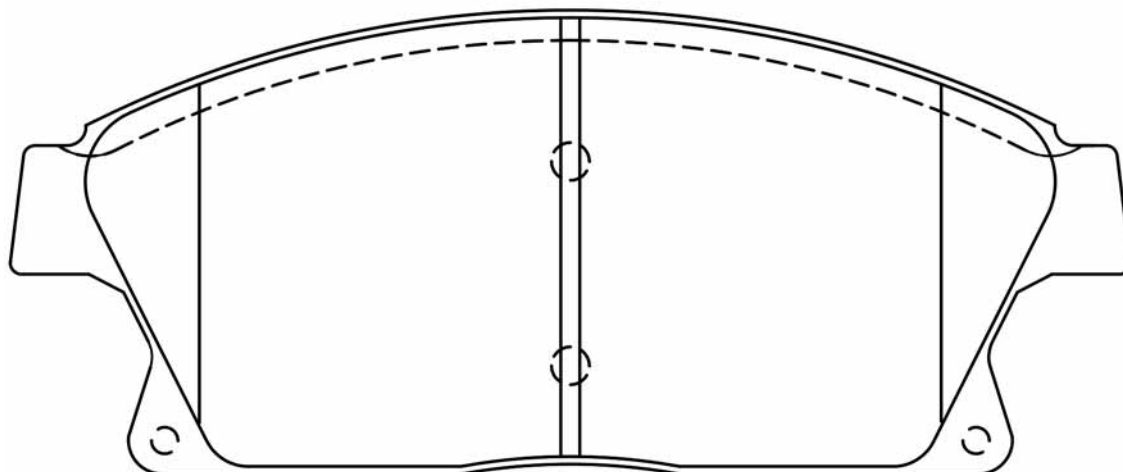
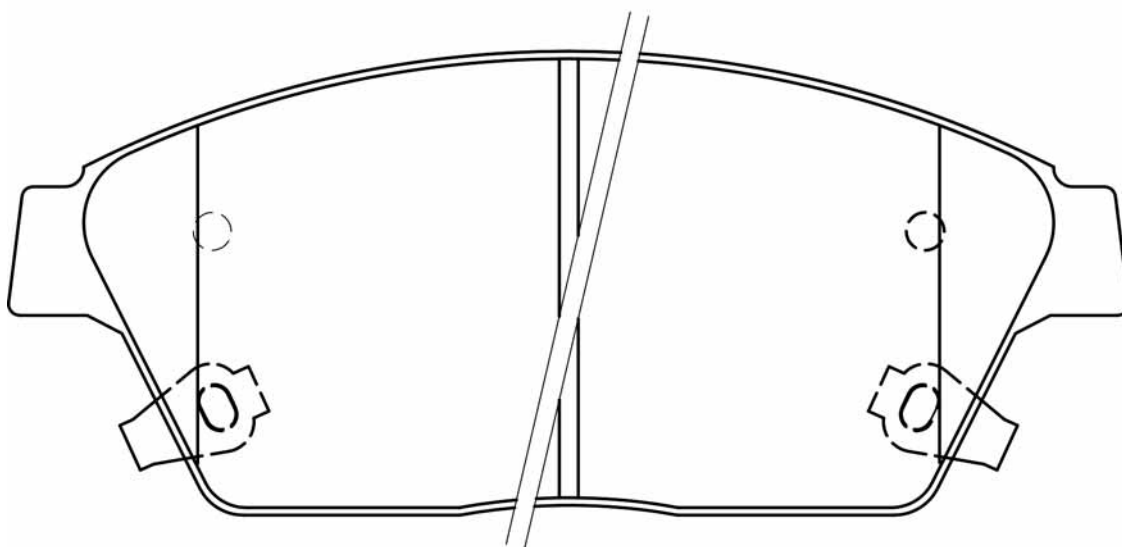

PICTURES BRAKE PADS FRONT
 ABBILDUNGEN BREMSKLÖTZE VORN
 FIGURAS PASTILLAS DE FRENO DELANTORES
 ILLUSTRATIONS PLAQUETTES DE FREI AVANT
 IMMAGINI PASTIGLIE FRENO ANTERIORI



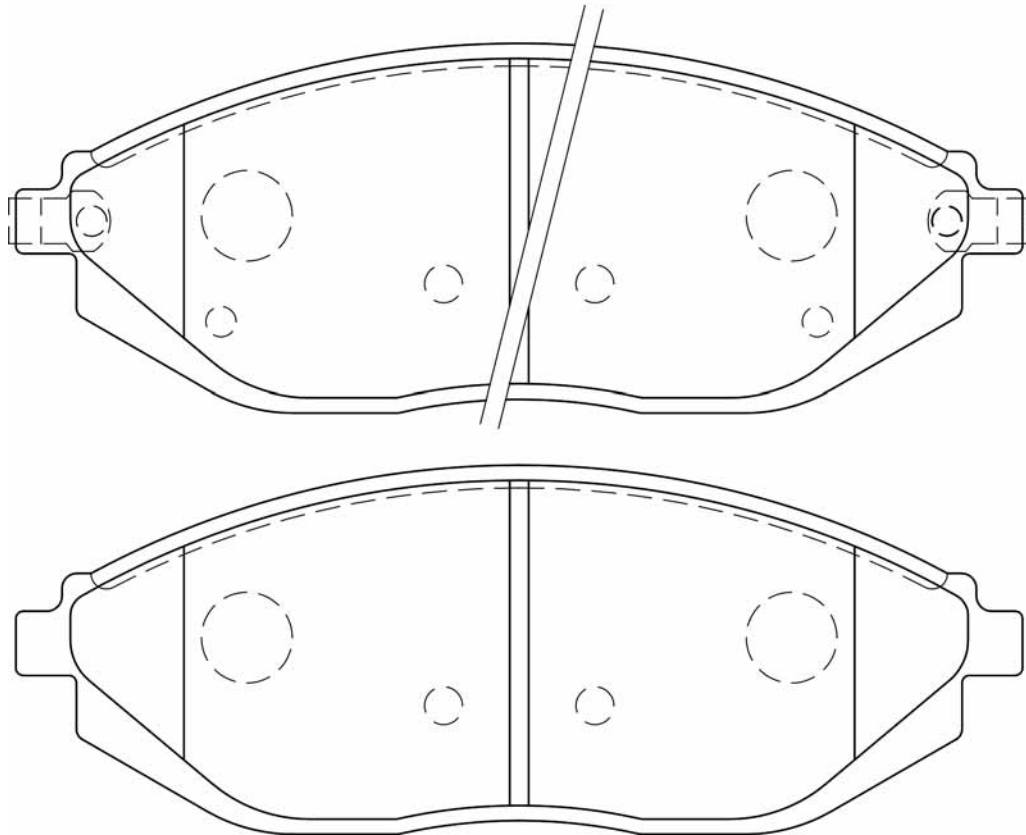

50-0W-W14				WVA
	CHEVROLET	L 133	H 49	
				25268





PICTURES BRAKE PADS FRONT
ABBILDUNGEN BREMSKLÖTZE VORN
FIGURAS PASTILLAS DE FRENO DELANTORES
ILLUSTRATIONS PLAQUETTES DE FREI AVANT
IMMAGINI PASTIGLIE FRENO ANTERIORI

51-00-001				WVA
JEEP	L	H	Th	
	142,5	49,5/53	18	

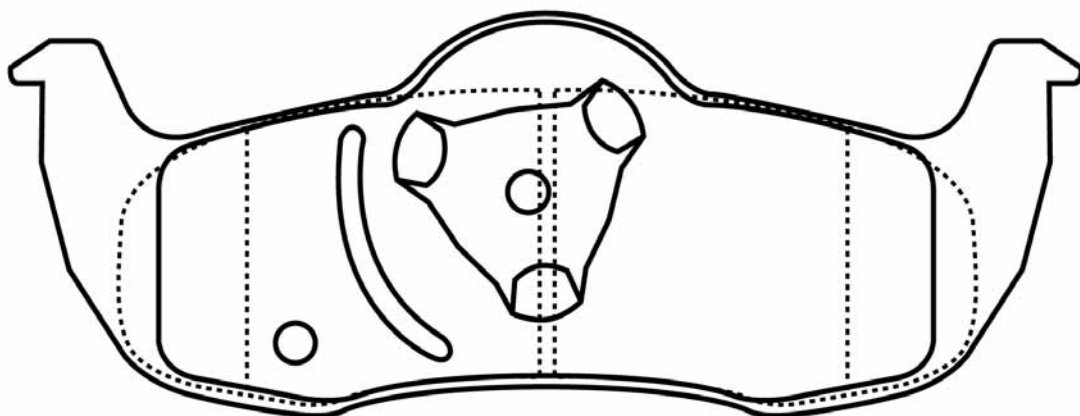

X2

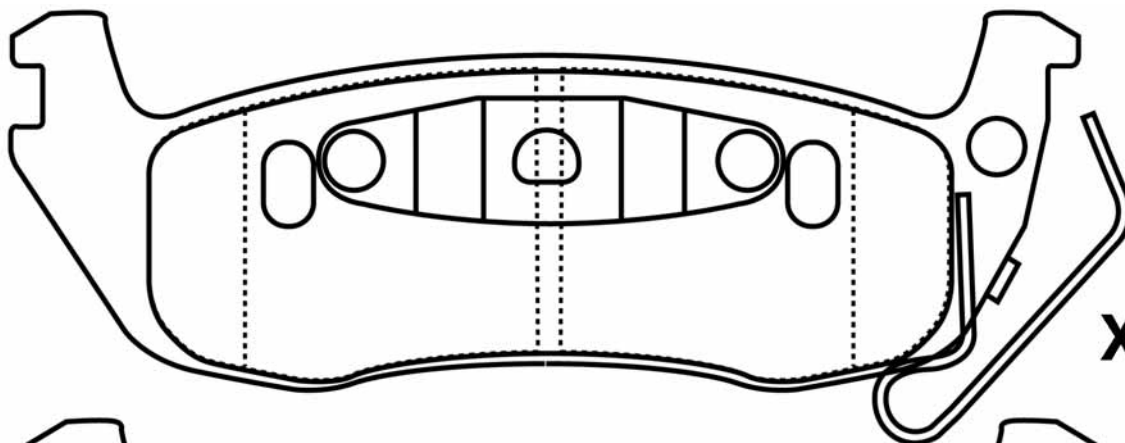

X1

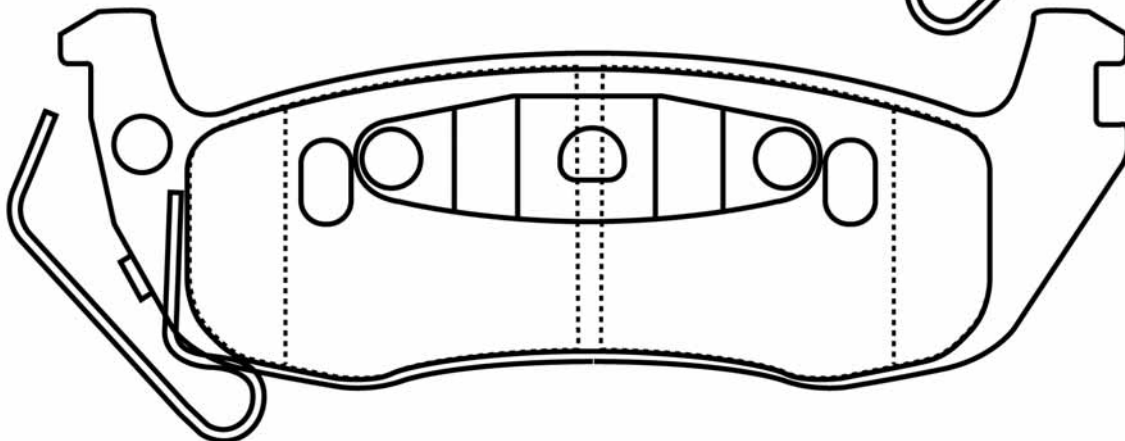

X1



51-00-003 HUMMER				WVA
	L 146	H 55	Th 15,4	

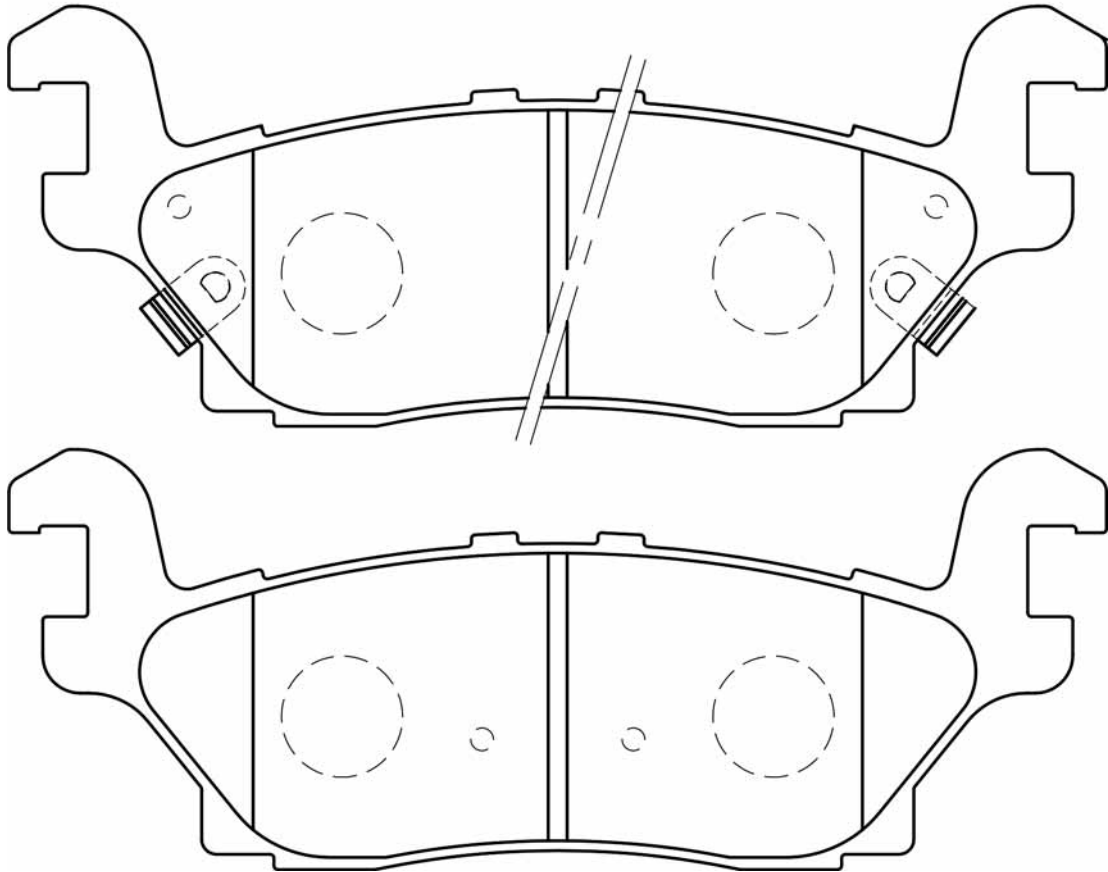



PICTURES BRAKE PADS FRONT
ABBILDUNGEN BREMSKLÖTZE VORN
FIGURAS PASTILLAS DE FRENO DELANTORES
ILLUSTRATIONS PLAQUETTES DE FREI AVANT
IMMAGINI PASTIGLIE FRENO ANTERIORI

51-00-004				WVA
HUMMER	L	H	Th	
	177	61	19,5	

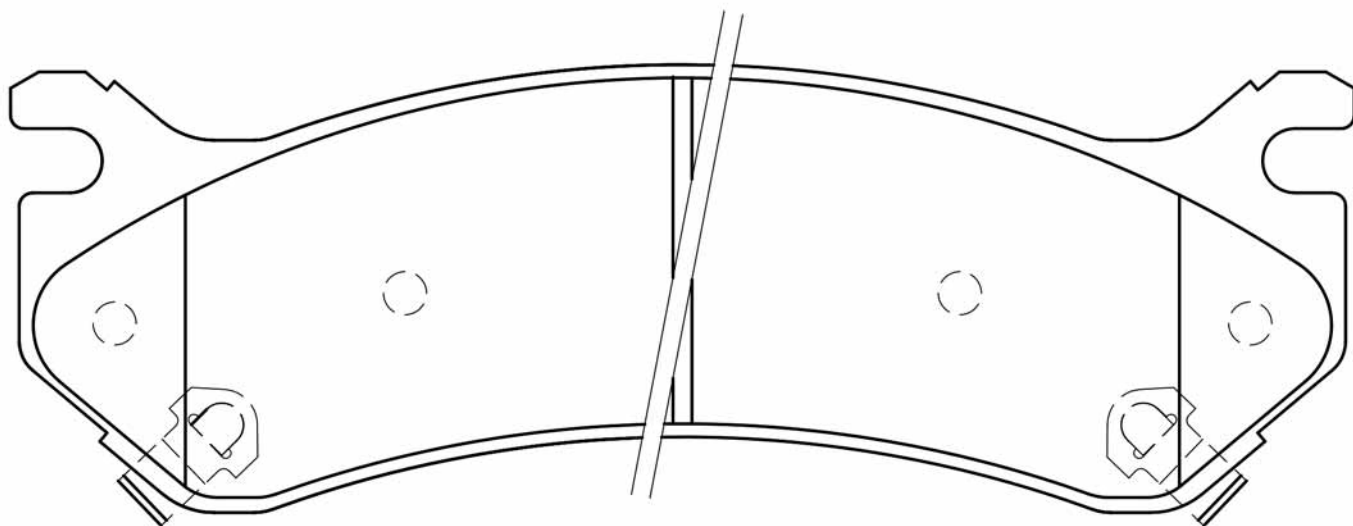
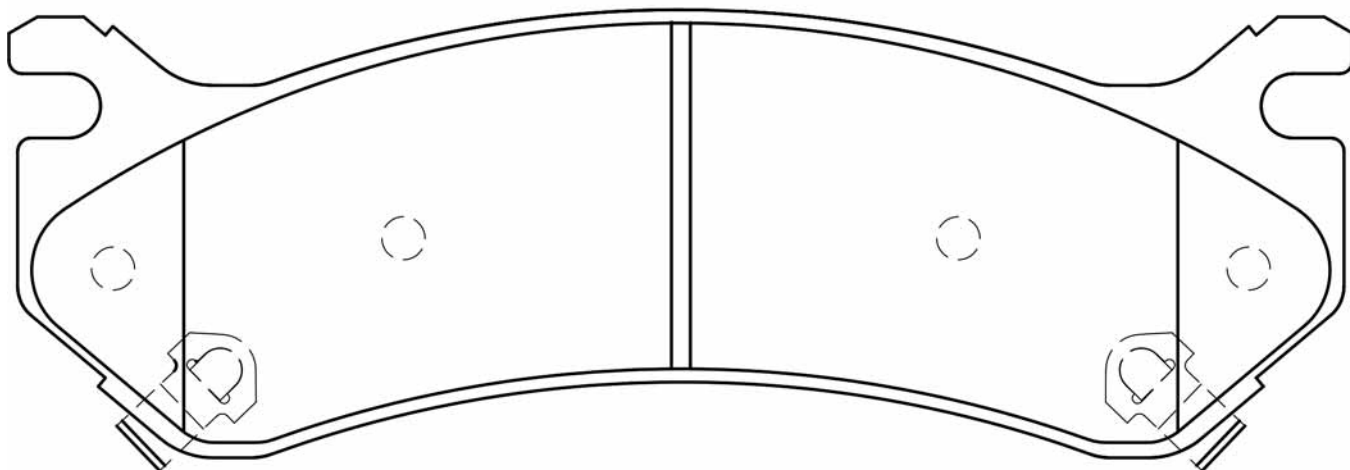



51-00-005

MAZDA - CADILLAC

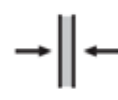
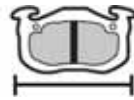

WVA

L

H

Th

123

52

16,5

24137

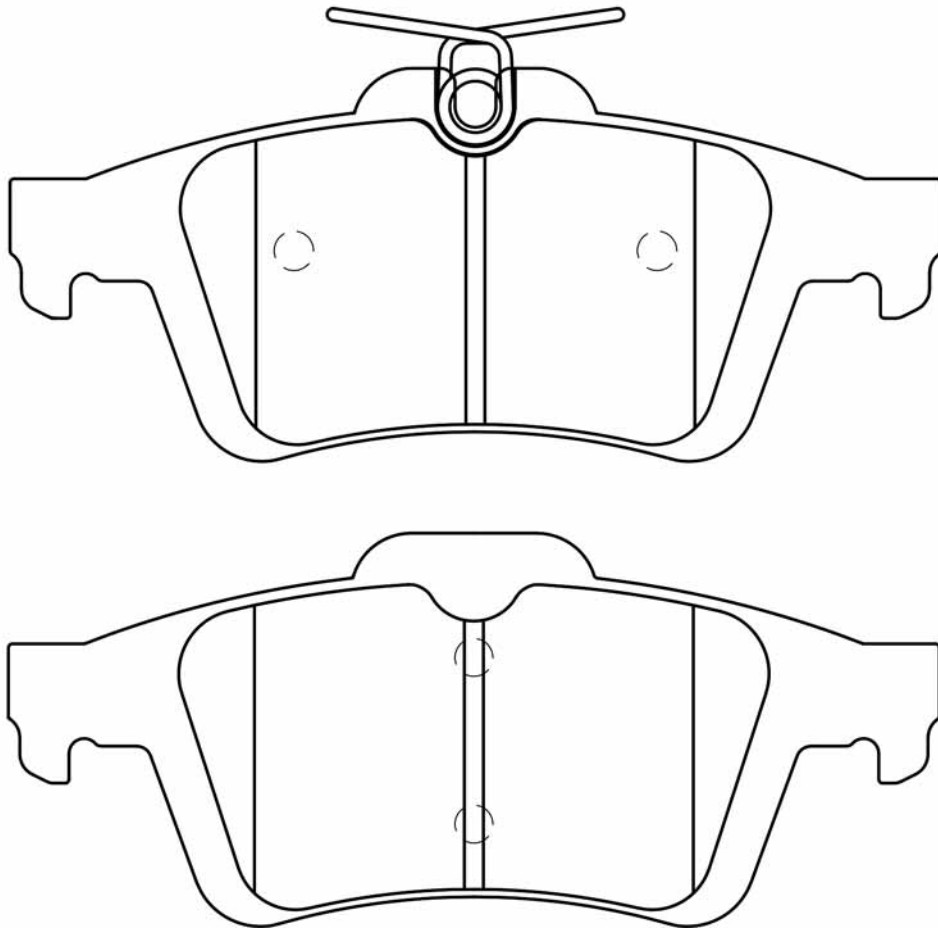



PICTURES BRAKE PADS REAR
ABBILDUNGEN BREMSKLÖTZE HINTEN
FIGURAS PASTILLAS DE FRENO POSTERIORES
ILLUSTRATIONS PLAQUETTES DE FREI ARRIÈRE
IMMAGINI PASTIGLIE FRENO POSTERIORI

51-00-006				WVA
CADILLAC	L	H	Th	
	132	77	15,5	23325

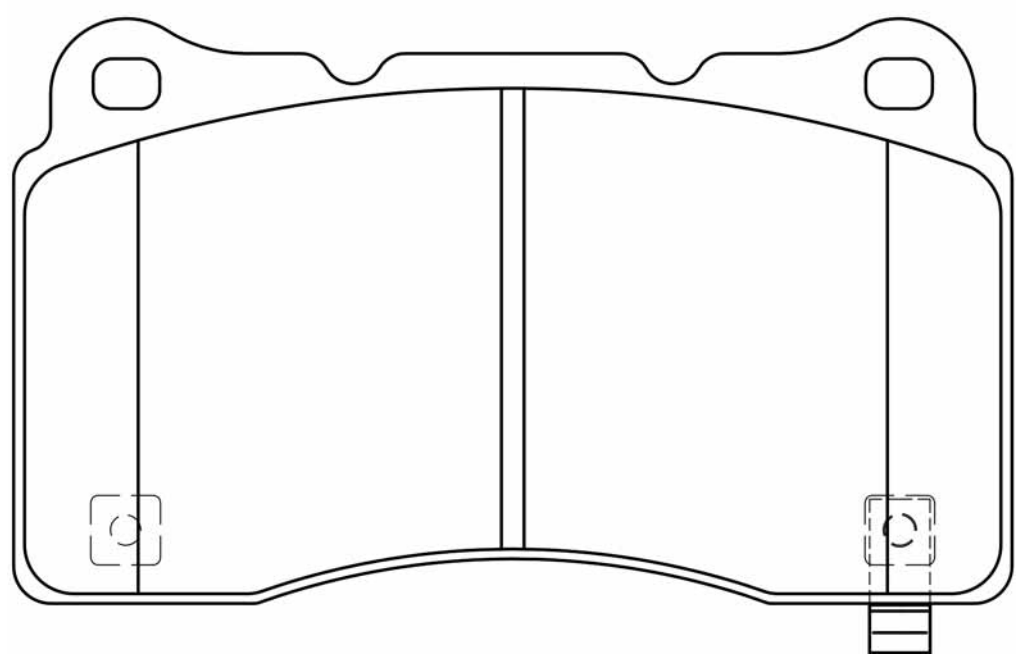



51-00-007

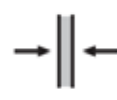
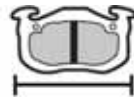

WVA

CADILLAC

L

H

Th

137,5

46

16,5

24546

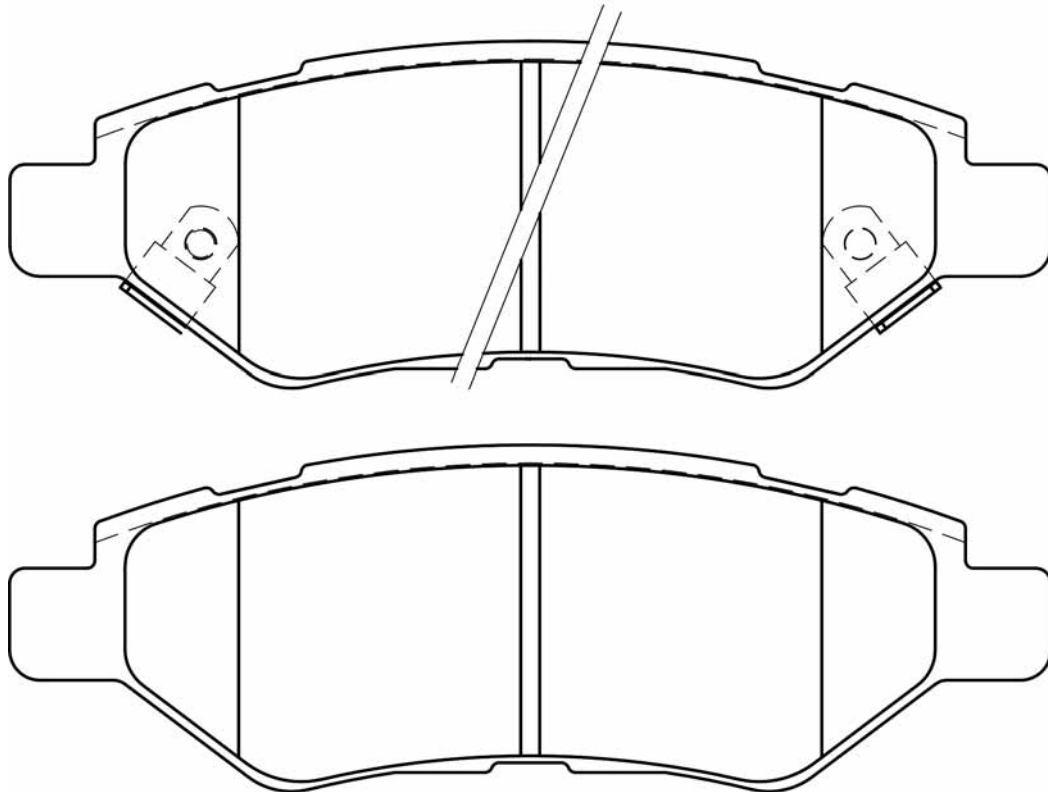



PICTURES BRAKE PADS REAR
ABBILDUNGEN BREMSKLÖTZE HINTEN
FIGURAS PASTILLAS DE FRENO POSTERIORES
ILLUSTRATIONS PLAQUETTES DE FREI ARRIÈRE
IMMAGINI PASTIGLIE FRENO POSTERIORI

51-00-008				WVA
LIGIER	L	H	Th	
	97	43	8	

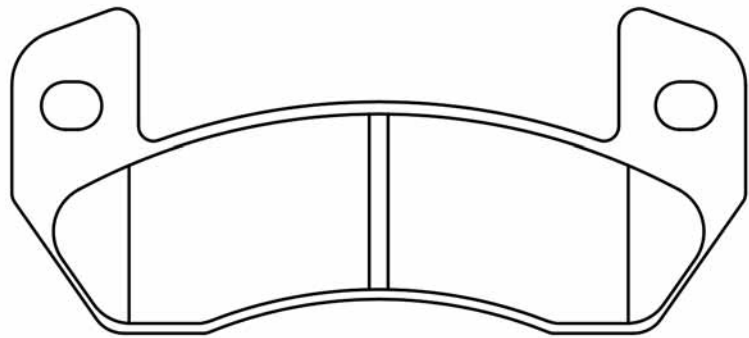



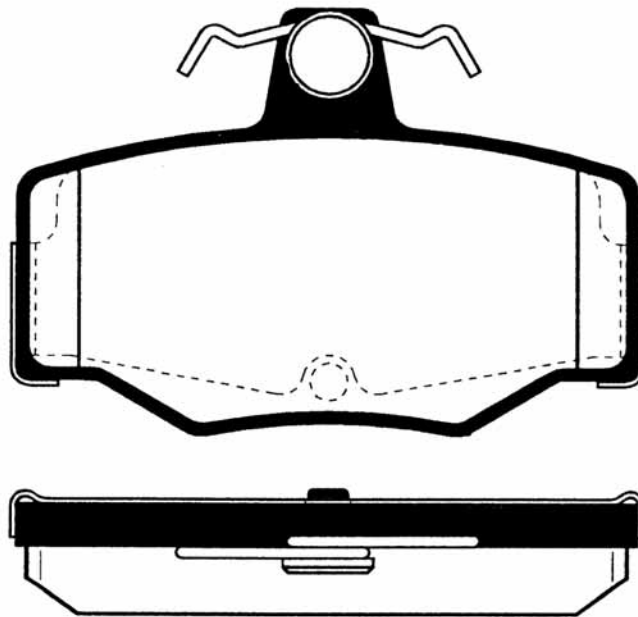

51-00-015				WVA
	NISSAN	L	H	Th
	82,2	57,5	14,5	21545



X4



PICTURES BRAKE PADS REAR
ABBILDUNGEN BREMSKLÖTZE HINTEN
FIGURAS PASTILLAS DE FRENO POSTERIORES
ILLUSTRATIONS PLAQUETTES DE FREI ARRIÈRE
IMMAGINI PASTIGLIE FRENO POSTERIORI

51-00-016				WVA
CHRYSLER	L	H	Th	
	133,5	39,3	16	23561

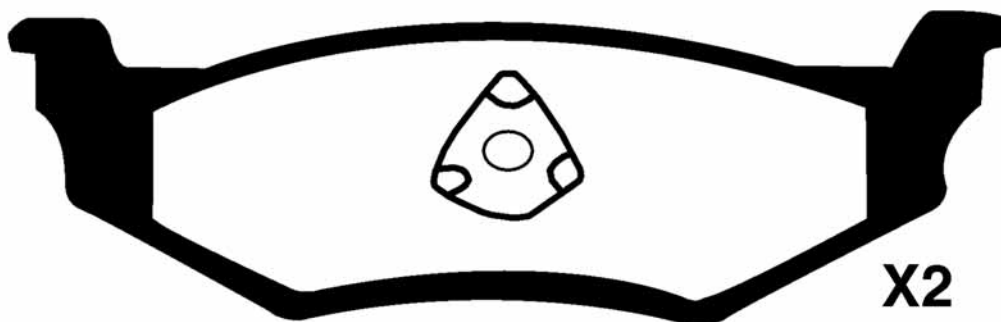
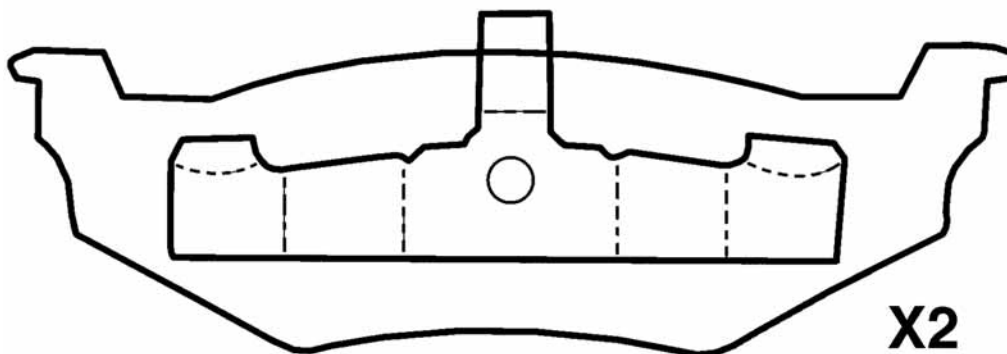



51-00-019				WVA
	JEEP	L	H	
	143,2	45,4	15	

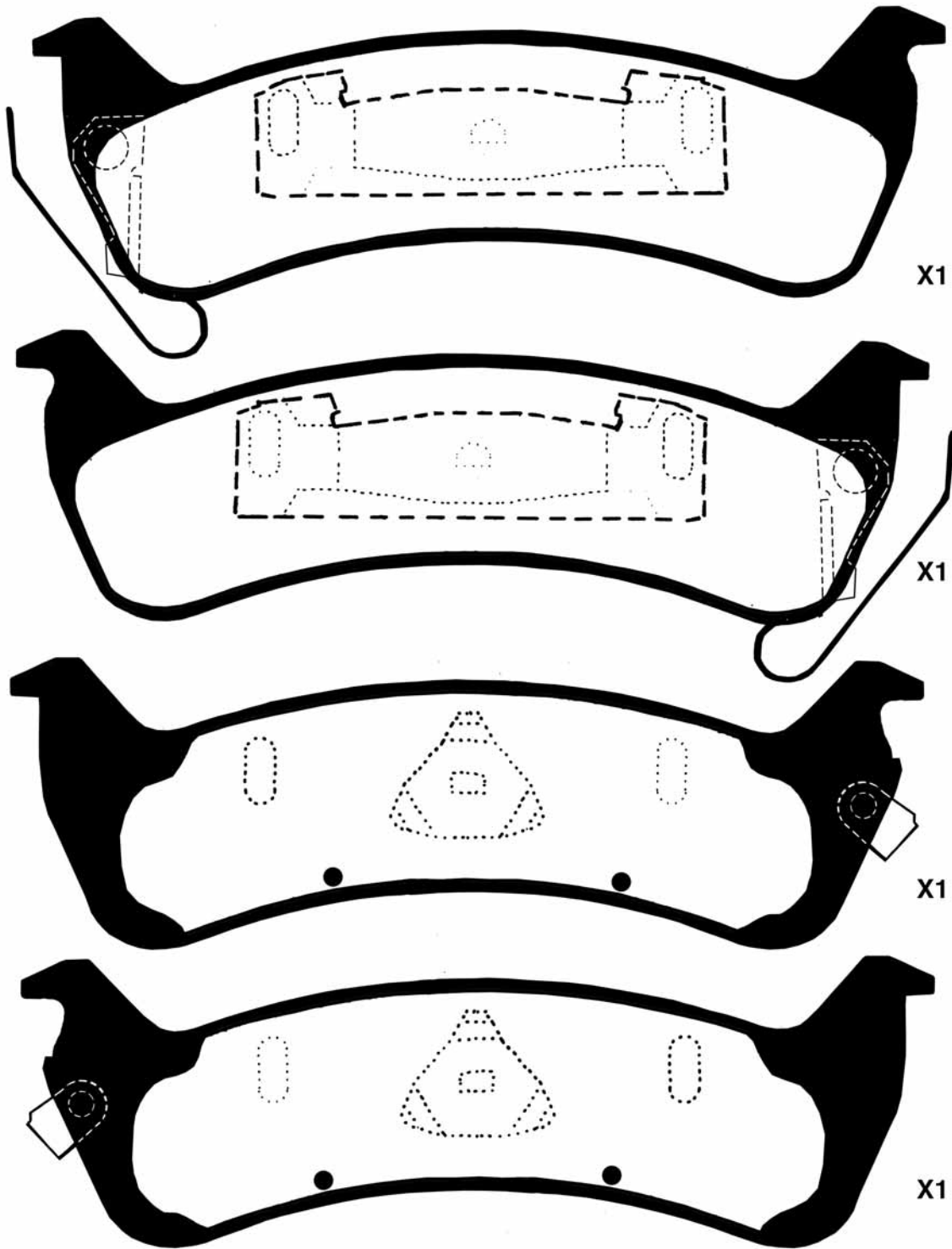



PICTURES BRAKE PADS REAR
ABBILDUNGEN BREMSKLÖTZE HINTEN
FIGURAS PASTILLAS DE FRENO POSTERIORES
ILLUSTRATIONS PLAQUETTES DE FREI ARRIÈRE
IMMAGINI PASTIGLIE FRENO POSTERIORI

51-01-100				WVA
NISSAN	L	H	Th	
	164,5	66,5	20	

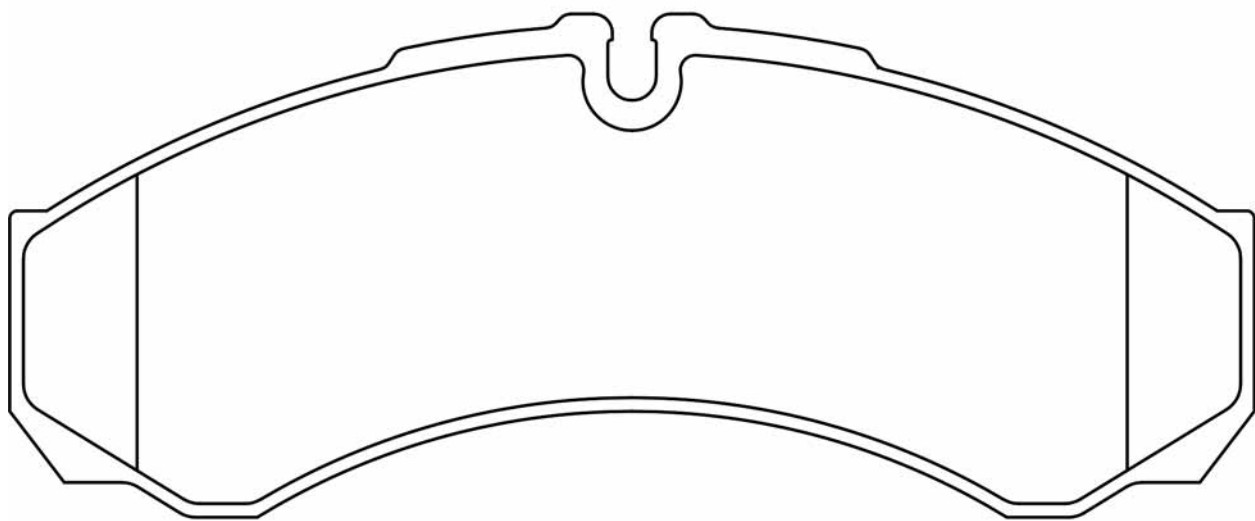



51-01-101				WVA
	NISSAN	L	H	Th
	109,5	50	20	23921

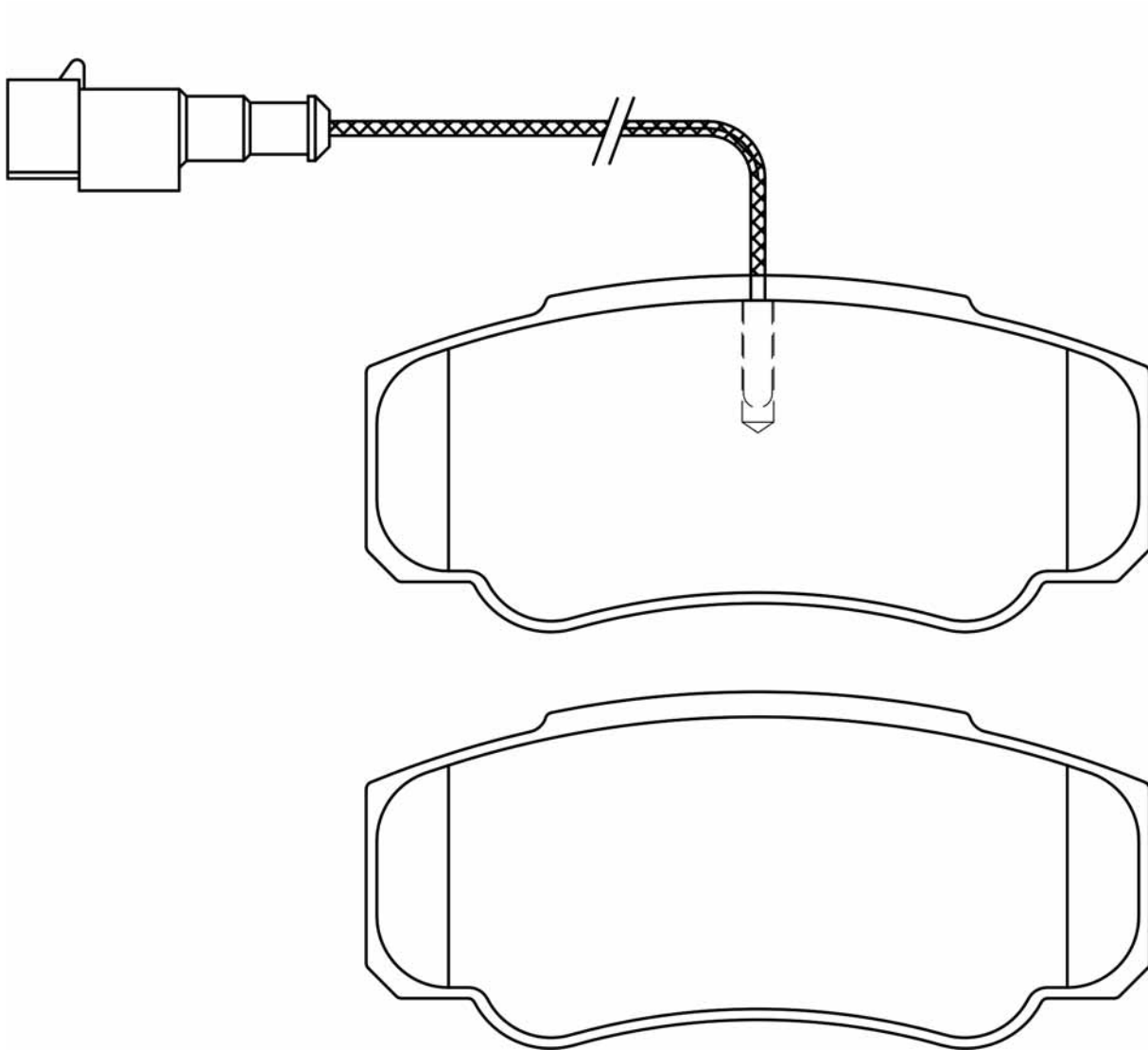



PICTURES BRAKE PADS REAR
ABBILDUNGEN BREMSKLÖTZE HINTEN
FIGURAS PASTILLAS DE FRENO POSTERIORES
ILLUSTRATIONS PLAQUETTES DE FREI ARRIÈRE
IMMAGINI PASTIGLIE FRENO POSTERIORI

51-01-109

NISSAN

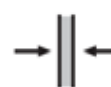

WVA

L

95

H

57,6

Th

16,5

23980

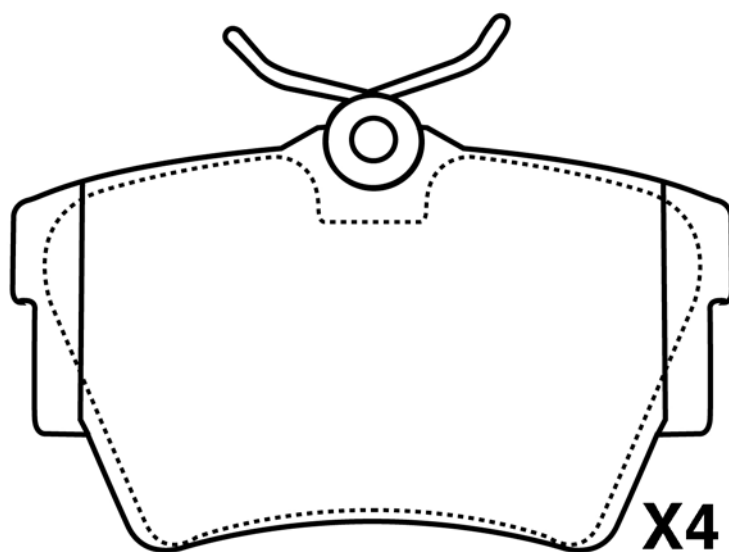



51-01-119

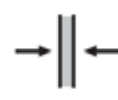
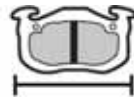

WVA

NISSAN

L

76,8

H

65,7

Th

14,3

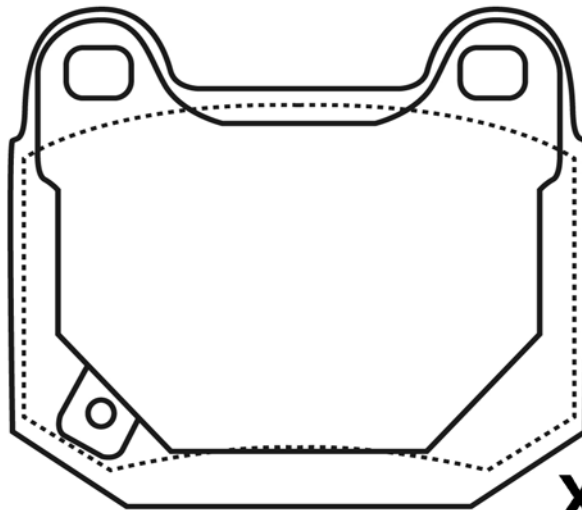

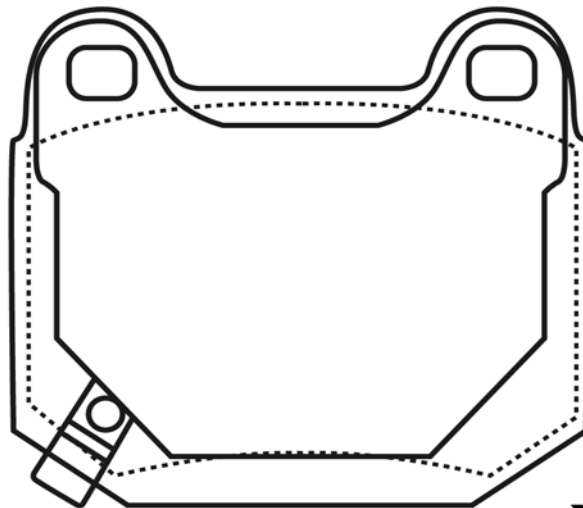

X2



X2



PICTURES BRAKE PADS REAR
ABBILDUNGEN BREMSKLÖTZE HINTEN
FIGURAS PASTILLAS DE FRENO POSTERIORES
ILLUSTRATIONS PLAQUETTES DE FREI ARRIÈRE
IMMAGINI PASTIGLIE FRENO POSTERIORI

51-01-120				WVA
NISSAN	L	H	Th	
	58	55	14	20850

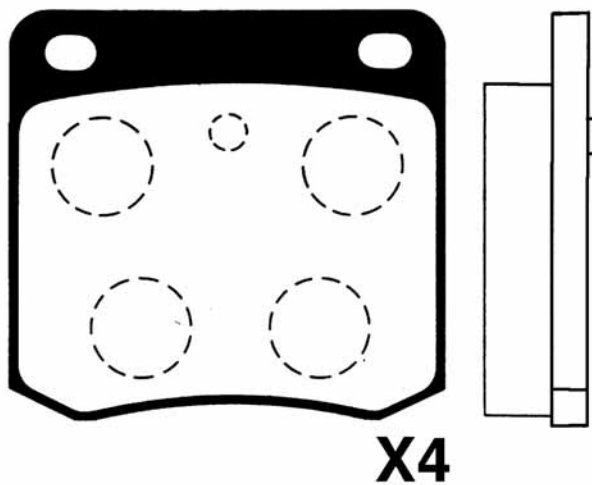



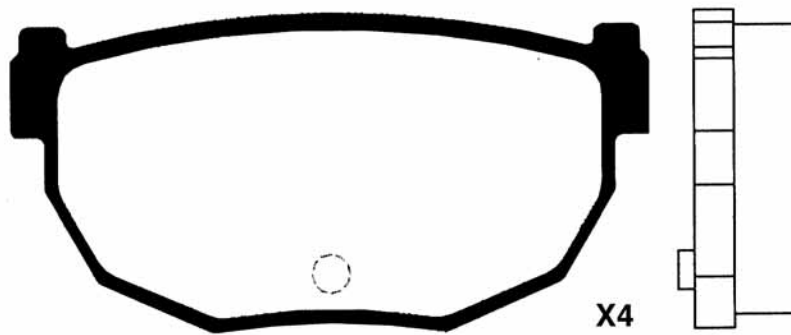

51-01-121				WVA
	NISSAN	L	H	Th
	85	42	14	21329



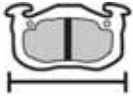

PICTURES BRAKE PADS REAR
ABBILDUNGEN BREMSKLÖTZE HINTEN
FIGURAS PASTILLAS DE FRENO POSTERIORES
ILLUSTRATIONS PLAQUETTES DE FREI ARRIÈRE
IMMAGINI PASTIGLIE FRENO POSTERIORI

51-01-122				WVA
NISSAN	L	H	Th	
	85	42,4	14	21329

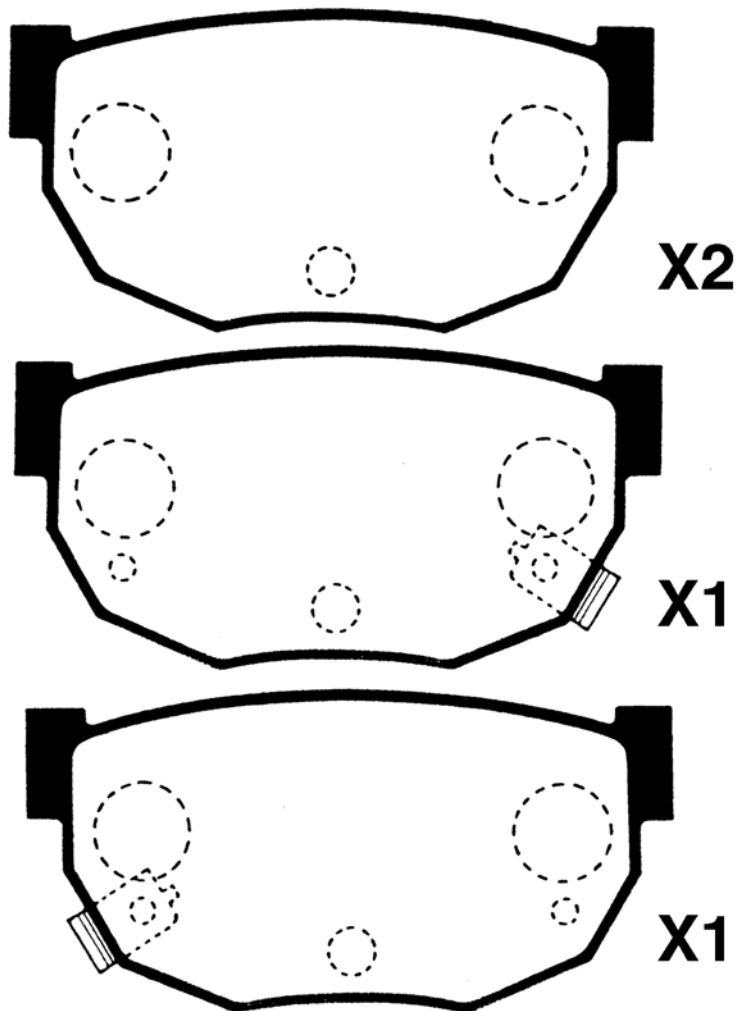



51-01-123				WVA
	NISSAN	L 85	H 46	Th 13,5
				21122

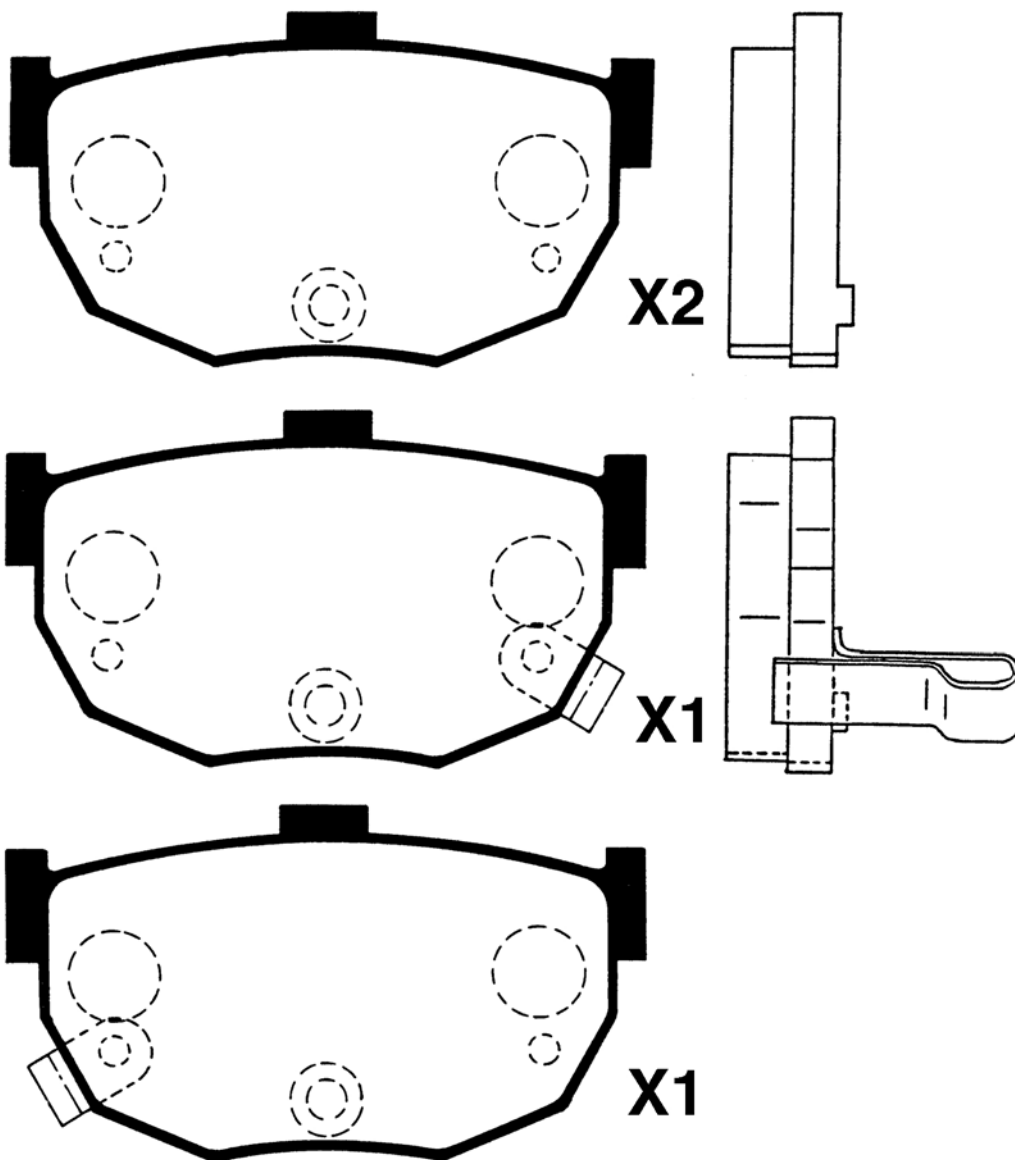



PICTURES BRAKE PADS REAR
ABBILDUNGEN BREMSKLÖTZE HINTEN
FIGURAS PASTILLAS DE FRENO POSTERIORES
ILLUSTRATIONS PLAQUETTES DE FREI ARRIÈRE
IMMAGINI PASTIGLIE FRENO POSTERIORI

51-01-124				WVA
	NISSAN	L	H	Th
	98,7	34,8	15	21342

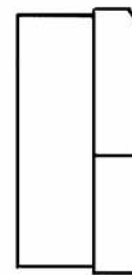
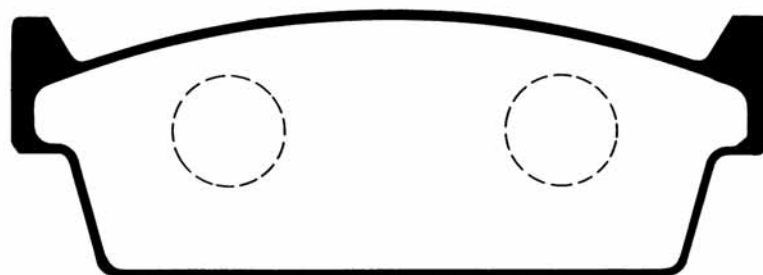

X2

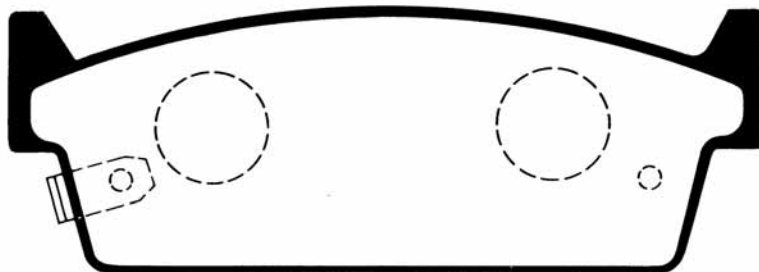

X1

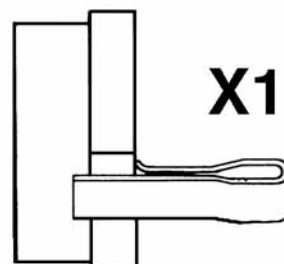
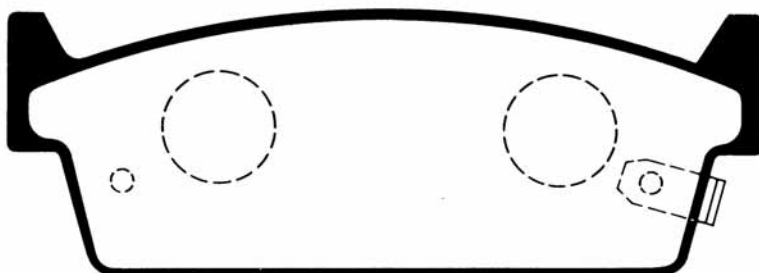

X1



51-01-125				WVA
	NISSAN	L	H	Th
	99	33,6	13,8	21734

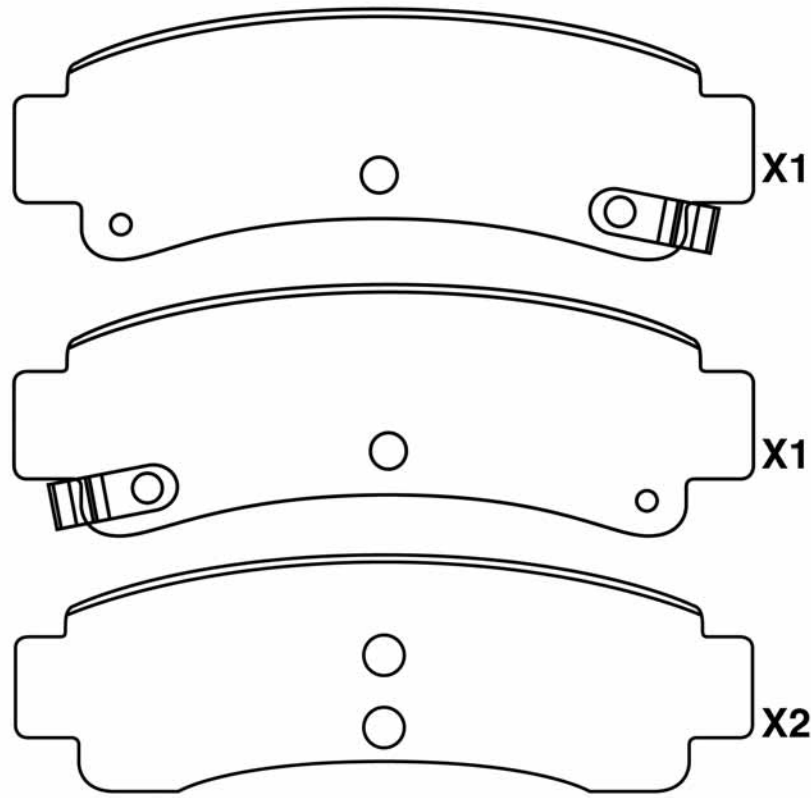



PICTURES BRAKE PADS REAR
ABBILDUNGEN BREMSKLÖTZE HINTEN
FIGURAS PASTILLAS DE FRENO POSTERIORES
ILLUSTRATIONS PLAQUETTES DE FREI ARRIÈRE
IMMAGINI PASTIGLIE FRENO POSTERIORI

51-01-127				WVA
INFINITI - NISSAN	L	H	Th	
	105,3	47,2	16,2	21715

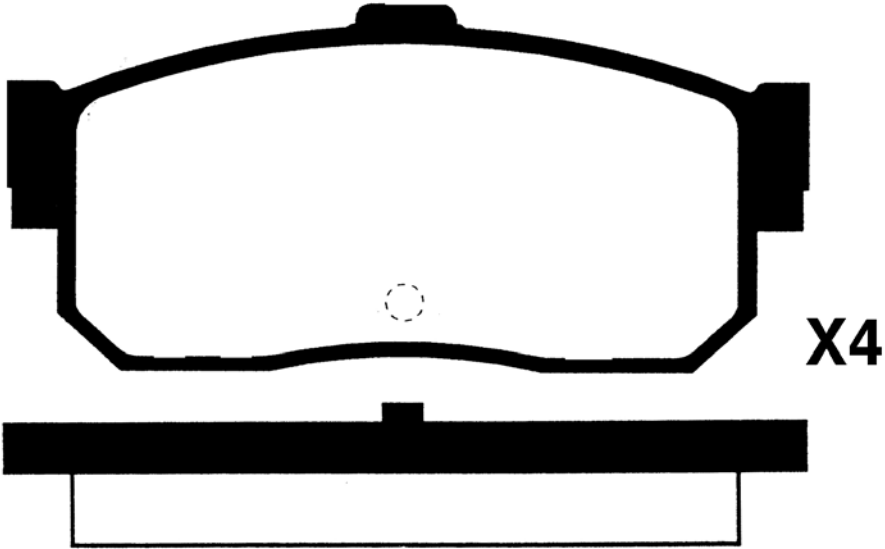



51-01-128				WVA
	NISSAN	L	H	
	115	45	15,3	

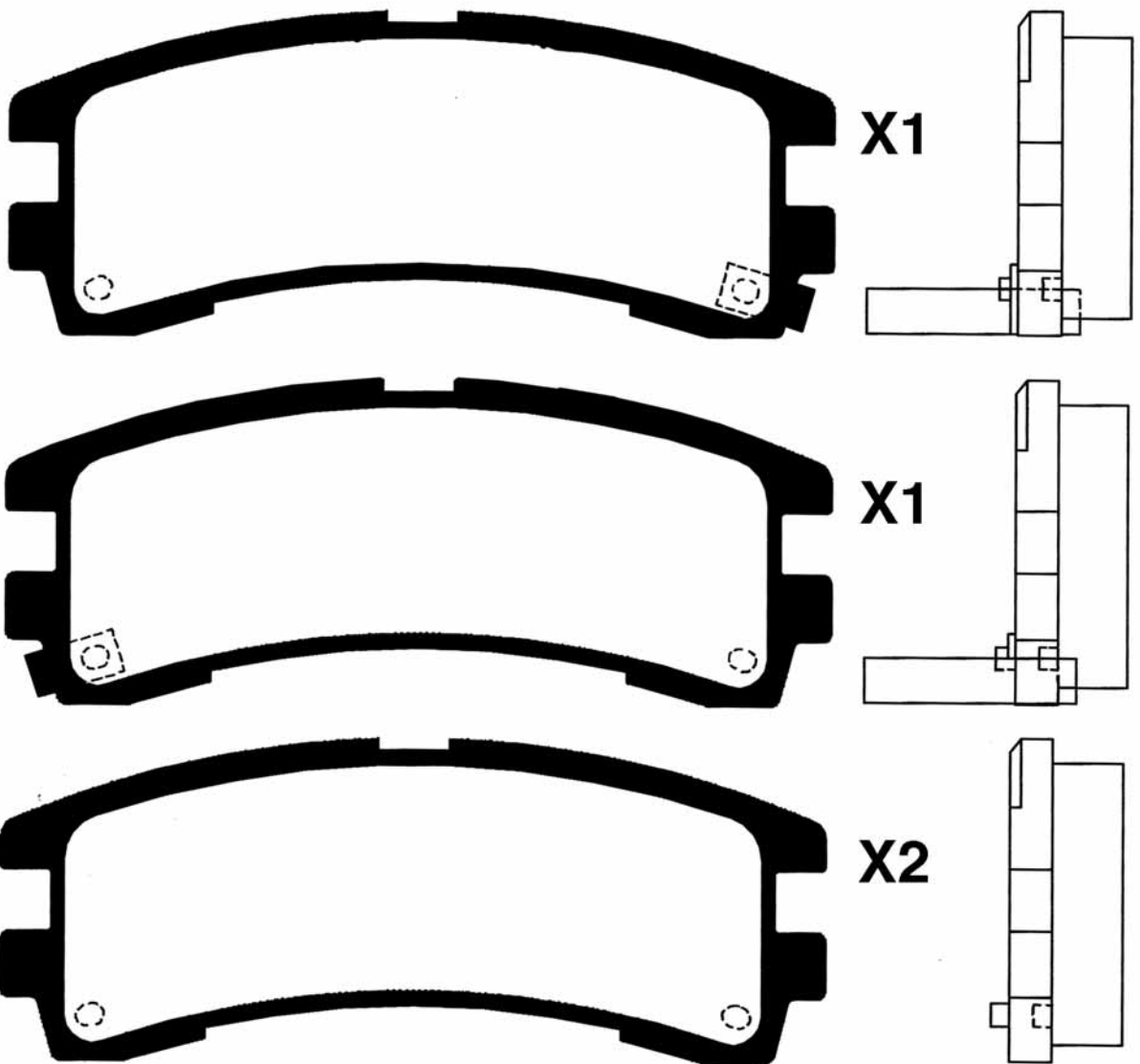



PICTURES BRAKE PADS REAR
ABBILDUNGEN BREMSKLÖTZE HINTEN
FIGURAS PASTILLAS DE FRENO POSTERIORES
ILLUSTRATIONS PLAQUETTES DE FREI ARRIÈRE
IMMAGINI PASTIGLIE FRENO POSTERIORI

51-01-129 NISSAN - SUBARU				WVA
	L 73,4	H 54,4	Th 15,8	23381

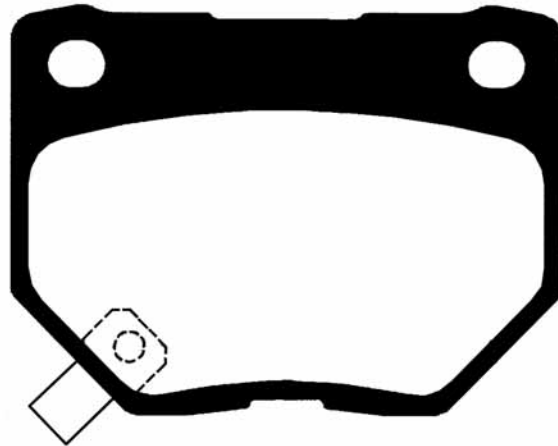

X1

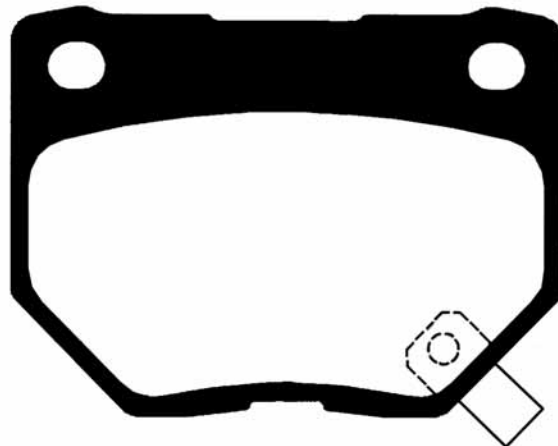

X1

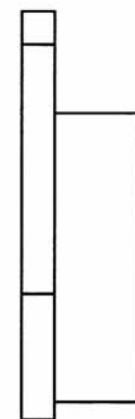

X2



51-01-130				WVA
	NISSAN	L	H	Th
	110,7	41,5	16	24240

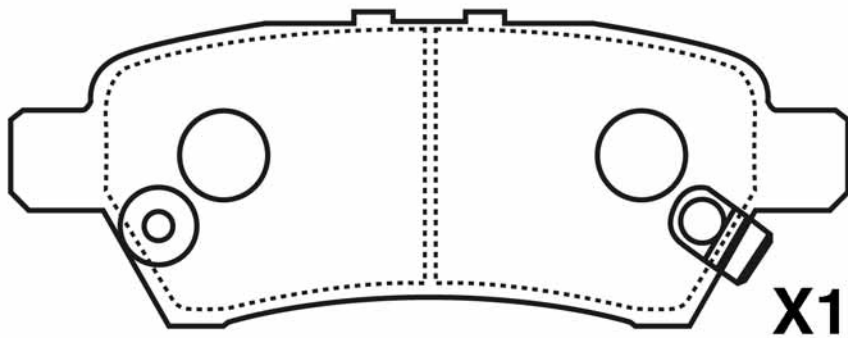
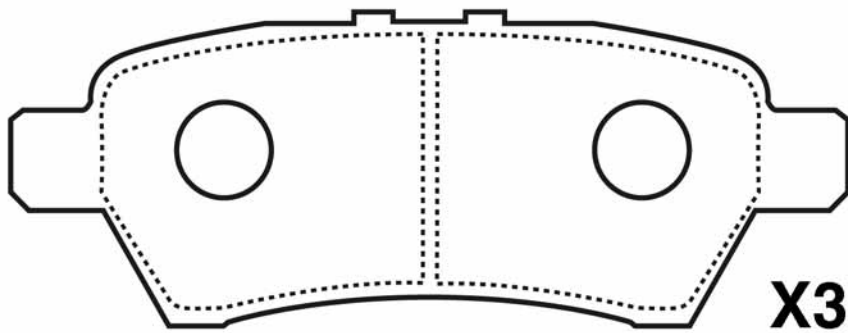



PICTURES BRAKE PADS REAR
ABBILDUNGEN BREMSKLÖTZE HINTEN
FIGURAS PASTILLAS DE FRENO POSTERIORES
ILLUSTRATIONS PLAQUETTES DE FREI ARRIÈRE
IMMAGINI PASTIGLIE FRENO POSTERIORI

51-01-133

NISSAN

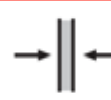
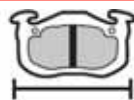

WVA

L

105,5

H

47

Th

16,3

21715

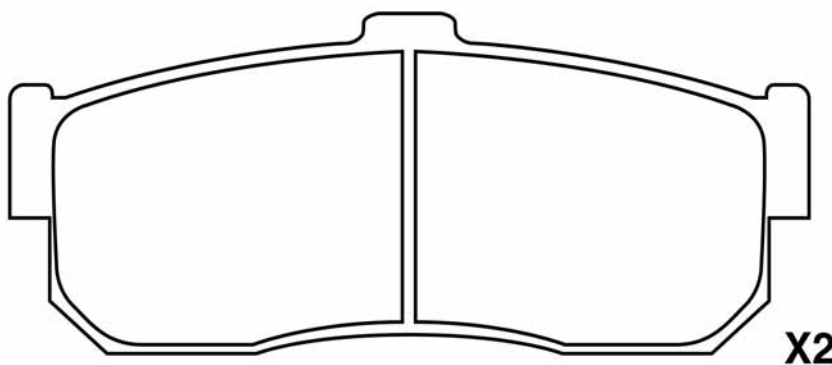
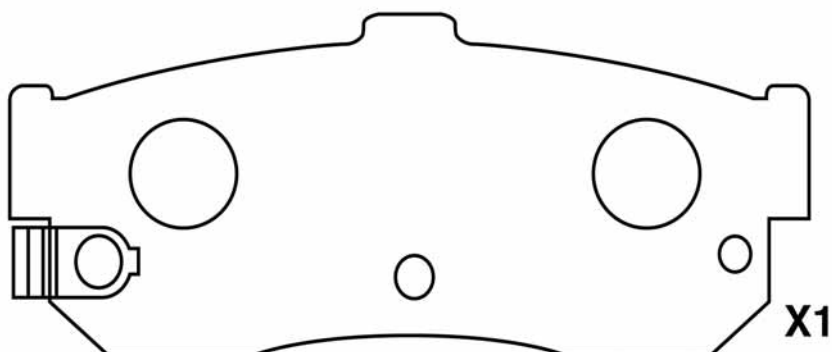
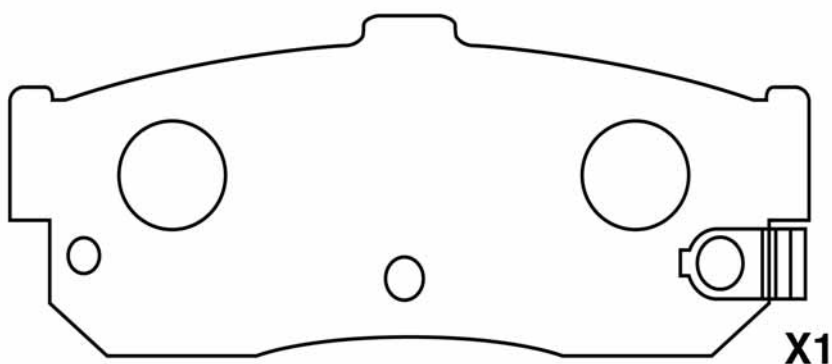



51-01-136				WVA
	NISSAN	L	H	Th
	127,6	50,7	16,5	20098

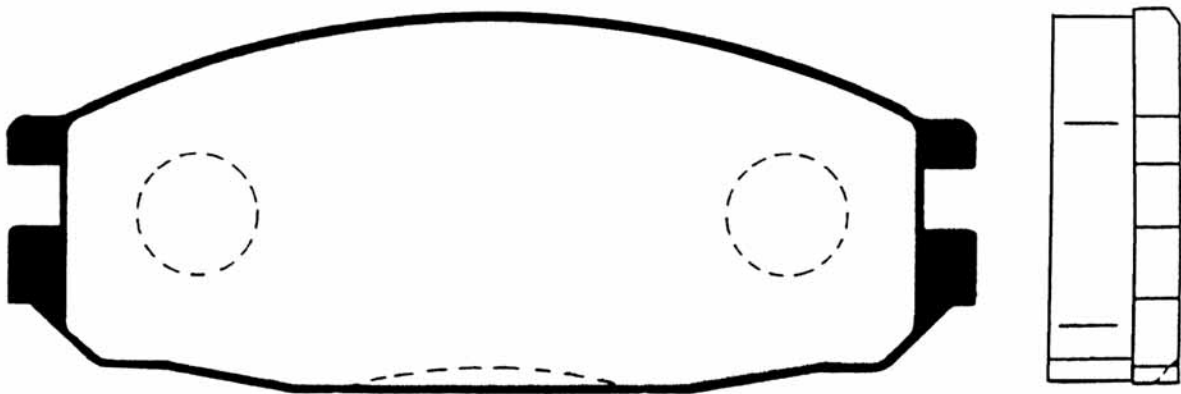

X4



PICTURES BRAKE PADS REAR
ABBILDUNGEN BREMSKLÖTZE HINTEN
FIGURAS PASTILLAS DE FRENO POSTERIORES
ILLUSTRATIONS PLAQUETTES DE FREI ARRIÈRE
IMMAGINI PASTIGLIE FRENO POSTERIORI

51-01-137				WVA
	NISSAN	L	H	Th
	121	50	15,5	23503

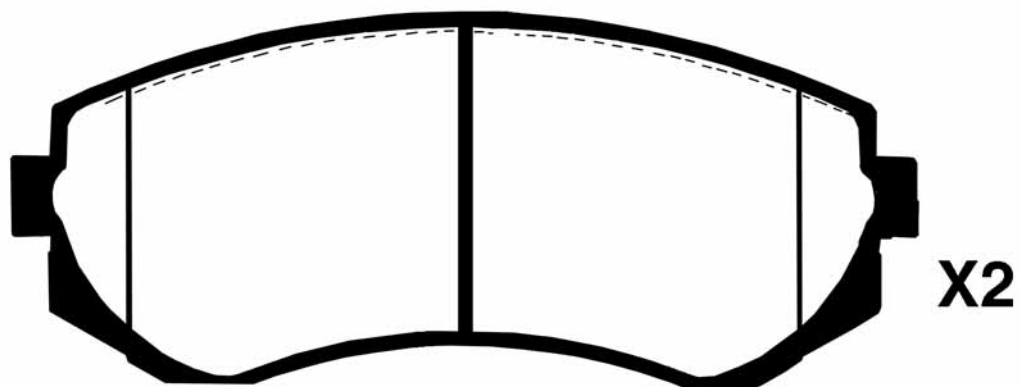
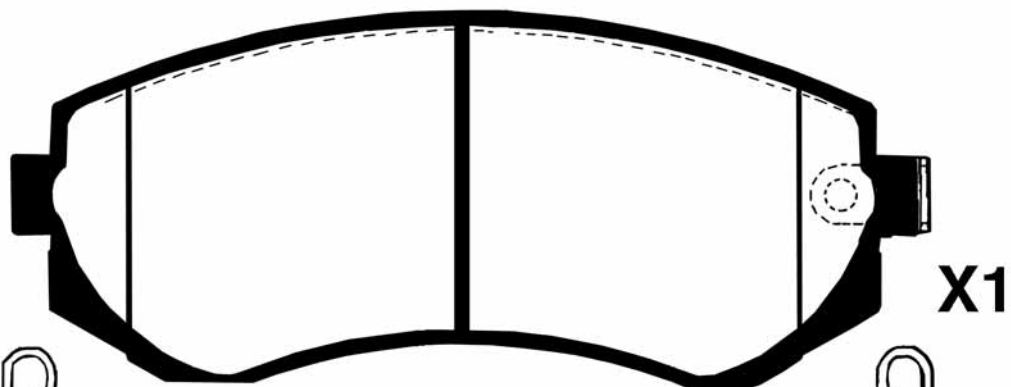
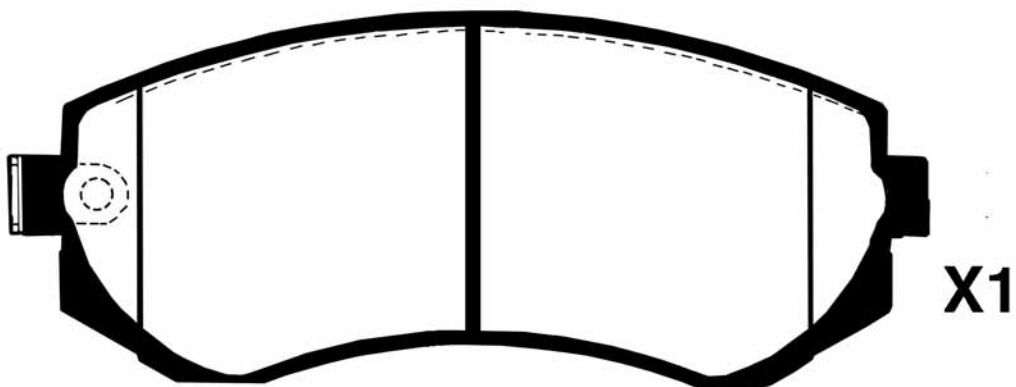



51-01-138 MAZDA - NISSAN				WVA 23482
	L 123	H 52	Th 16,4	

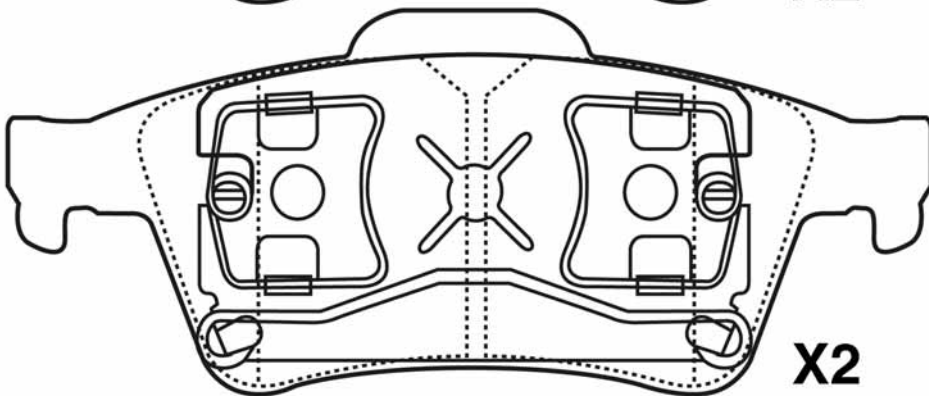
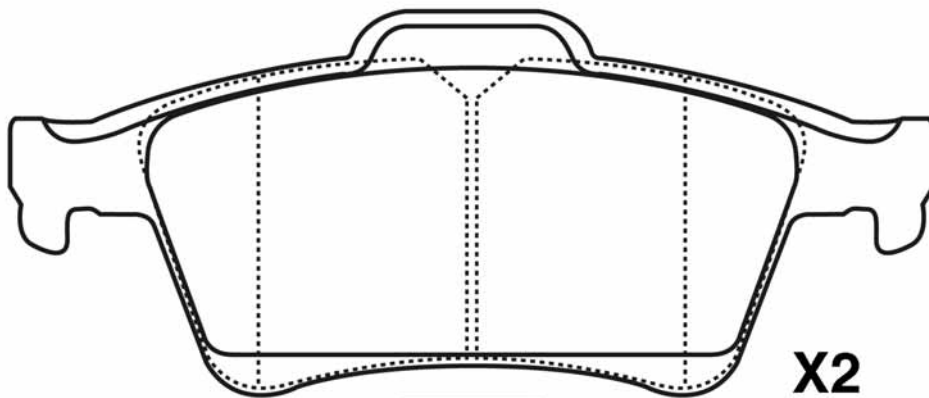



PICTURES BRAKE PADS REAR
ABBILDUNGEN BREMSKLÖTZE HINTEN
FIGURAS PASTILLAS DE FRENO POSTERIORES
ILLUSTRATIONS PLAQUETTES DE FREI ARRIÈRE
IMMAGINI PASTIGLIE FRENO POSTERIORI

51-01-154 INFINITI - NISSAN				WVA
	L 105,4	H 37,6	Th 14,5	23871

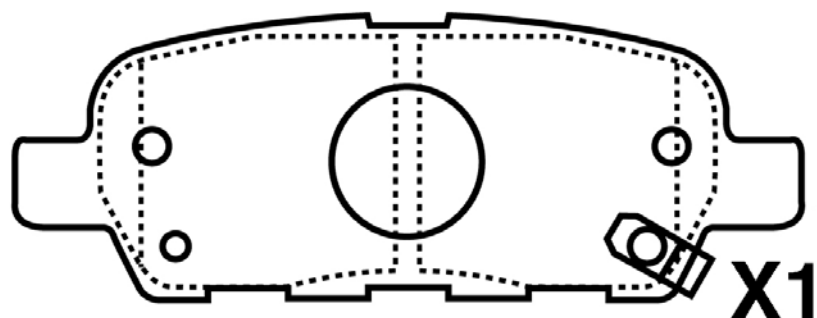
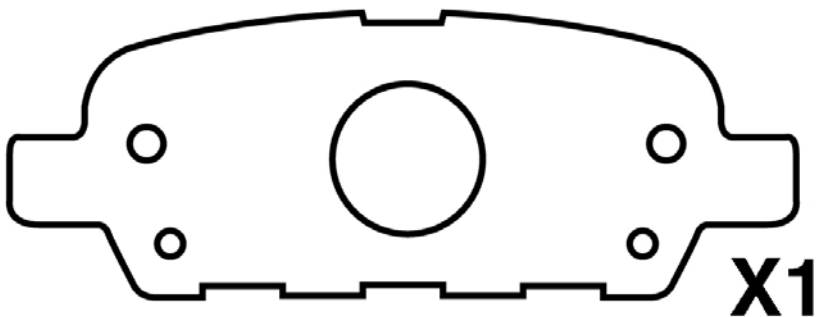
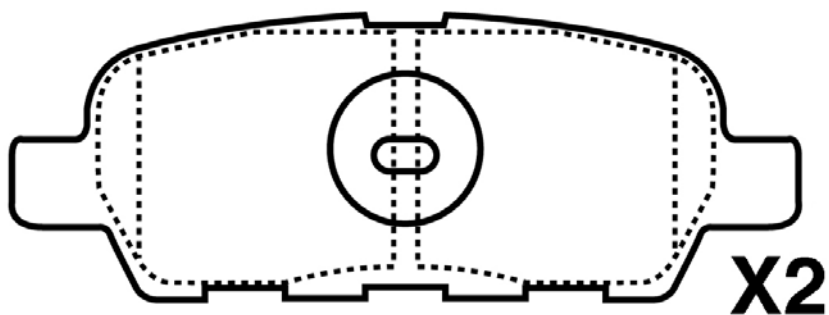



51-01-194				WVA
	NISSAN	L 85	H 43	

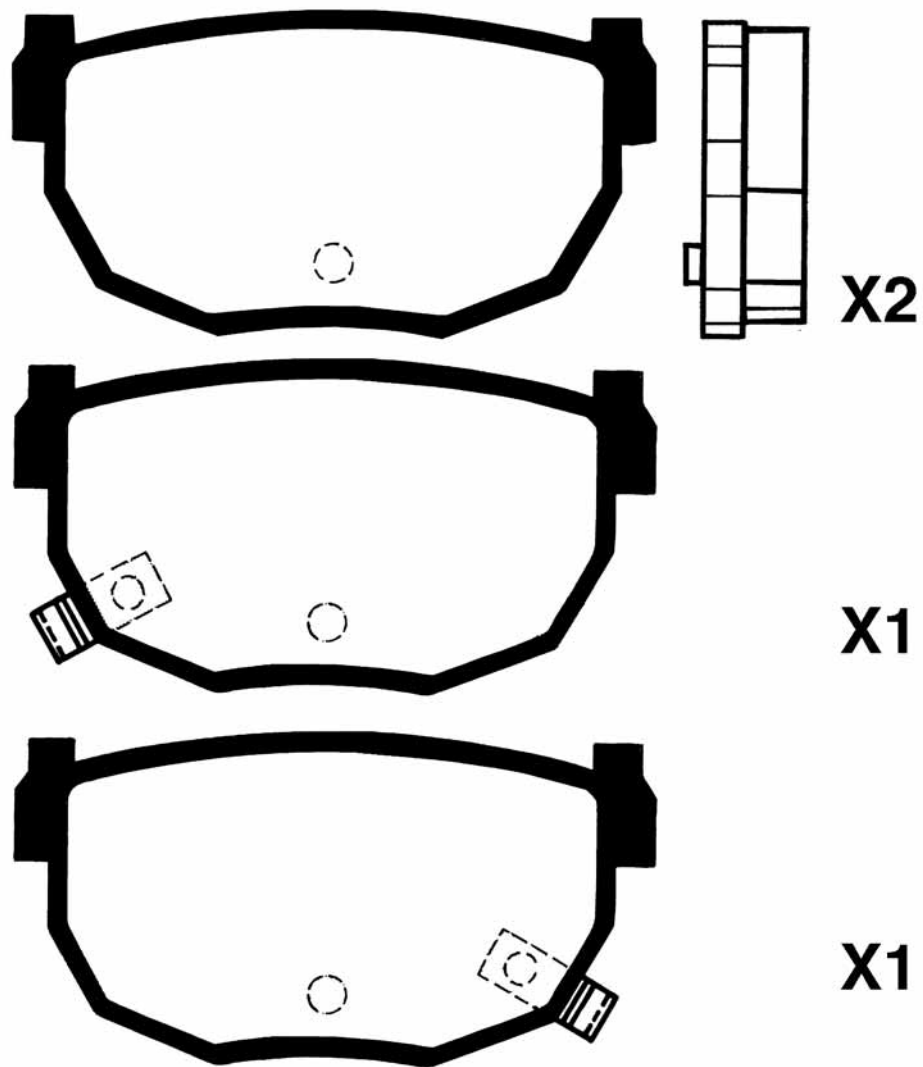



PICTURES BRAKE PADS REAR
ABBILDUNGEN BREMSKLÖTZE HINTEN
FIGURAS PASTILLAS DE FRENO POSTERIORES
ILLUSTRATIONS PLAQUETTES DE FREI ARRIÈRE
IMMAGINI PASTIGLIE FRENO POSTERIORI

51-01-196				WVA
	NISSAN	L	H	
	99,4	39,8	15	23024

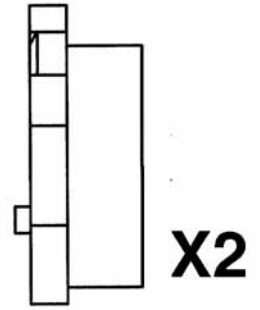
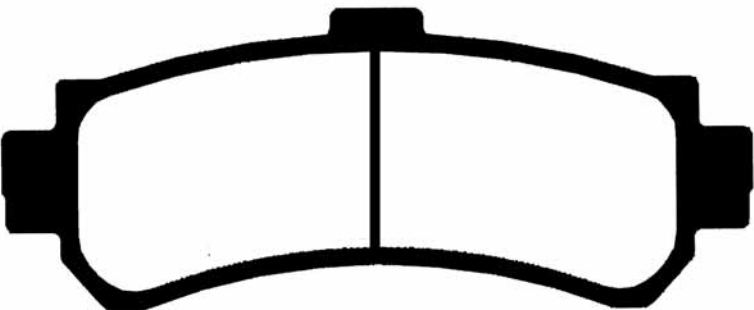
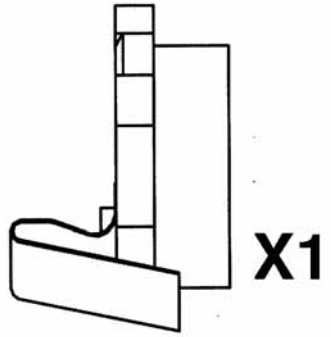
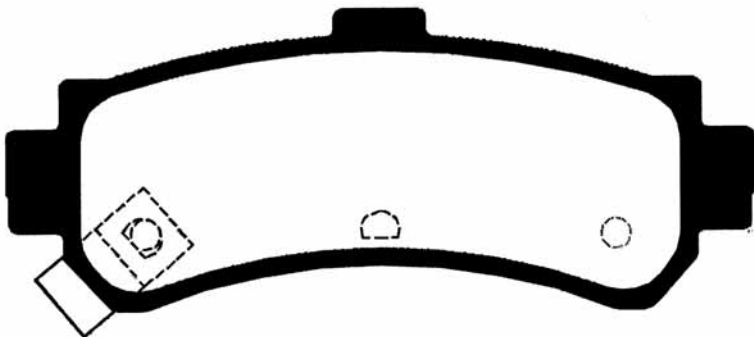
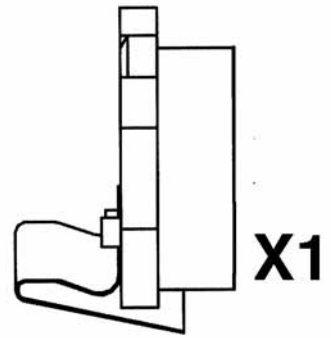
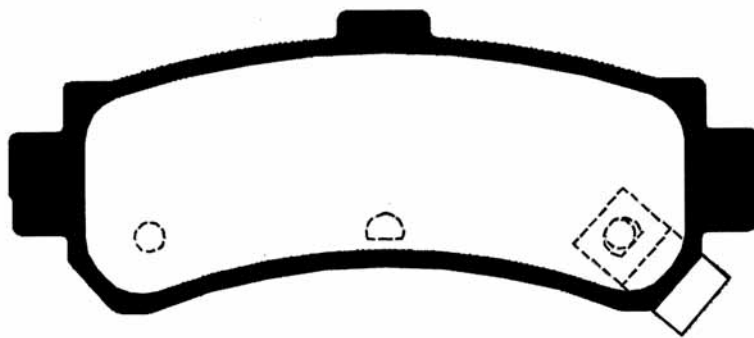



51-01-197				WVA
	NISSAN	L	H	Th
	89	45,7	14,7	23454

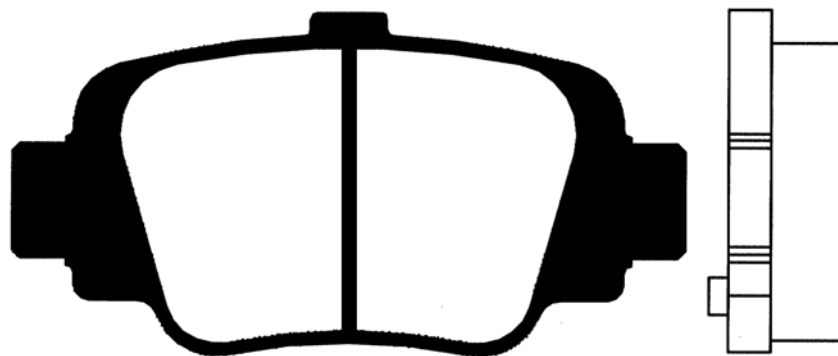

X4



PICTURES BRAKE PADS REAR
ABBILDUNGEN BREMSKLÖTZE HINTEN
FIGURAS PASTILLAS DE FRENO POSTERIORES
ILLUSTRATIONS PLAQUETTES DE FREI ARRIÈRE
IMMAGINI PASTIGLIE FRENO POSTERIORI

51-02-200

TOYOTA

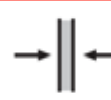
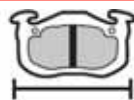

WVA

L

H

Th

102

46

16,3

23620

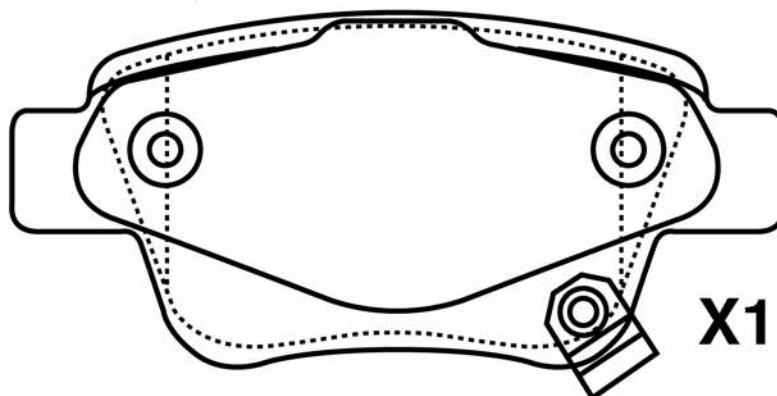
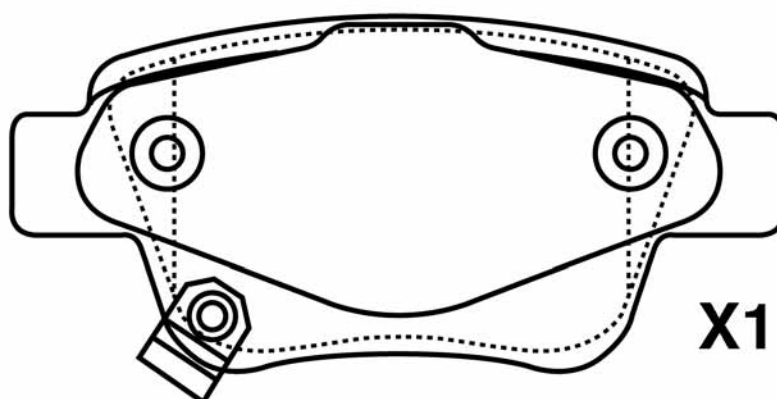
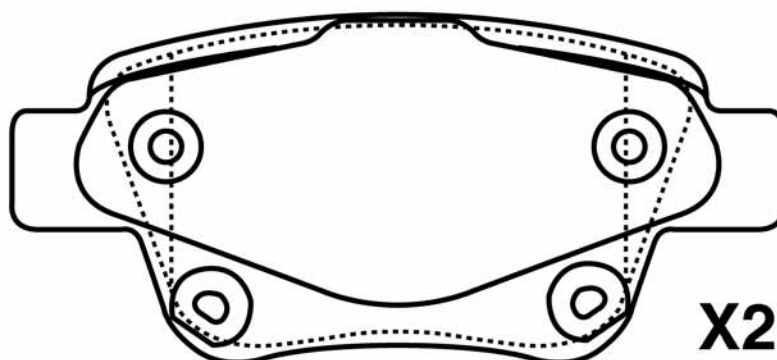



51-02-202				WVA
	TOYOTA	L	H	
	92,8	50,4	14,4	20567

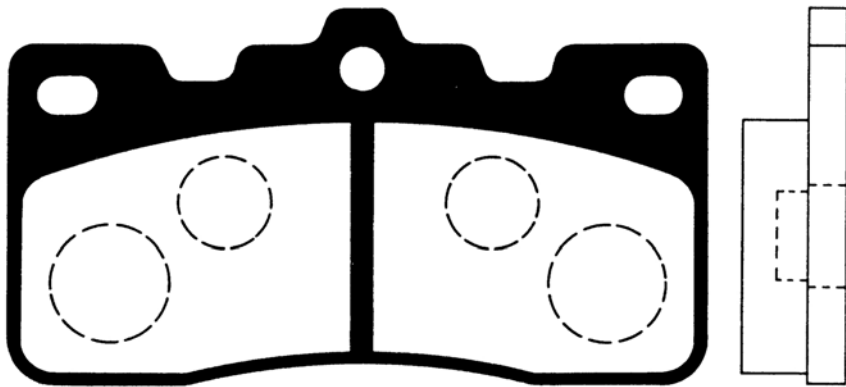

X4



PICTURES BRAKE PADS REAR
ABBILDUNGEN BREMSKLÖTZE HINTEN
FIGURAS PASTILLAS DE FRENO POSTERIORES
ILLUSTRATIONS PLAQUETTES DE FREI ARRIÈRE
IMMAGINI PASTIGLIE FRENO POSTERIORI

51-02-203				WVA
	TOYOTA	L		
	78,5	52,3/55,4	13,3	23523

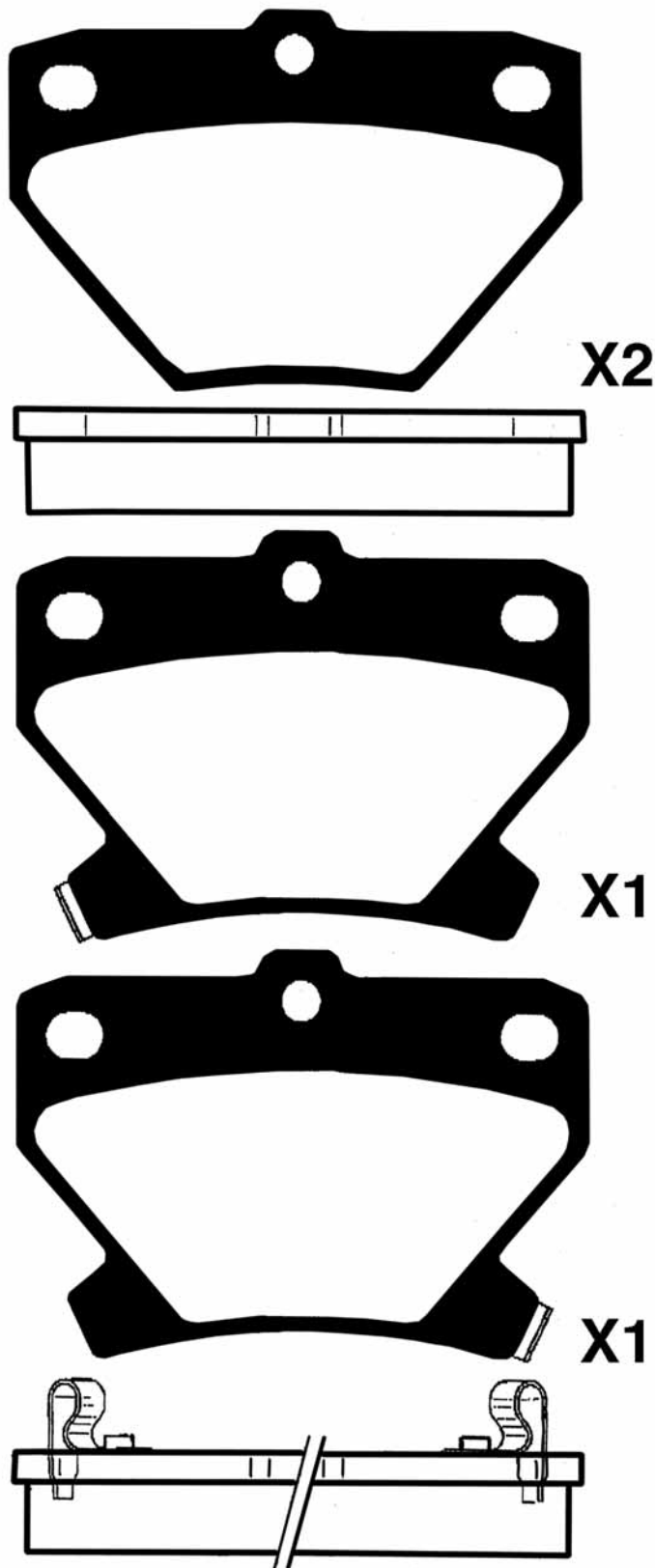



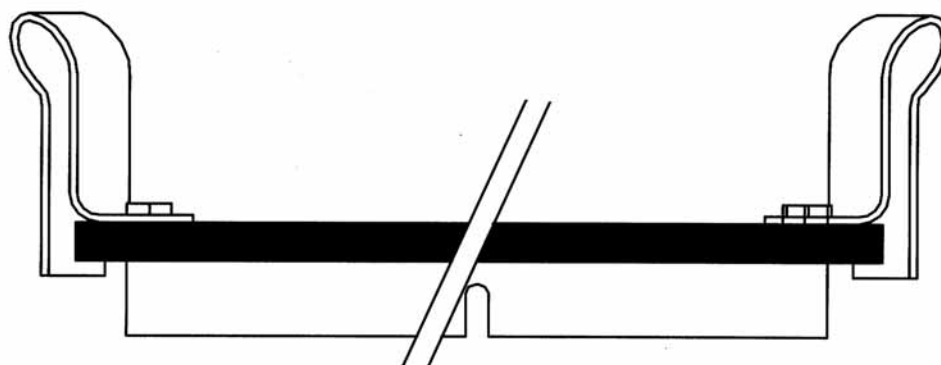
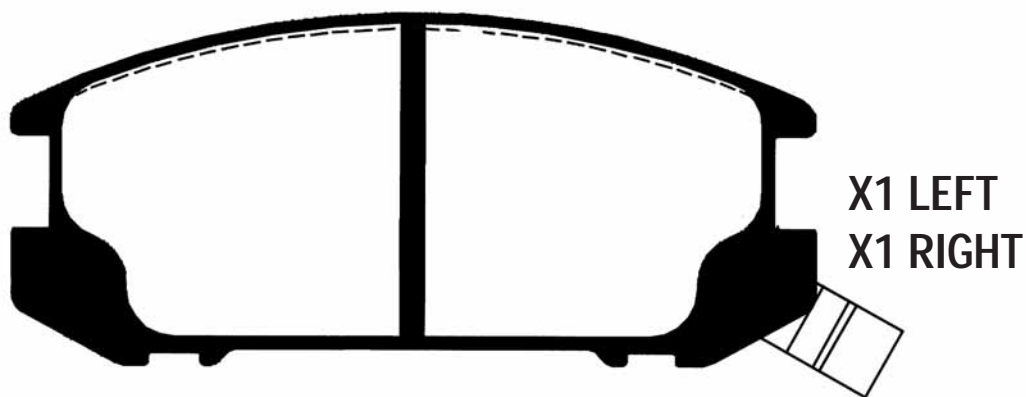
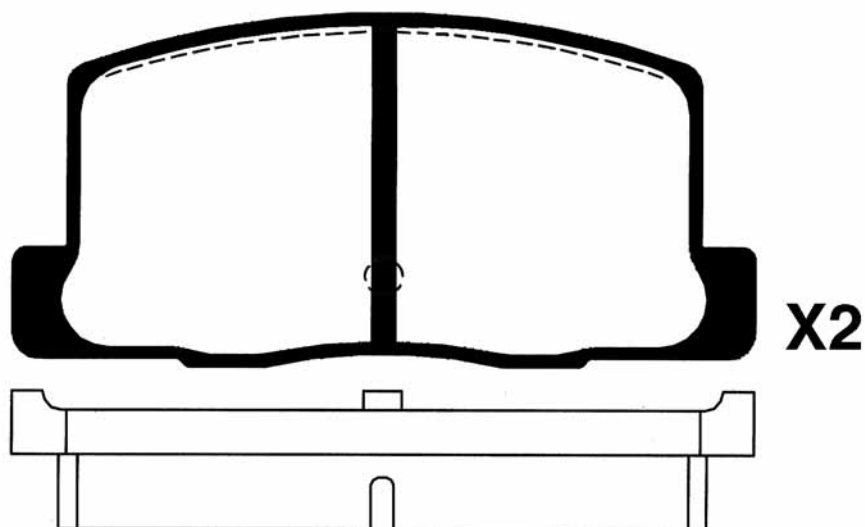

51-02-204				WVA
	TOYOTA	L	H	Th
	106,6/98,5	47	14,7/15,6	21759



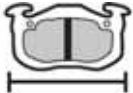

PICTURES BRAKE PADS REAR
ABBILDUNGEN BREMSKLÖTZE HINTEN
FIGURAS PASTILLAS DE FRENO POSTERIORES
ILLUSTRATIONS PLAQUETTES DE FREI ARRIÈRE
IMMAGINI PASTIGLIE FRENO POSTERIORI

51-02-206				WVA
TOYOTA - LEXUS	L	H	Th	
	125,6	42,4	14,9	20004

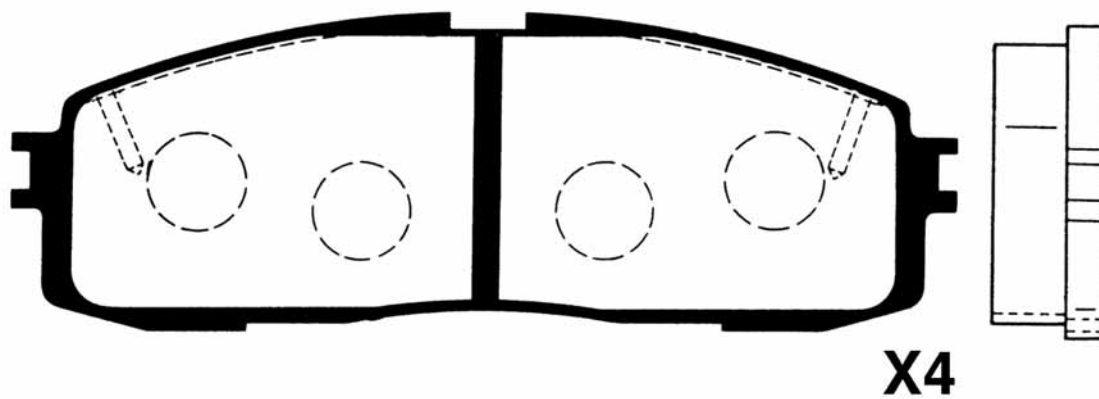



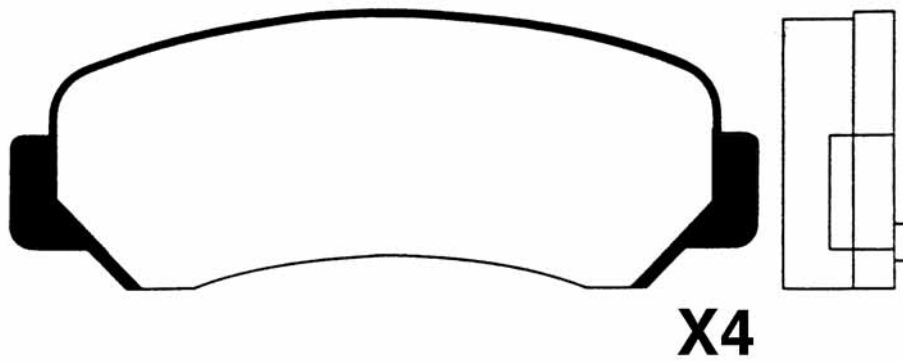

51-02-207				WVA
	TOYOTA	L	H	Th
	98,9	37	14,2	21046



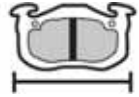

PICTURES BRAKE PADS REAR
ABBILDUNGEN BREMSKLÖTZE HINTEN
FIGURAS PASTILLAS DE FRENO POSTERIORES
ILLUSTRATIONS PLAQUETTES DE FREI ARRIÈRE
IMMAGINI PASTIGLIE FRENO POSTERIORI

51-02-210				WVA
TOYOTA - MITSUBISHI	L	H	Th	
	116,2	44	15	21947

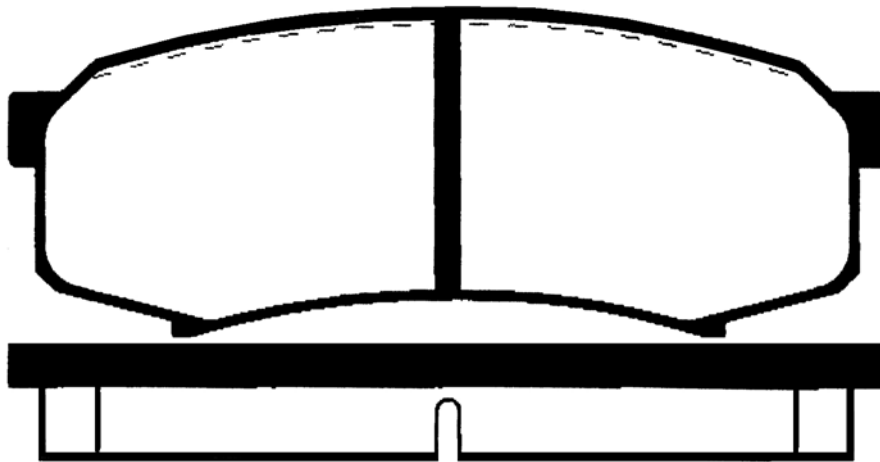

X4



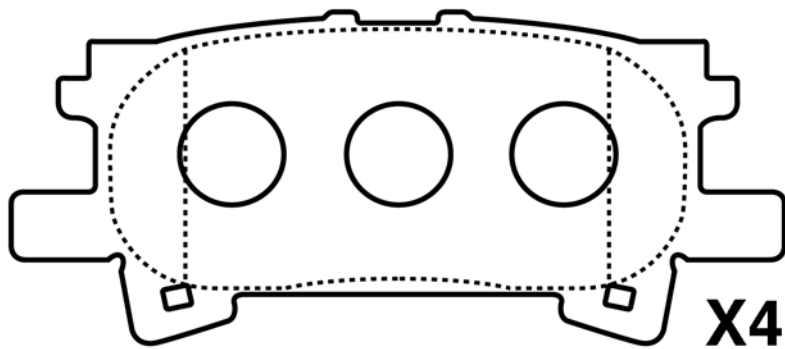

51-02-211				WVA
	L	H	Th	
LEXUS	102	43,6	15,5	





PICTURES BRAKE PADS REAR
ABBILDUNGEN BREMSKLÖTZE HINTEN
FIGURAS PASTILLAS DE FRENO POSTERIORES
ILLUSTRATIONS PLAQUETTES DE FREI ARRIÈRE
IMMAGINI PASTIGLIE FRENO POSTERIORI

51-02-212				WVA
LEXUS	L	H	Th	
	122	41	15,4	

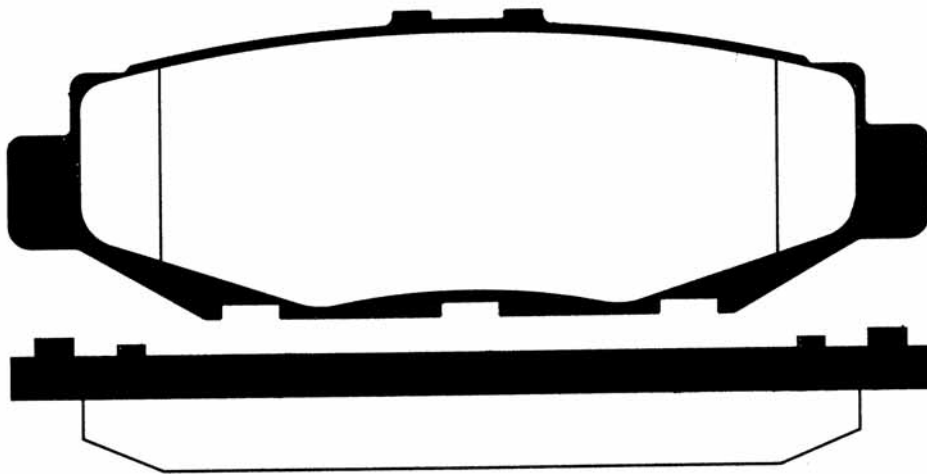

X4



51-02-213 TOYOTA - LEXUS				WVA
	L 108	H 43,1	Th 15	20076

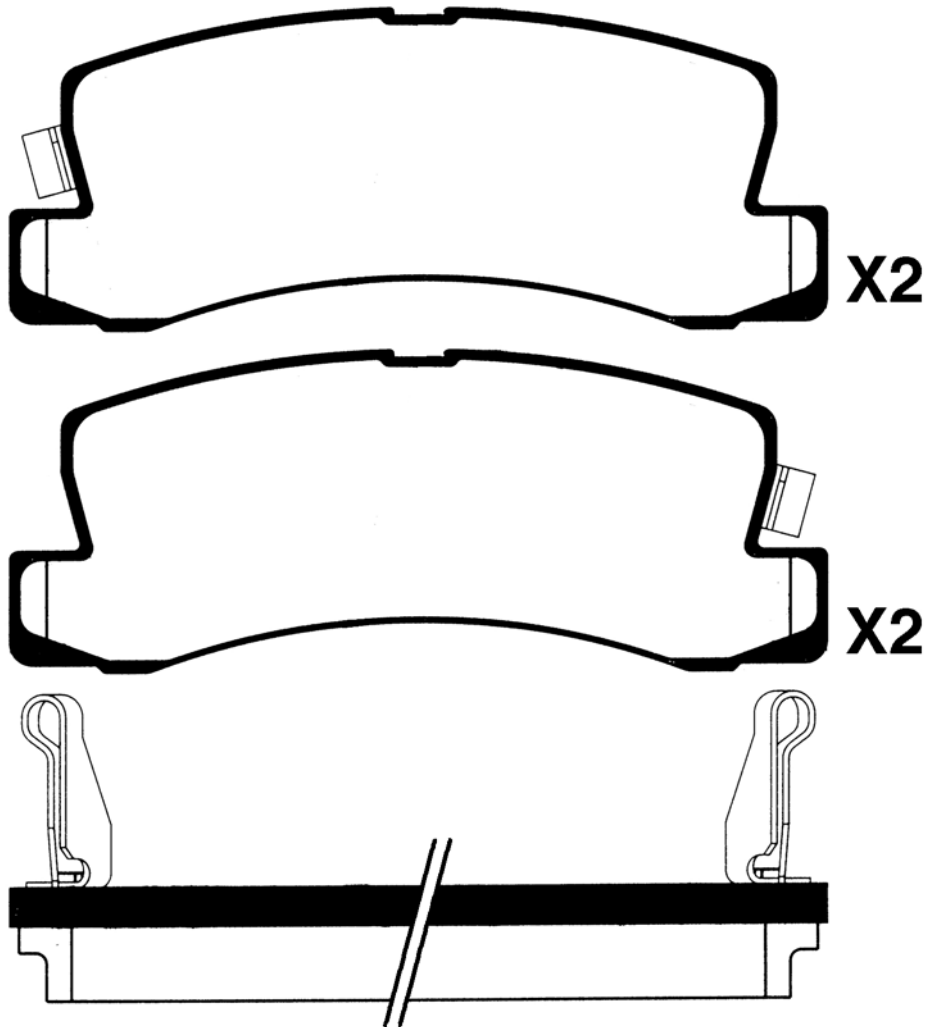



PICTURES BRAKE PADS REAR
ABBILDUNGEN BREMSKLÖTZE HINTEN
FIGURAS PASTILLAS DE FRENO POSTERIORES
ILLUSTRATIONS PLAQUETTES DE FREI ARRIÈRE
IMMAGINI PASTIGLIE FRENO POSTERIORI

51-02-214 TOYOTA - SUBARU - LEXUS				WVA
	L	H	Th	24610
	98,2	42,5	14,8	

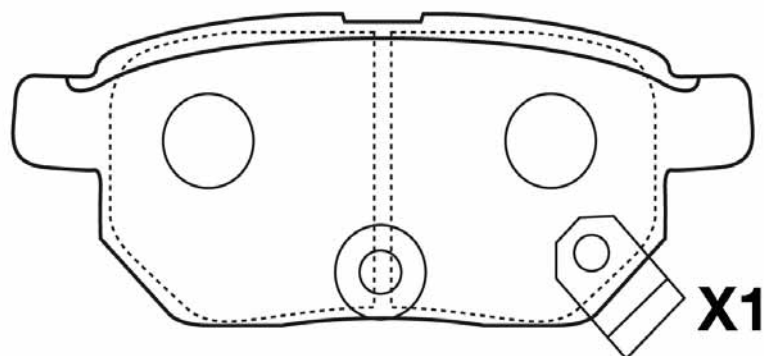
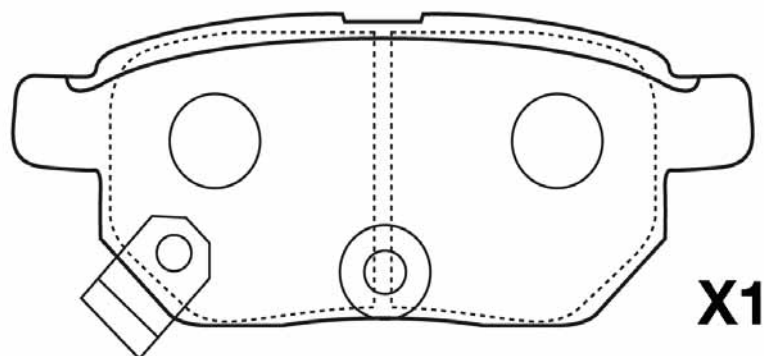
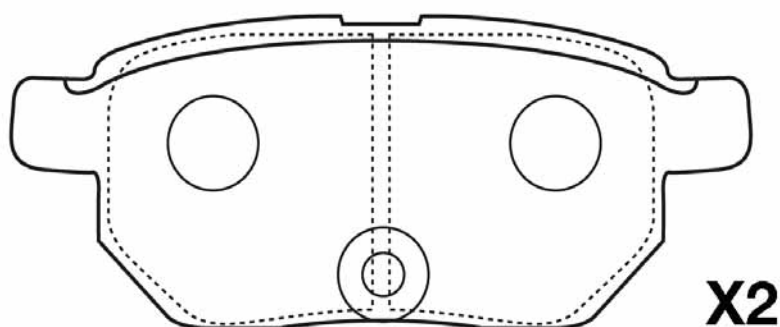



51-02-216				WVA
	TOYOTA	L	H	Th
	92,9	37,8	15,8	23702

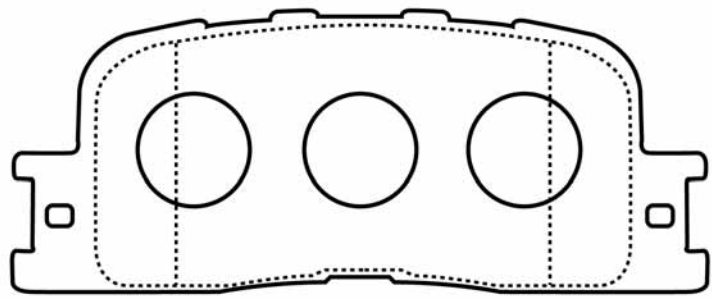

X4



PICTURES BRAKE PADS REAR
ABBILDUNGEN BREMSKLÖTZE HINTEN
FIGURAS PASTILLAS DE FRENO POSTERIORES
ILLUSTRATIONS PLAQUETTES DE FREI ARRIÈRE
IMMAGINI PASTIGLIE FRENO POSTERIORI

51-02-217

LEXUS

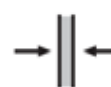

WVA

L

H

Th

88

58

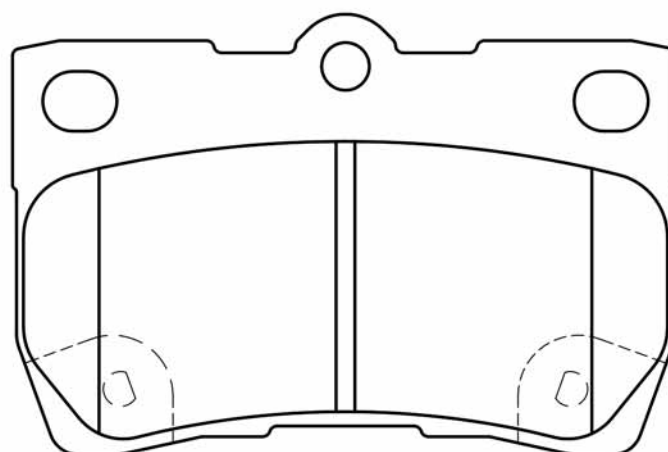
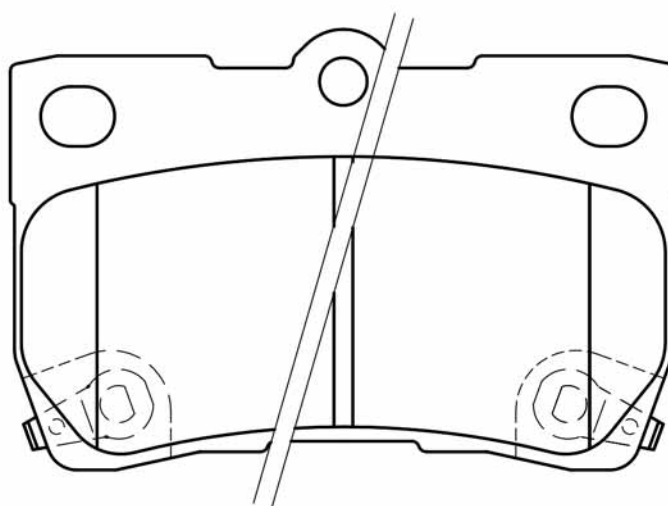

15,5

24323



PICTURES BRAKE PADS REAR
ABBILDUNGEN BREMSKLÖTZE HINTEN
FIGURAS PASTILLAS DE FRENO POSTERIORES
ILLUSTRATIONS PLAQUETTES DE FREI ARRIÈRE
IMMAGINI PASTIGLIE FRENO POSTERIORI



51-02-218				WVA
	TOYOTA	L		
	96,8	49,5	15,2	24338

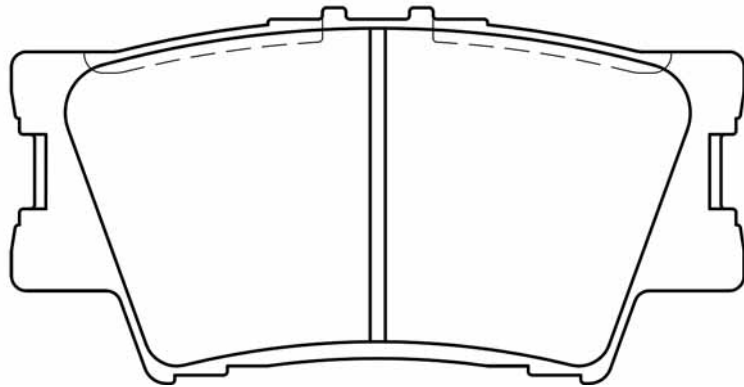



PICTURES BRAKE PADS REAR
ABBILDUNGEN BREMSKLÖTZE HINTEN
FIGURAS PASTILLAS DE FRENO POSTERIORES
ILLUSTRATIONS PLAQUETTES DE FREI ARRIÈRE
IMMAGINI PASTIGLIE FRENO POSTERIORI

51-02-219

TOYOTA

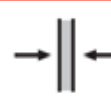
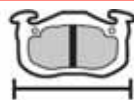

WVA

L

H

Th

87

50

16

24013

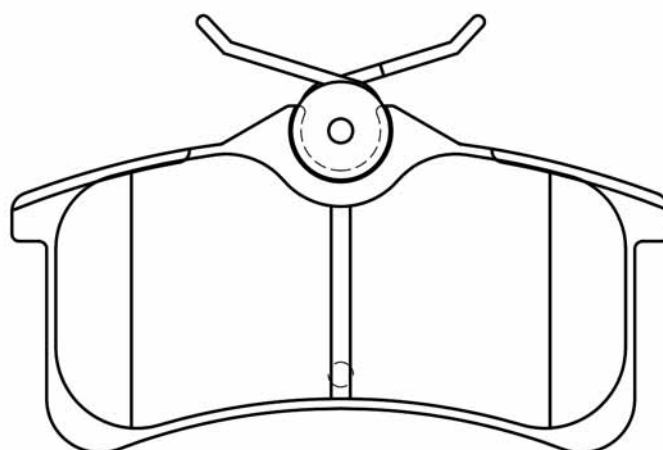
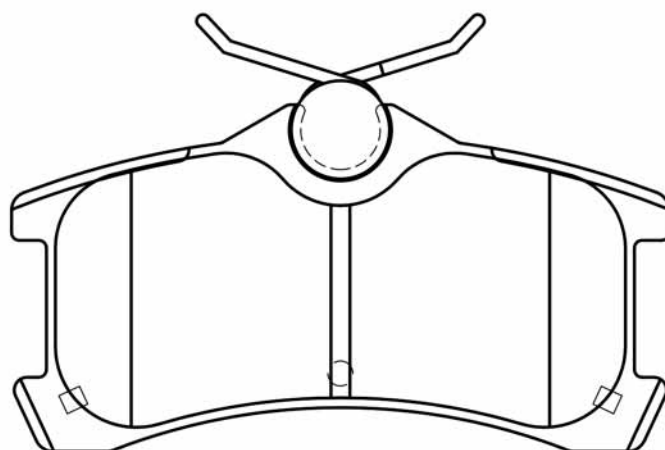



51-02-220 TOYOTA				WVA
	L	H	Th	24664
	102	46	16	

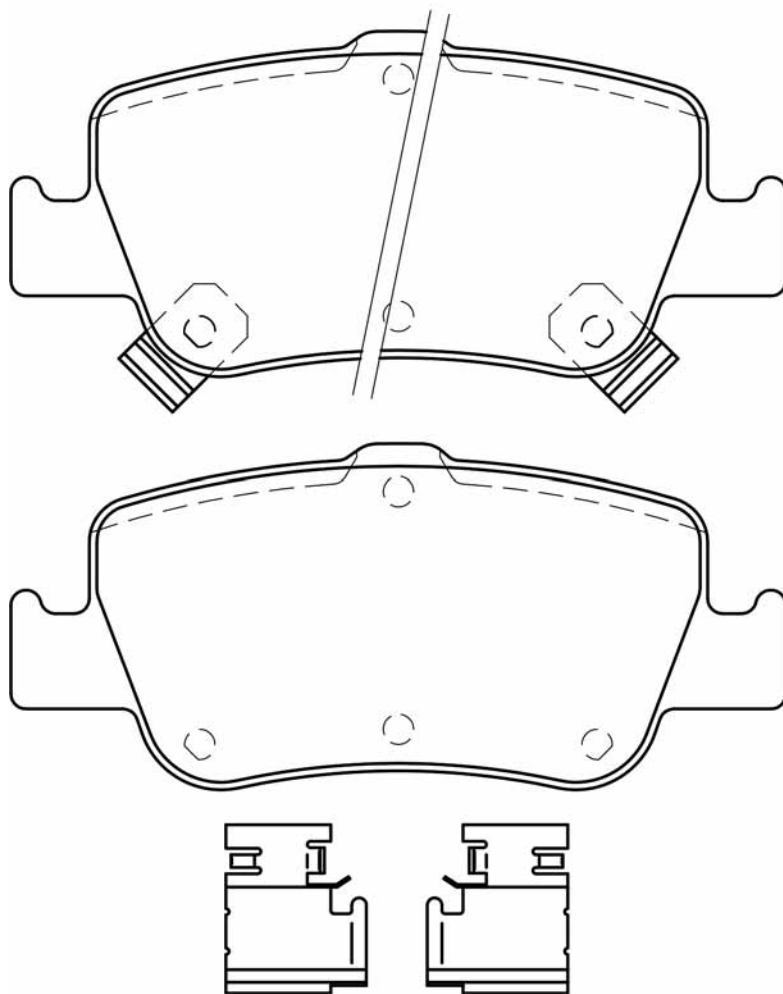



PICTURES BRAKE PADS REAR
ABBILDUNGEN BREMSKLÖTZE HINTEN
FIGURAS PASTILLAS DE FRENO POSTERIORES
ILLUSTRATIONS PLAQUETTES DE FREI ARRIÈRE
IMMAGINI PASTIGLIE FRENO POSTERIORI

51-02-221

TOYOTA

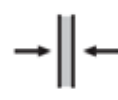
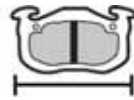

WVA

L

H

Th

116

45

17,5

24653

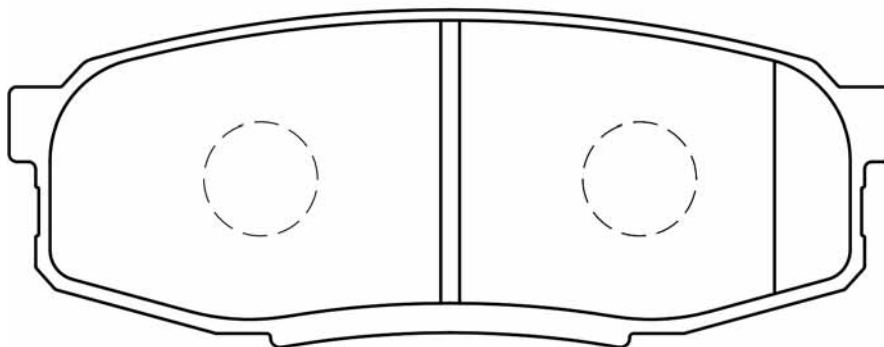



51-02-222

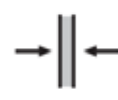
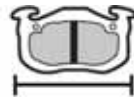

WVA

LEXUS

L

H

Th

96

62

15

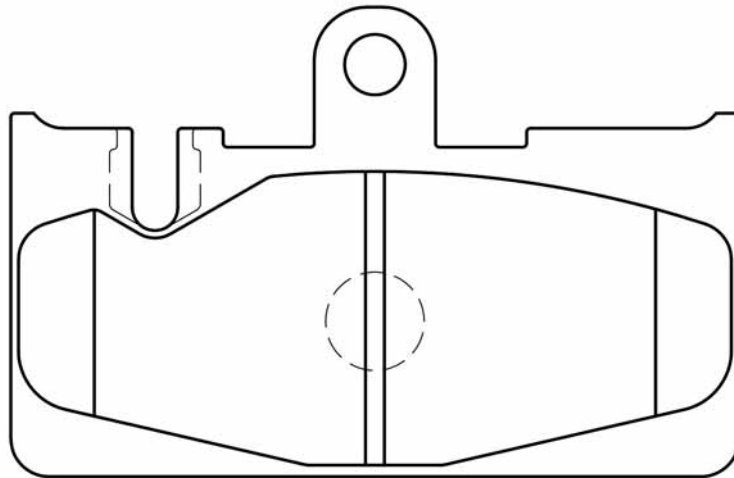



PICTURES BRAKE PADS REAR
ABBILDUNGEN BREMSKLÖTZE HINTEN
FIGURAS PASTILLAS DE FRENO POSTERIORES
ILLUSTRATIONS PLAQUETTES DE FREI ARRIÈRE
IMMAGINI PASTIGLIE FRENO POSTERIORI

51-02-223

TOYOTA

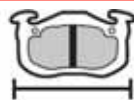

WVA

L

H

Th

109

50

16,5

24885

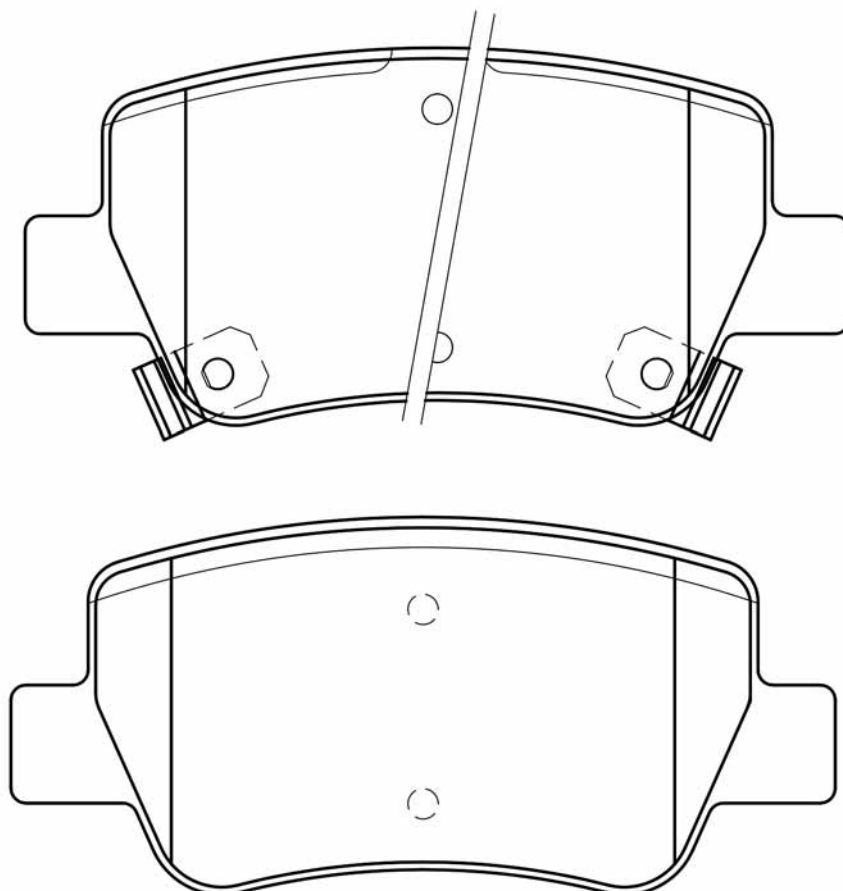



51-02-224				WVA
	TOYOTA	L	H	Th
	102	49	16,5	24926

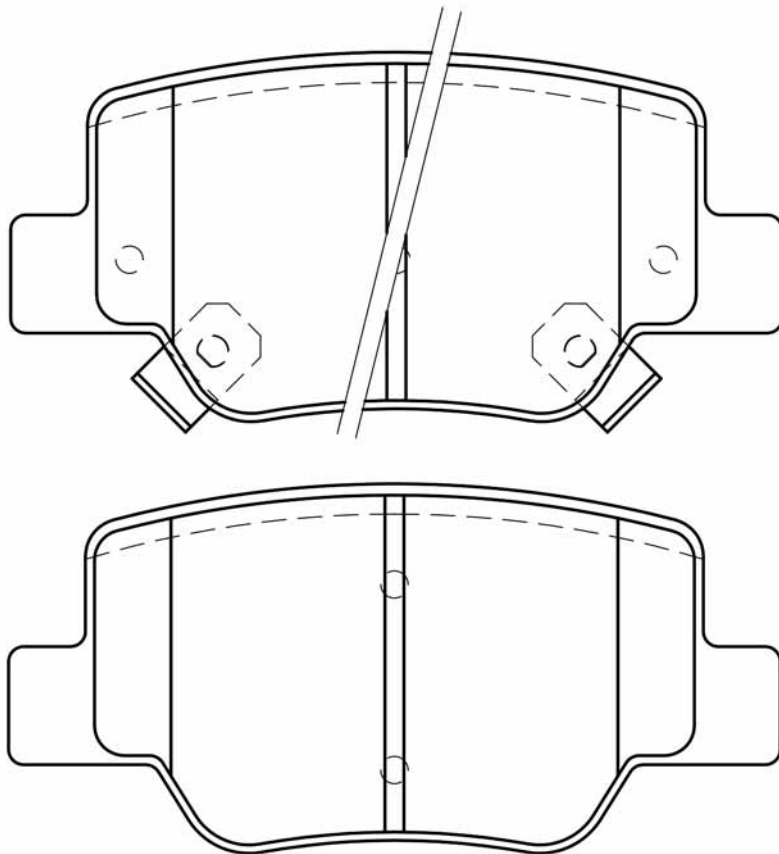



PICTURES BRAKE PADS REAR
ABBILDUNGEN BREMSKLÖTZE HINTEN
FIGURAS PASTILLAS DE FRENO POSTERIORES
ILLUSTRATIONS PLAQUETTES DE FREI ARRIÈRE
IMMAGINI PASTIGLIE FRENO POSTERIORI

51-02-225

TOYOTA



WVA

L

H

Th

123

44

15

24574

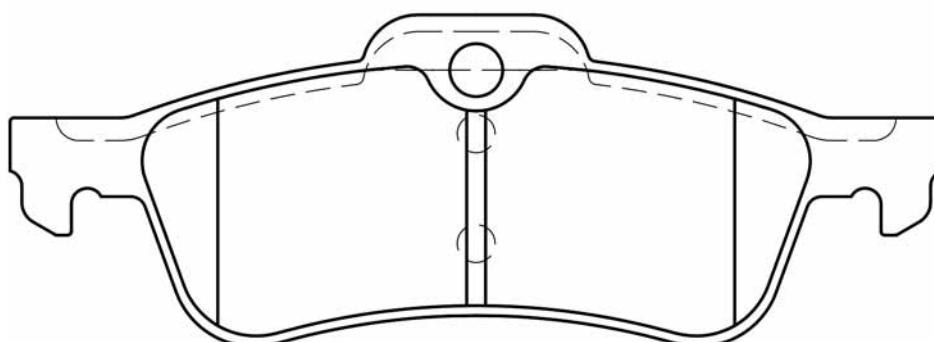
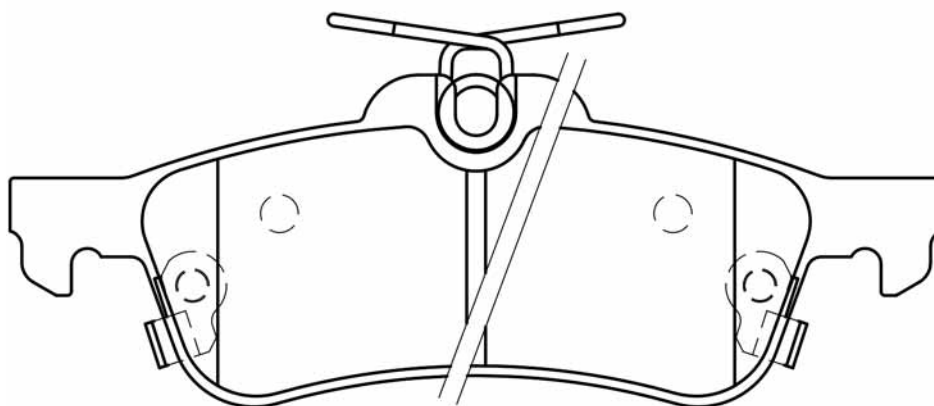



51-02-256				WVA
	TOYOTA - DR	L	H	Th
	78,5	54	13,6	23656

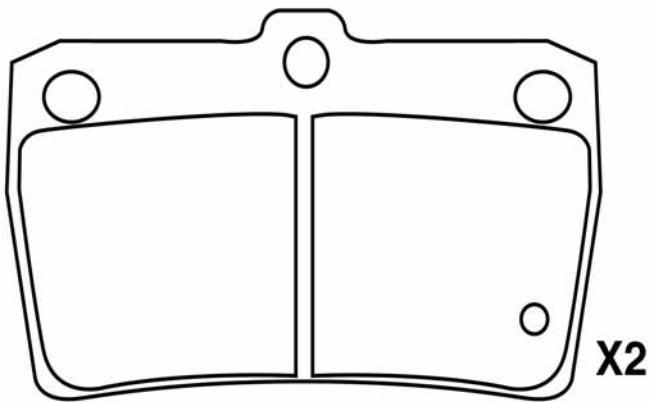
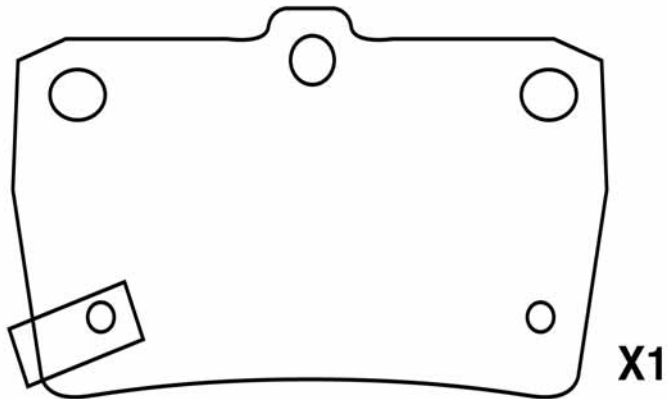
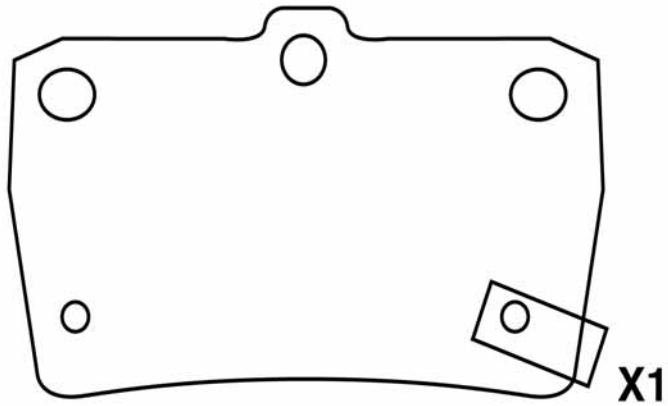



PICTURES BRAKE PADS REAR
ABBILDUNGEN BREMSKLÖTZE HINTEN
FIGURAS PASTILLAS DE FRENO POSTERIORES
ILLUSTRATIONS PLAQUETTES DE FREI ARRIÈRE
IMMAGINI PASTIGLIE FRENO POSTERIORI

51-02-257				WVA
TOYOTA	L	H	Th	
	95,6	38	14,7	23816

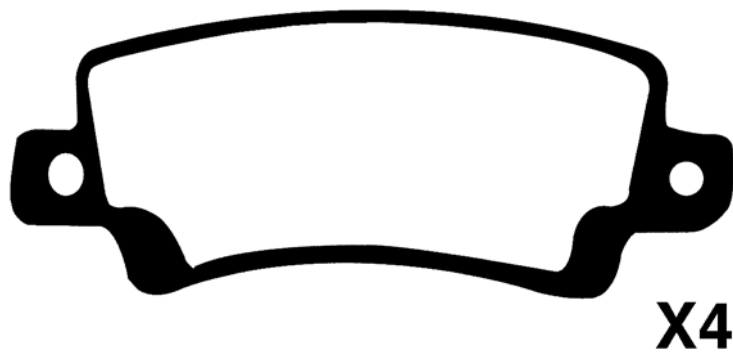



51-02-258				WVA
	TOYOTA	L	H	Th
	112,4	42,9	16	23646

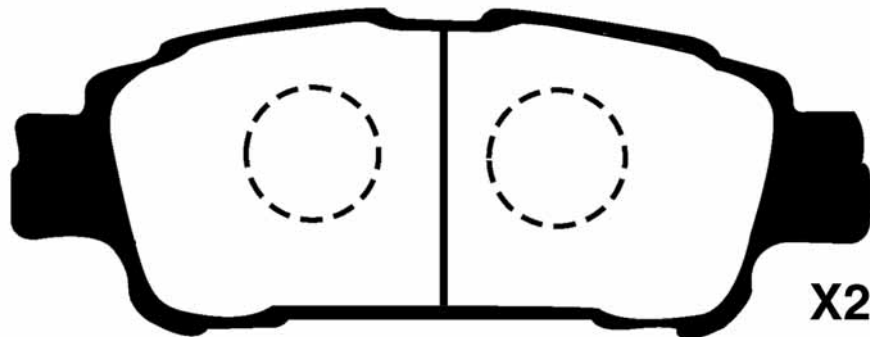
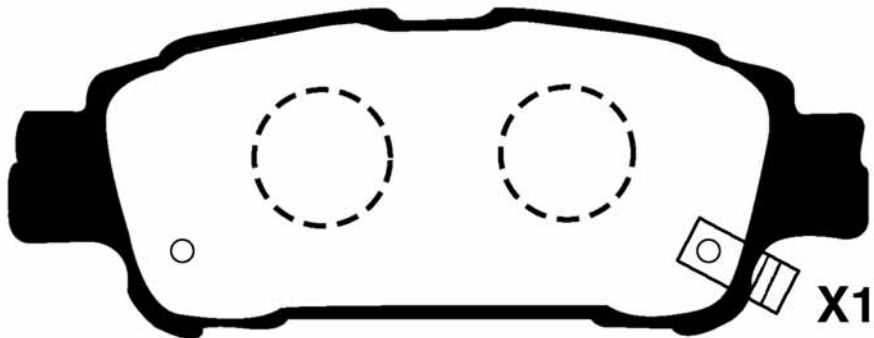
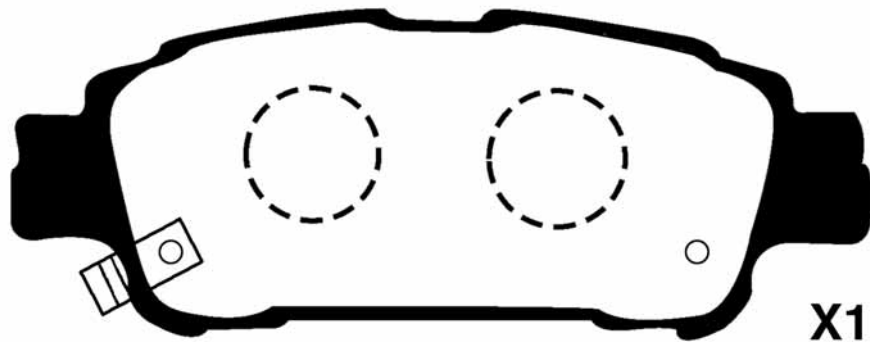



PICTURES BRAKE PADS REAR
ABBILDUNGEN BREMSKLÖTZE HINTEN
FIGURAS PASTILLAS DE FRENO POSTERIORES
ILLUSTRATIONS PLAQUETTES DE FREI ARRIÈRE
IMMAGINI PASTIGLIE FRENO POSTERIORI

51-02-259				WVA
TOYOTA	L	H	Th	
	123,2	45,6	17,7	23539

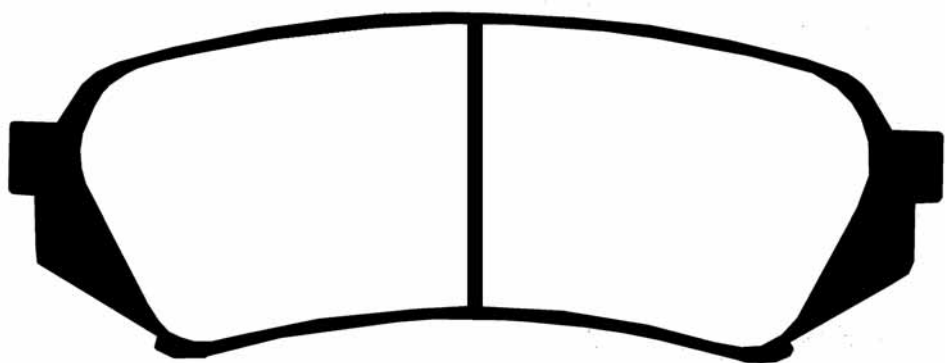

X4



51-02-260				WVA
LEXUS	L	H	Th	
	57,1	63,7	15,3	

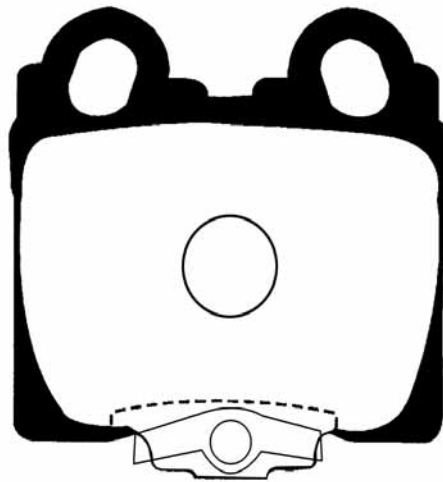

X4



PICTURES BRAKE PADS REAR
ABBILDUNGEN BREMSKLÖTZE HINTEN
FIGURAS PASTILLAS DE FRENO POSTERIORES
ILLUSTRATIONS PLAQUETTES DE FREI ARRIÈRE
IMMAGINI PASTIGLIE FRENO POSTERIORI

51-02-261 TOYOTA				WVA
	L	H	Th	
	105/107,1	45,9/43,4	14,9/14,6	

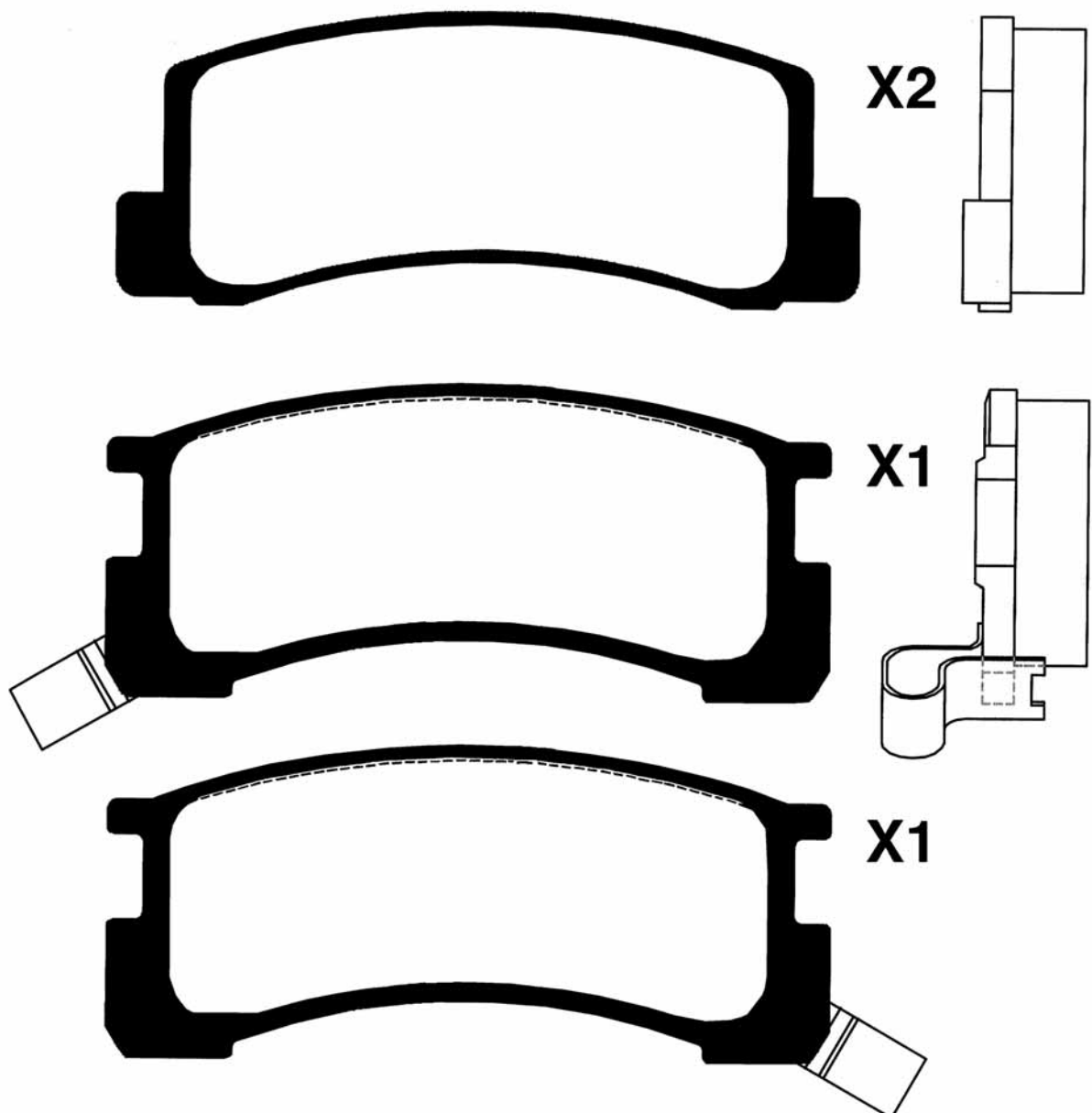



51-02-262

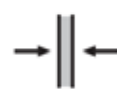
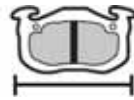

WVA

TOYOTA

L

H

Th

119,7

43

15,2

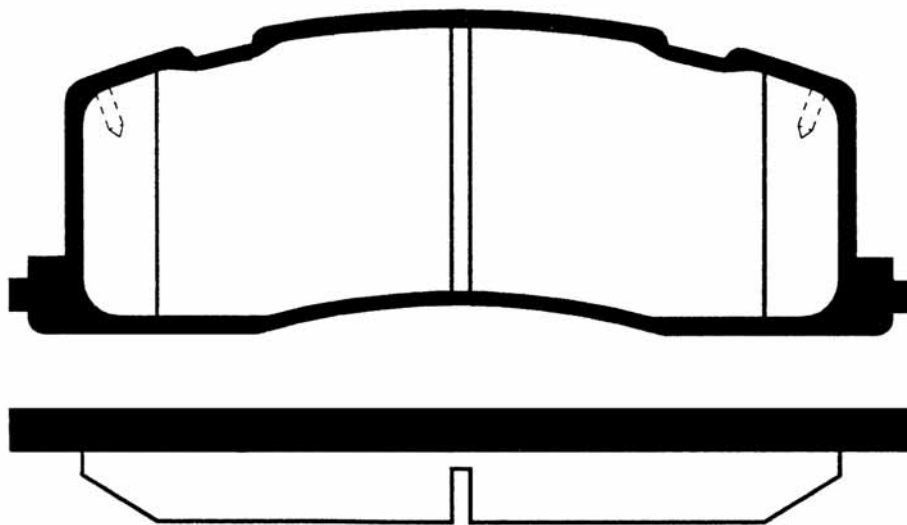

21668



X4



PICTURES BRAKE PADS REAR
ABBILDUNGEN BREMSKLÖTZE HINTEN
FIGURAS PASTILLAS DE FRENO POSTERIORES
ILLUSTRATIONS PLAQUETTES DE FREI ARRIÈRE
IMMAGINI PASTIGLIE FRENO POSTERIORI

51-02-265				WVA
LEXUS	L	H	Th	
	117	40,2	15	23429

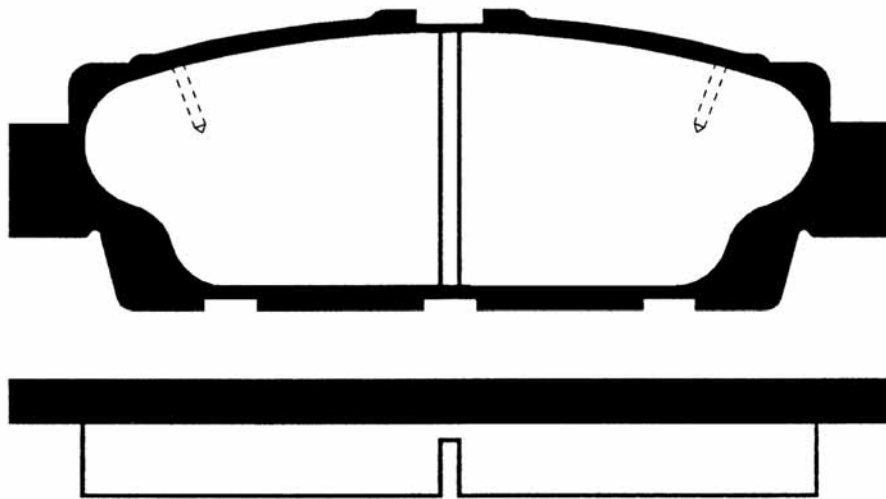

X4



51-02-294				WVA
	TOYOTA	L	H	Th
	81	69,6	16,8	21955

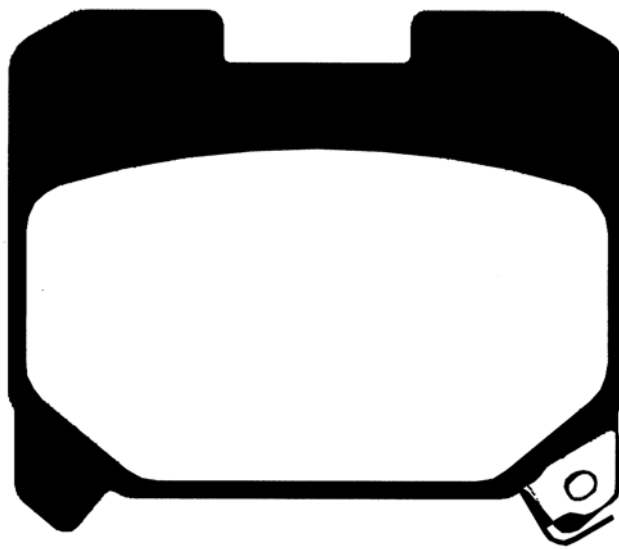

X2

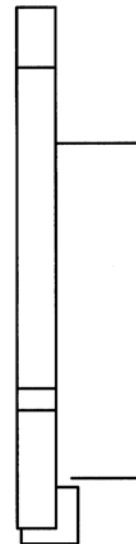
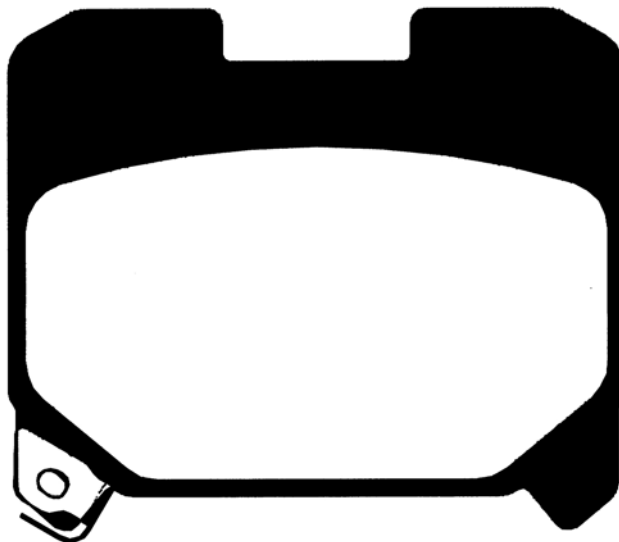

X2



PICTURES BRAKE PADS REAR
ABBILDUNGEN BREMSKLÖTZE HINTEN
FIGURAS PASTILLAS DE FRENO POSTERIORES
ILLUSTRATIONS PLAQUETTES DE FREI ARRIÈRE
IMMAGINI PASTIGLIE FRENO POSTERIORI

51-02-295				WVA
	LEXUS	L	H	
	122	40,9	15,2	

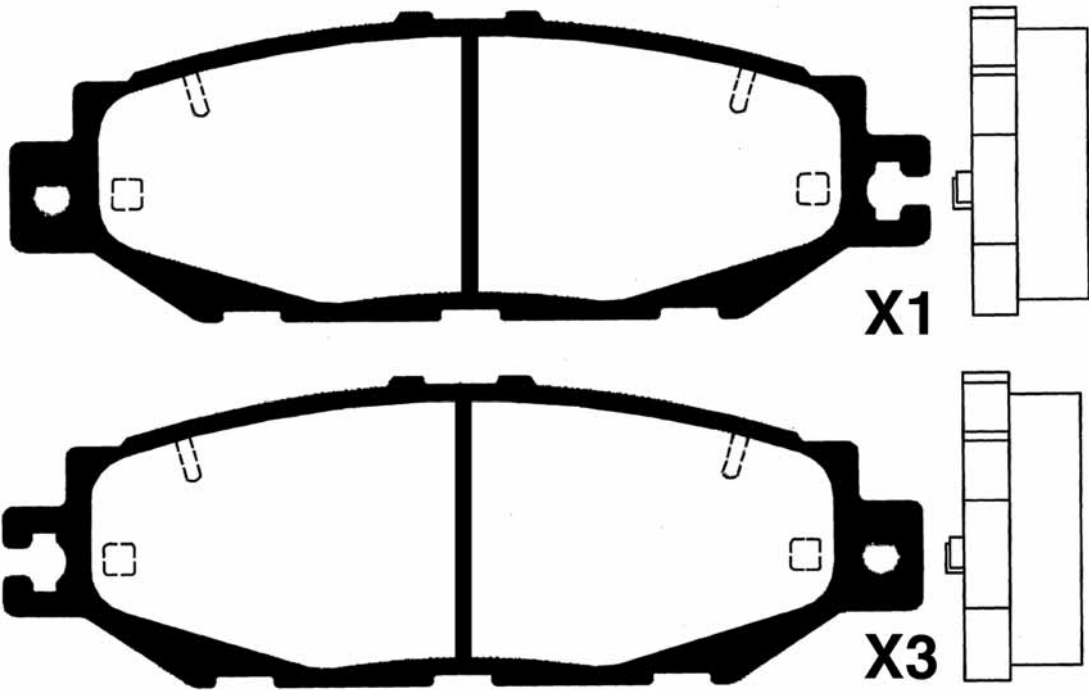



51-03-300				WVA
	MAZDA	L	H	
	149,3/138,6	48,1/47,5	12,7	20899

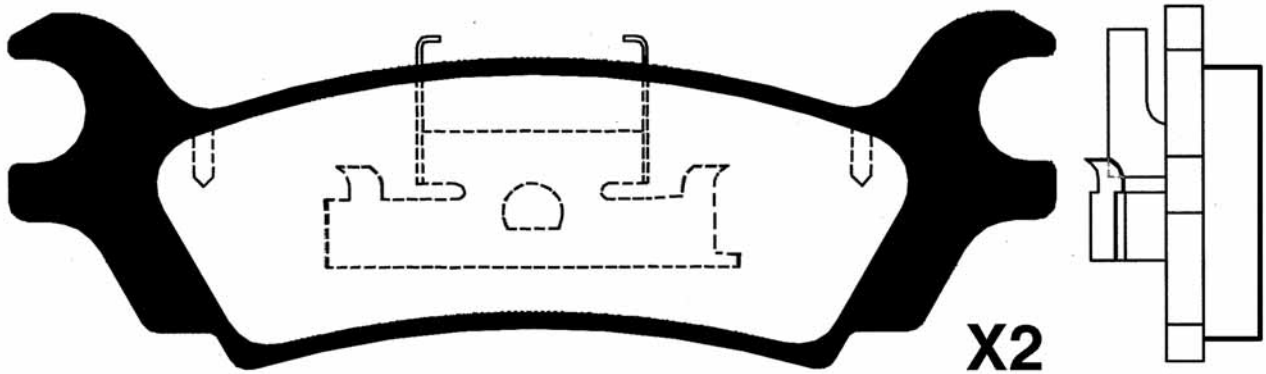
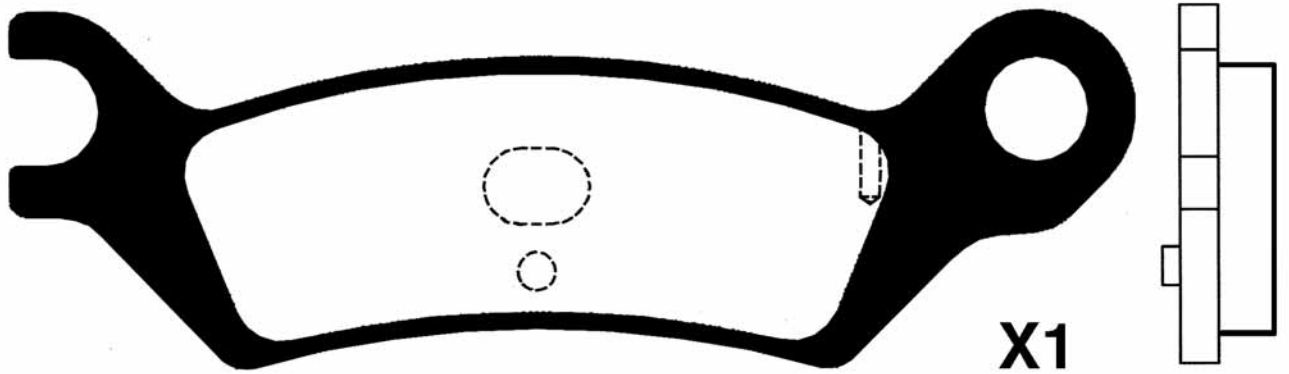
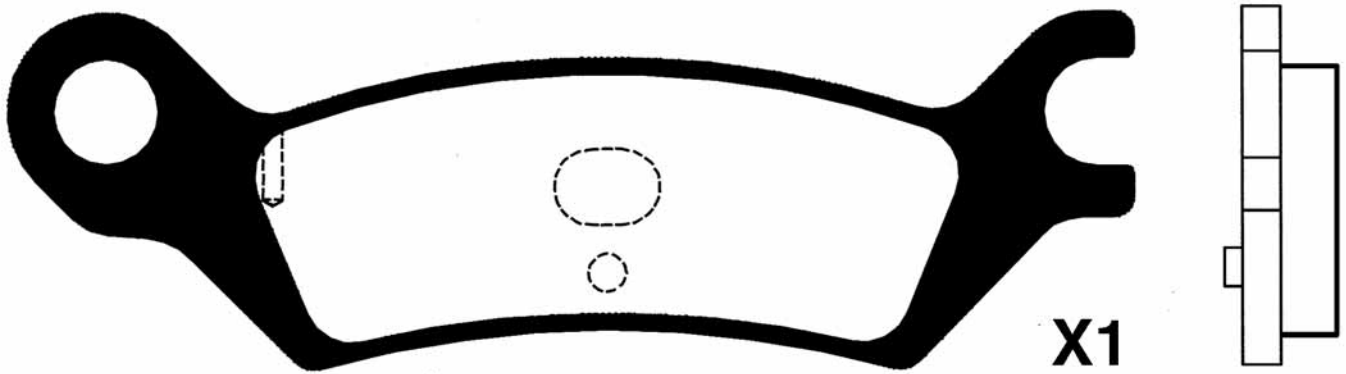



PICTURES BRAKE PADS REAR
ABBILDUNGEN BREMSKLÖTZE HINTEN
FIGURAS PASTILLAS DE FRENO POSTERIORES
ILLUSTRATIONS PLAQUETTES DE FREI ARRIÈRE
IMMAGINI PASTIGLIE FRENO POSTERIORI

51-03-301 MAZDA - ISUZU				WVA
	L	H	Th	
	99	39,4	13	20954

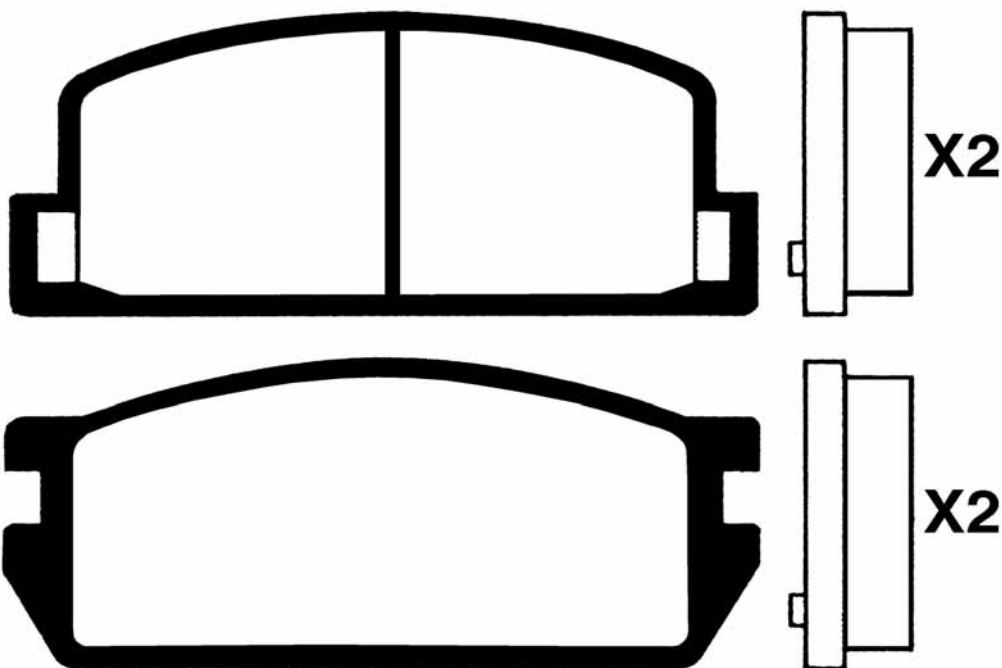



51-03-302				WVA	
	MAZDA	L	H	Th	20031
	108	39,7	12,7		

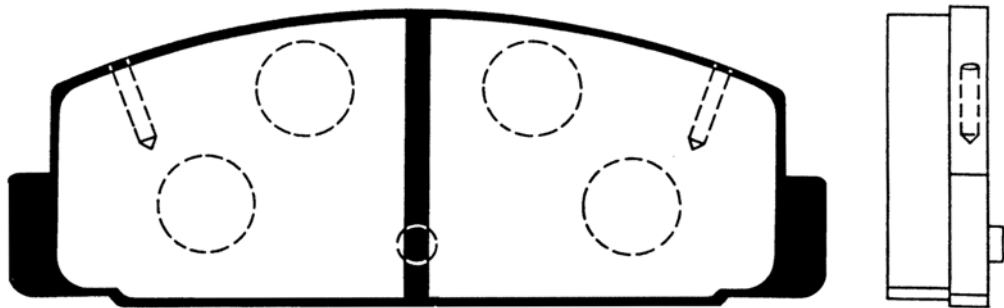

X4



PICTURES BRAKE PADS REAR
ABBILDUNGEN BREMSKLÖTZE HINTEN
FIGURAS PASTILLAS DE FRENO POSTERIORES
ILLUSTRATIONS PLAQUETTES DE FREI ARRIÈRE
IMMAGINI PASTIGLIE FRENO POSTERIORI

51-03-303				WVA
MAZDA - DAIHATSU	L	H	Th	
	101,8	42,7	12,1	20008

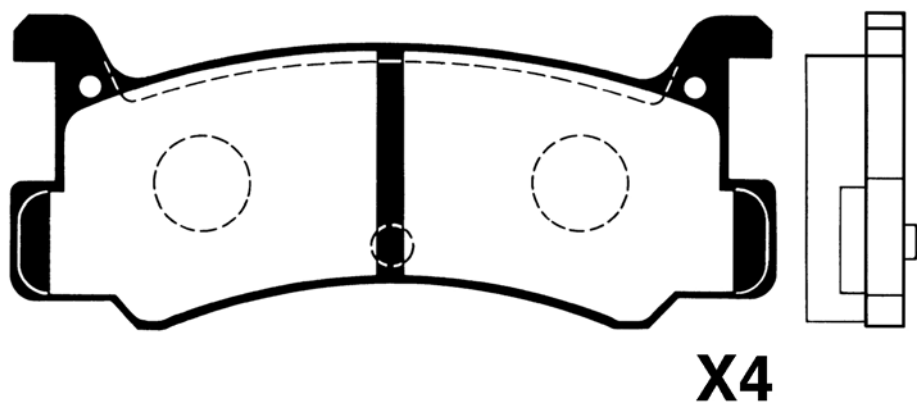



51-03-304				WVA
	MAZDA	L	H	Th
	105,5	43,1	14,4	24039

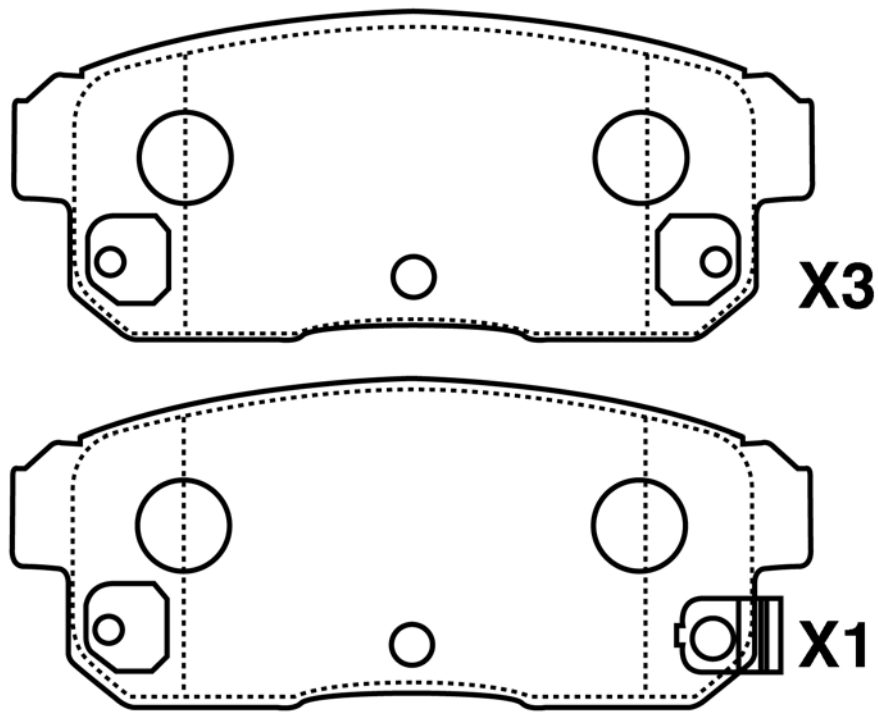



PICTURES BRAKE PADS REAR
ABBILDUNGEN BREMSKLÖTZE HINTEN
FIGURAS PASTILLAS DE FRENO POSTERIORES
ILLUSTRATIONS PLAQUETTES DE FREI ARRIÈRE
IMMAGINI PASTIGLIE FRENO POSTERIORI

51-03-305				WVA
MAZDA	L	H	Th	
	117	42,5	12,6	21569

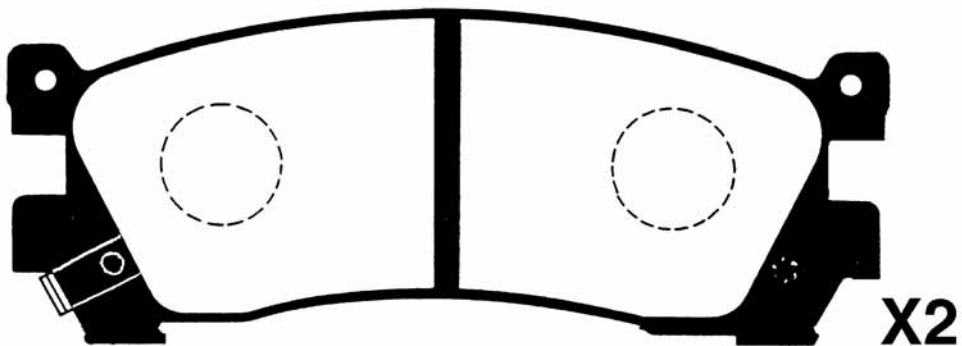
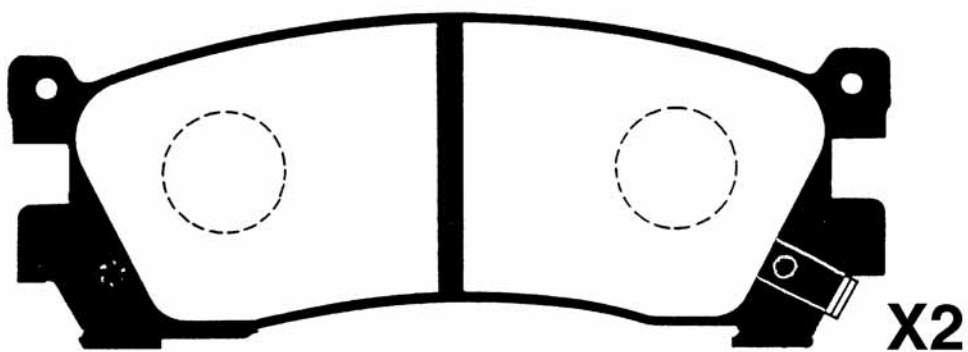



51-03-306				WVA
	MAZDA	L	H	Th
	104	41,4	12,7	21558

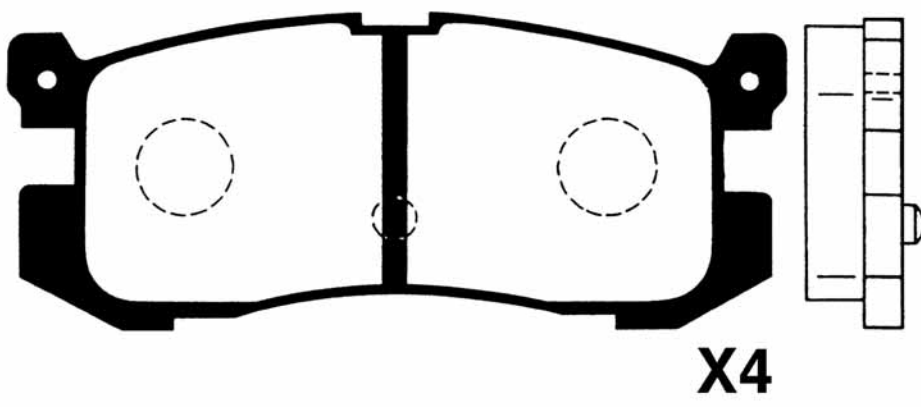



PICTURES BRAKE PADS REAR
ABBILDUNGEN BREMSKLÖTZE HINTEN
FIGURAS PASTILLAS DE FRENO POSTERIORES
ILLUSTRATIONS PLAQUETTES DE FREI ARRIÈRE
IMMAGINI PASTIGLIE FRENO POSTERIORI

51-03-307				WVA
MAZDA	L	H	Th	
	100,3	43,5	12,9	21766

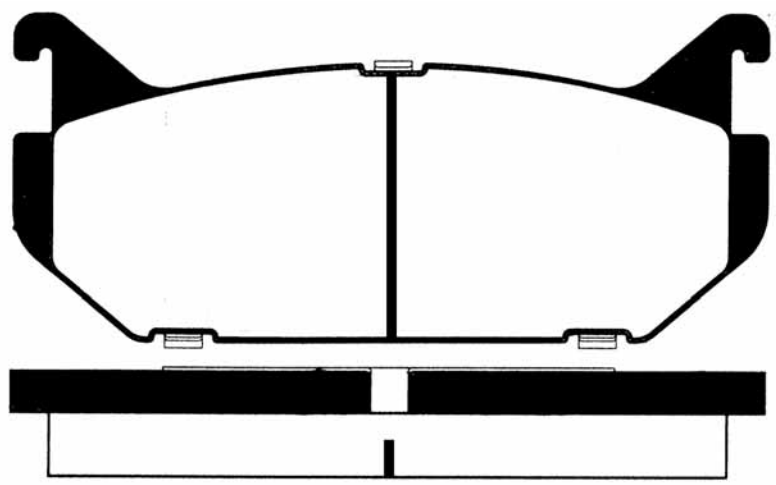

X4



51-03-309				WVA
	MAZDA	L	H	Th
	111	45	17	24545

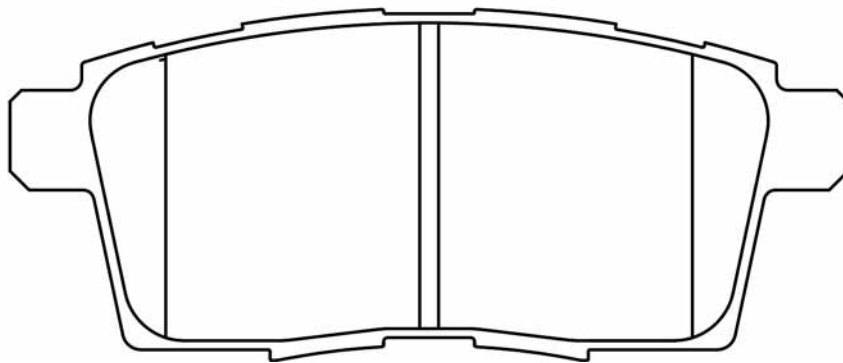



PICTURES BRAKE PADS REAR
ABBILDUNGEN BREMSKLÖTZE HINTEN
FIGURAS PASTILLAS DE FRENO POSTERIORES
ILLUSTRATIONS PLAQUETTES DE FREI ARRIÈRE
IMMAGINI PASTIGLIE FRENO POSTERIORI

51-03-310				WVA
MAZDA	L	H	Th	
	146	55,1	18	24670

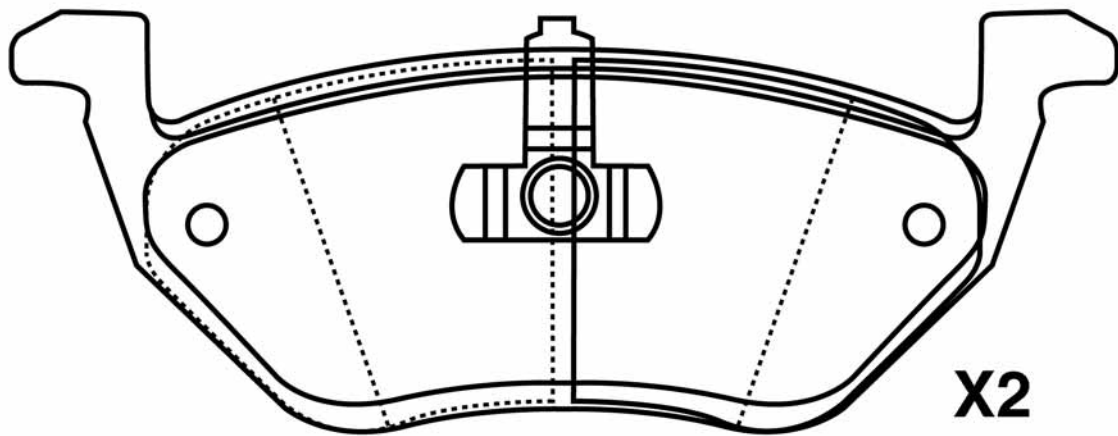
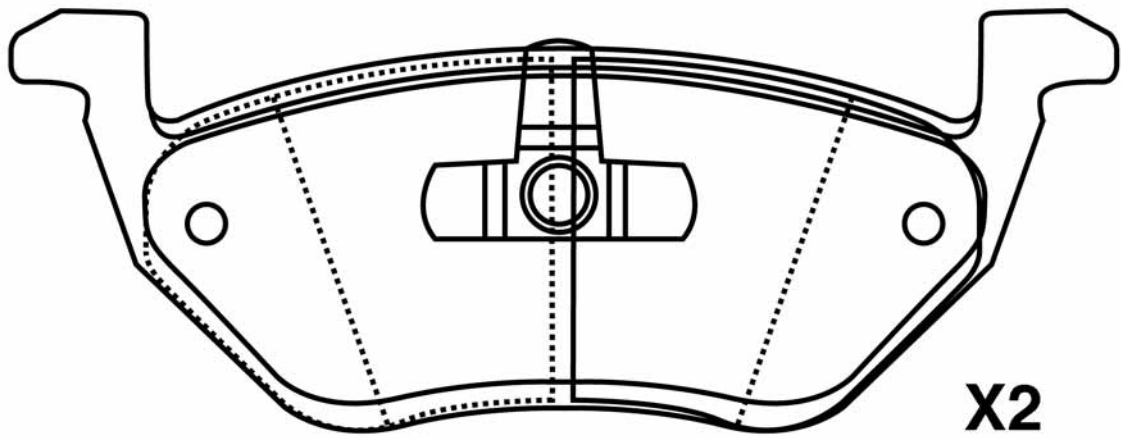

PICTURES BRAKE PADS REAR
ABBILDUNGEN BREMSKLÖTZE HINTEN
FIGURAS PASTILLAS DE FRENO POSTERIORES
ILLUSTRATIONS PLAQUETTES DE FREI ARRIÈRE
IMMAGINI PASTIGLIE FRENO POSTERIORI



51-03-311

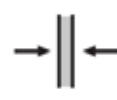
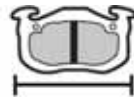

WVA

MAZDA

L

H

Th

99

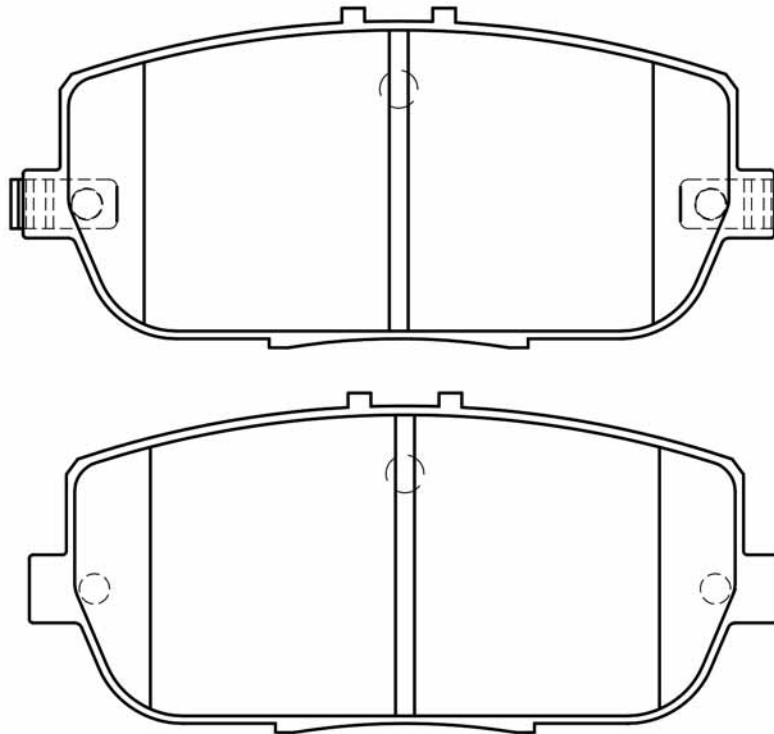

45

13,5





PICTURES BRAKE PADS REAR
ABBILDUNGEN BREMSKLÖTZE HINTEN
FIGURAS PASTILLAS DE FRENO POSTERIORES
ILLUSTRATIONS PLAQUETTES DE FREI ARRIÈRE
IMMAGINI PASTIGLIE FRENO POSTERIORI

51-03-312				WVA
MAZDA	L	H	Th	
	111	42	14,5	24581

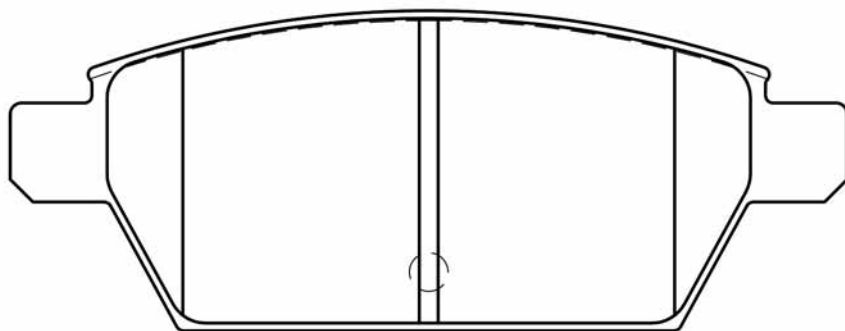



51-03-345				WVA
	MAZDA	L 102	H 43	Th 12,5
				24029

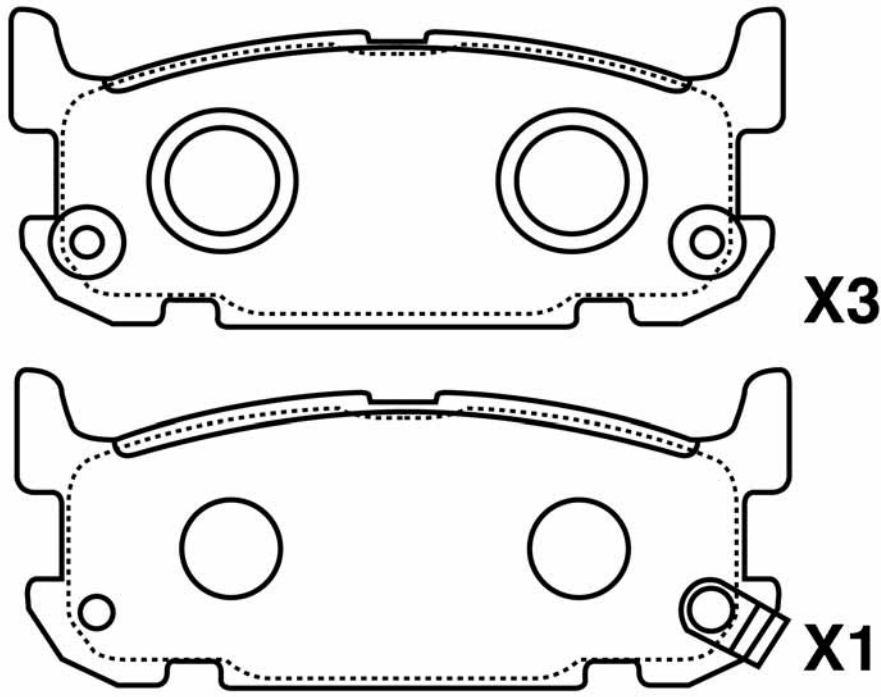



PICTURES BRAKE PADS REAR
ABBILDUNGEN BREMSKLÖTZE HINTEN
FIGURAS PASTILLAS DE FRENO POSTERIORES
ILLUSTRATIONS PLAQUETTES DE FREI ARRIÈRE
IMMAGINI PASTIGLIE FRENO POSTERIORI

51-03-391				WVA
MAZDA	L	H	Th	
	102,2	43	12	23389

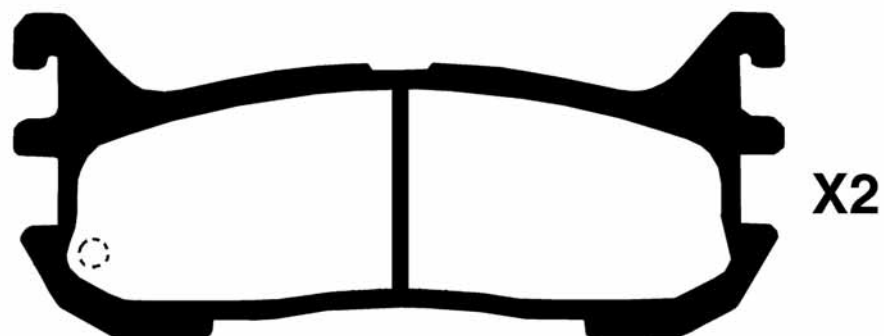
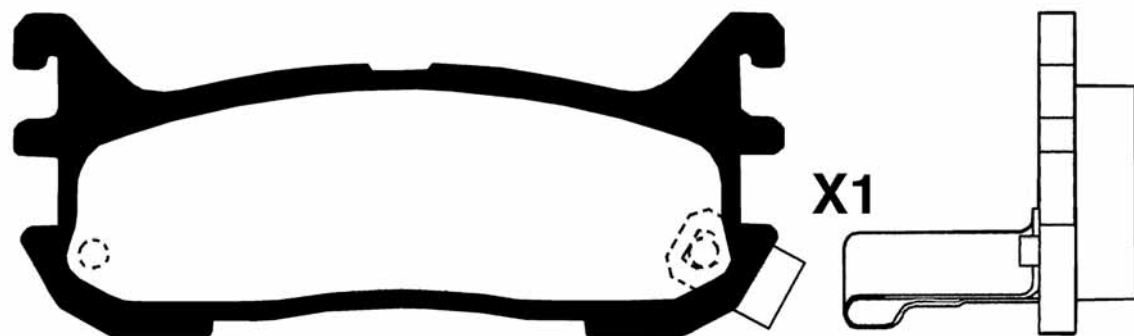
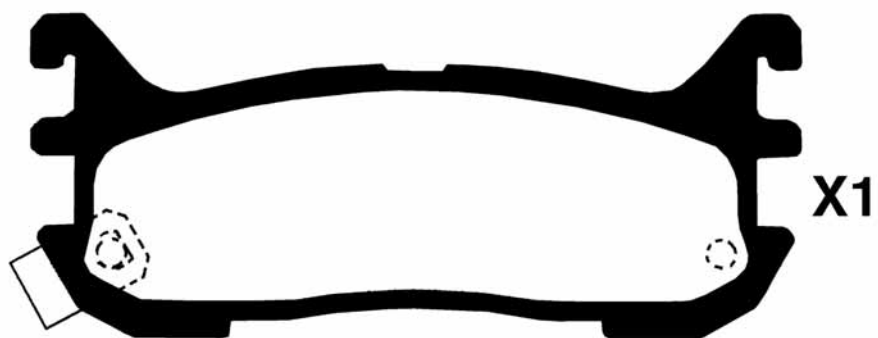



51-03-398

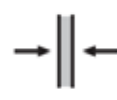
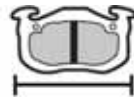

WVA

DAEWOO

L

H

Th

114,2

54,8

14,6

23237

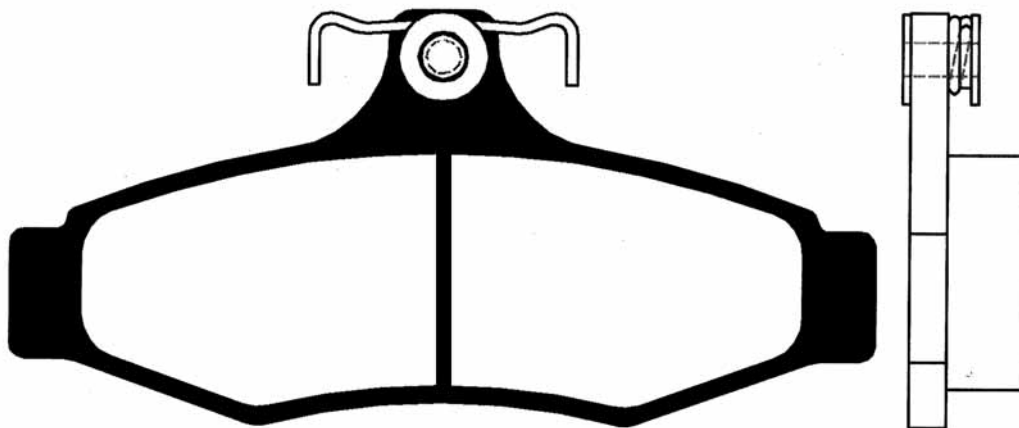

X4



PICTURES BRAKE PADS REAR
ABBILDUNGEN BREMSKLÖTZE HINTEN
FIGURAS PASTILLAS DE FRENO POSTERIORES
ILLUSTRATIONS PLAQUETTES DE FREI ARRIÈRE
IMMAGINI PASTIGLIE FRENO POSTERIORI

51-03-399				WVA
	HYUNDAI	L	H	Th
	137,7	40,2	14,4	21770

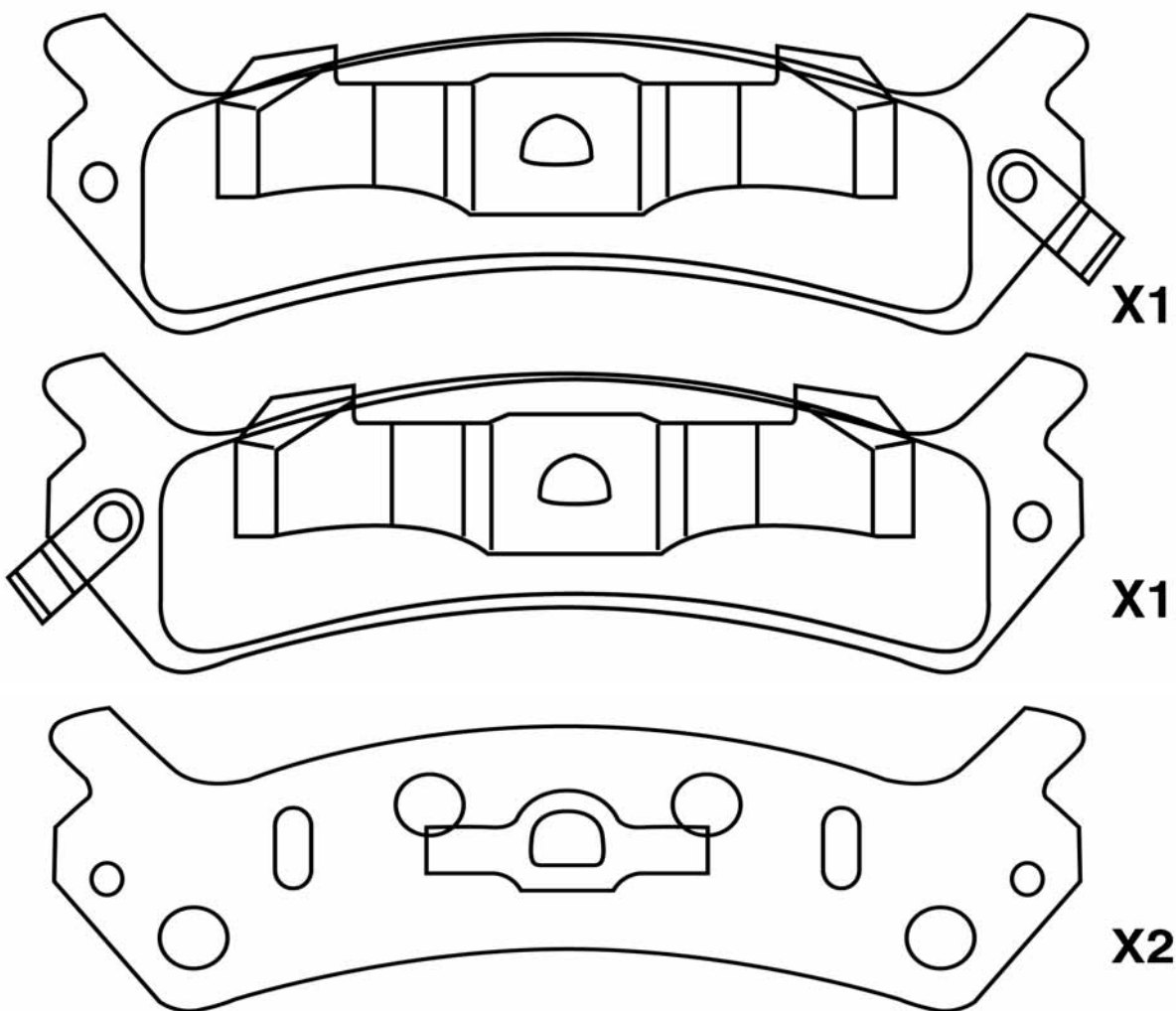



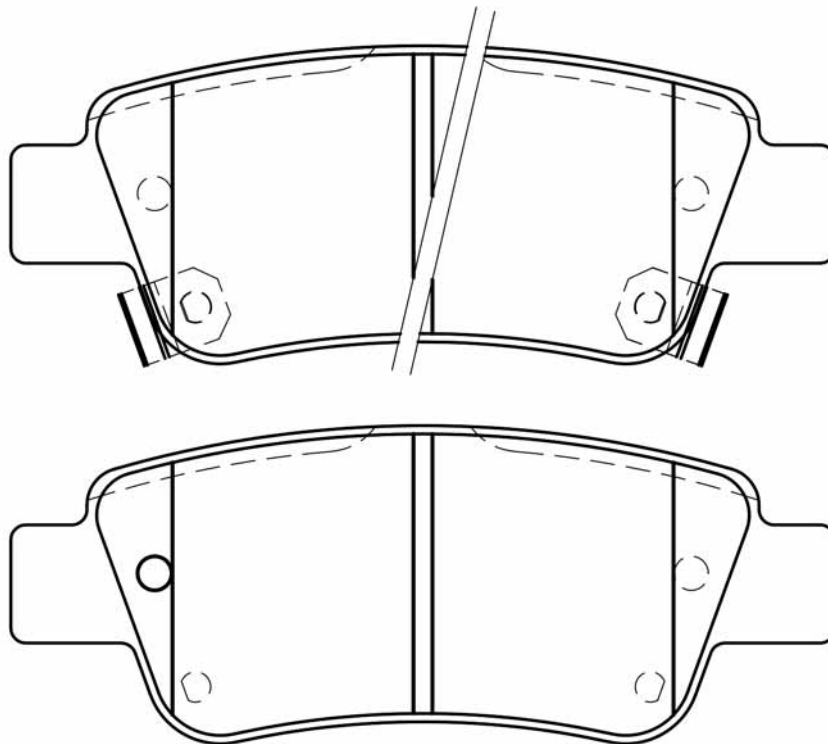

51-04-400				WVA
	HONDA	L 109	H 42	
				24635



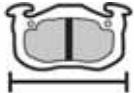

PICTURES BRAKE PADS REAR
ABBILDUNGEN BREMSKLÖTZE HINTEN
FIGURAS PASTILLAS DE FRENO POSTERIORES
ILLUSTRATIONS PLAQUETTES DE FREI ARRIÈRE
IMMAGINI PASTIGLIE FRENO POSTERIORI

51-04-401				WVA
HONDA	L	H	Th	
	85,6	38,8	12,6	

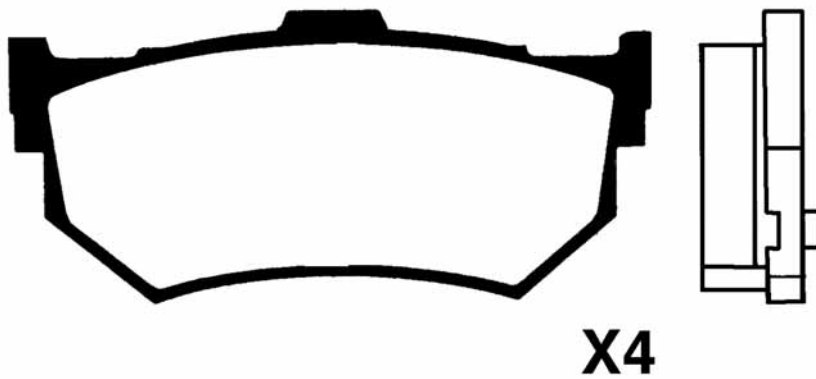



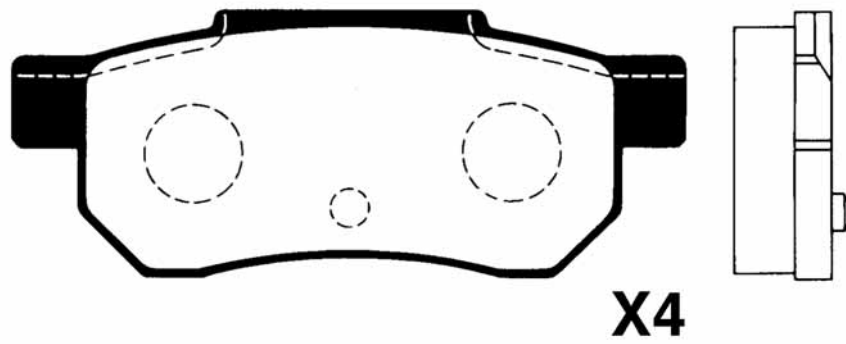

51-04-402				WVA
HONDA	L	H	Th	
	89	35,2	12,5	21312





PICTURES BRAKE PADS REAR
ABBILDUNGEN BREMSKLÖTZE HINTEN
FIGURAS PASTILLAS DE FRENO POSTERIORES
ILLUSTRATIONS PLAQUETTES DE FREI ARRIÈRE
IMMAGINI PASTIGLIE FRENO POSTERIORI

51-04-403				WVA
HONDA	L	H	Th	
	95,5	45	15,5	24086

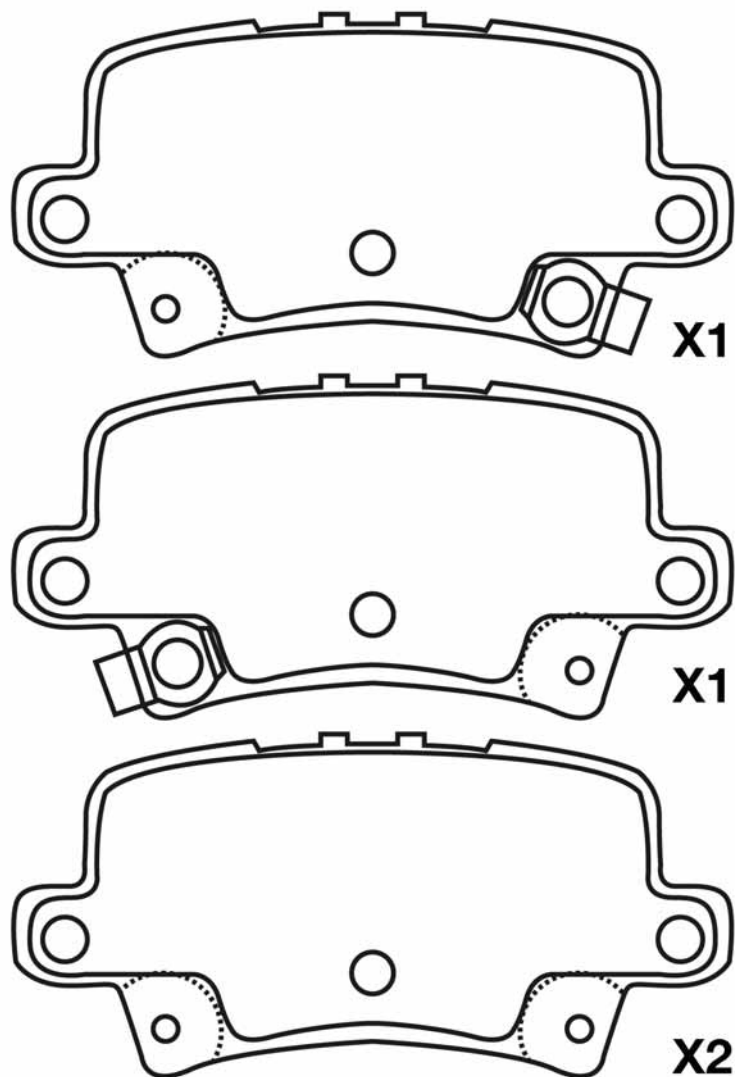



51-04-404				WVA
	ROVER - HONDA	L	H	Th
	89	35,3	12,4	21313

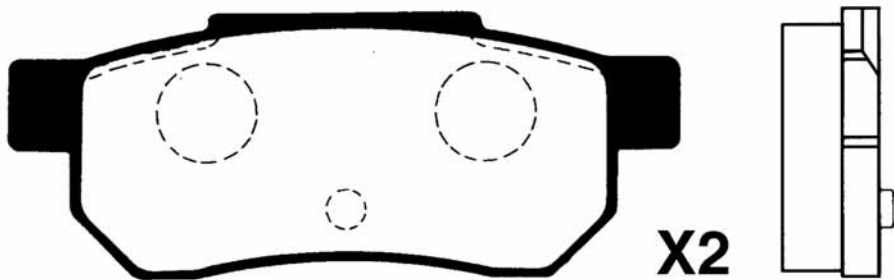
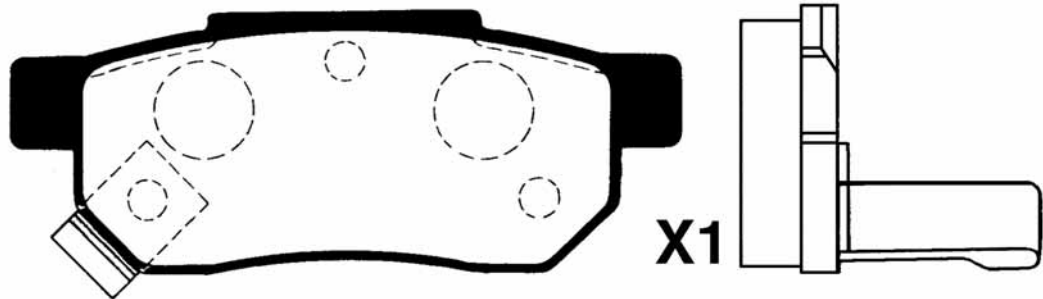
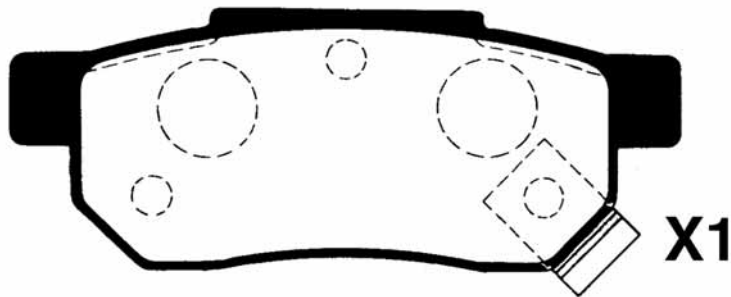



PICTURES BRAKE PADS REAR
ABBILDUNGEN BREMSKLÖTZE HINTEN
FIGURAS PASTILLAS DE FRENO POSTERIORES
ILLUSTRATIONS PLAQUETTES DE FREI ARRIÈRE
IMMAGINI PASTIGLIE FRENO POSTERIORI

51-04-405				WVA
ROVER - HONDA	L	H	Th	
	88,7	47,2	14	21721

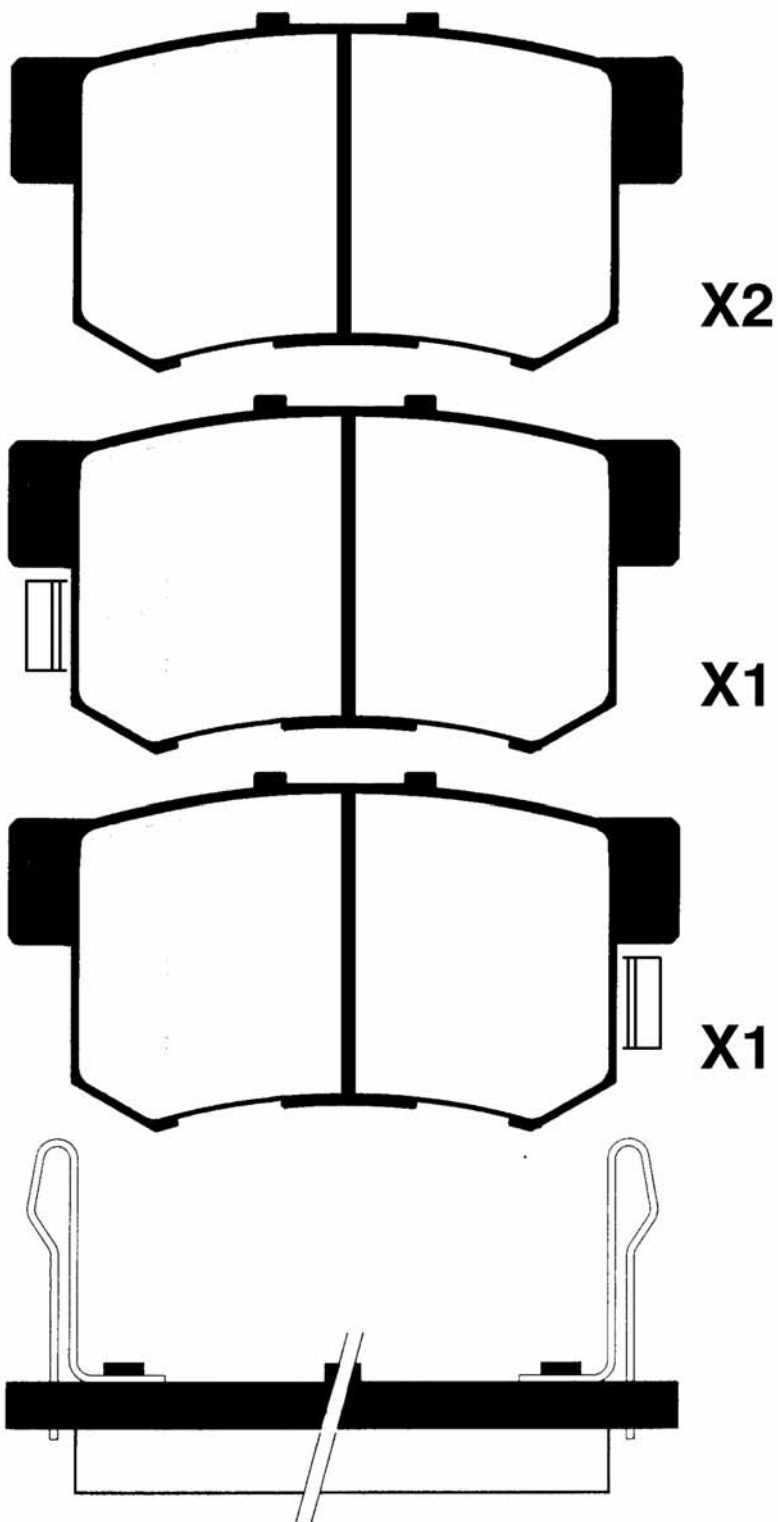



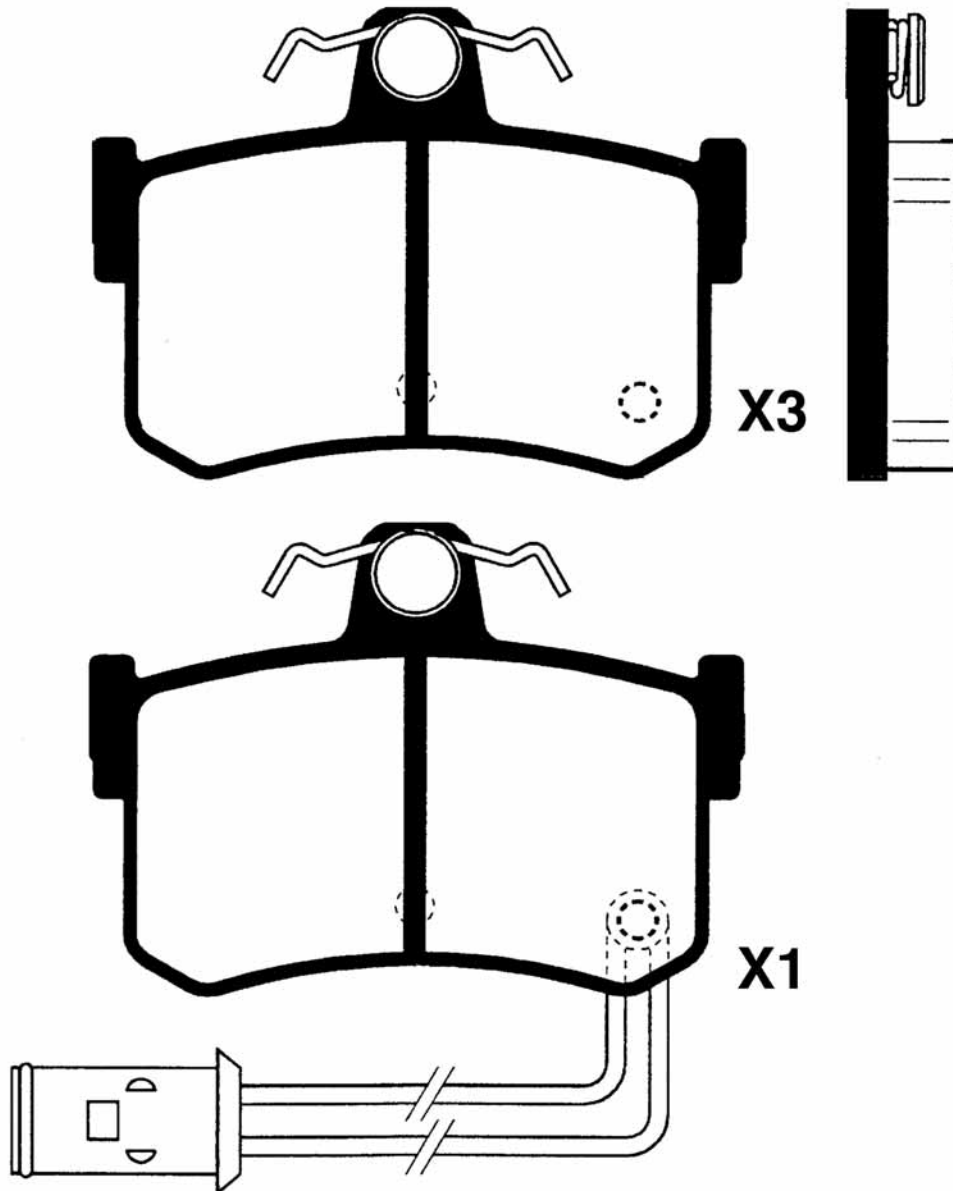

51-04-406				WVA
	ROVER - HONDA	L	H	Th
	85,3	62	13,7	20087





PICTURES BRAKE PADS REAR
ABBILDUNGEN BREMSKLÖTZE HINTEN
FIGURAS PASTILLAS DE FRENO POSTERIORES
ILLUSTRATIONS PLAQUETTES DE FREI ARRIÈRE
IMMAGINI PASTIGLIE FRENO POSTERIORI

51-04-407				WVA
HONDA	L	H	Th	
	86,9	53	14,2	23527

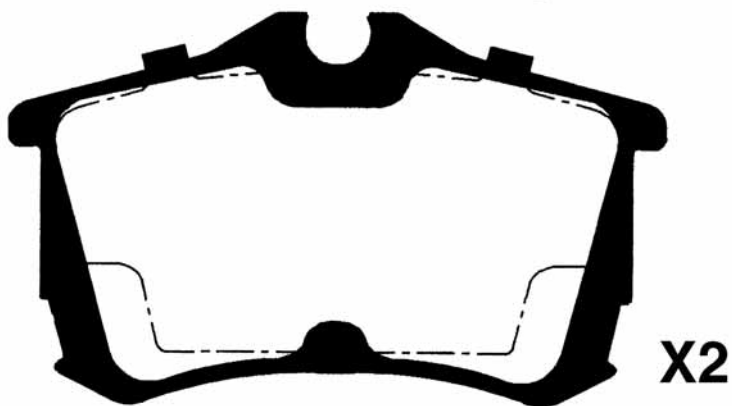
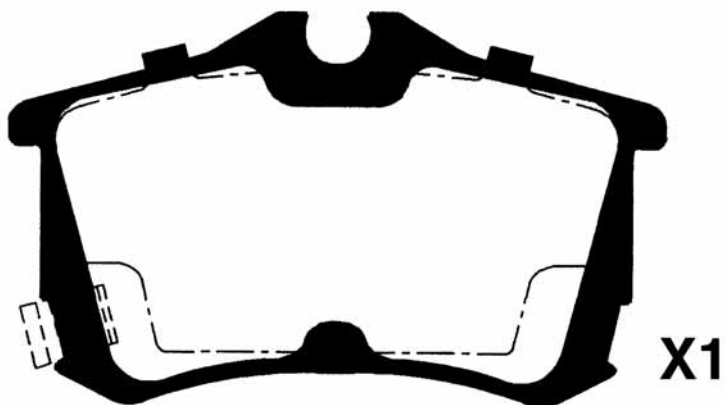
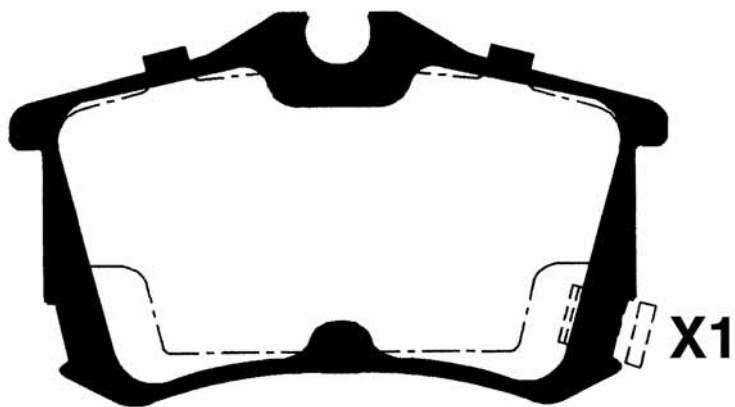



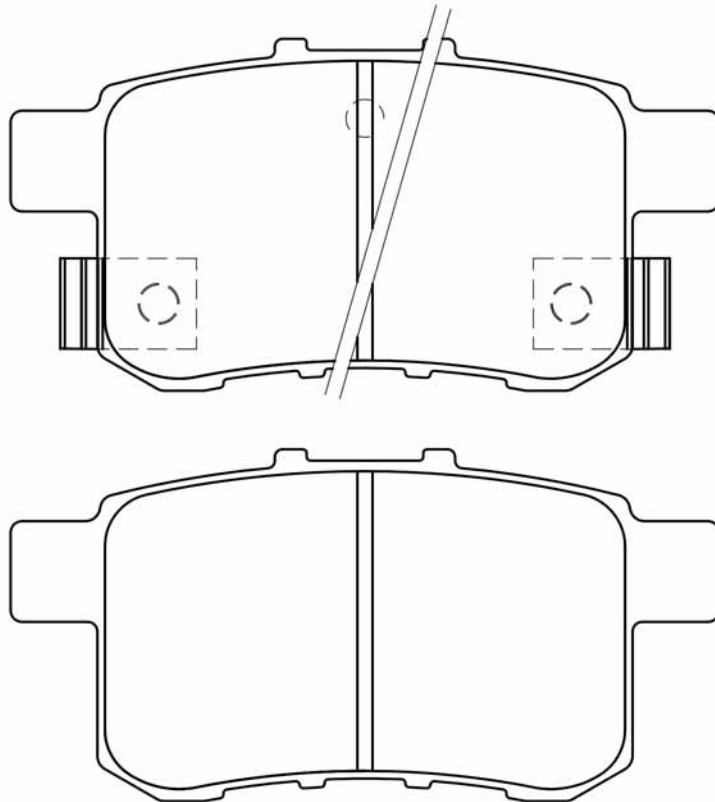

51-04-410				WVA
	HONDA	L	H	Th
	93,5	47	15	24435



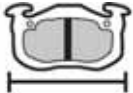

PICTURES BRAKE PADS REAR
ABBILDUNGEN BREMSKLÖTZE HINTEN
FIGURAS PASTILLAS DE FRENO POSTERIORES
ILLUSTRATIONS PLAQUETTES DE FREI ARRIÈRE
IMMAGINI PASTIGLIE FRENO POSTERIORI

51-04-445				WVA
HONDA	L	H	Th	
	89	47,5	14,7	

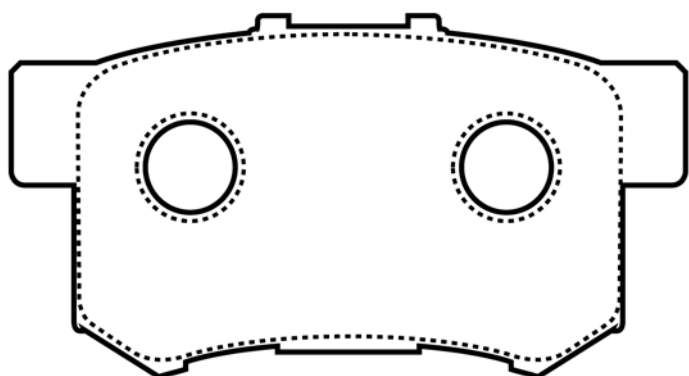

X2

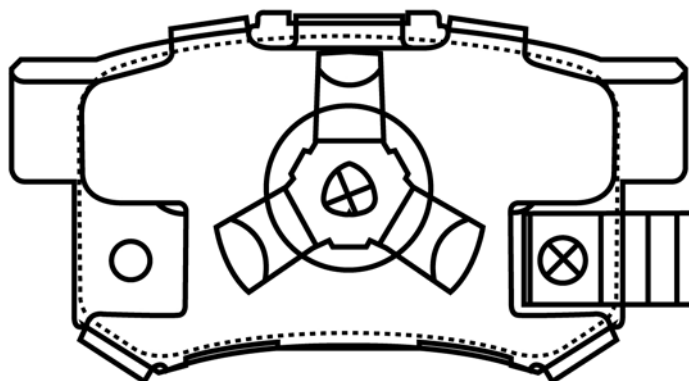

X1

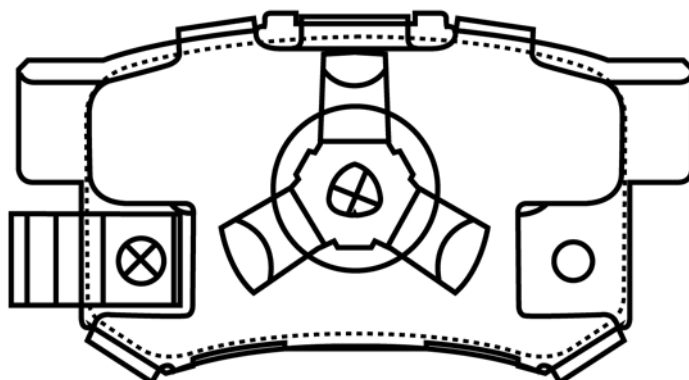

X1



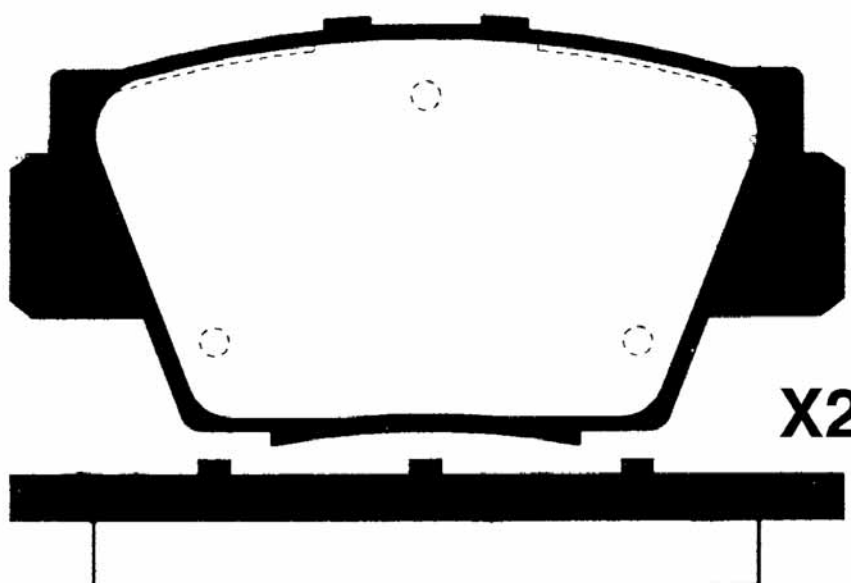
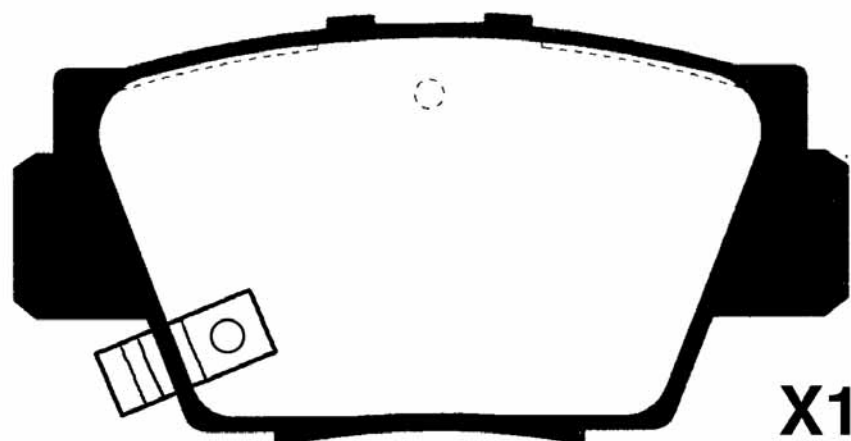
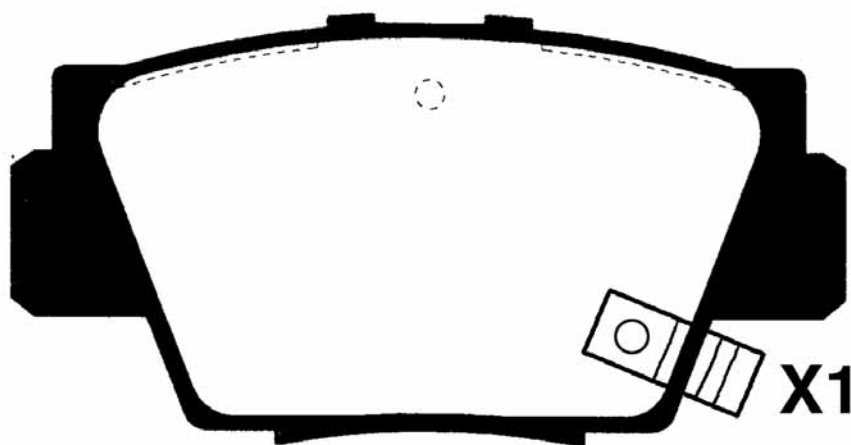

51-04-499				WVA
	HONDA	L	H	
	110,9	56,9	14,9	23375





PICTURES BRAKE PADS REAR
ABBILDUNGEN BREMSKLÖTZE HINTEN
FIGURAS PASTILLAS DE FRENO POSTERIORES
ILLUSTRATIONS PLAQUETTES DE FREI ARRIÈRE
IMMAGINI PASTIGLIE FRENO POSTERIORI

51-05-500				WVA
MITSUBISHI	L	H	Th	
	98,7	44,8	14,3	21125

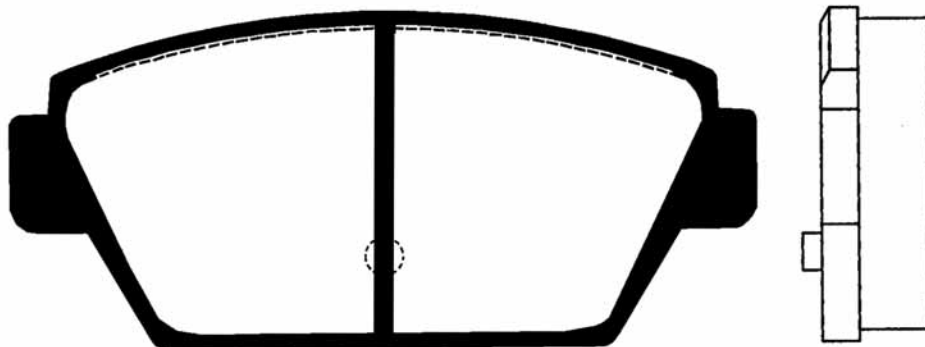

X4



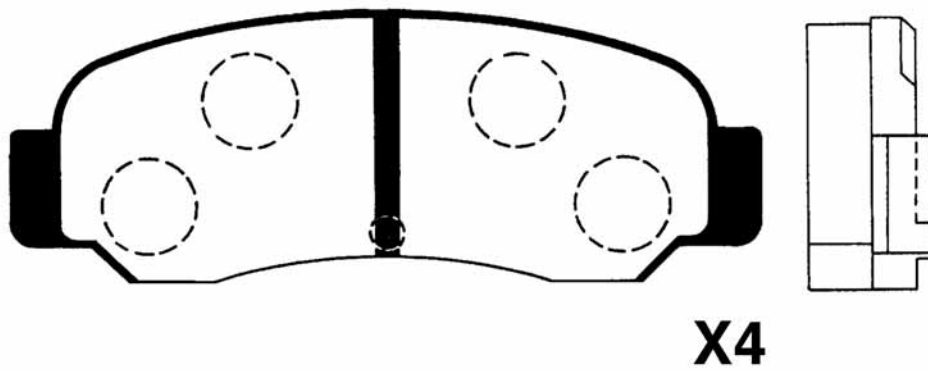

51-05-501				WVA
	MITSUBISHI	L	H	Th
	98,3	37	14	20864



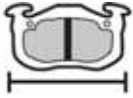

PICTURES BRAKE PADS REAR
ABBILDUNGEN BREMSKLÖTZE HINTEN
FIGURAS PASTILLAS DE FRENO POSTERIORES
ILLUSTRATIONS PLAQUETTES DE FREI ARRIÈRE
IMMAGINI PASTIGLIE FRENO POSTERIORI

51-05-502				WVA
MITSUBISHI	L	H	Th	
	107,4	39,5	14,3	20593

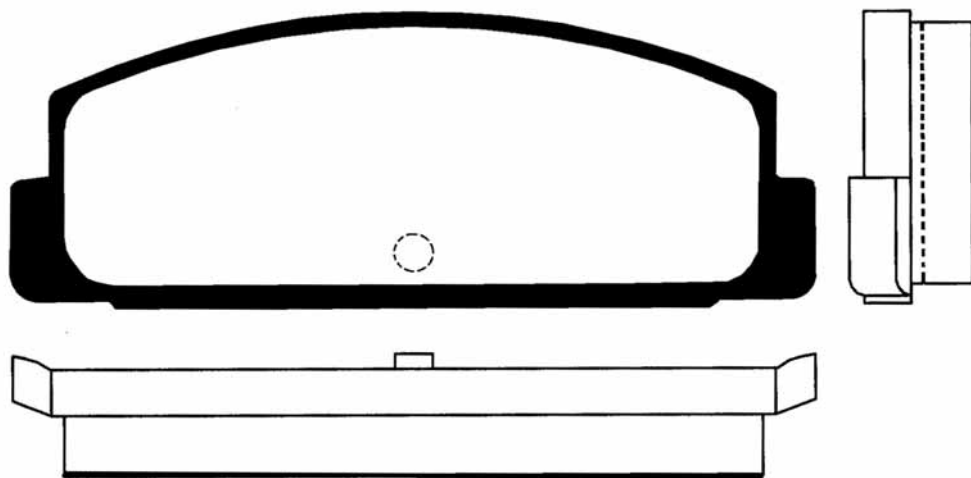

X4



51-05-504 MITSUBISHI - PROTON				WVA
	L	H	Th	21873
	98,7	37,6	13,9	

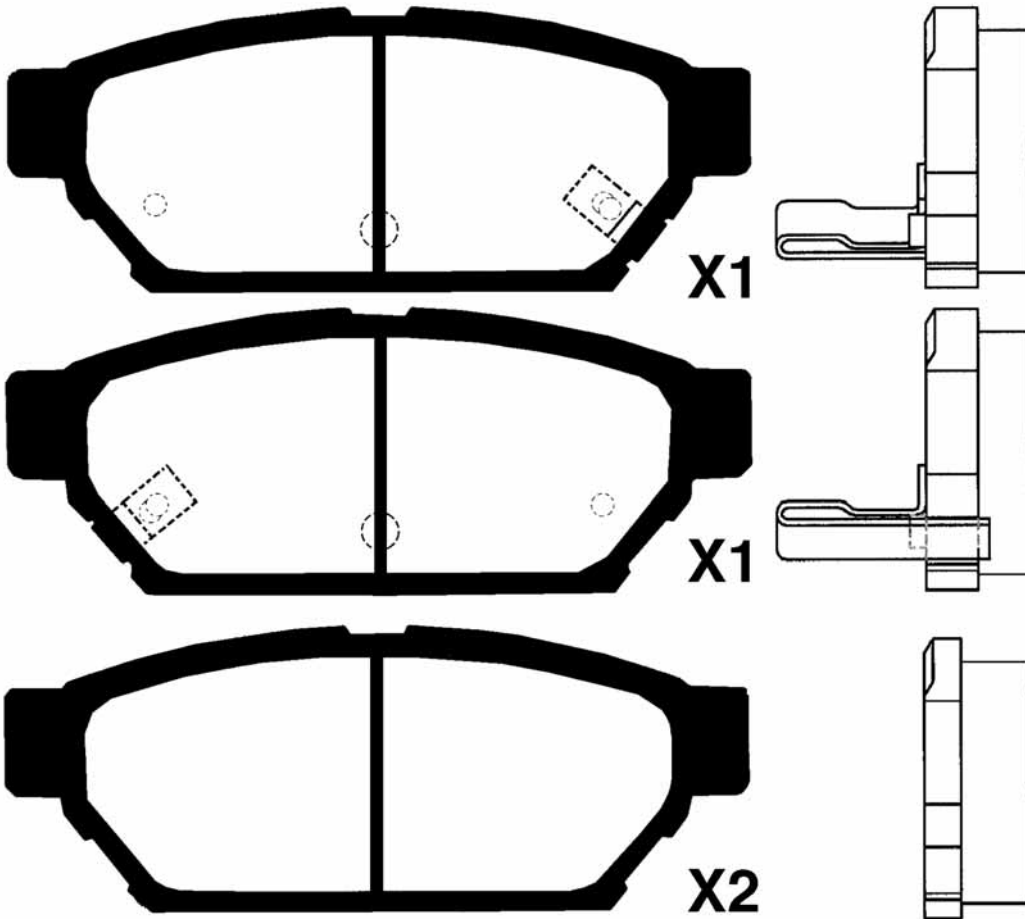



PICTURES BRAKE PADS REAR
ABBILDUNGEN BREMSKLÖTZE HINTEN
FIGURAS PASTILLAS DE FRENO POSTERIORES
ILLUSTRATIONS PLAQUETTES DE FREI ARRIÈRE
IMMAGINI PASTIGLIE FRENO POSTERIORI

51-05-505				WVA
	DODGE - CHRYSLER - MITSUBISHI - JEEP	L 111/91	H 45	Th 15

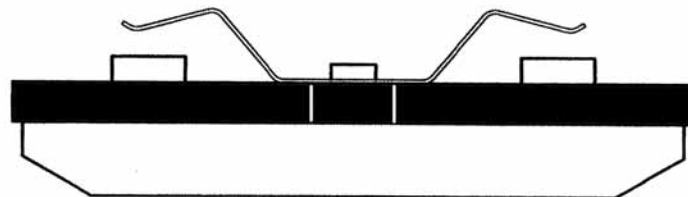
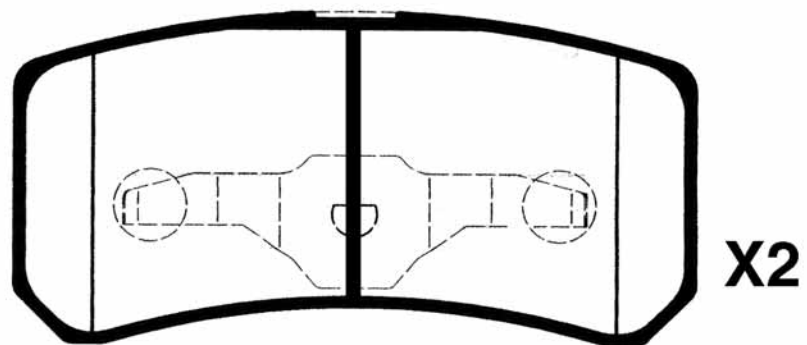
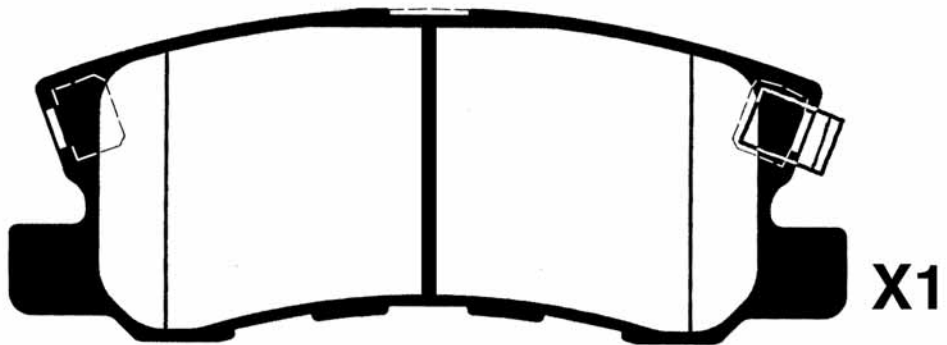
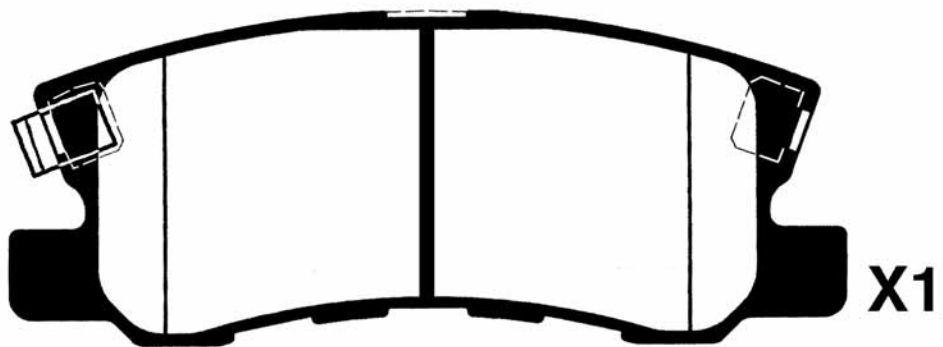



51-05-505P				WVA
	MITSUBISHI - DODGE	L 111/91	H 45	

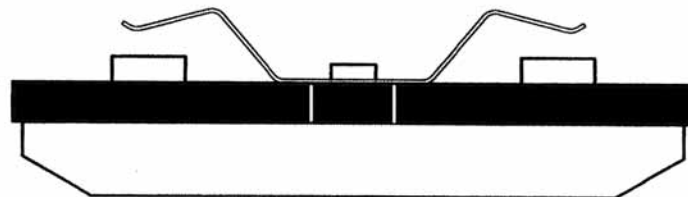
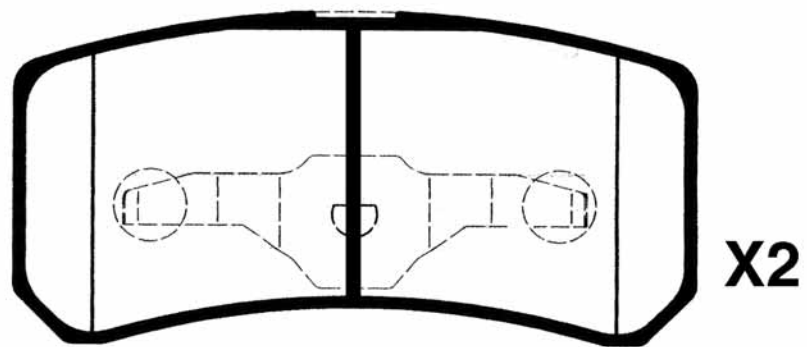
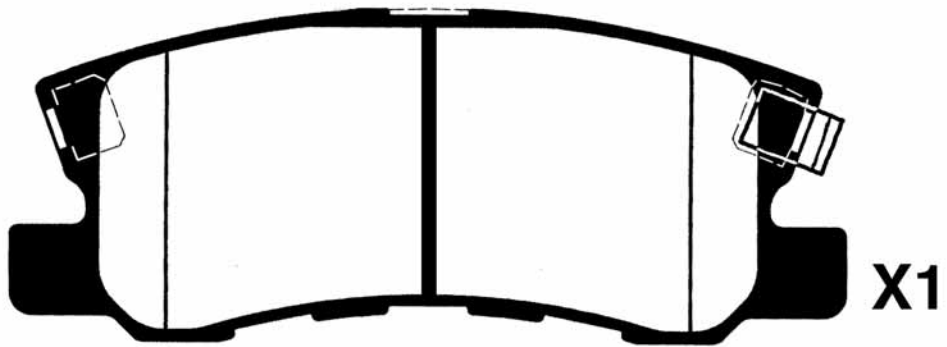
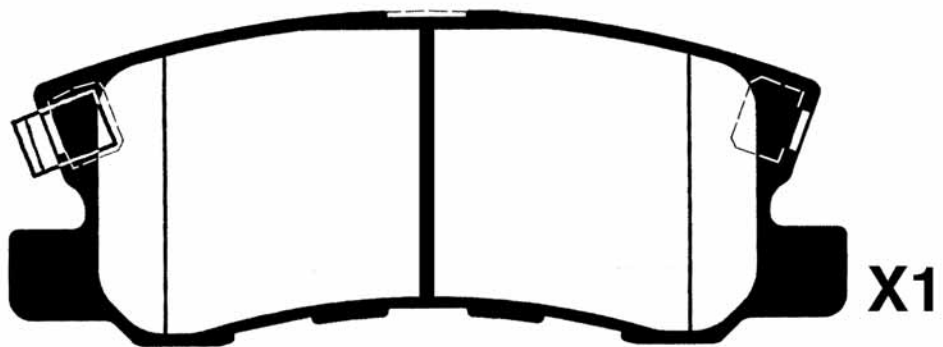



PICTURES BRAKE PADS REAR
ABBILDUNGEN BREMSKLÖTZE HINTEN
FIGURAS PASTILLAS DE FRENO POSTERIORES
ILLUSTRATIONS PLAQUETTES DE FREI ARRIÈRE
IMMAGINI PASTIGLIE FRENO POSTERIORI

51-05-506				WVA
NISSAN - MITSUBISHI	L	H	Th	
	76,5	65,4	16,1	

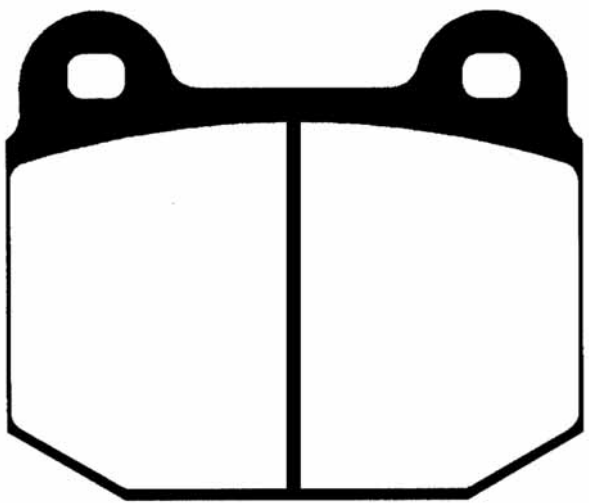

X4



51-05-507				WVA
	SMART - MITSUBISHI	L 87	H 47	Th 15,6
				21861

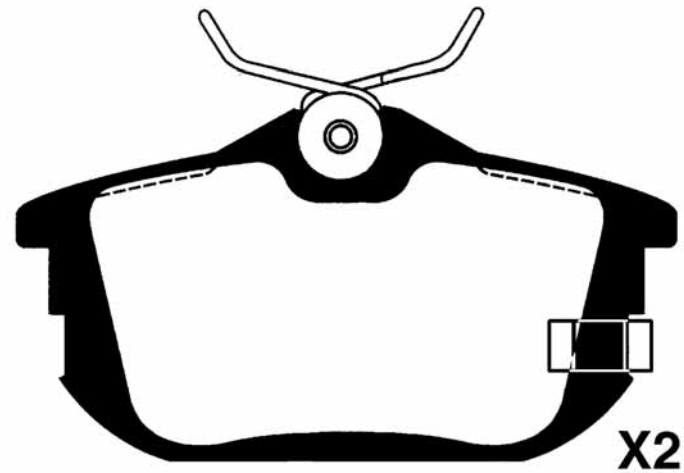
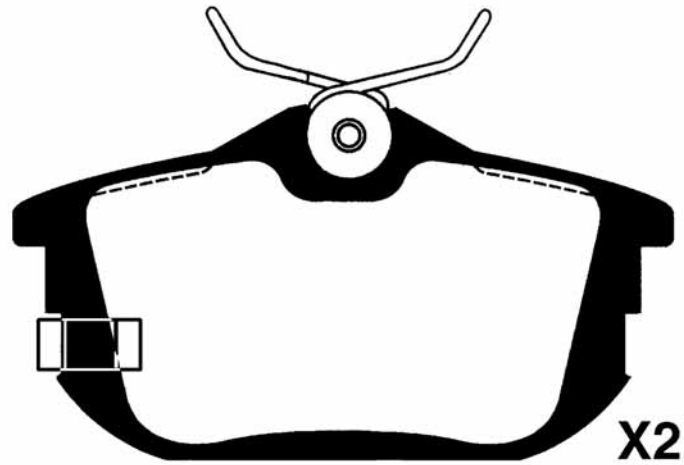



PICTURES BRAKE PADS REAR
ABBILDUNGEN BREMSKLÖTZE HINTEN
FIGURAS PASTILLAS DE FRENO POSTERIORES
ILLUSTRATIONS PLAQUETTES DE FREI ARRIÈRE
IMMAGINI PASTIGLIE FRENO POSTERIORI

51-05-508

**MITSUBISHI - DODGE -
JEEP**

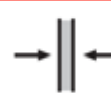
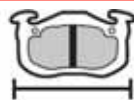

WVA

L

H

Th

106/85,5

35,2/40

15,5

24014

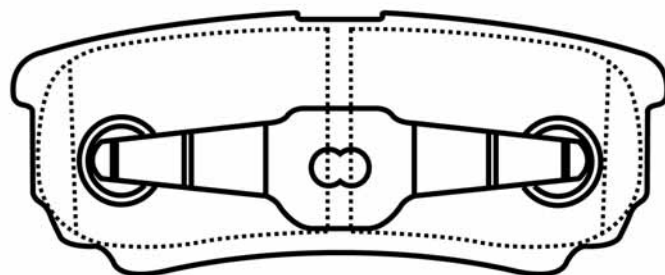

X2

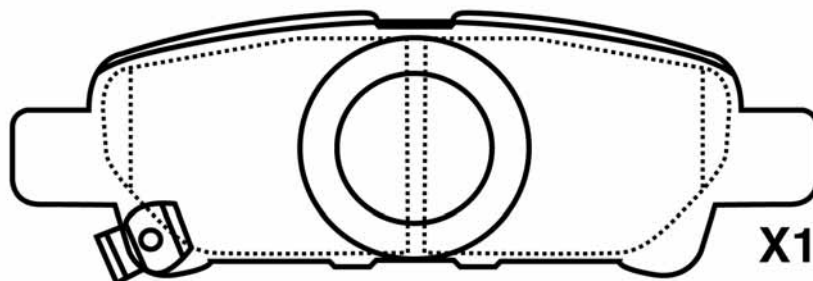

X1

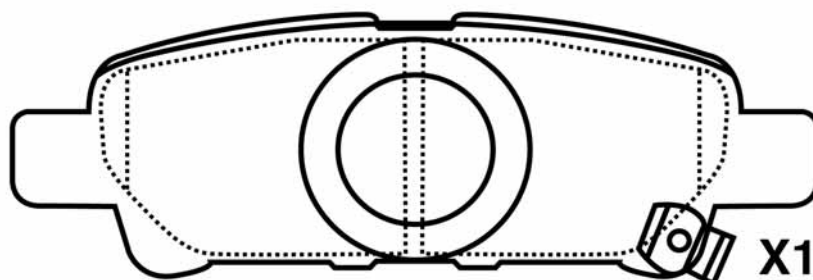

X1



51-05-510				WVA
	MITSUBISHI	L 108	H 46,3	Th 14,9
				23375

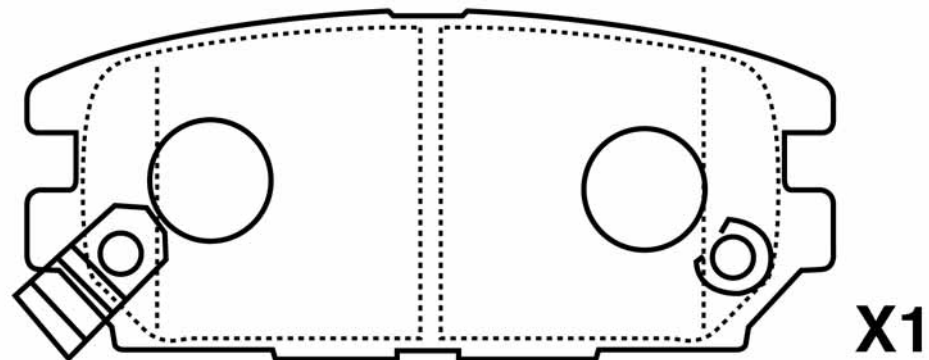
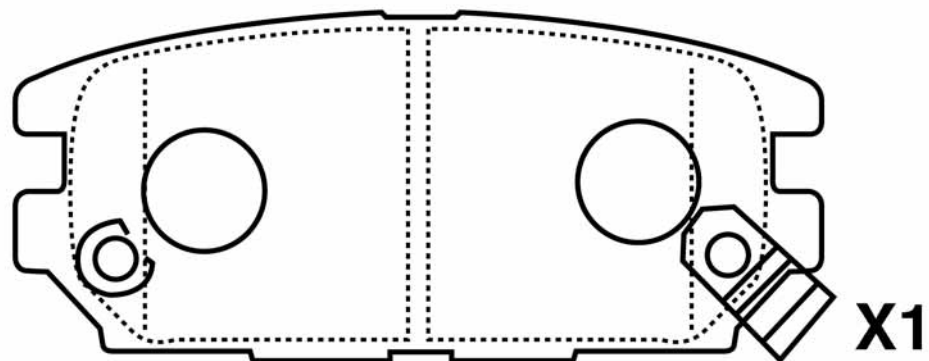
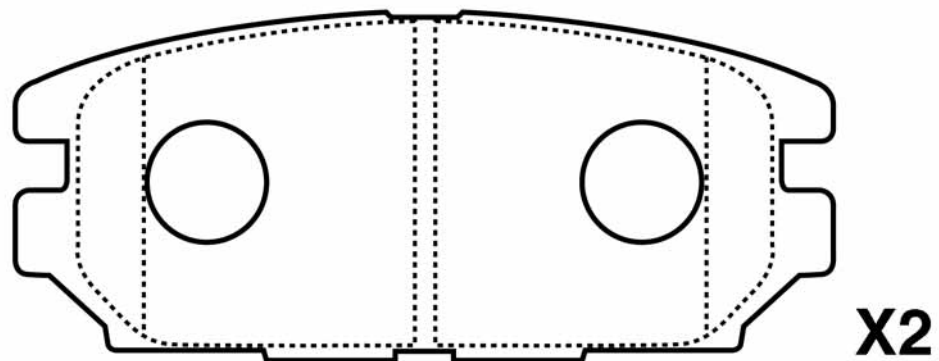



PICTURES BRAKE PADS REAR
ABBILDUNGEN BREMSKLÖTZE HINTEN
FIGURAS PASTILLAS DE FRENO POSTERIORES
ILLUSTRATIONS PLAQUETTES DE FREI ARRIÈRE
IMMAGINI PASTIGLIE FRENO POSTERIORI

51-05-592				WVA
	MITSUBISHI	L 79	H 59,3	Th 14,9

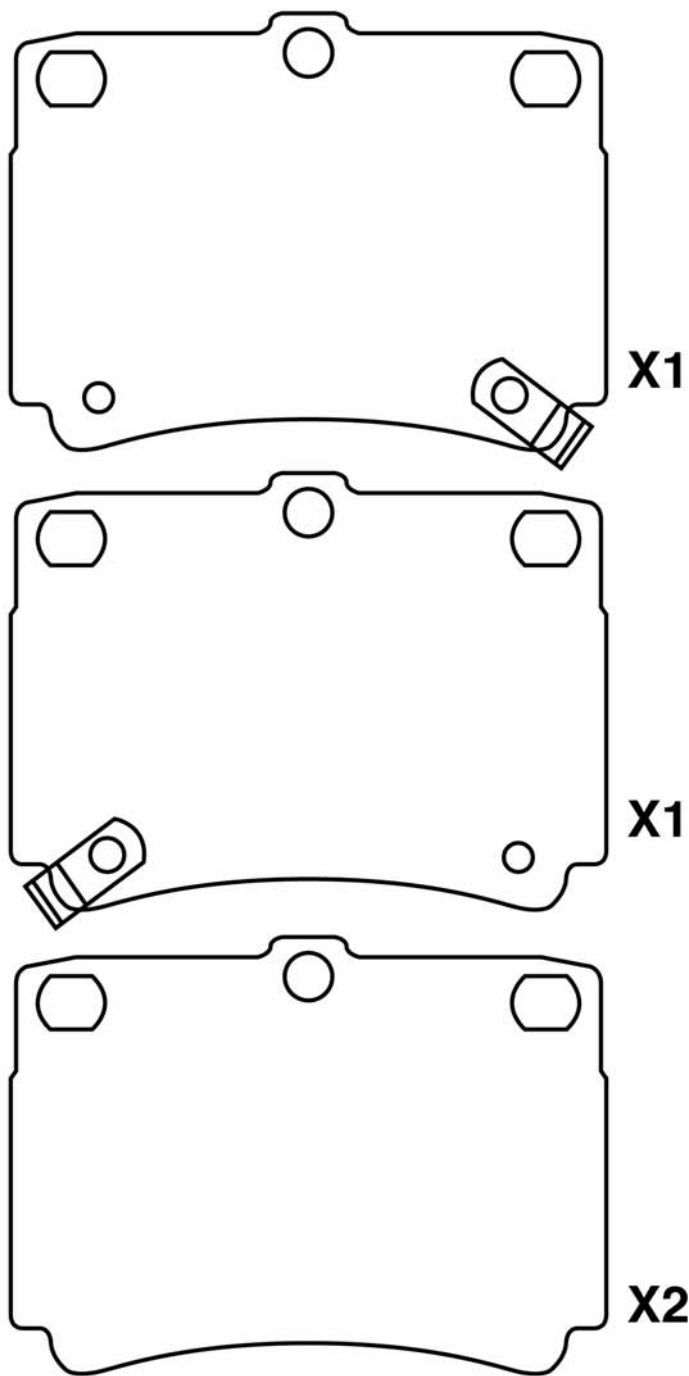



51-05-593

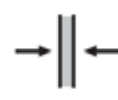
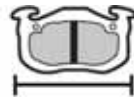

WVA

L

H

Th

107,6

40,7

12,4

20066

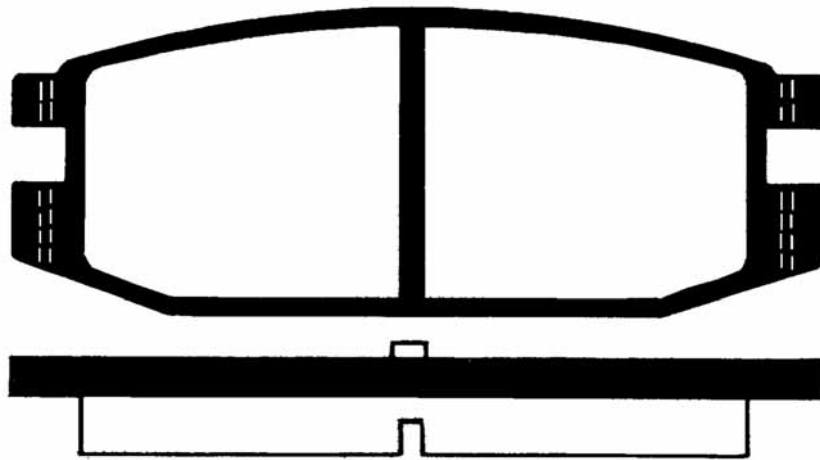

X4



PICTURES BRAKE PADS REAR
ABBILDUNGEN BREMSKLÖTZE HINTEN
FIGURAS PASTILLAS DE FRENO POSTERIORES
ILLUSTRATIONS PLAQUETTES DE FREI ARRIÈRE
IMMAGINI PASTIGLIE FRENO POSTERIORI

51-05-594 MITSUBISHI				WVA
	L 108	H 40,9	Th 15	21708

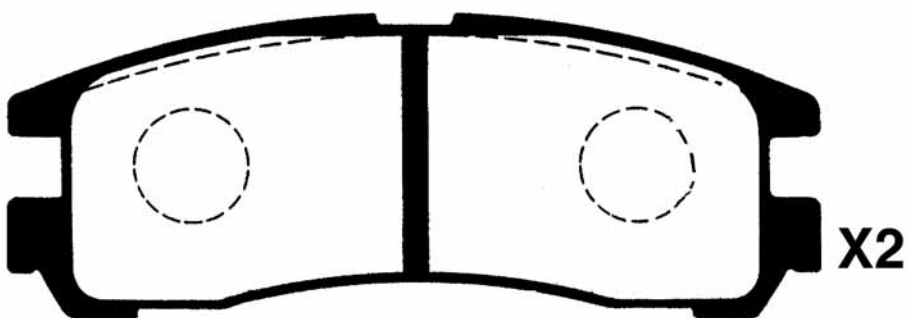
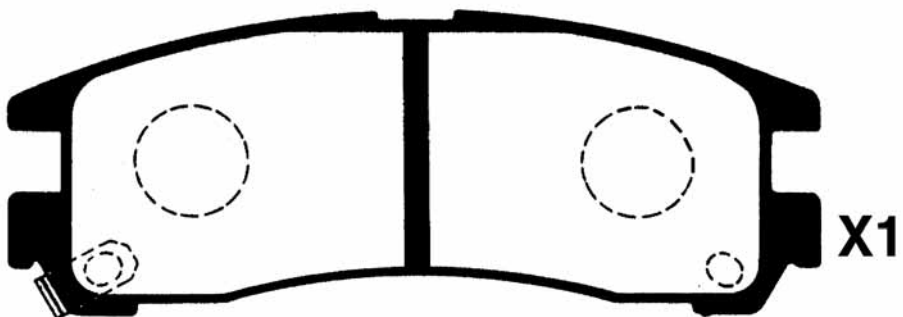
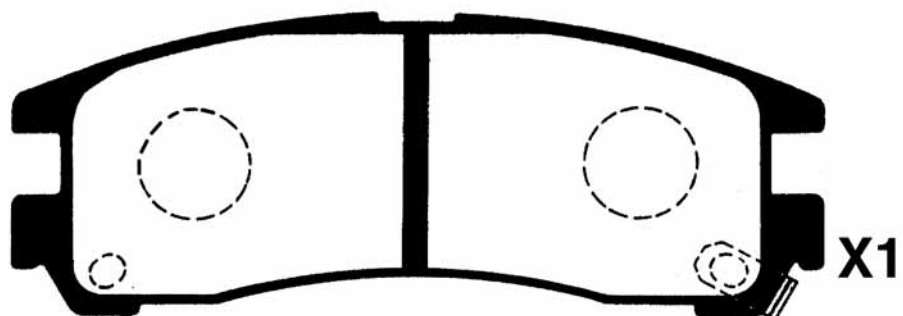



51-05-595				WVA
	KIA - HYUNDAI	L	H	Th
	85,3	46,5	14,7	21553

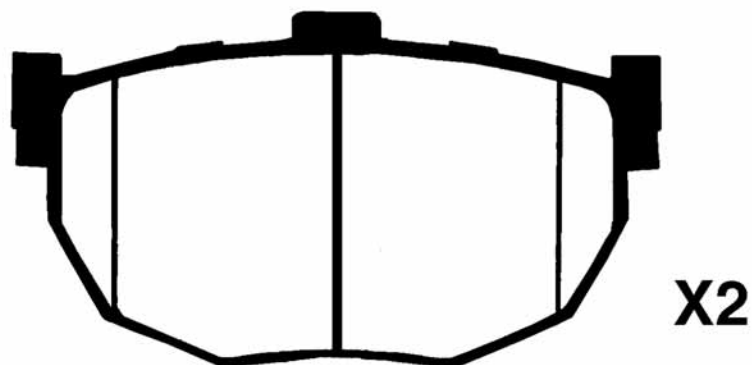
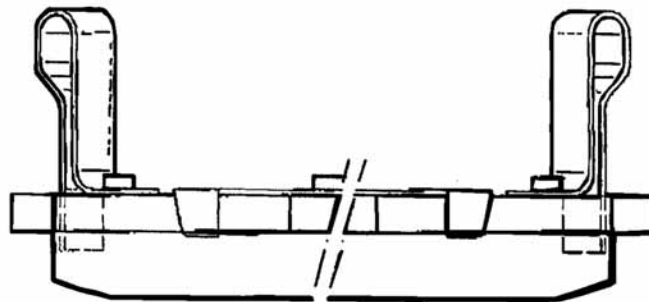
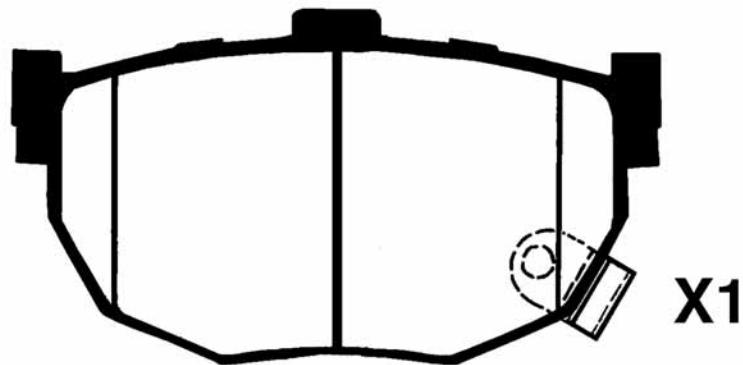
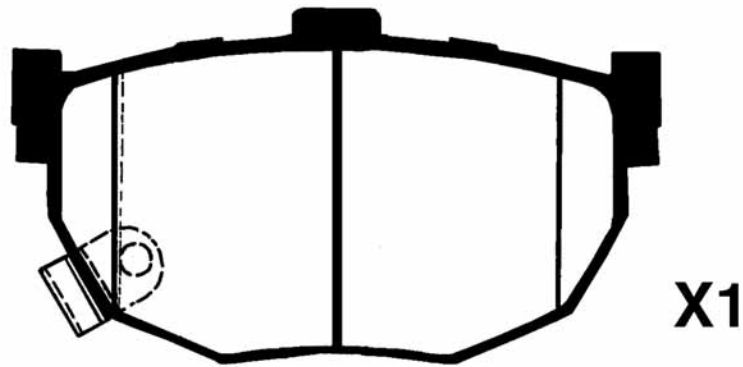



PICTURES BRAKE PADS REAR
ABBILDUNGEN BREMSKLÖTZE HINTEN
FIGURAS PASTILLAS DE FRENO POSTERIORES
ILLUSTRATIONS PLAQUETTES DE FREI ARRIÈRE
IMMAGINI PASTIGLIE FRENO POSTERIORI

51-05-598 HYUNDAI				WVA
	L 85	H 48,9	Th 15	20029

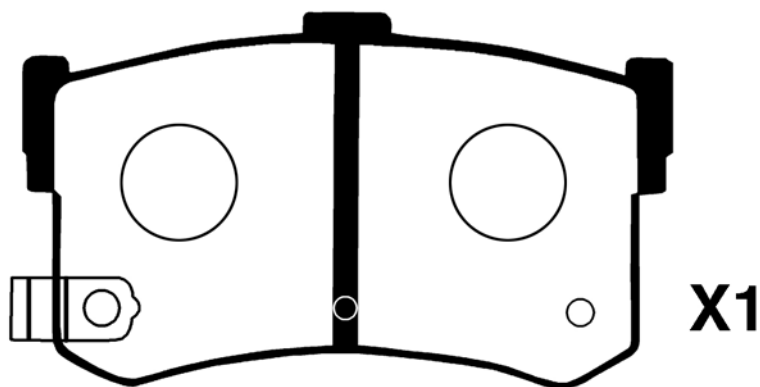
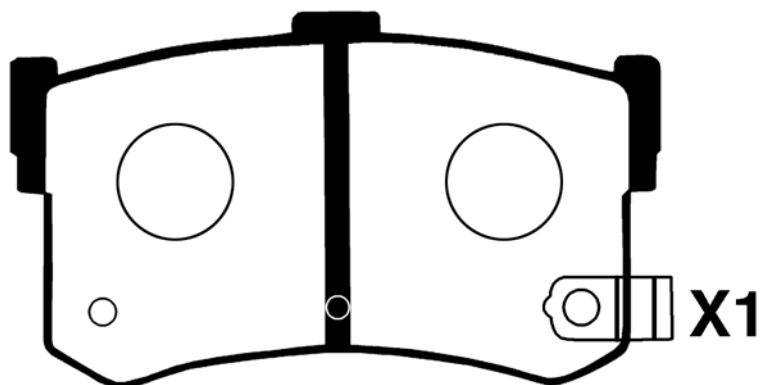
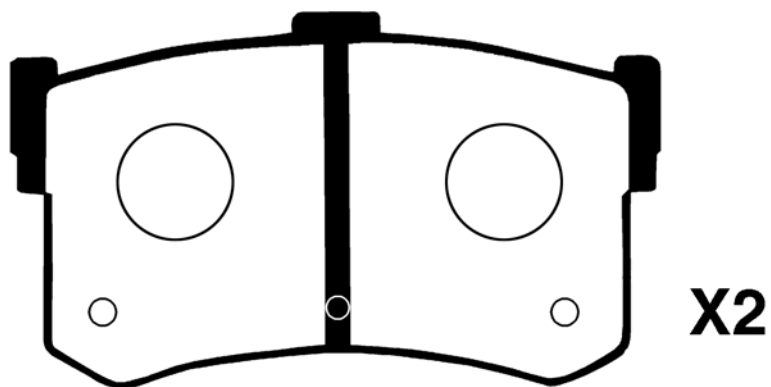



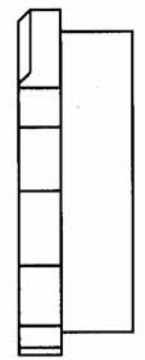
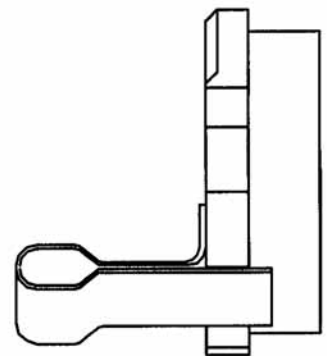
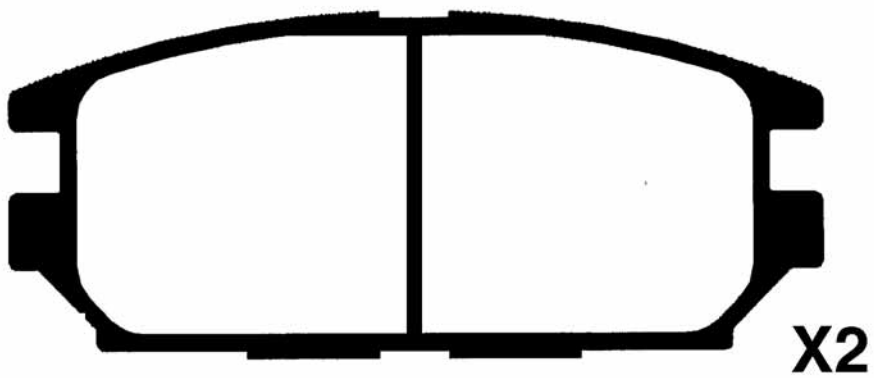
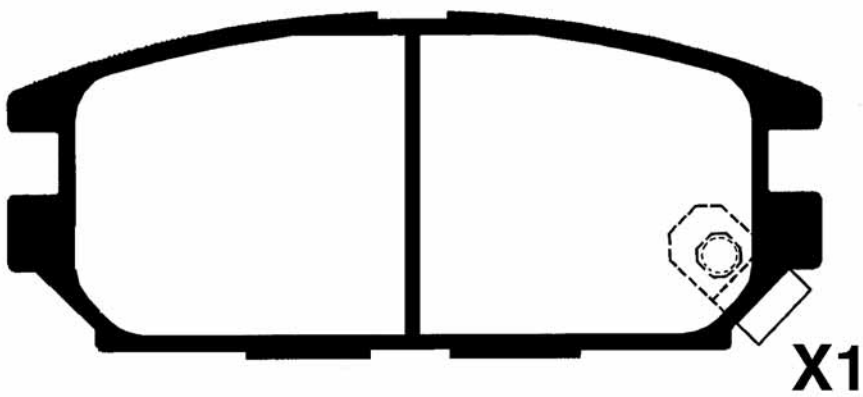
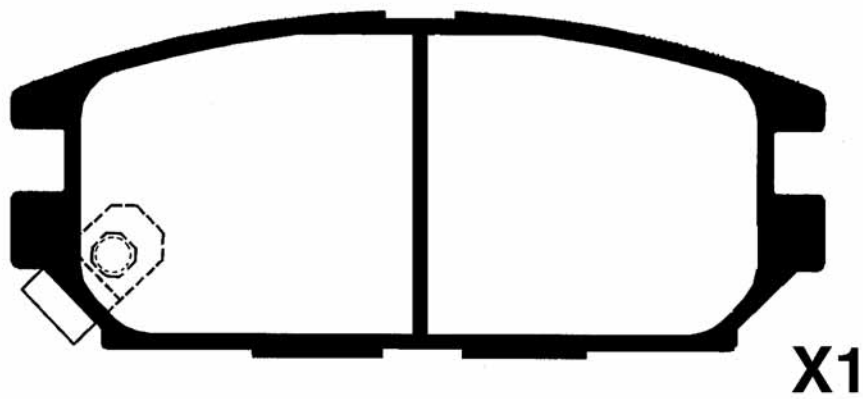

51-05-599				WVA
	MITSUBISHI	L	H	
	107,8	43,5	13,5	21842





PICTURES BRAKE PADS REAR
ABBILDUNGEN BREMSKLÖTZE HINTEN
FIGURAS PASTILLAS DE FRENO POSTERIORES
ILLUSTRATIONS PLAQUETTES DE FREI ARRIÈRE
IMMAGINI PASTIGLIE FRENO POSTERIORI

51-05-599P				WVA
MITSUBISHI	L	H	Th	
	107,8	43,5	13,5	

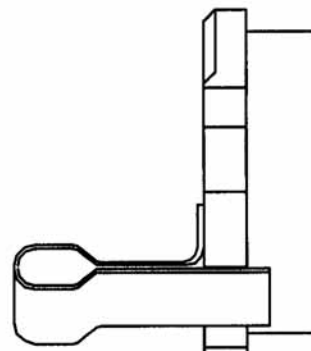
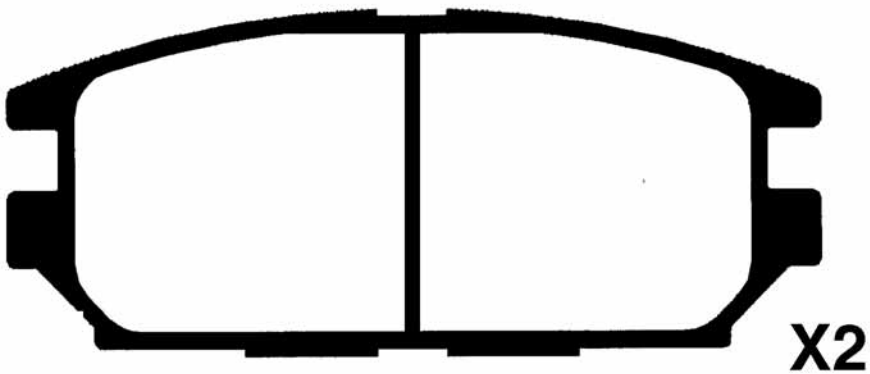
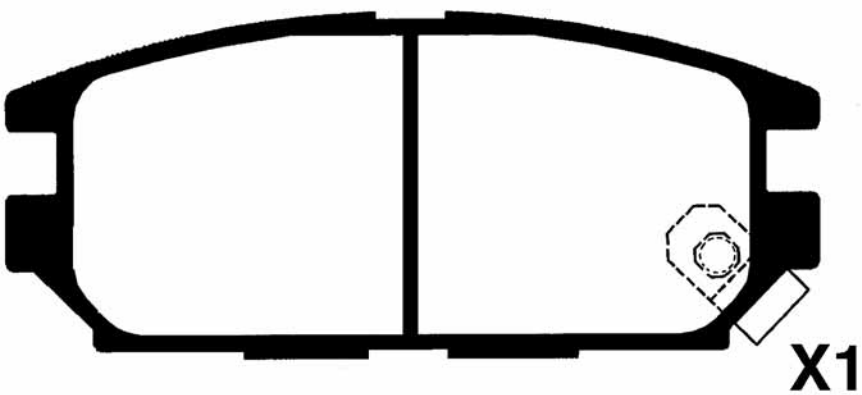
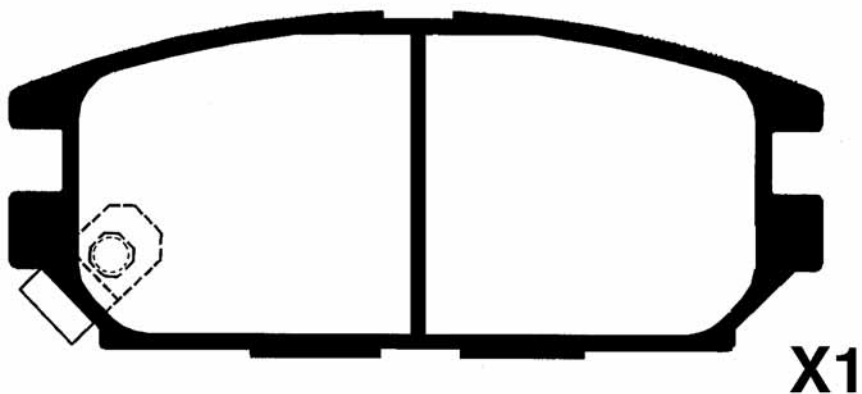



51-06-600				WVA
	DAIHATSU	L	H	Th
	128,5	35,7	13,3	21838

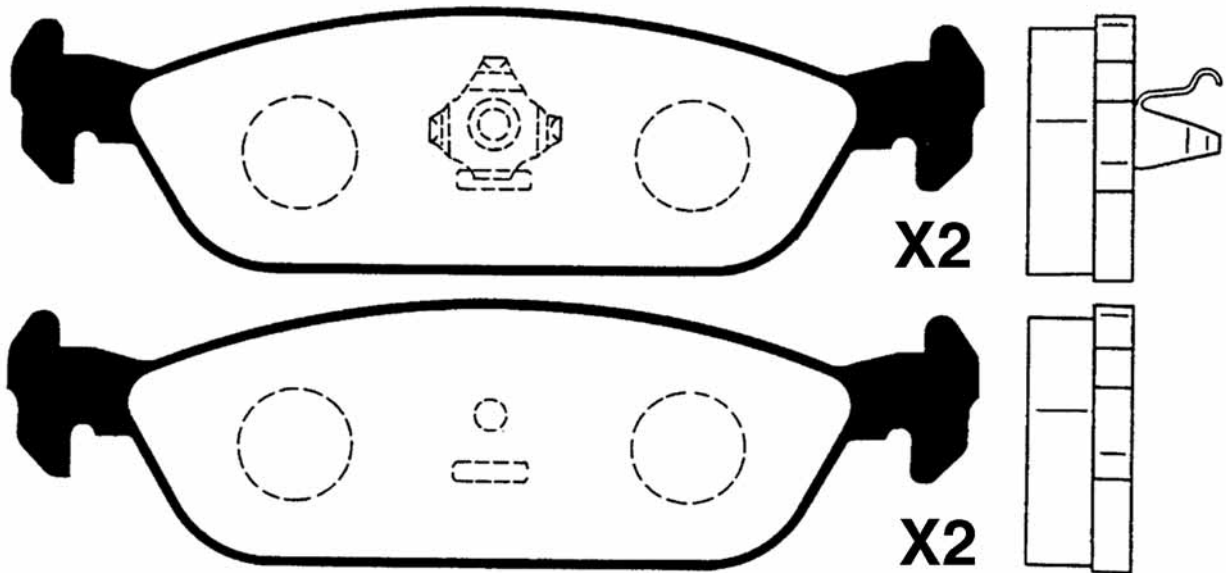



PICTURES BRAKE PADS REAR
ABBILDUNGEN BREMSKLÖTZE HINTEN
FIGURAS PASTILLAS DE FRENO POSTERIORES
ILLUSTRATIONS PLAQUETTES DE FREI ARRIÈRE
IMMAGINI PASTIGLIE FRENO POSTERIORI

51-06-601		WVA		
MAZDA - DAIHATSU - SUZUKI	L	H	Th	
	102,2	39	12	21559

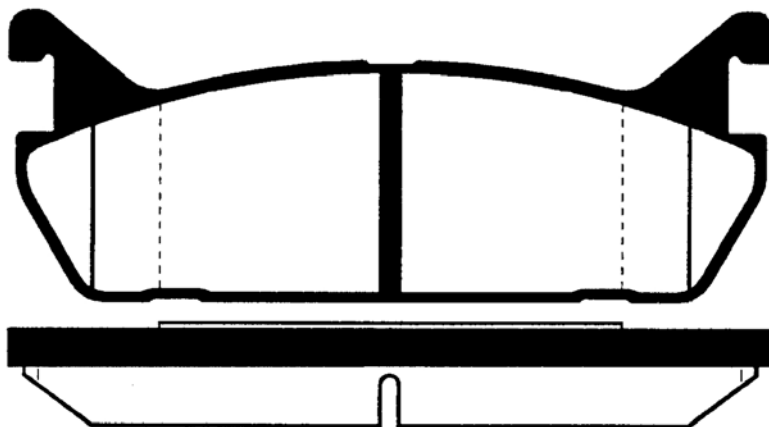

X4



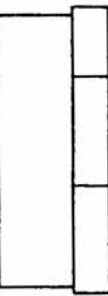
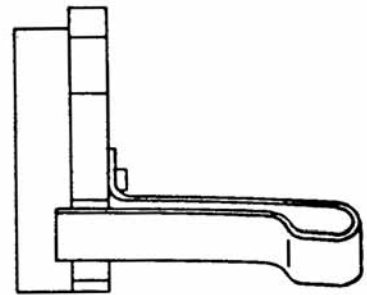
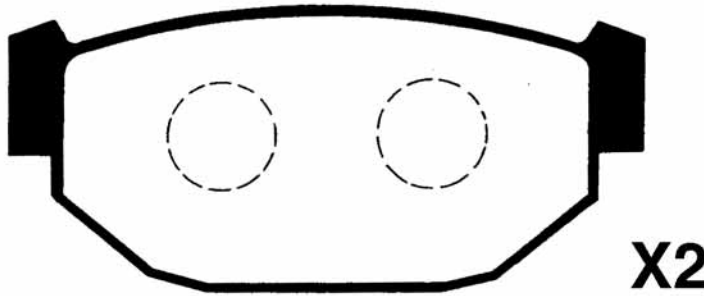
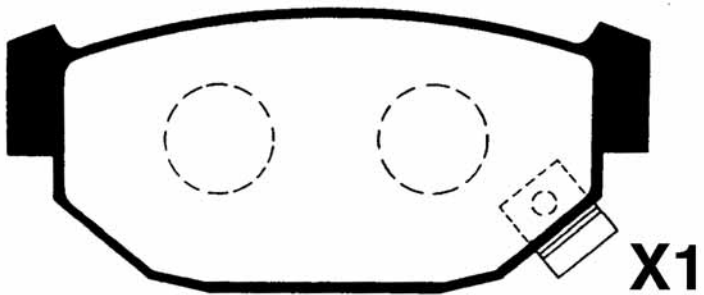
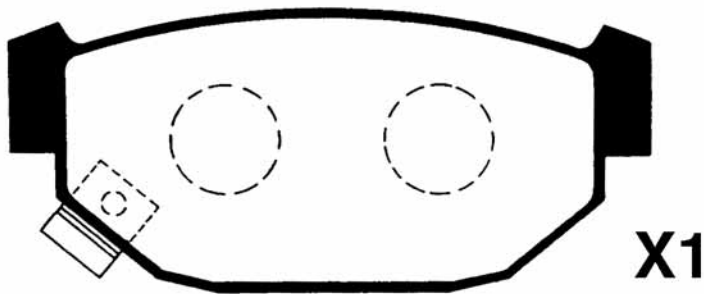

51-07-700 SUBARU				WVA
	L	H	Th	21844
	85,3	38	14,7	





PICTURES BRAKE PADS REAR
ABBILDUNGEN BREMSKLÖTZE HINTEN
FIGURAS PASTILLAS DE FRENO POSTERIORES
ILLUSTRATIONS PLAQUETTES DE FREI ARRIÈRE
IMMAGINI PASTIGLIE FRENO POSTERIORI

51-07-701 SUBARU				WVA
	L	H	Th	
	107,7	38,5	14,5	21704

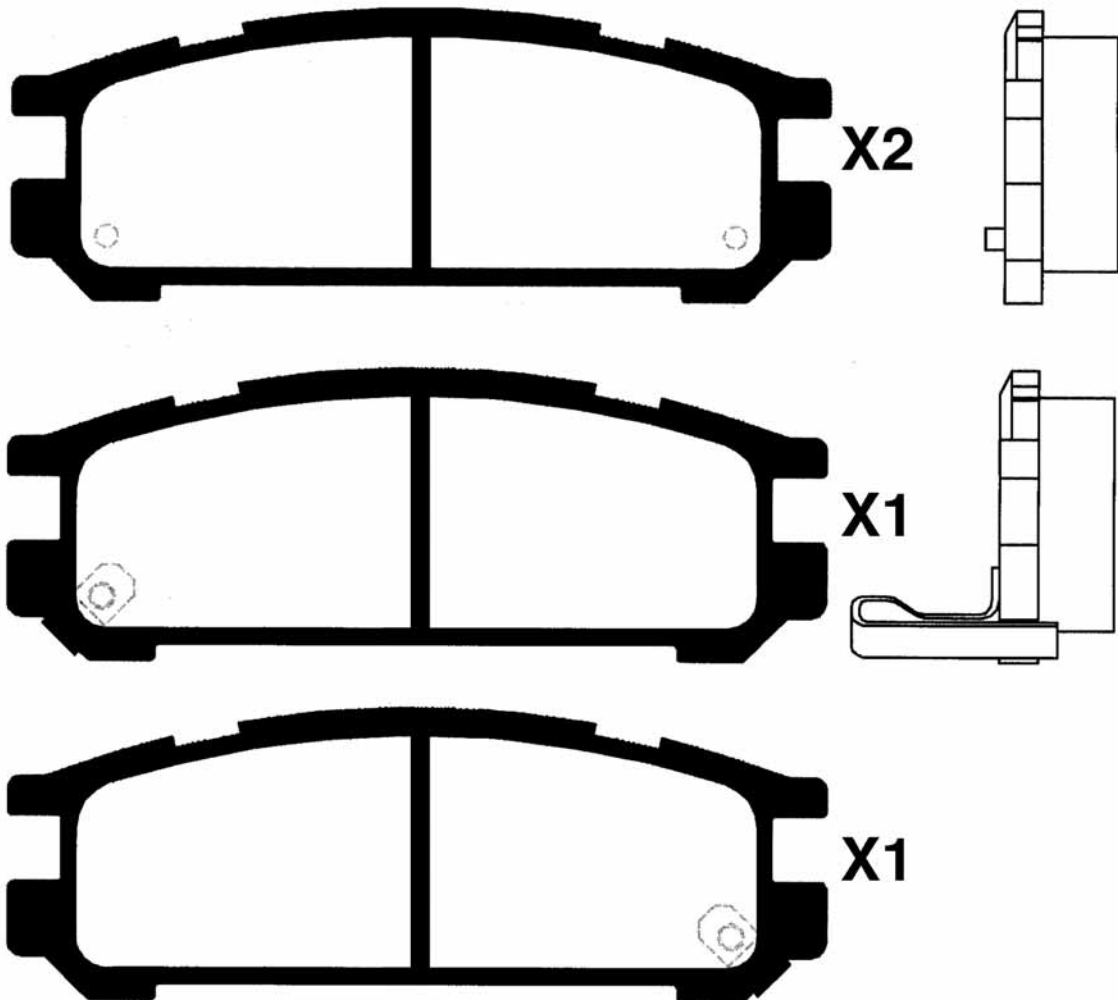



51-07-702				WVA
	SUBARU	L	H	Th
	108,4	41,4	13,6	23572

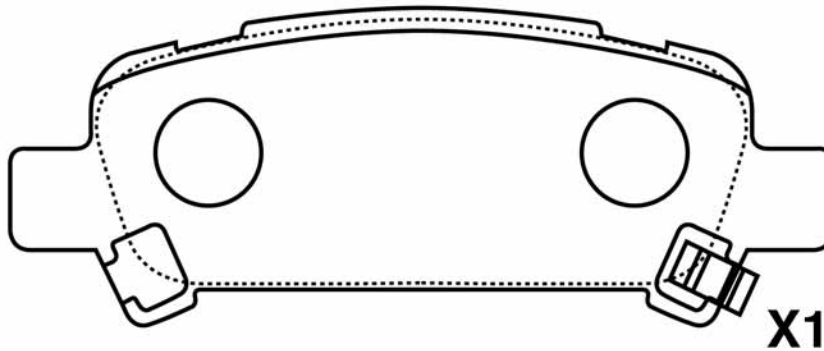
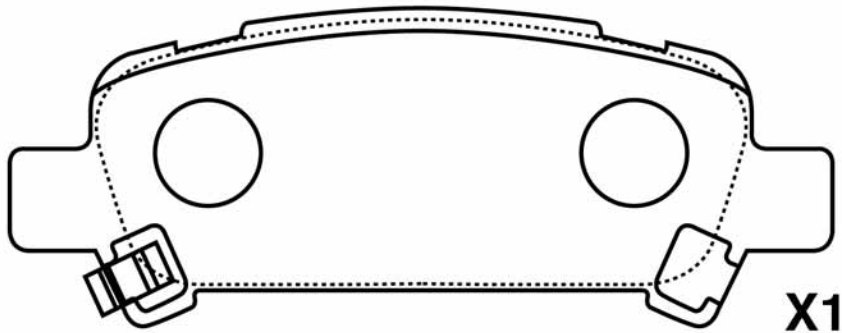
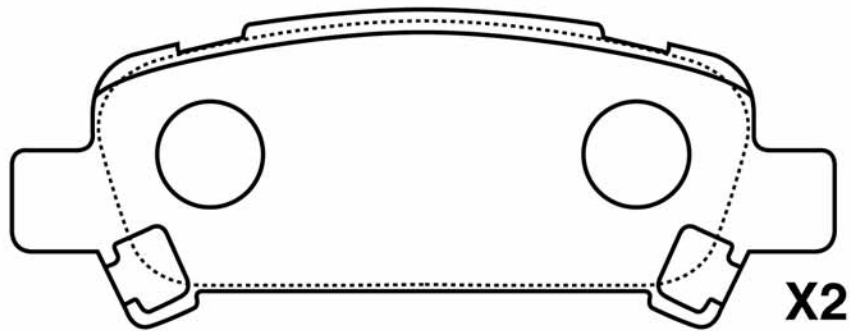



PICTURES BRAKE PADS REAR
ABBILDUNGEN BREMSKLÖTZE HINTEN
FIGURAS PASTILLAS DE FRENO POSTERIORES
ILLUSTRATIONS PLAQUETTES DE FREI ARRIÈRE
IMMAGINI PASTIGLIE FRENO POSTERIORI

51-07-703				WVA
SUBARU	L	H	Th	
	108,7	39,5	14	24331

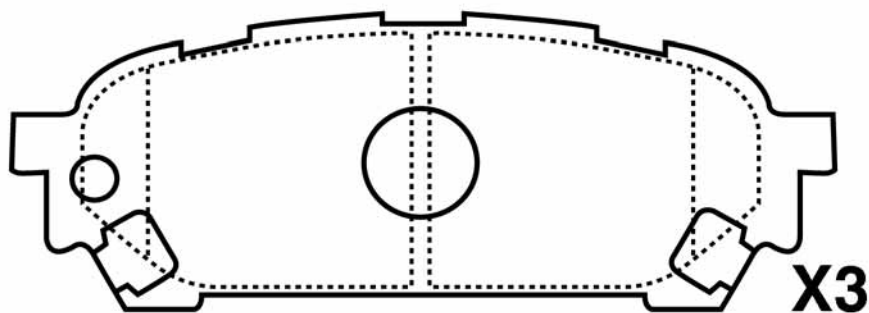
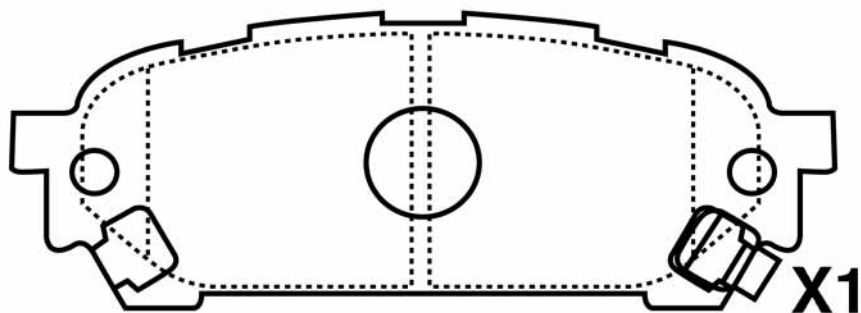



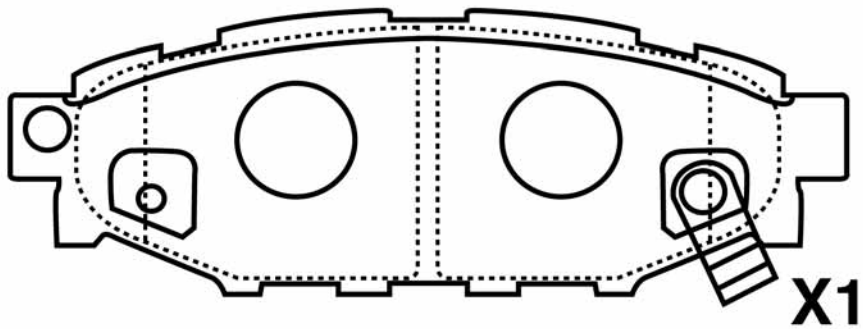
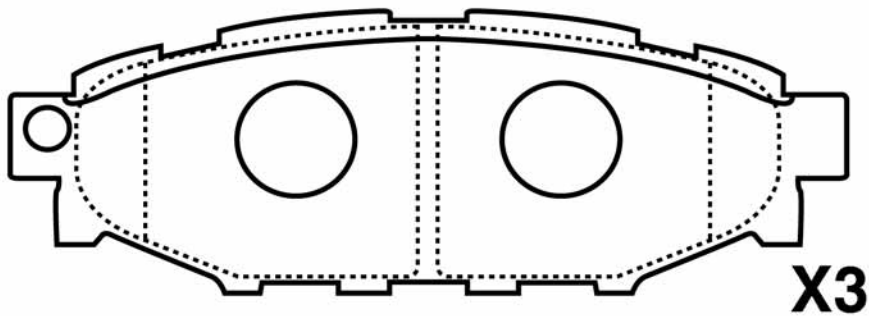

51-07-704				WVA
	SUBARU	L	H	Th
	110,5	37,5	14	24271





PICTURES BRAKE PADS REAR
ABBILDUNGEN BREMSKLÖTZE HINTEN
FIGURAS PASTILLAS DE FRENO POSTERIORES
ILLUSTRATIONS PLAQUETTES DE FREI ARRIÈRE
IMMAGINI PASTIGLIE FRENO POSTERIORI

51-07-705				WVA
SUBARU	L	H	Th	
	110,5	40	16	24854

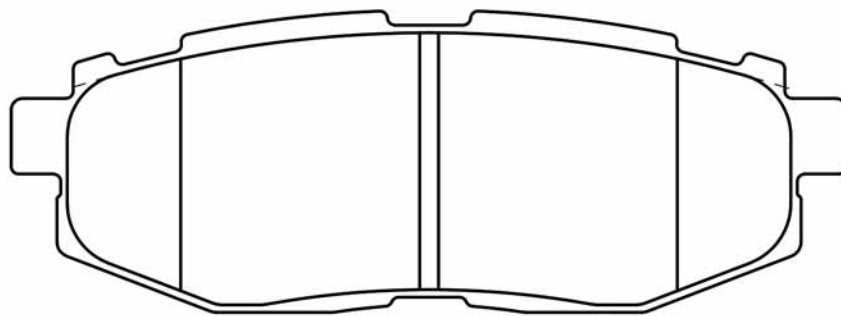
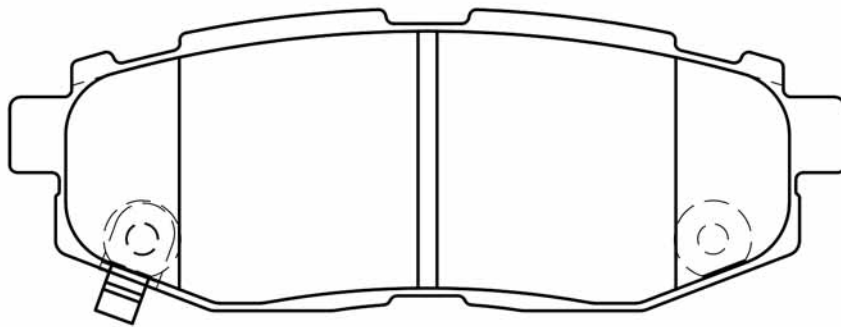



51-07-799

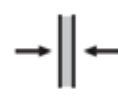
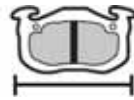

WVA

L

H

Th

54,2

49,2

14,9

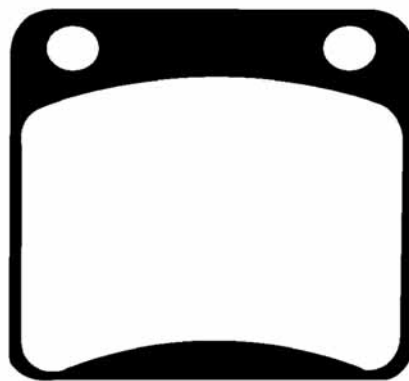

X4



PICTURES BRAKE PADS REAR
ABBILDUNGEN BREMSKLÖTZE HINTEN
FIGURAS PASTILLAS DE FRENO POSTERIORES
ILLUSTRATIONS PLAQUETTES DE FREI ARRIÈRE
IMMAGINI PASTIGLIE FRENO POSTERIORI

51-08-800 SUZUKI				WVA
	L	H	Th	
	85,6	38,9	12,5	21407

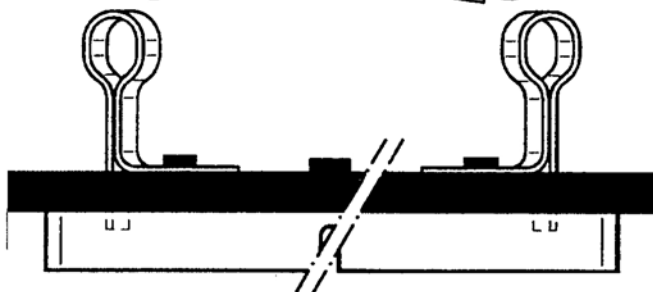
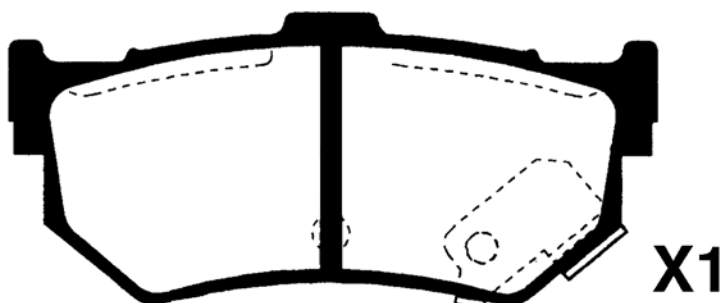
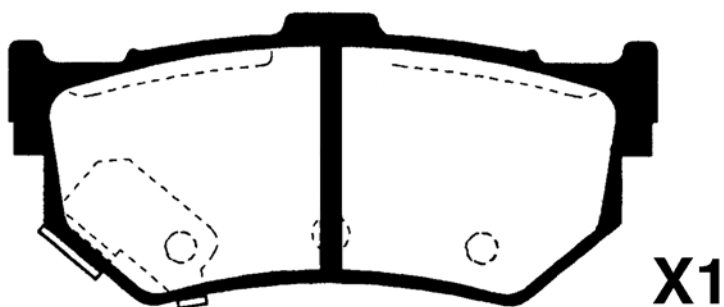
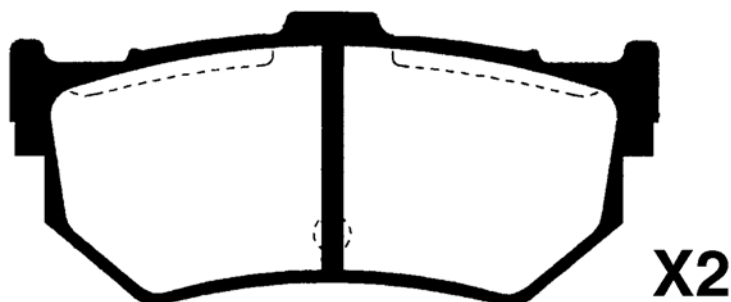



51-08-801

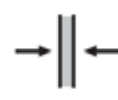
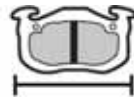

WVA

SUZUKI

L

H

Th

98,5

40

14

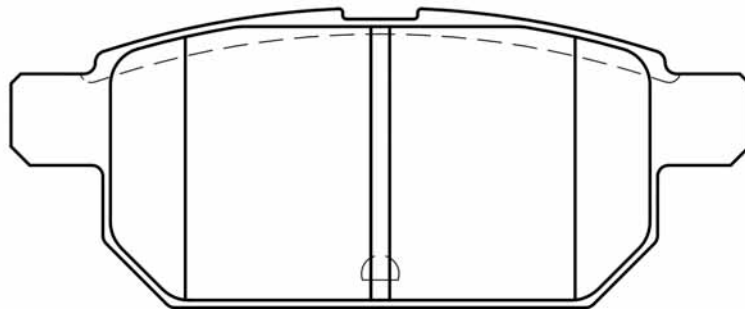
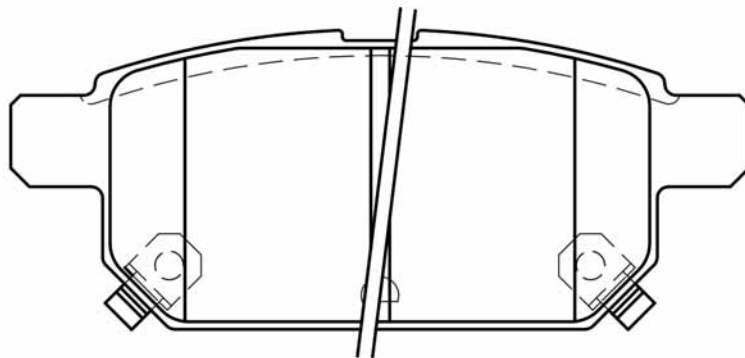



PICTURES BRAKE PADS REAR
ABBILDUNGEN BREMSKLÖTZE HINTEN
FIGURAS PASTILLAS DE FRENO POSTERIORES
ILLUSTRATIONS PLAQUETTES DE FREI ARRIÈRE
IMMAGINI PASTIGLIE FRENO POSTERIORI

51-09-900 ISUZU - OPEL				WVA
	L 131,5	H 41,8	Th 12,8	21744

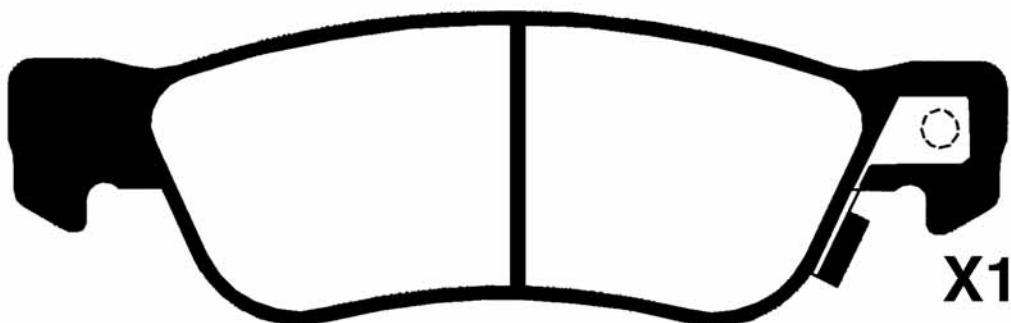
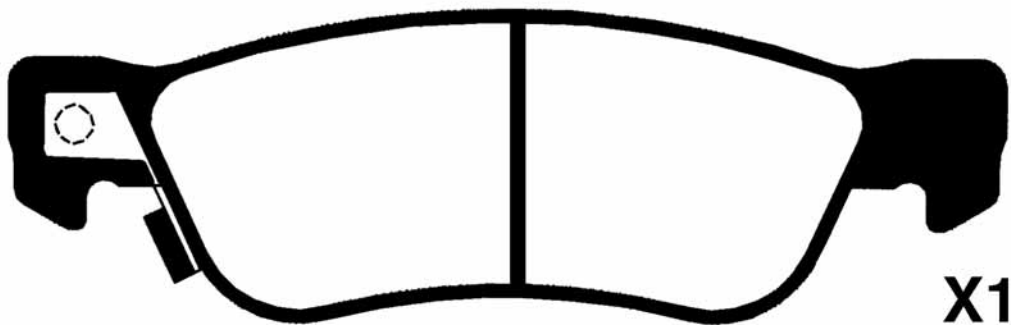
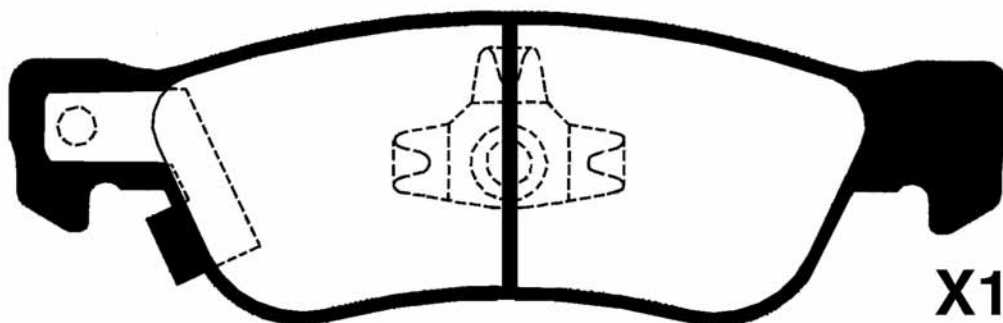
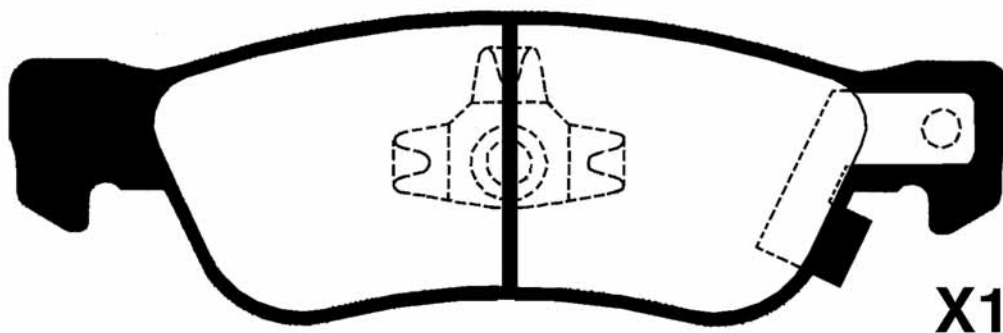



51-09-901				WVA
	JEEP - DODGE	L 116	H 45	

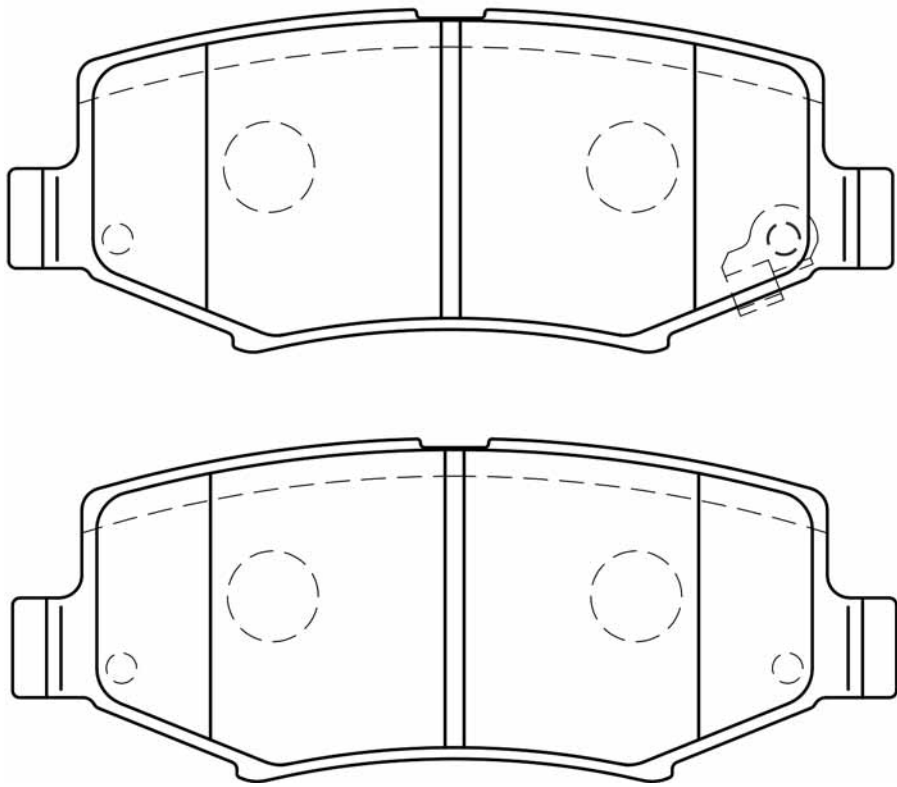



PICTURES BRAKE PADS REAR
ABBILDUNGEN BREMSKLÖTZE HINTEN
FIGURAS PASTILLAS DE FRENO POSTERIORES
ILLUSTRATIONS PLAQUETTES DE FREI ARRIÈRE
IMMAGINI PASTIGLIE FRENO POSTERIORI

51-09-902

CHRYSLER

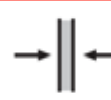
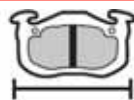

WVA

L

102

H

58

Th

18,2

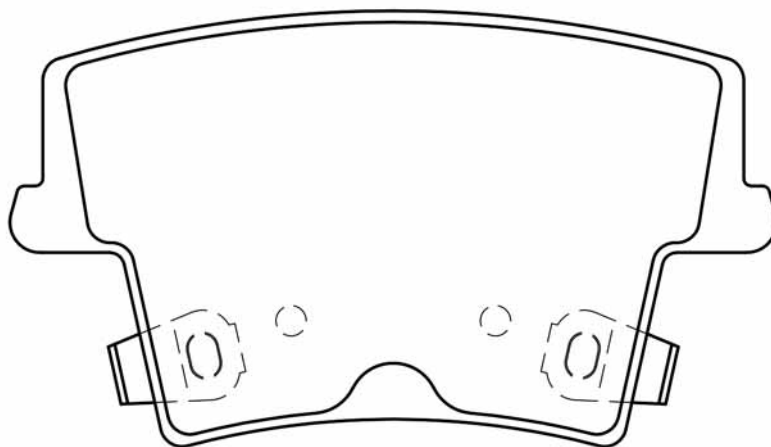



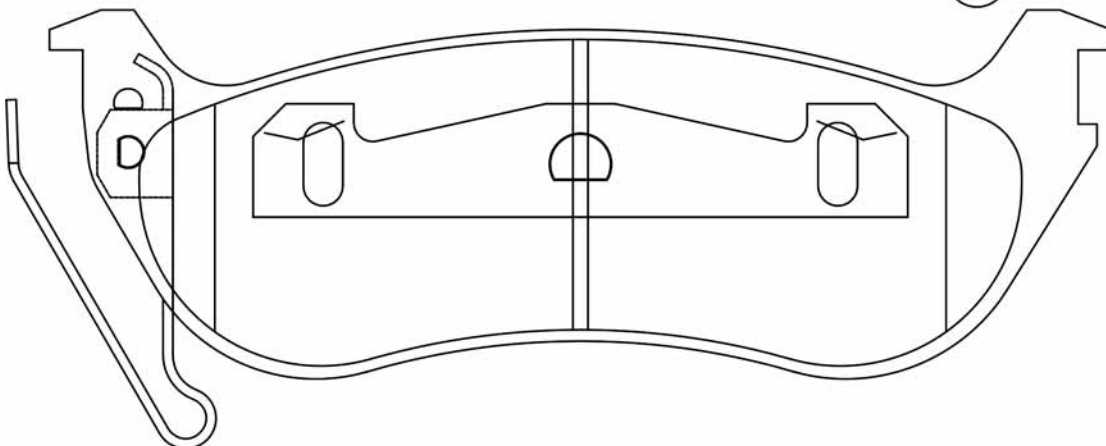
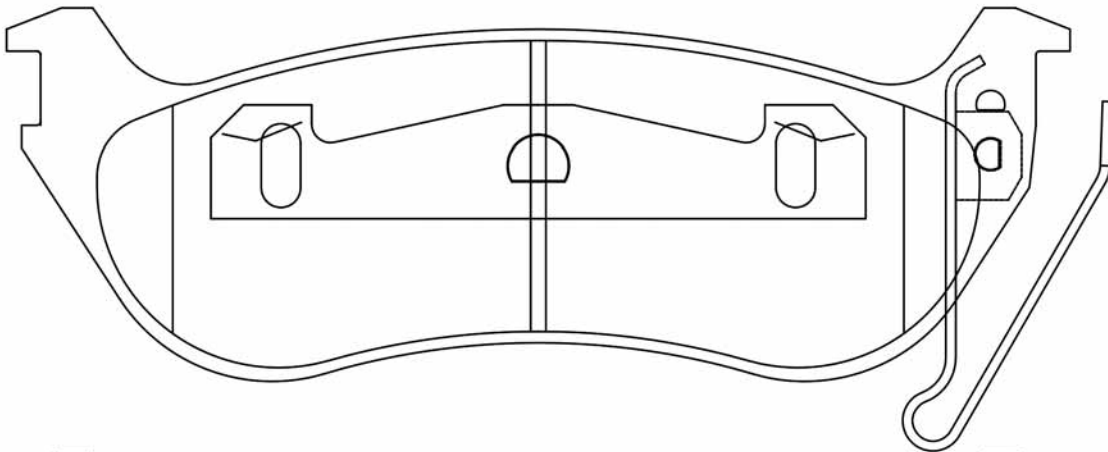
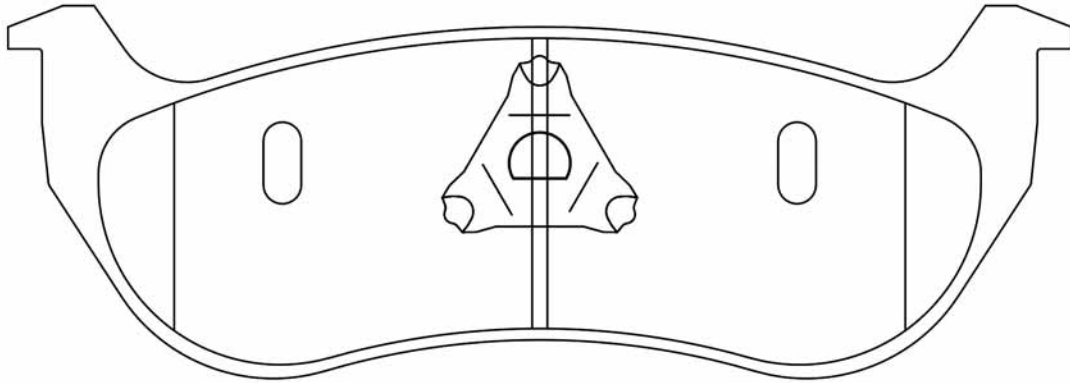

51-09-904				WVA
	JEEP	L 140	H 46,5	





PICTURES BRAKE PADS REAR
ABBILDUNGEN BREMSKLÖTZE HINTEN
FIGURAS PASTILLAS DE FRENO POSTERIORES
ILLUSTRATIONS PLAQUETTES DE FREI ARRIÈRE
IMMAGINI PASTIGLIE FRENO POSTERIORI

51-09-905				WVA
CHRYSLER - DODGE	L	H	Th	
	117	53	17	24822

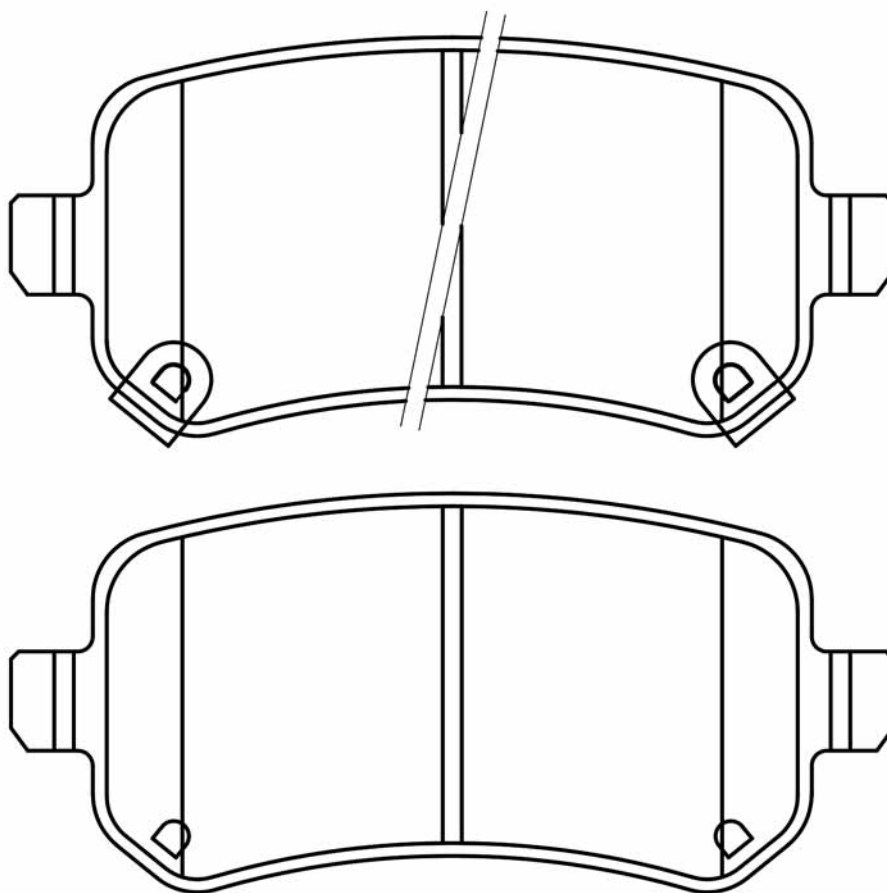



51-09-906				WVA
	JEEP	L	H	
	141,5/140,2	59,4/50,8	16,8	

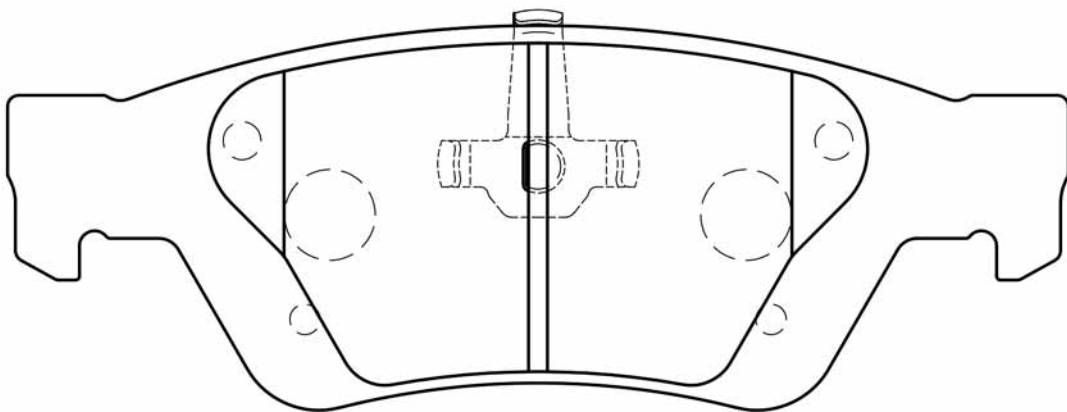
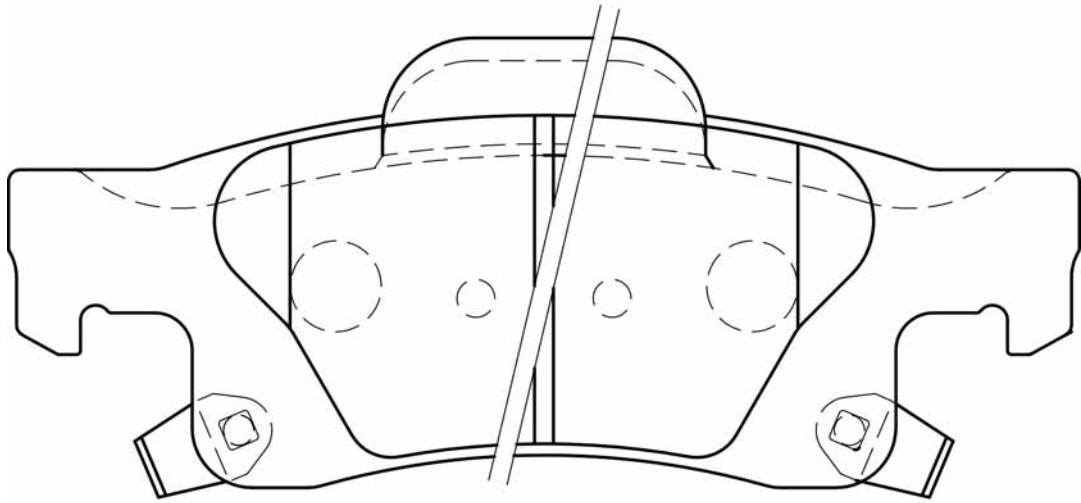



PICTURES BRAKE PADS REAR
ABBILDUNGEN BREMSKLÖTZE HINTEN
FIGURAS PASTILLAS DE FRENO POSTERIORES
ILLUSTRATIONS PLAQUETTES DE FREI ARRIÈRE
IMMAGINI PASTIGLIE FRENO POSTERIORI

51-09-992				WVA
JEEP	L	H	Th	
	141,4	59,1	17,7	

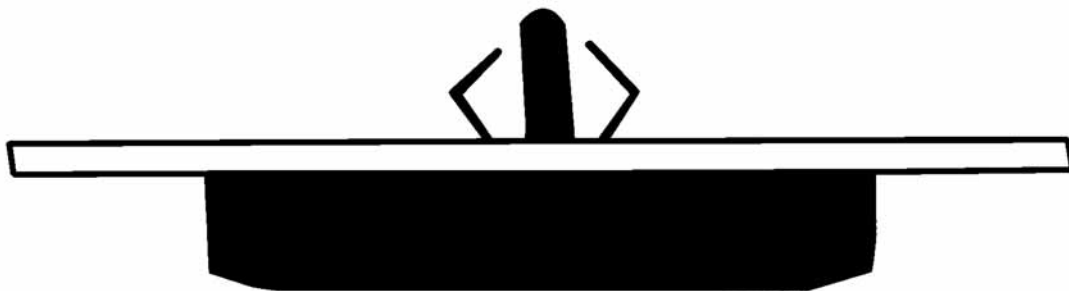
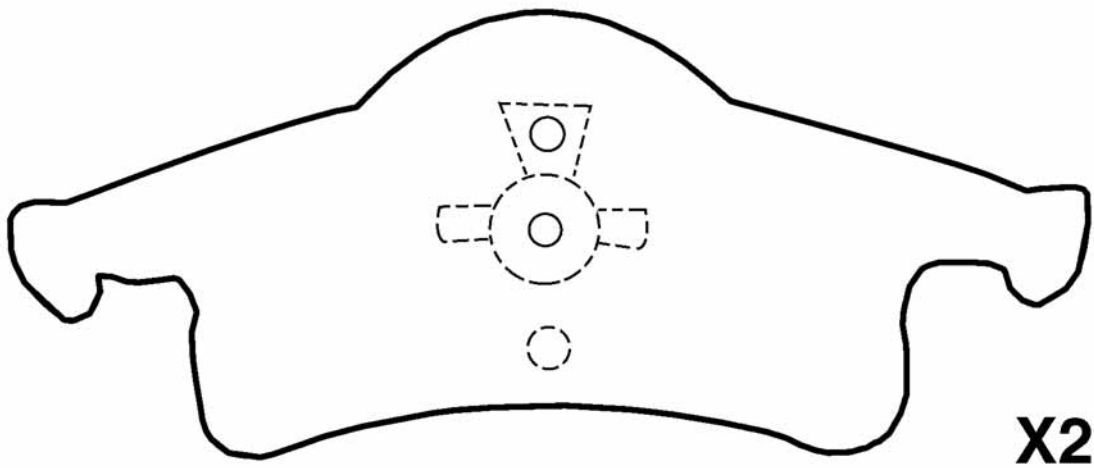
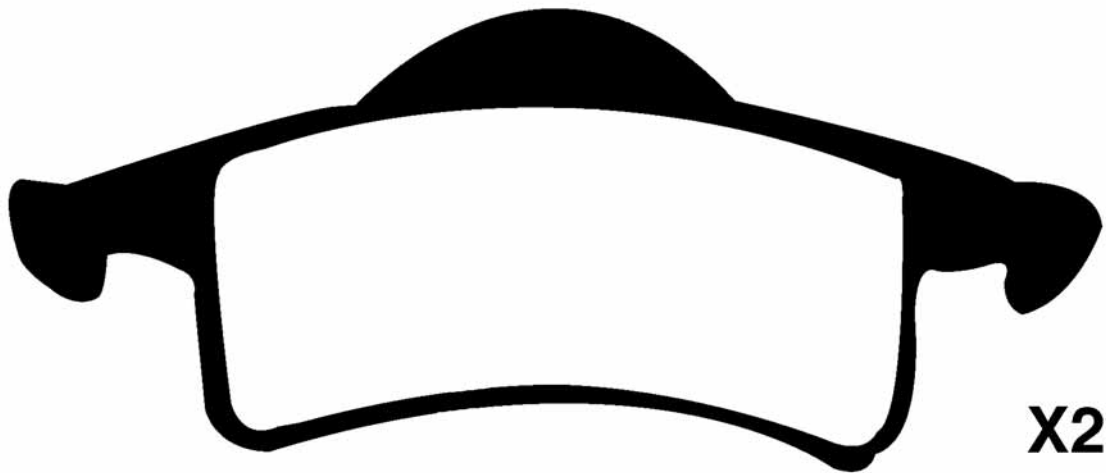



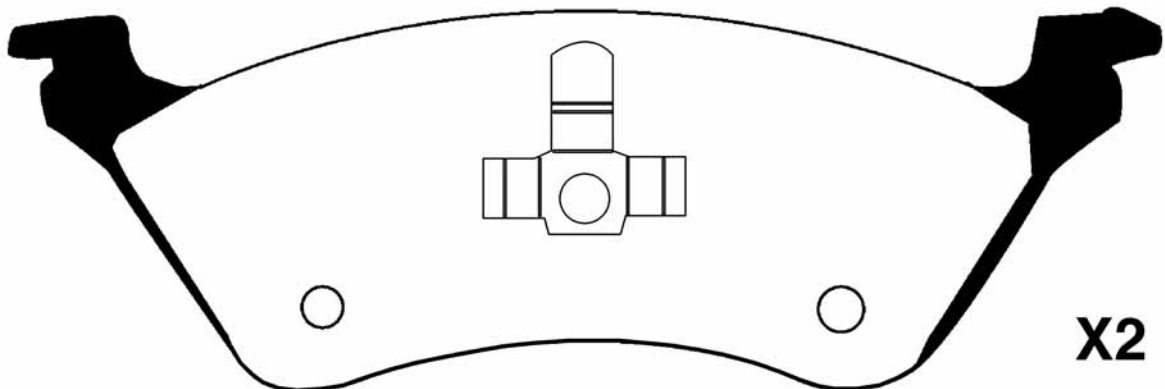
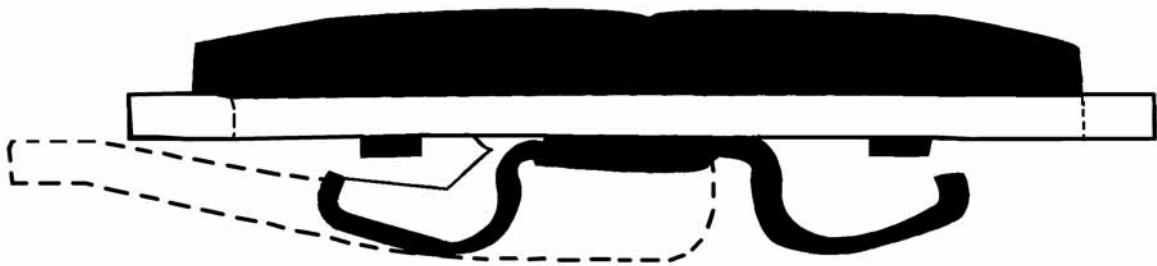
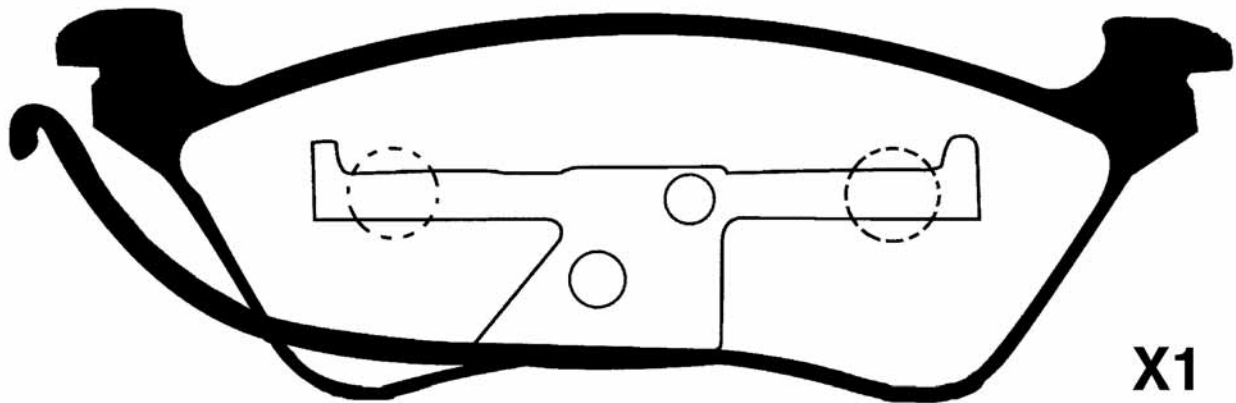
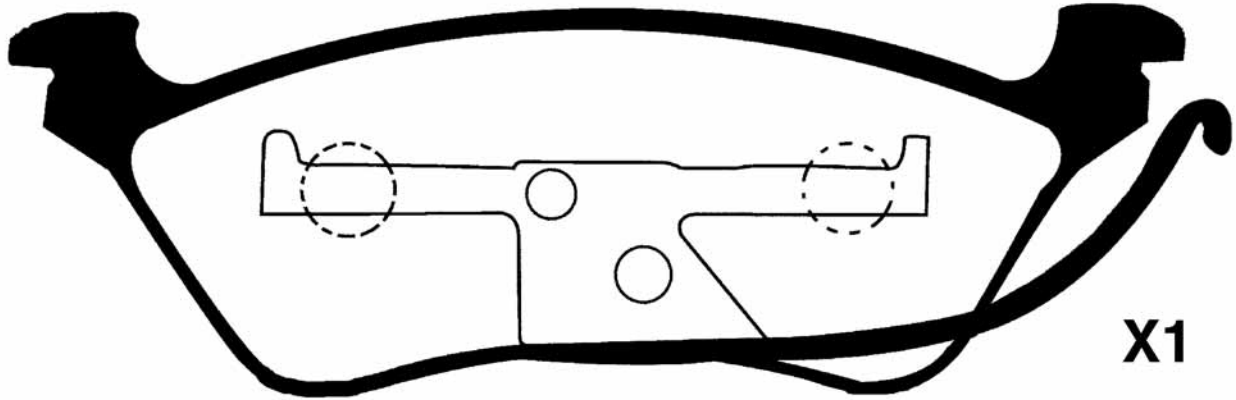

51-09-993				WVA
	CHRYSLER	L	H	Th
	155,4	50,7	16,6	24036



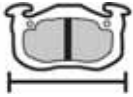

PICTURES BRAKE PADS REAR
ABBILDUNGEN BREMSKLÖTZE HINTEN
FIGURAS PASTILLAS DE FRENO POSTERIORES
ILLUSTRATIONS PLAQUETTES DE FREI ARRIÈRE
IMMAGINI PASTIGLIE FRENO POSTERIORI

51-09-994				WVA
CHRYSLER	L	H	Th	
	155,7	49,2	16,5	

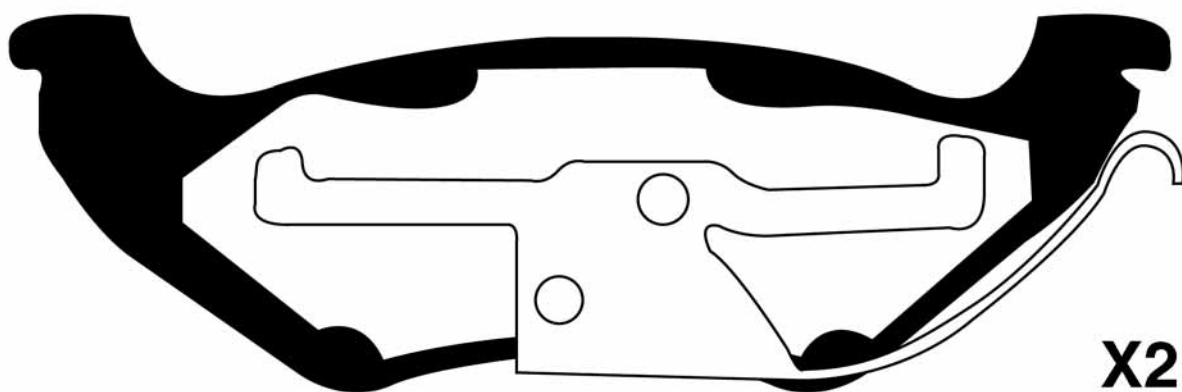
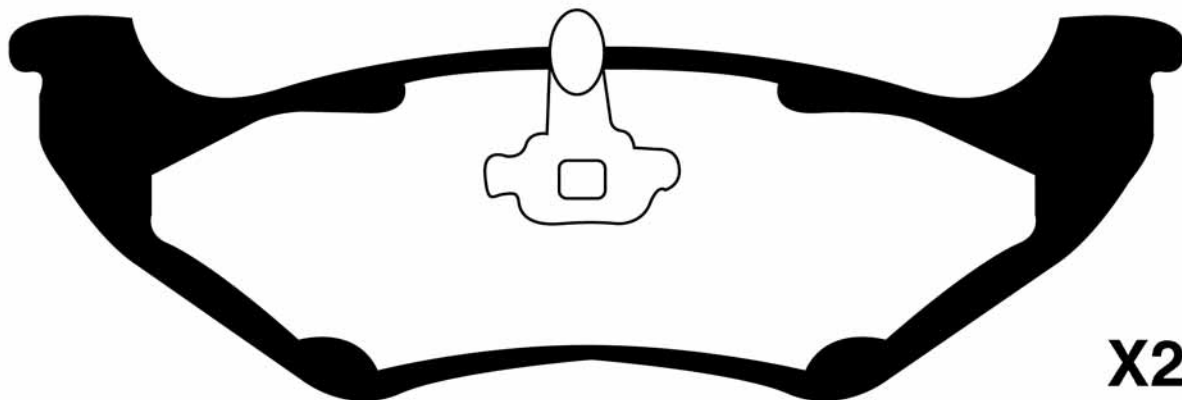



51-09-996				WVA
	ISUZU	L	H	Th
	107,1	40,9	15	

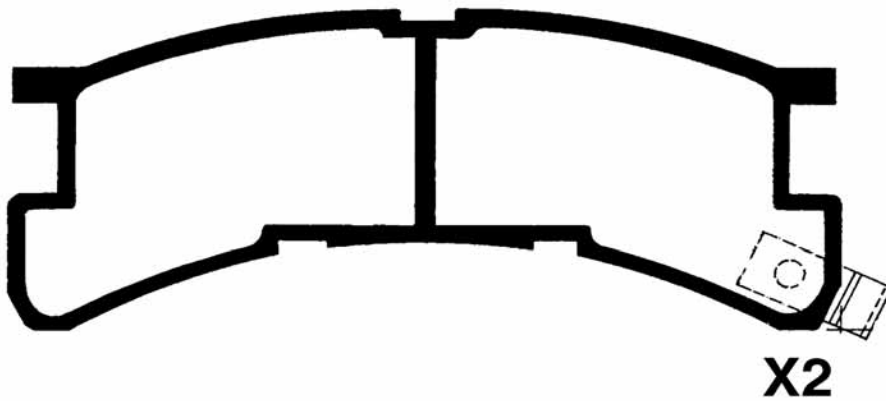
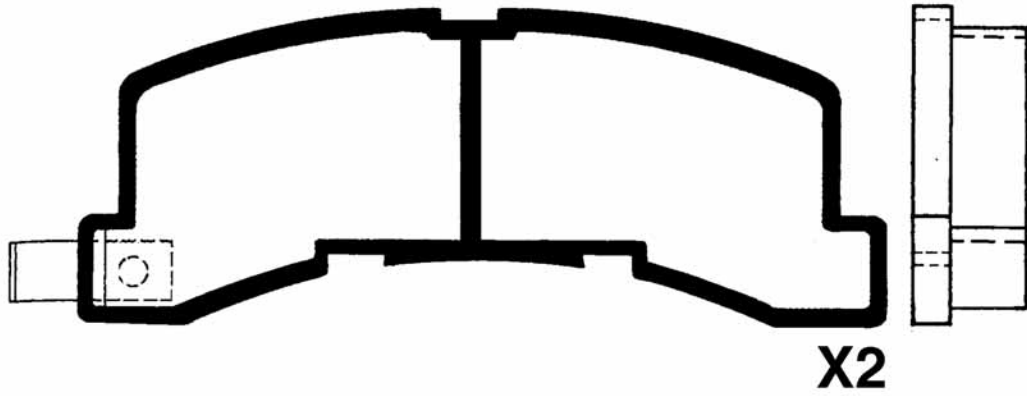



PICTURES BRAKE PADS REAR
ABBILDUNGEN BREMSKLÖTZE HINTEN
FIGURAS PASTILLAS DE FRENO POSTERIORES
ILLUSTRATIONS PLAQUETTES DE FREI ARRIÈRE
IMMAGINI PASTIGLIE FRENO POSTERIORI

51-09-997 SSANGYONG - DAEWOO				WVA
	L	H	Th	
	114	55,3	14	

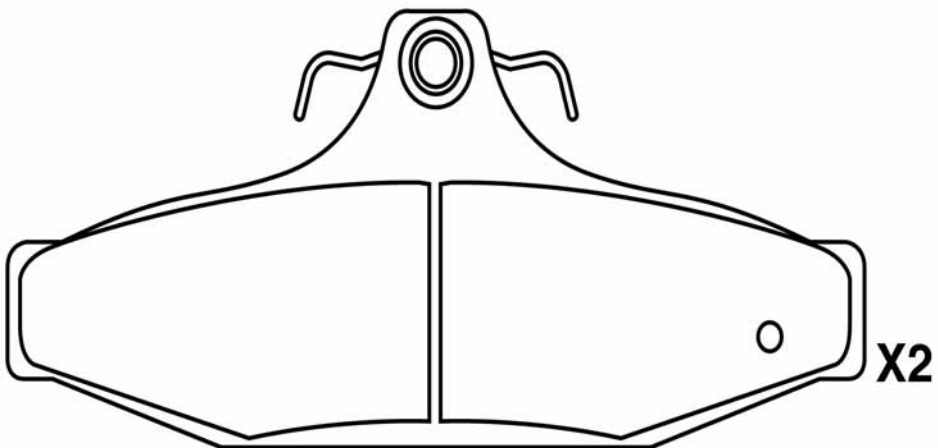
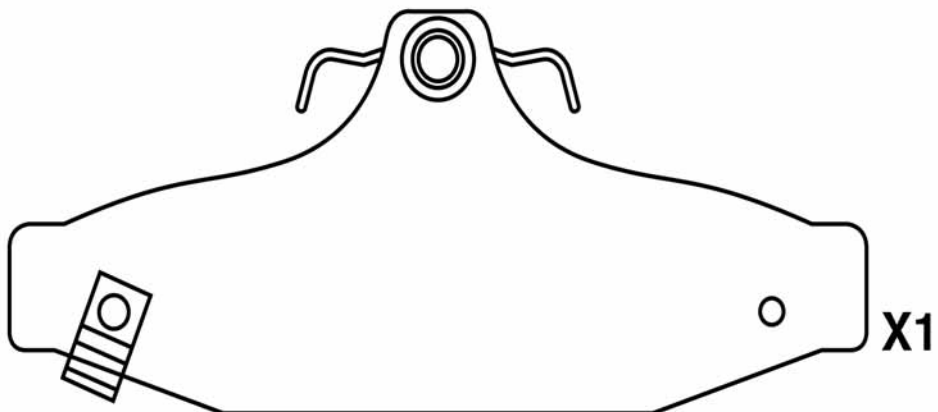
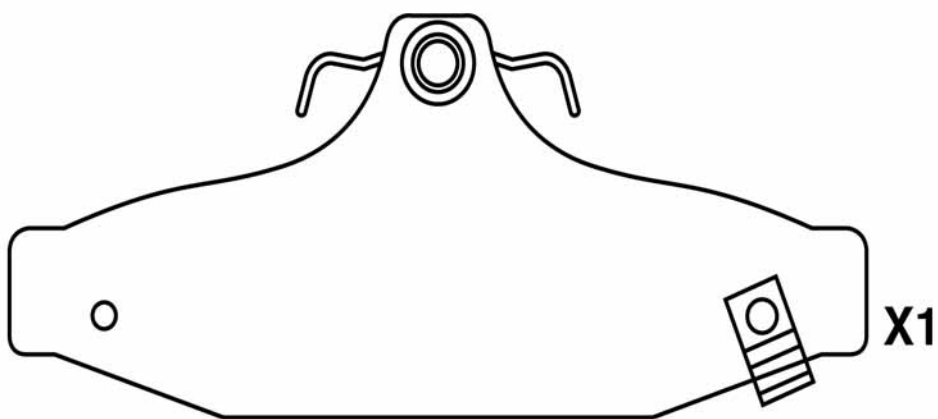



51-09-998				WVA
	JEEP	L 140	H 45,2	

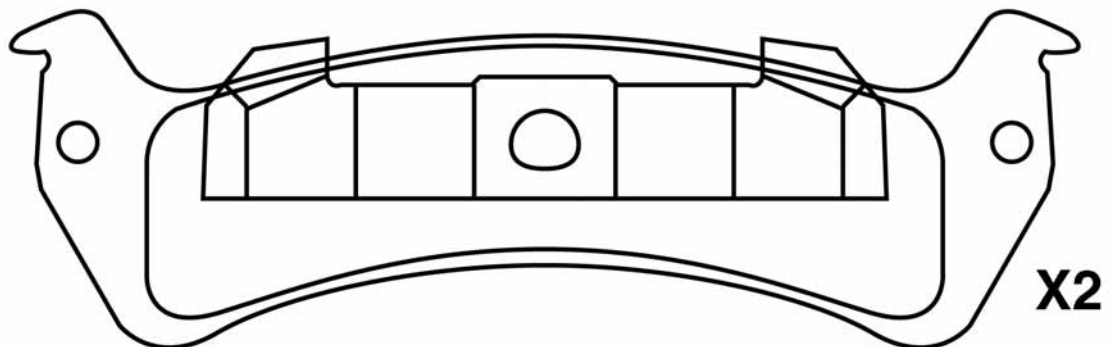
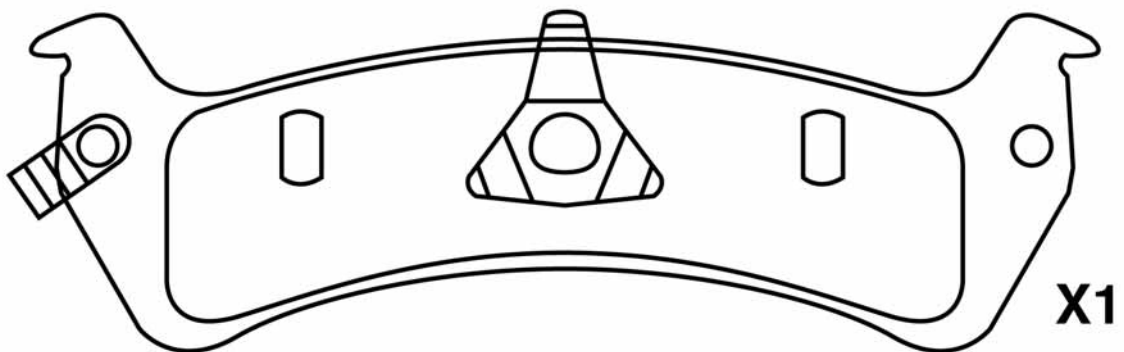
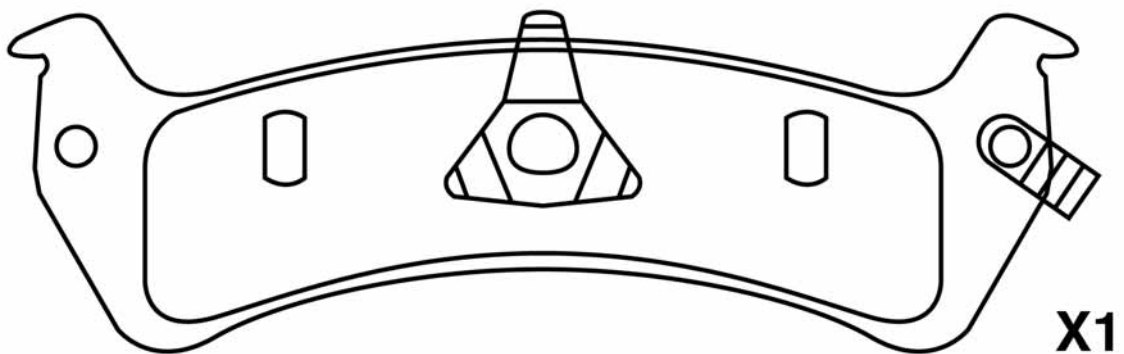



PICTURES BRAKE PADS REAR
ABBILDUNGEN BREMSKLÖTZE HINTEN
FIGURAS PASTILLAS DE FRENO POSTERIORES
ILLUSTRATIONS PLAQUETTES DE FREI ARRIÈRE
IMMAGINI PASTIGLIE FRENO POSTERIORI

51-09-999 GREAT WALL - ISUZU				WVA
	L 109,2	H 42	Th 15,5	

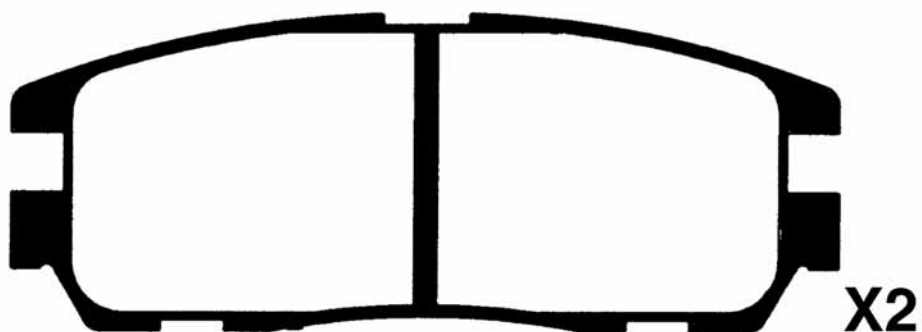
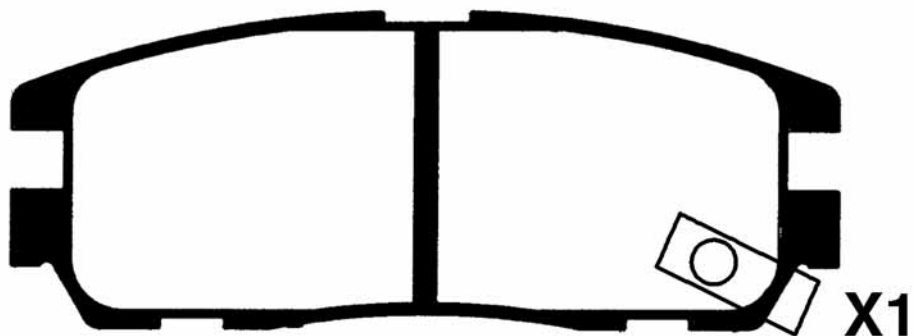
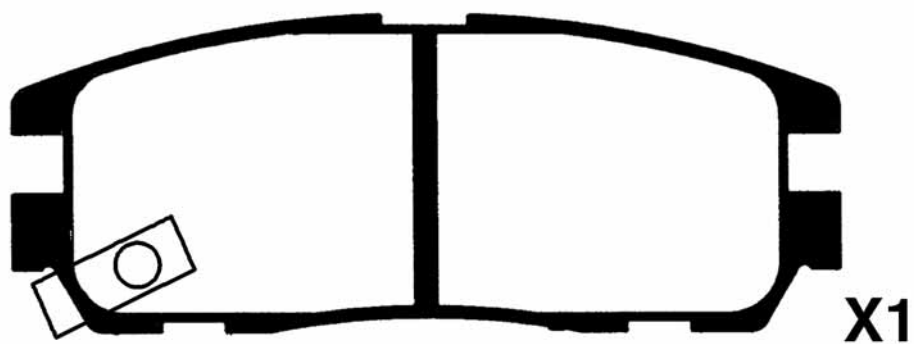



51-0H-H01				WVA
HYUNDAI	L	H	Th	
	100	41	16	

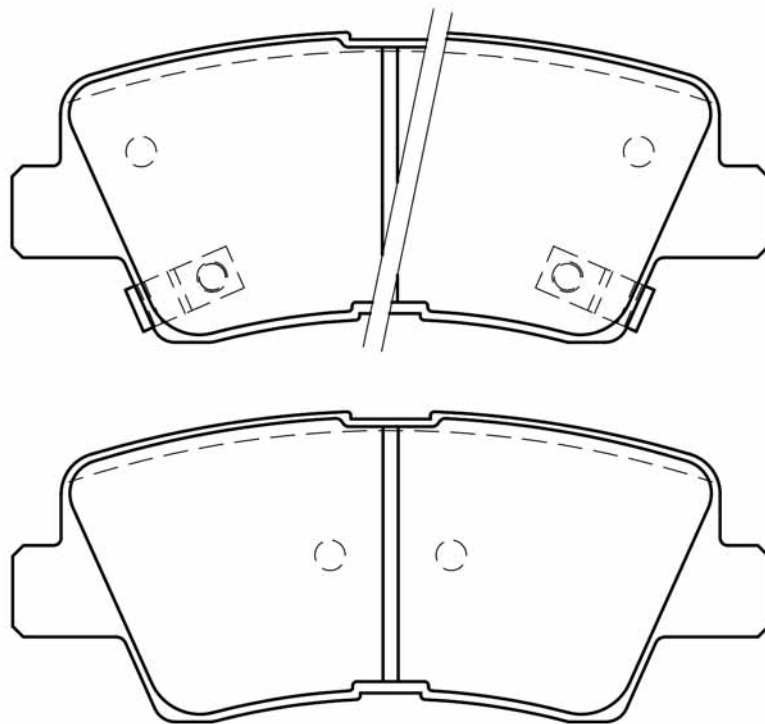



PICTURES BRAKE PADS REAR
ABBILDUNGEN BREMSKLÖTZE HINTEN
FIGURAS PASTILLAS DE FRENO POSTERIORES
ILLUSTRATIONS PLAQUETTES DE FREI ARRIÈRE
IMMAGINI PASTIGLIE FRENO POSTERIORI

51-0H-H02 KIA - HYUNDAI				WVA
	L 103	H 39,2	Th 15	23608

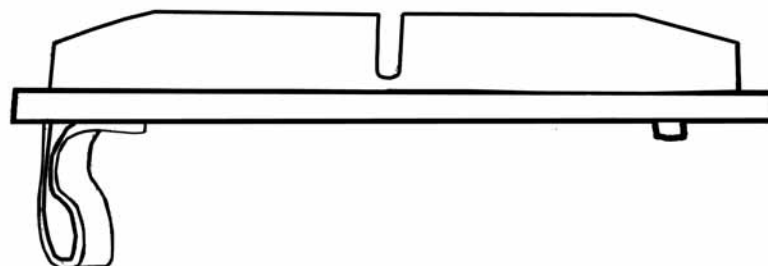
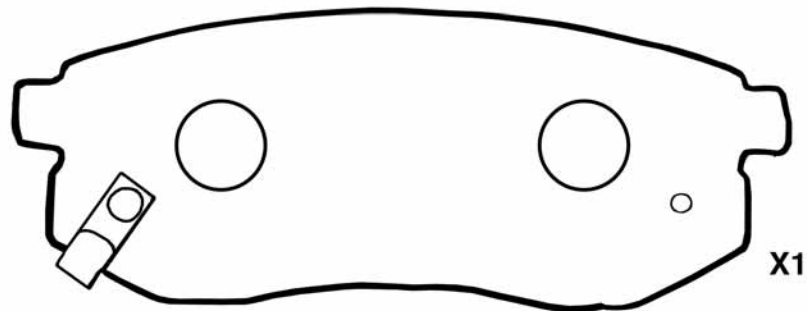
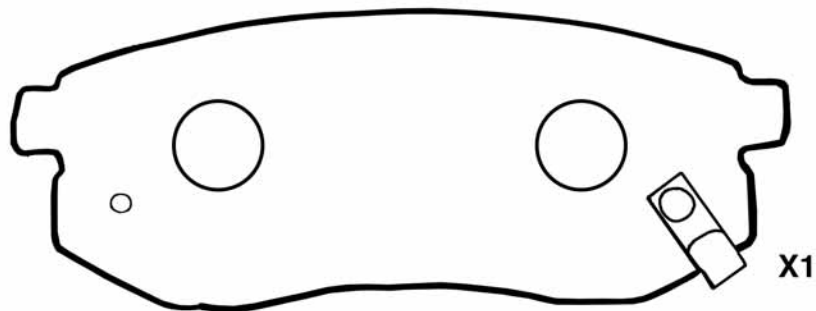
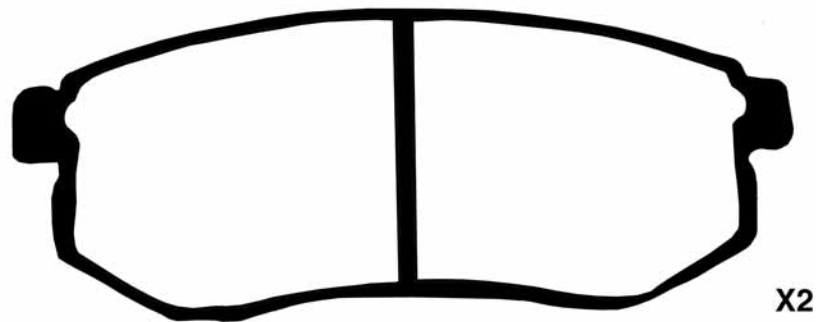



51-0H-H03				WVA
	GONOW - HYUNDAI - KIA	L	H	
	110,8	46,3	15,9	23813

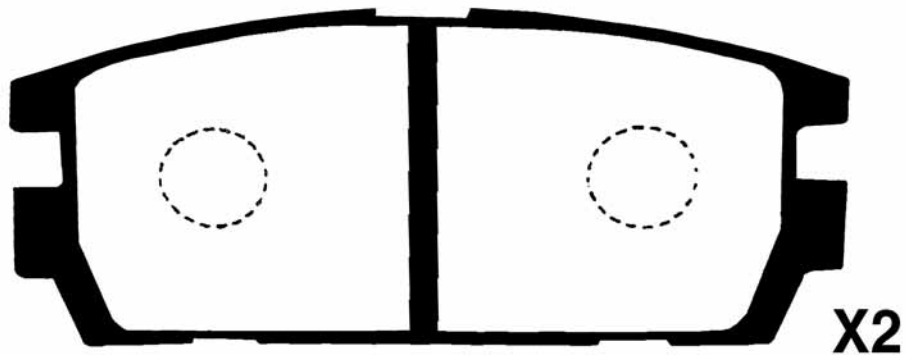
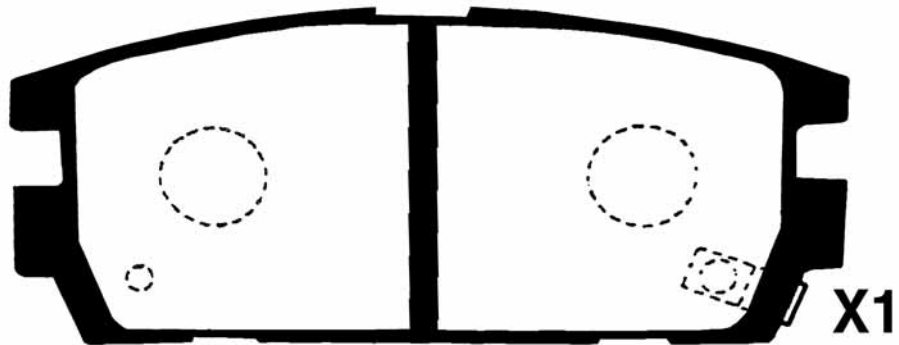
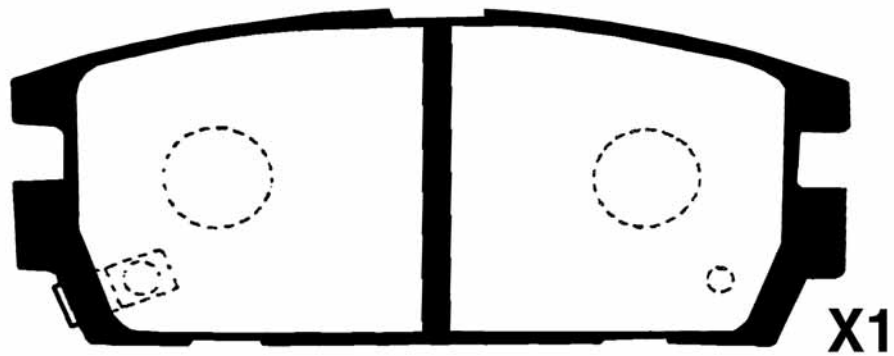



PICTURES BRAKE PADS REAR
ABBILDUNGEN BREMSKLÖTZE HINTEN
FIGURAS PASTILLAS DE FRENO POSTERIORES
ILLUSTRATIONS PLAQUETTES DE FREI ARRIÈRE
IMMAGINI PASTIGLIE FRENO POSTERIORI

51-0H-H04 HYUNDAI - KIA				WVA
	L	H	Th	
	98,6	40,7	15,5	23543

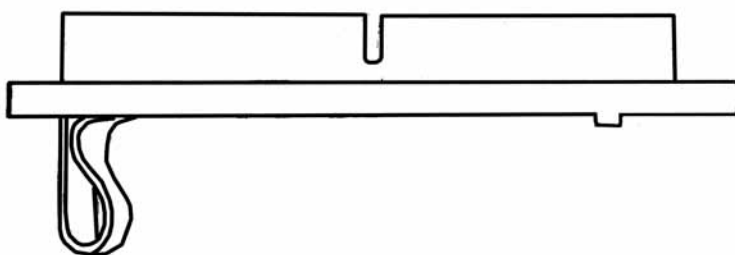
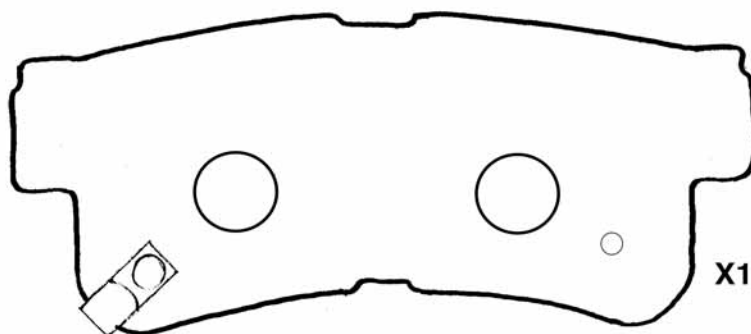
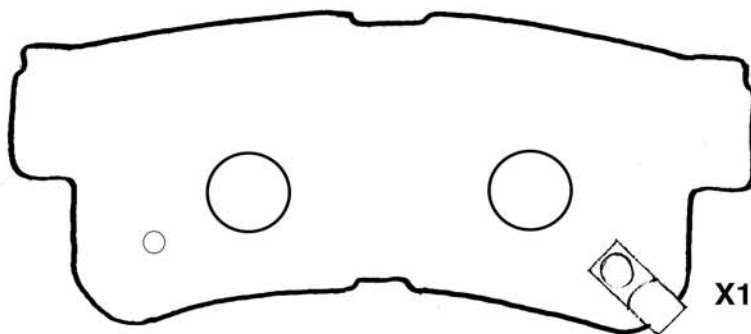
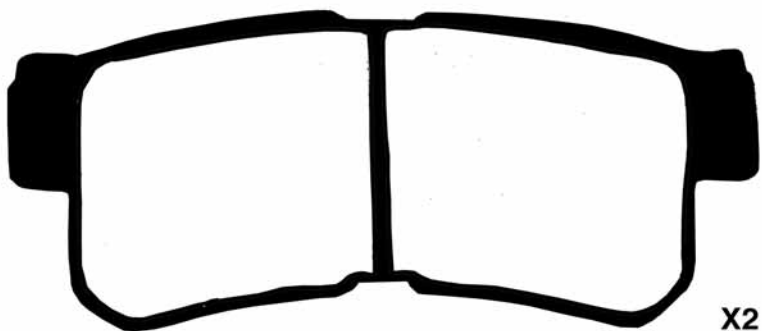



51-0H-H08				WVA
	HYUNDAI	L 118,5	H 47	
				24488

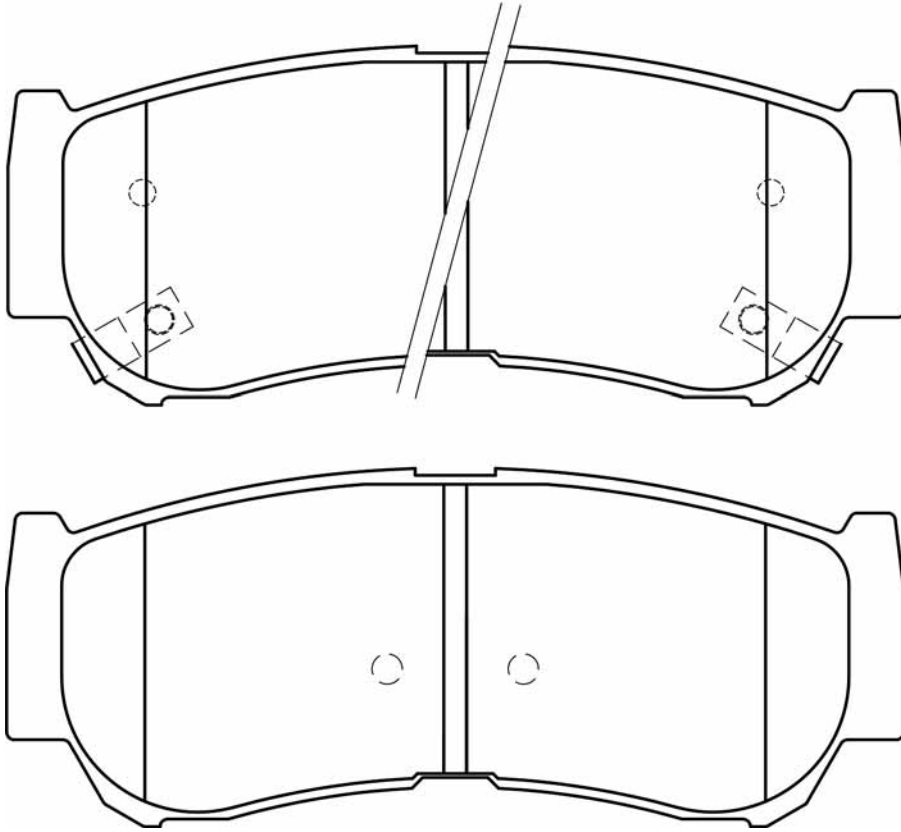



PICTURES BRAKE PADS REAR
ABBILDUNGEN BREMSKLÖTZE HINTEN
FIGURAS PASTILLAS DE FRENO POSTERIORES
ILLUSTRATIONS PLAQUETTES DE FREI ARRIÈRE
IMMAGINI PASTIGLIE FRENO POSTERIORI

51-0K-K00				WVA
KIA	L	H	Th	
	99	42	13	23456

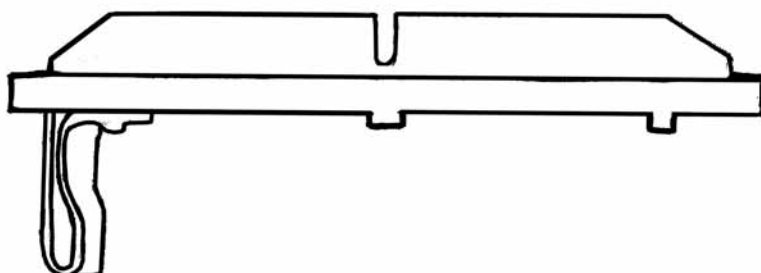
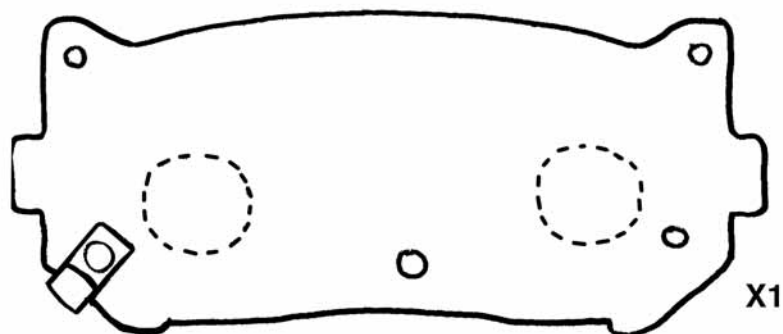
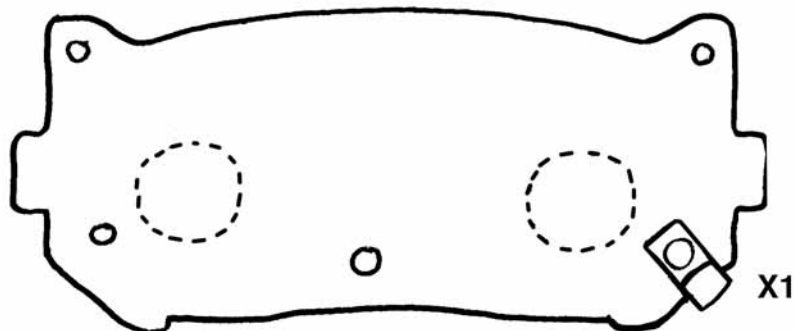
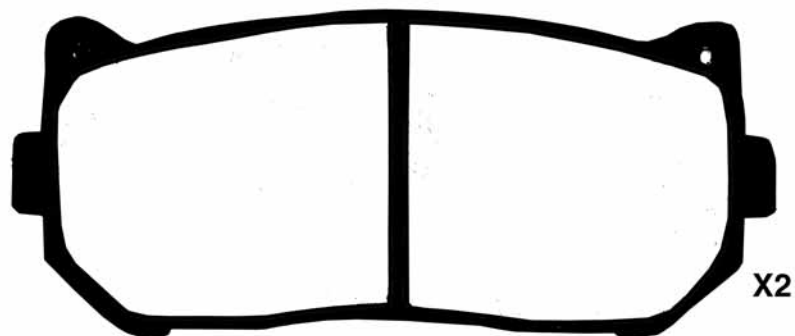



51-0K-K01				WVA
KIA	L	H	Th	
	61,7	51	14,6	21832

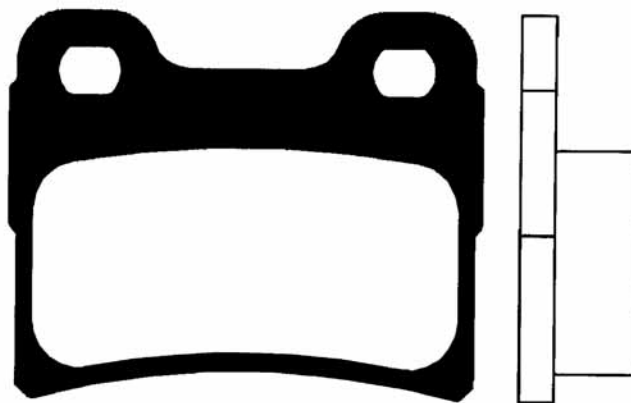

X4



PICTURES BRAKE PADS REAR
ABBILDUNGEN BREMSKLÖTZE HINTEN
FIGURAS PASTILLAS DE FRENO POSTERIORES
ILLUSTRATIONS PLAQUETTES DE FREI ARRIÈRE
IMMAGINI PASTIGLIE FRENO POSTERIORI

51-0K-K03				WVA
KIA	L	H	Th	
	118	46,8	15,6	24058

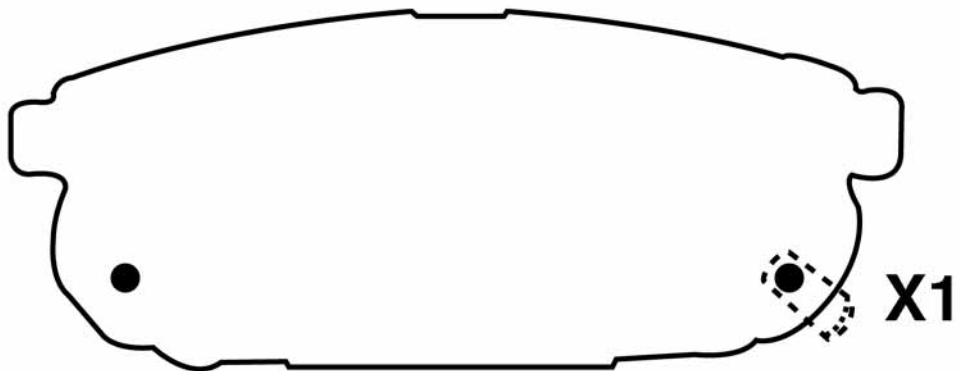
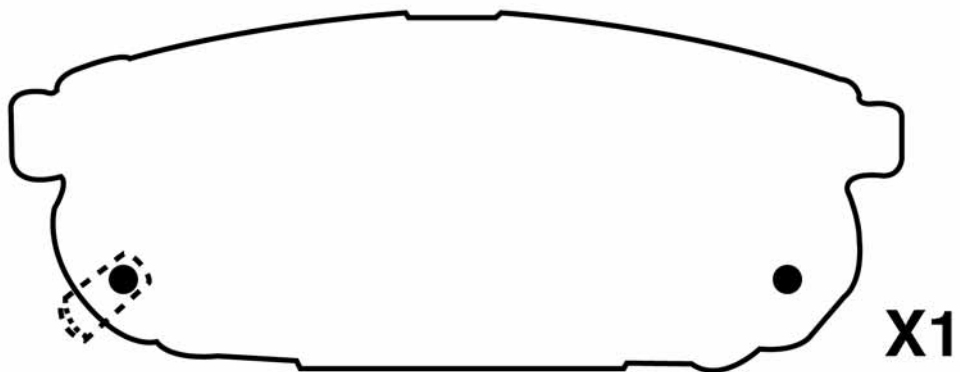
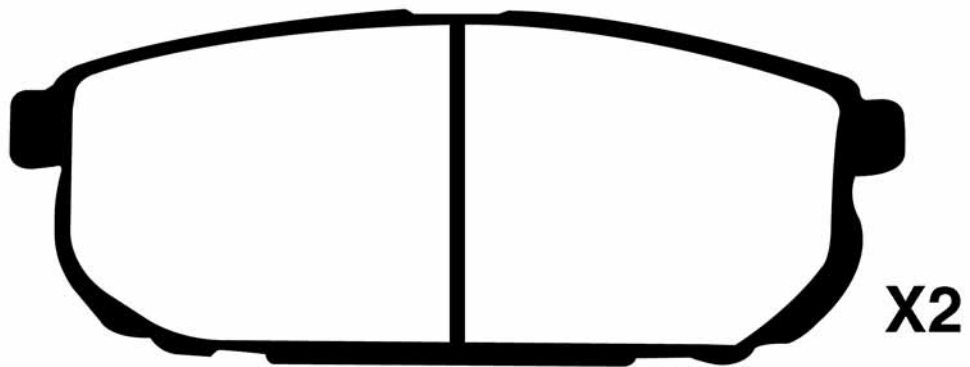



51-0K-004				WVA
	KIA - HYUNDAI	L 92,4	H 41	Th 14,7
				24276

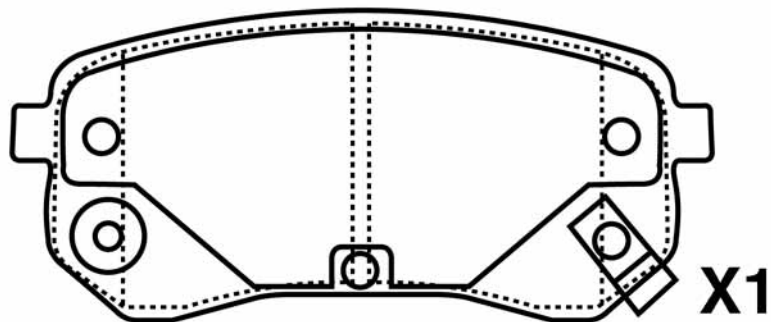
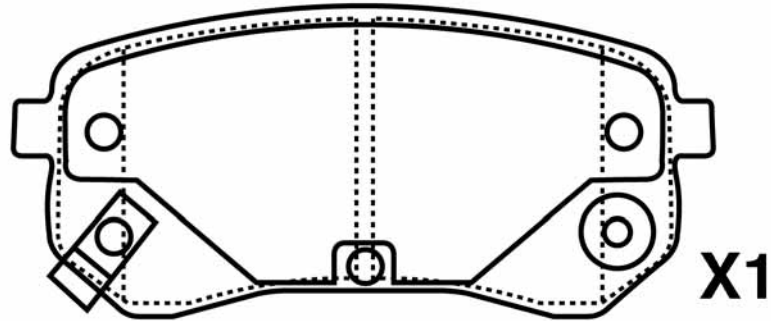
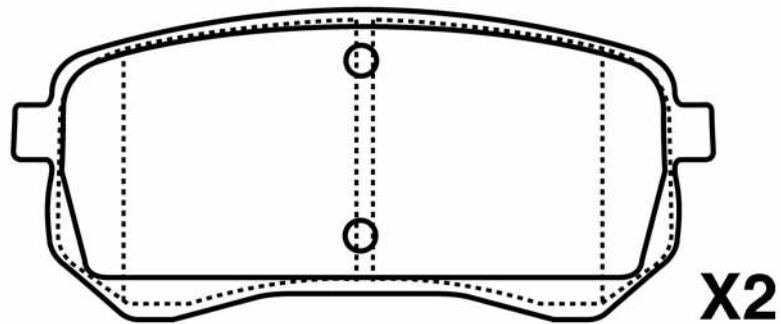



PICTURES BRAKE PADS REAR
ABBILDUNGEN BREMSKLÖTZE HINTEN
FIGURAS PASTILLAS DE FRENO POSTERIORES
ILLUSTRATIONS PLAQUETTES DE FREI ARRIÈRE
IMMAGINI PASTIGLIE FRENO POSTERIORI

51-0K-K06				WVA
KIA - SSANGYONG	L	H	Th	
	100	41	16	24934

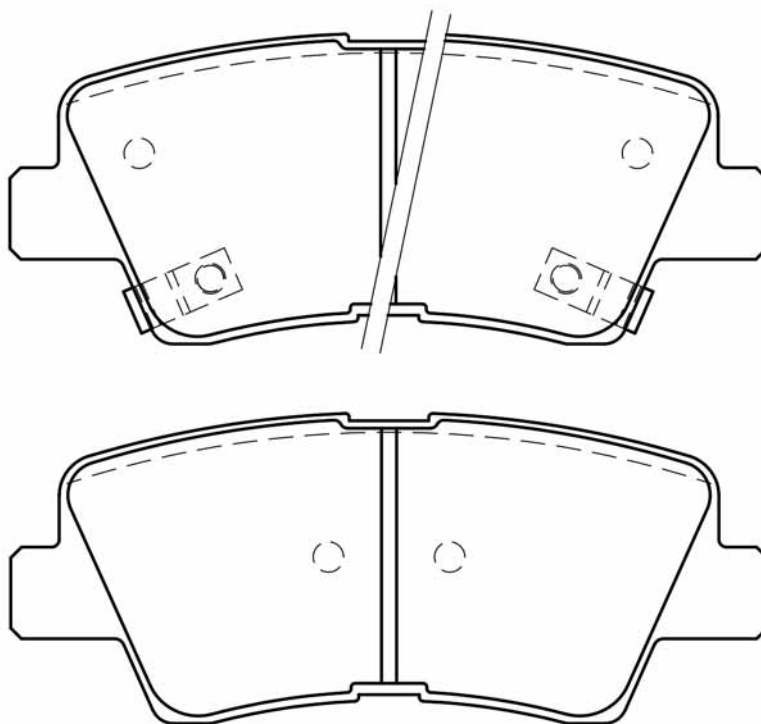



51-0K-K07 KIA - HYUNDAI				WVA 24599
	L 110	H 48	Th 15	

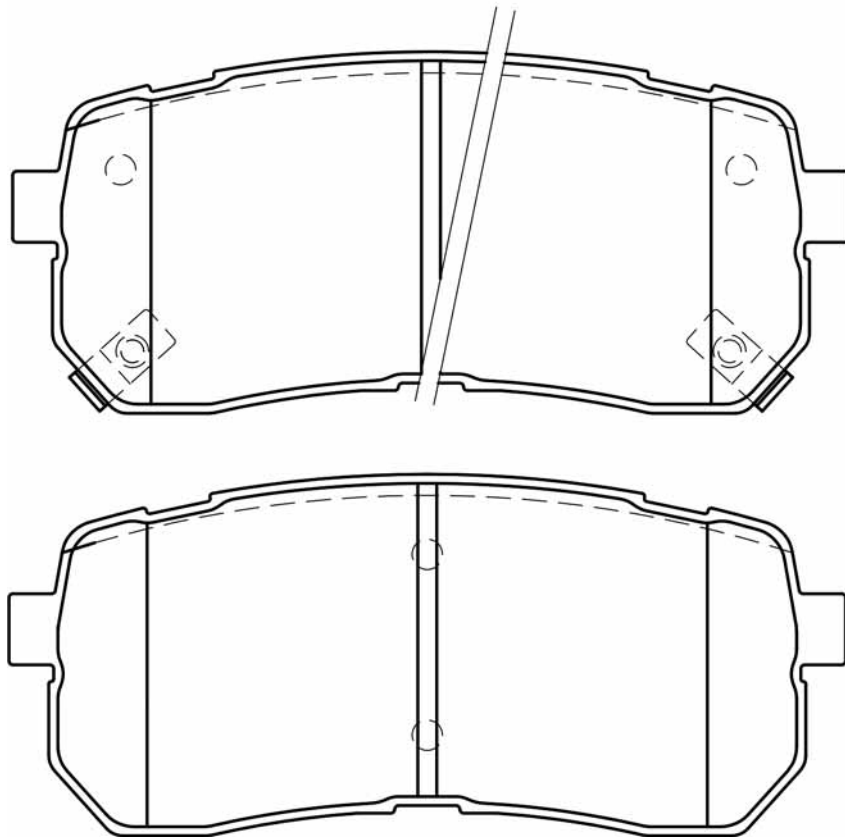



PICTURES BRAKE PADS REAR
ABBILDUNGEN BREMSKLÖTZE HINTEN
FIGURAS PASTILLAS DE FRENO POSTERIORES
ILLUSTRATIONS PLAQUETTES DE FREI ARRIÈRE
IMMAGINI PASTIGLIE FRENO POSTERIORI

51-0K-K09 HYUNDAI - KIA				WVA
	L	H	Th	
	93,3	41	16	24320

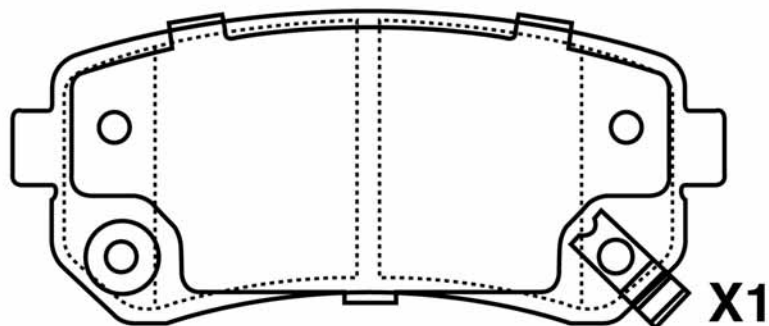
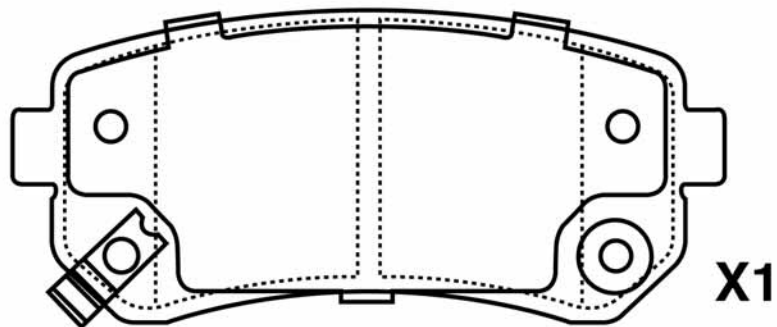
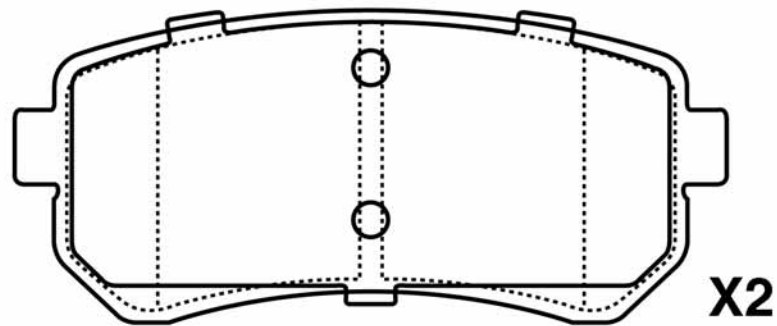



51-0K-K10				WVA
	KIA	L	H	Th
	100,5	44	16	24491

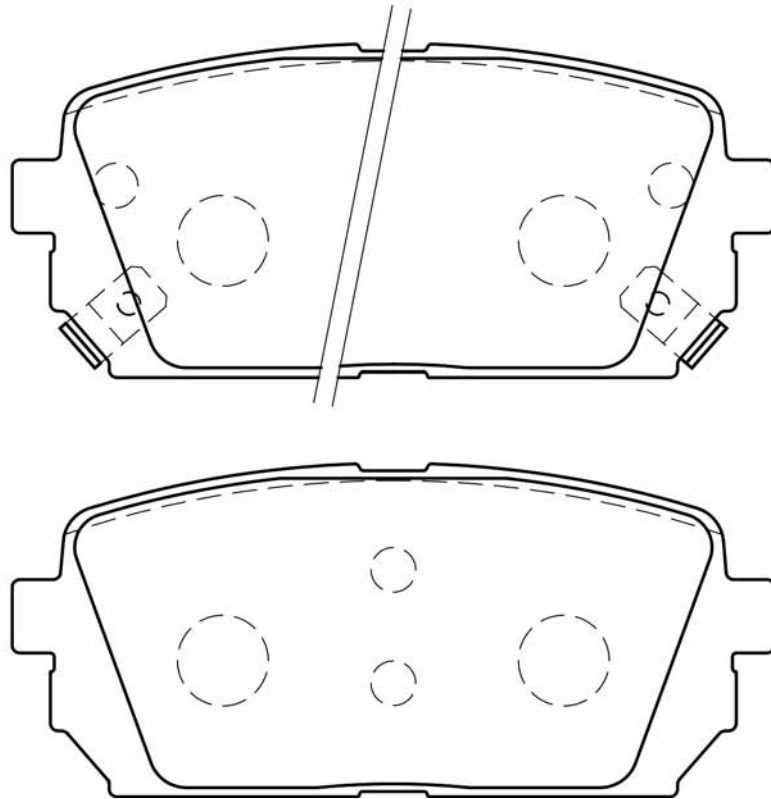



PICTURES BRAKE PADS REAR
ABBILDUNGEN BREMSKLÖTZE HINTEN
FIGURAS PASTILLAS DE FRENO POSTERIORES
ILLUSTRATIONS PLAQUETTES DE FREI ARRIÈRE
IMMAGINI PASTIGLIE FRENO POSTERIORI

51-0K-K11

HYUNDAI - KIA

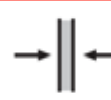
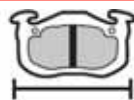

WVA

L

117

H

49

Th

15

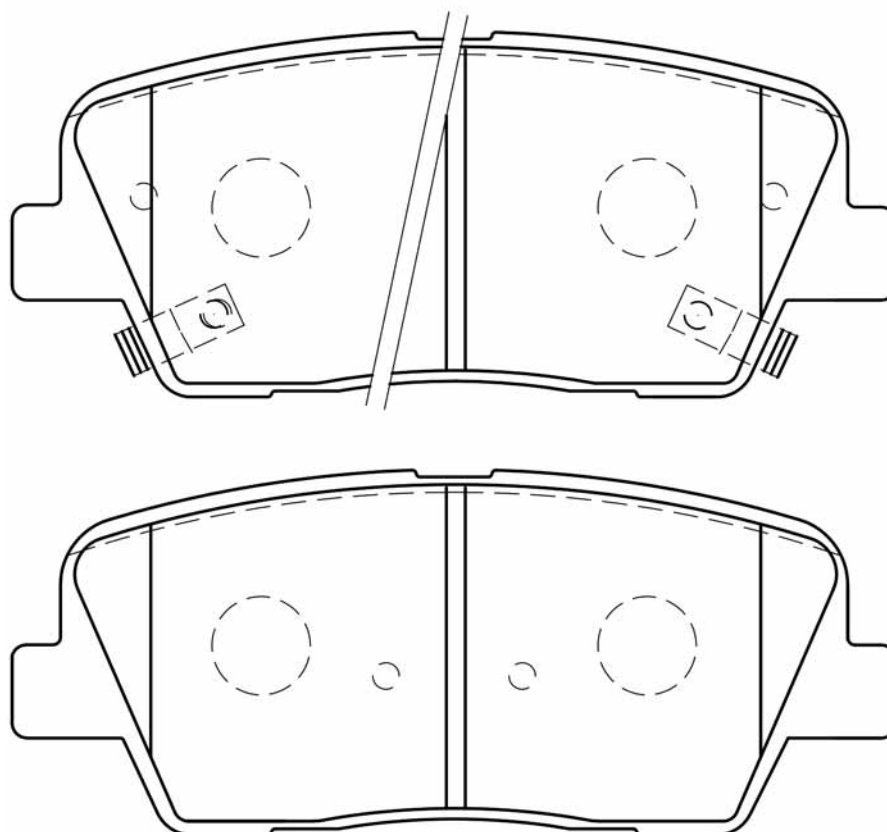



51-0K-K12

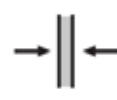
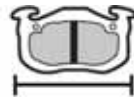

WVA

KIA

L

H

Th

95,5

43

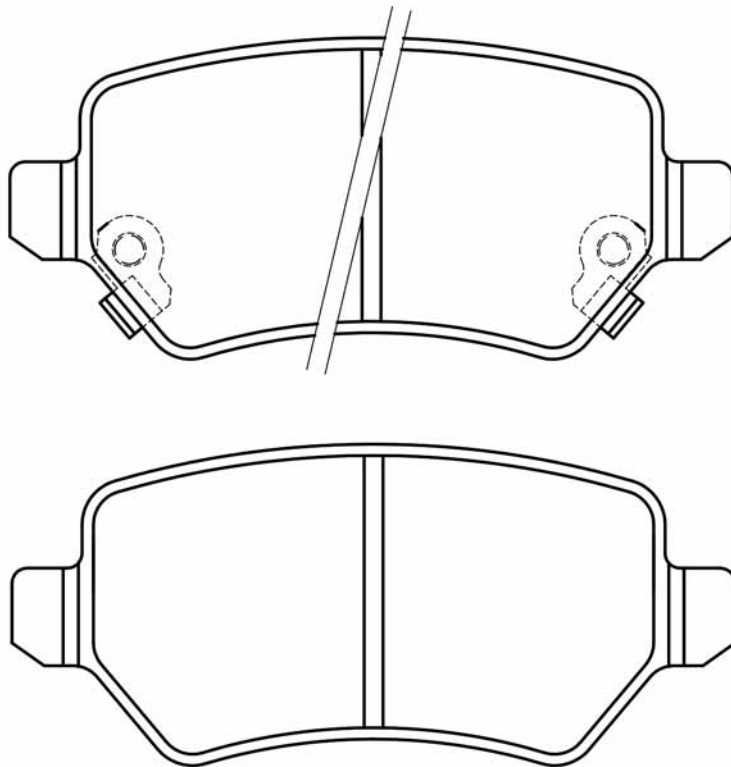

15

23417



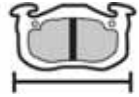

PICTURES BRAKE PADS REAR
ABBILDUNGEN BREMSKLÖTZE HINTEN
FIGURAS PASTILLAS DE FRENO POSTERIORES
ILLUSTRATIONS PLAQUETTES DE FREI ARRIÈRE
IMMAGINI PASTIGLIE FRENO POSTERIORI

51-0L-L00				WVA
LAND ROVER	L	H	Th	
	123	59	17	21487

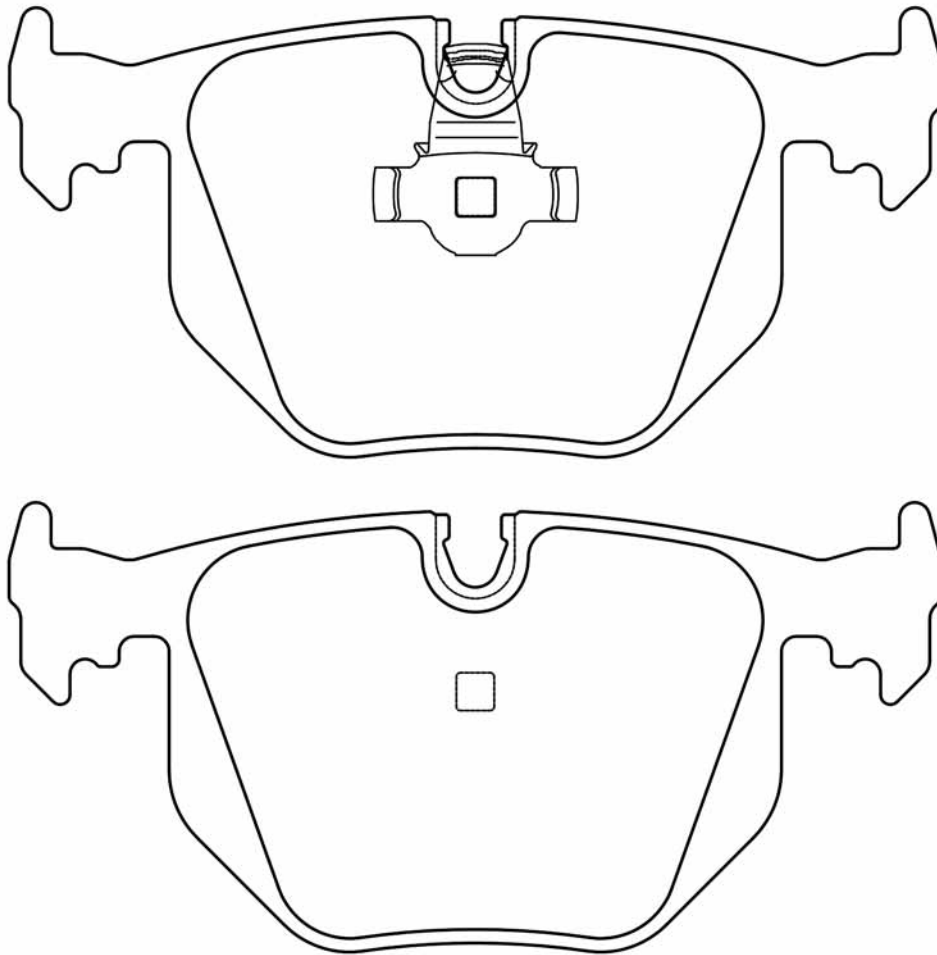



51-0L-L01 LAND ROVER				WVA
	L 116,5	H 46,5	Th 17	24192

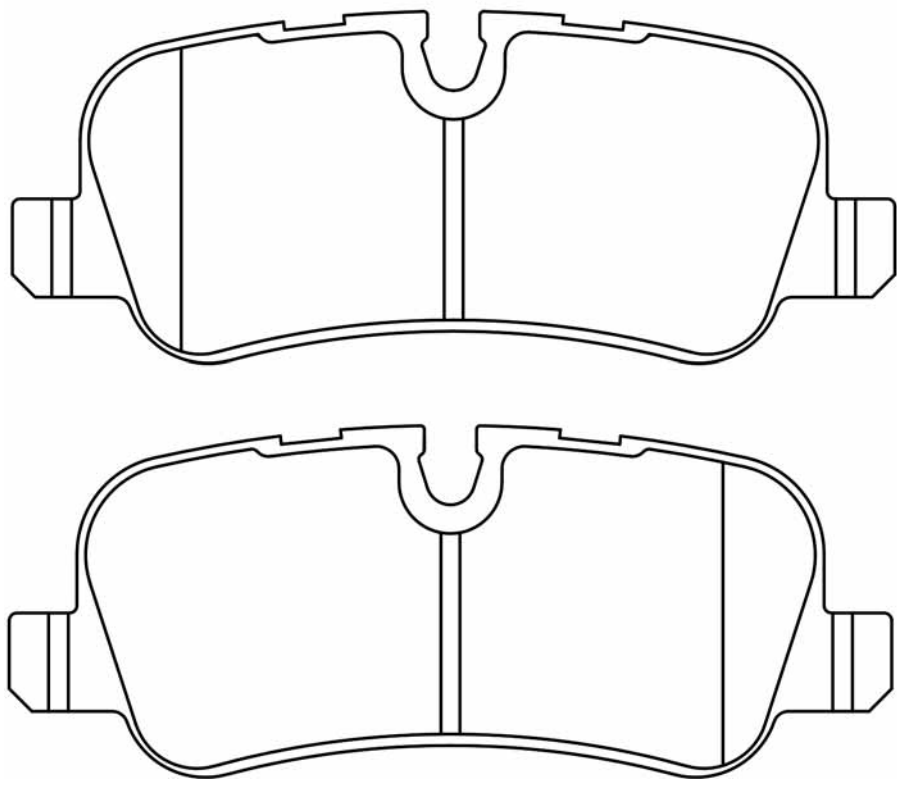



PICTURES BRAKE PADS REAR
ABBILDUNGEN BREMSKLÖTZE HINTEN
FIGURAS PASTILLAS DE FRENO POSTERIORES
ILLUSTRATIONS PLAQUETTES DE FREI ARRIÈRE
IMMAGINI PASTIGLIE FRENO POSTERIORI

51-0L-L02

LAND ROVER

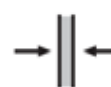

WVA

L

H

Th

95

52

16

23458

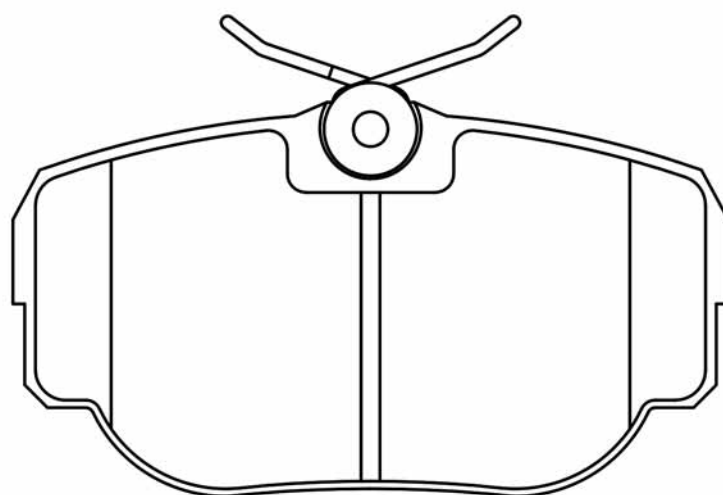



51-0L-L03				WVA
	LAND ROVER	L 95	H 43	Th 16
				24537

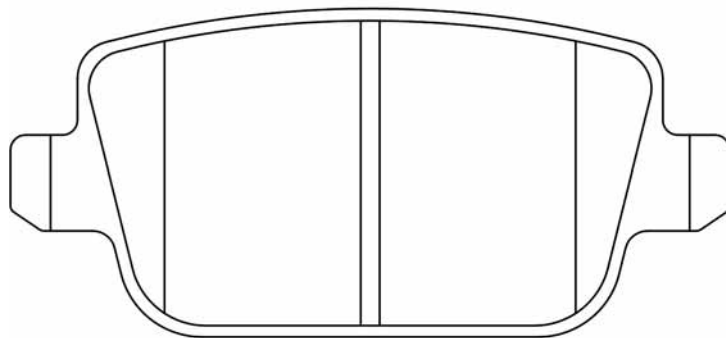



PICTURES BRAKE PADS REAR
ABBILDUNGEN BREMSKLÖTZE HINTEN
FIGURAS PASTILLAS DE FRENO POSTERIORES
ILLUSTRATIONS PLAQUETTES DE FREI ARRIÈRE
IMMAGINI PASTIGLIE FRENO POSTERIORI

51-0L-L04

LAND ROVER

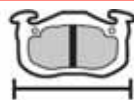

WVA

L

H

Th

89

72

15

20344

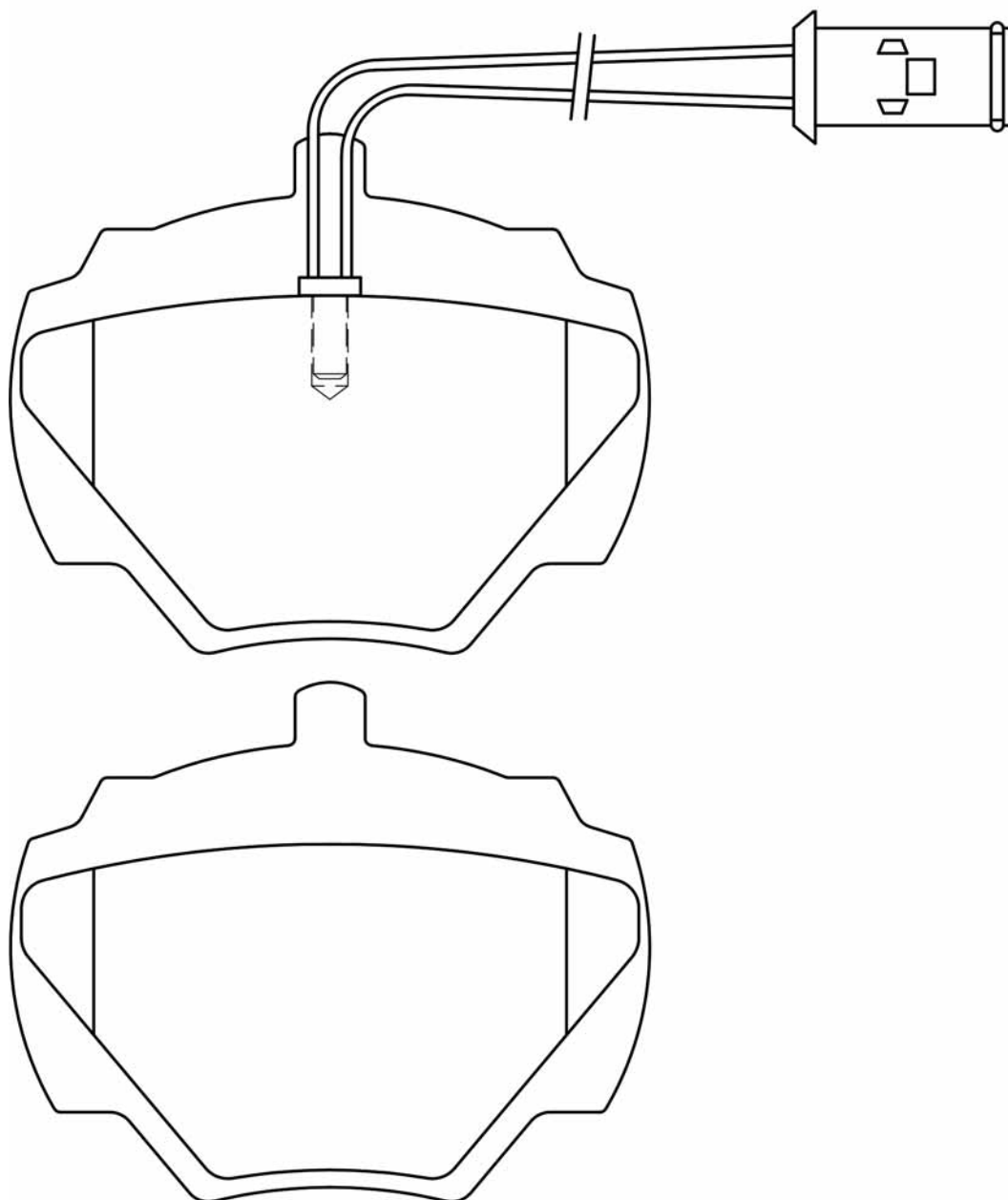

PICTURES BRAKE PADS REAR
ABBILDUNGEN BREMSKLÖTZE HINTEN
FIGURAS PASTILLAS DE FRENO POSTERIORES
ILLUSTRATIONS PLAQUETTES DE FREI ARRIÈRE
IMMAGINI PASTIGLIE FRENO POSTERIORI



51-0L-L05				WVA
	LAND ROVER	L	H	Th
	106	48	17	24496

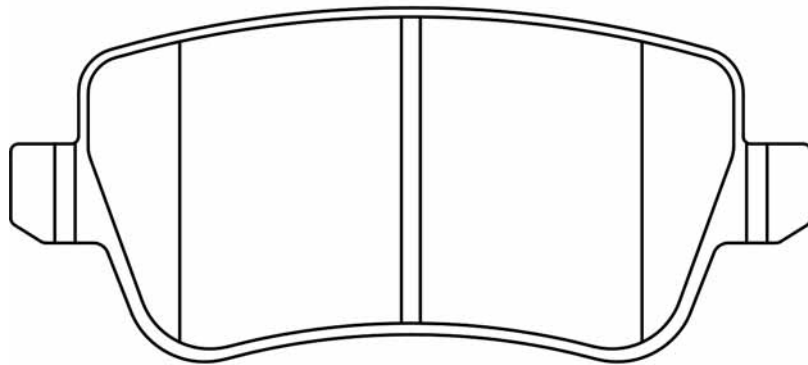



PICTURES BRAKE PADS REAR
ABBILDUNGEN BREMSKLÖTZE HINTEN
FIGURAS PASTILLAS DE FRENO POSTERIORES
ILLUSTRATIONS PLAQUETTES DE FREI ARRIÈRE
IMMAGINI PASTIGLIE FRENO POSTERIORI

51-0S-S01 DAEWOO - SSANGYONG				WVA
	L 98,6	H 42,8	Th 14,7	

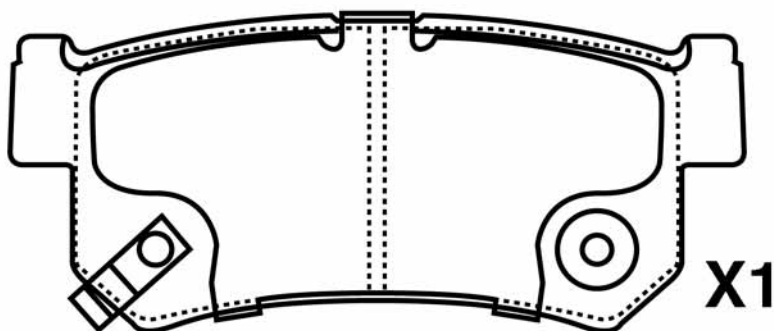
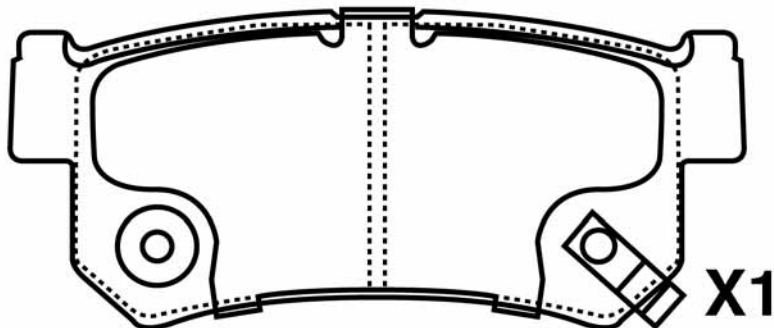
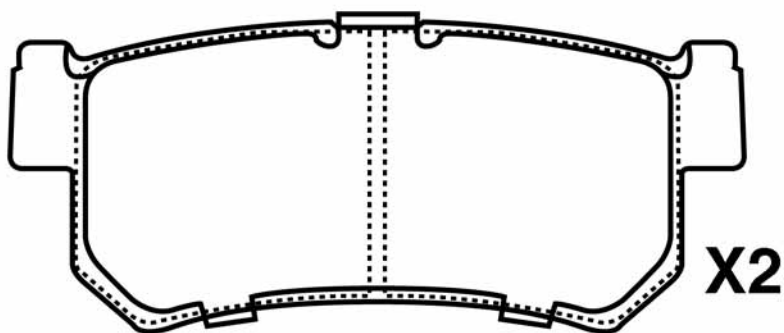



51-0S-S02				WVA
	SSANGYONG - SHUANGHUAN AUTO	L 118,6	H 48	
				23931

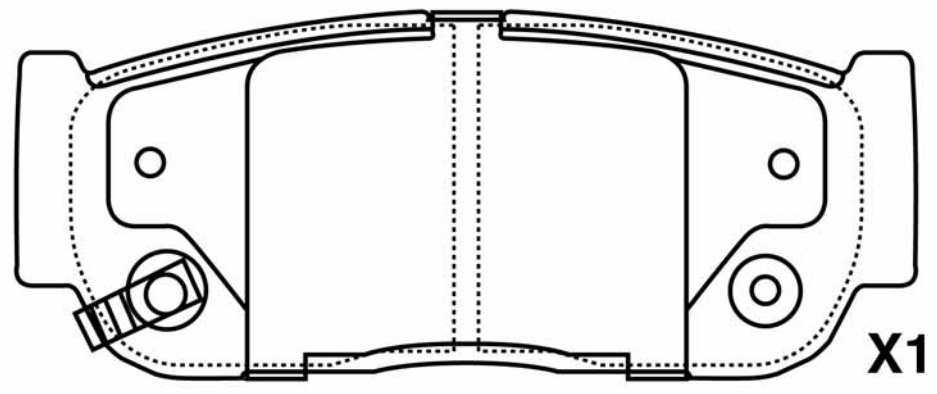
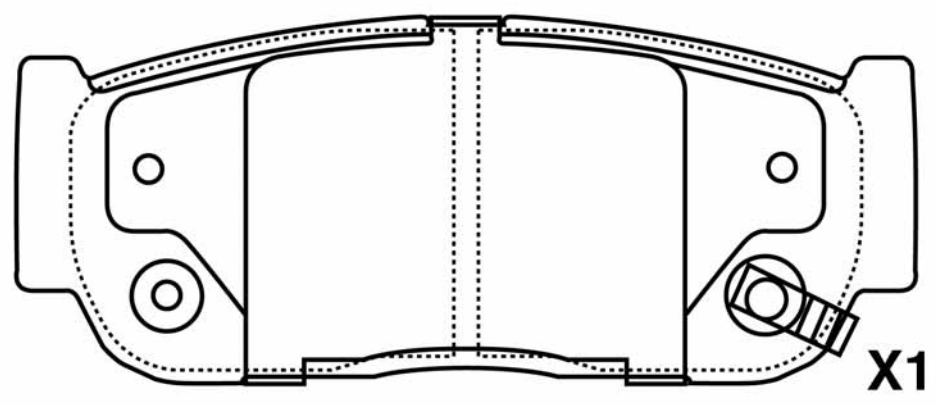
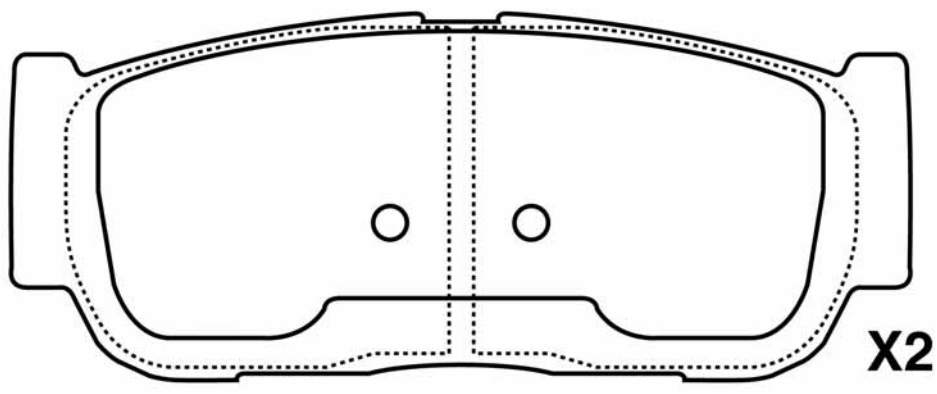



PICTURES BRAKE PADS REAR
ABBILDUNGEN BREMSKLÖTZE HINTEN
FIGURAS PASTILLAS DE FRENO POSTERIORES
ILLUSTRATIONS PLAQUETTES DE FREI ARRIÈRE
IMMAGINI PASTIGLIE FRENO POSTERIORI

51-0W-W01				WVA
DAEWOO - CHEVROLET	L	H	Th	
	121	37,6	14,6	23994

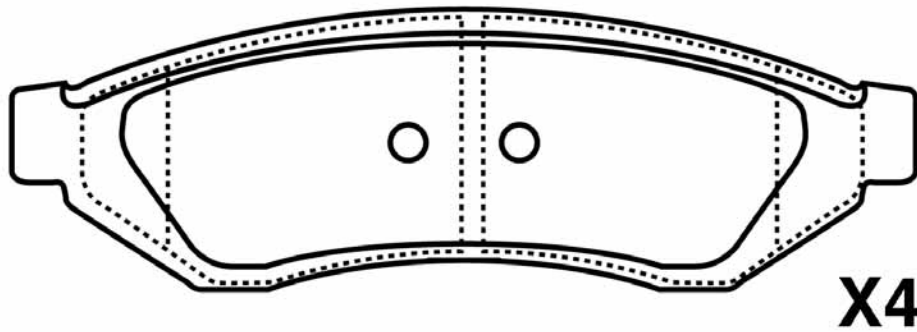



51-0W-W02				WVA
	DAEWOO - CHEVROLET	L	H	Th
	104,5	39	14,6	24071

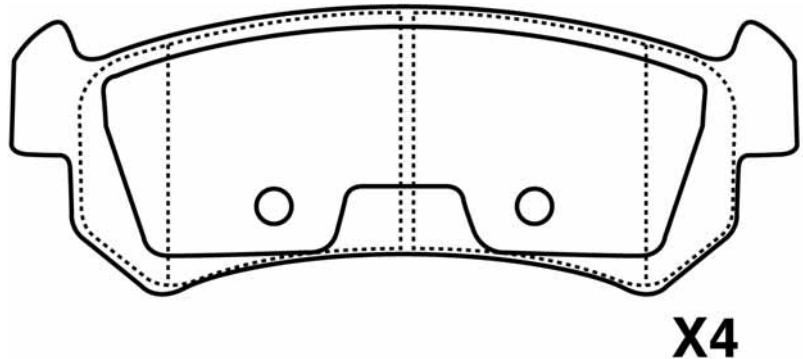



PICTURES BRAKE PADS REAR
ABBILDUNGEN BREMSKLÖTZE HINTEN
FIGURAS PASTILLAS DE FRENO POSTERIORES
ILLUSTRATIONS PLAQUETTES DE FREI ARRIÈRE
IMMAGINI PASTIGLIE FRENO POSTERIORI

51-0W-W03

CHEVROLET

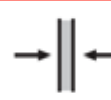

WVA

L

121

H

39

Th

14,5

24744

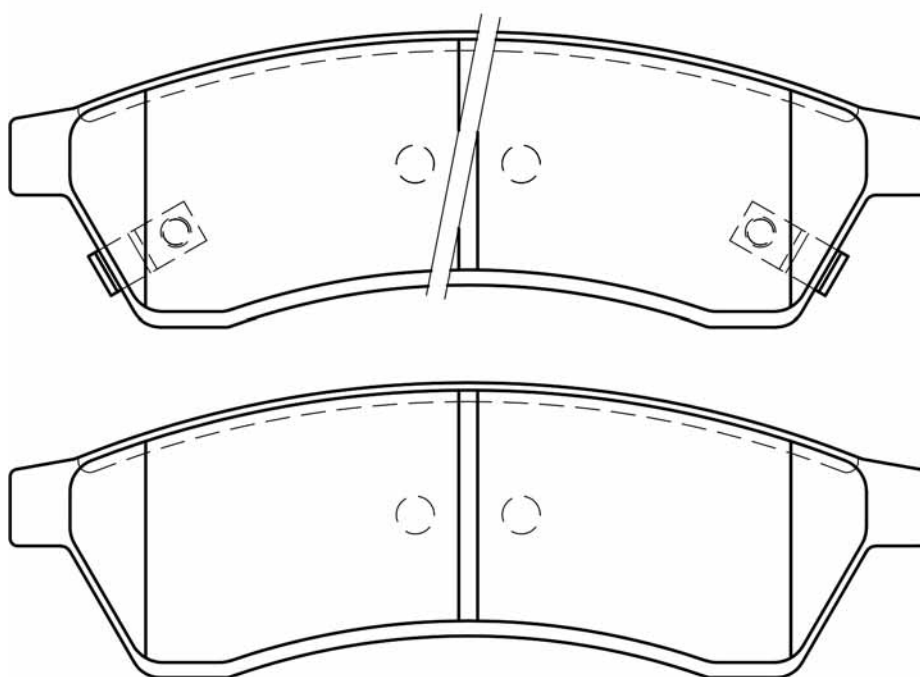



51-0W-W04

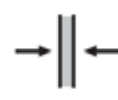
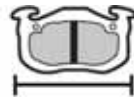

WVA

CHEVROLET

L

H

Th

110

46

15,2

24498

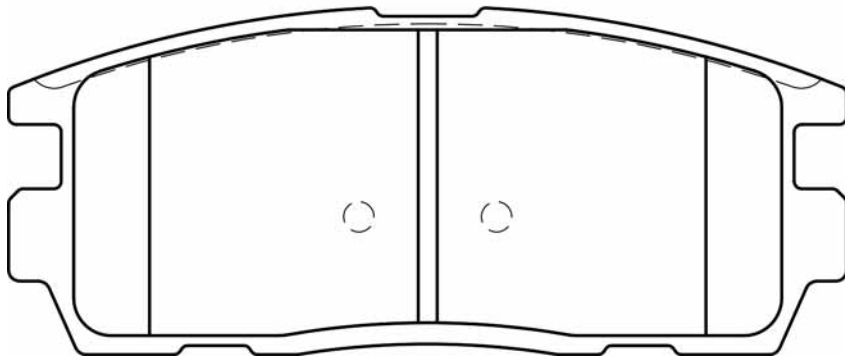
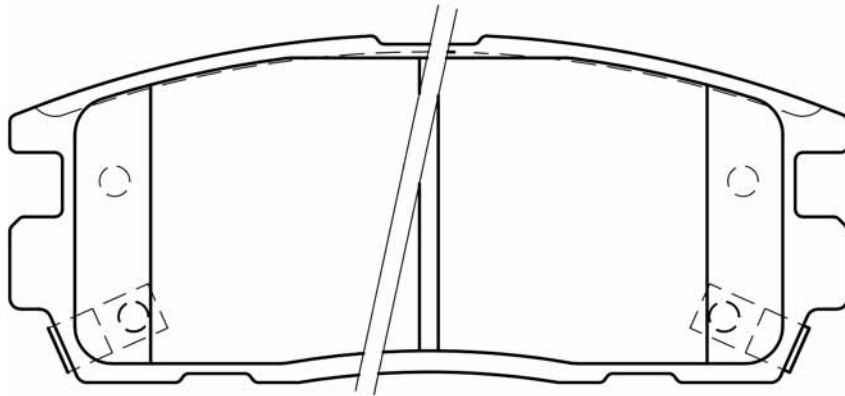



PICTURES BRAKE PADS REAR
ABBILDUNGEN BREMSKLÖTZE HINTEN
FIGURAS PASTILLAS DE FRENO POSTERIORES
ILLUSTRATIONS PLAQUETTES DE FREI ARRIÈRE
IMMAGINI PASTIGLIE FRENO POSTERIORI

51-0W-W05

CHEVROLET - OPEL



WVA

L

117

H

43

Th

16

25096

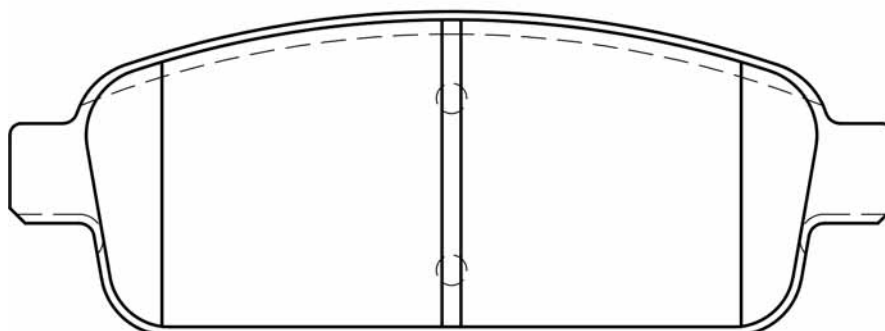
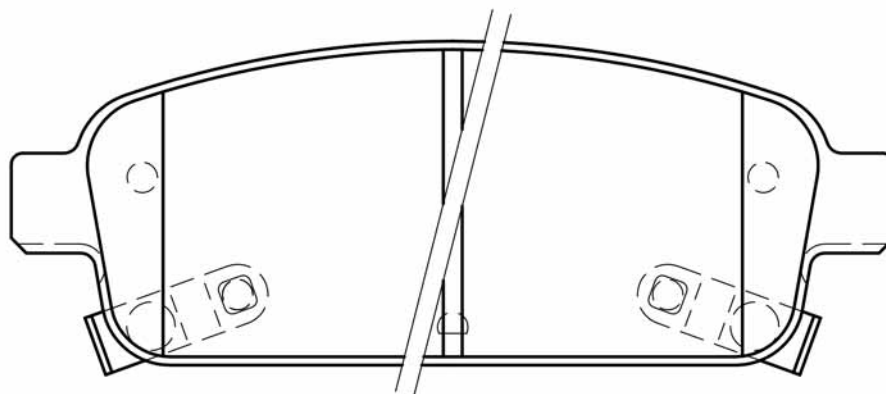

BIANCA



AIXAM	ASHIKA
18 2 043	51-00-008
181028L	55-00-008
181028L	55-00-009
6G028	60-00-024
6G065	50-00-021
6L028	60-00-023
ASIA MOTORS	ASHIKA
182326310B	55-03-325
885426310	55-03-325
885449230	55-03-325
CADILLAC	ASHIKA
18060682	60-00-014
25693146	61-00-009
25814674	51-00-007
88959947	50-00-014
88959954	50-00-014
88967250	50-00-014
89047725	51-00-006
93188111	50-00-011
93188112	50-00-011
CHATENET	ASHIKA
103015A	60-00-025
CHERY	ASHIKA
T11-3501080BA	50-00-022
CHEVROLET	ASHIKA
11046948372	50-03-390
1104695012	50-W0-003
11046952012	50-03-376
13300867	51-0W-W05
13301207	50-0W-W12
13301234	50-0W-W13
13319294	51-0W-W05
13502045	60-0W-W15
13502052	60-0W-W16
13502136	61-0W-W06
13502139	61-0W-W07
20789468	50-0W-W10
20876917	51-00-007
20955857	60-0W-W12
20968395	61-0W-W05
90121445	60-09-910
92230273	51-00-007
94564513	55-W0-003

95459513	51-0W-W04
96175281	56-W0-000
96179110	60-0W-005
96193771	56-W0-001
96219485	61-0W-001
96226110	55-03-395
96238672	60-0W-007
96238673	60-0W-008
96245179	51-03-398
96253383	50-W0-005
96264591	60-0W-009
96268686	55-W0-001
96286933	60-0W-013
96300035	60-0W-001
96312155	67-W0-003
96312559	60-0W-001
96312560	61-0W-000
96316582	50-W0-004
96316636	56-W0-002
96320531	60-0W-004
96320670	67-W0-002
96328254	61-0W-W04
96328338	60-0W-009
96329364	60-0W-W11
96333185	56-W0-003
96349066	55-W0-002
96386900	56-W0-006
96386901	56-W0-007
96389659	61-0W-W02
96391892	51-03-398
96405129	50-W0-005
96405131	51-0W-W02
96446176	50-W0-004
96470999	56-0W-W04
96471274	60-0W-010
96473229	55-W0-003
96475027	50-0W-W09
96475028	51-0W-W03
96496763	51-0W-W01
96496764	55-0W-W04
96518606	67-W0-002
96534653	50-W0-007
96549630	61-0W-W03
96549782	60-0W-009

96574633	60-0W-010
96574718	67-W0-006
96625871	55-0W-W05
96625873	61-0W-W05
96625948	60-0W-W12
96626070	50-0W-W10
96626076	51-0W-W04
96626083	55-0W-W05
96682858	50-0W-W14
96800089	51-0W-W02
NP 1464	55-03-395
PS4510005	50-W0-003
PS4510009	50-W0-003
PS4511001	50-W0-003
S4520001	55-03-395
S4520003	55-03-395
S4520005	55-03-395
S4520007	55-W0-003
CHRYSLER	ASHIKA
0-5135258AA	50-00-002
0.4313056	67-00-097
0.4423601	67-00-096
0.5093236AA	67-00-095
04423606	55-00-056
04509553AB	61-09-994
04509718	60-09-995
04721677AA	61-09-906
04721820AE	60-00-095
04721995AA	60-09-915
04779197AD	60-09-914
04779209AC	61-09-903
04879138AA	60-09-996
04879138AC	60-09-996
04882576	55-09-911
04897664AA	50-00-099
05066036AA	55-09-915
05073647AA	55-09-915
05073647AB	55-09-915
05142555AA	50-09-913
05142559AA	50-09-911
05142566AA	51-09-902
1-04721820AF	60-00-002
1-05093260AA	50-00-090
1-05135258AA	50-00-002



CHRYSLER	ASHIKA
1-05273038AA	60-00-001
1-08080871AB	51-00-001
4238827	55-09-914
4423715	50-00-056
4423725	50-00-056
4423812	50-00-060
4509553AC	61-09-994
4509994AA	60-09-994
4638634	50-00-059
4683433	56-09-901
4683918AB	60-09-992
4721023	61-09-993
4721023AF	61-09-993
4721023AG	61-09-993
4721263	56-09-901
4741772	55-09-915
4743999AA	61-09-904
4762537	55-09-914
4762669	51-00-016
4762682	50-00-099
4764934AB	61-09-990
4773264	50-00-099
4778058AB	50-00-057P
4778058AB	50-00-057
4779197AD	60-09-914
4779209AC	61-09-903
4877263	56-09-901
4877433	56-09-901
4879229AA	60-09-993
4882107	50-00-099
4882107	50-00-099P
4882576	55-09-911
4883717AA	51-00-019
4883833AA	55-00-097
5011969AA	50-00-097
5014036AA	51-09-994
5015365AA	50-00-096P
5015365AA	50-00-096
5016164AA	50-00-093
5016434AA	60-00-093
5018208AA	51-00-016
5018209AA	55-09-913
5018592AA	50-00-097

5018942AA	50-00-092
5019802AA	55-09-911
5066036AA	55-09-915
5066309AA	51-00-016
5066427AA	50-09-994
5072216AA	50-00-096P
5072216AA	50-00-096
5073647AA	55-09-915
5083853AA	50-00-094
5085650AA	61-09-990
5093236AA	67-00-095
5105514AA	60-00-003
5142559AA	50-09-911
5142566AA	51-09-902
52001151	56-00-099
52128247AA	60-09-991
55511-60A00	60-08-807
68028671AA	51-05-505
68029263AA	50-09-910
68032944AA	60-09-915
68044761AA	51-09-905
68052369AA	50-09-915
68052370AA	50-09-915
J8130744	55-00-056
DAEWOO	ASHIKA
3232-1800	50-0W-008
3232-1800/M	50-0W-008
35350125	60-0W-014
431335	67-W0-005
55201-78820-000	50-W0-000
55210-50E20	50-W0-000
7432-D553	51-03-305
90235420	67-W0-000
90235422	67-W0-001
90374075	67-W0-000
90443259	67-W0-000
96101972S	50-W0-002
96133555S	50-W0-002
96215669	60-09-910
96215670	60-0W-005
96446178	55-W0-001
96471783	56-W0-007
FS063576	50-W0-006
P96391892	51-03-398

DAIHATSU	ASHIKA
004491-87719	50-06-697
00491-87713	50-06-697
04465-B1020	50-08-809
04465-B1190	50-03-343
04465-B1320-000	50-03-343
04465-B2020	50-08-809
04465-B2040	50-06-609
04465-B2050	50-06-612
04465-B4030	50-05-528
04491-10020	50-06-600
04491-14150	50-07-701
04491-60020	50-06-601
04491-87101	50-06-606
04491-87103	50-06-606
04491-87104	50-06-606
04491-87201	50-06-604
04491-87209	50-06-610
04491-87501	50-06-605
04491-87503	50-06-605
04491-87504	50-06-605
04491-87601	50-06-601
04491-87602	50-06-601
04491-87603	50-06-601
04491-87605	50-06-601
04491-87607	50-06-607
04491-87611-000	50-06-607
04491-87612	50-06-607
04491-87614	50-06-601
04491-87701	50-06-600
04491-87702	50-06-602
04491-87706	50-06-606
04491-87708	50-06-606
04491-87710	50-06-606
04491-87712	50-06-606
04491-87716	50-06-602
04491-87724-000	50-06-699
04491-87725-000	50-06-699
04491-87727-000	50-06-699
04491-87728-000	50-06-699
04491-87731-000	50-06-699
04491-97201-000	50-06-615
04491-97212-000	50-06-615
04491-97213-000	50-06-608



CROSS REFERENCE LIST
VERGLEICHLISTE
LISTA DE REFERENCIAS CRUZADES
LISTA DE COMPARAISON
LISTA DI COMPARAZIONE

DAIHATSU	ASHIKA
04491-97214-000	50-06-609
04491.87226.000	50-06-603
04491.87511.000	50-06-605
04491.87619.000	50-06-607
04491.87621.000	50-06-698
04491.87701.000	50-06-600
04491.87721.000	50-06-606
04491.97403.000	50-06-615
0449187210000	50-06-603
0449187215000	50-06-603
0449187219000	50-06-603
04492-87101	51-06-601
04492-87102	51-06-601
04492-87701	51-06-600
04492-87702	51-06-600
04492-87707-000	51-03-303
04492-87708-000	51-03-303
04492.87703.000	51-06-600
04494-87601	55-06-600
04494-87602	55-06-600
04494-87604	55-06-600
04495-87202	55-08-813
04495-87212	55-08-813
04495-87215	55-06-619
04495-87502	55-06-604
04495-87504	55-06-604
04495-87508-000	55-06-620
04495-87601	55-06-607
04495-87602	55-06-607
04495-87605	55-06-607
04495-87606	55-06-607
04495-87702	55-06-603
04495-87704	55-06-611
04495-87706	55-06-611
04495-87707	55-08-811
04495-87709	55-06-603
04495-87714-000	55-06-620
04495-87Z01	55-06-699
04495-97203-000	55-06-618
04495-97204-000	55-06-618
04495-97206-000	55-06-617
04495-97208-000	55-06-617
04495-97213-000	55-06-617

04495-B1030-000	55-06-610
04495-B1170	55-06-610
04495-B2170	55-06-615
04495-B2220	55-06-616
04495-B4050	55-02-297
04495B2180	55-06-616
42403-87703-000	56-06-603
42403-87705	61-06-600
42403-87709	61-06-604
42403-87709-000	61-06-604
42403-97205-000	56-06-600
42403.87705.000	61-06-600
42431-87000	61-06-603
42431-87102	61-06-602
42431-87402-000	56-06-601
42431-87705	61-06-602
42431-87717	61-06-603
4243187602	56-06-602
4243187602000	56-06-602
43512-87210	60-06-611
43512-87215-000	60-06-619
43512-87220-000	60-06-615
43512-87402	60-06-610
43512-87506	60-06-608
43512-87509	60-06-609
43512-87511	60-06-612
43512-87515	60-06-605
43512-87519	60-06-697
43512-87601	60-06-601
43512-87603	60-06-601
43512-87604	60-06-607
43512-87605	60-06-607
43512-87607	60-06-601
43512-87608	60-06-607
43512-87702	60-06-600
43512-87703	60-06-602
43512-87704	60-06-602
43512-87709	60-06-604
43512-87710	60-06-603
43512-87717	60-06-604
43512-87722	60-06-604
43512-87723	60-06-603
43512-87725-000	60-06-603
43512-87Z02	60-06-696

43512-97202-000	60-06-614
43512-97207-000	60-06-613
43512-97402	60-06-618
43512-B1030	60-06-617
43512-B1050	60-06-614
43512-B4010	60-06-620
43512.87402.000	60-06-610
43512.87519.000	60-06-697
43512.87709.000	60-06-604
43512.97402.000	60-06-618
43513-87604	60-06-601
47410-87201	55-06-602
47410-87204	55-06-602
47410-87502	55-06-602
47410-87504	55-06-602
47410-87505	55-06-604
47410-87508	55-06-604
47420-87201	55-06-604
47420-87205	55-06-606
47420-87502	55-06-604
47420-87504	55-06-604
47420-87505	55-06-606
47420-87507	55-06-606
4742087501	55-06-618
47440-87501	55-06-604
47440-87502	55-06-604
47440-87504	55-06-604
47505-87210	67-06-600
47505-87211	67-06-602
47506-87210	65-06-600
47506-87504	65-06-604
47506-87702	65-06-600
47550-12060	67-02-208
47550-12060-000	67-02-208
47550-19135	67-02-208
47550-87222	67-06-611
47550-87222-000	67-06-611
47550-87230	67-06-611
47550-87507	67-06-607
47550-87507-000	67-06-607
47550-87508	67-06-608
47550-87605	67-06-612
47550-87608	67-06-614
47550-87609	67-06-612



DAIHATSU	ASHIKA
47550-87611	67-06-616
47550-87681	67-06-603
47550-87681	65-06-612
47550-87682	67-06-612
47550-87683	67-06-612
47550-87684	67-06-614
47550-87702	67-06-606
47550-87703	67-06-606
47550-87705	67-06-609
47550-87706	67-06-613
47550-87707	67-06-615
47550-87201	67-06-699
47550-97201-000	67-06-601
47550-97203-000	67-06-618
47550-97204-000	67-06-601
47550-B4010	67-02-209
47550B1010	67-06-630
47550B2020	67-06-632
47560-87507	65-06-607
47560-87507-000	65-06-607
47560-87508	65-06-608
47570-87606	65-06-616
47570-87608	65-06-614
47570-87609	65-06-616
47570-87702	67-06-606
47570-87704	65-06-609
47570-87705	65-06-609
47570-87706	65-06-615
47570-87706-000	65-06-615
47570B1010	67-06-631
52200-60840	55-08-811
52210-70C00	55-08-811
52210-70C10	55-08-811
53200-60841	55-08-811
55 72 01 310	60-06-699
55702 01310	60-06-699
NAY0-26-432	51-06-601
NAY1-26-43Z	51-03-303
NAY0-26-43Z	51-06-601
DODGE	ASHIKA
04721996AA	61-09-906
5105515AA	61-00-002
5191271AA	51-05-508

52109938AB	60-00-012
52129250AA	61-00-008
68003589AA	55-09-910
68029887AA	51-09-905
DR	ASHIKA
3370100005	50-00-022
3370100007	60-00-027
720050026	60-00-020
720050027	50-08-813
720060022	56-00-001
720060023	55-00-007
T11-3501075	60-00-019
T11-3501080	50-00-020
T11-3502075	61-02-221
T11-BJ3501080	51-02-256
FIAT	ASHIKA
71742853	50-08-801
FORD	ASHIKA
1-YL84-2L362 AD	55-03-309
GASOLONE	ASHIKA
2K000010900	50-00-016
80500001030	60-00-018
R1410920100	50-00-019
RI412751800	55-00-001
GONOW	ASHIKA
720050003	60-05-599
720050005	50-05-585
720060003	51-0H-H03
720060004	61-0H-005
GREAT WALL	ASHIKA
3501102	60-00-004
3501175	50-00-006
3501175-K00-J	50-00-006
3502126	61-00-003
3502277 (INTERNA)	51-09-999
3502278 (ESTERNA)	51-09-999
HONDA	ASHIKA
04421-S74-E00	55-04-410
04431S1AE60	55-04-407
04630-S2A-000	51-04-405
06022-SP8-000	51-04-404
06430-S0A-J00	51-04-405
06430-S5A-J00	51-04-405
06450S34000	50-04-411

12510-S5T-E00	61-04-446
42015-SP8-000	55-04-410
42152-5H0-A01	55-04-412
42152-601-004	55-04-400
42152-622-670	55-04-400
42152-671-002	55-04-400
42152-671-N51	55-04-400
42152-679-002	55-04-400
42152-679-012	55-04-400
42152-692-002	55-04-402
42152-692-601	55-04-406
42152-SA0-002	55-04-402
42152-SA0-012	55-04-402
42152-SA0-022	55-04-402
42152-SA0-671	55-04-402
42152-SA0-671	55-04-404
42152-SA0-672	55-04-402
42152-SA0-901	55-04-402
42152-SA0-901	55-04-404
42152-SA0-N51	55-04-402
42152-SA0-N51	55-04-402
42152-S	
42152-SA2-002	55-04-406
42152-SA2-012	55-04-406
42152-SA2-N51	55-04-406
42152-SA5-002	55-04-499
42152-SA5-671	55-04-499
42152-SA5-672	55-04-499
42152-SA6-002	55-04-499
42152-SA6-671	55-04-499
42152-SA6-672	55-04-499
42152-SB2-002	55-04-403
42152-SB2-601	55-04-403
42152-SB2-602	55-04-403
42152-SB6-002	55-04-409
42152-SB6-671	55-04-409
42152-SD9-671	55-04-409
42152-SD9-672	55-04-409
42152-SD9-N51	55-04-409
42152-SE0-002	55-04-499
42152-SE0-002	55-04-410
42152-SE0-002	55-04-494
42152-SE0-012	55-04-410
42152-SE0-012	55-04-499



CROSS REFERENCE LIST
VERGLEICHLISTE
LISTA DE REFERENCIAS CRUZADES
LISTA DE COMPARAISON
LISTA DI COMPARAZIONE

HONDA	ASHIKA
42152-SE0-N51	55-04-410
42152-SE0-S01	55-04-499
42152-SE0-S01	55-04-410
42152-SH2-A01	55-04-403
42152-SH2-A02	55-04-403
42152-SH2-G02	55-04-403
42152-SH5-A01	55-04-409
42152-SH5-G01	55-04-409
42152-SHS-G01	55-04-409
42152-SM4-A01	55-04-411
42152-SR2-002	55-04-412
42152-SR2-A01	55-04-412
42154-692-601	55-04-406
42154-692-N51	55-04-406
42154-SA0-002	55-04-402
42154-SA0-012	55-04-402
42154-SA0-901	55-04-404
42154-SA0-N51	55-04-402
42154-SA2-002	55-04-406
42154-SM4-A01	55-04-411
42155-SM4-A01	55-04-411
4250-SA5-950	61-04-400
42510-S1A-E00	61-04-414
42510-S1A-E20	61-04-494
42510-S2A-000	61-04-497
42510-S30900	61-04-413
42510-S5T-E00	61-04-446
42510-S6D-E00	61-04-495
42510-S7A-J50	61-04-496
42510-S9A-N00	61-04-441
42510-SA5-950	61-04-400
42510-SB0-950	61-04-401
42510-SB0-951	61-04-401
42510-SCA-E50	61-04-444
42510-SD2-A00	61-04-498
42510-SD4-000	61-04-404
42510-SD4-930	61-04-406
42510-SE0-000	61-04-402
42510-SE0-010	61-04-402
42510-SEA-E00	61-04-443
42510-SG9-000	61-04-405
42510-SG9-010	61-04-405
42510-SH3-G00	61-04-402

42510-SH3-G01	61-04-402
42510-SK3-E00	61-04-402
42510-SM4-950	61-04-407
42510-SNA-A00	61-04-412
42510-SP0-000	61-04-411
42510-SR3-000	61-04-409
42510-SR3-A10	61-04-409
42510-SR3-A11	61-04-409
42510-SR3-G00	61-04-409
42510-SR3-J00	61-04-409
42510-SS0-000	61-04-410
42510-ST7-R00	61-04-419
42510-SWW-G01	61-04-444
42510-SZ3-000	61-04-420
42510-SZ3-J00	61-04-442
42510-TA0-A00	61-04-415
42510-TF0-000	61-04-417
42510-TG5-H00	61-04-417
42510-TL0-G50	61-04-416
42510-TL0-G51	61-04-416
42510-TM8-G00	61-04-418
42610-S3Y-000	56-04-404
42610-S6A-G00	56-04-415
42610-S70-000	56-04-400
42610-SK3-E10	56-04-402
42610SE0000	56-04-403
42610SE0010	56-04-403
42610SR1000	56-04-403
42610SR3000	56-04-403
43015-SP8-000	55-04-410
43022-S15-000	51-04-405
43022-S1A-E03	51-04-407
43022-S2A-00	51-04-405
43022-S2A-000	51-04-405
43022-S3N-000	51-04-405
43022-S5A-J00	51-04-405
43022-S6D-000	51-04-405
43022-S9A-E00	51-04-445
43022-SA5-950	51-04-401
43022-SD2-930	51-04-402
43022-SE0-00	51-04-404
43022-SE0-000	51-04-402
43022-SE0-000	51-04-404
43022-SE0-930	51-04-402

43022-SE0-931	51-04-402
43022-SE0-932	50-04-424
43022-SE0-S00	51-04-402
43022-SF1-000	51-04-402
43022-SF1-G01	51-04-404
43022-SF1-S00	51-04-404
43022-SF1-S01	51-04-404
43022-SFD1-G01	51-04-404
43022-SG0-000	51-04-405
43022-SG0-010	51-04-405
43022-SG0-020	51-04-405
43022-SG0-505	51-04-405
43022-SG0-G00	51-04-405
43022-SG0-G01	51-04-405
43022-SG9-V00	51-04-406
43022-SH3-G00	51-04-404
43022-SL5-000	51-04-405
43022-SL5-505	51-04-405
43022-SL5-515	51-04-405
43022-SL5-525	51-04-405
43022-SM4-505	51-04-405
43022-SM4-515	51-04-405
43022-SM4-525	51-04-405
43022-SM4-950	51-04-405
43022-SM4-G00	51-04-405
43022-SM5-A00	51-04-405
43022-SMG-E01	51-04-403
43022-SN7-000	51-04-405
43022-SP0-E01	51-04-405
43022-SP0-E01	51-04-404
43022-SR3-G00	51-04-404
43022-SV4-000	51-04-405
43022-SV4-010	51-04-405
43022-SV4-020	51-04-405
43022-SV4-030	51-04-405
43022-SV4-A00	51-04-405
43022-SV4-A01	51-04-405
43022-SV4-A02	51-04-405
43022-SV4-A20	51-04-405
43022-SV4-A21	51-04-405
43022-SV4-A22	51-04-405
43022-SV4-G00	51-04-405
43022-SV4-G01	51-04-405
43022-SV4-G02	51-04-405

CROSS REFERENCE LIST
VERGLEICHLISTE
LISTA DE REFERENCIAS CRUZADES
LISTA DE COMPARAISON
LISTA DI COMPARAZIONE



HONDA	ASHIKA
43022-SV4-G20	51-04-405
43022-SV4-G21	51-04-405
43022-SV4-G22	51-04-405
43022-SWW-G01	51-04-400
43022-SY8-A00	51-04-405
43022-SY8-A01	51-04-405
43022-SY8-E50	51-04-405
43022-TA0-A80	51-04-410
43022-TF0-G01	51-04-404
43022-TL0-G51	51-04-445
43022-TL1-G01	51-04-410
43022-TM8-G01	51-04-405
43022SL0E50	51-04-499
43022SPRE01	51-04-499
43031-SP8-000	67-04-410
43053-S47-E50	55-04-408
43053-S9AE52	55-04-405
43152-601-004	55-04-400
43153-623-670	55-04-400
43153-692-003	55-04-402
43153-SAA-004	55-04-493
43153-SM4-A01	55-04-411
43154-S10-A01	55-04-411
43154-SAA-004	55-04-493
43154-SAA-004	55-04-412
43155-S10-A01	55-04-411
43155-SAA-004	55-04-412
43155-SAA-004	55-04-493
43300-634-670	67-04-400
43300-671-601	67-04-404
43300-671-632	67-04-407
43300-671-633	67-04-407
43300-692-003	67-04-406
43300-692-003	67-04-451
43300-692-013	67-04-450
43300-S10-003	67-04-461
43300-SA3-681	67-04-454
43300-SA5-003	67-04-455
43300-SA6-003	67-04-403
43300-SAA-G01	67-04-435
43300-SB2-003	65-04-400
43300-SE0-013	67-04-452
43300-SE0-013	67-04-452

43300-SH3-J01	65-04-401
43300-SH5-003	67-04-455
43300-SM4-A01	67-04-403
43300-SM4-A01	65-04-403
43300-SM5-A01	67-04-499
43300-SR3-003	65-04-403
43301-692-003	67-04-451
43301-S10-003	67-04-460
43301-S6A-003	67-04-436
43301-SA3-681	67-04-453
43301-SB2-003	67-04-403
43301-SH3-J01	67-04-456
43301-SM4-A01	67-04-457
43301-SM5-A01	67-04-460
43301-SR3-003	67-04-459
43513-S10-A01	55-04-411
4431S1AE50	55-04-407
45021-693-601	50-04-412
45022-634-003	50-04-400
45022-634-004	50-04-400
45022-634-024	50-04-400
45022-634-033	50-04-400
45022-634-650	50-04-400
45022-634-651	50-04-400
45022-634-670	50-04-402
45022-634-671	50-04-402
45022-634-920	50-04-402
45022-634-921	50-04-402
45022-659-000	50-04-400
45022-659-010	50-04-400
45022-659-020	50-04-400
45022-659-023	50-04-400
45022-671-672	50-04-406
45022-692-670	50-04-412
45022-692-671	50-04-412
45022-692-672	50-04-412
45022-692-N52	50-04-412
45022-693-600	50-04-412
45022-693-601	50-04-412
45022-693-N50	50-04-416
45022-S10-A00	50-04-432
45022-S10-G00	50-04-432
45022-S1A-E20	50-04-432
45022-S2A-E50	50-04-490

45022-S30-A00	50-04-432
45022-S30-G10	50-04-493
45022-S6D-E51	50-04-427
45022-S6F-E50	50-04-489
45022-S7A-E00	50-04-491
45022-S9AA01	50-04-401
45022-SA0-020	50-04-417
45022-SA0-670	50-04-404
45022-SA0-680	50-04-413
45022-SA3-670	50-04-406
45022-SA3-671	50-04-406
45022-SA3-672	50-04-406
45022-SA4-A11	50-04-426
45022-SA4-A12	50-04-426
45022-SA5-010	50-04-414
45022-SA6-600	50-03-339
45022-SA7-000	50-04-417
45022-SA7-010	50-04-417
45022-SA7-020	50-04-417
45022-SA7-952	50-04-414
45022-SAA-G00	50-04-425
45022-SB0-670	50-04-414
45022-SB0-671	50-04-414
45022-SB0-672	50-04-414
45022-SB2-780	50-04-424
45022-SB6-600	50-04-416
45022-SD2-A10	50-04-424
45022-SD2-A11	50-04-424
45022-SD2-A12	50-04-424
45022-SD4-000	50-04-421
45022-SD4-010	50-04-426
45022-SD4-020	50-04-426
45022-SD4-A10	50-04-424
45022-SD4-A10	50-04-426
45022-SD4-A11	50-04-426
45022-SDA-A10	50-04-426
45022-SE0-315	50-04-424
45022-SE0-316	50-04-424
45022-SE0-911	50-04-424
45022-SE0-912	50-04-424
45022-SE0-931	50-04-424
45022-SE0-932	50-04-424
45022-SE0-A00	50-04-424
45022-SE0-A01	50-04-424



CROSS REFERENCE LIST
VERGLEICHLISTE
LISTA DE REFERENCIAS CRUZADES
LISTA DE COMPARAISON
LISTA DI COMPARAZIONE

HONDA	ASHIKA
45022-SEA-E01	50-04-452
45022-SEA-J11	50-04-491
45022-SF0-600	50-04-421
45022-SF1-000	50-04-423
45022-SF1-010	50-04-423
45022-SF1-020	50-04-423
45022-SF1-930	50-04-423
45022-SF1-931	50-04-423
45022-SF1-932	50-04-423
45022-SG0-010	50-04-426
45022-SG0-020	50-04-426
45022-SG0-G10	50-04-426
45022-SG0-G11	50-04-426
45022-SG9-V00	50-04-428
45022-SH3-000	50-04-414
45022-SH3-010	50-04-414
45022-SH3-930	50-04-423
45022-SH3-931	50-04-423
45022-SH3-932	50-04-423
45022-SH3-G00	50-04-414
45022-SH3-G01	50-04-414
45022-SH3-G02	50-04-414
45022-SH3-G03	50-04-414
45022-SH3-G10	50-04-442
45022-SH3-G11	50-04-442
45022-SH3-G31	50-04-423
45022-SH3-G32	50-04-423
45022-SH3-G50	50-04-414
45022-SL0-G00	50-04-432
45022-SLO-G00	50-04-432
45022-SM4-A00	50-04-493
45022-SM4-G01	50-04-429
45022-SM5-A00	50-04-432
45022-SMG-E01	50-04-403
45022-SN7-000	50-04-493
45022-SN7-G00	50-04-493
45022-SN7-G50	50-04-432
45022-SNA-A52	50-04-493
45022-SR3-910	50-04-414
45022-SR3-G00	50-04-425
45022-SR3-G00	50-04-425
45022-SR3-V10	50-04-435
45022-SS0-G00	50-04-432

45022-ST3-E00	50-04-427
45022-SWW-G01	50-04-405
45022-TF0-G02	50-04-410
45022-TL0-G50	50-04-409
45022-TL0-G51	50-04-409
45022-TL1-G01	50-04-407
45022-TM8-G00	50-04-410
45022659-N50	50-04-400
45251-634-920	60-04-400
45251-634-921	60-04-400
45251-635-920	60-04-400
45251-671-020	61-04-408
45251-671-620	61-04-408
45251-671-670	61-04-408
45251-671-671	61-04-408
45251-672-000	60-04-406
45251-692-000	60-04-406
45251-692-003	60-04-406
45251-693-000	60-04-406
45251-S1A-E20	60-04-490
45251-S1A-G00	60-04-404
45251-S2A-000	60-04-495
45251-S2H-N00	60-04-496
45251-S30-000	60-04-434
45251-S50-G00	60-04-491
45251-S50-G00	60-04-493
45251-S6F-E10	60-04-492
45251-S6M-A10	60-04-433
45251-S7A-E10	60-04-407
45251-S7A-N10	60-04-494
45251-S9A-E50	60-04-431
45251-SA0-000	60-04-402
45251-SA0-010	60-04-402
45251-SA0-640	60-04-402
45251-SA0-660	60-04-406
45251-SA0-660	60-04-410
45251-SA5-000	60-04-406
45251-SA5-000	60-04-410
45251-SA5-010	60-04-406
45251-SA5-010	60-04-410
45251-SA5-670	60-04-409
45251-SA5-671	60-04-409
45251-SA5-740	60-04-409
45251-SA6-670	60-04-416

45251-SA7-000	60-04-415
45251-SA7-600	60-04-415
45251-SAA-G00	60-04-491
45251-SAA-G10	60-04-491
45251-SAA-G11	60-04-491
45251-SAA-G50	60-04-425
45251-SB0-000	60-04-414
45251-SB0-951	60-04-414
45251-SB2-000	60-04-411
45251-SB2-010	60-04-411
45251-SB2-020	60-04-411
45251-SB2-030	60-04-411
45251-SB2-720	60-04-411
45251-SB2-730	60-04-411
45251-SB2-731	60-04-411
45251-SB2-732	60-04-411
45251-SB2-750	60-04-413
45251-SB2-751	60-04-413
45251-SB2-752	60-04-413
45251-SB2-780	60-04-419
45251-SB2-781	60-04-419
45251-SB2-782	60-04-419
45251-SB2-920	60-04-413
45251-SB2-930	60-04-413
45251-SB2-931	60-04-413
45251-SB2-932	60-04-413
45251-SB2-980	60-04-419
45251-SCA-E50	60-04-431
45251-SCC-900	60-04-426
45251-SD4-000	60-04-418
45251-SDC-A00	60-04-428
45251-SEA-E00	60-04-420
45251-SEA-E30	60-04-403
45251-SEL-T00	60-04-491
45251-SF0-000	60-04-418
45251-SG0-000	60-04-421
45251-SG0-J00	60-04-421
45251-SG9-000	60-04-422
45251-SH1-A00	60-04-499
45251-SH3-A00	60-04-499
45251-SJH-E10	60-04-432
45251-SK7-A00	60-04-426
45251-SM4-000	60-04-423
45251-SM4-010	60-04-423



HONDA	ASHIKA
45251-SM4-020	60-04-423
45251-SM4-G00	60-04-424
45251-SM4-G01	60-04-424
45251-SM4-G02	60-04-424
45251-SM5-A00	60-04-401
45251-SN7-E40	60-04-423
45251-SP0-000	60-04-496
45251-SP0-E00	60-04-429
45251-SR3-A00	60-04-499
45251-SS0-000	60-04-430
45251-SS0-A00	60-04-427
45251-ST3E10	60-04-426
45251-SWW-G01	60-04-405
45251-SZ3-000	60-04-496
45251-SZ3-E00	60-04-496
45251-TA0-A00	60-04-428
45251-TG5-H00	60-04-426
45251-TL0-G50	60-04-417
45251-TL1-G00	60-04-412
5-86000-975-0	51-04-405
5-86011-847-0	51-04-405
5-86012-604-0	51-04-405
5-86014-313-0	51-04-405
5-86014-813-0	51-04-405
5-86015-195-0	51-04-405
55210-82020	50-04-404
AY060-HN003	51-04-405
AY060-HN006	51-04-405
GBD-90830	60-04-498
HUMMER	ASHIKA
15111376	61-00-004
15202106	60-00-007
15240794	50-00-008
15240812	51-00-003
15712801	61-00-005
18041762	51-00-004
18060215	60-00-008
88964201	50-00-009
HYUNDAI	ASHIKA
1-473-814	60-00-062
1-549-699	60-00-062
1-549-700	60-00-062
43512-26120	60-02-2013

44060-90E90	51-01-123
5022346	60-00-062
5022829	60-00-062
51712-02100	60-05-587
51712-02551	60-0H-007
51712-0X500	60-0K-010
51712-0X700	60-0K-K20
51712-1C000	60-0H-010
51712-1C050	60-0H-011
51712-1C100	60-0H-010
51712-1H000	60-0H-012
51712-1H100	60-0H-012
51712-21350	60-00-057
51712-21800	60-00-057
51712-21B00	60-00-057
51712-24100	60-00-057
51712-25060	60-0H-016
51712-25061	60-0H-016
51712-26000	60-0H-009
51712-26100	60-0H-H21
51712-28000	60-00-056
51712-28300	60-05-586
51712-28350	60-05-586
51712-2B700	60-0H-H19
51712-2C000	60-0H-012
51712-2D300	60-0H-008
51712-2D310	60-0H-008
51712-2L500	60-0H-H15
51712-2T100	60-0H-H17
51712-2V000	60-0H-H25
51712-33001	60-00-060
51712-38100	60-0H-018
51712-3B000	60-0H-009
51712-3D100	60-0K-015
51712-3D300	60-0K-015
51712-3K150	60-0H-H23
51712-3K160	60-0H-H23
51712-4H500	60-0H-H24
51712-H1000	60-0H-013
51712-H1030	60-0H-H22
52710-02000	56-H0-015
52710-02100	56-H0-015
52710-H1000	61-0H-005
52751-29000	56-H0-004

52761-44000	56-H0-002
58101-02A00	50-05-583
58101-02A10	50-H0-008
58101-05A10	50-05-583
58101-0WA00	50-0H-H14
58101-0XA01	50-0K-010
58101-0XA10	50-0K-010
58101-1CA10	50-03-339
58101-1JA10	50-0K-K12
58101-1KA00	50-0H-H17
58101-22A00	50-03-339
58101-22A10	50-03-339
58101-24B00	50-03-339
58101-24C00	50-03-339
58101-25A10	50-03-339
58101-26A00	50-H0-005
58101-26A30	50-H0-005
58101-28A00	50-05-590
58101-28A10	50-03-339
58101-29A00	50-05-590
58101-29A10	50-05-590
58101-29A30	50-05-590
58101-29A50	50-05-590
58101-2BA10	50-0H-H14
58101-2CA20	50-H0-010
58101-2DA20	50-05-590
58101-2DA40	50-H0-013
58101-2DA50	50-0H-H15
58101-2DA60	50-H0-013
58101-2EA10	50-H0-010
58101-2EA11	50-H0-010
58101-2SA70	50-0K-K20
58101-33A00	50-05-590
58101-34A10	50-05-590
58101-35A10	50-05-590
58101-38A40	50-05-590
58101-38A80	50-05-590
58101-39A20	50-H0-005
58101-3AA20	50-H0-005
58101-3KA20	50-H0-010
58101-3ZA10	50-0K-K20
58101-43A00	50-05-595
58101-4AA00	50-H0-002
58101-4AA10	50-H0-002



CROSS REFERENCE LIST
VERGLEICHLISTE
LISTA DE REFERENCIAS CRUZADES
LISTA DE COMPARAISON
LISTA DI COMPARAZIONE

HYUNDAI	ASHIKA
58101-4AA61	50-H0-002
58101-4HA50	50-0K-019
58101-H1A00	50-H0-006
58101-H1A10	50-H0-006
58101-H1A80	50-0S-S01
58101-M1A00	50-H0-001
58101-M2A00	50-05-590
58101-M2A01	50-05-530
581011JA60	50-0H-H12
581012VA50	50-0H-H18
581014AA26	50-H0-005
58101M2A02	50-K0-014
58103-31000	50-03-378
58129-44010	60-05-591
58129-44100	60-05-591
58129-4A000	60-0H-003
58129-4A200	60-0H-H14
58201-33A00	51-03-399
58201-33A02	51-03-399
58205-21A00	55-05-526
58215-11100	55-05-512
58225-11040	55-05-512
58302-0XA00	51-0K-004
58302-1CA00	51-0H-H04
58302-1JA30	51-0K-K09
58302-1KA30	51-0K-K09
58302-26A00	51-0H-H04
58302-28A01	51-05-595
58302-29A00	51-05-595
58302-29A10	51-05-595
58302-2BA00	51-0H-H08
58302-2BA20	51-0H-H08
58302-2DA10	51-05-595
58302-2EA30	51-0H-H04
58302-2MA90	51-0K-K11
58302-2SA30	51-0K-K09
58302-2SA70	51-0K-K09
58302-2YA30	51-0K-K09
58302-33A00	55-05-585
58302-34A00	51-05-598
58302-38A10	51-0H-H04
58302-3AA20	51-0H-H04
58302-3KA30	51-0H-H04

58302-3KA60	51-0H-H04
58302-3NA00	51-0K-K11
58302-3ZA10	51-0H-H01
58302-4HA50	51-0K-K07
58302-H1A00	51-0H-H03
58302-H1A10	51-0H-H03
58302-M2A	51-0H-H02
58302-M2A01	51-0H-H02
58302-M2A10	51-0H-H02
583022EA31	51-0H-H04
583022VA50	51-0H-H09
58305-05A00	55-05-584
58305-17A00	55-05-592
58305-1CA00	55-H0-005
58305-1CA10	55-H0-006
58305-21A00	55-05-526
58305-22A00	55-05-595
58305-22A01	55-05-595
58305-23A00	55-05-596
58305-24A30	55-H0-013
58305-25A00	55-H0-013
58305-26A00	55-0H-H08
58305-29A00	55-05-516
58305-34A10	55-05-585
58305-38A00	55-K0-008
58305-44A10	55-H0-001
58305-44A40	55-H0-001
58305-47A00	55-0H-H11
58305-4AA00	55-H0-002
58305-4BA00	55-0H-H15
58305-M2A10	55-H0-003
58320-44010	67-05-576
58320-44210	67-05-576
58320-47000	67-0H-H18
58320-4A000	67-H0-007
58320-4A020	67-H0-007
58320-4B001	67-0H-H15
58329-4A000	56-H0-003
58329-4AA00	56-H0-003
58330-02000	67-H0-001
58330-1G000	67-K0-008
58330-22000	67-05-589
58330-23300	67-05-573
58330-24002	67-05-575

58330-24003	67-05-572
58330-25000	67-H0-013
58330-28000	67-05-598
58330-28001	67-05-589
58330-2D000	67-H0-011
58330-3A000	67-H0-021
58350-1CA00	55-0H-H12
58350-1HA00	55-0K-K21
58350-38A30	55-0H-H12
58350-3AA00	55-H0-007
58350-3CA10	55-0H-H12
58350-H1A40	55-0H-H10
58380-02000	67-H0-002
58380-22000	67-05-590
58380-24002	67-05-574
58380-24003	67-05-573
58380-25000	67-H0-014
58380-28001	67-05-590
58380-28001	67-05-599
58380-2D000	67-H0-014
58380-33000	67-05-571
58380-3A000	67-H0-022
58411 1C800	61-0H-001
58411-02501	56-0H-012
58411-0X500	61-0K-002
58411-17100	56-H0-011
58411-17200	56-H0-011
58411-1C000	56-H0-008
58411-1C300	56-H0-009
58411-1K300	61-0K-K14
58411-22000	56-H0-001
58411-22010	56-H0-001
58411-25010	56-H0-013
58411-29000	56-H0-004
58411-29100	56-H0-004
58411-29300	61-05-596
58411-29350	61-05-596
58411-2B000	61-0H-H06
58411-2C000	61-0H-004
58411-33300	61-05-509
58411-38000	56-H0-014
58411-38310	61-0K-003
58411-3A000	56-H0-005
58411-3A300	61-0H-003



HYUNDAI	ASHIKA
58411-3K100	61-0H-H07
58411-3N020	61-0H-H08
58411-3X300	61-0H-H12
58411-3Z100	61-0H-H09
58411-3Z700	61-0H-H10
58411-4H300	61-0H-H11
58411-M2050	61-0H-002
5841122100	56-0H-H16
5841125010	56-0H-H16
5841125201	56-0H-H16
58420-44010	67-05-577
58420-44210	67-05-577
58420-47000	67-0H-H17
58420-4A000	67-H0-008
58420-4A020	67-H0-008
58420-4B001	67-0H-H16
58429-4AA00	56-H0-003
HB402121	67-H0-008
HB403101	60-0H-H20
HQ232405	60-0H-002
HR232029	67-H0-005
HR232030	67-H0-006
HR236352	56-H0-007
SB000027	50-H0-001P
SB000027	50-H0-001
SB000102	55-H0-002
ZB403101	60-0H-002
ZB436351	56-H0-000
ISUZU	ASHIKA
1605590	55-09-999
1605592	55-09-996
1605686	55-09-999
4202047	55-09-991
4202048	55-09-991
4202292	55-09-991
4212220	55-09-901
4212229	55-09-991
4212252	55-09-991
4212687	55-09-901
4215121	55-09-991
4217282	55-09-904
4220812	55-09-904
4301328	55-09-991

4310069	50-09-901
4310408	50-09-902
4310431	50-09-904
4310815	61-09-900
4311247	60-09-903
4311252	60-09-909
4312803	50-09-900
4312974	60-09-900
4313128	50-09-900
4313222	60-09-900
4313222	50-09-900
4313607	60-09-903
4314083	50-09-905
431438	60-09-904
4314838	60-09-904
4316845	51-09-900
4317089	51-09-900
4317604	51-09-900
4317965	50-09-900
4320831	50-09-902
4320842	50-09-901
4320858	50-09-902
4351183E00	56-08-817
4423601	67-09-996
45251-SB2-940	60-04-413
5-87831801-0	55-09-902
550142	67-09-901
569801	60-09-909
5871000770	55-09-991
7251-77331	67-09-907
8-94026-0	55-09-991
8-9404-258-0	55-09-901
8-94103-460-2	60-09-999
8-94104-258-1	55-09-901
8-94113-628-0	60-09-903
8-94113-628-1	60-09-903
8-94113-629-1	60-09-903
8-94123-041-1	50-09-900
8-94124-862	55-09-904
8-94124-862-1	55-09-904
8-94124-864	55-09-904
8-94124-964-1	55-09-904
8-94130-145-0	50-09-902
8-94130-153-0	50-09-900

8-94133-703-2	67-09-998
8-94136-642-0	50-09-901
8-94137-937-0	50-09-902
8-94172-376-0	60-09-909
8-94172-376-1	60-09-909
8-94173-244-0	61-09-900
8-94173-344-0	60-09-909
8-94173-345-0	60-09-909
8-94176-504-0	60-09-903
8-94220-529-0	55-09-901
8-94223-199-0	60-09-900
8-94224-172-0	60-09-900
8-94224-172-1	60-09-900
8-94226-829-1	56-09-902
8-94230-525-0	50-09-900
8-94230-541-0	67-09-901
8-94230-541-1	67-09-901
8-94230-845-0	60-09-900
8-94230-845-1	60-09-900
8-94232-375-0	60-09-906
8-94233-500-6	67-09-997
8-94240	55-09-991
8-94242-571-0	60-09-903
8-94248-258-0	55-09-901
8-94248-529-0	55-09-901
8-94256-308-5	65-09-997
8-94314-192-0	50-09-905
8-94337-743-0	50-09-902
8-94361-927-0	60-09-909
8-94361-927-1	60-09-909
8-94362-154-0	51-09-900
8-94372-435-0	60-09-909
8-94375-425-1	61-09-997
8-94375-533-4	60-09-997
8-94417-547-1	60-09-999
8-94417-547-2	60-09-999
8-94417-547-3	60-09-999
8-94448-775-0	60-09-904
8-94461-155-0	50-09-904
8-94467-328-0	50-09-901
8-94479-706	55-09-991
8-94479-706-0	55-09-991
8-94479-707	55-09-991
8-94479-707-0	55-09-991



CROSS REFERENCE LIST
VERGLEICHLISTE
LISTA DE REFERENCIAS CRUZADES
LISTA DE COMPARAISON
LISTA DI COMPARAZIONE

ISUZU	ASHIKA
8-94479-708	55-09-991
8-94479-708-0	55-09-991
8-94479-709-0	55-09-991
8-94479-710-0	55-09-991
8-94479-711-0	55-09-991
8-94483-223-0	51-09-900
8-97034-034-3	60-09-997
8-97034036-1	60-09-997
8-97039-669-0	51-09-999
8-97168-6311	60-09-912
8-97180-525-0	50-09-999
8-97329266-0	50-09-909
8-97329333-0	50-09-908
8-97349689-0	67-09-904
8-97349690-0	67-09-902
8-97349692-0	67-09-903
8-97360-505-0	56-09-900
8-97368254-0	55-09-900
8-97371-8760	60-09-912
8-98006259-0	60-09-921
8-98018036-0	55-09-900
8-980303850	56-09-903
8-98051117-0	50-09-908
8-98079104-0	50-09-914
8944426860	50-09-998
8970947100	50-09-907
8971686340	50-09-916
8973088680	60-09-920
8973193000	67-09-906
8973606780	60-09-921
8973682520	50-09-908
8973682530	55-09-912
90086193	60-09-911
94123041	50-09-900
94130145	50-09-902
94130153	50-09-900
94136642	50-09-901
94137937	50-09-902
94154012	51-09-996
9422-6829	56-09-902
94230525	50-09-900
94242571	60-09-903
94337743	50-09-902

94362154	51-09-900
94461155	50-09-904
94467328	50-09-901
94479706	55-09-991
94479707	55-09-991
94479708	55-09-991
94479709	55-09-991
94479710	55-09-991
94483223	51-09-900
JEEP	ASHIKA
0 623 5662	67-08-896
04743999AA	61-09-904
05011988AB	55-09-907
05066147AA	55-00-099
05066158AA	67-00-005
05083882AC	51-09-904
05086930AA	55-09-908
05086930AB	55-09-908
05093260AA	50-00-090
05105514AA	60-00-003
05191217AA	50-00-004
05191271AA	51-05-508
1-04313056	67-00-001
1-05080868AC	50-00-018
1-05080871AB	51-00-001
1-05105515AA	61-00-002
1-05191217AA	50-00-004
1-052089269AB	60-00-061
1-052089275AB	61-00-001
1-5105514AA	60-00-003
1605590	55-09-999
4313056	67-00-097
4423601	67-00-096
4423606	55-00-056
4509340	60-00-096
4638634	50-00-059
4713365	55-00-099
4713365	55-00-022
4762101	51-09-998
5010936AA	51-09-994
5011970AB	51-09-992
5015965AA	60-00-097
5019805AA	51-09-993
5071948AA	51-09-993

5083882AE	51-09-904
5093390AA	55-09-906
5191215AA	55-09-909
52008184	61-09-995
52060137AB	60-09-913
52060147AA	61-09-902
52098666	61-09-992
52098672	60-00-094
52128411AB	61-09-905
6753005	67-09-999
68003607AB	55-09-910
68003701AA	50-09-910
68003776AA	51-09-901
68035022AB	61-09-907
68035576AA	50-09-912
68052386AA	51-09-906
8303-251-156	60-00-059
8952005000	60-00-059
9883-251-156	60-00-059
EIS NX 462	55-00-023
J8131787	50-00-054
KIA	ASHIKA
0K011-26-251B	56-K0-008
0K011-26-38Z	55-03-342
0K011-26-610	67-K0-005
0K011-33-23Z	50-03-392
0K01A-33-251C	60-0K-009
0K01A-33-251D	60-0K-009
0K01A-33-25XB	60-03-397
0K040-26-251	56-K0-002
0K045-26-38Z	55-03-396
0K045-26-610	67-K0-002
0K045-33-23Z	50-K0-000
0K201-26-251	56-K0-005
0K201-26-251B	56-K0-009
0K201-26-610	67-K0-000
0K201-26-610A	67-K0-000
0K20A-33-23Z	50-03-398
0K20A-33-251	60-03-398
0K20H-26-251	61-0K-004
0K20H-33-23Z	51-0K-K01
0K239-33-23Z	50-03-398
0K23N-26-28Z	55-03-398
0K23N-26-38Z	55-03-398

CROSS REFERENCE LIST
VERGLEICHLISTE
LISTA DE REFERENCIAS CRUZADES
LISTA DE COMPARAISON
LISTA DI COMPARAZIONE



KIA	ASHIKA
OK2A-33-23Z	50-K0-002
OK2A4-33-23Z	50-03-398
OK2AA-26-251	61-0K-006
OK2AA-26-251A	61-0K-006
OK2AA-33-251B	60-03-398
OK2FA-26-251	56-K0-004
OK2FA-26-38Z	55-K0-000
OK2FA-26-610	67-K0-009
OK2FA-33-251	60-0K-006
OK2FC-26-28Z	51-0K-K00
OK2JA-33-28Z	50-K0-009
OK2N1-26-38Z	55-K0-012
OK2N1-33-251	60-0K-012
OK30A-26-251A	56-K0-010
OK30A-26-28Z	55-K0-007
OK30A-26-610	67-03-373
OK30C-26-250A	56-K0-012
OK552-26-251A	56-K0-001
OK552-26-38Z	55-00-097
OK552-26-610	67-K0-001
OK552-33-23Z	50-00-057
OK552-33-251A	60-0K-002
OK553-26-38Z	55-00-097
OK553-33-23Z	50-00-057P
OK553-33-23Z	50-00-057
OK55A-33-251	60-0K-003
OK55B-33-251	60-0K-003
OK56A-26-251A	56-K0-006
OK56A-26-38Z	55-K0-001
OK56A-26-38ZA	55-K0-001
OK56A-26-610	67-K0-012
OK56A-33-23Z	50-K0-005P
OK56A-33-23Z	50-K0-005
OK56B-26-610	67-K0-012
OK56B-26-620	67-0K-K10
OK58A-26-38Z	55-0K-K14
OK58A-33-23Z	50-0K-K13
OK58B-33-251	60-0K-K11
OK60A-33-251A	60-0K-004
OK60A-33-28Z	50-0K-018
OK60B-26-251A	56-0K-K16
OK63B-33-251A	60-0K-K22
OK71E-33251	60-0K-K13

OK72A-26-38Z	55-K0-013
OK72A-33-28Z	50-K0-001
OK72B-26-610A	67-0K-019
OK72B-26-710	67-K0-006
OK72F-33-251A	60-0K-007
OK74P-26-610	67-0K-K17
OK74P-26-710	67-0K-K20
OK7562638Z	55-0K-004
OK75B-33-28Z	50-K0-005
OK9A0-26-28Z	51-0K-K00
OK9A0-33-28Z	50-K0-002
OK9A6-26-23Z	55-K0-000
OK9A6-26-23ZA	55-K0-000
OK9A6-26-251	56-K0-000
OK9AA-26-251A	61-0K-000
OK9AA-26-251C	61-0K-008
OK9AA-33-251	60-03-396
OK9AA-33-251C	60-03-396
OK9B6-33-28Z	50-K0-017
OK9D0-33-28Z	50-K0-017
OK9M6-26-23Z	55-K0-000
OK9Y6-33-28Z	50-K0-002
OS0-8326-25-13	56-0K-K03
OS08326251C	56-0K-K03
51712-02010	60-05-587
51712-07500	60-0K-010
51712-0U000	60-0K-K18
51712-0Z000	60-0H-H23
51712-1D100	60-0H-012
51712-1G000	60-0K-K18
51712-2F100	60-0K-K17
51712-2K100	60-0H-012
51712-2P700	60-0H-H19
51712-38300	60-0K-014
51712-3C000	60-0K-014
51712-3C100	60-0K-015
51712-3E000	60-0K-005
51712-3E500	60-0K-005
51712-3K050	60-0H-012
51712-4D200	60-0K-K21
51712-FD300	60-0K-016
51712-M2000	60-0K-K19
51712-M2010	60-0K-K19
5171207700	60-0K-K20

52725-FD200	56-K0-013
58101 07A10	50-0K-010
58101-07A20	50-0K-010
58101-0ZA00	50-0K-K20
58101-1DE00	50-0K-K20
58101-1FE00	50-H0-010
58101-1FE01	50-H0-010
58101-1GA00	50-0K-K12
58101-1GE00	50-0K-K12
58101-1HA00	50-K0-009
58101-1PA00	50-0K-K22
58101-1WA05	50-0K-K24
58101-1WA35	50-0K-K24
58101-1YA30	50-0K-K23
58101-2FA20	50-0K-K11
58101-2KA10	50-H0-010
58101-2PA70	50-0H-H14
58101-3CA20	50-K0-014
58101-3CA20	50-0K-K12
58101-3CA80	50-H0-010
58101-3EE00	50-K0-008
58101-3EE01	50-K0-008
58101-3KA40	50-H0-010
58101-4DE00	50-0K-019
58101-M2A02	50-05-590
58115-020S0	50-05-583
58115-FDC00	50-K0-017
58302-07A00	51-0K-004
58302-07A10	51-0K-004
58302-0ZA00	51-0K-K09
58302-1DE00	51-0K-K10
58302-1FE00	51-0H-H04
58302-1GA00	51-0K-K09
58302-1HA00	51-0K-K09
58302-1PA30	51-0K-K12
58302-1WA35	51-0K-K06
58302-2GA00	51-0H-H04
58302-2KA10	51-0K-K06
58302-2PA70	51-0K-K11
58302-3CA10	51-0H-H04
58302-3ED00	51-0K-K03
58302-3EE00	51-0K-K03
58302-3KA31	51-0H-H04
58302-4DE00	51-0K-K07



CROSS REFERENCE LIST
 VERGLEICHLISTE
 LISTA DE REFERENCIAS CRUZADES
 LISTA DE COMPARAISON
 LISTA DI COMPARAZIONE

KIA	ASHIKA
58302-M2A01	51-0H-H02
58302-M2A01	51-0H-H02
58302-M2A	
58302-M2A10	51-0H-H02
58305-2KA00	55-0K-K16
58305-38A00	55-K0-008
58305-3CA00	55-K0-008
583052PA10	55-0S-S02
58315-FDA00	55-K0-011
58320-4E000	67-K0-015
58329-4E000	56-0K-014
58330-07000	67-0K-K16
58330-38010	67-K0-013
58330-FD100	67-K0-008
58350 4E000	55-0K-004
58350-07A00	55-0K-K15
58350-3ED00	55-0K-K17
58350-4DA00	55-0K-K19
58350-4EA00	55-0K-004
583501GA00	55-0K-K18
583503FA00	55-0K-K22
58380-38010	67-K0-014
58380-4E000	67-K0-007
58411-07300	61-0K-002
58411-07500	61-0K-002
58411-0U300	61-0K-K18
58411-1C800	61-0H-001
58411-1D000	61-0K-K13
58411-1H300	61-0K-K14
58411-1P300	61-0K-K17
58411-1Y000	56-0K-K15
58411-2F100	61-0K-K07
58411-2K300	61-0K-K15
58411-2P000	61-0K-K16
58411-38000	56-H0-014
58411-39600	61-0K-K10
58411-3C000	61-0K-003
58411-3E300	61-0K-005
58411-3E500	61-0K-K12
58411-4D000	61-0K-K11
58411-FD100	56-K0-011
K0Y2-33-23Z	50-03-392
K201-26-38Z	55-03-398

KDX74-43-251	60-0K-008
KJ002-33-251C	60-0K-002
MDX01-26-610A	67-K0-004
OK72A-33-28Z	50-K0-001
LADA	ASHIKA
04313056	67-00-097
04423601	67-00-096
2101-2502090	55-00-000
2121-350 1090	50-00-000
2121-350-1070	60-00-070
LAND ROVER	ASHIKA
576973	56-0L-L02
576974	56-0L-L01
FRC7329	60-0L-L12
FTC902	60-0L-L09
GBS655	55-0L-L06
GBS728	55-0L-L03
GBS753	55-0L-L02
GBS805	55-0L-L02
ICW100030	55-0L-L07
ICW5000010	55-0L-L07
LR000470	60-0L-L05
LR000571	60-0L-L13
LR001018	61-0L-L03
LR001019	61-0L-L06
LR001020	55-0L-L01
LR003657	51-0L-L03
LR004936	50-0L-L00
LR007055	60-0L-L13
LR015578	50-0L-L07
LR016684	50-0L-L08
LR016962	50-0L-L07
LR017804	61-0L-L02
LR017952	60-0L-L09
LR017953	61-0L-L05
LR019618	50-0L-L01
LR019627	51-0L-L01
LR020362	50-0L-L08
LR027123	61-0L-L09
LR027129	51-0L-L05
LR027309	50-0L-L00
NTC8780	60-0L-L07
RTC3171	55-0L-L03
RTC3403	55-0L-L06

RTC3411	55-0L-L03
RTC3418	55-0L-L02
RTC6179	55-0L-L06
SDB000201	60-0L-L11
SDB000211	61-0L-L04
SDB000330	61-0L-L08
SDB000380	60-0L-L01
SDB000470	61-0L-L07
SDB000602	60-0L-L04
SDB000603	60-0L-L04
SDB000604	60-0L-L04
SDB000614	60-0L-L08
SDB000622	60-0L-L02
SDB000623	60-0L-L02
SDB000624	60-0L-L02
SDB000635	61-0L-L00
SDB000636	61-0L-L00
SDB000644	61-0L-L01
SDB000645	61-0L-L01
SDB000646	61-0L-L01
SDB100830	60-0L-L10
SDB100980	61-0L-L08
SDB101070	60-0L-L00
SDB500182	60-0L-L06
SDB500192	60-0L-L03
SDB500193	60-0L-L03
SDB500201	61-0L-L02
SDB500202	61-0L-L02
SDB500203	61-0L-L02
SDC100110	56-0L-L00
SDC100130	56-0L-L00
SFC500080	50-0L-L05
SFP000020	50-0L-L03
SFP000260	50-0L-L02
SFP000270	51-0L-L04
SFP100490	51-0L-L02
SFP500010	50-0L-L01
SFP500020	50-0L-L01
SFP500020	51-0L-L01
SFP500021	51-0L-L01
SFP500022	51-0L-L01
SFP500040	51-0L-L01
SFP500070	50-0L-L06
SFP500100	50-0L-L03



LAND ROVER	ASHIKA
SFP500130	51-0L-L02
SFP500140	51-0L-L01
SFP500210	51-0L-L00
SFS000030	55-0L-L05
SFS000050	55-0L-L09
SFS000051	55-0L-L09
SFS000060	55-0L-L04
SFS000061K	55-0L-L04
SFS100140	55-0L-L04
SFS500010	55-0L-L00
SFS500012	55-0L-L08
STC1275	50-0L-L02
STC1525	55-0L-L07
STC2796	55-0L-L03
STC2952	50-0L-L02
STC2990	55-0L-L03
STC9187	50-0L-L04
STC965	55-0L-L06
LEXUS	ASHIKA
04465-30320	50-02-207
04465-30410	50-02-222
04465-48020	50-02-273
04465-48080	50-02-209
04465-48090	50-02-273
04465-50230	50-02-274
04465-53020	50-02-223
04466-22190	51-02-217
04466-48040	51-02-211
04466-50120	51-02-222
42431-30280	61-02-233
42431-30290	61-02-246
42431-48041	61-02-228
42431-53011	61-02-229
43512-22260	60-02-2025
43512-30310	60-02-2007
43512-48081	60-02-225
43516-22010	60-02-2026
58305-24020	55-H0-013
LIGIER	ASHIKA
182043	51-00-009
182052	60-00-022
MAHINDRA	ASHIKA
0602BB0710N	55-02-215

0603AA0200N	60-00-006
0603BB0150N	50-00-007
MAZDA	ASHIKA
0187-26-210	55-03-302
0305-33-251B	60-03-306
0305-33-625	50-03-308
0305-33-725	50-03-308
0433-26-610A	67-03-353
0433-26-710A	67-03-352
04491-12141	50-03-310
04491-14042	50-05-502
0482-49-220	55-03-302
0589-33-710	67-03-367
0613-26-610	67-03-300
0613-26-610A	67-03-300
0660-33-510	67-03-366
0813-26-610	67-03-368
0813-26-610B	67-03-368
0813-26-610C	67-03-368
0813-26-610D	67-03-368
0820-26-210	55-03-302
0820-33-251	60-03-304
0820-33-625A	50-03-304
0820-33625B	50-03-304
0820-49-230	50-03-304
0820-49-230B	50-03-304
0841-49-230	50-03-308
0841-49-230A	50-03-308
0866-33-251A	60-05-508
0870-49-280A	50-03-310
1011-26-210A	55-03-303
1011-26-28Z	55-03-303
1011-26-610	67-03-359
1011-26-610D	67-03-359
1011-26-710	67-03-358
1011-26-710D	67-03-358
101126310A	55-03-303
11046952012	50-03-376
1243-49-230	50-03-320
1243-49-230B	50-03-320
1291-26-210A	55-03-324
1291-26-220	55-03-324
1291-26210	55-03-324
1291-49-220	55-03-324

1292-49-220	55-03-324
1745-26-610	67-03-355
1745-26-610A	67-03-355
1745-26-710	67-03-354
1E00-26-28Z	55-03-394
1E01-26-251	56-03-301
1E10-33-23Z	50-03-302
2113-49-280	50-03-308
2113-49-280A	50-03-308
2772-26-210C	55-03-301
2958-26-210A	55-03-302
2958-26-210B	55-03-302
2958-26-28Z	55-03-302
2958-26-28Z9A	55-03-302
2960-26-210	55-03-302
2972-26-210	55-03-302
2972-26-210 9A	55-03-301
2972-26-210A	55-03-301
2972-26-210A9A	55-03-301
2972-26-210B	55-03-301
2972-26-210C	55-03-301
2972-26-210C9A	55-03-301
2981-33-625	50-03-308
2981-33-725	50-03-308
29Y2-26-210	55-03-301
29Y2-26-2109A	55-03-301
29Y8-26-210	55-03-301
3597-49-230	50-03-320
3597-49-230A	50-03-320
3648-49-230	50-03-308
3649-49-280 9A	50-03-308
41060-HA025	50-05-509
41060-HA026	50-05-509
41060-HA027	50-05-509
41060-HA028	50-05-509
4127-26-210	55-03-303
58101-23A10	50-03-337
58101-38A40	50-05-590
58101-38A80	50-05-590
58105-24000	50-03-339
58115-33050	50-05-590
58205-22A00	55-03-303
8118-49-230	50-03-320
8124-22-210	55-03-302



CROSS REFERENCE LIST
VERGLEICHLISTE
LISTA DE REFERENCIAS CRUZADES
LISTA DE COMPARAISON
LISTA DI COMPARAZIONE

MAZDA	ASHIKA
8148-33-28Z	50-03-320
8156-49-280	50-03-320
8173-33-251	60-03-316
8173-33-251 8173-33-	60-03-316
8173-33-251A	60-03-316
8173-49-280A	50-03-319
8173-49-280B	50-03-319
8173-49-280C	50-03-319
8174-49-280	50-03-319
8174-49-290	50-03-319
8175-49-280	50-03-319
8175-49-280 9A	50-03-319
8240-49-280A	50-03-319
8240-49-280B	50-03-319
82Y0-33-28Z	50-03-319
8471-26-210A	55-03-303
8521-22-210	55-03-302
8531-26-010	67-03-368
8532-33-625	50-03-314
8532-33-625A	50-03-314
8532-33-710	67-03-368
8532-33-725	50-03-314
8532-33-725A	50-03-314
8532-33-990B	67-03-368
8532-49-230	50-03-314
8532-49-230A	50-03-314
8532-49-280	67-03-368
8532-49-280	50-03-314
8532-49-280 9A	50-03-314
8532-49-2809A	67-03-368
8532-49-280A	67-03-368
8532-49-280A	50-03-314
8565-26-710	67-03-310
8569-33-251	60-03-312
8569-33-251A	60-03-312
8569-99-101	60-03-312
8595-26-210	55-03-303
8595-33-251	60-03-327
8595-33-251A	60-03-327
8595-33-251B	60-03-327
8595-49-280	50-03-320
8595-49-280A	50-03-320
85Y2-33-28Z	50-03-314

8854-26-210	55-03-313
8871-33-251A	60-03-302
8871-33-251B	60-03-302
8871-49-230	50-03-308
8871-49-280	50-03-308
8871-49-280A	50-03-308
8873-33-251A	60-03-301
88Y-33-28Z	50-03-308
88Y1-33-28Z	50-03-308
8957-26-610A	67-03-351
8957-26-610B	67-03-351
8957-26-710A	67-03-350
8957-26-710B	67-03-350
8980-26-210	55-03-303
8982-26-610A	67-03-361
8982-49-240	55-03-324
8982-49-290	50-05-502
89Y0-26-210	55-03-303
AY040-MA009	50-03-397
AY040-MA010	50-05-509
AY040-MA014	50-03-383
B001-26 210A	55-03-316
B001-26-610	67-03-312
B001-26-610A	67-03-312
B001-33-251	60-03-314
B001-33-251A	60-03-314
B001-33-251B	60-03-314
B001-33-251C	60-03-314
B001-49-280	50-03-316
B001-49-280A	50-03-316
B001-49-380	50-03-316
B002-49-280	50-03-316
B002-49-280 9A	50-03-316
B002-49-280A	50-03-316
B01C-26-251	61-03-399
B092-26-210	55-03-327
B092-26-28Z	55-03-327
B092-26-610	67-03-313
B09249380	55-03-327
BOY1-26-28Z 9A	55-03-316
BOY5-33-28Z	50-03-316
BOY5-33-28Z9A	50-03-316
B107-26-43Z	51-03-303
B107-26-48Z	51-03-303

B107-33-251	60-03-335
B107-49-280	51-03-303
B107-49-480	51-03-303
B21-22-6251	61-03-303
B216-26-210	55-03-328
B216-26-280	55-03-328
B216-26-280	55-03-328
B216-26-28Z	55-03-328
B216-26-610A	67-03-371
B216-26-610B	67-03-371
B216-49-280	55-03-328
B21H-26-610	67-03-398
B26Y-26-251	61-03-322
B2Y0-26-48Z	51-03-303
B2YD2438Z	55-03-397
B2YD2637ZA	55-03-397
B2YD2638Z	55-03-397
B455-26-251	56-03-302
B455-26-251A	56-03-302
B455-26-251B	56-03-302
B4Y1-26-48Z	51-03-303
B596-26-251	56-03-300
B596-26-251A	56-03-300
B596-26-251C	56-03-300
B596-26-251D	56-03-300
B5Y6-33-28Z	50-03-341
B5Y7-26-28Z	55-03-397
B6Y3-26-43Z	51-03-303
B6Y3-26-43ZA	51-03-303
B6Y3-26-48Z	51-03-303
B6Y3-26-48ZA	51-03-303
BB4C-26-251	61-03-308
BB62-26-210	55-03-301
BB62-26-610	67-03-302
BB62-26-610A	67-03-302
BB62-26-710	67-03-301
BB62-26-710A	67-03-301
BB7E-33-25XA	60-03-349
BC1D-26-610	67-03-398
BCYC-26-43ZA	51-03-391
BF68-26-251A	61-03-304
BF68-33-251	60-03-335
BF68-33-251A	60-03-335
BG34-49-280A	50-03-326

CROSS REFERENCE LIST
VERGLEICHLISTE
LISTA DE REFERENCIAS CRUZADES
LISTA DE COMPARAISON
LISTA DI COMPARAZIONE



MAZDA	ASHIKA
BG95-33-251	60-03-336
BG95-33-251A	60-03-336
BJ1Y-33-25X	60-03-320
BJYD-33-28Z	50-03-311
BJYM2638Z	55-03-397
BK14-26-251	61-03-303
BL52-26-28Z-JA	55-03-329
BL53-33-28Z	50-03-326
BL53-33-28Z9A	50-03-326
BL78-26-43Z	51-03-303
BL78-26-48Z	51-03-303
BOYW-33-23ZC	50-03-342
BP18-26-28Z	55-03-328
BP18-26-28Z9A	55-03-328
BP4Y-26-251C	61-03-321
BP4Y-33-25XD	60-03-311
BP6Y-26-251C	61-03-317
BP6Y-26-251D	61-03-317
BP6Y-33-25XE	60-03-309
BPYK-26-48ZA-9C	51-00-005
BPYK-33-23ZA	50-03-300
BPYK-33-23ZA-9C	50-03-300
BR70-33-25X	60-03-344
BR70-33-25XF	60-03-344
BR74-26-251A	61-03-308
BR74-33-25X	60-03-349
BRY4-33-23Z	50-03-342
BRY4-33-28Z	50-03-342
BRY7-33-23ZA	50-03-341
BW8Y-33-251	60-03-349
C23Y-26-251A	61-03-323
C24Y-26-251C	61-03-321
C24Y-33-25XC	60-03-311
C25Y-26-251B	61-03-317
C26Y-26251A	61-03-323
C26Y-33-25XB	60-03-309
C2Y3-26-48ZA	51-00-005
CBY4-33-23Z	50-03-318
D001 26 610A	67-03-399
D001-26-28Z	55-03-330
D001-26-610	67-03-399
D102-26-251	56-03-300
DA01-33-251	60-03-338

DA15-26-28Z	55-03-330
DA19-33-28Z	50-03-332
DA19-33-28ZA	50-03-332
DB0Y-33-251	60-03-356
DB0Y-33-251B	60-03-356
DB0Y-33-251C	60-03-356
DBYZ-26-28Z	55-03-399
DC03-26-610	67-03-379
DCY0-33-23ZB	50-03-341
DCY9-33-23Z	50-03-341
DCYO-33-28Z	50-03-341
DD63-33-25X	60-03-307
DDY2-26-710	67-03-318
DDY22638Z	55-03-307
DF7133251	60-03-325
DFY1-33-28ZA	50-03-343
DFY12638Z	55-03-314
E0Y8-26-43ZX	51-03-302
E100-33-25XA	60-03-395
E7GZ-1125B	60-03-335
E8GY-11-25A	60-03-336
EC02-33-25X	60-03-395
EC25-33-23ZA	50-03-322
ECY1-26-38ZC	55-03-309
ECY1-26-710A	67-03-305
EF91-26-251	61-03-365
EF91-33-25X	60-03-317
EF9Y-33-25X	60-03-395
EFY5-26-23Z	51-03-310
EFY5-33-23ZA	50-03-315
EH143325X	60-03-352
EHY23328Z	50-03-336
EHY4-26-43Z	51-03-309
EHY43328Z	50-03-336
F1YA-26-43Z	51-03-304
F1YA-33-23ZB	50-03-313
F2ZZ-11-25B	60-03-349
F3ZZ-11-25A	60-03-348
FA18-26-251	61-03-301
FA18-49-280	51-03-301
FA18-49-280A	51-03-301
FA66-26-251	61-03-307
FA66-26-251A	61-03-307
FA66-33-251	60-03-329

FA66-33-251A	60-03-329
FA66-33-251B	60-03-329
FA66-49-280	50-03-328
FA67-49-280	51-03-302
FAY8-26-48Z	50-03-301
FB05-26-251	61-03-306
FB05-26-251A	61-03-306
FB05-33-251	60-03-333
FB05-49-280A	50-03-329
FB06-49-280	51-03-302
FB34-49-280A	50-03-329
FB34-49-280B	50-03-329
FB34-49-280C	50-03-329
FB34-49-280D	50-03-329
FB71-26-28Z	51-03-302
FB71-26-28ZA	51-03-302
FB71-33-28Z	50-03-329
FB71-33-28ZA	50-03-329
FB71-33-28ZC	50-03-329
FC01-26-251	61-03-318
FC02-33-28Z	50-03-329
FD01-26-25X	61-03-319
FD01-33-25X	60-03-350
FE01-26-251	61-03-318
G020-26-210	55-03-305
G020-26-210B	55-03-305
G020-26-28Z	55-03-305
G030-26-610	67-03-303
G030-33-251A	60-03-301
G030-33-251B	60-03-301
G032-49-280 9A	50-03-301
G037 26 251C	61-03-305
G091-33-251	60-03-334
G091-33-251A	60-03-334
G091-33-251B	60-03-334
G091-33-251C	60-03-334
G0Y0-26-28Z	55-03-305
G1YN-33-28Z	50-03-318
G31Y26251	61-03-328
G31Y3325XA	60-03-351
G33Y3325X	60-03-353
G5Y6-26-43ZC	51-03-307
G5Y6-33-23Z	50-05-590
GA02-26-210	55-03-303



CROSS REFERENCE LIST
VERGLEICHLISTE
LISTA DE REFERENCIAS CRUZADES
LISTA DE COMPARAISON
LISTA DI COMPARAZIONE

MAZDA	ASHIKA
GA02-26-610	67-03-357
GA02-26-610A	67-03-357
GA02-26-710	67-03-356
GA02-26-710A	67-03-356
GA5Y-26-251	61-03-314
GA5Y-33-25X	60-03-348
GA7Y-26-251	61-03-315
GA97-33-251A	60-03-303
GA97-33-251B	60-03-303
GA97-49-280	50-03-301
GAYE-26-43ZB	51-03-307
GAYR-33-23ZA	50-03-399
GAYR-33-23ZB 9A	50-03-399
GB38-33-251	60-03-337
GB40-33-251	60-03-334
GB40-33-251	60-03-330
GB40-33-251A	60-03-334
GC88-33-251	60-03-330
GC88-33-251A	60-03-330
GC88-33-251B	60-03-330
GE61-26-251	61-03-305
GEYC-26-43Z	51-03-302
GF15-33-251	60-03-330
GF31-33-251	60-03-334
GF31-33-251A	60-03-334
GF3Y-26-251A	61-03-316
GG16-49-280	51-03-300
GG29-49-280	50-03-301
GG29-49-280 9A	50-03-301
GGY6-26-48Z9A	51-03-300
GGY8-33-28Z 9A	50-03-301
GGY9-33-28Z 9A	50-03-301
GJ21-26-28Z	55-03-329
GJ21-26-610A	67-03-368
GJ21-26-610C	67-03-368
GJ21-33-28Z	50-03-331
GJ21-33-28ZA	50-03-331
GJ21-33-28ZB	50-03-331
GJ25-26-251	61-03-309
GJ25-26-251B	61-03-309
GJ25-26-48ZA	51-03-306
GJ25-33-25XB	60-03-340
GJ25-33-25XC	60-03-340

GJ25-33-25XD	60-03-340
GJ55-33-25XA	60-03-340
GJ55-33-25XB	60-03-340
GJ55-33-25XC	60-03-340
GJ55-33-25XD	60-03-340
GJ6Y-33-25XA	60-03-305
GJ82-26-28Z	55-03-329
GJ82-26-28ZB	55-03-330
GJ87-26-48Z	51-03-306
GJ87-26-48ZA	51-03-306
GJ96-33-25XA	60-03-341
GJY1-33-28Z	50-03-331
GJY1-33-28Z 9A	50-03-331
GJY7-26-48Z 9A	51-03-306
GJYB2648Z9C	51-03-302
GJYB3323ZC	50-03-305
GJYC-33-28Z-9C	50-03-305
GJYF3323ZE	50-03-307
GJYG-33-23ZA	50-03-307
GM09-26-251B	61-03-313
GM39-26-251	61-03-302
GM39-26-251A	61-03-302
GM39-26-251B	61-03-302
GM39-26-251C	61-03-302
GN51-33-28Z	50-03-331
GO30-49-280	50-03-301
GO30-49-280A	50-03-301
GO30-49-280B	50-03-301
GO32-49-280	50-03-301
GO32-49-280 9A	50-03-301
GO37-26-251C	61-03-305
GO91-33-251	60-03-334
GO91-33-251A	60-03-334
GOY0-26-28Z	55-03-305
GPYA3323ZG	50-03-344
GPYB2643Z	51-03-312
GSYD3328ZA	50-03-346
H001-26-251	61-03-300
H001-33-251	60-03-324
H001-33-251A	60-03-324
H001-33-251B	60-03-324
H001-33-251C	60-03-324
H001-33-251D	60-03-324
H001-49-280	50-03-303

H001-49-280A	50-03-303
H002-49-280	50-03-303
H003-49-280	50-03-303
H010-48-280 9A	51-03-300
H010-49-280	51-03-300
H010-49-280A	51-03-300
H010-49-280B	51-03-300
H011-49-280 9A	51-03-300
H029-26-610	67-03-363
H029-26-710	67-03-362
H0Y0-26-48Z	51-03-300
H266-26-48Z	51-03-305
H266-26-48ZA	51-03-305
H3Y0-33-23Z	50-03-397
H3Y0-33-23ZA	50-03-397
H3Y0-33-28Z	50-03-397
H3Y1-33-23Z	50-03-397
H3Y1-33-23ZA	50-03-397
H3Y1-33-28Z	50-03-397
H3Y1-33-28ZA	50-03-397
H708-22-210	55-03-303
HA72-49-280 9A	50-03-320
HB16-33-251	60-03-324
HB16-33-251A	60-03-324
HB16-33-251B	60-03-324
HBV5-33-28Z 9A	50-03-303
HE01-33-25X	60-03-332
HE01-33-25XA	60-03-332
HE01-33-25XB	60-03-332
HE01-33-25XC	60-03-332
HE17-26-251	61-03-310
HE21-33-28Z	50-03-330
HE21-33-28ZA	50-03-330
HE21-33-28ZB	50-03-330
HE25-33-25X	60-03-332
HE25-33-25XA	60-03-332
HE25-33-25XB	60-03-332
HE25-33-25XC	60-03-332
HF05-33-251A	60-03-332
HF13-33-251A	60-03-332
HF39-26-480ZA	51-03-305
HF39-26-48Z	51-03-305
J001-26-251B	61-03-324
J001-26-251C	61-03-324



MAZDA	ASHIKA
JOY1-26-43ZB	51-03-305
JOY1-26-43ZB	51-03-305
K20A-33-251	60-03-398
KJ01-26-610	67-03-325
KJ01-26-610 (PB1126151	67-03-325
L12Y-33-25X	60-03-313
L20626251B	61-03-327
L2063325XA	60-03-347
L232-26-251B	61-03-329
L2Y62643Z	51-03-309
L2Y62648Z	51-03-309
L2Y63323Z	50-03-336
L2Y63328Z	50-03-336
L2Y72643Z	51-03-309
LA01-26-610	67-03-396
LA01-26-710	67-03-397
LAY3-33-28Z	50-05-509
LB82-33-25X	60-03-384
LBZ2-33-23Z	50-03-384
LC62-26-610C	67-03-306
LDY5-26-38ZA	55-03-300
MQ907152	50-05-509
MQ907154	50-05-509
N026-33-25X	60-03-358
N026-33-25XC	60-03-358
N06Y-26-251B	61-03-325
NOY3-33-23Z	50-03-383
NOY3-33-28Z	50-03-383
NOYY-33-25X	60-03-315
N12326251A	61-03-316
NA01-26-251A	61-03-312
NA01-33-25X	60-03-342
NA01-33-25XA	60-03-342
NA75-33-25X	60-03-358
NA75-33-25XC	60-03-358
NAY0-33-23ZA	50-03-340
NAY1-26-43Z	51-03-303
NAY1-33-23ZA	50-03-340
NAY5-26-43ZA	51-03-391
NAY5-33-23Z	50-03-383
NAY5-33-23ZA	50-03-383
NAY5-33-23ZB	50-03-383

NAY5-33-28Z	50-03-383
NAY5-33-28ZA	50-03-383
NAZ0-26-48Z	50-03-383
NCY1-33-23Z-9C	50-03-383
NCY3-26-43ZA	51-03-345
NCY3-33-23Z	50-03-317
NF4726251	61-03-316
NF4Y3325X	60-03-319
NFY7-26-43Z	51-03-311
NFY73323Z	50-03-335
NOYY-33-25X	60-03-315
OUY9-33-23ZA	50-03-382
S001-26-610A	67-03-365
S047-33-251	60-03-345
S082-26-210A	55-03-325
S083-26-610	67-03-365
S083-26-710	67-03-364
S083-33-251	60-03-326
S083-33-251A	60-03-326
S083-33-251B	60-03-326
S085-26-610	67-03-369
S085-26-710	67-03-370
S121-26-610	67-03-365
S152-26-610A	67-03-395
S152-26-710A	67-03-394
S231-33-251	60-03-399
S4512001	50-03-376
S49K-26-610A	67-03-315
S4YP-33-23Z	50-05-509
S4YP-33-23ZA	50-05-509
S4YP-33-28Z	50-05-509
S4YP-33-28ZA	50-05-509
SA14-49-240B	55-03-332
SA39-33-251	60-03-346
SA39-33251A	60-03-346
SA94-26-210	55-03-325
SA94-26-210A	55-03-325
SA94-26-220	55-03-325
SA94-26-220A	55-03-325
SA94-49-280 9A	50-03-326
SE28-26-210A	55-03-325
SE96-33-28Z	50-03-326
SE96-33-28Z 9A	50-03-326
SGY32638Z	55-03-391

SHY3-26-38Z	55-03-334
SO47-33-251	60-03-345
SO83-49-280	50-03-325
SO83-49-280A	50-03-326
T002-33-25XA	60-03-354
TY01-33-25X	60-03-354
TY32-26-251A	61-03-326
U0Y9-26-28ZA	55-03-393
UA25-26-210	55-03-313
UAYN-2638Z	55-03-312
UB39-33-251	60-03-326
UB39-33-251A	60-03-326
UB39-49-280	50-06-601
UBY2-26-28ZB	55-03-333
UG 52 33 25X	60-03-357
UGY9-33-23Z	50-03-312
UH71-26-610	67-03-307
UH7433251	60-03-355
UH81-33-251	60-03-318
UHY-33-23ZA	50-03-373
UHY-33-23ZB	50-03-373
UHY1-33-28ZA	50-03-373
UHY1-33-28ZB	50-03-373
UHY1-33-28ZD	50-03-373
UJY6-3323Z	50-03-373
UJY8-26-38Z	55-03-311
UMY1-3323ZA	50-03-323
UMY1-3328ZA	50-03-323
UMY4-3323Z	50-03-323
UOY9-33-23ZA	50-03-382
UR61-33251	60-03-323
URY2-2638Z	55-03-311
MG	ASHIKA
GBD-90817	61-04-402
MITSUBISHI	ASHIKA
11R-0515	67-05-589
4600A015	67-05-525
4600A106	55-05-510
4600A122	55-05-510
4605A041	50-05-509P
4605A041	50-05-509
4605A198	50-05-504
4605A447	51-05-505
4605A448	51-05-505P



CROSS REFERENCE LIST
VERGLEICHLISTE
LISTA DE REFERENCIAS CRUZADES
LISTA DE COMPARAISON
LISTA DI COMPARAZIONE

MITSUBISHI	ASHIKA
4605A448	51-05-505
4605A458	51-02-210
4605A472	50-02-205
4605A479	51-05-508
4605A481	50-02-205
4605A487	51-05-505
4605A492	50-05-599
4605A502	51-05-505
4605A557	50-05-501
4605A558	51-05-508
4605A730	50-05-599
4605A795	50-05-501
4615A035	61-05-501
4615A037	61-05-516
4615A038	60-05-536
4615A061	60-05-516
4615A115	60-05-543
4615A117	60-00-003
4615A121	61-09-904
47506-87701	67-06-600
47506-87710	67-06-600
4800A001	55-05-515
51712-02000	60-05-587
51712-11100	60-05-500
51712-21300	60-05-508
51712-21A00	60-05-508
8-97349691-0	67-09-905
AY060-MT001	51-05-593
M818027	60-05-540
M850976	50-05-516
M850978	51-05-507
MA161872	55-05-512
MA169882	60-05-500
MA180750	67-05-502
MA180751	67-05-500
MB001829	60-05-500
MB004040	67-05-503
MB004041	67-05-501
MB004062	55-05-502
MB044689	50-03-310
MB058197	50-05-502
MB0583553	67-05-596
MB058553	67-05-596

MB058553	67-05-531
MB058582	60-05-508
MB058916	50-05-502
MB060245	65-05-580
MB060246	65-05-581
MB060308	67-05-581
MB060309	67-05-583
MB060570	65-05-582
MB060580	67-05-584
MB060581	67-05-585
MB060582	67-05-586
MB060583	67-05-587
MB081580	61-05-500
MB081630	60-05-502
MB081850	61-05-500
MB082118	50-03-310
MB082119	50-03-310
MB08220	55-05-508
MB08221	55-05-508
MB08222	55-05-508
MB082439	50-05-502
MB082465	60-05-588
MB124822	55-05-514
MB129917	55-05-504
MB134694	61-05-502
MB134818	67-05-501
MB134828	67-05-501
MB134829	67-05-500
MB134845	60-05-506
MB139411	67-05-531
MB150655	55-05-508
MB150656	55-05-508
MB150657	55-05-508
MB150673	50-05-502
MB150674	51-05-502
MB150804	50-05-506
MB150824	50-05-506
MB150958	51-05-502
MB151001	51-05-501
MB151001	51-02-207
MB151050	67-05-509
MB151051	67-05-508
MB151059	55-05-520
MB151060	55-05-520

MB151061	55-05-520
MB151244	55-05-504
MB151323	50-05-508
MB151324	50-05-508
MB151387	60-05-501
MB151406	61-05-504
MB160993	61-05-504
MB162102	67-05-588
MB180751	67-05-500
MB192506	55-05-502
MB193216	50-05-508
MB193292	50-05-502
MB193294	50-05-502
MB193295	50-05-502
MB193296	50-05-502
MB193299	50-05-502
MB193411	67-05-532
MB193411	67-05-596
MB193425	50-03-310
MB193425	50-02-210
MB2228520	55-05-501
MB2228521	55-05-501
MB2228522	55-05-501
MB228107	55-05-504
MB228110	55-05-501
MB228111	55-05-501
MB228112	55-05-501
MB228114	55-05-501
MB228207	55-05-504
MB228262	55-05-508
MB228264	55-05-508
MB228265	55-05-508
MB228282	55-05-520
MB228284	55-05-520
MB228285	55-05-520
MB228520	55-05-501
MB228521	55-05-501
MB228862	55-05-508
MB234076	60-05-510
MB238076	60-05-510
MB238110	55-05-501
MB238111	55-05-501
MB238113	55-05-501
MB238114	55-05-501

CROSS REFERENCE LIST
VERGLEICHLISTE
LISTA DE REFERENCIAS CRUZADES
LISTA DE COMPARAISON
LISTA DI COMPARAZIONE



MITSUBISHI	ASHIKA
MB238250	51-05-502
MB238262	50-03-330
MB238262	50-05-520
MB238493	51-05-502
MB238495	60-05-512
MB238509	50-05-502
MB238510	67-05-534
MB238511	67-05-535
MB238520	55-05-501
MB238521	55-05-501
MB238522	55-05-501
MB238523	55-05-501
MB238615	60-05-509
MB238828	67-05-538
MB238829	67-05-537
MB242004	56-05-505
MB266142	55-05-527
MB266169	55-05-514
MB266442	55-05-526
MB266444	55-05-526
MB266445	55-05-526
MB266446	55-05-526
MB277192	50-05-525
MB277192	50-05-508
MB277193	50-05-525
MB277202	67-05-517
MB277619	50-05-522
MB277660	60-05-513
MB295549	50-05-586
MB295690	50-05-586
MB295878	50-05-586
MB295879	50-05-586
MB295886	50-05-586
MB295887	50-05-586
MB316080	61-05-506
MB316168	50-05-522
MB316168	50-05-525
MB316676	60-05-510
MB316677	60-05-509
MB316729	60-05-508
MB316757	50-05-525
MB366080	60-05-517
MB366139	67-05-536

MB366148	50-05-520
MB366284	50-05-525
MB366288	51-05-500
MB366326	67-05-533
MB366393	50-05-522
MB366429	61-05-506
MB366439	60-05-523
MB366466	60-05-514
MB366480	60-05-517
MB366486	60-05-515
MB366487	61-05-505
MB3666288	51-05-500
MB366969	50-05-524
MB377817	50-03-310
MB377818	50-03-310
MB377820	50-05-506
MB377822	50-03-310
MB377823	50-05-502
MB377825	51-05-502
MB377826	51-05-500
MB389570	51-05-593
MB389725	60-05-535
MB407030	60-05-518
MB407031	60-05-589
MB407036	60-05-521
MB407038	60-05-520
MB407039	60-05-520
MB407216	50-05-502
MB407390	51-05-593
MB407430	50-05-525
MB407450	50-05-525
MB407460	50-05-524
MB407639	60-05-522
MB409639	60-05-522
MB475331	60-05-535
MB500202	55-05-529
MB500202	55-05-504
MB500204	61-05-599
MB500482	67-05-501
MB500483	67-05-500
MB500484	67-05-534
MB500485	67-05-535
MB500502	55-05-529
MB500535	67-05-535

MB500555	61-05-508
MB500609	50-05-527P
MB500609	50-05-527
MB500609	50-05-525
MB500738	67-05-594
MB500739	67-05-593
MB500813	50-05-527P
MB500813	50-05-527
MB500815	50-05-527
MB500815	50-05-527P
MB500816	50-05-527P
MB500816	50-05-527
MB500819	50-05-527P
MB500819	50-05-527
MB500822	55-05-528
MB500960	50-05-525
MB500968	60-05-517
MB515476	56-05-505
MB524594	55-05-526
MB524595	55-05-526
MB524596	55-05-526
MB524597	55-05-526
MB524656	55-05-527
MB524696	55-05-526
MB534245	56-05-500
MB534398	50-05-529
MB534483	50-05-525
MB534583	50-05-524
MB534587	50-05-524
MB534607	60-05-523
MB534644	50-05-529
MB534649	61-05-505
MB534653	51-05-594
MB534712	50-05-525
MB534713	50-05-525
MB534995	51-05-500
MB587054	50-05-525
MB587168	55-05-529
MB587174	55-05-514
MB587432	61-05-597
MB587578	56-05-509
MB587579	61-05-513
MB58758	56-05-507
MB587658	55-05-528



CROSS REFERENCE LIST
VERGLEICHLISTE
LISTA DE REFERENCIAS CRUZADES
LISTA DE COMPARAISON
LISTA DI COMPARAZIONE

MITSUBISHI	ASHIKA
MB587659	55-05-501
MB587660	55-05-501
MB587661	55-05-501
MB597721	50-05-502
MB618108	50-05-520
MB618116	50-05-525
MB618188	67-05-539
MB618628	60-05-525
MB618629	60-05-525
MB618684	60-05-595
MB618716	60-05-599
MB618734	60-05-524
MB618735	60-05-524
MB618736	60-05-593
MB618737	60-05-593
MB618797	61-05-598
MB618828	61-05-595
MB618981	67-05-579
MB668083	61-05-510
MB668107	60-05-522
MB668336	50-05-530
MB668337	50-05-530
MB668338	50-05-530
MB668540	56-05-501
MB668722	50-05-524
MB668745	55-05-587
MB668745	55-05-526
MB668746	55-05-526
MB668746	55-05-587
MB668747	55-05-587
MB668747	55-05-526
MB668886	60-05-530
MB699116	55-05-520
MB699117	55-05-520
MB699174	50-05-530
MB699266	50-05-530
MB699281	60-05-538
MB699282	60-05-532
MB699283	60-05-532
MB699285	60-05-533
MB699287	61-05-514
MB699290	56-05-506
MB699291	56-05-507

MB699334	51-05-504
MB699346	51-05-504
MB699463	50-05-528
MB699464	50-05-525
MB699702	50-05-530
MB699716	60-05-505
MB699761	60-05-592
MB857336	51-05-594
MB858375	50-05-530
MB858380	51-05-594
MB858400	50-05-599P
MB858400	50-05-599
MB858463	51-05-599
MB858463	51-05-599P
MB858521	51-05-593
MB858665	55-05-587
MB858684	55-05-526
MB858685	55-05-526
MB858686	55-05-526
MB858799	60-05-529
MB87016	50-05-502
MB87061	50-05-525
MB895098	60-05-535
MB895154	55-05-520
MB895161	50-03-310
MB895212	55-05-508
MB895214	55-05-508
MB895258	55-05-528
MB895363	61-05-512
MB895444	60-05-529
MB895464	60-05-583
MB895470	56-05-508
MB895563	61-05-512
MB928049	50-05-599
MB928049	50-05-599P
MB928120	60-05-539
MB928314	51-05-504
MB928697	60-05-599
MB928716	61-05-521
MB928817	50-05-528
MB928994	60-05-522
MB950064	55-05-586
MB950065	55-H0-003
MB950181	67-05-569

MB950350	51-05-594
MB950570	60-05-530
MB950874	60-05-598
MB950951	56-05-500
MB950958	60-05-541
MC889515	55-05-517
MC894589	50-05-507
MC894601	50-05-514
MK499873	50-05-507
MN102276	60-05-534
MN102439	56-05-511
MN102617	50-05-582
MN102622	50-05-515
MN102625	51-05-510
MN102633	55-05-586
MN116329	60-05-543
MN116330	60-05-543
MN116332	61-05-517
MN116445	50-05-509P
MN116445	50-05-509
MN116512	55-05-583
MN116604	50-05-503
MN116929	51-05-508
MN116979	60-05-542
MN150861	55-05-513
MN186120	55-05-511
MN186303	55-05-507
MR 307375	60-05-544
MR 955638	60-05-544
MR128659	60-05-526
MR128661	61-05-523
MR129433	51-05-594
MR129592	50-05-530
MR129595	67-05-595
MR178826	55-05-583
MR178827	55-05-503
MR205144	51-05-594
MR205215	60-05-526
MR205377	51-05-504
MR205575	56-05-502
MR205585	60-05-522
MR249240	50-05-592
MR249779	50-05-528
MR249797	55-05-500



MITSUBISHI	ASHIKA
MR249797 DX	55-05-500
MR249798	55-05-500
MR249798 SX	55-05-500
MR289653	60-05-530
MR307746	56-05-510
MR307779	67-05-514
MR334996	60-05-507
MR334998	60-05-545
MR389512	50-05-528
MR389519	50-05-592
MR389547	50-05-585P
MR389547	50-05-585
MR389549	50-05-599P
MR389549	50-05-599
MR389569	51-05-504
MR389575	51-05-592
MR407116	60-05-516
MR407289	60-05-516
MR407946	50-05-593
MR418067	61-05-515
MR475453	50-05-505
MR485638	55-05-505
MR493392	67-05-528
MR493393	67-05-526
MR493489	61-05-503
MR510539	50-05-509
MR510544	51-05-505
MR510544	51-05-505P
MR510742	60-05-527
MR510966	60-05-537
MR527550	50-05-582
MR527675	50-05-501
MR527868	50-05-509P
MR527868	50-05-509
MR535718	55-05-513
MR569225	50-05-503
MR569403	50-05-501
MR913846	61-05-511
MR955407	61-05-520
MR977365	50-05-515
MT321692	67-05-580
MT321695	67-05-582
MZ690022	51-05-593

MZ690042	51-05-593
MZ690170	51-05-599
MZ690340	50-05-509
X3516006	51-05-505
X3516006	51-05-505P
XB082119	50-03-310
NISSAN	ASHIKA
04491-12012	50-01-124
04491-21110	50-01-108
04491-22052	50-01-108
04491-22070	50-01-108
04491-30080	50-01-116
04491-30081	50-01-116
04491-30120	50-01-116
061002950	60-01-197
06100368-0	60-01-190
06902174.0	67-01-116
06902278.0	67-01-195
06903011-0	67-01-116
06904142.0	67-01-194
06905294-1	50-01-196
06905294-1	50-01-196P
101-624	67-01-199
3225196	67-00-098
3225197	67-00-099
36160-C6025	55-01-133
36160-C9625	55-01-111
40060-06F86	50-01-141
40060-32F86	50-01-141
40060-D1787	50-01-141
40060-F5027	50-01-137
40060-F5027	50-01-141
40206-00QAA	60-01-142
40206-00QAD	60-01-120
40206-00QAE	60-01-134
40206-00QAF	60-01-134
40206-00QAG	60-01-134
40206-00QAH	60-01-134
40206-01B00	60-01-122
40206-01B01	60-01-122
40206-01G00	60-01-131
40206-01G01	60-01-131
40206-01G03	60-01-131
40206-02N01	60-01-143

40206-03P00	60-01-128
40206-03P02	60-01-128
40206-03P11	60-01-137
40206-03P13	60-01-137
40206-03P14	60-01-137
40206-03R00	60-01-125
40206-05A00	60-01-119
40206-05A01	60-01-119
40206-07P01	60-01-153
40206-07P10	60-01-153
40206-07P11	60-01-153
40206-07P12	60-01-153
40206-09W00	60-01-129
40206-09W01	60-01-129
40206-0M600	60-01-136
40206-0M601	60-01-136
40206-0M602	60-01-136
40206-0M801	60-01-135
40206-0M802	60-01-135
40206-10W00	60-01-132
40206-10W01	60-01-132
40206-15E00	60-01-127
40206-15E01	60-01-127
40206-16E00	60-01-187
40206-16R00	60-01-125
40206-17B01	60-01-148
40206-1HA0A	60-01-155
40206-1KA3A	60-01-154
40206-21B01	60-01-189
40206-22P01	60-01-149
40206-22P02	60-01-149
40206-27B01	60-01-150
40206-2F501	60-01-108
40206-2N301	60-01-111
40206-31G00	60-01-144
40206-31G01	60-01-144
40206-35G00	60-01-132
40206-35G01	60-01-132
40206-3LG0A	60-01-160
40206-3Y502	60-01-158
40206-40F01	60-01-151
40206-40F02	60-01-151
40206-40P02	60-01-194
40206-4U103	60-01-158



CROSS REFERENCE LIST
VERGLEICHLISTE
LISTA DE REFERENCIAS CRUZADES
LISTA DE COMPARAISON
LISTA DI COMPARAZIONE

NISSAN	ASHIKA
40206-54C01	60-01-185
40206-55F01	60-01-108
40206-58A00	60-01-139
40206-58A01	60-01-139
40206-5F001	60-01-198
40206-60Y01	60-01-139
40206-61A01	60-01-138
40206-61A11	60-01-138
40206-6W500	60-01-145
40206-71E01	60-00-015
40206-71E02	60-00-015
40206-71E05	60-01-196
40206-71E06	60-00-015
40206-72B00	60-01-113
40206-88E01	60-01-140
40206-88E03	60-01-140
40206-88E04	60-01-140
40206-90J01	60-00-010
40206-93J01	60-00-015
40206-94M01	60-01-146
40206-9C001	60-01-183
40206-9C100	60-01-191
40206-9X200	60-01-110
40206-9X401	60-01-117
40206-9X403	60-01-105
40206-AX602	60-00-013
40206-B9500	60-01-153
40206-C7000	60-01-126
40206-C7001	60-01-126
40206-CA010	60-01-152
40206-D0360	60-01-121
40206-D0361	60-01-121
40206-D4001	60-01-187
40206-EB300	60-01-115
40206-EB320	60-01-109
40206-EG000	60-01-152
40206-F3901	60-01-190
40206-G9500	60-01-126
40206-H1006	60-01-118
40206-JD00A	60-01-157
40206-JG00A	60-01-157
40206-M0800	60-01-114
40206-M3200	60-01-116

40206-M5600	60-01-101
40206-M7900	60-01-100
40206-MB600	60-01-161
40206-N3100	60-01-107
40206-P6500	60-01-112
40206-P6502	60-01-112
40206-P6510	60-01-112
40206-P7200	60-01-112
40206-P7210	60-01-112
40206-R8210	60-01-123
40206-R8211	60-01-123
40206-T6400	60-01-188
40206-U6700	60-01-102
40206-U7600	60-01-104
40206-VB000	60-01-103
40206-W1060	60-01-124
40206-W1070	60-01-124
40206-W1210	60-01-106
40206-W1260	60-01-106
40206-W1265	60-01-106
40206-W1270	60-01-106
40206-Y9500	56-01-101
40206-Y9503	60-01-199
402064A00G	60-08-822
40206EM10A	60-01-159
40207-15025	60-01-199
40207-15C25	60-01-199
40207-41L25	60-01-133
41060-00QAE	50-01-109
41060-00QAG	50-01-114
41060-01A90	50-01-101
41060-01W26	50-01-108
41060-02J91	50-01-134
41060-03A25	50-01-101
41060-04B25	50-01-103
41060-04B90	50-01-103
41060-04B91	50-01-103
41060-05B25	50-01-103
41060-05B26	50-01-103
41060-05B90	50-01-103
41060-07R88	50-01-193
41060-08N90	50-01-137
41060-08N91	50-01-137
41060-08N92	50-01-137

41060-09G90	50-01-137
41060-09W25	50-01-111
41060-09W25	50-01-195
41060-09W25	50-01-111P
41060-09W26	50-01-111
41060-09W26	50-01-111P
41060-09W93	50-01-111P
41060-09W93	50-01-111
41060-0N685	50-01-197
41060-0V090	50-01-143
41060-11P88	50-01-195
41060-11P91	50-01-195
41060-12A25	50-01-101
41060-13A25	50-01-101
41060-13E85	50-01-111
41060-13E85	50-01-111P
41060-13E85	50-01-195
41060-13E90	50-01-111P
41060-13E90	50-01-111
41060-13E90	50-01-195
41060-14A25	50-01-101
41060-15E90	50-01-143
41060-18W25	50-01-108
41060-1E590	50-01-143
41060-1N090	50-01-191
41060-23C90	50-01-137
41060-23C91	50-01-137
41060-23C92	50-01-137
41060-23C93	50-01-137
41060-23C94	50-01-137
41060-23P93	50-01-140
41060-23P94	50-01-140
41060-25A25	50-01-101
41060-28B86	50-01-135
41060-2F025	50-01-179
41060-2F025	50-00-015
41060-2F026	50-01-179
41060-31E86	50-01-111P
41060-31E86	50-01-111
41060-31E90	50-01-111
41060-31E90	50-01-111P
41060-31E90	50-01-195
41060-31E91	50-01-111P
41060-31E91	50-01-111

CROSS REFERENCE LIST
VERGLEICHLISTE
LISTA DE REFERENCIAS CRUZADES
LISTA DE COMPARAISON
LISTA DI COMPARAZIONE



NISSAN	ASHIKA
41060-31E93	50-01-111
41060-31E93	50-01-111P
41060-32G91	50-01-137
41060-32R93	50-01-142
41060-32R93	50-01-144
41060-32R94	50-01-144
41060-32R94	50-01-142
41060-35F90	50-01-135
41060-35F92	50-01-135
41060-35F93	50-01-135
41060-37G93	50-01-111
41060-37G93	50-01-111P
41060-37P90	50-01-147
41060-37P91	50-01-147
41060-38U90	50-01-192
41060-40U90	50-01-143
41060-40U92	50-01-143
41060-40V92	50-01-143
41060-41S86	50-01-105
41060-41S87	50-01-105
41060-44F92	50-01-142
41060-4L090	50-01-143
41060-4M526	50-00-015
41060-4U125	50-01-176
41060-4U126	50-01-176
41060-4U127	50-01-176
41060-50Y94	50-01-197
41060-51E87	50-00-010
41060-52F90	50-01-135
41060-54C87	50-00-010
41060-55F90	50-01-143
41060-58A86	50-01-135
41060-5M325	50-01-179
41060-62A90	50-01-101
41060-62A92	50-01-101
41060-62C90	50-01-197
41060-63C90	50-01-197
41060-64B10	50-01-135
41060-67A85	50-01-135
41060-67A90	50-01-101
41060-67R86	50-01-149
41060-71A89	50-01-135
41060-71J25	50-00-015

41060-71J26	50-00-015
41060-72A85	50-01-135
41060-72A86	50-01-135
41060-72A87	50-01-135
41060-72A88	50-01-135
41060-72A89	50-01-135
41060-72J25	50-00-010
41060-73A85	50-01-135
41060-73L85	50-01-143
41060-73L92	50-01-143
41060-73L93	50-01-143
41060-74F92	50-01-188
41060-75A92	50-01-101
41060-75T90	50-01-143
41060-75T91	50-01-143
41060-76A86	50-01-135
41060-76A87	50-01-135
41060-76A89	50-01-135
41060-80N90	50-01-142
41060-88E85	50-01-143
41060-88E91	50-01-143
41060-88E92	50-01-143
41060-88E94	50-01-143
41060-89A90	50-01-101
41060-89A91	50-01-101
41060-89E90	50-01-143
41060-89E91	50-01-143
41060-8H785	50-01-154
41060-94M85	50-01-135
41060-94M86	50-01-135
41060-99B25	50-00-012
41060-9C525	50-00-017P
41060-9C525	50-00-017
41060-9C526	50-00-017
41060-9C526	50-00-017P
41060-9X129	50-01-122
41060-9X226	50-01-110
41060-9X525	50-01-110
41060-A1126	50-01-102
41060-AX625	50-00-013
41060-B9526	50-01-108
41060-B9527	50-01-108
41060-C7126	50-01-132
41060-C7190	50-01-134

41060-C7192	50-01-134
41060-C7194	50-01-134P
41060-C7194	50-01-134
41060-C7892	50-01-134
41060-C7892	50-01-134P
41060-C7893	50-01-134
41060-C8185	50-01-134
41060-C8186	50-01-134P
41060-C8186	50-01-134
41060-CA090	50-01-118
41060-CA092	50-01-118
41060-CA093	50-01-118
41060-CG00J	50-01-118
41060-CG090	50-01-118
41060-CG091	50-01-118
41060-D1426	50-01-105
41060-D1426KE	50-01-105
41060-D1485	50-01-105
41060-D1486	50-01-105
41060-D1488	50-01-111
41060-D1488	50-01-195
41060-D1488	50-01-111P
41060-D1490	50-01-105
41060-D1726	50-01-105
41060-D6225	50-01-196P
41060-D6225	50-01-196
41060-D8593	50-01-108
41060-EB325	50-01-115
41060-EB326	50-01-121
41060-F5027	50-01-105
41060-F5029	50-01-105
41060-F5085	50-01-105
41060-G490A	50-01-196
41060-G8191	50-01-144
41060-G9501	50-01-134
41060-H1025	50-01-100
41060-M0125	50-01-124
41060-M0825	50-01-124
41060-M0826	50-01-124
41060-M0827	50-01-124
41060-M0828	50-01-100
41060-M3228	50-01-100
41060-M4325	50-01-100
41060-M4925	50-01-100



CROSS REFERENCE LIST
VERGLEICHLISTE
LISTA DE REFERENCIAS CRUZADAS
LISTA DE COMPARAISON
LISTA DI COMPARAZIONE

NISSAN	ASHIKA
41060-N4427	50-01-108
41060-N8525	50-01-108
41060-N9625	50-01-108
41060-N9685	50-01-108
41060-P6690	50-01-105
41060-P9125	51-01-122
41060-R5225	50-01-108
41060-R9	50-01-116
41060-R9025	50-01-116
41060-R9025	50-01-116
41060-R9	
41060-R9090	50-01-116
41060-R9093	50-01-116
41060-S0426	50-01-108
41060-S3427	50-01-108
41060-T7891	50-01-134
41060-T7893	50-01-134P
41060-T7893	50-01-134
41060-T7894	50-01-134
41060-U4026	50-01-102
41060-U6727	50-01-112
41060-U6728	50-01-112
41060-U7426	50-01-112
41060-U8725	50-01-108
41060-U8925	50-01-108
41060-U9525	50-01-112
41060-U9525	50-01-108
41060-V6728	50-01-112
41060-V6791	50-01-111
41060-V6791	50-01-111P
41060-V6794	50-01-111P
41060-V6794	50-01-111
41060-V7085	50-01-137
41060-V7091	50-01-137
41060-VB290	50-01-178
41060-VC091	50-01-178
41060-W1225	50-01-105
41060-W2225	50-01-105
41060-W2226	50-01-105
41060-W2285	50-01-105
41060-W2725	50-01-105
41060-W2727	50-01-105
41060-W5626	50-01-112

41060-W5627	50-01-112
4106000QAD	50-01-151
410606N091	50-01-150
410606N0X1	50-01-150
4106095FOA	50-01-150
4106095FOB	50-01-150
41060BM525	50-01-179
4160-04B25	50-01-103
41L26-41L27	60-01-133
43200-00Q0C	56-01-112
43200-00QAG	56-01-112
43202-03E01	61-01-124
43202-08M02	56-01-116
43206-00QAA	61-01-102
43206-00QAB	61-01-103
43206-00QAC	61-01-103
43206-00QAD	61-01-103
43206-02P01	61-01-112
43206-05J03	61-01-116
43206-05J04	61-01-116
43206-06P00	61-01-117
43206-06P01	61-01-117
43206-07P00	61-01-118
43206-07P01	61-01-118
43206-07P11	61-01-118
43206-08G11	56-01-113
43206-0F001	56-01-109
43206-14F09	61-01-114
43206-14F10	61-01-114
43206-15G11	56-01-114
43206-16E06	61-01-197
43206-1HA0A	56-01-115
43206-21B10	56-01-119
43206-24P01	61-01-113
43206-2F010	56-01-102
43206-2S600	56-01-103
43206-31G11	56-01-114
43206-31U12	61-01-101
43206-32G01	61-01-119
43206-42R01	61-00-016
43206-43P01	61-01-199
43206-43P01/2	61-01-199
43206-43P02	61-01-199
43206-44F01	61-01-121

43206-44F02	61-01-121
43206-4U001	61-01-101
43206-4U103	61-01-156
43206-50Y10	56-01-106
43206-53A01	61-01-136
43206-54C01	61-01-126
43206-54C03	61-01-131
43206-58Y01	61-01-130
43206-5F001	61-01-198
43206-5F011	56-01-105
43206-5F013	56-01-105
43206-88E03	61-01-123
43206-8H305	61-01-158
43206-8H701	61-01-158
43206-97J10	56-01-108
43206-99B25	51-01-197
43206-99B85	51-01-197
43206-99J01	61-00-015
43206-99J04	61-01-155
43206-AX650	56-01-104
43206-C6000	56-01-100
43206-CA000	61-01-106
43206-EB300	61-01-100
43206-EB360	56-01-120
43206-EG000	61-01-106
43206-G9500	56-01-100
43206-JD00A	61-01-120
43206-MB600	61-01-107
43206-N9500	61-01-111
43206-N9501	61-01-111
43206-N9502	61-01-111
43206-P9600	61-01-115
43206-P9601	61-01-115
43206-VB000	61-01-116
43206-VM00B	56-01-113
43206-VM30B	56-01-103
43206-WL000	61-01-106
432060W710	56-01-103
4320637G10	56-01-107
432064Z801	56-01-111
432066N000	56-01-111
432069C000	56-01-117
43207-9X100	61-01-104
43211-07P11	61-01-113

CROSS REFERENCE LIST
VERGLEICHLISTE
LISTA DE REFERENCIAS CRUZADES
LISTA DE COMPARAISON
LISTA DI COMPARAZIONE



NISSAN	ASHIKA
43222-50A00	56-01-116
44000 P7200	67-01-155
44010 P7200	67-01-155
44010-N3001	67-01-155
44010-S5900	67-01-150
440101W610	56-01-103
44060-00QAG	55-01-105
44060-01A25	55-01-101
44060-01A25	55-01-101
44060-41	
44060-01B25	55-01-103
44060-01J25	55-01-140
44060-01P25	51-01-122
44060-01P90	51-01-122
44060-01P91	51-01-121
44060-01P92	51-01-122
44060-01W25	55-01-128
44060-04A25	55-01-104
44060-04B25	55-01-103
44060-04S26	51-01-121
44060-04S27	51-01-121
44060-04U86	51-01-129
44060-05N25	55-01-138
44060-05W25	55-01-128
44060-06F25	55-01-106
44060-08E90	51-01-123
44060-08G25	55-01-138
44060-0M890	51-01-196
44060-0N690	51-01-127
44060-0X825	55-01-109
44060-10V85	51-01-124
44060-16C25	55-01-138
44060-16C26	55-01-137
44060-16C26	55-01-138
44060-18025	55-01-124
44060-18B25	55-01-124
44060-18B25	55-01-103
44060-20J25	55-01-140
44060-20W25	55-01-129
44060-21B25	55-01-103
44060-21G25	55-01-129
44060-21G25	55-01-136
44060-21P86	51-01-124

44060-25G25	55-01-136
44060-28B25	55-01-103
44060-32G85	51-01-128
44060-32G86	51-01-128
44060-33F90	51-01-121
44060-35F90	51-01-121
44060-35F91	51-01-122
44060-35F91	51-01-194
44060-3F025	51-00-015
44060-3J325	55-01-199
44060-41A25	55-01-101
44060-45L85	51-01-124
44060-47L25	55-01-134
44060-47L26	55-01-134
44060-50100	55-01-107
44060-50125	55-01-107
44060-50A86	51-01-125
44060-50Y25	55-01-142
44060-54C91	51-01-127
44060-55L25	55-01-134
44060-56L25	55-01-134
44060-56L26	55-01-134
44060-56L27	55-01-134
44060-58S85	51-01-124
44060-58Y86	51-01-133
44060-60Y25	55-01-134
44060-61E90	51-01-123
44060-68A25	55-01-101
44060-70J26	51-00-015
44060-70J28	55-00-010
44060-70N25	55-01-134
44060-73A85	51-01-125
44060-78N91	51-01-124
44060-7C325	55-01-195
44060-80W25	55-01-129
44060-8H385	51-01-154
44060-8H725	55-01-115
44060-8M126	55-01-191
44060-90E90	51-01-123
44060-99B25	51-01-197
44060-99B26	55-01-197
44060-9C025	55-01-195
44060-AV725	51-01-138
44060-AX625	55-00-013

44060-CA00J	55-01-114
44060-CY025	55-01-141
44060-D0125	55-01-100
44060-D0125	55-01-100
44060-M4	
44060-D3590	51-01-123
44060-D5725	55-01-134
44060-EA025	55-01-108
44060-EB325	51-01-130
44060-EB327	55-01-113
44060-H6126	55-01-126
44060-H7225	55-01-124
44060-M0225	55-01-112
44060-M1025	55-01-112
44060-M4925	55-01-100
44060-M6126	55-01-126
44060-M7025	55-01-100
44060-N8426	51-01-120
44060-N9594	51-01-121
44060-P6525	51-01-120
44060-P9125	51-01-122
44060-P9194	51-01-122
44060-Q0101	55-01-106
44060-Q0125	55-01-106
44060-Q1225	55-01-106
44060-T0425	55-01-132
44060-T6025	55-01-129
44060-T6425	55-01-132
44060-U8725	55-01-106
44060-V6786	51-01-124
44060-VB190	51-01-137
4406000QAE	51-01-102
4406000QAF	51-01-109
440600W725	55-01-196
4406020J85	51-01-136
4406032J85	51-01-136
4406037G25	55-01-196
4406037G26	55-01-196
4406056G26	55-01-196
440609X129	55-01-109
44060BM426	51-00-015
44070-04A25	55-01-104
44076 9X126	55-01-110
44100-00QAC	67-01-114



CROSS REFERENCE LIST
VERGLEICHLISTE
LISTA DE REFERENCIAS CRUZADES
LISTA DE COMPARAISON
LISTA DI COMPARAZIONE

NISSAN		ASHIKA			
44100-01A00	67-01-166	44100-G2800	67-01-179	D1060-11P87	50-01-195
44100-01J11	67-01-196	44100-G5110	67-01-180	D1060-11P90	50-01-195
44100-01W01	67-01-170	44100-G5110	67-01-181	D1060-11P91	50-01-195
44100-04B00	67-01-107	44100-G5111	67-01-181	D1060-11P92	50-01-111
44100-05N10	67-01-178	44100-G5510	67-01-182	D1060-11P92	50-01-111P
44100-08G10	67-01-173	44100-H6120	67-01-164	D1060-11P93	50-01-195
44100-08W10	67-01-168	44100-M4901	67-01-101	D1060-11P93	50-01-111
44100-08W11	67-01-168	44100-M7000	67-01-100	D1060-11P93	50-01-111P
44100-08W12	67-01-168	44100-N4601	67-01-110	D1060-11P94	50-01-195
44100-08W22	67-01-189	44100-N4602	67-01-150	D1060-1BN0A	50-01-115
44100-0X800	67-01-186	44100-Q1100	67-01-108	D1060-1HA0A	50-08-800
44100-0X900	67-01-111	44100-Q1110	67-01-108	D1060-1KA1A	50-01-143
44100-13A00	67-01-169	44100-U8710	67-01-104	D1060-1MF0A	50-01-115
44100-17C10	67-01-171	44100-U9200	67-01-102	D1060-2S790	50-01-137
44100-35G10	67-01-175	44101-3J310	67-01-161	D1060-2Y991	50-01-143
44100-37G01	67-01-174	44101-70J20	67-01-199	D1060-32E92	50-01-195
44100-37G10	67-01-190	44101-70J20	67-01-199	D1060-32E94	50-01-195
44100-37G10	67-01-174	44101-H6120	67-01-162	D1060-3Y690	50-01-120
44100-37G11	67-01-190	44110 N3001	67-01-155	D1060-88E85	50-01-143
44100-3W400	67-01-183	45022-634-671	50-01-100	D1060-88E86	50-01-143
44100-50C10	67-01-191	52000848	67-00-098	D1060-88E87	50-01-143
44100-55S10	67-01-106	52000849	67-00-099	D1060-88E89	50-01-143
44100-60A10	67-01-192	52005350	56-00-098	D1060-88E90	50-01-143
44100-60A11	67-01-192	55200-62810	50-01-135	D1060-88E91	50-01-143
44100-60A12	67-01-192	55200-63810	50-08-806	D1060-BM40A	50-00-015
44100-6F611	67-01-188	55250-64B10	50-01-135	D1060-BM50A	50-01-179
44100-70J20	65-01-199	55251-64B10	50-01-135	D1060-C7192	50-01-134P
44100-70J21	65-01-199	58101-33C00	50-05-590	D1060-C7192	50-01-134
44100-7F000	67-01-187	58101-33C00	50-01-144	D1060-C7194	50-01-134
44100-7F001	67-01-187	58205-22-C00	55-01-134	D1060-C7194	50-01-134P
44100-9X125	67-01-119	623.5709	67-01-195	D1060-C7892	50-01-134
44100-AX600	67-01-125	623.5921	67-01-194	D1060-C7892	50-01-134P
44100-C7100	67-01-172	6903011	67-01-116	D1060-C8186	50-01-134P
44100-C7101	67-01-172	72519-1630	50-01-101	D1060-C8186	50-01-134
44100-D0100	67-01-193	72519-1631	50-01-101	D1060-CD00C	50-01-113
44100-D0101	67-01-193	72519-1990	50-01-101	D1060-EM10A	50-01-143
44100-D0102	67-01-193	77003-14064	60-01-120	D1060-JD00A	50-01-123
44100-D0110	67-01-109	77003-14107	61-01-102	D1060-JE00A	50-01-123
44100-D5500	67-01-176	7701054772	51-01-109	D1060-JX50B	50-01-128
44100-D5510	67-01-176	AY040-NS121	50-01-118	D1060-MB600	50-01-117
44100-D6200	67-01-115	AY040-NS807	50-01-134	D1060-MB60A	50-01-117
44100-EB360	67-01-118	AY040-NS924	50-01-134	D1060-V6790	50-01-195
44100-ED010	67-01-117	D1060-11P26	50-01-195	D1060-V6793	50-01-195
		D1060-11P28	50-01-195	D1060-V6794	50-01-111P



NISSAN	ASHIKA
D1060-V6794	50-01-111
D1060-VK190	50-01-130
D10601JY00	50-01-127
D1060JL00E	50-01-146
D1060JL00K	50-01-146
D106M-N1887	50-01-135
D106M-N2585	50-01-143
D106M-S1827	50-01-135
D106M-S3685	50-01-134
D10F0-CD028	50-01-113
D4060 9N00A	51-01-154
D4060-01P90	51-01-122
D4060-01P90	51-01-121
D4060-01P91	51-01-121
D4060-01W00	55-01-128
D4060-04S26	51-01-121
D4060-04S27	51-01-121
D4060-1HD3B	55-01-117
D4060-33F90	51-01-121
D4060-35F90	51-01-121
D4060-35F91	51-01-121
D4060-8H385	51-01-154
D4060-8H725	55-01-115
D4060-8M126	55-01-191
D4060-JA00A	51-01-154
D4060-JA00J	51-01-154
D4060-JX00A	55-01-116
D4060-MA000	51-01-101
D4060-N9594	51-01-121
D4060MB40A	51-01-100
D40F0-CD026	51-01-119
D4M60-9N00A	51-01-154
D4M60-9N00B	51-01-154
DA060-05B25	50-01-103
DA060-05B25	50-01-101
DA060-06F93	50-01-141
DA060-13A85	50-01-101
DA060-31E86	50-01-111
DA060-31E86	50-01-111P
DA060-32E94	50-01-111
DA060-32E94	50-01-111P
DA060-B9525	50-01-108
DA060-D1485	50-01-105

DA060-D1486	50-01-108
DA060-M3290	50-01-100
DA060-M4990	50-01-112
DA060-T7890	50-01-134
DA060-T7890	50-01-134P
DA060-W5627	50-01-112
DA060EB325	50-01-115
DD060-P6525	51-01-120
L35-40	50-01-180
NISSAN L35-40	50-01-180
OPEL	ASHIKA
542120	50-0W-W12
93171497	60-00-011
93171500	60-00-009
93183140	51-00-005
93190338	51-00-005
PIAGGIO	ASHIKA
04495-87Z01000	55-06-699
4351287Z02000	60-06-696
PONTIAC	ASHIKA
12510-024	55-00-098
ROVER	ASHIKA
GBP90314AF	50-04-430
SAAB	ASHIKA
12762291	61-00-006
93188377	61-00-007
SMART	ASHIKA
004329V001000000	56-0M-M00
4341V002000000	60-0M-000
4514210010	50-0M-000
4514210112	60-0M-000
4514230008	55-M0-000
454 420 00 18	67-05-525
45442-00001	60-0M-M01
45442-00072	61-0M-M00
48311-05010	67-S0-099
7333V0010000	55-M0-000
96320670/96518606	67-W0-002
C0001431V00200000	50-0M-000
C0003414V00200000	60-0M-000
C0004331V00200000	67-M0-003
C0004332V00200000	67-M0-001
C0006644V001000000	67-M0-002
C0006645V001000000	67-M0-000

SSANGYONG	ASHIKA
41441-05000	60-0S-000
41441-08000	60-0S-S05
41441-08030	60-0S-S01
41441-08130	60-0S-S04
41441-09100	60-0S-S03
41441-21000	60-0S-S02
4144105110	60-0S-000
4144106210	60-0S-000
4144106211	60-0S-000
4144134000	60-0S-S06
48130-05000	50-K0-014
48130-05100	50-09-997
48130-05110	50-09-997
48130-08152	50-0S-S02
48130-08260	50-H0-005
48130-08BA0	50-H0-005
48130-091A0	50-H0-005
48130341A0	50-0H-H14
4813A-21100	50-0S-S01
482220-05000	55-01-194
48250-01000	55-S0-099
48311 05010	67-S0-099
4833A-34010	55-0S-S02
4833A34000	55-0S-S03
483KT05010	55-0S-S01
48401-05100	61-0S-000
48401-05101	61-0S-099
48401-09000	61-0S-S02
48401-09100	61-0S-S01
48401-21000	61-0S-S01
48401-34000	61-0S-S04
4840134100	61-0S-S03
48411-05000	51-09-997
48413-08051	51-0S-S01
48413-090A1	51-0S-S01
48413-091A1	51-0S-S02
48413-21A10	51-0S-S02
48413341A0	51-0K-K06
SUBARU	ASHIKA
04465-B1110	50-08-809
25177-GA-380	67-07-702
25177-GA350	67-07-704
25177-GA360	67-07-711



CROSS REFERENCE LIST
VERGLEICHLISTE
LISTA DE REFERENCIAS CRUZADES
LISTA DE COMPARAISON
LISTA DI COMPARAZIONE

SUBARU	ASHIKA
25178-GA100	55-07-705
25178-GA180	55-07-704
25178-GA200	55-07-705
25178-GA210	55-07-704
25178-GA211	55-07-704
25178-GA290	55-07-704
25178-GA310	55-07-704
25178-GA400	55-07-705
25191-GA530	51-07-700
25191-GA531	51-07-700
25191-GA532	51-07-700
25191-GA560	50-07-703
25191-GA720	50-07-703
25191-GA730	50-07-703
25191-GA930	50-07-703
25191-GA970	51-07-700
25431-GA170	60-07-703
25431-GA171	60-07-703
25431-GA180	61-07-700
25431-GA181	61-07-700
25431-GA200	60-07-703
25431-GA210	61-07-700
26214-KA020	55-07-797
26214-KA022	55-07-797
26221-KA040	67-07-799
26221-KA050	67-07-798
26221-KA052	67-07-798
26256-AA001	67-07-713
26256-AA011	67-07-712
26256-AA000	67-07-703
26256-AA010	67-07-705
26257-A010	55-07-798
26257-A020	55-07-798
26257-AA000	55-07-798
26257-AA020	55-07-709
26257-AA030	55-07-798
26257-AA040	55-07-709
26257-AA050	55-07-709
26290-KA080	55-07-797
26290-KA090	55-07-797
26290-KA100	55-07-797
26290-TA070	50-07-795
26296-AG040	50-07-706

26296-FE081	50-07-706
26296-SA030	50-07-706
26296-AA000	50-07-705
26296-AA020	50-07-705
26296-AA030	51-07-701
26296-AA060	51-07-701
26296-AA130	51-07-701
26296-AC010	50-07-711
26296-AC011	50-07-711
26296-AC050	50-07-796
26296-FA000	50-07-705
26296-FE020	50-07-706
26296-XA010	50-07-709
26298-AA030	55-07-710
26300-AE071	60-07-711
26300-SA000	60-07-725
26300-SA001	60-07-725
26300-XA00A	60-07-712
26300FE070	60-07-713
26310-AA010	60-07-705
26310-AA011	60-07-705
26310-AA031	60-07-706
26310-AA050	61-07-701
26310-AA111	61-07-702
26310-AA120	60-07-711
26310-AC040	60-07-725
26310-PA030	60-07-710
26310-PA070	61-07-703
26310-PA100	61-07-703
26311-KA000	60-07-707
26340AA010	56-07-700
26690-KC000	55-07-797
26694-AG000	55-07-711
26694FG000	55-05-515
26696-AG010	51-07-704
26696-AG030	51-07-704
26696-FA010	51-07-702
26696-FC002	51-07-702
26696-FE050	51-07-703
26696-XA010	51-07-705
26696XA000	51-07-705
26700-AE062	61-07-707
26700-AE080	61-07-705
26700-AG000	61-07-706

26700-AG001	61-07-706
26700-FE050	61-07-709
26700-FG000	61-07-708
26700-XA00A	61-07-704
29296-AA080	51-07-701
29296-PA060	51-07-701
41060-12A25	50-01-101
41060-25A25	50-01-101
53401-76G00	67-07-799
62520-0173	67-07-700
62520-0182	67-07-702
62520-0372	67-07-704
62520-1111	55-07-701
629031090	50-07-702
7251-77160	67-07-706
7251-77310	67-07-707
72516-1760	55-07-701
72517-7331	67-07-708
72517-7371	67-07-709
72517-8040	55-07-700
72517-8140	55-07-707
72517-8150	55-07-707
72517-8160	55-07-707
72517-8170	55-08-808
72517-8450	55-07-707
72517-8460	55-07-707
72517-8470	55-07-707
72517-8480	55-08-808
72517-8481	55-08-808
72517-8520	55-07-707
72519-1072	50-07-701
72519-1073	50-07-701
72519-1075	50-07-701
72519-1082	50-07-701
72519-1083	50-07-701
72519-1084	50-07-701
72519-1095	50-07-701
72519-1220	50-01-101
72519-1630	50-01-101
72519-1631	50-01-101
72519-1990	50-01-101
72519-3010	50-07-710
72519-3011	50-07-710
72519-3040	50-07-707



SUBARU	ASHIKA
72519-3041	50-07-707
72543-1000	60-07-700
72543-1070	60-07-701
72543-1090	60-07-704
72543-1092	60-07-704
72543-1150	60-07-702
72543-1290	60-07-709
72543-1300	60-07-702
72543-1301	60-07-702
72543-1310	60-07-702
SUZUKI	ASHIKA
00000-A-00154	50-08-899
00000-A00155	55-08-899
00000-A00156	55-08-899
00000-A00529	67-08-894
00000-A00902	55-08-899
00000-A01220	55-08-899
00000A00159	67-08-899
06902317.0	67-08-895
06905238.0	67-08-896
26257-A010	55-08-800
43500-83810	56-08-801
43511-52D00	56-08-812
43511-60A00	56-08-803
43511-60G00	56-08-811
43511-60G10	56-08-811
43511-62B00	56-08-810
43511-65D10	56-08-805
43511-70G20	56-08-808
43511-75F02	56-08-814
43511-76A00	56-08-813
43511-83001	56-08-800
43511-A60A00	56-08-803
43511-A83003	56-08-802
4351160F00	56-08-815
4351177E00	56-08-816
4351184040	56-08-815
52200-56200	55-08-898
52200-56810	55-08-898
52200-56820	55-08-898
52202-72050	55-08-801
52210-56A50	55-08-808
52210-60010	55-08-805

52210-72040	55-08-800
52210-72041	55-08-800
52210-72050	55-08-801
52210-72070	55-08-800
52210-75140	55-08-805
52210-77200	55-08-801
52210-77270	55-08-801
52210-78010	55-08-802
52210-78410	55-08-802
52210-78470	55-08-802
52210-79241	55-08-801
52210-79260	55-08-801
52210-80040	55-08-801
52210-80050	55-08-804
52210-80070	55-08-804
52210-82020	55-08-807
52210-82021	55-08-807
52210-82040	55-08-806
52210-82041	55-08-806
52210-82070	55-08-806
52210-84010	55-08-808
52210-84040	55-08-801
52210-85050	55-08-804
52210-85400	55-08-801
52210-86000	55-08-807
52401-73040	67-08-806
52401-73041	67-08-806
52401-79240	65-08-801
52401-85200	67-08-815
52401-M79220	65-08-801
52402-73040	65-08-806
52402-73041	65-08-806
52402-79240	67-08-801
52403-73040	67-08-807
52403-73041	67-08-807
52403-79240	67-08-800
52403-85200	67-08-814
52403-M79220	67-08-800
52404-73040	65-08-807
52404-73041	65-08-807
52404-79240	65-08-800
52404-M79220	65-08-800
53200-56200	55-08-814
53200-56810	55-08-814

53200-56810	55-08-898
53200-56820	55-08-814
53200-60810	55-08-812
53200-60820	55-08-813
53200-60821	55-08-813
53200-60840	55-08-811
53200-60880	55-08-830
53200-62J01	55-08-815
53200-62J01-000	55-08-815
53200-65D01	55-08-818
53200-65J00	55-08-824
53200-65J01-000	55-08-824
53200-70820	55-08-820
53200-70822	55-08-820
53200-75F01	55-07-797
53200-76G10	55-08-822
53200-76G31	55-08-822
53200-77811	55-08-894
53200-79J00	55-08-817
53200-81A11-000	55-04-411
53200-84E00	55-08-821
53200-M68K00	55-08-825
53201-70A00	55-08-810
53202-70A00	55-08-810
53202-82200	55-08-810
53210-60A00	55-08-812
53210-60B00	55-08-813
53210-60B10	55-08-813
53210-70C00	55-08-811
53210-70C00	55-08-810
53210-70C10	55-08-811
53210-80050	55-08-804
53210-80070	55-08-804
53210-85200	55-08-809
53210-85201	55-08-809
53210-85260	55-08-809
53210-86000	55-08-811
53210-86040	55-08-811
53400-58040	65-08-802
53400-75140	67-08-800
53400-78410	67-08-808
53400-80040	65-08-802
53401-56A00	67-08-813
53401-56B00	65-08-815



CROSS REFERENCE LIST
VERGLEICHLISTE
LISTA DE REFERENCIAS CRUZADES
LISTA DE COMPARAISON
LISTA DI COMPARAZIONE

SUZUKI	ASHIKA
53401-56B60	67-08-830
53401-60A00	67-08-820
53401-62J00	67-08-846
53401-63B00	67-08-832
53401-65D00	67-08-824
53401-70C00	67-08-892
53401-76G00	67-08-841
53401-79740	67-08-803
53401-80040	67-08-802
53401-80050	67-08-811
53401-81010	67-08-809
53401-81A00	67-08-842
53401-82030	67-08-818
53401-83040	67-08-812
53401-83310	67-08-804
53401-83E00	67-08-840
53401-84010	67-08-810
53401-85200	67-08-817
53401-86040	67-08-819
53401-M84010	67-08-810
53402-56B00	67-08-822
53402-56B60	67-08-829
53402-60A00	67-08-821
53402-63B00	67-08-837
53402-65D00	67-08-823
53402-70C00	67-08-893
53402-79740	65-08-803
53402-80050	65-08-811
53402-81A00	67-04-457
53402-83040	65-08-812
53402-83300	65-08-812
53402-85200	67-08-816
53800-60800	55-08-808
53800-60F90	55-08-808
53800-M70F10	55-08-808
54710-72040	55-08-805
54710-72070	55-08-805
55110-70A00	50-08-803
55110-70A00	50-08-803P
55110-80000	50-08-803P
55110-80000	50-08-803
55110-80010	50-08-803
55110-80010	50-08-803P

5511083300	50-08-898
5511083810	50-08-898
55200-50J02	50-08-807
55200-56831	50-08-897
55200-56852	50-04-404
55200-60810	50-08-806
55200-60810	50-08-806P
55200-60820	50-08-806P
55200-60820	50-08-806
55200-60a41	50-08-806
55200-60a41	50-08-806P
55200-60B11-000	50-08-805
55200-60B50	50-04-404
55200-61810	50-01-135
55200-61840	50-01-135
55200-61880	50-08-805
55200-62810	50-01-135
55200-62830	50-01-135
55200-62860	50-01-135
55200-63810	50-08-806P
55200-63810	50-08-806
55200-65J10	50-08-802
55200-65J11	50-08-802
55200-70810	50-08-803P
55200-70810	50-08-803
55200-70812	50-08-803
55200-70812	50-08-803P
55200-70860	50-04-404
55200-77E00	50-08-893
55200-80E10	50-08-818
55200-82830	50-08-804
55200-84A00-000	50-08-897
55200-86810	50-08-805
55200-86820	50-08-805
5520067D00	50-08-897
5520067D11	50-08-802
552050-60B80	50-08-805
55210-56A50	50-04-404
55210-78450	50-04-404
55210-78460	50-04-404
55210-82020	50-08-804
55210-85000	50-04-404
55210-85200	50-04-404
55210-86030	50-08-805

55211-56B00	60-08-808
55211-56B00-000	60-08-808
55211-60A00	60-08-807
55211-65D01	60-08-809
55211-65D10	60-08-811
55211-65D11	60-08-811
55211-65D13	60-08-819
55211-65J00	60-08-821
55211-76J00-000	60-08-824
55211-76J01-000	60-08-824
55211-76J10-000	60-08-808
55211-76J11-000	60-08-825
55211-77E00	60-08-816
55211-80000	60-08-807
55220-82020	50-08-804
55220-86030	50-08-805
55230-86030	50-08-805
55250-60B80	50-08-805
55250-64800	50-01-135
55250-64B00	50-01-135
55250-64B01	50-01-135
55250-64B10	50-01-135
55250-64B20	50-01-135
55251-60B80	50-08-805
55251-64B00	50-01-135
55251-64B01	50-01-135
55251-64B10	50-01-135
55251-64B20	50-01-135
55300-86820	50-08-805
55311-57K01-000	60-08-823
55311-60B11	60-08-801
55311-60B30	60-08-806
55311-61G00	60-08-814
55311-61G01	60-08-814
55311-62G00	60-08-891
55311-62G01	60-08-891
55311-62J00	60-08-815
55311-62J00-000	60-08-815
55311-68L00	60-08-826
55311-68L50	60-08-826
55311-75F00	60-08-812
55311-79J01	60-08-820
55311-80F00	60-08-806
55311-80F01	60-08-806



SUZUKI	ASHIKA
55311-80G00	60-08-890
55311-83E00	60-08-818
55311-86G02	60-08-817
55311-M68K10	60-08-822
55312-57K01-000	60-08-823
55511-60A00	60-08-807
55511-60B30	60-08-806
55511-60B40	60-08-805
55511-75100	60-08-802
55511-78400	60-08-800
55511-78401	60-08-800
55511-80000	60-08-807
55511-82000	60-08-801
55511-82001	60-08-801
55511-86030	60-08-804
55511-86031	60-08-804
55611-64B00	61-08-800
55611-64B01	61-08-800
55611-68L00-000	61-08-801
5561168L00	61-08-801
55800-60G00	50-08-896
55800-61G50	50-08-816
55800-61G60	50-08-816
55800-61G70	50-08-816
55800-62G01	51-06-601
55800-62G60	50-08-816
55800-68420	51-08-800
55800-68L00-000	51-08-801
55810-54G50	50-08-810
55810-54G61	50-08-810
55810-57K00	50-08-820
55810-57K00-000	50-08-820
55810-62J00	50-08-800
55810-62J01-000	50-08-800
55810-62J20-000	50-08-800
55810-62J31-000	50-08-800
55810-63J00	50-08-820
55810-63J00-000	50-08-820
55810-64G00	50-08-815
55810-68L00-000	50-03-343
55810-71L02-000	50-08-820
55810-75F00	50-08-813
55810-75F10	50-08-813

55810-75F32	50-08-813
55810-76G10	50-08-825
55810-79J00	50-08-801
55810-80G01	50-08-809
55810-80J51	50-08-819
55810-83E00	50-08-885
55810-M68K00-000	50-08-809
55860-64B00	51-08-800
55870-64B00	51-08-800
623.5662	67-08-896
623.5708	67-01-116
69023170	67-08-895
72517-8170	55-08-808
72517-8480	55-08-808
72517-8481	55-08-808
96052404	60-08-801
96058796	60-08-807
AS-018L	67-08-893
TATA (TELCO)	ASHIKA
00000-A00156	55-08-899
004491-87719	50-06-697
04465-17101	50-02-203
04465-20100	50-02-293
04465-44020	50-02-264
04465-52011	50-02-203
04491-100101	50-02-202
04491-10020	50-06-600
04491-10041	50-02-202
04491-10042	50-02-202
04491-10142	50-02-202
04491-12012	50-01-124
04491-12081	50-02-210
04491-12093	50-02-228
04491-12260	50-02-229
04491-14033	50-02-228
04491-14141	50-02-242
04491-14141	50-02-231
04491-14150	50-07-701
04491-14210	50-02-245
04491-14210	50-02-265
04491-14230	50-02-245
04491-14230	50-02-265
04491-17120	50-02-258
04491-20032	50-02-228

04491-20051	50-02-228
04491-20100	50-02-235
04491-20111	50-02-228
04491-20220	50-02-235
04491-20380	50-02-249
04491-20720	50-02-237
04491-22071	50-01-108
04491-22111	50-01-108
04491-22170	50-02-232
04491-22171	50-02-232
04491-22172	50-02-232
04491-26071	50-02-247
04491-28081	50-02-242
04491-28120	50-02-242
04491-28220	50-02-259
04491-30150	50-01-116
04491-30170	50-01-116
04491-30171	50-01-116
04491-32010	50-02-235
04491-32081	50-02-235
04491-32151	50-02-237
04491-32152	50-02-237
04491-35010	50-02-224
04491-35021	50-02-224
04491-35061	50-02-247
04491-50020	50-02-264
04491-60030	50-02-236P
04491-60030	50-02-236
04491-60050	50-02-236
04491-60050	50-02-236P
04491-60080	50-02-254P
04491-60080	50-02-254
04491-87603	50-06-601
04491-87605	50-06-601
04491-87716	50-06-602
04492-12031	51-02-207
04492-14071	51-02-210
04492-14100	51-02-206
04492-20010	51-02-213
04492-20011	51-02-213
04492-20021	51-02-213
04492-20060	51-02-213
04492-32080	51-02-213
04492-50020	51-02-212



TATA (TELCO)	ASHIKA
04492-60020	51-02-210
04492-87102	51-06-601
04492-87702	51-06-600
04494-87602	55-06-600
04494-87604	55-06-600
04495-10050	55-02-200
04495-10081	55-02-236
04495-12060	55-02-206
04495-12062	55-02-206
04495-12081	55-02-234
04495-12090	55-02-234
04495-12150	55-02-299
04495-12181	55-02-299
04495-12181	55-02-206
04495-16020	55-02-206
04495-16021	55-02-209
04495-20150	55-02-201
04495-22021	55-02-240
04495-22040	55-02-240
04495-22040A	55-02-240
04495-25110	55-02-239
04495-28010	55-02-206
04495-60010	55-02-205
04495-60020	55-02-205
04495-60050	55-02-205
04495-87401	55-06-601
04495-87502	55-06-604
04495-87602	55-06-607
04495-87605	55-06-607
04495-87606	55-06-607
04495-87706	55-06-611
04495-87709	55-06-603
04879-138AC	60-09-996
0820-33-625A	50-03-304
0K01A-33-251D	60-0K-009
0K2A-33-23Z	50-K0-002
0K55B-33-251	60-0K-003
0K9A6-26-23ZA	55-K0-000
2101-3502040	67-00-000
2654 4210 0135	56-00-005
2654 4213 0141	56-00-005
2654 4280 0128	50-00-003
2654-4230-0119	67-00-003

2654-4230-0132	55-00-003
2654-4230-0133	55-00-003
2654-4230-0134	55-00-003
265442300151	55-00-003
2667 3375 3701	60-00-005
2699 4280 0137	55-00-003
270242100185	50-08-805
270242103714	60-00-081
2719-4210-0114	50-00-001
271942103701	60-00-017
271942103704	60-00-016
277942100114	50-00-080
277942103704	60-00-080
277942300125	67-00-002
277942300126	67-00-004
277942300130	67-00-004
277942300130	67-00-002

TOYOTA	ASHIKA
004491-12030	50-02-228
04465-02030	50-02-201
04465-02050	50-02-216
04465-02061	50-02-211
04465-02130	50-02-211
04465-02190	50-02-244
04465-02200	50-02-250
04465-02210	50-02-250
04465-02280	50-02-244
04465-05020	50-02-282
04465-05050	50-02-221
04465-05080	50-02-221
04465-05090	50-02-221
04465-05131	50-02-206
04465-05210	50-02-206
04465-05260	50-02-276
04465-0D010	50-02-204
04465-0D050	50-02-238
04465-0F010	50-02-244
04465-0H020	50-02-217
04465-0K020	50-02-226
04465-0K130	50-02-225
04465-0K140	50-02-226
04465-0K160	50-02-243
04465-0W141	50-02-219
04465-12540	50-02-264

04465-12610	50-02-269
04465-13020	50-02-203
04465-13030	50-02-212
04465-14080	50-02-295
04465-14081	50-02-295
04465-17101	50-02-203
04465-20100	50-02-293
04465-20120	50-02-264
04465-25020	50-02-285
04465-26050	50-02-224
04465-26100	50-02-286
04465-26320	50-02-286
04465-28460	50-02-270
04465-28490	50-02-271
04465-2B020	50-02-263
04465-30110	50-02-295
04465-30270	50-02-295
04465-30271	50-02-295
04465-33320	50-02-218
04465-35140	50-02-291
04465-35210	50-02-236
04465-35220	50-02-214
04465-35270	50-02-214
04465-35290	50-02-205
04465-42080	50-02-280
04465-42110	50-02-280
04465-42130	50-02-280
04465-42140	50-02-230
04465-42160	50-02-269
04465-42190	50-02-230
04465-44020	50-02-264
04465-44060	50-02-213
04465-52010	50-02-203
04465-52011	50-02-203
04465-52200	50-02-219
04465-52270	50-02-220
04465-53010	50-02-295
04465-59020	50-02-281
04465-60020	50-02-292
04465-60110	50-02-292
04465-60120	50-02-268
04465-60280	50-02-272
04465-74020	50-02-275
04465-YZZAA	50-02-235

CROSS REFERENCE LIST
VERGLEICHLISTE
LISTA DE REFERENCIAS CRUZADES
LISTA DE COMPARAISON
LISTA DI COMPARAZIONE



TOYOTA	ASHIKA
04465-YZZAB	50-02-264
04465-YZZAD	50-02-286
04465-YZZAL	50-02-292
04465-YZZAX	50-02-256
0446533440	50-02-277
0446533450	50-02-277
0446560120	50-02-268
04466-02020	51-02-257
04466-02060	51-02-219
04466-02070	51-02-257
04466-02180	51-02-220
04466-02181	51-02-220
04466-02190	51-02-220
04466-05010	51-02-200
04466-05040	51-02-223
04466-0D010	51-02-225
04466-0F010	51-02-224
04466-12120	51-02-213
04466-12130	51-02-214
04466-14010	51-02-294
04466-17080	51-02-204
04466-20130	51-02-219
04466-28020	51-02-262
04466-28040	51-02-258
04466-32010	51-02-213
04466-33130	51-02-216
04466-42020	51-02-256
04466-42050	51-02-256
04466-42060	51-02-218
04466-47020	51-02-214
04466-52010	51-02-203
04466-52120	51-02-214
04466-52140	51-02-214
04466-60010	51-02-210
04466-60020	51-02-210
04466-60030	51-02-259
04466-60070	51-02-259
04466-60090	51-02-210
04466-60110	51-02-259
04466-60120	51-02-221
04466-YZZC4	51-02-259
04491-100101	50-02-202
04491-10020	50-06-600

04491-10030	50-02-202
04491-10040	50-02-202
04491-10041	50-02-202
04491-10042	50-02-202
04491-10060	50-02-202
04491-10070	50-02-202
04491-10101	50-02-202
04491-10142	50-02-202
04491-10160	50-02-235
04491-12030	50-02-228
04491-12031	50-02-228
04491-12050	50-02-210
04491-12060	50-02-210
04491-12061	50-02-210
04491-12063	50-02-210
04491-12080	50-02-210
04491-12081	50-02-210
04491-12093	50-02-228
04491-12190	50-02-229
04491-12230	50-02-235
04491-12231	50-02-235
04491-12240	50-02-235
04491-12241	50-02-235
04491-12250	50-02-235
04491-12260	50-02-235
04491-12260	50-02-229
04491-12280	50-02-235
04491-12290	50-02-235
04491-12320	50-02-235
04491-12421	50-02-235
04491-12590	50-02-263
04491-12650	50-02-264
04491-14011	50-02-228
04491-14030	50-02-228
04491-14031	50-02-228
04491-14032	50-02-228
04491-14033	50-02-228
04491-14090	50-02-228
04491-14140	50-02-231
04491-14141	50-02-242
04491-14141	50-02-231
04491-14141	50-02-235
04491-14150	50-07-701
04491-14150	50-02-229

04491-14160	50-02-231
04491-14200	50-02-245
04491-14210	50-02-265
04491-14210	50-02-245
04491-14230	50-02-245
04491-14230	50-02-265
04491-14240	50-02-245
04491-16030	50-02-235
04491-16040	50-02-235
04491-16041	50-02-235
04491-16050	50-02-235
04491-16200	50-02-235
04491-17020	50-02-235
04491-17021	50-02-235
04491-17100	50-02-258
04491-17110	50-02-258
04491-17120	50-02-258
04491-20031	50-02-228
04491-20032	50-02-228
04491-20050	50-02-228
04491-20051	50-02-228
04491-20051	55-06-601
04491-20100	50-02-235
04491-20111	50-02-228
04491-20170	50-02-235
04491-20220	50-02-235
04491-20310	50-02-235
04491-20311	50-02-235
04491-20360	50-02-249
04491-20380	50-02-249
04491-20390	50-02-247
04491-20391	50-02-247
04491-20480	50-02-237
04491-20481	50-02-237
04491-20501	50-02-235
04491-20581	50-02-247
04491-20680	50-02-237
04491-20720	50-02-237
04491-22150	50-02-232
04491-22160	50-02-232
04491-22161	50-02-232
04491-22162	50-02-232
04491-22170	50-02-232
04491-22171	50-02-232



CROSS REFERENCE LIST
VERGLEICHLISTE
LISTA DE REFERENCIAS CRUZADES
LISTA DE COMPARAISON
LISTA DI COMPARAZIONE

TOYOTA	ASHIKA
04491-22172	50-02-232
04491-25020	50-02-285
04491-25030	50-02-285
04491-25030	50-02-267
04491-26040	50-02-247
04491-26060	50-02-224
04491-26070	50-02-247
04491-26071	50-02-247
04491-26100	50-02-286
04491-26110	50-02-286
04491-26150	50-02-247
04491-26151	50-02-247
04491-26160	50-02-286
04491-26170	50-02-286
04491-26180	50-02-286
04491-26210	50-02-286
04491-26250	50-02-224
04491-26270	50-02-286
04491-27010	50-02-233
04491-28080	50-02-242
04491-28081	50-02-242
04491-28120	50-02-242
04491-28150	50-02-239
04491-28220	50-02-259
04491-2B040	50-02-293
04491-30150	50-01-116
04491-30341	50-02-295
04491-32010	50-02-235
04491-32031	50-02-235
04491-32081	50-02-235
04491-32150	50-02-237
04491-32152	50-02-237
04491-33040	50-02-264
04491-33040	50-02-245
04491-33091	50-02-245
04491-35010	50-02-224
04491-35020	50-02-224
04491-35021	50-02-224
04491-35061	50-02-247
04491-35070	50-02-236
04491-35070	50-02-236P
04491-35071	50-02-236
04491-35071	50-02-236P

04491-35080	50-02-236P
04491-35080	50-02-236
04491-35190	50-02-254P
04491-35190	50-02-254
04491-35200	50-02-247
04491-50020	50-02-245
04491-50020	50-02-264
04491-50020	50-02-265
04491-50060	50-02-235
04491-60010	50-02-236
04491-60010	50-02-236P
04491-60030	50-02-236P
04491-60030	50-02-236
04491-60040	50-02-236P
04491-60040	50-02-236
04491-60050	50-02-236P
04491-60050	50-02-236
04491-60080	50-02-254
04491-60080	50-02-254P
04491-60110	50-02-256
04491-60150	50-02-292
04491-60160	50-02-292
04491-60170	50-02-292
04491-60180	50-02-255
04492-12030	51-02-207
04492-12031	51-02-207
04492-14002	50-02-259
04492-14070	51-02-210
04492-14070	51-02-261
04492-14071	51-02-210
04492-14090	51-02-206
04492-14100	51-02-206
04492-14110	51-02-206
04492-17010	51-02-204
04492-17030	51-02-204
04492-17040	51-02-213
04492-20010	51-02-213
04492-20011	51-02-213
04492-20020	51-02-213
04492-20021	51-02-213
04492-20030	51-02-213
04492-20050	51-02-213
04492-20060	51-02-213
04492-20090	51-02-213

04492-20110	51-02-294
04492-22010	51-02-202
04492-22020	51-02-202
04492-28020	51-02-262
04492-32070	51-02-213
04492-32080	51-02-213
04492-50011	51-02-212
04492-50020	51-02-212
04492-60010	51-02-210
04492-60020	51-02-210
04494-60010	55-02-210
04494-60020	55-02-211
04495-05010	55-02-220
04495-05020	55-02-216
04495-0D020	55-02-212
04495-0D040	55-02-221
04495-0D090	55-02-221
04495-0K010	55-02-219
04495-0K060	55-02-219
04495-0K070	55-02-215
04495-0K120	55-02-217
04495-10020	55-02-200
04495-10021	55-02-200
04495-10040	55-02-200
04495-10041	55-02-200
04495-10042	55-02-200
04495-10050	55-02-200
04495-10050	55-02-202
04495-10060	55-02-202
04495-10061	55-02-202
04495-10070	55-02-236
04495-10071	55-02-236
04495-10080	55-02-236
04495-10081	55-02-236
04495-10110	55-02-247
04495-10120	55-02-247
04495-12010	55-02-206
04495-12050	55-02-206
04495-12051	55-02-206
04495-12060	55-02-206
04495-12061	55-02-206
04495-12062	55-02-206
04495-12070	55-06-601
04495-12080	55-02-234

CROSS REFERENCE LIST
VERGLEICHLISTE
LISTA DE REFERENCIAS CRUZADES
LISTA DE COMPARAISON
LISTA DI COMPARAZIONE



TOYOTA	ASHIKA
04495-12081	55-02-234
04495-12082	55-02-234
04495-12083	55-02-234
04495-12090	55-02-234
04495-12111	55-02-234
04495-12120	55-02-299
04495-12141	55-02-206
04495-12150	55-02-299
04495-12170	55-02-234
04495-12171	55-02-234
04495-12181	55-02-206
04495-12181	55-02-299
04495-12220	55-02-234
04495-14010	55-06-601
04495-14020	55-06-601
04495-14021	55-06-601
04495-14040	55-06-601
04495-14041	55-06-601
04495-16010	55-02-202
04495-16011	55-02-202
04495-16020	55-02-200
04495-16020	55-02-209
04495-16020	55-02-206
04495-16021	55-02-209
04495-16021	55-02-200
04495-16060	55-02-200
04495-20011	55-02-206
04495-20020	55-06-601
04495-20021	55-06-601
04495-20022	55-06-601
04495-20050	55-06-601
04495-20051	55-06-601
04495-20060	55-06-601
04495-20061	55-06-601
04495-20070	55-02-237
04495-20080	55-06-601
04495-20090	55-02-201
04495-20091	55-02-201
04495-20092	55-02-201
04495-20100	55-02-201
04495-20101	55-02-201
04495-20102	55-02-201
04495-20120	55-02-201

04495-20121	55-02-201
04495-20150	55-02-201
04495-22010	55-02-234
04495-22010	55-02-201
04495-22011	55-02-206
04495-22011	55-02-201
04495-22020	55-02-240
04495-22020	55-06-601
04495-22020	55-02-201
04495-22021	55-06-601
04495-22021	55-02-240
04495-22021	55-02-201
04495-22021	55-02-206
04495-22040	55-02-240
04495-22040	55-06-601
04495-22041	55-02-240
04495-22041	55-06-601
04495-25010	55-02-210
04495-25051	55-02-224
04495-25051	55-02-233
04495-25052	55-02-233
04495-25060	55-02-237
04495-25090	55-02-224
04495-25090	55-02-233
04495-25100	55-02-233
04495-25101	55-02-233
04495-25111	55-02-239
04495-25120	55-02-233
04495-25121	55-02-233
04495-25122	55-02-233
04495-25151	55-02-239
04495-26020	55-02-224
04495-26020	55-02-233
04495-26021	55-02-224
04495-26040	55-02-233
04495-26040	55-02-224
04495-26041	55-02-233
04495-26051	55-02-239
04495-26060	55-02-239
04495-26061	55-02-239
04495-26110	55-02-237
04495-26111	55-02-237
04495-26121	55-02-237
04495-26180	55-02-242

04495-27040	55-06-601
04495-27041	55-06-601
04495-27050	55-06-601
04495-27051	55-06-601
04495-28010	55-02-206
04495-28011	55-02-206
04495-28040	55-02-237
04495-28041	55-02-237
04495-28050	55-02-237
04495-28051	55-02-237
04495-35170	55-02-237
04495-35200	55-02-242
04495-36070	55-02-229
04495-40020	55-02-237
04495-40021	55-02-237
04495-42050	55-02-214
04495-42080	55-02-214
04495-44010	55-02-297
04495-52020	55-02-204
04495-52100	55-02-204
04495-60010	55-02-205
04495-60011	55-02-205
04495-60020	55-02-205
04495-60021	55-02-205
04495-60040	55-02-237
04495-60041	55-02-237
04495-60050	55-02-205
04495-60051	55-02-205
04495-60060	55-02-205
04495-60061	55-02-237
04495-74020	55-02-204
04495-87401	55-06-601
0449502070	55-02-232
0449502120	55-02-232
0449502180	55-02-232
0449502190	55-02-232
0449505040	55-02-231
04497-12060	55-02-234
04497-14010	55-06-601
04497-14020	55-06-601
04497-26020	55-02-233
04497-26020	55-02-224
04497-36080	55-02-229
04497-36090	55-02-229



CROSS REFERENCE LIST
VERGLEICHLISTE
LISTA DE REFERENCIAS CRUZADES
LISTA DE COMPARAISON
LISTA DI COMPARAZIONE

TOYOTA	ASHIKA				
0466-60020	51-02-210	42431-20090	61-02-202	42431-60180	61-02-219
1011-26-610D	67-02-259	42431-20100	61-02-205	42431-60200	61-02-209
14491-24080	50-02-285	42431-20150	61-02-208	42431-60201	61-02-209
14495-12110	55-02-234	42431-20190	56-02-208	42431-60280	61-02-223
2981-33-251	60-02-251	42431-20210	61-02-224	42431-60290	61-02-237
41060-P6625	50-01-116	42431-20240	61-02-208	4243104020	56-02-221
42043-19065	61-02-251	42431-20250	56-02-207	424310K090	56-02-219
42431-02070	61-02-217	42431-20420	61-02-210	424310K120	56-02-219
42431-02080	61-02-215	42431-20430	61-02-236	424310K130	56-02-219
42431-02081	61-02-215	42431-24010	61-02-211	4243135110	56-02-221
42431-02100	56-02-211	42431-26081	56-02-220	4243135180	56-02-221
42431-02170	61-02-234	42431-26181	56-02-204	4243135200	56-02-221
42431-05020	56-02-202	42431-28090	61-02-258	42512-26160	60-02-2023
42431-05030	61-02-214	42431-30240	61-02-259	43412-20280	60-02-282
42431-05040	61-02-244	42431-30260	61-02-229	43431-28100	56-02-214
42431-05050	61-02-242	42431-32050	61-02-225	43431-42050	56-02-214
42431-05070	61-02-240	42431-33010	61-02-225	43512 52020	60-02-278
42431-0D010	56-02-212	42431-33040	61-02-225	43512-02060	60-02-276
42431-0D030	56-02-216	42431-33050	61-02-226	43512-02070	60-02-207
42431-0D060	61-02-238	42431-33080	61-02-249	43512-02080	60-02-201
42431-0F010	61-02-231	42431-33130	61-02-247	43512-02081	60-02-201
42431-0F020	61-02-245	42431-33140	61-02-249	43512-02180	60-02-229
42431-0H010	56-02-203	42431-35030	56-02-210	43512-02190	60-02-264
42431-12070	61-02-200	42431-35130	56-02-210	43512-05010	60-02-281
42431-12090	61-02-201	42431-35190	56-02-210	43512-05020	60-02-215
42431-12130	56-02-207	42431-42040	61-02-221	43512-05030	60-02-279
42431-12150	61-02-235	42431-42041	61-02-221	43512-05040	60-02-211
42431-12180	56-02-207	42431-42060	61-02-230	43512-05070	60-02-235
42431-12190	61-02-248	42431-44010	56-02-205	43512-05090	60-02-2015
42431-12210	61-02-218	42431-47010	56-02-213	43512-06090	60-02-2020
42431-12260	61-02-243	42431-48010	61-02-249	43512-0D010	60-02-278
42431-12280	61-02-234	42431-48020	61-02-249	43512-0D030	60-02-221
42431-12310	61-02-241	42431-50020	61-02-216	43512-0D060	60-02-284
42431-14070	61-02-206	42431-51010	61-02-250	43512-0F010	60-02-264
42431-14100	61-02-207	42431-52020	56-02-206	43512-0F030	60-02-2016
42431-14120	61-02-207	42431-52021	56-02-206	43512-0H010	60-02-269
42431-16031	56-02-209	42431-52050	61-02-222	43512-0K010	60-02-2009
42431-17010	61-02-203	42431-52070	56-02-215	43512-0K030	60-02-2009
42431-17020	61-02-204	42431-52080	61-02-232	43512-0K060	60-02-2008
42431-17030	61-02-213	42431-52150	61-02-239	43512-0K070	60-02-2008
42431-17070	61-02-227	42431-60040	56-02-200	43512-10030	60-02-202
42431-17080	61-02-220	42431-60080	61-02-212	43512-10040	60-02-202
42431-20080	56-02-218	42431-60110	56-02-201	43512-10050	60-02-202
		42431-60170	61-02-219	43512-10060	60-02-241



TOYOTA	ASHIKA
43512-10070	60-02-244
43512-10160	60-02-261
43512-12012	60-02-206
43512-12020	60-02-206
43512-12021	60-02-206
43512-12022	60-02-206
43512-12060	60-02-218
43512-12100	60-02-212
43512-12110	60-02-212
43512-12120	60-02-228
43512-12130	60-02-240
43512-12140	60-02-247
43512-12160	60-02-239
43512-12230	60-02-265
43512-12240	60-02-265
43512-12250	60-02-266
43512-12260	60-02-266
43512-12270	60-02-288
43512-12290	60-02-266
43512-12310	60-02-288
43512-12330	60-02-266
43512-12440	60-02-266
43512-12460	60-02-288
43512-12490	60-02-288
43512-12500	60-02-249
43512-12550	60-02-233
43512-12670	60-02-2018
43512-12680	60-02-264
43512-12690	60-02-229
43512-12710	60-02-2014
43512-13020	60-02-219
43512-13021	60-02-219
43512-13030	60-02-208
43512-14040	60-02-214
43512-14070	60-02-223
43512-14080	60-02-226
43512-14090	60-02-227
43512-14091	60-02-227
43512-14120	60-02-295
43512-14141	60-02-253
43512-16020	60-02-204
43512-16030	60-02-232
43512-16031	60-02-232

43512-16070	60-02-255
43512-16080	60-02-221
43512-16120	60-02-255
43512-16130	60-02-221
43512-17010	60-02-250
43512-17040	60-02-299
43512-17070	60-02-299
43512-17080	60-02-217
43512-17090	60-02-217
43512-17130	60-02-230
43512-20030	60-02-210
43512-20031	60-02-210
43512-20032	60-02-210
43512-20040	60-02-288
43512-20080	60-02-243
43512-20100	60-02-246
43512-20110	60-02-246
43512-20120	60-02-248
43512-20150	60-02-246
43512-20160	60-02-248
43512-20180	60-02-243
43512-20190	60-02-282
43512-20210	60-02-282
43512-20260	60-02-259
43512-20270	60-02-248
43512-20330	60-02-298
43512-20360	60-02-262
43512-20390	60-02-263
43512-20400	60-02-262
43512-20410	60-02-262
43512-20470	60-02-203
43512-20500	60-02-215
43512-20520	60-02-294
43512-20610	60-02-289
43512-20700	60-02-203
43512-21010	60-02-277
43512-22010	60-02-292
43512-22011	60-02-292
43512-22030	60-02-216
43512-22032	60-02-216
43512-22040	60-02-216
43512-22060	60-02-267
43512-22090	60-02-242
43512-25060	60-02-2028

43512-25061	60-02-2028
43512-26030	60-02-222
43512-26031	60-02-222
43512-26040	60-02-270
43512-26081	60-02-296
43512-26081	60-02-293
43512-26090	60-02-268
43512-26140	60-02-2023
43512-28020	60-02-254
43512-28030	60-02-237
43512-28040	60-02-251
43512-28050	60-02-245
43512-28051	60-02-245
43512-28060	60-02-280
43512-28080	60-02-296
43512-28100	60-02-297
43512-28130	60-02-245
43512-28181	60-02-2000
43512-30070	60-02-220
43512-30090	60-02-220
43512-30091	60-02-220
43512-30100	60-02-220
43512-30241	60-02-286
43512-31110	60-02-236
43512-32020	60-02-236
43512-32030	60-02-258
43512-32040	60-02-236
43512-32060	60-02-236
43512-32070	60-02-236
43512-32090	60-02-252
43512-32110	60-02-236
43512-32120	60-02-258
43512-32130	60-02-258
43512-32140	60-02-236
43512-32180	60-02-252
43512-32181	60-02-252
43512-32190	60-02-258
43512-33020	60-02-291
43512-33040	60-02-275
43512-33041	60-02-213
43512-33043	60-02-2002
43512-33060	60-02-275
43512-33100	60-02-2000
43512-35040	60-02-257



CROSS REFERENCE LIST
VERGLEICHLISTE
LISTA DE REFERENCIAS CRUZADES
LISTA DE COMPARAISON
LISTA DI COMPARAZIONE

TOYOTA	ASHIKA
43512-35040	60-02-249
43512-35051	60-02-249
43512-35070	60-02-257
43512-35070	60-02-249
43512-35080	60-02-2021
43512-35081	60-02-2021
43512-35110	60-02-271
43512-35180	60-02-270
43512-35190	60-02-271
43512-35200	60-02-287
43512-35210	60-02-205
43512-35250	60-02-287
43512-35260	60-02-270
43512-35280	60-02-2024
43512-35310	60-02-2024
43512-42010	60-02-274
43512-42030	60-02-229
43512-42031	60-02-229
43512-42040	60-02-2010
43512-42050	60-02-2006
43512-42100	60-02-2006
43512-47020	60-02-276
43512-47030	60-02-2027
43512-47040	60-02-277
43512-47050	60-02-277
43512-48010	60-02-2001
43512-48011	60-02-2001
43512-50040	60-02-292
43512-50060	60-02-283
43512-50100	60-02-286
43512-50120	60-02-286
43512-52040	60-02-221
43512-52120	60-02-2017
43512-60040	60-02-234
43512-60050	60-02-272
43512-60090	60-02-2005
43512-60130	60-02-224
43512-60140	60-02-2019
43512-60150	60-02-2003
43512-60151	60-02-2003
43512-60170	60-02-224
43512-60180	60-02-2011
43512-60190	60-02-2029

43512-60410	60-02-2019
43512-69015	60-02-234
43512-69016	60-02-234
43512-74010	60-02-2012
4351212340	60-02-2022
4351212350	60-02-2022
4351212360	60-02-2022
4351212580	60-02-2022
4351212590	60-02-2022
43516-20010	60-02-289
449132031	50-02-235
46540-28010	55-02-223
46540-42020	55-02-228
46540-44010	55-02-223
46540-50010	55-02-223
46540-60050	55-02-235
4654020080	55-02-231
4654032020	55-02-231
46550-28010	55-02-223
46550-44010	55-02-223
46550-50010	55-02-223
46550-60070	55-02-230
46580-50010	55-02-223
46590-28010	55-02-223
46590-44010	55-02-223
46590-50010	55-02-223
47510-29145	67-02-241
47510-69055	67-02-288
47520-29065	67-02-240
47520-29235	67-02-240
47520-69015	67-02-287
47530-29145	65-02-241
47530-69045	67-02-286
47540-29065	65-02-240
47540-29135	65-02-240
47540-29135	65-02-241
47540-69015	67-02-285
47550 11032	67-02-206
47550-05020	67-02-224
47550-05040	67-02-203
47550-09040	67-02-207
47550-09070	67-02-211
47550-09090	67-02-211
47550-0K010	67-02-223

47550-10042	67-02-215
47550-12060	67-02-208
47550-12060-000	67-02-208
47550-12090	67-02-243
47550-16030	67-02-217
47550-16060	67-02-243
47550-19055	67-02-200
47550-19095	67-02-215
47550-19096	67-02-215
47550-19097	67-02-215
47550-19105	67-02-204
47550-19106	67-02-204
47550-19115	67-02-206
47550-19116	67-02-206
47550-19117	67-02-206
47550-19125	67-02-213
47550-19135	67-02-208
47550-19155	67-02-217
47550-20051	67-02-219
47550-20120	67-02-217
47550-20130	67-02-294
47550-20140	67-02-294
47550-20141	67-02-294
47550-20150	67-02-294
47550-20211	67-02-274
47550-22060	67-02-293
47550-22090	67-02-291
47550-22090-87	67-02-291
47550-22091	67-02-291
47550-22100	67-02-292
47550-22100-87	67-02-292
47550-26090	67-02-249
47550-26100	67-02-212
47550-26110	67-05-527
47550-29105	67-02-213
47550-29105-000	67-02-213
47550-29106	67-02-213
47550-29106-000	67-02-213
47550-29115	67-02-208
47550-29125	67-02-212
47550-29175	67-02-212
47550-29275	67-02-212
47550-29305	67-02-289
47550-30100	67-02-251

CROSS REFERENCE LIST
VERGLEICHLISTE
LISTA DE REFERENCIAS CRUZADES
LISTA DE COMPARAISON
LISTA DI COMPARAZIONE



TOYOTA	ASHIKA
47550-30120	67-02-212
47550-30130	67-02-221
47550-32010	67-02-294
47550-32010	67-02-220
47550-35160	67-02-289
47550-35170	67-02-290
47550-35190	67-02-290
47550-39115	67-02-249
47550-39215	67-02-212
47550-39275	67-02-221
47550-39285	67-02-294
47550-39285	67-02-220
47550-42020	67-02-209
47550-52010	67-02-278
47550-52011	67-02-278
47550-60120	67-02-250
47550-60120	67-02-218
47550-60130	67-02-280
47550-69015	67-02-285
47550-69085	67-02-284
47550-69105	67-02-218
47550-71010	67-02-223
47560-69065	67-02-283
47570-05020	67-02-225
47570-05040	67-02-201
47570-16010	67-02-216
47570-19035	67-02-216
47570-20030	67-02-216
47570-20040	67-02-219
47570-20050	67-02-219
47570-20060	67-02-295
47570-20080	67-02-219
47570-20101	67-02-275
47570-20180	67-02-220
47570-32010	67-02-219
47570-32020	67-02-240
47570-39115	67-02-219
47570-47010	67-02-210
47570-52010	67-02-279
47570-52011	67-02-279
47570-69075	67-02-282
47580-69065	67-02-281
47620-12070B	55-02-201

8982-33-251	60-02-222
91611-60814	67-02-212
94840417	60-02-239
94845061	60-02-243
94846350	60-02-248
AY040-TY019	50-02-292
B001-26-210	55-03-316
B001-26-210A	55-03-316
BOY1-26-28Z	55-03-316

Certificate of Registration



The Governing Board of
Q.A. International Certification Limited
hereby grants to:

JAPANPARTS S.r.l.

Registration No. : QAIC / IT / 90039 - A

(hereinafter called the Registered Company) the right to be listed in the Directory of Registered Companies in respect of the services listed below. These services shall be offered by the Registered Company at or from only the address given below in accordance with the quality management system in compliance with ISO 9001:2008.

Address to which this Certificate refers :

Via Della Meccanica, 1/A 37139 VERONA - Italy

Approved Scope to which this Certificate refers
(Scopo della Certificazione cui il Certificato riferisce)

**Commercialisation of Automotive Parts and Accessories
(Commercializzazione di Ricambi per Autoveicoli)**

(Further clarification regarding the Scope of this Certificate and the applicability of ISO 9001:2008 requirements may be obtained by consulting the organisation)

Signed for and on behalf of the Board

CHAIRMAN
A. J. Duffield

SCHEME MANAGER
A. Carter

Certificate Issue Date : 9th February 2012 - Certificate Expiry Date : 24th January 2013
Date of Initial Registration : 25th January 2000 - Re-assessment Date : 24th January 2015
This Certificate of Registration is granted subject to the Regulations approved by the Board.

QA INTERNATIONAL

Q.A. International Certification Ltd.
Dudley Court
Dudley Road
Darlington
Co. Durham
DL1 4GG

Tel: +44 (0)1325 384272
Fax: +44 (0)1325 480980
www.qai.co.uk



The use of the Accreditation Mark indicates accreditation in respect of the activities covered by the accreditation certificate number 045.

Rechtliche Hinweise - Disclaimer - Avvertenze Legali Information juridique - Advertencias/Juridische Informatie



DE Wir haben uns um die weitestgehende Richtigkeit der in diesem Katalog enthaltenen Angaben bemüht. Wir haften indes nicht für eventuelle Unrichtigkeiten. Dieser Katalog enthält Produkte, die dem Erstausstattungsstandard entsprechen. Wir behalten uns jederzeit technische Änderungen vor. Die im Katalog angeführten Originalnummern und Herstellernamen dienen ausschließlich der Identifizierung des Bauteils und sind nicht auf Lieferscheinen und Rechnungen verwendbar. Die vollständige und auch teilweise Reproduktion unserer Referenzangaben und unseres Katalogs ist verboten.

EN We have made every effort to ensure that the data in this catalogue are as accurate as possible. However, we decline all responsibility for any inaccuracies.
This catalogue contains products of "initial equipment" quality. We reserve the right to make technical changes at any time. The original numbers and manufacturers' names mentioned in this catalogue are provided solely to allow identification of the component and may not be used on delivery notes and invoices.
Even partial reproduction of our references and catalogue is forbidden.

I Ci siamo adoperati affinché i dati contenuti in questo catalogo siano i più esatti possibili. Tuttavia decliniamo ogni responsabilità per eventuali inesattezze.
Questo catalogo contiene prodotti di qualità "primo equipaggiamento". Ci riserviamo il diritto di apportare modifiche tecniche in qualsiasi momento. I numeri originali e i nomi dei fabbricanti citati in questo catalogo servono esclusivamente a scopo identificativo del componente e non possono essere utilizzati sulle bolle di accompagnamento e fatture.
La riproduzione, anche parziale dei nostri riferimenti e del nostro catalogo è vietata.

FR Nous avons fait tout notre possible pour que les données de ce catalogue soient exactes. Toutefois, nous déclinons toute responsabilité pour d'éventuelles inexactitudes.
Ce catalogue contient des produits de qualité "équipement standard". Nous nous réservons le droit d'apporter à tout moment des modifications techniques. Les numéros originaux et les noms des fabricants cités dans ce catalogue servent exclusivement à identifier le composant et ne peuvent pas être utilisés sur les bulletins d'accompagnement et les factures.
La reproduction, même partielle, de nos références et de notre catalogue est rigoureusement interdite.

ES Hemos procurado que los datos que figuran en este catálogo sean lo más exactos posible. No obstante declinamos toda responsabilidad por eventuales imprecisiones.
Este catálogo incluye productos de calidad de "equipos de serie". Nos reservamos el derecho de introducir modificaciones técnicas en cualquier momento.
Los números originales y los nombres de los fabricantes citados en este catálogo se ofrecen exclusivamente a efectos de identificación del componente y no podrán ser empleados en las cartas de porte ni en las facturas.
Queda prohibida la reproducción total o parcial de nuestros códigos de referencia y nuestro catálogo.

NL Wij hebben ons ingespannen om ervoor te zorgen dat de gegevens in deze catalogus zo exact mogelijk zouden zijn. Wij kunnen echter niet aansprakelijk worden gesteld voor eventuele onnauwkeurigheden.
Deze catalogus bevat producten van "standaarduitrusting" kwaliteit. Wij behouden ons het recht voor om op ieder gewenst ogenblik technische wijzigingen aan te brengen. De in deze catalogus genoemde oorspronkelijke nummers en namen van de fabrikanten dienen uitsluitend ter identificatie van de component en kunnen niet worden gebruikt op de geleidebrieven en facturen. De, ook gedeeltelijke, reproductie van ons referentiemateriaal en de catalogus is verboden.

I NOSTRI CATALOGHI OUR CATALOGUES



JA-GENERAL
2011
Catalogo Generale
General Catalogue



JA-FILTRI
2012/2013
FILTRI: carburante, aria, olio, abitacolo, ecologici (gamma completa)
FILTERS: fuel, air, oil, cabin, ecological (complet range)



JA-FRIZIONI
2007
FRIZIONE: dischi, spingidisco, reggispinta, volani, kit con/senza volano, idraulica
CLUTCHES: discs, covers, bearings, flywheel, kit, hydraulic parts



JA-CINGHIE
2007
Cinghie distribuzione, tendicinghia, guidacinghia, kit completi
Timings belt, tensioners, guide, timings kit



JA-CAT5D
2010/2011
Motorini avviamento e alternatori
Starters and alternators



JA-GIUNTI
2008/2009
Kit giunti omocinetici con cuffia fascette e grasso
CV Joints kit, with casing, metal clips and grease



JA-CAT7MM
2008/2009
Ammortizzatori a gas, ammortizzatori sterzo
Gas shock absorbers, steering dampers



JJ-RADIATORI
2011/2012
Radiatori, intercooler, elettroventole, compressori, condensatori, riscaldatori, evaporatori
Radiators, intercooler, fans, compressors, condensers, heaters, evaporators



JA-CAT11
2007
Pompe acqua, termostati, giunti viscositatici, tappi radiatore
Water pumps, thermostates, viscous coupling, radiator caps



JA-CAT12
2008/2009
Spazzole tergi universali, applicazioni Asiatiche ed Europee
Universal wiper blades, Asian and European applications



JA-FLAT
2008/2009
Spazzole tergicristallo tipo Fiat universali
Universal wiper blades, type Fiat



JA-TIRANT
2010/2011
Pari sterzo e sospensioni
Steering and suspension parts



JA-KITRUOTA
2008/2009
Kit cuscinetti ruote
Wheel bearings kit



JA-CAT17
2007
Candele Japanparts
Glowplugs Japanparts



JA-CUFFIE
2007
Kit cuffie con fascette e grasso
Boots kit with metal clips and grease



JA-CROCIERE
2007
Crociere trasmissione
Universal joints



JA-TAMA
2008/2009
Valvole termostatiche TAMA
Thermostatic valves TAMA



JA-NSFILTRI
2012/2013
Prontuario della gamma prodotti esclusi i filtri
Handbook of the products range excluding filters



JA-FAST MOVING
2009/2010
Tutto il Fast Moving asiatico
All the Asian Fast Moving



JA-MMBOOT
2008/2009
Kit parapolvere universali in gomma e uretano per ammortizzatori
Bump rubber kit universal type



JA-COMMERCIAL
2008/2009
I nostri prodotti per veicoli commerciali
Our products for commercial vehicles



JA-MBL
2009
Cinghie servizi MITSUBOSHI (Made in Japan)
Automotive belts MITSUBOSHI (Made in Japan)



JA-PAPREMIUM
2009
Pastiglie freno PREMIUM alta qualità
PREMIUM top quality brake pads



JD-DENSO
2010/2011
Candele, candele e candele Iridium DENSO
DENSO spark plugs and glow plugs, Iridium spark plugs



JD-DENSOSONDE
2010/2011
Sonde lambda DENSO
DENSO lambda sensors



JD-SPAZZOLE
2010/2011
Spazzole tergicristallo DENSO
DENSO wiper blades



JE-FRIZIONI
2012
Frizioni sportive Racing EXEDY
EXEDY racing clutches



JJ-HKTA
2012
Candele HKT applicazioni Asiatiche ed Europee
HKT glowplugs for Asiatic and European applications



SCARICA I CATALOGHI IN PDF DAL NOSTRO SITO INTERNET

DOWNLOAD PDF CATALOGUES BY OUR WEB SITE

www.ashika.it



TOKYO · SINGAPORE · SYDNEY · ATLANTA · AMSTERDAM · FRANKFURT · WARSAW · SALZBURG · BRÜSSEL · VERONA · ZÜRICH · KOPENAGHEN

www.ashika.eu



8 033001 077247