



IGNITION CABLES AND COILS CATALOGUE



2013
2014



WORLDWIDE QUALITY

NOTICE: Were you see European flag means complete range for european cars.

NOTA: Bandiera Europea significa gamma completa per auto europea.



FILTRI - FILTERS FILTRES - FILTER FILTROS - FILTROS

	10	Filtri olio - Oil filters Filtres à huile - Ölfilter Filtros do óleo - Filtros de aceite
	20	Filtri aria - Air filters Filtres à air - Luftfilter Filtros de ar - Filtros de aire
	21	Filtri abitacolo - Cabin filters Filtres d'habitacle - Oollenfilter Filtros de hanbitáculo - Filtros depuración
	30	Filtri carburante - Fuel filters Filtres à carburant - Kraftstofffilter Filtros de combustível - Filtros de carburante
	10-ECO	Filtri olio eco - Eco oil filters Filtres à huile eco - Ölfilter eco Eco filtros do óleo - Eco filtros de aceite
	30-ECO	Filtri carburante eco - Eco fuel filters Filtres à carburant eco - Kraftstofffilter eco Eco filtros de combustível - Eco filtros de carburante
	74	Kit filtri per tagliando - Service filter kit Kit filtres entretien - Filter service satz Kit de filtros da revisão - Kit filtros para revisión
	10-GAS	Filtro depurazione gpl - Gpl purification filter Filtre purification gpl - ReinigungsfILTER gpl Filtro gás para a filtragem do gpl Gas filtro depuração gpl
	99	Supporto filtro - Filter support Filtre d'appui - Filtre halterung Suporte do filtro - Soporte filtri



FRENANTE - BRAKES BREMS - FREINAGE TRAVÕES - FRENOS

	50	Pastiglie freno ant. - Brake pads front Plaquettes de frein avant - Bremsklötze vorne Pastilhas dos travões da frente - Pastillas de freno ant.
	51	Pastiglie freno post. - Brake pads rear Plaquettes de frein arrière - Bremsklötze hinten Pastilhas dos travões de trás - Pastillas de freno post.
	60	Dischi freno ant. - Brake discs front Disques de frein avant - Bremsscheiben vorne Discos dos travões da frente - Discos de freno ant.
	61	Dischi freno post. - Brake discs rear Disques de frein arrière - Bremsscheiben hinten Discos dos travões de trás - Discos de freno post.
	55	Ganasce freno - Brake shoes Machoières de frein - Bremsbacken Maxilas de travão - Zapatas de freno
	56	Tamburi freno - Brake drums Tambours de frein - Bremstrommel Tambores dos travões - Tambores de freno
	65	Cilindretti freno dx - Rear wheel cylinder right Cylindre de roue droit - Radbremszylinder, rechts Cilindro de travão de trás direito - Cilindros de freno dx
	67	Cilindretti freno sx - Rear wheel cylinder left Cylindre de roue gauche - Radbremszylinder, links Cilindro de travão de trás esquerdo - Cilindros de freno sx



68 Pompe freno - Brake master cylinders
Maître cylindres - Hauptbremszylinder
Bombas dos travões - Bombas de freno



69 Tubi freno - Brake hoses
Fléxibles de frein - Bremsschläuche
Tubos dos travões - Tubos de freno



114 Kit riparazione pompa freno
Repair kit, brake master cylinder
Kit de réparation, maître cylindre de frein
Reparatursatz, hauptbremszylinder
Kit reparação da bomba dos travões
Kit reparación bomba de freno



120-133 Kit riparazione pinza freno - Brake calipers repair kit
Kit de reparation etriers de frein
Reparatursatz Bremssattel - Kit reparação pinça travão
Kit reparación pinza de freno



131 Cavi freno - Brake Cable
Câbles de frein - Bremskabel
Cabo de aço - Cable de freno



FRIZIONI - CLUTCH KUPPLUNG - EMBRAYAGE EMBRAIAGEM - EMBRAGUE



92 Kit frizione - Clutch kits
Kit embrayages - Kupplungssätze
Kit embraiagem - Kit embrague



98 Kit frizione completo di volano - Clutch kit with flywheel
Kit embrayage avec volant - KupplungsKIT mit schwungra
Kit de embraiagem com volante
4PCS Kit embrague completo con volante de inercia



80 Dischi frizione - Clutch discs
Disques d'embrayage - Kupplungsscheiben
Disco de embraiagem - Disco de embrague



70 Spingidisco frizione - Clutch cover
Mécanisme d'embrayage - Druckplattenkupplung
Prato de pressão da embraiagem - Prensa de embrague



91 Volani - Flywheels
Volants - Schwungräder
Volantes Bi-Massa - Volantes



90 Cuscinetti frizione - Clutch bearings
Butées d'embrayage - Kupplungs-ausrücklager
Rolamento de embraiagem - Cojinetes de embrague



54 Bullone, porta corona dentata volano
Bolt, flywheel ring gear
Carrier vis boulon au support du pignon pour volant d'inertie
Schraube, zahnkranzträgerschwungrad
Perno, soporte corona - Dentada, volante



95 Pompe frizione - Clutch master cylinders
Cylindre émetteur - Kupplungs-hauptzylinder
Bombas embraiagem - Bomba embrague



85 Cilindretti frizione - Clutch slave cylinders
Cylindre récepteur - Kupplungs-nehmerzylinder
Bomba secundária da embraiagem
Cilindros embrague



123 Kit riparazione pompa frizione
Repair kit, clutch master cylinder
Kit d'assemblage, cylindre émetteur d'embrayage
Reparatursatz, kupplungsgeberzylinder
Kit de reparação da bomba de embraiagem principal
Kit reparación bomba de embrague

GAMMA PRODOTTI

PRODUCT RANGE













124
 Kit riparazione cilindretto frizione
 Repair kit, clutch slave cylinder
 Kit d'assemblage, cylindre récepteur d'embrayage
 Reparatursatz, kupplungsnehmerzylinder
 Kit de reparação da bomba de embraiagem secundária
 Kit reparación cilindro embrague



DISTRIBUZIONE - DISTRIBUTION VERTEILUNG - DISTRIBUTION DISTRIBUIÇÃO - DISTRIBUCIÓN

	KCK	Kit distribuzione catena - Timing chain kit Kit chaines de distribution - Steuerkettensatz Kit da corrente de distribuição Kit distribución de cadena
	KCT	Kit cinghia e tendicinghia - Timing belt kit Kit de distribution - Zahnriemensatz Kit de distribuição de correia - Kit correa y tensor de correa
	SKC	Pompa acqua + kit cinghie - Water pump & timing belt kit Pompe à eau + kit de courroie de distribution Wasserpumpe + Zahnriemensatz Bomba de água + kit de correia dentada Bomba de agua + kit correa distribución
	45	Cuscinetti tendicinghia - Timing belt tensioners Galet tendeur - Spannrollen Tensores da correia de distribuição Cojinetes de tensor de correa
	40	Cinghie distribuzione - Timing belts Courroies de distribution - Zahnriemen Correia de distribuição - Correias de distribución
	94	Cinghia servizi - Fan belts Courroie - Keilriemen Correia de ventoinha - Correa de servicios
	109	Cinghia servizi Mitsuboshi - Fan belt Mitsuboshi Courroie Mitsuboshi - Keilriemen Mitsuboshi Correia de ventoinha Mitsuboshi - Correa de servicios Mitsuboshi
	96	Cinghie servizi scanalate - Fan belts - Courroies Keilrippenriemen - Correia de ventoinha - Correa de servicios
	112	Cinghia servizi scanalata Mitsuboshi - Fan belt Mitsuboshi Courroies Mitsuboshi - Keilrippenriemen Mitsuboshi Correia de ventoinha Mitsuboshi - Correa de servicios Mitsuboshi
	41	Catene distribuzione - Timing chains Chaines de distribution - Steuerketten Correntes de distribuição - Cadenas de distribución
	128	Tenditore cinghia Poly-V - Timing belt tensioner Tendeur, courroie trapézoïdale - Spannarm, Keilrippenriemen Tensor, correia trapezoidal - Brazo tensor, correa Poly-V
	129	Galoppino/Guidacinghia, Cinghia Poly-V Deflection/Guide Pulley, V-ribbed belt - Poulie courroie trapézoïdale - Umlenk-/Führungsrolle, Keilrippenriemen Polea correa Poly-V - Polia correia trapezoidal
	140	Rullo tenditore, Cinghia Poly-V - Poly-V belt tensioner Poulie-tendeur, courroie trapézoïdale à nervures Spannrolle, Keilrippenriemen - Rolo tensor, correia trapezoidal estriada - Polea tensora, correa trapezoidal con dentado interior
	146	Smorzatore vibrazioni, Cinghia Poly-V Vibration damper V-ribbed belt Amortisseur de vibrations, courroie trapézoïdale à nervures Schwingungsdämpfer, Keilrippenriemen Amortecedor de vibrações, correia trapezoidal estriada Amortiguador vibraciones, correa trapez. Poly-V

RAFFREDDAMENTO - COOLING ABKÜHLUNG - REFROIDISSEMENT ARREFECIMENTO - REFRIGERACIÓN

	35	Pompe acqua - Water pumps Pompes à eau - Wasserpumpen Bombas da água - Bombas de agua
	36	Giunti viscosi - Viscous couplings Visco coupleur - Visco-kupplungen Juntas viscosas - Juntas viscosas
	38	Valvole termostatiche - Thermostats Thermostates - Thermostate Termostatos - Válvulas termostáticas
	22	Valvola termostatica tama - Thermostate tama Vanne thermostatique tama - Thermostatventil tama Termostatos tama - Válvula termostática tama
	RDA	Radiatore - Radiator Radiateur - Kühler Radiador - Radiador
	33	Tappi radiatore - Radiator caps Bouchons radiateurs - Kuhler verschluss kappe Tampões de radiator - Tapones radiator
	CMP	Compressore - Compressor Compresseur - Kompressor Compresor - Compressor
	CND	Condensatore - Condenser Condenseur - Kondensator Condensador - Condensador
	EVP	Evaporatore - Evaporator Evaporateur - Verdampfer Evaporador - Evaporador
	RSD	Riscaldatore - Heat Exchanger, interior heating Système de chauffage - Heizung Radiador de calefacción - Permutador de calor
	VNT	Ventola, Raffreddamento motore - Fan, radiator Ventilateur - Lüfter Ventilador - Ventilador

GIUNTI E CUFFIE - JOINTS AND BOOTS KUPPLUNGEN UND ACHSMANSCHETTEN COUPLEUR, SOUFFLET DE CARDAN - JUNTAS DE TRANSMISSÃO E FOLAS - JUNTAS Y FUELLES

	62	Giunti omocinetici lato ruota Constant velocity joints Joint homocinétique - Antriebswellen Juntas homocinéticas lado roda Juntas homocinéticas de lado de rueda
	63	Kit cuffia - Boot kits Soufflet de cardana - Achsmanschetten Kit de folas - Kit de fuelles
	66	Crociere - Universal joints Croisillons de trans - Universal gelenke Cruzetas de cardan - Crucetas



















SOSPENSIONI - SUSPENSIONS LENKUNGS UND AUFHÄNGUNGSTEILE SUSPENSION - SUSPENSÃO SUSPENSIONA

	44	Kit cuscinetti ruota - Wheelbearing kits Kit de roulements de roues - Radlagersätze Jogos de rolamentos das rodas - Kit cojinetes de rueda
---	-----------	--

FR GAMME DES PRODUITS

DE PRODUKTELINIE

	MA	Ammortizzatori - Shock absorbers Amortisseurs - Stossdämpfer Amortecedores - Amortiguador
	GOM	Gommini - Rubbers Silent blocs - Motoraufhängung Borrachas - Tapones de goma
	72	Trapezio - Suspension triangle Triangle de suspension - Trapez Triângulo da suspensão - Trapecio
	71-102	Braccio oscillante - Suspension arms Bras oscillants - Schwenkarme Braços da suspensão - Brazo oscilante
	59	Leve rinvio sterzo - Steering relay Leviers de renvoi de la direction - Lenkradhebel Pendural da barra de direcção Levas de reenvío de la dirección
	53	Testine sospensione - Ball joint Rotule (pour suspension et direction) Aufhängeköpfe - Rotula da suspensão Cabezales de suspensión
	105	Barre accoppiamento - Coupling bars Barres d'accouplement - Pleuelstangen Barras da direcção - Barras de acoplamiento
	111	Testa barra d'accoppiamento - Tie-rod end Rotule de barre de connexion Spurstangenkopf - Terminal da direcção Cabeza de barra de acoplamiento
	106	Stabilizzatore, chassis - Stabilizer, chassis Stabilisateur, chassis - Stabilisator, fahrwerk Estabilizador, chassi - Estabilizador, chasis
	103-76	Giunto assiale, asta trasversale - Axial rod, tie rod Rotule de direction intérieure, barre de connexion Axialgelenk, spurstange - Rótula da direcção interior Junta axial, asta transversal
	52	Leve rinvio sterzo - Steering relay Leviers de renvoi de la direction - Lenkradhebel Braço do pendural da direcção Levas de reenvío de la dirección
	26	Braccio oscillante, sospensione ruota Track control arm Bras de liaison, suspension de roue Lenker, radaufhängung - Braço de suspensão Brazo oscilante, suspensión de rueda
	27	Barra d'accoppiamento - Tie rod, steering Barre de connexion spurstange Verbindungstange - Barra de junção Barra de acoplamiento
	73	Giunto di supporto/guida Support/steering link Rotule de suspension Trag/führungsgelenk Rótula da suspensão Junta de soporte /guía
	63-OA	Cuffie ammortizzatori universali Universal bump rubber kit Soufflet de cardan Universale dämpferkappen Kits de folas universais dos amortecedores Fuelles amortiguadores universales





	IMPIANTO ELETTRICO - ELECTRICAL PARTS ELEKTRISCHE TEILE - ÉLECTRIQUE PARTS MATERIAL ELÉCTRICO - PARTES ELECTRICAS	
	002	Alternatori - Alternators Alternateurs - Lichtmaschinen Alternadores - Alternadores
	003	Motorini avviamento - Starters Démarreurs - Anlasser Motores de arranque - Arrancador
	DENSO	Candele - Spark plugs Bougies d'allumage - Kerzen Denso velas - Denso bujías
	01	Candele - Glow plugs Bougies de pré-chauffage - Gluhkerzen Velas de incandescência - Bujias
	HKT	Candele hkt - Hkt glow plugs Bougies de préchauffage hkt - Gluhkerzen hkt Velas de incandescência hkt - Candelillas hkt
	DENSO	Candele denso - Denso glow plugs Bougies de préchauffage denso - Gluhkerzen denso Velas de incandescência denso - Candelillas denso
	43	Sonde lambda - Oxygen sensors Sonde lambda - Lambda sonde Sondas lambda - Sensor oxygen
	DENSO	Sonde lambda denso - Oxygen sensors denso Sonde lambda denso - Lambda sonde denso Sondas lambda denso - Sondas lambda
	SA-X	Spazzole tergicristallo Wiper blades - Balais essuie glaces Wischerblätter - Escovas limpa vidros Escobillas
	SA-F	Spazzole tergicristallo universali - Universal wiper blades Balais essuie glaces universelles - Universale wischerblätter Escovas limpa vidros universais - Escobillas limpiaparabrisas universales
	SA-R	Spazzole tergicristallo universali posteriori - Universal Rear wiper Blades Balais d'essuie-glaces arrières universelles - Hintere universal Scheibenwischer Escovas limpa vidros traseiras universales Escobillas limpiaparabrisas traseras universales
	SA-RE70C - SA-RE70L - SA-RE75BH	Refill universali per spazzole normali/flat Universal refill for normal wiper blades/flat wiper blades Refill universel pour balais essuie glace norm. et balais "flat" Universal refill fuer normale/wischerblaetter Und fuer flat wischerblaetter Recargas universais para escovas flat normais Recambios universales para escobillas normales
	HY	Spazzola ibrida - Hybrid wiper blade - Hybrid balai d'essuie-glace Hybrid wischblatt - Und fuer flat wischerblaetter Escova hibrida de limpa-vidros - Escobilla hibrida
	HY-U	Spazzola ibrida universale - Universal Hybrid wiper blade Balais d'essuie-glaces hybrid universelles - Hybrid universal Scheibenwischer Escovas limpa vidros Ibridas universales - Escobillas limpiaparabrisas Ibridas universales
	64	Bulbi elettroventola - Temp. sensors Capteur de température - Ventilugeln Sensores de temperatura - Sensor temperatura
	05	Pompe benzina - Fuel pump Pompe a carburant - Benzinpumpen Bombas gasolina - Bombas de gasolina
	77	Regolatori - Regulators Regulateur de tension - Spannungsregler Reguladores - Reguladores

GAMA DE PRODUTOS

GAMMA PRODUCTO

	97	Spazzole accensione - Rotor arms Rotors d'allumeurs - Verteilerfinger Rotores - Rotor del distribuidor
	XX-C	Kit cavi accensione - Electric-cable ignition kit Kit câbles d'allumage - Zündkabel set Jogo de fios de vela - Kit cables de encendido
	78	Bobina di accensione - Coil, ignition Bobine d'allumage - Zündspule Bobina de ignição - Bobina de encendido
	13	Condensatore - Condenser, ignition Condenseur, système d'allumage Kondensator, zündanlage Condensador - Condensador
	06	Kit contatti accensione - Contact breaker Distributor jeu de contacts d'allumage Kontaktsatz, zündverteiler Jogo de platinados - kit contactos de encendido
	09 08 07	Gruppo universale koito - Insert, headlight koito Bloc-optique de phare koito Scheinwerfereinsatz, hauptscheinwerfer koito Óptica koito - Grupo universal koito
	00	Interruttore stop - Interrupteur des feux de freins Brake light switch - Bremslichtschalter Interruptor stop - Interruptor de luces de freno
	12	Interruttore temperatura, ventola radiatore Temperature switch, radiator fan Interrupteur de température, ventilateur de radiateur Temperaturschalter, kühlerlüfter Interruptor temperatura, ventoinha radiador Interruptor temperatura, ventilador radiador
	11	Pressostato olio - Oil pressure switch Switch de pression d'huile - Öldruckschalter Interruptor da pressão do óleo - Interruptor presión de aceite
	06	Spinterogeno - Distributor Distributeur - Verteiler Distribuidor - Distribuidor
	02	Sensore massa aria - Mass sensor Capteur de masse - Sensorenmesser Sensor massa ar - Sensor masa de aire
	75	Corpo farfallato elettrico - Throttle housing Boîtier de papillon - Drosselklappenstutzen Corpo de mariposa eléctrico Cuerpo de mariposa eléctrico
	130	Puleggia alternatore - Freewheel Clutch, alternator Poulie roue libre, alternateur - Generatorfreilauf Rueda libre alternador - Roda livre do alternador
	121	Calotte spinterogeno - Distributor caps Tête d'allumeur - Verteilekappen Tampas do distribuidor - Tapa distribuidor

	47	Guarnizioni coperchio valvole - Valves cover gaskets Joint de couvre culbuteur - Dichtungen des klappendeckels Juntas da cabeça - Tapa de culata de cilindro
	46	Guarnizioni testata - Head gaskets Joints de culasses - Zylinderköpfe dichturg Jogo de juntas da cabeça - Juntas de culata
	48	Kit guarnizioni testata - Head gaskets set Kit joints de culasses - Zylinderkopfdichtungssätze Kit guarnições cabeça - Kit juntas de culata
	39	Kit pistoni - Pistons kit - Kit pistons Kolben rep. Sätze - Jogo de pistões - Kit pistones
	49	Kit guarnizioni motore - Full set gasket Kit pochette joint moteur - Motor dichtungssätze Jogo de juntas completo - Kit juntas de motor
	15	Valvole - Engine valves - Soupapes Ventile - Valvúlas - Válvulas
	23	Testate - Cylinder heads - Culasses Zilinderköpfe - Cabeças - Culata del cilindro
	88	Bielle - Connecting rods - Bielle Pleuel - Bielas - Bielas
	88	Boccola biella - Piston pin bushings - Bagues tête de bielle Kolben-pleuel-buchse - Casquilhos de biela - Casq. de biela
	34	Fascia elastica - Piston ring Segment de piston - Kolbenring Segmento - Aros del pistón
	86	Bronzina banco - Main bearings Coussinets de palier - Hauptlager Bronzes de apoio - Cojinete de bancada
	82	Bronzina di biella - Big end bearings Coussinet de bielle - Pleuellager Bronzes de biela - Cojinete de biela
	19	Kit canne cilindro motore - Cylinder liner kits Kit chemises - Laufbuchsensätze Jogos de camisas - Kit barras de cilindro de motor
	17	Bilancieri valvole - Balances valves Valves d'équilibres - Balancen ventile - Balancoen ventile Martelos - Balancines de las válvulas
	89 83	Bronzina albero a camme - Camshaft bearings Coussinets arbre à cames - Nockenwellenlager Bronzes da árvore de cames - Cojinete de árbol de levas
	79	Rasamenti - Thrust washers Cales latérale - Anlaufscheibe Anilhas de folga da cambota - Enrases
	115	Bulloni testata - Cylinder head bolt Boulon de culasse de cylindre - Zylinderkopfschraube Pernos da cabeça - Pernos de cabezal
		Valvola ricircolo gas di scarico Exhaust gas recirculation valve Vanne egr ventil - Abgasrückführventil Valvúla de reciclo do gás de escape Válvula de recirculación de gas de descarga
		Pompa olio - Oil pump Pompe à huile - Ölpumpe Bomba óleo - Bomba de aceite
		Iniettore - Injector - Injecteur Injektoren - Injector - Injector
		Motore completo - Complete engine Moteur complet - Motor komplett Motor completo - Motor completo
		Turbina - Turbocharger - Turbocompresseur Turbolader - Turbo - Turbina

	MOTORE - ENGINE MOTOR - MOTEUR MOTOR - MOTOR	
	16	Alberi a camme - Camshafts - Arbres a cames Nockenwellen - Árvores de cames - Árboles de levas
	18	Alberi motore - Crankshafts - Vilebrequins Kurbelwellen - Cambotas - Árboles de moto
	122	Puleggia albero motore - Crank shaft pulleys Poulie de vilebrequin - Motor-welle rolle Polia da cambota - Polea del eje motor



INDICE GENERALE GENERAL INDEX

Cavi candela 8
Ignition cables 8

Disegni cavi 26
Ignition cables drawings 26

Bobine di accensione 50
Ignition coils 50

Foto bobine 64
Ignition coils pictures 64

Cross-ref. cavi candela 75
Cross-ref. ignition cables 75

Cross-ref. bobine di acc. 81
Cross-ref. ignition coils 81



INDICE INDEX

Chevrolet (Daewoo)	8
Chrysler	9
Daihatsu	10
DR	11
Great Wall	11
Honda	11
Hyundai	12
Isuzu	14
Lexus	15
Mazda	15
Mitsubishi	16
Nissan	19
Piaggio	20
Subaru	20
Suzuki	21
Tata	23
Toyota	23

MARCA-MODELLO CAR MODEL	CC	MOTORE ENGINE	ANNO YEAR	CIL./CYL.	ASHIKA CODE
CHEVROLET (DAEWOO)					
Aranos					
Aranos 16V (66 Kw)	1500	V15L	95-96	4	132-0W-W01
Aranos (70 Kw)	1800	Y18L	95-97	4	132-0W-W02
Aranos (81 Kw)	2000	Y20L	95-97	4	132-0W-W02
Aveo					
Aveo (53-62 Kw)	1200	F12S3	06→	4	132-0W-W14
Aveo (62 Kw)	1200		2010	4	132-0W-W17
Aveo (62 Kw) LPG Eco	1200		2010	4	132-0W-W17
Captiva					
Captiva (100 Kw)	2400		06→	4	132-0W-W20
Captiva (100 Kw) LPG Eco	2400		06→	4	132-0W-W20
Cruze (83 Kw) 16V	1600		10	4	132-0W-W21
Espero					
Espero 16V	1500		95	4	132-0W-W13
Espero 16V (66 Kw)	1500	A15MF	95-99	4	132-0W-W01
Espero i (70-66 Kw)	1800	OHC C18LE	95-99	4	132-0W-W02
Espero MPi (77 Kw)	2000	OHC C20LE	95-99	4	132-0W-W02
Evanda (96 Kw)	2000		02	4	132-0W-W05
Kalos					
Kalos (53 Kw)	1200	E-Tec II	03	4	132-0W-W08
Kalos (53 Kw)	1200	S-TEC-B12S1	05→	4	132-0W-W14
Kalos (61 Kw)	1400	E-Tec II	02	4	132-0W-W08
Kalos (69 Kw)	1400		03	4	132-0W-W12
Kalos (63 Kw)	1500	A15SM	02	4	132-0W-W12
Lacetti					
Lacetti 8V (70 Kw)	1400		04	4	132-0W-W15
Lacetti	1400		10/07	4	132-0W-W18
Lacetti (70 Kw)	1400		10→	4	132-0W-W19
Lacetti (70 Kw) LPG Eco	1400		10→	4	132-0W-W19
Lacetti Dual Power 16V (80 Kw)	1600	E-TEC II	04	4	132-0W-W15
Lacetti	1600		06/03	4	132-0W-W19
Lacetti 8V (90 Kw)	1800		4	4	132-0W-W05
Lanos					
Lanos 8V	1300	E-TEC	01	4	132-0W-W08
Lanos 8V (55 Kw)	1400	A14SMS	97	4	132-0W-W03
Lanos 8V (63 Kw)	1500	A15SMS	97	4	132-0W-W03
Lanos 16V (78 Kw)	1600	A16SMS	97	4	132-0W-W04
Lanos 16V	1600		06/03	4	132-0W-W19
Leganza					
Leganza i 16V	2000		01	4	132-0W-W11
Leganza 16V D-TEC (98 Kw)	2000	X20SED	97	4	132-0W-W05
Leganza i 16V (100 Kw)	2200	T22SED	99	4	132-0W-W05
Matiz					
Matiz 800 (38 Kw)	800	M-TEC	98→	3	132-0W-W06
Matiz City-Smile-Planet-Star (38 Kw)	800	F8CV	00→	3	132-0W-W09
Matiz Ecologica-GPL	800		09→	3	132-0W-W09
Matiz Energy - Star (47 Kw)	1000	S-TEC	03→	4	132-0W-W14
Matiz Energy (47-49 Kw)	1100	B10S-B10S1	05→	4	132-0W-W14
Nexia					
Nexia 16V GLX-GTX (66 Kw)	1500	A15MF	95-97	4	132-0W-W01
Nexia 8V	1500	GMSMF	97	4	132-0W-W07
Nubira					
Nubira J150 16V	1600		01	4	132-0W-W12
Nubira 16V (78 Kw)	1600	A16DMS	97	4	132-0W-W04
Nubira VSX 16V (80 Kw)	1600	E-TEC II	03	4	132-0W-W15

MARCA-MODELLO CAR MODEL	CC	MOTORE ENGINE	ANNO YEAR	CIL./CYL.	ASHIKA CODE
Nubira (80 Kw)	1600		10→	4	132-0W-W19
Nubira (80 Kw) LPG Eco	1600		10→	4	132-0W-W19
Nubira 16V	2000		01	4	132-0W-W11
Nubira 16V (98 Kw)	2000	X20SED	06/97	4	132-0W-W05
Rezzo					
Rezzo (77 Kw)	1600		00	4	132-0W-W12
Rezzo (72 Kw)	1800	A18DMS	00	4	132-0W-W10
Rezzo (94 Kw)	2000		00	4	132-0W-W11
Spark					
Spark (38 Kw)	800	F8CV	00→	3	132-0W-W09
Spark (47-50 Kw)	1000	G10CV	02→	4	132-0W-W14
Spark SX (46 Kw)	1000		05→	4	132-0W-W14
Spark (50 Kw)	1000		10→	4	132-0W-W17
Spark (50 Kw) LPG Eco	1000		10→	4	132-0W-W17
Spark (50 Kw)	1200		10→	4	132-0W-W17
Spark (50 Kw) LPG Eco	1200		10→	4	132-0W-W17
Tacuma					
Tacuma 16V	1600	E-TEC-A16DMS	05	4	132-0W-W16
Tacuma 8V	1800	E-TEC-A18DMS		4	132-0W-W03
Tacuma 8V SX (72 Kw)	1800	F18N2	00	4	132-0W-W10
Tacuma 16V	2000		01	4	132-0W-W11
Tacuma	2000		00-03	4	132-0W-W18
Tacuma 16V (89-90 Kw)	2000	T20SED	05	4	132-0W-W05
Tico					
Tico	800		96	3	132-0W-W06
CHRYSLER					
Cirrus					
Cirrus 16V (112 Kw)	2400	EDZ	96-00	4	132-09-908
Cirrus 16V (96 Kw)	2400	ECB	96-00	4	132-09-910
Crossfire (160 Kw)	3200	EGX	03	6	132-09-915
Jeep					
Jeep Cherokee L	2500		93	4	132-09-904
Jeep Grand Cherokee L	4000	ERH	86-90	6	132-09-901
Jeep Wrangler Laredo L	4000	ERH	95	6	132-09-901
Jeep Cherokee Country L	4000		95	6	132-09-901
Jeep Grand Cherokee Laredo-Hard L	4000		95	6	132-09-901
Jeep Grand Cherokee L	5200		92-93	8	132-09-916
Le Baron					
Le Baron L V6	3000		89	6	132-09-902
Neon					
Neon 16V (85 Kw)	1800		97-99	4	132-09-910
Neon 16V (85 Kw)	1800	EDB	97-99	4	132-09-913
Neon 16V (98 Kw)	2000	420H	94-99	4	132-09-910
Neon 16V (109-107-118 Kw)	2000	420T-ECC	94-99	4	132-09-908
Neon 16V II (85 Kw)	1600		01	4	132-09-914
New Yorker					
New Yorker i (155 Kw)	3500	F01	93	6	132-09-909
PT Cruiser					
PT Cruiser 16V (85 Kw)	1600		01	4	132-09-914
PT Cruiser 16V (104 Kw)	2000	ECC	00	4	132-09-906
PT Cruiser 16V (110 Kw)	2400	EDZ	00	4	132-09-906
PT Cruiser 16V (105 Kw) Convertible	2400		04	4	132-09-906
PT Cruiser GT (164 Kw)	2400		03	4	132-09-911
PT Cruiser GT (164 Kw) Convertible	2400		04	4	132-09-911

MARCA-MODELLO CAR MODEL	CC	MOTORE ENGINE	ANNO YEAR	CIL./CYL.	ASHIKA CODE
Saratoga					
Saratoga	2500			4	132-09-905
Saratoga L V6	3000		89	6	132-09-902
Sebring					
Sebring 16V (104 Kw)	2000	ECB	95-01	4	132-09-910
Sebring 16V (104 Kw)	2000		01	4	132-09-910
Sebring 16V (104 Kw) Convertible	2000		01	4	132-09-906
Sebring 16V (103 Kw)	2400	EDZ	96-00	4	132-09-908
Sebring 16V (112 Kw) (cavo 5mm)	2400	EY7	00	4	132-05-506
Stratus					
Stratus 16V (98 Kw)	2000		95	4	132-09-910
Stratus LE (96 Kw)	2000	C00-420X	95-01	4	132-09-910
Stratus 16V (103 Kw)	2400		95-01	4	132-09-908
Voyager					
Voyager	2500			4	132-09-905
Voyager L V6	3000		89-92	6	132-09-902
Voyager LE-SE L V6	3300	EGA	89	6	132-09-903
Voyager L V6	3300		92	6	132-09-902
Voyager II 16V (98 Kw)	2000		95-01	4	132-09-907
Voyager II 16V (98 Kw)	2000	C00	95-01	4	132-09-910
Voyager II 16V (111 Kw)	2400	B00	95-01	4	132-09-907
Voyager III 16V (108 Kw)	2400		00	4	132-09-906
Voyager II (110 Kw)	3300	EGA	90-95	6	132-09-909
Voyager II (116 Kw)	3300	R00	95	6	132-09-909
Voyager II (122-131 Kw)	3500		95	6	132-09-909
Voyager III (128 Kw)	3300	EGA-AWD	00	6	132-09-912
DAIHATSU					
Applause					
Applause 16 V	1600			4	132-06-612
Applause 16 V	1600	HDE	89-97	4	132-06-607
Charade					
Charade i 16V (cavo 5mm)	1300	HCE-4WD	87	4	132-06-603
Charade I 16V	1300	HCE	88-92	4	132-06-607
Charade III L i 16V (66 Kw)	1300	HCE - G102/G200	88-93	4	132-06-606
Charade III L i 16V (55-66 Kw)	1300	HCE - 4WD G112/ HC - 4WD G102	88-93	4	132-06-606
Charade i 16V (cavo 5mm)	1300	OHC	89-93	4	132-06-606
Charade i 16V (cavo 5mm)	1500	OHC	89-93	4	132-06-606
Charade i 16V (cavo 5mm)	1500	HEEG-OHC	94	4	132-06-603
Charade IV L i 16V (66 Kw)	1500	HEE-G203	93→	4	132-06-606
Charade IV GTI L i 16V (77 Kw)	1500	HDE-G201	93-96	4	132-06-606
Charade I 16V	1300	HEE	94	4	132-06-607
Charade i 16V (cavo 5mm)	1600	OHC	89-93	4	132-06-606
Charade i 16V (cavo 5mm)	1600	HDE-OHC	93	4	132-06-603
Cuore					
Cuore 850 - 4WD	850	ED10	85-90	3	132-06-605
Cuore 850 - L201 (29 Kw)	850	ED-ED10	85-90	3	132-06-602
Domino					
Domino			86-90	3	132-06-605
Domino-Cuore i (cavo 5mm)	850	AD	96	3	132-06-602
Feroza					
Feroza i.e.	1600	HDC/HDE	88	4	132-06-612
Grand Move					
Grand Move i 16V (cavo 5mm)	1500		97	4	132-06-606
Mira					
Mira-Cuore i (cavo 5mm)	850		93-95	3	132-06-602

MARCA-MODELLO CAR MODEL	CC	MOTORE ENGINE	ANNO YEAR	CIL./CYL.	ASHIKA CODE
Mira 850i	850	ED10	93	3	132-06-605
Move					
Move i (cavo 5mm)	850	OHC	97	3	132-06-602
Move 850i (31 Kw)	850	ED20	97	3	132-06-605
Move Gran i (cavo 5mm)	1500	HEEG-OHC	97	4	132-06-603
Move Gran 16V i (cavo 5mm)	1500	HE-G	97-98	4	132-02-244
Rocky					
Rocky Soft Top (65 Kw)	2000	3Y	85-93	4	132-06-604
Rocky Hard Top (65 Kw)	2000	3Y	85-93	4	132-06-604
Valera					
Valera I 16V	1500	HE-EG	93	4	132-06-607
Wildcat					
Wildcat	2000	3Y	84-92	4	132-06-604
DR					
DR 1 Eco Power-BiFuel (61 Kw)	1300		09→	4	132-00-001
DR 2 Eco Power-BiFuel (61 Kw)	1300		09→	4	132-00-001
DR 5 Eco Power-BiFuel (80 Kw)	1300		10→	4	132-00-002
DR 5 Eco Power-BiFuel (80 Kw)	1600	SQR481F	10→	4	132-00-002
DR 5 Eco Power-BiFuel 4WD (93-95 Kw)	2000		10→	4	132-00-002
GREAT WALL					
Hover					
Hover 4WD	2350	4G64S4M	05-08→	4	132-00-003
HONDA					
Accord					
Accord i 16V	1800		93	4	132-04-401
Accord 16V (99 Kw)	1800	F18B2-SOHC/V-TEC	96	4	132-04-414
Accord Aerodeck i	2000		84-89	4	132-04-418
Accord i 16V Catalizzata	2000		90-93	4	132-04-419
Accord i LS 16V	2000		95	4	132-04-401
Accord i 16V (110 Kw)	2200	V-TEC-F22Z2	96	4	132-04-413
Accord i 16V (116 Kw)	2300	H23A	93	4	132-04-401
Civic					
Civic 16V Lsi (55 Kw)	1300	D13B1/B2	88	4	132-04-400
Civic i 16V	1300	V-TEC	94	4	132-04-402
Civic 16V LSi	1400		88	4	132-04-400
Civic i 16V Aerodeck	1400	D14W3	97	4	132-04-414
Civic i 16V	1400	SOHC	98	4	132-04-415
Civic i 16V LSi	1500		93-95	4	132-04-400
Civic i 16V	1500	V-TEC	94	4	132-04-402
Civic i 16V	1600	D16A6	87-90	4	132-04-400
Civic i 16V	1600	D16Z-D15Z	90-94	4	132-04-400
Civic 16V	1600		94	4	132-04-400
Civic i 16V Coupé (92 Kw)	1600	D16Z9 - V-TEC	94	4	132-04-402
Civic i 16V Aerodeck	1600	D16W3	97	4	132-04-414
Concerto					
Concerto i 16V	1400		89	4	132-04-419
Concerto i 16V	1500		93	4	132-04-419
Concerto i 16V	1600	D16A8	89	4	132-04-419
CR-X					
CR-X i 16V (118 Kw)	1600	B16A2	93	4	132-04-401
CR-X i 16V (92 Kw)	1600	D16Z5	93	4	132-04-414
CR-V					
CR-V i 16V (94-98 Kw)	2000	B20B4-B20Z1-B20B9	94-02	4	132-04-416

MARCA-MODELLO CAR MODEL	CC	MOTORE ENGINE	ANNO YEAR	CIL./CYL.	ASHIKA CODE
CR-V i 16V (108 Kw)	2000	B20B3-B20Z3	94-02	4	132-04-416
Logo					
Logo (48 Kw)	1300	GA3 - SOHC	99-02	4	132-04-415
HR-V					
HR-V 4WD 16V (77 Kw)	1600	D16W1/2/5	99	4	132-04-414
Integra					
Integra R	1800		97-01	4	132-04-401
Prelude					
Prelude i 16V (98 Kw)	2000	F20A4	91	4	132-04-401
Prelude i 16V (118 Kw)	2300	H23A2	92	4	132-04-401
Prelude GTi	2200	H2215	97	4	132-04-417
Shuttle					
Shuttle 2.2 (110 Kw)	2200	F22B8	95	4	132-04-401
Shuttle 2.3 (110 Kw)	2300	F27A3	98	4	132-04-401
HYUNDAI					
Accent					
Accent i 12V (44-55-62 Kw)	1300	G4EH	94-00	4	132-0H-H04
Accent i 12V (55-63 Kw)	1300	G4EA	00	4	132-0H-H04
Accent 12V	1300		97	4	132-0H-H07
Accent 12V	1400	SOHC	99	4	132-0H-H11
Accent i 12V (65 Kw)	1500	G4EK	94-00	4	132-0H-H04
Accent i 16V (73 Kw)	1500	G4ER	96-99	4	132-0H-H19
Accent I 16V (73 Kw)	1500	G4FK	99-02	4	132-0H-H19
Accent I 16V (77 Kw)	1600	G4ED	02→	4	132-0H-H19
Amica					
Amica 12V (40 Kw)	1000	G4AC	00	4	132-0H-H06
Atos					
Atos i MY - Premium Plus (40 Kw)	1000	G4AC	00→	4	132-0H-H06
Atos Prime i 12V GL - GLS (40 Kw)	1000	G4HC	00-03	4	132-0H-H13
Atos Prime i 12V (43 Kw)	1000	G4HCE	00-03	4	132-0H-H13
Atos i 12V (40 Kw)	1000	G4AC	97-03	4	132-0H-H06
Atos Prime i (43-46 Kw)	1100	G4HD-G4HG	03→	4	132-0H-H04
Atos Prime i 12V	1100	G4HD	05→	4	132-0H-H13
Coupè					
Coupè 16V	1600		01	4	132-0H-H12
Coupè Tiburon i 16V	1600	G4GR-DOHC	98	4	132-0H-H12
Coupè 16V (77 Kw)	1600	G4EDG	02→	4	132-0H-H19
Coupè 16V	2000	4G61-DOHC	96-02	4	132-0H-H15
Coupè 16V	2000	DOHC	02	4	132-0H-H15
Coupè i 16V (102 Kw)	2000	DOHC-G4GF	96	4	132-0H-H05
Coupè (102 Kw)	2000	G4GC-G	02	4	132-0H-H21
Coupè V6 (123 Kw)	2700	G6BA-G	02→	6	132-0H-H14
Elantra					
Elantra i 16V (79 Kw)	1600	G4ED-DOHC	00	4	132-0H-H15
Excel					
Excel i 12V (49 Kw)	1300	G4AN	85-89	4	132-0H-H20
Excel i 12V (63 Kw)	1300	G4EH	94-99	4	132-0H-H04
Excel i 12V (53 Kw)	1500	G4AJ	85-89	4	132-0H-H20
Excel i 12V (65 Kw)	1500	G4EK	94-99	4	132-0H-H04
Excel i 12V (73 Kw)	1500	G4ER	96-99	4	132-0H-H19
Getz					
Getz	1100		01	4	132-0H-H13
Getz (46 Kw)	1100	G4HD	02-05	4	132-0H-H13
Getz (49 Kw)	1100	G4HDE	05→	4	132-0H-H04
Getz (60 Kw)	1300	G4E-A	02	4	132-0H-H04

MARCA-MODELLO CAR MODEL	CC	MOTORE ENGINE	ANNO YEAR	CIL./CYL.	ASHIKA CODE
Getz (71 Kw)	1400	G4EE	05→	4	132-0H-H19
Getz (77 Kw)	1600	G4EDG	02-05	4	132-0H-H15
Getz (78 Kw)	1600	G4EDG	05→	4	132-0H-H19
Galloper					
Galloper (107 Kw)	3000	G6AT	99	6	132-0H-H18
i10					
i10 (49 Kw) 12V (48 Kw)	1100	G4HG	07→	4	132-0K-K06
i10 (49 Kw) 12V LPG BluDrive (49 Kw)	1100	G4HG	07→	4	132-0K-K06
i10 (57 Kw) 16V	1200		09	4	132-0H-H22
i10 (57 Kw) 16V LPG BluDrive	1200		09	4	132-0H-H22
i20					
i20 (57 Kw) 16V	1200		09	4	132-0H-H22
i20 (57 Kw) 16V LPG BluDrive	1200		09	4	132-0H-H22
i30					
i30 (105 Kw)	2000	G4GC-G	07→	4	132-0H-H12
i30 (105 Kw) CW	2000	G4GC-G	08→	4	132-0H-H12
Lantra					
Lantra i	1500		91	4	132-0H-H00
Lantra 12V GL	1500		97	4	132-0H-H11
Lantra i 12V	1500		96-00	4	132-0H-H04
Lantra (63 Kw)	1500	G15B	90-95	4	132-0H-H17
Lantra (63 Kw)	1500	G4DJ	90-95	4	132-0H-H03
Lantra i 16V (78-84 Kw)	1600	G4CR-DOHC	90-95	4	132-0H-H01
Lantra i 16V (66 Kw)	1600	G4GR-DOHC	95-00	4	132-0H-H10
Lantra Kombi i 16V (66 Kw)	1600	G4GR-DOHC	95-00	4	132-0H-H10
Lantra (66 Kw)	1600	4G61	95-00	4	132-0H-H10
Lantra i 16V	1800	G4CN-DOHC	92-95	4	132-0H-H01
Lantra i 16V (94 Kw)	1800	G4GM-DOHC	96-00	4	132-0H-H10
Lantra	1800	G4CN	90-95	4	132-0H-H17
Lantra (93 Kw)	1800	G4CN	90-95	4	132-0H-H03
Lantra (102 Kw)	2000	G4GF	95-00	4	132-0H-H10
Matrix					
Matrix i (76 Kw)	1600	G4ED	01→	4	132-0H-H19
Matrix (90 Kw)	1800	G4GB	01→	4	132-0H-H21
Pony					
Pony i 12V (50 Kw)	1300	G13B	85-89	4	132-0H-H20
Pony GLS	1300	G4DG	91	4	132-0H-H03
Pony I 12V	1300	G4EH	94-99	4	132-0H-H04
Pony GLS (61-62 Kw)	1500	G15B-G4DJ	93-95	4	132-0H-H03
Pony I 12V	1500	G4EK	94-99	4	132-0H-H04
Santamo					
Santamo i 16V	2000	DOHC	99	4	132-0H-H08
SCoupé					
SCoupé LS 8V (53 Kw)	1500	G4DJ	90-96	4	132-0H-H03
SCoupé LS i 12V	1500		92	4	132-0H-H02
SCoupé	1500	G15B-G4DJ	90-95	4	132-0H-H17
SCoupé (65 Kw)	1500	G4EK	91-95	4	132-0H-H17
SCoupé 12V	1600	G4EK	92-96	4	132-0H-H04
Sonata					
Sonata i (70 Kw)	1800		88-93	4	132-0H-H17
Sonata i (80 Kw)	1800	G4CP-U	91-93	4	132-0H-H17
Sonata i (63 Kw) GLS	1800		96-98	4	132-0H-H17
Sonata i (72 Kw)	2000	G4CM	93-98	4	132-0H-H17
Sonata i (70-77 Kw)	2000	G4CP	94-98	4	132-0H-H17
Sonata i (96 Kw)	2000	G4CP	91-93	4	132-0H-H17
Sonata i	2000		91	4	132-0H-H00

MARCA-MODELLO CAR MODEL	CC	MOTORE ENGINE	ANNO YEAR	CIL./CYL.	ASHIKA CODE
Sonata i 16V (96-92-102 Kw)	2000	G4CP	91-96	4	132-0H-H01
Sonata (100 Kw)	2000	G4JP-G	98-01	4	132-0H-H05
Sonata (105 Kw)	2400		98-01	4	132-0H-H05
Sonata i SOHC	2400	G4CS	88-91	4	132-0H-H03
Sonata (107 Kw)	3000	G6AT	93	6	132-0H-H18
Sonica					
Sonica i 16V	2000		95	4	132-0H-H01
Sonica i 16V	2000	DOHC	99	4	132-0H-H09
Santa Fe					
Santa Fe (100 Kw)	2400	G4JS-G	01	4	132-0H-H05
Santa Fe V6 - 24V 4WD (127 Kw)	2700	G6BA-G	01→	6	132-0H-H14
Trajt					
Trajt i 16v	2000		00	4	132-0H-H16
Verna					
Verna i 12V (63 Kw)	1300	G4EA	99→	4	132-0H-H04
Verna i 12V (66 Kw)	1500	G4EB	99→	4	132-0H-H04
ISUZU					
Aska					
Aska i.e. Turbo	1800		83	4	132-01-117
Aska i.e. Turbo	2000		83	4	132-01-117
Gemini					
Gemini i.e. Turbo	1500		77-90	4	132-01-117
Gemini i.e. GTi	1600		77-90	4	132-01-117
Gemini i.e. GTi	1800		77-90	4	132-01-117
Gemini (Cruise) L	1600	DOHC/W/WO	91	4	132-09-900
Gemini (Cruise-CTRL) 1.8 L	1800	DOHC/W/WO	92	4	132-09-900
Impulse					
Impulse Turbo L	1600	DOHC/4XE1	91-92	4	132-09-900
Impulse Turbo L	1600	DOHC/W/WO	92-93	4	132-09-900
Impulse Turbo L	1600	WO/4XE1	91	4	132-09-900
Impulse Turbo L	1800	WO/4XF1	92	4	132-09-900
Stylus					
Stylus i.e.	1600		92	4	132-09-900
Stylus i.e.	1800		92	4	132-09-900
KIA					
Cerato					
Cerato (77 Kw)	1300	G3ED	05→	4	132-0H-H19
Picanto					
Picanto i 8V (45 Kw)	1000	G4FG	04→	4	132-0K-K06
Picanto 12V	1000		10	4	132-0K-K06
Picanto 12V LPG BiFuel	1000		10	4	132-0K-K06
Picanto i 8V (48 Kw)	1100	G4HG	04→	4	132-0K-K06
Picanto (46 Kw) 12V	1100		10	4	132-0K-K06
Picanto (46 Kw) 12V LPG BiFuel	1100		10	4	132-0K-K06
Pride					
Pride i	1100	B1	91	4	132-0K-K01
Pride i	1200		91	4	132-0K-K01
Pride (Siemens)			01	4	132-0K-K07
Pride (Sagem)			01	4	132-0K-K08
Rio					
Rio RS - LS (55-60 Kw)	1300		01	4	132-0K-K03
Rio RS - LS 16V	1500	MI-TECH	01	4	132-0K-K04
Rio II (71Kw)	1400	G4EE	05→	4	132-0H-H19
Rio II (82Kw)	1600	G4ED	05→	4	132-0H-H19

MARCA-MODELLO CAR MODEL	CC	MOTORE ENGINE	ANNO YEAR	CIL./CYL.	ASHIKA CODE
Sephia					
Sephia i	1600	SOHC-B6-1K	94	4	132-0K-K01
Sorento					
Sorento JC V6 24V	3500	30D	03	4	132-05-513
Sportage					
Sportage i	2000	SOHC-FEDi	94	4	132-0K-K01
Sportage i (cavo 5mm)	2000	DOHC-FED	94	4	132-0K-K02
Sportage	2000		99	4	132-0K-K05
LEXUS					
GS300					
GS300 i.e. 24V (cavo 5mm)	3000	2JZGE	93	6	132-02-248
GS300 i 24V VVTI (cavo 5mm) (163 Kw)	3000	2JZGE-JZS160	97→	6	132-02-231
GS300 i 24V VVTI (cavo 5mm) (156 Kw)	3000	2JZGE-JZS147	93-97	6	132-02-248
LS400					
LS400 i.e. 32V (cavo 5mm)	4000	1UFZE	90	8	132-02-249
LS400 UCF10-UCF20 (cavo 5mm) (180Kw)	4000	1UZ-FE	89-94	8	132-02-249
MAZDA					
121					
121 16V (55 Kw)	1300	DHG-DHF	96-98	4	132-03-323
121 16V (55 Kw)	1300	DHG-DHF	98	4	132-03-324
121 LX 16V - Cabrio	1300		91-94	4	132-03-303
121 8V (37-44-55 Kw)	1300	DHA	96	4	132-03-305
121 (37-44 Kw)	1300		96	4	132-03-325
121 16V (55 Kw)	1300	ZQ	96	4	132-03-314
2					
2 16V (55 Kw)	1300	FUJA	03	4	132-03-326
2 16V (59 Kw)	1400	FXJA/B	03	4	132-03-326
2 16V (74 Kw)	1600	FYJA	03	4	132-03-326
3					
323 16V	1300	B3	90	4	132-03-311
323 F VI (BJ) 16V (53 Kw)	1400	B3	01-04	4	132-03-320
323 F VI (BJ) 16V (54 Kw)	1400	B3ME	01-04	4	132-03-320
323 S VI (BJ) 16V (53 Kw)	1400	B3	01-04	4	132-03-320
323 S VI (BJ) 16V (54 Kw)	1400	B3ME	01-04	4	132-03-320
323	1500	DACT - AZ5	94	4	132-03-300
323F F 16V - Lantis	1500	DOHC	98	4	132-03-307
323 16V	1500	Z5	98	4	132-03-318
323	1600	DACT - AZ5	94	4	132-03-300
323F 16V - GT	1800	DOHC	90-94	4	132-03-300
323F 16V - Lantis (85 Kw)	1800	DOHC-BPE4	94-96	4	132-03-301
323F 16V - Lantis (85 Kw)	1800	DOHC-BP3G-BP3H	96	4	132-03-301
323F F 16V (84 Kw)	1800	DOHC-BP-ZE	94-98	4	132-03-301
323F S 16V (84 Kw)	1800	DOHC-BPE4-BP3H	94-98	4	132-03-301
323F V6 - 24V	2000		94-98	6	132-03-306
6					
6 16V (88 Kw)	1800	L813	02→	4	132-03-319
6 16V (104 Kw)	2000	LF17-LF18	02→	4	132-03-319
6 16V (122 Kw)	2300	L3C1	02→	4	132-03-319
6 16V (119 Kw) AWD	2300		02→	4	132-03-319
626					
626 (74 Kw)	1800	FPA1	99	4	132-03-316
626 (72 Kw)	1800	FPA9	99	4	132-03-316
626 (66 Kw)	1800		99	4	132-03-316
626	1900		97-00	4	132-03-316

MARCA-MODELLO CAR MODEL	CC	MOTORE ENGINE	ANNO YEAR	CIL./CYL.	ASHIKA CODE
626 16V - GE - IV (66 Kw)	1900	FP-FS / DOHC	91-97	4	132-03-304
626 (77 Kw)	1900	FS	91-97	4	132-03-317
626 (66 Kw)	1900		97-00	4	132-03-316
626	2000		97-00	4	132-03-316
626 16V - GE - IV (85 Kw)	2000	FS-DOHC	91-97	4	132-03-304
626 (85 Kw)	2000	FS	91-97	4	132-03-317
626 (66 Kw)	2000	FS	97-00	4	132-03-316
626 II	1800	F8-F8G7	88-92	4	132-03-321
626 II (GC) (74-88 Kw)	2000	FE	88-97	4	132-03-321
626 II 12V	2000	FE-FE4J-FE4K	87-90	4	132-03-321
626 III (GD) 12V (65 Kw)	1800	F8-F8G7	87-92	4	132-03-321
626 III (GD) (66 Kw)	2000	FE	87-90	4	132-03-321
626 III (GD) 12V (79 Kw)	2000	FE	87-92	4	132-03-321
626 III Coupè (GD) (65 Kw)	1800	F8-F8G7	87-91	4	132-03-321
626 III Coupè (GD) (66 Kw)	2000	FE	87-90	4	132-03-321
626 III Coupè (GD) 12V (79 Kw)	2000	FE	87-88	4	132-03-321
626 III Hatchback (GD) (65 Kw)	1800	F8-F8G7	87-92	4	132-03-321
626 III Hatchback (GD) (66 Kw)	2000	FE	87-90	4	132-03-321
626 III Hatchback (GD) 12V (79 Kw)	2000	FE	87-92	4	132-03-321
626 III Station Wagon (GV) (65 Kw)	1800	F8-F8G7	88-92	4	132-03-321
626 III Station Wagon (GV) (66 Kw)	2000	FE	88-97	4	132-03-321
626 III Station Wagon (GV) 12V (81 Kw)	2000	FE	87-90	4	132-03-321
626 IV i	2500		92-97	6	132-03-306
626 16V	2000	DOHC	02	4	132-03-315
Demio					
Demio 16V (46-53 Kw)	1350	B3	98	4	132-03-310
Demio 16V (55Kw)	1500	B5	98	4	132-03-310
MX3					
MX3		EC13-B6	05/91	4	132-03-309
MX3 V6 (95-98 Kw)	1800	K819	95	6	132-03-308
MX3 i (79 Kw)	1800	DOHC-B6D	94	4	132-03-301
MX3 i	1800		93-98	6	132-03-306
MX3 V6	2000	DOHC	95	6	132-03-308
MX5					
MX5 i.e. 16V	1500		94	4	132-03-302
MX5 i.e. 16V	1600		89-92	4	132-03-313
MX5 i.e. 16V	1600		94	4	132-03-302
MX5 i.e. 16V	1800		94	4	132-03-302
MX6					
MX6 (85 Kw)	2000	FS	92	4	132-03-317
MX6 i V6 24V	2500	DOHC-KF	92	6	132-03-306
Premacy					
Premacy i 16V (cavo 5mm)	1800		99→	4	132-03-322
Xedos					
Xedos 6 i.e. 16V (83 Kw)	1600	B69	93-00	4	132-03-302
Xedos 6 i.e. 16V (79 Kw)	1600	B6 (210758)	94	4	132-03-302
Xedos 6 V6 24V (105 Kw)	2000	DOHC-KF	93-00	6	132-03-306
Xedos 9 V6 24V (123 Kw)	2500	DOHC-KL	93-00	6	132-03-306
Xedos 9 V6 24V (120 Kw)	2500	DOHC	00	6	132-03-306
Xedos 6 V6 24V (103 Kw)	2000	DOHC-KF1	94	6	132-03-312
MITSUBISHI					
Carisma					
Carisma i.e. 16V (66 Kw)	1600	4G92-OHC	95	4	132-05-507
Carisma (cavo 5mm) (66-76 Kw)	1600	4G92 (DA1A)	96-00	4	132-05-506
Carisma (cavo 5mm) (85-103 Kw)	1800	4G93 (DA2A)	96-99	4	132-05-506

MARCA-MODELLO CAR MODEL	CC	MOTORE ENGINE	ANNO YEAR	CIL./CYL.	ASHIKA CODE
Carisma i.e. 16V (85 Kw)	1800	4G93-SOHC	96	4	132-05-507
Carisma i.e. 16V (cavo 5mm)	1800	4G93-DOHC	97	4	132-05-506
Colt					
Colt	1200	OHC	84-90	4	132-05-508
Colt i.e. 12V (OHC)	1300	OHC	90	4	132-05-515
Colt V L i (cavo 5mm) (55 Kw)	1300		00→	4	132-05-506
Colt	1300	OHC	84-90	4	132-05-508
Colt GLi	1300			4	132-05-510
Colt GLX 12V	1300	4G13	92	4	132-05-513
Colt	1500	OHC	84-90	4	132-05-508
Colt Turbo	1600	DOHC	84-88	4	132-05-508
Colt i.e. GTi 16V	1600	DOHC	88-90	4	132-05-512
Colt i.e. 16V	1600	4G92-OHC	92-96	4	132-05-507
Colt i.e. 16V (cavo 5mm)	1600	OHC	96	4	132-05-506
Colt i.e. 16V (cavo 5mm)	1600	OHC	96	4	132-05-520
Colt V i (cavo 5mm) (55-74 Kw)	1600	4G92 (CJ4A)	96→	4	132-05-506
Colt V i 16V (cavo 5mm)	1600	4G92 (CA4A)	96 - 01	4	132-05-520
Colt i.e. 16V (100 Kw)	1800	4G67-DOHC	90-92	4	132-05-512
Colt GTI	1800	EU	91	4	132-05-518
Colt i.e. 16V	1800		94	4	132-05-511
Colt i.e. 16V	1800	4G93	92-95	4	132-05-516
Eclipse					
Eclipse	1800	4G37	88	4	132-05-512
Eclipse Turbo	2000		97	4	132-05-512
Eclipse (D22A) i.e. 16V	2000	4G63 DOHC	91-95	4	132-05-509
Eclipse i.e. 16V (147 Kw) Turbo	2000	4G63 DOHC	94-99	4	132-05-509
Eclipse i.e. 16V (107 Kw)	2000	4G63 DOHC	95-99	4	132-05-509
Evolution					
Evolution i 16V Turbo (cavo 5mm)	2000		96-01	4	132-05-529
Expo					
Expo 4WD	1800	4G93	96	4	132-05-507
Galant					
Galant	1600	OHC	84-88	4	132-05-508
Galant i.e. 16V	1800	4G93-OHC	93-96	4	132-05-507
Galant i 16V (cavo 5mm)	2000	Type EA2A	97	4	132-05-506
Galant i.e. Turbo	2000	OHC	82-88	4	132-05-508
Galant (Type E)	2000	OHC	84-88	4	132-05-508
Galant i.e.	2000	4G63/4G63B-DOHC	88-93	4	132-05-508
Galant i.e. GTi 16V	2000	4G63-OHC	88-93	4	132-05-512
Galant i.e. 16V (Type E55)	2000	4G63-OHC	93-97	4	132-05-507
Galant i.e. 16V (cavo 5mm)	2000	A2A-OHC	97	4	132-05-519
Galant VI i. 16V (cavo 5mm)	2000	4G63 EA2A/W	97	4	132-05-519
Galant i.e. 16V (82 Kw)	2400	G64B	85-88	4	132-05-523
Galant i.e. 24V	2500	4WD/4WS (6G73)	93-97	6	132-05-517
Lancer					
Lancer	1200	4G16-OHC	84-87	4	132-05-508
Lancer	1200	4G11-OHC	76-88	4	132-05-510
Lancer	1300	4G13-OHC	89-90	4	132-05-508
Lancer i.e.	1300	4G13-OHC	90-92	4	132-05-515
Lancer i.e. 12V (55 Kw)	1300	4C61A-4G13	92-96	4	132-05-515
Lancer i.e. 16V	1300	4G92-OHC	96	4	132-05-515
Lancer VII L (cavo 5mm) (60 Kw)	1300		03→	4	132-05-506
Lancer (50 Kw)	1400	4G12-OHC		4	132-05-510
Lancer (61 Kw)	1500	4G15-OHC	84-90	4	132-05-508
Lancer 12V (66 Kw)	1500	4G15-OHC	90-92	4	132-05-515
Lancer GTi 16V	1600	4G61-OHC	88-90	4	132-05-512

MARCA-MODELLO CAR MODEL	CC	MOTORE ENGINE	ANNO YEAR	CIL./CYL.	ASHIKA CODE
Lancer i.e. 16V	1600	4G92-OHC	92-96	4	132-05-507
Lancer Combi - 4WD	1600		92	4	132-05-510
Lancer i.e. 16V (cavo 5mm)	1600	4G92-OHC	96	4	132-05-506
Lancer i.e. 16V (cavo 5mm)	1600	4G92-OHC	96	4	132-05-520
Lancer IV L 16V(cavo 5mm) (66 Kw)	1600		92-94	4	132-05-506
Lancer VI (cavo 5mm) (66 Kw)	1600	4G92	96→	4	132-05-506
Lancer VI i 16V (cavo 5mm)	1600	4G92 (CK4A)	96→	4	132-05-520
Lancer VII L (cavo 5mm) (72 Kw)	1600		03→	4	132-05-506
Lancer i.e.	1800	G37B-OHC	86-90	4	132-05-508
Lancer i.e. 4WD	1800	OHC	89-92	4	132-05-508
Lancer 16V	1800	4G67-DOHC	90-92	4	132-05-512
Lancer GTI	1800	EU	91	4	132-05-518
Lancer Turbo	2000	OHC	81-84	4	132-05-508
Pajero					
Pajero (76 Kw)	2600	4G54B	85-88	4	132-05-524
Pajero Eci - Multi - V6	3000			6	132-05-503
Pajero Pinin L (cavo 5mm)	1800		03→	4	132-05-506
Pajero V6 24V (104 Kw)	3000	4G72	88-90	6	132-05-514
Pajero V6 24V (110 Kw)	3000	4G72	90-95	6	132-05-514
Pajero Sport i 24V (96 Kw) (cavo 5mm)	3000	6G72	98→	6	132-05-527
Pajero Sport i 24V (cavo 5mm)	3500	6G74	98→	6	132-05-527
Pajero Shogun V6 (cavo 5mm)	3500	GDi 6G74 V65W	94	6	132-05-513
Pajero Shogun 24V V6 (cavo 5mm)	3500	GDi 6G74 V75W	00	6	132-05-513
Pajero Shogun Sport i 24V(cavo 5mm)	3000	6G72 K86/96W	98→	6	132-05-527
Pajero Shogun Sport i 24V(cavo 5mm)	3500	6G74 K86/96W	98→	6	132-05-527
Pajero - Shogun V6 (cavo 5mm)	3500	DOHC	94	6	132-05-521
Pick Up					
Pick Up	2400	4G64	89-94	4	132-0H-H17
Precis					
Precis i	1500	G4DJ	94	4	132-0H-H03
Sapporo					
Sapporo i.e.	2400	OHC	87-89	4	132-05-508
Sigma					
Sigma i V6 24V	3000	DOHC	91-96	6	132-05-517
Space Gear					
Space Gear 16V (83-85 Kw)	2000	4G63	94-00	4	132-05-522
Space Gear 4x4 (97 Kw)	2400	4G64	94-00	4	132-05-522
Space Runner					
Space Runner i.e. 16V (90 Kw)	1800	4G93-OHC	91	4	132-05-507
Space Runner i.e. 16V (85 Kw)	1800	4G93-OHC	96-99	4	132-05-507
Space Runner i.e. 4x4 (85 Kw)	1800	4G93-OHC	96-99	4	132-05-507
Space Star					
Space Star i.e. 16V	1300	4G13	98	4	132-05-525
Space Star i.e. 16V (60 Kw) (cavo 5mm)	1300	4G13	00	4	132-05-506
Space Star (cavo 5mm) (63 Kw)	1300	4G13-DG1A	98→	4	132-05-528
Space Star (cavo 5mm) (74 Kw)	1600	4G92-DG3A	01→	4	132-05-528
Space Star 16V (72 Kw) (cavo 5mm)	1600	4G18	09/01→	4	132-05-506
Space Star (cavo 5mm) (81-90 Kw)	1800	4G93-DG3A	98→	4	132-05-528
Space Wagon					
Space Wagon (cavo 5mm) (96 Kw)	2000	4G63	00→	4	132-05-528
Space Wagon i.e. 16V	1800	OHC	91-96	4	132-05-507
Space Wagon i.e. 16V Gli - 4x4 (74-75 Kw)	2000	4G63	85-91	4	132-05-526
Space Wagon i.e. 4WD	2000		85-91	4	132-05-508
Space Wagon i.e. 16V	2000	4G63-OHC	91-96	4	132-05-507
Space Wagon 4x4	2400	4G63B	95	4	132-05-522

MARCA-MODELLO CAR MODEL	CC	MOTORE ENGINE	ANNO YEAR	CIL./CYL.	ASHIKA CODE
Truck					
Truck	2400	4G64	89→	4	132-0H-H17
L200					
L200	2000		87-95	4	132-05-508
L200 (82 Kw)	2400	4G64	90-97	4	132-0H-H17
L300					
L300 (83-85-63-66 Kw)	2000	G63/64-G64B	86-90	4	132-05-508
L300 (65-66-82 Kw)	2400	G63/64-G64B	86→	4	132-05-508
NISSAN					
NX					
NX 16V	1400		96	4	132-01-118
NX 100 i.e.	1600	GA16DE	90-94	4	132-01-123
NX 100 i.e.	1600	GA16DS	90-94	4	132-01-121
NX 16V	1600	GA16DE	96	4	132-01-118
NX 100 i.e.	2000	SR20DE	92	4	132-01-123
NX 100 Coupé 16V			91-93	4	132-01-121
200 SX					
200 SX Turbo 16V	2000		94	4	132-01-122
Almera					
Almera 16V GTi-LX-GX-S	1400	GA14DE	96	4	132-01-118
Almera	1400	GA14DE	95	4	132-01-116
Almera 16V GTi-SLX-SR	1600	GA16DE	95	4	132-01-118
Almera Tino 16V	2000	SR20DE	00	4	132-01-118
Bluebird					
Bluebird	1600	CA16	85-90	4	132-01-108
Bluebird	1800	CA18DE	85-90	4	132-01-108
Kubistar					
Kubistar	1200	D7F 764	03→	4	132-01-119
Kubistar 16V (55 Kw)	1200	D4F 712	04/06→	4	132-01-120
Kubistar Furgonato 16V (55 Kw)	1200	D4F 712	04/06→	4	132-01-120
Kubistar (64 Kw)	1600	K7J	03→	4	132-01-125
Maxima					
Maxima V6 12V L	3000		86-90	6	132-01-107
Maxima V6 L	3000		89	6	132-01-107
Maxima V6 L	3000		90-91	6	132-01-107
Maxima V6 i	3000		91	6	132-01-107
Micra					
Micra	1000		85-92	4	132-01-105
Micra i.e. 16V - Twin Cam (40 Kw)	1000	CG10DE	92	4	132-01-123
Micra 16V	1000		96	4	132-01-110
Micra 16V	1000		98	4	132-01-110
Micra	1200		85-92	4	132-01-105
Micra i.e. 16V - Twin Cam (55 Kw)	1300	CG13DE	92-00	4	132-01-123
Micra 16V SLX	1300		94	4	132-01-110
Micra (55 Kw)	1300	CG13	94	4	132-01-114
Patrol					
Patrol L	2800		80-88	6	132-01-111
Patrol L	3000		89-92	6	132-01-112
Patrol L	4200		91	6	132-01-112
Primera					
Primera 16V	1600	GA16DE	90-93	4	132-01-121
Primera (66 Kw)	1600	GA16DS	90-96	4	132-01-123
Primera 16V (66 Kw)	1600	GA16DS	96	4	132-01-123
Primera i.e. 16V	1600		93	4	132-01-124
Primera i.e. 16V Twin Cam	1600	GA16DE	96	4	132-01-109

MARCA-MODELLO CAR MODEL	CC	MOTORE ENGINE	ANNO YEAR	CIL./CYL.	ASHIKA CODE
Primera Traveller	1600	GA16DE	95	4	132-01-116
Primera 16V	2000	SR20DI	90-96	4	132-01-122
Primera (92 Kw)	2000	SR20DE	95-96	4	132-01-109
Primera (96 Kw)	2000	SR20DE	96	4	132-01-109
Primera 16V (103 Kw)	2000	SR20DE	96	4	132-01-109
Primera 16V STH (110 Kw)	2000	SR20DE	96	4	132-01-109
Primera i.e. 16V GT	2000		90-96	4	132-01-122
Sunny					
Sunny	1300		82	4	132-01-106
Sunny	1400	GA14DS	90-92	4	132-01-123
Sunny 16V	1400	GA14DS	92	4	132-01-123
Sunny i.e. 16V	1400	N14-GA16DE	91-93	4	132-01-121
Sunny i.e. 16V	1400	GA14DE	93-95	4	132-01-118
Sunny	1400	GA14DE	95	4	132-01-116
Sunny	1500		82	4	132-01-106
Sunny	1600	GA16DS	90-95	4	132-01-123
Sunny i.e. 16V	1600	N14-GA16DE	91-93	4	132-01-121
Sunny i.e. 16V	1600	GA16DE	93-96	4	132-01-124
Sunny	1600	GA16DE	95	4	132-01-116
Sunny 16V GTi	2000		91	4	132-01-122
Serena					
Serena	1600		94	4	132-01-121
Serena i.e.	2000		92-96	4	132-01-122
Terrano					
Terrano 12V	2400	KA24E	93-96	4	132-01-113
Terrano	2400	KA24E	96	4	132-01-113
Terrano i	2400	Z24i	87	4	132-01-115
Terrano	2400	Z24i	87-92	4	132-01-115
Terrano V6 i L	3000		89	6	132-01-107
Vanette					
Vanette	1500		80	4	132-01-117
King Vannette		CG22	86	4	132-01-117
PIAGGIO					
Porter					
Porter Glass Van				3	132-06-608
Porter i 16V	1000			3	132-06-609
Porter i 16V	1000			3	132-06-611
Porter 16V (cavo 5mm)	1300			4	132-06-610
SUBARU					
Forester					
Forester	2000		97-98	4	132-07-704
Forester	2000	EJ20	98-02	4	132-07-713
Forester (90 Kw)	2000	EJ20	97-98	4	132-07-707
Forester	2000	EJ20	02	4	132-07-714
Forester (125 Kw)	2000	EJ20	98-01	4	132-07-715
Forester	2500		02	4	132-07-714
Impreza					
Impreza 4WD	1600	EJ16	96-97	4	132-07-704
Impreza Sports Wagon	1600	EJ16	92-97	4	132-07-704
Impreza	1600		97-98	4	132-07-706
Impreza 4WD	1600		92-00	4	132-07-712
Impreza Sports Wagon	1800	EJ18	92-97	4	132-07-704
Impreza	1800		97-98	4	132-07-706
Impreza 4WD	1800	EJ81	97-02	4	132-07-714

MARCA-MODELLO CAR MODEL	CC	MOTORE ENGINE	ANNO YEAR	CIL./CYL.	ASHIKA CODE
Impreza	2000	EJ20	96-98	4	132-07-706
Impreza 4WD	2000	EJ20	96	4	132-07-704
Impreza 4WD	2000	EJ201	95-00	4	132-07-714
Impreza Turbo	2000		98-00	4	132-07-715
Impreza	2000		00	4	132-07-714
Impreza	2200	EJE	93-98	4	132-07-714
Impreza	2500	EJ253	93-98	4	132-07-714
Impreza	2000		01	4	132-07-714
Justy					
Justy				3	132-07-701
Justy i 4WD	1300			4	132-07-705
Legacy					
Legacy I	1600			4	132-07-704
Legacy I	1800		91	4	132-07-708
Legacy I	2000		94-96	4	132-07-704
Legacy I	2000		96-98	4	132-07-706
Legacy III (101 Kw)	2000	EJ20	03→	4	132-07-710
Legacy III (92 Kw)	2000	EJ20	98	4	132-07-714
Legacy II	2200	EJ22	96	4	132-07-704
Legacy II	2200	EJ22	96-97	4	132-07-706
Legacy IV (115 Kw)	2500	EJ25	03→	4	132-07-711
Leone					
Leone	1800		89-92	4	132-07-709
Libero					
Libero (37 Kw)	1000	EF10	83-93	3	132-07-700
Libero (38-40 Kw)	1200	EF12	83-93	3	132-07-700
Serie L					
Serie L				4	132-07-702
Outback					
Outback	2500	EJ201	00	4	132-07-714
Vivio					
Vivio 4WD	650	ENO7E	92-95	4	132-07-703
SUZUKI					
Alto					
Alto i (29 Kw)	800	F8B-OHC	86-93	3	132-08-803
Alto i.e.	1000		93	4	132-08-809
Alto i (39-43 Kw)	1000	ENG.G10B	97	4	132-08-814
Alto 16V (50 Kw)	1000		9	4	132-08-821
Alto IV 16V (46 Kw)	1100		2002→	4	132-08-812
Baleno					
Baleno 16V	1600		97	4	132-08-818
Baleno 16V - SW (52-63 Kw)	1300		97-99	4	132-08-813
Baleno 16V - SW (63 Kw)	1300	G13BB	97-02	4	132-08-812
Baleno 16V - SW (63 Kw)	1300	G13B	99-02	4	132-08-812
Baleno 16V - SW	1600		92	4	132-08-806
Baleno 16V - SW (72-73 Kw)	1600	G16B	99-02	4	132-08-812
Baleno 16V - 4x4 (72-73 Kw)	1600	G16B	99-02	4	132-08-812
Carry					
Carry (58 Kw)	1300	G16B	99→	4	132-08-812
Carry 16V (58 Kw)	1600	G16BB	00→	4	132-08-812
Esteem					
Esteem (70 Kw)	1600	G16B	98→	4	132-08-812
Grand Vitara					
Grand Vitara 4x4 (78 Kw)	1300	M16A	05→	4	132-08-816

MARCA-MODELLO CAR MODEL	CC	MOTORE ENGINE	ANNO YEAR	CIL./CYL.	ASHIKA CODE
Ignis					
Ignis I 16V (61 Kw)	1300	M13A	00-03	4	132-08-816
Ignis II 16V (69 Kw)	1300	M13A	03→	4	132-08-816
Ignis 16V	1300		04	4	132-08-821
Ignis II 16V (73 Kw)	1500	M15A	03→	4	132-08-816
Jimmy					
Jimmy 16V - SW	1300		01	4	132-08-817
Jimmy 16V - SW (59 Kw)	1300	G13BB	98→	4	132-08-812
Jimmy (63 Kw) 16V	1300		05	4	132-08-821
Liana					
Liana 16V (66 Kw)	1300	M13A	01→	4	132-08-816
Liana 16V (76 Kw)	1600	M16A	01-04	4	132-08-816
Liana 16V (78 Kw)	1600	M16A	02→	4	132-08-816
Liana 16V	1600		05	4	132-08-821
Maruti					
Maruti (tutte)	800		91	4	132-08-803
Samurai					
Samurai I (44-47-51 Kw)	1300	G13BA	94	4	132-08-819
Samurai I (44-47 Kw)	1300	G13B-G13A	90-93	4	132-08-820
Santana					
Santana	1000			4	132-08-815
Santana (44-47 Kw)	1300	G13BA	94	4	132-08-819
Sidekick					
Sidekick 16V 4x4 (71 Kw)	1600	G16B	89-96	4	132-08-807
Sidekick 16V (59 Kw)	1600	G16A	89-98	4	132-08-807
SJ					
SJ 410 (33 Kw)	1000	CTG.M1		4	132-08-822
SJ 410 (33 Kw)	1000	F10A	81-88	4	132-08-800
SJ 413 (44 Kw)	1300	G13A	86-90	4	132-08-800
SJ 413 i (44-47 Kw)	1300	G13B-G13A	90-93	4	132-08-820
Splash					
Splash (48 Kw) 16V	1000		10	4	132-08-824
Splash (48 Kw) 16V	1200		10	4	132-08-824
Swift					
Swift 16V Gti (74 Kw)	1300	G13A-G13B	86-01	4	132-01-104
Swift GLS	1000	G10-G10A	97	3	132-08-811
Swift i 8V GTi (37 Kw)	1000	G10A	89	4	132-08-805
Swift i 8V GTi (50-54 Kw)	1300	G13A-G13BA	84-01	4	132-08-805
Swift 16V (68 Kw)	1300	M13A	05→	4	132-08-816
Swift 16V (68 Kw)	1300	M13A	05→	4	132-08-816
Swift 16V (68 Kw)	1300		10/05	4	132-08-821
Swift 16V (74 Kw)	1500	M15A	05→	4	132-08-816
Swift 16V (92 Kw)	1600	M16A	06→	4	132-08-816
SX					
SX4 (73 Kw)	1500	M15A	06→	4	132-08-816
SX4 (74 Kw)	1600	M16A	06→	4	132-08-816
Vitara					
Vitara 16V	1600		10/92	4	132-08-808
Vitara 16V (59 Kw)	1600	G16A	88-98	4	132-08-807
Vitara 16V (71 Kw)	1600	G16B	90-94	4	132-08-807
Vitara (tutte)			91	4	132-08-801
Vitara 8V	1600	G16A	95	4	132-08-817
Vitara S.W. 16V	1600		92	4	132-08-802
Vitara 16V	1600		92	4	132-08-823
Vitara 16V	1600	G16B	99→	4	132-08-812

MARCA-MODELLO CAR MODEL	CC	MOTORE ENGINE	ANNO YEAR	CIL./CYL.	ASHIKA CODE
Wagon R+					
Wagon R+ i.e. 16V (48-51 Kw)	1000	K10A - Z10 EXP	98-00	4	132-08-810
Wagon R+ i.e. 16V (51 Kw)	1200	K12A	98-00	4	132-08-810
Wagon R+ i.e. 16V (56-65 Kw)	1300	G13BB - M13A	00→	4	132-08-812
Wagon R+ i.e. 4x4 (56 Kw)	1300		01→	4	132-08-812
Wagon R+ i.e. 16V	1300		05	4	132-08-821
Wagon R+ 16V (65-69 Kw)	1300	M13A	03→	4	132-08-816
TATA					
INDICA					
Indica GLX (44 Kw)	1400	745 Si	98-02	4	132-00-004
Indica L (55 Kw)	1400	745 Si	98→	4	132-00-004
TOYOTA					
Avensis					
Avensis i.e. 16V (cavo 5mm) (74-81 Kw)	1600	4AFE DOHC	97-00	4	132-02-200
Avensis i (cavo 5mm) (81 Kw)	1800	7AFE	97-00	4	132-02-200
Avensis i.e. 16V (cavo 5mm)	1800	DOHC	98	4	132-02-201
Avensis i.e. 16V (cavo 5mm)	2000	DOHC	98	4	132-02-202
Avensis (cavo 5mm) (94 Kw)	2000	3SFE	97-00	4	132-02-222
Avensis i 16V (cavo 5mm)	2000	3SFE	98-00	4	132-02-246
Camry					
Camry	1800	1SL/1SE-OHC	83	4	132-02-208
Camry	2000	3SFE	86-91	4	132-02-228
Camry i (cavo 5mm)	2200	DOHC	96	4	132-02-222
Camry i (cavo 5mm) (92-100 Kw)	2200	5S-FE/5S-FNE	96-01	4	132-02-222
Camry (cavo 5mm) (100 Kw)	2200	5S-FE (SXV10)	91-93	4	132-02-240
Camry i (118 Kw) (cavo 5mm)	2500	2VZFE	89-91	6	132-02-230
Camry i (138 Kw) (cavo 5mm)	3000	2VZFE	91-95	6	132-02-231
Camry i (cavo 5mm) (140 Kw)	3000	3VZ-FE (VCV10)	91-96	4	132-02-231
Carina					
Carina (55-65 Kw)	1600	2T/2TB-OHV	70-84	4	132-02-215
Carina (63 Kw)	1800	3T-OHV	82-84	4	132-02-215
Carina E 16V (AT171) (72-75 Kw)	1600	4-AFE	89-92	4	132-02-233
Carina E i.e. 16V (cavo 5mm) (72-75 Kw)	1600	4A-FE/DOHC	92	4	132-02-200
Carina E (cavo 5mm) (78 Kw)	1600	4AFE		4	132-02-232
Carina i E (cavo 5mm)	1800	4AFE	95-97	4	132-02-200
Carina E (cavo 5mm) (98 Kw)	2000	3S-FE	92	4	132-02-240
Carina E i.e. 16V (cavo 5mm) (93 Kw)	2000	3S-FE/DOHC	92	4	132-02-202
Carina II					
Carina II	1600	4A-L/OHC	84-88	4	132-02-218
Carina II i 16V GLi	1600	4-AFE/DOHC	88-92	4	132-02-219
Carina II (coil M4)	1600	4AFE	95	4	132-02-229
Carina II 16V (AT171) (66-67 Kw)	1600	4-AF	88	4	132-02-232
Carina II 16V (AT180) (72-75 Kw)	1600	4-AFE	88	4	132-02-233
Carina E i.e. 16V (cavo 5mm)	1600	4A-FE/DOHC	92	4	132-02-200
Carina E i.e. 16V (cavo 5mm) (79 Kw)	1800	7A-FE/DOHC	95	4	132-02-201
Carina II	2000	3SFE	87-92	4	132-02-228
Carina E i.e. 16V (cavo 5mm) (98 Kw)	2000	3S-GE/DOHC	92-96	4	132-02-203
Celica					
Celica	1600	2T-2TB-2TG/DOHC	70-83	4	132-02-215
Celica	1600	2TB/OHV	76-82	4	132-02-215
Celica i.e. 16V	1600	4A-GEL/DOHC	85-87	4	132-02-216
Celica 16V (AT180) (77 Kw)	1600	4-AFE	90-94	4	132-02-233
Celica i.e. 16V (cavo 5mm) (77 Kw)	1600	4A-FE/DOHC	90-94	4	132-02-200
Celica i.e. 16V (cavo 5mm)	1600	4AGE		4	132-02-221

MARCA-MODELLO CAR MODEL	CC	MOTORE ENGINE	ANNO YEAR	CIL./CYL.	ASHIKA CODE
Celica (AT160) (85-91 Kw)	1600	4AGEL	85-87	4	132-02-234
Celica (AT160) (91-96 Kw)	1600	4AGEL/C	86-93	4	132-02-234
Celica i.e. 16V (cavo 5mm)	1800	7A-FE/DOHC	92	4	132-02-200
Celica i.e. 16V (cavo 5mm) (85 Kw)	1800	7A-FE/DOHC	95	4	132-02-201
Celica i.e. GT 16V	2000	3S-GE/DOHC	85-94	4	132-02-217
Celica (110 Kw)	2000	3SGEL	85-92	4	132-02-235
Celica	2000	3SFE	86-89	4	132-02-228
Celica i.e. 16V 4WD (cavo 5mm)	2000	3SGE	90-94	4	132-02-227
Celica i.e. 16V 4WD (115-118 Kw)	2000	3SGE	90-91	4	132-02-236
Celica i.e. 16V GT (cavo 5mm)	2000	3SGTE	90-94	4	132-02-227
Celica i.e. 16V GT (136-153 Kw)	2000	3SGTE	87-93	4	132-02-236
Celica i.e. T 4WD (cavo 5mm)	2000	3SGTE	90-94	4	132-02-227
Celica i.e. T 4WD (136-153 Kw)	2000	3SGTE	88-89	4	132-02-236
Celica 4WD (ST205) (136-153 Kw)	2000	3SGTE	90-92	4	132-02-250
Celica GT 16V i (cavo 5mm) (178 Kw)	2000	3SGE	94	4	132-02-238
Celica 4WD- GT4 i (cavo 5mm) (136-153 Kw)	2000	3SGTE	90-93	4	132-02-239
Celica GT4 i (cavo 5mm)	2000	3SGTE	94→	4	132-02-245
Corolla					
Corolla	1200	3K-4K/OHV	70-87	4	132-02-209
Corolla	1300	3K-4K/OHV	70-87	4	132-02-209
Corolla 12V (55 Kw)	1300	2E-L/2E OHC	85-92	4	132-02-210
Corolla i.e. 16V (cavo 5mm) (55-65 Kw)	1300	4E-FEDOHC	92	4	132-02-204
Corolla i.e. 16V (cavo 5mm) (55-65 Kw)	1300	DOHC	97	4	132-02-204
Corolla E11 i 16V	1300	4E-FE	97-99	4	132-02-241
Corolla E10 51 Kw	1300	2E	92-97	4	132-02-222
Corolla i.e. 16V (cavo 5mm) (55-65 Kw)	1400	4E-FE/DOHC	92	4	132-02-204
Corolla	1600	2T/2T- B OHV	77-81	4	132-02-215
Corolla 16V	1600	4A - F	87-92	4	132-02-219
Corolla (AE86) (85 Kw)	1600	4AGE	82-92	4	132-02-234
Corolla i.e.	1600	4AL-4ALC	83-87	4	132-02-218
Corolla i.e. 16V	1600	4A-G/DOHC	83-92	4	132-02-216
Corolla 16V (AE) (66 Kw)	1600	4-AF	87-92	4	132-02-232
Corolla i 16V E9 (cavo 5mm)	1600	4-AF	87-92	4	132-02-247
Corolla E10i L (cavo 5mm) (85 Kw)	1600	4AFE	92-97	4	132-02-200
Corolla E11 i L (cavo 5mm) (79 Kw)	1600	4AFE	97-00	4	132-02-200
Corolla i.e. 16V (cavo 5mm)	1600	4A-FE/DOHC	92	4	132-02-200
Corolla i.e. 16V (cavo 5mm) (84 Kw)	1600	7A-FE/DOHC	92	4	132-02-200
Corolla i.e. 16V (cavo 5mm)	1600	DOHC	97	4	132-02-204
Corolla E10i L (cavo 5mm) (79 Kw)	1800	4AFE	97-00	4	132-02-200
Corona					
Corona	1800	3T-OHV	79-80	4	132-02-215
Cressidra					
Cressidra i.e. MX73 (125 Kw)	2800	5M-GE/DOHC	82-85	6	132-02-211
Cressidra i.e. MX73 (125 Kw)	2800	5M-GE/DOHC	82-95	6	132-02-211
Land Cruiser					
Land Cruiser (81 Kw)	2400	22R/OHC	83-89	4	132-02-212
Land Cruiser i.e.	2400	22RE/OHC	90	6	132-02-213
Land Cruiser i.e. V6 24V (cavo 5mm)	3400	DOHC-5VZ-FE	96	6	132-02-223
Land Cruiser i.e. V6 24V (cavo 5mm)	4500	DOHC-1FZ-FE	95	6	132-02-223
Land Cruiser 24V (cavo 5mm) (151 Kw)	4500	DOHC-1FZ-FE	92-98	6	132-02-223
Lite - Ace					
Lite - Ace (cavo 5mm)	1500		92-94	4	132-02-244
MR2					
MR2 16V	1600	4AGEL/DOHC	85-90	4	132-02-216

MARCA-MODELLO CAR MODEL	CC	MOTORE ENGINE	ANNO YEAR	CIL./CYL.	ASHIKA CODE
MR2 (AW11) (91 Kw)	1600	4AGEL/C	84-89	4	132-02-234
MR2 L (cavo 5mm) (115 Kw)	2000	3 SFE - RWD	90→	4	132-02-203
MR2 L Turbo (cavo 5mm) (165 Kw)	2000	3 SGTE	92-95	4	132-02-227
MR2 16V	2000			4	132-02-218
MR2 16V GT	2000	3S-GE SW20	93→	4	132-02-205
MR2 L (cavo 5mm)	2000	3 SFE	89-92	4	132-02-207
MR2 L (cavo 5mm) (96 Kw)	2200	5 SFE	89-92	4	132-02-207
MR2 L (cavo 5mm) (96 Kw)	2200	5SFE	92-93	4	132-02-202
MR2 i.e. 16V GT (cavo 5mm) (129 Kw)	2200	3S-GE/DOHC	90	4	132-02-205
Paseo					
Paseo 16V (cavo 5mm) (66 Kw)	1500	DOHC-5EFE	96	4	132-02-224
Picnic					
Picnic 16V (cavo 5mm) (94-95 Kw)	2000	DOHC-3SFE	96	4	132-02-222
Previa					
Previa 16V i (cavo 5mm) (97 Kw)	2400	DOHC-2TZFE	90	4	132-02-225
Rav 4					
Rav 4 16V i (cavo 5mm) (95 Kw)	2000	DOHC-3SFE (SXA10)	94-00	4	132-02-226
Rav 4 I 16V (cavo 5mm) (88-95 Kw)	2000	3S-FE (SXA10)	94-97	4	132-02-222
Rav 4 I 16V (cavo 5mm) (88-95 Kw)	2000	3S-FE (SXA10)	94-97	4	132-02-240
Starlet					
Starlet	1000	2K/OHV	78-85	4	132-02-209
Starlet (84 Kw)	1000	1E-L/OHC	85-90	4	132-02-214
Starlet (cavo 5mm) (84 Kw)	1000	1E-LC	90-93	4	132-02-237
Starlet (cavo 5mm) (40 Kw)	1000	1E-1ELC (EP70-80)	92-96	4	132-02-222
Starlet	1200	3K-H/OHV	79-82	4	132-02-209
Starlet (cavo 5mm)	1300	2E,2EE	89-96	4	132-02-222
Starlet	1300	4K/OHV	82-83	4	132-02-209
Starlet (55 Kw)	1300	2E-L 2E OHC	89-90	4	132-02-210
Starlet (55 Kw) (cavo 5mm)	1300	4AFE	96-99	4	132-02-200
Starlet (cavo 5mm) (55 Kw)	1300	2EE-1ELC	91	4	132-02-237
Starlet 16V (cavo 5mm)	1300	4F-FE/OHC	96	4	132-02-206
Supra					
Supra i.e. (125 Kw)	2800	5M-GE/DOHC	82-85	6	132-02-211
Supra (165 Kw) (cavo 5mm)	3000	2JZ-GE	93-98	6	132-02-248
Truck					
Truck (105 Kw)	3000	3VZ-E (VZN130)	88→	6	132-02-243
Hi Ace / Hi Lux / Lite Ace					
Hi Ace	1800	2Y-OHV	83-84	4	132-02-209
Hi Ace	2000	3Y-OHV	84-89	4	132-02-209
Hi Ace i (cavo 5mm)	2400	2RZ-E	89→	4	132-02-242
Hi Lux	1800	2Y-OHV	84-90	4	132-02-209
Hi Lux	2000	3Y-OHV	84-88	4	132-02-209
Hi Lux	2200	4Y-OHC	86-88	4	132-02-209
Hi Lux (cavo 5mm)	3000	3VZ-E (VZN130)	89→	6	132-02-243
Lite Ace	1300	4K-OHV	86-92	4	132-02-209
Lite Ace	1500	5K-OHV	86-92	4	132-02-209
Lite Ace	1500	5K KR27	92-94	4	132-02-244
4 Runner					
4 Runner V6 (cavo 5mm)	3000	3VZ-E	91	6	132-02-220
4 Runner i V6 (cavo 5mm) (105 Kw)	3000	3VZ-E (VZN130)	89-96	6	132-02-243

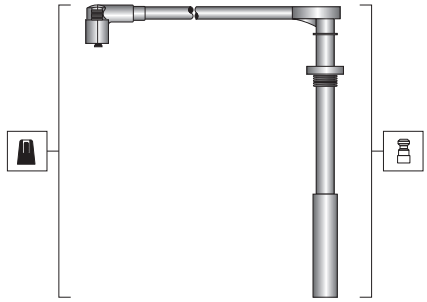
132-00-001	Ø 7 - Cavo Silicone ww Mag-Wire - Silicone Cable ww	Cyl.	Coil	
	DR DR1 Eco Power-Bifuel 1300 (61 Kw) 09→ DR2 Eco Power-Bifuel 1300 (61 Kw) 09→	98 80 74 68	--	

132-00-002	Ø 7 - Cavo Silicone ww Mag-Wire - Silicone Cable ww	Cyl.	Coil	
	DR DR5 Eco Power-Bifuel 1600 (80 Kw) 10→ DR5 Eco Power-Bifuel 4WD 2000 (93-95 Kw) 10→	32 38 47 59	--	

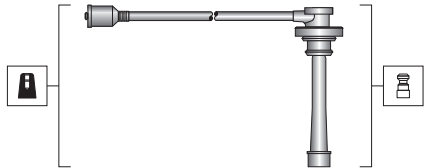
132-00-003	Ø 7 - Cavo Silicone ww Mag-Wire - Silicone Cable ww	Cyl.	Coil	
	Great Wall Hover 4WD 2350 05-08→	41 50 56 65	--	

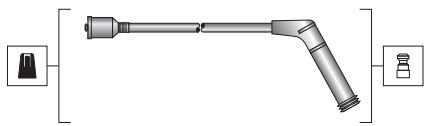
132-00-004	Ø 7 - Cavo Silicone - Silicone Cable	Cyl.	Coil	
	Tata Indica GLX (44 Kw) 1400 (475 Si) 06/1998-09/2002 Indica L (55 Kw) 1400 (475 Si) 98→	55 55 45 45	--	

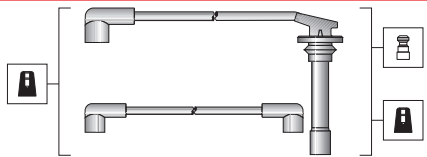
132-01-121	Ø 7 - Cavo Silicone - Silicone Cable	Cyl.	Coil	
	Nissan NX 100 Coupè 16V 91-93 NX 100 1600i.e. 93→ Primera 1600 16V (GA16DE) 90-93 Sunny 1400i.e. 16V (N14-GA16DE) 91-93 Sunny 1600i.e. 16V (N14-GA16DE) 91-93 Serena 1600 94→	50 60 70 70	40	

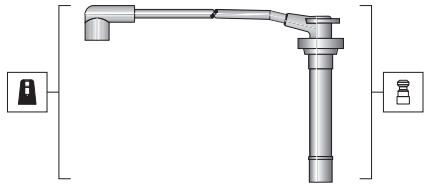
132-01-124	Ø 7 - Cavo Silicone - Silicone Cable	Cyl.	Coil	
	Nissan Primera 1600i.e. 16V 93→ Sunny 1600i.e. 16V (GA16DE) 93-96E 89→	90 80 70 60	--	

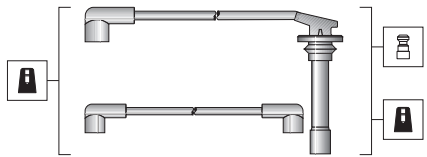
132-01-122	Ø 7 - Cavo Silicone - Silicone Cable	Cyl.	Coil	
	Nissan 200 2000 Turbo 16V 94→ Primera 2000i.e. 16V GT 90-96 Sunny 2000 16V GTi 91→ Serena 2000i.e. 92-96	50 60 70 80	20	

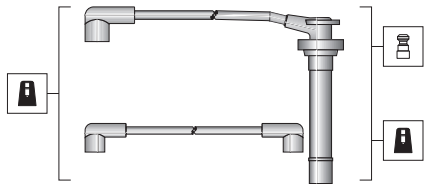
132-01-123	Ø 7 - Cavo Silicone - Silicone Cable	Cyl.	Coil	
	Nissan NX 100 2000i.e. (SR20DE) 92→ Micra 1000i.e. 16V - 1300i.e. 16V 92→ Micra 1000 16V CG10DE 92→ Micra 1300 16V CG13DE 92→	50 60 70 80	20	

132-01-104	Ø 7 - Cavo Silicone - Silicone Cable	Cyl.	Coil	
	Suzuki Swift 1300i 16V GTi 86-93 Swift 1600 16V GTi 89-95	80 60 60 50	40	

132-01-105	Ø 7 - Cavo Silicone - Silicone Cable	Cyl.	Coil	
	Nissan Micra 1000 85-92 Micra 1200 MA12 (40 Kw) 85-92	40 50 70 80	50	

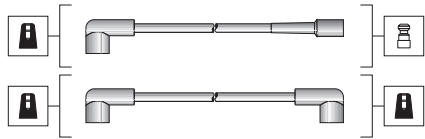
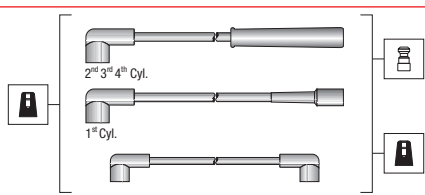
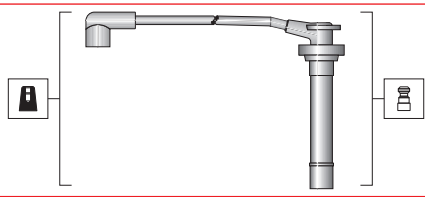
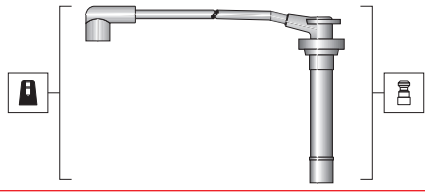
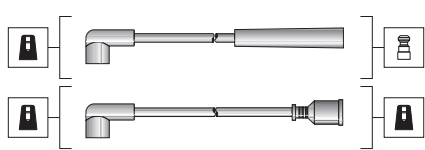
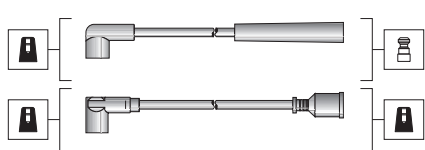
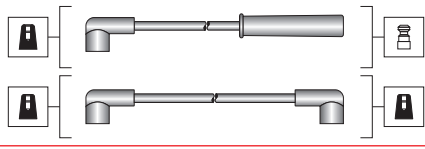
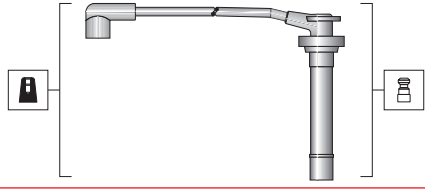
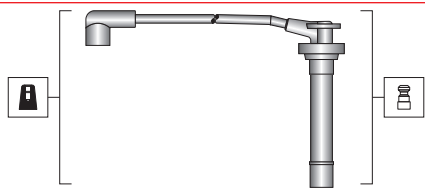
132-01-106	Ø 7 - Cavo Silicone - Silicone Cable		Cyl.	Coil	
	Nissan Sunny 1300 - 1500 82→		50 55 70 80	55	
132-01-107	Ø 7 - Cavo Silicone - Silicone Cable		Cyl.	Coil	<p style="text-align: center;">Illustration not available</p> <p style="text-align: center;">Illustrazione non disponibile</p>
	Nissan Maxima V6 12V L 3000 86-90 Maxima V6 L 3000 89	Maxima V6 L 3000 91 Maxima V6i 3000 91 Terrano V6i L 3000 89	--	--	
132-01-108	Ø 7 - Cavo Silicone - Silicone Cable		Cyl.	Coil	
	Nissan Bluebird 1800 87-90		80 80 50 50	40	
132-01-109	Ø 7 - Cavo Silicone - Silicone Cable		Cyl.	Coil	
	Nissan Primera 1600 16V 96→ Primera 2000 16V (SR20DE) 96→ Primera 2000 16V STH (SR20DE) 96→	Ford Maverick 2400 16V (K424E) 93→	80 70 60 50	--	
132-01-110	Ø 7 - Cavo Silicone - Silicone Cable		Cyl.	Coil	
	Nissan Micra 1.0 16V 98→		70 70 50 50	--	
132-01-111	Ø 7 - Cavo Silicone - Silicone Cable		Cyl.	Coil	
	Nissan Patrol 2800 L 80-88		80 80 80 80 105 105	50	
132-01-112	Ø 7 - Cavo Silicone - Silicone Cable		Cyl.	Coil	
	Nissan Patrol 3000 L 89-92 Patrol 4200 L 91→		60 70 80 90 110 110	50	
132-01-113	Ø 7 - Cavo Silicone - Silicone Cable		Cyl.	Coil	
	Nissan Terrano 2400 12V (KA24E) 93-96 Terrano 2400 (KA24E) 96→		70 50 50 40	70	
132-01-114	Ø 7 - Cavo Silicone - Silicone Cable		Cyl.	Coil	
	Nissan Micra 1300 (CG13) (55Kw) 94→		70 70 50 40	--	
132-01-115	Ø 7 - Cavo Silicone - Silicone Cable		Cyl.	Coil	<p style="text-align: center;">Illustration not available</p> <p style="text-align: center;">Illustrazione non disponibile</p>
	Nissan Terrano i 2400 (Z24i) 87 Terrano 2400 (Z24i) 87-92		--	--	
132-01-116	Ø 7 - Cavo Silicone - Silicone Cable		Cyl.	Coil	
	Nissan Almera 1.4 GX-LX (GA14DE) 95→ Almera I Hatchback-S-GX-LX 1.4 (G14DE) 1.6 (G16DE) 1.6 SLX (G16DE) Primera Traveller 1.6i (G16DE) Sunny 1.6i 16V (GA16DE) III 1.4/1.6 16V Sunny III Hatchback 1.4/1.6 16V (Mot. =)		90 80 70 60	--	

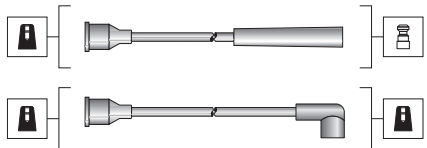
		Ø 7 - Cavo Silicone - Silicone Cable		Cyl.	Coil		
132-01-117	Isuzu Aska 1800 i.e. Turbo 83→ Aska 2000 i.e. Turbo 83→ Gemini 1500 i.e. Turbo 77-90 Gemini 1600 i.e. Turbo 77-90 Gemini 1800 i.e. Turbo 77-90	Nissan Vanette 1500 80→ King Vanette 86→		40 40 50 50	45		

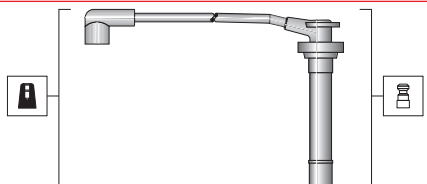
		Ø 7 - Cavo Silicone - Silicone Cable		Cyl.	Coil		
132-01-118	Nissan NX 1400-1600 16V 10/92→ Almera 1400 16V (GA14DE) 07/95→ Almera 1600 16V (GA16DE) 07/95→ Sunny 1400 16V (GA14DE) 01/93 - 12/95			50 60 80 80	--		

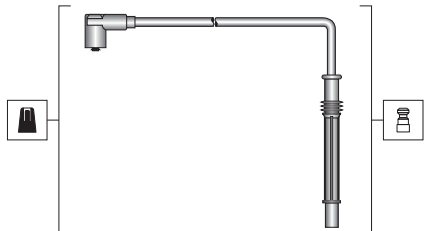
		Ø 7 - Cavo Silicone - Silicone Cable		Cyl.	Coil		
132-01-119	Nissan Kubistar 1200 (D7F764) 03→			58 41 41 38	--		

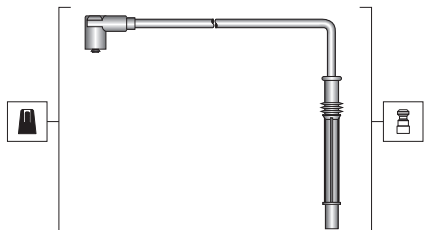
		Ø 7 - Cavo Silicone - Silicone Cable		Cyl.	Coil		
132-01-120	Nissan Kubistar 16V (55 Kw) (D4F712) 04/06→ Kubistar Furgonato 16V (55 Kw) (D4F712) 04/06→			56 56 58 56	--		

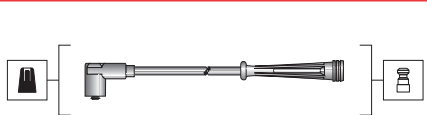
		Ø 7 - Cavo Silicone ww Mag-Wire - Silicone Cable ww		Cyl.	Coil		
132-01-125	Renault Clio 1400 (E7J) 98→ Clio 1600 (K7J-K7M) 98→ Kangoo 1400 (E7J) 97→ Kangoo 1600 (K7M) 97→	Megane Classic 1600 (55-66 Kw) (K7M) 98→ Megane Coach 1600 (55-66 Kw) (K7M) 98→ Megane Cabriolet 1600 (55-66 Kw) (K7M) 98→ Megane Scenic 1600 (55-66 Kw) (K7M) 98→		30 40 40 60	--		

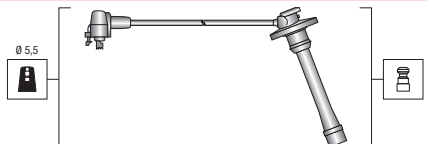
		Ø 5 - Cavo Silicone - Silicone Cable		Cyl.	Coil		
132-02-200	Toyota Avenis 1.6i 16V (DOHC) 98→ Carina E 1.6i 16V (4AFE) 92→	Celica 1.6i 16V (4AFE) 90-94 Celica 1.8i 16V (7AFE) 92→ Corolla 1.6i 16V (4AFE-7EFE) 92→		70 60 50 40	--		

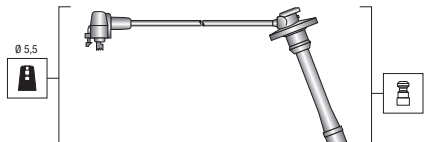
		Ø 5 - Cavo Silicone - Silicone Cable		Cyl.	Coil		
132-02-201	Toyota Avenis 1800i 16V (DOHC) 98→ Carina E 1800i 16V (7AFE) 95→	Celica 1600i 16V (4AF) 90-94 Celica 1800i 16V (7AFE) 95→		70 60 50 40	--		

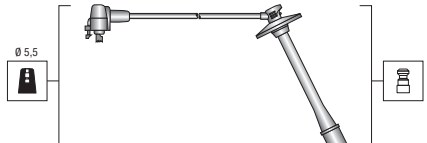
		Ø 5 - Cavo Silicone - Silicone Cable		Cyl.	Coil		
132-02-202	Toyota Avenis 2000i 16V (DOHC) 98→ Carina E 2000i 16V (3SFE) 92→			80 60 50 40	--		

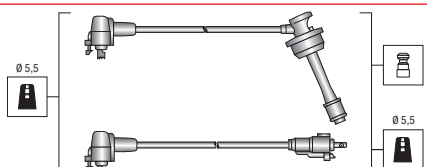
		Ø 5 - Cavo Silicone - Silicone Cable		Cyl.	Coil		
132-02-203	Toyota Carina E 2000i 16V (3SGE) 92-96			60 40 40 30	30		

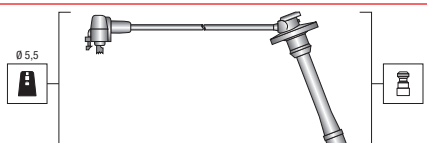
		Ø 5 - Cavo Silicone - Silicone Cable		Cyl.	Coil		
132-02-204	Toyota Corolla 1.3i 16V (4EFE) 92→ Corolla 1.4i 16V (4EFE) 92→ Corolla 1.6i 16V (DOHC) 97→			60 50 40 30	--		



132-02-205	Ø 5 - Cavo Silicone - Silicone Cable		Cyl.	Coil	
	Toyota MR2 2200i 16V 90→		40 40 40 50	30	
132-02-206	Ø 5 - Cavo Silicone - Silicone Cable		Cyl.	Coil	
	Toyota Starlet 1300i 16V (4F-FE) 96→		60 60 40 40	--	
132-02-207	Ø 5 - Cavo Silicone - Silicone Cable		Cyl.	Coil	
	Toyota MR2 2200i 16V (3SFE) 90-92		60 50 50 60	30	
132-02-208	Ø 5 - Cavo Silicone - Silicone Cable		Cyl.	Coil	
	Toyota Camry 1800 (1SL-1SE) 83→		50 50 50 50	--	
132-02-209	Ø 7 - Cavo Silicone - Silicone Cable		Cyl.	Coil	
	Toyota Corolla 1200-1300 (3K-4K) 70-87 Starlet 1000 (2K-OHV) 78-85 Starlet 1200 (3K-OHV) 79-82 Starlet 1300 (4K-OHV) 82-83	Hi Ace 1800-2000 (2Y-3Y) 83-89 Hi Lux 1800 (2Y) 84-90 Hi Lux 2000 (3Y) 84-88 Hi Lux 2200 (4Y) 86-88 Lite Ace 1500 (5K) 86-92	40 60 60 60	80	
132-02-210	Ø 7 - Cavo Silicone - Silicone Cable		Cyl.	Coil	
	Toyota Corolla 1300 12V (2E-L) 85-92		60 80 50 70	--	
132-02-211	Ø 7 - Cavo Silicone - Silicone Cable		Cyl.	Coil	
	Toyota Cressida 2800 (5MGE) 82-85 Supra 2800i (5MGE) 82-85		70 70 80 100 100 110	70	
132-02-212	Ø 7 - Cavo Silicone - Silicone Cable		Cyl.	Coil	
	Toyota Land Cruiser 2400 (22R) 84→		40 60 60 80	80	
132-02-213	Ø 7 - Cavo Silicone - Silicone Cable		Cyl.	Coil	
	Toyota Land Cruiser 2400i (22RE) 90→		40 40 50 50 50 60	70	
132-02-214	Ø 7 - Cavo Silicone - Silicone Cable		Cyl.	Coil	
	Toyota Starlet 1000 (1E-L) 85-90		50 50 60 80	60	
132-02-215	Ø 7 - Cavo Silicone - Silicone Cable		Cyl.	Coil	
	Toyota Carina 1600 - 1800 80-83 Celica 1600 (2TG-2TB) 76-82 Corolla 1600 - 1800 77-81		50 50 80 80	50	

132-02-216	Ø 7 - Cavo Silicone - Silicone Cable	Cyl.	Coil	
	Toyota Celica 1600i 16V (4A-GEL) 85-87 Corolla 1600i 16V (4A-G) 83-92 MR2 1600i 16V (4A-GEL) 85-90	40 50 50 60	70	
132-02-217	Ø 7 - Cavo Silicone - Silicone Cable	Cyl.	Coil	
	Toyota Celica 2000i 16V (3S-GE) 85-94	40 50 60 80	40	
132-02-218	Ø 7 - Cavo Silicone - Silicone Cable	Cyl.	Coil	
	Toyota Carina II 1600 (4A-L) 84-88 Corolla 1600 (4AL-4ALC) 83-87 MR2 2000 16V	70 50 50 40	--	
132-02-219	Ø 5 - Cavo Silicone - Silicone Cable	Cyl.	Coil	
	Toyota Carina 1600i 16V (4-AFE) 88-92 Corolla 1600i 16V (4-AFE) 87-92	70 70 50 50	60	
132-02-220	Ø 5 - Cavo Silicone - Silicone Cable	Cyl.	Coil	
	Toyota 4 Runner 3000 V6 91→	130 120 110 60 50 50	50	
132-02-221	Ø 5 - Cavo Silicone - Silicone Cable	Cyl.	Coil	<p style="text-align: center;">Illustration not available</p> <p style="text-align: center; color: red;">Illustrazione non disponibile</p>
132-02-222	Ø 5 - Cavo Silicone - Silicone Cable	Cyl.	Coil	
	Toyota Camry 2200i (DOHC) 96→ Pic Nic 2000i 16V (DOHC) 97→	90 90 80 70	--	
132-02-223	Ø 5 - Cavo Silicone - Silicone Cable	Cyl.	Coil	
	Toyota Land Cruiser 3400i V6 96→ Land Cruiser 4500i V6 95→	110 100 80 70 50 40	70	
132-02-224	Ø 5 - Cavo Silicone - Silicone Cable	Cyl.	Coil	
	Toyota Paseo 1500 16V 96→	70 60 50 40	--	
132-02-225	Ø 5 - Cavo Silicone - Silicone Cable	Cyl.	Coil	
	Toyota Previa 2400i 16V 90→	60 50 40 20	--	
132-02-226	Ø 5 - Cavo Silicone - Silicone Cable	Cyl.	Coil	
	Toyota Rav 4 2000i 16V 94→	70 60 50 40	--	

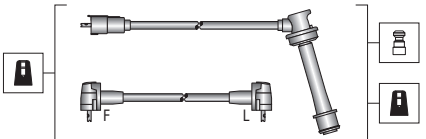
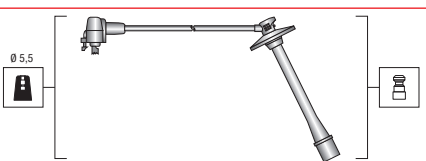
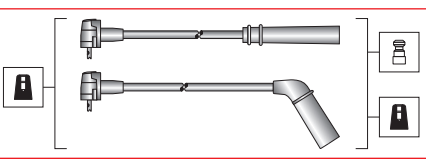
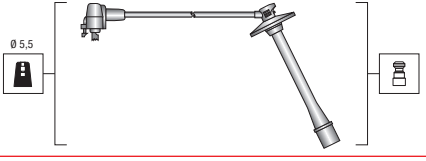
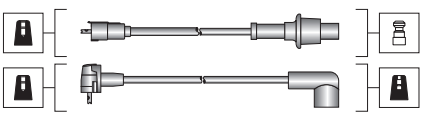
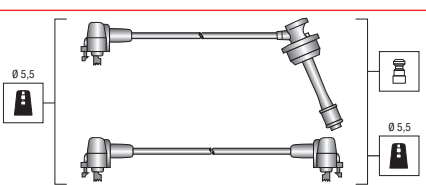
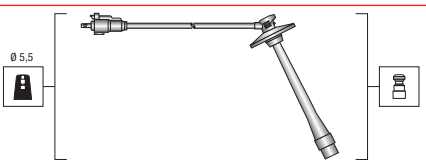
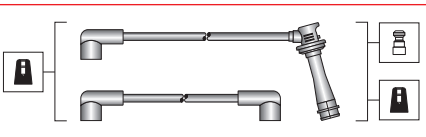
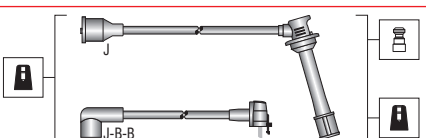
132-02-227	Ø 5 - Cavo Silicone - Silicone Cable	Cyl.	Coil	
	Toyota Celica 2000i 16V (3SGE) 90-94 Celica 2000i 16V (3SGTE) 90-94	Celica 2000ie 4WD 16V (3SGTE) 90-94	80 70 70 60	
132-02-228	Ø 5 - Cavo Silicone - Silicone Cable	Cyl.	Coil	Illustration not available Illustrazione non disponibile
	Toyota Camry 2.0 (3SFE) 86-91 Carina II 2.0 (3SFE) 87-92	Celica 2.0 (3SFE) 86-88	--	
132-02-229	Ø 5 - Cavo Silicone - Silicone Cable	Cyl.	Coil	Illustration not available Illustrazione non disponibile
	Toyota Carina II 1600 (4AFE) 95→	--	--	
132-02-230	Ø 7 - Cavo Silicone - Silicone Cable	Cyl.	Coil	
	Toyota Camry 2500i (2VZFE) (118 Kw) 89-91	50 60 70 70 80 80	60	
132-02-231	Ø 5 - Cavo Silicone - Silicone Cable	Cyl.	Coil	
	Toyota Camry 3000i 24V (3VZFE) (138 Kw) 91-95	45 60 70 70 70 80	40	
132-02-232	Ø 7 - Cavo Silicone - Silicone Cable	Cyl.	Coil	
	Toyota Carina II 1600 16V (4AEF) (66-77 Kw) 88→ Corolla 1600 (4AEF) (67 Kw) 87-92	40 50 60 70	--	
132-02-233	Ø 7 - Cavo Silicone - Silicone Cable	Cyl.	Coil	
	Toyota Carina E 1600i 16V (4AFE) (72-75 Kw) 89-92 Carina II 1600i 16V (4AFE) (72-75 Kw) 88-92	Celica 1600i 16V (4AFE) (77 Kw) 90-94	40 50 60 70	
132-02-234	Ø 7 - Cavo Silicone - Silicone Cable	Cyl.	Coil	
	Toyota Celica 1600 (4AGEL) (85-91 Kw) 85-87 Celica 1600 16V (4AGEL/C) (91-96 Kw) 86-93	Corolla 1600i 16V GT/GTi (4AGE) (85 Kw) 82-92 MR2 1600i 16V (4AGEL/C) (91 Kw) 84-89	30 40 50 50	
132-02-235	Ø 7 - Cavo Silicone - Silicone Cable	Cyl.	Coil	
	Toyota Celica 2000 (3SGEL) 85-92	40 40 50 60	45	
132-02-236	Ø 7 - Cavo Silicone - Silicone Cable	Cyl.	Coil	
	Toyota Celica 2000 16V (3SGE) (115-118 Kw) 90-91 Celica 2000i 16V 4WD (3SGTE) (136-153 Kw) 87-93	40 40 50 50	30	
132-02-237	Ø 5 - Cavo Silicone - Silicone Cable	Cyl.	Coil	
	Toyota Starlet 1000 (1ELC) (40 Kw) 90-93 Starlet II 1300i (2EE) (55 Kw) 91→	30 40 60	70	
132-02-238	Ø 7 - Cavo Silicone - Silicone Cable	Cyl.	Coil	
	Toyota Celica 2000i GT (3SGE) (178 Kw) 94→	50 60 60 70	30	

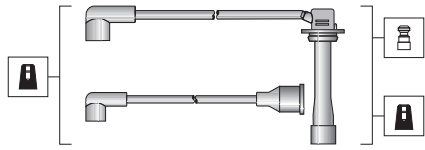
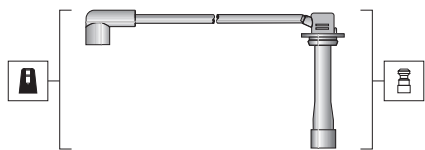
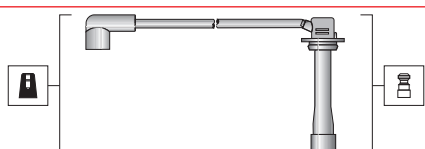
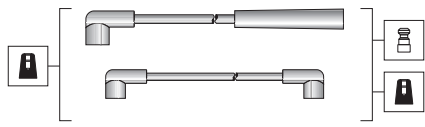
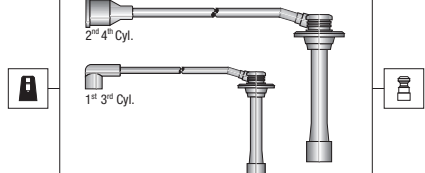
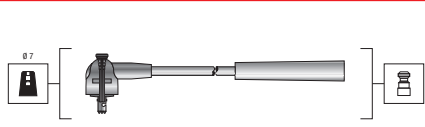
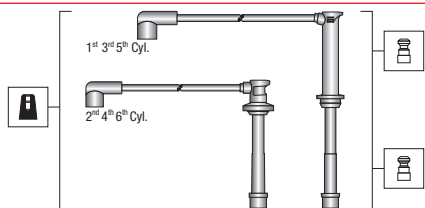
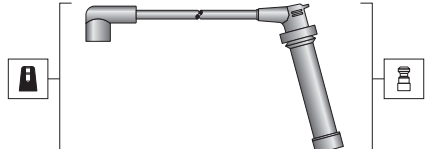
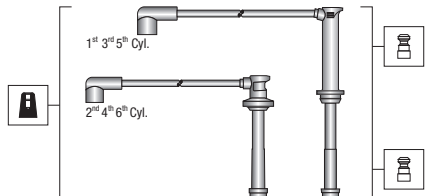
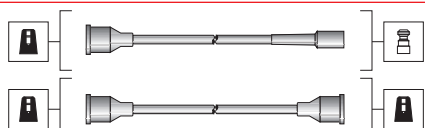
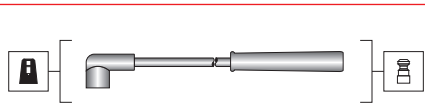
132-02-239	Ø 5 - Cavo Silicone - Silicone Cable	Cyl.	Coil	
	Toyota Celica 2000i 4WD (3SGTE) (136-153 Kw) 90-93	30 50 50 60	30	
132-02-240	Ø 5 - Cavo Silicone - Silicone Cable	Cyl.	Coil	
	Toyota Camry (100 Kw) 2200 5S-Fe (SXV10) 91-93 Carina E (98 Kw) 2000 3S-FE 92 Rav 4 I 16V (88-95 Kw) 2000 3S-FE (SXA10) 94-97	--	--	
132-02-241	Ø 5 - Cavo Silicone - Silicone Cable	Cyl.	Coil	<p style="text-align: center;">Illustration not available</p> <p style="text-align: center;">Illustrazione non disponibile</p>
132-02-242	Ø 5 - Cavo Silicone - Silicone Cable	Cyl.	Coil	
	Toyota Hi Ace i 2400 2RZ-E 89→	58 66 79 86	--	
132-02-243	Ø 5 - Cavo Silicone - Silicone Cable	Cyl.	Coil	
	Toyota Truck 3000 3Vz-E (VZN130) 88→ Hi Lux 3000 3Vz-E (VZN130) 89→ 4 Runner i V6 (105 Kw) 3000 3Vz-E (VZN130) 89-96	52 66 70 85	--	
132-02-244	Ø 5 - Cavo Silicone - Silicone Cable	Cyl.	Coil	
	Daihatsu Move Gran 16V i 1500 HE-G 97-98	18 26 26 26	26	
132-02-245	Ø 5 - Cavo Silicone - Silicone Cable	Cyl.	Coil	
	Toyota Celica GT4 i 2000 (3SGTE) 94→	64 65 72 38	--	
132-02-246	Ø 5 - Cavo Silicone - Silicone Cable	Cyl.	Coil	
	Toyota Avensis i 16V 2000 (3SFE) 98-00	43 61 70 73	--	
132-02-247	Ø 5 - Cavo Silicone - Silicone Cable	Cyl.	Coil	
	Toyota Corolla i 16V E9 1600 (4-AF) 87-92	53 44 55 43	66	
132-02-248	Ø 5 - Cavo Silicone - Silicone Cable	Cyl.	Coil	<p style="text-align: center;">Illustration not available</p> <p style="text-align: center;">Illustrazione non disponibile</p>
132-02-249	Ø 5 - Cavo Silicone - Silicone Cable	Cyl.	Coil	<p style="text-align: center;">Illustration not available</p> <p style="text-align: center;">Illustrazione non disponibile</p>
	Lexus LS 400 ie 32V 4000 (1UFZE) 90→ LS 400 (180 Kw) 4000 (1UFZE) 89-94	107 105 98 98 72 70 46 36	23 32	
132-02-250	Ø 7 - Cavo Silicone - Silicone Cable	Cyl.	Coil	
	Toyota Celica 2000i 4WD (3SGTE) (136-153 Kw) 90-92	40 50 50 60	30	

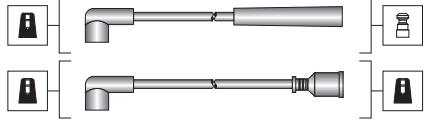
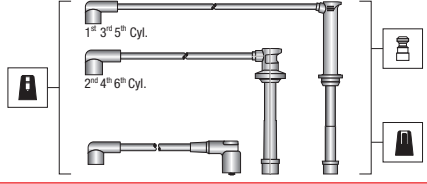

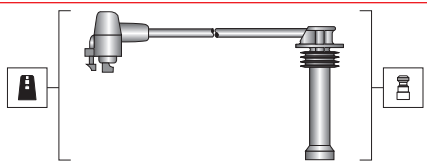
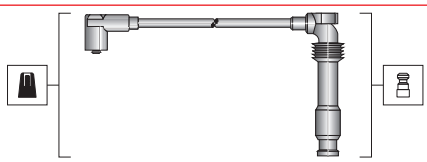
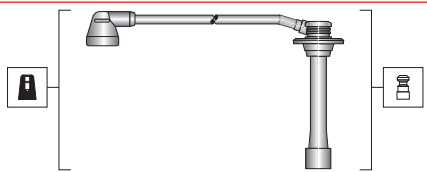
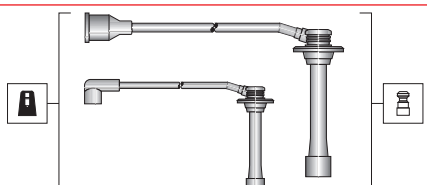
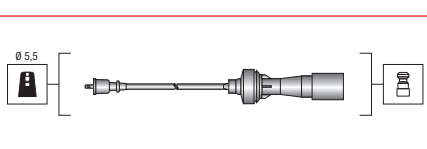
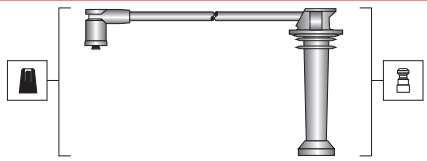
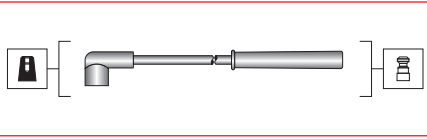
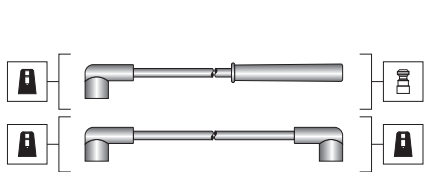
132-03-300	Ø 7 - Cavo Silicone - Silicone Cable		Cyl.	Coil	
	Mazda 323 1500 (DACT-AZ5) 94→ 323 1600 (DACT-AZ5) 94→ 323F 1800 GT 90-94		70 60 50 50	60	
132-03-301	Ø 7 - Cavo Silicone - Silicone Cable		Cyl.	Coil	
	Mazda 323 1800 16V - Lantis (BPE4) (85 Kw) 94→ 323 1800 16V - Lantis (BP3G-BP3H) (85 Kw) 94→ 323 1800 16V - Lantis (BP-ZE) (84 Kw) 94→ 323 1800 16V - Lantis (BPE4-BP3H) (84 Kw) 94→ MX3 1800 (79 Kw) (B6D) 94→		70 60 50 50	--	
132-03-302	Ø 7 - Cavo Silicone - Silicone Cable		Cyl.	Coil	
	Mazda MX5 1500i.e. 16V 94→ MX5 1600i.e. 16V 94→	MX5 1800i.e. 16V 94→ Xedos 6 1600i.e. 16V (83 Kw) 93→ Xedos 1600 (79 Kw) 94→	50 40 30 30	--	
132-03-303	Ø 7 - Cavo Silicone - Silicone Cable		Cyl.	Coil	
	Mazda 121 1300 16V - Cabrio 91-94		80 80 50 50	45	
132-03-304	Ø 7 - Cavo Silicone - Silicone Cable		Cyl.	Coil	
	Mazda 626 1900 16V (FP-DOHC) 91-97 626 1900 16V (FS-DOHC) 91-97 626 2000 16V (FS-DOHC) 91-97		70 70 50 50	--	
132-03-305	Ø 8 - Cavo Silicone - Silicone Cable		Cyl.	Coil	
	Ford Ka 1300 EFI 8V (36 Kw) (JLJ/D/F/G/H) 96-99 Ka 1300 EFI 8V (44 Kw) (J4D/K/M/N/P) 96-99 Endura 1300 EFI 96→ Fiesta IV 1000 (38 Kw) 96-98	Fiesta IV 1300 (44 Kw) (JJA/C/E/J/K/M) 96-98 Fiesta IV 1300 (44 Kw) (J4C/J/L/Q/R/T) 96-98 Mazda 121 1300 8V 96→	105 90 90 80	--	
132-03-306	Ø 7 - Cavo Silicone - Silicone Cable		Cyl.	Coil	
	Mazda 323 F V6 24V 94-98 626 V6 24V 2500i 92-94 MX3 1800i V6 24V 93-98	MX6 2500i V6 24V 92→ Xedos 6 - 2000 V6 24V 96→ Xedos 9 - 2000 V6 24V 96→	140 90 150 70 155 50	--	
132-03-307	Ø 7 - Cavo Silicone - Silicone Cable		Cyl.	Coil	
	Mazda 323F 1500 16V Lantis 98→		70 70 50 50	--	
132-03-308	Ø 7 - Cavo Silicone - Silicone Cable		Cyl.	Coil	
	Mazda MX3 1800 - 2000 V6 95→		110 80 90 60 80 70	--	
132-03-309	Ø 7 - Cavo Silicone - Silicone Cable		Cyl.	Coil	
	Mazda MX3 (EC13-BE) 5/91→		30 30 35 30	35	
132-03-310	Ø 7 - Cavo Silicone - Silicone Cable		Cyl.	Coil	
	Mazda Demio 1350 16V 98→ Demio 1500 16V 98→		70 60 50 50	--	

132-03-311	Ø 7 - Cavo Silicone - Silicone Cable		Cyl.	Coil	
	Mazda 323 1300 16V (B3) 90→		50 60 70 70	60	
132-03-312	Ø 7 - Cavo Silicone - Silicone Cable		Cyl.	Coil	
	Mazda Xedos 6 2000 V6 24V (DOHC) 6 cil. 97→		130 80 130 60 150 70	70	
132-03-313	Ø 7 - Cavo Silicone - Silicone Cable		Cyl.	Coil	
	Mazda MX5 1600i 16V 89-92		50 40 30 30	--	
132-03-314	Ø 7 - Cavo Silicone - Silicone Cable		Cyl.	Coil	
	Mazda 121 1300 16V (ZQ) 96→		40 50 60 70	--	
132-03-315	Ø 7 - Cavo Silicone - Silicone Cable		Cyl.	Coil	
	Mazda 626 2000 16V 02→		60 50 40 30	--	
132-03-316	Ø 7 - Cavo Silicone - Silicone Cable		Cyl.	Coil	
	Mazda 626 1800 (FPA1) (74 Kw) 99→ 626 1800 (FPA9) (72 Kw) 99→ 626 1800 (66 Kw) 97-00	626 16V 1800 99→ 626 1900 (66 Kw) 97-00 626 2000 (FS) (66 Kw) 97-00		70 50 40 40	
132-03-317	Ø 7 - Cavo Silicone - Silicone Cable		Cyl.	Coil	
	Mazda 626 1900 (FS) (77 Kw) 91-97 626 2000 (FS) (85 Kw) 91-97 MX6 (FS) (85 Kw) 92→		80 80 60 60	--	
132-03-318	Ø 7 - Cavo Silicone - Silicone Cable		Cyl.	Coil	
	Mazda 323 16V 1500 (Z5) 98		34 -- 39 --	--	
132-03-319	Ø 8 - Cavo Silicone - Silicone Cable		Cyl.	Coil	
	Mazda Mazda 6 Hatchback 1800 (L813) 02→ Mazda 6 Hatchback 2000 (LF17-LF18) 02→		60 40 40 30	--	
132-03-320	Ø 8 - Cavo Silicone - Silicone Cable		Cyl.	Coil	
	Mazda 323 F VI (BJ) (53-54 Kw) 16V 1400 (B3-B3ME) 01-04 323 S VI (BJ) (53-54 Kw) 16V 1400 (B3-B3ME) 01-04		65 65 50 44	--	
132-03-321	Ø 8 - Cavo Silicone - Silicone Cable		Cyl.	Coil	
	Mazda 626 II 1800 (F8-F8G7) 88-92 626 II (GC) (74-88 Kw) 2000 (FE) 88-97 626 II 12V 2000 (FE-FE4J-FE4K) 87-90 626 III (GD) 12V (65 Kw) 1800 (F8-F8G7) 87-92 626 III (GD) (66 Kw) 2000 (FE) 87-90 626 III (GD) 12V (79 Kw) 2000 (FE) 87-92 626 III Coupé (GD) (65 Kw) 1800 (F8-F8G7) 87-91	626 III Coupé (GD) (66 Kw) 2000 (FE) 87-90 626 III Coupé (GD) 12V (79 Kw) 2000 (FE) 87-88 626 III Hatchback (GD) (65 Kw) 1800 (F8-F8G7) 87-92 626 III Hatchback (GD) (66 Kw) 2000 (FE) 87-90 626 III Hatchback (GD) 12V (79 Kw) 2000 (FE) 87-92 626 III Station Wagon (GV) (65 Kw) 1800 (F8-F8G7) 88-92 626 III Station Wagon (GV) (66 Kw) 2000 (FE) 88-97 626 III Station Wagon (GV) 12V (81 Kw) 2000 (FE) 87-90		83 65 59 47	

132-03-322	Ø 8 - Cavo Silicone - Silicone Cable		Cyl.	Coil	
	Mazda Premacy i 16V 1800 99→		-- 62 -- 26	--	
132-03-323	Ø 8 - Cavo Silicone - Silicone Cable		Cyl.	Coil	
	Ford Fiesta IV 1250 16V (Zetec S - DHA/B/C/D/E/F/G) 95-02 Fiesta IV 1400 16V 96→ Puma 1400 i 16V (Zetec S - DHA) 97→ Puma 1700 i 16V (Zetec S - DHA) 97→	Mazda 121 1300 16V 96→	55 50 30 30	--	
132-03-324	Ø 8 - Cavo Silicone - Silicone Cable		Cyl.	Coil	
	Ford Focus 1600 (FYDA/B/C/D) 98-04 Focus 1800 16V (EYDB/C/D/E/F) 98-04 Focus 2000 16V (EDDB/C/D/F) 98-04 Focus 2000 (127-158 Kw) 04→ Maverick 2000 (91 Kw) 01→ Mondeo II 1600 16V (L1J-L1F) 96-00	Mondeo II 1800 16V (RKA/B/F/H/J/K) 96-00 Mondeo II 2000 16V (NGA/B/C/D) 96-00 Cougar 2000 16V (Zetec - S/EDBA) 09/98→	50 50 40 20	--	
132-03-325	Ø 8 - Cavo Silicone - Silicone Cable		Cyl.	Coil	
	Ford Fiesta IV 1000 (38Kw) 98-99 Fiesta IV 1300 (44Kw) (JJA-JJC-JJE-JJJ-JJK-JJM) 98-02 Fiesta IV 1300 (44Kw) (J4C-J4J-J4L-J4Q-J4R-J4T) 98-02 Ka 1300 (36Kw) (JJL-JJD-JJF-JJG-JJH) 99-03	Ka 1300 (44Kw) (J4D-J4K-J4M-J4N-J4P) 99-03 Mazda 121 1300 (37-44 Kw) 96→	90 90 100 100	--	
132-03-326	Ø 8 - Cavo Silicone - Silicone Cable		Cyl.	Coil	
	Ford C-Max 1600 (100cv) (CB1) 09→ Fiesta IV 1250 16V (55 Kw) (DHA/B/C/D/E/F/G) 95-08 Fiesta V 1400 16V (59 Kw) (Zetec SE-FXJA-FXJB) 95-08 Fiesta IV 1600 16V (76 Kw) (Zetec SE-L1T-L1V) 00-02 Fiesta V 1600 16V (74 Kw) (Zetec SE-FYJA) 01→ Fiesta V 1250 (EF180) 09→ Fiesta V 1200-1400-1600 (55 Kw) (CB1) 10→ Focus 1600 16V C-Max (Duratec) 03→ Focus 1600 (100-115cv) (CB1) 09→	Fusion 1400 16V (59Kw) (Zetec SE-FXJA-FXJB) 02→ Fusion 1600 16V (74Kw) (Zetec SE-FXJA-FXJB) 02→ Mondeo 1600 (Duratec) 07→ Puma 1400 16V (FHD-FHF) 97→ Puma 1700 16V (MHA-MHB) 97→ Mazda 2 1300 (55 Kw) (FUJA) 03→ 2 1400 (59 Kw) (FXJA/B) 03→ 2 1600 (74 Kw) (FYJA) 03→	50 40 30 30	--	
132-04-400	Ø 7 - Cavo Silicone - Silicone Cable		Cyl.	Coil	
	Honda Civic 1300 16V (D13B1/B2) 88→ Civic 1400 16V 88→	Civic 1500 i.e. 16V 93-95 Civic 1600 i.e. 16V (D16A6) 87-90 Civic 1600 16V (D16Z/D15Z) 90-94	80 80 70 60	--	
132-04-401	Ø 7 - Cavo Silicone - Silicone Cable		Cyl.	Coil	
	Honda Accord 1800i 16V 93→ Accord 2000i LS 16V 95→ Accord 2300i 16V 93→ CRX 1600i 16V (B16A2) 93→ Integra R 1800 11.97-10.01 Prelude 2000i 16V (F20A4) 91→	Prelude 2300i 16V (H23A2) 92→ Shuttle 2200 (F22B8) 95→ Shuttle 2300 (RA1) 98→ Rover 618 1800 16V (F18A3) 95→	90 80 80 60	--	
132-04-402	Ø 7 - Cavo Silicone - Silicone Cable		Cyl.	Coil	
	Honda Civic 1300i 16V (V-TEC) 94→ Civic 1500i 16V (V-TEC) 94→ Civic 1600i 16V (V-TEC) 94→ Civic Coupé 16V (V-TEC) 94→		60 60 80 80	--	
132-04-419	Ø 7 - Cavo Silicone - Silicone Cable		Cyl.	Coil	
	Rover 216 GSi 16V - Coupé 90→ 416 GTi 16V 90→	Honda Accord 2.0i 16V Cat. 90-93 Concerto 1.4i 16V 89→ Concerto 1.5i 16V 93→ Concerto 1.6i 16V (D16A8) 89→	50 60 80 80	--	
132-04-413	Ø 7 - Cavo Silicone - Silicone Cable		Cyl.	Coil	
	Honda Accord 2200i 16V (V-TEC) (F22Z2) 96→		80 80 70 60	--	

132-04-414	Ø 7 - Cavo Silicone - Silicone Cable		Cyl.	Coil	
	Honda Accord 1800 16V (F18B2) (SOHC/V-TEC) 96→ Civic 1400i 16V Aerodeck (D14W3) 97→ Civic 1600i 16V Aerodeck (D16W3) 97→ CRX 1600i 16V 93→ HR-V 1590 4WD 16V (D16W1) 99→		80 70 60 50	--	
132-04-415	Ø 7 - Cavo Silicone - Silicone Cable		Cyl.	Coil	
	Honda Civic 1400i (SOHC) 98→ Logo 1300 (GA3-SOHC) 99-02		80 70 70 50	--	
132-04-416	Ø 7 - Cavo Silicone - Silicone Cable		Cyl.	Coil	
	Honda CR-V 2000i 16V (B20B) 95→		90 80 70 50	--	
132-04-417	Ø 7 - Cavo Silicone - Silicone Cable		Cyl.	Coil	
	Honda Prelude GTI 2.2 (Mot. H2215) →97		40 50 70 70	--	
132-04-418	Ø 7 - Cavo Silicone - Silicone Cable		Cyl.	Coil	
	Rover 214 1400 8V 90→ 214 1400i 8V (75cv) 90-92	Honda Accord Aerodeck 2000i 84-89	60 60 50 50	80	
132-05-503	Ø 7 - Cavo Silicone - Silicone Cable		Cyl.	Coil	
	Mitsubishi Pajero ECi - Multi - V6 3000		60 60 70 60 60 80	30	
132-05-506	Ø 5 - Cavo Silicone - Silicone Cable		Cyl.	Coil	
	Mitsubishi Carisma 1800i 16V 97→ Colt 1600i 16V (OHC) 96→	Galant 2000i 16V (EA2A) 97→ Lancer 1600i 16V (4G92-OHC) 96→ Spacestar 1300i 16V (4G13) 00→	40 20	--	
132-05-507	Ø 7 - Cavo Silicone - Silicone Cable		Cyl.	Coil	
	Mitsubishi Carisma 1600 i.e. 16V (OHC) 95→ Carisma 1800 i.e. 16V (114cv) 95-97 Colt 1600 i.e. 16V (OHC) Expo 1800 4WD (4G93) 96→ Galant 1800 i.e. 16V (OHC) 93-96	Galant 2000 i.e. 16V (type E55) (OHC) Lancer 1600 i.e. 16V (4G92) (OHC) 92-96 Space Runner 1800 i.e. 16V (OHC) 91→ Space Wagon 1800 i.e. 16V (OHC) 91→ Space Wagon 2000 i.e. 16V (OHC) 91→	80 80 60 50	--	
132-05-508	Ø 7 - Cavo Silicone - Silicone Cable		Cyl.	Coil	
	Mitsubishi Colt 1200 - 1300 - 1500 (OHC) 84-90 Colt 1600 Turbo (DOHC) 84-88 Galant 1600 (OHC) 84-88 Galant 2000 (Type E) (OHC) 84-88 Galant 2000 i.e. (4G63/4G63B) (DOHC) 88-93 Lancer 1200 (4G16) (OHC) 84-87 Lancer 1300 (4G13) (OHC) 89-90	Lancer 1500 (OHC) 84-90 Lancer 1800 i.e. (G37B) (OHC) 86-90 Lancer 1800 i.e. 4WD (OHC) 89-92 Lancer 2000 i.e. Turbo (OHC) 81-84 Sapporo 2400 i.e. (OHC) 87-89 Space Wagon 2000 i.e. 4WD 85-91 L200 2000 87-95 L300 2000-2400 (G63/64-G64B) 86→	120 90 100 90	50	
132-05-509	Ø 7 - Cavo Silicone - Silicone Cable		Cyl.	Coil	
	Mitsubishi Eclipse (D22A) 2000 i.e. 16V (4G63) (DOHC) 91-95		70 80 70 50	--	
132-05-510	Ø 7 - Cavo Silicone - Silicone Cable		Cyl.	Coil	
	Mitsubishi Colt 1300 GLi Lancer 1200 Lancer 1400 Lancer 1600 - Combi - 4WD 92→		80 80 90 100	45	

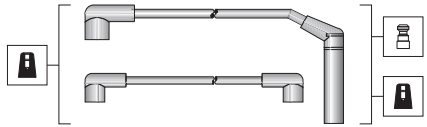
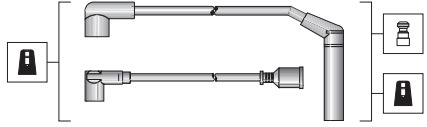
132-05-511	Ø 7 - Cavo Silicone - Silicone Cable	Cyl.	Coil	
	Mitsubishi Colt 1.8 16V 94→	50 60 70 70	--	
132-05-512	Ø 7 - Cavo Silicone - Silicone Cable	Cyl.	Coil	
	Mitsubishi Colt 1600 i.e. GTi 16V (DOHC) 88-90 Colt 1800 i.e. 16V (4G67) (DOHC) 90-92	Galant 2000 i.e. 16V GTi 16V (OHC) 88-93 Lancer 1600 GTi 16V (4G61) (OHC) 88-90 Lancer 1800 16V (4G67) (DOHC) 90-92	50 70 70 70 80	
132-05-513	Ø 7 - Cavo Silicone - Silicone Cable	Cyl.	Coil	
	Mitsubishi Colt GLX 1.3 12V	70 60 50 50	--	
132-05-514	Ø 7 - Cavo Silicone - Silicone Cable	Cyl.	Coil	
	Mitsubishi Pajero V6 24V 89-94 Sigma 3000i V6 24V 6472 91→	70 70 80 80 80 90	50	
132-05-515	Ø 7 - Cavo Silicone - Silicone Cable	Cyl.	Coil	
	Mitsubishi Colt 1300 i.e. 12V (OHC) 90→ Colt 1500 i.e. 12V (OHC) 90→	Lancer 1300 i.e. (4G13) (OHC) 90-92 Lancer 1300 i.e. (4G92) (OHC) 96→ Lancer 1500 12V (OHC) 90-92	80 80 90 90	
132-05-516	Ø 7 - Cavo Silicone - Silicone Cable	Cyl.	Coil	
	Mitsubishi Colt 1800i 16V (4G93) 92-95	50 60 70 70	--	
132-05-517	Ø 7 - Cavo Silicone - Silicone Cable	Cyl.	Coil	
	Mitsubishi Galant 2.5 i.e. V6 24V 4WD/4WS (6G73) 93-97 Sigma 3000i V6 24V (DOHC) 91-96	40 50 60 80 90 90	--	
132-05-518	Ø 7 - Cavo Silicone - Silicone Cable	Cyl.	Coil	
	Mitsubishi Colt 1800 GTi (EU) 91→ Lancer 1800 GTi (EU) 91→	50 50 70 70	--	
132-05-519	Ø 5 - Cavo Silicone - Silicone Cable	Cyl.	Coil	
	Mitsubishi Galant 2000 16V (A2A-OHC) 97→	43 -- 26 --	--	
132-05-520	Ø 5 - Cavo Silicone - Silicone Cable	Cyl.	Coil	
	Mitsubishi Colt 1600 16V (OHC) 96→ Lancer 1600 16V (4G92) 96→	46 -- 29 --	--	
132-05-521	Ø 5 - Cavo Silicone - Silicone Cable	Cyl.	Coil	
	Mitsubishi Pajero-Shogun 3500 V6 (DOHC) 94→	118 -- 106 --	95 --	
132-05-522	Ø 5 - Cavo Silicone - Silicone Cable	Cyl.	Coil	
	Mitsubishi Space Gear 2000 16V (4G63) 95→ Space Gear 2400 4x4 (4G64) 95→ Space Wagon 2400 4x4 (4G63B) 95→	40 60 60 70	35	

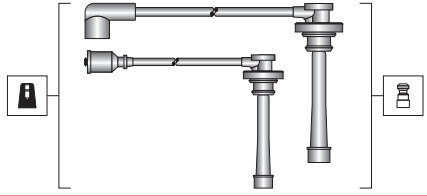
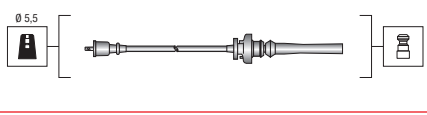
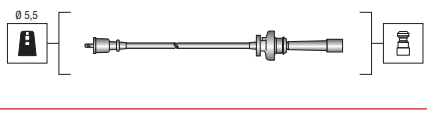
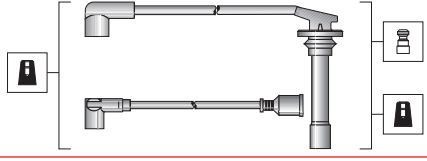
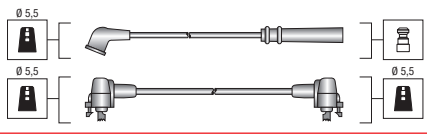
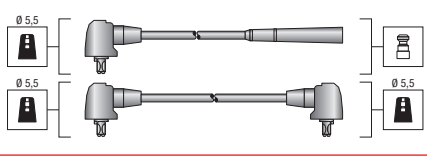
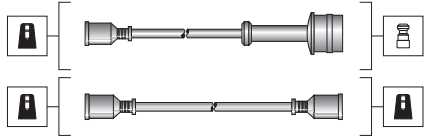
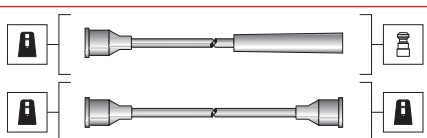
132-05-523	Ø 7 - Cavo Silicone - Silicone Cable	Cyl.	Coil	
	Mitsubishi Galant 2400 (G64B) (82 Kw) 85-88	70 80 80 100	40	
132-05-524	Ø 7 - Cavo Silicone - Silicone Cable	Cyl.	Coil	
	Mitsubishi Galant 2400 (G64B) (82 Kw) 85-88 Pajero 2600 (4G54B) (76 Kw) 83-90	70 80 90 90	50	
132-05-525	Ø 7 - Cavo Silicone - Silicone Cable	Cyl.	Coil	
	Mitsubishi Space Star 1300i 16V 98→	70 60 60 50	--	
132-05-526	Ø 7 - Cavo Silicone - Silicone Cable	Cyl.	Coil	
	Mitsubishi Space Wagon 2000 4x4 (4G63) 85-91 Space Wagon 2000 GLXi (4G63) 88-91 Space Wagon 2000 GLXi 4x4 (4G63) 88-91	100 80 80 70	--	
132-05-527	Ø 7 - Cavo Silicone - Silicone Cable	Cyl.	Coil	
	Mitsubishi Pajero Sport i 24V (96 Kw) 3000 (6G72) 98→ Pajero Sport i 24 V 3500 (6G74) 98→ Pajero Shogun Sport i 24V 3000 (6G72 K86/96W) 98→ Pajero Shogun Sport i 24V 3500 (6G74 K86/96W) 98→	70 58 47 38 72 59	--	
132-05-528	Ø 7 - Cavo Silicone - Silicone Cable	Cyl.	Coil	
	Mitsubishi Space Star (81-90 Kw) 1800 (4G93-DG3A) 98→ Space Star (63 Kw) 1300 (4G13-DG1A) 98→ Space Star (74 Kw) 1600 (4G92-DG3A) 01→ Space Wagon (96 Kw) 2000 (4G63) 00→	-- 24 -- 48	--	
132-05-529	Ø 7 - Cavo Silicone - Silicone Cable	Cyl.	Coil	
	Mitsubishi Evolution i 16V Turbo 2000 96-01	-- 38 -- 21	--	
132-06-612	Ø 7 - Cavo Silicone - Silicone Cable	Cyl.	Coil	
	Daihatsu Applause 1600 16V Feroza 1600 i.e.	70 70 60 50	45	
132-06-602	Ø 7 - Cavo Silicone - Silicone Cable	Cyl.	Coil	
	Daihatsu Domino Cuore 850i 97→ Mira Cuore 850i 93-95 Move 850i 97→	70 60 50	40	
132-06-603	Ø 7 - Cavo Silicone - Silicone Cable	Cyl.	Coil	
	Daihatsu Charade 1300i 16V (HCE-4WD) 87→ Charade 1500i 16V (HEG-OHC) 94→ Charade 1600i 16V (HDE-OHC) 93→ Move Gran 1500i 16V (HEG-OHC) 97→	50 60 70 80	70	
132-06-604	Ø 7 - Cavo Silicone - Silicone Cable	Cyl.	Coil	
	Daihatsu Rocky SoftTop 2000 (3Y) 85→ Rocky HardTop 2000 (3Y) 85→ Wildcat (3Y) 84-92	40 50 50 50	45	
132-06-605	Ø 7 - Cavo Silicone - Silicone Cable	Cyl.	Coil	
	Daihatsu Cuore 850 - 4WD 85-90 Domino 86-90 Grand Move 850i 16V (ED20) 93→	80 50 50	50	

132-06-606	Ø 5 - Cavo Silicone - Silicone Cable	Cyl.	Coil	
	Daihatsu Charade 1.3i (OHC) 89-93 Charade 1.5i (OHC) 89-93 Charade 1.6i (OHC) 89-93 Grand Move 1500i 16V 97→	70 60 50 40	70	

132-06-607	Ø 7 - Cavo Silicone - Silicone Cable	Cyl.	Coil	
	Daihatsu Applause 1600 16V (HDE) 89-97 Charade 1300 16V (HCE-HEE) 88-92 Valera 1500 16V (HEEG) 93→	75 60 60 40	65	

132-06-608	Ø 7 - Cavo Silicone - Silicone Cable	Cyl.	Coil	
	Piaggio Porter Glass Van	50 40 30	40	

132-06-609	Ø 7 - Cavo Silicone - Silicone Cable	Cyl.	Coil	
	Piaggio Porter 1000i 16V	50 40 30	50	

132-06-610	Ø 7 - Cavo Silicone - Silicone Cable	Cyl.	Coil	<p style="text-align: center;">Illustration not available</p> <p style="text-align: center;">Illustrazione non disponibile</p>
	Piaggio Porter 1000i 16V	50 40 30	50	

132-06-611	Ø 7 - Cavo Silicone - Silicone Cable	Cyl.	Coil	
	Piaggio Porter i 16V 1000	50 35 29	32	

132-07-700	Ø 7 - Cavo Silicone - Silicone Cable	Cyl.	Coil	
	Subaru Libero 1000 (EF10) 83-93 Libero 1200 (EF12) 83-93	60 50 40	90	

132-07-701	Ø 7 - Cavo Silicone - Silicone Cable	Cyl.	Coil	
	Subaru Justy	50 60 40	60	

132-07-702	Ø 7 - Cavo Silicone - Silicone Cable	Cyl.	Coil	
	Subaru L-Series	70 70 40 40	55	

132-07-703	Ø 7 - Cavo Silicone - Silicone Cable	Cyl.	Coil	
	Subaru Vivio 650 4WD 92-95	50 50 60 70	50	

132-07-704	Ø 7 - Cavo Silicone - Silicone Cable		Cyl.	Coil	
	Subaru				
	Forester 2000 97-98	Impreza 4WD 2000 (EJ20) 96→	60	--	
	Impreza 4WD (EJ16) 1600 i.e. 96-97	Legacy I 1600	60		
	Impreza Sport Wagon 1600 (EJ16) 92-97	Legacy I 2000 i.e. 94-96	70		
	Impreza Sport Wagon 1800 (EJ18) 92-97	Legacy II 2200 (EJ22) 96→	70		

132-07-705	Ø 7 - Cavo Silicone - Silicone Cable		Cyl.	Coil	
	Subaru				
	Justy 1300i 4WD 96→		50	--	
			60		
			70		
			80		

132-07-706	Ø 7 - Cavo Silicone ww 350 Ohm - Silicone Cable ww 350 Ohm		Cyl.	Coil	
	Subaru				
	Impreza 2000 (EJ20) 96-98		70	--	
	Impreza 1600 97-98	Legacy I 2000 96-98	70		
	Impreza 1800 97-98	Legacy II 2200 (EJ22) 96-97	70		
			70		

132-07-707	Ø 7 - Cavo Silicone - Silicone Cable		Cyl.	Coil	
	Subaru				
	Forester 2000 (90 Kw) 97-98		70	--	
			70		
			70		
			70		

132-07-708	Ø 7 - Cavo Silicone - Silicone Cable		Cyl.	Coil	
	Subaru				
	Legacy I 1800 91→		70	--	
			70		
			70		
			70		

132-07-709	Ø 7 - Cavo Silicone - Silicone Cable		Cyl.	Coil	
	Subaru				
	Leone 1800 89-92		30	35	
			30		
			110		
			110		

132-07-710	Ø 7 - Cavo Silicone - Silicone Cable		Cyl.	Coil	
	Subaru				
	Legacy III 2000 03→		80	--	
			80		
			70		
			70		

132-07-711	Ø 7 - Cavo Silicone - Silicone Cable		Cyl.	Coil	
	Subaru				
	Legacy IV 2500 03→		105	--	
			105		
			80		
			70		

132-07-712	Ø 7 - Cavo Silicone - Silicone Cable		Cyl.	Coil	
	Subaru				
	Impreza 4WD 1600 92-00		80	--	
			80		
			65		
			65		

132-07-713	Ø 7 - Cavo Silicone - Silicone Cable		Cyl.	Coil	
	Subaru				
	Forester 2000 98-02		80	--	
			80		
			65		
			65		

132-07-714	Ø 7 - Cavo Silicone - Silicone Cable		Cyl.	Coil	
	Subaru				
	Forester 2000 02→	Impreza 2200 (EJE) 93-98	80	--	
	Forester 2500 02→	Impreza 2500 (EJ253) 93-98	80		
	Impreza 4WD 2000 (EJ201) 95-00	Legacy III 2000 98→	60		
	Impreza 2000 00→	Outback 2500 (EJ201) 00→	60		

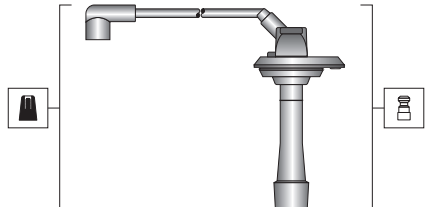
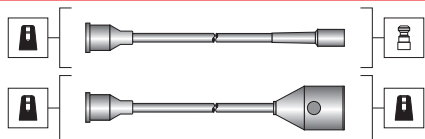
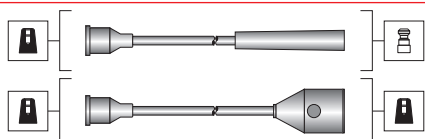
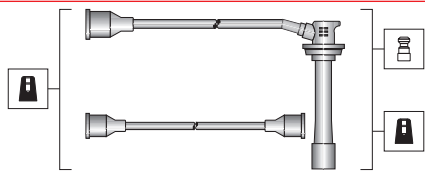
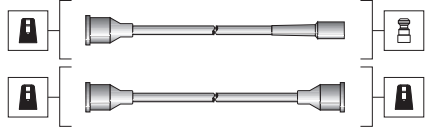
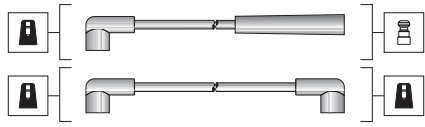
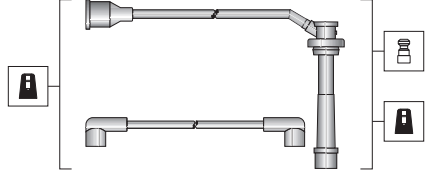
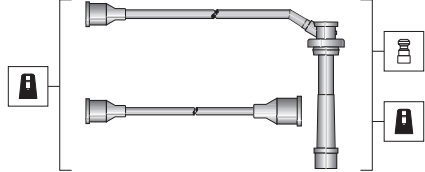
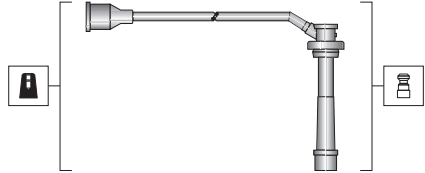
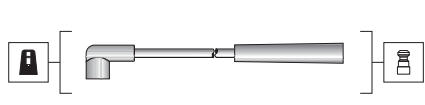
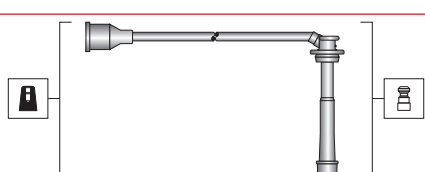
132-07-715	Ø 7 - Cavo Silicone ww Mag Wire - Silicone Cable ww	Cyl.	Coil	
	Subaru Forester 2000s Turbo (125 Kw) 98-01 Impreza 2000 Turbo GTi (160 Kw) 98-00	70 70 80 70	--	
132-08-800	Ø 7 - Cavo Silicone - Silicone Cable	Cyl.	Coil	
	Suzuki SJ 410 1000 SJ 413 1300	60 60 60 70	35	
132-08-801	Ø 7 - Cavo Silicone - Silicone Cable	Cyl.	Coil	
	Suzuki Vitara (tutte) - 91	60 60 70 70	50	
132-08-802	Ø 7 - Cavo Silicone - Silicone Cable	Cyl.	Coil	
	Suzuki Vitara Station 1600 16V 92→	40 50 60 60	30	
132-08-803	Ø 7 - Cavo Silicone - Silicone Cable	Cyl.	Coil	
	Suzuki Alto 800i (F8B) 86-93 Maruti 800 3 cil. (tutte) 91→	55 60 60	35	
132-08-805	Ø 7 - Cavo Silicone - Silicone Cable	Cyl.	Coil	
	Suzuki Swift 1300i 8V GTi 84→ Swift 1000i 8V GTi (G10A) 89→	80 80 60 60	60	
132-08-806	Ø 7 - Cavo Silicone - Silicone Cable	Cyl.	Coil	
	Suzuki Baleno 1300 16V - SW 92→ Baleno 1500 16V - SW 92→ Baleno 1600 16V - SW 92→	40 50 60 60	40	
132-08-807	Ø 7 - Cavo Silicone - Silicone Cable	Cyl.	Coil	
	Suzuki Vitara 1600 16V 92→ Vitara 1600 16V 88-95	40 40 50 60	30	
132-08-808	Ø 7 - Cavo Silicone (con rame Sn) - Silicone Cable with tinned copper core	Cyl.	Coil	
	Suzuki Vitara 1600 16V 10/96→ Swift 1600 16V - 1600 4WD 96→	70 60 50 50	--	
132-08-809	Ø 7 - Cavo Silicone - Silicone Cable	Cyl.	Coil	
	Suzuki Alto 1000i.e. 93→	80 80 60 60	--	
132-08-810	Ø 7 - Cavo Silicone - Silicone Cable	Cyl.	Coil	
	Suzuki Wagon R+ 1000 16V 02→	50 50 65 70	--	

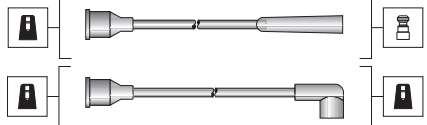
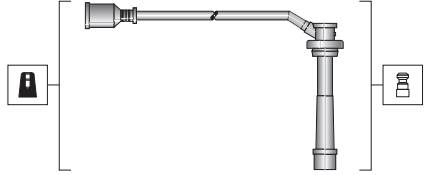
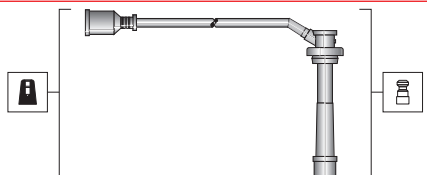
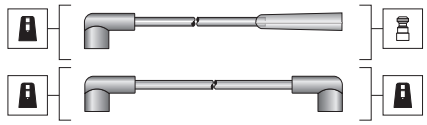
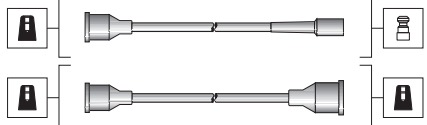
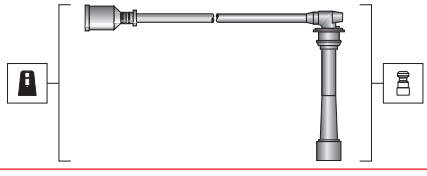
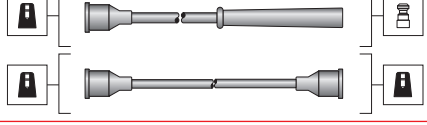
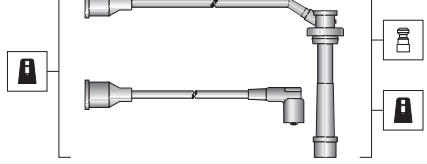
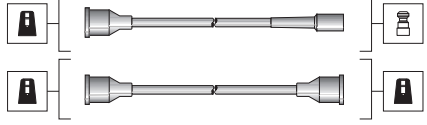
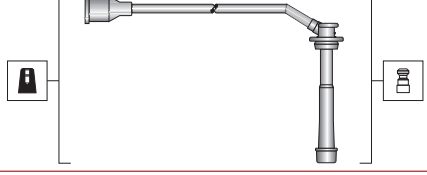
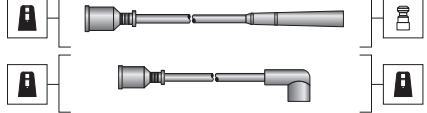
132-08-811	Ø 7 - Cavo Silicone - Silicone Cable		Cyl.	Coil	
	Suzuki Swift 1000 (3 Cil.) GLS 97→		70 70 50	45	
132-08-812	Ø 7 - Cavo Silicone - Silicone Cable		Cyl.	Coil	
	Suzuki Alto 1100 16V 05→ Baleno 1300 (1° - 3° cil.) 16V 99→	Baleno 1600 (1° - 3° cil.) 16V 99→ Jimmy 1300 (1° - 3° cil.) 16V 99→ Wagon R+ 1300 16V 02→	35 -- 20 --	--	
132-08-813	Ø 7 - Cavo Silicone - Silicone Cable		Cyl.	Coil	
	Suzuki Baleno 1300 16V 97-99		60 50 50 30	--	
132-08-814	Ø 7 - Cavo Silicone - Silicone Cable		Cyl.	Coil	
	Suzuki Alto 1000i (G10B) 97→		70 70 60 50	60	
132-08-815	Ø 7 - Cavo Silicone - Silicone Cable		Cyl.	Coil	
	Suzuki Santana 1000		50 60 60 60	30	
132-08-816	Ø 7 - Cavo Silicone - Silicone Cable		Cyl.	Coil	
	Suzuki Ignis 1300i 16V		50 -- 20 --	--	
132-08-817	Ø 7 - Cavo Silicone - Silicone Cable		Cyl.	Coil	
	Suzuki Vitara 1600 8V (G16A) 95→ Jimmy 1300 16V 01→		70 60 60 60	50	
132-08-818	Ø 7 - Cavo Silicone - Silicone Cable		Cyl.	Coil	
	Suzuki Baleno 16V 1600 97		70 60 60 60	50	
132-08-819	Ø 7 - Cavo Silicone - Silicone Cable		Cyl.	Coil	
	Suzuki Samurai 1300 (G13BA) (44-47 Kw) 94→ Santana 1300 (G13BA) (44-47 Kw) 94→		70 70 60 60	35	
132-08-821	Ø 7 - Cavo Silicone - Silicone Cable		Cyl.	Coil	
	Suzuki Alto 1000 16V 09→ Ignis 1300 16V 04→ Jimmy 1300 16V 05→	Liana 1600 16V 05→ Swift 1300 16V 05→ Wagon R+ 1300 16V 05→	38 -- 20 --	--	
132-08-822	Ø 7 - Cavo Silicone - Silicone Cable		Cyl.	Coil	
	Suzuki SJ 410 LA (CTG.M1) 1000		60 60 50 55	30	

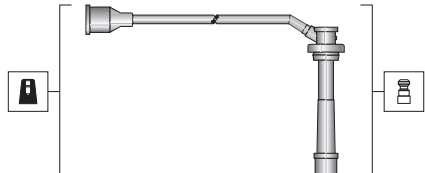
		Ø 7 - Cavo Silicone - Silicone Cable	Cyl.	Coil	
132-08-823	Suzuki Vitara 16V 1600 92→		74	--	
			74		
			71		
			68		

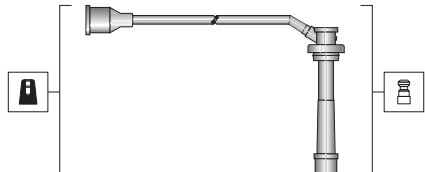
		Ø 7 - Cavo Silicone - Silicone Cable	Cyl.	Coil	
132-08-824	Suzuki Splash 16V 1000 (48 Kw) 10→ Splash 16V 1200 (48 Kw) 10→		--	--	

		Ø 7 - Cavo Silicone - Silicone Cable	Cyl.	Coil	
132-09-900	Isuzu Impulse Turbo L 1600 (DOHC/W/W/D) 92-93 Gemini (Cruise) L 1600 (DOHC/W/W/O) 91 Gemini (Cruise-CTRL) 1.8 L 1800 (DOHC/W/W/O) 92 Impulse Turbo L 1600 (WO/4XE1) 91 Impulse Turbo L 1800 (WO/4XF1) 92 Impulse Turbo L 1600 (DOHC/4XE1) 91-92 Stylus i.e. 1600-1800 92		--	--	Illustration not available Illustrazione non disponibile

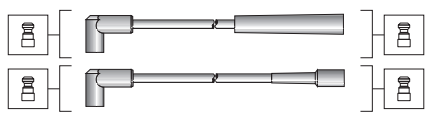
		Ø 7 - Cavo Silicone ww Mag-Wire - Silicone Cable ww	Cyl.	Coil	
132-09-901	Chrysler Jeep Grand Cherokee 4000L 86→ Jeep Wrangler Laredo 4000L 95→ Jeep Cherokee Country 4000L 95→ Jeep Grand Cherokee Laredo 4000L 95→		60	40	
			50		
			40		
			40		
			40		

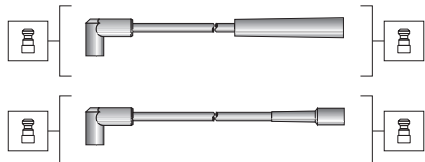
		Ø 7 - Cavo Silicone - Silicone Cable	Cyl.	Coil	
132-09-902	Chrysler Voyager 3000L V6 89-92 Voyager 3300L V6 92→ Le Baron 3000L V6 89→ Sartoga 3000L V6 89→		50	50	
			70		
			50		
			50		
			70		
			60		

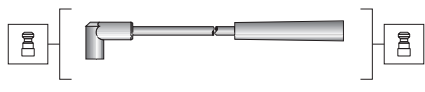
		Ø 7 - Cavo Silicone - Silicone Cable	Cyl.	Coil	
132-09-903	Chrysler Voyager LE-SE 3300L V6 (EGA) 89→		40	--	
			50		
			60		
			70		
			70		
			80		

		Ø 7 - Cavo Silicone - Silicone Cable	Cyl.	Coil	
132-09-904	Chrysler Jeep Cherokee 2500L 93→		50	50	
			50		
			50		
			50		

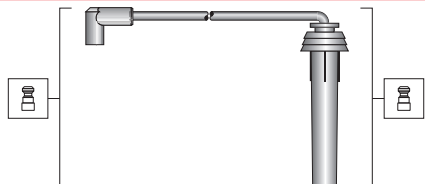
		Ø 7 - Cavo Silicone - Silicone Cable	Cyl.	Coil	
132-09-905	Chrysler Voyager 2500 Saratoga 2500		30	--	
			30		
			30		
			30		

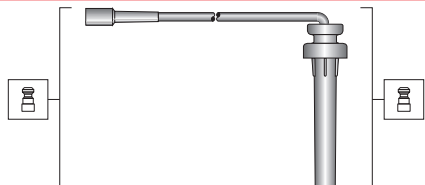
		Ø 7 - Cavo Silicone - Silicone Cable	Cyl.	Coil	
132-09-906	Chrysler PT Cruiser 2000 16V (104 Kw) 00→ PT Cruiser 2400 16V (110 Kw) 00→ PT Cruiser 2400 16V (105 Kw) 04→ Sebring 2000 16v (104 Kw) 01→ Voyager III 2400 16V (108 Kw) 00→		40	--	
			40		
			40		
			40		

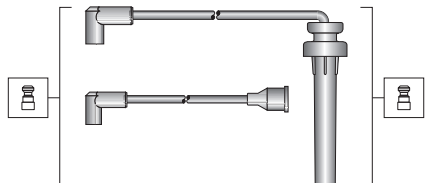
		Ø 7 - Cavo Silicone - Silicone Cable	Cyl.	Coil	
132-09-907	Chrysler Voyager II 2000 16V (98 Kw) 95-01 Voyager II 2400 16V (111 Kw) 95-01		40	35	
			40		
			45		
			45		

		Ø 7 - Cavo Silicone - Silicone Cable		Cyl.	Coil	
132-09-908	Chrysler			35	--	
		Cirrus 2400 16V (EDZ) (112 Kw) 96-00		35		
		Neon 2000 16V (420T-ECC) 94-99		30		
		Sebring 2400 16V (EDZ) 96-00		30		
		Stratus 2400 16V 95-01				

		Ø 7 - Cavo Silicone - Silicone Cable		Cyl.	Coil	
132-09-909	Chrysler			40	60	
		Newyorker 3500 (155 Kw) 93→		60		
		Voyager II 3300 (110 Kw) 90-95		60		
		Voyager II 3300 (116 Kw) 95→		70		
		Voyager II 3500 (122-131 Kw) 95→		70		

		Ø 7 - Cavo Silicone - Silicone Cable		Cyl.	Coil	
132-09-910	Chrysler			25	--	
		Cirrus 2400 16V (ECB) (96 Kw) 96-00	Sebring 2000 16V 95→	25		
		Neon 1800 16V (85 Kw) 97-99	Stratus 2000 16V (98 Kw) 95→	30		
		Neon 2000 16V (420H) (98 Kw) 94-99	Stratus LE 2000 16V (C00420X) (96 Kw) 95-01	30		
			Voyager II 2000 16V (C00) (98 Kw) 95-01			

		Ø 7 - Cavo Silicone - Silicone Cable		Cyl.	Coil	
132-09-911	Chrysler			35	--	
		PT Cruiser GT 2400 (164 Kw) 03→		35		
		PT Cruiser GT 2400 Convertible 04→		30		
				30		



		Ø 7 - Cavo Silicone - Silicone Cable		Cyl.	Coil	
132-09-912	Chrysler			35	--	Illustration not available Illustrazione non disponibile
		PT Cruiser GT 2400 (164 Kw) 03→		35		
		PT Cruiser GT 2400 Convertible 04→		30		
				30		

		Ø 7 - Cavo Silicone - Silicone Cable		Cyl.	Coil	
132-09-913	Chrysler			29	--	
		Neon 16V (85 Kw) 1800 (EDB) 97-99		23		
				23		
				29		



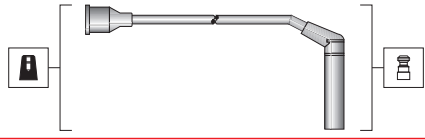
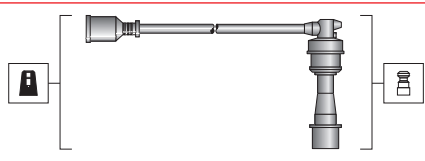
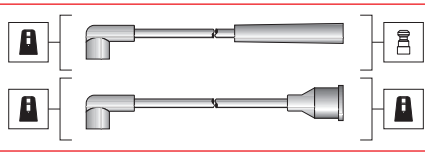
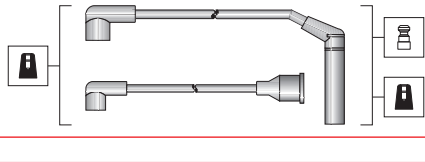
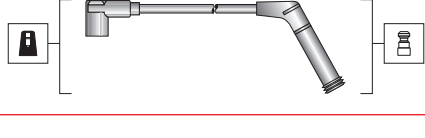
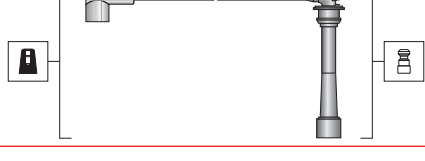
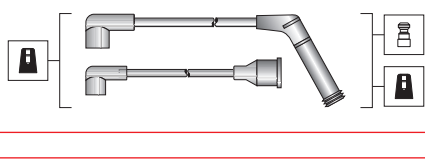
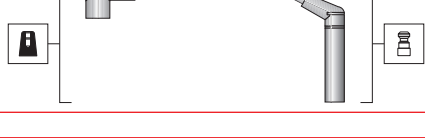
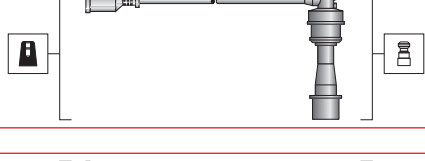
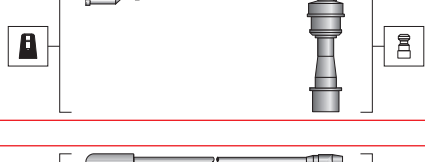

		Ø 7 - Cavo Silicone - Silicone Cable		Cyl.	Coil	
132-09-914	Chrysler			30	30	
		Neon II 1600 01→	Mini	35		
		PT Cruiser 1600 01→	Mini Cooper Cabrio 1300 09/94→	35		
				35		

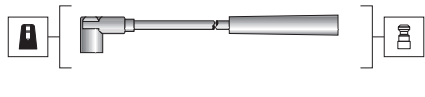



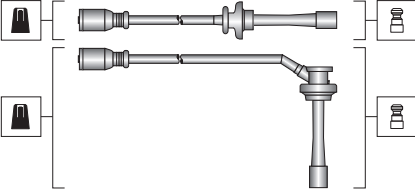
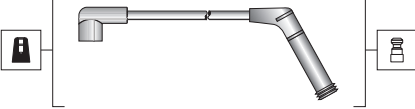
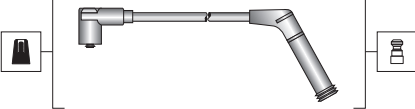

		Ø 7 - Cavo Silicone (con rame Sn) - Silicone Cable with tinned copper core		Cyl.	Coil	
132-09-915	Mercedes			29	--	
		C240 (M112.911) (125 Kw) 00→	E320 (M112.917) (130 Kw) 03→	29		
		C280 (M112.929) (145 Kw) 97-00	E320 (M112.949-954) (165 Kw) 02→	29		
		C320 (M112.961-940) (160 Kw) 00→	G320 (M112.945) (158 Kw) 97→	29		
		CLK320 (M112.940) (160 Kw) 97→	ML320 (M112.942) (160 Kw) 98-05	29		
		E240 (M112.911) (125 Kw) 97-02	MI350 (M112.970) (180 Kw) 05→	29		
		E240 (M112.913-917) (130 Kw) 02→	S280-SL280 (M112.921) (150 Kw) 98→	29		
		E280 (M112.921) (150 Kw) 96-02	S320-SL320 (M112.940) (165 Kw) 98→	29		
		E320 (M112.940) (165 Kw) 96-02	SLK 350 (M112.947) (160 Kw) 00-04	29		
				29		
				29		
				29		

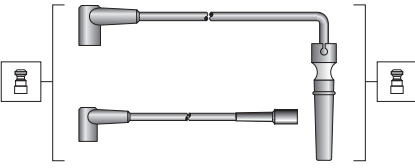
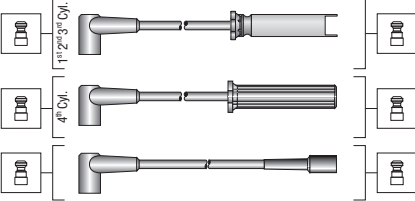
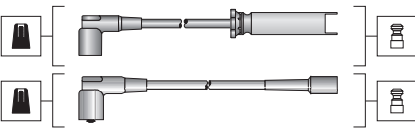
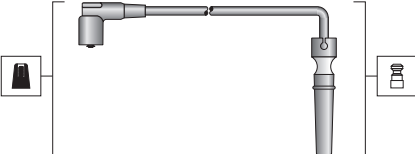

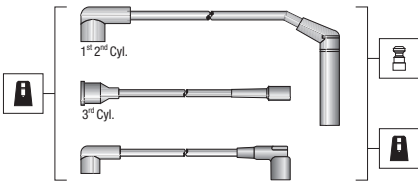
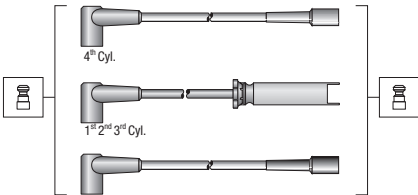
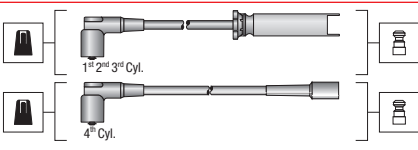
		Ø 7 - Cavo Silicone - Silicone Cable		Cyl.	Coil	
132-09-916	Chrysler			50	50	
		Jeep Grand Cherokee 5200L 92-93		50		
				60		
				80		
				80		
				80		
				80		
				80		

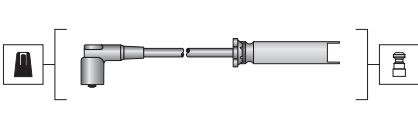
132-0H-H00	Ø 7 - Cavo Silicone - Silicone Cable	Cyl.	Coil	
	Hyundai Lantra 1500i 91→ Sonata 2000i 91→	70 80 80 90	--	
132-0H-H01	Ø 7 - Cavo Silicone - Silicone Cable	Cyl.	Coil	
	Hyundai Lantra 1600i (G4CR-DOHC) 91-95 Lantra 1800i 16V (G4CN-DOHC) 92-95 Sonata 2000i 91-96 Sonica 2000i 16V 95→	50 70 80 80	--	
132-0H-H02	Ø 7 - Cavo Silicone - Silicone Cable	Cyl.	Coil	
	Hyundai SCoupé LS 1500i 12V 92→	40 50 60 60	50	
132-0H-H03	Ø 7 - Cavo Silicone - Silicone Cable	Cyl.	Coil	
	Hyundai Lantra 1500 GLS - 1500 GLSi (G4DJ) 91→ Pony GLS 1300 - 1500 91→ SCoupé 1500 8V 90→	90 80 90 70	45	
132-0H-H04	Ø 7 - Cavo Silicone - Silicone Cable	Cyl.	Coil	
	Hyundai Accent 1300i 12V 94-00 Accent 1500i 12V 95→ Pony 1300i 12V 94-99 Getz 1300i 12V 02→ Lantra 1500i 12V 96-00 SCoupé 1600 12V 92→	70 50 50 40	--	
132-0H-H05	Ø 7 - Cavo Silicone - Silicone Cable	Cyl.	Coil	
	Hyundai Coupé 2000i 16V (G4F-0HC) 96→ Sonata 2000 (G4JP-G) 98-01 Santa Fe 2400 (G4JS) 01→	50 60 70 80	--	
132-0H-H06	Ø 7 - Cavo Silicone - Silicone Cable	Cyl.	Coil	
	Hyundai Atos 1000i 12V 98→ Atos 1000i MY-Premium plus 00→ Amica 1000i 12V 00→	60 60 50 50	30	
132-0H-H07	Ø 7 - Cavo Silicone - Silicone Cable	Cyl.	Coil	
	Hyundai Accent 1300 12V 97→	30 30 20 20	--	
132-0H-H08	Ø 7 - Cavo Silicone - Silicone Cable	Cyl.	Coil	
	Hyundai Santamo 2000i 16V (DOHC) 99→	60 60 80 70	--	
132-0H-H09	Ø 7 - Cavo Silicone - Silicone Cable	Cyl.	Coil	
	Hyundai Sonica 2000i 16V (DOHC) 99→	70 70 80 80	--	
132-0H-H10	Ø 7 - Cavo Silicone - Silicone Cable	Cyl.	Coil	
	Hyundai Lantra 1600i - Combi (G4GR-DOHC) 95-00 Lantra 1800i 16V (G4GM-DOHC) 96-00 Lantra 2000 (G4G-F) 95-00	80 70 60 40	--	
132-0H-H11	Ø 7 - Cavo Silicone - Silicone Cable	Cyl.	Coil	
	Hyundai Accent 1400i 12V (SOHC) 99→ Lantra 1500 12V 97→	60 60 50 50	--	

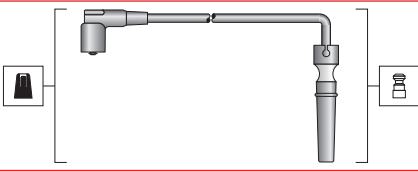
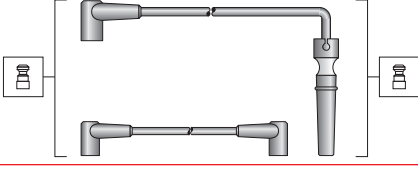
132-0H-H12	Ø 7 - Cavo Silicone - Silicone Cable		Cyl.	Coil	
	Hyundai Coupè 1600 16V 01→ Coupè Tibouron 1600 (G4G3-DOHC) 98→		40 50 60 70	--	
132-0H-H13	Ø 7 - Cavo Silicone - Silicone Cable		Cyl.	Coil	
	Hyundai Atos Prime 1000 12V 01→ Atos Prime 1100 12V 05→ Getz 1100 01→		50 50 40 40	--	
132-0H-H14	Ø 7 - Cavo Silicone - Silicone Cable		Cyl.	Coil	
	Hyundai Santa Fe 2700 V6 01→		100 50 70 40 90 30	--	
132-0H-H15	Ø 7 - Cavo Silicone - Silicone Cable		Cyl.	Coil	
	Hyundai Coupè 2000 16V 00→ Elantra 1600i 01→ Getz 1600 (G4ED-G) 02→		60 50 50 40	--	
132-0H-H16	Ø 7 - Cavo Silicone - Silicone Cable		Cyl.	Coil	
	Hyundai Trajet 2000i 16V 00→		40 -- 20 --	--	
132-0H-H17	Ø 7 - Cavo Silicone - Silicone Cable		Cyl.	Coil	
	Hyundai Lantra 1500 (G15B) (63 Kw) 90-95 Lantra 1800 (G4CN) 90-95	SCoupè 1500 (G15B-G4DJ) 91-98 Sonata 2000i (G4) 91-93 Sonata 2000i (G4CP) 94-98	90 70 70 60	20	
132-0H-H18	Ø 7 - Cavo Silicone - Silicone Cable		Cyl.	Coil	
	Hyundai Gallopèr 3000 (G6AT) (107 Kw) 99→ Sonata 3000 (G6AT) (107 Kw) 93→		40 50 50 60 70 70	40	
132-0H-H19	Ø 7 - Cavo Silicone - Silicone Cable		Cyl.	Coil	
	Hyundai Accent 1500i 16V (DOHC) (73 Kw) 95-00 Accent 1500i 16V (G4FK) (73 Kw) 99→	Excel 1500i (G4ER) 96-99 Matrix 1600i (G4ED) 01→	70 60 50 40	--	
132-0H-H20	Ø 7 - Cavo Silicone - Silicone Cable		Cyl.	Coil	
	Hyundai Excel 1300i (G4AN) (49Kw) 85-89 Excel 1500i (G4AJ) 85-89 Pony 1300i (G13B) 85-89		90 80 70 70	70	
132-0H-H21	Ø 7 - Cavo Silicone - Silicone Cable		Cyl.	Coil	
	Hyundai Coupè 2000 (102 Kw) (G4GC-G) 02→ Matrix 1800 (90 Kw) (G4GB-G) 01→		35 46 50 65	--	
132-0H-H22	Ø 7 - Cavo Silicone - Silicone Cable		Cyl.	Coil	
	Hyundai i10 (57 Kw) 16V 1200 09 i10 (57 Kw) 16V LPG BluDrive 1200 09	i20 (57 Kw) 16V 1200 09 i20 (57 Kw) 16V LPG BluDrive 1200 09	--	--	
132-0K-K01	Ø 7 - Cavo Silicone - Silicone Cable		Cyl.	Coil	
	Zastava Tavria		70 70 60 50	60	

132-0K-K02	Ø 5 - Cavo Silicone - Silicone Cable		Cyl.	Coil	<p style="text-align: center;">Illustration not available</p> <p style="text-align: center; color: red;">Illustrazione non disponibile</p>
	Kia Sportage 2000i (DOHC-FED) 94→		21 -- 37 --	--	
132-0K-K03	Ø 7 - Cavo Silicone - Silicone Cable		Cyl.	Coil	
	Kia Rio 1300 01→		60 50 50 40	--	
132-0K-K04	Ø 7 - Cavo Silicone - Silicone Cable		Cyl.	Coil	
	Kia Rio RS-LS 1500 16V (MI-TECH) 01→		60 50 40 30	--	
132-0K-K05	Ø 7 - Cavo Silicone - Silicone Cable		Cyl.	Coil	
	Kia Clarus I 1800 00-02 Clarus II 1800 02→ Clarus 1800i 96→ Sportage 2000 16V 99→		40 -- 20 --	--	
132-0K-K06	Ø 7 - Cavo Silicone - Silicone Cable		Cyl.	Coil	
	Kia Picanto 1000 8V 04→ Picanto 1000 GL 8V (LPG) 10→ Picanto 1100 8V 04→ Picanto 1100 GL (LPG) 10→	Hyundai i10 1100 12V 09→ i10 1100 12V (LPG) 09→	50 50 40 40	--	
132-0K-K07	Ø 7 - Cavo Silicone - Silicone Cable		Cyl.	Coil	
	Kia Pride (Siemens) 01		--	--	
132-0K-K08	Ø 7 - Cavo Silicone - Silicone Cable		Cyl.	Coil	
	Kia Pride (Sagem) 01		--	--	
132-0W-W01	Ø 7 - Cavo Silicone - Silicone Cable		Cyl.	Coil	
	Chevrolet (Daewoo) Aranos 1500 16V (V15L) 95-96 Espero 1500 16V (A15MF) 95→ Nexia 1500 16V (A15MF) 95→		80 70 50 50	60	
132-0W-W02	Ø 7 - Cavo Silicone - Silicone Cable		Cyl.	Coil	
	Chevrolet (Daewoo) Aranos 1800 (Y18L) 95-97 Aranos 2000 (Y20L) 95-97 Espero 1800i (OHC-C18LE) 95-99 Espero 2000 Mpi (OHC-C20LE) 95-99		100 90 70 60	50	
132-0W-W03	Ø 7 - Cavo Silicone - Silicone Cable		Cyl.	Coil	
	Chevrolet (Daewoo) Lanos 1400 8V (A14SMS) 97→ Lanos 1500 8V (A15SMS) 97→ Tacuma 1800 (E-TEC) 00→		60 60 50 50	--	
132-0W-W04	Ø 7 - Cavo Silicone - Silicone Cable		Cyl.	Coil	
	Chevrolet (Daewoo) Lanos 1600 16V (A16SMS) 97→ Nubira 1600 16V (A16DMS) 97→		60 60 50 50	--	

132-0W-W05	Ø 7 - Cavo Silicone - Silicone Cable	Cyl.	Coil	
	Chevrolet (Daewoo) Evanda 2000 (96 Kw) 02→ Lacetti 1800 8V 04→ Leganza 2000 16V (D-TEC) (X20SED) 99→	Leganza 2300i 16V (DOHC) 99→ Nubira 2000 (X20SED) 06/97→ Tacuma 2000 (9-90 Kw) (T20SED) 05→	60 50 40 30	
132-0W-W06	Ø 7 - Cavo Silicone - Silicone Cable	Cyl.	Coil	
	Chevrolet (Daewoo) Matiz 800 (M-TEC) 97→ Tico 96→		60 50 50	
132-0W-W07	Ø 7 - Cavo Silicone - Silicone Cable	Cyl.	Coil	
	Chevrolet (Daewoo) Nexia 1500 8V (GMSMF) 97→		70 60 50 40	
132-0W-W08	Ø 7 - Cavo Silicone - Silicone Cable	Cyl.	Coil	
	Chevrolet (Daewoo) Kalos 1200 (E-TEC II) 03→ Kalos 1400 (E-TEC II) 02→ Lanos 1300 (E-TEC II) 01→		60 50 50 40	
132-0W-W09	Ø 7 - Cavo Silicone - Silicone Cable	Cyl.	Coil	
	Chevrolet (Daewoo) Matiz City SE 800cc (F8CV) 00→ Matiz Ecologic GPL 09→		20 20 20	
132-0W-W10	Ø 7 - Cavo Silicone - Silicone Cable	Cyl.	Coil	
	Chevrolet (Daewoo) Rezzo 1800 (72 Kw) (A18DMS) 00→ Tacuma 1800 8V SX (72 Kw) (F18N2) 00→		50 50 40 50	
132-0W-W11	Ø 7 - Cavo Silicone - Silicone Cable	Cyl.	Coil	
	Chevrolet (Daewoo) Leganza 2000i 16V 01→ Nubira 2000i 16V 01→ Tacuma 2000i 16V 01→ Rezzo 2000 00→		50 40 30 30	
132-0W-W12	Ø 7 - Cavo Silicone - Silicone Cable	Cyl.	Coil	
	Chevrolet (Daewoo) Kalos 1400 (69 Kw) 03→ Kalos 1500 (63 Kw) (A15SM) 02→ Nubira 1600i 16V 01→ Rezzo 1600 (77 Kw) 00→		50 50 50 40	
132-0W-W13	Ø 7 - Cavo Silicone - Silicone Cable	Cyl.	Coil	
	Chevrolet (Daewoo) Espero 1500i 16V 95→		70 60 50 50	
132-0W-W14	Ø 7 - Cavo Silicone - Silicone Cable	Cyl.	Coil	
	Chevrolet (Daewoo) Kalos 1200 S-Tec 05→ Matiz Energy-Star 1000 S-Tec 03→ Matiz Energy 1100 S-Tec 05→		25 25 25 40	
132-0W-W15	Ø 7 - Cavo Silicone - Silicone Cable	Cyl.	Coil	
	Chevrolet (Daewoo) Lacetti 1400 8V 04→ Lacetti Dual Power 1600 E-Tec II 04→ Nubira SX 1600 16V E-Tec II 03→		60 50 40 30	

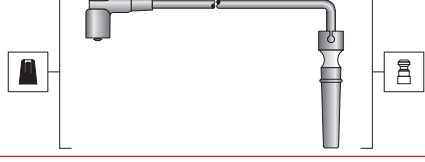
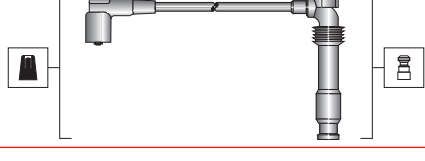
132-0W-W16	Ø 7 - Cavo Silicone - Silicone Cable	Cyl.	Coil	
	Chevrolet (Daewoo) Tacuma 1600 16V E-Tec 05→	60 50 40 30	--	
132-0W-W17	Ø 7 - Cavo Silicone - Silicone Cable	Cyl.	Coil	
	Chevrolet (Daewoo) Aveo 1200 02-10 Spark 1000cc 10→	45 40 35 25	--	
132-0W-W18	Ø 7 - Cavo Silicone - Silicone Cable	Cyl.	Coil	
	Chevrolet (Daewoo) Lacetti 1400 16V 07-10 Tacuma 2000 00-03	30 45 50 55	--	
132-0W-W19	Ø 7 - Cavo Silicone - Silicone Cable	Cyl.	Coil	
	Chevrolet (Daewoo) Lancetti 1600 16V 03-06 Lanos 1600 16V 03-06 Nubira 1600 16V 03-06 Nubira 1600 16V LPG ECO 10→	30 45 50 50	--	
132-0W-W20	Ø 7 - Cavo Silicone - Silicone Cable	Cyl.	Coil	
	Chevrolet (Daewoo) Captiva 2400 16V 06-09 Captiva 2400 16V LPG ECO 06-09	30 45 50 50	--	
132-0W-W21	Ø 5 - Cavo Silicone - Silicone Cable	Cyl.	Coil	<p style="text-align: center;">Illustration not available</p> <p style="text-align: center; color: red;">Illustrazione non disponibile</p>
	Chevrolet (Daewoo) Cruze 1600 16V 10→	--	--	



INDICE BOBINE

Dacia	51
Daewoo	51
Dahiatsu	51
Honda	52
Hyundai	53
Kia	55
Mazda	57
Mitsubishi	58
Nissan	58
Suzuki	61
Toyota	61

MARCA-MODELLO CAR MODEL	CC	MOTORE ENGINE	KW	ANNO YEAR	ASHIKA CODE
DACIA					
Logan					
Logan	1400	K7J710	55	04→	78-00-000
Logan	1400	LSOA-LSOC-LSOE-LSOG		04→	78-00-001
Logan	1600	LSOB-LSOD-LSOF-LSOH		04→	78-00-001
DAEWOO					
Espero					
Espero 16V	1500	A15MF	66	02.95 - 06.99	78-0W-W04
Evanda					
Evanda	2000		96	08.02→	78-0W-W03
Frontera					
Frontera B i	2200	X22SE, Y22SE	100	10.98→	78-0W-W02
Kalos					
Kalos	1200		53	04.03→	78-0W-W03
Kalos	1400		61	09.02→	78-0W-W03
Lacetti					
Lacetti 16V	1400	F14D3	70	03.05→	78-0W-W05
Lacetti	1600	F16D3	80	03.05→	78-0W-W05
Lanos					
Lanos	1400	A14SMS	55	05.97→	78-0W-W02
Lanos	1500	A15SMS	63	05.97→	78-0W-W03
Lanos 16V	1600	A16DMS	78	05.97→	78-0W-W02
Leganza					
Leganza 16V	2000	X20SED	98	06.97 - 12.02	78-0W-W02
Matiz					
Matiz	800	F8CV	38	09.98→	78-W0-000
Matiz	1000		47	01.03→	78-0W-W03
Nexia					
Nexia	1500	G15MF	55	02.95 - 08.97	78-0W-W04
Nexia	1500	G15MF	44	08.96 - 08.97	78-0W-W04
Nexia	1500	G15MF	52	02.95 - 08.97	78-0W-W04
Nexia 16V	1500	A15MF	66	02.95 - 08.97	78-0W-W04
Nubira					
Nubira Kombi	1600	F16D3	80	03.05→	78-0W-W05
Nubira	1600		80	07.03→	78-0W-W05
Nubira Wagon	1600		80	07.03→	78-0W-W05
Nubira 16V	1600	A16DMS	78	05.97→	78-0W-W02
Nubira 16V	2000	X20SED	98	05.97→	78-0W-W02
Nubira Wagon 16V	1600	A16DMS	78	05.97→	78-0W-W02
Nubira Wagon 16V	2000	X20SED	98	05.97→	78-0W-W02
Rezzo					
Rezzo	1600		77	09.00→	78-0W-W03
Rezzo	1800		74	09.00→	78-0W-W03
Rezzo	1800	F18D2	67	09.00→	78-0W-W03
Rezzo	2000	X20SED	89	09.01→	78-0W-W03
Rezzo	2000		94	09.00→	78-0W-W03
Tacuma					
Tacuma	1800			03→	78-0W-W03
DAIATSU					
Sirion					
Sirion	1000	1KRFE	51	04.05 - 03.08	78-03-303

MARCA-MODELLO CAR MODEL	CC	MOTORE ENGINE	KW	ANNO YEAR	ASHIKA CODE
HONDA					
Accord					
Accord VII 1.6i	1600	D16B6	85	10.98 - 12.02	78-04-403
Accord IV	1900	CE - CF		96-98	78-04-401
Accord IV	2000	CE - CF		96-98	78-04-401
Accord IV	2200	CE - CF		96-98	78-04-401
Accord IV 16V	2000	CB3-CB7		90-93	78-04-400
Accord IV 16V	2200	CB3-CB7		90-93	78-04-400
Accord IV Aerodeck 16V	2000	CB8-CC		93→	78-04-400
Accord IV Aerodeck 16V	2200	CB8-CC		93→	78-04-400
Accord IV Coupè 16V	2000	CC1		92-93	78-04-400
Accord V Aerodeck 16V	2000	CE		93-98	78-04-400
Accord V Aerodeck 16V	2200	CE		93-98	78-04-400
Accord V Coupè 16V	2000	CD7-CD9		93-97	78-04-400
Accord V Coupè 16V	2200	CD7-CD9		93-97	78-04-400
Accord V SR	2000	CC7		93-96	78-04-400
Accord V SR	2300	CC7		93-96	78-04-400
Accord VII 16V Coupè	1800	CG		98-01	78-04-401
Accord VII 16V Coupè	2000	CG		98-01	78-04-401
Accord VII 16V Coupè	2200	CG		99→	78-04-400
Accord VII 3.0 V6 24V	3000	J30A1	147	02.98 - 06.03	78-04-404
Accord VIII 2.0	2000	K20A6	114	02.03→	78-04-405
Accord VIII 2.0 Tourer	2000	K20A6	114	04.03→	78-04-405
Accord VIII 2.4	2400	K24A	140	04.03→	78-04-405
Accord VIII 2.4	2400	K24A, K24A3	140	02.03→	78-04-405
Civic					
Civic V Fastback 16V	1500	MB		97-01	78-04-401
Civic V Fastback 16V	1600	MB		97-01	78-04-400
Civic II 16V	1500	D15B2	69	01.88 - 11.91	78-04-402
Civic II i 16V 4WD	1600	D16A6	81	01.88 - 02.95	78-04-402
Civic III i 16V	1500	D15B2	66	10.87 - 09.91	78-04-402
Civic III i 16V	1600	D16A6	80	10.87 - 09.91	78-04-402
Civic III i 16V	1600	D16Z2	81	10.87 - 09.91	78-04-402
Civic III i 16V 4x4	1600	D16A6	80	10.89 - 09.91	78-04-402
Civic III i 16V Vtec	1600	B16A1	110	10.89 - 09.91	78-04-402
Civic IV 16V	1500	EJ9-EK3/4		95-01	78-04-400
Civic IV 16V	1600	EJ9-EK3/4		95-01	78-04-400
Civic IV 16V - VTI	1500	EG-EH		91-95	78-04-400
Civic IV 16V - VTI	1600	EG-EH		91-95	78-04-400
Civic IV Coupè	1400	MA - MB		94-96	78-04-401
Civic IV Coupè	1500	MA - MB		94-96	78-04-401
Civic IV Coupè	1600	MA - MB		94-96	78-04-401
Civic IV Coupè VTEC	1500	EJ		94-95	78-04-400
Civic IV Coupè VTEC	1600	EJ		94-95	78-04-400
Civic IV Hatchback 16V	1500	EG		91-95	78-04-400
Civic IV Hatchback 16V	1600	EG		91-95	78-04-400
Civic V Aerodeck 16V	1500	MC		98-01	78-04-401
Civic V Aerodeck 16V	1800	MC		98-01	78-04-400
Civic V Hatchback 16V	1500	EJ9-EK1/3/4		95-01	78-04-400
Civic V Hatchback 16V	1600	EJ9-EK1/3/4		95-01	78-04-400
Civic V Hatchback 16V	1600	EJ9-EK1/3/4		95-01	78-04-401
Civic VII 1.4 i	1400	---	55	02.01 - 09.05	78-04-404
Civic VII 1.4 iS	1400	D14Z5, D14Z6	66	02.01 - 09.05	78-04-404
Civic VII 1.6 i	1600	D16V1	81	02.01 - 12.05	78-04-404
Civic VII 1.7 i	1700	D17A8	88	05.01 - 12.05	78-04-404
Civic VII 1.7 i VTEC	1700	D17A5, D17A9	92	05.01 - 12.05	78-04-404

MARCA-MODELLO CAR MODEL	CC	MOTORE ENGINE	KW	ANNO YEAR	ASHIKA CODE
Civic VII 2.0 i Sport	2000	K20A3	118	01.04 - 09.05	78-04-405
Civic VII 2.0 Type-R	2000	K20A2	147	09.01 - 09.05	78-04-405
Civic VII 2.0 Type-R	2000	K20Z4	148	09.06→	78-04-405
Concerto					
Concerto i 16V	1600	D16A8	90	08.89 - 03.95	78-04-402
Concerto i 16V	1600	D16Z2	82	08.89 - 03.95	78-04-402
CR-V					
CR-V 16V	2000	RD		99→	78-04-400
CR-V II 2.0	2000	K20A4	110	07.02 - 09.06	78-04-405
CR-V III 2.0 i	2000	R20A4	110	01.07→	78-04-405
CRX					
CRX II i 16V	1600	D16Z5	91	10.87 - 02.92	78-04-402
CRX II i 16V	1600	D16A9	96	10.87 - 12.89	78-04-402
CRX II i 16V Vtec	1600	B16A1	110	10.89 - 02.92	78-04-402
CRX III ESI	1600	EH-EG		92-98	78-04-400
FR-V					
FR-V 1.7	1700	D17A2	92	02.05→	78-04-404
FR-V 2.0	2000	K20A9	110	02.05→	78-04-405
HR-V					
HR-V 16V - 4WD	1600	GH		99→	78-04-400
Integra					
Integra	1800	DC2		97-01	78-04-400
Legend					
Legend IV 3.5 V6 4WD	3500	C35A8	217	05.06→	78-04-404
Logo					
Logo	1300	GA3		99-02	78-04-400
Prelude					
Prelude 16V	2000	BB		92-96	78-04-400
Prelude 16V	2200	BB		92-96	78-04-400
Prelude 16V	2300	BB		92-96	78-04-400
Shuttle					
Shuttle 16V	2200	RA		94-98	78-04-400
Shuttle 16V	2300	RA		98-01	78-04-401
Stream					
Stream 1.7 16V	1700	D17A2	92	05.01→	78-04-404
Stream 2.0 16V	2000	K20A1	110	05.01→	78-04-405
HYUNDAI					
Accent					
Accent	1300	G4EH	55	10.94-01.00	78-0H-H05
Accent	1300	G4EH	44	10.94-01.00	78-0H-H05
Accent	1300	G4EH	55	10.94 - 01.00	78-0H-H05
Accent	1300	G4E-A	63	01.00→	78-0H-H10
Accent i 12V	1300	G4EH	62	10.94 - 01.00	78-0H-H05
Accent i 12V	1500	G4EK	65	10.94 - 01.00	78-0H-H05
Accent III 1.4 GL	1400	G4EE	71	11.05→	78-0K-K10
Accent III 1.6 GLS	1600	G4ED	82	11.05→	78-0K-K10
Atos					
Atos	1000			98→	78-0H-H04
Atos	1000			01→	78-0H-H04
Atos 1.0 i	1000	G4HC	40	02.98 - 03.02	78-0H-H04
Atos 1.0 i	1000	G4HC-E	43	03.01→	78-0H-H04
Atos i	1000	G4HC	40	02.98→	78-0H-H03
Atos I	1000	MX		98→	78-0H-H03
Atos Prime	1100			03→	78-0H-H04
Atos Prime 1.0 i	1000	G4HC	40	08.99→	78-0H-H04

MARCA-MODELLO CAR MODEL	CC	MOTORE ENGINE	KW	ANNO YEAR	ASHIKA CODE
Atos Prime 1.0 i	1000	G4HC-E	43	03.01→	78-0H-H04
Atos Prime i	1000	G4HC	40	08.99→	78-0H-H03
Atos Prime i	1000	MX		99→	78-0H-H03
Atos Prime I	1000			99→	78-0H-H04
Atos Prime I	1000			01→	78-0H-H04
Coupe					
Coupe 16V	1600	G4GR	85	03.98 - 04.02	78-0H-H06
Coupe 16V	2000	G4GF	102	08.96 - 04.02	78-0H-H06
Coupe 2.0	2000	G4GC-G	102	03.02→	78-0H-H14
Coupe 2.0	2000	G4GC-G	100	08.01→	78-0H-H14
Coupe 2.0 GLS	2000	G4GC-G	105	02.03→	78-0H-H14
Coupe i 16V	1600	4G61	84	12.96 - 04.02	78-0H-H06
Elantra					
Elantra 1.8	1800	G4BB	97	06.00→	78-0H-H14
Elantra 2.0	2000	G4GC	104	06.00→	78-0H-H14
Elantra 2.0	2000	G4GC	105	10.03→	78-0H-H14
Elantra 2.0	2000	G4GC-G	102	06.00→	78-0H-H14
Getz					
Getz	1100	G4HD	46	09.02→	78-0H-H09
Getz	1300	G4E-A	60	09.02→	78-0H-H10
Getz 1.4 i	1400	G4EE	71	08.05→	78-0K-K10
Getz 1.1	1100	G4HD	46	09.02→	78-0H-H13
H-1					
H-1 Kasten 2.4	2400	---	82	03.00→	78-0H-H11
H-1 Starex 2.4	2400	G4CS	82	10.97→	78-0H-H11
H100 Bus 2.4	2400	G4CS	90	07.93 - 03.00	78-0H-H11
H100 Bus 2.4	2400	G4CS	84	01.97 - 03.00	78-0H-H11
i10					
i10 1.1	1100	---	51	04.11→	78-0H-H04
i10 1.1	1100	G4HG	49	01.08→	78-0H-H04
i10 1.2	1200	G4LA	57	11.08→	78-0K-K09
i20					
i20 1.2	1200	G4LA	57	09.08→	78-0K-K09
i20 1.4	1400	G4FA	74	09.08→	78-0K-K12
i20 1.6	1600	G4FC	93	09.08→	78-0K-K13
i30					
i30 1.4	1400	---	80	10.07→	78-0K-K12
i30 1.6	1600	---	85	10.07→	78-0K-K13
i30 1.6	1600	---	90	10.07→	78-0K-K13
i30 1.6	1600	G4FC	90	02.08→	78-0K-K13
i30 1.6	1600	G4FC	93	10.07→	78-0K-K13
i30 2.0	2000	G4GC-G	105	10.07→	78-0H-H14
i30 CW 1.4	1400	G4FA	80	11.09→	78-0K-K12
i30 CW 1.6	1600	---	85	02.08→	78-0K-K13
i30 CW 1.6	1600	G4FC	90	02.08→	78-0K-K13
i30 CW 1.6	1600	G4FC	93	02.08→	78-0K-K13
i30 CW 2.0	2000	G4GC-G	105	02.08→	78-0H-H14
Infin					
Infin G20	2000		85	01.90 - 12.97	78-0H-H07
ix20					
ix20 1.4	1400	---	80	11.10→	78-0K-K12
ix20 1.6	1600	G4FC	92	11.10→	78-0K-K13
Lantra					
Lantra I 1.6 i.e. 16V	1600	G4CR	84	10.90 - 11.95	78-0H-H12
Lantra I 1.6 i.e. 16V	1600	G4CR	78	10.90 - 11.95	78-0H-H12
Lantra I 1.8 i.e. 16V	1800	G4CN	93	10.90 - 11.95	78-0H-H12

MARCA-MODELLO CAR MODEL	CC	MOTORE ENGINE	KW	ANNO YEAR	ASHIKA CODE
Lantra I i.e.	1500	G15B, G4DJ	63	10.90 - 11.95	78-05-501
Lantra II 12V	1500		65	12.96 - 09.00	78-0H-H05
Lantra II 16V	1600	4G61	84	11.95 - 09.00	78-0H-H06
Lantra II 16V	1800	G4GM	94	11.95 - 09.00	78-0H-H06
Lantra II 16V	2000	G4GF	102	08.96 - 09.00	78-0H-H06
Lantra II i	1600	G4GR	66	11.95 - 09.00	78-0H-H06
Lantra II Wagon 16V	1600	4G61	84	02.96→	78-0H-H06
Lantra II Wagon 16V	1800	G4GM	94	02.96→	78-0H-H06
Lantra II Wagon 16V	2000	G4GF	102	12.96→	78-0H-H06
Lantra II Wagon i	1600	G4GR	66	02.96→	78-0H-H06
Matrix					
Matrix 1.8	1800	G4GB-G	90	06.01→	78-0H-H14
Pony / Excel					
Pony / Excel i	1500	G15B, G4DJ	62	01.90 - 01.95	78-05-501
S Coupe					
S Coupe i	1500	G15B, G4DJ	62	02.90 - 05.96	78-05-501
Santa Fe					
Santa Fe	2000	G4BP	99	08.01→	78-0H-H02
Santa Fe 16V	2400	G4JS-G	107	02.01→	78-0H-H02
Santa Fe 16V	2400	G4JS-G	100	02.01→	78-0H-H02
Santa Fe 16V 4x4	2400	G4JS-G	107	02.01→	78-0H-H02
Santa Fe 16V 4x4	2400	G4JS-G	100	02.01→	78-0H-H02
Santa Fe V6 4x4	2700	G6BA-G	127	02.01→	78-0H-H08
Sonata					
Sonata		EF			78-0H-H00
Sonata I 2.0i	2000	G4CP-U	80	01.91 - 10.93	78-0H-H12
Sonata I 2.0i 16V	2000	G4CP-D	96	01.91 - 10.93	78-0H-H12
Sonata I 3.0i V6	3000	G6AT	107	01.91 - 10.93	78-0H-H11
Sonata II 2.0i	2000	G4CP	77	06.94 - 08.96	78-0H-H11
Sonata II 2.0i 16V	2000	G4CP-D	102	05.93 - 06.98	78-0H-H12
Sonata III 16V	2000	G4JP-G	100	06.98 - 10.01	78-0H-H02
Sonata III V6 24V	2500	G6BV-G	118	06.98 - 10.01	78-0H-H07
Sonata IV	2000	G4JP-EG	96	10.01 - 11.04	78-0H-H02
Sonata IV V6	2700	G6BA-G	127	10.01 - 11.04	78-0H-H07
Starex					
Starex 2.4	2400	---	82	06.97→	78-0H-H11
Starex 2.4 4WD	2400	---	82	02.98→	78-0H-H11
Terracan					
Terracan I V6 4WD	3500	HP		01→	78-0H-H01
Trajet					
Trajet	2000		103	01.04→	78-0H-H02
Trajet V6	2700		127	09.00→	78-0H-H07
Tucson					
Tucson 2.0	2000	G4GC	104	08.04→	78-0H-H14
XG					
XG 350				03→	78-0H-H01
KIA					
Carens					
Carens					78-0H-H00
Carens II	1600		77	07.02→	78-0K-K06
Carens II	1800		93	07.02→	78-0K-K01
Carens II 2.0 CVVT	2000	G4GC	102	08.04→	78-0H-H14
Carens III 1.6 CVVT	1600	G4FC	93	08.09→	78-0K-K13
Carens III 1.6 CVVT	1600	G4FC	97	10.10→	78-0K-K13

MARCA-MODELLO CAR MODEL	CC	MOTORE ENGINE	KW	ANNO YEAR	ASHIKA CODE
Carnival					
Carnival	3000			99→	78-0K-K00
Carnival II	3500			02→	78-0H-H01
Carnival II V6	2500		110	10.01→	78-0K-K05
Cee'd					
Cee'd 1.4	1400	G4FA	80	12.06→	78-0K-K12
Cee'd 1.4 CVVT	1400	G4FA-L	66	06.10→	78-0K-K12
Cee'd 1.6	1600	G4FC	90	12.06→	78-0K-K13
Cee'd 1.6 CVVT	1600	G4FC	92	10.10→	78-0K-K13
Cee'd 2.0	2000	4GGC	105	02.08→	78-0H-H14
Cee'd 2.0	2000	G4GC	105	09.07→	78-0H-H14
Cee'd 2.0	2000	G4GC	105	12.06→	78-0H-H14
Cerato					
Cerato	1600		77	07.04→	78-0K-K07
Cerato	2000		105	04.04→	78-0K-K08
Cerato 1.6	1600	G4ED	77	07.04→	78-0K-K10
Cerato 1.6	1600	G4ED	77	04.04→	78-0K-K10
Cerato 1.6	1600	G4FC	90	05.06→	78-0K-K13
Cerato 2.0	2000	---	105	04.04→	78-0H-H14
Cerato 2.0	2000	G4GC	105	04.04→	78-0H-H14
Joice					
Joice	2000		102	02.00→	78-0K-K02
Matrix					
Matrix	1800	G4GB-G	90	06.01→	78-0K-K08
Opirus					
Opirus	3500			03→	78-0H-H01
Optima					78-0H-H00
Picanto					
Picanto	1100	G4HG	48	04.04→	78-0K-K03
Picanto 1.0	1000	---	51	05.11→	78-0K-K14
Picanto 1.0 Bi-Fuel	1000	---	60	05.11→	78-0K-K14
Picanto 1.2	1200	---	63	09.11→	78-0K-K09
Pride					
Pride 16V	1300	DA		90→	78-05-502
Pride 16V	1300	DA		96→	78-05-502
Pro Cee'd					
Pro Cee'd 1.4	1400	G4FA	80	02.08→	78-0K-K12
Pro Cee'd 1.4	1400	G4FA	77	02.08→	78-0K-K12
Pro Cee'd 1.6	1600	G4FC	80	02.08→	78-0K-K13
Pro Cee'd 1.6	1600	G4FC	90	02.08→	78-0K-K13
Pro Cee'd 1.6 CVVT	1600	G4FC	92	10.10→	78-0K-K13
Rio					
Rio	1300		60	08.02 - 02.05	78-0K-K04
Rio	1300		55	09.00 - 02.05	78-0K-K04
Rio Combi	1500		71	09.02 - 02.05	78-0K-K06
Rio Combi	1500		72	08.00 - 02.05	78-0K-K06
Rio II 1.4 16V	1400	G4EE	71	03.05→	78-0K-K10
Rio II 1.6 16V	1600	G4ED	82	03.05→	78-0K-K10
Rio II 1.6 CVVT	1600	G4ED	82	03.05→	78-0K-K10
Rio II 16V	1600		82	03.05→	78-0K-K07
Sepia					
Sepia i 16V	1800		82	01.95→	78-0K-K01
Sorento					
Sorento V6	3500	JC		02→	78-0H-H01
Soul					
Soul 1.6 CVVT	1600	G4FC	93	02.09→	78-0K-K13

MARCA-MODELLO CAR MODEL	CC	MOTORE ENGINE	KW	ANNO YEAR	ASHIKA CODE
Sportage					
Sportage 16V 4WD	2000	G4GC	104	09.04→	78-0K-K08
Sportage 2.0 16V 4WD	2000	G4GC	104	09.04→	78-0H-H14
Sportage 2.0 i 16V	2000	G4GC	104	09.04→	78-0H-H14
Sportage 2.0i 4WD	2000	FE	70	04.94 - 08.99	78-0K-K11
Tucson					
Tucson	2000		104	08.04→	78-0K-K08
Venga					
Venga 1.4 CVVT	1400	G4FC	90	02.10→	78-0K-K12
Venga 1.6 CVVT	1600	G4FC	92	02.10→	78-0K-K13
MAZDA					
2					
2 1.3	1300	ZJ-VE	63	10.07→	78-03-303
2 1.3	1300	ZJ-VE	55	10.07→	78-03-303
2 1.4 MZR	1400	---	50	01.08→	78-03-303
2 1.5	1500	ZY-DE, ZY-VE	76	10.07→	78-03-303
2 1.6	1600	---	66	10.08→	78-03-303
3					
3 1.4	1400	---	62	10.03→	78-03-304
3 1.6	1600	---	85	11.10→	78-03-303
3 1.6	1600	Z6	77	02.04→	78-03-303
3 1.6	1600	BGZE	77	10.03→	78-03-304
3 1.6 MZR	1600	---	77	06.09→	78-03-303
3 2.0	2000	LF17	110	10.03→	78-03-304
3 2.0	2000	LF17	110	02.04→	78-03-303
3 2.0 MZR	2000	---	110	06.09→	78-03-303
3 2.0 MZR DISI	2000	---	111	06.09→	78-03-303
3 2.3 MPS	2300	---	191	12.06→	78-03-304
323					
323 C IV 16V	1300		54	09.89 - 07.94	78-03-301
323 C IV 16V 4WD	1800	BP Kat.	76	11.91 - 12.93	78-03-301
323 F IV 16V	1600	B6	65	03.91 - 10.94	78-03-301
323 F VI 1.9 16V	1900	---	84	09.98 - 01.01	78-03-306
323 F VI 2.0	2000	FS7E, FS7G	96	01.01 - 05.04	78-03-306
323 S IV 16V	1300	B3 (16V)	54	04.91 - 07.94	78-03-301
323 S IV 16V	1600	B6	65	08.89 - 10.94	78-03-301
323 S VI 1.9 16V	1900	---	84	09.98 - 05.04	78-03-306
323 S VI 2.0	2000	FS7E, FS7G	96	01.01 - 05.04	78-03-306
MX-3					
MX-3 i	1600	B69	65	07.91→	78-03-301
MX-5					
MX-5 II 1.6 16V	1600	---	81	05.98 - 10.05	78-03-302
MX-5 II 1.9 16V	1900	---	102	11.00 - 10.05	78-03-302
MX-5 II 1.9 16V	1900	---	107	11.00 - 10.05	78-03-302
MX-5 II 1.9 16V	1900	BP-ZE	103	05.98 - 10.05	78-03-302
Premacy					
Premacy 1.8	1800	FP	74	07.99→	78-03-306
Premacy 1.9	1900	FP	84	07.99→	78-03-306
Premacy 2.0	2000	FS7E, FS7G	96	11.01→	78-03-306
RX					
RX 8 2.6 Wankel	1300	---	141	10.03→	78-03-305
RX 8 2.6 Wankel	1300	---	170	10.03→	78-03-305
Tribute					
Tribute I	2000			00→	78-03-300

MARCA-MODELLO CAR MODEL	CC	MOTORE ENGINE	KW	ANNO YEAR	ASHIKA CODE
MITSUBISHI					
Colt					
Colt III 1.6 GTI 16V	1600	4G61	91	04.88 - 05.90	78-0H-H12
Galant					
Galant III 2.4 GLS	2400	G64B	82	07.85 - 12.87	78-0H-H11
Galant III Turbo Eci	2000	4G63T	110	06.84 - 05.85	78-05-501
Galant IV	2000	4G63	80	04.89 - 10.92	78-05-501
Galant IV 2.0	2000	4G63	80	04.89 - 10.92	78-0H-H11
Galant IV 2.0 4x4	2000	4G63	80	04.89 - 10.92	78-0H-H11
Galant IV 2.0 GTI 16V	2000	4G63	107	11.88 - 10.92	78-0H-H12
Galant IV 2.0 GTI 16V	2000	4G63	106	11.88 - 10.92	78-0H-H12
Galant IV 2.0 GTI 16V 4x4	2000	4G63	106	07.89 - 12.92	78-0H-H12
Galant IV 4x4	2000	4G63	80	04.89 - 10.92	78-05-501
Galant IV GTI 16V	2000	4G63	106	11.87 - 10.92	78-05-501
Galant IV GTI 16V 4x4	2000	4G63	106	06.88 - 10.92	78-05-501
Galant IV GTI 16V 4x4 Kat.	2000	4G63	110	09.91 - 10.92	78-05-501
Lancer					
Lancer III Station Wagon	1500	4G15	61	09.88 - 12.90	78-05-501
Lancer III Station Wagon	1500	4G15	55	09.85 - 12.87	78-05-501
Lancer IV	1500	4G15	62	04.88 - 05.92	78-05-501
Lancer IV 12V	1500	4G15 (12V)	66	05.89 - 05.92	78-05-501
Lancer IV GLXi 4x4	1800	4G37	71	09.89 - 06.92	78-05-501
Pajero					
Pajero II	2400	V2_W - V4_W		91-00	78-05-502
Pajero II	2400	4G64	82	04.91 - 04.00	78-05-501
Sapporo					
Sapporo III 2.4	2400	4G64	91	06.87 - 08.90	78-0H-H11
Sigma					
Sigma SW V7	3000	F07W		93-96	78-05-502
Sigma V6	3000	F16A		90-96	78-05-502
Space Star					
Space Star GDI	1800		82	10.02→	78-05-500
Space Wagon					
Space Wagon 2.0 GLXi	2000	4G63	74	06.88 - 04.91	78-0H-H11
Space Wagon 2.0 GLXi 4x4	2000	4G63	74	06.88 - 04.91	78-0H-H11
Space Wagon GDI	2000		98	04.02→	78-05-500
NISSAN					
100 NX					
100 NX 1.6	1600	GA 16 DS	66	03.90 - 10.94	78-01-116
100 NX 1.6 SR	1600	GA 16 DE	75	09.93 - 10.94	78-01-116
Almera					
Almera II	1500	QG15DE	66	01.00 - 11.02	78-01-108
Almera II	1800	QG18DE	84	01.00 - 11.02	78-01-108
Almera Tino	1800	QG18DE	84	04.00 - 12.01	78-01-108
Almera II	1500	QG15DE	72	12.02 - 11.06	78-01-109
Almera II	1800	QG18DE	85	12.02 - 11.06	78-01-109
Almera Tino	1800	QG18DE	85	06.03 - 11.05	78-01-109
Almera I Hatchback 1.6 SR, SLX	1600	GA 16 DE	66	09.95 - 03.00	78-01-116
Almera II	1500	N16			78-01-102
Almera II	1800	N16			78-01-102
Almera II	1500	N16			78-01-102
Almera II	1800	N16			78-01-102
Almera II Hatchback	1800	N16			78-01-102
Almera Tino	1800	V10			78-01-102

MARCA-MODELLO CAR MODEL	CC	MOTORE ENGINE	KW	ANNO YEAR	ASHIKA CODE
Bluebird					
Bluebird Hatchbackturbo	1800	T72-T12		85-90	78-05-502
Bluebird Sylphy 1.5	1500	HR 15 DE	80	09.05→	78-01-114
Bluebird Turbo	1800	U11		84-90	78-05-502
Cube					
Cube 1.5	1500	HR 15 DE	80	03.10→	78-01-114
Cube 1.6 16V	1600	HR 16 DE	81	03.10→	78-01-112
Juke					
Juke 1.5	1500	HR 15 DE	80	06.10→	78-01-114
Juke 1.6	1600	HR 16 DE	86	06.10→	78-01-112
Juke 1.6	1600	MR 16 DDT	140	06.10→	78-01-115
Latio					
Latio 1.5	1500	HR 15 DE	80	11.04→	78-01-114
Latio 1.6	1600	HR 16 DE	81	03.07→	78-01-112
Maverick					
Maverick 2.4	2400	KA24E	91	02.93 - 08.96	78-01-116
Maxima					
Maxima QX II	2000	VQ200E	103	01.00 - 09.03	78-01-107
Maxima QX II 24v	3000	VQ300E	147	01.00 - 09.03	78-01-107
Maxima 3.0i	3000	VG 30 E	125	10.88 - 06.94	78-01-107
Maxima i	3000	VG30E linksseitig / left sided	125	10.88 - 06.94	78-01-105
Maxima QX	2000	VQ20DE rechtsseitig / right sided	103	02.95 - 08.00	78-01-103
Maxima QX	2000	VQ20DE linksseitig / left sided	103	02.95 - 08.00	78-01-104
Maxima QX	3000	VQ30DE rechtsseitig / right sided	142	01.95 - 08.00	78-01-103
Maxima QX	3000	VQ30DE linksseitig / left sided	142	01.95 - 08.00	78-01-104
Maxima QX V6 24V	2000	VQ20DE rechtsseitig / right sided	103	03.00→	78-01-103
Maxima QX V6 24V	2000	VQ20DE linksseitig / left sided	103	03.00→	78-01-104
Maxima QX V6 24V	3000	VQ30DE rechtsseitig / right sided	147	03.00→	78-01-103
Maxima QX V6 24V	3000	VQ30DE linksseitig / left sided	147	03.00→	78-01-104
Maxima Station Wagon QX	2000	VQ20DE rechtsseitig / right sided	103	10.97→	78-01-103
Maxima Station Wagon QX	2000	VQ20DE linksseitig / left sided	103	10.97→	78-01-104
Maxima Station Wagon QX	3000	VQ30DE rechtsseitig / right sided	142	10.97→	78-01-103
Maxima Station Wagon QX	3000	VQ30DE linksseitig / left sided	142	10.97→	78-01-104
Micra					
Micra III	1600	HR16DE	81	06.05 - 06.10	78-01-110
Micra CC	1600	HR16DE	81	06.05→	78-01-110
Micra 16V	1000	K11		92-00	78-01-101
Micra 16V	1000	K11		00-03	78-01-101
Micra 16V	1400	K11		00-03	78-01-101
Micra C+C 1.4 16V	1400	CR14DE	65	08.05→	78-01-111
Micra C+C 1.6 160 SR	1600	HR 16 DE	81	08.05→	78-01-112
Micra III 1.0 16V	1000	CG10DE	48	01.03→	78-01-111
Micra III 1.2 16V	1200	CG12DE, CR12DE	59	01.03→	78-01-111
Micra III 1.2 16V	1200	CG12DE, CR12DE	48	01.03→	78-01-111
Micra III 1.4 16V	1400	CR 14 DE	65	01.03→	78-01-111
Note					
Note	1600	HR16DE	81	01.06→	78-01-110
Note 1.4	1400	CR14DE	65	03.06→	78-01-111
Note 1.6	1600	HR 16 DE	81	03.06→	78-01-112
NV200					
NV200 Van - Bus	1600	HR16DE	80	08.09→	78-01-110
NV200 1.6 16V	1600	HR 16 DE	81	07.10→	78-01-112
Prairie					
Prairie Pro 2.0i	2000	CA 20 E	72	10.88 - 04.92	78-01-116
Primastar					
Primastar	2000				78-01-100

MARCA-MODELLO CAR MODEL	CC	MOTORE ENGINE	KW	ANNO YEAR	ASHIKA CODE
Primera					
Primera II	1800	QG18DE	84	06.99 - 12.01	78-01-108
Primera III	1600	QG16DE	80	01.02 - 12.04	78-01-109
Primera III	1800	QG18DE	85	01.02 - 12.04	78-01-109
Primera III	2000	QG20DE	103	01.02 - 12.04	78-01-109
Primera	1800	P12		02→	78-01-102
Primera 1.6	1600	GA 16 DE	75	06.93 - 01.96	78-01-116
Primera 1.6	1600	GA 16 DS	66	06.90 - 01.96	78-01-116
Primera 1.6 16V	1600	GA 16 DE	66	09.96 - 12.01	78-01-116
Primera 1.6 16V	1600	GA 16 DE	73	09.96 - 10.00	78-01-116
Primera 16V	1800	P11		99	78-01-102
Primera 16V	1600	P11		96-00	78-01-106
Primera 16V 4x4	1600	P10		90-96	78-01-106
Primera 16V 4x4	2000	P10		90-96	78-01-106
Primera 2.0	2000	QR 20 DE	103	07.02→	78-01-113
Primera 2.0 16V	2000	SR 20 DI	85	06.90 - 01.96	78-01-116
Primera 2.0 16V 4x4	2000	SR 20 DI	85	04.91 - 06.96	78-01-116
Primera Hatchback 1.6	1600	GA 16 DS	66	06.90 - 01.96	78-01-116
Primera Hatchback 1.6 16V	1600	GA 16 DE	66	09.96 - 07.02	78-01-116
Primera Hatchback 1.6 16V	1600	GA 16 DE	73	09.96 - 07.02	78-01-116
Primera Hatchback 16V	1800	P11		99	78-01-102
Primera Hatchback 16V	1600	P11		96-02	78-01-106
Primera Hatchback 16V 4x4	1600	P10		90-96	78-01-106
Primera Hatchback 16V 4x4	2000	P10		90-96	78-01-106
Primera Hatchback 2.0 16V	2000	SR 20 DI	85	06.90 - 01.96	78-01-116
Primera Hatchback 2.0 16V 4x4	2000	SR 20 DI	85	04.91 - 06.96	78-01-116
Primera Traveller 1.6 16V	1600	GA 16 DE	73	04.98 - 12.01	78-01-116
Primera Traveller 1.6 16V	1600	GA 16 DE	66	04.98 - 12.01	78-01-116
Primera Traveller 1.6i	1600	GA 16 DE	75	03.94 - 03.98	78-01-116
Primera Traveller 1.6i	1600	GA 16 DS	66	07.90 - 03.98	78-01-116
Primera Traveller 16V	1800	WP11		99	78-01-102
Primera Traveller 16V	1600	WP11		98	78-01-106
Primera Traveller 16V	1600	W10		90-98	78-01-106
Primera Traveller 2.0i	2000	SR 20 DI	85	07.90 - 03.98	78-01-116
Qashqai					
Qashqai	1600	HR16DE	84	07.10→	78-01-110
Qashqai	1600	HR16DE	84	10.06 - 01.10	78-01-110
Qashqai	2000	MR20DE	104	10.06 - 01.10	78-01-110
Qashqai +2	1600	HR16DE	86	08.08→	78-01-110
Qashqai 1.6	1600	HR 16 DE	84	02.07→	78-01-112
Sentra					
Sentra 2.5	2500	QR 25 DE	132	09.06→	78-01-113
Sentra 2.5	2500	QR 25 DE	129	06.02 - 08.06	78-01-113
Sunny					
Sunny III 1.4i	1400	GA 14 DE, GA 14 DS	55	10.90 - 05.95	78-01-116
Sunny III 1.6i	1600	GA 16 DE, GA 16 DS	66	10.90 - 05.95	78-01-116
Sunny III 1.6i 16V 4WD	1600	GA 16 DS	66	10.90 - 05.95	78-01-116
Sunny III Hatchback 1.4i	1400	GA 14 DE, GA 14 DS	55	10.90 - 05.95	78-01-116
Sunny III Hatchback 1.6i	1600	GA 16 DE, GA 16 DS	66	10.90 - 05.95	78-01-116
Sunny III Hatchback 2.0 GTI 16V	2000	SR 20 DE	105	10.90 - 05.95	78-01-116
Sunny III Hatchback 2.0 GTI-R 4x4	2000	SR 20 DET	162	10.90 - 05.95	78-01-116
Sunny III Liftback 1.4i	1400	GA 14 DE, GA 14 DS	55	10.90 - 05.95	78-01-116
Sunny III Liftback 1.6i	1600	GA 16 DE, GA 16 DS	66	10.90 - 05.95	78-01-116
Sunny III Liftback 2.0i 16V	2000	SR 20 DE	105	10.90 - 05.95	78-01-116
Sunny III Traveller 1.6i	1600	GA 16 DE, GA 16 DS	66	06.91 - 03.00	78-01-116

MARCA-MODELLO CAR MODEL	CC	MOTORE ENGINE	KW	ANNO YEAR	ASHIKA CODE
Terrano					
Terrano I 3.0i 4WD	3000	VG 30 E	109	01.90 - 12.95	78-01-116
Terrano I 4WD	3000	WD21		90-95	78-01-106
Terrano II 2.4i 12V 4WD	2400	KA 24 E	91	02.93 - 06.96	78-01-116
Tiida					
Tiida 1.5	1500	HR 15 DE	80	05.04 - 02.07	78-01-114
Tiida 1.6	1600	HR 16 DE	81	09.07→	78-01-112
X-Trail					
X-Trail II	2000	MR20DE	104	03.07→	78-01-110
X-Trail 2.0	2000	QR 20 DE	103	07.01→	78-01-113
SUZUKI					
Baleno					
Baleno Combi i 16V	1800	J18A	89	08.96 - 05.02	78-08-800
Baleno GT	1800	J18A	89	03.96 - 05.02	78-08-800
Baleno GT	1800	J18A	89	03.96 - 05.02	78-08-800
Grand Vitara					
Grand Vitara	2000	J20A	94	03.98→	78-08-800
Grand Vitara	2000		103	10.05→	78-08-800
Grand Vitara V6	2700		127	09.01→	78-08-800
Grand Vitara V6 24V	2500	H25A	116	08.04→	78-08-800
Grand Vitara V6 24V	2500	H25A	106	04.98→	78-08-800
Grand Vitara XL-7	2700		135	04.03→	78-08-800
Vitara					
Vitara 16V	2000	J20A	97	12.96 - 03.98	78-08-800
Vitara Cabrio 16V	2000	J20A	97	12.96 - 03.99	78-08-800
Vitara V6 24V	2000	H20A	100	12.94 - 03.98	78-08-800
Vitara V6 24V	2500		118	12.95 - 03.98	78-08-800
TOYOTA					
4 Runner					
4 Runner i	3400	5VZ-FE	136	11.95→	78-02-201
4 Runner i 24V	3400	5VZ-FE	131	04.96→	78-02-201
Auris					
Auris 1.4 VVT-i	1400	4ZZ-FE	71	03.07→	78-02-207
Auris 1.6	1600	1ZR-FAE	97	05.09→	78-02-207
Avensis					
Avensis I	1600	4AFE	81	10.97 - 06.00	78-02-210
Avensis I	1600	4AFELB		10.97 - 06.00	78-02-210
Avensis 1.6	1600	1ZR-FAE	97	02.09→	78-02-207
Avensis 1.6 VVT-i	1600	3ZZ-FE	81	10.00 - 02.03	78-02-207
Avensis 1.6 VVT-i	1600	3ZZ-FE	81	04.03→	78-02-207
Avensis 1.8	1800	1ZZ-FE	95	04.03→	78-02-207
Avensis 1.8 VVT-i	1800	1ZZ-FE	95	10.00 - 02.03	78-02-207
Avensis Verso 2.0 VVT-i	2000	1AZ-FE	110	08.01→	78-02-208
Aygo					
Aygo 1.0	1000	1KR-FE	50	07.05→	78-02-207
Camry					
Camry 2.4 VVT-i	2400	2AZ-FE	112	11.01→	78-02-208
Carina					
Carina E 1.6 GLI	1600	4A-FE	79	04.92 - 09.97	78-02-202
Carina E 16V	1600	4A-FE	85	12.94 - 09.97	78-02-202
Carina E GLI	1600	4A-FE	79	04.92 - 09.97	78-02-202
Carina E Sportswagon GLI	1600	4A-FE	79	01.93 - 09.97	78-02-202
Carina E Sportswagon i	1600	4A-FE	73	02.95 - 09.97	78-02-202
Carina II	1600	4A-F	66	12.87 - 11.89	78-02-202

MARCA-MODELLO CAR MODEL	CC	MOTORE ENGINE	KW	ANNO YEAR	ASHIKA CODE
Carina II Station Wagon	1600	4A-F	66	12.87 - 12.89	78-02-202
Celica					
Celica	1600	4A-L	63	04.86 - 02.90	78-02-202
Celica 1.8 16V TS	1800	2ZZ-GE	141	11.99→	78-02-205
Celica 1.8 16V VT-i	1800	1ZZ-FE	105	11.99→	78-02-205
Celica 1.8 16V VT-i	1800	1ZZ-FE	105	11.99→	78-02-207
Celica i 16V	1800	7A-FE	85	11.93 - 11.99	78-02-202
Corolla					
Corolla	1600	4A-F	66	08.87 - 12.89	78-02-202
Corolla	1600	4A-FE	81	04.97 - 02.00	78-02-202
Corolla	1600	4A-F	66	08.87 - 12.89	78-02-202
Corolla Aut.	1600	4A-FE	79	04.97 - 02.00	78-02-202
Corolla Si	1600	4A-FE	84	09.95 - 04.97	78-02-202
Corolla 1.4 VVT-i	1400	4ZZ-FE	71	01.02→	78-02-207
Corolla 1.6 16V	1600	3ZZ-FE	81	02.00 - 01.02	78-02-207
Corolla 1.8 VVTL-i TS	1800	2ZZ-GE	141	01.02→	78-02-205
Corolla 1.8 VVTL-i TS	1800	2ZZ-GE	165	02.05→	78-02-205
Corolla Compact	1300	2E	55	08.87 - 12.89	78-02-202
Corolla Compact	1600	4A-F	66	08.87 - 04.92	78-02-202
Corolla Compact	1600	4A-FE	81	04.97 - 02.00	78-02-202
Corolla Compact 12V	1300	2E	53	07.92 - 05.95	78-02-202
Corolla Compact Aut.	1600	4A-FE	79	04.97 - 02.00	78-02-202
Corolla Compact GT	1800	7A-FE	86	11.92 - 05.95	78-02-202
Corolla Compact i	1300	2E-E	55	06.89 - 04.92	78-02-202
Corolla Compact Si	1600	4A-FE	84	07.92 - 04.97	78-02-202
Corolla Compact XLI 16V	1300	4E-FE	65	07.92 - 09.95	78-02-202
Corolla i	1300	2E, 2E-E	55	08.87 - 12.92	78-02-202
Corolla Liftback	1600	4A-F	66	08.87 - 04.92	78-02-202
Corolla Liftback i	1300	2E, 2E-E	55	08.87 - 04.92	78-02-202
Corolla Station Wagon	1300	2E	55	12.87 - 12.89	78-02-202
Corolla Station Wagon	1600	4A-F	66	02.88 - 05.92	78-02-202
Corolla Station Wagon i	1300	2E-E	55	06.89 - 06.92	78-02-202
Corolla Verso 1.6	1600	3ZZ-FE	81	04.04→	78-02-207
Corolla Verso 1.6 VVT-i	1600	3ZZ-FE	81	01.02 - 05.04	78-02-207
Corolla Verso 1.8	1800	1ZZ-FE	95	04.04→	78-02-205
Corolla Verso 1.8	1800	1ZZ-FE	95	04.04→	78-02-207
Corolla Verso 1.8 VVT-i	1800	1ZZ-FE	99	01.02 - 05.04	78-02-205
Corolla Verso 1.8 VVT-i	1800	1ZZ-FE	99	01.02 - 05.04	78-02-207
Corolla Wagon	1600	4A-FE	81	04.97 - 02.00	78-02-202
Corolla Wagon XLI	1300	4E-FE	55	09.95 - 04.97	78-02-202
Corolla Wagon XLI 16V	1300	4E-FE	65	07.92 - 09.95	78-02-202
Corolla Wagon 16V	1800	7A-FE	81	09.95 - 04.97	78-02-202
Corolla Wagon Aut.	1600	4A-FE	79	04.97 - 02.00	78-02-202
Corolla Wagon Si	1600	4E-FE	84	07.92 - 04.97	78-02-202
Corolla XLI	1300	4E-FE	55	09.95 - 04.97	78-02-202
Corolla 1.4 16V	1400	4ZZ-FE	71	02.00 - 01.02	78-02-209
Corolla Compact 1.4	1400	4ZZ-FE	71	02.00 - 01.02	78-02-209
Corolla Liftback 1.4	1400	4ZZ-FE	71	02.00 - 01.02	78-02-209
Corolla Wagon 1.4 16V	1400	4ZZ-FE	71	02.00 - 01.02	78-02-209
GS					
GS 430	4300	3UZ-FE	208	11.00 - 03.05	78-02-206
GS 450 h	3500	2GR-FSE	218	02.06→	78-02-206
Hiace					
Hiace III	2000	1RZ	74	02.90 - 08.95	78-02-202
Hiace III Wagon	2000	1RZ	74	08.89 - 08.95	78-02-202
Hiace IV	2400	2RZ-E	85	08.95 - 04.98	78-02-202

MARCA-MODELLO CAR MODEL	CC	MOTORE ENGINE	KW	ANNO YEAR	ASHIKA CODE
Hiace IV Wagon	2400	2RZ-E	85	08.95 - 04.98	78-02-202
IQ					
IQ 1.0	1000	1KR-FE	50	01.09→	78-02-207
IS					
IS 200	2000	1G-FE	114	04.99→	78-02-206
LS					
LS 460	4600	1UR-FSE	280	04.06→	78-02-206
LS 600 h	5000	2UR-FSE	290	08.07→	78-02-206
MR 2					
MR 2 1.8 16V VT-i	1800	1ZZ-FE	103	04.00→	78-02-207
Paseo					
Paseo 16V	1500	5E-FE	66	08.95 - 07.99	78-02-202
Paseo Cabriolet 16V	1500	5E-FE	66	10.96 - 03.99	78-02-202
Preva					
Preva 2.4 16V	2400	2AZ-FE	115	08.00→	78-02-208
Prius					
Prius	1500	NHW11_		00-04	78-02-200
RAV 4					
RAV 4 II 1.8 VVT-i	1800	1ZZ-FE	92	02.01→	78-02-207
RAV 4 II 2.0 VVT-i 4WD	2000	1AZ-FE	110	06.00→	78-02-208
RAV 4 III 2.0 VVT-i	2000	1AZ-FE	112	03.06→	78-02-208
RAV 4 III 2.4 VVT-i	2400	2AZ-FE	125	11.05→	78-02-208
RX 300					
RX 300	3000	1MZ-FE	150	05.03→	78-02-204
RX 300 V6	3000	1MZ-FE	148	10.00 - 05.03	78-02-204
Starlet					
Starlet	1000	1E	40	12.89 - 12.92	78-02-202
Starlet	1300	4E-FE	55	04.96 - 03.99	78-02-202
Starlet 12V	1300	2E-E	55	12.89 - 03.96	78-02-202
Verso					
Verso 1.6	1600	1ZR-FAE	97	04.09→	78-02-207
Yaris					
Yaris 1.0 VVT-i	1000	1KR-FE	51	01.06→	78-02-207
Yaris III	1000	1KRFE	51	02.09 - 07.11	78-02-203
Yaris III	1000	1KRFE	51	02.09 - 07.11	78-02-203
Yaris 16V	1000	_CP10		04.03 - 10.05	78-02-200
Yaris 16V	1000	_CP10		01.99 - 03.03	78-02-200
Yaris 16V	1300	_CP10		08.99 - 07.02	78-02-200
Yaris Verso	1300	NC/LP2_		04.03 - 10.05	78-02-200

BOBINE DI ACCENSIONE DIRETTA

Pencil Coils

78-00-000 DACIA

151402 6000592931 6001544755



78-01-102 NISSAN

22448-4M500

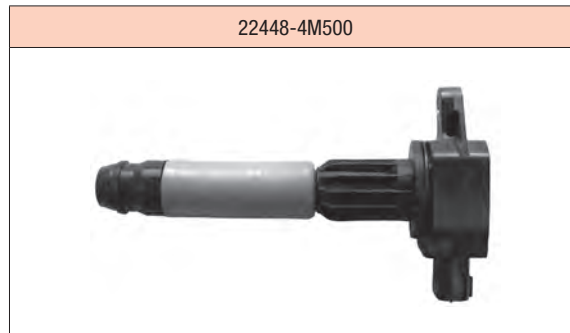

78-00-001 RENAULT

6001543604 7700274008 2244800QAC

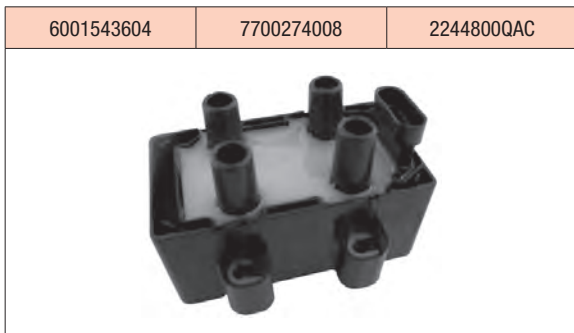

78-01-103 NISSAN

22448 31U01

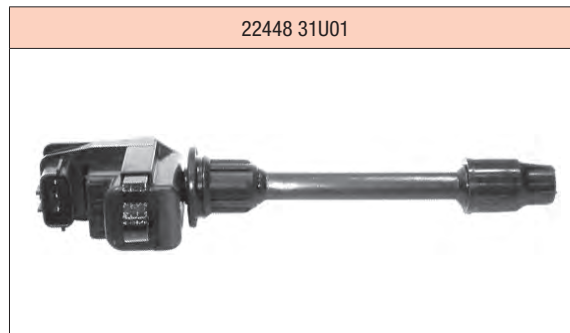

78-01-100 RENAULT

7700107177 7700875000 8200154186
8200154186A 8200208611 7700113357

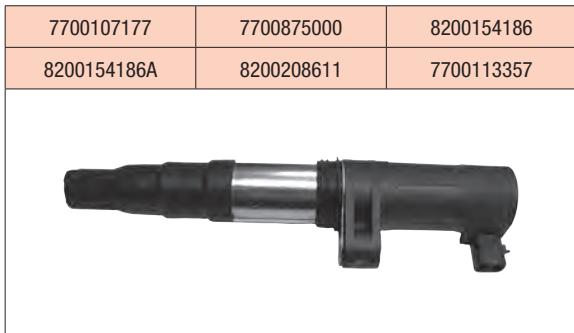

78-01-104 NISSAN

22448 31U06

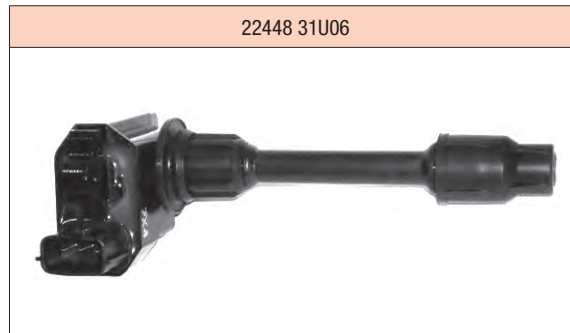

78-01-101 NISSAN

22448 1F700

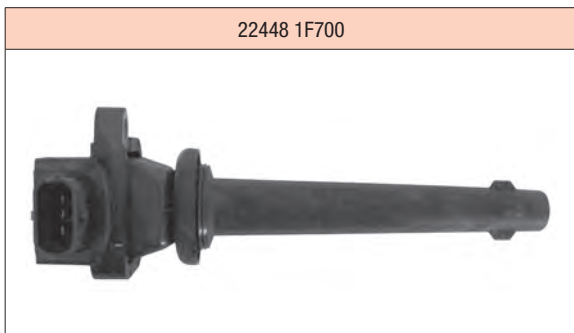

78-01-105 NISSAN

22448 2Y005

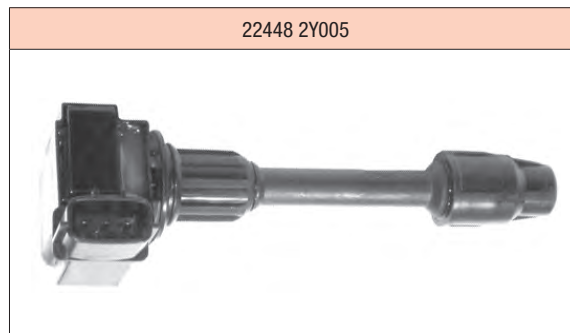

BOBINE DI ACCENSIONE DIRETTA

Pencil Coils

78-01-106 FORD

1953302-1953306	22433-55S10	F3XA/F5XZ12029AA
-----------------	-------------	------------------

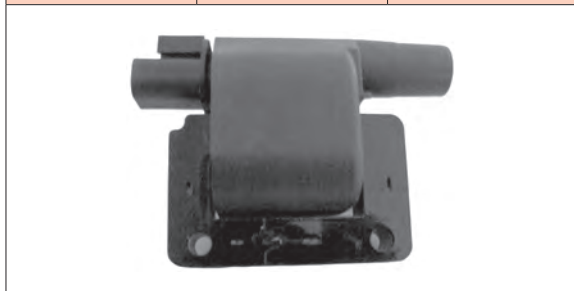

78-01-110 NISSAN

22448 ED800	22448 ED800EP
-------------	---------------



78-01-107 NISSAN

22448 2Y000



78-01-111 NISSAN

22448-AX001



78-01-108 NISSAN

22448 4M500



78-01-112 NISSAN

22448-1KT0A



78-01-109 NISSAN

22448 6N000	22448 6N002	22448 6N010
A132-04-4004G	22448 6N015	22448 6N012



78-01-113 NISSAN

22448-8H315



BOBINE DI ACCENSIONE DIRETTA

Pencil Coils

78-01-114 NISSAN

22448-JA00C



78-02-201 TOYOTA

90919 02212



78-01-115 NISSAN

22448-1K00A



78-02-202 TOYOTA

90919-02164

F000ZS0117

94853695

94404545



78-01-116 NISSAN

22448-D4000



78-02-203 TOYOTA

90919-T2002



78-02-200 TOYOTA

90919-02240



78-02-204 TOYOTA

90919-02234



BOBINE DI ACCENSIONE DIRETTA

Pencil Coils

78-02-205 TOYOTA

90919-02238



78-02-209 TOYOTA

90080-19017



78-02-206 TOYOTA

90919-02230



78-02-210 TOYOTA

90080-19005

**Picture
not available**

Immagine non disponibile

78-02-207 TOYOTA

90919-02262



78-03-300 FORD

1067601

1317972

1130402

988F12029AB/AC



78-02-208 TOYOTA

90919-02266



78-03-301 MAZDA

F1CZ12029A

B6S71810XA



BOBINE DI ACCENSIONE DIRETTA

Pencil Coils

78-03-302 TOYOTA

BP6D-18-100A

**Picture
not available**

Immagine non disponibile

78-03-306 MAZDA

FP85-18-100C



78-03-303 TOYOTA

ZJ20-18-100A



78-04-400 ROVER

30510-PT2-006

GCL195

NEC100530

ZEC275



78-03-304 TOYOTA

ZJ01-18-100A



78-04-401 ROVER

30500POHA01

30500P0AA01

5862061610

5862071980

GCL207



78-03-305 TOYOTA

N3H1-18-100B

**Picture
not available**

Immagine non disponibile

78-04-402 ROVER

GCL161

30500PM5A02

30500PM5403



BOBINE DI ACCENSIONE DIRETTA

Pencil Coils

78-04-403 HONDA

30520-PDF E11



78-05-501 MITSUBISHI

0 986 221 010

27301-24510

MD114994



78-04-404 HONDA

30520-RCA-A02



78-05-502 HYUNDAI

KK137-18-10X/C

MD160532

22448-03E01



78-04-405 HONDA

30520-RRA-007



78-08-800 SUZUKI

33410-77E22



78-05-500 HONDA

MD 362907



78-0H-H00 HYUNDAI

BAE 400 D



BOBINE DI ACCENSIONE DIRETTA

Pencil Coils

78-OH-H01 HYUNDAI

27300-39800



78-OH-H05 HYUNDAI

27301 22040

27301 22050



78-OH-H02 HYUNDAI

27301-38020



78-OH-H06 HYUNDAI

27301 23003



78-OH-H03 HYUNDAI

27301-02502

0986221006

96.294



78-OH-H07 HYUNDAI

27301 37100



78-OH-H04 HYUNDAI

27301-02600

09860221005



78-OH-H08 HYUNDAI

27301 37110

27301 37120



BOBINE DI ACCENSIONE DIRETTA

Pencil Coils

78-0H-H09 HYUNDAI

27301 02100

**Picture
not available**

Immagine non disponibile

78-0H-H13 HYUNDAI

27301-02100



78-0H-H10 HYUNDAI

27301 22600



78-0H-H14 HYUNDAI

27301-23700



78-0H-H11 HYUNDAI

27301-32820



78-0K-K00 KIA

BAE 400 B



78-0H-H12 HYUNDAI

27301-33020



78-0K-K01 KIA

OK247 18 100 A



BOBINE DI ACCENSIONE DIRETTA

Pencil Coils

78-OK-K02 KIA

27301 33510

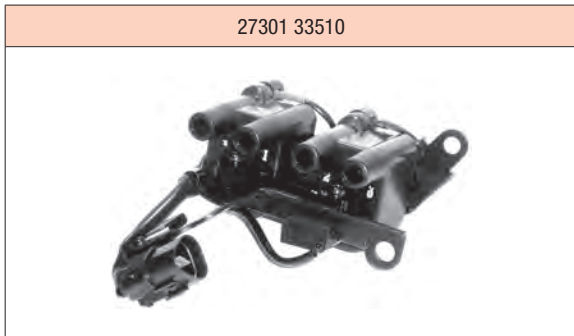

78-OK-K06 KIA

OK30E 18 10X

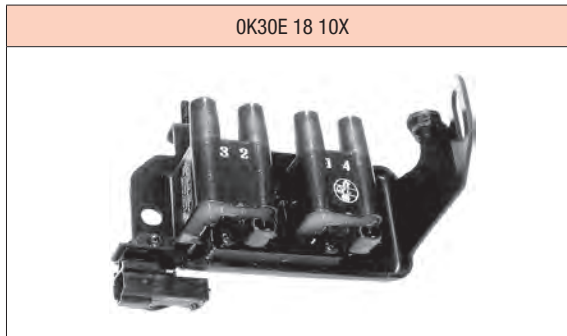

78-OK-K03 KIA

27301 02700



78-OK-K07 KIA

27301 26600

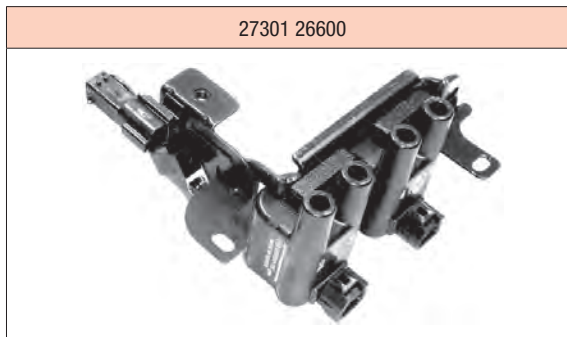

78-OK-K04 KIA

OK30A 18 10X



78-OK-K08 KIA

27301 23700



78-OK-K05 KIA

OK9BV 18 10X

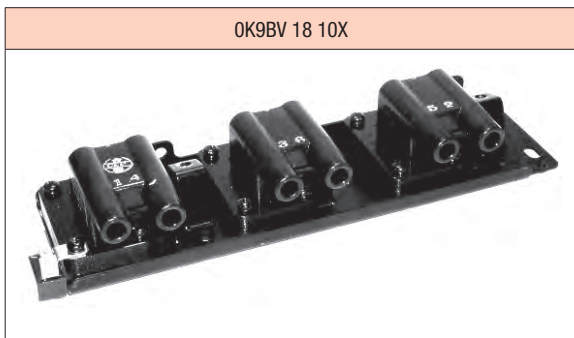

78-OK-K09 HYUNDAI

27301-03110



BOBINE DI ACCENSIONE DIRETTA

Pencil Coils

78-OK-K10 HYUNDAI

27301-26640



78-OK-K14 HYUNDAI

27301-04000



78-OK-K11 HYUNDAI

OK011-18-100

**Picture
not available**

Immagine non disponibile

78-W0-000 OPEL

96320818

2243342L00

96336522

94136766

8941367660

4294029



78-OK-K12 HYUNDAI

27301-2B000



78-0W-W02 CHEVROLET

96350585

1208051



78-OK-K13 HYUNDAI

27301-2B010



78-0W-W03 OPEL

96253555



BOBINE DI ACCENSIONE DIRETTA

Pencil Coils

78-0W-W04 CHEVROLET

01115467

96165049



78-0W-W05 CHEVROLET

96 453 420

**Picture
not available**

Immagine non disponibile

Cross Reference

CAVI CANDELA - IGNITION CABLES

OEM	ASHIKA
2245071J26	132-01-121
2245074Y26	132-01-121
2244057Y10	132-01-124
2244073C10	132-01-124
224402J210	132-01-122
2245089J26	132-01-122
2244099B05	132-01-123
3370564B10	132-01-104
2245016B27	132-01-105
2245019B27	132-01-105
22450-36A25	132-01-106
2244086J10	132-01-109
22440-99B06	132-01-110
2,25E+31	132-01-113
22440-99B06	132-01-114
2244057Y10	132-01-116
22440-57Y10	132-01-118
22440-73C00	132-01-118
22440-73C10	132-01-118
8200805133	132-01-119
8200713680	132-01-120
8200506297	132-01-125
9091921541	132-02-200
9091922327	132-02-201
9091922370	132-02-202
9091921591	132-02-203
9091922325	132-02-204
9091921537	132-02-205
90919-22373	132-02-206
9091921486	132-02-207
9091921259	132-02-209
9091921342	132-02-209
9091922168	132-02-210
9091922209	132-02-210
9091921324	132-02-211
90919-12460	132-02-214
90919-21492	132-02-214
9091921287000	132-02-215
90919-21328	132-02-216
90919-21332	132-02-216
90919-21350	132-02-216
9091922386	132-02-222
9091922373	132-02-224
90919211489	132-02-225
9091922370	132-02-226
9091921524	132-02-227
9091921525	132-02-227
9091921519	132-02-231
9091922211	132-02-232
9091922285	132-02-233
9091921373	132-02-234
9091921395	132-02-234

OEM	ASHIKA
9091921401	132-02-234
9091921370	132-02-235
9091921370	132-02-236
9091921400	132-02-236
9091921468	132-02-236
9091922329	132-02-237
9091921577	132-02-238
9091921524	132-02-239
90919-22386	132-02-240
90919-22400	132-02-240
90919-22272	132-02-242
90919-22273	132-02-242
90919-22141	132-02-244
90919-22258	132-02-244
90919-22132	132-02-244
9091921563	132-02-248
9091921597	132-02-248
9091921494	132-02-250
9091921578	132-02-250
B6BF18140A	132-03-300
8AB218140	132-03-300
B69F18140A	132-03-300
ZX1818140	132-03-300
8BBG18140	132-03-301
B6BF18140	132-03-301
B69F18140C	132-03-302
BPE818140P	132-03-302
1018119	132-03-305
1018131	132-03-305
7388354	132-03-305
7388355	132-03-305
Z50118140A	132-03-307
ZE2518140	132-03-308
ZE2818140	132-03-308
B31R18140	132-03-310
FSD718140B	132-03-316
ZX2918140	132-03-317
1E0518160B	132-03-319
1E0518170B	132-03-319
1E0518180B	132-03-319
1E0518190B	132-03-319
B 33G 18 140A	132-03-320
B33G 18 140 B	132-03-320
8 BGA 18 140	132-03-321
8 BGA 18 140A	132-03-321
1004427	132-03-323
1004430	132-03-323
1004431	132-03-323
1004432	132-03-323
1006346	132-03-323
1006347	132-03-323
1006348	132-03-323

OEM	ASHIKA
1006349	132-03-323
1012436	132-03-323
1063615	132-03-323
1092379	132-03-324
1114743	132-03-324
1089980	132-03-325
1095589	132-03-325
1095591	132-03-325
1095592	132-03-325
1119840	132-03-325
1335369	132-03-326
1335371	132-03-326
1335374	132-03-326
1335377	132-03-326
32722P1KE01	132-04-400
32722P2A003	132-04-400
32722PM1B01	132-04-400
32722PM6B00	132-04-400
32700POD000	132-04-401
32700PTO000	132-04-401
32700TPO000	132-04-401
32701PTOG00	132-04-401
32722PR3003	132-04-402
32722-P01-000	132-04-419
MD976524	132-05-503
MD134754	132-05-506
MD334031	132-05-507
MD030936	132-05-508
MD080566	132-05-508
MD139120	132-05-508
MD997318	132-05-508
MD997319	132-05-508
MD997328	132-05-508
MD997387	132-05-508
MD997424	132-05-508
MD997426	132-05-508
MD997506	132-05-508
MD997523	132-05-508
MD997313	132-05-510
MD134754	132-05-512
MD195228	132-05-512
MD997422	132-05-512
MD976524	132-05-514
MD997668	132-05-514
MD997423	132-05-515
MD334041	132-05-516
MD176915	132-05-516
MD156560	132-05-517
MD331260	132-05-517
MD334041	132-05-518
MD975309	132-05-522
MD080570	132-05-523

Cross Reference

CAVI CANDELA - IGNITION CABLES

OEM	ASHIKA
MD023742	132-05-524
MD997426	132-05-526
MD365102	132-05-528
1990187186000	132-06-612
19901-87B87-000	132-06-602
1990187B84000	132-06-603
1990187B87000	132-06-603
1990187188000	132-06-607
1990187189000	132-06-607
1990187A81000	132-06-607
1990187183000	132-06-607
SOA430Q114	132-07-701
3370551G10	132-07-705
22451-AA640	132-07-707
22451-AA630	132-07-707
22451-AA800	132-07-714
22451-AA810	132-07-714
22451AA793	132-07-715
22451AA822	132-07-715
22452AA682	132-07-715
3370551G10	132-08-800
3370563B10	132-08-800
3370580X51	132-08-800
3370683X50	132-08-800
33700-60A10	132-08-801
33700-60A20	132-08-801
33700-B60A10	132-08-802
33700-82011	132-08-805
3370560G20000	132-08-806
3370557B21	132-08-807
3370560G20	132-08-807
3370571C20	132-08-807
3370557B21	132-08-808
3370575F03	132-08-810
3370566D00	132-08-812
3370551G20000	132-08-813
33705-51G10	132-08-814
33705-80G00-000	132-08-816
33705-86G00-000	132-08-816
71742423	132-08-816
3370583020	132-08-819
8300156	132-09-901
4883233	132-09-905
4883233AB	132-09-905
05018394AA	132-09-906
4883233	132-09-907
4773841	132-09-908
05019593AA	132-09-912
82110393996	132-09-914
82110404488	132-09-914
A1121500118	132-09-915
A1121500218	132-09-915

OEM	ASHIKA
2750133A00	132-0H-H01
2750124B10	132-0H-H03
2750124C10	132-0H-H03
2750122B10	132-0H-H04
2750102D00	132-0H-H04
2750122B00	132-0H-H04
2750123A00	132-0H-H05
2750102A00	132-0H-H06
27501-23A00	132-0H-H10
2750102H00	132-0H-H13
2750102D00	132-0H-H13
2750122B00	132-0H-H13
27501-37B00	132-0H-H14
2750126A00	132-0H-H15
2750126C00	132-0H-H15
2750126D00	132-0H-H15
2750122A00	132-0H-H17
2750135B00	132-0H-H18
2750135C00	132-0H-H18
27501-26A00	132-0H-H19
27501-26C00	132-0H-H19
27501-26D00	132-0H-H19
7775810	132-0K-K03
0K30E 18140	132-0K-K04
27400 2X140	132-0K-K04
OK24718160A	132-0K-K05
OK247180A	132-0K-K05
27501-02H00	132-0K-K06
kia pride (iran)	132-0K-K07
kia pride (iran)	132-0K-K08
NP1149	132-0W-W01
92060980	132-0W-W02
96211948	132-0W-W04
96190263	132-0W-W05
96256433	132-0W-W06
NP1332	132-0W-W07
96305387	132-0W-W08
96291306	132-0W-W09
96342284	132-0W-W10
96190263	132-0W-W11
96497773	132-0W-W12
96211948	132-0W-W12
96288956	132-0W-W14
96450249	132-0W-W15
96984145	132-0W-W17
96450249	132-0W-W19

BERU	BERU	ASHIKA
ZEF1000	0300891000	132-02-238
ZEF1002	0300891002	132-03-308
ZEF1004	0300891004	132-04-417

BERU	BERU	ASHIKA
ZEF1081	0300891081	132-04-416
ZEF1082	0300891082	132-05-506
ZEF1084	0300891084	132-02-238
ZEF1085	0300891085	132-02-239
ZEF1103	0300891103	132-03-310
ZEF1104	0300891104	132-05-508
ZEF1105	0300891105	132-0W-W06
ZEF1108	0300891108	132-07-707
ZEF1109	0300891109	132-07-701
ZEF1115	0300891115	132-03-324
ZEF1129	0300891129	132-0W-W04
ZEF1130	0300891130	132-0H-H06
ZEF1135	0300891135	132-0H-H04
ZEF1136	0300891136	132-0H-H15
ZEF1137	0300891137	132-0W-W01
ZEF1142	0300891142	132-0W-W08
ZEF1144	0300891144	132-0H-H17
ZEF1147	0300891147	132-08-812
ZEF1166	0300891166	132-03-307
ZEF1173	0300891173	132-03-323
ZEF1178	0300891178	132-03-305
ZEF1227	0300891227	132-09-907
ZEF1245	0300891245	132-07-715
ZEF1252	0300891252	132-03-316
ZEF1327	0300891327	132-09-906
ZEF1328	0300891328	132-05-514
ZEF1340	0300891340	132-09-907
ZEF1371	0300891371	132-05-517
ZEF1372	0300891372	132-05-510
ZEF1375	0300891375	132-03-308
ZEF1376	0300891376	132-05-508
ZEF1377	0300891377	132-01-109
ZEF1385	0300891385	132-07-701
ZEF1387	0300891387	132-05-514
ZEF1409	0300891409	132-09-909
ZEF1442	0300891442	132-09-915
ZEF1475	0300891475	132-03-325
ZEF1485		132-0H-H14
ZEF1497	0300891497	132-07-713
ZEF1509	0300891509	132-0W-W11
ZEF1519	0300891519	132-0H-H04
ZEF1520	0300891520	132-0H-H21
ZEF1528	0300891528	132-07-715
ZEF1530	0300891530	132-0H-H13
ZEF1539	0300891539	132-04-418
ZEF1540	0300891540	132-03-319
ZEF1545	0300891545	132-09-912
ZEF1546	0300891546	132-01-125
ZEF1549	0300891549	132-03-326
ZEF1561	0300891561	132-07-714
ZEF672	0300890672	132-0W-W05
ZEF773	0300890773	132-01-108

Cross Reference

CAVI CANDELA - IGNITION CABLES

BERU	BERU	ASHIKA
ZEF825	0300890825	132-06-607
ZEF826	0300890826	132-06-607
ZEF828	0300890828	132-02-215
ZEF829	0300890829	132-06-603
ZEF830	0300890830	132-06-612
ZEF831	0300890831	132-06-606
ZEF834	0300890834	132-0W-W07
ZEF835	0300890835	132-0W-W02
ZEF836	0300890836	132-04-401
ZEF839	0300890839	132-04-400
ZEF842	0300890842	132-04-402
ZEF848	0300890848	132-0H-H03
ZEF849	0300890849	132-0H-H03
ZEF850	0300890850	132-0H-H05
ZEF850	0300890850	132-0H-H10
ZEF851	0300890851	132-0H-H01
ZEF853	0300890853	132-0H-H18
ZEF859	0300890859	132-03-317
ZEF860	0300890860	132-03-314
ZEF861	0300890861	132-03-305
ZEF862	0300890862	132-03-301
ZEF863	0300890863	132-03-300
ZEF870	0300890870	132-03-302
ZEF871	0300890871	132-03-301
ZEF874	0300890874	132-05-507
ZEF875	0300890875	132-05-515
ZEF876	0300890876	132-05-506
ZEF877	0300890877	132-05-512
ZEF878	0300890878	132-05-518
ZEF879	0300890879	132-05-509
ZEF881	0300890881	132-05-523
ZEF882	0300890882	132-05-508
ZEF883	0300890883	132-05-524
ZEF884	0300890884	132-05-514
ZEF887	0300890887	132-05-507
ZEF888	0300890888	132-05-517
ZEF889	0300890889	132-01-124
ZEF889	0300890889	132-01-118
ZEF890	0300890890	132-01-121
ZEF891	0300890891	132-01-122
ZEF894	0300890894	132-01-105
ZEF895	0300890895	132-01-123
ZEF896	0300890896	132-01-122
ZEF896	0300890896	132-01-110
ZEF899	0300890899	132-01-113
ZEF901	0300890901	132-07-705
ZEF906	0300890906	132-07-707
ZEF909	0300890909	132-08-800
ZEF909	0300890909	132-08-805
ZEF909	0300890909	132-08-814
ZEF910	0300890910	132-08-807
ZEF910	0300890910	132-08-806

BERU	BERU	ASHIKA
ZEF911	0300890911	132-02-220
ZEF912	0300890912	132-01-104
ZEF914	0300890914	132-08-819
ZEF915	0300890915	132-08-808
ZEF918	0300890918	132-02-230
ZEF919	0300890919	132-02-231
ZEF920	0300890920	132-02-232
ZEF921	0300890921	132-02-233
ZEF922	0300890922	132-02-215
ZEF923	0300890923	132-02-201
ZEF924	0300890924	132-02-202
ZEF925	0300890925	132-02-203
ZEF927	0300890927	132-02-234
ZEF928	0300890928	132-02-235
ZEF929	0300890929	132-02-227
ZEF930	0300890930	132-02-236
ZEF931	0300890931	132-02-250
ZEF932	0300890932	132-02-209
ZEF933	0300890933	132-02-210
ZEF934	0300890934	132-02-204
ZEF936	0300890936	132-02-200
ZEF937	0300890937	132-02-211
ZEF941	0300890941	132-02-223
ZEF944	0300890944	132-02-205
ZEF945	0300890945	132-02-207
ZEF946	0300890946	132-02-224
ZEF947	0300890947	132-02-222
ZEF948	0300890948	132-02-225
ZEF949	0300890949	132-02-226
ZEF951	0300890951	132-02-237

BOSCH	ASHIKA
0 986 356 702	132-01-105
0 986 356 703	132-01-121
0 986 356 705	132-01-124
0 986 356 716	132-07-707
0 986 356 721	132-04-401
0 986 356 728	132-06-612
0 986 356 732	132-08-800
0 986 356 739	132-0W-W02
0 986 356 756	132-08-808
0 986 356 762	132-08-819
0 986 356 766	132-06-607
0 986 356 780	132-01-108
0 986 356 782	132-0H-H01
0 986 356 799	132-01-123
0 986 356 821	132-01-122
0 986 356 837	132-03-317
0 986 356 838	132-0H-H03
0 986 356 841	132-08-805
0 986 356 871	132-03-301

BOSCH	ASHIKA
0 986 356 884	132-0W-W01
0 986 356 898	132-0H-H03
0 986 356 922	132-02-211
0 986 356 924	132-02-223
0 986 356 925	132-02-230
0 986 356 926	132-02-231
0 986 356 927	132-02-200
0 986 356 928	132-02-234
0 986 356 929	132-02-238
0 986 356 930	132-02-232
0 986 356 931	132-02-210
0 986 356 932	132-02-203
0 986 356 936	132-02-220
0 986 356 937	132-02-215
0 986 356 938	132-02-235
0 986 356 939	132-02-236
0 986 356 943	132-02-209
0 986 356 944	132-02-238
0 986 356 950	132-02-225
0 986 356 989	132-0H-H15

NGK	ASHIKA
RC-CR1202	132-09-907
RC-CR1203	132-09-906
RC-CR305	132-09-909
RC-CR606	132-09-907
RC-DW1201	132-0W-W07
RC-DW301	132-0W-W08
RC-DW302	132-0W-W04
RC-DW304	132-0W-W06
RC-DW402	132-0W-W02
RC-DW403	132-0W-W01
RC-ED1201	132-06-607
RC-ED1202	132-06-612
RC-EM1206	132-05-508
RC-EN1203	132-01-121
RC-ET1202	132-02-210
RC-ET1208	132-02-232
RC-ET1211	132-02-211
RC-ET1214	132-02-200
RC-ET1216	132-02-250
RC-EZ1202	132-07-705
RC-FD1205	132-03-325
RC-FD1207	132-04-418
RC-FD544	132-03-305
RC-FD548	132-03-323
RC-FD808	132-03-324
RC-FE30	132-07-701
RC-FT444	132-0H-H04
RC-FX31	132-07-707
RC-FX49	132-07-707

Cross Reference

CAVI CANDELA - IGNITION CABLES

NGK	ASHIKA
RC-FX51	132-07-715
RC-FX67	132-07-713
RC-HD1202	132-0H-H04
RC-HD301	132-0H-H06
RC-HD404	132-0H-H18
RC-HD407	132-0H-H10
RC-HD407	132-0H-H05
RC-HD408	132-0H-H03
RC-HD409	132-0H-H01
RC-HE53	132-04-400
RC-HE64	132-04-402
RC-HE77	132-04-401
RC-KA1204	132-0H-H13
RC-LC611	132-01-108
RC-MB223	132-09-915
RC-ME109	132-05-518
RC-ME51	132-05-524
RC-ME54	132-05-523
RC-ME64	132-05-512
RC-ME96	132-05-507
RC-MX1202	132-05-510
RC-NE08	132-01-118
RC-NX07	132-01-110
RC-NX07	132-01-122
RC-NX11	132-01-122
RC-NX93	132-01-113
RC-OP440	132-0W-W05
RC-SE02	132-08-807
RC-SE02	132-08-806
RC-SE17	132-08-812
RC-SE82	132-01-104
RC-SE93	132-08-814
RC-SE93	132-08-800
RC-SE93	132-08-805
RC-SE94	132-08-808
RC-TE42	132-02-231
RC-TE86	132-02-215
RC-TX06	132-02-236
RC-TX117	132-02-238
RC-TX118	132-02-237
RC-TX71	132-02-225
RC-ZE21	132-03-302
RC-ZE28	132-03-308
RC-ZE36	132-03-301
RC-ZE37	132-03-307
RC-ZX19	132-03-300
RC-ZX29	132-03-317
RC-ZX49	132-03-316

BREMI	ASHIKA
933	132-09-915
300/409	132-05-508
300/436	132-01-105
300/698	132-0K-K05
300/700	132-0H-H04
300/701	132-0H-H10
300/702	132-0H-H17
300/703	132-0H-H01
300/704	132-05-507
300/705	132-05-508
300/711	132-03-307
300/716	132-03-301
300/730	132-03-301
300/738	132-02-207
300/751	132-05-518
300/754	132-05-510
300/758	132-0W-W08
300/759	132-0W-W11
300/771	132-09-909
3A00/104	132-05-515
3A00/116	132-05-522
3A00/139	132-02-215
3A00/140	132-02-215
3A00/155	132-05-514
3A00/156	132-05-514
3A00/162	132-02-214
3A00/166	132-09-906
3A00/172	132-02-213
3A00/185	132-09-912
3A00/186	132-0H-H13
3A35/48	132-08-808
500/105	132-02-201
500/111	132-02-204
500/116	132-02-200
600/225	132-01-124
600/227	132-01-122
600/230	132-04-401
600/239	132-03-317
600/240	132-03-300
600/243	132-01-113
600/250	132-01-123
600/253	132-01-118
600/256	132-03-308
600/257	132-01-122
600/303	132-03-308
600/365	132-01-109
600/371	132-08-807
600/447	132-09-907
600/481	132-0H-H04
600/482	132-0H-H21
800/175	132-03-325
800/179	132-03-305

BREMI	ASHIKA
800/215	132-03-323

CAROL	ASHIKA
OES119	132-04-419
OES120	132-04-400
OES136	132-01-106
OES157	132-01-121
OES158	132-01-122
OES190	132-06-612
OES191	132-06-612
OES195	132-04-401
OES200	132-01-118
OES201	132-01-121
OES202	132-01-108
OES209	132-01-112
OES210	132-01-112
OES212	132-07-704
OES256	132-04-401
OES276	132-0W-W02
OES278	132-0W-W01
OES283	132-08-801
OES284	132-08-805
OES287	132-08-800
OES288	132-08-800
OES337	132-03-300
OES341	132-03-303
OES349	132-03-305
OES355	132-0H-H03
OES362	132-05-515
OES390	132-03-306
OES549	132-0H-H04
OES554	132-0K-K01
OES571	132-0W-W04
OES572	132-0W-W06
OES589	132-0H-H05
OES590	132-05-508
OES592	132-03-304
OES613	132-05-515
OES635	132-03-323

FACET	ASHIKA
4.7002	132-08-807
4.7004	132-08-807
4.7005	132-08-812
4.7006	132-0W-W14

Cross Reference

CAVI CANDELA - IGNITION CABLES

FACET	ASHIKA
4.7007	132-0W-W09
4.7012	132-08-807
4.7013	132-08-816
4.7015	132-05-526
4.7018	132-08-811
4.7019	132-08-811
4.7020	132-08-800
4.7023	132-01-104
4.7028	132-08-810
4.7100	132-07-710
4.7106	132-07-711
4.7108	132-05-508
4.7109	132-05-509
4.7110	132-05-508
4.7111	132-0H-H19
4.7112	132-0H-H02
4.7113	132-05-522
4.7118	132-0H-H20
4.7119	132-0H-H04
4.7120	132-0H-H06
4.7122	132-0H-H03
4.7128	132-01-108
4.7129	132-01-108
4.7135	132-05-514
4.7179	132-0H-H17
4.7182	132-09-901
4.7189	132-0K-K01
4.7230	132-01-119
4.7235	132-0H-H13
4.7236	132-0H-H14
4.7238	132-0H-H17
4.7242	132-03-326
4.7244	132-01-125
4.7245	132-03-319
4.7246	132-01-120
4.7247	132-0W-W20
4.7249	132-0W-W17
4.8608	132-01-110
4.8609	132-01-123
4.8671	132-01-122
4.8884	132-03-304
4.9278	132-05-507
4.9385	132-0H-H05
4.9385	132-0H-H12
4.9398	132-0K-K01
4.9401	132-0H-H01

FACET	ASHIKA
4.9402	132-04-414
4.9403	132-05-512
4.9404	132-06-602
4.9406	132-06-607
4.9407	132-05-508
4.9408	132-02-204
4.9413	132-08-800
4.9419	132-0W-W02
4.9420	132-05-515
4.9425	132-0W-W07
4.9433	132-0W-W01
4.9434	132-08-813
4.9436	132-06-602
4.9445	132-01-125
4.9507	132-09-910
4.9508	132-09-908
4.9509	132-0W-W15
4.9511	132-09-906
4.9568	132-03-325
4.9619	132-03-323
4.9624	132-03-324
4.9625	132-03-326
4.9634	132-0W-W06
4.9639	132-03-305
4.9649	132-09-915
4.9677	132-0W-W05
4.9680	132-0W-W12
4.9683	132-04-415
4.9684	132-03-311
4.9699	132-04-414
4.9709	132-04-416
4.9711	132-04-401
4.9719	132-09-914
4.9729	132-03-318
4.9730	132-0W-W10
4.9731	132-0W-W08
4.9732	132-06-612
4.9737	132-03-325
4.9738	132-03-307
4.9739	132-03-316
4.9760	132-03-312
4.9761	132-03-308
4.9762	132-03-306
4.9763	132-03-308
4.9764	132-05-506
4.9798	132-08-805

FACET	ASHIKA
4.9813	132-07-714
4.9814	132-07-714
4.9817	132-07-713
4.9819	132-07-712
4.9827	132-07-706
4.9835	132-07-704
4.9913	132-03-323
4.9990	132-09-911

MTA	ASHIKA
20.20949	132-01-109
20.20969	132-01-123
20.21389	132-03-301
20.21409	132-03-303
20.21429	132-0K-K01
20.21439	132-07-706
20.21519	132-0H-H04
20.21529	132-0H-H01
20.21539	132-06-612
20.21559	132-0W-W02
20.21579	132-05-507
20.21619	132-03-305
20.21649	132-04-414
20.21659	132-04-401
20.21669	132-04-415
20.21709	132-08-807
20.21719	132-01-104
20.21729	132-08-806
20.21779	132-08-803
20.21919	132-03-304
20.21929	132-02-202
20.22199	132-0H-H03
20.22209	132-0H-H04
20.22219	132-0H-H07
20.22609	132-04-419
20.22699	132-0W-W04
20.22709	132-0W-W06
20.22769	132-03-324
20.22779	132-03-325
20.22809	132-04-418
20.22859	132-08-812
20.22869	132-02-200
20.22899	132-03-307
20.23109	132-03-323
20.23129	132-03-326

MTA	ASHIKA
20.23249	132-03-306
20.23289	132-02-219
20.23299	132-02-216
20.23309	132-02-217
20.23339	132-02-209
20.23349	132-02-210
20.23359	132-02-211
20.23389	132-02-214
20.23439	132-02-208
20.23619	132-02-203
20.23629	132-02-202
20.23689	132-02-223
20.23709	132-02-207
20.23719	132-02-205
20.23729	132-02-224
20.23759	132-02-226
20.23859	132-06-602
20.23869	132-06-603
20.23879	132-0W-W07
20.23899	132-05-506
20.24019	132-0W-W08
20.24029	132-0W-W14
20.24039	132-0H-H13
20.24049	132-0H-H15
20.24059	132-0K-K03
20.24069	132-0K-K04

Cross Reference

BOBINE DI ACCENSIONE - IGNITION COILS

OEM	ASHIKA
151402	78-00-000
7700274008	78-00-001
245104	78-01-100
91159996	78-01-100
7700107177	78-01-100
7700113357	78-01-100
7700875000	78-01-100
8200154186	78-01-100
8200380267	78-01-100
8200405098	78-01-100
22448-00QAA	78-01-100
22448-1F700	78-01-101
22448-4M500	78-01-102
22448 31U01	78-01-103
22448-31U06	78-01-104
22448-2Y005	78-01-105
1953302	78-01-106
1953306	78-01-106
22433-55S10	78-01-106
22448-0C801	78-01-106
22448-2Y000	78-01-107
22448-4M500	78-01-108
22448-6N015	78-01-109
22448-ED800 EP	78-01-110
22448-AX001	78-01-111
22448-1KT0A	78-01-112
22448-8H315	78-01-113
22448-JA00C	78-01-114
22448-1KCOA	78-01-115
22448-D4000	78-01-116
22448-D4000	78-01-116
90919-02240	78-02-200
90919-02240	78-02-200
90919-02265	78-02-200
	78-02-201
90919-02164	78-02-202
90919-02164	78-02-202
90919-02164	78-02-202
90919-T2002	78-02-203
90080-19019	78-02-203
90080-19021	78-02-203
90919-02234	78-02-204
90919-02238	78-02-205
90919-02230	78-02-206
90919-02262	78-02-207
90919-02266	78-02-208
90080-19017	78-02-209
90080-19005	78-02-210
1130402	78-03-300
1317972	78-03-300
988F12024AB	78-03-300
988F12029AB-AC-AD	78-03-300

OEM	ASHIKA
B 6S7 18 10XA	78-03-301
B 6S8 10 10XA	78-03-301
B-6S8-10-10XA	78-03-301
F1CZ12029A	78-03-301
BP6D-18-100A	78-03-302
ZJ20-18-100A	78-03-303
ZJ01-18-100A	78-03-304
N3H1-18-100B	78-03-305
FP85-18-100C	78-03-306
30510-P73-A01	78-04-400
30510-P73-A02	78-04-400
30510-P73-A02	78-04-400
30510-PT2-006	78-04-400
GCL195	78-04-400
NEC100530	78-04-400
5862061610	78-04-401
5862071980	78-04-401
30500P0AA01	78-04-401
30500P0HA01	78-04-401
30500PAAA01	78-04-401
30500PCAA01	78-04-401
30500PDAA01	78-04-401
GCL207	78-04-401
NEC100750	78-04-401
GLC161	78-04-402
30520-PDF E11	78-04-403
30520-RCA-A02	78-04-404
30520-RRA-007	78-04-405
MD 362907	78-05-500
27301-24510	78-05-501
27301-24520	78-05-501
MD 114994	78-05-501
MD114994	78-05-501
22448-03E01	78-05-502
27310-35010	78-05-502
33410-77E22	78-08-800
27300-39800	78-0H-H00
27301-38020	78-0H-H01
27301-38020	78-0H-H02
27301-02502	78-0H-H03
27301-02502	78-0H-H03
27301-02502	78-0H-H03
27301-02600	78-0H-H04
27301-02600	78-0H-H04
MD160532	78-0H-H05
27301-22050	78-0H-H05
27301-22050	78-0H-H05
27301-23003	78-0H-H06
27301-37100	78-0H-H07
27301-37100	78-0H-H07
27301-37120	78-0H-H08
27301 02100	78-0H-H09

OEM	ASHIKA
27301-22600	78-0H-H10
27301-22600	78-0H-H10
27301-32820	78-0H-H11
27301-33020	78-0H-H12
27301-02100	78-0H-H13
27301-23700	78-0H-H14
0K247-18-100A	78-0K-K01
27301-33510	78-0K-K02
27301-02700	78-0K-K03
0K30A-18-10X	78-0K-K04
0K30A-18-10X	78-0K-K04
0K9BV-18-10X	78-0K-K05
0K9BV-18-10X	78-0K-K05
0K30E-18-10X	78-0K-K06
0K30E-18-10X	78-0K-K06
27301-26600	78-0K-K07
27301 23700	78-0K-K08
27301-03110	78-0K-K09
27301-26640	78-0K-K10
0K011-18-100	78-0K-K11
27301-2B000	78-0K-K12
27301-2B010	78-0K-K13
27301-04000	78-0K-K14
96320818	78-W0-000
96336522	78-W0-000
96 320 818	78-W0-000
1208051	78-0W-W02
96350585	78-0W-W02
96 350 585	78-0W-W02
96253555	78-0W-W03
96 253 555	78-0W-W03
96 253 555	78-0W-W03
96 165 049	78-0W-W04
96 453 420	78-0W-W05
96 453 420	78-0W-W05

BOSCH	ASHIKA
0221502002	78-02-210
0221503490	78-03-300
0221504017	78-01-101
0986221004	78-0H-H05
0986221005	78-0H-H04
0986221008	78-0H-H06
0986221018	78-0H-H01
0986221045	78-01-100
F000ZS0116	78-04-400
F000ZS0117	78-02-202
F000ZS0221	78-00-001

ERA	ASHIKA
880009	78-01-100
880044	78-0W-W02
880049	78-03-300
880052	78-04-400
880053	78-03-301
880054	78-05-501
880057	78-00-001
880058	78-0H-H03
880070	78-W0-000
880071	78-02-200
880072	78-02-202
880076	78-01-108
880091	78-00-000
880097	78-01-101
880113	78-0W-W04
880124	78-01-109
880139	78-0H-H05
880140	78-0H-H10
880141	78-0H-H06
880143	78-0H-H12
880144	78-0H-H08
880145	78-0H-H02
880146	78-0H-H07
880147	78-0K-K04
880148	78-0K-K06
880149	78-0K-K05
880150	78-0K-K02
880151	78-0W-W03
880155	78-01-111
880158	78-01-103
880159	78-01-104
880161	78-01-105
880164	78-0K-K03
880175	78-02-209
880186	78-0K-K01
880188	78-0K-K07
880188	78-0K-K07
880189	78-0W-W05
880190	78-05-500
880190	78-05-500
880202	78-02-210
880207	78-01-106
880241	78-02-204
880246	78-0K-K12
880256	78-02-206
880257	78-02-205
880258	78-04-405
880259	78-0K-K13

ERA	ASHIKA
880271	78-04-401
880273	78-0K-K08
880298	78-0K-K10
880302	78-01-113
880306	78-0H-H00
880318	78-01-114
880326	78-0K-K14
880327	78-0K-K09

BERU	BERU	ASHIKA
ZS052	0040100051	78-01-100
ZS264	0040100264	78-0H-H05
ZS265	0040100265	78-0H-H12
ZS266	0040100266	78-0H-H04
ZS267	0040100267	78-0H-H06
ZS269	0040100269	78-0H-H07
ZS270	0040100270	78-0H-H08
ZS275	0040100275	78-04-400
ZS277	0040100277	78-01-106
ZS279	0040100279	78-03-301
ZS301	0040100301	78-02-210
ZS337	0040100337	78-01-101
ZS350	0040100350	78-03-300
ZS354	0040100354	78-00-001
ZS356	0040100356	78-02-202
ZS521	0040100521	78-0K-K02
ZSE011	0040402011	78-0H-H03
ZSE021	0040102021	78-01-108
ZSE025	0040102025	78-0W-W02
ZSE502	0040102502	78-0H-H01

HELLA	ASHIKA
5DA749475031	78-00-001
5DA749475141	78-01-108
5DA749475241	78-0W-W02
5DA749475561	78-03-300
5DA749475751	78-02-200
5DA749475781	78-01-100

MEAT & DORIA	ASHIKA
10300	78-01-100
10318	78-03-300
10322	78-0W-W02
10336	78-00-001

MEAT & DORIA	ASHIKA
10344	78-04-400
10350	78-04-401
10357	78-02-200
10361	78-0H-H03
10368	78-0H-H04
10387	78-02-202
10390	78-W0-000
10400	78-0H-H06
10401	78-0H-H02
10403	78-0H-H07
10404	78-0H-H08
10406	78-01-108
10407	78-01-103
10408	78-01-104
10410	78-05-502
10412	78-05-500
10413	78-02-209
10415	78-02-201
10421	78-00-000
10422	78-08-800
10423	78-01-106
10429	78-05-501
10431	78-04-402
10441	78-0H-H05
10444	78-02-203
10446	78-0K-K01
10447	78-0K-K04
10448	78-0K-K05
10449	78-0K-K06
10450	78-0K-K08
10452	78-0K-K07
10453	78-0H-H10
10458	78-0K-K02
10459	78-0K-K03
10461	78-01-101
10467	78-01-113
10487	78-01-109
10488	78-0W-W04
10491	78-0H-H09
10493	78-0W-W03
10495	78-0W-W05
10500	78-01-110
10506	78-0H-H00
10514	78-01-111
10516	78-01-105
10517	78-01-107
10556	78-02-210
10557	78-02-204

Cross Reference

BOBINE DI ACCENSIONE - IGNITION COILS

MEAT & DORIA	ASHIKA
10558	78-02-206
10560	78-02-205
10563	78-04-405
10582	78-0K-K12
10591	78-0K-K13

NGK	ASHIKA
U5073	78-0K-K10
U5092	78-08-800
U5099	78-04-405
U5100	78-02-204
U5113	78-01-105
U5119	78-01-114
U5127	78-01-107

SIDAT	ASHIKA
8530218	78-04-401
8530228	78-02-200
8530232	78-02-210
8530273	78-0K-K01
8530274	78-05-500
8530278	78-0K-K12
8530289	78-0H-H00
8530302	78-03-300
8530306	78-0K-K13
8530317	78-04-405
8530329	78-02-204
8530330	78-02-206
8530332	78-02-205

NGK	ASHIKA
U1004	78-04-400
U1013	78-02-202
U1022	78-05-501
U1024	78-01-116
U2018	78-0W-W02
U2031	78-0W-W03
U2035	78-0H-H06
U2039	78-0H-H04
U2040	78-0H-H03
U2042	78-0H-H12
U2048	78-0H-H10
U2051	78-0H-H14
U2054	78-0K-K05
U2060	78-0K-K07
U2061	78-0K-K06
U2062	78-0W-W05
U2063	78-0K-K03
U2064	78-0K-K04
U2067	78-0H-H13
U4006	78-0H-H02
U4011	78-03-306
U4013	78-03-302
U4014	78-05-500
U4021	78-0K-K01
U5027	78-02-200
U5029	78-02-207
U5030	78-02-209
U5032	78-01-108
U5036	78-01-109
U5041	78-01-101
U5043	78-01-110
U5051	78-04-404
U5052	78-02-208
U5054	78-01-111
U5061	78-01-113
U5065	78-02-206
U5067	78-0K-K13
U5068	78-02-205
U5070	78-01-104
U5072	78-0K-K12

SIDAT	ASHIKA
8530001	78-0H-H02
8530003	78-0H-H05
8530004	78-0H-H12
8530005	78-0H-H06
8530006	78-0H-H07
8530007	78-0H-H08
8530008	78-0H-H03
8530010	78-0H-H10
8530011	78-0K-K07
8530014	78-0W-W04
8530015	78-0W-W03
8530016	78-0W-W02
8530017	78-W0-000
8530018	78-0W-W05
8530019	78-0K-K08
8530020	78-0K-K02
8530021	78-0K-K03
8530022	78-0K-K04
8530024	78-0K-K05
8530026	78-0K-K06
8530058	78-0H-H03
8530090	78-01-101
8530099	78-05-501
8530100	78-04-400
8530102	78-01-106
8530119	78-0H-H04
8530121	78-03-301
8530128	78-00-001
8530134	78-03-300
8530151	78-01-101
8530152	78-02-209
8530164	78-01-100
8530188	78-01-108
8530190	78-00-000
8530199	78-02-202
8530212	78-01-111
8530213	78-01-113
8530214	78-01-109

Certificate of Registration



The Governing Board of
Q.A. International Certification Limited
hereby grants to:

JAPANPARTS S.r.l.

Registration No. : QAIC / IT / 90039 - A

(hereinafter called the Registered Company) the right to be listed in the Directory of Registered Companies in respect of the services listed below. These services shall be offered by the Registered Company at or from only the address given below in accordance with the quality management system in compliance with ISO 9001:2008.

Address to which this Certificate refers :

Via Della Meccanica, 1/A 37139 VERONA - Italy

Approved Scope to which this Certificate refers
(Scopo della Certificazione cui il Certificato riferisce)

**Commercialisation of Automotive Parts and Accessories
(Commercializzazione di Ricambi per Autoveicoli)**
(Further clarification regarding the Scope of this Certificate and the applicability of
ISO 9001:2008 requirements may be obtained by consulting the organisation)

Signed for and on behalf of the Board

CHAIRMAN
A. J. Duffield

SCHEME MANAGER
A. Carter

Certificate Issue Date : 9th February 2012 - Certificate Expiry Date : 24th January 2013
Date of Initial Registration : 25th January 2000 - Re-assessment Date : 24th January 2015
This Certificate of Registration is granted subject to the Regulations approved by the Board.

QA INTERNATIONAL

Q.A. International Certification Ltd.
Dudley Court
Dudley Road
Darlington
Co. Durham
DL1 4GG

Tel: +44 (0)1325 384272
Fax: +44 (0)1325 480980
www.qai.co.uk



The use of the Accreditation Mark indicates an evaluation in respect of those activities controlled by the accreditation certificate number 945.

Rechtliche Hinweise - Disclaimer - Avvertenze Legali Information juridique - Advertencias/Juridische Informatie



DE Wir haben uns um die weitestgehende Richtigkeit der in diesem Katalog enthaltenen Angaben bemüht. Wir haften indes nicht für eventuelle Unrichtigkeiten. Dieser Katalog enthält Produkte, die dem Erstausstattungsstandard entsprechen. Wir behalten uns jederzeit technische Änderungen vor. Die im Katalog angeführten Originalnummern und Herstellernamen dienen ausschließlich der Identifizierung des Bauteils und sind nicht auf Lieferscheinen und Rechnungen verwendbar. Die vollständige und auch teilweise Reproduktion unserer Referenzangaben und unseres Katalogs ist verboten.

EN We have made every effort to ensure that the data in this catalogue are as accurate as possible. However, we decline all responsibility for any inaccuracies.
This catalogue contains products of "initial equipment" quality. We reserve the right to make technical changes at any time. The original numbers and manufacturers' names mentioned in this catalogue are provided solely to allow identification of the component and may not be used on delivery notes and invoices.
Even partial reproduction of our references and catalogue is forbidden.

I Ci siamo adoperati affinché i dati contenuti in questo catalogo siano i più esatti possibili. Tuttavia decliniamo ogni responsabilità per eventuali inesattezze.
Questo catalogo contiene prodotti di qualità "primo equipaggiamento". Ci riserviamo il diritto di apportare modifiche tecniche in qualsiasi momento. I numeri originali e i nomi dei fabbricanti citati in questo catalogo servono esclusivamente a scopo identificativo del componente e non possono essere utilizzati sulle bolle di accompagnamento e fatture.
La riproduzione, anche parziale dei nostri riferimenti e del nostro catalogo è vietata.

FR Nous avons fait tout notre possible pour que les données de ce catalogue soient exactes. Toutefois, nous déclinons toute responsabilité pour d'éventuelles inexactitudes.
Ce catalogue contient des produits de qualité "équipement standard". Nous nous réservons le droit d'apporter à tout moment des modifications techniques. Les numéros originaux et les noms des fabricants cités dans ce catalogue servent exclusivement à identifier le composant et ne peuvent pas être utilisés sur les bulletins d'accompagnement et les factures.
La reproduction, même partielle, de nos références et de notre catalogue est rigoureusement interdite.

ES Hemos procurado que los datos que figuran en este catálogo sean lo más exactos posible. No obstante declinamos toda responsabilidad por eventuales imprecisiones.
Este catálogo incluye productos de calidad de "equipos de serie". Nos reservamos el derecho de introducir modificaciones técnicas en cualquier momento.
Los números originales y los nombres de los fabricantes citados en este catálogo se ofrecen exclusivamente a efectos de identificación del componente y no podrán ser empleados en las cartas de porte ni en las facturas.
Queda prohibida la reproducción total o parcial de nuestros códigos de referencia y nuestro catálogo.

NL Wij hebben ons ingespannen om ervoor te zorgen dat de gegevens in deze catalogus zo exact mogelijk zouden zijn. Wij kunnen echter niet aansprakelijk worden gesteld voor eventuele onnauwkeurigheden.
Deze catalogus bevat producten van "standaarduitrusting" kwaliteit. Wij behouden ons het recht voor om op ieder gewenst ogenblik technische wijzigingen aan te brengen. De in deze catalogus genoemde oorspronkelijke nummers en namen van de fabrikanten dienen uitsluitend ter identificatie van de component en kunnen niet worden gebruikt op de geleidebrieven en facturen. De, ook gedeeltelijke, reproductie van ons referentiemateriaal en de catalogus is verboden.