



FILTERS

Filters for cars, 4WD and vans
Filtri per auto, fuoristrada e veicoli commerciali
Filtros para coches, todoterreno y vehiculos comerciales
Filtre pour voitures, tout terrain et véhicules commerciaux
Filter für Autos, Geländefahrzeuge und Nutzfahrzeuge



2012
2013



TecDoc
CERTIFIED DATA SUPPLIER

Oltre che sui cataloghi cartacei dei prodotti aftermarket di Ashika, è possibile trovare i prodotti Ashika anche in TecDoc, leader europeo nella produzione di catalogazione elettronica.

Ashika è "Fornitore di dati certificato" per TecDoc. Vale a dire che tutti i dati di Ashika presenti in TecDoc godono di ottima qualità, sono stati controllati e verificati da TecDoc, e supportati dagli specialisti di Ashika. I pezzi possono essere facilmente reperiti cliccando sul relativo veicolo e sul gruppo di prodotti. Quando vengono visualizzate le parti Ashika corrette, l'utente può visionare anche informazioni aggiuntive (ad es. dimensioni, caratteristiche o immagini).

Beside the paper catalogues of the Ashika Aftermarket products, Ashika products can also be found in TecDoc, European leader of electronic cataloguing.

Ashika is a "certified Data Supplier" to TecDoc. This means that all Ashika data in TecDoc is of the highest quality, controlled and checked by TecDoc, and maintained by Japanparts' own specialists. Parts can easily be found just by clicking on the proper vehicle and product-group. When the correct Ashika part(s) is/are displayed, also additional information can be viewed (i.e. dimensions, remarks or pictures).





PRODUCTS RANGE - PRODUKTE IM SORTIMENT	
GAMME DE PRODUITS - GAMA DE PRODUCTOS	
PRODOTTI IN GAMMA	
REPLACED CODES - ERSETZTE CODES	
CODES REMPLACÉS - CÓDIGOS SUBSTITUIDOS	
CODICI SOSTITUITI	
NEW CODES - NEUE CODES	
NOUVEAUX CODES - NUEVOS CODIGOS	
NUOVI CODICI	
	Pag.
ALFA ROMEO	1
ALPINA	3
ASIA MOTORS	4
AUDI	5
BMW	13
CADILLAC	28
CHEVROLET	29
CHRYSLER	31
CITROËN	34
DAEWOO	40
DAIHATSU	43
DODGE	47
DR	48
FIAT	49
FORD	52
GASOLONE	55
GONOW	56
GREAT WALL	57
HONDA	58
HUMMER	67
HYUNDAI	68
INFINITI	79
ISUZU	80
ISUZU COMMERCIAL	83
IVECO COMMERCIAL	84
JAGUAR	85
JEEP	86
KIA	88
LADA	94
LANCIA	95
LAND ROVER	96
LEXUS	99
MAHINDRA	101
MAN COMMERCIAL	102
MAYBACK	112
MAZDA	113
MERCEDES BENZ	126
MERCEDES BENZ COMMERCIAL	140
MG	151
MINI	152
MITSUBISHI	153
MITSUBISHI COMMERCIAL	165

	Pag.
MORGAN	167
NISSAN	168
NISSAN COMMERCIAL	183
OPEL	185
PEUGEOT	193
PIAGGIO	198
PORSCHE	199
RENAULT	200
ROVER	207
SAAB	208
SEAT	209
SHUANGHUAN AUTO	214
SKODA	215
SMART	219
SSANGYONG	220
SUBARU	221
SUZUKI	225
TATA (TELCO)	231
TOYOTA	232
VAUXHALL	253
VOLVO	260
VOLKSWAGEN	265
PICTURES OIL FILTERS	
ABBILDUNGEN ÖLFILTER	
FIGURAS FILTRES À HUILE	
ILLUSTRATIONS FILTROS ACEITE	
IMMAGINI FILTRI OLIO	275
PICTURES AIR FILTERS	
ABBILDUNGEN LUFTFILTER	
FIGURAS FILTRES FILTRES À AIR	
ILLUSTRATIONS FILTROS AIRE	
IMMAGINI FILTRI ARIA	304
PICTURES FUEL FILTERS	
ABBILDUNGEN KRAFTSTOFFFILTER	
FIGURAS FILTRES FILTRES À CARBURANT	
ILLUSTRATIONS FILTROS CARBURANTE	
IMMAGINI FILTRI CARBURANTE	357
PICTURES CABIN FILTERS	
ABBILDUNGEN INNENRAUMFILTER	
FIGURAS FILTRES HABITACLES	
ILLUSTRATIONS FILTROS HABITÁCULO	
IMMAGINI FILTRO ABITACOLO	392
CROSS REFERENCE LIST	
VERGLEICHSLISTE	
LISTA DE REFERENCIAS CRUZADES	
LISTE DE COMPARAISON	
LISTA DI COMPARAZIONE	411



10

OIL FILTERS
ÖLFILTER
FILTRES À HUILE
FILTROS ACEITE
FILTRI OLIO



20

AIR FILTERS
LUFTFILTER
FILTRES À AIR
FILTROS AIRE
FILTRI ARIA



21

INTERNAL FILTERS
INNENRAUMFILTER
FILTRES HABITACLES
FILTROS HABITÁCULO
FILTRI ABITACOLO



30

FUEL FILTERS
KRAFTSTOFFFILTER
FILTRES À CARBURANT
FILTROS CARBURANTE
FILTRI CARBURANTE



10-ECO 30-ECO

ECOLOGICAL FILTERS
ÖKOFILTER
FILTRES ECOLOGIQUES
FILTROS HABITÁCULO
FILTRI ECOLOGICI

FULL RANGE EUROPEAN AND ASIAN CAR
GAMMA COMPLETA PER AUTO EUROPEE E ASIATICHE

The pictures as shown in the catalogue are not a reproduction of original drawings and are only mean for visual and identifying purposes and cannot be objected with the original parts at all, Ashika declines any responsibility following improper uses of these pictures and possible mistakes.

I disegni riportati nel catalogo non sono riproduzioni di disegni originali e sono a solo uso visivo ed identificativo e non potranno costituire oggetto di contestazione con i pezzi originali, in ogni caso Ashika declina ogni responsabilità sull'uso improprio degli stessi e non risponderà di eventuali errori e/o omissioni.

Copyright by Ashika - Verona

All rights of reproduction are reserved for Ashika
Les droits de reproduction sont réservés à Ashika
Todos los derechos de la reproducción son reservados para Ashika
I diritti di riproduzione sono riservati ad Ashika

LETTURA DEL CODICE ASHIKA - THE KEY TO THE ASHIKA' CODE

ESEMPIO PER AUTO GIAPPONESI EXAMPLE FOR JAPANESE CARS

20 - 00 - 006

PARTE NUMERICA
NUMERICAL PART

COSTRUTTORE DEL VEICOLO
MOTOR BUILDER

IDENTIFICA IL PRODOTTO
IDENTIFY THE PRODUCT

- 0 = TATA-LADA-HUMMER
- 1 = NISSAN
- 2 = TOYOTA
- 3 = MAZDA
- 4 = HONDA
- 5 = MITSUBISHI
- 6 = DAIHATSU - PIAGGIO
- 7 = SUBARU
- 8 = SUZUKI - MARUTI
- 9 = ISUZU - JEEP - OPEL CHRYSLER

ESEMPIO PER AUTO COREANE EXAMPLE FOR KOREAN CARS

20 - 0H - H14

PARTE NUMERICA
NUMERICAL PART

COSTRUTTORE DEL VEICOLO
MOTOR BUILDER

IDENTIFICA IL PRODOTTO
IDENTIFY THE PRODUCT

- H = HYUNDAI
- K = KIA
- W = DAEWOO/CHEVROLET
- S = SSANGYONG
- M = SMART

FILTRI/FILTERS/FILTRES FILTER/FILTROS/FILTROS		
	10	FILTRI OLIO - OIL FILTERS - FILTRES À HUILE - ÖLFILTER - FILTROS DO ÓLEO - FILTROS DE ACEITE
	20	FILTRI ARIA - AIR FILTERS - FILTRES À AIR - LUFTFILTER - FILTROS DE AR - FILTROS DE AIRE
	21	FILTRI ABITACOLO - CABIN FILTERS - FILTRES D'HABITACLE - POLLENFILTER - FILTROS DE HANBITÁCULO - FILTROS DEPURACIÓN
	30	FILTRI CARBURANTE - FUEL FILTERS - FILTRES À CARBURANT - KRAFTSTOFFFILTER - FILTROS DE COMBUSTÍVEL - FILTROS DE CARBURANTE
	10-ECO	FILTRI OLIO ECO - ECO OIL FILTERS - FILTRES À HUILE ECO - ÖLFILTER ECO - ECO FILTROS DO ÓLEO - ECO FILTROS DE ACEITE
	30-ECO	FILTRI CARBURANTE ECO - ECO FUEL FILTERS - FILTRES À CARBURANT ECO - KRAFTSTOFFFILTER ECO - ECO FILTROS DE COMBUSTÍVEL - ECO FILTROS DE CARBURANTE
	74	KIT FILTRI PER TAGLIANDO - SERVICE FILTER KIT - KIT FILTRES ENTRETIEN - FILTER SERVICE SATZ - KIT DE FILTROS DA REVISÃO - KIT FILTROS PARA REVISIÓN
	10-GAS	FILTRO DEPURAZIONE GPL - GPL PURIFICATION FILTER - FILTRE PURIFICATION GPL - REINIGUNGSFILTER GPL - FILTRO DE GÁS PARA A FILTRAGEM DO GPL - GAS FILTRO DEPURACIÓN GPL
	99	SUPPORTO FILTRO - FILTER SUPPORT - FILTRE D'APPUI - FILTRE HALTERUNG - SUPORTE DO FILTRO - SOPORTE FILTRI

FRENANTE/BRAKES/BREMS FREINAGE/TRAVÕES/ FRENOS		
	67	CILINDRETTI FRENO SX - REAR WHEEL CYLINDER LEFT - CYLINDRE DE ROUE GAUCHE - RADBREM-SZYLINDER, LINKS - CILINDRO DE TRAVÃO DE TRÁS ESQUERDO - CILINDROS DE FRENO SX
	68	POMPE FRENO - BRAKE MASTER CYLINDERS - MAÎTRE CYLINDRES - HAUPTBREMSZYLINDER - BOMBAS DOS TRAVÕES - BOMBAS DE FRENO
	69	TUBI FRENO - BRAKE HOSES - FLÉXIBLES DE FREIN - BREMSCHLÄUCHE - TUBOS DOS TRAVÕES - TUBOS DE FRENO
	KFR	KIT FRENO (2 dischi+1 past. ant.) - BRAKE KIT (2 discs+1 pads front) - KIT DE FREINS - (2 disques+1 plaquettes avant) - BREMSSENSATZ (2 Scheiben+1 Klötze vorne) - KIT DOS TRAVÕES (2 discos+1 jogo de pastilhas da frente) - KIT DE FRENO (2 discos+1 past. ant.)
	KRR	KIT FRENO (2 dischi+1 past. post.) - BRAKE KIT (2 discs+1 pads rear) - KIT DE FREINS - (2 disques+1 plaquettes arrière) - BREMSSENSATZ (2 Scheiben+1 Klötze hinten) - KIT DOS TRAVÕES (2 discos+1 jogo de pastilhas de trás) - Kit de freno (2 discos+1 past. ant.)
	114	KIT RIPARAZIONE POMPA FRENO - REPAIR KIT, BRAKE MASTER CYLINDER - KIT DE RÉPARATION, MAÎTRE CYLINDRE DE FREIN - REPARATURSATZ, HAUPTBREMSZYLINDER - KIT REPARAÇÃO DA BOMBA DOS TRAVÕES - KIT REPARACIÓN BOMBA DE FRENO
	120	KIT RIPARAZIONE PINZA FRENO - BRAKE CALIPERS REPAIR KIT - KIT DE REPARATION ETRIERS DE FREIN - REPARATURSATZ BREMSSEL - KIT REPARAÇÃO PINÇA TRAVÃO - KIT REPARACIÓN PINZA DE FRENO

NEW

FULL RANGE

FRENANTE/BRAKES/BREMS FREINAGE/TRAVÕES/ FRENOS		
	50	PASTIGLIE FRENO ANT. - BRAKE PADS FRONT - PLAQUETTES DE FREIN AVANT - BREMSKLÖTZE VORNE - PASTILHAS DOS TRAVÕES DA FRENTE - PASTILLAS DE FRENO ANT.
	51	PASTIGLIE FRENO POST. - BRAKE PADS REAR - PLAQUETTES DE FREIN ARRIÈRE - BREMSKLÖTZE HINTEN - PASTILHAS DOS TRAVÕES DE TRÁS - PASTILLAS DE FRENO POST.
	60	DISCHI FRENO ANT. - BRAKE DISCS FRONT - DISQUES DE FREIN AVANT - BREMSSCHEIBEN VORNE - DISCOS DOS TRAVÕES DA FRENTE - DISCOS DE FRENO ANT.
	61	DISCHI FRENO POST. - BRAKE DISCS REAR - DISQUES DE FREIN ARRIÈRE - BREMSSCHEIBEN HINTEN - DISCOS DOS TRAVÕES DE TRÁS - DISCOS DE FRENO POST.
	55	GANASCE FRENO - BRAKE SHOES - MACHOIRES DE FREIN - BREMSBACKEN - MAXILAS DE TRAVÃO - ZAPATAS DE FRENO
	56	TAMBURI FRENO - BRAKE DRUMS - TAMBOURS DE FREIN - BREMSSTROMMEL - TAMBORES DOS TRAVÕES - TAMBORES DE FRENO
	65	CILINDRETTI FRENO DX - REAR WHEEL CYLINDER RIGHT - CYLINDRE DE ROUE DROIT - RADBREM-SZYLINDER, RECHTS - CILINDRO DE TRAVÃO DE TRÁS DIREITO - CILINDROS DE FRENO DX

FRIZIONI/CLUTCH/KUPPLUNG EMBRAYAGE/ EMBRAIAGEM / EMBRAGUE		
	80	DISCHI FRIZIONE - CLUTCH DISCS - DISQUES D'EMBRAYAGE - KUPPLUNGSSCHEIBEN - DISCO DE EMBRAIAGEM - DISCO DE EMBRAGUE
	70	SPINGIDISCO FRIZIONE - CLUTCH COVER - MÉCANISME D'EMBRAYAGE - DRUCKPLATTEN KUPPLUNG - PRATO DE PRESSÃO DA EMBRAIAGEM - PRENSA DE EMBRAGUE
	90	CUSCINETTI FRIZIONE - CLUTCH BEARINGS - BUTÉES D'EMBRAYAGE - KUPPLUNGS-AUSRÜCKLAGER - ROLAMENTO DE EMBRAIAGEM - COJINETES DE EMBRAGUE
	92	KIT FRIZIONE - CLUTCH KITS - KIT EMBRAYAGES - KUPPLUNGSSÄTZE - KIT EMBRAIAGEM - KIT EMBRAGUE
	91	VOLANI - FLYWHEELS - VOLANTS - SCHWUNGRÄDER - VOLANTES BI-MASSA - VOLANTES
	98	KIT FRIZIONE COMPLETO DI VOLANO - CLUTCH KIT WITH FLYWHEEL - KIT EMBRAYAGE AVEC VOLANT - KUPPLUNGSKIT MIT SCHWUNGRA - KIT DE EMBRAIAGEM COM VOLANTE - KIT EMBRAGUE COMPLETO CON VOLANTE DE INERCIA
	54	BULLONE, PORTA CORONA DENTATA VOLANO - BOLT, FLYWHEEL RING GEAR CARRIER - VIS BOULON AU SUPPORT DU PIGNON POUR VOLANT - D'INERTIE - SCHRAUBE, ZAHNKRANZTRÄGER - SCHWUNGRAD - PARAFUSO PORTA VOLANTE - PERNO, SOPORTE CORONA - DENTADA, VOLANTE

NOVITÀ

GAMMA COMPLETA

NEW
FULL RANGE
NOVITÀ
GAMMA COMPLETA
FRIZIONI/CLUTCH/KUPPLUNG
EMBRAYAGE/ EMBRAIAGEM / EMBRAGUE

	95	POMPE FRIZIONE - CLUTCH MASTER CYLINDERS - CYLINDRE ÉMETTEUR - KUPPLUNGS-HAUPTZYLINDER - BOMBAS EMBRAIAGEM - BOMBA EMBRAGUE
	85	CILINDRETTI FRIZIONE - CLUTCH SLAVE CYLINDERS - CYLINDRE RÉCEPTEUR - KUPPLUNGS-NEHMERZYLINDER - BOMBA SECUNDÁRIA DA EMBRAIAGEM - CILINDROS EMBRAGUE
	123	KIT RIPARAZIONE POMPA FRIZIONE - REPAIR KIT, CLUTCH MASTER CYLINDER - KIT D'ASSEMBLAGE, CYLINDRE ÉMETTEUR D'EMBRAYAGE - REPARATURSATZ, KUPPLUNGSGEBERZYLINDER - KIT DE REPARAÇÃO DA BOMBA DE EMBRAIAGEM PRINCIPAL - KIT REPARACIÓN BOMBA DE EMBRAGUE
	124	KIT RIPARAZIONE CILINDRETTO FRIZIONE REPAIR KIT, CLUTCH SLAVE CYLINDER - KIT D'ASSEMBLAGE, CYLINDRE - RÉCEPTEUR D'EMBRAYAGE - REPARATURSATZ, KUPPLUNGSNEHMERZYLINDER - KIT DE REPARAÇÃO DA BOMBA DE EMBRAIAGEM SECUNDÁRIA - KIT REPARACIÓN CILINDRO EMBRAGUE

DISTRIBUZIONE / DISTRIBUTION / VERTEILUNG
DISTRIBUTION/ DISTRIBUIÇÃO /DISTRIBUCIÓN

	45	CUSCINETTI TENDICINGHIA - TIMING BELT TENSIONERS - GALET TENDEUR - SPANNROLLEN - TENSORES DA CORREIA DE DISTRIBUIÇÃO - COJINETES DE TENSOR DE CORREA
	40	CINGHIE DISTRIBUZIONE - TIMING BELTS COURROIES DE DISTRIBUTION - ZAHNRIEMEN - CORREIA DE DISTRIBUIÇÃO - CORREAS DE DISTRIBUCIÓN
	41	CATENE DISTRIBUZIONE - TIMING CHAINS CHAINES DE DISTRIBUTION - STEUERKETTEN - CORRENTES DE DISTRIBUIÇÃO CADENAS DE DISTRIBUCIÓN
	KCK	KIT DISTRIBUZIONE CATENA - TIMING CHAIN KIT - KIT CHAINES DE DISTRIBUTION - STEUERKETTENSATZ - KIT DA CORRENTE DE DISTRIBUIÇÃO - KIT DISTRIBUCIÓN DE CADENA
	94	CINGHIA SERVIZI - FAN BELTS - COURROIE KEILRIEMEN - CORREIA DE VENTONHA - CORREA DE SERVICIOS
	109	CINGHIA SERVIZI MITSUBOSHI - FAN BELT MITSUBOSHI - COURROIE MITSUBOSHI - KEILRIEMEN MITSUBOSHI - CORREIA DE VENTONHA MITSUBOSHI CORREA DE SERVICIOS MITSUBOSHI
	96	CINGHIE SERVIZI SCANALATE FAN BELTS COURROIES - KEILRIIPPENRIEMEN CORREIA DE VENTONHA - CORREA DE SERVICIOS
	112	CINGHIA SERVIZI SCANALATA MITSUBOSHI - FAN BELT MITSUBOSHI - COURROIES MITSUBOSHI KEILRIIPPENRIEMEN MITSUBOSHI - CORREIA DE VENTONHA MITSUBOSHI - CORREA DE SERVICIOS MITSUBOSHI
	KCT	KIT CINGHIA E TENDICINGHIA - TIMING BELT KIT - KIT DE DISTRIBUTION - ZAHNRIEMENSATZ - KIT DE DISTRIBUIÇÃO DE CORREIA - KIT CORREA Y TENSOR DE CORREA

RAFFREDDAMENTO/COOLING/ABKÜHLUNG
REFROIDISSEMENT/ARREFECIMENTO/REFRIGERACIÓN

	35	POMPE ACQUA - WATER PUMPS - POMPES À EAU - WASSERPUMPEN - BOMBAS DA ÁGUA - BOMBAS DE AGUA
	SKC KCT+35	SUPERKIT DISTRIBUZIONE - TIMING SUPERKIT - ZAHNRIEMEN-SUPERSATZ - SUPERKIT DE DISTRIBUTION - SUPERKIT DE DISTRIBUCIÓN - SUPERKIT DE DISTRIBUIÇÃO
	36	GIUNTI VISCOSI - VISCOUS COUPLINGS - VISCO COUPLEUR - VISCO-KUPPLUNGEN - JUNTAS VISCOSAS - JUNTAS VISCOSAS
	38	VALVOLE TERMOSTATICHE - THERMOSTATS - THERMOSTATES - THERMOSTATE TERMOSTATOS - VÁLVULAS TERMOSTÁTICAS

RAFFREDDAMENTO/COOLING/ABKÜHLUNG
REFROIDISSEMENT/ARREFECIMENTO/REFRIGERACIÓN

	22	VALVOLA TERMOSTATICA TAMA - THERMOSTATE TAMA (made in japan) - VANNE THERMOSTATIQUE TAMA - THERMOSTATVENTIL TAMA - TERMOSTATOS TAMA - VÁLVULA TERMOSTÁTICA TAMA (MADE IN JAPAN)
	33	TAPPI RADIATORE - RADIATOR CAPS - BOUCHONS RADIATEURS - KÜHLER VERSCHLUSS KAPPE TAMPÕES DE RADIADOR - TAPONES RADIADOR











GIUNTI E CUFFIE / JOINTS AND BOOTS / KUPPLUNGEN UND
ACHSMANSCHETTEN / COUPLEUR, SOUFFLET DE CARDAN /
JUNTAS DE TRANSMISSÃO E FOLAS / JUNTAS Y FUELLES















	62	GIUNTI OMOCINETICI LATO RUOTA - CONSTANT VELOCITY JOINTS - JOINT HOMOCINÉTIQUE - ANTRIEBSWELLEN - JUNTAS HOMOCINÉTICAS LATO RODA - JUNTAS HOMOCINÉTICAS DE LATO DE RUEDA
	63	KIT CUFFIA - BOOT KITS - SOUFFLET DE CARDAN - ACHSMANSCHETTEN - KIT DE FOLAS - KIT DE FUELLES
	66	CROCIERE - UNIVERSAL JOINTS - CROISILLONS DE TRANS - UNIVERSAL GELENKE CRUZETAS DE CARDAN - CRUCETAS

SOSPENSIONI / SUSPENSIONS
LENKUNGS UND-AUFHÄNGUNGSTEILE
SUSPENSION / SUSPENSÃO/ SUSPENSÓN

	MA	AMMORTIZZATORI - SHOCK ABSORBERS AMORTISSEURS - STOSSDÄMPFER AMORTECEDORES - AMORTIGUADOR
	MR	KIT AMMORTIZZATORI SANKEI ROKI SHOCK ABSORBERS KIT SANKEI ROKI KIT AMORTISSEURS SANKEI ROKI - STOSSDÄMPFER KIT SANKEI ROKI - KIT DE AMORTECEDORES SANKEI ROKI - KIT DE AMORTIGUADOR SANKEI ROKI
	63-0A	CUFFIE AMMORTIZZATORI UNIVERSALI - UNIVERSAL BUMP RUBBER KIT - SOUFFLET DE CARDAN UNIVERSALE DÄMPFERKAPPEN KITS DE FOLAS UNIVERSAIS DOS AMORTECEDORES - FUELLES AMORTIGUADORES UNIVERSALES
	44	KIT CUSCINETTI RUOTA - WHEELBEARING KITS - KIT DE ROULEMENTS DE ROUES RADLAGERSÄTZE - JOGOS DE ROLAMENTOS DAS RODAS - KIT COJINETES DE RUEDA
	GOM	GOMMINI - RUBBERS - SILENT BLOCS MOTORAUFHÄNGUNG - BORRACHAS - TAPONES DE GOMA
	72	TRAPEZIO - SUSPENSION TRIANGLE TRIANGLE DE SUSPENSION - TRAPEZ - TRIÂNGULO DA SUSPENSÃO - TRAPECIO
	71 102	BRACCIO OSCILLANTE - SUSPENSION ARMS - BRAS OSCILLANTS - SCHWENKARME - BRAÇOS DA SUSPENSÃO - BRAZO OSCILANTE
	59	LEVE RINVIO STERZO - STEERING RELAY LEVIERS DE RENVOI DE LA DIRECTION - LENKRADHEBEL - PENDURAL DA BARRA DE DIRECÇÃO - LEVAS DE REENVÍO DE LA DIRECCIÓN
	53	TESTINE SOSPENSIONE - BALL JOINT - ROTULE (POUR SUSPENSION ET DIRECTION) - AUFHÄNGEKÖPFE - ROTULA DA SUSPENSÃO - CABEZALES DE SUSPENSÓN
	105	BARRE ACCOPPIAMENTO - COUPLING BARS - BARRES D'ACCOUPEMENT - PLEUELSTANGEN - BARRAS DA DIRECÇÃO BARRAS DE ACOPLAMIENTO
	111	TESTA BARRA D'ACCOPPIAMENTO - TIE-ROD END - ROTULE DE BARRE DE CONNEXION - SPURSTANGENKOPF - TERMINAL DA DIRECÇÃO - CABEZA DE BARRA DE ACOPLAMIENTO
	26	BRACCIO OSCILLANTE, SOSPENSIONE RUOTA - TRACK CONTROL ARM - BRAS DE LIAISON, SUSPENSION DE ROUE - LENKER, RADAUFHÄNGUNG - BRAÇO DE SUSPENSÃO - BRAZO OSCILANTE, SUSPENSÓN DE RUEDA

SOSPENSIONI / SUSPENSIONS LENKUNGS UND-AUFHÄNGUNGSTEILE SUSPENSION / SUSPENSÃO/ SUSPENSIÓN	
	52 LEVE RINVIO STERZO - STEERING RELAY LEVIERS DE RENVOI DE LA DIRECTION - LENKRADHEBEL - BRAÇO DO PENDURAL DA DIRECÇÃO - LEVAS DE REENVÍO DE LA DIRECCIÓN
	103 GIUNTO ASSIALE, ASTA TRASVERSALE AXIAL ROD, TIE ROD - ROTULE DE DIRECTION INTÉRIEURE, BARRE DE CONNEXION - AXIALGELENK, SPURSTANGE - RÓTULA DA DIRECÇÃO INTERIOR - JUNTA AXIAL, ASTA TRANSVERSAL
	106 STABILIZZATORE, CHASSIS - STABILIZER, CHASSIS - STABILISATEUR, CHASSIS - STABILISATOR, FAHRWERK - ESTABILIZADOR, CHASSI - ESTABILIZADOR, CHASSIS
	27 BARRA D'ACCOPIAMENTO - TIE ROD, STEERING BARRE DE CONNEXION SPURSTANGE - VERBINDUNGSTANGE - BARRA DE JUNÇÃO - BARRA DE ACOPLAMIENTO
	76 GIUNTO ASSIALE, ASTA TRASVERSALE AXIAL ROD, TIE ROD - ROTULE DE DIRECTION INTÉRIEURE, BARRE DE CONNEXION AXIALGELENK, SPURSTANGE - JUNTA AXIAL, FERRO TRANSVERSAL - JUNTA AXIAL, ASTA TRANSVERSAL
	73 GIUNTO DI SUPPORTO/GUIDA - SUPPORT/STEERING LINK - ROTULE DE SUSPENSION TRAG/FÜHRUNGSGELENK - RÓTULA DA SUSPENSÃO - JUNTA DE SOPORTE /GUÍA

IMPIANTO ELETTRICO / ELECTRICAL PARTS ELEKTRISCHE TEILE / ÉLECTRIQUE PARTS MATERIAL ELÉCTRICO/ PARTES ELECTRICAS	
	002 ALTERNATORI - ALTERNATORS - ALTERNATEURS - LICHTMASCHINEN - ALTERNADORES - ALTERNADORES
	003 MOTORINI AVVIAMENTO - STARTERS - DÉMARREURS - ANLASSER - MOTORES DE ARRANQUE - ARRANCADOR
	64 BULBI ELETTOVENTOLA - TEMP. SENSORS - CAPTEUR DE TEMPÉRATURE - VENTILKUGELN - SENSORES DE TEMPERATURA - SENSOR TEMPERATURA
	121 CALOTTE SPINTEROGENO - DISTRIBUTOR CAPS - TÊTE D'ALLUMEUR - VERTEILEKAPPEN - TAMPAS DO DISTRIBUIDOR - TAPA DISTRIBUIDOR
	01 CANDELETTE - GLOW PLUGS - BOUGIES DE PRÉ-CHAUFFAGE - GLUHKERZEN - VELAS DE INCANDESCÊNCIA - BUJIAS
	DENSO CANDELE - SPARK PLUGS - BOUGIES D'ALLUMAGE - KERZEN - DENSO VELAS - DENSO BUJÍAS
	HKT CANDELETTE HKT - HKT GLOW PLUGS BOUGIES DE PRÉCHAUFFAGE HKT - GLUHKERZEN HKT - VELAS DE INCANDESCÊNCIA HKT - CANDELILLAS HKT
	DENSO CANDELETTE DENSO - DENSO GLOW PLUGS - BOUGIES DE PRÉCHAUFFAGE DENSO - GLUHKERZEN DENSO - VELAS DE INCANDESCÊNCIA DENSO - CANDELILLAS DENSO
	43 SONDE LAMBDA - OXIGEN SENSORS SONDE LAMBDA - LAMBDA SÖNDE SONDAS LAMBDA - SENSOR OXIGEN
	DENSO SONDE LAMBDA DENSO - OXIGEN SENSORS DENSO SONDE LAMBDA DENSO - LAMBDA SÖNDE DENSO - SONDAS LAMBDA DENSO - SONDAS LAMBDA
	05 POMPE BENZINA - FUEL PUMP - POMPE A CARBURANT - BENZINPUMPEN - BOMBAS GASOLINA - BOMBAS DE GASOLINA

IMPIANTO ELETTRICO / ELECTRICAL PARTS ELEKTRISCHE TEILE / ÉLECTRIQUE PARTS MATERIAL ELÉCTRICO/ PARTES ELECTRICAS	
	77 REGOLATORI - REGULATORS - REGULATEUR DE TENSION - SPANNUNGSREGLER - REGULADORES - REGULADORES
	97 SPAZZOLE ACCENSIONE - ROTOR ARMS ROTORS D'ALLUMEURS - VERTEILERFINGER - ROTORES - ROTOR DEL DISTRIBUIDOR
	SA-X SPAZZOLE TERGICRISTALLO - WIPER BLADES - BALAIS ESSUIE GLACES - WISCHERBLÄTTER - ESCOVAS LIMPA VIDROS - ESCOBILLAS
	SA-F SPAZZOLE TERGICRISTALLO UNIVERSALI - UNIVERSAL WIPER BLADES - BALAIS ESSUIE GLACES UNIVERSELLES - UNIVERSALE WISCHERBLÄTTER - ESCOVAS LIMPA VIDROS UNIVERSAIS - ESCOBILLAS LIMPIAPARRABRISAS UNIVERSALES
	SA-RE60C SA-RE70C REFILL UNIVERSALI PER SPAZZOLE NORMALI/FLAT - UNIVERSAL REFILL FOR NORMAL WIPER BLADES/FLAT WIPER BLADES - REFILL UNIVERSEL POUR BALAIS ESSUIE GLACE NORMALES ET BALAIS "FLAT" UNIVERSAL REFILL FUER NORMALE - WISCHERBLÄTTER UND FUER FLAT WISCHERBLÄTTER - RECARGAS UNIVERSAIS PARA ESCOVAS FLAT NORMAIS - RECAMBIOS UNIVERSALES PARA ESCOBILLAS NORMALES
	SA-RE70VL SA-RE75BH REFILL UNIVERSALI PER SPAZZOLE NORMALI/FLAT VALEO (70CM)/BOSCH (75CM) UNIVERSAL REFILL FOR NORMAL WIPER BLADES AND FOR BOSCH AND VALEO FLAT WIPER BLADES - REFILL UNIVERSEL POUR BALAIS ESSUIE GLACE NORMALES ET BALAIS "FLAT" BOSCH ET VALEO - UNIVERSAL REFILL FUER NORMALE WISCHERBLÄTTER UND FUER BOSCH UND VALEO FLAT WISCHERBLÄTTER - RECARGAS UNIVERSAIS PARA ESCOVAS NORMAIS/FLAT VALEO (70CM)/BOSCH (75CM) - RECAMBIOS UNIVERSALES PARA ESCOBILLAS NORMALES/FLAT VALEO (70CM) / BOSCH (75CM)
	78 KIT CAVI ACCENSIONE - ELECTRIC-CABLE IGNITION KIT - KIT CÂBLES D'ALLUMAGE - ZÜNDKABEL SET - JOGO DE FIOS DE VELA KIT CABLES DE ENCENDIDO
	13 BOBINA DI ACCENSIONE - COIL, IGNITION BOBINE D'ALLUMAGE - ZÜNDSPULE - BOBINA DE IGNIÇÃO - BOBINA DE ENCENDIDO
	06 CONDENSATORE - CONDENSER, IGNITION CONDENSEUR, SYSTÈME D'ALLUMAGE - KONDENSATOR, ZÜNDANLAGE - CONDENSADOR - CONDENSADOR
	06 KIT CONTATTI ACCENSIONE - CONTACT BREAKER - DISTRIBUTOR JEU DE CONTACTS, - DISTRIBUTEUR D'ALLUMAGE - KONTAKTSATZ, ZÜNDVERTEILER - JOGO DE PLATINADOS - KIT CONTACTOS DE ENCENDIDO
	07 08 09 GRUPPO UNIVERSALE KOITO - INSERT, HEADLIGHT KOITO - BLOC-OPTIQUE DE PHARE KOITO - SCHEINWERFEREINSATZ, HAUPTSCHNITZERWERFER KOITO - ÓPTICA KOITO - GRUPO UNIVERSAL KOITO
	00 INTERRUPTORE STOP - INTERRUPTEUR DES FEUX DE FREINS - BRAKE LIGHT SWITCH - BREMSLICHTSCHALTER - INTERRUPTOR STOP - INTERRUPTOR DE LUCES DE FRENO
	12 INTERRUPTORE TEMPERATURA, VENTOLA RADIATORE - TEMPERATURE SWITCH, RADIATOR FAN - INTERRUPTEUR DE TEMPÉRATURE, VENTILATEUR DE RADIATEUR TEMPERATURSCHALTER, KÜHLERLÜFTER - INTERRUPTOR TEMPERATURA, VENTOINHA RADIADOR - INTERRUPTOR TEMPERATURA, VENTILADOR RADIADOR
	11 PRESSOSTATO OLIO - OIL PRESSURE SWITCH SWITCH DE PRESSION D'HUILE ÖLDRUCKSCHALTER - INTERRUPTOR DA PRESSÃO DO ÓLEO - INTERRUPTOR PRESIÓN DE ACEITE

NEW

FULL RANGE

NOVITÀ

GAMMA COMPLETA

NEW
FULL RANGE

NOVITÀ
GAMMA COMPLETA

IMPIANTO ELETTRICO / ELECTRICAL PARTS ELEKTRISCHE TEILE / ÉLECTRIQUE PARTS MATERIAL ELÉCTRICO/ PARTES ELECTRICAS		
	06	SPINTEROGENO - DISTRIBUTOR - DISTRIBUTEUR - VERTEILER - DISTRIBUIDOR - DISTRIBUIDOR
	02	SENSORE MASSA ARIA - MASS SENSOR - CAPTEUR DE MASSE - SENSORENMESSEUR - SENSOR MASSA AR - SENSOR MASA DE AIRE
	75	CORPO FARFALLATO ELETTRICO - THROTTLE HOUSING - BOÏTIER DE PAPILLON - DROSSELKLAPPENSTUTZEN - CORPO DE MARIPOSA ELÉCTRICO - CUERPO DE MARIPOSA ELÉCTRICO
		SENSORE TEMPERATURA ARIA ASPIRATA - SENDER UNIT, INTAKE AIR TEMPERATURE - CAPTEUR, TEMPÉRATURE DE L'AIR D'ADMISSION - SENSOR, ANSAUGLUFTTEMPERATUR - SENSOR DA TEMPERATURA DO AR DE ADMISSÃO - SENSOR DE TEMPERATURA DE AIRE ASPIRADO

MOTORE / ENGINE / MOTOR MOTEUR / MOTOR / MOTOR		
	16	ALBERI A CAMME - CAMSHAFTS - ARBRES A CAMES - NOCKENWELLEN - ÁRVORES DE CAMES - ÁRBOLES DE LEVAS
	18	ALBERI MOTORE - CRANKSHAFTS - VILEBREQUINS - KURBELWELLEN - CABBOTAS - ÁRBOLES DE MOTOR
	122	PULEGGIA ALBERO MOTORE - CRANK SHAFT PULLEYS - POULIE DE VILEBREQUIN - MOTOR-WELLE ROLLE - POLIA DA CABBOTA - POLEA DEL EJE MOTOR
	47	GUARNIZIONI COPERCHIO VALVOLE - VALVES COVER GASKETS - JOINT DE COUVRE CULBUTEUR - DICHTUNGEN DES KLAPPENDECKELS - JUNTAS DA CABBÇA - TAPA DE CULATA DE CILINDRO
	46	GUARNIZIONI TESTATA - HEAD GASKETS - JOINTS DE CULASSES - ZYLINDERKÖPFE DICHTURG - JOGO DE JUNTAS DA CABBÇA - JUNTAS DE CULATA
	48	KIT GUARNIZIONI TESTATA - HEAD GASKETS SET - KIT JOINTS DE CULASSES - ZYLINDERKOPFDICHTUNGSSATZE - KIT GUARNIÇÕES CABBÇA - KIT JUNTAS DE CULATA
	39	KIT PISTONI - PISTONS KIT - KIT PISTONS - KOLBEN REP. SÄTZE - JOGO DE PISTÕES - KIT PISTONES
	49	KIT GUARNIZIONI MOTORE - FULL SET GASKET - KIT POCHETTE JOINT MOTEUR - MOTOR DICHTUNGSSATZE - JOGO DE JUNTAS COMPLETO - KIT JUNTAS DE MOTOR
	15	VALVOLE - ENGINE VALVES - SOUPAPES - VENTILE - VALVÚLAS - VÁLVULAS
		TESTATE - CYLINDER HEADS - CULASSES - ZILINDERKÖPFE - CABBÇAS - CULATA DEL CILINDRO
		COLLETTORE DI ASPIRAZIONE - INDUCTION MANIFOLD - COLLECTEUR D'ADMISSION - ANSAUGKOLLEKTOR - COLECTOR DE ADMISSÃO - COLECTOR DE ASPIRACIÓN
	23	BIELLE - CONNECTING RODS - BIELLE - PLEUEL - BIELAS - BIELAS
	05	BOCCOLA BIELLA - PISTON PIN BUSHINGS - BAGUES TÊTE DE BIELLE - KOLBEN-PLEUEL-BUCHSE - CASQUILHOS DE BIELA - CASQUILLO DE BIELA
	34	FASCIA ELASTICA - PISTON RING - SEGMENT DE PISTON - KOLBENRING - SEGMENTO - AROS DEL PISTÓN
	86	BRONZINA BANCO - MAIN BEARINGS - COUSSINETS DE PALIER - HAUPTLAGER - BRONZES DE APOIO - COJINETE DE BANCADA

MOTORE / ENGINE / MOTOR MOTEUR / MOTOR / MOTOR		
	82	BRONZINA DI BIELLA - BIG END BEARINGS - COUSSINET DE BIELLE - PLEUELLAGER - BRONZES DE BIELA - COJINETE DE BIELA
	19	KIT CANNE CILINDRO MOTORE - CYLINDER LINER KITS - KIT CHEMISES - LAUFBUCHSENSÄTZE - JOGOS DE CAMISAS - KIT BARRAS DE CILINDRO DE MOTOR
	17	BILANCIERI VALVOLE - BALANCES VALVES - VALVES D'ÉQUILIBRES - BALANÇEN VENTILE - BALANÇEN VENTILE - MARTELOS - BALANÇINES DE LAS VÁLVULAS
	83	BRONZINA ALBERO A CAMME - CAMSHAFT BEARINGS - COUSSINETS ARBRE À CAMES - NOCKENWELLENLAGER - BRONZES DA ÁRVORE DE CAMES - COJINETE DE ÁRBOL DE LEVAS
	79	RASAMENTI - THRUST WASHERS - CALES LATÉRALE - ANLAUFSCHLEIBE - ANILHAS DE FOLGA DA CABBOTA - ENRASES
	115	BULLONI TESTATA - CYLINDER HEAD BOLT - BOULON DE CULASSE DE CILINDRE - ZYLINDERKOPFSCHRAUBE - PERNOS DA CABBÇA - PERNOS DE CABEZAL
		VALVOLA RICIRCOLO GAS DI SCARICO - EXHAUST GAS RECIRCULATION VALVE - VANNE EGR - EGR VENTIL - AGR VENTIL - VALVÚLA DE RECICLO DO GÁS DE ESCAPE - VÁLVULA DE RECIRCULACIÓN DE GAS DE DESCARGA
		POMPA OLIO - OIL PUMP - POMPE À HUILE - ÖLPUMPE - BOMBA ÓLEO - BOMBA DE ACEITE
		INIETTORE - INJECTOR - INJECTEUR - INJEKTOREN - INJECTOR - INYECTOR
		MOTORE COMPLETO - COMPLETE ENGINE - MOTEUR COMPLET - MOTOR KOMPLETT - MOTOR COMPLETO - MOTOR COMPLETO
		TURBINA - TURBOCHARGER - TURBOCOMPRESSEUR - TURBOLADER - TURBO - TURBINA

URETHANE CUSHION

CODE MA-A	CODE MA-B	CODE MA-C	CODE MA-D	CODE MA-E	CODE MA-F

NEW "CON SOLO 6 CODICI, GAMMA COMPLETA!!!"

PULITORE GAS IMPIANTI LPG/GPL

CODE XX-GAS

NEW

www.ashika.eu



ashika

committed to total quality spare parts for appliances and kitchen tools

FILTRI DEPURAZIONE IMPIANTI GPL



10-GASS
Imp. "BRC"



10-GAS1S
Imp. "BRC"



10-GAS2S
Imp. "LANDI"



10-GAS3S
Imp.: "Zavoli/Bedini/
MotorGas/E-Gas"



10-GAS4S
Imp. "EMER"



10-GAS5S
Imp. "ZAVOLI"



10-GAS6S
Imp. "BEDINI"



10-GAS7S
Imp. "IMEGA"



10-GAS8S
Imp. "BIGAS"



10-GAS9S
Imp. "LOVATO"



10-GAS10S
Imp. ROMANO



10-GAS11S
Imp. "EMMEGAS"



10-GAS12S
Imp. Tartarini



10-GAS13S
Universale



10-GAS14S
Imp. "BRC"



10-GAS15S
Universale



10-GAS16S
Imp. ROMANO



10-GAS17S
Imp. "LANDI"



10-GAS18S
Imp. Stefanelli



10-GAS19S
Imp. Tomasetto



10-GAS20S
Imp. EMMA-GAS



10-GAS21S
Imp. "LANDI"



10-GAS22S
Imp. "MEDA"



10-GAS23S
Imp. "OMNIA"



10-GAS24S
Imp. "MARINI"



10-GAS25S
Imp. "MED"



10-GAS26S
Imp. "LOVATO"



10-GAS27S
Imp. "BEDINI"



10-GAS28S
Imp. Ags/Stella



10-GAS29S
Imp. "RMG"



10-GAS30S
Universale



10-GAS31S
Universale



10-GAS32S
Imp. "FIAT"



10-GAS33S
Imp. "FIAT"



ORING
Guarnizione
10-GAS1S (BRC)

1. RIDUCE IL FUMO
2. AUMENTA LA POTENZA DEL MOTORE (+4,3%)

new novità

3. PULISCE GLI INIETTORI E PROLUNGA LA DURATA DEL MOTORE
4. RISPARMIA CARBURANTE



MAX POWER

Diesel Filter

Filtro Diesel

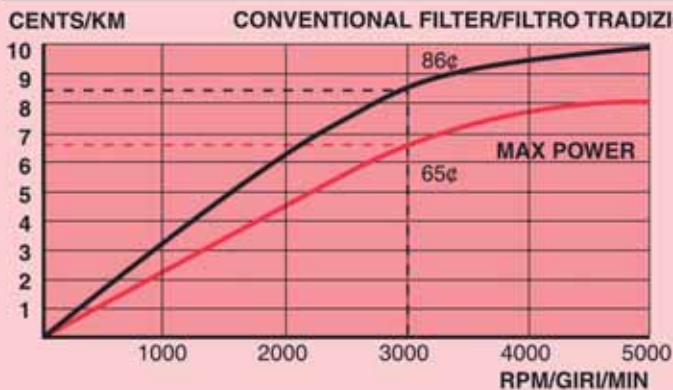
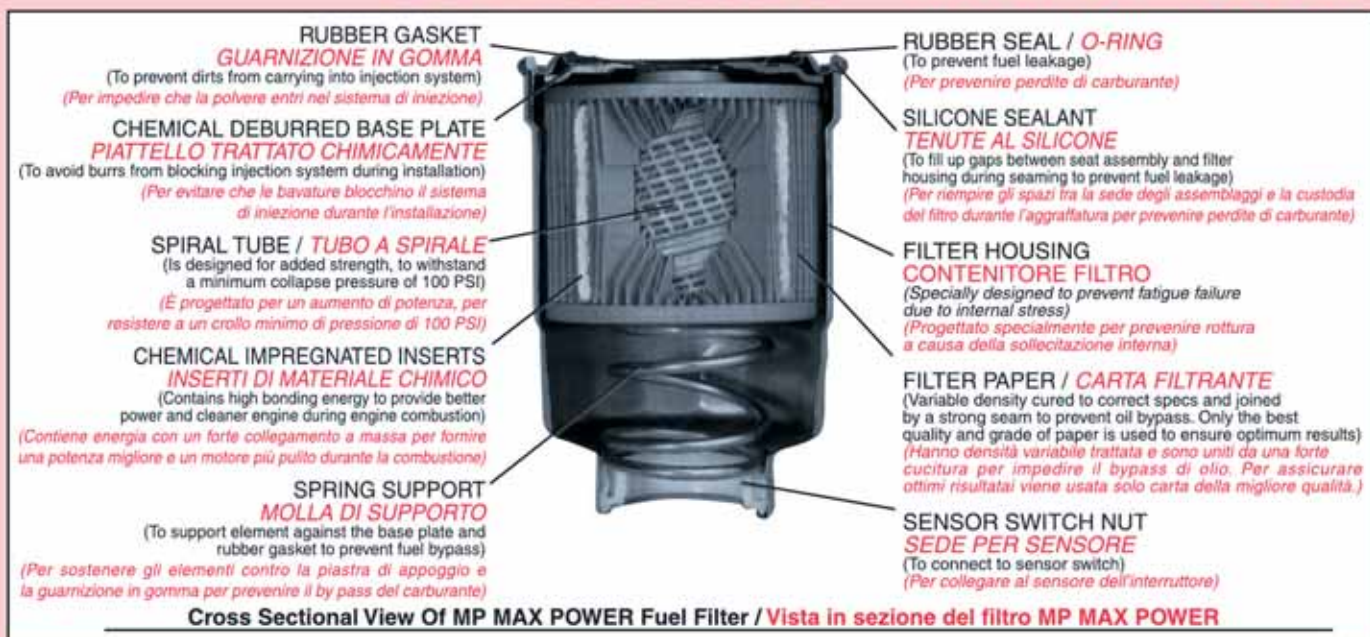

* Data collected from Toyota LJ70/Dati raccolti su Toyota LT70

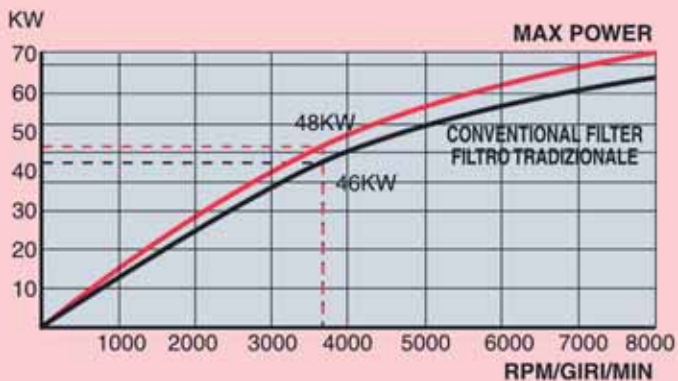

* Data collected from Mitsubishi Pajero 4D56T/Dati raccolti su Mitsubishi Pajero 4D56T

FUEL CONSUMPTION / CONSUMO CARBURANTE

General tests on the road using Toyota LJ70, Mitsubishi, Pajero 4D56T, Nissan Patrol RD28T had shown a drastic reduction in diesel fuel consumption. Besides, the vehicles were running more smoothly and energetic than before according to the drivers.

Test generali su strada, usando Toyota LJ70, Mitsubishi, Pajero 4D56T, Nissan Patrol RD28T, hanno fatto vedere una drastica riduzione del consumo di carburante. Inoltre l'accelerazione del veicolo, secondo il guidatore, era più omogenea.

PERFORMANCE / PERFORMANCE

Data collected from performance test by Sirim using MAHA LPS 13 chasis dynamometer according to normal Power Test procedure.

I dati del test prestazionale sono stati ricavati usando il dinamometro MAHA LPS 13 secondo la normale procedura Power Test.

Measurement / Misurazioni	Conventional filter / Filtro convenzionale	Max Power Filter	Difference / Differenza
Engine Power (KW) / Potenza motore (KW)	46KW @ 3700 rpm/giri/min	48KW @ 3700 rpm/giri/min	+4.3% (increase/aumento)

30-01-109MP

OEM DIESEL

16403-59E00 16405-05E01
16405-59E00 16405-05E02
16400-V7200

APPLICATION/APPLICAZIONI

NISSAN ALMERA
2000D N15 ENGINE CD20
NISSAN BLUEBIRD
2000D T12 ENGINE LD2
NISSAN KING-CAB
2500 D/TD D21 ENGINE SD25/TD25
NISSAN PATROL
2800D ENGINE A428 EBRO
NISSAN PATROL SAFARI
2800TD 160/200 ENGINE RD28T PATROL GR 2800TD Y60 ENGINE RD28T
NISSAN PATROL GR
2800TD '98 Y61 ENGINE RD28ETI
NISSAN PICK-UP
2500D/TD 4WD/I720/D21 ENGINE SD25/TD25
NISSAN PRIMERA
2000D P10E ENGINE CD2
NISSAN PRIMERA
2000TD P11E ENGINE CD20
NISSAN PRIMERA
2000D STATION WAGON W10 ENGINE CD20
NISSAN SERENA
2000D C23M ENGINE LD20H
NISSAN SERENA/VANNETTE
2300D C23 ENGINE LD23
NISSAN SUNNY
1700D N13/B12/B11 ENGINE CD17
NISSAN TERRANO
2700TD WD21 ENGINE TD27T
NISSAN TRADE
2000D K0 ENGINE LD20E
NISSAN TRADE
2800D K0 ENGINE A4.28H
NISSAN TRADE
3000D
NISSAN L35.09/L 70.09
4000D - (ENGINE B440 EBRO)
NISSAN VANETTE
2000D C220 ENGINE LD20H
NISSAN VANETTE PRACTIC
2000D C120/GC22/C220 ENGINE LD20

30-02-215MP

OEM DIESEL

23303-64010
23303-64020
23303-64021

APPLICATION/APPLICAZIONI

TOYOTA NUOVA COROLLA
2.0 TD
TOYOTA HI-ACE
2400D LH102 ENGINE 2L
TOYOTA HI-LUX
2400D LN65 ENGINE 2L
TOYOTA HI-LUX
2400DLN85/LN105/LN110/ENGINE2L
TOYOTA LANDCRUISER
3400 D BJ70/BJ73 ENGINE 3B
TOYOTA LANDCRUISER
3400 TD BJ71/ENGINE 138T
TOYOTA LANDCRUISER
2400 D LJ70 ENGINE 2L
TOYOTA LANDCRUISER
2400TD LJ70/LJ73 ENGINE 2LT
TOYOTA LANDCRUISER
3000TD KZJ90 ENGINE 1KZTE
TOYOTA LANDCRUISER
3000TD KZJ95 ENGINE 1KZTE
TOYOTA LANDCRUISER
4200TD HD80 ENGINE 1HDT
TOYOTA LANDCRUISER
4200TD 24v HD80 ENGINE 1HDT
TOYOTA 4 Runner
2400 LN130 ENGINE 2LT
TOYOTA 4 Runner
3000TD KZN130 ENGINE 1KZT
VOLKSWAGEN Taro
2400D ENGINE 2L TOYOT

30-05-502MP





OEM DIESEL

MB129675 22715-01000 94369299
MB220900 4318265 31973-44100 HY
8-94177-327-0 8-94248-070-0 31973-44001
8-94369-299-0 818506

APPLICATION/APPLICAZIONI

BEDFORD MIDI
2000 D/TD 98570 - 98770 ENGINE 4FC1-T ISUZU
BEDFORD MIDI
2200D 98670 - 98870 ENGINE 4FD1 ISUZU
HYUNDAI GALLOPER
2500TD JKC4 ENGINE D48H
HYUNDAI H100
2500D FD27A ENGINE D48A
HYUNDAI H100
2500D FD27X ENGINE D48X
HYUNDAI H1
2500 TD WWH7F ENGINE D48F
ISUZU CAMPO
2500D I.D. TFR54 ENGINE 4JA1
ISUZU TROOPER
2200 D/TD UBS 52 ENGINE C223-C223T
ISUZU TROOPER
2800TD Intercooler UBS55 ENGINE 4JB1T
ISUZU PICK-UP
2200D KBD27/KBD37/KBD42 ENGINE C223
ISUZU PICK-UP
3.1 TD
MITSUBISHI LANCER
1500i 12v C62A ENGINE 4G15
MITSUBISHI L200 D
K24 ENGINE 4D65 DIESEL
MITSUBISHI L200 TD
4WD K34/K74T ENGINE 4D56 TD
MITSUBISHI L300
P02P12/P15T/P25V ENGINE 4G32/4D56 - 1600/1800/2200/2500 DIESEL
MITSUBISHI PAJERO
2300 D/TD L043/L048 ENGINE 4D55T
MITSUBISHI PAJERO
2500 D/TD L044/L049L 149V/24CV/V44/ENGINE 4D56T
MITSUBISHI PAJERO
2500 TD I SPORT K94W ENGINE 4D56
MITSUBISHI PAJERO
2800 TD V46W ENGINE 4M40
MITSUBISHI SPACE GEAR
2500TD PA5W ENGINE 4D56T
OPEL CAMPO
2500D I.D. Crewcab LS TFR54/TFR54 ENGINE 4JA1 ISUZU

COMPARISON OF FUNCTIONS BETWEEN MP MAX POWER AND NORMAL FILTER CONFRONTO DELLE FUNZIONI TRA MP MAX POWER E I NORMALI FILTRI

FUNCTION FUNZIONE	MP MAX POWER FUEL FILTER FILTRO CARBURANTE MP MAX POWER	CONVENTIONAL FUEL FILTER FILTRO CARBURANTE TRADIZIONALE
1	Filtration <i>Filtrazione</i>	Filtration <i>Filtrazione</i>
2 	Reduces smoke emission environmental friendly <i>Riduce l'emissione di gas di scarico</i>	—
3 	Increases engine power Difference: +4.3% (increase) <i>Aumenta la potenza del motore</i> Differenza: +4.3% (aumento)	—
4 	Cleans injectors & prolongs engine life <i>Pulisce gli iniettori e prolunga la durata del motore</i>	—
5 	Fuel economy <i>Risparmio di carburante</i>	—

COMPARISON OF ADVANTAGES AND DISADVANTAGE BETWEEN MP MAX POWER FUEL FILTER AND CONVENTIONAL FUEL ADDITIVE CONFRONTO DEI VANTAGGI E SVANTAGGI TRA IL FILTRO CARBURANTE MP MAX POWER E NORMALI FILTRI

ADVANTAGES & DISADVANTAGES VANTAGGI & SVANTAGGI	MP MAX POWER FUEL FILTER FILTRO CARBURANTE MP MAX POWER	CONVENTIONAL FUEL ADDITIVES FILTRO CARBURANTE TRADIZIONALE
1	Consistent power boost due to unique saturated solubility property of chemical selected in fuel filter <i>Consistente aumento di potenza dovuto alle proprietà delle sostanze chimiche contenute nel filtro carburante</i>	Power is inconsistent. The solubility of most of the additives is infinite. Therefore, the power is depending on the amount of additive added
2	Usage is convenient to user. Need to change the filter after 15,000-25,000 km of travel once installed <i>L'uso è conveniente per l'utilizzatore. Il filtro necessita di essere sostituito ogni 15.000/25.000 km</i>	Usage is inconvenient in that the user need to top up frequently and is time consuming job. The amount to add in is sometime difficult to users <i>L'uso è sconveniente in quanto l'utilizzatore deve frequentemente aggiungere additivi, valutare la qualità da aggiungere è difficile ed aumenta il dispendio di tempo e lavoro</i>
3	Overall cheap <i>Economico rispetto alle prestazioni fornite</i>	Expensive <i>Costoso</i>

SUBST. BY



Code Article Codice Articolo	Sostituito da Replaced by
20-01-120N	20-01-120
20-02-218	20-02-238
20-02-222	20-02-215
20-02-230	20-02-208
20-03-328	20-03-329
20-05-574	20-03-383
20-05-585	20-05-515
20-07-709	20-01-108
20-07-712	20-07-797
20-08-814	20-03-308
20-08-816	20-08-813
20-08-895	20-08-802
20-09-972	20-09-908
20-09-976	20-08-813
21-HY-H00	21-KI-K06
21-HY-H14	21-KI-K14
21-HY-H15	21-KI-K14
21-HY-H19	21-KI-K07
21-MA-MA3	21-MA-MA0
21-TY-TY6	21-TY-TY2
30-01-191	30-01-109
30-02-222	30-02-293
30-02-285	30-02-247
30-03-396	30-03-315
30-04-417	30-04-411
30-04-419	30-04-411
30-04-497	30-04-411
30-05-530	30-05-505
30-05-531	30-ECO015
30-05-576	30-05-514
30-05-579	30-05-598
30-05-581	30-ECO015
30-05-591	30-05-578
30-06-604	30-05-583
30-06-606	30-05-502
30-06-607	30-05-509
30-08-802	30-ECO011
30-08-819	30-08-897
30-09-902	30-02-208
30-09-903	30-05-501
30-09-906	30-03-301
30-09-998	30-02-208

Code Article Codice Articolo	Sostituito da Replaced by
30-ECO006	30-ECO011
10-01-103E	10-01-112E
10-02-278	10-02-210
10-03-390	10-02-279
10-03-396	10-05-505
10-03-399	10-09-900
10-04-403	10-04-402
10-05-509	10-05-597
10-09-995	10-ECO013
10-09-998	10-09-997
10-ECO007	10-ECO021
10-ECO029	10-H0-004
10-ECO043	10-H0-004
10-ECO057	10-ECO054
10-K0-001	10-03-313
10-K0-004	10-K0-002
10-W0-000	10-06-601



NEW ITEMS

NEW CODES
NEUE CODES
NOUVEAUX CODES
NUEVOS CODIGOS
NUOVI CODICI

ASHIKA CODE	OEM	APPLICATIONS / APPLICAZIONI
OIL\GAS FILTER-ÖL\GASFILTER-FILTRES À HUILE\GAS-FILTRO DE ACEITE\GAS-FILTRO DE ÓLEO\GAS-FILTRO OLIO\GAS		
10-OL-L08	4508334	LAND ROVER RANGE ROVER SPORT 4.2 - LAND ROVER RANGE ROVER SPORT 4.4
10-ECO079	11427501676	BMW 1 (E87) 120i - BMW 3 (E90) 316i
10-ECO080	11421709856	BMW 5 (E34) 518 i - BMW 3 (E30) 316 i
10-ECO081	11 42 7 521 008	BMW 6 Cabriolet (E64) 650i - BMW 7 (E65, E66) 735i
10-ECO082	11 42 7 834 734	BMW 5 (E60) M5 - BMW 6 (E63) M6
10-ECO083	11 42 7 833 242	BMW 3 (E36) M3 3.0 - BMW Z4 3.2 M
10-ECO084	000 180 21 09	AUDI - MAZDA
10-ECO085	079 115 561 B	AUDI A4 (8EC) S4 quattro - VW PHAETON (3D2) 4.2 V8 4motion
10-ECO086	077 115 561 H	VW TOUAREG (7LA) 4.2 V8
10-ECO087	079 115 561 F	AUDI A4 (8EC) RS4 quattro - AUDI R8 Spyder 4.2 FSI quattro
10-ECO088	275 180 00 09	MERCEDES-BENZ CLASSE S (W221) S 65 AMG - MERCEDES-BENZ SL (R230) 600
10-ECO089	077 115 561 F	AUDI A8 (4D2, 4D8) 3.7 - AUDI A8 (4D2, 4D8) S 8 quattro
10-ECO090	11 42 1 729 628	ALPINA B10 (E34) 4.0 - BMW 7 (E32) 750 i,iL V12
10-ECO091	11 42 1 267 268	BMW 7 (E23) 745 i - BMW 5 (E12) 528 i
10-ECO092	03C 115 562	VW GOLF V Variant 1.4 TSI - VW POLO (9N_) 1.6 16V
10-ECO093	26320-3C250	HYUNDAI GRANDEUR 2.2 CRDi - HYUNDAI SONATA V 2.0 CRDi
10-ECO094	04152-51010	LEXUS IS IS F (USE20)
10-ECO096	26320-2F000	HYUNDAI ix35 2.0 CRDi - KIA SORENTO 2.0 CRDi
10-ECO098	03L115466	VW POLO (6R_) 1.6 TDI - VW PASSAT Variant (3C5) 1.6 TDI
10-ECO099	1109-AV	LAND ROVER DISCOVERY III 3.0 TD - LAND ROVER DISCOVERY IV (LA) 3.0 TD
10-ECO100	11 42 7 805 707	BMW X3 xDrive20d - BMW 3 (E90) 318d
10-ECO101	11 42 7 808 443	BMW 3 (E90) 330d - BMW 5 Touring (F11) 530d
10-ECO103	8-980188580	ISUZU Comm. N-Serie NKR85EA, NPR85G, NPR85L
10-ECO107	71740470	ALFA ROMEO BRERA 2.4 JTDM 20V - ALFA ROMEO 159 2.4 JTDM
10-ECO108	958.107.222.00	AUDI A4 (8EC) 3.2 FSI - AUDI A6 (4F2) 2.4
10-ECO109	11 42 7 787 697	BMW 7 (E65, E66) 745 d - BMW 3 (E90) 320d
10-ECO111	11 42 7 788 454	BMW X5 (E70) xDrive35d - BMW 3 (E90) 325d
10-ECO112	11 42 7 837 997	BMW 3 (E90) M3
10-ECO115	629 180 01 09	MERCEDES-BENZ CLASSE S (W221) S 420 CDI
10-ECO118	03D 115 466 A	SKODA FABIA 1.2 - VW FOX (5Z1) 1.2 - VW POLO (6R_) 1.2
10-GAS12S		IMP. TARTARINI
10-GAS13S		UNIVERSAL APPLICATIONS
10-GAS14S		IMP. BRC
10-GAS16S		IMP. ROMANO
10-GAS17S		IMP. LANDI
10-GAS18S		IMP. STEFANELLI
10-GAS20S		IMP. EMMA-GAS
10-GAS21S		IMP. LANDI
10-GAS22S		IMP. MEDA
10-GAS23S		IMP. OMNIA
10-GAS24S		IMP. MARINI



ASHIKA CODE	OEM	APPLICATIONS / APPLICAZIONI
OIL/GAS FILTER-ÖL/GASFILTER-FILTRES À HUILE/GAS-FILTRO DE ACEITE/GAS-FILTRO DE ÓLEO/GAS-FILTRO OLIO/GAS		
10-GAS26S		IMP. LOVATO
10-GAS27S		IMP. BEDINI
10-GAS30S		UNIVERSAL APPLICATIONS
10-GAS31S		UNIVERSAL APPLICATIONS
AIR FILTER - LUFTFILTER - FILTRES À AIR - FILTROS AIRE - FILTRO DE AR - FILTRI ARIA		
20-00-025	46806576	DR DR5 1.9 D
20-00-026	S21-1109111	DR DR2 1.3
20-00-027	25099149	CHEVROLET CORVETTE (C06) 6.0 - CADILLAC XLR 4.6
20-00-029		CADILLAC SRX 3.6 - CADILLAC SRX 4.6
20-01-137	16546-00QOH	NISSAN PRIMASTAR dCi 90 - NISSAN PRIMASTAR dCi 120
20-01-139	16546-06J00	NISSAN PATROL GR I (Y60) 4.2 Cat. - NISSAN PATROL GR I (Y60) 4.2 D (Y60GR)
20-01-142	16546-1HC2A	NISSAN MICRA (K13) 1.2
20-01-143	16546-EG000	INFINITI M35 3.5 Luxury - INFINITI M35 3.5 Luxury 4WD
20-02-2000	17801-37020	TOYOTA PRIUS 1.8 HSD - TOYOTA PRIUS (ZVW30) 1.8
20-02-2001	17801-38010	LEXUS LS 600 h - LEXUS LS (FE) 460
20-02-2004	17801-78020	TOYOTA DYNA 4.6 D4d
20-03-340	LFBL13Z40	MAZDA CX-7 2.2 MZR-CD
20-03-341	Y642 13 Z40B	MAZDA 5 1.6 CD - MAZDA 3 (BL) 1.6 MZR
20-04-415	17220-PH7-661	HONDA LEGEND I (HS, KA) 2.5 i (HS)
20-04-449	17220-PZA-000	HONDA CIVIC VI 1.3 IMA
20-04-450	17220-RMX-000	HONDA CIVIC VII 1.3
20-04-453	17220-REA-Z00	HONDA CITY Tre volumi 1.5 Vtec
20-06-619	17801-97206-000	DAIHATSU COPEN 0.7
20-08-830	16546-4A00C	SUZUKI ALTO V (GF) 1.0 - NISSAN PIXO 1.0
20-08-831	1378078K00	SUZUKI GRAND VITARA 3.2 4WD
20-08-832	71750719	SUZUKI SX4 1.6 VVT - SUZUKI SX4 1.6 VVT 4x4
20-09-912	04891675AA	CHRYSLER PT CRUISER 2.2 CRD
20-09-915	53034018AD	JEEP WRANGLER II (TJ) 3.8
20-0H-H20	28113-3K200	HYUNDAI GRANDEUR 3.3
20-0H-H22	28113-4H000	HYUNDAI H-1 2.5 CRDi
20-0H-H23	28113-2S000	HYUNDAI i40 1.7 CRDi - HYUNDAI ix35 2.0
20-0H-H24	28113-0X200	HYUNDAI i10 1.2
20-0K-K26	0K6B023603	KIA K2700 2.7 D
20-0K-K27	28113-2P100	KIA SORENTO 2.4 16V - HYUNDAI SANTA F 2.4
20-0K-K28	28113-2P300	KIA SORENTO 2.2 CRDi - KIA SORENTO 2.0 CRDi
20-0K-K29	28113-04000	KIA PICANTO (TA) 1.0
20-0L-L00	NRC 9238	LAND ROVER 90/110 2.5 - LAND ROVER 88/109 2.3 D (LR 88 DL, LR 109 DL)
20-0L-L15	605191	LAND ROVER RANGE ROVER I 3.5
20-0W-W11	13272717	OPEL ASTRA J 1.6 - CHEVROLET ORLANDO 1.8
20-0W-W13	96827723	CHEVROLET SPARK 1.2 - CHEVROLET SPARK 1.0
FUEL FILTER - KRAFTSTOFFFILTER - FILTRES À CARBURANT - FILTRO COMBUSTIBLE - FILTRO CARBURANTE		









NEW ITEMS

NEW CODES
NEUE CODES
NOUVEAUX CODES
NUEVOS CODIGOS
NUOVI CODICI

ASHIKA CODE	OEM	APPLICATIONS / APPLICAZIONI
FUEL FILTER - KRAFTSTOFFFILTER - FILTRES À CARBURANT - FILTRO COMBUSTIBILE - FILTRO CARBURANTE		
30-00-020	B14-1117110	DR DR1 1.3 Ecopower - DR DR2 1.3
30-01-124	16400-2Y501	NISSAN X-TRAIL (T30) 2.5 4x4 - NISSAN ALMERA TINO (V10) 1.8
30-02-239	23300-11150	TOYOTA RAV 4 I/ FUNCRAISER (SXA1_) 2.0 16V
30-04-400	17315-S5A-932	HONDA CIVIC VI 1.4 (ES4)
30-04-425	16010-SAA-000	HONDA JAZZ 1.2 - HONDA CITY Tre volumi 1.5 Vtec
30-04-427	17048-TA0-000	HONDA ACCORD IX 2.4 - HONDA ACCORD IX 2.0
30-04-428	16010-S84-A01	HONDA S2000 (AP) 2.0
30-05-523	MR552780	MITSUBISHI COLT VI 1.3 - MITSUBISHI LANCER Tre volumi 1.3
30-09-911	04721303AA	CHRYSLER VOYAGER III (RG) 2.8 CRD
30-09-912	52100283AD	JEEP GRAND CHEROKEE II (WJ, WG) 4.7 V8
30-09-913	05097052AA	CHRYSLER CROSSFIRE Roadster SRT-6 - CHRYSLER CROSSFIRE 3.2
30-0H-H15	31112-2B000	HYUNDAI GENESIS COUPE 2.0 Turbo Sport
30-0H-H16	31112-1C000	HYUNDAI GETZ (TB) 1.3 - HYUNDAI GETZ (TB) 1.1
30-0K-K28	31112-3Q500	HYUNDAI ix35 2.0 - KIA SPORTAGE 2.0 16V CVVT
30-ECO016	96816473	CHEVROLET EPICA 2.0 - CHEVROLET CAPTIVA 2.0 D 4WD
30-ECO018	16901-RL0-G01	HONDA ACCORD SW 2.2 i-DTEC - HONDA ACCORD IX 2.2 i-DTEC
30-ECO019	1906-A5	SUZUKI GRAND VITARA (FT, GT) 2.0 HDI 110 - PEUGEOT 806 (221) 2.0 HDI
30-ECO020	13263262	OPEL MERIVA B 1.7 CDTI - CHEVROLET CRUZE (J3000) 2.0 CDI
30-ECO021	8-98037011-0	ISUZU Comm. N-Serie NPR85L
CABIN FILTER - INNENRAUMLUFTFILTER - FILTRES À AIR POUR HABITACLE - FILTRO ARIA ABITACOLO		
21-DW-W16	95947238	CHEVROLET SPARK 1.0 - CHEVROLET SPARK 1.2
21-DW-W17	52493319	CHEVROLET HHR 2.4
21-DW-W18	22753219	CHEVROLET CAPTIVA 2.2 D - CHEVROLET CAPTIVA 2.2 D
21-H0-H014	79831-S2A-003	HONDA S2000 (AP) 2.0
21-H0-H015	79371-SZ3-A01	HONDA LEGEND III (KA9) 3.5 i 24V
21-KI-K20	97133-1P000	HYUNDAI ix20 1.6 - KIA VENGA 1.4 16V
21-MA-MA13	E112-61-J6X	MAZDA TRIBUTE (EP) 2.0 - MAZDA TRIBUTE (EP) 2.0 4WD
21-MA-MA14	LDY4-61-J6X-9A	MAZDA RX 8 2.6 - MAZDA MPV II (LW) 2.0
21-NS-NS13	27277-00A26	NISSAN Juke 1.6 - NISSAN Juke 1.5 dCi
21-NS-NS14	B7277-JN20A	NISSAN MURANO (Z51) 3.5 4x4 - NISSAN MURANO 2.5 dCi
21-NS-NS15	27277-1HE0E	NISSAN MICRA (K13) 1.2
21-NS-NS16	27277-EG000	INFINITI M35 3.5 Luxury
21-NS-NS17	27274ED000	NISSAN TIIDA (SC11X) 1.6 - NISSAN NV200 1.6 16V
21-NS-NS18	27891-1FC0A	NISSAN LEAF Electric - NISSAN CUBE (Z12) 1.5 dCi
21-SZ-SZ10	27891-4A00C	SUZUKI ALTO V (GF) 1.0 - NISSAN PIXO 1.0
21-SZ-SZ11	95860-80J00	SUZUKI SX4 1.5 - SUZUKI SX4 2.0 DDIs
21-TY-TY12	87139-28010	LEXUS RX 400h - TOYOTA CAMRY (_V30) 3.0 V6



	KW						
				OIL FILTER FILTRO OLIO	AIR FILTER FILTRO ARIA	FUEL FILTER FILTRO CARBURANTE	CABIN FILTER FILTRO ABITACOLO
159/ 159 Sportwagon							
1.8 MPI	103	03.07	939A4.000	10-ECO073			
1.8 TBi	147	05.09	939 B1.000	10-ECO095			
1.9 JTDM 16V	100	09.05	939A8.000 937 A8.000	10-ECO058 →02.08 10-ECO095 03.08→			
1.9 JTDM 16V	110	09.05	939A2.000	10-ECO058 →02.08 10-ECO095 03.08→			
1.9 JTDM 8V	85	09.05	939A7.000 937A7.000	10-ECO058 →02.08 10-ECO095 03.08→			
1.9 JTDM 8V	88	09.05	939A1.000	10-ECO058 →02.08 10-ECO095 03.08→			
1.9 JTS	118	09.05	939A6.000	10-ECO019			
2.0 JTDM	100	06.10	939 B4.000	10-ECO095			
2.0 JTDM	125	05.09	939 B3.000	10-ECO095			
2.2 JTS	136	09.05	939A5.000	10-ECO019			
2.4 JTDM	147	09.05	939A3.000	10-ECO107			
2.4 JTDM	154	05.07	939 A.9000	10-ECO107			
2.4 JTDM Q4	154	05.07	939 A.9000	10-ECO107			
3.2 JTS	191	02.08	939A.000	10-ECO070			
3.2 JTS Q4	191	12.05	939A.000	10-ECO070			
BRERA							
1.8 TBi	147	05.09	939 B1.000	10-ECO095			
2.0 JTDM	125	05.09	939 B3.000	10-ECO095			
2.2 JTS	136	01.06	939A5.000	10-ECO019			
2.4 JTDM 20V	147	01.06	939A3.000	10-ECO107			
2.4 JTDM 20V	154	05.07	939 A.9000	10-ECO107			
3.2 JTS	191	03.08	939A.000	10-ECO070			
3.2 JTS Q4	191	01.06	939A.000	10-ECO070			
GIULIETTA (940)							
1.4 TB	125	04.10	940 A2.000	10-ECO044			
1.4 TB	88	04.10	198 A4.000	10-ECO044			
1.8 TBi	173	04.10	940 A1.000	10-ECO095			
MITO							
1.3 JTDM	66	09.08	199 A3.000	10-ECO065			
1.3 JTDM	70	10.09	199 B1.000	10-ECO065			
1.4	77	08.10	955 A6.000	10-ECO044			
1.4	88	09.08	198 A4.000	10-ECO044			
1.4 TB	114	09.08	199 A8.000	10-ECO044			
1.4 TB	125	10.09	940 A2.000	10-ECO044			
1.4 TB	99	10.09	955 A2.000 955 A7.000	10-ECO044			

NEW CODES - NEUE CODES - NOUVEAUX CODES - NUEVOS CODIGOS - NUOVI CODICI

	KW			 OIL FILTER FILTRO OLIO	 AIR FILTER FILTRO ARIA	 FUEL FILTER FILTRO CARBURANTE	 CABIN FILTER FILTRO ABITACOLO
---	----	---	---	--	--	---	---







MITO

1.4 Turbo	110	09.08	198 A1.000	10-ECO044
1.6 JTDM	85	09.08	955 A4.000	10-ECO044
1.6 JTDM	88	09.08	198 A2.000 955 A3.000	10-ECO095 for start-stop







SPIDER

1.8 TBi	147	05.09	939 B1.000	10-ECO044
2.0 JTDM	125	05.09	939 B3.000	10-ECO044
2.2 JTS	136	09.06	939A5.000	10-ECO019
2.4 JTDM	147	04.07	939A3.000	10-ECO107
2.4 JTDM	154	03.08	939A3.000	10-ECO107
3.2 JTS	191	03.08	939A.000	10-ECO070
3.2 JTS Q4	191	09.06	939A.000	10-ECO070



	KW						
				OIL FILTER FILTRO OLIO	AIR FILTER FILTRO ARIA	FUEL FILTER FILTRO CARBURANTE	CABIN FILTER FILTRO ABITACOLO
B10 (E34)/ Touring							
3.5	187	04.88 → 12.92		10-ECO091			
3.5 Biturbo	265	01.89 → 06.93		10-ECO091			
4.0	232	04.93 → 11.94		10-ECO090			
4.6	250	03.94 → 04.95		10-ECO090			
B12 Coupe (E31)							
5.0	258	06.90 → 05.94		10-ECO090			
5.7	306	11.92 → 12.96		10-ECO090			
B6 (E21)							
2.8	147	03.78 → 08.81		10-ECO091			
2.8	160	09.81 → 03.83		10-ECO091			
B6 (E30)							
2.8	154	11.83 → 07.86		10-ECO091			
3.5	187	08.86 → 12.90		10-ECO091			
3.5	192	08.84 → 07.87		10-ECO091			
B6 (E36)							
2.8	177	03.92 → 07.93		10-ECO091			
B7 (E12)							
3.0	221	12.78 → 02.82		10-ECO091			
3.5	243	11.81 → 05.82		10-ECO091			
B7 (E28)							
3.0	221	04.84 → 07.87		10-ECO091			
3.5	235	08.86 → 12.87		10-ECO091			
B7 Coupe (E24)							
3.0	221	12.78 → 02.82		10-ECO091			
3.5	235	10.86 → 06.88		10-ECO091			
3.5	243	05.82 → 08.87		10-ECO091			
B8 (E36)							
4.6	245	01.95 → 03.98		10-ECO090			
B9 (E28)							
3.0	180	11.81 → 12.85		10-ECO091			
B9 Coupe (E24)							
3.5	180	07.82 → 12.85		10-ECO091			



	KW			 OIL FILTER FILTRO OLIO	 AIR FILTER FILTRO ARIA	 FUEL FILTER FILTRO CARBURANTE	 CABIN FILTER FILTRO ABITACOLO
HI-TOPIC (AM 725)							
2.7 D	55	06.93	SS		20-0K-012	30-06-611	
ROCSTA							
1.8 i 4x4	57	06.93	F804 R2	10-03-313	20-01-124	30-03-302	
2.2 D	45	07.93 → 12.98	R2	10-05-502	20-09-983	30-06-611	
2.2 D 4x4	45	06.93	R2 R2	10-05-502	20-09-983	30-06-611	



	KW						
				OIL FILTER FILTRO OLIO	AIR FILTER FILTRO ARIA	FUEL FILTER FILTRO CARBURANTE	CABIN FILTER FILTRO ABITACOLO
A2 (8Z0)							
1.2 TDI	45	03.01 → 08.05	ANY	10-ECO023		30-ECO076	
1.4 TDI	55	02.00 → 08.05	AMF BHC	10-ECO023		30-ECO076	
1.4 TDI	66	11.03 → 08.05	ATL	10-ECO023		30-ECO076	
A3 (8L1)							
1.9 TDI	66	09.96 → 07.01	AGR ALH	10-ECO008			
1.9 TDI	74	10.00	ATD AXR	10-ECO008			
1.9 TDI	81	08.97 → 07.01	AHF ASV	10-ECO008			
1.9 TDI	96	08.00	ASZ	10-ECO008			
1.9 TDI quattro	96	08.00	ASZ	10-ECO008			
A3 (8P1)/ A3 Sportback							
1.4 TFSI	92	09.07	CAXC CMSA	10-ECO092 →06.08			
1.6	75	05.03	BGU BSE BSF CCSA CMXA	10-ECO092			
1.6 TDI	66	05.09	CAYB	10-ECO098		30-ECO024	
1.6 TDI	77	05.09	CAYC	10-ECO098		30-ECO024	
1.9 TDI	77	05.03	BKC BLS BXE	10-ECO023		30-ECO024 04.06→ VIN 8P_6_176001 -> 30-ECO033 →03.06 VIN ->8P_6_176000 30-ECO034	
2.0	120	06.06		10-ECO023			
2.0 FSI	110	05.03	AXW BLX BLY BMB BLR BVY BVZ	10-ECO063			
2.0 TDI	100	05.03	AZV CBAA CFFA	10-ECO023		30-ECO024 30-ECO033 →03.06 VIN ->8P_6_176000 30-ECO034	
2.0 TDI	103	06.05	BMM	10-ECO023		30-ECO024 30-ECO033 →03.06 VIN ->8P_6_176000 30-ECO034	
2.0 TDI	120	06.06 → 06.08	BUY	10-ECO023		30-ECO024	
2.0 TDI	125	03.06	BMN CBBB CFGB	10-ECO023		30-ECO024	
2.0 TDI quattro	103	01.06	BMM	10-ECO023		30-ECO024 30-ECO033 →03.06 VIN ->8P_6_176000 30-ECO034	

NEW CODES - NEUE CODES - NOUVEAUX CODES - NUEVOS CODIGOS - NUOVI CODICI

	KW						
				OIL FILTER FILTRO OLIO	AIR FILTER FILTRO ARIA	FUEL FILTER FILTRO CARBURANTE	CABIN FILTER FILTRO ABITACOLO

A3 (8P1)/ A3 Sportback

2.0 TDI 16V	103	05.03	BKD CBAB CFFB CLJA	10-ECO023	30-ECO024 30-ECO033 →03.06 VIN ->8P_6_176000 30-ECO034
2.0 TDI 16V quattro	103	08.04	BKD CBAB CFFB	10-ECO023	30-ECO024 30-ECO033 →03.06 VIN ->8P_6_176000 30-ECO034
2.0 TDI quattro	100	05.03	AZV	10-ECO023	30-ECO024 30-ECO033 →03.06 VIN ->8P_6_176000 30-ECO034
2.0 TDI quattro	125	03.06	BMN CBBB CFGB	10-ECO023	30-ECO024
2.0 TFSI	147	09.04	AXX BWA CAWB CCZA	10-ECO063	
2.0 TFSI quattro	147	09.04	AXX BWA CCZA	10-ECO063	
3.2 V6 quattro	184	07.03	BDB BMJ BUB	10-ECO023	
S3 quattro	188	02.07	BZC CDLC	10-ECO063	
S3 quattro	195	11.06	BHZ CDLA	10-ECO063	

A3 Cabriolet

1.6 TDI	77	05.09	CAYC	10-ECO098	30-ECO024
1.9 TDI	77	04.08	BLS	10-ECO023	30-ECO024
2.0 TDI	100	04.08	CBAA CFFA	10-ECO023	30-ECO024
2.0 TDI	103	04.08	CBAB CFFB	10-ECO023	30-ECO024
2.0 TFSI	147	04.08	CAWB CCZA	10-ECO063	

A4 (8D2, B5)/ A4 Avant

1.9 TDI	85	03.00 → 11.00	AJM	10-ECO008	
1.9 TDI quattro	85	03.00 → 11.00	AJM ATJ	10-ECO008	
2.5 TDI	110	09.97 → 11.00	AFB AKN	10-ECO010	
2.5 TDI quattro	110	09.97 → 11.00	AFB AKN	10-ECO010	

A4 (8E2, B6)/ A4 Avant

1.9 TDI	74	05.01 → 12.04	AVB	10-ECO008	
1.9 TDI	85	06.04 → 12.04	BKE	10-ECO008	
1.9 TDI	96	11.00 → 12.04	AVF AWX	10-ECO008	
1.9 TDI quattro	96	11.01 → 12.04	AVF	10-ECO008	
2.5 TDI	114	08.01 → 07.02	AYM	10-ECO010	
2.5 TDI	120	07.02 → 12.04	BFC BCZ BDG	10-ECO010	

NEW CODES - NEUE CODES - NOUVEAUX CODES - NUEVOS CODIGOS - NUOVI CODICI



	KW						
				OIL FILTER FILTRO OLIO	AIR FILTER FILTRO ARIA	FUEL FILTER FILTRO CARBURANTE	CABIN FILTER FILTRO ABITACOLO

A4 (8E2, B6)/ A4 Avant

2.5 TDI quattro	132	11.00 → 12.04	AKE BAU BDH	10-ECO010
S4 quattro	253	03.03 → 12.04	BBK	10-ECO085

A4 (8EC)/ A4 Avant

1.9 TDI	85	11.04	BKE BRB	10-ECO008
2.0 TDI	100	11.04	BNA BRF	10-ECO023
2.0 TDI	103	11.04	BPW	10-ECO008
2.0 TDI	120	06.06	BVA	10-ECO023
2.0 TDI	125	06.06	BRD	10-ECO023
2.0 TDI	89	09.05 → 09.06	BVG	10-ECO023
2.0 TDI 16V	103	11.04	BLB BRE	10-ECO023
2.0 TDI quattro	103	01.06	BPW	10-ECO008
2.0 TDI quattro	120	06.06	BVA	10-ECO023
2.0 TDI quattro	125	06.06	BRD	10-ECO023
2.0 TFSI	147	11.04	BGB BWE BWT BPG	10-ECO063
2.0 TFSI	162	06.05	BUL	10-ECO063
2.0 TFSI quattro	147	11.04	BGB BWE BWT BPG	10-ECO063
2.0 TFSI quattro	162	06.05	BUL	10-ECO063
2.5 TDI	120	11.04 → 05.06	BDG	10-ECO010
2.7 TDI	120	11.05	BSG	10-ECO069
2.7 TDI	132	01.06	BPP	10-ECO069
3.0 TDI quattro	150	11.04	BKN	10-ECO069
3.0 TDI quattro	171	01.06	ASB	10-ECO069
3.2 FSI	188	01.05	AUK	10-ECO108
3.2 FSI quattro	188	01.05	AUK BKH	10-ECO108
RS4 quattro	309	09.05	BNS	10-ECO087
S4 quattro	253	11.04	BBK BHF	10-ECO085

A4 Allroad (8KH)

2.0 TDI quattro	100	09.09	CAGB	10-ECO023
2.0 TDI quattro	105	09.09	CAGA	10-ECO023
2.0 TDI quattro	120	04.09	CAHB	10-ECO023
2.0 TDI quattro	125	04.09	CAHA	10-ECO023
3.0 TDI quattro	176	04.09	CCWA	10-ECO069

A4 Cabriolet (8H7)

2.0 TDI	100	01.06	BRC	10-ECO063
2.0 TDI	103	01.06	BPW	10-ECO008
2.0 TFSI 16V	147	01.06	BWE BWT	10-ECO063

NEW CODES - NEUE CODES - NOUVEAUX CODES - NUEVOS CODIGOS - NUOVI CODICI

	KW			 OIL FILTER FILTRO OLIO	 AIR FILTER FILTRO ARIA	 FUEL FILTER FILTRO CARBURANTE	 CABIN FILTER FILTRO ABITACOLO
---	----	---	---	---	---	--	--

A4 Cabriolet (8H7)

2.5 TDI	120	08.02 → 12.05	BFC BCZ BDG	10-ECO010			
2.7 TDI	132	06.06	BPP	10-ECO069			
3.0 TDI quattro	171	01.06	ASB	10-ECO069			
3.2 FSI	188	01.06	AUK	10-ECO108			
3.2 FSI quattro	188	01.06	AUK	10-ECO108			
RS4 quattro	309	06.06	BNS	10-ECO087			
S4 quattro	253	03.04	BBK	10-ECO085			

A4/ A4 AVANT

2.0 TDI	100	11.07	CAGB CJCB	10-ECO023			
2.0 TDI	105	11.07	CAGA CMEA	10-ECO023			
2.0 TDI	120	08.08	CAHB	10-ECO069			
2.0 TDI	125	01.08	CAHA	10-ECO023			
2.0 TDi	88	06.08	CAGC	10-ECO023			
2.0 TDI quattro	105	11.08	CAGA	10-ECO023			
2.0 TDi quattro	125	01.08	CAHA	10-ECO023			
2.7 TDI	120	11.07	CAMB CGKB	10-ECO069			
2.7 TDI	140	11.07	CAM CGKA	10-ECO069			
3.0 TDI quattro	176	11.07	CAP CCWA CCLA	10-ECO069			
3.2 FSI	195	09.08	CAL	10-ECO108			
3.2 FSI quattro	195	11.07	CAL	10-ECO108			
S4 quattro	245	11.08	CAKA CCBA	10-ECO108			

A5 Cabriolet (8F)

2.0 TDI	120	05.09	CAHB	10-ECO023			
2.0 TDI	125	05.09	CAHA	10-ECO023			
2.7 TDI	120	05.09	CGKB	10-ECO069			
2.7 TDI	140	03.09	CGKA	10-ECO069			
3.0 TDI quattro	176	03.09	CCWA	10-ECO069			
3.2 FSI	195	03.09	CAL	10-ECO108			
3.2 FSI quattro	195	03.09	CAL	10-ECO108			
S5 quattro	245	06.09	CAKA CCBA	10-ECO108			

A5/ A5 Sportback

2.0 TDI	120	08.08	CAHB	10-ECO023			
2.0 TDI	125	08.08	CAHA	10-ECO023			
2.0 TDI quattro	125	08.08	CAHA	10-ECO023			
2.7 TDI	120	09.07	CAMB CGKB	10-ECO069			
2.7 TDI	140	06.07	CAM CGKA	10-ECO069			
3.0 TDI quattro	176	06.07	CAP CCWA	10-ECO069			
3.2 FSI	195	06.07	CAL	10-ECO108			

NEW CODES - NEUE CODES - NOUVEAUX CODES - NUEVOS CODIGOS - NUOVI CODICI



	KW						
				OIL FILTER FILTRO OLIO	AIR FILTER FILTRO ARIA	FUEL FILTER FILTRO CARBURANTE	CABIN FILTER FILTRO ABITACOLO

A5/ A5 Sportback

3.2 FSI quattro	195	06.07	CAL	10-ECO108
S5 quattro	260	06.07	CAUA	10-ECO087

A6 (4B, C5)/ A6 Avant

1.9 TDI	85	07.00 → 01.05	AJM	10-ECO008
1.9 TDI	96	08.01 → 01.05	AVF AWX	10-ECO008
2.5 TDI	110	07.97 → 01.05	AFB AKN	10-ECO010
2.5 TDI	114	08.01 → 01.05	AYM	10-ECO010
2.5 TDI	120	07.02 → 01.05	BFC BCZ BDG	10-ECO010
2.5 TDI	132	02.00 → 01.05	AKE BAU BDH BND	10-ECO010
2.5 TDI quattro	110	07.97 → 01.05	AFB AKN	10-ECO010
2.5 TDI quattro	132	02.00 → 01.05	AKE BAU BDH	10-ECO010

A6 (4F2)/ A6 Avant

2.0 TDI	100	07.04	BNA BRF CAGB	10-ECO023
2.0 TDI	103	07.04 → 10.08	BLB BRE	10-ECO023
2.0 TDI	120	04.09	CAHB	10-ECO023
2.0 TDI	125	11.08	CAHA	10-ECO063
2.0 TDI	89	09.05 → 06.06	BVG	10-ECO023
2.0 TFSI	125	06.05	BPJ BYK	10-ECO063
2.4	130	05.04 → 10.08	BDW	10-ECO108
2.4 quattro	130	01.05 → 10.08	BDW	10-ECO108
2.7 TDI	120	11.04	BSG CANB	10-ECO069
2.7 TDI	132	11.04 → 10.08	BPP	10-ECO069
2.7 TDI quattro	120	06.05	BSG CAND	10-ECO069
2.7 TDI quattro	132	11.04 → 10.08	BPP	10-ECO069
2.7 TDI quattro	140	10.08	CANC	10-ECO069
2.8 FSI	140	10.08	CCDA	10-ECO108
2.8 FSI	154	11.06 → 10.08	BDX	10-ECO108
2.8 FSI	162	10.08	CCEA	10-ECO108
2.8 FSI quattro	140	10.08	CCDA	10-ECO108
2.8 FSI quattro	154	06.07 → 10.08	BDX	10-ECO108
2.8 FSI quattro	162	10.08	CCEA	10-ECO108
3.0 TDI	171	06.06	ASB	10-ECO069
3.0 TDI quattro	155	05.04	BNG CDYB	10-ECO069
3.0 TDI quattro	165	05.04 → 05.06	BMK	10-ECO069
3.0 TDI quattro	171	06.06 → 10.08	ASB	10-ECO069
3.0 TFSI quattro	213	10.08	CAJA	10-ECO108

NEW CODES - NEUE CODES - NOUVEAUX CODES - NUEVOS CODIGOS - NUOVI CODICI

	KW			 OIL FILTER FILTRO OLIO	 AIR FILTER FILTRO ARIA	 FUEL FILTER FILTRO CARBURANTE	 CABIN FILTER FILTRO ABITACOLO
---	----	---	---	--	--	---	---

A6 (4F2)/ A6 Avant

3.2 FSI	188	05.04 → 10.08	AUK BKH	10-ECO108
3.2 FSI quattro	183	09.06 → 10.08	BYU	10-ECO108
3.2 FSI quattro	188	05.04 → 10.08	AUK BKH	10-ECO108
4.2 quattro	246	05.04 → 05.06	BAT	10-ECO085
4.2 FSI quattro	257	06.06	BVJ	10-ECO087
RS6 quattro	426	09.08	BUH	10-ECO087
S6 quattro	320	03.06	BXA	10-ECO087

A6 Allroad (4FH)

2.7 TDI quattro	120	05.06	BSG CAND	10-ECO069
2.7 TDI quattro	132	05.06	BPP	10-ECO069
2.7 TDI quattro	140	10.08	CANC	10-ECO069
3.0 TDI quattro	155	05.06	BNG CDYB	10-ECO069
3.0 TDI quattro	171	05.06	ASB	10-ECO069
3.0 TDI quattro	176	10.08	CDYA	10-ECO069
3.2 FSI quattro	188	05.06	AUK	10-ECO023
4.2 FSI quattro	257	05.06	BVJ	10-ECO087

A7 Sportback

2.8 FSI quattro	150	10.10	CHVA CNYA	10-ECO108
3.0 TFSI quattro	220	10.10	CGWB	10-ECO108

A8 (4D2, 4D8)

2.5 TDI	110	01.97 → 04.00	AFB AKN	10-ECO010
2.5 TDI	132	09.00 → 09.02	AKE	10-ECO010
2.5 TDI quattro	110	07.97 → 04.00	AFB AKN	10-ECO010
2.5 TDI quattro	132	09.00 → 09.02	AKE	10-ECO010
3.7	169	07.95 → 12.98	AEW	10-ECO089
3.7	191	11.98 → 09.02	AQG AKC	10-ECO013
3.7 quattro	169	07.95 → 11.98	AEW AKJ	10-ECO089
3.7 quattro	191	11.98 → 09.02	AQG AKC	10-ECO013
4.2 quattro	175	02.99 → 04.00	ARU	10-ECO013
4.2 quattro	180	03.94 → 07.96	AEM	10-ECO089
4.2 quattro	220	03.94 → 11.98	ABZ AKG	10-ECO089
4.2 quattro	228	11.98 → 09.02	AQF AUX AUW	10-ECO013
S 8 quattro	250	07.96 → 06.99	AHC AKH	10-ECO089
S 8 quattro	265	06.99 → 09.02	AQH AVP	10-ECO013

A8 (4E_)

2.8 FSI	154	08.07	BDX	10-ECO108
3.0 TDI quattro	155	11.03	BNG	10-ECO069
3.0 TDI quattro	171	08.03	ASB	10-ECO069

NEW CODES - NEUE CODES - NOUVEAUX CODES - NUEVOS CODIGOS - NUOVI CODICI

	KW						
				OIL FILTER FILTRO OLIO	AIR FILTER FILTRO ARIA	FUEL FILTER FILTRO CARBURANTE	CABIN FILTER FILTRO ABITACOLO

A8 (4E_)

3.2 FSI	191	06.05	BPK	10-ECO108	
3.2 FSI quattro	191	06.05	BPK	10-ECO108	
3.7 quattro	206	10.02	BFL	10-ECO085	
4.0 TDI quattro	202	03.03	ASE	10-ECO069	
4.2 quattro	246	10.02	BFM	10-ECO085	
4.2 TDI quattro	235	07.05	BMC	10-ECO069	
4.2 TDI quattro	240	07.05	BVN	10-ECO069	
S8 quattro	331	06.06	BSM	10-ECO087	

A8 (4H_)

3.0 TFSI quattro	213	07.10	CGWA CGXA	10-ECO108	
4.2 FSI quattro	273	11.09	CDRA	10-ECO087	

ALLROAD (4BH)

2.5 TDI quattro	120	05.03 → 08.05	BCZ	10-ECO010	
2.5 TDI quattro	132	05.00 → 08.05	AKE BAU	10-ECO010	
4.2 V8 quattro	220	07.02 → 08.05	BAS	10-ECO085	

CABRIOLET (8G7, B4)

1.9 TDI	66	06.95 → 08.00	1Z AHU	10-ECO013	
---------	----	---------------	-----------	-----------	--

Q5

2.0 TDI	100	08.09	CAGB	10-ECO023	
2.0 TDI	105	08.09	CAGA CJCA	10-ECO023	
2.0 TDI	120	11.08	CAHB CGLA	10-ECO023	
2.0 TDI	125	11.08	CAHA CGLB CMGA	10-ECO023	
3.0 TDI	155	11.08	CCWB	10-ECO069	
3.0 TDI	176	11.08	CCWA	10-ECO069	
3.2 FSI	199	11.08	CALB	10-ECO108	

Q7

3.0 TDi	155	03.06	BUN CASB	10-ECO069	30-ECO025
3.0 TDI	171	03.06	BUG	10-ECO069	30-ECO025
3.0 TDI	176	11.07	CASA CCMA CJGA	10-ECO069	30-ECO025
3.0 TFSI	200	05.10	CJTC CJWC	10-ECO108	
3.0 TFSI	245	05.10	CJTB CJWB CNAA	10-ECO108	
3.6 FSI	206	08.06	BHK	10-ECO013	
4.2 FSI	257	03.06	BAR	10-ECO087	
4.2 TDI	240	03.07	BTR	10-ECO069	30-ECO025
4.2 TDI	250	05.09	CCFA CCFC	10-ECO069	30-ECO025
6.0 TDI	368	09.08	CCGA	10-ECO069	

R8/ R8 SPYDER

NEW CODES - NEUE CODES - NOUVEAUX CODES - NUEVOS CODIGOS - NUOVI CODICI

	KW			 OIL FILTER FILTRO OLIO	 AIR FILTER FILTRO ARIA	 FUEL FILTER FILTRO CARBURANTE	 CABIN FILTER FILTRO ABITACOLO
---	-----------	---	---	--	--	---	---

R8/ R8 SPYDER

4.2 FSI quattro	309	04.07	BYH	10-ECO087	
4.2 FSI quattro	316	07.10	CNDA	10-ECO087	
5.2 FSI quattro	386	04.09	BUJ	10-ECO087	

TT

2.0 TDI quattro	125	06.08	CBBB CFGB	10-ECO023	30-ECO024
2.0 TFSI	147	10.06	BWA BPY CCTA CCZA	10-ECO063	
2.0 TFSI quattro	147	06.08	CCZA	10-ECO063	
2.0 TFSI quattro	200	06.08	CDLB	10-ECO063	
2.5 TFSI quattro	250	05.09	CEPA	10-ECO063	
3.2 V6 quattro	184	10.06	BUB	10-ECO023	

TT (8N3)

3.2 VR6 quattro	184	07.03	BHE BPF	10-ECO023	
-----------------	-----	-------	------------	-----------	--

TT Roadster (8J9)

2.0 TDI quattro	125	06.08	CBBB CFGB	10-ECO023	30-ECO024
2.0 TFSI	147	02.07	BWA BPY CCTA CCZA	10-ECO063	
2.0 TFSI quattro	147	06.08	CCZA	10-ECO063	
2.0 TFSI quattro	200	06.08	CDLB	10-ECO063	
2.5 TFSI quattro	250	05.09	CEPA	10-ECO063	
3.2 V6 quattro	184	02.07	BUB	10-ECO023	

TT Roadster (8N9)

3.2 VR6 quattro	184	07.03	BHE BPF	10-ECO023	
-----------------	-----	-------	------------	-----------	--

	KW						
				OIL FILTER FILTRO OLIO	AIR FILTER FILTRO ARIA	FUEL FILTER FILTRO CARBURANTE	CABIN FILTER FILTRO ABITACOLO

Serie 1 (E87)

116d	85	09.04	N47D20A N47 D20 C	10-ECO100
116i	85	09.04	N45B16A N 45 B 16 N 45 B 16 TU2	10-ECO079
116i	90	01.09	N43B20A	10-ECO079
116i	90	09.07	N 45 B 16 TU2	10-ECO079
118d	100	03.07	N47D20A N47 D20 C	10-ECO100
118d	105	04.07	N47D20A N47 D20 C	10-ECO100
118d	90	09.04	M47N204D4	10-ECO109
118i	105	04.07	N43B20A	10-ECO079
118i	95	09.04	N42B20B N 46 B 20	10-ECO079
120d	120	09.04	M47N204D4 N47D20A	10-ECO109
120d	130	03.07	N47D20A N47 D20 C	10-ECO100
120i	110	09.04	N42B20A N 46 B 20	10-ECO079
120i	120	03.07	N43B20A	10-ECO079
120i	125	04.07	N46B20B N43B20A	10-ECO079
123d	150	10.07	N47D20B	10-ECO100
130i	190	03.05	N52B30A	10-ECO062
130i	195	09.05	N52B30A N 52 B 30	10-ECO062

Serie 1 Cabriolet (E88)

118d	100	09.08	N47D20A N47 D20 C	10-ECO100
118d	105	09.08	N47D20A N47 D20 C	10-ECO100
118i	105	03.08	N43B20A	10-ECO079
120d	120	03.08	N47D20A	10-ECO100
120d	130	03.08	N47D20A N47 D20 C	10-ECO100
120i	120	03.08	N43B20A	10-ECO079
120i	125	03.08	N46B20B N43B20A	10-ECO079
123d	150	09.08	N47D20B	10-ECO100
125i	160	03.08	N52B30A	10-ECO062
135i	225	03.08	N54B30A	10-ECO062

Serie 1 Coupé (E82)

118d	105	09.09	N47 D20 C	10-ECO100
120d	120	10.07	N47D20A	10-ECO100
120d	130	10.07	N47D20A N47 D20 C	10-ECO100
120i	125	09.09	N46B20B N43B20A	10-ECO079
123d	150	10.07	N47D20B	10-ECO100
125i	160	10.07	N53B30A	10-ECO062
135i	225	10.07	N54B30A	10-ECO062

Serie 3 (E30)/ Serie 3 Touring

NEW CODES - NEUE CODES - NOUVEAUX CODES - NUEVOS CODIGOS - NUOVI CODICI

	KW						
				OIL FILTER FILTRO OLIO	AIR FILTER FILTRO ARIA	FUEL FILTER FILTRO CARBURANTE	CABIN FILTER FILTRO ABITACOLO

Serie 3 (E30)/ Serie 3 Touring

316 i	73	09.87 → 06.91	M 40 B 16 (Kat.)	10-ECO080	
316 i	75	07.88 → 06.91	M 40 B 16	10-ECO080	
318 i	75	12.84 → 08.88	M 10 B 18	10-ECO080	
318 i	83	09.87 → 06.91	M 40 B 18	10-ECO080	
318 i	85	09.87 → 06.91	M 40 B 18	10-ECO080	
318 is	100	09.89 → 08.91	M 42 B 18	10-ECO080	
324 d	63	09.85 → 08.91	M 21 D 24 W	10-ECO113	
324 td	85	09.87 → 08.91	M 21 D 24 WA M 21 D 24 (Kat.)	10-ECO113	

Serie 3 (E36)/ Serie 3 Touring

316 i	73	09.90 → 09.93	M 40 B 16 (Kat.)	10-ECO080	
316 i	75	07.93 → 02.98	M 43 B 16	10-ECO080	
316 i	75	09.90 → 09.93	M 43 B 16 M 40 B 16	10-ECO080	
318 i	83	12.90 → 10.93	M 40 B 18	10-ECO080	
318 i	85	10.93 → 02.98	M 43 B 18	10-ECO004 10-ECO080 →08.95	
318 is	103	03.93 → 09.97	M 42 B 18	10-ECO004 10-ECO080 →08.95	
318 is	103	09.95 → 02.98	M 44 B 19	10-ECO004	
318 tds	66	01.95 → 02.98	M 41 D 18 (Inter.)	10-ECO110	
320 i	110	09.90 → 02.98	M 52 B (20 6 S3) Vanos M 50 B (20 6 S1) M 50 B (20 6 S2) Vanos M 50 B 20 M 50 B 20 TU M 52 B 20	10-ECO012	
323 i 2.5	125	03.95 → 02.98	M 52 B 25 (Vanos)	10-ECO012	
325 i	141	09.90 → 09.95	M 50 B 25 M 50 B 25 (Vanos) M 50 B 25 TU	10-ECO012	
325 td	85	09.91 → 02.98	M 51 D 25	10-ECO011	
325 tds	105	05.93 → 02.98	M 51 D 25 (Inter.)	10-ECO011	
328 i	142	01.95 → 02.98	M 52 B 28 M 52 B 28 TU	10-ECO012	
M3 3.0	210	08.94 → 09.95	S 50 B 30	10-ECO083	
M3 3.2	236	09.95 → 02.98	S 50 B 32	10-ECO083	

Serie 3 (E46)/ Serie 3 Touring

316 i	77	04.00 → 02.05	M 43 B 16 M 43 B 16 (16 4 E3)	10-ECO004	
316 i	77	09.98 → 02.05	M43164E3 M 43 B 19 TU	10-ECO004	
316 i	85	02.02 → 02.05	N 42 B 18 N46B18A N 46 B 18	10-ECO079	
316 i	85	06.02 → 02.05	N45B16A N 45 B 16	10-ECO079	
318 d	85	03.03 → 02.05	M47N204D4	10-ECO109	30-ECO026

NEW CODES - NEUE CODES - NOUVEAUX CODES - NUEVOS CODIGOS - NUOVI CODICI

	KW						
				OIL FILTER FILTRO OLIO	AIR FILTER FILTRO ARIA	FUEL FILTER FILTRO CARBURANTE	CABIN FILTER FILTRO ABITACOLO

Serie 3 (E46)/ Serie 3 Touring

318 d	85	09.01 → 03.03	M 47 D 20 M47204D1	10-ECO021	30-ECO026
318 i	105	09.01 → 02.05	N 42 B 20 N46B20A N 46 B 20	10-ECO079	
318 i	87	02.98 → 09.01	M 43 B 19 M 43 B 19 TU	10-ECO004	
320 d	100	04.98 → 09.01	M 47 D 20 M47204D1	10-ECO012	30-ECO026
320 d	110	09.01 → 02.05	M47N204D4	10-ECO109	
320 i	110	03.98 → 09.00	M 52 B (20 6 S3) Vanos M 52 B 20	10-ECO012	
320 i	125	09.00 → 02.05	M 54 B 22 M54226S1	10-ECO012	
323 i	125	03.98 → 09.00	M 52 B 25 (Vanos) M 52 B 25 TU	10-ECO012	
325 i	141	09.00 → 02.05	M54256S5 M 54 B 25	10-ECO012	
325 xi	141	09.00 → 02.05	M54256S5	10-ECO012	
328 i	142	02.98 → 06.00	M 52 B 28	10-ECO012	
330 d	135	10.99 → 02.05	M 57 D 30 M57306D1	10-ECO035	
330 d	150	03.03 → 02.05	M57N306D2	10-ECO111	
330 i	170	06.00 → 02.05	M54306S3 M 54 B 30	10-ECO012	
330 xd	135	06.00 → 02.05	M 57 D 30	10-ECO035	
330 xd	150	03.03 → 02.05	M57N306D2	10-ECO111	
330 xi	170	06.00 → 02.05	M54306S3	10-ECO012	

Serie 3 (E90)/ Serie 3 Touring

316d	85	07.09	N47 D20 C	10-ECO100	
316i	85	02.06	N45B16A N 45 B 16 N 45 B 16 TU2	10-ECO079	
316i	90	09.07	N43B16A	10-ECO079	
318d	100	07.07	N47 D20 C	10-ECO100	
318d	105	09.05	N47D20A N47 D20 C	10-ECO100	
318d	90	09.05	M47N204D4	10-ECO109	
318i	105	09.07	N43B20A N 46 B 20 TU2	10-ECO079	
318i	95	09.05 → 03.07	N46B20B N 46 B 20	10-ECO079	
320 si	127	05.06	N45B20A	10-ECO079	
320d	110	09.05	M47N204D4	10-ECO100 10-ECO109 →08.07	
320d	120	01.05	M47N204D4 N47 D20 C	10-ECO100 10-ECO109 →08.07	
320d	130	09.07	N47D20A	10-ECO100	
320d xDrive	130	09.08	N47 D20 C	10-ECO100	
320i	110	01.05 → 03.07	N46B20A N46B20C N 46 B 20	10-ECO079	
320i	125	09.07	N43B20A	10-ECO079	

NEW CODES - NEUE CODES - NOUVEAUX CODES - NUEVOS CODIGOS - NUOVI CODICI

	KW			 OIL FILTER FILTRO OLIO	 AIR FILTER FILTRO ARIA	 FUEL FILTER FILTRO CARBURANTE	 CABIN FILTER FILTRO ABITACOLO
---	----	---	---	--	--	---	---

Serie 3 (E90)/ Serie 3 Touring

320xd	130	09.07	N47 D20 C	10-ECO100
325d	145	09.06	M57306D3	10-ECO111
325d	150	01.10	N57 D30 A	10-ECO101
325i	160	01.05	N52B25A N 52 B 25	10-ECO062
325i	160	09.07	N53B30A N 53 B 30	10-ECO062
325i xDrive	160	09.08	N53B30A	10-ECO062
325xi	160	01.05	N52B25A	10-ECO062
325xi	160	09.07	N53B30A	10-ECO062
328i	187	07.05 → 11.07	N52NB30A	10-ECO062
330d	170	09.05	M57306D3 M57 TU2 D30	10-ECO111
330d	180	01.09	M57N2 306 D3 N57 D30 A	10-ECO101
330d xDrive	180	01.09	N57 D30 A	10-ECO101
330i	190	01.05	N52B30A N 52 B 30	10-ECO062
330i	200	09.07	N52B30A N53B30A N 53 B 30	10-ECO062
330i xDrive	200	09.08	N53B30A	10-ECO062
330xd	170	09.05	M57306D3 M57 TU2 D30	10-ECO111
330xi	190	01.05	N52B30A	10-ECO062
330xi	200	09.07	N53B30A	10-ECO062
335d	210	09.06	M57N306D5	10-ECO111
335i	225	09.06	N54B30A	10-ECO062
335i xDrive	225	09.08	N54B30A	10-ECO062
335xi	225	09.07	N54B30A	10-ECO062
M3	309	03.07	S65B40	10-ECO112

Serie 3 Cabriolet (E30)

318 i	83	09.90 → 10.93	M 40 B 18	10-ECO080
-------	----	---------------	-----------	-----------

Serie 3 Cabriolet (E36)

318 i	85	01.94 → 04.99	M 43 B 18	10-ECO004 10-ECO080 →08.95
320 i	110	12.93 → 04.99	M 52 B (20 6 S3) Vanos M 50 B (20 6 S2) Vanos M 50 B 20 M 50 B 20 TU M 52 B 20	10-ECO012
323 i 2.5	125	06.95 → 04.99	M 52 B 25 (Vanos)	10-ECO012
325 i	141	03.93 → 03.95	M 50 B 25 M 50 B 25 TU	10-ECO012
328 i	142	03.95 → 04.99	M 52 B 28 M 52 B 28 TU	10-ECO012
M3 3.0	210	01.94 → 10.95	S 50 B 30	10-ECO083
M3 3.2	236	10.95 → 04.99	S 50 B 32	10-ECO083

Serie 3 Cabriolet (E46)

NEW CODES - NEUE CODES - NOUVEAUX CODES - NUEVOS CODIGOS - NUOVI CODICI



	KW						
				OIL FILTER FILTRO OLIO	AIR FILTER FILTRO ARIA	FUEL FILTER FILTRO CARBURANTE	CABIN FILTER FILTRO ABITACOLO

Serie 3 Cabriolet (E46)

318 Ci	105	09.01	N 42 B 20 N 46 B 20	10-ECO079	
318 Ci	110	02.05	N46B20B	10-ECO079	
320 Cd	110	02.05	M47N204D4	10-ECO109	
320 Ci	125	09.00	M 54 B 22 M54226S1	10-ECO012	
323 Ci	125	04.00 → 09.00	M 52 B 25 (Vanos)	10-ECO012	
325 Ci	141	09.00	M54256S5	10-ECO012	
330 Cd	150	08.05	M57N306D2	10-ECO111	
330 Ci	170	06.00	M54306S3	10-ECO012	
M3 3.2	252	04.01	S54326S4 S 54 B 32	10-ECO083	

Serie 3 Cabriolet (E93)

320d	130	03.07	N47D20A	10-ECO100	
320i	110	03.07 → 08.07	N46NB20B N 46 B 20	10-ECO079	
320i	125	03.07	N43B20A	10-ECO079	
323i	130	03.07	N52NB25A	10-ECO062	
325d	145	03.07	M57 TU2 D30 N57306D3	10-ECO111	
325i	160	03.07	N53B30A N 53 B 30	10-ECO062	
325i	160	03.07	N52B25A N 52 B 25	10-ECO062	
330d	170	03.07	M57 TU2 D30 N57N306D3	10-ECO111	
330d	180	01.09	M57N2 306 D3 N57 D30 A	10-ECO101	
330i	190	03.07	N52NB30B	10-ECO062	
330i	200	03.07	N52B30A N53B30A N 53 B 30	10-ECO062	
335i	225	03.07	N54B30A N54B30B	10-ECO062	
M3	309	03.07	S65B40	10-ECO112	

Serie 3 Compact (E36)

316 g	75	12.95 → 08.00		10-ECO004	
316 i	75	03.94 → 08.00	M 43 B 16	10-ECO004	
316 i	77	12.98 → 08.00	M43164E3 M 43 B 19 TU	10-ECO004	
318 tds	66	01.95 → 08.00	M 41 D 18 (Inter.)	10-ECO110	
318 ti	103	07.95 → 08.00	M 44 B 19	10-ECO004 →02.98	
318 ti	103	11.94 → 08.95	M 42 B 18	10-ECO080	
323 ti	125	08.97 → 08.00	M 52 B 25 (Vanos)	10-ECO012	

Serie 3 Compact (E46)

316 ti	85	06.01 → 02.05	N 42 B 18 N46B18A	10-ECO079	
316 ti	85	06.02 → 02.05	N40B16A N45B16A	10-ECO079	
318 td	85	03.03 → 02.05	M47N204D4	10-ECO109	30-ECO026
318 ti	105	09.01 → 02.05	N 42 B 20 N46B20A	10-ECO079	

NEW CODES - NEUE CODES - NOUVEAUX CODES - NUEVOS CODIGOS - NUOVI CODICI

	KW						
				OIL FILTER FILTRO OLIO	AIR FILTER FILTRO ARIA	FUEL FILTER FILTRO CARBURANTE	CABIN FILTER FILTRO ABITACOLO

Serie 3 Compact (E46)

320 td	110	09.01 → 02.05	M47N204D4	10-ECO109
325 ti	141	06.01 → 02.05	M54256S5 M 54 B 25	10-ECO012

Serie 3 Coupe (E36)

316 i	75	09.93 → 04.99	M 43 B 16	10-ECO012 10-ECO080 →08.95
318 is	103	03.92 → 10.95	M 42 B 18	10-ECO004 10-ECO080 →08.95
318 is	103	09.95 → 04.99	M 44 B 19	10-ECO004
320 i	110	03.92 → 04.99	M 52 B (20 6 S3) Vanos M 50 B (20 6 S1) M 50 B (20 6 S2) Vanos M 50 B 20 M 50 B 20 TU M 52 B 20	10-ECO012
323 i 2.5	125	03.95 → 04.99	M 52 B 25 (Vanos)	10-ECO012
325 i	141	03.92 → 04.99	M 50 B 25 M 50 B 25 (Vanos) M 50 B 25 TU	10-ECO012
328 i	142	01.95 → 04.99	M 52 B 28 M 52 B 28 TU	10-ECO012
M3 3.0	210	10.92 → 01.95	S 50 B 30	10-ECO083
M3 3.0	217	01.95 → 10.95	S 50 B 30	10-ECO083
M3 3.2	236	10.95 → 04.99	S 50 B 32	10-ECO083

Serie 3 Coupe (E46)

316 Ci	77	04.00	M 43 B 16 (16 4 E3)	10-ECO004
316 Ci	85	06.02	N45B16A	10-ECO079
318 Ci	105	09.01	N 42 B 20 N 46 B 20	10-ECO079
318 Ci	110	03.05	N46B20A	10-ECO079
318 Ci	87	11.99 → 09.01	M 43 B 19	10-ECO004
320 Cd	110	11.03	M47N204D4	10-ECO109
320 Ci	110	08.99 → 09.00	M 52 B (20 6 S4) M 52 B 20	10-ECO012
320 Ci	125	09.00	M 54 B 22 M54226S1	10-ECO012
323 Ci	125	04.99 → 09.00	M 52 B 25 (Vanos)	10-ECO012
325 Ci	141	09.00	M54256S5	10-ECO012
328 Ci	142	04.99 → 06.00	M 52 B 28	10-ECO012
330 Cd	150	03.03	M57N306D2	10-ECO111
330 Ci	170	06.00	M54306S3	10-ECO012
330 xi	170	06.00	M54306S3	10-ECO012
M3 3.2	252	06.00	S54326S4 S 54 B 32	10-ECO083
M3 CSL	265	06.03	S54N326S4 S 54 B 32	10-ECO083

Serie 3 Coupé (E92)

320d	130	03.07	N47D20A	10-ECO100
------	-----	-------	---------	-----------

NEW CODES - NEUE CODES - NOUVEAUX CODES - NUEVOS CODIGOS - NUOVI CODICI

	KW						
				OIL FILTER FILTRO OLIO	AIR FILTER FILTRO ARIA	FUEL FILTER FILTRO CARBURANTE	CABIN FILTER FILTRO ABITACOLO

Serie 3 Coupé (E92)

320d xDrive	130	09.08	N47 D20 C	10-ECO100
320i	125	03.07	N43B20A	10-ECO079
320xd	130	03.07	N47D20A	10-ECO100
323i	130	06.06	N52NB25A	10-ECO062
325d	145	03.07	M57 TU2 D30 N57N306D3	10-ECO111
325d	150	04.10	M57N2 306 D3 N57 D30 A	10-ECO101
325i	160	09.06	N52B25C N52B25A N 52 B 25	10-ECO062
325i	160	09.07	N53B30A N 53 B 30	10-ECO062
325i xDrive	160	09.08	N53B30A	10-ECO062
325xi	160	09.06	N52B25C N52B25A	10-ECO062
325xi	160	09.07	N53B30A	10-ECO062
330d	170	09.06	M57306D3 M57 TU2 D30	10-ECO111
330d	180	01.09	M57N2 306 D3 N57 D30 A	10-ECO101
330d xDrive	180	01.09	N57 D30 A	10-ECO101
330i	190	09.06	N52B30A	10-ECO062
330i	200	09.06	N52B30A N53B30A N 53 B 30	10-ECO062
330i xDrive	200	09.08	N53B30A	10-ECO062
330xd	170	09.06	M57306D3 M57 TU2 D30	10-ECO111
330xd	180	01.09	M57N2 306 D3 N57 D30 A	10-ECO101
330xi	190	09.06	N52B30A	10-ECO062
330xi	200	09.06	N52B30A	10-ECO062
335d	210	09.06	M57N306D5	10-ECO111
335i	225	09.06	N54B30A	10-ECO062
335i xDrive	225	09.08	N54B30A	10-ECO062
335xi	225	09.06	N54B30A	10-ECO062
M3	309	03.07	S65B40	10-ECO112

Serie 5 (E12)

525	107	08.73 → 10.76	M 30 B 25 (32/40 INAT)	10-ECO091
525	110	08.76 → 05.81	M 30 B 25 (32/40 INAT)	10-ECO091
528	121	01.75 → 08.77	M 30 B 28 (32/40 INAT)	10-ECO091
528	125	01.75 → 08.77	M 30 B 28 (32/40 INAT)	10-ECO091
528 i	130	04.77 → 05.81	M 30 B 28 (32/40 INAT)	10-ECO091
528 i	135	04.77 → 05.81	M 30 B 28 (32/40 INAT)	10-ECO091
M 535 i	160	06.80 → 08.81	M 30 B 35 (Motronic, 9.3:1)	10-ECO091

Serie 5 (E28)

524 d	63	03.86 → 12.87	M 21 D 24 W	10-ECO113
-------	----	---------------	-------------	-----------

NEW CODES - NEUE CODES - NOUVEAUX CODES - NUEVOS CODIGOS - NUOVI CODICI

	KW			 OIL FILTER FILTRO OLIO	 AIR FILTER FILTRO ARIA	 FUEL FILTER FILTRO CARBURANTE	 CABIN FILTER FILTRO ABITACOLO
---	----	---	---	--	--	---	---

Serie 5 (E28)

524 td	85	09.83 → 12.87	M 21 D 24 WA M 21 D 24 (Kat.)	10-ECO113
525 i	110	06.81 → 12.87		10-ECO091
528 i	135	06.81 → 12.87	M 30 B 28 (32/40 INAT)	10-ECO091
535 i, M 535 i	136	01.85 → 12.87	M 30 B 35	10-ECO091
535 i, M 535 i	141	01.85 → 12.87	M 30 B 35 (Motronic)	10-ECO091
535 i, M 535 i	160	01.85 → 12.87	M 30 B 35	10-ECO091
M5 3.5	211	08.85 → 12.87	S 38 B 35	10-ECO091

Serie 5 (E34)

518 i	83	08.89 → 09.95	M 40 B 18	10-ECO004 10-ECO080 →08.95
518 i	85	08.89 → 09.95	M 43 B 18	10-ECO004 10-ECO080 →08.95
520 i 24V	110	09.89 → 09.95	M 50 B (20 6 S1) M 50 B (20 6 S2) Vanos M 50 B 20 M 50 B 20 TU	10-ECO012
525 i 24V	141	09.89 → 09.95	M 50 B 25 M 52 B 25 (Vanos) M 50 B 25 TU	10-ECO012
525 i X 24V	141	10.91 → 09.95	M 52 B 25 (Vanos)	10-ECO012
525 td	85	04.93 → 09.95	M 51 D 25	10-ECO011
525 tds	105	09.91 → 09.95	M 51 D 25 (Inter.)	10-ECO011
530 i	138	01.88 → 08.91	M 30 B 30	10-ECO091
530 i V8	160	09.92 → 09.95	M 60 B 30	10-ECO090
535 i	155	01.88 → 09.95	M 30 B 35	10-ECO091
540 i V8	210	09.92 → 09.95	M 60 B 40	10-ECO090
M5 3.6	232	10.88 → 05.92	S 38 B 36	10-ECO091
M5 3.6 Cat.	232	10.88 → 05.92	S 38 B 36 (Kat)	10-ECO091
M5 3.8	250	03.92 → 09.95	S 38 B 38	10-ECO091

Serie 5 (E39)/ Serie 5 Touring

520 d	100	02.00 → 06.03	M 47 D 20 M47204D1	10-ECO021
520 i	100	04.99 → 06.03	M 52 B (20 6 S3) Vanos	10-ECO012
520 i	110	01.96 → 09.00	M 52 B (20 6 S3) Vanos M 52 B (20 6 S4) M 52 B 20	10-ECO012
520 i	125	09.00 → 06.03	M 54 B 22	10-ECO012
523 i	125	11.95 → 09.00	M 52 B 25 (Vanos) M 52 B 25 TU	10-ECO012
525 d	120	02.00 → 06.03	M57256D1 M 57 D 25	10-ECO035
525 i	141	09.00 → 06.03	M54256S5 M 54 B 25	10-ECO012
525 td	85	01.97 → 06.03	M 51 D 25	10-ECO011

NEW CODES - NEUE CODES - NOUVEAUX CODES - NUEVOS CODIGOS - NUOVI CODICI



	KW						
				OIL FILTER FILTRO OLIO	AIR FILTER FILTRO ARIA	FUEL FILTER FILTRO CARBURANTE	CABIN FILTER FILTRO ABITACOLO

Serie 5 (E39)/ Serie 5 Touring

525 tds	105	01.96 → 06.03	M 51 D 25 (Inter.)	10-ECO011
528 i	142	11.95 → 09.00	M 52 B 28 M 52 B 28 TU	10-ECO012
530 d	135	08.98 → 09.00	M 57 D 30	10-ECO035
530 d	142	09.00 → 06.03	M 57 D 30	10-ECO035
530 i	170	09.00 → 06.03	M54306S3 M 54 B 30	10-ECO012
535 i	173	04.96 → 03.99	M 62 B (35 8 S1) M 62 B 35	10-ECO014
535 i	180	04.99 → 06.03	M 62 B (35 8 S2) M 62 B 35 TU	10-ECO014
540 i	210	04.96 → 06.03	M 62 B 44 M62448S2 M 62 B 44 TU	10-ECO014
M5	294	10.98 → 06.03	S 38 B 49 S 62 B 50	10-ECO014

Serie 5 (E60)/ Serie 5 Touring

520d	110	09.05	M47N204D4	10-ECO109
520d	120	07.05	M47N204D5 N47D20A	10-ECO109
520d	130	09.07	M47N204D4 N47D20A N47 D20 C	10-ECO100
520i	125	07.03	M 54 B 22 M54226S1	10-ECO012
520i	125	09.07	N43B20A	10-ECO079
523i	130	07.05	N52B25A N 52 B 25	10-ECO062
523i	140	01.07	N52B25A	10-ECO062
525d	120	12.04	M57256D1	10-ECO111
525d	130	06.04	M57N256D4 M 57 D 25 TU	10-ECO111
525d	145	01.07	M57306D3	10-ECO111
525d xDrive	145	09.08	N57306D3	10-ECO111
525i	141	09.03	M54256S5 M 54 B 25	10-ECO012
525i	160	01.07	N53B30A N 53 B 30	10-ECO062
525i	160	07.05	N52B25A N 52 B 25	10-ECO062
525i xDrive	160	09.08	N53B30A	10-ECO062
525xd	145	01.07	M57306D3	10-ECO111
525xi	160	01.07	N53B30A	10-ECO062
525xi	160	07.05	N52B25A	10-ECO062
530d	160	07.03	N57306D2	10-ECO111
530d	170	07.03	M57306D3	10-ECO111
530d	173	01.07	M57306D3	10-ECO111
530d xDrive	173	09.08	M57N2 306 D3	10-ECO111
530i	170	07.03	M54306S3 M 54 B 30	10-ECO012
530i	190	07.05	N52B30A N 52 B 30	10-ECO062
530i	200	01.07	N52B30A N53B30A N 53 B 30	10-ECO062
530i xDrive	200	09.08	N53B30A	10-ECO062

NEW CODES - NEUE CODES - NOUVEAUX CODES - NUEVOS CODIGOS - NUOVI CODICI

	KW			 OIL FILTER FILTRO OLIO	 AIR FILTER FILTRO ARIA	 FUEL FILTER FILTRO CARBURANTE	 CABIN FILTER FILTRO ABITACOLO
---	----	---	---	--	--	---	---

Serie 5 (E60)/ Serie 5 Touring

530xd	170	07.05	M57306D3	10-ECO111
530xd	173	01.07	M57306D3	10-ECO111
530xi	190	07.05	N52B30A	10-ECO062
530xi	200	01.07	N52B30A N53B30A	10-ECO062
535d	200	09.04	M57306D4	10-ECO111
535d	210	01.07	M57N306D5	10-ECO111
540i	225	07.05	N62B40A	10-ECO081
545i	245	09.03	N 62 B 44	10-ECO042
550i	270	07.05	N62B48B	10-ECO081
M5	373	09.04	S85B50A	10-ECO082

Serie 5 (F10)

523i	150	03.10	N53B30A	10-ECO062
525d	150	03.10	N57 D30 A	10-ECO101
528i	190	03.10	N52B30A N53B30A	10-ECO062
530d	180	03.10	N57 D30 A	10-ECO101
535d	220	09.10	N57S D30 B	10-ECO101
535i	225	03.10	N55 B30 A	10-ECO062

Serie 5 GRAN TURISMO

530d	180	10.09	N57 D30 A	10-ECO101
530d xDrive	180	09.10	N57 D30 A	10-ECO101
535d	220	09.10	N57S D30 B	10-ECO101
535d xDrive	220	09.10	N57S D30 B	10-ECO101
535i	225	10.09	N55 B30 A	10-ECO062
535i xDrive	225	09.10	N55 B30 A	10-ECO062

Serie 5 Touring (E34)

518 g	85	11.95 → 06.96	M 43 B 18	10-ECO004
518 i	83	03.93 → 09.94	M 40 B 18	10-ECO080
518 i	85	09.94 → 01.97	M 43 B 18	10-ECO004 10-ECO080 →08.95
520 i	110	11.91 → 01.97	M 50 B (20 6 S1) M 50 B (20 6 S2) Vanos M 50 B 20 M 50 B 20 TU	10-ECO012
525 i	141	11.91 → 01.97	M 50 B 25 M 50 B 25 TU	10-ECO012
525 i X	141	02.92 → 01.97	M 50 B 25 M 52 B 25 (Vanos)	10-ECO012
525 td	85	03.93 → 01.97	M 51 D 25	10-ECO011
525 tds	105	12.91 → 01.97	M 51 D 25 (Inter.)	10-ECO011
530 i V8	160	09.92 → 01.97	M 60 B 30	10-ECO014
540 i	210	09.93 → 01.97	M 60 B 40	10-ECO014
M5 3.8	250	09.94 → 01.97	S 38 B 38	10-ECO091

Serie 6 (E24)

NEW CODES - NEUE CODES - NOUVEAUX CODES - NUEVOS CODIGOS - NUOVI CODICI

	KW						
				OIL FILTER FILTRO OLIO	AIR FILTER FILTRO ARIA	FUEL FILTER FILTRO CARBURANTE	CABIN FILTER FILTRO ABITACOLO

Serie 6 (E24)

3.5	191	03.83 → 10.89		10-ECO091
628 CSi	135	09.79 → 08.87	M 30 B 28 (32/40 INAT)	10-ECO091
630 CS	135	04.76 → 08.79	M 30 B 30	10-ECO091
630 CS	136	04.76 → 08.79	M 30 B 30	10-ECO091
633 CSi	145	09.78 → 08.84	M 30 B 32	10-ECO091
633 CSi	147	04.76 → 09.78		10-ECO091
635 CSi	136	01.85 → 05.89	M 30 B 35 (Motronic, 8:1, Kat .)	10-ECO091
635 CSi	141	04.85 → 09.90	M 30 B 35	10-ECO091
635 CSi	155	08.87 → 05.89	M 30 B 35	10-ECO091
635 CSi	160	06.78 → 08.88	M 30 B 35 (Motronic, 9.3:1) M 30 B 35 (L-Jetronic, 10:1) M 30 B 35 (Motronic, 10:1)	10-ECO091
M 635 CSi	191	10.86 → 10.88	S 38 B 35 (Kat)	10-ECO091
M 635 CSi	211	03.84 → 05.89	S 38 B 35	10-ECO091

Serie 6 (E63)

630i	190	09.04	N52B30A N 52 B 30	10-ECO062
635d	210	07.07	N57N306D5	10-ECO111
645Ci	245	01.04	N 62 B 44 N62B44A	10-ECO042
650i	270	07.05	N62B48B	10-ECO081
M6	373	09.05	S85B50A	10-ECO082

Serie 6 Cabriolet (E64)

630i	190	09.04	N52B30A N 52 B 30	10-ECO062
630i	200	07.07	N52B30A N 53 B 30	10-ECO062
635d	210	07.07	M57N306D5	10-ECO111
645Ci	245	04.04	N 62 B 44 N62B44A	10-ECO042
650i	270	07.05	N62B48B	10-ECO081
M6	373	07.06	S85B50A	10-ECO082

Serie 7 (E23)

3.4	160	06.82 → 06.86		10-ECO091
728	125	05.77 → 08.79	M 30 B 28 (32/40 INAT)	10-ECO091
728 i	135	07.78 → 08.86	M 30 B 28 (32/40 INAT)	10-ECO091
730	135	05.77 → 08.79	M 30 B 30	10-ECO091
732 i	145	09.79 → 08.86		10-ECO091
732 i/733 i	145	05.77 → 08.86	M 30 B 32	10-ECO091
735 i	136	01.85 → 08.86	M 30 B 35 (Motronic, 8:1, Kat .)	10-ECO091
735 i	160	09.79 → 08.86	M 30 B 35 (Motronic, 9.3:1) M 30 B 35 (Motronic, 10:1)	10-ECO091

NEW CODES - NEUE CODES - NOUVEAUX CODES - NUEVOS CODIGOS - NUOVI CODICI

	KW			 OIL FILTER FILTRO OLIO	 AIR FILTER FILTRO ARIA	 FUEL FILTER FILTRO CARBURANTE	 CABIN FILTER FILTRO ABITACOLO
---	----	---	---	--	--	---	---

Serie 7 (E23)

745 i	185	04.80 → 04.83	M 30 B 32 (Turbo,7.5:1)	10-ECO091
745 i	185	05.83 → 08.86	M 30 B 35	10-ECO091

Serie 7 (E32)

730 i,iL	138	12.86 → 09.94	M 30 B 30	10-ECO091
730 i,iL	145	12.86 → 09.94	M 30 B 30	10-ECO091
730 i,iL V8	160	04.92 → 09.94	M 60 B 30	10-ECO014
735 i,iL	155	09.86 → 09.92	M 30 B 35	10-ECO091
735 i,iL	162	09.86 → 12.87	M 30 B 35 (Motronic,9.2:1)	10-ECO091
740 i,iL V8	210	04.92 → 09.94	M 60 B 40	10-ECO014
750 i,iL V12	220	09.87 → 09.94	M 70 B 50	10-ECO090

Serie 7 (E38)

725 tds	105	04.96 → 11.01	M 51 D 25 (Inter.)	10-ECO011
728 i,iL	142	08.95 → 11.01	M 52 B 28 M 52 B 28 TU	10-ECO012
730 d	135	08.98 → 04.00	M 57 D 30	10-ECO035
730 d	142	04.00 → 11.01	M57306D1	10-ECO035
730 i,iL	155	10.94 → 11.01	M 60 B 30	10-ECO014
730 i,iL	160	10.94 → 11.01	M 60 B 30	10-ECO014
735 i,iL	173	01.96 → 11.01	M 62 B (35 8 S1) M 62 B 35	10-ECO014
740 d	180	05.99 → 11.01	M 67 D 39	10-ECO012
740 i,iL	210	01.96 → 11.01	M 62 B 44 M62448S2 M 62 B 44 TU	10-ECO014
740 i,iL	210	10.94 → 11.01	M 60 B 40	10-ECO014
750 i,iL	240	12.94 → 11.01	M 73 B 54	10-ECO014

Serie 7 (E65, E66)

730 d	160	10.02	M57N2306D2	10-ECO111
730 i,Li	170	03.03	M54306S3 M 54 B 30	10-ECO062
730 i,Li	190	03.05	N52B30A N 52 B 30	10-ECO062
730 Ld	170	07.05	M57306D3 N57N306D2	10-ECO111
735 i,Li	200	11.01	N 62 B 36	10-ECO042
735i	225	03.05	N62B40A	10-ECO081
740 d	190	10.02	N67398D1	10-ECO012
740 i,Li	225	07.05	N62B40A	10-ECO081
745 d	220	03.05 → 08.05	N67N448D1	10-ECO109
745 d	242	07.05	N67N448D2	10-ECO109
745 i,Li	245	11.01	N 62 B 44 N62B44A	10-ECO042
750 i,Li	270	07.05	N62B48B	10-ECO081
760 i,Li	327	01.03	N 73 B 60	10-ECO081

Serie 7 (F01, F02)

730d	180	10.08	N57 D30 A	10-ECO101
740d	225	09.09	N57S D30 B	10-ECO101

NEW CODES - NEUE CODES - NOUVEAUX CODES - NUEVOS CODIGOS - NUOVI CODICI

	KW						
				OIL FILTER FILTRO OLIO	AIR FILTER FILTRO ARIA	FUEL FILTER FILTRO CARBURANTE	CABIN FILTER FILTRO ABITACOLO

Serie 7 (F01, F02)

740d xDrive	225	09.09	N57S D30 B	10-ECO101
-------------	-----	-------	------------	-----------

Serie 8 (E31)

840 Ci	210	01.96 → 12.99	M 62 B 44 M 62 B 44 TU	10-ECO014
840 i	210	02.93 → 02.96	M 60 B 40	10-ECO014
850 Ci	240	09.94 → 12.99	M 73 B 54	10-ECO014
850 CSi	280	04.93 → 12.96	M 70 B 56	10-ECO014
850 i,Ci	220	04.90 → 10.94	M 70 B 50	10-ECO090

X1

sDrive18d	100	03.09	N47 D20 C	10-ECO100
sDrive18d	105	10.09	N47 D20 C	10-ECO100
sDrive18i	110	01.10	N46B20B	10-ECO079
sDrive20d	120	03.10	N47 D20 C	10-ECO100
sDrive20d	130	10.09	N47 D20 C	10-ECO100
xDrive18d	100	03.09	N47 D20 C	10-ECO100
xDrive18d	105	10.09	N47 D20 C	10-ECO100
xDrive20d	120	03.10	N47 D20 C	10-ECO100
xDrive20d	130	10.09	N47 D20 C	10-ECO100
xDrive23d	150	10.09	N47S D20 D	10-ECO100
xDrive25i	160	01.10	N52B30A	10-ECO062
xDrive28i	190	10.09	N52B30A	10-ECO062

X3

2.0 d	110	10.04	M47N204D4	10-ECO109
2.0 d	130	09.07	N47D20A	10-ECO100
2.0 i	110	07.05	N46B20A N 46 B 20	10-ECO079
2.5 i	141	01.04	M54256S5 M 54 B 25	10-ECO012
2.5 si	160	09.06	N52B25A	10-ECO062
3.0 d	150	01.04	M54N306D2	10-ECO111
3.0 d	160	01.04	M57N2306D2	10-ECO111
3.0 i	170	01.04	M54306S3 M 54 B 30	10-ECO012
3.0 sd	210	09.06	M57 306 D5	10-ECO111
3.0 si	200	09.06	N52B30A	10-ECO062
xDrive18d	105	09.08	M47N204D4	10-ECO100
xDrive20d	130	09.08	N47 D20 C	10-ECO100
xDrive20i	110	09.08	N46B20B	10-ECO079
xDrive25i	160	09.08	N52B25A	10-ECO062
xDrive30d	160	09.08	M57N2 306 D3	10-ECO111
xDrive30i	200	09.08	N52B30A	10-ECO062
xDrive35d	210	09.08	N57N306D5	10-ECO111

X3 (F25)

xDrive 35i	225	09.10	N55 B30 A	10-ECO062
------------	-----	-------	-----------	-----------

X5

3.0 d	135	05.01	M57306D1	10-ECO035
-------	-----	-------	----------	-----------

NEW CODES - NEUE CODES - NOUVEAUX CODES - NUEVOS CODIGOS - NUOVI CODICI

	KW						
				OIL FILTER FILTRO OLIO	AIR FILTER FILTRO ARIA	FUEL FILTER FILTRO CARBURANTE	CABIN FILTER FILTRO ABITACOLO

X5

3.0 d	160	12.03	M57N306D4	10-ECO111
3.0 d 4 ruote motrici	155	08.04		10-ECO111
3.0 i	163	05.00	M54306S3	10-ECO012
3.0 i	170	05.00	M54306S3 M 54 B 30	10-ECO012
4.4 i	210	05.00	M 62 B 44 M 62 B 44 TU	10-ECO014
4.4 i	235	12.03	N 62 B 44 N62B44A	10-ECO042
4.6 is	255	02.02	M67468S1 M 62 B 46	10-ECO014
4.8 is	265	04.04	N62B48A	10-ECO042

X5 (E70)

3.0 d	173	02.07	M57306D3	10-ECO111
3.0 d 4 ruote motrici	155	02.07	M57N2 306 D3	10-ECO111
3.0 sd	210	09.07	M57N306D5	10-ECO111
3.0 si	200	02.07	N52B30A N 52 B 30	10-ECO062
4.8 i	261	02.07	N62B48B	10-ECO081
xDrive30d	173	09.08	N57 D30 A	10-ECO111
xDrive30d	180	09.10	N57 D30 A	10-ECO101
xDrive30i	200	09.08	N52B30A	10-ECO062
xDrive35d	210	09.08	M57N306D5	10-ECO111
xDrive35i	225	09.10	N55 B30 A	10-ECO062
xDrive40d	225	09.10	N57S D30 B	10-ECO101
xDrive48i	261	09.08	N62B48B	10-ECO081

X6







30d	173	05.08	M57N2 306 D3	10-ECO111
35d	210	05.08	N57N306D5	10-ECO111
35i	225	05.08	N54B30A	10-ECO062
xDrive30d	173	09.08	N57 D30 A	10-ECO111
xDrive30d	180	09.10	M57N2 306 D3 N57 D30 A	10-ECO101
xDrive35d	210	09.08	N57N306D5	10-ECO111
xDrive35i	225	09.08	N54B30A	10-ECO062
xDrive40d	225	10.10	N57S D30 B	10-ECO101

Z3/ Z3 Coupé

1.8	85	10.95 → 10.98	M 43 B 18	10-ECO004
1.9	103	10.95 → 03.99	M 44 B 19	10-ECO004
1.9	85	01.99 → 01.03	M43194E1	10-ECO004
1.9	87	07.98 → 01.03	M 43 B 19 M43194E1 M 43 B 19 TU	10-ECO004
2.0	110	04.99 → 01.03	M 52 B (20 6 S4) M 52 B 20	10-ECO012
2.2	125	08.00 → 01.03	M 54 B 22 M54226S1	10-ECO012
2.8	141	04.97 → 06.00	M 52 B 28 M 52 B 28 TU	10-ECO012
3.0	170	06.00 → 01.03	M54306S3 M 54 B 30	10-ECO012







NEW CODES - NEUE CODES - NOUVEAUX CODES - NUEVOS CODIGOS - NUOVI CODICI



	KW						
				OIL FILTER FILTRO OLIO	AIR FILTER FILTRO ARIA	FUEL FILTER FILTRO CARBURANTE	CABIN FILTER FILTRO ABITACOLO
Z3/ Z3 Coupé							
M 3.2	236	03.97 → 06.01	S 50 B 32	10-ECO083			
M 3.2	239	06.01 → 01.03	S 54 B 32 (32 6 S4) S 54 B 32	10-ECO083			
Z4 (E89)							
sDrive23i	150	05.09	N52B25A	10-ECO062			
sDrive30i	190	05.09	N52B30A	10-ECO062			
sDrive35i	225	05.09	N54B30A	10-ECO062			
sDrive35is	250	09.10	N54B30A	10-ECO062			
Z4/ Z4 Coupé							
2.0 i	110	04.05	N46B20A N 46 B 20	10-ECO079			
2.2 i	125	10.03	M 54 B 22 M54226S 1	10-ECO012			
2.5 i	130	01.06	N52B25A	10-ECO062			
2.5 i	141	02.03	M54256S5 M 54 B 25	10-ECO012			
2.5 si	160	01.06	N52B25A	10-ECO062			
3.0 i	170	02.03	M54306S3 M 54 B 30	10-ECO012			
3.0 si	195	01.06	N52B30A N 52 B 30	10-ECO062			
3.2 M	252	03.06	S54326S4 S 54 B 32	10-ECO083			
Z8							
4.9	294	06.00 → 06.03	S 38 B 49 S 62 B 50	10-ECO014			

CADILLAC



	KW						
				OIL FILTER FILTRO OLIO	AIR FILTER FILTRO ARIA	FUEL FILTER FILTRO CARBURANTE	CABIN FILTER FILTRO ABITACOLO
BLS							
1.9 D	110	04.06	Z19DTH	10-ECO058	20-00-019	30-00-011	21-CD-CD0
1.9 D	132	12.07	Z 19 DTR	10-ECO058	20-00-019	30-00-011	21-CD-CD0
2.0 T	129	04.06	B207L	10-ECO019	20-00-019	30-W0-001	21-CD-CD0
2.0 T	154	04.06	B207R	10-ECO019	20-00-019	30-W0-001	21-CD-CD0
2.8 T	188	04.06	B284L	10-ECO117	20-00-019	30-W0-001	21-CD-CD0
BLS Wagon							
2.8 T	188	12.07					
CTS							
2.8	155	01.08	LP1	10-ECO070			21-CD-CD1
2.8	158	03.05	LP1	10-ECO070	20-00-021	30-00-016	21-CD-CD1
3.6	189	03.05	LY7	10-ECO070	20-00-021	30-00-016	21-CD-CD1
3.6	229	01.08	LLT	10-ECO070			21-CD-CD1
3.6 AWD	229	01.08	LLT	10-ECO070			21-CD-CD1
ESCALADE							
6.2 4x4	301	10.06	L92 L94	10-00-014			21-CD-CD1
SEVILLE							
4.6 SLS V8	205	09.97	LH2	10-00-013	20-00-027		
4.6 STS V8	224	09.97	LH2	10-00-013	20-00-027		
SRX							
3.6	190	07.04	LY7	10-ECO019	20-00-029	30-00-016	21-CD-CD1
4.6	239	07.04	LH2	10-00-013	20-00-029	30-00-016	21-CD-CD1
4.6 Trazione posteriore	240	01.04	LH2		20-00-029		
XLR							
4.6	240	03.04	LH2	10-00-013	20-00-027		21-HY-H09

NEW CODES - NEUE CODES - NOUVEAUX CODES - NUEVOS CODIGOS - NUOVI CODICI



CHEVROLET

	KW						
				OIL FILTER FILTRO OLIO	AIR FILTER FILTRO ARIA	FUEL FILTER FILTRO CARBURANTE	CABIN FILTER FILTRO ABITACOLO
AVEO							
1.2	53	03.06	F12S3	10-W0-001	20-W0-005	30-W0-001	21-DW-W11
1.2	62	04.08	B12D1	10-W0-W02	20-W0-005	30-W0-001	21-DW-W11
1.4	69	03.06	F14D3	10-03-398	20-W0-005	30-W0-001	21-DW-W11
1.4	74	01.08	F14D4	10-ECO073	20-W0-005	30-W0-001	21-DW-W11
BERETTA							
2.2	71	01.91	LN2	10-03-398		30-03-393	
2.3 16V	130	09.90	LGO	10-03-398			
BLAZER '94							
4.3 V6 4 ruote motrici	142	01.94	L35	10-00-098		30-03-393	
BLAZER S '82							
2.8 4WD	93	09.82 → 12.89	LR2	10-00-098	20-01-123		
4.3	115	09.88 → 08.94	LB4	10-00-098			
CAMARO '98/ Cabriolet							
3.8 V6	142	07.98	L36	10-03-398			
CAPRICE '83							
5.7	120	01.83 → 01.90				30-03-393	
CAPTIVA							
2.0 D	110	09.07	Z 20 S	10-ECO059	20-0W-W08	30-ECO016	21-DW-W12
2.0 D 4WD	110	10.06	Z 20 S	10-ECO059	20-0W-W08	30-ECO016	21-DW-W12
2.2 D	120	12.10			20-0W-W08		21-DW-W18
2.2 D	135	12.10			20-0W-W08		21-DW-W18
2.4	100	06.06	Z 24 SED	10-03-398	20-0W-W08	30-W0-001	21-DW-W12
2.4 4WD	100	06.06	Z 24 SED	10-03-398	20-0W-W08	30-W0-001	21-DW-W12
3.2 4WD	169	06.06	10 HM		20-0W-W08	30-W0-001	21-DW-W12
CORSICA							
2.2	82	01.94 → 12.96	LN2	10-03-398			
3.1 V6	104	04.87 → 12.96	LHO	10-03-398			
CORVETTE (C06)/ Cabriolet							
6.0	298	09.04	LS2	10-00-014	20-00-027		21-HY-H09
CRUZE							
2.0 CDI	90	05.09		10-ECO059	20-0W-W12	30-ECO020	21-DW-W15
CRUZE (J3000)							
1.6	83	05.09	F16D4	10-ECO073	20-0W-W11	30-ECO020	21-DW-W15
2.0 CDI	110	05.09	Z 20 S1	10-ECO059	20-0W-W12	30-ECO020	21-DW-W15
EPICA							
2.0	105	06.06	X 20 D1	10-H0-002	20-03-332	30-W0-001	21-DW-W2
2.0	98	01.05 → 12.06	T20SED	10-ECO059	20-0W-W10	30-ECO016	21-DW-W2
2.0 D	110	01.07	Z 20 S	10-ECO059	20-0W-W10	30-ECO016	21-DW-W2
2.5	115	06.06	X 25 D1	10-H0-002	20-03-332	30-W0-001	21-DW-W2
EVANDA							
2.0	96	03.05	X20SED	10-03-398	20-03-332	30-W0-001	21-DW-W2

NEW CODES - NEUE CODES - NOUVEAUX CODES - NUEVOS CODIGOS - NUOVI CODICI

Per nuove applicazioni e novità si prega di accedere al sito www.ashika.eu - For new applications and new items, please go to www.ashika.eu

CHEVROLET









	KW						
				OIL FILTER FILTRO OLIO	AIR FILTER FILTRO ARIA	FUEL FILTER FILTRO CARBURANTE	CABIN FILTER FILTRO ABITACOLO
HHR							
2.4	125	10.07		10-ECO019			21-DW-W17
KALOS							
1.2	53	03.05	B12S1	10-W0-001	20-W0-005	30-W0-001	21-DW-W11
1.4	61	03.05	F14S3	10-03-398	20-W0-005	30-W0-001	21-DW-W11
1.4 16V	69	03.05	F14D3	10-03-398	20-W0-005	30-W0-001	21-DW-W11
KALOS Tre volumi							
1.4 16V	69	03.05	F14D3	10-03-398	20-W0-005	30-W0-001	21-DW-W11
LACETTI							
1.4 16V	70	03.05	F14D3	10-03-398	20-03-331	30-W0-001	21-DW-W10
1.6	80	03.05	F16D3	10-03-398	20-03-331	30-W0-001	21-DW-W10
1.8	89	08.05	F18D3	10-03-398	20-03-331	30-W0-001	21-DW-W10
1.8	90	03.05	T18SED	10-03-398	20-03-331	30-W0-001	21-DW-W10
2.0 D	89	01.07	Z 20 DM	10-ECO059	20-0W-W09	30-ECO016	21-DW-W10
MATIZ							
0.8	38	03.05	F8CV	10-W0-001	20-0W-W07	30-W0-001	21-DW-W14
1.0	47	03.05	B10S	10-06-601	20-0W-W07	30-03-393	21-DW-W14
1.0	49	03.05	B10S1	10-06-601	20-0W-W07	30-03-393	21-DW-W14
NUBIRA Station wagon/ Tre volumi							
1.6	80	03.05	F16D3	10-03-398	20-03-331	30-W0-001	21-DW-W13
1.8	89	08.05	F18D3	10-03-398	20-03-331	30-W0-001	21-DW-W13
1.8	90	03.05	T18SED	10-03-398	20-03-331	30-W0-001	21-DW-W13
2.0 D	89	01.07	Z 20 DM Z 20 S	10-ECO059	20-03-331 20-0W-W09	30-W0-001	21-DW-W13
ORLANDO							
1.8	104	12.10	F18D4	10-ECO073	20-0W-W11		21-DW-W15
2.0 D	120	12.10	Z 20 D1		20-0W-W12	30-ECO020	21-DW-W15
2.0 D	96	12.10			20-0W-W12	30-ECO020	21-DW-W15
REZZO							
1.6	77	03.05	A16DMS	10-03-398	20-W0-004	30-W0-001	21-DW-W3
1.6	79	08.05	A16DMS	10-03-398	20-W0-004	30-W0-001	21-DW-W3
2.0	89	03.05	T20SED	10-03-398	20-W0-004	30-W0-001	21-DW-W3
2.0	90	08.05	T20SED	10-03-398	20-W0-004	30-W0-001	21-DW-W3
SPARK							
1.0	50	02.10	B10D1	10-W0-W02	20-0W-W13	30-W0-001	21-DW-W16
1.2	60	02.10	B12D1	10-W0-W02	20-0W-W13	30-W0-001	21-DW-W16
TAHOE							
5.3 V8	201	12.99	LM7			30-03-393	
VOLT							
EV 150	111	11.11		10-03-398			21-DW-W15

NEW CODES - NEUE CODES - NOUVEAUX CODES - NUEVOS CODIGOS - NUOVI CODICI



	KW						
				OIL FILTER FILTRO OLIO	AIR FILTER FILTRO ARIA	FUEL FILTER FILTRO CARBURANTE	CABIN FILTER FILTRO ABITACOLO
300 C/ Touring							
2.7	142	09.04	2.7FX EER	10-09-986	20-09-911		21-CH-CH4
3.0 CRD	160	09.05	M664	10-ECO053	20-09-910	30-M0-002	21-CH-CH4
3.0 V6 CRD	155	11.10	EXL	10-ECO053	20-09-910	30-M0-002	21-CH-CH4
3.5	183	09.04	3.5CSP	10-09-986	20-09-911		21-CH-CH4
5.7	250	09.04	EZD EZH EZB	10-09-986	20-09-911		21-CH-CH4
6.1 SRT8	317	06.05	ESF	10-09-986	20-09-911	30-M0-002	21-CH-CH4
300 M (LR)							
2.7 V6 24V	149	11.98 → 08.00	EER	10-09-986	20-00-015		
2.7 V6 24V	150	08.00 → 09.04	EER	10-09-986	20-00-015		
3.5 V6 24V	185	08.00 → 09.04	EGG	10-09-986	20-00-015		
3.5 V6 24V	187	07.98 → 08.00	EGG	10-09-986	20-00-015		
CROSSFIRE/ Roadster							
3.2	160	07.03	EGX	10-ECO006	20-09-914	30-09-913	21-CH-CH2
SRT-6	246	09.04	EGZ	10-ECO006	20-09-916	30-09-913	21-CH-CH2
LE BARON/ Cabriolet							
3.0 i V6	105	01.90 → 12.94	EFA	10-02-279 10-09-986 01.91→	20-09-987		
NEON (PL)							
1.8 16V	85	09.97 → 08.99	EBD	10-09-986	20-09-987		
2.0 16V	107	06.94 → 08.99	ECC	10-09-986	20-09-987		
2.0 16V	109	04.96 → 08.99	420T	10-09-986	20-09-987		
2.0 16V	98	05.94 → 08.99	420H	10-09-986	20-09-987		
NEON II							
1.6	85	11.01	EJD	10-00-007			
2.0 16V	98	08.99	420H	10-09-986	20-09-987		
2.0 16V R/T	110	10.01	ECH	10-02-279	20-09-987		
NEW YORKER							
3.5 i 24V	155	04.93 → 09.98	F01	10-09-986			
PT CRUISER							
1.6	85	11.01	EJD	10-00-007	20-00-007 →08.05 20-09-918 09.05→		21-CH-CH1
2.0	104	06.00	ECC	10-02-279	20-00-007 →08.05 20-09-918 09.05→		21-CH-CH1
2.2 CRD	110	08.05		10-00-008	20-09-912	30-00-007	21-CH-CH1
2.2 CRD	89	03.02	EDJ	10-00-008	20-00-008	30-00-007	21-CH-CH1
2.4	110	06.00	EDZ	10-09-913	20-00-007 →08.05 20-09-918 09.05→		21-CH-CH1

NEW CODES - NEUE CODES - NOUVEAUX CODES - NUEVOS CODIGOS - NUOVI CODICI

	KW						
				OIL FILTER FILTRO OLIO	AIR FILTER FILTRO ARIA	FUEL FILTER FILTRO CARBURANTE	CABIN FILTER FILTRO ABITACOLO
PT CRUISER							
GT 2.4	164	08.03	EDV	10-09-913	20-00-007 →08.05		21-CH-CH1
PT CRUISER Cabriolet							
2.4	105	03.04	EDZ	10-09-913	20-00-007 →08.05 20-09-918 09.05→		21-CH-CH1
2.4 GT	164	03.04	EDV	10-09-913	20-00-007 →08.05		21-CH-CH1
SARATOGA							
2.5	72	10.89→09.91	EDM	10-09-913			
SEBRING							
2.0 CRD	103	07.07	ECD	10-ECO023	20-09-974	30-00-001	21-CH-CH3
SEBRING (JR)/ Cabriolet (JR)							
2.0	104	04.01	ECC	10-02-279	20-00-009	30-02-224	
2.4	112	04.01	EDZ	10-02-279	20-00-009 →12.06 20-05-599 01.07→		
2.7 V6 24V	149	04.01	EES	10-09-986	20-00-009		21-CH-CH3
STRATUS (JA)/ Cabriolet (JX)							
2.0 16V	98	12.95	ECB	10-02-279	20-00-010	30-00-008	
2.0 LE	96	12.95→04.01	C00	10-02-279	20-00-010	30-00-008	
2.4 16 V	103	12.95→04.01	EDZ	10-02-279	20-00-010		
2.4 16V	112	12.95	EDZ	10-02-279	20-00-010		
2.5 LX V6	120	12.95→04.01	H00 EEB	10-09-986	20-00-010		
2.5 V6	125	12.95		10-09-986	20-00-010		
VIPER/ Convertible							
8.0	282	07.98	EPD	10-09-986			
8.0	290	08.92	EPA	10-09-986			
8.0	335	08.92	EPT	10-09-986			
VISION							
3.5 TSi	155	09.93	F00 F01	10-09-986			
VOYAGER I (ES)							
2.5 i	72	08.84→09.95	K00	10-02-279		30-00-010	21-CH-CH0
2.5 i	74	08.90→09.95	K	10-02-279			21-CH-CH0
2.5 TD	87	01.92→09.95	09B M00	10-00-097	20-09-999	30-09-997	21-CH-CH0
3.0 i	108	08.84→09.95	6G72 300	10-05-502 →06.91 10-05-510	20-05-510 06.91→ 20-05-516 →06.91	30-02-298 06.91→ 30-05-518 →06.91	21-CH-CH0
3.3 i	110	08.90→09.95	EGA	10-09-986		30-00-010	21-CH-CH0
3.3 i	120	08.90→09.95	EGA	10-09-986		30-00-010	21-CH-CH0
3.3 i AWD	110	08.90→09.95	EGA	10-09-986		30-00-010	21-CH-CH0



	KW						
				OIL FILTER FILTRO OLIO	AIR FILTER FILTRO ARIA	FUEL FILTER FILTRO CARBURANTE	CABIN FILTER FILTRO ABITACOLO
VOYAGER I (ES)							
3.3 i AWD	120	08.90 → 09.95	R00	10-09-986		30-00-010	21-CH-CH0
VOYAGER II (GS)							
2.0 i	98	01.95 → 03.01	C00	10-02-279	20-09-987	30-09-914	21-CH-CH0
2.4 i	111	01.95 → 03.01	B00	10-09-986	20-09-987	30-09-914	21-CH-CH0
2.5 TD	85	01.95 → 03.01	425 CLIRS/X	10-00-097 06.96→ →06.00	20-09-987	30-09-995	21-CH-CH0
3.0	112	01.95 → 03.01		10-09-986	20-09-987	30-09-914	21-CH-CH0
3.3 i	116	01.95 → 03.01	R00	10-09-986	20-09-987	30-09-914	
3.8 i AWD	122	01.95 → 03.01	L00	10-09-986	20-09-987	30-09-914	21-CH-CH0
3.8 i AWD	131	01.95 → 03.01	EGH	10-09-986	20-09-987	30-09-914	
VOYAGER III (RG)							
2.4	108	02.00	EDZ	10-02-279	20-09-974	30-09-914	21-CH-CH0
2.5 CRD	105	02.00	ENC	10-00-097 06.02→ 10-H0-004	20-09-974 06.02→	30-09-989 06.02→	21-CH-CH0 06.02→
2.8 CRD	110	06.04	ENR	10-00-097	20-09-974	30-09-911 01.05→ 30-09-989 06.04→ →12.04	21-CH-CH0
3.3	128	02.00	EGA	10-09-986	20-09-974	30-09-914	21-CH-CH0
3.8	160	02.00	EGH	10-09-986	20-09-974		21-CH-CH0
VOYAGER IV							
2.8 CRD	120	10.07		10-ECO072	20-09-974	30-K0-018	21-H0-H00

	KW						
				OIL FILTER FILTRO OLIO	AIR FILTER FILTRO ARIA	FUEL FILTER FILTRO CARBURANTE	CABIN FILTER FILTRO ABITACOLO

BERLINGO

1.6	66	04.08	NFR (TU5JP4B)	10-ECO060			
1.6	80	04.08	NFU (TU5JP4)	10-ECO060			
1.6 VTi 120	88	11.09	5FS (EP6C)	10-ECO060			
1.6 VTi 95	72	07.10	5FK (EP6 CB)	10-ECO060			

BERLINGO (MF)

1.1 i (MFHDZ)	44	07.96	HDZ (TU1M) HFX (TU1JP)	10-ECO037			
1.4	53	11.02 → 10.05		10-ECO037			
1.4	54	05.05		10-ECO037			
1.4 GNC	48	11.02		10-ECO037			
1.4 i (MFKFX)	55	07.96	KFX (TU3JP) KFW (TU3JP)	10-ECO037			
1.4 i bivalent	55	04.03	KFW (TU3JP)	10-ECO037			
1.6	81	11.02	NFU (TU5JP4)	10-ECO037			
1.6 16V (MFNFU)	80	10.00	NFU (TU5JP4)	10-ECO037			
1.9 D (MFWJZ)	51	07.98	WJZ (DW8) WJY (DW8B)			30-ECO004	
1.9 D 4WD (MFWJZ)	51	07.98	WJZ (DW8)			30-ECO004	
2.0 HDi	66	11.02 → 10.05	RHY (DW10TD) DW10TD			30-ECO008 30-ECO019	
2.0 HDi 90 (MFRHY)	66	12.99	RHY (DW10TD)			30-ECO008 30-ECO019	

BERLINGO Furgonato/Box

1.1 i (MAHDZ, MBHDZ)	44	07.96	HDZ (TU1M) HFX (TU1JP)	10-ECO037			
1.4 bivalent	48	11.02		10-ECO037			
1.4 i (MBKFX)	55	07.96	KFX (TU3JP) KFW (TU3JP)	10-ECO037			
1.4 i bivalent	55	04.03	KFW (TU3JP)	10-ECO037			
1.6	66	04.08	NFR (TU5JP4B)	10-ECO060			
1.6	80	04.08	NFU (TU5JP4)	10-ECO060			
1.6 16V	80	10.00	NFU (TU5JP4)	10-ECO037			
1.6 VTi 95	72	07.10	5FK (EP6 CB)	10-ECO060			
1.9 D 70 4WD	51	07.98	WJZ (DW8)			30-ECO004	
1.9 D 70 (MBWJZ, MCWJZ)	51	04.99	WJZ (DW8)			30-ECO004	
2.0 HDi 90 4WD	66	11.00	RHY (DW10TD)			30-ECO019	
2.0 HDi 90 (MBRHY, MCRHY)	66	12.99	RHY (DW10TD)			30-ECO019	

C-CROSSER

2.2 HDi	115	02.07	4HN (DW12MTED4)	10-ECO060	20-05-531	30-0L-L11	21-MI-MI7
---------	-----	-------	--------------------	-----------	-----------	-----------	-----------

C1

1.0	50	06.05	1KR-FE	10-02-210	20-02-288		21-TY-TY10
1.4 HDi	40	06.05	DV4D	10-03-351	20-03-351	30-03-351	21-TY-TY10

C15 (VD-_)

1.9 D	44	12.00 → 12.05				30-ECO004	
-------	----	---------------	--	--	--	-----------	--

C2

1.1	44	09.03	HFX (TU1JP)	10-ECO037			
-----	----	-------	-------------	-----------	--	--	--

NEW CODES - NEUE CODES - NOUVEAUX CODES - NUEVOS CODIGOS - NUOVI CODICI



	KW						
				OIL FILTER FILTRO OLIO	AIR FILTER FILTRO ARIA	FUEL FILTER FILTRO CARBURANTE	CABIN FILTER FILTRO ABITACOLO
C2							
1.4	54	09.03	KFV (TU3JP)	10-ECO037			
1.4 16V	65	06.06	KFU (ET3J4)	10-ECO060			
1.6	80	09.03	NFU (TU5JP4)	10-ECO037			
1.6 VTS	90	01.05	NFS (TU5JP4S)	10-ECO060			
C3							
1.1	44	11.09		10-ECO060			
1.1 i	44	02.02	HFX (TU1JP)	10-ECO037			
1.4	54	11.09	KFT (TU3A)	10-ECO060			
1.4 16V	65	12.03	KFU (ET3J4)	10-ECO037			
1.4 16V	70	11.09		10-ECO060			
1.4 i Bivalent	54	02.02	KFV (TU3JP)	10-ECO037			
1.6 16V	80	02.02	NFU (TU5JP4)	10-ECO037			
1.6 16V	88	11.09	5FS (EP6C)	10-ECO060			
C3 Picasso/ Pluriel							
1.4	70	02.09	8FS (EP3)	10-ECO060			
1.6	88	02.09	5FS (EP6C) 5FW (EP6)	10-ECO060			
C4							
1.4 16V	65	11.04	KFU (ET3J4)	10-ECO060			
1.6 16V	80	11.04	NFU (TU5JP4)	10-ECO060			
1.6 16V Bio-Flex	80	09.07	NFU (TU5JP4)	10-ECO060			
1.6 THP 140	103	07.08	5FT (EP6DT)	10-ECO060			
1.6 THP 150	110	07.08	5FX (EP6DT)	10-ECO060			
1.6 VTi 120	88	07.08	5FW (EP6)	10-ECO060			
2.0 16V	103	11.04	EW10A RFJ-EW10A	10-ECO060			
2.0 HDi	100	11.04	DW10BTED4 RHR (DW10BTED4)	10-ECO060		30-ECO027	
2.0 HDi	103	07.08		10-ECO060		30-ECO027	
C4 (B7)							
1.4	70	11.09	8FP (EP3)	10-ECO060			
1.6 16V	115	11.09	5FV (EP6DT)	10-ECO060			
1.6 16V	88	11.09	5FS (EP6C)	10-ECO060			
2.0 HDi	110	11.09		10-ECO060		30-ECO028	
C4 Coupe							
1.4 16V	65	11.04	KFU (ET3J4)	10-ECO060			
1.6 16V	80	11.04	NFU (TU5JP4)	10-ECO060			
1.6 THP 150	110	07.08	5FX (EP6DT)	10-ECO060			
1.6 VTi 120	88	07.08	5FW (EP6)	10-ECO060			
2.0 HDi	100	11.04	DW10BTED4 RHR (DW10BTED4)	10-ECO060		30-ECO027	
2.0 HDi	103	07.08		10-ECO060		30-ECO027	
C4 Picasso							
1.6 16V	110	07.08	5FX (EP6DT)	10-ECO060			

NEW CODES - NEUE CODES - NOUVEAUX CODES - NUEVOS CODIGOS - NUOVI CODICI

	KW			 OIL FILTER FILTRO OLIO	 AIR FILTER FILTRO ARIA	 FUEL FILTER FILTRO CARBURANTE	 CABIN FILTER FILTRO ABITACOLO
---	----	---	---	--	--	---	---

C4 Picasso

1.6 THP 140	103	07.08	5FT (EP6DT)	10-ECO060	
1.6 VTi 120	88	07.08	5FW (EP6)	10-ECO060	
1.8 i 16V	92	02.07	6FY-EW7A	10-ECO060	
2.0 HDi	100	02.07	RHJ-DW10BTED 4 RHR (DW10BTED4)	10-ECO060	30-ECO027
2.0 HDi	110	07.09		10-ECO060	30-ECO028
2.0 i 16V	103	02.07	RFJ-EW10A	10-ECO060	

C4 Tre volumi

1.6 16V	80	07.06	NFU (TU5JP4)	10-ECO060	
2.0 16V	103	07.06	EW10A	10-ECO060	

C5 (RD_)/ C5 Break

1.6 16V	115	04.09	5FV (EP6DT)	10-ECO060	
1.6 VTI 120	88	07.10	5FS (EP6C)	10-ECO060	
1.8 16V	92	02.08	6FY-EW7A	10-ECO060	
2.0 16V	103	02.08	EW10A RFJ-EW10A	10-ECO060	
2.0 16V BioFlex	103	02.08	RFJ-EW10A	10-ECO060	
2.0 HDi	100	02.08	DW10BTED4	10-ECO060	30-ECO027
2.0 HDi	103	04.09		10-ECO060	30-ECO027
2.0 HDi	120	04.09	RHH (DW10CTED4)	10-ECO060	30-ECO028
2.2 HDi	125	02.08	4HT (DW12BTED4)	10-ECO060	
2.7 HDi	150	02.08	DT17ED4	10-ECO048	30-ECO029
3.0 HDi	177	04.09	DT20C	10-ECO099	

C5/ C5 Break

1.8 16V	92	09.05	6FY-EW7A	10-ECO060	
2.0 16V (RCRFJB, RCRFJC)	103	09.04	EW10A RFJ-EW10A	10-ECO060	
2.0 HDi	79	03.01 → 08.04	RHZ (DW10ATED) RHS (DW10ATED)		30-ECO019
2.0 HDi (DCRHBY)	66	03.01 → 08.04	RHY (DW10TD)		30-ECO019
2.0 HDi (DCRHZB, DCRHZE)	80	03.01 → 08.04	RHZ (DW10ATED)		30-ECO019
2.0 HDi (RCRHRH)	100	09.04	DW10BTED4	10-ECO060	30-ECO027
2.2 HDi	125	04.06	4HT (DW12BTED4)		
2.2 HDi (DC4HXB, DC4HXE)	98	03.01 → 08.04	4HX (DW12TED4/FA P)		30-ECO019
2.2 HDi (RC4HXE)	98	09.04	4HX (DW12TED4/FA P)		30-ECO019







C6

2.2 HDi	125	06.06	4HT (DW12BTED4)	10-ECO060	
2.7 HDi	150	09.05	DT17ED4 UHZ (DT17BTED4)	10-ECO048	30-ECO029









	KW						
				OIL FILTER FILTRO OLIO	AIR FILTER FILTRO ARIA	FUEL FILTER FILTRO CARBURANTE	CABIN FILTER FILTRO ABITACOLO
C6							
3.0 HDi	177	04.09	DT20C	10-ECO099			
C8							
2.0 16V	103	09.05	RFJ-EW10A	10-ECO060			
2.0 16V	104	09.05	RFJ-EW10A	10-ECO060			
2.0 HDi	100	03.06	RHR (DW10BTED4)	10-ECO060		30-ECO027 30-ECO028	
2.0 HDi	120	03.06	RHH (DW10CTED4) RHE (DW10CTED4)	10-ECO060		30-ECO028	
2.0 HDi	79	07.02	RHM (DW10ATED4) RHT (DW10ATED4) RHW (DW10ATED4)			30-ECO019	
2.0 HDi	88	02.07	RHK (DW10UTED4)	10-ECO060		30-ECO027	
2.2 HDi	125	06.06	4HT (DW12BTED4)	10-ECO060			
2.2 HDi	94	07.02	4HW (DW12TED4)			30-ECO019	
DS3							
1.4 16V	70	04.10	8FP (EP3)	10-ECO060			
1.6 16V	115	04.10	5FR (EP6DT)	10-ECO060			
1.6 16V	88	04.10	5FS (EP6C)	10-ECO060			
1.6 Racing	149	02.11		10-ECO060			
EVASION (22, U6)							
2.0 HDi	80	08.99 → 07.02	RHZ (DW10ATED)			30-ECO019	
2.0 HDi 16V	80	09.99 → 07.02	RHW (DW10ATED4)			30-ECO011	
GRAND C4 PICASSO							
1.6 16V	103	07.08	5FT (EP6DT)	10-ECO060			
1.6 16V	110	10.08	5FX (EP6DT)	10-ECO060			
1.6 16V	88	07.08	5FW (EP6)	10-ECO060			
1.8 i 16V	92	10.06	6FY-EW7A	10-ECO060			
2.0 HDi	100	10.06	RHJ-DW10BTED 4 RHR (DW10BTED4)	10-ECO060		30-ECO027	
2.0 HDi	110	07.09		10-ECO060		30-ECO028	
2.0 i 16V	103	10.06	RFJ-EW10A	10-ECO060			
2.0 HDi	62	04.02	DW10UTD			30-ECO016	
2.2 HDi	74	04.02	DW12TED			30-ECO016	
2.8 HDi	107	05.04	8140.43N			30-ECO016	
2.8 HDi	94	04.02	8140.43S			30-ECO016	
2.8 HDi 4x4	94	04.02	8140.43S			30-ECO016	
JUMPER (244, Z_)							
2.0 HDi	62	04.02	DW10UTD			30-ECO016	
2.2 HDi	74	04.02	DW12TED			30-ECO016	







NEW CODES - NEUE CODES - NOUVEAUX CODES - NUEVOS CODIGOS - NUOVI CODICI

	KW						
				OIL FILTER FILTRO OLIO	AIR FILTER FILTRO ARIA	FUEL FILTER FILTRO CARBURANTE	CABIN FILTER FILTRO ABITACOLO
JUMPER (244, Z_)							
2.8 HDi	94	04.02	8140.43S				30-ECO016
JUMPER Tutti i modelli/ All models							
2.2 HDi 100	74	04.06	4HV	10-ECO060			30-ECO016
2.2 HDi 120	88	04.06	4HU	10-ECO060			30-ECO016
3.0 HDi 155	115	07.10	F1CE0481D (F30DT)				30-ECO016
3.0 HDi 160	115	09.06	F1CE0481D (F30DT)				30-ECO016
JUMPY							
1.9 D 70	51	04.98	WJZ (DW8)				30-ECO004
2.0 HDi 110	80	01.02	RHZ (DW10ATED)				30-ECO011
2.0 HDi 120	88	01.07	RHK (DW10UTED4)	10-ECO060			30-ECO027
2.0 HDi 140	100	01.07	RHR (DW10BTED4)	10-ECO060			30-ECO027
2.0 HDi 165	120	07.10	RHH (DW10CTED4)	10-ECO060			30-ECO028
2.0 HDi 95	69	10.99	RHX (DW10BTED)				30-ECO019
2.0 i	103	01.07	RFH (EW10A)	10-ECO060			
JUMPY (U6U)							
1.9 D 70	51	04.98	WJZ (DW8)				30-ECO004
2.0 HDi 110	80	03.00	RHZ (DW10ATED)				30-ECO019
2.0 HDi 95	69	10.99	RHX				30-ECO019
NEMO (AA_)/ Station wagon							
1.2 HDi 75	55	10.10	FHZ (F13DTE5)	10-ECO065			
1.4	54	02.08	KFV (TU3A)	10-ECO060			
SAXO (S0, S1)							
1.1 X,SX	44	05.96 → 09.03	HDZ (TU1M) HFX (TU1JP)	10-ECO037			
1.4 VTS	55	05.96 → 06.03	KFX (TU3JP) KFW (TU3JP)	10-ECO037			
1.6	74	02.01 → 04.04	NFT	10-ECO037			
1.6 VTS	72	09.00 → 09.03	NFT	10-ECO037			
XANTIA (X2)/ Break (X2)							
2.0 HDi 109	80	02.99 → 04.03	RHZ (DW10ATED)				30-ECO019
2.0 HDi 90	66	03.99 → 04.03	RHY (DW10TD)				30-ECO019
XSARA (N1)/ Break (N2)/ Coupe (N0)							
1.4 i	55	04.97 → 03.05	KFX (TU3JP) KFW (TU3JP)	10-ECO037			
1.6 16V	80	09.00 → 03.05	NFU (TU5JP4)	10-ECO037			
1.9 D	51	07.98 → 03.05	WJZ (DW8) WJY (DW8B)				30-ECO004
2.0 HDi 109	80	05.01 → 03.05	RHZ (DW10ATED)				30-ECO019
2.0 HDi 90	66	02.99 → 03.05	RHY (DW10TD)				30-ECO019
XSARA PICASSO (N68)							
1.6	65	06.00	NFZ (TU5JP)	10-ECO037			

NEW CODES - NEUE CODES - NOUVEAUX CODES - NUEVOS CODIGOS - NUOVI CODICI



	KW						
				OIL FILTER FILTRO OLIO	AIR FILTER FILTRO ARIA	FUEL FILTER FILTRO CARBURANTE	CABIN FILTER FILTRO ABITACOLO
XSARA PICASSO (N68)							
1.6	67	06.02					
1.6	70	09.00	NFV (TU5JP)	10-ECO037			
1.6 16V	80	09.05	NFU (TU5JP4)	10-ECO060			
2.0 HDi	66	12.99	RHY (DW10TD)			30-ECO019	







	KW						
				OIL FILTER FILTRO OLIO	AIR FILTER FILTRO ARIA	FUEL FILTER FILTRO CARBURANTE	CABIN FILTER FILTRO ABITACOLO
ARANOS							
1.5	66	01.95 → 11.97	V15L	10-03-398	20-03-394	30-03-393	
1.8	70	01.95 → 11.97	Y18L	10-03-398	20-03-394	30-03-393	
2.0	77	01.95 → 11.97	C20LE	10-03-398	20-03-394	30-03-393	
ESPERO (KLEJ)							
1.5	55	10.97 → 09.99		10-03-398	20-03-394	30-03-393	
1.5 16V	65	10.93 → 09.94		10-03-398	20-03-394	30-03-393	
1.5 16V	66	02.95 → 06.99	A15MF	10-03-398	20-03-394	30-03-393	
1.8	66	02.95 → 09.99	C18LE	10-03-398	20-03-394	30-03-393	
1.8	70	02.95 → 06.99	C18LE	10-03-398	20-03-394	30-03-393	
2.0	74	10.91 → 09.93	C20LZ	10-03-398	20-03-394	30-03-393	
2.0	77	02.95 → 06.99	C20LE	10-03-398	20-03-394	30-03-393	
2.0	81	10.93 → 09.94	C20LE	10-03-398	20-03-394	30-03-393	
EVANDA (KLAL)							
2.0	96	08.02	X20SED L88	10-03-398	20-03-332	30-W0-001	21-DW-W2
FSO Truck Pick Up							
1.9 D	0	01.84		10-06-699	20-W0-003	30-W0-003	
KALOS (KLAS)							
1.2	53	04.03	B12S1	10-W0-001	20-W0-005	30-W0-001	21-DW-W11
1.4	61	09.02	F14S3	10-03-398	20-W0-005	30-W0-001	21-DW-W11
1.4 16V	69	04.03	F14D3	10-03-398	20-W0-005	30-W0-001	21-DW-W11
KORANDO (KJ)							
2.3	105	01.99		10-ECO009	20-09-980		21-DW-W5
2.9 D	72	01.99	MB-OM 662	10-09-997	20-09-979	30-09-991	21-DW-W5
2.9 TD	88	01.99	MB-OM 601 29TD	10-09-997	20-03-396	30-09-991	21-DW-W5
3.2	156	01.99	M 104.995	10-ECO009	20-09-980		21-DW-W5
KORANDO Cabrio (KJ)							
2.0 16V	94	02.99		10-ECO009	20-09-980		
2.3	105	02.99		10-ECO009	20-09-980		21-DW-W5
2.9 D	72	02.99	MB-OM 662	10-09-997	20-09-979	30-09-991	21-DW-W5
2.9 TD	88	02.99	MB-OM 601 29TD	10-09-997	20-03-396	30-09-991	21-DW-W5
LACETTI (KLAN)							
1.4	70	02.04	F14D3	10-03-398	20-03-331	30-W0-001	21-DW-W10
1.6	80	02.04	F16D3	10-03-398	20-03-331	30-W0-001	21-DW-W10
1.8	90	02.04	T18SED	10-03-398	20-03-331	30-W0-001	21-DW-W10
LANOS (KLAT)/ Tre volumi (KLAT)							
1.3 (A13SM)	55	01.97		10-03-398	20-03-385	30-W0-001	21-DW-W1
1.4	55	05.97	A14SMS	10-03-398	20-03-385	30-W0-001	21-DW-W1
1.5	63	05.97	A15SMS	10-03-398	20-03-385	30-W0-001	21-DW-W1
1.6 16V	78	05.97	A16DMS	10-03-398	20-03-385	30-W0-001	21-DW-W1
LEGANZA (KLAV)							
1.8 CD	70	06.97 → 07.03	C18LE	10-03-398	20-W0-001	30-W0-001	21-DW-W0

NEW CODES - NEUE CODES - NOUVEAUX CODES - NUEVOS CODIGOS - NUOVI CODICI



	KW						
				OIL FILTER FILTRO OLIO	AIR FILTER FILTRO ARIA	FUEL FILTER FILTRO CARBURANTE	CABIN FILTER FILTRO ABITACOLO
LEGANZA (KLAV)							
2.0 16V	93	07.00	T20SED	10-03-398	20-W0-001	30-W0-001	21-DW-W0
2.0 16V	98	06.97 → 12.02	X20SED	10-03-398	20-W0-001	30-W0-001	21-DW-W0
2.2 16V	100	04.99 → 12.02	T22SED	10-03-398	20-W0-001	30-W0-001	21-DW-W0
LUBLIN II Tutti i modelli/ All models							
2.4 D (3302)	52	04.97	4C90	10-01-101E	20-0W-006	30-08-891	
2.4 TD (3304)	66	04.97	4CT90-1	10-01-101E	20-0W-006	30-08-891	
2.8 TD	0	04.97		10-01-101E	20-0W-006	30-08-891	
MATIZ (KLYA)							
0.8	38	09.98	F8CV	10-06-601 →12.99 10-W0-001 01.00→	20-W0-002	30-W0-001	21-DW-W14
1.0	47	01.03	B10S	10-W0-001	20-W0-002	30-03-393	21-DW-W14
MUSSO (FJ)							
2.2 TD	74	09.99	MB OM 601	10-09-997	20-09-979 20-09-980 →12.04	30-09-991	
2.3	103	01.99	M 111.970	10-ECO009	20-09-980	30-01-192	21-DW-W5
2.9 D	73	01.99 → 09.99	MB-OM 662	10-09-997	20-09-979	30-09-991	21-DW-W5
2.9 TD	88	01.99	MB-OM 601 29TD	10-09-997	20-09-980	30-09-991	21-DW-W5
3.2	162	01.99	M 104.992	10-ECO009	20-09-980	30-01-192	21-DW-W5
NEXIA (KLETN) Tutti i modelli/ All models							
1.5	44	08.96 → 08.97	G15MF	10-03-398	20-03-394	30-03-393	
1.5	52	02.95 → 08.97	G15MF	10-03-398	20-03-394	30-03-393	
1.5	55	02.95 → 08.97	G15MF	10-03-398	20-03-394	30-03-393	
1.5 16V	66	02.95 → 08.97	A15MF	10-03-398	20-03-394	30-03-393	
1.8	0	10.97		10-03-398	20-03-394	30-03-393	
1.8	74	10.95 → 08.97		10-03-398	20-03-394	30-03-393	
NUBIRA (KLAJ) Tutti i modelli/ All models							
1.6 16V	76	07.00	A16DMS	10-03-398	20-03-387	30-W0-001	21-DW-W1
1.6 16V	78	05.97	A16DMS	10-03-398	20-03-387	30-W0-001	21-DW-W1
1.6 16V	78	05.97	A16DMS	10-03-398	20-03-387	30-W0-001	21-DW-W1
2.0 16V	93	12.00	T20SED	10-03-398	20-03-387	30-W0-001	21-DW-W1
2.0 16V	98	05.97	X20SED	10-03-398	20-03-387	30-W0-001	21-DW-W1
2.0 16V	98	05.97	X20SED Z20L	10-03-398	20-03-387	30-W0-001	21-DW-W1
NUBIRA (KLAN) Tutti i modelli/ All models							
1.6	80	07.03	F16D3	10-03-398	20-03-331	30-W0-001	21-DW-W1
1.8	90	07.03	T18SED	10-03-398	20-03-331	30-W0-001	21-DW-W1
REXTON							
2.9 TD	88	04.02		10-ECO031	20-0S-S01	30-09-991	21-DW-W7 21-SS-S01 For Extra UE
3.2 V6	162	04.02		10-ECO009	20-0S-S02		21-DW-W7
TACUMA (KLAU)							







NEW CODES - NEUE CODES - NOUVEAUX CODES - NUEVOS CODIGOS - NUOVI CODICI

	KW						
				OIL FILTER FILTRO OLIO	AIR FILTER FILTRO ARIA	FUEL FILTER FILTRO CARBURANTE	CABIN FILTER FILTRO ABITACOLO
TACUMA (KLAU)							
1.6	77	09.00	A16DMS	10-03-398	20-W0-004	30-W0-001	21-DW-W3
1.6 SX	66	08.01 → 12.04		10-03-398	20-W0-004	30-W0-001	21-DW-W3
1.8	66	09.00		10-03-398	20-W0-004	30-W0-001	21-DW-W3
1.8	67	09.00	F18D2	10-03-398	20-W0-004	30-W0-001	21-DW-W3
1.8	72	09.00	A18DMS	10-03-398	20-W0-004	30-W0-001	21-DW-W3
1.8	74	09.00		10-03-398	20-W0-004	30-W0-001	21-DW-W3
2.0	89	09.01	X20SED	10-03-398	20-W0-004	30-W0-001	21-DW-W3
2.0	94	09.00	T20SED	10-03-398	20-W0-004	30-W0-001	21-DW-W3
TICO (KLY3)							
0.8	35	02.95 → 12.00	F8C	10-06-601	20-W0-000 20-W0-002	30-W0-001	
0.8	38	01.96 → 12.00	F8CV	10-06-601	20-W0-000 20-W0-002	30-W0-001	



	KW						
				OIL FILTER FILTRO OLIO	AIR FILTER FILTRO ARIA	FUEL FILTER FILTRO CARBURANTE	CABIN FILTER FILTRO ABITACOLO
APPLAUSE I (A101, A111)							
1.6 16V (A101)	66	06.89 → 07.97	HD	10-06-604	20-02-224	30-06-620	
1.6 16V (A101)	77	06.89 → 07.97	HD-E	10-06-604	20-02-224	30-06-620	
1.6 16V 4WD (A111)	77	06.89 → 07.97	HD-E	10-06-604	20-02-224	30-06-620	
APPLAUSE II							
1.6 16V	73	07.97	HD-E	10-06-604 06.98→	20-02-224	30-06-620 06.98→	
CHARADE I (G10)							
1.0	37	10.77 → 02.81	CB 20	10-06-604	20-06-601 →12.79	30-06-601	
1.0	38	02.81 → 02.83	CB 20 CB 22	10-06-604	20-06-603	30-06-601	
CHARADE II (G11, G30)							
1.0 (G11)	38	10.83 → 03.87	CB 20 CB 22	10-06-604	20-06-601	30-06-614	
1.0 D (G30)	27	10.83 → 03.87	CL 10	10-06-604	20-06-606	30-06-608	
1.0 TD (G30)	34	02.85 → 03.87	CL 60	10-06-604	20-06-606	30-06-608	
1.0 Turbo (G11)	50	10.83 → 03.87	CB 60	10-06-604	20-06-606	30-06-610	
CHARADE III (G100, G101, G102) Tutti i modelli/ All models							
1.0 (G100)	38	03.87 → 12.92	CB 23	10-06-604	20-06-601	30-06-614	
1.0 (G100)	40	11.90 → 12.92	CB 90	10-06-604	20-02-224	30-02-224	
1.0 (G100)	41	04.89 → 12.92	CB 90	10-06-604	20-02-224	30-02-224	
1.0 D (G101)	27	03.87 → 12.92	CL 11	10-06-604	20-06-606	30-06-608	
1.0 GTi (G100)	74	03.87 → 12.92	CB 80	10-06-604	20-02-224	30-02-224	
1.0 TD (G101)	35	03.87 → 12.92	CL CL 61	10-06-604	20-02-224	30-06-608	
1.0 Turbo (G100)	50	03.87 → 10.90	CB 61	10-06-604	20-02-224	30-06-616	
1.3	56	09.88 → 01.92	HC-C	10-06-604	20-06-610	30-06-614	
1.3 i (G102)	66	06.88 → 12.92	HCE	10-06-604	20-02-224	30-02-224	
1.3 i 4WD (G102)	66	06.88 → 01.93	HCE	10-06-604	20-02-224	30-02-224	
CHARADE IV (G200, G202) Tutti i modelli/ All models							
1.0	38	09.94 → 03.96	CB 22	10-06-604	20-06-601	30-06-614	
1.3	44	09.96 → 11.99	HC	10-06-604 06.98→	20-02-224 06.98→	30-02-224 06.98→	
1.3 16V	55	05.96 → 11.99	HCE	10-06-604 06.98→	20-02-224	30-02-224	
1.3 16V	62	01.93 → 11.99	HC	10-06-604	20-02-224	30-05-506	
1.5 16V	66	01.97 → 11.99	HEE HEEG	10-06-604	20-02-224	30-02-224	
1.6 GTi	77	03.93 → 11.99	HD-E	10-06-604	20-02-224	30-05-506	
CHARMANT (A)							
1.3 (A35)	48	11.81 → 07.87	4K	10-02-201	20-02-205	30-02-201	
1.6 (A45)	55	12.81 → 09.84	2T	10-02-201	20-02-201	30-02-201	
1.6 (A60)	57	09.85 → 07.87	4A	10-02-201	20-02-207	30-02-220	
1.6 (A60)	60	05.86 → 07.87	4A	10-02-201	20-02-207	30-02-220	
1.6 (A60)	61	08.83 → 07.87	4A	10-02-201	20-02-207	30-02-220	
COPEN							
0.7	50	09.03	JB		20-06-619		

NEW CODES - NEUE CODES - NOUVEAUX CODES - NUEVOS CODIGOS - NUOVI CODICI

	KW						
				OIL FILTER FILTRO OLIO	AIR FILTER FILTRO ARIA	FUEL FILTER FILTRO CARBURANTE	CABIN FILTER FILTRO ABITACOLO
COPEN							
1.3	64	03.06	K3-VE	10-06-604	20-06-617		
CUORE							
1.0	51	04.07	1KR-FE	10-06-604	20-06-600		21-DH-DH1
CUORE I (L55, L60)							
0.5 (L55)	20	10.80 → 09.85	AB 30	10-06-601	20-01-102	30-06-602	
0.6 (L60)	22	08.82 → 09.85	AD 10	10-06-604	20-06-602	30-06-609	
CUORE II (L80, L81)							
0.8 (L80)	29	11.89 → 12.90	ED 10	10-06-604	20-01-102	30-06-613	
0.8 (L80)	32	09.85 → 06.90	ED 10	10-06-604	20-01-102	30-06-613	
0.8 4WD (L81)	32	09.86 → 10.88	ED 10	10-06-604	20-01-102	30-06-613	
CUORE III (L201)							
0.8	30	10.90 → 12.94	ED 10 K	10-06-604	20-06-699	30-06-621	
CUORE IV (L501)							
0.8	32	01.95 → 11.96	ED 20	10-06-604	20-06-697	30-06-694	
CUORE V (L5)							
0.8	31	11.96 → 10.98	ED 20	10-06-604	20-06-697	30-06-694	
CUORE VI							
1.0 i (L701)	41	10.98 → 05.03	EJDE	10-06-604	20-06-693	30-06-621	
CUORE VII							
1.0	43	05.03	EJ-VE	10-06-604	20-06-613	30-06-692	21-DH-DH1
FEROZA (F300) Tutti i modelli/ All models							
1.6 16V	63	10.88	HDC	10-06-604	20-06-610 →06.91 20-06-618 01.92→	30-06-619 →06.91	
1.6 i 16V	70	10.88	HD-E	10-06-604	20-06-618 01.92→	30-05-506 →06.91 30-06-693 06.91→ →06.98	
GRAN MOVE (G3)							
1.5 16V (G303)	66	10.96 → 07.98	HEEG	10-06-604	20-02-224	30-02-224	
1.6 16V (G301)	67	05.98	HDEP	10-06-604	20-02-224	30-02-224	
HIJET I Autobus							
0.8	29	06.86 → 12.89	CD	10-06-604	20-06-605	30-06-622	
1.0	33	06.86 → 12.89	CB	10-06-604	20-06-605	30-06-622	
HIJET I Furgonato							
0.8	29	06.86 → 12.89	CD	10-06-604	20-06-605	30-06-622	
1.0	33	06.86 → 12.89	CB	10-06-604	20-06-605	30-06-622	
1.0 4x4	33	07.86 → 10.90	CB 10	10-06-604	20-06-608	30-06-622	
HIJET II Tutti i modelli/ All models							
1.0	33	12.92 → 05.98	CB41	10-06-604	20-06-608	30-06-623	
1.0 i	35	07.94 → 05.98	CB42	10-06-604	20-06-605	30-06-623	

NEW CODES - NEUE CODES - NOUVEAUX CODES - NUEVOS CODIGOS - NUOVI CODICI



	KW						
				OIL FILTER FILTRO OLIO	AIR FILTER FILTRO ARIA	FUEL FILTER FILTRO CARBURANTE	CABIN FILTER FILTRO ABITACOLO

HIJET II Tutti i modelli/ All models

1.2 D	26	05.95 → 03.98	LDW12	10-06-699	20-06-605	30-06-695
1.3 i 16V	48	05.98	HCE	10-06-604	20-06-608	30-06-624
1.4 D	28	03.98	LDW14	10-06-699	20-06-698	30-06-695

MATERIA

1.3	67	10.06	K3-VE	10-ECO051	20-06-616	21-DH-DH1
1.5	76	10.06	3-SZVE	10-ECO051	20-06-616	21-DH-DH1
1.5 ECO 4WD	76	10.06	3-SZVE	10-ECO051	20-06-616	21-DH-DH1

MOVE (L6, L9)

0.8	31	10.96	ED 20	10-06-604 06.97→ →06.99	20-06-697 06.97→ →06.99	30-06-694 06.97→ →06.99	21-DH-DH1
1.0 i	41	10.98	EJDE	10-06-604 06.99→	20-06-693 06.99→	30-06-694 06.99→	21-DH-DH1

ROCKY Hard Top (F7, F8)

2.0	65	02.85 → 04.93	3Y	10-02-200 →06.89	20-02-204 →06.89	30-06-605 →06.89
2.8 D	54	02.85	DL	10-05-503 →06.88	20-02-246	30-05-502MP 30-05-502
2.8 TD	67	12.87 → 04.93	DL 51	10-05-503	20-05-523	30-05-502MP 30-05-502
2.8 TD	72	05.93	DL 52 DLT-C	10-03-314 06.93→	20-02-246	30-05-502MP 30-05-502
2.8 TD	75	09.91	DL 52	10-04-406	20-02-246	30-05-502MP 30-05-502

SIRION

1.0	51	01.05	1KR-FE	10-ECO051	20-02-288	30-06-692
1.3	64	01.05	K3-VE	10-ECO051	20-06-692	30-06-692
1.3	67	03.08	K3-VE	10-ECO051	20-06-694	30-06-692
1.3 4WD	67	03.08	K3-VE	10-ECO051	20-06-694	30-06-692
1.5	76	03.08	3-SZVE	10-ECO051	20-06-694	30-06-692

SIRION (M1)







0.7 Turbo 4WD	88	09.98 → 01.05		10-06-604	20-06-693	
1.0	40	04.98 → 10.00	EJDE		20-06-693	30-06-692
1.0 i	43	09.00 → 01.05	EJ-VE	10-06-604	20-06-693	30-06-692
1.0 i (M100)	41	04.98 → 09.00	EJDE	10-06-604	20-06-693	30-06-692
1.0 i 4WD	41	04.99 → 09.00	EJDE	10-06-604	20-06-693	30-06-692
1.0 i 4WD	43	09.00 → 01.05	EJ-VE	10-06-604	20-06-693	30-06-692
1.3 DVVT 16V	75	02.01 → 04.05	K3-VE	10-06-604	20-06-693	30-06-692
1.3 Sport	75	08.00 → 01.05	K3-VE2	10-06-604	20-06-693	30-06-692
1.3 Sport 4WD	75	08.00 → 01.05	K3-VE2	10-06-604	20-06-693	30-06-692

SPARCAR/BUS WIDE Tutti i modelli/ All models







0.55	20	01.80 → 12.86		10-06-604	20-06-605	30-06-601
0.8	29	09.83 → 05.86	CD	10-06-604	20-06-605	30-06-601
1.0	33	09.83 → 05.86	CB	10-06-604	20-06-605	30-06-601

TAFT

NEW CODES - NEUE CODES - NOUVEAUX CODES - NUEVOS CODIGOS - NUOVI CODICI

	KW						
				OIL FILTER FILTRO OLIO	AIR FILTER FILTRO ARIA	FUEL FILTER FILTRO CARBURANTE	CABIN FILTER FILTRO ABITACOLO
TAFT							
1.6 D 4x4 (F20, F25)	49	09.76 → 02.85	12R	10-02-200	20-02-201	30-06-605	
2.5 D 4x4 (F50, F55)	45	08.78 → 08.82	DG	10-05-503	20-02-246	30-05-502MP 30-05-502	
2.8 D 4x4 (F60, F65)	51	08.82 → 02.85	DL	10-05-503	20-06-618	30-05-502MP 30-05-502	
TERIOS (J1)							
1.3	63	09.01 → 10.05	K3-VE	10-06-604	20-06-694	30-06-692	21-SZ-Z08
1.3 4WD	61	10.97 → 10.00	HE-EJ	10-06-604	20-02-239	30-06-692	21-SZ-Z08
1.3 4WD	63	10.00 → 10.05	K3-VE	10-06-604	20-06-694	30-06-692	21-SZ-Z08
1.3 DVVT FWD	63	10.02 → 10.05	K3-VE	10-06-604	20-06-616	21-SZ-Z08	
1.3 DVVT Turbo 4WD	103	10.02 → 10.05		10-06-604	20-06-616	30-06-692	21-SZ-Z08
1.5 4WD	77	05.06	3-SZVE	10-06-604	20-06-616	21-SZ-Z08	
TREVIS							
1.0	43	06.06	EJ-VE	10-06-604	20-06-613	21-DH-DH1	
WILDCAT/ROCKY (F70)							
2.8 D	54	02.85 → 03.87	DL	10-05-503	20-02-246	30-05-502MP 30-05-502	
2.8 TD	65	09.85 → 04.87	DL 50	10-05-503	20-02-246	30-05-502MP 30-05-502	
YRV (M2)							
1.0	43	02.01	EJ-VE	10-06-604	20-06-693	30-06-692	
1.3	64	02.01	K3-VE	10-06-604	20-06-692	30-06-692	
1.3 4WD	64	02.01	K3-VE	10-06-604	20-06-692	30-06-692	
1.3 GTti	95	07.02	K3-VET	10-06-604	20-06-692	30-06-692	







	KW						
				OIL FILTER FILTRO OLIO	AIR FILTER FILTRO ARIA	FUEL FILTER FILTRO CARBURANTE	CABIN FILTER FILTRO ABITACOLO
AVENGER							
2.0	115	06.07	ECN	10-00-010	20-00-024		21-CH-CH3
2.0 CRD	103	06.07	ECD	10-ECO023	20-09-974	30-00-001	21-CH-CH3
2.4	129	06.07	ED3 EDG	10-00-010	20-00-024		21-CH-CH3
CALIBER							
1.8	110	06.06	EBA	10-00-010	20-00-018		21-CH-CH3
2.0	115	06.06	ECN	10-00-010	20-00-018		21-CH-CH3
2.0 CRD	103	06.06	ECD ECE	10-ECO023	20-00-001	30-00-001	21-CH-CH3
2.4	125	10.06	ED3	10-00-010	20-00-024		21-CH-CH3
JOURNEY							
2.0 CRD	103	06.08	ECE	10-ECO023	20-00-024	30-00-001	21-CH-CH3
2.4	125	01.09	ED3	10-00-010	20-00-018		21-CH-CH3
2.7 FLEXFUEL	136	01.09	EER	10-00-010	20-00-024		21-CH-CH3
NITRO							
2.8 CRD	130	06.07	ENR ENS	10-ECO067	20-00-020	30-K0-018	21-DG-DG0
2.8 CRD 4WD	130	06.07	ENR ENS	10-ECO067	20-00-020	30-K0-018	21-DG-DG0
4.0 V6	191	07.07		10-09-986	20-00-020		21-DG-DG0

	KW			 OIL FILTER FILTRO OLIO	 AIR FILTER FILTRO ARIA	 FUEL FILTER FILTRO CARBURANTE	 CABIN FILTER FILTRO ABITACOLO
DR1							
1.3 Ecopower	61	10.09	SQR473	10-02-279	20-02-249	30-00-020	
DR2							
1.3	0	06.10	SQR473	10-02-279	20-00-026	30-00-020	
DR5							
1.6	75	06.07		10-00-015	20-00-023	30-00-018	21-DR-DR0
1.9 D	88	06.07		10-01-122	20-00-025	30-ECO016	21-DR-DR0



	KW						
				OIL FILTER FILTRO OLIO	AIR FILTER FILTRO ARIA	FUEL FILTER FILTRO CARBURANTE	CABIN FILTER FILTRO ABITACOLO
500							
1.3 D Multijet	55	10.07	169 A1.000	10-ECO044 10-ECO065		30-ECO016	
1.3 D Multijet	70	12.09	199 B1.000	10-ECO065			
1.4 Abarth	118	08.08	312 A1.000	10-ECO044			
1.4 Abarth	132	08.08	312 A3.000	10-ECO044			
1.4 Abarth	140	08.08		10-ECO044			
1.4 Abarth	99	08.08	312 A1.000	10-ECO044			
500 C							
1.3 D Multijet	55	09.09	169 A1.000	10-ECO065		30-ECO016	
1.4 Abarth	103	09.09	312 A3.000	10-ECO044			
BRAVO							
1.4 T-Jet	110	09.07	198 A1.000	10-ECO044			
1.4 T-Jet	88	09.07	198 A4.000	10-ECO044			
1.6 D Multijet	66	03.08	198 A6.000	10-ECO095			
1.6 D Multijet	77	03.08	198 A3.000	10-ECO095			
1.6 D Multijet	88	03.08	198 A2.000	10-ECO095			
2.0 D Multijet	121	09.08	198 A5.000 844 A2.000	10-ECO095			
CROMA (194)							
1.8 16V	103	12.05	939 A4.000	10-ECO073			
1.9 D Multijet	110	06.05	939A2.000	10-ECO058		30-ECO016	
1.9 D Multijet	85	06.05	939 A7.000	10-ECO058		30-ECO016	
1.9 D Multijet	88	06.05	939A1.000	10-ECO058		30-ECO016	
2.2 16V	108	06.05	194A1.000	10-ECO019			
2.4 D Multijet	147	06.05	939A3.000	10-ECO107			
DOBLO (152)							
1.3 D Multijet	66	02.10	199 A3.000 263 A2.000	10-ECO095			
1.6 D Multijet	77	02.10	198 A3.000	10-ECO095			
DOBLO (223)							
1.3 D Multijet	62	10.05	223 A9.000	10-ECO065		30-ECO016	
DOBLO Cargo (223)							
1.3 D Multijet	55	10.05	199 A2.000	10-ECO065		30-ECO016	
1.3 JTD 16V	51	05.04	188 A9.000	10-ECO044 10-ECO065		30-ECO016	
1.3 JTD 16V Multijet	62	08.06	223 A9.000	10-ECO065		30-ECO016	
DOBLO Cargo (263)							
1.3 D Multijet	66	02.10	199 A3.000 263 A2.000	10-ECO095			
1.6 D 16V Multijet	77	02.10	198 A3.000	10-ECO095			
1.6 D Multijet	74	02.10	263 A3.000	10-ECO095			
2.0 JTD	62	04.02	RHV (DW10)			30-ECO016	
2.3 JTD	81	04.02	F1AE0481C			30-ECO016	
2.8 JTD	94	04.02	8140.43S			30-ECO016	
2.8 JTD 4x4	94	10.02	8140.43S			30-ECO016	

NEW CODES - NEUE CODES - NOUVEAUX CODES - NUEVOS CODIGOS - NUOVI CODICI

	KW			 OIL FILTER FILTRO OLIO	 AIR FILTER FILTRO ARIA	 FUEL FILTER FILTRO CARBURANTE	 CABIN FILTER FILTRO ABITACOLO
DUCATO (244, Z_)							
2.8 JTD Power	107	05.04	8140.43N				30-ECO016
DUCATO Tutti i modelli/ All models							
100 Multijet 2,2 D	74	07.06	4HV	10-ECO060			30-ECO016
120 Multijet 2,3 D	88	07.06	F1AE0481D				30-ECO016
160 Multijet Power 3,0 D	116	07.06	F1CE0481D F1CE3481M				30-ECO016
FIORINO Tutti i modelli/ All models							
1.3 D Multijet	55	02.08	199 A2.000 199 A9.000	10-ECO065			
1.3 D Multijet	70	10.09	199 B1.000	10-ECO065			
1.4	54	02.08	KFT KFV	10-ECO060			
GRANDE PUNTO (199)							
1.3 D Multijet	55	10.05	199 A2.000	10-ECO044 10-ECO065			
1.3 D Multijet	66	10.05	199 A3.000	10-ECO044 10-ECO065			
1.9 D Multijet	88	10.05	939A1.000	10-ECO058			
1.9 D Multijet	96	10.05	199 A5.000	10-ECO058			
IDEA							
1.3 D Multijet	66	10.05	199 A3.000	10-ECO044			
1.3 JTD	51	01.04	188 A9.000	10-ECO044			30-ECO016
1.9 JTD	74	01.04	188 B2.000				30-ECO016
LINEA							
1.3 D Multijet	66	06.07	199 A3.000	10-ECO065			
1.4 T-Jet	88	09.07	198 A4.000	10-ECO044			
1.6 D Multijet	77	06.09	198 A3.000	10-ECO095			
PANDA (169) Tutti i modelli/ All models							
1.2 4x4	51	10.04	169 A4.000	10-ECO065			30-ECO016
1.3 D 16V Multijet 4x4	55	09.03	169 A1.000	10-ECO095			30-ECO016
1.3 D Multijet	51	09.03	188 A9.000	10-ECO044 10-ECO065			30-ECO016
1.3 D Multijet	55	06.06	169 A1.000	10-ECO095			30-ECO016
1.3 D Multijet 4x4	51	10.04	188 A9.000	10-ECO044 10-ECO065			30-ECO016
PUNTO (188)							
1.3 JTD 16V	51	06.03	188 A9.000	10-ECO044 10-ECO065			30-ECO016
1.9 JTD	63	10.01	188 A7.000				30-ECO016
1.9 JTD	74	06.03	188 B2.000				30-ECO016
PUNTO EVO							
1.3 16V Multijet	63	10.09	223 A9.000	10-ECO095			
1.3 D Multijet	55	10.09	199 A2.000 199 A9.000	10-ECO095			
1.3 D Multijet	66	10.09	199 A3.000	10-ECO065			
1.3 D Multijet	70	10.09	199 B1.000	10-ECO095			
1.4 16V	77	10.09	955 A6.000	10-ECO044			

NEW CODES - NEUE CODES - NOUVEAUX CODES - NUEVOS CODIGOS - NUOVI CODICI



	KW						
				OIL FILTER FILTRO OLIO	AIR FILTER FILTRO ARIA	FUEL FILTER FILTRO CARBURANTE	CABIN FILTER FILTRO ABITACOLO
PUNTO EVO							
1.4 16V	99	10.09	955 A2.000	10-ECO044			
1.4 Abarth	120	10.09	955 A8.000	10-ECO044			
1.6 D Multijet	88	10.09	955 A3.000	10-ECO095			
PUNTO Van (188AX)							
1.3 JTD	51	06.03 → 10.05	188 A9.000	10-ECO065		30-ECO016	
1.9 JTD	63	02.00	188 A7.000			30-ECO016	
SCUDO							
2.0 D Multijet	100	01.07	RHR	10-ECO060		30-ECO027	
2.0 D Multijet	121	01.07	RHH	10-ECO060		30-ECO028	
2.0 D Multijet	88	01.07	RHK	10-ECO060		30-ECO027	
SCUDO (220P)							
1.9 D	51	04.98	WJZ (DW8)			30-ECO005	
2.0 JTD	80	12.99	RHZ			30-ECO011	
SCUDO Furgonato (220L)							
1.9 D	51	04.98	WJZ (DW8)			30-ECO004	
2.0 JTD	69	12.99	RHX			30-ECO019	
2.0 JTD	80	12.02	RHZ			30-ECO019	
SEDICI							
1.9 D Multijet	88	06.06	D19AA	10-ECO058	20-08-827	30-ECO016	21-SZ-Z08
2.0 D Multijet	99	06.06	D20AA	10-ECO095		30-ECO016	
2.0 D Multijet 4x4	99	06.06	D20AA	10-ECO095		30-ECO016	
SIENA							
1.3 JTD	51	09.03	188 A9.000	10-ECO065		30-ECO016	
STRADA (178E)							
1.3 D Multijet	62	05.06	223 A9.000	10-ECO065		30-ECO016	
ULYSSE (179AX)							
2.0 D Multijet	100	05.06	RHR	10-ECO060		30-ECO027	
2.0 D Multijet	88	05.06	RHK			30-ECO027	
2.0 JTD	79	05.03	RHM(DW10ATE D4)			30-ECO019	
2.0 JTD	80	08.02	RHW(DW10ATE D4)			30-ECO019	
2.2 D Multijet	125	03.08	4HS 4HT (DW12BTED4)	10-ECO060			
2.2 JTD	94	08.02	4HW(DW12ATE D4)			30-ECO019	
ULYSSE (220)							
2.0 JTD	80	10.99 → 08.02	RHZ			30-ECO019	

	KW			 OIL FILTER FILTRO OLIO	 AIR FILTER FILTRO ARIA	 FUEL FILTER FILTRO CARBURANTE	 CABIN FILTER FILTRO ABITACOLO
---	----	---	---	--	--	---	---

C-MAX

2.0 TDCi	100	02.07	G6DA G6DB G6DD G6DG	10-ECO060	30-ECO027 30-ECO028 03.10→
2.0 TDCi	81	02.08	IXDA	10-ECO060	30-ECO027 30-ECO028 03.10→

FOCUS C-MAX

1.8 TDCi	85	01.05→03.07	KKDA		30-ECO075
2.0 TDCi	100	10.03→03.07	G6DA G6DB G6DD G6DG	10-ECO060	30-ECO027

FOCUS II Tutti i modelli/ All models

1.8 TDCi	85	01.05	KKDA KKDB		30-ECO075
2.0 TDCi	100	11.04	G6DA G6DB G6DD	10-ECO060	30-ECO027
2.0 TDCi	81	02.08	IXDA	10-ECO060	30-ECO027 30-ECO028 03.10→
2.5 RS	224	01.09	JZDA	10-ECO032	
2.5 RS 500	257	05.10		10-ECO032	
2.5 ST	166	10.05	HYDA	10-ECO032	

GALAXY

1.8 TDCi	74	05.06	FFWA		30-ECO075
1.8 TDCi	92	05.06	QYWA		30-ECO075
2.0 TDCi	100	05.06	AZWC UKWA	10-ECO060	30-ECO027 30-ECO028 03.10→
2.0 TDCi	103	05.06	QXWA QXWB QXWC UFWA	10-ECO060	30-ECO027 30-ECO028 03.10→
2.0 TDCi	120	03.10		10-ECO060	30-ECO028
2.0 TDCi	85	11.07	KLWA TYWA	10-ECO060	30-ECO027 30-ECO028 03.10→
2.0 TDCi	96	05.06	AZWA	10-ECO060	30-ECO027 30-ECO028 03.10→
2.2 TDCi	129	03.08	Q4BA Q4WA	10-ECO060	
2.3	118	07.07	SEWA	10-ECO036	

GALAXY (WGR)

1.9 TDI	110	05.05	BTB	10-ECO023	
1.9 TDI	66	03.95	AHU 1Z ANU	10-ECO008 02.96→	
1.9 TDI	85	04.00	AUY	10-ECO008	
1.9 TDI	96	02.03	ASZ	10-ECO023	
2.8 i V6	128	11.95→04.00	AAA AMY	10-ECO013	

NEW CODES - NEUE CODES - NOUVEAUX CODES - NUEVOS CODIGOS - NUOVI CODICI



	KW						
				OIL FILTER FILTRO OLIO	AIR FILTER FILTRO ARIA	FUEL FILTER FILTRO CARBURANTE	CABIN FILTER FILTRO ABITACOLO

GALAXY (WGR)

2.8 i V6 4x4	128	04.96 → 04.00	AAA AMY	10-ECO013	
2.8 V6	150	04.00	AYL	10-ECO023	

GRAND C-MAX

2.0 TDCi	120	12.10		10-ECO060	30-ECO028
----------	-----	-------	--	-----------	-----------

KA

1.3 TDCi	55	02.09	FD4	10-ECO065	
----------	----	-------	-----	-----------	--

KUGA

2.0 TDCi	100	03.08	G6DG UKDA	10-ECO060	30-ECO027
2.0 TDCi	103	03.10	UFDA	10-ECO060	30-ECO028
2.0 TDCi 4x4	100	03.08	G6DG UKDA	10-ECO060	30-ECO027
2.0 TDCi 4x4	103	03.10	UFDA	10-ECO060	30-ECO028
2.0 TDCi 4x4	120	03.10		10-ECO060	30-ECO028
2.5	147	03.09	HYDB	10-ECO032	
2.5 4x4	147	03.09	HYDB	10-ECO032	

MONDEO III (B5Y) Tutti i modelli/ All models

1.8 16V	81	11.00	CGBA CGBB	10-ECO036	
1.8 16V	92	11.00	CHBA CHBB	10-ECO036	
1.8 SCi	96	06.03	CFBA	10-ECO036	
2.0 16V	107	11.00	CJBA CJBB	10-ECO036	
2.0 16V DI / TDDi / TDCi	66	11.00	D5BA SDBA	10-ECO022	
2.0 16V TDDi / TDCi	85	11.00	D6BA HJBA HJBB HJBC	10-ECO022	
2.0 TDCi	96	10.01	FMBA N7BA	10-ECO022	
2.2 TDCi	114	09.04	QJBA QJBB	10-ECO022	

MONDEO IV

2.0 TDCi	100	03.07	AZBC UKBA	10-ECO060	30-ECO028 30-ECO030 →02.10
2.0 TDCi	103	03.07	QXBB UFBA	10-ECO060	30-ECO028 30-ECO030 →02.10
2.0 TDCi	120	03.10	TXBA	10-ECO060	
2.0 TDCi	85	11.07	KLBA LPBA TYBA	10-ECO060	30-ECO028 30-ECO030 →02.10
2.0 TDCi	96	03.07	AZBA	10-ECO060	30-ECO028 30-ECO030 →02.10
2.2 TDCi	129	03.08	Q4BA	10-ECO060	
2.3	118	07.07	SEBA	10-ECO036	
2.5	162	03.07	HUBA	10-ECO032	

S-MAX

NEW CODES - NEUE CODES - NOUVEAUX CODES - NUEVOS CODIGOS - NUOVI CODICI

	KW			 OIL FILTER FILTRO OLIO	 AIR FILTER FILTRO ARIA	 FUEL FILTER FILTRO CARBURANTE	 CABIN FILTER FILTRO ABITACOLO
---	-----------	---	---	--	--	---	---

S-MAX

2.0 TDCi	100	05.06	AZWC UKWA	10-ECO060	30-ECO027 30-ECO028 03.10→
2.0 TDCi	103	05.06	QXWA QXWB QXWC UFWA	10-ECO060	30-ECO027 30-ECO028 03.10→
2.0 TDCi	120	03.10		10-ECO060	30-ECO028
2.0 TDCi	85	11.07	KLWA TYWA	10-ECO060	30-ECO027 30-ECO028 03.10→
2.0 TDCi	96	05.06	AZWA	10-ECO060	30-ECO027 30-ECO028 03.10→
2.2 TDCi	129	03.08	Q4WA	10-ECO060	

TRANSIT







2.2 TDCi	103	10.07	PGFA PGFB	10-ECO060	
2.2 TDCi	63	07.06	P8FA P8FB	10-ECO060	
2.2 TDCi	81	07.06	QVFA	10-ECO060	
2.2 TDCi	85	10.08	SRFA SRFB SRFC SRFD SRFE	10-ECO060	
2.2 TDCi	96	07.06	QWFA	10-ECO060	
2.4 TDCi	103	07.06	H9FD	10-ECO060	
2.4 TDCi	74	07.06	PHFA PHFC	10-ECO060	
2.4 TDCi	85	07.06	JXFA JXFC	10-ECO060	
2.4 TDCi 4 ruote motrici	103	11.06	H9FB	10-ECO060	
3.2 TDCi	147	02.08	SAFA SAFB	10-ECO060	

TRANSIT (FD_Y, FB_Y, FS_Y, FZ_Y, FC_Y)

2.0 DI (F_E_, F_F_, F_G_)	55	08.00	D3FA	10-ECO022	
2.0 DI (F_E_, F_F_, F_G_)	63	08.00	F3FA	10-ECO022	
2.0 DI (F_E_, F_F_, F_G_)	74	08.00	ABFA	10-ECO022	
2.0 TDCi (F_F_, F_E_, F_G_)	92	08.02	FIFA	10-ECO022	
2.4 DI (F_B_, F_C_, F_A_)	66	01.00	D2FA D2FE D2FB	10-ECO022	
2.4 DI [RWD] (F_B_, F_C_)	55	01.00	F4FA	10-ECO022	
2.4 DI [RWD] (F_B_, F_C_, F_A_)	88	01.00	D4FA	10-ECO022	
2.4 TD	55	08.00→08.03	F4FA	10-ECO022	
2.4 TDCi	101	03.04	H9FA	10-ECO022	
2.4 TDDi	66	10.01→03.06	D2FE	10-ECO022	
2.4 TDDi	88	08.00→08.03	D4FA	10-ECO022	
2.4 TDE	85	03.04	FXFA	10-ECO022	
2.4 TDE (F_C_, F_B_, F_A_)	92	07.01	DOFA	10-ECO022	









GASOLONE

	KW			 OIL FILTER FILTRO OLIO	 AIR FILTER FILTRO ARIA	 FUEL FILTER FILTRO CARBURANTE	 CABIN FILTER FILTRO ABITACOLO
GASOLONE							
35 2.5 D	59			10-05-505P 10-05-505	20-09-991	30-05-502MP 30-05-502	
35D11S	81	10.07		10-ECO045	20-H0-009	30-0H-H03 30-H0-005	
FD29	65	10.07		10-ECO045	20-H0-009	30-0H-H03 30-H0-005	







NEW CODES - NEUE CODES - NOUVEAUX CODES - NUEVOS CODIGOS - NUOVI CODICI

Per nuove applicazioni e novità si prega di accedere al sito www.ashika.eu - For new applications and new items, please go to www.ashika.eu

	KW			 OIL FILTER FILTRO OLIO	 AIR FILTER FILTRO ARIA	 FUEL FILTER FILTRO CARBURANTE	 CABIN FILTER FILTRO ABITACOLO
TROY							
1.9 TD 4X4	81	05.06		10-01-112E	20-00-022	30-00-017	
2.0 16V	93	05.06		10-05-510	20-00-022		
VICTORY							
1.9 TD 4X4	81	05.06		10-01-112E	20-00-022	30-00-017	
2.0 16V	93	05.06		10-05-510	20-00-022		









GREAT WALL



	KW			 OIL FILTER FILTRO OLIO	 AIR FILTER FILTRO ARIA	 FUEL FILTER FILTRO CARBURANTE	 CABIN FILTER FILTRO ABITACOLO
HOVER							
CUV 2.4	93	01.07		10-03-316	20-05-598	30-0M-000	
STEED							
2.4	93	01.10		10-03-316		30-0M-000	

NEW CODES - NEUE CODES - NOUVEAUX CODES - NUEVOS CODIGOS - NUOVI CODICI

Per nuove applicazioni e novità si prega di accedere al sito www.ashika.eu - For new applications and new items, please go to www.ashika.eu

	KW						
				OIL FILTER FILTRO OLIO	AIR FILTER FILTRO ARIA	FUEL FILTER FILTRO CARBURANTE	CABIN FILTER FILTRO ABITACOLO
ACCORD I (SJ, SY)/ Hatchback (SJ, SY)							
1.6 L/EX (SY)	59	01.78 → 09.83	EL EG	10-04-401 →12.78 10-04-402 01.79 → →12.82	20-03-302 01.79 → →12.82 20-05-510 →12.78	30-04-401 →12.78 30-04-404 01.79 → →12.82 30-04-407 01.82 →	
ACCORD II (AC, AD)/ Hatchback (AC, AD)							
1.6 EX (AC)	65	09.83 → 10.85	EZ	10-04-406 06.84 →	20-05-510	30-04-405 06.84 →	
1.8 EX (AD)	74	09.83 → 10.85	ET1	10-04-406 06.84 →	20-05-510	30-04-405 06.84 →	
ACCORD III (CA4, CA5)/ Aerodeck (CA5)							
1.6 L (CA4)	65	11.85 → 12.89	A16A1	10-04-406 06.86 →	20-04-412 06.86 →	30-04-408 06.86 →	
2.0 EX (CA5)	75	11.85 → 12.89	A20A1	10-04-406	20-04-412	30-04-408	
2.0 EX (CA5)	76	11.85 → 12.89	A20A1	10-04-406	20-04-412	30-04-408	
2.0 EX (CA5)	78	11.85 → 05.89	A20A2	10-04-406 06.86 →	20-04-412 06.86 →	30-04-408 06.86 →	
2.0 EXi (CA5)	85	01.86 → 12.89	A20A3	10-04-406	20-04-413	30-04-409	
2.0 EXi (CA5)	90	11.85 → 12.87	A20A4	10-04-406	20-04-413	30-04-409	
2.0 i 16V (CA5)	101	01.87 → 12.87	B20A2	10-04-406	20-04-413	30-04-409	
2.0 i 16V (CA5)	98	10.87 → 12.89	B20A8	10-04-406	20-04-413	30-04-409	
ACCORD IV (CB3, CB7)							
2.0 16V (CB3)	66	01.90 → 03.93	F20A6	10-04-406	20-04-421	30-04-408	
2.0 16V (CB3)	81	01.90 → 03.93	F20A2 F20A3	10-04-406	20-04-421	30-04-408	
2.0 i 16V (CB3)	98	01.90 → 03.93	F20A4 F20A8	10-04-406	20-04-422	30-04-411	
2.2 i 16V (CB7)	110	01.90 → 03.93	F22A3	10-04-406	20-04-422	30-04-411	
2.2 i 16V Automatic (CB7)	108	01.90 → 03.93	F22A3	10-04-406	20-04-422	30-04-411	
ACCORD IV Aerodeck (CB8, CC)							
2.0 i 16V (CC9)	98	03.93 → 12.93	F20Z3	10-04-498	20-04-422	30-04-411	
2.2 i 16V (CB8)	108	01.91 → 12.93	F22A8	10-04-406	20-04-422	30-04-411	
2.2 i 16V (CB8)	110	01.91 → 12.93	F22A7	10-04-406	20-04-422	30-04-411	
ACCORD IV Coupe (CC1)							
2.0 i 16V	98	01.92 → 09.93	F20A7	10-04-406	20-04-422	30-04-411	
ACCORD IX/ Station wagon							
2.0	115	07.08	R20A3	10-04-410	20-04-442	30-04-427 Nel serbatoio carb. /Inside tank fuel	21-H0-H011
2.2 i-DTEC	110	07.08	N22B1	10-ECO055	20-04-441	30-ECO018	21-H0-H011
2.4	148	07.08	K24Z3	10-04-410	20-04-443	30-04-427 Nel serbatoio carb. /Inside tank fuel	21-H0-H011
ACCORD V (CC7)							
2.0 i	85	03.93 → 01.96	F20Z2	10-04-498	20-04-422	30-04-411	
2.0 i S	96	03.93 → 01.96	F20Z1	10-04-406	20-04-422	30-04-411	
2.3 i SR	116	03.93 → 01.96	H23A3	10-04-406	20-04-422	30-04-411	



	KW						
				OIL FILTER FILTRO OLIO	AIR FILTER FILTRO ARIA	FUEL FILTER FILTRO CARBURANTE	CABIN FILTER FILTRO ABITACOLO
ACCORD V Aerodeck (CE)							
2.0 i LS 16V (CE2)	100	09.93 → 02.98	F20B3	10-04-498	20-04-495	30-04-411	
2.2 i ES (CE1)	110	09.93 → 02.98	F22B5	10-04-498	20-04-495	30-04-411	
ACCORD V Coupe (CD7, CD9)							
2.0 (DC9)	100	09.93 → 12.97	F20B3	10-04-406	20-04-495	30-04-498	
2.2 i ES	110	09.93 → 02.98	F22B5	10-04-406	20-04-495	30-04-498	
ACCORD VI (CE, CF)							
1.9 i (CE7)	85	02.96 → 10.98	F18A3	10-04-498	20-04-422	30-04-498	21-H0-H03
2.0 i LS (CE8)	96	02.96 → 10.98	F20Z1	10-04-498	20-04-422	30-04-498	21-H0-H03
2.0 TDi (CF1)	77	04.96 → 10.98	20T2N	10-04-497	20-04-488	30-04-496 30-0L-L02	21-H0-H03
2.2 i VTEC (CE9)	110	02.96 → 10.98	F22Z2	10-04-498	20-04-422	30-04-498	21-H0-H03
ACCORD VII (CG)							
1.6 i	85	10.98 → 12.02	D16B6	10-04-498	20-04-424	30-04-423	21-H0-H03
1.8 i	100	10.98 → 12.02	F18B2	10-04-498	20-04-424	30-04-423	21-H0-H03
2.0 i	108	10.98 → 01.01	F20B6	10-04-498	20-04-424	30-04-423	21-H0-H03
2.0 Turbo Di	77	02.99 → 12.02	20T2N	10-04-497	20-04-488	30-04-496 30-0L-L02	21-H0-H03
2.2 Type-R	156	02.99 → 12.02	H22A7	10-04-498	20-04-495	30-04-423	21-H0-H03
2.3	113	01.01 → 12.02	F23A1 F23Z5	10-04-498	20-04-495	30-04-423	21-H0-H03
ACCORD VII Aerodeck							
2.3 16 V	118	02.98	F23A7	10-04-498	20-04-422	30-04-423	21-H0-H03
ACCORD VII Coupe (CG)							
2.0 i 16V	108	02.98 → 06.03	F20B5 F20B7	10-04-498	20-04-424 20-04-495	30-04-423	21-H0-H03
3.0 V6 24V	147	02.98 → 06.03	J30A1	10-04-406	20-04-425	30-04-423	21-H0-H03
ACCORD VII Hatchback (CH)							
1.8 i (CH6)	100	12.99 → 12.02	F18B2	10-04-498	20-04-424	30-04-423	21-H0-H03
2.0 (CH7)	108	12.99 → 12.02	F20B6	10-04-498	20-04-424	30-04-423	21-H0-H03
2.0 TDi	77	12.99 → 10.00	20T2N	10-04-497	20-04-488	30-04-496 30-0L-L02	21-H0-H03
2.3 (CL4)	113	11.00 → 12.02	F23Z5	10-04-498	20-04-495	30-04-423	21-H0-H03
ACCORD VIII							
2.0 (CL7)	114	02.03	K20A6	10-04-410	20-04-435	30-04-498	21-H0-H07
2.0 4 ruote motrici (CL8)	114	02.03	K20A6	10-04-410	20-04-435	30-04-498	21-H0-H07
2.2 i-CTDi	103	01.04	N22A1	10-00-008	20-04-436	30-04-418	21-H0-H07
2.4 (CL9)	140	02.03	K24A K24A3	10-04-410	20-04-435	30-04-498	21-H0-H07
ACCORD VIII Tourer							
2.0 (CM1)	114	04.03	K20A6	10-04-410	20-04-435	30-04-498	21-H0-H07
2.2 i-CTDi	103	01.04	N22A1	10-00-008	20-04-436	30-04-418	21-H0-H07
2.4 (CM2)	140	04.03	K24A	10-04-410	20-04-435	30-04-498	21-H0-H07
ACTY TN							
0.6	23	08.79 → 06.86	EH	10-05-503	20-04-404	30-04-498	

NEW CODES - NEUE CODES - NOUVEAUX CODES - NUEVOS CODIGOS - NUOVI CODICI

	KW						
				OIL FILTER FILTRO OLIO	AIR FILTER FILTRO ARIA	FUEL FILTER FILTRO CARBURANTE	CABIN FILTER FILTRO ABITACOLO

CAPA

1.5 16V	72	04.98 → 09.02	D15B	10-04-498	20-04-487	30-04-498	
---------	----	---------------	------	-----------	-----------	-----------	--

CITY Tre volumi

1.5 Vtec	65	08.00 → 09.03		10-04-410	20-04-453	30-04-425	Nel serbatoio carb. /Inside tank fuel
----------	----	---------------	--	-----------	-----------	-----------	--

CIVIC I (SL)/ Wagon (WC)

1300 L	33	09.80 → 09.83	EN2	10-04-402	20-04-403	30-04-407	
1300 L	44	09.80 → 09.83	EN1	10-04-402	20-04-403	30-04-404	
1300 S	52	10.79 → 12.84	EN4	10-04-402 06.82 → → 06.83	20-04-405	30-04-404 06.82 → → 06.83	

CIVIC I Hatchback (SB, SS)

1200 (SB1)	40	07.72 → 02.77	EB1	10-04-401	20-04-403	30-04-401	
1200 (SB2)	40	03.77 → 12.80	EB2	10-04-401	20-04-403	30-04-404	
1200 (SB2)	44	09.77 → 12.80	EB3	10-04-401	20-04-403	30-04-404	
1300 L (SS)	44	09.79 → 09.83	EN1	10-04-402	20-04-403	30-04-407	

CIVIC II/ Hatchback

1.2	40	01.85 → 10.87	D12B1 ZA2	10-04-402	20-04-406	30-04-405	
1.3	52	10.83 → 10.87	EV2	10-04-402	20-04-406	30-04-405	
1.5 GL	63	10.83 → 10.87	EW2	10-04-402	20-04-406	30-04-405	
1.5 GT	74	01.85 → 10.87	EW3	10-04-402	20-04-407	30-04-416	
1.5 GTI	66	03.86 → 10.87	EW4	10-04-402	20-04-407	30-04-407	

CIVIC III Hatchback (EC, ED, EE)

1.3 (EC8)	55	10.87 → 12.89	D13B1	10-04-406 06.88 →	20-04-417 06.88 →	30-04-408 06.88 →	21-H0-H00
1.3 16 V (EC8) Cat.	55	09.89 → 09.91	D13B2	10-04-406	20-04-417	30-04-408	21-H0-H00
1.4 L (EC9)	66	10.87 → 12.89	D14A1	10-04-406	20-04-418	30-04-405	
1.5 i 16V	66	10.88 → 09.91	D15B2	10-04-406	20-04-416	30-04-413	21-H0-H00
1.5 i 16V (ED6)	69	10.88 → 09.91	D15B2	10-04-406	20-04-416	30-04-413	21-H0-H00
1.6 i 16V	96	09.87 → 09.91	D16A9 D16A7	10-04-498	20-04-423	30-04-413	21-H0-H00
1.6 i 16V (ED7)	80	10.87 → 09.91	D16A6	10-04-406	20-04-416	30-04-413	21-H0-H00
1.6 i 16V (ED7)	81	10.87 → 09.91	D16Z2	10-04-406	20-04-416	30-04-413	21-H0-H00
1.6 i 16V Vtec (EE9)	110	10.89 → 09.91	B16A1	10-04-498	20-04-423	30-04-413	21-H0-H00

CIVIC III Tre volumi (ED)

1.3	55	10.87 → 12.89	D13B1	10-04-406	20-04-417	30-04-408	21-H0-H00
1.4 L (ED2)	66	10.87 → 12.89	D14A1	10-04-406	20-04-418	30-04-405	21-H0-H00
1.5 i 16V	66	10.87 → 09.91	D15B2	10-04-406	20-04-416	30-04-413	21-H0-H00
1.5 i 16V (ED3)	69	10.87 → 09.91	D15B2	10-04-406	20-04-416	30-04-413	21-H0-H00
1.6 i 16V	96	09.87 → 09.91	D16A7	10-04-498	20-04-423	30-04-413	21-H0-H00
1.6 i 16V (ED4)	80	11.87 → 09.91	D16A6	10-04-406	20-04-416	30-04-413	21-H0-H00
1.6 i 16V (ED4)	81	10.87 → 09.91	D16Z2	10-04-406	20-04-416	30-04-413	21-H0-H00
1.6 i 16V 4x4	80	10.89 → 09.91	D16A6	10-04-406	20-04-416	30-04-413	21-H0-H00

CIVIC IV Coupe (EJ)

1.5 i LSi (EJ2)	74	01.94 → 11.95	D15B7	10-04-498	20-04-496	30-04-411	21-H0-H00
-----------------	----	---------------	-------	-----------	-----------	-----------	-----------

NEW CODES - NEUE CODES - NOUVEAUX CODES - NUEVOS CODIGOS - NUOVI CODICI



	KW						
				OIL FILTER FILTRO OLIO	AIR FILTER FILTRO ARIA	FUEL FILTER FILTRO CARBURANTE	CABIN FILTER FILTRO ABITACOLO
CIVIC IV Coupe (EJ)							
1.6 i (EJ6)	77	01.94 → 11.95	D16Y7	10-04-498	20-01-196	30-04-498	21-H0-H00
1.6 i Vtec	118	01.94 → 11.95	B16A2	10-04-498	20-04-418	30-04-498	21-H0-H00
1.6 i Vtec (EJ1)	92	01.94 → 03.96	D16Z9 D16Y6	10-04-498	20-04-496	30-04-411	21-H0-H00
CIVIC IV Fastback (MA, MB)							
1.4 i (MA8)	55	09.95 → 01.97	D14A5	10-04-498	20-01-196	30-04-498	21-H0-H01
1.4 i (MA8)	66	09.94 → 01.97	D14A2	10-04-498	20-04-496	30-04-498	21-H0-H01
1.5 i Vtec-E (MA9)	66	09.94 → 01.97	D15Z3	10-04-498	20-04-496	30-04-498	21-H0-H01
1.6 i (MB1)	83	09.94 → 01.97	D16Y3	10-04-498	20-04-496	30-04-498	21-H0-H01
1.6 i Vtec (MB1)	93	09.94 → 01.97	D16Y2	10-04-498	20-04-496	30-04-498	21-H0-H01
CIVIC IV Tutti i modelli\ All models							
1.3 16V (EG3)	55	10.91 → 11.95	D13B2	10-04-406	20-04-417	30-04-403	21-H0-H00
1.5 i 16V	66	10.91 → 11.95	D15B2 D15Z2	10-04-406	20-04-496	30-04-411	21-H0-H00
1.5 i 16V (EG4)	69	10.91 → 11.95	D15Z1 D15B2	10-04-406	20-04-496	30-04-411	21-H0-H00
1.6 16V Vtec (EG5)	92	10.91 → 11.95	D16Z6	10-04-406	20-04-496	30-04-413	21-H0-H00
1.6 VTi 16V (EG6)	118	10.91 → 11.95	B16A2	10-04-406	20-04-496	30-04-413	21-H0-H00
CIVIC Shuttle I (AN, AR)							
1.5 (AN)	63	10.83 → 10.87	EW2	10-04-402	20-04-406	30-04-405	
1.5 4WD (AR)	63	01.85 → 10.87	EW2	10-04-402	20-04-406	30-04-405	
CIVIC Shuttle II (EE)							
1.4 i 16V (EE1)	66	01.88 → 12.92	D14A1	10-04-406 →12.89	20-04-418 →12.89	30-04-405 →06.89	21-H0-H00
1.5 i 16V (EE2)	69	01.88 → 11.91	D15B2	10-04-406	20-04-416	30-04-413	21-H0-H00
1.6 4x4	85	01.88 → 12.92	D16A7 D16A	10-04-406	20-04-416	30-04-413	21-H0-H00
1.6 16V 4WD D16Z2	0	01.90		10-04-406	20-04-416	30-04-413	21-H0-H00
1.6 i 16V 4WD (EE4)	80	01.88 → 12.89	D16A6	10-04-406	20-04-416	30-04-413	21-H0-H00
1.6 i 16V 4WD (EE4)	81	01.88 → 02.95	D16A6	10-04-406 06.88 → →06.92	20-04-416 06.88 → →06.92	30-04-413 06.88 → →06.92	21-H0-H00
CIVIC V (EJ9, EK3/4)							
1.4 i (EJ9)	66	11.95 → 02.01	D14A4 D14Z2	10-04-498	20-01-196	30-04-498	21-H0-H01
1.5 i (EK3)	84	11.95 → 02.01	D15Z6	10-04-498	20-04-496	30-04-498	21-H0-H00
1.6 i Vtec	92	11.95 → 02.01	D16Y8 D16Y6	10-04-498	20-04-487	30-04-498	21-H0-H00
1.6 VTi (EK4)	118	11.95 → 02.01	B16A2	10-04-498	20-04-487	30-04-498	21-H0-H00
CIVIC V Coupe (EJ6, EJ8)							
1.6 i	77	03.96 → 03.00	D16Y7	10-04-498	20-01-196	30-04-498	21-H0-H01
1.6 i Vtec	118	04.99 → 12.00	B16A2	10-04-498	20-04-487	30-04-411	21-H0-H01
1.6 i Vtec	92	03.96 → 03.00	D16Y8	10-04-498	20-04-487	30-04-498	21-H0-H01
CIVIC V Fastback (MB)							
1.4 16V (MB2)	55	01.97 → 02.01	D14A7	10-04-498	20-04-487	30-04-498	21-H0-H01
1.4 16V (MB2)	66	01.97 → 02.01	D14A8	10-04-498	20-04-487	30-04-498	21-H0-H00 21-H0-H01
1.5 16V (MB3)	84	01.97 → 02.01	D15Z8	10-04-498	20-04-487	30-04-498	21-H0-H01

NEW CODES - NEUE CODES - NOUVEAUX CODES - NUEVOS CODIGOS - NUOVI CODICI

	KW						
				OIL FILTER FILTRO OLIO	AIR FILTER FILTRO ARIA	FUEL FILTER FILTRO CARBURANTE	CABIN FILTER FILTRO ABITACOLO
CIVIC V Fastback (MB)							
1.6 16V (MB4)	85	01.97 → 02.01	D16B2	10-04-498	20-04-487	30-04-498	21-H0-H00
1.6 VTi	118	01.97 → 02.01	B16A2	10-04-498	20-04-487	30-04-498	21-H0-H01
1.8 16V (MB6)	124	01.97 → 02.01	B18C4	10-04-498	20-04-496	30-04-498	21-H0-H01
2.0 i TD (MB7)	63	01.97 → 02.01	20T2R	10-04-497	20-04-488	30-04-496 30-0L-L02	21-H0-H01
CIVIC VI							
1.3 IMA	61	01.04 → 09.05	LDA1	10-04-498	20-04-449	30-04-408	21-H0-H08
1.4 (ES4)	66	02.01 → 09.05	D14Z5	10-04-410	20-04-429	30-04-400	21-H0-H08
1.6	81	02.01 → 09.05	D16V1	10-04-410	20-04-429		21-H0-H08
1.6	84	09.05 → 09.05	R16A1	10-04-410	20-04-429		21-H0-H08
1.7	85	02.01 → 09.05	D17A6	10-04-498	20-04-428		21-H0-H08
CIVIC VI Aerodeck (MB,MC)							
1.4 16V (MB8)	55	04.98 → 02.01	D14A7	10-04-498	20-04-487	30-04-498	21-H0-H00
1.4 16V (MB8)	66	04.98 → 02.01	D14A8	10-04-498	20-04-487	30-04-498	21-H0-H01
1.5 16V (MB9)	84	04.98 → 02.01	D15Z8	10-04-498	20-04-496	30-04-498	21-H0-H00
1.6 16V (MC1)	85	04.98 → 02.01	D16B2	10-04-498	20-04-487	30-04-498	21-H0-H00
1.8 16V (MC2)	124	04.98 → 02.01	B18C4	10-04-498	20-04-496	30-04-498	21-H0-H00 21-H0-H01
2.0 i D (MC3)	77	04.98 → 02.01	20T2N	10-04-497	20-04-488	30-0L-L02	21-H0-H01
CIVIC VI Coupe (EM)							
1.6 i	81	02.01 → 12.05	D16V1	10-04-410	20-04-429		21-H0-H08
1.7 i	88	05.01 → 12.05	D17A8	10-04-498	20-04-428	30-04-400	21-H0-H08
1.7 i VTEC	92	05.01 → 12.05	D17A5 D17A9	10-04-498	20-04-428	30-04-400	21-H0-H08
CIVIC VI Hatchback (EJ,EK)							
1.4 i (EJ9)	55	11.95 → 02.01	D14A3 D14Z1	10-04-498	20-04-487	30-04-498	21-H0-H01
1.4 i S (EJ9)	66	11.95 → 02.01	D14A4 D14Z2	10-04-498	20-01-196	30-04-498	21-H0-H01
1.5 i (EK3)	84	11.95 → 02.01	D15Z6	10-04-498	20-04-496	30-04-498	21-H0-H00
1.6 i (EK1)	84	11.95 → 02.01	D16Y5	10-04-498	20-04-487	30-04-498	21-H0-H01
1.6 VTi (EK4)	118	11.95 → 02.01	B16A2	10-04-498	20-04-487	30-04-498	21-H0-H01
CIVIC VI Hatchback (EU_, EP_)							
1.4 i	55	02.01 → 09.05	D14Z6	10-04-410	20-04-429	30-04-498	21-H0-H01
1.4 iS (EP1)	66	02.01 → 09.05	D14Z5 D14Z6	10-04-410	20-04-429	30-04-400	21-H0-H08
1.6 i	81	02.01 → 09.05	D16V1	10-04-410	20-04-429	30-04-400	21-H0-H08
1.7 CTDi	74	01.02 → 09.05	4EE-2	10-ECO038	20-04-437	30-04-418	21-H0-H08
2.0 i Sport	118	01.04 → 09.05	K20A3	10-04-410	20-04-432	30-04-400	21-H0-H08
2.0 Type-R	147	09.01 → 09.05	K20A2	10-04-410	20-04-432	30-04-400	21-H0-H04
CIVIC VII							
1.3	70	01.06	LDA2	10-04-410	20-04-450		21-H0-H07
1.4	61	01.06	L13A7	10-04-410	20-04-439		21-H0-H09
1.8	103	01.06	R18A2	10-04-410	20-04-439		21-H0-H09
1.8	103	09.05	R18A1	10-04-410	20-04-439		21-H0-H07
2.2 CTDi	103	01.06	N22A2	10-ECO055	20-04-438	30-02-240	21-H0-H09









	KW						
				OIL FILTER FILTRO OLIO	AIR FILTER FILTRO ARIA	FUEL FILTER FILTRO CARBURANTE	CABIN FILTER FILTRO ABITACOLO
CIVIC VII Hatchback							
1.4	73	10.08	L13Z1	10-04-410			21-H0-H09
Type R	148	09.06	K20Z4	10-04-410			21-H0-H09
CONCERTO (HW) Tutti i modelli\ All models							
1.4	61	10.89 → 10.92	D14A1	10-04-406	20-04-418	30-04-411	
1.4	66	08.89 → 10.91	D14A1 D14A8	10-04-406	20-04-418	30-04-411	
1.5 i 16V	66	08.89 → 03.95	D15B2	10-04-406 06.90 →	20-04-498 06.90 →	30-04-411 06.90 →	
1.6 16V	78	08.89 → 03.95	D16Z2	10-04-406	20-04-498	30-04-411	
1.6 i 16V	82	08.89 → 03.95	D16Z2	10-04-406 06.90 →	20-04-498 06.90 →	30-04-411	
1.6 i 16V	90	08.89 → 03.95	D16A8	10-04-406	20-04-498	30-04-411	
CR-V I (RD)							
2.0 16V (RD1, RD3)	108	01.99 → 02.02	B20Z1	10-04-498	20-04-487 →06.01	30-04-498	21-H0-H00
2.0 16V (RD1, RD3)	94	10.95 → 01.99	B20B	10-04-498	20-04-487 06.97 →	30-04-498	21-H0-H00
CR-V II							
2.0	110	07.02 → 09.06	K20A4	10-04-406	20-04-432	30-04-498	21-H0-H04
2.0 i-VTEC	110	01.07	R20A2	10-04-410	20-04-400		21-H0-H011
2.2 CTDi	103	02.05 → 09.06	N22A2	10-00-008	20-04-474	30-02-240	21-H0-H04
2.2 i-CTDi	103	01.07	N22A2	10-ECO055	20-04-474	30-04-424	21-H0-H011
CR-V III							
2.2 i-DTEC	110	01.07	N22B3	10-ECO055	20-04-474	30-02-240	21-H0-H07
CR-Z (ZF1)							
1.5 Hybrid	84	06.10	LEA1				21-H0-H012
CRX I (AF, AS)							
1.3	52	10.83 → 10.87	EV2	10-04-402	20-04-406	30-04-405	
1.5 i (AF)	74	10.83 → 11.86	EW3	10-04-402 06.84 → →06.86	20-04-407 06.84 → →06.86	30-04-416	
1.6 i 16V (AS)	92	03.86 → 10.87	ZC1	10-04-402	20-04-407	30-04-416	
CRX II (ED, EE)							
1.6 i 16V	79	10.87 → 05.88	D16A6 D16A	10-04-406	20-04-416	30-04-413	
1.6 i 16V (ED9)	91	10.87 → 02.92	D16Z5	10-04-406	20-04-416	30-04-413	
1.6 i 16V (ED9)	96	10.87 → 12.89	D16A8 D16A9	10-04-406	20-04-416	30-04-413	
1.6 i 16V Vtec (EE8)	110	10.89 → 02.92	B16A1	10-04-406	20-04-423	30-04-413	
CRX III (EH, EG)							
1.6 ESi (EH6)	92	03.92 → 12.98	D16Y8 D16Z6	10-04-406	20-04-496	30-04-413	
1.6 i VTi (EG2)	118	03.92 → 12.98	B16A2	10-04-406	20-04-496	30-04-413	
FR-V							
1.7	92	02.05	D17A2	10-04-410	20-04-429	30-04-498	21-H0-H04
1.8	103	01.07	R18A1	10-04-410	20-04-439		21-H0-H04
2.0	110	02.05	K20A9	10-04-410	20-04-432		21-H0-H04







NEW CODES - NEUE CODES - NOUVEAUX CODES - NUEVOS CODIGOS - NUOVI CODICI

	KW						
				OIL FILTER FILTRO OLIO	AIR FILTER FILTRO ARIA	FUEL FILTER FILTRO CARBURANTE	CABIN FILTER FILTRO ABITACOLO
FR-V							
2.2 i CTDi	103	07.05	N22A1	10-00-008	20-04-474	30-02-240	21-H0-H04
HR-V (GH)							
1.6 16V	77	03.99	D16W1	10-04-498	20-04-487	30-04-498	21-H0-H02
1.6 16V 4WD	77	03.99	D16W1	10-04-498	20-04-487	30-04-498	21-H0-H02
1.6 16V 4WD	91	10.99	D16W5	10-04-498	20-04-487 06.01→	30-04-498	21-H0-H02
INSIGHT							
1.3	65	04.09	LDA3	10-04-410	20-04-445		21-H0-H012
INSIGHT (ZE)							
1.0	56	04.00→12.06	ECA1	10-03-313	20-04-487		21-H0-H00
INTEGRA							
2.0	118	02.02	K20A3	10-04-410	20-04-432	30-04-498	
2.0 16V Type-R	162	02.02		10-04-406	20-04-431	30-04-498	
INTEGRA (DA_)							
1.5	63	10.85→08.89	D15A1	10-04-402	20-04-406	30-04-405	
1.6	88	03.86→08.89	D16A3	10-04-402	20-04-490	30-04-405	
INTEGRA (DC2)							
1.8 Type-R	140	11.97→10.01	B18C6	10-04-406 06.98→	20-04-431 06.98→	30-04-498	
JAZZ							
1.2	66	03.08					
1.2	66	07.08	L12B1	10-04-410	20-04-444	30-04-425 Nel serbatoio carb. /Inside tank fuel 30-04-426 Nel serbatoio carb. /Inside tank fuel	21-H0-H012
1.4	73	03.08					
1.4	73	07.08	L13Z1	10-04-410	20-04-444	30-04-425 Nel serbatoio carb. /Inside tank fuel 30-04-426 Nel serbatoio carb. /Inside tank fuel	21-H0-H012
JAZZ (AA)							
45 1.2	33	02.84→10.86	ER2	10-04-402	20-04-408	30-04-407	21-H0-H05
55 1.2	40	09.84→10.86	ER4	10-04-402	20-04-408	30-04-407	21-H0-H05
56 1.2	41	10.83→10.86	ER1	10-04-402	20-04-408	30-04-407	21-H0-H05
JAZZ (GD)							
1.2	57	03.02	L12A1	10-04-410	20-04-434 →03.05 20-04-440 04.05→	30-04-425 Nel serbatoio carb. /Inside tank fuel	21-H0-H05
1.4	61	03.02	L13A1	10-04-410	20-04-434 →03.05 20-04-440 04.05→	30-04-425 Nel serbatoio carb. /Inside tank fuel	21-H0-H05
LEGEND I (HS, KA)\ Coupé							









	KW						
				OIL FILTER FILTRO OLIO	AIR FILTER FILTRO ARIA	FUEL FILTER FILTRO CARBURANTE	CABIN FILTER FILTRO ABITACOLO
LEGEND I (HS, KA)\ Coupé							
2.5 i (HS)	110	01.86 → 12.87	C25A1	10-04-408	20-04-415	30-04-411	
2.5 i (HS)	127	02.87 → 06.88	C25A2	10-04-408	20-04-415	30-04-411	
2.7 i 24V (KA4)	124	01.88 → 12.90	C27A1	10-04-407	20-04-415	30-04-411	
LEGEND II (KA7)\ Coupé							
3.2 i 24V	151	01.91 → 02.96	C32A2	10-04-407	20-04-497	30-04-411	
LEGEND III (KA9)							
3.5 i 24V	151	02.96	C35A2	10-04-406 06.96 → → 06.98 10-04-498 06.98 → → 06.01	20-04-492 06.96 → → 06.99	30-04-498	21-H0-H015 21-H0-H07
3.7 VTEC V6	217	07.08	J37A3			30-04-411	
LOGO (GA3)							
1.3	48	03.99 → 03.02	D13B7	10-04-498	20-04-486	30-04-498	21-H0-H02
N III							
600	31	05.68 → 08.74	N600E	10-04-406			
NSX Cabriolet (NA)							
3.0 24V Vtec	201	03.95 → 09.05	C30A3	10-04-407		30-04-499	
3.0 24V Vtec Automatic	188	03.95 → 09.05	C30A4	10-04-407		30-04-499	
3.2 24V Vtec	206	01.97 → 09.05	C32B2	10-04-407		30-04-499	
NSX Coupe (NA)							
3.0 24V Vtec (NA1)	201	06.90 → 09.05	C30A3	10-04-407		30-04-499	
3.0 24V Vtec Automatic (NA1)	188	06.90 → 09.05	C30A4	10-04-407		30-04-499	
3.2 24V Vtec (NA2)	206	01.97 → 09.05	C32B2	10-04-407		30-04-499	
PRELUDE I Coupe (SN)							
1.6	59	11.78 → 10.82	EL EL14	10-04-402	20-03-302	30-04-404	
PRELUDE II (AB)							
1.8 EX	74	11.85 → 04.87	ET3 ET4	10-04-406	20-04-409	30-04-405	
1.8 EX	77	11.83 → 04.87	ET3 ET2	10-04-406	20-04-409	30-04-405	
PRELUDE III (BA)							
2.0 (BA4)	84	08.87 → 01.92	B20A4	10-04-406	20-04-419	30-04-408	
2.0 EX (BA4)	80	04.87 → 01.92	B20A3	10-04-406	20-04-419	30-04-408	
2.0 i EX 16V	101	04.86 → 12.87	B20A1	10-04-406	20-04-413	30-04-414	
2.0 i EX 16V	110	10.87 → 12.90	B20A7	10-04-406	20-04-420	30-04-415	
2.0 i EX 16V (BA2)	101	04.86 → 12.87	B20A1	10-04-406	20-04-413	30-04-414	
2.0 i EX 16V (BA4)	103	04.90 → 01.92	B20A9	10-04-406	20-04-420	30-04-415	
2.0 i EX 16V (BA4) Cat.	101	04.87 → 01.92	B20A5	10-04-406	20-04-420	30-04-415	
PRELUDE IV (BB)							
2.0 i 16V (BB3)	98	02.92 → 09.96	F20A4	10-04-406	20-04-427	30-04-411	21-H0-H010
2.2 i 16V Vtec (BB1)	136	02.93 → 09.96	H22A2	10-04-406	20-04-427	30-04-411	21-H0-H010
2.3 i 16V (BB2)	118	02.92 → 09.96	H23A2	10-04-406	20-04-427	30-04-411	21-H0-H010

NEW CODES - NEUE CODES - NOUVEAUX CODES - NUEVOS CODIGOS - NUOVI CODICI

	KW						
				OIL FILTER FILTRO OLIO	AIR FILTER FILTRO ARIA	FUEL FILTER FILTRO CARBURANTE	CABIN FILTER FILTRO ABITACOLO
PRELUDE V (BB)							
2.0 16V (BB9)	98	10.96 → 10.00	F20A4	10-04-498	20-04-427	30-04-498	21-H0-H010
2.2 16V	147	10.96 → 10.00	H22A5	10-04-498	20-04-427	30-04-498	21-H0-H010
2.2 16V (BB6, BB8)	136	10.96 → 10.00	H22A5	10-04-498	20-04-427	30-04-498	21-H0-H010
QUINTET (SU)							
1.6 EX	59	02.80 → 12.84	EL	10-04-402	20-03-302	30-04-405	
S2000 (AP)							
2.0	177	06.99	F20C VTEC	10-09-914	20-04-430 06.99→	30-04-428 Nel serbatoio carb. /Inside tank fuel	21-H0-H014
SHUTTLE (RA)							
2.2 16V	110	10.94 → 02.98	F22B8	10-04-498	20-04-495 06.95→	30-04-498	
2.3 16V	110	10.97 → 06.02	F23A7	10-04-498	20-04-495	30-04-498	
STREAM (RN)							
1.7 16V	92	05.01	D17A2	10-04-498	20-04-429		21-H0-H06
2.0 16V	115	05.01	K20A1	10-04-410	20-04-432		21-H0-H06



HUMMER

	KW			 OIL FILTER FILTRIO OLIO	 AIR FILTER FILTRIO ARIA	 FUEL FILTER FILTRIO CARBURANTE	 CABIN FILTER FILTRIO ABITACOLO
HUMMER H2							
6.0 4 ruote motrici	232	09.02 → 09.04	LQ4	10-00-014	20-00-013	30-00-002	21-HM-H00
HUMMER H2 SUT							
6.0	237	09.04	LQ4	10-00-014	20-00-013	30-00-002	21-HM-H00
HUMMER H3							
3.5	162	04.05	L52	10-00-013	20-00-012		
3.7 4 ruote motrici	180	09.06	LLR	10-00-013	20-00-012		

NEW CODES - NEUE CODES - NOUVEAUX CODES - NUEVOS CODIGOS - NUOVI CODICI

Per nuove applicazioni e novità si prega di accedere al sito www.ashika.eu - For new applications and new items, please go to www.ashika.eu

	KW						
				OIL FILTER FILTRO OLIO	AIR FILTER FILTRO ARIA	FUEL FILTER FILTRO CARBURANTE	CABIN FILTER FILTRO ABITACOLO
ACCENT (LC)\ Tre volumi (LC)							
1.3	55	01.00	G4E-A	10-05-599	20-H0-002	30-05-573	21-HY-H08
1.3	61	01.00	G4E-A	10-05-599	20-H0-002	30-05-573	21-HY-H08
1.3	62	08.02		10-05-599	20-H0-002	30-05-573	21-HY-H08
1.3	63	01.00	G4E-A	10-05-599	20-H0-002	30-05-573	21-HY-H08
1.5	66	01.00	G4EB	10-05-599	20-H0-002	30-05-573	21-HY-H08
1.5	75	09.00	G4EC-G	10-05-599	20-H0-002	30-05-573	21-HY-H08
1.5 CRDi	60	04.02	D3-EA	10-H0-003	20-0H-013	30-0H-H03 30-H0-005 03.04→ 30-0H-H18 →02.04	21-HY-H08
1.6	77	12.02	G4ED-G	10-05-599	20-H0-002	30-H0-022 04.03→ Nel serbatoio carb. /Inside tank fuel	21-HY-H08
ACCENT (MC)\ Tre volumi (LC)							
1.4 GL	71	11.05	G4EE	10-05-599	20-0K-K15	30-0K-K22 Nel serbatoio carb. /Inside tank fuel	21-HY-H28
1.5 CRDi GLS	81	11.05	D4FA	10-ECO045	20-0K-K16	30-0H-H03 30-H0-005	21-HY-H28
1.6 GLS	82	11.05	G4ED	10-05-599	20-0K-K15	30-H0-022 Nel serbatoio carb. /Inside tank fuel	21-HY-H28
ACCENT/EXCEL (X-3)\ Tre volumi (X-3)							
1.3	44	10.94→01.00	G4EH	10-05-599	20-05-592	30-05-501	21-HY-H08
1.3	55	10.94→01.00	G4EH	10-05-599	20-05-592	30-05-501	21-HY-H08
1.3 i 12V	62	10.94→01.00	G4EH	10-05-599	20-05-592	30-05-514	21-HY-H08
1.5 i 12V	65	10.94→01.00	G4EK	10-05-599	20-05-592	30-05-514	21-HY-H08
1.5 i 16V	73	12.95→01.00	G4ER	10-05-599	20-05-593	30-05-514	21-HY-H08
ATOS (MX)\ PRIME (MX)							
1.0 i	40	08.99	G4HC	10-05-593	20-05-578	30-05-585	
1.0 i	43	03.01	G4HC-E	10-05-593	20-05-578	30-05-585	
1.1	43	06.03	G4HD	10-0H-005	20-0H-011	30-0H-012	
1.1	46	09.05	G4HG	10-0H-005	20-0H-H18	30-0H-012	
COUPE							
1.6	77	02.06		10-05-599	20-H0-010	30-H0-022 Nel serbatoio carb. /Inside tank fuel	21-HY-H03
2.0	105	02.06		10-05-599	20-H0-010	30-H0-022 Nel serbatoio carb. /Inside tank fuel	21-HY-H03
2.7 V6	121	02.06		10-05-599	20-H0-010	30-H0-022 Nel serbatoio carb. /Inside tank fuel	21-HY-H03
COUPE (GK)							
1.6 16V	77	03.02	G4ED-G	10-05-599	20-05-593	30-H0-022 Nel serbatoio carb. /Inside tank fuel	21-HY-H03
1.6 16V	79	03.02	G4ED-G	10-05-599	20-05-593	30-H0-022 Nel serbatoio carb. /Inside tank fuel	21-HY-H03



	KW						
				OIL FILTER FILTRO OLIO	AIR FILTER FILTRO ARIA	FUEL FILTER FILTRO CARBURANTE	CABIN FILTER FILTRO ABITACOLO

COUPE (GK)

2.0	102	03.02	G4GC-G	10-05-599	20-H0-010	30-05-594	21-HY-H03
2.0 GLS	105	02.03	G4GC-G	10-05-599	20-H0-010	30-H0-022 Nel serbatoio carb. /Inside tank fuel	21-HY-H03
2.7 V6	123	03.02	G6BA-G	10-05-599	20-H0-010	30-H0-023 Nel serbatoio carb. /Inside tank fuel	21-HY-H03

COUPE (RD)

1.6 16V	85	03.98 → 04.02	G4GR	10-05-599	20-05-590	30-05-594	21-HY-H03
1.6 i 16V	84	12.96 → 04.02	4G61	10-05-599 →06.99	20-05-590	30-05-594 →06.99	21-HY-H03
2.0 16V	102	08.96 → 04.02	G4GF	10-05-599 →06.99	20-05-590 06.00→	30-05-594 06.00→	21-HY-H03
2.0 16V	99	03.01 → 04.02	G4DF	10-05-599	20-05-590	30-05-594	21-HY-H03

ELANTRA (XD)\ Tre volumi (XD)

1.6	77	05.03	G4ED-G	10-05-599	20-H0-010	30-H0-022 Nel serbatoio carb. /Inside tank fuel	21-HY-H03
1.6	79	06.00	G4ED-G	10-05-599	20-05-590	30-05-594	21-HY-H03
1.6	82	09.03	G4GA	10-05-599	20-H0-010	30-H0-022 Nel serbatoio carb. /Inside tank fuel	21-HY-H03
1.8	97	06.00	G4BB	10-05-599	20-05-516	30-H0-022 Nel serbatoio carb. /Inside tank fuel	21-HY-H03
1.8	98	11.02	G4GB	10-05-599	20-05-516	30-H0-022 Nel serbatoio carb. /Inside tank fuel	21-HY-H03
2.0	102	06.00	G4GC-G	10-05-599	20-05-590	30-05-594	21-HY-H03
2.0	104	06.00	G4GC	10-05-599	20-05-590	30-05-594	21-HY-H03
2.0	105	10.03	G4GC	10-05-599	20-H0-010	30-H0-022 Nel serbatoio carb. /Inside tank fuel	21-HY-H03
2.0 CRDi	83	04.01	D4EA	10-H0-004	20-H0-010	30-H0-004	21-HY-H03
CRDi	85	02.06	D4FB	10-ECO045 →08.08 10-ECO076 09.08→	20-0K-K21	30-H0-004	21-HY-H28

GALLOPER I







2.5 TD	62	08.91 → 07.98	4D56T	10-05-505P 10-05-505	20-09-991	30-05-502MP 30-05-502	
2.5 TD intercooler	70	08.91 → 07.98	4D56T	10-05-505P 10-05-505	20-09-991	30-05-502MP 30-05-502	
3.0 V6	104	08.91 → 07.98	6G72	10-05-599	20-05-516	30-05-518	

GALLOPER II (JK-01)

2.5 TCi D	77	08.98	D4BH	10-05-505P 10-05-505	20-09-991	30-05-502MP 30-05-502	
2.5 TD	65	08.98	D4BA	10-05-505P 10-05-505	20-09-991	30-05-502MP 30-05-502	
2.5 TD intercooler	73	08.98	D4BH	10-05-505P 10-05-505	20-09-991	30-05-502MP 30-05-502	
3.0 V6	104	08.98	G6AT	10-05-599	20-05-516	30-05-518	

GENESIS COUPE

NEW CODES - NEUE CODES - NOUVEAUX CODES - NUEVOS CODIGOS - NUOVI CODICI

	KW						
				OIL FILTER FILTRO OLIO	AIR FILTER FILTRO ARIA	FUEL FILTER FILTRO CARBURANTE	CABIN FILTER FILTRO ABITACOLO
GENESIS COUPE							
2.0 Turbo Sport	157	12.10		10-05-599	20-0H-H25	30-0H-H15 Nel serbatoio carb. /Inside tank fuel	21-HY-H11
GETZ (TB)							
1.1	46	09.02	G4HD	10-05-593	20-H0-008	30-05-594 30-0H-H16 Nel serbatoio carb. /Inside tank fuel	21-HY-H05
1.1	49	09.05	G4HD	10-05-593	20-H0-008	30-05-594	21-HY-H05
1.3	60	09.02	G4E-A	10-05-599	20-H0-008	30-05-594 30-0H-H16 Nel serbatoio carb. /Inside tank fuel	21-HY-H05
1.3	63	09.03	G4E-A	10-05-599	20-H0-008	30-05-594	21-HY-H05
1.4	71	08.05	G4EE	10-05-599	20-H0-008	30-05-594	21-HY-H05
1.5 CRDi	60	03.03	D3-EA	10-ECO045 11.04→ 10-H0-003 →10.04	20-H0-009	30-0H-H03 30-H0-005	21-HY-H05
1.5 CRDi	65	08.05		10-ECO045	20-H0-009	30-0H-H03 30-H0-005	21-HY-H05
1.5 CRDi GLS	81	08.05	D4FA	10-ECO045	20-H0-009	30-0H-H03 30-H0-005	21-HY-H05
1.6	77	09.02	G4ED-G	10-05-599	20-H0-008	30-H0-006 Nel serbatoio carb. /Inside tank fuel	21-HY-H05
GRANDEUR							
2.2 CRDi	110	06.06	D4EB	10-ECO093	20-0H-H15	30-0H-H03	21-HY-H23
2.2 CRDi	114	06.06	D4EB	10-ECO093	20-0H-H15	30-0H-H03	21-HY-H23
3.3	173	04.05	G6DB	10-ECO075	20-0H-H20	30-02-247	21-HY-H23
H-1							
2.5 CRDi	103	12.02		10-K0-006	20-0H-H22	30-H0-011	
2.5 CRDi	125	02.08	D4CB	10-K0-006	20-0H-H22	30-H0-011	21-HY-H27
2.5 CRDi	81	02.08		10-K0-006	20-0H-H22	30-H0-011	21-HY-H27
H-1/H-200							
2.4	82	03.00	G4CS	10-05-599	20-05-516	30-02-247	21-HY-H07
2.5 CRDi	103	08.03	D4CB	10-K0-006	20-H0-001	30-0H-H03 30-H0-005	21-HY-H27
2.5 CRDi	81	01.07		10-K0-005	20-H0-001	30-05-502MP 30-05-502	21-HY-H27
2.5 TD	59	03.00→09.00	D4BF	10-05-505P 10-05-505	20-H0-001	30-05-502MP 30-05-502	21-HY-H07
2.5 TD	73	03.00	D4BH	10-05-505P 10-05-505	20-H0-001	30-05-502MP →08.04 30-05-502 →08.04	21-HY-H07



	KW						
				OIL FILTER FILTRO OLIO	AIR FILTER FILTRO ARIA	FUEL FILTER FILTRO CARBURANTE	CABIN FILTER FILTRO ABITACOLO
H-1/H-200							
2.5 TD	74	10.01	D4BH	10-05-505P 10-05-505	20-H0-001	30-05-502MP →08.04 30-05-502 →08.04 30-0H-H03 →09.04 30-H0-005 09.04→	21-HY-H07
H-1/H-200/SATELLITE							
2.4	82	10.97	G4CS	10-05-599 06.00→	20-05-516 06.00→	30-05-594	21-HY-H07
2.5 D	57	10.97		10-05-505P 10-05-505	20-H0-001	30-05-502MP 30-05-502	21-HY-H07
2.5 TD	59	10.97	D4BF	10-05-505P 10-05-505	20-H0-001	30-05-502MP 30-05-502	21-HY-H07
2.5 TD	73	10.99 → 11.01	D4BH	10-05-505P 06.00→ 10-05-505 06.00→	20-H0-001 06.00→	30-05-502MP 06.00→ 30-05-502 06.00→	21-HY-H07
2.5 TD	74	11.01	D4BH	10-05-505P 10-05-505	20-H0-001	30-05-502MP →08.04 30-05-502 →08.04 30-0H-H03 →09.04 30-H0-005 09.04→	21-HY-H07
H100							
2.5 D	55	07.93 → 12.94	D4BA D4BX	10-05-505P 10-05-505	20-09-991	30-05-502MP 30-05-502	21-HY-H07
2.5 D	57	12.94 → 03.00		10-05-505P 10-05-505	20-09-991	30-05-502MP 30-05-502	
2.6 D	57	10.99					
H100 Autobus (P)							
2.4	84	01.97 → 03.00	G4CS	10-05-599	20-05-516	30-05-594	21-HY-H07
2.4	90	07.93 → 03.00	G4CS	10-05-599 →06.98	20-05-517 →06.98	30-05-594 →06.98	21-HY-H07
2.5 D	55	07.93 → 12.94	D4BA D4BX	10-05-505P →06.94 10-05-505 →06.94	20-09-991 →06.94	30-05-502MP →06.94 30-05-502 →06.94	21-HY-H07
2.5 D	57	12.94 → 03.00	D4BA	10-05-505P 10-05-505	20-09-991	30-05-502MP 30-05-502	21-HY-H07
2.5 TD	59	07.93 → 03.00	D4BF	10-05-505P 06.97→ 10-05-505 06.97→	20-09-991 06.97→	30-05-502MP 06.97→ 30-05-502 06.97→	
H100 TRUCK							
2.5 D	57	07.93 → 12.97	D4BA	10-05-505	20-09-991	30-05-502	21-HY-H07
2.5 D	59	05.96 → 12.97	D4BF	10-K0-005	20-09-991	30-05-502	21-HY-H07
HIGHWAY VAN							
2.0 16V	100	03.00		10-05-599	20-H0-003	30-H0-002	21-KI-K06
2.7 V6 24V	125	03.00		10-05-599	20-H0-003	30-H0-002	21-KI-K06

NEW CODES - NEUE CODES - NOUVEAUX CODES - NUEVOS CODIGOS - NUOVI CODICI

	KW						
				OIL FILTER FILTRO OLIO	AIR FILTER FILTRO ARIA	FUEL FILTER FILTRO CARBURANTE	CABIN FILTER FILTRO ABITACOLO
i10							
1.1	48	12.07	G4HG	10-0H-005	20-0H-H16	30-0K-K23 Nel serbatoio carb. /Inside tank fuel	21-KI-K09
1.1	49	01.08	G4HG	10-0H-005	20-0H-H16	30-0K-K23 Nel serbatoio carb. /Inside tank fuel	21-KI-K09
1.1 CRDi	55	01.08	D3FA	10-ECO045	20-0H-H17	30-H0-011	21-KI-K09
1.2	57	11.08	G4LA	10-0H-005	20-0H-H24	30-0K-K23 Nel serbatoio carb. /Inside tank fuel	21-KI-K09
i20							
1.2	57	04.09		10-0H-005	20-0K-K22	30-0K-K23 Nel serbatoio carb. /Inside tank fuel	21-H0-H013
1.2	57	09.08	G4LA	10-0H-005	20-0K-K22	30-0K-K23 Nel serbatoio carb. /Inside tank fuel	21-H0-H013
1.4	74	04.09		10-05-599	20-0K-K22	30-0K-K23 Nel serbatoio carb. /Inside tank fuel	21-H0-H013
1.4	74	09.08	G4FA	10-05-599	20-0K-K22	30-0K-K23 Nel serbatoio carb. /Inside tank fuel	21-H0-H013
1.4 CRDi	55	04.09	D4FC	10-ECO076	20-0K-K22	30-H0-011	21-H0-H013
1.6	93	09.08	G4FC	10-05-599		30-0K-K22 Nel serbatoio carb. /Inside tank fuel	21-H0-H013
1.6 CRDi	85	04.09		10-ECO076	20-0K-K22	30-H0-011	21-H0-H013
1.6 CRDi	85	09.08	D4FB	10-ECO076	20-0K-K22	30-H0-011	21-H0-H013
i30\CW Station wagon							
1.4	77	10.07	G4FA	10-05-599	20-0K-K21	30-0K-K23 Nel serbatoio carb. /Inside tank fuel	21-KI-K18
1.4	80	10.07	G4FA	10-05-599	20-0K-K21	30-0K-K23 Nel serbatoio carb. /Inside tank fuel	21-KI-K18
1.6	85	10.07		10-05-599	20-0K-K21	30-0K-K23 Nel serbatoio carb. /Inside tank fuel	21-KI-K18
1.6	90	10.07	G4FC	10-05-599	20-0K-K21	30-0K-K23 Nel serbatoio carb. /Inside tank fuel	21-KI-K18
1.6 CRDi	66	10.07		10-ECO076	20-0K-K21	30-H0-011	21-KI-K18
1.6 CRDi	85	10.07	D4FB	10-ECO076	20-0K-K21	30-H0-011	21-KI-K18
2.0	105	10.07	G4GC-G G4GC	10-05-599	20-0K-K21		21-KI-K18
2.0 CRDi	103	10.07	D4EA	10-ECO056	20-0K-K21	30-H0-011	21-KI-K18
i40							
1.6 GDi	99	06.11		10-05-599	20-0H-H23	30-0H-H17 Nel serbatoio carb. /Inside tank fuel	21-HY-H11
1.7 CRDi	100	06.11		10-ECO076	20-0H-H23	30-0H-H03	21-HY-H11
1.7 CRDi	85	06.11		10-ECO076	20-0H-H23	30-0H-H03	21-HY-H11
2.0 GDi	130	06.11		10-05-599	20-0H-H23	30-0H-H17 Nel serbatoio carb. /Inside tank fuel	21-HY-H11



	KW						
				OIL FILTER FILTRO OLIO	AIR FILTER FILTRO ARIA	FUEL FILTER FILTRO CARBURANTE	CABIN FILTER FILTRO ABITACOLO
ix20							
1.4	66	11.10		10-05-599	20-0K-K22	30-0K-K23 Nel serbatoio carb. /Inside tank fuel	21-KI-K20
1.4 CRDi	57	11.10	D4FC	10-ECO076	20-0K-K22	30-0H-H03	21-KI-K20
1.6	92	11.10	G4FC	10-05-599	20-0K-K22	30-0K-K23 Nel serbatoio carb. /Inside tank fuel	21-KI-K20
ix35							
1.7 CRDi	85	03.10		10-ECO076	20-0H-H23	30-H0-011	21-HY-H29
2.0	120	03.10	G4KD	10-05-599	20-0H-H23	30-0K-K28 Nel serbatoio carb. /Inside tank fuel	21-HY-H29
2.0 CRDi	100	03.10		10-ECO096	20-0H-H23	30-H0-011	21-HY-H29
2.0 CRDi	135	03.10	D4HA	10-ECO096	20-0H-H23	30-H0-011	21-HY-H29
ix55							
3.0 V6 CRDi	176	09.08	D6EA		20-0H-H26	30-0H-H03	21-HY-H30
LANTRA I (J-1)							
1.5 i.e.	63	10.90 → 11.95	G15B G4DJ	10-05-599	20-05-516 →06.94 20-05-522 07.94→	30-05-598	
1.6 i.e. 16V	78	10.90 → 11.95	G4CR	10-05-599	20-05-516	30-05-599	
1.6 i.e. 16V	84	10.90 → 11.95	G4CR	10-05-599	20-05-516	30-05-599	
1.8 i.e. 16V	93	10.90 → 11.95	G4CN	10-05-599	20-05-516	30-05-599	
LANTRA II (J-2)\ Wagon (J2)							
1.5 12V	65	12.96 → 09.00	G4EK	10-05-599 06.97→	20-05-593 06.97→	30-05-594 06.97→	
1.6 16V	84	11.95 → 09.00	4G61	10-05-599	20-05-590	30-05-594	
1.6 i	66	11.95 → 09.00	G4GR	10-05-599	20-05-590	30-05-594	
1.8 16V	94	11.95 → 09.00	G4GM	10-05-599	20-05-590	30-05-594	
1.9 D	50	03.98 → 09.00	DJY	10-H0-002	20-05-590	30-W0-003	
2.0 16V	102	08.96 → 09.00	G4GF	10-05-599 06.97→	20-05-590 06.97→	30-05-594 06.97→	
MATRIX (FC)							
1.5 CRDi	60	10.01	D3-EA	10-H0-003	20-H0-005	30-0H-H03 30-H0-005	21-HY-H03
1.5 CRDi	75	12.04	D4FA	10-ECO045	20-H0-005	30-0H-H03 30-H0-005	21-HY-H03
1.5 CRDi VGT	81	08.05	D4FA		20-H0-005	30-0H-H03	21-HY-H03
1.6	76	06.01	G4ED-G	10-05-599	20-H0-005	30-H0-006 Nel serbatoio carb. /Inside tank fuel	21-HY-H03
1.8	90	06.01	G4GB-G	10-05-599	20-H0-005	30-H0-006 Nel serbatoio carb. /Inside tank fuel	21-HY-H03
MAXI VAN							
2.5 D (D4BX)	57	01.94		10-05-505P 10-05-505	20-05-529	30-05-502MP 30-05-502	
MIGHTY							
2.5 D (D4AF)	0	01.96			20-05-576		21-HY-H20

NEW CODES - NEUE CODES - NOUVEAUX CODES - NUEVOS CODIGOS - NUOVI CODICI

	KW						
				OIL FILTER FILTRO OLIO	AIR FILTER FILTRO ARIA	FUEL FILTER FILTRO CARBURANTE	CABIN FILTER FILTRO ABITACOLO
PONY (X-2)\ Tre volumi							
1.3	43	10.89 → 01.95	G4DG	10-05-599 06.92 → →06.93	20-05-510	30-05-501 06.92 → →06.93	
1.3	49	10.89 → 01.95		10-05-599	20-05-510	30-05-501	
1.5	53	10.89 → 01.95	G15B G4DJ	10-05-599 →06.92	20-05-510	30-05-501 →06.92	
1.5 i	61	10.89 → 01.95	G15B G4DJ	10-05-599	20-05-516	30-05-598	
1.5 i	62	10.89 → 01.95	G15B G4DJ	10-05-599	20-05-516	30-05-598	
PONY Tutti i modelli\All models							
1.2	40	06.74		10-05-599	20-05-510	30-05-501	
1.3	50	10.85 → 09.89	G13B	10-05-599	20-05-502	30-05-501	
1.4	50	08.77		10-05-599	20-05-510	30-05-501	
1.5	53	10.85 → 09.89	G15B G4DJ	10-05-599	20-05-510	30-05-501	
PORTER Furgonato							
2.5 TD	57	07.94 → 04.04	D4BA	10-05-505P 10-05-505	20-09-991	30-05-502MP 30-05-502	
S COUPE (SLC)							
1.5 i	62	02.90 → 05.96	G15B G4DJ	10-05-599	20-05-516	30-05-598	
1.5 i	65	04.92 → 05.96	G4EK	10-05-599	20-05-521	30-05-514	
1.5 i Turbo	85	04.91 → 05.96	G4EK-TC	10-05-599	20-05-521	30-05-514	
SANTA FÉ							
2.2 CRDi	102	03.06		10-ECO056 →10.06 10-0H-H01 11.06 →	20-0H-H14	30-0H-H03 30-H0-005	21-HY-H23
2.2 CRDi	114	03.06	D4EB	10-ECO056 →10.06 10-0H-H01 11.06 →	20-0H-H14	30-0H-H03 30-H0-005	21-HY-H23
2.2 CRDi	145	01.09	D4HB	10-ECO056 →10.06	20-0H-H14	30-0H-H03	21-HY-H23
2.2 CRDi 4x4	102	03.06		10-ECO056 →10.06 10-0H-H01 11.06 →	20-0H-H14	30-0H-H03 30-H0-005	21-HY-H23
2.2 CRDi 4x4	114	03.06	D4EB	10-ECO056 →10.06 10-0H-H01 11.06 →	20-0H-H14	30-H0-005	21-HY-H23
2.2 CRDi GLS	110	03.06	D4EB	10-ECO056 →10.06 10-0H-H01 11.06 →	20-0H-H14	30-0H-H03 30-H0-005	21-HY-H23
2.2 CRDi GLS 4x4	110	03.06	D4EB	10-ECO056 →10.06 10-0H-H01 11.06 →	20-0H-H14	30-0H-H03 30-H0-005	21-HY-H23
2.4	128	11.10	G4KE	10-05-502	20-0K-K27		21-HY-H23
2.7	125	03.06		10-05-502	20-0H-H14	30-H0-007 Nel serbatoio carb. /Inside tank fuel	21-HY-H23



	KW						
				OIL FILTER FILTRO OLIO	AIR FILTER FILTRO ARIA	FUEL FILTER FILTRO CARBURANTE	CABIN FILTER FILTRO ABITACOLO
SANTA FÉ							
2.7 4x4	125	03.06		10-05-502	20-0H-H14	30-H0-007 Nel serbatoio carb. /Inside tank fuel	21-HY-H23
2.7 V6 GLS	139	03.06	G6EA	10-05-502	20-0H-H14	30-H0-007 Nel serbatoio carb. /Inside tank fuel	21-HY-H23
2.7 V6 GLS 4x4	139	03.06	G6EA	10-05-502	20-0H-H14	30-H0-007 Nel serbatoio carb. /Inside tank fuel	21-HY-H23
SANTA FE' (SM)							
2.0	99	08.01	G4BP	10-05-599	20-H0-004	30-H0-007 Nel serbatoio carb. /Inside tank fuel	21-KI-K06 →03.03 21-KI-K11 04.03→
2.0 CRDi	83	08.01	D4EA	10-H0-004 10-H0-004U	20-H0-004	30-H0-004 →12.02 30-H0-011 01.03→	21-KI-K06 →12.02 21-KI-K11 01.03→
2.0 CRDi 4 ruote motrici	107	11.03→02.06		10-H0-004U	20-H0-004	30-H0-011	21-KI-K11
2.0 CRDi 4x4	83	04.01	D4EA	10-H0-004 10-H0-004U	20-H0-004	30-H0-004 →12.02 30-H0-011 01.03→	21-KI-K06 →12.02 21-KI-K11 01.03→
2.0 CRDi 4x4	92	08.03	D4EA	10-H0-004 10-H0-004U	20-H0-004	30-H0-011	21-KI-K11 01.03→
2.2 CRDi	110	10.05	D4EB	10-ECO056	20-0H-H14	30-0H-H03 30-H0-005	21-HY-H23
2.4 16V	100	02.01	G4JS-G	10-05-599	20-H0-004	30-H0-007 Nel serbatoio carb. /Inside tank fuel	21-KI-K06 →03.03 21-KI-K11 04.03→
2.4 16V	107	02.01	G4JS-G	10-05-599	20-H0-004	30-H0-007 Nel serbatoio carb. /Inside tank fuel	21-KI-K06 →03.03 21-KI-K11 04.03→
2.7	139	10.05	G6EA	10-05-502 10-05-599	20-0H-H14	30-H0-007 Nel serbatoio carb. /Inside tank fuel	21-HY-H23
2.7 V6 4x4	127	02.01	G6BA-G	10-05-599	20-H0-004	30-H0-007 Nel serbatoio carb. /Inside tank fuel	21-KI-K06 →03.03 21-KI-K11 04.03→
SANTAMO							
2.0 16V	102	05.99		10-05-599	20-05-516	30-K0-015	
SONATA I (Y-2)							
1.8 i	70	09.88→10.93	4G62	10-05-599	20-05-516	30-08-887	21-KI-K06
2.0 i	74	09.88→08.91	G4CP	10-05-599	20-05-516	30-08-887	21-KI-K06
2.0 i	80	01.91→10.93	G4CP-U	10-05-599	20-05-516	30-08-887	21-KI-K06
2.0 i 16V	96	01.91→10.93	G4CP-D	10-05-599	20-05-516	30-08-887	21-KI-K06
2.4 i	83	09.88→08.91	G4CS	10-05-599	20-05-516	30-08-887	21-KI-K06
3.0 i V6	107	01.91→10.93	G6AT	10-05-599	20-05-516	30-08-887	21-KI-K06
SONATA II (Y-3)							
1.8 i	72	05.93→06.98	G4CM	10-05-599	20-05-516	30-08-887	21-KI-K06

NEW CODES - NEUE CODES - NOUVEAUX CODES - NUEVOS CODIGOS - NUOVI CODICI

	KW						
				OIL FILTER FILTRO OLIO	AIR FILTER FILTRO ARIA	FUEL FILTER FILTRO CARBURANTE	CABIN FILTER FILTRO ABITACOLO
SONATA II (Y-3)							
2.0 i	70	08.96 → 06.98		10-05-599	20-05-516	30-02-247	21-KI-K06
2.0 i	77	06.94 → 08.96	G4CP	10-05-599	20-05-516	30-08-887	21-KI-K06
2.0 i 16V	102	05.93 → 06.98	G4CP-D	10-05-599	20-05-516	30-02-247	21-KI-K06
2.0 i 16V	92	06.96 → 06.98	G4CP-DM	10-05-599	20-05-516	30-02-247	21-KI-K06
3.0 i V6	107	05.93 → 06.98	G6AT	10-05-599	20-05-516 06.96 → → 06.98 20-H0-003 → 05.96	30-02-247	21-KI-K06
SONATA III (EF)							
2.0 16V	100	06.98 → 10.01	G4JP-G	10-05-599	20-H0-003	30-02-247	21-KI-K06
2.4 16V	105	03.98 → 10.01		10-05-599	20-05-516	30-02-247	21-KI-K06
2.5 V6 24V	118	06.98 → 10.01	G6BV-G	10-05-599	20-H0-003	30-02-247	21-KI-K06
SONATA IV/ SONICA							
2.0	96	10.01 → 11.04	G4JP-EG	10-05-599	20-H0-003	30-0H-013 Nel serbatoio carb. /Inside tank fuel	21-KI-K06
2.7 V6	127	10.01 → 11.04	G6BA-G	10-05-599	20-H0-003	30-0H-013 Nel serbatoio carb. /Inside tank fuel	21-KI-K06
2.7 V6	129	11.02 → 11.04	G6BA	10-05-599	20-H0-003	30-0H-013 Nel serbatoio carb. /Inside tank fuel	21-KI-K06
SONATA V							
2.0 CRDi	100	02.06	D4EA	10-ECO056	20-0H-H15	30-0H-H03	21-HY-H23
2.0 CRDi	103	02.06	D4EA	10-ECO056	20-0H-H15	30-0H-H03	21-HY-H23
2.0 CRDi	110	03.09	D4EA	10-ECO056	20-0H-H15	30-0H-H03	21-HY-H23
2.0 VVTi GLS	106	05.05		10-05-502	20-H0-003	30-0H-013 Nel serbatoio carb. /Inside tank fuel	21-HY-H23
2.2 CRDi GLS	110	02.06	D4EB	10-ECO056	20-0H-H15	30-H0-005	21-HY-H23
2.4	119	01.05	G4KC	10-05-599	20-0H-H15	30-0H-013 Nel serbatoio carb. /Inside tank fuel	21-HY-H23
3.3	171	01.05	G6DB	10-ECO075	20-0H-H15	30-0H-013 Nel serbatoio carb. /Inside tank fuel	21-HY-H23
3.3	173	06.05	G6DB	10-ECO075	20-0H-H15	30-0H-013 Nel serbatoio carb. /Inside tank fuel	21-HY-H23
SONICA							
2.0 CRDi	103	05.06		10-ECO056	20-0H-H15	30-0H-H03 30-H0-005	21-HY-H23
2.4	119	05.06		10-05-599		30-0H-H14 Nel serbatoio carb. /Inside tank fuel	21-HY-H23
STAREX (H1)							
2.4	82	06.97	G4CS	10-05-599	20-05-516	30-02-247	21-HY-H07
2.4 4WD	82	02.98	G4CS	10-05-599	20-05-516	30-02-247	21-HY-H07
2.5 D	62	10.97 → 04.04					21-HY-H07
2.5 TD	59	06.97	D4BF	10-05-505P 10-05-505	20-H0-001	30-05-502MP 30-05-502	21-HY-H07

NEW CODES - NEUE CODES - NOUVEAUX CODES - NUEVOS CODIGOS - NUOVI CODICI



	KW						
				OIL FILTER FILTRO OLIO	AIR FILTER FILTRO ARIA	FUEL FILTER FILTRO CARBURANTE	CABIN FILTER FILTRO ABITACOLO

STAREX (H1)

2.5 TD 4WD	59	02.98	D4BF	10-05-505P 10-05-505	20-H0-001	30-05-502MP 30-05-502	21-HY-H07
------------	----	-------	------	-------------------------	-----------	--------------------------	-----------

STELLAR

1.4	50	10.83 → 08.86	4G33	10-05-599	20-04-417	30-05-501	
1.6	56	10.83 → 12.91	G32B	10-05-599	20-04-417	30-05-501	
2.0 (4G63B)	61	01.86 → 12.89		10-05-599	20-05-504	30-05-501	
2.0 GSL	74	09.86 → 12.89		10-05-599	20-05-504	30-05-501	

TERRACAN (HP)

2.5 TD	74	12.01	D4BH	10-05-505P 10-05-505	20-H0-006	30-K0-009	21-HY-H04 →01.04 21-HY-H17 01.05→
2.9 CRDi	110	12.01	J3	10-05-505P 10-05-505	20-H0-006	30-K0-009	21-HY-H04 →01.04 21-HY-H17 01.05→
2.9 CRDi	120	11.03	J3	10-05-505P 10-05-505	20-H0-006	30-K0-009	21-HY-H04 →01.04 21-HY-H17 01.05→
3.5 i V6 4WD	143	12.01	G6CU	10-05-599	20-H0-006	30-06-692	21-HY-H04 →01.04 21-HY-H17 01.05→
3.5 i V6 4WD	147	12.01	G6CU	10-05-599	20-H0-006	30-06-692	21-HY-H04 →01.04 21-HY-H17 01.05→







TRAJET (FO)

2.0	100	03.00	G4JP-G	10-05-599	20-H0-003	30-H0-002	21-KI-K06
2.0	103	01.04	G4GC-G	10-05-599	20-H0-003	30-H0-002	21-KI-K06
2.0	104	11.03	G4GC	10-05-599	20-H0-003	30-H0-002	21-KI-K11
2.0 CRDi	83	04.01	D4EA	10-H0-004	20-H0-003	30-H0-004	21-KI-K06
2.7 V6	127	09.00	G6BA-G	10-05-599	20-H0-003	30-H0-002	21-KI-K06

TUCSON (JM)







2.0	104	08.04	G4GC	10-05-599	20-0H-012	30-H0-002 30-0K-K25 Nel serbatoio carb. /Inside tank fuel	21-HY-H11
2.0 4 ruote motrici	104	08.04	G4GC	10-05-599	20-0H-012	30-H0-002 30-0K-K25 Nel serbatoio carb. /Inside tank fuel	21-HY-H11
2.0 CRDi	100	01.06	D4EA	10-ECO056	20-0H-012	30-H0-011	21-HY-H29
2.0 CRDi	103	01.06	D4EA-V	10-ECO056	20-0H-012	30-H0-011	21-HY-H29
2.0 CRDi	83	08.04	D4EA	10-H0-004U	20-0H-012	30-H0-011	21-HY-H11
2.0 CRDi 4 ruote motrici	100	01.06	D4EA	10-ECO056	20-0H-012	30-H0-011	21-HY-H29
2.0 CRDi 4 ruote motrici	103	01.06	D4EA-F D4EA-V	10-ECO056	20-0H-012	30-H0-011	21-HY-H29
2.0 CRDi 4 ruote motrici	83	08.04	D4EA	10-H0-004U	20-0H-012	30-H0-011	21-HY-H11

NEW CODES - NEUE CODES - NOUVEAUX CODES - NUEVOS CODIGOS - NUOVI CODICI

	KW			 OIL FILTER FILTRO OLIO	 AIR FILTER FILTRO ARIA	 FUEL FILTER FILTRO CARBURANTE	 CABIN FILTER FILTRO ABITACOLO
TUCSON (JM)							
2.7 4 ruote motrici	129	08.04	G6BA-G	10-05-599	20-0H-012	30-H0-002 30-0K-K25 Nel serbatoio carb. /Inside tank fuel	21-HY-H11
XG							
25	120	12.98		10-05-599 06.00→	20-H0-003 06.00→	30-02-247	21-KI-K06
30/300	138	12.98	G6CT-G	10-05-599 06.00→	20-H0-007 06.00→	30-02-247	21-KI-K06
350	145	04.03	G6CU	10-05-599	20-H0-007	30-02-247	21-KI-K06



INFINITI

	KW						
				OIL FILTER FILTRO OLIO	AIR FILTER FILTRO ARIA	FUEL FILTER FILTRO CARBURANTE	CABIN FILTER FILTRO ABITACOLO
FX							
35	206	01.03	VQ35DE	10-01-120	20-01-108	30-01-198	21-NS-NS8
37	235	10.08	VQ37VHR	10-01-198	20-01-196	30-01-198	21-NS-NS8
45	232	01.03	VK45DE	10-01-120	20-01-108	30-01-198	21-NS-NS8
50	287	10.08	VK50VE	10-01-198	20-01-196	30-01-198	21-NS-NS8
G Coupé\ Tre volumi							
37	243	10.08		10-01-120		30-01-198	21-NS-NS8
G20							
2.0	85	01.90 → 12.97	SR20DE	10-01-117	20-01-108	30-01-111	
I30							
3.0	142	01.97	VQ30DE	10-01-198	20-01-108	30-01-198	
J30							
3.0	157	01.92 → 12.97	VG30DE	10-01-111	20-01-108	30-01-198	
M30 Convertible\ Coupé							
3.0	121	01.90 → 12.93	VG30E	10-01-111	20-01-108	30-01-111	
M35							
3.5 Luxury	206	01.05	VQ35DE	10-01-120	20-01-143		21-NS-NS16
3.5 Luxury 4 ruote motrici	206	01.05	VQ35DE	10-01-120	20-01-143		21-NS-NS16
Q45							
4.1	205	01.93	VH41DE	10-01-111		30-01-111	
4.5	205	01.89 → 12.93	VH45DE	10-01-111		30-01-111	
QX4							
3.3	125	01.97	VG33E	10-03-316	20-01-108	30-01-111	

NEW CODES - NEUE CODES - NOUVEAUX CODES - NUEVOS CODIGOS - NUOVI CODICI

Per nuove applicazioni e novità si prega di accedere al sito www.ashika.eu - For new applications and new items, please go to www.ashika.eu

	KW						
				OIL FILTER FILTRO OLIO	AIR FILTER FILTRO ARIA	FUEL FILTER FILTRO CARBURANTE	CABIN FILTER FILTRO ABITACOLO

CAMPO (KB)

1.6 (KB26/41)	59	01.83		10-05-599	20-01-101	30-05-501
2.0 (KB23)	52	01.83 → 03.88	4ZC1	10-05-599	20-01-101	30-05-501
2.0 (KB28)	58	06.85 → 12.88	G200Z	10-05-599	20-01-101	30-05-501
2.0 4WD (KB43, KB48)	52	01.83 → 03.88	4ZC1	10-05-599	20-01-101	30-05-501
2.0 4WD (KB48)	58	06.85 → 12.88	G200Z	10-05-599	20-01-101	30-05-501
2.0 D (KBD26/41)	37	01.81 → 12.86		10-09-900	20-01-101	30-05-502MP 30-05-502
2.0 D (KBD23, KBD28)	36	08.78 → 12.82	C220	10-09-900	20-01-101	30-05-502MP 30-05-502
2.0 D 4WD (KBD42, KBD46)	36	04.77 → 12.82	C220	10-09-900	20-01-101	30-05-502MP 30-05-502
2.2 (TFS)	66	01.89 → 12.90	4ZD1	10-05-599	20-01-101	
2.2 D (TFR52 / TFS52)	39	08.88		10-09-900	20-01-101	30-05-502MP 30-05-502
2.2 D (KBD27)	39	04.86 → 12.90	C223	10-09-900 06.88 →	20-01-101 06.88 →	30-05-502MP 30-05-502
2.2 D (KBD27)	45	01.83 → 12.91	C223	10-09-900 01.88 →	20-01-101 01.88 →	30-05-502MP 01.88 → 30-05-502 01.88 →
2.2 D 4WD (KBD42, KBD47)	39	01.83 → 12.90	C223	10-09-900 06.88 →	20-01-101 06.88 →	30-05-502MP 30-05-502
2.3 (TFR16)	68	08.88		10-05-599	20-01-101	30-05-501
2.3 4WD (TFS16)	68	08.88		10-05-599	20-01-101	30-05-501
2.5 D (98470) Pick-Up	0	02.94		10-03-314	20-09-997	30-05-502MP 30-05-502
2.5 D (TFR54)	0	08.88		10-09-906	20-09-995	30-05-502MP 30-05-502
2.5 D (TFS54) Pick-Up	0	01.93 → 12.99		10-03-314	20-09-997	30-05-502MP 30-05-502
2.5 D (KBD27)	55	01.83 → 12.90		10-09-900 06.86 → →06.88 10-09-906 06.89 →	20-09-995	30-02-208 06.86 → →06.88 30-05-502MP 06.89 → 30-05-502 06.89 →
2.5 D 4WD (KBD47)	55	01.83 → 12.90	4JA1	10-09-900 06.89 →	20-09-995 06.86 → →06.88	30-02-208 06.86 → →06.88

D-MAX

2.4 4x4	94	05.02	C 24 SE		20-05-500	30-09-909	21-IS-IS1
2.5 D	74	10.02	4JA1-TC	10-01-111	20-09-906	30-02-208	21-IS-IS1
2.5 DiTD	100	10.06	4JK1-TC	10-09-912	20-09-913	30-ECO013	21-IS-IS1
3.0 D 4x4	120	01.07	4JJ1-TC	10-09-912	20-09-913	30-ECO013	21-IS-IS1
3.0 DiTD	96	10.02	4JH1-TC	10-01-111	20-09-906	30-02-208	21-IS-IS1

GEMINI (JT) Tre volumi







1.5	52	02.88 → 12.90	4XC1U Kat.	10-09-996 06.90 →	20-09-998 06.90 →	30-09-990 06.90 →
1.5 D	37	02.88 → 12.90	4EC1	10-04-406	20-01-108	30-05-509 06.88 →

NEW CODES - NEUE CODES - NOUVEAUX CODES - NUEVOS CODIGOS - NUOVI CODICI









	KW						
				OIL FILTER FILTRO OLIO	AIR FILTER FILTRO ARIA	FUEL FILTER FILTRO CARBURANTE	CABIN FILTER FILTRO ABITACOLO
GEMINI (JT) Tre volumi							
1.5 TD	49	02.88 → 12.90	4EC1T	10-04-406	20-01-108	30-05-509 06.88 →	
1.6 GTI 16V	84	08.88 → 12.90	4XE1	10-05-599	20-09-994	30-01-198	
GEMINI\ Tre volumi							
1.5	73	01.90 → 12.93		10-09-996	20-09-998	30-09-990	
1.6	132	01.90 → 12.93		10-05-599	20-01-101	30-05-501	
1.6	97	01.90 → 12.93		10-05-599	20-01-101	30-05-501	
1.7 TD	65	01.90 → 12.93		10-04-406	20-01-108	30-05-509	
1.8	105	01.90 → 12.93		10-05-599	20-01-101	30-05-501	
IMPULSE							
1.6	120	01.90 → 12.93		10-05-599	20-01-101	30-05-501	
1.6	71	01.90 → 12.93		10-05-599	20-01-101	30-05-501	
KB D (4JA1) TFR54/TFS54							
2.5 Pick-Up	56	08.88		10-09-906	20-09-995	30-05-502MP 30-05-502	
MIDI Tutti i modelli\ All models							
1.8	56	01.83 → 12.90		10-05-599	20-02-246	30-05-501	
2.0 (98000)	61	01.89	4ZC1	10-05-599	20-02-246	30-05-501	
2.0 4WD (94000)	61	01.89	4ZC1	10-05-599	20-02-246	30-05-501	
2.0 D 4WD 4FC1	0	06.88		10-09-901	20-09-902	30-05-502MP 30-05-502 30-05-509	
2.0 TD (98000)	51	01.89	4FC1T	10-07-703	20-09-902	30-05-502MP 30-05-502 30-05-509	
2.2 D (98000)	45	01.89	4FD1	10-05-599 10-09-910	20-09-902	30-05-509	
2.2 D 4WD (94000)	45	01.89	4FD1	10-05-599 10-09-910	20-09-902	30-05-509	
2.4 TD (98000)	56	01.94	4FG1T	10-01-111	20-01-112	30-05-509	
NPR 55							
2.8 TD (4JB1)	0	01.00 → 12.02		10-03-314	20-09-979	30-02-208	
NPR 65							
4.0 D 4BD2TC	0	01.97		10-09-999	20-09-979	30-02-208	
NPR 69							
3.0 D (4JG2)	0	01.97		10-03-314	20-02-246	30-02-208	
NPR 77\ NKR 77							
3.0 D	0	01.02		10-03-314	20-09-979	30-05-502MP 30-05-502	
PIAZZA							
2.0 Turbo	104	06.85 → 12.90	4ZC1-T	10-05-599	20-02-246	30-01-102	
TROOPER							
3.0 DTI	118	04.00	4 JX1	10-09-912	20-09-906 06.01 →	30-09-910 06.01 →	21-IS-IS2
3.5 V6 24V	158	04.00	6 VE1	10-09-996	20-09-977 con ABS	30-09-909	21-IS-IS2

NEW CODES - NEUE CODES - NOUVEAUX CODES - NUEVOS CODIGOS - NUOVI CODICI

	KW			 OIL FILTER FILTRO OLIO	 AIR FILTER FILTRO ARIA	 FUEL FILTER FILTRO CARBURANTE	 CABIN FILTER FILTRO ABITACOLO
TROOPER (UB)							
3.1 TD	84	08.91 → 07.98	4JG2T	10-03-314	20-09-997	30-05-502MP 30-05-502	21-IS-IS3
3.2	130	08.91 → 07.98	6VD1	10-05-599	20-09-977	30-01-111	21-IS-IS3
TROOPER (UBS)							
2.2 D 4x4	39	05.84 → 12.89	C223	10-09-900	20-09-900	30-05-502MP 30-05-502	
2.8 TD (UBS55)	71	10.87 → 12.91	4JB1T	10-03-314	20-09-900 06.88 →	30-05-502MP 30-05-502	
2.8 TD (UBS55)	78	10.88 → 12.91	4JB1TC	10-03-314	20-09-900	30-05-502MP 30-05-502	









ISUZU Comm.

	KW			 OIL FILTER FILTRO OLIO	 AIR FILTER FILTRO ARIA	 FUEL FILTER FILTRO CARBURANTE	 CABIN FILTER FILTRO ABITACOLO
N-Serie							
NHR 150	67	09.08		10-09-906		30-05-502	
NKR69S, NPR69M, NPR69L	61	01.98 → 12.01		10-03-314			
NKR85EA, NPR85G, NPR85L	110	10.06		10-ECO103			
NPR85L	110	10.06		10-ECO103		30-ECO021	
NPR85L, NPR85P	110	10.06		10-ECO103			

NEW CODES - NEUE CODES - NOUVEAUX CODES - NUEVOS CODIGOS - NUOVI CODICI







IVECO Comm.









	KW			 OIL FILTER FILTRO OLIO	 AIR FILTER FILTRO ARIA	 FUEL FILTER FILTRO CARBURANTE	 CABIN FILTER FILTRO ABITACOLO
Daily II							
35 C 9, 35 S 9	66	11.01 → 04.06					30-ECO022
35 S 9 V	66	11.01 → 04.06					30-ECO022

NEW CODES - NEUE CODES - NOUVEAUX CODES - NUEVOS CODIGOS - NUOVI CODICI



	KW						
				OIL FILTER FILTRO OLIO	AIR FILTER FILTRO ARIA	FUEL FILTER FILTRO CARBURANTE	CABIN FILTER FILTRO ABITACOLO
S-TYPE (CCX)							
2.7 D	152	06.04		10-ECO048			
X-TYPE (CF1)\ Estate							
2.0 D	96	07.03 → 10.05	R4-X404	10-ECO022			
2.2 D	107	01.07	LJ46G	10-ECO022			
2.2 D	114	10.05	LJ46G	10-ECO022			
XF							
2.7 D	152	03.08	AJD	10-ECO048			
3.0 D	155	03.09	AJV6D	10-ECO099			
3.0 D	177	03.09	AJV6D	10-ECO099			
3.0 D	202	03.09	AJV6D	10-ECO099			
XJ							
6 2,7 D	152	10.05		10-ECO048			
XJ (X 351)							
3.0 V6 D	202	01.10		10-ECO099			

	KW						
				OIL FILTER FILTRO OLIO	AIR FILTER FILTRO ARIA	FUEL FILTER FILTRO CARBURANTE	CABIN FILTER FILTRO ABITACOLO
CHEROKEE (KJ)							
2.4	108	09.01	ED1	10-02-279	20-00-017		21-JE-JE1
2.5 CRD	105	09.01	R 425 DOHC	10-H0-004	20-09-908	30-09-997	21-JE-JE1
2.8 CRD	110	11.02		10-00-097	20-09-908	30-09-997	21-JE-JE1
2.8 CRD	120	11.04	ENR	10-00-097 04.05→ →12.06 10-ECO067 01.07→	20-09-908	30-09-907	21-JE-JE1
3.7 V6	150	08.03	EKG	10-09-913	20-09-908		21-JE-JE1
3.7 V6	155	09.01	EKG	10-09-913	20-09-908		21-JE-JE1
CHEROKEE (XJ)							
2.1 D 4x4	59	10.86→09.92	J8S 742	10-05-595	20-09-999	30-09-999	
2.1 TD	59	06.89→03.92	J8S	10-09-990	20-09-999	30-09-999	
2.1 TD	64	10.84	J8S	10-09-990	20-09-999	30-09-999	
2.5	89	10.90→09.96	EPE	10-09-986	20-09-990	30-00-010	
2.5	89	10.95		10-00-097 01.97→	20-09-975 02.97→ 20-09-999		
2.5 i	87	11.96	EPE	10-09-986	20-09-990		
2.5 i 4x4	90	12.91	EPE HX	10-09-986	20-09-990		
2.5 TD	85	01.88	ENC	10-00-097	20-09-999	30-09-997	
2.5 Tdi 4x4	85	10.96→09.01		10-00-097	20-09-975	30-09-997	
4.0 i	127	07.98		10-09-986	20-09-990		
4.0 i	131	01.95	ERH	10-09-986	20-09-990		
4.0 i	135	02.99		10-09-986	20-09-990		
4.0 i	135	12.91	MX	10-09-986	20-09-990	30-00-010	
4.0 i	136	01.88	ERH	10-09-986	20-09-990		
CJ5 - CJ8							
2.1 D	44	01.83→12.87	J8S-800	10-08-891	20-09-999		
2.5	78	01.84→12.87		10-09-990	20-00-016		
CJ7/CJ6 RENEGADE LAREDO							
2.4 D 4WD C240	0	01.79		10-09-901	20-09-999	30-02-208	
COMMANDER							
3.0 CRD	160	04.06		10-ECO053	20-09-908	30-00-012	21-JE-JE1
3.7 V6	157	09.05	EKG	10-09-913	20-09-908		21-JE-JE1
4.7 V8	170	09.05	EVA	10-09-986	20-09-908		21-JE-JE1
5.7 V8	240	09.05	EZB	10-09-986	20-09-908		21-JE-JE1
COMPASS							
2.0 CRD 4x4	103	09.06	ECE	10-ECO023	20-00-001	30-00-001	21-CH-CH3
2.2 D	120	04.11				30-K0-018	21-CH-CH3
2.4 4x4	125	09.06	ERZ	10-00-010	20-00-018	30-00-001	21-CH-CH3
GRAND CHEROKEE I (Z)							
2.5 TD (Z)	85	10.95→04.99	M51 M52	10-09-985	20-09-985	30-09-997	
4.0 i (Z)	130	10.95→04.99	S01	10-09-986	20-09-980		

	KW						
				OIL FILTER FILTRO OLIO	AIR FILTER FILTRO ARIA	FUEL FILTER FILTRO CARBURANTE	CABIN FILTER FILTRO ABITACOLO
GRAND CHEROKEE I (Z)							
4.0 i (ZJ)	132	09.91 → 04.99	ERH	10-09-986 06.95→	20-09-990 06.95→	30-00-010	
4.0 i (ZJ)	135	09.91 → 04.99	MX	10-09-986 06.95→	20-09-990 06.95→	30-00-010	
5.2 (Z)	156	10.95 → 04.99	Y01	10-09-986	20-09-985	30-09-996	
5.2 i (ZJ)	155	01.92 → 04.99	ELF	10-09-986	20-09-985	30-09-996	
5.2 i (ZJ)	158	09.92 → 04.99	Y	10-09-986 06.95→	20-09-985	30-09-996	
5.9 i	177	08.97 → 04.99		10-09-986	20-09-985	30-09-996	
GRAND CHEROKEE II (WJ, WG)							
2.7 CRD 4x4	120	10.01	ENF	10-ECO021	20-09-985	30-09-988	21-JE-JE1
2.7 CRD 4x4	120	10.04 → 09.05		10-ECO021	20-09-985	30-09-988	
3.1 TD	103	04.99		10-ECO013	20-09-985	30-09-997	21-JE-JE1
4.0 4x4	140	04.99		10-09-989	20-09-985	30-09-912	21-JE-JE1
4.7 V8	162	04.99 → 08.00	EVA	10-09-986	20-09-985	30-09-912	21-JE-JE1
4.7 V8	164	08.00	EVA	10-09-986	20-09-985	30-09-912	21-JE-JE1
4.7 V8	190	10.01	EVC	10-09-986	20-09-985	30-09-912	21-JE-JE1
4.7 V8 4x4	167	06.03	EVA	10-09-986	20-09-985		21-JE-JE1
GRAND CHEROKEE III							
3.0 CRD	155	05.06	EXL	10-ECO053	20-09-985	30-00-012	21-JE-JE1
3.0 CRD	160	06.05	EXL	10-ECO053	20-09-908	30-00-012	21-JE-JE1
4.7 V8	170	06.05	EVA	10-09-986	20-09-908		21-JE-JE1
5.7 V8	240	06.05	EZB	10-09-986	20-09-908		21-JE-JE1
6.1 V8	313	03.06	ESF	10-09-986	20-09-908		
PATRIOT							
2.0 CRD	103	01.08	ECD ECE	10-ECO023	20-00-001	30-00-001	21-CH-CH3
2.4	125	01.08	ED3	10-00-010	20-00-018		21-CH-CH3
WRANGLER I							
2.5	76	01.88 → 12.91		10-09-989	20-00-016	30-00-010	
2.5	89	12.91 → 08.96	EPE	10-09-986	20-00-016	30-00-010	
4.0	131	12.91 → 08.96	ERH	10-09-986	20-00-016	30-00-010	
4.2	84	08.86 → 08.89	6L <C 2V>	10-09-990			
WRANGLER II (TJ)							
2.4	105	11.02	ED1	10-02-279	20-00-017		
2.5	87	08.96	P00	10-09-986	20-00-014	30-00-010	
3.8	153	02.06	EGT	10-02-279	20-09-915		
4.0	124	06.98		10-09-986	20-00-014		
4.0	130	08.96	S01	10-09-986	20-00-014		
4.0 Rubicon	128	08.03		10-09-986	20-00-014		
WRANGLER III (JK)							
2.8 CRD	130	04.07	ENS	10-ECO067	20-09-909	30-K0-018	

	KW						
				OIL FILTER FILTRO OLIO	AIR FILTER FILTRO ARIA	FUEL FILTER FILTRO CARBURANTE	CABIN FILTER FILTRO ABITACOLO
BESTA Furgonato							
2.2 D	48	02.96	R2	10-03-306 10-05-599	20-09-983	30-05-502MP 30-05-502	
CARENS I (FC)							
1.8	81	11.00→07.02	T8	10-05-593	20-K0-007	30-K0-005	21-KI-K01
CARENS II							
1.6	77	07.02		10-05-593	20-K0-007	30-K0-005	21-KI-K05
1.8	93	07.02		10-05-593	20-K0-007	30-K0-005	21-KI-K05
2.0 CRDi	83	07.02	D4EA	10-H0-004	20-K0-007	30-K0-018	21-KI-K05
2.0 CVVT	102	08.04	G4GC	10-05-593	20-K0-007	30-K0-018	21-KI-K05
CARENS III							
2.0 CRDi	103	09.06	D4EA	10-ECO056	20-0K-K18	30-0H-H03 30-H0-005	21-HY-H11
2.0 CVVT	106	09.06	G4KA	10-05-599	20-0K-K20	30-0K-K23 Nel serbatoio carb. /Inside tank fuel	21-HY-H11
CARNIVAL (UP)							
2.5 V6	121	08.99→10.01		10-K0-002	20-K0-008	30-03-313	21-KI-K00
2.9 TD	93	08.99→10.01	J3	10-05-505P 10-05-505	20-K0-002	30-K0-003	21-KI-K00
CARNIVAL II							
2.5 V6	110	10.01	K5	10-K0-002	20-K0-008	30-K0-024 Nel serbatoio carb. /Inside tank fuel	21-KI-K00 21-KI-K08
2.7 V6	139	06.06	G6EA	10-05-599	20-0K-K19	30-03-313 Nel serbatoio carb. /Inside tank fuel 30-K0-024 Nel serbatoio carb. /Inside tank fuel	21-KI-K10
2.9 CRDi	106	10.01	J3	10-K0-005	20-K0-002	30-K0-009	21-KI-K08
2.9 CRDi	136	06.06	J3	10-K0-005	20-0K-K19	30-K0-009	21-KI-K10
3.5	143	07.02	G6CU	10-K0-002	20-K0-008	30-K0-003	21-KI-K08
CEE'D\ Station wagon							
1.4	80	12.06	G4FA	10-05-599	20-0K-K21	30-0K-K23 Nel serbatoio carb. /Inside tank fuel	21-KI-K18
1.6	90	12.06	G4FC	10-05-599	20-0K-K21	30-0K-K23 Nel serbatoio carb. /Inside tank fuel	21-KI-K18
1.6	93	02.08	G4FC	10-05-599	20-0K-K21	30-0K-K23 Nel serbatoio carb. /Inside tank fuel	21-KI-K18
1.6 CRDi 115	85	12.06	D4FB	10-ECO045 →09.10 10-ECO076 10.10→	20-0K-K21	30-H0-011	21-KI-K18
1.6 CRDi 90	66	12.06	D4FB-L	10-ECO045 →09.10 10-ECO076 10.10→	20-0K-K21	30-H0-011	21-KI-K18
2.0	105	12.06	G4GC	10-05-599	20-0K-K21	30-0K-K23 Nel serbatoio carb. /Inside tank fuel	21-KI-K18

NEW CODES - NEUE CODES - NOUVEAUX CODES - NUEVOS CODIGOS - NUOVI CODICI

**KIA**

	KW						
				OIL FILTER FILTRO OLIO	AIR FILTER FILTRO ARIA	FUEL FILTER FILTRO CARBURANTE	CABIN FILTER FILTRO ABITACOLO
CEE'D\ Station wagon							
2.0 CRDi	103	09.07	D4EA-F	10-ECO056	20-0K-K21	30-H0-011	21-KI-K18
CERATO\ Tre volumi							
1.5 CRDi	75	07.05	D4FA	10-ECO045	20-0H-012	30-H0-011	21-KI-K10
1.6	77	07.04	G4ED	10-05-599	20-H0-010	30-H0-011	21-KI-K10
1.6 CRDi	85	06.05	D4FB	10-ECO045	20-0H-012	30-H0-011	21-KI-K10
2.0	105	04.04	G4GC	10-05-599	20-H0-010	30-H0-011	21-KI-K10
2.0 CRDi	83	04.04	D4EA	10-H0-004	20-0H-012	30-H0-011	21-KI-K10
CLARUS (K9A)\ Station wagon (GC)							
1.8 i 16V	85	07.96	T8	10-03-313	20-09-982	30-03-312	21-KI-K15
2.0 i 16V	98	07.96	FE (16 V)	10-K0-002	20-09-982	30-K0-008	21-KI-K15
JOICE							
2.0	102	02.00	G4CP	10-05-599	20-05-516	30-K0-015	
2.0	88	09.01		10-05-599	20-05-516	30-K0-015	
K2500							
2.5 D	69	01.03	D4BH	10-K0-005	20-0K-013 →05.04 20-0K-014 06.04→	30-05-502MP 30-05-502	
K2700							
2.7 D	59	10.99	J2	10-K0-005	20-0K-013 →09.04 20-0K-K26 10.04→	30-05-502MP 30-05-502	
MAGENTIS							
2.0	106	11.05	G4KA	10-K0-006	20-0K-K20	30-0K-K26 Nel serbatoio carb. /Inside tank fuel	21-HY-H23
2.0	121	07.09	G4KD	10-05-599	20-0K-K20	30-02-247	21-HY-H23
2.0 CRDi	103	04.06	D4EA	10-ECO056	20-0K-K18	30-0H-H03 30-H0-005	21-HY-H23
2.0 CRDi	110	04.06	D4EA	10-ECO056	20-0K-K18	30-0H-H03	21-HY-H23
2.7	138	11.05	G6EA	10-05-599	20-0K-K20		21-KI-K06
MAGENTIS (GD)							
2.0	100	05.01	G4JP	10-05-599	20-H0-003	30-K0-020 Nel serbatoio carb. /Inside tank fuel	21-KI-K06
2.5 V6	124	05.01	G6BV	10-05-599	20-H0-003	30-K0-020 Nel serbatoio carb. /Inside tank fuel	21-KI-K06
OPIRUS							
3.5	149	09.03	G6CU	10-05-599	20-H0-007	30-0H-013 Nel serbatoio carb. /Inside tank fuel	21-KI-K14
3.8 V6	196	10.06	G6DA	10-ECO075	20-H0-007	30-K0-024	21-KI-K14
PICANTO							
1.0	45	09.05	G4HE	10-05-593	20-0K-011	30-0K-017 Nel serbatoio carb. /Inside tank fuel	21-KI-K09

NEW CODES - NEUE CODES - NOUVEAUX CODES - NUEVOS CODIGOS - NUOVI CODICI

Per nuove applicazioni e novità si prega di accedere al sito www.ashika.eu - For new applications and new items, please go to www.ashika.eu

	KW						
				OIL FILTER FILTRO OLIO	AIR FILTER FILTRO ARIA	FUEL FILTER FILTRO CARBURANTE	CABIN FILTER FILTRO ABITACOLO
PICANTO							
1.0	46	02.08	G4HE	10-05-593	20-0K-011	30-0K-017 Nel serbatoio carb. /Inside tank fuel	21-KI-K09
1.1	48	02.08		10-05-593	20-0K-011	30-0K-017 Nel serbatoio carb. /Inside tank fuel	21-KI-K09
1.1	48	04.04	G4HG	10-05-593	20-0K-011	30-0K-017 Nel serbatoio carb. /Inside tank fuel	21-KI-K09
1.1 CRDi	55	02.08		10-ECO045	20-0K-K17	30-H0-011	21-KI-K09
1.1 CRDi	55	11.05	D3FA	10-ECO045	20-0K-K17	30-H0-011	21-KI-K09
PICANTO (TA)							
1.0	51	05.11		10-05-593	20-0K-K29	30-0K-017 Nel serbatoio carb. /Inside tank fuel	21-KI-K09
PREGIO (TB)							
2.5 Tci D	69	09.02	D4BH	10-K0-000	20-0K-012	30-05-502MP 30-05-502	
2.7 D	60	10.97	J2	10-K0-000	20-K0-001	30-K0-003	
PRIDE (DA)							
1.1 i	38	01.91	Mazda B1	10-03-313	20-03-316	30-K0-012	
1.3 16V	44	01.90	B3	10-03-313	20-03-384	30-K0-013	
1.3 16V	47	10.96	B3	10-03-313	20-03-384	30-K0-013	
1.3 16V	53	01.90	B3	10-03-313	20-03-384	30-K0-013	
1.3 i	51	01.90		10-03-313	20-03-384	30-K0-013	
PRIDE Station wagon							
1.3	47	08.99		10-03-313	20-03-384	30-K0-013	
PRO CEE'D							
1.4	80	02.08	G4FA	10-05-599	20-0K-K21	30-0K-K23 Nel serbatoio carb. /Inside tank fuel	21-KI-K18
1.6	93	02.08	G4FC	10-05-599	20-0K-K21	30-0K-K23 Nel serbatoio carb. /Inside tank fuel	21-KI-K18
1.6 CRDi 115	85	02.08	D4FB	10-ECO045 →09.10 10-ECO076 10.10→	20-0K-K21	30-H0-011	21-KI-K18
1.6 CRDi 90	66	02.08	D4FB-L	10-ECO045 →09.10 10-ECO076 10.10→	20-0K-K21	30-H0-011	21-KI-K18
2.0	105	02.08	G4GC	10-05-599	20-0K-K21	30-0K-K23 Nel serbatoio carb. /Inside tank fuel	21-KI-K18
2.0 CRDi	103	02.08	D4EA-F	10-ECO056	20-0K-K21	30-H0-011	21-KI-K18
RETONA (CE)							
2.0 16V	94	05.00	FE (16 V)	10-03-315	20-03-395	30-03-394	
2.0 TD	61	06.99	RF	10-05-599	20-03-388	30-K0-001	
RIO III Tre volumi							









	KW						
				OIL FILTER FILTRO OLIO	AIR FILTER FILTRO ARIA	FUEL FILTER FILTRO CARBURANTE	CABIN FILTER FILTRO ABITACOLO
RIO III Tre volumi							
1.4 16V	71	03.05	G4EE	10-05-599	20-0K-K15	30-0K-K22 Nel serbatoio carb. /Inside tank fuel	21-HY-H11
1.5 CRDi	81	03.05	D4FA	10-ECO045	20-0K-K16	30-0H-H03 11.06→ 30-H0-005 →10.06	21-HY-H11
1.6 16V	82	03.05	G4ED	10-05-599	20-0K-K15	30-0K-K22 Nel serbatoio carb. /Inside tank fuel	21-HY-H11
RIO\ Station wagon (DC)							
1.1 CRDi	55	09.11		10-ECO076	20-0K-K31	30-H0-011	21-HY-H11
1.2	63	09.11		10-05-593			21-HY-H11
1.3	55	09.00→02.05		10-03-313	20-K0-006	30-03-322	21-KI-K07
1.3	60	08.02→02.05		10-03-313	20-K0-006	30-03-322	21-KI-K07
1.4 CRDi	66	09.11		10-ECO076	20-0K-K31	30-H0-011	21-HY-H11
1.5	72	09.00→02.05		10-03-313	20-K0-006	30-03-322	21-KI-K07
ROADSTER							
1.8	100	08.99		10-03-313	20-03-398		
SEPHIA (FA)\ Tre volumi (FA)							
1.5 i 16V	59	02.96	B5	10-03-313	20-03-398	30-03-398	
1.6 16V	65	01.99		10-03-313	20-K0-007	30-K0-005	
1.6 i	59	01.95	B6	10-03-313	20-03-398	30-03-398	
1.8 16V	82	01.99		10-03-313	20-K0-007	30-K0-005	
1.8 i 16V	82	01.95	OK24N OK26Y	10-03-313	20-03-398	30-K0-014	
SHUMA (FB)							
1.5 i 16V	65	10.97→03.01		10-03-313	20-K0-007	30-K0-005	21-KI-K15
1.8 i 16V	81	10.97→03.01	T8	10-03-313	20-K0-007	30-K0-005	21-KI-K15
SHUMA II (FB)\Tre volumi (FB)							
1.6	75	05.01→08.04	GA6D	10-03-313	20-K0-007	30-K0-005	21-KI-K15
1.8	84	04.03→08.04	T8	10-03-313	20-K0-007	30-K0-005	FAA-K15
SHUMA Tre volumi (FB)							
1.5	59	03.96→12.98	OK280	10-03-313	20-K0-007	30-K0-005	21-KI-K15
1.5 i 16V	65	10.97→10.01		10-03-313	20-K0-007	30-K0-005	FAA-K15
SORENTO							
2.0 CRDi	110	11.10		10-ECO096	20-0K-K28	30-0H-H03	21-KI-K10
2.0 CRDi 4WD	110	11.10		10-ECO096	20-0K-K28	30-0H-H03	21-KI-K10
2.2 CRDi	145	11.09		10-ECO096	20-0K-K28	30-0H-H03	21-KI-K10
2.4 16V	129	11.09	G4KE	10-05-599	20-0K-K27	30-0H-H03 30-0K-K29 Nel serbatoio carb. /Inside tank fuel	21-KI-K10
SORENTO (JC)							
2.4	102	08.02	G4JS	10-05-599	20-K0-010	30-K0-005 30-0K-K27 Nel serbatoio carb. /Inside tank fuel	21-KI-K06

NEW CODES - NEUE CODES - NOUVEAUX CODES - NUEVOS CODIGOS - NUOVI CODICI

	KW						
				OIL FILTER FILTRO OLIO	AIR FILTER FILTRO ARIA	FUEL FILTER FILTRO CARBURANTE	CABIN FILTER FILTRO ABITACOLO
SORENTO (JC)							
2.5 CRDi	103	08.02	D4CB	10-K0-006	20-K0-010	30-K0-016	21-KI-K06
2.5 CRDi	125	12.06	D4CB	10-K0-006	20-K0-010	30-0H-H03 30-H0-005	21-KI-K17
3.3 V6	177	12.06		10-05-599 10-ECO075	20-K0-010	30-K0-005	21-KI-K17
3.3 V6	182	11.07	G6DB	10-ECO075	20-K0-010	30-K0-005	21-KI-K17
3.5 V6	143	08.02	G6CU	10-05-599	20-K0-010	30-K0-005 30-0K-K27 Nel serbatoio carb. /Inside tank fuel	21-KI-K06
SOUL							
1.6	93	02.09	G4FC	10-05-599	20-0K-K22		21-KI-K19
1.6 CRDi	85	02.09	D4FB	10-ECO076			
1.6 CRDi	93	02.09	D4FB	10-ECO076	20-0K-K22	30-H0-011	21-KI-K19
SPORTAGE							
1.7 CRDi	85	02.11	D4FD-L	10-ECO076	20-0H-H23	30-H0-011	21-HY-H29
2.0 16V	104	09.04	G4GC	10-05-599	20-0H-012	30-H0-002 30-0K-K25 Nel serbatoio carb. /Inside tank fuel	21-HY-H11
2.0 16V CRDi VGT	100	10.10	D4HA	10-ECO096	20-0H-H23	30-H0-011	21-HY-H29
2.0 16V CVVT	120	10.10		10-05-599	20-0H-H23	30-0K-K28 Nel serbatoio carb. /Inside tank fuel	21-HY-H29
2.0 CRDi	100	01.06	D4EA	10-ECO056	20-0H-012	30-H0-011	21-HY-H11
2.0 CRDi	110	09.08	D4EA	10-ECO056	20-0H-012	30-H0-011	21-HY-H11
2.0 CRDi	83	02.05	D4EA	10-H0-004	20-0H-012	30-H0-011	21-HY-H11
2.0 CRDi 4WD	103	01.06	D4EA-V D4EA-F	10-ECO056	20-0H-012	30-H0-011	21-HY-H11
2.7 V6 4WD	129	09.04	G6BA	10-05-599	20-0H-012	30-H0-002 30-0K-K25 Nel serbatoio carb. /Inside tank fuel	21-HY-H11
SPORTAGE (K00)							
2.0	87	10.00 → 08.03		10-03-315	20-03-395	30-K0-004	21-HY-H11
2.0 4WD	87	10.00 → 08.03		10-03-315	20-03-395	30-K0-004	21-HY-H11
2.0 CRDi	103	01.06	D4EA-V	10-ECO056	20-03-388	30-K0-001	21-HY-H11
2.0 i 16V	94	10.99 → 08.03	FE (16 V)	10-03-315	20-03-395	30-K0-004	21-HY-H11
2.0 i 16V 4WD	94	04.94 → 08.03	FE (16 V)	10-03-315	20-03-395	30-03-394	21-HY-H11
2.0 i 4WD	70	04.94 → 08.99	FE	10-03-315	20-03-395	30-03-394	21-HY-H11
2.0 TD 4WD	61	10.97 → 08.03	RF	10-03-306 Bypass Filter 10-03-321	20-03-388	30-K0-001	21-HY-H11
2.2 D 4x4	52	08.94 → 04.99		10-03-306 Bypass Filter 10-03-321	20-03-388	30-K0-001	
VENGA							
1.4 16V	66	02.10		10-05-599	20-0K-K22	30-0K-K23 Nel serbatoio carb. /Inside tank fuel	21-KI-K20
1.4 CRDi	55	02.10		10-ECO076	20-0K-K22	30-0H-H03	21-KI-K20

	KW						
				OIL FILTER FILTRO OLIO	AIR FILTER FILTRO ARIA	FUEL FILTER FILTRO CARBURANTE	CABIN FILTER FILTRO ABITACOLO
VENGA							
1.4 CRDi	66	02.10		10-ECO076	20-0K-K22	30-0H-H03	21-KI-K20
1.6 16V	92	02.10	G4FC	10-05-599	20-0K-K22	30-0K-K23 Nel serbatoio carb. /Inside tank fuel	21-KI-K20
1.6 CRDi	85	02.10	D4FB	10-ECO076	20-0K-K22	30-0H-H03	21-KI-K20
1.6 CRDi	94	02.10	D4FB	10-ECO076	20-0K-K22	30-0H-H03	21-KI-K20

	KW						
				OIL FILTER FILTRO OLIO	AIR FILTER FILTRO ARIA	FUEL FILTER FILTRO CARBURANTE	CABIN FILTER FILTRO ABITACOLO
110							
1.5	54	01.95		10-09-985		30-00-000	
1.5	57	01.95	VAZ-2111	10-09-985		30-00-000	
1.5 16V	70	01.95	VAZ-2112	10-09-985		30-00-000	
2.0 i	110	08.96	C 20 XE	10-03-398			
Wankel	88	06.97	VAZ-415	10-09-985			
111							
1.5	57	01.96	VAZ-2111	10-09-985		30-00-000	
1.5 16V	70	01.95	VAZ-2112	10-09-985		30-00-000	
112							
1.5	54	01.95		10-09-985			
1.5	57	01.95	VAZ-2111	10-09-985			
1.5 16V	70	01.95	VAZ-2112	10-09-985			
NIVA (2121)							
1600	54	01.87 → 03.95	BA3 2121	10-09-985	20-00-000	30-00-000 06.90 →	
1600	56	04.80 → 12.87	BA3 2121	10-09-985	20-00-000	30-00-000	
1600	56	12.76 → 05.87	BA3 2121	10-09-985	20-00-000		
1700 i	59	06.96	BA3 21214	10-09-985	20-00-000		
1700 i 4x4	60	10.00		10-09-985			
1900 Diesel	47	01.93	XUD9A	10-01-189			
SAMARA (2108, 2109)							
1100	39	02.88 → 12.94	BA3 21081	10-09-985	20-00-000	30-00-000	
1100	43	02.96	BA3 21081 (KAT)	10-09-985	20-00-000	30-00-000	
1300	45	09.91	BA3 2108 (KAT)	10-09-985	20-00-000		
1300	46	01.88	BA3 2108	10-09-985	20-00-000	30-00-000	
1300	48	01.86 → 12.94	BA3 2108	10-09-985	20-00-000	30-00-000	
1300	50	02.96	BA3 21115	10-09-985	20-00-000		
1500	50	09.91	BA3 21083 (KAT)	10-09-985	20-00-000		
1500	52	02.95	BA3 2111	10-09-985	20-00-000		
1500	53	01.88	BA3 21083	10-09-985	20-00-000	30-00-000	
SAMARA FORMA (21099)							
1100	39	07.91	BA3 21081 (KAT)	10-09-985	20-00-000		
1300	45	07.91	BA3 2108	10-09-985			
1300	46	05.90		10-09-985			
1300	48	05.89 → 07.97	BA3 2108	10-09-985	20-00-000		
1300	50	02.96		10-09-985		30-00-000	
1500	50	07.91	BA3 21083 (KAT)	10-09-985			
1500	52	11.94	BA3 2111	10-09-985			
1500	53	09.91	BA3 21083	10-09-985			
TOSCANA							
1300 (VAZ2107)	48	12.85	BA3 2105	10-09-985	20-00-000	30-00-000	
1500 (VAZ2107)	55	09.83 → 02.93	BA3 2103	10-09-985	20-00-000	30-00-000	

NEW CODES - NEUE CODES - NOUVEAUX CODES - NUEVOS CODIGOS - NUOVI CODICI



	KW						
				OIL FILTER FILTRO OLIO	AIR FILTER FILTRO ARIA	FUEL FILTER FILTRO CARBURANTE	CABIN FILTER FILTRO ABITACOLO

DELTA III

1.4	110	09.08	198 A1.000	10-ECO044	
1.4	88	09.08	198 A4.000	10-ECO044	
1.4 16V	103	07.10	198 A7.000	10-ECO044	
1.6 D Multijet	88	09.08	198 A2.000	10-ECO095	
1.8	147	01.09	939 B1.000	10-ECO095	
1.8 16V	147	02.09	939 B1.000	10-ECO095	
1.9 D Multijet	140	01.09	844 A1.000	10-ECO095	
2.0 D Multijet	121	09.08	198 A5.000 198 A8.000	10-ECO095	

MUSA

1.3 D Multijet	51	10.04	188 A9.000	10-ECO044 10-ECO065	30-ECO016
1.3 D Multijet	66	09.06	199 A3.000	10-ECO065	30-ECO016
1.3 D Multijet	70	08.09	199 B1.000	10-ECO095	
1.6 D Multijet	85	07.08	350 A2.000 350 A3.000	10-ECO095	
1.6 D Multijet	88	07.08	350 A2.000	10-ECO095	
1.9 D Multijet	74	10.04	188 B2.000		30-ECO016

PHEDRA (179)

2.0 D Multijet	100	07.06	RHR	10-ECO060	30-ECO027
2.0 JTD	79	07.03	RHM		30-ECO019
2.0 JTD	88	06.06	RHK		30-ECO027
2.0 JTD (179AXB1A)	80	09.02	RHW(DW10ATE D4)		30-ECO019
2.2 D Multijet	125	03.08	4HS 4HT	10-ECO060	
2.2 JTD (179AXC1A)	94	09.02	4HW(DW12ATE D4)		30-ECO019

THESIS (841AX)

2.4 D Multijet	136	04.06	841 P.000	10-ECO107	
----------------	-----	-------	-----------	-----------	--

YPSILON

1.3 D Multijet	55	09.06	199 A2.000	10-ECO065	30-ECO016
1.3 D Multijet	66	09.06	199 A3.000	10-ECO065	30-ECO016
1.3 D Multijet	77	05.07	199 A3.000	10-ECO065	30-ECO016
1.3 JTD	51	10.03	188 A9.000	10-ECO044 10-ECO065	30-ECO016

LAND ROVER



	KW						
				OIL FILTER FILTRO OLIO	AIR FILTER FILTRO ARIA	FUEL FILTER FILTRO CARBURANTE	CABIN FILTER FILTRO ABITACOLO

88/109 \ Hardtop

2.3 (LR 88 OL, LR 109 OL)	51	09.63 → 12.86		10-02-204 11.79 → → 12.82	20-0L-L00	30-05-578
2.3 D (LR 88 DL, LR 109 DL)	46	09.63 → 12.86			20-0L-L00	30-08-891
3.5	68	01.80 → 12.83		10-02-204		

90/110

2.5	62	09.85 → 07.90	17H	10-0L-L02	20-0L-L00	30-05-501
2.5 TD	63	09.86 → 07.90		10-0L-L02	20-0L-L00	30-08-891
3.5 V8	100	09.83 → 07.90		10-0L-L02	20-0L-L16	

DEFENDER Tutti i modelli \ All models

2.4 Td4	90	05.07	244DT	10-ECO060		
2.5 90,110 TDI	83	09.90 → 12.98	11 L 16 L 23 L	10-0L-L02	20-0L-L11 → 12.94 20-0L-L12 01.95 →	30-0L-L08
2.5 Td5 4WD	90	06.98		10-0L-L05	20-0L-L01	30-0L-L09
3.5 4x4	86	09.90 → 08.93		10-0L-L02	20-0L-L16	
3.9 V8	136	11.98		10-0L-L02	20-0L-L04	30-03-393

DISCOVERY I

2.0 16 V	99	09.93 → 06.94		10-0L-L03	20-0L-L03	30-03-393
2.5 TDI	83	09.89 → 06.94	12 L 17 L 19 L 21 L	10-0L-L02	20-0L-L03 11.93 → 20-0L-L11 → 10.93	30-0L-L08
3.5 (SALLJG)	113	09.89 → 06.94	22 D	10-0L-L02	20-0L-L04	30-03-393
3.9 V8	134	09.93 → 06.94	35 D 36 D	10-0L-L02	20-0L-L03	30-03-393

DISCOVERY II (LJ, LT)

2.0 16 V	99	06.94		10-0L-L03	20-0L-L03	30-03-393
2.5 Td5	102	01.99	10 P	10-0L-L05	20-0L-L01	30-0L-L09
2.5 TDI	83	08.96		10-0L-L02	20-0L-L03 01.99 → 20-0L-L09	30-0L-L08
2.5 TDI	90	10.95		10-0L-L02	20-0L-L03 01.99 → 20-0L-L09	30-0L-L08
3.9 V8	134	06.94 → 11.98		10-0L-L02	20-0L-L01 09.96 → 20-0L-L07 → 08.96	30-03-393
4.0 V8	136	11.98		10-0L-L02	20-0L-L01	30-03-393

DISCOVERY III

2.7 TD	140	10.04	276DT	10-ECO048	20-0L-L02	30-0L-L05	21-LR-LR4
3.0 TD	180	09.09	306DT	10-ECO099	20-0L-L02	30-0L-L12	21-LR-LR4
4.4	220	10.04	448PN	10-0L-L08	20-0L-L02		21-LR-LR4
5.0 V8	375	09.09			20-0L-L17		21-LR-LR4

DISCOVERY IV (LA)

2.7 TD	140	09.09	276DT	10-ECO048	20-0L-L02	30-0L-L05
--------	-----	-------	-------	-----------	-----------	-----------

NEW CODES - NEUE CODES - NOUVEAUX CODES - NUEVOS CODIGOS - NUOVI CODICI



LAND ROVER

	KW						
				OIL FILTER FILTRO OLIO	AIR FILTER FILTRO ARIA	FUEL FILTER FILTRO CARBURANTE	CABIN FILTER FILTRO ABITACOLO
DISCOVERY IV (LA)							
3.0 TD	155	05.10	30DDTX	10-ECO099	20-0L-L02	30-0L-L12	
FREELANDER (LN)							
1.8 16V	86	11.00	18 K4F	10-0L-L03	20-0L-L10	30-03-393	21-LR-LR2 VIN 1A000001-> 21-LR-LR6 VIN->YA999999
1.8 i 16V	88	02.98 → 11.00		10-0L-L03	20-0L-L10	30-03-393	21-LR-LR2 VIN 1A000001-> 21-LR-LR6 VIN->YA999999
2.0 DI	72	02.98 → 11.00		10-04-497	20-0L-L10	30-04-496 30-0L-L02	21-LR-LR2 VIN 1A000001-> 21-LR-LR6 VIN->YA999999
2.0 Td4	80	11.01		10-ECO021	20-0L-L05	30-0L-L03 →04.02	21-LR-LR2 VIN 1A000001-> 21-LR-LR6 VIN->YA999999
2.0 Td4	82	11.00		10-ECO021	20-0L-L05	30-0L-L03 11.00→ →04.02	21-LR-LR2 VIN 1A000001-> 21-LR-LR6 VIN->YA999999
2.5 V6	130	11.00	25 K4F	10-0L-L03	20-0L-L01	30-0L-L00	21-LR-LR2 VIN 1A000001-> 21-LR-LR6 →VIN->YA999999
FREELANDER 2							
2.2 TD4	112	01.07	224DT	10-ECO060	20-0L-L14	30-0L-L11	21-LR-LR5
2.2 TD4	118	10.06	224DT	10-ECO060	20-0L-L14	30-0L-L11	21-LR-LR5
2.2 TD4 4x4	115	10.06	224DT	10-ECO060	20-0L-L14	30-0L-L11	21-LR-LR5
3.2	171	10.06	B 6324 S	10-ECO012	20-0L-L14		21-LR-LR5
FREELANDER Soft Top							
1.8 i 16V	88	02.98	18 K4F	10-0L-L03	20-0L-L10	30-03-393	21-LR-LR2 VIN 1A000001-> 21-LR-LR6 →VIN->YA999999
2.0 DI	72	02.98		10-04-497	20-0L-L01	30-04-496 30-0L-L02	21-LR-LR2 VIN 1A000001-> 21-LR-LR6 →VIN->YA999999
RANGE ROVER EVOQUE							
2.0 Si4	177	06.11		10-0L-L09	20-0L-L18		21-LR-LR5
2.2 SD4	140	06.11		10-ECO060	20-0L-L18	30-0L-L11	21-LR-LR5
2.2 TD4	110	06.11		10-ECO060	20-0L-L18	30-0L-L11	21-LR-LR5
RANGE ROVER I							
2.4 Diesel	78	04.86 → 12.90	11 A	10-0L-L02	20-0L-L11	30-0L-L08	
2.5 TD 4x4	89	10.89 → 04.94			20-0L-L11	30-06-695	
3.5	107	01.87 → 09.90	31 D	10-0L-L02	20-0L-L04	30-01-192	
3.5	97	07.70 → 08.81		10-0L-L02	20-0L-L15	30-01-192	
3.5 Vogue	120	10.85 → 09.90	24 D 25 D	10-0L-L02	20-0L-L04	30-01-192	

NEW CODES - NEUE CODES - NOUVEAUX CODES - NUEVOS CODIGOS - NUOVI CODICI

Per nuove applicazioni e novità si prega di accedere al sito www.ashika.eu - For new applications and new items, please go to www.ashika.eu

	KW			 OIL FILTER FILTRO OLIO	 AIR FILTER FILTRO ARIA	 FUEL FILTER FILTRO CARBURANTE	 CABIN FILTER FILTRO ABITACOLO
---	----	---	---	--	--	---	---

RANGE ROVER I

3.5 Vogue	93	08.81 → 09.90	11 D	10-0L-L02	20-0L-L04	30-01-192	
3.9 Cat.	127	11.88 → 07.94	37 D 38 D	10-0L-L02	20-0L-L04	30-01-192	
3.9 Vogue SEI	134	11.88 → 07.94	35 D 36 D	10-0L-L02	20-0L-L04	30-01-192	
4.3 Vogue LSE	149	09.92 → 07.94	40 D	10-0L-L02		30-01-192	

RANGE ROVER II (LP)

2.5 D	100	07.94 → 03.02	25 6T (BMW)	10-ECO011	20-0L-L01 09.96 → 20-0L-L07 →08.96	30-0L-L07	21-LR-LR3
2.5 D	83	08.94 → 03.02	14 L	10-0L-L02	20-0L-L01 09.96 → 20-0L-L07 →08.96	30-0L-L07	21-LR-LR3
3.9	140	07.94 → 03.02	42 D	10-0L-L02	20-0L-L01 09.96 → 20-0L-L07 →08.96	30-01-192	21-LR-LR3
4.0	136	06.98 → 03.02		10-0L-L02	20-0L-L01	30-03-393	21-LR-LR3
4.6	160	06.98 → 03.02		10-0L-L02	20-0L-L01	30-03-393	21-LR-LR3
4.6	165	07.94 → 03.02	46 D	10-0L-L02	20-0L-L01	30-01-192	21-LR-LR3

RANGE ROVER III (LM)







3.0 TD 6	130	03.02		10-ECO035	20-0L-L06	30-0L-L06	21-LR-LR1
3.6 TD 8	200	04.06	368DT	10-ECO069	20-0L-L02	30-0L-L06	21-LR-LR4
4.2	291	05.05		10-0L-L08	20-0L-L02	30-0L-L06	21-LR-LR1
4.4	210	03.02		10-ECO014	20-0L-L16	30-0L-L06 30-0L-L13	21-LR-LR1
4.4	225	05.05		10-ECO014	20-0L-L02	30-0L-L06 30-0L-L13	21-LR-LR1

RANGE ROVER SPORT

2.7 TDVM	140	02.05	276DT	10-ECO048	20-0L-L02	30-0L-L05	21-LR-LR4
3.0 TD	180	09.09	30DDTX	10-ECO099	20-0L-L02	30-0L-L12	21-LR-LR4
3.0 TD V6	155	05.10	30DDTX	10-ECO099	20-0L-L02	30-0L-L12	21-LR-LR4
3.6 TD 8	200	04.06	368DT	10-ECO069	20-0L-L02	30-0L-L12	21-LR-LR4
4.2	287	02.05		10-0L-L08	20-0L-L02		21-LR-LR4
4.4	220	02.05	448PN	10-0L-L08	20-0L-L02		21-LR-LR4







	KW						
				OIL FILTER FILTRO OLIO	AIR FILTER FILTRO ARIA	FUEL FILTER FILTRO CARBURANTE	CABIN FILTER FILTRO ABITACOLO
CT							
200h	73	03.11	2ZR-FXE	10-ECO078	20-02-2000		21-TY-TY9
ES (F1, F2)							
250	118	12.89 → 09.91	2VZ-FE	10-02-279	20-02-277	30-02-224	21-SB-SB2
300	138	09.91 → 12.97	3VZ-FE	10-02-279	20-02-298	30-02-247	21-SB-SB2
GS							
3.0	170	04.05	3GR-FSE 3GR-FE	10-ECO054	20-02-294		21-TY-TY9
300	183	04.05	3GR-FSE	10-02-279	20-02-294	30-02-237	21-TY-TY9
430	208	04.05	3UZ-FE	10-02-279	20-02-260	30-02-253	21-TY-TY9
450 h	218	02.06	2GR-FSE	10-02-279	20-02-294		21-TY-TY9
GS (JZS147)							
300	156	03.93 → 08.97	2JZ-GE	10-02-279	20-02-295	30-02-247	21-TY-TY3
GS (JZS160)							
300	161	10.00 → 03.05	2JZ-GE	10-02-279	20-02-280	30-02-253	21-TY-TY5
300 T3	163	08.97 → 10.00	2JZ-GE	10-02-279	20-02-280	30-02-253	21-TY-TY5
400	216	12.97 → 11.00	1UZ-FE	10-02-279	20-02-281	30-02-280	21-TY-TY3
430	208	11.00 → 03.05	3UZ-FE	10-02-215	20-02-294	30-02-234 Nel serbatoio carb. /Inside tank fuel	21-TY-TY4
IS							
220 d (ALE20)	130	10.05	2AD-FHV	10-ECO054	20-02-255	30-02-200	21-TY-TY9
250 (GSE20)	153	10.05	4GR-FSE	10-ECO054	20-02-260		21-TY-TY9
IS F (USE20)	311	03.08	2UR-GSE	10-ECO094	20-02-2003		21-TY-TY9
IS (GXE10) \ SportCross							
200	114	04.99	1G-FE	10-02-279	20-02-276	30-02-234 Nel serbatoio carb. /Inside tank fuel	21-TY-TY5
300	157	09.01	2JZ-GE	10-02-279	20-02-293		21-TY-TY5
LS							
460 AWD	280	12.08	1UR-FSE	10-ECO054	20-02-2001		
600 h	290	08.07	2UR-FSE	10-ECO054	20-02-2001		21-TY-TY9
LS (FE)							
430	207	10.00	3UZ-FE	10-02-215	20-02-281	30-02-234 Nel serbatoio carb. /Inside tank fuel	21-TY-TY4
460	280	04.06	1UR-FSE	10-ECO054	20-02-2001		21-TY-TY9
LS (UCF10)							
400	180	12.89 → 12.94	1UZ-FE	10-02-215	20-02-247	30-02-247	
LS (UCF20)							
400	194	12.94 → 08.97	1UZ-FE	10-02-215	20-02-294	30-02-247	21-TY-TY3
400	203	09.98	1UZ-FE	10-02-215	20-02-247	30-02-247	21-TY-TY3
400	209	09.97	1UZ-FE	10-02-215	20-02-247	30-02-247	21-TY-TY3
RX							
300	150	05.03	1MZ-FE	10-02-279	20-02-252	30-02-231	21-TY-TY5

NEW CODES - NEUE CODES - NOUVEAUX CODES - NUEVOS CODIGOS - NUOVI CODICI

	KW						
				OIL FILTER FILTRO OLIO	AIR FILTER FILTRO ARIA	FUEL FILTER FILTRO CARBURANTE	CABIN FILTER FILTRO ABITACOLO
RX							
350	203	02.06	2GR-FE	10-02-279	20-02-252		21-TY-TY9
400h	155	09.04		10-02-279	20-02-265	30-02-234 Nel serbatoio carb. /Inside tank fuel	21-TY-TY12 21-TY-TY8
400h	155	09.04	3MZ-FE	10-02-279	20-02-265	30-02-234 Nel serbatoio carb. /Inside tank fuel	21-TY-TY12 21-TY-TY8
400h FWD	155	09.05	3MZ-FE	10-02-279	20-02-265	30-02-234 Nel serbatoio carb. /Inside tank fuel	21-TY-TY12 21-TY-TY8
RX (GYL_)							
450h AWD	183	04.09	2GR-FXE	10-02-279	20-02-2001	30-02-234 Nel serbatoio carb. /Inside tank fuel	21-TY-TY9
RX (XU1)							
3.0 2WD	148	07.00 → 03.03	1MZ-FE	10-02-279	20-02-298	30-02-234 Nel serbatoio carb. /Inside tank fuel	21-TY-TY5
300 V6	148	10.00 → 05.03	1MZ-FE	10-02-279	20-02-298	30-02-234 Nel serbatoio carb. /Inside tank fuel	21-TY-TY5
SC							
430	210	08.01	3UZ-FE	10-02-279	20-02-281	30-02-234 Nel serbatoio carb. /Inside tank fuel	21-TY-TY4



MAHINDRA

	KW			 OIL FILTER FILTRO OLIO	 AIR FILTER FILTRO ARIA	 FUEL FILTER FILTRO CARBURANTE	 CABIN FILTER FILTRO ABITACOLO
GOA							
2.5 TD	79	01.07		10-00-012	20-00-002	30-K0-018	







NEW CODES - NEUE CODES - NOUVEAUX CODES - NUEVOS CODIGOS - NUOVI CODICI

Per nuove applicazioni e novità si prega di accedere al sito www.ashika.eu - For new applications and new items, please go to www.ashika.eu

	KW			 OIL FILTER FILTRO OLIO	 AIR FILTER FILTRO ARIA	 FUEL FILTER FILTRO CARBURANTE	 CABIN FILTER FILTRO ABITACOLO
---	----	---	---	--	--	---	---

F 2000							
19.293 FAC,FAK,FAC	213	01.94		10-ECO002			
19.293 FC,19.293 FLC,19.293 FLLC	213	01.94		10-ECO002			
19.293 FK,19.293 FLK	213	01.94		10-ECO002			
19.293 FS,19.293 FLS,19.293 FLLS	213	01.94		10-ECO002			
19.314 FC,19.314 FLC,19.314 FLLC	228	06.98		10-ECO002			
19.314 FK,19.314 FLK	228	06.98		10-ECO002			
19.314 FS,19.314 FLS,19.314 FLLS	228	06.98		10-ECO002			
19.323 FAC	235	01.94 → 12.95		10-ECO015			
19.323 FAK	235	01.94 → 12.95		10-ECO015			
19.323 FAS	235	01.94 → 12.95		10-ECO015			
19.323 FC,19.323 FLC,19.323 FLLC	235	01.94 → 12.95		10-ECO015			
19.323 FK,19.323 FLK	235	01.94 → 12.95		10-ECO015			
19.323 FS,19.323 FLS,19.323 FLLS	235	01.94 → 12.95		10-ECO015			
19.343 FAC	250	01.94		10-ECO002			
19.343 FAK	250	01.94		10-ECO002			
19.343 FAS	250	01.94		10-ECO002			
19.343 FC,19.343 FLC,19.343 FLLC	250	01.94		10-ECO002			
19.343 FK,19.343 FLK	250	01.94		10-ECO002			
19.343 FS,19.343 FLS,19.343 FLLS	250	01.94		10-ECO002			
19.364 FAC	265	06.98		10-ECO002			
19.364 FAK	265	06.98		10-ECO002			
19.364 FAS	265	06.98		10-ECO002			
19.364 FC,19.364 FLC,19.364 FLLC	265	06.98		10-ECO002			
19.364 FK,19.364 FLK	265	06.98		10-ECO002			
19.364 FS,19.364 FLS,19.364 FLLS	265	06.98		10-ECO002			
19.373 FAC	272	01.94 → 12.95		10-ECO015			
19.373 FAK	272	01.94 → 12.95		10-ECO015			
19.373 FAS	272	01.94 → 12.95		10-ECO015			
19.373 FC,19.373 FLC,19.373 FLLC	272	01.94 → 12.95		10-ECO015			
19.373 FK,19.373 FLK	272	01.94 → 12.95		10-ECO015			
19.373 FS,19.373 FLS,19.373 FLLS	272	01.94 → 12.95		10-ECO015			
19.403 FAC	294	01.94		10-ECO002			
19.403 FAK	294	01.94		10-ECO002			
19.403 FAS	294	01.94		10-ECO002			
19.403 FC,19.403 FLC,19.403 FLLC	294	01.94		10-ECO002			
19.403 FK,19.403 FLK	294	01.94		10-ECO002			
19.403 FS,19.403 FLS,19.403 FLLS	294	01.94		10-ECO002			
19.414 FAC	301	06.98		10-ECO002			
19.414 FAK	301	06.98		10-ECO002			
19.414 FAS	301	06.98		10-ECO002			
19.414 FC,19.414 FLC,19.414 FLLC	301	06.98		10-ECO002			
19.414 FK,19.414 FLK	301	06.98		10-ECO002			
19.414 FS,19.414 FLS,19.414 FLLS	301	06.98		10-ECO002			
19.423 FAC	309	01.94 → 12.95		10-ECO015			



	KW						
				OIL FILTER FILTRO OLIO	AIR FILTER FILTRO ARIA	FUEL FILTER FILTRO CARBURANTE	CABIN FILTER FILTRO ABITACOLO
F 2000							
19.423 FAK	309	01.94 → 12.95		10-ECO015			
19.423 FAS	309	01.94 → 12.95		10-ECO015			
19.423 FC,19.423 FLC,19.423 FLLC	309	01.94 → 12.95		10-ECO015			
19.423 FK,19.423 FLK	309	01.94 → 12.95		10-ECO015			
19.423 FS,19.423 FLS,19.423 FLLS	309	01.94 → 12.95		10-ECO015			
19.463 FAC	338	01.94		10-ECO002			
19.463 FAK	338	01.94		10-ECO002			
19.463 FAS	338	01.94		10-ECO002			
19.463 FC,19.463 FLC,19.463 FLLC	338	01.94		10-ECO002			
19.463 FK,19.463 FLK	338	01.94		10-ECO002			
19.463 FS,19.463 FLS,19.463 FLLS	338	01.94		10-ECO002			
19.464 FAK	338	06.98		10-ECO002			
19.464 FAS	338	06.98		10-ECO002			
19.464 FC,19.464 FLC,19.464 FLLC	338	06.98		10-ECO002			
19.464 FK,19.464 FLK	338	06.98		10-ECO002			
19.464 FS,19.464 FLS,19.464 FLLS	338	06.98		10-ECO002			
19.603 FLS	441	04.96		10-ECO002			
23.293 FNLLC	213	01.94		10-ECO002			
23.343 FNLLC	250	01.94		10-ECO002			
23.403 FNLLC	294	01.94		10-ECO002			
23.463 FNLLC	338	01.94		10-ECO002			
24.273 FNLLC	198	01.94 → 12.95		10-ECO015			
24.293 FNLLC	213	01.94		10-ECO002			
24.323 FNLLC	235	01.94 → 12.95		10-ECO002 10-ECO015			
24.343 FNLLC	250	01.94		10-ECO002			
24.373 FNLLC	272	01.94 → 12.95		10-ECO015			
24.403 FNLLC	294	01.94		10-ECO015			
24.423 FNLLC	309	01.94 → 12.95		10-ECO015			
24.463 FNLLC	338	01.94		10-ECO015			
26.233 FVLCNG	170	09.96		10-ECO015			
26.273 DFC,26.273 DFCLC	198	01.94 → 12.95		10-ECO015			
26.273 DFK,26.273 DFLK	198	01.94 → 12.95		10-ECO015			
26.273 DFS,26.273 DFSL	198	01.94 → 12.95		10-ECO015			
26.273 FNLC,26.273 FNLLC,26.273 FVLC	198	01.94 → 12.95		10-ECO015			
26.273 FNLS,26.273 FVLS	198	01.94 → 12.95		10-ECO015			
26.293 DFC,26.293 DFCLC	213	01.94		10-ECO002			
26.293 DFK,26.293 DFLK	213	01.94		10-ECO002			
26.293 DFS,26.293 DFSL	213	01.94		10-ECO002			
26.293 FNLC,26.293 FNLLC,26.293 FVLC	213	01.94		10-ECO002			
26.293 FNLS,26.293 FVLS	213	01.94		10-ECO002			
26.323 DFC,26.323 DFCLC	235	01.94 → 12.95		10-ECO015			
26.323 DFK,26.323 DFLK	235	01.94 → 12.95		10-ECO015			
26.323 DFS,26.323 DFSL	235	01.94 → 12.95		10-ECO015			
26.323 FNLC,26.323 FNLLC,26.323 FVLC	235	01.94 → 12.95		10-ECO015			

NEW CODES - NEUE CODES - NOUVEAUX CODES - NUEVOS CODIGOS - NUOVI CODICI

	KW			 OIL FILTER FILTRO OLIO	 AIR FILTER FILTRO ARIA	 FUEL FILTER FILTRO CARBURANTE	 CABIN FILTER FILTRO ABITACOLO
---	----	---	---	--	--	---	---

F 2000							
26.323 FNLS,26.323 FVLS	235	01.94 → 12.95		10-ECO015			
26.343 DFC,26.343 DFCL	250	01.94		10-ECO002			
26.343 DFK,26.343 DFLK	250	01.94		10-ECO002			
26.343 DFS,26.343 DFSL	250	01.94		10-ECO002			
26.343 FNLC,26.343 FNLLC,26.343 FVLC	250	01.94		10-ECO002			
26.343 FNLS,26.343 FVLS	250	01.94		10-ECO002			
26.373 DFC,26.373 DFCL	272	01.94 → 12.95		10-ECO015			
26.373 DFK,26.373 DFLK	272	01.94 → 12.95		10-ECO015			
26.373 DFS,26.373 DFSL	272	01.94 → 12.95		10-ECO015			
26.373 FNLC,26.373 FNLLC,26.373 FVLC	272	01.94 → 12.95		10-ECO015			
26.373 FNLS,26.373 FVLS	272	01.94 → 12.95		10-ECO015			
26.403 DFC,26.403 DFCL	294	01.94		10-ECO002			
26.403 DFK,26.403 DFLK	294	01.94		10-ECO002			
26.403 DFS,26.403 DFSL	294	01.94		10-ECO002			
26.403 FNLC,26.403 FNLLC,26.403 FVLC	294	01.94		10-ECO002			
26.403 FNLS,26.403 FVLS	294	01.94		10-ECO002			
26.423 DFC,26.423 DFCL	309	01.94 → 12.95		10-ECO015			
26.423 DFK,26.423 DFLK	309	01.94 → 12.95		10-ECO015			
26.423 DFS,26.423 DFSL	309	01.94 → 12.95		10-ECO015			
26.423 FNLC,26.423 FNLLC,26.423 FVLC	309	01.94 → 12.95		10-ECO015			
26.423 FNLS,26.423 FVLS	309	01.94 → 12.95		10-ECO015			
26.463 DFC,26.463 DFCL	338	01.94		10-ECO002			
26.463 DFK,26.463 DFLK	338	01.94		10-ECO002			
26.463 DFS,26.463 DFSL	338	01.94		10-ECO002			
26.463 FNLC,26.463 FNLLC,26.463 FVLC	338	01.94		10-ECO002			
26.463 FNLS,26.463 FVLS	338	01.94		10-ECO002			
26.603 DFC,26.603 DFCL	441	06.96		10-ECO002			
26.603 DFK,26.603 DFLK	441	06.96		10-ECO002			
26.603 DFS,26.603 DFSL	441	06.96		10-ECO002			
27.273 DFAC	198	01.94 → 12.95		10-ECO015			
27.273 DFAK	198	01.94 → 12.95		10-ECO015			
27.273 DFAS	198	01.94 → 12.95		10-ECO015			
27.273 DFC	198	01.94 → 12.95		10-ECO015			
27.273 DFK	198	01.94 → 12.95		10-ECO015			
27.273 DFS	198	01.94 → 12.95		10-ECO015			
27.293 DFAC	213	01.94		10-ECO002			
27.293 DFAK	213	01.94		10-ECO002			
27.293 DFAS	213	01.94		10-ECO002			
27.293 DFC	213	01.94		10-ECO002			
27.293 DFK	213	01.94		10-ECO002			
27.293 DFS	213	01.94		10-ECO002			
27.323 DFAC	235	01.94 → 12.95		10-ECO015			
27.323 DFAK	235	01.94 → 12.95		10-ECO015			
27.323 DFAS	235	01.94 → 12.95		10-ECO015			

NEW CODES - NEUE CODES - NOUVEAUX CODES - NUEVOS CODIGOS - NUOVI CODICI



MAN Comm.

	KW			 OIL FILTER FILTRO OLIO	 AIR FILTER FILTRO ARIA	 FUEL FILTER FILTRO CARBURANTE	 CABIN FILTER FILTRO ABITACOLO
---	----	---	---	--	--	---	---

F 2000

27.323 DFC	235	01.94 → 12.95		10-ECO015
27.323 DFK	235	01.94 → 12.95		10-ECO015
27.323 DFS	235	01.94 → 12.95		10-ECO015
27.343 DFAC	250	01.94		10-ECO002
27.343 DFAK	250	01.94		10-ECO002
27.343 DFAS	250	01.94		10-ECO002
27.343 DFC	250	01.94		10-ECO002
27.343 DFK	250	01.94		10-ECO002
27.343 DFS	250	01.94		10-ECO002
27.373 DFAC	272	01.94 → 12.95		10-ECO015
27.373 DFAK	272	01.94 → 12.95		10-ECO015
27.373 DFAS	272	01.94 → 12.95		10-ECO015
27.373 DFC	272	01.94 → 12.95		10-ECO015
27.373 DFK	272	01.94 → 12.95		10-ECO015
27.373 DFS	272	01.94 → 12.95		10-ECO015
27.403 DFAC	294	01.94		10-ECO002
27.403 DFAK	294	01.94		10-ECO002
27.403 DFAS	294	01.94		10-ECO002
27.403 DFC	294	01.94		10-ECO002
27.403 DFK	294	01.94		10-ECO002
27.403 DFS	294	01.94		10-ECO002
27.423 DFAC	309	01.94 → 12.95		10-ECO015
27.423 DFAK	309	01.94 → 12.95		10-ECO015
27.423 DFAS	309	01.94 → 12.95		10-ECO015
27.423 DFC	309	01.94 → 12.95		10-ECO015
27.423 DFK	309	01.94 → 12.95		10-ECO015
27.423 DFS	309	01.94 → 12.95		10-ECO015
27.463 DFAC	338	01.94		10-ECO002
27.463 DFAK	338	01.94		10-ECO002
27.463 DFAS	338	01.94		10-ECO002
27.463 DFC	338	01.94		10-ECO002
27.463 DFK	338	01.94		10-ECO002
27.463 DFS	338	01.94		10-ECO002
27.603 DFAS	441	01.96		10-ECO002
27.603 DFS	441	01.96		10-ECO002
32.293 VFC	213	08.95		10-ECO002
32.343 VFC	250	08.95		10-ECO002
32.343 VFK	250	08.95		10-ECO002
32.403 VFC	294	08.95		10-ECO002
32.403 VFK	294	08.95		10-ECO002
32.463 VFC	338	08.95		10-ECO002
32.463 VFK	338	08.95		10-ECO002
33.323 DFAC	235	01.94 → 12.95		10-ECO015
33.323 DFAK	235	01.94 → 12.95		10-ECO015

NEW CODES - NEUE CODES - NOUVEAUX CODES - NUEVOS CODIGOS - NUOVI CODICI

Per nuove applicazioni e novità si prega di accedere al sito www.ashika.eu - For new applications and new items, please go to www.ashika.eu

	KW			 OIL FILTER FILTRO OLIO	 AIR FILTER FILTRO ARIA	 FUEL FILTER FILTRO CARBURANTE	 CABIN FILTER FILTRO ABITACOLO
---	----	---	---	--	--	---	---

F 2000							
33.323 DFAS	235	01.94 → 12.95		10-ECO015			
33.323 DFC	235	01.94 → 12.95		10-ECO015			
33.323 DFK	235	01.94 → 12.95		10-ECO015			
33.323 DFS	235	01.94 → 12.95		10-ECO015			
33.343 DFAC	250	01.94		10-ECO002			
33.343 DFAK	250	01.94		10-ECO002			
33.343 DFAS	250	01.94		10-ECO002			
33.343 DFC	250	01.94		10-ECO002			
33.343 DFK	250	01.94		10-ECO002			
33.343 DFS	250	01.94		10-ECO002			
33.373 DFAC	272	01.94 → 12.95		10-ECO015			
33.373 DFAK	272	01.94 → 12.95		10-ECO015			
33.373 DFAS	272	01.94 → 12.95		10-ECO015			
33.373 DFC	272	01.94 → 12.95		10-ECO015			
33.373 DFK	272	01.94 → 12.95		10-ECO015			
33.373 DFS	272	01.94 → 12.95		10-ECO015			
33.403 DFAC	294	01.94		10-ECO002			
33.403 DFAK	294	01.94		10-ECO002			
33.403 DFAS	294	01.94		10-ECO002			
33.403 DFC	294	01.94		10-ECO002			
33.403 DFK	294	01.94		10-ECO002			
33.403 DFS	294	01.94		10-ECO002			
33.423 DFAC	309	01.94 → 12.95		10-ECO015			
33.423 DFAK	309	01.94 → 12.95		10-ECO015			
33.423 DFAS	309	01.94 → 12.95		10-ECO015			
33.423 DFC	309	01.94 → 12.95		10-ECO015			
33.423 DFK	309	01.94 → 12.95		10-ECO015			
33.423 DFS	309	01.94 → 12.95		10-ECO015			
33.463 DFAC	338	01.94		10-ECO002			
33.463 DFAK	338	01.94		10-ECO002			
33.463 DFAS	338	01.94		10-ECO002			
33.463 DFC	338	01.94		10-ECO002			
33.463 DFK	338	01.94		10-ECO002			
33.463 DFS	338	01.94		10-ECO002			
33.603 DFAC	441	06.96		10-ECO002			
33.603 DFAS	441	06.96		10-ECO002			
33.603 DFC	441	06.96		10-ECO002			
33.603 DFS	441	06.96		10-ECO002			
35.343 VFC	250	08.95		10-ECO002			
35.343 VFK	250	08.95		10-ECO002			
35.403 VFC	294	08.95		10-ECO002			
35.403 VFK	294	08.95		10-ECO002			
35.463 VFC	338	08.95		10-ECO002			
35.463 VFK	338	08.95		10-ECO002			

NEW CODES - NEUE CODES - NOUVEAUX CODES - NUEVOS CODIGOS - NUOVI CODICI



	KW						
				OIL FILTER FILTRO OLIO	AIR FILTER FILTRO ARIA	FUEL FILTER FILTRO CARBURANTE	CABIN FILTER FILTRO ABITACOLO

F 2000

41.343 VFC	250	08.95		10-ECO002
41.343 VFK	250	08.95		10-ECO002
41.403 VFC	294	08.95		10-ECO002
41.403 VFK	294	08.95		10-ECO002
41.463 VFC	338	08.95		10-ECO002
41.463 VFK	338	08.95		10-ECO002

F 90

19.342 F,19.342 FL,19.342 FLL	250	05.94 → 05.95		10-ECO001
19.342 FA	250	05.94 → 06.96		10-ECO001
19.342 FAK	250	05.94 → 06.96		10-ECO001
19.342 FAS	250	05.94 → 06.96		10-ECO001
19.342 FK	250	05.94 → 05.95		10-ECO001
19.342 FS,19.342 FLS,19.342 FLLS	250	05.94 → 05.95		10-ECO001
19.402 F,19.402 FL,19.402 FLL	294	05.94 → 05.95		10-ECO015
19.402 FA	294	05.94 → 06.96		10-ECO015
19.402 FAK	294	05.94 → 06.96		10-ECO015
19.402 FAS	294	05.94 → 06.96		10-ECO015
19.402 FK	294	05.94 → 05.95		10-ECO015
19.402 FS,19.402 FLS,19.402 FLLS	294	05.94 → 05.95		10-ECO015
24.342 FNL,24.342 FNLL	250	05.94 → 05.95		10-ECO015
24.402 FNL,24.402 FNLL	294	05.94 → 05.95		10-ECO015
26.402 DF,26.402 DFL	294	05.94 → 06.96		10-ECO015
26.402 DFK,26.402 DFLK	294	05.94 → 06.96		10-ECO015
26.402 DFS	294	05.94 → 12.95		10-ECO015
26.402 FNL,26.402 FNLL,26.402 FVL	294	05.94 → 06.96		10-ECO015
26.402 FNLS,26.402 FVLS	294	05.94 → 06.96		10-ECO015
32.342 VFK	250	05.94 → 06.96		10-ECO015
32.402 VFK	294	05.94 → 06.96		10-ECO015
33.342 DF	250	05.94 → 06.96		10-ECO015
33.342 DFA	250	05.94 → 06.96		10-ECO015
33.402 DF	294	05.94 → 06.96		10-ECO015
33.402 DFA	294	05.94 → 06.96		10-ECO015
33.402 DFAK	294	05.94 → 06.96		10-ECO015
33.402 DFK	294	05.94 → 06.96		10-ECO015
33.402 DFS	294	05.94 → 06.96		10-ECO015
35.342 VF	250	05.94 → 06.96		10-ECO015
35.342 VFK	250	05.94 → 06.96		10-ECO015
35.402 VF	294	05.94 → 06.96		10-ECO015
35.402 VF	294	05.94 → 12.97		10-ECO015
35.402 VFK	294	05.94 → 12.97		10-ECO015
35.402 VFK	294	05.94 → 06.96		10-ECO015
40.402 DF	294	05.95 → 06.96		10-ECO015
40.402 DFA	294	05.95 → 06.96		10-ECO015
41.342 VF	250	05.94 → 06.96		10-ECO015

NEW CODES - NEUE CODES - NOUVEAUX CODES - NUEVOS CODIGOS - NUOVI CODICI

	KW			 OIL FILTER FILTRO OLIO	 AIR FILTER FILTRO ARIA	 FUEL FILTER FILTRO CARBURANTE	 CABIN FILTER FILTRO ABITACOLO
---	----	---	---	--	--	---	---

F 90

41.402 VF	294	05.94 → 06.96		10-ECO015
-----------	-----	---------------	--	-----------

L 2000

10.145 LC,10.145 LLC (LE140C)	103	09.00		10-ECO031
10.145 LK (LE140C)	103	09.00		10-ECO031
10.145 LLS (LE145C)	103	09.00		10-ECO031
10.185 LAEC	132	09.00		10-ECO031
10.185 LAEK (LE180C)	132	09.00		10-ECO031
10.185 LC,10.185 LLC (LE180C)	132	09.00		10-ECO031
10.185 LK (LE180C)	132	09.00		10-ECO031
10.185 LLS (LE180C)	132	09.00		10-ECO031
10.225 LAEC (LE220C)	162	09.00		10-ECO031
10.225 LAEK (LE220C)	162	09.00		10-ECO031
10.225 LC	162	09.00		10-ECO031
10.225 LK (LE220C)	162	09.00		10-ECO031
10.225 LLS (LE220C)	162	09.00		10-ECO031
12.185 LC, LLC	132	09.99		10-ECO031
12.225 LC, LLC (LE220C)	162	09.99		10-ECO031
8.145 LC,8.145 LLC (LE140C)	103	09.00		10-ECO031
8.145 LLS (LE140C)	103	09.00		10-ECO031
8.185 LC, 8.185 LCC	132	09.00		10-ECO031
8.185 LK (LE180C)	132	09.00		10-ECO031
8.185 LLS (LE180C)	132	09.00		10-ECO031
8.224 LC,8.224 LLC (LE	162	09.00		10-ECO031
8.225 LK (LE220C)	162	09.00		10-ECO031
8.225 LLS (LE220C)	162	09.00		10-ECO031
9.145 LK (LE140C)	103	09.00		10-ECO031
9.145 LLS (LE140C)	103	09.00		10-ECO031
9.145LC	103	09.00		10-ECO031
9.185 LC,9.185 LLC (LE180C)	132	09.00		10-ECO031
9.185 LK (LE180C)	132	09.00		10-ECO031
9.185 LLS (LE 180C)	132	09.00		10-ECO031
9.225 LC,9.225 LLC (LE220C)	162	09.00		10-ECO031
9.225 LK (LE220C)	162	09.00		10-ECO031
9.225 LLS (LE220C)	162	09.00		10-ECO031

TGA

18.310 FAC	228	09.02		10-ECO002
18.310 FAK	228	09.02		10-ECO002
18.310 FAS	228	09.02		10-ECO002
18.310 FC,18.310 FLC,18.310 FLLC,18.310	228	04.00		10-ECO002
18.310 FLLS,18.310 FLLS/N	228	04.00		10-ECO002
18.360 FAC	265	09.02		10-ECO002
18.360 FAK, FALK, FAK-L, FALK-L	265	09.02		10-ECO002
18.360 FAS, FALS	265	09.02		10-ECO002
18.360 FC,18.360 FLC,18.360 FLLC,18.360	265	04.00		10-ECO002

NEW CODES - NEUE CODES - NOUVEAUX CODES - NUEVOS CODIGOS - NUOVI CODICI



	KW			 OIL FILTER FILTRO OLIO	 AIR FILTER FILTRO ARIA	 FUEL FILTER FILTRO CARBURANTE	 CABIN FILTER FILTRO ABITACOLO
--	----	--	--	-------------------------------	-------------------------------	--------------------------------------	--------------------------------------

TGA							
18.360 FK,18.360 FLK	265	12.00					10-ECO002
18.360 FLS,18.360 FLLS,18.360 FLLS/N	265	04.00					10-ECO002
18.360 FPLS	265	12.00					10-ECO002
18.410 FAC,	301	09.02					10-ECO002
18.410 FAK, FAK-L	301	09.02					10-ECO002
18.410 FAS	301	09.02					10-ECO002
18.410 FK,18.410 FLK	301	12.00					10-ECO002
18.410 FLC,18.410 FLLC	301	04.00					10-ECO002
18.410 FLS,18.410 FLLS	301	04.00					10-ECO002
18.460 FK,18.460 FLK	338	12.00					10-ECO002
18.460 FLC,18.460 FLLC	338	04.00					10-ECO002
18.460 FLS,18.460 FLLS	338	04.00					10-ECO002
18.480 FAC	353	09.02					10-ECO002
18.480 FAK	353	09.02					10-ECO002
18.480 FAS	353	09.02					10-ECO002
18.480 FC, 18.480 FLC,	353	09.02					10-ECO002
18.480 FK, 18.480 FLK	353	09.02					10-ECO002
18.480 FS	353	09.02					10-ECO002
18.510 FC,18.510 FLC,18.510 FLLC,18.510 FLLS	375	09.00					10-ECO002
18.510 FLS,18.510 FLLS,18.510 FLLS/N	375	04.00					10-ECO002
18.530 FLS	390	09.02					10-ECO002
18.533 FC, FLC, FLLC, FLLC/N, FLLW	390	09.02					10-ECO002
24.360 FNLLC/N	265	09.01					10-ECO002
24.410 FNLLC/N	301	09.01					10-ECO002
24.460 FNLLC/N	338	09.01					10-ECO002
24.480 FNLL/N	353	09.02					10-ECO002
24.510 FNLLC/N	375	09.01					10-ECO002
24.530 FNLLC/N	390	09.01					10-ECO002
26	375	12.00					10-ECO002
26.310 FD-TM	228	10.00					10-ECO002
26.310 FDAC	228	02.02					10-ECO002
26.310 FDAK	228	02.02					10-ECO002
26.310 FDAS	228	02.02					10-ECO002
26.310 FDK, FDLK	228	09.02					10-ECO002
26.310 FDLS	228	01.01					10-ECO002
26.310 FNLC,26.310 FNLLC	228	09.00					10-ECO002
26.310 FVL-KO	228	12.00					10-ECO002
26.310 FVLS	228	12.00					10-ECO002
26.310 FVLS,26.310 FPLS	228	12.00					10-ECO002
26.310, 26.320 FDH-TM	2280	06.05					10-ECO002
26.330 FNLC, FNLLC, FNLLW	240	11.02					10-ECO002
26.360 FD-TM	265	01.01					10-ECO002
26.360 FDAC	265	02.02					10-ECO002
26.360 FDAK	265	02.02					10-ECO002

NEW CODES - NEUE CODES - NOUVEAUX CODES - NUEVOS CODIGOS - NUOVI CODICI

	KW			 OIL FILTER FILTRO OLIO	 AIR FILTER FILTRO ARIA	 FUEL FILTER FILTRO CARBURANTE	 CABIN FILTER FILTRO ABITACOLO
---	----	---	---	--	--	---	---

TGA

26.360 FDC	265	01.01		10-ECO002
26.360 FDK	265	02.02		10-ECO002
26.360 FDK, FDLK	265	09.02		10-ECO002
26.360 FNLC,26.360 FNLLC,26.360 FNLLV	265	09.00		10-ECO002
26.360 FVL-KO	265	12.00		10-ECO002
26.410 FD-TM	301	01.01		10-ECO002
26.410 FDAC	301	02.02		10-ECO002
26.410 FDAK	301	02.02		10-ECO002
26.410 FDAS	301	02.02		10-ECO002
26.410 FDC	301	01.01		10-ECO002
26.410 FDK	301	09.01		10-ECO002
26.410 FDS, FDLS	301	06.01		10-ECO002
26.410 FNLC,26.410 FNLLC,26.410 FNLLV	301	04.00		10-ECO002
26.410 FVL-KO	301	12.00		10-ECO002
26.413 FPLS	301	12.00		10-ECO002
26.460 FD-TM	338	01.01		10-ECO002
26.460 FDAC,FDAS	353	09.02		10-ECO002
26.460 FDC	338	01.01		10-ECO002
26.460 FDK	338	01.01		10-ECO002
26.460 FDS, FDLS	338	06.01		10-ECO002
26.460 FNLC,26.460 FNLLC,26.460 FNLLV	338	04.00		10-ECO002
26.460 FPLS	338	12.00		10-ECO002
26.460 FVL-KO	338	12.00		10-ECO002
26.460 FVLC	338	02.01		10-ECO002
26.480 FD-TM	353	09.02		10-ECO002
26.480 FDAK	353	09.02		10-ECO002
26.480 FDC, FDLC	353	09.02		10-ECO002
26.480 FDK, FDLK	353	09.02		10-ECO002
26.480 FDS, FDLS, FDLS/M	353	09.02		10-ECO002
26.480 FNLC, FNLLC, FVLC	353	09.02		10-ECO002
26.480 FNLS, FNLLS, FPLS, FVLS	353	09.02		10-ECO002
26.510 FDC, FDLC, FDC/M	375	01.01		10-ECO002
26.510 FDS, FDLS, FDLS/M	375	01.01		10-ECO002
26.510 FLC	390	09.02		10-ECO002
26.510 FNLC,26.510 FNLLW	375	12.00		10-ECO002
26.530 FDC, FDLC, FDC/M,	390	01.01		10-ECO002
26.530 FDK, FDKL	390	09.02		10-ECO002
26.530 FDS, FDLS, FDLS/M	390	01.01		10-ECO002
26.530 FNLS, FPLS, FVLS,	390	09.02		10-ECO002
32.310	228	01.02		10-ECO002
32.310 FFDC, FFDLC	228	01.02		10-ECO002
32.310 FFDK, FFDLK	228	01.02		10-ECO002
32.360 FFD-TM	265	01.02		10-ECO002
32.360 FFDC, FFDLC	265	01.02		10-ECO002

NEW CODES - NEUE CODES - NOUVEAUX CODES - NUEVOS CODIGOS - NUOVI CODICI



MAN Comm.

	KW						
				OIL FILTER FILTRO OLIO	AIR FILTER FILTRO ARIA	FUEL FILTER FILTRO CARBURANTE	CABIN FILTER FILTRO ABITACOLO







TGA							
32.360 FFDK, FFDLK	265	01.02					10-ECO002
32.410 FFD-TM	301	01.02					10-ECO002
32.410 FFDC, FFDLC	301	01.02					10-ECO002
32.410 FFDK, FFDLK	301	01.02					10-ECO002
32.460 FFD-TM	338	01.02					10-ECO002
32.460 FFDC, FFDLC	338	01.02					10-ECO002
32.460 FFDK, FFDLK	338	01.02					10-ECO002
32.480 FFD-TM	353	09.02					10-ECO002
32.480 FFDC, FFDLC	353	09.02					10-ECO002
32.480 FFDK, FFDLK	353	09.02					10-ECO002
33.360 FD-TM	265	01.01					10-ECO002
33.360 FDAC	265	09.02					10-ECO002
33.360 FDAK	265	09.02					10-ECO002
33.360 FDAS	265	09.02					10-ECO002
33.360 FDC	265	10.00					10-ECO002
33.360 FDK	265	01.01					10-ECO002
33.360 FDS	265	10.00					10-ECO002
33.410 FDAC	301	09.02					10-ECO002
33.410 FDAK	301	09.02					10-ECO002
33.410 FDAS	301	09.02					10-ECO002
33.410 FDC	301	10.00					10-ECO002
33.410 FDK	301	10.00					10-ECO002
33.410 FDK	301	10.00					10-ECO002
33.410 FDS	301	10.00					10-ECO002
33.460 FD-TM	338	09.02					10-ECO002
33.460 FDC	338	09.02					10-ECO002
33.460 FDK	338	09.02					10-ECO002
33.460 FDS	338	09.02					10-ECO002
33.480 FD-TM	353	09.02					10-ECO002
33.480 FDAC	353	09.02					10-ECO002
33.480 FDAC	375	09.02					10-ECO002
33.480 FDAK	353	09.02					10-ECO002
33.480 FDAS	353	09.02					10-ECO002
33.480 FDC	353	09.02					10-ECO002
33.480 FDK	353	09.02					10-ECO002
33.480 FDS	353	09.02					10-ECO002
33.510 FDS	375	09.02					10-ECO002
33.530 FDC, FDC/M	390	09.02					10-ECO002
33.530 FDK	390	09.02					10-ECO002
33.530 FDS	390	09.02					10-ECO002
41.360 FFDC	265	01.03					10-ECO002

NEW CODES - NEUE CODES - NOUVEAUX CODES - NUEVOS CODIGOS - NUOVI CODICI

Per nuove applicazioni e novità si prega di accedere al sito www.ashika.eu - For new applications and new items, please go to www.ashika.eu

MAYBACH









	KW			 OIL FILTER FILTRO OLIO	 AIR FILTER FILTRO ARIA	 FUEL FILTER FILTRO CARBURANTE	 CABIN FILTER FILTRO ABITACOLO
MAYBACH (240_)							
5.5 V12 57/62 (240.078, 240.178)	405	09.02	M 285.950	10-ECO088			
6.0 V12 57S (240.079)	450	09.05		10-ECO088			

NEW CODES - NEUE CODES - NOUVEAUX CODES - NUEVOS CODIGOS - NUOVI CODICI



	KW						
				OIL FILTER FILTRO OLIO	AIR FILTER FILTRO ARIA	FUEL FILTER FILTRO CARBURANTE	CABIN FILTER FILTRO ABITACOLO
1000							
1.0	33	01.75 → 01.77	PC	10-03-313	20-03-302	30-03-301	
121 I (DA)							
1.1	42	10.87 → 10.90	B1 B116	10-03-313	20-03-316 06.88→	30-03-302 06.88→	
1.3	40	04.89 → 10.90	B3	10-03-313	20-03-316	30-03-302	
1.3	44	10.87 → 11.90	B3	10-03-313	20-03-316 06.88→	30-03-302 06.88→	21-MA-MA7
1.4 16V (DA1)	71	11.87 → 12.94			20-03-316	30-03-302 30-03-313	
1.8	65	01.75		10-04-406	20-03-302	30-03-301	
2.0	64	01.75		10-04-406	20-03-302	30-03-301	
121 II (DB)							
1.3 16V	39	11.90 → 03.96	B3 (16V)	10-03-313	20-03-316	30-03-315	
1.3 16V	53	11.90 → 03.96	B3 (16V)	10-03-313 06.91→	20-03-316 06.91→	30-03-315	
121 III (JASM, JBSM)							
1.25	55	03.96	DHF DHG	10-02-279	20-03-321	30-03-388	21-MA-MA7
1.3	37	03.96	JJK JJM	10-02-279	20-03-321	30-03-388 06.96→	21-MA-MA7
1.3	44	03.96	J4R J4T	10-02-279	20-03-321	30-03-388 06.96→	21-MA-MA7
1.3i 16V CABRIO (JJA)	0	03.96		10-03-313	20-03-316	30-03-315	21-MA-MA7
1.8 D	44	03.96	RTJ RTK	10-03-394 06.96→	20-03-321	30-03-387 06.96→	21-MA-MA7
1300							
1.3	44	01.75 → 01.77	TC	10-03-313	20-03-302	30-03-301	
2							
1.25	55	04.03	FUJA	10-03-394	20-03-350	30-03-350	21-MA-MA5
1.3	55	10.07	ZJ-VE	10-03-313	20-03-335	30-03-325	21-MA-MA9
1.3	63	10.07	ZJ-VE	10-03-313	20-03-335	30-03-325	21-MA-MA9
1.4	59	04.03	FXJA	10-03-394	20-03-350	30-03-350	21-MA-MA5
1.4 CD	50	04.03	F6JA F6JB	10-03-351	20-03-351	30-03-351	21-MA-MA5
1.4 MZR-CD	50	01.08		10-03-351	20-03-351	30-03-351	21-MA-MA9
1.5	76	10.07	ZY-VE ZY-DE	10-03-313	20-03-335	30-03-325	21-MA-MA9
1.6	74	04.03	FYJA	10-03-394	20-03-350	30-03-350	21-MA-MA5
1.6 MZ-CD	66	10.08		10-03-351	20-03-351	30-03-300	21-MA-MA9
3							
1.4	59	02.04		10-03-313	20-03-335	30-03-325	21-MA-MA8
1.4	62	10.03	ZJ-VE	10-03-313	20-03-335	30-03-325	21-MA-MA8
1.6	77	10.03	B6ZE	10-03-313	20-03-335		21-MA-MA8
1.6 DI Turbo	80	06.04	Y601	10-03-351	20-03-336	30-03-300 VIN ->185433 30-03-320 VIN 502448 ->	21-MA-MA8
1.6 MZR	77	06.09	Z6	10-03-313	20-03-335		21-MA-MA12
1.6 MZR-CD	80	06.09	Y601	10-03-351	20-03-336	30-03-320	21-MA-MA8

NEW CODES - NEUE CODES - NOUVEAUX CODES - NUEVOS CODIGOS - NUOVI CODICI

	KW						
				OIL FILTER FILTRO OLIO	AIR FILTER FILTRO ARIA	FUEL FILTER FILTRO CARBURANTE	CABIN FILTER FILTRO ABITACOLO
3							
2.0	110	10.03	LF17	10-03-394	20-03-337	30-03-325	21-MA-MA8
2.0 MZR	110	06.09	LF17 LF-DE	10-ECO036	20-03-337	30-03-325	21-MA-MA12
2.0 MZR-CD	105	12.06	RF7J	10-04-406	20-03-337	30-02-295	21-MA-MA8
2.2 MZR-CD	110	06.09		10-05-599	20-03-337	30-03-317	21-MA-MA12
2.3 DiSi Turbo MPS	184	06.06		10-ECO036	20-03-337	30-03-325	
2.3 MPS	191	12.06	L3-VDT L3N9	10-ECO036	20-03-337	30-03-325	21-MA-MA8
3 (BL)							
1.6 MZR	85	11.10		10-03-351	20-03-341	30-03-320	21-MA-MA12
2.0 MZR DISI	111	06.09	LF5H LF5W	10-03-394	20-03-337	30-03-325	21-MA-MA12
3 Tre volumi							
1.6	77	02.04	Z6	10-03-351	20-03-335	30-03-325	21-MA-MA8
1.6 DI Turbo	80	06.04	Y601	10-03-351	20-03-336	30-03-300	21-MA-MA8
2.0	110	02.04	LF17	10-03-394	20-03-337	30-03-325	21-MA-MA8
2.0 MZR-CD	105	12.06	RF7J	10-04-406	20-03-337	30-02-295	21-MA-MA8
3 Tre volumi (BL)							
2.2 MZR-CD	110	06.09		10-03-306	20-03-337	30-03-317	21-MA-MA12
2.2 MZR-CD	136	06.09		10-05-599	20-03-337	30-03-317	21-MA-MA12
323 F IV (BG)							
1.6	62	09.89 → 06.91	B6E	10-04-406	20-03-323	30-03-315	
1.6 16V	65	03.91 → 10.94	B6	10-03-313	20-03-323	30-03-315	
1.8 4WD	76	01.91 → 04.94	BPC	10-03-313	20-03-323	30-03-315	
1.8 16V	103	09.89 → 03.93	BP31	10-03-313	20-03-323	30-03-315	
1.8 16V	76	08.89 → 07.94	BP	10-03-313	20-03-323	30-03-315	
1.8 16V GT	94	08.89 → 07.94	BP (DOHC)	10-03-313 01.91 → 10-04-406 → 12.91	20-03-323	30-03-315	
323 F V (BA)							
1.5 16V	65	07.94 → 09.98	Z5-DE	10-03-313	20-03-397	30-03-315 06.97 →	21-MA-MA6
1.8 16V	84	08.94 → 09.98	BP-ZE	10-03-313	20-03-397	30-03-315	21-MA-MA6
2.0 24V	106	08.94 → 09.98	KF	10-03-316	20-03-321	30-03-399	21-MA-MA6
323 F VI (BJ)							
1.4	53	01.01 → 05.04	B3 (16V)	10-03-313	20-03-338	30-03-350	21-MA-MA0
1.4 16V	54	09.98 → 01.01	B3 ME	10-03-313	20-03-338	30-03-350	21-MA-MA0
1.5 16V	65	09.98 → 01.01		10-03-313	20-03-397	30-03-315	21-MA-MA0
1.6	70	01.01 → 05.04	ZM	10-03-313	20-03-397	30-03-350	21-MA-MA0
1.6	72	01.01 → 05.04	ZM	10-03-313	20-03-397	30-03-350	21-MA-MA0
1.9 16V	84	09.98 → 01.01		10-03-313	20-03-397	30-03-315	21-MA-MA0
2.0	96	01.01 → 05.04	FS7E FS7G	10-03-313	20-03-397	30-03-315	21-MA-MA0
2.0 D	52	09.98 → 05.04	RF1G	10-05-599	20-03-389	30-05-502MP 30-05-502	21-MA-MA0
2.0 TD	66	09.98 → 01.01		10-05-599	20-03-389	30-02-295	21-MA-MA0



	KW						
				OIL FILTER FILTRO OLIO	AIR FILTER FILTRO ARIA	FUEL FILTER FILTRO CARBURANTE	CABIN FILTER FILTRO ABITACOLO

323 F VI (BJ)

2.0 TD	74	01.01 → 05.04	RF4F	10-05-599	20-03-389	30-02-295	21-MA-MA0
--------	----	---------------	------	-----------	-----------	-----------	-----------

323 I (FA)

1.0	33	06.77 → 05.80	P PC	10-03-313	20-03-301	30-03-301	
1.3	44	01.77 → 05.80	TC T	10-03-313	20-03-301	30-03-301	
1.4	51	05.78 → 05.80	U UC	10-03-313	20-03-301	30-03-301	

323 I Station Wagon (FA)

1.3	44	05.78 → 05.86	TC	10-03-313	20-03-301 06.81 →	30-03-301 → 06.80 30-03-302 01.81 →	
1.4	51	05.78 → 08.82	UC	10-03-313	20-03-301	30-03-301 06.78 → → 06.81	
1.5	52	04.82 → 05.86	D5	10-03-313	20-03-301	30-03-302	

323 II (BD) \ Hatchback (BD)

1.1	40	11.80 → 10.85	E1	10-03-313	20-04-417	30-03-302	
1.3	44	09.81 → 10.85	E3	10-03-313	20-04-417	30-03-302	
1.3	50	11.80 → 10.89	E3	10-03-313	20-04-417 → 06.85	30-03-302 → 06.85	
1.5	55	05.81 → 12.85	E5	10-03-313	20-03-304	30-03-302	
1.5	59	11.80 → 07.85	E5	10-03-313	20-03-304	30-03-302	
1.5	65	03.82 → 09.86	E5	10-03-313	20-03-304	30-03-302	

323 III (BF) \ Hatchback (BF)

1.1	40	08.85 → 04.90	E1	10-04-406 → 06.87	20-04-417 → 06.87	30-03-302 → 06.87	
1.3	44	08.85 → 05.89	E3	10-04-406	20-04-417	30-03-302 → 06.87	
1.4	44	04.87 → 07.89	B3	10-03-313	20-03-308	30-03-302	
1.5	54	09.87 → 10.89	B5	10-04-406	20-03-308 → 06.89	30-03-302 → 06.89	
1.5	55	08.85 → 05.89	E5	10-04-406	20-04-417	30-03-302 → 06.87	
1.5 i	70	08.85 → 05.89	E5E3	10-04-406	20-04-417	30-03-302	
1.5 i Turbo	85	08.85 → 05.89	E5E2	10-04-406	20-04-417	30-03-302	
1.6 GT	63	11.86 → 10.89	B6	10-04-406	20-03-312	30-03-308	
1.6 GT	77	01.86 → 12.88	B6	10-04-406	20-03-312	30-03-308	
1.6 GT Turbo	103	10.85 → 11.91	B6	10-04-406 09.89 →	20-03-312	30-03-308	
1.7 D	40	09.86 → 05.89	PN27	10-03-306 10-05-599	20-03-314	30-05-502MP 30-05-502	
1.7 D	42	01.87 → 05.89	PN46	10-03-306 10-05-599	20-03-314	30-05-502MP 30-05-502	

323 III Station Wagon (BW)

1.3	44	07.86 → 04.90	E3	10-04-406	20-04-417	30-03-302	
1.5	54	01.87 → 05.89	B50 B53 B5	10-04-406	20-03-308 06.87 →	30-03-302 06.87 →	







NEW CODES - NEUE CODES - NOUVEAUX CODES - NUEVOS CODIGOS - NUOVI CODICI

	KW						
				OIL FILTER FILTRO OLIO	AIR FILTER FILTRO ARIA	FUEL FILTER FILTRO CARBURANTE	CABIN FILTER FILTRO ABITACOLO
323 III Station Wagon (BW)							
1.5	55	05.86 → 05.89	B50 B53 E5	10-04-406	20-04-417	30-03-302	
1.6	54	09.87 → 10.89	B68	10-03-313	20-03-312	30-03-308	
1.6	63	09.86 → 10.95	B6E B65M B6	10-03-313 06.91 → 10-04-406 01.90 → →12.91	20-03-312 01.90 →	30-03-308 01.90 →	
1.6 4x4	63	05.90 → 03.93	B6E B65M	10-03-313	20-03-312	30-03-308	
1.7 D	40	11.86 → 08.87	PN26	10-03-306 10-05-599	20-03-314	30-05-502MP 30-05-502	
1.7 D	41	10.89 → 03.93	PN26 PN54	10-03-317	20-03-314	30-05-502MP 30-05-502	
1.7 D	42	11.86 → 10.89	PN26 PN54	10-03-306 10-05-599	20-03-314	30-05-502MP 30-05-502	
323 IV C (BG)							
1.3	49	09.89 → 07.94	B3E	10-03-313 →06.91 10-04-406 →06.91	20-03-323 07.91 → 20-03-324 →06.91	30-03-315	
1.3 16V	54	09.89 → 07.94		10-03-313 06.91 → →06.94	20-03-323 06.91 → →06.94 20-03-324 →12.91	30-03-315 →06.91	
1.6	62	09.89 → 06.91	B6E	10-04-406	20-03-323	30-03-315	
1.6 16V	65	03.91 → 10.94	B6	10-03-313	20-03-323	30-03-315	
1.7 D	41	08.89 → 07.94	PN54	10-03-317	20-03-314	30-05-502MP 30-05-502	
1.8 16V	103	09.89 → 03.93	BP22 BP31	10-04-406	20-03-323	30-03-315	
1.8 16V 4WD	76	11.91 → 12.93	BP	10-03-313	20-03-323	30-03-315	
1.8 16V GT	94	09.89 → 03.93	BP (DOHC)	10-03-313 01.91 → 10-04-406	20-03-323	30-03-315	
1.8 16V Turbo 4WD	120	09.90 → 12.92	BP Turbo	10-03-313	20-03-323	30-03-315	
1.8 16V Turbo 4WD	136	01.93 → 07.94	BP Turbo	10-03-313	20-03-323	30-03-315	21-MA-MA6
323 IV S (BG)							
1.3	49	09.89 → 06.91	B3E B383	10-04-406	20-03-324	30-03-315	
1.3 16V	54	04.91 → 07.94	B3 (16V)	10-03-313 →06.91	20-03-323 06.91 → →06.94 20-03-324 →12.91	30-03-315 →06.91	
1.6	62	09.89 → 06.91	B6E	10-04-406	20-03-323	30-03-315	
1.6 16V	65	08.89 → 10.94	B6	10-03-313	20-03-323	30-03-315	
1.7 D	41	08.89 → 07.94	PN46 PN54 PN62	10-03-317	20-03-314	30-05-502MP 30-05-502	
1.8 16V	76	08.89 → 07.94	BP52	10-03-313	20-03-323	30-03-315	
1.8 16V 4WD	76	09.91 → 07.94	BP52	10-03-313	20-03-323	30-03-315	



	KW						
				OIL FILTER FILTRO OLIO	AIR FILTER FILTRO ARIA	FUEL FILTER FILTRO CARBURANTE	CABIN FILTER FILTRO ABITACOLO
323 IV S (BG)							
1.8 16V GT	94	06.89 → 07.94	BP (DOHC)	10-03-313	20-03-323	30-03-315	
1.8 16V Turbo 4WD	120	01.91 → 07.94	BP Turbo	10-03-313	20-03-323	30-03-315	
323 V C (BA)							
1.3 16V	54	08.94 → 09.98	B3 (16V)	10-03-313	20-03-397	30-03-315	21-MA-MA6
1.5 16V	65	08.94 → 09.98	Z5-DE	10-03-313	20-03-397	30-03-315	21-MA-MA6
1.8 16V	84	08.94 → 09.98	BP-ZE	10-03-313	20-03-397	30-03-395	21-MA-MA6
323 V P (BA)							
1.3 16V	54	10.96	B3 (16V)	10-03-313	20-03-397	30-03-315	21-MA-MA1 →09.98 21-MA-MA6
1.5 16V	65	10.96	Z5-DE	10-03-313	20-03-397	30-03-315	21-MA-MA1 →09.98 21-MA-MA6
2.0 D	52	10.96	RF1G	10-05-599	20-03-389	30-05-502MP 30-05-502	21-MA-MA1 →09.98 21-MA-MA6
323 V S (BA)							
1.3 16V	54	08.94 → 09.98	B3 (16V)	10-03-313	20-03-397	30-03-315	21-MA-MA6
1.5 16V	65	08.94 → 09.98	Z5-DE	10-03-313	20-03-397	30-03-315	21-MA-MA6
1.6 TD	60	05.94 → 09.98	4EE1-T	10-04-406	20-03-389	30-05-502MP 30-05-502	21-MA-MA6
1.8 16V	84	08.94 → 09.98	BP-ZE	10-03-313	20-03-397	30-03-395	21-MA-MA6
2.0 D	52	10.96 → 09.98	RF1G	10-05-599	20-03-389	30-05-502MP 30-05-502	21-MA-MA6
323 VI P (BJ)							
1.4 16V	54	09.98		10-03-313	20-03-338	30-03-350	21-MA-MA0
1.5 16V	65	09.98		10-03-313	20-03-397	30-03-315	21-MA-MA0
323 VI S (BJ)							
1.4	53	01.01 → 05.04	B3 (16V)	10-03-313	20-03-338	30-03-350	21-MA-MA0
1.4 16V	54	09.98 → 01.01	B3 ME	10-03-313	20-03-338	30-03-350	21-MA-MA0
1.5 16V	65	09.98 → 01.01		10-03-313	20-03-397	30-03-315	21-MA-MA0
1.6	70	01.01 → 05.04	ZM	10-03-313	20-03-397	30-03-350	21-MA-MA0
1.6	72	01.01 → 05.04	ZM	10-03-313	20-03-397	30-03-350	21-MA-MA0
1.9 16V	84	09.98 → 05.04		10-03-313	20-03-397	30-03-315	21-MA-MA0
2.0	96	01.01 → 05.04	FS7E FS7G	10-03-313	20-03-397	30-03-315	21-MA-MA0
2.0 D	52	09.98 → 05.04		10-05-599	20-03-389	30-05-502MP 30-05-502	21-MA-MA6
2.0 TD	66	09.98 → 05.04	RF3F	10-05-599	20-03-389	30-02-295	21-MA-MA0
5							
1.6 CD	85	12.10		10-03-351	20-03-341	30-03-321	21-MA-MA8
1.8	85	03.05	L823	10-03-394	20-03-337	30-03-318	21-MA-MA8
1.8	85	12.10		10-03-394	20-03-337	30-03-318	21-MA-MA8
2.0	107	03.05	LFF7	10-03-394	20-03-337	30-03-318	21-MA-MA8
2.0	110	09.10	LF5H	10-03-394	20-03-337	30-03-318	21-MA-MA8
2.0 CD	105	06.05	RF7J	10-05-599	20-03-337	30-03-317	21-MA-MA8
2.0 CD	107	03.05		10-05-599	20-03-337	30-03-317	21-MA-MA8







NEW CODES - NEUE CODES - NOUVEAUX CODES - NUEVOS CODIGOS - NUOVI CODICI

	KW						
				OIL FILTER FILTRO OLIO	AIR FILTER FILTRO ARIA	FUEL FILTER FILTRO CARBURANTE	CABIN FILTER FILTRO ABITACOLO
5							
2.0 CD	81	03.05		10-05-599	20-03-337	30-03-317	21-MA-MA8
6 (GG) \ Tutti i modelli \ All models							
1.8	88	08.02	L813	10-03-394 VIN 176451-> 10-ECO036 VIN->176450	20-03-325	30-02-295	21-MA-MA5
2.0	104	06.02	LF17 LF18	10-03-394 VIN 195596-> 10-ECO036	20-03-325	30-02-295	21-MA-MA5
2.0	108	03.05	LFF7	10-03-394	20-03-325		21-MA-MA5
2.0 DI	100	06.02	RF5C	10-05-599	20-03-325	30-02-295	21-MA-MA5
2.0 DI	105	06.05	RF7J	10-05-599	20-03-325	30-02-215MP 30-02-215	21-MA-MA5
2.0 DI	89	08.02	RF5C	10-05-599	20-03-325	30-02-295	21-MA-MA5
2.3	122	06.02	L3C1	10-ECO036	20-03-325	30-02-295	21-MA-MA5
2.3	191	12.05	L3KG	10-ECO036	20-03-325		21-MA-MA5
3.0	162	07.03 → 02.05		10-04-406	20-03-325		21-MA-MA5
6 WAGON							
2.2 MRZ-CD	120	01.09		10-04-406	20-03-325	30-02-295	21-MA-MA10
2.2 MRZ-CD	136	01.09		10-04-406	20-03-325	30-02-295	21-MA-MA10
2.2 MRZ-CD	92	01.09		10-04-406	20-03-325	30-02-295	21-MA-MA10
2.5	125	04.08		10-ECO036	20-03-318		21-MA-MA10
2.5 MRZ	125	02.08	L5-VE	10-ECO036			21-MA-MA10
6 \ Tutti i modelli \ All models							
1.8 MRZ	88	08.07	L813	10-03-394	20-03-325		21-MA-MA5
2.0 CD	103	04.08		10-05-599	20-03-318	30-03-317	21-MA-MA10
2.0 MRZ	108	08.07	LF17	10-03-394	20-03-318		21-MA-MA10
2.0 MRZ-CD	103	08.07	RF7J	10-05-599	20-03-318	30-03-317	21-MA-MA10
2.2 CD	120	04.08		10-05-599	20-03-325	30-03-317	21-MA-MA5
2.2 D	95	01.10		10-05-599	20-03-317 20-03-325		21-MA-MA5
2.2 MRZ-CD	120	01.09		10-05-599	20-03-325	30-03-317	21-MA-MA5
2.2 MRZ-CD	136	01.09		10-05-599	20-03-325	30-03-317	21-MA-MA10
2.2 MRZ-CD	92	01.09		10-05-599	20-03-325	30-02-215MP 30-02-215	21-MA-MA5
2.2 MZR-CD	132	01.10		10-05-599	20-03-317 20-03-325	30-03-317	21-MA-MA5
2.5 MRZ	125	08.07	L5-VE	10-ECO036	20-03-318		21-MA-MA10
616							
1.6	55	06.73 → 02.78	NA	10-04-406	20-03-302 06.75 →	30-03-302 06.75 →	
626 (CB)							
1.6	55	05.79 → 05.82	H6 N NA	10-04-406	20-03-302	30-03-301	
2.0	66	05.79 → 05.82	HE3 MA M	10-04-406	20-03-302	30-03-301	



	KW						
				OIL FILTER FILTRO OLIO	AIR FILTER FILTRO ARIA	FUEL FILTER FILTRO CARBURANTE	CABIN FILTER FILTRO ABITACOLO
626 II (GC)\ Hatchback (GC)							
1.6	59	11.82 → 06.87	F6	10-04-406	20-03-302	30-03-302	
2.0	68	11.86 → 09.87	FE	10-03-315	20-03-307	30-03-302	
2.0	74	03.83 → 09.87	FE	10-04-406	20-03-302	30-03-302	
2.0	88	01.86 → 09.87	FE	10-04-406	20-03-307	30-03-310	
2.0 D	46	01.83 → 06.87	RF46	10-03-306 10-05-599	20-03-309	30-03-303	
626 III (GD) Tutti i modelli\ All models							
1.6	60	06.87 → 05.92		10-04-406	20-03-323	30-03-315	
1.6	60	06.87 → 05.92		10-04-406	20-03-323	30-03-315	
1.8	65	11.87 → 05.92	F8	10-04-406	20-03-302	30-03-302	
1.8	65	11.87 → 05.92	F8	10-04-406	20-03-302	30-03-302	
1.8	69	11.87 → 05.92		10-04-406	20-03-302	30-03-302	
2.0	66	09.87 → 10.90	FE	10-04-406	20-03-302	30-03-302	
2.0	66	09.87 → 10.90	FE	10-04-406	20-03-321	30-03-302	
2.0 12V	79	09.87 → 05.92	FE (12V)	10-04-406	20-03-302 →06.90 20-03-321 01.90→	30-03-302 →06.90 30-03-311 01.90→	
2.0 12V	79	11.87 → 05.92	FE (12V)	10-04-406	20-03-302 →06.90 20-03-321 01.90→	30-03-302 →06.90 30-03-311 01.90→	
2.0 16V	103	11.87 → 05.92	FE Kat. (16V)	10-03-315 10-03-397	20-03-321	30-03-311	
2.0 16V	103	11.87 → 10.90	FE Kat. (16V)	10-03-315	20-03-321	30-03-397	
2.0 16V	109	06.87 → 08.89	FE Kat. (16V)	10-03-315	20-03-321	30-03-311	
2.0 16V	109	07.87 → 09.89	FE Kat. (16V)	10-03-315	20-03-321	30-03-311	
2.0 D	44	07.87 → 07.91	RF-N	10-03-315	20-03-318	30-05-502MP 30-05-502	
2.0 D	44	07.87 → 07.91	RF-N	10-03-315	20-03-318	30-05-502MP 30-05-502	
2.2 12V	85	06.88 → 04.92	F2	10-04-406	20-03-321	30-03-311	
2.2 12V	85	11.87 → 07.91	F2	10-04-406	20-03-321	30-03-311	
2.2 12V 4WD	85	11.87 → 07.90	F2	10-04-406	20-03-321	30-03-311	
626 III Station Wagon (GV)							
1.8	65	01.88 → 03.92	F8	10-04-406	20-03-302	30-03-302	
2.0	66	10.88 → 09.97	FE	10-04-406	20-03-321	30-03-311	
2.0 12V	81	09.87 → 01.90	FE (12V)	10-04-406	20-03-321	30-03-311	
2.0 16V	103	01.88 → 03.92	FE Kat. (16V)	10-03-315	20-03-321	30-03-311	
2.0 D	44	09.88 → 07.91	RF-N	10-03-315	20-03-318	30-05-502MP 30-05-502	
2.0 D	60	11.94 → 09.97	RF-G5	10-03-315	20-03-318	30-05-502MP 30-05-502	
2.0 D Complex	55	05.93 → 11.96	RF-CX	10-03-315	20-03-318	30-05-502MP 30-05-502	
2.0 i	110	11.94 → 09.97		10-03-313	20-03-321	30-03-311	
2.2 12V	85	03.89 → 11.96	F2	10-04-406	20-03-321	30-03-311	
2.2 12V 4WD	85	05.91 → 11.92	F2 F2L1	10-04-406	20-03-321	30-03-311	







NEW CODES - NEUE CODES - NOUVEAUX CODES - NUEVOS CODIGOS - NUOVI CODICI

	KW						
				OIL FILTER FILTRO OLIO	AIR FILTER FILTRO ARIA	FUEL FILTER FILTRO CARBURANTE	CABIN FILTER FILTRO ABITACOLO
626 IV (GE)							
1.8 i	66	08.94 → 04.97		10-03-313	20-03-327	30-03-397	
1.8 i	77	01.92 → 04.97	FP	10-03-315	20-03-327	30-03-397	
2.0 D	56	05.94 → 06.97		10-03-314	20-03-318	30-05-502	
2.0 D GLX Complex	55	10.92 → 04.97	RF OHC	10-03-314	20-03-318	30-05-502MP 30-05-502	
2.0 i	85	01.92 → 04.97	FS	10-03-315	20-03-327	30-03-397	
2.0 i 4WD	85	04.92 → 04.97	FS	10-03-315	20-03-327	30-03-397	
626 IV Hatchback (GE)							
1.8	66	08.94 → 04.97		10-03-315	20-03-327	30-03-397	
1.8	77	08.91 → 04.97	FP	10-03-315	20-03-327	30-03-397	
2.0 D GLX Complex	55	01.93 → 04.97	RF OHC	10-03-314	20-03-318	30-05-502MP 30-05-502	
2.0 i	85	08.91 → 04.97	FS	10-03-315	20-03-327	30-03-397	
2.0 i 4WD	85	04.92 → 04.97	FS	10-03-315	20-03-327	30-03-397	
2.5 24V	120	08.94 → 04.97	KL	10-03-316	20-03-327	30-03-397	
2.5 24V	121	01.92 → 04.97	KL	10-03-316	20-03-327	30-03-397	
626 V (GF)							
1.8	66	05.97 → 12.99	FPY3	10-03-313	20-03-327	30-03-397	21-MA-MA0
1.8	74	12.99 → 10.02	FP9A	10-03-313	20-03-327	30-03-397	21-MA-MA0
2.0	100	04.98 → 10.02	FS2C	10-03-313	20-03-327	30-03-397	21-MA-MA0
2.0	85	05.97 → 10.02	FS	10-03-313	20-03-327	30-03-397	21-MA-MA0
2.0 DITD	66	04.98 → 10.02	RF3F	10-05-599	20-03-325	30-02-295	21-MA-MA0
2.0 TD	81	10.00 → 10.02		10-05-599	20-03-325	30-02-295	21-MA-MA0
2.0 Turbo DI	74	04.98 → 10.02		10-05-599	20-03-325	30-02-295	21-MA-MA0
626 V Hatchback (GF)							
1.8	66	05.97 → 12.99		10-03-313	20-03-327	30-03-397	21-MA-MA0
1.8	74	12.99 → 10.02	FP	10-03-313	20-03-327	30-03-397	21-MA-MA0
2.0	85	05.97 → 10.02	FS	10-03-313	20-03-327	30-03-397	21-MA-MA0
2.0 DITD	66	04.98 → 10.02	RF3F	10-05-599	20-03-325	30-02-295	21-MA-MA0
2.0 H.P.	100	02.98 → 10.02	FS2C	10-03-313	20-03-327	30-03-397	21-MA-MA0
2.0 TD	81	10.00 → 10.02		10-05-599	20-03-325	30-02-295	21-MA-MA0
2.0 Turbo DI	74	04.98 → 10.02		10-05-599	20-03-325	30-02-295	21-MA-MA0
626 V Station Wagon (GW)							
1.8	66	02.98 → 01.00		10-03-313	20-03-327	30-03-397	21-MA-MA0
1.8	74	01.00 → 10.02	FP9A	10-03-313	20-03-327	30-03-397	21-MA-MA0
2.0	85	02.98 → 10.02	FS	10-03-313	20-03-327	30-03-397	21-MA-MA0
2.0 DITD	66	09.99 → 10.02	RF3F	10-05-599	20-03-325	30-02-295	21-MA-MA0
2.0 H.P.	100	02.98 → 10.02	FS2C	10-03-313	20-03-327	30-03-397	21-MA-MA0
2.0 TD	81	10.00 → 10.02		10-05-599	20-03-325	30-02-295	21-MA-MA0
2.0 Turbo DI	74	04.98 → 10.02	RF4F	10-05-599	20-03-325	30-02-295	21-MA-MA0
818 Station wagon							
1.3	44	01.74 → 10.78	TC	10-05-599	20-03-301	30-03-301	
1.6	55	01.77 → 10.78	NA	10-04-406	20-03-302	30-03-301	



	KW						
				OIL FILTER FILTRO OLIO	AIR FILTER FILTRO ARIA	FUEL FILTER FILTRO CARBURANTE	CABIN FILTER FILTRO ABITACOLO
929 I (LA)							
1.8	66	01.74 → 12.81		10-04-406	20-03-302	30-03-301	
2.0	66	05.79 → 07.86	MA M	10-04-406	20-03-307 01.81→	30-03-302 01.81→	
929 II (HB) Tutti i modelli All models							
2.0	66	05.82 → 03.84	HEE MA	10-04-406	20-03-302	30-03-302	
2.0	74	03.84 → 07.87	FE	10-04-406	20-03-302	30-03-302	
2.0 i GLX	88	10.84 → 07.87	FE	10-04-406	20-03-320	30-03-302	
929 III (HC)							
2.0	85	06.87 → 12.88	FE FEFA	10-04-406	20-03-302	30-03-302	
2.2 12V	85	01.88 → 04.89	F2 F21 F2E	10-04-406	20-03-302	30-03-302	
2.2 12V	94	04.89 → 06.91	F2-C	10-04-406	20-03-307	30-03-315	
2.2 i	100	05.87 → 12.88	F2-EGI	10-04-406	20-03-307	30-03-313	
3.0	123	01.90 → 06.91	JE3	10-04-406	20-03-317	30-03-313	
3.0	125	01.88 → 12.89	JE3	10-04-406	20-03-317	30-03-313	
3.0	140	06.87 → 06.91	JE	10-04-406	20-03-317	30-03-313	
B-SERIE (PE)							
1.6	55	02.77 → 09.78	NA	10-04-406	20-03-302	30-03-301	
1.8	60	02.77 → 01.82	VC	10-04-406	20-03-302	30-03-301	
B-SERIE (UD)							
1.8	62	10.81 → 08.85	H816 H817	10-04-406	20-03-302	30-03-302	
2.0	57	01.83 → 12.84	UA	10-04-406		30-03-302	
B-SERIE (UF)							
1.6	60	01.85 → 03.96		10-04-406	20-03-302	30-03-302	
2.0	62	01.85 → 12.91	FE	10-04-406	20-03-302	30-03-302	
2.0	65	01.85 → 03.96		10-04-406 →06.89	20-03-302 →06.89	30-03-302 →06.89	
2.2	68	08.91 → 12.96	F2L8	10-03-397	20-03-393	30-03-302	
2.2 D	47	01.85 → 03.96	R290	10-03-306	20-03-313	30-03-303	
2.5 D	63	02.96 → 06.99		10-05-505P 10-05-505	20-03-392	30-03-303	
2.5 D 4WD	57	09.98 → 06.99		10-05-505P 10-05-505	20-03-392	30-03-303	
2.5 D 4WD	63	02.96 → 06.99		10-05-505P 10-05-505	20-03-392	30-03-303	
2.6 4WD	73	01.87 → 10.90	4G54	10-05-502	20-05-504	30-03-302	
2.6 12V 4WD	90	01.90 → 06.99	G6MPV	10-03-316	20-03-317	30-03-302	
B-SERIE (UN)							
2.2 4WD	60	02.99	R5A2	10-03-313	20-03-317		
2.2 8V 4WD	68	06.99	JL22	10-03-313	20-03-317		
2.5 D	57	06.99	MD25NA	10-05-505P 10-05-505	20-03-383 06.99→	30-03-317 06.99→	
2.5 D	61	11.99 → 12.01		10-05-505	20-03-383	30-03-317	
2.5 D	62	12.02	WLE7	10-05-505P 10-05-505	20-03-383	30-03-317	







NEW CODES - NEUE CODES - NOUVEAUX CODES - NUEVOS CODIGOS - NUOVI CODICI

	KW						
				OIL FILTER FILTRO OLIO	AIR FILTER FILTRO ARIA	FUEL FILTER FILTRO CARBURANTE	CABIN FILTER FILTRO ABITACOLO
B-SERIE (UN)							
2.5 D 4WD	57	06.99	MD25NA	10-05-505P 10-05-505	20-03-383 06.99→	30-03-317 06.99→	
2.5 D 4WD	62	12.02	WLE7	10-05-505P 10-05-505	20-03-383	30-03-317	
2.5 TD 4WD	80	06.99	MD25T1	10-05-505P 10-05-505	20-03-383 06.99→	30-03-317 06.99→	
2.6 12V 4WD	90	06.99	JK26	10-03-316	20-03-317		
BT-50							
2.5 CD 4WD	105	12.06	WLAA	10-02-215	20-02-259	30-02-215	
CX-7							
2.2 MZR-CD	127	09.09		10-05-599	20-03-340	30-02-215	21-MA-MA5
2.3 MZR DISI Turbo	190	10.07	L3-VDT	10-ECO056	20-03-300	30-03-318	21-CH-CH3
DEMIO (DW)							
1.3 16V	46	08.98	B3 ME	10-03-313	20-03-384	30-02-224	21-MA-MA2
1.3 16V	53	08.98→04.00	B3 (16V)	10-03-313	20-03-384	30-02-224	21-MA-MA2
1.5 16V	55	04.00	B5 E	10-03-313	20-03-384	30-02-224	21-MA-MA11
E 1600							
1.6	51	08.80→06.84	NA	10-04-406	20-03-306	30-03-301	
E 2000,2200 (SR1)							
2.0	63	11.84→02.88	FE18 FEV4	10-04-406	20-03-307	30-03-302	
2.0 4WD	60	10.88→09.89	FEBN	10-04-406	20-03-307	30-03-302	
2.2 D	46	01.84→02.88	R207	10-03-306 10-05-599	20-03-310	30-03-303	
E 2000,2200 (SR2)							
2.0	60	03.91→05.94	FE FE60 FE61	10-04-406	20-03-307	30-03-302	
2.0	63	05.85→04.89	FE18 FE58	10-04-406	20-03-307 →06.88	30-03-302 →06.88	
2.0	70	06.94	FE	10-03-313	20-03-307	30-03-315	
2.2 D	46	05.85→02.88	R203 R207	10-03-306 10-05-599	20-03-313	30-03-303	
2.2 D	47	03.91	R203 R207	10-03-306 10-05-599	20-03-310	30-03-303	
2.2 D	52	02.97→08.02	R2	10-03-306 10-05-599	20-03-310 06.97→ →06.99	30-03-317 06.97→ →06.99	
2.2 D 4WD	47	03.91	R203 R207	10-03-306 10-05-599	20-03-310	30-03-303	
2.2 D 4WD	52	02.97	R2	10-03-306 10-05-599	20-03-313	30-03-317	
E-SERIE (SD1)							
E2000	60	10.89→05.95	FEBN	10-04-406	20-03-307	30-03-302	
E2000	63	11.88→09.89		10-03-316	20-03-307	30-03-302	
E2000	65	11.88→07.91		10-03-316	20-03-307		
E2000	71	04.97→08.98	FEY9	10-04-406	20-03-307		
E2200	47	11.88→03.97	R281		20-03-307	30-03-303	



	KW						
				OIL FILTER FILTRO OLIO	AIR FILTER FILTRO ARIA	FUEL FILTER FILTRO CARBURANTE	CABIN FILTER FILTRO ABITACOLO
E-SERIE (SD1)							
E2200	52	04.97 → 07.99		10-05-505	20-03-310	30-03-317	
E-SERIE (SD1, SL)							
E2000	71	09.99 → 09.04		10-03-316	20-03-307	30-03-302	
E2200	52	09.99 → 07.04		10-05-505	20-03-310	30-03-303	
E2500D							
2.5 EXR	0	01.77 → 12.00		10-03-308	20-03-319		
E3000D							
3.0 TAB	0	01.77		10-03-308	20-03-319		
MPV I (LV)							
2.5 TD	85	05.96 → 09.99	WL-T	10-05-505P 10-05-505	20-03-390	30-05-502MP 30-05-502	21-MA-MA14 21-MA-MA4
3.0 i V6	109	05.96 → 09.99	JE94	10-03-316	20-03-317	30-03-391	
3.0 i V6	113	03.95 → 09.99	JE94	10-03-316	20-03-317	30-03-391	21-MA-MA14 21-MA-MA4
MPV II (LW)							
2.0	88	08.00 → 07.02	FS	10-03-313	20-03-325	30-02-295	21-MA-MA14 21-MA-MA4
2.0	90	09.99 → 08.00	FS-DS	10-03-313	20-03-325	30-03-387	21-MA-MA14 21-MA-MA4
2.0 DI	100	07.02	RF5C	10-05-599	20-03-325	30-02-295	21-MA-MA14 21-MA-MA4
2.3	104	07.02	L3	10-ECO036	20-03-325		21-MA-MA14 21-MA-MA4
2.5 V6	125	09.99 → 03.02	GY-DE	10-03-320	20-03-325	30-03-308	21-MA-MA14 21-MA-MA4
3.0 V6	147	03.02	AJ	10-03-316	20-03-325	30-03-391	21-MA-MA14 21-MA-MA4
MX-3 (EC)							
1.6 i	65	07.91	B69	10-03-313	20-03-330	30-03-315	
1.6 i	79	01.94	B6D	10-03-313	20-03-330	30-03-315	
1.8 i V6	95	01.94	K838	10-03-316	20-03-323	30-03-399	
1.8 i V6	98	01.92 → 01.94	K819	10-03-316	20-03-330	30-03-399	
MX-5 I (NA)							
1.6	66	01.95 → 04.98		10-03-313	20-03-323	30-03-316	
1.6	85	05.90 → 01.94	B64F	10-03-313	20-03-323	30-03-315	
1.8	96	02.94 → 04.98	BP (DOHC) BPF1	10-03-313	20-03-323	30-03-316	
MX-5 II (NB)							
1.6 16V	81	05.98 → 10.05	B6D	10-03-313	20-03-327	30-03-316	
1.8	103	01.98 → 07.02	BPD	10-03-313	20-03-327	30-03-316	
1.8 16V	103	05.98 → 10.05	BP-ZE	10-03-313	20-03-327	30-03-316	
1.9 16V	102	11.00 → 10.05	BPD	10-03-313	20-03-327	30-03-352	
1.9 16V	107	11.00 → 10.05	BPD	10-03-313	20-03-327	30-03-352	
MX-5 III (NC)							
1.8	93	03.05	L8-DE L828	10-03-394	20-03-339	30-03-316	

NEW CODES - NEUE CODES - NOUVEAUX CODES - NUEVOS CODIGOS - NUOVI CODICI

	KW						
				OIL FILTER FILTRO OLIO	AIR FILTER FILTRO ARIA	FUEL FILTER FILTRO CARBURANTE	CABIN FILTER FILTRO ABITACOLO
MX-5 III (NC)							
2.0	118	03.05	LF-DE LF62	10-03-394	20-03-339		
MX-6 (GE6)							
2.0	85	02.92	FS	10-03-315	20-03-327	30-03-397	
2.5 24V	121	02.92	KL	10-03-316	20-03-327	30-03-397	
2.5 i 24V	120	08.94	KL	10-03-316	20-03-327	30-03-397	
PREMACY (CP)							
1.8	74	07.99	FP	10-03-313	20-03-397	30-03-315 30-03-319 08.01→ Nel serbatoio carb. /Inside tank fuel	21-MA-MA0
1.9	84	07.99	FP	10-03-313	20-03-397	30-03-315 30-03-319 08.01→ Nel serbatoio carb. /Inside tank fuel	21-MA-MA0
2.0	96	11.01	FS7E FS7G	10-03-313	20-03-397	30-03-397	21-MA-MA0
2.0 TD	66	10.99→07.00	RF3F	10-05-599	20-03-389	30-02-295	21-MA-MA0
2.0 TD	74	07.00	RF4F	10-05-599	20-03-389	30-02-295	21-MA-MA0
RX 5							
1.1 Wankel	92	06.75→12.81	12A	10-05-503		30-03-301	
RX 7 I (SA)							
Wankel	77	05.79→05.81	12AN2	10-04-406	20-03-305	30-03-302	
Wankel	83	03.84→03.86	12AN2	10-04-406	20-03-305	30-03-302	
Wankel	85	01.81→03.84	12AN2	10-04-406	20-03-305	30-03-302	
RX 7 II (FC)							
Turbo	133	06.87→11.89	RE13B	10-05-599	20-03-315	30-03-315	
Turbo	147	03.89→12.91	RE13B	10-05-599	20-03-315	30-03-315	
Wankel	110	11.85→04.89	RE13B	10-05-599	20-03-315 06.86→	30-03-315	
RX 7 III (FD)							
Wankel Twin Turbo	176	07.92	RE13B	10-03-313	20-03-329	30-03-390	
RX 8							
2.6	170	10.03	13B-MSP	10-03-313	20-03-334		21-MA-MA14 21-MA-MA4
Wankel	141	10.03	13B-MSP	10-03-313	20-03-334		21-MA-MA14 21-MA-MA4
TRIBUTE (EP)							
2.0	91	03.00	YF	10-03-320	20-03-333	30-03-318	21-MA-MA13
2.0 4WD	91	03.00	YF	10-03-320	20-03-333	30-03-318	21-MA-MA13
2.3 AWD	110	04.04	L3-VE	10-03-394	20-03-333	30-03-318	21-MA-MA13
3.0 V6 24V 4WD	145	03.00	AJ	10-03-320	20-03-333	30-03-318	21-MA-MA13
3.0 V6 AWD	149	04.04	AJ	10-03-320	20-03-333	30-03-318	21-MA-MA13
XEDOS 6 (CA)							
1.6 16V	79	06.94	B6	10-03-316		30-03-397	



	KW						
				OIL FILTER FILTRO OLIO	AIR FILTER FILTRO ARIA	FUEL FILTER FILTRO CARBURANTE	CABIN FILTER FILTRO ABITACOLO

XEDOS 6 (CA)

1.6 16V	83	08.92 → 05.94	B69	10-03-316	20-03-399	30-03-397
2.0 V6	103	06.94	KF1	10-03-316	20-03-399	30-03-397
2.0 V6	106	01.92 → 05.94	KF1	10-03-316	20-03-399	30-03-397

XEDOS 9 (TA)

2.0 24V	105	08.93 → 01.00	KF	10-03-316	20-05-599	30-03-389
2.3 24V	155	02.95 → 01.00	KJ-ZEM	10-03-316	20-02-249	30-03-389
2.5 24V	123	07.93 → 07.00	KL	10-03-316	20-05-599 →06.98	30-03-389 →06.98
2.5 V6	120	07.00	KL	10-03-316	20-05-599	30-03-389

	KW			 OIL FILTER FILTRO OLIO	 AIR FILTER FILTRO ARIA	 FUEL FILTER FILTRO CARBURANTE	 CABIN FILTER FILTRO ABITACOLO
---	----	---	---	--	--	---	---

CABRIOLET (A124)

300 CE-24 (124.061)	162	04.92 → 06.93	M 104.980	10-ECO009
---------------------	-----	---------------	-----------	-----------

CLASSE A (W168)

A 140 (168.031, 168.131)	60	01.01 → 08.04	M 166.960	10-ECO003
A 140 (168.031, 168.131)	60	07.97 → 08.04	M 166.940	10-ECO003
A 160 (168.033, 168.133)	75	07.97 → 08.04	M 166.960	10-ECO003
A 160 CDI (168.006)	55	02.01 → 08.04	OM 668.940	10-ECO039
A 160 CDI (168.007)	44	07.98 → 02.01	OM 668.941	10-ECO003
A 170 CDI (168.008)	66	07.98 → 02.01	OM 668.940	10-ECO039
A 170 CDI (168.009, 168.109)	70	02.01 → 08.04	OM 668.942	10-ECO039
A 190 (168.032, 168.132)	92	03.99 → 08.04	M 166.990	10-ECO003
A 210 (168.035, 168.135)	103	03.02 → 08.04	M 166.995	10-ECO003

CLASSE A (W169)

A 150 (169.031, 169.331)	70	09.04	M 266.920	10-ECO074
A 160 (169.031, 169.331)	70	04.09	M 266.920	10-ECO074
A 160 CDI (169.006, 169.306)	60	09.04	OM 640.942	10-ECO050
A 170 (169.032, 169.332)	85	09.04	M 266.940	10-ECO074
A 180 CDI (169.007, 169.307)	80	09.04	OM 640.940	10-ECO050
A 200 (169.033, 169.333)	100	09.04	M 266.960	10-ECO074
A 200 CDI (169.008, 169.308)	103	09.04	OM 640.941	10-ECO050
A 200 TURBO (169.034, 169.334)	142	09.05	M 266.980	10-ECO074

CLASSE B (W245)

B 150	70	03.05		10-ECO074
B 150 (245.231)	70	03.05	M 266.920	10-ECO074
B 160 (245.231)	70	04.09	M 266.920	10-ECO074
B 170 (245.232)	85	03.05	M 266.940	10-ECO074
B 170 NGT (245.233)	85	04.08	M 266.960	10-ECO074
B 180 (245.232)	85	04.09	M 266.940	10-ECO074
B 180 CDI (245.207)	80	03.05	OM 640.940	10-ECO050
B 180 NGT (245.233)	85	04.08	M 266.960	10-ECO074
B 200 (245.233)	100	03.05	M 266.960	10-ECO074
B 200 CDI (245.208)	103	03.05	OM 640.941	10-ECO050
B 200 TURBO (245.234)	142	03.05	M 266.980	10-ECO074

CLASSE C (W202) \ Tutti i modelli \ All models

C 180 (202.018)	89	11.94 → 05.00	M 111.921	10-ECO009
C 180 (202.018)	90	03.93 → 05.00	M 111.920 M 111.921	10-ECO009
C 180 T (202.078)	90	06.96 → 09.00	M 111.920 M 111.921	10-ECO009
C 180 T (202.081)	95	09.00 → 03.01	M 111.952	10-ECO009
C 200 (202.020)	100	01.94 → 05.00	M 111.941 M 111.945	10-ECO009
C 200 CDI (202.134)	75	03.98 → 05.00	OM 611.960	10-ECO021 30-ECO002
C 200 D (202.120)	55	03.93 → 05.00	OM 601.913	10-ECO031
C 200 D (202.122)	65	10.96 → 05.00	OM 604.915	10-ECO031
C 200 Kompressor (202.025)	132	10.95 → 05.00	M 111.944	10-ECO009

NEW CODES - NEUE CODES - NOUVEAUX CODES - NUEVOS CODIGOS - NUOVI CODICI



	KW						
				OIL FILTER FILTRO OLIO	AIR FILTER FILTRO ARIA	FUEL FILTER FILTRO CARBURANTE	CABIN FILTER FILTRO ABITACOLO

CLASSE C (W202)\ Tutti i modelli\ All models

C 200 Kompressor (202.025)	141	11.96 → 05.00	M 111.944	10-ECO009	
C 200 T (202.080)	100	06.96 → 03.01	M 111.941 M 111.945	10-ECO009	
C 200 T CDI (202.194)	75	03.98 → 03.01	OM 611.960	10-ECO021	30-ECO002
C 200 T D (202.180)	65	10.96 → 03.01	OM 604.915	10-ECO031	
C 200 T Kompressor (202.087)	120	09.00 → 03.01	M 111.956	10-ECO009	
C 200 T Kompressor (202.082)	141	11.96 → 03.01	M 111.944	10-ECO009	
C 220 (202.022)	110	03.93 → 05.00	M 111.961	10-ECO009	
C 220 CDI (202.133)	92	09.97 → 05.00	OM 611.960	10-ECO021	30-ECO002
C 220 D	55	07.96 → 05.00	OM 604.910	10-ECO031	
C 220 D (202.121)	70	08.93 → 05.00	OM 604.910	10-ECO031	
C 220 T CDI (202.193)	92	09.97 → 03.01	OM 611.960	10-ECO021	30-ECO002
C 220 T D	55	06.96 → 03.01	OM 604.910	10-ECO031	
C 220 T D (202.182)	70	06.96 → 09.98	OM 604.910	10-ECO031	
C 230 (202.023)	110	06.96 → 06.97	M 111.974	10-ECO009	
C 230 Kompressor (202.024)	142	10.95 → 05.00	M 111.975	10-ECO009	
C 230 T (202.083)	110	06.96 → 06.98	M 111.974	10-ECO009	
C 230 T Kompressor (202.085)	142	06.97 → 09.00	M 111.975	10-ECO009	
C 240 (202.026)	125	06.97 → 05.00	M 112.910	10-ECO006	
C 240 T (202.086)	125	06.97 → 09.00	M 112.910	10-ECO006	
C 240 T (202.088)	125	09.00 → 03.01	M 112.915	10-ECO006	
C 250 D (202.125)	83	05.93 → 05.00	OM 605.910	10-ECO031	
C 250 T Turbo-D (202.188)	110	06.96 → 03.01	OM 605.960	10-ECO021	
C 250 Turbo-D (202.128)	110	10.95 → 05.00	OM 605.960	10-ECO021	
C 280 (202.028)	142	05.93 → 05.00	M 104.941	10-ECO009	
C 280 (202.029)	145	06.97 → 05.00	M 112.920	10-ECO006	
C 280 T (202.089)	145	06.97 → 03.01	M 112.920	10-ECO006	
C 36 AMG (202.028)	206	05.94 → 05.00	M 104.941 (AMG 3.6)	10-ECO009	
C 43 AMG (202.033)	225	08.97 → 05.00	M 113.944	10-ECO006	
C 43 AMG (202.093)	225	08.97 → 03.01	M 113.944	10-ECO006	

CLASSE C (W203)\ Tutti i modelli\ All models

C 180 (203.035)	95	10.00 → 05.02	M 111.951	10-ECO009	
C 180 Kompressor (203.046)	105	05.02	M 271.946	10-ECO061	
C 200 CDI	75	02.01	OM 646.962	10-ECO021	
C 200 CDI (203.004)	85	09.00	OM 611.962	10-ECO021	
C 200 CDI (203.007)	90	04.03	OM 646.962	10-ECO021	
C 200 CGI Kompressor (203.043)	125	07.03	M 271.942	10-ECO061	
C 200 Kompressor (203.042)	120	05.02	M 271.940	10-ECO061	
C 200 Kompressor (203.045)	120	05.00 → 05.02	M 111.955	10-ECO009	
C 220 CDI (203.006)	105	05.00	OM 611.962	10-ECO021	
C 220 CDI (203.008)	110	02.04	OM 646.963	10-ECO021	
C 230 (203.052)	150	01.05	M 272.920	10-ECO021	
C 230 Kompressor (203.040)	141	02.04	M 271.948	10-ECO061	
C 240 (203.061)	125	05.00	M 112.912	10-ECO006	

NEW CODES - NEUE CODES - NOUVEAUX CODES - NUEVOS CODIGOS - NUOVI CODICI

	KW			 OIL FILTER FILTRO OLIO	 AIR FILTER FILTRO ARIA	 FUEL FILTER FILTRO CARBURANTE	 CABIN FILTER FILTRO ABITACOLO
---	----	---	---	--	--	---	---

CLASSE C (W203)\ Tutti i modelli\ All models

C 240 4-matic (203.081)	125	07.02	M 112.916	10-ECO006
C 270 CDI (203.016)	125	12.00	OM 612.962	10-ECO021
C 280 (203.054)	170	01.05	M 272.940	10-ECO006
C 280 4-matic (203.092)	170	01.05	M 272.941	10-ECO006
C 30 CDI AMG (203.018)	170	01.03	OM 612.990	10-ECO041
C 32 AMG Kompressor (203.065)	260	02.01	M 112.961	10-ECO006
C 320 (203.064)	160	05.00	M 112.946	10-ECO006
C 320 4-matic (203.084)	160	07.02	M 112.953	10-ECO006
C 320 CDI (203.020)	165	01.05	OM 642.910	10-ECO053
C 350 (203.056)	200	01.05	M 272.960	10-ECO006
C 350 4-matic (203.087)	200	01.05	M 272.970	10-ECO006
C 55 AMG (203.076)	270	02.04	M 113.988	10-ECO006

CLASSE C (W204)\ Tutti i modelli\ All models

C 180 Kompressor	115	01.08	M 271.910	10-ECO061
C 180 Kompressor (204.046)	115	01.07	M 271.952	10-ECO061
C 200 CDI (204.007)	100	01.07	OM 646.811 OM 646.812	10-ECO021
C 200 Kompressor (204.041)	135	01.07	M 271.950	10-ECO061
C 220 CDI (204.008)	125	01.07	OM 646.811	10-ECO021
C 230 (204.052)	150	01.07	M 272.921	10-ECO006
C 230 4-matic (204.085)	150	07.07	M 272.911	10-ECO006
C 280 (204.054)	170	01.07	M 272.947	10-ECO006
C 280 4-matic (204.081)	170	07.07	M 272.948	10-ECO006
C 300 (204.054)	170	07.09	M 272.947	10-ECO006
C 300 4-matic (204.081)	170	07.07	M 272.948	10-ECO006
C 320 CDI (204.022)	165	01.07	OM 642.960	10-ECO053
C 320 CDI 4-matic (204.089)	165	07.07	OM 642.961	10-ECO053
C 350 (204.056)	200	01.07	M 272.961	10-ECO006
C 350 4-matic (204.087)	200	07.07	M 272.971	10-ECO006
C 350 CDI (204.022)	165	07.09	OM 642.960	10-ECO053
C 350 CDI (204.025)	170	10.09	OM 642.830	10-ECO053
C 350 CDI 4-matic (204.089)	165	07.09	OM 642.961	10-ECO053
C 350 CDI 4-matic (204.092)	170	10.09	OM 642.832	10-ECO053
C 350 CGI	215	09.08	M 272.982	10-ECO006

CLASSE C Coupe (CL203)

C 160 Kompressor (203.730)	90	05.02	M 271.921	10-ECO061
C 180 (203.735)	95	03.01 → 05.02	M 111.951	10-ECO009
C 180 Kompressor (203.746)	105	05.02	M 271.946	10-ECO061
C 200 CDI (203.707)	90	07.03	OM 646.962	10-ECO021
C 200 CGI Kompressor (203.743)	125	07.03	M 271.942	10-ECO061
C 200 Kompressor (203.742)	120	05.02	M 271.940	10-ECO061
C 200 Kompressor (203.745)	120	03.01 → 05.02	M 111.955	10-ECO009
C 220 CDI (203.706)	105	03.01	OM 611.962	10-ECO021
C 220 CDI (203.708)	110	02.04	OM 646.963	10-ECO021



	KW						
				OIL FILTER FILTRO OLIO	AIR FILTER FILTRO ARIA	FUEL FILTER FILTRO CARBURANTE	CABIN FILTER FILTRO ABITACOLO

CLASSE C Coupe (CL203)

C 230 (203.752)	150	01.05	M 272.920	10-ECO061
C 230 Kompressor (203.740)	141	05.02	M 271.948	10-ECO061
C 230 Kompressor (203.747)	145	03.01 → 05.02	M 111.981	10-ECO009
C 30 CDI AMG (203.718)	170	09.02	OM 612.990	10-ECO041
C 32 AMG Kompressor (203.765)	260	05.02	M 112.961	10-ECO006
C 320 (203.764)	160	09.02	M 112.946	10-ECO006
C 350 (203.756)	200	01.05	M 272.960	10-ECO006

CLASSE CLC

CLC 160 (203.731)	95	02.09	M 271.911	10-ECO061
CLC 180 Kompressor (203.746)	105	05.08	M 271.946	10-ECO061
CLC 200 CDI (203.707)	90	05.08	OM 646.962	10-ECO021
CLC 200 Kompressor (203.741)	135	05.08	M 271.955	10-ECO061
CLC 220 CDI (203.708)	110	05.08	OM 646.963	10-ECO021
CLC 230 (203.752)	150	05.08	M 272.920	10-ECO006
CLC 350 (203.756)	200	05.08	M 272.960	10-ECO006

CLASSE E (W124)\ Tutti i modelli\ All models

E 200 (124.019)	100	06.93 → 06.95	M 111.940	10-ECO009
E 220 (124.022)	110	06.93 → 06.95	M 111.960	10-ECO009
E 250 D (124.126, 124.129)	83	07.93 → 06.95	OM 605.911	10-ECO031
E 250 Turbo-D (124.128)	93	06.93 → 06.95	OM 602.962	10-ECO031
E 280 (124.028)	145	06.93 → 06.95	M 104.942	10-ECO009
E 280 long (124.029)	142	06.93 → 06.95	M 104.942	10-ECO009
E 320 (124.032)	162	06.93 → 06.95	M 104.992	10-ECO009
E 36 AMG	200	07.94 → 01.95		10-ECO009

CLASSE E (W210)\ Tutti i modelli\ All models

E 200 (210.035)	100	06.95 → 08.00	M 111.942	10-ECO009	
E 200 CDI (210.007)	75	06.98 → 03.02	OM 611.961	10-ECO021	30-ECO002
E 200 CDI (210.007)	85	07.99 → 03.02	OM 611.961	10-ECO021	30-ECO002
E 200 D (210.003)	65	01.96 → 03.02	OM 604.917	10-ECO031	
E 200 Kompressor (210.045)	137	06.97 → 03.02	M 111.947	10-ECO009	
E 200 Kompressor (210.048)	120	08.00 → 03.02	M 111.957	10-ECO009	
E 220 CDI (210.006)	105	07.99 → 03.02	OM 611.961	10-ECO021	30-ECO002
E 220 CDI (210.006)	92	06.98 → 07.99	OM 611.961	10-ECO021	30-ECO002
E 220 D	55	05.96 → 03.02	OM 604.912	10-ECO031	
E 220 D (210.004)	70	06.95 → 07.99	OM 604.912	10-ECO031	
E 230 (210.037)	110	06.95 → 06.97	M 111.970	10-ECO009	
E 240 (210.061)	125	06.97 → 08.00	M 112.911	10-ECO006	
E 240 (210.062)	125	08.00 → 03.02	M 112.914	10-ECO006	
E 250 D (210.010)	83	06.95 → 07.99	OM 605.912	10-ECO031	
E 250 Turbo-D (210.015)	110	06.97 → 07.99	OM 605.962	10-ECO031	
E 270 CDI (210.016)	125	07.99 → 03.02	OM 612.961	10-ECO021	30-ECO002
E 280 (210.053)	142	01.96 → 06.97	M 104.945	10-ECO009	
E 280 (210.063)	150	12.96 → 03.02	M 112.921	10-ECO006	
E 280 4-matic (210.081)	150	12.96 → 03.02	M 112.921	10-ECO006	

NEW CODES - NEUE CODES - NOUVEAUX CODES - NUEVOS CODIGOS - NUOVI CODICI

	KW			 OIL FILTER FILTRO OLIO	 AIR FILTER FILTRO ARIA	 FUEL FILTER FILTRO CARBURANTE	 CABIN FILTER FILTRO ABITACOLO
---	----	---	---	--	--	---	---

CLASSE E (W210)\ Tutti i modelli\ All models

E 290 Turbo-D (210.017)	95	03.96 → 07.99	OM 602.982	10-ECO031	
E 300 D (210.020)	100	06.95 → 06.97	OM 606.912	10-ECO031	
E 300 Turbo-D (210.025)	130	12.96 → 07.99	OM 606.962	10-ECO031	
E 320 (210.055)	162	06.95 → 06.97	M 104.995	10-ECO009	
E 320 (210.065)	165	06.97 → 03.02	M 112.941	10-ECO006	
E 320 4-matic (210.082)	165	06.97 → 03.02	M 112.941	10-ECO006	
E 320 CDI (210.026)	145	07.99 → 03.02	OM 613.961	10-ECO041	30-ECO002
E 36 AMG	200	04.96 → 01.98		10-ECO009	
E 430 (210.070)	205	06.97 → 03.02	M 113.940	10-ECO006	
E 430 4-matic (210.083)	205	05.99 → 03.02	M 113.940	10-ECO006	
E 55 AMG (210.074)	260	08.97 → 03.02	M 113.980	10-ECO006	
E 55 AMG 4-matic (210.083)	260	03.01 → 03.02	M 113.980	10-ECO006	

CLASSE E (W211)\ Tutti i modelli\ All models

E 200 CDI (211.004)	75	07.02	OM 646.951	10-ECO021	
E 200 CDI (211.004)	90	07.02	OM 646.951	10-ECO021	
E 200 CDI (211.007)	100	04.06	OM 646.820	10-ECO021	
E 200 CGI	125	11.02	M 271.946	10-ECO061	
E 200 Kompressor (211.041)	135	04.06	M 271.956	10-ECO061	
E 200 Kompressor (211.042)	120	11.02	M 271.941	10-ECO061	
E 220 CDI (211.006)	100	03.02	OM 646.961	10-ECO021	
E 220 CDI (211.006)	110	03.02	OM 646.961	10-ECO021	
E 220 CDI (211.008)	125	04.06	OM 646.821	10-ECO021	
E 230	150	09.07	M 272.922	10-ECO006	
E 240 (211.061)	130	03.02	M 112.917 M 112.913	10-ECO006	
E 240 4-matic (211.080)	130	03.03	M 112.917	10-ECO006	
E 270 CDI (211.016)	130	03.02	OM 647.961	10-ECO021	
E 280 (211.054)	170	03.05	M 272.943	10-ECO006	
E 280 4-matic (211.092)	170	01.06	M 272.943	10-ECO006	
E 280 CDI (211.020)	140	03.05	OM 642.920	10-ECO053	
E 280 CDI (211.023)	130	05.04	OM 648.961	10-ECO041	
E 280 CDI 4-matic	140	03.05	OM 642.921	10-ECO053	
E 300 BLUETEC	155	09.07	OM 642.920	10-ECO053	
E 320 (211.065)	165	03.02	M 112.949	10-ECO006	
E 320 4-matic (211.082)	165	03.03	M 112.954	10-ECO006	
E 320 CDI (211.022)	165	03.05	OM 642.920	10-ECO053	
E 320 CDI (211.026)	150	11.02	OM 648.961	10-ECO041	
E 320 CDI 4-matic	165	03.05	OM 642.910	10-ECO053	
E 350 (211.056)	200	03.05	M 272.964	10-ECO006	
E 350 4-matic (211.087)	200	03.05	M 272.964 M 272.972	10-ECO006	
E 350 CGI	215	09.07	M 272.985	10-ECO006	
E 400 CDI (211.028)	191	02.03	OM 628.961	10-ECO064	
E 420 CDI (211.029)	231	01.06	OM 629.910	10-ECO115	
E 500 (211.070)	225	03.02	M 113.967	10-ECO006	

NEW CODES - NEUE CODES - NOUVEAUX CODES - NUEVOS CODIGOS - NUOVI CODICI



	KW						
				OIL FILTER FILTRO OLIO	AIR FILTER FILTRO ARIA	FUEL FILTER FILTRO CARBURANTE	CABIN FILTER FILTRO ABITACOLO

CLASSE E (W211)\ Tutti i modelli\ All models

E 500 (211.072)	285	04.06	M 273.960	10-ECO006
E 500 4-matic (211.083)	225	10.03	M 113.969	10-ECO006
E 500 4-matic (211.090)	285	04.06	M 273.962	10-ECO006
E 55 AMG Kompressor (211.076)	350	10.02	M 113.990	10-ECO006
E200 NGT	120	03.04	M 271.941	10-ECO061

CLASSE E (W212)\ Tutti i modelli\ All models

E 350 4-matic	200	01.09	M 272.977	10-ECO006
E 350 BlueTEC	155	01.09	OM 642.850	10-ECO053
E 350 CDI	170	01.09	OM 642.850	10-ECO053
E 350 CDI 4-matic (212.089, 212.093)	170	09.09	OM 642.856	10-ECO053
E 350 CGI	215	01.09	M 272.983	10-ECO006
E 500	285	01.09	M 273.971	10-ECO006
E 500 4-matic	285	01.09	M 273.970	10-ECO006

CLASSE E Cabriolet (A207)

E 350 CDI (207.422)	170	01.10	OM 642.836	10-ECO053
E 350 CGI (207.457)	215	01.10	M 272.982 M 272.984	10-ECO006
E 500 (207.472)	285	01.10	M 273.966	10-ECO006

CLASSE E Coupe (C124)

E 200 (124.040)	100	06.93 → 06.97	M 111.940	10-ECO009
E 220 (124.042)	110	06.93 → 06.97	M 111.960	10-ECO009
E 320 (124.052)	162	06.93 → 06.97	M 104.992	10-ECO009
E 36 AMG (124.052)	195	06.93 → 04.95	M 104.992 (AMG 3.6)	10-ECO009
E 36 AMG (124.052)	200	05.94 → 06.97	M 104.992 (AMG 3.6)	10-ECO009

CLASSE E Coupé (C207)

E 350 CDI	170	01.09	OM 642.836	10-ECO053
E 350 CGI	215	01.09	M 272.982 M 272.984	10-ECO006
E 500	285	01.09	M 273.966	10-ECO006

CLASSE G (W461)

G 290 TD (461.335, 461.336)	88	07.97	OM 602.983	10-ECO031
G 320 CDI	135	04.09		10-ECO053
G 350 CDI	135	04.10		10-ECO053

CLASSE G (W463)\ Cabrio (W463)

300 GE (463)	128	06.90	M 103.987	10-ECO009
300 GE (463.227, 463.228)	125	06.90	M 103.987	10-ECO009
G 270 CDI (463.322, 463.323)	115	10.01	OM 612.965	10-ECO021
G 300 TD (463.330, 463.331)	130	08.96	OM 606.964	10-ECO031
G 320 (463.230, 463.231)	155	09.94 → 12.97	M 104.996	10-ECO009
G 320 (463.232, 463.233)	158	07.97	M 112.945	10-ECO006
G 320 CDI	165	09.06	OM 642.970	10-ECO053
G 36 AMG	200	01.95		10-ECO009
G 400 CDI (463.332, 463.333)	184	12.00	OM 628.962	10-ECO064

NEW CODES - NEUE CODES - NOUVEAUX CODES - NUEVOS CODIGOS - NUOVI CODICI

	KW			 OIL FILTER FILTRO OLIO	 AIR FILTER FILTRO ARIA	 FUEL FILTER FILTRO CARBURANTE	 CABIN FILTER FILTRO ABITACOLO
---	----	---	---	---	---	--	--

CLASSE G (W463) Cabrio (W463)

G 500 (463.247, 463.248, 463.249)	218	04.98	M 113.962	10-ECO006
G 55 AMG	350	06.04	M 113.993	10-ECO006
G 55 AMG	373	08.08	M 113.993	10-ECO006
G 55 AMG (463.243, 463.246)	260	04.99	M 113.982	10-ECO006

CLASSE GL

GL 320 CDI (164.822)	165	09.06	OM 642.940	10-ECO053
GL 350 CDI	165	05.09	OM 642.940	10-ECO053
GL 350 CDI BlueTEC (164.824, 164.825)	155	12.09	OM 642.820	10-ECO053
GL 420 CDI (164.828)	225	09.06	OM 629.912	10-ECO115
GL 450	250	09.06	M 273.923	10-ECO006
GL 450 CDI	225	05.09	OM 629.912	10-ECO115
GL 500 (164.886)	285	09.06	M 273.963	10-ECO006

CLASSE GLK (X204)

280 4-matic	170	06.08	M 272.948	10-ECO006
300 4-matic (204.981)	170	07.09	M 272.948	10-ECO006
320 CDI 4-matic	165	06.08	OM 642.961	10-ECO053
350 4-matic	200	06.08	M 272.971	10-ECO006
350 CDI 4-matic (204.992)	165	07.09	OM 642.832	10-ECO053

CLASSE M (W163)

ML 230 (163.136)	110	02.98 → 06.05	M 111.977	10-ECO009	
ML 270 CDI (163.113)	120	12.99 → 06.05	OM 612.963	10-ECO021	30-ECO002
ML 320 (163.154)	160	02.98 → 08.02	M 112.942	10-ECO006	
ML 350	173	02.03 → 06.05	M 112.970	10-ECO006	
ML 350 (163.157)	180	08.02 → 06.05	M 112.970	10-ECO006	
ML 400 CDI (163.128)	184	09.01 → 06.05	OM 628.963	10-ECO064	
ML 430 (163.172)	200	02.98 → 06.05	M 113.942	10-ECO006	
ML 500 (163.175)	215	09.01 → 06.05	M 113.964 M 113.965	10-ECO006	
ML 55 AMG (163.174)	255	02.00 → 06.05	M 113.981	10-ECO021	

CLASSE M (W164)

ML 280 CDI 4-matic (164.120)	140	07.05	OM 642.940	10-ECO053
ML 300 CDI 4-matic	140	07.09	OM 642.940	10-ECO053
ML 300 CDI 4-matic (164.121)	150	02.10		10-ECO053
ML 320 CDI 4-matic (164.122)	165	07.05	OM 642.940	10-ECO053
ML 350 4-matic (164.186)	200	07.05	M 272.962 M 272.967	10-ECO006
ML 350 BlueTEC 4-matic	155	09.09	OM 642.820	10-ECO053
ML 350 CDI 4-matic	165	07.09	OM 642.940	10-ECO053
ML 350 CDI 4-matic (164.125)	170	02.10		10-ECO053
ML 420 CDI 4-matic (164.128)	225	02.06	OM 629.912	10-ECO115
ML 450 CDI 4-matic	225	09.09	OM 629.912	10-ECO115
ML 500 4-matic	285	12.07	M 273.963	10-ECO006
ML 500 4-matic (164.175)	225	07.05	M 113.964	10-ECO006

CLASSE R

NEW CODES - NEUE CODES - NOUVEAUX CODES - NUEVOS CODIGOS - NUOVI CODICI



	KW						
				OIL FILTER FILTRO OLIO	AIR FILTER FILTRO ARIA	FUEL FILTER FILTRO CARBURANTE	CABIN FILTER FILTRO ABITACOLO

CLASSE R

R 280 (251.054)	170	01.07	M 272.945	10-ECO006
R 280 CDI (251.026, 251.126)	140	05.06	OM 642.950	10-ECO053
R 280 CDI 4-matic (251.020)	140	05.06	OM 642.950	10-ECO053
R 300	170	07.09	M 272.945	10-ECO006
R 300 CDI	140	07.09	OM 642.950	10-ECO053
R 300 CDI 4-matic	140	07.09	OM 642.950	10-ECO053
R 320 CDI 4-matic (251.022, 251.122)	165	01.06	OM 642.950	10-ECO053
R 350 (251.056, 251.156)	200	01.07	M 272.967	10-ECO006
R 350 4-matic	155	07.09	OM 642.950	10-ECO053
R 350 4-matic (251.065)	200	01.06	M 272.967	10-ECO006
R 350 CDI 4-matic	165	07.09	OM 642.950	10-ECO053
R 500 4-matic (251.072, 251.172)	285	01.07	M 273.963	10-ECO006
R 500 4-matic (251.075, 251.175)	225	01.06	M 113.971	10-ECO006

CLASSE S (W140)

300 SE 2.8 (140.028)	145	01.93 → 10.98	M 104.944	10-ECO009
300 SE,SEL/S320 (140.032, 140.033)	170	03.91 → 10.98	M 104.990 M 104.994	10-ECO009
600 SE,SEL (140.056, 140.057)	300	04.91 → 12.92	M 120.980 M 120.982	10-ECO040
S 280 (140.028)	142	02.93 → 10.98	M 104.944	10-ECO009 03.94 →
S 300 Turbo-D (140.135)	130	05.96 → 10.98	OM 606.961	10-ECO031
S 600 (140.056, 140.057)	290	01.93 → 10.98	M 120.980 M 120.982	10-ECO040

CLASSE S (W220)

S 280 (220.063, 220.163)	150	10.98 → 08.05	M 112.922	10-ECO006
S 320 (220.065, 220.165)	165	10.98 → 08.05	M 112.944	10-ECO006
S 320 CDI (220.025, 220.125)	150	09.02 → 08.05	OM 648.960	10-ECO041
S 320 CDI (220.026, 220.126)	145	08.99 → 09.02	OM 613.960	10-ECO041
S 350 (220.067, 220.167)	180	09.02 → 08.05	M 112.972	10-ECO006
S 350 4-matic (220.087, 220.187)	180	06.03 → 08.05	M 112.975	10-ECO006
S 400 CDI (220.028, 220.128)	184	06.00 → 08.05	OM 628.960	10-ECO064
S 400 CDI (220.028, 220.128)	191	06.03 → 08.05	OM 628.960	10-ECO064
S 430 (220.070, 220.170)	205	10.98 → 08.05	M 113.941	10-ECO006
S 430 4-matic (220.083, 220.183)	205	09.02 → 08.05	M 113.948	10-ECO006
S 500 (220.075, 220.175, 220.875)	225	10.98 → 08.05	M 113.960	10-ECO006
S 500 4-matic (220.084, 220.184)	225	09.02 → 08.05	M 113.966	10-ECO006
S 55 AMG (220.073, 220.173)	265	04.99 → 08.05	M 113.986	10-ECO006
S 55 AMG Kompressor (220.074, 220.174)	368	06.02 → 08.05	M 113.991	10-ECO006
S 600 (220.176)	368	09.02 → 08.05	M 275.950	10-ECO088
S 600 (220.878, 220.178)	270	01.00 → 08.05	M 137.970	10-ECO006
S 63 AMG	326	09.01 → 08.05	M 137.980	10-ECO006
S 65 AMG (220.179)	450	03.04 → 08.05	M 275.980	10-ECO088

CLASSE S (W221)

S 320 CDI (221.022)	173	12.05	OM 642.930	10-ECO053
S 320 CDI 4-matic	173	10.06	OM 642.930	10-ECO053

NEW CODES - NEUE CODES - NOUVEAUX CODES - NUEVOS CODIGOS - NUOVI CODICI

	KW			 OIL FILTER FILTRO OLIO	 AIR FILTER FILTRO ARIA	 FUEL FILTER FILTRO CARBURANTE	 CABIN FILTER FILTRO ABITACOLO
---	----	---	---	--	--	---	---

CLASSE S (W221)

S 350 (221.056, 221.156)	200	10.05	M 272.965	10-ECO006
S 350 4-matic	200	02.08	M 272.965	10-ECO006
S 400 Hybrid	205	01.09	M 272.974	10-ECO006
S 420 CDI	235	10.06	OM 629.911	10-ECO115
S 450	250	12.05	M 273.923	10-ECO006
S 450 4-matic	250	12.05	M 273.922	10-ECO006
S 500 (221.071, 221.171)	285	10.05	M 273.961	10-ECO006
S 500 4-matic	285	10.05	M 273.961	10-ECO006
S 600 (221.176)	380	12.05	M 275.953	10-ECO088
S 65 AMG	450	12.05	M 275.982	10-ECO088

CLASSE V (638/2)

V 200 (638.214)	95	02.97 → 07.03	M 111.948 M 111.950	10-ECO009
V 200 CDI (638.294)	75	03.99 → 07.03	OM 611.980	10-ECO021
V 220 CDI (638.294)	90	03.99 → 07.03	OM 611.980	10-ECO021
V 230 (638.234)	105	10.96 → 07.03	M 111.978 M 111.980	10-ECO009
V 230 TD (638.274)	72	09.96 → 07.03	OM 601.970	10-ECO031
V 280 (638.244)	128	08.97 → 07.03	M 104.900	10-ECO013

CLK (C208)\ Cabriolet (A208)

200 (208.335)	100	06.97 → 06.02	M 111.941 M 111.945	10-ECO009
200 Kompressor (208.344)	120	06.00 → 06.02	M 111.956	10-ECO009
200 Kompressor (208.345)	141	06.97 → 06.00	M 111.944	10-ECO009
230 Kompressor (208.347)	142	06.97 → 06.00	M 111.973 M 111.975	10-ECO009
230 Kompressor (208.348)	145	06.00 → 06.02	M 111.982	10-ECO009
320 (208.365)	160	06.97 → 06.02	M 112.940	10-ECO006
430 (208.370)	205	07.98 → 06.02	M 113.943	10-ECO006
55 AMG (208.374)	255	08.99 → 06.02	M 113.981 M 113.984	10-ECO006

CLK (C209)\ Cabriolet (A209)

200 CGI (209.343)	125	07.03	M 271.942	10-ECO061	
200 Kompressor (209.341)	135	10.06	M 271.955	10-ECO061	
200 Kompressor (209.342)	120	09.02	M 271.940	10-ECO061	
220 CDI (209.308)	110	01.05	OM 646.966	10-ECO021	
240 (209.361)	125	06.02	M 112.912	10-ECO006	
270 CDI (209.316)	125	10.02	OM 612.962 OM 612.967	10-ECO021	30-ECO002
280 (209.354)	170	01.05	M 272.940	10-ECO006	
320 (209.365)	160	06.02	M 112.955	10-ECO006	
320 CDI (209.320)	165	01.05	OM 642.910	10-ECO053	
350 (209.356)	200	01.05	M 272.960	10-ECO006	
500 (209.375)	225	06.02	M 113.968	10-ECO006	
55 AMG (209.376)	270	09.02	M 113.987	10-ECO006	
CLK DTM AMG	428	06.04	M 113.994	10-ECO006	

CLS (C218)

NEW CODES - NEUE CODES - NOUVEAUX CODES - NUEVOS CODIGOS - NUOVI CODICI



	KW						
				OIL FILTER FILTRO OLIO	AIR FILTER FILTRO ARIA	FUEL FILTER FILTRO CARBURANTE	CABIN FILTER FILTRO ABITACOLO
CLS (C218)							
350 CDI	195	01.11	OM 642.853	10-ECO053			
CLS (C219)							
280	170	07.08	M 272.943	10-ECO006			
300	170	04.09	M 272.943	10-ECO006			
320 CDI (219.322)	165	01.05	OM 642.910 OM 642.920	10-ECO053			
350 (219.356)	200	10.04	M 272.964	10-ECO006			
350 (219.357)	215	04.06	M 272.985	10-ECO006			
350 CDI	165	04.09	OM 642.920	10-ECO053			
350 CGI	215	04.09	M 272.985	10-ECO006			
500	285	04.06	M 273.960	10-ECO006			
500 (219.375)	225	10.04	M 113.967	10-ECO006			
CLS 55 AMG (219.376)	350	01.05	M 113.990	10-ECO006			
COUPE (C124)							
220 CE (124.042)	110	10.92 → 05.93	M 111.960	10-ECO009			
300 CE-24 (124.051)	162	09.89 → 12.92	M 104.980	10-ECO009			
300 CE-24 (124.051)	170	09.89 → 12.92	M 104.980	10-ECO009			
320 CE (124.052)	162	10.92 → 05.93	M 104.992	10-ECO009			
KOMBI Station wagon (S124)							
200 TE (124.079)	100	10.92 → 06.93	M 111.940	10-ECO009			
220 TE (124.082)	110	10.92 → 05.93	M 111.960	10-ECO009			
280 TE (124.088)	145	10.92 → 06.93	M 104.942	10-ECO009			
300 TE-24 (124.091)	162	09.89 → 08.92	M 104.980	10-ECO009			
300 TE-24 (124.091)	170	09.89 → 08.92	M 104.980	10-ECO009			
320 TE (124.092)	162	10.92 → 06.93	M 104.992	10-ECO009			
SL (R129)							
280 (129.058)	142	08.93 → 10.01	M 104.943	10-ECO009			
280 (129.059)	150	05.98 → 10.01	M 112.923 M 112.925	10-ECO006			
300 SL-24 (129.061)	170	03.89 → 07.93	M 104.981	10-ECO009			
320 (129.063)	170	09.93 → 10.01	M 104.991	10-ECO009			
320 (129.064)	165	05.98 → 10.01	M 112.943	10-ECO006			
500 (129.068)	225	05.98 → 10.01	M 113.961	10-ECO006			
55 AMG (129.068)	260	03.00 → 10.01	M 113.985	10-ECO006			
60 AMG (129.067)	280	05.97 → 10.01	M 122.981	10-ECO040			
600 (129.076)	290	07.92 → 10.01	M 120.981 M 120.983	10-ECO040			
SL (R230)							
280	170	03.08	M 272.949	10-ECO006			
300	170	04.09	M 272.949	10-ECO006			
350	200	03.06	M 272.966	10-ECO006			
350	232	04.08	M 272.968	10-ECO006			
350 (230.467)	180	03.03	M 112.973	10-ECO006			
500	285	03.06	M 273.965	10-ECO006			
500 (230.475)	225	10.01	M 113.963	10-ECO006			

NEW CODES - NEUE CODES - NOUVEAUX CODES - NUEVOS CODIGOS - NUOVI CODICI

	KW			 OIL FILTER FILTRO OLIO	 AIR FILTER FILTRO ARIA	 FUEL FILTER FILTRO CARBURANTE	 CABIN FILTER FILTRO ABITACOLO
---	----	---	---	--	--	---	---

SL (R230)

55 AMG	380	03.06	M 113.995	10-ECO006
55 AMG (230.474)	350	10.01 → 06.02	M 113.992	10-ECO006
55 AMG Kompressor (230.474)	368	06.02	M 113.992	10-ECO006
600	380	03.06	M 275.954	10-ECO088
600 (230.476)	368	04.03	M 275.951	10-ECO088
65 AMG (230.479)	450	03.04	M 275.981	10-ECO088
65 AMG Black Series	493	07.08		10-ECO088
65 AMG Black Series	493	07.08		10-ECO088

SLK (R170)

200 (170.435)	100	09.96 → 03.00	M 111.946	10-ECO009
200 Kompressor (170.444)	120	03.00 → 04.04	M 111.958	10-ECO009
200 Kompressor (170.445)	141	10.96 → 03.00	M 111.943	10-ECO009
230 Kompressor (170.447)	142	09.96 → 03.00	M 111.973	10-ECO009
230 Kompressor (170.449)	145	03.00 → 04.04	M 111.983	10-ECO009
32 AMG Kompressor (170.466)	260	03.01 → 04.04	M 112.960	10-ECO006
320 (170.465)	160	03.00 → 04.04	M 112.947	10-ECO006

SLK (R171)

200 Kompressor (171.442)	120	03.04	M 271.944	10-ECO061
200 Kompressor (171.445)	135	01.08	M 271.954	10-ECO061
280 (171.454)	170	01.05	M 272.942	10-ECO006
300 (171.454)	170	04.09	M 272.942	10-ECO006
350 (171.456)	200	06.04	M 272.963	10-ECO006
350 (171.458)	224	01.08	M 272.969	10-ECO006
55 AMG (171.473)	265	06.04	M 113.989	10-ECO006

SPRINTER 2-t (901, 902)\ Tutti i modelli\ All models

208 CDI	60	04.00 → 05.06	OM 611.987	10-ECO021
208 D	58	02.95 → 04.00	OM 601.943	10-ECO031
208 D	60	10.96 → 04.00	OM 601.943	10-ECO031
210 D	75	01.97 → 04.00	OM 602.980	10-ECO031
211 CDI	80	04.00 → 05.06	OM 611.981	10-ECO021
212 D	90	02.95 → 04.00	OM 602.980	10-ECO031
213 CDI	95	04.00 → 05.06	OM 611.981	10-ECO021
214	105	02.95 → 05.06	M 111.979 M 111.984	10-ECO009
214 NGT	92	04.00 → 05.06	M 111.984	10-ECO009
216 CDI	115	04.00 → 05.06	OM 612.981	10-ECO021

SPRINTER 3,5-t (906)\ Tutti i modelli\ All models

309 CDI	65	06.06	OM 646.984	10-ECO021
311 CDI	80	06.06	OM 646.985	10-ECO021
311 CDI 4x4 (906.633, 906.635, 906.637)	80	02.08	OM 646.985	10-ECO021
313 CDI	95	06.06	OM 646.986	10-ECO021
315 CDI	110	06.06	OM 646.990	10-ECO021
315 CDI 4x4 (906.633, 906.635, 906.637)	110	02.08	OM 646.990	10-ECO021
316 (906.633, 906.365, 906.637)	115	09.08	M 271.951	10-ECO061

NEW CODES - NEUE CODES - NOUVEAUX CODES - NUEVOS CODIGOS - NUOVI CODICI



	KW						
				OIL FILTER FILTRO OLIO	AIR FILTER FILTRO ARIA	FUEL FILTER FILTRO CARBURANTE	CABIN FILTER FILTRO ABITACOLO

SPRINTER 3,5-t (906)\ Tutti i modelli\ All models

316 NGT (906.633, 906.635)	115	09.08	M 271.951	10-ECO061
318 CDI	135	06.06	OM 642.992	10-ECO053
318 CDI 4x4 (906.633, 906.635, 906.637)	135	02.08	OM 642.992	10-ECO053
319 CDI (906.631, 906.633, 906.635, 906.637)	140	03.09	OM 642.992	10-ECO053
319 CDI 4x4	140	03.09	OM 642.992	10-ECO053
324	190	06.06	M 272.979	10-ECO006

SPRINTER 3-t (903)\ Tutti i modelli\ All models

308 CDI	60	04.00 → 05.06	OM 611.987	10-ECO021
308 D 2.3	58	02.95 → 04.00	OM 601.943	10-ECO031
308 D 2.3	60	11.96 → 04.00	OM 601.943	10-ECO031
310 D 2.9	75	01.97 → 04.00	OM 602.980	10-ECO031
311 CDI	80	04.00 → 05.06	OM 611.981	10-ECO021
311 CDI 4x4	80	08.02 → 05.06	OM 611.981	10-ECO021
312 D 2.9	90	02.95 → 04.00	OM 602.980	10-ECO031
313 CDI	95	04.00 → 05.06	OM 611.981	10-ECO021
313 CDI 4x4	95	08.02 → 05.06	OM 611.981	10-ECO021
314	105	02.95 → 05.06	M 111.979 M 111.984	10-ECO009
314 4x4	105	08.02 → 05.06	M 111.979 M 111.984	10-ECO009
314 NGT	92	04.00 → 05.06		10-ECO009
316 CDI	115	04.00 → 05.06	OM 612.981	10-ECO021
316 CDI 4x4	115	08.02 → 05.06	OM 612.981	10-ECO021

SPRINTER 3-t (906)

209 CDI	65	06.06	OM 646.984	10-ECO021
211 CDI	80	06.06	OM 646.985	10-ECO021
213 CDI	95	03.09		10-ECO021
213 CDI	95	06.06	OM 646.986	10-ECO021
215 CDI	110	06.06	OM 646.990	10-ECO021
216 (906.113, 906.213)	115	09.08	M 271.951	10-ECO061
218 CDI	135	06.06	OM 642.992	10-ECO053
219 CDI	140	03.09	OM 642.992	10-ECO053
224	190	06.06	M 272.979	10-ECO006

SPRINTER 4,6-t (906)

415 CDI (906.153, 906.155, 906.253, 906.254)	110	06.06	OM 646.990	10-ECO021
418 CDI	135	06.06	OM 642.992	10-ECO053
419 CDI	140	03.09	OM 642.992	10-ECO053
424	190	06.06	M 272.979	10-ECO006

SPRINTER 4,6-t Furgonato (906)

419 CDI	140	03.09	OM 642.992	10-ECO053
---------	-----	-------	------------	-----------

SPRINTER 4-t (904)\ Tutti i modelli\ All models

408 CDI	60	04.00 → 05.06	OM 611.987	10-ECO021
408 D	58	02.96 → 05.06	OM 601.943	10-ECO031
410 D	75	02.96 → 05.06	OM 602.980	10-ECO031

NEW CODES - NEUE CODES - NOUVEAUX CODES - NUEVOS CODIGOS - NUOVI CODICI

	KW			 OIL FILTER FILTRO OLIO	 AIR FILTER FILTRO ARIA	 FUEL FILTER FILTRO CARBURANTE	 CABIN FILTER FILTRO ABITACOLO
---	----	---	---	--	--	---	---

SPRINTER 4-t (904)\ Tutti i modelli\ All models

410 D 4x4	75	05.97 → 05.06	OM 602.980	10-ECO031
411 CDI	80	04.00 → 05.06	OM 611.981	10-ECO021
411 CDI 4x4	80	04.00 → 05.06	OM 611.981	10-ECO021
412 D	85	02.96 → 05.06	OM 602.980	10-ECO031
412 D	90	02.96 → 05.06	OM 602.980	10-ECO031
412 D 4x4	85	05.97 → 05.06	OM 602.980	10-ECO031
412 D 4x4	90	05.97 → 05.06	OM 602.980	10-ECO031
413 CDI	95	04.00 → 05.06	OM 611.981	10-ECO021
413 CDI 4x4	95	04.00 → 05.06	OM 611.981	10-ECO021
414	105	02.96 → 05.06	M 111.979 M 111.984	10-ECO009
414 4x4	105	05.97 → 05.06	M 111.979 M 111.984	10-ECO009
416 CDI	115	04.00 → 05.06	OM 612.981	10-ECO021
416 CDI 4x4	115	04.00 → 05.06	OM 612.981	10-ECO021

SPRINTER 5-t (906)\ Tutti i modelli\ All models

509 CDI	65	06.06	OM 646.984	10-ECO021
511 CDI	80	06.06	OM 646.985	10-ECO021
513 CDI	95	06.06	OM 646.986	10-ECO021
515 CDI	110	06.06	OM 646.990	10-ECO021
516 (906.153, 906.155, 906.253, 906.255)	115	09.08	M 271.951	10-ECO061
516 NGT (906.153, 906.155)	115	09.08	M 271.951	10-ECO061
518 CDI	135	06.06	OM 642.992	10-ECO053
519 CDI	140	03.09	OM 642.992	10-ECO053
524 (906.153, 906.155, 906.253, 905.255)	190	06.06	M 272.979	10-ECO006

Tre volumi (W124)

200 E (124.019)	100	10.92 → 06.93	M 111.940	10-ECO009
220 E (124.022)	110	10.92 → 06.93	M 111.960	10-ECO009
280 E (124.028)	145	10.92 → 06.93	M 104.942	10-ECO009
300 E-24 (124.031)	162	09.88 → 08.92	M 104.980	10-ECO009
300 E-24 (124.031)	170	09.88 → 08.92	M 104.980	10-ECO009
320 E (124.032)	162	10.92 → 06.93	M 104.992	10-ECO009

VANEO (414)

1.6 (414.700)	60	02.02	M 166.961	10-ECO003
1.6 (414.700)	75	02.02	M 166.961	10-ECO003
1.7 CDI (414.700)	55	02.02	OM 668.914	10-ECO039
1.7 CDI (414.700)	67	02.02	OM 668.914	10-ECO039
1.9 (414.700)	92	02.02	M 166.991	10-ECO003

VIANO (W639)

2.2 CDI	85	08.05	OM 646.982	10-ECO021
3.0 CDI	150	03.06	OM 642.990	10-ECO053
3.2	140	09.03	M 112.951	10-ECO006
3.2	160	09.03	M 112.951	10-ECO006
3.5 126	190	09.07	M 272.979	10-ECO006
3.7	170	06.04	M 112.976	10-ECO006

NEW CODES - NEUE CODES - NOUVEAUX CODES - NUEVOS CODIGOS - NUOVI CODICI



	KW						
				OIL FILTER FILTRO OLIO	AIR FILTER FILTRO ARIA	FUEL FILTER FILTRO CARBURANTE	CABIN FILTER FILTRO ABITACOLO

VIANO (W639)

CDI 2.2	110	09.03	OM 646.982	10-ECO021
CDI 2.2	80	09.03	OM 646.982	10-ECO021
CDI 2.2 4-matic	110	07.05	OM 646.982	10-ECO021
CDI 2.2 4-matic	80	07.05	OM 646.982	10-ECO021

VITO (638)

108 CDI 2.2	60	03.99 → 07.03	OM 611A (60 KW CDI)	10-ECO021
108 D 2.3 (638.064)	58	03.97 → 07.03	OM 601.942	10-ECO031
110 CDI 2.2	75	03.99 → 07.03	OM 611LA (75 KW CDI)	10-ECO021
110 D 2.3 (638.074)	72	03.97 → 07.03	OM 601.970	10-ECO031
112 CDI 2.2	90	03.99 → 07.03	OM 611.980	10-ECO021
113 2.0 (638.014)	95	03.97 → 07.03	M 111.948 M 111.950	10-ECO009
114 2.3 (638.034)	105	03.97 → 07.03	M 111.978 M 111.980	10-ECO009

VITO (W639)

109 CDi	70	08.06	OM 646.981	10-ECO021
109 CDI 2.2	65	09.03	OM 646.983	10-ECO021
111 CDI 2.2	80	09.03	OM 646.982	10-ECO021
111 CDI 2.2	85	09.07	OM 646.982	10-ECO021
111 CDI 2.2 4x4	80	09.07	OM 646.982	10-ECO021
115 CDI 2.2	110	09.03	OM 646.982	10-ECO021
115 CDI 2.2 4x4	110	09.07	OM 646.982	10-ECO021
119 3.2	140	09.03	M 112.951	10-ECO006
120 CDI	150	09.07	OM 642.990	10-ECO053
122 3.2	160	09.03	M 112.951	10-ECO006

MERCEDES Comm.



	KW						
				OIL FILTER FILTRO OLIO	AIR FILTER FILTRO ARIA	FUEL FILTER FILTRO CARBURANTE	CABIN FILTER FILTRO ABITACOLO







ACTROS 1996

	KW				
1831 AK	230	04.97		10-ECO001	30-ECO001
1831 K	230	04.97		10-ECO001	30-ECO001
1831 S,1831 LS	230	09.96		10-ECO001	30-ECO001
1835 AK	260	04.97		10-ECO001	30-ECO001
1835 K	260	04.97		10-ECO001	30-ECO001
1835 S,1835 LS	260	09.96		10-ECO001	30-ECO001
1835,1835 L	260	09.96		10-ECO001	30-ECO001
1840 AK	290	04.97		10-ECO001	30-ECO001
1840 K	290	04.97		10-ECO001	30-ECO001
1840 S,1840 LS	290	09.96		10-ECO001	30-ECO001
1840,1840 L	290	09.96		10-ECO001	30-ECO001
1843 AK	315	04.97		10-ECO001	30-ECO001
1843 K	315	04.97		10-ECO001	30-ECO001
1843 S,1843 LS	315	09.96		10-ECO001	30-ECO001
1843,1843 L	315	09.96		10-ECO001	30-ECO001
1848 AK	350	04.97		10-ECO001	30-ECO001
1848 K	350	04.97		10-ECO001	30-ECO001
1848 S,1848 LS	350	09.96		10-ECO001	30-ECO001
1848,1848 L	350	09.96		10-ECO001	30-ECO001
1853 S,1853 LS	390	09.96		10-ECO001	30-ECO001
1853,1853 L	390	09.96		10-ECO001	30-ECO001
1857 L	420	04.97		10-ECO001	30-ECO001
1857 LS	420	04.97		10-ECO001	30-ECO001
2031	230	04.97		10-ECO001	30-ECO001
2031 A	230	04.97		10-ECO001	30-ECO001
2031 AK	203	09.96		10-ECO001	30-ECO001
2031 AS	230	04.96		10-ECO001	30-ECO001
2031 K	230	04.97		10-ECO001	30-ECO001
2031 S	230	04.96		10-ECO001	30-ECO001
2035 A	260	04.97		10-ECO001	30-ECO001
2035 S	260	04.96 → 10.02		10-ECO001	30-ECO001
2040	290	09.96		10-ECO001	30-ECO001
2040 AK	290	09.96		10-ECO001	30-ECO001
2040 AS	290	04.96		10-ECO001	30-ECO001
2040 S	290	04.96		10-ECO001	30-ECO001
2043 AS	315	04.96 → 10.02		10-ECO001	30-ECO001
2048 AS	350	04.96 → 10.02		10-ECO001	30-ECO001
2053 S	390	04.96		10-ECO001	30-ECO001
2531 LS	230	09.96		10-ECO001	30-ECO001
2531,2531 L	230	09.96		10-ECO001	30-ECO001
2535 L	260	09.96		10-ECO001	30-ECO001
2535 LS	260	09.96		10-ECO001	30-ECO001
2535 LS	335	09.02		10-ECO001	30-ECO001
2540 LS	290	09.96		10-ECO001	30-ECO001

NEW CODES - NEUE CODES - NOUVEAUX CODES - NUEVOS CODIGOS - NUOVI CODICI



MERCEDES Comm.

	KW						
				OIL FILTER FILTRO OLIO	AIR FILTER FILTRO ARIA	FUEL FILTER FILTRO CARBURANTE	CABIN FILTER FILTRO ABITACOLO
ACTROS 1996							
2540,2540 L	290	09.96		10-ECO001		30-ECO001	
2543 LS	315	09.96		10-ECO001		30-ECO001	
2543,2543 L	315	09.96		10-ECO001		30-ECO001	
2548 LS	350	09.96		10-ECO001		30-ECO001	
2548,2548 L	350	09.96		10-ECO001		30-ECO001	
2553 LS	390	09.96		10-ECO001		30-ECO001	
2553,2553 L	390	09.96		10-ECO001		30-ECO001	
2557 L	420	09.96		10-ECO001		30-ECO001	
2631 B	230	04.97		10-ECO001		30-ECO001	
2631 K	230	04.97		10-ECO001		30-ECO001	
2631,2631 L	230	04.97		10-ECO001		30-ECO001	
2635 B	260	04.97		10-ECO001		30-ECO001	
2635 K	260	04.97		10-ECO001		30-ECO001	
2635,2635 L	260	04.97		10-ECO001		30-ECO001	
2640 B	290	04.97		10-ECO001		30-ECO001	
2640 K,2640 LK	290	04.97		10-ECO001		30-ECO001	
2640 S,2640 LS	290	09.96		10-ECO001		30-ECO001	
2640,2640 L	290	04.97		10-ECO001		30-ECO001	
2643 B	315	04.97		10-ECO001		30-ECO001	
2643 K,2643 LK	315	04.97		10-ECO001		30-ECO001	
2643 S,2643 LS	315	04.97		10-ECO001		30-ECO001	
2643,2643 L	315	04.97		10-ECO001		30-ECO001	
2648 K,2648 LK	350	04.97		10-ECO001		30-ECO001	
2648 S,2648 LS	350	09.96		10-ECO001		30-ECO001	
2648,2648 L	350	09.96		10-ECO001		30-ECO001	
2653 K,2653 LK	390	04.97		10-ECO001		30-ECO001	
2653 S,2653 LS	390	09.96		10-ECO001		30-ECO001	
2653,2653 L	390	04.97		10-ECO001		30-ECO001	
2657 K,2657 LK	420	04.97		10-ECO001		30-ECO001	
2657 L	420	04.97		10-ECO001		30-ECO001	
2657 S	420	04.97		10-ECO001		30-ECO001	
3231 B	230	04.97		10-ECO001		30-ECO001	
3231 K	230	04.97		10-ECO001		30-ECO001	
3235	260	04.97		10-ECO001		30-ECO001	
3235 B	260	04.97		10-ECO001		30-ECO001	
3235 K	260	04.97		10-ECO001		30-ECO001	
3240	290	04.97		10-ECO001		30-ECO001	
3240 B	290	04.97		10-ECO001		30-ECO001	
3240 K	290	04.97		10-ECO001		30-ECO001	
3243	315	04.97		10-ECO001		30-ECO001	
3243 B	315	04.97		10-ECO001		30-ECO001	
3243 K	315	04.97		10-ECO001		30-ECO001	
3331	230	04.97		10-ECO001		30-ECO001	
3331 A	230	04.97		10-ECO001		30-ECO001	

NEW CODES - NEUE CODES - NOUVEAUX CODES - NUEVOS CODIGOS - NUOVI CODICI

Per nuove applicazioni e novità si prega di accedere al sito www.ashika.eu - For new applications and new items, please go to www.ashika.eu

MERCEDES Comm.



	KW						
				OIL FILTER FILTRO OLIO	AIR FILTER FILTRO ARIA	FUEL FILTER FILTRO CARBURANTE	CABIN FILTER FILTRO ABITACOLO

ACTROS 1996

3331 AK	230	04.97		10-ECO001	30-ECO001
3331 AS	230	04.97		10-ECO001	30-ECO001
3331 B	230	04.97		10-ECO001	30-ECO001
3331 K	230	04.97		10-ECO001	30-ECO001
3331 S	230	04.97		10-ECO001	30-ECO001
3335	260	04.97		10-ECO001	30-ECO001
3335 B	260	04.97		10-ECO001	30-ECO001
3335 K	260	04.97		10-ECO001	30-ECO001
3335 S	260	04.97		10-ECO001	30-ECO001
3340	290	04.97		10-ECO001	30-ECO001
3340 A	290	04.97		10-ECO001	30-ECO001
3340 AK	290	04.97		10-ECO001	30-ECO001
3340 AS	290	04.97		10-ECO001	30-ECO001
3340 B	290	04.97 → 10.02		10-ECO001	30-ECO001
3340 B	290	04.97		10-ECO001	30-ECO001
3340 K	290	04.97		10-ECO001	30-ECO001
3340 S	290	04.97		10-ECO001	30-ECO001
3343	315	04.97		10-ECO001	30-ECO001
3343 AK	315	04.97		10-ECO001	30-ECO001
3343 AS	315	04.97		10-ECO001	30-ECO001
3343 B	315	04.97 → 10.02		10-ECO001	30-ECO001
3343 K	315	04.97		10-ECO001	30-ECO001
3343 S	315	04.97		10-ECO001	30-ECO001
3348	350	04.97		10-ECO001	30-ECO001
3348 AK	350	04.97		10-ECO001	30-ECO001
3348 AS	350	04.97		10-ECO001	30-ECO001
3348 K	350	04.97		10-ECO001	30-ECO001
3348 S	350	04.97		10-ECO001	30-ECO001
3353	390	04.97		10-ECO001	30-ECO001
3353 AS	390	04.97		10-ECO001	30-ECO001
3353 S	390	04.97		10-ECO001	30-ECO001
3357	420	04.97		10-ECO001	30-ECO001
3357 S	420	04.97		10-ECO001	30-ECO001
4140 AK	290	04.97		10-ECO001	30-ECO001
4140 B	290	04.97		10-ECO001	30-ECO001
4140 K	290	04.97		10-ECO001	30-ECO001
4140 K	290	04.97		10-ECO001	30-ECO001
4143 AK	315	04.97		10-ECO001	30-ECO001
4143 K	315	04.97		10-ECO001	30-ECO001
4143 K	315	04.97		10-ECO001	30-ECO001
4148 AK	350	04.97		10-ECO001	30-ECO001
4148 K	350	04.97		10-ECO001	30-ECO001
4148 K	350	04.97		10-ECO001	30-ECO001
521831,1831 L	230	09.96		10-ECO001	30-ECO001

NEW CODES - NEUE CODES - NOUVEAUX CODES - NUEVOS CODIGOS - NUOVI CODICI



MERCEDES Comm.

	KW						
				OIL FILTER FILTRO OLIO	AIR FILTER FILTRO ARIA	FUEL FILTER FILTRO CARBURANTE	CABIN FILTER FILTRO ABITACOLO

ACTROS 2003

1832	235	04.03		10-ECO001		30-ECO001	
1832 LS	235	04.03		10-ECO001		30-ECO001	
1832, L, LL	235	04.03		10-ECO001		30-ECO001	
1832, L, LL	265	04.03		10-ECO001		30-ECO001	
1836 AK	235	04.03		10-ECO001		30-ECO001	
1836 K	265	04.03		10-ECO001		30-ECO001	
1836 LS	265	04.03		10-ECO001		30-ECO001	
1836, L, LL	265	04.03		10-ECO001		30-ECO001	
1836, L, LL	300	04.03		10-ECO001		30-ECO001	
1841 K	300	04.03		10-ECO001		30-ECO001	
1841, L, LL	300	04.03		10-ECO001		30-ECO001	
1841, L, LL	300	04.03		10-ECO001		30-ECO001	
1841, L, LL	320	04.03		10-ECO001		30-ECO001	
1841, L, LL	335	04.03		10-ECO001		30-ECO001	
1844 K	320	04.03		10-ECO001		30-ECO001	
1844 LS	320	04.03		10-ECO001		30-ECO001	
1844, L, LL	320	04.03		10-ECO001		30-ECO001	
1846 K	335	04.03		10-ECO001		30-ECO001	
1846 LS	335	04.03		10-ECO001		30-ECO001	
1846, L, LL	335	04.03		10-ECO001		30-ECO001	
1846, L, LL	370	04.03		10-ECO001		30-ECO001	
1850 K	370	04.03		10-ECO001		30-ECO001	
1850 LS	370	04.03		10-ECO001		30-ECO001	
1850, L, LL	370	04.03		10-ECO001		30-ECO001	
1850, L, LL	395	04.03		10-ECO001		30-ECO001	
1854, L	425	04.03		10-ECO001		30-ECO001	
1854, L, LL	395	04.03		10-ECO001		30-ECO001	
1858, L	425	04.03		10-ECO001		30-ECO001	
2032	230	04.03		10-ECO001			
2032 A	230	04.03		10-ECO001			
2032 A	235	04.03		10-ECO001		30-ECO001	
2032 AK	230	04.03		10-ECO001			
2032 K	230	04.03		10-ECO001			
2032 S	230	04.03		10-ECO001			
2036	260	04.03		10-ECO001			
2036 A	260	04.03		10-ECO001			
2036 S	260	04.03		10-ECO001			
2041	290	04.03		10-ECO001			
2041 AK	290	04.03		10-ECO001			
2041 K	290	04.03		10-ECO001			
2041 S	290	04.03		10-ECO001			
2044	315	04.03		10-ECO001			
2044 S	315	04.03		10-ECO001			
2046	335	04.03		10-ECO001			

NEW CODES - NEUE CODES - NOUVEAUX CODES - NUEVOS CODIGOS - NUOVI CODICI

Per nuove applicazioni e novità si prega di accedere al sito www.ashika.eu - For new applications and new items, please go to www.ashika.eu

MERCEDES Comm.



	KW			 OIL FILTER FILTRO OLIO	 AIR FILTER FILTRO ARIA	 FUEL FILTER FILTRO CARBURANTE	 CABIN FILTER FILTRO ABITACOLO
--	----	--	--	-------------------------------	-------------------------------	--------------------------------------	--------------------------------------

ACTROS 2003

2046 S	335	04.03		10-ECO001
2050 S	370	04.03		10-ECO001
2532, L	235	04.03		10-ECO001
2536, L	265	04.03		10-ECO001
2541, L	290	04.03		10-ECO001
2544, L	315	04.03		10-ECO001
2546, L	335	04.03		10-ECO001
2632 K	235	04.03		10-ECO001
2632 LS	235	04.03		10-ECO001
2636 K	265	04.03		10-ECO001
2636 LS	265	04.03		10-ECO001
2636, L	265	04.03		10-ECO001
2641 K	300	04.03		10-ECO001
2641 S, LS	300	04.03		10-ECO001
2641, L	300	04.03		10-ECO001
2644 K	320	04.03		10-ECO001
2644 S, LS	320	04.03		10-ECO001
2644, L	320	04.03		10-ECO001
2646 K	335	04.03		10-ECO001
2646 S, LS	335	04.03		10-ECO001
2646, L	335	04.03		10-ECO001
2650 K	370	04.03		10-ECO001
2650 S, LS	370	04.03		10-ECO001
2650, L	370	04.03		10-ECO001
2654 K	395	04.03		10-ECO001
2654 S, LS	395	04.03		10-ECO001
2654, L	395	04.03		10-ECO001
2658 K	425	04.03		10-ECO001
2658 L	425	04.03		10-ECO001
2658 LS	425	04.03		10-ECO001

ATEGO 2

1016, 1016 L	115	10.04		10-ECO020
1018 A	130	10.04		10-ECO020
1018, 1018 L	130	10.04		10-ECO020
1022, 1022 L	160	10.04		10-ECO020
1023 A, 1024 A	1700	10.04		10-ECO034
1023, 1023 L, 1024, 1024 L	1700	10.04		10-ECO034
1215, 1215 L, 1216, 1216 L	1120	10.04		10-ECO020
1218, 1218 L	130	10.04		10-ECO020
1222, 1222 L	160	10.04		10-ECO020
1223, 1223 L, 1224, 1224 L	1700	10.04		10-ECO034
1226, 1226 L	188	10.04		10-ECO034
1228, 1228 L, 1229, 1229 L	2050	10.04		10-ECO034
1318 A	130	10.04		10-ECO020

NEW CODES - NEUE CODES - NOUVEAUX CODES - NUEVOS CODIGOS - NUOVI CODICI



MERCEDES Comm.

	KW						
				OIL FILTER FILTRO OLIO	AIR FILTER FILTRO ARIA	FUEL FILTER FILTRO CARBURANTE	CABIN FILTER FILTRO ABITACOLO

ATEGO 2

1318, 1318 L	130	10.04		10-ECO020
1322 LS	160	10.04		10-ECO020
1322, 1322 L	160	10.04		10-ECO020
1323 A, 1324 A	1700	10.04		10-ECO034
1323 LS, 1324 LS	1700	10.04		10-ECO034
1323, 1323 L, 1324, 1324 L	1700	10.04		10-ECO034
1326 LS	188	10.04		10-ECO034
1326, 1326 L	188	10.04		10-ECO034
1328 LS, 1329 LS	2050	10.04		10-ECO034
1328, 1328 L, 1329, 1329 L	2050	10.04		10-ECO034
1518 A	130	10.04		10-ECO020
1518, 1518 L	130	10.04		10-ECO020
1522, 1522 L	160	10.04		10-ECO020
1523 A, 1524 A	1700	10.04		10-ECO034
1523, 1523 L, 1524, 1524 L	1700	10.04		10-ECO034
1526, 1526 L	188	10.04		10-ECO034
1528, 1528 L, 1529, 1529 L	2050	10.04		10-ECO034
712, 713	900	10.04		10-ECO020
715, 715 L, 716, 716 L	1120	10.04		10-ECO020
812, 813	900	10.04		10-ECO020
815 K, 816 K	1120	10.04		10-ECO020
815 K, 816 K	1120	10.04		10-ECO020
815, 815 L, 816, 816 L	1120	10.04		10-ECO020
818, 818 L	130	10.04		10-ECO020
818, 818 L	130	10.04		10-ECO020
822, 822 L	160	10.04		10-ECO020
822, 822 L	160	10.04		10-ECO020
823, 823 L, 824, 824 L	1700	01.98		10-ECO034
915, 915 L, 916, 916 L	1120	10.04		10-ECO020
918, 918 L	130	10.04		10-ECO020
922, 922 L	160	10.04		10-ECO020
923, 923 L, 924, 924 L	1700	10.04		10-ECO034

ATEGO I

1017 A	125	01.98		10-ECO020	30-ECO003
1017 AK	125	01.98		10-ECO020	30-ECO003
1017 K	125	01.98		10-ECO020	30-ECO003
1017 K	125	01.98		10-ECO020	30-ECO003
1017 KO	125	01.98		10-ECO020	30-ECO003
1017,1017 L	125	01.98		10-ECO020	30-ECO003
1023,1023 L	170	01.98		10-ECO034	30-ECO003
1214, 1214 L	100	01.98 → 10.04		10-ECO020	30-ECO003
1215 K	112	01.98		10-ECO020	30-ECO003
1215,1215 L	112	01.98		10-ECO020	30-ECO003
1217 K	125	01.98		10-ECO020	30-ECO003

NEW CODES - NEUE CODES - NOUVEAUX CODES - NUEVOS CODIGOS - NUOVI CODICI

Per nuove applicazioni e novità si prega di accedere al sito www.ashika.eu - For new applications and new items, please go to www.ashika.eu

MERCEDES Comm.



	KW			 OIL FILTER FILTRO OLIO	 AIR FILTER FILTRO ARIA	 FUEL FILTER FILTRO CARBURANTE	 CABIN FILTER FILTRO ABITACOLO
--	----	--	--	-------------------------------	-------------------------------	--------------------------------------	--------------------------------------

ATEGO I

1217 KO	125	01.98		10-ECO020	30-ECO003
1217,1217 L	125	01.98		10-ECO020	30-ECO003
1223,1223 L	170	01.98		10-ECO034	30-ECO003
1225 AF	180	01.98		10-ECO034	30-ECO003
1225 F	180	01.98		10-ECO034	30-ECO003
1228,1228 L	205	01.98		10-ECO034	30-ECO003
1317 A	125	01.98		10-ECO020	30-ECO003
1317 AK	125	01.98		10-ECO020	30-ECO003
1317 K	125	01.98		10-ECO020	30-ECO003
1317 KO	125	01.98		10-ECO020	30-ECO003
1317,1317 L	125	01.98		10-ECO020	30-ECO003
1323 KO	170	01.98		10-ECO034	30-ECO003
1323 LS	170	01.98		10-ECO034	30-ECO003
1323,1323 L	170	01.98		10-ECO034	30-ECO003
1325 AF	180	01.98		10-ECO034	30-ECO003
1325 F	180	01.98		10-ECO034	30-ECO003
1328 AF	205	01.98		10-ECO034	30-ECO003
1328 F	205	01.98		10-ECO034	30-ECO003
1328 LS	205	01.98		10-ECO034	30-ECO003
1328,1328 L	205	01.98		10-ECO034	30-ECO003
1517 A	125	01.98		10-ECO020	
1517 K	125	01.98		10-ECO020	30-ECO003
1517,1517 L	125	01.98		10-ECO020	30-ECO003
1523 A	170	01.98		10-ECO034	30-ECO003
1523 AK	170	01.98		10-ECO034	
1523 K	170	01.98		10-ECO034	30-ECO003
1523 KO	170	01.98		10-ECO034	30-ECO003
1523,1523 L	170	01.98		10-ECO034	30-ECO003
1525 AF	180	01.98		10-ECO034	30-ECO003
1528 AF	205	01.98		10-ECO034	30-ECO003
1528 F	205	01.98		10-ECO034	30-ECO003
1528,1528 L	205	01.98		10-ECO034	30-ECO003
712	90	01.98		10-ECO020	30-ECO003
714	100	01.98		10-ECO020	
715,715 L	112	01.98		10-ECO020	30-ECO003
717	125	01.98		10-ECO020	30-ECO003
812	90	01.98		10-ECO020	30-ECO003
814, 814 L	100	01.98 → 10.04			30-ECO003
815 F	112	01.98		10-ECO020	30-ECO003
815 K	112	01.98		10-ECO020	30-ECO003
815 K	112	01.98		10-ECO020	30-ECO003
815,815 L	112	01.98		10-ECO020	30-ECO003
815,815 L	112	01.98		10-ECO020	30-ECO003
817 K	125	01.98		10-ECO020	30-ECO003

NEW CODES - NEUE CODES - NOUVEAUX CODES - NUEVOS CODIGOS - NUOVI CODICI



MERCEDES Comm.

	KW						
				OIL FILTER FILTRO OLIO	AIR FILTER FILTRO ARIA	FUEL FILTER FILTRO CARBURANTE	CABIN FILTER FILTRO ABITACOLO

ATEGO I

817 K	125	01.98		10-ECO020	30-ECO003
817,817 L	125	01.98		10-ECO020	30-ECO003
817,817 L	125	01.98		10-ECO020	30-ECO003
823 K	170	01.98		10-ECO034	30-ECO003
823,823 L	170	01.98		10-ECO034	30-ECO003
917 AF	125	01.98		10-ECO020	30-ECO003
917 K	125	01.98		10-ECO020	30-ECO003
917,917 L	125	01.98		10-ECO020	30-ECO003
923 K	170	01.98		10-ECO034	30-ECO003
923,923 L	170	01.98		10-ECO034	
925 AF	205	01.98		10-ECO034	

ATEGO II

1823 AK	170	05.98 → 09.04		10-ECO034	30-ECO003
1823 K	170	05.98 → 09.04		10-ECO034	30-ECO003
1823 LS	170	05.98 → 09.04		10-ECO034	30-ECO003
1823,1823 L	170	01.98 → 09.04		10-ECO034	30-ECO003
1828 A	205	05.98 → 09.04		10-ECO034	30-ECO003
1828 AK	205	05.98 → 09.04		10-ECO034	30-ECO003
1828 K	205	05.98 → 09.04		10-ECO034	30-ECO003
1828 LS	205	05.98 → 09.04		10-ECO034	30-ECO003
1828,1828 L	205	05.98 → 09.04		10-ECO034	30-ECO003
2523 L	205	05.98 → 09.04		10-ECO034	30-ECO003
2528 L	205	05.98 → 09.04		10-ECO034	30-ECO003
2628	205	05.98 → 09.04		10-ECO034	30-ECO003
2628 B	205	05.98 → 09.04		10-ECO034	30-ECO003
2628 K	205	05.98 → 09.04		10-ECO034	30-ECO003

AXOR

1823	170	01.02		10-ECO034	
1823 K	170	01.02		10-ECO034	
1835 LS	260	01.02		10-ECO084	30-ECO001
1840 LS	295	01.02		10-ECO084	30-ECO001
1843 LS	315	01.02		10-ECO084	30-ECO001
2523	170	01.02		10-ECO034	
2523 K	170	01.02		10-ECO034	
2528	205	01.02		10-ECO034	
2535 LS	260	01.02			30-ECO001
2535 LS	260	01.02 → 10.04		10-ECO084	
2540 LS	295	01.02			30-ECO001
2540 LS	295	01.02 → 10.04		10-ECO084	
2543 LS	315	01.02			30-ECO001
2543 LS	315	01.02 → 10.04		10-ECO084	
2623 L	170	01.02		10-ECO034	
2628 B	205	01.02		10-ECO034	
2628 K	205	01.02		10-ECO034	

NEW CODES - NEUE CODES - NOUVEAUX CODES - NUEVOS CODIGOS - NUOVI CODICI

Per nuove applicazioni e novità si prega di accedere al sito www.ashika.eu - For new applications and new items, please go to www.ashika.eu

MERCEDES Comm.



	KW						
				OIL FILTER FILTRO OLIO	AIR FILTER FILTRO ARIA	FUEL FILTER FILTRO CARBURANTE	CABIN FILTER FILTRO ABITACOLO

AXOR

2628 L	205	01.02		10-ECO034	
3228	205	01.02		10-ECO034	

AXOR 2

1836 LS	265	10.04		10-ECO084	
1840 LS	295	10.04		10-ECO084	
1843 LS	315	10.04		10-ECO084	
2436 LS	2600	10.04		10-ECO084	
2440 LS	295	10.04		10-ECO084	
2443 LS	315	10.04		10-ECO084	
2536 L	265	10.04		10-ECO084	
2540 L	295	10.04		10-ECO084	
2543 L	315	10.04		10-ECO084	
2636	265	10.04		10-ECO084	
2640	295	10.04		10-ECO084	
2643	315	10.04		10-ECO084	
3243	315	03.05		10-ECO084	
3335	260	10.04		10-ECO084	
3340	295	10.04		10-ECO084	
3340 B	315	10.04		10-ECO084	
3340 K	295	10.04		10-ECO084	
3343	315	10.04		10-ECO084	

CITARO (O 530)

Citaro	180	04.99		10-ECO034	30-ECO001
Citaro	220	01.98		10-ECO034	30-ECO001
Citaro	260	01.98		10-ECO034	30-ECO001
Citaro G	185	01.98		10-ECO034	30-ECO001
Citaro G	205	01.99		10-ECO034	
Citaro N	170	01.98		10-ECO034	30-ECO001
Citaro N	185	01.98		10-ECO034	30-ECO001
Citaro N	205	01.98		10-ECO034	30-ECO001
Citaro N	205	01.99		10-ECO034	30-ECO001

CITO (O 520)

177 kW	130	06.99		10-ECO020	30-ECO003
--------	-----	-------	--	-----------	-----------

CONECTO (O 345)

CONECTO C, H, M, UE	185	11.01		10-ECO034	30-ECO001
CONECTO C, H, M, UE	220	11.01		10-ECO034	30-ECO001
CONECTO C, H, M, UE	260	11.01		10-ECO034	30-ECO001
CONECTO C, H, UE	205	11.01		10-ECO034	30-ECO001







ECONIC

1823 LL	170	03.98		10-ECO034	30-ECO003
1828 LL	205	03.98		10-ECO034	30-ECO003
2628	205	01.98		10-ECO034	30-ECO003
2628 LL	205	03.98		10-ECO034	30-ECO003

NEW CODES - NEUE CODES - NOUVEAUX CODES - NUEVOS CODIGOS - NUOVI CODICI



MERCEDES Comm.







	KW						
				OIL FILTER FILTRO OLIO	AIR FILTER FILTRO ARIA	FUEL FILTER FILTRO CARBURANTE	CABIN FILTER FILTRO ABITACOLO
LK/LN2							
1117 K	125	03.96 → 12.98		10-ECO020			
1117 LO	125	03.96 → 12.98		10-ECO020			
1117 S	125	03.96 → 12.98		10-ECO020			
1117,1117 L	125	01.84 → 12.98		10-ECO020			
1317 K	125	03.96 → 12.98		10-ECO020		30-ECO003	
1317 KO	125	03.96 → 12.98		10-ECO020		30-ECO003	
1317 LS	125	03.96 → 12.98		10-ECO020		30-ECO003	
1317,1317 L	125	01.84 → 12.98		10-ECO020			
1517 K	125	03.96 → 12.98		10-ECO020		30-ECO003	
711	90	03.96 → 12.98		10-ECO020		30-ECO003	
811	90	03.96 → 12.98		10-ECO020		30-ECO003	
811 K	77	03.94 → 12.98		10-ECO020		30-ECO003	
811 K	90	03.96 → 12.98		10-ECO020		30-ECO003	
814 F	100	03.96 → 12.98		10-ECO020		30-ECO003	
814 K	100	03.96 → 12.98		10-ECO020		30-ECO003	
814 LO	100	03.96 → 12.98		10-ECO020		30-ECO003	
814 S	100	03.96 → 12.98		10-ECO020		30-ECO003	
814,814L	100	01.84 → 12.98		10-ECO020			
817 F	125	03.96 → 12.98		10-ECO020		30-ECO003	
817 K	125	03.96 → 12.98		10-ECO020		30-ECO003	
817 LO	125	03.96 → 12.98		10-ECO020		30-ECO003	
817 S,817 LS	125	01.84 → 12.98				30-ECO003	
817,817 L	125	03.96 → 12.98		10-ECO020		30-ECO003	
917	125	03.96 → 12.98		10-ECO020			
917 K	125	03.96 → 12.98		10-ECO020			
917 KO	125	03.96 → 12.98		10-ECO020			
TRAVEGO (O 580)							
O 580-15 RHD	310	10.99				30-ECO001	
O 580-17 RHD	310	10.99		10-ECO001		30-ECO001	
O 580-17 RHD	320	10.99		10-ECO001		30-ECO001	
O 580-17 RHD	350	10.99		10-ECO001		30-ECO001	
O 580/15 RH	260	10.99		10-ECO001		30-ECO001	
UNIMOG							
U 300	130	03.00		10-ECO020		30-ECO003	
U 3000	110	09.02		10-ECO020		30-ECO003	
U 400	130	03.00		10-ECO020		30-ECO003	
U 5000	160	09.02		10-ECO020		30-ECO003	
U 90	85	07.96		10-ECO031			
U300	110	03.00		10-ECO020		30-ECO003	
UX 100H,UX 100M	80	09.96		10-ECO031			
VARIO							
512 D	90	09.96		10-ECO031			
512 D	90	09.96		10-ECO031			
612 D	90	09.96		10-ECO031			

NEW CODES - NEUE CODES - NOUVEAUX CODES - NUEVOS CODIGOS - NUOVI CODICI







Per nuove applicazioni e novità si prega di accedere al sito www.ashika.eu - For new applications and new items, please go to www.ashika.eu

MERCEDES Comm.



	KW			 OIL FILTER FILTRO OLIO	 AIR FILTER FILTRO ARIA	 FUEL FILTER FILTRO CARBURANTE	 CABIN FILTER FILTRO ABITACOLO
VARIO							
612 D	90	09.96		10-ECO031			
612 D	90	09.96		10-ECO031			
614 D	100	09.96		10-ECO020			
614 D	100	09.96		10-ECO020			
614 D	100	09.96		10-ECO020			
615 D	112	09.98		10-ECO020		30-ECO003	
615 D	112	09.98		10-ECO020		30-ECO003	
615 D	112	09.98		10-ECO020		30-ECO003	
810 DT	75	09.96		10-ECO020		30-ECO003	
812 D	90	09.96		10-ECO031			
812 D	90	09.96		10-ECO031			
812 D	90	09.96		10-ECO031			
812 DT	100	09.96		10-ECO031			
812 DT	112	09.96		10-ECO031			
814 D	100	09.96		10-ECO020		30-ECO003	
814 D	100	09.96		10-ECO020		30-ECO003	
814 D	100	09.96		10-ECO020		30-ECO003	
814 DA	100	09.96		10-ECO020		30-ECO003	
814 DA	100	09.96		10-ECO020		30-ECO003	
814D	100	09.96		10-ECO020		30-ECO003	
815 D	112	09.96		10-ECO020		30-ECO003	
815 D	112	09.96		10-ECO020		30-ECO003	
815 D	112	09.96		10-ECO020		30-ECO003	
815 DA	112	09.96		10-ECO020		30-ECO003	
815 DA	112	09.96		10-ECO020		30-ECO003	
815 DA	112	09.96		10-ECO020		30-ECO003	
O 810	75	09.96		10-ECO020		30-ECO003	
O 812	90	09.96		10-ECO031			
O 814	100	09.96		10-ECO020		30-ECO003	
O 815	112	09.96		10-ECO020		30-ECO003	

NEW CODES - NEUE CODES - NOUVEAUX CODES - NUEVOS CODIGOS - NUOVI CODICI

	KW						
				OIL FILTER FILTRO OLIO	AIR FILTER FILTRO ARIA	FUEL FILTER FILTRO CARBURANTE	CABIN FILTER FILTRO ABITACOLO
MG ZT							
2.0 CDTi	85	06.02 → 09.03	204D2	10-ECO021			
2.0 CDTi	96	11.02	204D2	10-ECO021			
MG ZT- T							
2.0 CDTi	85	06.02 → 09.03	204D2	10-ECO021			
2.0 CDTi	96	11.02	204D2	10-ECO021			

	KW			 OIL FILTER FILTRO OLIO	 AIR FILTER FILTRO ARIA	 FUEL FILTER FILTRO CARBURANTE	 CABIN FILTER FILTRO ABITACOLO
---	-----------	---	---	--	--	---	---

MINI

Cooper	88	10.06	N12B16A	10-ECO060
Cooper S	128	10.06	N14 B16 A	10-ECO060
One	70	03.07	N12B14A	10-ECO060

MINI (R56)

Cooper	90	03.10	N16 B16 A	10-ECO060
Cooper S	135	03.10	N18 B16 A	10-ECO060
John Cooper Works	155	03.08	N14 B16 C	10-ECO060
One	55	03.09	N12B14A	10-ECO060
One	55	03.10		10-ECO060
One	72	03.10		10-ECO060

MINI Cabriolet (R57)

Cooper	88	03.09	N12B16A	10-ECO060
Cooper	90	03.10	N16 B16 A	10-ECO060
Cooper S	128	03.09	N14 B16 A	10-ECO060
Cooper S	135	03.10	N18 B16 A	10-ECO060
John Cooper Works	155	03.08	N14 B16 C	10-ECO060
One	72	03.10		10-ECO060







MINI CLUBMAN

Cooper	88	10.07	N12B16A	10-ECO060
Cooper	90	03.10	N16 B16 A	10-ECO060
Cooper S	120	10.07	N14 B16 A	10-ECO060
Cooper S	128	10.07	N14 B16 A	10-ECO060
Cooper S	135	03.10	N18 B16 A	10-ECO060
John Cooper Works	155	03.08	N14 B16 C	10-ECO060
One	70	03.10	N12B14A	10-ECO060

MINI COUNTRYMAN (R60)

COOPER	90	06.10	N16 B16 A	10-ECO060
COOPER S	135	06.10	N18 B16 A	10-ECO060
COOPER S ALL4	135	06.10	N18 B16 A	10-ECO060
ONE	72	06.10		10-ECO060



	KW						
				OIL FILTER FILTRO OLIO	AIR FILTER FILTRO ARIA	FUEL FILTER FILTRO CARBURANTE	CABIN FILTER FILTRO ABITACOLO
3000 GT (Z16A)							
3.0 i 24V 4x4	210	06.92 → 08.99	6G72	10-07-703	20-05-598	30-05-518	
ASX							
1.6	86	08.10	4A92	10-03-316	20-05-531		21-MI-MI7
1.8 4WD	102	02.10	4B10	10-03-316	20-05-531		21-MI-MI7
1.8 DI-D	110	08.10	4N13	10-03-316	20-02-299		21-MI-MI7
CARISMA (DA_) \ Tre volumi (DA_)							
1.6	66	07.95 → 06.06	4 G 92	10-03-316	20-05-589 →06.97	30-05-590	21-MI-MI0
1.6	70	12.98 → 06.06	4 G 92	10-03-316	20-05-589	30-05-590	21-MI-MI2
1.6	73	05.97 → 06.06	4 G 92	10-03-316	20-05-589 06.97→ →06.99	30-05-590	21-MI-MI0
1.6	76	09.00 → 06.06	4 G 92	10-03-316	20-05-589	30-05-590	21-MI-MI2
1.8	85	07.95 → 06.06	4G93	10-03-316	20-05-589 →06.98	30-05-590	21-MI-MI0
1.8 16V	103	07.95 → 06.06	4G93	10-05-510	20-05-589	30-05-590	21-MI-MI0
1.8 16V GDI	92	09.97 → 06.06	4G93	10-03-316	20-05-589 →06.99	30-05-590	21-MI-MI0
1.8 GDI	90	10.00 → 06.06	4G93	10-03-316	20-05-589	30-05-590	21-MI-MI0
1.9 DI-D	75	09.00 → 06.06	F9Q1	10-05-595	20-05-588	30-ECO015	21-MI-MI0
1.9 DI-D	85	09.00 → 06.06	F9Q2	10-05-595	20-05-588	30-ECO015	21-MI-MI0
1.9 TD	66	10.96 → 09.00	F8QT	10-05-595	20-05-588	30-05-578	21-MI-MI0
2.0 16V GT EVO VI/VII	206	11.99 → 06.06	4 G 63 Turbo	10-03-316	20-05-587	30-05-590	21-MI-MI0
CELESTE (A7_)							
1.6 ST (A73)	54	01.77 → 06.81	4G32	10-05-502	20-05-501	30-05-501	
2.0 GSR (A78)	66	10.75 → 06.81	4G52	10-05-502	20-02-201	30-05-501	
2.0 GSR (A78)	71	01.77 → 06.81	4G52	10-05-502	20-02-201	30-05-501	
2.0 GSR (A78)	77	01.79 → 06.81	4G52	10-05-502	20-02-201	30-05-501	
COLT CZC Cabriolet							
1.5	80	05.06	4A91	10-M0-001	20-M0-001		21-SM-SM1
1.5 Turbo	110	05.06	4G15T	10-M0-001	20-M0-001		21-SM-SM1
COLT I (A15_A)							
1.2 GL (A151A)	40	12.78 → 01.84	4 G 11	10-05-502	20-05-502	30-05-501	
1.4 GLX,GT (A152A)	51	05.79 → 01.84	4 G 12	10-05-502	20-05-502	30-05-501 30-05-504	
1.4 Turbo (A152A)	77	09.81 → 01.84	4 G 12 T	10-05-502	20-05-510	30-05-501 30-05-504	
COLT II (C1_A)							
1.2 EL,GL (C15A)	40	02.84 → 09.86	4G16	10-05-502	20-05-510	30-05-512	
1.2 EL,GL (C15A)	44	09.86 → 04.88	4G16	10-05-502	20-05-510	30-05-512	
1.3 EL,GL (C11A)	49	06.86 → 04.88	G13B	10-05-502	20-05-510	30-05-512	
1.5 GLX (C12A)	51	09.85 → 04.88	G15B	10-05-502	20-05-510	30-05-501	
1.5 GLX (C12A)	55	09.84 → 04.88	4 G 15	10-05-502	20-05-510	30-05-501	
1.6 Turbo ECi (C13A)	77	07.86 → 04.88	G32BT	10-05-502	20-05-509	30-05-512	
1.6 Turbo ECi (C13A)	92	02.84 → 04.88	4 G 32 T/C	10-05-502	20-05-509	30-05-501	

NEW CODES - NEUE CODES - NOUVEAUX CODES - NUEVOS CODIGOS - NUOVI CODICI

	KW						
				OIL FILTER FILTRO OLIO	AIR FILTER FILTRO ARIA	FUEL FILTER FILTRO CARBURANTE	CABIN FILTER FILTRO ABITACOLO

COLT II (C1_A)

1.8 GL Diesel (C14A)	43	02.84 → 09.86	4 D 65	10-05-503	20-05-513	30-05-502MP 30-05-502
1.8 GL Diesel (C14A)	44	09.86 → 04.88	4 D 65	10-05-505P 10-05-505	20-05-513	30-05-509

COLT III (C5_A)

1.3 (C51A)	51	04.88 → 05.92	4 G 13	10-05-502 →06.90	20-05-510 →06.90	30-05-512 →06.90
1.3 12V (C51A)	55	04.88 → 05.92	4 G 13 (BJ90-92, 12V)	10-05-502	20-05-525 01.90→ 20-05-597 06.90→	30-05-512
1.3 GL	44	04.88 → 12.90	4 G 13	10-05-502	20-05-510	30-05-512
1.5 (C52A) Cat.	66	07.90 → 05.92	4 G 15	10-05-502	20-05-525 20-05-597	30-02-224
1.5 GLXi (C52A)	62	04.88 → 05.92	4 G 15	10-05-502 →06.90	20-05-516 →06.90	30-08-887
1.6 GTi 16V (C53A)	91	04.88 → 05.90	4G61	10-03-316	20-05-596	30-05-588
1.8 Diesel GLX (C54A)	44	04.88 → 05.92	4 D 65	10-05-505P 10-05-505	20-05-513	30-05-509
1.8 GTi 16V (C58A) Cat.	100	06.90 → 05.92	4G67	10-05-502	20-05-516	30-08-887

COLT IV (CA_A)

1.3 GLi 12V (CA1A)	55	04.92 → 04.96	4 G 13 (BJ92-..., 12V)	10-03-316	20-05-525 20-05-596 06.92→	30-02-224	21-MI-MIO
1.6	66	02.94 → 04.96	4 G 92	10-05-502	20-05-516	30-02-224	21-MI-MIO
1.6 GLXi 16V (CA4A)	83	04.92 → 04.96	4 G 92	10-03-316	20-05-525 20-05-596	30-02-224	21-MI-MIO
1.8 GTi 16V (CA5A)	103	04.92 → 04.96	4G93	10-03-316	20-05-596	30-05-588	21-MI-MIO

COLT LANCER (A7_) Station Wagon (A7_K)

1.2	40	01.78 → 09.79	4G36	10-05-502	20-05-501	30-05-501
1.4	50	01.78 → 09.79	4G33	10-05-502	20-05-501	30-05-501
1.6	60	01.78 → 09.79	4G32 GS	10-05-502	20-05-501	30-05-501

COLT V (CJ_A)

1300	60	09.00 → 07.05	4 G 13 (16V)	10-03-316	20-05-587	30-05-590	21-MI-MIO
1300 GL, GLX (CJ1A)	55	05.96 → 09.00	4 G 13 (BJ90-92, 12V)	10-05-510	20-05-587	30-05-590	21-MI-MIO
1500 (CJ2A)	69	11.95 → 07.05	4 G 15 (16V)	10-05-502	20-05-587	30-05-501	21-MI-MI2
1600	76	09.00 → 07.05	4 G 92	10-03-316	20-05-587	30-05-590	21-MI-MIO
1600 GLX (CJ4A)	66	05.96 → 09.00	4 G 92	10-05-510	20-05-587	30-05-590	21-MI-MIO

COLT VI

1.1	55	10.04	3A91	10-M0-001	20-M0-001	30-05-523 Nel serbatoio carb. /Inside tank fuel	21-SM-SM1
1.3	70	06.04	4A90	10-M0-001	20-M0-001	30-05-523 Nel serbatoio carb. /Inside tank fuel	21-SM-SM1
1.5	80	06.04	4A91	10-M0-001	20-M0-001	30-05-523 Nel serbatoio carb. /Inside tank fuel	21-SM-SM1



	KW						
				OIL FILTER FILTRO OLIO	AIR FILTER FILTRO ARIA	FUEL FILTER FILTRO CARBURANTE	CABIN FILTER FILTRO ABITACOLO

COLT VI

1.5 CZT	110	03.05	4G15T	10-M0-001	20-M0-001	30-05-523 Nel serbatoio carb. /Inside tank fuel	21-SM-SM1
1.5 DI-D	50	08.04		10-M0-003	20-M0-001	30-M0-002	21-SM-SM1
1.5 DI-D	70	08.04	OM639	10-M0-003	20-M0-001	30-M0-002	21-SM-SM1

COLT VII (CZ)

1.5 Ralliart (Z37AM)	110	09.08	4G15T	10-05-502	20-M0-001		21-SM-SM1
----------------------	-----	-------	-------	-----------	-----------	--	-----------

CORDIA (A21_A)

1.6 GSL (A212A)	55	10.82 → 12.86	4G32	10-05-502	20-05-510	30-05-501	
1.6 Turbo (A212A)	84	10.82 → 05.85	4G32 T	10-05-502	20-05-510	30-05-501	
1.6 Turbo (A212A)	85	07.83 → 05.85	4G32 T	10-05-502	20-05-510	30-05-501	
1.8 GSL (A215A)	66	10.86 → 12.86	4G37	10-05-502	20-05-512	30-05-501	
1.8 Turbo ECi (A213A)	100	10.84 → 12.86	4G62 T	10-05-502	20-05-509	30-05-514	

ECLIPSE I (D2_A)

2.0 i 16V (D22A)	110	04.91 → 11.95	4 G 63	10-03-316	20-05-516	30-02-224	
2.0 i 16V 4x4	110	04.91 → 11.95	4 G 63	10-03-316	20-05-516	30-02-224	

ECLIPSE II (D3_)

2000 GS 16V	107	12.95 → 04.99	4 G 63	10-05-510	20-05-599	30-02-224	
2000 GT 16V	157	12.95 → 04.99		10-05-510	20-05-599	30-02-224	
2400 GS 16V	105	09.98 → 04.99		10-05-510	20-05-599	30-02-224	

GALANT I (A12_) \ Station Wagon (A12_V)

1.6	55	01.77 → 08.80	4G32	10-05-502	20-05-501	30-05-501	
2.0	72	01.79 → 08.80	4G52	10-05-502	20-02-201	30-05-501	
2.0 GLX	63	01.77 → 08.80	4G52	10-05-502	20-02-201	30-05-501	

GALANT II (A16_) \ Station Wagon (A16_V)

1.6 GLX (A161A)	55	09.80 → 05.84	4G32	10-05-502	20-05-501	30-05-501	
2.0 GLS (A163)	75	09.80 → 05.84	4G63	10-05-502	20-05-504	30-05-501	
2.0 Turbo ECi (A164)	125	05.82 → 05.84	4 G 63 T (ECi)	10-05-502	20-05-509	30-05-501	
2.3 Turbo-D (A167)	62	09.80 → 05.84	4 D 55 T	10-05-503	20-05-508	30-05-502MP 30-05-502	

GALANT III (E1_A)

1.6 GLX (E11A)	55	06.84 → 12.87	4G32	10-05-502	20-05-512	30-05-512	
1.8 Turbo-D (E14A)	60	06.84 → 12.87	4 D 65 T	10-05-503	20-05-515	30-05-509	
2.0 GLS (E15A)	66	06.86 → 12.87	G63B	10-05-502	20-05-512	30-05-501	
2.0 GLS (E15A)	75	06.84 → 12.87	4G63	10-05-502	20-05-512	30-05-512	
2.0 Turbo ECi (E15A)	110	06.84 → 05.85	4 G 63 T	10-05-502	20-05-509	30-02-224	
2.4 GLS (E16A)	82	07.85 → 12.87	G64B	10-05-502	20-05-516	30-08-887	

GALANT IV (E3_A) \ Tutti i modelli \ All models

1.6	55	01.88 → 10.92	4G32	10-05-502	20-05-512	30-05-501	
1.8 (E32A)	63	11.87 → 08.90	4G37	10-05-502	20-05-512	30-05-512	
1.8 (E32A)	66	11.87 → 10.92	4G37	10-05-502 →06.90	20-05-516	30-05-512 →06.90	

NEW CODES - NEUE CODES - NOUVEAUX CODES - NUEVOS CODIGOS - NUOVI CODICI

	KW			 OIL FILTER FILTRO OLIO	 AIR FILTER FILTRO ARIA	 FUEL FILTER FILTRO CARBURANTE	 CABIN FILTER FILTRO ABITACOLO
---	----	---	---	--	--	---	---

GALANT IV (E3_A)\ Tutti i modelli\ All models

1.8 (E32A)	66	11.88 → 10.92	4G37	10-05-502	20-05-512 →06.90 20-05-516 06.90→	30-05-512	
1.8 Turbo-D (E34A)	55	11.88 → 10.92	4 D 65 T	10-05-505P 10-05-505	20-05-516	30-05-509	
1.8 Turbo-D (E34A)	55	12.87 → 10.92	4 D 65 T	10-05-505P 10-05-505	20-05-516	30-05-509	
2.0 (E33A)	80	04.89 → 10.92	4G63	10-05-502	20-05-516	30-02-224	
2.0 (E33A)	80	11.87 → 10.92	4G63	10-05-502	20-05-516	30-02-224	
2.0 4x4 (E38A)	80	12.88 → 10.92	4G63	10-05-502	20-05-516	30-02-224	
2.0 4x4 (E38A, E39A)	80	04.89 → 10.92	4G63	10-05-502	20-05-516	30-02-224	
2.0 GTi 16V	107	11.88 → 10.92	4 G 63	10-05-502	20-05-516	30-02-224	
2.0 GTi 16V (E33A)	106	11.87 → 10.92	4 G 63	10-05-502	20-05-516	30-02-224	
2.0 GTi 16V (E33A)	106	11.88 → 10.92	4 G 63	10-05-502	20-05-516	30-02-224	
2.0 GTi 16V (E33A)	107	11.88 → 10.92	4 G 63	10-05-502	20-05-516	30-02-224	
2.0 GTi 16V 4x4	106	06.88 → 10.92	4 G 63	10-05-502	20-05-516	30-02-224	
2.0 GTi 16V 4x4 (E39A)	106	07.89 → 12.92	4 G 63	10-05-502	20-05-516	30-02-224	
2.0 GTi 16V 4x4 Cat.	110	09.91 → 10.92	4 G 63	10-05-502	20-05-516	30-02-224	

GALANT V (E5_A, E7_A, E8_A)\ Tutti i modelli\ All models

1.8 (E52A)	85	02.94 → 08.96	4G93	10-05-510	20-05-599	30-02-224	
1.8 GLSI (E52A)	93	11.92 → 08.96	4G93	10-05-510	20-05-599	30-02-224	
2.0 GLSI (E55A)	101	11.92 → 08.96	4G63	10-05-510	20-05-599	30-02-224	
2.0 GLSI 4x4 (E75A)	101	11.92 → 08.96	4G63	10-05-510	20-05-599	30-02-224	
2.0 GLSTD (E57A)	66	11.92 → 08.96	4 D 68	10-05-505P 10-05-505	20-05-517	30-05-509	
2.0 V6-24 (E54A)	110	11.92 → 08.96	6A12	10-03-316	20-05-599	30-02-224	
2.5 V6-24 4x4 (E88A)	125	11.92 → 08.96	6G73	10-07-703	20-05-599	30-02-224	

GALANT VI (EA_)\ Station wagon (EA_)

2.0	98	09.00 → 10.04	4 G 63	10-03-316	20-03-383	30-05-519	21-MI-MI1
2.0 (EA2A)	100	09.96 → 09.00	4 G 63	10-03-316	20-03-383	30-05-519	21-MI-MI1
2.0 TDI (EA6A)	66	09.96 → 10.04	4D68 SOHC	10-05-505P 10-05-505	20-05-516	30-05-509	21-MI-MI1
2.4 GDI	106	09.00 → 10.04	4G64 (GDI)	10-05-510	20-03-383	30-05-520	21-MI-MI1
2.4 GDI	110	02.99 → 09.00	4G64 (GDI)	10-05-510	20-03-383	30-05-520	21-MI-MI1
2.5 V6 24V	118	09.00 → 10.04	6A13	10-05-510	20-03-383	30-05-519	21-MI-MI1
2.5 V6 24V (EA5A)	120	09.96 → 09.00	6A13	10-05-510	20-03-383	30-05-519	21-MI-MI1

GRANDIS

2.0 DI-D	100	09.05	BSY	10-ECO023	20-05-530	30-05-528	21-MI-MI5
2.0 DI-D	103	02.07	BWC	10-ECO023	20-05-530	30-05-528	21-MI-MI5
2.4	121	04.04	4G69	10-05-510	20-03-383		21-MI-MI5

L 200

2.5 DI-D	123	10.07	4 D 56 HP	10-05-505	20-05-500	30-02-215	21-MI-MI5
2.5 DI-D [RWD] (KA4T)	94	04.10		10-05-505	20-05-500	30-05-500	21-MI-MI5
2.5 DiD [RWD]	100	11.05	4 D 56 HP	10-05-505P 10-05-505	20-05-500	30-05-500	21-MI-MI2



	KW						
				OIL FILTER FILTRO OLIO	AIR FILTER FILTRO ARIA	FUEL FILTER FILTRO CARBURANTE	CABIN FILTER FILTRO ABITACOLO
L 200 (K_T)							
2.0	75	11.86 → 08.96	4G63		20-05-504	30-05-512	
2.0 (K62T)	90	06.96	4G63	10-03-321	20-05-504	30-05-512	21-MI-MI2
2.0 4x4	75	11.86 → 05.92	4G63	10-05-502	20-05-504	30-05-512	
2.4 4x4 (K75T)	97	06.96	4G64	10-03-316	20-02-205	30-05-514	21-MI-MI2
2.5 D (K14T)	51	11.86 → 08.96	4 D 56	10-05-505P 10-05-505	20-06-611	30-05-502MP 30-05-502	21-MI-MI2
2.5 D (K64T)	55	06.96	4 D 56	10-05-505P 10-05-505 06.97 →	20-02-246 06.97 →	30-05-502MP 06.97 → 30-05-502 06.97 →	21-MI-MI2
2.5 D 4WD (K24T)	51	12.87 → 05.93	4 D 56	10-05-505P 10-05-505	20-06-611	30-05-502MP 30-05-502	21-MI-MI2
2.5 DI-D	100	11.05	4 D 56 HP	10-05-505P 10-05-505	20-05-500	30-05-500	21-MI-MI2
2.5 TD 4WD	98	08.03	4 D 56 T	10-05-505P 10-05-505	20-05-523	30-05-502MP 30-05-502	21-MI-MI2
2.5 TD 4WD (K34T)	64	11.92 → 08.96	4 D 56 T	10-05-505P 10-05-505	20-05-523	30-05-502MP 30-05-502	21-MI-MI2
2.5 TD 4WD (K74T)	85	09.01	4 D 56 T	10-05-505P 10-05-505	20-05-523	30-05-502MP 30-05-502	21-MI-MI2
2.5 TD 4x4	74	11.01	4 D 56 T	10-05-505P 10-05-505	20-05-523	30-05-502MP 30-05-502	21-MI-MI2
2.5 TD 4x4 (K74T)	73	06.96	4 D 56 TD	10-05-505P 10-05-505	20-05-523	30-05-502MP 30-05-502	21-MI-MI2
2.6 4WD (K33T)	76	11.89 → 05.95	G54B	10-05-502	20-05-504	30-05-512	21-MI-MI2
L 300 (L03_P)							
1.6 (L032P, L062P)	48	05.80 → 10.86	4G32	10-05-502	20-05-503	30-05-501	
1.6 (L062P)	51	04.83 → 04.94	4G32	10-05-502 06.86 →	20-05-517 06.86 →	30-05-512 06.86 →	
2.3 D (L038P, L068P)	50	09.83 → 10.86	4 D 55	10-05-503	20-09-991	30-05-502MP 30-05-502	
2.5 D (L039P)	51	11.86 → 04.94	4 D 56	10-05-505P 10-05-505	20-09-991	30-05-502MP 30-05-502	
L 300 (L03_P/G, L0_2P)							
1.6 (L032P, L062P)	48	09.81 → 10.86	4G32	10-05-502	20-05-503	30-05-501	
1.6 (L032P, L062P)	51	11.84 → 02.87	4G32	10-05-502 06.86 →	20-05-517 06.86 →	30-05-512 06.86 →	
1.8 4x4 (L035G)	60	08.84 → 02.87	4G62	10-05-502	20-05-503	30-05-501	
2.0 4x4 (L037G)	65	11.86 → 02.87	4G63	10-05-502	20-05-517	30-05-512	
2.3 D (L038P)	50	04.83 → 10.86	4 D 55	10-05-503	20-09-991	30-05-502MP 30-05-502	
L 300 (P0_W, P1_W)							
1.6 (P12V, P02V)	51	11.86 → 05.94	4G32	10-05-502	20-05-517	30-05-512	
2.0 (P03V, P13V)	64	11.86	G63B	10-05-510	20-05-517	30-05-518	
2.4	82	11.86 → 08.97	4G64 G64B	10-05-510	20-05-517	30-05-518	
2.5 D (P05V, P05W, P15V)	51	11.86	4 D 56	10-05-505P 10-05-505	20-09-991	30-05-502MP 30-05-502	
L 300 (P0_W, P1_W, P2_W)							
1.6 (P02V, P12V)	51	11.86	4G32	10-05-502	20-05-517	30-05-512	

NEW CODES - NEUE CODES - NOUVEAUX CODES - NUEVOS CODIGOS - NUOVI CODICI

	KW						
				OIL FILTER FILTRO OLIO	AIR FILTER FILTRO ARIA	FUEL FILTER FILTRO CARBURANTE	CABIN FILTER FILTRO ABITACOLO
L 300 (P0_W, P1_W, P2_W)							
2.0 (P00W)	83	07.96	4 G 63	10-05-510	20-05-517	30-05-512	
2.0 (P03W)	64	11.86	G63B	10-05-510	20-05-517	30-05-512	
2.0 (P03W, P03V, P13V)	66	11.86	4G63	10-05-510	20-05-517	30-05-518	
2.0 4WD (P23V, P23W)	65	12.86	4G63	10-05-510	20-05-517	30-05-512	
2.0 4WD (P23W)	66	11.86	4G63	10-05-510	20-05-517	30-05-512	
2.4 (P04W, P14V, P04V)	82	11.90	4G64	10-03-316	20-05-517	30-05-502	
2.4 4WD (P24W, P24V)	80	11.86 → 12.90	G64B	10-03-316	20-05-517	30-05-514	
2.4 4WD (P24W, P24V)	82	11.90	4G64	10-03-316	20-05-517		
2.5 D (P05W, P05V, P15V)	51	11.86	4 D 56	10-05-505P 10-05-505	20-09-991	30-05-502MP 30-05-502	
2.5 TD 4WD (P25W, P25V)	64	11.88	4 D 56 T	10-05-505P 10-05-505	20-09-991	30-05-502MP 30-05-502	
L 300 (P1_T)							
2.0 (P13T)	85	07.94	4 G 63	10-05-510	20-05-517	30-05-512	
2.5 D (P15T)	64	11.94	4 D 56 T	10-05-505P 10-05-505	20-09-991	30-05-502MP 30-05-502	
L 400 (PAOV)							
2.0	85	06.96 → 03.01	4G63	10-05-510	20-05-598	30-02-224	
2.4 16V i	97	01.95 → 10.98		10-05-510	20-05-598	30-02-224	
2500 TD	64	09.96	4 D 56 T	10-05-505P 10-05-505	20-05-583	30-05-502MP 30-05-502	
2500 TD 4x4	64	09.96	4 D 56 T	10-05-505P 10-05-505	20-05-583	30-05-502MP 30-05-502	
LANCER F II (A17_)							
1.2 GLX (A171)	40	03.83 → 01.84	4 G 11	10-05-502	20-05-501	30-05-501	
1.4 GLX (A172)	51	03.83 → 01.84	4 G 12	10-05-502	20-05-501	30-05-501 30-05-504	
1.4 Turbo	77	03.83 → 01.84	4 G 12 T	10-05-510	20-05-501	30-05-501 30-05-504	
LANCER I (A17_)							
1.2 (A171)	40	01.80 → 12.81	4 G 11	10-05-502	20-05-501	30-05-501	
1.4 GLX (A172)	50	09.79 → 02.83	4 G 12	10-05-502	20-05-501	30-05-501 30-05-504	
1.6 (A174)	60	09.79 → 02.83	4G32 GS	10-05-502	20-05-506	30-05-501	
1.6 (A174)	62	01.81 → 02.83	4G32 GS	10-05-502	20-05-506	30-05-501	
2.0 Turbo ECi (A176)	125	03.81 → 02.83	4 G 32 T (ECi)	10-05-502	20-05-505	30-05-501	
LANCER III (C1_A, C6_A)							
1.2 (C65A)	44	08.86 → 04.88	4G16	10-05-502	20-05-510	30-05-512	
1.2 GL (C15AS)	40	01.84 → 10.86	4G16	10-05-502	20-05-510	30-05-501	
1.5 GLX (C12AS)	51	06.85 → 04.88	G15B	10-05-502 06.86 →	20-05-510 06.86 →	30-05-512 06.86 →	
1.5 GLX (C12AS)	55	11.83 → 04.88	4 G 15	10-05-502 06.84 → →06.86	20-05-510 06.84 → →06.86	30-05-501 06.84 → →06.86	
1.8 Diesel (C14AS)	43	01.84 → 09.86	4 D 65	10-05-503	20-05-513	30-05-502MP 30-05-502	
1.8 Diesel (C14AS)	44	09.86 → 04.88	4 D 65	10-05-505P 10-05-505	20-05-513	30-05-509	

NEW CODES - NEUE CODES - NOUVEAUX CODES - NUEVOS CODIGOS - NUOVI CODICI



	KW						
				OIL FILTER FILTRO OLIO	AIR FILTER FILTRO ARIA	FUEL FILTER FILTRO CARBURANTE	CABIN FILTER FILTRO ABITACOLO

LANCER III Station Wagon (C1_V, C3_V)

1.5 (C12V)	51	09.85 → 08.89	G15B	10-05-502	20-05-510	30-05-501
1.5 (C12V)	55	09.85 → 12.87	4 G 15	10-05-502	20-05-510	30-05-501
1.5 (C12V)	61	09.88 → 12.90	4 G 15	10-05-502	20-05-516	30-08-887
1.5 12V (C12V)	66	09.90 → 12.91	4G15 (12V)	10-05-502	20-05-516	30-02-224
1.8 4x4 (C37V)	61	01.87 → 08.89	G37B	10-05-502	20-05-512	30-05-512
1.8 4x4 (C37V)	63	03.89 → 12.90	4G37	10-05-502	20-05-512	30-05-512
1.8 4x4 (C37V)	66	01.87 → 12.87	4G37	10-05-502	20-05-512	30-05-512
1.8 4x4 (C37V)	69	08.90 → 06.92	4G37	10-05-502	20-05-512	30-05-512
1.8 D (C14V)	43	09.85 → 09.86	4 D 65	10-05-503	20-05-513	30-05-502MP 30-05-502
1.8 D (C14V)	44	08.86 → 06.92	4 D 65	10-05-505P 10-05-505	20-05-513	30-05-509

LANCER IV (C6_A, C7_A)\ Tutti i modelli\ All models

1.3 12V (C61A)	55	06.92 → 05.94	4 G 13 (BJ90-92, 12V)	10-03-316	20-05-516	30-02-224
1.5	62	06.88 → 05.92	4 G 15	10-05-502 →12.90	20-05-516 →12.90	30-05-518 →12.90
1.5 12V (C62A)	66	05.89 → 05.92	4G15 (12V)	10-05-502	20-05-516	30-02-224
1.6 16V (C66A)	83	06.92 → 05.94	4 G 92	10-03-316	20-05-516	30-02-224
1.8 4x4 (C77A)	71	09.89 → 06.92	4G37	10-05-502	20-05-516	30-08-887
1.8 D (C64A)	44	04.88 → 05.92	4 D 65	10-05-505P 10-05-505	20-05-513	30-05-509
1.8 GTi 16V (C68A)	100	11.89 → 05.92	4G67	10-05-502	20-05-516	30-08-887
1.8 GTi 16V (C69A)	103	06.92 → 12.93	4G93	10-03-316	20-05-516	30-02-224

LANCER Tre volumi\ Tutti i modelli\ All models

1.3	60	09.03	4 G 13 (16V)	10-03-316	20-05-587	30-05-523 Nel serbatoio carb. /Inside tank fuel	21-MI-MI5
1.5	80	06.08	4A91	10-M0-001	20-05-531		21-MI-MI7
1.6	72	09.03	4G18	10-03-316	20-05-587	30-05-523 Nel serbatoio carb. /Inside tank fuel	21-MI-MI5
1.8	105	06.08	4B10	10-03-316	20-05-531		21-MI-MI7
1.8 DI-D	85	05.10	4N13	10-03-316	20-05-531	30-05-528	21-MI-MI7
1.8 DI-D (CX9A)	110	06.10	4N13	10-03-316	20-02-299	30-05-528	21-MI-MI7
1.8 DI-D (CY9A)	110	06.10	4N13	10-03-316	20-02-299	30-05-528	21-MI-MI7
2.0	99	12.03	4 G 63	10-05-510	20-05-587		21-MI-MI5
2.0 DI-D	103	01.08	BKD	10-ECO023	20-05-531	30-05-528	21-MI-MI7
2.0 EVO	217	06.08	4B11 T/C	10-07-703	20-05-531		21-MI-MI7

LANCER V (CB/D_A)

1.3 (CB1A)	55	06.92	4 G 13 (BJ92..., 12V)	10-03-316	20-05-516	30-02-224
1.6	66	02.94	4 G 92	10-03-316	20-05-516	30-02-224
1.6 16V (CB4A)	83	06.92	4 G 92	10-03-316	20-05-516	30-02-224
1.6 16V 4WD (CD4A)	83	06.92	4 G 92	10-03-316	20-05-516	30-02-224
1.8 16V (CB5A)	103	06.92 → 12.93	4G93	10-03-316	20-05-516	30-02-224
2.0 Diesel (CB8A)	50	06.92	4 D 68	10-05-505P 10-05-505	20-05-517	30-05-509

NEW CODES - NEUE CODES - NOUVEAUX CODES - NUEVOS CODIGOS - NUOVI CODICI

Per nuove applicazioni e novità si prega di accedere al sito www.ashika.eu - For new applications and new items, please go to www.ashika.eu

	KW						
				OIL FILTER FILTRO OLIO	AIR FILTER FILTRO ARIA	FUEL FILTER FILTRO CARBURANTE	CABIN FILTER FILTRO ABITACOLO

LANCER VI (CK/P_A)

1.3 12V (CK1A)	55	12.95 → 08.03	4 G 13 (BJ90-92, 12V)	10-05-510	20-05-587	30-05-590	21-MI-MI0
1.5 16V (CK2A)	69	12.95 → 08.03	4 G 15 (16V)	10-03-316	20-05-587	30-05-501	21-MI-MI0
1.6 16V (CK4A)	66	12.95 → 08.03	4 G 92	10-03-316	20-05-587	30-05-590	21-MI-MI0
2.0 16V EVO IX	206	01.06	4 G 63 Turbo	10-05-510	20-05-587	30-05-590	21-MI-MI5
2.0 16V EVO VI / VII (CP9A)	206	01.99 → 08.03	4 G 63 Turbo	10-05-510	20-05-587	30-05-590	21-MI-MI0
2.0 16V EVO VIII	195	03.04		10-05-510	20-05-587	30-05-590	21-MI-MI5

OUTLANDER

2.0	100	05.03	4 G 63	10-05-510	20-05-587	30-05-520	21-MI-MI5
2.0 4WD	100	05.03	4 G 63	10-05-510	20-05-587	30-05-520	21-MI-MI5
2.0 4WD	177	05.03		10-05-510	20-05-587	30-05-520	21-MI-MI5
2.0 4WD	93	05.03	4 G 63	10-05-510	20-05-587	30-05-520	21-MI-MI5
2.0 DI-D	103	02.07	BSY	10-ECO023	20-05-531	30-05-528	21-MI-MI7
2.0 Turbo 4WD	148	04.04	4 G 63 T	10-05-510	20-05-587		21-MI-MI5
2.2 DI-D	115	08.07	4HK 4HN	10-ECO060	20-05-531	30-0L-L11	21-MI-MI7
2.2 DI-D	130	11.06	4N14	10-ECO060	20-05-531	30-05-520	21-MI-MI7
2.4 4WD	102	05.03	4G64 (SOHC 16V)	10-05-510	20-05-587	30-05-520	21-MI-MI5
2.4 4WD	118	11.03	4G69	10-05-510	20-05-587	30-05-520	21-MI-MI5
2.4 4WD	119	05.03	4G69	10-05-510	20-05-587	30-05-520	21-MI-MI5
2.4 Mivec	125	09.07	4B12	10-03-316	20-05-531	30-05-520	21-MI-MI7

PAJERO CLASSIC (V2_W)

2.5 TD	85	07.02	4 D 56 T	10-05-505P 10-05-505	20-02-246	30-05-502MP 30-05-502	21-MI-MI4
3.2 DI-D	118	05.05	4M41	10-05-597	20-05-524	30-05-574	21-MI-MI4

PAJERO I (L04_G, L14_G)

2.5 TD (L044G, L049G)	64	01.90 → 12.91	4 D 56 T	10-05-505P 10-05-505	20-05-508	30-05-502MP 30-05-502	
2.5 TD (L044G, L049G)	70	11.89 → 11.90	4 D 56 T	10-05-505P 10-05-505	20-05-508	30-05-502MP 30-05-502	
3.0 V6 (L141G, L146G)	104	11.88 → 11.90	6G72	10-05-502	20-05-516	30-05-518	



PAJERO I Fuoristrada aperto (L04_G)

2.3 TD (L043G, L048G)	62	12.82 → 04.86	4 D 55 T	10-05-503	20-05-508	30-05-502MP 30-05-502	
2.5 TD (L044G, L049G)	62	05.86 → 10.89	4 D 56 T	10-05-505P 10-05-505	20-05-508	30-05-502MP 30-05-502	
2.5 TD (L044G, L049G)	70	11.89 → 11.90	4 D 56 T	10-05-505P 10-05-505	20-05-508	30-05-502MP 30-05-502	
2.6 (L042G, L047G)	76	01.83 → 11.90	4G54	10-05-502 →06.86	20-05-511 →06.86	30-05-501 →06.86	







PAJERO II (V2_W, V4_W) \ Fuoristrada aperto

2.4	82	04.91 → 04.00	4G64	10-03-316 →06.94	20-05-598 →06.94	30-05-518 →06.94	
2.5 TD (V24C, V24W)	73	12.90 → 04.00	4 D 56 TD	10-05-505P 10-05-505	20-05-508	30-05-502MP 30-05-502	
2.8 TD (V46W)	92	06.94 → 04.00	4M40-T	10-05-597	20-05-508 06.95→	30-05-502MP 30-05-502	



	KW						
				OIL FILTER FILTRO OLIO	AIR FILTER FILTRO ARIA	FUEL FILTER FILTRO CARBURANTE	CABIN FILTER FILTRO ABITACOLO
PAJERO II (V2_W, V4_W) Fuoristrada aperto							
3.0 V6 (V23W, V43W, V23C)	110	12.90 → 12.95	6G72 6G72	10-05-502	20-05-516	30-05-518	
3.0 V6 24V	130	06.97 → 04.00	6G72	10-07-703	20-05-586	30-02-224	
3.0 V6 24V	133	06.94 → 05.97	6G72	10-07-703	20-05-586	30-02-224	
3.5 V6 24V	143	07.97 → 04.00	6G74 DOHC 6G74 (SOHC 24V)	10-07-703	20-05-586	30-02-224	
3.5 V6 24V (V25W, V45W)	153	06.94 → 04.00	6G74 DOHC	10-07-703	20-05-586	30-02-224	
PAJERO III (V60)							
2.5 TDi (V64W, V74W)	73	04.00	4 D 56 T	10-05-505	20-05-524	30-05-574	21-MI-MI4
2.5 TDi (V64W, V74W)	85	09.01	4 D 56 T	10-05-505	20-05-524	30-05-574	21-MI-MI4
3.2 DI-D (V68W, V78W)	118	10.01	4M41	10-05-597	20-05-524	30-02-215MP 01.07→ 30-02-215 01.07→ 30-05-574 →12.06	21-MI-MI4 →12.06
3.2 DI-D (V68W, V78W)	121	04.00 → 10.01	4M41	10-05-597	20-05-524	30-05-574	21-MI-MI4
3.5 V6 GDI (V65W, V75W)	149	04.00	6G74 DOHC	10-07-703	20-05-586	30-02-224	21-MI-MI4
PAJERO IV (V80)							
3.2 DI-D (V88W, V98W)	118	02.07	4M41	10-05-597	20-05-524	30-05-574	21-MI-MI4
3.2 DI-D (V88W, V98W)	125	02.07	4M41	10-05-597	20-05-524	30-05-574	21-MI-MI4
3.8 V6 (V87W, V97W)	184	02.07	6G75	10-07-703	20-05-524	30-02-224	21-MI-MI4
PAJERO PININ (H6_W, H7_W)							
1.8	84	11.01	4G93	10-04-410	20-05-599	30-05-590	21-MI-MI8
1.8 GDI (H66W)	88	10.99	4G93	10-05-510 →06.01	20-05-599 →06.01	30-05-505 →06.01 Nel serbatoio carb. /Inside tank fuel	21-MI-MI8
2.0 GDI (H67W, H77W)	95	10.00	4G94	10-05-510 06.01→	20-05-599 06.01→	30-05-505 06.01→ Nel serbatoio carb. /Inside tank fuel	21-MI-MI8
PAJERO SPORT (K90)							
2.5 TD	73	11.98	4 D 56 T	10-05-505P 10-05-505	20-02-246	30-05-502MP 30-05-502	21-MI-MI2
2.5 TD	85	07.02	4 D 56 T	10-05-505P 10-05-505	20-02-246	30-05-502MP 30-05-502	21-MI-MI2
2.5 TD	98	08.03	4 D 56 T	10-05-505P 10-05-505	20-02-246	30-05-502MP 30-05-502	21-MI-MI2
3.0 V6	123	03.03	6G72	10-07-703	20-05-598	30-02-298	21-MI-MI2
3.0 V6	125	06.00	6G72	10-07-703	20-05-598	30-02-298 30-05-519	21-MI-MI2
3.0 V6	130	11.98	6G72 6G72 (SOHC 24V)	10-07-703 06.00→	20-05-598 06.00→	30-02-298 06.00→ 30-05-519	21-MI-MI2
SANTAMO							
2.0 16V	102	05.99	4 G 63	10-07-703	20-05-516	30-K0-015	
2.0 16V 4x4	102	05.99	4 G 63	10-07-703	20-05-516	30-K0-015	
SAPPORO I (A12_)							
1.6 SL, GL (A121)	55	04.78 → 07.80	4G32	10-07-703	20-05-501	30-05-501	

NEW CODES - NEUE CODES - NOUVEAUX CODES - NUEVOS CODIGOS - NUOVI CODICI







	KW						
				OIL FILTER FILTRO OLIO	AIR FILTER FILTRO ARIA	FUEL FILTER FILTRO CARBURANTE	CABIN FILTER FILTRO ABITACOLO
SAPORO I (A12_)							
2.0 (A123)	66	04.78 → 07.80	4G52	10-05-502	20-02-201 20-05-501	30-05-501	
2.0 (A123)	72	04.78 → 07.80	4G52	10-05-502	20-02-201	30-05-501	
2.0 (A123)	79	01.79 → 07.80	4G52	10-05-502	20-02-201	30-05-501	
SAPORO II (A16_A)							
1.6 GLX (A161A)	55	08.80 → 09.84	4G32	10-05-502	20-05-501	30-05-501	
2.0 GSL (A164A)	75	08.80 → 08.83	4G63	10-05-502 06.81 →	20-05-507 06.81 →	30-05-501 06.81 →	
2.0 GSR (A164A)	82	08.80 → 09.84	4G63	10-05-502	20-05-507	30-05-501	
2.0 Turbo ECi (A164)	125	08.82 → 08.83	4 G 63 T (ECi)	10-05-502	20-05-509	30-05-501	
SAPORO III (E16A)							
2.4 (E16A)	91	06.87 → 08.90	4G64	10-05-502	20-05-516	30-08-887	
SIGMA (F16A)							
3.0 V6 (F16A)	130	12.90 → 07.96	6G72	10-07-703 06.91 → →06.93	20-05-598 06.91 → →06.93	30-02-224 06.91 → →06.93	
3.0 V6 (F16A)	151	12.90 → 07.96	6G72	10-07-703	20-05-598	30-02-224	
SIGMA Station Wagon (F07W)							
3.0 (V6)	125	01.93 → 07.96	6G72	10-07-703	20-05-598	30-02-224	
SPACE GEAR (PA/B/D_V/W)							
2.0 16V (PA3V/W, PB3V)	83	08.96 → 05.00	4 G 63	10-03-316	20-05-598	30-02-224	
2.0 16V (PA3V/W, PB3V)	85	05.95 → 05.00	4 G 63	10-03-316	20-05-598	30-02-224	
2.4 i (PA4W)	97	05.95 → 05.00	4G64	10-03-316	20-05-598	30-02-224	
2.4 i 4x4 (PD4V/W)	97	05.95 → 05.00	4G64	10-03-316	20-05-598	30-02-224	
2.5 TD (PA5V/W, PB5V)	64	05.95 → 05.00	4 D 56 T	10-05-505P 10-05-505	20-05-583	30-05-502MP 30-05-502	
2.5 TD (PA5V/W, PB5V)	73	05.95 → 05.00	4 D 56 TD	10-05-505P 10-05-505	20-05-583	30-05-502MP 30-05-502	
2.5 TD 4x4 (PD5V/W)	73	05.95 → 05.00	4 D 56 TD	10-05-505P 10-05-505	20-05-583	30-05-502MP 30-05-502	
SPACE RUNNER (N1_W, N2_W)							
1.8 (N11W)	85	06.96 → 08.99	4G93	10-03-316	20-05-599	30-02-224	
1.8 (N11W)	90	10.91 → 08.99	4G93	10-03-316	20-05-599	30-02-224	
1.8 4x4 (N21W)	85	06.96 → 08.99	4G93	10-03-316	20-05-599	30-02-224	
1.8 4x4 (N21W)	90	10.91 → 08.99	4G93	10-03-316	20-05-599	30-02-224	
2.0 16V	98	06.97 → 08.99	4 G 63	10-05-510	20-05-599	30-02-224	
2.0 TD (N18W)	60	10.92 → 08.99	4 D 68	10-05-505P 10-05-505	20-05-516	30-05-509	
SPACE RUNNER (N50)							
2.0	100	08.99	4 G 63	10-05-510	20-05-599	30-05-514	21-MI-MI3
2.4 GDI	110	08.99	4G64 (GDI)	10-05-510	20-03-383	30-05-514	21-MI-MI3
SPACE STAR (DG0)							
1.3 16V	60	09.00	4 G 13 (16 V)	10-03-316	20-05-589	30-05-590	21-MI-MI2
1.3 16V	61	12.98	4 G 13 (16 V)	10-03-316	20-05-589	30-05-590	21-MI-MI2
1.3 16V	63	06.98	4 G 13 (16 V)	10-03-316	20-05-589	30-05-590	21-MI-MI2

NEW CODES - NEUE CODES - NOUVEAUX CODES - NUEVOS CODIGOS - NUOVI CODICI



	KW						
				OIL FILTER FILTRO OLIO	AIR FILTER FILTRO ARIA	FUEL FILTER FILTRO CARBURANTE	CABIN FILTER FILTRO ABITACOLO
SPACE STAR (DG0)							
1.6 16V	72	01.01	4G18	10-03-316	20-05-589	30-05-590	21-MI-MI2
1.8 GDI	82	10.02	4G93	10-03-316	20-05-589	30-05-505 Nel serbatoio carb. /Inside tank fuel	21-MI-MI2
1.8 GDI	87	06.98	4G93	10-03-316	20-05-589	30-05-505 Nel serbatoio carb. /Inside tank fuel	21-MI-MI2
1.8 GDI	90	06.98	4G93	10-03-316	20-05-589	30-05-505 Nel serbatoio carb. /Inside tank fuel	21-MI-MI0
1.9 DI-D	75	02.01	F9Q1	10-05-595	20-05-588	30-ECO015	21-MI-MI2
1.9 DI-D	85	10.02	F9Q2	10-05-595	20-05-588	30-ECO015	21-MI-MI2
SPACE WAGON (D0_V/W)							
1.8 4x4 (D05V, D05W)	66	10.87 → 08.88	4G37	10-05-502	20-05-512	30-05-501	
1.8 GLX (D05V, D05W)	66	01.84 → 12.88	4G37	10-05-502	20-05-512	30-05-501	
1.8 TD (D09W)	55	06.86 → 04.91	4 D 65 T	10-05-503 →10.87 10-05-506 11.87→	20-05-515	30-05-509	
2.0 4x4 (D08W)	75	03.85 → 04.91	4G63	10-05-502	20-05-516	30-05-512	
2.0 GLX (D04W)	62	06.86 → 05.88	G63B	10-05-502	20-05-512	30-05-512	
2.0 GLX 4x4 (D08W)	62	06.86 → 05.88	G63B	10-05-502	20-05-512	30-05-512	
2.0 GLXi (D04W)	74	06.88 → 04.91	4G63	10-05-502	20-05-516	30-02-224	
2.0 GLXi 4x4 (D08W)	74	06.88 → 04.91	4G63	10-05-502	20-05-516	30-05-512	
SPACE WAGON (N3_W, N4_W)							
1.8 (N31W)	90	10.91 → 10.98	4G93	10-03-316 06.93→ 10-05-502 →06.93	20-05-599	30-02-224	
1.8 4x4 (N41W)	90	10.91 → 10.98	4G93	10-05-502 →06.93	20-05-599 →06.93	30-02-224	
1.8 TD (N35W)	55	10.91 → 10.98	4 D 65 T	10-05-505P 10-05-505 →06.93	20-05-516 →06.93	30-05-509 →06.93	
2.0 (N33W)	98	10.92 → 10.98	4 G 63	10-05-502	20-05-599	30-02-224	
2.0 4x4 (N43W)	98	10.92 → 10.98	4 G 63	10-05-502	20-05-599	30-02-224	
2.0 TD (N38W)	60	10.92 → 10.98	4D68 T	10-05-505P 10-05-505	20-05-517	30-05-509	
2.4 i	102	10.92 → 10.98	4G64 (SOHC 16V)	10-05-510	20-05-599	30-02-224	
2.4 i (N34W)	85	10.91 → 05.96		10-05-510	20-05-599	30-02-224	
2.4 i AWD (N34W)	85	10.91 → 05.96		10-05-510	20-05-599	30-02-224	
SPACE WAGON (N5_W)							
2.0 GDI	98	04.02	4 G 63	10-05-510	20-03-383	30-05-520	21-MI-MI3
2.4 GDI	108	09.00	4G64 (GDI)	10-05-510	20-03-383	30-05-520	21-MI-MI3
2.4 GDI	110	10.98	4G64 (GDI)	10-05-510	20-03-383	30-05-505 Nel serbatoio carb. /Inside tank fuel	21-MI-MI3
STARION (A18_A)							
2.0 Turbo ECi (A183A)	125	06.82 → 12.85	4 G 63 T (ECi)	10-05-502	20-05-509	30-05-501	
2.0 Turbo ECi (A183A)	132	05.85 → 08.87	4 G 63 T/C	10-05-502	20-05-509	30-05-501	

NEW CODES - NEUE CODES - NOUVEAUX CODES - NUEVOS CODIGOS - NUOVI CODICI

	KW			 OIL FILTER FILTRO OLIO	 AIR FILTER FILTRO ARIA	 FUEL FILTER FILTRO CARBURANTE	 CABIN FILTER FILTRO ABITACOLO
STARION (A18_A)							
2.6 Turbo ECi (A187A)	114	09.87 → 06.90	G 54 B/T/C	10-05-502 06.89 →	20-05-509 06.89 →	30-05-506 06.89 →	
TREDIA (A21_)							
1.4 GLX (A211)	51	10.82 → 08.85	4 G 12	10-05-502	20-05-510	30-05-501 30-05-504	
1.6 Turbo (A212)	84	09.82 → 05.85	4G32 T	10-05-502	20-05-510	30-05-501	
1.6 Turbo (A212)	85	09.82 → 07.84	4G32 T	10-05-502	20-05-510	30-05-501	
1.8 GLS (A215)	66	08.84 → 07.86	4G37	10-05-502	20-05-512	30-05-501	
1.8 Turbo	100	08.84 → 07.86	G62B	10-05-502	20-05-509	30-05-514	
GLS 1.6 (A212)	55	09.82 → 10.87	4G32	10-05-502	20-05-510	30-05-501	



MITSUBISHI Comm.







	KW						
				OIL FILTER FILTRO OLIO	AIR FILTER FILTRO ARIA	FUEL FILTER FILTRO CARBURANTE	CABIN FILTER FILTRO ABITACOLO
CANTER 35 / 55							
3.0 D	92	09.01		10-05-597	20-05-575	30-05-582	
CANTER 60 / 75							
4.0 D	105	09.01		10-05-597	20-05-575	30-05-582	
CANTER D							
3.6 / 4.2 / 4.6 / 5.2	0	01.93			20-05-577		
CANTER Truck D (4D30)							
3.3 D (FE101/111)	86	01.78 → 12.79		10-05-581	20-05-581		
CANTER Truck D (4D31T)							
3.3 D (FE214) Turbo	86	01.82 → 12.89		10-05-507 10-09-900	20-05-582	30-05-582	
CANTER Truck D (4D32)							
3.6 D (FE305/315/325) Turbo	0	01.85		10-05-507 10-09-900	20-05-580	30-05-582	
CANTER Truck D (4D32T)							
3.6 D (FE434/444)	0	01.85		10-05-507 10-09-900	20-05-582	30-05-582	
CANTER Truck D (4D33)							
4.2 D (FE307/317)	100	01.85		10-05-507 10-09-900	20-05-580 20-05-582	30-05-582	
CANTER Truck D (4D34/2AT6 - T4)							
4.0 D (FE649/659) Turbo Intercooler	100	01.97		10-05-597	20-05-575	30-05-582	
CANTER Truck D (4D34T)							
4.2 D (FE439/449) Turbo	100	01.89		10-05-597	20-05-527	30-05-582	
CANTER Truck D (4D55)							
2.3 D (FB433)	48	01.83 → 12.90		10-05-503 01.86→	20-05-580	30-05-502MP 01.86→ 30-05-502 01.86→	
CANTER Truck D (4D56)							
2.5 D (FB346)	51	01.86 → 12.96		10-05-503 10-05-508	20-05-580	30-05-502MP 30-05-502	
CANTER Truck D (4DR5)							
2.7 D (FE100/120)	54	01.79 → 12.80		10-05-580	20-05-581	30-05-580	
CANTER Truck D (4DR5-4DR51)							
2.7 D (FB100/120)	54	01.81 → 12.90		10-09-900	20-05-512	30-05-582	
CANTER Truck D (4DR7)							
2.8 D (FB308)	69	01.89		10-09-900	20-05-580	30-05-582	
CANTER Truck D (4M40 - 2AT/0AT)							
2.8 D (FB631/641/531/534) Turbo Intercooler	85	01.97		10-05-597	20-05-526	30-05-502MP 30-05-502	
CANTER Truck D (6D31)							

NEW CODES - NEUE CODES - NOUVEAUX CODES - NUEVOS CODIGOS - NUOVI CODICI

Per nuove applicazioni e novità si prega di accedere al sito www.ashika.eu - For new applications and new items, please go to www.ashika.eu

MITSUBISHI Comm.









	KW			 OIL FILTER FILTRO OLIO	 AIR FILTER FILTRO ARIA	 FUEL FILTER FILTRO CARBURANTE	 CABIN FILTER FILTRO ABITACOLO
CANTER Truck D (6D31)							
4.9 D (FK330)	115	01.88		10-05-507 →12.90 10-05-578 →12.90 10-05-597	20-05-527	30-05-583	
CANTER Truck D(4D30)							
3.3 D (FE111/121/211)	86	01.80		10-05-507 10-05-581 01.80→ →12.81 10-09-900 01.81→	20-05-580 20-05-581 01.80→ →12.82	30-05-582	

NEW CODES - NEUE CODES - NOUVEAUX CODES - NUEVOS CODIGOS - NUOVI CODICI



MORGAN

	KW			 OIL FILTER FILTRO OLIO	 AIR FILTER FILTRO ARIA	 FUEL FILTER FILTRO CARBURANTE	 CABIN FILTER FILTRO ABITACOLO
AERO 8							
4.4	210	10.00	M62448S2	10-ECO014			

NEW CODES - NEUE CODES - NOUVEAUX CODES - NUEVOS CODIGOS - NUOVI CODICI

Per nuove applicazioni e novità si prega di accedere al sito www.ashika.eu - For new applications and new items, please go to www.ashika.eu

	KW						
				OIL FILTER FILTRO OLIO	AIR FILTER FILTRO ARIA	FUEL FILTER FILTRO CARBURANTE	CABIN FILTER FILTRO ABITACOLO
100 NX (B13)							
1.6	66	03.90 → 10.94	GA16DS	10-01-111 06.91 → →06.93	20-01-121 06.91 → →06.93	30-01-115 06.91 → →06.93	
1.6 SR	75	09.93 → 10.94	GA16DE	10-01-111	20-01-196	30-01-111	
2.0	110	10.90 → 10.94	SR20DE	10-01-117		30-09-909	
2.0 GTI	105	03.91 → 10.94	SR20DE	10-01-117	20-01-108	30-01-111	
200 SX (S13)							
1.8 Turbo	124	07.88 → 11.93	CA18DET	10-01-111	20-01-108	30-01-111	
2.0 i 16V	103	07.88 → 11.93	SR20DE	10-01-111	20-01-108	30-01-111	
200 SX (S14)							
2.0 i 16V	118	10.93 → 12.99	SR20DE	10-01-120	20-01-108	30-01-111	
2.0 i 16V Turbo	147	10.93 → 12.99	SR20DET	10-01-111 →12.97 10-01-120 06.97 → →06.99	20-01-108 06.97 → →06.99 20-01-196 →12.97	30-01-111	
260Z (S30)							
1.5 GLS	55	10.88 → 06.91		10-01-110	20-01-125	30-05-501	
280 ZX,ZXT (HGS130)							
2.8	103	10.78 → 06.83	L28E	10-01-112	20-01-103	30-01-102	
2.8	108	02.80 → 09.82	L28E	10-01-112	20-01-115	30-01-102	
2.8	110	01.82 → 02.84	L28E	10-01-112	20-01-115	30-01-102	
2.8	147	01.83 → 02.84	L28ET	10-01-112	20-01-115	30-01-102	
300 ZX (Z31)							
3.0	125	01.84 → 12.87	VG30E	10-01-111	20-01-104	30-01-111	
3.0 Turbo	149	05.87 → 10.90	VG30ET	10-01-111	20-01-108	30-01-111	
3.0 Turbo	168	04.84 → 10.90	VG30T	10-01-111	20-01-104 →12.87 20-01-108 01.87 →	30-01-111	
300 ZX (Z32)							
3.0 Twin Turbo	197	05.90 → 09.95	VG30DETT	10-01-111	20-01-196	30-01-102	
3.0 Twin Turbo	208	05.90 → 09.95	VG30DETT	10-01-111	20-01-196	30-01-102	
350 ZI Roadster							
3.5	206	10.03	VQ35DE	10-01-120	20-01-108		
3.5	221	04.06	VQ35DE	10-01-120	20-01-108		
3.5	221	04.06	VQ35DE	10-01-120	20-01-108		
3.5	230	09.05	VQ35HR	10-01-120	20-01-108		
370 Z							
3.7	243	06.09	VQ37HR	10-01-120			
3.7	243	06.09	VQ37VHR	10-01-120			
ALMERA I (N15)\ Tutti i modelli\ All models							
1.4	64	09.95 → 03.00	GA14DE	10-01-111	20-01-196	30-01-111	21-NS-NS3
1.4 S,GX,LX	55	09.95 → 03.00	GA14DE	10-01-111	20-01-196	30-01-111	21-NS-NS3



	KW						
				OIL FILTER FILTRO OLIO	AIR FILTER FILTRO ARIA	FUEL FILTER FILTRO CARBURANTE	CABIN FILTER FILTRO ABITACOLO

ALMERA I (N15)\ Tutti i modelli\ All models

1.6	73	09.95 → 03.00	GA16DE	10-01-111	20-01-196	30-01-111	21-NS-NS3
1.6 SR,SLX	66	09.95 → 03.00	GA16DE	10-01-111	20-01-196	30-01-111	21-NS-NS3
2.0 D	55	11.95 → 03.00	CD20	10-01-112 →03.96 10-01-114 04.96→	20-01-108	30-01-109MP 30-01-109	21-NS-NS3
2.0 GTi	105	07.96 → 03.00	SR20DE	10-01-120	20-01-108	30-01-111	21-NS-NS3

ALMERA II (N16)\ Hatchback (N16)

1.5	66	07.00	QG15DE	10-01-120	20-01-108	30-01-111	21-NS-NS4
1.5	72	10.02	QG15DE	10-01-120	20-01-108	30-01-111	21-NS-NS4
1.5	77	03.01	GA15DE QG15DE	10-01-120	20-01-108	30-01-111	21-NS-NS4
1.5 dCi	60	01.03	K9K 722	10-08-891	20-01-100	30-01-108	21-NS-NS4
1.8	84	07.00	QG18DE	10-01-120	20-01-108	30-01-111 30-01-124 Nel serbatoio carb. /Inside tank fuel	21-NS-NS4
1.8	85	10.02	QG18DE	10-01-120	20-01-108	30-01-111 30-01-124 Nel serbatoio carb. /Inside tank fuel	21-NS-NS4
2.2 dCi	100	09.03	YD22DDTi	10-01-112E	20-01-108	30-01-109MP 30-01-109 30-01-190	21-NS-NS4
2.2 dCi	82	09.03	YD22DDT	10-01-112E	20-01-108	30-01-109MP 30-01-109 30-01-190	21-NS-NS4
2.2 Di	81	07.00	YD22DDT	10-01-112E 04.03→ 10-01-195 →03.03	20-01-108	30-01-190	21-NS-NS4

ALMERA TINO (V10)

1.8	84	08.00	QG18DE	10-01-120	20-01-108	30-01-111 30-01-124 Nel serbatoio carb. /Inside tank fuel	21-NS-NS4
1.8	85	12.02	QG18DE	10-01-120	20-01-108	30-01-111 30-01-124 Nel serbatoio carb. /Inside tank fuel	21-NS-NS4
2.0	100	08.00	SR20DE	10-01-120	20-01-108	30-01-111 30-01-124 Nel serbatoio carb. /Inside tank fuel	21-NS-NS4
2.2 dCi	100	09.03	YD22DDTi	10-01-112E	20-01-108	30-01-109MP 30-01-109	21-NS-NS4
2.2 dCi	82	09.03	YD22DDT	10-01-112E	20-01-108	30-01-109MP 30-01-109	21-NS-NS4
2.2 Di	84	08.00	YD22DDTi	10-01-112E 10-01-195 →03.03	20-01-108	30-01-109	21-NS-NS4

BLUEBIRD (910)

1.6	60	01.80 → 11.83	L16	10-01-112	20-01-101	30-05-501	
1.8	65	01.80 → 12.83	L18S	10-01-112	20-01-101	30-05-501	

NEW CODES - NEUE CODES - NOUVEAUX CODES - NUEVOS CODIGOS - NUOVI CODICI







	KW						
				OIL FILTER FILTRO OLIO	AIR FILTER FILTRO ARIA	FUEL FILTER FILTRO CARBURANTE	CABIN FILTER FILTRO ABITACOLO
BLUEBIRD (910)							
2.0 D	44	01.80 → 12.83	LD20	10-01-110	20-01-108	30-01-106	
2.0 i	80	01.82 → 12.83	Z20E	10-01-112	20-01-108	30-01-111	
BLUEBIRD (B610)							
1.8	65	07.74 → 11.79	L18	10-01-110	20-01-101	30-05-501	
BLUEBIRD (T72 , T12)							
1.6	61	03.86 → 06.90	CA16S	10-01-111	20-01-107	30-01-110	
1.6	66	12.85 → 02.90	CA16S	10-01-111	20-01-107	30-01-110	
1.8 i 16V (RLT72)	95	02.89 → 12.90	CA18D	10-01-111	20-01-104	30-01-102	
1.8 Turbo	99	12.85 → 05.90	CA18T	10-01-111	20-01-104	30-01-111	
2.0 (T12)	75	12.85 → 12.87	CA20S	10-01-111	20-01-107	30-01-110	
2.0 D (SLT72, T12)	49	03.86 → 12.90	LD20	10-01-112	20-01-104	30-01-109MP 30-01-109	
2.0 i	85	09.88 → 09.90	CA20E	10-01-111	20-01-104	30-01-111	
2.0 i (HLT72, T12)	77	12.85 → 12.90	CA20E	10-01-111	20-01-104	30-01-111	
2.0 LX	66	12.85 → 02.90	CA20S	10-01-111	20-01-107	30-01-110	
BLUEBIRD (U11)							
1.8	66	11.83 → 06.88	CA18S	10-01-111 06.84 → → 06.86	20-01-107 06.84 → → 06.86	30-01-110 06.84 → → 06.86	
1.8 Turbo	99	04.84 → 05.90	CA18T	10-01-111	20-01-104	30-01-111	
2.0 D	43	04.84 → 01.88	LD20	10-01-112	20-01-104 06.84 → → 06.86	30-01-109MP 30-01-109	
2.0 i	77	04.84 → 01.88	CA20E	10-01-111	20-01-107	30-01-110	
BLUEBIRD Coupe (910)							
1.8	66	01.80 → 05.84	L18T	10-01-112	20-01-101	30-05-501	
1.9 i	80	01.82 → 05.84	Z20E	10-01-112 06.82 →	20-01-108 06.82 →	30-01-111 06.82 →	
BLUEBIRD Hatchback (T72, T12)							
1.6	61	03.86 → 06.90	CA16S	10-01-111	20-01-107	30-01-110	
1.6	66	03.86 → 06.91	CA16S	10-01-111	20-01-107	30-01-110	
1.8 i 16V (FRLT72)	95	02.89 → 12.90	CA18D	10-01-111	20-01-104	30-01-102	
1.8 Turbo	99	12.85 → 05.90	CA18T	10-01-104 10-01-111	20-01-104	30-01-111	
2.0 (T12)	75	12.85 → 12.87	CA20S	10-01-111	20-01-107	30-01-110	
2.0 D (FSLT72, T12)	49	03.86 → 12.90	LD20	10-01-112	20-01-104	30-01-109MP 30-01-109	
2.0 i	85	09.88 → 09.90	CA20E	10-01-111	20-01-104	30-01-111	
2.0 i (FHLT72, T12)	77	12.85 → 12.90	CA20E	10-01-111	20-01-104	30-01-111	
BLUEBIRD Station Wagon (WU11)							
2.0	75	04.86 → 09.90	CA20S	10-01-111	20-01-107	30-01-110	
2.0 D	43	04.84 → 01.88	LD20	10-01-112	20-01-104	30-01-109MP 30-01-109	
2.0 D	49	03.86 → 12.90	LD20	10-01-112	20-01-104	30-01-109MP 06.86 → → 06.88 30-01-109	

NEW CODES - NEUE CODES - NOUVEAUX CODES - NUEVOS CODIGOS - NUOVI CODICI



	KW						
				OIL FILTER FILTRO OLIO	AIR FILTER FILTRO ARIA	FUEL FILTER FILTRO CARBURANTE	CABIN FILTER FILTRO ABITACOLO
BLUEBIRD Station Wagon (WU11)							
2.0 i	77	04.84 → 12.90	CA20E	10-01-111 01.86→	20-01-104 01.86→	30-01-111 01.86→	
2.0 i	85	09.88 → 09.90	CA20E	10-01-111	20-01-104	30-01-111	
BLUEBIRD Traveller (W910)							
1.8	65	01.80 → 05.84	L18S	10-01-112 06.80→	20-01-101 06.80→	30-05-501	
2.0 D	44	01.80 → 05.84	LD20	10-01-110	20-01-108	30-01-106	
CHERRY (E10)							
1.0	33	09.70 → 09.78	A10	10-01-111	20-01-102	30-05-501	
CHERRY (N10)\ Tutti i modelli\ All models							
1.0	32	08.78 → 07.81	A10S	10-01-111	20-01-102	30-05-501	
1.2	38	08.78 → 07.81	A12	10-01-111	20-01-102	30-05-501	
1.3	44	08.81 → 09.82	E13	10-01-111	20-01-102	30-05-501	
1.4 i.e.	59	08.80 → 07.81	A14S	10-01-111	20-01-106	30-05-501	
1.5	51	08.81 → 12.82	E15	10-01-111	20-01-102	30-01-102 30-05-501	
CHERRY (N12)							
1.0	37	05.82 → 05.86	E10	10-01-111	20-01-102	30-01-110 01.84→ 30-05-501 →12.84	
1.3	44	05.82 → 10.86	E13	10-01-111	20-01-102	30-01-110 06.84→ →06.86 30-05-501 06.82→ →06.84	
1.5	55	11.83 → 10.86	E15S	10-01-111	20-01-102	30-01-110 06.84→ →06.86 30-05-501 →06.84	
1.5 Turbo	77	01.83 → 12.85	E15ET	10-01-111	20-01-102	30-01-111	
1.6	51	05.84 → 07.86	E16	10-01-111	20-01-102	30-01-115	
1.7 D	40	10.82 → 12.86	CD17	10-01-112	20-01-110	30-01-106 →06.84 30-01-109MP 06.84→ →06.86 30-01-109 06.84→ →06.86	
CHERRY Traveller (VN10)							
1.2	38	10.78 → 07.81	A12	10-01-111	20-01-102	30-05-501	
1.3	44	09.81 → 12.83	E13	10-01-111	20-01-102	30-05-501	
1.4	59	08.80 → 07.81	A14S	10-01-111	20-01-106	30-05-501	
CUBE (Z12)							
1.5 dCi	78	03.10		10-08-891	20-01-100	30-01-108	21-NS-NS18
1.5 dCi	81	03.10		10-01-122	20-01-128	30-01-108	21-NS-NS18
1.6 16V	81	03.10	HR 16 DE	10-01-120	20-01-134	30-01-120	21-NS-NS18







NEW CODES - NEUE CODES - NOUVEAUX CODES - NUEVOS CODIGOS - NUOVI CODICI

	KW						
				OIL FILTER FILTRO OLIO	AIR FILTER FILTRO ARIA	FUEL FILTER FILTRO CARBURANTE	CABIN FILTER FILTRO ABITACOLO
DATSUN 100 A (E10, BLF10)\ Station wagon (WBLF10)							
1.0 (E10)	33	12.74 → 06.78	A10	10-01-111	20-01-109	30-05-501	
F-II 1.0 (BLF10)	33	12.75 → 08.80	A10	10-01-111	20-01-109	30-05-501	
DATSUN 120							
A F-II 1.2 (LF10)	38	12.75 → 07.80	A12	10-01-111	20-01-109	30-05-501	
Y 1.2 (B210)	38	09.74 → 07.80	A12	10-01-111	20-01-109	30-05-501	
Y 1.2 (LB210)	38	06.76 → 07.80		10-01-111	20-01-109	30-05-501	
DATSUN 120 Y Coupe (KB 210)							
1.2 (KB210)	38	04.62 → 07.80	A12	10-01-111	20-01-109	30-05-501	
A F-II 1.2 (KLF10)	38	12.75 → 08.80	A12	10-01-111	20-01-109	30-05-501	
DATSUN 140 Y Station wagon (HLB310)							
1.4	49	02.79 → 06.83		10-01-111	20-01-109	30-05-501	
DATSUN 240 Coupe (KMLGC210)							
KGT 2.4	96	09.78 → 07.81	L24	10-01-110	20-01-109	30-05-501	
DATSUN/VIOLET 140 J							
1.4	48	01.73 → 05.77		10-01-110	20-01-102	30-05-501	
DATSUN/VIOLET 160 J (710, A10)							
1.6	61	01.73 → 02.82	L16T	10-01-110	20-01-101	30-05-501	
1.6 (710)	53	01.73 → 01.78	L16S	10-01-110	20-01-101	30-05-501	
1.6 i.e. (A10)	65	01.78 → 02.82	L16	10-01-110	20-01-101	30-05-501	
DATSUN/VIOLET 180 B (PL810)							
1.8	65	05.77 → 01.81	L18S	10-01-110	20-01-101	30-05-501	
1.8 (KPL810)	66	05.77 → 01.81		10-01-110	20-01-101	30-05-501	
ECO T100							
	0			10-01-101E	20-01-126	30-01-109MP 30-01-109	
EVALIA							
1.5 dCi	66	01.11		10-01-122	20-01-128	30-01-108	21-NS-NS17
1.5 dCi	81	01.11		10-01-122	20-01-128	30-01-108	21-NS-NS17
1.6	81	01.11		10-01-120	20-01-134		21-NS-NS17
INTERSTAR\ Tutti i modelli\ All models							
dCi 100	73	11.03		10-ECO030	20-01-133	30-ECO010	
dCi 100	74	04.06	G9U 720	10-ECO068			
dCi 120	84	07.02	G9U 720	10-ECO030	20-01-133	30-ECO010	
dCi 120	88	07.02	G9U 650	10-ECO030	20-01-133	30-ECO017	
dCi 140	100	11.03	ZD30	10-01-194	20-01-138	30-ECO014 30-ECO017	
dCi 150	107	09.06	G9U 632	10-ECO068		30-ECO017	
dCi 80	60	07.02	F9Q 772	10-08-891	20-01-133	30-ECO010	
dCi 90	66	07.02	G9T 722	10-ECO030	20-01-133	30-ECO010	
Juke							
1.5 dCi	81	10.10		10-01-122	20-01-128	30-01-108 30-01-125	21-NS-NS13



	KW						
				OIL FILTER FILTRO OLIO	AIR FILTER FILTRO ARIA	FUEL FILTER FILTRO CARBURANTE	CABIN FILTER FILTRO ABITACOLO
Juke							
1.6	86	10.10	MR16DDT	10-01-120	20-01-196		21-NS-NS13
KUBISTAR							
1.2	44	08.03	D7F 764	10-01-121	20-01-132	30-01-120	21-NS-NS12
1.2 16V	55	04.06	D4F 712	10-01-121	20-01-132	30-01-120	21-NS-NS12
1.5 dCi	48	08.03	K9K 704	10-08-891	20-01-100	30-01-108	21-NS-NS12
1.5 dCi	60	08.03	K9K 722	10-08-891	20-01-100	30-01-108	21-NS-NS12
1.5 dCi 70	50	04.06	K9K 700	10-08-891	20-01-100	30-01-108	21-NS-NS12
1.5 dCi 85	62	04.06	K9K 276	10-08-891	20-01-100	30-01-108	21-NS-NS12
1.6 16V	70	08.03	K4M 752	10-08-891	20-01-130	30-01-120	21-NS-NS12
L35.09/L70.90 EBRO							
4.0 D	0			10-01-101E 10-01-110	20-00-004	30-01-109MP 30-01-109	
LAUREL (HLC230)							
2.0	71	03.77 → 05.83	L20A	10-01-110	20-01-101	30-05-501	
2.4	83	12.77 → 05.83	L24	10-01-112 06.80 → → 06.82	20-01-101 06.80 → → 06.82	30-01-104 06.80 → → 06.82	
LAUREL (JC31)							
2.0	71	01.81 → 01.84	L20A	10-01-112	20-01-101	30-01-111	
2.4	83	01.81 → 01.84	L24	10-01-112E	20-01-101	30-01-110	
2.4	88	09.83 → 12.85	L24	10-01-112 → 06.85	20-01-101 → 06.85	30-01-110 → 06.85	
2.8 D	62	01.81 → 10.85	LD28	10-01-110	20-01-108	30-01-106 06.81 → → 06.82 30-01-112 06.82 → → 06.85	
LAUREL (JC32)							
2.4	94	01.85 → 12.87	L24E L24S	10-01-112	20-01-108	30-01-111	
2.8 D	62	01.85 → 12.87	LD28	10-01-110	20-01-108	30-01-109MP 30-01-109	
2.8 D	66	01.85 → 12.89	RD28	10-01-110	20-01-116 06.87 → → 06.89	30-01-109MP 30-01-109	
3.0i 16V VG30E	112	01.85 → 12.90		10-01-111	20-01-108	30-01-111	
LEAF							
Electric	80	11.10	EM61				21-NS-NS18
M115/M130							
	0			10-01-199	20-01-116	30-01-109MP 30-01-109	
MAXIMA (J30)							
3.0 i	125	10.88 → 06.94	VG30E	10-01-111	20-01-108	30-01-111	
MAXIMA QX (A32)							
2.0	103	02.95 → 08.00	VQ20DE	10-01-198	20-01-108	30-01-111 06.00 →	21-NS-NS1
2.5 V6 24V	140	02.95 → 08.00	VQ25DE	10-01-198	20-01-108	30-01-111	21-NS-NS1

NEW CODES - NEUE CODES - NOUVEAUX CODES - NUEVOS CODIGOS - NUOVI CODICI

	KW			 OIL FILTER FILTRO OLIO	 AIR FILTER FILTRO ARIA	 FUEL FILTER FILTRO CARBURANTE	 CABIN FILTER FILTRO ABITACOLO
MAXIMA QX (A32)							
3.0	142	01.95 → 08.00	VQ30DE	10-01-198	20-01-108	30-01-111	21-NS-NS1
MAXIMA QX (A33)\Station Wagon							
2.0 V6 24V	103	03.00	VQ20DE	10-01-120	20-01-108	30-01-111	21-NS-NS5
2.5 V6 24V	154	03.00	VQ25DE	10-01-120	20-01-108	30-01-111	21-NS-NS5
3.0 V6 24V	147	03.00	VQ30DE	10-01-120	20-01-108	30-01-111	21-NS-NS5
MICRA (K10)							
1.0	37	12.82 → 12.89	MA10S	10-01-108	20-01-114 06.83 →	30-05-501	
1.0	40	12.82 → 05.89	MA10S	10-01-108	20-01-114	30-05-501	
1.0	43	12.82 → 05.91		10-01-108	20-01-114	30-05-501	
1.2	40	07.86 → 07.92	MA12S	10-01-108 01.89 →	20-01-114 01.89 →	30-05-501 01.89 →	
1.2	44	07.86 → 07.92	MA12S	10-01-108 01.89 →	20-01-114 01.89 →	30-05-501 01.89 →	
MICRA (K11)							
1.0 i 16V	40	08.92 → 09.00	CG10DE	10-01-117	20-01-197	30-01-111	21-NS-NS2
1.0 i 16V	44	09.00 → 02.03	CG10DE	10-01-117	20-01-197	30-01-111	21-NS-NS2
1.3 i 16V	55	08.92 → 09.00	CG13DE	10-01-117	20-01-197	30-01-111	21-NS-NS2 06.96 → →06.00
1.4 i 16V	60	09.00 → 02.03	CGA3DE	10-01-117	20-01-197	30-01-111	21-NS-NS2
1.5 D	42	02.98 → 02.03	TD15	10-01-189 06.01 →	20-01-189 06.01 →	30-01-189 06.01 →	21-NS-NS2
MICRA (K12)							
1.0 16V	48	01.03	CG10DE	10-01-117	20-01-197	30-01-111	21-NS-NS6
1.2 16V	48	01.03	CR12DE CG12DE	10-01-117	20-01-197	30-01-111	21-NS-NS6
1.2 16V	59	01.03	CR12DE CG12DE	10-01-117	20-01-197	30-01-111	21-NS-NS6
1.4 16V	65	01.03	CR14DE	10-01-117	20-01-197	30-01-111	21-NS-NS6
1.5 dCi	48	01.03	K9K 704	10-08-891	20-01-128	30-01-108	21-NS-NS6
1.5 dCi	50	06.05		10-08-891	20-01-128	30-01-108	21-NS-NS6
1.5 dCi	60	09.03	K9K 722	10-08-891	20-01-128	30-01-108	21-NS-NS6
1.5 dCi	63	06.05	K9K 276	10-08-891	20-01-128	30-01-108	21-NS-NS6
160 SR	81	05.05	HR 16 DE	10-01-120	20-01-134	30-01-111	21-NS-NS6
MICRA (K13)							
1.2	59	05.10	HR 12 DE	10-01-120	20-01-142		21-NS-NS15
MICRA C+C							
1.4 16V	65	08.05	CR14DE	10-01-117	20-01-197	30-01-115	21-NS-NS6
1.6 160 SR	81	08.05	HR 16 DE	10-01-117	20-01-197	30-01-111	21-NS-NS6
MURANO							
2.5 dCi	140	10.10		10-01-112E		30-01-122	21-NS-NS14
3.5 4x4	172	03.05	VQ35DE	10-01-120	20-01-108	30-01-198	21-NS-NS8
MURANO (Z51)							
3.5 4x4	188	10.08	VQ35DE	10-01-120	20-01-108	30-01-198	21-NS-NS14



	KW						
				OIL FILTER FILTRO OLIO	AIR FILTER FILTRO ARIA	FUEL FILTER FILTRO CARBURANTE	CABIN FILTER FILTRO ABITACOLO

NAVARA

2.5 dCi	106	07.05	YD25DDTi	10-01-112E	20-01-129	30-01-190	21-NS-NS9
2.5 dCi 4WD	126	10.06	YD25DDTi	10-01-112E	20-01-129	30-01-100	21-NS-NS9
2.5 dCi 4WD	128	07.05	YD25DDTi	10-01-112E	20-01-129	30-01-190	21-NS-NS9

NAVARA (D40)

2.5 dCi	140	03.10		10-01-112E	20-01-129	30-01-100	21-NS-NS9
3.0 dCi	170	03.10		10-01-112E	20-01-129	30-01-120	21-NS-NS9

NOTE

1.4	65	03.06	CR14DE	10-01-117	20-01-197	30-01-111	21-NS-NS6
1.5 dCi	50	03.06	K9K 700	10-08-891	20-01-134	30-01-108	21-NS-NS6
1.5 dCi	63	03.06	K9K 276	10-08-891	20-01-134	30-01-108	21-NS-NS6
1.6	81	03.06	HR 16 DE	10-01-117	20-01-197	30-01-111	21-NS-NS6

NP300

2.5 dCi 4x4	98	04.08	YD25DDTi	10-01-112E	20-01-111	30-01-109MP 30-01-109	21-NS-NS9
-------------	----	-------	----------	------------	-----------	--------------------------	-----------

NV200 Autobus\ Furgonato

1.5 dci	63	02.10		10-01-122	20-01-128	30-01-108	21-NS-NS17
1.6 16V	81	07.10	HR 16 DE	10-01-120	20-01-134		21-NS-NS17

PATHFINDER

2.5 dCi 4WD	126	10.06	YD25DDTi	10-01-112E	20-01-129	30-01-100	21-NS-NS9
2.5 dCi 4WD	128	03.05	YD25DDTi	10-01-112E	20-01-129	30-01-109 30-01-190	21-NS-NS9
2.5 dCi 4WD	140	08.10		10-01-112E	20-01-129	30-01-100	21-NS-NS9
3.0 dCi	170	08.10			20-01-129		
4.0 4WD	198	09.05	VQ40DE	10-01-198	20-09-985	30-01-109MP 30-01-109	21-NS-NS9

PATHFINDER (R50)

2.7 TD 4WD	96	09.97 → 12.04	TD27ETi	10-01-198	20-01-108	30-01-109MP 30-01-109	
3.2 TD 4WD	110	09.97 → 12.04	QD32ETi		20-01-108	30-01-111	
3.3 V6 4WD	110	03.98 → 10.00	VG33E	10-01-198	20-01-108	30-01-111	
3.3 V6 4WD	125	09.97 → 12.04	VG33E	10-01-198	20-01-108	30-01-111	
3.5 V6 4WD	162	11.00 → 12.04	VQ35	10-01-120	20-01-108 06.01 →	30-01-111	

PATROL GR I (Y60)

2.8 TD (Y60A)	85	09.88 → 06.97	RD28T	10-01-110 →08.95 10-01-114 08.95 →	20-01-120	30-01-109MP 30-01-109	
4.2 Cat.	121	11.88 → 06.97	TB42E	10-01-112 06.93 →	20-01-108 06.93 → 20-01-139	30-01-198 06.93 →	
4.2 D (Y60GR)	85	11.88 → 06.97	TD42	10-01-112 06.92 → →06.95	20-01-108 06.92 → →06.95 20-01-139	30-01-198 06.92 → →06.95	

PATROL GR II (Y61)

NEW CODES - NEUE CODES - NOUVEAUX CODES - NUEVOS CODIGOS - NUOVI CODICI







	KW						
				OIL FILTER FILTRO OLIO	AIR FILTER FILTRO ARIA	FUEL FILTER FILTRO CARBURANTE	CABIN FILTER FILTRO ABITACOLO
PATROL GR II (Y61)							
2.8 TD	95	06.97 → 05.00	RD28Ti	10-01-114	20-01-193	30-01-109MP 30-01-109	21-NS-NS7
3.0 DTi	116	05.00	ZD30DDTi	10-01-194	20-01-193	30-01-109MP 30-01-109	21-NS-NS7
3.0 DTi	118	05.00	ZD30DDTi	10-01-194	20-01-193	30-01-109MP 30-01-109	21-NS-NS7
PATROL Hardtop (K160)\ Station Wagon (W160)							
2.8 (K160)	88	07.80 → 08.88	L28	10-01-112	20-01-101	30-01-111	
2.8 (K160)	89	07.80 → 08.88	L28	10-01-112 06.82 →	20-01-101 06.82 →	30-01-111 06.82 →	
3.2 TD (K160)	81	07.83 → 08.88	SD33T	10-01-104	20-01-105	30-01-103	
3.3 D (K160)	70	11.79 → 08.88	SD33	10-01-104 06.82 → → 06.83 10-01-109 06.83 →	20-01-105	30-01-106 06.82 → 30-01-195 → 06.82	
PATROL Hardtop (K260)\ Station Wagon (W260)							
2.8	88	05.86 → 06.90	L28	10-01-112	20-01-101	30-01-111	
2.8 TD	85	05.86 → 06.90	RD28T	10-01-110 → 08.95 10-01-114	20-01-120	30-01-109MP 30-01-109	
3.2 D	81	08.88 → 06.90	SD33T	10-01-109	20-01-105	30-01-106	
PICK UP/KING CAB (720)							
1.8	59	01.83 → 03.86	L18	10-01-112	20-01-101	30-01-109MP 30-01-109	
2.2 4WD	71	04.83 → 03.86	Z22	10-01-112	20-01-104	30-01-111	
2.2 D	47	01.82 → 01.84	SD22	10-01-107	20-01-101	30-02-215	
2.3 D	51	04.83 → 03.86	SD23	10-01-110	20-01-101	30-01-106	
2.5 D 4WD	53	04.83 → 03.86	SD25	10-01-110 10-01-113	20-01-101	30-01-106	
PICK UP/KING CAB (D21)							
2.0	64	09.85 → 07.88	Z20	10-01-112	20-01-101	30-01-111	
2.0	66	09.88 → 08.91	Z20	10-01-112	20-01-101	30-01-111	
2.3 D	51	09.85 → 08.88	SD23	10-01-113	20-01-101	30-01-103 30-01-119 Made in Japan	
2.4 i 12V	91	04.92 → 02.98	KA24E	10-01-111	20-01-108	30-01-111	
2.4 i 12V 4WD	93	04.92 → 02.98	KA24E	10-01-111	20-01-108	30-01-111	
2.4 i 4WD	74	03.86 → 04.92	Z24i	10-01-112	20-01-101	30-01-111	
2.5 D	55	09.87 → 02.98	TD25	10-01-114	20-01-101	30-01-109MP 30-01-109	
2.5 D	59	09.94 → 08.96	TD25	10-01-110	20-01-101	30-01-109MP 30-01-109	
2.5 D	61	03.96 → 02.98	TD25	10-01-110	20-01-101	30-01-109MP 30-01-109	
2.5 D 4WD	53	09.85 → 08.88	SD25	10-01-114	20-01-101	30-01-109MP 30-01-109	
2.5 D 4WD	55	03.86 → 08.91	SD25	10-01-114	20-01-101	30-01-109MP 30-01-109 30-01-119 Made in Spain	

NEW CODES - NEUE CODES - NOUVEAUX CODES - NUEVOS CODIGOS - NUOVI CODICI



	KW						
				OIL FILTER FILTRO OLIO	AIR FILTER FILTRO ARIA	FUEL FILTER FILTRO CARBURANTE	CABIN FILTER FILTRO ABITACOLO
PICK UP/KING CAB (D21)							
2.5 D 4WD	59	08.87 → 02.98	TD25	10-01-114	20-01-101	30-01-109MP 30-01-109	
2.5 D 4WD	61	03.96 → 02.98	TD25	10-01-114	20-01-101	30-01-109MP 30-01-109	
2.7 D 4WD	58	09.87 → 08.91	TD27	10-01-114	20-01-101	30-01-109MP 30-01-109	
2.7 D 4WD	73	08.87 → 02.98	TD27	10-01-114	20-01-101	30-01-109MP 30-01-109	
3.0 i V6 4WD	109	09.90 → 02.98	VG30E	10-01-111	20-01-108	30-01-102	
PICK UP/KING CAB/NAVARA (D22)							
2.4 i	88	02.98	KA24E	10-01-111	20-01-108	30-01-111	
2.4 i 4WD	98	03.02	KA24DE	10-01-111	20-01-108	30-01-111	
2.5 D	61	02.98	TD25	10-01-110	20-01-190	30-01-109MP 30-01-109	
2.5 Di	98	03.02	YD25DDTi	10-01-112E 04.03→ 10-01-195 →03.03	20-01-111	30-01-109MP 30-01-109	
2.5 TD 4WD	76	05.98	TD25Ti	10-01-110	20-01-190	30-01-109MP 30-01-109	
3.2 D 4WD	76	12.98	QD32	10-01-110	20-01-190	30-01-109MP 30-01-109	
PIXO							
1.0	50	06.09	K10 B	10-02-210	20-08-830	30-08-897	21-SZ-SZ10
PRAIRIE (M10, NM10)							
1.5 S (M10)	55	01.84 → 12.87	E15S	10-01-111	20-01-102	30-01-110	
1.8 SGL (M10)	65	07.83 → 12.85	CA18S	10-01-111	20-01-107	30-01-110	
1.8 SGL (M10)	66	05.85 → 10.87	CA18S	10-01-111	20-01-107	30-01-110	
2.0 4x4 (NM10)	68	06.86 → 09.88	CA20S	10-01-111	20-01-107	30-01-110	
PRAIRIE PRO (M11)							
2.0 i	72	10.88 → 04.92	CA20E	10-01-111	20-01-108	30-01-111	
2.0 i 4x4	72	10.88 → 12.92	CA20E	10-01-111	20-01-108	30-01-111	
2.4 i	98	04.92 → 07.94	KA24E	10-01-111	20-01-108	30-01-111	
2.4 i 4x4	98	04.92 → 07.94	KA24E	10-01-111	20-01-108	30-01-111	
PRIMASTAR							
2.0	88	03.01	F4R 720 F4R 722	10-01-122	20-01-130	30-01-120	21-NS-NS11
dCi 100	74	03.01	F9Q 760	10-01-122	20-01-131	30-ECO010	21-NS-NS11
dCi 115	84	09.08	G9U 720	10-ECO068	20-01-137	30-ECO014	21-NS-NS11
dCi 120	84	09.06	M9R 780	10-ECO068	20-01-137	30-ECO010	21-NS-NS11
dCi 140	99	07.03	G9U730	10-ECO030	20-01-137	30-ECO017	21-NS-NS11
dCi 150	107	09.06	G9U 632	10-ECO068	20-01-137	30-ECO017	21-NS-NS11
dCi 80	60	03.01	F9Q 762	10-01-122	20-01-131	30-ECO010	21-NS-NS11
dCi 90	66	09.06	M9R 782	10-ECO068	20-01-137		
PRIMERA (P10)							
1.6	66	06.90 → 01.96	GA16DS	10-01-111 →12.93	20-01-121 →12.93	30-01-192 →12.93	

NEW CODES - NEUE CODES - NOUVEAUX CODES - NUEVOS CODIGOS - NUOVI CODICI

	KW						
				OIL FILTER FILTRO OLIO	AIR FILTER FILTRO ARIA	FUEL FILTER FILTRO CARBURANTE	CABIN FILTER FILTRO ABITACOLO
PRIMERA (P10)							
1.6	71	06.90 → 01.96	GA16DS	10-01-111	20-01-121 →12.93 20-01-196 01.93→	30-01-192	
1.6	75	06.93 → 01.96	GA16DE	10-01-111	20-01-196	30-01-192	
2.0	105	06.90 → 04.93	SR20DE	10-01-117	20-01-108	30-01-192	
2.0 16V	85	06.90 → 01.96	SR20DI (SPI)	10-01-117 06.90→ →06.93	20-01-108 06.90→ →06.93	30-01-192 06.90→ →06.93	
2.0 D	55	01.91 → 01.96	CD20	10-01-114	20-01-108	30-01-109MP 30-01-109	
2.0 GT	110	06.90 → 01.96	SR20DE	10-01-117	20-01-108	30-01-192	
2.0 i	92	01.95 → 06.96	SR20DE	10-01-117	20-01-196	30-01-192	
PRIMERA (P11)							
1.6 16V	66	09.96 → 12.01	GA16DE	10-01-111	20-01-196	30-01-111	21-NS-NS0
1.6 16V	73	09.96 → 10.00	GA16DE	10-01-111	20-01-196	30-01-111	21-NS-NS0
1.6 16V	78	06.96 → 12.01	QG16DE	10-01-111	20-01-196	30-01-111	21-NS-NS0
1.8 16V	84	08.99 → 12.01	QG18DE	10-01-120	20-01-108	30-01-111	21-NS-NS0
2.0 16V	103	08.99 → 12.01	SR20DE	10-01-120	20-01-108	30-01-111	21-NS-NS0
2.0 16V	110	09.96 → 12.01	SR20DE	10-01-120	20-01-108	30-01-111	21-NS-NS0
2.0 16V	85	09.96 → 12.01	SR20De	10-01-120	20-01-108	30-01-111	21-NS-NS0
2.0 16V	96	09.96 → 12.01	SR20DE	10-01-120	20-01-108	30-01-111	21-NS-NS0
2.0 TD	66	09.96 → 12.01	CD20T	10-01-112 10-01-114	20-01-108	30-01-109MP 30-01-109	21-NS-NS0
PRIMERA (P12)							
1.6	78	03.02	QG16DE	10-01-120	20-01-108	30-01-192	21-NS-NS4
1.6	80	01.02	QG16DE	10-01-120	20-01-108	30-01-192	21-NS-NS4
1.8	85	03.02	QG18DE	10-01-120	20-01-108	30-01-124 Nel serbatoio carb. /Inside tank fuel 30-01-192	21-NS-NS4
1.9 dCi	85	08.02		10-08-891	20-01-127	30-ECO015	21-NS-NS4
1.9 dCi	88	04.03		10-08-891	20-01-127	30-ECO015	21-NS-NS4
2.0	103	03.02	QR20DE	10-01-120	20-01-108	30-01-192	21-NS-NS4
2.2 dCi	102	04.03	YD22DDT	10-01-112E	20-01-108	30-01-109MP 30-01-109 30-01-190	21-NS-NS4
2.2 Di	93	03.02	YD22DDT	10-01-112E 04.03→ 10-01-195 →03.03	20-01-108	30-01-109MP 30-01-109 30-01-190	21-NS-NS4
Q-BIC (Y10)							
1.6 16V (GA16DS)	66	01.94		10-01-111	20-01-121	30-01-115	
1.7 D (CD17)	40	01.94		10-01-112E	20-01-108	30-01-109MP 30-01-109	
2.0 D (CD20)	55	01.92		10-01-114	20-01-108	30-01-109MP 30-01-109	
QASHQAI							
1.5 dCi	76	07.08		10-08-891	20-01-134	30-01-122	21-NS-NS10

NEW CODES - NEUE CODES - NOUVEAUX CODES - NUEVOS CODIGOS - NUOVI CODICI



	KW						
				OIL FILTER FILTRO OLIO	AIR FILTER FILTRO ARIA	FUEL FILTER FILTRO CARBURANTE	CABIN FILTER FILTRO ABITACOLO
QASHQAI							
1.5 dCi	78	02.07		10-08-891	20-01-134	30-01-122	21-NS-NS10
1.6	84	02.07	HR 16 DE	10-01-120	20-01-135		21-NS-NS10
1.6 dCi	96	11.11			20-01-135		21-NS-NS10
2.0	103	02.07	MR20DE	10-01-120	20-01-135		21-NS-NS10
2.0 dCi	110	02.07	M1D M9R	10-ECO068	20-01-135	30-01-122	21-NS-NS10
SERENA (C23M)							
1.6 16V	71	02.93	GA16DE	10-01-111	20-01-108	30-01-192	
2.0 16V	93	11.92	SR20DE	10-01-117	20-01-108	30-01-192	
2.0 D	49	11.92	LD20	10-01-112E 10-01-114	20-01-108 →06.94	30-01-109MP →06.94 30-01-109 →06.94	
2.3 D	55	01.95	LD23	10-01-112E 10-01-112 →12.97 10-01-114 06.97→	20-01-108	30-01-109MP 30-01-109	
SILVIA (S110)							
1.8	68	01.79 → 05.83	L18E	10-01-110	20-01-104	30-01-102	
1.8 i (L18E)	68	02.78		10-01-110	20-01-104	30-01-102	
SILVIA (S12)							
1.8	90	07.86 → 04.88	CA18ET	10-01-111	20-01-104	30-01-102	
2.0 GP	107	04.84 → 09.88	FJ20E	10-01-112	20-01-104	30-01-111	
STANZA (T11)							
1.6	60	08.81 → 12.85	CA16S	10-01-111	20-01-107	30-01-105	
1.8 SGL	66	03.83 → 12.85	CA18S	10-01-111	20-01-107	30-01-105	
SUNNY (140Y, 150Y)							
1.4 (HBL310)	48	01.70 → 02.82	A14	10-01-111	20-01-102	30-05-501	
1.4 (HBL310)	49	06.79 → 02.82	A14	10-01-111	20-01-102	30-05-501	
1.5 (HBL310)	51	06.79 → 02.82	A15	10-01-111	20-01-102	30-05-501	
SUNNY (Y10)							
1.6 i 16V	66	10.92 → 03.00	GA16DE	10-01-111	20-01-196	30-01-111	
1.7 D	40	11.90 → 03.00	CD17	10-01-112	20-01-108	30-01-109MP 30-01-109	
SUNNY I (B11)							
1.3	44	03.82 → 09.87	E13	10-01-111	20-01-102	30-01-110 06.84→ →06.86 30-05-501 06.82→ →06.84	
1.5	55	03.82 → 10.86	E15S	10-01-111	20-01-102	30-01-110 06.84→ →06.86 30-05-501 06.82→ →06.84	
1.6	51	05.84 → 02.86	E16	10-01-111	20-01-102	30-01-110	

NEW CODES - NEUE CODES - NOUVEAUX CODES - NUEVOS CODIGOS - NUOVI CODICI

	KW						
				OIL FILTER FILTRO OLIO	AIR FILTER FILTRO ARIA	FUEL FILTER FILTRO CARBURANTE	CABIN FILTER FILTRO ABITACOLO
SUNNY I (B11)							
1.6 SLX 4x4	62	07.86 → 10.88	E16S	10-01-111	20-01-102	30-01-115	
1.7 D	40	03.82 → 10.86	CD17	10-01-112	20-01-110	30-01-106 06.82 → →06.84 30-01-109MP 06.84 → →06.86 30-01-109 06.84 → →06.86	
SUNNY II (N13)							
1.0	37	07.86 → 09.90	E10S	10-01-111	20-01-102	30-01-115	
1.3	44	07.86 → 10.91	E13S	10-01-111	20-01-102	30-01-115	
1.4 LX	55	10.88 → 08.91	GA14S	10-01-111	20-01-121	30-01-115	
1.5	52	06.86 → 10.88	E15S	10-01-111	20-01-102	30-01-115	
1.6	62	06.86 → 10.88	E16S	10-01-111	20-01-102	30-01-115	
1.6	88	02.87 → 10.88	GA16DE	10-01-111	20-01-108	30-01-111	
1.6 4x4	66	07.86 → 10.88	GA16S	10-01-111	20-01-102	30-01-111	
1.6 GTI 16V	81	02.87 → 10.88	CA16D	10-01-111	20-01-122	30-01-111	
1.6 i	54	06.86 → 10.90	E16i	10-01-111	20-01-102	30-01-115	
1.6 i 12V	66	10.88 → 06.91	GA16i	10-01-111	20-01-122	30-01-111	
1.7 D	40	06.86 → 05.89	CD17	10-01-112	20-01-108	30-01-109MP 30-01-109	
SUNNY III (N14)							
1.4	60	10.90 → 06.95	GA14DS	10-01-111	20-01-121	30-01-115	
1.4 i	55	10.90 → 05.95	GA14DE GA14DS	10-01-111	20-01-121	30-01-115	
1.4 i 16V	64	10.90 → 05.95	GA14DE	10-01-111 06.92 →	20-01-196 06.92 →	30-01-111 06.92 →	
1.5	51	10.90 → 05.95		10-01-111	20-01-121	30-01-115	
1.6 i	66	10.90 → 05.95	GA16DE GA16DS GA16DEL	10-01-111	20-01-121	30-01-115	
1.6 i 16V	75	10.92 → 05.95	GA16DE	10-01-111	20-01-196	30-01-111	
2.0 D	55	10.90 → 05.95	CD20	10-01-112 10-01-114	20-01-108	30-01-109MP 30-01-109	
2.0 GTI 16V	105	10.90 → 05.95	SR20DE	10-01-117	20-01-121	30-01-198	
2.0 GTI-R 4x4	162	10.90 → 05.95	SR20DET	10-01-117	20-01-108	30-01-198	
SUNNY Traveller (140Y, 150Y)							
1.4 (HBL310)	48	06.79 → 02.82	A14	10-01-111	20-01-102	30-05-501	
1.5 (HBL310)	51	06.79 → 02.82	A15	10-01-111	20-01-102	30-05-501	
TERRANO I (WD21)							
2.4 i 4WD	76	10.87 → 02.93	Z24i	10-01-112	20-01-123	30-01-102	
2.7 TD 4WD	73	02.89 → 02.96	TD27T	10-01-101E Made in Spain 10-01-114	20-01-110	30-01-109MP 30-01-109	
3.0 i 4WD	109	01.90 → 12.95	VG30E	10-01-111	20-01-108	30-01-102	
TERRANO II (R20)							
2.4 4WD	85	05.96 → 01.02	KA24E	10-01-111	20-01-108 01.98 →	30-01-111	21-NS-NS0

NEW CODES - NEUE CODES - NOUVEAUX CODES - NUEVOS CODIGOS - NUOVI CODICI



	KW						
				OIL FILTER FILTRO OLIO	AIR FILTER FILTRO ARIA	FUEL FILTER FILTRO CARBURANTE	CABIN FILTER FILTRO ABITACOLO
TERRANO II (R20)							
2.4 4WD	87	05.96	KA24E	10-01-111	20-01-108 01.98→	30-01-111	21-NS-NS0
2.4 i 12V 4WD	91	02.93 → 06.96	KA24E	10-01-111	20-01-108	30-01-111	21-NS-NS0
2.7 TD 4WD	74	02.93 → 01.02	TD27T	10-01-101E →12.96 Made in Spain 10-01-114 →06.96	20-01-110 →06.96	30-01-109MP →06.96 30-01-109 →06.96	21-NS-NS0 →12.96
2.7 TDi 4WD	92	05.96	TD27TI	10-01-101E Made in Spain 10-01-110	20-01-194	30-01-109MP 30-01-109	21-NS-NS0
3.0 Di 4WD	113	05.02	ZD30	10-01-194	20-01-194	30-01-190	21-NS-NS0
TIIDA 2 volumi							
1.6	81	05.04 → 02.07	HR 16 DE	10-01-120	20-01-134		21-NS-NS17
TIIDA 2 volumi (C11X)							
1.5 dCi	78	09.07	K9K 728	10-08-891	20-01-128	30-01-108	21-NS-NS17
1.6	81	09.07	HR 16 DE	10-01-120	20-01-134	30-01-111	21-NS-NS17
1.8	93	09.07	MR18DE	10-01-120	20-01-134	30-01-111	21-NS-NS17
TRADE							
2.0 D	44	11.86 → 03.93	LD20	10-01-101E Made in Spain 10-01-110	20-01-116	30-01-109MP 30-01-109	
2.3 D	55	06.96 → 10.01	LD23	10-01-112E Made in Spain 10-01-112	20-01-116	30-01-109MP 30-01-109	
2.8 D	59	12.86 → 06.94	A428II	10-01-101E 10-01-110	20-01-116	30-01-109MP 30-01-109	
3.0 D	63	04.93 → 10.98	BD30II	10-01-101E 10-01-110	20-01-116	30-01-109MP 30-01-109	
3.0 D (KE) BD30TI	78	01.97		10-01-101E 10-01-110	20-01-188	30-01-109MP 30-01-109	
URVAN (E23)							
2.0	55	07.81 → 11.82	H20	10-01-111	20-01-110	30-05-501	
2.0 (E23B)	64	12.82 → 11.88	Z20	10-01-111	20-01-110	30-01-110	
2.2 D	47	07.81 → 11.82		10-01-107	20-01-112		
2.3 D	50	11.82 → 05.87	SD23	10-01-107	20-01-112	30-01-106 →06.85 30-01-109MP 01.85→ 30-01-109 01.85→	
2.3 D (E23B)	51	04.85 → 11.88	SD23	10-01-107	20-01-112	30-01-109MP 30-01-109	
URVAN (E24)							
2.0	64	05.87 → 05.97	Z20	10-01-111	20-01-110	30-01-111	
2.3 D	51	01.88 → 05.97	TD23	10-01-110	20-01-118	30-01-109MP 30-01-109	
2.4 i	74	05.89 → 09.93	Z24i	10-01-111	20-01-110	30-01-111	
2.5 D	59	12.88 → 05.97	TD25	10-01-110	20-01-118	30-01-109MP 30-01-109	
VANETTE (C22)							

NEW CODES - NEUE CODES - NOUVEAUX CODES - NUEVOS CODIGOS - NUOVI CODICI

	KW						
				OIL FILTER FILTRO OLIO	AIR FILTER FILTRO ARIA	FUEL FILTER FILTRO CARBURANTE	CABIN FILTER FILTRO ABITACOLO

VANETTE (C22)

1.5	51	10.86 → 12.95	A15S	10-01-111	20-01-110	30-01-110
2.0	66	07.87 → 08.94	Z20S	10-01-111		30-09-909
2.0 D	49	07.91 → 01.95	LD20II	10-01-112E Made in Spain 10-01-112	20-01-119	30-01-109MP 30-01-109
2.0 D (ULC22)	47	10.86 → 12.95	LD20	10-01-112E Made in Spain 10-01-112	20-01-119	30-01-109MP 30-01-109
2.0 D (ULC22)	49	10.86 → 12.95	LD20	10-01-112E Made in Spain 10-01-112	20-01-119	30-01-109MP 30-01-109
2.4 i (SLC22)	74	10.86 → 12.95	Z24i	10-01-111	20-01-110	30-01-115
2.4 i (SLC22)	77	10.86 → 12.95	Z24i	10-01-111	20-01-110	30-01-115

VANETTE (KC120)

1.5	51	01.83 → 12.87	A15	10-01-111	20-01-113	30-01-104
-----	----	---------------	-----	-----------	-----------	-----------

VANETTE CARGO (HC 23)

1.6 i	71	01.95	GA16DE	10-01-111	20-01-108	30-01-192
2.0 D	49	01.95	LD20	10-01-112E 10-01-112	20-01-110	30-01-109MP 30-01-109
2.3 D	55	01.95	LD23	10-01-112E 10-01-114	20-01-108	30-01-109MP 30-01-109

X-TRAIL (T30)

2.0	103	07.01	QR20DE	10-01-120	20-01-108	30-01-111 30-01-124 Nel serbatoio carb. /Inside tank fuel	21-NS-NS8
2.0 4x4	110	09.01	QR20DE	10-01-120	20-01-108	30-01-111 30-01-124 Nel serbatoio carb. /Inside tank fuel	21-NS-NS8
2.2 dCi	100	12.03	YD22DDTi	10-01-112E	20-01-108	30-01-109	21-NS-NS8
2.2 Di 4x4	84	07.01	YD22ETi	10-01-112E 04.03 → 10-01-195 → 03.03	20-01-108	30-01-109	21-NS-NS8
2.5 4x4	121	01.03	QR25DE	10-01-120	20-01-108	30-01-124 Nel serbatoio carb. /Inside tank fuel	21-NS-NS8
2.5 4x4	132	11.02	QR25DE	10-01-120	20-01-108	30-01-124 Nel serbatoio carb. /Inside tank fuel	21-NS-NS8

X-TRAIL (T31)

2.0	104	06.07	MR20DE	10-01-120	20-01-135		21-NS-NS10
2.0 dCi	110	06.07	M9R	10-ECO068	20-01-135	30-01-123	21-NS-NS10
2.0 dCi	127	06.07	M9R 760	10-ECO068	20-01-135	30-01-122	21-NS-NS10
2.5	124	06.07	QR25DE	10-01-120	20-01-196		21-NS-NS10



NISSAN Comm.







	KW						
				OIL FILTER FILTRO OLIO	AIR FILTER FILTRO ARIA	FUEL FILTER FILTRO CARBURANTE	CABIN FILTER FILTRO ABITACOLO
ATLEON							
120.35	88	09.00			20-01-126	30-01-190 06.01→	
120.56	88	09.00			20-01-126	30-01-190 06.01→	
140.75	100	09.00			20-01-126	30-01-190 06.01→	
165.75	117	09.00				30-01-190 06.01→	
3.0 (120.35 - 120.56)	88	09.00		10-01-110 10-01-194 01.07→	20-01-126	30-01-109MP 30-01-109 30-01-123 01.07→ 30-01-190	
CABSTAR							
1.6 F22	62	01.82 → 09.92		10-01-111	20-01-102	30-05-501	
2,0	60	01.82 → 12.87		10-01-111			
2,0	64	01.86 → 06.92		10-01-111			
2,3	50	12.81 → 06.92		10-ECO037 10-01-111			
2,5	53	02.83 → 12.90		10-03-351 10-01-111			
2.0 (F22)	66	01.82 → 06.92		10-01-111	20-01-107	30-01-104	
2.0 F22	66	06.82 → 12.94		10-01-111	20-01-107 01.85→	30-01-110 01.85→	
2.3D F22	51	06.85 → 06.92		10-01-110	20-01-112 →12.87	30-01-109MP 30-01-109	
2.5D F22	53	01.83		10-01-110	20-01-191 01.85→	30-01-109MP 30-01-109	
2.5D F22	55	10.85		10-01-107 10-01-110	20-01-112 20-01-191 01.85→	30-01-106 30-01-109MP 30-01-109	
2.7D F22	66	02.83 → 12.90			20-01-192		
28.11	81	10.06		10-01-112E	20-01-136	30-01-190	
3,3	71	02.83 → 12.90		10-ECO060 10-01-111			
3.0 D TL35DC	0	09.04		10-01-101E	20-01-188	30-01-190	
35.13	96	10.06		10-01-112E	20-01-136	30-01-190	
35.15	101	10.06		10-01-112E	20-01-136	30-01-123 30-01-190	
35.15	101	10.06		10-01-194	20-01-136	30-01-123	
45.13	96	10.06		10-01-112E		30-01-190	
45.15	110	10.06		10-01-194		30-01-123	
CABSTAR E							
110.35	78	10.98 → 10.06				30-01-190 06.01→	
110.35 3.0 D	78	10.98		10-01-110	20-01-188	30-01-109MP 30-01-109	
110.45	78	10.98 → 10.06				30-01-190 06.01→	
110.45 3.0 D	78	10.98		10-01-110	20-01-188	30-01-109MP 30-01-109	
120.35	88	10.98 → 10.06				30-01-190 06.01→	

NEW CODES - NEUE CODES - NOUVEAUX CODES - NUEVOS CODIGOS - NUOVI CODICI

Per nuove applicazioni e novità si prega di accedere al sito www.ashika.eu - For new applications and new items, please go to www.ashika.eu

NISSAN Comm.



	KW						
				OIL FILTER FILTRO OLIO	AIR FILTER FILTRO ARIA	FUEL FILTER FILTRO CARBURANTE	CABIN FILTER FILTRO ABITACOLO
CABSTAR E							
120.35 3.0 D	88	10.98		10-01-110	20-01-188	30-01-109MP 30-01-109	
120.45	88	10.98 → 10.06				30-01-190 06.01 →	
120.45 3.0 D	88	10.98		10-01-110	20-01-188	30-01-109MP 30-01-109	
75.28	55	10.98 → 10.06				30-01-190 06.01 →	
90.32	66	10.98 → 10.06				30-01-190 06.01 →	
90.32 2.7 D	66	10.98		10-01-110	20-01-188	30-01-109MP 30-01-109	
CABSTAR Pick-up							
2.0	66	07.92 → 05.94		10-01-111	20-01-107	30-01-115	

NEW CODES - NEUE CODES - NOUVEAUX CODES - NUEVOS CODIGOS - NUOVI CODICI

**OPEL**

	KW						
				OIL FILTER FILTRO OLIO	AIR FILTER FILTRO ARIA	FUEL FILTER FILTRO CARBURANTE	CABIN FILTER FILTRO ABITACOLO
AGILA							
1.3 CDTI	55	09.07	Z 13 DTJ	10-ECO065		30-ECO016	21-SZ-Z09
AGILA (H00)							
1.0	44	08.03	Z 10 XEP	10-ECO017			
1.0 12V	43	09.00	Z 10 XE	10-ECO017			
1.2 16V	55	09.00	Z 12 XE	10-ECO017			
1.2 16V Twinport	59	07.04	Z 12 XEP	10-ECO017			
1.3 CDTI	51	08.03	Z 13 DT	10-ECO044 10-ECO065		30-ECO016	
AMPERA							
EV 150	111	11.11		10-03-398			21-DW-W15
ANTARA							
2.0 CDTI	110	05.06	Z 20 DMH Z 20 S	10-ECO059		30-ECO016	
2.0 CDTI	93	03.07	Z 20 S	10-ECO059		30-ECO016	
2.0 CDTI FWD	93	09.08	Z 20 DM	10-ECO059		30-ECO016	
ARENA (THB),(TB, TF)							
1.9 D	44	03.98 → 08.01	F8Q 600 F8Q 606	10-05-595		30-ECO007	
2.5 D	55	03.98 → 08.01	S8U 758 S8U 780 S8U 782			30-ECO007	
ASTRA F CLASSIC 2 volumi							
1.2 i	48	03.98 → 08.00	X 12 XE	10-ECO073			
1.8 i	85	03.98 → 08.00	X 18 XE1	10-ECO018			
2.0 Di	60	03.98 → 08.00	X 20 DTL	10-ECO005			
2.0 DTi	74	08.99 → 08.00	X 20 DTH	10-ECO005			
ASTRA G 2							
1.2 16V	48	02.98 → 09.00	X 12 XE	10-ECO017 10-ECO073			
1.2 16V	55	09.00 → 01.05	Z 12 XE	10-ECO017 10-ECO073			
1.4 16V	66	02.98 → 01.05	X 14 XE Z 14 XE	10-ECO017 09.98 →			
1.7 CDTI	59	04.03 → 01.05	Z 17 DTL	10-ECO038		30-ECO009	
1.7 DTI 16V	55	02.00 → 01.05	Y 17 DT	10-ECO038		30-ECO009	
1.7 TD	50	02.98 → 08.00	X 17 DTL			30-ECO009	
1.8	81	02.03 → 01.04	Z 18 XEL	10-ECO018			
1.8 16V	85	02.98 → 09.00	X 18 XE1	10-ECO018			
1.8 16V	92	09.00 → 01.05	Z 18 XE	10-ECO018			
2.0 DI	60	02.98 → 01.05	X 20 DTL Y 20 DTL	10-ECO005		30-ECO009	
2.0 DTI 16V	74	08.99 → 01.05	X 20 DTH Y 20 DTH	10-ECO005		30-ECO009	
2.2 16V	108	03.01 → 01.05	Z 22 SE	10-ECO019			
2.2 DTI	92	09.02 → 01.05	Y 22 DTR	10-ECO005		30-ECO009	
ASTRA H							
1.2	48	10.06	X 12 XE	10-ECO073			
1.2	59	08.05	Z 12 XEP	10-ECO073			

NEW CODES - NEUE CODES - NOUVEAUX CODES - NUEVOS CODIGOS - NUOVI CODICI

Per nuove applicazioni e novità si prega di accedere al sito www.ashika.eu - For new applications and new items, please go to www.ashika.eu

	KW			 OIL FILTER FILTRO OLIO	 AIR FILTER FILTRO ARIA	 FUEL FILTER FILTRO CARBURANTE	 CABIN FILTER FILTRO ABITACOLO
---	----	---	---	--	--	---	---

ASTRA H

1.3 CDTI	66	08.05	Z 13 DTH	10-ECO044		30-ECO016
1.4	59	04.04 → 10.04	Z 14 XEL	10-ECO073		
1.4	66	03.04	Z 14 XEP	10-ECO017		
1.6	85	12.06	Z 16 XER A 16 XER	10-ECO073		
1.6 Turbo	132	02.07	Z 16 LET	10-ECO073		
1.7 CDTI	59	03.04	Z 17 DTL	10-ECO038		30-ECO009
1.7 CDTI	74	03.04	Z 17 DTH	10-ECO038		30-ECO009
1.7 CDTI	81	02.07	A 17 DTJ Z 17 DTJ	10-ECO116		30-ECO009
1.7 CDTI	92	02.07	Z 17 DTR A 17 DTR			30-ECO009
1.8	103	01.06	Z 18 XER A 18 XER	10-ECO073		
1.9 CDTI	110	09.04	Z 19 DTH	10-ECO058		30-ECO016
1.9 CDTI	74	09.05	Z 19 DTL	10-ECO058		30-ECO016
1.9 CDTI 16V	88	04.04	Z 19 DTJ	10-ECO058		30-ECO016

ASTRA J

1.3 CDTI ecoFLEX	70	12.09	A 13 DTE	10-ECO095	20-0W-W12	30-ECO020
1.4 ecoFLEX	64	12.09	A 14 XEL	10-ECO073	20-0W-W11	
1.4 ecoFLEX	74	12.09	A 14 XER	10-ECO073	20-0W-W11	
1.4 Turbo	103	12.09	A 14 NET	10-ECO073	20-0W-W12	
1.6	85	12.09	A 16 XER	10-ECO073	20-0W-W11	
1.6 Turbo	132	12.09	A 16 LET	10-ECO073	20-0W-W12	
1.7 CDTI	81	12.09	A 17 DTJ A 17 DTC A 17 DTE	10-ECO116	20-0W-W12	30-ECO020
1.7 CDTI	92	12.09	A 17 DTR	10-ECO116	20-0W-W12	30-ECO020
2.0 CDTI	118	12.09	A 20 DTH		20-0W-W12	30-ECO020

COMBO

1.3 CDTI 16V	51	08.05	Z 13 DT	10-ECO044 10-ECO065		30-ECO016
1.3 CDTI 16V	55	10.05	Z 13 DTJ	10-ECO044		30-ECO016
1.4 16V	66	08.05	Z 14 XEP	10-ECO073		
1.7 DI 16V	48	10.01	Y 17 DTL	10-ECO038		30-ECO009
1.7 DTI 16V	55	10.01	Y 17 DT	10-ECO038		30-ECO009

CORSA A 2 volumi (93_, 94_, 98_, 99_)

1.2	33	09.82 → 08.90	12 NC E 12 GV	10-ECO018 01.85 → → 10.89		30-09-909
1.2 i	33	09.89 → 03.93	C 12 NZ	10-ECO018		
1.2 N	38	01.90 → 03.93	12 NV	10-ECO018		
1.2 S	40	09.82 → 02.90	12 ST	10-ECO018		
1.3	44	09.85 → 10.89	13 NB	10-ECO018		
1.3 S	51	09.82 → 10.89	13 SB	10-ECO018		
1.4 i	44	01.90 → 03.93	C 14 NZ	10-ECO018		
1.4 S	53	01.90 → 03.93	14 NV	10-ECO018		
1.4 Si	60	09.91 → 03.93	C 14 SE	10-ECO018		



	KW						
				OIL FILTER FILTRO OLIO	AIR FILTER FILTRO ARIA	FUEL FILTER FILTRO CARBURANTE	CABIN FILTER FILTRO ABITACOLO

CORSA A TR (91_, 92_, 96_, 97_)

1.2 i	33	09.89 → 03.93	C 12 NZ	10-ECO018
1.2 N	33	01.85 → 10.87	12 NC E 12 GV	10-ECO018
1.2 S	40	09.82 → 03.93	12 ST	10-ECO018 →02.90
1.2 S	43	09.82 → 10.87	12 S	10-ECO018
1.3	44	09.85 → 10.87	13 NB C 13 N	10-ECO018
1.3 S	51	09.82 → 10.87	13 SB	10-ECO018
1.4 i	44	10.89 → 03.93	C 14 NZ	10-ECO018
1.4 S	53	09.89 → 03.93	14 NV	10-ECO018

CORSA B (73_, 78_, 79_, F35_)

1.0 i 12V	40	11.96 → 09.00	X 10 XE	10-ECO017
1.2 i 16V	48	03.98 → 09.00	X 12 XE	10-ECO017
1.4 i	44	03.93 → 09.00	C 14 NZ X 14 SZ	10-ECO018 →10.96
1.4 i 16V	66	09.94 → 09.00	X 14 XE	10-ECO018
1.6 i 16V	78	09.94 → 09.00	X 16 XE	10-ECO018

CORSA C (F08, F68)

1.0	43	09.00	Z 10 XE	10-ECO017	
1.0	44	06.03	Z 10 XEP	10-ECO017	
1.2	55	09.00	Z 12 XE	10-ECO017	
1.2 Twinport	59	07.04	Z 12 XEP	10-ECO017	
1.3 CDTI	51	06.03	Z 13 DT	10-ECO044 10-ECO065	30-ECO016
1.4 Twinport	66	06.03	Z 14 XEP	10-ECO017	
1.7 CDTI	74	06.03	Z 17 DTH	10-ECO038	30-ECO009
1.7 DI	48	09.00	Y 17 DTL	10-ECO038	30-ECO009
1.7 DTI	55	09.00	Y 17 DT	10-ECO038	30-ECO009
1.8	92	09.00	Z 18 XE	10-ECO018	

CORSA C (F08, W5L)

1.2	59	07.05	Z 12 XEP	10-ECO017	
1.2 16V	55	09.00	Z 12 XE	10-ECO017	
1.3 CDTI 16V	51	08.05	Z 13 DT	10-ECO044 10-ECO065	30-ECO016
1.4	66	08.03	Z 14 XEP	10-ECO073	
1.7 CDTi	74	08.03	Z 17 DTH	10-ECO038	30-ECO009
1.7 DI 16V	48	09.00	Y 17 DTL	10-ECO038	30-ECO009
1.7 DTI 16V	55	09.00	Y 17 DT	10-ECO038	30-ECO009

CORSA D

1.0	44	07.06	Z 10 XEP	10-ECO017
1.2	51	06.10	A 12 XEL	10-ECO073
1.2	59	07.06	Z 12 XEP	10-ECO017
1.2	63	06.10	A 12 XER	10-ECO073
1.2 ecoFLEX	57	09.09	Z 12 XEP	10-ECO073
1.3 CDTI	55	07.06	Z 13 DTJ A 13 DTC	10-ECO065

NEW CODES - NEUE CODES - NOUVEAUX CODES - NUEVOS CODIGOS - NUOVI CODICI

	KW			 OIL FILTER FILTRO OLIO	 AIR FILTER FILTRO ARIA	 FUEL FILTER FILTRO CARBURANTE	 CABIN FILTER FILTRO ABITACOLO
---	----	---	---	--	--	---	---

CORSA D

1.3 CDTI	66	07.06	Z 13 DTH	10-ECO065	
1.3 CDTI	70	06.10	Z 13 DTR A 13 DTR Z 13 DTE	10-ECO095	
1.4	66	07.06	Z 14 XEP	10-ECO073	
1.4	66	07.06	Z 14 XEP	10-ECO017	
1.4	74	06.10	A 14 XER	10-ECO073	
1.4 ecoFLEX	64	09.09	A 14 XEL	10-ECO073	
1.6 Turbo	110	02.07	Z 16 LEL A 16 LEL	10-ECO073	
1.6 Turbo	141	02.07	Z 16 LER A 16 LER	10-ECO073	
1.7 CDTI	92	07.06	Z 17 DTR	10-ECO116	
1.7 CDTI	96	06.10	A 17 DTS	10-ECO116	

FRONTERA B (6B_)

2.2 DTI	88	09.02	Y 22 DTH	10-ECO005	30-ECO009
2.2 DTI (6B_ZC, 6B_VF, 6B_66, 6B_76)	85	10.98 → 09.02	X 22 DTH Y 22 DTH	10-ECO005	30-ECO009

INSIGNIA

1.6	85	07.08	A 16 XER	10-ECO073	
1.6 Turbo	132	01.09	A 16 LET	10-ECO073	
1.8	103	07.08	A 18 XER	10-ECO073	
2.0 Biturbo CDTI	140	07.08	A 20 DTR		30-ECO020
2.0 Biturbo CDTI 4x4	140	07.08	A 20 DTR		30-ECO020
2.0 CDTI	118	07.08	A 20 DTH		30-ECO020
2.0 CDTI	81	07.08	A 20 DTC A 20 DTL		30-ECO020
2.0 CDTI	96	07.08	A 20 DTJ A 20 DT		30-ECO020
2.0 CDTI 4x4	118	06.10	A 20 DTH		30-ECO020
2.0 Turbo	162	07.08	A 20 NHT	10-ECO019	
2.0 Turbo 4x4	162	07.08	A 20 NHT	10-ECO019	
2.8 V6 Turbo 4x4	191	07.08	A 28 NET	10-ECO117	
2.8 V6 Turbo 4x4 OPC	239	07.09	A 28 NER	10-ECO117	

MERIVA

1.3 CDTI	51	04.05	Z 13 DT Y 13 DT	10-ECO065	
1.3 CDTI	55	09.03	Z 13 DTJ	10-ECO044	
1.4 16V Twinport	66	07.04	Z 14 XEP	10-ECO017	
1.6 Turbo	132	09.05	Z 16 LET	10-ECO073	
1.7 CDTI	74	09.03	Z 17 DTH Z 17 DT	10-ECO038	30-ECO009
1.7 CDTI	92	09.06	Z 17 DTR A 17 DTR	10-ECO116	
1.7 DTI	55	09.03	Y 17 DT	10-ECO038	30-ECO009

MERIVA B

1.3 CDTI	55	06.10	A 13 DTC	10-ECO095	30-ECO020
1.3 CDTI	70	06.10	A 13 DTE	10-ECO095	30-ECO020
1.4	103	06.10	A 14 NET	10-ECO073	

NEW CODES - NEUE CODES - NOUVEAUX CODES - NUEVOS CODIGOS - NUOVI CODICI



	KW						
				OIL FILTER FILTRO OLIO	AIR FILTER FILTRO ARIA	FUEL FILTER FILTRO CARBURANTE	CABIN FILTER FILTRO ABITACOLO
MERIVA B							
1.4	74	06.10	A 14 XER	10-ECO073			
1.4 ecoFlex	88	06.10	A 14 NEL	10-ECO073			
1.7 CDTI	74	06.10	A 17 DT	10-ECO116		30-ECO020	
1.7 GDTI	81	06.10	A 17 DTC	10-ECO116		30-ECO020	
1.7 CDTI	96	06.10	A 17 DTS	10-ECO116		30-ECO020	
MOVANO (F9)							
1.9 DTI	59	09.00 → 10.01	F9Q 770			30-ECO015	
1.9 DTI	60	10.01	F9Q 774 F9Q 772			30-ECO015	
2.2 DTI	66	09.00	G9T 720 G9T 722 G9T 750	10-ECO030		30-ECO010	
2.5 CDTI	107	08.06	G9U 632 G9U 650	10-ECO068			
2.5 CDTI	74	08.06	G9U 650	10-ECO068		30-ECO017	
2.5 CDTI	88	08.06	G9U 632 G9U 650	10-ECO068			
2.5 D	59	01.99 → 09.00	S8U 770 S8U 772			30-ECO015	
2.5 DTi	73	10.03	G9U 754	10-ECO030			
2.5 DTI	84	10.01	G9U 720 G9U 724 G9U 754	10-ECO030		30-ECO017	
2.8 DTI	84	01.99 → 10.01	S9W 702 S9W 700			30-ECO015	
MOVANO (H9)							
2.2 DTI	66	09.00	G9T 720 G9T 722 G9T 750	10-ECO030		30-ECO017	
2.5 CDTI	107	08.06	G9U 632 G9U 650	10-ECO068			
2.5 CDTI	74	08.06	G9U 650	10-ECO068			
2.5 CDTI	88	08.06	G9U 632 G9U 650	10-ECO068			
2.5 D	59	01.99 → 09.00	S8U 770 S8U 772			30-ECO015	
2.5 DTi	74	10.03	G9U 754	10-ECO030		30-ECO017	
2.8 DTI	84	01.99 → 10.01	S9W 702 S9W 700			30-ECO015	
MOVANO (U9, E9)							
2.2 DTI	66	09.00	G9T 720 G9T 722 G9T 750	10-ECO030		30-ECO017	
2.5 CDTI	107	08.06	G9U 632 G9U 650	10-ECO068			
2.5 CDTI	74	08.06	G9U 650	10-ECO068			
2.5 CDTI	88	08.06	G9U 632 G9U 650	10-ECO068			
2.5 D	59	07.98 → 09.00	S8U 770 S8U 772			30-ECO015	
2.5 DTi	73	10.03	G9U 754	10-ECO068		30-ECO014 30-ECO017	
2.5 DTI	84	10.01	G9U 720 G9U 724 G9U 754 G9U 750	10-ECO030		30-ECO017	
2.8 DTI	84	07.98 → 10.01	S9W 702 S9W 700			30-ECO015	

NEW CODES - NEUE CODES - NOUVEAUX CODES - NUEVOS CODIGOS - NUOVI CODICI

	KW						
				OIL FILTER FILTRO OLIO	AIR FILTER FILTRO ARIA	FUEL FILTER FILTRO CARBURANTE	CABIN FILTER FILTRO ABITACOLO

MOVANO (U9, E9)

3.0 DTI	100	10.03	ZD3 200 ZD3 202	10-01-194	30-ECO014 30-ECO017
---------	-----	-------	--------------------	-----------	------------------------

MOVANO B

2.3 CDTI FWD	107	05.10	M9T 678 M9T 680		30-ECO017
2.3 CDTI FWD	74	05.10	M9T 670 M9T 672 M9T 676		30-ECO017
2.3 CDTI FWD	92	05.10	M9T 670 M9T 672 M9T 676		30-ECO017
2.3 CDTI [RWD]	107	05.10	M9T 694 M9T 696 M9T 698		30-ECO017
2.3 CDTI [RWD]	74	05.10	M9T 690 M9T 692		30-ECO017
2.3 CDTI [RWD]	92	05.10	M9T 686 M9T 690 M9T 696		30-ECO017

MOVANO Combi (J9)

1.9 DTI	59	09.00 → 10.01	F9Q 770		30-ECO015
1.9 DTI	60	10.01	F9Q 774 F9Q 772		30-ECO015
2.2 DTI	66	09.00	G9T 720 G9T 722 G9T 750	10-ECO030	30-ECO017
2.5 CDTI	107	08.06	G9U 632 G9U 650	10-ECO068	30-ECO017
2.5 CDTI	74	09.07	G9U 650	10-ECO068	30-ECO017
2.5 CDTI	88	08.06	G9U 632 G9U 650	10-ECO068	30-ECO017
2.5 D	59	07.98 → 09.00	S8U 770 S8U 772		30-ECO015
2.5 DTI	84	10.01	G9U 720 G9U 724 G9U 754 G9U 750	10-ECO030	30-ECO017
2.8 DTI	84	07.98 → 10.01	S9W 702 S9W 700		30-ECO015

OMEGA B (25_, 26_, 27_) Station wagon

2.0 DTI 16V	74	09.97 → 09.00	X 20 DTH	10-ECO005	
2.2 DTI 16V	88	09.00 → 07.03	Y 22 DTH	10-ECO005	
2.5 DTI	110	09.01 → 07.03	Y 25 DT	10-ECO035	
2.5 TD	96	04.94 → 07.03	25 DT X 25 DT X 25 TD	10-ECO011	
2.5 V6	125	03.94 → 09.00	X 25 XE	10-ECO018	
2.6 V6	132	09.00 → 07.03	Y 26 SE	10-ECO018	
3.0 V6	155	04.94 → 02.01	X 30 XE	10-ECO018	
3.2 V6	160	02.01 → 07.03	Y 32 SE	10-ECO018	

SIGNUM

1.8	103	09.05	Z 18 XER	10-ECO073	
1.9 CDTI	110	04.04	Z 19 DTH	10-ECO058	30-ECO016
1.9 CDTI	74	08.05	Z 19 DT	10-ECO058	30-ECO016
1.9 CDTI	88	04.04	Z 19 DT	10-ECO058	30-ECO016

	KW						
				OIL FILTER FILTRO OLIO	AIR FILTER FILTRO ARIA	FUEL FILTER FILTRO CARBURANTE	CABIN FILTER FILTRO ABITACOLO

SIGNUM

2.0 DTI	74	05.03	Y 20 DTH	10-ECO005	30-ECO009
2.0 Turbo	129	05.03	Z 20 NET	10-ECO019	
2.2 direct	114	05.03	Z 22 YH	10-ECO019	
2.2 DTI	92	05.03	Y 22 DTR	10-ECO005	30-ECO009
2.8 V6 Turbo	169	09.05	Z 28 NEL	10-ECO117	
2.8 V6 Turbo	184	01.06	Z 28 NET	10-ECO117	
3.0 V6 CDTI	130	05.03	Y 30 DT		30-ECO009
3.0 V6 CDTI	135	09.05	Z 30 DT		30-ECO009
3.2 V6	155	05.03	Z 32 SE	10-ECO018	

SINTRA

2.2 DTI	85	07.97 → 04.99	X 22 DTH	10-ECO005	30-ECO009
3.0 i 24V	148	11.96 → 04.99	X 30 XE	10-ECO018	

SPEEDSTER

2.2	108	09.00	Z 22 SE	10-ECO019	
-----	-----	-------	---------	-----------	--

TIGRA TwinTop

1.3 CDTI	51	06.04	Z 13 DT	10-ECO044 10-ECO065	30-ECO016
1.4	66	06.04	Z 14 XEP	10-ECO017	

VECTRA B (36_)

1.8 i 16V	85	10.95 → 09.00	X 18 XE1	10-ECO018	
1.8 i 16V	92	09.00 → 04.02	Z 18 XE	10-ECO018	
2.0 DI 16V	60	11.96 → 04.02	X 20 DTL	10-ECO005	
2.0 DTI 16V	74	06.97 → 04.02	X 20 DTH Y 20 DTH	10-ECO005	
2.2 DTI 16V	92	09.00 → 04.02	Y 22 DTR	10-ECO005	
2.2 i 16V	108	09.00 → 04.02	Z 22 SE	10-ECO019	
2.5 i V6	125	10.95 → 09.00	X 25 XE	10-ECO018	
2.6 i V6	125	09.00 → 04.02	Y 26 SE	10-ECO018	

VECTRA C

1.8	103	01.06	Z 18 XER	10-ECO073	
1.9 CDTI	110	04.04	Z 19 DTH	10-ECO058	30-ECO016
1.9 CDTI	74	10.05	Z 19 DT	10-ECO058	
1.9 CDTI	88	04.04	Z 19 DT	10-ECO058	30-ECO016
2.0 16V Turbo	129	03.03	Z 20 NET	10-ECO019	
2.0 DTI 16V	74	04.02	Y 20 DTH	10-ECO005	
2.2 16V	108	04.02	Z 22 SE	10-ECO019	
2.2 direct	114	10.03	Z 22 YH	10-ECO019	
2.2 DTI 16V	92	04.02	Y 22 DTR	10-ECO005	
2.8 V6 Turbo	169	08.05	Z 28 NEL	10-ECO117	
2.8 V6 Turbo	184	08.06	Z 28 NET	10-ECO117	
2.8 V6 Turbo	188	08.05	Z 28 NET	10-ECO117	
3.2 V6	155	08.02	Z 32 SE	10-ECO018	

VIVARO Combi

NEW CODES - NEUE CODES - NOUVEAUX CODES - NUEVOS CODIGOS - NUOVI CODICI

	KW			 OIL FILTER FILTRO OLIO	 AIR FILTER FILTRO ARIA	 FUEL FILTER FILTRO CARBURANTE	 CABIN FILTER FILTRO ABITACOLO
---	----	---	---	--	--	---	---

VIVARO Combi

1.9 DI	60	08.01	F9Q 774 F9Q762		30-ECO010
1.9 DTI	74	08.01	F9Q 760		30-ECO010
2.0 CDTI	66	08.06	M9R 780 M9R 782 M9R 786	10-ECO068	30-ECO015
2.0 CDTI	84	08.06	M9R 780 M9R 784 M9R 786 M9R 788	10-ECO068	30-ECO015
2.5 CDTI	107	08.06	G9U 630	10-ECO068	30-ECO014
2.5 CDTI	84	08.06	G9U 630	10-ECO068	
2.5 DTI	99	05.03	G9U730 G9U 630	10-ECO030	30-ECO014 30-ECO017

ZAFIRA

1.6	69	01.06	Z 16 YNG	10-ECO073	
1.6	85	01.08	Z 16 XER A 16 XER	10-ECO073	
1.6 CNG Turbo	110	02.09	Z 16 XNT A 16 XNT	10-ECO073	
1.7 CDTI	81	01.08	A 17 DTJ Z 17 DTJ	10-ECO116	
1.7 CDTI	92	01.08	A 17 DTR	10-ECO116	
1.8	103	07.05	Z 18 XEP Z 18 XER A 18 XER	10-ECO073	
1.9 CDTI	110	07.05	Z 19 DTH	10-ECO058	30-ECO016
1.9 CDTI	74	07.05	Z 19 DTL	10-ECO058	30-ECO016
1.9 CDTI	88	07.05	Z 19 DT	10-ECO058	30-ECO016
2.2	110	07.05	Z 22 YH	10-ECO019	

ZAFIRA (F75_)

1.6 16V	74	04.99→06.05	X 16 XEL Z 16 XE	10-ECO018	
1.8 16V	85	04.99→09.00	X 18 XE1	10-ECO018	
1.8 16V	92	09.00→06.05	Z 18 XE	10-ECO018	
2.0 DI 16V	60	10.99→06.05	X 20 DTL	10-ECO005	30-ECO009
2.0 DTI 16V	74	09.00→06.05	Y 20 DTH	10-ECO005	30-ECO009
2.2 16V	108	09.00→06.05	Z 22 SE	10-ECO019	
2.2 DTI 16V	92	01.02→06.05	Y 22 DTR	10-ECO005	30-ECO009



	KW						
				OIL FILTER FILTRO OLIO	AIR FILTER FILTRO ARIA	FUEL FILTER FILTRO CARBURANTE	CABIN FILTER FILTRO ABITACOLO
1007							
1.4	54	04.05	KFV (TU3JP)	10-ECO060			
1.4 16V	65	10.05	KFU (ET3J4)	10-ECO060			
1.6 16V	80	04.05	NFU (TU5JP4)	10-ECO060			
106 II (1)							
1.1 i	40	01.97	HDY (TU1M)	10-ECO037			
1.1 i	44	05.96	HDZ (TU1M) HFX (TU1JP)	10-ECO037			
1.4 i	55	05.96	KFX (TU3JP) KFW (TU3JP)	10-ECO037			
1.6 i	65	05.96	NFZ (TU5JP)	10-ECO037			
107							
1.0	50	06.05	1KR (384 F)	10-02-210	20-02-288		21-TY-TY10
1.4 HDi	40	06.05	8HT (DV4TD)	10-03-351	20-03-351	30-03-351	21-TY-TY10
206 (2A/C)							
1.4	55	03.07	KFW (TU3JP)	10-ECO060			
1.6 16V	80	03.07	NFU (TU5JP4)	10-ECO060			
206 (2A/C) Tutti i modelli\ All models							
1.1 i	44	09.98	HFX (TU1JP) HFX (TU1JP)	10-ECO037			
1.4 16V	65	10.03	KFU (ET3J4)	10-ECO060			
1.4 i	55	09.98	KFX (TU3JP) TU 3 JP KFW (TU3JP)	10-ECO037			
1.6 16V	80	12.00	NFU (TU5JP4)	10-ECO037			
2.0 HDI 90	66	12.99	RHY (DW10TD)			30-ECO019	
206+ (T3E)							
1.1	44	01.09	HFX (TU1JP) HFX (TU1A) TU1AE5	10-ECO060			
1.4 i	55	01.09	KFV (TU3A) KFW (TU3A)	10-ECO060			
207 Tutti i modelli\ All models							
1.4	53	02.06	KFV (TU3A)	10-ECO060			
1.4 16V	65	02.06	KFU (ET3J4)	10-ECO060			
1.4 16V	70	06.07	EP3	10-ECO060			
1.6 16V	80	02.06	NFU (TU5JP4)	10-ECO060			
1.6 16V RC	128	02.07	5FY (EP6DTS)	10-ECO060			
1.6 16V Turbo	110	02.06	EP6DT	10-ECO060			
1.6 16V Turbo	115	10.09	5FR (EP6DT)	10-ECO060			
1.6 16V VTi	88	02.07	EP6 5FS (EP6C)	10-ECO060			
3008							
1.6 THP	110	06.09	5FX (EP6DT)	10-ECO060			
1.6 THP	115	06.09	5FV (EP6DT)	10-ECO060			
1.6 VTi	88	06.09	EP6 5FS (EP6C)	10-ECO060			
2.0 HDi	110	06.09	RHE (DW10CTED4)	10-ECO060		30-ECO028	
2.0 HDi	120	06.09	RHH (DW10CTED4)	10-ECO060		30-ECO028	

NEW CODES - NEUE CODES - NOUVEAUX CODES - NUEVOS CODIGOS - NUOVI CODICI

	KW						
				OIL FILTER FILTRO OLIO	AIR FILTER FILTRO ARIA	FUEL FILTER FILTRO CARBURANTE	CABIN FILTER FILTRO ABITACOLO

306 (7B, N3, N5)

1.4 SL	55	06.94 → 05.01	KDX (TU3MC) KFX (TU3JP) KFW (TU3JP)	10-ECO037	
1.6	66	07.00 → 05.01		10-ECO037	
1.6	72	10.00 → 05.01	NFT	10-ECO037	
1.6 SR	65	06.94 → 10.00	NFZ (TU5JP)	10-ECO037	
1.9 D	51	09.98 → 05.01	WJZ (DW8) WJY (DW8B)		30-ECO004
2.0 HDi 90	66	06.99 → 05.01	RHY (DW10TD)		30-ECO008

307 (3A/C)

1.4	55	08.00	KFW (TU3JP)	10-ECO037	
1.4 16V	65	11.03	KFU (ET3J4)	10-ECO060	
1.6 16V	80	08.00	NFU (TU5JP4)	10-ECO037	
1.6 BioFlex	80	09.07	NFU (TU5JP4)	10-ECO060	
2.0 16V	103	03.05	RFJ (EW10A)	10-ECO060	
2.0 HDi 110	79	08.00	RHS (DW10ATED)		30-ECO019
2.0 HDi 135	100	10.03	RHR (DW10BTED4)	10-ECO060	30-ECO027
2.0 HDi 90	66	08.00	RHY (DW10TD)		30-ECO019

308

1.4 16V	70	09.07	8FS (EP3)	10-ECO060	
1.4 16V	72	12.09		10-ECO060	
1.6 16V	103	09.07	5FT (EP6DT)	10-ECO060	
1.6 16V	110	09.07	EP6DT	10-ECO060	
1.6 16V	115	10.09	EP6CDT	10-ECO060	
1.6 16V	128	03.08	5FY (EP6DTS)	10-ECO060	
1.6 16V	88	09.07	EP6	10-ECO060	
1.6 Bioflex	82	03.09	NFU (TU5JP4)	10-ECO060	
2.0 Bioflex	103	01.08	RFJ (EW10A)	10-ECO060	
2.0 HDi	100	09.07	RHR (DW10BTED4)	10-ECO060	30-ECO027
2.0 HDi	103	09.07		10-ECO060	30-ECO027
2.0 HDi	120	06.09	RHH (DW10CTED4)	10-ECO060	30-ECO028

4007

2.2 HDi	115	02.07	4HN (DW12MTED4)	10-ECO060	
---------	-----	-------	--------------------	-----------	--

406 (8B)

2.0 HDi 110	79	08.01 → 05.04	RHZ (DW10ATED) RHS (DW10ATED)		30-ECO019
2.0 HDi 110	80	06.98 → 08.01	RHZ (DW10ATED)		30-ECO019
2.2 HDi	98	03.00 → 05.04	4HX (DW12TED4/FA P)		30-ECO019

407

1.8 16V	92	09.05	6FY (EW7A)	10-ECO060	
2.0 16V	103	09.05	RFJ (EW10A)	10-ECO060	

NEW CODES - NEUE CODES - NOUVEAUX CODES - NUEVOS CODIGOS - NUOVI CODICI



	KW						
				OIL FILTER FILTRO OLIO	AIR FILTER FILTRO ARIA	FUEL FILTER FILTRO CARBURANTE	CABIN FILTER FILTRO ABITACOLO

407

2.0 Bioflex	103	01.08	RFJ (EW10A)	10-ECO060	
2.0 HDi	100	10.05	RHR (DW10BTED4)	10-ECO060	30-ECO027
2.0 HDi	103	08.08		10-ECO060	30-ECO027
2.0 HDi	120	07.09	RHH (DW10CTED4)	10-ECO060	30-ECO028
2.0 HDi	93	05.04 → 07.08		10-ECO060	30-ECO027
2.0 HDi 135	100	05.04	RHR (DW10BTED4)	10-ECO060	30-ECO027
2.2 HDi	120	06.08	4HP (DW12BTED4)	10-ECO060	30-ECO028
2.2 HDi 170	125	05.06	4HT (DW12BTED4)	10-ECO060	
2.7 HDi	150	10.05	UHZ (DT17)	10-ECO048	30-ECO029
3.0 HDi	177	06.09	DT20C	10-ECO099	

5008

1.6 16V	115	09.09	EP6CDT	10-ECO060	
1.6 16V	88	09.09	EP6 5FS (EP6C)	10-ECO060	
2.0 HDi	110	06.09	RHE (DW10CTED4)	10-ECO060	30-ECO028
2.0 HDi	120	09.09	RHH (DW10CTED4)	10-ECO060	30-ECO028

508 | SW

1.6 THP	115	11.10	EP6CDT	10-ECO060	
2.0 HDi	103	11.10		10-ECO060	30-ECO027

607 (9D)

2.0 HDi	100	09.05	RHR (DW10BTED4)	10-ECO060	30-ECO027
2.0 HDi	80	05.00	RHZ (DW10ATED)		30-ECO019
2.2 HDi	125	05.06	4HT (DW12BTED4)	10-ECO060	
2.2 HDi	98	02.00	4HX (DW12TED4/FA P)		30-ECO019
2.7 HDi 24V	150	12.04	DT17TED4	10-ECO048	30-ECO029

806 (221)

2.0 HDi	80	08.99 → 08.02	RHZ (DW10ATED)		30-ECO019
2.0 HDi 16V	80	08.99 → 08.02	RHW (DW10ATED4)		30-ECO019

807 (E)

2.0 16V	103	09.05	RFJ (EW10A)	10-ECO060	
2.0 HDi	100	06.06	RHR (DW10BTED4)	10-ECO060	30-ECO027
2.0 HDi	79	06.02	RHW (DW10ATED4) RHM (DW10ATED4) RHT (DW10ATED4)		30-ECO019
2.0 HDi	80	04.04 → 05.06			30-ECO019
2.0 HDi	88	11.06	DW10UTED4-R HK	10-ECO060	30-ECO027

NEW CODES - NEUE CODES - NOUVEAUX CODES - NUEVOS CODIGOS - NUOVI CODICI

	KW			 OIL FILTER FILTRO OLIO	 AIR FILTER FILTRO ARIA	 FUEL FILTER FILTRO CARBURANTE	 CABIN FILTER FILTRO ABITACOLO
---	----	---	---	--	--	---	---

807 (E)

2.2 HDi	125	06.06	4HT (DW12BTED4)	10-ECO060	
---------	-----	-------	--------------------	-----------	--

BIPPER Tepee

1.4	54	04.08	KFV (TU3A)	10-ECO060	
-----	----	-------	------------	-----------	--

BOXER

2.2 HDi 100	74	04.06	4HV	10-ECO060	30-ECO016
2.2 HDi 120	88	04.06	4HU	10-ECO060	30-ECO016
3.0 HDi	107	04.10			30-ECO016
3.0 HDi 160	115	04.06			30-ECO016

BOXER (244)

2.0 HDi	62	04.02	RHV (DW10UTD) RHV (DW10TD)		30-ECO016
2.2 HDi	74	04.02	4HY (DW12UTED)		30-ECO016
2.8 HDi	107	04.04	8140.43N		30-ECO016
2.8 HDi	94	04.02	8140.43S		30-ECO016
2.8 HDi 4x4	94	04.02	8140.43S		30-ECO016

EXPERT

2.0 16V	103	01.07	RFJ (EW10A) RFH (EW10A)	10-ECO060	
2.0 HDi 120	88	01.07	DW10UTED4-R HK	10-ECO060	30-ECO027
2.0 HDi 140	100	01.07	RHR (DW10BTED4)	10-ECO060	30-ECO027
2.0 HDi 165	120	09.09	RHH (DW10CTED4)	10-ECO060	30-ECO028

EXPERT (222)

1.9 D 70	51	12.98	WJZ (DW8) WJY (DW8B)		30-ECO004
2.0 HDI	69	07.00	RHX (DW10BTED)		30-ECO019
2.0 HDI	80	07.00	RHZ (DW10ATED)		30-ECO019
2.0 HDI	80	07.00	RHW (DW10ATED4)		30-ECO019

EXPERT (224)

2.0 HDI	80	07.00	RHW (DW10ATED4)		30-ECO019
2.0 HDI	80	07.00	RHZ (DW10ATED)		30-ECO019

EXPERT Tepee







2.0 16V	103	01.07	RFJ (EW10A) RFH (EW10A)	10-ECO060	
2.0 HDi 120	88	01.07	DW10UTED4-R HK	10-ECO060	30-ECO027
2.0 HDi 140	100	01.07	RHR (DW10BTED4)	10-ECO060	30-ECO027
2.0 HDi 165	120	09.09	RHH (DW10CTED4)	10-ECO060	30-ECO028







PARTNER

1.6	66	04.08	NFR (TU5JP4B)	10-ECO060	
1.6	80	04.08	NFU (TU5JP4)	10-ECO060	

NEW CODES - NEUE CODES - NOUVEAUX CODES - NUEVOS CODIGOS - NUOVI CODICI









	KW						
				OIL FILTER FILTRO OLIO	AIR FILTER FILTRO ARIA	FUEL FILTER FILTRO CARBURANTE	CABIN FILTER FILTRO ABITACOLO
PARTNER (5)							
1.1	44	06.96	HDZ (TU1M)	10-ECO037			
1.4	55	06.96	KFX (TU3JP) TU32	10-ECO037			
1.4 BiFuel	55	04.03	KFW (TU3JP)	10-ECO037			
1.9 D	51	06.96	WJZ (DW8) WJY (DW8B)			30-ECO004	
1.9 D 4x4	51	04.04	WJY (DW8B)			30-ECO004	
2.0 HDi	66	04.00	RHY (DW10TD)			30-ECO019	
2.0 HDi 4x4	66	04.04	RHY (DW10TD)			30-ECO019	
PARTNER Combispace (5F)							
1.1	44	06.96	HDZ (TU1M) HFX (TU1JP)	10-ECO037			
1.4	54	11.02 → 10.06		10-ECO037			
1.4	55	06.96	KFX (TU3JP) TU32 KFW (TU3JP)	10-ECO037			
1.6 16V	80	07.01	NFU (TU5JP4)	10-ECO037			
1.9 D	51	12.98	WJZ (DW8) WJY (DW8B)			30-ECO004	
2.0 HDi	66	02.00	RHY (DW10TD)			30-ECO019	
2.0 HDi 4x4	66	04.04 → 08.05	RHY (DW10TD)			30-ECO019	
PARTNER Tepee							
1.6	66	04.08	NFR (TU5JP4B)	10-ECO060			
1.6	72	08.10		10-ECO060			
1.6	80	04.08	NFU (TU5JP4)	10-ECO060			
1.6	88	04.10	5FS (EP6C)	10-ECO060			
RCZ							
1.6 16V	115	03.10	EP6CDT	10-ECO060			
1.6 16V	147	06.10	EP6CDTX	10-ECO060			
2.0 HDi	120	03.10	RHH (DW10CTED4)	10-ECO060		30-ECO028	

	KW			 OIL FILTER FILTRO OLIO	 AIR FILTER FILTRO ARIA	 FUEL FILTER FILTRO CARBURANTE	 CABIN FILTER FILTRO ABITACOLO
PORTER							
1.0	33	05.95 → 05.98	CB41	10-06-604	20-06-605 Panel filter 20-06-608 Cylindric filter	30-06-612	
1.2 D	26	05.95	LDW12	10-06-699	20-06-614	30-06-695	
1.3 i 16V	48	05.98		10-06-604	20-06-615	30-06-624	
1.3 i 16V 4x4	48	05.98		10-06-604	20-06-615	30-06-623	
1.4 D	28	04.98		10-06-699	20-06-614	30-06-695	
VESPACAR							
0.4 D	11	08.93		10-09-986		30-06-695	



PORSCHE

	KW			 OIL FILTER FILTRO OLIO	 AIR FILTER FILTRO ARIA	 FUEL FILTER FILTRO CARBURANTE	 CABIN FILTER FILTRO ABITACOLO
CAYENNE							
S Hybrid 3.0	245	06.10	M 06.EC MCG.EA MCG.FA	10-ECO108			
CAYENNE (955)							
3.0 TDI	176	02.09		30-ECO025			
3.2	184	10.03	M02.2Y	10-ECO013			

NEW CODES - NEUE CODES - NOUVEAUX CODES - NUEVOS CODIGOS - NUOVI CODICI

Per nuove applicazioni e novità si prega di accedere al sito www.ashika.eu - For new applications and new items, please go to www.ashika.eu

	KW						
				OIL FILTER FILTRO OLIO	AIR FILTER FILTRO ARIA	FUEL FILTER FILTRO CARBURANTE	CABIN FILTER FILTRO ABITACOLO
AVANTIME (DE0)							
2.2 dCi (DE01)	110	05.02 → 05.03	G9T 712	10-ECO030		30-ECO015	
CLIO II (B/C/B0/1_, CB0/1/2_)							
1.2	44	03.99 → 05.01	D7F 722	10-ECO024			
1.2	55	06.01 → 10.03		10-ECO024			
1.2 (B/CB0F, B/CB0A, B/CB10, B/CB1K, E	43	09.98	D7F 710 D7F 720 D7F 726 D7F 766	10-ECO024			
1.2 16V (B/CB05)	55	06.01	D4F 712 D4F 714 D4F 722	10-ECO024			
1.9 D (B/CB0E)	47	09.98 → 05.05	F8Q 630			30-ECO007 BOSCH Injection	
1.9 dTi (B/CB0U)	59	02.00 → 05.05	F9Q 780			30-ECO007 BOSCH Injection	
CLIO II (SB0_)							
1.1 (SB0A)	43	09.98	D7F 720 D7F 722	10-ECO024			
1.2	44	03.99 → 10.03	D7F 726 D7F 746	10-ECO024			
1.9 D (SB0E)	47	09.98	F8Q 662 F8Q 630			30-ECO007	
ESPACE III (JE_)							
2.2 12V TD (JE0E, JE0H, JE0P)	83	11.96 → 10.00	G8T 760 G8T 714 G8T 716			30-ECO015	
2.2 dCi (JE0K)	95	10.00 → 10.02	G9T 710 G9T 642	10-ECO030			
2.2 dCi (JE0S)	85	07.00 → 10.02	G9T 710	10-ECO030			
ESPACE IV (JK0_)							
1.9 dCi (JK0U, JK0G)	88	11.02	F9Q 680 F9Q 820 F9Q 826			30-ECO015	
2.0 dCi	110	01.06	M9R 740 M9R 760	10-ECO068			
2.0 dCi	127	01.06	M9R 760	10-ECO068			
2.0 dCi	96	01.06		10-ECO068			
2.2 dCi	102	02.06	G9T 645	10-ECO068			
2.2 dCi (JK0HA6, JK0HC6, JK0HAB, JK0H	110	11.02	G9T 742 G9T 743	10-ECO030		30-ECO015	
3.0 dCi (JK0JAB, JK0JCB)	130	11.02	P9X 701 P9X 715			30-ECO015	
GRAND SCENIC							
1.9 dCi	81	05.05	F9Q E 804			30-ECO015	
1.9 dCi	88	04.04	F9Q 812			30-ECO015	
1.9 dCi	96	05.05	F9Q EE 804 F9Q J 803 F9Q 816 F9Q 818			30-ECO015	
2.0 dCi	110	02.09	M9R 615	10-ECO068			
2.0 dCi	110	09.05	M9R 700 M9R 721	10-ECO068			

NEW CODES - NEUE CODES - NOUVEAUX CODES - NUEVOS CODIGOS - NUOVI CODICI



	KW						
				OIL FILTER FILTRO OLIO	AIR FILTER FILTRO ARIA	FUEL FILTER FILTRO CARBURANTE	CABIN FILTER FILTRO ABITACOLO

GRAND SCENIC

2.0 dCi	118	04.09	M9R 610	10-ECO068
---------	-----	-------	---------	-----------

KANGOO (KC0_) \ Express (FC0_)

1.2	44	07.98 → 07.01	D7F 764	10-ECO024
1.2 (FC01, FC0A, FC0F)	43	08.97	D7F 710 D7F 720 D7F 726 D7F 722 D7F 744 D7F 746	10-ECO024
1.2 16V (FC05)	55	10.01	D4F 712 D4F 714	10-ECO024
1.9 D	48	09.99 → 06.03	F8Q 632	30-ECO007
1.9 dCi	62	07.03	F9Q 790	30-ECO015
1.9 dCi 4x4	62	07.03	F9Q 790	30-ECO015
1.9 dCi 4x4 (FC0V)	59	10.01	F9Q 790 F9Q 782	30-ECO007
1.9 dTi (FC0U)	59	02.00	F9Q 780	30-ECO007
D 55 1.9 (FC0D)	40	08.97	F8Q 662	30-ECO008
D 65 1.9 (FC0E, FC02, FC0J, FC0N)	47	08.97	F8Q 630 F8Q 632	30-ECO008

KOLEOS

2.0 dCi	110	09.08	M9R D 833 M9R G 832 M9R 832	10-ECO068
2.0 dCi	130	09.08	M9R 830	10-ECO068
2.0 dCi 4x4	110	09.08	M9R G 832 M9R 832	10-ECO068
2.0 dCi 4x4	127	09.08	M9R 830	10-ECO068

LAGUNA (B56_, 556_) \ Grandtour (K56_)

1.9 dTi (B56J)	72	10.97 → 03.01	F9Q 710 F9Q 716 F9Q 717	30-ECO008
2.2 D (B56F/2)	61	11.93 → 03.01	G8T 706 G8T 752 G8T 790 G8T 794	30-ECO015
2.2 dT (B569)	83	03.96 → 03.01	G8T 760	30-ECO015

LAGUNA Coupé

2.0 dCi	110	10.07	M9Ra 742 M9Rk 802 M9Rk 805	10-ECO068
2.0 dCi (DT1M)	127	09.08	M9R 816 M9Rk 806	10-ECO068
2.0 dCi GT	131	03.08	M9Rk 816	10-ECO068

LAGUNA II Grandtour (KG0_, KG1_) \ (BG0_, BG1_)

1.9 dCi	68	03.04	F9Q 664	30-ECO015
1.9 dCi	79	03.01	F9Q 718 F9Q 754	30-ECO015
1.9 dCi	81	01.05	F9Q 674	30-ECO015
1.9 dCi	96	05.05	F9Q 758 F9Q 759	30-ECO015
1.9 dCi (KG0E)	77	06.01	F9Q 752	30-ECO015
1.9 dCi (KG0G)	88	03.01	F9Q 750 F9Q 756 F9Q 670	30-ECO015

NEW CODES - NEUE CODES - NOUVEAUX CODES - NUEVOS CODIGOS - NUOVI CODICI

	KW						
				OIL FILTER FILTRO OLIO	AIR FILTER FILTRO ARIA	FUEL FILTER FILTRO CARBURANTE	CABIN FILTER FILTRO ABITACOLO

LAGUNA II Grandtour (KG0_, KG1_) \ (BG0_, BG1_)

2.0 dCi	110	08.05	M9R 740 M9R A 700	10-ECO068	30-ECO015
2.0 dCi	127	01.06	M9R 760	10-ECO068	30-ECO015
2.2 dCi	102	05.05	G9T 600 G9T 706 G9T 707	10-ECO030	30-ECO015
2.2 dCi	85	04.04 → 10.05	G9T 600	10-ECO030	30-ECO015
2.2 dCi (KG0F)	110	10.01	G9T 702	10-ECO030	30-ECO015

LAGUNA III Grandtour

2.0 dCi	110	10.07	M9R 740 M9Ra 742 M9Rk 802 M9Rk 805 M9R 744 M9R 746 M9R 748	10-ECO068	
2.0 dCi	127	01.08	M9R 800 M9R 809	10-ECO068	
2.0 dCi	96	10.07	M9Ra 742 M9R 802	10-ECO068	
2.0 dCi GT	131	03.08	M9R 816	10-ECO068	

MASTER II

1.9 dCi 80	60	11.01	F9Q 772 F9Q 774		30-ECO015
1.9 dTi	59	09.00	F9Q 770		30-ECO015
2.2 dCi 90	66	09.00	G9T 720 G9T 722 G9T 750	10-ECO030	30-ECO010
2.5 D	59	07.98 → 01.01	S8U 770		30-ECO015
2.5 dCi 100 (HD0U, FD0U, HD0V, FD0V)	73	10.03	G9U 754	10-ECO030	30-ECO014 30-ECO017
2.5 dCi 120	84	10.01	G9U 720 G9U 754	10-ECO030	30-ECO017
2.8 dTi	84	07.98 → 10.01	S9W 702		30-ECO015
3.0 dCi 120	85	06.05	ZD3 600	10-ECO030	30-ECO017
3.0 dCi 140 (HD0S, FD0S, HD1S)	100	10.03	ZD3 202	10-01-194	30-ECO014 30-ECO017
3.0 dCi 160	115	06.05	ZD3 A 604	10-01-194	30-ECO014 30-ECO017

MASTER III

2.5 dCi	107	08.06	G9U 632	10-ECO068	
2.5 dCi	74	08.06	G9U 754	10-ECO068	
2.5 dCi	84	01.04	G9U 750	10-ECO030	
2.5 dCi	88	08.06	G9U 650	10-ECO068	

MEGANE 2 volumi /Coda spiovente

2.0 dCi	110	10.10	M9R 615	10-ECO068	
2.0 dCi	118	04.09	M9R 610	10-ECO068	

MEGANE CC







2.0 dCi	118	06.10	M9R 610	10-ECO068	
---------	-----	-------	---------	-----------	--

MEGANE Classic (LA)



--	--	--	--	--	--

NEW CODES - NEUE CODES - NOUVEAUX CODES - NUEVOS CODIGOS - NUOVI CODICI



	KW						
				OIL FILTER FILTRO OLIO	AIR FILTER FILTRO ARIA	FUEL FILTER FILTRO CARBURANTE	CABIN FILTER FILTRO ABITACOLO
MEGANE Classic (LA)							
1.9 dTi (LA08, LA0N)	72	03.97 → 02.01	F9Q 730 F9Q 734 F9Q 731 F9Q 736				30-ECO008
1.9 dTi (LA1U)	59	02.01	F9Q 744				30-ECO007
1.9 TDI	69	09.96	F8Q 784				30-ECO007
MEGANE Coach (DA0/1_)							
1.6 e (DA0F)	66	03.96 → 03.99	K7M 702 K7M 703				30-ECO008
1.9 dTi (DA0N)	72	03.97 → 02.01	F9Q 734 F9Q 731 F9Q 736				30-ECO007
MEGANE Coupé							
2.0 dCi	110	04.09	M9R 615	10-ECO068			
2.0 dCi	118	04.09	M9R 610	10-ECO068			
MEGANE Grandtour (KA)							
1.9 D (KA0J, KA0R)	47	04.99	F8Q 790 F8Q 622				30-ECO008
1.9 dTi (KA0N)	72	03.99 → 02.01	F9Q 731 F9Q 736				30-ECO007
1.9 dTi (KA1U)	59	02.01	F9Q 744				30-ECO007
MEGANE I (BA)							
1.9 dTi (BA08, BA0N)	72	03.97 → 02.01	F9Q 730 F9Q 734 F9Q 731 F9Q 736				30-ECO008
1.9 dTi (BA1U)	59	02.01	F9Q 744				30-ECO007
1.9 TDI	69	09.96	F8Q 784				30-ECO007 30-ECO008
MEGANE II (BM0_, CM0_)							
1.9 dCi	66	11.02 → 12.05	F9Q 808				30-ECO015
1.9 dCi	68	03.04	F9Q 808				30-ECO015
1.9 dCi	81	05.05	F9Q 804 F9Q 818				30-ECO015
1.9 dCi	85	01.06	F9Q 804 F9Q 816 F9Q 818				30-ECO015
1.9 dCi	96	05.05	F9Q 803 F9Q 816				30-ECO015
1.9 dCi (BM0G, CM0G)	88	11.02	F9Q 750				30-ECO015
2.0 dCi	110	09.05	M9R 700 M9R 722	10-ECO068			
2.0 dCi	127	01.07	M9R 724	10-ECO068			
MEGANE II Coupe-Cabriolet (EM0/1_)							
1.9 dCi	81	05.05	F9Q 804 F9Q 816 F9Q 818				30-ECO015
1.9 dCi	85	01.06	F9Q 804 F9Q 816 F9Q 818				30-ECO015
1.9 dCi	88	09.03	F9Q 800				30-ECO015
1.9 dCi	96	05.05	F9Q 803				30-ECO015
2.0 dCi	110	09.05	M9R 700 M9R 722	10-ECO068			

NEW CODES - NEUE CODES - NOUVEAUX CODES - NUEVOS CODIGOS - NUOVI CODICI

	KW						
				OIL FILTER FILTRO OLIO	AIR FILTER FILTRO ARIA	FUEL FILTER FILTRO CARBURANTE	CABIN FILTER FILTRO ABITACOLO
MEGANE II Station wagon (KM0/1_)							
1.9 dCi	66	04.04 → 12.05	F9Q 808				30-ECO015
1.9 dCi	68	03.04	F9Q 808				30-ECO015
1.9 dCi	81	05.05	F9Q 804 F9Q 818				30-ECO015
1.9 dCi	85	05.05	F9Q 818				30-ECO015
1.9 dCi	88	08.03	F9Q 800				30-ECO015
1.9 dCi	96	05.05	F9Q 803 F9Q 804				30-ECO015
2.0	99	08.03	F4R 770 F4R 771				30-ECO015
2.0 dCi	110	09.05	M9R 700 M9R 722	10-ECO068			
MEGANE II Tre volumi (LM0/1_)							
1.9 dCi	66	09.03 → 12.05	F9Q 808				30-ECO015
1.9 dCi	68	03.04	F9Q 808				30-ECO015
1.9 dCi	81	05.05	F9Q 804 F9Q 818				30-ECO015
1.9 dCi	88	09.03	F9Q 800				30-ECO015
1.9 dCi	96	05.05	F9Q 803				30-ECO015
2.0 dCi	110	09.05	M9R 700 M9R 722	10-ECO068			
MEGANE Scenic (JA0_)							
1.9 dTi (JA0N)	72	04.97 → 09.99	F9Q 730 F9Q 734				30-ECO007
MEGANE Station wagon (KZ0/1)							
2.0 dCi	110	10.10	M9R 615	10-ECO068			
2.0 dCi (KZ0L)	118	04.09	M9R 610	10-ECO068			
SAFRANE II (B54_)							
2.2 dT (B54G)	83	07.96 → 12.00	G8T 740				30-ECO015
SCÉNIC							
2.0 dCi	110	02.09	M9R 615	10-ECO068			
2.0 dCi	118	04.09	M9R 610	10-ECO068			
SCENIC (JA)							
1.9 dTi (JA0N)	72	09.99 → 08.03	F9Q 734 F9Q 731 F9Q 736				30-ECO007
1.9 dTi (JA1U)	59	02.01 → 08.03	F9Q 744				30-ECO007
SCENIC II (JM)							
1.9 D	85	06.06	F9Q J 803 F9Q 812				30-ECO015
1.9 dCi	81	05.05	F9Q E 804 F9Q 803				30-ECO015
1.9 dCi	92	06.03	F9Q 804				30-ECO015
1.9 dCi	96	05.05	F9Q J 803 F9Q 804				30-ECO015
1.9 dCi (JM12)	88	06.03	F9Q 812				30-ECO015
2.0 dCi	110	09.05	M9R 700 M9R 721	10-ECO068			
THALIA (LB0/1/2_)							
1.2 16V	55	04.02	D4F 712	10-ECO024			

NEW CODES - NEUE CODES - NOUVEAUX CODES - NUEVOS CODIGOS - NUOVI CODICI



	KW						
				OIL FILTER FILTRO OLIO	AIR FILTER FILTRO ARIA	FUEL FILTER FILTRO CARBURANTE	CABIN FILTER FILTRO ABITACOLO

TRAFIC (FL)

1.9 dCi 100	74	03.01	F9Q 760		30-ECO017
1.9 dCi 80	60	03.01	F9Q 762		30-ECO017
2.0 dCi 115	84	08.06	M9R 780	10-ECO068	
2.0 dCi 90	66	08.06	M9R 780 M9R 782	10-ECO068	
2.5 dCi 135 (FL0D)	99	05.03	G9U 730	10-ECO030	
2.5 dCi 145	107	08.06	G9U 630	10-ECO068	

TRAFIC (JL)

1.9 dCi 100	74	03.01	F9Q 760		30-ECO017
1.9 dCi 80	60	03.01	F9Q 762		30-ECO017
2.0 dCi 115	84	08.06	M9R 780	10-ECO068	30-ECO017
2.0 dCi 90	66	08.06	M9R 782	10-ECO068	30-ECO017
2.5 dCi 115	84	02.08		10-ECO068	30-ECO017
2.5 dCi 135 (JL0D)	99	05.03	G9U 730	10-ECO030	30-ECO017
2.5 dCi 145	107	08.06	G9U 630		30-ECO017

TRAFIC (TXW)

1.9 D	44	06.97 → 03.01	F8Q 606		30-ECO007 30-ECO015
-------	----	---------------	---------	--	------------------------

TRAFIC (TXX)

1.9 D	44	06.97 → 03.01	F8Q 606		30-ECO007 30-ECO015
-------	----	---------------	---------	--	------------------------

TRAFIC II (EL)

1.9 dCi 100 (ELOC)	74	03.01	F9Q 760		30-ECO017
1.9 dCi 80 (ELOB)	60	03.01	F9Q 762		30-ECO017
2.0 dCi 115	84	08.06	M9R 780	10-ECO068	30-ECO017
2.0 dCi 90	66	08.06	M9R 780 M9R 782	10-ECO068	
2.5 dCi 135 (EL0D)	99	03.01	G9U 730	10-ECO030	30-ECO014 30-ECO017
2.5 dCi 145	107	08.06	G9U 630	10-ECO068	30-ECO014 30-ECO017







TWINGO (C06_)(S06_)

1.2	44	09.98 → 08.00	D7F 702 D7F 703 D7F 704	10-ECO024	
1.2 (C066, C068)	43	05.96	D7F 700 D7F 701 D7F 702 D7F 703 D7F 704	10-ECO024	
1.2 (C067)	40	05.96	D7F 700 D7F 701	10-ECO024	
1.2 16V (C06C, C06D, C06K)	55	01.01	D4F 702 D4F 704	10-ECO024	

VEL SATIS (BJ0)







2.0 dCi	110	08.05	M9R 760	10-ECO068	30-ECO015
2.0 dCi	127	01.06	M9R 760	10-ECO068	30-ECO015
2.2 dCi	102	09.04	G9T 600 G9T 700 G9T 606	10-ECO030	30-ECO015

NEW CODES - NEUE CODES - NOUVEAUX CODES - NUEVOS CODIGOS - NUOVI CODICI

	KW			 OIL FILTER FILTRO OLIO	 AIR FILTER FILTRO ARIA	 FUEL FILTER FILTRO CARBURANTE	 CABIN FILTER FILTRO ABITACOLO
VEL SATIS (BJ0)							
2.2 dCi (BJ0E)	110	06.02	G9T 702 G9T 703	10-ECO030		30-ECO015	
2.2 dCi (BJ0H)	85	04.04	G9T 600	10-ECO030		30-ECO015	
3.0 dCi	133	06.06	P9X 715			30-ECO015	
3.0 dCi (BJ0J0B)	130	06.02	P9X 701			30-ECO015	









ROVER

	KW			 OIL FILTER FILTRO OLIO	 AIR FILTER FILTRO ARIA	 FUEL FILTER FILTRO CARBURANTE	 CABIN FILTER FILTRO ABITACOLO
75 (RJ)							
2.0 CDT	85	02.99	M 47 R	10-ECO021			
2.0 CDTi	96	02.03	204D2	10-ECO021			

NEW CODES - NEUE CODES - NOUVEAUX CODES - NUEVOS CODIGOS - NUOVI CODICI

Per nuove applicazioni e novità si prega di accedere al sito www.ashika.eu - For new applications and new items, please go to www.ashika.eu

	KW						
				OIL FILTER FILTRO OLIO	AIR FILTER FILTRO ARIA	FUEL FILTER FILTRO CARBURANTE	CABIN FILTER FILTRO ABITACOLO
9-3 (YS3D)							
2.2 TiD	85	02.98 → 11.00	X 22.DTH D223L	10-ECO005		30-ECO009	
2.2 TiD	92	11.00 → 09.02	D223L	10-ECO005		30-ECO009	
9-3 (YS3F)							
1,8t	110	09.02	B207E	10-ECO019			
1,8t BioPower	110	01.07	B207E	10-ECO019			
1,8t BioPower	129	05.09	B207L	10-ECO019			
1.8 i	90	01.04	Z18XE	10-ECO018			
1.9 TiD	110	09.04	Z19DTH	10-ECO058		30-ECO016	
1.9 TiD	88	09.04	Z19DT	10-ECO058		30-ECO016	
1.9 TTiD	132	12.07	Z 19 DTR A 19 DTR	10-ECO058			
2.0 t	129	09.02	B207L	10-ECO019			
2.0 T	154	09.02	B207R	10-ECO019			
2.0 t BioPower	129	01.07	B207L	10-ECO019			
2.0 t BioPower	145	06.07		10-ECO019			
2.0 t BioPower	147	05.09		10-ECO019			
2.0 T BioPower	154	09.02	B207R	10-ECO019			
2.0 Turbo XWD	154	09.02	B207R	10-ECO019			
2.2 TiD	92	09.02	D223L	10-ECO005		30-ECO009	
2.8 Turbo V6	184	03.05		10-ECO117			
2.8 Turbo V6	188	12.07	B284L	10-ECO117			
2.8 Turbo V6	203	04.08	B284L	10-ECO117			
2.8 Turbo V6 XWD	206	05.08	B284R	10-ECO117			
9-3X							
1.9 TTiD	132	02.09	Z 19 DTR A 19 DTR	10-ECO095			
2.0 T	154	02.09	B207R	10-ECO019			
2.0 T BioPower	154	02.09	B207R	10-ECO019			
9-5 (YS3E)							
1.9 TiD	110	01.06	Z19DTH	10-ECO058			
2.2 TiD	88	03.02	D223L	10-ECO005		30-ECO009	
3.0 TiD	130	07.01	D308L			30-ECO009	
9-5 (YS3G)							
1.6 T	132	05.10	A 16 LET	10-ECO073			
2.0 TiD	118	05.10	A 20 DTH			30-ECO020	
2.0 TTiD	140	05.10	A 20 DTR			30-ECO020	
2.0 TTiD XWD	140	05.10	A 20 DTR			30-ECO020	
2.8 T V6 XWD	221	05.10	A 28 NER	10-ECO117			
9-5 Station wagon (YS3E)							
1.9 TiD	110	01.06	Z19DTH	10-ECO058			
1.9 TiD	129	01.07		10-ECO058			
2.2 TiD	88	03.02	D223L	10-ECO005		30-ECO009	
3.0 TiD	130	07.01	D308L			30-ECO009	



	KW						
				OIL FILTER FILTRO OLIO	AIR FILTER FILTRO ARIA	FUEL FILTER FILTRO CARBURANTE	CABIN FILTER FILTRO ABITACOLO

ALHAMBRA (7V8, 7V9)

1.9 TDI	110	05.05	ARL BTB	10-ECO023
1.9 TDI	66	04.96	1Z AHU ANU	10-ECO008
1.9 TDI	85	06.00	AUY BVK	10-ECO008
1.9 TDI	96	11.02	ASZ	10-ECO023
1.9 TDI 4motion	85	02.01	AUY BVK	10-ECO008
1.9 Tdi 4x4	96	06.05	ASZ	10-ECO023
2.0 TDI	103	11.05	BRT	10-ECO023
2.8 V6	150	06.00	AYL AUE	10-ECO023
2.8 V6 4motion	150	02.01	AYL AUE	10-ECO023

ALTEA (5P1)\ XL (5P5)

1.4 TSI	92	11.07	CAXC	10-ECO092
1.6	75	03.04	BGU BSE BSF CCSA CMXA	10-ECO092
1.6 TDI	66	11.10	CAYB	30-ECO024
1.6 TDI	77	10.09	CAYC	30-ECO024
1.9 TDI	66	08.09	BXF	10-ECO023 30-ECO024 30-ECO033
1.9 TDI	77	04.04	BKC BJB BLS BXE	10-ECO023 30-ECO024 30-ECO033 30-ECO034
2.0 FSI	110	05.04	BLR BLY BYY BVZ	10-ECO063
2.0 TDI	100	03.04	AZV	10-ECO023 30-ECO024 30-ECO033 30-ECO034
2.0 TDI	103	11.05	BMM	10-ECO023 30-ECO024 30-ECO033 30-ECO034
2.0 TDI	125	03.06	BMN CEGA	10-ECO023 30-ECO024 30-ECO033 30-ECO034
2.0 TDI 16V	103	03.04	BKD CBDB CFHC	10-ECO023 30-ECO024 30-ECO033 30-ECO034
2.0 TFSI	147	04.06	BWA	10-ECO063

AROSA (6H)

1.4 TDI	55	01.00 → 06.04	AMF	10-ECO023
---------	----	---------------	-----	-----------

CORDOBA (6K2)

1.9 SDI	50	06.99 → 10.02	AQM AGP	10-ECO008
1.9 TDI	66	06.99 → 10.02	ALH AGR	10-ECO008
1.9 TDI	81	06.99 → 10.02	ASV ASK	10-ECO008

NEW CODES - NEUE CODES - NOUVEAUX CODES - NUEVOS CODIGOS - NUOVI CODICI

	KW			 OIL FILTER FILTRO OLIO	 AIR FILTER FILTRO ARIA	 FUEL FILTER FILTRO CARBURANTE	 CABIN FILTER FILTRO ABITACOLO
---	----	---	---	--	--	---	---

CORDOBA (6L2)

1.2	47	10.02	AZQ BME	10-ECO118
1.2 12V	51	05.06	BXV	10-ECO118
1.4 TDI	51	05.05	BNM	10-ECO023
1.4 TDI	55	10.02	AMF	10-ECO023
1.4 TDI	59	06.05	BMS BNV	10-ECO023
1.6 16V	77	11.06	BTS	10-ECO092
1.9 SDI	47	09.02	ASY	10-ECO023
1.9 TDI	74	09.02	ATD AXR BMT	10-ECO023
1.9 TDI	96	10.02	ASZ BLT	10-ECO023

CORDOBA 2 volumi

1.9 D	66	07.96 → 04.99	1Z AHU	10-ECO008
-------	----	---------------	-----------	-----------

CORDOBA Vario (6K5)

1.9 SDI	50	06.99	AQM AGP	10-ECO008
1.9 TDI	66	06.99	ALH AGR	10-ECO008
1.9 TDI	81	06.99	ASV ASK	10-ECO008

EXEO (3R) ST (3R)

2.0 TDI	105	03.09	CAGA	10-ECO023
2.0 TDI	125	03.09	CAHA	10-ECO023
2.0 TDI	88	08.09	CAGC	10-ECO023
2.0 TFSI	147	03.09	BWE	10-ECO063

IBIZA III (6K1)

1.9 SDI	50	08.99 → 02.02	AQM AGP	10-ECO008
1.9 TDI	66	08.99 → 02.02	ALH AGR	10-ECO008
1.9 TDI	81	08.99 → 02.02	ASV ASK	10-ECO008

IBIZA IV (6L1)

1.2	44	06.07 → 05.08	BBM	10-ECO118
1.2	47	02.02 → 06.06	AZQ BME	10-ECO118
1.2 12V	51	05.06	BXV	10-ECO118
1.4 TDI	51	05.05	BNM	10-ECO023
1.4 TDI	55	05.02 → 12.05	AMF	10-ECO023
1.4 TDI	59	06.05	BMS BNV	10-ECO023
1.6 16V	77	11.06	BTS	10-ECO092
1.9 SDI	47	02.02 → 12.05	ASY	10-ECO023
1.9 TDI	74	02.02	ATD AXR BMT	10-ECO023
1.9 TDI	96	02.02	ASZ BLT	10-ECO023
1.9 TDI Cupra R	110	01.04		10-ECO023

	KW						
				OIL FILTER FILTRO OLIO	AIR FILTER FILTRO ARIA	FUEL FILTER FILTRO CARBURANTE	CABIN FILTER FILTRO ABITACOLO

IBIZA IV (6L1)

1.9 TDI Cupra R	118	03.04 → 02.08	BPX BUK	10-ECO023
-----------------	-----	---------------	------------	-----------

IBIZA V (6J5)\ SPORTCOUPE (6J1)

1.2	44	07.09	CGPB	10-ECO118
1.2	51	03.08	BZG CGPA	10-ECO118
1.4 TDI	59	07.08	BMS	10-ECO023
1.6	77	05.08	BTS	10-ECO092
1.6 TDI	66	05.09	CAYB	10-ECO098
1.9 TDI	66	07.08	BXJ	10-ECO023
1.9 TDI	77	03.08	BLS	10-ECO023

IBIZA V ST (6J8)

1.2	44	05.10	CGPB	10-ECO118
1.2	51	05.10	CGPA	10-ECO118

INCA (6K9)

1.9 D	47	11.95	1Y	10-ECO008
1.9 SDI	47	11.95	AEY AYQ	10-ECO008

LEON (1M1)

1.9 SDI	50	11.99	AQM	10-ECO008
1.9 TDI	110	02.01	ARL	10-ECO008
1.9 TDI	66	11.99	ALH AGR	10-ECO008
1.9 TDI	74	10.05	AXR	10-ECO008
1.9 TDI	81	11.99	AHF ASV	10-ECO008
1.9 TDI	96	05.03	ASZ	10-ECO008
1.9 TDI Syncro	110	05.02	ARL	10-ECO008
2.8 Cupra 4	150	02.01	AUE	10-ECO008

LEON (1P1)

1.4 TSI	92	11.07	CAXC	10-ECO092
1.6 16V	77	09.05		10-ECO092
1.6 TDI	66	11.10	CAYB	30-ECO024
1.6 TDI	77	02.10	CAYC	30-ECO024
1.9 TDI	66	06.07	BXF	10-ECO023 30-ECO024 30-ECO033 30-ECO034
1.9 TDI	77	07.05	BKC BLS BXE	10-ECO023 30-ECO024 30-ECO033 30-ECO034
1.9 TDI	81	09.05		10-ECO023
1.9 TDi	81	10.05	ASV	10-ECO023
2.0 FSI	110	07.05	BLR BLY BVY BVZ	10-ECO063
2.0 TDI	100	07.05	AZV	10-ECO023 30-ECO024 30-ECO033 30-ECO034

NEW CODES - NEUE CODES - NOUVEAUX CODES - NUEVOS CODIGOS - NUOVI CODICI

	KW			 OIL FILTER FILTRO OLIO	 AIR FILTER FILTRO ARIA	 FUEL FILTER FILTRO CARBURANTE	 CABIN FILTER FILTRO ABITACOLO
---	----	---	---	---	---	--	--

LEON (1P1)

2.0 TDI	103	10.05	BMM	10-ECO023	30-ECO024 30-ECO033 30-ECO034
2.0 TDI	125	05.06	BMN CEGA CFJA	10-ECO023	30-ECO024 30-ECO033 30-ECO034
2.0 TDI 16V	103	07.05	BKD CFHC CLCB	10-ECO023	30-ECO024 30-ECO033 30-ECO034
2.0 TFSI	136	09.05 → 05.06	BWA1	10-ECO063	
2.0 TFSI	147	05.05	BWA	10-ECO063	
2.0 TFSI	177	11.06	BWJ CDLD	10-ECO063	
2.0 TFSI	195	09.09	CDLA	10-ECO063	

TERRA (24)\(024A)

1.3 D	33	03.90 → 12.94	MN	10-ECO013	
1.4 D	35	10.90 → 12.95	1 W	10-ECO013	

TOLEDO I (1L)







1.9 D	47	12.95 → 03.99	1Y	10-ECO013	
1.9 D	50	05.91 → 03.99	1Y	10-ECO013	
1.9 SDI	47	12.95 → 03.99		10-ECO013	
1.9 TD	55	05.91 → 03.99	AAZ	10-ECO013	

TOLEDO II (1M2)

1.9 SDI	50	11.99 → 06.04	AQM	10-ECO008	
1.9 TDI	110	10.00 → 05.06	ARL	10-ECO008	
1.9 TDI	66	04.99 → 05.06	ALH AGR	10-ECO008	
1.9 TDI	81	04.99 → 05.06	AHF ASV	10-ECO008	
1.9 TDI	96	05.03 → 05.06	ASZ	10-ECO008	
2.3 V5	110	04.99 → 05.01	AGZ	10-ECO023	
2.3 V5 20V	125	05.01 → 05.06	AQN	10-ECO023	







TOLEDO III (5P2)

1.9 TDI	77	10.04	BKC BJB BLS BXE	10-ECO023	30-ECO024 30-ECO033 30-ECO034
2.0 FSI	110	10.04	BLR BLY BVY BVZ	10-ECO063	
2.0 TDI	100	09.04 → 05.09	AZV	10-ECO023	30-ECO024 30-ECO033 30-ECO034
2.0 TDI	103	11.05 → 05.09	BMM	10-ECO023	30-ECO024 30-ECO033 30-ECO034
2.0 TDI	125	01.06 → 05.09	BMN CEGA	10-ECO023	30-ECO024 30-ECO033 30-ECO034

	KW						
				OIL FILTER FILTRO OLIO	AIR FILTER FILTRO ARIA	FUEL FILTER FILTRO CARBURANTE	CABIN FILTER FILTRO ABITACOLO
TOLEDO III (5P2)							
2.0 TDI 16V	103	04.04 → 05.09	BKD	10-ECO023		30-ECO024 30-ECO033 30-ECO034	
2.0 TFSI	147	11.05 → 05.09	BWA	10-ECO063			

SHUANGHUAN AUTO



	KW			 OIL FILTER FILTRO OLIO	 AIR FILTER FILTRO ARIA	 FUEL FILTER FILTRO CARBURANTE	 CABIN FILTER FILTRO ABITACOLO
CEO							
2.4 16V Bi-Fuel	93	06.10		10-03-316	20-05-586	30-06-692	

NEW CODES - NEUE CODES - NOUVEAUX CODES - NUEVOS CODIGOS - NUOVI CODICI

	KW						
				OIL FILTER FILTRO OLIO	AIR FILTER FILTRO ARIA	FUEL FILTER FILTRO CARBURANTE	CABIN FILTER FILTRO ABITACOLO

FABIA (6Y2)\ Combi (6Y5)

1.2	40	08.02	AWY BMD	10-ECO118
1.2	47	01.03	AZQ BME	10-ECO118
1.4 TDI	51	10.05	BNM	10-ECO023
1.4 TDI	55	04.03	AMF	10-ECO023
1.4 TDI	59	10.05	BNV	10-ECO023
1.9 SDI	47	12.99	ASY	10-ECO023
1.9 TDI	74	01.00	ATD AXR	10-ECO023
1.9 TDI RS	96	06.03	ASZ BLT	10-ECO023

FABIA Praktik

1.2	40	05.03	AWY BMD	10-ECO118
1.2	47	01.03	AZQ BME	10-ECO118
1.2	51	03.07	BZG CGPA	10-ECO118
1.4 TDI	51	03.07	BNM	10-ECO023
1.4 TDI	51	10.05	BNM	10-ECO023
1.4 TDI	59	03.07	BNV BMS	10-ECO023
1.9 SDI	47	04.02	ASY	10-ECO023

FABIA Tre volumi (6Y3)

1.2	40	07.01	AWY BMD	10-ECO118
1.2	47	01.03	AZQ BME	10-ECO118
1.4 TDI	51	10.05	BNM	10-ECO023
1.4 TDI	55	04.03	AMF	10-ECO023
1.4 TDI	59	10.05	BNV	10-ECO023
1.9 SDI	47	11.99	ASY	10-ECO023
1.9 TDI	74	01.00	ATD AXR	10-ECO023

FABIA\ Combi

1.2	44	12.06	BBM CHFA	10-ECO118
1.2	51	01.07	BZG CEVA CGPA CHTA	10-ECO118
1.4 TDI	51	02.07	BNM	10-ECO023
1.4 TDI	59	01.07	BNV BMS	10-ECO023
1.6	77	04.07	BTS CFNA	10-ECO092
1.9 TDI	77	04.07	BLS BSW	10-ECO023

OCTAVIA (1U2)

1.9 SDI	47	09.96		10-ECO008
1.9 SDI	50	06.97	AQM AGP	10-ECO008
1.9 TDI	66	09.96	ALH AGR	10-ECO008
1.9 TDI	74	10.05	AXR	10-ECO008

NEW CODES - NEUE CODES - NOUVEAUX CODES - NUEVOS CODIGOS - NUOVI CODICI

	KW			 OIL FILTER FILTRO OLIO	 AIR FILTER FILTRO ARIA	 FUEL FILTER FILTRO CARBURANTE	 CABIN FILTER FILTRO ABITACOLO
---	----	---	---	--	--	---	---

OCTAVIA (1U2)

1.9 TDI	81	08.97	ASV AHF	10-ECO008	
1.9 TDI	96	01.03	ASZ	10-ECO008	

OCTAVIA (1Z3)

1.6 FSI	85	02.04	BLF	10-ECO092	
1.6 TDI	77	06.09	CAYC		30-ECO024
1.9 TDI	77	06.04	BKC BJB BLS BXE	10-ECO023	30-ECO024 30-ECO033 04.06→ 30-ECO034
2.0 FSI	110	11.04	BLY BLR BVY BVZ	10-ECO063	
2.0 RS	147	10.05	BWA CCZA	10-ECO063	
2.0 TDI	100	02.04	AZV	10-ECO023	30-ECO024 30-ECO033 04.06→ 30-ECO034
2.0 TDI	103	11.05	BMM	10-ECO023	30-ECO024 30-ECO033 04.06→ 30-ECO034
2.0 TDI	125	04.06	BMN CEGA	10-ECO023	30-ECO024 30-ECO033
2.0 TDI 16V	103	02.04	BKD CFHC CLCB	10-ECO023	30-ECO024 30-ECO033 04.06→ 30-ECO034

OCTAVIA Combi (1U5)

1.9 SDI	50	07.98	AQM AGP	10-ECO008	
1.9 TDI	66	07.98	ALH AGR	10-ECO008	
1.9 TDI	74	08.00	ATD AXR	10-ECO008	
1.9 TDI	81	07.98	ASV AHF	10-ECO008	
1.9 TDI	96	01.03	ASZ	10-ECO008	
1.9 TDI 4x4	66	11.99→09.00	AGR	10-ECO008	
1.9 TDI 4x4	74	09.00	ATD	10-ECO008	

OCTAVIA Combi (1Z5)

1.6 FSI	85	02.04	BLF	10-ECO092	
1.6 TDI	77	06.09	CAYC		30-ECO024
1.6 TDI 4x4	77	06.09	CAYC		30-ECO024
1.9 TDI	77	09.04	BKC BJB BLS BXE	10-ECO023	30-ECO024 30-ECO033 04.06→ 30-ECO034
1.9 TDI 4x4	77	11.04	BKC BLS BXE	10-ECO023	30-ECO024 30-ECO033 04.06→ 30-ECO034

NEW CODES - NEUE CODES - NOUVEAUX CODES - NUEVOS CODIGOS - NUOVI CODICI



	KW						
				OIL FILTER FILTRO OLIO	AIR FILTER FILTRO ARIA	FUEL FILTER FILTRO CARBURANTE	CABIN FILTER FILTRO ABITACOLO

OCTAVIA Combi (1Z5)

2.0 FSI	110	11.04	BLY BLR BVI BVZ	10-ECO063			
2.0 FSI 4x4	110	11.04	BLX BVX	10-ECO063			
2.0 RS	147	10.05	BWA CCZA	10-ECO063			
2.0 TDI	103	11.05	BMM	10-ECO023		30-ECO024 30-ECO033 04.06→ 30-ECO034	
2.0 TDI	125	04.06	BMN CEGA	10-ECO023		30-ECO024 30-ECO033	
2.0 TDI 4x4	103	07.06	BMM	10-ECO023		30-ECO024 30-ECO033 30-ECO034	
2.0 TDI 16V	100	02.04	AZV	10-ECO023		30-ECO024 30-ECO033 04.06→ 30-ECO034	
2.0 TDI 16V	103	02.04	BKD CFHC CLCB	10-ECO023		30-ECO024 30-ECO033 04.06→ 30-ECO034	

ROOMSTER

1.2	47	05.06→01.07	BME	10-ECO118			
1.2	51	01.07	BZG CGPA	10-ECO118			
1.4 TDI	51	07.06	BNM	10-ECO023			
1.4 TDI	59	09.06	BNV BMS	10-ECO023			
1.6	77	09.06	BTS CFNA	10-ECO092			
1.9 TDI	77	09.06	BLS BSW	10-ECO023			







SUPERB (3T)\ Station wagon (3T5)

1.4 TSI	92	07.08	CAXC	10-ECO092			
1.9 TDI	77	07.08	BLS BXE	10-ECO023		30-ECO024	
2.0 TDI	103	07.08	BMP	10-ECO023		30-ECO024	
2.0 TDI	125	07.08	CBBB CFGB	10-ECO023		30-ECO024	
2.0 TDI 16V	103	01.09	BKD CFFB CLJA	10-ECO023		30-ECO024	
2.0 TDI 4x4	125	09.08	CBBB CFGB	10-ECO023		30-ECO024	
3.6 4x4	191	11.08	CDVA	10-ECO023			



SUPERB (3U4)

1.9 TDI	74	08.02	AVB	10-ECO008			
1.9 TDI	77	10.05	BSV	10-ECO008			
1.9 TDI	85	01.07	BPZ	10-ECO008			
1.9 TDI	96	02.02	AWX AVF	10-ECO008			
2.0 TDI	103	10.05	BSS	10-ECO008			

NEW CODES - NEUE CODES - NOUVEAUX CODES - NUEVOS CODIGOS - NUOVI CODICI

	KW			 OIL FILTER FILTRO OLIO	 AIR FILTER FILTRO ARIA	 FUEL FILTER FILTRO CARBURANTE	 CABIN FILTER FILTRO ABITACOLO
SUPERB (3U4)							
2.5 TDI	114	02.02	AYM	10-ECO010			
2.5 TDI	120	06.03	BDG	10-ECO010			
YETI							
2.0 TDI	81	11.09	CFHA CLCA	30-ECO024			
2.0 TDI 4x4	103	05.09	CBDB CFHC CLCB	10-ECO023	30-ECO024		
2.0 TDI 4x4	125	11.09	CEGA CFJA	10-ECO023	30-ECO024		
2.0 TDI 4x4	81	11.09	CFHF	30-ECO024			



	KW						
				OIL FILTER FILTRO OLIO	AIR FILTER FILTRO ARIA	FUEL FILTER FILTRO CARBURANTE	CABIN FILTER FILTRO ABITACOLO
CABRIO							
0.6	52	06.02 → 01.04	M 160.910	10-0M-000	20-0M-000	30-0M-000	21-SM-SM0
0.6 (S1OLA1)	40	03.00 → 01.04	M 160 E6AL B03	10-0M-000	20-0M-000	30-0M-000	21-SM-SM0
0.6 (S1OLD2)	45	01.01 → 01.04	M 160 E6AL B05	10-0M-000	20-0M-000	30-0M-000	21-SM-SM0
0.7	45	01.03 → 01.04		10-0M-000	20-0M-000	30-0M-000	21-SM-SM0
0.7	55	01.03 → 01.04		10-0M-000	20-0M-000	30-0M-000	21-SM-SM0
0.8 CDI (S1OLC1)	30	03.01 → 01.04	OM 660 DE 8LA	10-0M-000	20-0M-000	30-0M-001	21-SM-SM0
CITY-COUPÉ (MC01)							
0.6	45	01.01 → 01.04	M 160 E6AL B05	10-0M-000	20-0M-000	30-0M-000	21-SM-SM0
0.6	52	06.02 → 01.04	M 160.910	10-0M-000	20-0M-000	30-0M-000	21-SM-SM0
0.6 (S1CLA1)	40	07.98 → 01.04	M 160 E6AL B03	10-0M-000	20-0M-000	30-0M-000	21-SM-SM0
0.6 (S1CLB1)	33	07.98 → 01.04	M 160 E6AL B04	10-0M-000	20-0M-000	30-0M-000	21-SM-SM0
0.7	37	01.03 → 01.04		10-0M-000	20-0M-000	30-0M-000	21-SM-SM0
0.7	45	01.03 → 01.04		10-0M-000	20-0M-000	30-0M-000	21-SM-SM0
0.7	55	01.03 → 01.04		10-0M-000	20-0M-000	30-0M-000	21-SM-SM0
0.8 CDI (S1CLC1)	30	11.99 → 01.04	OM 660 DE 8LA	10-0M-000	20-0M-000	30-0M-001	21-SM-SM0
CROSSBLADE							
0.6	52	06.02		10-0M-000	20-M0-002	30-0M-000	21-SM-SM0
FORFOUR							
1.1 (454.030)	55	01.04	M 134.910	10-M0-001	20-M0-001		21-SM-SM1
1.3 (454.031)	70	01.04	M 135.930	10-M0-001	20-M0-001		21-SM-SM1
1.5	90	01.04		10-M0-001	20-M0-001		21-SM-SM1
1.5 (454.032)	80	01.04	M 135.950	10-M0-001	20-M0-001		21-SM-SM1
1.5 BRABUS (454.034)	130	05.05		10-M0-001	20-M0-001		21-SM-SM1
1.5 CDI (454.000)	50	09.04	OM 639.939	10-M0-003	20-M0-001	30-M0-002	21-SM-SM1
1.5 CDI (454.001)	70	09.04	OM 639.939	10-M0-003	20-M0-001	30-M0-002	21-SM-SM1
FORTWO cabrio\ Coupé							
0.7 (450.432)	45	01.04		10-0M-000	20-0M-000	30-0M-000	21-SM-SM0
0.7 (450.433)	55	01.04		10-0M-000	20-0M-000	30-0M-000	21-SM-SM0
0.8 CDI (450.400)	30	01.04	OM 660 DE 8LA	10-0M-000	20-0M-000	30-0M-001	21-SM-SM0
0.8 CDi (451.400)	33	01.07	OM660.950	10-0M-000	20-0M-M03	30-01-120	21-SM-SM2
1.0 (451.431)	52	01.07	M132.910	10-0M-M02	20-0M-M03		21-SM-SM2
1.0 Brabus (451.433)	72	01.08	M132.930	10-0M-000	20-M0-002		21-SM-SM2
1.0 Turbo (451.432)	62	01.07	M132.930	10-0M-M02	20-0M-M03		21-SM-SM2
ROADSTER\ Coupé							
0.7 (452.432)	45	04.03		10-0M-000	20-M0-002	30-0M-000	21-SM-SM1
0.7 (452.434)	60	04.03		10-0M-000	20-M0-002	30-0M-000	21-SM-SM1
0.7 Brabus (452.437)	74	12.03	M 160.923	10-0M-000	20-M0-002	30-0M-000	21-SM-SM1







	KW						
				OIL FILTER FILTRO OLIO	AIR FILTER FILTRO ARIA	FUEL FILTER FILTRO CARBURANTE	CABIN FILTER FILTRO ABITACOLO
ACTYON SPORTS Pick-up							
2.3	110	11.06		10-ECO009	20-0S-S03	30-0S-001	21-SS-S04
200 Xdi 4WD	104	10.06		10-ECO009	20-0S-S03	30-0S-001	21-SS-S04
KORANDO							
2.0 e-XDi	129	11.10		10-ECO105		30-0S-S04	21-SS-S05
KORANDO (K4)							
2.2 D	50	12.88 → 12.96	DC23	10-09-997	20-09-978	30-09-991	
KORANDO (KJ)							
2.0	94	05.97		10-ECO009	20-09-980		21-DW-W5
2.3	103	05.97	M 111.970	10-ECO009	20-09-980		21-DW-W5
2.3	105	01.99		10-ECO009	20-09-980		21-DW-W5
2.3 D (KJ)	58	12.96	OM 601.940	10-09-997	20-09-978	30-09-991	21-DW-W5
2.9 D	73	06.97 → 10.00		10-09-997	20-09-907	30-09-991	21-DW-W5
2.9 D (KJ)	72	12.96	MB-OM 662	10-09-997	20-09-907	30-09-991	21-DW-W5
2.9 TD	88	04.98		10-09-997	20-09-980	30-09-991	21-DW-W5
3.2	156	01.99	M 104.995	10-ECO009	20-09-980		21-DW-W5
3.2	162	06.97		10-ECO009	20-09-980		21-DW-W5
3.2 (KJ)	154	12.96	M 104.995	10-ECO009	20-09-980		21-DW-W5
KYRON							
2.0 Xdi	104	05.05		10-ECO009	20-0S-S03	30-0S-001	21-SS-S04
2.7 Xdi	121	05.05		10-ECO009	20-0S-S03	30-0S-001	21-SS-S04
MUSSO (FJ)							
2.0	93	10.96	E20	10-ECO009	20-09-980		21-DW-W5
2.3	103	10.96	M 111.970	10-ECO009	20-09-980		21-DW-W5
2.3	110	04.03		10-ECO009	20-09-980		21-DW-W5
2.3 D	59	10.95	OM 601.940 MB-OM 661	10-09-997	20-09-978	30-09-991	21-DW-W5
2.9 D	73	03.96	MB-OM 662	10-09-997	20-09-907	30-09-991	21-DW-W5
2.9 TD	88	04.98		10-09-997	20-09-980	30-09-991	21-DW-W5
3.2	162	06.96	M 104.992	10-ECO009	20-09-980		21-DW-W5
MUSSO SPORTS							
2.9 D	88	08.04		10-09-997	20-09-907	30-09-991	21-DW-W5
REXTON							
2.7 D 4x4	137	05.06		10-ECO009	20-0S-S01	30-0S-001	21-SS-S01
2.7 Xdi	120	08.04		10-ECO009	20-0S-S01	30-0S-001	21-DW-W7 For European market 21-SS-S01
2.9 TD	88	04.02		10-ECO031	20-0S-S01	30-09-991	21-DW-W7 For European market 21-SS-S01
3.2	162	04.02		10-ECO009	20-0S-S02	30-0S-002	21-DW-W7 For European market 21-SS-S01
RODIUS							
2.7 Xdi	120	05.05		10-ECO009	20-0S-S03	30-0S-001	21-SS-S03
2.7 Xdi 4WD	120	05.05		10-ECO009	20-0S-S03	30-0S-001	21-SS-S03

NEW CODES - NEUE CODES - NOUVEAUX CODES - NUEVOS CODIGOS - NUOVI CODICI



	KW						
				OIL FILTER FILTRO OLIO	AIR FILTER FILTRO ARIA	FUEL FILTER FILTRO CARBURANTE	CABIN FILTER FILTRO ABITACOLO
1400							
1.4 A62/A64	45	01.76 → 01.80		10-01-111	20-01-102	30-03-301	
1600							
1.6 A67	53	01.78 → 01.80		10-01-111	20-01-102	30-03-301	
1800 XT COUPE (XT)							
Turbo 4WD	100	11.84 → 12.90	EA82	10-01-111	20-01-104	30-07-704	
Turbo 4WD	88	01.88 → 12.90	EA82	10-01-111	20-01-104	30-07-704	
Turbo 4WD	96	01.87 → 12.90	EA82	10-01-111	20-01-104	30-07-704	
E WAGON (E12)							
1.2 i (EF12)	40	05.94		10-07-703	20-07-711	30-07-796	
E10 (KJ5)							
1.0 (EF10)	37	01.88 → 07.93		10-07-703	20-07-703	30-07-702	
E12 (KA)							
1.2 (EF12)	0	05.88 → 02.96		10-07-703	20-07-703	30-07-702	
E12 (KJ8)							
1.2 (EF12)	49	01.88 → 07.93		10-07-703	20-07-703	30-07-702	
FORESTER							
2.0	110	01.08		10-03-313	20-07-714	30-07-707	21-SB-SB3
FORESTER (SF)							
2.0	90	08.97 → 09.02	EJ20	10-07-705	20-01-108	30-07-707	21-SB-SB0
2.0	92	06.98 → 09.02	EJ20	10-07-705	20-01-108	30-07-707	21-SB-SB0
2.0 S Turbo	125	06.98 → 04.01	EJ20	10-07-705	20-01-108	30-07-707	21-SB-SB0
2.0 S Turbo	130	04.01 → 09.02	EJ205	10-07-705	20-01-108	30-07-707	21-SB-SB0
FORESTER (SG)							
2.0	92	09.02	EJ20	10-07-705	20-01-108	30-07-707	21-SB-SB5
2.0 S Turbo	130	09.02	EJ20	10-07-705	20-01-108	30-07-707	21-SB-SB5
2.0 X	116	09.05	EJ204	10-07-705	20-01-108	30-07-707	21-SB-SB5
2.5	155	12.03	EJ25	10-07-703	20-01-108	30-07-707	21-SB-SB5
2.5 XT	169	09.05		10-07-705	20-01-108	30-07-707	21-SB-SB5
FORESTER (SH)							
2.0	110	01.08	EJ20	10-03-313	20-07-714	30-07-707	21-SB-SB3
2.0 D	108	09.08		10-04-406	20-07-714	30-05-574	21-SB-SB3
IMPREZA							
1.5	79	02.08		10-03-313	20-07-714		21-SB-SB3
2.0	110	02.08		10-03-313	20-07-714		21-SB-SB3
2.0 D 4 ruote motrici	110	01.09		10-04-406	20-07-714	30-02-215	21-SB-SB3
2.0R	110	08.07		10-03-313	20-07-714		21-SB-SB3
2.5	221	02.08		10-03-313	20-07-714		21-SB-SB3
2.5 4 ruote motrici	221	01.08	EJ257	10-03-313	20-07-714		21-SB-SB3
IMPREZA (GC) Station wagon							
1.6 i	66	08.92 → 12.00	EJ16	10-07-705	20-01-108	30-07-707	
1.6 i	70	06.98 → 12.00	EJ161	10-07-705	20-01-108	30-07-707	21-SB-SB0

NEW CODES - NEUE CODES - NOUVEAUX CODES - NUEVOS CODIGOS - NUOVI CODICI



	KW						
				OIL FILTER FILTRO OLIO	AIR FILTER FILTRO ARIA	FUEL FILTER FILTRO CARBURANTE	CABIN FILTER FILTRO ABITACOLO
IMPREZA (GC)\ Station wagon							
1.6 i 4WD	70	06.98 → 12.00	EJ161	10-07-705	20-01-108	30-07-707	21-SB-SB0
1.6 i 4WD	66	08.92 → 12.00	EJ16	10-07-705	20-01-108	30-07-707	
1.8 i 4WD	76	08.92 → 12.00	EJ18 EJ18E	10-07-705	20-01-108	30-07-707	
2.0 i 4WD	85	10.95 → 12.00	EJ20	10-07-705	20-01-108	30-07-707	21-SB-SB0
2.0 i 4WD	92	06.98 → 12.00	EJ20	10-07-705	20-01-108	30-07-707	21-SB-SB0
2.0 Turbo GT 4WD	155	03.94 → 12.00	EJ20 (Turbo)	10-07-705	20-01-108	30-07-707	21-SB-SB0
2.0 Turbo GT 4WD	160	06.98 → 12.00	EJ205	10-07-705	20-01-108	30-07-707	21-SB-SB0
IMPREZA (GD, GG)\ Station wagon							
1.5 AWD	81	10.05		10-07-705	20-01-108		21-SB-SB0
1.6 AWD	70	12.00	EJ16	10-07-705	20-01-108	30-07-707	21-SB-SB0
2.0	92	12.00	EJ20	10-07-705	20-01-108	30-07-707	21-SB-SB0
2.0 R	118	09.05	EJ204	10-03-313	20-01-108	30-07-707	21-SB-SB0
2.0 WRX STi	195	11.01	EJ207	10-07-705	20-01-108	30-07-707	21-SB-SB0
2.0 WRX STi	235	02.04		10-07-705	20-01-108	30-07-707	21-SB-SB0
2.0 WRX Turbo	160	12.00	EJ205	10-07-705	20-01-108	30-07-707	21-SB-SB0
2.0 WRX Turbo	165	12.02	EJ205	10-07-705	20-01-108	30-07-707	21-SB-SB0
2.5 WRX	169	09.05	EJ255	10-03-313	20-01-108	30-07-707	21-SB-SB0
2.5 WRX ST1	206	09.05	EJ257	10-03-313	20-01-108	30-07-707	21-SB-SB0
IMPREZA Coupe (GFC)							
1.6	66	12.96 → 12.00	EJ16E	10-07-705	20-01-108	30-07-707	21-SB-SB0
1.6 4WD	66	12.96 → 12.00	EJ161	10-07-705	20-01-108	30-07-707	21-SB-SB0
2.0 4WD	85	12.95 → 12.00	EJ20	10-07-705	20-01-108	30-07-707	21-SB-SB0
2.0 Turbo 4WD	155	12.96 → 12.00	EJ20G	10-07-705	20-01-108	30-07-707	21-SB-SB0
JUSTY I (KAD)							
1000	37	05.87 → 10.95	EF10	10-03-313	20-01-102	30-02-221	
1000	40	11.84 → 06.89	EF10	10-03-313	20-01-102	30-02-221	
1200	49	05.87 → 10.95	EF12	10-03-313	20-01-102	30-02-221	
1200 4WD	50	10.86 → 12.90	EF12	10-03-313	20-01-102	30-02-221	
1200 4WD	55	10.90 → 12.94	EF12	10-03-313	20-07-711	30-07-799	
1200 4WD (KAD-A)	49	05.87 → 05.91	EF12	10-03-313	20-01-102	30-02-221	
JUSTY II (JMA, MS)							
1.3 4x4	63	04.01 → 11.03	G13BB	10-02-279	20-08-813	30-08-810 30-08-890	
1.3 GX 4x4	50	10.95 → 11.03	EF13	10-02-279	20-07-797 20-08-813	30-08-810 30-08-890	
JUSTY III (G3X)							
1.3	69	09.03	M13A	10-08-898	20-07-715	30-08-810 30-08-890	21-SZ-Z03
1.5	73	09.03	M15A	10-08-898	20-07-715	30-08-810 30-08-890	21-SZ-Z03
JUSTY IV							
1.0	51	01.07	1KR-FE	10-ECO051	20-02-288		
LEGACY I (BC)\ Station wagon (BJF)							
1.6i 16V	0	02.89		10-07-705	20-07-716	30-07-707	

NEW CODES - NEUE CODES - NOUVEAUX CODES - NUEVOS CODIGOS - NUOVI CODICI



	KW						
				OIL FILTER FILTRO OLIO	AIR FILTER FILTRO ARIA	FUEL FILTER FILTRO CARBURANTE	CABIN FILTER FILTRO ABITACOLO
LEGACY I (BC)\ Station wagon (BJF)							
1800	76	01.89 → 12.93	EJ18 SPI	10-07-705	20-07-716	30-07-707	
1800 4WD	76	01.89 → 09.91	EJ18 SPI	10-07-705	20-07-716	30-07-707	
2000 4WD	85	08.91 → 07.94	EJ20 EMPi	10-07-705	20-07-716	30-07-707	
2000 Turbo 4WD	147	05.92 → 07.94	EJ20-GN	10-07-705	20-01-108	30-07-707	
2200 4WD	100	01.89 → 07.94	EJ22 EMPi	10-07-705	20-01-108	30-07-707	
LEGACY II (BD, BG)\ Station wagon (BD, BG)							
2.0 i	85	09.94 → 03.99	EJ20E	10-07-705	20-01-108	30-07-707	
2.0 i 4WD	85	09.94 → 03.99	EJ20	10-07-705	20-01-108	30-07-707	
2.2 i 4WD	94	09.94 → 03.99	EJ22 EMPi	10-07-705	20-01-108	30-07-707	
2.2 i 4WD	96	06.96 → 03.99	EJ22 EMPi	10-07-705	20-01-108	30-07-707	
2.5 i 4WD	110	06.96 → 03.99	EJ25D	10-07-705	20-01-108	30-07-707	
LEGACY III (BE, BH)\ Station wagon (BE, BH)							
2.0	92	04.99 → 08.03	EJ20	10-07-705	20-07-796	30-07-701	21-SB-SB1
2.5	115	10.98 → 08.03	EJ25	10-07-705	20-07-796	30-07-701	21-SB-SB1
LEGACY IV\ Station wagon							
2.0	101	09.03	EJ20	10-03-313	20-07-714	30-07-701	21-SB-SB2
2.0 D	110	06.08		10-04-406	20-07-714	30-02-215	21-SB-SB4
2.5	121	09.03	EJ25	10-03-313	20-07-714	30-07-701	21-SB-SB2
3.0	180	09.03	EZ30	10-07-706	20-01-108	30-07-701	21-SB-SB2
LEGACY V\ Station wagon							
2.0 D	110	09.09		10-05-503	20-07-714	30-05-574	21-TY-TY9
2.0 i	110	09.09	EJ204	10-07-705	20-07-714		21-TY-TY9
2.5 i	123	09.09	EJ253	10-07-705	20-07-714		21-TY-TY9
LEONE I (AB) Tutti i modelli\ All models							
1300	45	03.79 → 10.84	EA65	10-01-111	20-07-700	30-03-301	
1600	63	03.79 → 10.84	EA71	10-01-111	20-07-700	30-03-301	
1600 4WD	52	03.79 → 10.84	EA71	10-01-111	20-07-700	30-03-301	
1800 4WD	60	09.80 → 10.84	EA81	10-01-111	20-07-700	30-03-301	
1800 4WD (AM)	59	09.80 → 10.84	EA81	10-01-111	20-07-700	30-03-301	
LEONE II\ Station wagon							
1.8	77	06.85 → 07.86		10-01-111	20-07-700	30-03-302	
1300	48	11.84 → 09.91	EA65	10-01-111	20-07-700	30-03-301	
1600	55	11.84 → 09.91	EA71	10-01-111	20-07-700	30-03-302	
1800 4WD	66	11.84 → 12.90	EA82	10-01-111	20-07-700	30-03-302	
1800 4WD	72	01.88 → 12.90	EA82	10-01-111	20-01-104	30-07-704	
1800 4WD	88	01.88 → 12.90	EA82	10-01-111	20-01-104	30-07-704	
1800 4WD Cat.	70	07.86 → 09.91	EA82	10-01-111	20-01-104	30-07-704	
1800 Turbo 4WD	100	11.84 → 12.90	EA82	10-01-111	20-01-104	30-07-704	
1800 Turbo 4WD	96	03.89 → 12.90	EA82	10-01-111	20-01-104	30-07-704	
LIBERO (E10, E12)							
1.0 4WD (E10, KJ6)	37	01.83 → 12.87	EF10	10-07-703	20-07-703	30-07-702	
1.2 4WD (E12, KJ8)	38	08.86 → 02.00	EF12	10-07-703	20-07-703	30-07-702	

NEW CODES - NEUE CODES - NOUVEAUX CODES - NUEVOS CODIGOS - NUOVI CODICI

	KW						
				OIL FILTER FILTRO OLIO	AIR FILTER FILTRO ARIA	FUEL FILTER FILTRO CARBURANTE	CABIN FILTER FILTRO ABITACOLO
LIBERO (E10, E12)							
1.2 i 4WD (E12, FA)	40	08.91 → 02.00	EF12	10-07-703	20-07-703	30-07-796	
MINIBUS (EK42)							
0.7 VAN (KR3)	0	01.83		10-07-703	20-07-704	30-02-221	
MV (AS_)							
1.8	60	05.81 → 08.86	EA81	10-01-111	20-07-700	30-07-700	
OUTBACK							
2.0 D	110	09.08		10-04-406	20-07-714	30-02-215	21-SB-SB2
2.5	121	11.03	EJ25D	10-03-313	20-07-714	30-07-701	21-SB-SB2
2.5 i	123	09.09	EJ253	10-07-705	20-07-714		21-TY-TY9
3.0	180	11.03	EZ30	10-07-706	20-01-108	30-07-701	21-SB-SB2
3.6 R	191	09.09	EZ36D	10-05-503	20-07-714		21-TY-TY9
OUTBACK (BE, BH)							
2.5	115	10.00 → 08.03	EJ25	10-07-706	20-07-796	30-07-701	21-SB-SB1
3.0 H6	154	10.00 → 08.03	EZ30	10-07-706	20-01-108	30-07-701	21-SB-SB2
REX I							
550	23	08.77 → 08.81	EK23	10-07-703	20-06-602	30-02-221	
REX II/ MINI JUMBO							
550	23	08.81 → 06.87	EK23	10-07-703	20-06-602	30-02-221	
550 Turbo	30	07.84 → 06.87		10-07-703	20-07-708	30-07-700	
700	27	08.82 → 06.89	EK42	10-07-703	20-07-708	30-02-221	
REX III/ MINI JUMBO/ M80-70							
0.5	28	06.89 → 07.90	EN05	10-07-703	20-07-708	30-03-302	
0.5 4WD	28	06.89 → 07.90	EN05	10-07-703	20-07-708	30-03-302	
0.5 Kompressor	45	06.89 → 07.90	EN05	10-07-703	20-07-708	30-03-302	
0.7	35	07.90 → 03.92	EN07E	10-07-703	20-07-708	30-03-302	
0.7 4WD	35	07.90 → 03.92	EN07E	10-07-703	20-07-708	30-03-302	
0.7 Kompressor 4WD	47	07.90 → 02.92	EN07 Super Charger	10-07-703	20-07-708	30-03-302	
0.8	31	06.89 → 03.92	EN08	10-07-703	20-07-708	30-03-302	
SVX (CX)							
3.3 i 24V 4WD (CXW)	162	09.94 → 12.97	EG33 DOHC	10-07-706	20-01-108	30-07-707	
3.3 i 24V 4WD (CXW)	169	09.92 → 09.94	EG33 DOHC	10-07-705	20-01-108	30-07-707	
TREZIA							
1.3i	73	01.11		10-ECO051	20-02-286		21-TY-TY9
1.4 D	66	01.11		10-ECO077	20-02-269	30-02-295	21-TY-TY9
TRIBECA (B9)							
3.0	180	10.06	EZ30	10-07-706	20-07-714	30-07-701	21-SB-SB2
3.0	184	01.05	EZ30	10-07-706	20-07-714	30-07-701	21-SB-SB2
3.6 V6	190	09.07	EZ36D	10-07-706	20-07-714	30-07-701	21-SB-SB2
VIVIO							
660 4WD	32	03.92 → 10.95	EN07E	10-07-703	20-07-799	30-07-797	







SUZUKI

	KW						
				OIL FILTER FILTRO OLIO	AIR FILTER FILTRO ARIA	FUEL FILTER FILTRO CARBURANTE	CABIN FILTER FILTRO ABITACOLO
ALTO I (SS80)							
0.8 (SS80F, SS80G)	29	06.82 → 12.85	F8B	10-06-601	20-08-802	30-08-800	
ALTO II (EC)							
0.8 (SB308/CA)	29	01.86 → 11.93	F8B	10-06-601	20-08-802	30-08-899	
ALTO III (EF)							
0.8 i cat. (SB308)	26	01.95 → 12.99		10-02-279	20-08-888	30-08-897	
1.0	39	09.94 → 06.02	G10B	10-02-279	20-08-802 →06.98 20-08-894 06.98→	30-08-897	
1.0	43	01.00	G10B G10BB	10-06-601	20-08-894	30-08-897	
ALTO IV (FF)							
1.1	46	06.02	F10DN F10D	10-06-601	20-08-889	30-08-897	
ALTO V (GF)							
1.0	50	01.09	K10B	10-02-210	20-08-830		21-SZ-SZ10
BALENO (EG)							
1.3	52	09.96 → 05.02	G13BA	10-06-604	20-08-896	30-08-896	
1.3 i 16V	63	07.95 → 05.02	G13B	10-06-604	20-08-896	30-08-896	
1.6 i 16V	72	07.95 → 05.02	G16B	10-06-604	20-08-896	30-08-896	
1.6 i 16V 4x4	72	07.95 → 05.02	G16B	10-06-604	20-08-896	30-08-896	
1.8 GT	89	03.96 → 05.02	J18A	10-08-898	20-08-896	30-08-896	
1.9 TD	55	04.98 → 05.02		10-H0-002	20-08-896	30-08-891	
CAPPUCINO							
0.7	47	02.92 → 08.95	F6A	10-06-601	20-08-894	30-08-895	
CARRY (FD),(ST90V)							
0.8 (DA21) F8A	29	01.86		10-06-601	20-08-803	30-08-807	
1.0 (SK410) F10A	33	10.85		10-06-601	20-08-803	30-08-807	
1.3	58	03.99	G13B	10-06-601	20-08-885	30-08-896	
1.3 16 V	58	03.00	G13BB	10-06-601	20-08-885	30-08-896	
GRAND VITARA							
1.6 4 ruote motrici	78	04.05	M16A	10-08-898	20-08-824	30-08-823	21-SZ-Z07
1.9 DDiS	95	10.05		10-08-891	20-08-824	30-ECO015	21-SZ-Z07
1.9 TD	55	01.98		10-03-314	20-08-897	30-05-502MP 30-05-502	21-SZ-Z01 06.98→ →06.03 21-SZ-Z02 06.03→
2.0 4 ruote motrici	103	10.05	J20A	10-08-898	20-08-824		21-SZ-Z07
3.2 4 ruote motrici	171	01.09	N32A	10-00-010	20-08-831		21-SZ-Z07
GRAND VITARA (FT, GT)							
1.6	69	03.98	G16B	10-08-898	20-08-897	30-08-823	21-SZ-Z01 06.98→ →06.03 21-SZ-Z02 06.03→

NEW CODES - NEUE CODES - NOUVEAUX CODES - NUEVOS CODIGOS - NUOVI CODICI

Per nuove applicazioni e novità si prega di accedere al sito www.ashika.eu - For new applications and new items, please go to www.ashika.eu

	KW						
				OIL FILTER FILTRO OLIO	AIR FILTER FILTRO ARIA	FUEL FILTER FILTRO CARBURANTE	CABIN FILTER FILTRO ABITACOLO
GRAND VITARA (FT, GT)							
2.0	94	03.98	J20A	10-08-898	20-08-897	30-08-823	21-SZ-Z01
2.0 HDI 110	80	07.01	RHW	10-01-189	20-08-897	30-ECO019	21-SZ-Z01 →06.03 21-SZ-Z02 06.03→
2.0 TD Intercooler	64	03.98	RF	10-03-314	20-08-897	30-05-502MP 30-05-502	21-SZ-Z01 06.99→ →06.03 21-SZ-Z02 06.03→
2.5 V6 24V	116	04.01	H 25 A	10-08-800	20-08-897	30-08-823	21-SZ-Z02
2.5 V6 24V (FT)	106	04.98	H 25 A	10-08-800	20-08-897	30-08-823	21-SZ-Z01 06.98→ →06.03 21-SZ-Z02 06.03→
2.7 XL-7	127	09.01		10-08-800	20-08-833 20-08-897	30-08-826	21-SZ-Z01 →06.03 21-SZ-Z02 06.03→
2.7 XL-7	135	04.03	H 27 A	10-08-800	20-08-833 20-08-897	30-08-826	21-SZ-Z02
IGNIS (FH)							
1.3	61	10.00→09.03	M13A	10-08-898	20-08-884	30-08-824 Nel serbatoio carb. /Inside tank fuel	21-SZ-Z03
1.3 4WD	61	10.00→09.03	M13A	10-08-898	20-08-884	30-08-824 Nel serbatoio carb. /Inside tank fuel	21-SZ-Z03
IGNIS II							
1.3	69	09.03	M13A	10-08-898	20-07-715	30-08-897	21-SZ-Z03
1.3 DDiS	51	09.03	Z13DT	10-ECO044 10-ECO065	20-08-818	30-ECO016	21-SZ-Z03
1.5	73	09.03	M15A	10-08-898	20-07-715	30-08-824 Nel serbatoio carb. /Inside tank fuel	21-SZ-Z03
1.5 Sport	80	12.03	M15A	10-08-898	20-07-715	30-08-824 Nel serbatoio carb. /Inside tank fuel	21-SZ-Z03
JIMNY (FJ)							
1.3 4x4	63	09.98→08.00	G13BB	10-08-898	20-08-815	30-08-887	21-SZ-Z06
1.3 16V	59	09.98	G13BB	10-08-898	20-08-815	30-08-887	21-SZ-Z06
1.3 16V	60	02.01	M13A	10-08-898	20-08-815		21-SZ-Z06
1.3 16V 4x4	63	08.05	M13A	10-08-898	20-08-815		21-SZ-Z06
1.5 DDiS 4WD	48	12.03	K9K 700	10-08-891	20-08-823	30-01-108	21-SZ-Z06
1.5 DDiS 4x4	63	08.05	K9K 266	10-01-122	20-08-823	30-01-108 →05.07 30-01-122 06.07→	21-SZ-Z06
LIANA (ER)\ Station wagon (ER)							
1.3	66	03.02	M13A	10-08-898	20-08-801 03.03→ 20-08-886	30-08-897	21-SZ-Z04
1.4 DDiS	66	03.05	8HY	10-03-351	20-08-826	30-03-300	21-SZ-Z04

NEW CODES - NEUE CODES - NOUVEAUX CODES - NUEVOS CODIGOS - NUOVI CODICI









SUZUKI

	KW						
				OIL FILTER FILTRO OLIO	AIR FILTER FILTRO ARIA	FUEL FILTER FILTRO CARBURANTE	CABIN FILTER FILTRO ABITACOLO
LIANA (ER)\ Station wagon (ER)							
1.6	76	03.02	M16A	10-08-898	20-08-801 03.03→ 20-08-886	30-08-897	21-SZ-Z04
1.6	78	04.02	M16A	10-08-898	20-08-801 03.03→ 20-08-886	30-08-897	21-SZ-Z04
LJ 80							
0.8	29	01.80→01.84	F8A	10-06-601	20-08-806	30-08-800	
SAMURAI (SJ)							
1.0 (SJ 410)	33	11.88	F10A	10-08-800	20-08-803	30-08-800	
1.3	59	01.00		10-08-898	20-08-807	30-08-887	
1.3 (SJ 413)	44	11.88	G13A	10-08-800	20-08-807	30-08-800	
1.3 (SJ 413)	47	11.88	G13A	10-08-800	20-08-807	30-08-800	
1.3 (SJ 413)	51	11.88	G13BA	10-08-800	20-08-807	30-08-887	
1.9 TD	46	11.98	XUD9	10-08-891 06.01→ 10-08-893 01.01→	20-08-825	30-08-821 06.01→ 30-08-822 06.01→	
1.9 TD	47	11.98		10-08-893		30-08-891	
SANTANA							
1.0 (SJ410) F10A MADE IN SPAIN	0	04.82→03.88		10-08-800	20-08-803	30-08-800	
1.3 (SJ413)	0	01.85		10-08-800	20-08-807	30-08-800	
SIDEKICK							
1.6 (JLX - JS - JX)	59	04.89→04.96		10-02-279	20-08-898	30-02-216	
SJ 410							
1.0	33	09.81→12.88	F10A	10-08-800	20-08-803 06.82→ →06.85	30-08-800 06.82→ →06.85	
SJ 413							
1.3	44	08.86→08.90	G13A	10-08-800	20-08-807	30-08-800	
1.3	47	09.84→12.88	G13A	10-08-800	20-08-807	30-08-800	
SPLASH							
1.0	48	01.08	K10B	10-06-604	20-08-817	30-08-897	21-SZ-Z09
1.2	63	01.08	K12B	10-06-604	20-08-817		21-SZ-Z09
1.3 CDTI	55	01.08	D13A Z13DTJ	10-ECO044 10-ECO065	20-08-822	30-ECO016	21-SZ-Z09
SUPER CARRY (ED)							
1.0	30	09.94→03.99	F10A	10-06-601	20-08-803	30-08-807	
1.0	31	10.92→03.99	F10A	10-06-601	20-08-803	30-08-807	
1.0	33	10.85→03.99	F10A	10-06-601	20-08-803	30-08-807	
SUPERCARRY Pick-Up , Van (SK410)							
1.0 (F10A)	33	01.86		10-06-601	20-08-803	30-08-807	
SWIFT (SF413)							
1.3 (SF413, AK35)	50	09.91→10.96	G13BA	10-06-601	20-08-813	30-08-810 30-08-890	

NEW CODES - NEUE CODES - NOUVEAUX CODES - NUEVOS CODIGOS - NUOVI CODICI

Per nuove applicazioni e novità si prega di accedere al sito www.ashika.eu - For new applications and new items, please go to www.ashika.eu

	KW						
				OIL FILTER FILTRO OLIO	AIR FILTER FILTRO ARIA	FUEL FILTER FILTRO CARBURANTE	CABIN FILTER FILTRO ABITACOLO
SWIFT I (AA)							
1.0 (SA310, AA41/43)	37	10.83 → 03.89	G10A G10	10-06-601	20-08-805	30-04-404	
1.0 Turbo (SA310)	52	02.85 → 12.89		10-06-601	20-08-805	30-04-404	
1.3 (SA413, AA51)	50	10.84 → 03.89	G13A	10-06-601	20-08-805	30-04-404	
1.3 (SA413, AA51/53)	54	10.84 → 03.89	G13A	10-06-601	20-08-805	30-04-404	
1.3 (SA413, AA53)	47	08.86 → 03.89	G13A	10-06-601	20-08-805	30-04-404	
1.3 GTi/GXi (SA413, AA33)	74	08.86 → 03.89	G13B	10-06-601	20-08-808	30-04-499	
SWIFT II (AH, AJ)							
1.3 (SF413, AH35)	52	03.89 → 12.91	G13A	10-06-601	20-08-813	30-08-810 30-08-890	
1.3 (SF413, AH35, MA)	50	03.89 → 05.01	G13A	10-02-279 06.95 → 10-06-601 → 12.91	20-08-813 06.95 →	30-08-810 06.95 → 30-08-890 06.95 → 30-W0-000 → 12.91	
1.6 (SF416, AH14)	70	11.89 → 12.91	G16B	10-06-601	20-08-812	30-08-810 30-08-890	
1.6 i (SF416, AH14)	68	01.90 → 05.01	G16B	10-06-601 → 12.97	20-08-812 → 12.97	30-08-810 → 12.97 30-08-890 → 12.97	
SWIFT II (EA, MA)							
1.0 (SF310, AA44)	37	03.89 → 05.01	G10A	10-06-601	20-08-811	30-W0-000	
1.0 i (SF310, AA44)	39	09.91 → 05.01	G10A	10-02-279 06.95 →	20-08-813 06.95 →	30-08-810 06.95 → 30-08-890 06.95 →	
1.0 i (SF310, AA44)	40	03.89 → 12.91	G10A	10-06-601	20-08-813	30-08-810 30-08-890	
1.3 (SF413, AB35)	50	03.89 → 05.01	G13A	10-02-279 06.95 →	20-08-813 06.95 →	30-08-810 06.95 → 30-08-890 06.95 →	
1.3 (SF413, AB35)	52	03.89 → 12.91	G13A	10-06-601	20-08-813	30-08-810 30-08-890	
1.3 GTi (SF413, AA34)	74	03.89 → 05.01	G13B	10-06-601 → 06.97	20-08-809 20-08-813 → 06.97	30-04-499 → 06.97 30-08-890 07.97 →	
SWIFT III (SG)							
1.3	68	02.05	M13A	10-08-898	20-08-819	30-08-897	21-SZ-Z08
1.3 4x4	66	01.06	M13A	10-08-898	20-08-829	30-08-897	21-SZ-Z08
1.3 4x4	68	02.05	M13A	10-08-898	20-08-829	30-08-897	21-SZ-Z08
1.3 DDiS	51	08.05	Z13DT	10-ECO044 10-ECO065	20-08-822	30-ECO016	21-SZ-Z08
1.3 DDiS	55	08.05	D13A Z13DTJ	10-ECO044 10-ECO065	20-08-822	30-ECO016	21-SZ-Z08
1.5	75	02.05	M15A	10-08-898	20-08-819	30-08-897	21-SZ-Z08
1.6	92	05.06	M16A	10-08-898	20-08-819	30-08-897	21-SZ-Z08
SWIFT IV							
1.2	66	10.10	K12B	10-06-604	20-08-817		21-SZ-Z08









SUZUKI

	KW						
				OIL FILTER FILTRO OLIO	AIR FILTER FILTRO ARIA	FUEL FILTER FILTRO CARBURANTE	CABIN FILTER FILTRO ABITACOLO
SWIFT IV							
1.2	69	10.10	K12B	10-06-604	20-08-817		21-SZ-Z08
1.2 4x4	66	10.10	K12B	10-06-604	20-08-817		21-SZ-Z08
1.2 4x4	69	10.10	K12B	10-06-604	20-08-817		21-SZ-Z08
1.3 DDiS	55	10.10	D13A	10-ECO095	20-08-822	30-ECO016	21-SZ-Z08
SX4							
1.5	73	06.06	M15A	10-08-898	20-08-828 →05.09 20-08-832 06.09→	30-08-897	21-SZ-Z08 21-SZ-SZ11 Made in Japan
1.6 DDIS	66	04.07	9HX	10-03-351	20-08-826	30-03-300	21-SZ-Z08 21-SZ-SZ11 Made in Japan
1.6 VVT	79	06.06	M16A	10-08-898	20-08-828 →05.09 20-08-832 06.09→	30-08-897	21-SZ-Z08 21-SZ-SZ11 Made in Japan
1.6 VVT	88	07.09	M16A	10-08-898	20-08-832		21-SZ-Z08
1.9 DDiS	88	06.06	D19AA	10-ECO058	20-08-827	30-ECO016	21-SZ-Z08 21-SZ-SZ11 Made in Japan
2.0 DDiS	99	07.09	D20AA	10-ECO095	20-08-827	30-ECO016	21-SZ-Z08 21-SZ-SZ11 Made in Japan
VITARA (ET, TA)\ Cabrio (ET, TA)							
1.6 (ET)	60	07.88 → 12.91	G16A	10-08-800	20-03-308 →10.90 20-08-891 11.90→	30-02-216 30-08-813	
1.6 (TA)	59	07.88 → 03.98	G16A	10-08-800	20-03-308 →10.90 20-08-891 11.90→	30-02-216	
1.6 16V (ET)	71	07.90 → 03.98	G16B	10-08-800	20-08-899	30-02-216	
1.9 D (ET)	50	01.95 → 03.98	XUD9A	10-08-893	20-08-898	30-08-891	
1.9 D (ET)	55	08.96 → 03.98	XUD9SD	10-08-893	20-08-898	30-08-891	
2.0 16V (ET)	97	12.96 → 03.98	J20A	10-02-279	20-08-897	30-02-216	
2.0 TD (ET)	52	12.94 → 03.98	RF	10-03-314 06.96→	20-08-897 06.96→	30-05-502MP 01.96→ 30-05-502 01.96→	
2.0 TD Intercooler (ET)	64	12.95 → 03.98	RF	10-03-314	20-08-897	30-05-502MP 30-05-502	
2.0 V6 24V (ET)	100	12.94 → 03.98	H 20 A	10-08-800	20-08-899	30-02-216	
2.5 V6 24V (FT)	118	12.95 → 03.98	H 25 A	10-08-800	20-08-897	30-02-216	
WAGON R+ (EM)							
1.0	48	02.98 → 05.00	K10A	10-06-604	20-08-889	30-08-897	21-SZ-Z05
1.2	51	02.98 → 05.00	K12A	10-06-604	20-08-889	30-08-897	21-SZ-Z05
WAGON R+ (MM)							
1.3	56	05.00	G13BB	10-08-898	20-08-887	30-08-897	21-SZ-Z05
1.3	69	09.03	M13A	10-08-898	20-07-715	30-08-897	21-SZ-Z05







NEW CODES - NEUE CODES - NOUVEAUX CODES - NUEVOS CODIGOS - NUOVI CODICI

Per nuove applicazioni e novità si prega di accedere al sito www.ashika.eu - For new applications and new items, please go to www.ashika.eu

	KW			 OIL FILTER FILTRO OLIO	 AIR FILTER FILTRO ARIA	 FUEL FILTER FILTRO CARBURANTE	 CABIN FILTER FILTRO ABITACOLO
WAGON R+ (MM)							
1.3 DDiS	51	09.03	Z13DT	10-ECO044 10-ECO065	20-08-818	30-ECO016	21-SZ-Z05
X-90 (EL)							
1.6 i 16V	71	09.95	G16B	10-02-279	20-08-898	30-02-216	



TATA (TELCO)

	KW						
				OIL FILTER FILTRO OLIO	AIR FILTER FILTRO ARIA	FUEL FILTER FILTRO CARBURANTE	CABIN FILTER FILTRO ABITACOLO
2000 D							
2.0 D	0			10-00-003	20-00-003	30-08-891	
2000 TD							
2.0 TD	0			10-00-004	20-00-004	30-00-004	
INDICA							
1.4 D	39	10.98	475 DL	10-00-006	20-00-006	30-08-891	
1.4 i	55	10.98	475 Si	10-00-006 06.02→	20-00-006 06.02→	30-08-891 06.02→	
1.4 TD	52	07.03		10-00-011	20-00-011	30-K0-009	
INDIGO\ MARINA							
1.4	62	01.03		10-00-006	20-00-011		
1.4 D	46	01.03		10-00-011	20-00-011	30-08-891	
LOADBETA							
1.9 D	50	08.94		10-02-212	20-00-003	30-08-891	
1.9 D	66	11.95		10-02-212	20-00-003	30-08-891	
SAFARI							
1.9 D	66	04.00	483 DL	10-00-004	20-00-005	30-08-891	
2.0 16V	101	06.99	483 PL	10-03-321			
2.0 TD 4X4 (403.001)	0	02.01		10-00-004	20-00-005	30-08-891	
2.2 TDiC	103	07.06		10-00-004	20-0S-S01	30-K0-009	
XENON							
2.2 DiCOR	103	01.09		10-00-004	20-0S-S01	30-K0-009	

NEW CODES - NEUE CODES - NOUVEAUX CODES - NUEVOS CODIGOS - NUOVI CODICI

Per nuove applicazioni e novità si prega di accedere al sito www.ashika.eu - For new applications and new items, please go to www.ashika.eu

	KW						
				OIL FILTER FILTRO OLIO	AIR FILTER FILTRO ARIA	FUEL FILTER FILTRO CARBURANTE	CABIN FILTER FILTRO ABITACOLO
1000 (KP36V_)							
1.0	33	04.69	2K	10-02-210	20-02-203	30-03-302	
1000 / COPAIN (KP30_)							
1.0	33	04.69	2K	10-02-210	20-02-203 veicolo guida a destra/right hand	30-03-302	
4 RUNNER							
3.0 Turbo-D	92	11.95	1KZ-T	10-02-213	20-02-270	30-02-215MP 30-02-215	
4 RUNNER (_N130)							
2.4 (RN61)	82	08.87 → 03.96	22REC	10-02-279	20-02-233	30-02-247	
2.4 TD (LN130)	66	01.90 → 01.93		10-02-213	20-02-234 →12.91	30-02-215MP 30-02-215	
2.4 TD 4x4	66	08.89 → 11.95	2L-T	10-02-213	20-02-234	30-02-215	
2.7 i 4x4	112	11.95 → 03.96	3RZ-FE	10-02-279	20-02-299	30-02-250	
3.0 Turbo-D (KZN 130)	92	10.93 → 03.96	1KZ-T	10-02-213	20-02-270	30-02-215MP 30-02-215	
3.0 V6 (VZN 130)	105	07.90 → 11.95	3VZ-E	10-02-279	20-02-233	30-02-247	
3.4 i 4x4	136	11.95 → 03.96	5VZ-FE	10-02-279	20-02-254	30-02-247	
AURIS							
1.33 Dual-VVTi	74	05.09	1NR-FE	10-ECO051	20-02-261		21-TY-TY9
1.4 D-4D	66	03.07	1ND-TV	10-02-279	20-02-262	30-02-256	21-TY-TY9
1.4 VVTi	71	03.07	4ZZ-FE	10-02-210	20-02-261		21-TY-TY9
1.6	97	05.09	1ZR-FAE	10-ECO078	20-02-261		21-TY-TY9
1.6 VVTi	91	03.07	1ZR-FE	10-02-210	20-02-261		21-TY-TY9
1.8	108	02.09	2ZR-FAE	10-02-203	20-02-261		21-TY-TY9
2.0 D-4D	93	03.07	1AD-FTV	10-ECO054	20-02-262	30-02-256	21-TY-TY9
2.2 D	130	03.07	2AD-FHV	10-ECO054	20-02-262	30-02-256	21-TY-TY9
AVENSIS (T25)							
1.6 VVT-i	81	04.03	3ZZ-FE	10-02-210	20-00-098	30-02-240	21-TY-TY7
1.8	95	04.03	1ZZ-FE	10-02-210	20-02-283	30-02-244	21-TY-TY7
2.0	108	04.03	1AZ-FSE	10-02-210	20-02-283	30-02-240	21-TY-TY7
2.0 D-4D	85	04.03	1CD-FTV	10-02-297	20-02-278	30-02-295	21-TY-TY7
2.0 D-4D	93	03.06	1AD-FTV	10-ECO054	20-02-253	30-02-295	21-TY-TY7
2.2 D-4D	110	10.05	2AD-FTV	10-02-297	20-02-253	30-02-215MP 30-02-215	21-TY-TY7
2.2 D-CAT	130	07.05	2AD-FHV	10-02-297	20-02-253	30-02-215MP 30-02-215	21-TY-TY7
2.4	120	10.03	2AZ-FSE	10-02-210	20-02-283	30-02-240	21-TY-TY7
2.4	125	09.03	2AZ-FSE	10-02-210	20-02-283	30-02-240	21-TY-TY7
AVENSIS (_T22_)							
1.6 (AT220_)	74	09.97 → 10.00	4A-FE	10-02-210	20-00-098	30-02-224	21-TY-TY1
1.6 (AT220_)	81	09.97 → 10.00	4A-FE	10-02-210	20-00-098	30-02-224	21-TY-TY1
1.6 VVT-i	81	10.00 → 02.03	3ZZ-FE	10-02-210	20-00-098	30-02-244	21-TY-TY1
1.8 (AT221_)	81	09.97 → 10.00	7A-FE	10-02-210	20-00-098	30-02-224	21-TY-TY1
1.8 VVT-i	95	10.00 → 02.03	1ZZ-FE	10-02-210	20-00-098	30-02-244	21-TY-TY1



	KW						
				OIL FILTER FILTRO OLIO	AIR FILTER FILTRO ARIA	FUEL FILTER FILTRO CARBURANTE	CABIN FILTER FILTRO ABITACOLO

AVENSIS (_T22_)

1.9 D	85	09.02 → 02.03	1CD-FTV	10-02-297	20-02-238	30-02-295	21-TY-TY1
2.0 (ST220_)	94	09.97 → 10.00	3S-FE	10-02-210	20-00-098	30-02-224	21-TY-TY1
2.0 D-4D (CDT220_)	81	10.99 → 02.03	1CD-FTV	10-02-213	20-02-277 20-02-296 →12.00	30-02-295	21-TY-TY1
2.0 TD (CT220_)	66	09.97 → 02.03	2C-TE	10-02-297	20-02-296	30-02-295	21-TY-TY1
2.0 VVT-i	110	10.00 → 02.03	1AZ-FSE	10-02-214	20-00-098	30-02-244	21-TY-TY1

AVENSIS VERSO

2.0 D-4D	85	08.01	1CD-FTV	10-02-297	20-02-277	30-02-295	21-TY-TY1
2.0 VVT-i	110	08.01	1AZ-FE	10-02-214	20-02-283	30-02-244 →06.03 30-02-255 06.03→ Nel serbatoio carb. /Inside tank fuel	21-TY-TY1

AVENSIS(T27)

1.6	97	02.09	1ZR-FAE	10-ECO078	20-02-261		21-TY-TY9
1.6 VVT-i	97	05.09		10-ECO078	20-02-261		21-TY-TY9
1.8	108	02.09	2ZR-FAE	10-ECO078	20-02-261		21-TY-TY9
2.0 D	93	02.09	1AD-FTV	10-ECO054	20-02-262	30-02-295	21-TY-TY9
2.2 D	130	02.09	2AD-FHV	10-ECO054	20-02-262	30-02-295	21-TY-TY9
2.2 D-CAT	130	05.09		10-ECO054	20-02-262	30-02-295	21-TY-TY9

AYGO

1.0	50	07.05	1KR-FE	10-02-210	20-02-288		21-TY-TY10
1.4 HDi	40	07.05	2WZ-TV	10-03-351	20-03-351	30-03-351	21-TY-TY10

CAMRY (_V1_) Station Wagon\ Tre Volumi

2.2 (SXV10)	100	06.91 → 08.96	5S-FE	10-02-210	20-02-298	30-02-224	
3.0 (VCV10)	138	06.91 → 08.96	3VZ-FE	10-02-210	20-02-298	30-02-224	

CAMRY (_V20)

2.2	93	11.00 → 11.01	5S-FE	10-02-210	20-02-298	30-02-224	
2.2 (SXV20_)	96	08.96 → 11.01	5S-FE	10-02-210	20-02-298	30-02-224	
3.0 24V (MCV20_)	140	08.96 → 11.01	1MZ-FE	10-02-279	20-02-298	30-02-224	
3.0 V6	135	08.96 → 11.01	1MZ-FE	10-02-279	20-02-298	30-02-224	

CAMRY (_V2_) Station Wagon (_V2_)



1.8 i (SV20_)	66	10.86 → 08.88	1S-L	10-02-210	20-02-201 20-02-248	30-02-220	
2.0 (SV21_, SV25_)	94	11.86 → 05.91	3S-FE	10-02-210	20-02-224	30-02-224	
2.0 4x4	94	08.88 → 05.91	3S-FE	10-02-210	20-02-224	30-02-224	
2.0 Gli 16V (SV21_, SV25_)	89	11.86 → 05.91	3S-FE	10-02-210	20-02-224	30-02-224	
2.0 GLi 4x4	88	10.87 → 07.88	3S-FE	10-02-210	20-02-224	30-02-224	
2.0 Turbo-D (CV20_)	62	11.86 → 05.91	2C-T	10-02-212	20-02-238	30-02-215MP 30-02-215	
2.0 Turbo-D (CV20_)	63	11.88 → 05.91	2C-T	10-02-212	20-02-238	30-02-215MP 30-02-215	
2.5 V6 GXI (VZV21_)	118	02.88 → 05.91	2VZ-FE	10-02-279	20-02-238	30-02-224	

CAMRY (_V30)

NEW CODES - NEUE CODES - NOUVEAUX CODES - NUEVOS CODIGOS - NUOVI CODICI

	KW			 OIL FILTER FILTRO OLIO	 AIR FILTER FILTRO ARIA	 FUEL FILTER FILTRO CARBURANTE	 CABIN FILTER FILTRO ABITACOLO
CAMRY (_V30)							
2.4 VVT-i	112	11.01	2AZ-FE	10-02-214	20-02-252	30-02-224	21-TY-TY12 21-TY-TY8
2.4 VVTi Hybrid	105	01.06	2AZ-FXE	10-02-214	20-02-252	30-02-224	21-TY-TY9
2.4 VVTi LE	116	01.06	2AZ-FE				21-TY-TY9
3.0 V6	137	11.01	1MZ-FE	10-02-279	20-02-252	30-02-224	21-TY-TY12 21-TY-TY8
CAMRY Liftback (V1)							
1.8	66	02.83 → 10.86	1S-L	10-02-210	20-02-201	30-02-220	
1.8 Turbo-D	54	10.84 → 01.88	1C-TL	10-02-210	20-02-238 →06.85 20-02-254 01.86→	30-02-215MP 30-02-215	
2.0	73	04.86 → 01.88	2S-ELC	10-02-210	20-02-224	30-02-224	
CARINA (TA1_)							
1.6	55	02.76 → 03.78	2T	10-02-201 06.76→	20-02-201	30-02-201 06.76→	
1.6	63	10.75 → 03.78	2TB	10-02-201	20-02-202	30-02-201	
1.6 (TA12)	58	05.73 → 03.78	2T	10-02-201 06.76→	20-02-201 06.76→	30-02-201	
CARINA (TA4L, TA6_L)							
1.6 (TA4L, TA60L)	55	01.78 → 09.83	2T	10-02-201	20-02-201	30-02-201	
1.8	57	01.78 → 05.83	3T-C 3T	10-02-201	20-02-201	30-02-201	
1.8	63	01.82 → 02.87	3T	10-02-201	20-02-201	30-02-201	
1.8 D	48	04.82 → 09.83	1C	10-02-201	20-02-238	30-02-215MP 30-02-215	
1.8 XE	62	08.81 → 09.83	3T	10-02-201	20-02-201	30-02-201	
CARINA E (_T19_)							
1.6 (AT190)	73	01.95 → 09.97	4A-FE	10-02-210	20-00-098 20-02-238	30-02-242	21-TY-TY1
1.6 (AT190)	78	10.95 → 09.97	4A-FE	10-02-201	20-00-098 20-02-238	30-02-242	21-TY-TY1
1.6 (AT190)	79	01.93 → 09.97	4A-FE	10-02-210	20-02-238	30-02-242	21-TY-TY1
1.6 16V (AT190_)	85	12.94 → 09.97	4A-FE	10-02-210	20-00-098 06.96→ 20-02-238	30-02-242	21-TY-TY1
1.8	85	04.92 → 09.97	7A-FE	10-02-210	20-02-238	30-02-242	21-TY-TY1
1.8 GL	92	10.94 → 09.97	7A-FE	10-02-210	20-02-238	30-02-242	21-TY-TY1
1.8 i 16V (AT191)	79	01.95 → 09.97	7A-FE	10-02-210	20-00-098	30-02-242	21-TY-TY1
2.0 (ST191)	98	01.93 → 09.97	3S-FE	10-02-210	20-02-238	30-02-224	21-TY-TY1
2.0 D (CT190)	54	08.92 → 01.96	2C	10-02-212	20-02-238	30-02-215MP 30-02-215	21-TY-TY1
2.0 GTi (ST191_)	116	04.92 → 02.94	3S-GE	10-02-210	20-02-238	30-02-224	21-TY-TY1
2.0 GTi 16V (ST191_)	129	03.94 → 09.97	3S-GE	10-02-210	20-02-238	30-02-224	21-TY-TY1
2.0 i (ST191)	93	12.92 → 09.97	3S-FE	10-02-210	20-00-098	30-02-242	21-TY-TY1
2.0 TD (CT190_)	61	01.96 → 09.97	2C-T	10-02-297	20-02-296	30-02-295	21-TY-TY1
CARINA II (_T15_)							
1.6 (AT151)	55	10.83 → 11.87	4A-LC	10-02-210	20-02-207	30-02-220	



	KW						
				OIL FILTER FILTRO OLIO	AIR FILTER FILTRO ARIA	FUEL FILTER FILTRO CARBURANTE	CABIN FILTER FILTRO ABITACOLO
CARINA II (T15)							
1.6 (AT151)	62	10.83 → 11.87	4A-L	10-02-210	20-02-207	30-02-220	
1.6 (AT151)	63	10.86 → 11.87	4A-L	10-02-210	20-02-207	30-02-220	
1.8 GLI (ST150)	74	10.83 → 11.87	1S-L	10-02-210 06.85→	20-02-224 06.85→	30-02-225 06.85→	
2.0 D	50	02.84 → 05.88	2C-L	10-02-201	20-02-238	30-02-215MP 30-02-215	
2.0 D (CT150)	51	12.85 → 11.87	2C-L	10-02-201	20-02-238	30-02-215MP 30-02-215	
CARINA II (T17)							
1.6 (AT171)	66	12.87 → 11.89	4A-F	10-02-210	20-02-240	30-03-302	
1.6 (AT171)	72	12.87 → 03.92	4A-FE	10-02-210 01.89→	20-02-239 01.89→	30-02-224 01.89→	
1.6 (AT171)	75	12.87 → 03.92	4A-FE	10-02-201 06.89→	20-02-239 06.89→	30-02-224 06.89→	
2.0 D	54	03.88 → 06.93	2C-L	10-02-212	20-02-238	30-02-215MP 30-02-215	
2.0 GLi	94	12.87 → 03.92	3S-FE	10-02-210	20-02-224	30-02-224	
2.0 GLI (ST171)	89	12.87 → 03.92	3S-FE	10-02-210	20-02-238	30-02-224	
CARINA Station Wagon (TA4K, TA6K)							
1.6 (TA4K)	54	03.81 → 01.82	2T	10-02-201	20-02-201	30-02-201	
1.6 (TA4K, TA60LG)	55	04.78 → 09.83	2T	10-02-201	20-02-201	30-02-201	
1.8	57	08.82 → 12.82	3T-C	10-02-201	20-02-201	30-02-201	
1.8 D	48	04.82 → 09.83	1C	10-02-210	20-02-238	30-02-215MP 30-02-215	
CELICA (ST16_)							
1.6	63	04.86 → 02.90	4A-L	10-02-210	20-02-207	30-02-220	
1.6 GT 16V	91	04.86 → 08.89	4A-GEL	10-02-210	20-02-224	30-02-225	
2.0	110	01.87 → 08.90	3S-GEL	10-02-210	20-02-238 →06.89	30-02-225 →06.89	
CELICA (T16)							
1.6	63	04.86 → 02.90	4A-L	10-02-210	20-02-207	30-02-220	
1.6 GT	85	08.87 → 08.89	4A-GELC	10-02-210	20-02-224	30-02-225	
1.6 GT 16V	91	09.85 → 08.89	4A-GEL	10-02-210	20-02-224	30-02-225	
2.0 GT	103	09.85 → 08.89	3S-GELC	10-02-210	20-02-238	30-02-225	
2.0 GT	110	08.85 → 08.89	3S-GEL	10-02-210	20-02-238	30-02-225	
CELICA (TA2)							
1.6 GT (TA2, TA22)	79	12.74 → 03.78	2T-G	10-02-201	20-02-203	30-02-201	
1.6 LT (TA2)	55	02.76 → 03.78	2T	10-02-201	20-02-201	30-02-201	
1.6 LT (TA22)	58	05.73 → 03.78		10-02-201	20-02-201	30-02-201	
1.6 ST (TA2, TA22)	63	05.73 → 03.78	2TB	10-02-201	20-02-202	30-02-201	
2.0	63	10.75 → 07.77	18R	10-02-201	20-02-245	30-02-201	
2.2	71	10.75 → 07.77		10-02-210	20-02-298	30-05-590	
CELICA (TA60, RA40, RA6_)							
1.6	91	08.83 → 07.85	4A-GE	10-02-210	20-02-205	30-02-225	
1.6 ST (TA60)	63	08.77 → 08.85	2TB	10-02-201	20-02-202	30-02-201	
1.6 ST (TA60)	66	02.79 → 08.83	2T	10-02-201	20-02-202	30-02-201	

NEW CODES - NEUE CODES - NOUVEAUX CODES - NUEVOS CODIGOS - NUOVI CODICI

	KW						
				OIL FILTER FILTRO OLIO	AIR FILTER FILTRO ARIA	FUEL FILTER FILTRO CARBURANTE	CABIN FILTER FILTRO ABITACOLO
CELICA (TA60, RA40, RA6_)							
2.0 GT (RA63)	90	02.78 → 08.83	18R-G	10-02-200	20-02-203	30-02-201	
2.0 XT (RA40)	65	01.80 → 12.82	18R	10-02-200	20-02-203	30-02-201	
2.0 XT (RA40)	66	02.79 → 07.85	18R	10-02-200	20-02-203	30-02-201	
2.0 XT (RA61)	77	02.82 → 08.85	21R-C	10-02-204	20-02-210	30-02-201 →12.84 30-02-221 01.84→	
CELICA (ZZT23_)							
1.8 16V TS (ZZT231_)	141	11.99	2ZZ-GE	10-02-210	20-02-239	30-02-284 Nel serbatoio carb. /Inside tank fuel	21-SB-SB2
1.8 16V VT-i (ZZT230_)	105	11.99	1ZZ-FE	10-02-210	20-02-239	30-02-284 Nel serbatoio carb. /Inside tank fuel	21-SB-SB2
CELICA (_T18_)							
2.0 GTi (ST182)	115	05.91 → 01.94	3S-GE	10-02-210	20-02-238	30-02-224	
CELICA (_T20_)							
1.8 i 16V (AT200/ST)	85	11.93 → 11.99	7A-FE	10-02-214	20-02-298	30-05-590	
2.0 i 16V	125	04.96 → 11.99	3S-GE	10-02-214	20-02-298	30-05-590	
2.0 i 16V (ST202/GT)	129	11.93 → 11.99	3S-GE	10-02-214	20-02-298	30-05-590	
2.0 i Turbo 4WD (ST205)	178	02.94 → 11.99	3S-GTE	10-02-214	20-02-298	30-05-590	
CELICA Coupe (RA6)							
1.6	91	12.83 → 10.86	4A-GE	10-02-210	20-02-205	30-02-225	
2.0	77	01.82 → 10.86	21R-U	10-02-204	20-02-210	30-02-201 →06.84 30-02-221 06.84→	
2.0	88	01.82 → 10.86	18R-G	10-02-200	20-02-203	30-02-201	
CELICA Coupe (T16F)							
2.0	103	08.87 → 08.89	3S-GEL 3S-GELC	10-02-210	20-02-238	30-02-235	
2.0 Turbo 4x4	136	03.88 → 08.90	3S-GTE	10-02-210	20-02-238	30-02-224	
CELICA Coupe (TA4C, TA60)							
1.6 GT (TA4C)	80	04.78 → 02.82	2T-G	10-02-201	20-02-203	30-02-201	
1.6 GT (TA4C)	81	04.80 → 02.82		10-02-201	20-02-203	30-02-201	
1.6 LT (TA4C)	55	02.79 → 07.83	2TB	10-02-201	20-02-202	30-02-201	
1.6 ST (TA4C, TA60)	63	08.77 → 08.85	4A-L 2TB	10-02-201	20-02-202	30-02-201	
1.6 ST (TA60)	66	02.79 → 08.83	2T	10-02-201	20-02-202	30-02-201	
CELICA Coupe (_T18_)							
1.6 STi (AT180)	77	10.89 → 01.94	4A-FE	10-02-210	20-02-239	30-02-224	
2.0 GTi (ST182)	115	10.89 → 01.94	3S-GE	10-02-210	20-02-238	30-02-224	
2.0 Turbo 4WD (ST185)	150	10.89 → 01.94	3S-GTE	10-02-210	20-02-238	30-02-224	
2.0 Turbo 4WD (ST185)	153	10.89 → 01.94	3S-GTE	10-02-210	20-02-238	30-02-224	
CELICA SUPRA (MA61)							
2.8 i	125	05.82 → 10.86	5M-GE	10-02-204	20-02-206	30-02-216	
COROLLA (KE)							



	KW						
				OIL FILTER FILTRO OLIO	AIR FILTER FILTRO ARIA	FUEL FILTER FILTRO CARBURANTE	CABIN FILTER FILTRO ABITACOLO

COROLLA (KE)

1.2 (KE20, KE25)	43	10.72 → 06.77	3K-B 3K-C 3K-H	10-02-210	20-02-203	30-03-302	
1.2 (KE20, KE25, KE30)	40	08.74 → 12.80	3K-B 3K-C 3K-H	10-02-210	20-02-203	30-03-302	

COROLLA (KE, TE)

1.6	54	09.76 → 01.80	2T	10-02-201	20-02-202	30-03-302	
1.6	62	09.76 → 01.80	2TB	10-02-201	20-02-202	30-03-302	

COROLLA (_E10_)

1.3 12V (EE100_)	53	07.92 → 04.97	2E	10-02-210	20-02-250	30-02-235	
1.3 XLI (EE101_)	55	09.95 → 04.97	4E-FE	10-02-210	20-02-250	30-02-235	
1.3 XLI 16V (EE101)	65	07.92 → 09.95	4E-FE	10-02-210	20-02-250	30-02-235	
1.6 Si (AE101_)	84	09.95 → 04.97	4A-FE	10-02-210	20-02-249	30-02-235	
2.0 D (CE100_)	53	07.92 → 04.97	2C	10-02-297	20-02-238	30-02-215MP 30-02-215	

COROLLA (_E11_)

1.4 (EE111_)	63	04.97 → 02.00	4E-FE	10-02-210	20-02-250 20-07-710	30-02-235	21-TY-TY0
1.4 16V (ZZE111_)	71	02.00 → 01.02	4ZZ-FE	10-02-210	20-02-258	30-02-236	21-TY-TY0
1.6 (AE111_)	81	04.97 → 02.00	4A-FE	10-02-210	20-02-249	30-02-225 30-02-235	21-TY-TY0
1.6 16V (ZZE112_)	81	02.00 → 01.02	3ZZ-FE	10-02-210	20-02-258	30-02-236	21-TY-TY0
1.9 D (WZE110_)	51	02.00 → 01.02	1WZ	10-02-297	20-02-238	30-02-215MP 30-02-215	21-TY-TY0
2.0 D (CE110_)	53	04.97 → 02.00	2C-E	10-02-297	20-02-238	30-02-215MP 30-02-215	21-TY-TY0
2.0 D-4D	66	09.00 → 01.02	1CD-FTV	10-02-297	20-02-277	30-02-295	21-TY-TY0

COROLLA (_E12U_)

1.4 D	66	07.04	1ND-TV	10-02-279	20-02-278	30-02-295	21-TY-TY7
1.4 VVT-i	71	01.02	4ZZ-FE	10-02-210	20-02-283	30-02-231	21-TY-TY7
1.6 VVT-i	81	01.02	3ZZ-FE	10-02-210	20-02-283	30-02-231	21-TY-TY7
1.8 VVTL-i TS	141	01.02	2ZZ-GE	10-02-210	20-02-283	30-02-236	21-TY-TY7
2.0 D-4D	66	01.02	1CD-FTV	10-02-297	20-02-278	30-02-215MP 09.04 → 30-02-215 09.04 → 30-02-295 →08.04	21-TY-TY7
2.0 D-4D	81	01.02	1CD-FTV	10-02-297	20-02-278	30-02-215MP 09.04 → 30-02-215 09.04 → 30-02-295 →08.04	21-TY-TY7
2.0 D-4D	85	05.03	1CD-FTV	10-02-297	20-02-278	30-02-215MP 09.04 → 30-02-215 09.04 → 30-02-295 →08.04	21-TY-TY7

COROLLA (_E7_)

NEW CODES - NEUE CODES - NOUVEAUX CODES - NUEVOS CODIGOS - NUOVI CODICI

	KW						
				OIL FILTER FILTRO OLIO	AIR FILTER FILTRO ARIA	FUEL FILTER FILTRO CARBURANTE	CABIN FILTER FILTRO ABITACOLO

COROLLA (_E7_)

1.3 (KE70)	44	09.79 → 06.83	4K	10-02-210	20-02-205	30-02-201
1.3 (KE70)	44	09.79 → 01.82	4K	10-02-210	20-02-205	30-02-201
1.3 (KE70)	48	02.82 → 06.83	4K	10-02-210	20-02-205	30-02-201
1.3 (KE70)	48	02.82 → 05.83	4K	10-02-210	20-02-205	30-02-201
1.6 (TE71)	54	09.79 → 05.83	2T	10-02-201	20-02-202	30-02-201
1.6 (TE71)	55	09.79 → 05.83	2T	10-02-201	20-02-202	30-02-201 06.80 →
1.6 (TE71)	55	10.82 → 09.83	2T	10-02-201	20-02-202	30-02-201
1.6 (TE71)	63	09.79 → 05.83	2TB	10-02-201 06.80 →	20-02-202 06.80 →	30-02-201 06.80 →
1.6 GT (TE71)	81	05.80 → 09.83	2T-G	10-02-201	20-02-202	30-02-201
1.8 D (CE70)	43	01.83 → 09.83	1C	10-02-201	20-02-238	30-02-215MP 30-02-215
1.8 D (CE70)	48	01.83 → 09.83	1C	10-02-201	20-02-238	30-02-215MP 30-02-215

COROLLA (_E8_)

1.3 (AE80)	51	06.83 → 10.84	2A-L	10-02-203	20-02-207	30-02-220
1.3 (AE80/EE80)	55	10.84 → 08.87	2E-LC 2E-L	10-02-210	20-02-226	30-02-220
1.6	54	12.85 → 05.88	4A-LC	10-02-210	20-02-207	30-02-220
1.6 (AE82)	53	08.85 → 08.87	4A-LC	10-02-210	20-02-207	30-02-220
1.6 (AE82)	62	06.83 → 08.87	4A-L	10-02-210	20-02-207	30-02-220
1.8 D	43	06.83 → 05.88	1C	10-02-201	20-02-238	30-02-215MP 30-02-215
1.8 D	47	07.85 → 05.88	1C-L	10-02-201	20-02-238	30-02-215MP 30-02-215

COROLLA (_E9_)

1.3 i (EE90)	55	08.87 → 12.92	2E 2E-E	10-02-210	20-02-226 →06.90 20-02-239 06.89 →	30-02-220 →06.90 30-02-225 06.89 →
1.6 (AE92)	66	08.87 → 12.89	4A-F	10-02-210	20-02-240	30-02-220
1.6 GL 4x4	70	10.87 → 08.90	4A-F	10-02-210	20-02-240	30-02-220
1.6 i	77	11.89 → 06.93	4A-FE	10-02-210	20-02-238	30-02-225
1.8 D	47	07.87 → 06.93	1C	10-02-212	20-02-238	30-02-215MP 30-02-215
1.8 D	49	11.89 → 06.93	1C	10-02-212	20-02-238	30-02-215MP 30-02-215

COROLLA Combi (KE)

1.2 (KE36)	40	07.75 → 01.80	3K-B 3K 3K-H	10-02-210	20-02-203	30-03-302
------------	----	---------------	--------------------	-----------	-----------	-----------

COROLLA Compact (_E10_)







1.3 12V (EE100_)	53	07.92 → 05.95	2E	10-02-210	20-02-250	30-02-235
1.3 XLI (EE101_)	55	09.95 → 04.97	4E-FE	10-02-210	20-02-250	30-02-235
1.3 XLI 16V (EE101)	65	07.92 → 09.95	4E-FE	10-02-210	20-02-250	30-02-235
1.6 Si (AE101_)	84	07.92 → 04.97	4A-FE	10-02-210	20-02-249	30-02-235
1.8 GT (AE102_)	86	11.92 → 05.95	7A-FE	10-02-210	20-02-249	30-02-235

NEW CODES - NEUE CODES - NOUVEAUX CODES - NUEVOS CODIGOS - NUOVI CODICI



	KW						
				OIL FILTER FILTRO OLIO	AIR FILTER FILTRO ARIA	FUEL FILTER FILTRO CARBURANTE	CABIN FILTER FILTRO ABITACOLO
COROLLA Compact (_E10_)							
2.0 D (CE100_)	53	07.92 → 04.97	2C	10-02-297	20-02-238	30-02-215MP 30-02-215	
COROLLA Compact (_E11_)							
1.4 (EE111_)	63	04.97 → 02.00	4E-FE	10-02-210	20-02-250 20-07-710 Made in U.K.	30-02-235	21-TY-TY0
1.4 (ZZE111_)	71	02.00 → 01.02	4ZZ-FE	10-02-210	20-02-258	30-02-236	21-TY-TY0
1.6 (AE111_)	81	04.97 → 02.00	4A-FE	10-02-210	20-02-249	30-02-225 30-02-235	21-TY-TY0
1.6 (ZZE112_)	81	02.00 → 01.02	3ZZ-FE	10-02-210	20-02-258	30-02-236	21-TY-TY0
1.9 D (WZE110_)	51	02.00 → 01.02	1WZ	10-02-297	20-02-238	30-02-215MP 30-02-215	21-TY-TY0
2.0 D (CE110_)	53	04.97 → 02.00	2C-E	10-02-297	20-02-238	30-02-215MP 30-02-215	21-TY-TY0
2.0 D-4D	66	09.00 → 01.02	1CD-FTV	10-02-297	20-02-277	30-02-295	21-TY-TY0
COROLLA Compact (_E9_)							
1.3 (EE90)	55	08.87 → 12.89	2E	10-02-210	20-02-226	30-02-220	
1.3 i (EE90)	55	06.89 → 04.92	2E-E	10-02-210	20-02-239	30-02-225	
1.6 (AE92)	66	08.87 → 04.92	4A-F	10-02-210 →12.90	20-02-240 →06.90	30-02-220 →06.90	
1.6 (AE92)	77	08.89 → 04.92	4A-FE	10-02-210	20-02-238	30-02-225	
1.6 GL 4x4	70	10.87 → 08.90	4A-F	10-02-210	20-02-240	30-02-220	
1.6 GTi (AE92)	85	08.87 → 04.92	4A-GE	10-02-214	20-02-238 06.89→ 20-02-239 →06.89	30-02-225	
1.8 D (CE90)	47	08.87 → 04.92	1C	10-02-212	20-02-238	30-02-215MP 30-02-215	
1.8 D (CE90)	49	08.89 → 04.92	1C	10-02-212	20-02-238	30-02-215MP 30-02-215	
COROLLA Coupe (AE86)							
1.6 16V	85	12.85 → 04.87	4A-GEC	10-02-210	20-02-224	30-02-224	
1.6 GT 16V (AE86)	91	08.83 → 07.87	4A-GE	10-02-210	20-02-223 →06.85 20-02-224 06.85→	30-02-224	
1.6 SR 16V	57	05.83 → 04.87	4A-C	10-02-210	20-02-207	30-02-220	
COROLLA Coupe (KE)							
1.2 (KE35)	40	07.75 → 01.80	3K-B 3K-C 3K-H	10-02-210	20-02-203	30-03-302	
COROLLA FX Compact (E8B)							
1.3	55	08.85 → 08.87	2E-L	10-02-210	20-02-226	30-02-220	
1.3	60	10.84 → 04.87	2E	10-02-210	20-02-224	30-02-220	
1.6	54	01.87 → 09.87	4A-LC	10-02-210	20-02-207	30-02-220	
1.6	55	08.84 → 08.87	4A-C	10-02-210	20-02-207	30-02-220	
1.6 GT 16V	89	08.85 → 08.87	4A-GEL	10-02-210	20-02-224	30-02-224	
1.8 D	43	01.85 → 05.88	1C	10-02-201	20-02-238	30-02-215MP 30-02-215	

NEW CODES - NEUE CODES - NOUVEAUX CODES - NUEVOS CODIGOS - NUOVI CODICI





	KW						
				OIL FILTER FILTRO OLIO	AIR FILTER FILTRO ARIA	FUEL FILTER FILTRO CARBURANTE	CABIN FILTER FILTRO ABITACOLO
COROLLA FX Compact (E8B)							
1.8 D	47	08.85 → 08.87	1C-L	10-02-201	20-02-238	30-02-215MP 30-02-215	
COROLLA Liftback (_E10_)							
1.3 12V (EE100_)	53	07.92 → 05.95	2E	10-02-210	20-02-250	30-02-235	
1.3 XLI (EE101_)	65	07.92 → 04.97	4E-FE	10-02-210	20-02-250	30-02-235	
1.6 GLI (AE101_)	84	07.92 → 04.97	4A-FE	10-02-210	20-02-249	30-02-235	
1.8 GT (AE102_)	86	11.92 → 05.95	7A-FE	10-02-210	20-02-249	30-02-235	
2.0 D (CE100_)	53	07.92 → 04.97	2C	10-02-297	20-02-238	30-02-215MP 30-02-215	
COROLLA Liftback (_E11_)							
1.4 (EE111_)	63	04.97 → 02.00	4E-FE	10-02-210	20-02-250 20-07-710 Made in U.K.	30-02-235	21-TY-TY0
1.4 (ZZE111_)	71	02.00 → 01.02	4ZZ-FE	10-02-210	20-02-258	30-02-236	21-TY-TY0
1.6 (AE111_)	81	04.97 → 02.00	4A-FE	10-02-210	20-02-249	30-02-225 30-02-235	21-TY-TY0
1.6 (ZZE112_)	81	02.00 → 01.02	3ZZ-FE	10-02-210	20-02-258	30-02-236	21-TY-TY0
1.9 D (WZE110_)	51	02.00 → 01.02	1WZ	10-02-297	20-02-238	30-02-238	21-TY-TY0
2.0 D (CE110)	53	04.97 → 02.00	2C-E	10-02-297	20-02-238	30-02-215MP 30-02-215	21-TY-TY0
2.0 D-4D	66	09.00 → 01.02	1CD-FTV	10-02-297	20-02-277	30-02-295	21-TY-TY0
COROLLA Liftback (_E8_)							
1.3	60	08.83 → 04.87	2E	10-02-210	20-02-226	30-02-220	
1.3 (AE80)	51	06.83 → 09.84	2A-L	10-02-203	20-02-207	30-02-220	
1.3 (EE80)	55	01.85 → 08.87	2E-LC 2E-L	10-02-210	20-02-226	30-02-220	
1.6	63	07.85 → 05.88	4A-L	10-02-210	20-02-207	30-02-220	
1.6 (AE82)	54	08.85 → 08.87	4A-LC	10-02-210	20-02-207	30-02-220	
1.6 (AE82)	62	06.83 → 08.87	4A-L	10-02-210	20-02-207	30-02-220	
1.8 D	43	06.83 → 05.88	1C	10-02-201	20-02-238	30-02-215MP 30-02-215	
1.8 D (CE80)	47	06.83 → 08.87	1C-L	10-02-201	20-02-238	30-02-215MP 30-02-215	
COROLLA Liftback (_E9_)							
1.3 i (EE90)	55	08.87 → 04.92	2E 2E-E	10-02-210	20-02-226 →12.89 20-02-239 06.89→	30-02-220 →06.90 30-02-225 06.89→ →04.92	
1.6	70	08.87 → 04.92	4A-F	10-02-210 →06.90	20-02-240 →06.90	30-02-220 →06.90	
1.6 (AE92)	66	08.87 → 04.92	4A-F	10-02-210	20-02-240	30-02-220	
1.6 (AE92)	77	08.89 → 04.92	4A-FE	10-02-210	20-02-238	30-02-225	
1.6 GTI	92	07.87 → 06.93	4A-GE	10-02-214	20-02-238 20-02-239 →06.89	30-02-225	
1.8 D (CE90)	47	08.87 → 04.92	1C	10-02-212	20-02-238	30-02-215MP 30-02-215	
1.8 D (CE90)	49	08.89 → 04.92	1C	10-02-212	20-02-238	30-02-215MP 30-02-215	

NEW CODES - NEUE CODES - NOUVEAUX CODES - NUEVOS CODIGOS - NUOVI CODICI



	KW						
				OIL FILTER FILTRO OLIO	AIR FILTER FILTRO ARIA	FUEL FILTER FILTRO CARBURANTE	CABIN FILTER FILTRO ABITACOLO
COROLLA MPV / Space Wagon							
2.2 D-4D	100	10.05	2AD-FTV	10-ECO054	20-02-253	30-02-295	21-TY-TY7
COROLLA Station Wagon (_E12J_)							
1.4 D	66	07.04	1ND-TV	10-02-279	20-02-278	30-02-295	21-TY-TY7
1.4 VVT-i	71	01.02	4ZZ-FE	10-02-210	20-02-283	30-02-231	21-TY-TY7
1.6 VVT-i	81	01.02	3ZZ-FE	10-02-210	20-02-283	30-02-231	21-TY-TY7
2.0 D-4D	66	01.02	1CD-FTV	10-02-297	20-02-278	30-02-215MP 09.04→ 30-02-215 09.04→ 30-02-295 →08.04	21-TY-TY7
2.0 D-4D	85	04.04	1CD-FTV	10-02-297	20-02-278	30-02-215MP 30-02-215	21-TY-TY7
COROLLA Station Wagon (_E7_)							
1.3 (KE70)	44	12.79 → 01.82	4K-C	10-02-210	20-02-205	30-02-201	
1.3 (KE70)	48	02.82 → 08.87	4K	10-02-210	20-02-207	30-02-220	
1.8 D (CE70)	44	05.83 → 08.87	1C	10-02-201	20-02-238	30-02-215MP 30-02-215	
COROLLA Station Wagon (_E9_)							
1.3 (EE90)	55	12.87 → 12.89	2E	10-02-210	20-02-226	30-02-220	
1.3 i (EE90)	55	06.89 → 06.92	2E-E	10-02-210	20-02-239	30-02-225	
1.6 (AE92)	66	02.88 → 05.92	4A-F	10-02-210	20-02-240	30-02-220	
1.6 (AE92)	70	12.87 → 04.92	4A-F	10-02-210	20-02-240	30-02-220	
1.6 XLI	77	11.89 → 06.92	4A-FE	10-02-210	20-02-238	30-02-225	
1.6 XLI 4x4 (AE95)	77	08.88 → 06.92	4A-FE	10-02-210	20-02-238	30-02-225	
1.8 D (CE90)	47	12.87 → 06.92	1C	10-02-212	20-02-238	30-02-215MP 30-02-215	
1.8 D (CE90)	49	08.89 → 06.92	1C	10-02-212	20-02-238	30-02-215MP 30-02-215	
COROLLA Tre volumi (_E12_)							
1.4 D	66	07.04	1ND-TV	10-02-279	20-02-278	30-02-295	21-TY-TY7
1.4 VVT-i	71	08.02	4ZZ-FE	10-02-210	20-02-283	30-02-234 Nel serbatoio carb. /Inside tank fuel	21-TY-TY7
1.6 VVT-i	81	08.02	3ZZ-FE	10-02-210	20-02-283	30-02-231	21-TY-TY7
2.0 D-4D	66	08.02	1CD-FTV	10-02-297	20-02-278	30-02-215MP 09.04→ 30-02-215 09.04→ 30-02-295 →08.04	21-TY-TY7
2.0 D4d	85	06.04	1CD-FTV	10-02-297	20-02-278	30-02-295	21-TY-TY7
COROLLA Verso							
1.6	81	04.04	3ZZ-FE	10-02-210	20-02-283	30-02-255 Nel serbatoio carb. /Inside tank fuel	21-TY-TY7
1.8	95	04.04	1ZZ-FE	10-02-210	20-02-283	30-02-255 Nel serbatoio carb. /Inside tank fuel	21-TY-TY7
2.0 D-4D	85	04.04	1CD-FTV	10-02-297	20-02-278	30-02-215MP 30-02-215	21-TY-TY7







NEW CODES - NEUE CODES - NOUVEAUX CODES - NUEVOS CODIGOS - NUOVI CODICI

	KW						
				OIL FILTER FILTRO OLIO	AIR FILTER FILTRO ARIA	FUEL FILTER FILTRO CARBURANTE	CABIN FILTER FILTRO ABITACOLO
COROLLA Verso							
2.2 D-4D	130	10.05	2AD-FHV	10-ECO054	20-02-253	30-02-295	21-TY-TY7
COROLLA Verso (_E12J_)							
1.4 VVT-i	71	01.02 → 05.04	4ZZ-FE	10-02-210	20-02-283	30-02-236	21-TY-TY7
1.6 VVT-i	81	01.02 → 05.04	3ZZ-FE	10-02-210	20-02-283	30-02-236	21-TY-TY7
1.8 VVT-i	99	01.02 → 05.04	1ZZ-FE	10-02-210	20-02-283	30-02-234 Nel serbatoio carb. /Inside tank fuel	21-TY-TY7
2.0 D-4D	66	01.02 → 05.04	1CD-FTV	10-02-297	20-02-278	30-02-295	21-TY-TY7
COROLLA Wagon (_E10_)							
1.3 12V (EE100_)	53	07.92 → 05.95	2E	10-02-210	20-02-250	30-02-235	
1.3 XLI (EE101_)	55	09.95 → 04.97	4E-FE	10-02-210	20-02-250	30-02-235	
1.3 XLI 16V (EE101_)	65	07.92 → 09.95	4E-FE	10-02-210	20-02-250	30-02-235	
1.6 Si (AE101_)	84	07.92 → 04.97	4A-FE	10-02-210	20-02-249	30-02-235	
1.8 16V 4WD (AE103_)	81	09.95 → 04.97	7A-FE	10-02-210	20-02-249	30-02-235	
2.0 D (CE100_)	53	07.92 → 04.97	2C	10-02-297	20-02-238	30-02-215MP 30-02-215	
COROLLA Wagon (_E11_)							
1.4 (EE111_)	63	04.97 → 02.00	4E-FE	10-02-210	20-02-250 20-07-710	30-02-235	21-TY-TY0
1.4 16V (ZZE111_)	71	02.00 → 01.02	4ZZ-FE	10-02-210	20-02-258	30-02-236	21-TY-TY0
1.6 (AE111_)	81	04.97 → 02.00	4A-FE	10-02-210	20-02-249	30-02-225 30-02-235	21-TY-TY0
1.6 16V (ZZE112_)	81	02.00 → 01.02	3ZZ-FE	10-02-210	20-02-258	30-02-236	21-TY-TY0
1.6 Aut. (AE111_)	79	04.97 → 02.00	4A-FE	10-02-210	20-02-249	30-02-225 30-02-235	21-TY-TY0
1.8 AWD (AE115_)	81	04.97 → 01.02	7A-FE	10-02-210	20-02-250	30-02-201	21-TY-TY0
1.9 D (WZE110_)	51	02.00 → 01.02	1WZ	10-02-297	20-02-238	30-02-215MP 30-02-215	21-TY-TY0
2.0 D (CE110_)	53	04.97 → 02.00	2C-E	10-02-297	20-02-238	30-02-215MP 30-02-215	21-TY-TY0
2.0 D-4D	66	09.00 → 01.02	1CD-FTV	10-02-297	20-02-277	30-02-295	21-TY-TY0
CORONA							
1.8	79	02.92 → 09.97	7A-FE	10-02-210	20-02-249	30-02-225	
CORONA (RX, RT)							
1.8 (TT1)	63	06.79 → 01.81	3T	10-02-201	20-02-201	30-03-302	
2.0 (RT104)	65	01.76 → 05.79	18R	10-02-201	20-02-204	30-03-302	
2.0 Mark II (RX12)	65	12.75 → 10.77	18R	10-02-201	20-02-204	30-03-302	
2.0 Mark II (RX22)	65	12.75 → 10.77		10-02-201	20-02-204	30-03-302	
CORONA Station wagon							
1.8	79	02.92 → 09.97	7A-FE	10-02-210	20-02-249	30-02-225	
CORONA Station wagon (RT118)							
2.0	65	09.75 → 05.79	18R	10-02-201	20-02-204	30-03-302	
CORONA(TT)							
1.8	63	06.79 → 07.81	3T	10-02-201	20-02-201	30-03-302	
CRESSIDA (RX3_) \ Station Wagon (RX3_)							









	KW						
				OIL FILTER FILTRO OLIO	AIR FILTER FILTRO ARIA	FUEL FILTER FILTRO CARBURANTE	CABIN FILTER FILTRO ABITACOLO
CRESSIDA (RX3_) \ Station Wagon (RX3_)							
2.0 (RX30)	66	07.77 → 07.81	18R	10-02-202	20-02-204	30-03-302	
CRESSIDA (_X6_) \ Station Wagon (X6K)							
2.0	125	10.88 → 09.91		10-02-204	20-02-233	30-02-215MP 30-02-215	
2.0 (RX60)	77	05.81 → 03.85	21R 21R-C	10-02-204	20-02-210	30-03-302	
2.0 D (LX60)	0	01.81 → 12.83		10-02-206	20-02-219	30-02-208	
2.0 GLi	110	08.82 → 09.92		10-02-204	20-02-233		
2.0 GLI	80	11.82 → 12.84	1G-E	10-02-206	20-02-235		
2.2 D (LX60)	49	09.80 → 07.84	L	10-02-206	20-02-219	30-02-208	
2.4 D	63	08.84		10-02-206	20-02-234	30-02-215MP 30-02-215	
2.4 TD	66	05.85 → 09.88	2L-T	10-02-206	20-02-234	30-02-215MP 30-02-215	
CROWN (_S1_) \ Station Wagon (_S1_)							
2.0 (5R)	0	01.75 → 12.84		10-02-206	20-02-204 20-02-210	30-02-203	
2.2 D (LS110_)	53	04.80 → 07.83	L	10-02-206	20-09-900	30-02-208	
2.8 i Super Saloon (S12)	125	02.84 → 03.85	5M-GE	10-02-204	20-02-206	30-05-506	
2.8 SI (MS112)	107	04.80 → 07.83	5M 5M-E	10-02-204	20-02-206	30-02-224	
DYNA							
2.0	79	09.84 → 08.87	3Y	10-02-200	20-02-290	30-02-203	
2.4 D	55	09.84 → 08.87	2J	10-02-206	20-02-229	30-02-215MP 30-02-215	
2.5 D4d	65	08.01	2KD-FTV	10-02-297	20-02-213	30-02-240	
2.5 D4d	75	08.01	2KD-FTV	10-02-297	20-02-213	30-02-240	
3.0 D4d	80	09.06	1KD-FTV	10-02-215	20-02-213	30-02-240	
3.4 D	66	09.84 → 08.87	13B	10-02-206	20-02-213	30-01-195 30-02-208	
4.6 D4d	96	06.03	S05C		20-02-2004		
DYNA (4Y)							
2.2 (YU210)	69	01.95		10-02-206	20-02-290	30-02-229	
DYNA (3L)							
2.8 D (LY60/61)	60	01.88 → 12.94		10-02-206 10-02-213 01.89 →	20-02-229 01.89 → 20-02-290 → 12.89	30-02-215MP 30-02-215	
DYNA (3RZ-FE)							
2.7 i (RZU100)	0	01.97		10-02-279	20-02-290	30-02-250	
DYNA (3Y)							
2.0 (YY211)	0	01.95		10-02-200	20-02-229	30-02-215MP 30-02-215	
2.0 (YY61)	65	01.87 → 12.94		10-02-200	20-02-213	30-03-302	
DYNA 100 (2Y)							
1.8 (YY100)	58	05.95		10-02-200	20-02-229	30-02-215MP 30-02-215	

NEW CODES - NEUE CODES - NOUVEAUX CODES - NUEVOS CODIGOS - NUOVI CODICI

	KW			 OIL FILTER FILTRO OLIO	 AIR FILTER FILTRO ARIA	 FUEL FILTER FILTRO CARBURANTE	 CABIN FILTER FILTRO ABITACOLO
DYNA 100 (2Y)							
2.4 D (LH80-LH81)	69	08.87→04.95		10-02-213	20-02-290	30-02-215MP 30-02-215	
DYNA 100 (2Y)							
1.8 (Y81)	58	10.80→04.95		10-02-200 01.87→ →12.90 10-02-214 01.90→	20-02-213	30-03-302	
DYNA 150							
3.4 D	66	09.88→04.95	3B	10-02-206	20-02-290	30-02-215	
DYNA 150 (3L / 5L)							
2.0	79	08.85→08.88	3Y	10-02-200	20-02-213	30-03-302	
2.8 D (LY211 / LY212)	0	05.95→11.97		10-02-213	20-02-290	30-02-215MP 30-02-215	
DYNA Autobus							
2.4 D	55	08.77→02.79	2J	10-02-206	20-02-290	30-02-215MP 30-02-215	
3.4 D	66	08.77→08.87	13B	10-02-206	20-02-213	30-02-208	
DYNA D (2L)							
2.8 D (LY100)	53	01.95		10-02-213	20-02-229	30-02-215MP 30-02-215	
DYNA D (15BF)							
4.1 D (BU10/11)	85	01.97		10-02-213	20-02-290	30-02-208	
DYNA D (15BF-15BFT)							
4.1 D 16V - Turbo (BU21/142/22)	85	01.96		10-02-206	20-02-274	30-02-208	
DYNA D (3B)							
3.4 D (BU100/140)	0	06.95		10-02-206	20-02-290	30-02-208	
HIACE I (_H_)							
1.6	49	01.79→12.84	12R	10-02-200	20-02-213	30-02-210	
1.6 (RH11)	48	01.75→01.77		10-02-208	20-02-213	30-02-201	
HIACE I (_H_)							
1.6 (RH20-30)	49	02.77→03.83	12R	10-02-200	20-02-213	30-02-210	
2.0 (RH25-32)	65	07.77→03.83	18R	10-02-200	20-02-219	30-02-201	
2.2 D (LH20-30)	46	01.79→03.83	L	10-02-206	20-09-900	30-02-208	
HIACE II (H5_)							
1.8	58	03.83→11.89	2Y	10-02-200 →06.86	20-02-221 →06.86	30-02-221 →06.86	
1.8 (H5G)	58	03.83→11.89	2Y	10-02-200 →06.86	20-02-221 →06.86	30-02-221 →06.86	
2.0	65	01.84→11.89	3Y	10-02-200	20-02-221	30-02-221	
2.0 (H5G)	65	01.85→08.89	3Y	10-02-200	20-02-221	30-02-221	
2.2 D	49	03.83→11.89	L	10-02-206 →06.85	20-02-215	30-02-208 →06.85	
2.2 D (H5G)	49	03.83→11.89	L	10-02-206 →06.85	20-02-215	30-02-208 →06.85	

NEW CODES - NEUE CODES - NOUVEAUX CODES - NUEVOS CODIGOS - NUOVI CODICI



	KW						
				OIL FILTER FILTRO OLIO	AIR FILTER FILTRO ARIA	FUEL FILTER FILTRO CARBURANTE	CABIN FILTER FILTRO ABITACOLO
HIACE II (H5_)							
2.4 D	55	05.84 → 11.89	2L	10-02-206 06.85 → → 06.87 10-02-213 06.87 → → 06.89	20-02-215	30-02-215MP 30-02-215	
2.4 D 4WD (H5F)	54	01.87 → 01.88	2L	10-02-206	20-02-215	30-02-215MP 30-02-215	
HIACE III (_H10_)							
2.0	74	02.90 → 08.95	1RZ	10-02-279	20-02-245	30-02-221	
2.4	88	08.89 → 08.95	2RZ-E	10-02-279	20-02-245	30-08-887	
2.4 D	57	10.93 → 08.95	2L	10-02-213	20-02-245	30-02-215MP 30-02-215	
2.4 D (LH102)	55	08.89 → 08.95	2L	10-02-213	20-02-245	30-02-215MP 30-02-215	
2.8 D	61	08.89 → 08.95	3L	10-02-206	20-02-245	30-02-215MP 30-02-215	
HIACE IV (_H1_, _H2_)							
2.4 (RCH12_, RCH22_)	85	08.95 → 04.98	2RZ-E	10-02-279	20-02-291	30-08-887	
2.4 4WD (RCH18_)	85	08.95 → 04.98	2RZ-E	10-02-279	20-02-291	30-08-887	
2.4 D	55	07.99	2L	10-02-213	20-02-291		
2.4 D (LXH12_, LXH22_)	58	08.95	2L	10-02-213	20-02-291	30-02-215MP 30-02-215	
2.4 TD (LXH12_, LXH22_)	66	08.95	2L-T	10-02-213	20-02-291	30-02-215MP 30-02-215	
2.4 TD 4WD (H18/28)	66	08.95	2L-T	10-02-213	20-02-291	30-02-215MP 30-02-215	
2.4 TD 4WD (LXH18_, LXH28_)	66	08.95	2L-T	10-02-213	20-02-291	30-02-215MP 30-02-215	
2.5 D-4D	65	11.01	2KD-FTV	10-02-201	20-02-291	30-02-240	
2.5 D-4D	70	08.06	2KD-FTV	10-02-279	20-02-291	30-02-240	
2.5 D-4D	75	11.01	2KD-FTV	10-02-201	20-02-291	30-02-240	
2.5 D-4D	86	08.06	2KD-FTV	10-02-279	20-02-291	30-02-240	
2.7	106	11.01	3RZ-FE	10-02-279	20-02-291	30-02-250	
2.7 (RCH13_, RCH23_)	105	04.98	3RZ-FE	10-02-279	20-02-291	30-02-250 06.98 →	
2.7 4WD (RCH19_, RCH29_)	105	04.98	3RZ-FE	10-02-279	20-02-291	30-02-250	
HILUX							
2.4 TD 4x4	66	08.97 → 07.01	2L-T	10-02-213	20-02-287	30-02-295	
HILUX Pick-up							
2.5 D 4x4	75	08.05	2KD-FTV	10-02-279	20-02-259	30-02-200	21-TY-TY9
2.5 D 4x4	88	12.07	2KD-FTV	10-02-279	20-02-259	30-02-200	21-TY-TY9
3.0 D 4x4	126	12.07	1KD-FTV	10-02-279	20-02-259	30-02-200	21-TY-TY9
HILUX Pick-up (_N_)							
1.6	48	08.78 → 08.88	1Y	10-02-200	20-02-201	30-02-201	
1.8 (YN85_, YN90_)	61	08.88 → 07.94	2Y	10-02-200	20-02-204	30-02-201	
2.0	65	01.84 → 12.86	3Y	10-02-200	20-02-204	30-02-201	
2.2 4WD (YN106_, YN110_)	69	01.87 → 12.89	4Y	10-02-200	20-02-204	30-02-201	

NEW CODES - NEUE CODES - NOUVEAUX CODES - NUEVOS CODIGOS - NUOVI CODICI

	KW						
				OIL FILTER FILTRO OLIO	AIR FILTER FILTRO ARIA	FUEL FILTER FILTRO CARBURANTE	CABIN FILTER FILTRO ABITACOLO

HILUX Pick-up (_N_)

2.2 D	49	08.83 → 08.84	L	10-02-279	20-02-299	30-02-297
2.2 D 2WD/ 4WD	0	01.79 → 12.95	L	10-02-206	20-09-900	30-02-208
2.4 D	55	07.98 → 01.02	2L	10-02-213	20-02-273	30-02-288
2.4 D	58	03.95	2L	10-02-213	20-02-282 20-02-287	30-02-295
2.4 D	59	01.92	2L	10-02-213	20-02-234	30-02-215MP 30-02-215
2.4 D	61	08.88	2L	10-02-213	20-02-234	30-02-215MP 30-02-215
2.4 D AWD	55	01.84 → 08.88	2L	10-02-206	20-09-900	30-02-208
2.4 i 4WD	103	08.97	2RZ-FE	10-02-279	20-02-273	30-02-288
2.4 i 4WD	84	06.89	22R	10-02-279	20-02-299	30-02-247
2.4 TD 4WD	66	08.98 → 01.02	2L-T	10-02-213	20-02-282 20-02-287	30-02-295
2.5 D-4D	65	11.01	2KD-FTV	10-02-201	20-02-291	30-02-215MP 30-02-215
2.5 D-4D 4WD	75	11.01	2KD-FTV	10-02-201	20-02-291	30-02-215MP 30-02-215
2.8 D	0	01.00 → 12.01		10-02-206	20-02-246	30-02-215MP 30-02-215

iQ

1.0	50	01.09	1KR-FE	10-02-210	20-02-267	21-TY-TY11
1.33	72	01.09	1NR-FE	10-ECO051	20-02-267	21-TY-TY11
1.4 D-4D	66	01.09	1ND-TV	10-ECO077	20-02-269	30-02-295 21-TY-TY11

LAND CRUISER (J12)

3.0 D-4D (KDJ120)	120	01.03	1KD-FTV	10-02-213	20-02-251	30-02-240 21-SB-SB2
3.0 D-4D (KDJ120)	122	08.04	1KD-FTV	10-02-213	20-02-251	30-02-215MP 30-02-215 21-SB-SB2
3.0 D-4D (KDJ120)	127	01.07	1KD-FTV	10-02-213	20-02-251	30-02-215MP 30-02-215 21-SB-SB2
4.0 (GRJ12)	183	01.03	1GR-FE	10-02-215	20-02-266	30-02-237 21-SB-SB2

LAND CRUISER (_J4_)

3.0 D (BJ40_V, BJ43_)	59	02.74 → 10.84	B	10-02-206 06.77 → →06.83	20-02-211 06.77 → →06.79 20-02-231 06.79 → →06.83	30-02-208 06.77 → →06.83
3.4 D (BJ42_V, BJ45_V, BJ46_)	66	08.80 → 10.84	3B	10-02-206	20-02-231	30-02-215MP 30-02-215
3.6 D (HJ45_V)	66	04.79 → 07.80	H	10-02-206	20-02-231	30-02-208
3.6 L	0	01.75		10-02-207	20-02-213	30-02-214
3.9 (FJ40_, FJ43_, FJ45_, FJ55_V)	96	03.69 → 01.75	F	10-02-206	20-02-213	30-02-212
4.0 D (HJ47_V)	76	08.80 → 10.84	2H	10-02-209	20-02-231	30-02-208
4.2 (FJ40_V, FJ43_, FJ45_V, FJ55_)	89	01.75 → 04.86	2F	10-02-206	20-02-211	30-02-231

LAND CRUISER (_J6_)

3.4 Diesel (BJ60_V)	66	10.81 → 08.87	3B	10-02-206	20-02-231	30-02-215MP 30-02-215
4.0 (FJ62_G)	115	08.87 → 12.89	3F-E	10-02-206	20-02-231	30-02-223

NEW CODES - NEUE CODES - NOUVEAUX CODES - NUEVOS CODIGOS - NUOVI CODICI



	KW						
				OIL FILTER FILTRO OLIO	AIR FILTER FILTRO ARIA	FUEL FILTER FILTRO CARBURANTE	CABIN FILTER FILTRO ABITACOLO

LAND CRUISER (_J6_)

4.0 (FJ62_V)	101	11.84 → 08.87	3F	10-02-206 →06.87	20-02-275	30-02-231 →06.87	
4.0 Diesel (HJ60)	74	01.82 → 12.85	2H	10-02-209	20-02-231	30-02-208	
4.0 Diesel (HJ60)	76	01.85 → 12.87	2H	10-02-209	20-02-231	30-02-208	
4.0 Diesel (HJ60_V)	77	10.81 → 01.88	2H	10-02-209	20-02-231	30-02-208	
4.0 Turbo-D (HJ61_V)	100	10.85 → 12.89	12HT	10-02-209	20-02-231	30-02-208	
4.2 (FJ60_V)	88	10.81 → 01.88	2F	10-02-206 →06.84	20-02-211 →06.84	30-02-231 →06.84	

LAND CRUISER (_J7_) \ Hardtop (_J7_)

2.4 (RJ70_V, RJ73_V)	84	12.88 → 12.96	22RE	10-02-279	20-02-233	30-02-297	
2.4 (RJ70_, RJ73_)	77	11.84 → 05.93	22R	10-02-204 06.86→ →06.90	20-02-210 06.86→ →06.90	30-02-232	
2.4 (RJ70_, RJ73_)	81	11.84 → 05.93	22R	10-02-279 06.89→ →06.92	20-02-233 06.89→ →06.92	30-02-232	
2.4 D (LJ70_)	53	11.84 → 10.85	2L	10-02-206	20-02-246	30-02-215MP 30-02-215	
2.4 TD (LJ70)	66	01.90 → 05.93	2L-T	10-02-213	20-02-246	30-02-215MP 30-02-215	
2.4 TD (LJ70_, LJ73_)	63	10.85 → 05.90	2L-T	10-02-206 06.88→	20-02-246 01.88→	30-02-215MP 06.88→ 30-02-215 06.88→	
3.0 TD (KZJ70_, KZJ73_, KZJ77_)	92	05.93 → 05.96	1KZ-T	10-02-213	20-02-292	30-02-215MP 30-02-215	
3.4 D (BJ70_V, BJ73_)	70	11.84 → 12.96	3B	10-02-206 06.86→ →06.90 10-02-213 01.90→	20-02-231 06.86→ →06.90	30-02-215MP 06.86→ →06.90 30-02-215 06.86→ →06.90	
3.4 TD (BJ71_V)	91	10.85 → 08.86	13BT	10-02-206	20-02-231	30-02-215MP 30-02-215	
3.5 D	85	01.90 → 12.93	1PZ	10-02-213	20-02-231	30-02-215MP 30-02-215	
4.2 TD (HZJ7_V)	96	01.90	1H-Z	10-02-213	20-02-231	30-02-215MP 30-02-215	

LAND CRUISER 100 (_J10_)

4.2 TD (HDJ100_)	150	01.98	1HD-FTE	10-02-213	20-02-271	30-02-240	21-TY-TY9
4.7	175	02.02	2UZ-FE	10-02-215	20-02-272	30-02-295	21-TY-TY9
4.7 (UZJ100_)	173	01.98	2UZ-FE	10-02-215	20-02-272	30-02-280	21-TY-TY9

LAND CRUISER 80 (_J8_)

4.0 (FJ80_)	115	01.90 → 08.92	3F-E	10-02-206	20-02-231	30-02-223	
4.2 D (HZJ80_)	99	01.90 → 12.97	1H-Z	10-02-213	20-02-231	30-02-215MP 30-02-215	
4.2 TD (HDJ80)	118	10.92 → 12.97	1HD-T	10-02-213	20-02-231	30-02-215MP 30-02-215	
4.2 TD (HDJ80)	123	01.90 → 12.97	1HD-T	10-02-213 →06.94	20-02-231 →06.94	30-02-215MP →06.94 30-02-215 →06.94	

NEW CODES - NEUE CODES - NOUVEAUX CODES - NUEVOS CODIGOS - NUOVI CODICI

	KW						
				OIL FILTER FILTRO OLIO	AIR FILTER FILTRO ARIA	FUEL FILTER FILTRO CARBURANTE	CABIN FILTER FILTRO ABITACOLO
LAND CRUISER 80 (_J8_)							
4.2 TD 24V (HDJ80_)	125	03.95 → 12.97	1HD-FT	10-02-213	20-02-231	30-02-215MP 30-02-215	
4.5 24V (FZJ80_)	151	08.92 → 12.97	1FZ-FE	10-02-213	20-02-231	30-02-215MP 30-02-215	
LAND CRUISER 90 (_J9_)							
3.0 D-4D	120	10.00	1KD-FTV	10-02-213	20-02-292	30-02-240	
3.0 TD (KZJ90_, KZJ95_)	92	04.96	1KZ-TE	10-02-213	20-02-292	30-02-215MP 30-02-215 30-02-240 06.99 → →06.00	
3.4 i 24V (VZJ90_, VZJ95_)	131	04.96	5VZ-FE	10-02-279	20-02-293	30-02-247	
LAND CRUISER Pick-up (_J4_)							
3.4 D (BJ45_P)	66	08.80 → 10.84	3B	10-02-206	20-02-231	30-02-215MP 30-02-215	
3.6 D (HJ45_P)	66	01.75 → 07.80	H	10-02-206	20-02-231	30-02-208	
3.9 (FJ45_P)	96	03.69 → 01.75	F	10-02-206	20-02-213	30-02-212	
4.0 D (HJ47_P)	76	08.80 → 10.84	2H	10-02-209	20-02-231	30-02-208	
4.2 (FJ45_P)	89	01.75 → 04.86	2F	10-02-206	20-02-211	30-02-231	
LAND CRUISER V8							
4.5 D V8	210	01.08	1VD-FTV	10-ECO071	20-02-264	30-ECO012	21-TY-TY9
4.7 V8	212	01.08	2UZ-FE	10-02-215	20-02-263	30-02-280	21-TY-TY9
LITEACE (CM30_G, KM30_G)							
1.5 (KM30LG)	51	10.85 → 08.89	5K	10-02-200	20-02-232	30-03-302	
1.5 (KM30LG)	52	07.89 → 01.92	5K	10-02-200	20-02-232	30-03-302	
2.0 D (CM30LG)	53	08.88 → 01.92	2C	10-02-212 06.90 →	20-02-215 06.90 →	30-02-215MP 06.90 → 30-02-215 06.90 →	
LITEACE (CM3_V, KM3_V)							
1.5 (KM31_V, KM36_V)	51	05.86 → 09.91	5K	10-02-200	20-02-232	30-03-302	
1.8 D (CM35_V)	46	10.85 → 08.88	1C	10-02-201	20-02-215	30-02-215MP 30-02-215	
2.0 D (CM36_V)	53	08.88 → 01.92	2C	10-02-212 06.90 →	20-02-215 01.90 →	30-02-215MP 06.90 → 30-02-215 06.90 →	
LITEACE (M2_V)\ (M2_G)							
1.3	42	10.79 → 10.86	4K 4K-C	10-02-200 →06.83 10-02-210 06.83 →	20-02-213 →06.83 20-02-225 06.83 →	30-02-201 →06.83 30-02-221 06.83 →	
1.3	43	10.79 → 09.85	4K	10-02-200 →06.83 10-02-210 06.83 →	20-02-213 →06.83 20-02-225 06.83 →	30-02-201 →06.83 30-02-221 06.83 →	
1.8 D	41	10.82 → 09.85	1C	10-02-201	20-02-219	30-02-215MP 30-02-215	
LITEACE (_R2_LG)\ (_R2_V)							

NEW CODES - NEUE CODES - NOUVEAUX CODES - NUEVOS CODIGOS - NUOVI CODICI



	KW						
				OIL FILTER FILTRO OLIO	AIR FILTER FILTRO ARIA	FUEL FILTER FILTRO CARBURANTE	CABIN FILTER FILTRO ABITACOLO
LITEACE (_R2_LG)\ (_R2_V)							
1.5 (KR21LG)	52	01.92 → 01.95	5K	10-02-200	20-02-235	30-02-221	
2.0 D (CR21LG)	53	01.92 → 05.94	2C	10-02-201	20-02-236	30-02-215MP 30-02-215	
2.2 (YR22LG)	72	01.92 → 01.95	4Y-EC	10-02-200 10-02-214 01.93→	20-02-235	30-05-506	
MODELL F Autobus (_R2_, 31)							
1.8 De Luxe (YR20)	58	11.82 → 08.84	2Y 2Y-C	10-02-200	20-02-219	30-02-221	
2.0 (YR21_G)	66	08.88 → 01.90	3Y	10-02-200	20-02-219	30-02-221	
2.0 Super (YR21)	65	08.84 → 08.88	3Y-C 3Y	10-02-200	20-02-219	30-02-221	
2.2 (YR22LG, YR31LG)	72	08.87 → 01.90	4Y-EC	10-02-200	20-02-235	30-05-506	
MR 2 (_W1_)							
1.6 16V (AW11)	85	11.84 → 06.90	4A-GELC	10-02-214 06.87→ →06.89	20-02-233 06.87→ →06.89	30-02-224 06.87→ →06.89	
1.6 16V (AW11)	91	11.84 → 06.90	4A-GEL	10-02-210	20-02-223	30-02-224	
MR 2 (_W2_)							
2.0 16V	125	12.89 → 05.00	3S-GE	10-02-210	20-02-238	30-02-293	
2.0 16V	129	12.89 → 05.00	3S-GE	10-02-210	20-02-238	30-02-293	
2.0 16V (SW20)	115	12.89 → 05.00	3S-GE	10-02-210	20-02-238	30-02-293	
MR 2 (_W3_)							
1.8 16V VT-i (ZZW30)	103	04.00	1ZZ-FE	10-02-210	20-02-239	30-02-284 Nel serbatoio carb. /Inside tank fuel	
PASEO (EL54)\ Cabriolet (EL54)							
1.5 16V	66	08.95 → 07.99	5E-FE	10-02-210	20-02-285 20-02-297	30-02-239 30-02-292	
PICNIC (_XM10)							
2.0	90	01.01 → 12.01	3S-FE	10-02-210	20-02-238	30-02-288	21-TY-TY1
2.0 16V (SXM10_)	94	05.96 → 12.01	3S-FE	10-02-210	20-02-238	30-02-288	21-TY-TY1
2.2 D (CMX10_)	66	08.97 → 12.01	3C-TE	10-02-297	20-02-254	30-02-295	21-TY-TY1
PREVIA (ACR3_)							
2.0 D-4D	85	03.01	1CD-FTV	10-02-297	20-02-277	30-02-295	21-SB-SB2
2.4 16V	115	08.00	2AZ-FE	10-02-214	20-02-284	30-02-231	21-SB-SB2
PREVIA (TCR1_, 2_)							
2.4	97	05.90 → 08.00	2TZ-FE	10-02-279	20-02-299	30-02-298	21-SB-SB2
PRIUS							
1.5	57	08.03	1NZ-FXE	10-02-210	20-02-256	30-02-231	21-SB-SB2
1.8 HSD	100	02.09		10-ECO078	20-02-2000		21-TY-TY9
PRIUS (NHW11_)							
1.5	53	05.00 → 01.04	1NZ-FXE	10-02-210	20-02-256	30-02-253	21-TY-TY2
PRIUS (ZVW30)							
1.8	73	01.09	2ZR-FXE	10-ECO078	20-02-2000		21-TY-TY9

NEW CODES - NEUE CODES - NOUVEAUX CODES - NUEVOS CODIGOS - NUOVI CODICI

	KW						
				OIL FILTER FILTRO OLIO	AIR FILTER FILTRO ARIA	FUEL FILTER FILTRO CARBURANTE	CABIN FILTER FILTRO ABITACOLO
RAV 4 I Cabrio/ FUNCRUISER (SXA1_)							
2.0 16V	94	12.97 → 06.00	3S-FE	10-02-210	20-02-238	30-02-239 30-02-292	21-TY-TY2
RAV 4 II (XA2)							
1.8 VVTi	92	02.01	1ZZ-FE	10-02-210	20-02-276	30-02-284 Nel serbatoio carb. /inside tank fuel	21-TY-TY2
2.0 D-4D 4WD	85	09.01	1CD-FTV	10-02-297	20-02-277	30-02-215 30-02-295	21-TY-TY2
2.0 VVTi 4WD	110	06.00	1AZ-FE	10-02-214	20-02-284	30-02-244 → 12.02 30-02-255 01.03 → Nel serbatoio carb. /inside tank fuel	21-TY-TY2
RAV 4 III							
2.0	116	12.08	3ZR-FAE	10-02-214	20-02-261		21-TY-TY9
2.0 VVT-i	112	03.06	1AZ-FE	10-02-214	20-02-257		21-TY-TY9
2.2 D-4D	100	03.06	2AD-FTV	10-ECO054	20-02-255	30-02-295	21-TY-TY9
2.2 D-4D	110	12.08	2AD-FHV 2AD-FTV	10-ECO054	20-02-255	30-02-295	21-TY-TY9
2.2 D-CAT	130	03.06	2AD-FHV	10-ECO054	20-02-255	30-02-295	21-TY-TY9
STARLET (EP91)							
1.3	55	04.96 → 03.99	4E-FE	10-02-210	20-02-285 20-02-297	30-02-224	
STARLET (KP6_)							
1.0 (KP60)	33	02.78 → 09.84	2K	10-02-210	20-02-203 → 06.82 20-02-205 06.82 →	30-03-302	
1.2 S (KP62)	39	10.78 → 08.82	3K-H	10-02-210	20-02-203	30-03-302	
1.3 S (KP61)	48	08.82 → 09.84	4K	10-02-200	20-02-205	30-03-302	
STARLET (_P7_)							
1.0 (EP70L)	40	10.84 → 12.89	1E-L	10-02-210	20-02-226	30-02-201	
1.3 (EP71L)	55	10.84 → 12.89	2E-LC	10-02-210	20-02-226	30-02-201	
1.5 D (NP70L)	40	12.86 → 12.89	1N	10-02-212	20-02-224	30-02-215MP 30-02-215	
STARLET (_P8_)							
1.0 (EP80_)	40	12.89 → 12.92	1E	10-02-210	20-02-226	30-02-201	
1.3 12V (EP81) Cat.	55	12.89 → 03.96	2E-E	10-02-210	20-02-243	30-02-224	
1.3 12V (EP81_)	55	12.89 → 12.92	2E 2E-E	10-02-210	20-02-243	30-02-224	
1.5 D (NP80_)	40	12.89 → 03.96	1N	10-02-212	20-02-224	30-02-215MP 30-02-215	
STARLET 1000 Kombi (KP)							
1.0	33	05.76 → 08.78		10-02-210	20-02-203	30-02-204	
STARLET Station wagon (KP6_)							
1.0 (KP60)	33	02.78 → 09.84	2K	10-02-210	20-02-203 → 06.82 20-02-205 06.82 →	30-03-302	

NEW CODES - NEUE CODES - NOUVEAUX CODES - NUEVOS CODIGOS - NUOVI CODICI



TOYOTA

	KW						
				OIL FILTER FILTRO OLIO	AIR FILTER FILTRO ARIA	FUEL FILTER FILTRO CARBURANTE	CABIN FILTER FILTRO ABITACOLO
STARLET Station wagon (KP6_)							
1.2	41	02.78 → 09.82	3K-H	10-02-210	20-02-203	30-03-302	
SUPRA (JZA80)							
3.0 i Bi-Turbo	243	05.93 → 08.98	2JZ-GTE	10-02-279	20-02-293	30-02-239 30-02-292	
SUPRA (MA60)							
2,8 24V	103	12.81 → 12.85		10-02-279			
SUPRA (MA70)							
3.0	140	01.86 → 08.90	7M-GE	10-02-279	20-02-233	30-02-226	
3.0 24V	150	01.86 → 08.88	7M-GE	10-02-279	20-02-233	30-02-226	
3.0 Turbo	173	09.87 → 04.93	7M-GTE	10-02-279	20-02-233	30-02-226	
3.0 Turbo	175	08.88 → 05.93	7M-GTE	10-02-279	20-02-233	30-02-226	
TERCEL (AL2_)							
1.5 4WD	52	10.82 → 01.88	3A	10-02-210	20-02-207	30-02-201	
1.5 4WD (AL25)	50	05.86 → 01.88	3A-C	10-02-210	20-02-207	30-02-201	
TERCEL (_L1_, _L2_)							
1.3 (AL20, AL11)	48	03.79 → 01.88	2A	10-02-200 →06.82 10-02-210 06.82→	20-02-207	30-02-201	
1.45 (AL21)	52	08.83 → 05.85	3A-C	10-02-210	20-02-207	30-02-201	
URBAN CRUISER							
1.3 VVT-i	74	05.09		10-ECO051	20-02-286		21-TY-TY9
1.4 D-4D	66	05.09		10-ECO077	20-02-269	30-02-295	21-TY-TY9
VERSO							
1.6	97	04.09	1ZR-FAE	10-ECO078	20-02-261		21-TY-TY9
1.8	108	04.09	2ZR-FAE	10-ECO078	20-02-261		21-TY-TY9
2.0 D-4D	93	04.09	1AD-FTV	10-ECO054	20-02-262	30-02-295	21-TY-TY9
2.2 D-4D	110	04.09	2AD-FHV	10-ECO054	20-02-262	30-02-295	21-TY-TY9
2.2 D-CAT	130	04.09	2AD-FHV	10-ECO054	20-02-262	30-02-295	21-TY-TY9
VERSO-S							
1.3 VVT-i	73	01.11		10-ECO051	20-02-286		21-TY-TY9
1.4 D	66	01.11		10-ECO077	20-02-269	30-02-295	21-TY-TY9
YARIS							
1.0 VVT-i	51	01.06	1KR-FE	10-02-210	20-02-288	30-02-257	21-TY-TY9
1.0 VVT-i	51	10.11		10-02-210	20-02-288		21-TY-TY9
1.3 VVT-i	64	01.06	2SZ-FE	10-02-210	20-02-288		21-TY-TY9
1.3 VVT-i	73	10.11		10-ECO051	20-02-286		21-TY-TY9
1.4 D-4D	66	10.11		10-ECO077	20-02-269		21-TY-TY9
1.8 VVTi	98	01.07	2ZR-FE	10-ECO078	20-02-261		21-TY-TY9
D-4D	66	01.06	1ND-TV	10-02-279 →10.08 10-ECO051 11.08→	20-02-200	30-02-295	21-TY-TY9
YARIS (_CP10)							

NEW CODES - NEUE CODES - NOUVEAUX CODES - NUEVOS CODIGOS - NUOVI CODICI

Per nuove applicazioni e novità si prega di accedere al sito www.ashika.eu - For new applications and new items, please go to www.ashika.eu

	KW						
				OIL FILTER FILTRO OLIO	AIR FILTER FILTRO ARIA	FUEL FILTER FILTRO CARBURANTE	CABIN FILTER FILTRO ABITACOLO
YARIS (_CP10)							
1.0 16V	48	03.03	1SZ-FE	10-02-210	20-02-288	30-02-284 Nel serbatoio carb. /Inside tank fuel	21-SB-SB2 Made in France 21-TY-TY2 Made in Japan
1.0 16V (SCP10_)	50	04.99	1SZ-FE	10-02-210	20-02-288	30-02-284 Nel serbatoio carb. /Inside tank fuel	21-SB-SB2 Made in France 21-TY-TY2 Made in Japan
1.3	64	04.02	2SZ-FE	10-02-210	20-02-286	30-02-284 Nel serbatoio carb. /Inside tank fuel	21-SB-SB2 Made in France 21-TY-TY2 Made in Japan
1.3 16V (NCP10_)	63	11.99	2NZ-FE	10-02-210	20-02-286	30-02-284 Nel serbatoio carb. /Inside tank fuel	21-SB-SB2 Made in France 21-TY-TY2 Made in Japan
1.4 D-4D	55	12.01	1ND-TV	10-02-279	20-02-279	30-02-295	21-SB-SB2 Made in France 21-TY-TY2 Made in Japan
1.5 TS (NCP13)	77	01.03	1NZ-FE	10-02-210	20-02-286	30-02-284 Nel serbatoio carb. /Inside tank fuel	21-SB-SB2 Made in France 21-TY-TY2 Made in Japan
1.5 VVT-i TS	110	03.03 → 07.05		10-02-210	20-02-286	30-02-284 Nel serbatoio carb. /Inside tank fuel	21-TY-TY2
1.5 VVT-i TS	78	04.01	1NZ-FE	10-02-210	20-02-286	30-02-284 Nel serbatoio carb. /Inside tank fuel	21-SB-SB2 Made in France 21-TY-TY2 Made in Japan
YARIS VERSO (NC/LP2_)							
1.3 (NCP22)	62	01.03	2NZ-FE	10-02-210	20-02-286	30-02-284 Nel serbatoio carb. /Inside tank fuel	21-SB-SB2 Made in France 21-TY-TY2 Made in Japan
1.3 (NCP22)	63	11.99	2NZ-FE	10-02-210	20-02-286	30-02-284 Nel serbatoio carb. /Inside tank fuel	21-SB-SB2 Made in France 21-TY-TY2 Made in Japan
1.4 D-4D (NLP22)	55	12.01	1ND-TV	10-02-279	20-02-279	30-02-295	21-SB-SB2 Made in France 21-TY-TY2 Made in Japan
1.5 (NCP21)	77	05.03	1NZ-FE	10-02-210	20-02-286	30-02-284 Nel serbatoio carb. /Inside tank fuel	21-SB-SB2 Made in France 21-TY-TY2 Made in Japan
1.5 (NCP21)	78	03.00	1NZ-FE	10-02-210	20-02-286	30-02-284 Nel serbatoio carb. /Inside tank fuel	21-SB-SB2 Made in France 21-TY-TY2 Made in Japan



	KW						
				OIL FILTER FILTRO OLIO	AIR FILTER FILTRO ARIA	FUEL FILTER FILTRO CARBURANTE	CABIN FILTER FILTRO ABITACOLO

AGILA

1.0 12V	43	09.00	Z 10 XE	10-ECO017	
1.0 12V	44	08.03	Z 10 XEP	10-ECO073	
1.2	58	05.09		10-ECO073	
1.2 16V	55	09.00	Z 12 XE	10-ECO017	
1.2 16V Twinport	59	07.04	Z 12 XEP	10-ECO073	
1.3 CDTI	55	01.08	Z 13 DTJ D13A	10-ECO065	30-ECO016

ANTARA

2.0 CDTI	110	11.06	Z 20 DMH	10-ECO059	30-ECO016
2.0 CDTi	93	06.07	Z 20 DM	10-ECO059	30-ECO016

ARENA Combi

1.9 D	44	03.98 → 08.01	F8Q 600 F8Q 606		30-ECO007
2.5 D	55	03.98 → 08.01	S8U 758 S8U 780 S8U 782		30-ECO007

ARENA Van

1.9 D	44	03.98 → 08.01	F8Q 600 F8Q 606		30-ECO007
2.5 D	55	03.98 → 08.01	S8U 758 S8U 780 S8U 782		30-ECO007

ASTRA Mk IV

1.2 16V	48	09.98 → 09.00	X 12 XE	10-ECO017	
1.2 16V	55	09.00	Z 12 XE	10-ECO017	
1.7 CDTI 16V	59	04.03	Z 17 DTL	10-ECO038	30-ECO009
1.7 DTI 16V	55	02.00	Y 17 DT	10-ECO038	30-ECO009
1.7 TD	50	09.98 → 08.00	X 17 DTL		30-ECO009
1.8 16V	85	09.98 → 09.00	X 18 XE1	10-ECO018	
1.8 16V	92	09.00	Z 18 XE	10-ECO018	
1.8 16V Dualfuel	87	09.02	Z 18 XE	10-ECO018	
2.0 DI	60	09.98	X 20 DTL Y 20 DTL	10-ECO005	30-ECO009
2.0 DTI 16V	74	08.99	X 20 DTH Y 20 DTH	10-ECO005	30-ECO009
2.2 16V	108	03.01	Z 22 SE	10-ECO019	

ASTRA MK V

1.3 CDTi	66	04.05	Z 13 DTH	10-ECO065	30-ECO016
1.3 CDTI	66	10.05	Z 13 DTH	10-ECO065	30-ECO016
1.4	66	03.04	Z 14 XEP	10-ECO017	
1.4 i 16V	66	03.05	Z 14 XEP	10-ECO073	
1.6	132	10.06	Z 16 LET	10-ECO073	
1.6	85	10.06	Z 16 XER	10-ECO073	
1.6 i 16V	85	12.06	Z 16 XER	10-ECO073	
1.7 CDTI	59	03.04	Z 17 DTL	10-ECO038	30-ECO009
1.7 CDTi	74	02.05	Z 17 DTH	10-ECO038	30-ECO009
1.7 CDTI	74	03.04	Z 17 DTH	10-ECO038	30-ECO009
1.7 CDTi	81	02.07	A 17 DTJ Z 17 DTJ	10-ECO116	30-ECO020

NEW CODES - NEUE CODES - NOUVEAUX CODES - NUEVOS CODIGOS - NUOVI CODICI

	KW			 OIL FILTER FILTRO OLIO	 AIR FILTER FILTRO ARIA	 FUEL FILTER FILTRO CARBURANTE	 CABIN FILTER FILTRO ABITACOLO
---	----	---	---	--	--	---	---

ASTRA MK V

1.7 CDTi 16V	81	02.07	A 17 DTJ	10-ECO116	30-ECO020
1.7 TD	79	09.08		10-ECO116	30-ECO009
1.8	101	03.07	Z 18 XER A 18 XER	10-ECO073	
1.8	101	03.07		10-ECO073	
1.8	103	04.06	Z 18 XER A 18 XER	10-ECO073	
1.9 CDTi	110	02.05	Z 19 DTH	10-ECO058	30-ECO016
1.9 CDTi	110	06.04	Z 19 DTH	10-ECO058	30-ECO016
1.9 CDTi	74	08.05	Z 19 DTL	10-ECO058	30-ECO016
1.9 CDTi	88	02.05	Z 19 DT	10-ECO058	30-ECO016
1.9 CDTi	88	08.05	Z 19 DT	10-ECO058	30-ECO016
1.9 CDTi 16V	88	04.04	Z 19 DTJ	10-ECO058	30-ECO016

ASTRA MK VI

1.3 CDTi 16V	70	12.09	A 13 DTE	10-ECO065	30-ECO020
1.4 i 16v VVT	74	12.09	A 14 XER	10-ECO073	
1.4 i 16v VVT Turbo	103	12.09	A 14 NET	10-ECO073	
1.6 i 16v Turbo	132	12.09	A 16 LET	10-ECO073	
1.6 i 16v VVT	85	12.09	A 16 XER	10-ECO073	
1.7 CDTi	81	12.09	A 17 DTC A 17 DTE A 17 DTJ	10-ECO116	30-ECO020
1.7 CDTi	92	12.09	A 17 DTR	10-ECO116	30-ECO020
2.0 CDTi	118	12.09	A 20 DTH		30-ECO020

ASTRA TwinTop

1.6	85	10.06	Z 16 XER	10-ECO073	
1.8	101	05.08	Z 18 XER	10-ECO073	
1.9 CDTi 16v	110	01.06	Z 19 DTH	10-ECO058	30-ECO016

ASTRAVAN Mk IV

1.7 CDTi	59	04.04	Z 17 DTL	10-ECO038	30-ECO009
1.7 DTI	55	04.01	Y 17 DT	10-ECO038	30-ECO009
1.7 TD	50	08.98	X 17 DTL		30-ECO009
2.0 DI	60	08.98	X 20 DTL	10-ECO005	30-ECO009
2.0 DTI	74	04.04	Y 20 DTH	10-ECO005	30-ECO009

ASTRAVAN MK V





1.3 CDTi 16V	66	08.05	Z 13 DTH	10-ECO065	30-ECO016
1.4 i 16V	66	03.05	Z 14 XEP	10-ECO073	
1.7 CDTi	59	03.05 → 07.06	Z 17 DTL	10-ECO038	30-ECO009
1.7 CDTi 16V	74	03.05	Z 17 DTH	10-ECO038	30-ECO009
1.9 CDTi	88	03.05	Z 19 DT	10-ECO058	30-ECO016
1.9 CDTi 16V	110	03.05	Z 19 DTH	10-ECO058	30-ECO016







COMBO

1.3 CDTi 16V	55	10.05	Z 13 DTJ		30-ECO016
1.7 CDTi 16V	74	12.04	Z 17 DTH		30-ECO009
1.7 DI 16V	48	09.01	Y 17 DTL	10-ECO038	30-ECO009

NEW CODES - NEUE CODES - NOUVEAUX CODES - NUEVOS CODIGOS - NUOVI CODICI



	KW						
				OIL FILTER FILTRO OLIO	AIR FILTER FILTRO ARIA	FUEL FILTER FILTRO CARBURANTE	CABIN FILTER FILTRO ABITACOLO
COMBO							
1.7 DTI 16V	55	10.01	Y 17 DT	10-ECO038		30-ECO009	
CORSA							
1.0 i 12V	40	11.96 → 09.00	X 10 XE	10-ECO017			
1.2 i 16V	48	03.98 → 09.00	X 12 XE	10-ECO017			
CORSA Mk II							
1.0 12V	43	09.00	Z 10 XE	10-ECO017			
1.0 12V	44	11.03	Z 10 XEP	10-ECO073			
1.2 16V	55	09.00	Z 12 XE	10-ECO017			
1.2 16V Dualfuel	55	08.01	Z 12 XE	10-ECO017			
1.3 CDTI 16V	52	04.04	Z 13 DT	10-ECO065		30-ECO016	
1.7 CDTI 16V	74	04.04	Z 17 DTH	10-ECO038		30-ECO009	
1.7 DI 16V	48	09.00	Y 17 DTL	10-ECO038		30-ECO009	
1.7 DTI 16V	55	09.00	Y 17 DT	10-ECO038		30-ECO009	
1.8 16V	92	09.00	Z 18 XE	10-ECO018			
CORSA Mk III							
1.0	44	07.06	Z 10 XEP A 10 XEP	10-ECO073			
1.0 i 12V	48	06.10	A 10 XEP	10-ECO073			
1.2	59	07.06	Z 12 XEP	10-ECO073			
1.2 i 16V	63	06.10	A 12 XER	10-ECO073			
1.3 CDTI	55	07.06	Z 13 DTJ A 13 DTC	10-ECO065			
1.3 CDTI	66	07.06	Z 13 DTH	10-ECO065			
1.3 CDTI 16V	70	07.10	A 13 DTE Z 13 DTE Z 13 DTR	10-ECO095			
1.4	66	07.06	Z 14 XEP	10-ECO073			
1.4 i 16V	74	07.10	A 14 XER	10-ECO073			
1.6 SRi	110	05.07	A 16 LEL	10-ECO073			
1.6 Turbo	141	02.07	Z 16 LER A 16 LER	10-ECO073			
1.7 CDTI	92	07.06	A 17 DTR	10-ECO116			
1.7 CDTI 16V	96	07.10	A 17 DTS	10-ECO116			
CORSAVAN MK II							
1.2 16V	55	09.00	Z 12 XE	10-ECO017 10-ECO073			
1.2 16V Dualfuel	55	08.01	Z 12 XE	10-ECO017 10-ECO073			
1.3 CDTI 16V	52	04.04	Z 13 DT	10-ECO065		30-ECO016	
1.4	66	11.03 → 11.06	Z 14 XEP	10-ECO073			
1.7 DI 16V	48	09.00	Y 17 DTL	10-ECO038		30-ECO009	
1.7 DTI 16V	55	09.00	Y 17 DT	10-ECO038		30-ECO009	
CORSAVAN MK III							
1.2 i 16V	51	07.06	A 12 XEL	10-ECO073			
1.3 CDTI 16V	55	07.06	Z 13 DTJ	10-ECO065			
1.3 CDTI 16V	66	07.06	Z 13 DTH	10-ECO073			

	KW						
				OIL FILTER FILTRO OLIO	AIR FILTER FILTRO ARIA	FUEL FILTER FILTRO CARBURANTE	CABIN FILTER FILTRO ABITACOLO
FRONTERA Mk II							
2.2 DTI	85	10.98	X 22 DTH Y 22 DTH	10-ECO005		30-ECO009	
INSIGNIA \ Station wagon							
1.6	85	07.08	A 16 XER	10-ECO073			
1.6 Turbo	131	04.09		10-ECO073			
1.6 Turbo	131	04.09		10-ECO073			
1.6 Turbo	132	01.09	A 16 LET	10-ECO073			
1.6 Turbo	132	01.09	A 16 LET	10-ECO073			
1.8	103	07.08	A 18 XER	10-ECO073			
1.8	103	07.08	A 18 XER	10-ECO073			
2.0 CDTI	118	07.08	A 20 DTH			30-ECO020	
2.0 CDTI	118	07.08	A 20 DTH			30-ECO020	
2.0 CDTI	81	07.08	A 20 DTC			30-ECO020	
2.0 CDTI	96	07.08	A 20 DTJ			30-ECO020	
2.0 CDTI	96	07.08	A 20 DTJ			30-ECO020	
2.0 CDTI 16V 4x4	118	07.08	A 20 DTH			30-ECO020	
2.0 CDTI 16V 4x4	118	07.08	A 20 DTH			30-ECO020	
2.8 i V6 24V	239	07.09	A 28 NER	10-ECO117			
2.8 i V6 24V	239	07.09	A 28 NER	10-ECO117			
2.8 V6 Turbo	191	07.08	A 28 NET	10-ECO117			
2.8 V6 Turbo	191	07.08	A 28 NET	10-ECO117			
MERIVA							
1.3 CDTI	55	09.03	Z 13 DTJ	10-ECO065		30-ECO016	
1.4 16V Twinport	66	07.04	Z 14 XEP	10-ECO073			
1.6 Turbo	132	05.06	Z 16 LET	10-ECO073			
1.7 CDTi	92	08.06	Z 17 DTR	10-ECO116			
1.7 CDTI 16V	74	04.04	Z 17 DTH	10-ECO038		30-ECO009	
MERIVA MK II							
1.3 CDTI 16V	55	06.10	A 13 DTC	10-ECO095		30-ECO020	
1.3 CDTi 16V	70	10.10	A 13 DTE	10-ECO095		30-ECO020	
1.4 i 16V	74	06.10	A 14 XER	10-ECO073			
1.4 i 16V Turbo	103	06.10	A 14 NET	10-ECO073			
1.4 i 16V Turbo	88	06.10	A 14 NEL	10-ECO073			
1.7 CDTI 16V	74	06.10	A 17 DT	10-ECO116		30-ECO020	
1.7 CDTi 16V	96	10.10	A 17 DTS	10-ECO116		30-ECO020	
MOVANO Combì Chassis/Cab							
1.9 DTI	59	09.00 → 10.01	F9Q 770			30-ECO015	
1.9 DTI	60	10.01	F9Q 774			30-ECO015	
2.2 DTI	66	09.00	G9T 720 G9T 750	10-ECO030		30-ECO010	
2.5 CDTI	107	08.06	G9U 632	10-ECO068		30-ECO017	
2.5 CDTI	74	04.04	G9U 754	10-ECO030		30-ECO014 30-ECO017	
2.5 CDTI	88	08.06	G9U 630	10-ECO068		30-ECO017	
2.5 D	59	10.98 → 09.00	S8U 770			30-ECO015	

NEW CODES - NEUE CODES - NOUVEAUX CODES - NUEVOS CODIGOS - NUOVI CODICI



	KW						
				OIL FILTER FILTRO OLIO	AIR FILTER FILTRO ARIA	FUEL FILTER FILTRO CARBURANTE	CABIN FILTER FILTRO ABITACOLO

MOVANO Combil Chassis/Cab

2.5 DTI	84	10.01	G9U 720 G9U 750 G9U 754	10-ECO030	30-ECO010
2.8 DTI	84	10.98 → 10.01	S9W 702		30-ECO015
3.0 DTi	100	10.03	ZD3 200	10-01-194	30-ECO014

MOVANO MK II Chassis/Cab

2.5 CDTI 16V	107	05.10			30-ECO017
2.5 CDTI 16V	74	05.10			30-ECO017
2.5 CDTI 16V	88	05.10			30-ECO017

MOVANO MK II VAN

2.3 CDTI 16V FWD	107	05.10	M9T 678 M9T 680 M9T 694		30-ECO017
2.3 CDTI 16V FWD	74	05.10	M9T 670 M9T 672 M9T 676		30-ECO017
2.3 CDTI 16V FWD	92	05.10	M9T 670 M9T 672 M9T 676 M9T 680		30-ECO017
2.3 CDTI 16V [RWD]	107	05.10	M9T 694 M9T 696 M9T 698		30-ECO017
2.3 CDTI 16V [RWD]	74	05.10	M9T 690 M9T 692		30-ECO017
2.3 CDTI 16V [RWD]	92	05.10	M9T 686 M9T 690 M9T 692 M9T 696 M9T 698		30-ECO017

OMEGA Station wagon

2.0 DTI 16V	74	10.98 → 09.00	X 20 DTH	10-ECO005	30-ECO009
2.2 DTI 16V	88	09.00	Y 22 DTH	10-ECO005	30-ECO009
2.5 DTI 24V	110	09.01	Y 25 DT	10-ECO035	30-ECO009
2.5 TD	96	04.94 → 02.01	X 25 DT 25 DT	10-ECO011	
2.5 V6	125	03.94 → 09.00	X 25 XE	10-ECO018	
2.6 V6	132	09.00	Y 26 SE	10-ECO018	
3.0 V6	155	04.94	X 30 XE	10-ECO018	
3.2 V6	160	02.01	Y 32 SE	10-ECO018	

SIGNUM

1.8	103	08.05	Z 18 XER	10-ECO073	
1.9 CDTI	88	04.04	Z 19 DT	10-ECO058	
1.9 CDTI 16V	110	04.04	Z 19 DTH	10-ECO058	
2.0 DTI	74	05.03	Y 20 DTH	10-ECO005	30-ECO009
2.0 i Turbo	129	05.03	Z 20 NET	10-ECO019	
2.2 DTI	92	05.03	Y 22 DTR	10-ECO005	30-ECO009
2.2 i	114	05.03	Z 22 YH	10-ECO019	
2.8 V6 Turbo	169	08.05	Z 28 NEL	10-ECO117	
3.0 CDTi	130	05.03	Y 30 DT		30-ECO009
3.0 V6 CDTI	135	09.05	Z 30 DT		30-ECO009
3.2 V6	155	05.03	Z 32 SE	10-ECO018	

NEW CODES - NEUE CODES - NOUVEAUX CODES - NUEVOS CODIGOS - NUOVI CODICI

	KW			 OIL FILTER FILTRO OLIO	 AIR FILTER FILTRO ARIA	 FUEL FILTER FILTRO CARBURANTE	 CABIN FILTER FILTRO ABITACOLO
---	----	---	---	--	--	---	---

SINTRA

2.2 DTI	85	07.97 → 04.99	X 22 DTH	10-ECO005	30-ECO009
3.0 i 24V	148	11.96 → 04.99	X 30 XE	10-ECO018	

TIGRA TwinTop

1.3 CDTI	51	06.04	Z 13 DT	10-ECO065	
1.4	66	06.04	Z 14 XEP	10-ECO073	

VECTRA

1.8 i 16V	85	10.95 → 09.00	X 18 XE X 18 XE1	10-ECO018	
1.8 i 16V	92	09.00	Z 18 XE	10-ECO018	
2.0 DI 16V	60	11.96	X 20 DTL	10-ECO005	30-ECO009
2.0 DTI 16V	74	06.97	X 20 DTH Y 20 DTH	10-ECO005	30-ECO009
2.2 DTI 16V	92	09.00	Y 22 DTR	10-ECO005	30-ECO009
2.2 i 16V	108	09.00	Z 22 SE	10-ECO019	
2.5 i GSi	143	05.98 → 09.99	X 25 XE	10-ECO018	
2.5 i V6	125	10.95 → 09.00	X 25 XE	10-ECO018	
2.6 i V6	125	09.00	Y 26 SE	10-ECO018	







VECTRA Mk II

1.8	103	01.06	Z 18 XER	10-ECO073	
1.8	81	04.02	Z 18 XEL	10-ECO073	
1.9 CDTI	74	10.05	Z 19 DTL		30-ECO016
1.9 CDTI	88	04.04	Z 19 DT	10-ECO058	30-ECO016
1.9 CDTI 16V	110	04.04	Z 19 DTH	10-ECO058	30-ECO016
2.0 16V Turbo	129	03.03	Z 20 NET	10-ECO019	
2.0 DTI 16V	74	04.02	Y 20 DTH	10-ECO005	30-ECO009
2.2 16V	108	04.02	Z 22 SE	10-ECO019	
2.2 direct	114	10.03	Z 22 YH	10-ECO019	
2.2 DTI 16V	92	04.02	Y 22 DTR	10-ECO005	30-ECO009
2.8 V6 Turbo	169	08.05	Z 28 NEL	10-ECO117	
2.8 V6 Turbo	184	08.06	Z 28 NET	10-ECO117	
2.8 V6 Turbo	188	08.05	Z 28 NET	10-ECO117	
3.0 CDTi	135	08.05	Z 30 DT		30-ECO009
3.0 V6 CDTI	130	06.03	Y 30 DT		30-ECO009
3.2 V6	155	06.03	Z 32 SE	10-ECO018	

VIVARO Combi

1.9 DI	59	08.01			30-ECO010
1.9 DTI	74	08.01	F9Q 760		30-ECO010
2.0 CDTI	66	01.06	M9R 782 M9R 630	10-ECO068	
2.0 CDTI	66	01.06	M9R 782 M9R 630	10-ECO068	
2.0 CDTI	84	08.06	M9R 780 M9R 630 M9R 788	10-ECO068	
2.0 CDTI	84	08.06	M9R 780 M9R 630 M9R 788	10-ECO068	
2.5 CDTI	107	08.06	G9U730	10-ECO068	

NEW CODES - NEUE CODES - NOUVEAUX CODES - NUEVOS CODIGOS - NUOVI CODICI

	KW						
				OIL FILTER FILTRO OLIO	AIR FILTER FILTRO ARIA	FUEL FILTER FILTRO CARBURANTE	CABIN FILTER FILTRO ABITACOLO
VIVARO Combi							
2.5 CDTI	99	04.03 → 07.06	G9U730	10-ECO030			
2.5 CDTI 16V	107	01.06	G9U 630	10-ECO068			
2.5 CDTI 16V	107	08.06	G9U 630	10-ECO068			
2.5 DTI	99	04.04	G9U730	10-ECO030		30-ECO014 30-ECO017	
VX220							
2.2 i	108	09.00	Z 22 SE	10-ECO019			
ZAFIRA							
1.8 16V	85	04.99 → 09.00	X 18 XE1	10-ECO018			
1.8 16V	92	09.00	Z 18 XE	10-ECO018			
2.0 DI 16V	60	10.99	X 20 DTL	10-ECO005		30-ECO009	
2.0 DTI 16V	74	04.99	Y 20 DTH	10-ECO005		30-ECO009	
2.2 16V	108	09.00	Z 22 SE	10-ECO019			
2.2 D	92	06.01 → 06.05	Y 22 DTR	10-ECO005		30-ECO009	
2.2 DTI 16V	92	01.02		10-ECO005			
ZAFIRA Mk II							
1.6	83	12.07	A 16 XER Z 16 XER	10-ECO073			
1.7 TD	79	04.09	Z 17 DTJ	10-ECO116			
1.8	103	07.05	Z 18 XEP Z 18 XER A 18 XER	10-ECO073			
1.9 CDTI	110	07.05	Z 19 DTH	10-ECO058		30-ECO016	
1.9 CDTI	88	07.05	Z 19 DT	10-ECO058		30-ECO016	
2.2	110	07.05	Z 22 YH	10-ECO019			

	KW			 OIL FILTER FILTRO OLIO	 AIR FILTER FILTRO ARIA	 FUEL FILTER FILTRO CARBURANTE	 CABIN FILTER FILTRO ABITACOLO
---	-----------	---	---	--	--	---	---

C30

2.0 D	100	10.06	D 4204 T	10-ECO060	30-ECO027
2.4 D5	120	10.06	D 5244 T9	10-ECO032	30-ECO030
2.4 i	125	10.06	B 5244 S4	10-ECO032	
D5	132	10.06	D 5244 T8 D 5244 T13	10-ECO032	30-ECO030
T5	162	10.06	B 5254 T3	10-ECO032	
T5	169	03.07	B 5254 T7	10-ECO032	

C70 Cabriolet\ Coupé

2.0 D	100	01.08	D 4204 T	10-ECO060	30-ECO027
2.0 T	120	03.00 → 10.05	B 5204 T4	10-ECO033	
2.0 T	166	03.98 → 10.05	B 5204 T3	10-ECO033	
2.3 T-5	176	03.98 → 10.05	B 5234 T3	10-ECO033	
2.3 T5	180	07.02 → 10.05	B 5234 T9	10-ECO033	
2.4	103	03.06	B 5244 S5	10-ECO032	
2.4 i	125	03.06	B 5244 S4	10-ECO032	
2.4 T	147	07.02 → 10.05	B 5244 T7	10-ECO033	
2.5	125	06.98 → 10.05	B 5254 S	10-ECO033	
2.5 T	142	03.98 → 10.05	B 5254 T B 5244 T	10-ECO033	
D5	132	03.06	D 5244 T8 D 5244 T13		30-ECO030
T5	162	03.06	B 5254 T3	10-ECO032	
T5	169	03.07	B 5254 T7	10-ECO032	

S40 I (VS)

1.6	77	09.95 → 08.99	B 4164 S	10-ECO033	
1.6	80	03.99 → 12.03	B 4164 S2	10-ECO033	
1.8	85	07.95 → 08.99	B 4184 S B 4184 S3	10-ECO033	
1.8	90	03.99 → 12.03	B 4184 S2 B 4184 S9	10-ECO033	
1.8 i	90	06.01 → 12.03	B 4184 SJ	10-ECO033	
1.9 DI	75	07.00 → 12.03	D 4192 T4		30-ECO015
1.9 DI	85	07.00 → 12.03	D 4192 T3		30-ECO015
1.9 T4	147	05.97 → 07.00	B 4194 T B 4194 T2	10-ECO033	
2.0	100	07.95 → 12.03	B 4204 S B 4204 S2	10-ECO033	
2.0	103	07.95 → 08.99	B 4204 S	10-ECO033	
2.0 T	118	10.97 → 07.00	B 4204 T	10-ECO033	
2.0 T	120	06.01 → 12.03	B 4204 T3	10-ECO033	
2.0 T	121	07.00 → 06.01	B 4204 T3	10-ECO033	
2.0 T4	147	07.00 → 12.03	B 4204 T5	10-ECO033	

S40 II

2.0 D	100	01.04	D 4204 T	10-ECO060	30-ECO027
2.4	103	01.04	B 5244 S5	10-ECO032	
2.4	125	01.04	B 5244 S	10-ECO032	
2.4 D5	132	03.06	D 5244 T8	10-ECO032	
T5	162	01.04	B 5254 T3	10-ECO032	

NEW CODES - NEUE CODES - NOUVEAUX CODES - NUEVOS CODIGOS - NUOVI CODICI



	KW						
				OIL FILTER FILTRO OLIO	AIR FILTER FILTRO ARIA	FUEL FILTER FILTRO CARBURANTE	CABIN FILTER FILTRO ABITACOLO

S40 II

T5	169	03.07	B 5254 T7	10-ECO032	
T5 AWD	162	04.04	B 5254 T3	10-ECO032	
T5 AWD	169	03.07	B 5254 T7	10-ECO032	

S60

2.0 T	132	09.01	B 5204 T5	10-ECO033	
2.4	103	11.00	B 5244 S2	10-ECO033	
2.4	125	11.00	B 5244 S	10-ECO033	
2.4 Bifuel	103	06.02	B 5244 SG2	10-ECO033	
2.4 D	120	01.07	D 5244 T5	10-ECO032	30-ECO031
2.4 D	93	09.05	D 5244 T7	10-ECO032	30-ECO031
2.4 D	96	12.01	D 5244 T2	10-ECO032	30-ECO031
2.4 D5	120	07.01	D 5244 T	10-ECO032	30-ECO031
2.4 D5	136	09.05	D 5244 T4	10-ECO032	30-ECO031
2.4 T	147	11.00	B 5244 T3	10-ECO033	
2.4 T AWD	147	11.01	B 5244 T3	10-ECO033	
2.4 T5	191	04.04	B 5244 T5	10-ECO033	
2.5 T	154	02.04	B 5254 T2	10-ECO033	
2.5 T AWD	154	04.04	B 5254 T2	10-ECO033	
R 2,5 T AWD	221	03.03	B 5254 T4	10-ECO033	
T5	184	11.00	B 5234 T3	10-ECO033	

S60 II

D3	120	04.10	D 5204 T2		30-ECO030
D5	151	04.10	D 5244 T10		30-ECO030
D5 AWD	151	04.10	D 5244 T10		30-ECO030
T6 AWD	224	04.10	B 6304 T4	10-ECO012	

S70

2.0 Turbo	155	01.97 → 11.00	B 5204 T	10-ECO033	
2.0 Turbo	166	01.97 → 11.00	B 5204 T3	10-ECO033	
2.3	195	04.99 → 09.00	B 5234 T7	10-ECO033	
2.3 T-5	176	01.97 → 11.00	B 5234 T3	10-ECO033	
2.3 Turbo	184	01.97 → 11.00	B 5234 FT+	10-ECO033	
2.4	103	08.99 → 11.00	B 5244 S2 B 5244 SG	10-ECO033	
2.4 AWD	103	04.99 → 09.00	B 5244 S2	10-ECO033	
2.4 Turbo	142	01.97 → 11.00	B 5254 T B 5244 T	10-ECO033	
2.5 Bifuel	103	07.99 → 11.00	B 5244 SG	10-ECO033	

S80

2.0	120	06.98 → 07.06	B 5204 T4	10-ECO033	
2.0 T	132	12.99 → 07.06	B 5204 T5	10-ECO033	
2.0 T	166	06.98 → 07.06	B 5204 T3	10-ECO033	
2.4	103	01.99 → 07.06	B 5244 S2	10-ECO033	
2.4	125	01.99 → 07.06	B 5244 S	10-ECO033	
2.4 Bifuel	103	09.01 → 07.06	B 5244 SG2	10-ECO033	
2.4 D	96	10.01 → 07.06	D 5244 T2	10-ECO032	

NEW CODES - NEUE CODES - NOUVEAUX CODES - NUEVOS CODIGOS - NUOVI CODICI

	KW			 OIL FILTER FILTRO OLIO	 AIR FILTER FILTRO ARIA	 FUEL FILTER FILTRO CARBURANTE	 CABIN FILTER FILTRO ABITACOLO
---	----	---	---	--	--	---	---

S80

2.4 D5	120	08.01 → 07.06	D 5244 T	10-ECO032	30-ECO031
2.4 LTP	132	06.04 → 07.06	B 5244 T4	10-ECO033	
2.4 T	147	06.00 → 07.06	B 5244 T3	10-ECO033	
2.5 T	154	03.03 → 07.06	B 5254 T2	10-ECO033	
2.5 T AWD	154	07.03 → 07.06	B 5254 T2	10-ECO033	
2.8 T6	200	05.98 → 07.06	B 6284 T	10-ECO033	
2.9	147	03.99 → 07.06	B 6294 S	10-ECO033	
2.9	150	05.98 → 07.06	B 6304 S3	10-ECO033	
3.0	144	06.01 → 07.06	B 6294 S2	10-ECO033	
3.0 T6	200	06.01 → 07.06	B 6294 T	10-ECO033	

S80 II

2.4 D	120	03.06	D 5244 T D 5244 T5	10-ECO032	30-ECO031
2.4 D	129	01.10	D 5244 T14		30-ECO030
2.4 D5	136	03.06	D 5244 T4	10-ECO032	30-ECO030 30-ECO031
2.4 D5 AWD	136	01.07	D 5244 T4	10-ECO032	30-ECO030 30-ECO031
2.5 T	147	03.06	B 5254 T6	10-ECO032	
2.5 T	170	01.10	B 5254 T10	10-ECO032	
2.5 T AWD	147	10.06	B 5254 T6	10-ECO032	
2.5 T FlexFuel	147	05.08	B 5254 T8	10-ECO032	
2.5 T FlexFuel	170	01.10	B 5254 T11	10-ECO032	
3.0 T6 AWD	210	01.07	B 6304 T2	10-ECO012	
3.2	175	03.06	B 6324 S	10-ECO012	
3.2 AWD	175	01.07	B 6324 S	10-ECO012	
4.4 V8 AWD	232	03.06	B 8444 S	10-ECO033	
D5	151	01.10	D 5244 T10		30-ECO030
D5 AWD	151	01.10	D 5244 T10		30-ECO030

V40 Station wagon (VW)

1.6	77	12.95 → 08.99	B 4164 S	10-ECO033	
1.6	80	03.99 → 06.04	B 4164 S2	10-ECO033	
1.8	85	07.95 → 08.99	B 4184 S B 4184 S3	10-ECO033	
1.8	90	03.99 → 06.04	B 4184 S2 B 4184 S9	10-ECO033	
1.9 DI	75	07.00 → 06.04	D 4192 T4		30-ECO015
1.9 DI	85	07.00 → 06.04	D 4192 T3		30-ECO015
1.9 T4	147	05.97 → 07.00	B 4194 T	10-ECO033	
2.0	100	07.95 → 06.04	B 4204 S B 4204 S2	10-ECO033	
2.0	103	07.95 → 08.99	B 4204 S	10-ECO033	
2.0 T	118	10.97 → 07.00	B 4204 T	10-ECO033	
2.0 T	120	06.01 → 06.04	B 4204 T3	10-ECO033	
2.0 T	121	07.99 → 06.01	B 4204 T2	10-ECO033	
2.0 T4	147	07.00 → 06.04	B 4204 T5	10-ECO033	

V50

NEW CODES - NEUE CODES - NOUVEAUX CODES - NUEVOS CODIGOS - NUOVI CODICI



	KW						
				OIL FILTER FILTRO OLIO	AIR FILTER FILTRO ARIA	FUEL FILTER FILTRO CARBURANTE	CABIN FILTER FILTRO ABITACOLO

V50

2.0 D	100	04.04	D 4204 T	10-ECO060	30-ECO027
2.4	103	04.04	B 5244 S5	10-ECO032	
2.4	125	04.04	B 5244 S	10-ECO032	
2.4 D5	132	03.06	D 5244 T8 D 5244 T13	10-ECO032	30-ECO030
T5	162	04.04	B 5254 T3	10-ECO032	
T5	169	03.07	B 5254 T7	10-ECO032	
T5 AWD	162	04.04	B 5254 T3	10-ECO032	
T5 AWD	169	03.07	B 5254 T7	10-ECO032	

V70 I Station wagon

2.0 Turbo	155	01.97 → 03.00	B 5204 T	10-ECO033	
2.3 T-5	176	01.97 → 03.00	B 5234 T3	10-ECO033	
2.3 T-5 AWD	176	01.97 → 03.00	B 5234 T3	10-ECO033	
2.4	103	08.99 → 05.00	B 5244 S2 B 5244 SG2	10-ECO033	
2.4	125	01.97 → 05.00	B 5254 S	10-ECO033	
2.4 Bifuel	103	08.99 → 03.00	B 5244 SG	10-ECO033	
2.4 Turbo	142	01.97 → 03.00	B 5254 T B 5244 T	10-ECO033	
2.5 AWD	195	03.99 → 03.00		10-ECO033	
2.5 Bifuel	106	10.98 → 08.99	GB 5252 S	10-ECO033	
2.5 Turbo AWD	142	01.97 → 05.00	B 5254 T B 5244 T	10-ECO033	

V70 II Station wagon

2.0 T	132	07.01	B 5204 T5	10-ECO033	
2.3 T5	184	03.00	B 5234 T3 B 5234 T4	10-ECO033	
2.4	103	03.00	B 5244 S2	10-ECO033	
2.4	125	03.00	B 5244 S	10-ECO033	
2.4 Bifuel	103	09.01	B 5244 SG	10-ECO033	
2.4 D	93	05.05	D 5244 T7	10-ECO032	30-ECO031
2.4 D	96	12.01	D 5244 T2	10-ECO032	30-ECO031
2.4 D5	120	08.01	D 5244 T	10-ECO032	30-ECO031
2.4 D5	136	12.05	D 5244 T4	10-ECO032	30-ECO031
2.4 D5 AWD	120	03.03	D 5244 T2	10-ECO032	30-ECO031
2.4 D5 AWD	136	12.05	D 5244 T4	10-ECO032	30-ECO031
2.4 T	147	03.00	B 5244 T3	10-ECO033	
2.4 T AWD	147	09.01	B 5244 T3	10-ECO033	
2.4 T5	191	04.04	B 5244 T5	10-ECO033	
2.5 T	154	04.04	B 5254 T2	10-ECO033	
2.5 T AWD	154	09.02	B 5254 T2	10-ECO033	
R 2,5 T AWD	221	03.03	B 5254 T4	10-ECO033	

V70 III Station wagon

2.0 D	100	10.07	D 4204 T	10-ECO060	30-ECO030
2.4 D	120	08.07	D 5244 T5	10-ECO032	30-ECO030
2.4 D	129	10.09	D 5244 T14	10-ECO032	30-ECO030
2.4 D5	136	08.07	D 5244 T4	10-ECO032	30-ECO030

NEW CODES - NEUE CODES - NOUVEAUX CODES - NUEVOS CODIGOS - NUOVI CODICI

	KW						
				OIL FILTER FILTRO OLIO	AIR FILTER FILTRO ARIA	FUEL FILTER FILTRO CARBURANTE	CABIN FILTER FILTRO ABITACOLO

V70 III Station wagon

2.4 D5	151	12.09	D 5244 T10		30-ECO030
2.4 D5 AWD	136	10.07	D 5244 T4	10-ECO032	30-ECO030
2.4 D5 AWD	151	12.09	D 5244 T10		30-ECO030
2.5 T	147	08.07	B 5254 T6	10-ECO032	
2.5 T	170	01.10	B 5254 T10	10-ECO032	
2.5 T FlexFuel	147	05.08	B 5254 T8	10-ECO032	
2.5 T FlexiFuel	170	10.09	B 5254 T11	10-ECO032	
3.0 T6 AWD	210	08.07	B 6304 T2	10-ECO012	
3.2	175	08.07	B 6324 S	10-ECO012	
3.2 AWD	175	08.07	B 6324 S	10-ECO012	

XC 90

2.5 T	154	10.02	B 5254 T2	10-ECO033	
3.2	175	05.06	B 6324 S	10-ECO012	
D5	120	04.09	D 5244 T5	10-ECO032	30-ECO031
D5	120	10.02	D 5244 T	10-ECO032	30-ECO031
D5	136	05.06	D 5244 T4	10-ECO032	30-ECO031
T6	200	10.02	B 6294 T	10-ECO033	
V8	232	01.05	B 8444 S	10-ECO033	

XC60

2.4 D	129	07.09	D 5244 T14	10-ECO032	30-ECO030
2.4 D AWD	120	05.08	D 5244 T5 D 5244 T16 D 5244 T17	10-ECO032	30-ECO030
3.2 AWD	175	07.09	B 6324 S	10-ECO012	
3.2 AWD	179	03.10	B 6324 S5	10-ECO012	
D3	120	03.10	D 5204 T2		30-ECO030
D5 AWD	136	05.08	D 5244 T4	10-ECO032	30-ECO030
D5 AWD	151	07.09	D 5244 T10	10-ECO032	30-ECO030
T6 AWD	210	05.08	B 6304 T2	10-ECO012	
T6 AWD	224	03.10	B 6304 T4	10-ECO012	

XC70 CROSS COUNTRY

2.4 D5 AWD	136	12.05	D 5244 T4	10-ECO032	30-ECO031
2.4 D5 XC AWD	120	09.02	D 5244 T	10-ECO032	30-ECO031
2.4 T XC AWD	142	11.97 → 09.02	B 5254 T	10-ECO033	
2.4 T XC AWD	147	03.00 → 09.02	B 5244 T3	10-ECO033	
2.5 T XC AWD	154	09.02	B 5254 T2	10-ECO033	

XC70 II

2.4 D	129	01.10	D 5244 T14		30-ECO030
2.4 D AWD	120	08.07	D 5244 T5 D 5244 T16	10-ECO032	30-ECO030
2.4 D5 AWD	136	08.07	D 5244 T4	10-ECO032	30-ECO030
2.4 D5 AWD	151	12.09	D 5244 T10		30-ECO030
3.0 T6 AWD	210	01.08	B 6304 T2	10-ECO012	
3.2 AWD	175	08.07	B 6324 S	10-ECO012	

	KW						
				OIL FILTER FILTRO OLIO	AIR FILTER FILTRO ARIA	FUEL FILTER FILTRO CARBURANTE	CABIN FILTER FILTRO ABITACOLO

BORA (1J2)\ Station wagon (1J6)

1.9 SDI	50	10.98 → 05.05	AGP AQM	10-ECO008
1.9 TDI	110	05.00 → 05.05	ARL	10-ECO008
1.9 TDI	66	10.98 → 06.01	AGR ALH	10-ECO008
1.9 TDI	74	09.00 → 05.05	ATD AXR	10-ECO008
1.9 TDI	81	10.98 → 06.01	AHF ASV	10-ECO008
1.9 TDI	85	12.98 → 06.01	AJM AUY	10-ECO008
1.9 TDI	96	11.00 → 05.05	ASZ	10-ECO008
2.3 V5	110	10.98 → 10.00	AGZ	10-ECO023
2.3 V5	125	10.00 → 05.05	AQN	10-ECO023
2.8 V6 4motion	150	03.99 → 05.05	AQP AUE BDE	10-ECO023
2.8 VR6	128	08.02 → 07.05		10-ECO087

CADDY II (9K9A)

1.9 D	47	11.95 → 01.04	1Y	10-ECO008
1.9 SDI	47	11.95 → 01.04	AEY AYQ	10-ECO008
1.9 TDI	66	09.96 → 01.04	1Z AHU ALH	10-ECO008

CADDY II(9K9B)

1.9 D	47	11.95 → 01.04	1Y	10-ECO008
1.9 SDI	47	11.95 → 01.04	AEY AYQ	10-ECO008
1.9 TDI	66	10.96 → 01.04	AHU ALH ALE	10-ECO008

CADDY III (2KA)\ (2KB)

1.6 TDI	55	08.10	CAYE	30-ECO024
1.6 TDI	75	08.10	CAYD	30-ECO024
1.9 TDI	55	09.05	BSU	10-ECO023 30-ECO024 30-ECO033 VIN ->2K_6_090 000 30-ECO034
1.9 TDI	77	04.04	BJB BLS	10-ECO023 30-ECO024 30-ECO033 VIN ->2K_6_090 000 30-ECO034
1.9 TDI 4motion	77	11.08 → 08.10	BLS	10-ECO023 30-ECO024 30-ECO033 VIN ->2K_6_090 000 30-ECO034
2.0 SDI	51	03.04	BDJ BST	10-ECO023 30-ECO024 30-ECO033 VIN ->2K_6_090 000 30-ECO034
2.0 TDI	103	09.07	BMM	10-ECO023 30-ECO024
2.0 TDI 16V	103	11.10	CFHC	30-ECO024
2.0 TDI 4motion	81	10.10	CFHF	30-ECO024

NEW CODES - NEUE CODES - NOUVEAUX CODES - NUEVOS CODIGOS - NUOVI CODICI

	KW						
				OIL FILTER FILTRO OLIO	AIR FILTER FILTRO ARIA	FUEL FILTER FILTRO CARBURANTE	CABIN FILTER FILTRO ABITACOLO

CRAFTER 30-50 (2E)

2.5 TDI	100	04.06	BJL CECA	10-ECO008	30-ECO032
2.5 TDI	120	04.06	BJM CECB	10-ECO008	30-ECO032
2.5 TDI	65	04.06	BJJ CEBA	10-ECO008	30-ECO032
2.5 TDI	80	04.06	BJK CEBB	10-ECO008	30-ECO032

EOS

1.6 FSI	85	06.06	BLF	10-ECO092	
2.0 FSI	110	03.06	BVY BVZ	10-ECO063	
2.0 TDI	103	06.06	BMM	10-ECO023	30-ECO024
2.0 TDI 16V	103	05.08	CBAB CFFB	10-ECO023	30-ECO024
2.0 TFSI	147	03.06	BWA BPY CAWB CBFA CCTA CCZA	10-ECO063	
3.2 V6	184	06.06	BUB CBRA	10-ECO023	
3.6 V6	191	05.09	CDVA	10-ECO023	

FOX (5Z1)

1.2	40	04.05	BMD CHFB	10-ECO118	
1.2	44	09.10	CHFA	10-ECO118	
1.4 TDI	51	04.05	BNM	10-ECO023	

GOLF IV (1J1)\ Variant (1J5)

1.9 SDI	50	08.97 → 06.05	AGP AQM	10-ECO008	
1.9 TDI	110	05.00 → 06.05	ARL	10-ECO008	
1.9 TDI	66	10.97 → 05.04	AGR ALH	10-ECO008	
1.9 TDI	74	09.00 → 06.05	ATD AXR	10-ECO008	
1.9 TDI	81	08.97 → 05.04	AHF ASV	10-ECO008	
1.9 TDI	85	12.98 → 06.01	AJM AUY	10-ECO008	
1.9 TDI	96	11.00 → 06.05	ASZ	10-ECO008	
2.3 V5	110	08.97 → 10.00	AGZ	10-ECO023	
2.3 V5	125	10.00 → 06.05	AQN	10-ECO023	
2.8 V6 4motion	150	03.99 → 06.05	AQP AUE BDE	10-ECO023	
3.2 R32 4motion	177	09.02 → 06.05	BFH BML	10-ECO023	

GOLF V (1K1)

1.4 FSI	66	10.03	BKG BLN	10-ECO092	
1.4 TSI	103	05.06	BMY	10-ECO092	
1.4 TSI	125	11.05	BLG	10-ECO092	
1.4 TSI	90	05.07	CAXA	10-ECO092	

NEW CODES - NEUE CODES - NOUVEAUX CODES - NUEVOS CODIGOS - NUOVI CODICI

	KW						
				OIL FILTER FILTRO OLIO	AIR FILTER FILTRO ARIA	FUEL FILTER FILTRO CARBURANTE	CABIN FILTER FILTRO ABITACOLO

GOLF V (1K1)

1.6 FSI	85	10.03	BAG BLF BLP	10-ECO092			
1.9 TDI	66	05.04	BRU BXF BXJ	10-ECO023		30-ECO033 30-ECO034	
1.9 TDI	77	10.03	BKC BLS BXE	10-ECO023		30-ECO033 30-ECO034	
2.0	85	08.06	BHY	10-ECO063			
2.0 FSI	110	01.04	AXW BLX BLY BLR BVY BVZ BVX	10-ECO063			
2.0 GTI	147	10.04	AXX BWA BPY CAWB CBFA CCTA	10-ECO063			
2.0 SDI	55	01.04	BDK	10-ECO023		30-ECO033 30-ECO034	
2.0 TDI	100	10.03	AZV CBDA	10-ECO023		30-ECO033 30-ECO034	
2.0 TDI	103	12.04	BMM	10-ECO023		30-ECO033 30-ECO034	
2.0 TDI	125	11.05	BMN	10-ECO023		30-ECO033 30-ECO034	
2.0 TDI 16V	103	10.03	BKD	10-ECO023		30-ECO033 30-ECO034	
3.2 R32 4motion	184	11.05	BUB CBR CBRA	10-ECO023			

GOLF V PLUS (1KP)

1.4 FSI	66	07.05 → 05.06	BLN	10-ECO092			
1.4 TSI	103	05.06	BMY	10-ECO092			
1.4 TSI	125	05.06	BLG	10-ECO092			
1.4 TSI	90	06.07	CAXA	10-ECO092			
1.6 FSI	85	01.05	BLF	10-ECO092			
1.6 TDI	66	02.09	CAYB			30-ECO033	
1.6 TDI	77	03.09	CAYC	10-ECO098		30-ECO024 30-ECO033	
1.9 TDI	66	05.05	BRU BXF BXJ	10-ECO023		30-ECO033 30-ECO034	
1.9 TDI	77	01.05	BKC BLS BXE	10-ECO023		30-ECO033 30-ECO034	
2.0 FSI	110	05.05	BLY BLR BVY BVZ	10-ECO063			
2.0 TDI	100	05.05	AZV CBDA CFHB	10-ECO023		30-ECO033 30-ECO034	

NEW CODES - NEUE CODES - NOUVEAUX CODES - NUEVOS CODIGOS - NUOVI CODICI

	KW						
				OIL FILTER FILTRO OLIO	AIR FILTER FILTRO ARIA	FUEL FILTER FILTRO CARBURANTE	CABIN FILTER FILTRO ABITACOLO

GOLF V PLUS (1KP)

2.0 TDI	103	12.05	BMM	10-ECO023	30-ECO033 30-ECO034
2.0 TDI	81	03.09	CBDC CLCA	10-ECO023	30-ECO033
2.0 TDI 16V	103	01.05	BKD CBDB CFHC	10-ECO023	30-ECO033 30-ECO034

GOLF V Variant

1.4 TSI	103	06.07	BMV	10-ECO092	
1.4 TSI	125	06.07	BLG	10-ECO092	
1.4 TSI	90	06.07	CAXA	10-ECO092	
1.9 TDI	77	06.07	BKC BLS BXE	10-ECO023	30-ECO033 30-ECO034
2.0	147	06.07	BWA CAWB CCTA	10-ECO063	
2.0 TDI	103	06.07	BMM	10-ECO023	30-ECO033 30-ECO034
2.0 TDI 16V	103	06.07	BKD CBDB	10-ECO023	30-ECO033 30-ECO034

GOLF VI

1.6 TDI	66	02.09	CAYB		30-ECO033
1.6 TDI	77	02.09	CAYC	10-ECO098	30-ECO033
2.0 R 4motion	199	11.09	CDLF	10-ECO063	
2.0 TDI	100	10.08	CBAA CFFA	10-ECO023	30-ECO033
2.0 TDI	103	10.08	CBAB CFFB CJAA	10-ECO023	30-ECO033
2.0 TDI	125	04.09	CBBB CFGB	10-ECO023	30-ECO033
2.0 TDI	81	10.08	CBDC CLCA	10-ECO023	30-ECO033

GOLF VI Variant

1.6 TDI	66	12.09	CAYB		30-ECO033
1.6 TDI	77	07.09	CAYC		30-ECO033
1.6 TDI 4motion	77	07.09	CAYC		30-ECO033
2.0 TDI	100	07.09	CBDA CFHB	10-ECO023	30-ECO033
2.0 TDI	103	07.09	CBDB CFHC	10-ECO023	30-ECO033
2.0 TDI	103	07.09	BMM	10-ECO023	30-ECO033

JETTA III (1KM)

1.4 TSI	103	07.06	BMV	10-ECO092	
1.4 TSI	125	07.06	BLG	10-ECO092	
1.4 TSI	90	05.07	CAXA	10-ECO092	
1.6 FSI	85	09.05	BLF	10-ECO092	
1.6 TDI	77	06.09	CAYC		30-ECO033
1.9 TDI	77	08.05	BKC BLS BXE	10-ECO023	30-ECO033 30-ECO034

NEW CODES - NEUE CODES - NOUVEAUX CODES - NUEVOS CODIGOS - NUOVI CODICI

	KW						
				OIL FILTER FILTRO OLIO	AIR FILTER FILTRO ARIA	FUEL FILTER FILTRO CARBURANTE	CABIN FILTER FILTRO ABITACOLO

JETTA III (1KM)

2.0 FSI	110	08.05	BLY BLR BYY BVZ	10-ECO063			
2.0 TDI	100	09.05	AZV CBDA	10-ECO023		30-ECO033 30-ECO034	
2.0 TDI	103	10.05	BMM	10-ECO023		30-ECO033 30-ECO034	
2.0 TDI	125	10.06	BMN CEGA	10-ECO023		30-ECO033	
2.0 TDI 16V	103	08.05	BKD CBDB CJAA	10-ECO023		30-ECO033 30-ECO034	
2.0 TFSI	147	10.05	BWA BPY CAWB CBFA CCTA CCZA	10-ECO063			
2.5 FSI	110	01.06	BGP BTK	10-ECO063			
2.5 FSI	125	07.08	CBTA CBUA CCCA	10-ECO023		30-ECO033	

LT 28-46 II (2DX0AE) Tutti i modelli\ All models

2.3	105	05.96	AGL	10-ECO009			
2.5 SDI	55	09.96	AGX	10-ECO008			
2.5 TDI	61	05.01	BBE	10-ECO008			
2.5 TDI	66	05.99	APA	10-ECO008			
2.5 TDI	70	05.01	BBF	10-ECO008			
2.5 TDI	75	05.96 → 08.99	AHD	10-ECO008			
2.5 TDI	80	05.99	ANJ AVR	10-ECO008			

LUPO (6X1, 6E1)

1.2 TDI 3L	45	07.99 → 07.05	ANY AYZ	10-ECO023			
1.4 TDI	55	01.99 → 07.05	AMF	10-ECO023			

MULTIVAN V (7HM)

1.9 TDI	77	04.03	AXB	10-ECO023			
2.5 TDI	128	04.03	AXE BPC	10-ECO023			
2.5 TDI	96	04.03	AXD BNZ	10-ECO023			
3.2 V6	170	02.04 → 06.04	BDL	10-ECO013			
3.2 V6	173	02.04	BKK CFLA	10-ECO013			

NEW BEETLE (9C1, 1C1)

1.9 TDI	66	01.98 → 06.04	ALH	10-ECO008			
1.9 TDI	74	02.01	ATD BEW	10-ECO008			
1.9 TDI	77	07.05	BSW	10-ECO008			
2.3 V5	125	10.00	AQN	10-ECO023			
2.5	110	07.05	BPR BPS	10-ECO063			
RSI 3.2 (1C9)	165	04.00 → 05.01	AXJ	10-ECO023			

NEW CODES - NEUE CODES - NOUVEAUX CODES - NUEVOS CODIGOS - NUOVI CODICI

	KW						
				OIL FILTER FILTRO OLIO	AIR FILTER FILTRO ARIA	FUEL FILTER FILTRO CARBURANTE	CABIN FILTER FILTRO ABITACOLO

NEW BEETLE Cabriolet (1Y7)

1.9 TDI	74	06.03	AXR	10-ECO008
1.9 TDI	77	07.05	BSW	10-ECO008
2.5	110	07.05	BPR BPS	10-ECO063

PASSAT (3B2) Variant (3B5)

1.9 TDI	74	02.00 → 11.00	AVB	10-ECO008
1.9 TDI	85	08.98 → 11.00	AJM ATJ	10-ECO008
2.3 VR5	110	10.96 → 11.00	AGZ	10-ECO013
2.5 TDI	110	07.98 → 11.00	AKN AFB	10-ECO010

PASSAT (3B3) Variant

1.9 TDI	74	11.00 → 05.05	AVB	10-ECO008
1.9 TDI	96	11.00 → 05.05	AVF AWX	10-ECO008
2.0 TDI	100	12.03 → 05.05	BGW BHW	10-ECO023
2.3 V5	125	11.00 → 05.05	AZX	10-ECO013
2.5 TDI	110	11.00 → 05.05	AKN AFB	10-ECO010
2.5 TDI	120	05.03 → 05.05	BDG	10-ECO010
2.5 TDI 4motion	132	01.03 → 05.05	BAU BDH	10-ECO010
4.0 W8 4motion	202	09.01 → 05.05	BDN BDP	10-ECO013

PASSAT (3C2) Variant

1.4 TSI	90	05.07	CAXA	10-ECO092	
1.6 FSI	85	03.05	BLF	10-ECO092	
1.6 TDI	77	08.09	CAYC	10-ECO098	30-ECO024
1.9 TDI	77	03.05	BKC BLS BXE	10-ECO023	30-ECO024
2.0 BlueTDI	105	01.09	CBAC	10-ECO023	30-ECO024
2.0 FSI	110	03.05	BLY BLR BYY BVZ	10-ECO063	
2.0 FSI 4motion	110	09.05	BLX BLY BVX	10-ECO063	
2.0 TDI	100	03.05	BMA CBAA	10-ECO023	30-ECO024
2.0 TDI	103	03.05	BMP	10-ECO023	30-ECO024
2.0 TDI	120	08.05	BUZ	10-ECO023	30-ECO024
2.0 TDI	125	08.05	BMR CBBB	10-ECO023	30-ECO024
2.0 TDI	81	11.08	CBDC	10-ECO023	30-ECO024
2.0 TDI	90	08.05 → 07.06	BVE	10-ECO023	30-ECO024
2.0 TDI 4motion	103	03.05	BMP	10-ECO023	30-ECO024
2.0 TDI 16V	103	03.05	BKP CBAB	10-ECO023	30-ECO024
2.0 TDI 4motion	125	05.09	CBBB		30-ECO024

NEW CODES - NEUE CODES - NOUVEAUX CODES - NUEVOS CODIGOS - NUOVI CODICI

	KW						
				OIL FILTER FILTRO OLIO	AIR FILTER FILTRO ARIA	FUEL FILTER FILTRO CARBURANTE	CABIN FILTER FILTRO ABITACOLO
PASSAT (3C2)\ Variant							
2.0 TFSI	147	07.05	AXX BWA BPY CAWB CBFA CCTA CCZA	10-ECO063			
3.2 FSI 4motion	184	11.05	AXZ	10-ECO023			
3.6 FSI 4motion	206	09.05	BLV	10-ECO023			
3.6 R36 4motion	220	04.07	BWS	10-ECO023			
PASSAT CC							
2.0 BlueTDI	105	05.09	CBAC	10-ECO023		30-ECO024	
2.0 TDI	100	06.08	CBAA CFFA	10-ECO023		30-ECO024	
2.0 TDI	103	06.08	CBAB CFFB	10-ECO023		30-ECO024	
2.0 TDI	125	06.08	CBBB CFGB CLLA	10-ECO023		30-ECO024	
2.0 TDI 4motion	103	08.09	CBAB CFFB	10-ECO023		30-ECO024	
2.0 TSI	147	06.08	CAWB CBFA CCTA CCZA	10-ECO063			
3.6 4motion	220	06.08	BWS	10-ECO023			
PHAETON (3D2)							
3.0 V6 TDI 4motion	165	09.04	BMK	10-ECO069			
3.0 V6 TDI 4motion	171	06.07	CARA	10-ECO069			
3.0 V6 TDI 4motion	176	11.08	CARB CEXA	10-ECO069			
3.2 V6	177	04.02	AYT BKL	10-ECO013			
3.2 V6 4motion	177	02.04	BKL BRK	10-ECO013			
3.6 V6 4motion	206	11.08	CHNA CMVA	10-ECO013			
4.2 V8 4motion	246	05.03	BGH BGJ	10-ECO085			
6.0 W12 4motion	309	04.02	BAN	10-ECO013			
POLO (6N2)							
1.4 TDI	55	10.99 → 09.01	AMF	10-ECO023			
POLO (6R_)							
1.2	44	06.09	CGPB	10-ECO118			
1.2	51	06.09	CGPA	10-ECO118			
1.6 TDI	55	06.09	CAYA	10-ECO098			
1.6 TDI	66	06.09	CAYB	10-ECO098			
1.6 TDI	77	06.09	CAYC CLNA	10-ECO098			
POLO (9N_)							
1.2	40	01.02 → 05.07	AWY BMD	10-ECO118			
1.2	44	05.07	BBM	10-ECO118			
1.2 12V	47	10.01 → 07.07	AZQ BME	10-ECO118			

NEW CODES - NEUE CODES - NOUVEAUX CODES - NUEVOS CODIGOS - NUOVI CODICI

	KW						
				OIL FILTER FILTRO OLIO	AIR FILTER FILTRO ARIA	FUEL FILTER FILTRO CARBURANTE	CABIN FILTER FILTRO ABITACOLO

POLO (9N_)

1.2 12V	51	05.07	BZG	10-ECO118	
1.4 FSI	63	02.02 → 07.06	AXU	10-ECO092	
1.4 TDI	51	04.05	BNM BWB	10-ECO023	
1.4 TDI	55	10.01 → 06.05	AMF BAY	10-ECO023	
1.4 TDI	59	04.05	BMS BNV	10-ECO023	
1.6 16V	77	05.06	BTS	10-ECO092	
1.9 SDI	47	10.01	ASY	10-ECO023	
1.9 TDI	74	10.01	ATD AXR BMT	10-ECO023	
1.9 TDI	96	11.03	ASZ BLT	10-ECO023	

POLO CLASSIC (6KV2)\ Variant (6KV5)

68 1.9 SDI	50	08.99 → 09.01	AGP AQM	10-ECO008	
90 1.9 TDI	66	09.96 → 09.01	AHU AGR ALH ALE	10-ECO008	

POLO Tre volumi

1.4 TDI	55	07.03	BAY	10-ECO023	
1.9 SDI	47	09.02	ASY	10-ECO023	
1.9 TDi	74	09.02	ATD	10-ECO023	

SCIROCCO

2.0 R	195	11.09	CDLA	10-ECO063	
2.0 TDI	103	09.08	CBDB CFHC	10-ECO023	30-ECO024
2.0 TDI	125	05.09	CBBB CFGB	10-ECO023	30-ECO024

SHARAN (7M8, 7M9, 7M6)

1.9 TDI	110	06.05	BTB	10-ECO023	
1.9 TDI	66	09.95	1Z AHU ANU	10-ECO008	
1.9 TDI	85	04.00	AUY BVK	10-ECO008	
1.9 TDI	96	11.02	ASZ	10-ECO023	
2.0 TDI	103	11.05	BRT	10-ECO023	
2.8 V6 24V	150	04.00	AYL	10-ECO023	
2.8 VR6	128	09.95 → 04.00	AAA AMY	10-ECO013	

TIGUAN

1.4 TSI	110	11.08	BWK CAVA	10-ECO092	
2.0 TDI	81	05.10	CFFD		30-ECO024
2.0 TDI 4motion	100	11.07	CBAA CFFA	10-ECO023	30-ECO024
2.0 TDI 4motion	125	09.07	CBBB CFGB	10-ECO023	30-ECO024

TOUAREG (7LA)

NEW CODES - NEUE CODES - NOUVEAUX CODES - NUEVOS CODIGOS - NUOVI CODICI

	KW						
				OIL FILTER FILTRO OLIO	AIR FILTER FILTRO ARIA	FUEL FILTER FILTRO CARBURANTE	CABIN FILTER FILTRO ABITACOLO

TOUAREG (7LA)

2.5 R5 TDI	120	08.03	BLK BPD	10-ECO023			
2.5 R5 TDI	128	01.03	BAC BPE	10-ECO023			
3.0 V6 TDI	165	11.04	BKS CATA	10-ECO069		30-ECO025	
3.0 V6 TDI	176	11.07	CASA CASC	10-ECO069		30-ECO025	
3.2 V6	162	10.02 → 11.06	AZZ BKJ BMX BAA BMV BRJ	10-ECO013			
3.2 V6	177	11.04 → 11.06		10-ECO013			
3.6 V6 FSI	206	03.06	BHK BHL	10-ECO013			
4.2 V8	228	12.02 → 11.06	AXQ	10-ECO086			
5.0 R50 TDI	257	11.07	CBWA			30-ECO035	
5.0 V10 TDI	230	10.02	AYH BLE BWF			30-ECO035	

TOUAREG (7P5)

3.0 V6 TDI	176	04.10	CASA CNRB	10-ECO069			
3.0 V6 TSI Hybrid	245	04.10	CGEA CGFA	10-ECO108			
3.6 V6 FSI	206	04.10	CGRA	10-ECO013			
4.2 V8 TDI	250	04.10	CKDA	10-ECO069			

TOURAN

1.4 FSI	125	12.06	BLG CAVB	10-ECO092			
1.4 TSI	103	02.06	BMV CAVC	10-ECO092			
1.6 FSI	85	02.03	BAG BLF BLP	10-ECO092			
1.6 TDI	66	05.10	CAYB			30-ECO024	
1.6 TDI	77	05.10	CAYC			30-ECO024	
1.9 TDI	66	11.04	BRU BXF BXJ	10-ECO023		30-ECO024 30-ECO034	
1.9 TDI	74	02.03	AVQ	10-ECO023		30-ECO034	
1.9 TDI	77	08.03	BKC BLS BXE	10-ECO023		30-ECO024 30-ECO034	
2.0 FSI	110	10.03	AXW BLX BLY BLR BVY BVZ	10-ECO063			
2.0 FSI	85	10.04	BJZ	10-ECO063			
2.0 TDI	100	02.03	AZV	10-ECO023		30-ECO024 30-ECO034	
2.0 TDI	103	12.05	BMM	10-ECO023		30-ECO024 30-ECO034	
2.0 TDI	125	12.05	BMN CFJA	10-ECO023		30-ECO024	

NEW CODES - NEUE CODES - NOUVEAUX CODES - NUEVOS CODIGOS - NUOVI CODICI

	KW			 OIL FILTER FILTRO OLIO	 AIR FILTER FILTRO ARIA	 FUEL FILTER FILTRO CARBURANTE	 CABIN FILTER FILTRO ABITACOLO
TOURAN							
2.0 TDI 16V	103	08.03	BKD CFHC	10-ECO023		30-ECO024 30-ECO034	
TRANSPORTER IV							
2.8 V6	150	04.00 → 04.03	AMV	10-ECO023			
2.8 VR 6	103	11.95 → 04.00	AES	10-ECO013 →09.98			
TRANSPORTER V (7HB, 7HJ)\ (7HA, 7HH)\ (7JD, 7JE, 7JL)							
1.9 TDI	62	01.06	BRR	10-ECO023			
1.9 TDI	63	04.03	AXC	10-ECO023			
1.9 TDI	75	06.06	BRS	10-ECO023			
1.9 TDI	77	04.03	AXB	10-ECO023			
2.5 TDi	120	11.03	BLJ	10-ECO023			
2.5 TDI	128	04.03	AXE BPC	10-ECO023			
2.5 TDI	96	04.03	AXD BNZ	10-ECO023			
2.5 TDI 4motion	128	07.04	AXE BPC	10-ECO023			
2.5 TDI 4motion	96	07.04	AXD BNZ	10-ECO023			
3.2 V6	170	02.04 → 06.04	BDL	10-ECO013			
3.2 V6	173	02.04	BKK CFLA	10-ECO013			

10-00-002	
	Length/Lungh. [mm]
	100
	Outer Diam./Diam. est. [mm]
	80
	Fitted Diam./Diam. montaggio [mm]
62	
Inner Thread/Filett int. [mm]	
3/4 x 16	
CHRYSLER - HONDA	

10-00-003	
	Length/Lungh. [mm]
	116,5
	Outer Diam./Diam. est. [mm]
	64,4
	Inner Diam./Diam. int. [mm]
	31
	Inner Diam. 1/Diam. int. 1 [mm]
37	
Fitted Diam./Diam. montaggio [mm]	
46,6	
CHRYSLER - HONDA	

10-00-003	
	Length/Lungh. [mm]
	100
	Outer Diam./Diam. est. [mm]
	94,5
	Fitted Diam./Diam. montaggio [mm]
71,6	
Inner Thread/Filett int. [mm]	
M20 x 1,5	
TATA	

10-00-010	
	Length/Lungh. [mm]
	76
	Outer Diam./Diam. est. [mm]
	81
	Fitted Diam./Diam. montaggio [mm]
64	
Inner Thread/Filett int. [mm]	
M22 x 1,5	
DODGE - JEEP	

10-00-004	
	Length/Lungh. [mm]
	153
	Outer Diam./Diam. est. [mm]
	94,5
	Fitted Diam./Diam. montaggio [mm]
71	
Inner Thread/Filett int. [mm]	
M24 x 1,5	
TATA	

10-00-011	
	Length/Lungh. [mm]
	79,4
	Outer Diam./Diam. est. [mm]
	107,4
	Fitted Diam./Diam. montaggio [mm]
70,7	
Inner Thread/Filett int. [mm]	
M24 x 1,5	
TATA	

10-00-006	
	Length/Lungh. [mm]
	89,7
	Outer Diam./Diam. est. [mm]
	87,6
	Fitted Diam./Diam. montaggio [mm]
71	
Inner Thread/Filett int. [mm]	
M20 x 1,5	
TATA	

10-00-012	
	Length/Lungh. [mm]
	117
	Outer Diam./Diam. est. [mm]
	93
	Fitted Diam./Diam. montaggio [mm]
70	
Inner Thread/Filett int. [mm]	
M 20 X 1,5	
MAHINDRA	

10-00-007	
	Length/Lungh. [mm]
	83
	Outer Diam./Diam. est. [mm]
	70,5
	Inner Diam./Diam. int. [mm]
	22
Inner Diam. 1/Diam. int. 1 [mm]	
33,4	
Fitted Diam./Diam. montaggio [mm]	
55	
CHRYSLER	

10-00-013	
	Length/Lungh. [mm]
	104
	Outer Diam./Diam. est. [mm]
	75
	Fitted Diam./Diam. montaggio [mm]
70	
Outer Thread/Filett est. [mm]	
13/ 16X16	
CADILLAC - HUMMER	

10-00-014	
	Length/Lungh. [mm]
	88
	Outer Diam./Diam. est. [mm]
	75
	Fitted Diam./Diam. montaggio [mm]
70	
Inner Thread/Filett int. [mm]	
13/ 16X16	
CADILLAC - CHEVROLET - HUMMER	

10-01-103E	
	Length/Lungh. [mm]
	100,6
	Outer Diam./Diam. est. [mm]
	94
	Fitted Diam./Diam. montaggio [mm]
71	
Inner Thread/Filett int. [mm]	
3/4 x 16	
Subst. by 10-01-112E	

10-00-015	
	Length/Lungh. [mm]
	103
	Outer Diam./Diam. est. [mm]
	90
	Fitted Diam./Diam. montaggio [mm]
86	
Inner Thread/Filett int. [mm]	
M 20 X 1,5	
DR	

10-01-104	
	Length/Lungh. [mm]
	162,5
	Outer Diam./Diam. est. [mm]
	100,5
	Inner Diam./Diam. int. [mm]
44,2	
Inner Diam. 1/Diam. int. 1 [mm]	
1	
NISSAN	

10-00-097	
	Length/Lungh. [mm]
	120
	Outer Diam./Diam. est. [mm]
	77,8
	Fitted Diam./Diam. montaggio [mm]
73	
Inner Thread/Filett int. [mm]	
3/4 x 16	
CHRYSLER - JEEP	

10-01-107	
	Length/Lungh. [mm]
	166,3
	Outer Diam./Diam. est. [mm]
	80
	Fitted Diam./Diam. montaggio [mm]
63	
Inner Thread/Filett int. [mm]	
3/4 x 16	
NISSAN	

10-00-098	
	Length/Lungh. [mm]
	92
	Outer Diam./Diam. est. [mm]
	73,7
	Fitted Diam./Diam. montaggio [mm]
71,5	
Inner Thread/Filett int. [mm]	
M18 x 1,5	
CHEVROLET	

10-01-108	
	Length/Lungh. [mm]
	72,5
	Outer Diam./Diam. est. [mm]
	80
	Fitted Diam./Diam. montaggio [mm]
63	
Inner Thread/Filett int. [mm]	
3/4 x 16	
NISSAN	

10-01-101E	
	Length/Lungh. [mm]
	135
	Outer Diam./Diam. est. [mm]
	94,6
	Fitted Diam./Diam. montaggio [mm]
71	
Inner Thread/Filett int. [mm]	
3/4 x 16	
DAEWOO - NISSAN	

10-01-109	
	Length/Lungh. [mm]
	171
	Outer Diam./Diam. est. [mm]
	94
	Fitted Diam./Diam. montaggio [mm]
73	
Inner Thread/Filett int. [mm]	
1 x 12	
NISSAN	

10-01-110	
	Length/Lungh. [mm]
	131
	Outer Diam./Diam. est. [mm]
	94,5
	Fitted Diam./Diam. montaggio [mm]
73	
Inner Thread/Filett int. [mm]	
3/4 x 16	
NISSAN	

10-01-114	
	Length/Lungh. [mm]
	131
	Outer Diam./Diam. est. [mm]
	94
	Fitted Diam./Diam. montaggio [mm]
72	
Inner Thread/Filett int. [mm]	
1 x 12	
By-pass	
NISSAN	

10-01-111	
	Length/Lungh. [mm]
	102,4
	Outer Diam./Diam. est. [mm]
	80
	Fitted Diam./Diam. montaggio [mm]
63	
Inner Thread/Filett int. [mm]	
3/4 x 16	
CHEVROLET - ISUZU - NISSAN - SUBARU	

10-01-117	
	Length/Lungh. [mm]
	86
	Outer Diam./Diam. est. [mm]
	65,2
	Fitted Diam./Diam. montaggio [mm]
63	
Inner Thread/Filett int. [mm]	
3/4 x 16	
INFINITI - NISSAN	

10-01-112E	
	Length/Lungh. [mm]
	100
	Outer Diam./Diam. est. [mm]
	94
	Fitted Diam./Diam. montaggio [mm]
71	
Inner Thread/Filett int. [mm]	
3/4 x 16	
CHEVROLET - GONOW - NISSAN	

10-01-120	
	Length/Lungh. [mm]
	71,5
	Outer Diam./Diam. est. [mm]
	65,4
	Fitted Diam./Diam. montaggio [mm]
61,5	
Inner Thread/Filett int. [mm]	
M20 x 1,5	
INFINITI - NISSAN	

10-01-112	
	Length/Lungh. [mm]
	101
	Outer Diam./Diam. est. [mm]
	94,4
	Fitted Diam./Diam. montaggio [mm]
73	
Inner Thread/Filett int. [mm]	
3/4 x 16	
NISSAN	

10-01-121	
	Length/Lungh. [mm]
	59,5
	Outer Diam./Diam. est. [mm]
	69
	Fitted Diam./Diam. montaggio [mm]
62	
Inner Thread/Filett int. [mm]	
M 20 X 1,5	
NISSAN	

10-01-113	
	Length/Lungh. [mm]
	175
	Outer Diam./Diam. est. [mm]
	94,4
	Fitted Diam./Diam. montaggio [mm]
71	
Inner Thread/Filett int. [mm]	
1 x 12	
By-pass	
NISSAN	

10-01-122	
	Length/Lungh. [mm]
	65
	Outer Diam./Diam. est. [mm]
	76
	Fitted Diam./Diam. montaggio [mm]
71	
Inner Thread/Filett int. [mm]	
M20 x 1,5	
DR - NISSAN - SUZUKI	

10-01-189	
	Length/Lungh. [mm]
	88
	Outer Diam./Diam. est. [mm]
	77
	Inner Thread/Filett int. [mm]
	M 20 X 1,5
LADA - NISSAN - SUZUKI	

10-01-199	
	Length/Lungh. [mm]
	210,5
	Outer Diam./Diam. est. [mm]
	107,6
	Fitted Diam./Diam. montaggio [mm]
	87
	Inner Thread/Filett int. [mm]
	1 1/8 x 16
NISSAN	

10-01-194	
	Length/Lungh. [mm]
	106
	Outer Diam./Diam. est. [mm]
	76
	Inner Diam./Diam. int. [mm]
	30
	Inner Diam. 1/Diam. int. 1 [mm]
	30
	Fitted Diam./Diam. montaggio [mm]
	40
CHEVROLET - NISSAN - OPEL - RENAULT	

10-02-200	
	Length/Lungh. [mm]
	125,5
	Outer Diam./Diam. est. [mm]
	80
	Fitted Diam./Diam. montaggio [mm]
	64
	Inner Thread/Filett int. [mm]
	3/4 x 16
DAIHATSU - TOYOTA	

10-01-195	
	Length/Lungh. [mm]
	74
	Outer Diam./Diam. est. [mm]
	73
	Inner Diam./Diam. int. [mm]
	29
	Inner Diam. 1/Diam. int. 1 [mm]
	29
	Fitted Diam./Diam. montaggio [mm]
	41
NISSAN	

10-02-201	
	Length/Lungh. [mm]
	99
	Outer Diam./Diam. est. [mm]
	94,3
	Fitted Diam./Diam. montaggio [mm]
	72,7
	Inner Thread/Filett int. [mm]
	3/4 x 16
DAIHATSU - TOYOTA	

10-01-196	
	Length/Lungh. [mm]
	180
	Outer Diam./Diam. est. [mm]
	108
	Fitted Diam./Diam. montaggio [mm]
	102
	Inner Thread/Filett int. [mm]
	1 1/8 x 16
TOYOTA	

10-02-202	
	Length/Lungh. [mm]
	140,5
	Outer Diam./Diam. est. [mm]
	80
	Fitted Diam./Diam. montaggio [mm]
	63
	Inner Thread/Filett int. [mm]
	3/4 x 16
TOYOTA	

10-01-198	
	Length/Lungh. [mm]
	86
	Outer Diam./Diam. est. [mm]
	65,4
	Fitted Diam./Diam. montaggio [mm]
	61,5
	Inner Thread/Filett int. [mm]
	M20 x 1,5
INFINITI - NISSAN	

10-02-203	
	Length/Lungh. [mm]
	80
	Outer Diam./Diam. est. [mm]
	80
	Fitted Diam./Diam. montaggio [mm]
	64
	Inner Thread/Filett int. [mm]
	3/4 x 16
TOYOTA	

10-02-204	
	Length/Lungh. [mm]
	122
	Outer Diam./Diam. est. [mm]
	94,5
	Fitted Diam./Diam. montaggio [mm]
71	
Inner Thread/Filett int. [mm]	
3/4 x 16	
LAND ROVER - TOYOTA	

10-02-209	
	Length/Lungh. [mm]
	142
	Outer Diam./Diam. est. [mm]
	110
	Fitted Diam./Diam. montaggio [mm]
87	
Inner Thread/Filett int. [mm]	
M30 x 1,5	
TOYOTA	

10-02-205	
	Length/Lungh. [mm]
	99,3
	Outer Diam./Diam. est. [mm]
	80
	Fitted Diam./Diam. montaggio [mm]
64	
Inner Thread/Filett int. [mm]	
3/4 x 16	

10-02-210	
	Length/Lungh. [mm]
	76,2
	Outer Diam./Diam. est. [mm]
	65,5
	Fitted Diam./Diam. montaggio [mm]
62	
Inner Thread/Filett int. [mm]	
3/4 x 16	
NISSAN - SUZUKI - TOYOTA	

10-02-206	
	Length/Lungh. [mm]
	140
	Outer Diam./Diam. est. [mm]
	94,3
	Fitted Diam./Diam. montaggio [mm]
72	
Inner Thread/Filett int. [mm]	
3/4 x 16	
TOYOTA	

10-02-212	
	Length/Lungh. [mm]
	87,5
	Outer Diam./Diam. est. [mm]
	99,8
	Fitted Diam./Diam. montaggio [mm]
79	
Inner Thread/Filett int. [mm]	
M24 x 1,5 By-pass	
TATA - TOYOTA	

10-02-207	
	Length/Lungh. [mm]
	138,4
	Outer Diam./Diam. est. [mm]
	92
	Inner Diam./Diam. int. [mm]
18,5	
Inner Diam. 1/Diam. int. 1 [mm]	
18,5	
TOYOTA	

10-02-213	
	Length/Lungh. [mm]
	121,5
	Outer Diam./Diam. est. [mm]
	100
	Fitted Diam./Diam. montaggio [mm]
80	
Inner Thread/Filett int. [mm]	
M24 x 1,5 By-pass	
TOYOTA	

10-02-208	
	Length/Lungh. [mm]
	109,6
	Outer Diam./Diam. est. [mm]
	72,3
Inner Diam./Diam. int. [mm]	
19,4	
TOYOTA	

10-02-214	
	Length/Lungh. [mm]
	91
	Outer Diam./Diam. est. [mm]
	65,4
	Fitted Diam./Diam. montaggio [mm]
62	
Inner Thread/Filett int. [mm]	
3/4 x 16	
TOYOTA	

10-02-215	
	Length/Lungh. [mm]
	102
	Outer Diam./Diam. est. [mm]
	73,5
	Fitted Diam./Diam. montaggio [mm]
70	
Inner Thread/Filett int. [mm]	
3/4 x 16	
LEXUS - MAZDA - TOYOTA	

10-03-306	
	Length/Lungh. [mm]
	84,3
	Outer Diam./Diam. est. [mm]
	101,4
	Fitted Diam./Diam. montaggio [mm]
98,5	
Inner Thread/Filett int. [mm]	
M20 x 1,5	
By-pass	
KIA - MAZDA	

10-02-278	
	Length/Lungh. [mm]
	77
	Outer Diam./Diam. est. [mm]
	65
	Fitted Diam./Diam. montaggio [mm]
63	
Inner Thread/Filett int. [mm]	
3/4 x 16	
Subst. by 10-02-210	

10-03-307	
	Length/Lungh. [mm]
	102
	Outer Diam./Diam. est. [mm]
	80
	Fitted Diam./Diam. montaggio [mm]
63	
Inner Thread/Filett int. [mm]	
M20 x 1,5	

10-02-279	
	Length/Lungh. [mm]
	87,2
	Outer Diam./Diam. est. [mm]
	76,5
	Fitted Diam./Diam. montaggio [mm]
71,4	
Inner Thread/Filett int. [mm]	
3/4 x 16	
DR - JEEP - MAZDA - SUZUKI - TOYOTA	

10-03-308	
	Length/Lungh. [mm]
	175
	Outer Diam./Diam. est. [mm]
	94,5
	Fitted Diam./Diam. montaggio [mm]
99,5	
Inner Thread/Filett int. [mm]	
1 - 12 UNF	
MAZDA	

10-02-297	
	Length/Lungh. [mm]
	104,5
	Outer Diam./Diam. est. [mm]
	100
	Fitted Diam./Diam. montaggio [mm]
79	
Inner Thread/Filett int. [mm]	
M24 x 1,5	
By-pass	
TOYOTA	

10-03-312	
	Length/Lungh. [mm]
	127
	Outer Diam./Diam. est. [mm]
	80
	Fitted Diam./Diam. montaggio [mm]
62	
Inner Thread/Filett int. [mm]	
M 20 X 1,5	

10-03-300	
	Length/Lungh. [mm]
	82
	Outer Diam./Diam. est. [mm]
	90
	Fitted Diam./Diam. montaggio [mm]
87	
Inner Thread/Filett int. [mm]	
M20 x 1,5	

10-03-313	
	Length/Lungh. [mm]
	67
	Outer Diam./Diam. est. [mm]
	68
	Fitted Diam./Diam. montaggio [mm]
63	
Inner Thread/Filett int. [mm]	
M20 x 1,5	
HONDA - KIA - MAZDA - SUBARU	



10-03-314	
	Length/Lungh. [mm]
	125
	Outer Diam./Diam. est. [mm]
	89,8
	Fitted Diam./Diam. montaggio [mm]
	86
Inner Thread/Filett int. [mm]	
M26 x 1,5	
	By-pass
CHEVROLET - DAIHATSU - MAZDA - SUZUKI	

10-03-321	
	Length/Lungh. [mm]
	101,5
	Outer Diam./Diam. est. [mm]
	93
	Fitted Diam./Diam. montaggio [mm]
	65
Inner Thread/Filett int. [mm]	
M 20 X 1,5	
KIA - MITSUBISHI - TATA	

10-03-315	
	Length/Lungh. [mm]
	86,4
	Outer Diam./Diam. est. [mm]
	68,1
	Fitted Diam./Diam. montaggio [mm]
	64
Inner Thread/Filett int. [mm]	
M20 x 1,5	
KIA - MAZDA	

10-03-351	
	Length/Lungh. [mm]
	82,5
	Outer Diam./Diam. est. [mm]
	65
	Inner Diam./Diam. int. [mm]
	25,5
Inner Diam. 1/Diam. int. 1 [mm]	
20	
CITROEN - MAZDA - SUZUKI - TOYOTA	

10-03-316	
	Length/Lungh. [mm]
	86,6
	Outer Diam./Diam. est. [mm]
	68
	Fitted Diam./Diam. montaggio [mm]
	63
Inner Thread/Filett int. [mm]	
M20 x 1,5	
INFINITI - MAZDA - MITSUBISHI	

10-03-390	
	Length/Lungh. [mm]
	87,4
	Outer Diam./Diam. est. [mm]
	76,5
	Fitted Diam./Diam. montaggio [mm]
	71
Inner Thread/Filett int. [mm]	
3/4 x 16	
Subst. by 10-02-279	

10-03-317	
	Length/Lungh. [mm]
	100,5
	Outer Diam./Diam. est. [mm]
	90
	Fitted Diam./Diam. montaggio [mm]
	87
Inner Thread/Filett int. [mm]	
M26 x 1,5	
	By-pass
MAZDA	

10-03-394	
	Length/Lungh. [mm]
	97
	Outer Diam./Diam. est. [mm]
	71,3
	Fitted Diam./Diam. montaggio [mm]
	71
Inner Thread/Filett int. [mm]	
3/4 x 16	
MAZDA	

10-03-320	
	Length/Lungh. [mm]
	122
	Outer Diam./Diam. est. [mm]
	75,6
	Fitted Diam./Diam. montaggio [mm]
	72
Inner Thread/Filett int. [mm]	
3/4 x 16 UNF	
MAZDA	

10-03-396	
	Length/Lungh. [mm]
	128
	Outer Diam./Diam. est. [mm]
	102
	Fitted Diam./Diam. montaggio [mm]
	72
Inner Thread/Filett int. [mm]	
M26 x 1,5	
Subst. by 10-05-505	

10-03-397	
	Length/Lungh. [mm]
	153
	Outer Diam./Diam. est. [mm]
	79
	Fitted Diam./Diam. montaggio [mm]
	64
	Inner Thread/Filett int. [mm]
	M20 x 1,5
MAZDA	

10-04-403	
	Length/Lungh. [mm]
	83
	Outer Diam./Diam. est. [mm]
	90
	Fitted Diam./Diam. montaggio [mm]
	64,5
	Inner Thread/Filett int. [mm]
	M22 x 1,5
Subst. by 10-04-402	

10-03-398	
	Length/Lungh. [mm]
	86
	Outer Diam./Diam. est. [mm]
	76
	Fitted Diam./Diam. montaggio [mm]
	71
	Inner Thread/Filett int. [mm]
	M18 x 1,5
CHEVROLET - DAEWOO - LADA	

10-04-406	
	Length/Lungh. [mm]
	102,3
	Outer Diam./Diam. est. [mm]
	78
	Fitted Diam./Diam. montaggio [mm]
	63
	Inner Thread/Filett int. [mm]
	M20 x 1,5
DAIHATSU - HONDA - ISUZU - MAZDA - SUBARU	

10-03-399	
	Length/Lungh. [mm]
	127,5
	Outer Diam./Diam. est. [mm]
	102,3
	Fitted Diam./Diam. montaggio [mm]
	99,5
	Inner Thread/Filett int. [mm]
	M20 x 1,5
Subst. by 10-09-900	

10-04-407	
	Length/Lungh. [mm]
	112
	Outer Diam./Diam. est. [mm]
	80
	Fitted Diam./Diam. montaggio [mm]
	77
	Inner Thread/Filett int. [mm]
	M22 x 1,5
HONDA	

10-04-401	
	Length/Lungh. [mm]
	82
	Outer Diam./Diam. est. [mm]
	90
	Fitted Diam./Diam. montaggio [mm]
	64,7
	Inner Thread/Filett int. [mm]
	M20 x 1,5
HONDA	

10-04-408	
	Length/Lungh. [mm]
	112
	Outer Diam./Diam. est. [mm]
	71
	Inner Diam./Diam. int. [mm]
	23,4
	Fitted Diam./Diam. montaggio [mm]
	34,6
HONDA	

10-04-402	
	Length/Lungh. [mm]
	82,8
	Outer Diam./Diam. est. [mm]
	90
	Fitted Diam./Diam. montaggio [mm]
	64,4
	Inner Thread/Filett int. [mm]
	M22 x 1,5
HONDA	

10-04-410	
	Length/Lungh. [mm]
	86,7
	Outer Diam./Diam. est. [mm]
	65
	Fitted Diam./Diam. montaggio [mm]
	62,7
	Inner Thread/Filett int. [mm]
	M20 x 1,5
HONDA - MITSUBISHI	



10-04-497	
	Length/Lungh. [mm]
	82
	Outer Diam./Diam. est. [mm]
	94
	Fitted Diam./Diam. montaggio [mm]
89	
Outer Thread/Filett est. [mm]	
13 / 16X16	
HONDA - LAND ROVER	

10-05-505	
	Length/Lungh. [mm]
	127,4
	Outer Diam./Diam. est. [mm]
	102,4
	Fitted Diam./Diam. montaggio [mm]
73	
Inner Thread/Filett int. [mm]	
M26 x 1,5	
By-pass	
HYUNDAI - KIA - MAZDA - MITSUBISHI	

10-04-498	
	Length/Lungh. [mm]
	92
	Outer Diam./Diam. est. [mm]
	76
	Fitted Diam./Diam. montaggio [mm]
62	
Inner Thread/Filett int. [mm]	
M20 x 1,5	
HONDA	

10-05-506	
	Length/Lungh. [mm]
	147,5
	Outer Diam./Diam. est. [mm]
	90
	Fitted Diam./Diam. montaggio [mm]
86	
Inner Thread/Filett int. [mm]	
M26 x 1,5	
By-pass	
MITSUBISHI	

10-05-502	
	Length/Lungh. [mm]
	81
	Outer Diam./Diam. est. [mm]
	90
	Fitted Diam./Diam. montaggio [mm]
63	
Inner Thread/Filett int. [mm]	
M20 x 1,5	
CHRYSLER - HYUNDAI - MAZDA - MITSUBISHI	

10-05-507	
	Length/Lungh. [mm]
	100
	Outer Diam./Diam. est. [mm]
	90
	Fitted Diam./Diam. montaggio [mm]
63	
Inner Thread/Filett int. [mm]	
M18 x 1,5	
MITSUBISHI	

10-05-503	
	Length/Lungh. [mm]
	125,6
	Outer Diam./Diam. est. [mm]
	90
	Fitted Diam./Diam. montaggio [mm]
63	
Inner Thread/Filett int. [mm]	
M20 x 1,5	
DAIHATSU - HONDA - MAZDA - NISSAN	

10-05-508	
	Length/Lungh. [mm]
	83
	Outer Diam./Diam. est. [mm]
	102
	Fitted Diam./Diam. montaggio [mm]
73	
Inner Thread/Filett int. [mm]	
M26 x 1,5	
By-pass	
MITSUBISHI	

10-05-505P	
	Length/Lungh. [mm]
	126
	Outer Diam./Diam. est. [mm]
	99,7
	Fitted Diam./Diam. montaggio [mm]
72	
Inner Thread/Filett int. [mm]	
M26 x 1,5	
HYUNDAI - KIA - MAZDA - MITSUBISHI	

10-05-509	
	Length/Lungh. [mm]
	152
	Outer Diam./Diam. est. [mm]
	106,5
	Fitted Diam./Diam. montaggio [mm]
71,6	
Inner Thread/Filett int. [mm]	
M26 x 1,5	
By-pass	
Subst. by 10-05-597	

10-05-510	
	Length/Lungh. [mm]
	67
	Outer Diam./Diam. est. [mm]
	80,3
	Fitted Diam./Diam. montaggio [mm]
63	
Inner Thread/Filett int. [mm]	
M20 x 1,5	
CHRYSLER - GONOW - MITSUBISHI	

10-05-583	
	Length/Lungh. [mm]
	312
	Outer Diam./Diam. est. [mm]
	127,5
	Inner Diam./Diam. int. [mm]
	58
	Inner Diam. 1/Diam. int. 1 [mm]
21	
Fitted Diam./Diam. montaggio [mm]	
84	
HYUNDAI - ISUZU - KIA - MAZDA	

10-05-578	
	Length/Lungh. [mm]
	160
	Outer Diam./Diam. est. [mm]
	108
	Fitted Diam./Diam. montaggio [mm]
103	
Inner Thread/Filett int. [mm]	
1 1/8 - 16 UNF	
MITSUBISHI	

10-05-593	
	Length/Lungh. [mm]
	77,6
	Outer Diam./Diam. est. [mm]
	68
	Fitted Diam./Diam. montaggio [mm]
	64
Inner Thread/Filett int. [mm]	
M20 x 1,5	
HYUNDAI - KIA	

10-05-580	
	Length/Lungh. [mm]
	109,6
	Outer Diam./Diam. est. [mm]
	91
Inner Diam. 1/Diam. int. 1 [mm]	
18,5	
MITSUBISHI	

10-05-595	
	Length/Lungh. [mm]
	69
	Outer Diam./Diam. est. [mm]
	94,5
	Fitted Diam./Diam. montaggio [mm]
	70,5
Inner Thread/Filett int. [mm]	
M20 x 1,5	
JEEP - MITSUBISHI - OPEL	

10-05-581	
	Length/Lungh. [mm]
	162,8
	Outer Diam./Diam. est. [mm]
	91,4
	Inner Diam./Diam. int. [mm]
18,5	
Inner Diam. 1/Diam. int. 1 [mm]	
18,5	
MITSUBISHI	

10-05-597	
	Length/Lungh. [mm]
	152
	Outer Diam./Diam. est. [mm]
	102,3
	Fitted Diam./Diam. montaggio [mm]
	71,6
	Inner Thread/Filett int. [mm]
26 X 1,5 By-pass	
FIAT - MITSUBISHI	

10-05-582	
	Length/Lungh. [mm]
	199,5
	Outer Diam./Diam. est. [mm]
	110
	Inner Diam./Diam. int. [mm]
	33,8
Inner Diam. 1/Diam. int. 1 [mm]	
18,4	
Fitted Diam./Diam. montaggio [mm]	
44,4	
HYUNDAI - ISUZU - KIA - MAZDA	

10-05-599	
	Length/Lungh. [mm]
	76
	Outer Diam./Diam. est. [mm]
	80
	Fitted Diam./Diam. montaggio [mm]
	64
Inner Thread/Filett int. [mm]	
M20 x 1,5	
HYUNDAI - ISUZU - KIA - MAZDA	

10-06-601	
	Length/Lungh. [mm]
	77
	Outer Diam./Diam. est. [mm]
	80
	Fitted Diam./Diam. montaggio [mm]
63	
Inner Thread/Filett int. [mm]	
3/4 - 16 UNF	
CHEVROLET - DAEWOO - DAIHATSU - SUZUKI	

10-07-706	
	Length/Lungh. [mm]
	76
	Outer Diam./Diam. est. [mm]
	80
	Fitted Diam./Diam. montaggio [mm]
62	
Inner Thread/Filett int. [mm]	
M20 x 1,5	
SUBARU	

10-06-604	
	Length/Lungh. [mm]
	67
	Outer Diam./Diam. est. [mm]
	68
	Fitted Diam./Diam. montaggio [mm]
64	
Inner Thread/Filett int. [mm]	
3/4 x 16	
DAIHATSU - PIAGGIO - SUZUKI	

10-08-800	
	Length/Lungh. [mm]
	102
	Outer Diam./Diam. est. [mm]
	80
	Fitted Diam./Diam. montaggio [mm]
63	
Inner Thread/Filett int. [mm]	
3/4 - 16 UNF	
SUZUKI	

10-06-699	
	Length/Lungh. [mm]
	87,4
	Outer Diam./Diam. est. [mm]
	76
	Fitted Diam./Diam. montaggio [mm]
71	
Inner Thread/Filett int. [mm]	
M20 x 1,5	
DAEWOO - DAIHATSU - PIAGGIO	

10-08-891	
	Length/Lungh. [mm]
	57
	Outer Diam./Diam. est. [mm]
	76
	Fitted Diam./Diam. montaggio [mm]
71,4	
Inner Thread/Filett int. [mm]	
M20 x 1,5	
JEEP - NISSAN - SUZUKI	

10-07-703	
	Length/Lungh. [mm]
	77
	Outer Diam./Diam. est. [mm]
	80
	Fitted Diam./Diam. montaggio [mm]
63	
Inner Thread/Filett int. [mm]	
M20 x 1,5	
ISUZU - MITSUBISHI - SUBARU	

10-08-893	
	Length/Lungh. [mm]
	89,7
	Outer Diam./Diam. est. [mm]
	87,4
	Fitted Diam./Diam. montaggio [mm]
71	
Inner Thread/Filett int. [mm]	
M20 x 1,5	
SUZUKI	

10-07-705	
	Length/Lungh. [mm]
	72,7
	Outer Diam./Diam. est. [mm]
	80,5
	Fitted Diam./Diam. montaggio [mm]
63	
Inner Thread/Filett int. [mm]	
M20 x 1,5	
SUBARU	

10-08-898	
	Length/Lungh. [mm]
	87
	Outer Diam./Diam. est. [mm]
	68
	Fitted Diam./Diam. montaggio [mm]
62,6	
Inner Thread/Filett int. [mm]	
3/4 - 16 UNF	
SUBARU - SUZUKI	

10-09-900	
	Length/Lungh. [mm]
	127
	Outer Diam./Diam. est. [mm]
	101
	Fitted Diam./Diam. montaggio [mm]
98	
Inner Thread/Filett int. [mm]	
M20 x 1,5	
ISUZU - MITSUBISHI - SSANGYONG	

10-09-910	
	Length/Lungh. [mm]
	84
	Outer Diam./Diam. est. [mm]
	101,5
	Fitted Diam./Diam. montaggio [mm]
98	
Inner Thread/Filett int. [mm]	
5/8 - 18 UNF By-pass	
ISUZU	

10-09-901	
	Length/Lungh. [mm]
	125
	Outer Diam./Diam. est. [mm]
	90,4
	Fitted Diam./Diam. montaggio [mm]
86	
Inner Thread/Filett int. [mm]	
M20 x 1,5	
ISUZU - JEEP	

10-09-912	
	Length/Lungh. [mm]
	160,6
	Outer Diam./Diam. est. [mm]
	80
	Fitted Diam./Diam. montaggio [mm]
75	
Inner Thread/Filett int. [mm]	
M26 X 1,5	
ISUZU	

10-09-902	
	Length/Lungh. [mm]
	142
	Outer Diam./Diam. est. [mm]
	72
	Inner Diam./Diam. int. [mm]
	34
	Inner Diam. 1/Diam. int. 1 [mm]
34	
Fitted Diam./Diam. montaggio [mm]	
43	
ISUZU - JEEP	

10-09-913	
	Length/Lungh. [mm]
	122
	Outer Diam./Diam. est. [mm]
	75,5
	Fitted Diam./Diam. montaggio [mm]
72	
Inner Thread/Filett int. [mm]	
3/4 - 16 UNF	
CHRYSLER - JEEP	

10-09-904	
	Length/Lungh. [mm]
	133
	Outer Diam./Diam. est. [mm]
	108
	Fitted Diam./Diam. montaggio [mm]
72	
Inner Thread/Filett int. [mm]	
1 - 12 UNF By-pass	
ISUZU	

10-09-914	
	Length/Lungh. [mm]
	81,7
	Outer Diam./Diam. est. [mm]
	80
	Fitted Diam./Diam. montaggio [mm]
61,5	
Inner Thread/Filett int. [mm]	
M20 x 1,5	
HONDA	

10-09-906	
	Length/Lungh. [mm]
	93
	Outer Diam./Diam. est. [mm]
	90
	Fitted Diam./Diam. montaggio [mm]
86	
Inner Thread/Filett int. [mm]	
M20 x 1,5	
ISUZU - TOYOTA	

10-09-985	
	Length/Lungh. [mm]
	97
	Outer Diam./Diam. est. [mm]
	94
	Fitted Diam./Diam. montaggio [mm]
72	
Inner Thread/Filett int. [mm]	
3/4 - 16 UNF	
JEEP - LADA	

10-09-986	
	Length/Lungh. [mm]
	100
	Outer Diam./Diam. est. [mm]
	94
	Fitted Diam./Diam. montaggio [mm]
73	
Inner Thread/Filett int. [mm]	
3/4 - 16 UNF	
CHRYSLER - DODGE - JEEP - PIAGGIO	

10-09-997	
	Length/Lungh. [mm]
	168
	Outer Diam./Diam. est. [mm]
	82,7
	Inner Diam./Diam. int. [mm]
	14
	Inner Diam. 1/Diam. int. 1 [mm]
27	
Fitted Diam./Diam. montaggio [mm]	
24,3	
DAEWOO - SSANGYONG	

10-09-989	
	Length/Lungh. [mm]
	101
	Outer Diam./Diam. est. [mm]
	94,6
	Fitted Diam./Diam. montaggio [mm]
71	
Inner Thread/Filett int. [mm]	
M20 x 1,5	
JEEP	

10-09-998	
	Length/Lungh. [mm]
	170
	Outer Diam./Diam. est. [mm]
	83
	Inner Diam./Diam. int. [mm]
	14
	Inner Diam. 1/Diam. int. 1 [mm]
27	
Fitted Diam./Diam. montaggio [mm]	
24,3	
Subst. by 10-09-997	

10-09-990	
	Length/Lungh. [mm]
	89
	Outer Diam./Diam. est. [mm]
	95,4
	Fitted Diam./Diam. montaggio [mm]
70,5	
Inner Thread/Filett int. [mm]	
M20 x 1,5	
JEEP	

10-09-999	
	Length/Lungh. [mm]
	150
	Outer Diam./Diam. est. [mm]
	120
	Fitted Diam./Diam. montaggio [mm]
115	
Inner Thread/Filett int. [mm]	
1 1/2 x 12	
ISUZU	

10-09-995	
	Length/Lungh. [mm]
	113
	Outer Diam./Diam. est. [mm]
	83
	Inner Diam./Diam. int. [mm]
	42
Inner Diam. 1/Diam. int. 1 [mm]	
25	
Fitted Diam./Diam. montaggio [mm]	
63	
Subst. by 10-ECO013	

10-ECO001	
	Length/Lungh. [mm]
	313
	Outer Diam./Diam. est. [mm]
	117
	Inner Diam./Diam. int. [mm]
	56
Fitted Diam./Diam. montaggio [mm]	
45	
AUDI - CHRYSLER - DAEWOO - JEEP	

10-09-996	
	Length/Lungh. [mm]
	87,5
	Outer Diam./Diam. est. [mm]
	65
	Fitted Diam./Diam. montaggio [mm]
62	
Inner Thread/Filett int. [mm]	
M20 x 1,5	
ISUZU	

10-ECO002	
	Length/Lungh. [mm]
	148
	Outer Diam./Diam. est. [mm]
	121,3
	Inner Diam./Diam. int. [mm]
	50
Fitted Diam./Diam. montaggio [mm]	
72	
HONDA - LADA - TOYOTA	

10-ECO003	
	Length/Lungh. [mm]
	79
	Outer Diam./Diam. est. [mm]
	52,5
	Inner Diam./Diam. int. [mm]
20	
Fitted Diam./Diam. montaggio [mm]	
33,5	
MERCEDES-BENZ	

10-ECO008	
	Length/Lungh. [mm]
	154
	Outer Diam./Diam. est. [mm]
	65
	Inner Diam./Diam. int. [mm]
22	
Fitted Diam./Diam. montaggio [mm]	
40	
AUDI - FORD - SEAT - SKODA - VW	

10-ECO004	
	Length/Lungh. [mm]
	105
	Outer Diam./Diam. est. [mm]
	65
	Inner Diam./Diam. int. [mm]
21	
Fitted Diam./Diam. montaggio [mm]	
40	
BMW	

10-ECO009	
	Length/Lungh. [mm]
	161
	Outer Diam./Diam. est. [mm]
	62
	Inner Diam./Diam. int. [mm]
18,5	
Fitted Diam./Diam. montaggio [mm]	
33	
DAEWOO - MERCEDES-BENZ - SSANGYONG -	

10-ECO005	
	Length/Lungh. [mm]
	115
	Outer Diam./Diam. est. [mm]
	65
	Inner Diam./Diam. int. [mm]
28	
OPEL - SAAB - VAUXHALL	

10-ECO010	
	Length/Lungh. [mm]
	197
	Outer Diam./Diam. est. [mm]
	72,4
	Inner Diam./Diam. int. [mm]
32	
Inner Diam. 1/Diam. int. 1 [mm]	
11	
Fitted Diam./Diam. montaggio [mm]	
31,3	
AUDI - SKODA - VW	

10-ECO006	
	Length/Lungh. [mm]
	115
	Outer Diam./Diam. est. [mm]
	65
	Inner Diam./Diam. int. [mm]
27	
Fitted Diam./Diam. montaggio [mm]	
42	
CHRYSLER - MERCEDES-BENZ	

10-ECO011	
	Length/Lungh. [mm]
	165
	Outer Diam./Diam. est. [mm]
	83
	Inner Diam./Diam. int. [mm]
33	
Fitted Diam./Diam. montaggio [mm]	
51	
BMW - LAND ROVER - OPEL - VAUXHALL	

10-ECO007	
	Length/Lungh. [mm]
	116
	Outer Diam./Diam. est. [mm]
	65
	Inner Diam./Diam. int. [mm]
28	
Fitted Diam./Diam. montaggio [mm]	
42	
Subst. by 10-ECO021	

10-ECO012	
	Length/Lungh. [mm]
	106
	Outer Diam./Diam. est. [mm]
	83
	Inner Diam./Diam. int. [mm]
38	
Fitted Diam./Diam. montaggio [mm]	
54	
BMW - LAND ROVER - VOLVO	





10-ECO013	
	Length/Lungh. [mm]
	113
	Outer Diam./Diam. est. [mm]
	83
	Inner Diam./Diam. int. [mm]
	36
Inner Diam. 1/Diam. int. 1 [mm]	
20	
Fitted Diam./Diam. montaggio [mm]	
63	
AUDI - FORD - JEEP - SEAT - VW	

10-ECO019	
	Length/Lungh. [mm]
	90
	Outer Diam./Diam. est. [mm]
	62
	Inner Diam./Diam. int. [mm]
	28,5
Fitted Diam./Diam. montaggio [mm]	
53	
CHEVROLET - FIAT - OPEL	

10-ECO014	
	Length/Lungh. [mm]
	161
	Outer Diam./Diam. est. [mm]
	83,6
	Inner Diam./Diam. int. [mm]
	36
Inner Diam. 1/Diam. int. 1 [mm]	
25	
Fitted Diam./Diam. montaggio [mm]	
35	
BMW - LAND ROVER - MORGAN	

10-ECO020	
	Length/Lungh. [mm]
	152
	Outer Diam./Diam. est. [mm]
	83,2
	Inner Diam./Diam. int. [mm]
	35
Inner Diam. 1/Diam. int. 1 [mm]	
9	
Fitted Diam./Diam. montaggio [mm]	
27,5	
MAZDA - NISSAN - SUBARU - SUZUKI	

10-ECO015	
	Length/Lungh. [mm]
	216
	Outer Diam./Diam. est. [mm]
	83
	Inner Diam./Diam. int. [mm]
	36
Fitted Diam./Diam. montaggio [mm]	
28	
AUDI - MITSUBISHI - NISSAN - TOYOTA	

10-ECO021	
	Length/Lungh. [mm]
	116
	Outer Diam./Diam. est. [mm]
	64
	Inner Diam./Diam. int. [mm]
	31
Fitted Diam./Diam. montaggio [mm]	
47	
BMW - JEEP - LAND ROVER - ROVER	

10-ECO017	
	Length/Lungh. [mm]
	88
	Outer Diam./Diam. est. [mm]
	62
	Inner Diam./Diam. int. [mm]
	27
Inner Diam. 1/Diam. int. 1 [mm]	
9	
Fitted Diam./Diam. montaggio [mm]	
27,4	
OPEL - VAUXHALL	

10-ECO022	
	Length/Lungh. [mm]
	60
	Outer Diam./Diam. est. [mm]
	91
	Inner Diam./Diam. int. [mm]
	33,4
Fitted Diam./Diam. montaggio [mm]	
52	
FORD - JAGUAR	

10-ECO018	
	Length/Lungh. [mm]
	79,5
	Outer Diam./Diam. est. [mm]
	62,2
	Inner Diam./Diam. int. [mm]
	28
Fitted Diam./Diam. montaggio [mm]	
24,5	
OPEL - SAAB - VAUXHALL	

10-ECO023	
	Length/Lungh. [mm]
	141
	Outer Diam./Diam. est. [mm]
	71,4
	Inner Diam./Diam. int. [mm]
	29,4
Inner Diam. 1/Diam. int. 1 [mm]	
23	
Fitted Diam./Diam. montaggio [mm]	
53	
CHRYSLER - DODGE - JEEP - MITSUBISHI	

10-ECO024	
	Length/Lungh. [mm]
	91
	Outer Diam./Diam. est. [mm]
	53
	Inner Diam./Diam. int. [mm]
25	
Fitted Diam./Diam. montaggio [mm]	
37	
RENAULT	

10-ECO032	
	Length/Lungh. [mm]
	125
	Outer Diam./Diam. est. [mm]
	65
	Inner Diam./Diam. int. [mm]
28	
Fitted Diam./Diam. montaggio [mm]	
42	
FORD - VOLVO	

10-ECO028	
	Length/Lungh. [mm]
	89
	Outer Diam./Diam. est. [mm]
	65
	Outer Diam. 1/Diam. est. 1 [mm]
	62
Inner Diam./Diam. int. [mm]	
35	
Inner Diam. 1/Diam. int. 1 [mm]	
29	
Fitted Diam./Diam. montaggio [mm]	
52	

10-ECO033	
	Length/Lungh. [mm]
	79
	Outer Diam./Diam. est. [mm]
	73
	Inner Diam./Diam. int. [mm]
23	
Fitted Diam./Diam. montaggio [mm]	
40	
VOLVO	

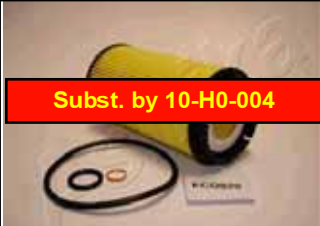
10-ECO029	
	Length/Lungh. [mm]
	118
	Outer Diam./Diam. est. [mm]
	62
	Inner Diam./Diam. int. [mm]
27,5	
Fitted Diam./Diam. montaggio [mm]	
54	
Subst. by 10-H0-004	

10-ECO034	
	Length/Lungh. [mm]
	213
	Outer Diam./Diam. est. [mm]
	83,4
	Inner Diam./Diam. int. [mm]
	36
Inner Diam. 1/Diam. int. 1 [mm]	
9	
Fitted Diam./Diam. montaggio [mm]	
28	
NISSAN - SSANGYONG - SUZUKI - TOYOTA	

10-ECO030	
	Length/Lungh. [mm]
	93
	Outer Diam./Diam. est. [mm]
	91
	Inner Diam./Diam. int. [mm]
33	
Fitted Diam./Diam. montaggio [mm]	
52	
MERCEDES-BENZ - NISSAN - OPEL - RENAULT	

10-ECO035	
	Length/Lungh. [mm]
	78
	Outer Diam./Diam. est. [mm]
	73
	Inner Diam./Diam. int. [mm]
24	
Fitted Diam./Diam. montaggio [mm]	
41	
BMW - LAND ROVER - OPEL - VAUXHALL	

10-ECO031	
	Length/Lungh. [mm]
	174
	Outer Diam./Diam. est. [mm]
	83
	Inner Diam./Diam. int. [mm]
33	
Fitted Diam./Diam. montaggio [mm]	
50	
DAEWOO - MERCEDES-BENZ - OPEL - SSANGYONG	

10-ECO036	
	Length/Lungh. [mm]
	74
	Outer Diam./Diam. est. [mm]
	65
	Inner Diam./Diam. int. [mm]
28	
Fitted Diam./Diam. montaggio [mm]	
43	
FORD - MAZDA	

10-ECO037	
	Length/Lungh. [mm]
	140
	Outer Diam./Diam. est. [mm]
	59
	Inner Diam./Diam. int. [mm]
	22
CITROEN - PEUGEOT	

10-ECO042	
	Length/Lungh. [mm]
	104
	Outer Diam./Diam. est. [mm]
	73
	Inner Diam./Diam. int. [mm]
	34
	Inner Diam. 1/Diam. int. 1 [mm]
	9
	Fitted Diam./Diam. montaggio [mm]
	32
BMW	

10-ECO038	
	Length/Lungh. [mm]
	94
	Outer Diam./Diam. est. [mm]
	72
	Inner Diam./Diam. int. [mm]
	31
	Fitted Diam./Diam. montaggio [mm]
	47
HONDA - OPEL - VAUXHALL	

10-ECO043	
	Length/Lungh. [mm]
	118
	Outer Diam./Diam. est. [mm]
	62
	Inner Diam./Diam. int. [mm]
	28
	Fitted Diam./Diam. montaggio [mm]
	54
Subst. by 10-H0-004	

10-ECO039	
	Length/Lungh. [mm]
	117
	Outer Diam./Diam. est. [mm]
	53
	Inner Diam./Diam. int. [mm]
	19
	Fitted Diam./Diam. montaggio [mm]
	33
MERCEDES-BENZ	

10-ECO044	
	Length/Lungh. [mm]
	81
	Outer Diam./Diam. est. [mm]
	65,5
	Inner Diam./Diam. int. [mm]
	24
	Fitted Diam./Diam. montaggio [mm]
	53,5
ALFA ROMEO - FIAT - OPEL - SUZUKI	

10-ECO040	
	Length/Lungh. [mm]
	216
	Outer Diam./Diam. est. [mm]
	62
	Inner Diam./Diam. int. [mm]
	19
	Fitted Diam./Diam. montaggio [mm]
	33
MERCEDES-BENZ	

10-ECO045	
	Length/Lungh. [mm]
	120,4
	Outer Diam./Diam. est. [mm]
	60,5
	Inner Diam./Diam. int. [mm]
	25,5
	Fitted Diam./Diam. montaggio [mm]
	39
GASOLONE - HYUNDAI - KIA	

10-ECO041	
	Length/Lungh. [mm]
	139
	Outer Diam./Diam. est. [mm]
	63,5
	Inner Diam./Diam. int. [mm]
	31,5
	Fitted Diam./Diam. montaggio [mm]
	46
MERCEDES-BENZ	

10-ECO048	
	Length/Lungh. [mm]
	151
	Outer Diam./Diam. est. [mm]
	88,5
	Inner Diam./Diam. int. [mm]
	25,5
CITROEN - JAGUAR - LAND ROVER - PEUGEOT	

10-ECO050	
	Length/Lungh. [mm]
	115
	Outer Diam./Diam. est. [mm]
	53
	Inner Diam./Diam. int. [mm]
19	
Fitted Diam./Diam. montaggio [mm]	
33	
MERCEDES-BENZ	

10-ECO056	
	Length/Lungh. [mm]
	110
	Outer Diam./Diam. est. [mm]
	72
	Inner Diam./Diam. int. [mm]
33	
Fitted Diam./Diam. montaggio [mm]	
43,7	
HYUNDAI - KIA - MAZDA	

10-ECO051	
	Length/Lungh. [mm]
	84
	Outer Diam./Diam. est. [mm]
	60,2
	Inner Diam./Diam. int. [mm]
28	
Fitted Diam./Diam. montaggio [mm]	
14	
DAIHATSU - SUBARU - TOYOTA	

10-ECO057	
	Length/Lungh. [mm]
	82
	Outer Diam./Diam. est. [mm]
	70
	Inner Diam./Diam. int. [mm]
28	
Subst. by 10-ECO054	

10-ECO053	
	Length/Lungh. [mm]
	94,5
	Outer Diam./Diam. est. [mm]
	71
	Inner Diam./Diam. int. [mm]
31	
CHRYSLER - JEEP - MERCEDES-BENZ	

10-ECO058	
	Length/Lungh. [mm]
	73,5
	Outer Diam./Diam. est. [mm]
	64
	Inner Diam./Diam. int. [mm]
31	
FIAT - OPEL - SAAB - SUZUKI	

10-ECO054	
	Length/Lungh. [mm]
	82
	Outer Diam./Diam. est. [mm]
	70
	Inner Diam./Diam. int. [mm]
29	
LEXUS - TOYOTA	

10-ECO059	
	Length/Lungh. [mm]
	83
	Outer Diam./Diam. est. [mm]
	63
	Inner Diam./Diam. int. [mm]
26	
CHEVROLET - OPEL - VAUXHALL	

10-ECO055	
	Length/Lungh. [mm]
	94,5
	Outer Diam./Diam. est. [mm]
	64,4
	Inner Diam./Diam. int. [mm]
31	
Fitted Diam./Diam. montaggio [mm]	
46,5	
HONDA	

10-ECO060	
	Length/Lungh. [mm]
	70
	Outer Diam./Diam. est. [mm]
	67
	Inner Diam./Diam. int. [mm]
24	
FIAT - LAND ROVER - MINI - MITSUBISHI	

10-ECO061	
	Length/Lungh. [mm]
	155
	Outer Diam./Diam. est. [mm]
	47
	Inner Diam./Diam. int. [mm]
20	
Fitted Diam./Diam. montaggio [mm]	
34	
MERCEDES-BENZ	

10-ECO067	
	Length/Lungh. [mm]
	142
	Outer Diam./Diam. est. [mm]
	72
	Inner Diam./Diam. int. [mm]
26	
DODGE - JEEP	

10-ECO062	
	Length/Lungh. [mm]
	80
	Outer Diam./Diam. est. [mm]
	73
	Inner Diam./Diam. int. [mm]
36	
Fitted Diam./Diam. montaggio [mm]	
53	
BMW	

10-ECO068	
	Length/Lungh. [mm]
	113
	Outer Diam./Diam. est. [mm]
	58
	Inner Diam./Diam. int. [mm]
24	
NISSAN - OPEL - RENAULT - VAUXHALL	

10-ECO063	
	Length/Lungh. [mm]
	124
	Outer Diam./Diam. est. [mm]
	65
	Inner Diam./Diam. int. [mm]
28	
Fitted Diam./Diam. montaggio [mm]	
43	
AUDI - SEAT - SKODA - VW	

10-ECO069	
	Length/Lungh. [mm]
	196
	Outer Diam./Diam. est. [mm]
	75
	Inner Diam./Diam. int. [mm]
28	
Inner Diam. 1/Diam. int. 1 [mm]	
29	
AUDI - LAND ROVER - VW	

10-ECO064	
	Length/Lungh. [mm]
	150
	Outer Diam./Diam. est. [mm]
	83
	Inner Diam./Diam. int. [mm]
34	
Fitted Diam./Diam. montaggio [mm]	
50	
MERCEDES-BENZ	

10-ECO070	
	Length/Lungh. [mm]
	96
	Outer Diam./Diam. est. [mm]
	53
	Inner Diam./Diam. int. [mm]
	18
	Inner Diam. 1/Diam. int. 1 [mm]
18	
Fitted Diam./Diam. montaggio [mm]	
36	
ALFA ROMEO - CADILLAC	

10-ECO065	
	Length/Lungh. [mm]
	100
	Outer Diam./Diam. est. [mm]
	67
	Inner Diam./Diam. int. [mm]
14	
Fitted Diam./Diam. montaggio [mm]	
39	
ALFA ROMEO - CITROEN - FIAT - SUZUKI	

10-ECO071	
	Length/Lungh. [mm]
	117
	Outer Diam./Diam. est. [mm]
	70
	Inner Diam./Diam. int. [mm]
28	
Fitted Diam./Diam. montaggio [mm]	
35	
TOYOTA	

10-ECO072	
	Length/Lungh. [mm]
	124
	Outer Diam./Diam. est. [mm]
	65
	Inner Diam./Diam. int. [mm]
22	
Inner Diam. 1/Diam. int. 1 [mm]	
17	
CHRYSLER	

10-ECO077	
	Length/Lungh. [mm]
	67
	Outer Diam./Diam. est. [mm]
	70
Inner Diam./Diam. int. [mm]	
29	
SUBARU - TOYOTA	

10-ECO073	
	Length/Lungh. [mm]
	106
	Outer Diam./Diam. est. [mm]
	57
	Inner Diam./Diam. int. [mm]
	23
Inner Diam. 1/Diam. int. 1 [mm]	
9	
Fitted Diam./Diam. montaggio [mm]	
36	
ALFA ROMEO - CHEVROLET - FIAT - OPEL	

10-ECO078	
	Length/Lungh. [mm]
	56
	Outer Diam./Diam. est. [mm]
	60
Inner Diam./Diam. int. [mm]	
28	
TOYOTA	

10-ECO074	
	Length/Lungh. [mm]
	81
	Outer Diam./Diam. est. [mm]
	57
	Inner Diam./Diam. int. [mm]
	27
Inner Diam. 1/Diam. int. 1 [mm]	
10	
Fitted Diam./Diam. montaggio [mm]	
32	
MERCEDES-BENZ	

10-ECO079	
	Length/Lungh. [mm]
	80
	Outer Diam./Diam. est. [mm]
	72
	Inner Diam./Diam. int. [mm]
32	
Fitted Diam./Diam. montaggio [mm]	
42,5	
BMW	

10-ECO075	
	Length/Lungh. [mm]
	132
	Outer Diam./Diam. est. [mm]
	73
	Inner Diam./Diam. int. [mm]
40	
Fitted Diam./Diam. montaggio [mm]	
51	
HYUNDAI - KIA	

10-ECO080	
	Length/Lungh. [mm]
	87,5
	Outer Diam./Diam. est. [mm]
	82
Inner Diam./Diam. int. [mm]	
28	
BMW	

10-ECO076	
	Length/Lungh. [mm]
	104
	Outer Diam./Diam. est. [mm]
	65
Inner Diam./Diam. int. [mm]	
20	
HYUNDAI - KIA	

10-ECO081	
	Length/Lungh. [mm]
	103
	Outer Diam./Diam. est. [mm]
	76,5
	Inner Diam./Diam. int. [mm]
	32
Inner Diam. 1/Diam. int. 1 [mm]	
14	
Fitted Diam./Diam. montaggio [mm]	
31,5	
BMW	

10-ECO082	
	Length/Lungh. [mm]
	108
	Outer Diam./Diam. est. [mm]
	82
	Inner Diam./Diam. int. [mm]
30	
BMW	

10-ECO087	
	Length/Lungh. [mm]
	128
	Outer Diam./Diam. est. [mm]
	68
	Inner Diam./Diam. int. [mm]
	26
Inner Diam. 1/Diam. int. 1 [mm]	
20	
Fitted Diam./Diam. montaggio [mm]	
61	
AUDI - VW	

10-ECO083	
	Length/Lungh. [mm]
	108,5
	Outer Diam./Diam. est. [mm]
	82
Inner Diam./Diam. int. [mm]	
28	
BMW	

10-ECO088	
	Length/Lungh. [mm]
	135
	Outer Diam./Diam. est. [mm]
	64
Inner Diam./Diam. int. [mm]	
31	
MAYBACH - MERCEDES-BENZ	

10-ECO084	
	Length/Lungh. [mm]
	265
	Outer Diam./Diam. est. [mm]
	120,8
	Inner Diam./Diam. int. [mm]
	54
	Inner Diam. 1/Diam. int. 1 [mm]
14	
Fitted Diam./Diam. montaggio [mm]	
44	
AUDI - MAZDA	

10-ECO089	
	Length/Lungh. [mm]
	85
	Outer Diam./Diam. est. [mm]
	94,6
Inner Diam./Diam. int. [mm]	
24,5	
AUDI	

10-ECO085	
	Length/Lungh. [mm]
	144
	Outer Diam./Diam. est. [mm]
	73
	Inner Diam./Diam. int. [mm]
	36
Inner Diam. 1/Diam. int. 1 [mm]	
9	
Fitted Diam./Diam. montaggio [mm]	
45	
AUDI - VW	

10-ECO090	
	Length/Lungh. [mm]
	160,5
	Outer Diam./Diam. est. [mm]
	83
	Inner Diam./Diam. int. [mm]
	38
	Inner Diam. 1/Diam. int. 1 [mm]
24,5	
Fitted Diam./Diam. montaggio [mm]	
35,5	
ALPINA - BMW	

10-ECO086	
	Length/Lungh. [mm]
	112
	Outer Diam./Diam. est. [mm]
	83
	Inner Diam./Diam. int. [mm]
	37
Inner Diam. 1/Diam. int. 1 [mm]	
21	
Fitted Diam./Diam. montaggio [mm]	
63	
VW	

10-ECO091	
	Length/Lungh. [mm]
	127
	Outer Diam./Diam. est. [mm]
	82
Inner Diam./Diam. int. [mm]	
28	
ALPINA - BMW	

10-ECO092	
 <p>ECO092</p>	
	AUDI - SEAT - SKODA - VW

10-ECO098	
 <p>ECO098</p>	Length/Lungh. [mm]
	101
	Outer Diam./Diam. est. [mm]
	65
	Inner Diam./Diam. int. [mm]
	21
AUDI - SEAT - VW	

10-ECO093	
 <p>ECO093</p>	
	HYUNDAI

10-ECO099	
 <p>ECO099</p>	Length/Lungh. [mm]
	95
	Outer Diam./Diam. est. [mm]
	78
	Inner Diam./Diam. int. [mm]
	38
CITROEN - JAGUAR - LAND ROVER - PEUGEOT	

10-ECO094	
 <p>ECO094</p>	Length/Lungh. [mm]
	117
	Outer Diam./Diam. est. [mm]
	70
	Inner Diam./Diam. int. [mm]
	28
	Fitted Diam./Diam. montaggio [mm]
	35
LEXUS	

10-ECO100	
 <p>ECO100</p>	Length/Lungh. [mm]
	172
	Outer Diam./Diam. est. [mm]
	64
	Inner Diam./Diam. int. [mm]
	26
BMW	

10-ECO095	
 <p>ECO095</p>	Overall Length/Lungh. totale [mm]
	105
	Outer Diam./Diam. est. [mm]
	65,7
	Inner Diam./Diam. int. [mm]
	41
	Inner Diam. 1/Diam. int. 1 [mm]
	18
	Fitted Diam./Diam. montaggio [mm]
	48,5
ALFA ROMEO - FIAT - OPEL - SUZUKI	

10-ECO101	
 <p>ECO101</p>	Length/Lungh. [mm]
	154
	Outer Diam./Diam. est. [mm]
	71
	Inner Diam./Diam. int. [mm]
	30
BMW	

10-ECO096	
 <p>ECO096</p>	Length/Lungh. [mm]
	130
	Outer Diam./Diam. est. [mm]
	65
	Inner Diam./Diam. int. [mm]
	20
HYUNDAI - KIA	

10-ECO103	
 <p>ECO103</p>	Length/Lungh. [mm]
	157
	Outer Diam./Diam. est. [mm]
	65
	Inner Diam./Diam. int. [mm]
	18
	Fitted Diam./Diam. montaggio [mm]
	35
CHEVROLET	

10-ECO105		
 <p>ECO105</p> <p>SSANGYONG</p>	Length/Lungh. [mm]	125
	Outer Diam./Diam. est. [mm]	62
	Inner Diam./Diam. int. 1 [mm]	25
	Fitted Diam./Diam. montaggio [mm]	23

10-ECO111		
 <p>ECO111</p> <p>BMW</p>	Length/Lungh. [mm]	152
	Outer Diam./Diam. est. [mm]	65
	Inner Diam./Diam. int. [mm]	33

10-ECO107		
 <p>ECO107</p> <p>ALFA ROMEO - FIAT - LANCIA</p>	Length/Lungh. [mm]	155
	Outer Diam./Diam. est. [mm]	63
	Inner Diam./Diam. int. [mm]	32

10-ECO112		
 <p>ECO112</p> <p>BMW</p>	Length/Lungh. [mm]	108
	Outer Diam./Diam. est. [mm]	83
	Inner Diam./Diam. int. [mm]	32

10-ECO108		
 <p>ECO108</p> <p>AUDI - PORSCHE - VW</p>	Length/Lungh. [mm]	155
	Outer Diam./Diam. est. [mm]	64
	Inner Diam./Diam. int. [mm]	31

10-ECO113		
 <p>ECO113</p> <p>BMW</p>	Length/Lungh. [mm]	182
	Outer Diam./Diam. est. [mm]	91
	Inner Diam./Diam. int. [mm]	26

10-ECO109		
 <p>ECO109</p> <p>BMW</p>	Length/Lungh. [mm]	156
	Outer Diam./Diam. est. [mm]	64
	Inner Diam./Diam. int. [mm]	31

10-ECO115		
 <p>ECO115</p> <p>MERCEDES-BENZ</p>	Length/Lungh. [mm]	108
	Outer Diam./Diam. est. [mm]	83
	Inner Diam./Diam. int. [mm]	34

10-ECO110		
 <p>ECO110</p> <p>BMW</p>	Length/Lungh. [mm]	117
	Outer Diam./Diam. est. [mm]	83
	Inner Diam./Diam. int. [mm]	29
	Fitted Diam./Diam. montaggio [mm]	40

10-ECO116		
 <p>ECO116</p> <p>OPEL - VAUXHALL</p>	Length/Lungh. [mm]	92
	Outer Diam./Diam. est. [mm]	71
	Inner Diam./Diam. int. [mm]	31

10-ECO117	
	Length/Lungh. [mm]
	97
	Outer Diam./Diam. est. [mm]
	53
	Inner Diam./Diam. int. [mm]
19	
Fitted Diam./Diam. montaggio [mm]	
34	
CADILLAC - OPEL - SAAB - VAUXHALL	

10-GAS13S	
	Length/Lungh. [mm]
	99
	Outer Diam./Diam. est. [mm]
	50
	Diam. 1/ Diam. 2 [mm]
IN/OUT:14	
UNIVERSAL APPLICATIONS	

10-ECO118	
	Length/Lungh. [mm]
	63
	Outer Diam./Diam. est. [mm]
	63
	Inner Diam./Diam. int. [mm]
31	
SEAT - SKODA - VW	

10-GAS14S	
	Outer Diam./Diam. est. [mm]
	37
	Inner Diam./Diam. int. [mm]
	18
	Inner Diam. 1/Diam. int. 1 [mm]
	10
Fitted Diam./Diam. montaggio [mm]	
20	
Height/Altezza [mm]	
27	
IMP. BRC	

10-GAS10S	
	Length/Lungh. [mm]
	92
	Outer Diam./Diam. est. [mm]
	38
Diam. 1/ Diam. 2 [mm]	
13	
IMP. ROMANO	

10-GAS15S	
	Length/Lungh. [mm]
	100
	Inner Diam./Diam. int. [mm]
	50
Diam. 1/ Diam. 2 [mm]	
IN/OUT:12	
UNIVERSAL APPLICATIONS	

10-GAS11S	
	Length/Lungh. [mm]
	124
	Outer Diam./Diam. est. [mm]
	45
Diam. 1/ Diam. 2 [mm]	
12	
IMP. EMMEGAS	

10-GAS16S	
	Outer Diam./Diam. est. [mm]
	20,5
	Inner Diam./Diam. int. [mm]
	6
	Fitted Diam./Diam. montaggio [mm]
10,5	
Height/Altezza [mm]	
19	
IMP. ROMANO	

10-GAS12S	
	Length/Lungh. [mm]
	45
	Outer Diam./Diam. est. [mm]
	34
Inner Diam./Diam. int. [mm]	
12,5	
IMP. TARTARINI	

10-GAS17S	
	Outer Diam./Diam. est. [mm]
	28
	Inner Diam./Diam. int. [mm]
	14
	Inner Diam. 1/Diam. int. 1 [mm]
4	
Height/Altezza [mm]	
20	
IMP. LANDI	

10-GAS18S	
	Outer Diam./Diam. est. [mm]
	39
	Inner Diam./Diam. int. [mm]
	16
	Inner Diam. 1/Diam. int. 1 [mm]
	7,8
	Height/Altezza [mm]
	17,5
IMP. STEFANELLI	

10-GAS22S	
	Outer Diam./Diam. est. [mm]
	37
	Outer Diam. 1/Diam. est. 1 [mm]
	35
	Inner Diam./Diam. int. [mm]
	15
	Inner Diam. 1/Diam. int. 1 [mm]
	8
	Height/Altezza [mm]
	22
IMP. MEDA	

10-GAS19S	
	Outer Diam./Diam. est. [mm]
	36
	Inner Diam./Diam. int. [mm]
	16
	Inner Diam. 1/Diam. int. 1 [mm]
	8,5
	Height/Altezza [mm]
	20
IMP. TOMASETTO	

10-GAS23S	
	Outer Diam./Diam. est. [mm]
	18
	Inner Diam./Diam. int. [mm]
	4
	Fitted Diam./Diam. montaggio [mm]
	7
	Height/Altezza [mm]
	32
IMP. OMNIA	

10-GAS1S	
	Length/Lungh. [mm]
	58
	Outer Diam./Diam. est. [mm]
	42
	Inner Diam./Diam. int. [mm]
	17
IMP. BRC NEW GENERATION	

10-GAS24S	
	Outer Diam./Diam. est. [mm]
	43,5
	Outer Diam. 1/Diam. est. 1 [mm]
	35,5
	Inner Diam./Diam. int. [mm]
	16
	Inner Diam. 1/Diam. int. 1 [mm]
	8
	Height/Altezza [mm]
	23,5
IMP. MARINI	

10-GAS20S	
	Outer Diam./Diam. est. [mm]
	31
	Inner Diam./Diam. int. [mm]
	10
	Inner Diam. 1/Diam. int. 1 [mm]
	8
	Height/Altezza [mm]
	20
IMP. EMMA-GAS	

10-GAS25S	
	Length/Lungh. [mm]
	50
	Outer Diam./Diam. est. [mm]
	42
	Inner Diam./Diam. int. [mm]
	17
IMP. MED	

10-GAS21S	
	Outer Diam./Diam. est. [mm]
	36
	Inner Diam./Diam. int. [mm]
	15
	Height/Altezza [mm]
	16
IMP. LANDI	

10-GAS26S	
	Outer Diam./Diam. est. [mm]
	39
	Inner Diam./Diam. int. [mm]
	16
	Inner Diam. 1/Diam. int. 1 [mm]
	8,5
	Height/Altezza [mm]
	21
IMP. LOVATO	

10-GAS27S	
	Outer Diam./Diam. est. [mm]
	29
	Inner Diam./Diam. int. [mm]
	4
Height/Altezza [mm]	5
IMP. BEDINI	

10-GAS31S	
	Length/Lungh. [mm]
	126
	Outer Diam./Diam. est. [mm]
	50
Diam. 1/ Diam. 2 [mm]	IN / OUT:12
UNIVERSAL APPLICATIONS	

10-GAS28S	
	Length/Lungh. [mm]
	44,5
	Outer Diam./Diam. est. [mm]
	31
	Inner Diam./Diam. int. [mm]
	10
Inner Diam. 1/Diam. int. 1 [mm]	8
IMP. AGS,STELLA	

10-GAS3S	
	Length/Lungh. [mm]
	54
	Outer Diam./Diam. est. [mm]
	42
Inner Diam./Diam. int. [mm]	17
IMP. ZAVOLI, BEDINI, E-GAS, MOTOR GAS	

10-GAS29S	
	Outer Diam./Diam. est. [mm]
	28
	Inner Diam./Diam. int. [mm]
	10
Height/Altezza [mm]	50
IMP. RMG	

10-GAS4S	
	Length/Lungh. [mm]
	89
	Outer Diam./Diam. est. [mm]
	66
Diam. 1/ Diam. 2 [mm]	11
IMP. EMER	

10-GAS2S	
	Length/Lungh. [mm]
	94
	Outer Diam./Diam. est. [mm]
	50
Diam. 1/ Diam. 2 [mm]	IN/OUT : 14
IMP. LANDI	

10-GAS5S	
	Length/Lungh. [mm]
	75
	Outer Diam./Diam. est. [mm]
	46
Diam. 1/ Diam. 2 [mm]	IN / OUT:12
IMP. ZAVOLI	

10-GAS30S	
	Length/Lungh. [mm]
	125
	Outer Diam./Diam. est. [mm]
	50
Diam. 1/ Diam. 2 [mm]	IN / OUT:14
UNIVERSAL APPLICATIONS	

10-GAS6S	
	Length/Lungh. [mm]
	118
	Outer Diam./Diam. est. [mm]
	55
Diam. 1/ Diam. 2 [mm]	11,5
IMP. BEDINI	

10-GAS7S	
	Length/Lungh. [mm]
	89
	Outer Diam./Diam. est. [mm]
	67
	Diam. 1/ Diam. 2 [mm]
	16
IMP. IMEGA	

10-H0-002	
	Length/Lungh. [mm]
	90
	Outer Diam./Diam. est. [mm]
	76
	Fitted Diam./Diam. montaggio [mm]
	73
	Inner Thread/Filett int. [mm]
	M20 x 1,5
CHEVROLET - HYUNDAI - SUZUKI	

10-GAS8S	
	Length/Lungh. [mm]
	98
	Outer Diam./Diam. est. [mm]
	50
	Diam. 1/ Diam. 2 [mm]
	11
IMP. BIGAS	

10-H0-003	
	Length/Lungh. [mm]
	88
	Outer Diam./Diam. est. [mm]
	64,8
	Inner Diam./Diam. int. [mm]
	36
	Fitted Diam./Diam. montaggio [mm]
	48
HYUNDAI	

10-GAS9S	
	Length/Lungh. [mm]
	52
	Outer Diam./Diam. est. [mm]
	42
	Inner Diam./Diam. int. [mm]
	17
IMP. LOVATO	

10-H0-004	
	Length/Lungh. [mm]
	118
	Outer Diam./Diam. est. [mm]
	62
	Inner Diam./Diam. int. [mm]
	33
	Inner Diam. 1/Diam. int. 1 [mm]
33	
	Fitted Diam./Diam. montaggio [mm]
	54
CHRYSLER - HYUNDAI - JEEP - KIA	

10-GASS	
	Length/Lungh. [mm]
	67
	Outer Diam./Diam. est. [mm]
	68
	Fitted Diam./Diam. montaggio [mm]
	63
	Inner Thread/Filett int. [mm]
	M20 x 1,5
IMP. BRC OLD GENERATION	

10-H0-004U	
	Length/Lungh. [mm]
	122
	Outer Diam./Diam. est. [mm]
	84
	Fitted Diam./Diam. montaggio [mm]
	70
	Inner Thread/Filett int. [mm]
	3/4 x 16 UNF
Veicolo guida a destra/For right-hand traffic	
HYUNDAI - KIA	

10-0H-H01	
	Length/Lungh. [mm]
	146,5
	Outer Diam./Diam. est. [mm]
	89
	Fitted Diam./Diam. montaggio [mm]
	70
	Inner Thread/Filett int. [mm]
	3/4X16
HYUNDAI	

10-0H-005	
	Length/Lungh. [mm]
	90
	Outer Diam./Diam. est. [mm]
	73
	Fitted Diam./Diam. montaggio [mm]
	65
	Inner Thread/Filett int. [mm]
	M20 x 1,5
HYUNDAI	

10-K0-000	
	Length/Lungh. [mm]
	148
	Outer Diam./Diam. est. [mm]
	102
	Fitted Diam./Diam. montaggio [mm]
99	
Inner Thread/Filett int. [mm]	
M20 x 1,5	
KIA	

10-K0-006	
	Length/Lungh. [mm]
	134
	Outer Diam./Diam. est. [mm]
	93,5
	Fitted Diam./Diam. montaggio [mm]
72	
Inner Thread/Filett int. [mm]	
M26 x 1,5	
HYUNDAI - KIA	

10-K0-001	
	Length/Lungh. [mm]
	67,7
	Outer Diam./Diam. est. [mm]
	68
	Fitted Diam./Diam. montaggio [mm]
65	
Inner Thread/Filett int. [mm]	
M20 x 1,5	
Subst. by 10-03-313	

10-0L-L02	
	Length/Lungh. [mm]
	110
	Outer Diam./Diam. est. [mm]
	93,3
	Fitted Diam./Diam. montaggio [mm]
71,7	
Inner Thread/Filett int. [mm]	
3/4 x 16	
LAND ROVER	

10-K0-002	
	Length/Lungh. [mm]
	87,3
	Outer Diam./Diam. est. [mm]
	68
	Fitted Diam./Diam. montaggio [mm]
64	
Inner Thread/Filett int. [mm]	
M20 x 1,5	
KIA	

10-0L-L03	
	Length/Lungh. [mm]
	94
	Outer Diam./Diam. est. [mm]
	76
	Fitted Diam./Diam. montaggio [mm]
73	
Inner Thread/Filett int. [mm]	
13/16 x 16	
LAND ROVER	

10-K0-004	
	Length/Lungh. [mm]
	102
	Outer Diam./Diam. est. [mm]
	93,5
	Fitted Diam./Diam. montaggio [mm]
72	
Inner Thread/Filett int. [mm]	
M26 x 1,5	
Subst. by 10-K0-002	

10-0L-L05	
	Length/Lungh. [mm]
	106,5
	Outer Diam./Diam. est. [mm]
	76,5
	Fitted Diam./Diam. montaggio [mm]
73	
Inner Thread/Filett int. [mm]	
3/4 x 16	
LAND ROVER	

10-K0-005	
	Length/Lungh. [mm]
	118
	Outer Diam./Diam. est. [mm]
	94,6
	Fitted Diam./Diam. montaggio [mm]
71	
Inner Thread/Filett int. [mm]	
M26 x 1,5	
HYUNDAI - KIA	

10-0L-L08	
	Length/Lungh. [mm]
	108
	Outer Diam./Diam. est. [mm]
	78,5
	Fitted Diam./Diam. montaggio [mm]
73	
Inner Thread/Filett int. [mm]	
1-12UNF	
LAND ROVER	

10-0L-L09	
	Length/Lungh. [mm]
	90
	Outer Diam./Diam. est. [mm]
	76
	Fitted Diam./Diam. montaggio [mm]
70	
Outer Thread/Filett est. [mm]	
3/4 X 16	
LAND ROVER	

10-P0-084	
	Length/Lungh. [mm]
	93
	Outer Diam./Diam. est. [mm]
	76
	Fitted Diam./Diam. montaggio [mm]
72	
Inner Thread/Filett int. [mm]	
M 20 X 1,5	

10-0M-000	
	Length/Lungh. [mm]
	54
	Outer Diam./Diam. est. [mm]
	53
	Inner Diam./Diam. int. [mm]
29	
Fitted Diam./Diam. montaggio [mm]	
39,5	
SMART	

10-W0-000	
	Length/Lungh. [mm]
	76
	Outer Diam./Diam. est. [mm]
	80
	Fitted Diam./Diam. montaggio [mm]
62	
Inner Thread/Filett int. [mm]	
3/4 - 16 UNF	
Subst. by 10-06-601	

10-M0-001	
	Length/Lungh. [mm]
	86,5
	Outer Diam./Diam. est. [mm]
	68
	Fitted Diam./Diam. montaggio [mm]
63	
Inner Thread/Filett int. [mm]	
M20 x 1,5	
MITSUBISHI - SMART	

10-W0-001	
	Length/Lungh. [mm]
	72,5
	Outer Diam./Diam. est. [mm]
	68
	Fitted Diam./Diam. montaggio [mm]
64	
Inner Thread/Filett int. [mm]	
3/4 - 16 UNF	
CHEVROLET - DAEWOO	

10-0M-M02	
	Length/Lungh. [mm]
	52
	Outer Diam./Diam. est. [mm]
	68
	Fitted Diam./Diam. montaggio [mm]
63	
Inner Thread/Filett int. [mm]	
M 20 X 1,5	
SMART	

10-W0-W02	
	Length/Lungh. [mm]
	72
	Outer Diam./Diam. est. [mm]
	68
	Fitted Diam./Diam. montaggio [mm]
63	
Inner Thread/Filett int. [mm]	
M 18 X 1,5	
CHEVROLET	

10-M0-003	
	Length/Lungh. [mm]
	101
	Outer Diam./Diam. est. [mm]
	76
	Fitted Diam./Diam. montaggio [mm]
71,6	
Inner Thread/Filett int. [mm]	
M20 x 1,5	
MITSUBISHI - SMART	

20-00-000	
	Height/Altezza [mm]
	62,2
	Outer Diam./Diam. est. [mm]
	231
	Inner Diam./Diam. int. [mm]
	182
LADA	

20-00-005	
	Height/Altezza [mm]
	341
	Outer Diam./Diam. est. [mm]
	150
	Inner Diam./Diam. int. [mm]
	70
TATA	

20-00-001	
	Length/Lungh. [mm]
	325
	Width/Largh. [mm]
	168
	Height/Altezza [mm]
	40
DODGE - JEEP	

20-00-006	
	Length/Lungh. [mm]
	301,4
	Width/Largh. [mm]
	160
	Height/Altezza [mm]
	42
TATA	

20-00-002	
	Length/Lungh. [mm]
	351
	Width/Largh. [mm]
	196
	Height/Altezza [mm]
	60
MAHINDRA	

20-00-007	
	Length/Lungh. [mm]
	254,7
	Width/Largh. [mm]
	189,3
	Height/Altezza [mm]
	37,8
CHRYSLER	

20-00-003	
	Height/Altezza [mm]
	181,4
	Outer Diam./Diam. est. [mm]
	163,3
	Inner Diam./Diam. int. [mm]
	100,4
TATA	

20-00-008	
	Length/Lungh. [mm]
	317,8
	Length 1/Lungh. 1 [mm]
	82,5
	Width/Largh. [mm]
	222,6
	Width 1/Largh. 1 [mm]
	102,7
	Height/Altezza [mm]
	42,2
CHRYSLER	

20-00-004	
	Height/Altezza [mm]
	335
	Outer Diam./Diam. est. [mm]
	149
	Inner Diam./Diam. int. [mm]
74	
	Inner Diam. 1/Diam. int. 1 [mm]
	10
NISSAN - TATA	

20-00-009	
	Height/Altezza [mm]
	158,2
	Outer Diam./Diam. est. [mm]
	127,3
	Inner Diam./Diam. int. [mm]
	83
CHRYSLER	

20-00-010	
	Length/Lungh. [mm]
	Width/Largh. [mm]
	Height/Altezza [mm]
CHRYSLER	

20-00-015	
	Length/Lungh. [mm]
	Width/Largh. [mm]
	Height/Altezza [mm]
CHRYSLER	

20-00-011	
	Length/Lungh. [mm]
	Width/Largh. [mm]
	Height/Altezza [mm]
TATA	

20-00-016	
	Length/Lungh. [mm]
	Width/Largh. [mm]
	Height/Altezza [mm]
JEEP	

20-00-012	
	Height/Altezza [mm]
	Outer Diam./Diam. est. [mm]
	Inner Diam./Diam. int. [mm]
HUMMER	

20-00-017	
	Length/Lungh. [mm]
	Width/Largh. [mm]
	Height/Altezza [mm]
JEEP	

20-00-013	
	Length/Lungh. [mm]
	Width/Largh. [mm]
	Height/Altezza [mm]
HUMMER	

20-00-018	
	Length/Lungh. [mm]
	Width/Largh. [mm]
	Height/Altezza [mm]
DODGE - JEEP	

20-00-014	
	Length/Lungh. [mm]
	Width/Largh. [mm]
	Height/Altezza [mm]
JEEP	

20-00-019	
	Length/Lungh. [mm]
	Width/Largh. [mm]
	Height/Altezza [mm]
CADILLAC	

20-00-020		
	Length/Lungh. [mm]	293
	Width/Largh. [mm]	229
	Height/Altezza [mm]	58
DODGE		

20-00-025		
	Length/Lungh. [mm]	230
	Width/Largh. [mm]	190
	Height/Altezza [mm]	59
DR		

20-00-021		
	Length/Lungh. [mm]	319
	Length 1/Lungh. 1 [mm]	274
	Width/Largh. [mm]	244
	Width 1/Largh. 1 [mm]	267
	Height/Altezza [mm]	32
CADILLAC		

20-00-026		
	Length/Lungh. [mm]	208
	Width/Largh. [mm]	195
	Height/Altezza [mm]	40
DR		

20-00-022		
	Height/Altezza [mm]	138
	Outer Diam./Diam. est. [mm]	184
	Inner Diam./Diam. int. [mm]	82
GONOW		

20-00-027		
	Length/Lungh. [mm]	237
	Width/Largh. [mm]	180
	Height/Altezza [mm]	40
CADILLAC - CHEVROLET		

20-00-023		
	Length/Lungh. [mm]	246
	Width/Largh. [mm]	222
	Height/Altezza [mm]	45
DR		

20-00-028		
	Length/Lungh. [mm]	311
	Width/Largh. [mm]	246
	Height/Altezza [mm]	59
CADILLAC		

20-00-024		
	Length/Lungh. [mm]	233
	Width/Largh. [mm]	213
	Height/Altezza [mm]	47
DODGE		

20-00-029		
	Length/Lungh. [mm]	295
	Width/Largh. [mm]	225
	Height/Altezza [mm]	32
CADILLAC		

20-00-098	
	Length/Lungh. [mm]
	312
	Width/Largh. [mm]
150	
Height/Altezza [mm]	
46	
TOYOTA	

20-01-104	
	Length/Lungh. [mm]
	272
	Width/Largh. [mm]
158,5	
Height/Altezza [mm]	
35,8	
NISSAN - SUBARU	

20-01-100	
	Length/Lungh. [mm]
	374,4
	Width/Largh. [mm]
83,8	
Height/Altezza [mm]	
57,4	
NISSAN	

20-01-105	
	Height/Altezza [mm]
	70,4
	Outer Diam./Diam. est. [mm]
	362
Inner Diam./Diam. int. [mm]	
296,5	
NISSAN	

20-01-101	
	Height/Altezza [mm]
	61
	Outer Diam./Diam. est. [mm]
	257,2
Inner Diam./Diam. int. [mm]	
201	
ISUZU - NISSAN	

20-01-106	
	Outer Length/Lungh. est. [mm]
	283
	Inner Length/Lungh. int. [mm]
	231
	Outer Width/Largh. est. [mm]
	233,5
Inner Width/Largh. int. [mm]	
186,8	
Height/Altezza [mm]	
45,6	
NISSAN	

20-01-102	
	Height/Altezza [mm]
	50,5
	Outer Diam./Diam. est. [mm]
	230,3
Inner Diam./Diam. int. [mm]	
173,5	
DAIHATSU - NISSAN - SUBARU	

20-01-107	
	Outer Length/Lungh. est. [mm]
	274
	Inner Length/Lungh. int. [mm]
	227,4
	Outer Width/Largh. est. [mm]
	224
Inner Width/Largh. int. [mm]	
177,5	
Height/Altezza [mm]	
60,6	
NISSAN	

20-01-103	
	Outer Length/Lungh. est. [mm]
	413
	Inner Length/Lungh. int. [mm]
	354
	Outer Width/Largh. est. [mm]
137,4	
Inner Width/Largh. int. [mm]	
77,8	
Height/Altezza [mm]	
47	
NISSAN	

20-01-108	
	Length/Lungh. [mm]
	279
	Width/Largh. [mm]
165	
Height/Altezza [mm]	
33	
INFINITI - ISUZU - NISSAN - SUBARU	

20-01-109	
	Height/Altezza [mm]
	62
	Outer Diam./Diam. est. [mm]
	271,5
	Inner Diam./Diam. int. [mm]
	222,4
NISSAN	

20-01-114	
	Height/Altezza [mm]
	60
	Outer Diam./Diam. est. [mm]
	196
	Inner Diam./Diam. int. [mm]
	146,3
NISSAN	

20-01-110	
	Height/Altezza [mm]
	176,5
	Outer Diam./Diam. est. [mm]
	127,3
	Inner Diam./Diam. int. [mm]
	70,7
	Inner Diam. 1/Diam. int. 1 [mm]
	10
NISSAN	

20-01-115	
	Outer Length/Lungh. est. [mm]
	340,2
	Inner Length/Lungh. int. [mm]
	282
	Outer Width/Largh. est. [mm]
	133,5
	Inner Width/Largh. int. [mm]
	74,6
	Height/Altezza [mm]
	80,8
NISSAN	

20-01-111	
	Height/Altezza [mm]
	229
	Outer Diam./Diam. est. [mm]
	146
	Outer Diam. 1/Diam. est. 1 [mm]
	135
	Inner Diam./Diam. int. [mm]
72,5	
	Inner Diam. 1/Diam. int. 1 [mm]
	62
NISSAN	

20-01-116	
	Height/Altezza [mm]
	293,2
	Outer Diam./Diam. est. [mm]
	124,8
	Inner Diam./Diam. int. [mm]
	64,8
	Inner Diam. 1/Diam. int. 1 [mm]
	9
NISSAN	

20-01-112	
	Height/Altezza [mm]
	195,5
	Outer Diam./Diam. est. [mm]
	158
	Outer Diam. 1/Diam. est. 1 [mm]
	154,7
	Inner Diam./Diam. int. [mm]
89	
	Inner Diam. 1/Diam. int. 1 [mm]
	14,5
ISUZU - NISSAN	

20-01-118	
	Height/Altezza [mm]
	286,8
	Outer Diam./Diam. est. [mm]
	135,3
	Outer Diam. 1/Diam. est. 1 [mm]
	132
	Inner Diam./Diam. int. [mm]
71,8	
	Inner Diam. 1/Diam. int. 1 [mm]
	14,5
NISSAN	

20-01-113	
	Outer Length/Lungh. est. [mm]
	204,7
	Inner Length/Lungh. int. [mm]
	154,7
	Outer Width/Largh. est. [mm]
	120,3
	Inner Width/Largh. int. [mm]
	69,2
	Height/Altezza [mm]
	70
NISSAN	

20-01-119	
	Height/Altezza [mm]
	200,5
	Outer Diam./Diam. est. [mm]
	155
	Inner Diam./Diam. int. [mm]
	88,7
NISSAN	

20-01-120	
	Height/Altezza [mm]
	288,5
	Outer Diam./Diam. est. [mm]
	135
	Outer Diam. 1/Diam. est. 1 [mm]
132	
Inner Diam./Diam. int. [mm]	
72	
NISSAN	

20-01-125	
	Outer Length/Lungh. est. [mm]
	420
	Inner Length/Lungh. int. [mm]
	365
	Outer Width/Largh. est. [mm]
	194,7
Inner Width/Largh. int. [mm]	
153,5	
Height/Altezza [mm]	
50	
NISSAN	

20-01-121	
	Height/Altezza [mm]
	42,1
	Outer Diam./Diam. est. [mm]
	273
Inner Diam./Diam. int. [mm]	
12,8	
NISSAN	

20-01-126	
	Height/Altezza [mm]
	376,3
	Outer Diam./Diam. est. [mm]
	155,2
Inner Diam./Diam. int. [mm]	
94,8	
BUICK - DAEWOO - NISSAN	

20-01-122	
	Height/Altezza [mm]
	42
	Outer Diam./Diam. est. [mm]
	274
Inner Diam./Diam. int. [mm]	
15,3	
NISSAN	

20-01-127	
	Length/Lungh. [mm]
	285
	Width/Largh. [mm]
	171
	Height/Altezza [mm]
59	
Height 1/Altezza 1 [mm]	
43	
NISSAN	

20-01-123	
	Height/Altezza [mm]
	71
	Outer Diam./Diam. est. [mm]
	245
Inner Diam./Diam. int. [mm]	
208,4	
CHEVROLET - NISSAN	

20-01-128	
	Length/Lungh. [mm]
	237,4
	Width/Largh. [mm]
	140,4
Height/Altezza [mm]	
58	
NISSAN	

20-01-124	
	Height/Altezza [mm]
	59,5
	Outer Diam./Diam. est. [mm]
	285,2
Inner Diam./Diam. int. [mm]	
231,9	
ASIA MOTORS	

20-01-129	
	Length/Lungh. [mm]
	285,5
	Width/Largh. [mm]
	180
Height/Altezza [mm]	
56	
NISSAN	

20-01-130		
	Length/Lungh. [mm]	171
	Width/Largh. [mm]	139
	Width 1/Largh. 1 [mm]	94
	Height/Altezza [mm]	74
NISSAN		

20-01-135		
	Length/Lungh. [mm]	237
	Width/Largh. [mm]	162
	Width 1/Largh. 1 [mm]	137
	Height/Altezza [mm]	60
NISSAN		

20-01-131		
	Length/Lungh. [mm]	307,8
	Width/Largh. [mm]	101,8
	Height/Altezza [mm]	41,5
NISSAN		

20-01-136		
	Height/Altezza [mm]	184
	Outer Diam./Diam. est. [mm]	173
	Inner Diam./Diam. int. [mm]	97
CHEVROLET - NISSAN		

20-01-132		
	Height/Altezza [mm]	179,8
	Outer Diam./Diam. est. [mm]	107
	Inner Diam./Diam. int. [mm]	72,2
NISSAN		

20-01-137		
	Length/Lungh. [mm]	300
	Width/Largh. [mm]	280
	Height/Altezza [mm]	55
NISSAN		

20-01-133		
	Length/Lungh. [mm]	316
	Width/Largh. [mm]	261
	Height/Altezza [mm]	43
NISSAN		

20-01-138		
	Length/Lungh. [mm]	356
	Width/Largh. [mm]	262
	Height/Altezza [mm]	47
NISSAN		

20-01-134		
	Length/Lungh. [mm]	231
	Width/Largh. [mm]	137
	Height/Altezza [mm]	34
NISSAN		

20-01-139		
	Outer Length/Lungh. est. [mm]	370
	Inner Length/Lungh. int. [mm]	301
	Outer Width/Largh. est. [mm]	205
	Inner Width/Largh. int. [mm]	134
	Height/Altezza [mm]	73,5
NISSAN		

20-01-142		
 142 NISSAN	Length/Lungh. [mm]	228
	Width/Largh. [mm]	168
	Height/Altezza [mm]	34

20-01-191		
 NISSAN	Height/Altezza [mm]	200
	Outer Diam./Diam. est. [mm]	200
	Inner Diam./Diam. int. [mm]	116,7
	Inner Diam. 1/Diam. int. 1 [mm]	24

20-01-143		
 143 INFINITI	Length/Lungh. [mm]	278
	Width/Largh. [mm]	186
	Height/Altezza [mm]	41
	Height 1/Altezza 1 [mm]	50

20-01-192		
 NISSAN	Height/Altezza [mm]	241,5
	Outer Diam./Diam. est. [mm]	154
	Inner Diam./Diam. int. [mm]	87,5
	Inner Diam. 1/Diam. int. 1 [mm]	17,2

20-01-188		
 NISSAN	Height/Altezza [mm]	331,8
	Outer Diam./Diam. est. [mm]	149
	Inner Diam./Diam. int. [mm]	74

20-01-193		
 NISSAN	Height/Altezza [mm]	140
	Outer Diam./Diam. est. [mm]	178
	Inner Diam./Diam. int. [mm]	92,8

20-01-189		
 NISSAN	Outer Length/Lungh. est. [mm]	132
	Inner Length/Lungh. int. [mm]	92,3
	Outer Width/Largh. est. [mm]	101,2
	Inner Width/Largh. int. [mm]	62,2
	Height/Altezza [mm]	211,3

20-01-195		
 NISSAN	Height/Altezza [mm]	372
	Outer Diam./Diam. est. [mm]	197
	Inner Diam./Diam. int. [mm]	105,5
	Inner Diam. 1/Diam. int. 1 [mm]	9,6

20-01-190		
 NISSAN	Height/Altezza [mm]	187,5
	Outer Diam./Diam. est. [mm]	148
	Inner Diam./Diam. int. [mm]	74

20-01-196		
 HONDA - INFINITI - NISSAN	Length/Lungh. [mm]	229,5
	Width/Largh. [mm]	169,8
	Height/Altezza [mm]	34,5

20-01-197	
	Length/Lungh. [mm]
	172
	Width/Largh. [mm]
	158,2
	Height/Altezza [mm]
	34,5
NISSAN	

20-02-2004	
	Height/Altezza [mm]
	259
	Outer Diam./Diam. est. [mm]
	233
	Fitted Diam./Diam. montaggio [mm]
	182
	Inner Diam./Diam. int. [mm]
	134
TOYOTA	

20-01-199	
	Outer Length/Lungh. est. [mm]
	340
	Inner Length/Lungh. int. [mm]
	213,4
	Outer Width/Largh. est. [mm]
	241,7
	Inner Width/Largh. int. [mm]
	93,2
	Height/Altezza [mm]
	36,8
NISSAN	

20-02-200	
	Length/Lungh. [mm]
	315
	Width/Largh. [mm]
	150
	Height/Altezza [mm]
	74
TOYOTA	

20-02-2000	
	Length/Lungh. [mm]
	220
	Width/Largh. [mm]
	187
	Height/Altezza [mm]
	36
TOYOTA	

20-02-201	
	Height/Altezza [mm]
	57,8
	Outer Diam./Diam. est. [mm]
	249,8
	Inner Diam./Diam. int. [mm]
	176,7
DAIHATSU - MITSUBISHI - TOYOTA	

20-02-2001	
	Length/Lungh. [mm]
	273
	Width/Largh. [mm]
	180
	Height/Altezza [mm]
	35
LEXUS	

20-02-202	
	Height/Altezza [mm]
	41,4
	Outer Diam./Diam. est. [mm]
	151,5
	Inner Diam./Diam. int. [mm]
	87,7
TOYOTA	

20-02-2003	
	Length/Lungh. [mm]
	265
	Width/Largh. [mm]
	231
	Height/Altezza [mm]
	35
LEXUS	

20-02-203	
	Height/Altezza [mm]
	69,5
	Outer Diam./Diam. est. [mm]
	190,5
	Inner Diam./Diam. int. [mm]
	108,5
TOYOTA	

20-02-204	
	Height/Altezza [mm]
	Outer Diam./Diam. est. [mm]
	Inner Diam./Diam. int. [mm]
DAIHATSU - TOYOTA	

20-02-210	
	Height/Altezza [mm]
	Outer Diam./Diam. est. [mm]
	Inner Diam./Diam. int. [mm]
TOYOTA	

20-02-205	
	Height/Altezza [mm]
	Outer Diam./Diam. est. [mm]
	Inner Diam./Diam. int. [mm]
DAIHATSU - MITSUBISHI - TOYOTA	

20-02-211	
	Outer Length/Lungh. est. [mm]
	Inner Length/Lungh. int. [mm]
	Outer Width/Largh. est. [mm]
	Inner Width/Largh. int. [mm]
	Height/Altezza [mm]
TOYOTA	

20-02-206	
	Height/Altezza [mm]
	Outer Diam./Diam. est. [mm]
	Inner Diam./Diam. int. [mm]
TOYOTA	

20-02-212	
	Height/Altezza [mm]
	Outer Diam./Diam. est. [mm]
	Inner Diam./Diam. int. [mm]

20-02-207	
	Height/Altezza [mm]
	Outer Diam./Diam. est. [mm]
	Inner Diam./Diam. int. [mm]
DAIHATSU - TOYOTA	

20-02-213	
	Height/Altezza [mm]
	Outer Diam./Diam. est. [mm]
	Inner Diam./Diam. int. [mm]
TOYOTA	

20-02-208	
	Height/Altezza [mm]
	Outer Diam./Diam. est. [mm]
	Inner Diam./Diam. int. [mm]

20-02-215	
	Height/Altezza [mm]
	Outer Diam./Diam. est. [mm]
	Inner Diam./Diam. int. [mm]
	Inner Diam. 1/Diam. int. 1 [mm]
TOYOTA	

20-02-218	
	Length/Lungh. [mm]
	307,3
	Width/Largh. [mm]
	156
Subst. by 20-02-238	
	Height/Altezza [mm]
	41,4
TOYOTA	

20-02-225	
	Height/Altezza [mm]
	151,4
	Outer Diam./Diam. est. [mm]
	153,3
	Inner Diam./Diam. int. [mm]
	88,7
TOYOTA	

20-02-219	
	Height/Altezza [mm]
	156,3
	Outer Diam./Diam. est. [mm]
	155
	Inner Diam./Diam. int. [mm]
	88,8
TOYOTA	

20-02-226	
	Height/Altezza [mm]
	38,7
	Outer Diam./Diam. est. [mm]
	255
	Inner Diam./Diam. int. [mm]
64,5	
	Inner Diam. 1/Diam. int. 1 [mm]
	20,7
TOYOTA	

20-02-221	
	Height/Altezza [mm]
	170
	Outer Diam./Diam. est. [mm]
	132
	Inner Diam./Diam. int. [mm]
67,8	
	Inner Diam. 1/Diam. int. 1 [mm]
	18
TOYOTA	

20-02-229	
	Height/Altezza [mm]
	144,8
	Outer Diam./Diam. est. [mm]
	153,3
	Inner Diam./Diam. int. [mm]
	77,2
TOYOTA	

20-02-223	
	Height/Altezza [mm]
	90,7
	Outer Diam./Diam. est. [mm]
	190,8
	Inner Diam./Diam. int. [mm]
	108,7
TOYOTA	

20-02-230	
	Height/Altezza [mm]
	107
	Outer Diam./Diam. est. [mm]
	164
Subst. by 20-02-208	
	Inner Diam./Diam. int. [mm]
	78
TOYOTA	

20-02-224	
	Length/Lungh. [mm]
	221
	Width/Largh. [mm]
	164,5
	Height/Altezza [mm]
	51
DAIHATSU - TOYOTA	

20-02-231	
	Height/Altezza [mm]
	143,3
	Outer Diam./Diam. est. [mm]
	216
	Inner Diam./Diam. int. [mm]
	112,5
TOYOTA	

20-02-232	
	Height/Altezza [mm]
	78
	Outer Diam./Diam. est. [mm]
	187
TOYOTA	

20-02-238	
	Length/Lungh. [mm]
	310
	Width/Largh. [mm]
	155
	Height/Altezza [mm]
	42
TOYOTA	

20-02-233	
	Height/Altezza [mm]
	68,3
	Outer Diam./Diam. est. [mm]
	219
TOYOTA	

20-02-239	
	Length/Lungh. [mm]
	247
	Width/Largh. [mm]
	153,5
	Height/Altezza [mm]
	41
DAIHATSU - TOYOTA	

20-02-234	
	Height/Altezza [mm]
	141,5
	Outer Diam./Diam. est. [mm]
	185
	Inner Diam./Diam. int. [mm]
	108,6
TOYOTA	

20-02-240	
	Height/Altezza [mm]
	33,5
	Outer Diam./Diam. est. [mm]
	255
	Inner Diam./Diam. int. [mm]
	20,8
TOYOTA	

20-02-235	
	Length/Lungh. [mm]
	258,6
	Width/Largh. [mm]
	171
	Height/Altezza [mm]
	51
TOYOTA	

20-02-243	
	Length/Lungh. [mm]
	307,3
	Width/Largh. [mm]
	121
	Height/Altezza [mm]
	42,5
TOYOTA	

20-02-236	
	Height/Altezza [mm]
	69,5
	Outer Diam./Diam. est. [mm]
	197,7
TOYOTA	

20-02-245	
	Height/Altezza [mm]
	280
	Outer Diam./Diam. est. [mm]
	134,5
	Inner Diam./Diam. int. [mm]
76,8	
	Inner Diam. 1/Diam. int. 1 [mm]
	13
TOYOTA	

20-02-246	
	Height/Altezza [mm]
	204
	Outer Diam./Diam. est. [mm]
	150
	Inner Diam./Diam. int. [mm]
86	
	Inner Diam. 1/Diam. int. 1 [mm]
14	
DAIHATSU - ISUZU - MITSUBISHI - TOYOTA	

20-02-251	
	Length/Lungh. [mm]
	313
	Width/Largh. [mm]
	231
	Height/Altezza [mm]
52	
TOYOTA	

20-02-247	
	Height/Altezza [mm]
	60,5
	Outer Diam./Diam. est. [mm]
	256,5
LEXUS	

20-02-252	
	Length/Lungh. [mm]
	317,5
	Width/Largh. [mm]
	193,2
	Height/Altezza [mm]
45,5	
LEXUS - TOYOTA	

20-02-248	
	Height/Altezza [mm]
	37
	Outer Diam./Diam. est. [mm]
	238
	Inner Diam./Diam. int. [mm]
65	
TOYOTA	

20-02-253	
	Length/Lungh. [mm]
	304
	Width/Largh. [mm]
	145
	Height/Altezza [mm]
88	
TOYOTA	

20-02-249	
	Length/Lungh. [mm]
	266,3
	Width/Largh. [mm]
	171,6
	Height/Altezza [mm]
42,3	
DR - MAZDA - TOYOTA	

20-02-254	
	Length/Lungh. [mm]
	306,7
	Width/Largh. [mm]
	154,5
	Height/Altezza [mm]
52	
TOYOTA	

20-02-250	
	Length/Lungh. [mm]
	227
	Width/Largh. [mm]
	167
	Height/Altezza [mm]
41	
TOYOTA	

20-02-255	
	Length/Lungh. [mm]
	242
	Width/Largh. [mm]
	236
	Width 1/Largh. 1 [mm]
170	
	Height/Altezza [mm]
80	
LEXUS - TOYOTA	

20-02-256	
	Length/Lungh. [mm]
	186
	Width/Largh. [mm]
	171,5
	Height/Altezza [mm]
	27
TOYOTA	

20-02-261	
	Length/Lungh. [mm]
	242
	Width/Largh. [mm]
	176
	Height/Altezza [mm]
	50
TOYOTA	

20-02-257	
	Length/Lungh. [mm]
	255
	Width/Largh. [mm]
	237
	Width 1/Largh. 1 [mm]
140	
	Height/Altezza [mm]
	60
TOYOTA	

20-02-262	
	Length/Lungh. [mm]
	269
	Width/Largh. [mm]
	235
	Height/Altezza [mm]
	70
TOYOTA	

20-02-258	
	Length/Lungh. [mm]
	268
	Width/Largh. [mm]
	160
	Height/Altezza [mm]
	35
TOYOTA	

20-02-263	
	Length/Lungh. [mm]
	315
	Width/Largh. [mm]
	296
	Height/Altezza [mm]
	52
TOYOTA	

20-02-259	
	Height/Altezza [mm]
	172
	Outer Diam./Diam. est. [mm]
	220
	Inner Diam./Diam. int. [mm]
	120
MAZDA - TOYOTA	

20-02-264	
	Length/Lungh. [mm]
	315
	Width/Largh. [mm]
	297
	Height/Altezza [mm]
	62
TOYOTA	

20-02-260	
	Length/Lungh. [mm]
	240
	Length 1/Lungh. 1 [mm]
	145
	Width/Largh. [mm]
	237
	Width 1/Largh. 1 [mm]
	178
	Height/Altezza [mm]
	52
LEXUS	

20-02-265	
	Length/Lungh. [mm]
	366
	Width/Largh. [mm]
	157
	Height/Altezza [mm]
	49
LEXUS	

20-02-266	
	Length/Lungh. [mm]
	356
	Width/Largh. [mm]
	166
Width 1/Largh. 1 [mm]	109
Height/Altezza [mm]	62
TOYOTA	

20-02-272	
	Length/Lungh. [mm]
	308
	Width/Largh. [mm]
	231
Height/Altezza [mm]	50
TOYOTA	

20-02-267	
	Length/Lungh. [mm]
	332
	Width/Largh. [mm]
	137
Height/Altezza [mm]	34
TOYOTA	

20-02-273	
	Height/Altezza [mm]
	146
	Outer Diam./Diam. est. [mm]
	197,2
Inner Diam./Diam. int. [mm]	86
TOYOTA	

20-02-269	
	Length/Lungh. [mm]
	305
	Width/Largh. [mm]
	140
Height/Altezza [mm]	42
SUBARU - TOYOTA	

20-02-274	
	Height/Altezza [mm]
	144,3
	Outer Diam./Diam. est. [mm]
	239,8
Inner Diam./Diam. int. [mm]	109,3
TOYOTA	

20-02-270	
	Height/Altezza [mm]
	150,6
	Outer Diam./Diam. est. [mm]
	199
Inner Diam./Diam. int. [mm]	120
TOYOTA	

20-02-275	
	Height/Altezza [mm]
	142
	Diam./Diam. [mm]
	232,5
Inner Diam./Diam. int. [mm]	8
TOYOTA	

20-02-271	
	Height/Altezza [mm]
	145
	Outer Diam./Diam. est. [mm]
	255
Inner Diam./Diam. int. [mm]	109
TOYOTA	

20-02-276	
	Outer Length/Lungh. est. [mm]
	333
	Inner Length/Lungh. int. [mm]
	120,8
	Outer Width/Largh. est. [mm]
	125
Inner Width/Largh. int. [mm]	70
Height/Altezza [mm]	52,3
LEXUS - TOYOTA	

20-02-277		
	Length/Lungh. [mm]	307
	Width/Largh. [mm]	153
	Height/Altezza [mm]	61,7
LEXUS - TOYOTA		

20-02-282		
	Height/Altezza [mm]	119,7
	Outer Diam./Diam. est. [mm]	219,4
	Inner Diam./Diam. int. [mm]	108,3
TOYOTA		

20-02-278		
	Length/Lungh. [mm]	317,3
	Width/Largh. [mm]	163
	Height/Altezza [mm]	66
TOYOTA		

20-02-283		
	Length/Lungh. [mm]	290
	Width/Largh. [mm]	150
	Height/Altezza [mm]	48
TOYOTA		

20-02-279		
	Length/Lungh. [mm]	266,9
	Width/Largh. [mm]	115,4
	Height/Altezza [mm]	61
TOYOTA		

20-02-284		
	Length/Lungh. [mm]	378,5
	Length 1/Lungh. 1 [mm]	214
	Width/Largh. [mm]	139,5
	Width 1/Largh. 1 [mm]	114
	Height/Altezza [mm]	46
	Height 1/Altezza 1 [mm]	44
TOYOTA		

20-02-280		
	Length/Lungh. [mm]	240
	Width/Largh. [mm]	210
	Height/Altezza [mm]	52
LEXUS		

20-02-285		
	Length/Lungh. [mm]	182
	Width/Largh. [mm]	174
	Height/Altezza [mm]	50
TOYOTA		

20-02-281		
	Length/Lungh. [mm]	252
	Width/Largh. [mm]	218,3
	Height/Altezza [mm]	53,5
LEXUS		

20-02-286		
	Length/Lungh. [mm]	250
	Width/Largh. [mm]	120
	Height/Altezza [mm]	52,8
SUBARU - TOYOTA		

20-02-287	
	Height/Altezza [mm]
	121
	Outer Diam./Diam. est. [mm]
	217,5
	Inner Diam./Diam. int. [mm]
	109
TOYOTA	

20-02-293	
	Length/Lungh. [mm]
	244,5
	Width/Largh. [mm]
	206
	Height/Altezza [mm]
	51,6
LEXUS - TOYOTA	

20-02-288	
	Length/Lungh. [mm]
	259
	Width/Largh. [mm]
	117,7
	Height/Altezza [mm]
	42,5
DAIHATSU - SUBARU - TOYOTA	

20-02-294	
	Length/Lungh. [mm]
	283
	Length 1/Lungh. 1 [mm]
	138
	Width/Largh. [mm]
	231,3
	Width 1/Largh. 1 [mm]
140	
	Height/Altezza [mm]
	58,6
LEXUS	

20-02-290	
	Height/Altezza [mm]
	145
	Outer Diam./Diam. est. [mm]
	190
	Inner Diam./Diam. int. [mm]
	87,6
TOYOTA	

20-02-295	
	Length/Lungh. [mm]
	275
	Width/Largh. [mm]
	209
	Height/Altezza [mm]
	51
LEXUS	

20-02-291	
	Height/Altezza [mm]
	281
	Outer Diam./Diam. est. [mm]
	145
	Inner Diam./Diam. int. [mm]
	85,3
TOYOTA	

20-02-296	
	Length/Lungh. [mm]
	312
	Width/Largh. [mm]
	150
	Height/Altezza [mm]
	67
TOYOTA	

20-02-292	
	Height/Altezza [mm]
	145
	Outer Diam./Diam. est. [mm]
	219,5
	Inner Diam./Diam. int. [mm]
	109
TOYOTA	

20-02-297	
	Length/Lungh. [mm]
	249
	Width/Largh. [mm]
	122
	Height/Altezza [mm]
	52
TOYOTA	

20-02-298		
	Length/Lungh. [mm]	308
	Width/Largh. [mm]	185,5
	Height/Altezza [mm]	41
LEXUS - TOYOTA		

20-03-304		
	Length/Lungh. [mm]	327,5
	Length 1/Lungh. 1 [mm]	272,5
	Width/Largh. [mm]	183
	Width 1/Largh. 1 [mm]	128,5
	Height/Altezza [mm]	41,6
MAZDA		

20-02-299		
	Length/Lungh. [mm]	250
	Width/Largh. [mm]	170
	Height/Altezza [mm]	51,5
MITSUBISHI - TOYOTA		

20-03-305		
	Height/Altezza [mm]	69,3
	Outer Diam./Diam. est. [mm]	261
	Inner Diam./Diam. int. [mm]	194,5
	MAZDA	

20-03-300		
	Length/Lungh. [mm]	310
	Width/Largh. [mm]	176
	Height/Altezza [mm]	47
MAZDA		

20-03-306		
	Height/Altezza [mm]	173
	Outer Diam./Diam. est. [mm]	150
	Inner Diam./Diam. int. [mm]	81
	MAZDA	

20-03-301		
	Height/Altezza [mm]	51
	Outer Diam./Diam. est. [mm]	236
	Inner Diam./Diam. int. [mm]	180
	MAZDA	

20-03-307		
	Length/Lungh. [mm]	250
	Width/Largh. [mm]	169
	Height/Altezza [mm]	43,5
MAZDA		

20-03-302		
	Height/Altezza [mm]	55,5
	Outer Diam./Diam. est. [mm]	285
	Inner Diam./Diam. int. [mm]	215
	HONDA - MAZDA	

20-03-308		
	Height/Altezza [mm]	59
	Outer Diam./Diam. est. [mm]	288
	Inner Diam./Diam. int. [mm]	229
	MAZDA - SUZUKI	

20-03-309	
	Height/Altezza [mm]
	188
	Outer Diam./Diam. est. [mm]
	174
	Inner Diam./Diam. int. [mm]
	101
MAZDA	

20-03-315	
	Length/Lungh. [mm]
	273
	Width/Largh. [mm]
	258
	Height/Altezza [mm]
	42
MAZDA	

20-03-310	
	Height/Altezza [mm]
	97
	Outer Diam./Diam. est. [mm]
	201,5
	Inner Diam./Diam. int. [mm]
	126
	Inner Diam. 1/Diam. int. 1 [mm]
	9,5
MAZDA	

20-03-316	
	Height/Altezza [mm]
	45
	Outer Diam./Diam. est. [mm]
	220
	Inner Diam./Diam. int. [mm]
	155
KIA - MAZDA	

20-03-312	
	Length/Lungh. [mm]
	230
	Width/Largh. [mm]
	196
	Height/Altezza [mm]
	46,7
MAZDA	

20-03-317	
	Length/Lungh. [mm]
	235,8
	Width/Largh. [mm]
	200,8
	Height/Altezza [mm]
	40
MAZDA	

20-03-313	
	Height/Altezza [mm]
	159
	Outer Diam./Diam. est. [mm]
	155
	Inner Diam./Diam. int. [mm]
	76
MAZDA	

20-03-318	
	Length/Lungh. [mm]
	320
	Width/Largh. [mm]
	176
	Height/Altezza [mm]
	51
MAZDA	

20-03-314	
	Length/Lungh. [mm]
	339
	Width/Largh. [mm]
	140
	Height/Altezza [mm]
	36
MAZDA	

20-03-319	
	Height/Altezza [mm]
	190
	Outer Diam./Diam. est. [mm]
	186,4
	Inner Diam./Diam. int. [mm]
	115
	Inner Diam. 1/Diam. int. 1 [mm]
	8
MAZDA	

20-03-320	
	Height/Altezza [mm]
	100,2
	Outer Diam./Diam. est. [mm]
	199,7
	Inner Diam./Diam. int. [mm]
	117
MAZDA	

20-03-327	
	Length/Lungh. [mm]
	255,3
	Width/Largh. [mm]
	166
	Height/Altezza [mm]
	38
MAZDA	

20-03-321	
	Length/Lungh. [mm]
	255
	Width/Largh. [mm]
	177
	Height/Altezza [mm]
	38
MAZDA	

20-03-328	
	Length/Lungh. [mm]
	275
	Width/Largh. [mm]
	260
	Height/Altezza [mm]
	45
Subst. by 20-03-329	

20-03-323	
	Length/Lungh. [mm]
	250
	Width/Largh. [mm]
	153
	Height/Altezza [mm]
	38
MAZDA	

20-03-329	
	Length/Lungh. [mm]
	278
	Width/Largh. [mm]
	262
	Height/Altezza [mm]
	46
MAZDA	

20-03-324	
	Height/Altezza [mm]
	23
	Outer Diam./Diam. est. [mm]
	293
	Inner Diam./Diam. int. [mm]
	120
MAZDA	

20-03-330	
	Length/Lungh. [mm]
	270
	Width/Largh. [mm]
	185
	Width 1/Largh. 1 [mm]
145	
	Height/Altezza [mm]
	40
MAZDA	

20-03-325	
	Length/Lungh. [mm]
	322
	Width/Largh. [mm]
	178
	Height/Altezza [mm]
	47
MAZDA	

20-03-331	
	Outer Length/Lungh. est. [mm]
	288
	Inner Length/Lungh. int. [mm]
	245,5
	Outer Width/Largh. est. [mm]
	222,5
	Inner Width/Largh. int. [mm]
	160
	Height/Altezza [mm]
	36,2
CHEVROLET - DAEWOO	

20-03-332	
	Length/Lungh. [mm]
	275
	Width/Largh. [mm]
247	
Height/Altezza [mm]	
45	
CHEVROLET - DAEWOO	

20-03-337	
	Length/Lungh. [mm]
	274
	Width/Largh. [mm]
187	
Height/Altezza [mm]	
53	
MAZDA	

20-03-333	
	Length/Lungh. [mm]
	254
	Width/Largh. [mm]
179	
Height/Altezza [mm]	
60	
MAZDA	

20-03-338	
	Length/Lungh. [mm]
	241
	Width/Largh. [mm]
148	
Height/Altezza [mm]	
42	
MAZDA	

20-03-334	
	Length/Lungh. [mm]
	375
	Width/Largh. [mm]
228	
Height/Altezza [mm]	
49	
MAZDA	

20-03-339	
	Length/Lungh. [mm]
	302
	Width/Largh. [mm]
161	
Height/Altezza [mm]	
40	
MAZDA	

20-03-335	
	Length/Lungh. [mm]
	315
	Width/Largh. [mm]
200	
Height/Altezza [mm]	
34	
MAZDA	

20-03-340	
	Length/Lungh. [mm]
	275
	Width/Largh. [mm]
161	
Height/Altezza [mm]	
51	
MAZDA	

20-03-336	
	Length/Lungh. [mm]
	267,2
	Width/Largh. [mm]
173,2	
Height/Altezza [mm]	
58	
MAZDA	

20-03-341	
	Height/Altezza [mm]
	209
	Outer Diam./Diam. est. [mm]
	153
	Inner Diam./Diam. int. [mm]
69	
Fitted Diam./Diam. montaggio [mm]	
82	
MAZDA	

20-03-350		
	Length/Lungh. [mm]	216
	Width/Largh. [mm]	168
	Height/Altezza [mm]	30
MAZDA		

20-03-387		
	Length/Lungh. [mm]	247,7
	Width/Largh. [mm]	204
	Height/Altezza [mm]	39,5
DAEWOO		

20-03-351		
	Length/Lungh. [mm]	380
	Length 1/Lungh. 1 [mm]	316,2
	Width/Largh. [mm]	140
	Width 1/Largh. 1 [mm]	50
	Height/Altezza [mm]	47,5
MAZDA - TOYOTA		

20-03-388		
	Length/Lungh. [mm]	274
	Width/Largh. [mm]	202
	Height/Altezza [mm]	59
KIA		

20-03-383		
	Length/Lungh. [mm]	249
	Width/Largh. [mm]	200
	Height/Altezza [mm]	53
MAZDA - MITSUBISHI		

20-03-389		
	Length/Lungh. [mm]	287
	Width/Largh. [mm]	166
	Height/Altezza [mm]	39
MAZDA		

20-03-384		
	Length/Lungh. [mm]	210
	Width/Largh. [mm]	153
	Height/Altezza [mm]	39
KIA - MAZDA		

20-03-390		
	Height/Altezza [mm]	247
	Outer Diam./Diam. est. [mm]	155
	Inner Diam./Diam. int. [mm]	86
MAZDA		

20-03-385		
	Length/Lungh. [mm]	209
	Width/Largh. [mm]	202
	Height/Altezza [mm]	39,5
DAEWOO		

20-03-392		
	Height/Altezza [mm]	179
	Outer Diam./Diam. est. [mm]	155
	Inner Diam./Diam. int. [mm]	88
MAZDA		

20-03-393	
	Height/Altezza [mm]
	111,3
	Outer Diam./Diam. est. [mm]
	201,3
	Inner Diam./Diam. int. [mm]
	126
MAZDA	

20-03-398	
	Length/Lungh. [mm]
	256
	Width/Largh. [mm]
	158
	Height/Altezza [mm]
	41
KIA	

20-03-394	
	Length/Lungh. [mm]
	248
	Width/Largh. [mm]
	212
	Height/Altezza [mm]
	40
DAEWOO	

20-03-399	
	Length/Lungh. [mm]
	198
	Width/Largh. [mm]
	182
	Width 1/Largh. 1 [mm]
164	
	Height/Altezza [mm]
	43
MAZDA	

20-03-395	
	Length/Lungh. [mm]
	264
	Width/Largh. [mm]
	183
	Height/Altezza [mm]
	37
KIA	

20-04-400	
	Length/Lungh. [mm]
	262
	Width/Largh. [mm]
	173
	Height/Altezza [mm]
	40
HONDA	

20-03-396	
	Height/Altezza [mm]
	159
	Outer Diam./Diam. est. [mm]
	170
	Inner Diam./Diam. int. [mm]
	78
DAEWOO	

20-04-403	
	Height/Altezza [mm]
	69
	Outer Diam./Diam. est. [mm]
	231
	Inner Diam./Diam. int. [mm]
	173
HONDA	

20-03-397	
	Length/Lungh. [mm]
	241
	Width/Largh. [mm]
	159
	Height/Altezza [mm]
	37,5
MAZDA	

20-04-404	
	Height/Altezza [mm]
	40
	Outer Diam./Diam. est. [mm]
	250
	Inner Diam./Diam. int. [mm]
	192
HONDA	

20-04-405		
	Length/Lungh. [mm]	296
	Length 1/Lungh. 1 [mm]	249
	Width/Largh. [mm]	165
	Width 1/Largh. 1 [mm]	118
	Height/Altezza [mm]	55
HONDA		

20-04-412		
	Outer Length/Lungh. est. [mm]	346,4
	Inner Length/Lungh. int. [mm]	280
	Outer Width/Largh. est. [mm]	216,5
	Inner Width/Largh. int. [mm]	150
	Height/Altezza [mm]	47
HONDA		

20-04-406		
	Height/Altezza [mm]	43
	Outer Diam./Diam. est. [mm]	270,7
	Inner Diam./Diam. int. [mm]	197,2
HONDA		

20-04-413		
	Length/Lungh. [mm]	269,4
	Width/Largh. [mm]	186
	Height/Altezza [mm]	33,3
HONDA		

20-04-407		
	Length/Lungh. [mm]	228,6
	Width/Largh. [mm]	139
	Height/Altezza [mm]	37,7
HONDA		

20-04-415		
	Length/Lungh. [mm]	322
	Width/Largh. [mm]	134,8
	Width 1/Largh. 1 [mm]	104,8
	Height/Altezza [mm]	86
HONDA		

20-04-408		
	Height/Altezza [mm]	47
	Outer Diam./Diam. est. [mm]	241
	Inner Diam./Diam. int. [mm]	190
HONDA		

20-04-416		
	Length/Lungh. [mm]	197,5
	Length 1/Lungh. 1 [mm]	157
	Width/Largh. [mm]	162,5
	Width 1/Largh. 1 [mm]	140
	Height/Altezza [mm]	36,5
HONDA		

20-04-409		
	Length/Lungh. [mm]	292
	Length 1/Lungh. 1 [mm]	241,5
	Width/Largh. [mm]	216,6
	Width 1/Largh. 1 [mm]	165,6
	Height/Altezza [mm]	68
HONDA		

20-04-417		
	Outer Length/Lungh. est. [mm]	281
	Inner Length/Lungh. int. [mm]	230,4
	Outer Width/Largh. est. [mm]	219,8
	Inner Width/Largh. int. [mm]	169,4
	Height/Altezza [mm]	44,3
HONDA - HYUNDAI - MAZDA		

20-04-418	
	Outer Length/Lungh. est. [mm]
	308
	Inner Length/Lungh. int. [mm]
	265
	Outer Width/Largh. est. [mm]
247	
Inner Width/Largh. int. [mm]	
192	
Height/Altezza [mm]	
43,4	
HONDA	

20-04-423	
	Length/Lungh. [mm]
	234,3
	Length 1/Lungh. 1 [mm]
	187,5
	Width/Largh. [mm]
157	
Width 1/Largh. 1 [mm]	
123	
Height/Altezza [mm]	
36	
HONDA	

20-04-419	
	Length/Lungh. [mm]
	290,3
	Length 1/Lungh. 1 [mm]
	145,3
	Width/Largh. [mm]
228,6	
Width 1/Largh. 1 [mm]	
150	
Height/Altezza [mm]	
64	
HONDA	

20-04-424	
	Length/Lungh. [mm]
	272
	Width/Largh. [mm]
	168,2
Height/Altezza [mm]	
41	
HONDA	

20-04-420	
	Height/Altezza [mm]
	186,5
	Outer Diam./Diam. est. [mm]
	134,5
Inner Diam./Diam. int. [mm]	
71,5	
HONDA	

20-04-425	
	Length/Lungh. [mm]
	317
	Width/Largh. [mm]
	160
Height/Altezza [mm]	
54	
HONDA	

20-04-421	
	Outer Length/Lungh. est. [mm]
	369,2
	Inner Length/Lungh. int. [mm]
	320,7
	Outer Width/Largh. est. [mm]
192,5	
Inner Width/Largh. int. [mm]	
143,5	
Height/Altezza [mm]	
61,5	
HONDA	

20-04-427	
	Length/Lungh. [mm]
	336
	Length 1/Lungh. 1 [mm]
	212
	Width/Largh. [mm]
152	
Width 1/Largh. 1 [mm]	
36	
Height/Altezza [mm]	
49	
HONDA	

20-04-422	
	Length/Lungh. [mm]
	242,2
	Width/Largh. [mm]
138	
Height/Altezza [mm]	
40	
HONDA	

20-04-428	
	Length/Lungh. [mm]
	318
	Length 1/Lungh. 1 [mm]
	171,6
	Width/Largh. [mm]
198	
Width 1/Largh. 1 [mm]	
98	
Height/Altezza [mm]	
37,5	
HONDA	

20-04-429		
	Length/Lungh. [mm]	317
	Length 1/Lungh. 1 [mm]	170
	Width/Largh. [mm]	200
	Width 1/Largh. 1 [mm]	80
	Height/Altezza [mm]	38,5
HONDA		

20-04-435		
	Length/Lungh. [mm]	340,8
	Length 1/Lungh. 1 [mm]	270
	Width/Largh. [mm]	149,5
	Width 1/Largh. 1 [mm]	100
	Height/Altezza [mm]	40,2
HONDA		

20-04-430		
	Height/Altezza [mm]	294,4
	Outer Diam./Diam. est. [mm]	187,3
	Outer Diam. 1/Diam. est. 1 [mm]	96,4
	Inner Diam./Diam. int. [mm]	80,8
HONDA		

20-04-436		
	Length/Lungh. [mm]	361
	Width/Largh. [mm]	114
	Height/Altezza [mm]	44
HONDA		

20-04-431		
	Height/Altezza [mm]	314,5
	Outer Diam./Diam. est. [mm]	129,5
	Inner Diam./Diam. int. [mm]	78,2
HONDA		

20-04-437		
	Length/Lungh. [mm]	324
	Length 1/Lungh. 1 [mm]	263
	Width/Largh. [mm]	214
	Width 1/Largh. 1 [mm]	100
	Height/Altezza [mm]	39
HONDA		

20-04-432		
	Height/Altezza [mm]	171
	Outer Diam./Diam. est. [mm]	138,2
	Inner Diam./Diam. int. [mm]	83
HONDA		

20-04-438		
	Length/Lungh. [mm]	305
	Width/Largh. [mm]	183
	Height/Altezza [mm]	42
HONDA		

20-04-434		
	Length/Lungh. [mm]	330
	Length 1/Lungh. 1 [mm]	244,4
	Width/Largh. [mm]	110
	Height/Altezza [mm]	39,5
HONDA		

20-04-439		
	Length/Lungh. [mm]	225
	Width/Largh. [mm]	195
	Height/Altezza [mm]	40
HONDA		

20-04-440	
	Length/Lungh. [mm]
	165
	Width/Largh. [mm]
	146
	Height/Altezza [mm]
	55
HONDA	

20-04-445	
	Length/Lungh. [mm]
	173
	Width/Largh. [mm]
	153
	Height/Altezza [mm]
	42
HONDA	

20-04-441	
	Length/Lungh. [mm]
	348
	Width/Largh. [mm]
	154
	Height/Altezza [mm]
	42
HONDA	

20-04-449	
 NEW	Length/Lungh. [mm]
	225
	Width/Largh. [mm]
	154
	Height/Altezza [mm]
	33
HONDA	

20-04-442	
	Length/Lungh. [mm]
	231
	Width/Largh. [mm]
	211
	Height/Altezza [mm]
	48
HONDA	

20-04-450	
 NEW	Length/Lungh. [mm]
	193
	Width/Largh. [mm]
	180
	Height/Altezza [mm]
	47
HONDA	

20-04-443	
	Length/Lungh. [mm]
	239
	Width/Largh. [mm]
	211
	Height/Altezza [mm]
	51
HONDA	

20-04-453	
 NEW	Length/Lungh. [mm]
	220
	Width/Largh. [mm]
	138
	Height/Altezza [mm]
	40
HONDA	

20-04-444	
	Length/Lungh. [mm]
	179
	Width/Largh. [mm]
	168
	Height/Altezza [mm]
58	
	Height 1/Altezza 1 [mm]
	42
HONDA	

20-04-474	
	Length/Lungh. [mm]
	297
	Width/Largh. [mm]
	200
	Height/Altezza [mm]
	42
HONDA	

20-04-486	
	Length/Lungh. [mm]
	Width/Largh. [mm]
	Height/Altezza [mm]
	HONDA

20-04-494	
	Length/Lungh. [mm]
	Width/Largh. [mm]
	Height/Altezza [mm]
	HONDA

20-04-487	
	Length/Lungh. [mm]
	Width/Largh. [mm]
	Height/Altezza [mm]
	HONDA

20-04-495	
	Length/Lungh. [mm]
	Length 1/Lungh. 1 [mm]
	Width/Largh. [mm]
	Width 1/Largh. 1 [mm]
	Height/Altezza [mm]
	HONDA

20-04-488	
	Length/Lungh. [mm]
	Width/Largh. [mm]
	Height/Altezza [mm]
	HONDA

20-04-496	
	Length/Lungh. [mm]
	Width/Largh. [mm]
	Height/Altezza [mm]
	HONDA

20-04-490	
	Length/Lungh. [mm]
	Length 1/Lungh. 1 [mm]
	Width/Largh. [mm]
	Width 1/Largh. 1 [mm]
	Height/Altezza [mm]
	HONDA

20-04-497	
	Length/Lungh. [mm]
	Width/Largh. [mm]
	Width 1/Largh. 1 [mm]
	Height/Altezza [mm]
	HONDA

20-04-492	
	Length/Lungh. [mm]
	Length 1/Lungh. 1 [mm]
	Width/Largh. [mm]
	Width 1/Largh. 1 [mm]
	Height/Altezza [mm]
	HONDA

20-04-498	
	Length/Lungh. [mm]
	Width/Largh. [mm]
	Height/Altezza [mm]
	HONDA

20-05-500		
	Length/Lungh. [mm]	240
	Width/Largh. [mm]	239
	Height/Altezza [mm]	65
ISUZU - MITSUBISHI		

20-05-505		
	Length/Lungh. [mm]	279,7
	Width/Largh. [mm]	186,2
	Height/Altezza [mm]	64
MITSUBISHI		

20-05-501		
	Height/Altezza [mm]	60,5
	Outer Diam./Diam. est. [mm]	250
	Inner Diam./Diam. int. [mm]	193
HYUNDAI - MITSUBISHI		

20-05-506		
	Length/Lungh. [mm]	315,5
	Length 1/Lungh. 1 [mm]	247,3
	Width/Largh. [mm]	157
	Width 1/Largh. 1 [mm]	87,7
	Height/Altezza [mm]	50
MITSUBISHI		

20-05-502		
	Height/Altezza [mm]	49,5
	Outer Diam./Diam. est. [mm]	250
	Inner Diam./Diam. int. [mm]	193
HYUNDAI - MITSUBISHI		

20-05-507		
	Outer Length/Lungh. est. [mm]	346,6
	Inner Length/Lungh. int. [mm]	272
	Outer Width/Largh. est. [mm]	192,8
	Inner Width/Largh. int. [mm]	123,8
	Height/Altezza [mm]	44,4
MITSUBISHI		

20-05-503		
	Height/Altezza [mm]	138,2
	Outer Diam./Diam. est. [mm]	170
	Inner Diam./Diam. int. [mm]	114,5
MITSUBISHI		

20-05-508		
	Outer Length/Lungh. est. [mm]	240,8
	Inner Length/Lungh. int. [mm]	163,5
	Outer Width/Largh. est. [mm]	152,3
	Inner Width/Largh. int. [mm]	75,6
	Height/Altezza [mm]	146,8
MITSUBISHI		

20-05-504		
	Height/Altezza [mm]	66
	Outer Diam./Diam. est. [mm]	271
	Inner Diam./Diam. int. [mm]	202
HYUNDAI - MAZDA - MITSUBISHI		

20-05-509		
	Height/Altezza [mm]	180,2
	Outer Diam./Diam. est. [mm]	172
	Outer Diam. 1/Diam. est. 1 [mm]	148
	Inner Diam./Diam. int. [mm]	134,5
	Inner Diam. 1/Diam. int. 1 [mm]	110,6
	MITSUBISHI	

20-05-510	
	Height/Altezza [mm]
	62
	Outer Diam./Diam. est. [mm]
	259
	Inner Diam./Diam. int. [mm]
	195,5
CHRYSLER - HONDA - HYUNDAI - MITSUBISHI	

20-05-516	
	Outer Length/Lungh. est. [mm]
	202
	Inner Length/Lungh. int. [mm]
	134,8
	Outer Width/Largh. est. [mm]
	191
	Inner Width/Largh. int. [mm]
	111,2
	Height/Altezza [mm]
	169,3
CHRYSLER - HYUNDAI - KIA - MITSUBISHI	

20-05-511	
	Height/Altezza [mm]
	85,8
	Outer Diam./Diam. est. [mm]
	229,8
	Inner Diam./Diam. int. [mm]
	174
MITSUBISHI	

20-05-517	
	Height/Altezza [mm]
	164,3
	Outer Diam./Diam. est. [mm]
	217
	Inner Diam./Diam. int. [mm]
	135
HYUNDAI - MITSUBISHI	

20-05-512	
	Outer Length/Lungh. est. [mm]
	325,6
	Inner Length/Lungh. int. [mm]
	257
	Outer Width/Largh. est. [mm]
	229
	Inner Width/Largh. int. [mm]
	163
	Height/Altezza [mm]
	59,8
MITSUBISHI	

20-05-518	
	Height/Altezza [mm]
	79,6
	Outer Diam./Diam. est. [mm]
	235,8
	Inner Diam./Diam. int. [mm]
	169,7

20-05-513	
	Height/Altezza [mm]
	213
	Outer Diam./Diam. est. [mm]
	170,5
	Outer Diam. 1/Diam. est. 1 [mm]
	120,9
	Inner Diam./Diam. int. [mm]
	116,8
	Inner Diam. 1/Diam. int. 1 [mm]
	66,8
MITSUBISHI	

20-05-521	
	Length/Lungh. [mm]
	232
	Width/Largh. [mm]
	155,6
	Height/Altezza [mm]
	42
HYUNDAI	

20-05-515	
	Height/Altezza [mm]
	180
	Outer Diam./Diam. est. [mm]
	172
	Inner Diam./Diam. int. [mm]
	124
MITSUBISHI	

20-05-522	
	Length/Lungh. [mm]
	250
	Width/Largh. [mm]
	152
	Height/Altezza [mm]
	46,7
HYUNDAI	

20-05-523	
	Height/Altezza [mm]
	196
	Outer Diam./Diam. est. [mm]
	158
	Outer Diam. 1/Diam. est. 1 [mm]
	155
Inner Diam./Diam. int. [mm]	
88,5	
Inner Diam. 1/Diam. int. 1 [mm]	
14,3	
DAIHATSU - MITSUBISHI	

20-05-529	
	Height/Altezza [mm]
	185,6
	Outer Diam./Diam. est. [mm]
	188
	Inner Diam./Diam. int. [mm]
	112
Inner Diam. 1/Diam. int. 1 [mm]	
12,2	
HYUNDAI	

20-05-524	
	Length/Lungh. [mm]
	359
	Width/Largh. [mm]
	237,2
Height/Altezza [mm]	
47,8	
mitsubishi	

20-05-530	
	Length/Lungh. [mm]
	257,5
	Width/Largh. [mm]
	209
Height/Altezza [mm]	
52	
mitsubishi	

20-05-525	
	Length/Lungh. [mm]
	151
	Width/Largh. [mm]
	54,3
Height/Altezza [mm]	
26	
mitsubishi	

20-05-531	
	Length/Lungh. [mm]
	268
	Width/Largh. [mm]
	184,5
Height/Altezza [mm]	
53,5	
mitsubishi	

20-05-526	
	Height/Altezza [mm]
	287,3
	Outer Diam./Diam. est. [mm]
	229
Inner Diam./Diam. int. [mm]	
116	
mitsubishi	

20-05-574	
	Length/Lungh. [mm]
	249,4
	Width/Largh. [mm]
	197
Height/Altezza [mm]	
50	
Subst. by 20-03-383	

20-05-527	
	Height/Altezza [mm]
	340,8
	Outer Diam./Diam. est. [mm]
	264,7
	Outer Diam. 1/Diam. est. 1 [mm]
	220
Inner Diam./Diam. int. [mm]	
137	
Inner Diam. 1/Diam. int. 1 [mm]	
23,2	
FIAT - MITSUBISHI	

20-05-575	
	Height/Altezza [mm]
	296
	Outer Diam./Diam. est. [mm]
	230
Inner Diam./Diam. int. [mm]	
122	
mitsubishi	

20-05-576	
	Height/Altezza [mm]
	214
	Outer Diam./Diam. est. [mm]
	194
	Inner Diam./Diam. int. [mm]
	130,2
HYUNDAI	

20-05-582	
	Height/Altezza [mm]
	190,2
	Outer Diam./Diam. est. [mm]
	201,3
	Inner Diam./Diam. int. [mm]
	126
	Inner Diam. 1/Diam. int. 1 [mm]
	14,5
MITSUBISHI	

20-05-577	
	Height/Altezza [mm]
	241,5
	Outer Diam./Diam. est. [mm]
	179,7
	Inner Diam./Diam. int. [mm]
	97,3
FIAT - MITSUBISHI	

20-05-583	
	Outer Length/Lungh. est. [mm]
	289
	Inner Length/Lungh. int. [mm]
	163,8
	Outer Width/Largh. est. [mm]
	199
	Inner Width/Largh. int. [mm]
	73,9
	Height/Altezza [mm]
	137
MITSUBISHI	

20-05-578	
	Length/Lungh. [mm]
	265,5
	Width/Largh. [mm]
	137
	Height/Altezza [mm]
	27
HYUNDAI	

20-05-584	
	Length/Lungh. [mm]
	169,8
	Width/Largh. [mm]
	143,6
	Height/Altezza [mm]
	196
MITSUBISHI	

20-05-580	
	Height/Altezza [mm]
	136
	Outer Diam./Diam. est. [mm]
	238,8
	Outer Diam. 1/Diam. est. 1 [mm]
	223,4
	Inner Diam./Diam. int. [mm]
	146
	Inner Diam. 1/Diam. int. 1 [mm]
	12,2
MITSUBISHI	

20-05-585	
	Outer Length/Lungh. est. [mm]
	172,3
	Inner Length/Lungh. int. [mm]
	124,6
	Outer Width/Largh. est. [mm]
	148,5
	Inner Width/Largh. int. [mm]
	100,7
	Height/Altezza [mm]
	190,5
Subst. by 20-05-515	

20-05-581	
	Height/Altezza [mm]
	137
	Outer Diam./Diam. est. [mm]
	225,5
	Inner Diam./Diam. int. [mm]
143,3	
	Inner Diam. 1/Diam. int. 1 [mm]
	17,5
MITSUBISHI	

20-05-586	
	Length/Lungh. [mm]
	252,5
	Width/Largh. [mm]
	227,5
	Height/Altezza [mm]
	46
MITSUBISHI - SHUANGHUAN AUTO	

20-05-587	
	Length/Lungh. [mm]
	Width/Largh. [mm]
	Height/Altezza [mm]
MITSUBISHI	

20-05-593	
	Length/Lungh. [mm]
	Width/Largh. [mm]
	Height/Altezza [mm]
HYUNDAI	

20-05-588	
	Length/Lungh. [mm]
	Width/Largh. [mm]
	Height/Altezza [mm]
MITSUBISHI	

20-05-596	
	Length/Lungh. [mm]
	Width/Largh. [mm]
	Height/Altezza [mm]
MITSUBISHI	

20-05-589	
	Length/Lungh. [mm]
	Width/Largh. [mm]
	Height/Altezza [mm]
MITSUBISHI	

20-05-597	
	Height/Altezza [mm]
	Outer Diam./Diam. est. [mm]
	Inner Diam./Diam. int. [mm]
	Inner Diam. 1/Diam. int. 1 [mm]
MITSUBISHI	

20-05-590	
	Length/Lungh. [mm]
	Width/Largh. [mm]
	Height/Altezza [mm]
HYUNDAI	

20-05-598	
	Length/Lungh. [mm]
	Width/Largh. [mm]
	Height/Altezza [mm]
MITSUBISHI	

20-05-592	
	Length/Lungh. [mm]
	Width/Largh. [mm]
	Height/Altezza [mm]
HYUNDAI	

20-05-599	
	Length/Lungh. [mm]
	Width/Largh. [mm]
	Height/Altezza [mm]
CHRYSLER - MAZDA - MITSUBISHI	

20-06-600		
	Length/Lungh. [mm]	209
	Width/Largh. [mm]	123
	Height/Altezza [mm]	50
DAIHATSU		

20-06-606		
	Length/Lungh. [mm]	208,5
	Width/Largh. [mm]	168,5
	Height/Altezza [mm]	57
DAIHATSU		

20-06-601		
	Height/Altezza [mm]	69
	Outer Diam./Diam. est. [mm]	236,2
	Inner Diam./Diam. int. [mm]	179,5
DAIHATSU		

20-06-608		
	Height/Altezza [mm]	161,2
	Outer Diam./Diam. est. [mm]	116,7
	Inner Diam./Diam. int. [mm]	56,2
DAIHATSU - PIAGGIO		

20-06-602		
	Height/Altezza [mm]	45,5
	Outer Diam./Diam. est. [mm]	225
	Inner Diam./Diam. int. [mm]	174,4
DAIHATSU		

20-06-610		
	Height/Altezza [mm]	35,4
	Outer Diam./Diam. est. [mm]	268
	Inner Diam./Diam. int. [mm]	77,7
	Inner Diam. 1/Diam. int. 1 [mm]	21,3
DAIHATSU		

20-06-603		
	Height/Altezza [mm]	78,4
	Outer Diam./Diam. est. [mm]	236,2
	Inner Diam./Diam. int. [mm]	179,6
DAIHATSU		

20-06-611		
	Height/Altezza [mm]	156,4
	Outer Width/Largh. est. [mm]	88,8
	Inner Width/Largh. int. [mm]	14,5
MITSUBISHI		

20-06-605		
	Length/Lungh. [mm]	170
	Width/Largh. [mm]	137
	Height/Altezza [mm]	59,4
DAIHATSU - PIAGGIO		

20-06-613		
	Length/Lungh. [mm]	308
	Width/Largh. [mm]	172
	Height/Altezza [mm]	33
DAIHATSU		

20-06-614	
	Length/Lungh. [mm]
	Width/Largh. [mm]
	Height/Altezza [mm]
PIAGGIO	

20-06-619	
	Length/Lungh. [mm]
	Width/Largh. [mm]
	Height/Altezza [mm]
DAIHATSU	

20-06-615	
	Length/Lungh. [mm]
	Width/Largh. [mm]
	Height/Altezza [mm]
PIAGGIO	

20-06-692	
	Length/Lungh. [mm]
	Width/Largh. [mm]
	Height/Altezza [mm]
DAIHATSU	

20-06-616	
	Length/Lungh. [mm]
	Width/Largh. [mm]
	Height/Altezza [mm]
DAIHATSU	

20-06-693	
	Length/Lungh. [mm]
	Width/Largh. [mm]
	Height/Altezza [mm]
DAIHATSU	

20-06-617	
	Length/Lungh. [mm]
	Width/Largh. [mm]
	Height/Altezza [mm]
DAIHATSU	

20-06-694	
	Length/Lungh. [mm]
	Width/Largh. [mm]
	Height/Altezza [mm]
DAIHATSU	

20-06-618	
	Height/Altezza [mm]
	Inner Diam./Diam. int. [mm]
	Outer Diam./Diam. est. [mm]
DAIHATSU	

20-06-697	
	Length/Lungh. [mm]
	Width/Largh. [mm]
	Height/Altezza [mm]
DAIHATSU - PIAGGIO	

20-06-698	
	Height/Altezza [mm]
	67
	Outer Diam./Diam. est. [mm]
	195,4
	Inner Diam./Diam. int. [mm]
	150,2
DAIHATSU	

20-07-708	
	Height/Altezza [mm]
	31
	Outer Diam./Diam. est. [mm]
	223,5
	Inner Diam./Diam. int. [mm]
	21
SUBARU	

20-06-699	
	Height/Altezza [mm]
	30
	Outer Diam./Diam. est. [mm]
	240
	Inner Diam./Diam. int. [mm]
	83,3
	Inner Diam. 1/Diam. int. 1 [mm]
	8
DAIHATSU	

20-07-710	
	Length/Lungh. [mm]
	224
	Width/Largh. [mm]
	167,2
	Height/Altezza [mm]
	38,3
TOYOTA	

20-07-700	
	Outer Length/Lungh. est. [mm]
	372,5
	Inner Length/Lungh. int. [mm]
	314
	Outer Width/Largh. est. [mm]
	167
	Inner Width/Largh. int. [mm]
	108,2
	Height/Altezza [mm]
	41,8
SUBARU	

20-07-711	
	Length/Lungh. [mm]
	196,5
	Width/Largh. [mm]
	185
	Height/Altezza [mm]
	35
SUBARU	

20-07-703	
	Height/Altezza [mm]
	83
	Outer Diam./Diam. est. [mm]
	226,2
	Inner Diam./Diam. int. [mm]
	142
	Inner Diam. 1/Diam. int. 1 [mm]
	7,8
SUBARU	

20-07-712	
	Length/Lungh. [mm]
	215
	Width/Largh. [mm]
	155
	Height/Altezza [mm]
	35,8
Subst. by 20-07-797	

20-07-704	
	Height/Altezza [mm]
	50
	Outer Diam./Diam. est. [mm]
	226,6
	Inner Diam./Diam. int. [mm]
	143,5
	Inner Diam. 1/Diam. int. 1 [mm]
	8
SUBARU	

20-07-714	
	Length/Lungh. [mm]
	218
	Width/Largh. [mm]
	216
	Height/Altezza [mm]
	32
SUBARU	

20-07-715	
	Length/Lungh. [mm]
	253,2
	Width/Largh. [mm]
	150
Height/Altezza [mm]	
38	
SUBARU - SUZUKI	

20-07-799	
	Length/Lungh. [mm]
	229,2
	Width/Largh. [mm]
	103
Height/Altezza [mm]	
32,3	
SUBARU	

20-07-716	
	Length/Lungh. [mm]
	226
	Width/Largh. [mm]
	165
Height/Altezza [mm]	
35	
SUBARU	

20-08-801	
	Length/Lungh. [mm]
	242
	Width/Largh. [mm]
	164
Height/Altezza [mm]	
55	
SUZUKI	

20-07-796	
	Length/Lungh. [mm]
	371,5
	Width/Largh. [mm]
	170,2
Height/Altezza [mm]	
32	
SUBARU	

20-08-802	
	Height/Altezza [mm]
	45
	Outer Diam./Diam. est. [mm]
	212
Inner Diam./Diam. int. [mm]	
159,4	
SUZUKI	

20-07-797	
	Length/Lungh. [mm]
	216
	Width/Largh. [mm]
	158
Height/Altezza [mm]	
37	
SUBARU	

20-08-803	
	Height/Altezza [mm]
	173
	Outer Diam./Diam. est. [mm]
	120,7
Inner Diam./Diam. int. [mm]	
69,8	
SUZUKI	

20-07-798	
	Length/Lungh. [mm]
	243
	Width/Largh. [mm]
	104
	Width 1/Largh. 1 [mm]
95	
Height/Altezza [mm]	
32	

20-08-805	
	Height/Altezza [mm]
	43,5
	Outer Diam./Diam. est. [mm]
	269
Inner Diam./Diam. int. [mm]	
199,8	
SUZUKI	

20-08-806	
	Height/Altezza [mm]
	Outer Diam./Diam. est. [mm]
	Inner Diam./Diam. int. [mm]
SUZUKI	

20-08-812	
	Height/Altezza [mm]
	Outer Diam./Diam. est. [mm]
	Inner Diam./Diam. int. [mm]
	Inner Diam. 1/Diam. int. 1 [mm]
SUZUKI	

20-08-807	
	Height/Altezza [mm]
	Outer Diam./Diam. est. [mm]
	Inner Diam./Diam. int. [mm]
SUZUKI	

20-08-813	
	Height/Altezza [mm]
	Outer Diam./Diam. est. [mm]
	Inner Diam./Diam. int. [mm]
	Inner Diam. 1/Diam. int. 1 [mm]
SUBARU - SUZUKI	

20-08-808	
	Length/Lungh. [mm]
	Width/Largh. [mm]
	Height/Altezza [mm]
SUZUKI	

20-08-815	
	Length/Lungh. [mm]
	Width/Largh. [mm]
	Height/Altezza [mm]
SUZUKI	

20-08-809	
	Height/Altezza [mm]
	Outer Diam./Diam. est. [mm]
	Inner Diam./Diam. int. [mm]
SUZUKI	

20-08-817	
	Length/Lungh. [mm]
	Width/Largh. [mm]
	Height/Altezza [mm]
SUZUKI	

20-08-811	
	Height/Altezza [mm]
	Outer Diam./Diam. est. [mm]
	Inner Diam./Diam. int. [mm]
	Inner Diam. 1/Diam. int. 1 [mm]
SUZUKI	

20-08-818	
	Length/Lungh. [mm]
	Width/Largh. [mm]
	Height/Altezza [mm]
	Height 1/Altezza 1 [mm]
SUZUKI	

20-08-819	
	Length/Lungh. [mm]
	231,5
	Width/Largh. [mm]
	147
	Height/Altezza [mm]
	42
SUZUKI	

20-08-826	
	Length/Lungh. [mm]
	315
	Width/Largh. [mm]
	113
	Height/Altezza [mm]
	61
SUZUKI	

20-08-822	
	Length/Lungh. [mm]
	240
	Width/Largh. [mm]
	120
	Height/Altezza [mm]
	46
SUZUKI	

20-08-827	
	Length/Lungh. [mm]
	184
	Width/Largh. [mm]
	171
	Height/Altezza [mm]
	57,5
FIAT - SUZUKI	

20-08-823	
	Length/Lungh. [mm]
	196,5
	Width/Largh. [mm]
	193
	Height/Altezza [mm]
	47
SUZUKI	

20-08-828	
	Length/Lungh. [mm]
	228
	Width/Largh. [mm]
	128
	Height/Altezza [mm]
	35
SUZUKI	

20-08-824	
	Length/Lungh. [mm]
	229
	Length 1/Lungh. 1 [mm]
	174
	Width/Largh. [mm]
	178
	Width 1/Largh. 1 [mm]
	120
	Height/Altezza [mm]
	50
SUZUKI	

20-08-829	
	Length/Lungh. [mm]
	236
	Width/Largh. [mm]
	143
	Height/Altezza [mm]
	32
SUZUKI	

20-08-825	
	Length/Lungh. [mm]
	256,5
	Width/Largh. [mm]
	210
	Height/Altezza [mm]
	42,4
SUZUKI	

20-08-830	
	Length/Lungh. [mm]
	244
	Width/Largh. [mm]
	146
	Height/Altezza [mm]
	39
NISSAN - SUZUKI	

20-08-831	
	Length/Lungh. [mm]
	241
	Width/Largh. [mm]
216	
Height/Altezza [mm]	
50	
SUZUKI	

20-08-887	
	Length/Lungh. [mm]
	244
	Width/Largh. [mm]
157	
Height/Altezza [mm]	
46	
SUZUKI	

20-08-832	
	Length/Lungh. [mm]
	280
	Width/Largh. [mm]
168	
Height/Altezza [mm]	
33	
SUZUKI	

20-08-888	
	Height/Altezza [mm]
	29,5
	Outer Diam./Diam. est. [mm]
223,5	
SUZUKI	

20-08-884	
	Length/Lungh. [mm]
	267,5
	Width/Largh. [mm]
173,5	
Height/Altezza [mm]	
31,3	
SUZUKI	

20-08-889	
	Length/Lungh. [mm]
	233,4
	Width/Largh. [mm]
135,2	
Height/Altezza [mm]	
41,2	
SUZUKI	

20-08-885	
	Length/Lungh. [mm]
	241,2
	Width/Largh. [mm]
143,7	
Height/Altezza [mm]	
52	
SUZUKI	

20-08-891	
	Length/Lungh. [mm]
	256,2
	Width/Largh. [mm]
206	
Height/Altezza [mm]	
43	
SUZUKI	

20-08-886	
	Length/Lungh. [mm]
	179
	Width/Largh. [mm]
162	
Height/Altezza [mm]	
58,8	
SUZUKI	

20-08-894	
	Length/Lungh. [mm]
	151
	Width/Largh. [mm]
148	
Height/Altezza [mm]	
50,8	
SUZUKI	

20-08-895	
	Height/Altezza [mm]
	44,5
	Outer Diam./Diam. est. [mm]
	212
Subst. by 20-08-802	
	Inner Diam./Diam. int. [mm]
	159,5

20-09-900	
	Height/Altezza [mm]
	124,3
	Outer Diam./Diam. est. [mm]
	182,3
	Inner Diam./Diam. int. [mm]
	84,8
ISUZU - TOYOTA	

20-08-896	
	Length/Lungh. [mm]
	190
	Width/Largh. [mm]
	154,6
	Height/Altezza [mm]
	52
SUZUKI	

20-09-902	
	Length/Lungh. [mm]
	237,8
	Width/Largh. [mm]
	182
	Height/Altezza [mm]
	56,5
ISUZU	

20-08-897	
	Length/Lungh. [mm]
	230
	Width/Largh. [mm]
	201
	Height/Altezza [mm]
	54,5
SUZUKI	

20-09-903	
	Height/Altezza [mm]
	70
	Outer Diam./Diam. est. [mm]
	220
ISUZU	

20-08-898	
	Length/Lungh. [mm]
	296
	Width/Largh. [mm]
	141,2
	Height/Altezza [mm]
	52,7
SUZUKI	

20-09-906	
	Height/Altezza [mm]
	144
	Outer Diam./Diam. est. [mm]
	167,7
	Inner Diam./Diam. int. [mm]
	81
ISUZU	

20-08-899	
	Length/Lungh. [mm]
	284,7
	Width/Largh. [mm]
	142,2
	Height/Altezza [mm]
	51,2
SUZUKI	

20-09-907	
	Length/Lungh. [mm]
	378,2
	Width/Largh. [mm]
	171
	Height/Altezza [mm]
	50,5
SSANGYONG	

20-09-908	
	Length/Lungh. [mm]
	Width/Largh. [mm]
	Height/Altezza [mm]
JEEP	

20-09-913	
	Length/Lungh. [mm]
	Width/Largh. [mm]
	Height/Altezza [mm]
ISUZU	

20-09-909	
	Length/Lungh. [mm]
	Width/Largh. [mm]
	Height/Altezza [mm]
JEEP	

20-09-914	
	Length/Lungh. [mm]
	Width/Largh. [mm]
	Height/Altezza [mm]
	Height 1/Altezza 1 [mm]
CHRYSLER	

20-09-910	
	Length/Lungh. [mm]
	Width/Largh. [mm]
	Height/Altezza [mm]
CHRYSLER	

20-09-915	
	Length/Lungh. [mm]
	Width/Largh. [mm]
	Height/Altezza [mm]
	Height 1/Altezza 1 [mm]
JEEP	

20-09-911	
	Length/Lungh. [mm]
	Width/Largh. [mm]
	Height/Altezza [mm]
CHRYSLER	

20-09-916	
	Length/Lungh. [mm]
	Width/Largh. [mm]
	Height/Altezza [mm]
CHRYSLER	

20-09-912	
	Length/Lungh. [mm]
	Width/Largh. [mm]
	Width 1/Largh. 1 [mm]
	Height/Altezza [mm]
CHRYSLER	

20-09-972	
	Length/Lungh. [mm]
	Width/Largh. [mm]
	Height/Altezza [mm]
Subst. by 20-09-908	
JEEP	

20-09-973	
	Length/Lungh. [mm]
	311
	Width/Largh. [mm]
	201,2
	Height/Altezza [mm]
	42
SSANGYONG	

20-09-978	
	Length/Lungh. [mm]
	289
	Width/Largh. [mm]
	171
	Height/Altezza [mm]
	50
SSANGYONG	

20-09-974	
	Length/Lungh. [mm]
	237,8
	Width/Largh. [mm]
	214,8
	Height/Altezza [mm]
	45
CHRYSLER - DODGE	

20-09-979	
	Height/Altezza [mm]
	261,5
	Outer Diam./Diam. est. [mm]
	201,5
	Inner Diam./Diam. int. [mm]
135,8	
	Inner Diam. 1/Diam. int. 1 [mm]
	23
DAEWOO - ISUZU	

20-09-975	
	Length/Lungh. [mm]
	236,2
	Width/Largh. [mm]
	160,6
	Height/Altezza [mm]
	48
JEEP	

20-09-980	
	Length/Lungh. [mm]
	278,2
	Width/Largh. [mm]
	190
	Height/Altezza [mm]
	58
DAEWOO - JEEP - SSANGYONG	

20-09-976	
	Height/Altezza [mm]
	35,8
	Outer Diam./Diam. est. [mm]
	238
	Inner Diam./Diam. int. [mm]
65,2	
	Inner Diam. 1/Diam. int. 1 [mm]
	20,9
Subst. by 20-08-813	

20-09-981	
	Length/Lungh. [mm]
	244
	Width/Largh. [mm]
	206
	Height/Altezza [mm]
	54,7
SSANGYONG	

20-09-977	
	Length/Lungh. [mm]
	309
	Width/Largh. [mm]
	203
	Height/Altezza [mm]
	51
ISUZU	

20-09-982	
	Length/Lungh. [mm]
	302,2
	Width/Largh. [mm]
	203
	Width 1/Largh. 1 [mm]
	125
	Height/Altezza [mm]
	36
KIA	

20-09-983	
	Height/Altezza [mm]
	138
	Outer Diam./Diam. est. [mm]
	217,7
	Outer Diam. 1/Diam. est. 1 [mm]
173,2	
Inner Diam./Diam. int. [mm]	
90,7	
ASIA MOTORS - KIA	

20-09-990	
	Length/Lungh. [mm]
	343,8
	Width/Largh. [mm]
	169
Height/Altezza [mm]	
41	
JEEP	

20-09-984	
	Height/Altezza [mm]
	158,2
	Outer Diam./Diam. est. [mm]
	158
	Outer Diam. 1/Diam. est. 1 [mm]
	153
Inner Diam./Diam. int. [mm]	
79,6	
Inner Diam. 1/Diam. int. 1 [mm]	
72,2	
SSANGYONG	

20-09-991	
	Height/Altezza [mm]
	287,2
	Outer Diam./Diam. est. [mm]
	135,6
	Outer Diam. 1/Diam. est. 1 [mm]
	132
Inner Diam./Diam. int. [mm]	
68	
Inner Diam. 1/Diam. int. 1 [mm]	
14,4	
GASOLONE - HYUNDAI - MITSUBISHI	

20-09-985	
	Length/Lungh. [mm]
	289
	Width/Largh. [mm]
	244
Height/Altezza [mm]	
41	
JEEP - NISSAN	

20-09-994	
	Height/Altezza [mm]
	176,2
	Outer Diam./Diam. est. [mm]
	127
	Inner Diam./Diam. int. [mm]
	79,7
Inner Diam. 1/Diam. int. 1 [mm]	
7,5	
ISUZU	

20-09-987	
	Length/Lungh. [mm]
	272,5
	Width/Largh. [mm]
	134
Height/Altezza [mm]	
40	
CHRYSLER	

20-09-995	
	Height/Altezza [mm]
	162,3
	Outer Diam./Diam. est. [mm]
	155
Inner Diam./Diam. int. [mm]	
77,6	
ISUZU	

20-09-989	
	Length/Lungh. [mm]
	215,2
	Width/Largh. [mm]
	168,2
Height/Altezza [mm]	
58	

20-09-997	
	Height/Altezza [mm]
	206
	Outer Diam./Diam. est. [mm]
	155,8
Inner Diam./Diam. int. [mm]	
79	
ISUZU	

20-09-998	
	Length/Lungh. [mm]
	246
	Width/Largh. [mm]
	171
	Height/Altezza [mm]
	50
ISUZU	

20-H0-004	
	Length/Lungh. [mm]
	259
	Width/Largh. [mm]
	179
	Height/Altezza [mm]
	50
HYUNDAI	

20-09-999	
	Height/Altezza [mm]
	304,4
	Outer Diam./Diam. est. [mm]
	129
	Inner Diam./Diam. int. [mm]
	83,5
CHRYSLER - JEEP	

20-H0-005	
	Length/Lungh. [mm]
	241,5
	Length 1/Lungh. 1 [mm]
	158,2
	Width/Largh. [mm]
	193
	Width 1/Largh. 1 [mm]
	59
	Height/Altezza [mm]
	34
HYUNDAI	

20-H0-001	
	Length/Lungh. [mm]
	227
	Length 1/Lungh. 1 [mm]
	170
	Width/Largh. [mm]
	137
	Width 1/Largh. 1 [mm]
	74,5
	Height/Altezza [mm]
	189
HYUNDAI	

20-H0-006	
	Length/Lungh. [mm]
	245,2
	Width/Largh. [mm]
	210
	Height/Altezza [mm]
	43
HYUNDAI	

20-H0-002	
	Length/Lungh. [mm]
	248,6
	Width/Largh. [mm]
	170
	Height/Altezza [mm]
	40,5
HYUNDAI	

20-H0-007	
	Length/Lungh. [mm]
	243
	Width/Largh. [mm]
	197
	Height/Altezza [mm]
	51
HYUNDAI - KIA	

20-H0-003	
	Length/Lungh. [mm]
	236,2
	Width/Largh. [mm]
	190,8
	Height/Altezza [mm]
	42
HYUNDAI - KIA	

20-H0-008	
	Length/Lungh. [mm]
	254,5
	Width/Largh. [mm]
	127
	Height/Altezza [mm]
	46,2
HYUNDAI	

20-H0-009				
	Length/Lungh. [mm]			
	Width/Largh. [mm]			
	Height/Altezza [mm]			
<table border="1"> <tr> <td>254,5</td> </tr> <tr> <td>124,4</td> </tr> <tr> <td>45,8</td> </tr> </table>		254,5	124,4	45,8
254,5				
124,4				
45,8				
GASOLONE - HYUNDAI				

20-0H-H14				
	Length/Lungh. [mm]			
	Width/Largh. [mm]			
	Height/Altezza [mm]			
<table border="1"> <tr> <td>269</td> </tr> <tr> <td>174</td> </tr> <tr> <td>61</td> </tr> </table>		269	174	61
269				
174				
61				
HYUNDAI				

20-H0-010				
	Length/Lungh. [mm]			
	Width/Largh. [mm]			
	Height/Altezza [mm]			
<table border="1"> <tr> <td>252</td> </tr> <tr> <td>172,5</td> </tr> <tr> <td>41,2</td> </tr> </table>		252	172,5	41,2
252				
172,5				
41,2				
HYUNDAI - KIA				

20-0H-H15				
	Length/Lungh. [mm]			
	Width/Largh. [mm]			
	Height/Altezza [mm]			
<table border="1"> <tr> <td>270</td> </tr> <tr> <td>181</td> </tr> <tr> <td>49</td> </tr> </table>		270	181	49
270				
181				
49				
HYUNDAI				

20-0H-011				
	Length/Lungh. [mm]			
	Width/Largh. [mm]			
	Height/Altezza [mm]			
<table border="1"> <tr> <td>271,4</td> </tr> <tr> <td>165</td> </tr> <tr> <td>30,5</td> </tr> </table>		271,4	165	30,5
271,4				
165				
30,5				
HYUNDAI				

20-0H-H16				
	Length/Lungh. [mm]			
	Width/Largh. [mm]			
	Height/Altezza [mm]			
<table border="1"> <tr> <td>235</td> </tr> <tr> <td>179</td> </tr> <tr> <td>31</td> </tr> </table>		235	179	31
235				
179				
31				
HYUNDAI				

20-0H-012				
	Length/Lungh. [mm]			
	Width/Largh. [mm]			
	Height/Altezza [mm]			
<table border="1"> <tr> <td>253,5</td> </tr> <tr> <td>172</td> </tr> <tr> <td>43,6</td> </tr> </table>		253,5	172	43,6
253,5				
172				
43,6				
HYUNDAI - KIA				

20-0H-H17				
	Length/Lungh. [mm]			
	Width/Largh. [mm]			
	Height/Altezza [mm]			
<table border="1"> <tr> <td>294</td> </tr> <tr> <td>89</td> </tr> <tr> <td>60</td> </tr> </table>		294	89	60
294				
89				
60				
HYUNDAI				

20-0H-013				
	Length/Lungh. [mm]			
	Width/Largh. [mm]			
	Height/Altezza [mm]			
<table border="1"> <tr> <td>247</td> </tr> <tr> <td>167,2</td> </tr> <tr> <td>31</td> </tr> </table>		247	167,2	31
247				
167,2				
31				
HYUNDAI				

20-0H-H18				
	Length/Lungh. [mm]			
	Width/Largh. [mm]			
	Height/Altezza [mm]			
<table border="1"> <tr> <td>275</td> </tr> <tr> <td>170</td> </tr> <tr> <td>40</td> </tr> </table>		275	170	40
275				
170				
40				
HYUNDAI				

20-0H-H20	
	Length/Lungh. [mm]
	236
	Length/Lungh. [mm]
	224
	Length 1/Lungh. 1 [mm]
214	
Height/Altezza [mm]	
58	
HYUNDAI	

20-K0-001	
	Height/Altezza [mm]
	100,3
	Outer Diam./Diam. est. [mm]
	223,6
	Inner Diam./Diam. int. [mm]
132	
Inner Diam. 1/Diam. int. 1 [mm]	
8	
KIA	

20-0H-H22	
	Length/Lungh. [mm]
	267
	Width/Largh. [mm]
	189
Height/Altezza [mm]	
51	
HYUNDAI	

20-K0-002	
	Length/Lungh. [mm]
	305
	Width/Largh. [mm]
196,3	
Height/Altezza [mm]	
60,8	
KIA	

20-0H-H23	
	Length/Lungh. [mm]
	259
	Width/Largh. [mm]
	164
Height/Altezza [mm]	
54	
HYUNDAI - KIA	

20-K0-006	
	Length/Lungh. [mm]
	262,8
	Width/Largh. [mm]
	144,5
Height/Altezza [mm]	
38,6	
KIA	

20-0H-H24	
	Length/Lungh. [mm]
	272
	Width/Largh. [mm]
	104
	Height/Altezza [mm]
75	
Height 1/Altezza 1 [mm]	
50	
HYUNDAI	

20-K0-007	
	Length/Lungh. [mm]
	340
	Width/Largh. [mm]
	172,5
Height/Altezza [mm]	
41,8	
KIA	

20-0H-H25	
	Length/Lungh. [mm]
	267
	Width/Largh. [mm]
223	
Height/Altezza [mm]	
54	
HYUNDAI	

20-K0-008	
	Length/Lungh. [mm]
	270,2
	Width/Largh. [mm]
191,4	
Height/Altezza [mm]	
39,5	
KIA	

20-K0-010		
	Length/Lungh. [mm]	297
	Width/Largh. [mm]	238,6
	Height/Altezza [mm]	32,4
KIA		

20-0K-K15		
	Length/Lungh. [mm]	264
	Width/Largh. [mm]	134
	Height/Altezza [mm]	55
HYUNDAI - KIA		

20-0K-011		
	Length/Lungh. [mm]	253
	Width/Largh. [mm]	115
	Height/Altezza [mm]	39
KIA		

20-0K-K16		
	Length/Lungh. [mm]	263
	Width/Largh. [mm]	134
	Height/Altezza [mm]	49
HYUNDAI - KIA		

20-0K-012		
	Height/Altezza [mm]	130
	Outer Diam./Diam. est. [mm]	206
	Inner Diam./Diam. int. [mm]	127
ASIA MOTORS - KIA		

20-0K-K17		
	Length/Lungh. [mm]	220
	Width/Largh. [mm]	120
	Height/Altezza [mm]	53
KIA		

20-0K-013		
	Height/Altezza [mm]	202
	Outer Diam./Diam. est. [mm]	179
	Inner Diam./Diam. int. [mm]	113,8
	Inner Diam. 1/Diam. int. 1 [mm]	12
KIA		

20-0K-K18		
	Length/Lungh. [mm]	265
	Width/Largh. [mm]	200
	Height/Altezza [mm]	53,5
KIA		

20-0K-014		
	Height/Altezza [mm]	270
	Outer Diam./Diam. est. [mm]	166,5
	Inner Diam./Diam. int. [mm]	111,5
KIA		

20-0K-K19		
	Length/Lungh. [mm]	304
	Width/Largh. [mm]	160
	Height/Altezza [mm]	55
KIA		

20-0K-K20		
	Length/Lungh. [mm]	256
	Width/Largh. [mm]	202
	Height/Altezza [mm]	44
KIA		

20-0K-K27		
	Length/Lungh. [mm]	277
	Width/Largh. [mm]	227
	Height/Altezza [mm]	41
HYUNDAI - KIA		

20-0K-K21		
	Length/Lungh. [mm]	199
	Width/Largh. [mm]	189
	Height/Altezza [mm]	50
HYUNDAI - KIA		

20-0K-K28		
	Length/Lungh. [mm]	277
	Width/Largh. [mm]	197
	Height/Altezza [mm]	41
KIA		

20-0K-K22		
	Length/Lungh. [mm]	247
	Width/Largh. [mm]	130
	Height/Altezza [mm]	54
HYUNDAI - KIA		

20-0K-K29		
	Length/Lungh. [mm]	214
	Width/Largh. [mm]	133
	Height/Altezza [mm]	34
KIA		

20-0K-K25		
		

20-0K-K31		
	Length/Lungh. [mm]	257
	Width/Largh. [mm]	146
	Height/Altezza [mm]	54
KIA		

20-0K-K26		
		
KIA		

20-0L-L00		
	Height/Altezza [mm]	220
	Outer Diam./Diam. est. [mm]	137
	Inner Diam./Diam. int. [mm]	70
	Inner Diam. 1/Diam. int. 1 [mm]	17
LAND ROVER		



20-0L-L01		
	Length/Lungh. [mm]	247
	Width/Largh. [mm]	207
	Height/Altezza [mm]	58
LAND ROVER		

20-0L-L06		
	Length/Lungh. [mm]	146
	Length 1/Lungh. 1 [mm]	99
	Width/Largh. [mm]	89
	Width 1/Largh. 1 [mm]	42
	Height/Altezza [mm]	498
LAND ROVER		

20-0L-L02		
	Length/Lungh. [mm]	300
	Width/Largh. [mm]	225
	Height/Altezza [mm]	58,5
LAND ROVER		

20-0L-L07		
	Length/Lungh. [mm]	254
	Width/Largh. [mm]	227,5
	Height/Altezza [mm]	57,2
LAND ROVER		

20-0L-L03		
	Length/Lungh. [mm]	263
	Width/Largh. [mm]	203
	Height/Altezza [mm]	57
LAND ROVER		

20-0L-L09		
	Height/Altezza [mm]	293,4
	Outer Diam./Diam. est. [mm]	173,8
	Outer Diam. 1/Diam. est. 1 [mm]	138,4
	Inner Diam./Diam. int. [mm]	72
	Inner Diam. 1/Diam. int. 1 [mm]	16,2
LAND ROVER		

20-0L-L04		
	Height/Altezza [mm]	166,8
	Outer Diam./Diam. est. [mm]	145
	Inner Diam./Diam. int. [mm]	88,9
LAND ROVER		

20-0L-L10		
	Length/Lungh. [mm]	271
	Width/Largh. [mm]	121
	Height/Altezza [mm]	58
LAND ROVER		

20-0L-L05		
	Length/Lungh. [mm]	376
	Width/Largh. [mm]	145,1
	Width 1/Largh. 1 [mm]	122
	Height/Altezza [mm]	88,1
LAND ROVER		

20-0L-L11		
	Height/Altezza [mm]	285,5
	Outer Diam./Diam. est. [mm]	138
	Inner Diam./Diam. int. [mm]	72
	Inner Diam. 1/Diam. int. 1 [mm]	16,5
LAND ROVER		

20-0L-L12	
	Height/Altezza [mm]
	286
	Outer Diam./Diam. est. [mm]
	131,5
	Inner Diam./Diam. int. [mm]
70	
Inner Diam. 1/Diam. int. 1 [mm]	
16,5	
LAND ROVER	

20-M0-001	
	Length/Lungh. [mm]
	247,5
	Width/Largh. [mm]
	116
Height/Altezza [mm]	
62,2	
MITSUBISHI - SMART	

20-0L-L14	
	Length/Lungh. [mm]
	273
	Width/Largh. [mm]
	182
Height/Altezza [mm]	
57	
LAND ROVER	

20-M0-002	
	Height/Altezza [mm]
	136
	Outer Diam./Diam. est. [mm]
	93
Inner Diam./Diam. int. [mm]	
50	
SMART	

20-0L-L15	
	Length/Lungh. [mm]
	179
	Inner Diam./Diam. int. [mm]
	122
Height/Altezza [mm]	
61	
LAND ROVER	

20-0M-M03	
	Length/Lungh. [mm]
	268
	Width/Largh. [mm]
	111
Height/Altezza [mm]	
36	
SMART	

20-0L-L17	
	Length/Lungh. [mm]
	345
	Width/Largh. [mm]
	163
Height/Altezza [mm]	
50	
LAND ROVER	

20-S0-000	
	Length/Lungh. [mm]
	266
	Width/Largh. [mm]
	194,5
Height/Altezza [mm]	
59,3	
SSANGYONG	

20-0M-000	
	Height/Altezza [mm]
	137,4
	Outer Diam./Diam. est. [mm]
	90,2
Inner Diam./Diam. int. [mm]	
47,5	
SMART	

20-0S-S01	
	Length/Lungh. [mm]
	361
	Width/Largh. [mm]
	170
Height/Altezza [mm]	
60	
DAEWOO - SSANGYONG - TATA	

20-0S-S02		
	Length/Lungh. [mm]	361
	Width/Largh. [mm]	204,5
	Height/Altezza [mm]	60,6
SSANGYONG		

20-W0-002		
	Length/Lungh. [mm]	203,5
	Width/Largh. [mm]	190,5
	Height/Altezza [mm]	35,5
DAEWOO		

20-0S-S03		
	Length/Lungh. [mm]	300
	Width/Largh. [mm]	239,5
	Height/Altezza [mm]	59
SSANGYONG		

20-W0-003		
	Length/Lungh. [mm]	240
	Width/Largh. [mm]	177
	Height/Altezza [mm]	57
DAEWOO		

20-0S-S04		
	Length/Lungh. [mm]	219
	Width/Largh. [mm]	145
	Height/Altezza [mm]	57
SSANGYONG		

20-W0-004		
	Length/Lungh. [mm]	266,3
	Length 1/Lungh. 1 [mm]	215,5
	Width/Largh. [mm]	176
	Width 1/Largh. 1 [mm]	63
	Height/Altezza [mm]	48
CHEVROLET - DAEWOO		

20-W0-000		
	Height/Altezza [mm]	30,7
	Outer Diam./Diam. est. [mm]	222,5
	Inner Diam./Diam. int. [mm]	33
DAEWOO		

20-W0-005		
	Length/Lungh. [mm]	220
	Length 1/Lungh. 1 [mm]	195
	Width/Largh. [mm]	187,5
	Width 1/Largh. 1 [mm]	162
	Height/Altezza [mm]	45
CHEVROLET - DAEWOO		

20-W0-001		
	Length/Lungh. [mm]	258
	Width/Largh. [mm]	222,2
	Height/Altezza [mm]	34
DAEWOO		

20-0W-006		
	Height/Altezza [mm]	342
	Outer Diam./Diam. est. [mm]	134,5
	Inner Diam./Diam. int. [mm]	85
DAEWOO		

20-0W-W07	
	Length/Lungh. [mm]
	223
	Width/Largh. [mm]
	193,5
	Height/Altezza [mm]
	27
CHEVROLET	

20-0W-W12	
	Length/Lungh. [mm]
	266
	Width/Largh. [mm]
	261
	Height/Altezza [mm]
	37
CHEVROLET - OPEL	

20-0W-W08	
	Length/Lungh. [mm]
	285
	Length 1/Lungh. 1 [mm]
	138
	Width/Largh. [mm]
	229
	Width 1/Largh. 1 [mm]
	97
	Height/Altezza [mm]
	49,5
CHEVROLET	

20-0W-W13	
	Length/Lungh. [mm]
	360
	Width/Largh. [mm]
	157
	Height/Altezza [mm]
	33
CHEVROLET	

20-0W-W09	
	Length/Lungh. [mm]
	290
	Width/Largh. [mm]
	197
	Width 1/Largh. 1 [mm]
178	
	Height/Altezza [mm]
	43
CHEVROLET	

20-0W-W10	
	Length/Lungh. [mm]
	266
	Width/Largh. [mm]
	216
	Height/Altezza [mm]
	45
CHEVROLET	

20-0W-W11	
	Length/Lungh. [mm]
	249
	Width/Largh. [mm]
	255
	Height/Altezza [mm]
	35
CHEVROLET - OPEL	

30-00-000	
	Length/Lungh. [mm]
	121
	Outer Diam./Diam. est. [mm]
	48
	Diam. 1/ Diam. 2 [mm]
	IN/OUT: 6
LADA	

30-00-008	
	Length/Lungh. [mm]
	136
	Outer Diam./Diam. est. [mm]
	55
	Diam. 1/ Diam. 2 [mm]
	IN/OUT: 8
CHRYSLER	

30-00-001	
	Length/Lungh. [mm]
	173,5
	Outer Diam./Diam. est. [mm]
	81,3
	Diam. 1/ Diam. 2 [mm]
	IN / OUT : 10
CHRYSLER - DODGE - JEEP	

30-00-010	
	Length/Lungh. [mm]
	152
	Outer Diam./Diam. est. [mm]
	73
	Diam. 1/ Diam. 2 [mm]
	IN : 9,5 /OUT :8
CHRYSLER - JEEP	

30-00-002	
	Length/Lungh. [mm]
	119
	Outer Diam./Diam. est. [mm]
	55
	Diam. 1/ Diam. 2 [mm]
	9,5
HUMMER	

30-00-011	
	Length/Lungh. [mm]
	136
	Outer Diam./Diam. est. [mm]
	83
	Fitted Diam./Diam. montaggio [mm]
	70
	Inner Thread/Filett int. [mm]
	M16 X 1,5
CADILLAC	

30-00-004	
	Length/Lungh. [mm]
	112
	Outer Diam./Diam. est. [mm]
	65,5
	Inner Diam./Diam. int. [mm]
	13
	Fitted Diam./Diam. montaggio [mm]
	25
TATA	

30-00-012	
	Length/Lungh. [mm]
	125
	Diam./Diam. [mm]
	91
	Diam. 1/ Diam. 2 [mm]
	IN:7 OUT:5
JEEP	

30-00-007	
	Length/Lungh. [mm]
	100
	Outer Diam./Diam. est. [mm]
	103,4
	Fitted Diam./Diam. montaggio [mm]
	89
CHRYSLER	

30-00-014	
	Length/Lungh. [mm]
	124
	Outer Diam./Diam. est. [mm]
	70,3
	Diam. 1/ Diam. 2 [mm]
	36,5
	Inner Thread/Filett int. [mm]
	IN/OUT: M12 x 1,25
CHRYSLER	

30-00-015	
	Length/Lungh. [mm]
	89
	Outer Diam./Diam. est. [mm]
	87,7
	Inner Thread/Filett int. [mm]
	IN/OUT: 12 x 1,25

30-00-098	
	Length/Lungh. [mm]
	162
	Outer Diam./Diam. est. [mm]
	55,6
	Diam. 1/ Diam. 2 [mm]
	IN/OUT: 9,5

30-00-016	
	Length/Lungh. [mm]
	156
	Outer Diam./Diam. est. [mm]
	55
	Diam. 1/ Diam. 2 [mm]
	IN 8 OUT 9,5
	Inner Thread/Filett int. [mm]
	M 16X1,5
CADILLAC	

30-01-100	
	Length/Lungh. [mm]
	139
	Outer Diam./Diam. est. [mm]
	93
	Diam. 1/ Diam. 2 [mm]
	10
NISSAN	

30-00-017	
	Length/Lungh. [mm]
	117
	Outer Diam./Diam. est. [mm]
	95
	Fitted Diam./Diam. montaggio [mm]
	70
	Inner Thread/Filett int. [mm]
	3 / 4 X16
GONOW	

30-01-102	
	Length/Lungh. [mm]
	118,5
	Outer Diam./Diam. est. [mm]
	78
	Diam. 1/ Diam. 2 [mm]
	IN/OUT: 8
ISUZU - NISSAN	

30-00-018	
	Length/Lungh. [mm]
	143
	Outer Diam./Diam. est. [mm]
	56
	Diam. 1/ Diam. 2 [mm]
	IN / OUT:8
DR	

30-01-103	
	Length/Lungh. [mm]
	83
	Outer Diam./Diam. est. [mm]
	84,2
	Fitted Diam./Diam. montaggio [mm]
	63
	Inner Thread/Filett int. [mm]
	3/4 X 16
NISSAN	

30-00-020	
	Length/Lungh. [mm]
	172
	Outer Diam./Diam. est. [mm]
	77
	Diam. 1/ Diam. 2 [mm]
	IN / OUT:8
DR	

30-01-104	
	Length/Lungh. [mm]
	61,6
	Outer Diam./Diam. est. [mm]
	46,4
	Diam. 1/ Diam. 2 [mm]
	IN/OUT: 7
NISSAN	

30-01-105	
	Length/Lungh. [mm]
	62
	Diam./Diam. [mm]
	41
	Diam. 1/ Diam. 2 [mm]
	7
NISSAN	

30-01-110	
	Length/Lungh. [mm]
	117,3
	Outer Diam./Diam. est. [mm]
	64
	Diam. 1/ Diam. 2 [mm]
	IN / OUT : 6
NISSAN	

30-01-106	
	Length/Lungh. [mm]
	122,5
	Outer Diam./Diam. est. [mm]
	83
	Fitted Diam./Diam. montaggio [mm]
	62
	Inner Thread/Filett int. [mm]
	IN : 3/4 X 16 / OUT : 8,3
	con sensore acqua/with water sensor
NISSAN	

30-01-111	
	Length/Lungh. [mm]
	118
	Outer Diam./Diam. est. [mm]
	61
	Diam. 1/ Diam. 2 [mm]
	IN/OUT: 8
INFINITI - ISUZU - NISSAN	

30-01-108	
	Length/Lungh. [mm]
	188
	Outer Diam./Diam. est. [mm]
	77
	Diam. 1/ Diam. 2 [mm]
	IN / OUT : 8
NISSAN - SUZUKI	

30-01-112	
	Length/Lungh. [mm]
	135
	Outer Diam./Diam. est. [mm]
	76,5
	Fitted Diam./Diam. montaggio [mm]
	62
	Inner Thread/Filett int. [mm]
	IN: 3/4 x 16 / OUT: 34,7
	con sensore acqua/with water sensor
NISSAN	

30-01-109MP	
	Length/Lungh. [mm]
	139
	Outer Diam./Diam. est. [mm]
	98
	Fitted Diam./Diam. montaggio [mm]
	72
	Inner Thread/Filett int. [mm]
	IN: 3/4 x 16 / OUT: 34,5
	con sensore acqua/with water sensor
NISSAN	

30-01-115	
	Length/Lungh. [mm]
	130
	Outer Diam./Diam. est. [mm]
	69
	Diam. 1/ Diam. 2 [mm]
	IN/OUT: 7
NISSAN	

30-01-109	
	Length/Lungh. [mm]
	144
	Outer Diam./Diam. est. [mm]
	99
	Fitted Diam./Diam. montaggio [mm]
73	
	Inner Thread/Filett int. [mm]
	IN : 3/4 X 16 / OUT : 34,5
NISSAN	

30-01-117	
	Length/Lungh. [mm]
	96,2
	Outer Diam./Diam. est. [mm]
	84,3
	Fitted Diam./Diam. montaggio [mm]
	62
	Inner Thread/Filett int. [mm]
	IN: 3/4 x 16 / OUT: 25
	con sensore acqua/with water sensor
NISSAN	

30-01-119	
	Length/Lungh. [mm]
	125
	Outer Diam./Diam. est. [mm]
	97
	Fitted Diam./Diam. montaggio [mm]
73	
Inner Thread/Filett int. [mm]	
3/4 x 16	
NISSAN	

30-01-125	
	Outer Diam./Diam. est. [mm]
	77
	Length/Lungh. [mm]
	188
	Diam. 1/ Diam. 2 [mm]
IN / OUT : 8	
NISSAN	

30-01-120	
	Length/Lungh. [mm]
	136,4
	Outer Diam./Diam. est. [mm]
	61
	Diam. 1/ Diam. 2 [mm]
IN/OUT: 8	
NISSAN - SMART	

30-01-189	
	Length/Lungh. [mm]
	135
	Outer Diam./Diam. est. [mm]
	85,3
	Fitted Diam./Diam. montaggio [mm]
70,5	
Inner Thread/Filett int. [mm]	
M16 x 1,5	
NISSAN	

30-01-122	
	Length/Lungh. [mm]
	123
	Outer Diam./Diam. est. [mm]
	93
	Diam. 1/ Diam. 2 [mm]
IN / OUT : 10	
NISSAN - SUZUKI	

30-01-190	
	Length/Lungh. [mm]
	153
	Outer Diam./Diam. est. [mm]
	97
	Fitted Diam./Diam. montaggio [mm]
72	
Inner Thread/Filett int. [mm]	
3 / 4 X 16	
BUICK - CHEVROLET - DAEWOO - NISSAN	

30-01-123	
	Length/Lungh. [mm]
	139
	Outer Diam./Diam. est. [mm]
	93
	Diam. 1/ Diam. 2 [mm]
IN / OUT: 10	
CHEVROLET - NISSAN	

30-01-191	
	Length/Lungh. [mm]
	129
	Outer Diam./Diam. est. [mm]
	97
	Fitted Diam./Diam. montaggio [mm]
72	
Inner Thread/Filett int. [mm]	
IN: 3/4 x 16 / OUT: 34,3 con sensore acqua/with water sensor	
Subst. by 30-01-109	

30-01-124	
	Fitting Position/Lato montaggio Nel serbatoio carburante/in fuel tank
	Length/Lungh. [mm]
	133
	Outer Diam./Diam. est. [mm]
	86
Diam. 1/ Diam. 2 [mm]	
IN / OUT : 18	
NISSAN	

30-01-192	
	Length/Lungh. [mm]
	162,6
	Outer Diam./Diam. est. [mm]
	80
	Diam. 1/ Diam. 2 [mm]
IN/OUT:8	
DAEWOO - LAND ROVER - NISSAN - SSANGYONG	



30-01-195	
	Length/Lungh. [mm]
	117
	Outer Diam./Diam. est. [mm]
	84,4
	Fitted Diam./Diam. montaggio [mm]
62,4	
Inner Thread/Filett int. [mm]	
3/4 x 16	
NISSAN - TOYOTA	

30-02-203	
	Length/Lungh. [mm]
	57
	Outer Diam./Diam. est. [mm]
	57
Diam. 1/ Diam. 2 [mm]	
8	
TOYOTA	

30-01-197	
	Length/Lungh. [mm]
	180
	Outer Diam./Diam. est. [mm]
	83
	Fitted Diam./Diam. montaggio [mm]
	62
Inner Thread/Filett int. [mm]	
34,5	
con sensore acqua/with water sensor	
NISSAN	

30-02-204	
	Length/Lungh. [mm]
	85
	Outer Diam./Diam. est. [mm]
	51
	Diam. 1/ Diam. 2 [mm]
IN/OUT: 6	
TOYOTA	

30-01-198	
	Length/Lungh. [mm]
	120
	Outer Diam./Diam. est. [mm]
	64
Diam. 1/ Diam. 2 [mm]	
IN/OUT: 8	
INFINITI - ISUZU - NISSAN	

30-02-206	
	Length/Lungh. [mm]
	86
	Outer Diam./Diam. est. [mm]
	51
	Diam. 1/ Diam. 2 [mm]
IN/OUT: 6,5	

30-02-200	
	Length/Lungh. [mm]
	76
	Outer Diam./Diam. est. [mm]
	84
Inner Diam./Diam. int. [mm]	
9	
LEXUS - TOYOTA	

30-02-208	
	Length/Lungh. [mm]
	89
	Outer Diam./Diam. est. [mm]
	84,5
	Fitted Diam./Diam. montaggio [mm]
62	
Inner Thread/Filett int. [mm]	
3/4 x 16	
ISUZU - JEEP - TOYOTA	

30-02-201	
	Length/Lungh. [mm]
	59
	Outer Diam./Diam. est. [mm]
	55,5
Fitted Diam./Diam. montaggio [mm]	
7	
DAIHATSU - TOYOTA	

30-02-210	
	Length/Lungh. [mm]
	86
	Outer Diam./Diam. est. [mm]
	51
	Diam. 1/ Diam. 2 [mm]
IN/OUT : 6,5	
TOYOTA	

30-02-211	
	Length/Lungh. [mm]
	103
	Outer Diam./Diam. est. [mm]
	83,5
	Inner Diam./Diam. int. [mm]
38,5	
Fitted Diam./Diam. montaggio [mm]	
58	
SUZUKI - TOYOTA	

30-02-216	
	Length/Lungh. [mm]
	131
	Outer Diam./Diam. est. [mm]
	70
	Inner Thread/Filett int. [mm]
IN/OUT : 12 X 1,25	
SUZUKI - TOYOTA	

30-02-212	
	Length/Lungh. [mm]
	88
	Outer Diam./Diam. est. [mm]
	56
Inner Thread/Filett int. [mm]	
M 12	
TOYOTA	

30-02-220	
	Length/Lungh. [mm]
	60
	Outer Diam./Diam. est. [mm]
	58
	Diam. 1/ Diam. 2 [mm]
IN/OUT : 7	
DAIHATSU - TOYOTA	

30-02-214	
	Length/Lungh. [mm]
	62
	Outer Diam./Diam. est. [mm]
	63
Inner Diam./Diam. int. [mm]	
16	
TOYOTA	

30-02-221	
	Length/Lungh. [mm]
	59,7
	Outer Diam./Diam. est. [mm]
	57
	Diam. 1/ Diam. 2 [mm]
IN/OUT : 7	
SUBARU - TOYOTA	

30-02-215MP	
	Length/Lungh. [mm]
	138
	Outer Diam./Diam. est. [mm]
	95
	Fitted Diam./Diam. montaggio [mm]
	63
Inner Thread/Filett int. [mm]	
IN: 3/4 X 16 /OUT: 34,5	
con sensore acqua/with water sensor	
MAZDA - MITSUBISHI - TOYOTA	

30-02-222	
	Length/Lungh. [mm]
	129
	Outer Diam./Diam. est. [mm]
	71,2
	Inner Thread/Filett int. [mm]
IN /OUT : M12 X 1,25	
Subst. by 30-02-293	

30-02-215	
	Length/Lungh. [mm]
	140
	Outer Diam./Diam. est. [mm]
	93,6
	Fitted Diam./Diam. montaggio [mm]
	64
Inner Thread/Filett int. [mm]	
IN: 3/4 X 16 / OUT: 34,5	
con sensore acqua/with water sensor	
MAZDA - MITSUBISHI - NISSAN - TOYOTA	

30-02-223	
	Length/Lungh. [mm]
	131
	Outer Diam./Diam. est. [mm]
	70,4
	Inner Thread/Filett int. [mm]
IN / OUT : M12 X 1,25	
TOYOTA	

30-02-224	
	Length/Lungh. [mm]
	115
	Outer Diam./Diam. est. [mm]
	71,7
Inner Thread/Filett int. [mm]	
IN : M14 X 1,5 / OUT: M12 X 1,25	
DAIHATSU - MAZDA - MITSUBISHI - TOYOTA	

30-02-232	
	Length/Lungh. [mm]
	110
	Outer Diam./Diam. est. [mm]
70	
TOYOTA	

30-02-225	
	Length/Lungh. [mm]
	116
	Outer Diam./Diam. est. [mm]
	71
Inner Thread/Filett int. [mm]	
IN: M14 X 1,5 / OUT: M12X1,25	
TOYOTA	

30-02-234	
	Length/Lungh. [mm]
	136
	Outer Diam./Diam. est. [mm]
	95
	Diam. 1/ Diam. 2 [mm]
IN:13/OUT:14,5	
LEXUS - TOYOTA	

30-02-226	
	Length/Lungh. [mm]
	123
	Outer Diam./Diam. est. [mm]
	70
Inner Thread/Filett int. [mm]	
IN: 12 X 1,25 / OUT: M14 X 1,5	
TOYOTA	

30-02-235	
	Length/Lungh. [mm]
	123
	Outer Diam./Diam. est. [mm]
	71
Inner Thread/Filett int. [mm]	
IN: M14 X 1,5 / OUT : M12 X 1,25	
TOYOTA	

30-02-229	
	Length/Lungh. [mm]
	76,5
	Outer Diam./Diam. est. [mm]
	57
Diam. 1/ Diam. 2 [mm]	
IN / OUT : 7	
TOYOTA	

30-02-236	
	Length/Lungh. [mm]
	174
	Outer Diam./Diam. est. [mm]
	71
Inner Thread/Filett int. [mm]	
IN: M14 X 1,5 / OUT : 8	
TOYOTA	

30-02-231	
	Length/Lungh. [mm]
	75
	Outer Diam./Diam. est. [mm]
	56,6
Diam. 1/ Diam. 2 [mm]	
IN / OUT : 8	
LEXUS - TOYOTA	

30-02-237	
	Length/Lungh. [mm]
	155
	Outer Diam./Diam. est. [mm]
	60
Diam. 1/ Diam. 2 [mm]	
IN / OUT : 8	
LEXUS - TOYOTA	

30-02-238	
	Length/Lungh. [mm]
	68
	Outer Diam./Diam. est. [mm]
	51
Diam. 1/ Diam. 2 [mm]	
IN / OUT : 8	
TOYOTA	

30-02-247	
	Length/Lungh. [mm]
	113,3
	Outer Diam./Diam. est. [mm]
	70,3
Inner Thread/Filett int. [mm]	
IN / OUT : M14 X 1,5	
HYUNDAI - KIA - LEXUS - TOYOTA	

30-02-239	
	Length/Lungh. [mm]
	99
	Outer Diam./Diam. est. [mm]
	64
Inner Thread/Filett int. [mm]	
IN: M14 x 1,5 OUT: M12 x 1,25	
TOYOTA	

30-02-248	
	Length/Lungh. [mm]
	173
	Outer Diam./Diam. est. [mm]
	93,5
	Fitted Diam./Diam. montaggio [mm]
	64
Inner Thread/Filett int. [mm]	
IN : 3/4 X 16 / OUT : 34,4	
con sensore acqua/with water sensor	
TOYOTA	

30-02-240	
	Length/Lungh. [mm]
	134
	Outer Diam./Diam. est. [mm]
	95
	Fitted Diam./Diam. montaggio [mm]
	66
Inner Thread/Filett int. [mm]	
IN: 3 / 4 X 16 / OUT: 34	
con sensore acqua/with water sensor	
HONDA - TOYOTA	

30-02-250	
	Length/Lungh. [mm]
	130
	Outer Diam./Diam. est. [mm]
	70
Inner Thread/Filett int. [mm]	
IN/OUT: M12 x 1,25	
TOYOTA	

30-02-242	
	Length/Lungh. [mm]
	119,4
	Outer Diam./Diam. est. [mm]
	70,3
Inner Thread/Filett int. [mm]	
IN : M14 X1,5 / OUT M12 X 1,25	
TOYOTA	

30-02-251	
	Length/Lungh. [mm]
	130
	Outer Diam./Diam. est. [mm]
	70
Inner Thread/Filett int. [mm]	
IN/OUT: M12 x 1,25	
TOYOTA	

30-02-244	
	Length/Lungh. [mm]
	153
	Outer Diam./Diam. est. [mm]
	65,6
Inner Thread/Filett int. [mm]	
IN : M14 X 1,5 / OUT : 8	
TOYOTA	

30-02-253	
	Length/Lungh. [mm]
	126
	Outer Diam./Diam. est. [mm]
	87
Diam. 1/ Diam. 2 [mm]	
IN:13 OUT:15	
LEXUS - TOYOTA	

30-02-255	
	Length/Lungh. [mm]
	141
	Outer Diam./Diam. est. [mm]
	94
Diam. 1/ Diam. 2 [mm]	
IN:13 OUT:15	
TOYOTA	

30-02-287	
	Length/Lungh. [mm]
	130
	Outer Diam./Diam. est. [mm]
	72
Inner Thread/Filett int. [mm]	
IN/OUT: M12 x 1,25	

30-02-256	
	Length/Lungh. [mm]
	118
	Outer Diam./Diam. est. [mm]
	90
	Fitted Diam./Diam. montaggio [mm]
63	
Inner Thread/Filett int. [mm]	
IN :3/4 X 16 OUT :34	
con sensore acqua/with water sensor	
TOYOTA	

30-02-288	
	Length/Lungh. [mm]
	125
	Outer Diam./Diam. est. [mm]
	65,5
Inner Thread/Filett int. [mm]	
IN:14 x 1,5 OUT:8	
TOYOTA	

30-02-280	
	Length/Lungh. [mm]
	120
	Outer Diam./Diam. est. [mm]
	71
Inner Thread/Filett int. [mm]	
IN:M14 x 1,5 OUT:8	
LEXUS - TOYOTA	

30-02-292	
	Length/Lungh. [mm]
	99
	Outer Diam./Diam. est. [mm]
	64
Inner Thread/Filett int. [mm]	
IN: M14 x 1,5 OUT: M12 x 1,25	
TOYOTA	

30-02-284	
	Length/Lungh. [mm]
	137
	Outer Diam./Diam. est. [mm]
	97
Diam. 1/ Diam. 2 [mm]	
IN:15/OUT:15,5	
TOYOTA	

30-02-293	
	Length/Lungh. [mm]
	130,5
	Outer Diam./Diam. est. [mm]
	72
Inner Thread/Filett int. [mm]	
IN/OUT: M12 x 1,25	
TOYOTA	

30-02-285	
	Length/Lungh. [mm]
	115
	Outer Diam./Diam. est. [mm]
	70,4
Inner Thread/Filett int. [mm]	
IN/OUT:M14 x 1,5	
Subst. by 30-02-247	
TOYOTA	

30-02-295	
	Length/Lungh. [mm]
	124
	Outer Diam./Diam. est. [mm]
	72
	Fitted Diam./Diam. montaggio [mm]
65	
Inner Thread/Filett int. [mm]	
IN:3/4 x 16 OUT:34,5	
MAZDA - SUBARU - TOYOTA	

30-02-297	
	Length/Lungh. [mm]
	129
	Outer Diam./Diam. est. [mm]
	71
	Inner Thread/Filett int. [mm]
	IN/OUT: 12 x 1,25
TOYOTA	

30-03-303	
	Length/Lungh. [mm]
	123
	Outer Diam./Diam. est. [mm]
	98,5
	Fitted Diam./Diam. montaggio [mm]
	73
	Inner Thread/Filett int. [mm]
	M20 x 1,5
MAZDA	

30-02-298	
	Length/Lungh. [mm]
	132,3
	Outer Diam./Diam. est. [mm]
	72
	Inner Thread/Filett int. [mm]
	IN/OUT: M12 x 1,25
CHRYSLER - MITSUBISHI - TOYOTA	

30-03-308	
	Length/Lungh. [mm]
	132
	Outer Diam./Diam. est. [mm]
	71
	Diam. 1/ Diam. 2 [mm]
	IN/OUT:8
MAZDA	

30-03-300	
	Length/Lungh. [mm]
	101
	Outer Diam./Diam. est. [mm]
	120
	Diam. 1/ Diam. 2 [mm]
	10
MAZDA - SUZUKI	

30-03-310	
	Length/Lungh. [mm]
	134
	Outer Diam./Diam. est. [mm]
	70
	Inner Thread/Filett int. [mm]
	IN:8 OUT: M12 x 1,25
MAZDA	

30-03-301	
	Length/Lungh. [mm]
	97
	Outer Diam./Diam. est. [mm]
	49
	Diam. 1/ Diam. 2 [mm]
	IN/OUT: 8
MAZDA - SUBARU	

30-03-311	
	Length/Lungh. [mm]
	178
	Diam. 1/ Diam. 2 [mm]
	8,5
MAZDA	

30-03-302	
	Length/Lungh. [mm]
	65
	Outer Diam./Diam. est. [mm]
	50
	Diam. 1/ Diam. 2 [mm]
	IN/OUT: 8
ASIA MOTORS - MAZDA - SUBARU - TOYOTA	

30-03-312	
	Length/Lungh. [mm]
	131
	Outer Diam./Diam. est. [mm]
	71
	Diam. 1/ Diam. 2 [mm]
	IN/OUT: 8
KIA	

30-03-313	
	Length/Lungh. [mm]
	136
	Outer Diam./Diam. est. [mm]
	71
	Diam. 1/ Diam. 2 [mm]
	IN/OUT: 8
KIA - MAZDA	

30-03-318	
	Length/Lungh. [mm]
	145
	Outer Diam./Diam. est. [mm]
	80
	Diam. 1/ Diam. 2 [mm]
	IN/OUT: 8
MAZDA	

30-03-314	
	Length/Lungh. [mm]
	66
	Outer Diam./Diam. est. [mm]
	50
	Diam. 1/ Diam. 2 [mm]
	IN/OUT: 8,5
ISUZU	

30-03-319	
	Length/Lungh. [mm]
	132
	Outer Diam./Diam. est. [mm]
	81
MAZDA	

30-03-315	
	Length/Lungh. [mm]
	170
	Outer Diam./Diam. est. [mm]
	71
	Diam. 1/ Diam. 2 [mm]
	IN/OUT: 8
MAZDA	

30-03-320	
	Length/Lungh. [mm]
	107
	Outer Diam./Diam. est. [mm]
	98
	Diam. 1/ Diam. 2 [mm]
	10
MAZDA	

30-03-316	
	Length/Lungh. [mm]
	150
	Outer Diam./Diam. est. [mm]
	71
	Diam. 1/ Diam. 2 [mm]
	IN/OUT: 8,5
MAZDA	

30-03-321	
	Length/Lungh. [mm]
	120
MAZDA	

30-03-317	
	Length/Lungh. [mm]
	141
	Outer Diam./Diam. est. [mm]
	93,4
	Fitted Diam./Diam. montaggio [mm]
	64
Inner Thread/Filett int. [mm]	
	IN: 3/4 x 16 OUT: 34,4
	con sensore acqua/with water sensor
MAZDA	

30-03-322	
	Length/Lungh. [mm]
	178
	Outer Diam./Diam. est. [mm]
	72
	Diam. 1/ Diam. 2 [mm]
	IN/OUT: 8
KIA	

30-03-325	
	Length/Lungh. [mm]
	182
	Outer Diam./Diam. est. [mm]
	55
	Diam. 1/ Diam. 2 [mm]
	8
MAZDA	

30-03-388	
	Length/Lungh. [mm]
	138
	Outer Diam./Diam. est. [mm]
	80
	Diam. 1/ Diam. 2 [mm]
	IN/OUT: 8
MAZDA	

30-03-350	
	Length/Lungh. [mm]
	204
	Outer Diam./Diam. est. [mm]
	56
	Diam. 1/ Diam. 2 [mm]
	IN/OUT: 8
MAZDA	

30-03-389	
	Length/Lungh. [mm]
	132,5
	Outer Diam./Diam. est. [mm]
	70,5
	Diam. 1/ Diam. 2 [mm]
	IN/OUT: 8,2
MAZDA	

30-03-351	
	Length/Lungh. [mm]
	124
	Outer Diam./Diam. est. [mm]
	91
	Diam. 1/ Diam. 2 [mm]
	IN/OUT 10
MAZDA - TOYOTA	

30-03-390	
	Length/Lungh. [mm]
	134
	Outer Diam./Diam. est. [mm]
	71
	Diam. 1/ Diam. 2 [mm]
	IN/OUT: 8
MAZDA	

30-03-352	
	Length/Lungh. [mm]
	156
	Outer Diam./Diam. est. [mm]
	71
	Diam. 1/ Diam. 2 [mm]
	IN/OUT: 8
MAZDA	

30-03-391	
	Length/Lungh. [mm]
	146
	Outer Diam./Diam. est. [mm]
	72
	Diam. 1/ Diam. 2 [mm]
	IN/OUT: 8
MAZDA	

30-03-387	
	Length/Lungh. [mm]
	177
	Outer Diam./Diam. est. [mm]
	86
	Diam. 1/ Diam. 2 [mm]
	IN/OUT: 8
MAZDA	

30-03-392	
	Length/Lungh. [mm]
	97
	Outer Diam./Diam. est. [mm]
	93
	Fitted Diam./Diam. montaggio [mm]
	64
MAZDA	

30-03-393	
	Length/Lungh. [mm]
	111
	Outer Diam./Diam. est. [mm]
	60
	Inner Thread/Filett int. [mm]
	IN/OUT: M16 x 1,5
CHEVROLET - DAEWOO - LAND ROVER	

30-03-398	
	Length/Lungh. [mm]
	165
	Outer Diam./Diam. est. [mm]
	72
	Diam. 1/ Diam. 2 [mm]
	IN/OUT: 8
KIA	

30-03-394	
	Length/Lungh. [mm]
	149
	Outer Diam./Diam. est. [mm]
	72
	Diam. 1/ Diam. 2 [mm]
	IN/OUT: 8
KIA	

30-03-399	
	Length/Lungh. [mm]
	141
	Outer Diam./Diam. est. [mm]
	71,5
	Diam. 1/ Diam. 2 [mm]
	IN/OUT:8
MAZDA	

30-03-395	
	Length/Lungh. [mm]
	163
	Outer Diam./Diam. est. [mm]
	71
	Diam. 1/ Diam. 2 [mm]
	IN/OUT: 8
MAZDA	

30-04-400	
	Length/Lungh. [mm]
	145
	Outer Diam./Diam. est. [mm]
	86
	Diam. 1/ Diam. 2 [mm]
	IN:13,5/OUT:16
HONDA	

30-03-396	
	Length/Lungh. [mm]
	150
	Outer Diam./Diam. est. [mm]
	71
	Diam. 1/ Diam. 2 [mm]
	IN/OUT: 8
Subst. by 30-03-315	

30-04-401	
	Length/Lungh. [mm]
	80
	Outer Diam./Diam. est. [mm]
	54
	Diam. 1/ Diam. 2 [mm]
	IN/OUT: 6
HONDA	

30-03-397	
	Length/Lungh. [mm]
	132
	Outer Diam./Diam. est. [mm]
	72
	Diam. 1/ Diam. 2 [mm]
	IN/OUT: 8
MAZDA	

30-04-403	
	Length/Lungh. [mm]
	68
	Outer Diam./Diam. est. [mm]
	50,6
	Diam. 1/ Diam. 2 [mm]
	IN/OUT: 8
HONDA	

30-04-404	
	Length/Lungh. [mm]
	67
	Outer Diam./Diam. est. [mm]
	56,7
	Diam. 1/ Diam. 2 [mm]
	IN/OUT: 6
HONDA - SUZUKI	

30-04-411	
	Length/Lungh. [mm]
	94,5
	Outer Diam./Diam. est. [mm]
	86
	Inner Thread/Filett int. [mm]
	IN: M14 x 1,5 OUT: M12 x 1,25
HONDA	

30-04-405	
	Length/Lungh. [mm]
	68
	Outer Diam./Diam. est. [mm]
	51
	Diam. 1/ Diam. 2 [mm]
	IN/OUT: 8
HONDA	

30-04-413	
	Length/Lungh. [mm]
	94
	Outer Diam./Diam. est. [mm]
	86
	Inner Thread/Filett int. [mm]
	IN/OUT: M12 x 1,25
HONDA	

30-04-407	
	Length/Lungh. [mm]
	64
	Outer Diam./Diam. est. [mm]
	49
	Diam. 1/ Diam. 2 [mm]
	IN/OUT: 6
HONDA	

30-04-414	
	Length/Lungh. [mm]
	95
	Outer Diam./Diam. est. [mm]
	86,3
	Inner Thread/Filett int. [mm]
	IN/OUT: M12 x 1,25
HONDA	

30-04-408	
	Length/Lungh. [mm]
	67
	Outer Diam./Diam. est. [mm]
	51
	Diam. 1/ Diam. 2 [mm]
	IN/OUT: 8
HONDA	

30-04-415	
	Length/Lungh. [mm]
	95
	Outer Diam./Diam. est. [mm]
	86
	Inner Thread/Filett int. [mm]
	IN/OUT: M12 x 1,25
HONDA	

30-04-409	
	Length/Lungh. [mm]
	93
	Outer Diam./Diam. est. [mm]
	86
	Inner Thread/Filett int. [mm]
	IN/OUT: M12 x 1,25
HONDA	

30-04-416	
	Length/Lungh. [mm]
	96
	Outer Diam./Diam. est. [mm]
	87
	Inner Thread/Filett int. [mm]
	IN/OUT: M12 x 1,25
HONDA	



30-04-417	
 <p>Subst. by 30-04-411</p>	Length/Lungh. [mm]
	107
	Outer Diam./Diam. est. [mm]
	86
Inner Thread/Filett int. [mm]	
IN: M14 x 1,5 OUT: M12 X 1,25	
HONDA	

30-04-425	
 <p>NEW</p>	Length/Lungh. [mm]
	126
	Outer Diam./Diam. est. [mm]
	107
Inner Diam./Diam. int. [mm]	
42	
HONDA	

30-04-418	
	Length/Lungh. [mm]
	194
	Outer Diam./Diam. est. [mm]
	90,2
Diam. 1/ Diam. 2 [mm]	
IN/OUT: 8	
HONDA	

30-04-426	
	Length/Lungh. [mm]
	126
	Outer Diam./Diam. est. [mm]
	107
Inner Diam./Diam. int. [mm]	
42	
HONDA	

30-04-419	
 <p>Subst. by 30-04-411</p>	Length/Lungh. [mm]
	97
	Outer Diam./Diam. est. [mm]
	86,4
Inner Thread/Filett int. [mm]	
IN: M14 x 1,5 OUT: M12 x 1,25	
HONDA	

30-04-427	
 <p>NEW</p>	Length/Lungh. [mm]
	126
	Outer Diam./Diam. est. [mm]
	107
Inner Diam./Diam. int. [mm]	
42	
HONDA	

30-04-423	
	Length/Lungh. [mm]
	170
	Outer Diam./Diam. est. [mm]
	54
Inner Thread/Filett int. [mm]	
IN:9,5 OUT:8	
HONDA	

30-04-428	
 <p>NEW</p>	Length/Lungh. [mm]
	222
	Diam./Diam. [mm]
	108
Fitting Position/Lato montaggio	
Nel serbatoio carburante/in fuel tank	
HONDA	

30-04-424	
	Length/Lungh. [mm]
	120
	Outer Diam./Diam. est. [mm]
	95
	Fitted Diam./Diam. montaggio [mm]
	63
Inner Thread/Filett int. [mm]	
IN:3/4 X 16	
Inner Thread/Filett int. [mm]	
OUT:35	
HONDA	

30-04-496	
	Length/Lungh. [mm]
	164
	Outer Diam./Diam. est. [mm]
	84
Diam. 1/ Diam. 2 [mm]	
IN/OUT:8	
HONDA - LAND ROVER	

30-04-497	
	Length/Lungh. [mm]
	107
	Outer Diam./Diam. est. [mm]
	86
Subst. by 30-04-411	
	Inner Thread/Filett int. [mm]
	IN:M12 x 1,25 OUT: M14 x 1,5
HONDA	

30-05-502MP	
	Length/Lungh. [mm]
	137
	Outer Diam./Diam. est. [mm]
	98
	Fitted Diam./Diam. montaggio [mm]
72	
	Inner Thread/Filett int. [mm]
	IN:M20 x 1,5 OUT:34
DAIHATSU - HYUNDAI - ISUZU - KIA - MAZDA	

30-04-498	
	Length/Lungh. [mm]
	112,5
	Outer Diam./Diam. est. [mm]
	75,4
	Inner Thread/Filett int. [mm]
	IN:M14 x 1,5 OUT:M12 x 1,25
HONDA	

30-05-502	
	Length/Lungh. [mm]
	138
	Outer Diam./Diam. est. [mm]
	98,4
	Fitted Diam./Diam. montaggio [mm]
73	
	Inner Thread/Filett int. [mm]
	IN:M20 x 1,5 OUT:M36 x 1,5
DAIHATSU - HYUNDAI - ISUZU - SUZUKI - TOYOTA	

30-04-499	
	Length/Lungh. [mm]
	96
	Outer Diam./Diam. est. [mm]
	86
	Inner Thread/Filett int. [mm]
	IN/OUT:M12 x 1,25
HONDA - SUZUKI	

30-05-504	
	Length/Lungh. [mm]
	63
	Outer Diam./Diam. est. [mm]
	41
	Inner Diam./Diam. int. [mm]
8	
	Fitted Diam./Diam. montaggio [mm]
	29
MITSUBISHI	

30-05-500	
	Length/Lungh. [mm]
	105
	Outer Diam./Diam. est. [mm]
	106,5
	Fitted Diam./Diam. montaggio [mm]
	73
	Inner Thread/Filett int. [mm]
	IN: 20 x 1,5 OUT: 34 con sensore acqua/with water sensor
MITSUBISHI	

30-05-505	
	Length/Lungh. [mm]
	110
	Outer Diam./Diam. est. [mm]
96	
MITSUBISHI	

30-05-501	
	Length/Lungh. [mm]
	88
	Outer Diam./Diam. est. [mm]
	52,3
	Diam. 1/ Diam. 2 [mm]
	IN/OUT: 8
HYUNDAI - ISUZU - LAND ROVER - NISSAN	

30-05-506	
	Length/Lungh. [mm]
	133
	Outer Diam./Diam. est. [mm]
	72,1
	Inner Thread/Filett int. [mm]
	IN/OUT: M12 x 1,25
DAIHATSU - MITSUBISHI - TOYOTA	



30-05-509	
	Length/Lungh. [mm]
	122
	Outer Diam./Diam. est. [mm]
	82,6
	Fitted Diam./Diam. montaggio [mm]
62	
Inner Thread/Filett int. [mm]	
IN:M20 x 1,5 OUT:M22 x 1,5	
con sensore acqua/with water sensor	
ISUZU - MITSUBISHI	

30-05-520	
	Length/Lungh. [mm]
	120
	Outer Diam./Diam. est. [mm]
	64,5
Inner Thread/Filett int. [mm]	
IN:8 OUT:M12 x 1,25	
MITSUBISHI	

30-05-512	
	Length/Lungh. [mm]
	71
	Outer Diam./Diam. est. [mm]
	54
Diam. 1/ Diam. 2 [mm]	
IN/OUT:8	
MITSUBISHI	

30-05-523	
	Fitting Position/Lato montaggio Nel serbatoio carburante/in fuel tank
	Length/Lungh. [mm]
	163
	Outer Diam./Diam. est. [mm]
	120
Diam. 1/ Diam. 2 [mm]	
IN: 9 OUT: 6	
MITSUBISHI	

30-05-514	
	Length/Lungh. [mm]
	119
	Outer Diam./Diam. est. [mm]
	70,5
Inner Thread/Filett int. [mm]	
IN:M14 x 1,5 OUT:M12 x 1,25	
HYUNDAI - MITSUBISHI	

30-05-528	
	Length/Lungh. [mm]
	160
	Outer Diam./Diam. est. [mm]
	81,3
Diam. 1/ Diam. 2 [mm]	
IN/OUT: 8	
MITSUBISHI	

30-05-518	
	Length/Lungh. [mm]
	129
	Outer Diam./Diam. est. [mm]
	72
Inner Thread/Filett int. [mm]	
IN/OUT: M12 x 1,25	
CHRYSLER - HYUNDAI - MITSUBISHI	

30-05-531	
	Length/Lungh. [mm]
	92
	Outer Diam./Diam. est. [mm]
	70
	Inner Diam./Diam. int. [mm]
20	
Fitted Diam./Diam. montaggio [mm]	
30	
Subst. by 30-ECO015	

30-05-519	
	Length/Lungh. [mm]
	125
	Outer Diam./Diam. est. [mm]
	65,5
Inner Thread/Filett int. [mm]	
IN:8 OUT:M14 x 1,5	
MITSUBISHI	

30-05-573	
	Length/Lungh. [mm]
	121,4
	Outer Diam./Diam. est. [mm]
	65
Diam. 1/ Diam. 2 [mm]	
IN/OUT:8	
HYUNDAI	

30-05-574	
	Length/Lungh. [mm]
	140
	Outer Diam./Diam. est. [mm]
	98
	Fitted Diam./Diam. montaggio [mm]
73	
Inner Thread/Filett int. [mm]	
IN:M20 x 1,5 OUT:M22 x 1,5	
FIAT - MITSUBISHI - SUBARU	

30-05-581	
	Length/Lungh. [mm]
	90,6
	Outer Diam./Diam. est. [mm]
	72,2
	Inner Diam./Diam. int. [mm]
19	
Fitted Diam./Diam. montaggio [mm]	
30	
Subst. by 30-05-531	

30-05-576	
	Length/Lungh. [mm]
	119
	Outer Diam./Diam. est. [mm]
	70,5
	Inner Thread/Filett int. [mm]
IN:M14 x 1,5 OUT:M12 x 1,25	
Subst. by 30-05-514	

30-05-582	
	Length/Lungh. [mm]
	81
	Outer Diam./Diam. est. [mm]
	92
	Fitted Diam./Diam. montaggio [mm]
62	
Inner Thread/Filett int. [mm]	
M20 x 1,5	
MITSUBISHI	

30-05-578	
	Length/Lungh. [mm]
	110
	Outer Diam./Diam. est. [mm]
	79,4
	Fitted Diam./Diam. montaggio [mm]
71,5	
Inner Thread/Filett int. [mm]	
M16 x 1,5	
LAND ROVER - MITSUBISHI	

30-05-583	
	Length/Lungh. [mm]
	127
	Outer Diam./Diam. est. [mm]
	94,3
	Fitted Diam./Diam. montaggio [mm]
63	
Inner Thread/Filett int. [mm]	
M20 x 1,5	
FIAT - MITSUBISHI	

30-05-579	
	Length/Lungh. [mm]
	129
	Outer Diam./Diam. est. [mm]
	70
	Inner Thread/Filett int. [mm]
IN/OUT: M12 x 1,25	
Subst. by 30-05-598	

30-05-584	
	Length/Lungh. [mm]
	175
	Outer Diam./Diam. est. [mm]
	98
	Fitted Diam./Diam. montaggio [mm]
89	
Inner Thread/Filett int. [mm]	
M24X1,5	
FIAT	

30-05-580	
	Length/Lungh. [mm]
	44,4
	Outer Diam./Diam. est. [mm]
	72
	Inner Diam./Diam. int. [mm]
19,3	
Fitted Diam./Diam. montaggio [mm]	
30	
MITSUBISHI	

30-05-585	
	Length/Lungh. [mm]
	123
	Outer Diam./Diam. est. [mm]
	70,7
	Inner Thread/Filett int. [mm]
IN/OUT: M14 x 1,5	
HYUNDAI	





30-05-588	
	Length/Lungh. [mm]
	124
	Outer Diam./Diam. est. [mm]
	72
	Inner Thread/Filett int. [mm]
	IN/OUT: M12 x 1,25
MITSUBISHI	

30-05-599	
	Length/Lungh. [mm]
	129
	Outer Diam./Diam. est. [mm]
	70
	Inner Thread/Filett int. [mm]
	IN/OUT: M12 x 1,25
HYUNDAI	

30-05-590	
	Length/Lungh. [mm]
	104,5
	Outer Diam./Diam. est. [mm]
	64,5
	Inner Thread/Filett int. [mm]
	IN: M14 x 1,5 OUT: M12 x 1,25
MITSUBISHI - TOYOTA	

30-06-601	
	Length/Lungh. [mm]
	85
	Outer Diam./Diam. est. [mm]
	51,3
	Diam. 1/ Diam. 2 [mm]
	IN:7 OUT:8
DAIHATSU	

30-05-591	
	Length/Lungh. [mm]
	109
	Outer Diam./Diam. est. [mm]
	79,4
	Inner Thread/Filett int. [mm]
	M16 x 1,5
Subst. by 30-05-578	
MITSUBISHI	

30-06-602	
	Length/Lungh. [mm]
	82
	Outer Diam./Diam. est. [mm]
	51
	Diam. 1/ Diam. 2 [mm]
	IN :6,2
	Diam. 1/ Diam. 2 [mm]
	OUT:8,3
DAIHATSU	

30-05-594	
	Length/Lungh. [mm]
	105,3
	Outer Diam./Diam. est. [mm]
	70
	Inner Thread/Filett int. [mm]
	IN: M14 x 1,5 OUT:11
HYUNDAI	

30-06-604	
	Length/Lungh. [mm]
	102
	Outer Diam./Diam. est. [mm]
	94
	Fitted Diam./Diam. montaggio [mm]
	62
	Inner Thread/Filett int. [mm]
	M20 x 1,5
Subst. by 30-05-583	
DAIHATSU	

30-05-598	
	Length/Lungh. [mm]
	129
	Outer Diam./Diam. est. [mm]
	70
	Inner Thread/Filett int. [mm]
	IN/OUT: M12 x 1,25
HYUNDAI	

30-06-605	
	Length/Lungh. [mm]
	89,6
	Outer Diam./Diam. est. [mm]
	51
	Diam. 1/ Diam. 2 [mm]
	IN/OUT: 7
DAIHATSU	

30-06-608	
	Length/Lungh. [mm]
	97
	Outer Diam./Diam. est. [mm]
	46
	Diam. 1/ Diam. 2 [mm]
	IN/OUT: 7
DAIHATSU	

30-06-613	
	Length/Lungh. [mm]
	74
	Outer Diam./Diam. est. [mm]
	45,5
	Diam. 1/ Diam. 2 [mm]
	IN/OUT: 7
DAIHATSU	

30-06-609	
	Length/Lungh. [mm]
	75
	Outer Diam./Diam. est. [mm]
	45,5
	Diam. 1/ Diam. 2 [mm]
	IN:7 OUT:8
DAIHATSU	

30-06-614	
	Length/Lungh. [mm]
	114
	Outer Diam./Diam. est. [mm]
	58
	Diam. 1/ Diam. 2 [mm]
	IN:7 OUT:8
DAIHATSU	

30-06-610	
	Length/Lungh. [mm]
	110
	Outer Diam./Diam. est. [mm]
	56
	Diam. 1/ Diam. 2 [mm]
	IN / OUT:6,5
DAIHATSU	

30-06-616	
	Length/Lungh. [mm]
	109
	Outer Diam./Diam. est. [mm]
	56,4
	Diam. 1/ Diam. 2 [mm]
	IN:6,5 OUT:7
DAIHATSU	

30-06-611	
	Length/Lungh. [mm]
	79
	Outer Diam./Diam. est. [mm]
	84,6
	Fitted Diam./Diam. montaggio [mm]
63	
	Inner Thread/Filett int. [mm]
	M20 x 1,5
ASIA MOTORS	

30-06-619	
	Length/Lungh. [mm]
	85
	Outer Diam./Diam. est. [mm]
	51
	Diam. 1/ Diam. 2 [mm]
	IN:7 OUT:8,3
DAIHATSU	

30-06-612	
	Length/Lungh. [mm]
	86
	Outer Diam./Diam. est. [mm]
	51,3
	Diam. 1/ Diam. 2 [mm]
	IN:6,5 OUT:8
PIAGGIO	

30-06-620	
	Length/Lungh. [mm]
	150
	Outer Diam./Diam. est. [mm]
	71
	Inner Thread/Filett int. [mm]
	IN:8 OUT:M12 x 1,25
DAIHATSU	

30-06-621	
	Length/Lungh. [mm]
	92
	Outer Diam./Diam. est. [mm]
	51
Diam. 1/ Diam. 2 [mm]	
IN/OUT: 7	
DAIHATSU	

30-06-693	
	Length/Lungh. [mm]
	134
	Outer Diam./Diam. est. [mm]
	71
Inner Thread/Filett int. [mm]	
IN: M12 x 1,25 OUT: 8	
DAIHATSU	

30-06-622	
	Length/Lungh. [mm]
	82
	Outer Diam./Diam. est. [mm]
	51
Diam. 1/ Diam. 2 [mm]	
IN/OUT: 6,5	
DAIHATSU	

30-06-694	
	Length/Lungh. [mm]
	103
	Outer Diam./Diam. est. [mm]
	71
Diam. 1/ Diam. 2 [mm]	
IN/OUT: 8	
DAIHATSU	

30-06-623	
	Length/Lungh. [mm]
	133
	Outer Diam./Diam. est. [mm]
	71
Diam. 1/ Diam. 2 [mm]	
IN/OUT: 8	
DAIHATSU - PIAGGIO	

30-06-695	
	Length/Lungh. [mm]
	154,5
	Outer Diam./Diam. est. [mm]
	86
	Fitted Diam./Diam. montaggio [mm]
71	
Inner Thread/Filett int. [mm]	
M16 x 1,5	
DAIHATSU - LAND ROVER - PIAGGIO	

30-06-624	
	Length/Lungh. [mm]
	122
	Outer Diam./Diam. est. [mm]
	71
Diam. 1/ Diam. 2 [mm]	
IN:8/OUT:M14x1,5	
DAIHATSU - PIAGGIO	

30-06-697	
	Length/Lungh. [mm]
	87
	Outer Diam./Diam. est. [mm]
	51,2
Diam. 1/ Diam. 2 [mm]	
IN/OUT: 6,5	
DAIHATSU	

30-06-692	
	Length/Lungh. [mm]
	134
	Outer Diam./Diam. est. [mm]
	71
Diam. 1/ Diam. 2 [mm]	
IN/OUT: 8	
DAIHATSU - HYUNDAI - SHUANGHUAN AUTO	

30-07-700	
	Length/Lungh. [mm]
	60
	Outer Diam./Diam. est. [mm]
	56,5
Diam. 1/ Diam. 2 [mm]	
IN/OUT: 8	
SUBARU	

30-07-701	
	Length/Lungh. [mm]
	92
	Outer Diam./Diam. est. [mm]
	46,4
	Inner Diam./Diam. int. [mm]
24,4	
Fitted Diam./Diam. montaggio [mm]	
30	
SUBARU	

30-07-797	
	Length/Lungh. [mm]
	113,4
	Outer Diam./Diam. est. [mm]
	71
	Diam. 1/ Diam. 2 [mm]
IN/OUT: 8	
SUBARU	

30-07-702	
	Length/Lungh. [mm]
	106,5
	Outer Diam./Diam. est. [mm]
	55,5
	Diam. 1/ Diam. 2 [mm]
IN/OUT: 7	
SUBARU	

30-07-799	
	Length/Lungh. [mm]
	153
	Outer Diam./Diam. est. [mm]
	71,5
	Diam. 1/ Diam. 2 [mm]
IN/OUT: 8	
SUBARU	

30-07-704	
	Length/Lungh. [mm]
	148
	Outer Diam./Diam. est. [mm]
	80
	Diam. 1/ Diam. 2 [mm]
IN/OUT: 8	
SUBARU	

30-08-800	
	Length/Lungh. [mm]
	78
	Outer Diam./Diam. est. [mm]
	60
	Diam. 1/ Diam. 2 [mm]
IN/OUT: 8	
SUZUKI	

30-07-707	
	Length/Lungh. [mm]
	121
	Outer Diam./Diam. est. [mm]
	86
	Diam. 1/ Diam. 2 [mm]
IN/OUT: 8	
SUBARU	

30-08-806	
	Length/Lungh. [mm]
	79
	Outer Diam./Diam. est. [mm]
	59
	Diam. 1/ Diam. 2 [mm]
IN:8 OUT:8,4	
SUZUKI	

30-07-796	
	Length/Lungh. [mm]
	156
	Outer Diam./Diam. est. [mm]
	71
	Diam. 1/ Diam. 2 [mm]
IN/OUT: 8	
SUBARU	

30-08-807	
	Length/Lungh. [mm]
	77
	Outer Diam./Diam. est. [mm]
	59
	Diam. 1/ Diam. 2 [mm]
IN:8 OUT:6	
SUZUKI	

30-08-810	
	Length/Lungh. [mm]
	103
	Outer Diam./Diam. est. [mm]
	86
	Diam. 1/ Diam. 2 [mm]
	IN/OUT: 8
SUBARU - SUZUKI	

30-08-824	
	Length/Lungh. [mm]
	145
	Outer Diam./Diam. est. [mm]
	113
	Diam. 1/ Diam. 2 [mm]
	IN :10 OUT :12
SUZUKI	

30-08-813	
	Length/Lungh. [mm]
	97
	Outer Diam./Diam. est. [mm]
	59
	Diam. 1/ Diam. 2 [mm]
	IN/OUT: 8
SUZUKI	

30-08-826	
	Length/Lungh. [mm]
	128
	Outer Diam./Diam. est. [mm]
	71
	Diam. 1/ Diam. 2 [mm]
	IN/OUT: 8
SUZUKI	

30-08-821	
	Length/Lungh. [mm]
	98
	Outer Diam./Diam. est. [mm]
	97
	Fitted Diam./Diam. montaggio [mm]
	72
	Inner Thread/Filett int. [mm]
	M20 x 1,5
SUZUKI	

30-08-887	
	Length/Lungh. [mm]
	130
	Outer Diam./Diam. est. [mm]
	71
	Diam. 1/ Diam. 2 [mm]
	M12 x 1,25
HYUNDAI - MITSUBISHI - SUZUKI - TOYOTA	

30-08-822	
	Length/Lungh. [mm]
	51
	Outer Diam./Diam. est. [mm]
	70
	Inner Diam./Diam. int. [mm]
	20
	Fitted Diam./Diam. montaggio [mm]
	36
SUZUKI	

30-08-890	
	Length/Lungh. [mm]
	92,3
	Outer Diam./Diam. est. [mm]
	88
	Diam. 1/ Diam. 2 [mm]
	IN/OUT: 8
SUBARU - SUZUKI	

30-08-823	
	Length/Lungh. [mm]
	135
	Outer Diam./Diam. est. [mm]
	72
	Diam. 1/ Diam. 2 [mm]
	IN/OUT: 8
SUZUKI	

30-08-891	
	Length/Lungh. [mm]
	71
	Outer Diam./Diam. est. [mm]
	88
	Inner Diam./Diam. int. [mm]
	19
	Fitted Diam./Diam. montaggio [mm]
	28
DAEWOO - LAND ROVER - SUZUKI - TATA	

30-08-895	
	Length/Lungh. [mm]
	103
	Outer Diam./Diam. est. [mm]
	71
	Diam. 1/ Diam. 2 [mm]
	IN/OUT: 8
SUZUKI	

30-09-903	
	Length/Lungh. [mm]
	100
	Outer Diam./Diam. est. [mm]
	48,5
	Diam. 1/ Diam. 2 [mm]
	IN/OUT: 8
Subst. by 30-05-501	

30-08-896	
	Length/Lungh. [mm]
	107,3
	Outer Diam./Diam. est. [mm]
	75,7
	Diam. 1/ Diam. 2 [mm]
	IN/OUT: 8
SUZUKI	

30-09-906	
	Length/Lungh. [mm]
	102
	Outer Diam./Diam. est. [mm]
	51,6
	Diam. 1/ Diam. 2 [mm]
	IN/OUT: 8
Subst. by 30-03-301	

30-08-897	
	Length/Lungh. [mm]
	100
	Outer Diam./Diam. est. [mm]
	70
	Diam. 1/ Diam. 2 [mm]
	IN/OUT: 8
NISSAN - SUZUKI	

30-09-907	
	Length/Lungh. [mm]
	174
	Outer Diam./Diam. est. [mm]
	85
	Fitted Diam./Diam. montaggio [mm]
	67
	Inner Thread/Filett int. [mm]
M 16 X 1,5	
	Inner Diam. 1/Diam. int. 1 [mm]
	10
JEEP	

30-08-899	
	Length/Lungh. [mm]
	75,5
	Outer Diam./Diam. est. [mm]
	54,2
	Diam. 1/ Diam. 2 [mm]
	IN:6 OUT:6,5
SUZUKI	

30-09-909	
	Length/Lungh. [mm]
	127
	Outer Diam./Diam. est. [mm]
	59,3
	Diam. 1/ Diam. 2 [mm]
	IN/OUT: 8
ISUZU - NISSAN - OPEL	

30-09-902	
	Length/Lungh. [mm]
	90
	Outer Diam./Diam. est. [mm]
	84
	Fitted Diam./Diam. montaggio [mm]
62	
	Inner Thread/Filett int. [mm]
	3/4 x 16
Subst. by 30-09-998	

30-09-910	
	Length/Lungh. [mm]
	101
	Outer Diam./Diam. est. [mm]
	83
	Fitted Diam./Diam. montaggio [mm]
	62
	Inner Thread/Filett int. [mm]
	3/4 x 16
ISUZU	

 <p>NEW</p> <p>911</p> <p>CHRYSLER</p>	30-09-911	
	Length/Lungh. [mm]	155
	Outer Diam./Diam. est. [mm]	85
	Fitted Diam./Diam. montaggio [mm]	70
	Inner Thread/Filett int. [mm]	M 16 X 1,5

	30-09-989	
	Length/Lungh. [mm]	75
	Outer Diam./Diam. est. [mm]	94
	Inner Diam./Diam. int. [mm]	43
	Fitted Diam./Diam. montaggio [mm]	62

 <p>NEW</p> <p>912</p> <p>JEEP</p>	30-09-912	
	Length/Lungh. [mm]	172
	Outer Diam./Diam. est. [mm]	54
	Diam. 1/ Diam. 2 [mm]	IN: 8 / OUT: 9,5

	30-09-990	
	Length/Lungh. [mm]	106
	Outer Diam./Diam. est. [mm]	60
	Inner Thread/Filett int. [mm]	IN/OUT: M14 x 1,5

 <p>NEW</p> <p>913</p> <p>CHRYSLER</p>	30-09-913	
	Length/Lungh. [mm]	158
	Outer Diam./Diam. est. [mm]	74
	Diam. 1/ Diam. 2 [mm]	IN: 8 / OUT: 10

	30-09-991	
	Length/Lungh. [mm]	103
	Outer Diam./Diam. est. [mm]	85,6
	Fitted Diam./Diam. montaggio [mm]	70
	Inner Thread/Filett int. [mm]	M 12X1,5

 <p>914</p> <p>CHRYSLER</p>	30-09-914	

	30-09-995	
	Length/Lungh. [mm]	70
	Outer Diam./Diam. est. [mm]	108,3
	Fitted Diam./Diam. montaggio [mm]	90
	Inner Thread/Filett int. [mm]	IN/OUT: 1 x 14

	30-09-988	
	Length/Lungh. [mm]	119
	Outer Diam./Diam. est. [mm]	90
	Diam. 1/ Diam. 2 [mm]	IN:8/OUT:10

	30-09-996	
	Length/Lungh. [mm]	164,4
	Outer Diam./Diam. est. [mm]	67
	Diam. 1/ Diam. 2 [mm]	IN:8/OUT:10

30-09-997	
	Length/Lungh. [mm]
	104
	Outer Diam./Diam. est. [mm]
	96,2
	Fitted Diam./Diam. montaggio [mm]
89	
Inner Thread/Filett int. [mm]	
IN:1 x 14 OUT:77,6	
CHRYSLER - JEEP	

30-ECO003	
	Length/Lungh. [mm]
	102
	Outer Diam./Diam. est. [mm]
	92
	Inner Diam./Diam. int. [mm]
	28
	Inner Diam. 1/Diam. int. 1 [mm]
6	
Fitted Diam./Diam. montaggio [mm]	
45	
MAZDA - NISSAN - SUBARU - SUZUKI - TOYOTA	

30-09-998	
	Length/Lungh. [mm]
	89
	Outer Diam./Diam. est. [mm]
	85
	Fitted Diam./Diam. montaggio [mm]
62	
Inner Thread/Filett int. [mm]	
3/4 x 16	
Subst. by 30-02-208	

30-ECO004	
	Length/Lungh. [mm]
	81
	Outer Diam./Diam. est. [mm]
	96
	Outer Diam. 1/Diam. est. 1 [mm]
	70
	Inner Diam./Diam. int. [mm]
19	
Fitted Diam./Diam. montaggio [mm]	
82	
CITROEN - FIAT - PEUGEOT	

30-09-999	
	Length/Lungh. [mm]
	161
	Width/Largh. [mm]
	85
	Height/Altezza [mm]
67	
Diam. 1/ Diam. 2 [mm]	
IN / OUT:7	
JEEP	

30-ECO005	
	Length/Lungh. [mm]
	65
	Outer Diam./Diam. est. [mm]
	82
Inner Diam./Diam. int. [mm]	
19	
FIAT	

30-ECO001	
	Length/Lungh. [mm]
	203
	Outer Diam. 1/Diam. est. 1 [mm]
	94
	Inner Diam./Diam. int. [mm]
	47
	Inner Diam. 1/Diam. int. 1 [mm]
11	
Fitted Diam./Diam. montaggio [mm]	
45	
CHRYSLER - DAEWOO - JEEP - TOYOTA	

30-ECO006	
	Length/Lungh. [mm]
	76
	Outer Diam./Diam. est. [mm]
	84,5
	Inner Diam./Diam. int. [mm]
	30,6
Fitted Diam./Diam. montaggio [mm]	
38	
Subst. by 30-ECO011	

30-ECO002	
	Length/Lungh. [mm]
	92
	Outer Diam./Diam. est. [mm]
	75,5
	Outer Diam. 1/Diam. est. 1 [mm]
	78,6
Inner Diam./Diam. int. [mm]	
18	
Fitted Diam./Diam. montaggio [mm]	
32	
MERCEDES-BENZ	

30-ECO007	
	Length/Lungh. [mm]
	52
	Outer Diam./Diam. est. [mm]
	69,4
	Inner Diam./Diam. int. [mm]
19,5	
Fitted Diam./Diam. montaggio [mm]	
32	
OPEL - RENAULT - VAUXHALL	

30-ECO008	
	Length/Lungh. [mm]
	Outer Diam./Diam. est. [mm]
	Inner Diam./Diam. int. [mm]
CITROEN - PEUGEOT - RENAULT	

30-ECO013	
	Length/Lungh. [mm]
	Outer Diam./Diam. est. [mm]
	Inner Diam./Diam. int. [mm]
ISUZU	

30-ECO009	
	Length/Lungh. [mm]
	Outer Diam./Diam. est. [mm]
	Inner Diam./Diam. int. [mm]
	Fitted Diam./Diam. montaggio [mm]
OPEL - SAAB - VAUXHALL	

30-ECO014	
	Length/Lungh. [mm]
	Outer Diam./Diam. est. [mm]
	Inner Diam./Diam. int. [mm]
	Fitted Diam./Diam. montaggio [mm]
NISSAN - OPEL - RENAULT - VAUXHALL	

30-ECO010	
	Length/Lungh. [mm]
	Outer Diam./Diam. est. [mm]
	Outer Diam. 1/Diam. est. 1 [mm]
	Inner Diam./Diam. int. [mm]
NISSAN - OPEL - RENAULT - VAUXHALL	

30-ECO015	
	Length/Lungh. [mm]
	Outer Diam./Diam. est. [mm]
	Inner Diam./Diam. int. [mm]
	Fitted Diam./Diam. montaggio [mm]
MITSUBISHI - NISSAN - RENAULT - SUZUKI	

30-ECO011	
	Length/Lungh. [mm]
	Outer Diam./Diam. est. [mm]
	Inner Diam./Diam. int. [mm]
	Inner Diam. 1/Diam. int. 1 [mm]
	Fitted Diam./Diam. montaggio [mm]
CITROEN - FIAT	

30-ECO016	
	Length/Lungh. [mm]
	Outer Diam./Diam. est. [mm]
	Inner Diam./Diam. int. [mm]
CHEVROLET - DR - FIAT - SUZUKI	

30-ECO012	
	Length/Lungh. [mm]
	Outer Diam./Diam. est. [mm]
	Inner Diam./Diam. int. [mm]
TOYOTA	

30-ECO017	
	Length/Lungh. [mm]
	Outer Diam./Diam. est. [mm]
	Inner Diam./Diam. int. [mm]
	Fitted Diam./Diam. montaggio [mm]
NISSAN - OPEL - RENAULT - VAUXHALL	

30-ECO018	
	Length/Lungh. [mm]
	123
	Outer Diam./Diam. est. [mm]
	67
	Inner Diam./Diam. int. [mm]
16	
Fitted Diam./Diam. montaggio [mm]	
27	
HONDA	

30-ECO024	
	Length/Lungh. [mm]
	137
	Outer Diam./Diam. est. [mm]
	77
Inner Diam./Diam. int. [mm]	
11	
AUDI - SEAT - SKODA - VW	

30-ECO019	
	Length/Lungh. [mm]
	64
	Outer Diam./Diam. est. [mm]
	77
Inner Diam./Diam. int. [mm]	
15	
CITROEN - FIAT - PEUGEOT - SUZUKI	

30-ECO025	
	Length/Lungh. [mm]
	79
	Outer Diam./Diam. est. [mm]
	102
Inner Diam./Diam. int. [mm]	
43	
AUDI - PORSCHE - VW	

30-ECO020	
	Length/Lungh. [mm]
	90
	Outer Diam./Diam. est. [mm]
	78
	Inner Diam./Diam. int. [mm]
25	
Fitted Diam./Diam. montaggio [mm]	
39	
CHEVROLET - OPEL - SAAB - VAUXHALL	

30-ECO026	
	Length/Lungh. [mm]
	123
	Outer Diam./Diam. est. [mm]
	82
Inner Diam./Diam. int. [mm]	
19	
BMW	

30-ECO021	
	Length/Lungh. [mm]
	115
	Outer Diam./Diam. est. [mm]
	97
Inner Diam./Diam. int. [mm]	
12	
CHEVROLET	

30-ECO027	
	Length/Lungh. [mm]
	74
	Outer Diam./Diam. est. [mm]
	91
Inner Diam./Diam. int. [mm]	
14	
CITROEN - FIAT - FORD - PEUGEOT	

30-ECO022	
	Length/Lungh. [mm]
	108,5
	Outer Diam./Diam. est. [mm]
	65
	Inner Diam./Diam. int. [mm]
12	
Fitted Diam./Diam. montaggio [mm]	
23	
CITROEN - FIAT - FORD - PEUGEOT	

30-ECO028	
	Length/Lungh. [mm]
	75
	Outer Diam./Diam. est. [mm]
	91
Inner Diam./Diam. int. [mm]	
24	
CITROEN - FIAT - FORD - PEUGEOT	

30-ECO029	
	Length/Lungh. [mm]
	118
	Outer Diam./Diam. est. [mm]
	83
	Inner Diam./Diam. int. [mm]
	24
CITROEN - PEUGEOT	

30-ECO034	
	Length/Lungh. [mm]
	142
	Outer Diam./Diam. est. [mm]
	83
	Inner Diam./Diam. int. [mm]
	39
	Fitted Diam./Diam. montaggio [mm]
	52
AUDI - SEAT - SKODA - VW	

30-ECO030	
	Length/Lungh. [mm]
	113
	Outer Diam./Diam. est. [mm]
	81
	Inner Diam./Diam. int. [mm]
	24
	Fitted Diam./Diam. montaggio [mm]
	44
FORD - VOLVO	

30-ECO075	
	Length/Lungh. [mm]
	109
	Outer Diam./Diam. est. [mm]
	79
	Inner Diam./Diam. int. [mm]
	20
	Fitted Diam./Diam. montaggio [mm]
	22
FORD	

30-ECO031	
	Length/Lungh. [mm]
	99
	Outer Diam./Diam. est. [mm]
	71
	Fitted Diam./Diam. montaggio [mm]
	17
VOLVO	

30-ECO076	
	Length/Lungh. [mm]
	98
	Outer Diam./Diam. est. [mm]
	75
	Inner Diam./Diam. int. [mm]
	15
	Fitted Diam./Diam. montaggio [mm]
	45,5
AUDI	

30-ECO032	
	Length/Lungh. [mm]
	118
	Outer Diam./Diam. est. [mm]
	72
	Fitted Diam./Diam. montaggio [mm]
	16
VW	

30-H0-001	
	Length/Lungh. [mm]
	120
	Outer Diam./Diam. est. [mm]
	70
	Inner Thread/Filett int. [mm]
	IN: M14 x 1,5 OUT: M12 x 1,25

30-ECO033	
	Length/Lungh. [mm]
	114
	Outer Diam./Diam. est. [mm]
	83
	Inner Diam./Diam. int. [mm]
	19
	Fitted Diam./Diam. montaggio [mm]
	27
AUDI - SEAT - SKODA - VW	

30-H0-002	
	Length/Lungh. [mm]
	128,3
	Outer Diam./Diam. est. [mm]
	65
	Inner Thread/Filett int. [mm]
	IN/OUT: 8
HYUNDAI - KIA	

30-0H-H03	
	Length/Lungh. [mm]
	144
	Outer Diam./Diam. est. [mm]
	80
	Fitted Diam./Diam. montaggio [mm]
70	
Inner Thread/Filett int. [mm]	
M 16X 1,5	
GASOLONE - HYUNDAI - KIA	

30-H0-011	
	Length/Lungh. [mm]
	141
	Outer Diam./Diam. est. [mm]
	86
	Fitted Diam./Diam. montaggio [mm]
70,5	
Inner Thread/Filett int. [mm]	
IN: M16 x 1,5 OUT: M12 x 1,25	
HYUNDAI - KIA	

30-H0-004	
	Length/Lungh. [mm]
	168,6
	Outer Diam./Diam. est. [mm]
	86
	Fitted Diam./Diam. montaggio [mm]
71	
Inner Thread/Filett int. [mm]	
IN: M16 x 1,5 OUT: 6	
HYUNDAI	

30-0H-012	
	Length/Lungh. [mm]
	144
	Outer Diam./Diam. est. [mm]
	71,3
	Inner Thread/Filett int. [mm]
IN: M14 x 1,5 OUT: 8	
HYUNDAI	

30-H0-005	
	Length/Lungh. [mm]
	144
	Outer Diam./Diam. est. [mm]
	85
	Inner Thread/Filett int. [mm]
M16 x 1,5	
GASOLONE - HYUNDAI - KIA	

30-0H-013	
	Length/Lungh. [mm]
	152
	Outer Diam./Diam. est. [mm]
	81
	Diam. 1/ Diam. 2 [mm]
IN:8/OUT:12	
HYUNDAI - KIA	

30-H0-006	
	Length/Lungh. [mm]
	142
	Outer Diam./Diam. est. [mm]
	82
	Diam. 1/ Diam. 2 [mm]
IN:13 OUT:12	
HYUNDAI	

30-0H-H14	
	Length/Lungh. [mm]
	152
	Outer Diam./Diam. est. [mm]
	89
	Diam. 1/ Diam. 2 [mm]
IN /8 OUT/20	
HYUNDAI	

30-H0-007	
	Length/Lungh. [mm]
	142
	Outer Diam./Diam. est. [mm]
	82
	Diam. 1/ Diam. 2 [mm]
IN:13 OUT:12	
HYUNDAI	

30-0H-H15	
	Length/Lungh. [mm]
	130
	Outer Diam./Diam. est. [mm]
	88
	Diam. 1/ Diam. 2 [mm]
IN: 8 OUT: 16	
HYUNDAI	

30-0H-H16	
	Length/Lungh. [mm]
	142
	Outer Diam./Diam. est. [mm]
	83
HYUNDAI	

30-K0-003	
	Length/Lungh. [mm]
	149
	Outer Diam./Diam. est. [mm]
	83
	Fitted Diam./Diam. montaggio [mm]
	62
	Inner Thread/Filett int. [mm]
	IN/OUT: M20 x 1,5
KIA	

30-0H-H17	
	Length/Lungh. [mm]
	113
	Diam./Diam. [mm]
	70
HYUNDAI	

30-K0-004	
	Length/Lungh. [mm]
	142
	Outer Diam./Diam. est. [mm]
	72
	Diam. 1/ Diam. 2 [mm]
	IN/OUT: 8
KIA	

30-H0-022	
	Length/Lungh. [mm]
	140
	Outer Diam./Diam. est. [mm]
	87,4
	Diam. 1/ Diam. 2 [mm]
	IN:12/OUT:13
HYUNDAI	

30-K0-005	
	Length/Lungh. [mm]
	165
	Outer Diam./Diam. est. [mm]
	72
	Diam. 1/ Diam. 2 [mm]
	IN/OUT: 8
KIA	

30-H0-023	
	Length/Lungh. [mm]
	141
	Outer Diam./Diam. est. [mm]
	81
	Diam. 1/ Diam. 2 [mm]
	IN:8/OUT:12
HYUNDAI	

30-K0-008	
	Length/Lungh. [mm]
	155
	Outer Diam./Diam. est. [mm]
	72,3
	Diam. 1/ Diam. 2 [mm]
	IN/OUT: 8
KIA	

30-K0-001	
	Length/Lungh. [mm]
	102
	Outer Diam./Diam. est. [mm]
	83
	Fitted Diam./Diam. montaggio [mm]
	62,5
	Inner Thread/Filett int. [mm]
	IN: M20 x 1,5 OUT: M22 x 1,5
KIA	

30-K0-009	
	Length/Lungh. [mm]
	189
	Outer Diam./Diam. est. [mm]
	87,7
	Diam. 1/ Diam. 2 [mm]
	IN/OUT: 10
	Inner Thread/Filett int. [mm]
	6,5
HYUNDAI - KIA - TATA	

30-K0-012	
	Length/Lungh. [mm]
	62
	Outer Diam./Diam. est. [mm]
	51,2
	Diam. 1/ Diam. 2 [mm]
	IN/OUT: 8,5
KIA	

30-0K-017	
	Length/Lungh. [mm]
	131
	Outer Diam./Diam. est. [mm]
	113
	Diam. 1/ Diam. 2 [mm]
	IN:12/OUT:16
Per pompa benzina/For Fuel Pump	
KIA	

30-K0-013	
	Length/Lungh. [mm]
	166
	Outer Diam./Diam. est. [mm]
	72
	Diam. 1/ Diam. 2 [mm]
	IN/OUT: 8
KIA	

30-K0-018	
	Length/Lungh. [mm]
	143
	Outer Diam./Diam. est. [mm]
	86
	Fitted Diam./Diam. montaggio [mm]
	68,4
	Inner Thread/Filett int. [mm]
	IN: M16 x 1,5 OUT: 10
CHRYSLER - JEEP - KIA - MAHINDRA	

30-K0-014	
	Length/Lungh. [mm]
	163
	Outer Diam./Diam. est. [mm]
	72
	Diam. 1/ Diam. 2 [mm]
	IN/OUT: 8
KIA	

30-K0-020	
	Length/Lungh. [mm]
	162
	Outer Diam./Diam. est. [mm]
	82
	Diam. 1/ Diam. 2 [mm]
	IN:7,4/OUT:11,6
KIA	

30-K0-015	
	Length/Lungh. [mm]
	145,6
	Outer Diam./Diam. est. [mm]
	70,4
	Diam. 1/ Diam. 2 [mm]
	IN/OUT: 8
HYUNDAI - KIA - MITSUBISHI	

30-0K-K22	
	Length/Lungh. [mm]
	136,5
	Outer Diam./Diam. est. [mm]
	104
	Diam. 1/ Diam. 2 [mm]
	IN:12 OUT:13
HYUNDAI - KIA	

30-K0-016	
	Length/Lungh. [mm]
	169
	Outer Diam./Diam. est. [mm]
	86,5
	Fitted Diam./Diam. montaggio [mm]
	70
	Inner Thread/Filett int. [mm]
	IN: M16 x 1,5 OUT: 10
KIA	

30-0K-K23	
	Length/Lungh. [mm]
	130
	Outer Diam./Diam. est. [mm]
	88
	Diam. 1/ Diam. 2 [mm]
	IN :9 OUT:13
HYUNDAI - KIA	

30-K0-024	
	Length/Lungh. [mm]
	120,4
	Outer Diam./Diam. est. [mm]
	82
KIA	

30-0K-K29	
	Length/Lungh. [mm]
	88
	Outer Diam./Diam. est. [mm]
	95
	Fitting Position/Lato montaggio Nel serbatoio carburante/in fuel tank
KIA	

30-0K-K25	
	Length/Lungh. [mm]
	144
	Outer Diam./Diam. est. [mm]
	137
HYUNDAI - KIA	

30-0L-L00	
	Length/Lungh. [mm]
	78
	Outer Diam./Diam. est. [mm]
	83
	Inner Diam./Diam. int. [mm]
	13,5
	Inner Diam. 1/Diam. int. 1 [mm]
	6
LAND ROVER	

30-0K-K26	
	Length/Lungh. [mm]
	134
	Outer Diam./Diam. est. [mm]
	88
KIA	

30-0L-L02	
	Length/Lungh. [mm]
	167
	Outer Diam./Diam. est. [mm]
	90,5
	Diam. 1/ Diam. 2 [mm]
	IN/OUT: 8
HONDA - LAND ROVER	

30-0K-K27	
	Length/Lungh. [mm]
	136
	Outer Diam./Diam. est. [mm]
	81
KIA	

30-0L-L03	
	Length/Lungh. [mm]
	161
	Outer Diam./Diam. est. [mm]
	83,3
	Fitted Diam./Diam. montaggio [mm]
	70
	Inner Thread/Filett int. [mm]
	M16 x 1,5
LAND ROVER	

30-0K-K28	
	Length/Lungh. [mm]
	88
	Outer Diam./Diam. est. [mm]
	95
	Fitting Position/Lato montaggio Nel serbatoio carburante/in fuel tank
HYUNDAI - KIA	

30-0L-L05	
	Length/Lungh. [mm]
	187
	Outer Diam./Diam. est. [mm]
	86,4
	Diam. 1/ Diam. 2 [mm]
	IN/OUT: 10
LAND ROVER	

30-0L-L06	
	Length/Lungh. [mm]
	177
	Outer Diam./Diam. est. [mm]
	83,3
	Diam. 1/ Diam. 2 [mm]
	IN/OUT: 8
LAND ROVER	

30-0L-L12	
	Length/Lungh. [mm]
	85
	Outer Diam./Diam. est. [mm]
	108
LAND ROVER	

30-0L-L07	
	Length/Lungh. [mm]
	183,5
	Outer Diam./Diam. est. [mm]
	85
	Fitted Diam./Diam. montaggio [mm]
	70
Inner Thread/Filett int. [mm]	M16 x 1,5
LAND ROVER	

30-0L-L13	
	Length/Lungh. [mm]
	207
	Outer Diam./Diam. est. [mm]
	55
	Diam. 1/ Diam. 2 [mm]
	IN / OUT: 8
LAND ROVER	

30-0L-L08	
	Length/Lungh. [mm]
	155
	Outer Diam./Diam. est. [mm]
	85
	Fitted Diam./Diam. montaggio [mm]
	69
Inner Thread/Filett int. [mm]	M16 x 1,5
LAND ROVER	

30-0M-000	
	Length/Lungh. [mm]
	135,5
	Outer Diam./Diam. est. [mm]
	59,5
Diam. 1/ Diam. 2 [mm]	IN/OUT: 8
SMART	

30-0L-L09	
	Length/Lungh. [mm]
	139
	Outer Diam./Diam. est. [mm]
	86,3
	Fitted Diam./Diam. montaggio [mm]
	70
Inner Thread/Filett int. [mm]	IN:M16X1,5 OUT:8
LAND ROVER	

30-0M-001	
	Length/Lungh. [mm]
	137
	Outer Diam./Diam. est. [mm]
	61,5
Diam. 1/ Diam. 2 [mm]	IN/OUT: 8
SMART	

30-0L-L11	
	Length/Lungh. [mm]
	150
	Outer Diam./Diam. est. [mm]
	128
Diam. 1/ Diam. 2 [mm]	IN / OUT:8
LAND ROVER - MITSUBISHI	

30-M0-002	
	Length/Lungh. [mm]
	119
	Outer Diam./Diam. est. [mm]
	90,4
Diam. 1/ Diam. 2 [mm]	IN:10/OUT:8
CHRYSLER - MITSUBISHI - SMART	

30-P0-084	
	Length/Lungh. [mm]
	135
	Outer Diam./Diam. est. [mm]
	43
	Diam. 1/ Diam. 2 [mm]
	IN/OUT: 6

30-W0-001	
	Length/Lungh. [mm]
	160
	Outer Diam./Diam. est. [mm]
	59,3
	Diam. 1/ Diam. 2 [mm]
	IN/OUT: 8

**CADILLAC - CHEVROLET -
DAEWOO - OPEL**

30-0S-001	
	Length/Lungh. [mm]
	176
	Outer Diam./Diam. est. [mm]
	86,2
	Diam. 1/ Diam. 2 [mm]
	IN / OUT : 10
	Inner Thread/Filett int. [mm]
	8,5

SSANGYONG

30-W0-003	
	Length/Lungh. [mm]
	61
	Outer Diam./Diam. est. [mm]
	81
	Inner Diam./Diam. int. [mm]
	13

DAEWOO - HYUNDAI

30-0S-002	
	Length/Lungh. [mm]
	104
	Outer Diam./Diam. est. [mm]
	70
	Diam. 1/ Diam. 2 [mm]
	IN/OUT: M14x1,5

SSANGYONG

30-0S-S04	
	Length/Lungh. [mm]
	184
	Outer Diam./Diam. est. [mm]
	95
	Diam. 1/ Diam. 2 [mm]
	IN / OUT : 10

SSANGYONG

30-W0-000	
	Length/Lungh. [mm]
	76
	Outer Diam./Diam. est. [mm]
	58
	Diam. 1/ Diam. 2 [mm]
	IN/OUT: 7

SUZUKI

21-CD-CD0		
	Length/Lungh. [mm]	331
	Width/Largh. [mm]	164
	Height/Altezza [mm]	30
CADILLAC		

21-CH-CH3		
	Length/Lungh. [mm]	216
	Width/Largh. [mm]	195
	Height/Altezza [mm]	25
CHRYSLER - DODGE - JEEP - MAZDA		

21-CD-CD1		
	Length/Lungh. [mm]	264
	Width/Largh. [mm]	234
	Height/Altezza [mm]	24
CADILLAC		

21-CH-CH4		
	Length/Lungh. [mm]	309
	Width/Largh. [mm]	212
	Height/Altezza [mm]	30
CHRYSLER		

21-CH-CH0		
	Length/Lungh. [mm]	306,5
	Width/Largh. [mm]	233
	Height/Altezza [mm]	22
CHRYSLER		

21-DW-W0		
	Length/Lungh. [mm]	267
	Length 1/Lungh. 1 [mm]	204
	Width/Largh. [mm]	200
	Width 1/Largh. 1 [mm]	63
	Height/Altezza [mm]	30,5
	Height 1/Altezza 1 [mm]	24,6
DAEWOO		

21-CH-CH1		
	Length/Lungh. [mm]	225,1
	Width/Largh. [mm]	115,2
	Height/Altezza [mm]	30
CHRYSLER		

21-DW-W1		
	Length/Lungh. [mm]	224
	Length 1/Lungh. 1 [mm]	170
	Width/Largh. [mm]	193,4
	Width 1/Largh. 1 [mm]	35
	Height/Altezza [mm]	24,4
DAEWOO		

21-CH-CH2		
	Length/Lungh. [mm]	261
	Width/Largh. [mm]	198
	Height/Altezza [mm]	53
CHRYSLER		

21-DW-W10		
	Length/Lungh. [mm]	230
	Width/Largh. [mm]	207
	Height/Altezza [mm]	25
CHEVROLET - DAEWOO		

21-DW-W11		
	Length/Lungh. [mm]	250,5
	Width/Largh. [mm]	205
	Height/Altezza [mm]	19
CHEVROLET - DAEWOO		

21-DW-W16		
	Length/Lungh. [mm]	214
	Width/Largh. [mm]	200
	Height/Altezza [mm]	20
CHEVROLET		

21-DW-W12		
	Length/Lungh. [mm]	273
	Width/Largh. [mm]	196
	Height/Altezza [mm]	27
CHEVROLET		

21-DW-W17		
	Length/Lungh. [mm]	247
	Width/Largh. [mm]	213
	Height/Altezza [mm]	23
CHEVROLET		

21-DW-W13		
	Length/Lungh. [mm]	234
	Width/Largh. [mm]	207
	Height/Altezza [mm]	26
CHEVROLET		

21-DW-W18		
	Length/Lungh. [mm]	273
	Width/Largh. [mm]	196
	Height/Altezza [mm]	27
CHEVROLET		

21-DW-W14		
	Length/Lungh. [mm]	210
	Width/Largh. [mm]	198
	Height/Altezza [mm]	10
CHEVROLET - DAEWOO		

21-DW-W2		
	Length/Lungh. [mm]	295
	Width/Largh. [mm]	185
	Width 1/Largh. 1 [mm]	137
	Height/Altezza [mm]	30
CHEVROLET - DAEWOO		

21-DW-W15		
	Length/Lungh. [mm]	240
	Width/Largh. [mm]	206
	Height/Altezza [mm]	35
CHEVROLET		

21-DW-W3		
	Length/Lungh. [mm]	273,3
	Width/Largh. [mm]	102
	Height/Altezza [mm]	20
	Required quantity/N° pezzi	2
CHEVROLET - DAEWOO		

21-DW-W4	
	Length/Lungh. [mm]
	Width/Largh. [mm]
	Height/Altezza [mm]
	Required quantity/N° pezzi

21-DW-W9	
	Length/Lungh. [mm]
	Width/Largh. [mm]
	Height/Altezza [mm]
	Required quantity/N° pezzi

21-DW-W5	
	Length/Lungh. [mm]
	Width/Largh. [mm]
	Width 1/Largh. 1 [mm]
	Height/Altezza [mm]
	Height 1/Altezza 1 [mm]
	Required quantity/N° pezzi

21-DG-DG0	
	Length/Lungh. [mm]
	Width/Largh. [mm]
	Height/Altezza [mm]
	Required quantity/N° pezzi
	Required quantity/N° pezzi

21-DW-W6	
	Length/Lungh. [mm]
	Width/Largh. [mm]
	Width 1/Largh. 1 [mm]
	Height/Altezza [mm]
	Height 1/Altezza 1 [mm]
	Required quantity/N° pezzi

21-DH-DH1	
	Length/Lungh. [mm]
	Width/Largh. [mm]
	Height/Altezza [mm]
	Required quantity/N° pezzi

21-DW-W7	
	Length/Lungh. [mm]
	Width/Largh. [mm]
	Height/Altezza [mm]
	Required quantity/N° pezzi
	Per mercato Europeo/ For UE

21-DR-DR0	
	Length/Lungh. [mm]
	Width/Largh. [mm]
	Width 1/Largh. 1 [mm]
	Height/Altezza [mm]
	Height 1/Altezza 1 [mm]
	Required quantity/N° pezzi

21-DW-W8	
	Length/Lungh. [mm]
	Width/Largh. [mm]
	Height/Altezza [mm]
	Required quantity/N° pezzi

21-DW-DW0	
	Length/Lungh. [mm]
	Length 1/Lungh. 1 [mm]
	Width/Largh. [mm]
	Width 1/Largh. 1 [mm]
	Height/Altezza [mm]
	Required quantity/N° pezzi

21-DW-DW1		
	Length/Lungh. [mm]	225
	Length 1/Lungh. 1 [mm]	173
	Width/Largh. [mm]	193
	Width 1/Largh. 1 [mm]	35
	Height/Altezza [mm]	24,5
HONDA		

21-H0-H012		
	Length/Lungh. [mm]	205
	Width/Largh. [mm]	211
	Height/Altezza [mm]	29
HONDA		

21-H0-H00		
	Length/Lungh. [mm]	225,5
	Width/Largh. [mm]	198,5
	Height/Altezza [mm]	30
CHRYSLER - HONDA		

21-H0-H013		
	Length/Lungh. [mm]	288
	Width/Largh. [mm]	81
	Height/Altezza [mm]	19
	Required quantity/N° pezzi	2
HYUNDAI		

21-H0-H01		
	Length/Lungh. [mm]	215,2
	Width/Largh. [mm]	211
	Height/Altezza [mm]	30
HONDA		

21-H0-H014		
	Length/Lungh. [mm]	160
	Width/Largh. [mm]	150
	Height/Altezza [mm]	20
HONDA		

21-H0-H010		
	Length/Lungh. [mm]	251
	Width/Largh. [mm]	96
	Height/Altezza [mm]	30
	Required quantity/N° pezzi	2
HONDA		

21-H0-H015		
	Length/Lungh. [mm]	195
	Width/Largh. [mm]	124
	Height/Altezza [mm]	19
HONDA		

21-H0-H011		
	Length/Lungh. [mm]	235
	Width/Largh. [mm]	225
	Height/Altezza [mm]	30
HONDA		

21-H0-H02		
	Length/Lungh. [mm]	180
	Width/Largh. [mm]	94,5
	Height/Altezza [mm]	29,5
	Required quantity/N° pezzi	2
HONDA		

21-H0-H03	
	Length/Lungh. [mm]
	296
	Width/Largh. [mm]
	211
	Height/Altezza [mm]
	25
HONDA	

21-H0-H08	
	Length/Lungh. [mm]
	224
	Width/Largh. [mm]
	109
	Height/Altezza [mm]
	29
HONDA	

21-H0-H04	
	Length/Lungh. [mm]
	224
	Width/Largh. [mm]
	109
	Height/Altezza [mm]
	29
	Required quantity/N° pezzi
	2
HONDA	

21-H0-H09	
	Length/Lungh. [mm]
	240
	Width/Largh. [mm]
	197
	Height/Altezza [mm]
	30
HONDA	

21-H0-H05	
	Length/Lungh. [mm]
	176,5
	Width/Largh. [mm]
	185
	Height/Altezza [mm]
	30
HONDA	

21-HM-H00	
	Length/Lungh. [mm]
	268
	Width/Largh. [mm]
	238
	Height/Altezza [mm]
	26
HUMMER	

21-H0-H06	
	Length/Lungh. [mm]
	111
	Width/Largh. [mm]
	225
	Height/Altezza [mm]
	29
	Required quantity/N° pezzi
	2
HONDA	

21-HY-H00	
	Length/Lungh. [mm]
	261,3
	Width/Largh. [mm]
	193
	Height/Altezza [mm]
	38
Subst. by 21-KI-K06	

21-H0-H07	
	Length/Lungh. [mm]
	225,2
	Width/Largh. [mm]
	235
	Height/Altezza [mm]
	30
HONDA	

21-HY-H01	
	Length/Lungh. [mm]
	251,8
	Width/Largh. [mm]
	201
	Height/Altezza [mm]
	24



21-HY-H02	
	Length/Lungh. [mm]
	257,7
	Width/Largh. [mm]
210	
Height/Altezza [mm]	
25	
HYUNDAI	

21-HY-H07	
	Length/Lungh. [mm]
	197,5
	Length 1/Lungh. 1 [mm]
	112,8
	Width/Largh. [mm]
182	
Width 1/Largh. 1 [mm]	
132,5	
Height/Altezza [mm]	
42,7	
HYUNDAI	

21-HY-H03	
	Length/Lungh. [mm]
	261
	Width/Largh. [mm]
238	
Height/Altezza [mm]	
29,4	
HYUNDAI	

21-HY-H08	
	Length/Lungh. [mm]
	251
	Width/Largh. [mm]
201,3	
Height/Altezza [mm]	
24	
HYUNDAI	

21-HY-H04	
	Length/Lungh. [mm]
	251
	Width/Largh. [mm]
205	
Height/Altezza [mm]	
25	
HYUNDAI	

21-HY-H09	
	Length/Lungh. [mm]
	270
	Width/Largh. [mm]
	264
	Width 1/Largh. 1 [mm]
238	
Height/Altezza [mm]	
72	
Height 1/Altezza 1 [mm]	
48,7	
CADILLAC - CHEVROLET - HYUNDAI	

21-HY-H05	
	Length/Lungh. [mm]
	250
	Width/Largh. [mm]
	109,3
Height/Altezza [mm]	
12	
Required quantity/N° pezzi	
2	
HYUNDAI	

21-HY-H10	
	Length/Lungh. [mm]
	235
	Width/Largh. [mm]
78	
Height/Altezza [mm]	
39,7	
HYUNDAI	

21-HY-H06	
	Length/Lungh. [mm]
	261
	Width/Largh. [mm]
238	
Height/Altezza [mm]	
40,7	
HYUNDAI	

21-HY-H11	
	Length/Lungh. [mm]
	225
	Width/Largh. [mm]
204	
Height/Altezza [mm]	
17	
HYUNDAI - KIA	

21-HY-H12	
	Length/Lungh. [mm]
	250
	Width/Largh. [mm]
	201
	Height/Altezza [mm]
	24
HYUNDAI	

21-HY-H17	
	Length/Lungh. [mm]
	247
	Width/Largh. [mm]
	105
	Height/Altezza [mm]
	25
	Required quantity/N° pezzi
	2
HYUNDAI	

21-HY-H13	
	Length/Lungh. [mm]
	294,4
	Width/Largh. [mm]
	192,6
	Height/Altezza [mm]
	25
HYUNDAI	

21-HY-H18	
	Length/Lungh. [mm]
	234
	Width/Largh. [mm]
	99,6
	Height/Altezza [mm]
	12
	Required quantity/N° pezzi
	2
HYUNDAI	

21-HY-H14	
	Length/Lungh. [mm]
	262
	Width/Largh. [mm]
	238
	Height/Altezza [mm]
	40,3
HYUNDAI	

21-HY-H19	
	Length/Lungh. [mm]
	233,3
	Width/Largh. [mm]
	102
	Height/Altezza [mm]
	24,7
	Required quantity/N° pezzi
	2
HYUNDAI	

21-HY-H15	
	Length/Lungh. [mm]
	262
	Width/Largh. [mm]
	239
	Height/Altezza [mm]
	40,3
HYUNDAI	

21-HY-H20	
	Length/Lungh. [mm]
	207
	Length 1/Lungh. 1 [mm]
	201
	Width/Largh. [mm]
	181
	Height/Altezza [mm]
	57
HYUNDAI	

21-HY-H16	
	Length/Lungh. [mm]
	261
	Length 1/Lungh. 1 [mm]
	240
	Width/Largh. [mm]
	188,6
	Height/Altezza [mm]
	68,5
	Height 1/Altezza 1 [mm]
	44,2
HYUNDAI	

21-HY-H21	
	Length/Lungh. [mm]
	232
	Width/Largh. [mm]
	75,5
	Height/Altezza [mm]
	39
HYUNDAI	

21-HY-H22	
	Length/Lungh. [mm]
	Width/Largh. [mm]
	Height/Altezza [mm]
	158
	151
	15
HYUNDAI	

21-HY-H28	
	Length/Lungh. [mm]
	Width/Largh. [mm]
	Height/Altezza [mm]
	240
	200
	19,5
HYUNDAI	

21-HY-H23	
	Length/Lungh. [mm]
	Width/Largh. [mm]
	Height/Altezza [mm]
	250,5
	218,5
	29
HYUNDAI - KIA	

21-HY-H29	
	Length/Lungh. [mm]
	Width/Largh. [mm]
	Height/Altezza [mm]
	237
	190
	19
HYUNDAI - KIA	

21-HY-H24	
	Length/Lungh. [mm]
	Width/Largh. [mm]
	Height/Altezza [mm]
	148
	115
	37
HYUNDAI	

21-IS-IS1	
	Length/Lungh. [mm]
	Width/Largh. [mm]
	Height/Altezza [mm]
	221
	210,9
	20
ISUZU	

21-HY-H25	
	Length/Lungh. [mm]
	Width/Largh. [mm]
	Height/Altezza [mm]
	291,4
	191
	39,4
HYUNDAI	

21-IS-IS2	
	Length/Lungh. [mm]
	Width/Largh. [mm]
	Height/Altezza [mm]
	Required quantity/N° pezzi
	229
	100
	20
	2
ISUZU	

21-HY-H26	
	Length/Lungh. [mm]
	Width/Largh. [mm]
	Height/Altezza [mm]
	261,3
	193
	38
HYUNDAI	

21-IS-IS3	
	Length/Lungh. [mm]
	Width/Largh. [mm]
	Height/Altezza [mm]
	229
	101
	20
ISUZU	

21-JE-JE1		
	Length/Lungh. [mm]	468,2
	Length 1/Lungh. 1 [mm]	389
	Width/Largh. [mm]	78
	Width 1/Largh. 1 [mm]	46
	Height/Altezza [mm]	40
JEEP		

21-KI-K04		
	Length/Lungh. [mm]	259
	Width/Largh. [mm]	106,8
	Height/Altezza [mm]	19,8
	Required quantity/N° pezzi	2

21-KI-K00		
	Length/Lungh. [mm]	260
	Width/Largh. [mm]	223,6
	Height/Altezza [mm]	21
KIA		

21-KI-K05		
	Length/Lungh. [mm]	258,5
	Width/Largh. [mm]	109
	Height/Altezza [mm]	20
	Required quantity/N° pezzi	2
KIA		

21-KI-K01		
	Length/Lungh. [mm]	261
	Width/Largh. [mm]	108
	Height/Altezza [mm]	12,3
	Required quantity/N° pezzi	2
KIA		

21-KI-K06		
	Length/Lungh. [mm]	261
	Width/Largh. [mm]	193
	Height/Altezza [mm]	38
HYUNDAI - KIA		

21-KI-K02		
	Length/Lungh. [mm]	240
	Width/Largh. [mm]	105
	Height/Altezza [mm]	20,3
	Required quantity/N° pezzi	2

21-KI-K07		
	Length/Lungh. [mm]	234
	Width/Largh. [mm]	101,5
	Height/Altezza [mm]	24,8
	Required quantity/N° pezzi	2
KIA		

21-KI-K03		
	Length/Lungh. [mm]	275
	Width/Largh. [mm]	127,5
	Width 1/Largh. 1 [mm]	99
	Height/Altezza [mm]	20
	Required quantity/N° pezzi	2

21-KI-K08		
	Length/Lungh. [mm]	259
	Width/Largh. [mm]	224,5
	Height/Altezza [mm]	20,7
KIA		

21-KI-K09	
	Length/Lungh. [mm]
	Width/Largh. [mm]
	Height/Altezza [mm]
	183
	181
	12
HYUNDAI - KIA	

21-KI-K14	
	Length/Lungh. [mm]
	Width/Largh. [mm]
	Height/Altezza [mm]
	262
	238,5
	40
KIA	

21-KI-K10	
	Length/Lungh. [mm]
	Width/Largh. [mm]
	Height/Altezza [mm]
	240
	210
	17
KIA	

21-KI-K15	
	Length/Lungh. [mm]
	Width/Largh. [mm]
	Height/Altezza [mm]
	Required quantity/N° pezzi
	240
	104,5
	20,3
	2
KIA	

21-KI-K11	
	Length/Lungh. [mm]
	Width/Largh. [mm]
	Height/Altezza [mm]
	Required quantity/N° pezzi
	257,3
	98,7
	37,7
	2
HYUNDAI	

21-KI-K16	
	Length/Lungh. [mm]
	Width/Largh. [mm]
	Height/Altezza [mm]
	262
	193
	38

21-KI-K12	
	Length/Lungh. [mm]
	Width/Largh. [mm]
	Height/Altezza [mm]
	237
	208
	16,8

21-KI-K17	
	Length/Lungh. [mm]
	Width/Largh. [mm]
	Height/Altezza [mm]
	Required quantity/N° pezzi
	218
	107
	17
	2
KIA	

21-KI-K13	
	Length/Lungh. [mm]
	Width/Largh. [mm]
	Height/Altezza [mm]
	148,7
	114,5
	37

21-KI-K18	
	Length/Lungh. [mm]
	Width/Largh. [mm]
	Height/Altezza [mm]
	248
	174
	20
HYUNDAI - KIA	

21-KI-K19	
	Length/Lungh. [mm]
	182
	Width/Largh. [mm]
	161
	Height/Altezza [mm]
	25
KIA	

21-LR-LR4	
	Length/Lungh. [mm]
	263,5
	Width/Largh. [mm]
	165
	Height/Altezza [mm]
	30
LAND ROVER	

21-KI-K20	
	Length/Lungh. [mm]
	230
	Width/Largh. [mm]
	180
	Height/Altezza [mm]
	20
HYUNDAI - KIA	

21-LR-LR5	
	Length/Lungh. [mm]
	268
	Width/Largh. [mm]
	196
	Height/Altezza [mm]
	32
LAND ROVER	

21-LR-LR1	
	Length/Lungh. [mm]
	533,1
	Width/Largh. [mm]
	248,3
	Height/Altezza [mm]
	30,5
LAND ROVER	

21-LR-LR6	
	Length/Lungh. [mm]
	272
	Width/Largh. [mm]
	165
	Height/Altezza [mm]
	53
LAND ROVER	

21-LR-LR2	
	Length/Lungh. [mm]
	243
	Width/Largh. [mm]
	219,8
	Width 1/Largh. 1 [mm]
	199
	Height/Altezza [mm]
	74,5
	Height 1/Altezza 1 [mm]
	32,5
LAND ROVER	

21-MA-MA0	
	Length/Lungh. [mm]
	118
	Width/Largh. [mm]
	215
	Height/Altezza [mm]
22	
	Required quantity/N° pezzi
	2
MAZDA	

21-LR-LR3	
	Length/Lungh. [mm]
	217,2
	Width/Largh. [mm]
	197
	Height/Altezza [mm]
24	
	Required quantity/N° pezzi
	2
LAND ROVER	

21-MA-MA1	
	Length/Lungh. [mm]
	207
	Width/Largh. [mm]
	199
	Height/Altezza [mm]
	32
MAZDA	



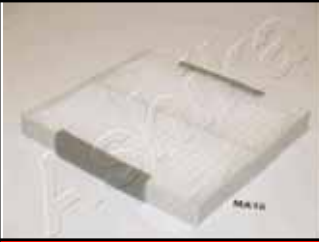

21-MA-MA10		
	Length/Lungh. [mm]	215
	Width/Largh. [mm]	195
	Height/Altezza [mm]	22
MAZDA		

21-MA-MA2		
	Length/Lungh. [mm]	192
	Width/Largh. [mm]	109
	Height/Altezza [mm]	20
	Height 1/Altezza 1 [mm]	14
	Required quantity/N° pezzi	2
MAZDA		

21-MA-MA11		
	Length/Lungh. [mm]	234
	Width/Largh. [mm]	103
	Height/Altezza [mm]	22
	Required quantity/N° pezzi	2
MAZDA		

21-MA-MA3		
	Length/Lungh. [mm]	117
	Width/Largh. [mm]	215
	Height/Altezza [mm]	22
	Required quantity/N° pezzi	2
MAZDA		

21-MA-MA12		
	Length/Lungh. [mm]	251
	Width/Largh. [mm]	104
	Height/Altezza [mm]	17
	Required quantity/N° pezzi	2
MAZDA		

21-MA-MA4		
	Length/Lungh. [mm]	235
	Width/Largh. [mm]	105
	Height/Altezza [mm]	22
MAZDA		

21-MA-MA13		
	Length/Lungh. [mm]	280
	Width/Largh. [mm]	170
	Height/Altezza [mm]	30
MAZDA		

21-MA-MA5		
	Length/Lungh. [mm]	216
	Width/Largh. [mm]	194
	Height/Altezza [mm]	24
MAZDA		

21-MA-MA14		
	Length/Lungh. [mm]	235
	Width/Largh. [mm]	105
	Height/Altezza [mm]	22
MAZDA		

21-MA-MA6		
	Length/Lungh. [mm]	201
	Width/Largh. [mm]	230
	Height/Altezza [mm]	24
	Required quantity/N° pezzi	3
MAZDA		

21-MA-MA7		
	Length/Lungh. [mm]	346
	Width/Largh. [mm]	157
	Height/Altezza [mm]	30
MAZDA		

21-MI-MI2		
	Length/Lungh. [mm]	227
	Width/Largh. [mm]	207
	Width 1/Largh. 1 [mm]	197
	Height/Altezza [mm]	37
	Height 1/Altezza 1 [mm]	25
MITSUBISHI		

21-MA-MA8		
	Length/Lungh. [mm]	235,8
	Width/Largh. [mm]	94
	Height/Altezza [mm]	21,5
	Required quantity/N° pezzi	2
MAZDA		

21-MI-MI3		
	Length/Lungh. [mm]	220
	Width/Largh. [mm]	210,6
	Width 1/Largh. 1 [mm]	157
	Height/Altezza [mm]	25
MITSUBISHI		

21-MA-MA9		
	Length/Lungh. [mm]	247
	Width/Largh. [mm]	199
	Height/Altezza [mm]	17
	Required quantity/N° pezzi	2
MAZDA		

21-MI-MI4		
	Length/Lungh. [mm]	240
	Length 1/Lungh. 1 [mm]	215
	Width/Largh. [mm]	217
	Height/Altezza [mm]	55
	Height 1/Altezza 1 [mm]	30,5
MITSUBISHI		

21-MI-MIO		
	Length/Lungh. [mm]	227,2
	Width/Largh. [mm]	207,2
	Width 1/Largh. 1 [mm]	196
	Height/Altezza [mm]	36,5
	Height 1/Altezza 1 [mm]	25
MITSUBISHI		

21-MI-MI5		
	Length/Lungh. [mm]	215
	Width/Largh. [mm]	210
	Height/Altezza [mm]	30
MITSUBISHI		

21-MI-MI1		
	Length/Lungh. [mm]	260
	Width/Largh. [mm]	173,5
	Width 1/Largh. 1 [mm]	108
	Height/Altezza [mm]	56
	Height 1/Altezza 1 [mm]	31
MITSUBISHI		

21-MI-MI7		
	Length/Lungh. [mm]	215
	Width/Largh. [mm]	201
	Height/Altezza [mm]	30
MITSUBISHI		



21-MI-MI8		
	Length/Lungh. [mm]	206
	Width/Largh. [mm]	100
	Height/Altezza [mm]	37
	Required quantity/N° pezzi	2
	MITSUBISHI	

21-NS-NS12		
	Length/Lungh. [mm]	231
	Width/Largh. [mm]	160
	Height/Altezza [mm]	30
	NISSAN	

21-NS-NS0		
	Length/Lungh. [mm]	258,5
	Width/Largh. [mm]	203
	Height/Altezza [mm]	20
NISSAN		

21-NS-NS13		
 NEW	Length/Lungh. [mm]	238
	Width/Largh. [mm]	151
	Height/Altezza [mm]	30
	NISSAN	

21-NS-NS1		
	Length/Lungh. [mm]	269
	Width/Largh. [mm]	108
	Height/Altezza [mm]	23,8
	Height 1/Altezza 1 [mm]	12
	Required quantity/N° pezzi	2
NISSAN		

21-NS-NS14		
 NEW	Length/Lungh. [mm]	270
	Width/Largh. [mm]	280
	Height/Altezza [mm]	20
	NISSAN	

21-NS-NS10		
	Length/Lungh. [mm]	265
	Width/Largh. [mm]	192
	Height/Altezza [mm]	20
NISSAN		

21-NS-NS15		
 NEW	Length/Lungh. [mm]	210
	Width/Largh. [mm]	225
	Height/Altezza [mm]	20
	NISSAN	

21-NS-NS11		
	Length/Lungh. [mm]	338
	Width/Largh. [mm]	180
	Height/Altezza [mm]	30
NISSAN		

21-NS-NS16		
 NEW	Length/Lungh. [mm]	228
	Width/Largh. [mm]	199
	Height/Altezza [mm]	32
	INFINITI	

21-NS-NS17		
 <p>NEW</p> <p>NS17</p>	Length/Lungh. [mm]	218
	Width/Largh. [mm]	180
	Height/Altezza [mm]	36
	NISSAN	

21-NS-NS5		
	Length/Lungh. [mm]	245
	Width/Largh. [mm]	84
	Height/Altezza [mm]	29
	NISSAN	

21-NS-NS18		
 <p>NEW</p> <p>NS18</p>	Length/Lungh. [mm]	259
	Width/Largh. [mm]	149
	Height/Altezza [mm]	25
	NISSAN	

21-NS-NS6		
	Length/Lungh. [mm]	222
	Length 1/Lungh. 1 [mm]	185
	Width/Largh. [mm]	189
	Width 1/Largh. 1 [mm]	182
	Height/Altezza [mm]	42
	Height 1/Altezza 1 [mm]	28
	NISSAN	

21-NS-NS2		
	Length/Lungh. [mm]	245
	Width/Largh. [mm]	209
	Height/Altezza [mm]	20,5
	NISSAN	

21-NS-NS7		
	Length/Lungh. [mm]	268,5
	Width/Largh. [mm]	106
	Height/Altezza [mm]	24
	Height 1/Altezza 1 [mm]	12
	Required quantity/N° pezzi	2
	NISSAN	

21-NS-NS3		
	Length/Lungh. [mm]	253
	Width/Largh. [mm]	106,5
	Height/Altezza [mm]	23,5
	Height 1/Altezza 1 [mm]	12
	Required quantity/N° pezzi	2
	NISSAN	

21-NS-NS8		
	Length/Lungh. [mm]	219
	Width/Largh. [mm]	198
	Height/Altezza [mm]	29
	INFINITI - NISSAN	

21-NS-NS4		
	Length/Lungh. [mm]	200
	Width/Largh. [mm]	219
	Height/Altezza [mm]	30
	NISSAN	

21-NS-NS9		
	Length/Lungh. [mm]	262
	Width/Largh. [mm]	100
	Height/Altezza [mm]	24,5
	Required quantity/N° pezzi	2
	NISSAN	





21-SB-SB0		
	Length/Lungh. [mm]	211
	Width/Largh. [mm]	185
	Height/Altezza [mm]	31,2
SUBARU		

21-SB-SB5		
	Length/Lungh. [mm]	216
	Width/Largh. [mm]	201
	Height/Altezza [mm]	30
	Height 1/Altezza 1 [mm]	40
SUBARU		

21-SB-SB1		
	Length/Lungh. [mm]	201
	Width/Largh. [mm]	202
	Height/Altezza [mm]	18
SUBARU		

21-SM-SM0		
	Length/Lungh. [mm]	225
	Width/Largh. [mm]	220
	Height/Altezza [mm]	40
SMART		

21-SB-SB2		
	Length/Lungh. [mm]	216
	Width/Largh. [mm]	212
	Height/Altezza [mm]	17,2
LEXUS - SUBARU - TOYOTA		

21-SM-SM1		
	Length/Lungh. [mm]	188,5
	Width/Largh. [mm]	202,7
	Height/Altezza [mm]	40
MITSUBISHI - SMART		

21-SB-SB3		
	Length/Lungh. [mm]	219
	Width/Largh. [mm]	220
	Height/Altezza [mm]	30
	Height 1/Altezza 1 [mm]	57,5
SUBARU		

21-SM-SM2		
	Length/Lungh. [mm]	215
	Width/Largh. [mm]	214
	Height/Altezza [mm]	26
SMART		

21-SB-SB4		
	Length/Lungh. [mm]	216
	Width/Largh. [mm]	195
	Height/Altezza [mm]	15
SUBARU		

21-SS-S01		
	Length/Lungh. [mm]	290
	Width/Largh. [mm]	101
	Height/Altezza [mm]	20
	Required quantity/N° pezzi	2
		Per mercati Extra-Europeo/For Extra UE
DAEWOO - SSANGYONG		

21-SS-S02		
	Length/Lungh. [mm]	207
	Width/Largh. [mm]	94,5
	Height/Altezza [mm]	20
	Required quantity/N° pezzi	2
SUZUKI		

21-SZ-Z02		
	Length/Lungh. [mm]	255
	Width/Largh. [mm]	209,2
	Height/Altezza [mm]	31
SUZUKI		

21-SS-S03		
	Length/Lungh. [mm]	207
	Width/Largh. [mm]	100
	Height/Altezza [mm]	19,9
	Required quantity/N° pezzi	2
SSANGYONG		

21-SZ-Z03		
	Length/Lungh. [mm]	231
	Width/Largh. [mm]	195
	Height/Altezza [mm]	18
SUBARU - SUZUKI		

21-SS-S04		
	Length/Lungh. [mm]	220
	Width/Largh. [mm]	98
	Height/Altezza [mm]	25
	Required quantity/N° pezzi	2
SSANGYONG		

21-SZ-Z04		
	Length/Lungh. [mm]	219,6
	Width/Largh. [mm]	226
	Width 1/Largh. 1 [mm]	192
	Height/Altezza [mm]	34,5
	Height 1/Altezza 1 [mm]	20,3
SUZUKI		

21-SS-S05		
	Length/Lungh. [mm]	222
	Width/Largh. [mm]	233
	Width 1/Largh. 1 [mm]	267
	Height/Altezza [mm]	42
	Height 1/Altezza 1 [mm]	23
SSANGYONG		

21-SZ-Z05		
	Length/Lungh. [mm]	246
	Width/Largh. [mm]	196
	Height/Altezza [mm]	19
SUZUKI		

21-SZ-Z01		
	Length/Lungh. [mm]	220
	Width/Largh. [mm]	114
	Height/Altezza [mm]	18,5
	Required quantity/N° pezzi	2
SUZUKI		

21-SZ-Z06		
	Length/Lungh. [mm]	215
	Width/Largh. [mm]	191
	Height/Altezza [mm]	20
SUZUKI		





21-SZ-Z07	
	Length/Lungh. [mm]
	Width/Largh. [mm]
	Height/Altezza [mm]
SUZUKI	

21-TY-TY0	
	Length/Lungh. [mm]
	Length 1/Lungh. 1 [mm]
	Width/Largh. [mm]
	Height/Altezza [mm]
	Required quantity/N° pezzi
TOYOTA	

21-SZ-Z08	
	Length/Lungh. [mm]
	Width/Largh. [mm]
	Height/Altezza [mm]
DAIHATSU - FIAT - SUZUKI	

21-TY-TY1	
	Length/Lungh. [mm]
	Width/Largh. [mm]
	Height/Altezza [mm]
	Required quantity/N° pezzi
TOYOTA	

21-SZ-Z09	
	Length/Lungh. [mm]
	Width/Largh. [mm]
	Height/Altezza [mm]
OPEL - SUZUKI	

21-TY-TY10	
	Length/Lungh. [mm]
	Width/Largh. [mm]
	Height/Altezza [mm]
TOYOTA	

21-SZ-SZ10	
	Length/Lungh. [mm]
	Width/Largh. [mm]
	Height/Altezza [mm]
NISSAN - SUZUKI	

21-TY-TY11	
	Length/Lungh. [mm]
	Width/Largh. [mm]
	Height/Altezza [mm]
TOYOTA	

21-SZ-SZ11	
	Length/Lungh. [mm]
	Width/Largh. [mm]
	Height/Altezza [mm]
SUZUKI	

21-TY-TY12	
	Length/Lungh. [mm]
	Width/Largh. [mm]
	Height/Altezza [mm]
LEXUS - TOYOTA	

21-TY-TY2	
	Length/Lungh. [mm]
	Width/Largh. [mm]
	Height/Altezza [mm]
TOYOTA	

21-TY-TY7	
	Length/Lungh. [mm]
	Width/Largh. [mm]
	Height/Altezza [mm]
TOYOTA	

21-TY-TY3	
	Length/Lungh. [mm]
	Width/Largh. [mm]
	Height/Altezza [mm]
LEXUS	

21-TY-TY8	
	Length/Lungh. [mm]
	Width/Largh. [mm]
	Height/Altezza [mm]
LEXUS - TOYOTA	

21-TY-TY4	
	Length/Lungh. [mm]
	Width/Largh. [mm]
	Height/Altezza [mm]
LEXUS	

21-TY-TY9	
	Length/Lungh. [mm]
	Width/Largh. [mm]
	Height/Altezza [mm]
LEXUS - SUBARU - TOYOTA	

21-TY-TY5	
	Length/Lungh. [mm]
	Width/Largh. [mm]
	Height/Altezza [mm]
LEXUS	

21-TY-TY6	
	Length/Lungh. [mm]
	Width/Largh. [mm]
	Height/Altezza [mm]
Subst. by 21-TY-TY2	
LEXUS	



ALFA ROMEO	ASHIKA
71741042	10-ECO070
ASIA MOTORS	ASHIKA
23303-87306	30-06-611
23303-87307	30-06-611
AC PF1225	10-00-098
R205-23-603	20-09-984
AUDI	ASHIKA
077 115 561 F	10-ECO089
077 198 563	10-ECO089
079 115 561 B	10-ECO085
079 115 561 F	10-ECO087
079 198 405	10-ECO085
079 198 405 A	10-ECO085
079 198 405 B	10-ECO087
8Z0127435A	30-ECO076
8Z0198567	30-ECO076
BMW	ASHIKA
11 42 1 267 268	10-ECO091
11 42 1 269 373	10-ECO091
11 42 1 285 749	10-ECO113
11 42 1 285 751	10-ECO113
11 42 1 706 867	10-ECO091
11 42 1 718 816	10-ECO091
11 42 1 729 628	10-ECO090
11 42 1 731 634	10-ECO090
11 42 2 241 165	10-ECO113
11 42 2 245 339	10-ECO110
11 42 2 245 406	10-ECO110
11 42 2 247 392	10-ECO035
11 42 7 510 717	10-ECO090
11 42 7 521 008	10-ECO081
11 42 7 542 021	10-ECO081
11 42 7 787 697	10-ECO109
11 42 7 788 454	10-ECO111
11 42 7 788 460	10-ECO111
11 42 7 788 461	10-ECO111
11 42 7 805 707	10-ECO100
11 42 7 807 177	10-ECO100
11 42 7 808 443	10-ECO101
11 42 7 833 242	10-ECO083
11 42 7 833 769	10-ECO083
11 42 7 834 734	10-ECO082
11 42 7 837 997	10-ECO112

11 42 7 840 594	10-ECO082
11 42 8 513 377	10-ECO111
11 42 9 061 199	10-ECO091
11 42 9 063 138	10-ECO091
11421427908	10-ECO012
11421432097	10-ECO004
11421709856	10-ECO080
11421727300	10-ECO080
11421745390	10-ECO014
11421745391	10-ECO014
11422246131	10-ECO011
11422247018	10-ECO021
11422247018	10-ECO007
11422247392	10-ECO035
11427-541-827	10-ECO062
11427-566-327	10-ECO062
11427501676	10-ECO079
11427508969	10-ECO079
11427511161	10-ECO042
11429064275	10-ECO113
13 32 2 246 881	30-ECO026
2 245 406	10-ECO110
BMW 11421745390	10-ECO014
BMW 11422246131	10-ECO011
M B 104.180.01.09	10-ECO009
V.A.G. 059115562	10-ECO010
CADILLAC	ASHIKA
1562718	21-CD-CD1
25177917	10-ECO070
25740404	21-CD-CD1
25763176	30-00-016
25798270	20-00-021
93175493	10-ECO019
CHERY	ASHIKA
473H-1012010	10-02-279
B14-1117110	30-00-020
S21-1109111	20-00-026
CHEVROLET	ASHIKA
13263262	30-ECO020
13271190	21-DW-W15
13271191	21-DW-W15
13272717	20-0W-W11
13272719	20-0W-W12
15410A-78B00	30-08-800

16510-73013	10-06-601
16510-A73013-000	10-06-601
22745824	20-0W-W08
22753219	21-DW-W18
25055129	30-03-393
25121074	30-W0-001
25181616	10-W0-W02
52493319	21-DW-W17
54410011	30-W0-001
92060868	20-03-394
92142009	10-03-398
93185674	10-ECO073
93743595	10-ECO059
94797406	10-03-398
95947238	21-DW-W16
96181263	20-03-387
96182220	20-03-385
96190645	21-DW-W1
96263897	20-W0-004
96314494	20-W0-002
96328718	20-03-332
96335719	30-W0-001
96351225	20-W0-001
96389188	10-H0-002
96434764	20-0W-W10
96438204	20-0W-W09
96444649	30-W0-001
96475855	10-W0-W02
9653 9649	21-DW-W11
96536696	20-W0-005
9655-4421	21-DW-W10
96553450	20-03-331
96565412	10-W0-001
96591485	20-0W-W07
96628890	20-0W-W08
96808900	10-ECO059
96816473	30-ECO016
96827723	20-0W-W13
EC96425700	21-DW-W14
EC96440878	21-DW-W12
EC96554378	21-DW-W13
CHRYSLER	ASHIKA
04591100AC	20-00-015
04721303AA	30-09-911



CHRYSLER	ASHIKA
04781452AA	10-09-913
04861480AA	20-09-974
04891675AA	20-09-912
04891791AA	20-09-974
05003558AA	10-00-097
05015171AA	10-ECO013
05015171AA	10-09-995
05019741AA	30-09-989
05058040AA	21-CH-CH1
05058693AA	21-CH-CH3
05072720AA	10-H0-004
05080825AA	30-00-007
05097052AA	30-09-913
05098424 AA	20-09-914
05098424 AB	20-09-914
05101438AA	21-CH-CH2
05166780AA	30-00-001
05174056AA	30-M0-002
05175571AA	10-ECO053
1-05018777AB	20-09-908
1-05058693AA	21-CH-CH3
1-0517571AA	10-ECO053
1-5019443AA	20-00-017
28113-32510	20-05-516
4105409	10-02-279
41152002A	10-09-985
4591100AC	20-00-015
4596501AB	21-CH-CH4
4798166	30-09-995
4809117AC	30-09-914
4809782AA	20-09-974
4861688AA	20-09-910
4882141AB	20-00-010
4891176AA	20-00-007
4891462AC	20-00-008
4897244AA	30-00-008
5-14215-007-0	20-02-246
5011836AA	20-00-009
5014171AA	10-ECO013
5014171AA	10-09-995
5015901AA	10-00-007
5019002AA	20-09-911
5080244AA	10-00-008

5080825AA	30-00-007
5098724AA	20-09-916
51.055.040.096	10-ECO015
51.055.040.105	10-ECO031
5135447AA	20-09-916
5179011AA	30-00-007
5203217	10-00-097
52100283AD	30-09-912
5281090	10-09-986
53007386	20-09-985
6460920501	30-M0-002
68031597AB	10-ECO072
68042866AA	21-H0-H00
72674028	10-00-097
8-25121-150-0	30-09-990
82205905	21-CH-CH0
83501843	20-09-999
Jeep 4723905	30-09-997
Jeep 83501843	20-09-999
MB504732	30-05-518
MB504752	30-05-518
MB906051	20-05-599
MD007360	10-05-502
MD603932	20-05-516
CITROEN	ASHIKA
100263102	10-GAS25S
1109-AV	10-ECO099
1109-X4	10-ECO060
1109.AW	10-ECO048
1109.R7	10-ECO037
1109.X8	10-ECO048
1109T3	10-03-351
1147685	10-03-351
1444X7	20-03-351
1901 76	30-ECO029
1901.61	30-ECO011
1901.61	30-ECO006
1906 90	30-ECO027
1906 96	30-ECO029
1906 A7	30-ECO028
1906 C0	30-ECO027
1906-A5	30-ECO019
1906.48	30-ECO004
1906.49	30-ECO004

1906.76	30-ECO019
1906.77	30-ECO019
6447TV	21-TY-TY10
67R-010278	10-GAS2S
DAEWOO	ASHIKA
13780-78B00	20-W0-000
15410-A78B00	30-W0-000
16510-A73013-000	10-W0-000
69210-11000	21-DW-W6
69230-05410	21-DW-W8
96190645	21-DW-DW1
96207422	21-DW-W0
96207422	21-DW-DW0
96208424	21-DW-W4
96211813	21-DW-W9
96327366	21-DW-W2
9633-1028	21-DW-W3
FSB066198	20-W0-003
LU782015714	20-0W-006
DAIHATSU	ASHIKA
04152-B1010	10-ECO051
1456-23-570A	30-05-502
1456-23-570A	30-06-606
1456-23-570A9A	30-05-502
1456-23-570A9A	30-06-606
1457434106	30-06-695
15601-16510	10-06-601
15601-73000	10-06-601
15601-73001	10-06-601
15601-82706	10-06-601
15601-87103	10-06-601
15601-87105	10-02-200
15601-87107	10-06-604
15601-87201	10-06-601
15601-87203	10-06-601
15601-87204	10-06-604
15601-87305	10-05-503
15601-87307	10-02-201
15601-87308	10-03-314
15601-87702	10-06-601
15601-87703	10-06-604
15601-87704	10-06-604
15601-87705	10-06-604
15601-87710	10-06-604



CROSS REFERENCE LIST
VERGLEICHLISTE
LISTA DE REFERENCIAS CRUZADES
LISTA DE COMPARAISON
LISTA DI COMPARAZIONE

DAIHATSU	ASHIKA
15601-87802	10-06-601
15601-97202	10-06-604
17801-13010	20-02-205
17801-15010	20-02-207
17801-34060	20-02-204
17801-87000	20-06-694
17801-87104	20-02-224
17801-87208	20-06-698
17801-87214	20-06-699
17801-87215	20-06-697
17801-87401	20-02-239
17801-87402	20-06-694
17801-87507	20-06-608
17801-87601-000	20-06-618
17801-87701	20-06-602
17801-87702	20-06-601
17801-87706	20-06-603
17801-87710	20-06-605
17801-87711	20-06-606
17801-87713	20-06-606
17801-87715	20-02-224
17801-87717	20-06-610
17801-87718	20-02-224
17801-87Z01	20-06-608
17801-87Z02	20-06-605
17801-87Z08	20-06-615
17801-97201	20-06-693
17801-97206-000	20-06-619
17801-97402	20-06-692
17801-B1010	20-06-616
17801-B2010	20-06-613
17801-B2010-000	20-06-613
17801-B2040	20-06-600
17801-B2060	20-06-617
23030-87603	30-06-605
23030-87606	30-06-619
23300-15010	30-02-220
23300-34100	30-02-201
23300-87101	30-06-620
23300-87102	30-06-620
23300-87207	30-06-613
23300-87214	30-06-694
23300-87217	30-06-621

23300-87402	30-06-692
23300-87403	30-06-692
23300-87507	30-06-624
23300-87512	30-06-623
23300-87614	30-05-506
23300-87625	30-06-693
23300-87680	30-05-506
23300-87701	30-06-601
23300-87702	30-06-601
23300-87704	30-06-602
23300-87705	30-06-601
23300-87708	30-06-609
23300-87711	30-05-509
23300-87711	30-06-607
23300-87712	30-06-610
23300-87713	30-06-622
23300-87719	30-06-614
23300-87727	30-06-616
23300-87729	30-02-224
23300-87731	30-02-224
23300-87Z02	30-06-697
23303-87304	30-05-583
23303-87304	30-06-604
23303-87308	30-06-606
23303-87308	30-05-502
23303-87309	30-06-606
23303-87309	30-05-502
23303-87780	30-06-608
23303-87781	30-06-608
31810-28000	30-05-506
87780	30-06-608
999-06850-M2-036	21-DH-DH1
999-06850-M2-037	21-DH-DH1
K467-23-570	30-06-606
R201-15-101B	30-06-606
R201-15-101B	30-05-502
RF83-13-ZA5	30-06-606
RF83-13-ZA5	30-05-502
DODGE	ASHIKA
05058381AA	21-CH-CH3
4884900AB	10-00-010
4891694AA	20-00-018
4891695AA	20-00-001
4891916AA	20-00-024

5058693AA	21-CH-CH3
5166780AA	30-00-001
5189933AA	20-00-020
68032204AA	10-ECO067
68033193AA	21-DG-DG0
DR	ASHIKA
481H-1012010	10-00-015
702060143	30-00-020
710011009	10-02-279
A21-1109111	20-00-023
T11-1117110	30-00-018
T11-8107910	21-DR-DR0
FIAT	ASHIKA
09SQ9901000	10-GAS1S
46806576	20-00-025
55206816	10-ECO095
55207208	10-ECO095
55214974	10-ECO095
71737926	10-ECO058
71740470	10-ECO107
71742069	20-08-828
71744410	10-ECO073
71750719	20-08-832
71751114	10-ECO095
71751127	10-ECO095
71751128	10-ECO095
73500049	10-ECO044
77362340	30-ECO016
77363600	30-ECO016
9401906648	30-ECO005
9401906768	30-ECO019
9401906898	30-ECO027
9467521180	10-ECO060
9467621680	30-ECO027
9467637280	30-ECO028
96098964	30-ECO005
G0910002	10-GASS
FORD	ASHIKA
1088 179	10-ECO022
11 40 778	20-03-350
1318 563	30-ECO027
1352443	30-ECO075
1352444	30-ECO075
1449182	10-02-215



FORD	ASHIKA
1449296	20-02-259
1471 765	30-ECO030
1482115	10-H0-004
1482115	10-ECO043
1681 999	30-ECO028
1682 001	30-ECO028
2 S 619601 CA	20-03-350
6G9N-9176-AB	30-ECO030
9645295780	20-03-351
9M5Q-9176-AA	30-ECO028
9M5Q9155AA	30-ECO028
9X2Q-6744-AA	10-ECO099
BF8T-9155-AA	30-0L-L09
FORD 1088 179	10-ECO022
WL51-14302	10-02-213
XS7Q-6744-AA	10-ECO022
GMC	ASHIKA
25099149	20-00-027
GONOW	ASHIKA
702050030	20-00-022
702060002	30-00-017
710020002	10-01-112E
710020004	10-05-510
GREAT WALL	ASHIKA
1109100-K01	20-05-598
1117100	30-0M-000
SDM360935	10-03-316
HONDA	ASHIKA
0222-14-300	10-04-406
06154-PH7-000	10-04-408
0813-23-802	10-04-406
0866-23-802	10-04-406
08R79-S2H-600	21-H0-H02
08R79-S5A-A00	21-H0-H08
08R79S30600F	21-H0-H010
15400-634-003	10-04-401
15400-634-010	10-04-401
15400-634-013	10-04-401
15400-634-014	10-04-401
15400-634-023	10-04-401
15400-634-033	10-04-401
15400-634-405	10-04-401
15400-634-505	10-04-401

15400-689-003	10-04-402
15400-689-003	10-04-403
15400-689-004	10-04-403
15400-689-004	10-04-402
15400-689-014	10-04-402
15400-P12-004	10-04-407
15400-P5T-600	10-04-497
15400-P5T-G00	10-04-497
15400-PA6-003	10-04-402
15400-PA6-004	10-04-402
15400-PA6-405	10-04-402
15400-PA6-F01	10-04-402
15400-PC6-003	10-04-406
15400-PC6-004	10-04-406
15400-PDD-E00	10-04-497
15400-PH1-003	10-04-406
15400-PH1-004	10-04-406
15400-PH1-014	10-04-406
15400-PH1-F01	10-04-498
15400-PH1-F02	10-04-498
15400-PH1-F03	10-04-406
15400-PH1-F03	10-04-498
15400-PH9-004	10-04-406
15400-PK1-003	10-04-406
15400-PL2-004	10-04-407
15400-PL2-015	10-04-407
15400-PLC-003	10-04-410
15400-PLC-004	10-04-410
15400-PR3-003	10-04-406
15400-PR3-004	10-04-406
15400-PR3-005	10-04-406
15400-PR3-305	10-04-406
15400-RBA-F01	10-04-410
15400-RTA-003	10-04-410
15430-PH7-000	10-04-408
15430-PH7-003	10-04-408
15430-RBD-E01	10-00-008
15430-RBD-E02	10-00-008
15430-RSR-E01	10-ECO055
16010-S84-A01	30-04-428
16010-SAA-000	30-04-425
16010-SB2-305	30-04-416
16010-SB2-315	30-04-416
16010-SB2-750	30-04-416

16010-SB2-751	30-04-416
16010-SD4-A50	30-04-411
16010-SD4-Z01	30-04-411
16010-SF0-670	30-04-414
16010-SF0-671	30-04-414
16010-SF1-A30	30-04-415
16010-SF1-A31	30-04-415
16010-SF1-A32	30-04-415
16010-SH3-931	30-04-413
16010-SH3-C30	30-04-413
16010-SK3-E30	30-04-411
16010-SK3-E30	30-04-419
16010-SK3-E31	30-04-411
16010-SK3-E31	30-04-419
16010-SM4-931	30-04-417
16010-SM4-931	30-04-411
16010-SM4-A30	30-04-411
16010-SS0-931	30-04-411
16010-SS0-931	30-04-497
16010-ST5-931	30-04-498
16010-ST5-932	30-04-498
16900-611-004	30-04-401
16900-611-014	30-04-401
16900-611-024	30-04-401
16900-671-003	30-04-401
16900-671-004	30-04-401
16900-671-013	30-04-401
16900-671-023	30-04-401
16900-671-024	30-04-401
16900-671-034	30-04-401
16900-S84-G01	30-04-423
16900-SA0-003	30-04-404
16900-SA0-013	30-04-404
16900-SA0-014	30-04-404
16900-SA0-023	30-04-404
16900-SA0-024	30-04-404
16900-SA0-033	30-04-404
16900-SA0-044	30-04-404
16900-SA0-901	30-04-407
16900-SA0-902	30-04-407
16900-SA5-003	30-04-405
16900-SA5-004	30-04-405
16900-SB2-681	30-04-416
16900-SB2-731	30-04-416



CROSS REFERENCE LIST
VERGLEICHLISTE
LISTA DE REFERENCIAS CRUZADES
LISTA DE COMPARAISON
LISTA DI COMPARAZIONE

HONDA	ASHIKA
16900-SB2-751	30-04-416
16900-SD4-671	30-04-411
16900-SD4-672	30-04-411
16900-SD4-A50	30-04-411
16900-SD4-A51	30-04-411
16900-SE0-003	30-04-408
16900-SE0-004	30-04-408
16900-SE0-931	30-04-409
16900-SE0-932	30-04-409
16900-SE0-A31	30-04-409
16900-SE0-G32	30-04-409
16900-SF0-670	30-04-414
16900-SF0-671	30-04-414
16900-SF1-A32	30-04-415
16900-SF1-A33	30-04-415
16900-SH3-A30	30-04-413
16900-SH3-C30	30-04-413
16900-SK3-E30	30-04-411
16900-SK3-E30	30-04-419
16900-SK3-E31	30-04-411
16900-SK3-E31	30-04-419
16900-SLO-A31	30-04-499
16900-SM4-931	30-04-411
16900-SM4-A30	30-04-411
16900-SM4-A31	30-04-411
16900-SR3-004	30-04-403
16900SA5005	30-04-405
16901-RJL-E01	30-04-424
16901-RL0-G01	30-ECO018
16901-RMA-E00	30-02-240
16901-S37-E30	30-0L-L02
16901-S6F-E02	30-04-418
17048-TA0-000	30-04-427
17048-TF0-000	30-04-426
17220-634-005	20-04-403
17220-657-000	20-04-404
17220-657-005	20-04-404
17220-671-000	20-05-510
17220-671-005	20-05-510
17220-679-003	20-04-404
17220-689-003	20-03-302
17220-689-781	20-03-302
17220-P13-000	20-04-427

17220-P1K-000	20-04-496
17220-P2A-005	20-01-196
17220-P2F-A01	20-01-196
17220-P2F-Y01	20-01-196
17220-P2J-003	20-04-487
17220-P2M-Y00	20-04-487
17220-P2P-A00	20-04-487
17220-P45-G00	20-04-422
17220-P5A-000	20-04-492
17220-P5T-600	20-04-488
17220-P5T-G00	20-04-488
17220-P72-000	20-04-431
17220-P7A-003	20-04-486
17220-P8C-A00	20-04-425
17220-PA0-003	20-05-510
17220-PA1-003	20-04-403
17220-PA1-603	20-04-403
17220-PA6-013	20-05-510
17220-PAA-A00	20-04-424
17220-PB9-003	20-04-405
17220-PB9-013	20-04-405
17220-PB9-023	20-04-405
17220-PC0-013	20-04-408
17220-PC2-661	20-03-302
17220-PC2-663	20-03-302
17220-PC3-661	20-03-302
17220-PC6-663	20-04-409
17220-PC7-000	20-04-409
17220-PCX-003	20-04-430
17220-PCX-Q01	20-04-430
17220-PD5-600	20-05-510
17220-PDA-E01	20-04-424
17220-PDF-E01	20-04-424
17220-PE0-661	20-04-406
17220-PE0-663	20-04-406
17220-PE2-000	20-04-407
17220-PE2-010	20-04-407
17220-PE3-601	20-04-406
17220-PE8-601	20-04-408
17220-PH2-003	20-04-412
17220-PH3-000	20-04-413
17220-PH4-305	20-04-412
17220-PH4-601	20-04-412
17220-PH4-661	20-04-412

17220-PH7-661	20-04-415
17220-PJ0-600	20-04-413
17220-PK1-003	20-04-419
17220-PK1-013	20-04-419
17220-PK1-661	20-04-419
17220-PK2-003	20-04-420
17220-PK2-661	20-04-420
17220-PK2-662	20-04-420
17220-PLC-000	20-04-428
17220-PLD-000	20-04-429
17220-PLZ-E01	20-04-437
17220-PM1-B01	20-04-417
17220-PM2-B01	20-04-418
17220-PM3-003	20-04-417
17220-PM4-003	20-04-418
17220-PM7-000	20-04-416
17220-PNA-003	20-04-432
17220-PNB-003	20-04-432
17220-PO7-000	20-04-496
17220-POA-000	20-04-495
17220-POC-Y00T	20-04-495
17220-PP4-E00	20-04-498
17220-PR3-000	20-04-490
17220-PR8-601	20-04-408
17220-PT0-003	20-04-421
17220-PT0-G01	20-04-421
17220-PT2-000	20-04-422
17220-PTO-003	20-04-421
17220-PW0-000	20-04-423
17220-PWA-J10	20-04-440
17220-PWC-000	20-04-434
17220-PWC-505HE	20-04-434
17220-PY3-000	20-04-497
17220-PZA-000	20-04-449
17220-R60-U00	20-04-442
17220-RAA-A00	20-04-435
17220-RB0-000	20-04-444
17220-RB6-Z00	20-04-444
17220-RBD-E00	20-04-436
17220-RBJ-000	20-04-445
17220-REA-Z00	20-04-453
17220-RL0-G00	20-04-441
17220-RL5-A00	20-04-443
17220-RMA-E00	20-04-474

CROSS REFERENCE LIST
VERGLEICHLISTE
LISTA DE REFERENCIAS CRUZADES
LISTA DE COMPARAISON
LISTA DI COMPARAZIONE



HONDA	ASHIKA
17220-RMX-000	20-04-450
17220-RNA-A00	20-04-439
17220-RND-M00	20-04-439
17220-RSR-E00	20-04-438
17220-RZP-G00	20-04-400
17232-PD2-305	20-05-510
17232-PD5-600	20-05-510
17244-P8C-A00	20-04-425
17315-S5A-932	30-04-400
17720-P5T-600	20-04-488
17720-PLC-000	20-04-428
22685725	10-ECO028
79370-S1A-G01	21-H0-H03
79371-SZ3-A01	21-H0-H015
79831-S2A-003	21-H0-H014
79831-ST3-E01	21-H0-H01
80290-ST3-E01	21-H0-H00
80291 S2H 505	21-H0-H02
80291 S2H E01	21-H0-H02
80291-ST3-E01	21-H0-H00
80291-TF0-E01	21-H0-H012
80291SAAE01	21-H0-H05
80292-S7A-003	21-H0-H06
80292-SAA-E01	21-H0-H05
80292-SCA-E11	21-H0-H04
80292-SDA-A01	21-H0-H07
80292-SDC-505HE	21-H0-H011
80292-SDC-A01	21-H0-H07
80292-SMG-E01	21-H0-H09
80292-SWW-G01	21-H0-H011
80292-TF0-G01	21-H0-H012
HE19-23-802	10-04-406
HUMMER	ASHIKA
15202408	20-00-012
15286805	20-00-013
88983068	30-00-002
88984215	10-00-014
88986533	21-HM-H00
89017342	10-00-013
HYUNDAI	ASHIKA
0324-14-300	10-05-599
26300-02500	10-05-593
26300-02750	10-0H-005

26300-02751	10-0H-005
26300-11100	10-05-502
26300-21000	10-07-703
26300-21010	10-05-502
26300-27000	10-ECO029
26300-27000	10-H0-004
26300-29000	10-H0-002
26300-35054	10-05-599
26300-35056	10-05-599
26300-35500	10-05-599
26300-35501	10-05-599
26300-42000	10-05-505
26300-42010	10-05-505
26300-42040	10-K0-005
2630042010	10-05-505P
26310-27200	10-H0-004U
26310-27420	10-0H-H01
26311-45001	10-05-597
26320-27000	10-H0-004
26320-27100	10-H0-003
26320-27200	10-H0-004
26320-27400	10-ECO056
26320-2A001	10-ECO045
26320-3C100	10-ECO075
26330-4X000	10-K0-005
28110-26000	20-H0-004
28113-02510	20-05-578
28113-02750	20-0H-011
28113-05700	20-0H-H18
28113-08000	20-0H-012
28113-0X000	20-0H-H16
28113-0X100	20-0H-H17
28113-0X200	20-0H-H24
28113-11010	20-05-501
28113-17500	20-H0-005
28113-1C000	20-H0-008
28113-1C500	20-H0-009
28113-21000	20-05-502
28113-21340	20-05-510
28113-22010	20-05-521
28113-22051	20-05-593
28113-22300	20-05-592
28113-22301	20-05-592
28113-22600	20-H0-002

28113-23001	20-05-590
28113-24570	20-05-522
28113-25500	20-0H-013
28113-26000	20-H0-004
28113-2B000	20-0H-H14
28113-2D000	20-H0-010
28113-2D001	20-H0-010
28113-2M000	20-0H-H25
28113-2S000	20-0H-H23
28113-31000	20-04-417
28113-37101	20-H0-003
28113-39000	20-H0-007
28113-3J000	20-0H-H26
28113-3K100	20-0H-H15
28113-3K200	20-0H-H20
28113-3Z100	20-0H-H23
28113-4H000	20-0H-H22
28113-H1915	20-H0-006
28117-21340	20-05-510
28130-44000	20-09-991
28130-4A001	20-H0-001
28432-D000	20-H0-010
29130-44001	20-09-991
31112-17000	30-H0-006
31112-1C000	30-0H-H16
31112-26000	30-H0-007
31112-26100	30-H0-007
31112-2B000	30-0H-H15
31112-3R000	30-0H-H17
31315-M2000	30-H0-001
31906-29001	30-W0-003
31910-21000	30-05-501
31910-23000	30-05-518
31910-23000	30-05-598
31910-23500	30-05-514
31910-33300	30-08-887
31910-36000	30-08-887
31911 2C000	30-H0-023
31911-02100	30-05-585
31911-05000	30-0H-012
31911-09000	30-0H-H14
31911-22000	30-05-514
31911-25000	30-05-573
31911-29000	30-05-594



CROSS REFERENCE LIST
 VERGLEICHLISTE
 LISTA DE REFERENCIAS CRUZADES
 LISTA DE COMPARAISON
 LISTA DI COMPARAZIONE

HYUNDAI	ASHIKA
31911-34000	30-02-247
31911-36000	30-05-598
31911-36000	30-05-579
31911-38204	30-0H-013
31911-3A000	30-H0-002
319112D000	30-H0-022
31922-17400	30-0H-H18
31922-26900	30-H0-004
31922-26910	30-H0-005
31922-2B900	30-0H-H03
31922-3A850	30-H0-011
31970-26900	30-H0-004
31973-44000	30-05-502
31973-44001	30-05-502
31973-44001-HY	30-05-502
31973-44100	30-05-502
31973-44100-HY	30-05-502
31980-26900	30-H0-004
96610-37000	21-HY-H01
97030-H1726	21-HY-H04
97030-H1742	21-HY-H17
97114-3B000	21-KI-K14
97114-3B000	21-HY-H14
97114-3B100	21-HY-H15
97114-3B100	21-KI-K14
97133-07010	21-KI-K09
97133-1E000	21-HY-H28
97133-1J000	21-H0-H013
97133-2B010	21-HY-H23
97133-2D000	21-HY-H03
97133-2D100	21-HY-H03
97133-2D200	21-HY-H02
97133-2E200	21-HY-H11
97133-2E250	21-HY-H29
97133-3J100	21-HY-H30
97133-3K000	21-HY-H23
97133-4F000	21-HY-H22
971332L000	21-KI-K18
97163-7C000	21-HY-H25
97164-5H000	21-HY-H20
97220-37100	21-HY-H09
97220-37101	21-HY-H09
97300-3B000	21-HY-H06

97304-3D000	21-HY-H10
97304-3D001	21-HY-H21
97304-3F000	21-HY-H24
97406-4A900	21-HY-H07
97610-37000	21-HY-H08
97610-37010	21-HY-H12
97613-7A000	21-HY-H13
97617-1C000	21-HY-H05
97617-1C001	21-HY-H05
97617-1C200	21-HY-H18
97617-25000	21-HY-H08
976174H000	21-HY-H27
976174H900	21-HY-H27
97619-38100	21-HY-H00
97619-38100	21-KI-K06
97619-3D100	21-KI-K11
97619-3D200	21-KI-K11
97619-FD200	21-HY-H19
97619-FD200	21-KI-K07
97919-3B500	21-HY-H16
N326-20-490	30-03-315
N326-23-802	10-05-599
ISUZU	ASHIKA
05018777AA	20-09-972
05018777AA	20-09-908
13211-018-0	10-09-900
2101-1012005	10-09-985
2105-1012005-001	10-09-985
23150-03700	20-09-981
28130-44001	20-09-991
4294303	20-09-902
4294623	30-09-903
4294623	30-05-501
4303049	10-09-900
4310005	20-09-903
4311792	10-09-904
4312420	30-09-902
4312420	30-02-208
4312420	30-09-998
4312537	20-01-101
4315152	20-09-900
4315358	10-09-901
4316047	20-01-101
4316138	10-09-900

4316740	20-01-101
4317341	10-09-900
4317577	20-01-101
4318007	20-01-101
4318015	10-09-900
4318337	20-01-101
5-13200-066-0	30-05-501
5-13200-066-0	30-09-903
5-13211-018-0	10-09-900
5-13240-023-0	30-09-902
5-13240-023-0	30-02-208
5-13240-023-0	30-09-998
5-14215-028-0	20-09-900
601.094.04.04	20-09-978
7984543	30-09-906
7984543	30-03-301
8-25055-364-0	30-09-909
8-2512-11500	30-09-990
8-91133-369-0	20-02-246
8-93156-634	30-05-502
8-93156-750-0	10-09-996
8-9402-8863	10-09-900
8-94125-784-0	30-01-111
8-94135-747-1	10-07-703
8-94137-339-0	20-08-813
8-94137-339-0	20-09-976
8-9414-4613	30-02-208
8-9414-4613	30-09-998
8-9414-8980	20-01-101
8-94143-205-0	10-09-904
8-94143-479-0	30-09-902
8-94143-479-0	30-02-208
8-94143-479-0	30-09-998
8-94144-611-0	30-02-208
8-94156-052-0	20-09-979
8-94156-455-0	10-05-502
8-94167-399-0	10-09-900
8-94169-779-0	30-03-301
8-94169-779-0	30-09-906
8-94169-779-2	10-09-910
8-94177-327-0	30-05-502
8-9420-6007	20-01-101
8-94201-942-2	10-05-599
8-94203-536-0	20-01-101

CROSS REFERENCE LIST
VERGLEICHLISTE
LISTA DE REFERENCIAS CRUZADAS
LISTA DE COMPARAISON
LISTA DI COMPARAZIONE



ISUZU	ASHIKA
8-94206-007-0	20-01-101
8-94207-533-0	30-01-102
8-94217-100-0	20-09-902
8-94217-272-1	10-09-901
8-94232-059-0	20-02-246
8-94235-769-0	10-09-900
8-94239-493-0	30-01-102
8-94241627-1	10-09-901
8-94243-502-0	10-05-502
8-94246-699-0	20-01-101
8-94248-070-0	30-05-502
8-94250-176-1	30-09-903
8-94250-176-1	30-05-501
8-94316-228-0	10-09-910
8-94325-769-0	10-09-900
8-94334-906-1	20-09-995
8-94337-035-1	20-09-994
8-94360-419-0	10-09-910
8-94360-427-0	10-03-314
8-94369-299-0	30-05-502
8-94369299-3	30-05-502
8-9437-63550	20-09-998
8-94382063-1	20-09-995
8-94394-079-1	30-09-910
8-94412-815-0	10-04-406
8-94414-796-3	30-02-208
8-94418-541-0	10-07-703
8-94428-931-0	10-09-900
8-9443-0983	10-09-906
8-94430-411-0	10-05-502
8-9445-6741	10-05-599
8-94455-838-0	20-01-108
8-94456-741-0	10-07-703
8-94456-741-2	10-09-914
8-94465-656-0	20-09-903
8-94473-708-0	20-09-903
8-953004383	20-09-990
8-97035-303-0	20-09-977
8-97049-282-0	10-09-999
8-97065-667-0	20-09-976
8-97065-667-0	20-08-813
8-9711-423-0	20-09-973
8-971117880	21-IS-IS3

8-97167-972-0	10-09-912
8-97178-609-0	20-09-906
8-97209-306-1	10-05-599
8-97309-92700	10-01-111
8-97329911-0	10-03-314
8-97358720-0	10-09-912
8-980188580	10-ECO103
8-98027480-0	20-09-913
8-98036321-0	30-ECO013
8-98037011-0	30-ECO021
834289	20-01-108
897170-8040	21-IS-IS2
8973561270	21-IS-IS1
8980084420	21-IS-IS1
8983501902	30-09-999
94023895	30-09-903
94023895	30-05-501
94028863	10-09-900
94030859	20-09-900
94125784	30-01-111
94137339	20-09-976
94137339	20-08-813
94217272	10-09-901
94369299	30-05-502
97167972	10-09-912
98008442	21-IS-IS1
MB052676	30-05-501
MB052676	30-09-903
MB433425	30-05-509
ME014833	10-09-900
ME014835	10-09-900
IVECO	ASHIKA
500315484	30-ECO022
550228	30-ECO022
JAGUAR	ASHIKA
4R8Q 6744 AA	10-ECO048
C2S 29685	10-ECO048
JDE 8751	10-ECO099
JEEP	ASHIKA
04797777AC	20-00-014
05013595AA	21-JE-JE1
05080477AA	30-09-988
05175429AB	30-00-012
1-04884900AB	10-00-010

1-04891694AA	20-00-018
1-04891695AA	20-00-001
1-05019443AA	20-00-017
1-05058381AA	21-CH-CH3
1-05166780AA	30-00-001
33000076	30-00-010
33321	21-JE-JE1
4213583	20-09-987
4317380	20-02-246
4317978	10-05-599
4318228	30-09-906
4318228	30-03-301
4318231	30-09-906
4318231	30-03-301
4318265	30-05-502
450-906172	30-04-496
450-906174	30-04-496
450902162	30-08-890
4723905	30-09-997
4796174	10-09-985
5015171AA	10-ECO013
5015171AA	10-09-995
52005131	30-09-996
52126-244AA	30-K0-018
52129238AA	30-09-907
53006317	20-00-016
53030688	20-09-985
53030730	20-09-975
53034018AD	20-09-915
53034019AD	20-09-909
68001297AA	10-ECO023
68032204AB	10-ECO067
68057228AA	30-K0-018
8-933004195	10-09-990
82208300	21-JE-JE1
83501843	20-09-999
8983501902	30-09-999
KIA	ASHIKA
0B631-14-302	10-03-313
0B631-14-302	10-K0-001
0FE3R-14-302	10-03-315
0FE3R-14-302	10-03-316
0JE15-14-302	10-K0-002
0JE45-14-302	10-K0-004



CROSS REFERENCE LIST
VERGLEICHLISTE
LISTA DE REFERENCIAS CRUZADES
LISTA DE COMPARAISON
LISTA DI COMPARAZIONE

KIA	ASHIKA
OJE45-14-302	10-K0-002
OK011-13-Z40	20-03-395
OK011-20-490B	30-03-394
OK017-13-Z40	20-03-388
OK024-13-Z40	20-03-388
OK054-23-570	30-K0-001
OK08A-20-490B	30-K0-004
OK201-13-Z00	20-03-398
OK240-20-490	30-K0-014
OK247-13-240	20-03-398
OK2A1-20-4904	30-K0-005
OK2A1-20-490A	30-K0-005
OK2A5-13-Z40	20-K0-007
OK2A5-13-Z40A	20-K0-007
OK2AA-20-490	30-K0-005
OK2C0-61-52X	21-KI-K01
OK2C0-61-53X	21-KI-K01
OK2FA-61-52X	21-KI-K05
OK2KK-13-483	30-K0-018
OK2N1-61-52X	21-KI-K15
OK30A-13-480	30-03-322
OK30C-13-Z40A	20-K0-006
OK410-23-802A	10-K0-000
OK52A-13-480	30-K0-009
OK52Y-20-490	30-K0-024
OK551-14-302	10-K0-005
OK551-23-570	30-K0-003
OK552-23-603A	20-K0-002
OK553-61-C14	21-KI-K00
OK556-61-C14	21-KI-K08
OK558-13-Z40	20-K0-008
OK558-20-490	30-03-313
OK55W-20-490	30-03-313
OK60A-23-603A	20-0K-013
OK6B023603	20-0K-K26
OK710-23-902A	10-05-599
OK71E-23-603	20-K0-001
OK72C23603	20-0K-012
OK902-13-Z40	20-03-307
OK912-20-490B	30-03-399
OK95A-61-52X	21-KI-K03
OK95A-61-52XA	21-KI-K02
OK95C-61-52X	21-KI-K04

OK9A2-13-Z40	20-09-982
OK9BV-20-490	30-K0-008
ORF03-23-802B	10-03-321
1457434310	30-K0-016
23300-25010	30-03-302
26300-02501	10-05-593
26300-02502	10-05-593
26300-2Y500	10-05-593
26300-35502	10-05-599
26300-35503	10-05-599
26300-35530	10-05-599
26310-4A000	10-K0-006
26320 2A000	10-ECO045
26320-2A500	10-ECO076
26320-2F000	10-ECO096
26320-2F010	10-ECO096
26320-3C250	10-ECO093
26321-2W000	10-03-306
28113-04000	20-0K-K29
28113-07100	20-0K-011
28113-07200	20-0K-K17
28113-14000	20-0K-K15
28113-14100	20-0K-K16
28113-1G000	20-0K-K15
28113-1G100	20-0K-K16
28113-1P000	20-0K-K22
28113-1R100	20-0K-K31
28113-2F000	20-H0-010
28113-2F250	20-0H-012
28113-2G000	20-0K-K20
28113-2G300	20-0K-K18
28113-2H000	20-0K-K21
28113-2K000	20-0K-K22
28113-2P100	20-0K-K27
28113-2P300	20-0K-K28
28113-37101	20-H0-003
28113-3E000	20-K0-010
28113-3E000	20-K0-010
28113-3E500	20-K0-010
28113-4D000	20-0K-K19
28113-4E000	20-0K-014
281132J000	20-0K-K25
31112-07000	30-0K-017
31112-14000	30-0K-K22

31112-1G000	30-0K-K22
31112-2P000	30-0K-K29
31112-3Q500	30-0K-K28
31300 3E 200	30-K0-016
31315M2002	30-K0-015
31390-H1970	30-K0-009
31910-2H000	30-0K-K23
31911-2E000	30-0K-K25
31911-2G000	30-0K-K26
31911-38201	30-K0-020
31911-3E200	30-0K-K27
31922-2E900	30-H0-011
31922-2R900	30-0H-H03
31922-3E200	30-H0-005
31922-4H000	30-H0-011
31922-4H001	30-H0-011
31973-H1000	30-K0-009
97114-3B100	21-KI-K14
97133-07000	21-KI-K09
97133-0X900	21-KI-K09
97133-1H000	21-KI-K18
97133-1P000	21-KI-K20
97133-2E210	21-HY-H11
97133-2E260	21-HY-H29
97133-2E900	21-KI-K17
97133-2E910	21-KI-K17
97133-2F000	21-KI-K12
97133-2F000	21-KI-K10
97133-2F010	21-KI-K10
97133-2K000	21-KI-K19
97304-3F000	21-KI-K13
97619-38100	21-HY-H00
97619-38100	21-HY-H26
97619-38100	21-KI-K06
97619-3C000	21-KI-K16
97619-3C100	21-KI-K06
97619-3D100	21-KI-K11
97619-3D200	21-KI-K11
97619-3E000	21-KI-K06
97619-FD200	21-KI-K07
B240-20-490	30-K0-014
FE3R-14-302	10-03-316
K011-13-Z40	20-03-395
K011-20-490	30-03-394



KIA	ASHIKA
K011-50-460	30-03-394
K201-13-Z00	20-03-398
K201-20-490	30-03-398
K467-23-570	30-05-502
K790-23-603B	20-09-983
KB359-20-490	30-K0-013
KF33-20-490	30-03-399
KK150-13-Z00	20-03-316
KKY01-13-470A	30-K0-012
KKY01-14-302	10-05-599
MB593-13-Z40	20-03-384
MB59313Z40	20-03-384
OK017-13-Z40	20-03-388
OK054-23-570	30-K0-001
OK20-13-Z00	20-03-398
OK410-23-802A	10-K0-000
OK553-61-C14	21-KI-K00
OK71E-23-570	30-K0-003
OK71E-23-603	20-K0-001
OK9A0-20-490B	30-03-312
OK9A2-13-Z40	20-09-982
P8790-2F000A	21-KI-K10
LADA	ASHIKA
2101-1109100-01	20-00-000
LAND ROVER	ASHIKA
1311289	10-ECO048
4508334	10-0L-L08
4H23-6714-CA	10-0L-L08
605191	20-0L-L15
AEU2147L	30-0L-L08
BTR8037	21-LR-LR3
ERR3340	10-0L-L02
ESR1049	20-0L-L09
ESR1445	20-0L-L03
ESR2623	20-0L-L12
ESR341	20-0L-L07
ESR4103	20-0L-L10
ESR4238	20-0L-L01
ESR4686	30-0L-L09
JKR 100280	21-LR-LR2
JKR100200	21-LR-LR6
JKR500020	21-LR-LR4
JMO 000010	21-LR-LR1

LPX 100590	10-0L-L05
LPZ000020	10-ECO035
LR 011593	20-0L-L17
LR 013 148	10-ECO099
LR000899	21-LR-LR5
LR001247	10-ECO060
LR001313	30-0L-L11
LR002338	10-ECO069
LR005816	20-0L-L14
LR007160	10-0L-L08
LR007478	20-0L-L05
LR009705	30-0L-L12
LR025306	10-0L-L09
MUN000010	30-0L-L03
NRC 9238	20-0L-L00
NTC1435	20-0L-L11
PHE000040	20-0L-L06
PHE000112	20-0L-L02
PHE100500L	20-0L-L05
RTC4683	20-0L-L04
STC2827	30-0L-L07
STC974	10-0L-L03
WFL 000020	30-0L-L13
WFL 000021	30-0L-L13
WFL000070	30-0L-L06
WFL100160	30-0L-L00
WJ1500020	30-0L-L12
WJN10046	30-0L-L02
WJN500025	30-0L-L05
LEXUS	ASHIKA
04152-31080	10-ECO054
04152-51010	10-ECO094
17801-20050	20-02-265
17801-31110	20-02-260
17801-38010	20-02-2001
17801-38020	20-02-2003
87139-28010	21-TY-TY12
87139-30040	21-TY-TY9
LOTUS	ASHIKA
8-94376355-0	20-09-998
MAHINDRA	ASHIKA
0305DC0161N	30-K0-018
0313AC2261N	20-00-002
9420000073	10-00-012

MAN	ASHIKA
51.05504.0096	10-ECO015
MAZDA	ASHIKA
00000-00-966	21-MA-MA0
0222-13-470A	30-03-301
0222-13-470B	30-03-301
0249-14-300	10-03-300
0259-14-300	10-03-300
0259-23-603	20-03-301
0305-23-603	20-03-302
0370-23-802	10-05-599
0559-23-603	20-03-319
0644-14-300	10-03-300
0778-23-802	10-03-300
0886-23-802	10-03-312
1305-23-802	10-03-308
1391-23-603	20-03-306
1456-23-603	20-03-310
1456-23-802A	10-03-397
1757-23-672	20-03-305
1E00-13-Z40	20-03-321
1E00-61-J6X	21-MA-MA7
1E03-14-302	10-03-390
1E03-14-302	10-02-279
1E05-13-490	30-03-388
1E05-14-302	10-02-279
1E07-13-480	30-03-387
1E07-14-302A	10-03-394
1E20-14-302	10-03-394
4100-77-731	21-MA-MA1
8-943604-271	10-03-314
8172-23-603	20-03-302
8173-23-603	20-03-302
8173-23-6039A	20-03-302
8173-23-802	10-04-406
8259-23-802	10-03-306
8574-13-321	20-03-320
8599-23-603	20-03-393
8914-23-603	20-03-301
8914-23-6039A	20-03-301
8FG1-23-802	10-05-599
8FG1-23-802	10-03-307
8FG1-23-8029A	10-03-316
9649448880	30-03-300



CROSS REFERENCE LIST
VERGLEICHLISTE
LISTA DE REFERENCIAS CRUZADES
LISTA DE COMPARAISON
LISTA DI COMPARAZIONE

MAZDA	ASHIKA
AJ03-13-480	30-03-318
AJ57 13Z40	20-03-300
AS01-13-Z40	20-03-321
B301-13-Z00	20-03-316
B301-13-Z40	20-03-316
B33G-13-Z40	20-03-338
B366-13-470	30-03-314
B366-13-470A	30-03-314
B366-13-470B	30-03-314
B366-13-Z409A	20-03-324
B593-13-Z40	20-03-384
B595-13-Z40	20-03-397
B595-20-490	30-03-395
B603-23-603	20-03-308
B603-23-6039A	20-03-308
B61P-20-490	30-03-316
B630-13-480A	30-03-308
B6BF-13-480	30-03-315
B6BF-20-490A	30-03-315
B6S7-13-Z40	20-03-323
B6S7-13-Z409A	20-03-323
B6Y0-14-300	10-05-599
B6Y1-14-302	10-03-313
B6Y1-14-3029A	10-03-313
BBP2-61-J6X	21-MA-MA12
BC5D-61-J6X	21-MA-MA6
BJ01-13-Z40	20-03-384
BP01-20-490	30-03-315
BP01-20-490A	30-03-315
BP26-20-490A	30-03-315
BP26-20-490A	30-03-396
BP4K-61-J6X	21-MA-MA8
BP4K-61-J6X-9A	21-MA-MA8
BP4K-61-J6XA-9A	21-MA-MA8
BP4W-13-480	30-03-352
BP8P-61-J6X	21-MA-MA8
BPY1-13-480	30-03-315
C601-13-Z40	20-03-350
CB12-61-J6X	21-MA-MA0
CB12-61-J6X	21-MA-MA3
CC2961J6X	21-MA-MA8
D350-13480	30-03-350
D65161J6X	21-MA-MA9

DC21-61-J6X	21-MA-MA2
DC35-61-J6X	21-MA-MA11
E112-61-J6X	21-MA-MA13
E301-23-603	20-04-417
E301-23-6039A	20-04-417
E508-13-470	30-03-302
E580-23-603	20-03-304
E580-23-603-9A	20-03-304
E5D3-23-603	20-03-312
E5D3-23-6039A	20-03-312
E5D3-23-603A	20-03-312
F201-13-Z40	20-03-321
F201-20-490A	30-03-311
F801-23-603	20-03-302
F802-23-802	10-03-307
F802-23-8029A	10-03-307
F802-23-8029A	10-04-406
F8B3-13-Z40	20-03-321
F8B3-13-Z409A	20-03-321
FE01-13-470	30-03-302
FE220-20-490	30-03-312
FE3N-20-490	30-03-312
FEH1-13-480	30-03-310
FER3R-14-302	10-03-316
FEY0-14-302	10-03-315
FEY0-14-302	10-03-316
FS05-13-Z40	20-03-327
GE6T-61-J6X	21-MA-MA0
GE6T-61-J6X	21-MA-MA3
GE6T-61-J6X-9B	21-MA-MA0
GE6T-61-J6XA	21-MA-MA0
GJ6A-61-P11	21-MA-MA5
GJ6A-61-P11A9B	21-MA-MA5
GS1D61P11	21-MA-MA10
HE19-23-603	20-03-307
HE19-23-6039A	20-03-307
JE01-20-490A	30-03-313
JE15-13-Z40	20-03-317
JE15-13-Z40-9A	20-03-317
JE15-20-490A	30-03-391
JE48-20-490	30-03-389
JEY0-14-302	10-03-316
JEY0-14-3029A	10-03-316
JF01-20-490A	30-03-313

K801-13-Z40	20-03-330
K801-20-490	30-03-399
KB359-13-Z40	20-03-384
KF11-13-Z40	20-03-399
KF11-13-Z40-9A	20-03-399
KL05-20-490A	30-03-397
KL05-20-490B	30-03-397
KL17-13-240	20-05-599
L321-14-302	10-ECO036
L321143029A	10-ECO036
LDY3-61-J6X-9A	21-MA-MA4
LDY4-61-J6X-9A	21-MA-MA14
LDY4-61-J6X-A9A	21-MA-MA14
LF01-14-302	10-ECO036
LF01-14-302-9A	10-ECO036
LF10-14-302-9A	10-03-394
LF50-13-Z40-9A	20-03-337
LFBL13Z40	20-03-340
LFG1-13-Z40	20-03-339
N231-23-802	10-05-599
N326-13-Z00	20-03-315
N326-13-Z40	20-03-315
N350-13-Z40	20-03-329
N350-13-Z40	20-03-328
N3A1-13-Z40	20-03-329
N3A1-20-490	30-03-390
N3H1-13-Z40	20-03-334
N3Y6-14-302	10-05-599
OB631-14-302	10-03-313
OK011-20-490B	30-03-394
OK201-13-200	20-03-398
ORF03-23-802A	10-03-306
PN11-13-Z00	20-03-314
PN11-13-Z40	20-03-314
PN11-13-Z409A	20-03-314
PN16-14-V61	10-03-306
PN47-13-ZA5	30-03-303
PNY2-14-302	10-03-317
R205-23-603	20-03-313
R209-13-Z40	20-03-313
R214-23-802	10-03-306
R2L1-13-ZA5	30-02-295
R2L1-13-ZA5A	30-02-295
R2N5-13-ZA5	30-03-317

CROSS REFERENCE LIST
VERGLEICHLISTE
LISTA DE REFERENCIAS CRUZADAS
LISTA DE COMPARAISON
LISTA DI COMPARAZIONE



MAZDA	ASHIKA
R2N5-13-ZA5-9A	30-03-317
RF01-13-Z40	20-03-310
RF01-23-802	10-05-599
RF01-23-802A	10-05-599
RF01-23-802A	10-03-306
RF01-23-802A9A	10-05-599
RF03-13-850A	30-03-303
RF03-23-570	30-03-303
RF03-23-603	20-03-309
RF03-23-603 9A	20-03-309
RF03-23-603A	20-03-309
RF03-23-802A	10-05-599
RF10-23-802	10-03-306
RF10-23-802A	10-03-306
RF2A-13-Z40A	20-03-325
RF4F-13-Z40	20-03-325
RF66-14-V61	10-03-306
RF66-14-V61A	10-03-306
RF71-13-Z00	20-03-318
RF71-13-Z40	20-03-318
RF71-13-Z40A	20-03-318
RF71-14-302	10-03-314
RF79-13-Z40	20-03-318
RF79-13-Z409A	20-03-318
RF79-13-Z40A	20-03-318
RF79-13-Z40A9A	20-03-318
RFY0-14-302	10-03-314
RFY2-14-302	10-05-599
RFY2143029A	10-05-599
RFY0-14-302	10-03-314
S201-13-850	30-03-392
SL02-23-802	10-03-308
TFY0-14-302	10-03-308
VSY1-14-302	10-05-505
VSY1-14-302	10-03-396
VSY1-14-302	10-05-505P
VSY3-14-302	10-05-505
WE01-13Z40	20-02-259
WE01-13ZA5A	30-02-215
WL01-13-Z40	20-03-390
WL31-13-Z40	20-03-392
WL81-13-Z40	20-03-383
WLY4-14302	10-02-215

Y401-13-Z40	20-03-351
Y401-14-302	10-03-351
Y401-14-302-9A	10-03-351
Y401-20-490	30-03-351
Y401-20-490B	30-03-351
Y601-13-Z40-9A	20-03-336
Y60113Z40	20-03-336
Y60213480	30-03-300
Y60213480A	30-03-300
Y603-13-480	30-03-320
Y642 13 Z40B	20-03-341
Y650-13-480	30-03-321
Y701-13-Z40	20-03-389
Y701-14-302	10-04-406
YF0913Z40	20-03-333
YF0914302	10-03-320
Z501-20-490	30-03-315
Z605-20-490A	30-03-325
Z605-20-490C	30-03-325
ZJ0113Z40	20-03-335
ZL0520490	30-03-319
MERCEDES-BENZ	ASHIKA
000 180 21 09	10-ECO084
000 180 29 09	10-ECO084
0001801609	10-ECO020
0011849425	10-ECO021
002 477 30 01	30-09-913
002 477 31 01	30-09-913
1 457 429 118	10-ECO035
1041800109	10-ECO009
1121840025	10-ECO006
1201800009	10-ECO040
166.180.00.09	10-ECO003
1661800009	10-ECO003
22685725	10-ECO028
2661800009	10-ECO074
2661840325	10-ECO074
271 180 00 09	10-ECO061
275 180 00 09	10-ECO088
275 184 00 25	10-ECO088
4312802	30-01-111
457 184 01 25	10-ECO084
51055040098	10-ECO002
5410900051	30-ECO001

5410900151	30-ECO001
5410920305	30-ECO001
5411800009	10-ECO001
602.094.02.04	20-09-978
6061800009	10-ECO031
6110900051	30-ECO002
6110900152	30-ECO002
6110900552	30-ECO002
6111800009	10-ECO021
6131800009	10-ECO041
62818-00009	10-ECO064
629 180 01 09	10-ECO115
640 180 00 09	10-ECO050
6543813	10-ECO036
6681800009	10-ECO039
74115562	10-ECO008
901251	30-ECO003
9041800009	10-ECO020
9060900051	30-ECO003
9060920105	30-ECO003
A 642 184 00 25	10-ECO053
A6420920101	30-00-012
M B 541.180.00.09	10-ECO001
M B 606 180 00 09	10-ECO031
MB 541.090.0151	30-ECO001
MB 611.090.0152	30-ECO002
MB 9060900051	30-ECO003
MB120.180.0009	10-ECO040
MB120.180.0009	10-ECO039
MB220791	30-05-599
MB504749	30-08-887
MB541.090.0051	30-ECO001
MB5410920305	30-ECO001
MB611.090.0051	30-ECO002
MB6110900552	30-ECO002
MB613.180.0009	10-ECO041
MB6131800009	10-ECO040
MB658684	30-02-224
MB668.180.0009	10-ECO039
MB6681800009	10-ECO041
MB844122	30-02-224
MB868455	30-02-224
MB901251	30-ECO003
MB9060920105	30-ECO003



MERCEDES-BENZ	ASHIKA
MD001445	10-05-502
MD603629	20-05-516
MD620385	20-05-516
MR323949	20-02-246
MR9011602	30-05-505
XR315876	21-MI-MI1
MITSUBISHI	ASHIKA
1230A045C	10-05-505
1230A046	10-05-509
1230A046	10-05-597
1500A023	20-05-531
1500A045	20-M0-001
1500A086	20-05-531
1500A098	20-05-500
1500A286	20-02-299
1770A012	30-05-500
1770A024	30-05-528
1770A040	30-0L-L11
1770A053	30-02-215
23300-87702	30-05-581
28113-44200	20-05-529
28130-45020	20-05-576
28311-11010	20-05-501
28311-21000	20-05-502
31240-53015	10-05-583
31240-53054	10-05-583
31340-12030	10-05-580
31340-12100	10-05-580
31340-12200	10-05-580
31440-12030	10-05-581
31440-12200	10-05-581
31662-01031	30-05-580
3166201030	30-05-580
31910-28000	30-05-599
4316591	10-05-502
7803A004	21-MI-MI7
7803A005	21-MI-MI7
7803A028	21-MI-MI4
95-619-441	20-05-584
9506190441	20-05-584
F220-20-490A	30-03-312
M851139	10-05-595
MB052591	30-05-501

MB052676	30-05-501
MB120108	20-05-580
MB120298	20-05-582
MB120389	20-05-580
MB120476	20-05-582
MB129675	30-05-502
MB220700	30-05-506
MB220792	30-05-506
MB220900	30-05-502MP
MB220900	30-05-502
MB247662	30-05-504
MB348127	30-05-514
MB433425	30-05-509
MB433774	30-05-512
MB504732	30-05-506
MB504732	30-05-518
MB504733	30-05-518
MB504735	30-05-518
MB504738	30-05-518
MB504739	30-05-518
MB504740	30-02-224
MB504740	30-05-588
MB504740	30-05-518
MB504747	30-05-518
MB504749	30-05-518
MB504752	30-05-518
MB504753	30-02-224
MB504757	30-02-224
MB504758	30-05-518
MB504760	30-02-224
MB504761	30-02-224
MB504762	30-02-224
MB507758	30-05-518
MB554681	30-05-518
MB658136	30-05-518
MB658689	30-02-224
MB868451	30-02-224
MB868452	30-02-224
MB868454	30-02-224
MB868457	30-02-224
MB868460	30-02-224
MB906051	20-05-599
MB906052	20-05-599
MB957348	30-05-590

MD-136790	10-07-703
MD013661	10-05-503
MD031805	10-05-502
MD069782	10-05-505P
MD069782	10-05-505
MD071462	10-05-502
MD084693	10-05-502
MD086786	10-05-508
MD110920	10-05-506
MD135737	10-03-316
MD136466	10-05-510
MD136790	10-07-703
MD162326	10-05-503
MD184086	10-05-505P
MD184086	10-05-505
MD322508	10-05-510
MD352626	10-07-703
MD360935	10-03-316
MD603014	20-05-501
MD603071	20-05-511
MD603117	20-05-506
MD603163	20-05-507
MD603330	20-05-502
MD603354	20-05-503
MD603360	20-05-525
MD603384	20-05-508
MD603446	20-09-991
MD603522	20-05-505
MD603800	20-05-510
MD603803	20-05-513
MD603832	20-05-515
MD603832	20-05-585
MD603932	20-05-516
MD604802	20-02-201
MD604880	20-05-504
MD604952	20-05-512
MD607648	20-05-509
MD620039	20-05-517
MD620047	20-05-518
MD620109	20-06-611
MD620456	20-05-598
MD620472	20-05-598
MD620508	20-05-597
MD620610	20-05-516

CROSS REFERENCE LIST
VERGLEICHLISTE
LISTA DE REFERENCIAS CRUZADAS
LISTA DE COMPARAISON
LISTA DI COMPARAZIONE



MITSUBISHI	ASHIKA
MD620737	20-05-596
MD620738	20-05-596
MD620837	20-05-586
ME006066	30-05-582
ME013307	10-05-597
ME013343	10-05-597
ME014838	10-05-507
ME015254	30-05-583
ME016823	30-05-582
ME016872	30-05-582
ME017242	20-05-577
ME017246	20-05-575
ME033717	20-05-527
ME034605	10-05-582
ME034611	10-05-582
ME035829	30-05-583
ME056280	30-05-584
ME088519	10-05-578
ME132525	30-05-574
ME215002	10-05-509
ME215002	10-05-597
ME294400	20-05-577
MEO34605	10-05-582
ML126032	20-05-526
MN135269	20-05-530
MN960320	10-M0-003
MN980125	10-ECO023
MR 360889	21-MI-MI3
MR127025	30-05-578
MR127025	30-05-591
MR127077	20-05-589
MR127078	20-05-588
MR188657	20-05-587
MR204132	30-05-590
MR204842	20-05-583
MR212200	30-05-519
MR227823	21-MI-MI0
MR239466	20-05-523
MR266494	30-05-520
MR266849	20-05-574
MR266849	20-03-383
MR315172	21-MI-MI8
MR315876	21-MI-MI1

MR355233	30-05-578
MR355667	30-05-590
MR398288	21-MI-MI5
MR404847	20-05-524
MR500058	21-MI-MI4
MR529773	20-03-383
MR529773	20-05-574
MR552780	30-05-523
MR552781	30-05-523
MR552782	30-05-523
MR597635	30-M0-002
MR911602	30-05-505
MR911602	30-05-530
MR911916	30-ECO015
MR911916	30-05-531
MR958017	21-SM-SM1
MR984204	10-M0-001
MR993130	20-M0-001
MT421158	20-05-581
MZ 311917	21-MI-MI2
MZ311782	20-05-599
MZ311785	20-05-508
MZ311786	20-05-523
MZ690071	10-05-505
MZ690071	10-05-505P
MZ690115	10-03-316
RFY2-13-302	10-05-503
SMD136466	10-05-510
XB220900	30-05-502
XD031805	10-05-502
XE033717	20-05-527
XR 360889	21-MI-MI3
XR404847	20-05-524
XR529773	20-05-574
XR529773	20-03-383
XZ 311917	21-MI-MI2
NISSAN	ASHIKA
035192-0	20-01-195
1109.6 R6	10-ECO037
15208-00Q0D	10-01-122
15208-00QAB	10-08-891
15208-00QAG	10-01-121
15208-01B01	10-01-108
15208-01B10	10-01-108

15208-01B15	10-01-108
15208-15G00	10-01-113
15208-18G00	10-01-113
15208-1HC0A	10-01-120
15208-20N00	10-01-114
15208-20N01	10-01-114
15208-20N02	10-01-114
15208-20N10	10-01-114
15208-31U00	10-01-198
15208-3J400	10-01-120
15208-40L00	10-01-114
15208-40L02	10-01-114
15208-43G00	10-01-110
15208-53J00	10-01-117
15208-53J01	10-01-117
15208-5M300	10-01-195
15208-60V00	10-01-111
15208-61525	10-01-104
15208-64W00	10-01-113
15208-65005	10-01-110
15208-65011	10-01-110
15208-65014	10-01-110
15208-65F00	10-01-120
15208-65FOA	10-01-120
15208-65FOB	10-01-120
15208-6F901	10-01-189
15208-70J00	10-01-117
15208-71J00	10-01-111
15208-7F400	10-01-101E
15208-9C600	10-01-112E
15208-9C600	10-01-103E
15208-9F600	10-01-120
15208-AD200	10-01-195
15208-AW300	10-01-122
15208-BN300	10-01-103E
15208-BN300	10-01-112E
15208-BN30A	10-01-112E
15208-BN700	10-08-891
15208-D9705	10-01-112
15208-G9903	10-01-110
15208-H1010	10-01-111
15208-H1011	10-01-111
15208-H8903	10-01-111
15208-H8905	10-01-111



CROSS REFERENCE LIST
VERGLEICHLISTE
LISTA DE REFERENCIAS CRUZADES
LISTA DE COMPARAISON
LISTA DI COMPARAZIONE

NISSAN	ASHIKA
15208-H8911	10-01-111
15208-H8916	10-01-111
15208-H8917	10-01-111
15208-KA000	10-03-313
15208-W1101	10-01-112
15208-W1103	10-01-112
15208-W1111	10-01-112
15208-W1113	10-01-112
15208-W1116	10-01-112
15208-W1120	10-01-110
15208-W1123	10-01-110
15208-W3401	10-01-110
15208-Y9701	10-01-110
15208-Z9001	10-01-199
15208-Z9003	10-01-199
15208-Z9004	10-01-199
15208-Z9005	10-01-196
15208-Z9007	10-01-199
15209-00Q0A	10-ECO068
15209-2W200	10-01-194
15209-76200	10-01-109
15209-C8600	10-01-109
15209-C8602	10-01-109
15209-J1800	10-01-107
15209-J2000	10-01-109
15209-J6500	10-01-109
15209-Y7502	10-01-107
15310-03200	10-05-599
16400-00Q0K	30-01-125
16400-00QAA	30-01-120
16400-00QAV	30-01-108
16400-09W00	30-01-103
16400-0W010	30-01-111
16400-2Y501	30-01-124
16400-2Y505	30-01-124
16400-41B00	30-01-111
16400-41B05	30-01-111
16400-41B25	30-01-111
16400-53J10	30-01-198
16400-59A00	30-01-115
16400-70J00	30-01-192
16400-72L00	30-01-198
16400-9F927	30-01-111

16400-BC40A	30-01-108
16400-BN700	30-01-108
16400-D0100	30-01-105
16400-E3000	30-05-501
16400-E3001	30-05-501
16400-E3025	30-05-501
16400-EC00A	30-01-100
16400-ES60A	30-01-123
16400-F5100	30-01-111
16400-G9601	30-01-111
16400-H8501	30-05-501
16400-JD50A	30-01-122
16400-JY00A	30-01-122
16400-JY09D	30-01-122
16400-N8601	30-01-102
16400-Q0800	30-01-102
16400-Q4000	30-01-103
16400-V2600	30-01-110
16400-V2700	30-01-111
16400-V2705	30-01-111
16400-V7200	30-01-109
16400-W1100	30-05-501
16400-W1105	30-05-501
16400-W1110	30-01-104
16403-09W00	30-01-103
16403-34W00	30-01-106
16403-4U105	30-01-109
16403-4U105	30-01-191
16403-4U11A	30-01-109
16403-4U11A	30-01-191
16403-59E00	30-01-109MP
16403-59E00	30-01-109
16403-6F900	30-01-189
16403-7F400	30-01-190
16403-7F401	30-01-190
16403-7F40A	30-01-190
16403-BN303	30-01-190
16403-G990A	30-01-109
16403-J2000	30-01-103
16403-R8300	30-01-106
16403-Z7000	30-01-115
16403-Z7000	30-01-103
16403-Z9000	30-01-195
16405 00QAA	30-ECO010

16405-00QAB	30-ECO014
16405-00QAC	30-ECO017
16405-01T70	30-01-197
16405-02N10	30-01-119
16405-05E01	30-01-109
16405-05E02	30-01-109
16405-18G00	30-01-117
16405-59E00	30-01-109
16405-V0701	30-01-106
16405-V5710	30-01-112
16510-66G02	10-H0-002
16510-82702	10-06-601
16510-82703	10-06-604
16510-87203	10-06-601
16516-73C10	20-01-196
16516-78E00	10-03-314
16543-73C11	20-01-196
16546 00QAA	20-01-130
16546 00QAE	20-01-131
16546 00QAG	20-01-132
16546 EB300	20-01-129
16546-00QAC	20-01-133
16546-00QAR	20-01-128
16546-00QOH	20-01-137
16546-01B00	20-01-114
16546-02N00	20-01-118
16546-04N00	20-01-110
16546-06J00	20-01-139
16546-06N00	20-01-120N
16546-06N00	20-01-120
16546-0F000	20-01-110
16546-0T006	20-01-191
16546-0U800	20-01-197
16546-10625	20-01-109
16546-18000	20-01-102
16546-1HC2A	20-01-142
16546-23000	20-01-101
16546-2S600	20-01-190
16546-30P00	20-01-196
16546-3J400	20-01-108
16546-3S903	20-01-192
16546-41B00	20-01-197
16546-42145	20-01-104
16546-4A00C	20-08-830

CROSS REFERENCE LIST
VERGLEICHLISTE
LISTA DE REFERENCIAS CRUZADES
LISTA DE COMPARAISON
LISTA DI COMPARAZIONE



NISSAN	ASHIKA
16546-64J02	20-01-199
16546-65000	20-01-105
16546-6F900	20-01-189
16546-7100	20-01-104
16546-71J00	20-01-121
16546-73C10	20-01-196
16546-73C11	20-01-196
16546-76000	20-01-110
16546-77A10	20-01-121
16546-7F000	20-01-194
16546-7F002	20-01-194
16546-80G00	20-01-110
16546-84A10	20-01-122
16546-88A00	20-01-121
16546-89W00	20-01-123
16546-AA010	20-01-104
16546-AW300	20-01-127
16546-AX600	20-01-197
16546-BC40A	20-01-128
16546-BN700	20-01-100
16546-BN701	20-01-128
16546-C6800	20-01-105
16546-D1100	20-01-107
16546-D6200	20-01-126
16546-ED000	20-01-134
16546-EG000	20-01-143
16546-G0300	20-01-113
16546-G4800	20-01-188
16546-G5500	20-01-119
16546-G9600	20-01-116
16546-G9601	20-01-116
16546-G9801	20-01-120
16546-J5570	20-01-192
16546-J5571	20-01-192
16546-JD20A	20-01-135
16546-JD20B	20-01-135
16546-M5600	20-01-106
16546-MA70A	20-01-136
16546-N3300	20-01-125
16546-N3310	20-01-125
16546-N4200	20-01-104
16546-N4201	20-01-104
16546-P6910	20-01-103

16546-P8260	20-01-115
16546-P9610	20-01-103
16546-R9000	20-01-110
16546-R9009	20-01-110
16546-S0100	20-01-101
16546-T3400	20-01-112
16546-T3401	20-01-112
16546-U6710	20-01-124
16546-V0100	20-01-108
16546-VB300	20-01-193
16546-VK501	20-01-111
1654600Q0G	20-01-138
1654600QAM	20-01-138
22275-0L901	21-NS-NS1
27274-EA000	21-NS-NS9
27274ED000	21-NS-NS17
27275-0L900	21-NS-NS1
27275-0L910	21-NS-NS1
27275-1N626	21-NS-NS3
27275-1N6P6	21-NS-NS3
27277-00A26	21-NS-NS13
27277-1HE0E	21-NS-NS15
27277-1KA0A	21-NS-NS13
27277-3Y525	21-NS-NS5
27277-EG000	21-NS-NS16
27277-EG025	21-NS-NS16
27277-EN000	21-NS-NS10
27277-EN025	21-NS-NS10
27298-00QAA	21-NS-NS11
27891-1FC0A	21-NS-NS18
27891-1FE0A	21-NS-NS18
27891-2F000	21-NS-NS0
27891-4A00C	21-SZ-SZ10
27891-AX010	21-NS-NS6
27891-BM400	21-NS-NS4
27891-BM401	21-NS-NS4
27891EL00A	21-NS-NS17
27893-2F900	21-NS-NS0
27893-6F600	21-NS-NS2
2F241-30450	21-NS-NS2
38087-2100	10-05-599
42072-AA010	30-07-707
42072-GA061	30-03-302
42145-5500	20-01-102

42145-5550	20-01-102
42145-5600	20-01-102
5-13240-017-0	10-00-002
5-13240-093-0	10-00-002
5-14215-003-0	20-01-101
7701045724	20-01-130
8-94148-980-0	20-01-101
8-94207-533-0	20-01-102
8-94412-815-0	10-00-002
84840-30450	21-NS-NS0
88087-4100	10-01-111
88087-4110	10-01-111
9-132240-088-0	10-00-002
9-13240-804-0	10-00-002
94023905-8	20-01-101
94206-007-0	20-01-101
A5208-01B01	10-01-108
A5208-01B02	10-01-108
A5208-70J00	10-01-117
A5208-H8904	10-01-111
A5208-W1103	10-01-112
A5208-W1103	10-01-103E
A5208-W1103	10-01-112E
A5208-W1106	10-01-103E
A5208-W1106	10-01-112
A5208-W1106	10-01-112E
A5208-Y9701	10-01-101E
A640C59EMOSA	30-01-109
B7277-JN20A	21-NS-NS14
B727A-79925	21-NS-NS8
B727C-79925	21-NS-NS7
B7298-00QAA	21-NS-NS12
B7891-1FC0A	21-NS-NS18
B7891-1FE0A	21-NS-NS18
OPEL	ASHIKA
12593333	10-ECO117
12786800	20-00-019
16400-N9600	30-01-102
21018801	10-ECO019
21018826	10-ECO018
2931095	10-ECO034
4252248	10-ECO034
4301672	10-09-906
4402894	30-ECO007



OPEL	ASHIKA
56 50 359	10-ECO073
5650316	10-ECO018
5650319	10-ECO005
5650354	10-ECO058
5650363	10-ECO117
5650375	10-ECO116
58 18 085	30-ECO020
650307	10-ECO017
8-94334-906-0	20-09-995
8-94382063-1	20-09-995
8-94430-983-0	10-09-906
8-97044-226-0	20-09-997
818506	30-05-502
834126	20-0W-W12
834585	20-09-989
835056	20-0W-W11
835619	20-00-027
835621	20-00-027
9006181	10-ECO117
90530260	10-ECO017
90537280	10-ECO019
90542912	30-ECO009
90570368	10-ECO005
9110894	30-ECO007
93172299	21-CD-CD0
93183412	10-ECO058
93186310	10-ECO117
93194847	21-SZ-Z09
93195891	20-08-817
94360427	10-03-314
97223218	10-ECO038
98018448	10-ECO116
GM21018801	10-ECO019
GM97223218	10-ECO038
MB433425	30-05-509
V.A.G045 115 466	10-ECO023
PEUGEOT	ASHIKA
1109-X3	10-ECO060
1109.X7	10-ECO048
1109.Z1	10-ECO060
1109N2	10-06-699
1109S5	10-03-351
1444X2	20-03-351

1901.56	30-ECO011
1901.56	30-ECO006
1906 95	30-ECO029
1906.38	30-W0-003
1906.64	30-W0-003
190652	30-ECO015
6447TT	21-TY-TY10
9641087880	30-ECO019
PIAGGIO	ASHIKA
15601-87204	10-06-604
15601-87703	10-06-604
17801 87208	20-06-615
17801-87505	20-06-608
17801-87710	20-06-605
17801-87201	20-06-608
17801-87202	20-06-605
23000 87507	30-06-624
23300 87512	30-06-623
23300-87625	30-06-693
23300-87705	30-06-612
263703	20-06-614
493063	10-06-699
493290	30-06-695
650308	10-ECO018
650311	10-ECO017
650391	10-03-314
PONTIAC	ASHIKA
25014233	10-00-098
25098522	20-00-098
25121466	30-00-098
25121468	30-00-098
PORSCHE	ASHIKA
955.110.134.00	30-ECO025
958.107.222.00	10-ECO108
RENAULT	ASHIKA
7700 109 402	10-ECO030
7700109402	10-ECO030
7700845961	30-01-120
7701 206 705	10-ECO024
7701038857	20-01-132
7701039857	20-01-132
7701043620	30-ECO007
7701043709	20-01-132
7701044595	20-01-133

7701044913	30-ECO015
7701047285	20-01-131
7701206119	30-ECO008
7701206705	10-ECO024
79,45	30-ECO004
79,450694444	30-ECO004
8200026237	30-01-108
8200248903	30-ECO010
8200257642	10-01-121
8200274858	10-01-122
8200362442	10-ECO068
ROVER	ASHIKA
15400-PA6-003	10-04-402
15400-PA6-004	10-04-402
17220-PE0-661	20-04-406
17220-PE0-663	20-04-406
SAAB	ASHIKA
12762671	30-00-011
12788338	20-00-019
SMART	ASHIKA
000 1110 V003	21-SM-SM0
0003041V003	10-0M-000
0003124V001	20-0M-000
0009997-V001-0000	20-M0-002
0013871V001	21-SM-SM1
160 1840 225	10-0M-000
6641800009	10-00-008
A 001 094 03 01	20-0M-M03
A 451 830 00 18	21-SM-SM2
A 4514770001	30-01-120
A0001802810	10-M0-001
A1321800010	10-0M-M02
A1350900501	20-M0-001
A1600940104	20-M0-002
A639 184 01 0	10-M0-003
A6390900501	20-M0-001
A6391840101	10-M0-003
A6460920301	30-M0-002
C0002591V003	30-0M-001
C0003124V001 0000	20-0M-000
C0003414V002 0000	30-0M-000
C0008034V001 0000	10-0M-000
SSANGYONG	ASHIKA
15310-01000	10-03-399



SSANGYONG	ASHIKA
15310-01000	10-09-900
1621803009	10-ECO009
22400-08000	30-0S-002
2240008020	30-0S-001
22470-34000	30-0S-S04
22715-01000	30-05-502
2311334100	20-0S-S04
23150-01000	20-03-396
23190 21000	20-0S-S03
23190 21001	20-0S-S03
23190-05320	20-09-980
23190-08040	20-0S-S02
23190-08400	20-0S-S01
23190-09000	20-0S-S03
60209-40204	20-09-907
6610903055	30-09-991
66109474504	20-S0-000
6611803009	10-09-998
6611803009	10-09-997
66509-21001	30-0S-001
6711803009	10-ECO105
68110-21000	21-SS-S02
68110-21030	21-SS-S03
68111-091A0	21-SS-S04
6811634000	21-SS-S05
68120-0803A	21-DW-W7
68120-08130	21-SS-S01
68120-0830	21-DW-W7
69230-05400	21-DW-W5
SUBARU	ASHIKA
13780-86000	20-08-813
13780-86G00	20-07-715
15208-AA000	10-01-111
15208-AA020	10-07-705
15208-AA021	10-07-705
15208-AA022	10-07-705
15208-AA023	10-07-705
15208-AA030	10-07-705
15208-AA030	10-07-703
15208-AA031	10-07-706
15208-AA031	10-05-599
15208-AA080	10-03-313
15208-AA100	10-03-313

15208-AA110	10-04-406
15208-KA010	10-03-313
16510-73010	10-06-601
16546-3J400	20-07-709
16546-42145	20-07-703
16546-5810	20-07-703
16546-AA010	20-01-104
16546-AA020	20-01-108
16546-AA020	20-07-709
16546-AA021	20-07-709
16546-AA021	20-01-108
16546-AA030	20-07-716
16546-AA070	20-07-796
16546-AA090	20-07-714
16546-AA120	20-07-714
16546-AA12A	20-07-714
16546-KA000	20-07-708
16546-KA030	20-07-703
16546-KA040	20-07-704
16546-KA050	20-07-704
16546-KA060	20-01-102
16546-KA080	20-07-704
16546-KA101	20-07-798
16546-KA120	20-07-711
16546-KA162	20-07-711
16546-KA163	20-07-712
16546-KA163	20-07-797
16546-KA190	20-07-799
16546-V0100	20-07-709
17801-23030-1	20-02-288
42033-5400	10-07-703
42033-5410	10-07-703
42033-5500	10-07-703
42033-7000	10-01-111
42033-7110	10-01-111
42072-AA011	30-07-707
42072-AE000	30-07-701
42072-AG060	30-02-215
42072-KC030	30-07-797
42072-PA010	30-07-707
42072-TA040	30-07-796
42145-5810	20-07-703
42145-5821	20-07-703
42145-6000	20-07-704

42145-7000	20-07-700
42145-7100	20-01-104
4295606	10-07-703
4317073	10-07-703
64201-0020	30-03-301
72880-AE000	21-SB-SB1
72880-AG000	21-SB-SB2
72880-AG010	21-SB-SB4
72880-FE000	21-SB-SB0
72880-FG000	21-SB-SB3
72880-XA00A	21-SB-SB2
74202-3000	30-07-700
74202-3010	30-02-221
74207-2040	30-07-704
74207-2080	30-07-702
74207-2280	30-07-799
82145-4110	20-01-102
82145-7110	20-01-102
9-13200-093-0	30-03-301
9-13200-250-0	30-03-301
G3010-SA100	21-SB-SB5
SUZUKI	ASHIKA
13780-52D00	20-08-833
13780-52D10	20-08-833
13780-54E00	20-08-894
13780-54G00	20-08-886
13780-54G10	20-08-801
13780-54LA0	20-08-832
13780-54LA0-000	20-08-832
13780-57B00	20-08-899
13780-58B00	20-08-898
13780-60A00	20-08-814
13780-60A00	20-03-308
13780-60B00	20-08-816
13780-60B00	20-08-813
13780-60G00	20-08-896
13780-61A00	20-08-891
13780-61A10	20-08-891
13780-62B00	20-08-811
13780-62J00	20-08-819
13780-62J50	20-08-822
13780-62J51	20-08-822
13780-63J00	20-08-829
13780-65J00	20-08-824



CROSS REFERENCE LIST
VERGLEICHLISTE
LISTA DE REFERENCIAS CRUZADES
LISTA DE COMPARAISON
LISTA DI COMPARAZIONE

SUZUKI	ASHIKA
13780-71C50	20-08-812
13780-73J00	20-08-826
13780-73KA0-000	20-08-817
13780-75103	20-08-803
13780-75F00	20-08-889
13780-77A00	20-08-885
13780-77E00	20-08-897
13780-78100	20-08-802
13780-78100	20-08-895
13780-78B10	20-08-802
13780-79201	20-08-803
13780-79210	20-08-803
13780-79510	20-08-806
13780-79J00-000	20-08-828
13780-79J50	20-08-827
13780-80GA0	20-08-884
13780-81A00	20-08-815
13780-82000	20-08-805
13780-82150	20-08-808
13780-82400	20-08-809
13780-82703	20-08-895
13780-83000	20-08-807
13780-83E00	20-08-887
13780-83G00	20-08-817
13780-84250	20-08-888
13780-84A00	20-08-823
13780-84E50	20-08-818
13780-86000	20-08-816
13780-86000	20-08-813
13780-M68K00-000	20-08-830
13780-T79J00	20-08-828
1378078K00	20-08-831
15310-75F00	30-08-819
15310-75F00	30-08-897
15310-78F00	30-08-824
15401-60B10	30-08-890
15410-52D00	30-08-826
15410-60B00	30-08-810
15410-60B01	30-08-810
15410-60G00	30-08-896
15410-62G00	30-08-896
15410-63400	30-08-800
15410-63401	30-08-800

15410-65D00	30-08-823
15410-65D10	30-08-823
15410-67B00	30-08-810
15410-67B01	30-08-810
15410-72F00	30-08-897
15410-72F01	30-08-897
15410-73J00-000	30-03-300
15410-78E01	30-05-502
15410-79100	30-08-800
15410-80000	30-08-813
15410-80200	30-08-806
15410-80C00	30-08-887
15410-80C10	30-08-887
15410-80F00	30-08-895
15410-84301	30-08-899
15410-84380	30-08-897
15410-84A00	30-01-108
15410-84A51-000	30-01-122
15410-85200	30-08-807
15410-85500	30-08-807
15410-85551	30-08-807
15410-86501	30-04-499
15410-86CA0	30-08-891
15410-86CA3	30-08-891
15410-M84320	30-08-899
15411-78E10	30-05-502
15411-84E60	30-ECO016
15412-66G00	30-08-891
15412-67G00	30-ECO011
15412-67G00	30-08-802
15412-67G00-000	30-ECO011
15412-84CT0	30-08-822
15412-86CC0	30-08-821
15415-67JA0	30-ECO015
15440-71500	30-08-800
15601-87309	10-05-503
15601-87310	10-04-406
15610-11402	30-08-896
16510-60B11	10-02-279
16510-61A01	10-08-898
16510-67JG0-000	10-01-122
16510-73000	10-06-601
16510-73001	10-06-601
16510-73002	10-06-601

16510-73J00-000	10-03-351
16510-79J50	10-ECO058
16510-83000	10-08-800
16510-83001	10-08-800
16510-83011	10-08-800
16510-83012	10-08-800
16510-84CT0	10-08-891
16510-86CA0	10-08-893
16510-87701	10-06-604
16510M68K00	10-02-210
16511-85E00	10-ECO044
16511-85E00-000	10-ECO044
16511-85E10	10-ECO065
28113-1J000	20-0K-K22
31976-43670	30-08-887
59115562	10-ECO010
82 00 033 408	10-08-891
9-88513-107-0	10-09-902
9-88513-107-1	10-09-902
9401906508	30-ECO011
94023895	10-05-599
94023905	20-01-101
94169779	30-03-301
94169779	30-09-906
9451-037-408	30-08-891
95860-51K00	21-SZ-Z09
95860-51K00-000	21-SZ-Z09
95860-62J00	21-SZ-Z08
95860-78F00	21-SZ-Z03
95860-78F10	21-SZ-Z03
95860-80J00	21-SZ-SZ11
95860-80J00-000	21-SZ-SZ11
95861-54G00	21-SZ-Z04
95861-64J00	21-SZ-Z07
95861M68K10	21-SZ-SZ10
99000-04270-2ND	21-SZ-Z05
99000-05050-2ND	21-SZ-Z06
99000-05130	21-SZ-Z02
99000-05130-2ND	21-SZ-Z02
99000-05430	21-SZ-Z01
99000-990YJ-004	20-08-825
TATA (TELCO) ASHIKA	
0009997V001000000	20-M0-002
0249-14-300	10-03-300

CROSS REFERENCE LIST
VERGLEICHLISTE
LISTA DE REFERENCIAS CRUZADES
LISTA DE COMPARAISON
LISTA DI COMPARAZIONE



TATA (TELCO)	ASHIKA
04152-31012	10-02-208
04152-46011	10-02-207
0644-14-300	10-03-300
0K2A5-13-Z40	20-K0-007
253409110117	30-K0-009
2547 0913 0182	20-00-005
2547 1813 0102	10-00-003
2547 1813 0108	10-00-004
2547 1813 0109	10-00-004
2547-0911-0119	30-08-891
2547-0913-0132	20-00-004
2547-0913-0132	20-00-003
2547-0913-0250	20-00-004
2547-0913-0296	20-00-005
2547-1813-108	10-00-004
2547-1813-109	10-00-004
254718130115	10-00-004
278909130106	20-0S-S01
2790 0913 0108	20-00-006
2790 1813 0101	10-00-006
2790 1813 0102	10-00-006
2790 1813 0106	10-00-011
2790-0912-0103	30-08-891
2790-1813-0103	10-00-006
279009130123	20-00-011
9451-037-407	30-00-004
TOYOTA	ASHIKA
04151-31060	10-ECO054
04152-0R010	10-ECO054
04152-31011	10-02-208
04152-31012	10-02-208
04152-31060	10-ECO057
04152-31060	10-ECO054
04152-31110	10-ECO077
04152-37010	10-ECO078
04152-38010	10-ECO054
04152-38020	10-ECO071
04152-46010	10-02-207
04152-46011	10-02-207
0415240060	10-ECO051
04234-48011	30-02-214
04234-48012	30-02-214
08922-02003	10-02-210

08922-02005	10-02-210
08974-00820	21-TY-TY6
08974-00820	21-TY-TY2
08974-00850	21-TY-TY7
15410-61A00	30-02-216
15600-13051	10-02-203
15600-25010	10-02-201
15600-31012	10-02-208
15600-41010	10-02-206
15600-41020	10-02-206
15600-87104	10-02-205
15601-13010	10-02-205
15601-13011	10-02-205
15601-33010	10-02-202
15601-33020	10-02-200
15601-33021	10-02-200
15601-41030	10-02-202
15601-44010	10-02-204
15601-44011	10-02-204
15601-68010	10-02-209
15601-96101	10-02-201
17801 20040	20-02-252
17801 30040	20-02-251
17801-02040	20-00-098
17801-02050	20-00-098
17801-02060	20-07-710
17801-02080	20-02-258
17801-03010	20-02-298
17801-0B010	20-02-296
17801-0B020	20-02-296
17801-0C010	20-02-259
17801-0D010	20-02-283
17801-0D060	20-02-261
17801-0G010	20-02-278
17801-0J020	20-02-288
17801-0N020	20-02-200
17801-0N040	20-02-269
17801-0R010	20-02-253
17801-0R030	20-02-262
17801-0Y010	20-02-286
17801-10030	20-02-226
17801-11050	20-02-285
17801-11060	20-02-243
17801-11070	20-02-250

17801-11080	20-02-297
17801-11090	20-02-250
17801-11100	20-02-226
17801-13010	20-02-205
17801-13030	20-02-225
17801-13050	20-02-232
17801-15010	20-02-207
17801-15060	20-02-240
17801-15070	20-02-249
17801-16010	20-02-236
17801-16020	20-02-239
17801-16040	20-02-239
17801-17010	20-02-271
17801-17020	20-02-271
17801-20010	20-02-208
17801-21011	20-02-205
17801-21020	20-02-256
17801-21030	20-02-286
17801-21050	20-02-261
17801-22010	20-02-203
17801-22020	20-02-283
17801-23010	20-02-205
17801-23020	20-02-208
17801-23030	20-02-288
17801-24010	20-02-203
17801-24020	20-02-202
17801-25010	20-02-201
17801-26010	20-02-255
17801-27010	20-02-277
17801-27020	20-02-278
17801-28010	20-02-284
17801-30030	20-02-292
17801-31010	20-02-201
17801-31050	20-02-246
17801-31058	20-02-246
17801-31060	20-02-230
17801-31060	20-02-213
17801-31060	20-02-208
17801-31090	20-02-266
17801-31120	20-02-257
17801-33040	20-02-279
17801-34010	20-02-204
17801-34060	20-02-204
17801-35020	20-02-299



CROSS REFERENCE LIST
VERGLEICHLISTE
LISTA DE REFERENCIAS CRUZADES
LISTA DE COMPARAISON
LISTA DI COMPARAZIONE

TOYOTA	ASHIKA
17801-37010	20-02-210
17801-37020	20-02-2000
17801-37090	20-02-210
17801-38030	20-02-263
17801-40040	20-02-267
17801-41050	20-02-210
17801-41070	20-02-212
17801-41071	20-02-212
17801-41100	20-02-224
17801-41110	20-02-206
17801-44020	20-02-204
17801-45020	20-02-224
17801-45020	20-02-223
17801-46060	20-02-293
17801-46080	20-02-280
17801-48010	20-02-290
17801-48011	20-02-290
17801-48012	20-02-290
17801-50010	20-02-247
17801-50020	20-02-295
17801-50030	20-02-281
17801-50040	20-02-272
17801-50060	20-02-294
17801-51020	20-02-264
17801-51083	20-02-294
17801-54010	20-09-900
17801-54020	20-06-611
17801-54030	20-09-900
17801-54040	20-02-215
17801-54050	20-02-219
17801-54070	20-02-229
17801-54080	20-02-246
17801-54100	20-02-245
17801-54120	20-02-246
17801-54130	20-02-295
17801-54140	20-02-291
17801-54150	20-02-282
17801-54160	20-02-287
17801-55010	20-02-224
17801-55020	20-02-299
17801-58010	20-02-290
17801-58030	20-02-274
17801-60040	20-02-213

17801-61010	20-02-211
17801-61030	20-02-231
17801-63020	20-02-248
17801-64010	20-02-218
17801-64010	20-02-238
17801-64020	20-02-218
17801-64020	20-02-238
17801-64030	20-02-215
17801-64030	20-02-222
17801-64040	20-02-254
17801-64060	20-02-254
17801-64070	20-02-238
17801-66030	20-02-231
17801-67030	20-02-292
17801-67050	20-02-270
17801-67060	20-02-292
17801-68010	20-02-275
17801-68020	20-02-231
17801-68030	20-02-231
17801-70010	20-02-235
17801-70020	20-02-233
17801-70050	20-02-276
17801-72010	20-02-221
17801-74010	20-02-224
17801-74020	20-02-238
17801-74040	20-02-224
17801-74060	20-02-298
17801-75020	20-02-291
17801-75030	20-02-273
17801-78020	20-02-2004
17801-87207	20-01-102
17801-87303	20-02-246
17801-87304	20-02-246
17801-87716	20-02-224
17801-94050	20-02-246
17801-94059	20-02-246
17801-94232	20-02-246
23030-11014	30-02-204
23030-24010	30-02-212
23030-24011	30-02-212
23030-24030	30-03-302
23030-31030	30-02-210
23030-31040	30-02-210
23030-31050	30-02-210

23030-31051	30-02-210
23030-31060	30-02-210
23030-60030	30-02-206
23030-79025	30-02-224
23300 21010	30-02-234
23300-11050	30-02-225
23300-11060	30-02-225
23300-11070	30-02-225
23300-11080	30-02-225
23300-11090	30-02-225
23300-11100	30-02-225
23300-11150	30-02-239
23300-11150	30-02-292
23300-11190	30-02-224
23300-13020	30-02-225
23300-15010	30-02-220
23300-15020	30-02-225
23300-16010	30-02-225
23300-16021	30-02-225
23300-16330	30-02-288
23300-19025	30-02-224
23300-19055	30-02-224
23300-19065	30-02-293
23300-19065	30-02-222
23300-19095	30-02-224
23300-19145	30-02-225
23300-19165	30-02-224
23300-19225	30-02-224
23300-19295	30-02-235
23300-19325	30-02-242
23300-19415	30-02-224
23300-19425	30-02-224
23300-19465	30-02-224
23300-19515	30-02-225
23300-19535	30-02-288
23300-19535	30-02-224
23300-22020	30-02-236
23300-22040	30-02-244
23300-22050	30-02-244
23300-23040	30-02-284
23300-24020	30-03-302
23300-25011	30-03-302
23300-25020	30-03-302
23300-25050	30-02-221

CROSS REFERENCE LIST
VERGLEICHLISTE
LISTA DE REFERENCIAS CRUZADES
LISTA DE COMPARAISON
LISTA DI COMPARAZIONE



TOYOTA	ASHIKA
23300-25060	30-02-221
23300-26060	30-02-221
23300-28010	30-02-244
23300-28030	30-02-284
23300-28040	30-02-255
23300-31100	30-02-237
23300-34100	30-02-201
23300-35060	30-02-232
23300-38010	30-02-231
23300-39035	30-02-297
23300-41030	30-02-203
23300-41031	30-02-203
23300-43020	30-02-216
23300-44060	30-02-229
23300-49025	30-02-216
23300-49035	30-02-224
23300-49055	30-02-216
23300-49065	30-02-216
23300-49145	30-05-506
23300-49155	30-02-226
23300-49195	30-02-239
23300-49195	30-02-292
23300-50020	30-02-247
23300-50090	30-02-280
23300-53020	30-02-247
23300-56040	30-02-208
23300-62030	30-02-247
23300-62030	30-02-285
23300-69035	30-02-223
23300-69045	30-02-287
23300-74310	30-02-288
23300-74330	30-02-253
23300-75020	30-02-238
23300-75100	30-02-288
23300-79045	30-02-251
23300-79046	30-02-251
23300-79055	30-05-506
23300-79095	30-02-225
23300-79105	30-02-225
23300-79175	30-02-224
23300-79185	30-02-224
23300-79235	30-02-224
23300-79275	30-02-293

23300-79285	30-02-298
23300-79305	30-02-251
23300-79335	30-02-224
23300-79345	30-02-224
23300-79425	30-05-590
23300-79446	30-02-250
23300-79455	30-02-292
23300-79455	30-02-239
23300-79505	30-08-887
23300-87711	30-06-608
23300-87722	30-06-622
23300-87724	30-02-224
23300-87725	30-02-224
23300-87733	30-02-224
23300-87742	30-02-224
23300-87780	30-06-607
23300-87Z01	30-06-622
23303-30011	30-02-211
23303-30012	30-02-211
23303-54010	30-02-208
23303-54011	30-02-208
23303-54071	30-02-208
23303-54072	30-02-208
23303-56030	30-02-208
23303-56031	30-02-208
23303-56040	30-02-248
23303-64010	30-02-215MP
23303-64010	30-02-215
23303-64020	30-02-215
23303-64021	30-02-215
23303-87781	30-06-607
23390-0L010	30-02-200
23390-26140	30-02-256
23390-30180	30-02-215
23390-33010	30-02-295
23390-33020	30-02-295
23390-33060	30-02-295
23390-51020	30-ECO012
23390-64450	30-02-295
23390-64480	30-02-240
31911-34000	30-02-285
4131078	30-02-208
4292431	20-02-246
87139-02020	21-TY-TY9

87139-06080	21-TY-TY9
87139-0D010	21-TY-TY9
87139-0D070	21-TY-TY9
87139-32010	21-TY-TY12
87139-33010	21-TY-TY8
87139-47010-83	21-SB-SB2
87139-48020	21-TY-TY5
87139-50010	21-TY-TY3
87139-50030	21-TY-TY4
87139-52020	21-TY-TY9
87139-YZZ03	21-TY-TY8
87139-YZZ07	21-TY-TY7
87139-YZZ08	21-TY-TY9
88508-0H010	21-TY-TY10
88508-12010	21-TY-TY0
88568-02030	21-TY-TY7
88568-12020	21-TY-TY7
88568-52010	21-TY-TY2
88568-52010-83	21-TY-TY2
88568-74010	21-TY-TY11
88880-20020	21-TY-TY1
88880-20060	21-TY-TY1
9-14215-802-0	20-02-246
90080-91045	10-02-210
90080-91045	10-02-278
90080-91058	10-02-210
90915-03001	10-02-210
90915-03002	10-02-279
90915-03003	10-02-212
90915-03004	10-02-214
90915-03005	10-02-215
90915-03006	10-02-213
90915-10001	10-02-210
90915-10002	10-02-214
90915-10003	10-02-210
90915-10003	10-02-278
90915-10004	10-02-214
90915-20001	10-02-279
90915-20002	10-02-215
90915-20003	10-02-279
90915-20004	10-02-215
90915-30001	10-02-212
90915-30002	10-02-213
90915-30002-8T	10-02-213



TOYOTA	ASHIKA
90915-30003	10-02-297
90915-30003-8T	10-02-297
90915-42207	10-02-278
90915-TA001	10-02-210
90915-TA002	10-02-214
90915-TB001	10-02-279
90915-YZZC7	10-02-278
90915-YZZC7	10-02-210
90915-YZZJ1	10-02-210
90915-YZZJ3	10-02-279
ND186100-1820	30-02-225
SU001-00653	20-03-351
SU001-00696	30-03-351
SU001-00741	10-03-351
SU001-00775	30-03-351
SU001-00794	30-03-351
VOLVO	ASHIKA
1275810	10-ECO033
30 681 552	30-ECO030
30671010	30-ECO031
30792514	30-ECO031
30794824	30-ECO030
31273979	30-ECO030
31336192	30-ECO030
650393	10-05-502
8621645	30-ECO030
8621882	30-ECO031
8642570	10-ECO032
8653668	30-ECO027
VOLVO 1275810	10-ECO033
VW	ASHIKA
021115562A	10-ECO013
03C 115 562	10-ECO092
03C 115 577A	10-ECO092
03D 115 466 A	10-ECO118
03D 198 819	10-ECO118
03D 198 819 A	10-ECO118
03L115466	10-ECO098
03L115562	10-ECO098
045115466	10-ECO023
059115562	10-ECO010
06D115562	10-ECO063
06E 115 466	10-ECO108

06E 115 562	10-ECO108
06E 115 562 A	10-ECO108
074115562	10-ECO008
077 115 561 H	10-ECO086
077 115 562	10-ECO086
17801-54060	20-02-234
1K0 127 177 A	30-ECO034
1K0 127 177 B	30-ECO033
1K0 127 434 A	30-ECO034
1K0 127 434 B	30-ECO033
2E0 127 159	30-ECO032
2E0 127 177	30-ECO032
3C0 127 177	30-ECO024
3C0 127 434	30-ECO024
7L6 127 177 B	30-ECO025
7L6 127 177 C	30-ECO025
7L6 127 434 A	30-ECO035
7L6 127 434 B	30-ECO025
7L6 127 434 C	30-ECO025
90915-03006	10-02-213
90915-30002	10-02-213

Certificate of Registration



The Governing Board of
Q.A. International Certification Limited
hereby grants to:

JAPANPARTS S.r.l.

Registration No. : QAIC / IT / 90039 - A

(hereinafter called the Registered Company) the right to be listed in the Directory of Registered Companies in respect of the services listed below. These services shall be offered by the Registered Company at or from only the address given below in accordance with the quality management system in compliance with ISO 9001:2008.

Address to which this Certificate refers :

Via Della Meccanica, 1/A 37139 VERONA - Italy

Approved Scope to which this Certificate refers
(Scopo della Certificazione cui il Certificato riferisce)

**Commercialisation of Automotive Parts and Accessories
(Commercializzazione di Ricambi per Autoveicoli)**

(Further clarification regarding the Scope of this Certificate and the applicability of ISO 9001:2008 requirements may be obtained by consulting the organisation)

Signed for and on behalf of the Board

CHAIRMAN
A. J. Duffield

SCHEME MANAGER
A. Carter

Certificate Issue Date : 9th February 2012 - Certificate Expiry Date : 24th January 2013
Date of Initial Registration : 25th January 2000 - Re-assessment Date : 24th January 2015
This Certificate of Registration is granted subject to the Regulations approved by the Board.

QA INTERNATIONAL

Q.A. International Certification Ltd.
Dudley Court
Dudley Road
Darlington
Co. Durham
DL1 4GG

Tel: +44 (0)1325 384272
Fax: +44 (0)1325 480980
www.qai.co.uk



The use of the Accreditation Mark indicates accreditation in respect of the activities covered by the accreditation certificate number 045.

Rechtliche Hinweise - Disclaimer - Avvertenze Legali Information juridique - Advertencias/Juridische Informatie



DE Wir haben uns um die weitestgehende Richtigkeit der in diesem Katalog enthaltenen Angaben bemüht. Wir haften indes nicht für eventuelle Unrichtigkeiten. Dieser Katalog enthält Produkte, die dem Erstausstattungsstandard entsprechen. Wir behalten uns jederzeit technische Änderungen vor. Die im Katalog angeführten Originalnummern und Herstellernamen dienen ausschließlich der Identifizierung des Bauteils und sind nicht auf Lieferscheinen und Rechnungen verwendbar. Die vollständige und auch teilweise Reproduktion unserer Referenzangaben und unseres Katalogs ist verboten.

EN We have made every effort to ensure that the data in this catalogue are as accurate as possible. However, we decline all responsibility for any inaccuracies.
This catalogue contains products of "initial equipment" quality. We reserve the right to make technical changes at any time. The original numbers and manufacturers' names mentioned in this catalogue are provided solely to allow identification of the component and may not be used on delivery notes and invoices.
Even partial reproduction of our references and catalogue is forbidden.

I Ci siamo adoperati affinché i dati contenuti in questo catalogo siano i più esatti possibili. Tuttavia decliniamo ogni responsabilità per eventuali inesattezze.
Questo catalogo contiene prodotti di qualità "primo equipaggiamento". Ci riserviamo il diritto di apportare modifiche tecniche in qualsiasi momento. I numeri originali e i nomi dei fabbricanti citati in questo catalogo servono esclusivamente a scopo identificativo del componente e non possono essere utilizzati sulle bolle di accompagnamento e fatture.
La riproduzione, anche parziale dei nostri riferimenti e del nostro catalogo è vietata.

FR Nous avons fait tout notre possible pour que les données de ce catalogue soient exactes. Toutefois, nous déclinons toute responsabilité pour d'éventuelles inexactitudes.
Ce catalogue contient des produits de qualité "équipement standard". Nous nous réservons le droit d'apporter à tout moment des modifications techniques. Les numéros originaux et les noms des fabricants cités dans ce catalogue servent exclusivement à identifier le composant et ne peuvent pas être utilisés sur les bulletins d'accompagnement et les factures.
La reproduction, même partielle, de nos références et de notre catalogue est rigoureusement interdite.

ES Hemos procurado que los datos que figuran en este catálogo sean lo más exactos posible. No obstante declinamos toda responsabilidad por eventuales imprecisiones.
Este catálogo incluye productos de calidad de "equipos de serie". Nos reservamos el derecho de introducir modificaciones técnicas en cualquier momento.
Los números originales y los nombres de los fabricantes citados en este catálogo se ofrecen exclusivamente a efectos de identificación del componente y no podrán ser empleados en las cartas de porte ni en las facturas.
Queda prohibida la reproducción total o parcial de nuestros códigos de referencia y nuestro catálogo.

NL Wij hebben ons ingespannen om ervoor te zorgen dat de gegevens in deze catalogus zo exact mogelijk zouden zijn. Wij kunnen echter niet aansprakelijk worden gesteld voor eventuele onnauwkeurigheden.
Deze catalogus bevat producten van "standaarduitrusting" kwaliteit. Wij behouden ons het recht voor om op ieder gewenst ogenblik technische wijzigingen aan te brengen. De in deze catalogus genoemde oorspronkelijke nummers en namen van de fabrikanten dienen uitsluitend ter identificatie van de component en kunnen niet worden gebruikt op de geleidebrieven en facturen. De, ook gedeeltelijke, reproductie van ons referentiemateriaal en de catalogus is verboden.

I NOSTRI CATALOGHI
OUR CATALOGUES



JA-GENERAL
2012/2013
Catalogo Generale
General Catalog



JA-FRIZIONI
2007
Kit frizione, Spingidisco frizione,
Disco frizione,
Cuscinetto frizione,
Volani, Parte idraulica frizione
*Clutch kits, clutch cover, clutch
disc, clutch bearings, flywheel*



JA-FRENO
2007
Dischi freno, Pastiglie freno,
Ganasce freno, Cilindretti
freno, Tamburi freno,
Pompe freno, Tubi freno
*Brake discs, brake pads,
brake shoes, wheel cylin-
ders, brake drums, brake
master cylinders, brake
hoses*



JA-CINGHIE
2007
Kit cinghie e Tendinghia
trasmissione, Cuscinetti
tendinghia e
Cinghie distribuzione
*Timing kits, tensioners,
timing belts*



JA-MOTORINI
2010/2011
Motorini e Alternatori
nuovi e revisionati
Starters, Alternators



JA-GIUNTI
2008/2009
Kit Giunti omocinetici
con fascetta e grasso
*Cv joint kits with metal clips
and grease*



JA-CAT7MM
2008/2009
Ammortizzatori gas,
Ammortizzatori sterzo
*Gas shock absorbers,
steering dampers*



JA-CAT11
2007
Pompe acqua, Termostati e
Giunti viscostatici
*Water pumps, Thermostates,
Viscous coupling,
Radiator cap*



JA-CAT12
2008/2009
Spazzole tergi
universali anche per
applicazioni europee
Universal wiper blades



JA-TIRANT
2010/2011
Parti sospensione
e Sterzo
*Steering
and suspension parts*



JA-KITRUOTA
2008/2009
Kit Cuscinetti ruote
Wheel bearing kits



JA-CAT17
2007
Candelette
Glowplugs



JA-CROCIERE
2007
Crociere
Universal joints



JA-CUFFIE
2007
Kit Cuffie
Boots Kit



JA-TAMA
2008/2009
Valvola termostatica TAMA
Thermostates TAMA



JA-MMBOOT
Kit protezione
universale per ammortizzatori
in gomma e Uretano
*Bump Rubber Kit
Universal Type*



JA-FLAT
2008/2009
Spazzole tergicristallo
universali FLAT
Universal wiper blades FLAT



JA-FAST MOVING
2009/2010
Tutto il Fast Moving
Asiatico e le ultime novità
*All the Asian Fast Moving
& the new items*



JA-COMMERCIAL
2008/2009
Veicoli commerciali
Commercial vehicles



JA-MBL
2009
Cinghie servizi
MITSUBOSHI
*Automotive Belts
MITSUBOSHI*



JA-KOITO
Gruppi Ottici universali
KOITO
Universal headlamps units



JJ-HKT
2008/2009
Candelette HKT
applicazioni europee
e asiatiche
*HKT glowplugs for
european and asiatic
applications*



JE-FRIZIONI
2012/2013
Frizioni sportive
Racing Exedy
Exedy Racing Clutches



JD-DENSOSONDE
2008/2009
Sonde Lambda DENSO
DENSO oxygen sensors



JD-DENSOMOTO
2008/2009
Candele DENSO moto
DENSO Spark plugs moto



JD-DENSO
2008/2009
Candele DENSO e
Candele IRIIDIUM
*DENSO Spark plugs,
IRIDIUM Spark plugs*



JD-CANDELETTE
2009/2010
Candelette DENSO
DENSO glowplugs



JD-SPAZZOLE
2007/2008
Spazzole Tergi DENSO
DENSO wiper blades



DOWNLOAD PDF CATALOGUES BY OUR WEB SITE
SCARICA I CATALOGHI IN PDF DAL NOSTRO SITO INTERNET



TOKYO · SINGAPORE · SYDNEY · ATLANTA · AMSTERDAM · FRANKFURT · WARSAW · SALZBURG · BRÜSSEL · VERONA · ZÜRICH · KOPENAGHEN

www.ashika.eu

