

1 987 720 228

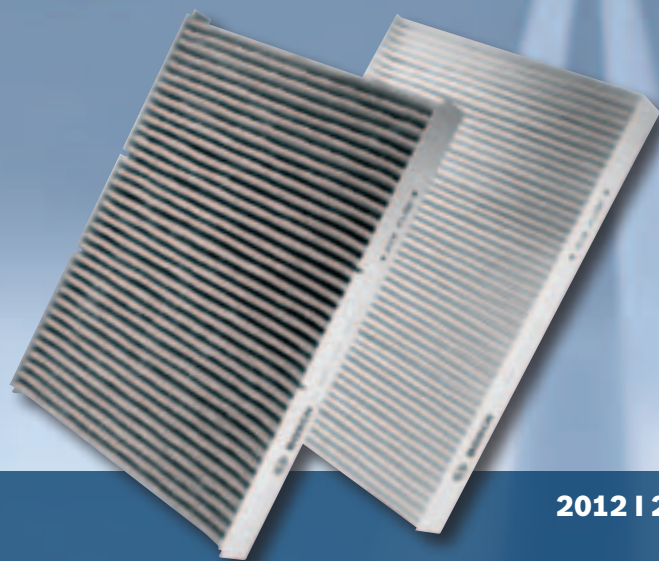

2012 | 2013

2012 | 2013



BOSCH

☎ 1 987 720 023/201205

AA/MK12 - 05.2012 - Int
© 2012 Robert Bosch GmbH
Automotive Aftermarket
Postfach 41 09 60
76225 Karlsruhe

Token fee: € 5,00

www.bosch.de/aa

Editorial closing: 29.02.2012
Subject to change without
notice. Please direct questions
and comments to our Authorized
Representative in your country.
This edition supersedes all
previous editions.



BOSCH



BOSCH





Breathe easy
or
be sneezy



de Wichtig: Innenraumfilterwechsel alle 15.000 km oder spätestens nach einem Jahr

en Important: Replace the cabin filter every 15,000 km or at least once a year

fr Important: Changer le filtre d'habitacle tous les 15 000 km ou chaque année

it Importante: cambiare il filtro abitacolo ogni 15.000 km o al più tardi dopo un anno

es Importante: Cambiar los filtros para el habitáculo cada 15.000 km o, como máximo, una vez al año

pt Importante: Mudança do filtro do habitáculo a cada 15.000 km ou uma vez por ano

nl Belangrijk: Vervanging interieurfilter iedere 15.000 km of uiterlijk na een jaar

cs Důležité: Výměna filtru pro vnitřní prostor po každých 15 000 km nebo nejpозději po jednom roce

ru Важно: Замена салонного фильтра через каждые 15 000 км или не позже, чем через год

tr Önemli: Kabin filtresi, her 15.000 km'de bir veya en geç her yıl değiştirilmelidir

de Das reinste Erfolgsprinzip: Aktivkohle-Innenraumfilter von Bosch

en The purest key to success – Activated carbon cabin filters from Bosch

fr Le secret de la pureté: Le filtre d'habitacle à charbon actif Bosch

it Per il benessere in auto: filtri abitacolo Bosch ai carboni attivi

es La base del éxito más puro: Filtros Bosch de carbón activo para el habitáculo

pt O mais puro princípio do sucesso: Filtro de habitáculo Bosch com carvão activo

nl De sleutel tot succes: interieurfilter met actieve koolstof van Bosch

cs Nejčistší princip úspěchu: Filtr pro vnitřní prostor s aktivním uhlím od společnosti Bosch

ru Чистейший принцип успеха: Салонный фильтр с активированным углем фирмы Bosch

tr Tertemiz bir Başarının prensibi: Bosch'un aktif karbon kabin filtresi



2-7

A



2-29

B



2-62

C





4-336

D



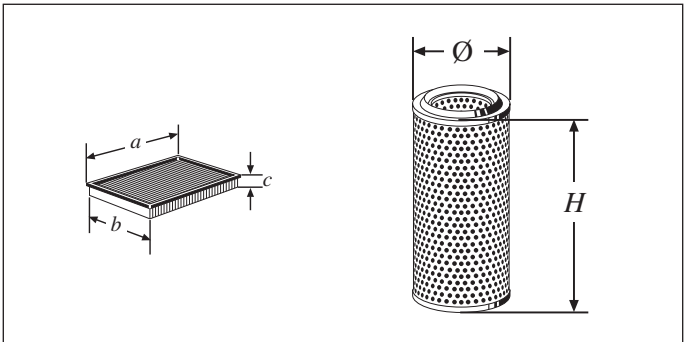
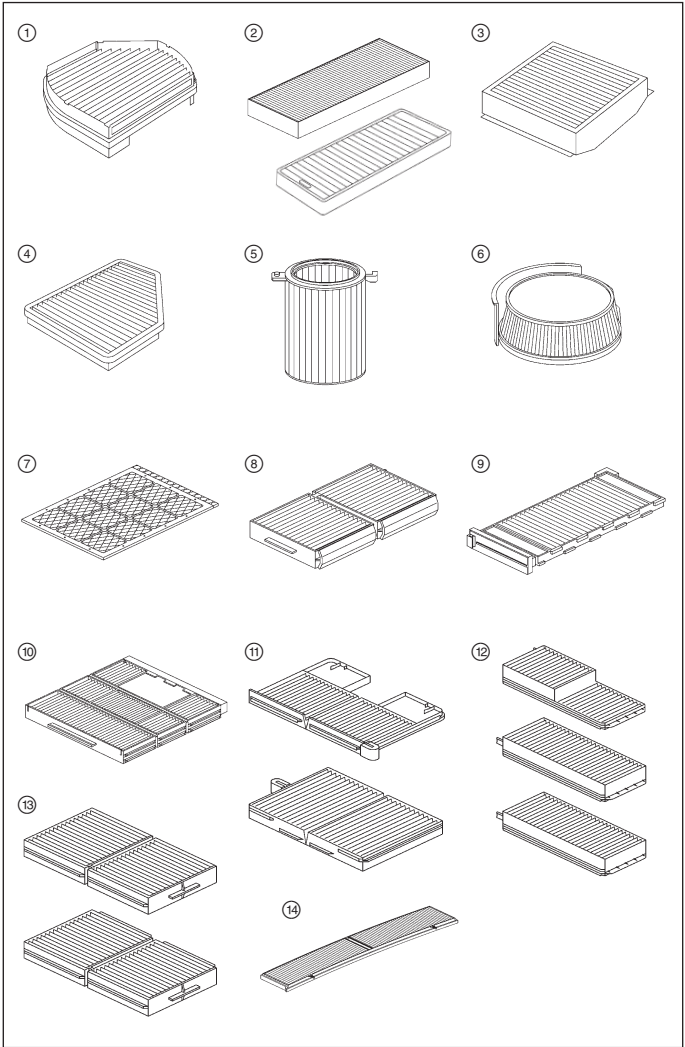

A



	Fig.	a x b x c mm	SC
1987432001	1	275 x 219 x 54	M 2001
1987432002	2	296 x 159 x 26	M 2002
1987432003	2	290 x 160 x 30	M 2003
1987432004	2	240 x 204 x 35	M 2004
1987432006	2	336 x 147 x 27	M 2006
1987432007	2	312 x 156 x 30	M 2007
1987432009	2	292 x 184 x 18	M 2009
1987432010	2	411 x 145 x 18	M 2010
1987432012	2	279 x 206 x 25	M 2012
1987432013	2	261 x 181 x 30	M 2013
1987432014	2	384 x 170 x 17	M 2014
1987432015	2	330 x 201 x 18	M 2015
1987432016	2	290 x 226 x 18	M 2016
1987432017	2	387 x 147 x 33	M 2017
1987432018	2	510 x 100 x 36	M 2018
1987432019	2	309 x 140 x 17	M 2019
1987432020	2	258 x 117 x 40	M 2020
1987432021	2	218 x 211 x 19	M 2021
1987432024	2	312 x 193 x 36	M 2024
1987432026	2	210 x 211 x 30	M 2026
1987432027	4	240 x 181 x 19	M 2027
1987432028	2	536 x 110 x 25	M 2028
1987432030	2	413 x 146 x 25	M 2030
1987432032	2	327 x 163 x 28	M 2032
1987432033	2	346 x 214 x 20	M 2033
1987432034	2	203 x 178 x 40	M 2034
1987432036	2	661 x 95 x 20	M 2036
1987432037	2	354 x 244 x 30	M 2037
1987432038	2	258 x 233 x 30	M 2038
1987432039	2	231 x 160 x 30	M 2039
1987432040	2	292 x 199 x 30	M 2040
1987432041	2	323 x 102 x 30	M 2041
1987432042	2	438 x 144 x 18	M 2042
1987432043	2	366 x 161 x 29	M 2043
1987432044	2	366 x 210 x 28	M 2044
1987432045	2	350 x 160 x 30	M 2045
1987432048	4	337 x 157 x 30	M 2048
1987432049	2	184 x 181 x 30	M 2049
1987432050	4	240 x 185 x 19	M 2050
1987432051	2	372 x 73 x 24	M 2051
1987432052	2	230 x 110 x 60	M 2052
1987432053	2	222 x 199 x 30	M 2053
1987432055	2	250 x 172 x 20	M 2055
1987432056	5	102 x 168	M 2056
1987432057	2	252 x 216 x 32	M 2057
1987432058	2	250 x 193 x 20	M 2058
1987432059	2	265 x 160 x 30	M 2059
1987432060	2	184 x 92 x 34	M 2060
1987432061	2	238 x 169 x 40	M 2061
1987432062	2	253 x 160 x 30	M 2062
1987432063	2	202 x 220 x 21	M 2063
1987432064	2	270 x 240 x 25	M 2064
1987432065	2	250 x 235 x 25	M 2065
1987432066	2	230 x 191 x 34	M 2066
1987432068	2	232 x 246 x 32	M 2068
1987432069	2	228 x 195 x 30	M 2069
1987432070	4	332 x 189 x 25	M 2070
1987432071	2	300 x 205 x 30	M 2071
1987432072	2	215 x 165 x 25	M 2072
1987432073	2	509 x 101 x 35	M 2073
1987432075	2	221 x 201 x 30	M 2075
1987432076	2	331 x 165 x 30	M 2076

	Fig.	a x b x c mm	SC
1987432077	2	267 x 198 x 21	M 2077
1987432078	2	240 x 108 x 20	M 2078
1987432079	2	285 x 175 x 36	M 2079
1987432080	2	210 x 208 x 30	M 2080
1987432081	4	310 x 258 x 34	M 2081
1987432082	2	460 x 118 x 30	M 2082
1987432083	2	220 x 224 x 33	M 2083
1987432084	2	206 x 186 x 17	M 2084
1987432085	2	206 x 206 x 17	M 2085
1987432086	9	225 x 213 x 25	M 2086
1987432087	2	240 x 190 x 34	M 2087
1987432088	2	219 x 200 x 20	M 2088
1987432089	2	257 x 230 x 20	M 2089
1987432090	2	234 x 223 x 18	M 2090
1987432091	2	405 x 164 x 33	M 2091
1987432092	2	196 x 216 x 25	M 2092
1987432093	2	261 x 187 x 41	M 2093
1987432094	3	239 x 238 x 47	M 2094
1987432096	2	441 x 126 x 30	M 2096
1987432097	4	211 x 272 x 33	M 2097
1987432100	2	372 x 142 x 39	M 2100
1987432102	2	316 x 170 x 30	M 2102
1987432103	2	314 x 164 x 30	M 2103
1987432104	6	73 x 164	M 2104
1987432106	2	203 x 178 x 17	M 2106
1987432109	2	240 x 209 x 35	M 2109
1987432111	2	212 x 243 x 30	M 2111
1987432113	2	235 x 209 x 35	M 2113
1987432114	2	278 x 219 x 30	M 2114
1987432115	3	178 x 183 x 28	M 2115
1987432116	3	244 x 219 x 75	M 2116
1987432117	8	198 x 108 x 22	M 2117
1987432118	9	244 x 102 x 24	M 2118
1987432119	3	242 x 205 x 21	M 2119
1987432120	3	226 x 189 x 43	M 2120
1987432121	2	222 x 198 x 30	M 2121
1987432122	2	297 x 99 x 30	M 2122
1987432124	14	832 x 123 x 20	M 2124
1987432132	2	287 x 81 x 19	M 2132
1987432133	3	218 x 200 x 30	M 2133
1987432136	2	201 x 157 x 30	M 2136
1987432137	2	290 x 96 x 30	M 2137
1987432148	2	162 x 192 x 20	M 2148
1987432154	2	120 x 114 x 10	M 2154
1987432155	10	197 x 200 x 20	M 2155
1987432156	12	213 x 108 x 17	M 2156
1987432157	2	187 x 156 x 42	M 2157
1987432158	11	227 x 263 x 34	M 2158
1987432160	2	248 x 194 x 38	M 2160
1987432161	12	239 x 196 x 12	M 2161
1987432163	12	216 x 173 x 22	M 2163
1987432164	11	174 x 175 x 12	M 2164
1987432166	3	224 x 234 x 30	M 2166
1987432167	3	181 x 93 x 29	M 2167
1987432169	2	217 x 196 x 25	M 2169
1987432170	3	227 x 201 x 17	M 2170
1987432171	3	189 x 196 x 10	M 2171
1987432172	3	199 x 178 x 17	M 2172
1987432173	3	178 x 186 x 30	M 2173
1987432179	9	222 x 204 x 12	M 2179
1987432182	2	386 x 248 x 30	M 2182
1987432183	3	257 x 164 x 21	M 2183

	Fig.	a x b x c mm	SC
1987432184	3	224 x 114 x 30	M 2184
1987432188	3	219 x 265 x 21	M 2188
1987432189	9	215 x 149 x 43	M 2189
1987432190	2	192 x 213 x 30	M 2190
1987432192	3	355 x 129 x 25	M 2192
1987432193	5	179 x 145	M 2193
1987432194	2	260 x 100 x 25	M 2194
1987432195	2	347 x 206 x 33	M 2195
1987432197	2	260 x 130 x 30	R 2197
1987432198	2	346 x 160 x 75	M 2198
1987432200	2	315 x 153 x 34	M 2177
1987432203	3	240 x 198 x 30	M 2203
1987432204	2	238 x 197 x 20	M 2204
1987432205	3	272 x 196 x 35	M 2205
1987432206	2	376 x 176 x 48	M 2206
1987432208	2	330 x 192 x 45	M 2208
1987432209	9	250 x 90 x 17	M 2209
1987432210	9	273 x 167 x 30	M 2210
1987432211	2	230 x 103 x 20	M 2211
1987432213	2	354 x 235 x 15	M 2213
1987432214	3	200 x 142 x 30	M 2214
1987432215	2	236 x 191 x 22	M 2215
1987432216	2	216 x 200 x 30	M 2216
1987432218	10	219 x 173 x 20	M 2218
1987432219	2	293 x 138 x 34	M 2219
1987432220	2	225 x 111 x 30	M 2220
1987432221	2	257 x 198 x 36	M 2221
1987432222	2	275 x 202 x 26	M 2222
1987432223	2	189 x 223 x 25	M 2223
1987432224	2	235 x 187 x 19	M 2224
1987432225	3	285 x 202 x 19	M 2225
1987432226	2	227 x 235 x 6	M 2226
1987432227	2	220 x 250 x 30	M 2227
1987432228	2	200 x 178 x 30	M 2228
1987432229	2	258 x 203 x 25	M 2229
1987432230	2	252 x 154 x 35	M 2230
1987432231	2	243 x 203 x 19	M 2231
1987432232	2	275 x 183 x 29	M 2232
1987432234	2	253 x 190 x 30	M 2234
1987432235	3	270 x 159 x 30	M 2235
1987432236	2	202 x 270 x 20	M 2236
1987432238	2	265 x 190 x 20	M 2238
1987432239	8	275 x 82 x 24	M 2239
1987432240	2	252 x 202 x 31	M 2240
1987432241	2	236 x 198 x 19	M 2241
1987432270	2	332 x 189 x 25	M 2270
1987432281	4	310 x 257 x 35	M 2281
1987432296	2	449 x 120 x 32	M 2296
1987432299	2	214 x 214 x 25	M 2299
1987432300	2	282 x 206 x 30	R 2300
1987432301	1	259 x 203 x 54	R 2301
1987432303	2	288 x 160 x 30	R 2303
1987432304	2	240 x 204 x 35	R 2304
1987432306	2	344 x 150 x 30	R 2306
1987432307	2	315 x 156 x 30	R 2307
1987432308	2	240 x 190 x 20	R 2308
1987432309	2	254 x 134 x 41	R 2309
1987432310	2	408 x 143 x 18	R 2310
1987432311	2	270 x 196 x 32	R 2311
1987432312	2	280 x 206 x 25	R 2312
1987432313	2	258 x 181 x 30	R 2313
1987432315	2	245 x 206 x 32	R 2315

	Fig.	a x b x c mm	SC
1987432317	2	387 x 147 x 33	R 2317
1987432318	2	510 x 103 x 30	R 2318
1987432319	2	215 x 230 x 30	R 2319
1987432320	2	215 x 207 x 19	R 2320
1987432324	2	310 x 194 x 30	R 2324
1987432326	1	260 x 246 x 44	R 2326
1987432327	2	257 x 157 x 35	R 2327
1987432328	2	536 x 111 x 30	R 2328
1987432330	2	412 x 142 x 25	R 2330
1987432333	2	346 x 214 x 20	R 2333
1987432336	2	661 x 95 x 20	R 2336
1987432337	2	353 x 241 x 36	R 2337
1987432343	2	366 x 161 x 29	R 2343
1987432345	2	348 x 164 x 30	R 2345
1987432348	4	337 x 157 x 30	R 2348
1987432354	2	255 x 200 x 30	R 2354
1987432357	2	246 x 216 x 32	R 2357
1987432361	2	253 x 190 x 30	R 2361
1987432362	2	358 x 165 x 30	R 2362
1987432363	2	202 x 220 x 21	R 2363
1987432364	2	226 x 207 x 40	R 2364
1987432365	4	222 x 207 x 30	R 2365
1987432368	2	232 x 246 x 32	R 2368
1987432369	4	278 x 143 x 36	R 2369
1987432370	4	332 x 189 x 25	R 2370
1987432371	2	300 x 205 x 30	R 2371
1987432373	2	509 x 99 x 35	R 2373
1987432376	2	331 x 165 x 30	R 2376
1987432377	2	232 x 182 x 21	R 2377
1987432378	2	198 x 202 x 40	R 2378
1987432379	2	285 x 178 x 36	R 2379
1987432380	2	210 x 208 x 30	R 2380
1987432381	4	310 x 258 x 34	R 2381
1987432382	2	460 x 118 x 30	R 2382
1987432383	2	220 x 224 x 33	R 2383
1987432386	2	174 x 138 x 30	R 2386
1987432387	2	240 x 190 x 35	R 2387
1987432389	2	257 x 230 x 20	R 2389
1987432390	2	234 x 223 x 18	R 2390
1987432391	2	405 x 164 x 33	R 2391
1987432393	2	261 x 187 x 41	R 2393
1987432394	3	239 x 238 x 47	R 2394
1987432397	4	211 x 272 x 33	R 2397
1987432398	2	346 x 160 x 75	R 2398
1987432399	2	503 x 141 x 38	R 2399
1987432400	2	372 x 142 x 39	R 2400
1987432401	3	316 x 190 x 56	R 2401
1987432402	2	317 x 180 x 30	R 2402
1987432405	3	272 x 196 x 32	R 2405
1987432406	2	376 x 176 x 48	R 2406
1987432407	2	315 x 153 x 34	R 2407
1987432409	2	240 x 209 x 35	R 2409
1987432410	2	394 x 184 x 32	R 2410
1987432411	2	243 x 212 x 30	R 2411
1987432412	2	315 x 150 x 40	R 2412
1987432413	2	231 x 209 x 35	R 2413
1987432415	2	236 x 190 x 22	R 2415
1987432416	2	216 x 200 x 30	R 2416
1987432419	2	303 x 144 x 34	R 2419
1987432422	2	297 x 99 x 30	R 2422
1987432423	1	406 x 213 x 58	R 2423
1987432424	14	832 x 122 x 20	R 2424

	Fig.	a x b x c mm	SC
1987432425	2	521 x 238 x 30	R 2425
1987432426	1	216 x 199 x 30	R 2426
1987432428	3	259 x 183 x 45	R 2428
1987432431	3	275 x 219 x 30	R 2431
1987432433	3	218 x 200 x 30	R 2433
1987432434	2	203 x 178 x 40	R 2434
1987432435	3	165 x 216 x 40	R 2435
1987432436	2	205 x 159 x 32	R 2436
1987432437	2	290 x 96 x 30	R 2437
1987432438	2	262 x 184 x 31	R 2438
1987432464	2	270 x 240 x 25	R 2464
1987432468	3	214 x 227 x 17	R 2468
1987432469	2	228 x 195 x 30	R 2469
1987432482	12	398 x 275 x 33	R 2482
1987432488	3	219 x 265 x 21	R 2488
1987432495	2	347 x 208 x 33	R 2495
1987432497	2	310 x 236 x 23	R 2497
1987432498	9	216 x 214 x 45	R 2498
1987432499	2	214 x 214 x 26	R 2499
1987432500	2	266 x 133 x 30	R 2500
1987432512	3	201 x 175 x 40	R 2512
1987432513	2	354 x 235 x 15	R 2513
1987432525	3	285 x 178 x 19	R 2525
1987432531	2	243 x 203 x 19	R 2531
1987432533	3	200 x 216 x 46	R 2533
1987432535	3	270 x 159 x 30	R 2535
1987432570	2	332 x 189 x 25	R 2570
1987432597	4	272 x 144 x 34	R 2597

A

de

Benutzerhinweise

In diesem Katalog sind die Daten von Fahrzeugen, Motoren und Geräten für den europäischen Markt von Baujahr 1991 bis einschließlich 2011 erfasst. Diese wurden aus Hersteller- und Importeurangaben, aus Fahrzeuguntersuchungen sowie aus Unterlagen von Bosch nach bestem Wissen sorgfältig zusammengestellt und geben den Stand zum Zeitpunkt der Drucklegung wieder.

Zwangsläufige Abweichungen durch länderspezifische technische Änderungen können nie ganz ausgeschlossen werden. Bosch kann daher insoweit nicht für die Vollständigkeit und Fehlerfreiheit der Daten haften. Für Irrtümer und Druckfehler, die zu Schäden am Eigentum oder Vermögen führen, haftet Bosch nur bei grob fahrlässiger Pflichtverletzung und bei Vorsatz für unmittelbare Schäden. Bei Personenschäden haftet Bosch auch bei leichter Fahrlässigkeit.

fr

A l'attention de l'utilisateur

Le présent catalogue mentionne les données spécifiques de véhicules, moteurs et appareils pour le marché européen depuis l'année de fabrication 1991 jusqu'au millésime 2011 inclus. Ces informations ont été rassemblées soigneusement et en toute impartialité à partir des indications des constructeurs et importateurs, des contrôles techniques des véhicules et de la documentation Bosch, et matérialisent le stade des connaissances au moment de la mise sous presse.

Il n'est jamais possible d'exclure totalement les divergences éventuelles dues aux modifications techniques, spécifiques des différents pays considérés. En aucun cas, Bosch n'engage sa responsabilité en ce qui concerne l'intégralité et l'exactitude des données. En ce qui concerne les erreurs et les fautes d'impression, qui peuvent entraîner des dommages à la propriété ou à la fortune, Bosch n'engage sa responsabilité pour les dommages directs qu'en cas d'atteinte et de négligence graves et intentionnelles envers ses obligations. En cas de dommages causés aux personnes, Bosch engage sa responsabilité aussi en cas de légère négligence.

en

Notes for users

This catalog contains the data from the vehicles, engines, and equipment for the European market from year of manufacture 1991 up to and including the year 2011. This data has been assembled from information provided by manufacturers and importers, and taken from Bosch documentation, as well as from investigations made on vehicles. It has been compiled to the best of our knowledge and belief, and reflects the status at the date of going to print.

It is impossible to avoid deviations caused by technical changes resulting from the conditions and regulations applying in a particular country. Bosch can therefore accept no liability for the completeness and faultlessness of the data. In case of mistakes and misprints which result in damage to property or assets, Bosch is only liable for immediate damages insofar as a gross breach of duty or wrongful intent apply. If personal injury is involved, Bosch is liable also in case of ordinary negligence.

it

Avvertenze per la consultazione

Nella seguente parte di catalogo sono contemplati veicoli, motori ed apparecchi a partire dall'anno di costruzione 1991 fino all'anno 2011. Tali informazioni sono state rilevate dalle documentazioni di Case Auto, Importatori, da verifiche eseguite sui veicoli, così come da documentazione Bosch.

Eventuali discordanze dovute a specifiche esigenze del Paese e variazioni tecniche non possono essere previste. Per questo Bosch non si assume alcuna responsabilità per mancanze ed eventuali errori riferite ai dati. Per danni a cose o danni patrimoniali, dovuti ad errori o refusi di stampa, Bosch è responsabile solo in caso di dolo o colpa grave. Per danni alla persona, Bosch è responsabile anche in caso di colpa meno grave.

es

Avertencia al usuario

Los datos recogidos en este catálogo para vehículos, motores y maquinaria del mercado europeo abarcan los años de fabricación entre 1991 y 2011, inclusive. Estos datos han sido recogidos del fondo documental de Bosch, así como de las inspecciones de vehículos, datos de fabricantes e importadores.

No obstante, y debido al cuantioso material de información, no se puede excluir la posibilidad de modificaciones, diferencias propias de aplicaciones específicas de los países, fallos, equivocaciones o errores. En caso de inexactitudes y errores de imprenta, la responsabilidad de Bosch se limita al daño inmediato, con posibles perjuicios patrimoniales, a no ser que el daño previsible y típico del contrato sea de mayor cuantía o se deba a dolo o culpa intencionada o a negligencia grave.

pt

Instruções para o utilizador

Este catálogo abrange os dados de veículos, motores e aparelhos para o mercado europeu, fabricados entre 1991 e 2011, inclusive. Estes mesmos dados foram recolhidos conscienciosamente a partir de indicações de fabricantes e importadores, inspeções a veículos e documentos da Bosch e reflectem o estado da técnica por altura da ida para a tipografia.

Não é, de todo, possível excluir a existência de discrepâncias decorrentes de alterações técnicas específicas dos diversos países. Nesta medida, a Bosch não pode garantir que os dados sejam completos e isentos de erros. A Bosch não se responsabiliza por erros, omissões e erros de impressão, que conduzam a perdas e danos, excepto nos casos de danos resultantes directamente de negligência grave ou dolo. Em caso de danos pessoais, a Bosch responsabilizase também por danos resultantes de negligência simples.

nl

Gebruikersinstructies

In deze catalogus zijn de gegevens van voertuigen, motoren en apparaten voor de Europese markt vanaf bouwjaar 1991 tot en met bouwjaar 2011 opgenomen. Deze zijn naar eer en geweten zorgvuldig samengesteld uit fabrikanten- en importeursgegevens, voertuigonderzoek alsmede informatie van Bosch en geven de stand op het tijdstip van publicatie weer.

Landspecifieke afwijkingen zijn echter onvermijdelijk en niet geheel uit te sluiten. Derhalve kan Bosch niet verantwoordelijk worden gehouden voor de volledigheid en het foutloos zijn van deze gegevens. Indien aperte onjuistheden of drukfouten leiden tot directe vermogensschade of directe schade aan eigendommen is Bosch slechts aansprakelijk in geval van grove nalatigheid of opzettelijk handelen. Indien aperte onjuistheden of drukfouten leiden tot letselschade is Bosch aansprakelijk in geval van toerekenbare tekortkoming, die zowel verwijtbaar is als voor haar risico komt.

tr

Kullanıcı Talimatı

Bu katalogta, Avrupa pazarında satılmak üzere yapım yılı 1991 ila 2011 arası olan araçlar, motorlar ve cihazlar ele alınmaktadır. Bu bilgiler, üretici ve ithalatçı kuruluşun verileri, araç muayeneleri ve Bosch firmasının belgeleri doğrultusunda özenli bir şekilde derlenmiştir ve katalogun baskı tarihindeki teknik gelişmeleri yansıtmaktadır.

Ülkeye özgü teknik değişikliklerden kaynaklanan kaçınılmaz bazı sapmaların tamamen bertaraf edilmesi mümkün değildir. Bu nedenle Bosch, verilerin eksiksiz ve doğru olduğu konusunda sorumlu addedilemez. Bosch, maddi hasara neden olan yanlışlık veya baskı hataları hususundan, sadece yükümlülüklerin ihlalinde büyük oranda ihmalkar davranmış ve doğrudan hasarda kasıt söz konusu ise sorumlu tutulabilir. Şahsi yaralanma hallerinde ise Bosch, küçük bir ihmalkarlık durumunda dahi yükümlülük altındadır.

cs

Pokyny pro uživatele

V tomto katalogu jsou obsaženy údaje vozidel, motorů a přístrojů pro evropský trh od roku výroby 1991 do roku 2011 včetně. Tyto údaje byly pečlivě sestaveny podle nejlepšího vědomí z údajů výrobců a dovozců automobilů a zachycují stav k datu předání do tisku.

Odchytky, způsobené technickými změnami specifickými pro některé země, není možné vyloučit. Proto nemůže firma Bosch ručit za úplnost a bezchybnost těchto údajů. Za omyly a chyby tisku, které by způsobily škodu na vlastnictví nebo majetku, ručí firma Bosch jen v případě hrubého a nedbalého porušení povinností a úmyslu bezprostřední škody. Pokud by měly za následek škody na zdraví osob, nese firma Bosch odpovědnost i v případě mírné nedbalosti.

ru

Вниманию пользователей

В настоящем каталоге приводятся данные по автомобилям, двигателям и прочему оборудованию на европейском рынке с 1991 по 2011 год выпуска включительно. Они были тщательно подобраны из информации, предоставленной производителями и импортерами, по результатам тестирования автомобилей, а также из документации компании Bosch и отражают состояние на момент подписания в печать.

Неизбежные расхождения из-за специфических для каждой страны технических модификаций не могут быть полностью исключены. Поэтому компания Bosch не несет ответственность за полноту и точность предоставленных данных. В случае, если ошибки или опечатки привели к ущербу для собственности или повлекли материальные затраты, компания Bosch принимает на себя ответственность только если это является преднамеренным вредом или грубой небрежностью со стороны фирмы Bosch. Если по! страдало физическое лицо, фирма Bosch несет ответственность даже при допущении незначительной небрежности.

B



SC



SC



1987...

1987...

ALFA ROMEO







Brera	[939]	01.06→		432 133	M 2133	432 433	R 2433	D 170
		05.09→	MKL					
GT	[937]	10.03→	2FE			432 386	R 2386	D 306
GTV	[916]	05.98-12.05	KL	432 014	M 2014			D 28
Mito	[145]	08.08→		432 188	M 2188			D 213
Spider	[916]	04.95-02.06	KL	432 014	M 2014			D 28
		03.06-12.10		432 133	M 2133	432 433	R 2433	D 170
145	[930]	04.94-12.00	KL	432 014	M 2014			D 28
146	[930]	12.94-12.00	KL	432 014	M 2014			D 28
147	[937]	11.00-12.10	2FE			432 386	R 2386	D 306
155	[167]	01.93-10.97	KL	432 014	M 2014			D 28
156 Berlina	[932]	10.97-12.01	LLE	432 003	M 2003	432 303	R 2303	D 8
156 Berlina		01.02-10.05	2FE,TW			432 386	R 2386	D 306
156 Cross Wagon Q4	[932]	10.04-12.05	2FE,TW			432 386	R 2386	D 306
156 Sport Wagon	[932]	06.00-12.01	LLE	432 003	M 2003	432 303	R 2303	D 8
156 Sport Wagon		01.02-12.05	2FE,TW			432 386	R 2386	D 306
156 Sport Wagon Q4	[932]	10.04-12.05	2FE,TW			432 386	R 2386	D 306
159	[939..]	06.10→	KL	432 133	M 2133			D 170
			MKL		432 433	R 2433	D 170	
159 Berlina	[939]	06.05-12.10	KL	432 133	M 2133			D 170
			MKL		432 433	R 2433	D 170	
159 Berlina Q4	[939]	01.06-12.08	KL	432 133	M 2133			D 170
			MKL		432 433	R 2433	D 170	
159 Sport Wagon	[939]	03.06→	KL	432 133	M 2133			D 170
			MKL		432 433	R 2433	D 170	
159 Sport Wagon Q4	[939]	03.06-12.08	KL	432 133	M 2133			D 170
			MKL		432 433	R 2433	D 170	
164	[164]	03.91-10.98	KL	432 005	M 2005			D 170
166	[936]	10.98-10.07	KL			432 360	R 2360	

ALPINA (B. BOVENSIEPEN KG)

B 7	[E 65,E 66]	12.03-06.08	2FE	432 103	M 2103			D 140
-----	-------------	-------------	-----	---------	--------	--	--	-------

AUDI

A1	[8X1]	05.10-06.10		432 057	M 2057	432 357	R 2357	
A2	[8Z0]	09.99-08.05		432 057	M 2057	432 357	R 2357	D 83
A3	[8L1]	09.96-06.03	H25	432 012	M 2012	432 312	R 2312	D 21
			H30		432 300	R 2300	D 21	
		05.03→	LLE	432 097	M 2097	432 397	R 2397	D 134
			RLE			432 597	R 2597	D 334
A3 Cabriolet	[8P7]	04.08→	LLE	432 097	M 2097	432 397	R 2397	D 134
			RLE		432 597	R 2597	D 334	
A3 Sportback	[8PA]	09.04→	LLE	432 097	M 2097	432 397	R 2397	D 134
			RLE		432 597	R 2597	D 334	

						SC		SC	
							1987...	1987...	
A4	[8D2, B5]	11.94-12.01		432 017	M 2017		432 317	R 2317	D 36
	[8E2, B6]	10.00-08.08		432 071	M 2071		432 371	R 2371	D 99
	[8EC, B7]	11.04-06.08	LLE	432 071	M 2071		432 371	R 2371	D 99
	[8K2, B8]	11.07→					432 369	R 2369	D 302
A4 Avant	[8D5, B5]	11.94-09.01		432 017	M 2017		432 317	R 2317	D 36
	[8E5, B6]	09.01-12.04		432 071	M 2071		432 371	R 2371	D 99
	[8ED, B7]	11.04-06.08	LLE	432 071	M 2071		432 371	R 2371	D 99
	[8K5, B8]	11.07→					432 369	R 2369	D 302
A4 Avant Allroad	[8KH]	04.09→					432 369	R 2369	D 302
A4 Cabriolet	[8H7, B6]	04.02-06.06		432 071	M 2071		432 371	R 2371	D 99
	[8HE, B7]	11.05-03.09		432 071	M 2071		432 371	R 2371	D 99
A5 Cabriolet	[8F7]	03.09→					432 369	R 2369	D 302
A5 Coupé	[8T3]	06.07→					432 369	R 2369	D 302
A5 Sportback	[8TA]	05.09→					432 369	R 2369	D 302
A6	[4A2, C4]	06.94-12.97	KL, LLE	432 033	M 2033		432 333	R 2333	D 56
			KL, LLE	432 024	M 2024		432 324	R 2324	D 47
	[4B2, C5]	04.97-07.99					432 324	R 2324	D 47
		11.98-05.04		432 071	M 2071		432 371	R 2371	D 99
	[4B4, C5]	04.99-07.04					432 371	R 2371	D 99
	[4F2, C6]	04.04→		432 122	M 2122		432 422	R 2422	D 165
A6 Avant	[4A5, C4]	06.94-12.98	KL, LLE	432 033	M 2033		432 333	R 2333	D 56
			KL	432 024	M 2024		432 324	R 2324	D 47
	[4B5, C5]	04.97-04.01					432 324	R 2324	D 47
	[4B5, C5]	11.98-01.05		432 071	M 2071		432 371	R 2371	D 99
	[4F5, C6]	03.05→		432 122	M 2122		432 422	R 2422	D 165
A6 Avant Allroad	[4BH, C5]	05.00-08.05					432 371	R 2371	
	[4FH, C6]	05.06→		432 122	M 2122		432 422	R 2422	D 165
A8	[4D2, D2]	06.94-09.02	ZE				432 367	R 2367	
	[4E, D3]	11.02-07.10					432 423	R 2423	D 314
Cabriolet	[8G7, B4]	06.91-08.00		432 017	M 2017		432 317	R 2317	D 36
Coupé	[89, B3]	08.91-12.95		432 017	M 2017		432 317	R 2317	D 36
Q3	[8UB]	06.11→	LLE	432 097	M 2097		432 397	R 2397	D 134
			RLE				432 597	R 2597	
Q5	[8RB]	11.08→					432 369	R 2369	D 302
Q7	[4LB]	03.06→					432 431	R 2431	D 320
RS3	[8PA]	01.11→	LLE				432 397	R 2397	D 134
			RLE				432 597	R 2597	
Sportback							432 597	R 2597	
RS4	[8EC, B7]	11.05-06.08		432 071	M 2071		432 371	R 2371	D 99
RS4 Avant	[8D5, B5]	05.00-09.01		432 017	M 2017				D 36
	[8ED, B7]	05.06-06.08		432 071	M 2071		432 371	R 2371	D 99
RS4 Cabriolet	[8HE, B7]	05.06-01.08		432 071	M 2071		432 371	R 2371	D 99
RS5 Coupé	[8T3]	03.10→					432 369	R 2369	D 302
RS6	[4B4]	07.02-04.04					432 371	R 2371	
RS6 Avant	[4B6]	05.02-09.04					432 371	R 2371	
R8	[422]	11.10→		432 122	M 2122		432 422	R 2422	
	[423; 429]	04.07→					432 422	R 2422	
S3	[8L1]	08.98-06.03	H25				432 312	R 2312	D 21
			H30				432 300	R 2300	D 21
	[8P1]	11.06→	LLE	432 097	M 2097		432 397	R 2397	D 134
			RLE				432 597	R 2597	
S3 Sportback	[8PA]	07.08→	LLE	432 097	M 2097		432 397	R 2397	D 134
			RLE				432 597	R 2597	
S4	[4A2, C4]	07.92-07.94	ZNE	432 024	M 2024		432 324	R 2324	
	[8D2, B5]	10.97-09.01		432 017	M 2017				D 36



◀ AUDI		1987...		1987...	
S4	[8E2, B6]	03.03-12.04	432 071	M 2071	432 371 R 2371 D 99
	[8EC, B7]	11.04-06.08 LLE	432 071	M 2071	432 371 R 2371 D 99
	[8K2, B8]	03.09→			432 369 R 2369 D 302
S4 Avant	[8D5, B5]	10.97-09.01	432 017	M 2017	D 36
	[8E5, B6]	03.03-12.04	432 071	M 2071	432 371 R 2371 D 99
	[8ED, B7]	11.04-06.08 LLE	432 071	M 2071	432 371 R 2371 D 99
	[8K5, B8]	03.09→			432 369 R 2369 D 302
S4 Cabriolet	[8HE, B7]	01.06-03.09	432 071	M 2071	432 371 R 2371 D 99
	[8H7, B7]	02.04-06.06 LLE	432 071	M 2071	432 371 R 2371 D 99
	[8F7]	05.09→			432 369 R 2369 D 302
S5 Coupé	[8T3]	06.07→			432 369 R 2369 D 302
S5 Sportback	[8TA]	01.10→			432 369 R 2369 D 302
S6	[4A2, C4]	06.94-10.97 KL	432 033	M 2033	432 333 R 2333 D 56
		KL	432 024	M 2024	432 324 R 2324 D 47
	[4B4, C5]	09.99-05.04			432 371 R 2371 D 99
	[4F2, C6]	06.06-08.11			432 422 R 2422 D 165
S6 Avant	[4A5, C4]	06.94-10.97 KL	432 033	M 2033	432 333 R 2333 D 56
		KL	432 024	M 2024	432 324 R 2324 D 47
	[4B6, C5]	09.99-01.05			432 371 R 2371 D 99
	[4F5, C6]	06.06→			432 422 R 2422 D 165
S8	[4D2]	09.96-09.02 ZE			432 367 R 2367
	[4E2]	06.06-07.10			432 423 R 2423 D 314
TT Coupé	[8J3]	07.06→ LLE			432 397 R 2397 D 134
		RLE			432 597 R 2597 D 334
	[8N3]	07.98-09.00	432 012	M 2012	
		09.00-06.06			432 300 R 2300
TT Roadster	[8J9]	02.07→ LLE			432 397 R 2397 D 134
		RLE			432 597 R 2597 D 334
	[8N9]	03.99-09.00	432 012	M 2012	
		09.00-06.06			432 300 R 2300
TT RS Coupé	[8J3]	07.09→ LLE			432 397 R 2397 D 134
		RLE			432 597 R 2597 D 334
TT RS Roadster	[8J9]	07.09→ LLE			432 397 R 2397 D 134
		RLE			432 597 R 2597 D 334
TTS Coupé	[8J3]	05.08→ LLE			432 397 R 2397 D 134
		RLE			432 597 R 2597 D 334
TTS Roadster	[8J9]	05.08→			432 397 R 2397 D 134
					432 597 R 2597 D 334
100	[4A2, C4]	01.91-07.94 ZNE	432 024	M 2024	432 324 R 2324 D 47
		12.93-07.98	432 024	M 2024	432 324 R 2324 D 47
100 Avant	[4A5, C4]	08.91-07.94 ZNE	432 024	M 2024	432 324 R 2324 D 47
80	[8C2, B4]	09.91-05.95	432 017	M 2017	432 317 R 2317 D 36
80 Avant	[8C5, B4]	03.92-07.95	432 017	M 2017	432 317 R 2317 D 36

BMW

Serie X1	[E 84]	10.09→	432 124	M 2124	432 424 R 2424
Serie X3	[E 83]	01.04-08.10	432 036	M 2036	432 336 R 2336 D 60
Serie X5	[E 53]	03.99-10.06			432 425 R 2425 D 315
		[E 70]	11.06→	2FE 432 219	M 2219 432 419 R 2419 D 243
Serie X6	[E 71; E 72]	03.08→	2FE 432 219	M 2219 432 419	R 2419 D 243
Serie Z4	[E 85; E 89]	10.02→	432 068	M 2068	432 368 R 2368 D 96
Serie Z4 Coupé	[E 86]	03.06-08.08	432 068	M 2068	432 368 R 2368 D 96



				1987...		1987...		
Serie 1	[E 81; E 87]	05.07→		432 124	M 2124	432 424	R 2424	D 167
Serie 1 Cabrio	[E 88]	03.08→		432 124	M 2124	432 424	R 2424	D 167
Serie 1 Coupé	[E 82]	10.07→		432 124	M 2124	432 424	R 2424	D 167
Serie 3	[E 36]	09.91-04.99	KL	432 002	M 2002			D 6
			2FE, KL	432 104	M 2104			D 141
	[E 46]	04.98→		432 036	M 2036	432 336	R 2336	D 60
	[E 90]	03.05→		432 124	M 2124	432 424	R 2424	D 167
Serie 3 Cabrio	[E 36]	03.93-12.99	KL	432 002	M 2002			D 6
			2FE, KL	432 104	M 2104			D 141
	[E 46]	03.00-08.06		432 036	M 2036	432 336	R 2336	D 60
	[E 93]	09.06→		432 124	M 2124	432 424	R 2424	D 167
Serie 3 Compact	[E 36]	03.94-09.00	2FE, KL	432 104	M 2104			D 141
	[E 46]	06.01-12.04		432 036	M 2036	432 336	R 2336	D 60
Serie 3 Coupé	[E 36]	03.91-12.99	KL	432 002	M 2002			D 6
			2FE, KL	432 104	M 2104			D 141
	[E 46]	04.98-05.06		432 036	M 2036	432 336	R 2336	D 60
	[E 92]	09.06→		432 124	M 2124	432 424	R 2424	D 167
Serie 3 Touring	[E 36]	03.95-12.99	KL	432 002	M 2002			D 6
			2FE, KL	432 104	M 2104			D 141
	[E 46]	10.98-09.05		432 036	M 2036	432 336	R 2336	D 60
	[E 91]	09.05→		432 124	M 2124	432 424	R 2424	D 167
Serie 5	[E 34]	09.91-12.95	KL, LLE	432 032	M 2032			D 54
	[E 39]	09.95-07.03	2FE			432 361	R 2361	D 298
	[E 60]	07.03-04.10	2FE	432 102	M 2102	432 402	R 2402	D 138
	[F 10]	03.10→	2FE			432 315	R 2315	D 291
Serie 5 GT	[F 07]	10.09→	2FE			432 315	R 2315	D 291
Serie 5 Touring	[E 34]	11.91-12.96	KL, LLE	432 032	M 2032			D 54
	[E 39]	12.96-05.04	2FE			432 361	R 2361	D 298
	[E 61]	05.04-08.10	2FE	432 102	M 2102	432 402	R 2402	D 138
	[F 11]	09.10→	2FE			432 315	R 2315	D 291
Serie 6 Coupé	[E 63]	01.04-07.10	2FE	432 102	M 2102	432 402	R 2402	D 138
	[F 13]	10.11→	2FE			432 315	R 2315	
Serie 6 Cabrio	[E 64]	04.04-07.10	2FE	432 102	M 2102	432 402	R 2402	D 138
	[F 12]	03.11→	2FE			432 315	R 2315	
Serie 7	[E 32]	09.91-10.94	KL, LLE	432 032	M 2032			D 54
	[E 38]	06.94-12.01	2FE			432 362	R 2362	D 299
	[E 65; E 66]	11.01-10.08	2FE	432 103	M 2103			D 140
	[F 01; F 02; F 04]	11.08→	2FE			432 315	R 2315	D 291

CADILLAC

BLS 10.05→ **432 076** M 2076 **432 376** R 2376

CHEVROLET

Astra 09.00-01.04 BHR, LLE **432 038** M 2038
DHI, ELH **432 040** M 2040

Aveo [KL1S, 08.03→ **432 241** M 2241 D 278
T250; KL1S,
T255]
[KL1T, 06.11→ **432 004** M 2004 **432 304** R 2304
T300]









◀ CHEVROLET			1987...		1987...	
Aveo Hatchback	[KL1S, T255]	04.08→	432 241	M 2241		D 278
	[KL1T, T300]	06.11→	432 004	M 2004	432 304	R 2304
Captiva		06.06→	432 222	M 2222		D 248
Cruze	[KL1J, J300]	05.09→	432 004	M 2004	432 304	R 2304
Cruze Hatchback	[KL1J, J305]	07.11→	432 004	M 2004	432 304	R 2304
Kalos	[KL1S, T200]	02.05-08.06	432 241	M 2241		D 278
Kalos Hatchback	[KL1S, T200]	02.05-04.08	432 241	M 2241		D 278
Lacetti	[KL1N, J200; KL1N, J200]	02.05→	432 223	M 2223		D 250
Matiz	[KL1K, M200]	02.05-12.10	432 171	M 2171		D 203
Niva		09.02→	432 230	M 2230		
Nubira	[KL1N, J200]	02.05→	432 223	M 2223		D 250
Nubira Wagon	[KL1N, J200]	02.05→	432 223	M 2223		D 250
Optra		06.03→	432 223	M 2223		
Orlando	[KL1Y, J309]	10.10→	432 004	M 2004	432 304	R 2304
Spark	[KL1K, M200]	02.05-12.10	432 171	M 2171		
Volt	[1G1]	11.11→	432 004	M 2004		

CHRYSLER

Crossfire Coupé	[ZH]	09.03-08.08	432 001	M 2001		
Crossfire Roadster	[ZH]	09.04-08.08	432 001	M 2001		
Pacifica	[CS]	09.02-08.08			432 497	R 2497
PT Cruiser	[PT]	06.00-12.10	432 184	M 2184		D 212
PT Cruiser Cabrio	[PT]	09.00-12.10	432 184	M 2184		D 212
Voyager	[RG; RS]	08.00→			432 497	R 2497 D 327

CITROEN

Berlingo	[M49]	07.96-12.00	LLE	432 021	M 2021		D 44
		01.01-11.02	LLE	432 083	M 2083		D 119
		07.96-11.02	RLE	432 021	M 2021		
Berlingo	[M59]	11.02-03.10	LLE	432 083	M 2083		D 119
			RLE	432 021	M 2021		
	[B9]	05.08→		432 137	M 2137	432 437	R 2437 D 174
Berlingo Electrique	[M59]	11.02-04.08	LLE	432 083	M 2083		D 119
			RLE	432 021	M 2021		
C-Crosser	[14]	09.07→			432 416	R 2416	D 241

						SC		SC	
				1987...			1987...		
C1	[B0]	06.05→		432 189	M 2189				D 216
C2	[A6]	09.03-12.09		432 079	M 2079	432 379	R 2379		
C3	[A8]	01.02-08.05		432 079	M 2079	432 379	R 2379	D 111	
	[A31]	09.05-12.09		432 079	M 2079	432 379	R 2379	D 111	
	[A51]	09.09→	2FE	432 136	M 2136	432 436	R 2436		
C3 Picasso	[A58]	02.09→		432 079	M 2079	432 379	R 2379	D 111	
C3-Pluriel	[A42]	05.03→		432 079	M 2079	432 379	R 2379	D 111	
C4	[B5]	11.04→		432 079	M 2079	432 379	R 2379		
	[B71]	09.10→		432 079	M 2079	432 379	R 2379		
C4 Coupé	[B5]	11.04→		432 079	M 2079	432 379	R 2379		
C4 Grand Picasso	[B58]	10.06→		432 137	M 2137	432 437	R 2437	D 174	
C4 Picasso	[B58]	02.07→		432 137	M 2137	432 437	R 2437	D 174	
C5	[X3]	10.04-03.08				432 412	R 2412		
	[X4]	03.01-09.04		432 198		432 398	R 2398	D 226	
	[X7]	04.08→				432 311	R 2311	D 290	
C5 Break	[X3]	10.04-03.08				432 412	R 2412		
	[X4]	06.01-09.04		432 198		432 398	R 2398	D 307	
C5 Tourer	[X7]	04.08→				432 311	R 2311	D 290	
C6	[X6]	11.05-07.08				432 412	R 2412		
		08.08→				432 311	R 2311	D 290	
C8	[V3]	06.02→		432 091	M 2091			D 129	
DS3	[A55]	11.09→	2FE	432 136	M 2136	432 436	R 2436		
DS4	[B75]	03.11→		432 079	M 2079	432 379	R 2379		
Evasion	[U60]	06.94-07.02	3FE	432 060	M 2060			D 87	
Jumper	[23]	02.94-02.02	KL	432 042	M 2042			D 68	
Jumper	[U5]	02.02-05.06		432 042	M 2042			D 68	
	[U9]	06.06→		432 065	M 2065			D 93	
	[23]	02.94-02.02	KL	432 042	M 2042			D 68	
Jumpy	[U64]	10.95-01.07	3FE	432 060	M 2060			D 87	
	[G9]	02.07→		432 206	M 2206	432 406	R 2406	D 233	
Saxo	[S8]	02.96-09.03		432 154	M 2154			D 179	
Xantia	[X1; X2]	03.93-12.01	KL	432 021	M 2021			D 44	
Xantia Break	[X1; X2]	09.95-12.01	KL	432 021	M 2021			D 44	
Xsara	[N6]	07.97-08.00	MKL	432 021	M 2021			D 44	
			MKL	432 077	M 2077			D 106	
	[N7]	09.00-12.05	MKL,LLE	432 083	M 2083			D 119	
			MKL,RLE	432 021	M 2021				
Xsara Break			MKL	432 077	M 2077			D 106	
	[N6]	10.97-08.00	MKL	432 021	M 2021			D 44	
			MKL	432 077	M 2077			D 106	
	[N7]	09.00-03.10	KL,MKL,	432 083	M 2083			D 119	
		LLE							
		KL,MKL,	432 021	M 2021					
		RLE							
		KL	432 021	M 2021					
		MKL	432 077	M 2077				D 106	
Xsara Coupé	[N6]	07.97-08.00	MKL	432 021	M 2021			D 44	
			MKL	432 077	M 2077			D 106	
	[N7]	09.00-12.05	MKL,LLE	432 083	M 2083			D 119	
			MKL,RLE	432 021	M 2021				
		KL	432 021	M 2021					
		MKL	432 077	M 2077				D 106	
Xsara Picasso	[N68]	01.00→				432 354	R 2354	D 297	



SC



SC



1987...

1987...

DACIA

Duster	[HS]	10.09→	432 120	M 2120
Logan	[LS]	07.04→	432 120	M 2120
Logan MCV	[KS/FS]	01.07→	432 120	M 2120
Logan Pick-Up	[US]	01.07→	432 120	M 2120
Sandero	[BS]	06.08→	432 120	M 2120

DAEWOO

Kalos	[KLAS]	05.02→	432 241	M 2241	D 278
Kalos	[KLAS]	09.02-01.05	432 241	M 2241	D 278
Hatchback					
Lacetti	[KLAN]	03.04-01.05	432 223	M 2223	D 250
Lanos	[KLAT]	04.97-09.03	432 105	M 2105	
Lanos	[KLAT]	11.96-09.03	432 105	M 2105	
Hatchback					
Leganza	[KLAJ, V100]	03.97-12.02 LLE	432 175	M 2175	
Nubira	[KLAJ, J100; KLAJ, 150, 190]	09.97-06.03 LLE	432 105	M 2105	
	[J200, KLAN]	07.03-01.05	432 223	M 2223	D 250
Nubira	[KLAJ, Hatchback J100]	09.97-09.99 LLE	432 105	M 2105	
Nubira Station	[KLAJ, Wagon J100; KLAJ, 150, 190]	09.97-06.03 LLE	432 105	M 2105	
	[J200, KLAN]	03.04-01.05	432 223	M 2223	D 250

DAIHATSU







Charade		03.11→	432 190	M 2190
---------	--	--------	----------------	--------

DODGE

Caravan	[RS]	09.00-08.07	432 497	R 2497	D 327
Sprinter 2500	[VA]	01.03-12.03	432 043	M 2043	
Sprinter 2501	[VB]	09.06-08.08	432 213	M 2213	

FIAT

Albea	[172..]	01.02→	432 183	M 2183	D 211
Brava	[182..]	10.95-12.01 LLE	432 003	M 2003	432 303 R 2303 D 8
Bravo	[182..]	10.95-09.01 LLE	432 003	M 2003	432 303 R 2303 D 8
	[198]	03.07→			432 377 R 2377
Coupé	[175..]	04.94-09.96 KL,LLE	432 014	M 2014	D 28
Croma	[154..]	05.91-11.92 KL	432 005	M 2005	
	[194..]	06.05-12.10			432 376 R 2376

				1987...		1987...		
					SC		SC	
Doblo	[119..]	07.00-02.01	KL			432 365	R 2365	
		03.01-09.05	KL	432 072	M 2072			D 101
		10.05-12.10				432 365	R 2365	
	[152..]	10.09→	KL	432 228	M 2228			D 258
Doblo Cargo	[223..]	07.00-02.01	KL			432 365	R 2365	
		03.01-09.05	KL	432 072	M 2072			D 101
		10.05-12.10				432 365	R 2365	
	[263..]	10.09→	KL	432 228	M 2228			D 258
Ducato	[230..;	03.94-03.02	KL	432 042	M 2042			D 68
	231...;232...;							
	234..]							
	[243..;	04.02→	KL	432 042	M 2042			D 68
	244...; 245...;							
	247]							
	[250..;	06.06→		432 065	M 2065			D 93
	251..]							
Fiorino	[225..]	12.07→	KL, LLE	432 228	M 2228			D 258
			KL, RLE	432 188	M 2188			
Idea	[135..]	01.04→	KL	432 072	M 2072			
Linea	[110..]	03.07→	KL, LLE	432 228	M 2228			D 258
Marea	[185..]	10.96-12.02		432 003	M 2003	432 303	R 2303	D 8
Marea Weekend		01.01-12.07		432 003	M 2003	432 303	R 2303	D 8
Marengo	[285..]	01.97-09.02	LLE	432 003	M 2003	432 303	R 2303	
Multipla	[186..]	01.99-12.10		432 059	M 2059			D 86
Palio	[171..]	07.01→	KL	432 108	M 2108			
		10.01→		432 183	M 2183			D 211
	[178..]	03.98-08.02	KL	432 107	M 2107			
		11.99-08.02		432 108	M 2108			
Palio Weekend	[173..]	10.01→		432 183	M 2183			D 211
		03.02-02.04	KL	432 108	M 2108			
	[178..]	09.97→	KL	432 107	M 2107			
				432 108	M 2108			
Panda	[169..]	10.03→		432 106	M 2106			D 143
Petra	[172..]	07.02→		432 183	M 2183			
Punto	[176]	08.93-08.99		432 019	M 2019			D 40
	[188]	07.99-02.01	KL			432 365	R 2365	D 301
		03.01-12.10	KL	432 072	M 2072			D 101
Punto Cabrio	[176]	04.94-08.99	EHX	432 019	M 2019			D 40
Punto Evo	[199]	10.09→	KL	432 188	M 2188			D 213
Punto Grande	[199]	10.05→	KL	432 188	M 2188			D 213
Punto GT	[176]	05.97-08.99		432 019	M 2019			D 40
Punto VAN	[276]	05.97-08.99		432 019	M 2019			D 40
	[288]	05.99→	KL	432 072	M 2072	432 365	R 2365	D 101
Qubo	[300..]	09.08→	KL, LLE	432 228	M 2228			D 258
			KL, RLE	432 188	M 2188			D 213
Scudo	[222..]	10.95-01.07	3FE	432 060	M 2060			D 87
		01.07→	KL			432 406	R 2406	D 233
			KL	432 206	M 2206			D 233
Sedici	[189]	05.06→		432 173	M 2173			D 205
Siena	[172..]	01.02-03.04		432 108	M 2108			
	[178..]	04.97-06.02	KL	432 107	M 2107			
				432 108	M 2108			
Stilo	[192..]	10.01-12.07				432 377	R 2377	D 303
Stilo Multi Wagon	[192..]	10.02-12.07				432 377	R 2377	D 303



◀ FIAT		1987...		1987...	
Strada	[278]	03.99-04.03	KL	432 108	M 2108
		04.03→		432 183	M 2183
Tempra	[159]	03.92-12.96	KL	432 014	M 2014
Tempra SW	[159]	01.91-12.96	KL	432 014	M 2014
Tipo	[160..]	01.92-10.95	KL	432 014	M 2014
Ulysse	[121..]	09.94-09.02	3FE	432 060	M 2060
	[179..]	10.02-12.10		432 091	M 2091
500	[150]	07.07→		432 106	M 2106
500 Cabrio	[150]	07.09→		432 106	M 2106

FORD

C-MAX		03.07-07.10		432 109	M 2109	432 409	R 2409	D 144
Cougar		08.98-12.00		432 018	M 2018	432 318	R 2318	D 39
Escort VII	[95]	01.95-09.01		432 084	M 2084			
Fiesta III	[89]	06.91-12.96	SAZ	432 006	M 2006			D 13
Fiesta III	[89]	09.91-08.96	SAZ	432 006	M 2006			D 13
Courier								
Fiesta IV	[96]	10.95-12.02		432 006	M 2006	432 306	R 2306	D 13
Fiesta IV	[96]	10.95-12.02		432 006	M 2006	432 306	R 2306	D 13
Courier								
Fiesta V	[02]	11.01-09.08		432 087	M 2087	432 387	R 2387	D 125
Fiesta VI	[09]	07.08→		432 215	M 2215	432 415	R 2415	D 240
Focus C-MAX		06.03-03.07		432 109	M 2109	432 409	R 2409	D 144
Focus I		08.98-05.05		432 045	M 2045	432 345	R 2345	D 72
Focus I Turnier		11.98-05.05		432 045	M 2045	432 345	R 2345	D 72
Focus II		07.04→		432 113	M 2113	432 413	R 2413	D 148
Focus II Cabriolet		07.06-07.10		432 113	M 2113	432 413	R 2413	D 148
Focus II Turnier		07.04→		432 113	M 2113	432 413	R 2413	D 148
Fusion		10.02→		432 087	M 2087	432 387	R 2387	D 125
Galaxy	[95]	02.95-03.00		432 028	M 2028	432 328	R 2328	D 52
	[00]	04.00-08.06		432 028	M 2028	432 328	R 2328	D 52
	[06]	03.06→		432 109	M 2109	432 409	R 2409	D 144
Ka		09.96-09.08		432 006	M 2006	432 306	R 2306	D 13
Ka		09.08→		432 106	M 2106			
Kuga		02.08→		432 109	M 2109	432 409	R 2409	D 144
Maverick	[UDS, UNS]	06.93-04.96		432 058	M 2058			D 84
Mondeo I	[93]	01.93-07.96		432 018	M 2018	432 318	R 2318	D 39
Mondeo I	[93]	04.93-07.96		432 018	M 2018	432 318	R 2318	D 39
Turnier								
Mondeo II	[97]	08.96-09.00		432 018	M 2018	432 318	R 2318	D 39
Mondeo II	[97]	08.96-09.00		432 018	M 2018	432 318	R 2318	D 39
Turnier								
Mondeo III	[01]	10.00-03.07		432 073	M 2073	432 373	R 2373	D 102
Mondeo III	[01]	10.00-03.07		432 073	M 2073	432 373	R 2373	D 102
Turnier								
Mondeo IV	[07]	02.07→		432 109	M 2109	432 409	R 2409	D 144
Mondeo IV	[07]	02.07→		432 109	M 2109	432 409	R 2409	D 144
Turnier								
Puma	[ECT]	06.97-12.01		432 006	M 2006	432 306	R 2306	D 13
S-MAX		03.06→		432 109	M 2109	432 409	R 2409	D 144
Streetka		12.02-12.05		432 006	M 2006	432 306	R 2306	D 13
Tourneo Connect		05.02→		432 045	M 2045	432 345	R 2345	
Transit Connect		05.02→		432 045	M 2045	432 345	R 2345	



			1987...	1987...	
Transit	[F__]	01.00-07.06	432 192	M 2192	D 218
Transit	[F__]	08.00-07.06	432 192	M 2192	D 218
Euroline, Nugget;Tourneo					

HOLDEN

Astra	[G]	09.00-08.09	BHR,LLE 432 038	M 2038	
			DHI,ELH 432 040	M 2040	

HONDA

Accord	[CL/CN/CM; CU/CW]	02.03→	432 166	M 2166	D 195
Accord Tourer	[CL/CN/CM; CU/CW]	02.03→	432 166	M 2166	D 195
City	[GM]	01.09→	432 234	M 2234	D 267
Civic	[MB/MC]	03.98-02.01	KL 432 053	M 2053	D 77
Aerodeck			KL 432 026	M 2026	D 77
Civic Coupé	[EJ]	09.95-08.00	LLE 432 026	M 2026	
	[EK]	02.01-12.05	ZE 432 074	M 2074	
Civic Fastback	[MA/MB/ MC]	09.94-02.01	KL 432 053	M 2053	D 77
			KL 432 026	M 2026	D 77
Civic Hatchback	[EJ/EK]	10.95-02.01	LLE 432 026	M 2026	D 49
	[EU/EP]	02.01-12.05	ZE 432 074	M 2074	
	[FK/FN]	09.05→	432 203	M 2203	D 229
Civic Hybrid	[ES]	01.02-12.05	432 074	M 2074	
	[FD]	01.06-08.09	432 166	M 2166	D 195
Civic Sedan	[EJ/EK]	10.95-02.01	LLE 432 026	M 2026	D 49
		02.01-01.06	432 074	M 2074	
	[ES]	02.01-12.02	432 074	M 2074	
	[FD]	09.06-08.09	TW 432 166	M 2166	D 195
	[FD6]	06.06-08.10	432 166	M 2166	D 195
CR-V	[KL]	07.03→	432 053	M 2053	
	[RD]	10.95-07.02	432 053	M 2053	D 77
		07.02-09.06	ZE 432 074	M 2074	
	[RE]	01.07→	432 166	M 2166	
CR-Z	[ZF]	03.10→	432 234	M 2234	D 267
FR-V	[BE]	01.05-06.09	432 074	M 2074	
HR-V	[GH]	12.98-12.05	LLE, ZE 432 167	M 2167	D 197
Insight Coupé	[ZE]	01.00-12.06	LLE 432 026	M 2026	D 267
Insight Hatchback	[ZE]	03.09→	432 234	M 2234	D 267
Jazz	[GD]	03.02-12.08	432 115	M 2115	D 152
	[GE/GG; GP]	10.08→	432 234	M 2234	D 267
Legend	[KB]	10.04→	432 166	M 2166	

HYUNDAI

Accent	[LC]	08.99-06.06	LLE 432 161	M 2161	
	[MC, MCT]	04.06→	TW 432 204	M 2204	D 230



◀ HYUNDAI

1987...

1987...

Accent	[LC]	08.99-06.06	LLE	432 161	M 2161	
Hatchback	[MC]	04.06→	TW	432 204	M 2204	D 230
Coupé	[GK]	10.01-08.09	LLE	432 158	M 2158	D 184
Elantra	[J2]	08.95-02.01		432 158	M 2158	D 184
	[XD]	06.00-09.06	LLE, TW	432 158	M 2158	D 184
			KL	432 229	M 2229	D 260
Elantra Hatchback	[XD]	06.00-09.06	LLE, TW	432 158	M 2158	D 184
			KL	432 229	M 2229	D 260
Genesis Coupé		09.10→		432 170	M 2170	
Getz	[TB]	09.02-06.09		432 161	M 2161	D 190
Grandeur	[TG]	07.05→	TW	432 160	M 2160	
				432 227	M 2227	
ix35	[LM]	01.10→	TW	432 170	M 2170	
ix55	[EN]	09.08→		432 240	M 2240	D 276
i10	[PA]	03.08→		432 164	M 2164	
i20	[PB, PBT]	10.08→	TW	432 132	M 2132	D 169
i30	[FD, FDH]	09.07→	LLE	432 055	M 2055	D 79
i30 CW	[FD, FDH]	02.08→	LLE	432 055	M 2055	D 79
i40	[VF]	04.11→		432 170	M 2170	
i40 CW	[VF]	04.11→		432 170	M 2170	
Lavita		04.01→		432 158	M 2158	
Matrix	[FC]	07.01-04.10		432 158	M 2158	D 184
Santa Fe	[CM]	03.06-11.09	TW	432 160	M 2160	D 186
				432 227	M 2227	D 256
	[SM]	04.01-12.05	ZE	432 160	M 2160	D 186
Solaris	[RB]	01.11→		432 170	M 2170	
Sonata	[EF]	04.03-01.05		432 160	M 2160	D 186
	[NF]	08.04-12.10	TW	432 160	M 2160	D 256
				432 227	M 2227	D 256
Trajt	[FO]	04.03-06.07	ZE	432 160	M 2160	D 186
Trajt XG		10.99→	ZE	432 160	M 2160	D 186
Tucson	[JM]	08.04-03.10	LLE, TW	432 170	M 2170	D 200
		12.06-03.10	LLE, TW	432 224	M 2224	D 252
Verna	[LC]	12.01-03.06	LLE	432 161	M 2161	
	[MC]	10.06→		432 160	M 2160	
XG	[F]	04.03-12.05		432 160	M 2160	D 186

IVECO

Daily		05.99-03.06		432 003	M 2003	
		04.06→	TW	432 003	M 2003	

JAGUAR

S-Type		10.98-03.08		432 428	R 2428	D 318
X-Type		03.01→	MKL	432 073	M 2073	
			MKL	432 373	R 2373	
X-Type Estate		03.03→	MKL	432 073	M 2073	
			MKL	432 373	R 2373	



1987...

1987...

KIA

Carens	[FG]	09.06→		432 170	M 2170	D 200
Cee'd	[ED, FF2]	11.06→	LLE	432 055	M 2055	
Cee'd Sporty Wagon	[ED, FF2]	09.07→	LLE	432 055	M 2055	
Cerato	[TD]	12.08→		432 170	M 2170	
Cerato Coup	[TD]	08.10→		432 170	M 2170	
Clarus II	[GC]	06.98-11.01		432 176	M 2176	
Clarus II Kombi	[GC]	06.98-11.01		432 176	M 2176	
Creato	[TD]	08.10→		432 170	M 2170	
Creato Coup	[TD]	08.10→		432 170	M 2170	
Magentis	[GE]	02.06-08.08		432 227	M 2227	D 256
		02.06→	TW	432 160	M 2160	
Mentor II	[FX]	01.01-08.04	LLE	432 211	M 2211	
Mentor II Hatchback	[FX]	01.01-08.04	LLE	432 211	M 2211	
Picanto	[BA; TA]	05.04→		432 164	M 2164	D 194
Pro Cee'd	[ED]	10.07→	LLE	432 055	M 2055	
Rio	[DC]	07.00-02.05		432 176	M 2176	
	[JB, DE]	03.05→		432 170	M 2170	D 200
Rio Hatchback	[JB, DE; UB]	03.05→		432 170	M 2170	D 200
Rio Kombi	[DC]	09.02-02.05	LLE	432 176	M 2176	
Shuma I	[FB]	01.98-12.00		432 211	M 2211	
Shuma I Hatchback	[FB]	01.98-12.00		432 211	M 2211	
Shuma II	[FB]	01.01-08.04	LLE	432 211	M 2211	
Shuma II Hatchback	[FB]	01.01-08.04	LLE	432 211	M 2211	
Sorento	[JC]	03.06-08.09	RLE	432 224	M 2224	
Spectra	[FB]	01.01-12.09	LLE	432 211	M 2211	
Spectra Hatchback		01.01-12.06	LLE	432 211	M 2211	
Sportage	[JE]	09.04-05.10	LLE	432 170	M 2170	D 200

LADA

Kalina		11.04→		432 230	M 2230	D 261
Kalina Hatchback		07.06→		432 230	M 2230	D 261
Kalina Kombi		07.07→		432 230	M 2230	D 261
Priora		11.06→	TW	432 435	R 2435	
Priora Coupé		01.10→	TW	432 435	R 2435	
Priora Hatchback		01.08→	TW	432 435	R 2435	
Priora Kombi		01.08→	TW	432 435	R 2435	
Serie 110		01.96→		432 435	R 2435	D 322
Serie 111		01.96→		432 435	R 2435	D 322
Serie 112		01.96→		432 435	R 2435	D 322
Serie 114		12.08→		432 435	R 2435	D 322
Serie 115		01.00→		432 435	R 2435	D 322
Serie 2114		10.01→		432 435	R 2435	D 322



1987...

1987...

LANCIA

Dedra Berlina	[835]	01.93-10.99	KL	432 014	M 2014		D 28
Dedra Station Wagon	[835]	10.94-10.99	KL	432 014	M 2014		D 28
Delta	[836]	10.93-12.99	KL	432 014	M 2014		D 28
	[844]	07.08→				432 377	R 2377
Kappa Berlina	[838]	07.96-12.00	KL			432 360	R 2360
Kappa Coupé	[838]	04.97-06.00	KL			432 360	R 2360
Kappa Station Wagon	[838]	07.96-12.00	KL			432 360	R 2360
Lybra Berlina	[839]	10.99-11.06	KL			432 303	R 2303 D 8
Lybra Station Wagon	[839]	10.99-11.06	KL			432 303	R 2303 D 8
Musa	[184]	10.04→		432 072	M 2072		
Phedra	[180]	09.02-12.10		432 091	M 2091		D 129
Y	[840]	01.96-06.03	KL	432 019	M 2019		D 40
Ypsilon	[843]	06.03→		432 072	M 2072		
ZETA	[122]	09.94-06.02	3FE,KL	432 060	M 2060		D 87

LAND ROVER GROUP

Discovery III		09.04-08.09		432 235	M 2235		D 270
Discovery IV		09.09→		432 235	M 2235		D 270
Freelander	[LN]	09.97-03.07		432 210	M 2210		D 237
Freelander	[LN]		KL	432 116	M 2116		D 154
Freelander II	[LF]	10.06→		432 205	M 2205	432 405	R 2405 D 231
Range Rover Evoque		09.11→		432 205	M 2205	432 405	R 2405
Range Rover II		09.94-08.02	ZE	432 169	M 2169		D 199
Range Rover III		03.02-08.09	XXX			432 425	R 2425
Range Rover IV		09.09→	XXX			432 425	R 2425
Range Rover Sport I		03.05-08.09		432 235	M 2235		D 270
Range Rover Sport II		09.09→		432 235	M 2235		D 270

LEXUS

CT		12.10→		432 190	M 2190		
ES	[V]	07.01-07.03				432 320	R 2320
		03.06→		432 190	M 2190		
GS	[S1]	07.00-01.07				432 319	R 2319 D 292
		01.05→		432 190	M 2190		
IS	[E2]	08.05→		432 190	M 2190		
IS F	[E2]	12.07→		432 190	M 2190		
LFA		12.10→		432 190	M 2190		
LS	[F2]	10.94-08.00				432 468	R 2468
	[F3]	08.00-08.06				432 319	R 2319 D 292
LX	[J2]	11.07→		432 190	M 2190		
RX	[U3]	02.03-12.08				432 320	R 2320 D 293
	[L1]	12.08→		432 190	M 2190		
SC Cabrio	[Z4]	05.01→				432 319	R 2319 D 292



1987...

1987...

MAYBACH







Serie 240 09.02→ 432 533 R 2533 D 332

MAZDA

Premacy	[CP]	03.99-05.05	2FE, KL	432 117	M 2117		
121	[JA/JB]	01.96-01.02		432 006	M 2006	432 306	R 2306 D 13
2	[DY]	02.03-06.07		432 092	M 2092		
3	[BK]	07.03-12.08		432 163	M 2163		D 192
3 Hatchback	[BK]	07.03-12.08		432 163	M 2163		D 192
323	[BJ]	05.98-09.03	2FE	432 117	M 2117		D 155
323 F Hatchback	[BA]	05.94-07.95	KL	432 162	M 2162		
323	[BA]	10.96-09.00		432 162	M 2162		
Hatchback	[BJ]	06.98-01.01	2FE	432 117	M 2117		D 155
5	[CR]	02.05-04.05	KL	432 163	M 2163		D 192
6	[GG/GY; GH]	02.02→		432 092	M 2092		D 130
6 Fastback	[GG/GY; GH]	04.02→		432 092	M 2092		D 130
6 Sedan	[GG/GY]	02.02-08.07		432 092	M 2092		D 130
6 Wagon	[GG/GY; GH]	06.02→		432 092	M 2092		D 130
626	[GF]	05.97-07.02	2FE, KL	432 117	M 2117		D 155
626 Fastback	[GF]	08.99-04.02	2FE, KL	432 117	M 2117		D 155
626 Hatchback	[GF]	04.97-07.02	2FE	432 117	M 2117		D 155
626 Wagon	[GW]	09.99-04.02	2FE, KL	432 117	M 2117		D 155

MERCEDES-BENZ

Serie A	[168]	10.97-08.04	KL		432 337	R 2337	D 61
			KL	432 037	M 2037		D 61
	[169]	04.04→			432 410	R 2410	D 312
Serie B	[245]	04.05→			432 410	R 2410	
Serie C	[202]	03.93-08.00	KL		432 301	R 2301	D 4
			KL	432 001	M 2001		D 4
	[203]	05.00-07.07	LLE, MKL	432 070	M 2070		D 98
			LLE, MKL		432 370	R 2370	D 98
			RLE		432 570	R 2570	
	[204]	01.07→			432 326	R 2326	D 294
Serie C (Coupé)	[204]	03.11→			432 326	R 2326	D 294
Serie C (Sportcoupe)	[203]	01.01-02.08	LLE, MKL	432 070	M 2070		D 98
			LLE, MKL		432 370	R 2370	D 98
			RLE		432 570	R 2570	
Serie C (T-Modell)	[202]	05.96-02.01	KL		432 301	R 2301	D 4
			KL	432 001	M 2001		D 4
	[203]	01.01-08.07	LLE, MKL	432 070	M 2070		D 98
			LLE, MKL		432 370	R 2370	D 98
			RLE		432 570	R 2570	
	[204]	09.07→			432 326	R 2326	D 294

							SC		SC	
◀ MERCEDES-BENZ										
							1987...		1987...	
Serie CL	[215]	09.99-08.06	2FE	432 020	M 2020			432 533	R 2533	
(Coupé)	[216]	06.06→						432 438	R 2438	
Serie CLC	[203]	03.08-10.10	LLE					432 370	R 2370	D 98
			RLE					432 570	R 2570	D 98
Serie CLK	[208]	09.96-01.03	KL					432 301	R 2301	D 4
(Cabrio)			KL	432 001	M 2001					D 4
	[209]	09.01-09.06	LLE	432 070	M 2070					D 98
			RLE					432 570	R 2570	
		04.05-12.09	LLE, MKL	432 070	M 2070			432 370	R 2370	D 98
			RLE, MKL					432 570	R 2570	
Serie CLK	[208]	01.97-09.02	KL					432 301	R 2301	D 4
(Coupé)			KL	432 001	M 2001					D 4
	[209]	08.01-04.09	LLE	432 070	M 2070					D 98
			RLE					432 570	R 2570	
		04.05-04.09	LLE, MKL					432 370	R 2370	D 98
Serie CLS	[218]	07.10→						432 326	R 2326	
	[219]	06.04-02.11						432 381	R 2381	D 116
Serie E	[124]	07.93-07.95	2FE	432 051	M 2051					D 75
	[210]	06.95-08.03	KL					432 301	R 2301	D 4
			KL	432 001	M 2001					D 4
			2FE, MKL	432 020	M 2020			432 533	R 2533	D 332
	[211]	03.02-03.09						432 512	R 2512	D 331
								432 381	R 2381	D 116
			LLE, MKL	432 081	M 2081					D 116
			RLE, MKL	432 281	M 2281					D 280
	[212]	08.08→						432 326	R 2326	D 294
Serie E	[124]	07.93-06.98	2FE	432 051	M 2051					D 75
(Cabrio)	[207]	01.10→						432 326	R 2326	D 294
Serie E	[124]	07.93-06.97	2FE	432 051	M 2051					D 75
(Coupé)	[207]	02.09→						432 326	R 2326	D 294
Serie E	[124]	07.93-05.96	2FE	432 051	M 2051					D 75
(T-Modell)	[210]	05.96-02.03	KL					432 301	R 2301	D 4
			KL	432 001	M 2001					D 4
			2FE, MKL	432 020	M 2020			432 533	R 2533	D 332
	[211]	02.03-08.09						432 512	R 2512	D 331
								432 381	R 2381	D 116
			LLE, MKL	432 081	M 2081					D 116
			RLE, MKL	432 281	M 2281					D 280
	[212]	08.09→						432 326	R 2326	D 294
Serie G	[463]	09.91→						432 357	R 2357	
Serie GL	[164]	02.06→						432 309	R 2309	D 288
Serie GLK	[204]	06.08→						432 326	R 2326	D 294
Serie ML	[163]	03.98-06.05						432 364	R 2364	D 300
	[164]	03.05→						432 309	R 2309	D 288
Serie R	[251]	09.05→						432 309	R 2309	D 288
Serie S	[220]	10.98-08.06	2FE	432 020	M 2020			432 533	R 2533	D 332
	[221]	09.05→						432 438	R 2438	D 326
Serie SLK	[170]	09.96-03.04	KL					432 301	R 2301	D 4
			KL	432 001	M 2001					D 4
Serie SLS	[197]	03.10→						432 326	R 2326	
(Coupé)										
Serie V	[638 TON]	04.96-09.03		432 044	M 2044					D 71
Serie 124	[124]	01.91-06.93	2FE	432 051	M 2051					
Serie 124	[124]	09.92-06.93	2FE	432 051	M 2051					
(T-Modell)										



				1987...		1987...	
Sprinter	[T1N]	02.95-05.06		432 043	M 2043	432 343	R 2343 D 69
	[NCV3]	04.06→		432 213	M 2213	432 513	R 2513 D 238
Vaneo	[414]	02.02-08.05	KL			432 337	R 2337
			KL	432 037	M 2037		
Viano	[639 TON]	09.03→	TER	432 195	M 2195		D 222
			TMT			432 495	R 2495 D 222
Vito	[638 TON]	11.95-09.03		432 044	M 2044		D 71
	[639 TON]	10.03→	TER	432 195	M 2195		D 222
			TMT			432 495	R 2495 D 222

MG

ZR		10.01-05.05		432 121	M 2121		
ZS		10.01-05.05	KL	432 026	M 2026		
ZT		10.01-05.05		432 182	M 2182	432 482	R 2482 D 208
ZT-Tourer		10.01-05.05		432 182	M 2182	432 482	R 2482 D 208

MINI (BMW)

Mini	[R 50;R53]	06.01-11.06		432 082	M 2082	432 382	R 2382 D 118
	[R 56]	11.06→		432 296	M 2296		D 282
Mini Cabrio	[R 52]	07.04-02.09		432 082	M 2082	432 382	R 2382 D 118
	[R 57]	03.09→		432 296	M 2296		D 282
Mini Clubman	[R 55]	11.07→		432 296	M 2296		D 282
Mini	[R 60]	09.10→		432 296	M 2296		D 282
Countryman							
Mini Coupé	[R 58]	09.11→		432 296	M 2296		D 282

MITSUBISHI

ASX	[GA]	04.10→		432 216	M 2216		D 241
Colt	[CJ]	11.95-06.03		432 086	M 2086		D 123
	[CZ]	04.04→		432 034	M 2034	432 434	R 2434 D 57
Colt Cabrio	[CZ]	03.06-07.08				432 434	R 2434 D 57
Galant	[EA]	10.96-05.03		432 207	M 2207		
Galant Station Wagon	[EA]	10.96-09.02		432 207	M 2207		
Lancer	[CK/CP/CN]	11.95-05.01		432 086	M 2086		D 123
	[CY/CZ]	03.07→		432 216	M 2216		D 241
Lancer Sportback	[CX]	07.08→		432 216	M 2216		D 241
Outlander	[CW]	02.07→		432 216	M 2216		D 241
Pajero	[V60; V70]	02.00-08.06	LLE			432 498	R 2498 D 328
	[V80, V90]	09.06→	LLE			432 498	R 2498 D 328
	[DG]	06.98-12.04	KL	432 086	M 2086		D 123
Spacestar			KL	432 157	M 2157		D 182

NISSAN

Almera	[H14, 15, 17]	01.00→		432 075	M 2075		D 103
--------	---------------	--------	--	----------------	--------	--	-------



◀ NISSAN		1987...		1987...		
Almera Hatchback	[N15]	01.98-04.00	KL,SA	432 179	M 2179	D 157
			2FE, MOO,NOR	432 118	M 2118	D 157
	[N16E]	01.00-11.06		432 075	M 2075	D 103
Almera Sedan	[N15]	01.98-04.00	KL,SA	432 179	M 2179	D 157
			2FE, MOO,NOR	432 118	M 2118	D 157
	[N16; N16E]	04.00-11.06		432 075	M 2075	D 103
Almera Tino	[V10M]	05.00-11.04		432 075	M 2075	D 103
		12.04-12.05	KKL	432 075	M 2075	D 103
Kubistar	[X76]	07.03→	KL	432 039	M 2039	D 219
			KL	432 193	M 2193	D 219
Maxima QX	[CA33]	01.00-10.00	ZE	432 239	M 2239	
		05.01-08.02	TW	432 239	M 2239	
Micra	[K11E]	08.92-10.02		432 119	M 2119	D 159
	[K12E]	11.02→		432 120	M 2120	D 160
Micra CC	[K12E]	09.05→		432 120	M 2120	D 160
Navara	[D40]	05.05→		432 194	M 2194	D 220
Note	[E11; E11E]	01.06→		432 120	M 2120	
Pathfinder	[R51]	01.05→		432 194	M 2194	D 220
Pixo Hatchback	[UA0]	03.09→	LLE	432 148	M 2148	D 178
Primastar	[X83]	07.02→		432 208	M 2208	D 234
Primera	[P12E]	12.01-09.10		432 075	M 2075	D 103
Primera Hatchback	[P11E]	06.96-12.01		432 058	M 2058	D 84
Primera Sedan	[P12E]	05.02-09.10		432 075	M 2075	D 103
Primera Wagon	[P11E]	06.96-12.01		432 058	M 2058	D 84
Pulsar	[P12E]	05.02-09.10		432 075	M 2075	D 103
Pulsar	[P11E]	06.96-12.01		432 058	M 2058	D 84
Qashqai	[J10]	12.06→		432 238	M 2238	D 273
Qashqai+2	[JJ10]	08.08→		432 238	M 2238	D 273
Terrano II	[R20]	01.96-12.06		432 058	M 2058	D 84
X-Trail	[T31]	04.07→		432 238	M 2238	D 273

OPEL

Agila	[A]	06.00-02.08		432 066	M 2066	D 95
	[B]	03.08→		432 214	M 2214	D 239
Ampera		10.11→		432 004	M 2004	432 304 R 2304
Antara		05.06→		432 222	M 2222	D 248
Astra	[F]	09.91-08.98		432 010	M 2010	432 310 R 2310
	[G]	09.97-01.05	BHR,LLE	432 038	M 2038	D 62
			DHI,ELH	432 040	M 2040	D 62
		01.03-05.06		432 040	M 2040	D 62
	[H]	03.04-03.10		432 040	M 2040	
	[J]	09.09→		432 004	M 2004	432 304 R 2304
Astra Cabrio	[F]	09.91-08.98		432 010	M 2010	432 310 R 2310
	[G]	09.97-08.05	BHR,LLE	432 038	M 2038	D 62
			DHI,ELH	432 040	M 2040	D 62
Astra Caravan	[F]	09.91-08.98		432 010	M 2010	432 310 R 2310



		1987...		1987...			
Astra Caravan	[G]	09.97-06.04	BHR, LLE	432 038	M 2038		D 62
			DHI, ELH	432 040	M 2040		D 62
	[H]	08.04→		432 040	M 2040		
Astra Classic	[F]	09.97-08.02		432 010	M 2010		D 17
Astra Classic Caravan	[F]	09.97-08.02		432 010	M 2010		D 17
Astra Coupé	[G]	09.97-02.05	BHR, LLE	432 038	M 2038		D 62
			DHI, ELH	432 040	M 2040		D 62
		03.02-02.05	DHI, RLE	432 040	M 2040		
Astra GTC	[H]	03.05→		432 040	M 2040		
	[J]	09.11→		432 004	M 2004	432 304	R 2304
Astra Sports Tourer	[J]	09.10→		432 004	M 2004	432 304	R 2304
Astra TwinTop	[H]	09.05→		432 040	M 2040		
Calibra		08.93-03.97		432 010	M 2010	432 310	R 2310 D 17
Combo		09.94-10.01	KL, LLE	432 010	M 2010	432 310	R 2310 D 17
			KL	432 015	M 2015		D 33
		08.08→	KL, LLE	432 010	M 2010	432 310	R 2310 D 17
			KL	432 015	M 2015		D 33
	[Tour]	10.01→	MOO	432 076	M 2076	432 376	R 2376 D 105
Corsa	[B]	03.93-09.00	KL, LLE	432 010	M 2010	432 310	R 2310 D 17
			KL	432 015	M 2015		D 33
	[C]	09.00-09.06	MOO	432 076	M 2076	432 376	R 2376 D 105
	[D]	07.06→		432 188	M 2188	432 488	R 2488 D 213
Insignia	[68; 69]	09.08→		432 004	M 2004	432 304	R 2304 D 11
Insignia	[35]	02.09→		432 004	M 2004	432 304	R 2304 D 11
Sports Tourer							
Meriva	[A]	03.03-03.10	KL	432 111	M 2111	432 411	R 2411 D 146
	[B]	04.10→		432 004	M 2004	432 304	R 2304
Omega	[B]	09.93-09.03		432 016	M 2016	432 366	R 2366 D 35
Signum		05.03-09.08		432 076	M 2076	432 376	R 2376
Sintra		09.96-09.99	2FE	432 052	M 2052		D 76
Tigra	[A]	09.94-08.99	KL, LLE	432 010	M 2010	432 310	R 2310 D 17
			KL	432 015	M 2015		D 33
Tigra TwinTop	[B]	06.04-12.09		432 076	M 2076	432 376	R 2376
Vectra	[B]	09.95-09.03		432 030	M 2030	432 330	R 2330 D 53
	[C]	09.01-10.08		432 076	M 2076	432 376	R 2376
Vectra Caravan	[B]	09.95-09.03		432 030	M 2030	432 330	R 2330 D 53
	[C]	09.03-10.08		432 076	M 2076	432 376	R 2376
Vivaro		03.01→		432 208	M 2208		D 234
Zafira	[A]	03.99-07.05	BHR	432 038	M 2038		D 62
	[B]	07.05→		432 038	M 2038		
	[C]	01.12→		432 004	M 2004	432 304	R 2304

PEUGEOT

Boxer	[U3; U5]	02.94-05.06	KL	432 042	M 2042		D 68
	[U9]	06.06→		432 065	M 2065		D 93
Expert	[U64]	09.95-01.07	3FE	432 060	M 2060		D 87
	[G9]	02.07→		432 206	M 2206	432 406	R 2406 D 233
Partner	[M4]	07.96-08.02	KL	432 021	M 2021		D 44
	[M5]	09.02-04.08	LLE	432 083	M 2083		D 119
			RLE	432 021	M 2021		
	[B9]	05.08→		432 137	M 2137	432 437	R 2437 D 174



◀ PEUGEOT			1987...	1987...		
Ranch	[M4]	07.97-08.02	KL	432 021	M 2021	D 44
RCZ	[T75]	01.10→		432 379	R 2379	
106	[S1; S2]	09.91-05.05		432 154	M 2154	D 179
107	[B0]	06.05→		432 189	M 2189	D 216
206	[T1]	06.98-02.09		432 048	M 2048	432 348 R 2348 D 73
206+	[T3E]	03.09→		432 048	M 2048	
206 CC	[T1]	09.00-03.07		432 048	M 2048	432 348 R 2348 D 73
206 Sedan	[T1]	03.07-12.10		432 048	M 2048	432 348 R 2348 D 73
206 SW	[T1]	03.02-12.06		432 048	M 2048	432 348 R 2348 D 73
207	[A7]	05.06→	2FE	432 136	M 2136	432 436 D 172
207 CC	[A7]	03.07→	2FE	432 136	M 2136	432 436 D 172
207 SW	[A7]	06.07→	2FE	432 136	M 2136	432 436 D 172
208		01.12→	2FE	432 136	M 2136	432 436
306		05.93→		432 041	M 2041	D 67
307	[T5/T6]	08.00→	MKL			432 379 R 2379 D 111
		08.00-08.07	MKL	432 079	M 2079	D 111
		11.04→		432 079	M 2079	D 111
307 Break/SW	[T5/T6]	03.02→	MKL			432 379 R 2379 D 111
			MKL	432 079	M 2079	D 111
307 CC	[T5]	10.03-05.05	MKL			432 379 R 2379 D 111
			MKL	432 079	M 2079	D 111
	[T6]	06.05-03.09				432 379 R 2379 D 111
			MKL	432 079	M 2079	D 111
307 Sedan	[T6]	08.06→		432 079	M 2079	432 379 R 2379 D 111
308	[T7]	09.07→		432 079	M 2079	432 379 R 2379
308 CC	[T7]	03.09→		432 079	M 2079	432 379 R 2379
308 SW	[T7]	05.08→		432 079	M 2079	432 379 R 2379
405	[4/15]	06.91→		432 022	M 2022	
405 Break	[4/15]	06.91-04.97		432 022	M 2022	
406	[D8; D9]	10.95-06.04	KL	432 007	M 2007	432 307 R 2307 D 15
406 Break	[D8; D9]	10.96-06.04	KL	432 007	M 2007	432 307 R 2307 D 15
406 Coupé	[D8; D9]	03.97-02.05	KL	432 007	M 2007	432 307 R 2307 D 15
407	[D2]	05.04-03.08				432 412 R 2412 D 313
		04.08→				432 311 R 2311 D 290
407 Coupé	[D2]	10.05-03.08				432 412 R 2412 D 313
		04.08→				432 311 R 2311 D 290
407 SW	[D2]	05.04-03.08				432 412 R 2412 D 313
		04.08→				432 311 R 2311 D 290
508		09.11→	MKL	432 137	M 2137	
508 SW		09.11→	MKL	432 137	M 2137	
607	[Z8; Z9]	03.00→				432 399 R 2399 D 308
806	[U60]	06.94-08.02	3FE	432 060	M 2060	D 87
807	[V2]	06.02→		432 091	M 2091	D 129
1007	[A8]	04.05→		432 079	M 2079	432 379 R 2379
3008	[T8]	05.09→	MKL	432 137	M 2137	D 174
4007	[I3]	09.07→				432 416 R 2416 D 241
5008	[T8]	09.09→	MKL	432 137	M 2137	D 174

PORSCHE

Boxster	[986/987]	10.96→		432 200	M 2200	432 407 R 2407 D 227
Cayenne	[9PA]	09.02-08.10				432 431 R 2431 D 320
Cayman	[987C]	11.05→				432 407 R 2407
911	[996/997]	09.97→		432 200	M 2200	432 407 R 2407 D 227



1987...

1987...

RENAULT

Avantime	[XEO]	09.01-12.03	2FE	432 049	M 2049			
Clio II	[BB./CB./SB.]	03.98→		432 039	M 2039	432 197	R 2197	D 64
Clio III	[BR./CR]	06.05→		432 120	M 2120			D 160
Clio III	[KR]	08.07→		432 120	M 2120			D 160
Grandtour								
Espace III	[JEO]	10.96-10.02	2FE	432 049	M 2049			D 74
Espace IV	[JK]	11.02→		432 100	M 2100	432 400	R 2400	D 137
Kangoo I	[FC./KC.]	10.97-12.07	KL	432 039	M 2039	432 197	R 2197	D 64
			KL	432 193	M 2193			D 219
Kangoo II	[FW./KW]	01.08→		432 078	M 2078			D 108
Laguna I	[B56; 556]	01.94-03.01	LLE	432 027	M 2027			D 51
			RLE	432 050	M 2050			
Laguna I	[A56; K56; S56]	02.95-02.01	LLE	432 027	M 2027			D 51
Grandtour			RLE	432 050	M 2050			
Laguna II	[BG.]	03.01-09.07				432 380	R 2380	D 114
Laguna II	[KG.]	03.01-09.07				432 380	R 2380	D 114
Grandtour								
Laguna III	[BT]	07.07→				432 500	R 2500	D 329
Laguna III	[DT]	02.08→				432 500	R 2500	D 329
Coupé								
Laguna III	[KT]	07.07→				432 500	R 2500	D 329
Grandtour								
Master		02.10→		432 078	M 2078			D 108
Megane I	[X64]	01.96-04.98		432 009	M 2009			D 16
		05.98-10.02	KL	432 061	M 2061			D 88
			KL	432 039	M 2039	432 197	R 2197	D 64
Megane I	[X64]	09.96-03.98		432 009	M 2009			D 16
Cabrio		04.98-09.03	KL	432 061	M 2061			D 88
			KL	432 039	M 2039	432 197	R 2197	D 64
Megane I	[X64]	09.96-03.98		432 009	M 2009			D 16
Classic		04.98-09.03	KL	432 061	M 2061			D 88
			KL	432 039	M 2039	432 197	R 2197	D 64
Megane I	[X64]	01.96-03.98		432 009	M 2009			D 16
Coupé		04.98-10.02	KL	432 061	M 2061			D 88
			KL	432 039	M 2039			D 64
Megane I	[X64]	07.98-09.03	KL	432 061	M 2061			D 88
Grandtour			KL	432 039	M 2039			D 64
Megane II	[LM]	09.02-10.09		432 093	M 2093	432 393	R 2393	D 131
Megane II	[EM]	10.03-03.10		432 093	M 2093	432 393	R 2393	D 131
Cabrio								
Megane II	[KM.]	10.03-01.06		432 093	M 2093			D 131
Grandtour		02.06-05.09				432 393	R 2393	
Megane II	[BM./CM./GM./SM.]	11.02-01.06		432 093	M 2093			D 131
Hatchback		02.06-10.08				432 393	R 2393	
Megane III CC	[EZ]	10.10→				432 327	R 2327	D 295
Megane III	[DZ]	01.09→				432 327	R 2327	D 295
Coupé								
Megane III	[KZ]	06.09→				432 327	R 2327	D 295
Grandtour								
Megane III	[BZ]	11.08→				432 327	R 2327	D 295
Hatchback								



◀ RENAULT

1987...

1987...

Modus	[FP/JP]	06.04→		432 120	M 2120			D 160
Sandero	[BS]	12.09→		432 120	M 2120			
Scenic I	[JA.]	01.96-12.97	KL, LLE	432 089	M 2089	432 389	R 2389	D 128
		01.98-09.99	KL, LLE	432 090	M 2090	432 390	R 2390	D 128
		10.99-04.03	KL, LLE	432 069	M 2069	432 469	R 2469	D 97
Scenic I (Megane Scenic)		01.96-04.03	KL, LLE	432 225	M 2225	432 525	R 2525	D 254
			RLE	432 226	M 2226			D 255
Scenic II	[JM]	05.03-04.09		432 094	M 2094	432 394	R 2394	D 132
Thalia	[LB]	10.99-10.07		432 039	M 2039	432 197	R 2197	D 64
Thalia	[LU]	10.08→		432 039	M 2039			
Trafic	[EL./FL./	05.01→		432 208	M 2208			D 234
	JL.]							
Twingo I	[CO./SO.]	03.93-05.07		432 095	M 2095			
Twingo II	[CN/GN]	04.07→		432 120	M 2120			
Vel Satis	[BJ]	04.02-12.09				432 380	R 2380	D 114
Wind	[E4]	04.10→		432 120	M 2120			

ROLLS-ROYCE

Ghost	[RR4]	12.09→	2FE			432 315	R 2315	D 291
--------------	-------	--------	-----	--	--	----------------	--------	-------

ROVER

Serie 400		05.95-02.96	AG, KL	432 053	M 2053			D 77
		05.95-03.00	GS, KL	432 121	M 2121			D 163
		05.95-03.00	KL	432 026	M 2026			D 49
Serie 400 Coupé		01.97-12.98	GS, KL	432 121	M 2121			D 163
			KL	432 026	M 2026			D 49
Serie 400 Tourer		05.95-02.96	AG, KL	432 053	M 2053			D 77
		05.95-03.00	GS, KL	432 121	M 2121			D 163
		05.95-03.00	KL	432 026	M 2026			D 49
Streetwise		09.03-05.05		432 121	M 2121			D 163
25		02.00-05.05		432 121	M 2121			D 163
45		02.00-05.05	KL	432 026	M 2026			
75		01.99-05.05		432 182	M 2182	432 482	R 2482	D 208
75 Tourer		01.01-05.05		432 182	M 2182	432 482	R 2482	D 208

SAAB (SAAB AUTOMOBILE AB)

900 II		09.93-10.98		432 096	M 2096			D 133
900 II Cabriolet		03.94-10.98		432 096	M 2096			D 133
900 II Coupé		03.94-10.98		432 096	M 2096			D 133
9-3	[9400]	03.98-09.02		432 096	M 2096			D 133
	[9440]	09.02→		432 076	M 2076	432 376	R 2376	
9-3 Cabriolet	[9400]	03.98-08.03		432 096	M 2096			D 133
	[9440]	08.03→		432 076	M 2076	432 376	R 2376	
9-3 Coupé	[9400]	03.98-08.03		432 096	M 2096			D 133
9-3 Kombi	[9440]	03.05→		432 076	M 2076	432 376	R 2376	
9-3X	[9440]	03.10→		432 076	M 2076	432 376	R 2376	
9-5	[9600]	06.97-02.10	KL			432 401	R 2401	D 310
	[650]	03.10→				432 304	R 2304	
9-5 Kombi	[9600]	06.97-02.10	KL			432 401	R 2401	D 310



SC



SC



1987...

1987...

SEAT

Alhambra	[7V8]	03.96-02.00	432 028	M 2028	432 328	R 2328	D 52
	[7V9]	06.00-03.10	432 028	M 2028	432 328	R 2328	D 52
	[710]	05.10→	LLE 432 097	M 2097	432 397	R 2397	D 134
			RLE		432 597	R 2597	D 334
Altea	[5P1]	03.04→	LLE 432 097	M 2097	432 397	R 2397	D 134
			RLE		432 597	R 2597	D 334
Altea Freetrack	[5P5, 5P8]	06.07→	LLE 432 097	M 2097	432 397	R 2397	D 134
			RLE		432 597	R 2597	D 334
Altea XL	[5P5]	05.06→	LLE 432 097	M 2097	432 397	R 2397	D 134
			RLE		432 597	R 2597	D 334
Arosa	[6H1]	02.97-06.04	432 012	M 2012	432 312	R 2312	
Cordoba	[6K2]	09.93-12.02	432 012	M 2012	432 312	R 2312	D 21
	[6L2]	09.02→	432 057	M 2057	432 357	R 2357	
Cordoba Vario	[6K5]	07.96-08.03	432 012	M 2012	432 312	R 2312	D 21
Exeo	[3R2]	12.08→	432 071	M 2071	432 371	R 2371	
Exeo ST	[3R5]	06.09→	432 071	M 2071	432 371	R 2371	
Ibiza	[6J5]	02.08-05.11	432 057	M 2057	432 357	R 2357	
	[6K1]	03.93-05.02	432 012	M 2012	432 312	R 2312	D 21
	[6L1]	09.01-11.09	432 057	M 2057	432 357	R 2357	
Ibiza Sportcoupé	[6J1]	02.08-05.11	432 057	M 2057	432 357	R 2357	
Ibiza ST	[6J8]	03.10-09.10	432 057	M 2057	432 357	R 2357	
Inca	[6K9]	11.95-06.03	432 012	M 2012	432 312	R 2312	D 21
Leon	[1M1]	10.98-06.06	432 012	M 2012	432 312	R 2312	
	[1P1]	05.05→	LLE 432 097	M 2097	432 397	R 2397	D 134
			RLE		432 597	R 2597	D 334
Toledo	[1L2]	05.91-03.99	432 011	M 2011			
	[1M2]	04.99-07.04	432 012	M 2012	432 312	R 2312	D 21
	[5P2]	09.04→	LLE 432 097	M 2097	432 397	R 2397	D 134
			RLE		432 597	R 2597	D 334

SKODA

Fabia	[6Y3]	09.99-12.07	432 057	M 2057	432 357	R 2357	D 83
	[SK250]	05.08→	432 057	M 2057	432 357	R 2357	
Fabia Combi	[6Y5]	12.99-12.07	432 057	M 2057	432 357	R 2357	D 83
	[5J5]	12.06-07.10	432 057	M 2057	432 357	R 2357	
Fabia Schrägheck	[6Y2]	09.99-03.08	432 057	M 2057	432 357	R 2357	D 83
Octavia	[5J2]	12.06-06.10	432 057	M 2057	432 357	R 2357	
	[1U2]	09.96-12.10	432 012	M 2012	432 300	R 2300	D 21
	[1Z3]	05.04→	LLE 432 097	M 2097	432 397	R 2397	D 134
			RLE		432 597	R 2597	D 334
Octavia Combi	[1U5]	10.96-12.10	432 012	M 2012	432 300	R 2300	D 21
	[1Z5]	05.04→	LLE 432 097	M 2097	432 397	R 2397	D 134
			RLE		432 597	R 2597	D 334
Praktik	[5J7]	03.07→	432 057	M 2057	432 357	R 2357	
Rapid	[NA2]	09.11→	432 057	M 2057	432 357	R 2357	
Roomster	[5J7]	03.06→	432 057	M 2057	432 357	R 2357	
Superb	[3U4]	12.01-03.08	432 012	M 2012			
	[3T4]	03.08→	LLE 432 097	M 2097	432 397	R 2397	D 134
			RLE		432 597	R 2597	D 334



◀ SKODA			1987...	1987...		
Superb Combi [3T5]	03.09→	LLE	432 097	M 2097	432 397	R 2397 D 134
		RLE			432 597	R 2597 D 334
Yeti [5L7]	05.09→	LLE	432 097	M 2097	432 397	R 2397 D 134
		RLE			432 597	R 2597 D 334

SMART (MCC)

Forfour [454]	01.04-06.07				432 434	R 2434 D 57
Fortwo Cabrio [450]	02.04-03.07 KL				432 378	R 2378 D 304
	[451] 04.07→		432 299	M 2299	432 499	R 2499 D 284
Fortwo Coupé [450]	02.04-03.07 KL				432 378	R 2378 D 304
	[451] 04.07→		432 299	M 2299	432 499	R 2499 D 284
Roadster	04.04→				432 434	R 2434 D 57
Smart Cabrio [450]	03.00-01.04 KL				432 378	R 2378 D 304
Smart Coupé [450]	07.98-01.04 KL				432 378	R 2378 D 304
Smart [450]	10.02-01.04 KL				432 378	R 2378 D 304
Crossblade						

SUBARU

Forester [SF]	01.97-05.02		432 218	M 2218		D 242
Impreza Coupé [GC,GF]	10.93-09.00		432 218	M 2218		D 242
Impreza Sedan [GC,GF]	01.93-09.00		432 218	M 2218		D 242
Justy [G3X]	09.03-08.07		432 066	M 2066		
Legacy [B14]	06.09→		432 190	M 2190		
Legacy Kombi [B14]	06.09→		432 190	M 2190		
Outback [B14]	06.09→		432 190	M 2190		

SUZUKI

Alto [AMF]	12.08→	LLE	432 148	M 2148		D 178
Grand Escudo	12.00-10.02		432 156	M 2156		
	11.02-06.05		432 221	M 2221		
Grand Vitara	03.98→		432 156	M 2156		D 181
			432 221	M 2221		D 247
	10.05→		432 236	M 2236		
Grand Vitara Cabrio	03.98-03.08		432 156	M 2156		D 181
Ignis Hatchback	10.03-12.07		432 066	M 2066		
Liana Hatchback	03.01-04.08		432 172	M 2172		D 204
Liana Sedan	04.02-12.07		432 172	M 2172		D 204
Splash [A5B]	01.08→		432 214	M 2214		D 239
Swift Hatchback [AZG; MZ/ EZ]	11.04→		432 173	M 2173		D 205
SX4 Hatchback	05.06→		432 173	M 2173		D 205

THINK NORDIC

Think City	08.10→		432 048	M 2048		
------------	--------	--	----------------	--------	--	--



1987...

1987...

TOYOTA

Auris	[E15; E15, JTN; E15, NMT, SB1]	09.06→		432 190	M 2190			D 217
Avensis	[T22]	10.97-01.03	LLE	432 159	M 2159			
	[T25]	01.03-11.08		432 088	M 2088			D 126
	[T27]	11.08→		432 190	M 2190			D 217
Avensis Liftback	[T22]	10.97-01.03	LLE	432 159	M 2159			
	[T25]	01.03-11.08		432 088	M 2088			D 126
Avensis Verso	[M2]	05.01→		432 085	M 2085			
Avensis Wagon	[T22]	10.97-01.03	LLE	432 159	M 2159			
	[T25]	01.03-11.08		432 088	M 2088			D 126
	[T27]	11.08→		432 190	M 2190			D 217
Aygo		02.05→		432 189	M 2189			D 216
Camry	[V3]	08.99-01.06		432 085	M 2085	432 320	R 2320	D 293
	[V4; V5; V40]	01.06→		432 190	M 2190			
Camry Sedan		03.03-12.05		432 085	M 2085			
Carina E Liftback	[T19]	12.93-10.97	LLE	432 159	M 2159			
Carina E Sedan	[T19]	02.92-10.97	LLE	432 159	M 2159			
Carina E Wagon	[T19]	11.92-10.97	LLE	432 159	M 2159			
Celica Coupé	[T23]	08.99-09.05		432 085	M 2085			
Century		04.97→				432 468	R 2468	
Corolla	[E11]	04.97-10.99		432 155	M 2155			D 180
	[E12]	08.00-08.08		432 084	M 2084			
	[E12, JTD]	10.01-11.06		432 088	M 2088			D 126
	[E12, NMT]	01.02-02.07		432 088	M 2088			D 126
	[E15]	11.06→		432 190	M 2190			
Corolla Fielder		08.00-10.06		432 084	M 2084			
Corolla Hatchback	[E11]	05.97-07.01		432 155	M 2155			D 180
	[E12]	11.01-12.07		432 084	M 2084			
			TW	432 088	M 2088			
Corolla Liftback	[E11]	05.97-09.01		432 155	M 2155			D 180
Corolla RunX	[E12]	09.02-07.07		432 084	M 2084			
Corolla Sedan	[E11]	04.97-06.02		432 155	M 2155			D 180
Corolla Verso	[E12]	09.01-01.04		432 084	M 2084			
			TW	432 088	M 2088			
	[R10/R11; R11]	02.04→		432 088	M 2088			D 126
	[R2]	02.09→		432 190	M 2190			D 217
Corolla Wagon	[E11]	04.97-09.01		432 155	M 2155			D 180
	[E12, JTD]	06.04-11.06		432 088	M 2088			D 126
	[E12, NMT]	08.02-02.07		432 088	M 2088			D 126
Echo		09.99→		432 084	M 2084			
Estima		02.00-01.06		432 085	M 2085			
Fortuner		02.06→		432 190	M 2190			
Hilux	[N15; N25; N26; N35]	07.05→		432 190	M 2190			



◀ TOYOTA		1987...	1987...
Hilux	[Raider]	03.02-05.05	432 085 M 2085
		08.08→	432 190 M 2190
Land Cruiser	[J6, J7, J10; J7, J10]	03.99-02.07	432 190 M 2190
	[J12]	09.02→	432 085 M 2085
	[J15; J20]	09.07→	432 190 M 2190
Land Cruiser Prado	[J12]	01.03→	432 085 M 2085
Picnic		09.96-05.01 LLE	432 159 M 2159
Previa		02.00→	432 085 M 2085
	[V4]	01.06-08.11	432 190 M 2190
Prius	[W11; W20]	09.00-03.09	432 085 M 2085
	[W30; W35]	04.09→	432 190 M 2190
RAV4	[A2]	05.00-01.06	432 084 M 2084
	[A3]	11.05→	432 084 M 2084
		TW	432 190 M 2190
Sequoia		09.07→	432 190 M 2190
Urban Cruiser	[P1]	01.09→	432 190 M 2190
Verso-S		11.10→	432 190 M 2190 D 217
Vitz		09.99-02.05	432 084 M 2084
Yaris	[P1]	01.99-08.05	432 084 M 2084 D 121
		01.01-08.06	432 085 M 2085
	[P9]	01.06→	432 084 M 2084 D 121
		TW	432 190 M 2190 D 217
	[P9, JTD]	08.05→	432 190 M 2190 D 217
	[P9, VNK]	11.05→	432 190 M 2190 D 217
Yaris Verso	[P2]	08.99-09.05	432 084 M 2084 D 121
4-Runner	[N21]	09.02→	432 085 M 2085

VAUXHALL

Agila	[A]	09.99-02.08	432 066 M 2066 D 95
	[B]	03.08→	432 214 M 2214 D 239
Ampera		10.11→	432 004 M 2004 432 304 R 2304
Astra	[F]	09.91-02.98	432 010 M 2010 D 17
	[G]	09.97-08.05	BHR, LLE 432 038 M 2038 D 62
			DHI, ELH 432 040 M 2040 D 62
	[H]	03.04→	432 040 M 2040
	[J]	09.09→	432 004 M 2004 432 304 R 2304
Astra Convertible	[F]	09.91-02.98	432 010 M 2010 D 17
	[G]	09.00-08.05	BHR, LLE 432 038 M 2038 D 62
			DHI, ELH 432 040 M 2040 D 62
Astra Coupé	[G]	09.97-08.05	BHR, LLE 432 038 M 2038 D 62
			DHI, ELH 432 040 M 2040 D 62
		03.03-08.05	DHI, RLE 432 040 M 2040
Astra Estate	[F]	09.91-02.98	432 010 M 2010 D 17
	[G]	09.97-08.05	BHR, LLE 432 038 M 2038 D 62
			DHI, ELH 432 040 M 2040 D 62
	[H]	08.04→	432 040 M 2040
Astra GTC	[H]	12.06→	432 040 M 2040
	[J]	09.11→	432 004 M 2004 432 304 R 2304



				1987...		1987...	
Astra Sports Tourer	[J]	09.10→		432 004	M 2004	432 304	R 2304
Astra TwinTop	[H]	03.06-12.09		432 040	M 2040		
Astra Van	[F]	09.91-02.98		432 010	M 2010		D 17
	[G]	09.97-08.05	BHR, LLE	432 038	M 2038		D 62
			DHI, ELH	432 040	M 2040		D 62
Calibra		03.92-07.97		432 010	M 2010		D 17
Combo		09.94-10.01	KL	432 015	M 2015		D 33
Combo	[Tour]	09.01→	MOO	432 076	M 2076	432 376	R 2376 D 105
Corsa	[B]	09.94-09.00	KL	432 015	M 2015		D 33
	[C]	09.00-09.06	MOO	432 076	M 2076	432 376	R 2376 D 105
	[D]	07.06→		432 188	M 2188	432 488	R 2488 D 213
Insignia	[68; 69]	11.08→		432 004	M 2004	432 304	R 2304 D 11
Insignia Sports Tourer	[35]	02.09→		432 004	M 2004	432 304	R 2304 D 11
Meriva	[A]	03.03-03.10	KL	432 111	M 2111	432 411	R 2411 D 146
	[B]	04.10→		432 004	M 2004	432 304	R 2304
Omega	[B]	09.93-09.04		432 016	M 2016		D 35
Signum		05.03-09.08		432 076	M 2076	432 376	R 2376
Sintra		09.96-09.99	2FE, WW	432 052	M 2052		D 76
Tigra	[A]	09.94-08.99	KL	432 015	M 2015		D 33
Tigra TwinTop	[B]	06.04-12.09		432 076	M 2076	432 376	R 2376
Vectra	[B]	09.95-09.02		432 030	M 2030	432 330	R 2330 D 53
	[C]	09.01-10.08		432 076	M 2076	432 376	R 2376
Vectra Estate	[B]	09.95-08.01		432 030	M 2030	432 330	R 2330 D 53
	[C]	09.03-10.08		432 076	M 2076	432 376	R 2376
Vivaro		03.01→		432 208	M 2208		D 234
Zafira	[A]	09.98-06.05	BHR	432 038	M 2038		D 62
	[B]	03.08→		432 038	M 2038		D 62

VOLVO

C30		10.06→		432 113	M 2113	432 413	R 2413
C70 Coupé		01.97-07.02		432 062	M 2062		D 89
C70 I Cabrio		02.98-03.06		432 062	M 2062		D 89
C70 II Cabrio		03.06→		432 113	M 2113	432 413	R 2413
S40 I		09.95-07.00	KL	432 157	M 2157		
		09.95-01.04	KL	432 063	M 2063	432 363	R 2363 D 90
S40 II		12.03→		432 113	M 2113	432 413	R 2413 D 148
S60 I		11.00-07.09	LLE			432 464	R 2464 D 91
S60 II		08.10→		432 205	M 2205	432 405	R 2405
S70		01.97-07.00		432 062	M 2062		D 89
S80 II		03.06→		432 205	M 2205	432 405	R 2405 D 231
S90		11.96-12.99		432 062	M 2062		
V40		01.95-06.04	KL	432 063	M 2063	432 363	R 2363 D 90
			KL	432 157	M 2157		
V50		04.04→		432 113	M 2113	432 413	R 2413 D 148
V60		09.10→		432 205	M 2205	432 405	R 2405
V70 I		01.97-03.00		432 062	M 2062		D 89
V70 II		03.00-07.07	LLE			432 464	R 2464 D 91
V70 III		08.07→		432 205	M 2205	432 405	R 2405 D 231
V90		01.97-07.98		432 062	M 2062		
XC60		03.09→		432 205	M 2205	432 405	R 2405 D 231
XC70 I		08.02-07.07	LLE			432 464	R 2464 D 91









◀ VOLVO

			1987...	1987...
XC70 II	08.07→		432 205 M 2205	432 405 R 2405
XC90	10.02→	LLE		432 464 R 2464 D 91
850	09.91-07.98	253	432 062 M 2062	
850 Kombi	09.91-07.98	253	432 062 M 2062	

VW (VOLKSWAGEN)

Amarok	[2H]	09.10→		432 114 M 2114	432 431 R 2431	
Bora	[1J2]	09.98-05.05			432 300 R 2300	D 285
	[9D, 152]	08.01-11.06	432 012 M 2012		432 300 R 2300	D 285
Bora Variant	[1J6]	09.98-05.05			432 300 R 2300	D 285
Caddy	[9K9]	11.95-06.03	432 012 M 2012		432 312 R 2312	D 21
	[2K; 2C]	02.04→	LLE 432 097 M 2097		432 397 R 2397	D 134
			RLE		432 597 R 2597	D 334
Caddy Pickup	[9U7]	06.96-12.00	432 012 M 2012		432 312 R 2312	D 21
California T4	[70, 7D]	11.92-06.03	432 056 M 2056			D 81
California T5	[7E]	09.09→	432 114 M 2114		432 431 R 2431	D 151
	[7H]	02.03-11.09	432 114 M 2114		432 431 R 2431	D 151
Caravelle T4	[70, 7D]	11.92-06.03	432 056 M 2056			D 81
Caravelle T5	[7E]	09.09→	432 114 M 2114		432 431 R 2431	D 151
	[7H]	02.03-11.09	432 114 M 2114		432 431 R 2431	D 151
Crafter	[2E, 2F]	04.06→	432 213 M 2213		432 513 R 2513	D 238
Eos	[1F7; 1F8]	05.06→	LLE 432 097 M 2097		432 397 R 2397	D 134
			RLE		432 597 R 2597	D 334
Fox	[5Z1]	04.05→	432 057 M 2057		432 357 R 2357	
Golf III	[1H1]	11.91-12.97	432 012 M 2012		432 300 R 2300	D 21
			WW		432 312 R 2312	D 21
Golf III	[1E7]	12.95-04.98	432 012 M 2012			D 21
Cabriolet						
Golf III Variant	[1H5]	07.93-02.99	432 012 M 2012			D 21
Golf IV	[1J1]	10.97→	432 012 M 2012		432 300 R 2300	D 285
Golf IV	[1E7]	04.98-06.02	432 012 M 2012		432 300 R 2300	D 285
Cabriolet						
Golf IV Variant	[1J5]	05.99-06.06			432 300 R 2300	D 285
Golf V	[1K1]	10.03-11.09	LLE 432 097 M 2097		432 397 R 2397	D 134
			RLE		432 597 R 2597	D 334
Golf V Variant	[1K5]	05.07-07.09	LLE 432 097 M 2097		432 397 R 2397	D 134
			RLE		432 597 R 2597	D 334
Golf VI	[5K1]	10.08→	LLE 432 097 M 2097		432 397 R 2397	D 134
			RLE		432 597 R 2597	D 334
Golf VI Cabrio	[517]	03.11→	LLE 432 097 M 2097		432 397 R 2397	D 134
			RLE		432 597 R 2597	D 334
Golf VI Variant	[AJ5]	06.09→	LLE 432 097 M 2097		432 397 R 2397	D 134
			RLE		432 597 R 2597	D 334
Golf Plus	[5M1; 521]	01.05→	LLE 432 097 M 2097		432 397 R 2397	D 134
			RLE		432 597 R 2597	D 334
Jetta	[1G2, 19E]	08.91-07.92	432 011 M 2011			
	[9M2]	10.98→			432 300 R 2300	
	[1K2]	01.05-10.10	LLE		432 397 R 2397	D 134
			RLE		432 597 R 2597	D 334
[162]	10.10→	LLE 432 097 M 2097		432 397 R 2397	D 134	
		RLE		432 597 R 2597		
Jetta IV		09.99-12.05			432 300 R 2300	
LT	[2D, 2H]	05.96-04.06	432 043 M 2043			D 69

						SC		SC	
						1987...		1987...	
Lupo	[6X1]	06.98-07.05				432 012	M 2012	432 300	R 2300 D 21
Multivan T4	[70, 7D]	11.92-06.03				432 056	M 2056		D 81
Multivan T5	[7E]	09.09→				432 114	M 2114	432 431	R 2431 D 151
	[7H]	02.03-11.09				432 114	M 2114	432 431	R 2431 D 151
New Beetle	[1C1, 9C1]	01.98→						432 300	R 2300 D 285
New Beetle Cabriolet	[1Y7]	01.03-10.10						432 300	R 2300 D 285
Passat	[312, 35I, 3A2]	03.91-03.97				432 013	M 2013	432 313	R 2313 D 26
	[3B2]	10.96-11.00				432 017	M 2017	432 317	R 2317 D 36
	[3B3]	10.00-05.05				432 012	M 2012	432 312	R 2312
	[3C2]	03.05-11.10	LLE			432 097	M 2097	432 397	R 2397 D 134
			RLE					432 597	R 2597 D 334
	[362]	08.10→	LLE			432 097	M 2097	432 397	R 2397 D 134
			RLE					432 597	R 2597
Passat Variant	[315, 35I, 3A5]	03.91-03.97				432 013	M 2013	432 313	R 2313 D 26
		10.94-12.95				432 017	M 2017	432 317	R 2317 D 36
	[3B5]	01.97-11.00				432 017	M 2017	432 317	R 2317 D 36
	[3B6]	10.00-05.05				432 012	M 2012	432 312	R 2312
	[3C5]	08.05-11.10	LLE			432 097	M 2097	432 397	R 2397 D 134
			RLE					432 597	R 2597 D 334
	[365]	08.10→	LLE			432 097	M 2097	432 397	R 2397 D 134
			RLE					432 597	R 2597
Passat CC	[357]	05.08→	LLE			432 097	M 2097	432 397	R 2397 D 134
			RLE					432 597	R 2597
Polo	[6N1]	10.94-12.99				432 012	M 2012	432 300	R 2300 D 21
								432 312	R 2312 D 21
	[6N2]	07.98-09.01	H25			432 012	M 2012	432 312	R 2312 D 21
			H30					432 300	R 2300 D 21
	[6R1]	06.09-05.10				432 057	M 2057	432 357	R 2357
	[9N1]	09.01-05.05				432 057	M 2057	432 357	R 2357
[9N2]	07.03-05.07				432 057	M 2057	432 357	R 2357	
[9N3]	04.05→				432 057	M 2057	432 357	R 2357	
Polo Classic	[6V2]	11.95-09.01	H25			432 012	M 2012	432 312	R 2312 D 21
Polo Variant	[6V5]	05.97-09.01	H25			432 012	M 2012	432 312	R 2312 D 21
Scirocco	[137]	08.08→	LLE			432 097	M 2097	432 397	R 2397 D 134
			RLE					432 597	R 2597 D 334
Sharan	[7M8]	09.95-02.00				432 028	M 2028	432 328	R 2328 D 52
	[7M9, 7M6]	04.00-03.10				432 028	M 2028	432 328	R 2328 D 52
	[7N1]	05.10→	LLE			432 097	M 2097	432 397	R 2397 D 134
			RLE				432 597	R 2597 D 334	
Tiguan	[5N1]	11.07-05.11	LLE			432 097	M 2097	432 397	R 2397 D 134
			RLE					432 597	R 2597 D 334
Touareg	[7LA; 7L6]	11.02-05.10						432 431	R 2431 D 320
Touran	[1T1; 1T2]	02.03-05.10	LLE			432 097	M 2097	432 397	R 2397 D 134
			RLE					432 597	R 2597 D 334
	[1T3]	05.10→	LLE					432 397	R 2397 D 134
			RLE					432 597	R 2597 D 334
Transporter T4	[70, 7D]	11.92-06.03				432 056	M 2056		D 81
Transporter T5	[7E; 7F]	09.09→				432 114	M 2114	432 431	R 2431 D 151
	[7H; 7J]	02.03-11.09				432 114	M 2114	432 431	R 2431 D 151
Vento	[1H2]	11.91-12.97				432 012	M 2012	432 312	R 2312 D 21

de

Gegenüberstellung**Benutzerhinweise**

Im nachfolgenden Katalogteil sind Bestellnummern von Herstellern anderer Marken, für die es einbaugleiche Bosch-Erzeugnisse oder -Teile gibt, aufgeführt. Da die verschiedenartigsten Bezeichnungssysteme angewendet werden, konnten die fremden Bestellnummern nur in einer einheitlichen, alphanumerischen Sortierfolge geordnet werden. Sie weicht bei einigen Herstellern von der dort üblichen Sortierfolge ab.

„Werden Bosch-Teile mit Teilenummern versehen, sind aus wettbewerbsrechtlichen Gründen in jedem Fall die jeweiligen Bosch-Teilenummern zu verwenden und als solche kenntlich zu machen. Daneben können auch fremde Teilenummern verwendet werden, um die technische bzw. funktionale Gleichwertigkeit der jeweiligen Produkte zum Ausdruck zu bringen.

Ggf. sollten nach Möglichkeit fremde Teilenummern sogleich mehrerer Hersteller aufgeführt werden. Eine fremde Teilenummer ist dabei eindeutig als solche eines anderen Herstellers kenntlich zu machen, wie insbesondere durch gleichzeitige Nennung des fremden Herstellers bzw. der fremden Marke sowie deren eindeutige Zuordnung zu der fremden Teilenummer.

Alle Angaben dürfen nur in Standard-Schrift erfolgen. Insbesondere dürfen keine Logos oder besondere Schriftzüge der fremden Hersteller verwendet und ihre Marken bzw. Namen auch sonst nicht besonders hervorgehoben werden.

Vielmehr sollte die Nennung fremder Namen, Marken und Teilenummern generell möglichst unauffällig erfolgen.“

fr

Table de correspondance**A l'attention de l'utilisateur**

Cette section du catalogue reprend les références des fabricants d'autres marques pour lesquelles il existe des produits ou des composants Bosch de montage identique. De multiples systèmes de codage étant utilisés, les références des produits d'autres marques ne peuvent être reprises que suivant un classement alphanumérique uniforme. Pour certains fabricants, ce classement peut différer de celui qu'ils utilisent habituellement.

«Si des pièces Bosch sont munies de références, pour des raisons liées à la législation sur la concurrence, les références Bosch correspondantes doivent être utilisées dans tous les cas et être rendues identifiables comme telles. Parallèlement, des références étrangères peuvent également être utilisées pour exprimer l'équivalence technique ou fonctionnelle des produits considérés.

Le cas échéant, indiquer si possible concomitamment les références étrangères de plusieurs fabricants.

Une référence étrangère doit être identifiée clairement comme étant celle d'un autre fabricant, notamment par l'indication simultanée de l'autre fabricant ou de l'autre marque, de même que par leur correspondance claire à la référence étrangère.

Toutes les indications doivent être effectuées dans la police standard. Aucun logo ou monogramme particulier des fabricants étrangers ne doit en particulier être utilisé et leurs marques ou noms ne doivent être mis en valeur d'aucune autre façon. Au contraire, les noms, marques et références étrangers doivent, d'une manière générale, être cités de façon aussi discrète que possible.»

en

Cross-reference**Notes for users**

The following catalog section lists part numbers of non-Bosch equipment for which there are interchangeable Bosch products or components available. Since a wide range of different designation systems are used, we were forced to arrange the non-Bosch part numbers in a uniform alphanumeric order. This differs from the customary order employed by some manufacturers.

“If part numbers are assigned to Bosch parts, the corresponding Bosch part numbers are always to be used and clearly identified as such to satisfy the law on competition. Use can additionally be made of non-Bosch part numbers to express the equivalent technical and functional properties of the products concerned.

If applicable, the non-Bosch part numbers of several manufacturers should be listed wherever possible.

When doing so, a non-Bosch part number is to be clearly identified as that of another manufacturer, in particular by naming the other manufacturer or the non-Bosch make and clearly assigning this to the non-Bosch part number.

All such information must always be given in standard typeface. In particular, use is not to be made of any logos or special emblems of other manufacturers and their brands and names are not to be specially highlighted in any other way.

On the contrary, mention should only be made of non-Bosch names, makes and part numbers as inconspicuously as possible.”

it

Comparazione**Avvertenze per la consultazione**

Nella seguente parte del catalogo vengono riportati i numeri di ordinazione di costruttori di prodotti d'altra marca, per i quali sono disponibili prodotti o parti di prodotti Bosch di corrispondente applicazione. Dato che vengono utilizzati i più diversi sistemi di denominazione, si è potuto ordinare i numeri di ordinazione di altra marca solo in una sequenza di classificazione unitaria ed alfanumerica. Per alcune case costruttrici si differenzia perciò dalla sequenza di classificazione normalmente usata. In questo confronto le sigle Bosch vanno considerate come dati indicativi.

«Qualora componenti Bosch vengano corredati di codici, per motivi legati alle leggi che regolano la concorrenza si devono utilizzare in ogni caso i relativi codici Bosch evidenziandoli come tali. L'utilizzo di codici di altra marca è comunque possibile per esprimere una equivalenza tecnica o funzionale dei relativi prodotti.

Possibilmente è da prediligere l'indicazione contemporanea di codici di diversi costruttori.

Un codice che non sia Bosch va evidenziato in modo univoco in tal senso, in particolare nominando contestualmente il costruttore o la marca di appartenenza.

Tutte le indicazioni devono essere riportate ricorrendo a caratteri standard. In particolare non si devono utilizzare loghi o scritte particolari usati dai costruttori di prodotti di altra marca né si devono mettere in risalto i relativi marchi o nomi.

Al contrario, l'indicazione di nomi, marche e codici diversi da Bosch dovrebbe essere in genere quanto più discreta possibile.»

es

Equivalencias**Indicaciones para el usuario**

A continuación se han relacionado números de pedido de fabricantes de otras marcas para los que existen productos o piezas Bosch de iguales características. Dado que se utilizan los más diversos sistemas de designación, los números de pedido ajenos han podido relacionarse tan sólo en un orden unificado, alfanumérico. En el caso de algunos fabricantes, el orden de esta clasificación difiere del que utilizan habitualmente.

«Si piezas Bosch se dotan de números de pieza, por motivos de índole legal relativos a la competencia se deben utilizar en cualquier caso los respectivos números de pieza Bosch, identificándolos como tales debidamente. Paralelamente se pueden usar también números de pieza ajenos para poner de manifiesto la equivalencia técnica o funcional de los respectivos productos.

En su caso y en la medida de lo posible, se deberían citar al mismo tiempo números de pieza ajenos de varios fabricantes.

Un número de pieza ajeno se debe identificar en estos casos claramente como perteneciente a otro fabricante, por ejemplo citando simultáneamente al fabricante ajeno o la marca ajena así como estableciendo la correspondencia de éstos con el número de pieza ajeno.

Todos los datos se deben escribir solo con letra estándar. En particular, no se permite utilizar logotipos o caracteres gráficos propios de los fabricantes ajenos, ni tampoco destacar sus marcas y nombres de manera especial.

Por el contrario, los nombres, las marcas y los números de piezas de empresas ajenas se deberían citar, en general, de la forma más discreta posible.»

nl

Opzoektabel**Aanwijzingen voor de gebruiker**

In het hierna volgende deel van de catalogus vindt u bestelnummers van fabrikanten van andere merken, waarvoor identiek geconstrueerde Bosch-producten of -onderdelen bestaan. Gezien de meest uiteenlopende nummeringssystemen in gebruik zijn, kunnen we de bestelnummers van andere fabrikanten slecht presenteren in één uniforme, alfanumerieke sorteervolgorde. In sommige gevallen wijkt deze volgorde af van de bij de betreffende fabrikant gebruikelijke sorteervolgorde.

"Indien Bosch-onderdeelnummers van onderdeelnummers worden voorzien, moeten om redenen van het concurrentierecht in elk geval de desbetreffende Bosch-onderdeelnummers worden gebruikt en als zodanig kenbaar worden gemaakt. Daarnaast kunnen ook externe onderdeelnummers worden gebruikt om de technische resp. functionele gelijkwaardigheid van de desbetreffende producten uit te drukken.

Eventueel moeten, indien mogelijk, externe onderdeelnummers van meerdere fabrikanten worden vermeld.

Een extern onderdeelnummer moet daarbij duidelijk als onderdeel van een andere fabrikant kenbaar worden gemaakt, zoals in het bijzonder door gelijktijdig de externe fabrikant resp. het externe merk te vermelden en dit duidelijk toe te wijzen aan het externe onderdeelnummer.

Alle gegevens mogen uitsluitend in een standaard lettertype plaatsvinden. In het bijzonder mogen er geen logo's of bijzondere lettertypes van de externe fabrikant worden gebruikt en hun merk resp. naam mag ook niet bijzonder worden geaccentueerd.

Het noemen van namen, merken en onderdeelnummers moet over het algemeen zo onopvallend als mogelijk gebeuren."

pt

Comparação**Instruções para o utilizador**

Na parte do catálogo que se segue, apresentam-se os números de referência de fabricantes de outras marcas e, em alguns casos, de fabricantes de veículos, para as quais existem produtos ou peças equivalentes aos da Bosch. Sendo os sistemas de designação dos mais variados tipos, os números de referência de fabricantes externos só puderam ser catalogados numa sequência alfanumérica única. Esta desvia-se da sequência de catalogação normalmente utilizada por alguns fabricantes.

«Se as peças Bosch estiverem identificadas com um número de peça, devem ser usados sempre os respectivos números de peça Bosch e ser identificados como tal, por motivos relacionados com a lei da concorrência. Podem ser usados adicionalmente números de peça de terceiros para destacar a equivalência técnica ou funcional dos respectivos produtos.

Se necessário, e consoante a possibilidade, deveriam ser indicados os números de peça de terceiros de vários fabricantes em simultâneo.

Contudo, um número de peça de terceiros deve ser claramente identificado como sendo de outro fabricante, nomeando tanto o outro fabricante ou a outra marca, como a respectiva atribuição inequívoca do número de peça de terceiros.

Todas as indicações têm de ser expressas em letra standard. Não podem, sobretudo, ser usados quaisquer logótipos ou inscrições especiais de outros fabricantes, nem ser destacada, de modo algum, a marca ou o nome.

Por norma, é desejável que a menção de nomes, marcas e números de peça de terceiros seja feita da forma menos visível possível.»

tr

Karşılaştırmalar**Kullanıcı Talimatı**

Mütekip katalog bölümünde aynı şekilde monte edilebilir Bosch ürünlerinin veya Bosch parçalarının bulunduğu başka marka üreticilerinin ve kısmen de otomobil üreticilerinin sipariş numaraları verilmektedir. Çok çeşitli tanımlama sistemleri kullanıldığından yabancı sipariş numaraları sadece alfanümerik düzenlenmiş olarak sistemli olarak verilebilmiştir. Bu düzenleme bazı üreticilerde orada uygulanan düzenleme sırasından değişiklik göstermektedir.

«Bosch parçalarını parça numaraları verildiğinde, haksız rekabet sebeplerinden dolayı her zaman ilgili Bosch parça numaraları kullanılmalı ve parçalar bu parça numaraları ile tanımlanmalıdır. Bunun haricinde, ilgili ürünlerin teknik ve işlevsel eşdeğerliğini ifade etmek için başka üreticilere ait parça numaraları da kullanılabilir.

Gerektiğinde, aynı anda çok sayıda üreticinin parça numaraları sunulmalıdır.

Başka üreticiye ait bir parça numarası, örneğin aynı anda ilgili üreticinin veya markanın adının belirtilmesi veya başka üreticiye ait bir parça numarası olduğunun benzersiz bir şekilde vurgulanması ile benzersiz bir şekilde ifade edilmelidir.

Tüm bilgiler standart yazı tipinde yazılmalıdır. Özellikle başka üreticilere ve bu üreticilerin markalarına ait logolar veya özel yazı stilleri kullanılmalı veya bunlar başka yöntemle vurgulanmamalıdır.

Genel olarak başka üreticinin adları, markaları ve parça numaraları mümkün olduğunca dikkat çekici olmayacak şekilde belirtilmelidir.»

cs

Převod**Покыны про uživatele**

V následujícím dílu katalogu jsou uvedena objednávací čísla výrobců jiných značek, pro něž existují montážně shodné výrobky nebo díly Bosch. Protože se používají nejrůznější systémy označování, mohou být cizí objednávací čísla uspořádána jen v jednotné, alfanumerické posloupnosti třídění. U některých výrobců se mohou vyskytovat odchylky od zde používané běžné posloupnosti třídění.

„Jestliže jsou díly Bosch opatřeny číslem dílu, je z konkurenčně legálních důvodů v každém případě nutno používat čísla dílů Bosch a jako takové je označovat. Kromě toho mohou být používána také cizí čísla dílů, aby se vyjádřila technická popř. funkční ekvivalence příslušného produktu.

Podle možnosti měla být případně uváděna cizí čísla dílů hned několika výrobců.

Cizí číslo dílu jiného výrobce je přitom jako takové třeba jednoznačně označit, zejména současným pojmenováním cizího výrobce popř. cizí značky a uvádět rovněž jejich jednoznačné přiřazení k cizímu číslu dílu.

Všechny údaje smí být uváděny jen standardním písmem. Zejména se nesmí používat žádná loga nebo zvláštní nápisy cizích výrobců, a jejich značky popř. jména také nesmí nijak zvlášť zvýrazňovat. Spíše by měla být pojmenování cizími názvy, značkami a čísly dílů obecně pokud možno nenápadná.“

ru

Сопоставления**Вниманию пользователей**

В следующей части каталога приводятся номера для заказов производителей других марок, для которых имеются идентичные изделия или запчасти компании Bosch. Поскольку используются различные системы обозначений, номера заказов других производителей располагаются в едином алфавитно-цифровом порядке. Для некоторых производителей они отличаются от используемого у них порядка классификации.

„Если изделия Bosch имеют номера деталей, то по причинам законодательных положений в области конкуренции в любом случае необходимо использовать соответствующие номера Bosch и показывать их. Кроме того, можно использовать также номера деталей других производителей, чтобы показать техническую и функциональную равноценность соответствующих изделий.

В отдельных случаях необходимо по возможности указывать номера деталей нескольких производителей.

Номер детали другого производителя явно показывать как таковой, например, одновременно называя другого производителя или другую марку, а также их однозначное отношение к номеру детали другого производителя.

Все данные должны указываться стандартным шрифтом. В особенности, не разрешается использовать логотипы и специальные надписи других производителей и особым образом выделять их марки и названия.

Напротив, названия, марки и номера деталей других производителей всегда необходимо указывать по возможности неброско.“

AC DELCO

CAF2	1 987 432 015	M 2015
CAF3	1 987 432 030	M 2030
CAF4	1 987 432 012	M 2012

CAF9	1 987 432 018	M 2018
CAF10	1 987 432 022	M 2022
CAF11	1 987 432 016	M 2016
CAF12	1 987 432 011	M 2011
CAF13	1 987 432 021	M 2021

CAF17	1 987 432 024	M 2024
CAF21	1 987 432 006	M 2006
CAF28	1 987 432 027	M 2027
CAF29	1 987 432 013	M 2013
CAF34	1 987 432 009	M 2009

MS-6130	1 987 431 175	M 1175
MS-6331	1 987 432 109	M 2109
MS-6372	1 987 432 236	M 2236
PUK1021E	1 987 432 357	R 2357
PUK1026E	1 987 432 313	R 2313

PUK1034E	1 987 432 312	R 2312
PUK1041E	1 987 432 303	R 2303
PUK1046E	1 987 432 366	R 2366
PUK1055 E	1 987 432 407	R 2407
PUK1070E	1 987 432 310	R 2310

PUK1081E	1 987 432 354	R 2354
PUK10822E	1 987 432 361	R 2361
PUK1083E	1 987 432 300	R 2300
PUK1085 E	1 987 432 597	R 2597
PUK1089E	1 987 432 337	R 2337

PU10023E	1 987 432 060	M 2060
PU1004E	1 987 432 011	M 2011
PU1007E	1 987 432 021	M 2021
PU1008E	1 987 432 026	M 2026
PU1010E	1 987 432 105	M 2105

PU1013E	1 987 432 075	M 2075
PU1015E	1 987 432 090	M 2090
PU1017E	1 987 432 027	M 2027
PU1018E	1 987 432 050	M 2050
PU1021E	1 987 432 057	M 2057

PU1026E	1 987 432 013	M 2013
PU1027E	1 987 432 089	M 2089
PU1033E	1 987 432 022	M 2022
PU1034E	1 987 432 012	M 2012
PU1038E	1 987 432 079	M 2079

PU1043E	1 987 432 009	M 2009
PU1046E	1 987 432 016	M 2016
PU1051E	1 987 432 024	M 2024
PU1059E	1 987 432 015	M 2015
PU1061E	1 987 432 006	M 2006

PU1062E	1 987 432 006	M 2006
PU1064E	1 987 432 045	M 2045
PU1065E	1 987 432 044	M 2044
PU1069E	1 987 432 030	M 2030
PU1072E	1 987 432 042	M 2042

PU1073E	1 987 432 018	M 2018
PU1096E	1 987 432 043	M 2043
PU1124E	1 987 432 026	M 2026

AL

ALC 5100	1 987 432 027	M 2027
ALC 5101	1 987 432 061	M 2061
ALC 5102	1 987 432 050	M 2050

ALC-5103	1 987 432 225	M 2225
ALC-5108	1 987 432 226	M 2226
ALC 5110	1 987 432 090	M 2090
ALC 51101	1 987 432 090	M 2090
ALC 5111	1 987 432 039	M 2039

ALC 5210	1 987 432 016	M 2016
ALC 52101	1 987 432 016	M 2016
ALC 5211	1 987 432 030	M 2030
ALC 52111	1 987 432 030	M 2030
ALC 5216	1 987 432 088	M 2088

ALC 5218	1 987 432 018	M 2018
ALC 52181	1 987 432 018	M 2018
ALC 5221	1 987 432 084	M 2084
ALC 5222	1 987 432 084	M 2084
ALC 5223	1 987 432 012	M 2012

ALC 52231	1 987 432 012	M 2012
ALC 5225	1 987 432 015	M 2015
ALC 52251	1 987 432 015	M 2015
ALC 5226	1 987 432 026	M 2026
ALC 52261	1 987 432 026	M 2026

ALC 5243	1 987 432 022	M 2022
ALC 5251	1 987 432 044	M 2044
ALC-5255	1 987 432 200	M 2200
ALC 5300	1 987 432 021	M 2021
ALC 5304	1 987 432 053	M 2053

ALC 5305	1 987 432 074	M 2074
ALC 53051	1 987 432 074	M 2074
ALC 5313	1 987 432 012	M 2012
ALC 5319	1 987 432 057	M 2057
ALC 53191	1 987 432 057	M 2057

ALC 53221	1 987 432 354	R 2354
ALC 5325	1 987 432 043	M 2043
ALC 53251	1 987 432 043	M 2043
ALC 5330	1 987 432 075	M 2075
ALC 53301	1 987 432 075	M 2075

ALC 5333	1 987 432 151	M 2151
ALC 53331	1 987 432 151	M 2151
ALC 53351	1 987 432 013	M 2013
ALC 5341	1 987 432 006	M 2006
ALC 53411	1 987 432 006	M 2006

ALC 5342	1 987 432 113	M 2113
ALC 5344	1 987 432 042	M 2042
ALC 5355	1 987 432 150	M 2150
ALC 5356	1 987 432 059	M 2059
ALC 5357	1 987 432 037	M 2037

ALC 5365	1 987 432 079	M 2079
ALC 5366	1 987 431 166	M 1166
ALC 5380	1 987 432 188	M 2188
ALC 5382	1 987 432 109	M 2109
ALC 5385	1 987 431 163	M 1163

ALC 5391	1 987 432 236	M 2236
ALC 5393	1 987 432 065	M 2065
ALC 5397	1 987 432 055	M 2055
ALC 5399	1 987 432 078	M 2078
ALC 5403	1 987 432 082	M 2082

ALC 5407	1 987 432 058	M 2058
ALC 5411	1 987 432 102	M 2102
ALC 5412/15	1 987 432 086	M 2086
ALC 5414	1 987 432 361	R 2361
ALC 5500	1 987 432 210	M 2210

ALC 5701/13	1 987 432 122	M 2122
ALC 5703/14	1 987 432 077	M 2077
ALC 6300/1	1 987 432 363	R 2363
ALC 6301	1 987 432 398	R 2398
ALC 6303	1 987 432 336	R 2336

ALC 6307	1 987 432 300	R 2300
ALC 6310	1 987 432 239	M 2239
ALC 63171	1 987 432 310	R 2310
ALC 6324/1	1 987 432 320	R 2320
ALC 6325	1 987 432 361	R 2361

ALC 6328/1	1 987 432 393	R 2393
ALC 6402	1 987 432 482	R 2482
ALC 6408	1 987 432 357	R 2357
ALC 64081	1 987 432 357	R 2357
ALC 64131	1 987 432 337	R 2337

ALC 64141	1 987 432 366	R 2366
ALC 64151	1 987 432 303	R 2303
ALC 64171	1 987 432 412	R 2412
ALC 64181	1 987 432 310	R 2310
ALC 64191	1 987 432 378	R 2378

ALC 6421	1 987 432 312	R 2312
ALC 6427/1	1 987 432 428	R 2428
ALC 6428/1	1 987 432 434	R 2434
ALC 64361	1 987 432 354	R 2354
ALC 64371	1 987 432 313	R 2313

ALC 6449/1	1 987 431 458	R 1458
ALC 6459/1	1 987 432 488	R 2488
ALC 6463	1 987 432 308	R 2308
ALC 84181	1 987 432 310	R 2310
AL 5102	1 987 432 050	M 2050

ALCO

MD9010	1 987 431 159	M 1159
MS6006	1 987 432 006	M 2006
MS6006C	1 987 432 306	R 2306

MS6013	1 987 432 014	M 2014
MS6017	1 987 432 009	M 2009
MS6018	1 987 432 021	M 2021
MS6020	1 987 432 328	R 2328
MS6020C	1 987 432 328	R 2328

MS6024	1 987 432 049	M 2049
MS6026	1 987 432 044	M 2044
MS6031	1 987 432 089	M 2089
MS6103	1 987 432 015	M 2015
MS6104	1 987 432 022	M 2022

MS6106	1 987 432 301	R 2301
MS6107	1 987 432 016	M 2016
MS6108	1 987 432 013	M 2013
MS6109	1 987 432 300	R 2300
MS6109C	1 987 432 312	R 2312

MS6110	1 987 432 014	M 2014
MS6112	1 987 432 019	M 2019
MS6113	1 987 432 024	M 2024
MS6114	1 987 432 027	M 2027
MS6115	1 987 432 367	R 2367

MS6116	1 987 432 024	M 2024
MS6118C	1 987 432 317	R 2317
MS6119	1 987 432 030	M 2030
MS6120	1 987 432 018	M 2018
MS6120C	1 987 432 318	R 2318

MS6121	1 987 432 011	M 2011
MS6123	1 987 432 003	M 2003
MS6124	1 987 432 032	M 2032
MS6132	1 987 432 062	M 2062
MS6133	1 987 432 056	M 2056

MS6140	1 987 432 360	R 2360
MS6141	1 987 432 361	R 2361
MS6141C	1 987 432 361	R 2361
MS6144	1 987 432 105	M 2105
MS6145	1 987 432 042	M 2042

MS6146	1 987 432 060	M 2060
MS6148	1 987 432 045	M 2045
MS6148C	1 987 432 345	R 2345
MS6149	1 987 432 107	M 2107
MS6150	1 987 432 007	M 2007



A

◀ ALCO

MS6151	1 987 432 039	M 2039
MS6152	1 987 432 033	M 2033
MS6153	1 987 432 026	M 2026
MS6154	1 987 432 053	M 2053
MS6155	1 987 432 360	R 2360

MS6158	1 987 432 090	M 2090
MS6161	1 987 432 040	M 2040
MS6162	1 987 432 061	M 2061
MS6164	1 987 432 062	M 2062
MS6166	1 987 431 165	M 1165

MS6167C	1 987 432 096	M 2096
MS6168C	1 987 432 401	R 2401
MS6170	1 987 431 154	M 1154
MS6171	1 987 432 151	M 2151
MS6173	1 987 432 037	M 2037

MS6175	1 987 432 058	M 2058
MS6176	1 987 432 048	M 2048
MS6177	1 987 432 371	R 2371
MS6178	1 987 432 072	M 2072
MS6179C	1 987 432 336	R 2336

MS6180	1 987 432 108	M 2108
MS6181	1 987 432 064	M 2064
MS6182	1 987 432 378	R 2378
MS6183	1 987 432 364	R 2364
MS6185	1 987 432 075	M 2075

MS6187	1 987 432 066	M 2066
MS6188	1 987 432 084	M 2084
MS6189	1 987 432 095	M 2095
MS6193	1 987 432 362	R 2362
MS6194	1 987 432 052	M 2052

MS6201	1 987 432 386	R 2386
MS6202	1 987 432 371	R 2371
MS6202C	1 987 432 371	R 2371
MS6203C	1 987 432 380	R 2380
MS6204	1 987 432 318	R 2318

MS6205	1 987 432 366	R 2366
MS6207	1 987 432 018	M 2018
MS6208	1 987 432 063	M 2063
MS6210	1 987 431 159	M 1159
MS6213	1 987 431 165	M 1165

MS6215	1 987 432 064	M 2064
MS6216	1 987 432 357	R 2357
MS6216C	1 987 432 357	R 2357
MS6219	1 987 432 152	M 2152
MS6223	1 987 432 354	R 2354

MS6224	1 987 432 376	R 2376
MS6224C	1 987 432 376	R 2376
MS6226	1 987 432 357	R 2357
MS6231	1 987 432 083	M 2083
MS6237	1 987 432 379	R 2379

MS6241	1 987 432 377	R 2377
MS6245	1 987 432 072	M 2072
MS6250	1 987 432 081	M 2081
MS6255	1 987 432 091	M 2091
MS6257	1 987 432 376	R 2376

MS6259C	1 987 432 387	R 2387
MS6267	1 987 432 088	M 2088
MS6271	1 987 432 093	M 2093
MS6274	1 987 432 397	R 2397
MS6274C	1 987 432 397	R 2397

MS6276	1 987 432 088	M 2088
MS6278	1 987 432 111	M 2111
MS6279	1 987 432 092	M 2092
MS-6282	1 987 431 166	M 1166
MS6283	1 987 432 120	M 2120

MS6285	1 987 432 094	M 2094
MS6296	1 987 432 082	M 2082
MS6296C	1 987 432 382	R 2382
MS6299	1 987 432 102	M 2102
MS6299C	1 987 432 402	R 2402

MS6301	1 987 432 050	M 2050
MS6302	1 987 432 106	M 2106
MS6303	1 987 432 113	M 2113
MS6303C	1 987 432 413	R 2413
MS6304	1 987 432 410	R 2410

MS6305	1 987 432 124	M 2124
MS6305C	1 987 432 424	R 2424
MS6306	1 987 432 412	R 2412
MS6308C	1 987 432 434	R 2434
MS6321	1 987 432 150	M 2150

MS6333	1 987 432 116	M 2116
MS6344C	1 987 432 423	R 2423
MS6346	1 987 432 068	M 2068
MS6371	1 987 432 222	M 2222

ALFA ROMEO

46721923	1 987 432 014	M 2014
52408346	1 987 432 133	M 2133
587820100	1 987 432 003	M 2003

60653641	1 987 432 003	M 2003
60653641	1 987 432 303	R 2303
60810570	1 987 432 014	M 2014
71754158	1 987 432 133	M 2133
77363481	1 987 432 133	M 2133

AMC (AMERICAN MOTORS CORP.)

DC7104	1 987 432 105	M 2105
HC8103	1 987 432 026	M 2026

HC8104	1 987 432 074	M 2074
HC8106	1 987 432 026	M 2026
HC8112	1 987 432 074	M 2074
HC8113	1 987 432 074	M 2074
MC 4016C	1 987 432 434	R 2434

MC5105	1 987 432 006	M 2006
NC2002	1 987 432 075	M 2075
NC2007	1 987 432 058	M 2058

AUDI

4A1 820 367	1 987 432 033	M 2033
4F0 819 439 A	1 987 432 422	R 2422
4F0 898 438	1 987 432 122	M 2122

4F0 898 438	1 987 432 422	R 2422
6Q0 820 367	1 987 432 057	M 2057
8K0 819 439 A	1 987 432 369	R 2369

BALDWIN-LIMA-HAMILTON

AF1294	1 987 432 113	M 2113
PA3414	1 987 431 159	M 1159

BEHR

U4026001	1 987 431 458	R 1458
U4029001	1 987 431 163	M 1163
68795	1 987 432 013	M 2013

68797	1 987 432 012	M 2012
68800	1 987 432 016	M 2016
68802	1 987 432 015	M 2015
68803	1 987 432 006	M 2006
68805	1 987 432 030	M 2030

68807	1 987 432 018	M 2018
7401352	1 987 432 310	R 2310
7401354	1 987 432 366	R 2366
7401358	1 987 432 021	M 2021
7401359	1 987 432 300	R 2300

7401365	1 987 432 006	M 2006
7401371	1 987 432 043	M 2043
7401372	1 987 432 044	M 2044
7401381	1 987 432 361	R 2361
7401385	1 987 432 090	M 2090

7401396	1 987 432 021	M 2021
7401399	1 987 432 024	M 2024
7401404	1 987 432 009	M 2009
7401414	1 987 432 027	M 2027
7401417	1 987 432 043	M 2043

7401418	1 987 432 044	M 2044
7401423	1 987 432 024	M 2024
7401425	1 987 432 089	M 2089
7401429	1 987 432 361	R 2361
7401430	1 987 432 045	M 2045

7401433	1 987 432 090	M 2090
7402360	1 987 432 357	R 2357
7402361	1 987 432 057	M 2057
9007428	1 987 432 006	M 2006
9007431	1 987 432 030	M 2030

9007433	1 987 432 018	M 2018
9007435	1 987 432 013	M 2013
9007436	1 987 432 012	M 2012
9007439	1 987 432 016	M 2016
9007441	1 987 432 015	M 2015

9010097	1 987 432 021	M 2021
---------	---------------	--------

BEHR HELLA THERMOCONTROLL

352102001	1 987 432 060	M 2060
352103001	1 987 432 060	M 2060

352104001	1 987 432 060	M 2060
352106001	1 987 432 011	M 2011
352108001	1 987 432 021	M 2021
352109001	1 987 432 026	M 2026
352112001	1 987 432 090	M 2090

352113001	1 987 432 027	M 2027
352114001	1 987 432 050	M 2050
352117001	1 987 432 013	M 2013
352118001	1 987 432 089	M 2089
352123001	1 987 432 022	M 2022

352124001	1 987 432 012	M 2012
352132001	1 987 432 009	M 2009
352135001	1 987 432 016	M 2016
352139001	1 987 432 024	M 2024
352143001	1 987 432 015	M 2015

352144001	1 987 432 006	M 2006
352145001	1 987 432 006	M 2006
352147001	1 987 432 045	M 2045
352148001	1 987 432 044	M 2044
352149001	1 987 432 043	M 2043

352152001	1 987 432 030	M 2030
352155001	1 987 432 042	M 2042
352156001	1 987 431 165	M 1165
352157001	1 987 432 018	M 2018
352202001	1 987 432 361	R 2361

**B**

◀ BEHR HELLA

352203001	1 987 432 300	R 2300
352204001	1 987 432 312	R 2312
352207001	1 987 432 303	R 2303
352212001	1 987 432 337	R 2337
352214001	1 987 432 310	R 2310

8FL352102001	1 987 432 060	M 2060
8FL352106001	1 987 432 011	M 2011
8FL352108001	1 987 432 021	M 2021
8FL352109001	1 987 432 026	M 2026
8FL352112001	1 987 432 090	M 2090

8FL352113001	1 987 432 027	M 2027
8FL352114001	1 987 432 050	M 2050
8FL352117001	1 987 432 013	M 2013
8FL352118001	1 987 432 089	M 2089
8FL352123001	1 987 432 022	M 2022

8FL352124001	1 987 432 012	M 2012
8FL352135001	1 987 432 016	M 2016
8FL352139001	1 987 432 024	M 2024
8FL352143001	1 987 432 015	M 2015
8FL352144001	1 987 432 006	M 2006

8FL352145001	1 987 432 006	M 2006
8FL352147001	1 987 432 045	M 2045
8FL352148001	1 987 432 044	M 2044
8FL352149001	1 987 432 043	M 2043
8FL352152001	1 987 432 030	M 2030

8FL352155001	1 987 432 042	M 2042
8FL352156001	1 987 431 165	M 1165
8FL352157001	1 987 432 018	M 2018
8FL352159061	1 987 432 021	M 2021
8FL352159161	1 987 432 027	M 2027

8FL352159191	1 987 432 043	M 2043
8FL352159201	1 987 432 044	M 2044
8FL352159241	1 987 432 024	M 2024
8FL352159251	1 987 432 089	M 2089
8FL352159281	1 987 432 361	R 2361

8FL352159291	1 987 432 045	M 2045
8FL352159301	1 987 432 090	M 2090
8FL352159321	1 987 432 057	M 2057
8FL352159361	1 987 432 006	M 2006
8FL352159381	1 987 432 030	M 2030

8FL352159401	1 987 432 018	M 2018
8FL352159411	1 987 432 013	M 2013
8FL352159421	1 987 432 012	M 2012
8FL352159451	1 987 432 016	M 2016
8FL352159471	1 987 432 015	M 2015

8FL352202001	1 987 432 361	R 2361
8FL352203001	1 987 432 300	R 2300
8FL352204001	1 987 432 300	R 2300
8FL352207001	1 987 432 303	R 2303
8FL352210001	1 987 432 310	R 2310

8FL352212001	1 987 432 337	R 2337
8FL352214001	1 987 432 310	R 2310
8FL352215011	1 987 432 310	R 2310
8FL352215031	1 987 432 366	R 2366
8FL352215061	1 987 432 018	M 2018

8FL352215071	1 987 432 021	M 2021
8FL352215081	1 987 432 012	M 2012
8FL352215141	1 987 432 006	M 2006
8FL352215181	1 987 432 043	M 2043
8FL352215191	1 987 432 044	M 2044

8FL352215231	1 987 432 361	R 2361
8FL352215241	1 987 432 090	M 2090
8FL352215271	1 987 432 357	R 2357

BMW

64 11 0 008 138	1 987 432 361	R 2361
64 11 1 393 241	1 987 432 104	M 2104
64 11 6 915 764	1 987 432 368	R 2368

64 11 6 921 018	1 987 432 103	M 2103
64 11 6 921 019	1 987 432 103	M 2103
64 11 8 390 447	1 987 432 362	R 2362
64 11 8 391 198	1 987 432 361	R 2361
64 11 8 391 200	1 987 432 361	R 2361

64 11 9 070 073	1 987 432 361	R 2361
64 11 9 163 329	1 987 432 315	R 2315
64 11 9 272 642	1 987 432 315	R 2315
64 11 9 404 386	1 987 432 104	M 2104
64 31 1 390 836	1 987 432 032	M 2032

64 31 1 496 710	1 987 432 082	M 2082
64 31 1 496 711	1 987 432 382	R 2382
64 31 6 379 959	1 987 432 103	M 2103
64 31 6 904 638	1 987 432 103	M 2103
64 31 6 915 763	1 987 432 068	M 2068

64 31 6 935 822	1 987 432 102	M 2102
64 31 6 935 823	1 987 432 402	R 2402
64 31 6 945 585	1 987 432 219	M 2219
64 31 6 945 586	1 987 432 419	R 2419
64 31 6 946 628	1 987 432 424	R 2424

64 31 6 946 629	1 987 432 124	M 2124
64 31 6 962 548	1 987 432 124	M 2124
64 31 6 962 549	1 987 432 424	R 2424
64 31 8 409 044	1 987 432 425	R 2425
64 31 9 069 926	1 987 432 362	R 2362

64 31 9 070 072	1 987 432 362	R 2362
64 31 9 071 935	1 987 432 336	R 2336
64 31 9 127 515	1 987 432 296	M 2296
64 31 9 142 114	1 987 432 124	M 2124
64 31 9 142 115	1 987 432 424	R 2424

64 31 9 195 193	1 987 432 068	M 2068
64 31 9 195 194	1 987 432 368	R 2368

BOSCH

1 987 431 006	1 987 432 006	M 2006
1 987 431 012	1 987 432 012	M 2012
1 987 431 013	1 987 432 013	M 2013

1 987 431 015	1 987 432 015	M 2015
1 987 431 016	1 987 432 016	M 2016
1 987 431 018	1 987 432 018	M 2018
1 987 431 021	1 987 432 021	M 2021
1 987 431 022	1 987 432 022	M 2022

1 987 431 024	1 987 432 024	M 2024
1 987 431 026	1 987 432 026	M 2026
1 987 431 027	1 987 432 027	M 2027
1 987 431 030	1 987 432 030	M 2030
1 987 431 034	1 987 432 090	M 2090

1 987 431 037	1 987 432 037	M 2037
1 987 431 039	1 987 432 039	M 2039
1 987 431 042	1 987 432 042	M 2042
1 987 431 043	1 987 432 043	M 2043
1 987 431 045	1 987 432 045	M 2045

1 987 431 050	1 987 432 050	M 2050
1 987 431 057	1 987 432 057	M 2057
1 987 431 058	1 987 432 058	M 2058
1 987 431 059	1 987 432 059	M 2059
1 987 431 060	1 987 432 060	M 2060

1 987 431 069	1 987 432 069	M 2069
1 987 431 073	1 987 432 018	M 2018
1 987 431 074	1 987 432 074	M 2074
1 987 431 075	1 987 432 075	M 2075
1 987 431 079	1 987 432 079	M 2079

1 987 431 089	1 987 432 089	M 2089
1 987 431 090	1 987 432 090	M 2090
1 987 431 102	1 987 432 102	M 2102
1 987 431 105	1 987 432 105	M 2105
1 987 431 113	1 987 432 113	M 2113

1 987 431 150	1 987 432 150	M 2150
1 987 431 151	1 987 432 151	M 2151
1 987 431 159	1 987 431 159	M 1159
1 987 431 163	1 987 431 163	M 1163
1 987 431 165	1 987 431 165	M 1165

1 987 431 166	1 987 431 166	M 1166
1 987 431 300	1 987 432 300	R 2300
1 987 431 303	1 987 432 303	R 2303
1 987 431 310	1 987 432 310	R 2310
1 987 431 312	1 987 432 312	R 2312

1 987 431 313	1 987 432 313	R 2313
1 987 431 316	1 987 432 366	R 2366
1 987 431 330	1 987 432 310	R 2310
1 987 431 337	1 987 432 337	R 2337
1 987 431 354	1 987 432 354	R 2354

1 987 431 357	1 987 432 357	R 2357
1 987 431 361	1 987 432 361	R 2361
1 987 431 366	1 987 432 366	R 2366
1 987 431 378	1 987 432 378	R 2378
1 987 431 412	1 987 432 412	R 2412

1 987 431 458	1 987 431 458	R 1458
1 987 431 560	1 987 432 105	M 2105
1 987 431 808	1 987 432 012	M 2012
1 987 431 809	1 987 432 013	M 2013
1 987 431 810	1 987 432 015	M 2015

1 987 431 812	1 987 432 018	M 2018
1 987 431 813	1 987 432 021	M 2021
1 987 431 814	1 987 432 030	M 2030
1 987 432 012	1 987 432 012	M 2012
1 987 432 013	1 987 432 013	M 2013

1 987 432 015	1 987 432 015	M 2015
1 987 432 016	1 987 432 016	M 2016
1 987 432 018	1 987 432 018	M 2018
1 987 432 021	1 987 432 021	M 2021
1 987 432 022	1 987 432 022	M 2022

1 987 432 024	1 987 432 024	M 2024
1 987 432 026	1 987 432 026	M 2026
1 987 432 027	1 987 432 027	M 2027
1 987 432 030	1 987 432 030	M 2030
1 987 432 037	1 987 432 037	M 2037

1 987 432 042	1 987 432 042	M 2042
1 987 432 043	1 987 432 043	M 2043
1 987 432 044	1 987 432 044	M 2044
1 987 432 045	1 987 432 045	M 2045
1 987 432 050	1 987 432 050	M 2050

1 987 432 057	1 987 432 057	M 2057
1 987 432 058	1 987 432 058	M 2058
1 987 432 059	1 987 432 059	M 2059
1 987 432 069	1 987 432 069	M 2069
1 987 432 074	1 987 432 074	M 2074

1 987 432 075	1 987 432 075	M 2075
1 987 432 079	1 987 432 079	M 2079
1 987 432 089	1 987 432 089	M 2089
1 987 432 090	1 987 432 090	M 2090
1 987 432 102	1 987 432 102	M 2102

1 987 432 105	1 987 432 105	M 2105
1 987 432 113	1 987 432 113	M 2113
1 987 432 150	1 987 432 150	M 2150
1 987 432 151	1 987 432 151	M 2151
1 987 432 300	1 987 432 300	R 2300

B

◀ BOSCH

1987 432 303	1987 432 303	R 2303
1987 432 310	1987 432 310	R 2310
1987 432 312	1987 432 312	R 2312
1987 432 313	1987 432 313	R 2313
1987 432 337	1987 432 337	R 2337

1987 432 354	1987 432 354	R 2354
1987 432 357	1987 432 357	R 2357
1987 432 361	1987 432 361	R 2361
1987 432 366	1987 432 366	R 2366
1987 432 378	1987 432 378	R 2378

1987 432 412	1987 432 412	R 2412
1987 432 700	1987 432 093	M 2093
1987 432 702	1987 432 060	M 2060
1987 432 703	1987 432 097	M 2097
1987 432 705	1987 432 076	M 2076

1987 432 707	1987 432 083	M 2083
1987 432 708	1987 432 040	M 2040
1987 432 709	1987 432 120	M 2120
1987 432 808	1987 432 012	M 2012
1987 432 809	1987 432 013	M 2013

1987 432 810	1987 432 015	M 2015
1987 432 812	1987 432 018	M 2018
1987 432 814	1987 432 030	M 2030
1987 432 815	1987 432 354	R 2354
1987 432 816	1987 432 361	R 2361

1987 432 818	1987 432 387	R 2387
1987 432 820	1987 432 380	R 2380

CADILLAC

1808617	1987 432 376	R 2376
1808624	1987 432 376	R 2376
9179904	1987 432 376	R 2376

9192320	1987 432 366	R 2366
93172129	1987 432 376	R 2376

CHAMPION

CAF 1700	1987 432 018	M 2018
CAF 1704	1987 432 052	M 2052
N 104	1987 432 018	M 2018

N 106	1987 432 012	M 2012
N 107	1987 432 015	M 2015
N 109	1987 432 014	M 2014
N 111	1987 432 015	M 2015
N 111	1987 432 018	M 2018

N 112	1987 432 019	M 2019
N 113	1987 432 012	M 2012
N 116	1987 432 032	M 2032
N 118	1987 432 070	M 2070
N 120	1987 432 022	M 2022

N 121	1987 432 016	M 2016
N 123	1987 432 006	M 2006
N 125	1987 432 028	M 2028
N 127	1987 432 053	M 2053
N 128	1987 432 013	M 2013

N 129	1987 432 030	M 2030
N 130	1987 432 021	M 2021
N 132	1987 432 015	M 2015
N 133	1987 432 303	R 2303
N 134	1987 432 033	M 2033

N 135	1987 432 024	M 2024
N 136	1987 432 003	M 2003
N 137	1987 432 027	M 2027
N 138	1987 432 009	M 2009
N 142	1987 432 062	M 2062

N 143	1987 432 360	R 2360
N 172	1987 432 386	R 2386
N 178	1987 432 360	R 2360
N 181	1987 432 120	M 2120

CHEVROLET

4803883	1987 432 222	M 2222
90386776	1987 432 015	M 2015
90458294	1987 432 016	M 2016

90464424	1987 432 030	M 2030
90509367	1987 432 015	M 2015
90510338	1987 432 016	M 2016
90512779	1987 432 030	M 2030
90541317	1987 432 310	R 2310

905658793	1987 432 310	R 2310
91132361	1987 432 310	R 2310
91132362	1987 432 366	R 2366
9121625	1987 432 310	R 2310
93182438	1987 432 016	M 2016

96 425 700	1987 432 171	M 2171
96 554 378	1987 432 223	M 2223
96 554 421	1987 432 223	M 2223

CHRYSLER

05101438AA	1987 432 301	R 2301
05101438AA	1987 432 805	M 2805
05103600AA	1987 432 043	M 2043

50580 040AA	1 987 432 184	M 2184
5101 438AA	1 987 432 301	R 2301
5101 438AA	1 987 432 805	M 2805
5103 600AA	1 987 432 043	M 2043
68012 876AA	1 987 432 213	M 2213

68012 876AA	1 987 432 513	R 2513
82205 905	1 987 432 497	R 2497

CITROEN

KN41079	1 987 432 060	M 2060
6441 G9	1 987 432 154	M 2154
6441 H7	1 987 432 021	M 2021

6447 AK	1 987 432 021	M 2021
6447 AZ	1 987 432 048	M 2048
6447 FG	1 987 432 077	M 2077
6447 F2	1 987 432 022	M 2022
6447 HP	1 987 432 083	M 2083

6447 HV	1 987 432 398	R 2398
6447 HO	1 987 432 060	M 2060
6447 H1	1 987 432 060	M 2060
6447 J0	1 987 432 042	M 2042
6447 LN	1 987 432 354	R 2354

6447 LV	1 987 432 021	M 2021
6447 LZ	1 987 432 091	M 2091
6447 NT	1 987 432 079	M 2079
6447 NV	1 987 432 379	R 2379
6447 P2	1 987 432 060	M 2060

6447 P3	1 987 432 060	M 2060
6447 S5	1 987 432 007	M 2007
6447 TC	1 987 432 412	R 2412
6447 TL	1 987 432 079	M 2079
6447 TV	1 987 432 189	M 2189

6447 TY	1 987 432 042	M 2042
6447 XF	1 987 432 137	M 2137
6447 XG	1 987 432 437	R 2437
6447 YC	1 987 432 065	M 2065
6447 YK	1 987 432 206	M 2206

6447 YN	1 987 432 406	R 2406
6447 ZY	1 987 432 216	M 2216
6447 Z4	1 987 432 021	M 2021
6447 Z5	1 987 432 021	M 2021
6447 93	1 987 432 022	M 2022

6479 C9	1 987 432 065	M 2065
6479 E9	1 987 432 416	R 2416
6479 43	1 987 432 412	R 2412
6479 45	1 987 432 311	R 2311
6479 62	1 987 432 228	M 2228

6479 75	1 987 432 379	R 2379
663399D	1 987 432 083	M 2083
95 667 986	1 987 432 021	M 2021
96 82 603 680	1 987 432 311	R 2311

CLEAN FILTERS

MC 1231	1 987 432 015	M 2015
MC 1232	1 987 432 016	M 2016
MC 1233	1 987 432 019	M 2019

MC 1235	1 987 432 032	M 2032
MC 1236	1 987 432 014	M 2014
MC 1238	1 987 432 018	M 2018
MC 1239	1 987 432 013	M 2013
MC 1240	1 987 432 009	M 2009

MC 1241	1 987 432 024	M 2024
MC 1242	1 987 432 011	M 2011
MC 1244	1 987 432 021	M 2021
MC 1245	1 987 432 003	M 2003
MC 1246	1 987 432 312	R 2312

MC 1248	1 987 432 360	R 2360
MC 1252	1 987 432 030	M 2030
MC 1253	1 987 432 006	M 2006
MC 1256	1 987 432 027	M 2027
MC 1259	1 987 432 013	M 2013

MC 1261	1 987 432 028	M 2028
MC 1264	1 987 432 042	M 2042
MC 1265	1 987 432 361	R 2361
MC 1266	1 987 432 052	M 2052
MC 1267	1 987 432 367	R 2367

MC 1269	1 987 432 049	M 2049
MC 1270	1 987 432 056	M 2056
MC 1272	1 987 432 039	M 2039
NC2002	1 987 432 015	M 2015
NC2003	1 987 432 016	M 2016

NC2004	1 987 432 019	M 2019
NC2005	1 987 432 014	M 2014
NC2007	1 987 432 018	M 2018
NC2008	1 987 432 009	M 2009
NC2009	1 987 432 024	M 2024

NC2010	1 987 432 021	M 2021
NC2011	1 987 432 003	M 2003
NC2012	1 987 432 012	M 2012
NC2013	1 987 432 360	R 2360
NC2014	1 987 432 030	M 2030

NC2015	1 987 432 006	M 2006
NC2018	1 987 432 027	M 2027
NC2019	1 987 432 328	R 2328
NC2020	1 987 432 053	M 2053
NC2021	1 987 432 042	M 2042



◀ CLEAN FILTERS

NC2022	1 987 432 049	M 2049
NC2024	1 987 432 039	M 2039
NC2025	1 987 432 105	M 2105
NC2028	1 987 432 011	M 2011
NC2029	1 987 432 007	M 2007

NC2030	1 987 432 013	M 2013
NC2031	1 987 432 037	M 2037
NC2032	1 987 432 045	M 2045
NC2033	1 987 432 095	M 2095
NC2034	1 987 432 090	M 2090

NC2035	1 987 432 040	M 2040
NC2036	1 987 432 059	M 2059
NC2038	1 987 432 043	M 2043
NC2040	1 987 432 062	M 2062
NC2041	1 987 432 033	M 2033

NC2042	1 987 432 048	M 2048
NC2043	1 987 432 151	M 2151
NC2045	1 987 432 072	M 2072
NC2046	1 987 432 386	R 2386
NC2047	1 987 432 057	M 2057

NC2048CA	1 987 432 377	R 2377
NC2049	1 987 432 069	M 2069
NC2050	1 987 432 022	M 2022
NC2053	1 987 432 066	M 2066
NC2054	1 987 432 084	M 2084

NC2055	1 987 432 079	M 2079
NC2056	1 987 432 062	M 2062
NC2058	1 987 432 044	M 2044
NC2059	1 987 432 150	M 2150
NC2060	1 987 432 032	M 2032

NC2062	1 987 432 076	M 2076
NC2063	1 987 432 380	R 2380
NC2064	1 987 432 087	M 2087
NC2067CA	1 987 432 337	R 2337
NC2068CA	1 987 432 378	R 2378

NC2069CA	1 987 432 361	R 2361
NC2070	1 987 432 361	R 2361
NC2072CA	1 987 432 303	R 2303
NC2073CA	1 987 432 360	R 2360
NC2074CA	1 987 432 312	R 2312

NC2075CA	1 987 432 317	R 2317
NC2076CA	1 987 432 328	R 2328
NC2077CA	1 987 432 301	R 2301
NC2078CA	1 987 432 366	R 2366
NC2079CA	1 987 432 310	R 2310

NC2082CA	1 987 432 300	R 2300
NC2083CA	1 987 432 313	R 2313
NC2085	1 987 432 056	M 2056
NC2086	1 987 432 064	M 2064
NC2087	1 987 432 064	M 2064

NC2088CA	1 987 432 336	R 2336
NC2089	1 987 432 060	M 2060
NC2090	1 987 432 053	M 2053
NC2091	1 987 432 075	M 2075
NC2092	1 987 432 058	M 2058

NC2093	1 987 432 061	M 2061
NC2095CA	1 987 432 345	R 2345
NC2096CA	1 987 432 306	R 2306
NC2097CA	1 987 432 357	R 2357
NC2098	1 987 432 070	M 2070

NC2102CA	1 987 432 379	R 2379
NC2103CA	1 987 432 307	R 2307
NC2104	1 987 432 072	M 2072
NC2106	1 987 432 071	M 2071
NC2108CA	1 987 432 371	R 2371

NC2109CA	1 987 432 376	R 2376
NC2110	1 987 432 082	M 2082
NC2111CA	1 987 432 382	R 2382
NC2112	1 987 432 091	M 2091
NC2113CA	1 987 432 387	R 2387

NC2115CA	1 987 432 370	R 2370
NC2120	1 987 432 088	M 2088
NC2122	1 987 432 107	M 2107
NC2123	1 987 432 108	M 2108
NC2124CA	1 987 432 318	R 2318

NC2126	1 987 432 111	M 2111
NC2127CA	1 987 432 411	R 2411
NC2129CA	1 987 432 397	R 2397
NC2131CA	1 987 432 434	R 2434
NC2132	1 987 432 097	M 2097

NC2133	1 987 432 093	M 2093
NC2134	1 987 432 106	M 2106
NC2135	1 987 432 083	M 2083
NC 2136	1 987 432 109	M 2109
NC2137CA	1 987 432 409	R 2409

NC2138	1 987 432 102	M 2102
NC2141	1 987 432 208	M 2208
NC2142	1 987 432 094	M 2094
NC 2147	1 987 432 041	M 2041
NC2151	1 987 432 085	M 2085

NC2152	1 987 432 114	M 2114
NC2154CA	1 987 432 412	R 2412
NC2160	1 987 431 167	M 1167
NC2161	1 987 431 159	M 1159
NC 2162	1 987 431 175	M 1175

NC2164	1 987 431 165	M 1165
NC2165	1 987 431 163	M 1163
NC2186	1 987 432 089	M 2089
NC2191	1 987 432 410	R 2410
NC2193	1 987 432 136	M 2136

NC2195	1 987 432 120	M 2120
NC2200	1 987 432 092	M 2092
NC2205	1 987 432 203	M 2203
NC2207	1 987 432 074	M 2074

COOPERS

ACE 004	1 987 432 021	M 2021
ACE 005	1 987 432 317	R 2317
ACE 006	1 987 432 012	M 2012

ACE 006	1 987 432 312	R 2312
ACE 007	1 987 432 018	M 2018
ACE 008	1 987 432 015	M 2015
ACE 012	1 987 432 200	M 2200
ACE 014	1 987 432 027	M 2027

ACE 015	1 987 432 009	M 2009
ACE 016	1 987 432 028	M 2028
ACE 017	1 987 432 006	M 2006
ACE 019	1 987 432 062	M 2062
ACE 020	1 987 432 030	M 2030

ACE 021	1 987 432 022	M 2022
ACE 022	1 987 432 026	M 2026
ACE 024	1 987 432 014	M 2014
ACE 025	1 987 432 033	M 2033
ACE 026	1 987 432 003	M 2003

ACE 027	1 987 432 019	M 2019
ACE 028	1 987 432 016	M 2016
ACE 029	1 987 432 061	M 2061
ACE 033	1 987 432 062	M 2062
ACE 034	1 987 432 337	R 2337

ACE 036	1 987 432 045	M 2045
ACE 037	1 987 432 049	M 2049
ACE 038	1 987 432 360	R 2360
ACE 039	1 987 432 310	R 2310
ACE 040	1 987 432 324	R 2324

ACE 040	1 987 432 333	R 2333
ACE 042	1 987 432 328	R 2328
ACE 043	1 987 432 330	R 2330
ACE 046	1 987 432 150	M 2150
ACE 047	1 987 432 300	R 2300

ACE 048	1 987 432 300	R 2300
ACE 049	1 987 432 303	R 2303
ACE052	1 987 432 024	M 2024
ACE053	1 987 432 318	R 2318
ACE058	1 987 432 044	M 2044

ACE059	1 987 432 152	M 2152
ACE061	1 987 432 032	M 2032
ACE062	1 987 432 050	M 2050
ACE065	1 987 432 040	M 2040
ACE066	1 987 432 060	M 2060

ACE067	1 987 432 060	M 2060
ACE068	1 987 432 043	M 2043
ACE069	1 987 432 048	M 2048
ACE070	1 987 432 066	M 2066
ACE071	1 987 432 063	M 2063

ACE072	1 987 432 058	M 2058
ACE074	1 987 432 318	R 2318
ACE076	1 987 432 084	M 2084
ACE080	1 987 432 306	R 2306
ACE081	1 987 432 151	M 2151

ACE083	1 987 432 387	R 2387
ACE084	1 987 431 163	M 1163
ACE086	1 987 432 076	M 2076
ACE087	1 987 432 071	M 2071
ACE088	1 987 432 082	M 2082

ACE089	1 987 432 057	M 2057
ACE090	1 987 432 357	R 2357
ACE093	1 987 432 079	M 2079
ACE096	1 987 432 379	R 2379
ACE097	1 987 432 386	R 2386

ACE100	1 987 432 056	M 2056
ACE101	1 987 432 091	M 2091
ACE104	1 987 432 013	M 2013
ACE104	1 987 432 313	R 2313
ACE106	1 987 432 075	M 2075

ACE108	1 987 432 380	R 2380
ACE111	1 987 432 401	R 2401
ACE112	1 987 432 120	M 2120
ACE116	1 987 432 336	R 2336
ACE118	1 987 432 092	M 2092

ACE120	1 987 432 085	M 2085
ACE121	1 987 432 083	M 2083
ACE124	1 987 432 114	M 2114
ACE125	1 987 432 097	M 2097
ACE127	1 987 432 377	R 2377

ACE130	1 987 432 088	M 2088
ACE133	1 987 432 397	R 2397
ACE134	1 987 432 365	R 2365
ACE135	1 987 432 111	M 2111
ACE136	1 987 432 376	R 2376

ACE139	1 987 432 093	M 2093
ACE141	1 987 432 094	M 2094
ACE145	1 987 432 410	R 2410
ACE146	1 987 431 166	M 1166
ACE147	1 987 432 096	M 2096

ACE154	1 987 432 106	M 2106
ACE158	1 987 432 113	M 2113
ACE160	1 987 432 116	M 2116
ACE180	1 987 431 154	M 1154
ACE181	1 987 431 451	R 1451



◀ COOPERS

ACE183	1 987 431 458	R 1458
ACE195	1 987 432 406	R 2406
ACE1132	1 987 432 074	M 2074
ACE1152	1 987 432 361	R 2361

CORTECO

CP1142	1 987 431 167	M 1167
MC738-2	1 987 432 309	R 2309
MP201-2	1 987 432 137	M 2137

21650107	1 987 432 018	M 2018
21651183	1 987 432 016	M 2016
21651184	1 987 432 015	M 2015
21651185	1 987 432 030	M 2030
21651197	1 987 432 032	M 2032

21651292	1 987 432 337	R 2337
21651293	1 987 432 048	M 2048
21651294	1 987 432 364	R 2364
21651295	1 987 432 378	R 2378
21651296	1 987 432 365	R 2365

21651298	1 987 432 050	M 2050
21651881	1 987 432 362	R 2362
21651882	1 987 432 361	R 2361
21651891	1 987 432 022	M 2022
21651892	1 987 432 360	R 2360

21651893	1 987 432 006	M 2006
21651894	1 987 432 019	M 2019
21651895	1 987 432 028	M 2028
21651895	1 987 432 328	R 2328
21651897	1 987 432 361	R 2361

21651898	1 987 432 013	M 2013
21651899	1 987 432 021	M 2021
21651901	1 987 432 003	M 2003
21651911	1 987 432 062	M 2062
21651912	1 987 432 012	M 2012

21651913	1 987 432 033	M 2033
21651914	1 987 432 024	M 2024
21651915	1 987 432 014	M 2014
21651916	1 987 432 027	M 2027
21651917	1 987 432 009	M 2009

21651920	1 987 432 007	M 2007
21651920	1 987 432 200	M 2200
21651951	1 987 432 014	M 2014
21651952	1 987 432 303	R 2303
21651953	1 987 432 303	R 2303

21651954	1 987 432 360	R 2360
21651955	1 987 432 312	R 2312
21651956	1 987 432 317	R 2317
21651957	1 987 432 324	R 2324
21651957	1 987 432 333	R 2333

21651958	1 987 432 333	R 2333
21651960	1 987 432 328	R 2328
21651961	1 987 432 301	R 2301
21651962	1 987 432 301	R 2301
21651963	1 987 432 366	R 2366

21651964	1 987 432 310	R 2310
21651965	1 987 432 376	R 2376
21651966	1 987 432 330	R 2330
21651967	1 987 432 300	R 2300
21651968	1 987 432 313	R 2313

21651972	1 987 432 026	M 2026
21651973	1 987 432 151	M 2151
21651976	1 987 432 043	M 2043
21651977	1 987 432 150	M 2150
21651979	1 987 432 040	M 2040

21651982	1 987 432 052	M 2052
21651983	1 987 432 039	M 2039
21651984	1 987 432 090	M 2090
21651986	1 987 432 062	M 2062
21651987	1 987 432 056	M 2056

21651991	1 987 432 095	M 2095
21651994	1 987 432 042	M 2042
21651995	1 987 432 045	M 2045
21652045	1 987 432 044	M 2044
21652046	1 987 432 052	M 2052

21652308	1 987 432 059	M 2059
21652317	1 987 432 064	M 2064
21652335	1 987 432 270	M 2270
21652336	1 987 432 336	R 2336
21652338	1 987 432 105	M 2105

21652342	1 987 432 060	M 2060
21652345	1 987 432 053	M 2053
21652345	1 987 432 121	M 2121
21652346	1 987 432 075	M 2075
21652347	1 987 432 058	M 2058

21652348	1 987 432 061	M 2061
21652349	1 987 432 069	M 2069
21652350	1 987 432 066	M 2066
21652351	1 987 432 063	M 2063
21652352	1 987 432 386	R 2386

21652353	1 987 432 366	R 2366
21652354	1 987 432 345	R 2345
21652355	1 987 432 006	M 2006
21652356	1 987 432 057	M 2057
21652357	1 987 432 357	R 2357

21652358	1 987 432 070	M 2070
21652358	1 987 432 377	R 2377
21652359	1 987 432 085	M 2085
21652540	1 987 432 379	R 2379
21652541	1 987 432 307	R 2307

21652541	1 987 432 407	R 2407
21652542	1 987 432 380	R 2380
21652544	1 987 432 072	M 2072
21652546	1 987 432 074	M 2074
21652548	1 987 432 079	M 2079

21652551	1 987 432 084	M 2084
21652552	1 987 432 367	R 2367
21652687	1 987 432 049	M 2049
21652688	1 987 432 037	M 2037
21652689	1 987 432 071	M 2071

21652713	1 987 432 371	R 2371
21652714	1 987 432 076	M 2076
21652715	1 987 432 376	R 2376
21652848	1 987 432 103	M 2103
21652849	1 987 432 068	M 2068

21652850	1 987 432 082	M 2082
21652852	1 987 432 368	R 2368
21652853	1 987 432 382	R 2382
21652856	1 987 432 091	M 2091
21652858	1 987 432 387	R 2387

21652861	1 987 432 370	R 2370
21652863	1 987 432 081	M 2081
21652867	1 987 432 086	M 2086
21652874	1 987 432 088	M 2088
21652898	1 987 432 423	R 2423

21652899	1 987 432 107	M 2107
21652900	1 987 432 108	M 2108
21652916	1 987 432 425	R 2425
21652959	1 987 432 318	R 2318
21652989	1 987 432 115	M 2115

21652992	1 987 432 092	M 2092
21652994	1 987 432 111	M 2111
21652995	1 987 432 411	R 2411
21653003	1 987 431 154	M 1154
21653005	1 987 431 163	M 1163

21653008	1 987 432 397	R 2397
21653009	1 987 432 495	R 2495
21653013	1 987 432 434	R 2434
21653014	1 987 432 378	R 2378
21653015	1 987 432 431	R 2431

21653017	1 987 432 182	M 2182
21653019	1 987 431 175	M 1175
21653020	1 987 432 114	M 2114
21653022	1 987 432 152	M 2152
21653024	1 987 432 097	M 2097

21653026	1 987 432 106	M 2106
21653027	1 987 432 377	R 2377
21653028	1 987 432 083	M 2083
21653032	1 987 432 077	M 2077
21653034	1 987 432 109	M 2109

21653035	1 987 432 409	R 2409
21653063	1 987 432 102	M 2102
21653064	1 987 432 402	R 2402
21653066	1 987 432 422	R 2422
21653070	1 987 432 049	M 2049

21653071	1 987 432 093	M 2093
21653102	1 987 432 412	R 2412
21653114	1 987 432 096	M 2096
21653140	1 987 432 089	M 2089
21653142	1 987 432 398	R 2398

21653143	1 987 432 410	R 2410
21653144	1 987 432 410	R 2410
21653145	1 987 432 092	M 2092
21653149	1 987 432 399	R 2399
26152355	1 987 432 306	R 2306

80000027	1 987 432 041	M 2041
80000060	1 987 432 116	M 2116
80000061	1 987 432 113	M 2113
80000062	1 987 432 413	R 2413
80000063	1 987 432 124	M 2124

800000633	1 987 431 159	M 1159
80000064	1 987 432 424	R 2424
80000067	1 987 432 239	M 2239
80000070	1 987 432 482	R 2482
80000072	1 987 432 208	M 2208

80000074	1 987 432 120	M 2120
80000080	1 987 432 094	M 2094
80000082	1 987 432 184	M 2184
80000114	1 987 432 039	M 2039
80000165	1 987 432 319	R 2319

80000331	1 987 432 434	R 2434
80000333	1 987 431 166	M 1166
80000338	1 987 432 378	R 2378
80000343	1 987 432 423	R 2423
80000344	1 987 432 077	M 2077

80000346	1 987 432 433	R 2433
80000364	1 987 431 458	R 1458
80000375	1 987 432 386	R 2386
80000376	1 987 432 360	R 2360
80000377	1 987 432 032	M 2032

80000406	1 987 432 163	M 2163
80000409	1 987 432 401	R 2401
80000416	1 987 432 058	M 2058
80000418	1 987 432 069	M 2069
80000419	1 987 432 084	M 2084

80000427	1 987 432 044	M 2044
80000428	1 987 432 053	M 2053
80000429	1 987 432 354	R 2354
80000432	1 987 432 042	M 2042
80000433	1 987 432 019	M 2019



C

◀ CORTECO

80000434	1 987 432 027	M 2027
80000435	1 987 432 009	M 2009
80000436	1 987 432 090	M 2090
80000438	1 987 432 088	M 2088
80000439	1 987 432 167	M 2167

80000541	1 987 432 188	M 2188
80000602	1 987 432 597	R 2597
80000615	1 987 432 437	R 2437
80000620	1 987 432 203	M 2203
80000621	1 987 432 376	R 2376

80000623	1 987 432 152	M 2152
80000628	1 987 432 011	M 2011
80000633	1 987 431 159	M 1159
80000636	1 987 432 011	M 2011
80000637	1 987 432 183	M 2183

80000647	1 987 432 309	R 2309
80000657	1 987 432 221	M 2221
80000666	1 987 432 136	M 2136
80000670	1 987 432 093	M 2093
80000671	1 987 432 435	R 2435

80000676	1 987 432 236	M 2236
80000740	1 987 432 296	M 2296
80000742	1 987 432 026	M 2026
80000745	1 987 432 085	M 2085
80000745	1 987 432 320	R 2320

80000746	1 987 432 075	M 2075
80000747	1 987 432 050	M 2050
80000750	1 987 432 061	M 2061
80000751	1 987 432 192	M 2192
80000752	1 987 432 095	M 2095

80000754	1 987 432 106	M 2106
80000755	1 987 432 107	M 2107
80000759	1 987 432 184	M 2184
80000762	1 987 432 089	M 2089
80000763	1 987 432 173	M 2173

80000765	1 987 432 060	M 2060
80000770	1 987 432 236	M 2236
80000775	1 987 432 116	M 2116
80000807	1 987 432 412	R 2412
80000812	1 987 432 205	M 2205

80000813	1 987 432 204	M 2204
80000815	1 987 432 065	M 2065
80000839	1 987 432 137	M 2137
80000848	1 987 432 219	M 2219
80000853	1 987 432 216	M 2216

80000865	1 987 432 206	M 2206
80000866	1 987 432 406	R 2406
80001023	1 987 432 156	M 2156
80001129	1 987 432 415	R 2415
80001186	1 987 432 304	R 2304

CROSLAND

EC305	1 987 432 303	R 2303
EC358	1 987 432 365	R 2365
EC380	1 987 432 386	R 2386

EC382	1 987 432 379	R 2379
EC387	1 987 432 371	R 2371
EC388	1 987 432 380	R 2380
EC398	1 987 432 387	R 2387
EC486	1 987 432 311	R 2311

EC528	1 987 431 458	R 1458
E302	1 987 432 019	M 2019
E303	1 987 432 360	R 2360
E305	1 987 432 003	M 2003
E305	1 987 432 303	R 2303

E307	1 987 432 310	R 2310
E308	1 987 432 021	M 2021
E309	1 987 432 014	M 2014
E310	1 987 432 015	M 2015
E311	1 987 432 012	M 2012

E312	1 987 432 018	M 2018
E313	1 987 432 317	R 2317
E314	1 987 432 014	M 2014
E315	1 987 432 060	M 2060
E316	1 987 432 060	M 2060

E319	1 987 432 009	M 2009
E320	1 987 432 027	M 2027
E323	1 987 432 006	M 2006
E332	1 987 432 089	M 2089
E333	1 987 432 361	R 2361

E335	1 987 432 013	M 2013
E344	1 987 432 039	M 2039
E345	1 987 432 090	M 2090
E346	1 987 432 016	M 2016
E348	1 987 432 061	M 2061

E359	1 987 432 021	M 2021
E365	1 987 432 069	M 2069
E369	1 987 432 064	M 2064
E382	1 987 432 079	M 2079
E396	1 987 432 083	M 2083

E408	1 987 432 091	M 2091
E411	1 987 432 120	M 2120
E510	1 987 431 165	M 1165
E511	1 987 432 152	M 2152
E521	1 987 431 166	M 1166

8900	1 987 432 019	M 2019
8904	1 987 432 021	M 2021
8905	1 987 432 015	M 2015
8906	1 987 432 012	M 2012
8907	1 987 432 018	M 2018

8909	1 987 432 003	M 2003
9008	1 987 431 159	M 1159

DACIA

27 27 728 35R	1 987 432 120	M 2120
---------------	---------------	--------

DAEWOO

EC 96 539 649	1 987 432 241	M 2241
96 190 645	1 987 432 105	M 2105
96 207 422	1 987 432 175	M 2175

96 259 613	1 987 432 105	M 2105
96 425 700	1 987 432 171	M 2171
96 449 577	1 987 432 241	M 2241
96 539 649	1 987 432 241	M 2241
96 962 173	1 987 432 241	M 2241

DAF

1322255	1 987 432 152	M 2152
1322259	1 987 431 164	M 1164
1347066	1 987 431 164	M 1164

1362124	1 987 431 169	M 1169
1362168	1 987 431 452	R 1452
1658991	1 987 432 152	M 2152
1659691	1 987 431 164	M 1164

DELPHI

CAF2	1 987 432 015	M 2015
CAF3	1 987 432 030	M 2030
CAF4	1 987 432 012	M 2012

CAF9	1 987 432 018	M 2018
CAF10	1 987 432 022	M 2022
CAF11	1 987 432 016	M 2016
CAF12	1 987 432 011	M 2011
CAF13	1 987 432 021	M 2021

CAF15	1 987 432 014	M 2014
CAF16	1 987 432 033	M 2033
CAF17	1 987 432 024	M 2024
CAF19	1 987 432 003	M 2003
CAF20	1 987 432 019	M 2019

CAF21	1 987 432 006	M 2006
CAF22	1 987 432 028	M 2028
CAF24	1 987 432 360	R 2360
CAF28	1 987 432 027	M 2027
CAF29	1 987 432 013	M 2013

CAF34	1 987 432 009	M 2009
CAF41	1 987 432 040	M 2040
CAF42	1 987 432 062	M 2062
CAF43	1 987 432 107	M 2107
CAF44	1 987 432 049	M 2049

CAF45	1 987 432 052	M 2052
TSP0325002	1 987 432 014	M 2014
TSP0325003C	1 987 432 317	R 2317
TSP0325004	1 987 432 012	M 2012
TSP0325004	1 987 432 300	R 2300

TSP0325004C	1 987 432 312	R 2312
TSP0325006	1 987 432 032	M 2032
TSP0325007	1 987 432 021	M 2021
TSP0325007C	1 987 432 021	M 2021
TSP0325009	1 987 432 303	R 2303

TSP0325009C	1 987 432 303	R 2303
TSP0325010	1 987 432 019	M 2019
TSP0325010C	1 987 432 019	M 2019
TSP0325011	1 987 432 318	R 2318
TSP0325012	1 987 432 006	M 2006

TSP0325012C	1 987 432 006	M 2006
TSP0325013	1 987 432 360	R 2360
TSP0325014	1 987 432 360	R 2360
TSP0325015	1 987 432 310	R 2310
TSP0325015C	1 987 432 310	R 2310

TSP0325016	1 987 432 015	M 2015
TSP0325017	1 987 432 016	M 2016
TSP0325018	1 987 432 022	M 2022
TSP0325019C	1 987 432 407	R 2407
TSP0325020	1 987 432 027	M 2027

TSP0325021	1 987 432 009	M 2009
TSP0325022	1 987 432 011	M 2011
TSP0325024	1 987 432 013	M 2013
TSP0325025	1 987 432 013	M 2013
TSP0325025	1 987 432 313	R 2313

TSP0325026	1 987 432 030	M 2030
TSP0325027C	1 987 432 300	R 2300
TSP0325028	1 987 432 040	M 2040
TSP0325029	1 987 432 328	R 2328
TSP0325031	1 987 432 090	M 2090

TSP0325031C	1 987 432 090	M 2090
TSP0325033	1 987 432 026	M 2026
TSP0325034	1 987 432 039	M 2039
TSP0325035	1 987 432 089	M 2089
TSP0325036	1 987 432 049	M 2049

TSP0325037	1 987 432 061	M 2061
TSP0325038	1 987 432 361	R 2361
TSP0325038C	1 987 432 361	R 2361
TSP0325039	1 987 432 024	M 2024
TSP0325039	1 987 432 324	R 2324



D

◀ DELPHI

TSP0325039	1 987 432 333	R 2333
TSP0325040	1 987 432 033	M 2033
TSP0325042	1 987 432 042	M 2042
TSP0325043	1 987 432 107	M 2107
TSP0325044	1 987 432 059	M 2059

TSP0325046	1 987 431 165	M 1165
TSP0325048	1 987 432 045	M 2045
TSP0325048C	1 987 432 345	R 2345
TSP0325052	1 987 432 105	M 2105
TSP0325055	1 987 432 096	M 2096

TSP0325057	1 987 432 062	M 2062
TSP0325058	1 987 432 062	M 2062
TSP0325059	1 987 432 053	M 2053
TSP0325059C	1 987 432 075	M 2075
TSP0325060	1 987 432 060	M 2060

TSP0325061	1 987 432 037	M 2037
TSP0325061C	1 987 432 337	R 2337
TSP0325062	1 987 432 048	M 2048
TSP0325067	1 987 432 371	R 2371
TSP0325072	1 987 432 058	M 2058

TSP0325072C	1 987 432 058	M 2058
TSP0325077	1 987 432 043	M 2043
TSP0325079	1 987 432 072	M 2072
TSP0325080	1 987 432 378	R 2378
TSP0325080C	1 987 432 378	R 2378

TSP0325082	1 987 432 084	M 2084
TSP0325083	1 987 432 070	M 2070
TSP0325083C	1 987 432 370	R 2370
TSP0325084	1 987 432 069	M 2069
TSP0325085	1 987 432 354	R 2354

TSP0325085C	1 987 432 354	R 2354
TSP0325088	1 987 432 062	M 2062
TSP0325096	1 987 432 050	M 2050
TSP0325098	1 987 432 052	M 2052
TSP0325102	1 987 432 066	M 2066

TSP0325105	1 987 432 095	M 2095
TSP0325106	1 987 432 063	M 2063
TSP0325107C	1 987 432 301	R 2301
TSP0325108	1 987 432 075	M 2075
TSP0325110	1 987 432 386	R 2386

TSP0325110C	1 987 432 386	R 2386
TSP0325111	1 987 432 057	M 2057
TSP0325111C	1 987 432 357	R 2357
TSP0325112	1 987 432 071	M 2071
TSP0325112C	1 987 432 371	R 2371

TSP0325113	1 987 432 083	M 2083
TSP0325115	1 987 432 072	M 2072
TSP0325115C	1 987 432 365	R 2365
TSP0325117	1 987 432 018	M 2018
TSP0325120	1 987 431 154	M 1154

TSP0325122	1 987 432 076	M 2076
TSP0325123	1 987 432 079	M 2079
TSP0325123	1 987 432 379	R 2379
TSP0325123C	1 987 432 379	R 2379
TSP0325129	1 987 432 064	M 2064

TSP0325130	1 987 431 159	M 1159
TSP0325131	1 987 431 160	M 1160
TSP0325132	1 987 432 043	M 2043
TSP0325139C	1 987 432 387	R 2387
TSP0325141	1 987 432 074	M 2074

TSP0325141C	1 987 432 074	M 2074
TSP0325148	1 987 432 088	M 2088
TSP0325148C	1 987 432 088	M 2088
TSP0325149	1 987 432 084	M 2084
TSP0325151	1 987 432 056	M 2056

TSP0325152	1 987 432 072	M 2072
TSP0325158	1 987 432 044	M 2044
TSP0325159	1 987 432 082	M 2082
TSP0325162	1 987 432 091	M 2091
TSP0325163	1 987 432 106	M 2106

TSP0325163C	1 987 432 106	M 2106
TSP0325164	1 987 432 109	M 2109
TSP0325164C	1 987 432 409	R 2409
TSP0325167	1 987 432 116	M 2116
TSP0325171	1 987 432 111	M 2111

TSP0325173	1 987 432 084	M 2084
TSP0325173C	1 987 432 084	M 2084
TSP0325174	1 987 432 097	M 2097
TSP0325174C	1 987 432 397	R 2397
TSP0325175	1 987 432 085	M 2085

TSP0325176C	1 987 432 092	M 2092
TSP0325178	1 987 432 120	M 2120
TSP0325178C	1 987 432 120	M 2120
TSP0325180	1 987 432 113	M 2113
TSP0325180C	1 987 432 413	R 2413

TSP0325183	1 987 432 412	R 2412
TSP0325183C	1 987 432 412	R 2412
TSP0325184	1 987 432 124	M 2124
TSP0325184C	1 987 432 424	R 2424
TSP0325185	1 987 432 434	R 2434

TSP0325186	1 987 432 410	R 2410
TSP0325186C	1 987 432 410	R 2410
TSP0325194	1 987 432 093	M 2093
TSP0325194C	1 987 432 093	M 2093
TSP0325195	1 987 432 094	M 2094

TSP0325195C	1 987 432 094	M 2094
TSP0325208	1 987 432 081	M 2081
TSP0325212	1 987 432 102	M 2102
TSP0325212C	1 987 432 402	R 2402
TSP0325226C	1 987 432 405	R 2405

TSP0325231	1 987 432 236	M 2236
TSP0325260	1 987 432 296	M 2296

P 78 4473	1 987 432 150	M 2150
P 78 5307	1 987 431 165	M 1165
P 78 6092	1 987 431 458	R 1458

DENSO

DCF001P	1 987 432 012	M 2012
DCF002K	1 987 432 300	R 2300
DCF006P	1 987 432 057	M 2057

DCF010P	1 987 432 030	M 2030
DCF012P	1 987 432 045	M 2045
DCF020P	1 987 432 006	M 2006
DCF027P	1 987 432 018	M 2018
DCF031P	1 987 432 015	M 2015

DCF033P	1 987 432 079	M 2079
DCF036P	1 987 432 016	M 2016
DCF037P	1 987 432 037	M 2037
DCF040P	1 987 432 043	M 2043
DCF045K	1 987 432 303	R 2303

DCF051K	1 987 432 357	R 2357
DCF053K	1 987 432 597	R 2597
DCF070P	1 987 432 042	M 2042
DCF074P	1 987 432 060	M 2060
DCF075P	1 987 432 105	M 2105

DCF083P	1 987 432 059	M 2059
DCF096P	1 987 432 124	M 2124
DCF102P	1 987 432 113	M 2113
DCF109P	1 987 432 026	M 2026
DCF113P	1 987 432 074	M 2074

DCF114P	1 987 431 166	M 1166
DCF132P	1 987 432 151	M 2151
DCF133P	1 987 431 163	M 1163
DCF134K	1 987 431 458	R 1458
DCF138K	1 987 432 006	M 2006

DCF139K	1 987 432 378	R 2378
DCF189P	1 987 432 075	M 2075
DCF190P	1 987 432 058	M 2058
DCF195K	1 987 432 310	R 2310
DCF196K	1 987 432 366	R 2366

DCF206P	1 987 432 022	M 2022
DCF211K	1 987 432 412	R 2412
DCF225K	1 987 432 312	R 2312
DCF229K	1 987 432 313	R 2313
DCF235P	1 987 432 113	M 2113

DONALDSON

P 53 5089	1 987 431 159	M 1159
P 61 2827	1 987 432 043	M 2043
P 78 1682	1 987 432 151	M 2151

EATON CORPORATION

302	1 987 432 012	M 2012
318	1 987 432 310	R 2310
328	1 987 432 018	M 2018

406	1 987 432 337	R 2337
411	1 987 432 300	R 2300
411	1 987 432 312	R 2312
412	1 987 431 165	M 1165
414	1 987 432 022	M 2022

417	1 987 432 313	R 2313
420	1 987 432 024	M 2024
421	1 987 432 021	M 2021
422	1 987 432 026	M 2026
429	1 987 432 089	M 2089

430	1 987 432 090	M 2090
438	1 987 432 027	M 2027
442	1 987 432 357	R 2357
444	1 987 432 026	M 2026
459	1 987 432 361	R 2361

468	1 987 432 044	M 2044
473	1 987 432 016	M 2016
483	1 987 432 060	M 2060
494	1 987 432 354	R 2354
497	1 987 432 378	R 2378

502	1 987 432 303	R 2303
511	1 987 432 300	R 2300
520	1 987 432 024	M 2024
524	1 987 432 045	M 2045
529	1 987 432 009	M 2009

531	1 987 432 006	M 2006
540	1 987 432 042	M 2042
542	1 987 432 357	R 2357
588	1 987 432 412	R 2412
1319	1 987 432 015	M 2015

1328	1 987 432 018	M 2018
1406	1 987 432 037	M 2037
1412	1 987 431 165	M 1165
1414	1 987 432 022	M 2022
1417	1 987 432 013	M 2013

1421	1 987 432 021	M 2021
1422	1 987 432 026	M 2026
1429	1 987 432 089	M 2089
1430	1 987 432 090	M 2090
1434	1 987 432 058	M 2058



E

◀ EATON CORPORATION

1436	1 987 432 030	M 2030
1438	1 987 432 027	M 2027
1438R	1 987 432 050	M 2050
1442	1 987 432 057	M 2057
1459	1 987 432 361	R 2361

1463	1 987 431 163	M 1163
1467	1 987 432 043	M 2043
1468	1 987 432 044	M 2044
1470	1 987 432 151	M 2151
1473	1 987 432 016	M 2016

1483	1 987 432 060	M 2060
1490	1 987 432 079	M 2079
1500	1 987 432 059	M 2059
1506	1 987 432 069	M 2069
1516	1 987 431 159	M 1159

1520	1 987 432 024	M 2024
1524	1 987 432 045	M 2045
1529	1 987 432 009	M 2009
1531	1 987 432 006	M 2006
1534	1 987 432 105	M 2105

1538	1 987 432 079	M 2079
1540	1 987 432 042	M 2042
1542	1 987 432 057	M 2057
1567	1 987 432 113	M 2113
1570	1 987 432 150	M 2150

1571	1 987 432 074	M 2074
1576	1 987 431 166	M 1166
1585	1 987 432 102	M 2102
1652	1 987 432 075	M 2075
4111	1 987 432 312	R 2312

14111	1 987 432 012	M 2012
-------	---------------	--------

FIAAM FILTER

PCK 8036	1 987 432 360	R 2360
PCK 8043	1 987 432 345	R 2345
PCK 8045	1 987 432 300	R 2300

PCK 8048	1 987 431 454	R 1454
PCK 8053	1 987 432 336	R 2336
PCK 8054	1 987 432 361	R 2361
PCK 80542	1 987 432 361	R 2361
PCK 8061	1 987 432 525	R 2525

PCK 8062	1 987 432 333	R 2333
PCK 8063	1 987 432 318	R 2318
PCK 8064	1 987 432 310	R 2310
PCK 8065	1 987 432 301	R 2301
PCK 8066	1 987 432 328	R 2328

PCK 8067	1 987 432 330	R 2330
PCK 8068	1 987 432 303	R 2303
PCK 8070	1 987 432 014	M 2014
PCK 8071	1 987 432 317	R 2317
PCK 8072	1 987 432 312	R 2312

PCK 8073	1 987 432 366	R 2366
PCK 8078	1 987 432 362	R 2362
PCK 8084	1 987 432 380	R 2380
PCK 8090	1 987 432 386	R 2386
PCK 8092	1 987 432 357	R 2357

PCK 8093	1 987 432 365	R 2365
PCK 8095	1 987 432 378	R 2378
PCK 8097	1 987 432 376	R 2376
PCK 8100	1 987 432 377	R 2377
PCK 8103	1 987 432 371	R 2371

PCK 8104	1 987 432 366	R 2366
PCK 8109	1 987 432 379	R 2379
PCK 8122	1 987 432 306	R 2306
PCK 8124	1 987 432 387	R 2387
PCK 8153	1 987 432 412	R 2412

PCK 8155	1 987 432 397	R 2397
PCK 8157	1 987 432 469	R 2469
PCK 8162	1 987 432 410	R 2410
PCK 81682	1 987 432 402	R 2402
PCK 8171-2	1 987 432 422	R 2422

PCK 8172	1 987 432 424	R 2424
PCK 8216	1 987 432 311	R 2311
PC 3567	1 987 432 045	M 2045
PC 8001	1 987 432 012	M 2012
PC 8003	1 987 432 021	M 2021

PC 8005	1 987 432 012	M 2012
PC 8006	1 987 432 018	M 2018
PC 8007	1 987 432 015	M 2015
PC 8009	1 987 432 033	M 2033
PC 8010	1 987 432 016	M 2016

PC 8011	1 987 432 003	M 2003
PC 8012	1 987 432 006	M 2006
PC 8013	1 987 432 014	M 2014
PC 8014	1 987 432 019	M 2019
PC 8017	1 987 432 026	M 2026

PC 8018	1 987 432 022	M 2022
PC 8020	1 987 432 007	M 2007
PC 8022	1 987 432 027	M 2027
PC 8023	1 987 432 009	M 2009
PC 8024	1 987 432 028	M 2028

PC 8025	1 987 432 360	R 2360
PC 8027	1 987 432 062	M 2062
PC 8028	1 987 432 030	M 2030
PC 8030	1 987 432 061	M 2061
PC 8031	1 987 432 032	M 2032

PC 8032	1 987 432 024	M 2024
PC 8034	1 987 432 011	M 2011
PC 8035	1 987 432 037	M 2037
PC 8038	1 987 432 089	M 2089
PC 8038	1 987 432 090	M 2090

PC 8039	1 987 432 151	M 2151
PC 8041	1 987 432 049	M 2049
PC 80412	1 987 432 049	M 2049
PC 8043	1 987 432 045	M 2045
PC 8044	1 987 432 059	M 2059

PC 8047	1 987 432 040	M 2040
PC 8049	1 987 432 021	M 2021
PC 8050	1 987 432 062	M 2062
PC 8051	1 987 432 042	M 2042
PC 8052	1 987 432 052	M 2052

PC 80522	1 987 432 052	M 2052
PC 8055	1 987 432 060	M 2060
PC 8056	1 987 432 060	M 2060
PC 8058	1 987 432 043	M 2043
PC 8059	1 987 432 039	M 2039

PC 8060	1 987 432 048	M 2048
PC 8075	1 987 432 069	M 2069
PC 8076	1 987 432 083	M 2083
PC 8077	1 987 432 057	M 2057
PC 8077	1 987 432 357	R 2357

PC 8079	1 987 432 066	M 2066
PC 8080	1 987 432 053	M 2053
PC 8080	1 987 432 121	M 2121
PC 8080	1 987 432 167	M 2167
PC 8081	1 987 432 058	M 2058

PC 8082	1 987 432 063	M 2063
PC 8083	1 987 432 075	M 2075
PC 8085	1 987 432 064	M 2064
PC 8087	1 987 432 105	M 2105
PC 8088	1 987 432 079	M 2079

PC 8093	1 987 432 072	M 2072
PC 8094	1 987 432 013	M 2013
PC 8096	1 987 432 084	M 2084
PC 8097	1 987 432 076	M 2076
PC 8101	1 987 432 076	M 2076

PC 8102	1 987 432 009	M 2009
PC 8104	1 987 432 016	M 2016
PC 8105	1 987 431 163	M 1163
PC 8106	1 987 431 162	M 1162
PC 8107	1 987 432 056	M 2056

PC 8108	1 987 432 091	M 2091
PC 8111	1 987 432 093	M 2093
PC 8112	1 987 432 095	M 2095
PC 8113	1 987 432 082	M 2082
PC 8114	1 987 431 165	M 1165

PC 8115	1 987 432 044	M 2044
PC 8117	1 987 432 071	M 2071
PC 8118	1 987 431 157	M 1157
PC 8119	1 987 431 164	M 1164
PC 8120	1 987 432 152	M 2152

PC 8125	1 987 432 155	M 2155
PC 8126	1 987 432 088	M 2088
PC 8128	1 987 432 120	M 2120
PC 8129	1 987 432 182	M 2182
PC 8129	1 987 432 482	R 2482

PC 8130	1 987 432 096	M 2096
PC 8143-2	1 987 432 074	M 2074
PC 8146	1 987 432 092	M 2092
PC 8147	1 987 432 070	M 2070
PC 8148	1 987 432 107	M 2107

PC 8151	1 987 432 111	M 2111
PC 8155	1 987 432 097	M 2097
PC 8158	1 987 432 114	M 2114
PC 8159	1 987 432 106	M 2106
PC 8161	1 987 432 113	M 2113

PC 8164	1 987 432 094	M 2094
PC 8166	1 987 432 166	M 2166
PC 8192	1 987 432 182	M 2182
PC 8217-2	1 987 432 078	M 2078
PC 8231	1 987 432 270	M 2270

PF 8107	1 987 432 056	M 2056
PF 8126	1 987 432 088	M 2088
8146	1 987 432 092	M 2092

FIAT

PCK8193	1 987 432 406	R 2406
PCK8198	1 987 432 405	R 2405
PC8154	1 987 432 208	M 2208

PC8197	1 987 432 205	M 2205
0002191	1 987 432 106	M 2106
1312764080	1 987 432 042	M 2042
1312766080	1 987 432 042	M 2042
1475478080	1 987 432 060	M 2060

1475479080	1 987 432 060	M 2060
1484383080	1 987 432 091	M 2091
1497497080	1 987 432 206	M 2206
1497498080	1 987 432 406	R 2406
46409630	1 987 432 014	M 2014

46442422	1 987 432 003	M 2003
46721374	1 987 432 019	M 2019
46722335	1 987 432 360	R 2360
46722862	1 987 432 365	R 2365
46722863	1 987 432 365	R 2365



◀ FIAT

46723245	1 987 432 365	R 2365
46723321	1 987 432 106	M 2106
46723331	1 987 432 072	M 2072
46723435	1 987 432 377	R 2377
46768502	1 987 432 003	M 2003

46770829	1 987 432 365	R 2365
46770834	1 987 432 365	R 2365
46794399	1 987 432 059	M 2059
46799653	1 987 432 386	R 2386
46844822	1 987 432 376	R 2376

51804377	1 987 432 106	M 2106
55702456	1 987 432 188	M 2188
60653641	1 987 432 303	R 2303
60812197	1 987 432 014	M 2014
60814643	1 987 432 360	R 2360

60815647	1 987 432 303	R 2303
7078711	1 987 432 107	M 2107
7079682	1 987 432 108	M 2108
7082301	1 987 432 183	M 2183
71712595	1 987 432 014	M 2014

71743821	1 987 432 173	M 2173
735372654	1 987 432 106	M 2106
77362394	1 987 432 072	M 2072
77363370	1 987 432 433	R 2433
77364063	1 987 432 065	M 2065

77364561	1 987 432 228	M 2228
77366065	1 987 432 106	M 2106

FILTRON

K1000 A	1 987 432 310	R 2310
K1001	1 987 432 016	M 2016
K1001 A	1 987 432 366	R 2366

K1002	1 987 432 015	M 2015
K1004 A	1 987 432 317	R 2317
K1005	1 987 432 012	M 2012
K1006	1 987 432 012	M 2012
K1006 A	1 987 432 312	R 2312

K1007	1 987 432 021	M 2021
K1008	1 987 432 018	M 2018
K1008 A	1 987 432 318	R 2318
K1009	1 987 432 030	M 2030
K1009 A	1 987 432 330	R 2330

K1010	1 987 432 006	M 2006
K1010 A	1 987 432 306	R 2306
K1011	1 987 432 105	M 2105
K1014	1 987 432 040	M 2040
K1016 A	1 987 432 301	R 2301

K1017	1 987 432 026	M 2026
K1018	1 987 432 022	M 2022
K1020 A	1 987 432 307	R 2307
K1020 A	1 987 432 407	R 2407
K1022	1 987 432 027	M 2027

K1023	1 987 432 009	M 2009
K1024	1 987 432 028	M 2028
K1024 A	1 987 432 328	R 2328
K1025	1 987 432 360	R 2360
K1027	1 987 432 062	M 2062

K1030	1 987 432 061	M 2061
K1031	1 987 432 032	M 2032
K1032	1 987 432 024	M 2024
K1032 A	1 987 432 324	R 2324
K1032 A	1 987 432 333	R 2333

K1033	1 987 432 014	M 2014
K1034	1 987 432 019	M 2019
K1035	1 987 432 003	M 2003
K1035	1 987 432 303	R 2303
K1035 A	1 987 432 303	R 2303

K1036	1 987 432 033	M 2033
K1037	1 987 432 056	M 2056
K1038	1 987 432 107	M 2107
K1040	1 987 432 049	M 2049
K10402x	1 987 432 049	M 2049

K1041	1 987 432 151	M 2151
K1042	1 987 432 150	M 2150
K1044	1 987 432 052	M 2052
K10442x	1 987 432 052	M 2052
K1045	1 987 432 013	M 2013

K1045 A	1 987 432 313	R 2313
K1046 A	1 987 432 301	R 2301
K1047 A	1 987 432 300	R 2300
K1051	1 987 432 090	M 2090
K1052	1 987 432 039	M 2039

K1054	1 987 432 045	M 2045
K1054 A	1 987 432 345	R 2345
K1056	1 987 432 042	M 2042
K1057	1 987 432 039	M 2039
K1058	1 987 432 095	M 2095

K1059	1 987 432 011	M 2011
K1060	1 987 432 075	M 2075
K1062	1 987 432 060	M 2060
K10622x	1 987 432 060	M 2060
K1063	1 987 432 060	M 2060

K1064	1 987 432 096	M 2096
K1065	1 987 432 037	M 2037
K1065 A	1 987 432 337	R 2337
K1066	1 987 432 048	M 2048
K1067	1 987 432 089	M 2089

K1068	1 987 432 013	M 2013
K1070	1 987 432 050	M 2050
K1071	1 987 432 041	M 2041
K1073A	1 987 432 362	R 2362
K1073A2X	1 987 432 362	R 2362

K1074A2x	1 987 432 361	R 2361
K1075 A	1 987 432 361	R 2361
K1075 A-2X	1 987 432 361	R 2361
K1078	1 987 432 071	M 2071
K1078 A	1 987 432 371	R 2371

K1079	1 987 432 057	M 2057
K1079 A	1 987 432 357	R 2357
K1080	1 987 432 006	M 2006
K1081	1 987 432 076	M 2076
K1081A	1 987 432 376	R 2376

K1083	1 987 432 084	M 2084
K1084	1 987 431 159	M 1159
K1087	1 987 432 053	M 2053
K1088	1 987 432 043	M 2043
K1089	1 987 432 379	R 2379

K1089 A	1 987 432 380	R 2380
K1090	1 987 432 066	M 2066
K1091	1 987 432 152	M 2152
K1093	1 987 432 079	M 2079
K1093A	1 987 432 079	M 2079

K1093A	1 987 432 379	R 2379
K1095	1 987 432 089	M 2089
K1096	1 987 432 058	M 2058
K1097	1 987 432 069	M 2069
K1101	1 987 432 072	M 2072

K1102	1 987 432 354	R 2354
K1103 A	1 987 432 377	R 2377
K1104 A	1 987 432 072	M 2072
K1104A	1 987 432 365	R 2365
K1105A2x	1 987 432 386	R 2386

K1106	1 987 432 070	M 2070
K1106A	1 987 432 370	R 2370
K1108	1 987 432 044	M 2044
K1110A	1 987 432 387	R 2387
K1111	1 987 432 097	M 2097

K1111A	1 987 432 397	R 2397
K1115	1 987 432 063	M 2063
K1116A	1 987 432 360	R 2360
K1117	1 987 432 062	M 2062
K1118A	1 987 432 423	R 2423

K1119	1 987 432 082	M 2082
K1119A	1 987 432 382	R 2382
K1120A	1 987 432 364	R 2364
K1123	1 987 432 088	M 2088
K1126	1 987 432 064	M 2064

K1127	1 987 432 083	M 2083
K1128	1 987 432 091	M 2091
K1130	1 987 432 094	M 2094
K1133	1 987 431 163	M 1163
K1133A	1 987 431 458	R 1458

K1136A	1 987 432 336	R 2336
K1138	1 987 432 111	M 2111
K1138A	1 987 432 411	R 2411
K1144	1 987 431 165	M 1165
K1146	1 987 432 081	M 2081

K1147A	1 987 432 412	R 2412
K1150	1 987 432 113	M 2113
K1150A	1 987 432 413	R 2413
K1152	1 987 432 120	M 2120
K 1153	1 987 431 154	M 1154

K1154	1 987 432 109	M 2109
K1154A	1 987 432 409	R 2409
K1155	1 987 432 114	M 2114
K1159A	1 987 432 401	R 2401
K1160A2x	1 987 432 402	R 2402

K11602x	1 987 432 102	M 2102
K1161A	1 987 432 092	M 2092
K1167	1 987 432 094	M 2094
K1169	1 987 432 124	M 2124
K1171	1 987 431 166	M 1166

K1176	1 987 432 108	M 2108
K1183	1 987 432 084	M 2084
K11982x	1 987 432 074	M 2074
K1202A	1 987 432 410	R 2410
K1204A	1 987 432 378	R 2378

K1211 A	1 987 432 597	R 2597
K1237A	1 987 432 405	R 2405
K1238A	1 987 432 406	R 2406
K1248-2X	1 987 432 078	M 2078
K1264	1 987 432 236	M 2236

FLEETGUARD

AF25630	1 987 432 151	M 2151
AF25695	1 987 432 150	M 2150
AF25956	1 987 432 043	M 2043

AF26143	1 987 431 163	M 1163
AF26146	1 987 431 166	M 1166
AF4608	1 987 431 159	M 1159

FORD

A92FX 9601 CA	1 987 432 006	M 2006
A95FX 16N619 AA	1 987 432 006	M 2006
FD02115C	1 987 432 428	R 2428



◀ FORD

F5RZ 19N619 C	1 987 432 018	M 2018
ME2SGH 16N619-AA	1 987 432 087	M 2087
XS4H1 6N619 AB	1 987 432 045	M 2045
XS4H1 9G244 AA	1 987 432 345	R 2345
XS4H1 9G244 BA	1 987 432 345	R 2345

XS4Z-16N619-AA	1 987 432 045	M 2045
XS4Z-16N619-CA	1 987 432 045	M 2045
XS4Z-19N619-AA	1 987 432 045	M 2045
XS4Z-19N619-CA	1 987 432 045	M 2045
YC1H 19N619 AB	1 987 432 192	M 2192

YC1J-19N619 AB	1 987 432 192	M 2192
YS4Z-19N619-AA	1 987 432 045	M 2045
YS4Z-19N619-DB	1 987 432 045	M 2045
1S7H1 6N619	1 987 432 073	M 2073
1S7H1 6N619 AC	1 987 432 018	M 2018

1S7H1 9G244 AC	1 987 432 373	R 2373
1S7J1 6N619 BA	1 987 432 018	M 2018
2S6H1 9G244 AA	1 987 432 387	R 2387
3M5J-18D543-BA	1 987 432 109	M 2109
3M5J1 9G244 AA	1 987 432 409	R 2409

3M5J 19G244-AAHF	1 987 432 409	R 2409
4M5J1 9G244 AA	1 987 432 413	R 2413
4M5J 19G244-AAHF	1 987 432 413	R 2413
4S7J1 9G244 AA	1 987 432 373	R 2373
6S8J1 6N619 AA	1 987 432 018	M 2018

8V5J-19G244-AA	1 987 432 308	R 2308
8V5J 19G244-AA	1 987 432 415	R 2415
8V51 18D543-AA	1 987 432 215	M 2215
9S51 16N619-AA	1 987 432 106	M 2106
9S51 19G244-AA	1 987 432 106	M 2106

93BW 16N619 AA	1 987 432 018	M 2018
93BW 16N619 AB	1 987 432 018	M 2018
93BW 19G244 BA	1 987 432 318	R 2318
93BW 19G244 BB	1 987 432 318	R 2318
94BW 19N619 AB	1 987 432 018	M 2018

95VW 19N551 AA	1 987 432 028	M 2028
96FJ 16N619-AB	1 987 432 006	M 2006
96FJ 19G244-AA	1 987 432 306	R 2306
96FW 16N619 AB	1 987 432 006	M 2006
96FW 16N619 AB	1 987 432 306	R 2306

96FW 19G244-AA	1 987 432 306	R 2306
1004051	1 987 432 006	M 2006
1054468	1 987 432 028	M 2028
1062253	1 987 432 045	M 2045
1097670	1 987 432 018	M 2018

1113627	1 987 432 328	R 2328
1115568	1 987 432 073	M 2073
1119613	1 987 432 073	M 2073
1119616	1 987 432 373	R 2373
1120475	1 987 432 306	R 2306

1121106	1 987 432 345	R 2345
1132445	1 987 432 318	R 2318
1139654	1 987 432 345	R 2345
1204459	1 987 432 087	M 2087
1204464	1 987 432 387	R 2387

1225788	1 987 432 318	R 2318
1253223	1 987 432 018	M 2018
1253223	1 987 432 318	R 2318
1315686	1 987 432 109	M 2109
1315687	1 987 432 409	R 2409

1349791	1 987 432 373	R 2373
1353267	1 987 432 192	M 2192
1353270	1 987 432 306	R 2306
1353271	1 987 432 006	M 2006
1354952	1 987 432 113	M 2113

1354953	1 987 432 413	R 2413
1451913	1 987 432 373	R 2373
1452344	1 987 432 409	R 2409
1452346	1 987 432 413	R 2413
1459 009	1 987 432 192	M 2192

1488903	1 987 432 318	R 2318
1491665	1 987 432 018	M 2018
1494691	1 987 432 413	R 2413
1494697	1 987 432 409	R 2409
1541456	1 987 432 215	M 2215

1557375	1 987 432 106	M 2106
1566997	1 987 432 308	R 2308
1566997	1 987 432 415	R 2415
1585216	1 987 432 087	M 2087
1594615	1 987 432 215	M 2215

1673744	1 987 432 106	M 2106
3401703	1 987 432 018	M 2018
4042703	1 987 432 192	M 2192
5028225	1 987 432 058	M 2058
5028226	1 987 432 058	M 2058

5029916	1 987 432 058	M 2058
5030481	1 987 432 006	M 2006
7180932	1 987 432 018	M 2018
7420372	1 987 432 028	M 2028

FRAM

CA5551	1 987 432 021	M 2021
CA5590	1 987 431 159	M 1159
CA5663	1 987 432 012	M 2012

CA5664	1 987 432 018	M 2018
CA5665	1 987 432 015	M 2015
CFA10055	1 987 432 410	R 2410
CFA101032	1 987 432 402	R 2402
CFA10199	1 987 432 433	R 2433

CFA10206	1 987 432 424	R 2424
CFA10209-2	1 987 432 422	R 2422
CFA10366	1 987 432 406	R 2406
CFA10435	1 987 432 405	R 2405
CFA10458	1 987 432 369	R 2369

CFA10474-2	1 987 432 500	R 2500
CFA10529	1 987 432 311	R 2311
CFA10612	1 987 432 499	R 2499
CFA10657	1 987 432 327	R 2327
CFA8046	1 987 432 318	R 2318

CFA8788	1 987 432 360	R 2360
CFA8831	1 987 432 345	R 2345
CFA8869	1 987 432 300	R 2300
CFA8874	1 987 432 366	R 2366
CFA8875	1 987 432 310	R 2310

CFA8876	1 987 432 333	R 2333
CFA8877	1 987 432 301	R 2301
CFA8878	1 987 432 328	R 2328
CFA8879	1 987 432 330	R 2330
CFA8882	1 987 432 317	R 2317

CFA8893	1 987 432 312	R 2312
CFA8894	1 987 432 303	R 2303
CFA8912	1 987 432 361	R 2361
CFA89122	1 987 432 361	R 2361
CFA8913	1 987 432 336	R 2336

CFA9322	1 987 432 362	R 2362
CFA9364	1 987 432 380	R 2380
CFA9404	1 987 432 357	R 2357
CFA9405	1 987 432 386	R 2386
CFA94052	1 987 432 386	R 2386

CFA9445	1 987 432 378	R 2378
CFA9495	1 987 432 376	R 2376
CFA9533	1 987 432 377	R 2377
CFA9546	1 987 432 525	R 2525
CFA9548	1 987 432 371	R 2371

CFA9567	1 987 432 366	R 2366
CFA9587	1 987 432 379	R 2379
CFA9619	1 987 431 165	M 1165
CFA9623	1 987 432 306	R 2306
CFA9666	1 987 432 387	R 2387

CFA9785	1 987 432 381	R 2381
CFA9920	1 987 432 412	R 2412
CFA9921	1 987 432 397	R 2397
CFA9931	1 987 432 469	R 2469
CF10025	1 987 432 106	M 2106

CF10059	1 987 432 113	M 2113
CF10062	1 987 432 166	M 2166
CF10067	1 987 432 094	M 2094
CF10087	1 987 432 116	M 2116
CF10204-2	1 987 432 136	M 2136

CF10285	1 987 432 190	M 2190
CF10322	1 987 432 190	M 2190
CF10411	1 987 432 203	M 2203
CF10413	1 987 432 228	M 2228
CF10431	1 987 432 216	M 2216

CF10442	1 987 432 205	M 2205
CF10450	1 987 432 270	M 2270
CF10536-2	1 987 432 137	M 2137
CF10621	1 987 432 195	M 2195
CF10659	1 987 432 215	M 2215

CF5551	1 987 432 021	M 2021
CF5662	1 987 432 317	R 2317
CF5663	1 987 432 012	M 2012
CF5664	1 987 432 018	M 2018
CF5665	1 987 432 015	M 2015

CF5816	1 987 432 016	M 2016
CF5817	1 987 432 006	M 2006
CF5818	1 987 432 019	M 2019
CF5819	1 987 432 003	M 2003
CF5823	1 987 432 014	M 2014

CF5824	1 987 432 033	M 2033
CF5846	1 987 432 007	M 2007
CF5846	1 987 432 200	M 2200
CF5848	1 987 432 027	M 2027
CF5849	1 987 432 009	M 2009

CF5850	1 987 432 028	M 2028
CF5853	1 987 432 062	M 2062
CF5863	1 987 432 030	M 2030
CF5864	1 987 432 022	M 2022
CF5865	1 987 432 026	M 2026

CF5893	1 987 432 061	M 2061
CF5935	1 987 432 032	M 2032
CF5942	1 987 432 024	M 2024
CF8046	1 987 432 018	M 2018
CF8046	1 987 432 318	R 2318

CF8714	1 987 432 062	M 2062
CF8773	1 987 431 175	M 1175
CF8777	1 987 432 037	M 2037
CF8788	1 987 432 360	R 2360
CF8799	1 987 432 089	M 2089

CF8799	1 987 432 090	M 2090
CF8800	1 987 432 151	M 2151
CF8831	1 987 432 045	M 2045
CF8832	1 987 432 049	M 2049
CF8838	1 987 432 039	M 2039

CF8850	1 987 431 455	R 1455
CF8868	1 987 432 040	M 2040
CF8874	1 987 432 016	M 2016
CF8875	1 987 432 040	M 2040
CF8876	1 987 432 324	R 2324



◀ FRAM

CF8877	1 987 432 301	R 2301
CF8878	1 987 432 028	M 2028
CF8879	1 987 432 030	M 2030
CF8881	1 987 432 014	M 2014
CF8890	1 987 432 042	M 2042

CF8893	1 987 432 012	M 2012
CF8894	1 987 432 003	M 2003
CF8912	1 987 432 361	R 2361
CF8913	1 987 432 336	R 2336
CF8914	1 987 432 052	M 2052

CF8947	1 987 432 060	M 2060
CF8948	1 987 432 060	M 2060
CF8989	1 987 432 107	M 2107
CF9051	1 987 432 043	M 2043
CF9071	1 987 432 048	M 2048

CF9077	1 987 432 059	M 2059
CF9086	1 987 432 050	M 2050
CF9293	1 987 432 069	M 2069
CF9294	1 987 432 083	M 2083
CF9323	1 987 432 057	M 2057

CF9335	1 987 432 066	M 2066
CF9336	1 987 432 063	M 2063
CF9337	1 987 432 058	M 2058
CF9338	1 987 432 053	M 2053
CF9338	1 987 432 121	M 2121

CF9338	1 987 432 167	M 2167
CF9363	1 987 432 075	M 2075
CF9383	1 987 432 044	M 2044
CF9386	1 987 431 164	M 1164
CF9387	1 987 432 152	M 2152

CF9395	1 987 432 105	M 2105
CF9396	1 987 432 064	M 2064
CF9398	1 987 432 079	M 2079
CF9414	1 987 432 013	M 2013
CF9442	1 987 432 093	M 2093

CF9466	1 987 432 084	M 2084
CF9485	1 987 432 192	M 2192
CF9495	1 987 432 076	M 2076
CF9509	1 987 432 050	M 2050
CF9531	1 987 432 076	M 2076

CF9545	1 987 432 091	M 2091
CF9562	1 987 432 398	R 2398
CF9566	1 987 432 084	M 2084
CF9567	1 987 432 366	R 2366
CF9569	1 987 431 163	M 1163

CF9576	1 987 431 162	M 1162
CF9579	1 987 432 056	M 2056
CF9586	1 987 432 091	M 2091
CF9594	1 987 432 082	M 2082
CF9595	1 987 432 095	M 2095

CF9640	1 987 432 182	M 2182
CF9640	1 987 432 482	R 2482
CF9645	1 987 432 071	M 2071
CF9659	1 987 432 155	M 2155
CF9666	1 987 432 087	M 2087

CF9686	1 987 432 088	M 2088
CF9691	1 987 432 120	M 2120
CF9724	1 987 432 096	M 2096
CF9740	1 987 432 159	M 2159
CF9787	1 987 432 109	M 2109

CF9807	1 987 432 111	M 2111
CF98192	1 987 432 074	M 2074
CF98192	1 987 432 220	M 2220
CF9846	1 987 432 085	M 2085
CF9846	1 987 432 320	R 2320

CF9862	1 987 432 092	M 2092
CF9881	1 987 432 114	M 2114
CF9905	1 987 432 070	M 2070
CF9922	1 987 432 097	M 2097
CF9934	1 987 432 208	M 2208

FREUDENBERG

AHC 190	1 987 432 377	R 2377
AKX 35154	1 987 432 200	M 2200
AKYE35128	1 987 432 045	M 2045

AKYE35647	1 987 432 366	R 2366
AKYE35651	1 987 432 361	R 2361
AKYE3576	1 987 432 044	M 2044
AK3576	1 987 432 044	M 2044
MC 505	1 987 432 301	R 2301

MC 509	1 987 432 310	R 2310
MC 511	1 987 432 317	R 2317
MC 517	1 987 432 306	R 2306
MC 525	1 987 432 328	R 2328
MC 530-2	1 987 432 361	R 2361

MC 532	1 987 432 330	R 2330
MC 537	1 987 432 337	R 2337
MC 538	1 987 432 336	R 2336
MC 539	1 987 432 303	R 2303
MC 541	1 987 432 345	R 2345

MC 544	1 987 432 312	R 2312
MC 548	1 987 432 333	R 2333
MC 549	1 987 432 324	R 2324
MC 555	1 987 432 307	R 2307
MC 559	1 987 432 370	R 2370

MC 560	1 987 432 357	R 2357
MC 561	1 987 432 354	R 2354
MC 564	1 987 432 380	R 2380
MC 571	1 987 432 379	R 2379
MC 576	1 987 432 318	R 2318

MC 578	1 987 432 365	R 2365
MC 589	1 987 432 313	R 2313
MC 590	1 987 432 378	R 2378
MC 591	1 987 432 360	R 2360
MC 592	1 987 432 300	R 2300

MC 593	1 987 432 362	R 2362
MC 594	1 987 432 364	R 2364
MC 596	1 987 432 377	R 2377
MC 597	1 987 432 373	R 2373
MC 599	1 987 432 366	R 2366

MC 600-2	1 987 432 367	R 2367
MC 606	1 987 432 371	R 2371
MC 607	1 987 432 376	R 2376
MC 613	1 987 432 397	R 2397
MC 614	1 987 432 387	R 2387

MC 615	1 987 432 400	R 2400
MC 630	1 987 432 382	R 2382
MC 639	1 987 432 411	R 2411
MC 640	1 987 432 412	R 2412
MC 641	1 987 432 431	R 2431

MC 642	1 987 432 409	R 2409
MC 649	1 987 432 425	R 2425
MC 659	1 987 432 399	R 2399
MC 661	1 987 432 410	R 2410
MC 666-2	1 987 432 402	R 2402

MC 670	1 987 432 434	R 2434
MC 685	1 987 432 422	R 2422
MC 686	1 987 432 435	R 2435
MC 689	1 987 432 401	R 2401
MC 695	1 987 432 424	R 2424

MC 700	1 987 432 433	R 2433
MP 002	1 987 432 032	M 2032
MP 012	1 987 432 022	M 2022
MP 013	1 987 432 042	M 2042
MP 014	1 987 432 040	M 2040

MP 015	1 987 432 016	M 2016
MP 017	1 987 432 006	M 2006
MP 018	1 987 432 015	M 2015
MP 020	1 987 432 043	M 2043
MP 021	1 987 432 019	M 2019

MP 023	1 987 432 044	M 2044
MP 024	1 987 432 056	M 2056
MP 025	1 987 432 028	M 2028
MP 028	1 987 432 184	M 2184
MP 029	1 987 432 026	M 2026

MP 031	1 987 432 013	M 2013
MP 032	1 987 432 030	M 2030
MP 033	1 987 432 039	M 2039
MP 034	1 987 432 021	M 2021
MP 037	1 987 432 037	M 2037

MP 039	1 987 432 003	M 2003
MP 041	1 987 432 045	M 2045
MP 042	1 987 432 105	M 2105
MP 043	1 987 432 175	M 2175
MP 044	1 987 432 012	M 2012

MP 048	1 987 432 033	M 2033
MP 049	1 987 432 024	M 2024
MP 050	1 987 432 014	M 2014
MP 051	1 987 432 027	M 2027
MP 052	1 987 432 009	M 2009

MP 055	1 987 432 007	M 2007
MP 057	1 987 432 048	M 2048
MP 058-2	1 987 432 052	M 2052
MP 059	1 987 432 070	M 2070
MP 060	1 987 432 057	M 2057

MP 062	1 987 432 095	M 2095
MP 063	1 987 432 075	M 2075
MP 068	1 987 432 049	M 2049
MP 069	1 987 432 062	M 2062
MP 070	1 987 432 151	M 2151

MP 071	1 987 432 079	M 2079
MP 075 RL	1 987 432 050	M 2050
MP 076	1 987 432 018	M 2018
MP 077	1 987 432 066	M 2066
MP 080	1 987 432 053	M 2053

MP 080	1 987 432 121	M 2121
MP 081	1 987 432 059	M 2059
MP 082	1 987 432 058	M 2058
MP 084	1 987 432 061	M 2061
MP 085	1 987 432 063	M 2063

MP 086	1 987 432 064	M 2064
MP 087-3	1 987 432 060	M 2060
MP 088	1 987 432 069	M 2069
MP 097	1 987 432 073	M 2073
MP 104	1 987 432 084	M 2084

MP 105	1 987 432 085	M 2085
MP 106	1 987 432 071	M 2071
MP 109	1 987 432 081	M 2081
MP 111-2	1 987 432 103	M 2103
MP 113	1 987 432 097	M 2097

MP 117	1 987 432 088	M 2088
MP 124-2	1 987 432 117	M 2117
MP 125	1 987 432 119	M 2119
MP 128-2	1 987 432 159	M 2159
MP 130	1 987 432 082	M 2082

MP 139	1 987 432 111	M 2111
MP 158	1 987 432 115	M 2115
MP 160	1 987 432 167	M 2167
MP 163	1 987 432 106	M 2106
MP 166-2	1 987 432 102	M 2102



F

◀ FREUDENBERG

MP 171	1 987 432 153	M 2153
MP 179	1 987 432 120	M 2120
MP 180	1 987 432 166	M 2166
MP 181	1 987 432 113	M 2113
MP 191	1 987 432 107	M 2107

MP 192	1 987 432 108	M 2108
MP 193	1 987 432 188	M 2188
MP 196	1 987 432 170	M 2170
MP 198	1 987 432 173	M 2173
MP 213	1 987 432 158	M 2158

MP 215-2	1 987 432 176	M 2176
MP 220	1 987 432 164	M 2164
MP 227-2	1 987 432 163	M 2163
MP 233	1 987 432 182	M 2182
MP 234	1 987 432 116	M 2116

MP 235	1 987 432 169	M 2169
MP 236	1 987 432 426	R 2426
MP 321	1 987 432 183	M 2183
21650107	1 987 432 018	M 2018
21651183	1 987 432 016	M 2016

21651185	1 987 432 030	M 2030
21651292	1 987 432 337	R 2337
21651298	1 987 432 050	M 2050
21651882	1 987 432 361	R 2361
21651891	1 987 432 022	M 2022

21651893	1 987 432 006	M 2006
21651899	1 987 432 021	M 2021
21651912	1 987 432 012	M 2012
21651914	1 987 432 024	M 2024
21651916	1 987 432 027	M 2027

21651917	1 987 432 009	M 2009
21651952	1 987 432 303	R 2303
21651955	1 987 432 300	R 2300
21651955	1 987 432 312	R 2312
21651963	1 987 432 366	R 2366

21651964	1 987 432 310	R 2310
21651967	1 987 432 300	R 2300
21651968	1 987 432 313	R 2313
21651972	1 987 432 026	M 2026
21651976	1 987 432 043	M 2043

21651977	1 987 431 154	M 1154
21651984	1 987 432 090	M 2090
21651994	1 987 432 042	M 2042
21651995	1 987 432 045	M 2045
21652045	1 987 432 044	M 2044

35681	1 987 432 412	R 2412
9632013680	1 987 432 354	R 2354
96609003	1 987 432 378	R 2378

GMC (GENERAL MOTORS CORP.)

09200067	1 987 432 091	M 2091
09207486	1 987 432 066	M 2066

12489480	1 987 432 018	M 2018
12489480	1 987 432 812	M 2812
12489487	1 987 432 052	M 2052
13271190	1 987 432 004	M 2004
13271191	1 987 432 304	R 2304

1808602	1 987 432 091	M 2091
52420930	1 987 432 304	R 2304
52425938	1 987 432 004	M 2004
55702468	1 987 432 488	R 2488
6808600	1 987 432 166	M 2166

90360171	1 987 432 091	M 2091
90360171	1 987 432 166	M 2166
90383627	1 987 432 091	M 2091
90386776	1 987 432 015	M 2015
90458294	1 987 432 016	M 2016

90464424	1 987 432 030	M 2030
90486282	1 987 432 091	M 2091
90486282	1 987 432 166	M 2166
90509367	1 987 432 015	M 2015
90510338	1 987 432 016	M 2016

90512779	1 987 432 030	M 2030
90541317	1 987 432 310	R 2310
905658793	1 987 432 310	R 2310
90590568	1 987 432 091	M 2091
91132361	1 987 432 310	R 2310

91132362	1 987 432 366	R 2366
91160128	1 987 432 208	M 2208
9121625	1 987 432 310	R 2310
9200067	1 987 432 091	M 2091
9200067	1 987 432 166	M 2166

9201440	1 987 432 076	M 2076
93182435	1 987 432 091	M 2091
93182435	1 987 432 166	M 2166
93182438	1 987 432 016	M 2016
93194847	1 987 432 214	M 2214

96554378	1 987 432 223	M 2223
96554421	1 987 432 223	M 2223
96800837	1 987 432 223	M 2223

GUD

AC18	1 987 432 300	R 2300
AC4	1 987 432 018	M 2018
AC5	1 987 432 006	M 2006

AC76	1 987 432 124	M 2124
AGC938	1 987 432 018	M 2018
AGC939	1 987 432 006	M 2006

HALFORDS

HCF201	1 987 432 018	M 2018
HCF202	1 987 432 012	M 2012
HCF203	1 987 432 015	M 2015

HCF204	1 987 432 006	M 2006
HCF205	1 987 432 022	M 2022
HCF206	1 987 432 030	M 2030
HCF207	1 987 432 050	M 2050
HCF211	1 987 432 016	M 2016

HCF213	1 987 432 021	M 2021
HCF214	1 987 432 009	M 2009
HCF215	1 987 432 026	M 2026

HELSA

KF 005	1 987 432 402	R 2402
KF 006	1 987 432 317	R 2317
KF 008	1 987 432 333	R 2333

KF 012	1 987 432 324	R 2324
KF 018	1 987 432 380	R 2380
KF 020	1 987 432 397	R 2397
KF 023	1 987 432 376	R 2376
KF 024	1 987 432 423	R 2423

KF 028	1 987 432 373	R 2373
KF 030	1 987 432 306	R 2306
KF 031	1 987 432 318	R 2318
KF 034	1 987 432 360	R 2360
KF 035	1 987 432 345	R 2345

KF 036	1 987 432 328	R 2328
KF 038	1 987 432 377	R 2377
KF 040	1 987 432 365	R 2365
KF 041	1 987 432 370	R 2370
KF 044	1 987 432 307	R 2307

KF 046	1 987 432 434	R 2434
KF 047	1 987 432 301	R 2301
KF 048	1 987 432 371	R 2371
KF 053	1 987 432 336	R 2336
KF 056	1 987 432 425	R 2425

KF 059	1 987 432 330	R 2330
KF 063	1 987 432 379	R 2379
KF 068	1 987 432 387	R 2387
KF 072	1 987 432 364	R 2364
KF 077	1 987 432 362	R 2362

KF 079	1 987 432 400	R 2400
KF 092	1 987 432 382	R 2382
KF 095	1 987 432 386	R 2386
KF 135	1 987 432 409	R 2409
KF 141	1 987 432 424	R 2424

KF 160	1 987 432 411	R 2411
KF 169	1 987 432 410	R 2410
KF 171	1 987 432 413	R 2413
KF 173	1 987 432 428	R 2428
KF 195	1 987 432 401	R 2401

KF 242	1 987 432 426	R 2426
NKF 035	1 987 432 431	R 2431
NPF 029	1 987 432 056	M 2056
NPF 035	1 987 432 114	M 2114
NPF 044	1 987 432 153	M 2153

NPF 095	1 987 432 152	M 2152
PF 003	1 987 432 014	M 2014
PF 004	1 987 432 003	M 2003
PF 008	1 987 432 033	M 2033
PF 009	1 987 432 052	M 2052

PF 011	1 987 432 081	M 2081
PF 016	1 987 432 032	M 2032
PF 020	1 987 432 097	M 2097
PF 022	1 987 432 107	M 2107
PF 023	1 987 432 076	M 2076

PF 025	1 987 432 039	M 2039
PF 026	1 987 432 019	M 2019
PF 028	1 987 432 073	M 2073
PF 029	1 987 432 053	M 2053
PF 033	1 987 432 040	M 2040

PF 036	1 987 432 028	M 2028
PF 037	1 987 432 106	M 2106
PF 040	1 987 432 072	M 2072
PF 041	1 987 432 070	M 2070
PF 048	1 987 432 071	M 2071

PF 052	1 987 432 048	M 2048
PF 062	1 987 432 108	M 2108
PF 067	1 987 432 083	M 2083
PF 070	1 987 432 062	M 2062
PF 071	1 987 432 063	M 2063

PF 074	1 987 432 049	M 2049
PF 080	1 987 432 064	M 2064
PF 081	1 987 432 066	M 2066
PF 092	1 987 432 082	M 2082
PF 105	1 987 432 061	M 2061

PF 107	1 987 432 093	M 2093
PF 108	1 987 432 091	M 2091
PF 110	1 987 432 094	M 2094
PF 112	1 987 432 173	M 2173
PF 115	1 987 432 120	M 2120



H

◀ HELSA

PF 116	1 987 432 092	M 2092
PF 120	1 987 432 088	M 2088
PF 121	1 987 432 084	M 2084
PF 122	1 987 432 085	M 2085
PF 136	1 987 432 104	M 2104

PF 144	1 987 432 188	M 2188
PF 151	1 987 432 116	M 2116
PF 160	1 987 432 111	M 2111
PF 181	1 987 432 117	M 2117
PF 190	1 987 432 096	M 2096

PF 208	1 987 432 179	M 2179
PF 209	1 987 432 118	M 2118
PF 210	1 987 432 155	M 2155
PF 225	1 987 432 119	M 2119
PF 238	1 987 432 156	M 2156

PF 265	1 987 432 157	M 2157
--------	---------------	--------

HENGST

E93LI	1 987 432 003	M 2003
E900LC	1 987 432 300	R 2300
E900LC	1 987 432 312	R 2312

E900LI	1 987 432 012	M 2012
E900LIC	1 987 432 312	R 2312
E901LC	1 987 432 310	R 2310
E901LIC	1 987 432 310	R 2310
E902LI	1 987 432 015	M 2015

E903LC	1 987 432 366	R 2366
E903LI	1 987 432 016	M 2016
E904LI	1 987 432 030	M 2030
E904LIC	1 987 432 330	R 2330
E905LC	1 987 432 317	R 2317

E905LIC	1 987 432 324	R 2324
E906LI	1 987 432 151	M 2151
E907LC	1 987 432 318	R 2318
E907LI	1 987 432 018	M 2018
E907LIC	1 987 432 318	R 2318

E908LC	1 987 432 306	R 2306
E908LI	1 987 432 006	M 2006
E909LI	1 987 432 052	M 2052
E910LI	1 987 432 040	M 2040
E912LI	1 987 432 043	M 2043

E913LC	1 987 432 337	R 2337
E913LI	1 987 432 037	M 2037
E914LC	1 987 432 301	R 2301
E914LC01	1 987 432 301	R 2301
E915LC	1 987 432 333	R 2333

E915LI	1 987 432 033	M 2033
E916LC	1 987 432 049	M 2049
E916LI	1 987 432 049	M 2049
E917LI	1 987 432 095	M 2095
E919LC	1 987 432 328	R 2328

E919LI	1 987 432 028	M 2028
E920LC	1 987 432 062	M 2062
E920LI	1 987 432 062	M 2062
E921LC	1 987 432 313	R 2313
E921LI	1 987 432 013	M 2013

E921LI	1 987 432 809	M 2809
E922LI	1 987 432 056	M 2056
E931LI	1 987 432 150	M 2150
E932LI01	1 987 431 175	M 1175
E933LC	1 987 431 456	R 1456

E934LI	1 987 432 003	M 2003
E935LI	1 987 432 026	M 2026
E936LC	1 987 432 333	R 2333
E936LI	1 987 432 024	M 2024
E938LI	1 987 431 165	M 1165

E940LI	1 987 432 021	M 2021
E941LC	1 987 432 345	R 2345
E941LI	1 987 432 045	M 2045
E943LI	1 987 432 019	M 2019
E944LI	1 987 432 152	M 2152

E947LC	1 987 431 451	R 1451
E947LI	1 987 431 167	M 1167
E948LI	1 987 431 160	M 1160
E950LI	1 987 432 107	M 2107
E951LC	1 987 432 307	R 2307

E951LC	1 987 432 407	R 2407
E951LI	1 987 432 200	M 2200
E952LI	1 987 432 027	M 2027
E953LI	1 987 432 042	M 2042
E954LC	1 987 431 458	R 1458

E954LI	1 987 431 163	M 1163
E955LC	1 987 432 371	R 2371
E955LI	1 987 432 071	M 2071
E956LI	1 987 432 153	M 2153
E959LI	1 987 432 032	M 2032

E960LC	1 987 432 361	R 2361
E960LI	1 987 432 361	R 2361
E961LC	1 987 432 357	R 2357
E961LI	1 987 432 057	M 2057
E962LI	1 987 432 039	M 2039

E963LI	1 987 432 044	M 2044
E964LC	1 987 432 378	R 2378
E965LI	1 987 432 009	M 2009
E967LI	1 987 432 090	M 2090
E968LI	1 987 432 018	M 2018

E970LC	1 987 432 370	R 2370
E970LI	1 987 432 070	M 2070
E971LI	1 987 432 048	M 2048
E971LI01	1 987 432 048	M 2048
E972LC	1 987 432 376	R 2376

E972LI	1 987 432 076	M 2076
E975LI	1 987 432 053	M 2053
E975LI	1 987 432 075	M 2075
E976LI	1 987 432 360	R 2360
E977LC	1 987 432 336	R 2336

E979LI	1 987 432 061	M 2061
E980LI	1 987 431 168	M 1168
E981LI	1 987 432 089	M 2089
E982LI	1 987 431 154	M 1154
E983LC	1 987 432 362	R 2362

E989LI	1 987 432 081	M 2081
E990LC	1 987 432 398	R 2398
E990LC01	1 987 432 412	R 2412
E991LI	1 987 432 157	M 2157
E992LC	1 987 432 377	R 2377

E994LC	1 987 432 382	R 2382
E994LI	1 987 432 082	M 2082
E997LC	1 987 432 380	R 2380
E998LC	1 987 432 397	R 2397
E998LC-R	1 987 432 597	R 2597

E998LC01	1 987 432 597	R 2597
E998LI	1 987 432 097	M 2097
E1903LC	1 987 432 387	R 2387
E1905LI	1 987 431 159	M 1159
E1906LI	1 987 432 074	M 2074

E1907LC	1 987 432 409	R 2409
E1907LI	1 987 432 109	M 2109
E1908LI	1 987 431 166	M 1166
E1909LC	1 987 432 402	R 2402
E1909LI	1 987 432 102	M 2102

E1910LC	1 987 432 431	R 2431
E1910LI	1 987 432 114	M 2114
E1911LC	1 987 432 379	R 2379
E1911LI	1 987 432 079	M 2079
E1912LC	1 987 432 364	R 2364

E1914LC	1 987 432 411	R 2411
E1914LI	1 987 432 111	M 2111
E1915LI	1 987 432 083	M 2083
E1916LI	1 987 432 064	M 2064
E1918LC	1 987 432 410	R 2410

E1918LI	1 987 432 410	R 2410
E1920LI	1 987 432 103	M 2103
E1921LI	1 987 432 014	M 2014
E1925LC	1 987 432 400	R 2400
E1926LC	1 987 432 092	M 2092

E1926LI	1 987 432 092	M 2092
E1927LI	1 987 432 088	M 2088
E1928LC	1 987 432 434	R 2434
E1929LI	1 987 432 106	M 2106
E193LI	1 987 432 087	M 2087

E1930LC	1 987 432 386	R 2386
E1932LC	1 987 432 482	R 2482
E1933LC	1 987 432 367	R 2367
E1934LC	1 987 432 303	R 2303
E1937LI	1 987 432 163	M 2163

E1939LI	1 987 432 093	M 2093
E1942LI	1 987 432 011	M 2011
E1943LC	1 987 432 425	R 2425
E1944LC	1 987 432 422	R 2422
E1948LC	1 987 432 059	M 2059

E1948LI	1 987 432 059	M 2059
E1953LI	1 987 432 066	M 2066
E1955LI	1 987 432 063	M 2063
E1959LC	1 987 432 424	R 2424
E1959LI	1 987 432 124	M 2124

E1960LI	1 987 432 060	M 2060
E1961LI	1 987 432 069	M 2069
E1962LI	1 987 432 072	M 2072
E1963LI	1 987 432 091	M 2091
E1975LI	1 987 432 058	M 2058

E1976LI	1 987 432 164	M 2164
E1978LC	1 987 432 423	R 2423
E1981LI	1 987 432 086	M 2086
E1981LI	1 987 432 134	M 2134
E1987LI	1 987 432 058	M 2058

E1988LC	1 987 432 401	R 2401
E1990LI	1 987 432 113	M 2113
E1998LC	1 987 432 426	R 2426
E2900LI	1 987 432 104	M 2104
E2905LI	1 987 432 120	M 2120

E2909LI	1 987 432 155	M 2155
E2912LC-2	1 987 432 309	R 2309
E2915LC	1 987 432 320	R 2320
E2915LI	1 987 432 085	M 2085
E2918LI	1 987 432 203	M 2203

E2925LI	1 987 432 170	M 2170
E2930LI	1 987 432 084	M 2084
E2931LI	1 987 432 154	M 2154
E2933LC	1 987 432 368	R 2368
E2933LI	1 987 432 068	M 2068

E2934LI	1 987 432 159	M 2159
E2936LI	1 987 432 094	M 2094
E2937LC	1 987 432 399	R 2399
E2939LI	1 987 432 188	M 2188
E2943LI	1 987 432 136	M 2136



H

◀ HENGST

E2947LI	1 987 432 296	M 2296
E2949LC	1 987 432 405	R 2405
E2949LI	1 987 432 205	M 2205
E2951LC	1 987 432 406	R 2406
E2951LI	1 987 432 206	M 2206

E2955LI	1 987 432 222	M 2222
E2961LI	1 987 432 007	M 2007
E2962LI	1 987 432 004	M 2004

HERTH U. BUSS

J1340903	1 987 432 105	M 2105
J1341002	1 987 432 075	M 2075
J1341003	1 987 432 058	M 2058

J1343002	1 987 432 006	M 2006
J1344004	1 987 432 026	M 2026
J1344006	1 987 432 074	M 2074
J1344012	1 987 432 074	M 2074

HOLDEN

13 175 553	1 987 432 040	M 2040
90 509 367	1 987 432 015	M 2015
90 520 689	1 987 432 040	M 2040

HONDA

08R79ST3600	1 987 432 026	M 2026
08R79 S2H 600	1 987 432 167	M 2167
08R79S5A600	1 987 432 074	M 2074

08R79-S5A-600	1 987 432 220	M 2220
08292-SCA-E11	1 987 432 074	M 2074
08292-SCA-E11	1 987 432 220	M 2220
19874-32053	1 987 432 053	M 2053
79831-ST3-EC1	1 987 432 026	M 2026

79831-ST3-E01	1 987 432 026	M 2026
79831-S04-003	1 987 432 026	M 2026
80290-ST3-E01	1 987 432 053	M 2053
80291-SAA-E01	1 987 432 115	M 2115
80291-SAA-E01	1 987 432 173	M 2173

80291-SAA-505	1 987 432 173	M 2173
80291-ST3-E01	1 987 432 053	M 2053
80291-ST3-505	1 987 432 053	M 2053
80291-ST3-515	1 987 432 053	M 2053
80291-ST3-515	1 987 432 121	M 2121

80291-S2H-E01	1 987 432 167	M 2167
80291-S2H-505	1 987 432 167	M 2167
80291-TF0-E01	1 987 432 234	M 2234
80292-SCA-E11	1 987 432 074	M 2074
80292-SCA-G01	1 987 432 074	M 2074

80292-SCA-G01	1 987 432 220	M 2220
80292-SDA-A01	1 987 432 166	M 2166
80292-SDC-A01	1 987 432 166	M 2166
80292-SDC-505-HE	1 987 432 166	M 2166
80292-SHJ-A41	1 987 432 166	M 2166

80292-SMG-E01	1 987 432 203	M 2203
80292-SWW-G01	1 987 432 166	M 2166
80292-S5A-003	1 987 432 074	M 2074
80292-S5A-003	1 987 432 220	M 2220
80292-S5D-A01	1 987 432 074	M 2074

80292-S5D-A01	1 987 432 220	M 2220
80292-S50-A01	1 987 432 074	M 2074
80292-S50-A01	1 987 432 220	M 2220
80292-S6D-G01	1 987 432 074	M 2074
80292-S6D-G01	1 987 432 220	M 2220

80292-S6M-901	1 987 432 074	M 2074
80292-S6M-901	1 987 432 220	M 2220
80292-TF0-G01	1 987 432 234	M 2234

HUAYANG

971333K000	1 987 432 160	M 2160
------------	---------------	--------

HYUNDAI

97133 07010	1 987 432 164	M 2164
971331E000	1 987 432 204	M 2204
971331E100	1 987 432 204	M 2204

971331J000	1 987 432 132	M 2132
97133 2D000	1 987 432 158	M 2158
971332D100	1 987 432 158	M 2158
971332D205	1 987 432 229	M 2229
97133 2E200	1 987 432 170	M 2170

971332G000	1 987 432 160	M 2160
97133-2L000	1 987 432 055	M 2055
97133-3J100	1 987 432 240	M 2240
971333K000	1 987 432 227	M 2227
97617 1C000	1 987 432 161	M 2161

976193D000	1 987 432 160	M 2160
976193D100	1 987 432 160	M 2160
976193D200	1 987 432 160	M 2160
9999Z07015	1 987 432 158	M 2158
9999Z07017	1 987 432 161	M 2161

ISUZU

2908429000	1 987 432 018	M 2018
------------	---------------	--------



K

IVECO

2995964	1 987 431 166	M 1166
2995966	1 987 431 165	M 1165
3799020	1 987 431 165	M 1165

500314688	1 987 432 003	M 2003
500387947	1 987 431 165	M 1165
504024890	1 987 431 166	M 1166
93162385	1 987 431 165	M 1165

JAGUAR

C2S 8619	1 987 432 073	M 2073
C2S 8619	1 987 432 373	R 2373
XR830254	1 987 432 428	R 2428

XR8 49205	1 987 432 428	R 2428
1S7H 16N 619	1 987 432 073	M 2073
1S7H 19G 244	1 987 432 373	R 2373
1X4H 16N 619	1 987 432 073	M 2073
1X4H 19G 244	1 987 432 373	R 2373

KIA

OK2N1 6152X	1 987 432 211	M 2211
OK9A4 6152S	1 987 432 176	M 2176
OK9A4 6152X	1 987 432 176	M 2176

OK9A4 6152XA	1 987 432 176	M 2176
97133 0X900	1 987 432 164	M 2164
97133 07000	1 987 432 164	M 2164
97133 1H000	1 987 432 055	M 2055
97619 FD200	1 987 432 176	M 2176

KNECHT

LA 8	1 987 432 021	M 2021
LA 9	1 987 432 022	M 2022
LA 19	1 987 432 011	M 2011

LA 21	1 987 432 015	M 2015
LA 23	1 987 432 027	M 2027
LA 25	1 987 432 018	M 2018
LA 25	1 987 432 073	M 2073
LA 27	1 987 432 050	M 2050

LA 31	1 987 432 012	M 2012
LA 32/2	1 987 432 307	R 2307
LA 32/3	1 987 432 200	M 2200
LA 33	1 987 432 009	M 2009
LA 34	1 987 432 014	M 2014

LA 35	1 987 432 019	M 2019
LA 36	1 987 432 016	M 2016
LA 38	1 987 432 041	M 2041
LA 39	1 987 432 225	M 2225
LA 40	1 987 432 089	M 2089

LA 41	1 987 432 226	M 2226
LA 42	1 987 432 150	M 2150
LA 44	1 987 432 013	M 2013
LA 46	1 987 432 024	M 2024
LA 48	1 987 432 193	M 2193

LA 49	1 987 432 030	M 2030
LA 50	1 987 432 152	M 2152
LA 52	1 987 432 028	M 2028
LA 54	1 987 432 064	M 2064
LA 55	1 987 431 164	M 1164

LA 55/1	1 987 431 164	M 1164
LA 56	1 987 432 003	M 2003
LA 57	1 987 432 048	M 2048
LA 58	1 987 432 033	M 2033
LA 60	1 987 432 090	M 2090

LA 65	1 987 432 056	M 2056
LA 67	1 987 432 151	M 2151
LA 71	1 987 431 169	M 1169
LA 75	1 987 432 040	M 2040
LA 76/S	1 987 432 049	M 2049

LA 77	1 987 432 006	M 2006
LA 78	1 987 432 045	M 2045
LA 79	1 987 432 062	M 2062
LA 82	1 987 432 026	M 2026
LA 83	1 987 432 043	M 2043

LA 84	1 987 432 121	M 2121
LA 85	1 987 431 157	M 1157
LA 87	1 987 432 039	M 2039
LA 93	1 987 432 071	M 2071
LA 97	1 987 432 059	M 2059

LA 100	1 987 432 053	M 2053
LA 100	1 987 432 121	M 2121
LA 108	1 987 432 061	M 2061
LA 109	1 987 432 084	M 2084
LA 117	1 987 432 076	M 2076

LA 118	1 987 432 192	M 2192
LA 119	1 987 432 075	M 2075
LA 120	1 987 432 057	M 2057
LA 121	1 987 432 044	M 2044
LA 122	1 987 432 074	M 2074

LA 122	1 987 432 220	M 2220
LA 123	1 987 432 042	M 2042
LA 129	1 987 432 070	M 2070
LA 129 1	1 987 432 270	M 2270
LA 130	1 987 432 058	M 2058

LA 131	1 987 432 085	M 2085
LA 134	1 987 432 069	M 2069
LA 138	1 987 432 079	M 2079
LA 144	1 987 432 072	M 2072
LA 148	1 987 431 167	M 1167

◀ KNECHT

LA 155	1 987 432 115	M 2115
LA 156	1 987 432 081	M 2081
LA 156 1	1 987 432 281	M 2281
LA 157	1 987 432 088	M 2088
LA 158	1 987 432 092	M 2092

LA 169	1 987 432 087	M 2087
LA 171	1 987 432 082	M 2082
LA 175	1 987 432 093	M 2093
LA 177	1 987 432 032	M 2032
LA 181	1 987 432 097	M 2097

LA 182	1 987 432 114	M 2114
LA 191 S	1 987 432 136	M 2136
LA 197	1 987 432 102	M 2102
LA 197 S	1 987 432 102	M 2102
LA 220	1 987 432 109	M 2109

LA 229	1 987 432 195	M 2195
LA 234	1 987 432 068	M 2068
LA 239	1 987 432 122	M 2122
LA 241	1 987 432 106	M 2106
LA 242	1 987 432 373	R 2373

LA 248	1 987 432 124	M 2124
LA 279	1 987 431 162	M 1162
LA 280	1 987 432 235	M 2235
LA 289	1 987 432 194	M 2194
LA 296 S	1 987 432 086	M 2086

LA 297	1 987 432 133	M 2133
LA 304	1 987 432 189	M 2189
LA 307	1 987 432 213	M 2213
LA 343	1 987 432 227	M 2227
LA 344	1 987 432 203	M 2203

LA 353	1 987 431 174	M 1174
LA 358	1 987 431 168	M 1168
LA 361	1 987 432 241	M 2241
LA 362	1 987 432 223	M 2223
LA 378	1 987 431 175	M 1175

LA 381	1 987 432 210	M 2210
LA 382	1 987 432 208	M 2208
LA 384	1 987 432 207	M 2207
LA 385	1 987 432 296	M 2296
LA 395	1 987 432 190	M 2190

LA 396	1 987 432 238	M 2238
LA 408	1 987 432 236	M 2236
LA 410	1 987 432 206	M 2206
LA 411	1 987 432 065	M 2065
LA 412	1 987 432 206	M 2206

LA 421	1 987 432 222	M 2222
LA 424	1 987 432 216	M 2216
LA 428 S	1 987 432 137	M 2137
LA 441	1 987 432 055	M 2055
LA 447	1 987 432 204	M 2204

LA 449	1 987 432 214	M 2214
LA 456	1 987 432 218	M 2218
LA 457	1 987 432 228	M 2228
LA 495	1 987 432 132	M 2132
LA 501 S	1 987 432 209	M 2209

LA 502	1 987 431 172	M 1172
LA 586	1 987 432 148	M 2148
LAG 113/S	1 987 432 117	M 2117
LAK 11	1 987 432 310	R 2310
LAK 25	1 987 432 318	R 2318

LAK 31	1 987 432 312	R 2312
LAK 32/1	1 987 432 307	R 2307
LAK 36	1 987 432 366	R 2366
LAK 37	1 987 432 301	R 2301
LAK 43	1 987 431 454	R 1454

LAK 44	1 987 432 313	R 2313
LAK 45	1 987 432 317	R 2317
LAK 46	1 987 432 324	R 2324
LAK 49	1 987 432 330	R 2330
LAK 52	1 987 432 328	R 2328

LAK 54	1 987 432 464	R 2464
LAK 56	1 987 432 303	R 2303
LAK 57	1 987 432 348	R 2348
LAK 59	1 987 432 307	R 2307
LAK 62	1 987 432 425	R 2425

LAK 63	1 987 432 300	R 2300
LAK 64	1 987 432 360	R 2360
LAK 70	1 987 432 399	R 2399
LAK 71	1 987 431 452	R 1452
LAK 73/S	1 987 432 361	R 2361

LAK 75	1 987 432 040	M 2040
LAK 77	1 987 432 306	R 2306
LAK 78	1 987 432 345	R 2345
LAK 81	1 987 432 337	R 2337
LAK 83	1 987 432 343	R 2343

LAK 85	1 987 431 456	R 1456
LAK 93	1 987 432 371	R 2371
LAK 96	1 987 432 378	R 2378
LAK 98	1 987 432 364	R 2364
LAK 102	1 987 432 336	R 2336

LAK 107	1 987 432 363	R 2363
LAK 117	1 987 432 376	R 2376
LAK 120	1 987 432 357	R 2357
LAK 124	1 987 432 365	R 2365
LAK 127	1 987 432 398	R 2398

LAK 129	1 987 432 370	R 2370
LAK 129/1	1 987 432 570	R 2570
LAK 131	1 987 432 320	R 2320
LAK 136	1 987 432 380	R 2380
LAK 138	1 987 432 379	R 2379

LAK 141	1 987 432 386	R 2386
LAK 142	1 987 432 377	R 2377
LAK 153	1 987 432 354	R 2354
LAK 156	1 987 432 381	R 2381
LAK 169	1 987 432 387	R 2387

LAK 171	1 987 432 382	R 2382
LAK 173	1 987 432 362	R 2362
LAK 175	1 987 432 393	R 2393
LAK 176	1 987 432 423	R 2423
LAK 181	1 987 432 397	R 2397

LAK 181/1	1 987 432 597	R 2597
LAK 182	1 987 432 114	M 2114
LAK 189	1 987 432 411	R 2411
LAK 220	1 987 432 409	R 2409
LAK 221/S	1 987 432 419	R 2419

LAK 229	1 987 432 495	R 2495
LAK 234	1 987 432 368	R 2368
LAK 248	1 987 432 424	R 2424
LAK 251	1 987 432 434	R 2434
LAK 252	1 987 432 410	R 2410

LAK 294	1 987 432 319	R 2319
LAK 295/S	1 987 432 309	R 2309
LAK 307	1 987 432 513	R 2513
LAK 358	1 987 431 457	R 1457
LAK 373	1 987 432 488	R 2488

LAK 386	1 987 432 369	R 2369
LAK 410	1 987 432 406	R 2406
LAK 412	1 987 432 406	R 2406
LAK 413	1 987 432 326	R 2326
LAK 426/S	1 987 432 500	R 2500

LAK 430	1 987 432 499	R 2499
LAK 437	1 987 432 311	R 2311
LAK 448	1 987 432 156	M 2156
LAK 463	1 987 432 308	R 2308
LAK 463	1 987 432 415	R 2415

LAK 589	1 987 432 498	R 2498
LKK 165/S	1 987 432 512	R 2512
LKK 72/S	1 987 432 533	R 2533

KS KOLBENSCHMIDT

702AC	1 987 432 057	M 2057
703AC	1 987 432 012	M 2012
704ACC	1 987 432 312	R 2312

705AC	1 987 432 024	M 2024
711ACC	1 987 432 361	R 2361
715ACC	1 987 432 337	R 2337
721ACC	1 987 432 310	R 2310
722AC	1 987 432 016	M 2016

723ACC	1 987 432 366	R 2366
724AC	1 987 432 015	M 2015
725ACC	1 987 432 300	R 2300
727ACC	1 987 432 313	R 2313
729AC	1 987 432 151	M 2151

732AC	1 987 432 150	M 2150
734AC	1 987 432 043	M 2043
736AC	1 987 432 045	M 2045
737AC	1 987 432 018	M 2018
739AC	1 987 432 006	M 2006

741AC	1 987 432 030	M 2030
752AC	1 987 432 102	M 2102
754AC	1 987 432 021	M 2021
755AC	1 987 432 027	M 2027
757AC	1 987 432 009	M 2009

761AC	1 987 432 079	M 2079
764AC	1 987 432 044	M 2044
767ACC	1 987 432 412	R 2412
774ACC	1 987 432 412	R 2412
778AC	1 987 432 059	M 2059

795AC	1 987 432 042	M 2042
890AC	1 987 432 113	M 2113
898AC	1 987 432 026	M 2026
899AC	1 987 432 074	M 2074
933AC	1 987 432 075	M 2075

934AC	1 987 432 058	M 2058
941ACC	1 987 432 357	R 2357
942ACC	1 987 432 378	R 2378
960AC	1 987 432 069	M 2069

LADA

11180 8122010 00	1 987 432 230	M 2230
11180 8122010 01	1 987 432 230	M 2230
11180 8122010 02	1 987 432 230	M 2230

11180 8122010 03	1 987 432 230	M 2230
21110 8122020	1 987 432 435	R 2435
21181 2202010	1 987 432 435	R 2435

LANCIA

1484383080	1 987 432 091	M 2091
46409630	1 987 432 014	M 2014
46442422	1 987 432 003	M 2003

46721374	1 987 432 019	M 2019
46722335	1 987 432 360	R 2360
512024302	1 987 432 360	R 2360
60812197	1 987 432 014	M 2014
60815647	1 987 432 003	M 2003



L

◀ LANCIA

60815647	1 987 432 303	R 2303

LAND ROVER GROUP

JKR 1002 00	1 987 432 210	M 2210
JKR 5000 10	1 987 432 235	M 2235
LR 000899	1 987 432 205	M 2205

LR 000901	1 987 432 405	R 2405
6G9N-180543-BA	1 987 432 205	M 2205
6G9N-19N619-BA	1 987 432 405	R 2405

LAUTRETTE

EKR7000	1 987 432 310	R 2310
EKR7002	1 987 432 366	R 2366
EKR7004	1 987 432 300	R 2300

EKR7019	1 987 432 303	R 2303
EKR7036	1 987 432 313	R 2313
EKR7073	1 987 432 337	R 2337
EKR7075	1 987 432 354	R 2354
EKR7076	1 987 432 357	R 2357

EKR7162	1 987 432 412	R 2412
EKR7522	1 987 431 458	R 1458
ELR7001	1 987 432 015	M 2015
ELR7002	1 987 432 016	M 2016
ELR7003	1 987 432 030	M 2030

ELR7004	1 987 432 012	M 2012
ELR7006	1 987 432 018	M 2018
ELR7007	1 987 432 006	M 2006
ELR7017	1 987 432 021	M 2021
ELR7018	1 987 432 042	M 2042

ELR7026	1 987 432 022	M 2022
ELR7029	1 987 432 027	M 2027
ELR7030	1 987 432 009	M 2009
ELR7033	1 987 432 012	M 2012
ELR7034	1 987 432 011	M 2011

ELR7036	1 987 432 013	M 2013
ELR7038	1 987 432 024	M 2024
ELR7042	1 987 432 060	M 2060
ELR7043	1 987 432 060	M 2060
ELR7045	1 987 432 089	M 2089

ELR7048	1 987 432 090	M 2090
ELR7051	1 987 432 026	M 2026
ELR7052	1 987 432 105	M 2105
ELR7055	1 987 432 045	M 2045
ELR7061	1 987 432 059	M 2059

ELR7070	1 987 432 050	M 2050
ELR7073	1 987 432 037	M 2037
ELR7076	1 987 432 057	M 2057
ELR7077	1 987 432 043	M 2043
ELR7089	1 987 432 044	M 2044

ELR7097	1 987 432 079	M 2079
ELR7100	1 987 432 058	M 2058
ELR7101	1 987 432 069	M 2069
ELR7113	1 987 432 075	M 2075
ELR7128	1 987 432 113	M 2113

ELR7500	1 987 432 150	M 2150
ELR7505	1 987 431 166	M 1166
JKR7015	1 987 432 361	R 2361
JLR7015	1 987 432 361	R 2361
JLR7064	1 987 432 060	M 2060

JLR7152	1 987 432 074	M 2074
JLR7161	1 987 432 102	M 2102

LEXUS

87139-YZZ02	1 987 432 468	R 2468
87139-50010	1 987 432 468	R 2468

LUBERFINER (CHAMP)

AC12	1 987 432 015	M 2015
AC20	1 987 432 018	M 2018
AC24	1 987 432 006	M 2006

AC25	1 987 432 016	M 2016
AC26	1 987 432 024	M 2024
AC30	1 987 432 027	M 2027
AC32	1 987 432 022	M 2022
AC35	1 987 432 021	M 2021

AC36	1 987 432 030	M 2030
AC40	1 987 432 012	M 2012
AC52	1 987 432 009	M 2009
CAF1700	1 987 432 018	M 2018
CAF1702	1 987 432 012	M 2012

CAF1715	1 987 432 016	M 2016
CAF1717	1 987 432 024	M 2024
CAF1741	1 987 432 013	M 2013
CAF1756	1 987 432 045	M 2045
CAF1758	1 987 432 074	M 2074

CAF7702	1 987 432 300	R 2300
CAF7702	1 987 432 312	R 2312
CAF7741	1 987 432 313	R 2313
LAF8628	1 987 431 159	M 1159
LAF8697	1 987 432 150	M 2150

LAF8999	1 987 432 151	M 2151
---------	---------------	--------

MAHLE

CU 3423	1 987 431 175	M 1175
---------	---------------	--------

LA8	1 987 432 021	M 2021
-----	---------------	--------

LA9	1 987 432 022	M 2022
-----	---------------	--------

LA19	1 987 432 011	M 2011
------	---------------	--------

LA21	1 987 432 015	M 2015
------	---------------	--------

LA23	1 987 432 027	M 2027
------	---------------	--------

LA25	1 987 432 018	M 2018
------	---------------	--------

LA27	1 987 432 050	M 2050
------	---------------	--------

LA31	1 987 432 012	M 2012
------	---------------	--------

LA33	1 987 432 009	M 2009
------	---------------	--------

LA34	1 987 432 014	M 2014
------	---------------	--------

LA35	1 987 432 019	M 2019
------	---------------	--------

LA36	1 987 432 016	M 2016
------	---------------	--------

LA38	1 987 432 041	M 2041
------	---------------	--------

LA39	1 987 432 225	M 2225
------	---------------	--------

LA40	1 987 432 089	M 2089
------	---------------	--------

LA41	1 987 432 226	M 2226
------	---------------	--------

LA42	1 987 432 150	M 2150
------	---------------	--------

LA43	1 987 431 154	M 1154
------	---------------	--------

LA44	1 987 432 013	M 2013
------	---------------	--------

LA46	1 987 432 024	M 2024
------	---------------	--------

LA49	1 987 432 030	M 2030
------	---------------	--------

LA50	1 987 432 152	M 2152
------	---------------	--------

LA52	1 987 432 028	M 2028
------	---------------	--------

LA54	1 987 432 064	M 2064
------	---------------	--------

LA56	1 987 432 003	M 2003
------	---------------	--------

LA57	1 987 432 048	M 2048
------	---------------	--------

LA58	1 987 432 033	M 2033
------	---------------	--------

LA60	1 987 432 090	M 2090
------	---------------	--------

LA65	1 987 432 056	M 2056
------	---------------	--------

LA67	1 987 432 151	M 2151
------	---------------	--------

LA75	1 987 432 040	M 2040
------	---------------	--------

LA76S	1 987 432 049	M 2049
-------	---------------	--------

LA77	1 987 432 006	M 2006
------	---------------	--------

LA78	1 987 432 045	M 2045
------	---------------	--------

LA79	1 987 432 062	M 2062
------	---------------	--------

LA82	1 987 432 026	M 2026
------	---------------	--------

LA83	1 987 432 043	M 2043
------	---------------	--------

LA87	1 987 432 039	M 2039
------	---------------	--------

LA93	1 987 432 071	M 2071
------	---------------	--------

LA97	1 987 432 059	M 2059
------	---------------	--------

LA99	1 987 431 159	M 1159
------	---------------	--------

LA100	1 987 432 053	M 2053
-------	---------------	--------

LA100	1 987 432 121	M 2121
-------	---------------	--------

LA107	1 987 432 063	M 2063
-------	---------------	--------

LA108	1 987 432 061	M 2061
-------	---------------	--------

LA109	1 987 432 084	M 2084
-------	---------------	--------

LA109	1 987 432 172	M 2172
-------	---------------	--------

LA117	1 987 432 076	M 2076
-------	---------------	--------

LA119	1 987 432 075	M 2075
-------	---------------	--------

LA120	1 987 432 057	M 2057
-------	---------------	--------

LA121	1 987 432 044	M 2044
-------	---------------	--------

LA122	1 987 432 074	M 2074
-------	---------------	--------

LA122	1 987 432 220	M 2220
-------	---------------	--------

LA123	1 987 432 042	M 2042
-------	---------------	--------

LA129	1 987 432 070	M 2070
-------	---------------	--------

LA129/1	1 987 432 270	M 2270
---------	---------------	--------

LA130	1 987 432 058	M 2058
-------	---------------	--------

LA131	1 987 432 085	M 2085
-------	---------------	--------

LA134	1 987 432 069	M 2069
-------	---------------	--------

LA138	1 987 432 079	M 2079
-------	---------------	--------

LA143	1 987 432 066	M 2066
-------	---------------	--------

LA144	1 987 432 072	M 2072
-------	---------------	--------

LA148	1 987 431 167	M 1167
-------	---------------	--------

LA154	1 987 431 163	M 1163
-------	---------------	--------

LA155	1 987 432 115	M 2115
-------	---------------	--------

LA156	1 987 432 081	M 2081
-------	---------------	--------

LA156/1	1 987 432 281	M 2281
---------	---------------	--------

LA157	1 987 432 088	M 2088
-------	---------------	--------

LA158	1 987 432 092	M 2092
-------	---------------	--------

LA167	1 987 432 091	M 2091
-------	---------------	--------

LA168/S	1 987 432 167	M 2167
---------	---------------	--------

LA170	1 987 431 166	M 1166
-------	---------------	--------

LA171	1 987 432 082	M 2082
-------	---------------	--------

LA175	1 987 432 093	M 2093
-------	---------------	--------

LA177	1 987 432 032	M 2032
-------	---------------	--------

LA181	1 987 432 097	M 2097
-------	---------------	--------

LA182	1 987 432 114	M 2114
-------	---------------	--------

LA184	1 987 432 083	M 2083
-------	---------------	--------

LA186/S	1 987 432 159	M 2159
---------	---------------	--------

LA189	1 987 432 111	M 2111
-------	---------------	--------

LA191/S	1 987 432 136	M 2136
---------	---------------	--------

LA197	1 987 432 102	M 2102
-------	---------------	--------

LA197S	1 987 432 102	M 2102
--------	---------------	--------

LA198	1 987 431 165	M 1165
-------	---------------	--------

LA216	1 987 432 166	M 2166
-------	---------------	--------

LA220	1 987 432 109	M 2109
-------	---------------	--------

LA220	1 987 432 113	M 2113
-------	---------------	--------

LA227	1 987 432 094	M 2094
-------	---------------	--------

LA230	1 987 432 120	M 2120
-------	---------------	--------

LA234	1 987 432 068	M 2068
-------	---------------	--------

LA237	1 987 432 095	M 2095
-------	---------------	--------

LA239	1 987 432 122	M 2122
-------	---------------	--------

M

◀ MAHLE

LA241	1 987 432 106	M 2106
LA248	1 987 432 124	M 2124
LA269	1 987 432 155	M 2155
LA280	1 987 432 235	M 2235
LA288	1 987 432 169	M 2169

LA289	1 987 432 194	M 2194
LA291	1 987 432 175	M 2175
LA296/S	1 987 432 086	M 2086
LA297	1 987 432 133	M 2133
LA301	1 987 432 170	M 2170

LA304	1 987 432 189	M 2189
LA307	1 987 432 213	M 2213
LA322	1 987 432 007	M 2007
LA323	1 987 432 200	M 2200
LA346/2	1 987 432 163	M 2163

LA343	1 987 432 227	M 2227
LA344	1 987 432 203	M 2203
LA353	1 987 431 174	M 1174
LA360	1 987 432 116	M 2116
LA361	1 987 432 241	M 2241

LA362	1 987 432 223	M 2223
LA381	1 987 432 210	M 2210
LA382	1 987 432 208	M 2208
LA384	1 987 432 207	M 2207
LA385	1 987 432 296	M 2296

LA395	1 987 432 190	M 2190
LA396	1 987 432 238	M 2238
LA408	1 987 432 236	M 2236
LA410	1 987 432 206	M 2206
LA411	1 987 432 065	M 2065

LA412	1 987 432 206	M 2206
LA421	1 987 432 150	M 2150
LA421	1 987 432 222	M 2222
LA422	1 987 432 108	M 2108
LA424	1 987 432 216	M 2216

LA428/S	1 987 432 137	M 2137
LA441	1 987 432 055	M 2055
LA447	1 987 432 204	M 2204
LA449	1 987 432 214	M 2214
LA456	1 987 432 218	M 2218

LA457	1 987 432 228	M 2228
LA495	1 987 432 132	M 2132
LA501	1 987 432 152	M 2152
LA501/S	1 987 432 209	M 2209
LA502	1 987 431 172	M 1172

LA586	1 987 432 148	M 2148
LAK11	1 987 432 310	R 2310
LAK13/1	1 987 432 320	R 2320
LAK15/4	1 987 431 458	R 1458
LAK17/3	1 987 432 362	R 2362

LAK18/2	1 987 432 431	R 2431
LAK23/4	1 987 432 368	R 2368
LAK25	1 987 432 318	R 2318
LAK25/0	1 987 432 428	R 2428
LAK25/1	1 987 432 434	R 2434

LAK29/4	1 987 432 319	R 2319
LAK29/7	1 987 432 433	R 2433
LAK30/7	1 987 432 513	R 2513
LAK31	1 987 432 312	R 2312
LAK32/1	1 987 432 407	R 2407

LAK36	1 987 432 366	R 2366
LAK37	1 987 432 301	R 2301
LAK41/0	1 987 432 406	R 2406
LAK41/2	1 987 432 406	R 2406
LAK41/3	1 987 432 326	R 2326

LAK43/7	1 987 432 311	R 2311
LAK44	1 987 432 313	R 2313
LAK45	1 987 432 317	R 2317
LAK46	1 987 432 333	R 2333
LAK46/3	1 987 432 415	R 2415

LAK52	1 987 432 328	R 2328
LAK54	1 987 432 464	R 2464
LAK56	1 987 432 303	R 2303
LAK57	1 987 432 348	R 2348
LAK58	1 987 432 333	R 2333

LAK62	1 987 432 425	R 2425
LAK63	1 987 432 300	R 2300
LAK64	1 987 432 360	R 2360
LAK70	1 987 432 399	R 2399
LAK73S	1 987 432 361	R 2361

LAK76S	1 987 432 049	M 2049
LAK77	1 987 432 306	R 2306
LAK78	1 987 432 345	R 2345
LAK79	1 987 432 062	M 2062
LAK81	1 987 432 037	M 2037

LAK81	1 987 432 337	R 2337
LAK83	1 987 432 343	R 2343
LAK93	1 987 432 371	R 2371
LAK96	1 987 432 378	R 2378
LAK98	1 987 432 364	R 2364

LAK102	1 987 432 336	R 2336
LAK107	1 987 432 363	R 2363
LAK117	1 987 432 376	R 2376
LAK120	1 987 432 357	R 2357
LAK124	1 987 432 365	R 2365

LAK129	1 987 432 370	R 2370
LAK129/1	1 987 432 570	R 2570
LAK136	1 987 432 380	R 2380
LAK138	1 987 432 379	R 2379
LAK141	1 987 432 386	R 2386

LAK142	1 987 432 377	R 2377
LAK153	1 987 432 354	R 2354
LAK156	1 987 432 381	R 2381
LAK169	1 987 432 387	R 2387
LAK171	1 987 432 382	R 2382

LAK175	1 987 432 393	R 2393
LAK176	1 987 432 423	R 2423
LAK181	1 987 432 397	R 2397
LAK181/1	1 987 432 597	R 2597
LAK189	1 987 432 411	R 2411

LAK197	1 987 432 402	R 2402
LAK197S	1 987 432 402	R 2402
LAK220	1 987 432 409	R 2409
LAK221/S	1 987 432 419	R 2419
LAK225	1 987 432 401	R 2401

LAK232	1 987 432 412	R 2412
LAK239	1 987 432 422	R 2422
LAK248	1 987 432 424	R 2424
LAK252	1 987 432 410	R 2410
LAK255	1 987 432 401	R 2401

LAK293	1 987 432 413	R 2413
LAK295/S	1 987 432 309	R 2309
LAK371	1 987 432 301	R 2301
LAK373	1 987 432 488	R 2488
LAK386	1 987 432 369	R 2369

LAK426/S	1 987 432 500	R 2500
LAK448	1 987 432 156	M 2156
LAK463	1 987 432 308	R 2308
LKK 165/S	1 987 432 512	R 2512
LKK72/S	1 987 432 533	R 2533

70351042	1 987 432 188	M 2188
----------	---------------	--------

MAN

81 61910 0011	1 987 432 151	M 2151
81 61910 0018	1 987 431 163	M 1163
81 61910 0019	1 987 431 458	R 1458

85 61950 0025	1 987 431 162	M 1162
---------------	---------------	--------

MANN (MANN & HUMMEL)

CUK 18 000-2	1 987 432 512	R 2512
CUK 1820-2	1 987 432 386	R 2386
CUK 1830	1 987 432 434	R 2434

CUK 2032	1 987 432 378	R 2378
CUK 2132	1 987 432 499	R 2499
CUK 2137	1 987 432 363	R 2363
CUK 2140	1 987 431 451	R 1451
CUK 2141	1 987 432 416	R 2416

CUK 2143	1 987 432 411	R 2411
CUK 2149	1 987 432 380	R 2380
CUK 22 000-2	1 987 432 533	R 2533
CUK 2226	1 987 432 320	R 2320
CUK 2230	1 987 432 498	R 2498

CUK 2231	1 987 432 426	R 2426
CUK 2232	1 987 432 433	R 2433
CUK 2240	1 987 432 469	R 2469
CUK 2243	1 987 432 488	R 2488
CUK 2246	1 987 432 319	R 2319

CUK 2335	1 987 432 365	R 2365
CUK 2338	1 987 432 364	R 2364
CUK 2339	1 987 432 368	R 2368
CUK 2422	1 987 432 377	R 2377
CUK 2430	1 987 432 394	R 2394

CUK 2433	1 987 432 387	R 2387
CUK 2435	1 987 432 390	R 2390
CUK 2436	1 987 432 308	R 2308
CUK 2436	1 987 432 415	R 2415
CUK 2440	1 987 432 413	R 2413

CUK 2442	1 987 432 304	R 2304
CUK 2533-2	1 987 432 315	R 2315
CUK 2534	1 987 431 452	R 1452
CUK 2545	1 987 432 357	R 2357
CUK 2551	1 987 432 326	R 2326

CUK 2559	1 987 432 409	R 2409
CUK 2639	1 987 432 327	R 2327
CUK 2646-2	1 987 432 309	R 2309
CUK 2672	1 987 432 313	R 2313
CUK 2680	1 987 432 354	R 2354

CUK 2722-2	1 987 432 438	R 2438
CUK 2723-2	1 987 432 500	R 2500
CUK 2733	1 987 432 405	R 2405
CUK 2734	1 987 432 389	R 2389
CUK 2736-2	1 987 432 361	R 2361

CUK 2742	1 987 432 311	R 2311
CUK 2842	1 987 432 431	R 2431
CUK 2855	1 987 432 464	R 2464
CUK 2862	1 987 432 300	R 2300
CUK 2882	1 987 432 312	R 2312

CUK 2897	1 987 432 301	R 2301
CUK 2939	1 987 432 397	R 2397
CUK 2939/1	1 987 432 597	R 2597
CUK 2940	1 987 432 379	R 2379
CUK 2941-2	1 987 432 419	R 2419



M

◀ MANN

CUK 2945	1 987 432 197	R 2197
CUK 2949	1 987 432 367	R 2367
CUK 2949-2	1 987 432 367	R 2367
CUK 2951	1 987 432 303	R 2303
CUK 3023-2	1 987 432 422	R 2422

CUK 3037	1 987 432 371	R 2371
CUK 3039-2	1 987 432 437	R 2437
CUK 3042	1 987 432 360	R 2360
CUK 3059	1 987 432 366	R 2366
CUK 3139-2	1 987 432 402	R 2402

CUK 3142	1 987 432 497	R 2497
CUK 3172	1 987 432 381	R 2381
CUK 3192	1 987 432 324	R 2324
CUK 3220	1 987 432 401	R 2401
CUK 3240	1 987 432 412	R 2412

CUK 3337	1 987 432 376	R 2376
CUK 3340	1 987 432 307	R 2307
CUK 3360	1 987 432 407	R 2407
CUK 3448	1 987 432 348	R 2348
CUK 3461	1 987 432 370	R 2370

CUK 3461/1	1 987 432 570	R 2570
CUK 3518	1 987 432 398	R 2398
CUK 3540	1 987 432 495	R 2495
CUK 3554	1 987 432 306	R 2306
CUK 3562	1 987 432 333	R 2333

CUK 3567	1 987 432 345	R 2345
CUK 3569	1 987 432 513	R 2513
CUK 3642-2	1 987 432 362	R 2362
CUK 3780	1 987 432 337	R 2337
CUK 3823	1 987 431 454	R 1454

CUK 3840	1 987 432 400	R 2400
CUK 3847	1 987 432 406	R 2406
CUK 3858	1 987 432 343	R 2343
CUK 3943	1 987 432 482	R 2482
CUK 3955	1 987 432 317	R 2317

CUK 3979	1 987 432 317	R 2317
CUK 4054	1 987 432 410	R 2410
CUK 4136	1 987 432 423	R 2423
CUK 4151	1 987 432 330	R 2330
CUK 4245	1 987 431 455	R 1455

CUK 4251	1 987 432 310	R 2310
CUK 4469	1 987 431 457	R 1457
CUK 4624	1 987 432 382	R 2382
CUK 4795	1 987 431 458	R 1458
CUK 5257	1 987 432 318	R 2318

CUK 5258	1 987 432 399	R 2399
CUK 5366	1 987 432 425	R 2425
CUK 5480	1 987 432 328	R 2328
CUK 5877	1 987 431 456	R 1456
CUK 6724	1 987 432 336	R 2336

CUK 8430	1 987 432 424	R 2424
CU1009	1 987 432 169	M 2169
CU12001	1 987 432 154	M 2154
CU1526	1 987 432 218	M 2218
CU1546	1 987 432 193	M 2193

CU17001	1 987 432 148	M 2148
CU1719	1 987 432 223	M 2223
CU1720-2	1 987 432 104	M 2104
CU1722	1 987 432 153	M 2153
CU1738	1 987 432 056	M 2056

CU1823	1 987 432 167	M 2167
CU1827	1 987 432 173	M 2173
CU1828	1 987 432 084	M 2084
CU1829	1 987 432 120	M 2120
CU1830	1 987 432 034	M 2034

CU1835	1 987 432 115	M 2115
CU1900/03	1 987 432 060	M 2060
CU1910	1 987 432 164	M 2164
CU1915	1 987 432 157	M 2157
CU1919	1 987 432 190	M 2190

CU1931-2	1 987 432 049	M 2049
CU1936	1 987 432 238	M 2238
CU2015	1 987 432 155	M 2155
CU2026	1 987 432 106	M 2106
CU2028	1 987 432 214	M 2214

CU2033-2	1 987 432 117	M 2117
CU2035	1 987 432 088	M 2088
CU2038	1 987 432 011	M 2011
CU2040	1 987 432 228	M 2228
CU2043	1 987 432 092	M 2092

CU21000-2	1 987 432 136	M 2136
CU21003	1 987 432 234	M 2234
CU2101	1 987 431 170	M 1170
CU2131	1 987 432 085	M 2085
CU2132	1 987 432 299	M 2299

CU2137	1 987 432 063	M 2063
CU2138	1 987 432 236	M 2236
CU2141	1 987 432 216	M 2216
CU2143	1 987 432 111	M 2111
CU2184	1 987 431 167	M 1167

CU2200/12	1 987 432 163	M 2163
CU2224-2	1 987 432 052	M 2052
CU2225	1 987 432 021	M 2021
CU2232	1 987 432 133	M 2133
CU2240	1 987 432 069	M 2069

CU2243	1 987 432 188	M 2188
CU2245	1 987 432 083	M 2083
CU2253	1 987 432 026	M 2026
CU23000-2	1 987 432 086	M 2086
CU23000-2	1 987 432 134	M 2134

CU2316	1 987 432 093	M 2093
CU2317	1 987 432 189	M 2189
CU2326	1 987 432 066	M 2066
CU2327	1 987 432 074	M 2074
CU2327-2	1 987 432 220	M 2220

CU2329	1 987 432 184	M 2184
CU2330	1 987 432 241	M 2241
CU2331	1 987 432 204	M 2204
CU2335	1 987 432 072	M 2072
CU2336	1 987 432 170	M 2170

CU2337	1 987 432 105	M 2105
CU2339	1 987 432 068	M 2068
CU2344	1 987 432 107	M 2107
CU2345	1 987 432 075	M 2075
CU2351	1 987 432 053	M 2053

CU2351	1 987 432 121	M 2121
CU2356	1 987 432 158	M 2158
CU2358	1 987 432 166	M 2166
CU2362	1 987 432 227	M 2227
CU2418-2	1 987 432 078	M 2078

CU2423	1 987 432 116	M 2116
CU2424	1 987 432 061	M 2061
CU2425	1 987 432 226	M 2226
CU2430	1 987 432 094	M 2094
CU2431	1 987 432 066	M 2066

CU2433	1 987 432 087	M 2087
CU2435	1 987 432 090	M 2090
CU2436	1 987 432 215	M 2215
CU2440	1 987 432 113	M 2113
CU2442	1 987 432 004	M 2004

CU2454	1 987 432 203	M 2203
CU2504	1 987 432 108	M 2108
CU2506-2	1 987 432 161	M 2161
CU2513	1 987 432 221	M 2221
CU2520	1 987 432 121	M 2121

CU2521-2	1 987 432 176	M 2176
CU2525	1 987 432 027	M 2027
CU2525/1	1 987 432 050	M 2050
CU2530	1 987 432 058	M 2058
CU2534	1 987 431 169	M 1169

CU2542-2	1 987 432 160	M 2160
CU2544	1 987 432 065	M 2065
CU2545	1 987 432 057	M 2057
CU2559	1 987 432 109	M 2109
CU26001	1 987 432 240	M 2240

CU26004	1 987 432 230	M 2230
CU26008-2	1 987 432 209	M 2209
CU2622	1 987 432 222	M 2222
CU2623	1 987 432 194	M 2194
CU2630	1 987 432 077	M 2077

CU2631	1 987 432 055	M 2055
CU2634	1 987 432 229	M 2229
CU2642	1 987 432 095	M 2095
CU2645	1 987 432 175	M 2175
CU2650	1 987 432 062	M 2062

CU2672	1 987 432 013	M 2013
CU2709	1 987 432 207	M 2207
CU2733	1 987 432 205	M 2205
CU2734	1 987 432 089	M 2089
CU2747	1 987 432 235	M 2235

CU2750	1 987 432 013	M 2013
CU2785	1 987 431 159	M 1159
CU2842	1 987 432 114	M 2114
CU2855	1 987 432 064	M 2064
CU2861	1 987 432 022	M 2022

CU2882	1 987 432 012	M 2012
CU29002-2	1 987 432 132	M 2132
CU2930	1 987 432 225	M 2225
CU2930	1 987 432 525	R 2525
CU2939	1 987 432 097	M 2097

CU2940	1 987 432 079	M 2079
CU2941-2	1 987 432 219	M 2219
CU2945	1 987 432 039	M 2039
CU2951	1 987 432 003	M 2003
CU3001	1 987 431 171	M 1171

CU3020	1 987 432 059	M 2059
CU3023-2	1 987 432 122	M 2122
CU3032	1 987 432 009	M 2009
CU3037	1 987 432 071	M 2071
CU3039-2	1 987 432 137	M 2137

CU3054	1 987 432 040	M 2040
CU3059	1 987 432 016	M 2016
CU3124-2	1 987 432 103	M 2103
CU3132	1 987 432 152	M 2152
CU3138	1 987 432 019	M 2019

CU3139-2	1 987 432 102	M 2102
CU3172	1 987 432 081	M 2081
CU3172/1	1 987 432 281	M 2281
CU3192	1 987 432 024	M 2024
CU3337	1 987 432 076	M 2076

CU3338	1 987 432 032	M 2032
CU3340	1 987 432 007	M 2007
CU3360	1 987 432 200	M 2200
CU3435	1 987 432 041	M 2041
CU3448	1 987 432 048	M 2048

CU3454	1 987 432 208	M 2208
CU3455	1 987 432 015	M 2015
CU3461	1 987 432 070	M 2070
CU3461/1	1 987 432 270	M 2270
CU3466	1 987 431 160	M 1160



M

◀ MANN

CU3478	1 987 431 174	M 1174
CU3540	1 987 432 195	M 2195
CU3554	1 987 432 006	M 2006
CU3562	1 987 432 033	M 2033
CU3567	1 987 432 045	M 2045

CU 3569	1 987 432 213	M 2213
CU3593	1 987 432 182	M 2182
CU3649	1 987 432 192	M 2192
CU37001	1 987 431 172	M 1172
CU3759	1 987 432 044	M 2044

CU3780	1 987 432 037	M 2037
CU3847	1 987 432 206	M 2206
CU3858	1 987 432 043	M 2043
CU3869	1 987 432 150	M 2150
CU3942	1 987 432 014	M 2014

CU3943	1 987 432 182	M 2182
CU40110	1 987 432 151	M 2151
CU4151	1 987 432 030	M 2030
CU4179	1 987 432 091	M 2091
CU4228	1 987 431 164	M 1164

CU4408	1 987 431 155	M 1155
CU4416	1 987 432 096	M 2096
CU4436	1 987 432 296	M 2296
CU4442	1 987 432 042	M 2042
CU4466	1 987 431 165	M 1165

CU4469	1 987 431 168	M 1168
CU4624	1 987 432 082	M 2082
CU4795	1 987 431 163	M 1163
CU5141	1 987 432 073	M 2073
CU5257	1 987 432 018	M 2018

CU5480	1 987 432 028	M 2028
CU5809	1 987 431 156	M 1156
CU5877	1 987 431 157	M 1157
CU8430	1 987 432 124	M 2124
LA378	1 987 431 175	M 1175

XCU1-1254	1 987 432 211	M 2211
21001/2	1 987 432 159	M 2159
22 002-2	1 987 432 156	M 2156
2450	1 987 432 369	R 2369
37230	1 987 431 162	M 1162

4594	1 987 431 166	M 1166
------	---------------	--------

MAPCO

65006	1 987 432 042	M 2042
65007	1 987 432 303	R 2303
65009	1 987 432 059	M 2059

65021	1 987 432 303	R 2303
65105	1 987 432 009	M 2009
65106	1 987 432 027	M 2027
65112	1 987 432 089	M 2089
65113	1 987 432 090	M 2090

65116	1 987 432 069	M 2069
65200	1 987 432 011	M 2011
65202	1 987 432 012	M 2012
65215	1 987 432 024	M 2024
65219	1 987 432 057	M 2057

65220	1 987 432 300	R 2300
65406	1 987 432 021	M 2021
65408	1 987 432 060	M 2060
65412	1 987 432 021	M 2021
65414	1 987 432 079	M 2079

65500	1 987 432 026	M 2026
65504	1 987 432 074	M 2074
65525	1 987 432 058	M 2058
65526	1 987 432 075	M 2075
65527	1 987 432 058	M 2058

65570	1 987 432 105	M 2105
65602	1 987 432 006	M 2006
65603	1 987 432 018	M 2018
65605	1 987 432 045	M 2045
65614	1 987 432 361	R 2361

65702	1 987 432 015	M 2015
65706	1 987 432 016	M 2016
65708	1 987 432 030	M 2030
65803	1 987 432 037	M 2037
65803	1 987 432 337	R 2337

65805	1 987 432 378	R 2378
66105	1 987 432 042	M 2042
66106	1 987 432 303	R 2303
66108	1 987 432 060	M 2060
66200	1 987 432 361	R 2361

662002	1 987 432 361	R 2361
66204	1 987 432 015	M 2015
66205	1 987 432 310	R 2310
66208	1 987 432 300	R 2300
66212	1 987 432 013	M 2013

66212	1 987 432 313	R 2313
66219	1 987 432 006	M 2006
66223	1 987 432 024	M 2024
66226	1 987 432 045	M 2045
66227	1 987 432 300	R 2300

66230	1 987 432 043	M 2043
66232	1 987 432 337	R 2337
66406	1 987 432 021	M 2021
66407	1 987 432 009	M 2009
66408	1 987 432 027	M 2027

66409	1 987 432 089	M 2089
66410	1 987 432 090	M 2090
66420	1 987 432 069	M 2069
66604	1 987 432 058	M 2058
66613	1 987 432 357	R 2357

67202	1 987 432 300	R 2300
67208	1 987 432 012	M 2012
67208	1 987 432 312	R 2312
67602	1 987 432 006	M 2006
67603	1 987 432 018	M 2018

67701	1 987 432 310	R 2310
-------	---------------	--------

MARELLI

BCF106	1 987 432 022	M 2022
BCF107	1 987 432 018	M 2018
BCF108	1 987 432 016	M 2016

BCF110	1 987 432 006	M 2006
BCF111	1 987 432 015	M 2015
BCF116	1 987 432 026	M 2026
BCF117	1 987 432 013	M 2013
BCF118	1 987 432 030	M 2030

BCF119	1 987 432 021	M 2021
BCF122	1 987 432 012	M 2012
BCF123	1 987 432 024	M 2024
BCF125	1 987 432 027	M 2027
BCF126	1 987 432 009	M 2009

BCF131	1 987 432 042	M 2042
BCF141	1 987 432 043	M 2043
BCF145	1 987 432 057	M 2057
BCF147	1 987 432 361	R 2361
BCF148	1 987 432 060	M 2060

BCF153	1 987 432 045	M 2045
BCF156	1 987 432 037	M 2037
BCF158	1 987 432 044	M 2044
BCF159	1 987 432 075	M 2075
BCF160	1 987 432 058	M 2058

BCF166	1 987 432 090	M 2090
BCF167	1 987 432 069	M 2069
BCF170	1 987 432 079	M 2079
BCF173	1 987 432 074	M 2074
BCF178	1 987 432 060	M 2060

BCF199	1 987 432 113	M 2113
BCF200	1 987 432 074	M 2074
BCF304	1 987 432 310	R 2310
BCF308	1 987 432 366	R 2366
BCF317	1 987 432 313	R 2313

BCF321	1 987 432 303	R 2303
BCF322	1 987 432 312	R 2312
BCF340	1 987 432 300	R 2300
BCF345	1 987 432 357	R 2357
BCF347	1 987 432 361	R 2361

BCF349	1 987 432 378	R 2378
BCF351	1 987 432 366	R 2366
BCF356	1 987 432 337	R 2337

MASERATI

5732289	1 987 432 360	R 2360
---------	---------------	--------

MAZDA

BBP261J6X	1 987 432 209	M 2209
BC5D61J6X	1 987 432 162	M 2162
BP4K61J6X	1 987 432 163	M 2163

BP8P61J6X	1 987 432 163	M 2163
CC2961J6X	1 987 432 163	M 2163
DD10 61 P11	1 987 432 092	M 2092
GE6T 61 J6X	1 987 432 117	M 2117
GI6A 61 P11A	1 987 432 092	M 2092

GJ6A 61 P11 A	1 987 432 092	M 2092
GJ6A 61 P11A 9A	1 987 432 092	M 2092
GJ6A-61-P11A 9B	1 987 432 092	M 2092
GS1D 61 P11	1 987 432 092	M 2092
KF6XOCC29	1 987 432 163	M 2163

KJ6XOCC29	1 987 432 163	M 2163
1E00 61 J6X	1 987 432 006	M 2006
1E00 61 J6XB	1 987 432 006	M 2006
4100-77-732	1 987 432 006	M 2006
4100-77-732	1 987 432 306	R 2306

MC LAREN

EKR 7163	1 987 432 368	R 2368
ELR 7163	1 987 432 068	M 2068
ELR 7203	1 987 432 068	M 2068

MECAFILTER

EKR 7027	1 987 432 407	R 2407
EKR 7045	1 987 432 389	R 2389
EKR 7048	1 987 432 390	R 2390

EKR 7101	1 987 432 469	R 2469
EKR 7218	1 987 432 406	R 2406
ELR 7027	1 987 432 007	M 2007
ELR 7041	1 987 431 159	M 1159
JKR 7201	1 987 432 309	R 2309



M

MERCEDES-BENZ

A 000 830 11 18	1 987 432 150	M 2150
A 000 830 12 18	1 987 431 154	M 1154
A 000 830 13 18	1 987 431 454	R 1454

A 000 830 15 18	1 987 431 455	R 1455
A 000 830 33 18	1 987 432 043	M 2043
A 000 830 34 18	1 987 431 454	R 1454
A 000 835 30 47	1 987 432 044	M 2044
A 000 835 69 47	1 987 431 174	M 1174

A 000 835 70 47	1 987 431 175	M 1175
A 001 835 30 47	1 987 432 044	M 2044
A 163 835 00 47	1 987 432 364	R 2364
A 163 835 02 47	1 987 432 364	R 2364
A 164 830 02 18	1 987 432 309	R 2309

A 168 830 00 18	1 987 432 037	M 2037
A 168 830 01 18	1 987 432 337	R 2337
A 168 830 07 18	1 987 432 337	R 2337
A 168 830 08 18	1 987 432 337	R 2337
A 169 830 02 18	1 987 432 410	R 2410

A 203 830 01 18	1 987 432 070	M 2070
A 203 830 02 18	1 987 432 270	M 2270
A 203 830 09 18	1 987 432 370	R 2370
A 203 830 10 18	1 987 432 570	R 2570
A 204 830 00 18	1 987 432 326	R 2326

A 204 830 05 18	1 987 432 326	R 2326
A 210 830 02 18	1 987 432 533	R 2533
A 210 830 03 18	1 987 432 533	R 2533
A 210 830 08 18	1 987 432 301	R 2301
A 210 830 09 18	1 987 432 301	R 2301

A 210 830 11 18	1 987 432 533	R 2533
A 210 830 12 18	1 987 432 301	R 2301
A 211 830 00 18	1 987 432 381	R 2381
A 211 830 02 18	1 987 432 081	M 2081
A 211 830 04 18	1 987 432 281	M 2281

A 211 830 08 18	1 987 432 512	R 2512
A 212 830 02 18	1 987 432 326	R 2326
A 220 830 01 18	1 987 432 533	R 2533
A 220 830 02 18	1 987 432 533	R 2533
A 221 830 00 18	1 987 432 438	R 2438

A 221 830 03 18	1 987 432 438	R 2438
A 221 830 07 18	1 987 432 438	R 2438
A 451 830 00 18	1 987 432 499	R 2499
A 451 835 02 47	1 987 432 299	M 2299
A 454 830 00 18	1 987 432 434	R 2434

A 463 830 00 18	1 987 432 357	R 2357
A 638 835 00 47	1 987 432 044	M 2044
A 639 835 02 47	1 987 432 195	M 2195
A 639 835 03 47	1 987 432 495	R 2495
A 901 830 00 18	1 987 432 043	M 2043

A 901 830 04 18	1 987 432 343	R 2343
A 901 830 05 18	1 987 432 043	M 2043
A 906 830 02 18	1 987 432 213	M 2213
A 906 830 03 18	1 987 432 213	M 2213
A 906 830 03 18	1 987 432 513	R 2513

A 940 835 00 47	1 987 431 168	M 1168
A 940 835 01 47	1 987 431 457	R 1457
A 940 835 02 47	1 987 431 155	M 1155
A 973 835 01 47	1 987 431 157	M 1157
A 973 835 02 47	1 987 431 156	M 1156

A 973 835 03 47	1 987 431 456	R 1456
B6 680 99 01	1 987 432 301	R 2301
B6 680 99 03	1 987 432 364	R 2364
B6 758 24 11	1 987 431 456	R 1456
B6 758 24 12	1 987 431 156	M 1156

B6 758 24 15	1 987 431 155	M 1155
000 830 11 18	1 987 432 150	M 2150
000 830 12 18	1 987 431 154	M 1154
000 830 13 18	1 987 431 454	R 1454
000 830 15 18	1 987 431 455	R 1455

000 830 33 18	1 987 432 043	M 2043
000 830 34 18	1 987 431 454	R 1454
000 835 30 47	1 987 432 044	M 2044
000 835 69 47	1 987 431 174	M 1174
000 835 70 47	1 987 431 175	M 1175

001 835 30 47	1 987 432 044	M 2044
163 835 00 47	1 987 432 364	R 2364
163 835 02 47	1 987 432 364	R 2364
164 830 02 18	1 987 432 309	R 2309
168 830 00 18	1 987 432 037	M 2037

168 830 01 18	1 987 432 337	R 2337
168 830 07 18	1 987 432 337	R 2337
168 830 08 18	1 987 432 337	R 2337
169 830 02 18	1 987 432 410	R 2410
203 830 01 18	1 987 432 070	M 2070

203 830 02 18	1 987 432 270	M 2270
203 830 09 18	1 987 432 370	R 2370
203 830 10 18	1 987 432 570	R 2570
204 830 00 18	1 987 432 326	R 2326
204 830 05 18	1 987 432 326	R 2326

210 830 02 18	1 987 432 533	R 2533
210 830 03 18	1 987 432 533	R 2533
210 830 08 18	1 987 432 301	R 2301
210 830 09 18	1 987 432 301	R 2301
210 830 11 18	1 987 432 533	R 2533

210 830 12 18	1 987 432 301	R 2301
211 830 00 18	1 987 432 381	R 2381
211 830 02 18	1 987 432 081	M 2081
211 830 04 18	1 987 432 281	M 2281
211 830 08 18	1 987 432 512	R 2512

2120830 00 18	1 987 432 326	R 2326
212 830 02 18	1 987 432 326	R 2326
220 830 01 18	1 987 432 533	R 2533
220 830 02 18	1 987 432 533	R 2533
221 830 00 18	1 987 432 438	R 2438

221 830 03 18	1 987 432 438	R 2438
221 830 07 18	1 987 432 438	R 2438
451 830 00 18	1 987 432 499	R 2499
451 835 02 47	1 987 432 299	M 2299
454 830 00 18	1 987 432 434	R 2434

463 830 00 18	1 987 432 357	R 2357
638 835 00 47	1 987 432 044	M 2044
639 835 02 47	1 987 432 195	M 2195
639 835 03 47	1 987 432 495	R 2495
901 830 00 18	1 987 432 043	M 2043

901 830 04 18	1 987 432 343	R 2343
901 830 05 18	1 987 432 043	M 2043
906 830 02 18	1 987 432 213	M 2213
906 830 03 18	1 987 432 213	M 2213
906 830 03 18	1 987 432 513	R 2513

940 835 00 47	1 987 431 168	M 1168
940 835 01 47	1 987 431 457	R 1457
940 835 02 47	1 987 431 155	M 1155
973 835 01 47	1 987 431 157	M 1157
973 835 02 47	1 987 431 156	M 1156

973 835 03 47	1 987 431 456	R 1456
---------------	---------------	--------

M-FILTER

MAC60008	1 987 432 062	M 2062
MAC6785	1 987 431 159	M 1159
MAC8001	1 987 432 043	M 2043

MAC8002	1 987 432 012	M 2012
MAC8012	1 987 432 113	M 2113
MAC8031	1 987 432 057	M 2057
MAC8073	1 987 432 021	M 2021
MAC8092	1 987 432 027	M 2027

MICRONAIR

MC505	1 987 432 301	R 2301
MC509	1 987 432 310	R 2310
MC511	1 987 432 317	R 2317

MC515	1 987 432 366	R 2366
MC517	1 987 432 306	R 2306
MC525	1 987 432 328	R 2328
MC526RL	1 987 432 301	R 2301
MC533	1 987 432 039	M 2039

MC537	1 987 432 337	R 2337
MC538	1 987 432 336	R 2336
MC539	1 987 432 303	R 2303
MC541	1 987 432 345	R 2345
MC544	1 987 432 312	R 2312

MC548	1 987 432 333	R 2333
MC549	1 987 432 333	R 2333
MC550	1 987 432 014	M 2014
MC555	1 987 432 307	R 2307
MC555	1 987 432 407	R 2407

MC556	1 987 432 319	R 2319
MC559	1 987 432 370	R 2370
MC560	1 987 432 357	R 2357
MC561	1 987 432 354	R 2354
MC563	1 987 432 075	M 2075

MC564	1 987 432 380	R 2380
MC571	1 987 432 379	R 2379
MC572	1 987 432 597	R 2597
MC574RL	1 987 432 070	M 2070
MC576	1 987 432 318	R 2318

MC578	1 987 432 365	R 2365
MC589	1 987 432 313	R 2313
MC590	1 987 432 378	R 2378
MC591	1 987 432 360	R 2360
MC592	1 987 432 300	R 2300

MC594	1 987 432 364	R 2364
MC596	1 987 432 377	R 2377
MC599	1 987 432 366	R 2366
MC606	1 987 432 371	R 2371
MC607	1 987 432 376	R 2376

MC609	1 987 432 381	R 2381
MC612	1 987 432 368	R 2368
MC613	1 987 432 397	R 2397
MC614	1 987 432 387	R 2387
MC630	1 987 432 382	R 2382

MC631	1 987 431 456	R 1456
MC639	1 987 432 411	R 2411
MC640	1 987 432 412	R 2412
MC642	1 987 432 409	R 2409
MC645	1 987 432 413	R 2413

MC647	1 987 432 092	M 2092
MC648	1 987 432 495	R 2495
MC649	1 987 432 425	R 2425
MC650	1 987 431 454	R 1454
MC654	1 987 431 452	R 1452

MC656	1 987 431 458	R 1458
MC661	1 987 432 410	R 2410
MC664	1 987 432 497	R 2497
MC670	1 987 432 434	R 2434
MC681	1 987 432 413	R 2413



M

◀ MICRONAIR

MC685-2	1 987 432 422	R 2422
MC689	1 987 432 401	R 2401
MC694	1 987 432 376	R 2376
MC695	1 987 432 424	R 2424
MC747	1 987 432 498	R 2498

MC771	1 987 432 369	R 2369
MC784	1 987 432 379	R 2379
MC800	1 987 432 406	R 2406
MC3253	1 987 432 413	R 2413
MC5302	1 987 432 361	R 2361

MC5582	1 987 432 052	M 2052
MC5932	1 987 432 362	R 2362
MC5952	1 987 432 386	R 2386
MC6662	1 987 432 402	R 2402
MP002	1 987 432 032	M 2032

MP012	1 987 432 022	M 2022
MP013	1 987 432 042	M 2042
MP014	1 987 432 040	M 2040
MP015	1 987 432 016	M 2016
MP017	1 987 432 006	M 2006

MP018	1 987 432 015	M 2015
MP020	1 987 432 043	M 2043
MP021	1 987 432 019	M 2019
MP023	1 987 432 044	M 2044
MP024	1 987 432 056	M 2056

MP025	1 987 432 028	M 2028
MP029	1 987 432 026	M 2026
MP031	1 987 432 013	M 2013
MP032	1 987 432 030	M 2030
MP033	1 987 432 039	M 2039

MP034	1 987 432 021	M 2021
MP037	1 987 432 037	M 2037
MP039	1 987 432 003	M 2003
MP040RL	1 987 432 003	M 2003
MP041	1 987 432 045	M 2045

MP042	1 987 432 105	M 2105
MP044	1 987 432 012	M 2012
MP048	1 987 432 033	M 2033
MP049	1 987 432 024	M 2024
MP050	1 987 432 014	M 2014

MP051	1 987 432 027	M 2027
MP052	1 987 432 009	M 2009
MP056	1 987 432 062	M 2062
MP057	1 987 432 048	M 2048
MP058-2	1 987 432 052	M 2052

MP059	1 987 432 070	M 2070
MP060	1 987 432 057	M 2057
MP062	1 987 432 095	M 2095
MP063	1 987 432 075	M 2075
MP065	1 987 432 090	M 2090

MP066-2	1 987 432 074	M 2074
MP066-2	1 987 432 220	M 2220
MP068-2	1 987 432 049	M 2049
MP069	1 987 432 062	M 2062
MP070	1 987 432 151	M 2151

MP071	1 987 432 079	M 2079
MP073	1 987 432 150	M 2150
MP075	1 987 432 050	M 2050
MP075RL	1 987 432 050	M 2050
MP076	1 987 432 018	M 2018

MP078	1 987 432 072	M 2072
MP080	1 987 432 053	M 2053
MP081	1 987 432 059	M 2059
MP082	1 987 432 058	M 2058
MP084	1 987 432 061	M 2061

MP085	1 987 432 063	M 2063
MP086	1 987 432 064	M 2064
MP087-3	1 987 432 060	M 2060
MP088	1 987 432 069	M 2069
MP101	1 987 432 192	M 2192

MP104	1 987 432 084	M 2084
MP106	1 987 432 071	M 2071
MP107	1 987 432 076	M 2076
MP109	1 987 432 081	M 2081
MP112	1 987 432 068	M 2068

MP113	1 987 432 097	M 2097
MP114	1 987 432 087	M 2087
MP116	1 987 432 091	M 2091
MP117	1 987 432 088	M 2088
MP121	1 987 432 190	M 2190

MP127	1 987 432 207	M 2207
MP130	1 987 432 082	M 2082
MP131	1 987 431 157	M 1157
MP132	1 987 431 168	M 1168
MP133	1 987 431 156	M 1156

MP134	1 987 431 155	M 1155
MP135	1 987 431 166	M 1166
MP139	1 987 432 111	M 2111
MP141	1 987 432 114	M 2114
MP145	1 987 432 113	M 2113

MP147	1 987 432 092	M 2092
MP148	1 987 432 195	M 2195
MP152	1 987 432 152	M 2152
MP153	1 987 431 164	M 1164
MP154	1 987 431 169	M 1169

MP155	1 987 431 162	M 1162
MP156	1 987 431 163	M 1163
MP161	1 987 432 410	R 2410
MP163	1 987 432 106	M 2106
MP166-2	1 987 432 102	M 2102

MP167	1 987 432 093	M 2093
MP172	1 987 432 092	M 2092
MP173	1 987 432 083	M 2083
MP176	1 987 432 235	M 2235
MP179	1 987 432 120	M 2120

MP181	1 987 432 113	M 2113
MP191	1 987 432 107	M 2107
MP192	1 987 432 108	M 2108
MP194	1 987 432 076	M 2076
MP195	1 987 432 124	M 2124

MP202	1 987 432 203	M 2203
MP223	1 987 432 208	M 2208
MP230	1 987 432 221	M 2221
MP234	1 987 432 116	M 2116
MP240	1 987 431 159	M 1159

MP241	1 987 431 160	M 1160
MP264	1 987 432 136	M 2136
MP266	1 987 432 194	M 2194
MP273	1 987 432 190	M 2190
MP300	1 987 432 206	M 2206

MP302	1 987 432 361	R 2361
028	1 987 432 184	M 2184
042	1 987 432 105	M 2105
080	1 987 432 121	M 2121
158	1 987 432 115	M 2115

181	1 987 432 113	M 2113
193	1 987 432 188	M 2188
233	1 987 432 182	M 2182
321	1 987 432 183	M 2183
632	1 987 431 457	R 1457

640	1 987 432 412	R 2412
641	1 987 432 431	R 2431
659	1 987 432 399	R 2399
686	1 987 432 435	R 2435
700	1 987 432 433	R 2433

1112	1 987 432 103	M 2103
------	---------------	--------

MITSUBISHI

MR227823	1 987 432 086	M 2086
MR227823	1 987 432 134	M 2134
MR262425	1 987 432 157	M 2157

MR315876	1 987 432 207	M 2207
MR398288	1 987 432 426	R 2426
MR460201	1 987 432 086	M 2086
MR460201	1 987 432 134	M 2134
MR500058	1 987 432 498	R 2498

MR958016	1 987 432 034	M 2034
MR958017	1 987 432 434	R 2434
MZ311916	1 987 432 157	M 2157
MZ311917	1 987 432 086	M 2086
MZ311917	1 987 432 134	M 2134

MZ312931	1 987 432 085	M 2085
MZ600163	1 987 432 134	M 2134
XR315876D	1 987 432 207	M 2207
XR398288	1 987 432 426	R 2426
XR398288D	1 987 432 426	R 2426

XR500058D	1 987 432 498	R 2498
XZ311916	1 987 432 157	M 2157
XZ311917	1 987 432 086	M 2086
XZ311917	1 987 432 134	M 2134
XZ311917D	1 987 432 086	M 2086

7803A004	1 987 432 216	M 2216
7803A028	1 987 432 498	R 2498
7803A043	1 987 432 416	R 2416
7903A005	1 987 432 416	R 2416

MOTORCRAFT

FP 004	1 987 432 018	M 2018
FP4	1 987 432 018	M 2018
R/FP/1	1 987 432 006	M 2006

MOTRIO

8671002078	1 987 432 024	M 2024
8671002080	1 987 432 012	M 2012
8671002085	1 987 432 006	M 2006

8671002086	1 987 432 018	M 2018
8671002089	1 987 432 016	M 2016
8671002090	1 987 432 015	M 2015
8671002091	1 987 432 030	M 2030
8671002093	1 987 432 022	M 2022

8671002098	1 987 432 011	M 2011
8671002100	1 987 432 013	M 2013
8671002333	1 987 432 026	M 2026
8671002335	1 987 432 042	M 2042

NIPPART

J1315015	1 987 432 120	M 2120
J1340903	1 987 432 105	M 2105
J1341000	1 987 432 118	M 2118

J1341002	1 987 432 075	M 2075
J1341003	1 987 432 058	M 2058
J1341005	1 987 432 119	M 2119
J1341017	1 987 432 039	M 2039
J1343001	1 987 432 117	M 2117



N

◀ NIPPART

J1343002	1 987 432 006	M 2006
J1344003	1 987 432 053	M 2053
J1344004	1 987 432 026	M 2026
J1344006	1 987 432 074	M 2074
J1344007	1 987 432 115	M 2115

J1344012	1 987 432 074	M 2074
----------	---------------	--------

NISSAN

B729800QAA	1 987 432 039	M 2039
27274 EA000	1 987 432 194	M 2194
27274 3Y700	1 987 432 239	M 2239

27275 1N625	1 987 432 179	M 2179
27275 1N626	1 987 432 118	M 2118
27277 EN000	1 987 432 238	M 2238
27277 EN025	1 987 432 238	M 2238
27298 00QAA	1 987 432 208	M 2208

27891 AX01A	1 987 432 120	M 2120
27891 AX010	1 987 432 120	M 2120
27891 BM400	1 987 432 075	M 2075
27891 BM401	1 987 432 075	M 2075
27891 BM401KE	1 987 432 075	M 2075

27891 BM410	1 987 432 075	M 2075
27891 00QAA	1 987 432 193	M 2193
27891 2F000	1 987 432 058	M 2058
27891 4A00C	1 987 432 148	M 2148
27893 2F900	1 987 432 058	M 2058

27893 6F600	1 987 432 119	M 2119
27893 9F500	1 987 432 058	M 2058
27893 9F500KE	1 987 432 058	M 2058

OPEL

09162646	1 987 432 366	R 2366
13175553	1 987 432 040	M 2040
1353269	1 987 432 387	R 2387

1718022	1 987 432 366	R 2366
1718044	1 987 432 310	R 2310
1718962	1 987 432 052	M 2052
1808246	1 987 432 304	R 2304
1808524	1 987 432 004	M 2004

1808600	1 987 432 091	M 2091
1808602	1 987 432 091	M 2091
1808602	1 987 432 166	M 2166
1808604	1 987 432 015	M 2015
1808605	1 987 432 016	M 2016

1808607	1 987 432 030	M 2030
1808608	1 987 432 330	R 2330
1808609	1 987 432 052	M 2052
1808610	1 987 432 040	M 2040
1808614	1 987 432 366	R 2366

1808616	1 987 432 366	R 2366
1808617	1 987 432 376	R 2376
1808618	1 987 432 366	R 2366
1808619	1 987 432 076	M 2076
1808624	1 987 432 376	R 2376

4408840	1 987 432 208	M 2208
4419683	1 987 432 078	M 2078
4705463	1 987 432 066	M 2066
4708106	1 987 432 066	M 2066
4710210	1 987 432 214	M 2214

52470574	1 987 432 052	M 2052
55702456	1 987 432 188	M 2188
55702468	1 987 432 488	R 2488
631916	1 987 432 366	R 2366
6806612	1 987 432 015	M 2015

6808600	1 987 432 091	M 2091
6808600	1 987 432 166	M 2166
6808601	1 987 432 076	M 2076
6808604	1 987 432 111	M 2111
6808605	1 987 432 411	R 2411

6808606	1 987 432 040	M 2040
6808610	1 987 432 091	M 2091
6808612	1 987 432 015	M 2015
6808613	1 987 432 016	M 2016
6808622	1 987 432 188	M 2188

6808623	1 987 432 488	R 2488
6818605	1 987 432 411	R 2411
90360171	1 987 432 091	M 2091
90386776	1 987 432 015	M 2015
90458294	1 987 432 016	M 2016

90464424	1 987 432 030	M 2030
90509367	1 987 432 015	M 2015
90510338	1 987 432 016	M 2016
90512779	1 987 432 030	M 2030
90520689	1 987 432 040	M 2040

90541317	1 987 432 330	R 2330
90568793	1 987 432 330	R 2330
90590568	1 987 432 091	M 2091
91132367	1 987 432 330	R 2330
9121624	1 987 432 366	R 2366

9121625	1 987 432 310	R 2310
9121653	1 987 432 052	M 2052
9173985	1 987 432 366	R 2366
9179904	1 987 432 376	R 2376
9192320	1 987 432 366	R 2366

9196805	1 987 432 066	M 2066
9201440	1 987 432 076	M 2076
9201441	1 987 432 076	M 2076
93165208	1 987 432 366	R 2366
93172129	1 987 432 376	R 2376

93172299	1 987 432 076	M 2076
93174800	1 987 432 111	M 2111
93174801	1 987 432 411	R 2411
93182437	1 987 432 015	M 2015
93188572	1 987 432 066	M 2066

96440878	1 987 432 222	M 2222
96800069	1 987 432 222	M 2222

PBR

AH 163	1 987 432 049	M 2049
AH 7002	1 987 432 018	M 2018
AH 7003	1 987 432 012	M 2012

AH 7004	1 987 432 022	M 2022
AH 7006	1 987 432 016	M 2016
AH 7007	1 987 432 013	M 2013
AH 7008	1 987 432 024	M 2024
AH 7010	1 987 432 015	M 2015

AH 7011	1 987 432 021	M 2021
AH 7012	1 987 432 014	M 2014
AH 7013	1 987 432 027	M 2027
AH 7014	1 987 432 009	M 2009
AH 7015	1 987 432 007	M 2007

AH 7015	1 987 432 307	R 2307
AH 7017	1 987 432 006	M 2006
AH 7019	1 987 432 361	R 2361
AH 7021	1 987 432 300	R 2300
AH 7023	1 987 432 019	M 2019

AH 7025	1 987 432 003	M 2003
AH 7026	1 987 432 033	M 2033
AH 7027	1 987 432 324	R 2324
AH 7028	1 987 432 030	M 2030
AH 7032	1 987 432 028	M 2028

AH 7034	1 987 432 040	M 2040
AH 7038	1 987 432 032	M 2032
AH 7040	1 987 432 360	R 2360
AH 7041	1 987 432 090	M 2090
AH 7045	1 987 432 045	M 2045

AH 7046	1 987 432 062	M 2062
AH 7047	1 987 432 042	M 2042
AH 7048	1 987 432 052	M 2052
AH 7049	1 987 432 026	M 2026
AH 7052	1 987 432 059	M 2059

AH 7053	1 987 432 037	M 2037
AH 7053	1 987 432 337	R 2337
AH 7054	1 987 432 061	M 2061
AH 7055	1 987 432 057	M 2057
AH 7056	1 987 432 318	R 2318

AH 7058	1 987 432 301	R 2301
AH 7059	1 987 432 028	M 2028
AH 7060	1 987 432 330	R 2330
AH 7061	1 987 432 303	R 2303
AH 7063	1 987 432 310	R 2310

AH 7065	1 987 432 317	R 2317
AH 7066	1 987 432 312	R 2312
AH 7067	1 987 432 060	M 2060
AH 7068	1 987 432 060	M 2060
AH 7070	1 987 432 043	M 2043

AH 7071	1 987 432 039	M 2039
AH 7077	1 987 432 151	M 2151
AH 7081	1 987 432 048	M 2048
AH 7084	1 987 432 058	M 2058
AH 7086	1 987 432 069	M 2069

AH 7088	1 987 432 075	M 2075
AH 7090	1 987 432 380	R 2380
AH 7091	1 987 432 150	M 2150
AH 7092	1 987 432 105	M 2105
AH 7094	1 987 432 365	R 2365

AH 7097	1 987 432 079	M 2079
AH 7101	1 987 432 357	R 2357
AH 7103	1 987 432 378	R 2378
AH 7106	1 987 432 076	M 2076
AH 7110	1 987 432 076	M 2076

AH 7116	1 987 432 366	R 2366
AH 7118	1 987 432 371	R 2371
AH 7119	1 987 432 377	R 2377
AH 7124	1 987 432 071	M 2071
AH 7128	1 987 432 044	M 2044

AH 7129	1 987 431 163	M 1163
AH 7199	1 987 432 113	M 2113
AI5031	1 987 431 159	M 1159
AK7019	1 987 432 361	R 2361
AK7021	1 987 432 300	R 2300

AK7057	1 987 432 310	R 2310
AK7061	1 987 432 303	R 2303
AK7066	1 987 432 312	R 2312
AK7069	1 987 432 366	R 2366
AK7101	1 987 432 357	R 2357

AK7103	1 987 432 378	R 2378
AK7116	1 987 432 366	R 2366
AK7122	1 987 432 306	R 2306
AK7169	1 987 432 407	R 2407



P

PEUGEOT

0024 35	1 987 432 348	R 2348
0024 84	1 987 432 041	M 2041
6441 91	1 987 432 154	M 2154

6447 AZ	1 987 432 048	M 2048
6447 F2	1 987 432 022	M 2022
6447 GW	1 987 432 399	R 2399
6447 HO	1 987 432 060	M 2060
6447 H1	1 987 432 060	M 2060

6447 JO	1 987 432 042	M 2042
6447 JO	1 987 432 042	M 2042
6447 KK	1 987 432 079	M 2079
6447 KL	1 987 432 379	R 2379
6447 KR	1 987 432 083	M 2083

6447 LY	1 987 432 091	M 2091
6447 NT	1 987 432 079	M 2079
6447 PE	1 987 432 348	R 2348
6447 PG	1 987 432 307	R 2307
6447 P2	1 987 432 060	M 2060

6447 P3	1 987 432 060	M 2060
6447 RG	1 987 432 412	R 2412
6447 SY	1 987 432 042	M 2042
6447 S5	1 987 432 007	M 2007
6447 S5	1 987 432 307	R 2307

6447 TC	1 987 432 412	R 2412
6447 TF	1 987 432 048	M 2048
6447 TT	1 987 432 189	M 2189
6447 VY	1 987 432 136	M 2136
6447 XF	1 987 432 137	M 2137

6447 YA	1 987 432 065	M 2065
6447 YJ	1 987 432 206	M 2206
6447 YL	1 987 432 406	R 2406
6447 ZX	1 987 432 216	M 2216
6447 Z4	1 987 432 021	M 2021

6447 Z5	1 987 432 021	M 2021
6447 93	1 987 432 022	M 2022
6479 C2	1 987 432 079	M 2079
6479 C9	1 987 432 065	M 2065
6479 E9	1 987 432 416	R 2416

6479 32	1 987 432 379	R 2379
6479 41	1 987 432 079	M 2079
6479 43	1 987 432 412	R 2412
6479 46	1 987 432 311	R 2311
6479 63	1 987 432 228	M 2228

6479 75	1 987 432 379	R 2379
6479 92	1 987 432 137	M 2137
9406447PG0	1 987 432 307	R 2307
9636 783 780	1 987 432 077	M 2077

PORSCHE

996 571 219 01	1 987 432 407	R 2407
996 571 219 03	1 987 432 407	R 2407
996 572 219 01	1 987 432 200	M 2200

996 572 219 02	1 987 432 200	M 2200
997 571 219 00	1 987 432 407	R 2407
997 571 219 01	1 987 432 407	R 2407

PURFLUX

AHC 101	1 987 432 021	M 2021
AHC 102	1 987 432 307	R 2307
AHC 102	1 987 432 407	R 2407

AHC 103	1 987 432 318	R 2318
AHC 107	1 987 432 303	R 2303
AHC 112	1 987 432 060	M 2060
AHC 113	1 987 432 060	M 2060
AHC 119	1 987 432 317	R 2317

AHC 122	1 987 432 006	M 2006
AHC 122	1 987 432 306	R 2306
AHC 124	1 987 432 330	R 2330
AHC 126	1 987 432 337	R 2337
AHC 128	1 987 432 366	R 2366

AHC 129	1 987 432 328	R 2328
AHC 130	1 987 432 032	M 2032
AHC 132	1 987 432 525	R 2525
AHC 133	1 987 432 389	R 2389
AHC 134	1 987 432 361	R 2361

AHC 136	1 987 432 313	R 2313
AHC 140	1 987 432 048	M 2048
AHC 143	1 987 432 197	R 2197
AHC 144	1 987 432 390	R 2390
AHC 145	1 987 432 367	R 2367

AHC 147	1 987 432 333	R 2333
AHC 154	1 987 432 365	R 2365
AHC 156	1 987 432 360	R 2360
AHC 166	1 987 432 354	R 2354
AHC 167	1 987 432 345	R 2345

AHC 169	1 987 432 469	R 2469
AHC 177	1 987 432 386	R 2386
AHC 178	1 987 432 300	R 2300
AHC 179	1 987 432 379	R 2379
AHC 184	1 987 432 371	R 2371

AHC 185	1 987 432 380	R 2380
AHC 187	1 987 432 336	R 2336
AHC 188	1 987 432 378	R 2378
AHC 190	1 987 432 377	R 2377
AHC 191	1 987 432 357	R 2357

AHC 192	1 987 432 382	R 2382
AHC 195	1 987 432 387	R 2387
AHC 198	1 987 432 376	R 2376
AHC 202	1 987 432 397	R 2397
AHC 211	1 987 432 381	R 2381

AHC 213	1 987 432 412	R 2412
AHC 219	1 987 432 402	R 2402
AHC 237	1 987 432 410	R 2410
AHC 239	1 987 432 361	R 2361
AHC 246	1 987 432 424	R 2424

AHC 247	1 987 432 122	M 2122
AHC 250	1 987 432 433	R 2433
AHC 258	1 987 432 406	R 2406
AHC 264	1 987 432 500	R 2500
AHC 269	1 987 432 369	R 2369

AHC 272	1 987 432 311	R 2311
AHC 277	1 987 432 499	R 2499
AH 101	1 987 432 021	M 2021
AH 102	1 987 432 007	M 2007
AH 102	1 987 432 200	M 2200

AH 103	1 987 432 018	M 2018
AH 104	1 987 432 012	M 2012
AH 105	1 987 432 015	M 2015
AH 107	1 987 432 003	M 2003
AH 107	1 987 432 018	M 2018

AH 108	1 987 432 019	M 2019
AH 110	1 987 432 014	M 2014
AH 112	1 987 432 060	M 2060
AH 113	1 987 432 060	M 2060
AH 114	1 987 432 022	M 2022

AH 116	1 987 432 009	M 2009
AH 117	1 987 432 027	M 2027
AH 121	1 987 432 014	M 2014
AH 122	1 987 432 006	M 2006
AH 124	1 987 432 030	M 2030

AH 125	1 987 432 013	M 2013
AH 126	1 987 432 037	M 2037
AH 127	1 987 432 026	M 2026
AH 127	1 987 432 053	M 2053
AH 127	1 987 432 121	M 2121

AH 127	1 987 432 121	M 2121
AH 128	1 987 432 016	M 2016
AH 129	1 987 432 028	M 2028
AH 130	1 987 432 032	M 2032
AH 132	1 987 432 225	M 2225

AH 133	1 987 432 089	M 2089
AH 134	1 987 432 361	R 2361
AH 135	1 987 432 011	M 2011
AH 136	1 987 432 013	M 2013
AH 139	1 987 432 024	M 2024

AH 139	1 987 432 033	M 2033
AH 140	1 987 432 048	M 2048
AH 141	1 987 432 193	M 2193
AH 142	1 987 432 095	M 2095
AH 143	1 987 432 039	M 2039

AH 144	1 987 432 090	M 2090
AH 147	1 987 432 024	M 2024
AH 150	1 987 432 061	M 2061
AH 151	1 987 432 159	M 2159
AH 157	1 987 432 052	M 2052

AH 158	1 987 432 043	M 2043
AH 159	1 987 432 044	M 2044
AH 160	1 987 432 084	M 2084
AH 161	1 987 432 312	R 2312
AH 163	1 987 432 049	M 2049

AH 165	1 987 432 121	M 2121
AH 167	1 987 432 045	M 2045
AH 169	1 987 432 069	M 2069
AH 170	1 987 432 040	M 2040
AH 173	1 987 432 064	M 2064

AH 174	1 987 432 107	M 2107
AH 175	1 987 432 066	M 2066
AH 179	1 987 432 079	M 2079
AH 182	1 987 432 056	M 2056
AH 184	1 987 432 071	M 2071

AH 186	1 987 432 208	M 2208
AH 188	1 987 432 378	R 2378
AH 189	1 987 432 088	M 2088
AH 191	1 987 432 057	M 2057
AH 193	1 987 432 083	M 2083

AH 194	1 987 432 070	M 2070
AH 198	1 987 432 076	M 2076
AH 199	1 987 432 093	M 2093
AH 201	1 987 432 072	M 2072
AH 202	1 987 432 097	M 2097

AH 204	1 987 432 075	M 2075
AH 205	1 987 432 091	M 2091
AH 206	1 987 432 111	M 2111
AH 207	1 987 432 120	M 2120
AH 209	1 987 432 114	M 2114

AH 210	1 987 432 085	M 2085
AH 212	1 987 432 109	M 2109
AH 220	1 987 432 074	M 2074
AH 220	1 987 432 220	M 2220
AH 221	1 987 432 166	M 2166

AH 224	1 987 432 192	M 2192
AH 225	1 987 432 058	M 2058
AH 226	1 987 432 105	M 2105
AH 227	1 987 432 482	R 2482
AH 228	1 987 432 096	M 2096



P

◀ PURFLUX

AH 231	1 987 432 042	M 2042
AH 233	1 987 432 106	M 2106
AH 234	1 987 432 094	M 2094
AH 238	1 987 432 113	M 2113
AH 245	1 987 432 136	M 2136

AH 256	1 987 432 190	M 2190
AH 259	1 987 432 190	M 2190
AH 260	1 987 432 227	M 2227
AH 261	1 987 432 137	M 2137
AH 262	1 987 432 216	M 2216

AH 265	1 987 432 228	M 2228
AH 266	1 987 432 203	M 2203
AH 273	1 987 432 078	M 2078
AH 280	1 987 432 195	M 2195
AH 282	1 987 432 215	M 2215

PUROLATOR

C14860	1 987 432 018	M 2018
C15439	1 987 432 074	M 2074
C15510	1 987 432 336	R 2336

C15537	1 987 432 082	M 2082
C15637	1 987 432 425	R 2425
C17724	1 987 432 019	M 2019
C17926	1 987 432 028	M 2028
C17926	1 987 432 328	R 2328

C18080	1 987 432 052	M 2052
C18081	1 987 432 049	M 2049
C18084	1 987 432 362	R 2362
C18085	1 987 432 362	R 2362
C18086	1 987 432 337	R 2337

C18116	1 987 432 089	M 2089
C18116	1 987 432 090	M 2090
C18117	1 987 432 300	R 2300
C18118	1 987 432 048	M 2048
C18120	1 987 432 040	M 2040

C18121	1 987 432 045	M 2045
C18122	1 987 432 033	M 2033
C18124	1 987 432 062	M 2062
C18126	1 987 432 360	R 2360
C18127	1 987 432 336	R 2336

C18128	1 987 432 058	M 2058
C18129	1 987 432 014	M 2014
C18147	1 987 432 043	M 2043
C18149	1 987 432 050	M 2050
C18150	1 987 432 096	M 2096

C18160	1 987 432 042	M 2042
C18163	1 987 432 030	M 2030
C18185	1 987 432 041	M 2041
C18185 FD	1 987 432 041	M 2041
C18189	1 987 432 095	M 2095

C18200	1 987 432 386	R 2386
C18323	1 987 432 091	M 2091
C18324	1 987 432 076	M 2076
C18332	1 987 432 093	M 2093
C18333	1 987 432 397	R 2397

C18335	1 987 432 111	M 2111
C18336	1 987 432 092	M 2092
C18337	1 987 432 120	M 2120
C18339	1 987 432 094	M 2094
C18354	1 987 432 082	M 2082

C19312	1 987 432 049	M 2049
C25246	1 987 432 052	M 2052
C25387	1 987 432 045	M 2045
C25480	1 987 432 030	M 2030
C25480	1 987 432 814	M 2814

C25483	1 987 432 062	M 2062
C25532	1 987 432 103	M 2103
C25542	1 987 432 096	M 2096
C25624	1 987 432 424	R 2424
C27687	1 987 432 030	M 2030

C27723	1 987 432 014	M 2014
C27727	1 987 432 003	M 2003
C27744	1 987 432 022	M 2022
C27745	1 987 432 007	M 2007
C27924	1 987 432 006	M 2006

C27924	1 987 432 306	R 2306
C28147	1 987 432 062	M 2062
C28155	1 987 432 009	M 2009
C28162	1 987 432 013	M 2013
C28165	1 987 432 401	R 2401

C28168	1 987 432 039	M 2039
C28169	1 987 432 061	M 2061
C28172	1 987 432 045	M 2045
C28178	1 987 432 048	M 2048
C28179	1 987 432 367	R 2367

C28181	1 987 432 108	M 2108
C28187	1 987 432 066	M 2066
C28190	1 987 432 070	M 2070
C28191	1 987 432 069	M 2069
C28195	1 987 432 076	M 2076

C28214	1 987 432 072	M 2072
C28226	1 987 432 079	M 2079
C28231	1 987 432 377	R 2377
C28233	1 987 432 056	M 2056
C28903	1 987 432 011	M 2011

C28904	1 987 432 013	M 2013
C28909	1 987 432 032	M 2032
C28910	1 987 432 015	M 2015
C29109	1 987 432 412	R 2412
C29110	1 987 432 434	R 2434

C29111	1 987 432 424	R 2424
C35402	1 987 432 053	M 2053
C35473	1 987 432 024	M 2024
C35473	1 987 432 333	R 2333
C35479	1 987 432 085	M 2085

C35484	1 987 432 071	M 2071
C35484	1 987 432 371	R 2371
C35509	1 987 432 361	R 2361
C35516	1 987 432 085	M 2085
C35519	1 987 432 166	M 2166

C35533	1 987 432 367	R 2367
C35541	1 987 432 116	M 2116
C35562	1 987 432 169	M 2169
C35586	1 987 432 097	M 2097
C35586	1 987 432 397	R 2397

C35666	1 987 432 011	M 2011
C37615	1 987 432 016	M 2016
C37646	1 987 432 027	M 2027
C37647	1 987 432 021	M 2021
C37726	1 987 432 360	R 2360

C38145	1 987 432 360	R 2360
C38152	1 987 432 033	M 2033
C38161	1 987 432 107	M 2107
C38167	1 987 432 090	M 2090
C38170	1 987 432 026	M 2026

C38171	1 987 432 040	M 2040
C38173	1 987 432 105	M 2105
C38180	1 987 432 365	R 2365
C38182	1 987 432 064	M 2064
C38183	1 987 432 378	R 2378

C38184	1 987 432 364	R 2364
C38186	1 987 432 075	M 2075
C38188	1 987 432 084	M 2084
C38197	1 987 432 357	R 2357
C38198	1 987 432 057	M 2057

C38201	1 987 432 071	M 2071
C38206	1 987 432 366	R 2366
C38210	1 987 432 063	M 2063
C38216	1 987 432 083	M 2083
C38236	1 987 432 088	M 2088

C38901	1 987 432 012	M 2012
C38907	1 987 432 012	M 2012
C38908	1 987 432 301	R 2301
C38908	1 987 432 805	M 2805
C39108	1 987 432 113	M 2113

C45383	1 987 432 012	M 2012
C45383	1 987 432 300	R 2300
C45383	1 987 432 808	M 2808
C45508	1 987 432 064	M 2064
C45621	1 987 432 113	M 2113

C45621	1 987 432 413	R 2413
C45662	1 987 432 158	M 2158
C47925	1 987 432 361	R 2361
I19202	1 987 432 041	M 2041

QUINTON HAZELL

QAP101	1 987 432 015	M 2015
QAP102	1 987 432 024	M 2024
QAP107	1 987 432 018	M 2018

QAP110	1 987 432 013	M 2013
QAP111	1 987 432 011	M 2011
QAP112	1 987 432 021	M 2021
QAP113	1 987 432 012	M 2012
QAP119	1 987 432 030	M 2030

QAP120	1 987 432 006	M 2006
QAP124	1 987 432 009	M 2009
QAP125	1 987 432 016	M 2016
QAP127	1 987 432 027	M 2027
QAP137	1 987 432 042	M 2042

QAP141	1 987 432 013	M 2013
QAP201	1 987 432 015	M 2015
QAP207	1 987 432 018	M 2018
QAP212	1 987 432 021	M 2021
QAP213	1 987 432 012	M 2012

QAP220	1 987 432 006	M 2006
QAP221	1 987 432 058	M 2058
QAP224	1 987 432 009	M 2009
QAP237	1 987 432 042	M 2042
QAP242	1 987 432 022	M 2022

QAP244	1 987 432 060	M 2060
QAP248	1 987 432 303	R 2303
QAP253	1 987 432 043	M 2043
QAP259	1 987 432 089	M 2089
QAP263	1 987 432 090	M 2090

QAP265	1 987 432 026	M 2026
QAP267	1 987 432 045	M 2045
QAP268	1 987 432 105	M 2105
QAP271	1 987 432 037	M 2037
QAP309	1 987 432 059	M 2059

QAP313	1 987 432 075	M 2075
QAP317	1 987 432 069	M 2069
QAP324	1 987 432 057	M 2057
QAP344	1 987 432 079	M 2079
QAP354	1 987 432 074	M 2074

QAP390	1 987 432 113	M 2113
QAP396	1 987 432 102	M 2102
QAP404	1 987 432 113	M 2113
QAP500	1 987 432 310	R 2310
QAP525	1 987 432 366	R 2366

◀ QUINTON HAZELL

QAP545	1 987 432 300	R 2300
QAP571	1 987 432 337	R 2337
QAP580	1 987 432 378	R 2378
QAP624	1 987 432 357	R 2357
QAP631	1 987 432 366	R 2366

QAP706	1 987 432 412	R 2412
--------	---------------	--------

RENAULT

20559447	1 987 431 170	M 1170
27 27 700 01R	1 987 432 500	R 2500
27 27 729 51R	1 987 432 500	R 2500

27 27 753 74R	1 987 432 120	M 2120
27 27 789 70R	1 987 432 327	R 2327
50 01 829 129	1 987 431 171	M 1171
50 01 844 054	1 987 431 171	M 1171
50 01 867 491	1 987 431 170	M 1170

60 25 370 624	1 987 432 049	M 2049
77 00 424 093	1 987 432 061	M 2061
77 00 424 098	1 987 432 039	M 2039
77 00 428 820	1 987 432 090	M 2090
77 00 834 816	1 987 432 027	M 2027

77 00 834 816	1 987 432 108	M 2108
77 00 835 266	1 987 432 050	M 2050
77 00 845 219	1 987 432 225	M 2225
77 00 845 222	1 987 432 089	M 2089
77 00 845 811	1 987 432 009	M 2009

77 00 846 236	1 987 432 226	M 2226
77 00 854 811	1 987 432 009	M 2009
77 01 040 543	1 987 432 009	M 2009
77 01 042 499	1 987 432 193	M 2193
77 01 047 513	1 987 432 069	M 2069

77 01 048 749	1 987 432 380	R 2380
77 01 050 319	1 987 432 208	M 2208
77 01 055 109	1 987 432 093	M 2093
77 01 055 110	1 987 432 094	M 2094
77 01 056 390	1 987 432 400	R 2400

77 01 059 997	1 987 432 120	M 2120
77 01 062 227	1 987 432 120	M 2120
77 01 064 235	1 987 432 393	R 2393
77 01 064 237	1 987 432 394	R 2394
77 01 205 278	1 987 432 009	M 2009

77 01 205 279	1 987 432 225	M 2225
77 01 205 281	1 987 432 089	M 2089
77 01 209 837	1 987 432 078	M 2078
77 01 409 324	1 987 432 095	M 2095
77 11 228 912	1 987 432 197	R 2197

77 11 228 915	1 987 432 389	R 2389
77 11 228 916	1 987 432 390	R 2390
77 11 228 917	1 987 432 525	R 2525
77 11 228 919	1 987 432 469	R 2469

ROVER

BTR 8037	1 987 432 169	M 2169
JKR 0000 40	1 987 432 482	R 2482
JKR 1000 20	1 987 432 121	M 2121

JKR 1000 80	1 987 432 053	M 2053
JKR 1000 80	1 987 432 121	M 2121
JKR 1001 83	1 987 432 182	M 2182
JKR 1001 93	1 987 432 482	R 2482
JKR 1002 80	1 987 432 116	M 2116

JKX 1000 10	1 987 432 026	M 2026
JKY 1000 20	1 987 432 121	M 2121
JMO 0000 10	1 987 432 425	R 2425

RYCO

RCA101P	1 987 432 030	M 2030
RCA102P	1 987 432 117	M 2117
RCA103P	1 987 432 012	M 2012

RCA103P	1 987 432 300	R 2300
RCA103P	1 987 432 312	R 2312
RCA104P	1 987 432 085	M 2085
RCA107P	1 987 432 161	M 2161
RCA112P	1 987 432 114	M 2114

RCA 114 P	1 987 432 040	M 2040
RCA115P	1 987 432 045	M 2045
RCA131P	1 987 432 076	M 2076
RCA134P	1 987 432 018	M 2018
RCA135C	1 987 432 425	R 2425

RCA138C	1 987 432 398	R 2398
RCA139P	1 987 432 071	M 2071
RCA140P	1 987 432 084	M 2084
RCA142P	1 987 432 021	M 2021
RCA144P	1 987 432 039	M 2039

RCA149C	1 987 432 097	M 2097
RCA149C	1 987 432 397	R 2397
RCA169C	1 987 432 402	R 2402

**SAAB
(SAAB AUTOMOBILE AB)**

12758727	1 987 432 401	R 2401
423 0322	1 987 432 096	M 2096

53 35 948	1 987 432 401	R 2401
53 35 955	1 987 432 401	R 2401
91 79 904	1 987 432 376	R 2376
91 79 905	1 987 432 076	M 2076

SEAT

6Q0 820 367	1 987 432 057	M 2057
SKODA		
6Q0 820 367	1 987 432 057	M 2057

SMART (MCC)

Q0001110V003	1 987 432 378	R 2378
Q0001110V004	1 987 432 378	R 2378
Q0013871V001	1 987 432 434	R 2434

000 1110 V003	1 987 432 378	R 2378
000 1110 V004	1 987 432 378	R 2378
001 3871 V001	1 987 432 434	R 2434
4548300018	1 987 432 434	R 2434

SOFIMA

S3001C	1 987 432 015	M 2015
S3004C	1 987 432 013	M 2013
S3006C	1 987 432 012	M 2012

S3010C	1 987 432 016	M 2016
S3011C	1 987 432 024	M 2024
S3012C	1 987 432 006	M 2006
S3014C	1 987 432 030	M 2030
S3016C	1 987 432 018	M 2018

S3018C	1 987 432 027	M 2027
S3021C	1 987 432 021	M 2021
S3027C	1 987 432 022	M 2022
S3031C	1 987 432 057	M 2057
S3033C	1 987 432 059	M 2059

S3034C	1 987 432 045	M 2045
S3035C	1 987 432 075	M 2075
S3036 C	1 987 432 089	M 2089
S3038C	1 987 432 079	M 2079
S3042C	1 987 432 042	M 2042

S3051A	1 987 431 159	M 1159
S3052C	1 987 432 058	M 2058
S3053C	1 987 432 151	M 2151
S3055C	1 987 431 165	M 1165
S3059C	1 987 432 043	M 2043

S3061C	1 987 432 009	M 2009
S3064C	1 987 432 037	M 2037
S3070C	1 987 432 060	M 2060
S3071C	1 987 432 011	M 2011
S3072C	1 987 432 150	M 2150

S3078C	1 987 431 166	M 1166
S3084C	1 987 432 090	M 2090
S3087C	1 987 432 069	M 2069
S3099C	1 987 432 050	M 2050
S3102C	1 987 432 113	M 2113

S3108C	1 987 432 074	M 2074
S3114C	1 987 432 044	M 2044
S3129C	1 987 432 113	M 2113
S4102CA	1 987 432 337	R 2337
S4107CA	1 987 432 303	R 2303

S4108CA	1 987 432 361	R 2361
S4109CA	1 987 432 300	R 2300
S4113CA	1 987 432 378	R 2378
S4114CA	1 987 432 357	R 2357
S4135CA	1 987 432 366	R 2366

S4142CA	1 987 432 412	R 2412
S4144CA	1 987 432 434	R 2434

SUBARU

G3210-FC000	1 987 432 218	M 2218
72880 AG000	1 987 432 085	M 2085
72880 AJ000	1 987 432 190	M 2190

87139 YZZ03	1 987 432 320	R 2320
95860 78F10	1 987 432 066	M 2066

SUZUKI

95860-51K00	1 987 432 214	M 2214
95860 51K00 000	1 987 432 214	M 2214
95860-62J00	1 987 432 173	M 2173

95860 62J00 000	1 987 432 173	M 2173
95860-63J10	1 987 432 173	M 2173
95860 63J10 000	1 987 432 173	M 2173
95860-78F00	1 987 432 066	M 2066
95860 78F 000	1 987 432 066	M 2066

95860 78F00 000	1 987 432 066	M 2066
95860-78F10	1 987 432 066	M 2066
95860 78F10 000	1 987 432 066	M 2066
95861 M68K10	1 987 432 148	M 2148
95861 M68K10B00	1 987 432 148	M 2148

95861-54G00	1 987 432 172	M 2172
95861 54G00 000	1 987 432 172	M 2172
95861-54J00	1 987 432 221	M 2221
95861 54J00 000	1 987 432 221	M 2221
95861-64J00	1 987 432 236	M 2236

◀ SUZUKI

95861 64J00 000	1 987 432 236	M 2236
95861-64J01	1 987 432 236	M 2236
95861 64J01 000	1 987 432 236	M 2236
95861-65D00	1 987 432 156	M 2156
95861 65D00 000	1 987 432 156	M 2156

TECALEMIT

E 344	1 987 432 039	M 2039
-------	---------------	--------

TECFIL

ACP004	1 987 432 111	M 2111
ACP131	1 987 432 072	M 2072

TECNOCAR

EC305	1 987 432 303	R 2303
EC319	1 987 432 009	M 2009
EC320	1 987 432 027	M 2027

EC323	1 987 432 306	R 2306
EC331	1 987 432 525	R 2525
EC332	1 987 432 089	M 2089
EC332	1 987 432 389	R 2389
EC344	1 987 432 039	M 2039

EC345	1 987 432 390	R 2390
EC346	1 987 432 366	R 2366
EC347	1 987 432 033	M 2033
EC348	1 987 432 061	M 2061
EC353	1 987 432 333	R 2333

EC355	1 987 432 360	R 2360
EC358	1 987 432 365	R 2365
EC363	1 987 432 345	R 2345
EC365	1 987 432 069	M 2069
EC378	1 987 432 062	M 2062

EC380	1 987 432 386	R 2386
EC3802	1 987 432 386	R 2386
EC381	1 987 432 300	R 2300
EC382	1 987 432 379	R 2379
EC387	1 987 432 371	R 2371

EC388	1 987 432 380	R 2380
EC390	1 987 432 336	R 2336
EC391	1 987 432 378	R 2378
EC393	1 987 432 377	R 2377
EC394	1 987 432 357	R 2357

EC395	1 987 432 382	R 2382
EC398	1 987 432 387	R 2387
EC400	1 987 432 376	R 2376
EC401	1 987 432 093	M 2093
EC404	1 987 432 301	R 2301

EC405	1 987 432 376	R 2376
EC409	1 987 432 397	R 2397
EC417	1 987 432 412	R 2412
EC420	1 987 432 402	R 2402
EC441	1 987 432 410	R 2410

EC443	1 987 432 361	R 2361
EC448	1 987 432 424	R 2424
E251	1 987 432 014	M 2014
E263	1 987 432 022	M 2022
E302	1 987 432 019	M 2019

E305	1 987 432 003	M 2003
E306	1 987 432 007	M 2007
E308	1 987 432 021	M 2021
E309	1 987 432 014	M 2014
E310	1 987 432 015	M 2015

E311	1 987 432 012	M 2012
E312	1 987 432 018	M 2018
E314	1 987 432 014	M 2014
E315	1 987 432 060	M 2060
E316	1 987 432 060	M 2060

E317	1 987 432 022	M 2022
E319	1 987 432 009	M 2009
E320	1 987 432 027	M 2027
E323	1 987 432 006	M 2006
E325	1 987 432 030	M 2030

E327	1 987 432 037	M 2037
E328	1 987 432 026	M 2026
E329	1 987 432 028	M 2028
E330	1 987 432 032	M 2032
E332	1 987 432 089	M 2089

E333	1 987 432 361	R 2361
E334	1 987 432 011	M 2011
E335	1 987 432 013	M 2013
E341	1 987 432 048	M 2048
E343	1 987 432 095	M 2095

E344	1 987 432 039	M 2039
E345	1 987 432 090	M 2090
E346	1 987 432 016	M 2016
E347	1 987 432 033	M 2033
E348	1 987 432 061	M 2061

E353	1 987 432 024	M 2024
E354	1 987 432 049	M 2049
E356	1 987 432 052	M 2052
E359	1 987 432 084	M 2084
E360	1 987 432 044	M 2044

E363	1 987 432 045	M 2045
E365	1 987 432 069	M 2069
E366	1 987 432 040	M 2040
E369	1 987 432 064	M 2064
E371	1 987 432 107	M 2107

E373	1 987 432 066	M 2066
E376	1 987 432 043	M 2043
E382	1 987 432 079	M 2079
E385	1 987 432 056	M 2056
E387	1 987 432 071	M 2071

E391	1 987 432 378	R 2378
E392	1 987 432 088	M 2088
E394	1 987 432 057	M 2057
E396	1 987 432 083	M 2083
E397	1 987 432 070	M 2070

E400	1 987 432 076	M 2076
E401	1 987 432 093	M 2093
E403	1 987 432 072	M 2072
E407	1 987 432 075	M 2075
E408	1 987 432 091	M 2091

E409	1 987 432 097	M 2097
E410	1 987 432 111	M 2111
E411	1 987 432 120	M 2120
E413	1 987 432 114	M 2114
E414	1 987 432 085	M 2085

E421	1 987 432 074	M 2074
E424	1 987 432 058	M 2058
E425	1 987 432 105	M 2105
E427	1 987 432 096	M 2096
E430	1 987 432 042	M 2042

E432	1 987 432 106	M 2106
E436	1 987 432 063	M 2063
E439	1 987 432 094	M 2094
E442	1 987 432 113	M 2113
E450	1 987 432 116	M 2116

E505	1 987 432 151	M 2151
E508	1 987 432 150	M 2150
E509	1 987 431 159	M 1159
E510	1 987 431 165	M 1165
E511	1 987 432 152	M 2152

E512	1 987 431 163	M 1163
------	---------------	--------

TEHO

21159	1 987 432 150	M 2150
21171	1 987 432 151	M 2151
21231	1 987 431 458	R 1458

29000	1 987 432 018	M 2018
29002	1 987 432 026	M 2026
29003	1 987 432 013	M 2013
29005	1 987 432 012	M 2012
29008	1 987 432 030	M 2030

29011	1 987 432 015	M 2015
29012	1 987 432 011	M 2011
29014	1 987 432 062	M 2062
29015	1 987 432 022	M 2022
29016	1 987 432 003	M 2003

29018	1 987 432 006	M 2006
29019	1 987 432 062	M 2062
29021	1 987 432 300	R 2300
29022	1 987 432 016	M 2016
29023	1 987 432 024	M 2024

29024	1 987 432 014	M 2014
29025	1 987 432 028	M 2028
29026	1 987 432 019	M 2019
29027	1 987 432 043	M 2043
29029	1 987 432 071	M 2071

29029	1 987 432 371	R 2371
29031	1 987 432 040	M 2040
29033	1 987 432 045	M 2045
29034	1 987 432 062	M 2062
29034	1 987 432 064	M 2064

29035	1 987 432 070	M 2070
29036	1 987 432 018	M 2018
29036	1 987 432 073	M 2073
29039	1 987 432 009	M 2009
29040	1 987 432 021	M 2021

29044	1 987 432 027	M 2027
29046	1 987 432 056	M 2056
29047	1 987 432 039	M 2039
29048	1 987 432 057	M 2057
29049	1 987 432 042	M 2042

29050	1 987 432 076	M 2076
29051	1 987 432 075	M 2075
29056	1 987 432 037	M 2037
29057	1 987 432 069	M 2069
29058	1 987 432 090	M 2090

29059	1 987 432 079	M 2079
29060	1 987 432 076	M 2076
29061	1 987 432 053	M 2053
29065	1 987 432 074	M 2074
29067	1 987 432 083	M 2083

TOYOTA

80508 20130	1 987 432 159	M 2159
87139 YZZ01	1 987 432 319	R 2319
87139-YZZ02	1 987 432 468	R 2468

87139YZZ03	1 987 432 320	R 2320
87139 YZZ07	1 987 432 088	M 2088
87139YZZ08	1 987 432 190	M 2190
87139-OD010	1 987 432 190	M 2190
87139 02020	1 987 432 190	M 2190



T

◀ TOYOTA

87139-06030	1 987 432 085	M 2085
87139-06040	1 987 432 085	M 2085
87139-06080	1 987 432 190	M 2190
87139-07010	1 987 432 190	M 2190
87139-08030	1 987 432 085	M 2085

87139-28010	1 987 432 085	M 2085
87139-30040	1 987 432 190	M 2190
87139-30070	1 987 432 190	M 2190
87139-32010	1 987 432 085	M 2085
87139-33010	1 987 432 320	R 2320

87139-47010	1 987 432 085	M 2085
87139-47010 83	1 987 432 085	M 2085
87139-49010	1 987 432 085	M 2085
87139-50010	1 987 432 468	R 2468
87139-50010	1 987 432 482	R 2482

87139-50030	1 987 432 319	R 2319
87139-52010	1 987 432 084	M 2084
87139-52020	1 987 432 190	M 2190
88508-0H010	1 987 432 189	M 2189
88508-12010	1 987 432 155	M 2155

88508-12020	1 987 432 155	M 2155
88508-12030	1 987 432 155	M 2155
88508-20040	1 987 432 159	M 2159
88508-20060	1 987 432 159	M 2159
88508-20070	1 987 432 159	M 2159

88508-20080	1 987 432 159	M 2159
88508-20090	1 987 432 159	M 2159
88508-20120	1 987 432 085	M 2085
88508-20150	1 987 432 159	M 2159
88568-02030	1 987 432 088	M 2088

88568-52010	1 987 432 084	M 2084
88568-52010 83	1 987 432 084	M 2084
88880-20020	1 987 432 159	M 2159
88880-20050	1 987 432 159	M 2159
88880-20060	1 987 432 159	M 2159

88880-20110	1 987 432 159	M 2159
88880-44040	1 987 432 159	M 2159

TTV GERMANY

TI1558	1 987 432 312	R 2312
TI545	1 987 432 015	M 2015
TI546	1 987 432 016	M 2016

TI551	1 987 432 018	M 2018
TI553	1 987 432 012	M 2012
TI555	1 987 432 011	M 2011
TI556	1 987 432 022	M 2022
TI557	1 987 432 021	M 2021

TI558	1 987 432 012	M 2012
TI564	1 987 432 024	M 2024
TI568	1 987 432 030	M 2030
TI569	1 987 432 006	M 2006
TI573	1 987 432 009	M 2009

TI577	1 987 432 013	M 2013
TI602	1 987 432 027	M 2027
TI605	1 987 432 043	M 2043
TI611	1 987 432 024	M 2024
TI616	1 987 432 089	M 2089

UFI

3005100	1 987 431 159	M 1159
5300100	1 987 432 015	M 2015
5300140	1 987 432 015	M 2015

5300200	1 987 432 033	M 2033
5300240	1 987 432 033	M 2033
5300400	1 987 432 013	M 2013
5300440	1 987 432 013	M 2013
5300600	1 987 432 012	M 2012

5300640	1 987 432 012	M 2012
5301000	1 987 432 016	M 2016
5301040	1 987 432 016	M 2016
5301100	1 987 432 024	M 2024
5301140	1 987 432 024	M 2024

5301200	1 987 432 006	M 2006
5301240	1 987 432 006	M 2006
5301400	1 987 432 030	M 2030
5301440	1 987 432 030	M 2030
5301600	1 987 432 018	M 2018

5301640	1 987 432 018	M 2018
5301700	1 987 432 028	M 2028
5301740	1 987 432 028	M 2028
5301800	1 987 432 027	M 2027
5301900	1 987 432 014	M 2014

5302100	1 987 432 021	M 2021
5302300	1 987 432 003	M 2003
5302400	1 987 432 019	M 2019
5302700	1 987 432 022	M 2022
5302800	1 987 432 007	M 2007

5302900	1 987 432 360	R 2360
5303100	1 987 432 057	M 2057
5303200	1 987 432 071	M 2071
5303300	1 987 432 059	M 2059
5303400	1 987 432 045	M 2045

5303500	1 987 432 075	M 2075
5303600	1 987 432 089	M 2089
5303700	1 987 432 049	M 2049
5303800	1 987 432 079	M 2079
5303900	1 987 432 083	M 2083

5304200	1 987 432 042	M 2042
5304300	1 987 432 072	M 2072
5304400	1 987 432 048	M 2048
5304500	1 987 432 076	M 2076
5304600	1 987 432 032	M 2032

5304700	1 987 432 040	M 2040
5305000	1 987 432 084	M 2084
5305200	1 987 432 058	M 2058
5305300	1 987 432 151	M 2151
5305500	1 987 431 165	M 1165

5305900	1 987 432 043	M 2043
5306000	1 987 432 039	M 2039
5306100	1 987 432 009	M 2009
5306200	1 987 432 152	M 2152
5306300	1 987 432 053	M 2053

5306400	1 987 432 037	M 2037
5306700	1 987 432 056	M 2056
5306800	1 987 432 052	M 2052
5306900	1 987 432 091	M 2091
5307000	1 987 432 060	M 2060

5307100	1 987 432 011	M 2011
5307200	1 987 432 150	M 2150
5307400	1 987 432 107	M 2107
5307500	1 987 432 066	M 2066
5307800	1 987 431 166	M 1166

5307900	1 987 432 062	M 2062
5308200	1 987 432 095	M 2095
5308300	1 987 432 061	M 2061
5308400	1 987 432 090	M 2090
5308700	1 987 432 069	M 2069

5308800	1 987 432 106	M 2106
5309100	1 987 432 064	M 2064
5309300	1 987 432 092	M 2092
5309400	1 987 432 070	M 2070
5309500	1 987 432 081	M 2081

5309800	1 987 432 111	M 2111
5309900	1 987 432 050	M 2050
5310100	1 987 432 082	M 2082
5310200	1 987 432 113	M 2113
5310300	1 987 432 085	M 2085

5310400	1 987 432 120	M 2120
5310500	1 987 432 116	M 2116
5310600	1 987 432 094	M 2094
5310700	1 987 432 093	M 2093
5310800	1 987 432 074	M 2074

5311300	1 987 432 183	M 2183
5311400	1 987 432 044	M 2044
5311700	1 987 432 155	M 2155
5312400	1 987 432 188	M 2188
5312500	1 987 432 088	M 2088

5312900	1 987 432 113	M 2113
5313600	1 987 432 206	M 2206
5315100	1 987 432 222	M 2222
5410000	1 987 432 376	R 2376
5410100	1 987 432 371	R 2371

5410200	1 987 432 337	R 2337
5410300	1 987 432 377	R 2377
5410400	1 987 432 386	R 2386
5410500	1 987 432 360	R 2360
5410600	1 987 432 345	R 2345

5410700	1 987 432 303	R 2303
5410800	1 987 432 361	R 2361
5410900	1 987 432 300	R 2300
5411100	1 987 432 379	R 2379
5411300	1 987 432 378	R 2378

5411400	1 987 432 357	R 2357
5411500	1 987 432 387	R 2387
5411600	1 987 432 306	R 2306
5411800	1 987 432 328	R 2328
5412100	1 987 432 336	R 2336

5412200	1 987 432 380	R 2380
5412400	1 987 432 397	R 2397
5412700	1 987 432 402	R 2402
5412800	1 987 432 425	R 2425
5413100	1 987 432 370	R 2370

5413400	1 987 432 411	R 2411
5413500	1 987 432 366	R 2366
5413600	1 987 432 409	R 2409
5413700	1 987 432 382	R 2382
5413900	1 987 432 401	R 2401

5414000	1 987 432 428	R 2428
5414200	1 987 432 412	R 2412
5414400	1 987 432 434	R 2434
5414600	1 987 432 410	R 2410
5414800	1 987 432 431	R 2431

5415000	1 987 432 433	R 2433
5415300	1 987 432 422	R 2422
5415400	1 987 432 424	R 2424
5415900	1 987 432 405	R 2405
5416000	1 987 432 406	R 2406

UNIPART

GFE2902	1 987 432 018	M 2018
GFE2904	1 987 432 015	M 2015
GFE2905	1 987 432 030	M 2030

GFE2906	1 987 432 022	M 2022
GFE2907	1 987 432 012	M 2012
GFE2909	1 987 432 024	M 2024
GFE2911	1 987 432 006	M 2006
GFE2914	1 987 432 016	M 2016



U

◀ UNIPART

GFE2919	1 987 432 011	M 2011
GFE2921	1 987 432 013	M 2013
GFE2933	1 987 432 042	M 2042
GFE2936	1 987 432 026	M 2026
GFE2939	1 987 432 009	M 2009

GFE2940	1 987 432 021	M 2021
GFE2941	1 987 432 050	M 2050

VALEO

006535	1 987 432 076	M 2076
651888	1 987 432 089	M 2089
656135	1 987 432 021	M 2021

656135L	1 987 432 021	M 2021
698146	1 987 432 021	M 2021
698149	1 987 432 009	M 2009
698159	1 987 432 012	M 2012
698160	1 987 432 012	M 2012

698161	1 987 432 011	M 2011
698163	1 987 432 013	M 2013
698166	1 987 432 015	M 2015
698167	1 987 432 016	M 2016
698168	1 987 432 018	M 2018

698170	1 987 432 032	M 2032
698173	1 987 432 027	M 2027
698174	1 987 432 014	M 2014
698177	1 987 432 089	M 2089
698196	1 987 432 026	M 2026

698197	1 987 432 003	M 2003
698198	1 987 432 019	M 2019
698201	1 987 432 006	M 2006
698202	1 987 432 030	M 2030
698203	1 987 432 007	M 2007

698205	1 987 432 022	M 2022
698235	1 987 432 022	M 2022
698246	1 987 432 361	R 2361
698247	1 987 432 028	M 2028
698255	1 987 432 039	M 2039

698279	1 987 432 090	M 2090
698290	1 987 432 049	M 2049
698470	1 987 432 362	R 2362
698475	1 987 432 037	M 2037
698478	1 987 432 052	M 2052

698487	1 987 432 045	M 2045
698488	1 987 432 048	M 2048
698489	1 987 432 336	R 2336
698512	1 987 432 069	M 2069
698535	1 987 432 072	M 2072

698535	1 987 432 336	R 2336
698606	1 987 432 371	R 2371
698662	1 987 432 040	M 2040
698664	1 987 432 079	M 2079
698679	1 987 432 012	M 2012

698680	1 987 432 354	R 2354
698682	1 987 432 324	R 2324
698685	1 987 432 057	M 2057
698686	1 987 432 312	R 2312
698687	1 987 432 303	R 2303

698691	1 987 432 107	M 2107
698695	1 987 432 303	R 2303
698696	1 987 432 328	R 2328
698700	1 987 432 070	M 2070
698702	1 987 432 081	M 2081

698707	1 987 432 058	M 2058
698710	1 987 432 376	R 2376
698714	1 987 432 379	R 2379
698716	1 987 432 300	R 2300
698732	1 987 432 060	M 2060

698733	1 987 432 060	M 2060
698734	1 987 432 075	M 2075
698735	1 987 432 074	M 2074
698739	1 987 432 357	R 2357
698744	1 987 432 337	R 2337

698746	1 987 432 366	R 2366
698768	1 987 432 431	R 2431
698774	1 987 432 378	R 2378
698776	1 987 432 425	R 2425
698779	1 987 432 030	M 2030

698792	1 987 432 423	R 2423
698802	1 987 432 434	R 2434
698840	1 987 432 043	M 2043
698852	1 987 432 057	M 2057
698854	1 987 432 069	M 2069

698858	1 987 432 042	M 2042
698863	1 987 432 102	M 2102
698884	1 987 432 412	R 2412
698885	1 987 432 012	M 2012
708146	1 987 432 021	M 2021

708149	1 987 432 009	M 2009
708163	1 987 432 013	M 2013
708166	1 987 432 015	M 2015
708167	1 987 432 016	M 2016
708168	1 987 432 018	M 2018

708173	1 987 432 027	M 2027
708177	1 987 432 089	M 2089
708196	1 987 432 026	M 2026
708201	1 987 432 006	M 2006
708202	1 987 432 030	M 2030

708235	1 987 432 022	M 2022
708246	1 987 432 361	R 2361
708279	1 987 432 090	M 2090
708454	1 987 432 059	M 2059
708475	1 987 432 037	M 2037

708487	1 987 432 045	M 2045
708512	1 987 432 069	M 2069
708530	1 987 432 060	M 2060
708664	1 987 432 079	M 2079
708679	1 987 432 012	M 2012

708685	1 987 432 057	M 2057
708686	1 987 432 312	R 2312
708707	1 987 432 058	M 2058
708716	1 987 432 300	R 2300
708735	1 987 432 074	M 2074

708748	1 987 432 407	R 2407
708884	1 987 432 412	R 2412
715502	1 987 432 124	M 2124
715505	1 987 432 428	R 2428
715510	1 987 432 113	M 2113

715528	1 987 432 207	M 2207
715530	1 987 432 060	M 2060
715564	1 987 432 236	M 2236
715577	1 987 432 044	M 2044
715609	1 987 432 236	M 2236

715612	1 987 432 354	R 2354
715613	1 987 432 206	M 2206
715614	1 987 432 406	R 2406
715627	1 987 432 113	M 2113
715632	1 987 432 310	R 2310

715646	1 987 432 041	M 2041
715665	1 987 432 597	R 2597
983186C	1 987 432 597	R 2597

VALMET

698 861	1 987 432 068	M 2068
698 862	1 987 432 368	R 2368
715 635	1 987 432 311	R 2311

VAUXHALL

1808600	1 987 432 091	M 2091
1808602	1 987 432 091	M 2091
1808619	1 987 432 076	M 2076

1808624	1 987 432 376	R 2376
55702468	1 987 432 488	R 2488
6808600	1 987 432 091	M 2091
6808601	1 987 432 076	M 2076
90386776	1 987 432 015	M 2015

90458294	1 987 432 016	M 2016
90509367	1 987 432 015	M 2015
90510338	1 987 432 016	M 2016
90512779	1 987 432 030	M 2030
9201440	1 987 432 076	M 2076

9201441	1 987 432 076	M 2076
93172129	1 987 432 376	R 2376
93172299	1 987 432 076	M 2076
93197779	1 987 432 078	M 2078

VEMO

10301001	1 987 432 011	M 2011
10301013	1 987 432 012	M 2012
10301016	1 987 432 013	M 2013

10301016	1 987 432 313	R 2313
10301025	1 987 432 024	M 2024
10302526	1 987 432 057	M 2057
10311013	1 987 432 312	R 2312
10311016	1 987 432 313	R 2313

10311025	1 987 432 024	M 2024
10311040	1 987 432 300	R 2300
10311043	1 987 432 357	R 2357
20301009	1 987 432 102	M 2102
20301040	1 987 432 361	R 2361

203010401	1 987 432 361	R 2361
20311036	1 987 432 361	R 2361
20311038	1 987 432 361	R 2361
22301001	1 987 432 042	M 2042
22301006	1 987 432 079	M 2079

22302020	1 987 432 021	M 2021
22311001	1 987 432 021	M 2021
22311002	1 987 432 042	M 2042
22311008	1 987 432 354	R 2354
24301002	1 987 432 059	M 2059

24301101	1 987 432 303	R 2303
24311101	1 987 432 303	R 2303
25301002	1 987 432 045	M 2045
25301071	1 987 432 018	M 2018
25301072	1 987 432 006	M 2006

25301075	1 987 432 018	M 2018
26301001	1 987 432 026	M 2026
26301004	1 987 432 074	M 2074
30301004	1 987 432 378	R 2378
30301012	1 987 432 037	M 2037

30301021	1 987 432 150	M 2150
30301025	1 987 432 043	M 2043
30301035	1 987 432 044	M 2044
30311026	1 987 432 337	R 2337
30311040	1 987 432 378	R 2378



V

◀ VEMO

30311044	1 987 432 044	M 2044
30311047	1 987 432 434	R 2434
34302000	1 987 432 151	M 2151
34302004	1 987 431 163	M 1163
34311000	1 987 432 151	M 2151

34311002	1 987 431 458	R 1458
38301003	1 987 432 075	M 2075
38301004	1 987 432 058	M 2058
40301100	1 987 432 310	R 2310
40301101	1 987 432 015	M 2015

40301102	1 987 432 016	M 2016
40301103	1 987 432 030	M 2030
403011031	1 987 432 030	M 2030
40311110	1 987 432 030	M 2030
40311111	1 987 432 366	R 2366

40311115	1 987 432 310	R 2310
42301201	1 987 432 022	M 2022
42311005	1 987 432 412	R 2412
46301002	1 987 432 090	M 2090
46301003	1 987 432 089	M 2089

46301004	1 987 432 069	M 2069
46301061	1 987 432 027	M 2027
46301062	1 987 432 009	M 2009
46311003	1 987 432 090	M 2090
46311004	1 987 432 009	M 2009

46311005	1 987 432 089	M 2089
46311009	1 987 432 069	M 2069

VOLVO

11007388	1 987 431 159	M 1159
110073889	1 987 431 159	M 1159
1313232	1 987 432 062	M 2062

1313232-3	1 987 432 062	M 2062
1343232-2	1 987 432 062	M 2062
1584575	1 987 431 159	M 1159
15845753	1 987 431 159	M 1159
20409908	1 987 431 451	R 1451

30612666	1 987 432 063	M 2063
30630754	1 987 432 464	R 2464
30676413	1 987 432 064	M 2064
30676413	1 987 432 464	R 2464
30676484	1 987 432 413	R 2413

30733893	1 987 432 405	R 2405
30733894	1 987 432 205	M 2205
30767022	1 987 432 205	M 2205
30767024	1 987 432 405	R 2405
30780377	1 987 432 413	R 2413

30818694	1 987 432 157	M 2157
30818694-9	1 987 432 157	M 2157
30883952	1 987 432 363	R 2363
4771477	1 987 431 159	M 1159
8687389	1 987 432 113	M 2113

9134577	1 987 432 062	M 2062
9171296	1 987 432 062	M 2062
9171296-8	1 987 432 062	M 2062
9171483	1 987 432 062	M 2062
9171756	1 987 432 464	R 2464

9184130	1 987 432 062	M 2062
9192522	1 987 432 062	M 2062
9192523	1 987 432 062	M 2062
9204626	1 987 432 064	M 2064
9204626-7	1 987 432 064	M 2064

VW (VOLKSWAGEN)

1H0 091 800	1 987 432 312	R 2312
1H0 819 644	1 987 432 012	M 2012
1H0 091 800	1 987 432 312	R 2312

1H0 091 800 SE	1 987 432 312	R 2312
1H0 819 638 A	1 987 432 012	M 2012
1H0 819 638 B	1 987 432 012	M 2012
1H0 819 644	1 987 432 012	M 2012
1H0 819 644 A	1 987 432 012	M 2012

1H0 819 644 B	1 987 432 012	M 2012
1J0 819 644	1 987 432 300	R 2300
1J0 819 644 A	1 987 432 300	R 2300
1K0 819 644	1 987 432 097	M 2097
1K0 819 644 A	1 987 432 097	M 2097

1K0 819 644 B	1 987 432 097	M 2097
1K1 819 653	1 987 432 397	R 2397
1K1 819 653 A	1 987 432 397	R 2397
1K1 819 653 B	1 987 432 397	R 2397
1K2 819 653	1 987 432 597	R 2597

1K2 819 653 A	1 987 432 597	R 2597
1K2 819 653 B	1 987 432 597	R 2597
191 091 700	1 987 432 011	M 2011
191 819 638	1 987 432 011	M 2011
2D0 819 638	1 987 432 043	M 2043

2D0 819 638 A	1 987 432 043	M 2043
2E0 819 638	1 987 432 213	M 2213
2E0 819 638 A	1 987 432 513	R 2513
3A0 091 800	1 987 432 313	R 2313
3A0 819 638	1 987 432 013	M 2013

3A0 819 644	1 987 432 013	M 2013
3B0 091 800	1 987 432 317	R 2317
4A0 091 800	1 987 432 333	R 2333
4A0 819 430 A	1 987 432 324	R 2324
4A0 819 439 A	1 987 432 024	M 2024

4A1 820 367	1 987 432 033	M 2033
4B0 091 800	1 987 432 324	R 2324
4B0 819 439	1 987 432 324	R 2324
4B0 819 439 A	1 987 432 324	R 2324
4B0 819 439 C	1 987 432 371	R 2371

4D0 819 439 A	1 987 432 367	R 2367
4E0 819 439 A	1 987 432 423	R 2423
4F0 819 439 A	1 987 432 422	R 2422
4F0 819 439 C	1 987 432 422	R 2422
4F0 898 438 A	1 987 432 422	R 2422

4F0 898 438 B	1 987 432 422	R 2422
4F0 898 438 C	1 987 432 422	R 2422
6Q0 819 653	1 987 432 357	R 2357
6Q0 820 367	1 987 432 057	M 2057
6Q0 820 367 B	1 987 432 057	M 2057

680 317 305 00	1 987 432 328	R 2328
7D0 819 989	1 987 432 056	M 2056
7H0819631	1 987 432 114	M 2114
7H0 819 631 A	1 987 432 431	R 2431
7M0 091 800	1 987 432 328	R 2328

7M0 819 638 A	1 987 432 028	M 2028
7M0 819 644	1 987 432 028	M 2028
703 819 989	1 987 432 056	M 2056
8D0 091 800	1 987 432 317	R 2317
8E0 819 439	1 987 432 071	M 2071

8L0 091 800	1 987 432 312	R 2312
-------------	---------------	--------

WEBASTO

9000709A	1 987 431 166	M 1166
----------	---------------	--------

WESFIL

WACF0016	1 987 432 012	M 2012
WACF0016	1 987 432 300	R 2300
WACF0019	1 987 432 030	M 2030

WACF0022	1 987 432 114	M 2114
WACF0038	1 987 432 117	M 2117
WACF0039	1 987 432 071	M 2071
WACF0040	1 987 432 084	M 2084
WACF0051	1 987 432 045	M 2045

WACF2225	1 987 432 021	M 2021
WACF2945	1 987 432 039	M 2039
WACF3054	1 987 432 040	M 2040
WACF3337	1 987 432 076	M 2076
WACF5231	1 987 432 085	M 2085

WACF5257	1 987 432 018	M 2018
----------	---------------	--------

WIX

SP9232	1 987 432 124	M 2124
WP2030	1 987 432 222	M 2222
WP6801	1 987 432 310	R 2310

WP6802	1 987 432 016	M 2016
WP6803	1 987 432 366	R 2366
WP6804	1 987 432 015	M 2015
WP6812	1 987 432 012	M 2012
WP6813	1 987 432 312	R 2312

WP6814	1 987 432 021	M 2021
WP6816	1 987 432 018	M 2018
WP6818	1 987 432 030	M 2030
WP6820	1 987 432 006	M 2006
WP6822	1 987 432 105	M 2105

WP6834	1 987 432 026	M 2026
WP6836	1 987 432 022	M 2022
WP6841	1 987 432 407	R 2407
WP6844	1 987 432 027	M 2027
WP6846	1 987 432 009	M 2009

WP6864	1 987 432 024	M 2024
WP6871	1 987 432 303	R 2303
WP6890	1 987 432 013	M 2013
WP6891	1 987 432 313	R 2313
WP6895	1 987 432 300	R 2300

WP6898	1 987 432 011	M 2011
WP6906	1 987 432 060	M 2060
WP6908	1 987 432 060	M 2060
WP6912	1 987 432 042	M 2042
WP6914	1 987 432 037	M 2037

WP6915	1 987 432 337	R 2337
WP6932	1 987 432 090	M 2090
WP6936	1 987 432 045	M 2045
WP6938	1 987 432 069	M 2069
WP6944	1 987 432 050	M 2050

WP6955	1 987 432 361	R 2361
WP6964	1 987 432 006	M 2006
WP6966	1 987 432 089	M 2089
WP6976	1 987 432 102	M 2102
WP6977	1 987 432 102	M 2102

WP6978	1 987 432 044	M 2044
WP6980	1 987 432 058	M 2058
WP6984	1 987 432 043	M 2043
WP9009	1 987 432 378	R 2378
WP9036	1 987 432 057	M 2057



W

◀ WIX

WP9037	1 987 432 357	R 2357
WP9094	1 987 432 050	M 2050
WP9104	1 987 432 075	M 2075
WP9112	1 987 432 079	M 2079
WP9144	1 987 432 060	M 2060
WP9164	1 987 432 109	M 2109
WP9165	1 987 432 109	M 2109
WP9183	1 987 432 412	R 2412
WP9206	1 987 432 074	M 2074
WP9230	1 987 432 113	M 2113
WP9271	1 987 432 378	R 2378
WP9309	1 987 432 405	R 2405
WP9311	1 987 432 406	R 2406
WP9336	1 987 432 078	M 2078
1153N	1 987 431 154	M 1154
24771	1 987 432 018	M 2018
24779	1 987 432 013	M 2013
24781	1 987 432 016	M 2016
24817	1 987 432 074	M 2074
24865	1 987 432 030	M 2030
93116E	1 987 432 151	M 2151
93223E	1 987 432 150	M 2150
93227E	1 987 431 163	M 1163
93228E	1 987 431 458	R 1458
93230E	1 987 431 165	M 1165



de

Einbauanleitung

Auf den folgenden Seiten finden Sie Hinweise zum Einbau des Innenraumfilters.

Die Referenznummern sind in aufsteigender Reihenfolge sortiert.

Hinweis: Wenn sich zwei Referenznummern auf einer Einbauanleitung befinden, steht die erste Nummer für das Standardprogramm, die zweite Nummer für das Aktivkohleprogramm, z. B. Standardprogramm 1 987 432 **012** und Aktivkohleprogramm 1 987 432 **312**.

en

Installation instructions

The following pages provide instructions for installing the interior filter.

The reference numbers are sorted in ascending order.

Note: If installation instructions have two reference numbers, the first number represents the standard program and the second number the activated charcoal program, e.g. standard program 1 987 432 **012** and activated charcoal program 1 987 432 **312**.

fr

Notice de montage

Vous trouverez sur les pages qui suivent les instructions de montage du filtre d'habitacle.

Les numéros de référence sont classés en ordre croissant.

Remarque: Si une notice de montage comporte deux numéros de référence, le premier numéro correspond à la gamme standard et le second à la gamme à charbon actif, par ex. gamme standard 1 987 432 **012** et gamme à charbon actif 1 987 432 **312**.

it

Istruzioni di montaggio

Le seguenti pagine contengono delle avvertenze relative al montaggio del filtro abitacolo.

I numeri di riferimento sono classificati in ordine crescente.

Nota: Se nelle istruzioni di montaggio vengono riportati due numeri di riferimento, il primo numero indica il programma standard, mentre il secondo numero indica il programma al carbone attivo, ad es. programma standard 1 987 432 **012** e programma al carbone attivo 1 987 432 **312**.

es

Instrucciones de montaje

En las siguientes páginas encontrará instrucciones para el montaje del filtro para el habitáculo.

Los números de referencia están ordenados en una secuencia ascendente.

Nota: Cuando hay dos números de referencia en las mismas instrucciones de montaje, el primero corresponde al programa estándar y el segundo al programa de carbón activo. Por ejemplo, programa estándar 1 987 432 **012** y programa de carbono activo 1 987 432 **312**.

pt

Instruções de montagem

Nas páginas que se seguem irá encontrar indicações para a montagem do filtro purificador do habitáculo.

Os números de referência estão ordenados por ordem ascendente.

Nota: Se existirem dois números de referência nas instruções de montagem, o primeiro número refere-se ao programa standard e o segundo ao programa de carvão activo, p. ex. programa standard 1 987 432 **012** e programa de carvão activo 1 987 432 **312**.

nl

Inbouwhandleiding

Op de volgende pagina's vindt u aanwijzingen over de inbouw van het interieurfilter.

De referentienummers zijn in oplopende volgorde gesorteerd.

Opmerking: Als er twee referentienummers op een inbouwhandleiding zijn, staat het eerste nummer voor het standaardprogramma, het tweede nummer voor het actieve koolprogramma b.v. standaardprogramma 1 987 432 **012** en actieve koolprogramma 1 987 432 **312**.

sv

Monteringsanvisning

De följande sidorna innehåller anvisningar för kupéfiltrets montering.

Referensnumren är sorterade i stigande ordningsföljd.

Anvisning: När två referensnummer finns på samma monteringsanvisning, avser det första numret standardprogrammet och det andra numret aktivtkolprogrammet, t.ex. standardprogram 1 987 432 **012** och aktivtkolprogram 1 987 432 **312**.

cs

Návod k montáži

Na následujících stránkách jsou pokyny k montáži filtru vnitřního prostoru.

Čísla referencí jsou seřazena ve vzestupném pořadí.

Upozornění: Nachází-li se v jednom návodu k montáži dvě čísla referencí, znamená první číslo standardní program, druhé číslo pak program filtru s aktivním uhlím, např. Standardní program je označen číslem 1 987 432 **012** a Program filtru s aktivním uhlím je označen číslem 1 987 432 **312**.

ru

Руководство по установке

На следующих страницах даются указания по установке фильтра салона.

Контрольные номера рассортированы в возрастающей последовательности.

Указание: Если в руководстве по установке имеется два контрольных номера, то первый номер означает стандартную программу, а второй – программу с активированным углем, например, стандартная программа 1 987 432 **012** и программа с активированным углем 1 987 432 **312**.

Mercedes-Benz

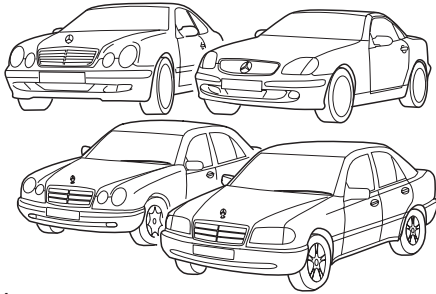

1 987 432 001
1 987 432 301

Mercedes-Benz

MB CLK	06.97 →
MB SLK	09.96 →
MB SLK	* 06.97 →
MB C 180 - C 280	03.93 →
MB E 200 - E 320	06.95 →

CLK, SLK

D

①

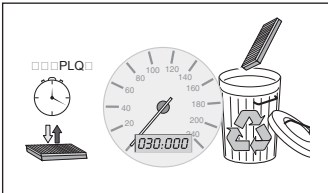

④

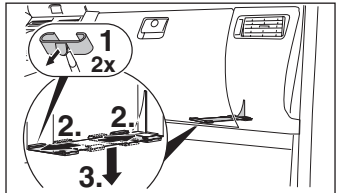

②

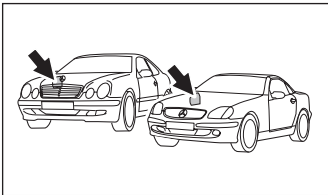

⑤

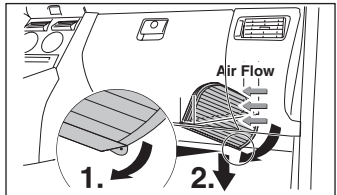

③

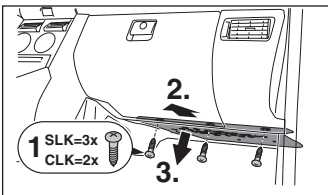

C 180 - C 280, E 200 - E 320

1

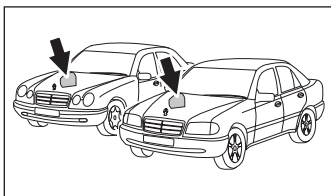

3

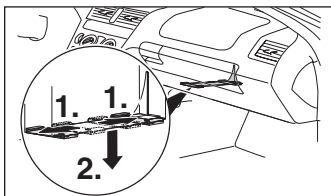

2

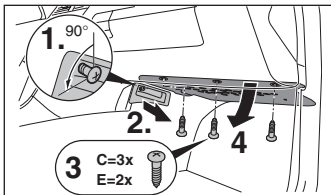

4

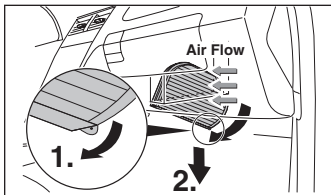

D

BMW

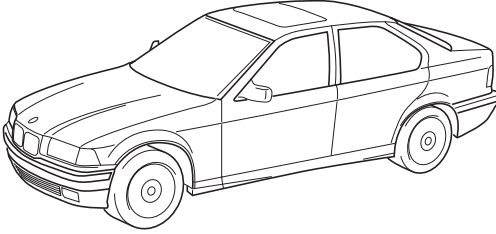

1 987 432 002

BMW 316i, 318i	* 12.90 →
BMW 320i, 325i	* 09.90 →
BMW 323i	* 06.95 →
BMW 328i	* 03.95 →
BMW 316 - 325 tds	* 09.91 →

316i - 328i, 316 - 325 tds

①

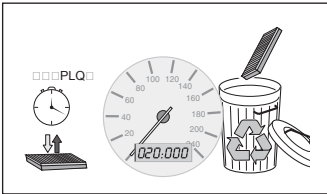

③

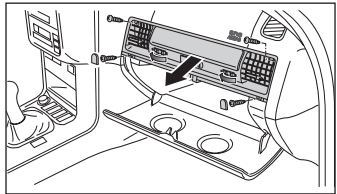

②

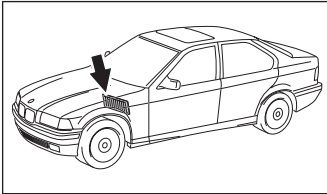

④

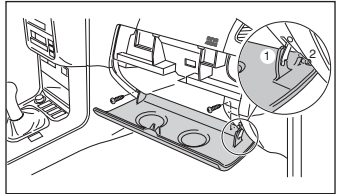

D

316i - 328i, 316 - 325 tds

5

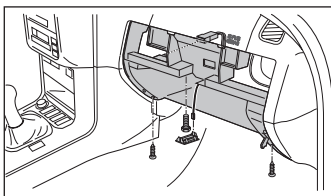

7

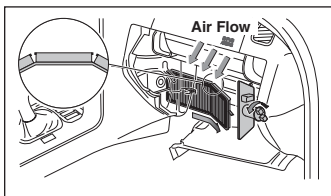

6

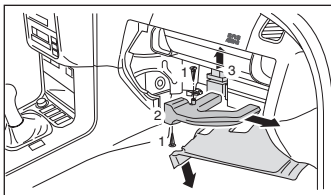

Alfa Romeo, Fiat, Lancia

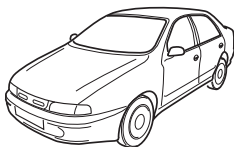
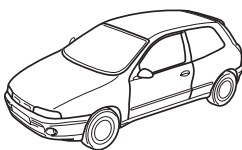
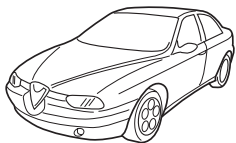

1 987 432 003
1 987 432 303

Alfa Romeo 156
Fiat Bravo/Brava
Fiat Marea
Lancia Lybra

* 10.97 →
* 10.95 →
* 10.96 →
* 10.99 →

156

①

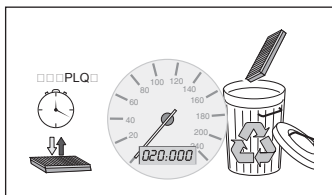

④

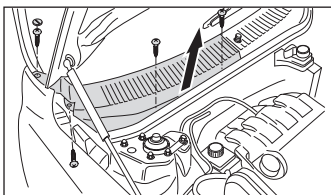

②

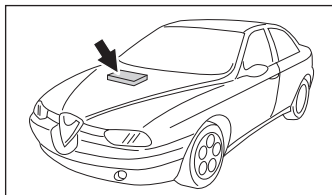

⑤

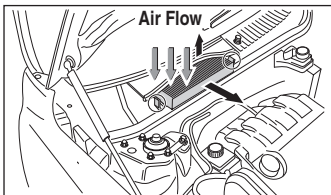

③

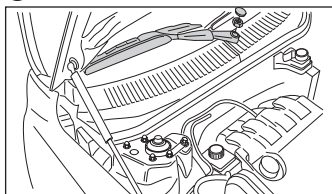

Bravo/Brava

①

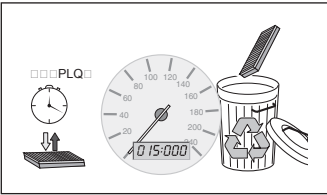

③

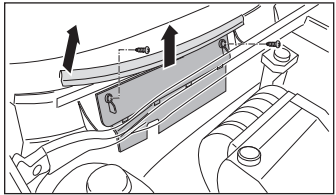

②

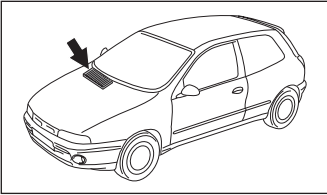

④

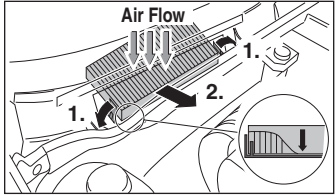

Marea

①

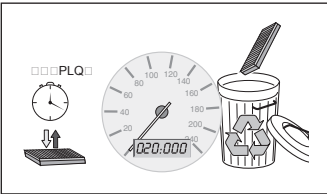

③

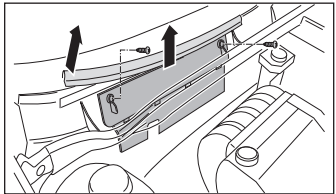

②

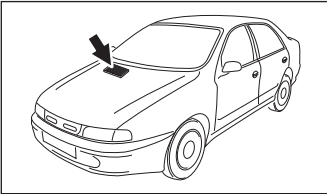

④

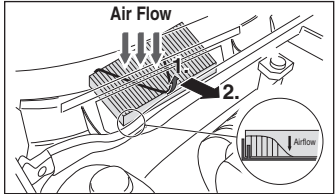

D

Lybra

①

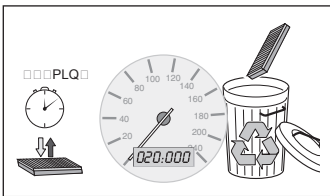

③

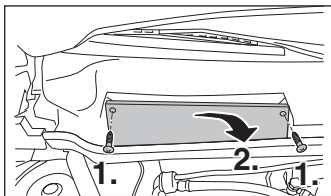

②

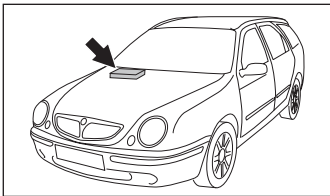

④

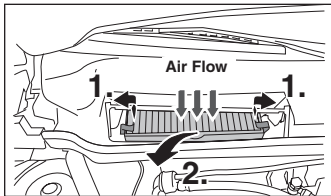

D

Opel

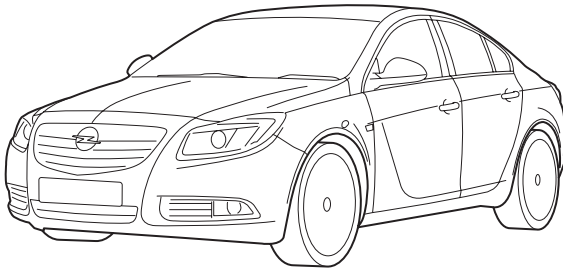

1 987 432 004
1 987 432 304

Opel Insignia

11.08 →

Insignia

①

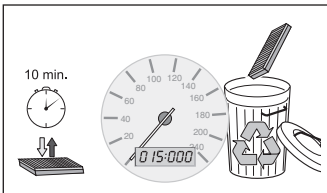

③

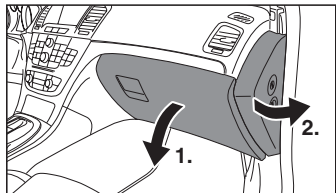

②

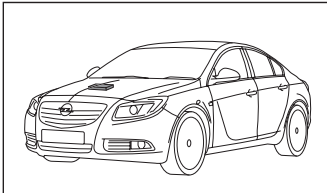

④

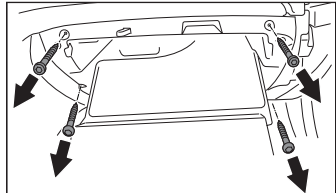

D

Insignia (continued)

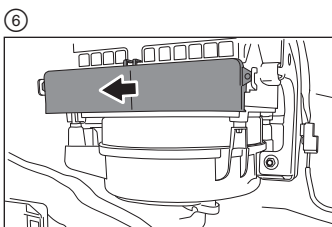
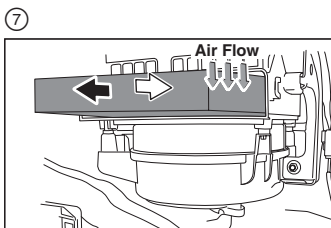
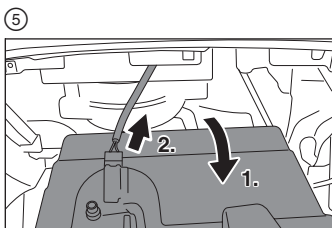

Mazda, Ford

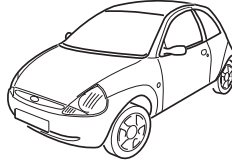
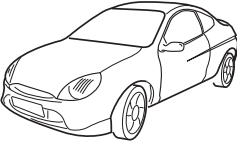

1 987 432 006
1 987 432 306

Mazda 121
Ford Fiesta
Ford Puma
Ford Ka
Options

01.96 →
10.95 →
05.97 →
09.96 →

121, Fiesta, Puma

①

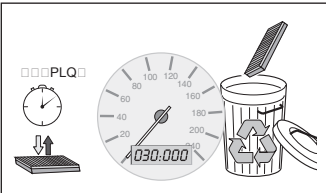

③

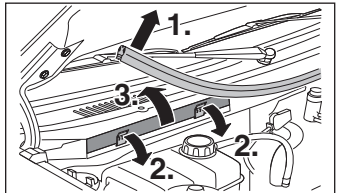

②

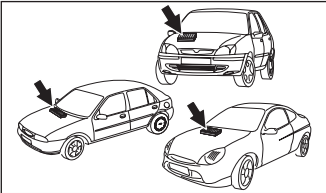

④

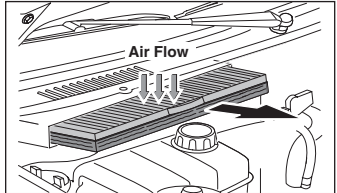

D

Ka

①

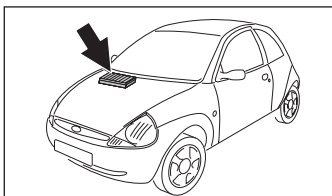

③

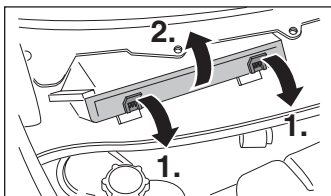

②

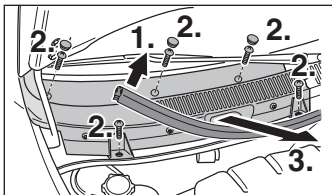

④

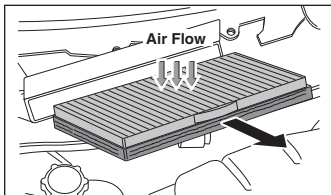

D

Peugeot

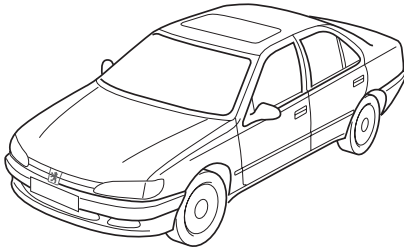

1 987 432 007
1 987 432 407

Peugeot 406

* 10.95 →

406

①

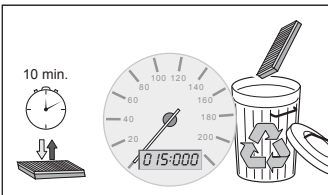

③

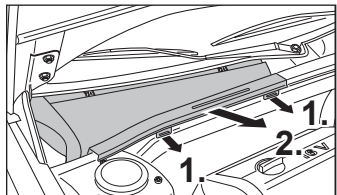

②

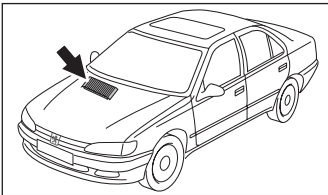

④

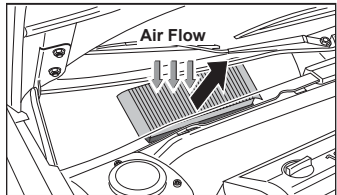

D

Renault

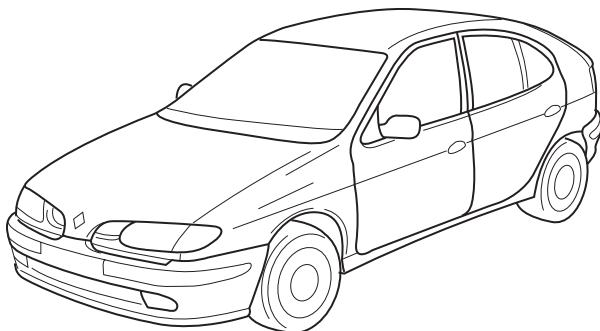

1 987 432 009

Renault Mégane

* 01.96 →

Mégane

①

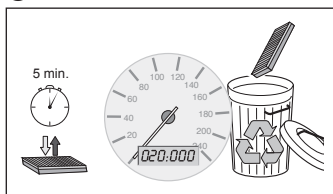

④

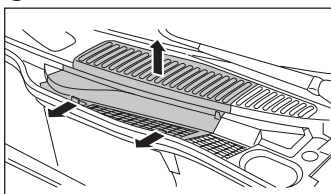

②

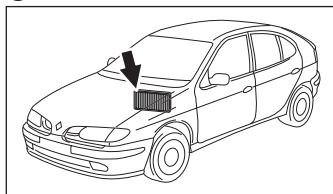

⑤

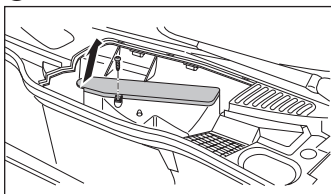

③

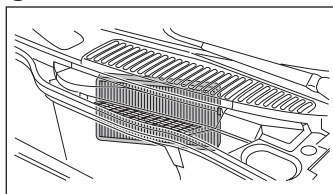

⑥

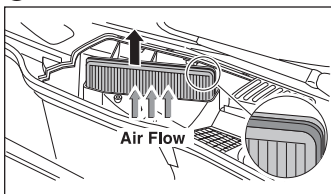

Opel

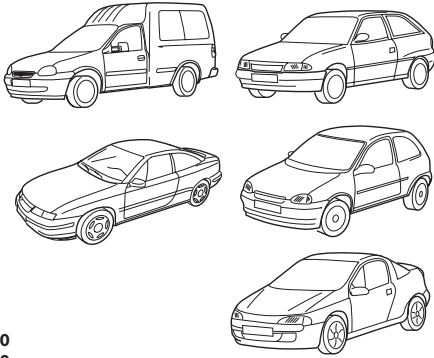

1 987 432 010
1 987 432 310

Opel Combo
Opel Astra
Opel Calibra
Opel Corsa
Opel Tigra

* 07.94 →
09.91 →
08.93 →
* 03.93 →
* 09.94 →

Combo

①

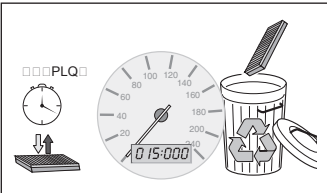

④

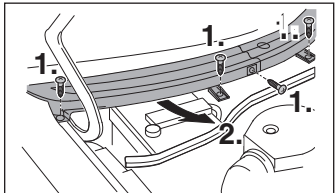

②

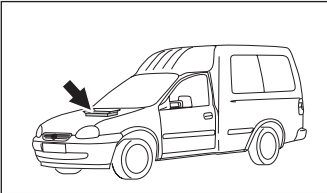

⑤

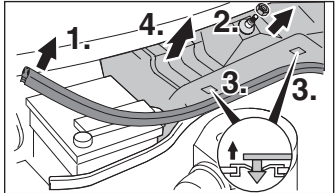

③

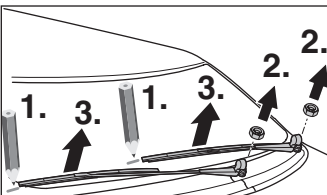

⑥

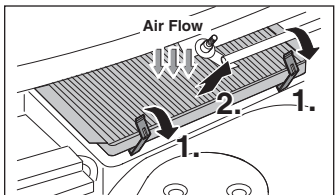

Astra

①

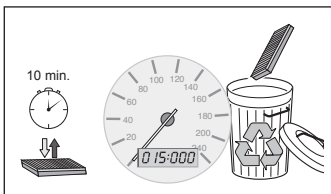

④

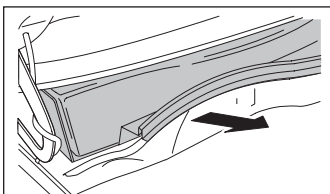

②

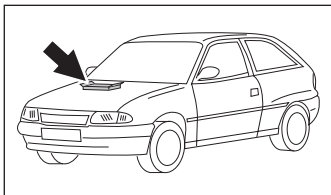

⑤

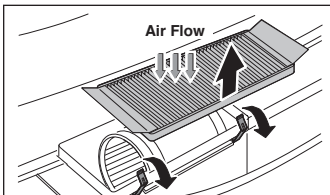

③

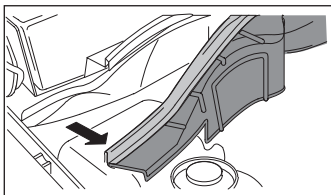

Calibra

①

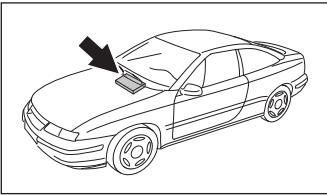

③

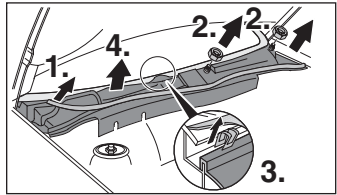

②

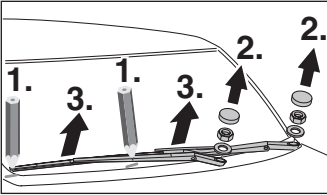

④

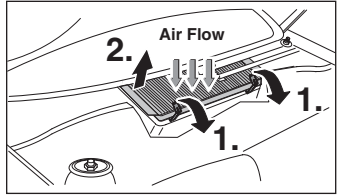

Corsa

①

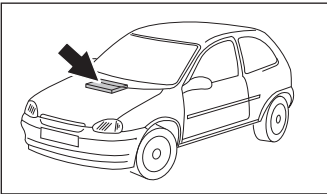

④

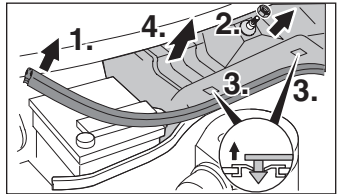

②

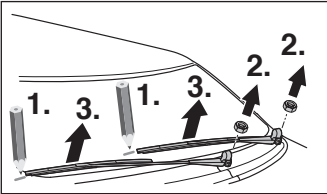

⑤

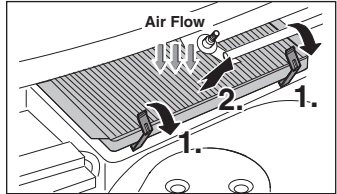

③

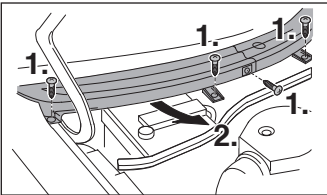

Tigra

①

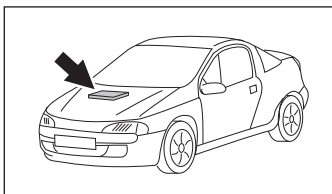

③

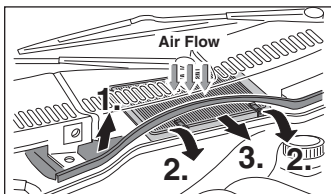

②

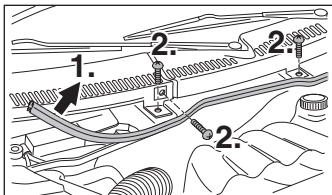

D

Audi, Seat, Skoda, VW

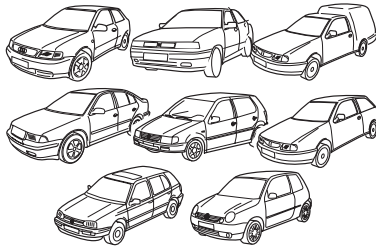

1 987 432 012
1 987 432 312

Audi A3	09.96 →
Seat Cordoba/optional	09.93 →
Seat Ibiza/optional	03.93 →
Seat Inca	11.95 →
Seat Toledo	06.95 →
Skoda Octavia	09.96 →
VW Lupo	06.98 →
VW Caddy	11.95 →
VW Golf III/Vento	04.93 →
VW Polo	10.94 →

A3

①

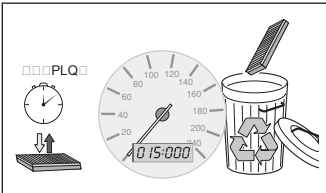

④

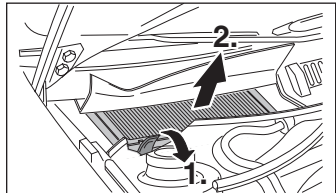

②

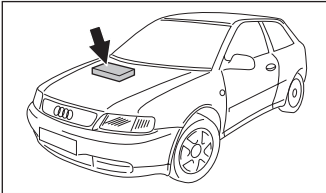

⑤

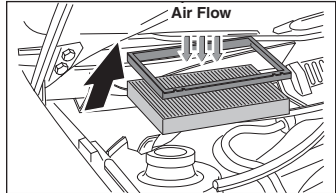

③

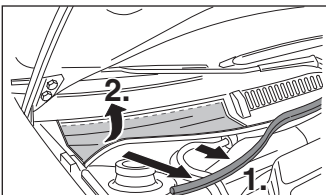

Cordoba, Ibiza, Inca

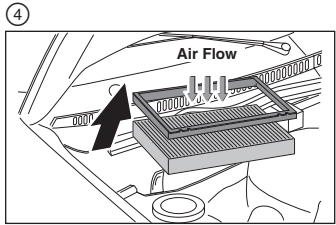
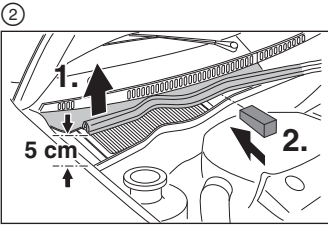
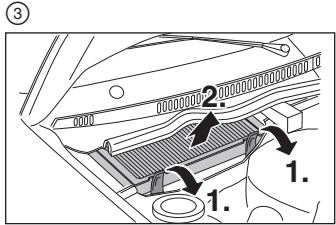
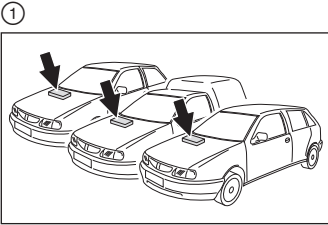

Toledo

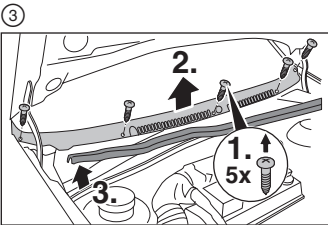
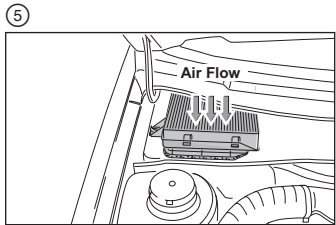
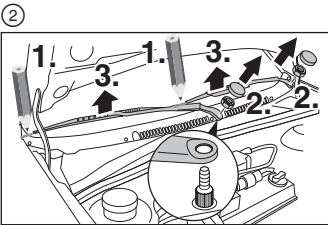
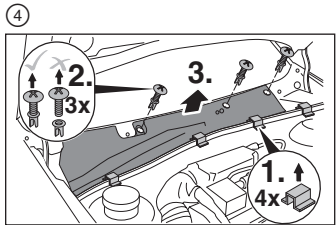
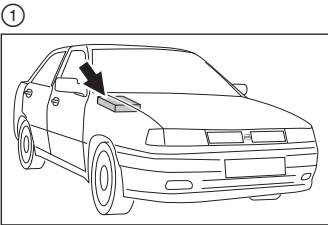

D

Oktavia

①

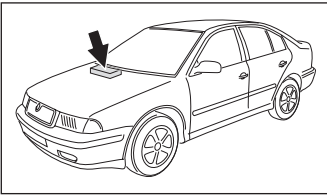

③

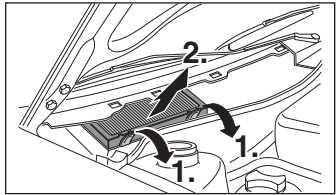

②

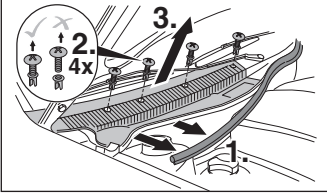

④

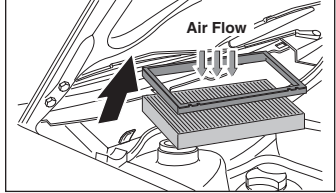

Lupo

①

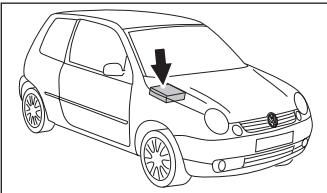

③

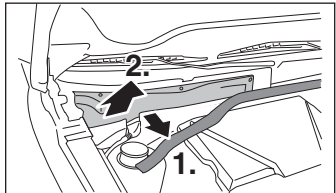

②

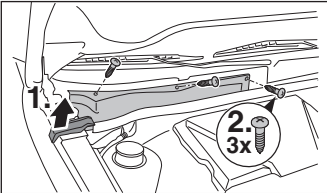

④

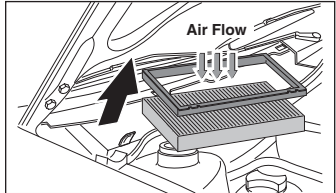

D

Caddy

①

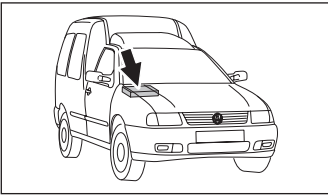

④

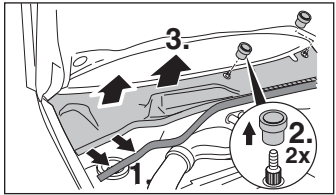

②

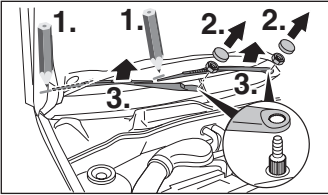

⑤

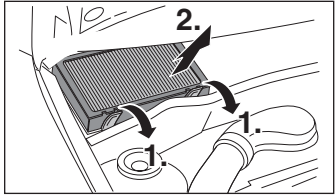

③

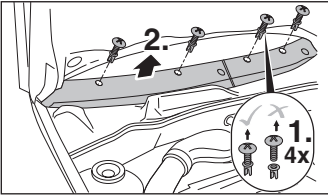

D

Golf III, Vento

①

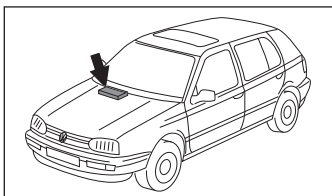

③

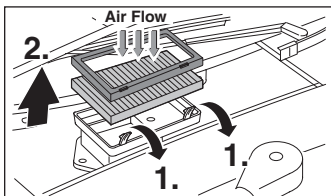

②

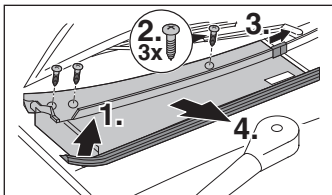

Polo

①

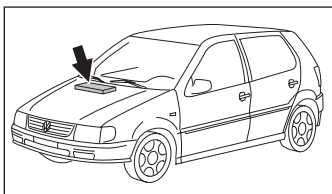

③

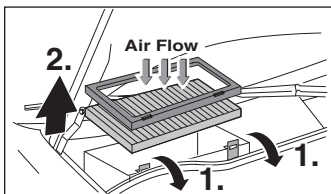

②

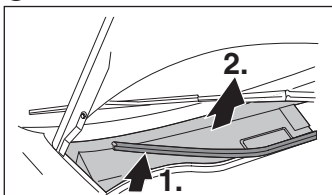

D

VW

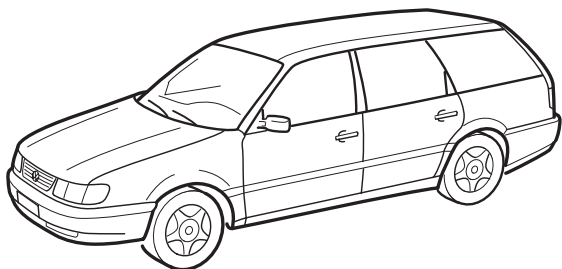

1 987 432 013
1 987 432 313

VW Passat

08.92 → 10.96

Passat

①

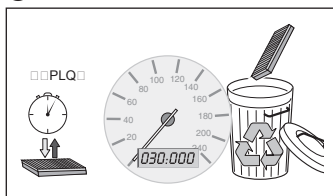

④

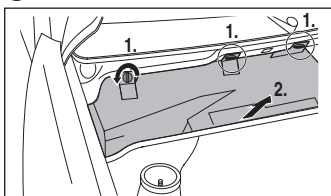

②

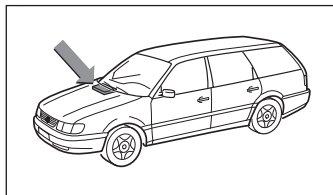

⑤

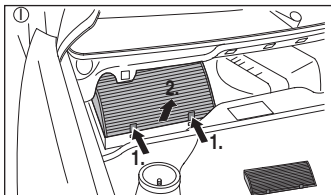

③

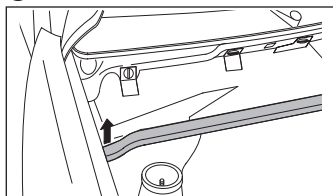

⑥

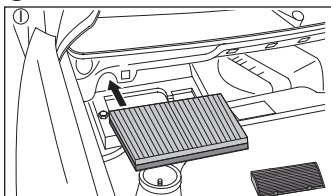

Passat

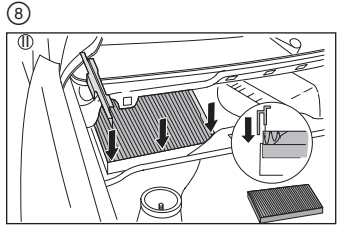
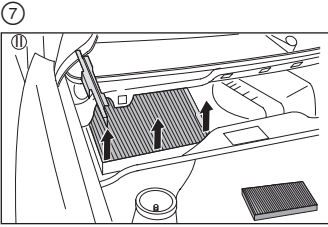

Alfa Romeo, Lancia, Fiat

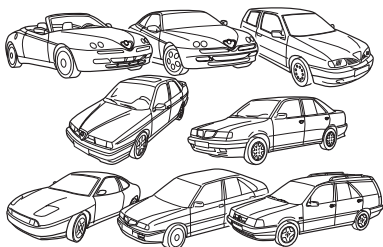

1 987 432 014

Alfa Spider	* 04.95 →
Alfa Romeo GTV	* 04.95 →
Alfa Romeo 145	* 04.95 →
Alfa Romeo 146	* 12.94 →
Alfa Romeo 155	* 01.93 →
Lancia Dedra	* 01.93 →
Lancia Delta	* 10.93 →
Fiat Coupé	* 06.95 →
Fiat Tempra	* 01.93 →
Fiat Tipo	* 03.95 →

Spider, Romeo GTV

①

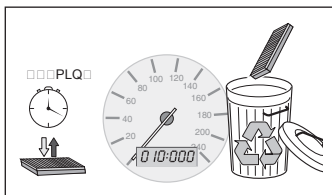

④

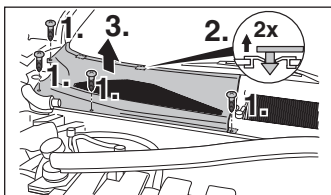

②

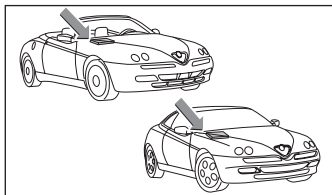

⑤

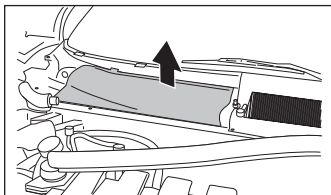

③

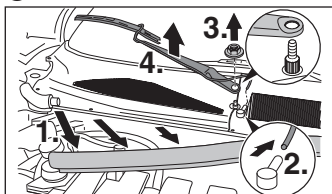

⑥

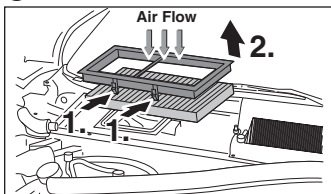

145, 146

①

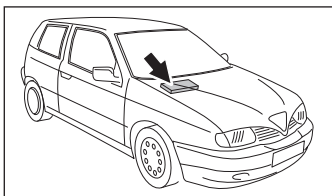

④

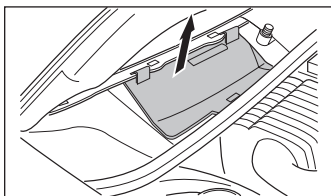

②

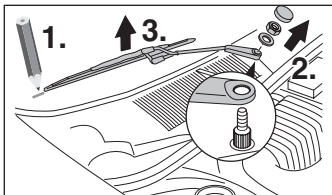

⑤

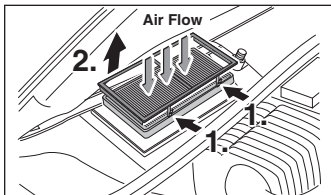

③

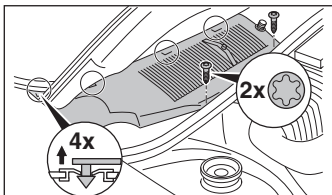

D

①

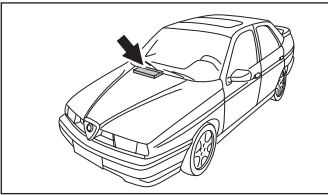

④

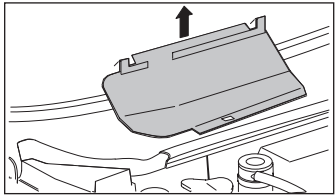

②

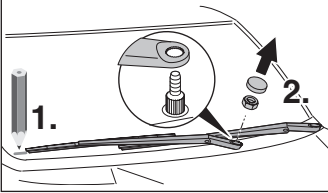

⑤

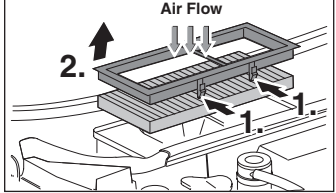

③

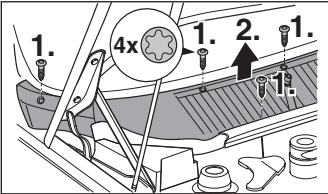

D

Dedra

①

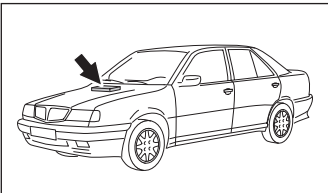

③

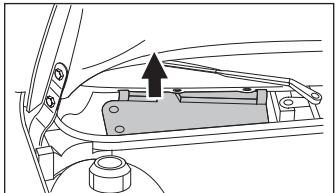

②

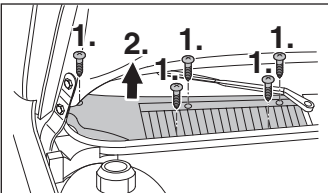

④

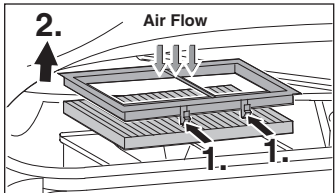

Delta

①

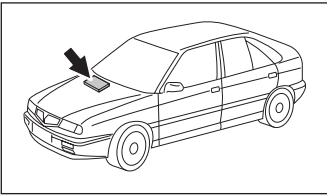

④

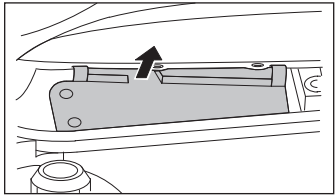

②

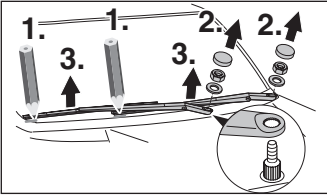

⑤

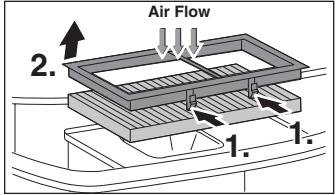

③

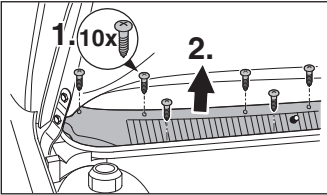

Coupé

①

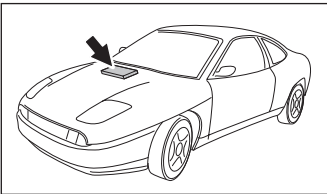

③

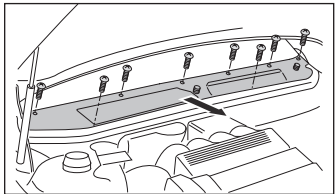

②

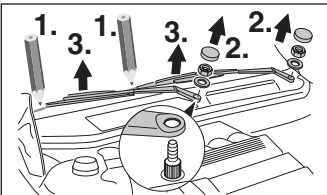

④

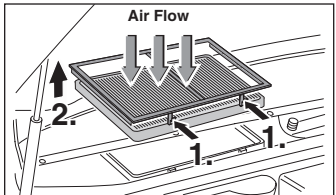

Tempra, Tipo

①

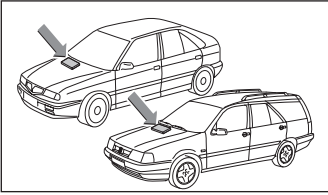

④

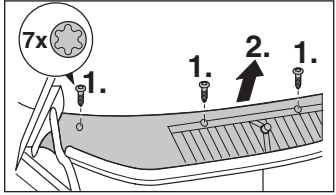

②

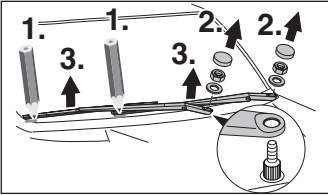

⑤

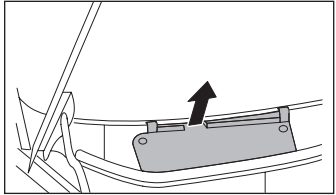

③

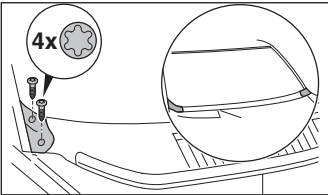

⑥

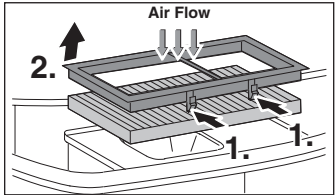

D

Opel

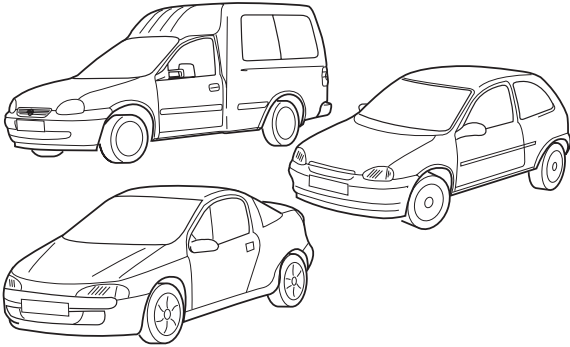

1 987 432 015

Opel Combo
Opel Corsa
Opel Tigra

07.94 →

03.93 →

09.94 →

Combo

①

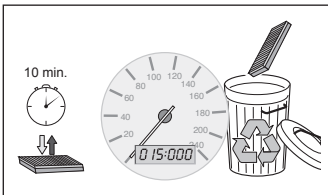

④

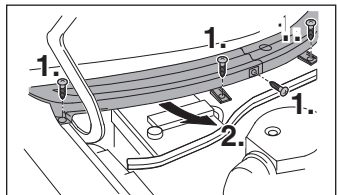

②

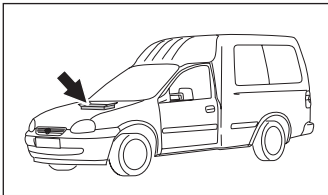

⑤

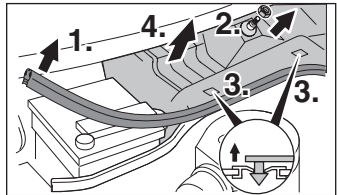

③

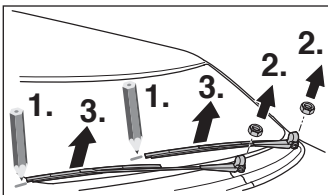

⑥

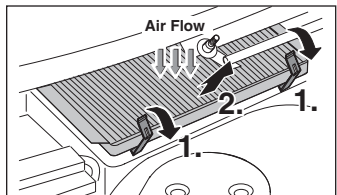

Corsa

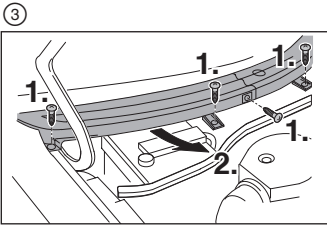
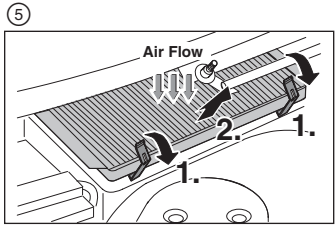
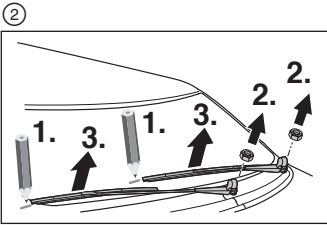
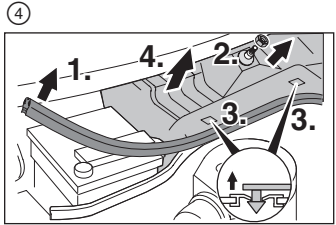
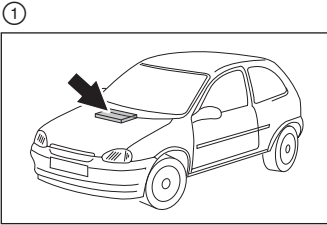

D

Tigra

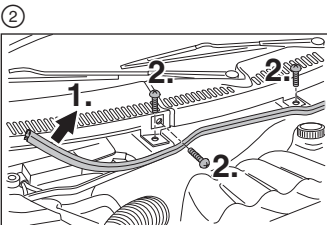
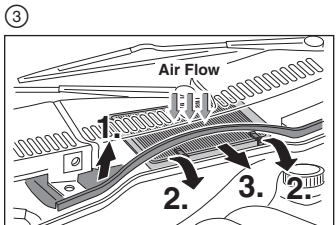
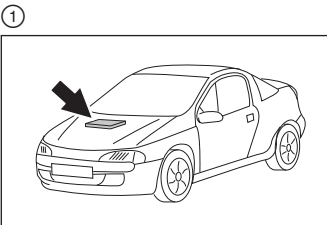

Opel, Vauxhall

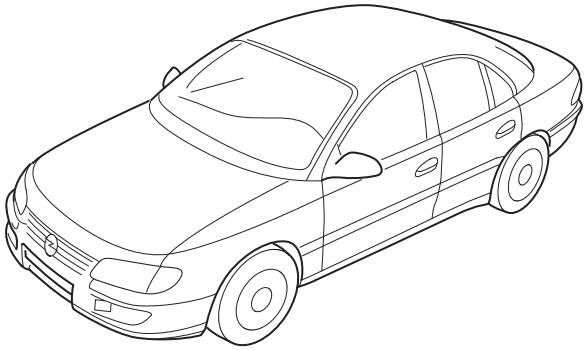

1 987 432 016

Opel Omega-B
Vauxhall Omega

04.94 →

04.94 →

Omega-B, Omega

①

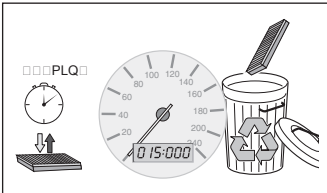

④

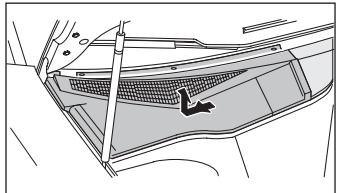

②

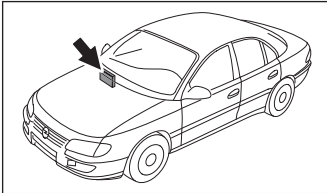

⑤

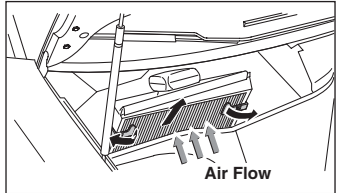

③

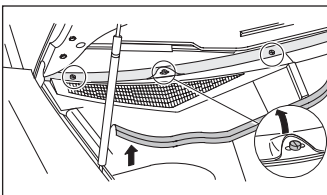

⑥



D

Audi, VW

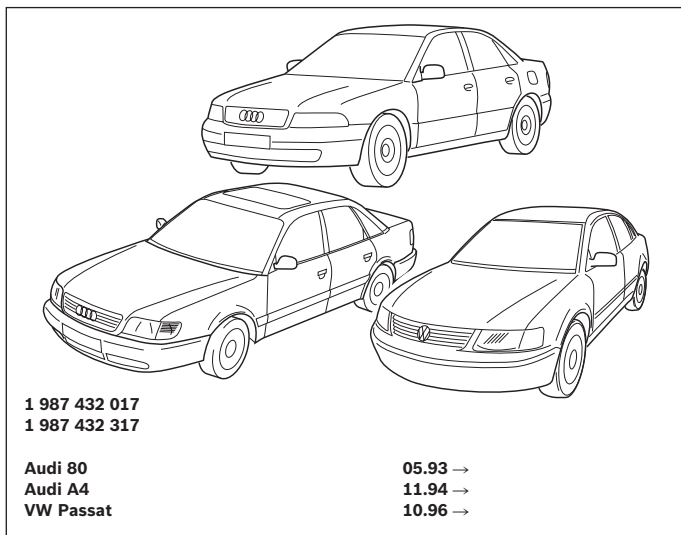

80

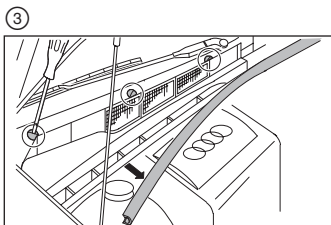
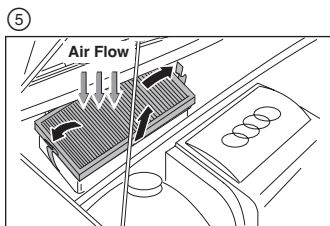
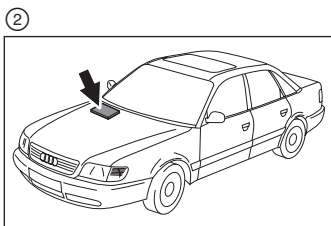
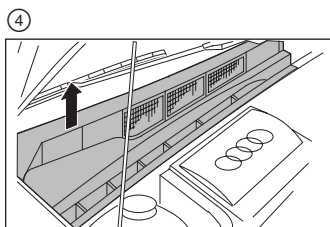
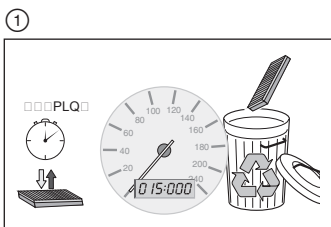

A4

①

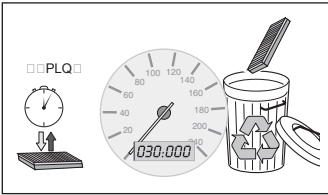

④

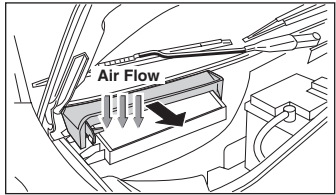

②

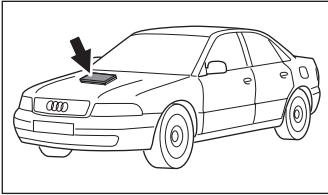

⑤

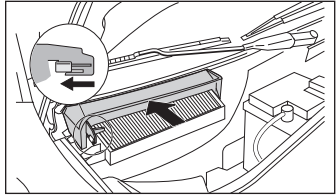

③

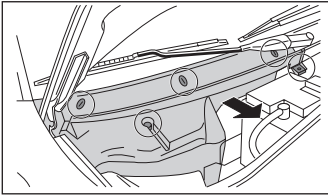

Passat

①

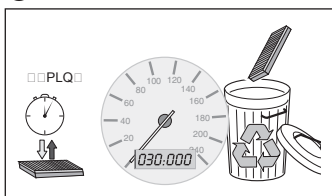

④

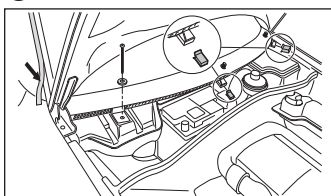

②

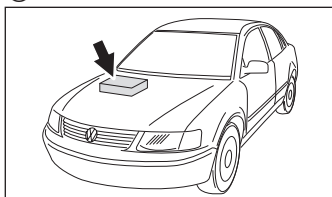

⑤

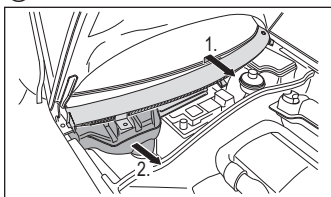

③

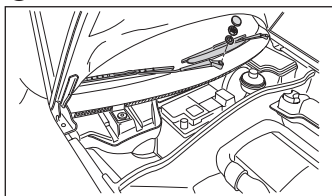

⑥

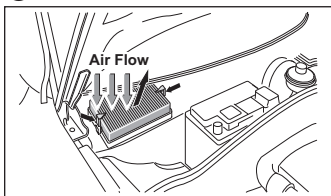

D

Ford

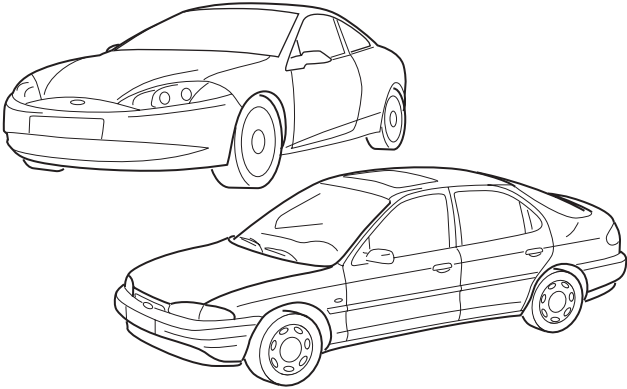

1 987 432 018
1 987 432 318

Ford Cougar
Ford Mondeo

04.98 →
02.93 →

Cougar, Mondeo

①

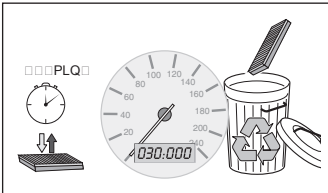

③

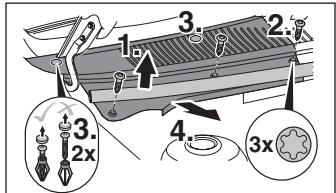

②

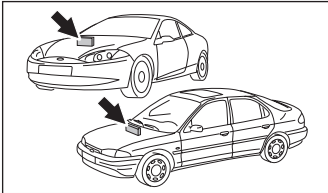

④

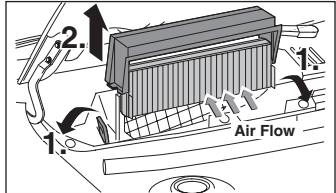

D

Fiat, Lancia

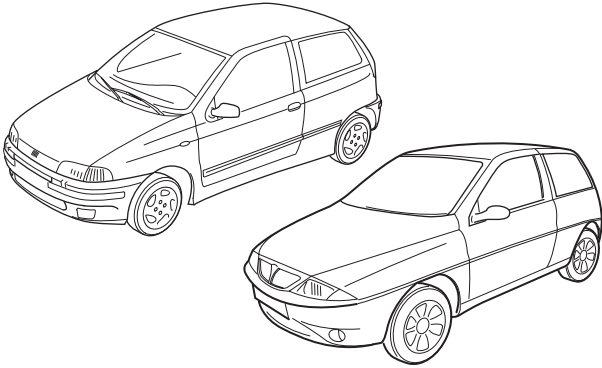

1 987 432 019

Fiat Punto
Lancia Y

08.93 →
01.96 →

Punto

1

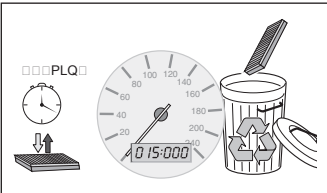

4

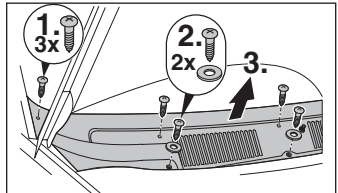

2

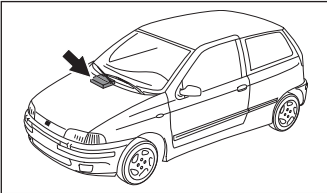

5

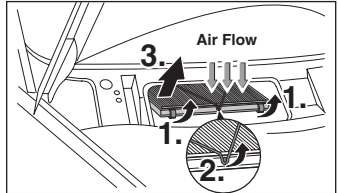

3

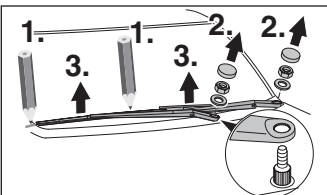

D

Y

①

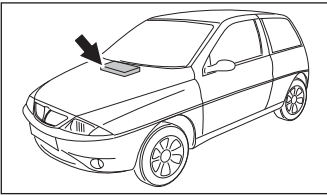

③

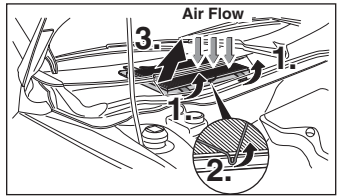

②

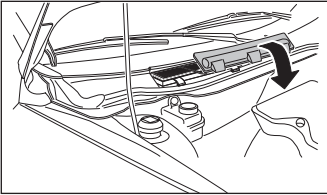

D

Mercedes-Benz

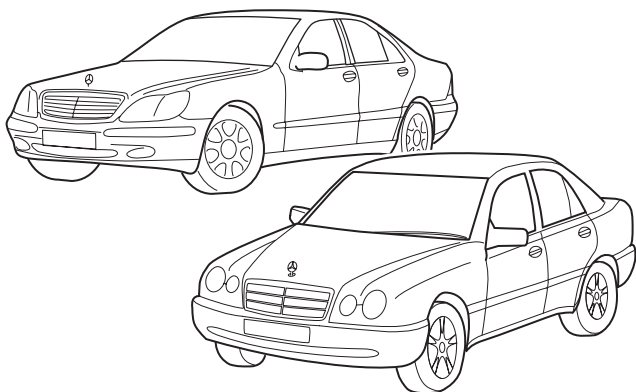

1 987 432 020

S-Klasse
E 200 - E 320

09.98 →

06.95 →

* automatic

S-Klasse

①

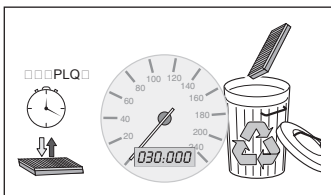

③

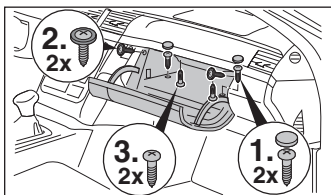

②

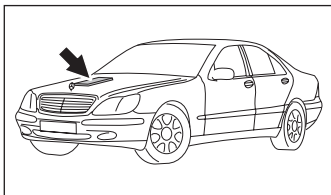

④

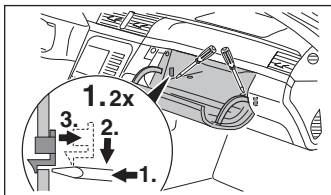

D

S-Klasse

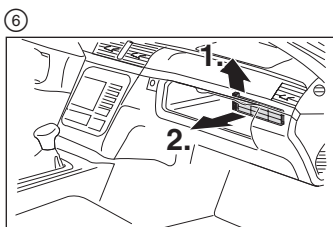
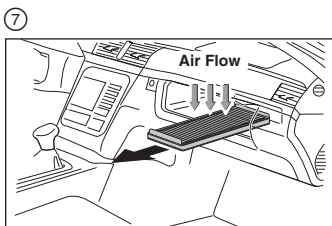
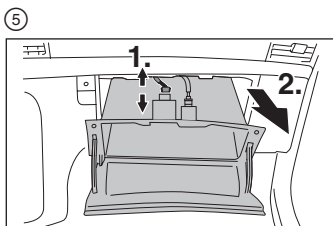

E 200 – E 230

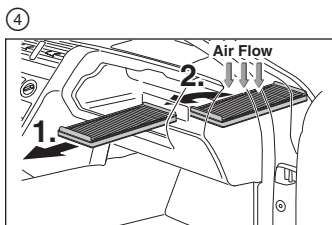
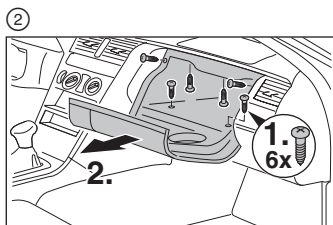
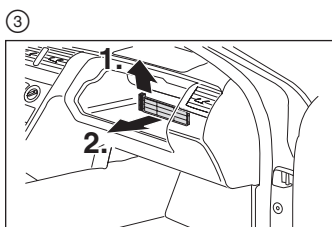
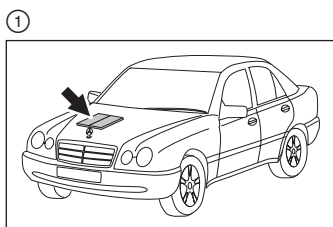

Citroën, Peugeot

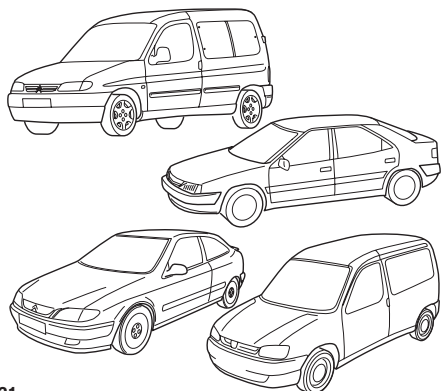

1 987 432 021

Citroën Berlingo
 Citroën Xantia
 Citroën Xsaria
 Peugeot Partner

* 07.96 →
 * 03.93 →
 * 07.97 →
 * 07.96 →

Berlingo

①

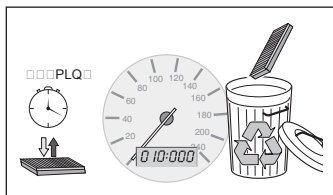

③

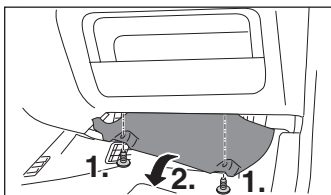

②

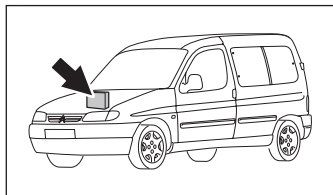

④

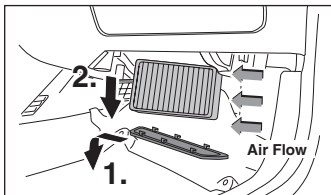

Xantia

①

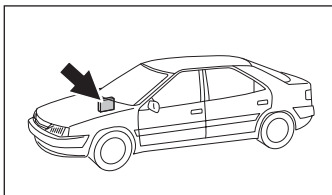

③

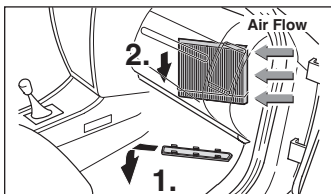

②

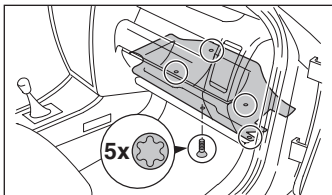

Xsara

①

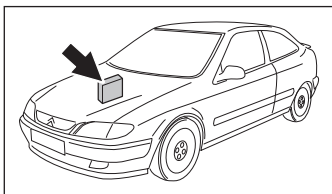

③

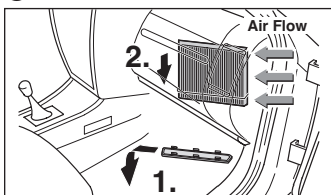

②

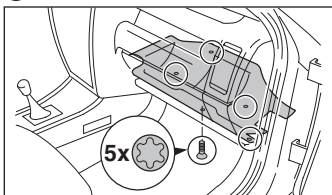

Partner

①

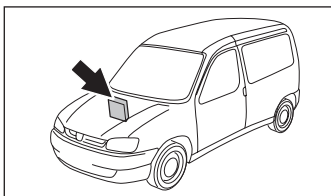

③

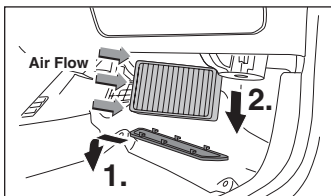

②

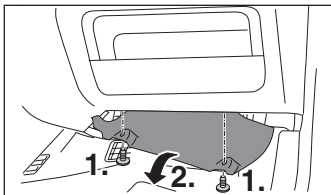

D

Audi

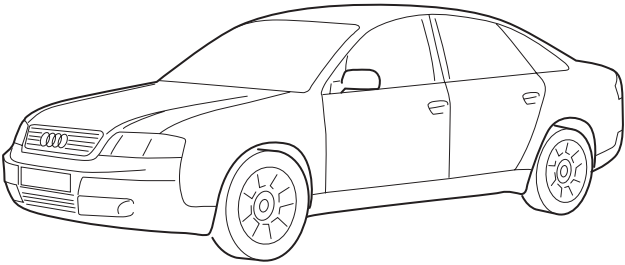

1 987 432 024
1 987 432 324

Audi A6
Audi A6

06.94 →
* 04.97 →

A6

①

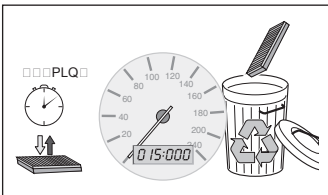

④

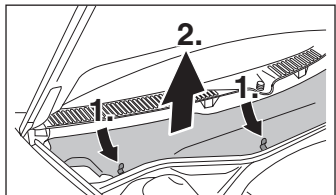

②

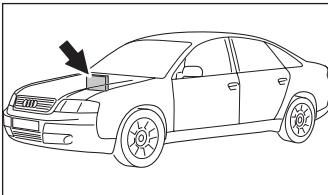

⑤

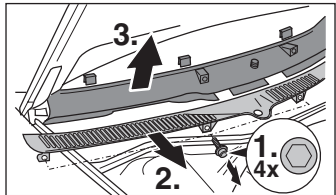

③

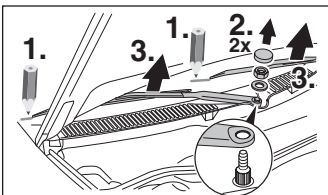

⑥

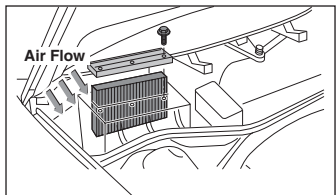

A6 *

①

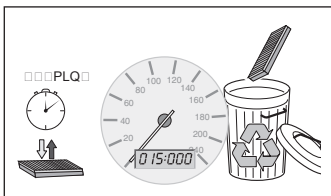

④

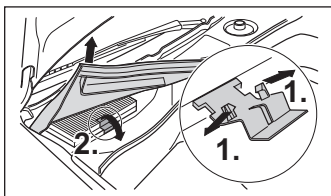

②

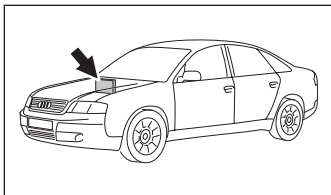

⑤

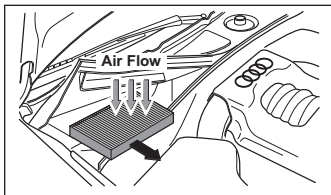

③

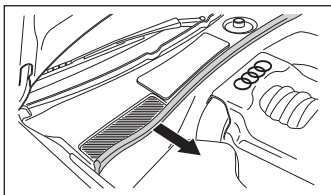

D

Honda, Rover

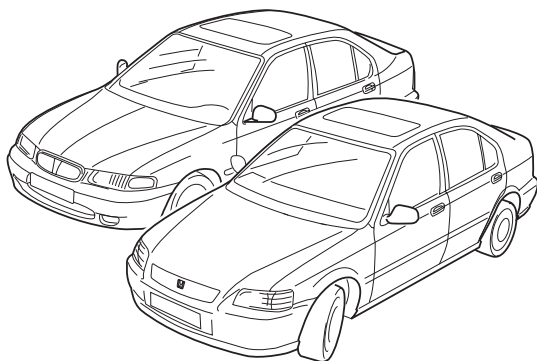

1 987 432 026

Honda Civic 5-door

Options

09.94 →

Rover 400

Options

10.95 →

Civic 5-door

①

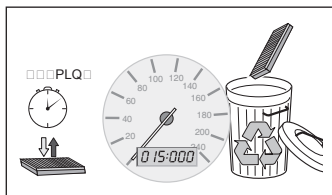

③

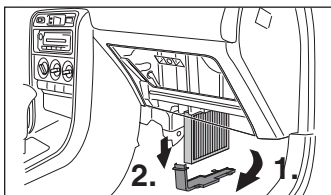

②

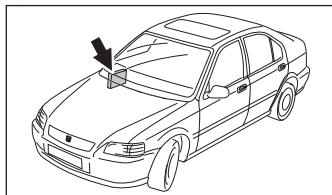

④

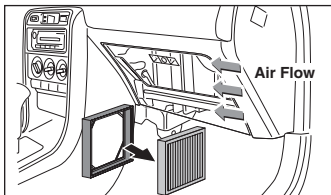

①

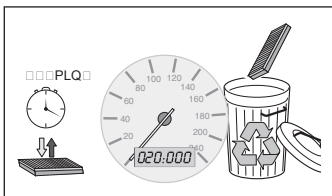

④

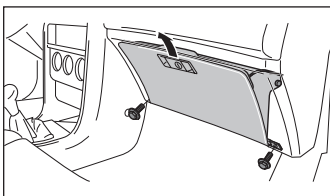

②

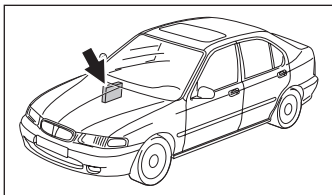

⑤

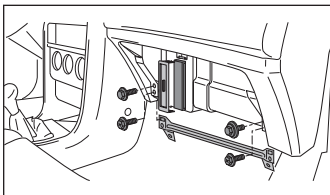

③

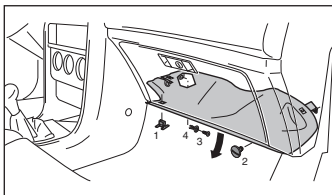

⑥

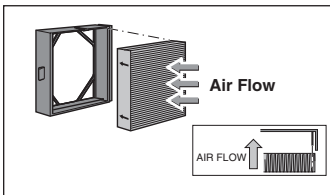

Renault

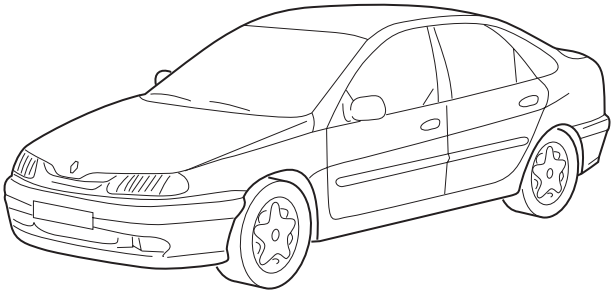

1 987 432 027

Renault Laguna

01.94 →

Laguna

①

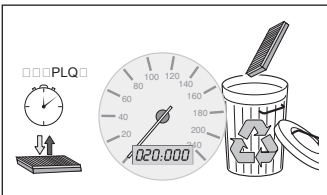

④

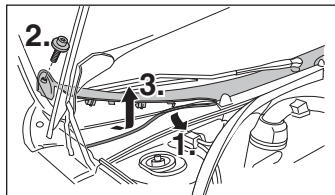

②

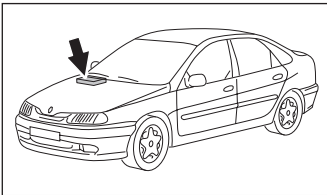

⑤

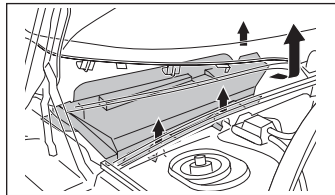

③

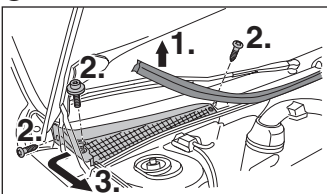

⑥

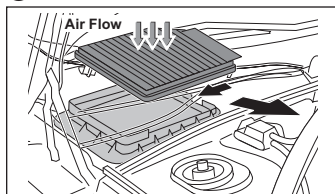

Ford, VW, Seat

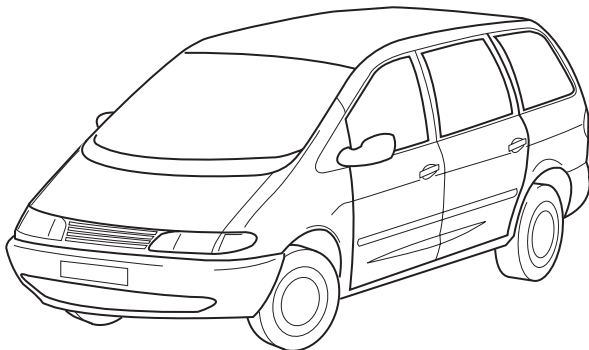

1 987 432 028
1 987 432 328

Ford Galaxy
VW Sharan
Seat Alhambra

05.95 →

09.95 →

03.96 →

Galaxy, Sharan, Alhambra

①

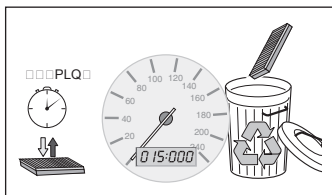

④

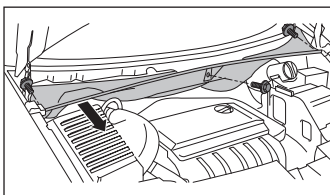

②

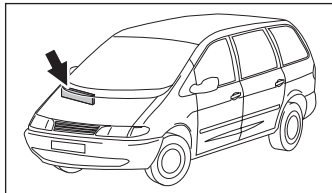

⑤

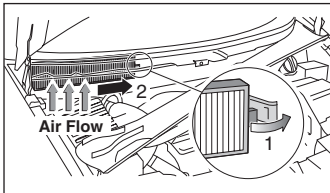

③

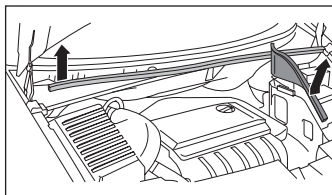

D

Opel, Vauxhall

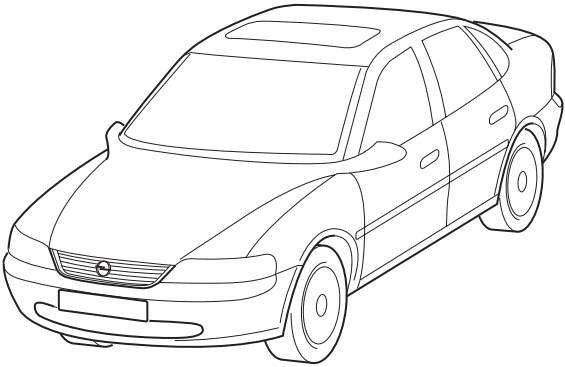

1 987 432 030
1 987 432 330

Opel Vectra-B
Vauxhall Vectra

09.95 →
09.95 →

Vectra-B, Vectra

①

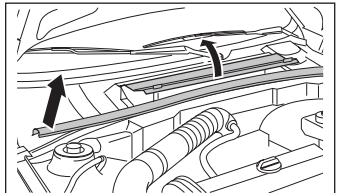
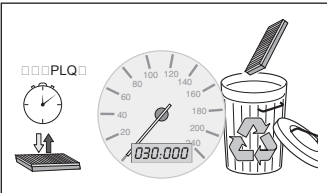

②

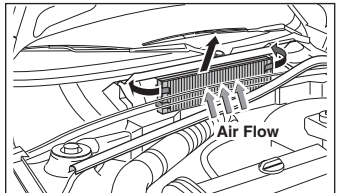
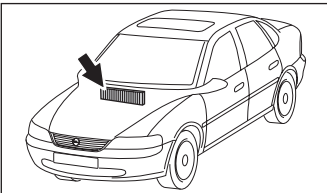

D

BMW

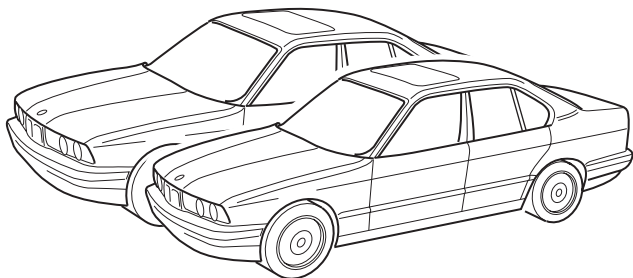

1 987 432 032

BMW 5 Series
BMW 7 Series

* 06.90 →

* 06.90 →

5, 7 Series

①

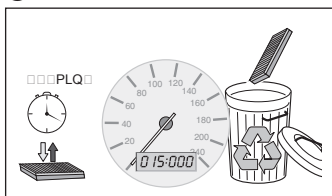

④

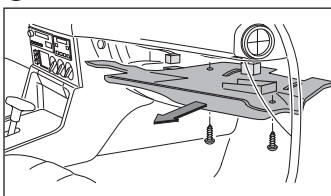

②

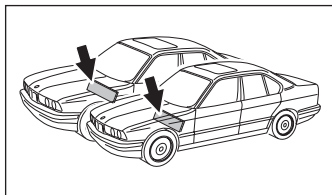

⑤

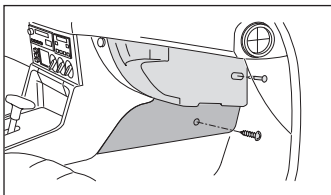

③

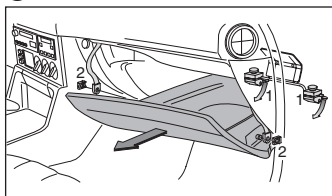

⑥

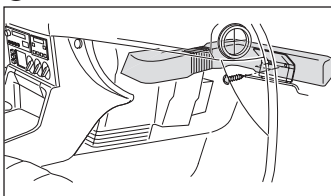

5, 7 Series

7

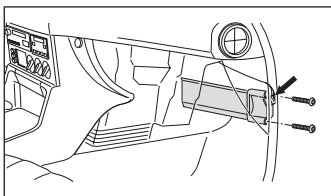

9

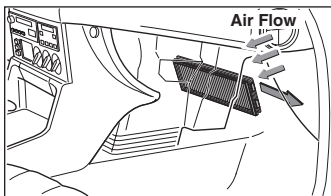

8

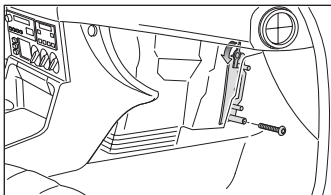

Audi

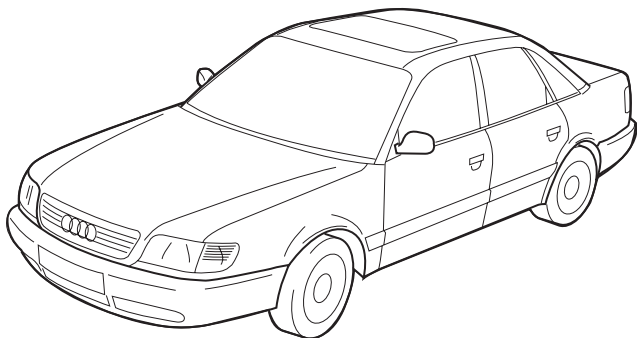

1 987 432 033
1 987 432 333

Audi A6

* 06.94 →

A6

D

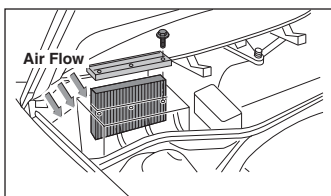
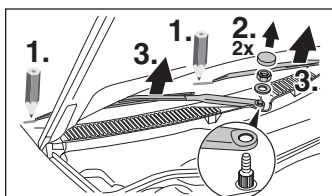
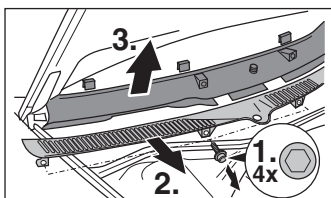
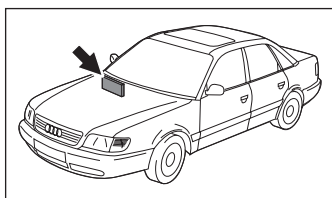
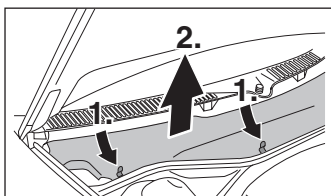
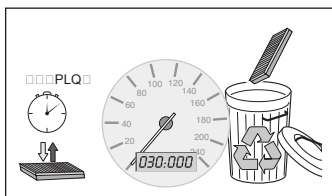

Mitsubishi, Smart

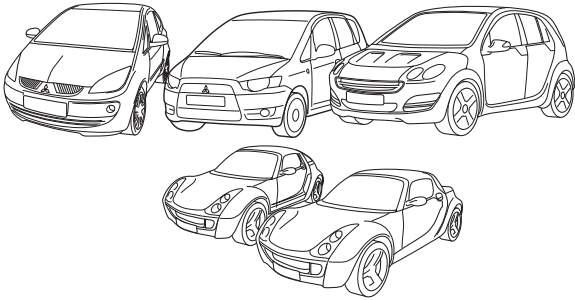

1 987 432 034
1 987 432 434

Mitsubishi Colt
Mitsubishi Colt
Smart For Four
Smart Roadster

04.04 → 10.08
11.08 →
04.04 →
04.04 →

Colt

①

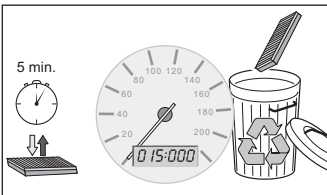

③

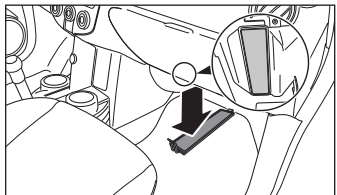

②

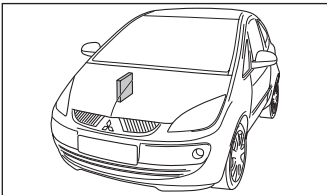

④

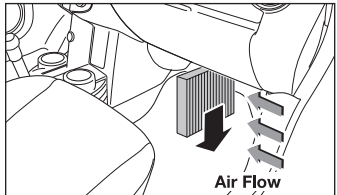

D

Smart

①

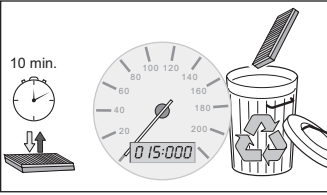

④

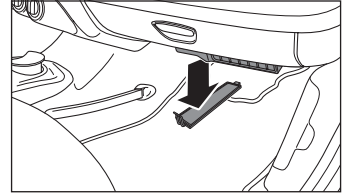

②

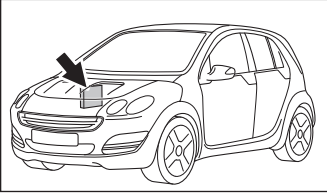

⑤

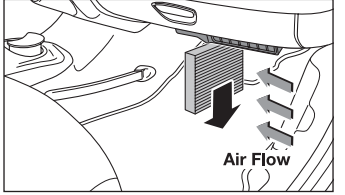

③

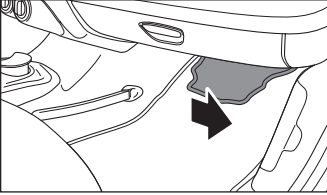

D

Smart Roasder

①

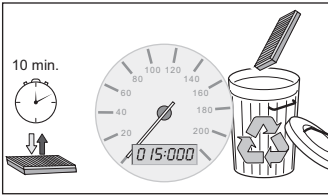

⑤

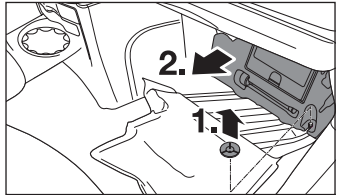

②

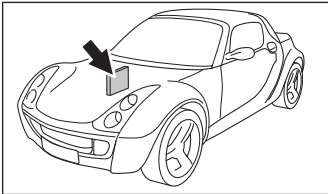

⑥

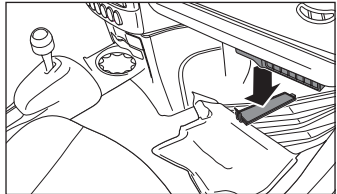

③

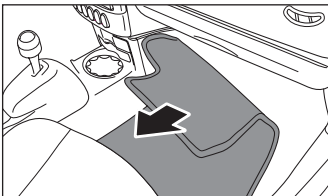

⑦

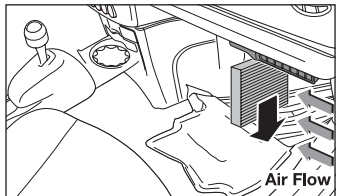

④

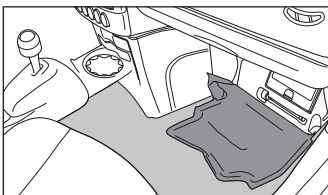

D

BMW

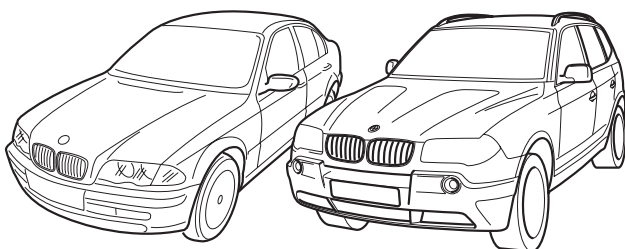

1 987 432 036

1 987 432 336

BMW 3 Series (E46)

04.98 →

3 Series

①

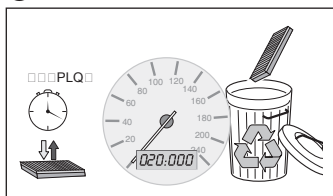

④

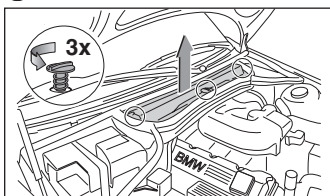

②

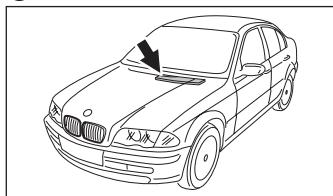

⑤

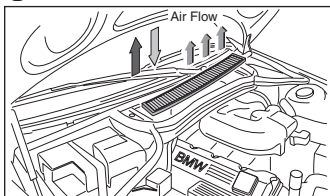

③

⑥

Mercedes-Benz

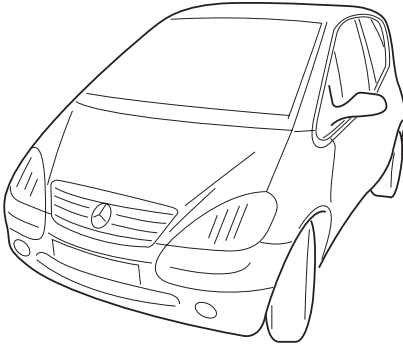

1 987 432 037
1 987 432 337

Mercedes-Benz

A-Klasse
A-Klasse

09.97 →
* 09.98 →

A-Klasse

D

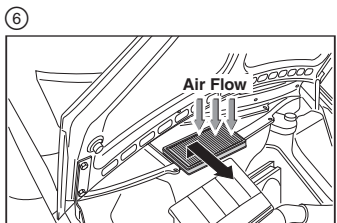
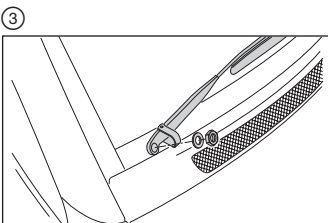
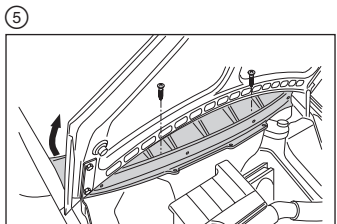
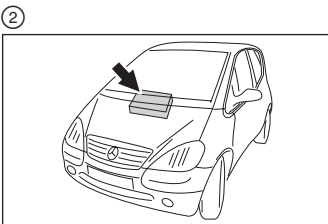
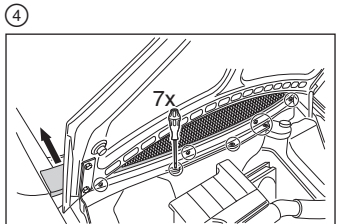
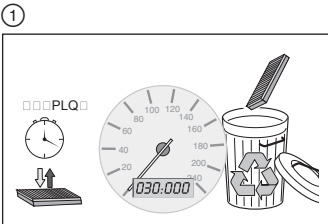

Opel

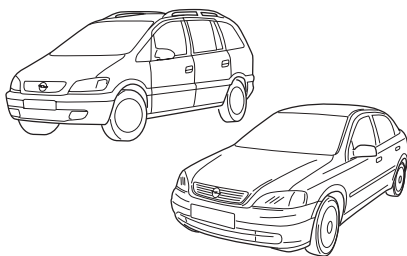

1 987 432 038

(O.E.-No. 90 559 549)

Opel Zafira

Opel Astra II

BEHR

* 03.99 →

* 03.98 →

1 987 432 040

(O.E.-Nr. 90 520 689)

Opel Zafira

Opel Astra II

BEHR

* 03.99 →

* 03.98 →

Zafira

①

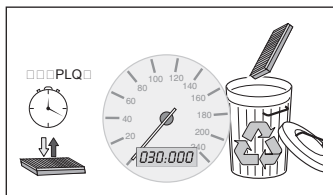

④

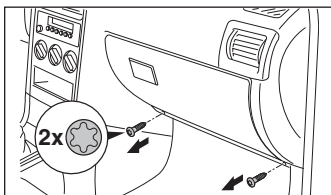

②

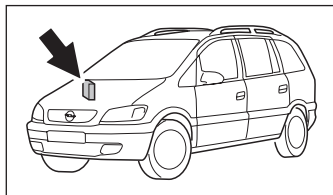

⑤

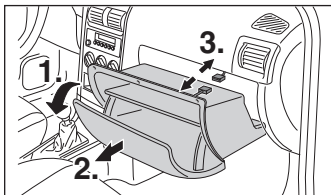

③

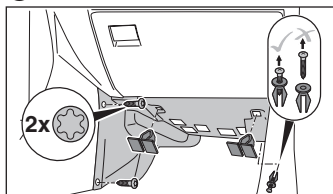

⑥

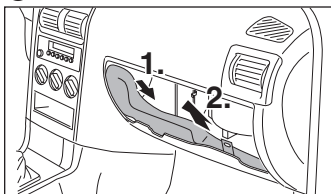

Zafira

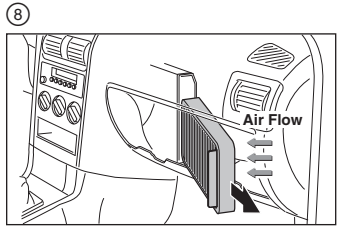
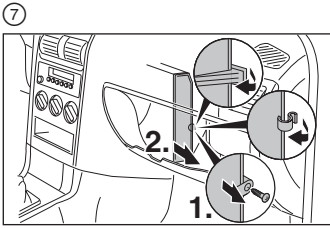

Astra II

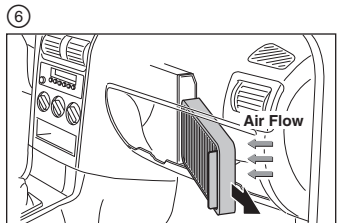
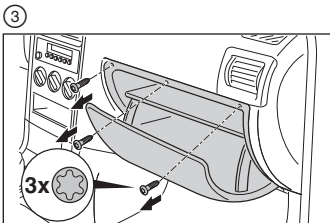
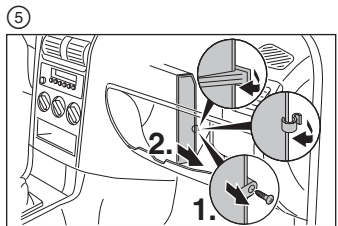
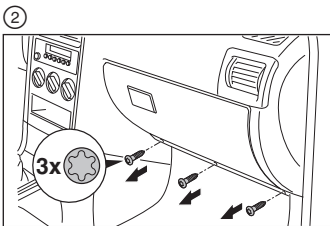
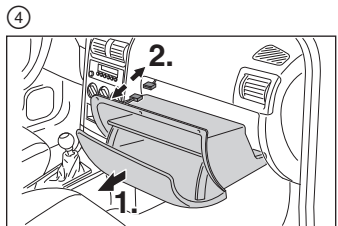
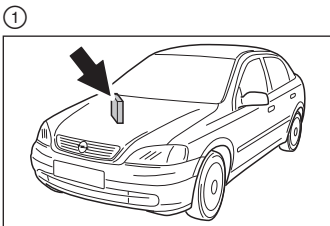

D

Renault

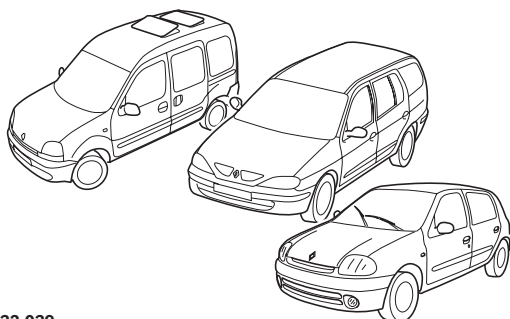

1 987 432 039

Renault Mégane
Break, Grandtour
Cabrio/Classic/Coupé

07.98 →

04.98 →

Renault Kangoo

* 10.97 →

Renault Clio II

* 03.98 →

Mégane Break, Grandtour, Cabrio/Classic/Coupé

①

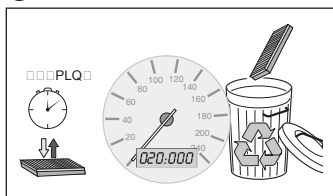

④

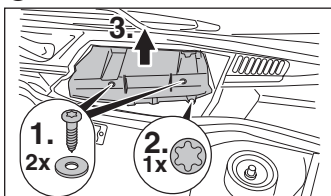

②

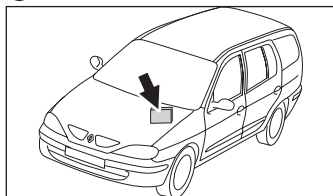

⑤

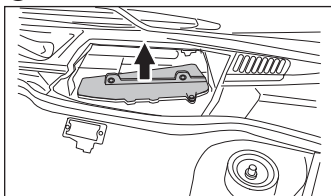

③

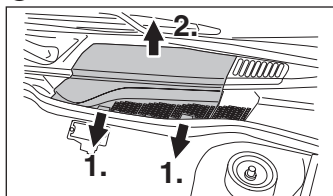

⑥

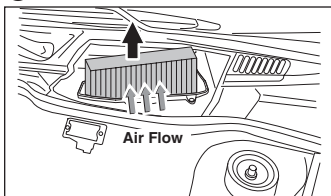

Kangoo

①

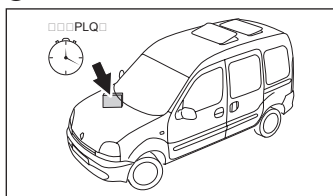

④

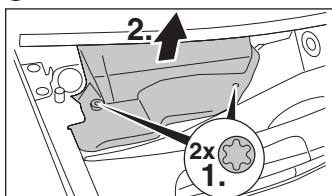

②

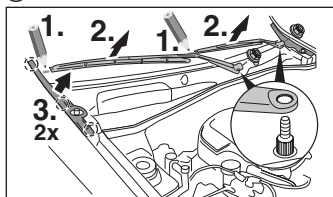

⑤

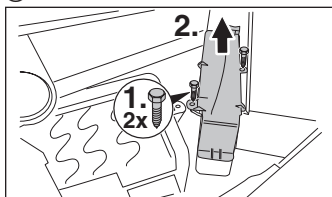

③

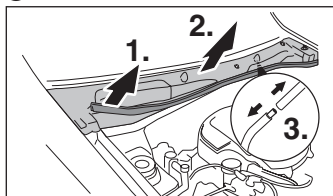

⑥

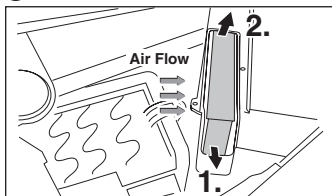

Clio II

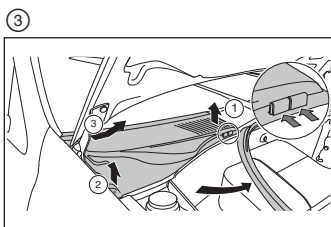
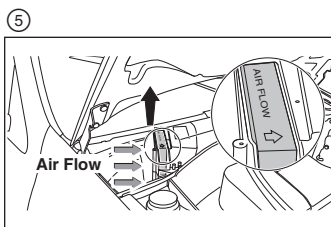
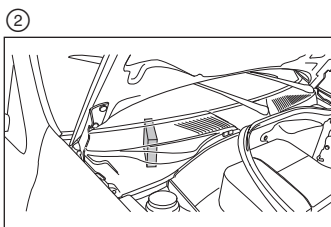
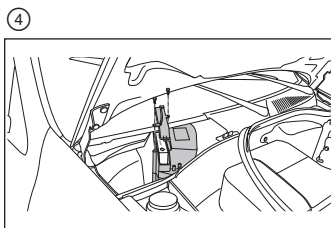
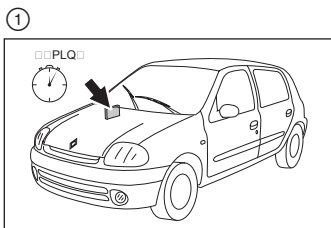

D

Peugeot

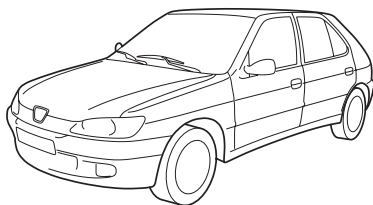

1 987 432 041

Peugeot 306



05.93 → 04.02 →

306

①

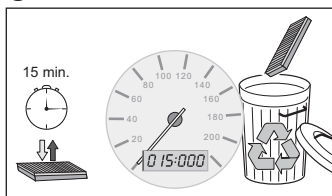

④

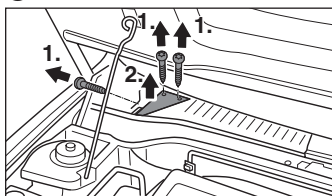

②

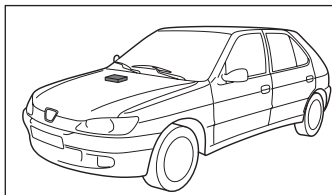

⑤

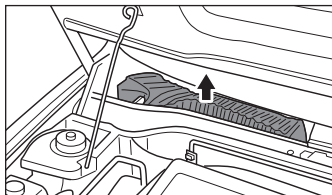

③

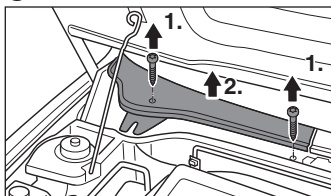

⑥

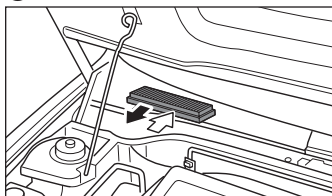

Fiat, Peugeot, Citroën

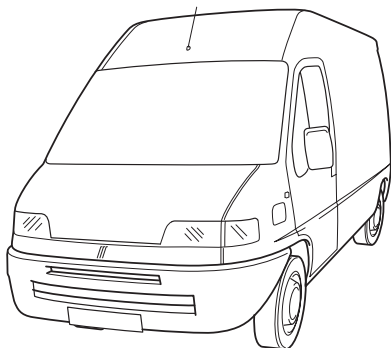

1 987 432 042

Fiat Ducato
Peugeot Boxer
Citroën Jumper

* 01.94 →

* 02.94 →

* 02.94 →

Ducato, Boxer, Jumper

①

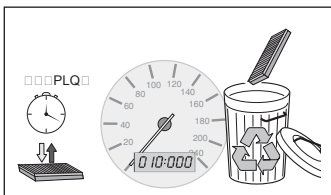

④

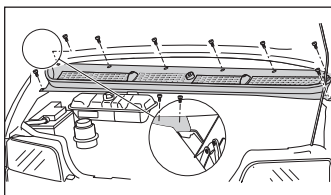

②

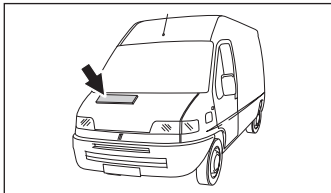

⑤

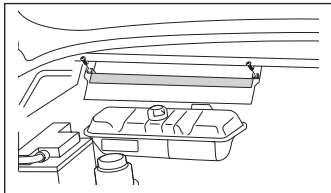

③

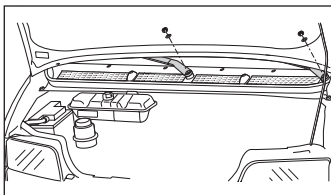

⑥

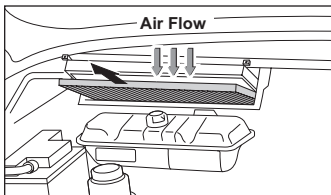

VW, Mercedes-Benz

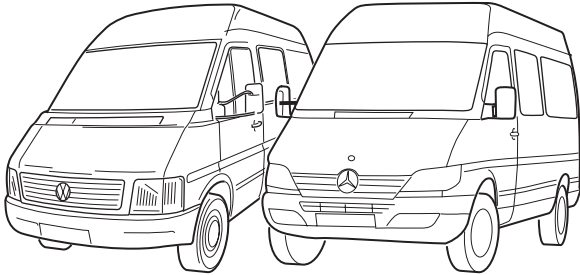

1 987 432 043
1 987 432 343

VW LT

05.96 → 07.06

Mercedes-Benz Sprinter

02.95 → 05.06

LT, Sprinter

①

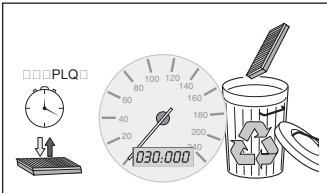

③

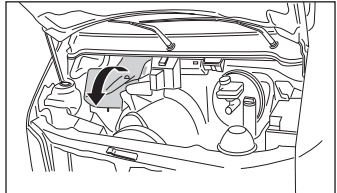

②

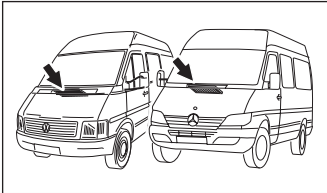

④

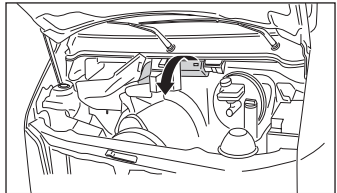

D

LT, Sprinter

5

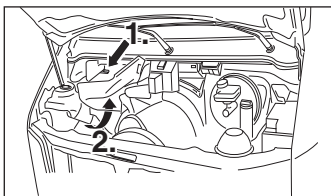

7

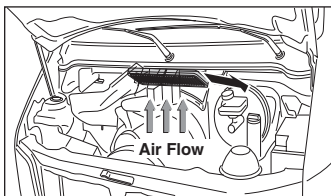

6

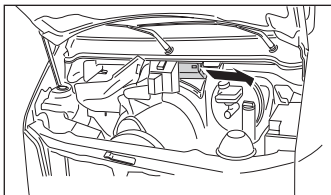

D

Mercedes-Benz

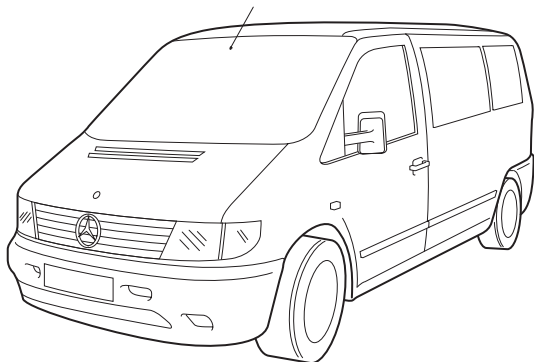

1 987 432 044

Mercedes-Benz
Vito, Viano, V-Klasse

11.95 →

Vito, Viano, V-Klasse

①

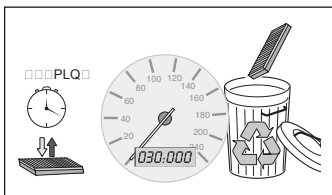

④

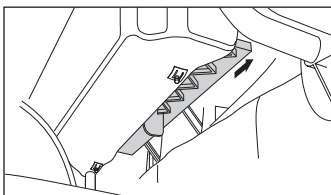

②

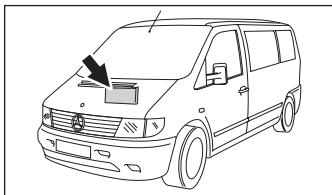

⑤

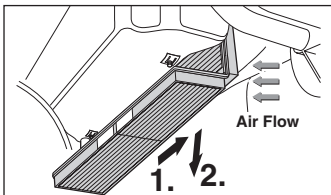

③

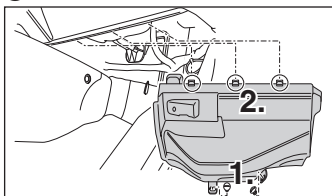

D

Ford

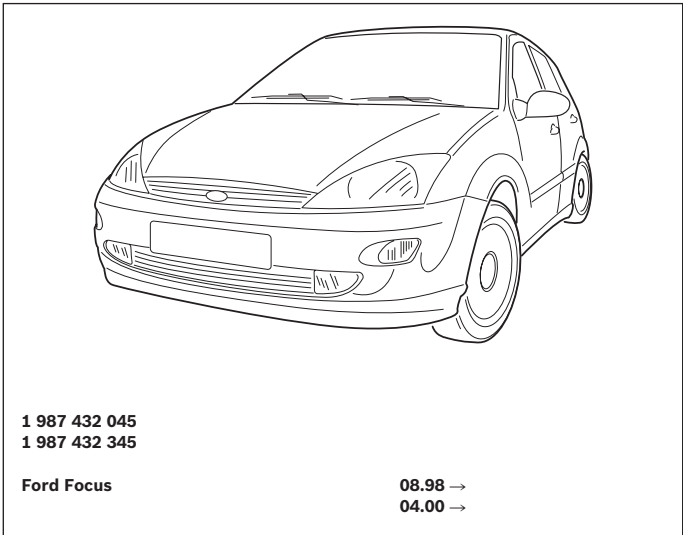

Focus

D

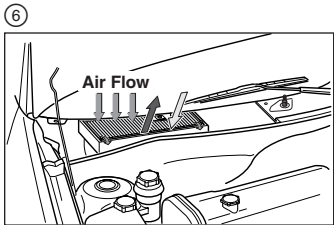
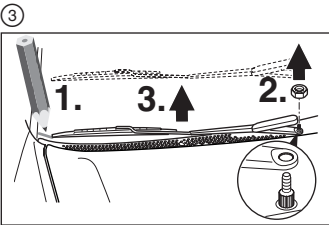
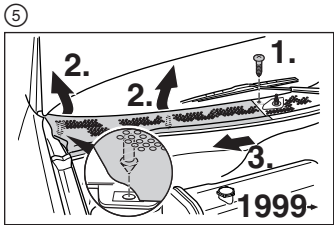
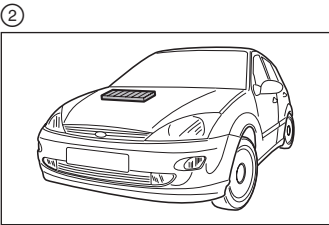
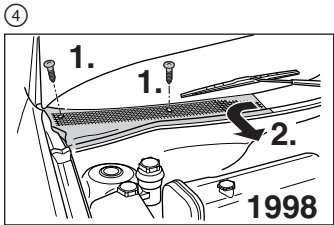
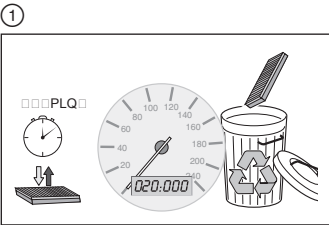

Peugeot

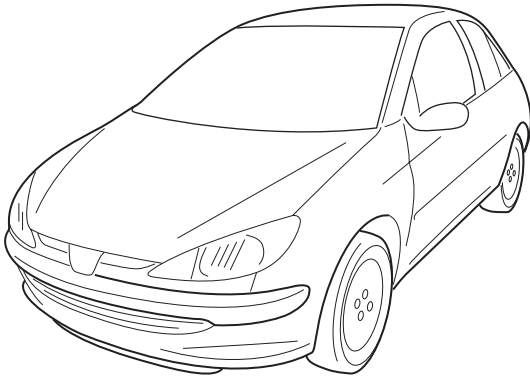

1 987 432 048

1 987 432 348

Peugeot 206

08.98 →

206

①

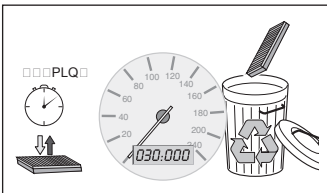

③

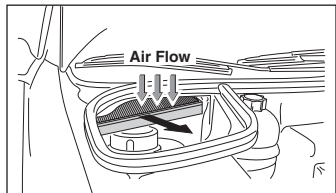

②

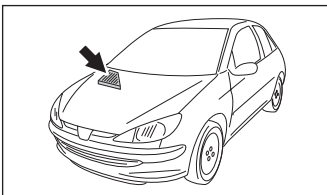

D

Renault

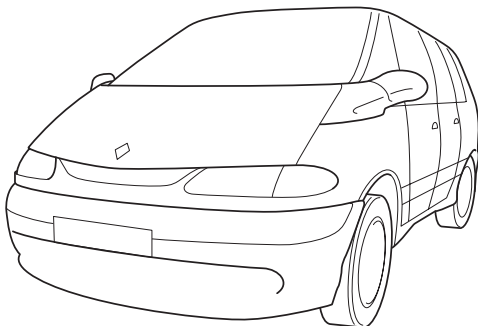

1 987 432 049

Renault Espace

10.96 →

Espace

①

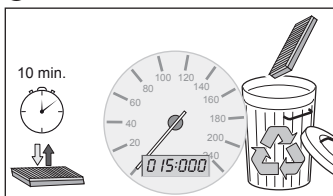

④

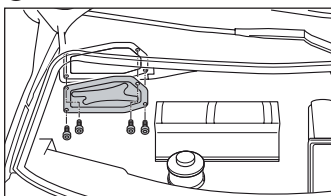

②

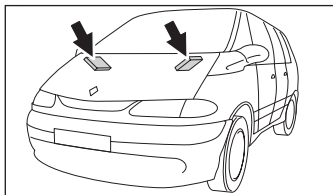

⑤

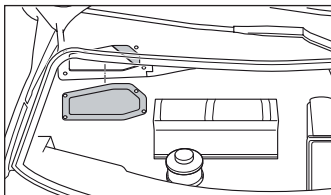

③

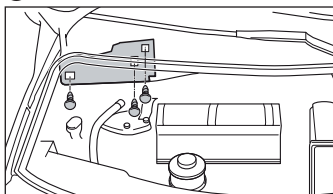

⑥

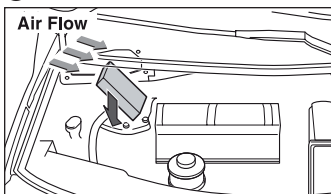

Mercedes-Benz

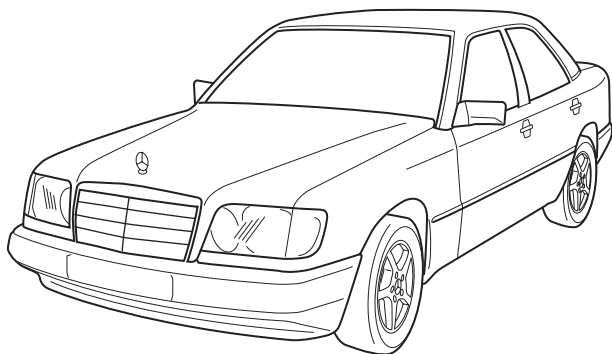

1 987 432 051

Mercedes-Benz

E-Klasse / optional
E-Klasse

07.93 → 06.95

* 07.93 → 06.95

E-Klasse

①

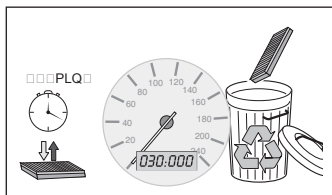

④

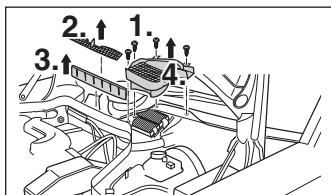

②

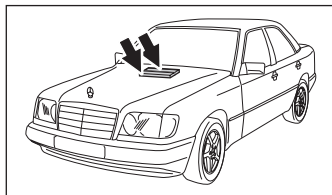

⑤

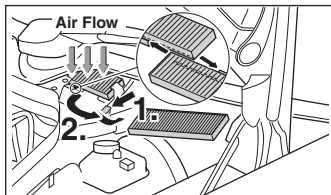

③

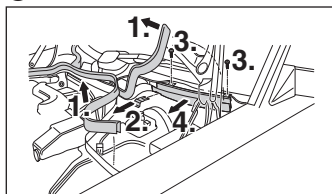

Opel

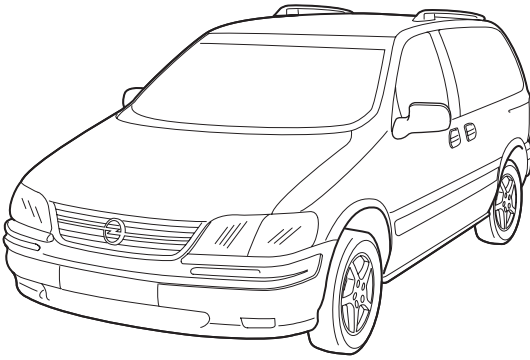

1 987 432 052

Opel Sintra

* 03.97 →

Sintra

D

1

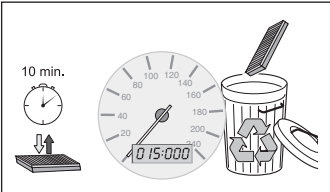

4

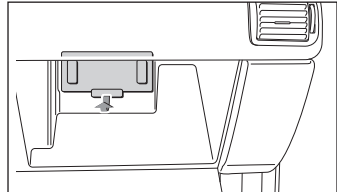

2

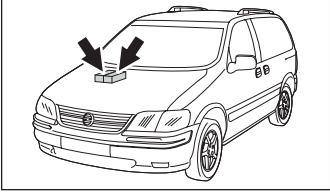

5

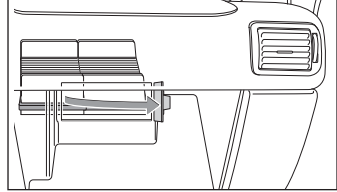

3

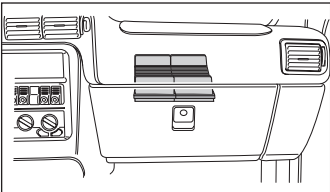

6

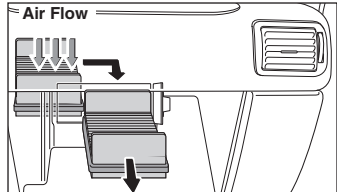

Honda, Rover

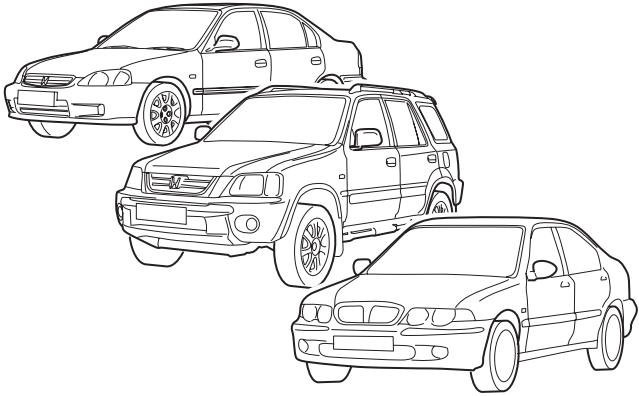

1 987 432 053

Honda Civic
 Honda CR-V
 Rover 400-Serie

* 10.95 →
 * 09.94 →
 * 10.95 →

Civic

①

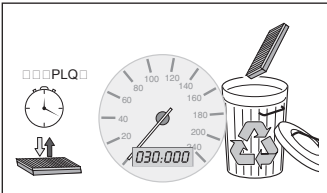

③

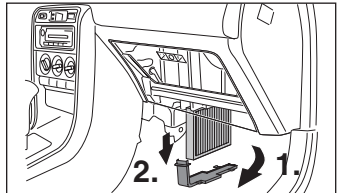

②

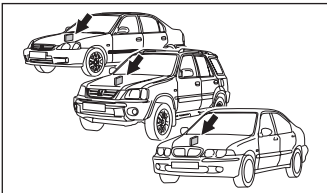

④

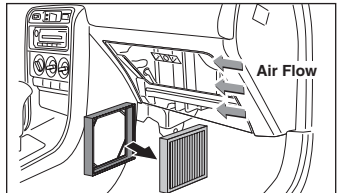

D

CR-V

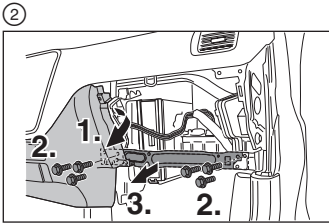
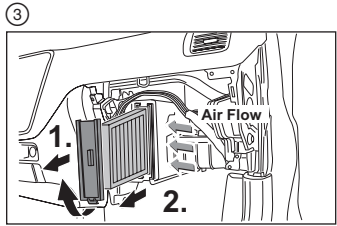
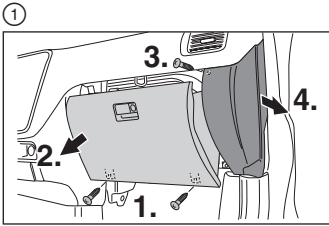

400-Serie

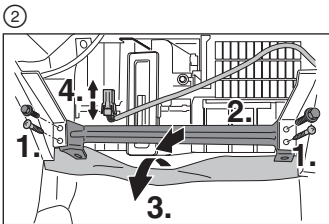
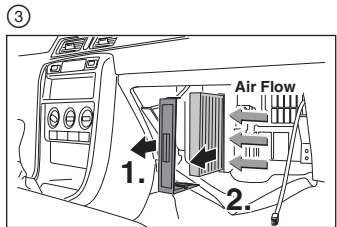
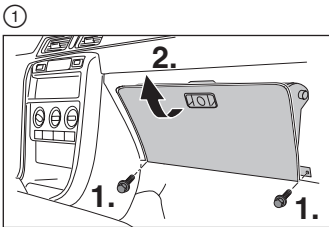

D

Hyundai

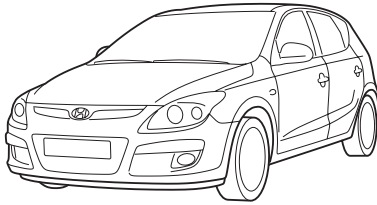

1 987 432 055

Hyundai i30

10.07 →

i30

①

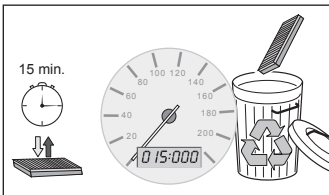

③

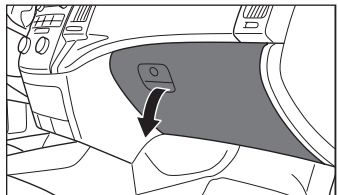

②

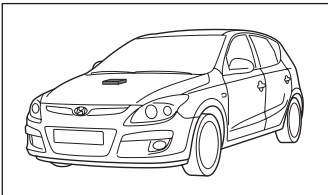

④

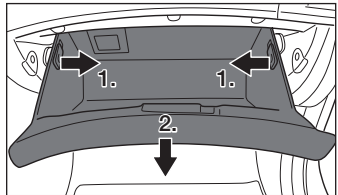

i30 (continued)

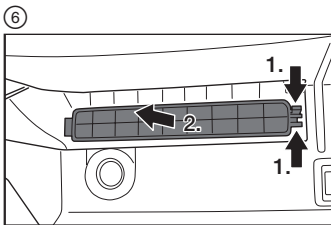
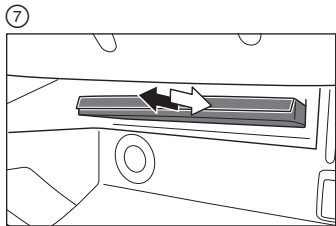
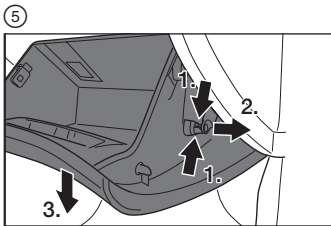

VW

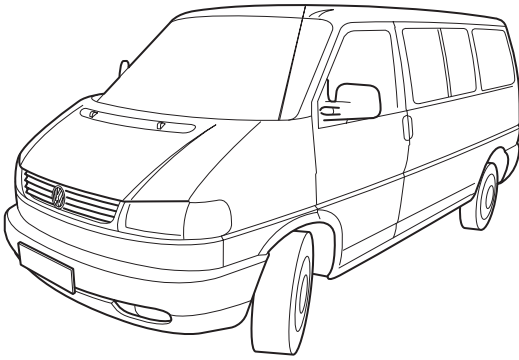

1 987 432 056

VW
 Transporter T4 (7D)
 Transporter T4 (70)

11.92 → 06.03
 07.94 → 06.03

Transporter T4

①

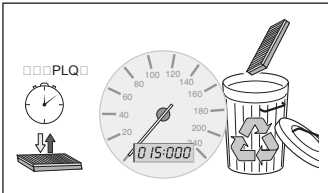

④

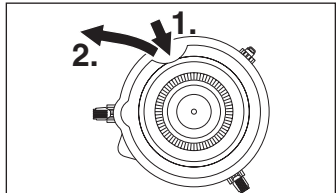

②

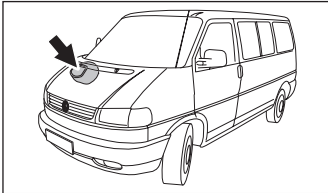

⑤

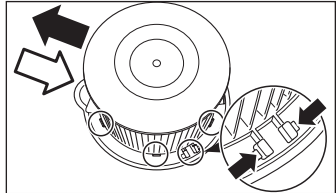

③

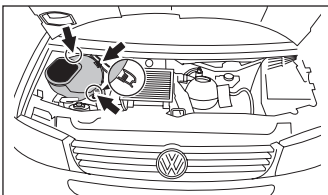

⑥

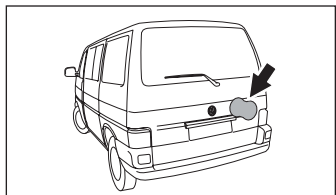

Transporter T4

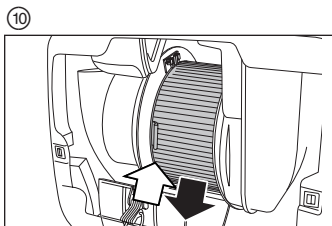
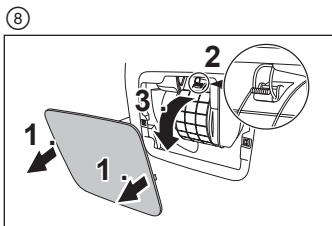
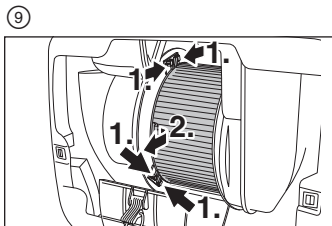
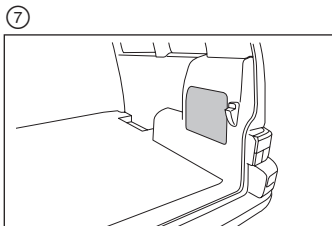

D

Audi, Skoda

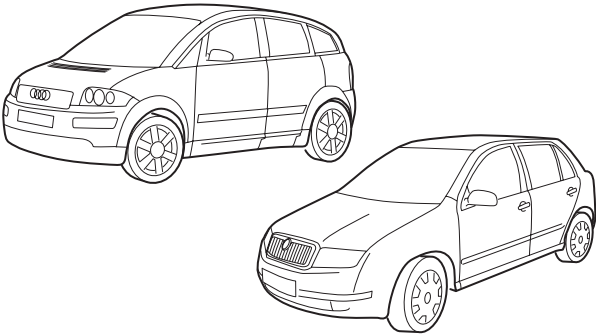

1 987 432 057
1 987 432 357

Audi A2
Skoda Fabia

09.99 →
09.99 →

A2, Fabia

①

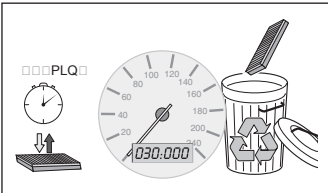

④

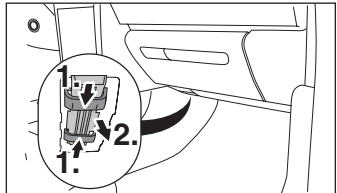

②

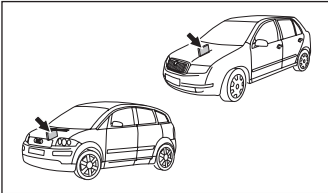

⑤

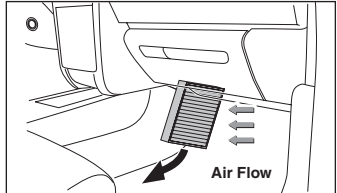

③

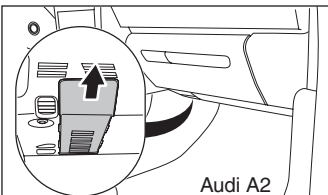

D

Ford, Nissan

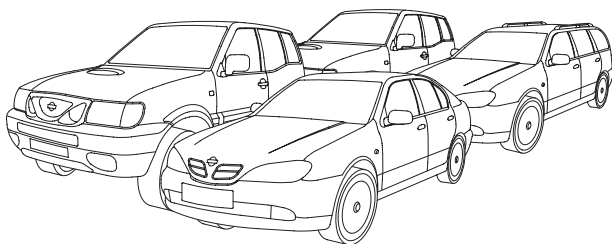

1 987 432 058

Ford Maverick
Nissan Terrano II
Nissan Primera

* 02.93 →

* 02.93 →

* 02.93 →

Maverick, Terrano II

①

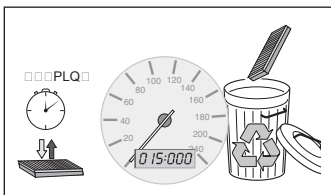

④

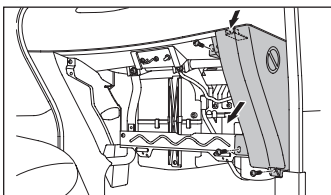

②

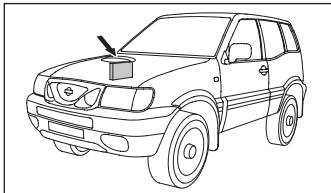

⑤

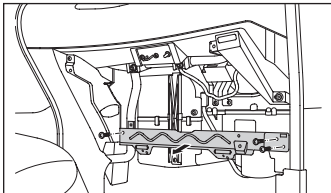

③

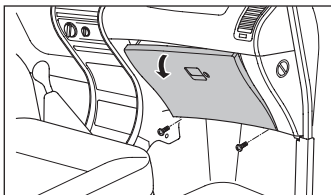

⑥

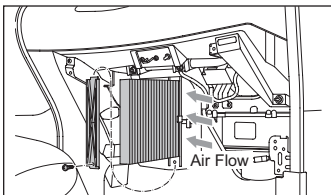

Primera

①

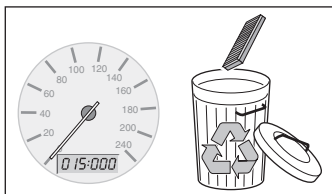

⑤

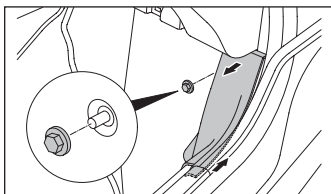

②

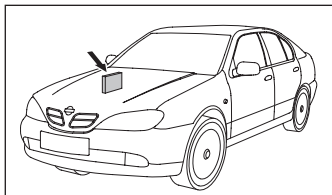

⑥

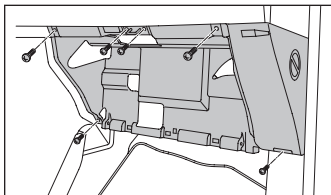

③

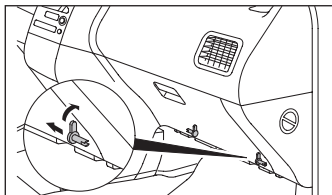

⑦

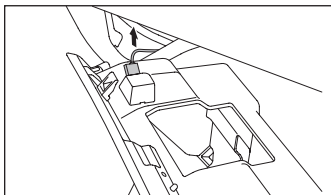

④

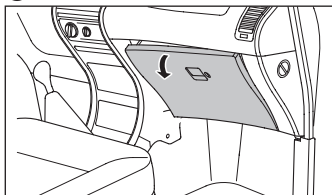

⑧

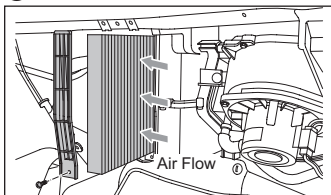

D

Fiat

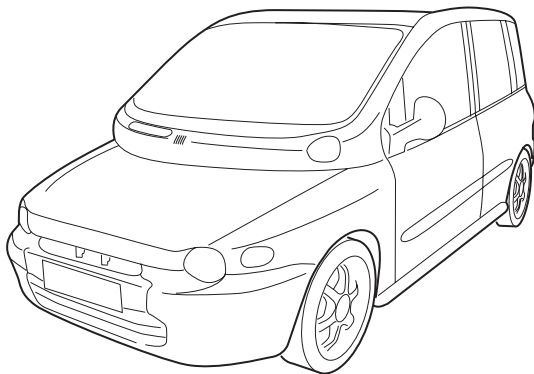

1 987 432 059

Fiat Multipla

01.99 →

Multipla

①

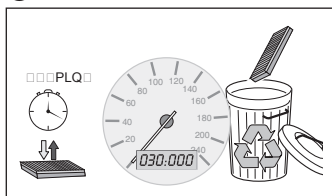

④

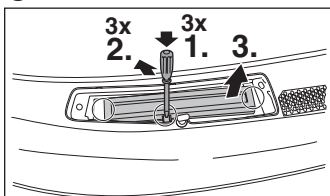

②

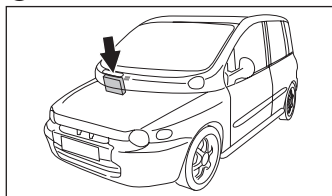

⑤

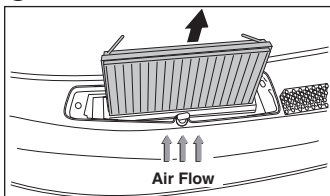

③

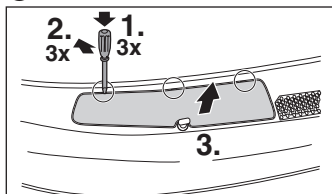

Fiat, Lancia, Citroën, Peugeot

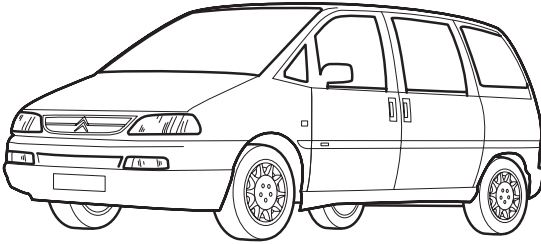

1 987 432 060

Fiat Ulysse
 Fiat Ulysse
 Lancia Zeta
 Citroën Evasion
 Peugeot 806
 Peugeot Expert

* 06.94 →
 * 07.97 →
 * 05.95 →
 * 06.94 →
 * 06.94 →
 * 02.96 →

Ulysse, Zeta, Evasion, 806, Expert

①

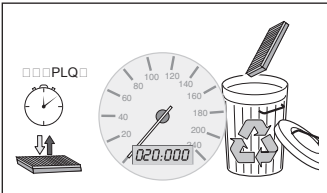

④

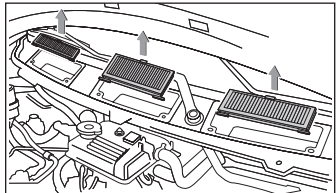

②

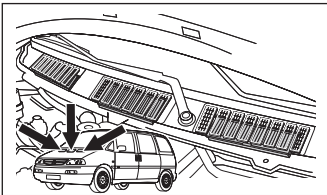

⑤

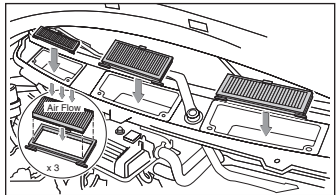

③

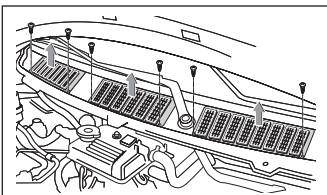

Renault

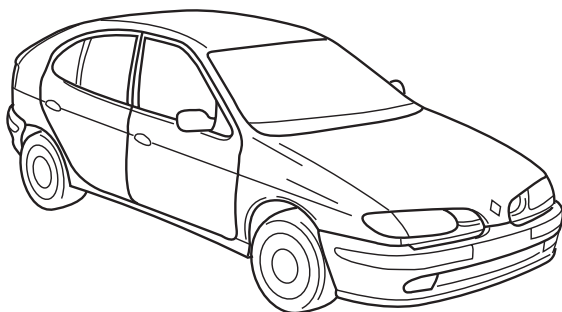

1 987 432 061

Renault Mégane

* 04.98 →

Mégane

1

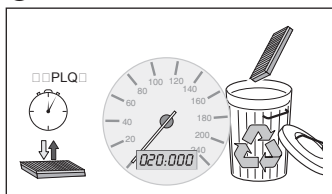

4

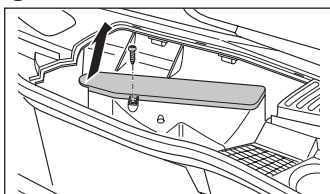

2

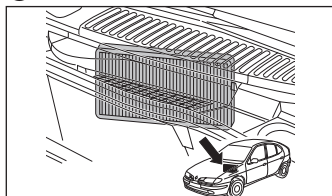

5

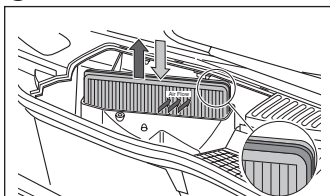

3

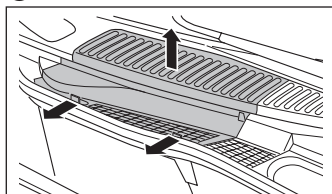

Volvo

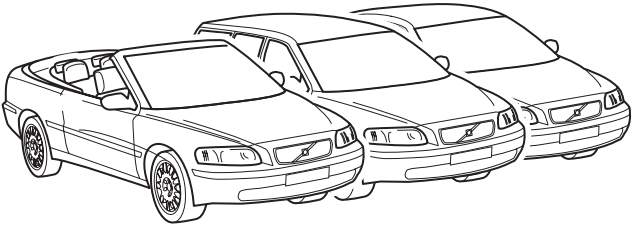

1 987 432 062

Volvo C70

Volvo S70

Volvo V70

* 06.97 →

* 06.97 →

* 06.97 →

C70, S70, V70

①

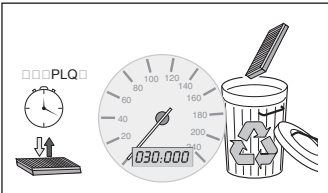

④

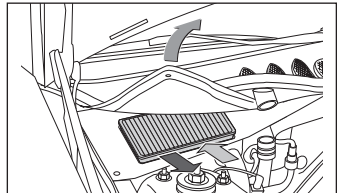

②

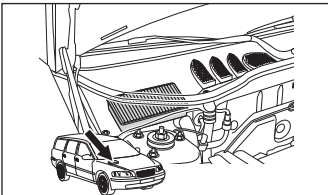

⑤

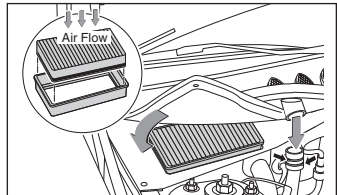

③

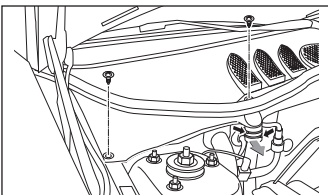

⑥

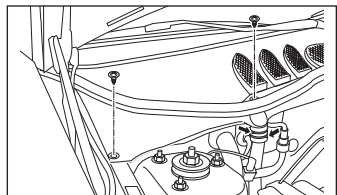

Volvo

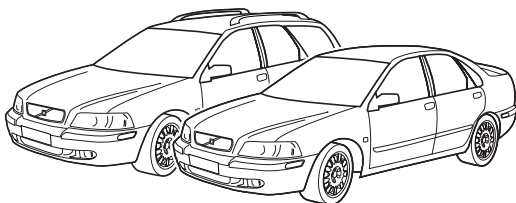

1 987 432 063
1 987 432 363

Volvo S40
Volvo V40

* 03.00 →
* 03.00 →

S40, V40

①

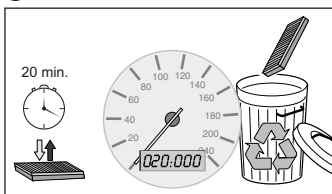

④

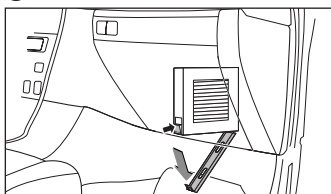

②

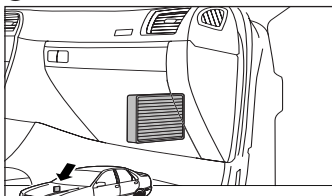

⑤

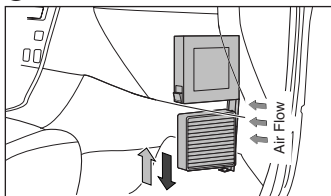

③

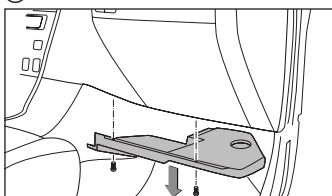

D

Volvo

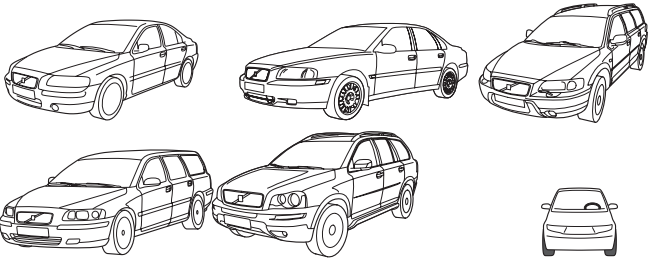

1 987 432 064
1 987 432 364

Volvo S60	07.00 →
Volvo S80	05.98 →
Volvo V70 II	03.00 → 09.07
Volvo XC70	03.00 → 09.07
Volvo XC90	10.02 →

S60, S80, V70 II, XC70, XC90

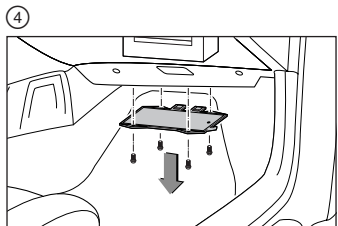
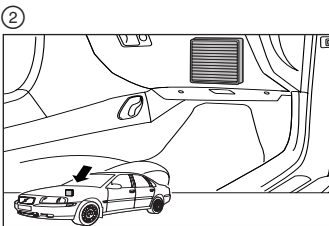
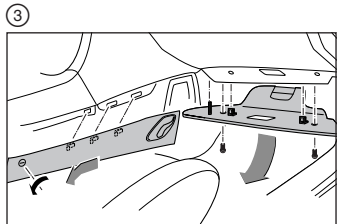
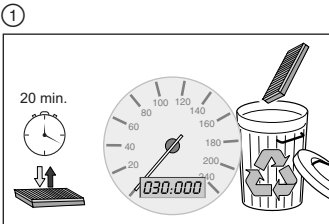

D

S60, S80, V70 II, XC70, XC90 (continued)

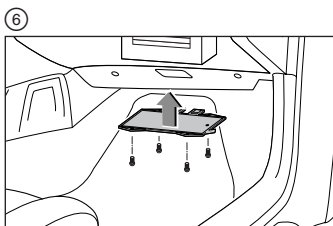
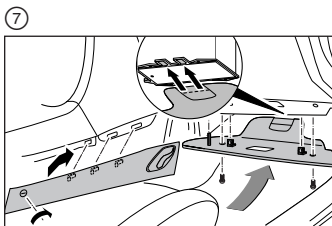
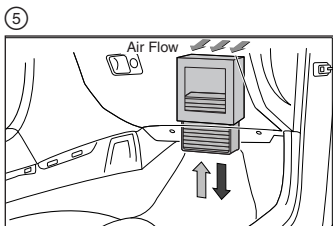

Citroën, Fiat, Peugeot



1 987 432 065

Citroën Jumper
Fiat Ducato
Peugeot Boxer

04.06 →

07.06 →

04.06 →

Jumper, Ducato, Boxer

①

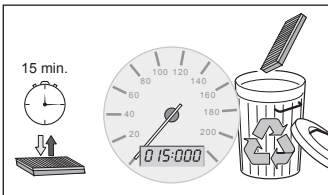

④

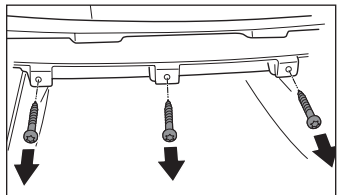

②

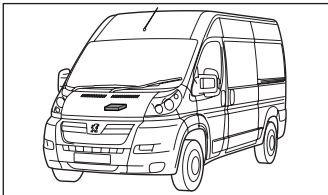

⑤

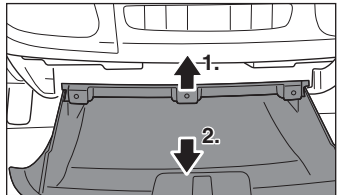

③

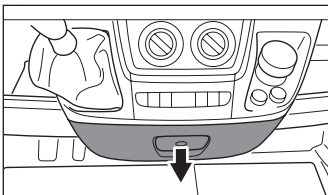

⑥

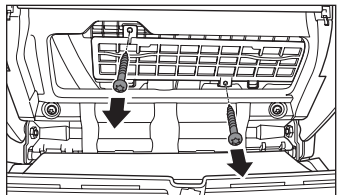

Jumper, Ducato, Boxer (continued)

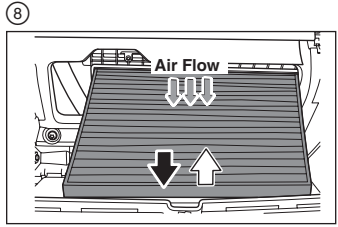
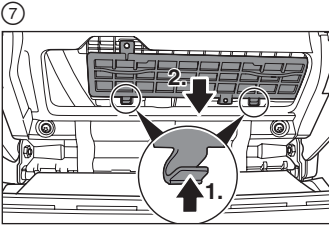

D

Opel

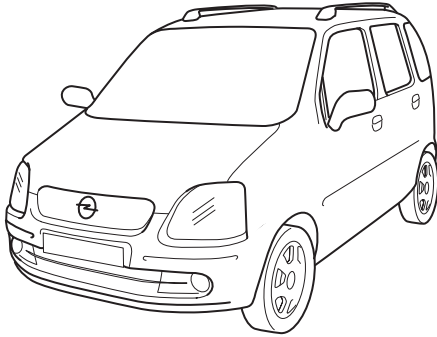

1 987 432 066

Opel Agila

01.00 →

Agila

①

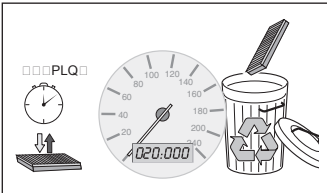

③

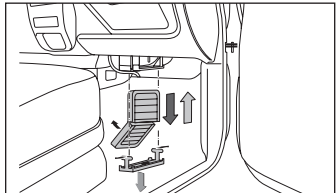

②

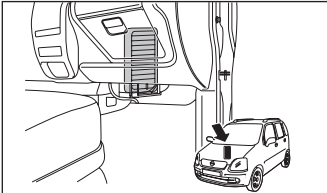

④

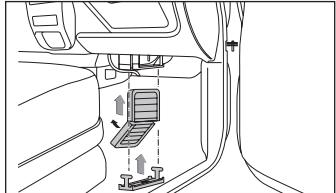

D

BMW

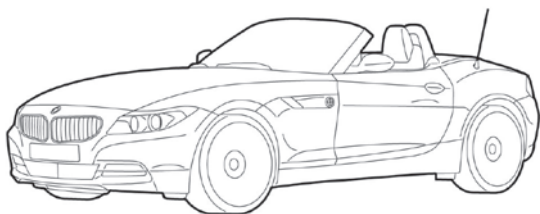

1 987 432 068

1 987 432 368

BMW Z4

02.03 →

Z4

①

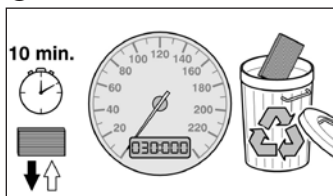

④

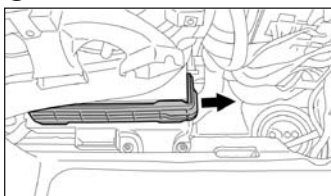

②

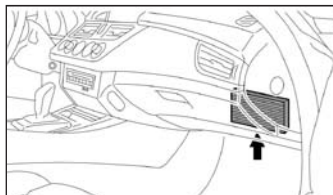

⑤

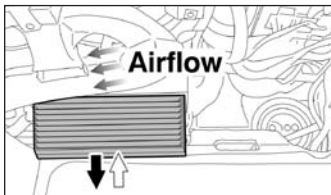

③

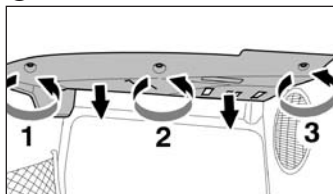

Renault

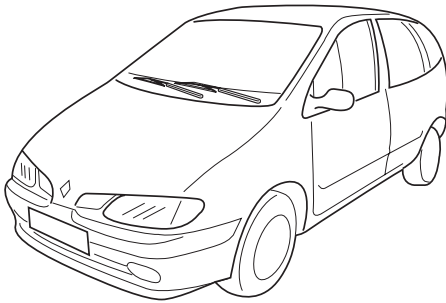

1 987 432 069
1 987 432 469

Renault Scenic

08.99 → 08.03

306

①

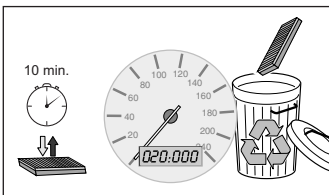

③

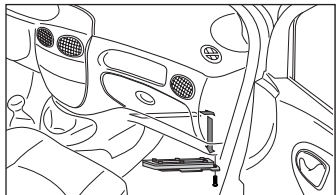

②

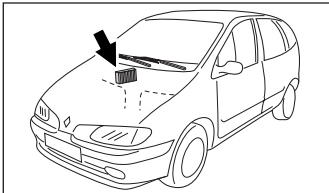

④

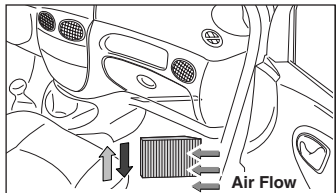

D

Mercedes-Benz

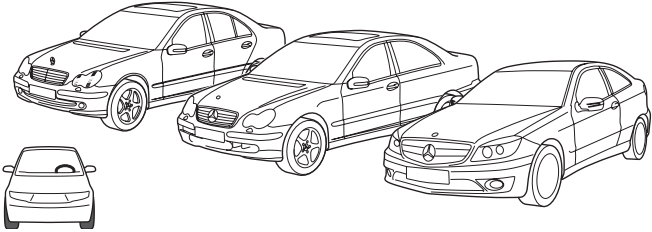

1 987 432 070
1 987 432 370

Mercedes-Benz
C-Klasse (W203, S203, CL 203) **05.00** →
CLC-Klasse (CL 203) **02.09** →
CLK-Klasse (C209, A 209) **06.02** →

C-Klasse, CLC-Klasse, CLK-Klasse

D

①

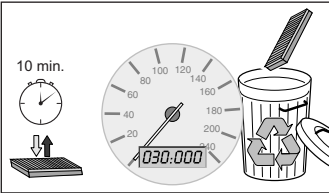

10 min.

④

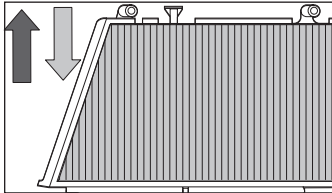

②

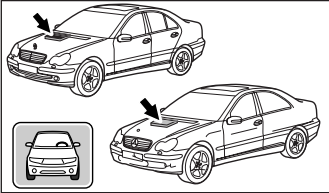

⑤

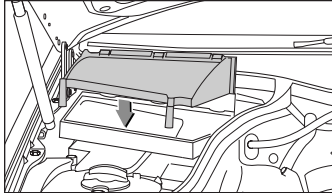

③

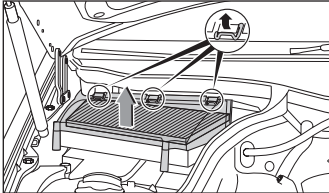

⑥

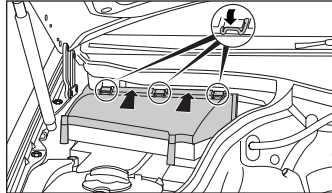

Audi

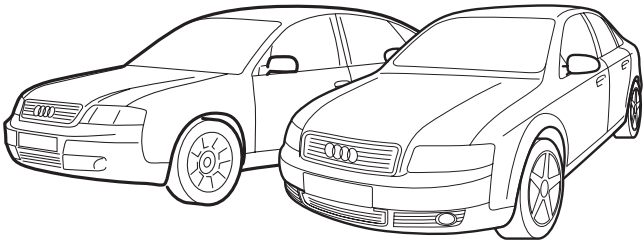

1 987 432 071
1 987 432 371

Audi A4	12.00 →
Audi A4 Avant	09.01 →
Audi A6	09.99 →
Audi A6 Avant	10.98 →

A4, A6 Avant

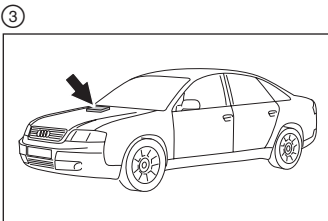
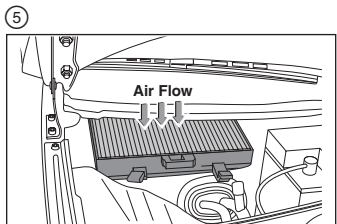
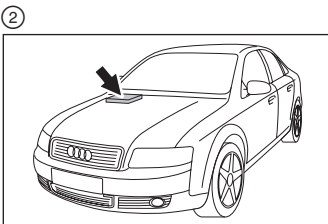
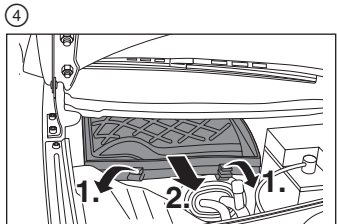
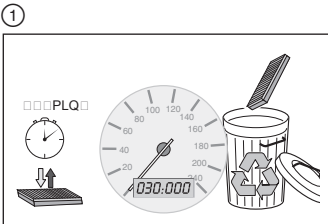

D

A6 Avant

①

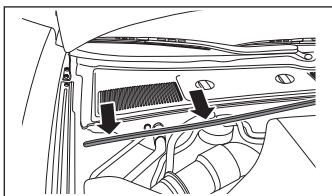

③

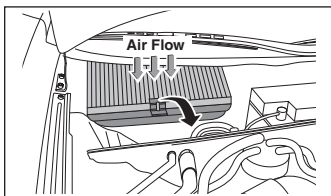

②

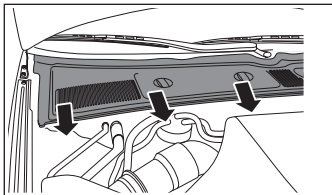

D

Fiat

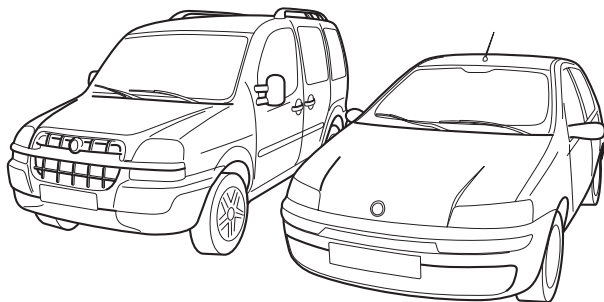

1 987 432 072

Fiat Doblo
Fiat Punto

* 03.01 →

* 03.01 →

Doblo, Punto

①

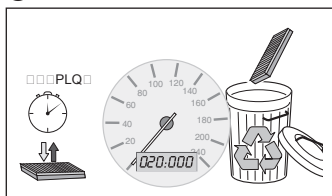

③

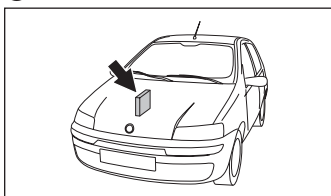

②

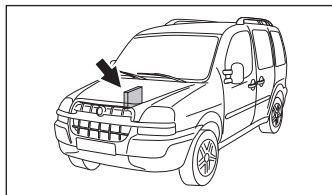

④

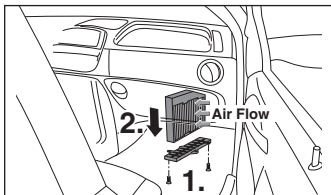

Ford

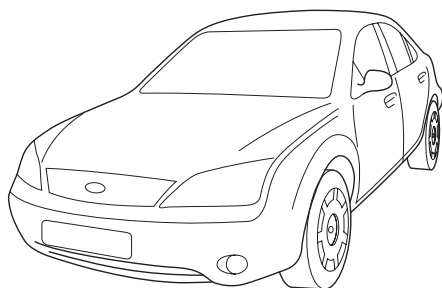

1 987 432 073

Ford Mondeo

* 10.00 →
manual

1 987 432 373

Ford Mondeo

* 10.00 →
automatic

Mondeo

①

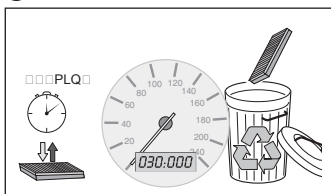

④

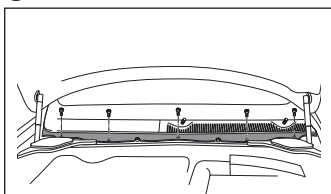

②

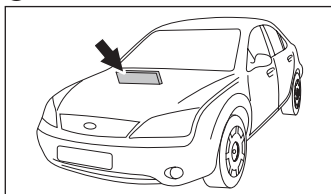

⑤

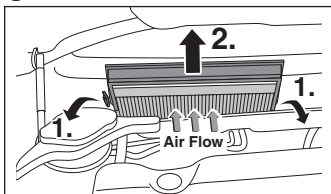

③

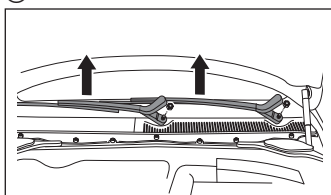

Nissan

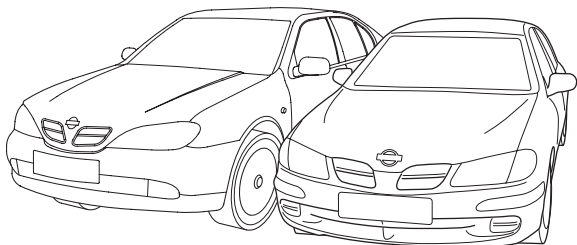

1 987 432 075

Nissan
Almera
Primera

01.01 →

12.01 →

Almera

①

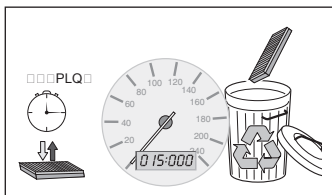

④

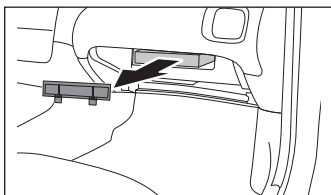

②

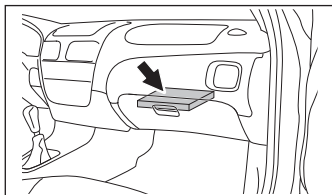

⑤

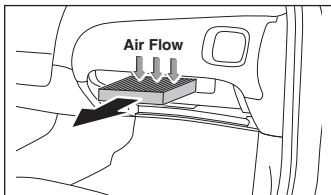

③

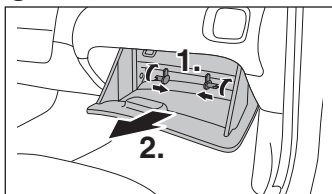

Primera

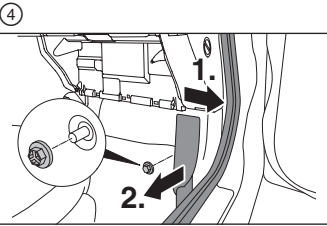
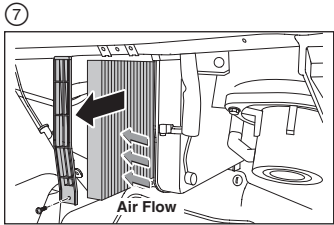
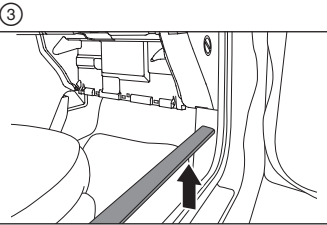
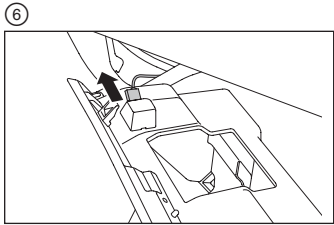
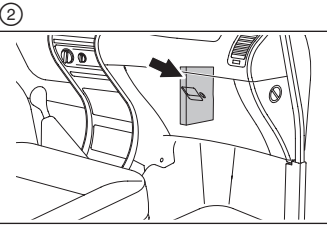
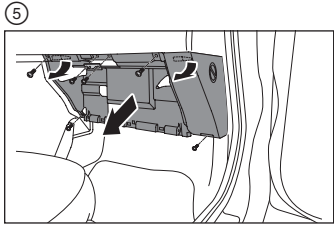
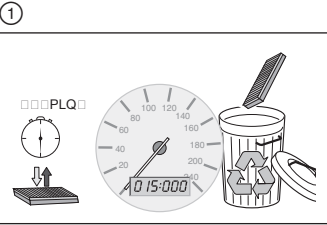

D

Opel, Vauxhall

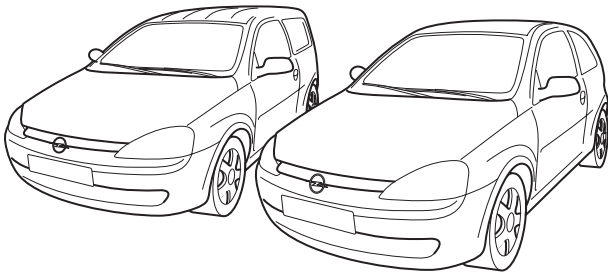

1 987 432 076
1 987 432 376

Opel, Vauxhall
Corsa C
Combo

10.00 →

10.01 →

Corsa C, Combo

①

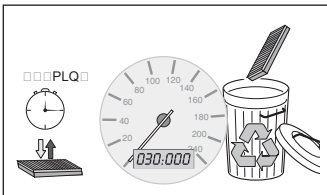

④

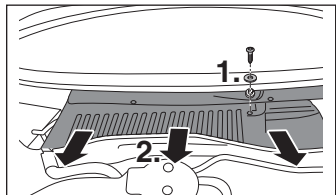

②

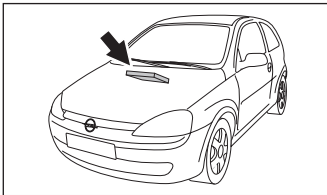

⑤

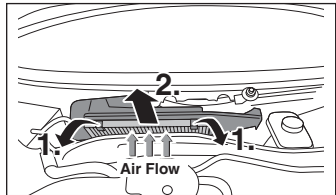

③

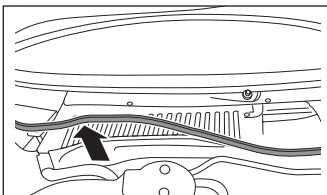

Citroën

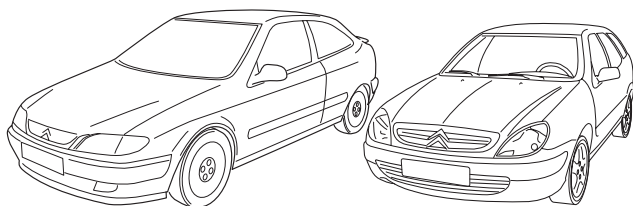

1 987 432 077

Citroën Xsara, Xsara II

04.97 → 03.05

Xsara

①

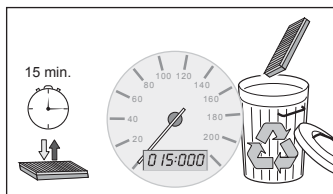

③

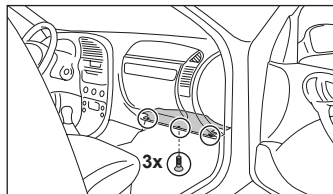

②

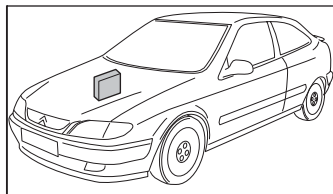

④

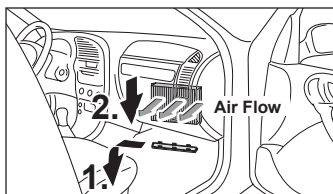

D

Xsara II

①

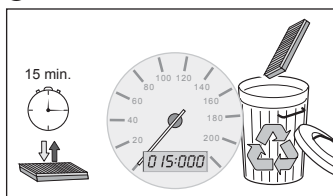

③

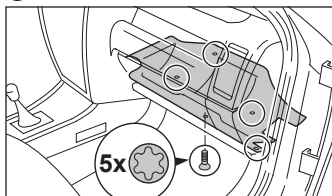

②

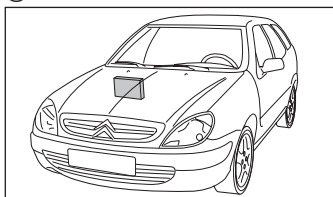

④

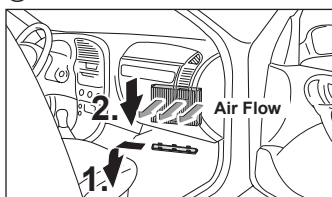

Renault

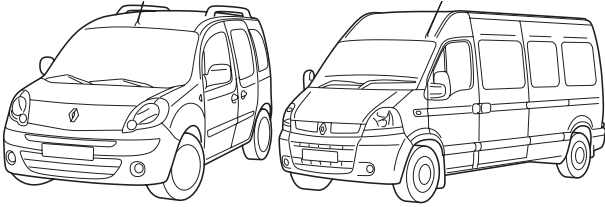

1 987 432 078

Kangoo II
Master IV

02.08 →
04.10 →

Kangoo

1

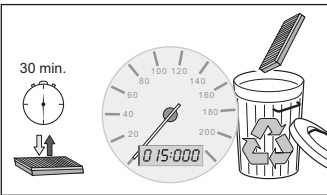

4

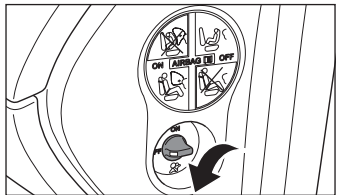

2

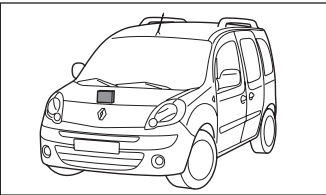

5

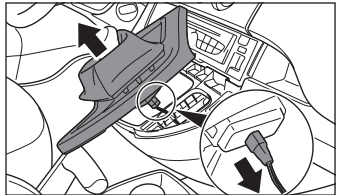

3

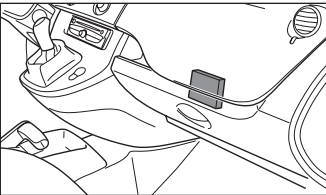

6

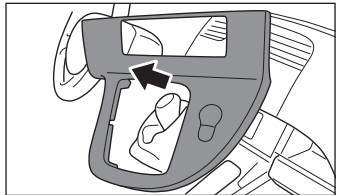

D

Kangoo

7

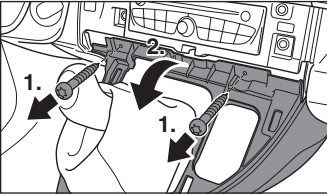

12

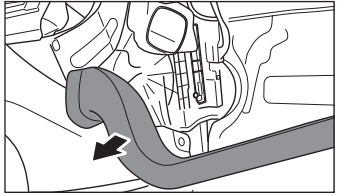

8

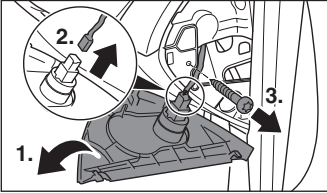

13

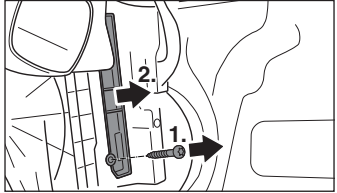

9

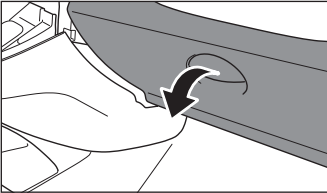

14

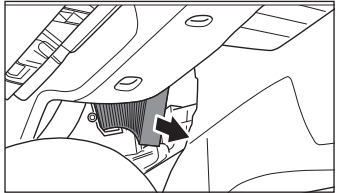

10

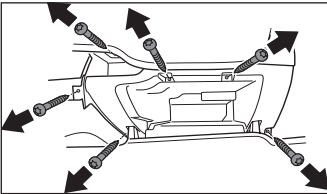

15

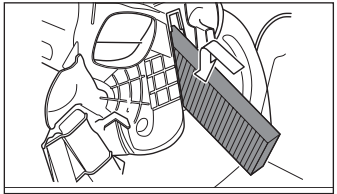

11

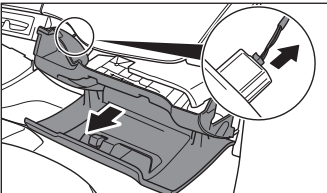

16

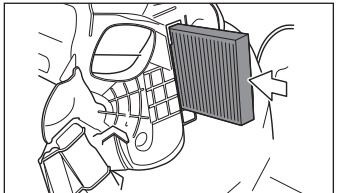

D

Master

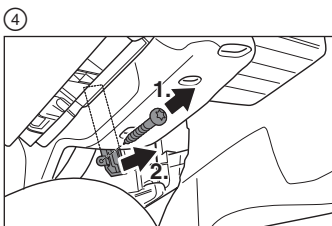
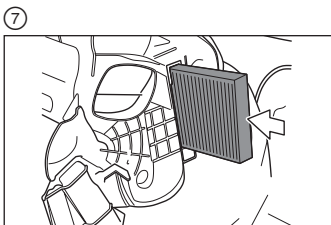
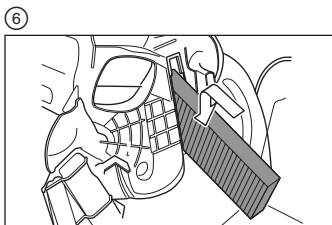
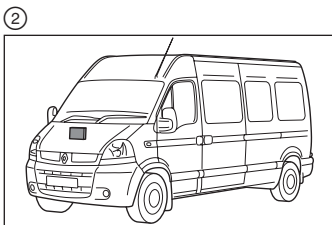
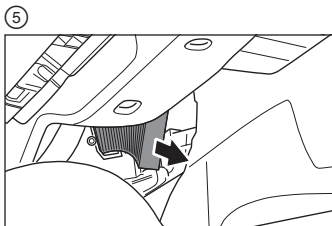
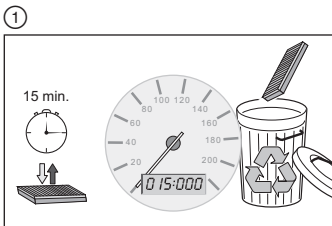

D

Citroën, Peugeot

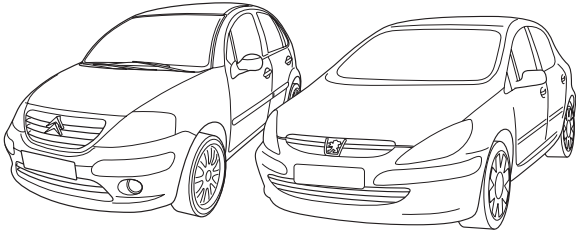

1 987 432 079
1 987 432 379

Citroën C3, Pluriel
Peugeot 307

01.02 →
* 08.00 →

C3, Pluriel

①

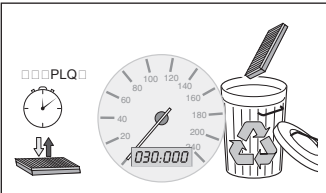

④

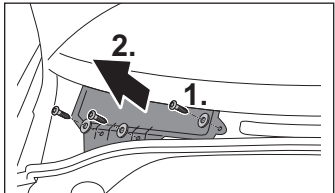

②

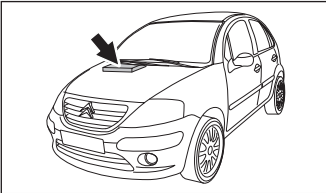

⑤

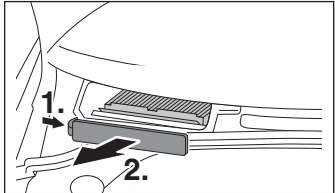

③

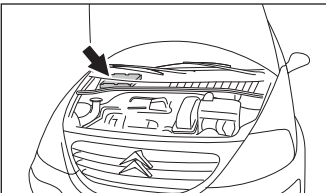

⑥

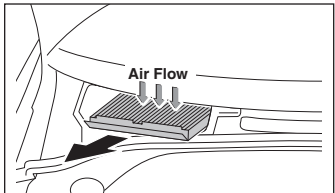

1

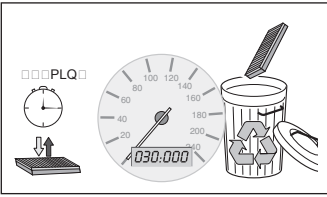

5

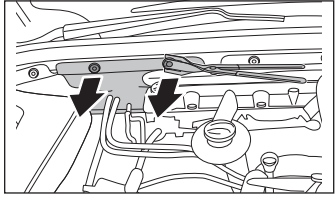

2

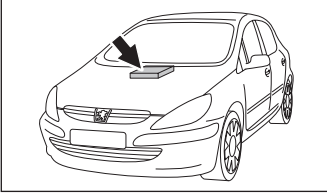

6

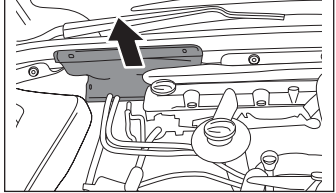

3

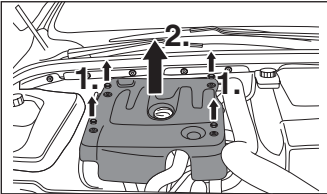

7

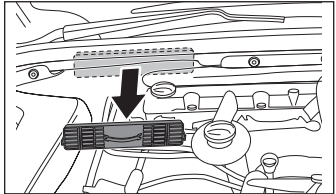

4

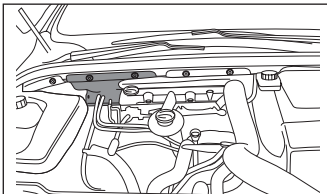

8

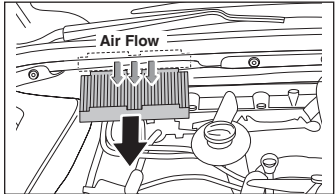

D

9

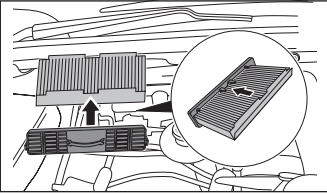

11

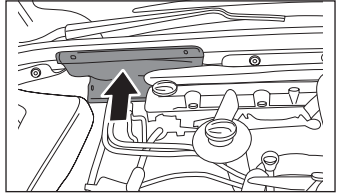

10

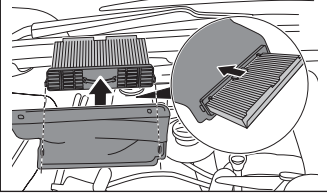

Renault

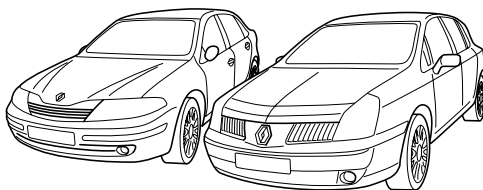

1 987 432 080
1 987 432 380

Laguna II
Vel Satis

03.01 →
* 04.02 →

Laguna II

①

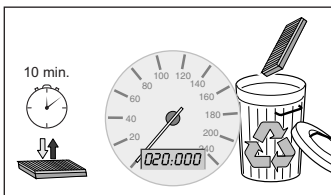

④

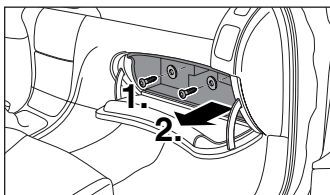

②

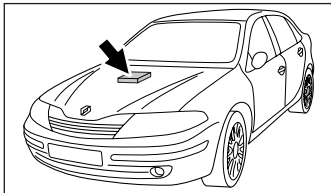

⑤

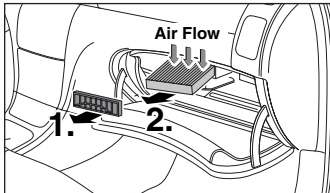

③

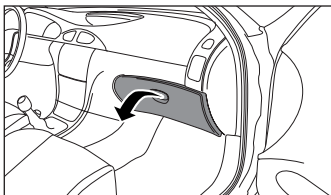

D

Vel Satis

①

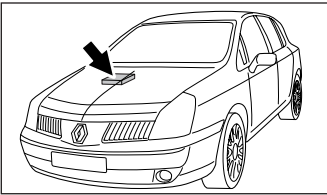

④

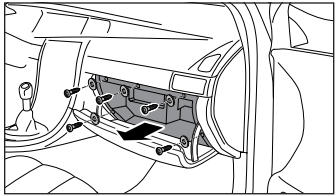

②

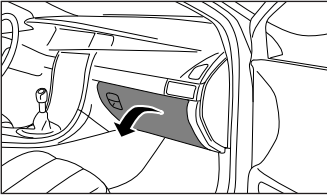

⑤

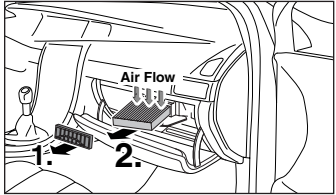

③

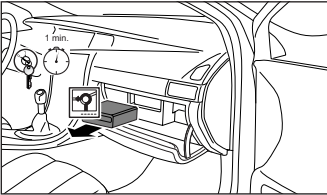

D

Mercedes-Benz

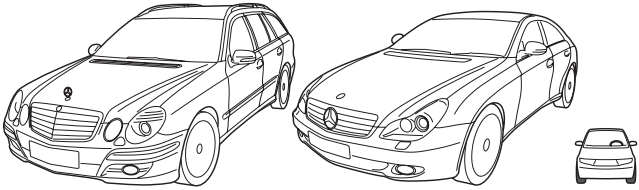

1 987 432 081
1 987 432 381

E-Klasse (W 211)
E-Klasse (S 211)
CLS (C 219)

03.02 →
03.02 →
10.04 →

E-Klasse (W 211, S 211), CLS (C 219)

①

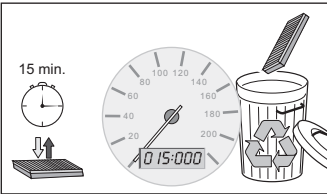

③

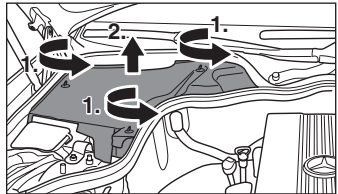

②

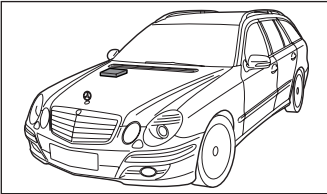

④

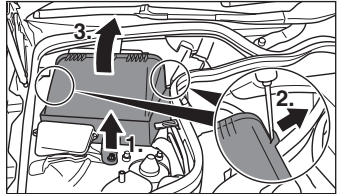

D

E-Klasse (W 211, S 211), CLS (C 219)

5

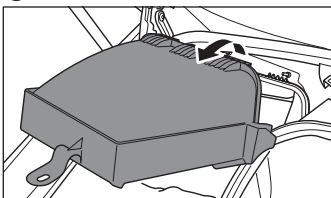

7

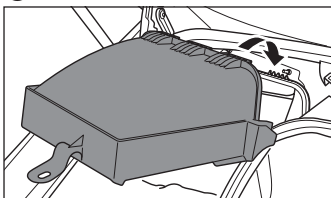

6

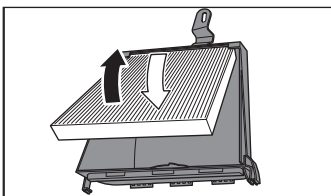

D

Mini Cooper

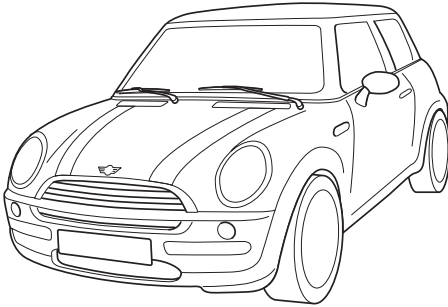

1 987 432 082
1 987 432 382

Mini Cooper

06.01 →

Cooper

①

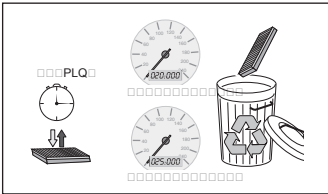

④

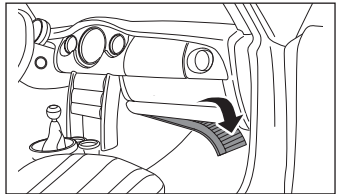

②

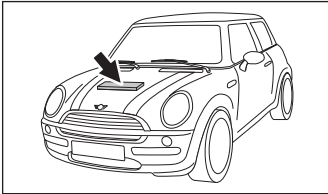

⑤

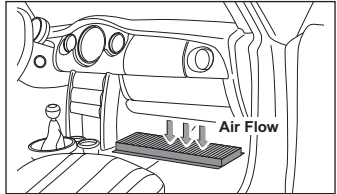

③

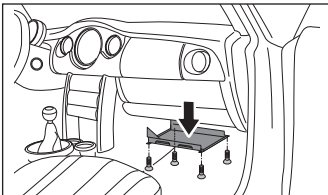

D

Citroën, Peugeot

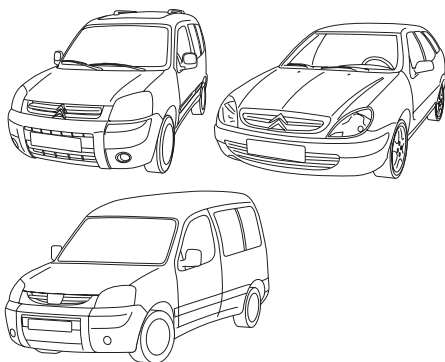

1 987 432 083
1 987 432 383

Citroën Berlingo
Citroën Xsara

01.01 →
* automatic 09.00 →

Peugeot Partner

* 09.02 →

Berlingo

①

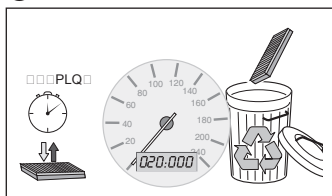

③

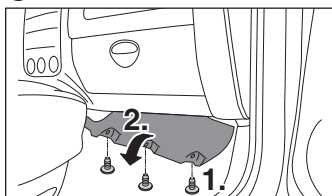

②

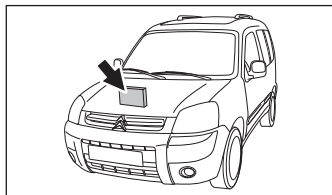

④

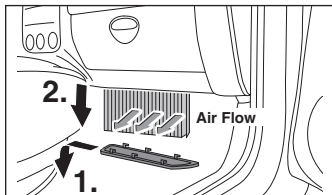

Xsara

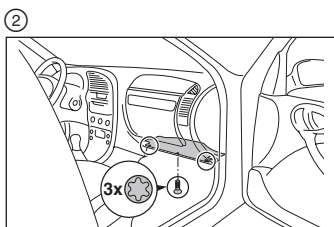
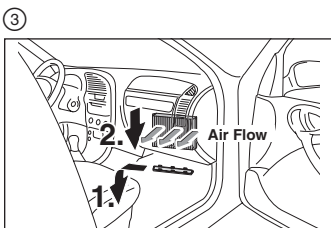
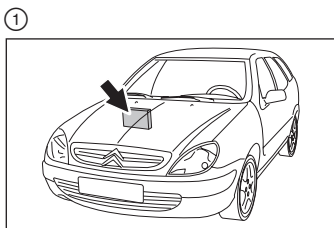

Partner

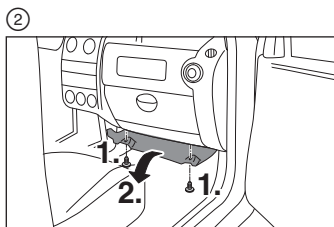
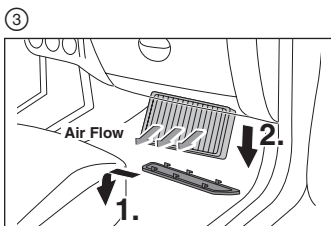
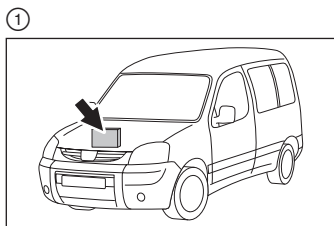

D

Toyota

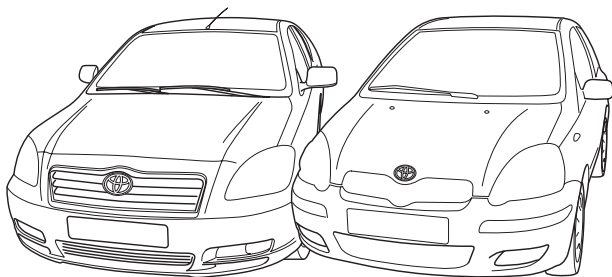

1 987 432 084
1 987 432 085

Toyota Avensis Verso
Toyota Yaris

05.01 → 01.03
01.99 →

Avensis Verso

①

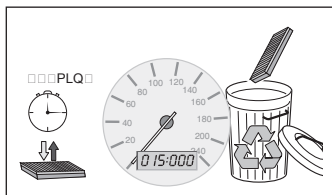

④

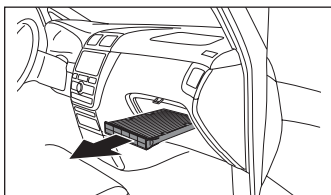

②

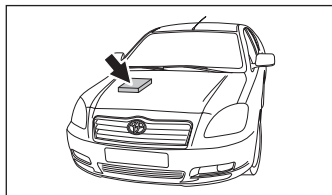

⑤

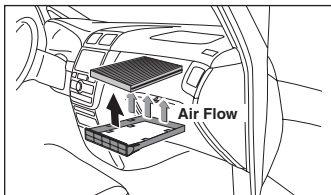

③

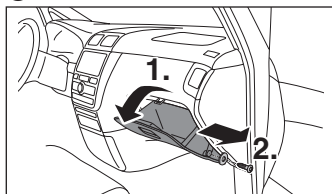

D

Yaris

①

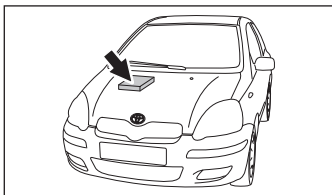

③

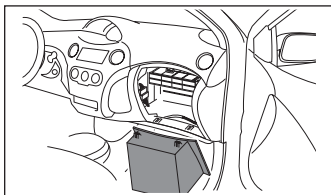

②

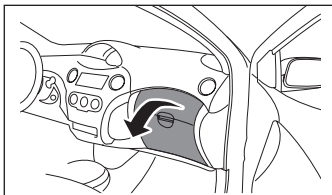

④

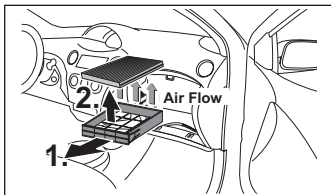

Mitsubishi

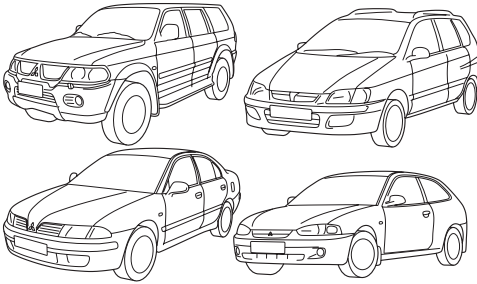

1 987 432 086

Mitsubishi Charisma
Mitsubishi Colt
Mitsubishi Pajero Sport
Mitsubishi Space Star

07.95 → 06.06
05.96 → 07.05
11.98 →
12.98 →

Charisma

①

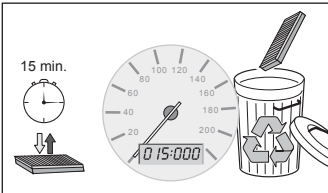

④

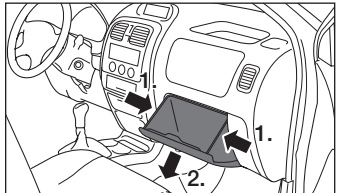

②

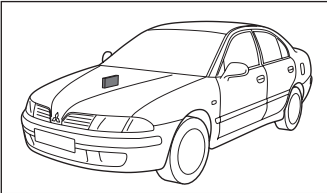

⑤

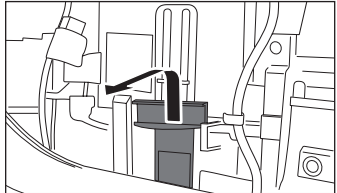

③

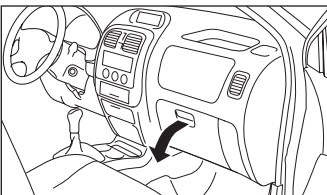

⑥

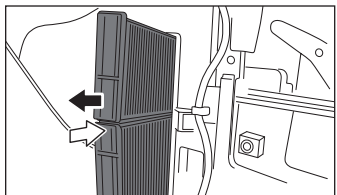

Pajero Sport

①

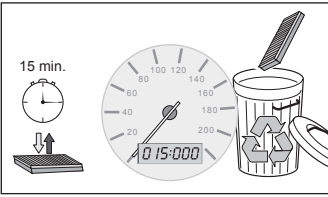

⑤

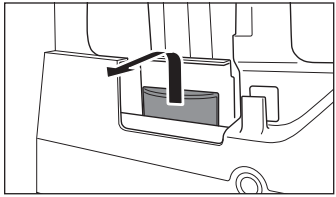

②

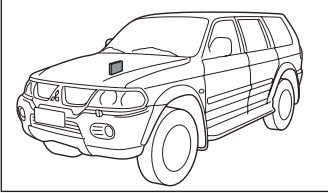

⑥

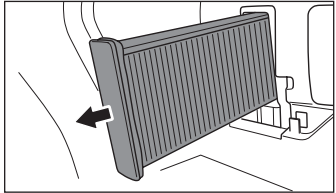

③

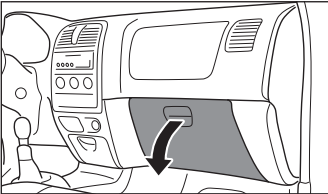

⑦

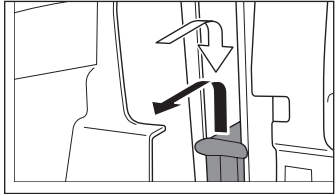

④

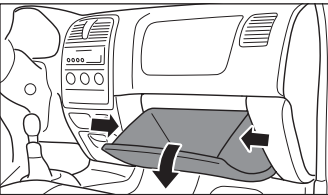

⑧

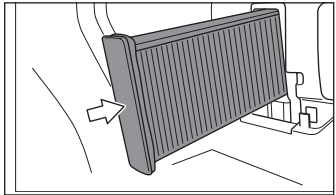

D

Ford

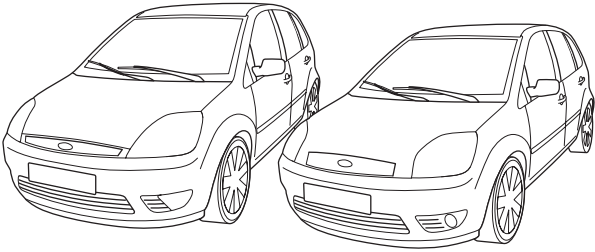

1 987 432 087
1 987 432 387

Ford Fiesta
Ford Fusion

11.01 →
10.02 →

Fiesta, Fusion

D

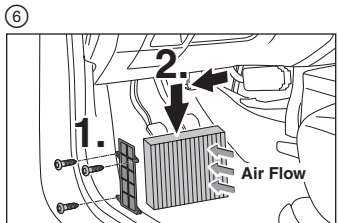
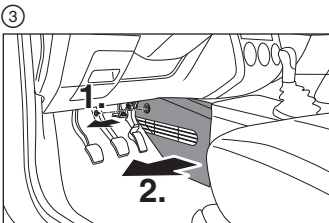
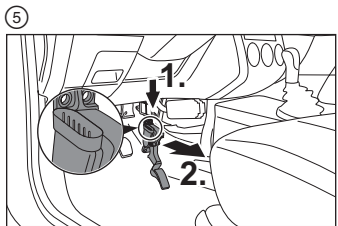
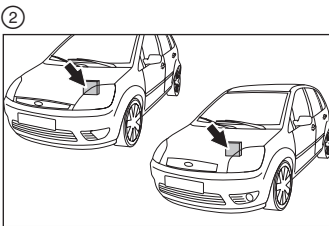
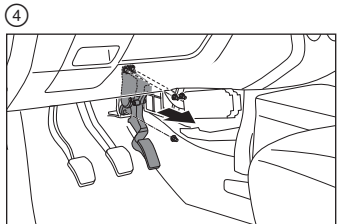
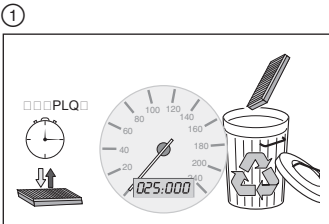

Toyota

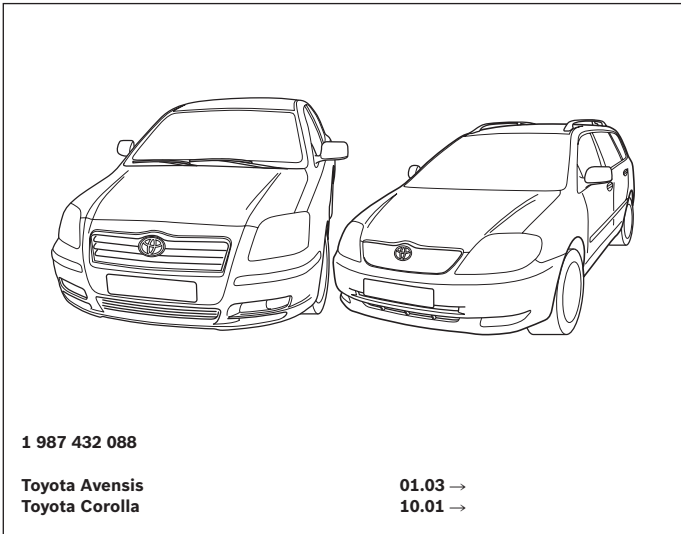

Avensis

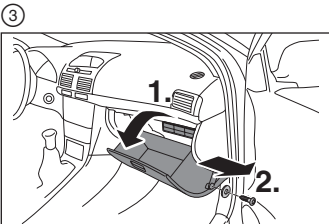
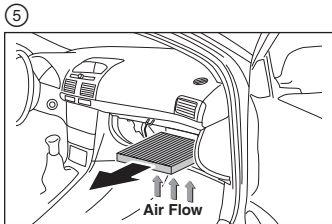
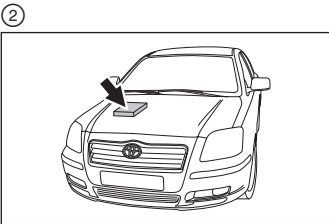
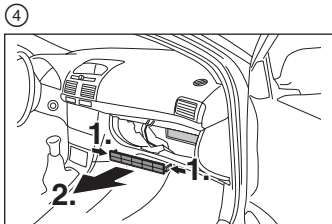
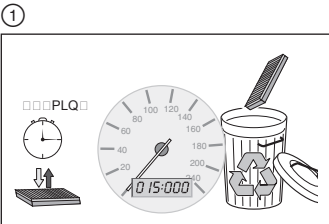

D

Corolla

①

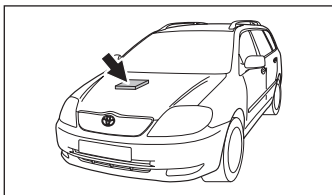

③

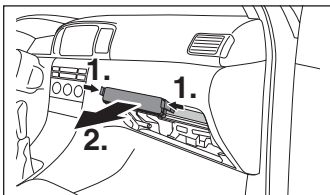

②

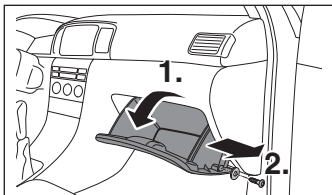

④

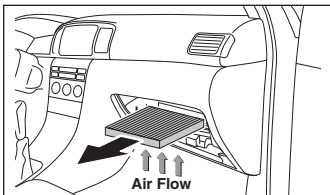

Renault

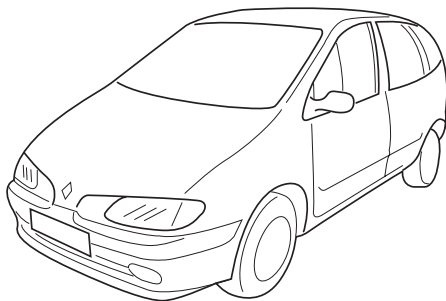

1 987 432 089
1 987 432 389
1 987 432 090
1 987 432 390

Renault Scenic
Renault Scenic

* 11.96 → 01.98
* 02.98 → 10.99

Scenic

①

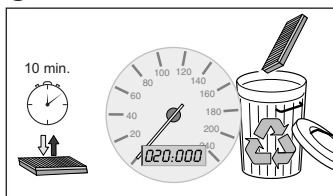

③

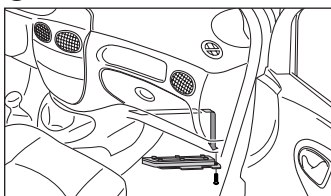

②

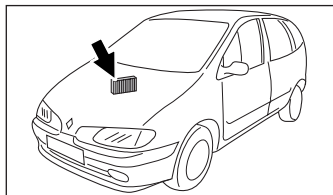

④

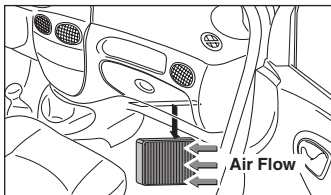

D

Citroën, Fiat, Lancia, Peugeot

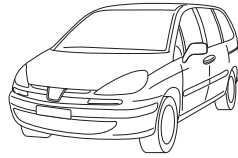
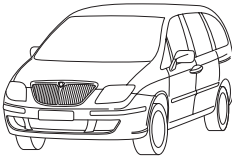
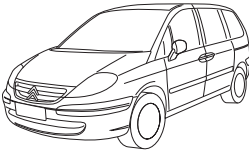

1 987 432 091
1 987 432 391

Citroën C8
Fiat Ulysse
Lancia Phedra
Peugeot 807

06.02 →
10.02 →
09.02 →
06.02 →

C8, Ulysse, Phedra, 807

①

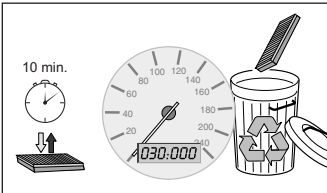

④

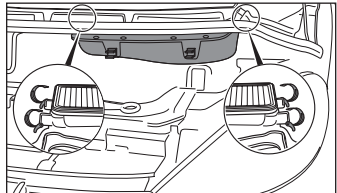

②

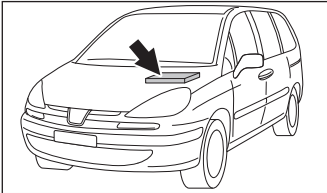

⑤

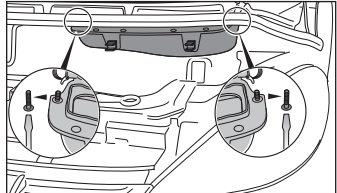

③

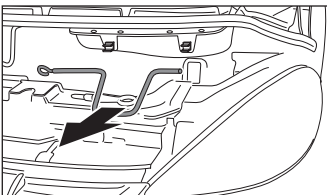

⑥

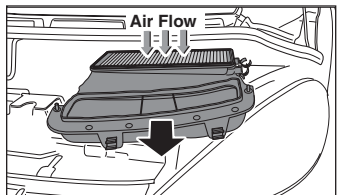

Mazda

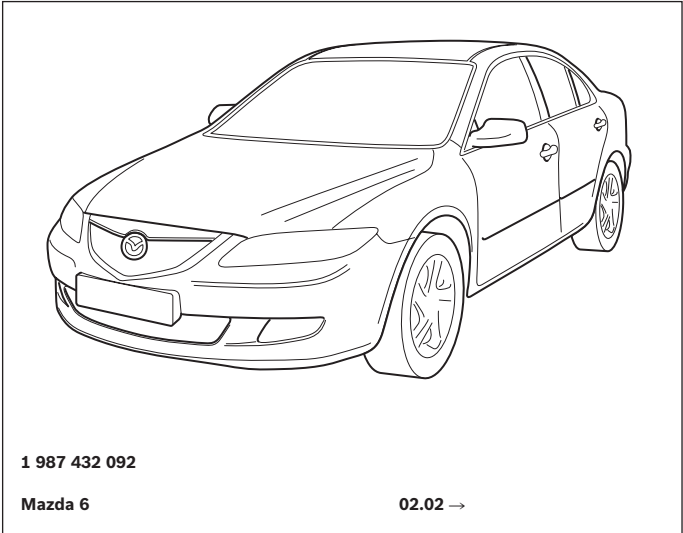

6

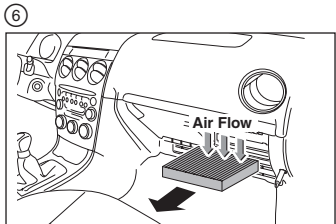
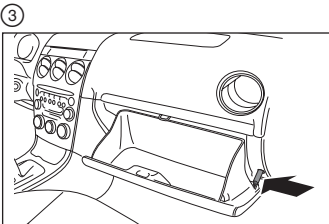
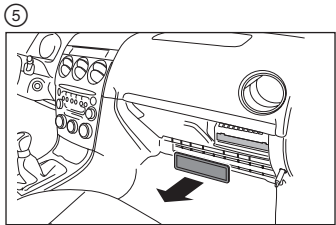
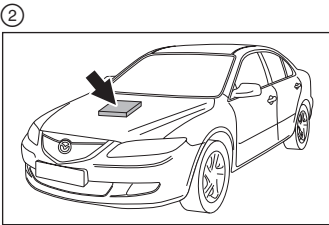
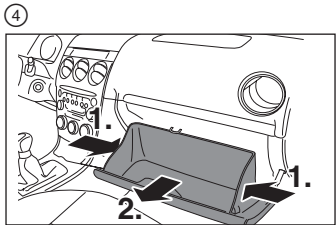
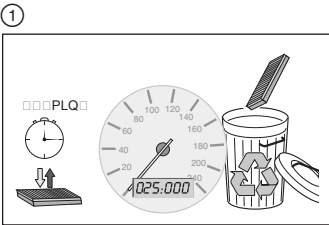

D

Renault

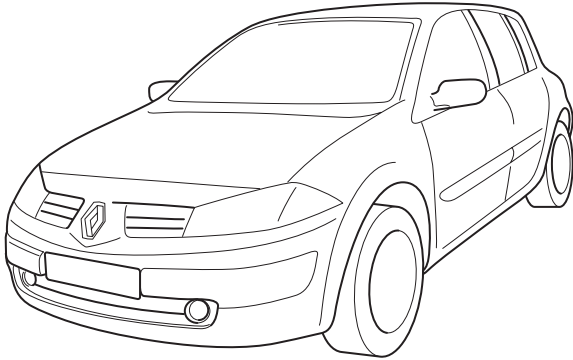

1 987 432 093
1 987 432 393

Renault Mégane II

11.02 →

Mégane II

①

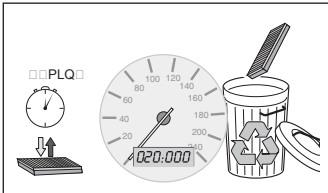

④

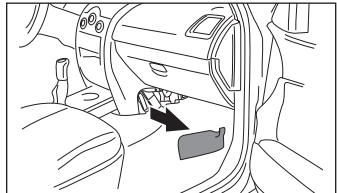

②

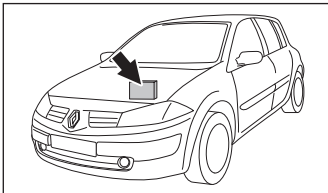

⑤

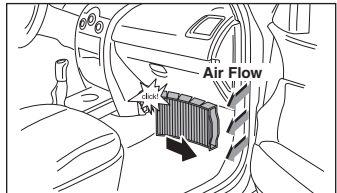

③

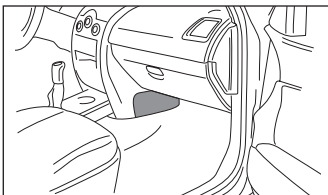

Renault

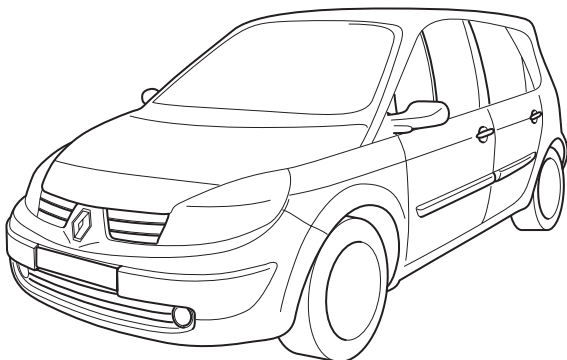

1 987 432 094
1 987 432 394

Renault Scenic II
Renault Grand Scenic II

05.03 →
05.03 →

Scenic II

①

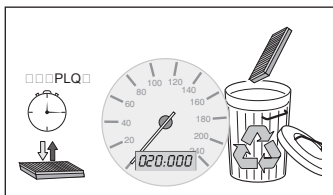

④

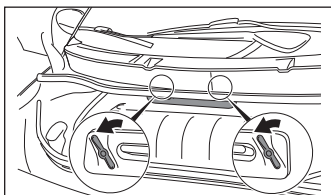

②

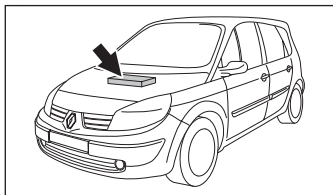

⑤

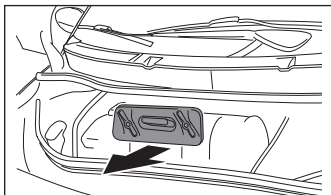

③

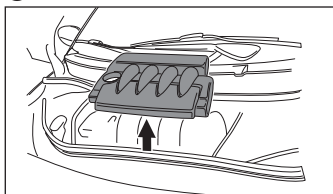

⑥

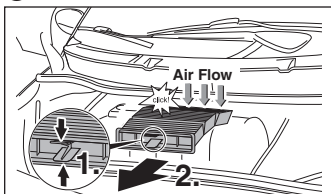

D

Saab

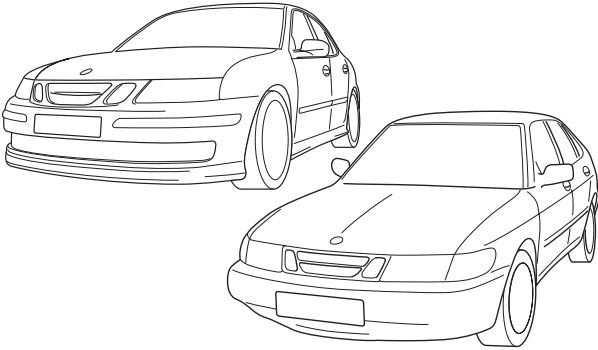

1 987 432 096

Saab 9-3
Saab 900 II

03.98 →
09.93 →

9-3, 900 II

①

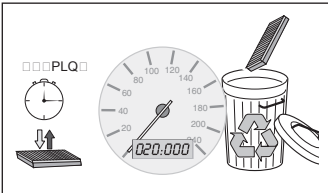

④

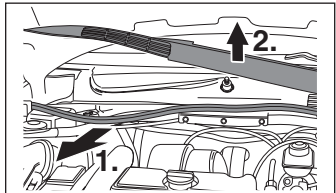

②

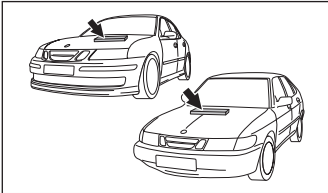

⑤

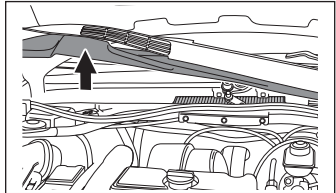

③

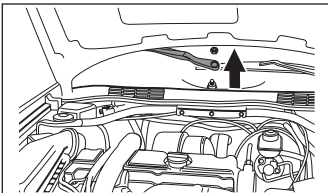

⑥

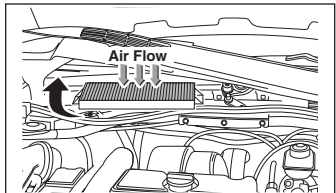

Audi, Seat, Skoda, VW

1 987 432 097
1 987 432 397



Audi A3	05.03 →
Audi TT	10.06 →
Seat Alhambra	06.10 →
Seat Altea	03.04 →
Seat Leon	07.05 →
Seat Toledo III	10.04 →
Skoda Octavia	05.04 →
Skoda Superb	03.08 →
Skoda Yeti	05.09 →
VW Caddy III	04.04 →
VW EOS	03.06 →
VW Golf /Plus V	10.03 → 11.08
VW Golf /Plus VI	12.08 →
VW Jetta III	10.05 →
VW Passat	03.05 →
VW Scirocco III	09.06 →
VW Sharan	05.10 →
VW Tiguan	09.07 →
VW Touran	02.03 →

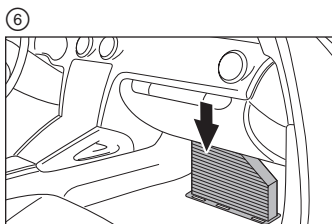
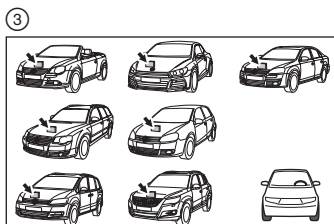
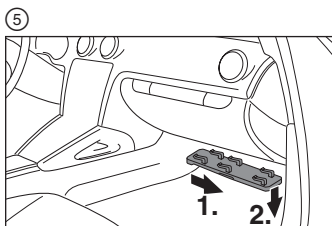
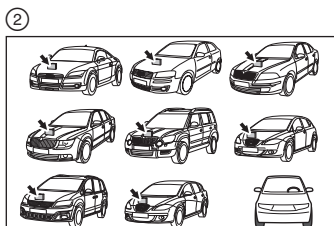
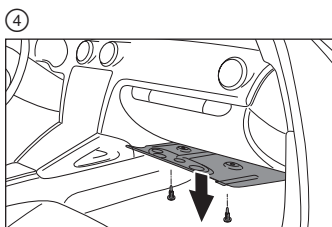
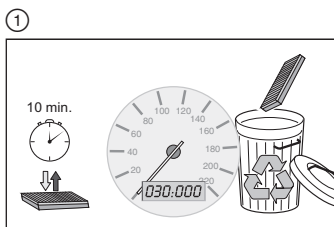

Altea

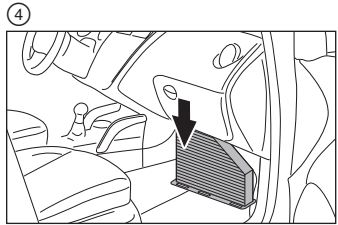
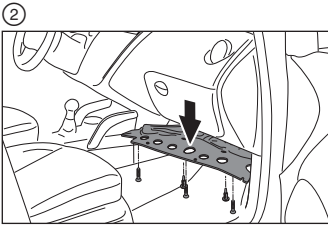
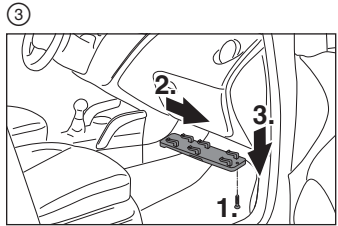
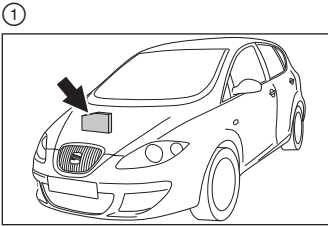

Caddy III

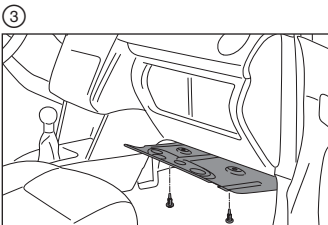
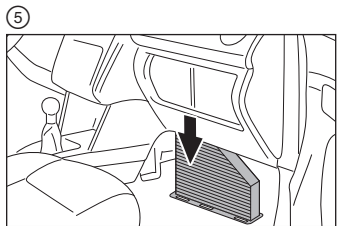
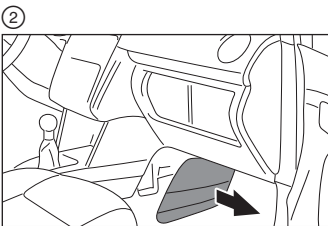
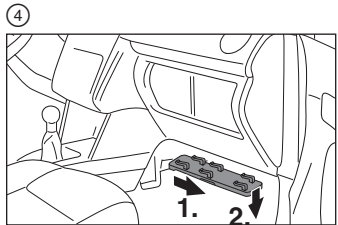
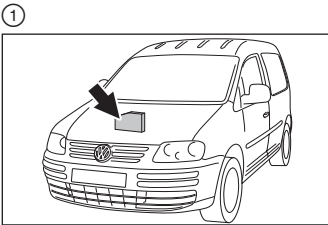

D

Touran

①

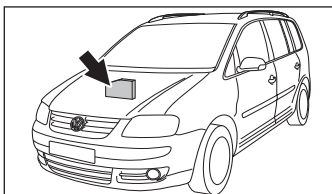

④

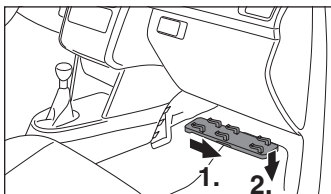

②

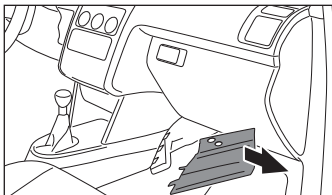

⑤

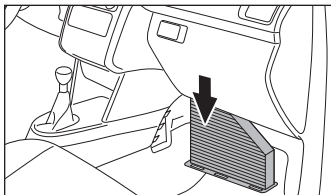

③

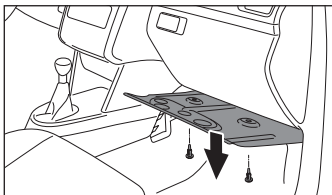

Renault

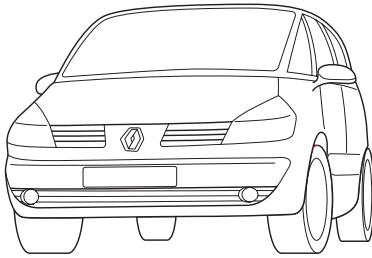

1 987 432 100
1 987 432 400

Renault Espace IV

11.02 →

Espace IV

①

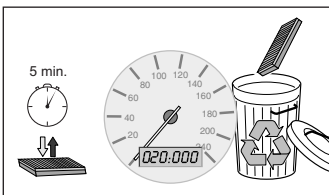

③

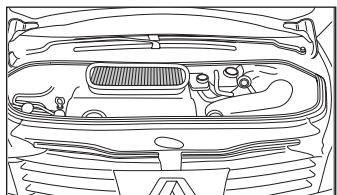

②

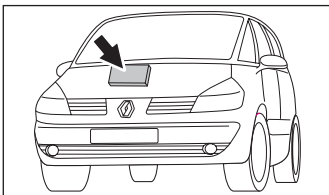

④

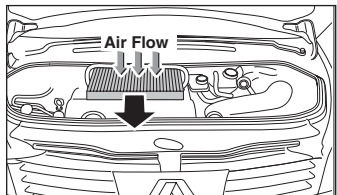

D

BMW

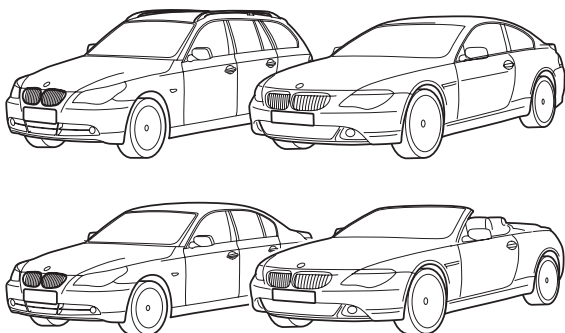

1 987 432 102
1 987 432 402

BMW 5 Series (E60)
BMW 5 Series (E61)
BMW 6 Series (E63)
BMW 5 Series (E64)

* **07.03** →
 * **05.04** →
 * **01.04** →
 * **04.04** →

5, 6 Series

①

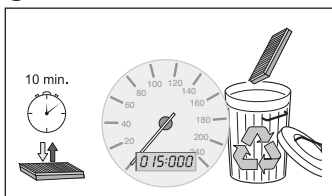

③

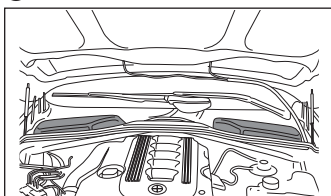

②

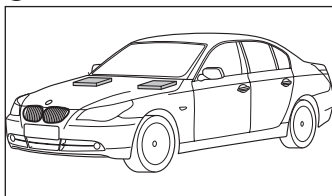

④

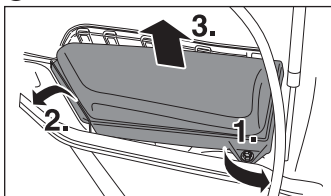

D

5, 6 Series

⑤

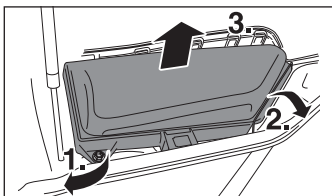

⑦

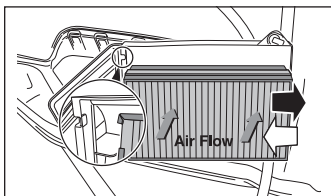

⑥

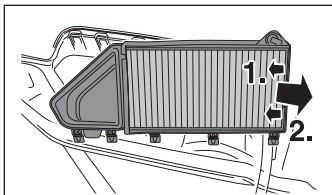

D

BMW

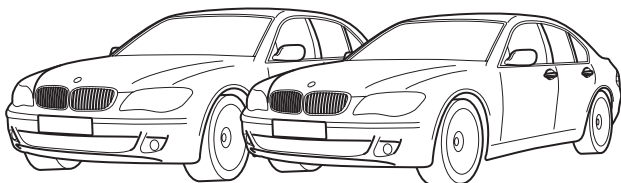

1 987 432 103

BMW 7 Series (E65)

* 11.01 →

BMW 7 Series (E66)

* 03.02 →

7 Series

①

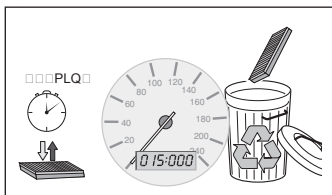

③

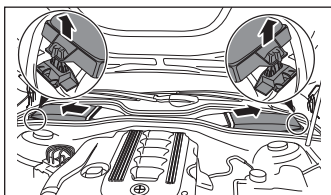

②

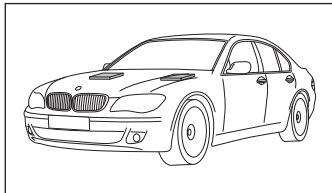

④

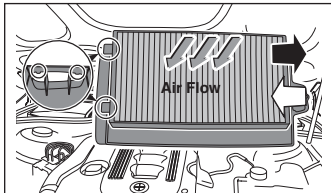

D

BMW

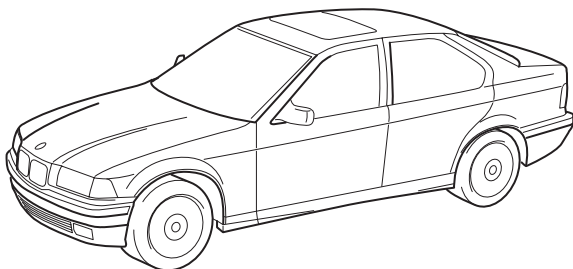

1 987 432 104

BMW 3 Series (E36)

09.90 → 09.00

3 Series

①

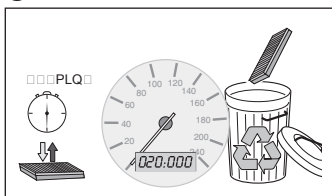

④

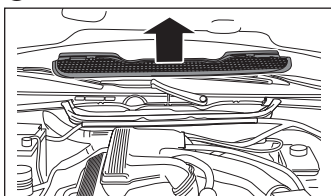

②

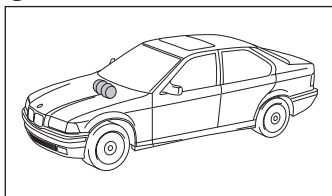

⑤

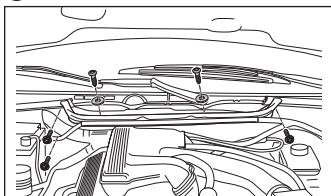

③

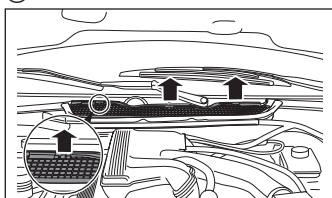

⑥

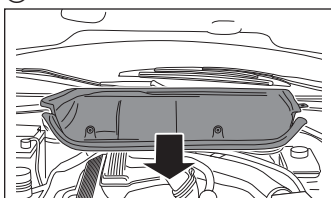

3 Series (continued)

7

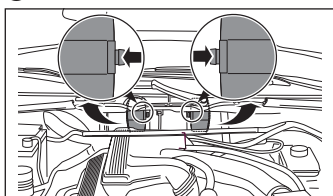

8

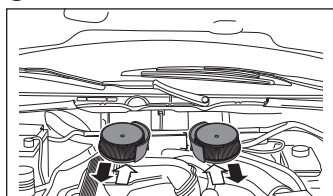

D

Fiat

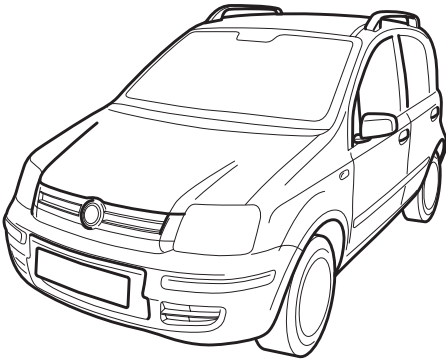

1 987 432 106

Fiat Panda

* 10.03 →

Panda

①

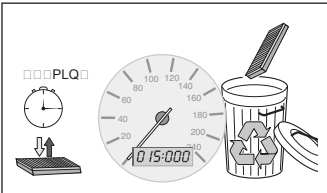

④

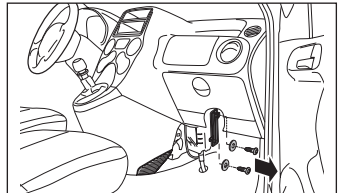

②

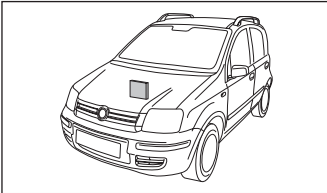

⑤

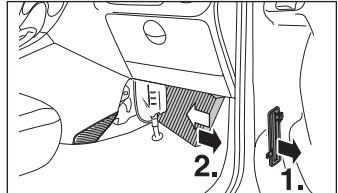

③

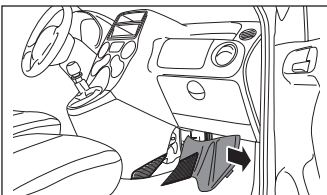

D

Ford

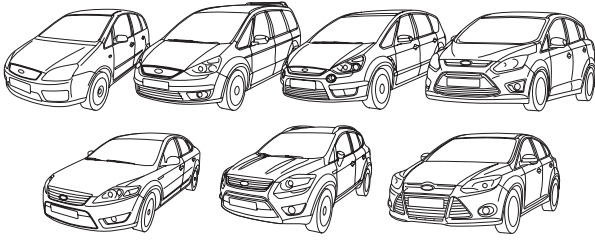

1 987 432 109
1 987 432 409

Ford Focus III	09.11 →
Ford (Focus) C-Max	06.03 → 08.10
Ford (Grand) C-Max II	09.10 →
Ford Galaxy II	05.06 →
Ford Kuga	03.08 →
Ford Mondeo IV	03.07 →
Ford S-Max	05.06 →

Focus, C-Max, Galaxy, Kuga, Mondeo, S-Max

D

①

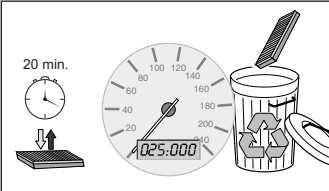

②

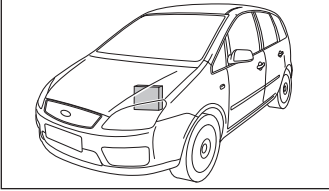

③

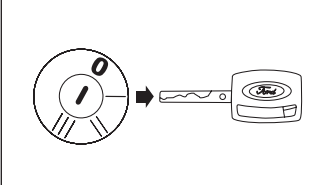

④

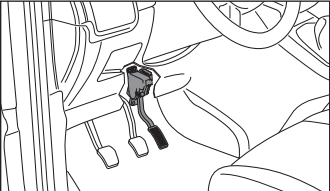

⑤

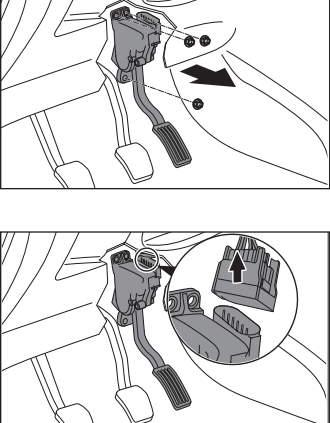

Focus, C-Max, Galaxy, Kuga, Mondeo, S-Max

7

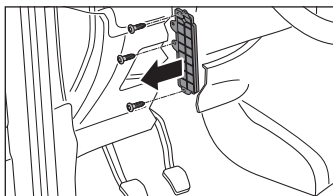

9

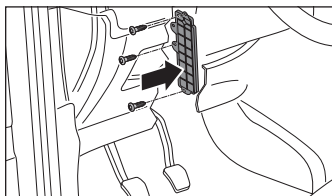

8

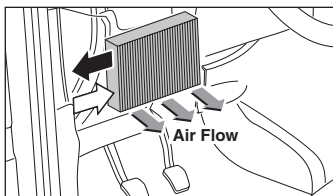

10

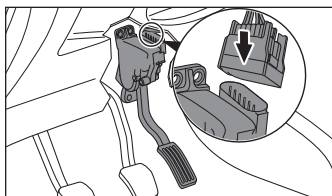

D

Opel

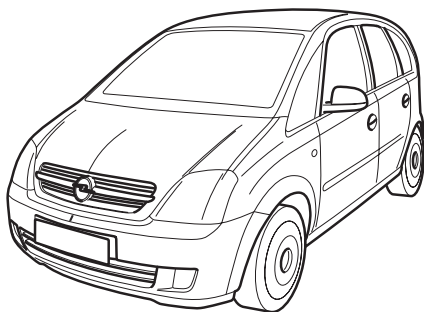

1 987 432 111
1 987 432 411

Opel Meriva

* 03.03 →

Meriva

①

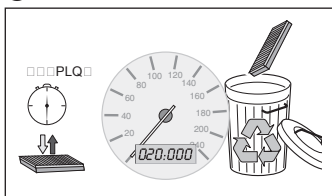

④

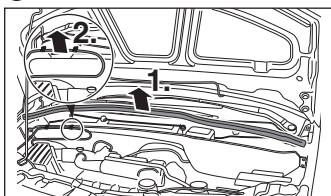

②

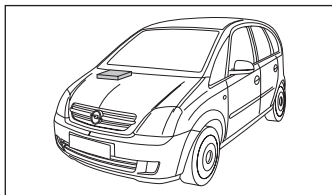

⑤

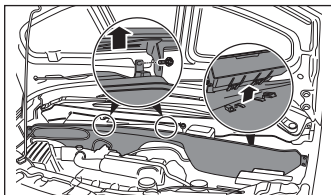

③

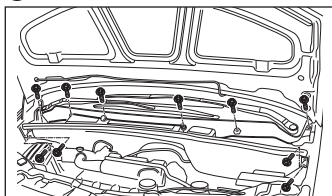

⑥

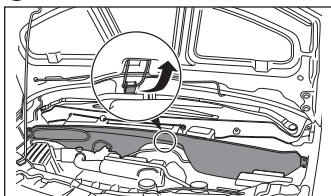

Meriva

7

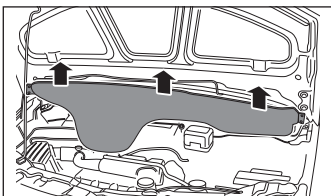

9

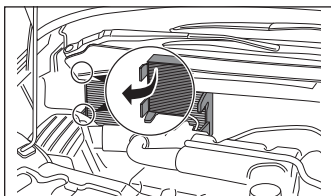

8

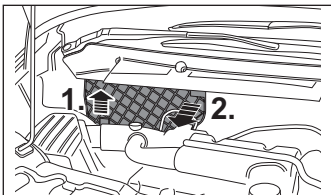

10

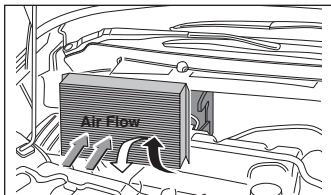

Volvo, Ford

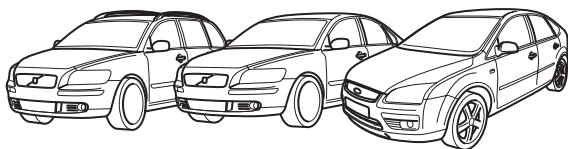

1 987 432 113
1 987 432 413

Volvo S40 II
Volvo V50
Ford Focus II

* 01.04 →
* 04.04 →
* 11.04 →

Focus II

①

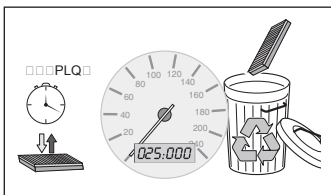

④

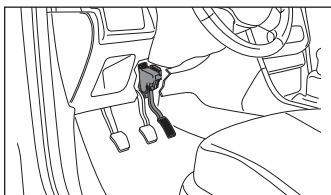

②

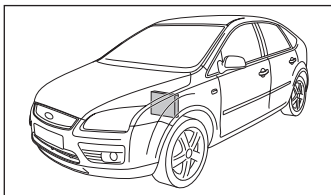

⑤

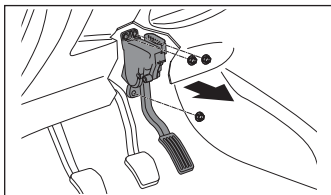

③

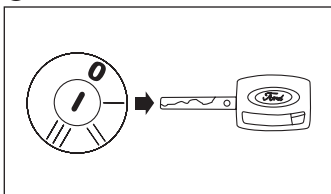

⑥

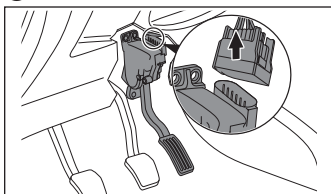

Focus II

7

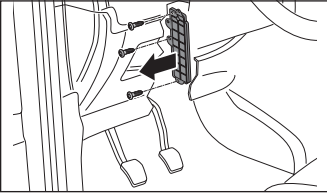

9

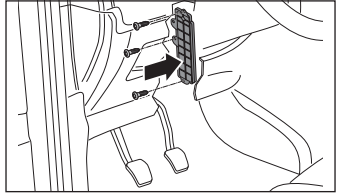

8

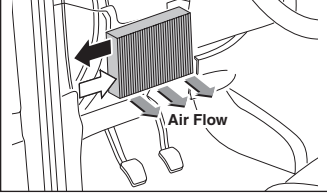

10

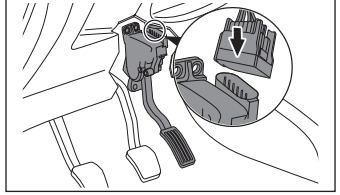

D

S40 II, V50

①

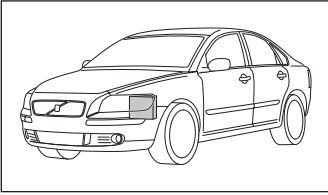

⑥

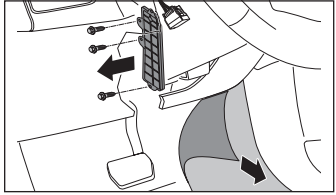

②

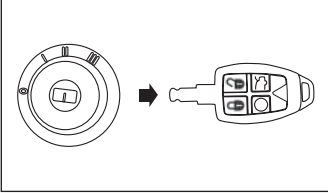

⑦

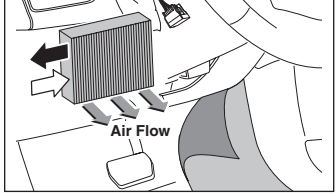

③

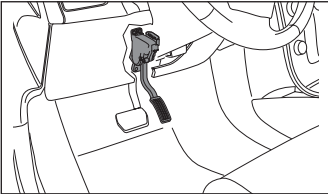

⑧

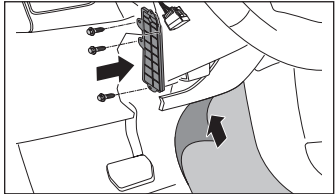

④

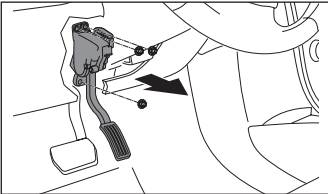

⑨

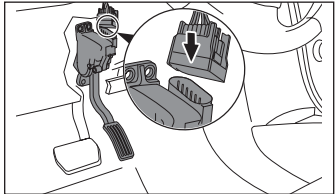

⑤

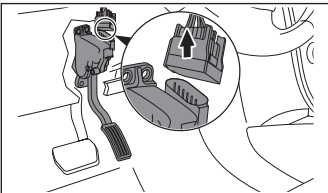

D

VW

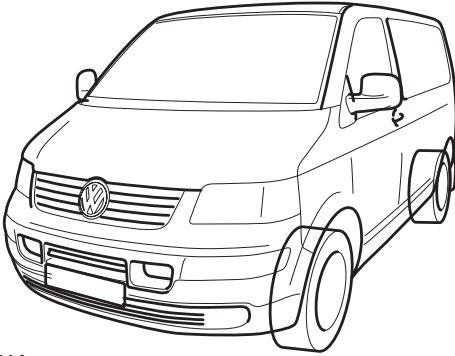

1 987 432 114

VW

Transporter T5 (7H)

T5 (7J)

T5 4 Motion

* 02.03 →

* 04.03 →

* 07.03 →

T5

①

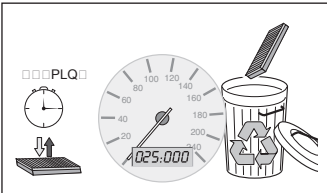

④

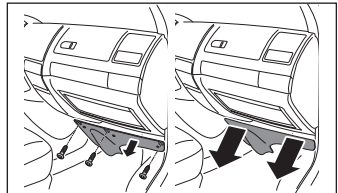

②

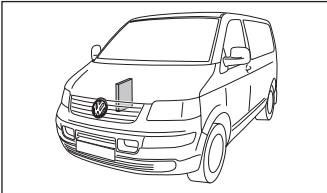

⑤

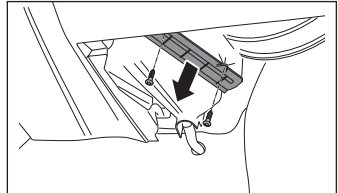

③

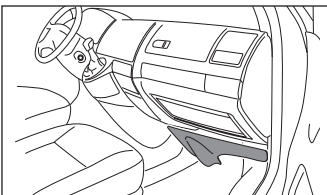

⑥

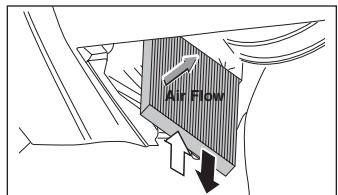

Honda

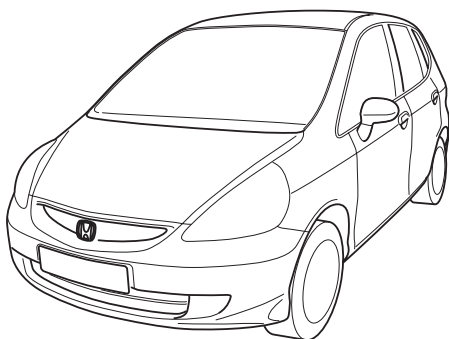

1 987 432 115

Honda Jazz

03.02 →

Jazz

①

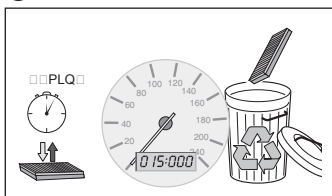

③

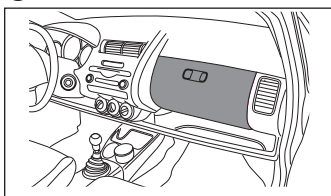

②

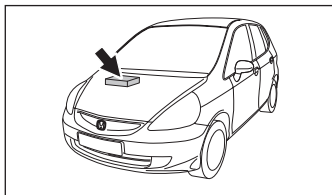

④

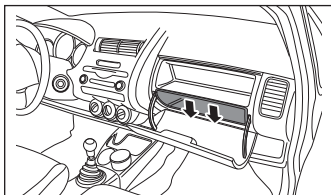

D

Jazz

⑤

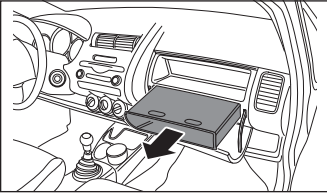

⑦

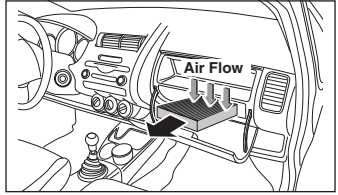

⑥

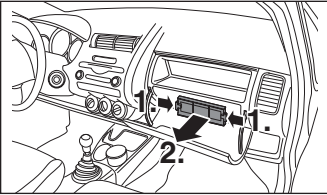

D

Land Rover

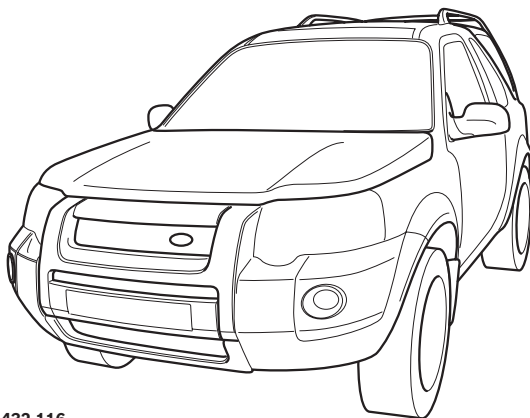

1 987 432 116

Land Rover
Freelander

09.97 →

Freelander

①

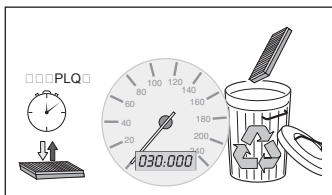

④

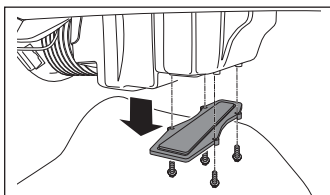

②

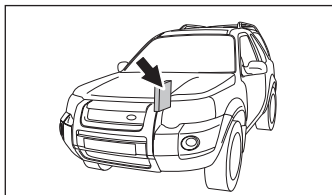

⑤

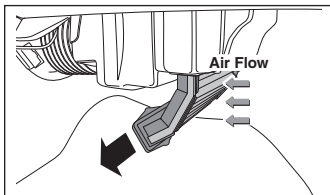

③

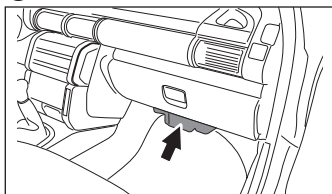

Mazda

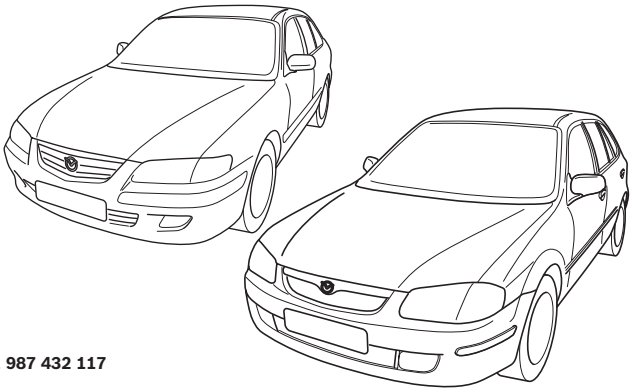

1 987 432 117

Mazda

323 F Hatchback

323 Sedan

626

626 Wagon

* 08.98 → 01.01

* 05.98 → 09.03

* 08.99 → 07.02

* 09.99 → 04.02

323 F Hatchback, 323 Sedan

①

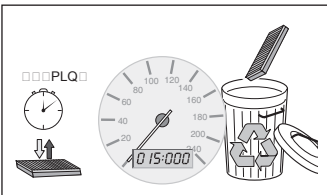

③

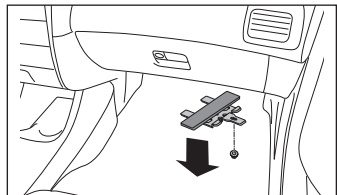

②

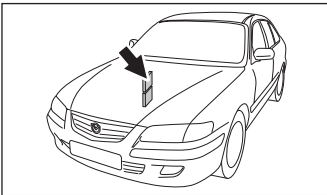

④

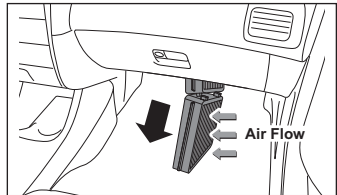

D

626 (Wagon)

①

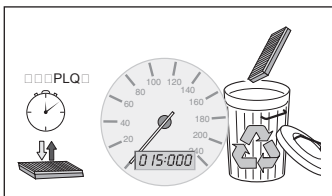

③

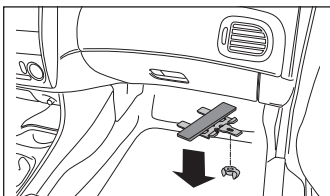

②

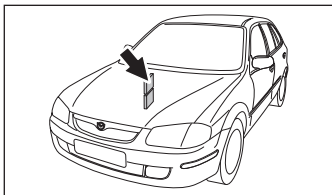

④

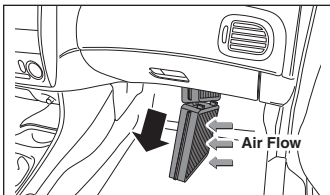

Nissan

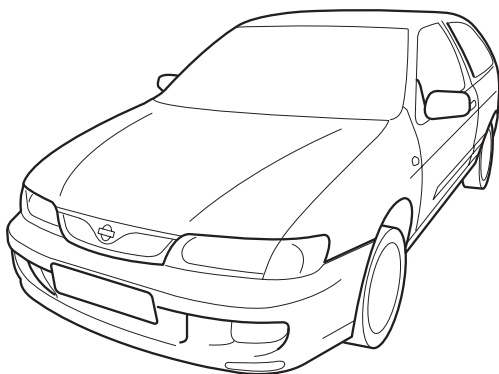

1 987 432 118

Nissan Almera (N 15)

01.98 → 04.00

Almera

①

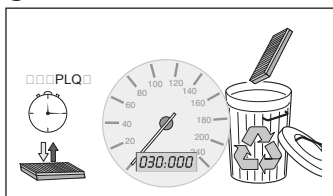

③

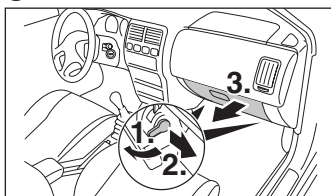

②

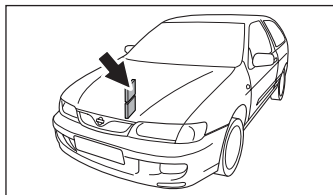

④

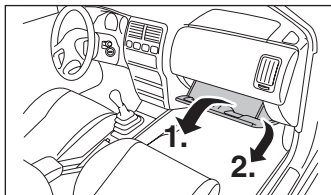

Almera (continued)

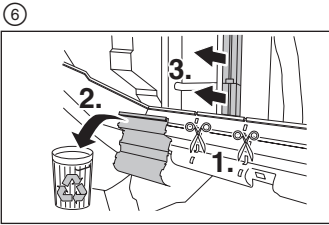
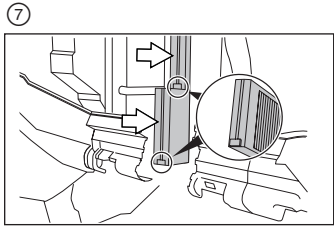
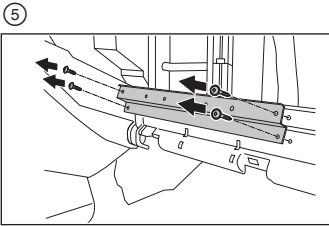

D

Nissan

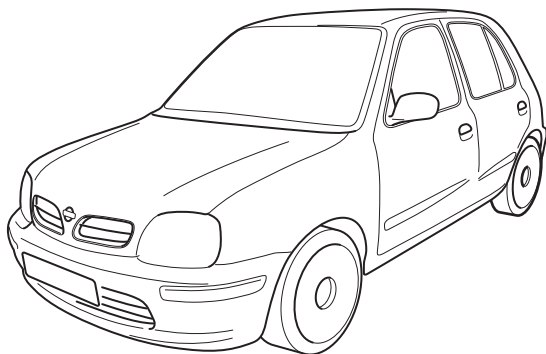

1 987 432 119

Nissan Micra (K12E)

* 02.98 → 10.02

Micra

①

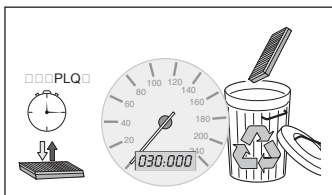

④

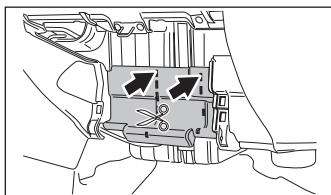

②

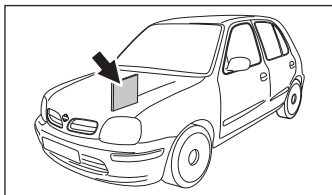

⑤

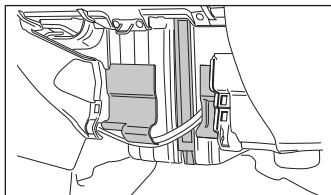

③

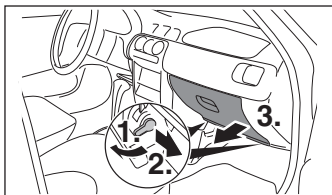

⑥

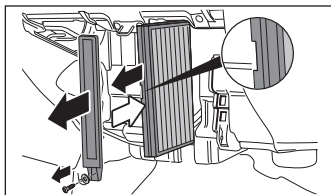

Nissan, Renault

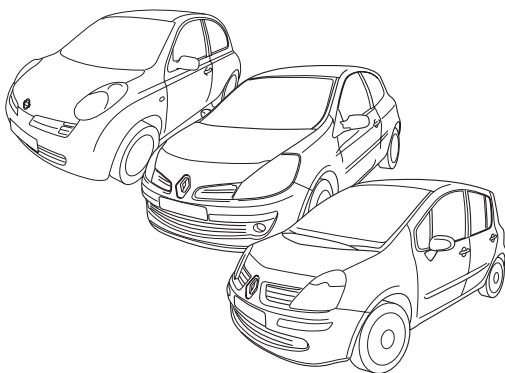

1 987 432 120

Nissan Micra (K12E)

11.02 →

Renault Clio III

06.05 →

Renault Modus

06.04 →

Micra

①

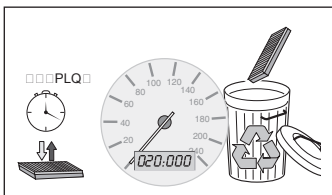

④

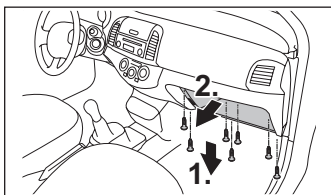

②

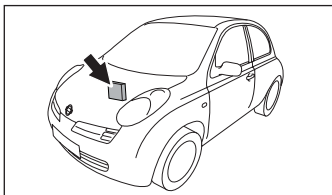

⑤

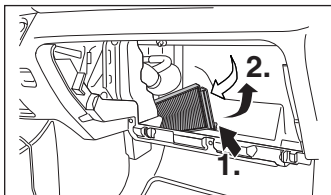

③

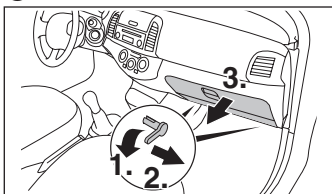

D

Clio III

①

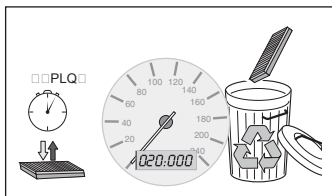

④

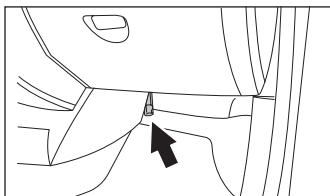

②

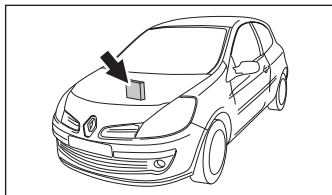

⑤

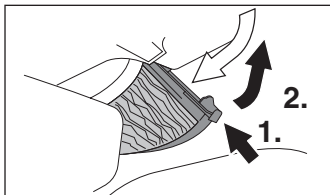

③

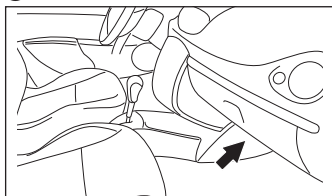

Modus

①

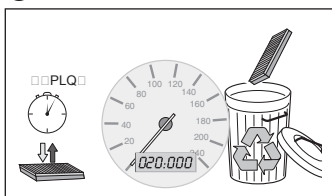

④

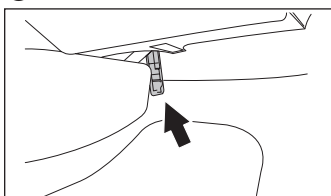

②

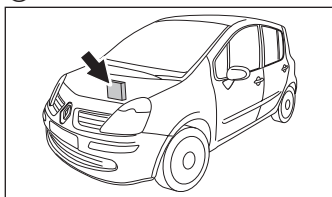

⑤

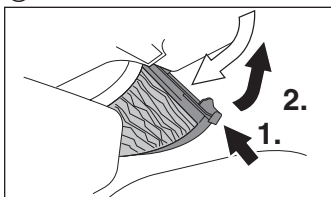

③

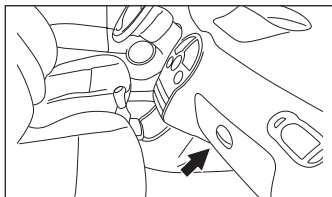

D

Rover

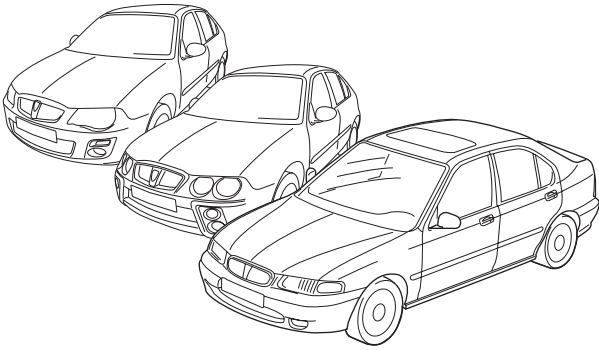

1 987 432 121

Rover Streetwise
Rover 25 Series
Rover 400 Series

* 09.03 → 05.05
* 02.00 → 05.05
* 05.95 → 03.00

Streetwise, 25 Series

①

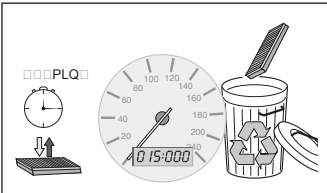

④

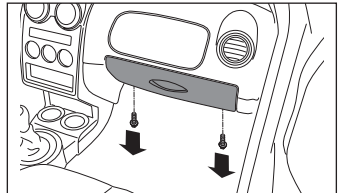

②

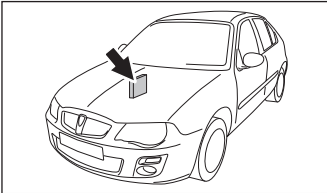

⑤

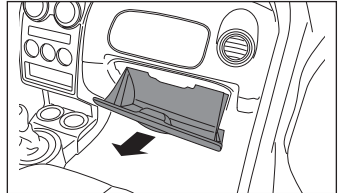

③

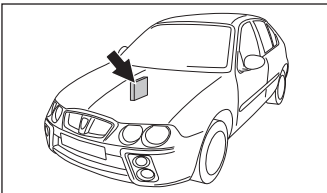

⑥

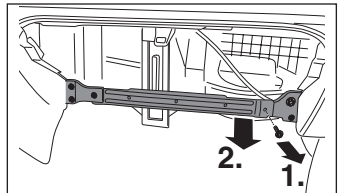

Streetwise, 25 Series (continued)

7

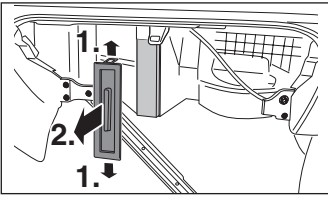

8

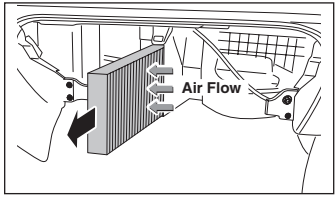

400 Series

1

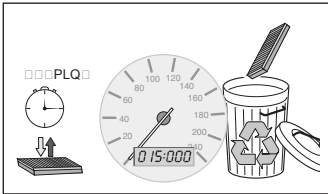

4

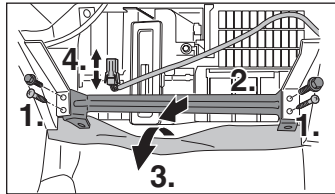

2

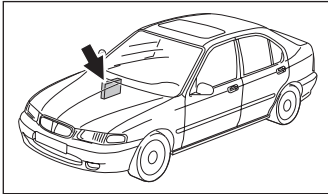

5

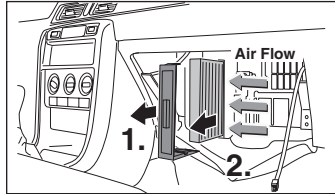

3

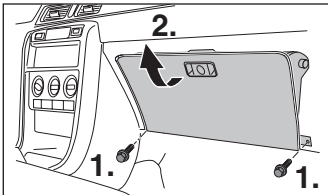

Audi

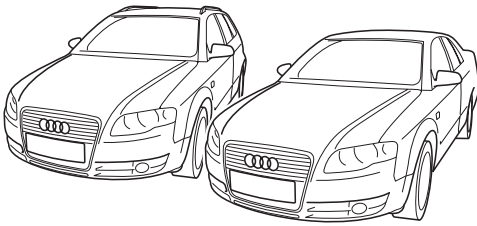

1 987 432 122
1 987 432 422

Audi A6
Audi A6 Avant
Audi A6 Quattro
Audi A6 Avant Quattro

04.04 →
04.04 →
04.04 →
04.04 →

Avant

①

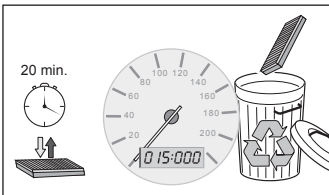

④

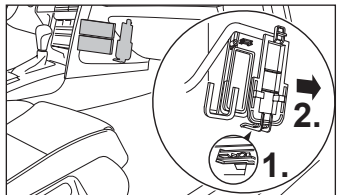

②

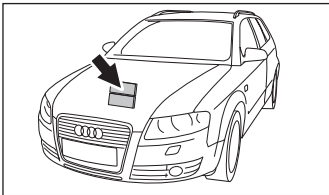

⑤

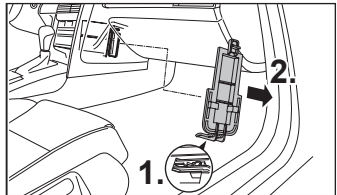

③

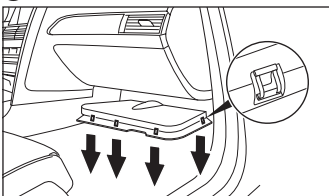

⑥

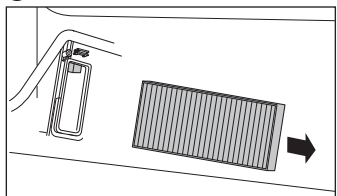

D

Avant (continued)

7

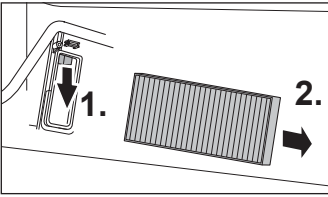

9

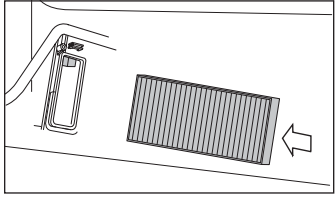

8

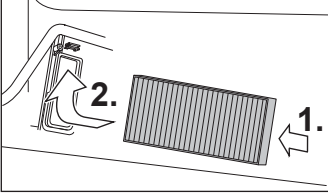

10

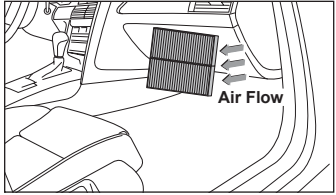

D

BMW

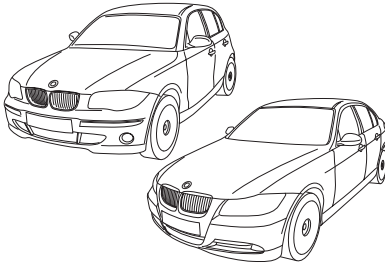

1 987 432 124
1 987 432 424

BMW 1 Series (E87)
BMW 3 Series (E90)
BMW 3 Series (E91)

* 09.04 →
* 03.05 →
* 09.05 →

1 Series

①

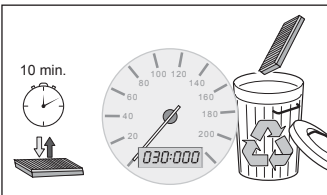

④

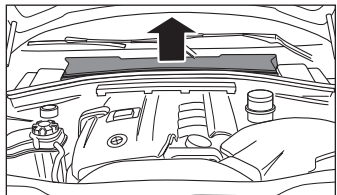

②

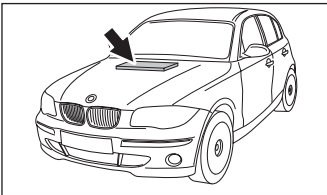

⑤

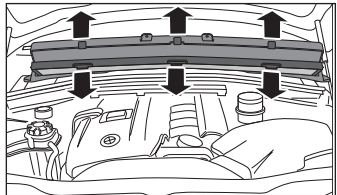

③

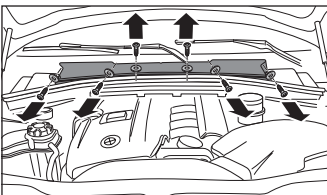

⑥

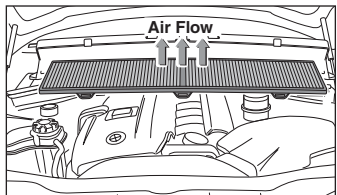

3 Series

①

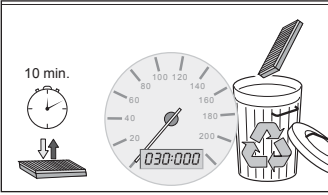

②

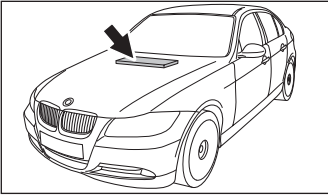

③

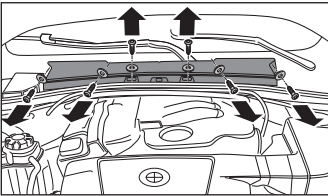

④

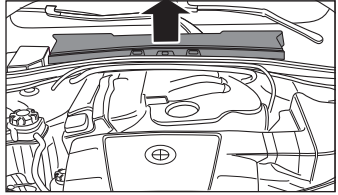

⑤

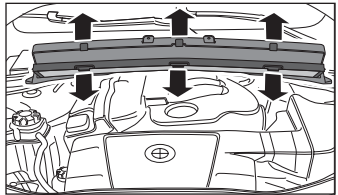

⑥

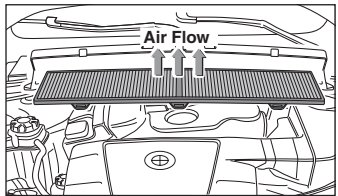

D

Hyundai



1 987 432 132

Hyundai i20

02.09 →

i20

①

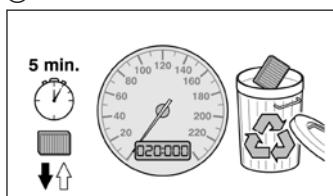

④

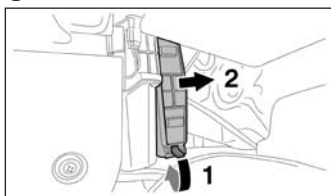

②



⑤

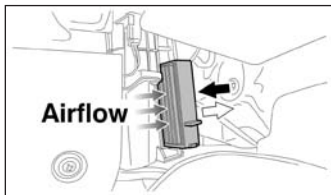

③

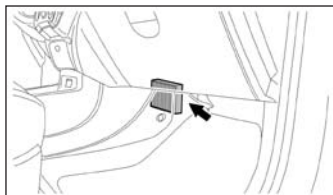

Alfa Romeo

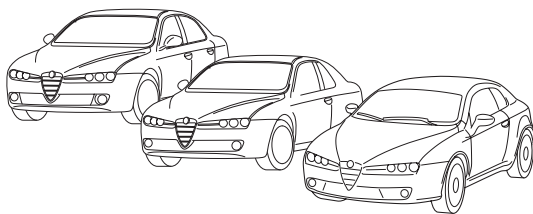

1 987 432 133
1 987 432 433

159
Brera
Spider

* 06.05 →
* 01.06 →
* 03.06 →

159, Brera, Spider

①

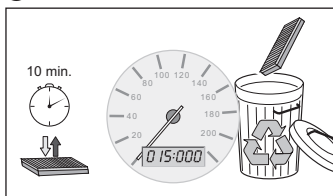

③

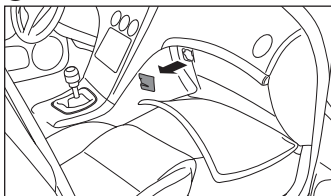

②

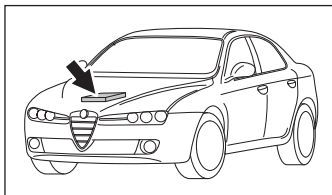

④

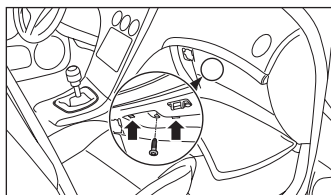

159, Brera, Spider

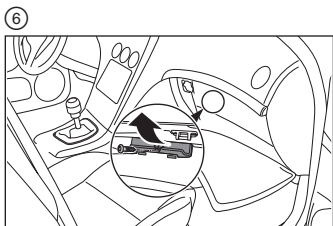
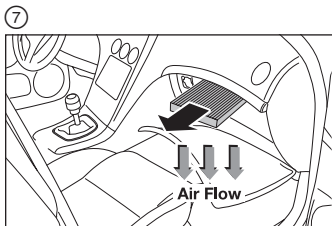
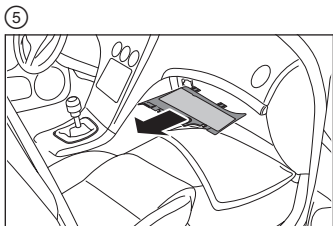

D

Peugeot

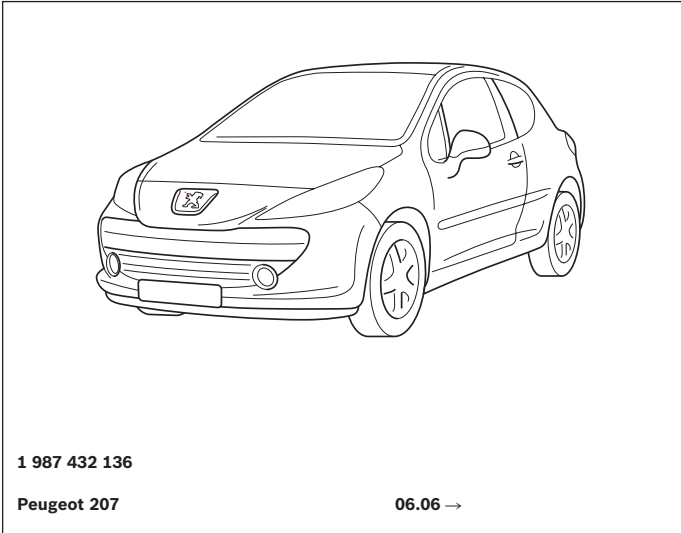

207

D

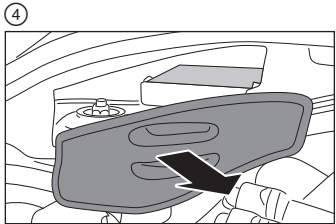
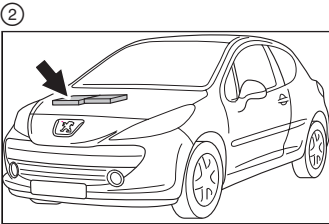
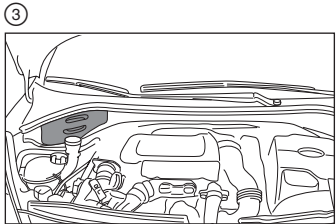
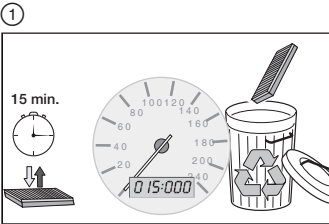

⑤

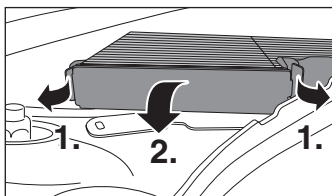

⑦

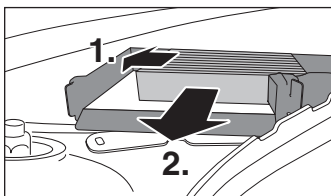

⑥

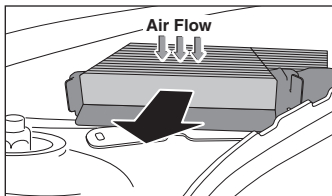

Citroën, Peugeot

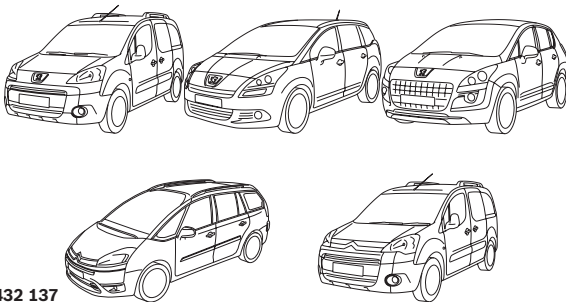

1 987 432 137
1 987 432 437

Citroën Berlingo	04.08 →
Citroën C4 Picasso	07.08 →
Citroën C4 Grand Picasso	10.06 →
Peugeot 3008	06.09 →
Peugeot 5008	06.09 →
Peugeot Partner	04.08 →

Berlingo, Partner

D

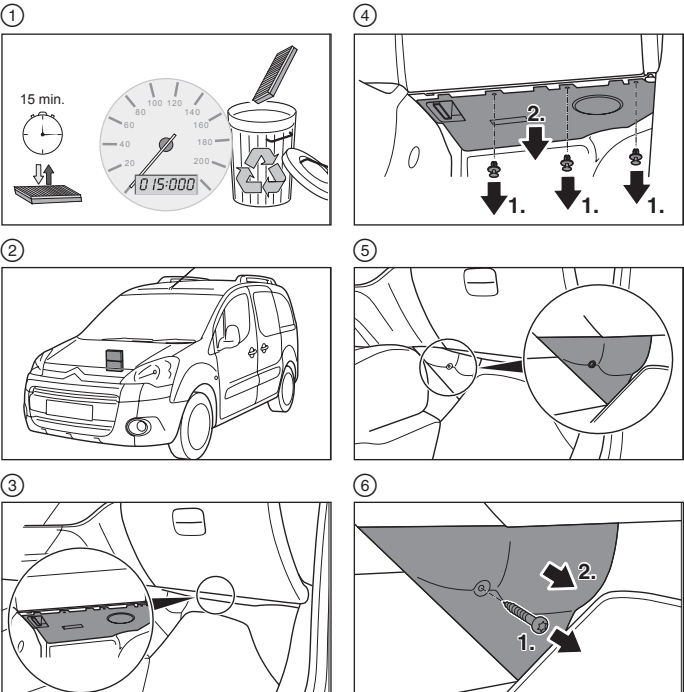

- ① 15 min.
- ②
- ③
- ④
- ⑤
- ⑥

Berlingo, Partner (continued)

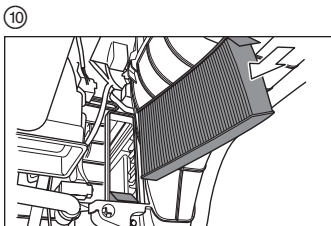
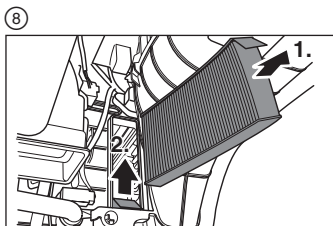
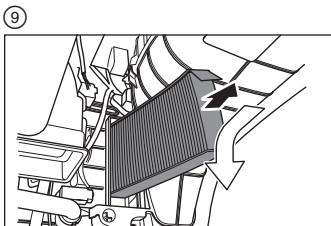
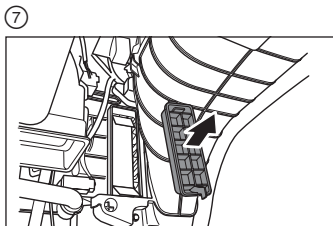

C4 Picasso, C4 Grand Picasso

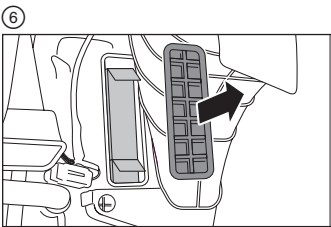
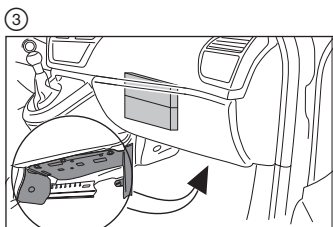
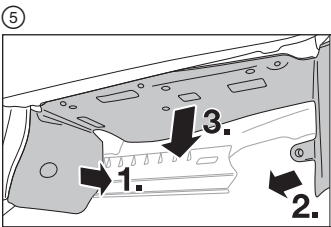
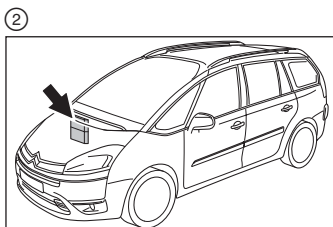
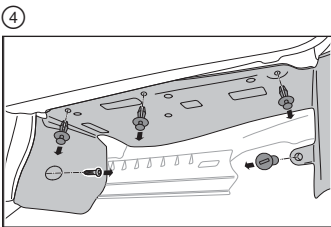
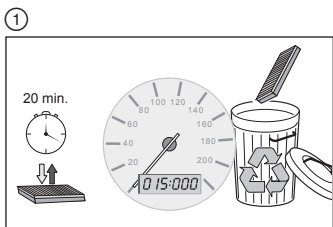

D

C4 Picasso, C4 Grand Picasso (continued)

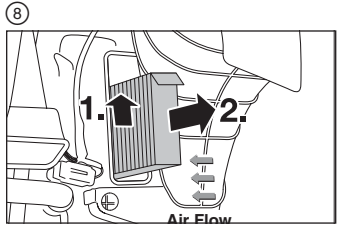
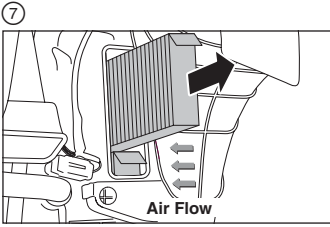

3005, 3008

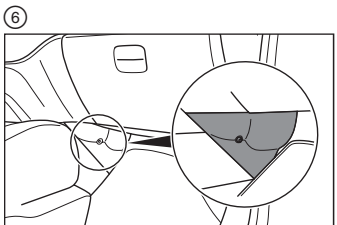
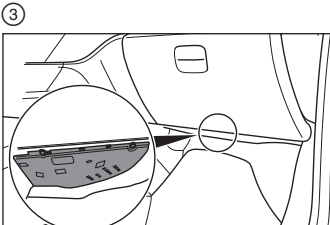
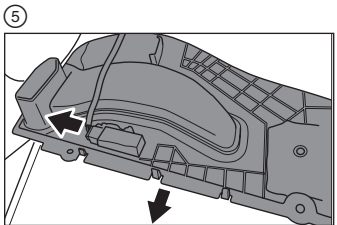
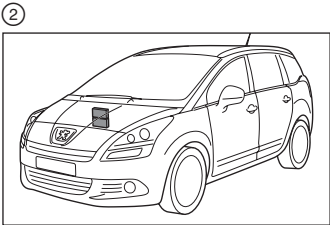
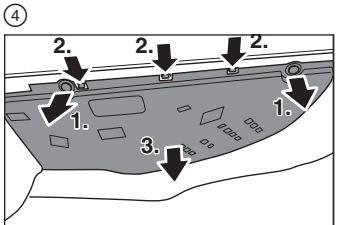
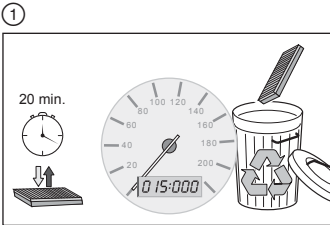

D

3005, 3008

7

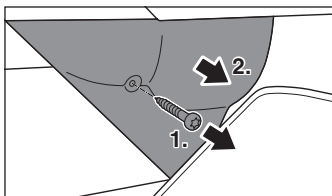

11

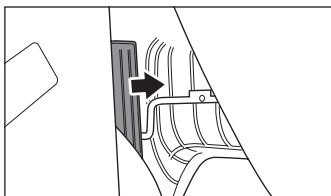

8

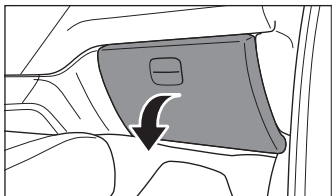

12

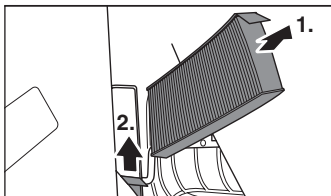

9

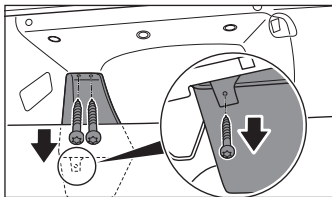

13

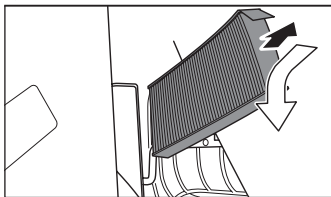

10

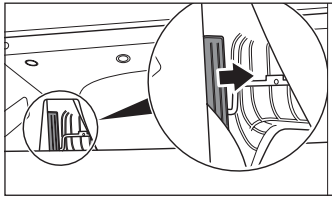

14

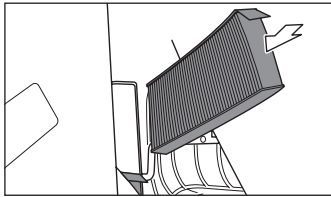

D

Nissan, Suzuki

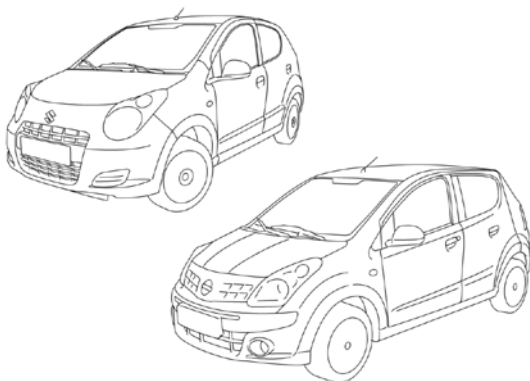

1 987 432 148

Nissan Pixo
Suzuki Alto V

06.09 →

01.09 →

Pixo, Alto V

①

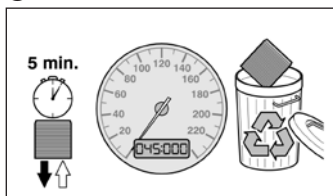

④

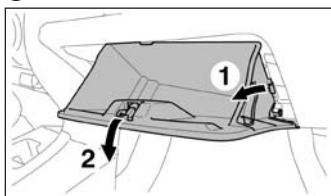

②

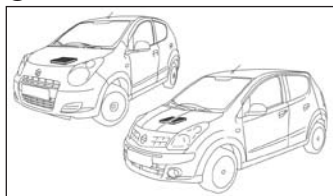

⑤

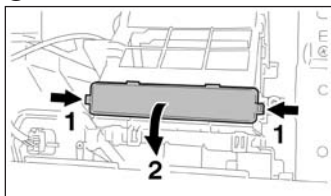

③

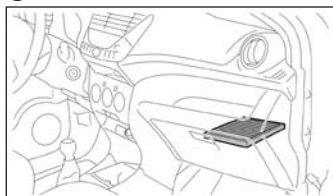

⑥

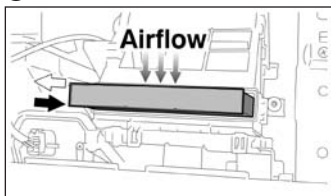

D

Citroën, Peugeot

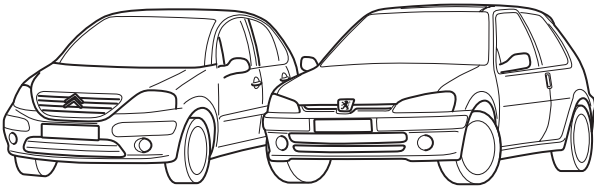

1 987 432 154

Citroën Saxo
Peugeot 106

05.96 →
01.91 →

Saxo, 106

①

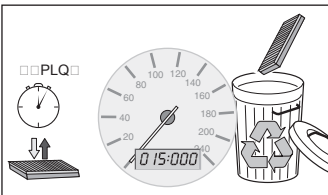

④

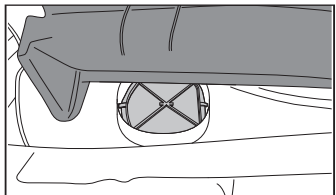

②

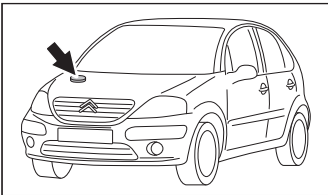

⑤

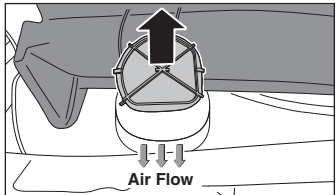

③

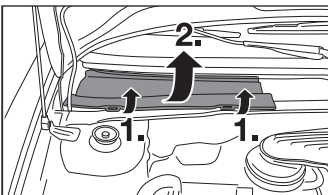

D

Toyota

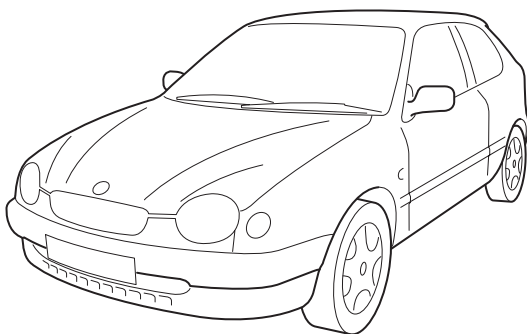

1 987 432 155

Toyota Corolla

* 04.97 → 01.02

Corolla

①

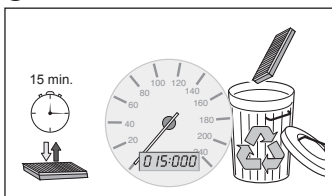

④

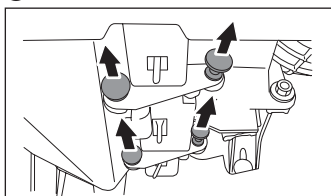

②

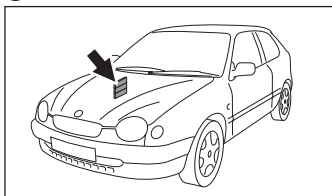

⑤

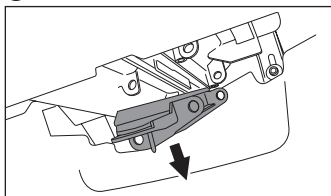

③

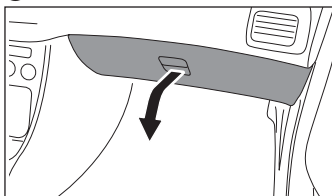

⑥

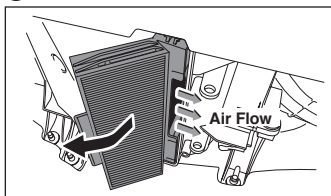

Suzuki

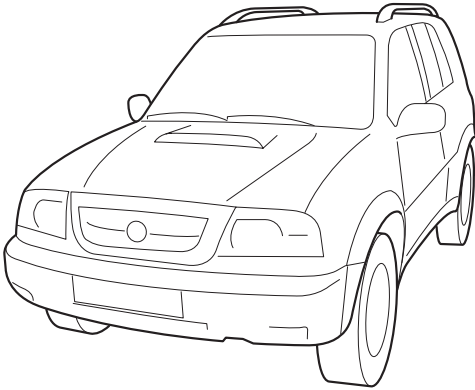

1 987 432 156

Suzuki Grand Vitara

* 03.98 → 03.03

Grand Vitara

①

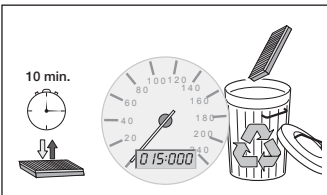

④

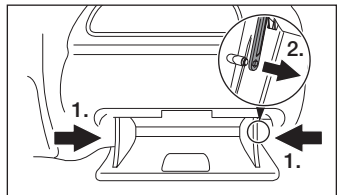

②

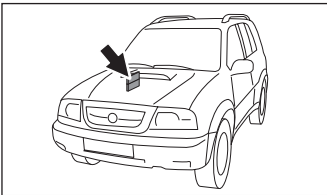

⑤

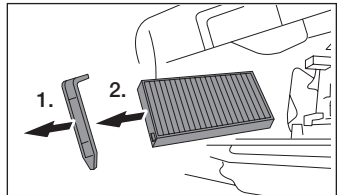

③

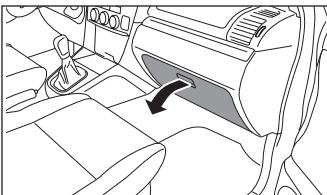

⑥

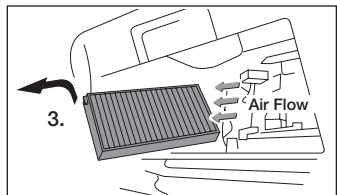

Mitsubishi

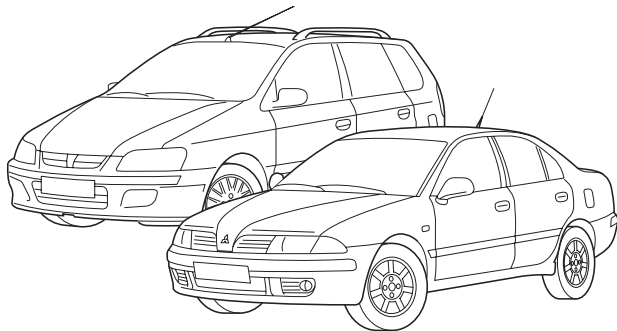

1 987 432 157

Mitsubishi Space Star
Mitsubishi Carisma

10.98 →

07.95 →

Space Star

①

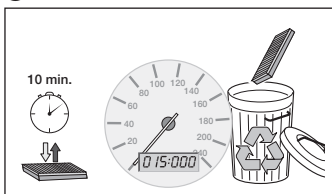

④

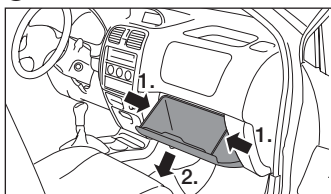

②

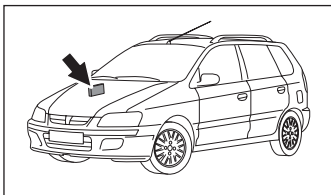

⑤

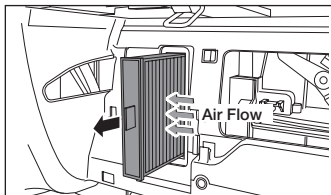

③

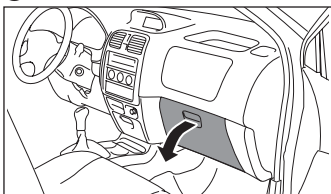

Carisma

①

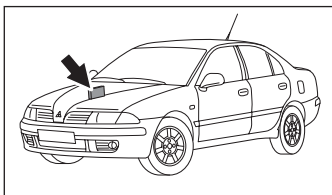

③

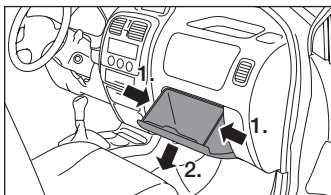

②

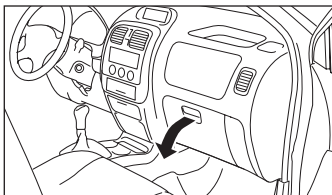

④

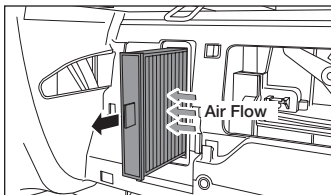

Hyundai

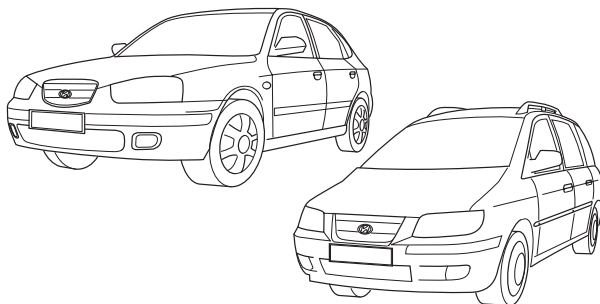

1 987 432 158

Hyundai Matrix
Hyundai Elantra
Hyundai Coupé

- * 03.01 →
- * 06.00 → 10.03
- * 03.02 →

Matrix

①

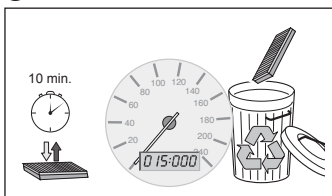

④

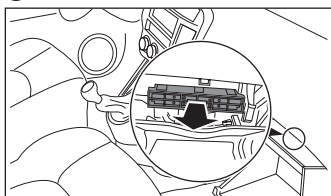

②

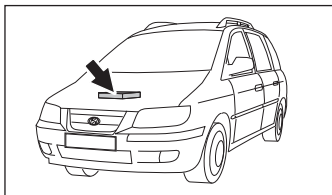

⑤

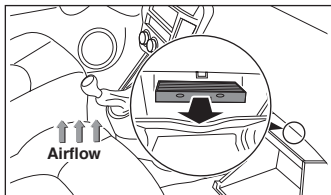

③

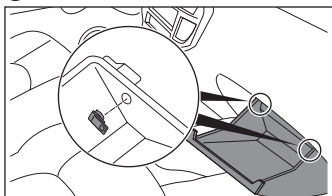

Elantra

①

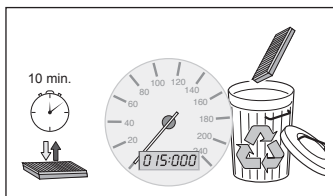

④

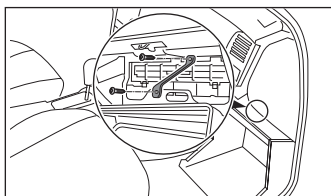

②

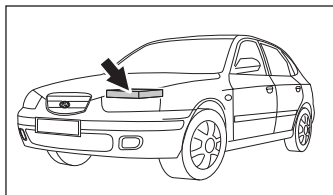

⑤

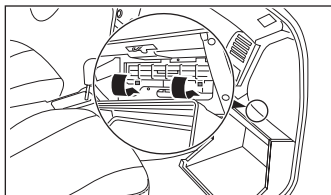

③

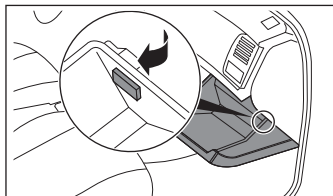

⑥

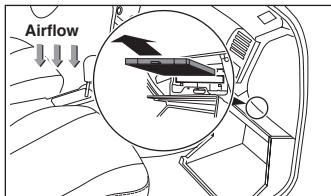

Hyundai

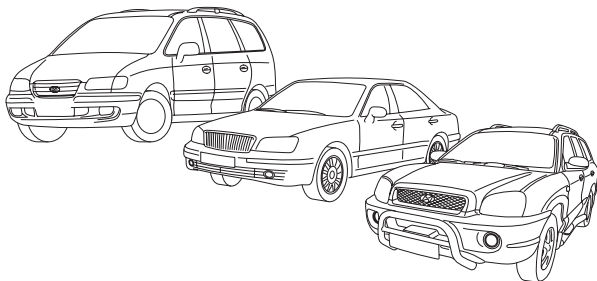

1 987 432 160

Hyundai Santa Fe
 Hyundai Trajet
 Hyundai XG 350
 Hyundai Sonata IV

* 11.04 → 03.06
 * 05.04 →
 * 04.03 → 04.05
 * 10.01 → 12.04

Santa Fe

①

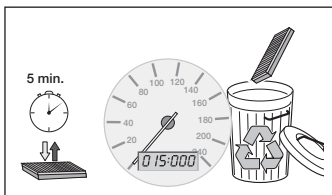

④

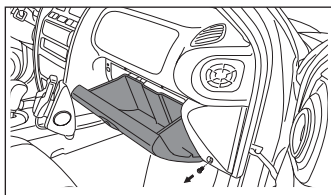

②

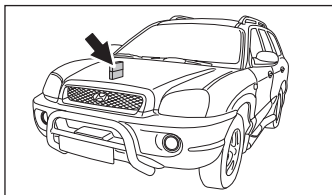

⑤

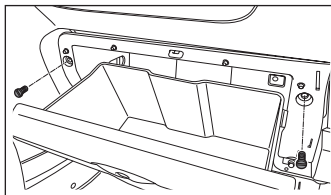

③

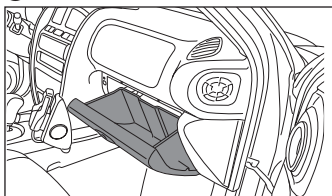

⑥

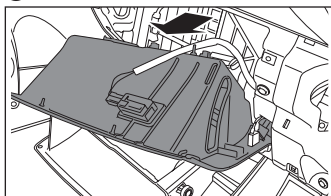

D

Santa Fe

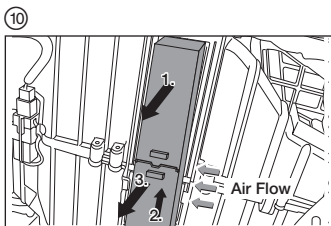
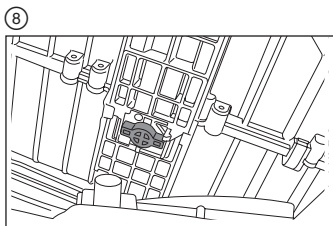
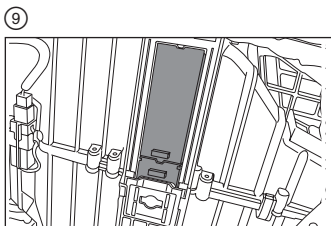
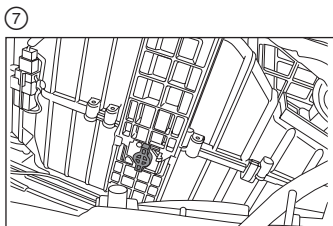

D

Traj

1

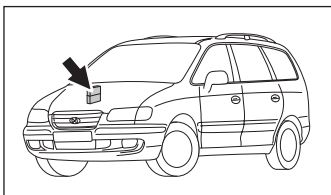

5

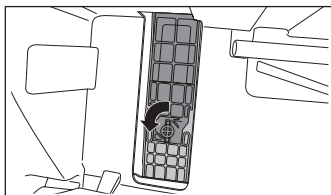

2

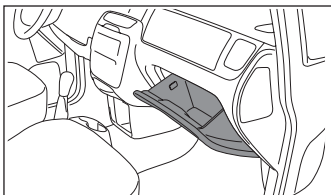

6

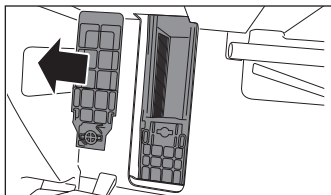

3

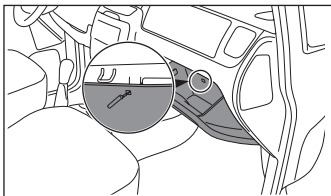

7

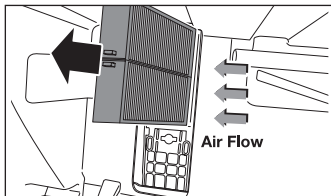

4

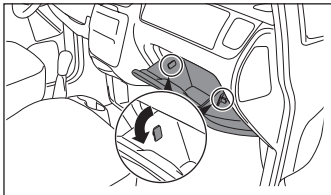

D

XG 350

①

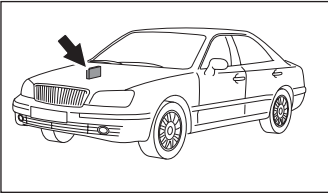

⑥

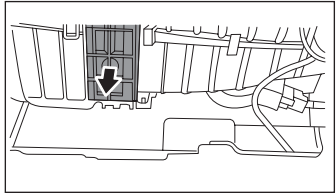

②

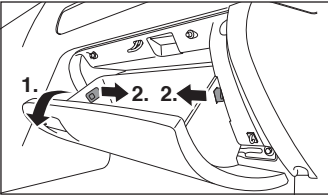

⑦

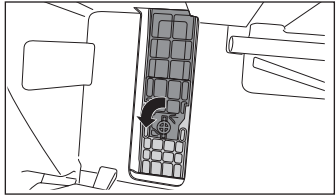

③

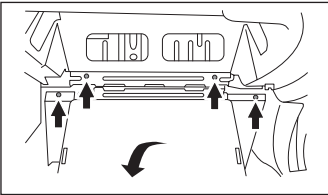

⑧

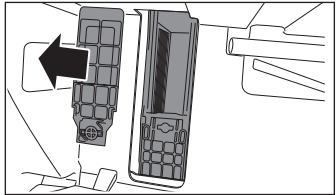

④

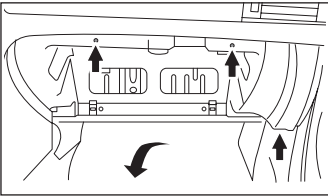

⑨

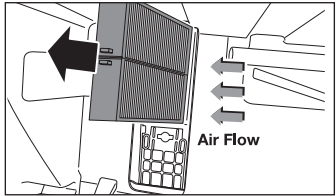

⑤

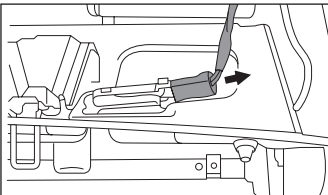

D

Hyundai

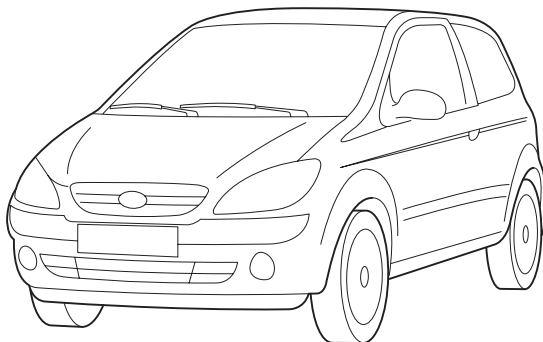

1 987 432 161

Hyundai Getz

* 09.02 →

Getz

①

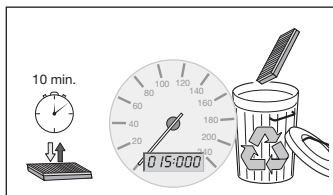

③

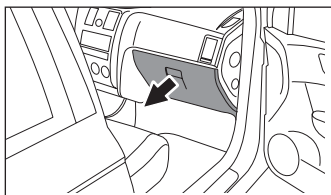

②

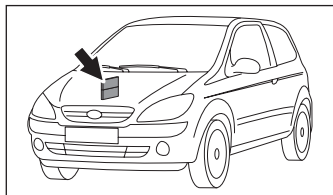

④

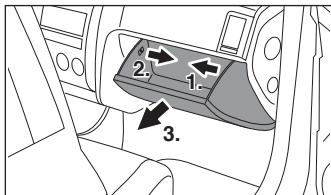

Getz

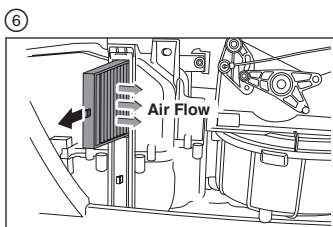
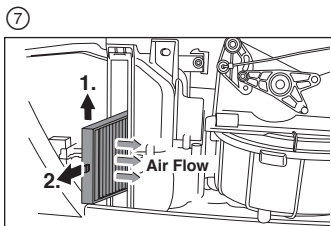
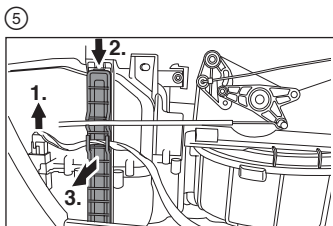

Mazda

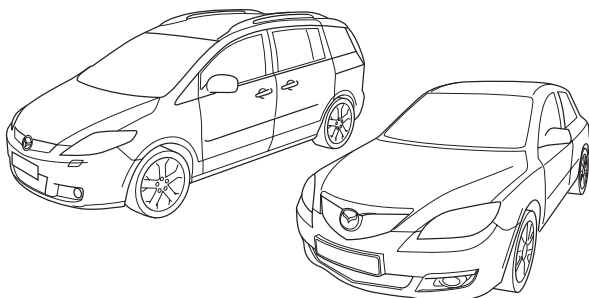

1 987 432 163

Mazda 3
Mazda 5

* 10.03 →

* 04.05 →

3

①

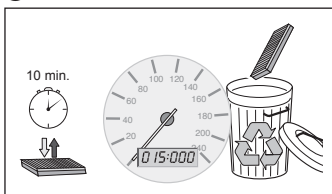

④

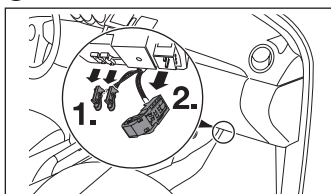

②

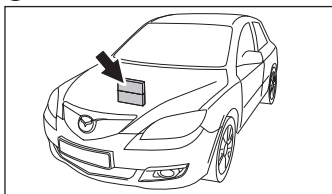

⑤

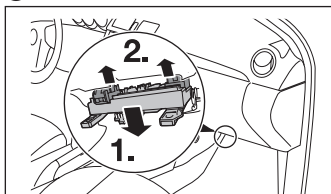

③

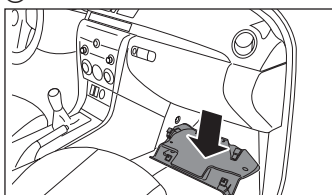

⑥

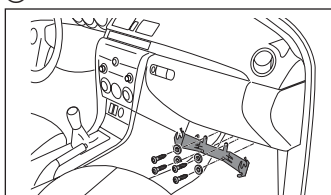

3

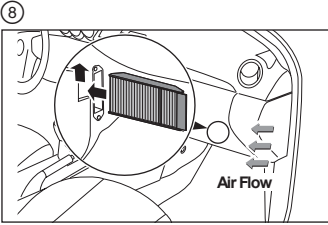
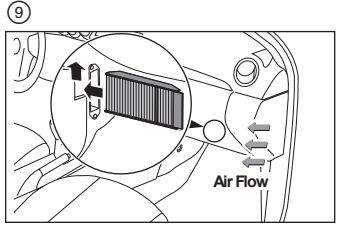
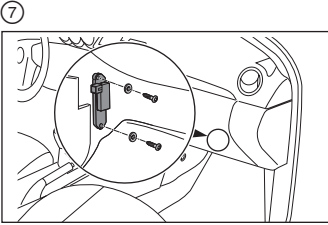

5

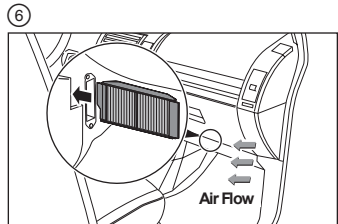
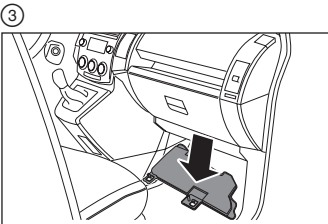
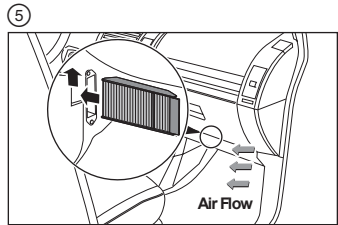
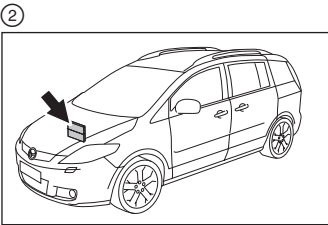
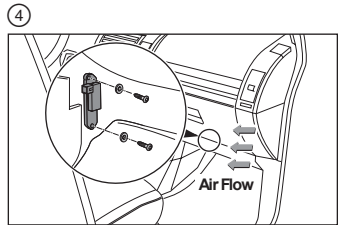
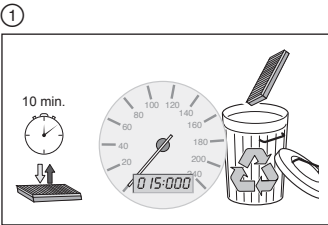

D

Kia

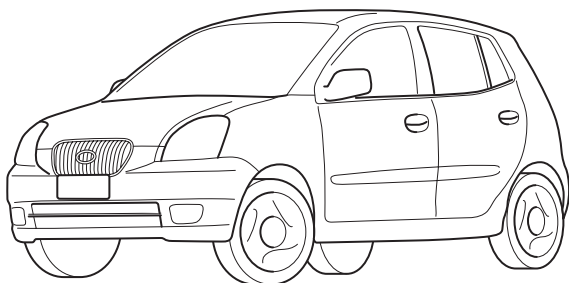

1 987 432 164

Kia Picanto

04.04 →

Picanto

1

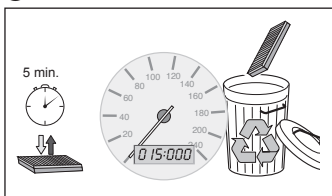

4

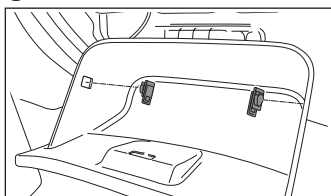

2

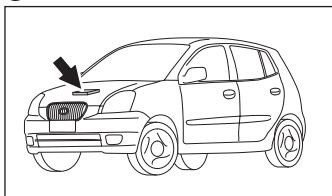

5

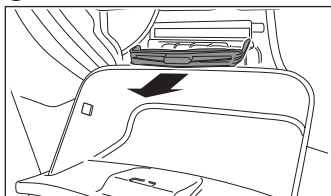

3

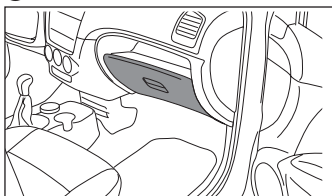

6

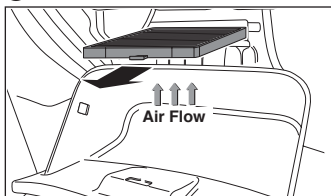

Honda

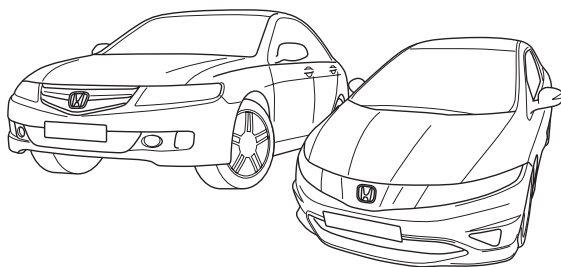

1 987 432 166

Honda Accord
Honda Civic

* 01.03 →

* 01.06 →

Accord

①

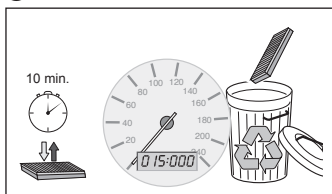

③

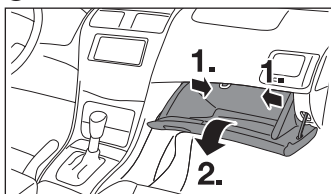

②

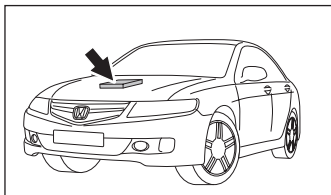

④

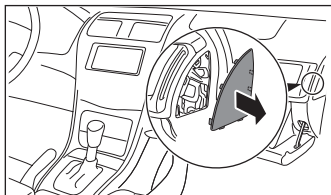

Accord (continued)

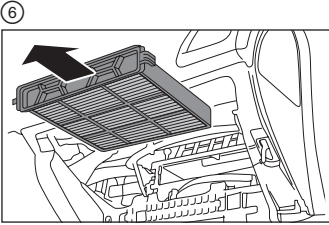
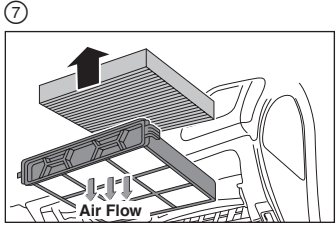
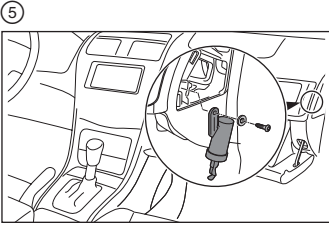

Civic

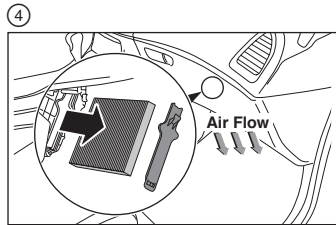
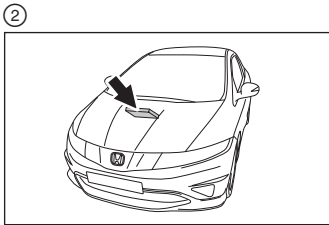
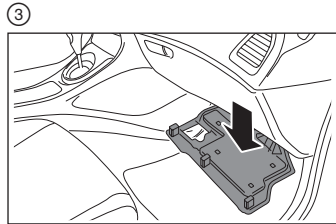
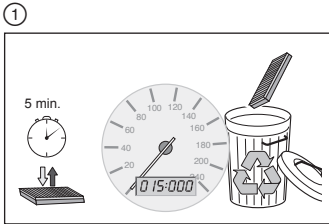

D

Honda

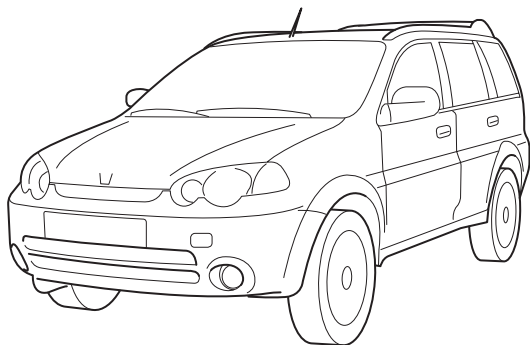

1 987 432 167

Honda HR-V

* 03.99 →

HR-V

①

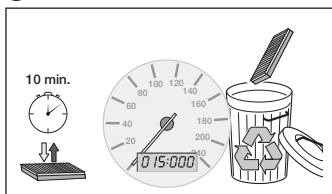

③

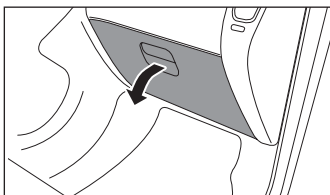

②

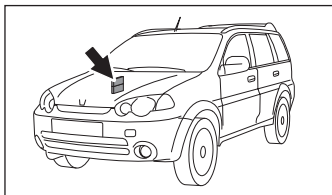

④

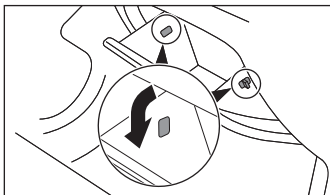

HR-V (continued)

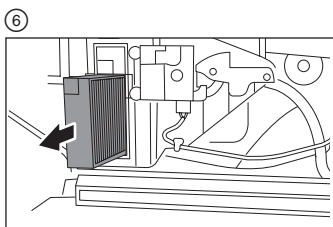
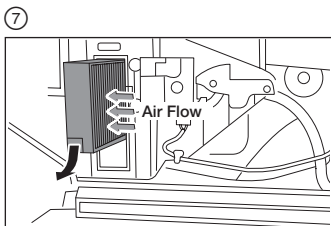
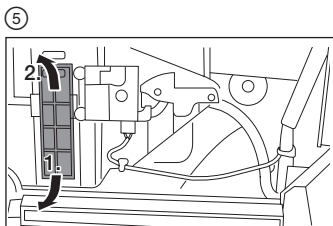

D

Range Rover

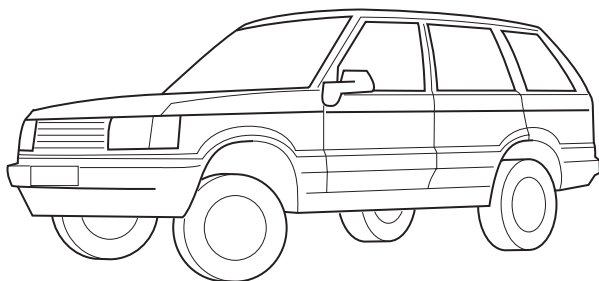

1 987 432 169

Range Rover II

07.94 → 03.02

Rover II

①

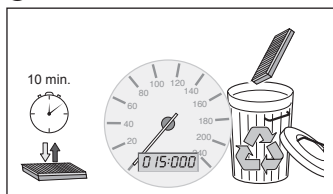

④

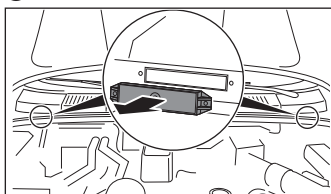

②

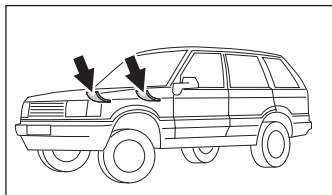

⑤

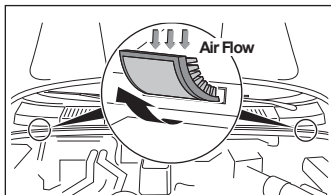

③

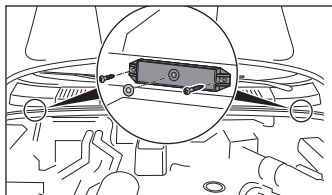

Hyundai, Kia

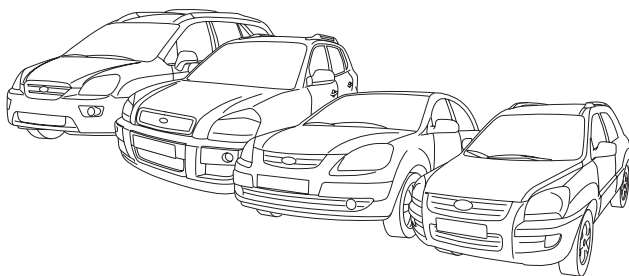

1 987 432 170

Hyundai Tucson 2.0

Kia Sportage New 2.0

Kia Rio 1.4 Hatchback

Kia Carens III

* 08.04 →

* 09.04 →

* 03.05 →

* 09.06 →

Tucson 2.0

①

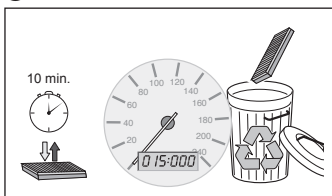

④

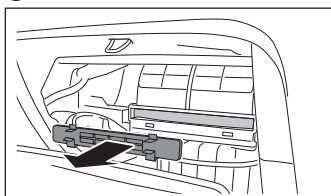

②

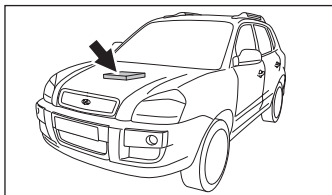

⑤

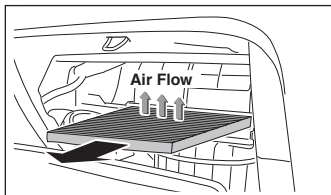

③

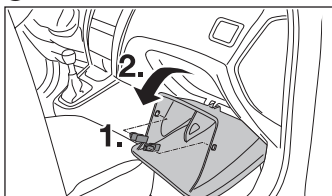

Sportage New 2.0

①

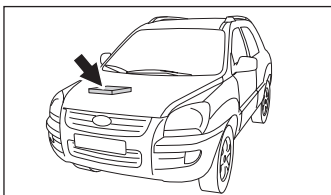

④

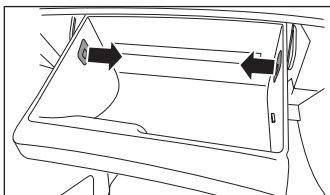

②

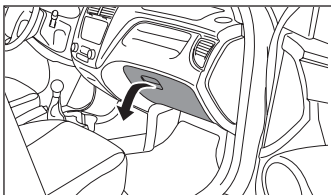

⑤

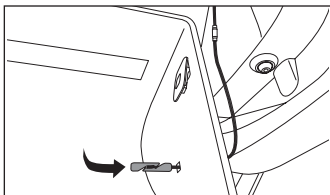

③

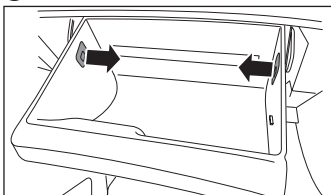

⑥

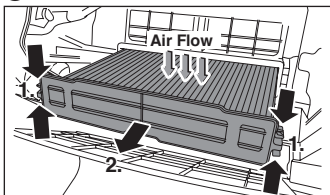

Rio 1.4 Hatchback

①

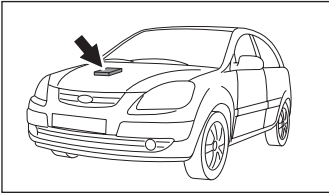

③

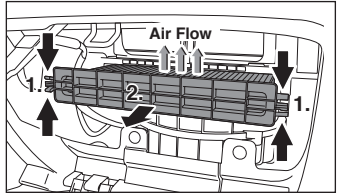

②

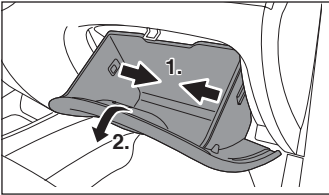

Carens III

①

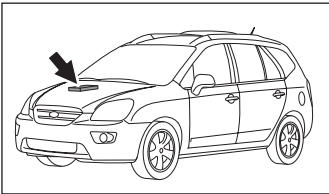

③

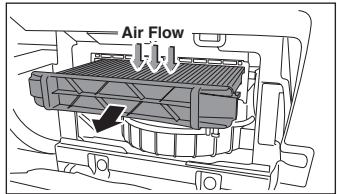

②

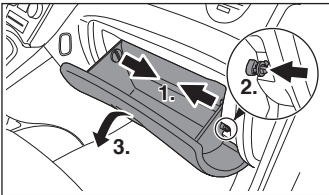

D

Daewoo

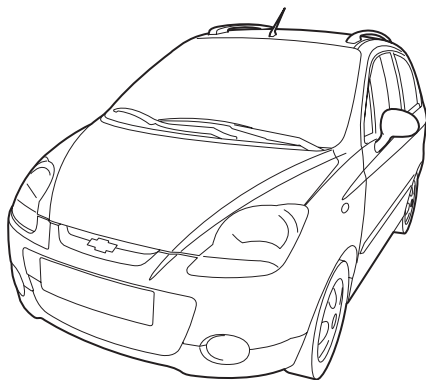

1 987 432 171

Daewoo Matiz

* 05.05 →

Matiz

①

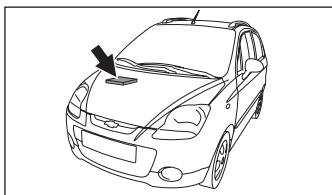

③

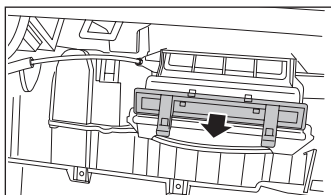

②

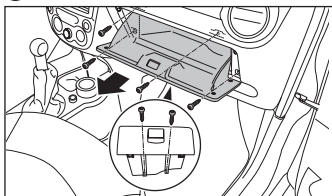

④

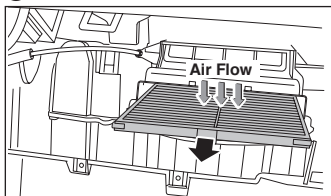

Suzuki

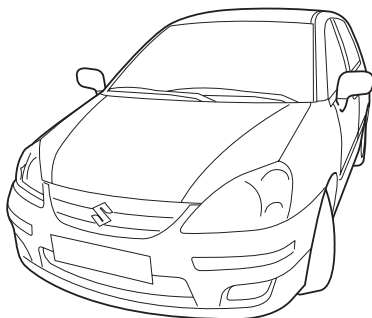

1 987 432 172

Suzuki Liana

12.02 →

Liana

①

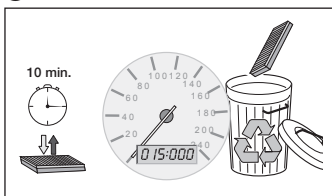

④

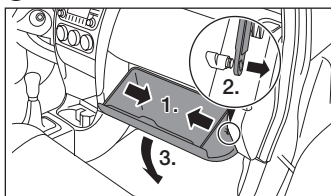

②

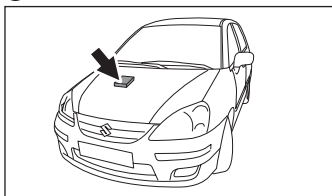

⑤

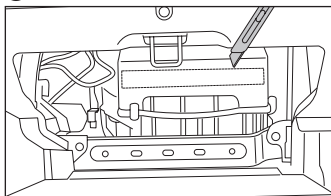

③

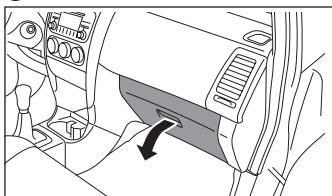

⑥

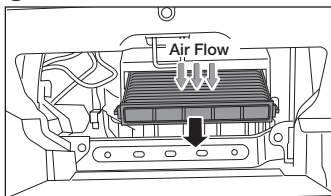

Fiat, Honda, Suzuki

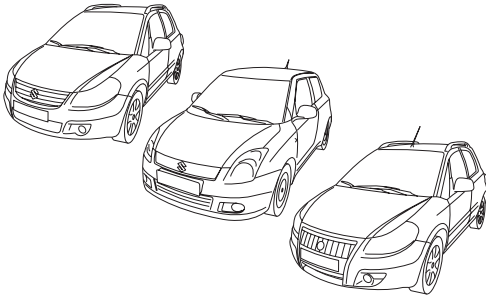

1 987 432 173

Fiat Sedici
Suzuki Swift
Suzuki SX4
Honda Jazz

* 05.06 →
* 04.05 →
* 05.06 →
* 03.02 →

Sedici

①

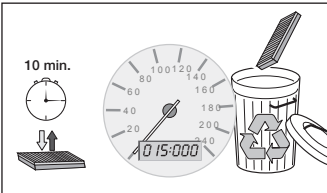

④

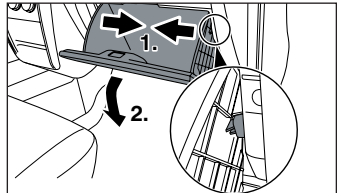

②

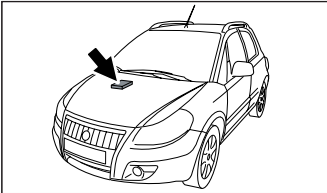

⑤

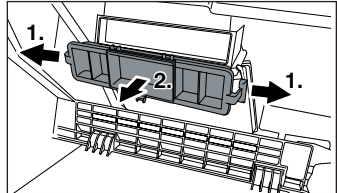

③

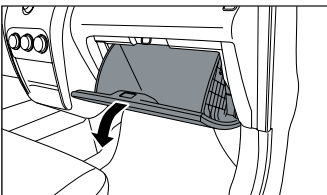

⑥

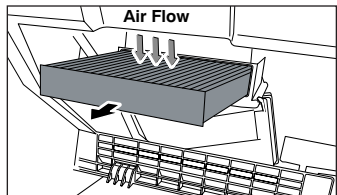

Swift

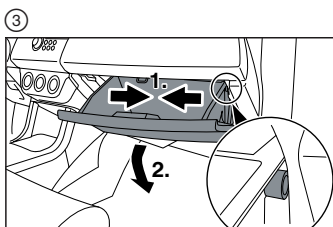
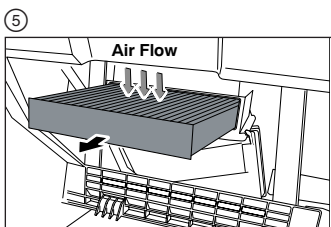
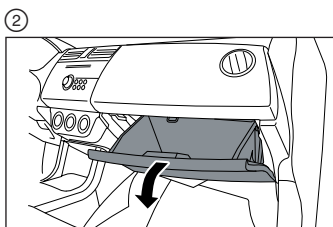
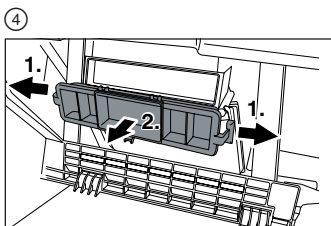
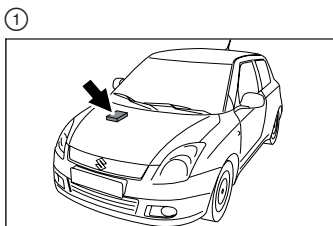

D

SX4

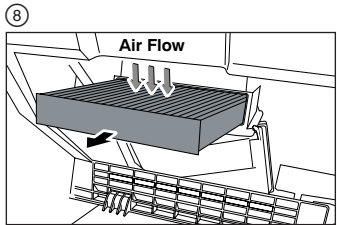
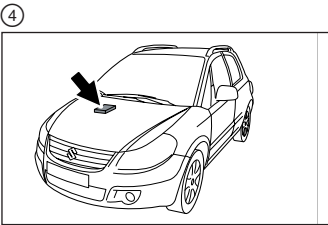
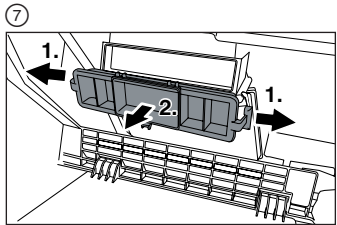
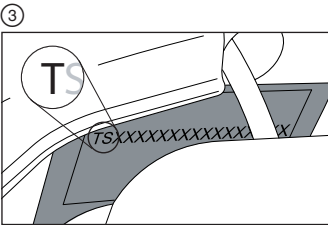
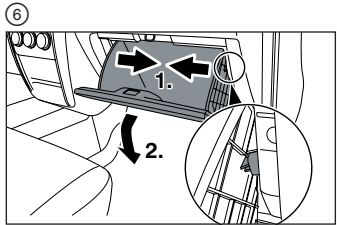
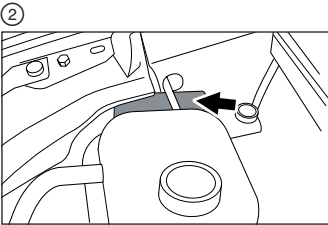
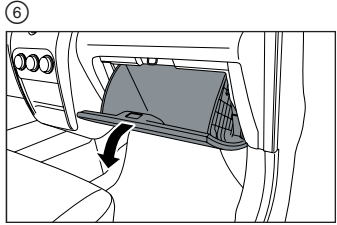
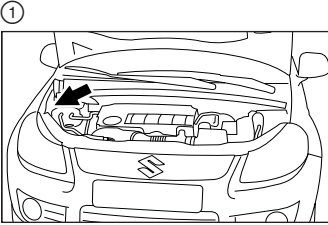

D

Rover

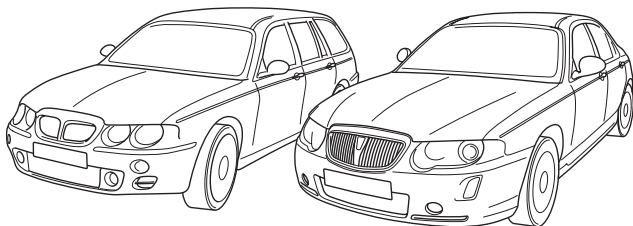

1 987 432 182
1 987 432 482

Rover 75 2.0 CDT
Rover ZT 135 2.0 CDTi

* 01.99 →
* 10.02 →

75 2.0 CDT

①

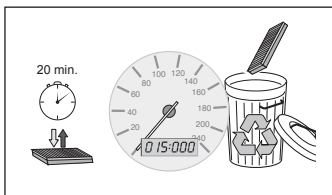

③

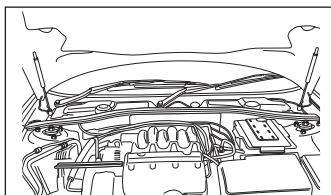

②

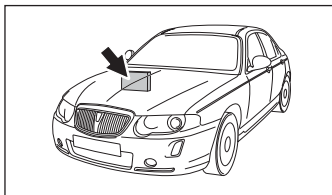

④

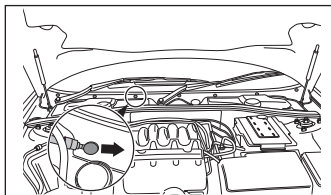

D

75 2.0 CDT

5

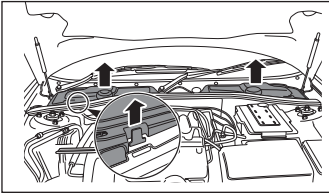

7

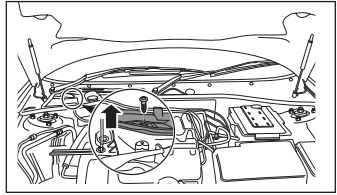

6

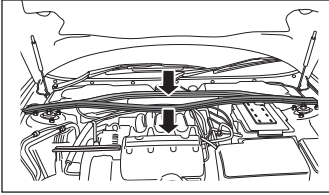

8

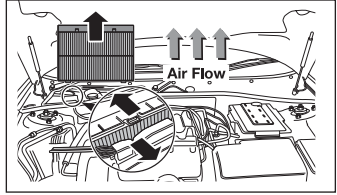

D

ZT 135 2.0 CDTi

1

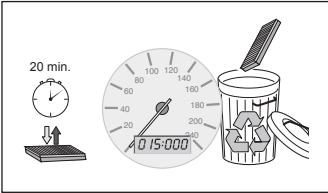

5

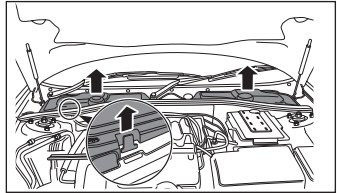

2

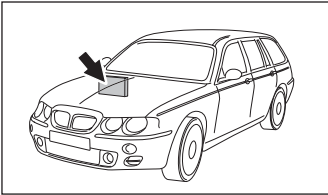

6

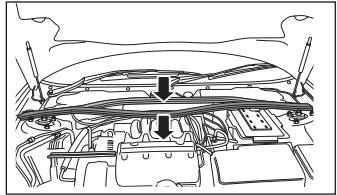

3

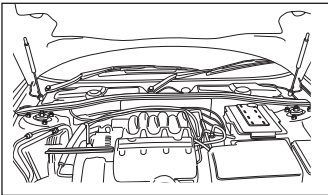

7

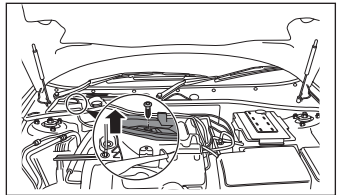

4

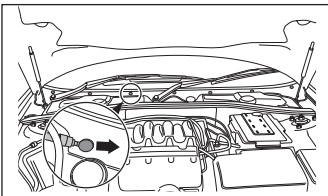

8

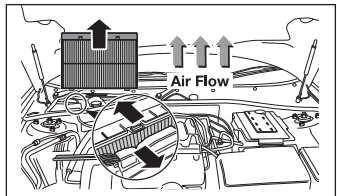

D

Fiat

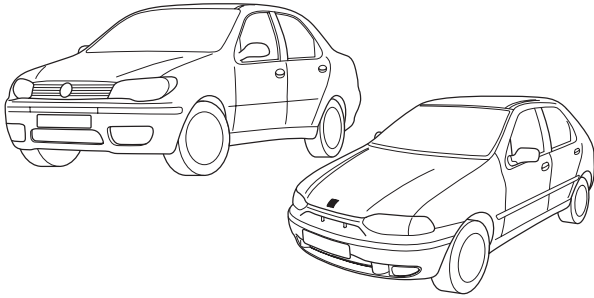

1 987 432 183

Fiat Albea
Fiat Palio

* 01.02 → 06.07
* 10.01 → 06.07

Albea, Palio

①

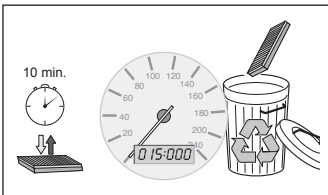

④

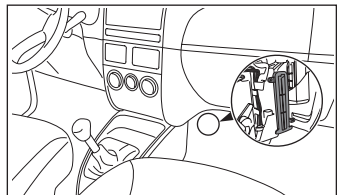

②

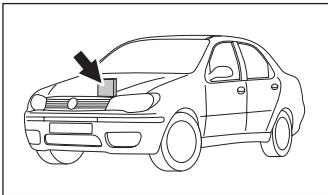

⑤

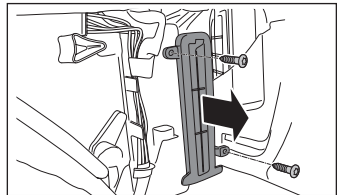

③

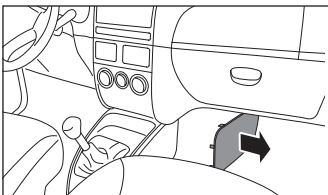

⑥

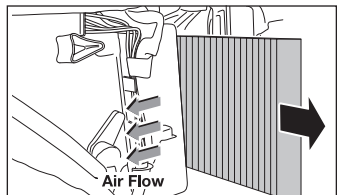

D

Chrysler

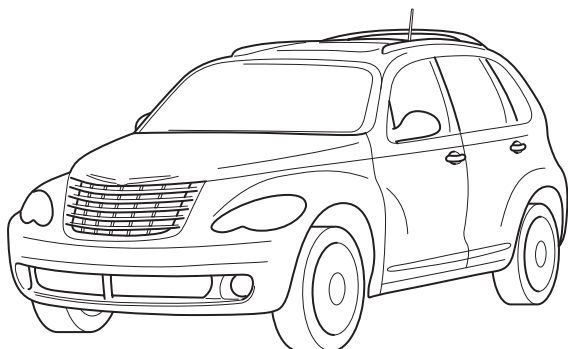

1 987 432 184

Chrysler PT Cruiser

* 06.00 →

PT Cruiser

①

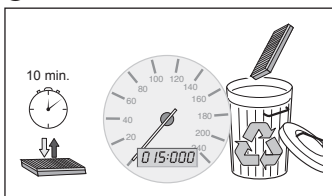

④

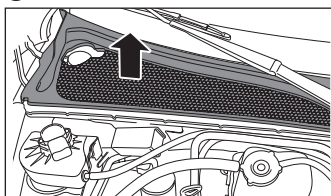

②

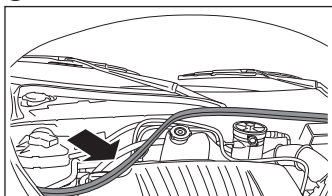

⑤

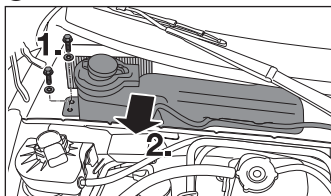

③

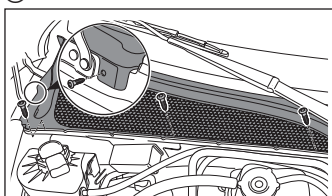

⑥

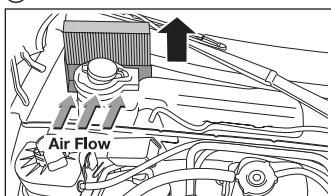

Alfa Romeo, Fiat, Opel

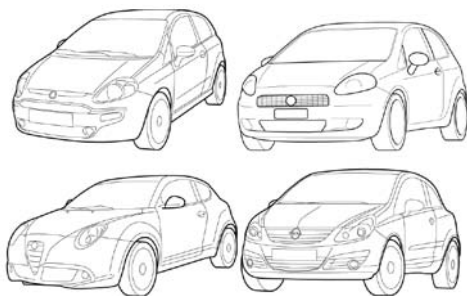

1 987 432 188
1 987 432 488

Alfa Mito

09.08 →

Fiat Grande Punto
Fiat PuntoEVO

10.05 →

10.09 →

Opel Corsa D

07.06 →

Grande Punto, Punto EVO, Mito

①

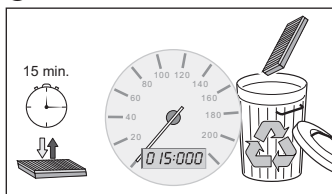

③

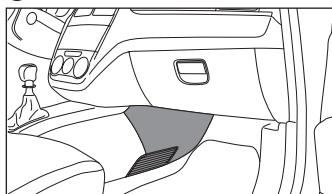

②

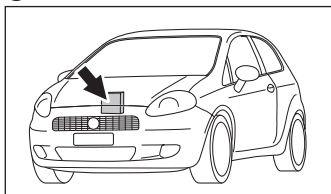

④

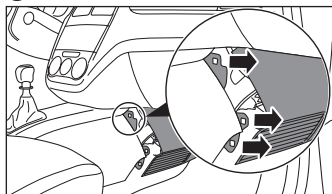

Grande Punto

5

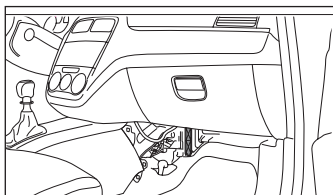

7

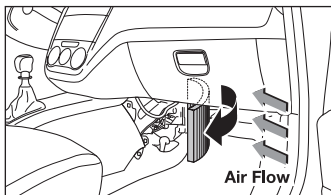

6

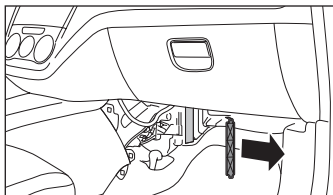

D

Corsa

①

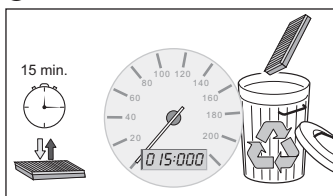

⑤

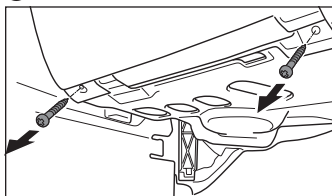

②

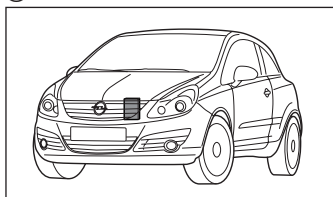

⑥

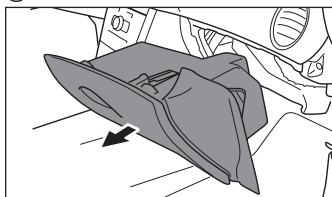

③

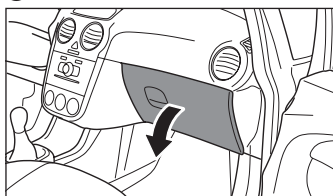

⑦

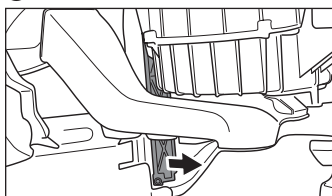

④

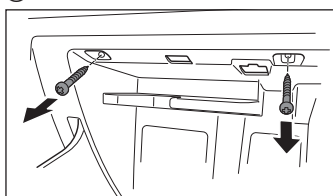

⑧

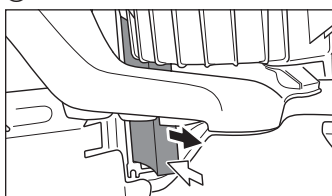

D

Peugeot, Citroën, Toyota

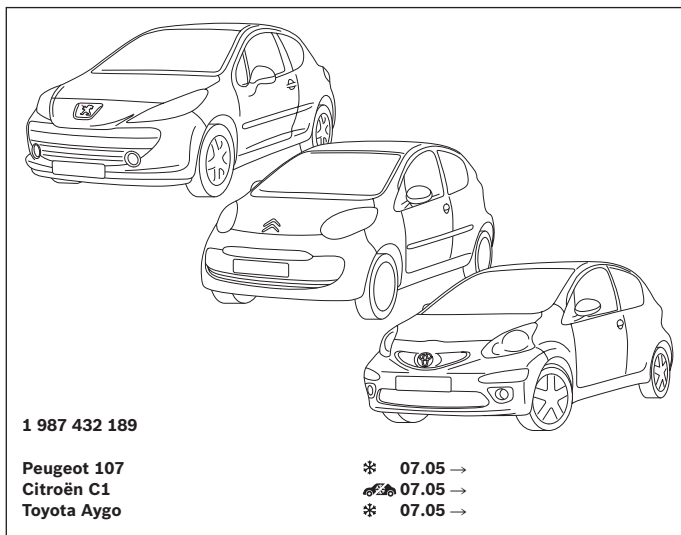

107, C1, Aygo

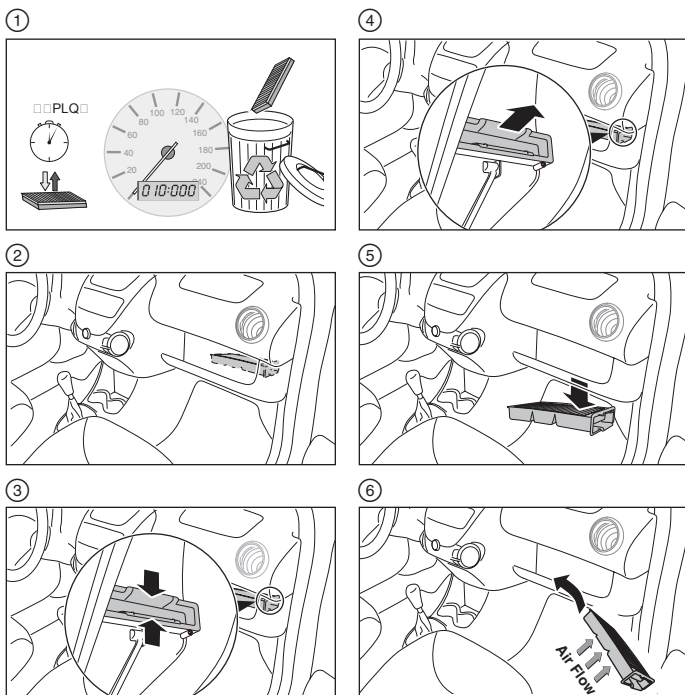

Toyota

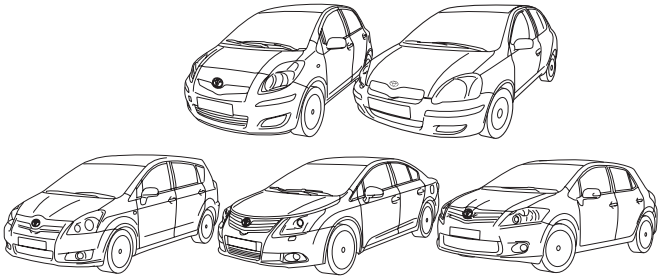

1 987 432 190

Toyota Yaris	08.05 →
Toyota Yaris 1.4 D4-D	11.06 →
Toyota Yaris II	01.06 →
Toyota Auris	02.07 →
Toyota Avensis III	01.09 →
Toyota Corolla Verso	04.09 →

Yaris, Yaris 1.4 D4-D, Yaris II, Auris, Avensis III, Verso

①

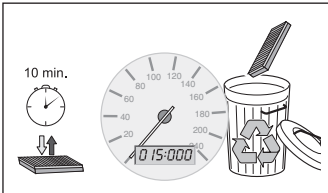

④

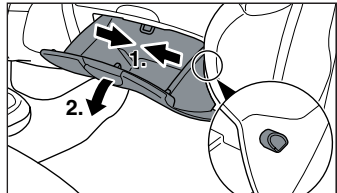

②

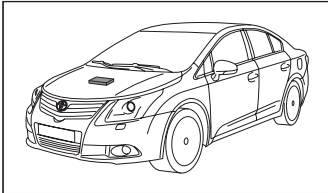

⑤

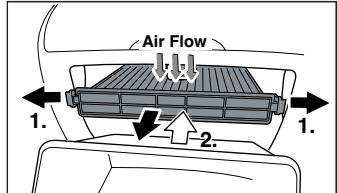

③

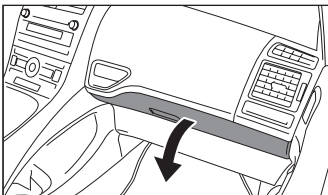

Ford

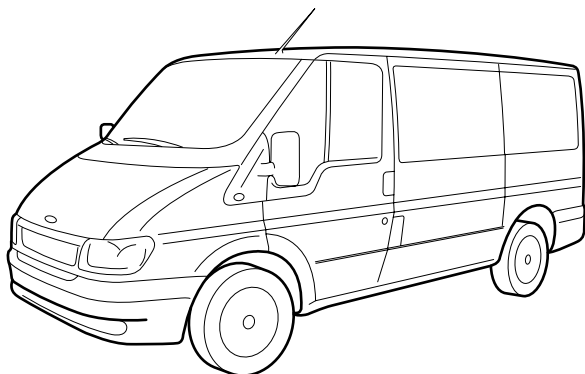

1 987 432 192

Ford Transit

* 08.00 → 07.06

Transit

①

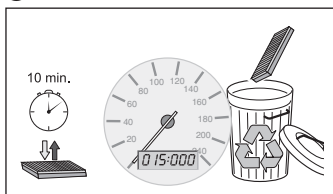

③

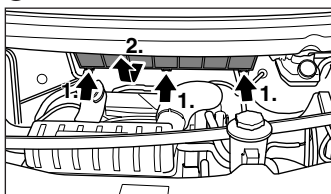

②

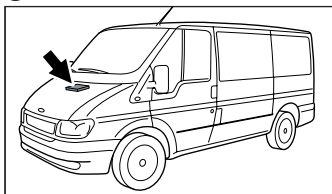

④

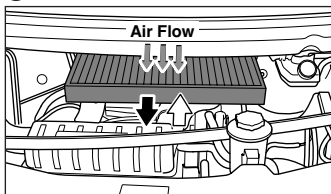

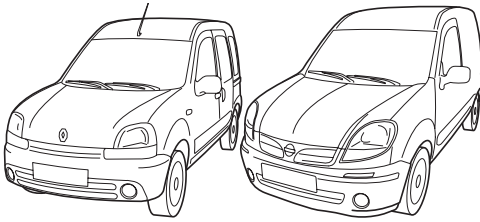

Renault, Nissan



1 987 432 193

Renault Kangoo
Nissan Kubistar

 11.97 →
 09.03 →

Kangoo, Kubistar

①

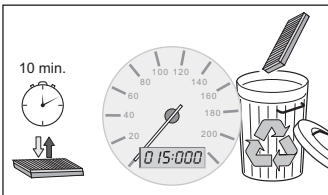

④

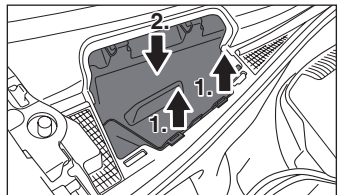

②

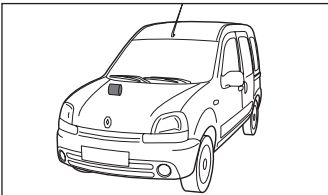

⑤

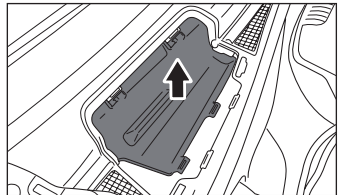

③

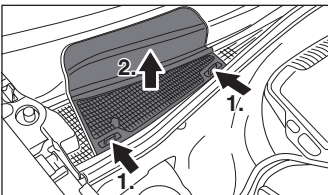

⑥

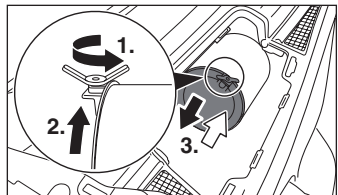

Nissan

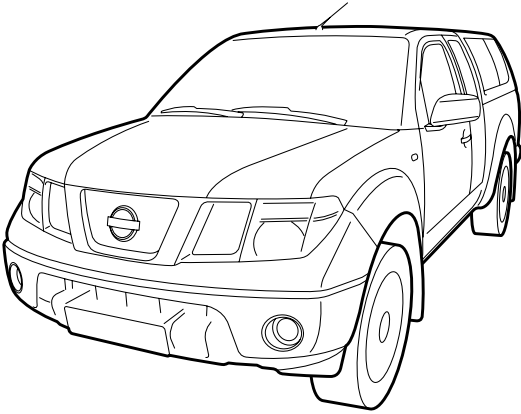

1 987 432 194

Nissan Navara

05.05 →

Navara

①

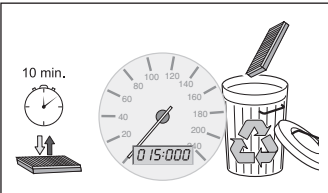

④

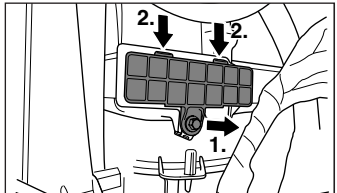

②

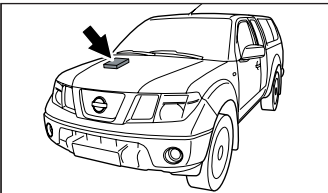

⑤

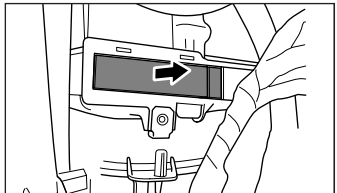

③

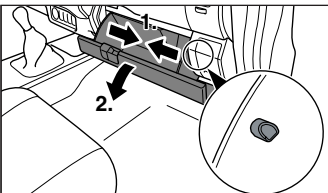

⑥

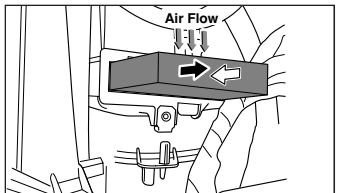

D

Navara

7

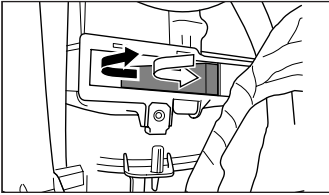

8

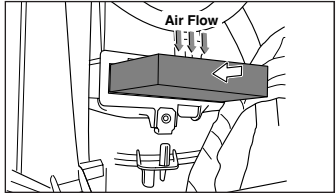

D

Mercedes-Benz

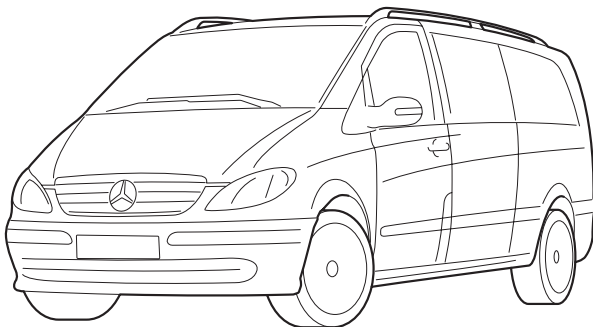

1 987 432 195
1 987 432 495

Mercedes-Benz Viano
Mercedes-Benz Vito II

09.03 →
09.03 →

Viano, Vito II

①

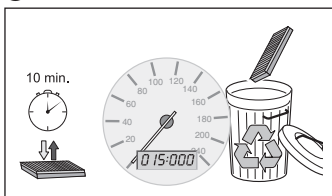

③

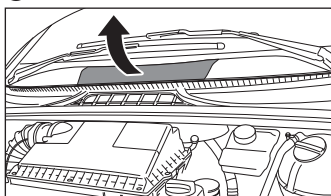

②

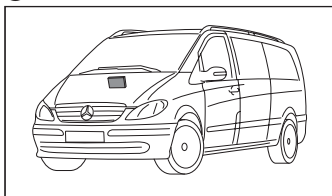

④

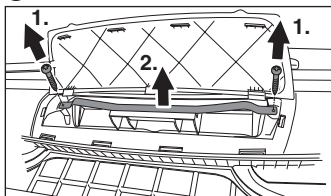

D

Viano, Vito II (continued)

5

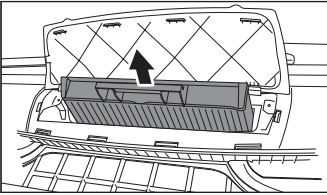

7

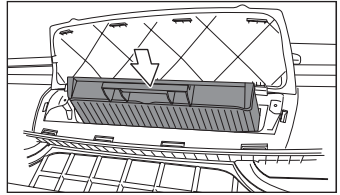

6

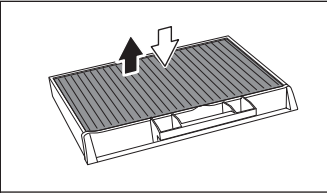

D

Renault, Nissan

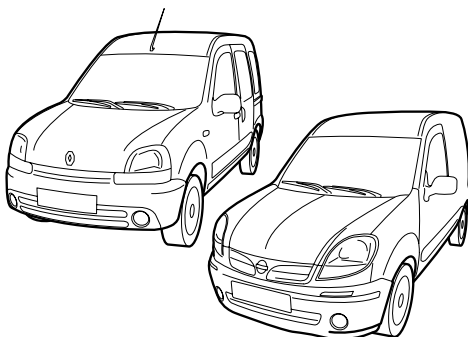

1 987 432 197

Renault Kangoo
Nissan Kubistar

* 02.00 →

* 02.00 →

Kangoo, Kubistar

1

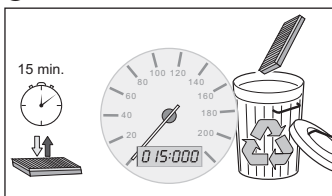

3

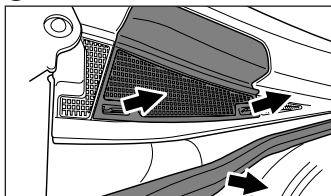

2

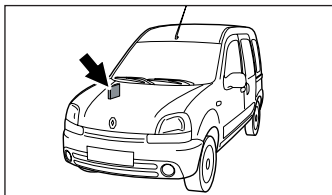

4

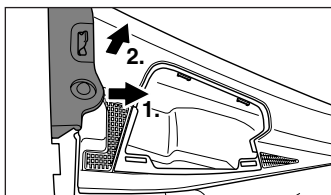

Kangoo, Kubistar

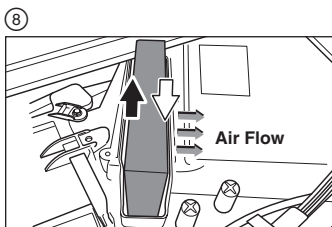
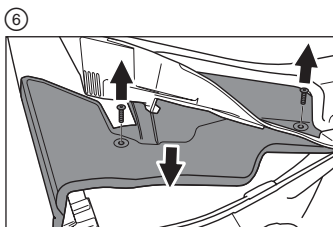
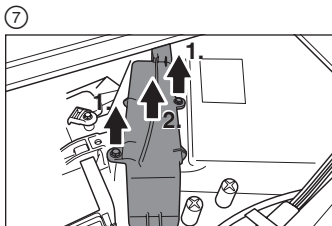
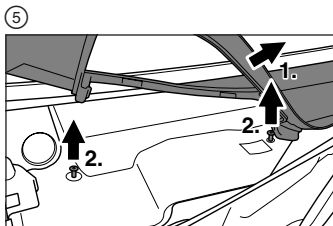

Citroën

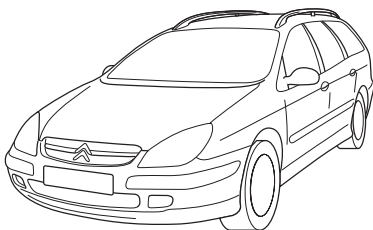

1 987 432 198
1 987 432 398

Citroën C5

03.01 → 08.04

C5

1

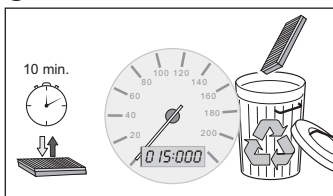

4

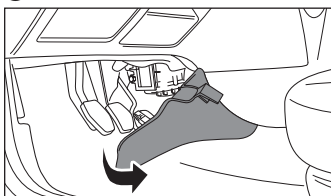

2

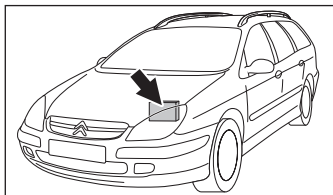

5

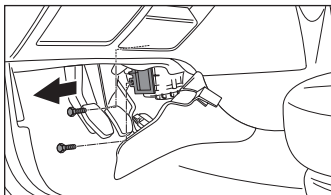

3

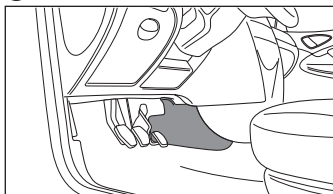

6

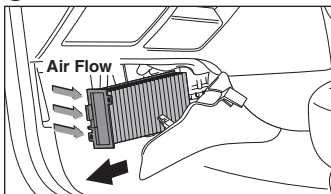

Porsche

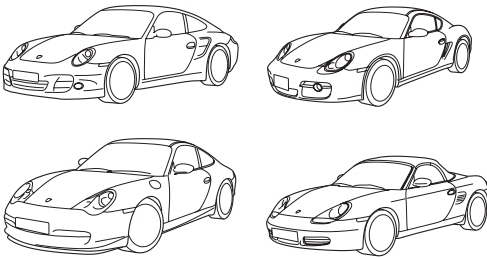

1 987 432 200
1 987 432 407

Porsche Boxter (986/987)
Porsche Cayman (987)
Porsche 911 (996)
Porsche 911 (997)

09.96 →
11.05 →
06.97 →
04.06 →

911 (996), Boxter (986)

①

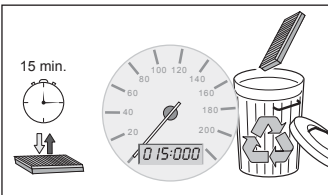

④

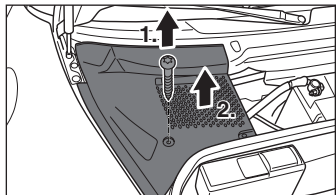

②

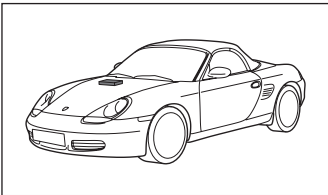

⑤

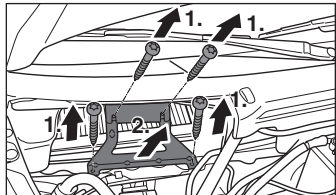

③

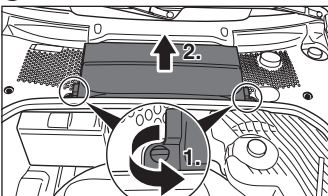

⑥

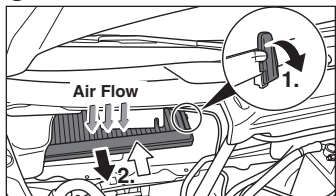

911 (997), Cayman, Boxster (987)

①

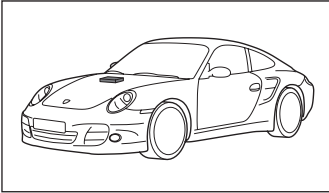

④

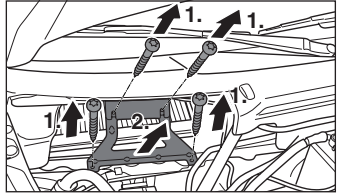

②

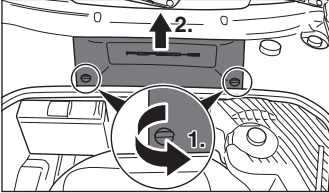

⑤

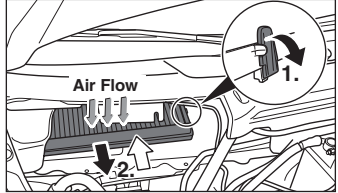

③

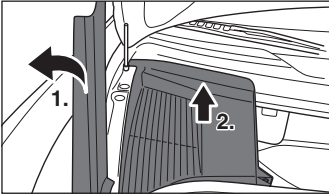

D

Honda

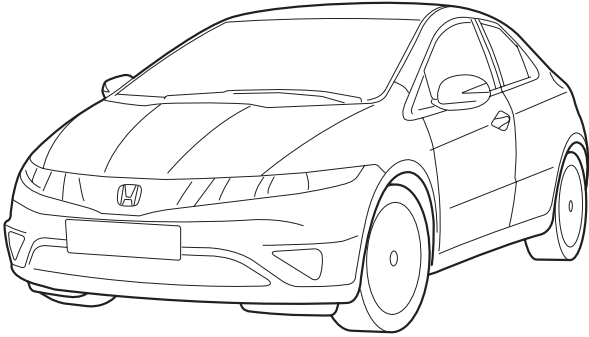

1 987 432 203

Honda Civic VIII

01.06 →

Civic VIII

①

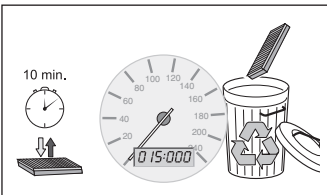

④

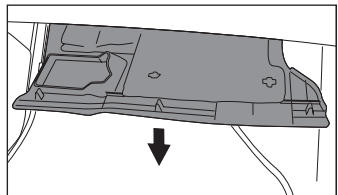

②

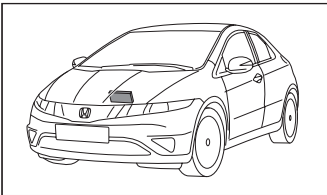

⑤

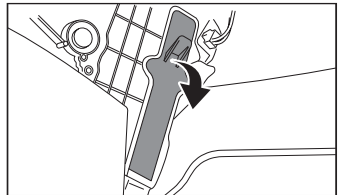

③

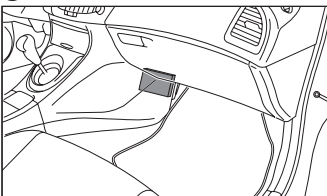

⑥

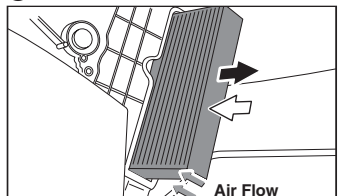

D

Hyundai

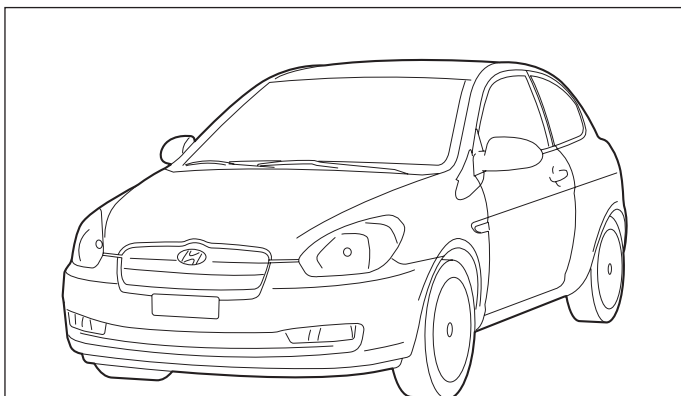

1 987 432 204

Hyundai Accent 1.4i
Hyundai Accent 1.5 CDRi

06.06 →

06.06 →

Accent

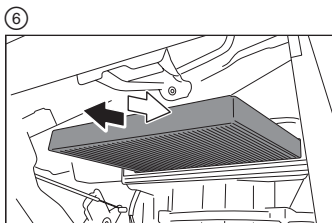
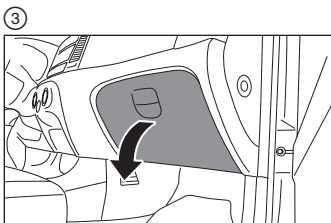
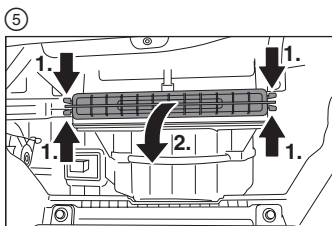
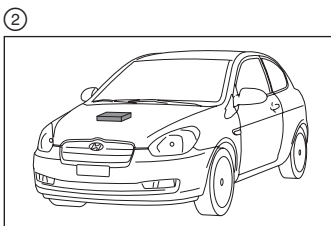
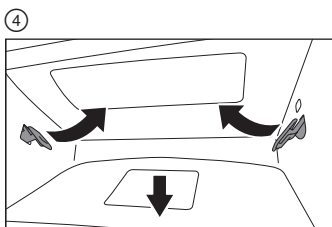
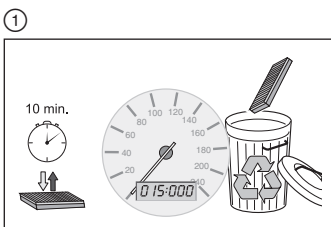

Volvo, Land Rover

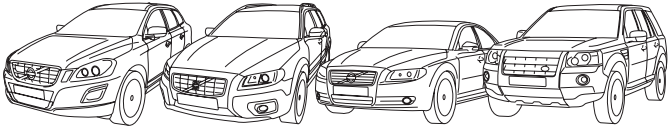

1 987 432 205
1 987 432 405

Volvo V70 III
Volvo S80 II
Volvo XC60
Land Rover Freelander II

08.07 →
07.06 →
10.08 →
01.07 →

V70 III, S80 II, XC60

①

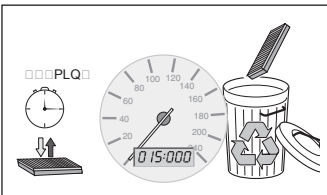

④

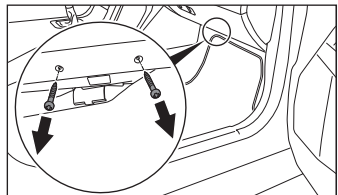

②

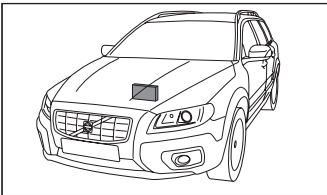

⑤

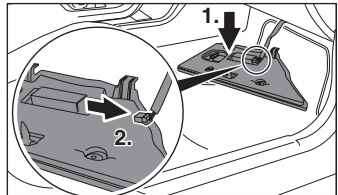

③

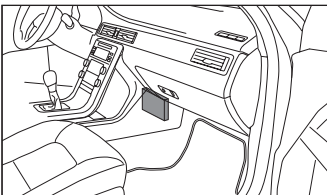

⑥

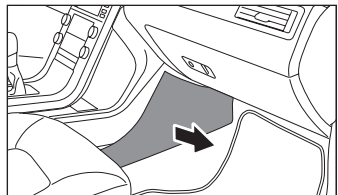

V70 III, S80 II, XC60 (continued)

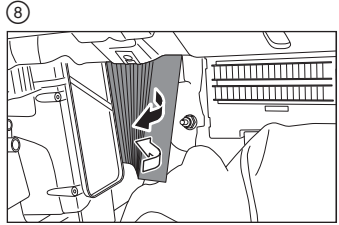
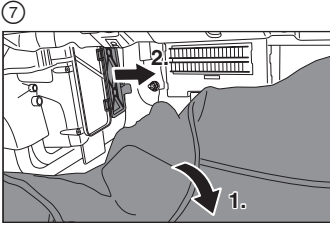

Freelander II

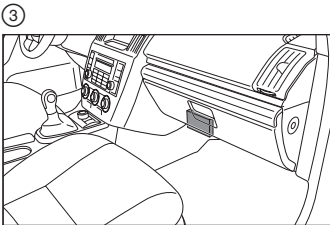
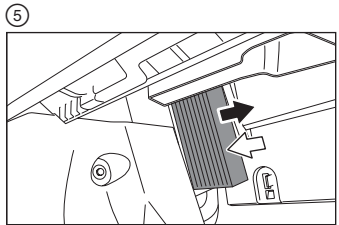
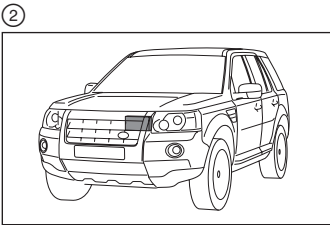
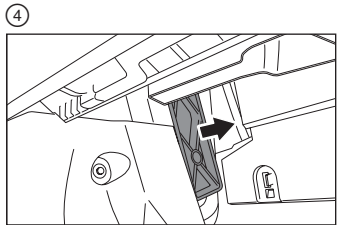
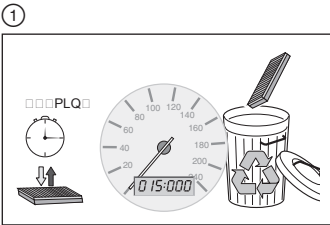

D

Peugeot, Fiat, Citroën



1 987 432 206
1 987 432 406

Peugeot Expert II
Fiat Scudo
Citroën Jumpy

01.07 →
01.07 →
01.07 →

Expert II, Scudo, Jumpy

①

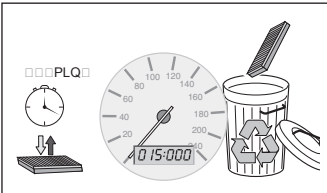

④

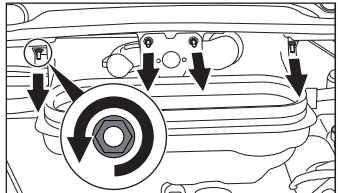

②

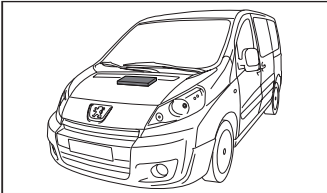

⑤

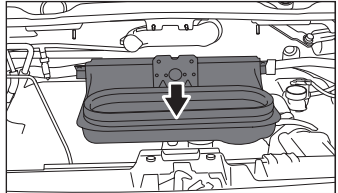

③

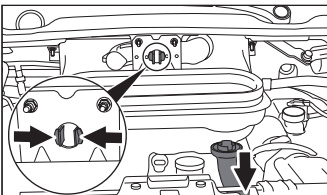

⑥

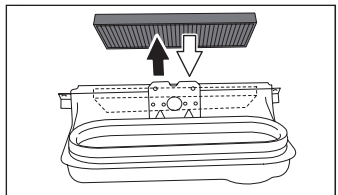

Renault, Opel, Nissan

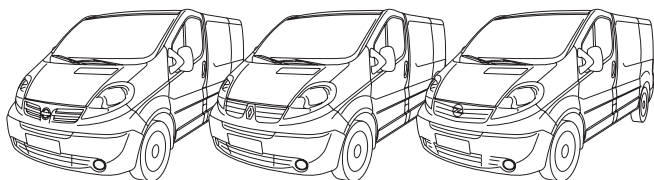

1 987 432 208

Renault Trafic II
Opel Vivaro
Nissan Primastar

02.01 →

03.01 →

09.02 →

Trafic II, Vivaro, Primastar

1

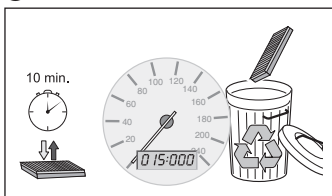

3

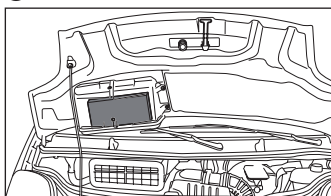

2

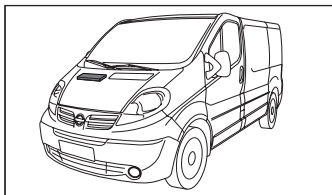

4

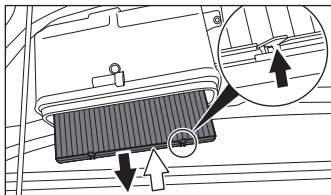

Mazda

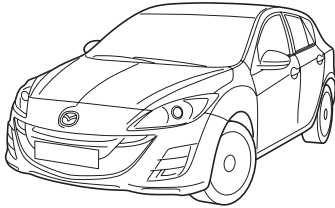

1 987 432 209

Mazda 3

06.09 →

Mazda 3

①

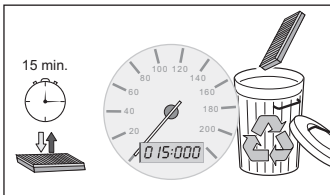

④

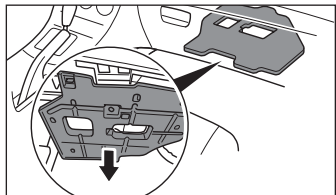

②

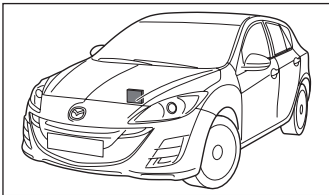

⑤

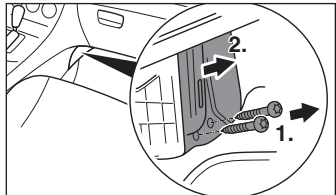

③

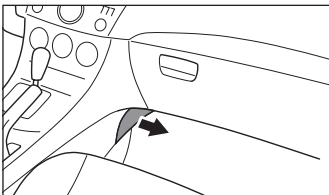

⑥

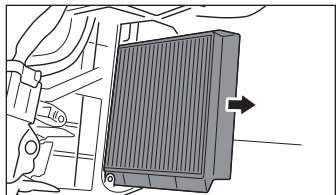

Mazda 3 (continued)

7

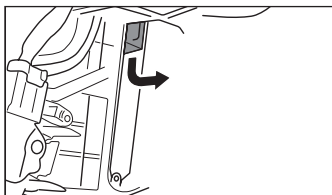

9

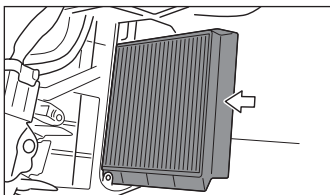

8

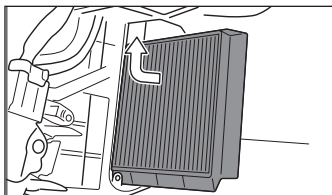

D

Land Rover

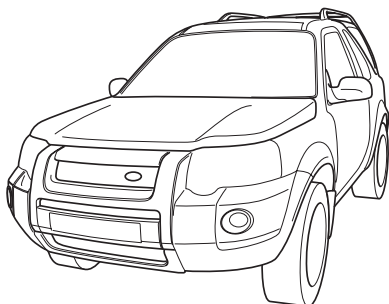

1 987 432 210

Land Rover Freelander

02.98 →

Freelander

①

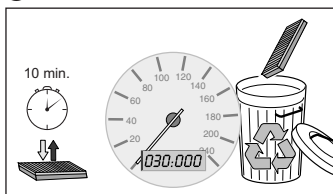

④

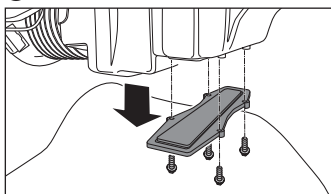

②

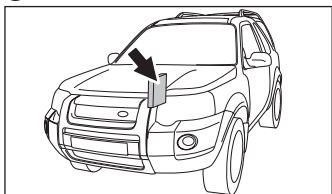

⑤

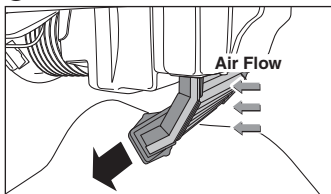

③

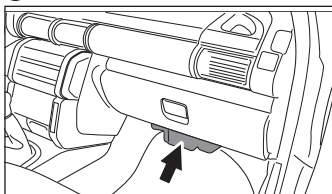

Mercedes-Benz, VW

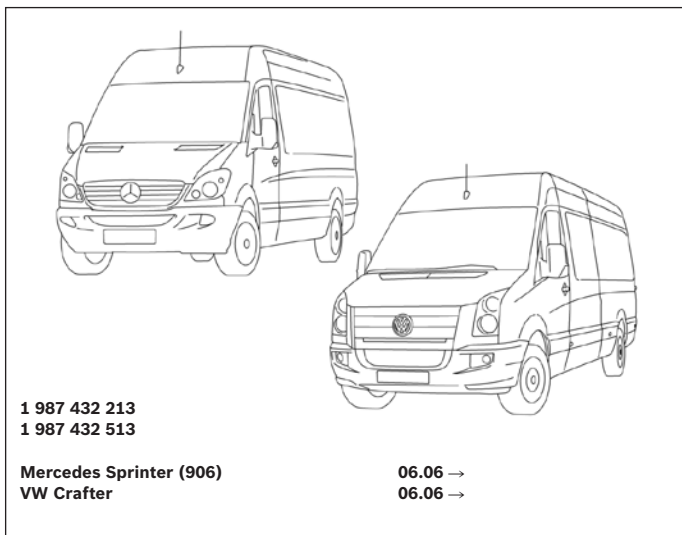

Sprinter, Crafter

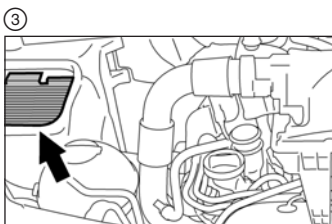
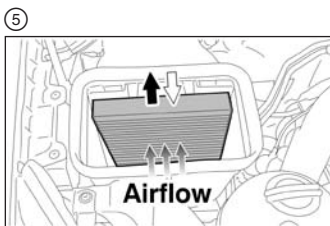
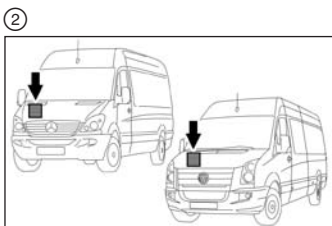
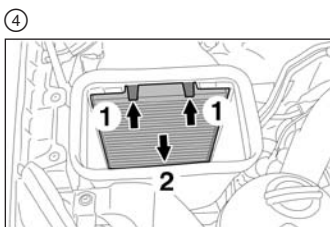
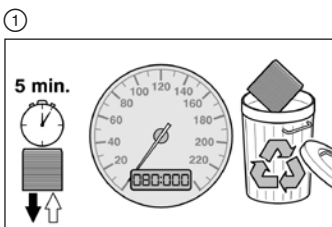

Opel, Suzuki

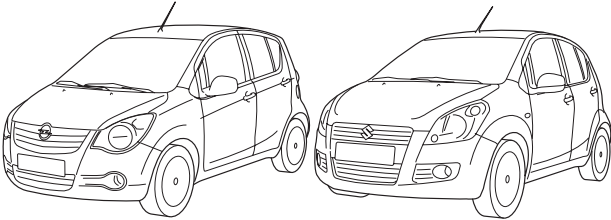

1 987 432 214

Opel Agila II
Suzuki Splash

04.08 →
05.08 →

Agila II, Splash

①

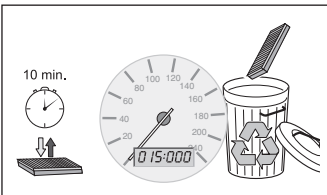

④

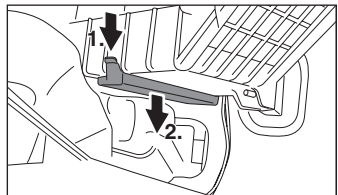

②

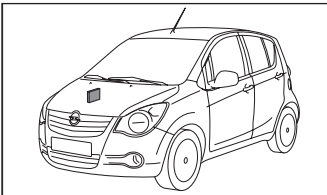

⑤

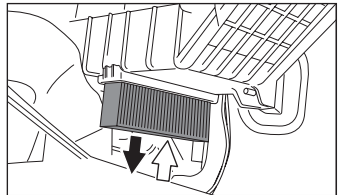

③

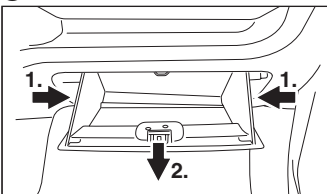

D

Ford

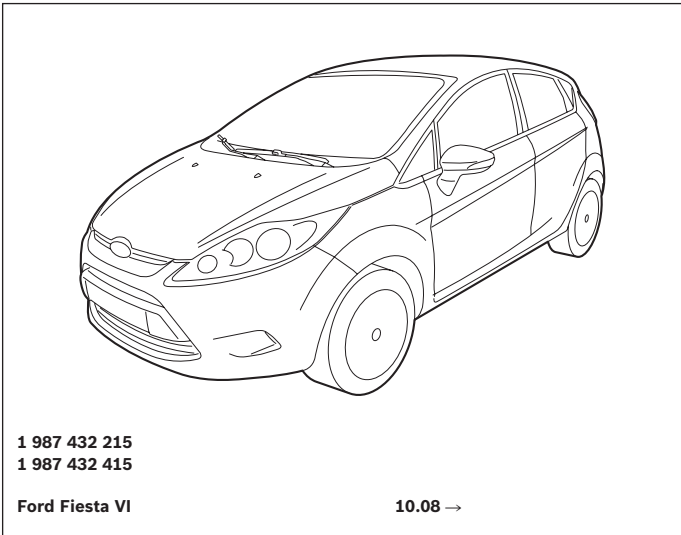

Fiesta VI

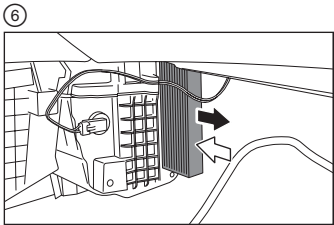
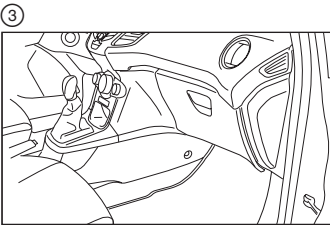
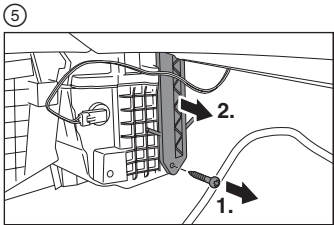
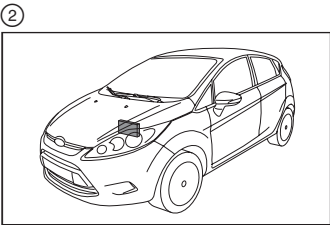
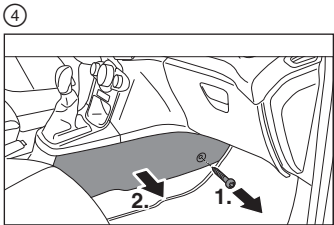
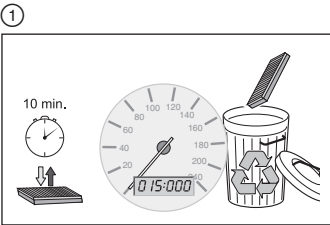

D

Peugeot, Citroën, Mitsubishi

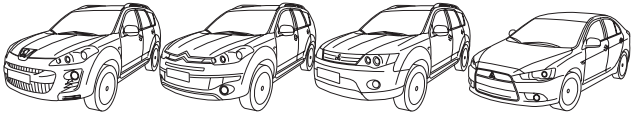

1 987 432 216
1 987 432 416

Peugeot 4007
Citroën C-Crosser
Mitsubishi Outlander II
Mitsubishi Lancer VIII

09.07 →
09.07 →
03.07 →
10.07 →

4007, C-Crosser, Outlander II, VIII

①

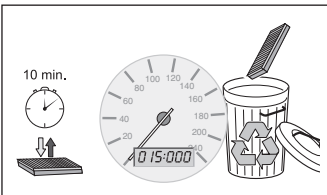

④

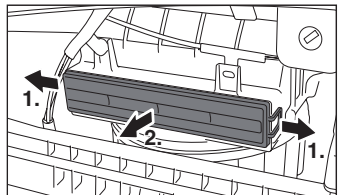

②

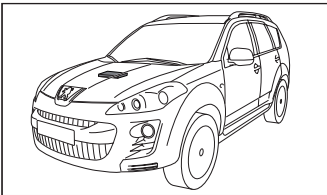

⑤

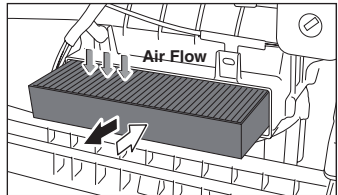

③

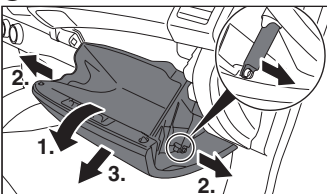

D

Subaru

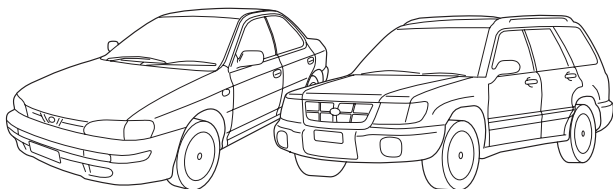

1 987 432 218

Subaru Impreza I
Subaru Foresta

08.98 → 12.00

08.98 → 12.00

Impreza I, Forester

①

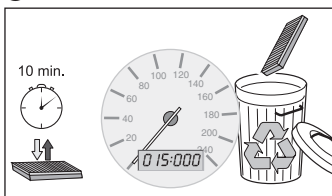

④

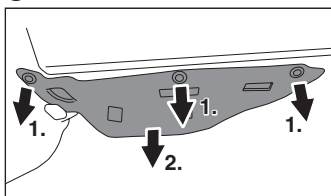

②

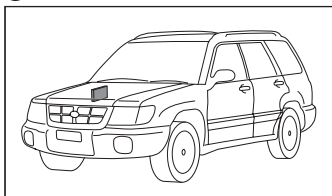

⑤

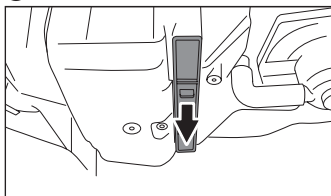

③

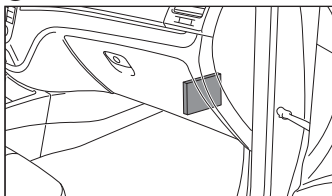

⑥

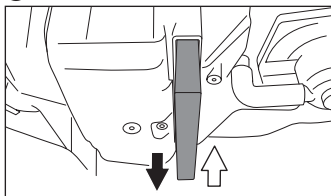

BMW

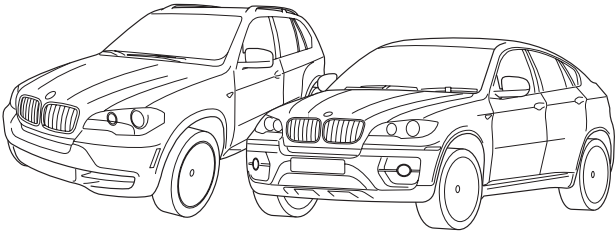

1 987 432 219
1 987 432 419

BMW X5 (E70)
BMW X6 (E71)
BMW X6 Hybrid (E72)

11.06 →
04.08 →
04.10 →

X5, X6

①

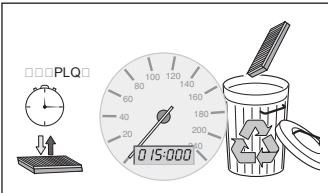

③

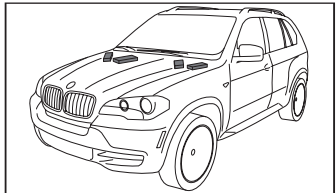

②

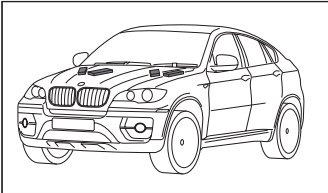

D

X5, X6 (continued)

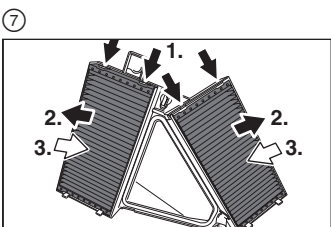
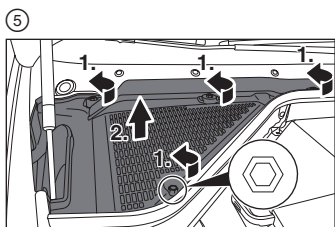
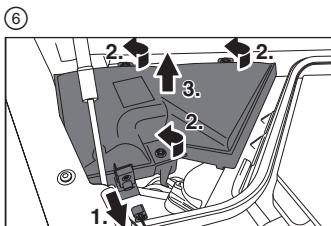
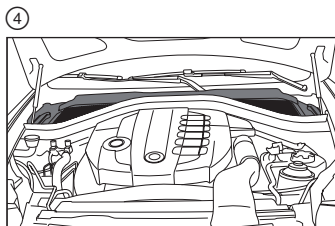

Honda

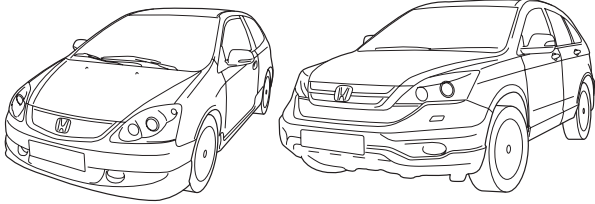

1 987 432 220

Honda Civic VII
Honda CR-V II

02.01 → 09.05
07.02 → 09.06

Civic VII, CR-V II

①

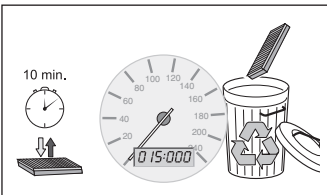

④

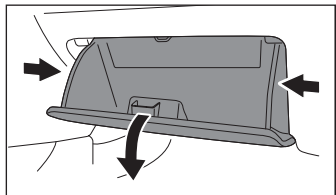

②

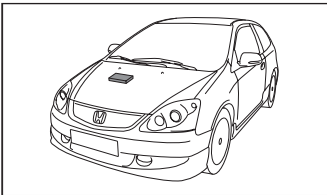

⑤

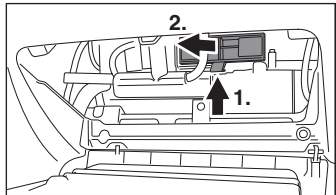

③

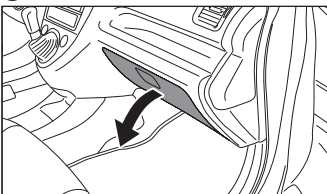

⑥

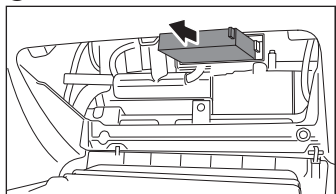

Civic VII, CR-V II

7

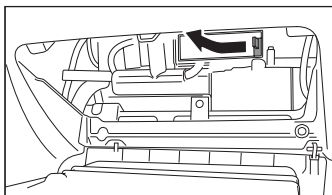

9

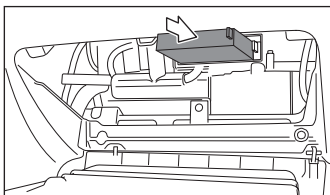

8

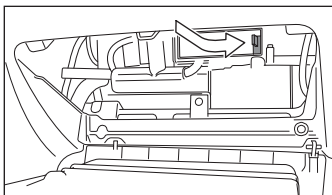

D

Suzuki

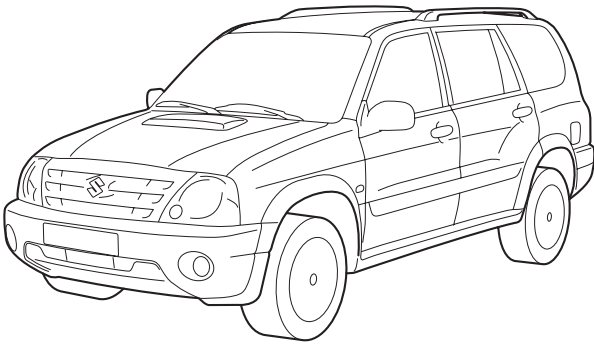

1 987 432 221

Suzuki Grand Vitara

* 11.02 →

Grand Vitara

①

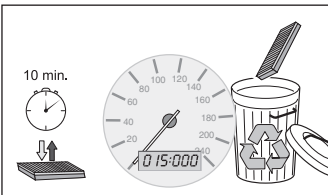

④

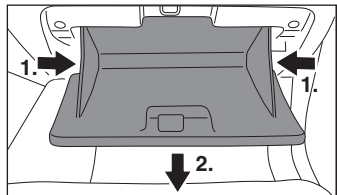

②

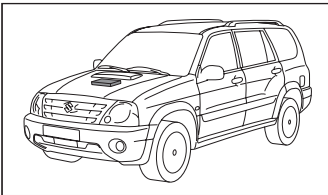

⑤

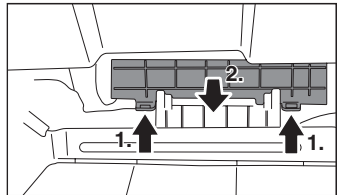

③

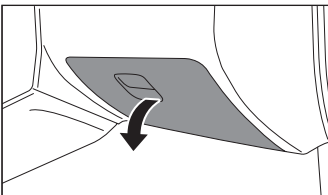

⑥

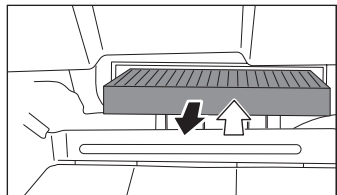

Chevrolet, Opel

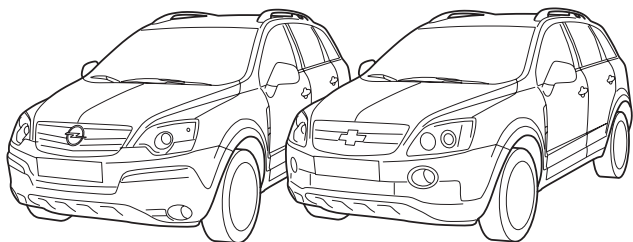

1 987 432 222

Chevrolet Captiva
Opel Antara

06.06 →

05.06 →

Captiva, Antara

①

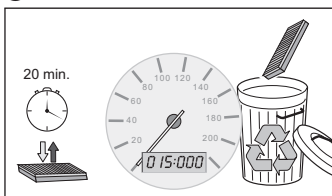

④

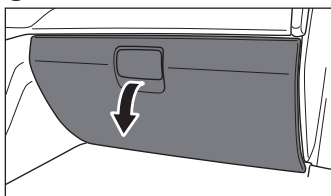

②

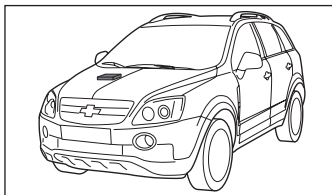

⑤

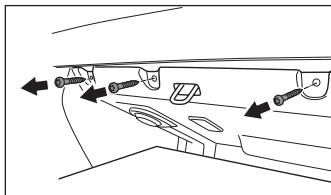

③

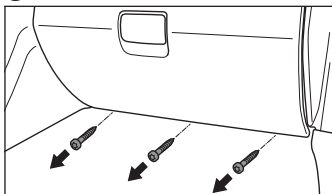

⑥

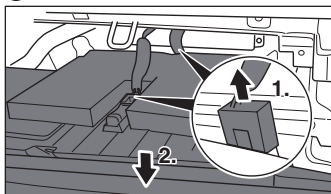

Captiva, Antara

7

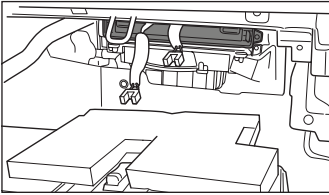

9

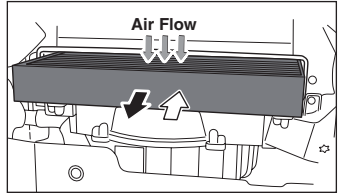

8

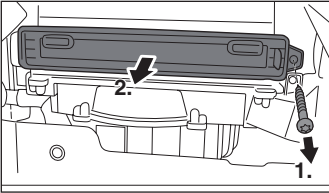

D

Chevrolet, Daewoo

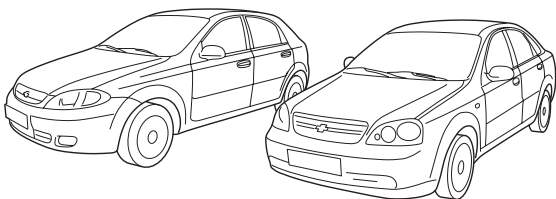

1 987 432 223

Chevrolet Lacetti
Chevrolet Nubira
Daewoo Lacetti
Daewoo Nubira

* 03.05 →
 * 01.05 →
 * 02.04 →
 * 07.03 →

Lacetti, Nubira

①

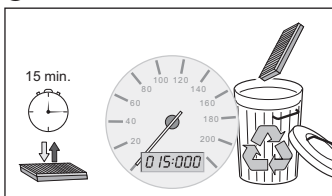

④

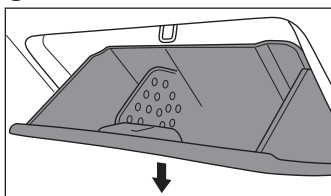

②

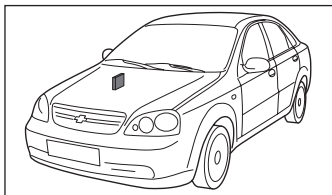

⑤

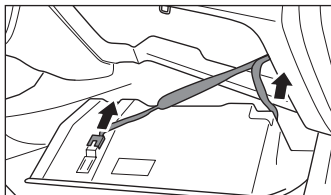

③

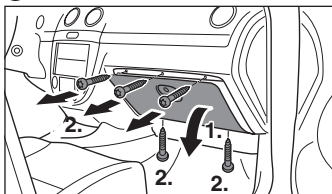

⑥

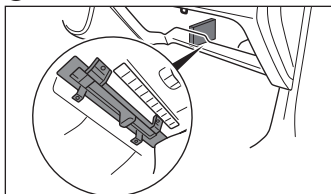

Lacetti, Nubira

7

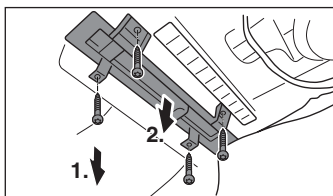

8

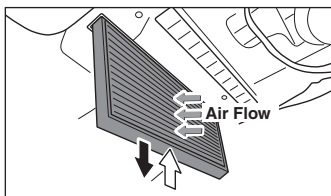

Hyundai

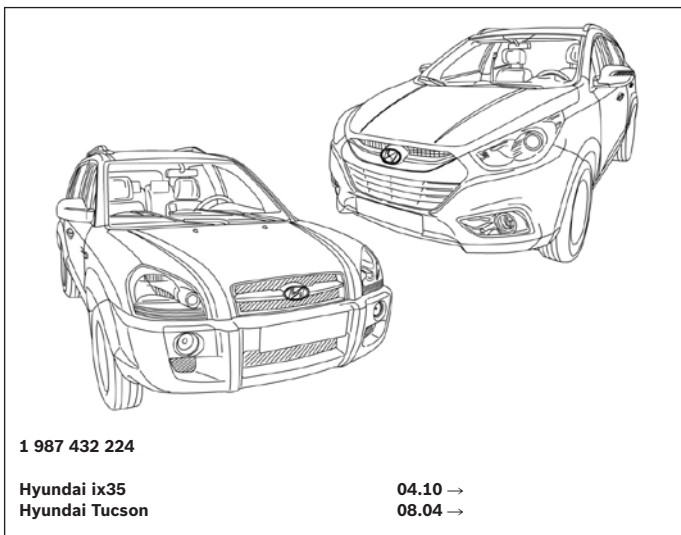

ix35

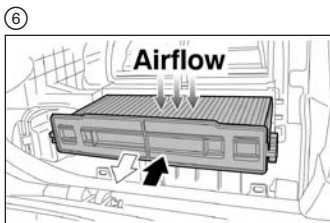
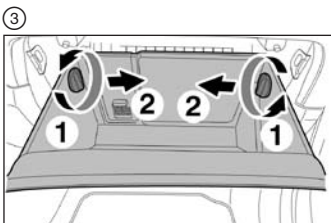
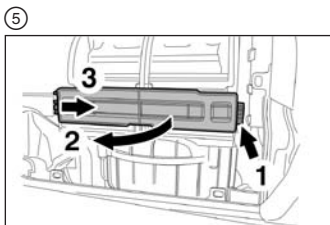
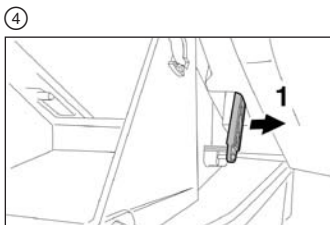
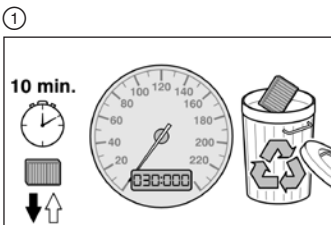

D

Tucson

①

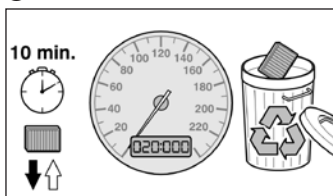

④

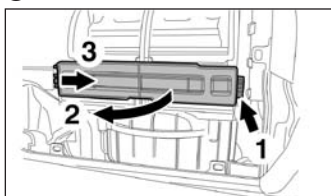

②



④

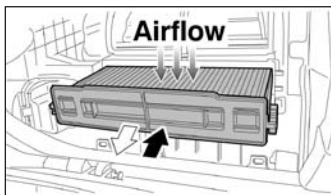

③

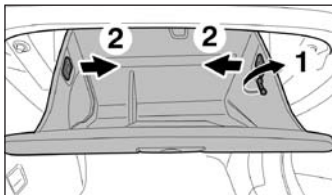

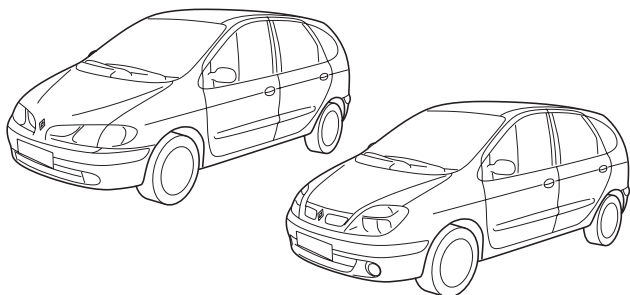

Renault



1 987 432 225

Renault Mégane Scénic
Renault Scénic

 01.97 → 09.99
 09.99 → 08.03

Scénic

①

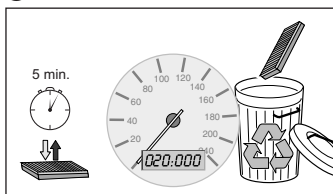

③

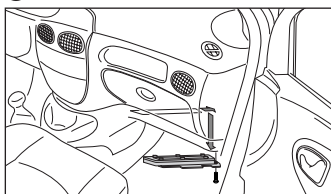

②

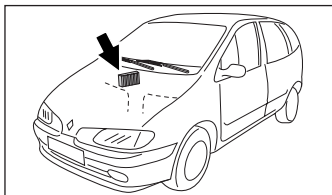

④

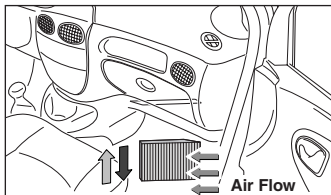

D

Renault

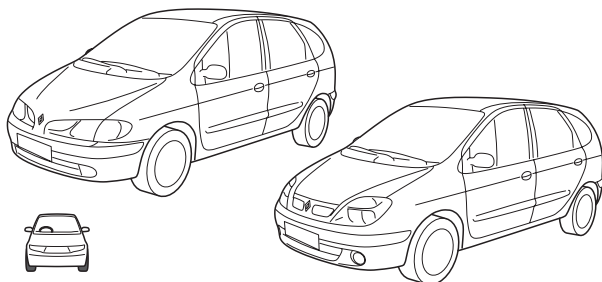

1 987 432 226

Renault Mégane Scénic
Renault Scénic

* 01.97 → 09.99

* 09.99 → 08.03

Scénic

①

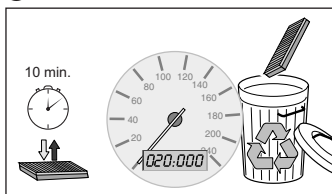

③

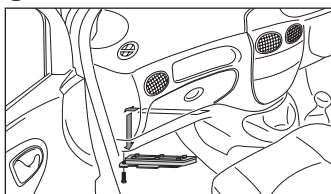

②

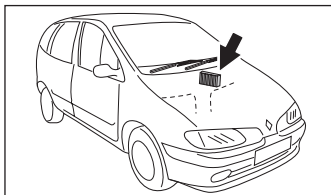

④

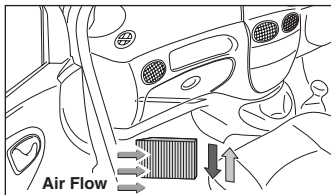

Hyundai, Kia



1 987 432 227

Hyundai Santa Fe
Hyundai Sonata

03.06 → 12.09

03.05 →

Kia Magentis

11.05 →

Santa Fe, Sonata, Magentis

1

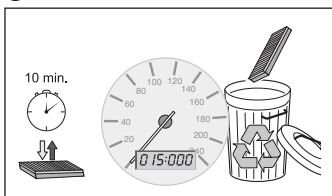

3

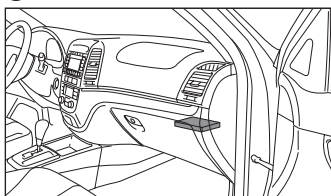

2

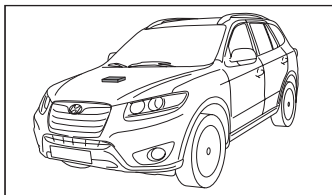

4

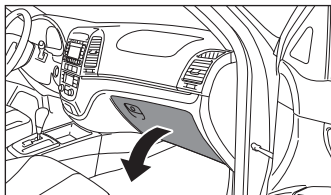

D

Santa Fe, Sonata, Magentis

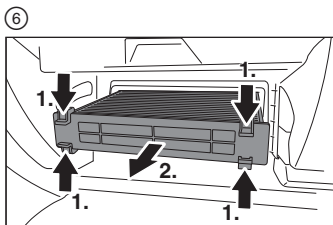
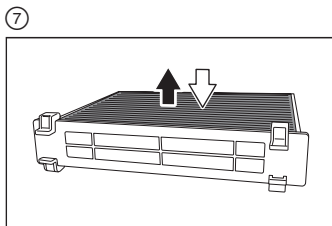
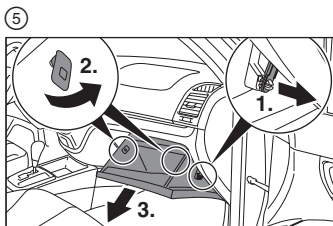

Citroën, Fiat, Peugeot

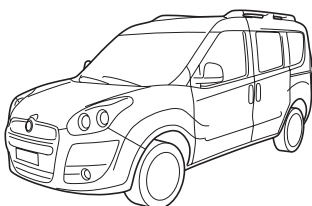
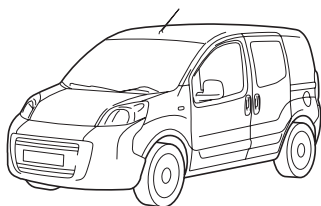

1 987 432 228

Citroen Nemo
 Fiat Doblo
 Fiat Fiorino II
 Fiat Linea
 Fiat Qubo
 Peugeot Bipper

02.08 →
 01.10 →
 02.08 →
 06.09 →
 09.08 →
 02.08 →

Fiorino, Qubo, Doblo, Bipper, Nemo

①

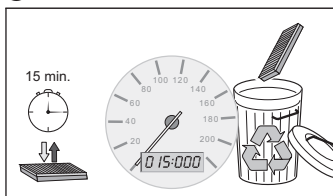

③

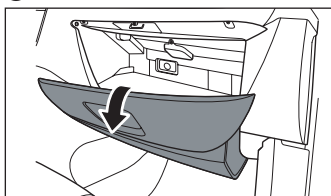

②

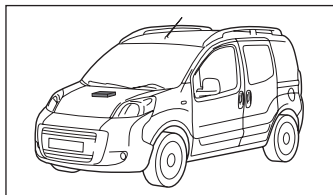

④

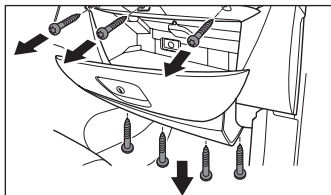

D

Fiorino, Qubo, Doblo, Bipper, Nemo

5

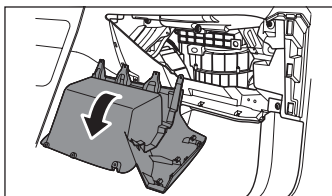

7

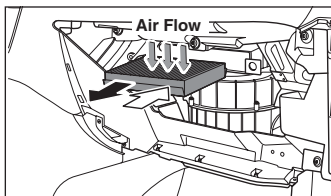

6

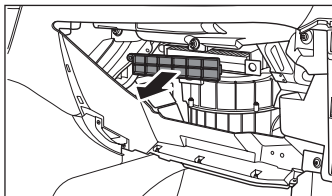

D

Hyundai



1 987 432 229

Hyundai Elantra mit Klima

* 05.03 →

Elantra

①

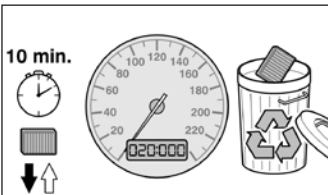

④

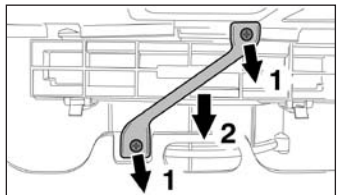

②



⑤

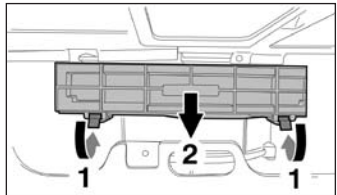

③

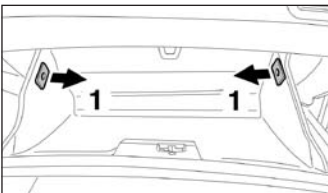

D

Lada

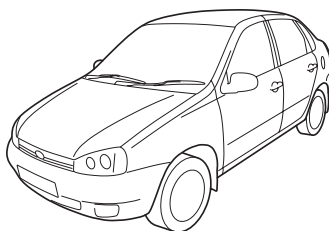

1 987 432 230

Lada Kalina

00.04 →

Kalina

①

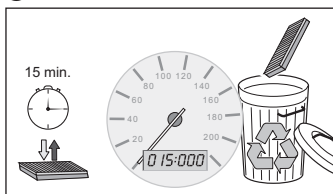

③

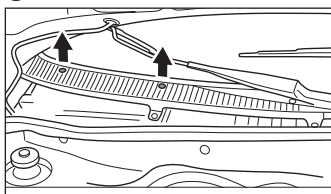

②

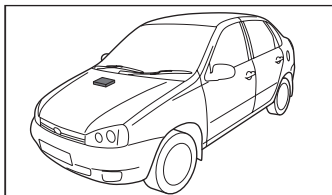

④

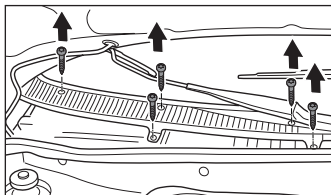

Lada

5

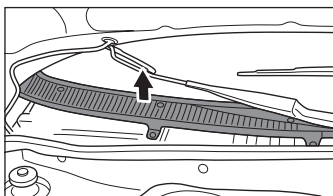

7

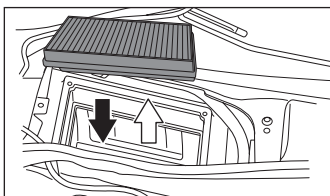

6

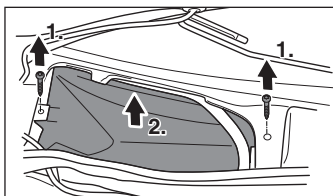

Volvo

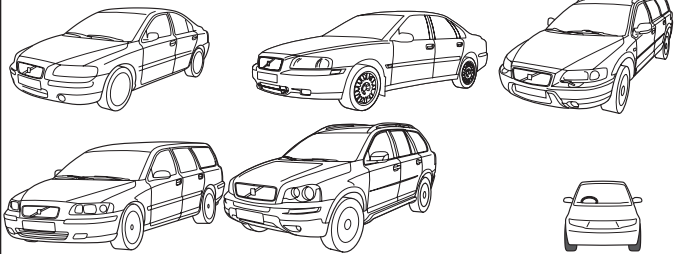

1 987 432 231
1 987 432 531

Volvo S60
Volvo S80
Volvo V70 II
Volvo XC70
Volvo XC90

07.00 →
05.98 →
03.00 → 09.07
03.00 → 09.07
10.02 →

S60, S80, V70 II, XC70, XC90

①

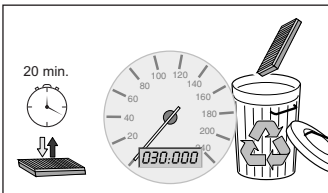

③

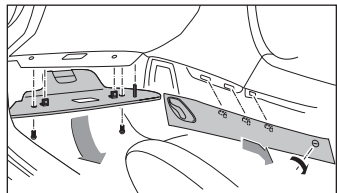

②

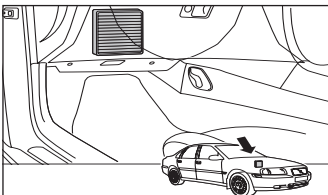

④

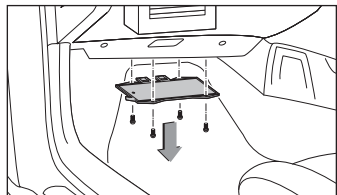

D

S60, S80, V70 II, XC70, XC90 (continued)

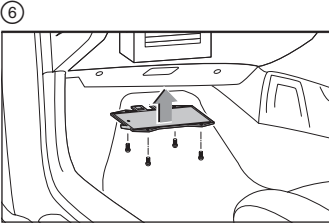
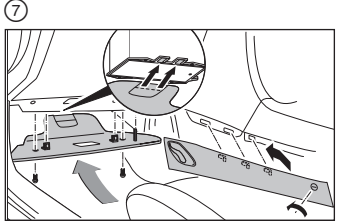
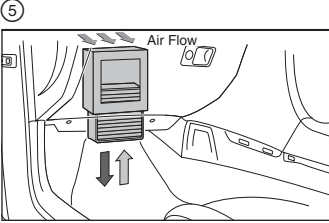

D

Nissan



1 987 432 232

Nissan Maxima (A 33)

03.00 →

Maxima (A 33)

①

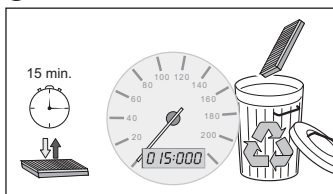

③

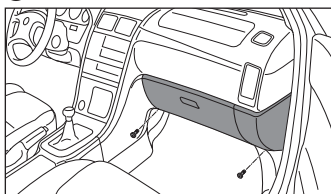

②

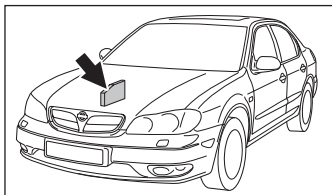

④

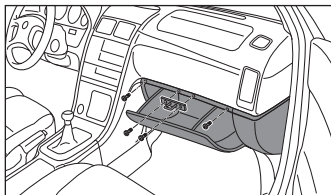

Maxima (A 33)

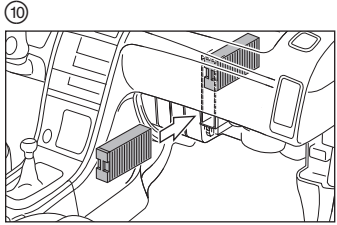
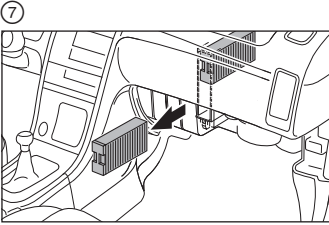
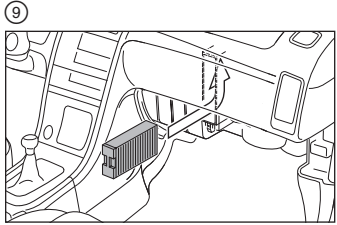
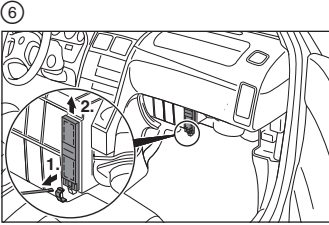
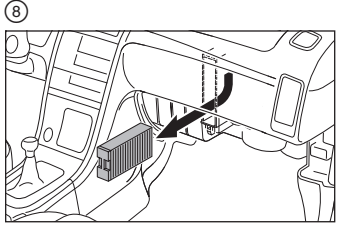
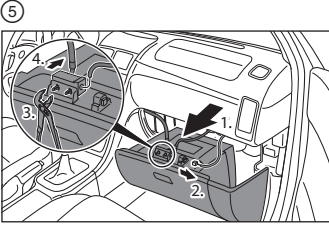

D

Honda

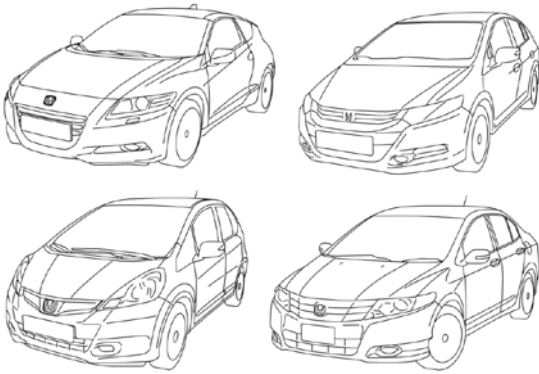

1 987 432 234

Honda CR-Z
 Honda Insight
 Honda Jazz III
 Honda City

06.10 →
 04.09 →
 07.08 →
 09.08 →

CR-Z

①

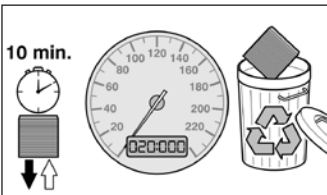

④

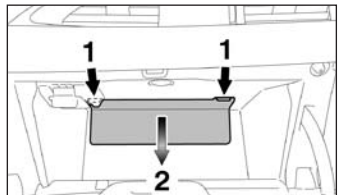

②

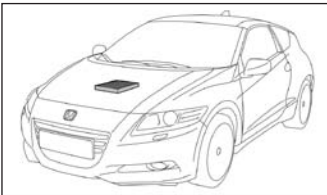

⑤

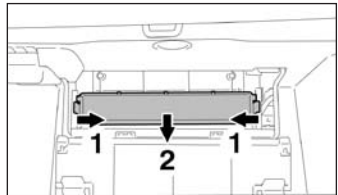

③

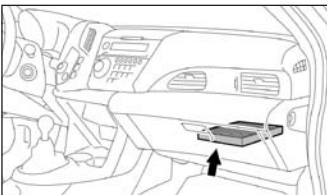

⑥

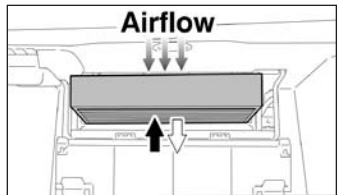

Insight

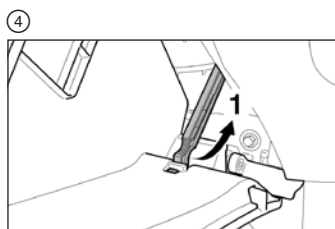
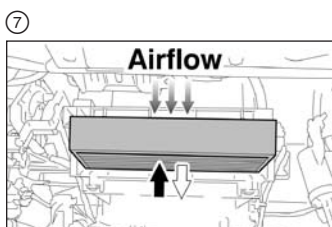
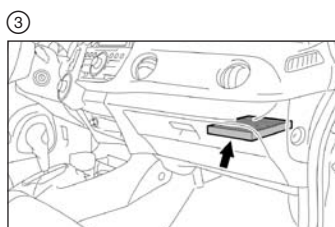
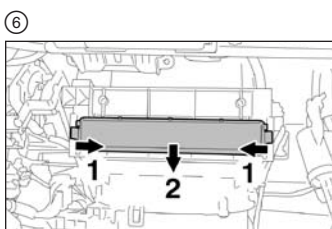
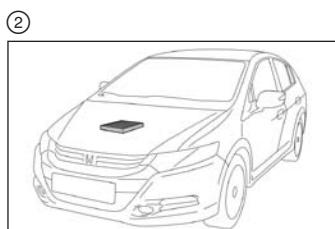
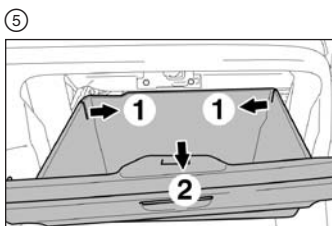
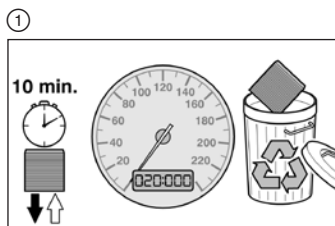

D

Jazz III, City

①

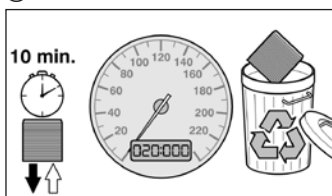

④

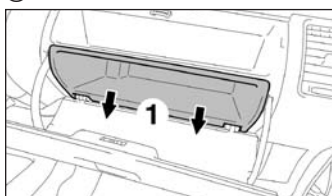

②

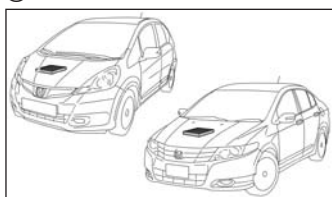

⑤

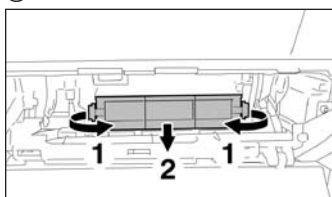

③

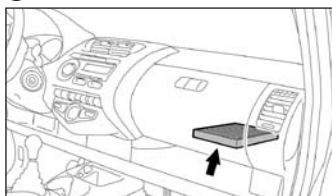

⑥

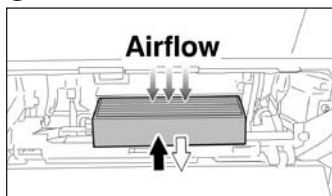

Land Rover, Range Rover

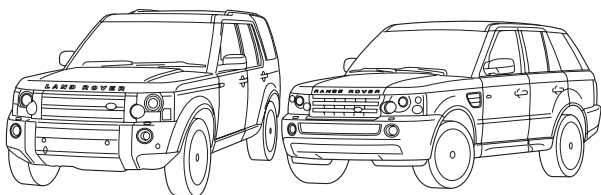

1 987 432 235
1 987 432 535

Land Rover Discovery III
Land Rover Discovery IV
Range Rover Sport

10.04 →

09.09 →

05.05 →

Discovery III, IV, Sport

①

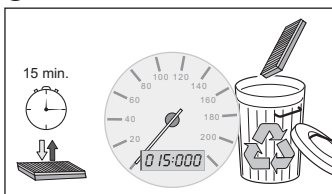

③

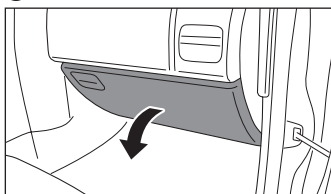

②

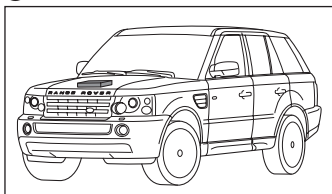

④

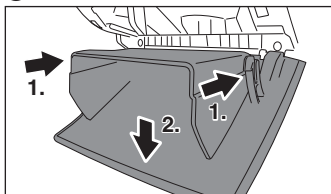

D

Discovery III, IV, Sport

⑤

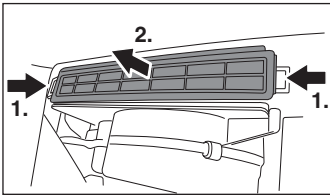

⑦

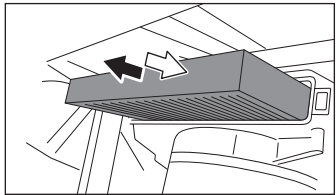

⑥

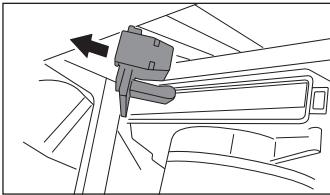

Suzuki

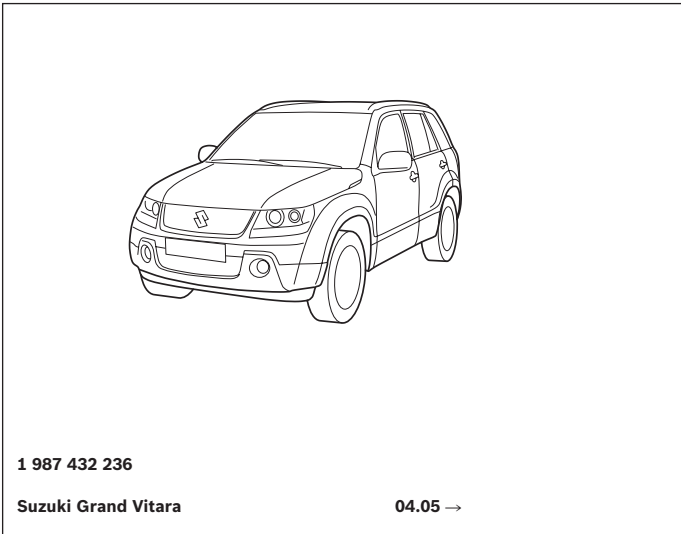

Grand Vitara

D

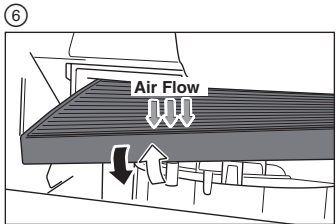
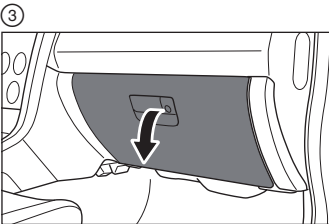
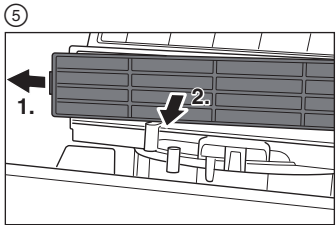
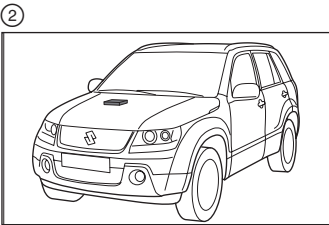
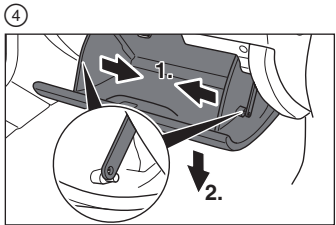
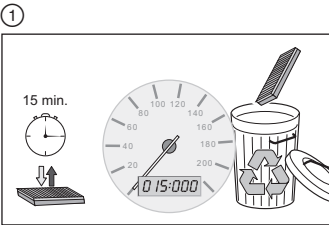

Nissan

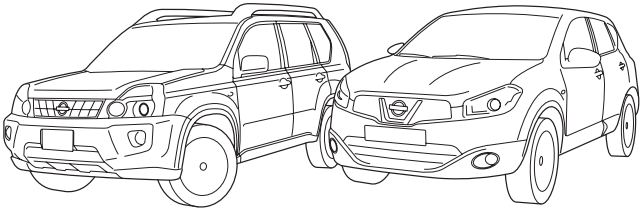

1 987 432 238

Nissan Qashqai
Nissan X-Trail II

02.07 →
07.07 →

Qashqai, X-Trail II

①

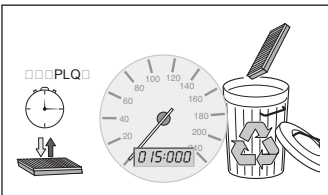

④

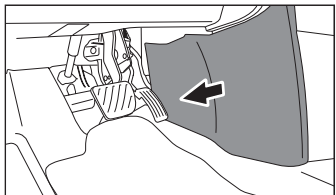

②

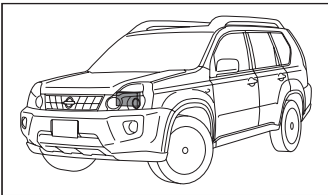

⑤

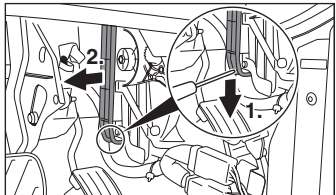

③

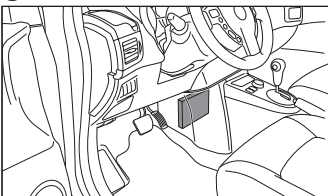

⑥

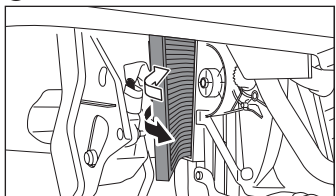

Nissan

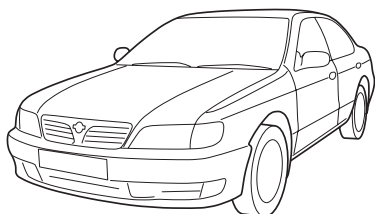

1 987 432 239

Nissan Maxima (A 32)

03.94 → 02.00

Maxima (A 32)

①

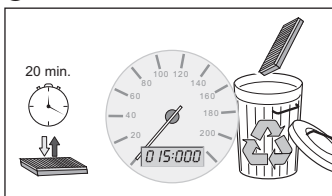

④

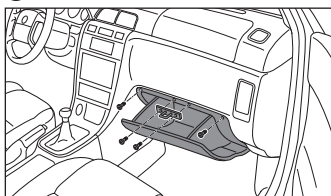

②

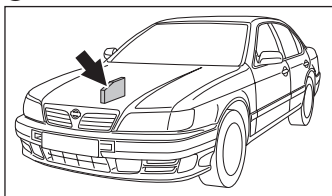

⑤

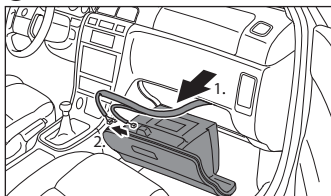

③

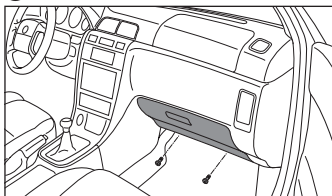

⑥

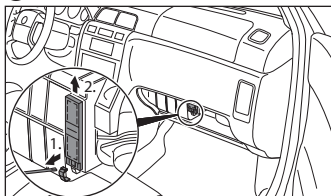

Maxima (A 32)

7

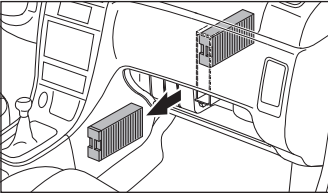

9

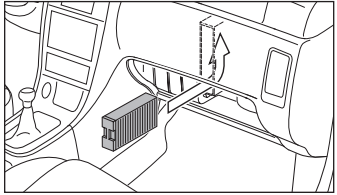

8

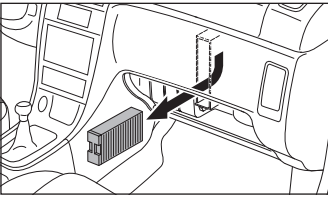

10

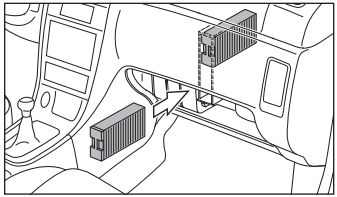

D

Hyundai



1 987 432 240

Hyundai ix55

04.09 →

ix55

①

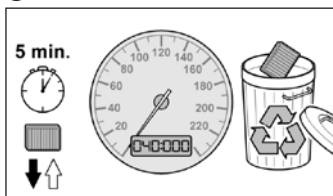

③

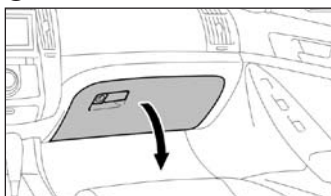

②

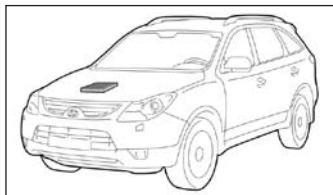

④

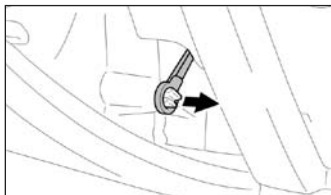

ix55

⑤

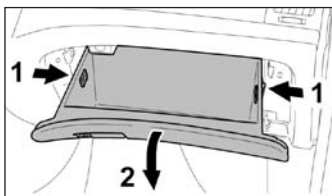

⑦

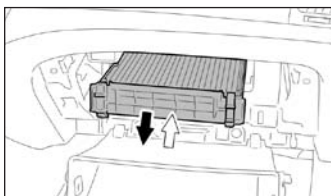

⑥

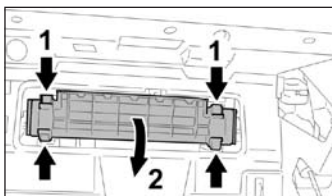

Chevrolet, Daewoo



1 987 432 241

Chevrolet Aveo
Chevrolet Kalos

03.06 →

03.05 →

Daewoo Kalos

09.02 →

Aveo, Kalos

①

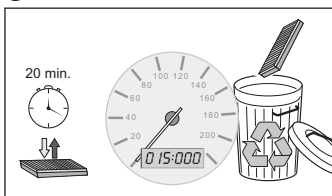

④

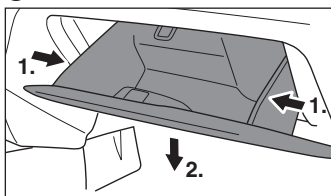

②

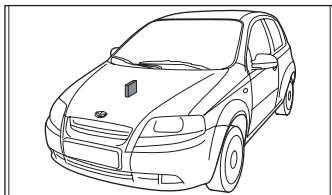

⑤

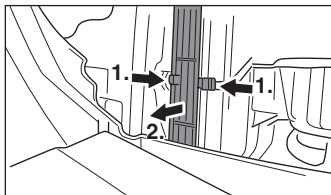

③

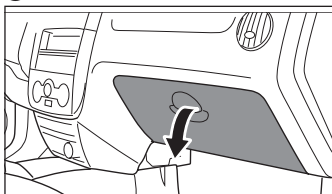

⑥

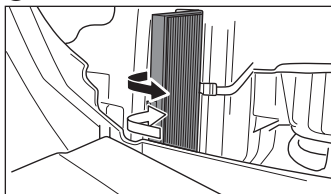

Mercedes-Benz

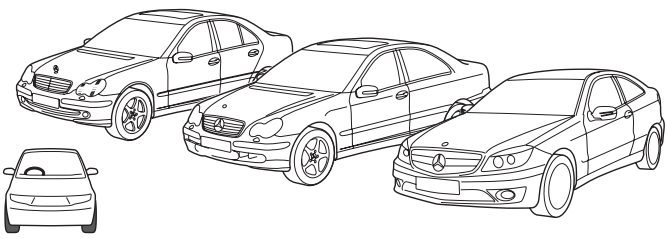

1 987 432 270
1 987 432 570

Mercedes-Benz C-Klasse (W203, S203, CL203)	05.00 →
Mercedes-Benz CLC-Klasse (CL203)	02.09 →
Mercedes-Benz CLK-Klasse (C209, A209)	06.02 →

C-Klasse, CLC-Klasse, CLK-Klasse

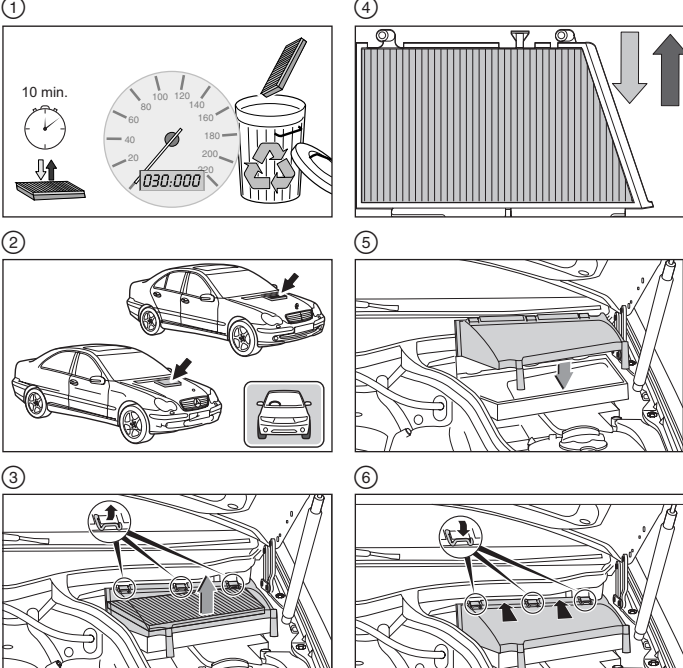

10 min.

1

2

3

4

5

6

D

Mercedes-Benz

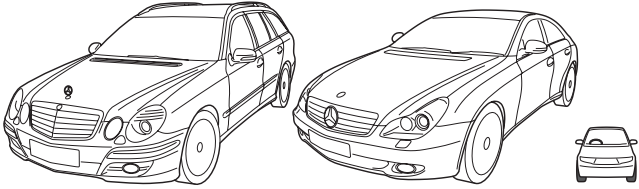

1 987 432 281

Mercedes-Benz E-Klasse (W211)
Mercedes-Benz E-Klasse (S211)
Mercedes-Benz CLS (C219)

03.02 →
03.02 →
10.04 →

E-Klasse, CLS

①

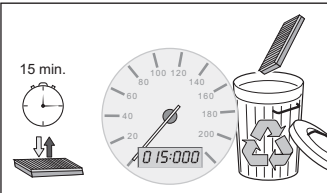

③

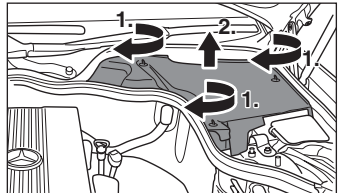

②

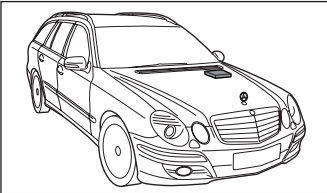

④

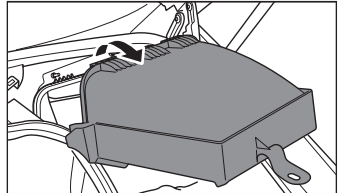

D

E-Klasse, CLS

5

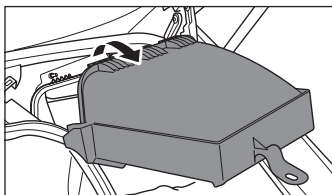

7

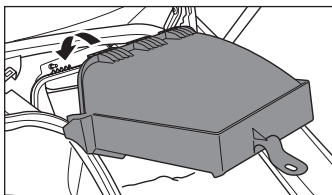

6

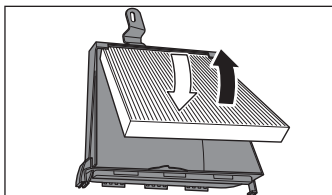

D

Mini (BMW)

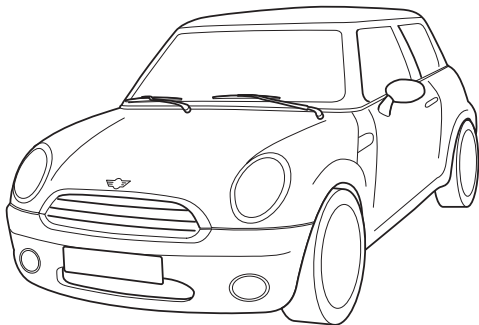

1 987 432 296

Mini Cooper II

04.07 →

Mini One II

04.07 →

Mini John Cooper Works

05.08 →

Cooper II, One II, John Cooper Works

①

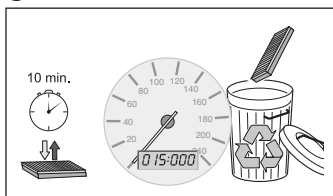

③

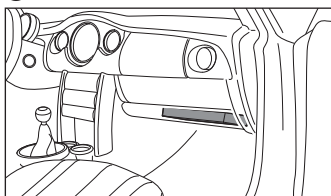

②

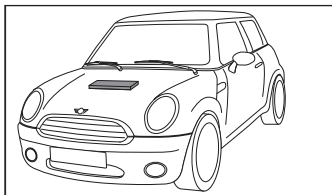

④

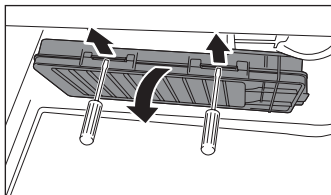

Cooper II, One II, John Cooper Works

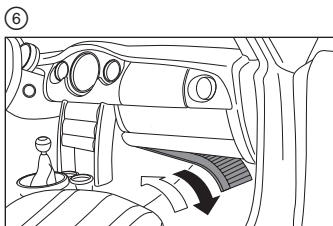
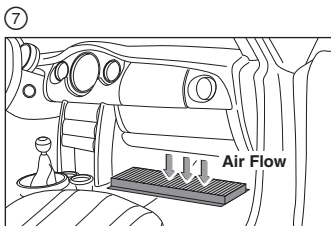
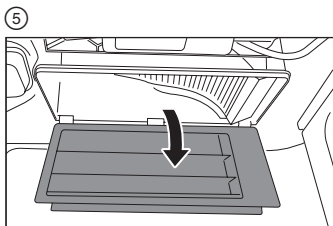

D

Smart

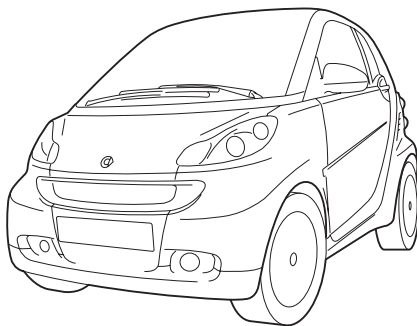

1 987 432 299
1 987 432 499

Smart Fortwo Coupé
Smart Fortwo Cabrio II

03.07 →

03.07 →

Fortwo Coupé, Fortwo Cabrio II

①

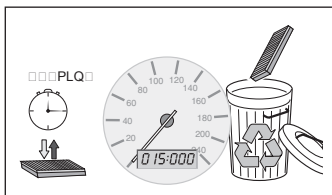

④

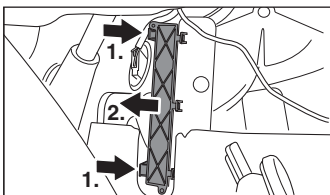

②

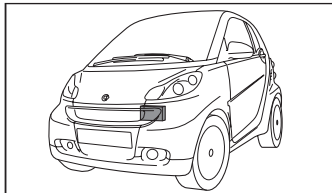

⑤

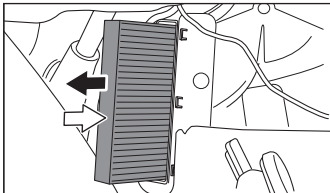

③

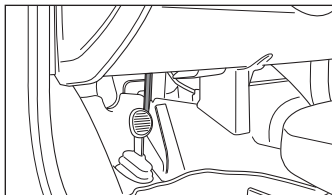

D

VW

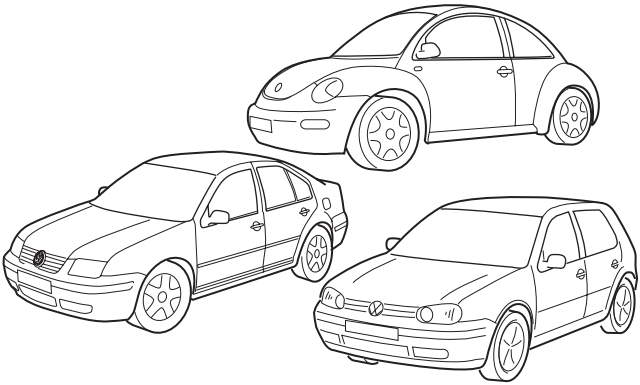

1 987 432 300

VW Beetle
 VW Bora
 VW Golf IV

01.98 →
 10.98 →
 06.97 →

Beetle

①

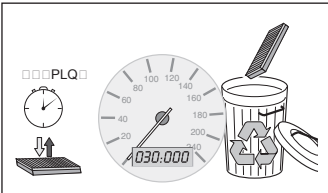

④

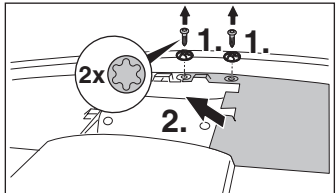

②

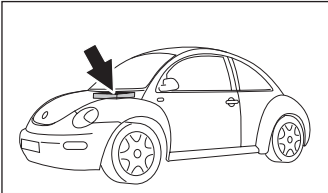

⑤

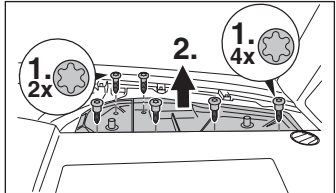

③

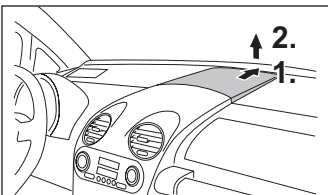

⑥

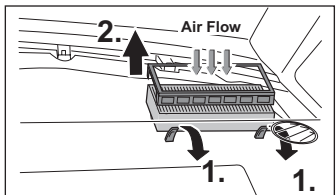

Bora

①

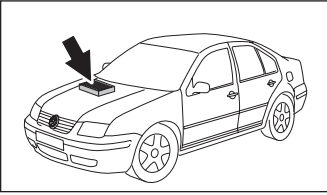

③

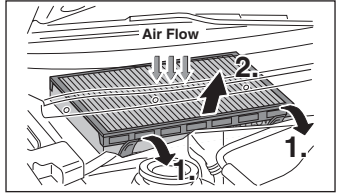

②

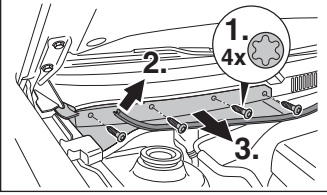

Golf IV

①

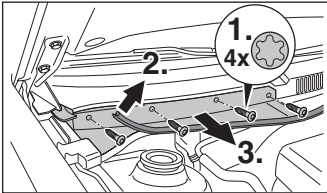

③

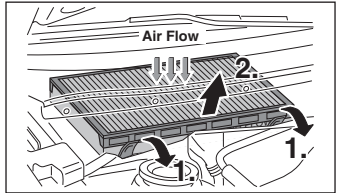

②

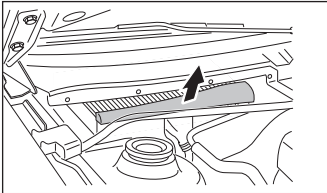

D

Ford



1 987 432 308

Ford Fiesta VI

10.08 →

Fiesta

①

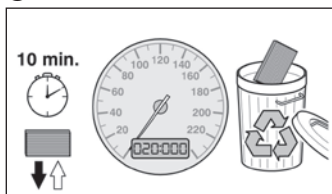

④

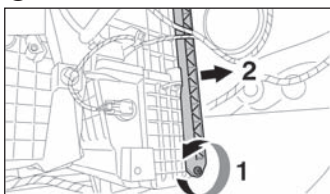

②

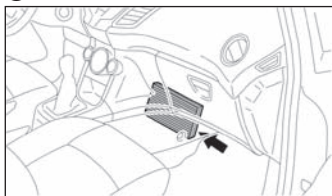

⑤

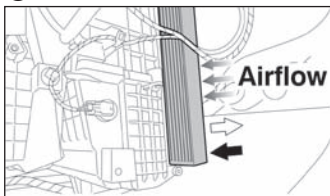

③

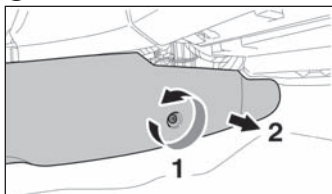

Mercedes-Benz



1 987 432 309

Mercedes-Benz M-Class
Mercedes-Benz R-Class
Mercedes-Benz GL-Class

07.05 →
01.06 →
09.06 →

M-Class, R-Class, GL-Class

D

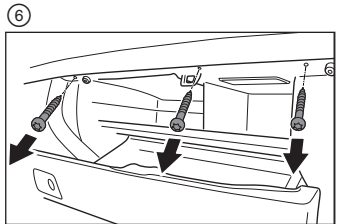
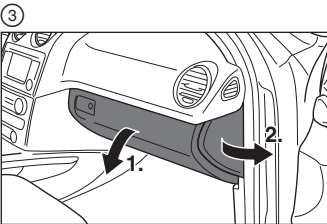
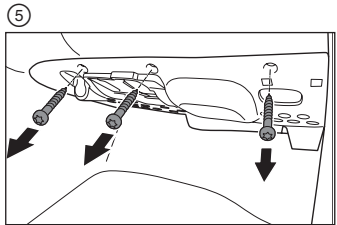
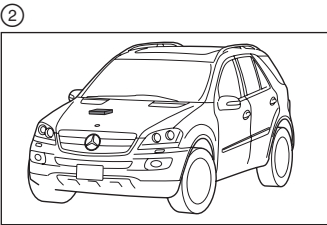
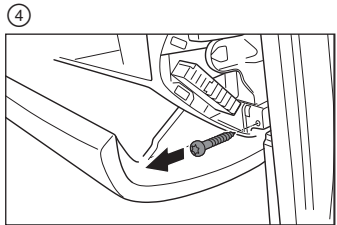
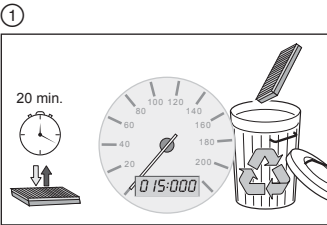

M-Class, R-Class, GL-Class (continued)

7

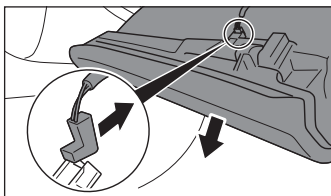

11

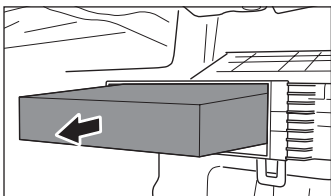

8

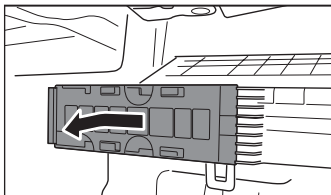

12

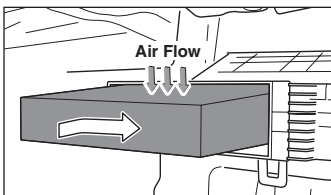

9

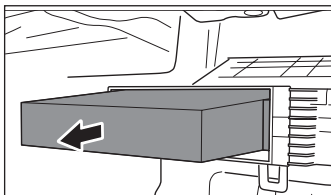

13

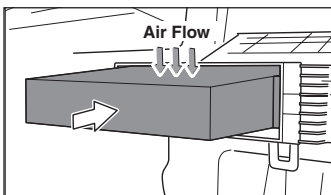

10

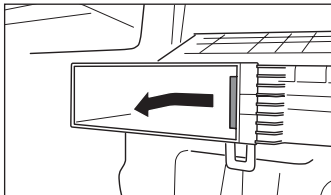

D

Citroën, Peugeot

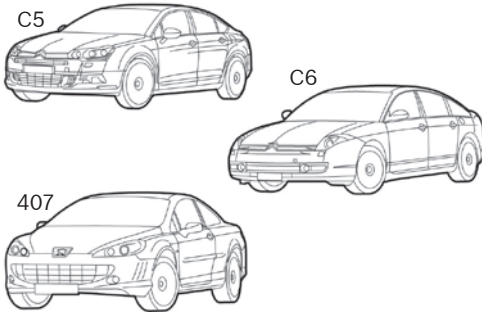

1 987 432 311

Citroën C5
 Citroën C6
 Peugeot 407

02.08 →
 07.08 →
 03.08 →

C5, C6, 407

D

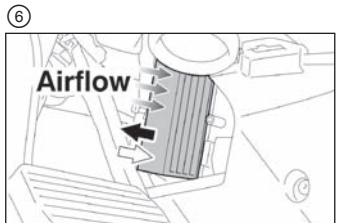
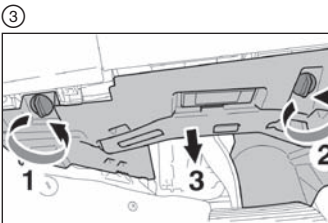
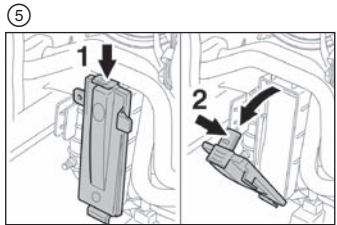
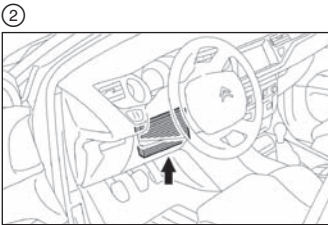
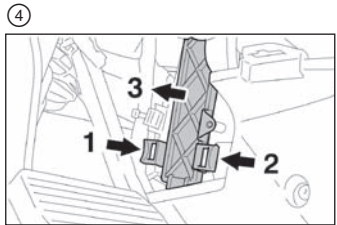
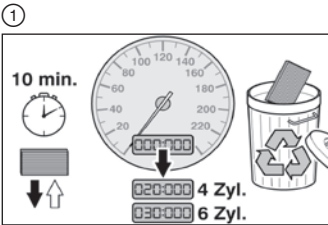

BMW



BMW 5er



BMW 5er GT



BMW 7er



BMW RR Ghost

1 987 432 315

BMW 5- series

03.10 →

BMW 5 GT

10.09 →

BMW 7er Serie

09.09 →

BMW ActiveHybrid 7

03.10 →

BMW RR Ghost

11.09 →

5, 5 GT, 7, RR Ghost

①

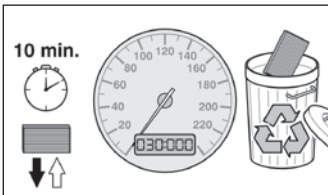

④

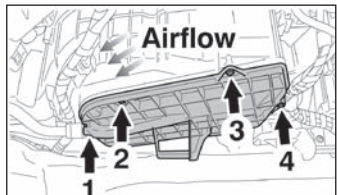

②

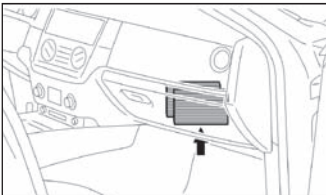

⑤

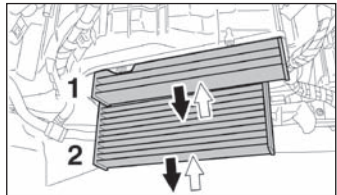

③

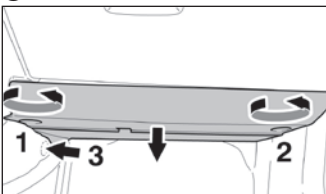

Lexus

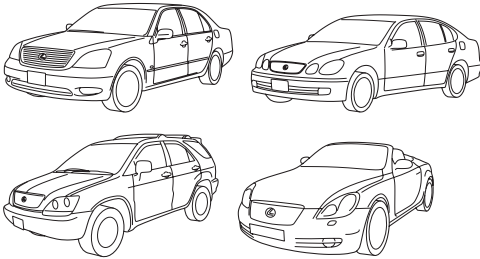

1 987 432 319

Lexus GS 300
 Lexus LS
 Lexus RX
 Lexus SC

10.00 → 04.05
 12.00 →
 10.00 → 04.03
 01.01 →

GS 300, LS, RX, SC

D

①

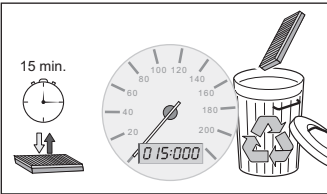

④

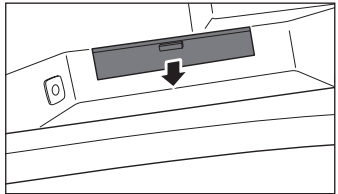

②

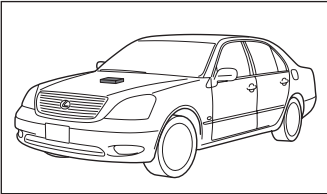

⑤

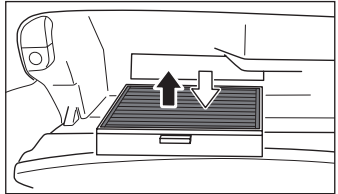

③

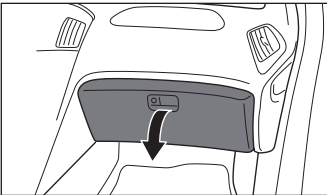

⑥

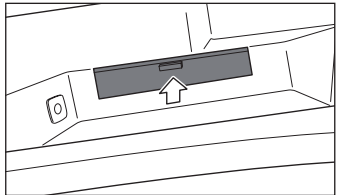

Lexus, Subaru, Toyota

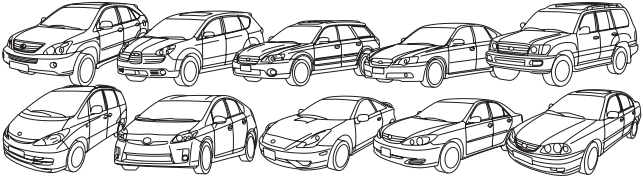

1 987 432 320

Lexus RX	05.03 → 04.05
Subaru Legacy IV	09.03 →
Subaru Outback	11.03 →
Subaru Tribeca	01.05 →
Toyota Avensis	10.00 →
Toyota Camry	11.01 →
Toyota Celica	11.99 → 09.05
Toyota Land Cruiser	09.02 →
Toyota Previa	08.00 →
Toyota Prius	05.00 →

RX, Legacy IV, Outback, Tribeca, Avensis, Camry, Celica, Land Cruiser, Previa, Prius

①

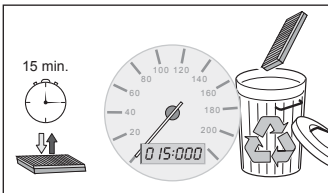

④

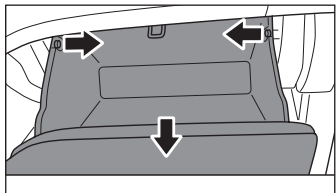

②

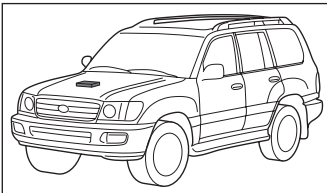

⑤

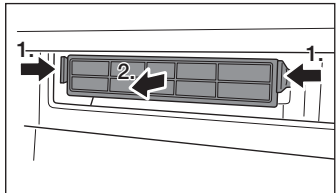

③

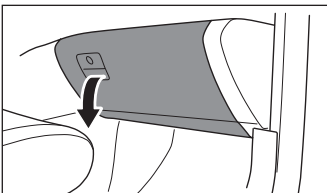

⑥

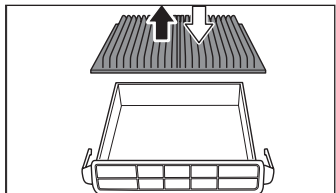

Mercedes-Benz



1 987 432 326

Mercedes-Benz E-Class
Mercedes-Benz C-Class
Mercedes-Benz GLK

08.09 →
03.07 →
10.08 →

E-Class, C-Class, GLK

D

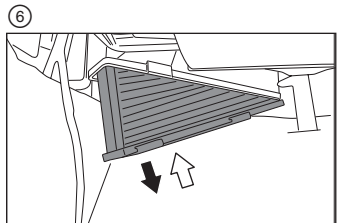
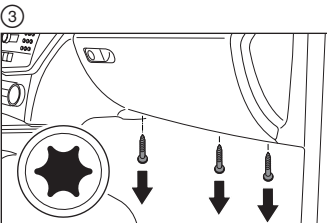
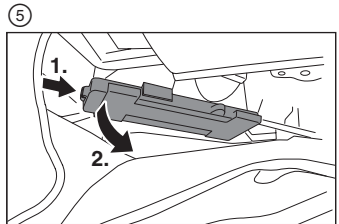
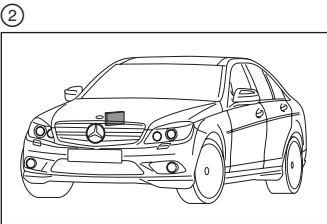
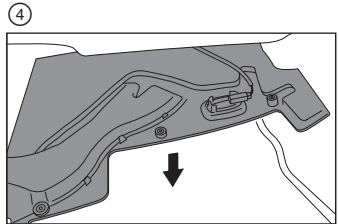
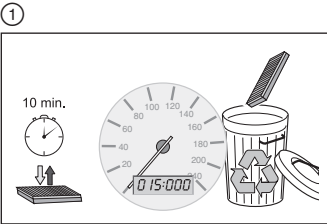

Renault

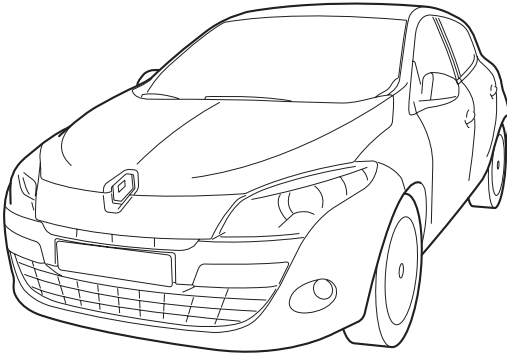

1 987 432 327

Renault Mégane III

11.08 →

Mégane III

①

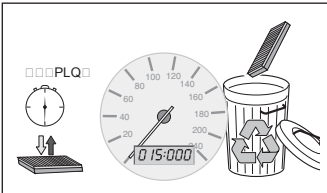

④

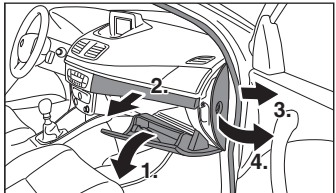

②

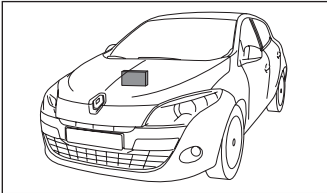

⑤

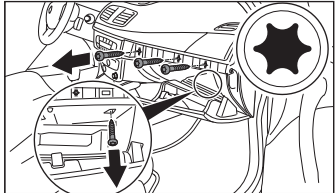

③

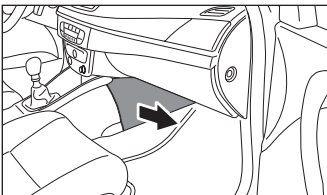

⑥

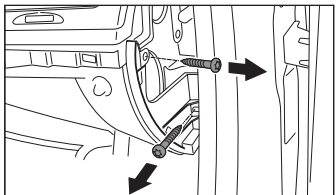

D

Mégane III

7

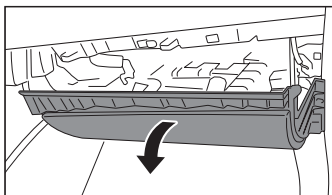

9

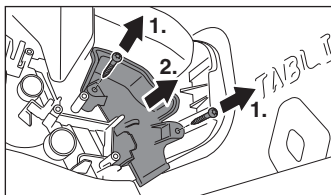

8

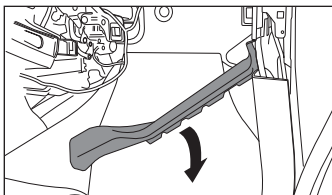

10

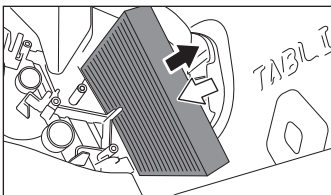

Citröen

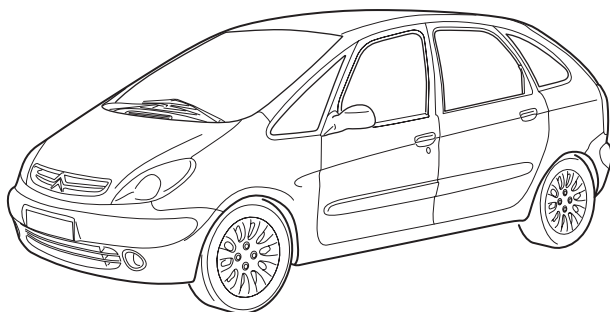

1 987 432 354

Citröen Xsara Picasso

01.00 →

Xsara Picasso

①

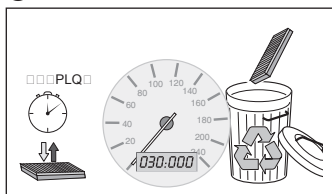

③

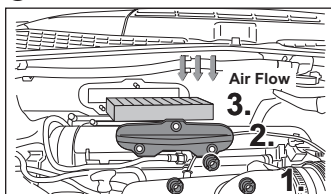

②

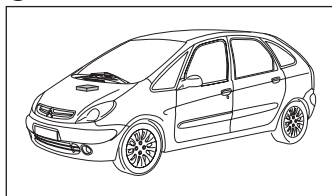

BMW

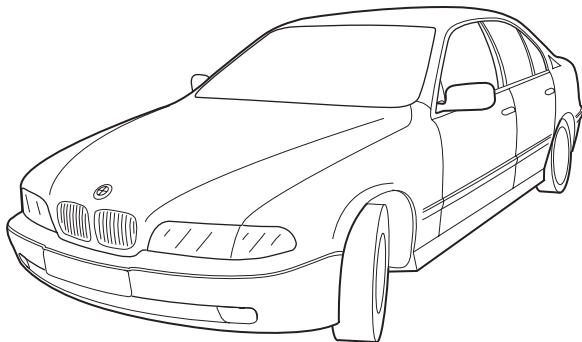

1 987 432 361

BMW 5 Series (E39)

* 09.95 →

5 Series

①

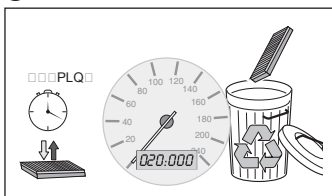

③

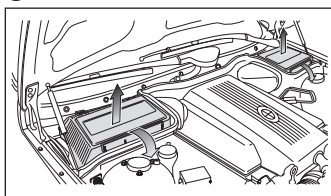

②

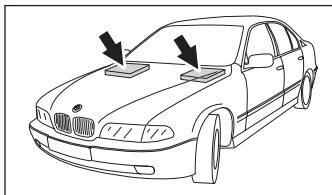

④

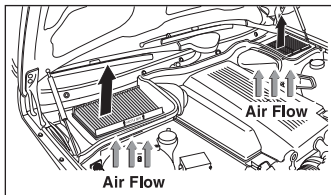

BMW

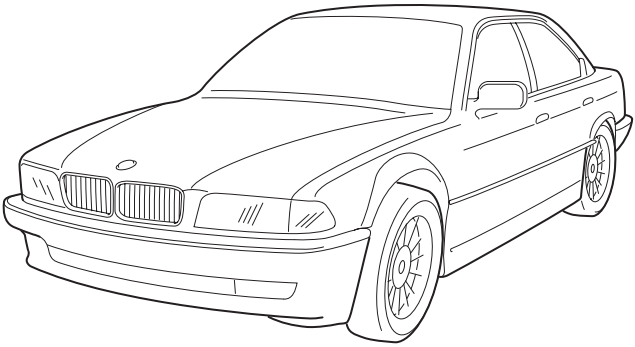

1 987 432 362

BMW 7 Series/optional
BMW 7 Series

05.95 →
* 05.95 →

7 Series

①

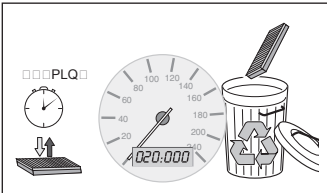

④

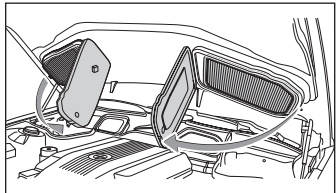

②

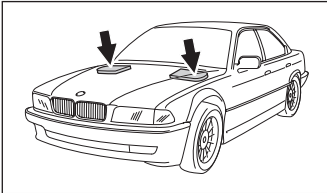

⑤

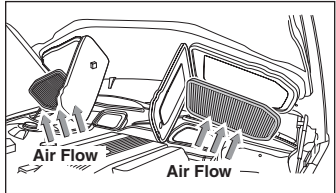

③

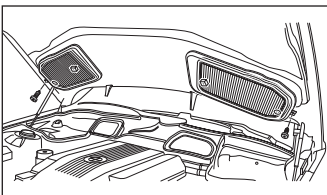

D

Mercedes-Benz

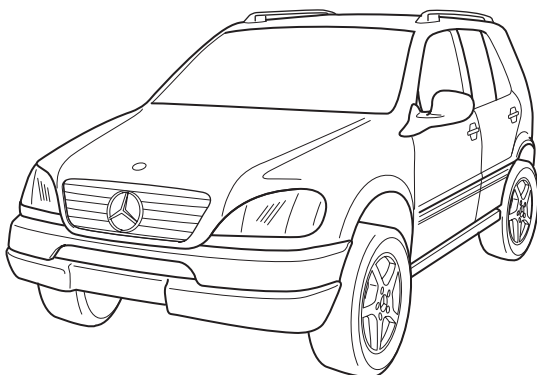

1 987 432 364

Mercedes-Benz
M-Klasse

04.98 →

M-Klasse

1

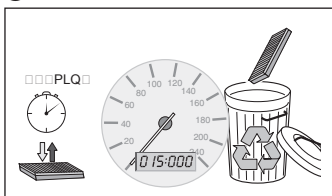

4

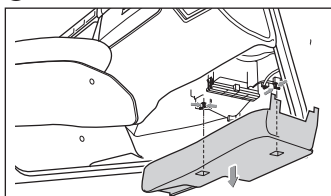

2

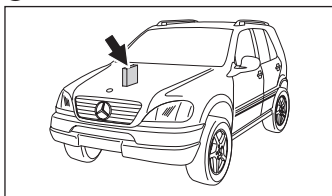

5

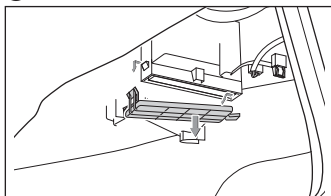

3

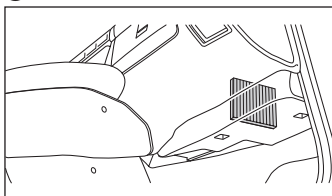

6

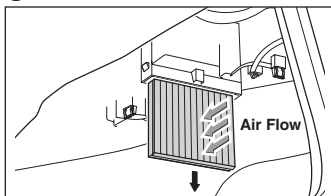

Fiat

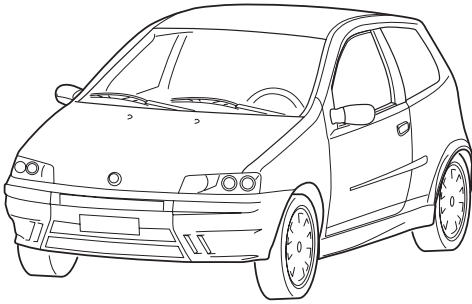

1 987 432 365

Fiat Punto

* 09.99 →

Punto

①

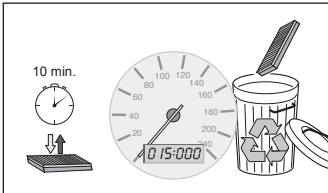

③

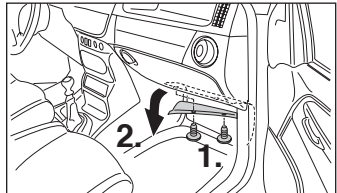

②

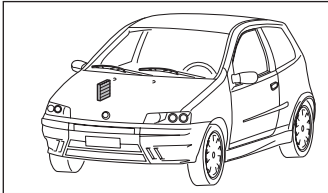

④

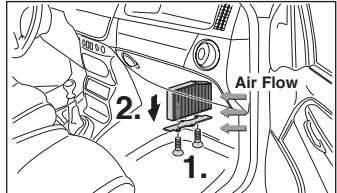

D

Audi

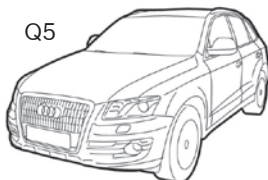
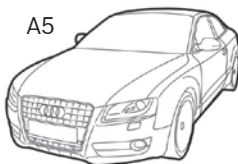

1 987 432 369

Audi A4

11.07 →

Audi A5

06.07 →

Audi Q5

08.09 →

A4, A5, Q5

①

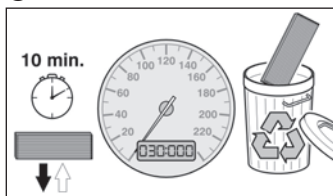

④

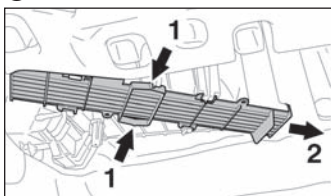

②

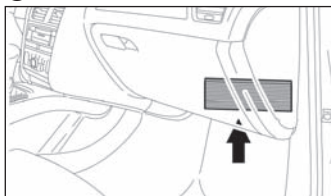

⑤

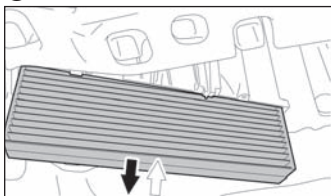

③

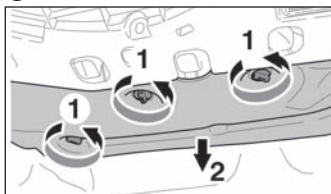

Fiat

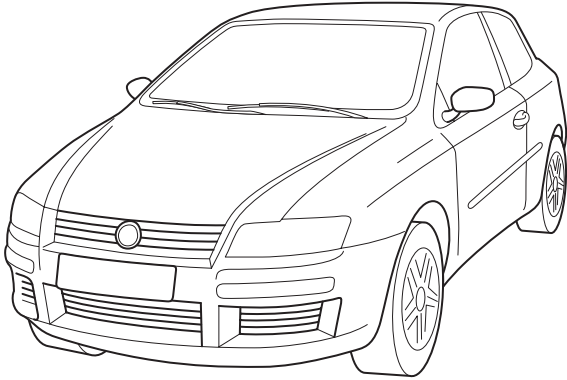

1 987 432 377

Fiat Stilo

10.01 →

Stilo

①

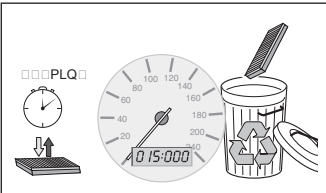

④

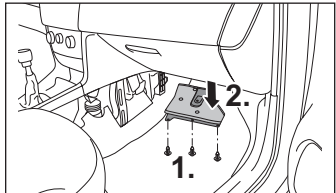

②

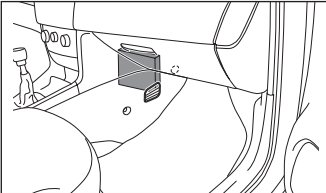

⑤

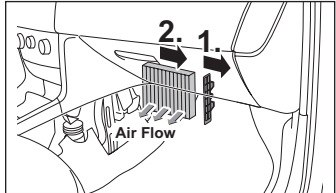

③

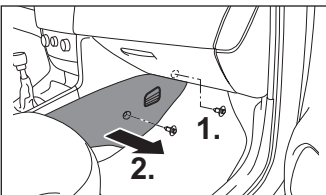

MCC Smart

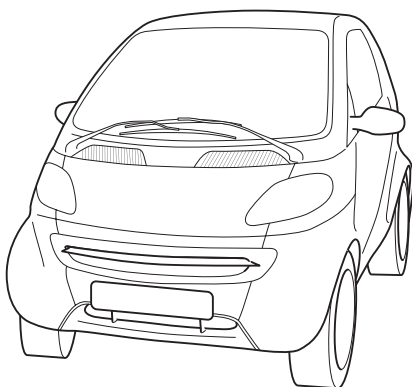

1 987 432 378

MCC Smart

07.99 →

Smart

①

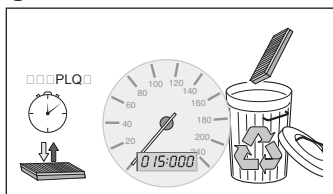

③

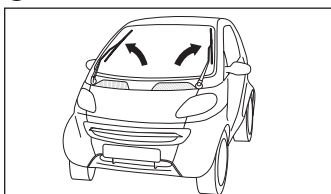

②

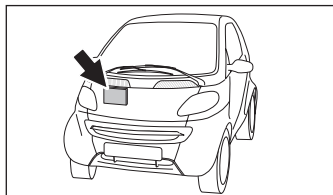

④

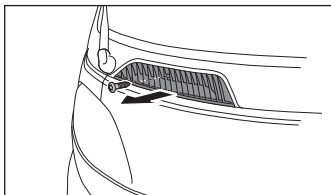

D

Smart

5

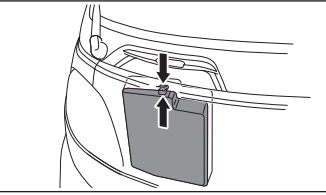

7

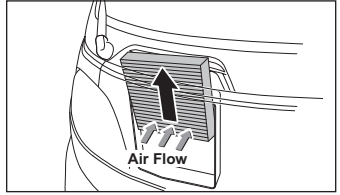

6

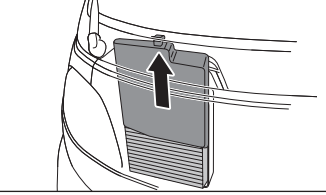

D

Alfa Romeo

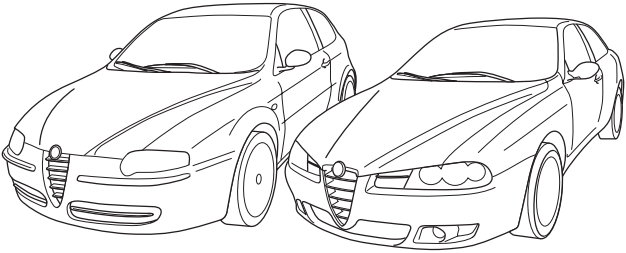

1 987 432 386

Alfa Romeo 147
Alfa Romeo 156

11.00 →
01.02 →

147, 156

1

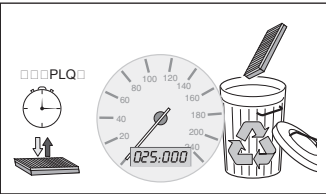

4

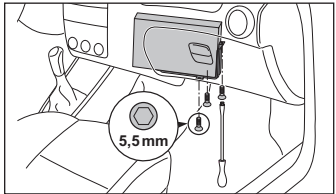

2

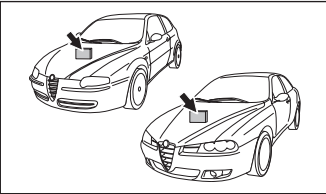

5

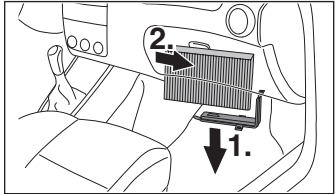

3

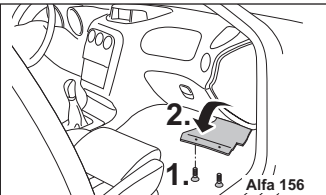

6

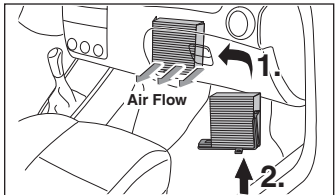

D

Citröen

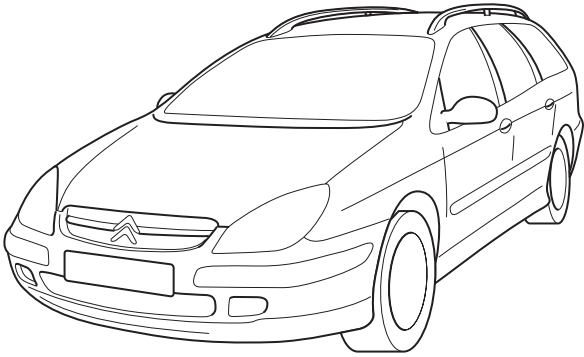

1 987 432 398

Citröen C5

03.01 → 08.04

C5

①

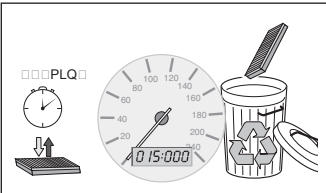

④

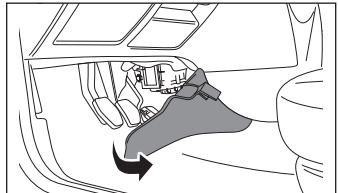

②

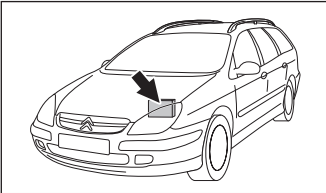

⑤

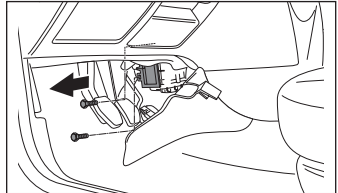

③

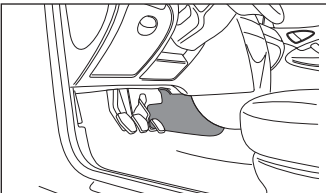

⑥

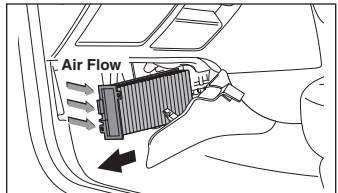

Peugeot

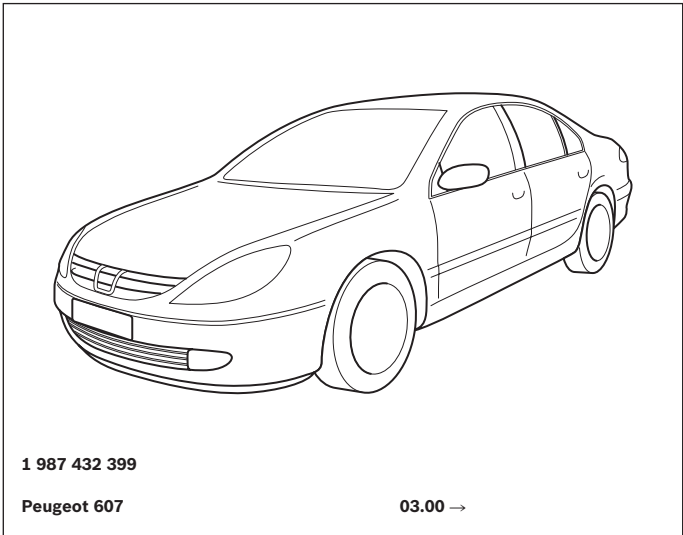

607

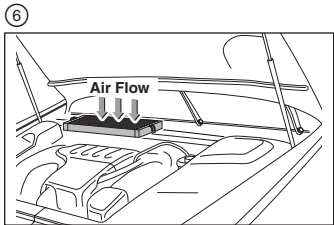
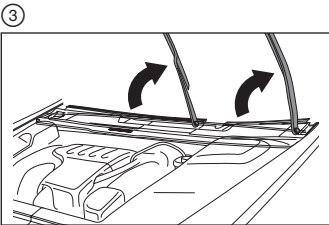
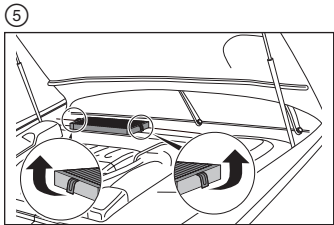
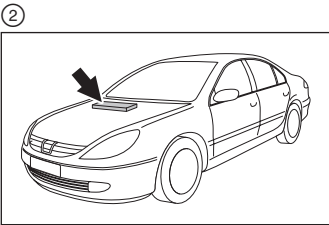
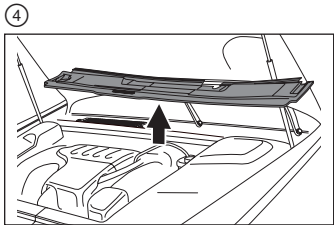
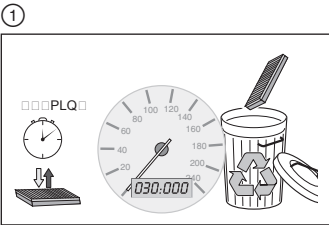

D

Renault

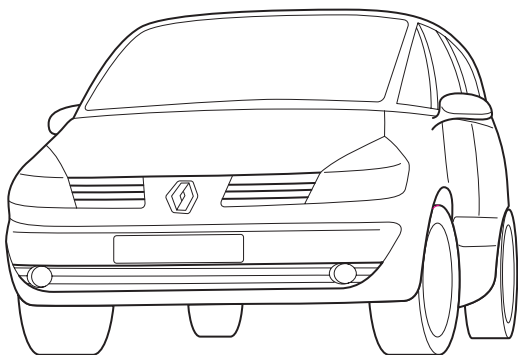

1 987 432 400

Renault Espace IV

11.02 →

Espace IV

①

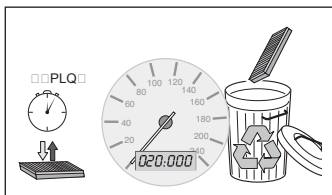

③

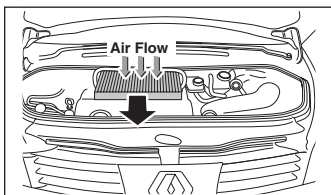

②

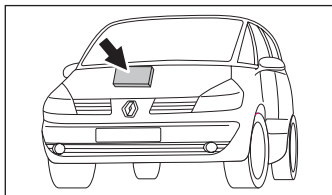

Saab

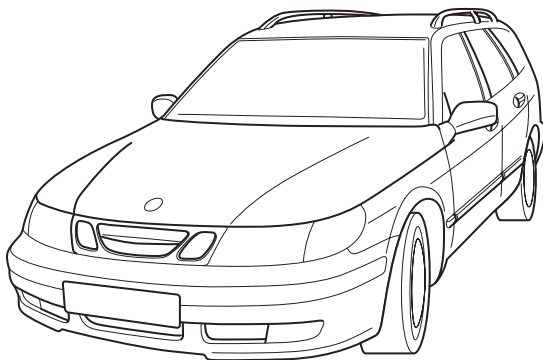

1 987 432 401

Saab 9-5

* 06.97 →

9-5

①

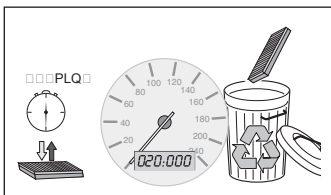

④

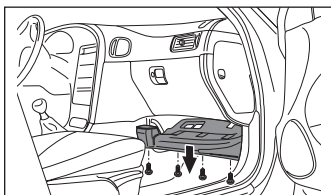

②

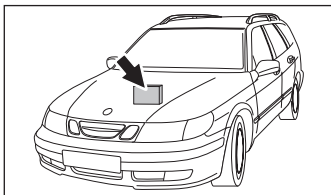

⑤

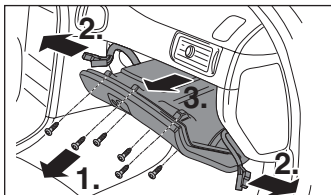

③

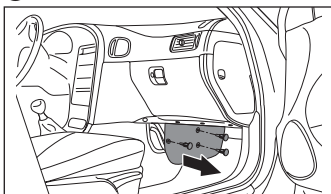

⑥

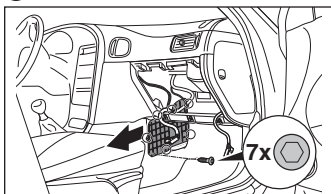

9-5

7

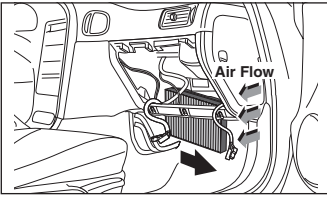

8

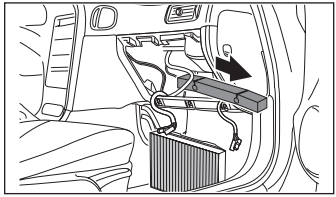

D

Mercedes-Benz

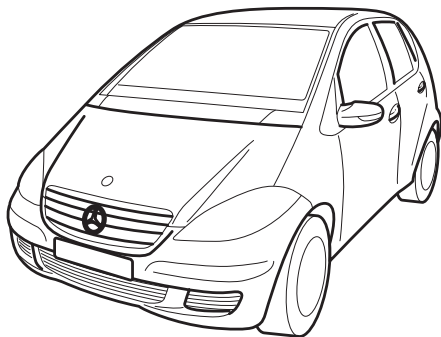

1 987 432 410

Mercedes-Benz
A-Klasse 169

* 09.94 →

A-Klasse 169

①

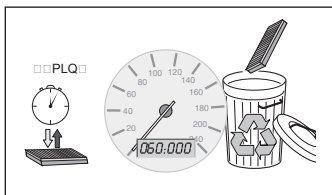

④

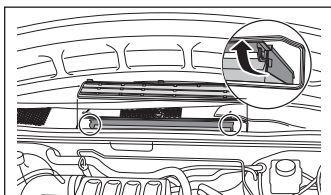

②

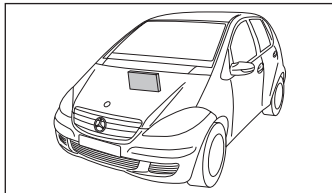

⑤

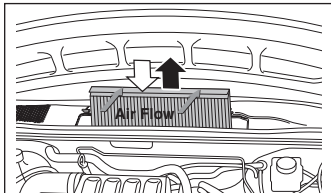

③

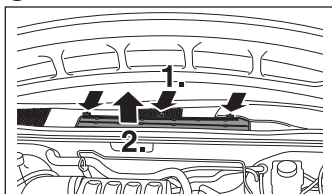

Peugeot

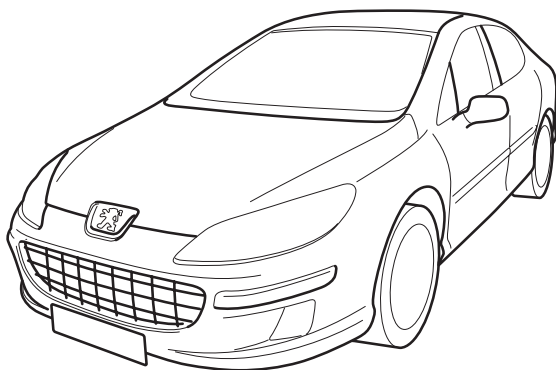

1 987 432 412

Peugeot 407

* 05.04 →

407

①

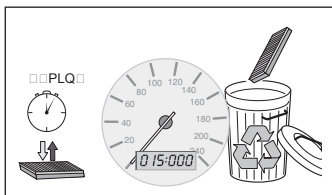

④

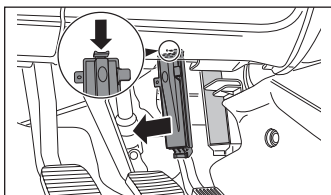

②

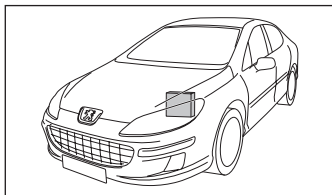

⑤

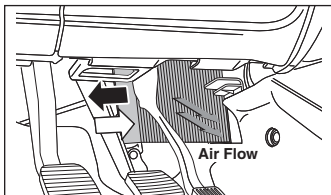

③

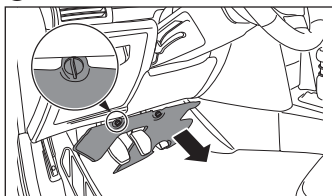

Audi

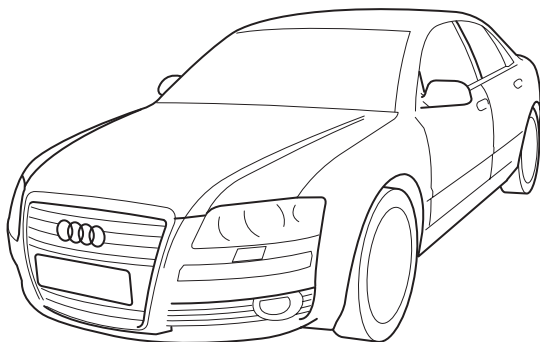

1 987 432 423

Audi

A8 (4E, D3)

A8 Quattro (4E, D3)

* 07.03 →

* 11.02 →

A8

①

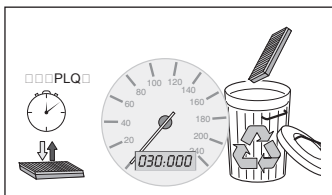

④

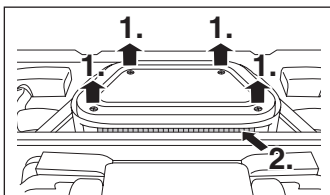

②

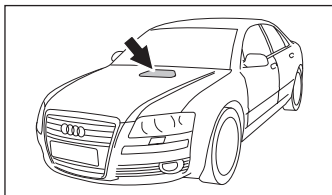

⑤

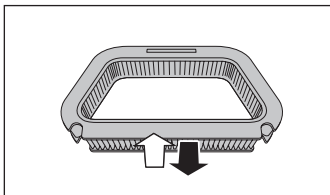

③

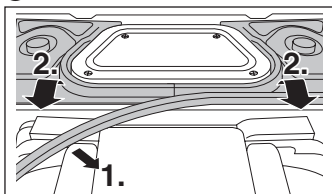

BMW

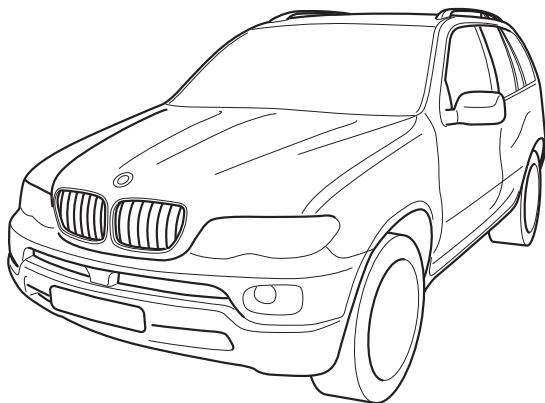

1 987 432 425

BMW X5 (E53)

* 03.99 →

X5

①

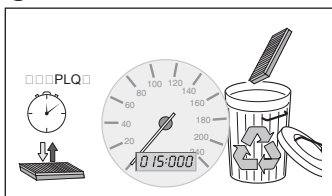

④

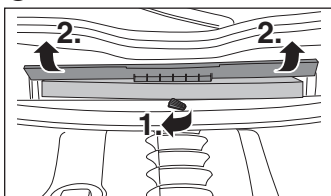

②

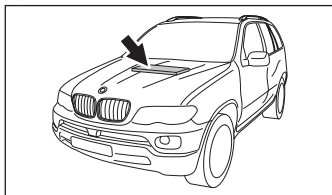

⑤

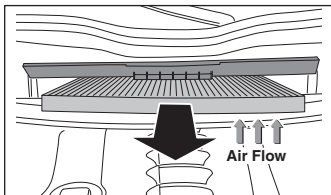

③

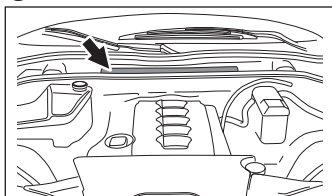

Mitsubishi

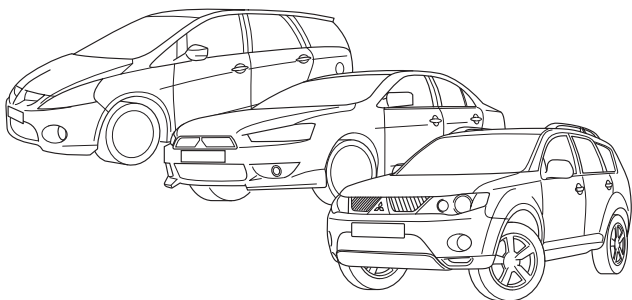

1 987 432 426

Mitsubishi Lancer VII
 Mitsubishi Grandis
 Mitsubishi Outlander I
 Mitsubishi Airtrek I

* 09.03 →
 * 04.04 →
 * 05.03 → 02.07
 * 06.01 → 06.05

Lancer VII

①

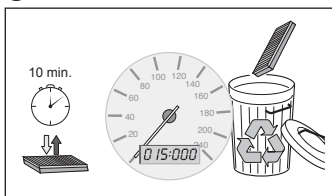

④

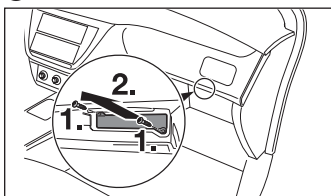

②

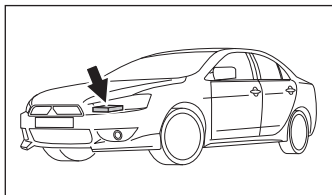

⑤

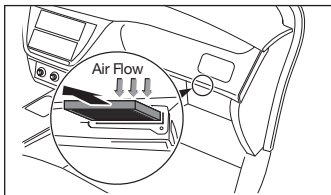

③

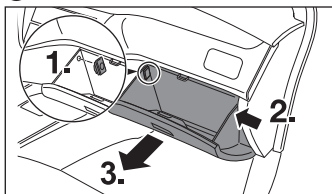

Grandis

①

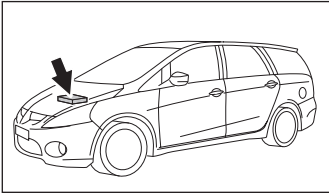

③

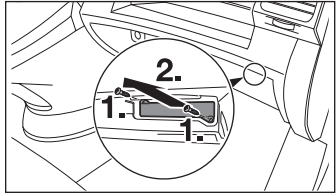

②

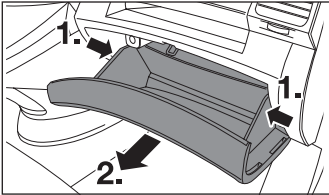

④

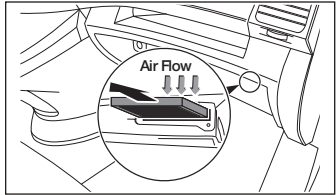

Outlander I

①

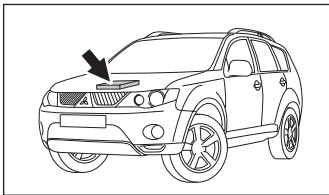

④

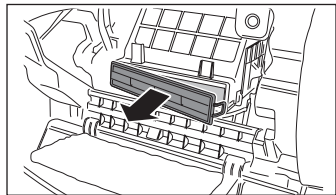

②

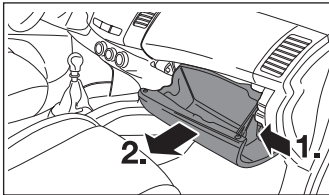

⑤

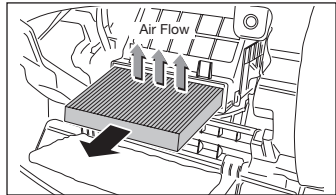

③

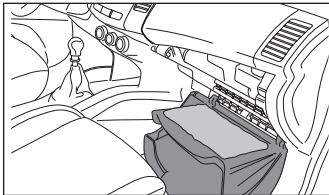

Jaguar

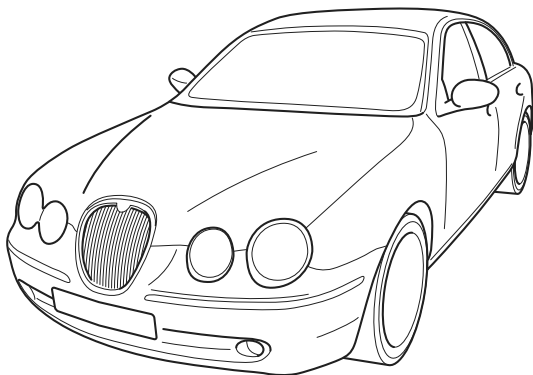

1 987 432 428

Jaguar S-Type 3.0
Jaguar S-Type 4.2

* 10.98 →
* 10.01 →

S-Type 3.0, 4.2

①

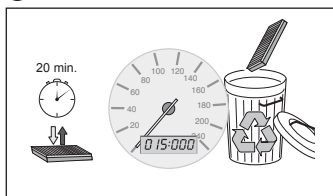

③

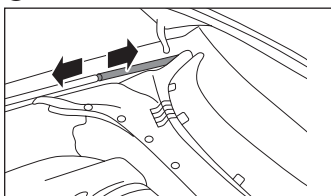

②

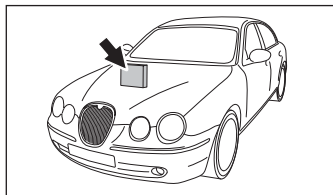

④

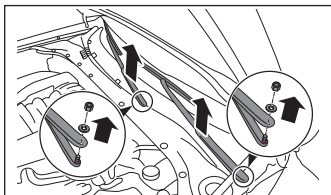

D

S-Type 3.0, 4.2

5

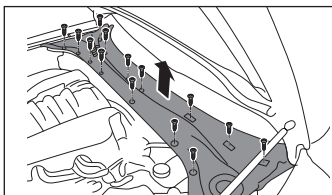

7

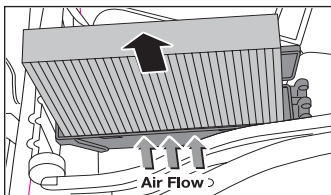

6

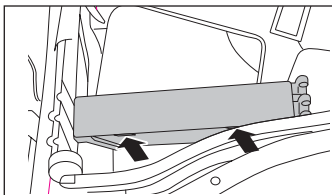

VW, Audi

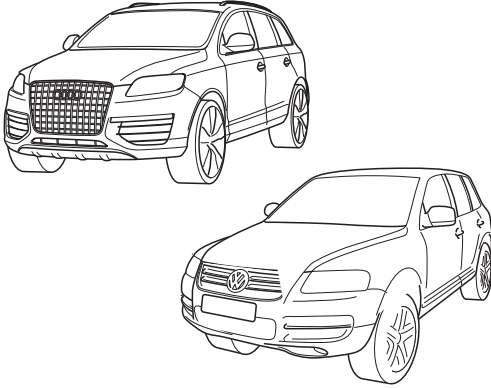

1 987 432 431

VW Touareg
Audi Q7

01.03 →
03.06 →

Touareg

①

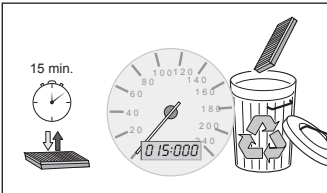

④

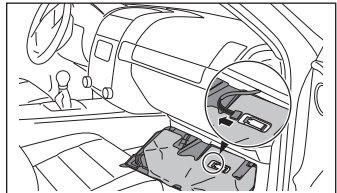

②

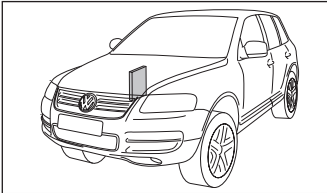

⑤

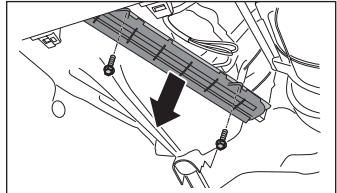

③

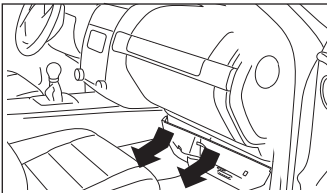

⑥

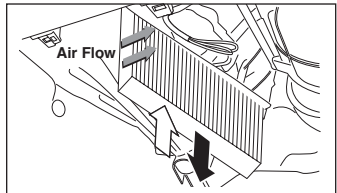

D

Q7

①

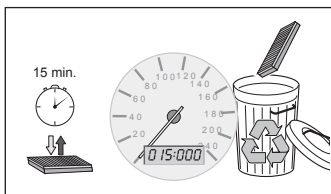

④

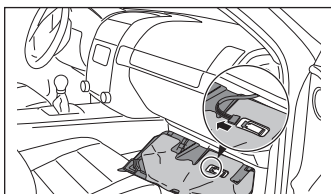

②

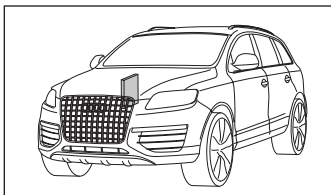

⑤

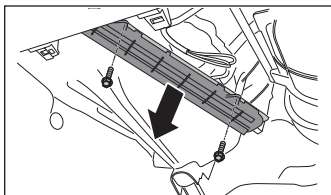

③

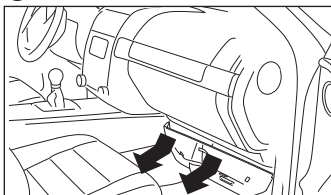

⑥

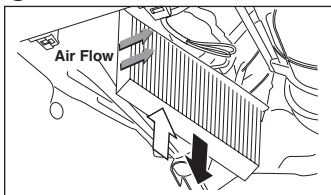

D

Lada

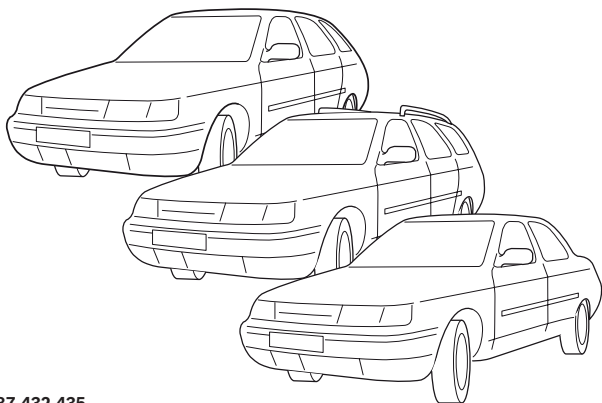

1 987 432 435

Lada 2110

01.98 →

Lada 2111

01.00 →

Lada 2112

01.01 →

2110, 2111, 2112

①

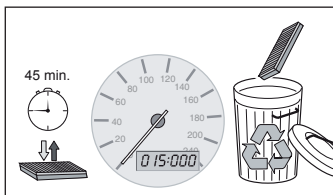

④

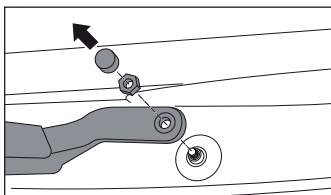

②

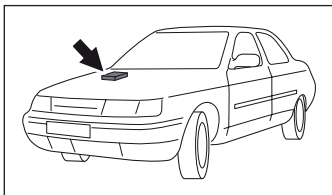

⑤

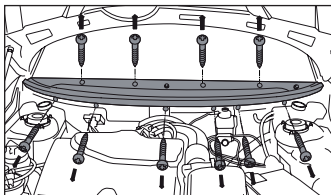

③

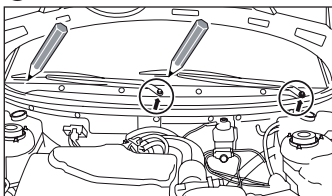

⑥

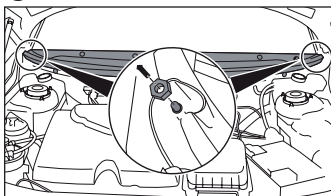

2110, 2111, 2112

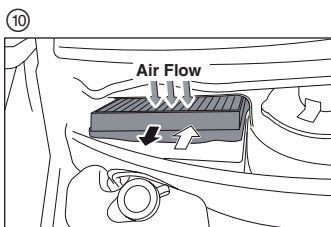
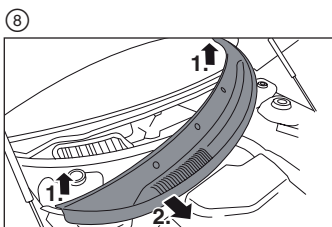
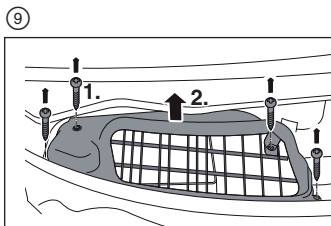
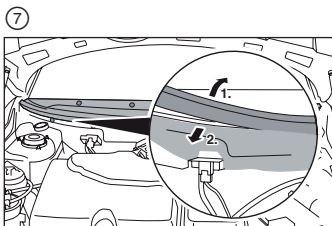

Peugeot

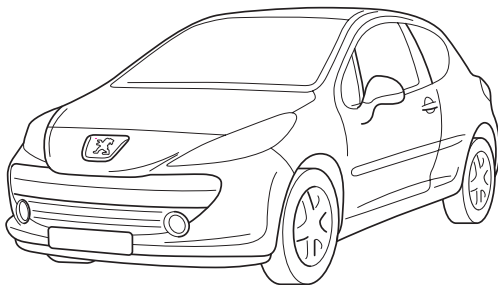

1 987 432 436

Peugeot 207

06.06 →

207

①

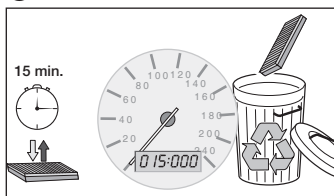

③

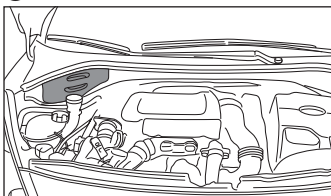

②

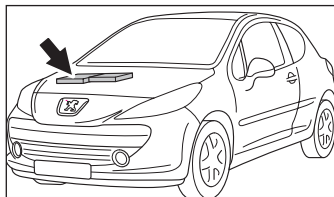

④

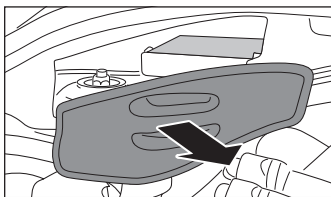

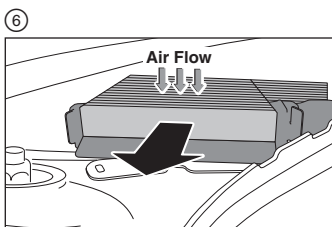
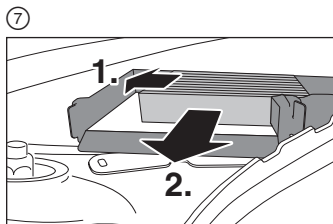
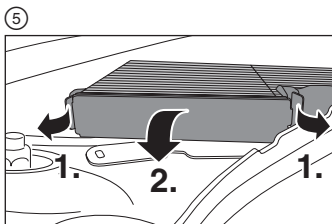

Mercedes-Benz

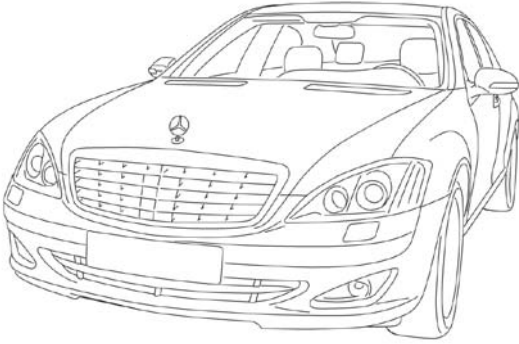

1 987 432 438

Mercedes-Benz S-Klasse (W221)

12.05 →

S-Klasse (W221)

①

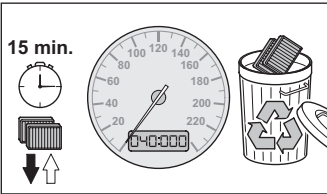

④

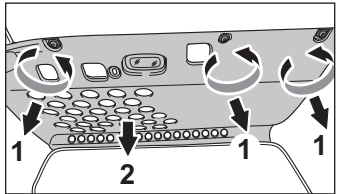

②

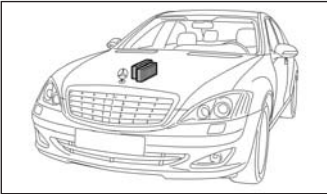

⑤

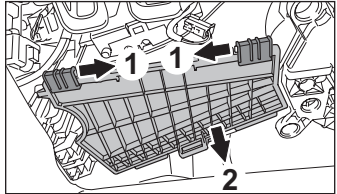

③

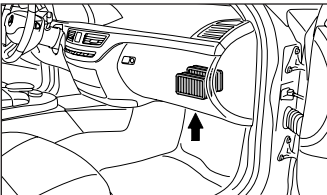

⑥

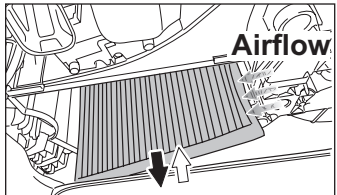

D

Chrysler

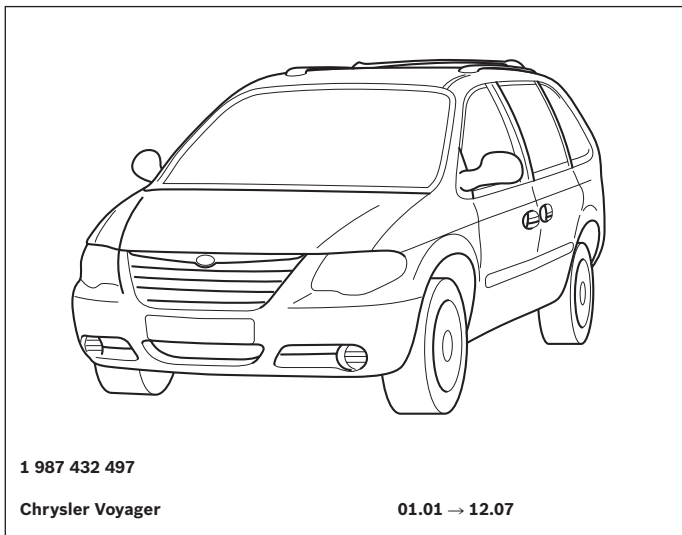

Voyager

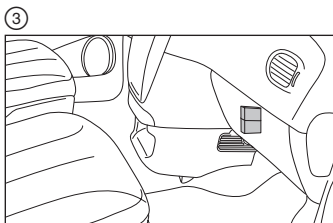
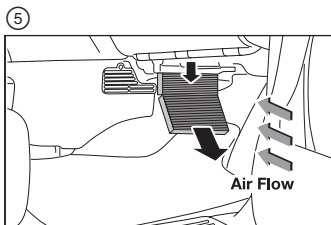
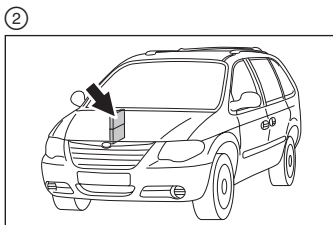
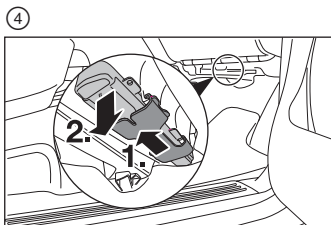
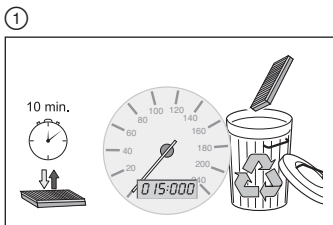

D

Mitsubishi

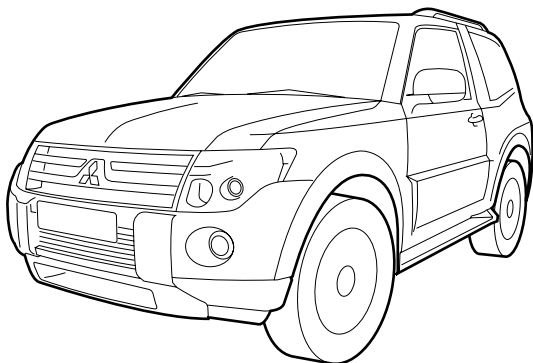

1 987 432 498

Mitsubishi Pajero
Mitsubishi Pajero
Mitsubishi Pajero

* 02.00 → 03.07

* 03.07 →

03.07 →

Pajero

①

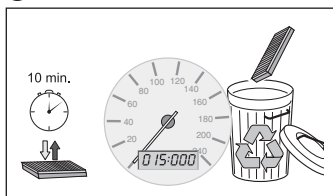

④

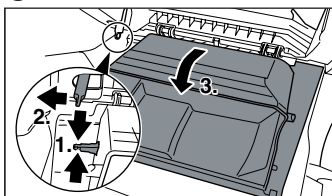

②

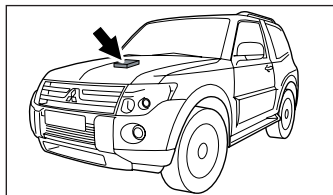

⑤

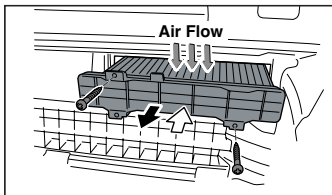

③

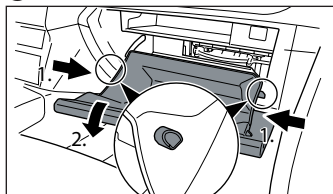

D

Renault

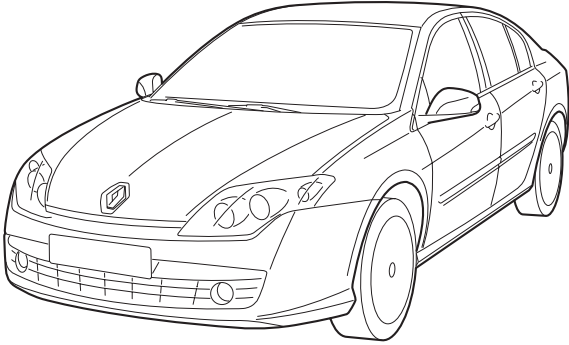

1 987 432 500

Renault Laguna III

10.07 →

Laguna III

①

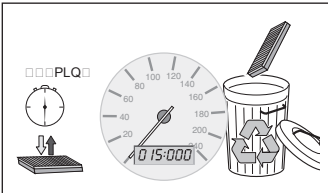

④

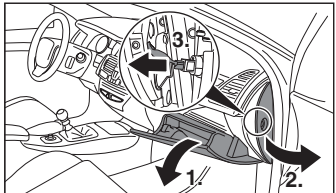

②

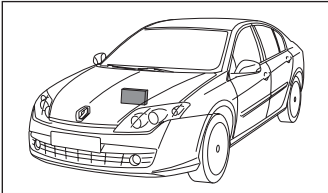

⑤

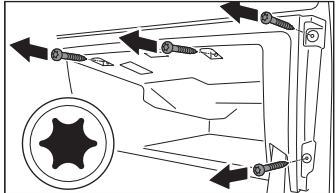

③

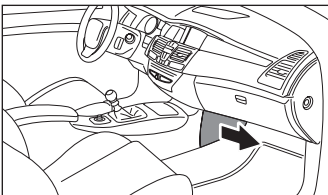

⑥

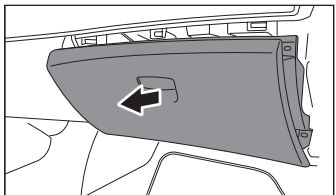

D

Laguna III (continued)

7

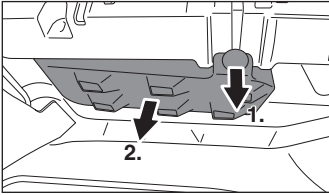

11

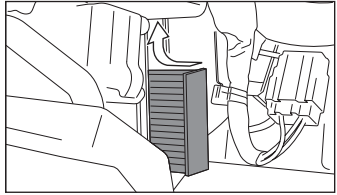

8

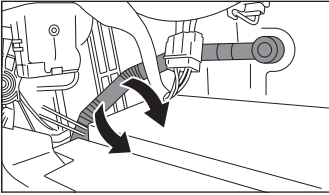

12

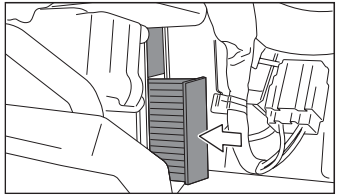

9

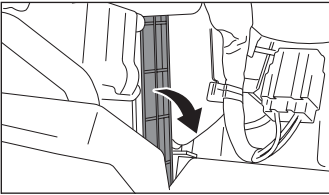

10

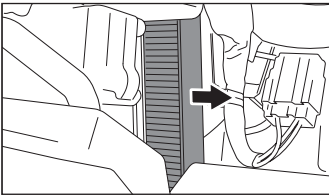

D

Mercedes-Benz

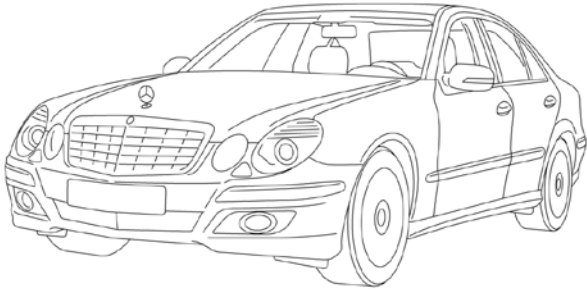

1 987 432 512

Mercedes-Benz E-Klasse (W211)

03.02 →

E-Klasse (W211)

①

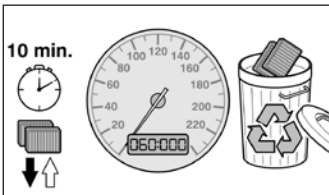

④

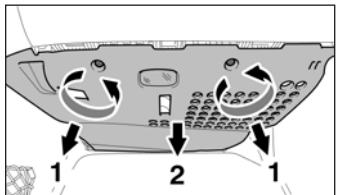

②

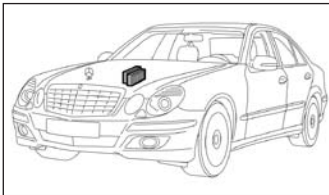

⑤

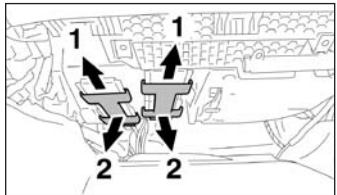

③

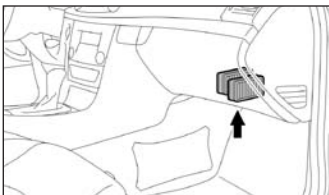

⑥

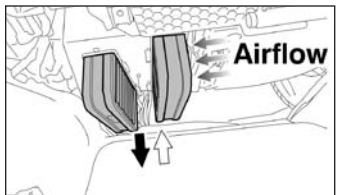

D

Maybach, Mercedes-Benz

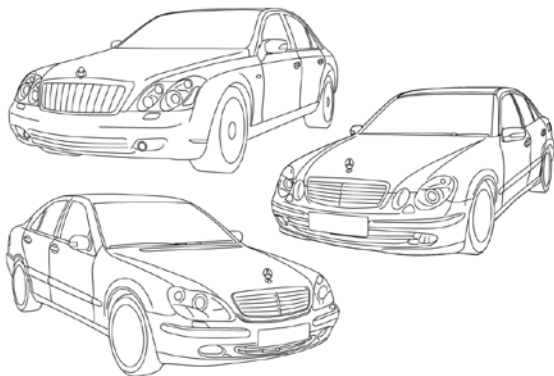

1 987 432 533

Maybach (240)

Mercedes-Benz S-Klasse (W220)

Mercedes-Benz E-Klasse (W210)

09.02 →

10.98 → 03.06

06.95 → 03.03

Maybach (240) S-Klasse (W220)

①

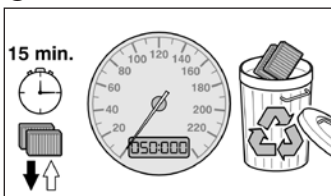

④

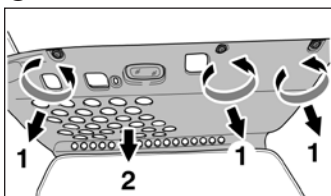

②

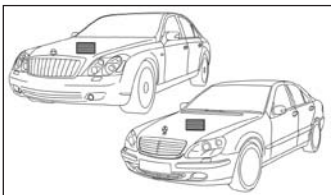

⑤

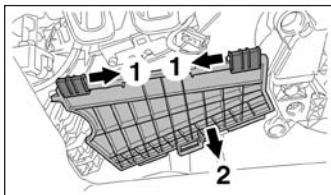

③

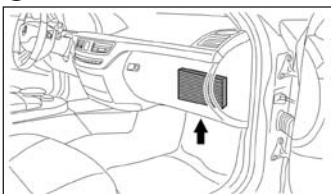

⑥

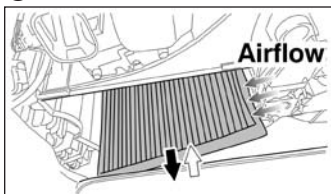

E-Klasse (W210)

①

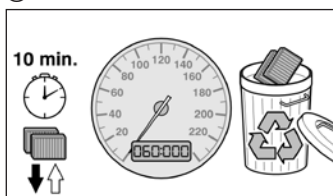

④

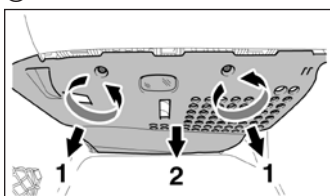

②

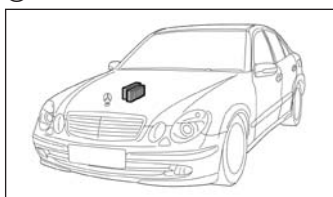

⑤

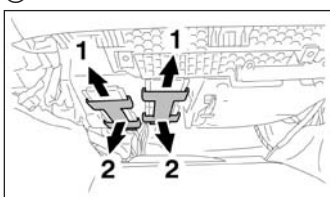

③

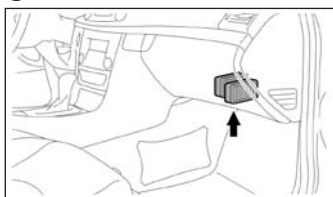

⑥

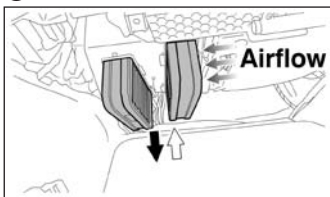

Audi, Seat, Skoda, VW

1 987 432 597



Audi A3	05.03 →
Audi TT	10.06 →
Seat Alhambra	06.10 →
Seat Altea	03.04 →
Seat Leon	07.05 →
Seat Toledo III	10.04 →
Skoda Octavia	05.04 →
Skoda Superb	03.08 →
Skoda Yeti	05.09 →
VW Caddy III	04.04 →
VW EOS	03.06 →
VW Golf /Plus V	10.03 → 11.08
VW Golf /Plus VI	12.08 →
VW Jetta III	10.05 →
VW Passat	03.05 →
VW Scirocco III	09.06 →
VW Sharan	05.10 →
VW Tiguan	09.07 →
VW Touran	02.03 →

Audi, Seat, Skoda, VW

①

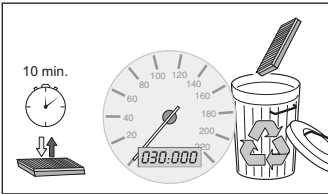

④

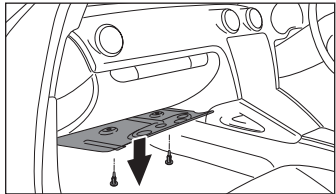

②

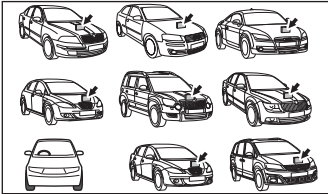

⑤

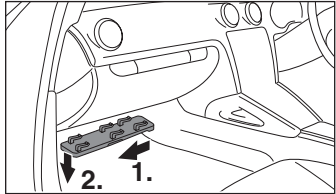

③

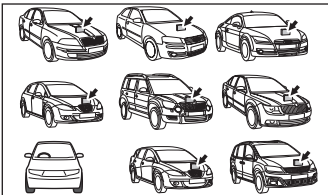

⑥

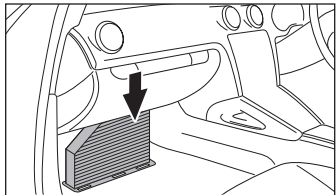

D

Seat Altea

①

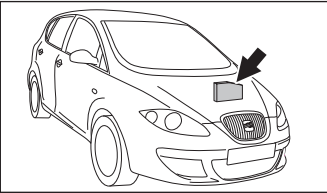

④

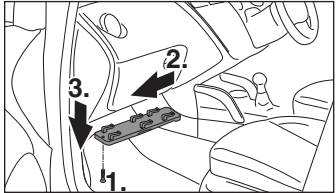

②

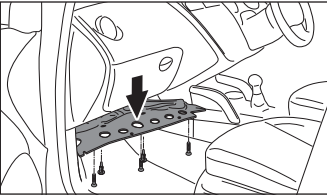

⑤

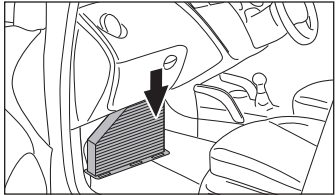

VW Caddy III

①

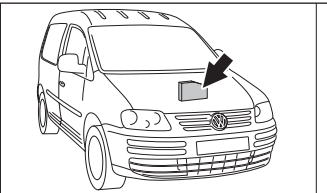

④

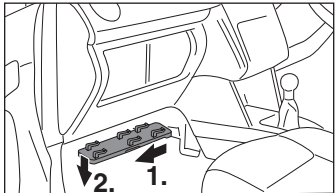

②

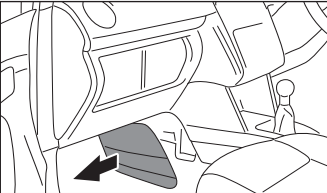

⑤

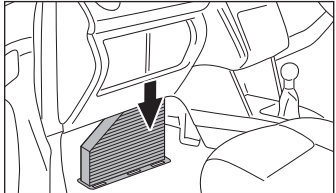

③

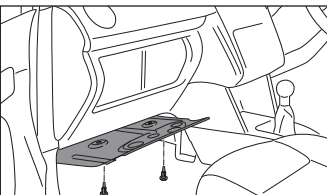

D

VW Touran

①

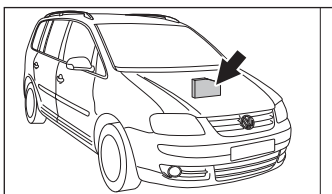

④

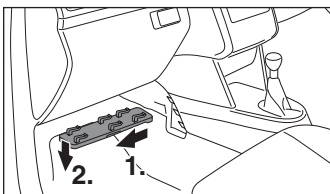

②

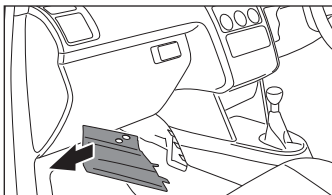

⑤

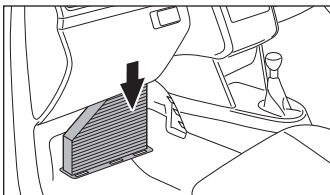

③

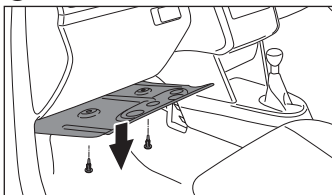

253	Länge: 253 mm
2FE	Set, besteht aus 2 Filterelementen
3FE	Set, besteht aus 3 Filterelementen
AG	Für Fahrzeuge mit automatischem Getriebe
BHR	Einbaugleiches Bosch-Erzeugnis oder Teil für Behr
DHI	Einbaugleiches Bosch-Erzeugnis oder Teil für Delphi
EHX	Für Fahrzeuge mit ELX-, HLX-Ausstattung
ELH	Für Fahrzeuge ohne elektrisches Heizungssystem
GS	Für Fahrzeuge mit Handschaltgetriebe
H25	Höhe 25 mm
H30	Höhe 30 mm
KL	Für Fahrzeuge mit Klimaanlage
KL	Für Fahrzeuge ohne Klimaanlage
LLE	Für Linkslenker

MKL	Für Fahrzeuge mit Klimaautomatik
MKL	Für Fahrzeuge ohne Klimaautomatik
MOO	Für Fahrzeuge mit und ohne Klimaanlage
NOR	Normale Ausführung
RLE	Für Rechtslenker
SA	Sonderausrüstung
SAZ	Satz
TER	Für Fahrzeuge mit Thematic
TMT	Für Fahrzeuge mit Thermotronic
TW	Eingebautes Erzeugnis muss am Fahrzeug oder Motor ermittelt werden.
WW	Wahlweise
XXX	Lieferung nur solange Vorrat
ZE	Zwei erforderlich
ZNE	Für Fahrzeuge bei nachträglichem Einbau



Pkw



Motortyp



Datum / Einbauzeitraum



Sonderfälle



Information / Erläuterung



Kurzsuchnummer



Abbildung



Innenraumfilter



Innenraumfilter mit Aktivkohle



Betriebsanleitung



Gegenüberstellung



253	Length: 253 mm
2FE	Set, consists of 2 filter elements
3FE	Set comprising 3 filter elements
AG	For vehicles with automatic transmission
BHR	Interchangeable Bosch product or part for Behr
DHI	Interchangeable Bosch product or part for Delphi
EHX	For vehicles with ELX, HLX equipment
ELH	For vehicles without electrical heating system
GS	For vehicles with manual transmission
H25	Height 25 mm
H30	Height 30 mm
KL	For vehicles with air conditioner
KL	For vehicles without air conditioner

LLE	For LHD vehicles
MKL	For vehicles with automatic air conditioner
MKL	For vehicles without automatic air conditioner
MOO	For vehicles with and without air conditioner
NOR	Standard version
RLE	For RHD vehicles
SA	Special equipment
SAZ	Set
TER	For vehicles with Thematic
TMT	For vehicles with Thermotronic
TW	The product fitted must be identified on the vehicle or engine
WW	Optional
XXX	Available while stocks last
ZE	Two required
ZNE	For vehicles where retrofitted



Passenger cars



Engine type



Date/ Production period



Special case



Information/Explanations



Short ID number



Illustration



Cabin filter



Cabin filter with activated carbon



Operating manual



Cross-reference



253	Longueur : 253 mm
2FE	Jeu, comprenant 2 éléments filtrants
3FE	Jeu, comprenant 3 éléments filtrants
AG	Pour véhicules avec boîte automatique
BHR	Produit Bosch équivalent ou pièce pour Behr
DHI	Produit Bosch équivalent ou pièce pour Delphi
EHX	Pour véhicules avec équipement ELX, HLX
ELH	Pour véhicules sans système de chauffage électrique
GS	Pour véhicules avec boîte manuelle
H25	Hauteur 25 mm
H30	Hauteur 30 mm
KL	Pour véhicules avec climatiseur
KL	Pour véhicules sans climatiseur
LLE	Pour véhicules avec direction à gauche

MKL	Pour véhicules avec climatiseur automatique
MKL	Pour véhicules sans climatiseur automatique
MOO	Pour véhicules avec ou sans climatiseur
NOR	Version standard
RLE	Pour véhicules avec direction à droite
SA	Équipement spécial
SAZ	Jeu
TER	Pour véhicules avec Thematic
TMT	Pour véhicules avec ThermoTronic
TW	Le produit monté doit être déterminé sur le véhicule ou le moteur.
WW	Au choix
XXX	Dans la limite des stocks disponibles
ZE	2 nécessaires
ZNE	Pour véhicules, pose ultérieure



Voiture particulière



Type de moteur



Date/période de montage



Cas spécial



Information / explication



Référence courte



Illustration



Filtre d'habitacle



Filtre d'habitacle à charbon actif



Manuel d'utilisation



Comparaison



253	Lunghezza: 253 mm
2FE	Kit comprendente 2 elementi filtranti
3FE	Kit comprendente 3 elementi filtranti
AG	Per veicoli con cambio automatico
BHR	Prodotto Bosch equivalente o pezzo per Behr
DHI	Prodotto o parte Bosch di dimensioni identiche per Delphi
EHX	Per veicoli con equipaggiamento ELX-, HLX
ELH	Per veicoli senza sistema di riscaldamento elettrico
GS	Per veicoli con cambio meccanico
H25	Altezza 25 mm
H30	Altezza 30 mm
KL	Per veicoli con climatizzatore
KL	Per veicoli senza climatizzatore
LLE	Per guida a sinistra

MKL	Per veicoli con climatizzatore automatico
MKL	Per veicoli senza climatizzatore automatico
MOO	Per veicoli con e senza climatizzatore
NOR	Versione normale
RLE	Per guida a destra
SA	Equipaggiamento speciale
SAZ	Serie
TER	Per veicoli con Thematic
TMT	Per veicoli con Thermotronic
TW	Il prodotto montato deve essere rilevato sul veicolo o sul motore.
WW	A scelta
XXX	Consegna solo fino ad esaurimento scorte
ZE	Sono necessari due pezzi
ZNE	Per veicoli con montaggio successivo



Autovettura



Tipo motore



Data/Periodo di montaggio



Caso specifico



Informazione / dichiarazione



Numero di ricerca breve



Illustrazione



Filtro abitacolo



Filtro abitacolo con carboni attivi



Istruzioni d'uso



Confronto



253	Longitud: 253 mm
2FE	Un juego esta integrado por 2 elementos filtradores
3FE	Un juego esta integrado por 3 elementos filtradores
AG	Para vehículos con cambio automático
BHR	Producto Bosch de dimensiones idénticas para BEHR
DHI	Producto Bosch de dimensiones idénticas para Delphi
EHX	Para vehículos con equipamiento ELX, HLX
ELH	Para vehículos sin sistema de calefacción eléctrico
GS	Para vehículos con cambio manual
H25	Altura 25 mm
H30	Altura 30 mm
KL	Para vehículos con acondicionador de aire
KL	Para vehículos sin acondicionador de aire
LLE	Para dirección a la izquierda

MKL	Para vehículos con climatizador automático
MKL	Para vehículos sin climatizador automático
MOO	Para vehículos con y sin acondicionador de aire
NOR	Versión normal
RLE	Para vehículos de volante a la derecha
SA	Equipo especial
SAZ	Juego
TER	Para vehículos con Thematic
TMT	Para vehículos con Thermotronic
TW	El producto montado se debe determinar en el vehículo o en el motor.
WW	A elección
XXX	Suministro mientras duren las reservas
ZE	2 necesarios
ZNE	Para vehículos en caso de montaje posterior



Turismo



Tipo de motor



Fecha/periodo de fabricación



Caso especial



Información / explicación



Número búsqueda corto



Ilustración



Filtro para el habitáculo



Filtro para el habitáculo con carbón activo



instrucciones de uso



Confrontación



253	Comprimento: 253 mm
2FE	Conjunto composto por 2 elementos filtrantes
3FE	Conjunto composto por 3 elementos filtrantes
AG	Para veículos com caixa de câmbio automática
BHR	Produto ou peça Bosch equivalente para Behr
DHI	Produto ou peça Bosch equivalente para Delphi
EHX	Para veículos com nível de equipamento ELX, HLX
ELH	Para veículos sem sistema elétrico de aquecimento
GS	Para veículos com caixa de câmbio manual
H25	Altura 25 mm
H30	Altura 30 mm
KL	Para veículos com ar condicionado
KL	Para veículos sem ar condicionado

LLE	Para volante à esquerda
MKL	Para veículos com sistema de climatização automático
MKL	Para veículos sem sistema de climatização automático
MOO	Para veículos com e sem ar condicionado
NOR	Versão normal
RLE	Para volante à direita
SA	Equipamento especial
SAZ	Kit
TER	Para veículos com Thematic
TMT	Para veículos com sistema Thermotronic
TW	Produto montado tem que ser averiguado no veículo ou no motor.
WW	Opcional
XXX	Disponível para entrega enquanto existir estoque
ZE	Necessários dois
ZNE	Para veículos com reequipamento



Veículo ligeiro



Tipo de motor



Data/Período de instalação



Caso especial



Informação / explicação



Número de busca curto



Ilustração



Filtro de Habitáculo



Filtro de Habitáculo com carvão activo



Manual de Instruções



Confrontação



253	Lengte: 253 mm
2FE	Set, bestaand uit 2 filterelementen
3FE	Set, bestaand uit 3 filterelementen
AG	Voor voertuigen met automatische transmissie
BHR	Bosch-product met identieke inbouw of onderdeel voor Behr
DHI	Bosch-product met identieke inbouw of onderdeel voor Delphi
EHX	Voor voertuigen met ELX-, HLX-uitrusting
ELH	Voor voertuigen zonder elektrisch verwarmingssysteem
GS	Voor voertuigen met handgeschakelde transmissie
H25	Hoogte 25 mm
H30	Hoogte 30 mm
KL	Voor voertuigen met airconditioning
KL	Voor voertuigen zonder airconditioning
LLE	Voor voertuigen met stuur links

MKL	Voor voertuigen met automatische airconditioning
MKL	Voor voertuigen zonder automatische airconditioning
MOO	Voor voertuigen met en zonder airconditioning
NOR	Standaardversie
RLE	Voor voertuig met stuur rechts
SA	Speciale uitrusting
SAZ	Set
TER	Voor voertuigen met Thematic
TMT	Voor voertuigen met Thermotronic
TW	Ingebouwd product moet aan het voertuig of de motor gedetecteerd worden.
WW	In optie
XXX	Leverbaar zo lang de voorraad strekt
ZE	Twee noodzakelijk
ZNE	Voor voertuigen met inbouw achteraf



Personenwagen



Motortype



Datum/ Ingebouwd van .. tot ..



Speciaal geval



Informatie / toelichting



Kort zoeknummer



Afbeelding



Interieurfilter



Interieurfilter met actieve kool



Bedieningshandleiding



Tegenoverstelling



253	Uzunluk: 253 mm
2FE	Set, 2 filtre elemanında oluşur
3FE	Set, 3 filtre elemanında oluşur
AG	Otomatik şanzımanlı araba için
BHR	Aynı montaj şekilli boş ürünü veya Behr parçası
DHI	Aynı montaj şekilli boş ürünü veya Delphi parçası
EHX	ELX-, HLX-Donanımlı araçlar için
ELH	Elektrikli ısıtma sistemine sahip araçlar için
GS	El vitesli araba için
H25	Yükseklik 25 mm
H30	Yükseklik 30 mm
KL	Klima donanımlı araba için
KL	Klima donanımı olmayan araba için
LLE	Sol direksiyon için
MKL	Otomatik klimalı araçlar için

MKL	Otomatik klimalı bulunmayan araçlar için
MOO	Klima tesisatlı veya tesisatsız vasıtalar için
NOR	Normal model
RLE	Sağ direksiyon için
SA	Özel model
SAZ	Takım
TER	Thermatic olan araçlar için
TMT	Thermotronic olan araçlar için
TW	Takılan ürün, araçta veya motorda belirlenmelidir.
WW	Tercihe göre
XXX	Teslimat stoklara göre yapılır
ZE	İki gerekli
ZNE	Sonradan montaj yapılan araçlar için



Binek otomobil



Motor tipi



Tarih/ montaj aralığı



Özel durum



Bilgi / Açıklama



Kısa arama numarası



Resim



İç filtre



Aktif karbonlu iç filtre



İşletim Kılavuzu



Karşılaştırma



253	Délka: 253 mm
2FE	Sada, skládá ze 2 filtračních prvků
3FE	Sada, skládá ze 3 filtračních prvků
AG	Pro vozidla s automatickou převodovkou
BHR	Montážně shodný výrobek Bosch nebo díl pro Behr
DHI	Montážně shodný výrobek Bosch nebo díl pro Delphi
EHX	Pro vozidla s výbavou ELX, HLX
ELH	Pro vozidla bez elektrického systému vyhřívání
GS	Pro vozidla s manuální převodovkou
H25	Výška 25 mm
H30	Výška 30 mm
KL	Pro vozidla s klimatizací
KL	Pro vozidla bez klimatizace
LLE	Pro řízení na levé straně

MKL	Pro vozidla s automatickou klimatizací
MKL	Pro vozidla bez automatické klimatizace
MOO	Pro vozidla s klimatizací nebo bez klimatizace
NOR	Normální provedení
RLE	Pro řízení na pravé straně
SA	Speciální výbava
SAZ	Sada
TER	Pro vozidla s jednotkou Thematic
TMT	Pro vozidla s jednotkou Thermotronic
TW	Namontovaný výrobek musí být uveden na vozidle nebo na motoru.
WW	Volitelné
XXX	Dodávky jen v rámci zásob
ZE	Jsou nutné dva
ZNE	Pro vozidla při dodatečné montáži



Osobní vozidlo



Typ motoru



Datum/období montáže



Zvláštní případ



Informace/vysvětlení



Krát. vyhl. číslo



Obrázek



Filtr pro vnitřní prostor



Filtr pro vnitřní prostor s aktivním uhlím



Návod k provozu



Porovnání



253	Длина: 253 мм
2FE	Комплект состоит из 2 фильтрующих элементов
3FE	Комплект состоит из 3 фильтрующих элементов
AG	для автомобилей с автоматической коробкой скоростей
BHR	Монтируемое таким же образом изделие Bosch или деталь для Behr
DHI	Монтируемое таким же образом изделие Bosch или деталь для Delphi
EHX	Для автомобилей с оборудованием ELX, HLX
ELH	Для автомобилей без электрической системы обогрева
GS	для автомобилей с коробкой передач с ручным управлением
H25	Высота 25 мм
H30	Высота 30 мм
KL	для автомобилей с кондиционером
KL	для автомобилей без кондиционера

LLE	для автомобилей с левосторонним расположением рулевого колеса
MKL	Для автомобилей с автоматическим кондиционером
MKL	Для автомобилей без автоматического кондиционера
MOO	Для транспортных средств с и без климатической установки
NOR	Обычное исполнение
RLE	для автомобилей с правосторонним расположением рулевого колеса
SA	специальное оборудование
SAZ	комплект
TER	Для автомобилей с Thematic
TMT	Для автомобилей с системой Thermotronic
TW	Встроенное издание должно определяться в автомобиле или двигателе.
WW	на выбор
XXX	Поставка, пока есть на складе
ZE	необходимо два
ZNE	Для автомобилей с более поздней установкой



Легковой автомобиль



Тип двигателя



Дата / Период сборки



Особый случай



Информация / Пояснение



Короткий номер поиска



Чертеж



Фильтр салона



Фильтр салона с активированным углем



Руководство по эксплуатации



Сравнение

