

# PRODUCT CATALOGUE

2015/16

**blacktech**<sup>™</sup>



**Vibracoustic  
CV Air Springs**





# INDEX

ROLL AIR SPRINGS

7-59

COMPLETE & SERVICE AIR SPRINGS

61-311

CONVOLUTED AIR SPRINGS

313-361

CABIN & SEAT & LIFT AIR SPRINGS

363-403

### **Vibracoustic CV Air Springs GmbH**

is specialized in the design and manufacturing of commercial vehicle air springs. Our company is headquartered in Hamburg (Germany) and has facilities in Hungary, Turkey, China and Mexico. The combination of German engineering and our standardized best in class processes ensures that Vibracoustic CV Air Springs consistently provide the highest level of quality and service to our customers, everywhere in the world. All our production locations are certified according the required standards of the automotive industry, such as TS16949, ISO14001, ISO18001 and Ghost-R. With its

own rubber mixing facility, Vibracoustic CV Air Springs is able to control the complete production process from raw material until the finished product, all under one roof. Our modern plant in Bursa has a total floor space of 22,000sq metres and produces more than two million Air Springs per year. The Blacktech brand has a high reputation within the global replacement market. The matching product design, constant quality and design to cost philosophy combined with a wide range of products ensures that Blacktech remains as a leading brand within the global air spring replacement market.



## Blacktech Air Spring Product Range

**Rolling lobe air springs** most common air springs for truck, trailer, bus and light commercial vehicles.

**Convolute air springs** used in a large variety of application areas. Mostly they are used in industrial pneumatic applications as pneumatic lifting cylinders or in vibration isolation as spring elements.

**Cabin air springs** to reduce the vibration of the cabin and to control the ride height and stiffness. These are adjustable depending to the loading and road conditions.

**Seat air springs** designed to provide maximum comfort for the driver and to decrease driver's fatigue, increase road safety and to decrease fuel consumption due to increasing driver's comfort.





**PRODUCT LIFE TEST**

**Blacktech Air Suspension Systems;**

- Provide equal suspension comfort under all kinds of load and road surface conditions.
- Do not need maintenance.
- Have easy and economical replacement.
- Ease loading and unloading by adjusting chassis height of the vehicle.
- Ease getting on and off the bus especially for disabled people and children in some bus types.
- Protect the vehicle and the road from vibrations while driving.
- Prevent the vehicle from leaning to one side in unbalanced loading conditions.
- Increase road holding of the vehicle.
- Protect fragile loads from vibration.
- Used in cabins and driver's seat to provide more comfortable driving.



**EXPANSION AND LIFTING TEST**

Blacktech Air Springs are put through wide-ranging tests procedures to ensure that the air springs operate correctly and comply with required quality standards. Combining its experience with the aim of being known as a worldwide company and supplying high quality products we direct our infrastructure investments covering the following quality tests and consequently creating most suitable production conditions.

**Product Life Test**

Based on annual audit plans and innovations in new product development, the products are put through a life test in order to determine the performance of the air springs on the vehicle. During this test the air springs are installed to a see-saw replicating the movement of the vehicle, and then set to work in proper ride height and under maximum pressure conditions specified in product specifications. Pressure and expansion levels are recorded, at the same time all the modifications of air springs are traced by computer. Test results are summarized in graphs and tables, then the accuracy and compliance of the results to the specifications verified by engineers. The out-put data from the life-test results are used as an indicator in Research & Development activities, product improvements, corrective and preventive actions. Blacktech Air Springs are tested for millions of cycles without product failure or performance degradation during the tests.



**BURST TEST**

**Expansion and Lifting Test**

The air springs are designed to prove balanced transportation of the heavy loads. Therefore it should be checked whether the air springs have required expansion and lifting rates. By generating load lifting conditions of air spring in the vehicle, it is checked if the air spring is reached intended lifting rates and diameter change under escalating load is observed. Since the tests are performed by computer automatically, it is possible to determine the diameter expansion according to the lifting force in every pressure level. Test results are summarized in graphs and tables, then compliance of the results to the specifications verified by engineers.

**Burst Test**

Burst tests are performed to determine maximum resistance pressure of air springs. In order to ensure work safety, air springs are inflated in a closed chamber. Consequent burst pressure is verified in accordance with product test specifications. Burst tests are also performed with computer control.

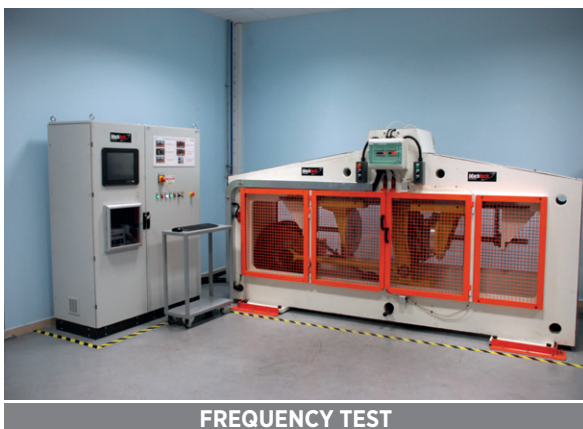

**FREQUENCY TEST**

**Frequency Test**

Products are tested for resistance on different frequencies. Frequency test is performed to calculate frequency under a certain pressure and certain load. Between 0.4 hz and 8.5 hz frequency are applied. Also it is possible to see the air spring's pressure and load level between bound and rebound movements by the frequency test.

# ROLL AIR SPRINGS

**blacktech**™



**Vibracoustic**  
CV Air Springs





## Components of Air Springs

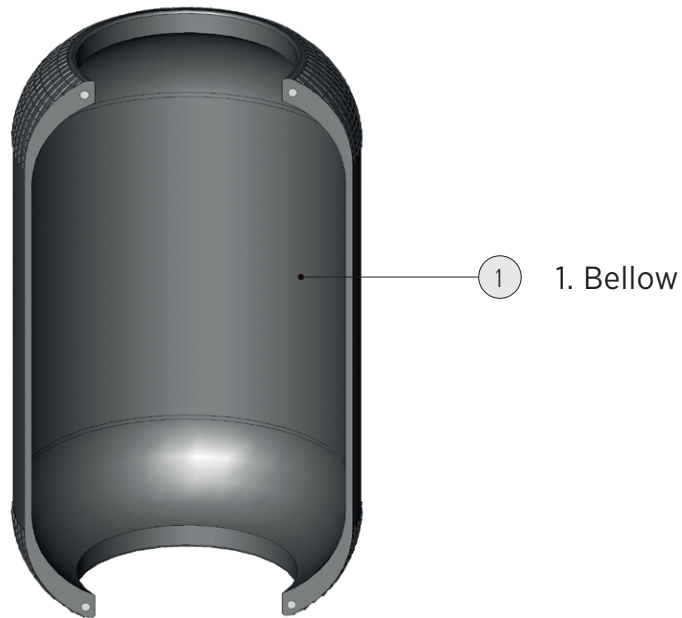

## Product Identification / Roll Air Springs

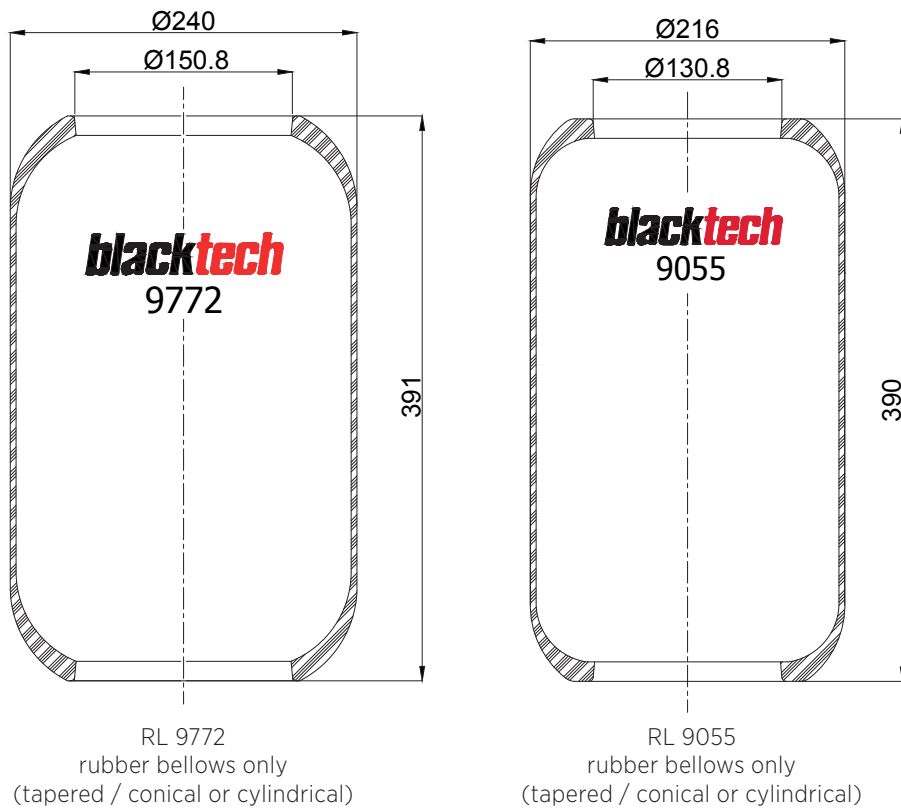

ROLL AIR SPRINGS OEM LIST					
MANUFACTURER	OEM PART NO	PART NO	TYPE	REMARKS	PAGE
AUTODROMO MODENA	577472	95471	Roll	Rolling Lobe	44
BARTOLETTI	91644001	92023	Roll	Rolling Lobe	36
BOVA	B510040	9812	Roll	Rolling Lobe	24
BUSSING	536905265	9755	Roll	Rolling Lobe	23
	546905134	9772	Roll	Rolling Lobe	23
	100110200	9773	Roll	Rolling Lobe	24
BREDAMENARINI BUS	S5001051	9054	Roll	Rolling Lobe	21
	178741	9056	Roll	Rolling Lobe	22
	199196	9755	Roll	Rolling Lobe	23
	178623	9784	Roll	Rolling Lobe	24
	325993	9784	Roll	Rolling Lobe	24
	192709	9920	Roll	Rolling Lobe	31
	252933	9928	Roll	Rolling Lobe	32
	D031115	9993	Roll	Rolling Lobe	33
	D020990	91994	Roll	Rolling Lobe	36
	178739	92023	Roll	Rolling Lobe	36
192709	95471	Roll	Rolling Lobe	44	
BPW	0220024400	9755	Roll	Rolling Lobe	23
	0220024600	9773	Roll	Rolling Lobe	24
	0220024000	9820	Roll	Rolling Lobe	25
	0220024100	9831	Roll	Rolling Lobe	26
	0220024200	9873	Roll	Rolling Lobe	29
	0220024700	9886	Roll	Rolling Lobe	29
	0220024300	92885	Roll	Rolling Lobe	39
CARDI	58050315	9908	Roll	Rolling Lobe	31
DAF	0818225	9820	Roll	Rolling Lobe	25
	0638148	9838			27
DAIMLER CHRYSLER	A3183280001	9857	Roll	Rolling Lobe	28
DENNIS	611896/12	9038	Roll	Rolling Lobe	20
	686 1/2	9039	Roll	Rolling Lobe	21
	870 3/4	9039	Roll	Rolling Lobe	21
	776 1/7	9039	Roll	Rolling Lobe	21
	1261	9907	Roll	Rolling Lobe	31
	806	9907	Roll	Rolling Lobe	31
	8001/2	9908	Roll	Rolling Lobe	31
	657489-2	97489	Roll	Rolling Lobe	47
DAEWOO	96708574	9870	Roll	Rolling Lobe	28
		9893	Roll	Rolling Lobe	30
EVO-BUS	A0003280001	9032	Roll	Rolling Lobe	20
	A6283230092	9057	Roll	Rolling Lobe	22
	A0003270101	9755	Roll	Rolling Lobe	23
	A4103270001	9772	Roll	Rolling Lobe	23

ROLL AIR SPRINGS OEM LIST					
MANUFACTURER	OEM PART NO	PART NO	TYPE	REMARKS	PAGE
EVO-BUS	A3833270001	9784	Roll	Rolling Lobe	24
	A3833280001	9784	Roll	Rolling Lobe	24
	A3823277101	9873	Roll	Rolling Lobe	29
	A3563270001	9561-36	Roll	Rolling Lobe	52
	A3563270201	9561-36	Roll	Rolling Lobe	52
	A6133270101	9561-36	Roll	Rolling Lobe	52
FLOOR	848	9773	Roll	Rolling Lobe	24
	862	9838	Roll	Rolling Lobe	27
GIGANT	166205	9820	Roll	Rolling Lobe	25
	196036	9820	Roll	Rolling Lobe	25
	196035	9873	Roll	Rolling Lobe	29
	196043	9838	Roll	Rolling Lobe	27
	196038	9886	Roll	Rolling Lobe	29
	196039	92885	Roll	Rolling Lobe	39
HEULIEZ	5000288982	9032	Roll	Rolling Lobe	20
	5000805284	9870	Roll	Rolling Lobe	28
HYUNDAI		9870	Roll	Rolling Lobe	28
		9893	Roll	Rolling Lobe	30
IKARUS		9755	Roll	Rolling Lobe	22
		9772	Roll	Rolling Lobe	23
	B510040	9812	Roll	Rolling Lobe	24
		9873	Roll	Rolling Lobe	29
		9873	Roll	Rolling Lobe	29
		9873	Roll	Rolling Lobe	29
IRIS BUS	5000288982	9032	Roll	Rolling Lobe	20
	5010151378	9032	Roll	Rolling Lobe	20
	5010151379	9032	Roll	Rolling Lobe	20
	5000819517	9826	Roll	Rolling Lobe	26
	5000786640	9870	Roll	Rolling Lobe	28
	5000805284	9870	Roll	Rolling Lobe	28
	5000954176	9893	Roll	Rolling Lobe	30
	5000324098	9893	Roll	Rolling Lobe	30
	5000805998	9928	Roll	Rolling Lobe	32
	5810805998	9928	Roll	Rolling Lobe	32
	5000768641	9928	Roll	Rolling Lobe	32
	5000296816	9987	Roll	Rolling Lobe	33
	5000296827	9987	Roll	Rolling Lobe	33
	5000301452	9995	Roll	Rolling Lobe	34
	5010294385	9995	Roll	Rolling Lobe	34
	5001843640	92035	Roll	Rolling Lobe	37
	5001021414	92526	Roll	Rolling Lobe	37
	5001857612	92893	Roll	Rolling Lobe	40

ROLL AIR SPRINGS OEM LIST					
MANUFACTURER	OEM PART NO	PART NO	TYPE	REMARKS	PAGE
INBUS	5001051	9054	Roll	Rolling Lobe	21
	4840005	9055	Roll	Rolling Lobe	21
	4890001	9055	Roll	Rolling Lobe	21
IVECO/IVECO BUS	99459166	9032	Roll	Rolling Lobe	20
	64537401	9039	Roll	Rolling Lobe	21
	6414040	9054	Roll	Rolling Lobe	21
	8160165	9054	Roll	Rolling Lobe	21
	4738008	9055	Roll	Rolling Lobe	21
	8188526	9055	Roll	Rolling Lobe	21
	4714025	9055	Roll	Rolling Lobe	21
	4722525	9055	Roll	Rolling Lobe	21
	5254025	9055	Roll	Rolling Lobe	21
	6657150	9055	Roll	Rolling Lobe	21
	4716989	9056	Roll	Rolling Lobe	22
	4746733	9772	Roll	Rolling Lobe	23
	41822247	9772	Roll	Rolling Lobe	23
	4763473	9826	Roll	Rolling Lobe	26
	4456111	9826	Roll	Rolling Lobe	26
	500324098	9893	Roll	Rolling Lobe	30
	8139068	9987	Roll	Rolling Lobe	33
	41022620	9987	Roll	Rolling Lobe	33
	8188539	9995	Roll	Rolling Lobe	34
	500301452	9995	Roll	Rolling Lobe	34
	97108363	9995	Roll	Rolling Lobe	34
	500310931	90931	Roll	Rolling Lobe	34
	500301776	91523	Roll	Rolling Lobe	36
	42531994	91994	Roll	Rolling Lobe	36
	41022620	92336	Roll	Rolling Lobe	37
	503130261	92527	Roll	Rolling Lobe	38
	503129220	92528	Roll	Rolling Lobe	38
	5000787632	92844	Roll	Rolling Lobe	39
	5000869179	92844	Roll	Rolling Lobe	39
	5000954176	92844	Roll	Rolling Lobe	39
	5010073847	92844	Roll	Rolling Lobe	39
	0501210851	92844	Roll	Rolling Lobe	39
	93166132	92899	Roll	Rolling Lobe	40
93166129	92920	Roll	Rolling Lobe	40	
98478799	92996	Roll	Rolling Lobe	41	
4843220	93220	Roll	Rolling Lobe	42	
4823495	93220	Roll	Rolling Lobe	42	
42549268	93351	Roll	Rolling Lobe	42	
500324098	94098	Roll	Rolling Lobe	43	

ROLL AIR SPRINGS OEM LIST					
MANUFACTURER	OEM PART NO	PART NO	TYPE	REMARKS	PAGE
IVECO/IVECO BUS	500364663	94663	Roll	Rolling Lobe	43
	41006926	95019	Roll	Rolling Lobe	44
	ZEV13541	95019	Roll	Rolling Lobe	44
	98445471	95471	Roll	Rolling Lobe	44
	931661129	95471	Roll	Rolling Lobe	44
	98411807	96032	Roll	Rolling Lobe	45
	41008929	97019	Roll	Rolling Lobe	45
	500364686	97026	Roll	Rolling Lobe	45
	500319479	97027	Roll	Rolling Lobe	46
	4716989	97743	Roll	Rolling Lobe	47
	2997743	97743	Roll	Rolling Lobe	47
	99459166	97756	Roll	Rolling Lobe	47
	2997756	97756	Roll	Rolling Lobe	47
	42568183	98183	Roll	Rolling Lobe	48
	8160165	98518	Roll	Rolling Lobe	48
	93197594	9561-36	Roll	Rolling Lobe	52
KAESSBOHRER	4771503000	9032	Roll	Rolling Lobe	20
	4771441000	9755	Roll	Rolling Lobe	23
	4731012000	9772	Roll	Rolling Lobe	23
	4731031000	9772	Roll	Rolling Lobe	23
	4731032000	9820	Roll	Rolling Lobe	25
	4731013000	9873	Roll	Rolling Lobe	29
	4731040000	9886	Roll	Rolling Lobe	29
	4731038000	92885	Roll	Rolling Lobe	39
KARSAN		99207	Roll	Rolling Lobe	50
		99208	Roll	Rolling Lobe	51
		99209	Roll	Rolling Lobe	51
KOGEL		9773	Roll	Rolling Lobe	24
	4731040000	9886	Roll	Rolling Lobe	29
LAG		9908	Roll	Rolling Lobe	31
MB TUERK	A0003270101	9755	Roll	Rolling Lobe	23
	A3563270001	9561-36	Roll	Rolling Lobe	52
	A3563270101	9561-36	Roll	Rolling Lobe	52
MAN	81436010095	9027	Roll	Rolling Lobe	20
	81436010097	9027	Roll	Rolling Lobe	20
	81436010100	9027	Roll	Rolling Lobe	20
	81436010102	9027	Roll	Rolling Lobe	20
	81436010105	9027	Roll	Rolling Lobe	20
	81436010126	9027	Roll	Rolling Lobe	20
	81436010138	9027	Roll	Rolling Lobe	20
	81436010017	9755	Roll	Rolling Lobe	23
	90831120144	9772	Roll	Rolling Lobe	23

**ROLL AIR SPRINGS OEM LIST**

MANUFACTURER	OEM PART NO	PART NO	TYPE	REMARKS	PAGE
MAN	81436010018	9773	Roll	Rolling Lobe	24
	81436010015	9773	Roll	Rolling Lobe	24
	81436010096	9817	Roll	Rolling Lobe	25
	81436010098	9817	Roll	Rolling Lobe	25
	81436010101	9817	Roll	Rolling Lobe	25
	81436010127	9817	Roll	Rolling Lobe	25
	81436010139	9817	Roll	Rolling Lobe	25
	81436010059	9826	Roll	Rolling Lobe	26
	81436010060	9826	Roll	Rolling Lobe	26
	81436010061	9826	Roll	Rolling Lobe	26
	81436010075	9826	Roll	Rolling Lobe	26
	81436010078	9826	Roll	Rolling Lobe	26
	81436010081	9826	Roll	Rolling Lobe	26
	81436010083	9826	Roll	Rolling Lobe	26
	81436010090	9826	Roll	Rolling Lobe	26
	81436010039	9827	Roll	Rolling Lobe	26
	81436010040	9827	Roll	Rolling Lobe	26
	81436010033	9831	Roll	Rolling Lobe	26
	81436010036	9831	Roll	Rolling Lobe	26
	81436010037	9831	Roll	Rolling Lobe	26
	81436010056	9831	Roll	Rolling Lobe	26
	81436010057	9831	Roll	Rolling Lobe	26
	81436010058	9831	Roll	Rolling Lobe	26
	81436010076	9831	Roll	Rolling Lobe	26
	81436010079	9831	Roll	Rolling Lobe	26
	81436010082	9831	Roll	Rolling Lobe	26
	81436010084	9831	Roll	Rolling Lobe	26
	81436010091	9831	Roll	Rolling Lobe	26
	81436010114	9831	Roll	Rolling Lobe	26
	81436010116	9831	Roll	Rolling Lobe	26
	81436010056	9838	Roll	Rolling Lobe	27
	81436010057	9838	Roll	Rolling Lobe	27
	81436010058	9838	Roll	Rolling Lobe	27
	81436010076	9838	Roll	Rolling Lobe	27
	81436010079	9838	Roll	Rolling Lobe	27
	81436010082	9838	Roll	Rolling Lobe	27
	81436010084	9838	Roll	Rolling Lobe	27
	81436010091	9838	Roll	Rolling Lobe	27
	81436010114	9838	Roll	Rolling Lobe	27
	81436010116	9838	Roll	Rolling Lobe	27
81436010049	9873	Roll	Rolling Lobe	29	
81436010052	9873	Roll	Rolling Lobe	29	

ROLL AIR SPRINGS OEM LIST

MANUFACTURER	OEM PART NO	PART NO	TYPE	REMARKS	PAGE
MAN	81436010053	9897	Roll	Rolling Lobe	30
	81436010065	9993	Roll	Rolling Lobe	33
	81436010067	9993	Roll	Rolling Lobe	33
	81436010070	9993	Roll	Rolling Lobe	33
	81436010092	9993	Roll	Rolling Lobe	33
	81436010093	9993	Roll	Rolling Lobe	33
	81436010103	9993	Roll	Rolling Lobe	33
	81436010121	9993	Roll	Rolling Lobe	33
	81436010132	9993	Roll	Rolling Lobe	33
	81436010071	9994	Roll	Rolling Lobe	33
	81436010072	9994	Roll	Rolling Lobe	33
	81436010110	9994	Roll	Rolling Lobe	33
	81436010128	9994	Roll	Rolling Lobe	33
	81436010137	9994	Roll	Rolling Lobe	33
	81436010066	9995	Roll	Rolling Lobe	34
	81436010068	9995	Roll	Rolling Lobe	34
	81436010069	9995	Roll	Rolling Lobe	34
	81436010106	9995	Roll	Rolling Lobe	34
	81436010108	9995	Roll	Rolling Lobe	34
	81436010104	92996	Roll	Rolling Lobe	41
	81436010109	92996	Roll	Rolling Lobe	41
	81436010111	92996	Roll	Rolling Lobe	41
	81436010123	92996	Roll	Rolling Lobe	41
	81436010125	92996	Roll	Rolling Lobe	41
	81436010140	92996	Roll	Rolling Lobe	41
	81436010150	92996	Roll	Rolling Lobe	41
	81436010161	92997	Roll	Rolling Lobe	41
	81436010163	92999	Roll	Rolling Lobe	41
MAGIRUS-DEUTZ	536905265	9755	Roll	Rolling Lobe	23
	02498667	9772	Roll	Rolling Lobe	23
	02491566	9784	Roll	Rolling Lobe	24
	04456111	9826	Roll	Rolling Lobe	26
MCW	X 664 1056	9039	Roll	Rolling Lobe	21
	X 664 1056	9039	Roll	Rolling Lobe	21
MERCEDES	A3833270001	9784	Roll	Rolling Lobe	24
	A3873280101	9831	Roll	Rolling Lobe	26
	A3933280101	9848	Roll	Rolling Lobe	27
	A3633280201	9868	Roll	Rolling Lobe	28
	A6743280301	9899	Roll	Rolling Lobe	30
	A0003280101	9920	Roll	Rolling Lobe	31
	A6743280001	9949	Roll	Rolling Lobe	32
	A6743280101	9984	Roll	Rolling Lobe	32

ROLL AIR SPRINGS OEM LIST					
MANUFACTURER	OEM PART NO	PART NO	TYPE	REMARKS	PAGE
MERCEDES	A6993280101	9993	Roll	Rolling Lobe	33
	A6553270001	92831	Roll	Rolling Lobe	39
	A6673280001	95471	Roll	Rolling Lobe	44
NEOPLAN		9032	Roll	Rolling Lobe	20
	100112254	9755	Roll	Rolling Lobe	23
	AA1001001	9772	Roll	Rolling Lobe	23
	100112251	9773	Roll	Rolling Lobe	24
	11016348	9773	Roll	Rolling Lobe	24
	102100200	9820	Roll	Rolling Lobe	25
	100112300	9831	Roll	Rolling Lobe	26
	102100300	9873	Roll	Rolling Lobe	29
	100112100	9899	Roll	Rolling Lobe	30
OPTARE	L5820005	9027	Roll	Rolling Lobe	20
	5800001	9086	Roll	Rolling Lobe	22
	R5800001	9086	Roll	Rolling Lobe	22
	R5800068	9086	Roll	Rolling Lobe	22
	UN15966	9920	Roll	Rolling Lobe	31
OTOKAR		99201	Roll	Rolling Lobe	49
		99202	Roll	Rolling Lobe	49
		99203	Roll	Rolling Lobe	49
		99205	Roll	Rolling Lobe	50
		99206	Roll	Rolling Lobe	50
PEGASO	199563	9054	Roll	Rolling Lobe	21
	197145	9056	Roll	Rolling Lobe	22
	4716989	9056	Roll	Rolling Lobe	22
	769388	9056	Roll	Rolling Lobe	22
		9831	Roll	Rolling Lobe	26
		9848	Roll	Rolling Lobe	27
	794686	9908	Roll	Rolling Lobe	31
	795097	9908	Roll	Rolling Lobe	31
		9994	Roll	Rolling Lobe	33
	8188539	9995	Roll	Rolling Lobe	34
93166129	92920	Roll	Rolling Lobe	40	
PORTESI	700176	9055	Roll	Rolling Lobe	21
RENAULT	5000819517	9826	Roll	Rolling Lobe	26
	5000954175	9879	Roll	Rolling Lobe	29
	523229	9055	Roll	Rolling Lobe	21
SCANIA + SCANIA BUSSAR	523229	9055	Roll	Rolling Lobe	21
		9056	Roll	Rolling Lobe	22
		9826	Roll	Rolling Lobe	26
		9870	Roll	Rolling Lobe	28
	411627	9907	Roll	Rolling Lobe	31



ROLL AIR SPRINGS OEM LIST					
MANUFACTURER	OEM PART NO	PART NO	TYPE	REMARKS	PAGE
SCANIA + SCANIA BUSSAR	411623	9908	Roll	Rolling Lobe	31
SCHMITZ	750209	9773	Roll	Rolling Lobe	24
	750215	9820	Roll	Rolling Lobe	25
	750212	9839	Roll	Rolling Lobe	27
	750225	92885	Roll	Rolling Lobe	39
SICCA	4890001	9054	Roll	Rolling Lobe	21
	4840005	9055	Roll	Rolling Lobe	21
TEMSA	SAFIR BUS (FRONT)	9001	Roll	Rolling Lobe	19
	SAFIR BUS (REAR)	9002	Roll	Rolling Lobe	19
	TE771107Y	9027	Roll	Rolling Lobe	20
		9032	Roll	Rolling Lobe	20
		9893	Roll	Rolling Lobe	30
		9920	Roll	Rolling Lobe	31
VAN HOOL	624319-610	9755	Roll	Rolling Lobe	23
	624319-690	9772	Roll	Rolling Lobe	23
	624319-860	9784	Roll	Rolling Lobe	24
	624319-640	9838	Roll	Rolling Lobe	27
	624319-860	9870	Roll	Rolling Lobe	28
	624319-460	9873	Roll	Rolling Lobe	29
	624319-680	9873	Roll	Rolling Lobe	29
	624319-560	9899	Roll	Rolling Lobe	30
VDL BUS	0689677	9755	Roll	Rolling Lobe	23
	0578361	9773	Roll	Rolling Lobe	24
	0627584	9784	Roll	Rolling Lobe	24
	0659561	9826	Roll	Rolling Lobe	26
	0638148	9838	Roll	Rolling Lobe	27
	0644425	9873	Roll	Rolling Lobe	29
VOITH		93856	Roll	Rolling Lobe	42
		93857	Roll	Rolling Lobe	43
		98739	Roll	Rolling Lobe	48
VOLVO / LEYLAND	3116354	9038	Roll	Rolling Lobe	20
	AAU2542	9038	Roll	Rolling Lobe	20
	3116983	9039	Roll	Rolling Lobe	21
	AAU2544	9039	Roll	Rolling Lobe	21
	1134445	9755	Roll	Rolling Lobe	23
	1199893	9755	Roll	Rolling Lobe	23
	1137888	9772	Roll	Rolling Lobe	23
	1611776	9784	Roll	Rolling Lobe	24
	1622116	9824	Roll	Rolling Lobe	25
	6797169	9824	Roll	Rolling Lobe	25
	6885533	9826	Roll	Rolling Lobe	26
	1593842	9827	Roll	Rolling Lobe	26

ROLL AIR SPRINGS OEM LIST					
MANUFACTURER	OEM PART NO	PART NO	TYPE	REMARKS	PAGE
VOLVO / LEYLAND	1590136	9831	Roll	Rolling Lobe	26
	1134446	9838	Roll	Rolling Lobe	27
	1612455	9879	Roll	Rolling Lobe	29
	21102227	9893	Roll	Rolling Lobe	30
	6782726	9899	Roll	Rolling Lobe	30
	1082085	9994	Roll	Rolling Lobe	33
	20540789	90789	Roll	Rolling Lobe	34
	3111277	91277	Roll	Rolling Lobe	35
	3112775291	91277	Roll	Rolling Lobe	35
	1075290	92532	Roll	Rolling Lobe	38
	20553875	95875	Roll	Rolling Lobe	44
	70377054	97054	Roll	Rolling Lobe	46
	20540792	97075	Roll	Rolling Lobe	46
	21347075	97075	Roll	Rolling Lobe	46
	3027271	9526-36	Roll	Rolling Lobe	51
	3027272	9526-39	Roll	Rolling Lobe	52
ZF SACHS	001748000160	9027	Roll	Rolling Lobe	20
	0502312548	9086	Roll	Rolling Lobe	22
	001748451100	92999	Roll	Rolling Lobe	41

**RL 9001**



Cross Section View

Top View

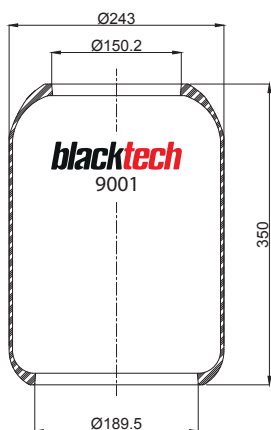

OEM PART NUMBER	MODEL NO	CROSS REFERENCES
TEMSA (Safir BUS Front)	TOYO	TRL 240

**RL 9002**



Cross Section View

Top View

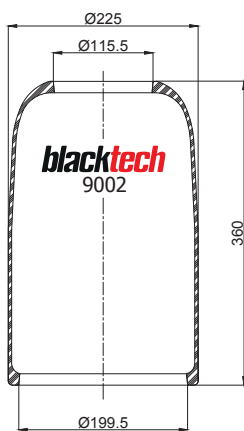

OEM PART NUMBER	MODEL NO	CROSS REFERENCES
TEMSA (Safir BUS Rear)	TOYO	F25

**RL 9003**



Cross Section View

Top View

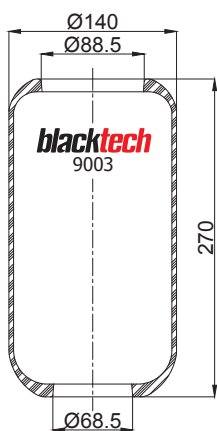

OEM PART NUMBER	MODEL NO	CROSS REFERENCES
	PHOENIX	1G 08

**RL 9027**



Cross Section View

Top View

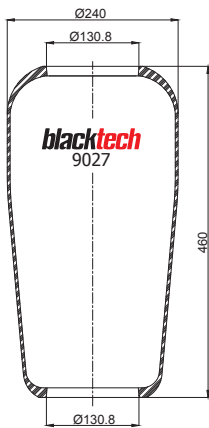

OEM PART NUMBER		MODEL NO	CROSS REFERENCES	
MAN	81436010095	EL 202	Contitech	916 N1
MAN	81436010097	MAN 322/422	Phoenix	1 F 21 C-5
MAN	81436010100	NL 202 München	Phoenix	1 F 21 C-6
MAN	81436010102	NG 272 Podestios	Firestone Style	2R2A460-295
MAN	81436010105	NL 202 F	Firestone No.	W01-095-0555
MAN	81436010126	NL 202 Podestios	Goodyear	9015
MAN	81436010126	NL CNG Podestl.	Taurus	B154
MAN	81436010126	NM 152 Midibus	Vibracoustic	V1F21C-5
MAN	81436010126	SL 250	Dunlop F	D12S05
MAN	81436010126	UEL 242	Gart Ref.	C289/C1
MAN	81436010138		Gart No.	289.0.455
Optare	L5820005	Bus and Coach		
Temsa	TE771107Y	Safari		
Temsa	TE771107Y	Diamond		
Temsa	TE771107Y	Eurosafari		
ZF Sachs	00 17 70 000 160	MAN Bus		

**RL 9032**



Cross Section View

Top View

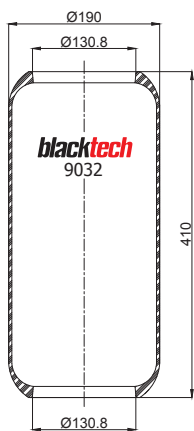

OEM PART NUMBER		MODEL NO	CROSS REFERENCES	
EvoBus	A 000 328 00 01	O 580 Travego 16/17 RHD	Contitech	921 N
Heuliez	5 000 288 982	PR 100-GX 107, PR 180-GX 187	Phoenix	1 E 17
IRISBUS	5.000.288.982	PR 100	Firestone Style	1R1A415-260
IRISBUS	5.010.151.378	PR 100	Firestone No.	W01-095-0226
IRISBUS	5.010.151.379	PR 100	Goodyear	8043
IVECO Bus	99459166		Taurus	B158
Neoplan			Vibracoustic	V1E17
Temsa			CF Gomma Ref.	1S285-23V
Kässbohrer	4.771.503.000	Setra S 415/416/417 HDH	CF Gomma No.	202728
			Dunlop F	D10S04
			Gart Ref.	D276/BS
			Gart No.	276.0.391

**RL 9038**



Cross Section View

Top View

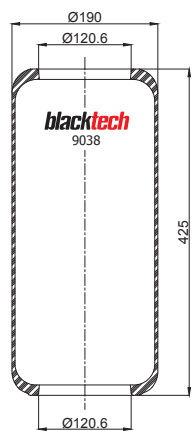

OEM PART NUMBER		MODEL NO	CROSS REFERENCES	
Dennis	685 2/3	Dart	Contitech	927 N
Dennis	685 2/3	Domino	Phoenix	2 E 18 B
Dennis	685 2/3	Dragon	Primeride	2927 A
Dennis	685 2/3	Javelin	Firestone Style	1R1J415-285
Dennis	685 2/3	Lancet	Firestone No.	W01-095-0244
Jonckheere		041 City Bus	Goodyear	8037
Jonckheere		046 City Bus	Taurus	B179
Volvo Leyland	3 116 354	Lynx	Vibracoustic	V2E18B
Volvo Leyland	3 116 354	Olympian	Dunlop UK	PNP300080100
Volvo Leyland	3 116 354	Royal Tiger		
Volvo Leyland	3 116 354	Super Volvo		
Volvo Leyland	3 116 354	Tiger		
Volvo Leyland	3 116 354	Titan		
Volvo Leyland	AAU 2542	Lynx		

**RL 9039**



Cross Section View      Top View

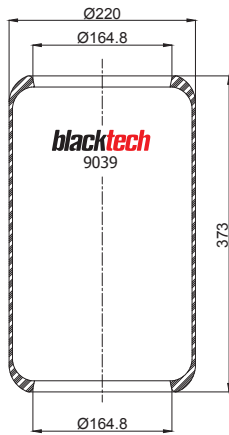

OEM PART NUMBER		MODEL NO	CROSS REFERENCES	
Dennis	686 1/2	Dart	Contitech	928 N
Dennis	686 1/2	Dominator	Phoenix	2 E 23 A
Dennis	686 1/2	Falcon	Primeride	2928 A
Dennis	870 3/4	Integral	Firestone Style	1R1K380-320
Dennis	776 1/7	Duple 425	Firestone No.	W01-095-0228
IVECO Bus	6453741		Goodyear	8042
MCW	X 664 1056	Metro Bus Mk I / II	Taurus	B178
MCW	X 664 1056	Metro Liner	Vibracoustic	V2E23A
Volvo Leyland	10 904 403	Lion	Dunlop F	D12S03
Volvo Leyland	3 116 983	National MK I / II	Dunlop UK	103308
Volvo Leyland	3 116 983	Olympian		
Volvo Leyland	3 116 983	Tiger		
Volvo Leyland	AAU 2544	Lion		

**RL 9054**



Cross Section View      Top View

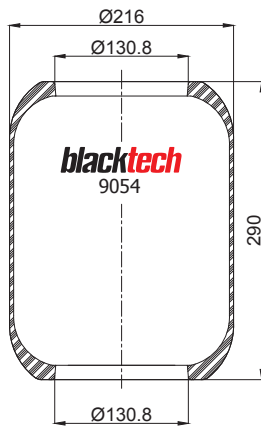

OEM PART NUMBER		MODEL NO	CROSS REFERENCES	
BredaMenarini	S5001051		Contitech	943 N
Inbus	500 1051	150-210-240-2001	Firestone Style	1R1A260-285
IVECO	6144040		Firestone No.	W01-095-0189
IVECO	8160165	MP 400 E	Goodyear	9001
IVECO Bus	6144040		CF Gomma Ref.	1S285-18
Pegaso	199563	5316	CF Gomma No.	88809
Sicca	4890 001		Dunlop F	D11S05
Pegaso			Dunlop UK	PNP316730100
			Gart Ref.	D276/D
			Gart No.	276.0.260
			Taurus	B194

**RL 9055**



Cross Section View      Top View

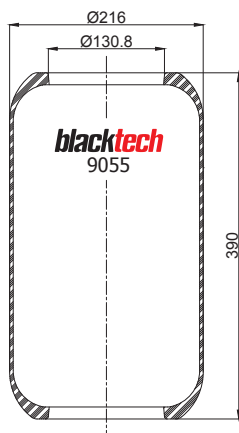

OEM PART NUMBER		MODEL NO	CROSS REFERENCES	
Inbus	484 0005		Contitech	944 N
Inbus	489 0001		Phoenix	1 E 21-6
IVECO	4714025		Firestone Style	1R1B390-270
IVECO	4738008		Firestone No.	W01-095-0121
IVECO	8188526	Eurotech	Goodyear	9009
IVECO Bus	4714025	Bus 220	Vibracoustic	V1E21-6
IVECO Bus	4722525	Bus 220	Vibracoustic	V1E19
IVECO Bus	4722525	Bus 320	CF Gomma Ref.	1S285-22
IVECO Bus	4722525	Carrozeria	CF Gomma No.	97619
IVECO Bus	5254025		Dunlop F	D11S04
IVECO Bus	6657150		Gart Ref.	D290/B
Portesi	700 176		Gart No.	290.0.390
Scania	523229	Bus (South America)	Taurus	B113
Sicca	4840 005			

**RL 9056**



Cross Section View

Top View

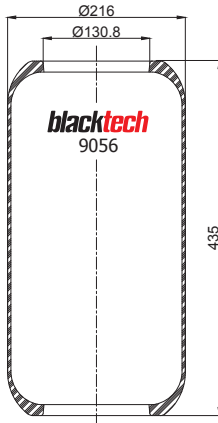

OEM PART NUMBER		MODEL NO	CROSS REFERENCES	
BredaMenarini	178 741	110 L	Contitech	945 N
BredaMenarini	178 741	120-101	Phoenix	1 E 21 C
IVECO	4716989		Firestone Style	1R1A460-290
IVECO Bus	4716989	Bus 370	Firestone No.	W01-095-0063
IVECO Bus	4716989	Bus 421 A	Goodyear	9014
Pegaso	197145		CF Gomma Ref.	1S285-25
Pegaso	4716989	5036 S	CF Gomma No.	97555
Pegaso	4716989	6100	Dunlop UK	PNP301000101
Pegaso	769388		Gart Ref.	D276
Hyundai			Gart No.	276.D.420
Scania		BF 86/110/111	Taurus	B124
Scania		BR CR 110	Dunlop F	D11S01
Scania		BR/CR 111/111 DH		
Scania		BR/CR 112		
Scania		BR/CR 116		
Scania		BR/CR 145		
Scania		CR 76		

**RL 9057**



Cross Section View

Top View

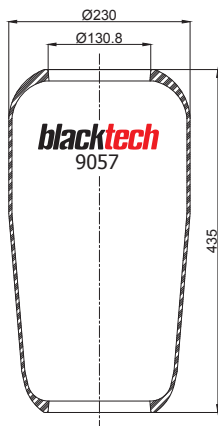

OEM PART NUMBER		MODEL NO	CROSS REFERENCES	
EvoBus	A 628 323 00 92	Citaro	Contitech	946 N
			Phoenix	1F 20 C
			Vibracoustic	V1F21C-6
			CF Gomma Ref.	1SC290-28
			CF Gomma No.	207725

**RL 9086**



Cross Section View

Top View

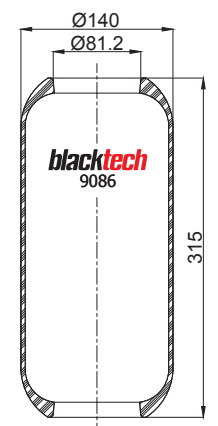

OEM PART NUMBER		MODEL NO	CROSS REFERENCES	
Optare	5800001	Bus and Coach	Contitech	975 N
ZF Sachs	0502.312.548		Phoenix	1E10 C
Optare	5800001	Bus and Coach	Firestone Style	1R1T320195
Optare	R5800001	Bus and Coach	Firestone No.	W01-095-0437
Optare	R5800068		Vibracoustic	V1E10
			Dunlop UK	00628A-AP
			Gart Ref.	D305
			Gart No.	305.D.320



**RL 9773**



Cross Section View

Top View

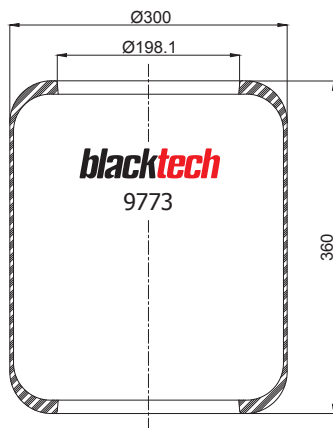

OEM PART NUMBER		MODEL NO	CROSS REFERENCES	
BPW	02.200.24.60.0		Contitech	662 N
Büssing	100 110 200	L16 / 22	Phoenix	1E 32
Büssing	100 112 251	L16 / 22	Primeride	2662 A
Floor	848		Firestone Style	1R1D355-355
MAN	81.436.010.018		Firestone No.	W01-095-0207
MAN	81.436.010.051		Goodyear	9007
Neoplan	1001 12 251	N 912. N 940	Taurus	BL143
Neoplan	1001 12 251	N 940	Vibracoustic	V1E32
Neoplan	1001 12 251	NB 26 L	CF Gomma Ref.	1SC360-30
Neoplan	1001 12 251	Skyliner	CF Gomma No.	92594
Neoplan	1001 12 251	TR 8. TR 12	Dunlop F	D13S01
Schmitz	750 209		Dunlop UK	PNP302730101
SMB		Truck alteration		
VDL Bus	0 578 361	SB 2000		
VDL Bus	0 578 361	SB 201		
Wackenhut		10 t axle		
Ikarus		19001		
Ikarus		Vöv - Bus		
Kögel				
Neoplan	11016348	Skyliner		

**RL 9784**



Cross Section View

Top View

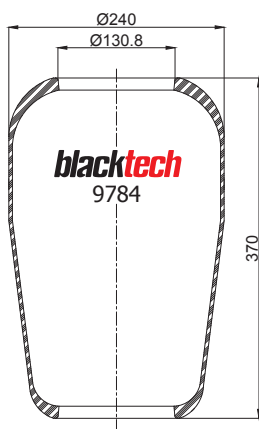

OEM PART NUMBER		MODEL NO	CROSS REFERENCES	
BredaMenarini	178 623	201-201/1LU	Contitech	673 N
BredaMenarini	325 993		Phoenix	1F 21 A
EvoBus	A 383 327 00 01		Primeride	2673 A
EvoBus	A 621 328 00 01		Firestone Style	1R1A370-285
Magirus-Deutz	0249 1566		Firestone No.	W01-095-0198
Mercedes	A 383 327 00 01	2028 LS	Goodyear	9051
Van Hool	624319-860		Taurus	B141
VDL Bus	0 627 584		Vibracoustic	V1F21A
Volvo	1 611 776		CF Gomma Ref.	1SC285-22
			CF Gomma No.	88786
			Dunlop F	D11S06

**RL 9812**



Cross Section View

Top View

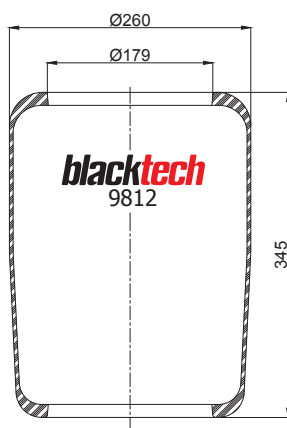

OEM PART NUMBER		MODEL NO	CROSS REFERENCES	
Bova	B 510040	Futura FLD	Contitech	701 N
Ikarus	B 510040	256, 260, 280	Phoenix	1E 26
			Primeride	2701 A
			Firestone Style	1R3M340-340
			Firestone No.	W01-095-0205
			Goodyear	9006
			Taurus	B116
			Vibracoustic	V1E26
			Gart Ref.	D276/C
			Gart No.	276.0.370



**RL 9817**



Cross Section View

Top View

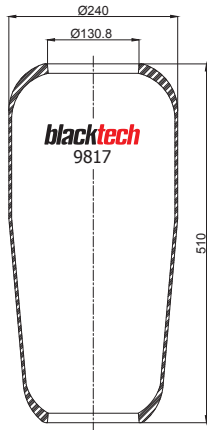

OEM PART NUMBER		MODEL NO	CROSS REFERENCES	
MAN	81436010096		Contitech	706 N
MAN	81.436.010.098		Goodyear	9067
MAN	81.436.010.101		Dunlop F	D12S16
MAN	81.436.010.127	FNL/FNLL -2000		
MAN	81.436.010.139			

**RL 9820**



Cross Section View

Top View

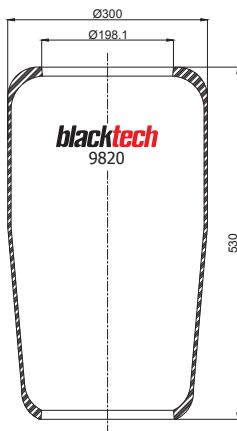

OEM PART NUMBER		MODEL NO	CROSS REFERENCES	
BPW	02.200.24.00.0		Contitech	719 N
DAF	0 818 225	FA 1300	Phoenix	1F 32 B
DAF	0 818 225	FA 2125	Firestone Style	1R2D530-360
DAF	0 818 225	FA 2305 DHS	Firestone No.	W01-095-0192
DAF	0 818 225	FA 2305 DHT	Goodyear	8118
DAF	0 818 225	FA 2500 DHS	Vibracoustic	V1F32B
DAF	0 818 225	FA 2500 DHT	CF Gomma Ref.	1SC360-43
DAF	0 818 225	FA 2505 DHS	CF Gomma No.	92593
DAF	0 818 225	FA 3300	Dunlop UK	PNP304620101
DAF	0 818 225	FA 3605	Gart Ref.	C292/E
DAF	0 818 225	FA G2505 DHS	Gart No.	292.0.520
DAF	0 818 225	FT 2100	Taurus	B153
DAF	0 818 225	FT 2125		
DAF	0 818 225	FT 3300		
DAF	0 818 225	FT 3600		
Gigant	166205	NLRM / NLRs Series		
Gigant	196036	NLRM / NLRs Se		
Kassbohrer	4.731.032.000			
Neoplan	1021.00.200			
Schmitz	750 215			

**RL 9824**



Cross Section View

Top View

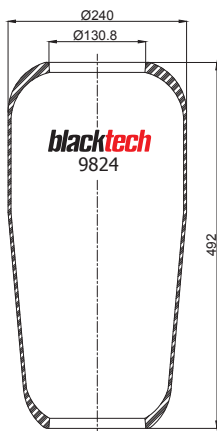

OEM PART NUMBER		MODEL NO	CROSS REFERENCES	
Volvo	1 622 116	FH 10 / FH 12	Contitech	713 N
Volvo	6 797 169	F 10/12	Phoenix	1F 21 D
Volvo	6 797 169	FH 10/12	Primeride	2713 A
			Goodyear	9066
			Vibracoustic	V1F21D
			Dunlop F	D12S15
			Gart Ref.	C304/B
			Gart No.	304.0.490

**RL 9826**



Cross Section View

Top View

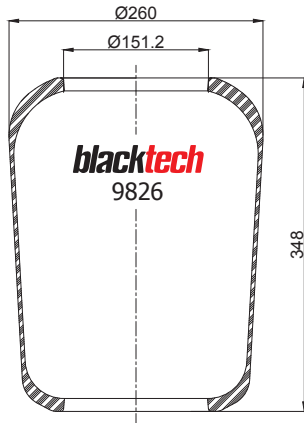

OEM PART NUMBER		MODEL NO	CROSS REFERENCES	
IRISBUS	5.000.819.517	R 310	Contitech	715 N
IRISBUS	5.000.819.517	R 340	Phoenix	1F 25
IRISBUS	5.000.819.517	R 420	Firestone Style	1R1C335-310
IVECO Bus	4456111	Carro 30-240	Firestone No.	W01-095-0087
IVECO Bus	4456111	Carro 38	Goodyear	8015
IVECO Bus	4763473		Vibracoustic	V1F25
Magirus-Deutz	0445 6111	310 D 22 FSL	CF Gomma Ref.	1SC310-16
MAN	81.436.010.059	MAN 292 /F	CF Gomma No.	93518
MAN	81.436.010.060	MAN 292/362 H	Dunlop UK	PNP304890101
MAN	81.436.010.061	MAN 362 F	Gart Ref.	C292/C
MAN	81.436.010.075	SD 242	Gart No.	292.0.380
MAN	81.436.010.078	SG 242/282	Taurus	B144
MAN	81.436.010.081	SG 242/292		
MAN	81.436.010.083	SG 242/292 F		
MAN	81.436.010.090	SG 292 F Israel		
Scania		BR/CR 112		
Scania		BR/CR 116		
VDL Bus	0 659 561	SB/R 2300		
Volvo	6 885 533			
Renault	5.000.819.517			

**RL 9827**



Cross Section View

Top View

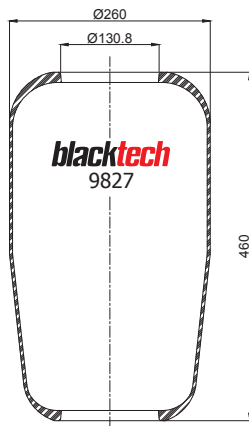

OEM PART NUMBER		MODEL NO	CROSS REFERENCES	
MAN	81.436.010.039		Contitech	716 N
MAN	81.436.010.040		Phoenix	1F 26 B-1
Volvo	1 593 842	FL 7/10	Firestone Style	1R2A450-305
			Firestone No.	W01-095-0145
			Goodyear	9073
			Taurus	B197
			Vibracoustic	V1F26B-1
			CF Gomma Ref.	1SC300-34
			CF Gomma No.	92548
			Dunlop F	D12S19

**RL 9831**



Cross Section View

Top View

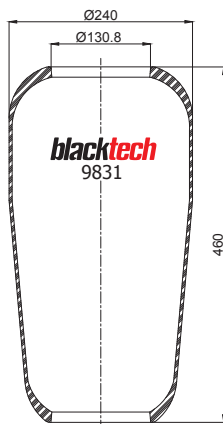

OEM PART NUMBER		MODEL NO	CROSS REFERENCES	
BPW	02.200.24.10.0		Contitech	720 N
MAN	81.436.010.033	13 168 FL/S/BL	Phoenix	1F 21
MAN	81.436.010.033	BG 120 N	Primeride	2720 A
MAN	81.436.010.036	13 192 F-OC	Firestone Style	1R2A460-295
MAN	81.436.010.037	13 192 FL	Firestone No.	W01-095-0195
MAN	81.436.010.037	13 192 H-OC	Goodyear	9008
MAN	81.436.010.037	14 168 FL/S/BL	Taurus	B152
MAN	81.436.010.037	14 192 FL/S/BL	Vibracoustic	V1F21
MAN	81.436.010.037	14 192 UL/BL	CF Gomma Ref.	1SC290-30
MAN	81.436.010.037	15 168 FL/S/BL	CF Gomma No.	88802
MAN	81.436.010.037	15 192 FL/S/BL	Dunlop F	D12S04
MAN	81.436.010.037	15 240 FLS/BL	Dunlop UK	PNP301000100
MAN	81.436.010.037	16 168 FL/S/BL	Gart Ref.	C299
Mercedes	A 387 328 01 01	813 LPL	Gart No.	299.0.450
Mercedes	A 387 328 01 01	813 LPS/LPLS		
Neoplan	100112.300			
Pegaso		B55		
Volvo	1 590 136	B 58		
Volvo	1 590 136	F 10/12		
Volvo	1 590 136	National Mk 1 / 11		

**RL 9838**



Cross Section View

Top View

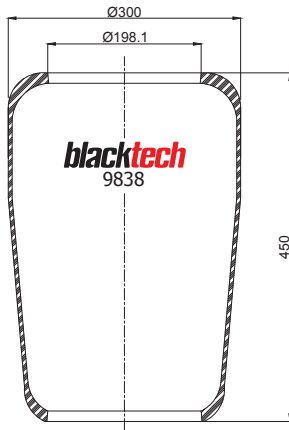

OEM PART NUMBER		MODEL NO	CROSS REFERENCES	
DAF	0 638 148	FT 2300	Contitech	727 N
DAF	0 638 148	FT 2800	Phoenix	1F 32A
Floor	862		Primeride	2727 A
Gigant	196043		Firestone Style	1R2D460-360
MAN	81.436.010.056	Bus 362 H	Firestone No.	W01-095-0191
MAN	81.436.010.057	MAN 292 /F	Goodyear	8117
MAN	81.436.010.058	MAN 292/362 H	Taurus	B149
MAN	81.436.010.076	MAN 362 F	Vibracoustic	V 1 F 32 A
MAN	81.436.010.079	SD 242	CF Gomma Ref.	1SC360-34
MAN	81.436.010.082	SG 242/282	CF Gomma No.	92575
MAN	81.436.010.084	SG 242/292	Dunlop F	D13S04
MAN	81.436.010.091	SG 242/292 F	Dunlop UK	PNP306420100
MAN	81.436.010.114	SG 292 F Israel	Gart Ref.	C 292/D
MAN	81.436.010.116	SUE 290 F Israel	Gart No.	292 D.450
Van Hool	624319-640	TD 824 Astromega		
Van Hool	624319-640	VHAU 115/1		
Van Hool	624319-640	VHCAU 124		
VDL Bus	0 638 148	SB 1604		
VDL Bus	0 638 148	SB 1605		
Volvo	1 134 446	B 10 R		

**RL 9839**



Cross Section View

Top View

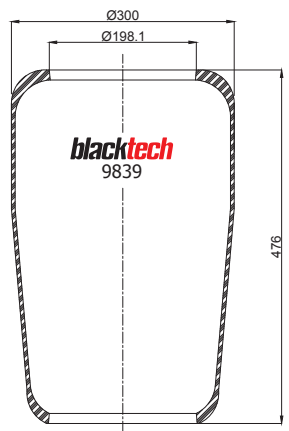

OEM PART NUMBER		MODEL NO	CROSS REFERENCES	
Schmitz	750 212		Contitech	728 N
			Phoenix	1F 32 A
			Firestone Style	1R2S470-360
			Firestone No.	W01-095-0419
			Goodyear	8117
			Vibracoustic	V1F32A
			CF Gomma Ref.	1SC360-34
			CF Gomma No.	92575
			Dunlop UK	PNP306420100

**RL 9848**



Cross Section View

Top View

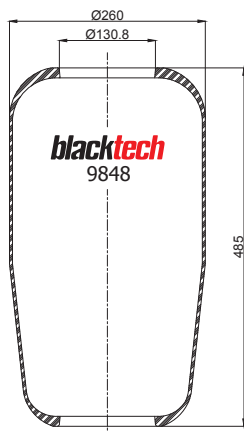

OEM PART NUMBER		MODEL NO	CROSS REFERENCES	
Mercedes	A 393 328 01 01		Contitech	737 N
Pegaso		5316	Phoenix	1F 26
Pegaso		5317	Firestone Style	1R2A480-330
			Firestone No.	W01-095-0211
			Goodyear	9075
			Taurus	BL127
			Vibracoustic	V1F26
			CF Gomma Ref.	1S320-23
			CF Gomma No.	89756
			Dunlop F	D13S06

**RL 9857**



Cross Section View

Top View

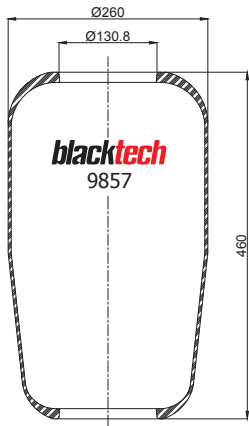

OEM PART NUMBER		MODEL NO	CROSS REFERENCES	
Daimler Chrysler	A 318 328 00 01		Contitech	746 N
			Dunlop F	D13 S07
			Goodyear	9076

**RL 9868**



Cross Section View

Top View

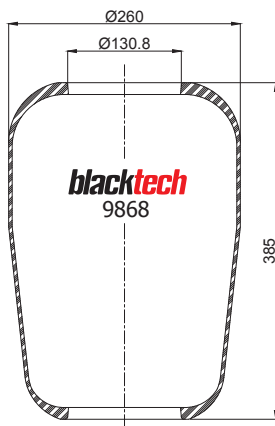

OEM PART NUMBER		MODEL NO	CROSS REFERENCES	
Mercedes	A 363 328 02 01		Contitech	757 N
			Phoenix	1F 26 C
			Firestone Style	1R2A380-305
			Firestone No.	W01-095-0212
			Goodyear	9077
			Taurus	B126
			Vibracoustic	V1F26C
			Dunlop F	D12S20

**RL 9870**



Cross Section View

Top View

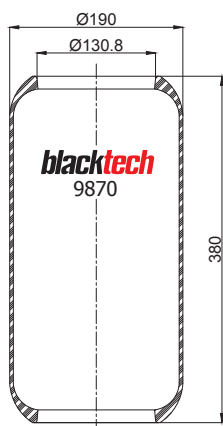

OEM PART NUMBER		MODEL NO	CROSS REFERENCES	
Daewoo	96708574		Contitech	769 N
Heuliez	5 000 805 284	PR 100-GX 107	Phoenix	1 E 18
Heuliez	5 000 805 284	PR 180-GX 187	Firestone Style	1R1A380-260
IRISBUS	5.000.786.640	ER/PR 180	Firestone No.	W01-095-0204
IRISBUS	5.000.805.284	PR 100	Goodyear	8053
IRISBUS	5.000.805.284	PR 100-GX 107 Heuliez	Taurus	B156
IRISBUS	5.000.805.284	PR 14	Vibracoustic	V1E18
IRISBUS	5.000.805.284	PR 180-GX 187 Heuliez	Dunlop F	D10S02
Van Hool	624319-860		Dunlop UK	PNP037690200
Hyundai				
Scania		BF 86/110/111		
Scania		BR CR 110		
Scania		BR/CR 111/111 DH		
Scania		BR/CR 112		
Scania		BR/CR 116		
Scania		BR/CR 145		
Scania		CR 76		

**RL 9873**



Cross Section View

Top View

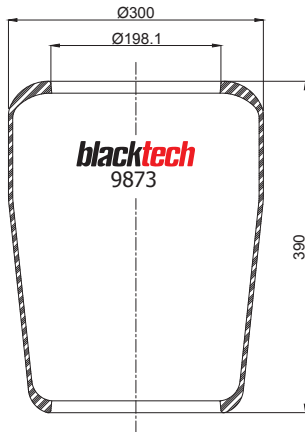

OEM PART NUMBER		MODEL NO	CROSS REFERENCES	
BPW	02.200.24.20.0		Contitech	762 N
Gigant	196035		Phoenix	1 F 32
Kässbohrer	4731013000		Firestone Style	1R2D390-360
MAN	81.436.010.049		Firestone No.	W01-095-0190
MAN	81.436.010.052		Goodyear	9010
Neoplan	1021.00.300		Vibracoustic	V1F32
Van Hool	624319-460	T9	CF Gomma Ref.	1SC360-30
Van Hool	624319-680		CF Gomma No.	92594
VDL Bus	0 644 425	SB 201	Dunlop F	D13S02
Ikarus		19001	Dunlop UK	PNP307800100
Ikarus		19002	Taurus	BL143
Ikarus		Vov - Bus		
EvoBus	A 382 327 71 01			

**RL 9879**



Cross Section View

Top View

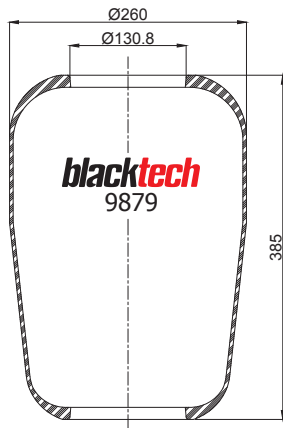

OEM PART NUMBER		MODEL NO	CROSS REFERENCES	
Volvo	1 612 455		Contitech	768 N
Renault	5.000.954.175		Phoenix	1 E 27
			Firestone Style	1R2A380-330
			Firestone No.	W01-095-0213
			Goodyear	9078
			Taurus	B125
			Dunlop F	D13S08
			Gart Ref.	C302/A
			Gart No.	302.0.385
			Vibracoustic	V1 E27

**RL 9886**



Cross Section View

Top View

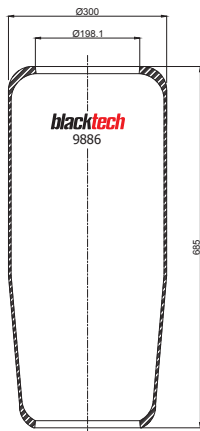

OEM PART NUMBER		MODEL NO	CROSS REFERENCES	
BPW	02.200.24.70.0		Contitech	775 N
Gigant	196038			
Kässbohrer	4.731.040.000			
Kögel	4.731.040.000			

**RL 9893**



Cross Section View

Top View

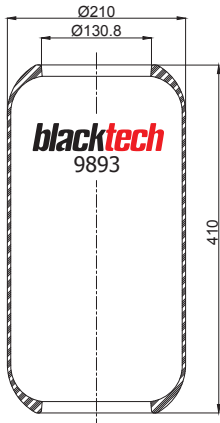

OEM PART NUMBER		MODEL NO	CROSS REFERENCES	
IRISBUS	5000954176	FR 1	Contitech	782 N
IRISBUS	5.000.954.176	Tracer	Phoenix	1 E 21 D
IRISBUS	5.000.324.098	Cityclass	Firestone Style	1R1A415-285
IVECO Bus	5003.24098	Bus 491 (Cityclass)	Firestone No.	W01-095-0197
Volvo	21 102 227		Goodyear	9013
Hyundai			Taurus	B124
Daewoo			Vibracoustic	V1E21D
Temsa			CF Gomma Ref.	1S290-23V
			CF Gomma No.	204427
			CF Gomma No.	204493
			Dunlop F	D11S02
			Gart Ref.	D290
			Gart No.	290.0.420

**RL 9897**



Cross Section View

Top View

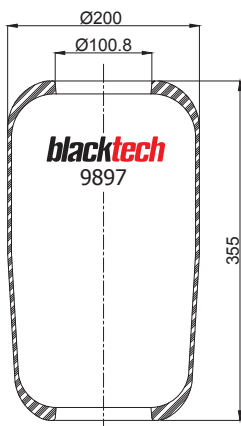

OEM PART NUMBER		MODEL NO	CROSS REFERENCES	
MAN	81.436.010.053	11.190	Contitech	786 N
			Phoenix	1F 14
			Firestone Style	1R1A355-245
			Firestone No.	W01-095-0436
			Vibracoustic	V1F14

**RL 9899**



Cross Section View

Top View

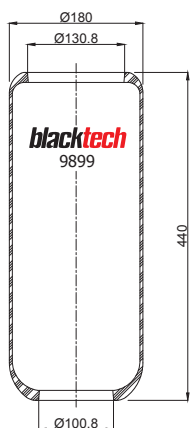

OEM PART NUMBER		MODEL NO	CROSS REFERENCES	
Mercedes	A 674 328 03 01	817 D	Contitech	788 N
Neoplan	1001 12 100		CF Gomma Ref.	1SC240-30
Van Hool	624319-560			
Volvo	6 782 726			

**RL 9907**



Cross Section View

Top View

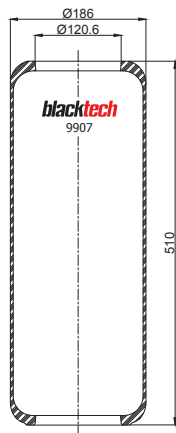

OEM PART NUMBER		MODEL NO	CROSS REFERENCES	
Dennis	1261	Dart SLF	Contitech	896 N
Dennis	806	Javelin	Phoenix	2 E 18 A
Dennis	806	Trident	Primeride	2896 A
Scania	411627	K 112 DR	Firestone Style	1R1J520-285 FF
Scania	411.627	K 112 OR	Firestone No.	W01-095-0245
Scania	411.627	K 112 TR	Goodyear	8040
Scania	411.627	K112 HDR	Taurus	B166
Scania	411.627	K113 DR	Dunlop F	SP2191
			Dunlop UK	PNP305140100

**RL 9908**



Cross Section View

Top View

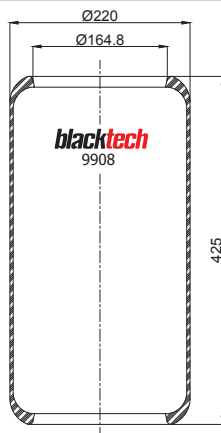

OEM PART NUMBER		MODEL NO	CROSS REFERENCES	
Cardi	58050315		Contitech	897 N
Dennis	800 1/2	Trident	Phoenix	2 E 23
Pegaso	794686	5231	Primeride	2897 A
Pegaso	795097	5231	Firestone Style	1R1K440-320
Scania	411.623	BR 116	Firestone No.	W01-095-0229
Scania	411.623	CR76 VA	Firestone No.	W01-095-0174
Scania	411.623	K 112 DR	Goodyear	8028
Scania	411.623	K 112 DR	Goodyear	8313
Scania	411.623	K 112 TR	Taurus	B165
Scania	411.623	K 113 T	Vibracoustic	V2E23
Scania	411.623	K 113 TLA	CF Gomma Ref.	1S320-30
Scania	411.623	K 82-112	CF Gomma No.	88788
Scania	411.623	K 93 / K113	Dunlop F	SP2192
Scania	411.623	L 113	Dunlop UK	PNP305210101
Scania	411623	L 113 CLD	Gart Ref.	D278
Scania	411623	L 92 / K 112	Gart No.	278.0.430
Scania	411623	L 92 / K 113		
LAG		E 180 Z		
LAG		EOS		
LAG		Galaxy		

**RL 9920**



Cross Section View

Top View

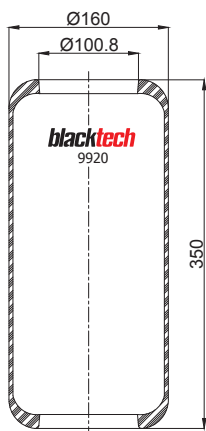

OEM PART NUMBER		MODEL NO	CROSS REFERENCES	
BredaMenarini	192 709		Contitech	819 N
Mercedes	A 000 328 01 01	Vario / TO	CF Gomma Ref.	1S215-22
Optare	UN15966	Bus and Coach	CF Gomma No.	90609
Temsa			CF Gomma No.	206730
			Gart Ref.	C296C
			Gart No.	296.0.360
			Vibracoustic	V 1E14

**RL 9928**



Cross Section View

Top View

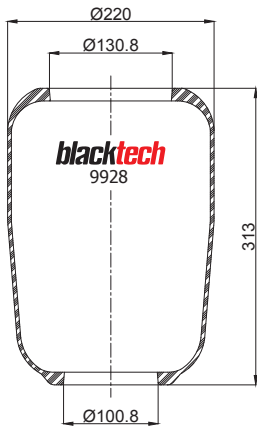

OEM PART NUMBER		MODEL NO	CROSS REFERENCES	
BredaMenarini	252 933	Bus 230	Contitech	817 N
IRISBUS	5.000.805.998		CF Gomma Ref.	ISC 260-30
IRISBUS	5.810.805.998		CF Gomma No.	97613
IRISBUS	5.000.768.641	PR 100 Algérie	Gart Ref.	C289/BS
			Gart No.	289.0.301

**RL 9949**



Cross Section View

Top View

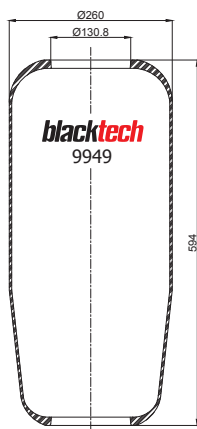

OEM PART NUMBER		MODEL NO	CROSS REFERENCES	
Mercedes	A 674 328 00 01		Contitech	838 N
			Phoenix	1F 26 D
			Goodyear	9074
			Vibracoustic	V1F26D
			Dunlop F	D13S05

**RL 9984**



Cross Section View

Top View

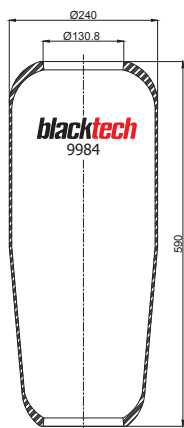

OEM PART NUMBER		MODEL NO	CROSS REFERENCES	
Mercedes	A 674 328 01 01		Contitech	873 N



**RL 9987**



Cross Section View

Top View

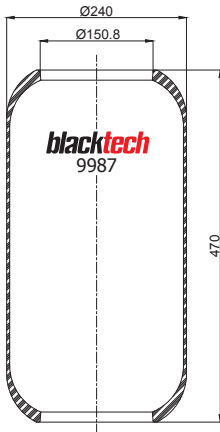

OEM PART NUMBER		MODEL NO	CROSS REFERENCES	
IRISBUS	5000296816	R 312	Contitech	876 N
IRISBUS	5.000.296.816	Tracer	Goodyear	8314
IRISBUS	5.000.296.827	Tracer R 333	CF Gomma Ref.	1S323-34
IVECO	8.139.068		CF Gomma No.	92477
IVECO	41.022.620		CF Gomma No.	203833
			Gart Ref.	D298/C
			Gart No.	298.0.460

**RL 9993**



Cross Section View

Top View

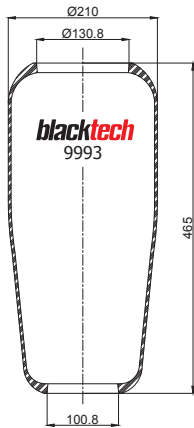

OEM PART NUMBER		MODEL NO	CROSS REFERENCES	
BredaMenarini	D031115		Contitech	882 N1
MAN	81.436.010.065	10.150	Phoenix	1F 16
MAN	81.436.010.067	F 90. F2000	Primeride	2882 A
MAN	81.436.010.070	F 90. F2000	Firestone Style	1R4R465-260
MAN	81.436.010.092	F 90. F2000	Firestone No.	W01-095-0435
MAN	81.436.010.099	F 90. F2000	Goodyear	9048
MAN	81.436.010.103	F 90. F2000	Taurus	B155
MAN	81.436.010.121	F 90. F2000	Vibracoustic	V1F16
MAN	81.436.010.132	F 90. F2000	CF Gomma Ref.	1SC250-28
Mercedes	A 699 328 01 01	F 90. F2000	CF Gomma No.	97042
			Dunlop F	D12S12
			Gart Ref.	C289/D
			Gart No.	289.0.400

**RL 9994**



Cross Section View

Top View

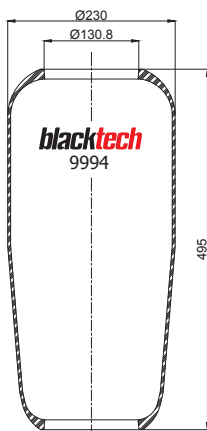

OEM PART NUMBER		MODEL NO	CROSS REFERENCES	
MAN	81436010071	F 90	Contitech	883 N1
MAN	81.436.010.072		Phoenix	1F 21 C-2
MAN	81.436.010.110		Goodyear	9012
MAN	81.436.010.128		Vibracoustic	V1F21C-2
MAN	81.436.010.137		CF Gomma Ref.	1SC250-28
Volvo	1 082 085		CF Gomma No.	204250
Pegaso			Dunlop F	D13S03

**RL 9995**



Cross Section View

Top View

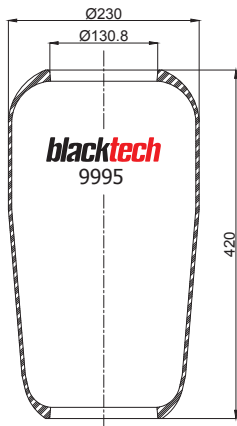

OEM PART NUMBER		MODEL NO	CROSS REFERENCES	
IRISBUS	5.000.301.452		Contitech	884 N1
IRISBUS	5.010.294.385		Phoenix	1F 20 A
IVECO	8188539	Eurotech MP/LP 180 E	Primeride	2884 A
IVECO	8188539	Eurotech MP/LP 190 E	Goodyear	9002
IVECO	8188.539	Eurotech MP/LP 240 E	Taurus	BL249
IVECO	8188.539	Eurotech MP/LP 260 E	Vibracoustic	V1F20A
IVECO	8188.539	Eurotech MP/LP 400 E	CF Gomma Ref.	1SC250-29
IVECO	8188.539	Eurotech MP/LP 440 E	CF Gomma No.	97608
IVECO Bus	5003 01452		CF Gomma No.	97043
IVECO Bus	97108.363	Bus 5522	Dunlop F	D12S06
MAN	81.436.010.066	14 232		
MAN	81.436.010.068	15 168 FL/BL		
MAN	81.436.010.069	15 200/40 FL		
MAN	81.436.010.106	15 240 FL/BL		
MAN	81.436.010.108	NL 202 München		
MAN	81.436.010.108	NL 202 Podestlos		
MAN	81.436.010.108	NL CNG Podestl.		
Pegaso	8188539	5035 N		
Pegaso	8188539	6031		
Pegaso	8188539	6035		

**RL 90541**



Cross Section View

Top View

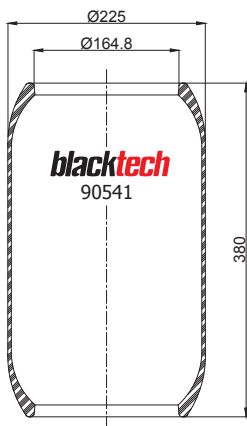

OEM PART NUMBER		MODEL NO	CROSS REFERENCES	
			Firestone Style	1R1K-380-300
			Firestone Style	W01 095 0541

**RL 90789**



Cross Section View

Top View

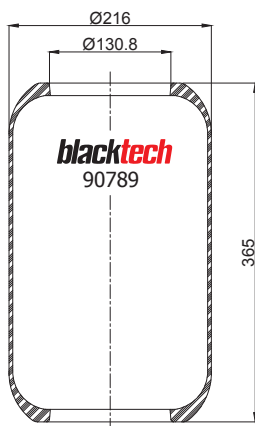

OEM PART NUMBER		MODEL NO	CROSS REFERENCES	
Volvo	20540789		Goodyear	9081

**RL 90907**



Cross Section View

Top View

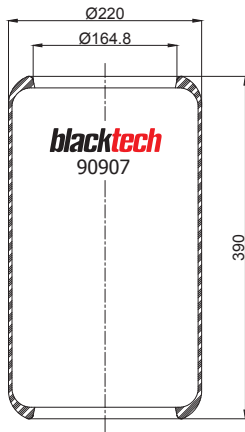

OEM PART NUMBER	MODEL NO	CROSS REFERENCES	
		Dunlop UK	PNP 309070100

**RL 90931**



Cross Section View

Top View

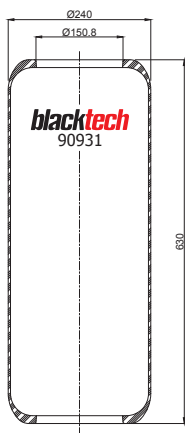

OEM PART NUMBER	MODEL NO	CROSS REFERENCES	
Iveco	500310931	Eurotech	CF Gamma Ref. 1S 323-40
		Eurostar (2000)	CF Gamma No. 204290

**RL 91277**



Cross Section View

Top View

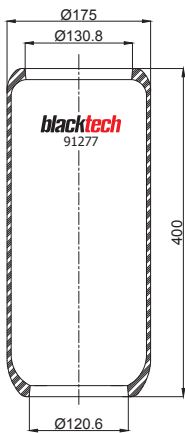

OEM PART NUMBER	MODEL NO	CROSS REFERENCES	
Volvo	3.111.277	Dunlop UK	A 310950013
Volvo	3.112.775.291	Firestone Style	1R4U 395-260
		Firestone Order	W01 095 0453

**RL 91523**



Cross Section View

Top View

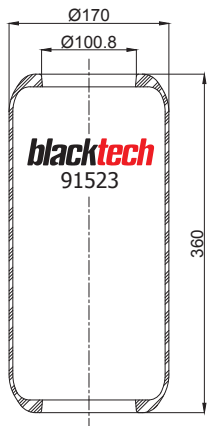

OEM PART NUMBER		MODEL NO	CROSS REFERENCES	
Iveco	500301776	Eurocargo 120 - 150	CF Gomma Ref.	1S 215-23
			CF Gomma No.	202189

**RL 91994**



Cross Section View

Top View

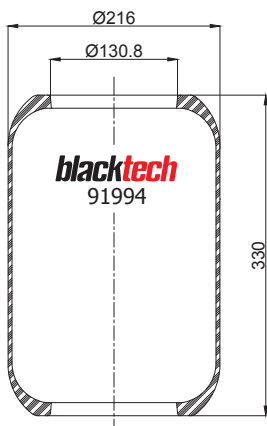

OEM PART NUMBER		MODEL NO	CROSS REFERENCES	
Iveco	42531994	Bus 491	CF Gomma Ref.	1S 270-20V
Iveco	42531994	Cityclass	CF Gomma No.	202773
BredaMenarini Bus	D020990		Gart Ref.	D290E
			Gart No.	290.0.340

**RL 92023**



Cross Section View

Top View

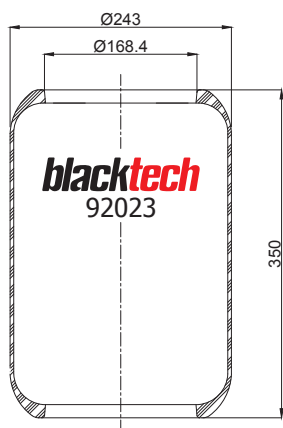

OEM PART NUMBER		MODEL NO	CROSS REFERENCES	
Bredamenaribus	178739	101-102-110L-120	CF Gomma Ref.	1S 320-23
Bartoletti	91644001		CF Gomma No.	88806

**RL 92035**



Cross Section View

Top View

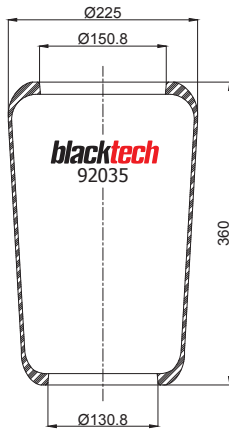

OEM PART NUMBER		MODEL NO	CROSS REFERENCES	
IRISBUS	5.001.843.640	Agora/Crystallis < 2004	Contitech	1924 N1
			Phoenix	2 F 18
			Gart Ref.	C298/E
			Gart No.	289.0.360

**RL 92336**



Cross Section View

Top View

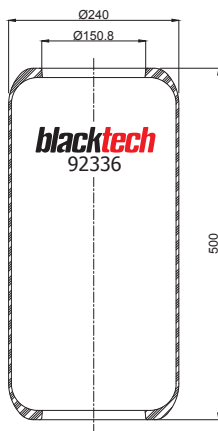

OEM PART NUMBER		MODEL NO	CROSS REFERENCES	
Iveco	41022620	Eurotech MP 240E-440E	CF Gomma Ref.	1S 323-36
		Eurostar 1997	CF Gomma No.	203833
		Eurorider		

**RL 92526**



Cross Section View

Top View

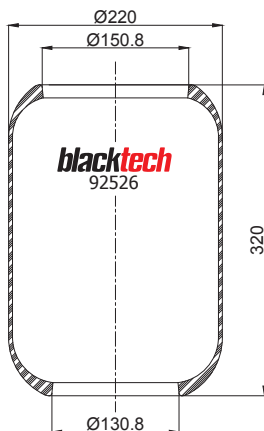

OEM PART NUMBER		MODEL NO	CROSS REFERENCES	
IRISBUS	5.001.021.414	Agora/Crystallis 2004	Contitech	1415 N
			Phoenix	1 E 23 A
			Goodyear	9113

**RL 92527**



Cross Section View

Top View

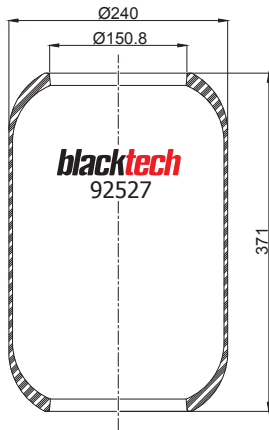

OEM PART NUMBER		MODEL NO	CROSS REFERENCES	
Iveco	503130261		Contitech	1416 N P01

**RL 92528**



Cross Section View

Top View

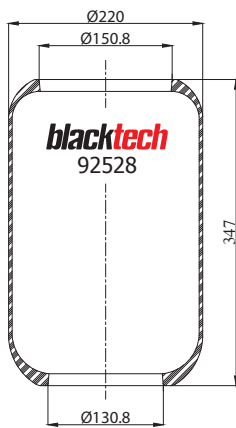

OEM PART NUMBER		MODEL NO	CROSS REFERENCES	
Iveco	503129220		Contitech	1417 N

**RL 92532**



Cross Section View

Top View

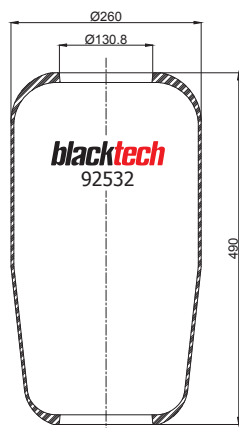

OEM PART NUMBER		MODEL NO	CROSS REFERENCES	
Volvo	1 075 290		Contitech	1421 N
			Firestone Style	1R2A490-305
			Firestone No.	W01-095-0472
			Goodyear	9072
			Dunlop F	D12S18
			Gart. Ref.	C299/E
			Gart No.	299.0.490

**RL 92831**



Cross Section View

Top View

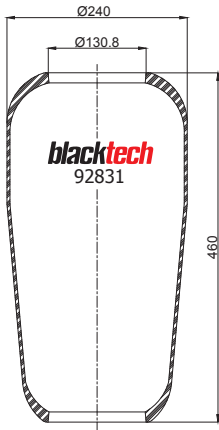

OEM PART NUMBER		MODEL NO	CROSS REFERENCES	
Mercedes	A 655 327 00 01		Contitech	1720 N
			Goodyear	9068
			Dunlop F	D12S17

**RL 92844**



Cross Section View

Top View

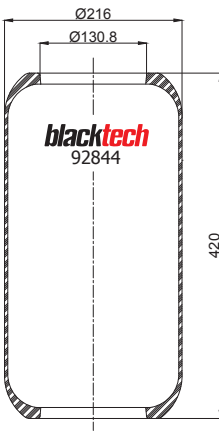

OEM PART NUMBER		MODEL NO	CROSS REFERENCES	
Iveco	5000787632	Eurotech 180 E	CF Gomma Ref.	1S 270-25 C
Iveco	5000869179	Eurotech 190 E	CF Gomma No.	97608
Iveco	5000954176	Eurotech 240 E		
Iveco	5010073847	Eurotech 260 E		
Iveco	5010151699	Eurotech 400 E		
Iveco	0501210851	Eurotech 440 E		
Iveco		Eurostar		

**RL 92885**



Cross Section View

Top View

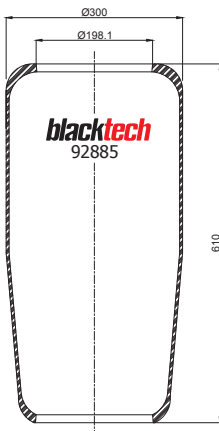

OEM PART NUMBER		MODEL NO	CROSS REFERENCES	
BPW	02.200.24.30.0		Contitech	1774 N
Gigant	196039			
Kässbohrer	4.731.038.000			
Schmitz	750 225			

**RL 92893**



Cross Section View

Top View

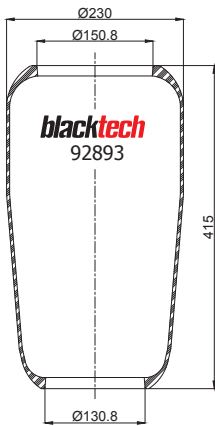

OEM PART NUMBER		MODEL NO	CROSS REFERENCES	
IRISBUS	5.001.857.612	Illade/Ares	Contitech	1782 N1
			CF Gomma Ref.	1SC285-30
			CF Gomma No.	207726
			Gart Ref.	C289/G
			Gart No.	289.0.460

**RL 92899**



Cross Section View

Top View

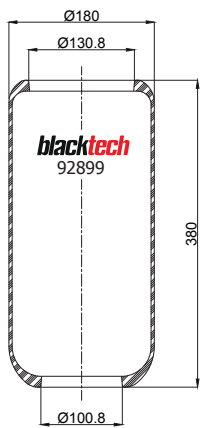

OEM PART NUMBER		MODEL NO	CROSS REFERENCES	
IVECO Bus	93166132	Bus 490 (Sicca)	Contitech	1788 N
			CF Gomma Ref.	1SC260-31
			CF Gomma No.	97569

**RL 92920**



Cross Section View

Top View

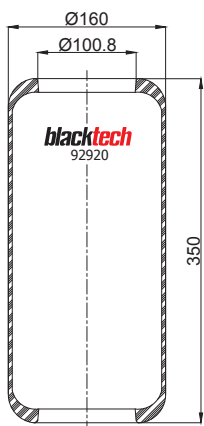

OEM PART NUMBER		MODEL NO	CROSS REFERENCES	
IVECO Bus	93166129	Bus 490 (Sicca)	Contitech	1819 N
Pegaso	93166129	5522	Phoenix	1E 14
Pegaso	93166129	6522	Firestone Style	1R1S350-225
			Firestone No.	W01-095-0543
			Vibracoustic	V1E14
			CF Gomma Ref.	1S215-23
			CF Gomma No.	202189
			Gart Ref.	D296/G
			Gart No.	296.0.360



**RL 92996**



Cross Section View

Top View

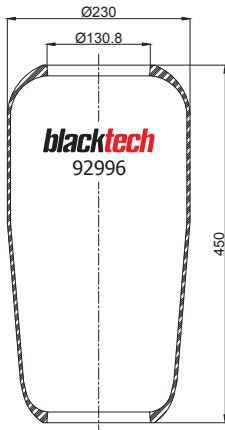

OEM PART NUMBER		MODEL NO	CROSS REFERENCES	
IVECO	98478799		Contitech	1885 N1
MAN	81.436.010.104		Phoenix	1 F 20 B
MAN	81.436.010.109		Primeride	21885 A
MAN	81.436.010.111	18 310	Firestone Style	1R2A445-280
MAN	81.436.010.123	18 313	Firestone No.	W01-095-0429
MAN	81.436.010.125	F2000 (24 232)	Goodyear	9003
MAN	81.436.010.125	FL (24 232)	Vibracoustic	V1F20B
MAN	81.436.010.125	FLAS (24 232)	CF Gomma Ref.	1SC270-28
MAN	81.436.010.125	FLL (24 232)	CF Gomma No.	97043
MAN	81.436.010.125	FLLS (24 232)	CF Gomma No.	202265
MAN	81.436.010.125	FLS (24 232)	Dunlop F	D12S07
MAN	81.436.010.140	F2000 (24 272)	Gart Ref.	C289/C
MAN	81.436.010.140	FNL (24 272)	Gart No.	289.0.450
MAN	81.436.010.140	FNLL (24 272)		
MAN	81.436.010.150	24 372		

**RL 92997**



Cross Section View

Top View

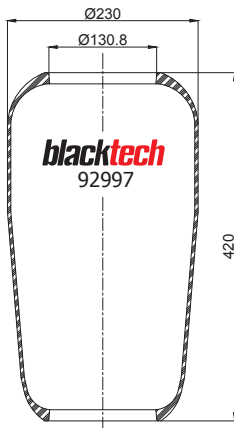

OEM PART NUMBER		MODEL NO	CROSS REFERENCES	
MAN	81.436.010.161	NEOMAN Bus	Contitech	1886 N
			Vibracoustic	V1F20A

**RL 92999**



Cross Section View

Top View

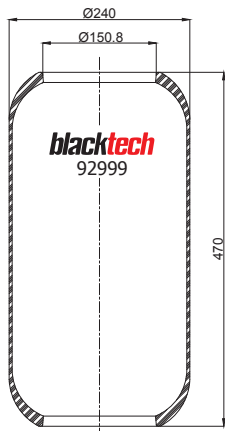

OEM PART NUMBER		MODEL NO	CROSS REFERENCES	
MAN	81.436.010.163		Contitech	1888 N
ZF Sachs	00 1748 451 100		Goodyear	9123

**RL 93220**



Cross Section View

Top View

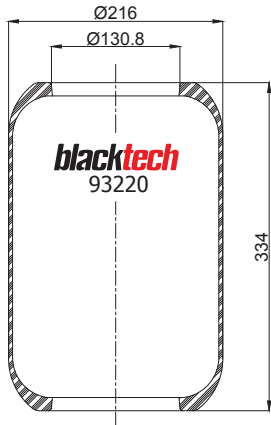

OEM PART NUMBER		MODEL NO	CROSS REFERENCES	
Iveco	4843220	Bus 480 - 580 - 680	CF Gamma Ref.	1S 285-20V
Iveco	4823495		CF Gamma No.	96534
			Gart. Ref.	276 / E
			Gart. No.	276.0.330

**RL 93351**



Cross Section View

Top View

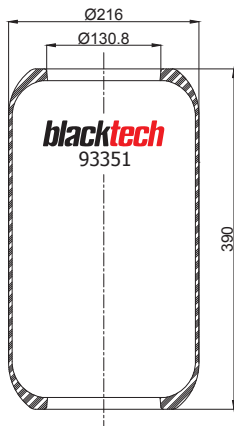

OEM PART NUMBER		MODEL NO	CROSS REFERENCES	
Iveco	42549268	Cityclass TT	CF Gamma Ref.	1S 270 23 V
			CF Gamma No.	206662

**RL 93856**



Cross Section View

Top View

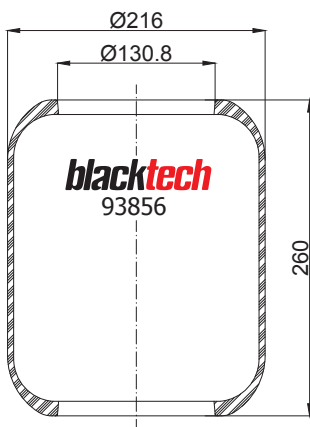

OEM PART NUMBER		MODEL NO	CROSS REFERENCES	
Voith				

**RL 93857**



Cross Section View

Top View

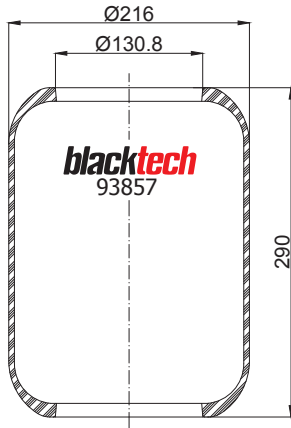

OEM PART NUMBER	MODEL NO	CROSS REFERENCES	
Voith			

**RL 94098**



Cross Section View

Top View

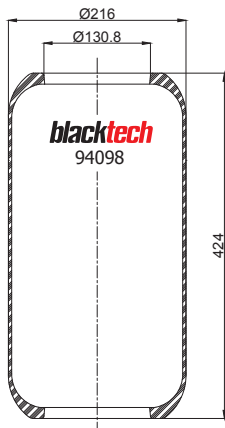

OEM PART NUMBER	MODEL NO	CROSS REFERENCES	
Iveco	500324098	Bus 491	CF Gomma Ref. 1S 290-23V
Iveco	500324098	Cityclass	CF Gomma No. 204427
		Gart	D286/ 286.0.420

**RL 94663**



Cross Section View

Top View

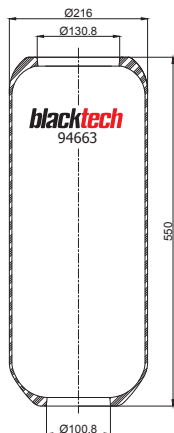

OEM PART NUMBER	MODEL NO	CROSS REFERENCES	
Iveco	500364663	Eurotech	CF Gomma Ref. 1S 290 30 V
			CF Gomma No. 205074

**RL 95019**



Cross Section View

Top View

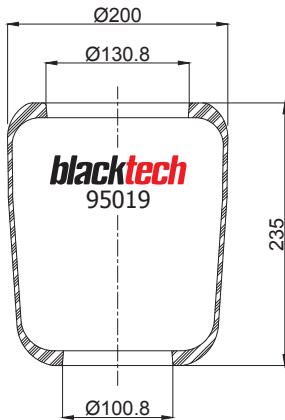

OEM PART NUMBER		MODEL NO	CROSS REFERENCES	
Iveco	41006926	Eurotech	CF Gamma Ref.	1SC 250-19
Iveco	ZEV13541	Modena-Rampini-ZEV	CF Gamma No.	201727
			Gart	C301/B - 301.0.235

**RL 95471**



Cross Section View

Top View

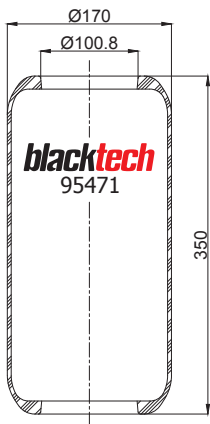

OEM PART NUMBER		MODEL NO	CROSS REFERENCES	
Iveco	98445471	Bus 490	CF Gamma Ref.	1S 215 22
Autodromo Modena	577472	Bus Ale	CF Gamma No.	90609 ( 206730 )
Iveco	93166129	Bus 490		
Bredamenaribus	192709	Bus 230		
Mercedes Benz	A6673280001			
Mercedes Benz	A6673280101			

**RL 95875**



Cross Section View

Top View

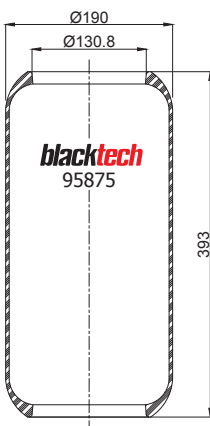

OEM PART NUMBER		MODEL NO	CROSS REFERENCES	
Volvo	20553875		Goodyear	9080
			Phoenix	1E 18D

**RL 96032**



Cross Section View

Top View

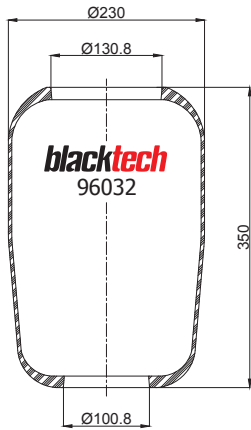

OEM PART NUMBER		MODEL NO	CROSS REFERENCES	
Iveco	98411807	Eurocargo 120E-150E	CF Gomma Ref.	ISC 260-32
			CF Gomma No.	96987
			Gart Ref.	C289
			Gart No.	289.0.350

**RL 97019**



Cross Section View

Top View

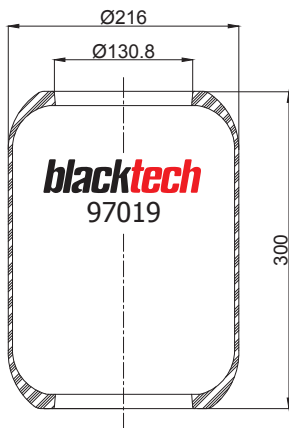

OEM PART NUMBER		MODEL NO	CROSS REFERENCES	
Iveco	41008929	Eurotech	CF Gomma Ref.	ISC 270-19
			CF Gomma No.	201732
			Gart Ref.	D 276/F
			Gart No.	276.0.300

**RL 97026**



Cross Section View

Top View

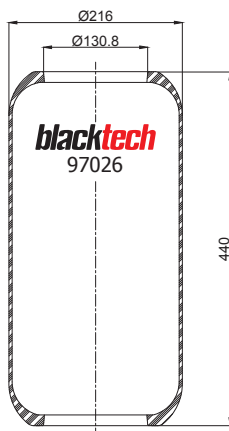

OEM PART NUMBER		MODEL NO	CROSS REFERENCES	
Iveco	500364686	Eurotech	CF Gomma Ref.	ISC 270-26
		Eurostar	CF Gomma No.	203933
			Gart Ref.	D 290/C
			Gart No.	290.0.440

**RL 97027**



Cross Section View

Top View

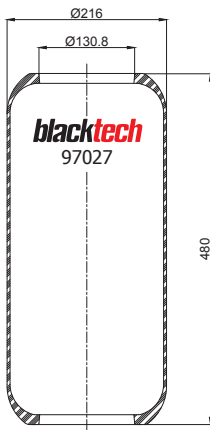

OEM PART NUMBER		MODEL NO	CROSS REFERENCES	
Iveco	500319479	Eurotech	CF Gomma Ref.	1SC 270-27
		Eurostar	CF Gomma No.	203698
		Stralis	Gart Ref.	D 290/D
			Gart No.	290.0.480

**RL 97054**



Cross Section View

Top View

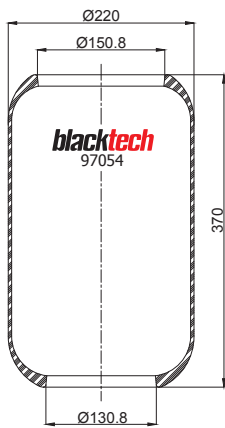

OEM PART NUMBER		MODEL NO	CROSS REFERENCES	
VOLVO	70377054	B7R/B9R/B11R/B13R	Contitech	6611 N
			Goodyear	9138

**RL 97075**



Cross Section View

Top View

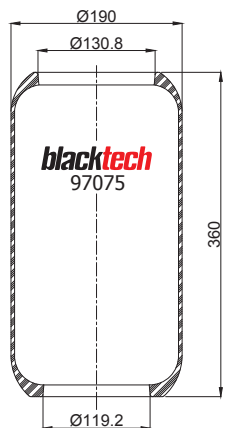

OEM PART NUMBER		MODEL NO	CROSS REFERENCES	
Volvo	20540792		Goodyear	9112
Volvo	21347075			

**RL 97489**



Cross Section View

Top View

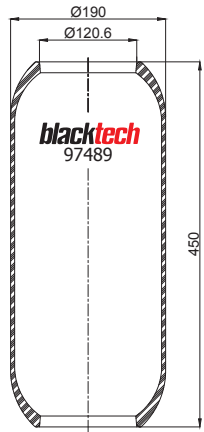

OEM PART NUMBER	MODEL NO	CROSS REFERENCES
Denis 657489-2		

**RL 97743**



Cross Section View

Top View

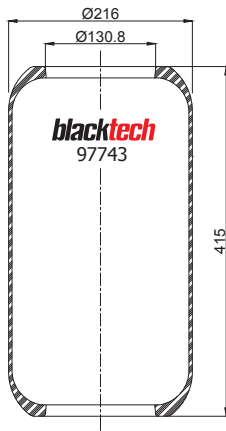

OEM PART NUMBER	MODEL NO	CROSS REFERENCES
Iveco 4716989 ( Old )	Bus 370 - 380	CF Gomma Ref. 1S 285 25 C
Iveco 2997743 ( New )	Bus 370 - 380	

**RL 97756**



Cross Section View

Top View

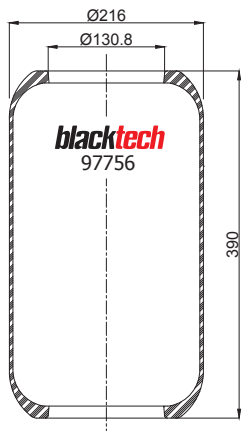

OEM PART NUMBER	MODEL NO	CROSS REFERENCES
Iveco 99459166 ( Old )	Bus 370 - 380	CF Gomma Ref. 1S 270-23V
Iveco 2997756 ( New )	Bus 370 - 380	

**RL 98183**



Cross Section View

Top View

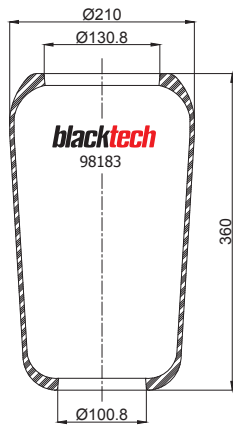

OEM PART NUMBER		MODEL NO	CROSS REFERENCES	
Iveco	42568183	Astra	CF Gamma Ref.	1SC 230-25

**RL 98518**



Cross Section View

Top View

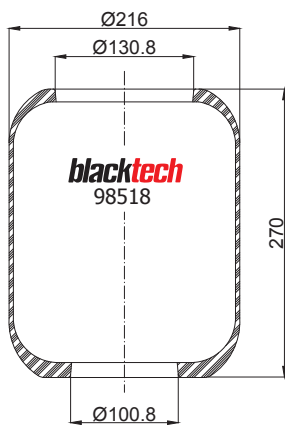

OEM PART NUMBER		MODEL NO	CROSS REFERENCES	
Iveco	8160165	Eurotech MP 400 E	CF Gamma Ref.	1S 285-18 C
			CF Gamma No.	97261

**RL 98739**



Cross Section View

Top View

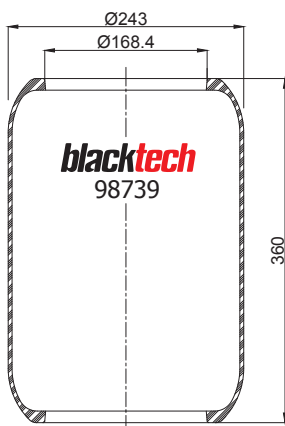

OEM PART NUMBER		MODEL NO	CROSS REFERENCES	
Voith				



**RL 99201**



Cross Section View

Top View

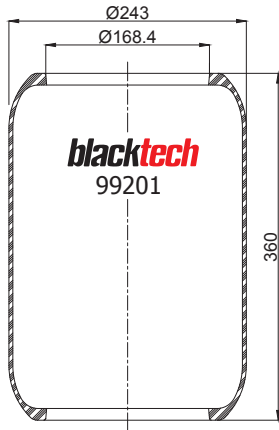

OEM PART NUMBER	MODEL NO	CROSS REFERENCES
Otokar		

**RL 99202**



Cross Section View

Top View

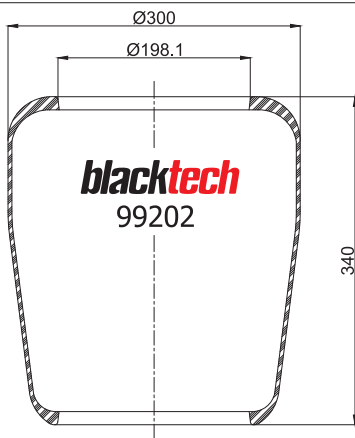

OEM PART NUMBER	MODEL NO	CROSS REFERENCES
Otokar		

**RL 99203**



Cross Section View

Top View

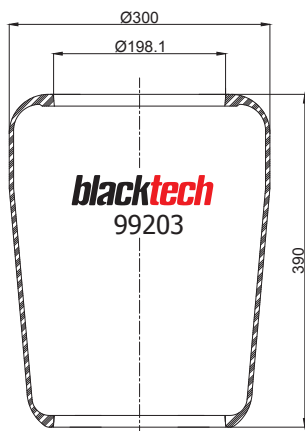

OEM PART NUMBER	MODEL NO	CROSS REFERENCES
Otokar		

**RL 99205**



Cross Section View

Top View

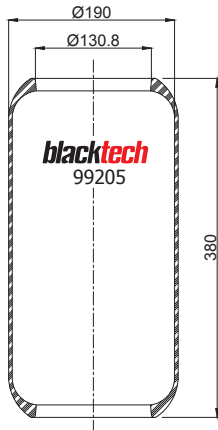

OEM PART NUMBER	MODEL NO	CROSS REFERENCES
Otokar		

**RL 99206**



Cross Section View

Top View

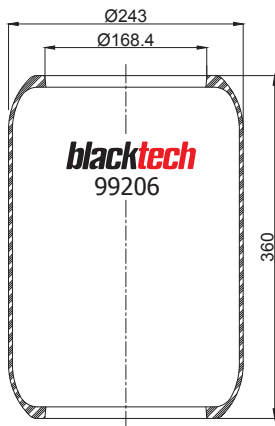

OEM PART NUMBER	MODEL NO	CROSS REFERENCES
Otokar		

**RL 99207**



Cross Section View

Top View

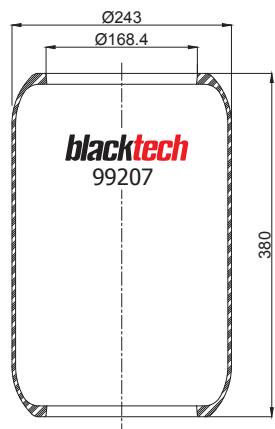

OEM PART NUMBER	MODEL NO	CROSS REFERENCES
Karsan		

**RL 99208**



Cross Section View

Top View

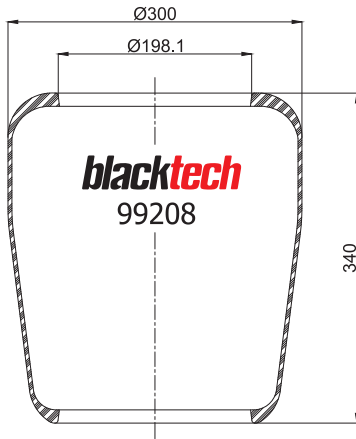

OEM PART NUMBER	MODEL NO	CROSS REFERENCES
Karsan		

**RL 99209**



Cross Section View

Top View

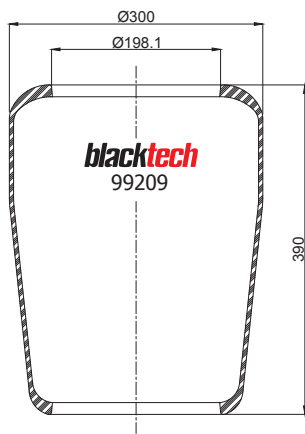

OEM PART NUMBER	MODEL NO	CROSS REFERENCES
Karsan		

**RL 9526-36**



Cross Section View

Top View

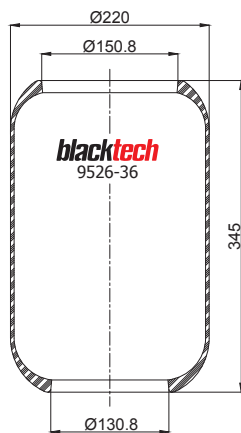

OEM PART NUMBER	MODEL NO	CROSS REFERENCES		
Volvo	3 027 271	B 10 M	Contitech	RZ 415-25
Volvo	3 027 271	B 10 M MK 4	Phoenix	2 G 20
Volvo	3 027 271	B 10 M MK III G	Primeride	2415-25 A
			Firestone Style	1R5P345-290
			Firestone No.	W01-095-0381
			Goodyear	9004
			Taurus	B271
			Vibracoustic	V2G20
			CF Gomma Ref.	1S280-25
			CF Gomma No.	203000
			Dunlop F	D12S08
			Dunlop UK	00986A-AP

**RL 9526-39**



Cross Section View

Top View

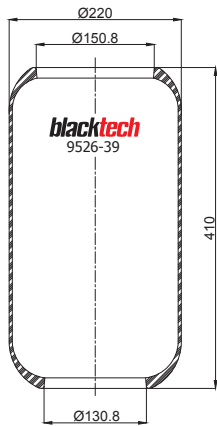

OEM PART NUMBER		MODEL NO	CROSS REFERENCES	
Volvo	3 027 272	B 10 B	Contitech	RZ 415-28
Volvo	3 027 272	B 10 M 4	Phoenix	2 G 20 A
Volvo	3 027 272	B 10 M MK III G	Primeride	2415-28 A
Volvo	3 027 272	B 10 M MK IV	Firestone Style	1R5P410-290
Volvo	3 027 272	B 12	Firestone No.	W01-095-0382
			Goodyear	9005
			Taurus	B272
			Vibracoustic	V2G20A
			CF Gamma Ref.	1S280-25
			CF Gamma No.	203001
			Dunlop F	D12S09

**RL 9561-36**



Cross Section View

Top View

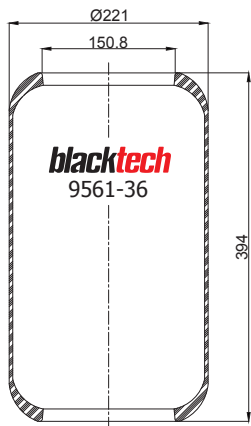

OEM PART NUMBER		MODEL NO	CROSS REFERENCES	
EvoBus	A 356 327 00 01	O 404	Contitech	RZ 450-25
EvoBus	A 356 327 02 01	O 403 RHD, SHD EURO 2/3	Phoenix	1E 23
IVECO Bus	93197594		Primeride	2450-25 A
MB Tuerk	A 356 327 00 01	O 404	Goodyear	9050
MB Tuerk	A 613 327 01 01	O 404	Taurus	BL128
EvoBus	A 613 327 01 01	O 350 Turismo O 403	Vibracoustic	V1E23
			CF Gamma Ref.	1S300-27
			CF Gamma No.	203386
			Dunlop F	D12S13



**ROLL AIR SPRINGS CROSS LIST**

	Blacktech	ContiTech	Phoenix	Firestone Style	Firestone No.	Goodyear	CF Gomma Ref. / CF Gomma No.
RL	9001						
RL	9002						
RL	9003		1G 08				
RL	9027	916 NI	1F 21 C-5 / 1F 21 C-6	2R2A460-295	W01 095 0555	9015	
RL	9032	921 N	1E 17	1R1A 415 260	W01 095 0226	8043	1S 285-23 / 202728
RL	9038	927 N	2 E 18 B	1R1J 415 285	W01 095 0244	8037	
RL	9039	928 N	2 E 23 A	1R1K 380 320	W01 095 0228	8042	
RL	9054	943 N		1R1A 260 285	W01 095 0189	9001	1S 285-18 / 88809
RL	9055	944 N	1E 21-6	1R1B 390 270	W01 095 0121	9009	1S 285-22 / 97619
RL	9056	945 N	1E 21 C	1R1A 460 290	W01 095 0063	9014	1S 285-25 / 97555
RL	9057	946 N	1F 20 C				1SC 290-28 / 207725
RL	9086	975 N	1E 10 C	1R1T 320 195	W01 095 0437		
RL	9755	644 N	1 E 21	1R1A 390-295	W01 095 0118	8017	1S 285-24 / 92574
RL	9756						
RL	9772	661 N	1 E 25	1R1C 390-310	W01 095 0021	8018	1S 310-28RF / 91016
RL	9773	662 N	1 E 32	1R1D 355-355	W01 095 0207	9007	1SC 360-30 / 92594
RL	9784	673 N	1F 21 A	1R1A 370-285	W01 095 0198	9051	1S 285-22 / 88786
RL	9812	701 N	1 E 26	1R3M 340-340	W01 095 0205	9006	
RL	9817	706 N				9067	
RL	9820	719 N	1F 32 B	1R2D 530-360	W01 095 0192	8118	1SC 360-43 / 92593
RL	9824	713 N	1F 21D			9066	
RL	9826	715 N	1F 25	1R1C 335-310	W01 095 0087	8015	1SC 310-16 / 93518
RL	9827	716 N	1F 26 B-1	1R2A 450-305	W01 095 0145	9073	1SC 310-16 / 92548
RL	9831	720 N	1F 21	1R2A 460-295	W01 095 0195	9008	1SC 290-30 / 88802
RL	9838	727 N	1F 32 A	1R2D 460-360	W01 095 0191	8117	1SC 360-34 / 92575
RL	9839	728 N	1F 32 A	1R1K 470 360	W01 095 0419	8117	1SC 360-34 / 92575
RL	9848	737 N	1F 26	1R2A 480-330	W01 095 0211	9075	1S 320-23 / 89756
RL	9857	746 N				9076	
RL	9868	757 N	1F 26 C	1R2A 380-305	W01 095 0212	9077	
RL	9870	769 N	1 E 18	1R1A 380-260	W01 095 0204	8053	
RL	9873	762 N	1F 32	1R2D 390-360	W01 095 0190	9010	1SC 360-30 / 92594
RL	9879	768 N	1 E 27	1R2A 380-330	W01 095 0213	9078	
RL	9886	775 N					
RL	9893	782 N	1 E 21 D	1R1A 415-285	W01 095 0197	9013	1S 290-23 V / 204427 - 204493
RL	9897	786 N	1F 14	1R2S 355 245	W01 095 0436		
RL	9899	788 N					1SC 240-30
RL	9907	896 N	2 E 18 A	1R1J 520-285 FF	W01 095 0245	8040	
RL	9908	897 N	2 E 23	1R1K 440-320	W01 095 0229	8028 / 8313	1S 320 30 / 88788
RL	9920	819 N					1S 215-22 / 90609 - 206730
RL	9928	817 N					1SC 260-30 / 97613
RL	9949	838 N	1F 26 D			9074	
RL	9984	873 N					

No.	Vibracoustic	Gart Ref. / Gart No.	Dunlop UK	Dunlop F (Springride)	Taurus	TOYO	Page
						TRL 240	19
						F 25	19
							19
	V1F 21C-5	C289/C1 - 289.0.455		D12S05	B 154		20
	V1E 17	D 276 BS - 276.0.391		D10S04	B 158		20
	V 2 E 18 B		PNP 300080100		B 179		20
	V 2 E 23 A		1C 3308	D12S03	B 178		21
		D 276/ D - 276.0.260	PNP 316730100	D11S05	B 194		21
	V1E 21-6	D 290/B - 290.0.390		D11S04	B 113		21
		D 276 - 276.0.420	PNP 301000101	D11S01	B 124		22
	V1F 20 C-6						22
	V1E 10	D305 - 305.0.320	00628A-AP				22
	V1E 21	D 276/B - 276.0.390	PNP 301470102	D11S01	BL 121		23
							23
	V1E 25	D 297 - 297.0.390	304980101	D12S02 RE	BL 114		23
	V1E 32		PNP 302730101	D13S01	BL 143		24
	V1F 21 A			D11S06	B 141		24
	V1E 26	D 276 / C - 276.0.370			B 116		24
				D12S16			25
	V1F 32 B	C 292 / E - 292.0.520	PNP 304620101		B 153		25
	V1F 21 D	C 304/B - 304.0.490		D12S15			25
	V1F 25	C292/C - 292.0.380	PNP 304890101		B 144		26
	V1F 26 B-1			D12S19	B 197		26
	V1F 21	C 299 - 299.0.450	PNP 301000100	D12S04	B 152		26
	V1F 32 A	C 292/D - 292.0.450	PNP 306420100	D13S04	B 149		27
	V1F 32 A		PNP 306420100				27
	V1F 26			D13S06	BL 127		27
				D13S07			28
	V1F 26 C			D12S20	B 126		28
	V1E 18		PNP 037690200	D10S02	B 156		28
	V1F 32		PNP 307800100	D13S02	BL 143		29
	V1E 27	C302/A - 302.0.385		D13S08	B 125		29
							29
	V1E 21 D	D 290 - 290.0.420		D11S02	B 124		30
	V1F 14						30
							30
			PNP 305140100	SP2191	B 166		31
	V 2 E 23	D 278 - 278.0.430	PNP 305210101	SP2192	B 165		31
	V1E 14	296/C - 296.0.360					31
		C 289/BS - 289.0.301					32
	V1F 26 D			D13S05			32
							32

**ROLL AIR SPRINGS CROSS LIST**

Blacktech	ContiTech	Phoenix	Firestone Style	Firestone No.	Goodyear	CF Gomma Ref. / CF Gomma No.
RL 9987	876 N				8314	1 S 323 34 / 92477 - 203833
RL 9993	882 N1	1 F 16	1R4R 465 260	W01 095 0435	9048	1 SC 250-28 / 97042
RL 9994	883 N1	1 F 21 C-2			9012	1 SC 270-28 / 204250
RL 9995	884 N1	1 F 20A			9002	1 SC 250-29 / 97043 - 97608
RL 90541			1R1K-380-300	W01 095 0541		
RL 90789					9081	
RL 90907						
RL 90931						1 S 323-40 / 204290
RL 91277			1R4U 395 260	W01 095 0453		
RL 91523						1 S 215-23 / 202189
RL 91994						1 S 270-20 V / 202773
RL 92023						1 S 320-23 / 88806
RL 92035	1924 N1	2 F 18				
RL 92336						1 S 323 - 36 / 203833
RL 92526	1415 N	1 E 23 A			9113	
RL 92527	1416 N P01					
RL 92528	1417 N					
RL 92532	1421 N		1R2A 490 305	W01 095 0472	9072	
RL 92831	1720 N				9068	
RL 92844						1 S 270 25 C / 97608
RL 92885	1774 N					
RL 92893	1782 N1					1 SC 285-30 / 207726
RL 92899	1788 N					1 SC 260-31 / 97569
RL 92920	1819 N	1 E 14	1R1S 350-225	W01 095 0543		1 S 215-23 / 202189
RL 92996	1885 N1	1 F 20 B	1R2A445 280	W01 095 0429	9003	1 SC 270-28 / 97043 - 202265
RL 92997	1886 N					
RL 92999	1888 N				9123	
RL 93220						1 S 285-20 V / 96534
RL 93351						1 S 270-23 V / 206662
RL 93856						
RL 93857						
RL 94098						1 S 290-23V / 204427
RL 94663						1 S 290-30 V / 205074
RL 95019						1 SC 250 19 / 201727
RL 95471						1 S 215-22 / 90609 - 206730
RL 95875		1 E 18 D			9080	
RL 96032						1 SC 260 32 / 96987
RL 97019						1 SC 270 19 / 201732
RL 97026						1 SC 270 26 / 203933
RL 97027						1 SC 270 27 / 203698
RL 97054	6611 N				9138	
RL 97075					9112	



No.	Vibracoustic	Gart Ref. / Gart No.	Dunlop UK	Dunlop F (Springride)	Taurus	TOYO	Page
		D 298/C 298.0.460					33
	V1F16	C 298 / D - 298.0.400		D12S12	B 155		33
	V1F21C-2			D13S03			33
	V1F20A			D12S06	BL 249		34
							34
							34
			PNP 30907100				35
							35
			A 310950013				35
							36
		D 290/E 290.0.340					36
							36
		C 298/E 298.0.360					37
		D 298/B 298.0.515					37
							37
							38
							38
		C 299/E 299.0.490		D12S18			38
				D12S17			39
							39
							39
		C289/G - 289.0.460					40
							40
	V1E14	D296/C - 296.0.360					40
	V1F20B	C289/C - 289.0.450		D12S07			41
	V1F20A						41
							41
		276/E 276.0.330					42
							42
							42
							43
		D286 286.0.420					43
							43
		C 301/B 301.0.235					44
							44
							44
		C289 289.0.350					45
		D 276/F 276.0.300					45
		D 290/C 290.0.440					45
		D 290/D 290.0.480					46
							46
							46

**ROLL AIR SPRINGS CROSS LIST**

	Blacktech	ContiTech	Phoenix	Firestone Style	Firestone No.	Goodyear	CF Gomma Ref. / CF Gomma No.
RL	97489						
RL	97743						1S 285-25 C
RL	97756						1S 270-23 V
RL	98183						1 SC 230 25
RL	98518						1S 285-18 C / 97261
RL	98739						
RL	99201						
RL	99202						
RL	99203						
RL	99205						
RL	99206						
RL	99207						
RL	99208						
RL	99209						
RL	9526-36	RZ 415-25	2 G 20	1R5P 345-290	W01 095 0381	9004	1S 280-25 / 203000
RL	9526-39	RZ 415-28	2 G 20 A	1R5P 410-290	W01 095 0382	9005	1S 280-25 / 203001
RL	9561-36	RZ 450-25	1E 23			9050	1S 300-27 / 203386

No.	Vibracoustic	Gart Ref. / Gart No.	Dunlop UK	Dunlop F (Springride)	Taurus	TOYO	Page
							47
							47
							47
							48
							48
							48
							49
							49
							49
							50
							50
							50
							51
							51
	V 2 G 20		00986A-AP	D12 S08	B 271		51
	V 2 G 20 A			D12 S09	B 272		52
	V 1E 23			D12 S13	BL 128		52



# SERVICE AND COMPLETE AIR SPRINGS





## Components of Air Springs

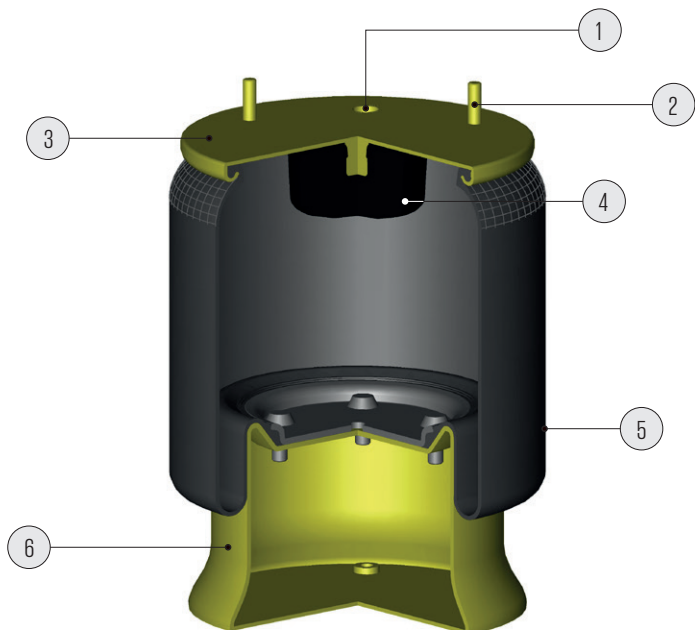

1. Air inlet
2. Mounting stud
3. Plate
4. Bumper (Generally used in air suspension applications as fail-safe device.)
5. Rubber air spring body
6. Piston (There two different complete applications such as with metal piston or plastic piston.)

## Product Identification / Roll Air Springs

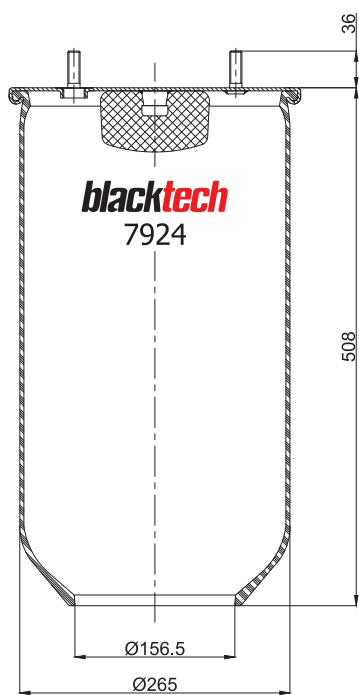

RML 7924  
Air spring system without piston

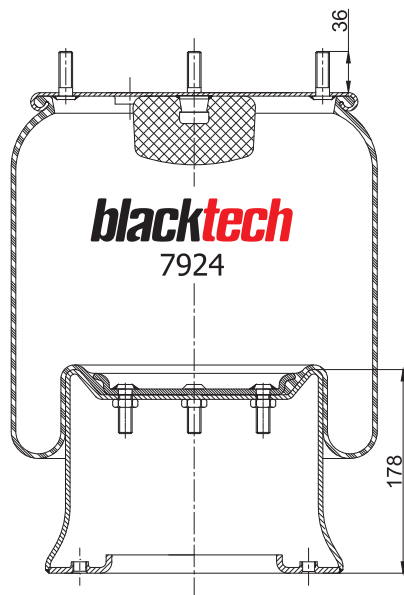

RML 7924 C  
Complete air spring  
assembly with crimped top plate  
and metal piston

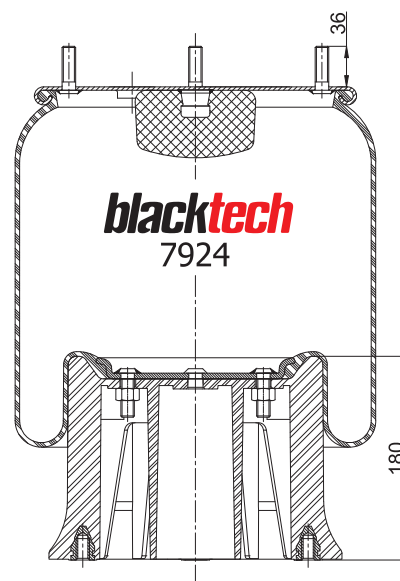

RML 7924 CP  
Complete air spring  
assembly with crimped top plate  
and plastic piston

COMPLETE & SERVICE AIR SPRINGS OEM LIST					
MANUFACTURER	OEM PARTNO	PARTNO	TYPE	REMARKS	PAGE
ACERBI	128140028	RML 75268 CP10	Complete	Plastic Piston	184
	800449526	RML 75268 CP10	Complete	Plastic Piston	184
ACERBI / VIBERTI	800448024	RML 71840 C	Complete	Metal Piston	130
	128147109	RML 76884 C	Complete	Metal Piston	211
AUSTERAS	99381009	RML 71420 C	Complete	Metal Piston	128
	99381010	RML 71480 C	Complete	Metal Piston	129
	99381031	RML 72520 C	Complete	Metal Piston	133
ARVIN MERITOR	21215761	RML 75267 C6	Complete	Metal Piston	176
	21215762	RML 75267 C6	Complete	Metal Piston	176
	21226046	RML 75267 C6	Complete	Metal Piston	176
AYATS	31001569	RML 9772 C1	Complete	Metal Piston	241
	30201085	RML 9987 C	Complete	Metal Piston	246
	30201085	RML 9987 C	Complete	Metal Piston	246
BATTAGLINO	2211907	RML 71421 C	Complete	Metal Piston	129
	2211900	RML 72421 C	Complete	Metal Piston	131
BELLE TRAILERS	BT0319	RML 75266 C	Complete	Metal Piston	175
BMC		RML 7573	Service Assy	Service	92
		RML 7573 C	Complete	Metal Piston	92
	7B100323	RML 7947-11	Service Assy	Service	109
	7B100323	RML 7947 C11	Complete	Metal Piston	112
	57RS308887	RML 78887 C	Complete	Metal Piston	227
	57RS308888	RML 78888 C	Complete	Metal Piston	228
	53RS900131	RML 9032 C3	Complete	Metal Piston	239
	53RS900144	RML 9032 C4	Complete	Metal Piston	239
	53RS900144	RML 9755 C3	Complete	Metal Piston	241
		RML 9755 C4	Complete	Metal Piston	241
	53RS900056	RML 9772 C4	Complete	Metal Piston	241
	53RS900142	RML 9772 C8	Complete	Metal Piston	242
	53RS900069	RML 95101 C	Complete	Metal Piston	252
	53RS900072	RML 95101 C2	Complete	Metal Piston	252
	BERTOJA	45402004	RML 75266 C	Complete	Metal Piston
45402004		RML 75267 C9	Complete	Metal Piston	177
46311001		RML 76884 C	Complete	Metal Piston	211
BREDAMENARINIBUS	178739	7010 SP	Service Assy	Service	84
BPW	05.429.40.91.0	RML 7051	Service Assy	Service	88
	05.429.40.59.1	RML 7051 C	Complete	Metal Piston	88
	05.429.41.37.1	RML 7051 C	Complete	Metal Piston	88
	0542941241	RML 7051 C	Complete	Metal Piston	88
	0542941281	RML 7051 C	Complete	Metal Piston	88
	05.429.40.93.1	RML 7051 C	Complete	Metal Piston	88
		RML 7051 C1	Complete	Metal Piston	89
	05.429.43.21.0	RML 7051 CP	Complete	Plastic Piston	89
	05.429.40.03.0	RML 7052	Service Assy	Service	90
	05.429.42.28.1	RML 7052 C	Complete	Metal Piston	90
	05.429.43.20.0	RML 7052 CP	Complete	Plastic Piston	90



COMPLETE & SERVICE AIR SPRINGS OEM LIST					
MANUFACTURER	OEM PARTNO	PARTNO	TYPE	REMARKS	PAGE
BPW	05.429.40.05.0	RML 7053	Service Assy	Service	91
	05.429.41.38.0	RML 7053 C	Complete	Metal Piston	91
	05.429.40.72.0	RML 7062	Service Assy	Service	92
	05.429.42.72.0	RML 7062	Service Assy	Service	92
		RML 7062 C	Complete	Metal Piston	92
		RML 7062 CP	Complete	Plastic Piston	124
	05.429.40.01.0	RML 7992	Service Assy	Service	113
	05.429.41.21.1	RML 7992 C	Complete	Metal Piston	113
	05.429.40.08.1	RML 7992 C	Complete	Metal Piston	113
	05.429.40.36.1	RML 7992 C	Complete	Metal Piston	113
	05.429.43.51.0	RML 7992 CP	Complete	Plastic Piston	114
	0.41.04.001.0	RML 72430 C	Complete	Metal Piston	132
	041.03.007.0	RML 74512 C	Complete	Metal Piston	140
	041.03.003.0	RML 74520 C	Complete	Metal Piston	141
	041.03.009.0	RML 74521 C	Complete	Metal Piston	142
	041.03.016.0	RML 74523 C	Complete	Metal Piston	143
	05.429.41.56.0	RML 75051	Service Assy	Service	152
		RML 75051 C	Complete	Metal Piston	152
		RML 75051 CP	Complete	Plastic Piston	153
	05.429.41.25.0	RML 75052	Service Assy	Service	153
		RML 75052 C	Complete	Metal Piston	153
		RML 75052 CP	Complete	Plastic Piston	154
	05.429.41.09.0	RML 75053	Service Assy	Service	154
	05.429.41.86.0	RML 75053 C1	Complete	Metal Piston	154
	05.429.41.77.0	RML 75071	Service Assy	Service	155
		RML 75071 C	Complete	Metal Piston	156
		RML 75071 CP	Complete	Plastic Piston	156
	05.429.42.04.0	RML 75072	Service Assy	Service	156
		RML 75072 CP	Complete	Plastic Piston	157
	05.429.42.03.0	RML 75073	Service Assy	Service	157
05.429.41.01.0	RML 75992	Service Assy	Service	196	
05.429.41.22.1	RML 75992 C	Complete	Metal Piston	196	
05.429.43.41.0	RML 75992 CP	Complete	Plastic Piston	197	
CAMPANA	05.020.0105	RML 7922 C2	Complete	Metal Piston	104
	28100006	RML 7922 C2	Complete	Metal Piston	104
	50.200.105	RML 7922 C3	Complete	Metal Piston	104
	28100006	RML 7922 C3	Complete	Metal Piston	104
	50.200.105	RML 7922 CP2	Complete	Plastic Piston	104
	28100006	RML 7922 CP2	Complete	Plastic Piston	104
	05.040.0200	RML 71421 C	Complete	Metal Piston	129
	05.040.0100	RML 72430 C	Complete	Metal Piston	132
	05.050.0100	RML 74512 C	Complete	Metal Piston	140
	28100002	RML 74512 C	Complete	Metal Piston	140
	05.020.0100	RML 74520 C	Complete	Metal Piston	141
CARDI		RML 7923	Service Assy	Service	105

COMPLETE & SERVICE AIR SPRINGS OEM LIST					
MANUFACTURER	OEM PARTNO	PARTNO	TYPE	REMARKS	PAGE
CARDI	58050700	RML 7923 C1	Complete	Metal Piston	105
	58050910	RML 75120 C	Complete	Metal Piston	159
	58051210	RML 75260 CP9	Complete	Plastic Piston	172
	58051400	RML 75266 C	Complete	Metal Piston	175
	58050900	RML 75270 C	Complete	Metal Piston	186
DAF		RML 7803	Service Assy	Service	93
	1 448 543	RML 7803 CP	Complete	Plastic Piston	94
	1 698 436	RML 7803 CP	Complete	Plastic Piston	94
	1 384 273	RML 7921 C	Complete	Metal Piston	100
	1 384 274	RML 7922	Service Assy	Service	101
	067306	RML 7922-1	Service Assy	Service	102
		RML 7922-2	Service Assy	Service	102
	1 384 274	RML 7922 C	Complete	Metal Piston	103
		RML 7922 C1	Complete	Metal Piston	103
	67306	RML 7923 C1	Complete	Metal Piston	105
	0 067 504	RML 7947	Service Assy	Service	108
	0 513 985	RML 7947-1	Service Assy	Service	108
	0 513 982	RML 7947-2	Service Assy	Service	109
	0 388 165	RML 7947 C1	Complete	Metal Piston	109
	1 697 678	RML 7947 C1	Complete	Metal Piston	109
	0 388 167	RML 7947-2 C1	Complete	Metal Piston	110
	0 526 651	RML 7947 C6	Complete	Metal Piston	110
	0 297 721	RML 7947 C7	Complete	Metal Piston	111
	1152221	RML 7947 C9	Complete	Metal Piston	111
	1794420	RML 7947 C10	Complete	Metal Piston	112
	1 276 846	RML 7990	Service Assy	Service	112
	1 279 141	RML 7990 C2	Complete	Metal Piston	113
	1 698 434	RML 7990 C2	Complete	Metal Piston	113
	0 513 983	RML 7998	Service Assy	Service	114
	0 392 022	RML 7998 C1	Complete	Metal Piston	114
	1 697 684	RML 7998 C1	Complete	Metal Piston	114
	0 392 011	RML 7998 C1	Complete	Metal Piston	114
	RML 7998-2 C1	Complete	Metal Piston	115	
1 286 251	RML 7998 C4	Complete	Metal Piston	115	
1 697 680	RML 7998 C4	Complete	Metal Piston	115	
DAIMLER TAS	A 946 328 19 01	RML 71901 C	Complete	Metal Piston	131
	A 946 328 14 01	RML 75268 CP14	Complete	Plastic Piston	185
DISCOS		RML 75268-4	Service Assy	Service	180
EVO-BUS	A 629 327 00 01	RML 95755	Service Assy	Service	263
	A 629 320 00 25	RML 95755 C2	Complete	Metal Piston	264
	A 629 320 00 25	RML 95755 C22	Complete	Metal Piston	264
FRUEHAUF	UJB0129001	RML 71304 C	Complete	Metal Piston	126
	UJB0129001	RML 71304 C1	Complete	Metal Piston	127
	M078580	RML 74544 CP	Complete	Plastic Piston	143
	UJB 0305	RML 74580 C	Complete	Metal Piston	144

COMPLETE & SERVICE AIR SPRINGS OEM LIST					
MANUFACTURER	OEM PARTNO	PARTNO	TYPE	REMARKS	PAGE
FRUEHAUF		RML 75260-5	Service Assy	Service	169
		RML 75260 C3	Complete	Metal Piston	169
	UJB 0203-001	RML 75260 C7	Complete	Metal Piston	170
		RML 75260 C10	Complete	Metal Piston	171
		RML 75260 C16	Complete	Metal Piston	171
	UJB 0358-001	RML 75260 CP9	Complete	Plastic Piston	172
	UJA 09030	RML 75260 CP9	Complete	Plastic Piston	172
	UJA 0894-001	RML 75260 CP14	Complete	Plastic Piston	173
	M001472	RML 75267 C7	Complete	Metal Piston	177
	UJB 0207-001	RML 75267 C9	Complete	Metal Piston	177
	UJB 0207	RML 75267 C9	Complete	Metal Piston	177
		RML 75267 CP14	Complete	Plastic Piston	179
	M001472	RML 75267 CP15	Complete	Plastic Piston	179
		RML 75268 CP3	Complete	Plastic Piston	182
	UJB 0975	RML 75268 CP10	Complete	Plastic Piston	184
FRUEHAUF / SMB	M001464	RML 71840 C	Complete	Metal Piston	130
FORD	DC46-5580-AA	RML 75580 C	Complete	Metal Piston	188
	DC46-5580-BA	RML 75581 C	Complete	Metal Piston	189
		RML 78887 C	Complete	Metal Piston	227
		RML 78888 C	Complete	Metal Piston	228
GIGANT	246169	RML 7835	Service Assy	Service	94
	3053	RML 7835	Service Assy	Service	94
		RML 7835 C1	Complete	Metal Piston	94
	166259	RML 7835 C2	Complete	Metal Piston	95
	166225	RML 7835 C3	Complete	Metal Piston	95
	246149	RML 7836	Service Assy	Service	95
	3653	RML 7836	Service Assy	Service	95
	166217	RML 7836 C2	Complete	Metal Piston	96
	3653 compl.	RML 7836 C2	Complete	Metal Piston	96
	166252	RML 7836 C3	Complete	Metal Piston	96
	3653 compl.	RML 7836 C3	Complete	Metal Piston	96
	166252	RML 7836 C4	Complete	Metal Piston	96
	166217	RML 7836 C5	Complete	Metal Piston	97
	246149	RML 7836 C5	Complete	Metal Piston	97
	246192	RML 7837	Service Assy	Service	97
	3661	RML 7837	Service Assy	Service	97
	247100	RML 7863	Service Assy	Service	97
	3671	RML 7863	Service Assy	Service	97
	166228	RML 7863 C	Complete	Metal Piston	98
	247104	RML 73042	Service Assy	Service	134
3042	RML 73042	Service Assy	Service	134	
3042	RML 73042 C	Complete	Metal Piston	135	
	RML 73836	Service Assy	Service	137	
GOLDSCHMITT	DLB 5339	RML 75339 CP	Complete	Plastic Piston	186
	DLB 5343	RML 75343 CA	Complete	Aluminium Piston	187

COMPLETE & SERVICE AIR SPRINGS OEM LIST						
MANUFACTURER	OEM PARTNO	PARTNO	TYPE	REMARKS	PAGE	
GOLDSCHMITT	DLB 8599	RML 78599 CP	Complete	Plastic Piston	225	
GRANNING	1359	RML 75267 CP14	Complete	Plastic Piston	179	
	1528	RML 75267 CP14	Complete	Plastic Piston	179	
HEULIEZ	0001066001	RML 92035 C	Complete	Metal Piston	247	
	5 006 172 377B	RML 92526 C	Complete	Metal Piston	248	
HENDRICKSON	507 782	RML 7023 C2	Complete	Metal Piston	86	
		RML 7921	Service Assy	Service	99	
	506 243	RML 7921 C	Complete	Metal Piston	100	
	506 243 / 01	RML 7921 C	Complete	Metal Piston	100	
	785 168	RML 7921 C	Complete	Metal Piston	100	
		RML 7921 C1	Complete	Metal Piston	100	
		RML 7921 C2	Complete	Metal Piston	100	
		RML 7924	Service Assy	Service	106	
	505 859	RML 7924 C	Complete	Metal Piston	106	
	505 859 / 01	RML 7924 C	Complete	Metal Piston	106	
	785 170	RML 7924 C	Complete	Metal Piston	106	
	HS 251087 / F	RML 70081 C	Complete	Metal Piston	116	
		RML 70082	Service Assy	Service	117	
		RML 70082 C	Complete	Metal Piston	117	
	HA 100310	RML 70310 C	Complete	Metal Piston	121	
		RML 75260-1	Service Assy	Service	168	
		RML 75260 C8	Complete	Metal Piston	170	
	B 3842	RML 75260 CP11	Complete	Plastic Piston	172	
	NA 1817	RML 75260 CP13	Complete	Plastic Piston	173	
	B2066	RML 75267 C4	Complete	Metal Piston	176	
	HA 1000001	RML 75267 C6	Complete	Metal Piston	176	
	HA100016	RML 75267 CP10	Complete	Plastic Piston	178	
		RML 75267 CP13	Complete	Plastic Piston	178	
	B 2066	RML 75267 CP14	Complete	Plastic Piston	179	
	HA100001	RML 75267 CP15	Complete	Plastic Piston	179	
		RML 76260	Service Assy	Service	207	
		RML 76260 C	Complete	Metal Piston	207	
	59053-2F	RML 76260 CP	Service Assy	Service	208	
		RML 76269	Service Assy	Service	208	
		RML 78263	Service Assy	Service	223	
	HS508263	RML 78263 C	Complete	Metal Piston	223	
		RML 78385	Service Assy	Service	224	
	HS508385	RML 78385 C	Complete	Metal Piston	224	
		RML 78586	Service Assy	Service	224	
		RML 78586 CP	Complete	Plastic Piston	225	
		RML 78643	Service Assy	Service	227	
	QE 100004/F	RML 78643 C	Complete	Metal Piston	227	
	HS 509328	RML 79328 C	Complete	Metal Piston	235	
	HUFFERMANN	6-AB8003-0100	RML 7992 CP	Complete	Plastic Piston	114
		6-AB8003-0200	RML 75992 CP	Complete	Plastic Piston	197

COMPLETE & SERVICE AIR SPRINGS OEM LIST					
MANUFACTURER	OEM PARTNO	PARTNO	TYPE	REMARKS	PAGE
IRISBUS	5.010.073.846	RML 9772 C1	Complete	Metal Piston	241
	5.000.785.792	RML 9870 C	Complete	Metal Piston	243
	5.000.805.999	RML 9870 C1	Complete	Metal Piston	243
	5.000.786.516	RML 9879 C	Complete	Metal Piston	244
	5.010.190.888	RML 9893 C3	Complete	Metal Piston	245
	5.000.786.641	RML 9928 C	Complete	Metal Piston	246
	5.810.111.355	RML 9928 C	Complete	Metal Piston	246
	5.006.172.377	RML 92526 C	Complete	Metal Piston	248
ISUZU		RML 93857 C	Complete	Metal Piston	250
IVECO	42559765	RML 70462	Service Assy	Service	121
	41270462	RML 70462 CP	Complete	Plastic Piston	122
	42559766	RML 70463	Service Assy	Service	122
	41270463	RML 70463 CP	Complete	Plastic Piston	122
	42559767	RML 70465	Service Assy	Service	123
	41270465	RML 70465 CP	Complete	Plastic Piston	123
	42559768	RML 70466	Service Assy	Service	123
	41270466	RML 70466 CP	Complete	Plastic Piston	124
	41289370	RML 70739 C	Complete	Metal Piston	124
	42559721	RML 72478	Service Assy	Service	132
	41272478	RML 72478 C	Complete	Metal Piston	133
	504035755	RML 75343 CA1	Complete	Aluminium Piston	187
	42566303	RML 77179	Service Assy	Service	212
	41297179	RML 77179 CP	Complete	Plastic Piston	212
	42566304	RML 77180	Service Assy	Service	213
	41297180	RML 77180 CP	Complete	Plastic Piston	213
		RML 77313	Service Assy	Service	215
	99458555	RML 77313 CP	Complete	Plastic Piston	216
	99458557	RML 77313 CP	Complete	Plastic Piston	216
	504117415	RML 77415 C	Complete	Metal Piston	218
	41289367	RML 77639 C	Complete	Metal Piston	220
	41289366	RML 77639 C1	Complete	Metal Piston	220
	42568188	RML 78188	Service Assy	Service	222
	41289377	RML 78188 C	Complete	Metal Piston	223
	41298919	RML 79198 C	Complete	Metal Piston	233
	41298917	RML 79198 C1	Complete	Metal Piston	233
	42559720	RML 79720	Service Assy	Service	235
	41298716	RML 79720 C	Complete	Metal Piston	235
	42559722	RML 79722-1	Service Assy	Service	236
	42559776	RML 79722-2	Service Assy	Service	236
	504190916	RML 79722 CP1	Complete	Plastic Piston	236
	504190917	RML 79722 CP2	Complete	Plastic Piston	237
	42568189	RML 79739	Service Assy	Service	237
	41289379	RML 79739 C	Complete	Metal Piston	237
	5010151378	RML 9032 C5	Complete	Metal Piston	239
	5010073847	RML 9893 C4	Complete	Metal Piston	245

COMPLETE & SERVICE AIR SPRINGS OEM LIST					
MANUFACTURER	OEM PARTNO	PARTNO	TYPE	REMARKS	PAGE
IVECO	5010347891	RML 92035 C	Complete	Metal Piston	247
	41026312	RML 92336 C	Complete	Metal Piston	247
	41297178	RML 92336 CP	Complete	Plastic Piston	247
	5006172527	RML 92526 C1	Complete	Metal Piston	248
	99462844	RML 92844 C	Complete	Metal Piston	248
	41026260	RML 92844 C1	Complete	Metal Piston	249
	5006223351	RML 93351 C	Complete	Metal Piston	249
	5006223352	RML 93351 C1	Complete	Metal Piston	250
	5006204505	RML 94098 C	Complete	Metal Piston	251
	500355474	RML 95019 C	Complete	Metal Piston	251
	500355475	RML 95019 C1	Complete	Metal Piston	251
	98490464	RML 96032 C	Complete	Metal Piston	273
	500364685	RML 97026 C	Complete	Metal Piston	274
	93195986	RML 97743 C	Complete	Metal Piston	274
	41026771	RML 97756 C	Complete	Metal Piston	275
	41026772	RML 97756 C1	Complete	Metal Piston	275
	42568183	RML 98183	Service Assy	Service	275
	41288309	RML 98183 C	Complete	Metal Piston	276
	41026263	RML 98518 C	Complete	Metal Piston	276
41026262	RML 98518 C1	Complete	Metal Piston	276	
JONCKHEERE	26.160.2033.00	RML 9893 C3	Complete	Metal Piston	245
KAESSBOHRER	4.731.029.000	RML 7922 SP	Service Assy	Service	103
KAISER	F01008696	RML 71309 C	Complete	Metal Piston	127
	F01008697	RML 71315 C	Complete	Metal Piston	128
	F01008697	RML 71315 C1	Complete	Metal Piston	128
	F01004307	RML 74307 C	Complete	Metal Piston	139
LOHR	29790-01	RML 75924 C1	Complete	Metal Piston	195
MAN	81.43601.6029	RML 7010 S	Service Assy	Service	84
	81.43601.0073	RML 7010 S	Service Assy	Service	84
	81.43601.0054	RML 7010 S	Service Assy	Service	84
	81.43601.0050	RML 7010 S	Service Assy	Service	84
	81.43601.6023	RML 7010 SP	Service Assy	Service	84
	81.43601.0025	RML 7910 S	Service Assy	Service	98
	81.43601.6002	RML 7910 SP	Service Assy	Service	98
	81.43601.6023	RML 7910 SP	Service Assy	Service	98
	81.43601.6025	RML 7910 SP	Service Assy	Service	98
	81.43601.6029	RML 7910 SP	Service Assy	Service	98
	81.43601.6030	RML 7910 SP	Service Assy	Service	98
	81.43601.0050	RML 7910 SP	Service Assy	Service	98
	81.43601.0047	RML 7921 S	Service Assy	Service	99
	81.43601.6019	RML 7921 SP	Service Assy	Service	99
	81.43601.0035	RML 7922 S	Service Assy	Service	102
	81.43601.0048	RML 7922 S	Service Assy	Service	102
	81.43601.0035	RML 7922 SP	Service Assy	Service	103
	81.43601.0048	RML 7922 SP	Service Assy	Service	103

COMPLETE & SERVICE AIR SPRINGS OEM LIST					
MANUFACTURER	OEM PARTNO	PARTNO	TYPE	REMARKS	PAGE
MAN	81.43601.0158	RML 75027	Service Assy	Service	151
	81.43600.6042	RML 75027 C7	Complete	Metal Piston	151
		RML 75267-12	Service Assy	Service	176
	81.43601.0155	RML 75816-1	Service Assy	Service	189
	81.43600.6039	RML 75816 C3	Complete	Metal Piston	189
	81.43600.6040	RML 75816 C4	Complete	Metal Piston	190
	81.43601.0168	RML 75973	Service Assy	Service	195
	81.43600.6049	RML 75973 C2	Complete	Metal Piston	196
	81.43601.0151	RML 75993	Service Assy	Service	197
	81.43601.0176	RML 75993	Service Assy	Service	197
	81.43600.6036	RML 75993 C5	Complete	Metal Piston	197
	81.43600.6056	RML 75993 C5	Complete	Metal Piston	197
		RML 75993 CP5	Complete	Plastic Piston	198
	81.43601.0153	RML 75994	Service Assy	Service	198
	81.43600.6037	RML 75994 C	Complete	Metal Piston	198
	81.43601.0174	RML 75995	Service Assy	Service	199
	81.43601.0175	RML 75995	Service Assy	Service	199
	81.43601.0173	RML 75995-2	Service Assy	Service	199
	81.43600.6035	RML 75995 C6	Complete	Metal Piston	200
	81.43600.6055	RML 75995 C6	Complete	Metal Piston	200
	81.43600.6041	RML 75995 C7	Complete	Metal Piston	200
		RML 75995 CP6	Complete	Plastic Piston	199
	81.43601.0160	RML 75996	Service Assy	Service	200
	81.43601.6071	RML 75996	Service Assy	Service	200
	81.43600.6044	RML 75996 C2	Complete	Metal Piston	201
	81.43601.0165	RML 75997	Service Assy	Service	201
	81.43600.6046	RML 75997 C1	Complete	Metal Piston	201
		RML 9027 C	Complete	Metal Piston	238
	RML 92996 C	Complete	Metal Piston	249	
MERCEDES	A 946 328 04 01	RML 70081 C	Complete	Metal Piston	116
		RML 71501	Service Assy	Service	130
	A 946 328 15 01	RML 71501 C	Complete	Metal Piston	130
	A 946 328 14 01	RML 75268 CP4	Complete	Plastic Piston	183
	A 942 320 59 21	RML 78263 C	Complete	Metal Piston	223
	A 667 328 01 01	RML 9920 C	Complete	Metal Piston	245
		RML 95294-1	Service Assy	Service	252
		RML 95294-2	Service Assy	Service	253
		RML 95294 C1	Complete	Metal Piston	253
	A 942 320 23 21	RML 95294 C21	Complete	Metal Piston	253
	A 942 320 22 21	RML 95294 C23	Complete	Metal Piston	254
	A 942 320 68 21	RML 95294 C23	Complete	Metal Piston	254
	A 942 320 23 21	RML 95294 C24	Complete	Metal Piston	254
	A 942 320 69 21	RML 95294 C24	Complete	Metal Piston	254
	A 974 328 02 01	RML 95296	Service Assy	Service	254
	A 974 320 00 21	RML 95296 C1	Complete	Metal Piston	255

**COMPLETE & SERVICE AIR SPRINGS OEM LIST**

MANUFACTURER	OEM PARTNO	PARTNO	TYPE	REMARKS	PAGE
MERCEDES	A 974 320 30 21	RML 95296 C21	Complete	Metal Piston	255
		RML 95298-1	Service Assy	Service	255
		RML 95298-2	Service Assy	Service	256
	A 942 320 18 21	RML 95298 C1	Complete	Metal Piston	256
	A 942 320 27 21	RML 95298 C2	Complete	Metal Piston	256
	A 942 320 26 21	RML 95298 C21	Complete	Metal Piston	257
	A 942 320 72 21	RML 95298 C21	Complete	Metal Piston	257
	A 942 320 73 21	RML 95298 C22	Complete	Metal Piston	257
	A 942 320 19 21	RML 95298 C22	Complete	Metal Piston	257
	A 942 328 00 01	RML 95401-1	Service Assy	Service	257
	A 942 328 01 01	RML 95401-2	Service Assy	Service	258
		RML 95401-3	Service Assy	Service	258
	A 942 320 01 21	RML 95401 C1	Complete	Metal Piston	258
	A 942 320 02 21	RML 95401 C2	Complete	Metal Piston	259
	A 942 320 04 21	RML 95401 C3	Complete	Metal Piston	259
	A 942 320 03 21	RML 95401 C4	Complete	Metal Piston	259
		RML 95401 C5	Complete	Metal Piston	260
	A 942 320 28 21	RML 95401 C21	Complete	Metal Piston	260
	A 942 320 49 21	RML 95401 C21	Complete	Metal Piston	260
	A 942 320 29 21	RML 95401 C22	Complete	Metal Piston	260
	A 942 320 50 21	RML 95401 C22	Complete	Metal Piston	260
	A 942 320 52 21	RML 95401 C23	Complete	Metal Piston	261
	A 942 328 06 01	RML 95402-1	Service Assy	Service	261
	A 942 328 07 01	RML 95402-2	Service Assy	Service	262
	A 942 320 06 21	RML 95402 C1	Complete	Metal Piston	262
	A 942 320 07 21	RML 95402 C2	Complete	Metal Piston	262
	A 942 320 53 21	RML 95402 C21	Complete	Metal Piston	263
	A 942 320 54 21	RML 95402 C22	Complete	Metal Piston	263
		RML 95848-1	Service Assy	Service	264
	A 946 320 03 21	RML 95848 C1	Complete	Metal Piston	265
	A 946 320 05 21	RML 95848 C2	Complete	Metal Piston	265
	A 946 320 00 17	RML 95848 C5	Complete	Metal Piston	265
	A 942 320 37 21	RML 95848 C21	Complete	Metal Piston	266
	A 942 320 39 21	RML 95848 C22	Complete	Metal Piston	266
	A 957 320 03 17	RML 95848 C25	Complete	Metal Piston	266
	A 942 327 04 01	RML 95860	Service Assy	Service	267
	A 942 327 02 01	RML 95860 C1	Complete	Metal Piston	268
	A 942 320 44 21	RML 95860 C21	Complete	Metal Piston	269
	A 942 320 02 17	RML 95860 C21	Complete	Metal Piston	269
	A 942 327 00 01	RML 95868-1	Service Assy	Service	268
	A 974 328 00 01	RML 95868-2	Service Assy	Service	268
	A 974 328 01 01	RML 95868-2	Service Assy	Service	268
	A 974 320 01 17	RML 95868 C1	Complete	Metal Piston	268
	A 974 327 04 17	RML 95868 C9	Complete	Metal Piston	269
	A 974 320 43 21	RML 95868 C21	Complete	Metal Piston	269



COMPLETE & SERVICE AIR SPRINGS OEM LIST					
MANUFACTURER	OEM PARTNO	PARTNO	TYPE	REMARKS	PAGE
MERCEDES	A 942 320 32 21	RML 95868 C29	Complete	Metal Piston	269
	A 974 320 02 17	RML 95868 C29	Complete	Metal Piston	269
	A 945 327 00 01	RML 95869-1	Service Assy	Service	270
	A 945 320 00 17	RML 95869 C1	Complete	Metal Piston	270
	A 942 320 48 21	RML 95869 C21	Complete	Metal Piston	270
	A 942 320 33 21	RML 95869 C23	Complete	Metal Piston	271
	A 942 320 06 17	RML 95869 C23	Complete	Metal Piston	271
	A 946 328 00 01	RML 95949-1	Service Assy	Service	271
	A 946 320 04 21	RML 95949 C1	Complete	Metal Piston	271
	A 946 320 02 21	RML 95949 C2	Complete	Metal Piston	272
	A 946 320 01 21	RML 95949 C3	Complete	Metal Piston	272
	A 942 320 38 21	RML 95949 C21	Complete	Metal Piston	272
	A 942 320 36 21	RML 95949 C22	Complete	Metal Piston	273
	A 942 320 35 21	RML 95949 C23	Complete	Metal Piston	273
MITSUBISHI	MK 432789	RML 72789	Service Assy	Service	134
MONTENEGRO		RML 75260 CP14	Complete	Plastic Piston	173
NEOPLAN	1021 215 00	RML 7010 S	Service Assy	Service	84
	1021 005 00	RML 7010 S	Service Assy	Service	84
NEWAY	21215632	RML 7921 C	Complete	Metal Piston	100
	90557009	RML 75260 C4	Complete	Metal Piston	169
	905 570 27	RML 75267 CP14	Complete	Plastic Piston	179
	905 570 33	RML 75267 CP14	Complete	Plastic Piston	179
	905 570 37	RML 75267 CP14	Complete	Plastic Piston	179
	905 570 54	RML 75267 CP14	Complete	Plastic Piston	179
	905 570 75	RML 75267 CP14	Complete	Plastic Piston	179
	905 572 33	RML 75268 CP8	Complete	Plastic Piston	184
		RML 77313	Service Assy	Service	215
	M0557019	RML 77313 CP	Complete	Plastic Piston	216
	M0557020	RML 77313 CP	Complete	Plastic Piston	216
	M0557030	RML 77313 CP	Complete	Plastic Piston	216
	M0557031	RML 77313 CP	Complete	Plastic Piston	216
		RML 79296 C	Complete	Metal Piston	234
M0057000G	RML 79910 C	Complete	Metal Piston	238	
OMAR	11804	RML 7923 C1	Complete	Metal Piston	105
	11815	RML 72670 C	Complete	Metal Piston	134
	11808	RML 75270 C	Complete	Metal Piston	186
OTOKAR		RML 9772 C6	Complete	Metal Piston	242
	16N00-03650-AB	RML 9772 C7	Complete	Metal Piston	242
	99000-33889-AA	RML 9928 C1	Complete	Metal Piston	246
	16H00-05484-AB	RML 99201 C	Complete	Metal Piston	278
	16M00-03652	RML 99203 C	Complete	Metal Piston	279
	16F00-03652-AC	RML 99205 C	Complete	Metal Piston	279
	13H00-05484-AA	RML 99206 C	Complete	Metal Piston	279
	9900-33888-AA	RML 99206 C1	Complete	Metal Piston	280
PAUL NFZ	P2700MB0813	RML 7924 C	Complete	Metal Piston	106

COMPLETE & SERVICE AIR SPRINGS OEM LIST					
MANUFACTURER	OEM PARTNO	PARTNO	TYPE	REMARKS	PAGE
PAUL NFZ	A 667 328 01 01	RML 9920 C	Complete	Metal Piston	245
PEGASO	174933	RML 7921 SP	Service Assy	Service	99
	175005	RML 7924 C	Complete	Metal Piston	106
PEZZIOLI	70100027	RML 72670 C	Complete	Metal Piston	134
	1006550	RML 75266 C	Complete	Metal Piston	175
RENAULT		RML 7012	Service Assy	Service	84
	5010052722	RML 7012 C	Complete	Metal Piston	85
	5010130683	RML 7012 C	Complete	Metal Piston	85
		RML 7013	Service Assy	Service	85
	5010211724	RML 7013 C	Complete	Metal Piston	85
	5000815749	RML 7013 C	Complete	Metal Piston	85
	5.000.452.939	RML 7921 C	Complete	Metal Piston	100
	5.000.745.918	RML 7922	Service Assy	Service	101
	5.000.745.918	RML 7922 C	Complete	Metal Piston	103
	5.000.790.692	RML 7924 C	Complete	Metal Piston	106
	5.010.130.925	RML 7924 C	Complete	Metal Piston	106
	5.010.557.622	RML 75020 C	Complete	Metal Piston	146
	5.010.630.457	RML 75020 C	Complete	Metal Piston	146
	21 978 484	RML 75020 C	Complete	Metal Piston	146
	5.011.294.308	RML 75022	Service Assy	Service	146
	5.010.294.308 C	RML 75022 C3	Complete	Metal Piston	147
	5.010.557.356	RML 75022 C4	Complete	Metal Piston	147
	25 364 097	RML 75022 C4	Complete	Metal Piston	147
	5.010.600.439	RML 75022 C6	Complete	Metal Piston	147
	5.010.305.464	RML 75022 C6	Complete	Metal Piston	147
	5.001.832.067	RML 75023	Service Assy	Service	148
	5.010.294.307	RML 75023 C7	Complete	Metal Piston	148
	5.010.557.355	RML 75023 C10	Complete	Metal Piston	149
	7422025566	RML 75023 C10	Complete	Metal Piston	149
	5.010.600.328	RML 75023 C13	Complete	Metal Piston	149
	21 978 494	RML 75023 C13	Complete	Metal Piston	149
	21 978 504	RML 75023 C13	Complete	Metal Piston	149
	5.001.855.856	RML 75026	Service Assy	Service	150
	5.010.294.309	RML 75026 C6	Complete	Metal Piston	150
	5.010.600.578	RML 75026 C6	Complete	Metal Piston	150
	21 978 500	RML 75026 C6	Complete	Metal Piston	150
	5.010.557.991	RML 75026 C6	Complete	Metal Piston	150
	22 190 563	RML 75026 C6	Complete	Metal Piston	150
		RML 75033	Service Assy	Service	151
	5 010 600 262	RML 75033 CP	Complete	Plastic Piston	152
	5.010.630.800	RML 75038 CP	Complete	Plastic Piston	155
	22 025 580	RML 75038 CP	Complete	Plastic Piston	155
	5.010.305.391	RML 75038 CP	Complete	Plastic Piston	155
		RML 75265	Service Assy	Service	173
	5.010.239.252	RML 75265 C5	Complete	Metal Piston	174

COMPLETE & SERVICE AIR SPRINGS OEM LIST					
MANUFACTURER	OEM PARTNO	PARTNO	TYPE	REMARKS	PAGE
RENAULT	5.010.488.071	RML 75265 C5	Complete	Metal Piston	174
	5.010.600.570	RML 75265 CP6	Complete	Plastic Piston	174
	5.010.305.438	RML 75265 CP6	Complete	Plastic Piston	174
	5.000.869.135	RML 9879 C	Complete	Metal Piston	244
	5.000.640.399	RML 9987 C	Complete	Metal Piston	246
ROLFO	112060	RML 7923 C1	Complete	Metal Piston	134
	112010	RML 72670 C	Complete	Metal Piston	105
ROR	2122 2673	RML 7023 C2	Complete	Metal Piston	86
		RML 7921	Service Assy	Service	99
	2120 8082	RML 7921 C	Complete	Metal Piston	100
	2121 5632	RML 7921 C	Complete	Metal Piston	100
		RML 7924	Service Assy	Service	106
	21215633	RML 7924 C	Complete	Metal Piston	106
	2121 5762	RML 75260 CP14	Complete	Plastic Piston	173
	2121 5891	RML 75260 CP14	Complete	Plastic Piston	173
	2122 6039	RML 75260 CP14	Complete	Plastic Piston	173
	2120 8939	RML 75267 CP14	Complete	Plastic Piston	179
	2121 5761	RML 75267 CP15	Complete	Plastic Piston	179
	2122 2442	RML 75268 CP9	Complete	Plastic Piston	184
ROR MERITOR	21221349	RML 74580 C	Complete	Metal Piston	144
		RML 75267 CP16	Complete	Plastic Piston	179
		RML 75268-4	Service Assy	Service	180
	21221307	RML 75268 CP4	Complete	Plastic Piston	183
		RML 78608	Service Assy	Service	225
	21229214	RML 78608 CP	Complete	Plastic Piston	226
		RML 79003 A3	Service Assy	Service	231
		RML 79003 A3 CP	Complete	Plastic Piston	231
	21222442	RML 79003 A3 CP1	Complete	Plastic Piston	232
		RML 79003 A8	Service Assy	Service	232
21221307	RML 79003 A8 CP	Complete	Plastic Piston	232	
	RML 79003 A8 CP1	Complete	Plastic Piston	233	
SAE	8403 / 102	RML 7924 C	Complete	Metal Piston	106
SAF HOLLAND	2918 V	RML 75921 C5	Complete	Metal Piston	193
	2918 V	RML 75921 C	Complete	Metal Piston	192
	2918 V	RML 75921 C1	Complete	Metal Piston	192
	2926 V	RML 7023 C1	Complete	Metal Piston	86
	2926 V	RML 7023 C3	Complete	Metal Piston	86
	2923 V	RML 75134 C	Complete	Metal Piston	164
	2923 V	RML 75134 C2	Complete	Metal Piston	164
	2923 V	RML 75134 C3	Complete	Metal Piston	165
	2924 V	RML 75134 CP2	Complete	Plastic Piston	166
	2924 V	RML 75134 CP3	Complete	Plastic Piston	166
	2924 V	RML 75134 CP4	Complete	Plastic Piston	166
	2919 V	RML 75921 CP	Complete	Plastic Piston	193
	2919 V	RML 75921 CP1	Complete	Plastic Piston	194

COMPLETE & SERVICE AIR SPRINGS OEM LIST					
MANUFACTURER	OEM PARTNO	PARTNO	TYPE	REMARKS	PAGE
SAF HOLLAND	2919 V	RML 75921 CP2	Complete	Plastic Piston	194
	2927 V	RML 7023 CP	Complete	Plastic Piston	87
	2927 V	RML 7023 CP1	Complete	Plastic Piston	87
	2927 V	RML 7023 CP2	Complete	Plastic Piston	88
	2618	RML 75115	Service Assy	Service	157
	3138	RML 75054	Service Assy	Service	155
	2618/2619 V	RML 75133	Service Assy	Service	161
	2618/2619 IL	RML 75133-1	Service Assy	Service	161
	2923 L	RML 75134 C1	Complete	Metal Piston	164
	2922 V / 250	RML 75921 C2	Complete	Metal Piston	192
	2923 VK	RML 75134 CP1	Complete	Plastic Piston	165
	2918	RML 75921 C7	Complete	Metal Piston	193
	2923	RML 7924 C	Complete	Metal Piston	106
	2623 V	RML 75131 C1	Complete	Metal Piston	160
	2623 V	RML 75131 C	Complete	Metal Piston	159
SAMRO	2500915	RML 70081 C	Complete	Metal Piston	116
	H25000361	RML 71302 C	Complete	Metal Piston	126
	H25000361	RML 74580 C	Complete	Metal Piston	144
	H2501122	RML 75026 C6	Complete	Metal Piston	150
	H2500425	RML 75260 C3	Complete	Metal Piston	169
		RML 75260 C6	Complete	Metal Piston	170
	2500425	RML 75260 CA18	Complete	Aluminium Piston	171
	H2500324	RML 75260 CP9	Complete	Plastic Piston	172
	H2501869	RML 75268 CP8	Complete	Plastic Piston	184
	H25000361	RML 71303 C	Complete	Metal Piston	126
SCANIA	1510195	RML 70195 C	Complete	Metal Piston	117
	1726257	RML 70303 C1	Complete	Metal Piston	119
		RML 71113	Service Assy	Service	125
	1731113	RML 71113 C	Complete	Metal Piston	125
	1903608	RML 73608 C	Complete	Metal Piston	137
	1944314	RML 73608 C	Complete	Metal Piston	137
	2024285	RML 74283 C	Complete	Metal Piston	138
	2024287	RML 74287 C	Complete	Metal Piston	139
	2024288	RML 74288 C	Complete	Metal Piston	139
	1434506	RML 74506 C	Complete	Metal Piston	140
	1379393	RML 75024	Service Assy	Service	149
	1379392	RML 75024 C	Complete	Metal Piston	150
	1440294	RML 75024 C	Complete	Metal Piston	150
		RML 75924	Service Assy	Service	194
	1107674	RML 75924 C	Complete	Metal Piston	195
	1314906	RML 75924 C	Complete	Metal Piston	195
	1865755	RML 75924 C	Complete	Metal Piston	195
	255293	RML 75924 C	Complete	Metal Piston	195
	298568	RML 75924 C	Complete	Metal Piston	195
	325748	RML 75924 C	Complete	Metal Piston	195

COMPLETE & SERVICE AIR SPRINGS OEM LIST					
MANUFACTURER	OEM PARTNO	PARTNO	TYPE	REMARKS	PAGE
SCANIA		RML 76199	Service Assy	Service	202
	1386199	RML 76199 C	Complete	Metal Piston	202
	1362145	RML 76199 C	Complete	Metal Piston	202
	1372146	RML 76199 C	Complete	Metal Piston	202
		RML 76200	Service Assy	Service	203
	1386200	RML 76200 C	Complete	Metal Piston	203
	1362147	RML 76200 C	Complete	Metal Piston	203
	1370744	RML 76200 C	Complete	Metal Piston	203
		RML 76200 C1	Complete	Metal Piston	203
	1726237	RML 76237 C	Complete	Metal Piston	204
	1726238	RML 76238 C	Complete	Metal Piston	204
	1726240	RML 76240 C	Complete	Metal Piston	204
	1726241	RML 76241 C	Complete	Metal Piston	205
	1726242	RML 76242 C	Complete	Metal Piston	205
	1726243	RML 76243 C	Complete	Metal Piston	205
	1726246	RML 76246 C	Complete	Metal Piston	206
		RML 76251	Service Assy	Service	206
	1394997	RML 76251 C	Complete	Metal Piston	206
	1314903	RML 76251 C	Complete	Metal Piston	206
	1402423	RML 76251 C	Complete	Metal Piston	206
	1865759	RML 76251 C	Complete	Metal Piston	206
	1863244	RML 76251 C	Complete	Metal Piston	206
	255295	RML 76251 C	Complete	Metal Piston	206
		RML 76251 CP	Complete	Plastic Piston	207
		RML 77283	Service Assy	Service	213
		RML 77283 C	Complete	Metal Piston	214
	1320151	RML 77283 CP	Complete	Plastic Piston	214
		RML 77308	Service Assy	Service	214
		RML 77308 C	Complete	Metal Piston	215
	1314905	RML 77308 CP	Complete	Plastic Piston	215
	1327144	RML 77308 CP	Complete	Plastic Piston	215
	255294	RML 77308 CP	Complete	Plastic Piston	215
	345879	RML 77308 CP	Complete	Plastic Piston	215
		RML 77315	Service Assy	Service	216
	1314904	RML 77315 C	Complete	Metal Piston	216
	277696	RML 77315 C	Complete	Metal Piston	216
		RML 77315 CP	Complete	Plastic Piston	217
		RML 77348	Service Assy	Service	217
	1865757	RML 77348 C	Complete	Metal Piston	218
	1434933	RML 78633 C	Complete	Metal Piston	227
	1434930	RML 78653 CP	Complete	Plastic Piston	227
	SCANIA BUSSAR	1440301	RML 70301 C	Complete	Metal Piston
1440302		RML 70302 C	Complete	Metal Piston	117
		RML 70303	Service Assy	Service	117
1440303		RML 70303 C	Complete	Metal Piston	118

COMPLETE & SERVICE AIR SPRINGS OEM LIST					
MANUFACTURER	OEM PARTNO	PARTNO	TYPE	REMARKS	PAGE
SCANIA BUSSAR	152114	RML 70303 C	Complete	Metal Piston	118
	1726239	RML 70303 C1	Complete	Metal Piston	119
		RML 70304	Service Assy	Service	119
	1440304	RML 70304 C	Complete	Metal Piston	120
	1440305	RML 70305 C	Complete	Metal Piston	120
	1440306	RML 70306 C	Complete	Metal Piston	120
	1440306	RML 70307 C	Complete	Metal Piston	121
SCHMITZ	S015323	RML 71501 C	Complete	Metal Piston	130
	17685	RML 74031 C	Complete	Metal Piston	138
	751 065	RML 75268 CP6	Complete	Plastic Piston	183
		RML 75269	Service Assy	Service	185
	750999	RML 75269 C	Complete	Metal Piston	185
	750999	RML 75269 CP	Complete	Plastic Piston	186
	014892	RML 75269 CP	Complete	Plastic Piston	186
	750 570	RML 75992	Service Assy	Service	196
		RML 76286	Service Assy	Service	209
	751020 HP	RML 76286 CP	Complete	Plastic Piston	209
		RML 76318	Service Assy	Service	210
	016512	RML 76318 CP	Complete	Plastic Piston	210
	US04031	RML 77685 C	Complete	Metal Piston	221
	750999	RML 79296 CP	Complete	Plastic Piston	234
	014892	RML 79296 CP	Complete	Plastic Piston	234
SMB	M001464	RML 71304 C	Complete	Metal Piston	126
	M001464	RML 71304 C1	Complete	Metal Piston	127
	M100152	RML 71314 C	Complete	Metal Piston	127
		RML 75260 C3	Complete	Metal Piston	169
	1518779	RML 75260 C7	Complete	Metal Piston	170
	1520356	RML 75260 C7	Complete	Metal Piston	170
	1524873	RML 75260 C7	Complete	Metal Piston	170
	M001782	RML 75260 C7	Complete	Metal Piston	170
	1525199	RML 75260 CP9	Complete	Plastic Piston	172
	M001774	RML 75260 CP9	Complete	Plastic Piston	172
		RML 75267-5	Service Assy	Service	175
		RML 75267 C7	Complete	Metal Piston	177
		RML 75267 CP15	Complete	Plastic Piston	179
	M078580	RML 75268 CP8	Complete	Plastic Piston	184
	M060924	RML 75268 CP10	Complete	Plastic Piston	184
SNVI	5.000.785.792	RML 9870 C	Complete	Metal Piston	243
	5.000.786.641	RML 9870 C	Complete	Metal Piston	243
STEFEN	M04010670	RML 75266 C	Complete	Metal Piston	175
	M04010495	RML 76884 C	Complete	Metal Piston	211
TEMSA		RML 9027 C	Complete	Metal Piston	238
		RML 9032 C	Complete	Metal Piston	238
	TM260133Y	RML 9920 C	Complete	Metal Piston	245
TIRSAN		RML 73836 C	Complete	Metal Piston	138

COMPLETE & SERVICE AIR SPRINGS OEM LIST					
MANUFACTURER	OEM PARTNO	PARTNO	TYPE	REMARKS	PAGE
TITAN	916 8770 0000	RML 7924 C	Complete	Metal Piston	106
TRAILOR	650 4646 G	RML 7921 C	Complete	Metal Piston	100
	003 6158 E	RML 7924 C	Complete	Metal Piston	106
	6502 3482	RML 7924 C	Complete	Metal Piston	106
	531233	RML 75260 CP12	Complete	Plastic Piston	172
TRANSPART	520 728	RML 75266 C	Complete	Metal Piston	175
	520 728	RML 75267 CP14	Complete	Plastic Piston	179
	03003000070	RML 71421 C	Complete	Metal Piston	129
TRASCAR	3003000060	RML 71481 C	Complete	Metal Piston	129
	03003000080	RML 72432 C	Complete	Metal Piston	132
	HB 10 315	RML 7921 C	Complete	Metal Piston	100
TROUILLET	ST 225-675	RML 7924 C	Complete	Metal Piston	106
	0 067 504	RML 7947	Service Assy	Service	108
VDL	0 513 985	RML 7947-1	Service Assy	Service	108
	0 513 982	RML 7947-2	Service Assy	Service	109
	0 377 498	RML 7947 C4	Complete	Metal Piston	110
	1 153 933	RML 7947 C8	Complete	Metal Piston	111
	1 153 934	RML 7947 C9	Complete	Metal Piston	111
	0 526 651	RML 7947 C6	Complete	Metal Piston	110
VDL BUS	0 513 983	RML 7998	Service Assy	Service	114
	1 153 935	RML 7998 C3	Complete	Metal Piston	115
	1 141 525	RML 7998 C6	Complete	Metal Piston	116
	1 154 761	RML 7998 C6	Complete	Metal Piston	116
	128147112	RML 7923 C	Complete	Metal Piston	105
VIBERTI	128147102	RML 7923 C1	Complete	Metal Piston	105
	128 147 122	RML 7924 C	Complete	Metal Piston	106
	644 285	RML 7924 C	Complete	Metal Piston	106
	128147109	RML 74514 C	Complete	Metal Piston	141
	H68.237001	RML 93856 C	Complete	Metal Piston	250
VOITH	H68.219201	RML 98739 C	Complete	Metal Piston	277
	311.00038701	RML 98739 C1	Complete	Metal Piston	277
	311.00044801	RML 98739 C2	Complete	Metal Piston	277
	311.00038501	RML 99202 C	Complete	Metal Piston	278
	311.00054901	RML 99202 C1	Complete	Metal Piston	278
	1 080 707	RML 7921 C	Complete	Metal Piston	100
VOLVO	20352247	RML 72247 CP	Complete	Plastic Piston	131
	20386228	RML 72247 CP	Complete	Plastic Piston	131
	7321690	RML 73108	Service Assy	Service	135
	20 573 108	RML 73108 C	Complete	Metal Piston	135
	70 321 692	RML 73108 C	Complete	Metal Piston	135
	70 376 919	RML 73108 C	Complete	Metal Piston	135
	70 321 690	RML 73108 C	Complete	Metal Piston	135
		RML 73311	Service Assy	Service	136
	20 573 311	RML 73311 C	Complete	Metal Piston	136
	3 195 240	RML 73311 C	Complete	Metal Piston	136

**COMPLETE & SERVICE AIR SPRINGS OEM LIST**

MANUFACTURER	OEM PARTNO	PARTNO	TYPE	REMARKS	PAGE
VOLVO		RML 73312	Service Assy	Service	136
	20 573 312	RML 73312 C	Complete	Metal Piston	137
	3 171 693	RML 73312 C	Complete	Metal Piston	137
	3 178 706	RML 73312 C	Complete	Metal Piston	137
	3 195 240	RML 73312 C	Complete	Metal Piston	137
	20 737 947	RML 74543 C	Complete	Metal Piston	143
	21 961 458	RML 74543 C	Complete	Metal Piston	143
	20 583 420	RML 74543 C	Complete	Metal Piston	143
	20 737 943	RML 74543 C	Complete	Metal Piston	143
	20 424 543	RML 74543 C	Complete	Metal Piston	143
	20 554 760	RML 74760 C	Complete	Metal Piston	144
	20 580 705	RML 74760 C	Complete	Metal Piston	144
	21 961 472	RML 74760 C	Complete	Metal Piston	144
	20 479 800	RML 74760 C	Complete	Metal Piston	144
	20 452 142	RML 74760 C	Complete	Metal Piston	144
	20 554 762	RML 74762 C	Complete	Metal Piston	144
	21 811 323	RML 74762 C	Complete	Metal Piston	144
	21 961 475	RML 74762 C	Complete	Metal Piston	144
	20 452 144	RML 74762 C	Complete	Metal Piston	144
	20554770	RML 74770 C	Complete	Metal Piston	145
		RML 74925	Service Assy	Service	145
	1 075 365	RML 74925 C	Complete	Metal Piston	145
	1 629 782	RML 74925 C	Complete	Metal Piston	145
	20 452 138	RML 74925 C	Complete	Metal Piston	145
	20 554 761	RML 74925 C	Complete	Metal Piston	145
	21 978 490	RML 75020 C	Complete	Metal Piston	146
	20 735 220	RML 75020 C	Complete	Metal Piston	146
	20 726 769	RML 75022 C6	Complete	Metal Piston	147
	21 978 502	RML 75022 C6	Complete	Metal Piston	147
	21 978 495	RML 75022 C6	Complete	Metal Piston	147
	20 722 412	RML 75023 C10	Complete	Metal Piston	149
	22 025 568	RML 75023 C10	Complete	Metal Piston	149
	20 726 768	RML 75023 C13	Complete	Metal Piston	149
	20 757 541	RML 75026 C6	Complete	Metal Piston	150
	22 025 613	RML 75026 C6	Complete	Metal Piston	150
	22 025 612	RML 75038 CP	Complete	Plastic Piston	155
	25 379 286	RML 75038 CP	Complete	Plastic Piston	155
	20 722 409	RML 75038 CP	Complete	Plastic Piston	155
	20 758 818	RML 75265 CP6	Complete	Plastic Piston	174
	21 978 506	RML 75265 CP6	Complete	Plastic Piston	174
	21 978 510	RML 75265 CP6	Complete	Plastic Piston	174
	1076075	RML 75531	Service Assy	Service	188
	1 076 075	RML 75531 C	Complete	Metal Piston	188
	1 076 076	RML 75531 C	Complete	Metal Piston	188
	20 554 756	RML 75531 C	Complete	Metal Piston	188



COMPLETE & SERVICE AIR SPRINGS OEM LIST

MANUFACTURER	OEM PARTNO	PARTNO	TYPE	REMARKS	PAGE
VOLVO	1076595	RML 75824	Service Assy	Service	190
	1076594	RML 75824 C	Complete	Metal Piston	190
	20554755	RML 75824 C	Complete	Metal Piston	190
	1079718	RML 75829	Service Assy	Service	191
	1 075 363	RML 75829 C	Complete	Metal Piston	191
	20 452 136	RML 75829 C	Complete	Metal Piston	191
	20 554 759	RML 75829 C	Complete	Metal Piston	191
	20 480 202	RML 76113 C	Complete	Metal Piston	202
	20 573 113	RML 76113 C	Complete	Metal Piston	202
	21 041 697	RML 76113 C	Complete	Metal Piston	202
	21 097 453	RML 76113 C	Complete	Metal Piston	202
	70 313 734	RML 76113 C	Complete	Metal Piston	202
	70 397 453	RML 76113 C	Complete	Metal Piston	202
	70 321 079	RML 76113 C	Complete	Metal Piston	202
		RML 76420	Service Assy	Service	211
	20 531 988	RML 76420 C	Complete	Metal Piston	211
	20 582 212	RML 76420 C	Complete	Metal Piston	211
	21 961 447	RML 76420 C	Complete	Metal Piston	211
	20 427 805	RML 76420 C	Complete	Metal Piston	211
	20 427 804	RML 76420 C	Complete	Metal Piston	211
	20703452	RML 77433	Service Assy	Service	218
	21013010	RML 77433	Service Assy	Service	218
	21513836	RML 77433	Service Assy	Service	218
	21513833	RML 77433 C	Complete	Metal Piston	218
	21097433	RML 77433 C	Complete	Metal Piston	218
	70311683	RML 77433 C	Complete	Metal Piston	218
	1076416	RML 77527	Service Assy	Service	219
	1 075 891	RML 77527 C	Complete	Metal Piston	219
	1 076 416	RML 77527 C	Complete	Metal Piston	219
	20 374 510	RML 77527 C	Complete	Metal Piston	219
	20 456 152	RML 77527 C	Complete	Metal Piston	219
	20 531 985	RML 77527 C	Complete	Metal Piston	219
	20 582 215	RML 77527 C	Complete	Metal Piston	219
	70 321 693	RML 77527 C	Complete	Metal Piston	219
	21 961 456	RML 77527 C	Complete	Metal Piston	219
		RML 77529	Service Assy	Service	219
	1 076 418	RML 77529 C	Complete	Metal Piston	220
	20 374 511	RML 77529 C	Complete	Metal Piston	220
	20 456 156	RML 77529 C	Complete	Metal Piston	220
	20 531 987	RML 77529 C	Complete	Metal Piston	220
	20 582 214	RML 77529 C	Complete	Metal Piston	220
	3 171 695	RML 77529 C	Complete	Metal Piston	220
70 321 695	RML 77529 C	Complete	Metal Piston	220	
21 961 451	RML 77529 C	Complete	Metal Piston	220	
20427804	RML 77804	Service Assy	Service	221	

COMPLETE & SERVICE AIR SPRINGS OEM LIST						
MANUFACTURER	OEM PARTNO	PARTNO	TYPE	REMARKS	PAGE	
VOLVO	20 531 988	RML 77805 C	Complete	Metal Piston	222	
	20 582 212	RML 77805 C	Complete	Metal Piston	222	
	21 961 447	RML 77805 C	Complete	Metal Piston	222	
	20 427 805	RML 77805 C	Complete	Metal Piston	222	
	20 427 804	RML 77805 C	Complete	Metal Piston	222	
		RML 77805	Service Assy	Service	222	
	20 375 227	RML 77804 C	Complete	Metal Piston	221	
	20 456 154	RML 77804 C	Complete	Metal Piston	221	
	20 531 986	RML 77804 C	Complete	Metal Piston	221	
	20 582 209	RML 77804 C	Complete	Metal Piston	221	
	3 171 694	RML 77804 C	Complete	Metal Piston	221	
	70 321 694	RML 77804 C	Complete	Metal Piston	221	
	20 427 801	RML 77804 C	Complete	Metal Piston	221	
	21 961 443	RML 77804 C	Complete	Metal Piston	221	
	20 427 805	RML 77804 C	Complete	Metal Piston	221	
	20 427 804	RML 77804 C	Complete	Metal Piston	221	
	20427803	RML 78914	Service Assy	Service	228	
	1 075 890	RML 78914 C	Complete	Metal Piston	228	
	1 076 415	RML 78914 C	Complete	Metal Piston	228	
	20 375 226	RML 78914 C	Complete	Metal Piston	228	
	20 427 800	RML 78914 C	Complete	Metal Piston	228	
	20 456 150	RML 78914 C	Complete	Metal Piston	228	
	20 531 984	RML 78914 C	Complete	Metal Piston	228	
	20 582 206	RML 78914 C	Complete	Metal Piston	228	
	21 961 374	RML 78914 C	Complete	Metal Piston	228	
	70377052	RML 97054 C	Complete	Metal Piston	274	
	WEWELER	US 96681	RML 7023 C2	Complete	Metal Piston	86
			RML 7921	Service Assy	Service	99
2120 8082		RML 7921 C	Complete	Metal Piston	100	
US 00622		RML 7921 C	Complete	Metal Piston	100	
US 07337		RML 7921 C	Complete	Metal Piston	100	
US 87413		RML 7921 C	Complete	Metal Piston	100	
US 874131		RML 7921 C	Complete	Metal Piston	100	
US 07337F		RML 7921 CP	Complete	Plastic Piston	101	
		RML 7924	Service Assy	Service	106	
US 07345		RML 7924 C	Complete	Metal Piston	106	
US 87408		RML 7924 C	Complete	Metal Piston	106	
US07385F		RML 71314 C	Complete	Metal Piston	127	
US96681F		RML 71314 C	Complete	Metal Piston	127	
US 04030P		RML 71501 C	Complete	Metal Piston	130	
US 04030G		RML 71501 C	Complete	Metal Piston	130	
US 07337RP		RML 71901 C	Complete	Metal Piston	131	
USD4031		RML 74031 C	Complete	Metal Piston	138	
USD4031F		RML 74031 C	Complete	Metal Piston	138	
US 07380F		RML 74580 C	Complete	Metal Piston	144	

COMPLETE & SERVICE AIR SPRINGS OEM LIST					
MANUFACTURER	OEM PARTNO	PARTNO	TYPE	REMARKS	PAGE
WEWELER	US 35864F	RML 75267 C6	Complete	Metal Piston	176
	US 09361F	RML 75267 CP14	Complete	Plastic Piston	179
	US 97306	RML 75267 CP14	Complete	Plastic Piston	179
	US 35864	RML 75267 CP15	Complete	Plastic Piston	179
		RML 75268	Service Assy	Service	180
		RML 75268-4	Service Assy	Service	180
	US 06287	RML 75268 CP4	Complete	Plastic Piston	183
	US 07364	RML 75268 CP4	Complete	Plastic Piston	183
	US 07074C	RML 75268 CP5	Complete	Plastic Piston	183
	US 07074P	RML 75268 CP5	Complete	Plastic Piston	183
	US 08840	RML 75268 CP5	Complete	Plastic Piston	183
	US 06316	RML 75268 CP6	Complete	Plastic Piston	183
	US 07074F	RML 75268 CP9	Complete	Plastic Piston	184
	US 07364	RML 75268 CP14	Complete	Plastic Piston	185
	US 06285	RML 75269 C	Complete	Metal Piston	185
	US 06285	RML 75269 CP	Complete	Plastic Piston	186
		RML 76286	Service Assy	Service	209
	US 06286 F	RML 76286 CP	Complete	Plastic Piston	209
	US06287F	RML 76287 CP	Complete	Plastic Piston	209
	US06288F	RML 76288 CP	Complete	Plastic Piston	210
		RML 76318	Service Assy	Service	210
	US06318F	RML 76318 CP	Complete	Plastic Piston	210
		RML 77308	Service Assy	Service	214
		RML 77308 C	Complete	Metal Piston	215
	US07348	RML 77308 CP	Complete	Plastic Piston	215
		RML 79002 A3	Service Assy	Service	229
	US 08840	RML 79002 A3 CP	Complete	Plastic Piston	231
		RML 79002 A3 CP1	Complete	Plastic Piston	232
		RML 79002 A8	Service Assy	Service	232
	US87 Euro F	RML 79002 A8 CP	Complete	Plastic Piston	232
		RML 79003 A3	Service Assy	Service	231
		RML 79003 A3 CP	Complete	Plastic Piston	231
US 07074C	RML 79003 A3 CP1	Complete	Plastic Piston	232	
US 07074P	RML 79003 A3 CP1	Complete	Plastic Piston	232	
US 06285	RML 79296 CP	Complete	Plastic Piston	234	
ZFSACHS		RML 9886 C	Complete	Metal Piston	244
	0501.210.851	RML 9893 C3	Complete	Metal Piston	245
ZORZI	1006553	RML 7923 C1	Complete	Metal Piston	105
	1006552	RML 71304 C	Complete	Metal Piston	126
	1006552	RML 71304 C1	Complete	Metal Piston	127
	1006557	RML 72670 C	Complete	Metal Piston	134
	1006550	RML 75266 C	Complete	Metal Piston	175
	1006551	RML 75270 C	Complete	Metal Piston	186
	1006546	RML 76884 C	Complete	Metal Piston	211
	1006545	RML 76885 C	Complete	Metal Piston	212

**RML 7010 S**



Cross Section View

Top View

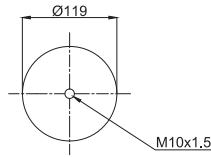
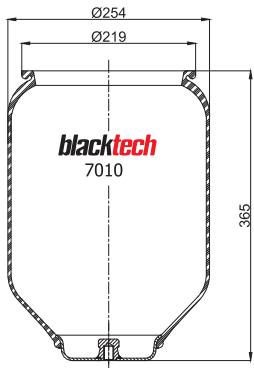

- Bolt or Stud
- Threaded hole
- ⊗ Combination Stud
- ⊗ Air Inlet

OEM PART NUMBER		MODEL NO	CROSS REFERENCES	
Man	81.43601.6029		Contitech	909 NT
Man	81.43601.0073		Firestone Style	1T15L-6
Man	81.43601.0054		Firestone No.	W01 M58 0031
Man	81.43601.0050		Phoenix	1 D 23 C
Neoplan	1021 215 00		Taurus	B 151
Neoplan	1021 005 00			

**RML 7010 SP**



Cross Section View

Top View

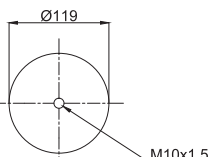
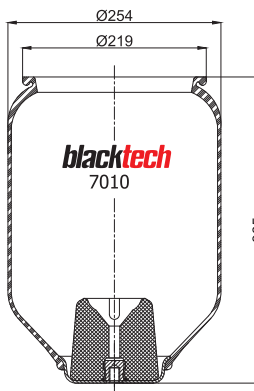

- Bolt or Stud
- Threaded hole
- ⊗ Combination Stud
- ⊗ Air Inlet

OEM PART NUMBER		MODEL NO	CROSS REFERENCES	
Man	81.43601.6023		Contitech	909 NTB
BredaMenaribus	178 739		Firestone Style	1T15L-6
			Firestone No.	W01 M58 0687
			Phoenix	1 D 23 C-1
			Goodyear	1R12-709
			CF Gomma Ref.	1T 320 SP / 89753
			CF Gomma No.	UR504-13
			Taurus	UR504-13

**RML 7012**



Cross Section View

Top View

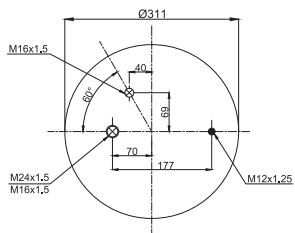
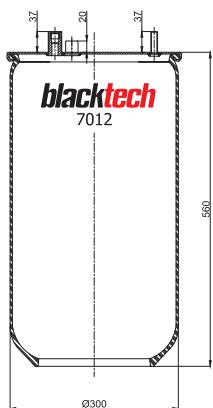

- Bolt or Stud
- Threaded hole
- ⊗ Combination Stud
- ⊗ Air Inlet

OEM PART NUMBER		MODEL NO	CROSS REFERENCES	
Renault				

### RML 7012 C



Cross Section View

Top View

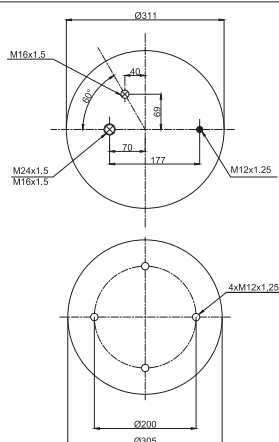
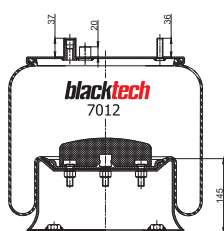

- Bolt or Stud
- Threaded hole
- ⊗ Combination Stud
- ⊗ Air Inlet

OEM PART NUMBER		MODEL NO	CROSS REFERENCES	
Renault	5010052722	Premium. Magnum	Contitech	901 MB
Renault	5010130683	Premium. Magnum		

### RML 7013



Cross Section View

Top View

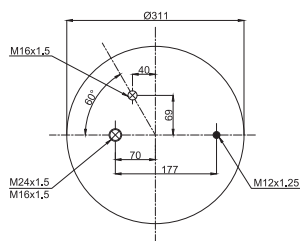
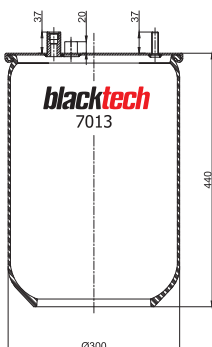

- Bolt or Stud
- Threaded hole
- ⊗ Combination Stud
- ⊗ Air Inlet

OEM PART NUMBER		MODEL NO	CROSS REFERENCES	
Renault				

### RML 7013 C



Cross Section View

Top View

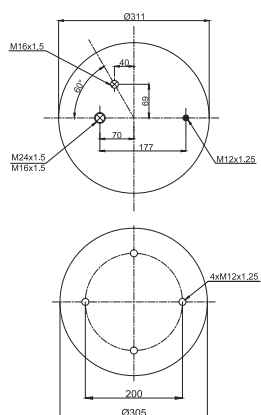
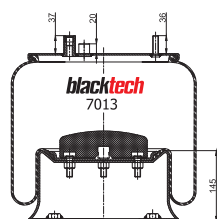

- Bolt or Stud
- Threaded hole
- ⊗ Combination Stud
- ⊗ Air Inlet

OEM PART NUMBER		MODEL NO	CROSS REFERENCES	
Renault	5010211724	Premium. Magnum R380	Contitech	902 MB
Renault	5000815749	Magnum	Firestone Style	1T19G-12
			Firestone No.	W01-M58-9910

**RML 7023 C1**

Cross Section View

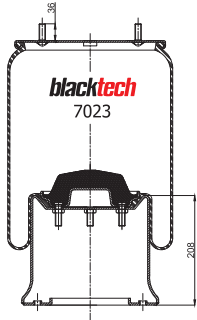

Top View

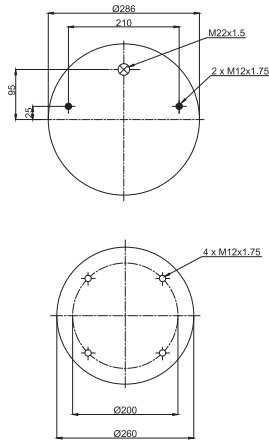

- Bolt or Stud
- Threaded hole
- ⊗ Combination Stud
- ⊗ Air Inlet



OEM PART NUMBER	MODEL NO	CROSS REFERENCES	
SAF	2926 V	Contitech	912 N P01
		Phoenix	1D 28 D-10
		Firestone Style	1T19L-14
		Firestone No.	W01-M58-8502
		Goodyear	1R14-728
		Vibracoustic	VID28D-10
		CF Gomma Ref.	1T19E-2L
		CF Gomma Ref.	1T19E-2L
		CF Gomma Ref.	1T19E-L
		CF Gomma No.	207737
		CF Gomma No.	207736
		CF Gomma No.	206333
		Dunlop F	D14B52
		Gart Ref.	D287/C
		Gart No.	287.4.601
		Gart No.	287.4.601/1

**RML 7023 C2**

Cross Section View

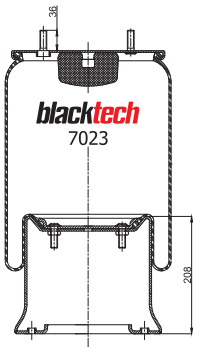

Top View

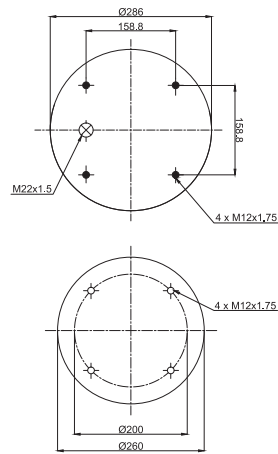

- Bolt or Stud
- Threaded hole
- ⊗ Combination Stud
- ⊗ Air Inlet



OEM PART NUMBER	MODEL NO	CROSS REFERENCES	
Hendrickson	507 782	Contitech	912 N P02
ROR	2122 2673	Phoenix	1D 28 D-2
Weweler	US 96681	Firestone Style	1T19L-14
		Firestone No.	W01-M58-8766
		Firestone No.	W01-M58-7385
		Goodyear	1R14-758
		Vibracoustic	VID28D-4
		CF Gomma Ref.	1T19E-4
		CF Gomma No.	96997
		CF Gomma No.	202442
		Dunlop F	D13B14
		Gart Ref.	D287/C
		Gart No.	287.4.600

**RML 7023 C3**

Cross Section View

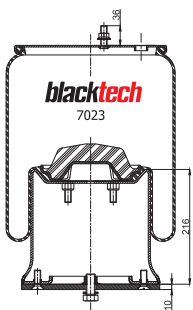

Top View

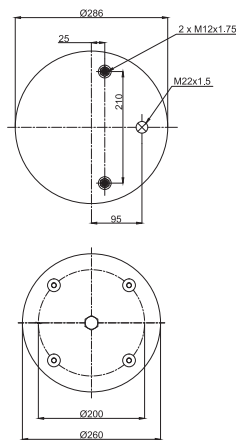

- Bolt or Stud
- Threaded hole
- ⊗ Combination Stud
- ⊗ Air Inlet



OEM PART NUMBER	MODEL NO	CROSS REFERENCES	
SAF	2926 V		

### RML 7023 C5



Cross Section View

Top View

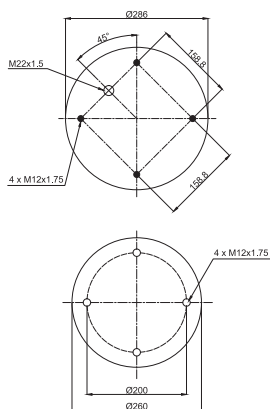
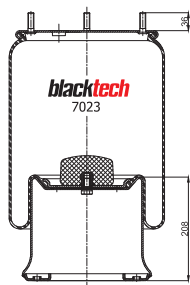

- Bolt or Stud
- Threaded hole
- ⊗ Combination Stud
- ⊗ Air Inlet

OEM PART NUMBER	MODEL NO	CROSS REFERENCES

### RML 7023 CP



Cross Section View

Top View

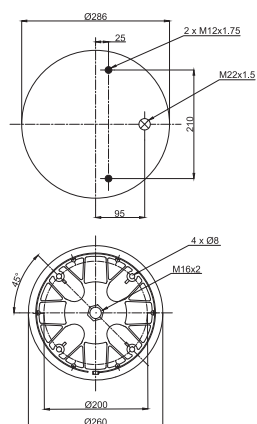
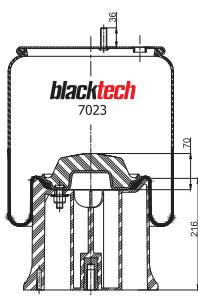

- Bolt or Stud
- Threaded hole
- ⊗ Combination Stud
- ⊗ Air Inlet

OEM PART NUMBER	MODEL NO	CROSS REFERENCES
SAF	2927 V	

### RML 7023 CP1



Cross Section View

Top View

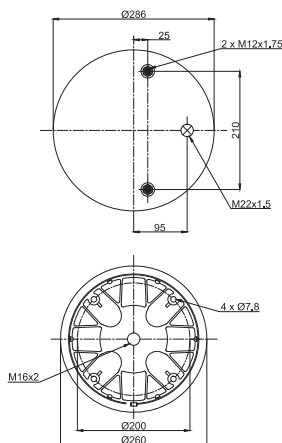
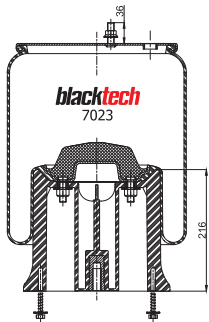

- Bolt or Stud
- Threaded hole
- ⊗ Combination Stud
- ⊗ Air Inlet

OEM PART NUMBER	MODEL NO	CROSS REFERENCES
SAF	2927 V	

**RML 7023 CP2**

Cross Section View

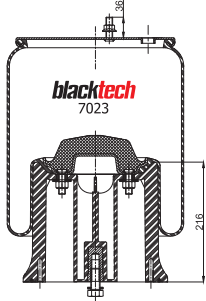

Top View

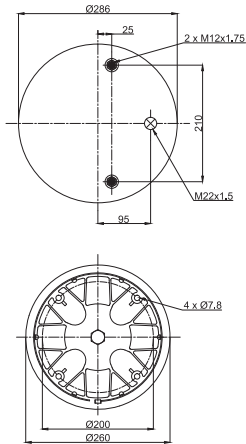

- Bolt or Stud
- Threaded hole
- ⊗ Combination Stud
- ⊗ Air Inlet

OEM PART NUMBER	MODEL NO	CROSS REFERENCES
SAF	2927 V	

**RML 7051**

Cross Section View

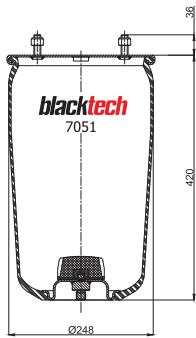

Top View

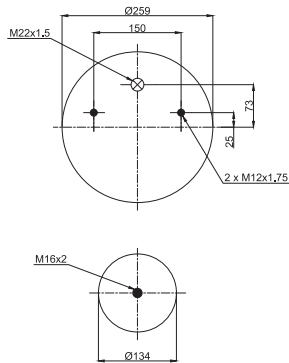

- Bolt or Stud
- Threaded hole
- ⊗ Combination Stud
- ⊗ Air Inlet

OEM PART NUMBER	MODEL NO	CROSS REFERENCES
BPW	05.429.40.91.0	30 K
		Contitech
		940 MB
		Phoenix
		1DK 21 K
		Primeride
		5940 A P02
		Firestone Style
		1T17D-4.3
		Firestone No.
		W01-M58-8613
		Goodyear
		1R11-703
		Taurus
		UR732-01
		Vibracoustic
		V1DK21K
		CF Gomma Ref.
		1TC300-30
		CF Gomma No.
		205536
		Dunlop F
		D11U31
		Gart Ref.
		C293/A
		Gart No.
		293.0.411

**RML 7051C**

Cross Section View

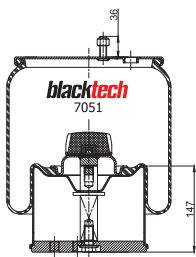

Top View

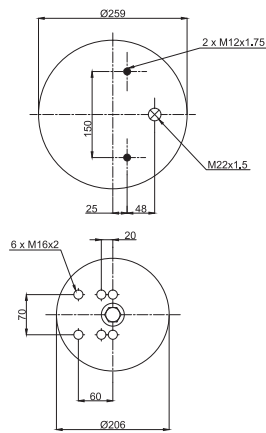

- Bolt or Stud
- Threaded hole
- ⊗ Combination Stud
- ⊗ Air Inlet

OEM PART NUMBER	MODEL NO	CROSS REFERENCES
BPW	05.429.40.59.1	30 K
BPW	05.429.41.37.1	30 K
BPW	05.429.41.24.1	30 K
BPW	05.429.41.26.1	30 K
BPW	05.429.40.93.1	30 K
		Contitech
		940 MB P30 (Metal piston)
		Firestone Style
		1T17D-4.3
		Firestone No.
		W01 M58 8609
		Phoenix
		1DK 21 K1
		Dunlop F
		D11B39
		Goodyear
		1R11-763
		Taurus
		KR 732-01
		Vibracoustic
		V1DK 21 K



### RML 7051 C1



Cross Section View

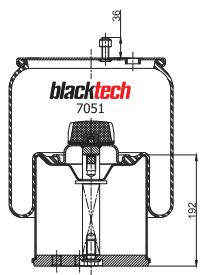

Top View

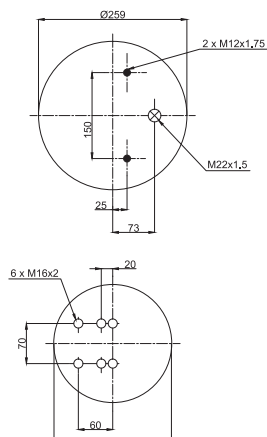

- Bolt or Stud
- Threaded hole
- ⊗ Combination Stud
- ⊗ Air Inlet

OEM PART NUMBER	MODEL NO	CROSS REFERENCES
BPW	30 K	

### RML 7051 CP



Cross Section View

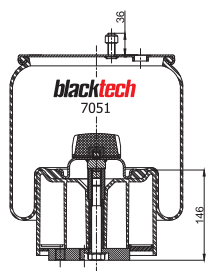

Top View

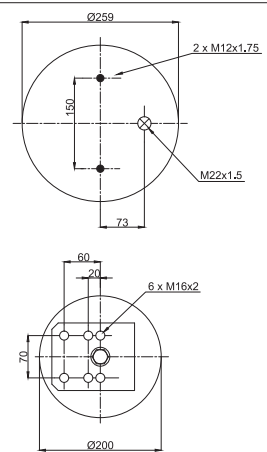

- Bolt or Stud
- Threaded hole
- ⊗ Combination Stud
- ⊗ Air Inlet

OEM PART NUMBER	MODEL NO	CROSS REFERENCES
BPW	05.429.43.21.0	30 K
		Contitech 940 MB P30
		Phoenix 1DK 21 K-2
		Primeride 5940 A P04
		Firestone Style 1T17D-4.3
		Firestone No. W01-M58-8585
		Goodyear 1R11-752
		Vibracoustic VIDK21K Y4
		CF Gomma Ref. 1TC300-30K
		CF Gomma No. 207308
		Dunlop F D11B36
		Dunlop UK 00936A-AP
		Gart Ref. C293/A
		Gart No. 293.2.412

### RML 7051 CP1



Cross Section View

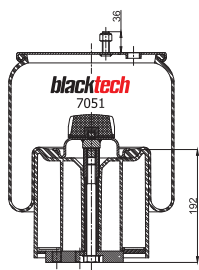

Top View

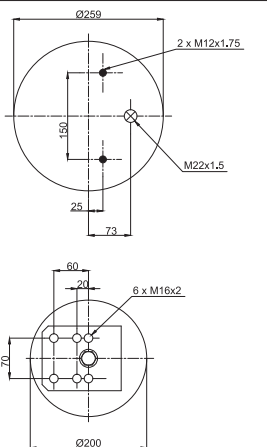

- Bolt or Stud
- Threaded hole
- ⊗ Combination Stud
- ⊗ Air Inlet

OEM PART NUMBER	MODEL NO	CROSS REFERENCES

**RML 7052**

Cross Section View

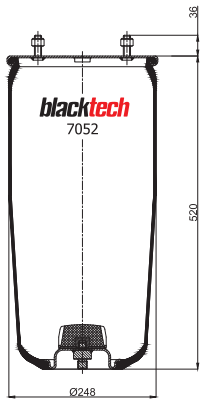

Top View

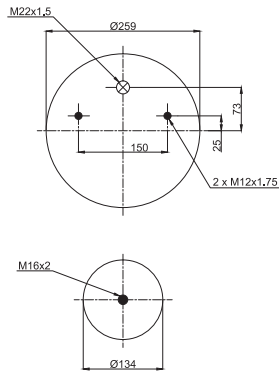

- Bolt or Stud
- Threaded hole
- ⊗ Combination Stud
- ⊗ Air Inlet

OEM PART NUMBER		MODEL NO	CROSS REFERENCES	
BPW	05.429.40.03.0	30	Contitech	941 MB
			Phoenix	1DK 21
			Primeride	5941 A P02
			Firestone Style	1T17D-8.3
			Firestone No.	W01-M58-8620
			Goodyear	1R11-700
			Taurus	UR730-01
			Vibracoustic	V1DK21
			CF Gomma Ref.	1TC300-36
			CF Gomma No.	204466
			Dunlop F	D11U30
			Gart Ref.	C293
			Gart No.	293.0.511

**RML 7052 C**

Cross Section View

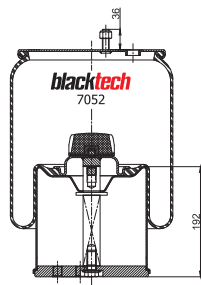

Top View

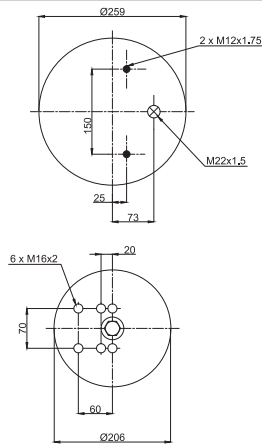

- Bolt or Stud
- Threaded hole
- ⊗ Combination Stud
- ⊗ Air Inlet

OEM PART NUMBER		MODEL NO	CROSS REFERENCES	
BPW	05.429.42.28.1	30	Contitech	941 MB P30 (metal piston)
			Firestone Style	1T17D-8.3
			Firestone No.	W01 M58 8619
			Phoenix	1DK 21
			Dunlop F	D11B38
			Goodyear	1R11-762
			CF Gomma Ref.	1TC 300-36
			CF Gomma No.	205170
			Taurus	UR 730-01

**RML 7052 CP**

Cross Section View

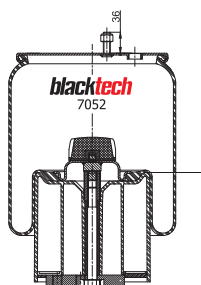

Top View

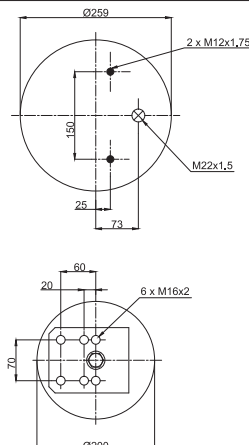

- Bolt or Stud
- Threaded hole
- ⊗ Combination Stud
- ⊗ Air Inlet

OEM PART NUMBER		MODEL NO	CROSS REFERENCES	
BPW	05.429.43.20.0	30	Contitech	941 MB P30
			Phoenix	1DK 21-2
			Primeride	5941 A P04
			Firestone Style	1T17D-8.3
			Firestone Style	1T17J-10.3
			Firestone No.	W01-M58-8618
			Firestone No.	W01-M58-8668
			Goodyear	1R11-743
			Vibracoustic	V1DK21Y1
			CF Gomma Ref.	1TC300-36
			CF Gomma No.	206356
			Dunlop F	D11B33
			Dunlop UK	00935A-AP
			Gart Ref.	C293
			Gart No.	293.2.512

### RML 7053

Cross Section View

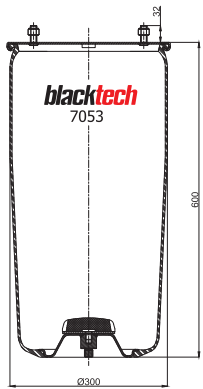

Top View

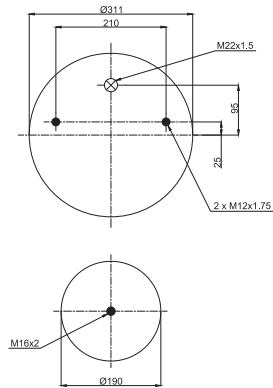

- Bolt or Stud
- Threaded hole
- ⊗ Combination Stud
- ⊗ Air Inlet

OEM PART NUMBER	MODEL NO	CROSS REFERENCES	
BPW 05.429.40.05.0	36-1	Contitech	942 MB
		Phoenix	1DK 32 L
		Firestone Style	1T66D13.5
		Firestone No.	W01-M68-8611
		Goodyear	1R14-700
		Vibracoustic	VIDK32L

### RML 7053 C

Cross Section View

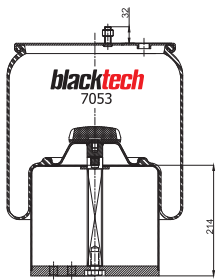

Top View

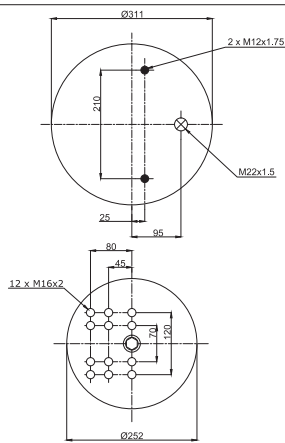

- Bolt or Stud
- Threaded hole
- ⊗ Combination Stud
- ⊗ Air Inlet

OEM PART NUMBER	MODEL NO	CROSS REFERENCES	
BPW 05.429.41.38.0	36-1	Contitech	942 MB
		Firestone Style	1T66F-13.5
		Firestone No.	W01 M58 8584
		Goodyear	1R14-781

### RML 7059

Cross Section View

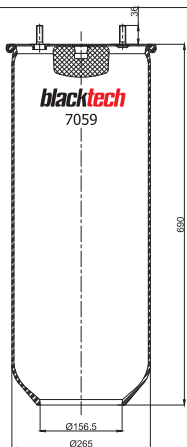

Top View

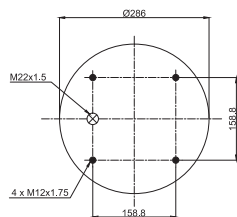

- Bolt or Stud
- Threaded hole
- ⊗ Combination Stud
- ⊗ Air Inlet

OEM PART NUMBER	MODEL NO	CROSS REFERENCES	
		Contitech	948 MB

**RML 7062**

Cross Section View

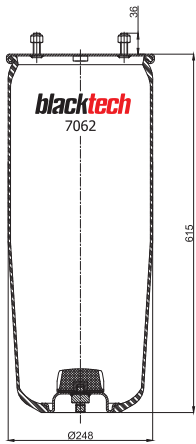

Top View

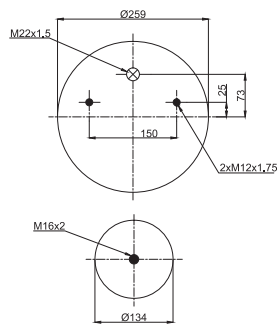

- Bolt or Stud
- Threaded hole
- ⊗ Combination Stud
- ⊗ Air Inlet

OEM PART NUMBER	MODEL NO	CROSS REFERENCES	
BPW 05.429.40.72.0	30-1	Contitech	951 MB
BPW 05.429.42.72.0	30-1	Firestone Style	1T17D-12
		Firestone No.	W01-M58-8621
		Goodyear	1R11-704
		Gart Ref.	C293/B
		Gart No.	293.0.611

**RML 7062 C**

Cross Section View

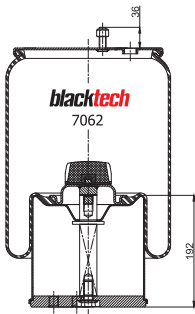

Top View

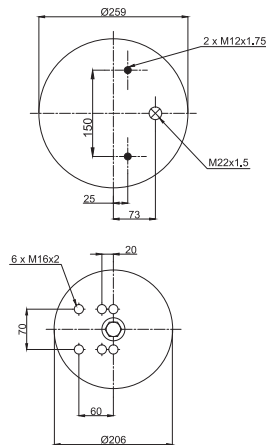

- Bolt or Stud
- Threaded hole
- ⊗ Combination Stud
- ⊗ Air Inlet

OEM PART NUMBER	MODEL NO	CROSS REFERENCES	
BPW			

**RML 7062 CP**

Cross Section View

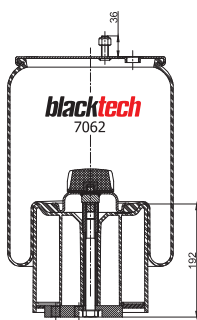

Top View

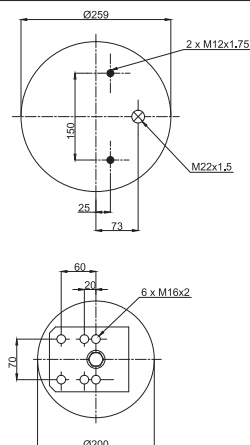

- Bolt or Stud
- Threaded hole
- ⊗ Combination Stud
- ⊗ Air Inlet

OEM PART NUMBER	MODEL NO	CROSS REFERENCES	
BPW			

### RML 7573



Cross Section View

Top View

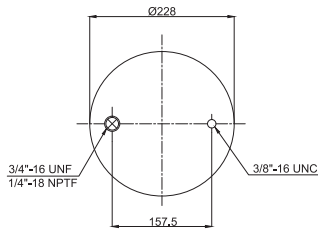
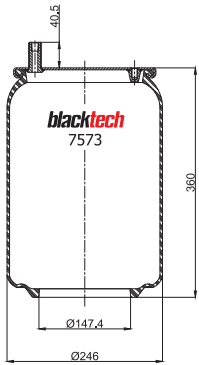

- Bolt or Stud
- Threaded hole
- ⊗ Combination Stud
- ⊗ Air Inlet

OEM PART NUMBER	MODEL NO	CROSS REFERENCES	
BMC	Truck		

### RML 7573 C



Cross Section View

Top View

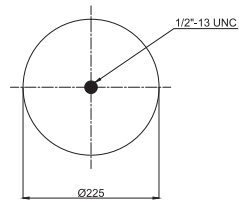
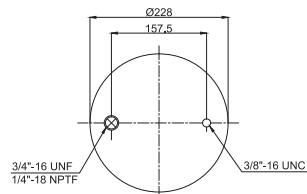
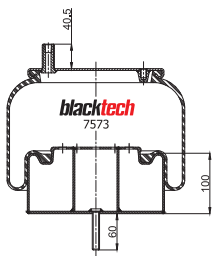

- Bolt or Stud
- Threaded hole
- ⊗ Combination Stud
- ⊗ Air Inlet

OEM PART NUMBER	MODEL NO	CROSS REFERENCES	
BMC	Truck	Goodyear	1R12-573

### RML 7803



Cross Section View

Top View

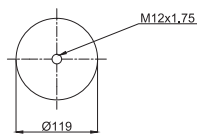
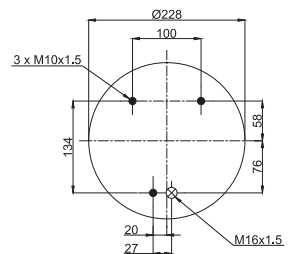
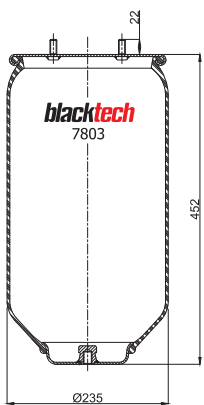

- Bolt or Stud
- Threaded hole
- ⊗ Combination Stud
- ⊗ Air Inlet

OEM PART NUMBER	MODEL NO	CROSS REFERENCES	
DAF			

**RML 7803 CP**



Cross Section View

Top View

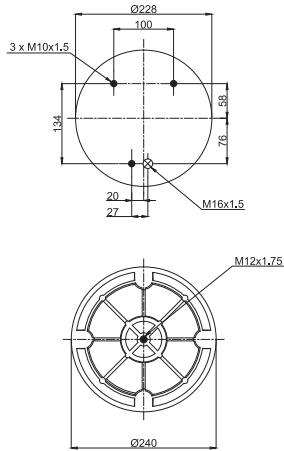
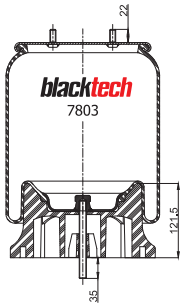

- Bolt or Stud
- Threaded hole
- ⊗ Combination Stud
- ⊗ Air Inlet

OEM PART NUMBER	MODEL NO	CROSS REFERENCES	
DAF 1448 543		Contitech	792 N P01
DAF 1698 436			
DAF 1698 436	CF 65		
DAF 1698 436	CF 75-85		
DAF 1698 436	LF 45-55		
DAF 1698 436	XF 95-105		

**RML 7835**



Cross Section View

Top View

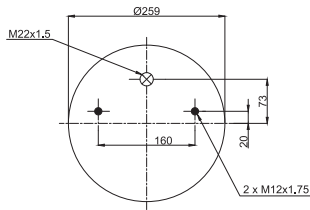
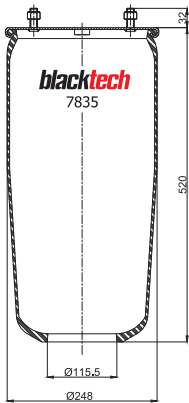

- Bolt or Stud
- Threaded hole
- ⊗ Combination Stud
- ⊗ Air Inlet

OEM PART NUMBER	MODEL NO	CROSS REFERENCES	
Gigant 246169		Contitech	724 N P01
Gigant 3053	724 N	Goodyear	1R11-711

**RML 7835 C1**



Cross Section View

Top View

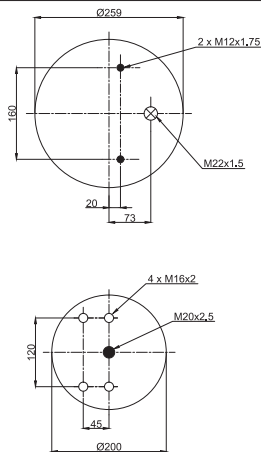
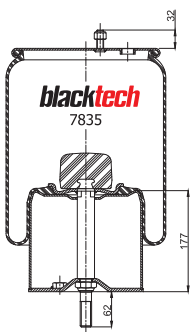

- Bolt or Stud
- Threaded hole
- ⊗ Combination Stud
- ⊗ Air Inlet

OEM PART NUMBER	MODEL NO	CROSS REFERENCES	
Gigant			

### RML 7835 C2

Cross Section View

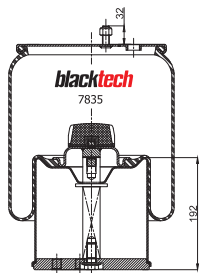

Top View

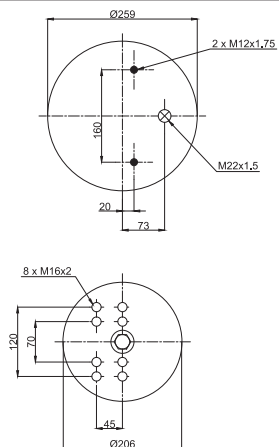

- Bolt or Stud
- Threaded hole
- ⊗ Combination Stud
- ⊗ Air Inlet

OEM PART NUMBER	MODEL NO	CROSS REFERENCES
Gigant 166259	3053	

### RML 7835 C3

Cross Section View

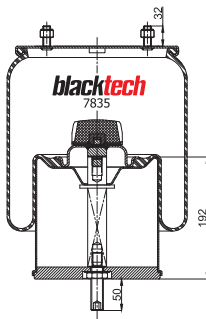

Top View

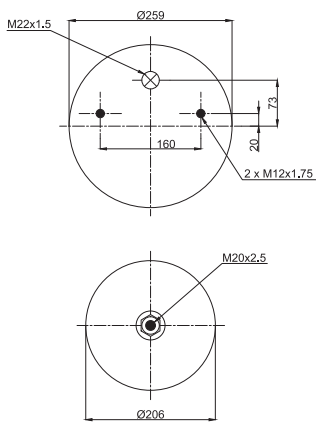

- Bolt or Stud
- Threaded hole
- ⊗ Combination Stud
- ⊗ Air Inlet

OEM PART NUMBER	MODEL NO	CROSS REFERENCES
Gigant 166225	3053	

### RML 7836

Cross Section View

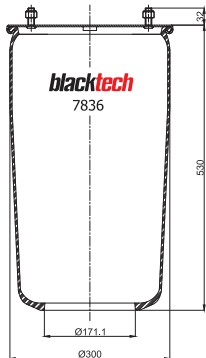

Top View

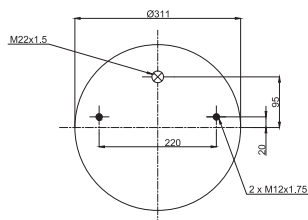

- Bolt or Stud
- Threaded hole
- ⊗ Combination Stud
- ⊗ Air Inlet

OEM PART NUMBER	MODEL NO	CROSS REFERENCES
Gigant 246149	NLRM / NLR Series	Conlitech 725 N P01
Gigant 3653	725 N	Primeride 5725 A P01
		Goodyear 1R14-704
		Vibracoustic VIDF32-246149
		CF Gomma Ref. 1TCS360-45
		CF Gomma No. 202964
		Dunlop F D14U38
		Gart Ref. C292/S
		Gart No. 292.0533

**RML 7836 C2**

Cross Section View

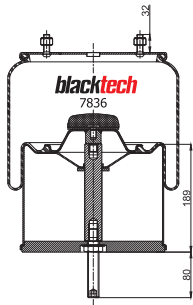

Top View

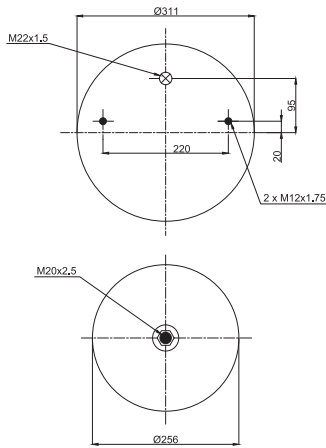

- Bolt or Stud
- Threaded hole
- ⊗ Combination Stud
- ⊗ Air Inlet

OEM PART NUMBER		MODEL NO	CROSS REFERENCES	
Gigant	166217		Contitech	725 N P02
Gigant	3653 compl.		Primeride	5725 A P02
			Firestone Style	1T66E-10.8
			Firestone No.	W01-M58-8969
			Goodyear	1R14-747
			Goodyear	1R14-813
			Vibracoustic	V1DF32-166217
			Dunlop F	D14B40
			Gart Ref.	C292/S
			Gart No.	2921.534

**RML 7836 C3**

Cross Section View

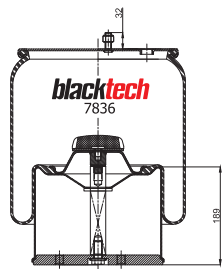

Top View

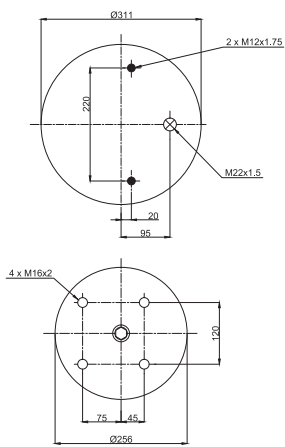

- Bolt or Stud
- Threaded hole
- ⊗ Combination Stud
- ⊗ Air Inlet

OEM PART NUMBER		MODEL NO	CROSS REFERENCES	
Gigant	166252		Contitech	725 N P03
Gigant	3653 compl.		Primeride	5725 A P03
			Firestone Style	1T66D-10.8
			Firestone No.	W01-M58-8610
			Goodyear	1R14-756
			Goodyear	1R14-814
			Vibracoustic	V1DF32-166252
			Dunlop F	D14B43
			Gart Ref.	C292/S

**RML 7836 C4**

Cross Section View

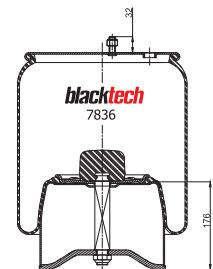

Top View

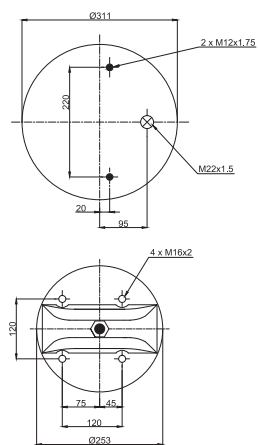

- Bolt or Stud
- Threaded hole
- ⊗ Combination Stud
- ⊗ Air Inlet

OEM PART NUMBER		MODEL NO	CROSS REFERENCES	
Gigant	166252		Goodyear	1R14-756



### RML 7836 C5

Cross Section View

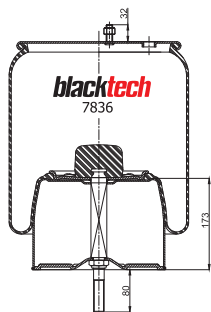

Top View

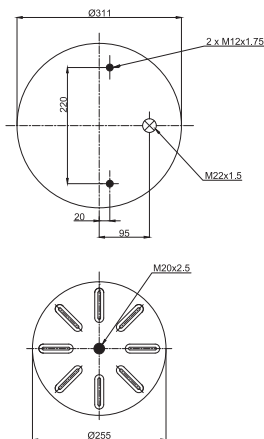

- Bolt or Stud
- Threaded hole
- ⊗ Combination Stud
- ⊗ Air Inlet

OEM PART NUMBER		MODEL NO	CROSS REFERENCES	
Gigant	166217		Goodyear	1R14-747
Gigant	246149			

### RML 7837

Cross Section View

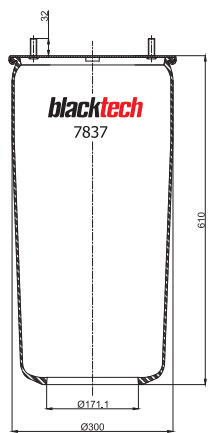

Top View

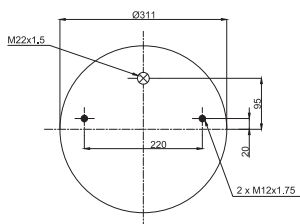

- Bolt or Stud
- Threaded hole
- ⊗ Combination Stud
- ⊗ Air Inlet

OEM PART NUMBER		MODEL NO	CROSS REFERENCES	
Gigant	246192		Contitech	726 N P01
Gigant	3661	726 N	Vibracoustic	V1DF32C-166253

### RML 7863

Cross Section View

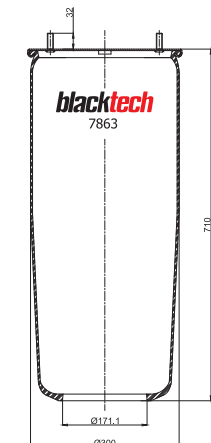

Top View

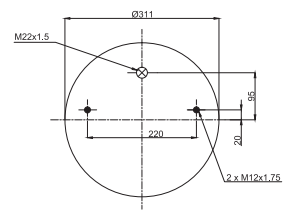

- Bolt or Stud
- Threaded hole
- ⊗ Combination Stud
- ⊗ Air Inlet

OEM PART NUMBER		MODEL NO	CROSS REFERENCES	
Gigant	247100		Contitech	752 N P01
Gigant	3671		Vibracoustic	V1DF32-166228

**RML 7863 C**

Cross Section View

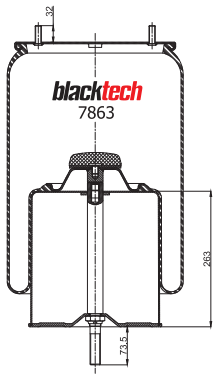

Top View

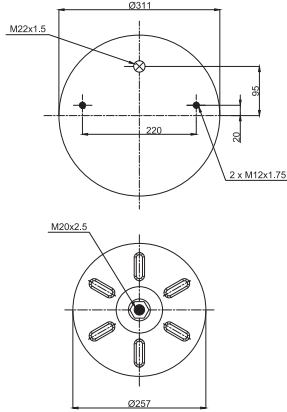

- Bolt or Stud
- Threaded hole
- ⊗ Combination Stud
- ⊗ Air Inlet

OEM PART NUMBER	MODEL NO	CROSS REFERENCES		
Gigant	166228	3671	Contitech	752 N P01

**RML 7910 S**

Cross Section View

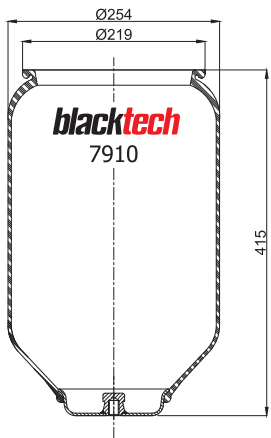

Top View

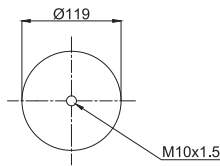

- Bolt or Stud
- Threaded hole
- ⊗ Combination Stud
- ⊗ Air Inlet

OEM PART NUMBER	MODEL NO	CROSS REFERENCES		
MAN	81.43601.0025	BUS	Contitech	809 NT
			Firestone Style	1T15L-6
			Firestone No.	W01 M58 0031
			Phoenix	1 D 23 B-2
			CF Gomma	1T 320 SP

**RML 7910 SP**

Cross Section View

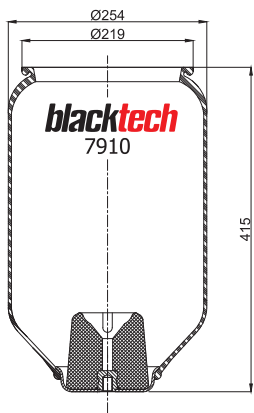

Top View

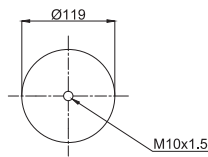

- Bolt or Stud
- Threaded hole
- ⊗ Combination Stud
- ⊗ Air Inlet

OEM PART NUMBER	MODEL NO	CROSS REFERENCES		
Man	81.43601.6002		Contitech	809 NTB
Man	81.43601.6023		Firestone Style	1T15L-6
Man	81.43601.6025		Firestone No.	W01 M58 0687
Man	81.43601.6029		Phoenix	1 D 23 C-1
Man	81.43601.6030		Goodyear	1R12-709
Man	81.43601.0050		CF Gomma	1T 320 SP
			Taurus	UR 504-13

### RML 7921



Cross Section View

Top View

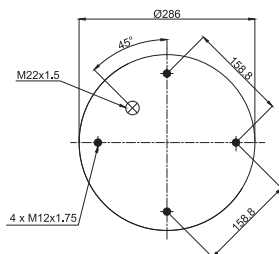
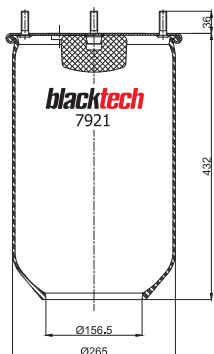

- Bolt or Stud
- Threaded hole
- ⊗ Combination Stud
- ⊗ Air Inlet

OEM PART NUMBER	MODEL NO	CROSS REFERENCES	
ROR	Service Assembly	Phoenix	1 D 28 A-5 NP
SAF - Holland	2918 Service Assembly	Primeride	5810 A P02
Hendrickson	Service Assembly	Firestone Style	1T19L-7
Weweler	Service Assembly	Firestone No.	W01-M58-7237
		Goodyear	1R14-868
		Taurus	RU621-26
		Vibracoustic	V1D28A-5 NP
		Dunlop UK	PNP307520000

### RML 7921S



Cross Section View

Top View

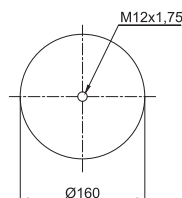
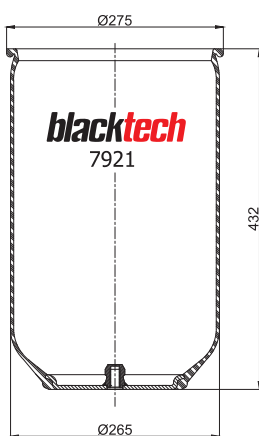

- Bolt or Stud
- Threaded hole
- ⊗ Combination Stud
- ⊗ Air Inlet

OEM PART NUMBER	MODEL NO	CROSS REFERENCES	
MAN	81.43601.0047	Contitech	810 NT

### RML 7921 SP



Cross Section View

Top View

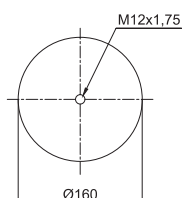
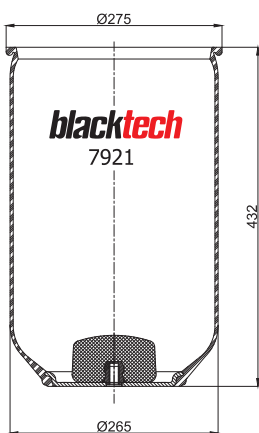

- Bolt or Stud
- Threaded hole
- ⊗ Combination Stud
- ⊗ Air Inlet

OEM PART NUMBER	MODEL NO	CROSS REFERENCES	
MAN	81.43601.6019	Contitech	810 NTB
Pegaso	174933	6420/6424/6425/6430	Phoenix
		Firestone Style	1T19L-7
		Firestone No.	W01-M58-0749
		Goodyear	1R14-713
		CF Gomma Ref.	1T19E-1
		CF Gomma No.	93702
		Dunlop UK	PNP311380000

**RML 7921 C**



Cross Section View

Top View

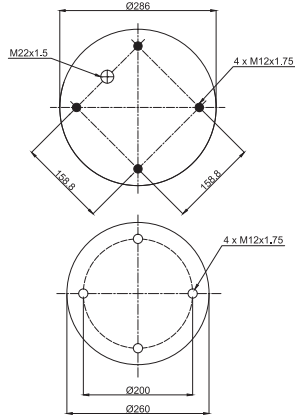
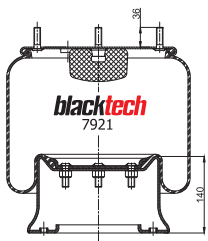

- Bolt or Stud
- Threaded hole
- ⊗ Combination Stud
- ⊗ Air Inlet

OEM PART NUMBER		MODEL NO	CROSS REFERENCES	
DAF	1384 273		Contitech	810 MB
Hendrickson	506 243	Tecair	Phoenix	1 D 28 A-2
Hendrickson	506 243 / 01	Tecair	Primeride	5810 A P03
Hendrickson	785 168		Firestone Style	1T19L-7
Neway	21215632		Firestone No.	W01-M58-6345
Renault	5.000.452.939		Firestone No.	W01-M58-8775
ROR	2120 8082		Goodyear	1R14-716
ROR	2121 5632	WFL 041	Taurus	KR621-26
Trailer	650 4646 G		Vibracoustic	VID28A-2
Trouillet	HB 10 315		CF Gomma Ref.	1T19E-1
Volvo	1080 707		CF Gomma No.	87413/1
Weweler	2120 8082		Dunlop F	D13B20
Weweler	US 00622		Dunlop F	D13B01
Weweler	US 07337		Dunlop UK	00984A-AP
Weweler	US 87413	AC 041/115/134		
Weweler	US 87413	AC 134 L/138		
Weweler	US 874131			
SAF - Holland	2918			

**RML 7921 C1**



Cross Section View

Top View

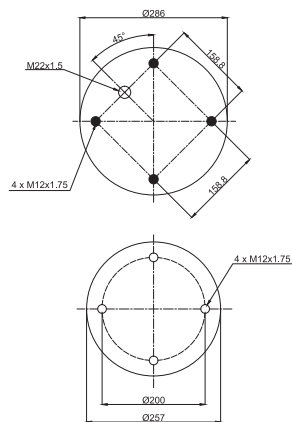
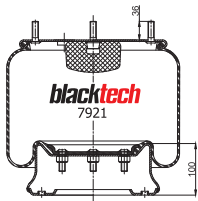

- Bolt or Stud
- Threaded hole
- ⊗ Combination Stud
- ⊗ Air Inlet

OEM PART NUMBER	MODEL NO	CROSS REFERENCES	
Hendrickson			

**RML 7921 C2**



Cross Section View

Top View

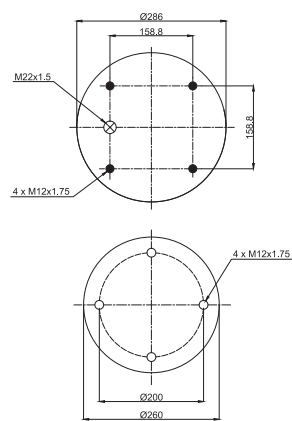
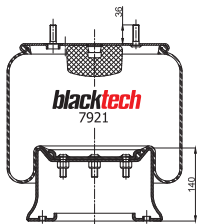

- Bolt or Stud
- Threaded hole
- ⊗ Combination Stud
- ⊗ Air Inlet

OEM PART NUMBER	MODEL NO	CROSS REFERENCES	
Hendrickson			

### RML 7921 C3



Cross Section View

Top View

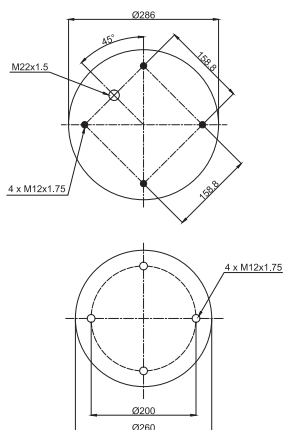
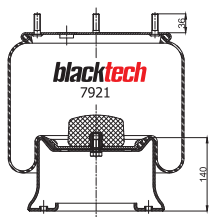

- Bolt or Stud
- Threaded hole
- ⊗ Combination Stud
- ⊗ Air Inlet

OEM PART NUMBER	MODEL NO	CROSS REFERENCES

### RML 7921 CP



Cross Section View

Top View

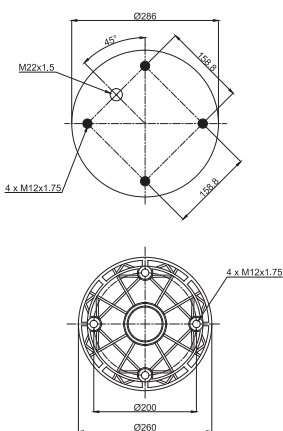
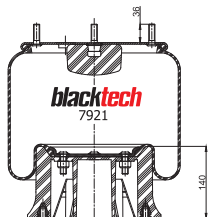

- Bolt or Stud
- Threaded hole
- ⊗ Combination Stud
- ⊗ Air Inlet

OEM PART NUMBER	MODEL NO	CROSS REFERENCES
Weweler	US 07337F	Contitech 810 MB Plastic Piston
		Firestone Style 1T19 L-7
		Firestone No. W01 M58 8775

### RML 7922



Cross Section View

Top View

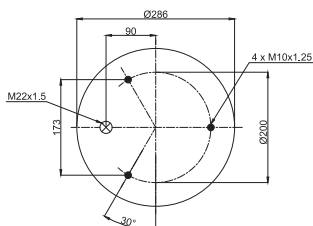
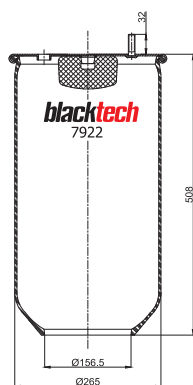

- Bolt or Stud
- Threaded hole
- ⊗ Combination Stud
- ⊗ Air Inlet

OEM PART NUMBER	MODEL NO	CROSS REFERENCES
DAF	1 384 274	FA 3000
Renault	5.000.745.918	
		Contitech 811 MB / 0
		Goodyear 1R14-718
		CF Gomma Ref. 1T19E-2
		CF Gomma No. 203878
		Dunlop F D13B34
		Dunlop UK PNP311670000
		Gart Ref. D277
		Gart No. 277.4.506

**RML 7922-1**



Cross Section View

Top View

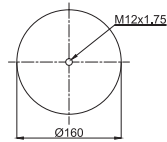
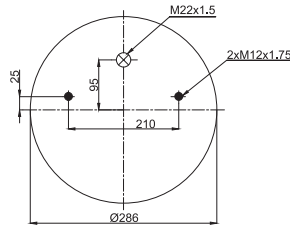
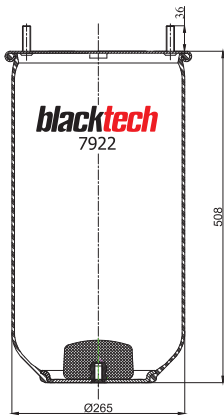

- Bolt or Stud
- Threaded hole
- ⊗ Combination Stud
- ⊗ Air Inlet

OEM PART NUMBER	MODEL NO	CROSS REFERENCES	
DAF	067306	BUS	

**RML 7922-2**



Cross Section View

Top View

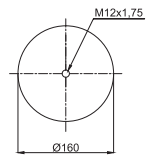
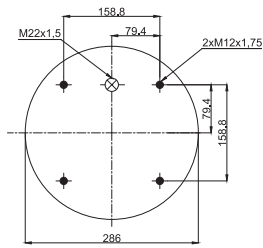
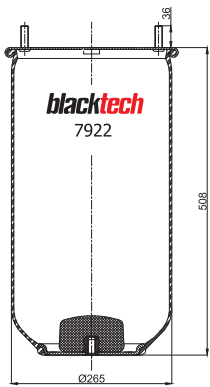

- Bolt or Stud
- Threaded hole
- ⊗ Combination Stud
- ⊗ Air Inlet

OEM PART NUMBER	MODEL NO	CROSS REFERENCES	
DAF		Phoenix	1D 28 B-2
		Goodyear	1R14-719
		Taurus	KR622-31

**RML 7922 S**



Cross Section View

Top View

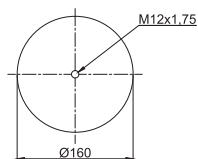
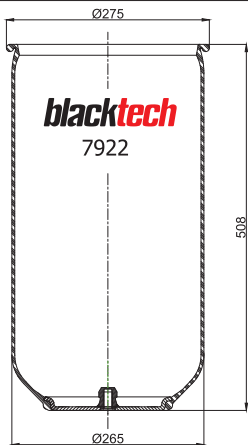

- Bolt or Stud
- Threaded hole
- ⊗ Combination Stud
- ⊗ Air Inlet

OEM PART NUMBER	MODEL NO	CROSS REFERENCES	
Man	81.43601.0035	BUS	Conlitech 811 NT
Man	81.43601.0048		Firestone Style 1T19L-10
			Firestone No. W01 M68 0028
			Phoenix 1 D 28 B
			Goodyear 1R14 715
			Dunlop F D13A02
			Taurus UR622-03

### RML 7922 SP



Cross Section View

Top View

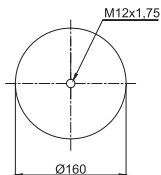
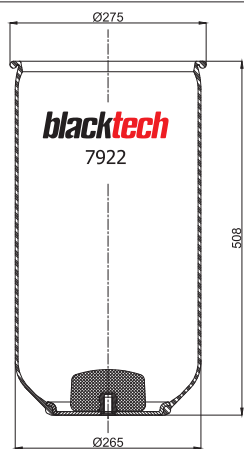

- Bolt or Stud
- Threaded hole
- ⊗ Combination Stud
- ⊗ Air Inlet

OEM PART NUMBER		MODEL NO	CROSS REFERENCES	
Man	81.43601.0035		Contitech	811 NTB
Man	81.43601.0048		Firestone Style	1T19L-10
KAESSBOHRER	4.731.029.000		Firestone No.	W01 M58 0747
			Goodyear	1R14-739
			Dunlop F	D14U49

### RML 7922 C



Cross Section View

Top View

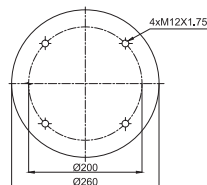
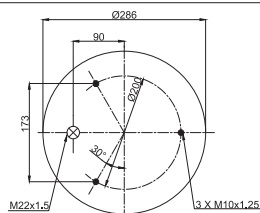
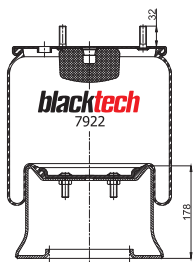

- Bolt or Stud
- Threaded hole
- ⊗ Combination Stud
- ⊗ Air Inlet

OEM PART NUMBER		MODEL NO	CROSS REFERENCES	
DAF	1 384 274	FA 3000	Contitech	811 MB
Renault	5.000.745.918		Goodyear	1R14-718
			CF Gomma Ref.	1T19E-2
			CF Gomma No.	203878
			Dunlop F	D13B34
			Dunlop UK	PNP31167/0000
			Gart Ref.	D277
			Gart No.	2774.506

### RML 7922 C1



Cross Section View

Top View

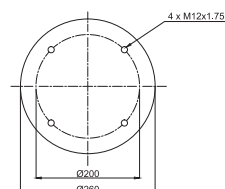
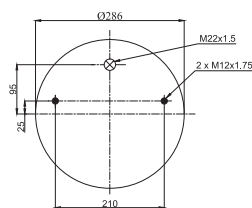
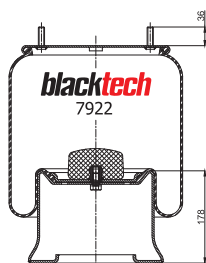

- Bolt or Stud
- Threaded hole
- ⊗ Combination Stud
- ⊗ Air Inlet

OEM PART NUMBER		MODEL NO	CROSS REFERENCES	
DAF				

**RML 7922 C2**

Cross Section View

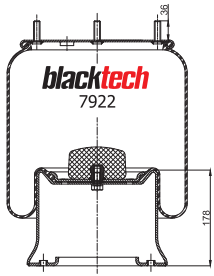

Top View

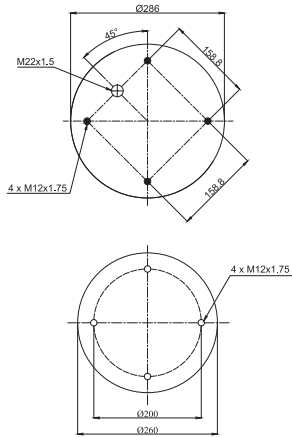

- Bolt or Stud
- Threaded hole
- ⊗ Combination Stud
- ⊗ Air Inlet

OEM PART NUMBER		MODEL NO	CROSS REFERENCES	
Campana	05.020.0105		Gart Ref.	D287
Campana	28100006		Gart No.	2874.522

**RML 7922 C3**

Cross Section View

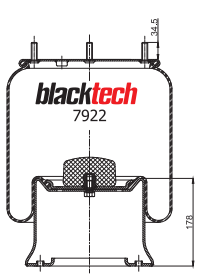

Top View

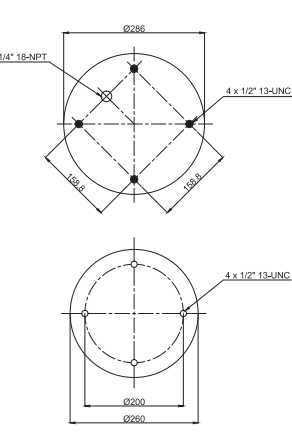

- Bolt or Stud
- Threaded hole
- ⊗ Combination Stud
- ⊗ Air Inlet

OEM PART NUMBER		MODEL NO	CROSS REFERENCES	
Campana	50.200.105		Gart Ref.	D287
Campana	28100006		Gart No.	2874.522 (UNC)

**RML 7922 CP2**

Cross Section View

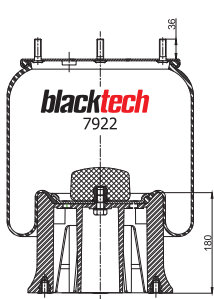

Top View

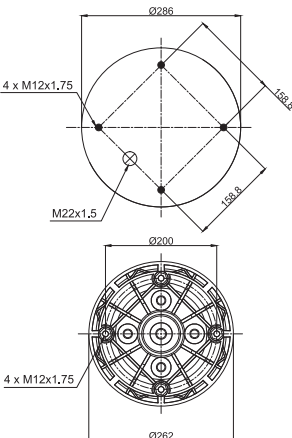

- Bolt or Stud
- Threaded hole
- ⊗ Combination Stud
- ⊗ Air Inlet

OEM PART NUMBER		MODEL NO	CROSS REFERENCES	
Campana	50.200.105		Gart Ref.	D287
Campana	28100006		Gart No.	2874.522



### RML 7923



Cross Section View

Top View

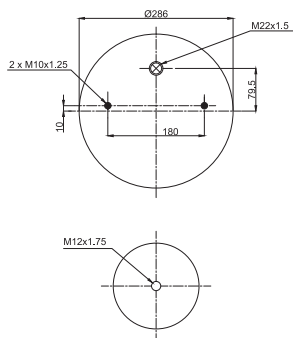
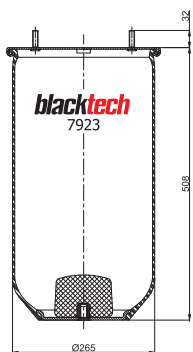

- Bolt or Stud
- Threaded hole
- ⊗ Combination Stud
- ⊗ Air Inlet

OEM PART NUMBER	MODEL NO	CROSS REFERENCES
Cardi		

### RML 7923 C



Cross Section View

Top View

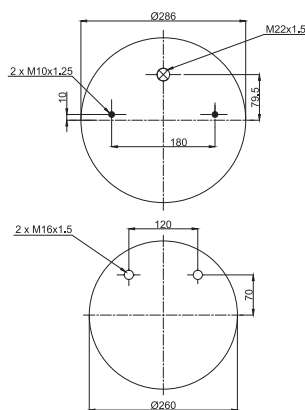
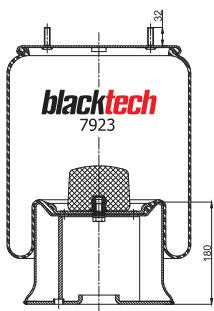

- Bolt or Stud
- Threaded hole
- ⊗ Combination Stud
- ⊗ Air Inlet

OEM PART NUMBER	MODEL NO	CROSS REFERENCES
Viberti	128147112	CF Gomma Ref. 1119 E2 CF Gomma No. 97730

### RML 7923 C1



Cross Section View

Top View

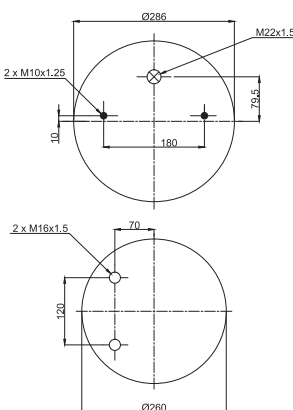
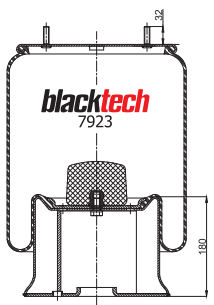

- Bolt or Stud
- Threaded hole
- ⊗ Combination Stud
- ⊗ Air Inlet

OEM PART NUMBER	MODEL NO	CROSS REFERENCES
Cardi	58050700	Gart Ref. D277/2F
DAF	67306	Gart No. 2772.500
Omar	11804	
Rolfo	112060	
Viberti	128147102	
Zorzi	1006553	

**RML 7924**

Cross Section View

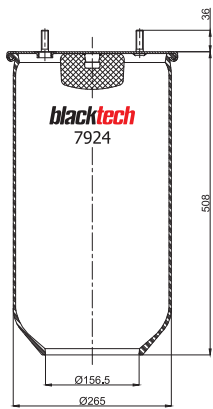

Top View

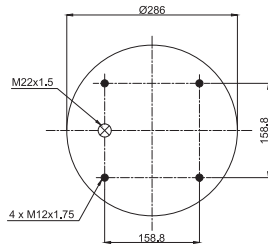

- Bolt or Stud
- Threaded hole
- ⊗ Combination Stud
- ⊗ Air Inlet

OEM PART NUMBER	MODEL NO	CROSS REFERENCES	
ROR	Service Assembly	Contitech	813 MB/0
Hendrickson	Service Assembly	Phoenix	1D 28 B-5 NP
Weweler	Service Assembly	Primeride	5813 A P02
		Firestone Style	1T19L-11
		Firestone No.	W01-M58-7238
		Goodyear	1R14-867
		Taurus	UR622-26
		Vibracoustic	V1D28B-2 NP

**RML 7924 C**

Cross Section View

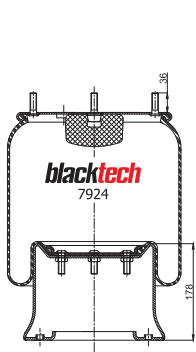

Top View

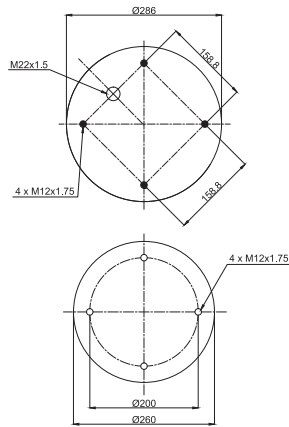

- Bolt or Stud
- Threaded hole
- ⊗ Combination Stud
- ⊗ Air Inlet

OEM PART NUMBER	MODEL NO	CROSS REFERENCES		
Hendrickson	505 859	Airpoise < 86	Contitech	813 MB
Hendrickson	505 859 / 01	Tecair	Phoenix	1D 28 B-2
Hendrickson	785 170		Primeride	5813 A P03
Kässbohrer	4.731.030.000		Firestone Style	1T19L-11
Kässbohrer	4.731.033.000		Firestone No.	W01-M58-6364
Paul NFZ	P2700MB0813		Firestone No.	W01-M58-6339
Pegaso	175005	Troner	Goodyear	1R14-705
Renault	5.000.790.692		Goodyear	1R14-857
Renault	5.010.130.925		Taurus	KR622-26
SAE	8403 / 102		Vibracoustic	V1D28B-2
Titan	916 8770 0000		CF Gomma Ref.	1T19E-2
Trailor	003 6158 E		CF Gomma No.	87408
Trailor	6502 3482		Dunlop F	D13B19
Trouillet	ST 225-675		Dunlop F	D13B02
Viberti	128 147 122		Dunlop UK	00985A-AP
Viberti	644 285		Gart Ref.	D277B
Weweler	US 07345		Gart Ref.	D287/A
Weweler	US 87408		Gart No.	277.4.500
ROR	21215633		Gart No.	287.4.510
SAF		2923		

**RML 7924 C1**

Cross Section View

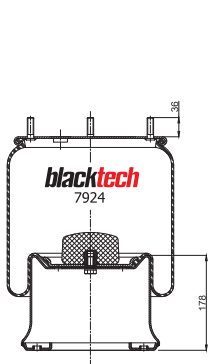

Top View

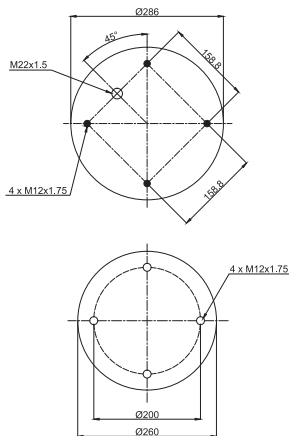

- Bolt or Stud
- Threaded hole
- ⊗ Combination Stud
- ⊗ Air Inlet

OEM PART NUMBER	MODEL NO	CROSS REFERENCES	

### RML 7924 C2



Cross Section View

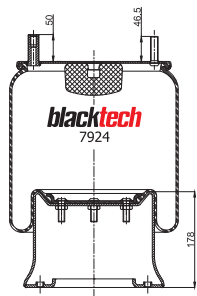

Top View

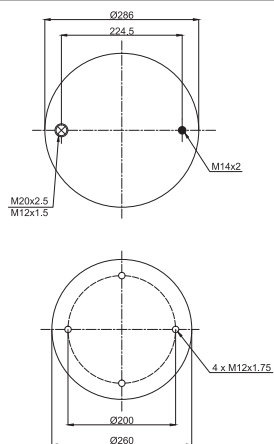

- Bolt or Stud
- Threaded hole
- ⊗ Combination Stud
- ⊗ Air Inlet

OEM PART NUMBER	MODEL NO	CROSS REFERENCES

### RML 7924 C3



Cross Section View

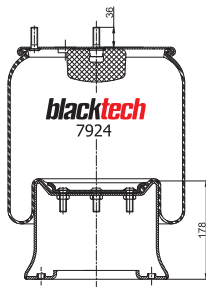

Top View

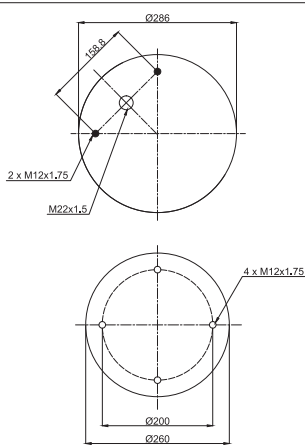

- Bolt or Stud
- Threaded hole
- ⊗ Combination Stud
- ⊗ Air Inlet

OEM PART NUMBER	MODEL NO	CROSS REFERENCES

### RML 7924 C4



Cross Section View

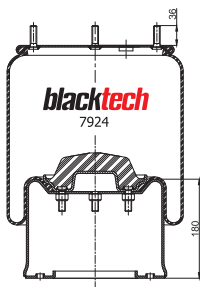

Top View

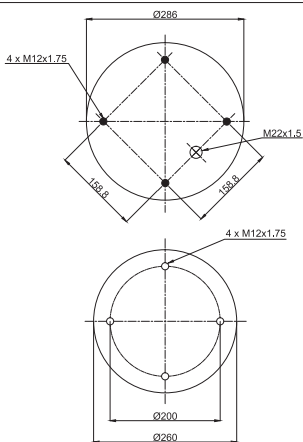

- Bolt or Stud
- Threaded hole
- ⊗ Combination Stud
- ⊗ Air Inlet

OEM PART NUMBER	MODEL NO	CROSS REFERENCES
SAF	2923 D 250	

**RML 7924 CP**



Cross Section View

Top View

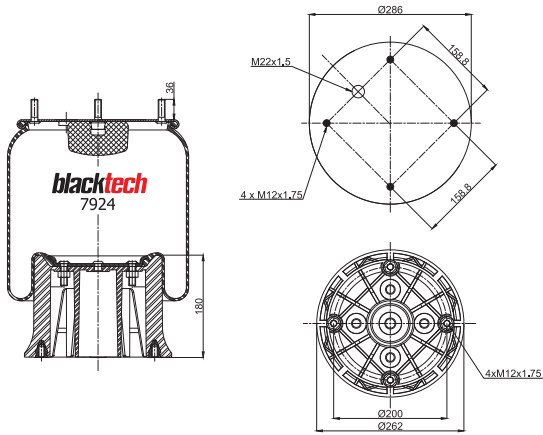

OEM PART NUMBER	MODEL NO	CROSS REFERENCES

**RML 7947**



Cross Section View

Top View

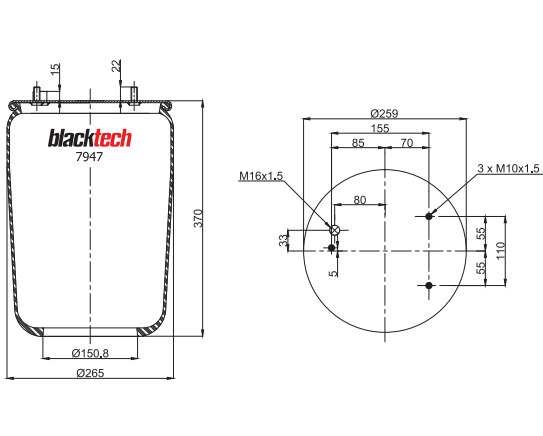

OEM PART NUMBER	MODEL NO	CROSS REFERENCES
DAF 0 067 504		Conlitech 836 M
VDL 0 067 504	Bus	Phoenix 1DF 25-1 NP
		Primeride 5836 A1
		Firestone Style 1T17AR-4.5
		Firestone No. W01-D08-0776
		Firestone No. W01-M58-0776
		Goodyear 1R12-700
		Taurus UR721-01
		Vibracoustic VIDF25-1
		Dunlop F D13U32
		Gart Ref. C302
		Gart No. 302.0.376

**RML 7947-1**



Cross Section View

Top View

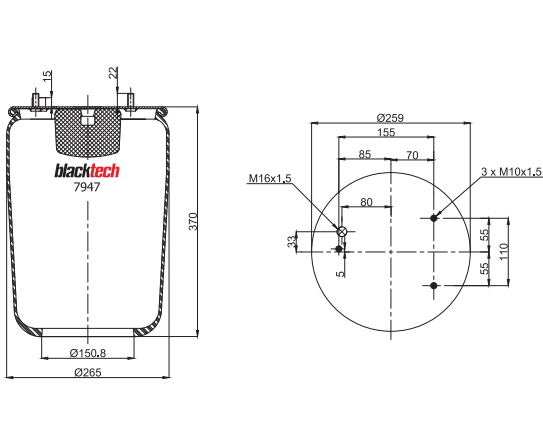

OEM PART NUMBER	MODEL NO	CROSS REFERENCES
DAF 0 513 985		Conlitech 836 MB
VDL 0 513 985	Bus	Phoenix 1DF 25-4 NP
		Firestone Style 1T17AR-4.5
		Firestone No. W01-M58-0775
		Goodyear 1R12-764
		Taurus UR721-04
		Vibracoustic VIDF25-4
		Dunlop F D12U27



**RML 7947-2 C1**



Cross Section View

Top View

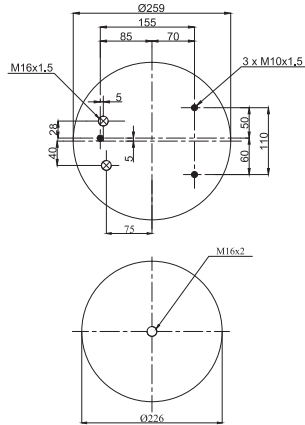
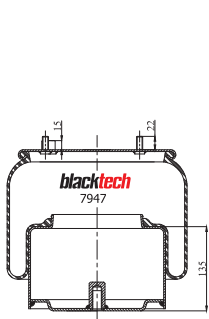

- Bolt or Stud
- Threaded hole
- ⊗ Combination Stud
- ⊗ Air Inlet

OEM PART NUMBER		MODEL NO	CROSS REFERENCES	
DAF	0 388 167		Contitech	836 M2 K1
			Phoenix	1DF 25-13
			Primeride	5836 A2 P01
			Firestone Style	1T17AR-4.5
			Firestone No.	W01-M58-8721
			Goodyear	1R12-711
			Taurus	KR721-03
			Vibracoustic	V1DF25-13
			Dunlop F	D13B31
			Gart Ref.	C302
			Gart No.	3021375/2

**RML 7947 C4**



Cross Section View

Top View

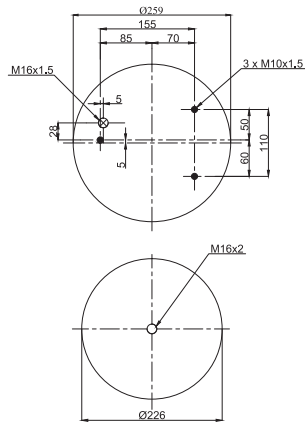
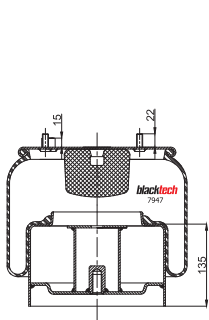

- Bolt or Stud
- Threaded hole
- ⊗ Combination Stud
- ⊗ Air Inlet

OEM PART NUMBER		MODEL NO	CROSS REFERENCES	
VDL	0 377 498	Bus	Contitech	836 MB K4
			Phoenix	1DF 25-14
			Firestone Style	1T17AR-4.5
			Firestone No.	W01-D08-8705
			Vibracoustic	V1DF25-14

**RML 7947 C6**



Cross Section View

Top View

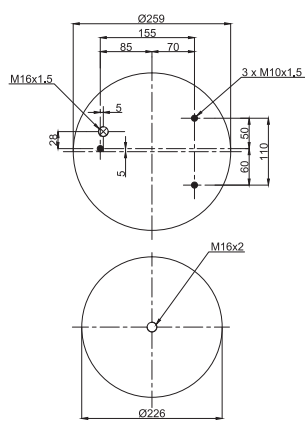
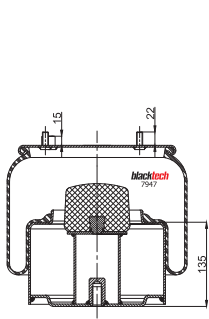

- Bolt or Stud
- Threaded hole
- ⊗ Combination Stud
- ⊗ Air Inlet

OEM PART NUMBER		MODEL NO	CROSS REFERENCES	
DAF	0 526 651		Contitech	836 MB K6
VDL Bus	0 526 651		Phoenix	1DF 25-15
			Firestone Style	1T17AR-4.5
			Firestone No.	W01-M58-8701
			Goodyear	1R12-768
			Taurus	KR721-05
			Vibracoustic	V1DF25-15
			Dunlop F	D13B43

### RML 7947 C7



Cross Section View

Top View

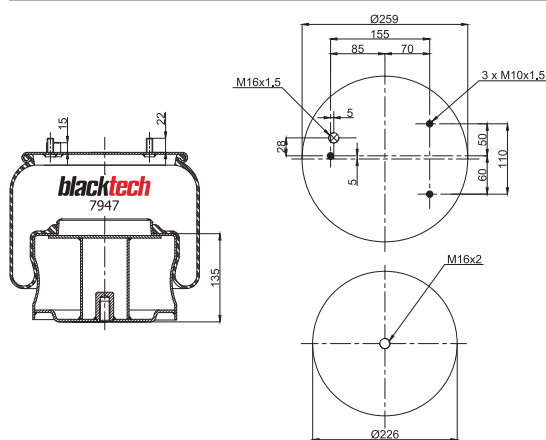

- Bolt or Stud
- Threaded hole
- ⊗ Combination Stud
- ⊗ Air Inlet

OEM PART NUMBER		MODEL NO	CROSS REFERENCES	
DAF	0 297 721		Contitech	836 M K7
			Firestone Style	1T17AR-4.5
			Firestone No.	W01 M68 8715
			Phoenix	1 DF 25-12
			Dunlop F	D13B33
			Goodyear	1R12-723
			Vibracoustic	V 1 DF 25-12

### RML 7947 C8



Cross Section View

Top View

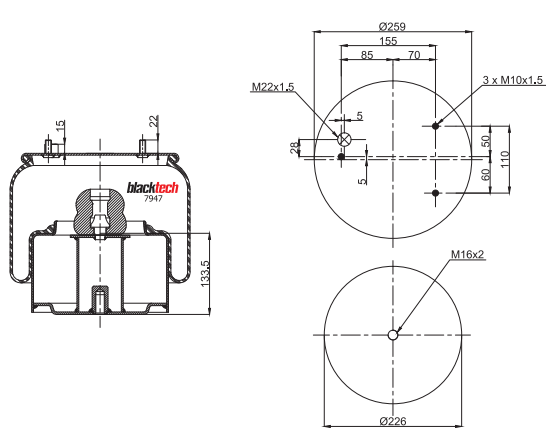

- Bolt or Stud
- Threaded hole
- ⊗ Combination Stud
- ⊗ Air Inlet

OEM PART NUMBER		MODEL NO	CROSS REFERENCES	
VDL	1 153 933	Bus	Contitech	836 N P05

### RML 7947 C9



Cross Section View

Top View

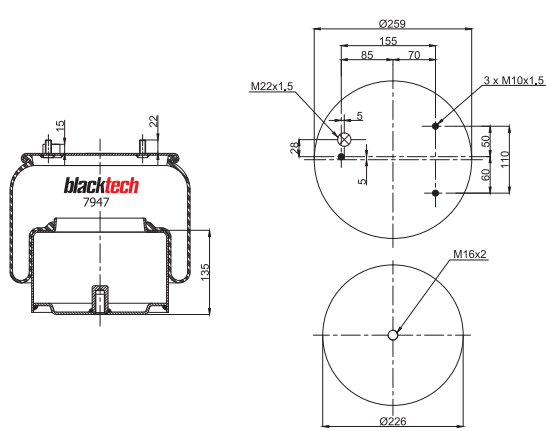

- Bolt or Stud
- Threaded hole
- ⊗ Combination Stud
- ⊗ Air Inlet

OEM PART NUMBER		MODEL NO	CROSS REFERENCES	
VDL	1 153 934	Bus	Contitech	836 N P06
DAF	1152221			

**RML 7947 C10**



Cross Section View

Top View

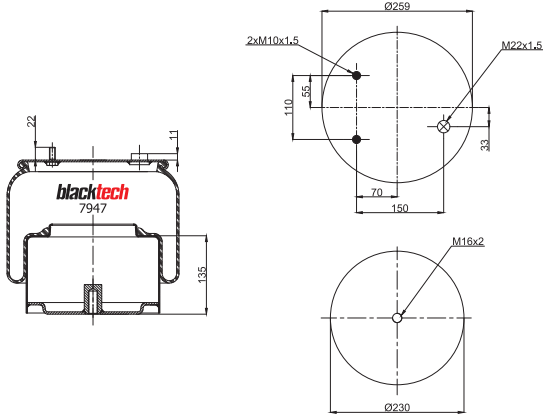

- Bolt or Stud
- Threaded hole
- ⊗ Combination Stud
- ⊗ Air Inlet

OEM PART NUMBER	MODEL NO	CROSS REFERENCES	
DAF	1794420	Contitech	836 N P10

**RML 7947 C11**



Cross Section View

Top View

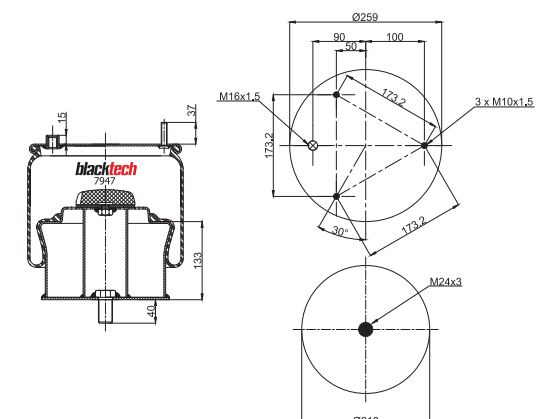

- Bolt or Stud
- Threaded hole
- ⊗ Combination Stud
- ⊗ Air Inlet

OEM PART NUMBER	MODEL NO	CROSS REFERENCES	
BMC	7B100323	Bus	

**RML 7990**



Cross Section View

Top View

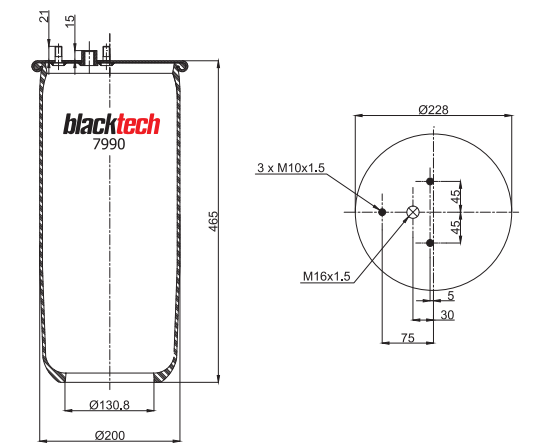

- Bolt or Stud
- Threaded hole
- ⊗ Combination Stud
- ⊗ Air Inlet

OEM PART NUMBER	MODEL NO	CROSS REFERENCES	
DAF	1276 846	Contitech	889 M
		Firestone Style	1T15LLR-5
		Firestone No.	W01-M58-0781
		Goodyear	1R11-842



### RML 7990 C2



Cross Section View

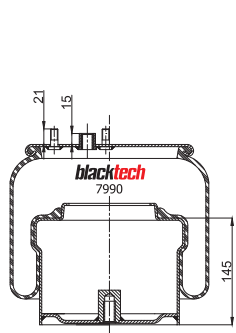

Top View

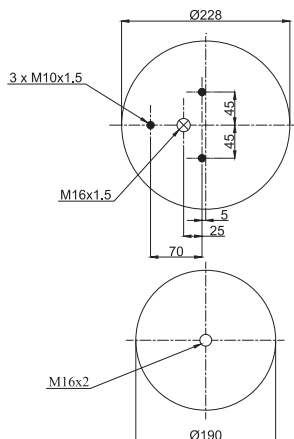

- Bolt or Stud
- Threaded hole
- ⊗ Combination Stud
- ⊗ Air Inlet

OEM PART NUMBER	MODEL NO	CROSS REFERENCES	
DAF 1279 141		Contitech	889 M K2
DAF 1698 434	CF 65	Firestone Style	1T15LLR-5
DAF 1698 434	CF 75-85	Firestone No.	W01-M58-8679
DAF 1698 434	LF 45-55	Goodyear	1R11-843
DAF 1698 434	XF 95-105		

### RML 7992



Cross Section View

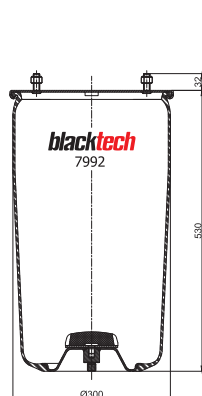

Top View

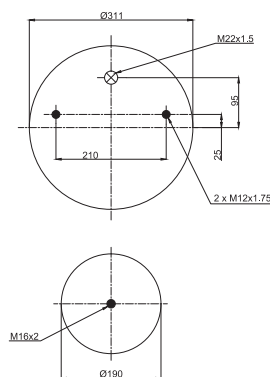

- Bolt or Stud
- Threaded hole
- ⊗ Combination Stud
- ⊗ Air Inlet

OEM PART NUMBER	MODEL NO	CROSS REFERENCES	
BPW 05.429.40.01.0	36	Contitech	881 MB
		Phoenix	1DK 32
		Primeride	5881 A P02
		Firestone Style	1T66D-10.8
		Firestone No.	W01-M58-8978
		Goodyear	1R14-708
		Taurus	UR836-01
		Vibracoustic	V1DK32
		CF Gamma Ref.	1TC360-45
		CF Gamma No.	204530
		Dunlop F	D14U36
		Gart Ref.	C292
		Gart No.	292.0531

### RML 7992 C



Cross Section View

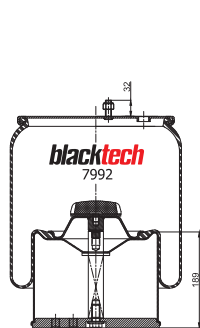

Top View

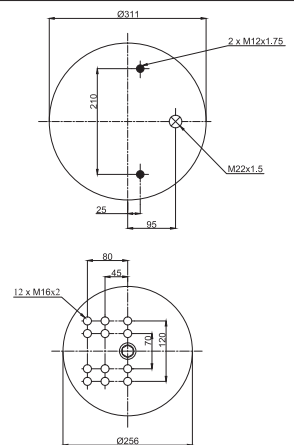

- Bolt or Stud
- Threaded hole
- ⊗ Combination Stud
- ⊗ Air Inlet

OEM PART NUMBER	MODEL NO	CROSS REFERENCES	
BPW 05.429.41.21.1	36	Contitech	881 MB P30
BPW 05.429.40.08.1	36	Firestone Style	1T66F-10.8
BPW 05.429.40.36.1	36	Firestone No.	W01 M58 8966
		Phoenix	1DK 32-1
		Dunlop F	D14B36
		Goodyear	1R14-703

**RML 7992 CP**



Cross Section View

Top View

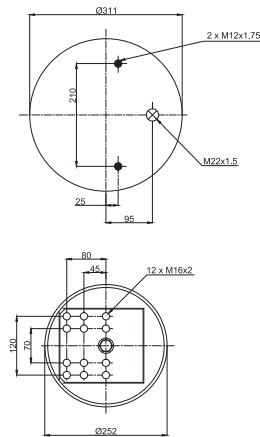
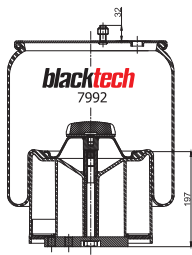

- Bolt or Stud
- Threaded hole
- ⊗ Combination Stud
- ⊗ Air Inlet

OEM PART NUMBER		MODEL NO	CROSS REFERENCES	
BPW	05.429.43.51.0	36	Contitech	881 MB P30
Hüffermann	6-AB8003-0100	36	Phoenix	1DK 32-2
			Primeride	5881 A P04
			Firestone Style	1T66F-10.8
			Firestone No.	W01-M58-8667
			Goodyear	1R14-748
			Vibracoustic	V1DK32 Y9
			CF Gomma Ref.	1TC360-45
			CF Gomma No.	206357
			Dunlop F	D14B41
			Gart Ref.	C292
			Gart No.	292.2.532

**RML 7998**



Cross Section View

Top View

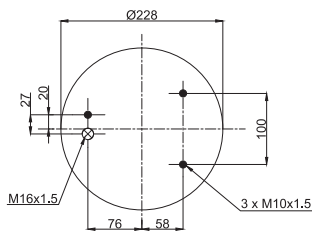
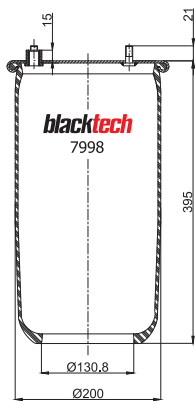

- Bolt or Stud
- Threaded hole
- ⊗ Combination Stud
- ⊗ Air Inlet

OEM PART NUMBER		MODEL NO	CROSS REFERENCES	
DAF	0 513 983		Contitech	887 M
VDL Bus	0 513 983		Firestone Style	1T15LNR-3
			Firestone No.	W01-M58-0780
			Goodyear	1R11-796
			Dunlop F	D11U41

**RML 7998 C1**



Cross Section View

Top View

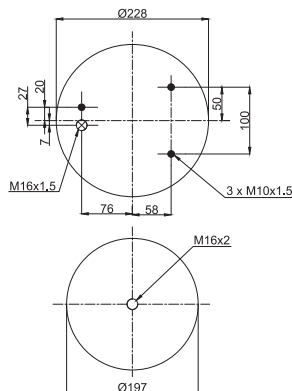
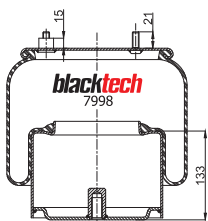

- Bolt or Stud
- Threaded hole
- ⊗ Combination Stud
- ⊗ Air Inlet

OEM PART NUMBER		MODEL NO	CROSS REFERENCES	
DAF	0 392 022		Contitech	887 M K1
DAF	1 697 684	CF 65	Firestone Style	1T15LNR-3
DAF	1 697 684	CF 75-85	Firestone No.	W01-M58-8683
DAF	1 697 684	LF 45-55	Goodyear	1R11-798
DAF	1 697 684	XF 95-105	Vibracoustic	V1DF18-2
DAF	0 392 011			

### RML 7998-2 C1



Cross Section View

Top View

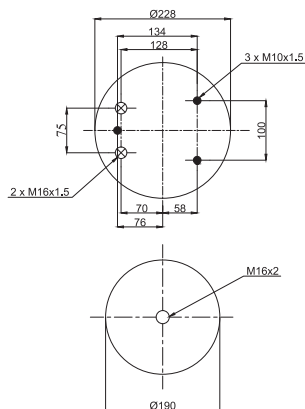
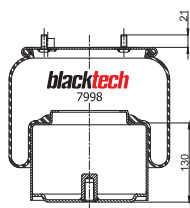

- Bolt or Stud
- Threaded hole
- ⊗ Combination Stud
- ⊗ Air Inlet

OEM PART NUMBER	MODEL NO	CROSS REFERENCES
DAF		

### RML 7998 C3



Cross Section View

Top View

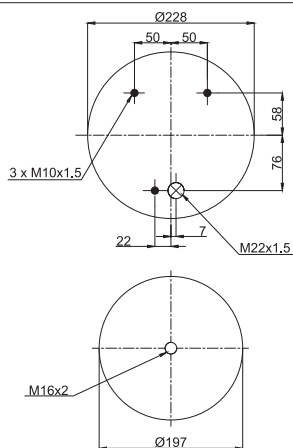
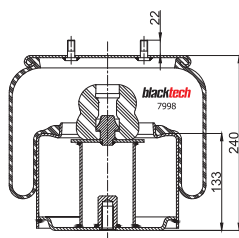

- Bolt or Stud
- Threaded hole
- ⊗ Combination Stud
- ⊗ Air Inlet

OEM PART NUMBER	MODEL NO	CROSS REFERENCES		
VDL Bus	1 153 935	SB 120	Contitech	887 N P03
VDL Bus	1 153 935	SB 180	Firestone No.	W01-M58-5786
VDL Bus	1 153 935	SB 200	Goodyear	1R11-888

### RML 7998 C4



Cross Section View

Top View

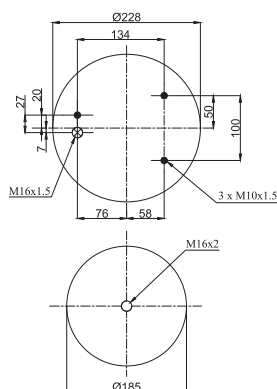
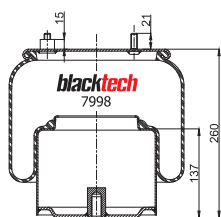

- Bolt or Stud
- Threaded hole
- ⊗ Combination Stud
- ⊗ Air Inlet

OEM PART NUMBER	MODEL NO	CROSS REFERENCES		
DAF	1 286 251		Contitech	887 M K4
DAF	1 697 680	CF 65	Firestone Style	1T15LNR-3
DAF	1 697 680	CF 75-85	Firestone No.	W01-M58-8681
DAF	1 697 680	LF 45-55		
DAF	1 697 680	XF 95-105		

**RML7998 C6**



Cross Section View

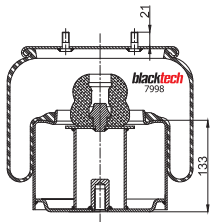

Top View

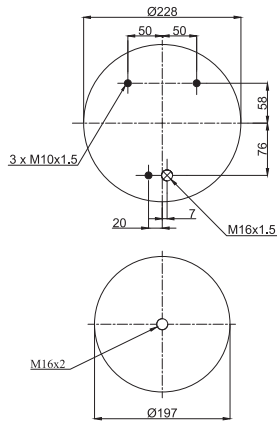

- Bolt or Stud
- Threaded hole
- ⊗ Combination Stud
- ⊗ Air Inlet

OEM PART NUMBER		MODEL NO	CROSS REFERENCES	
VDL Bus	1 141 525		Contitech	887 N P04 / 887 M K6
VDL Bus	1 154 761		Firestone Style	
VDL Bus	41 141 525		Firestone No.	W01-M58-5785
VDL Bus	41 154 761		Goodyear	1R11-797
			Vibracoustic	V1DF18-3

**RML 70081**



Cross Section View

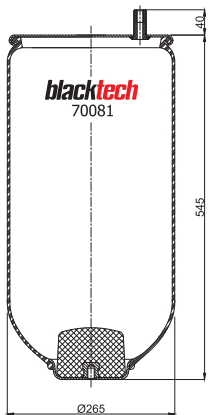

Top View

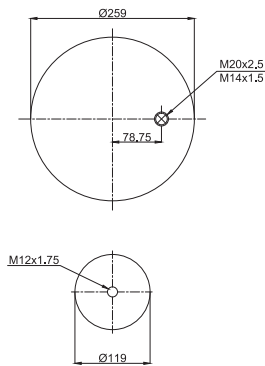

- Bolt or Stud
- Threaded hole
- ⊗ Combination Stud
- ⊗ Air Inlet

OEM PART NUMBER		MODEL NO	CROSS REFERENCES	

**RML 70081C**



Cross Section View

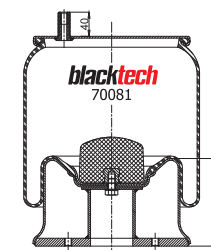

Top View

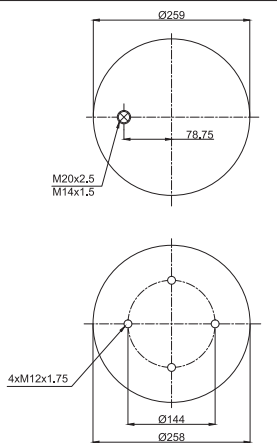

- Bolt or Stud
- Threaded hole
- ⊗ Combination Stud
- ⊗ Air Inlet

OEM PART NUMBER		MODEL NO	CROSS REFERENCES	
Mercedes	A 946 328 04 01		Firestone Style	1T17B-11
Hendrickson	HS 251087 / F		Firestone No.	W01 M58 8747
Samro	2500915		Dunlop F	D13B42
			Goodyear	1R13-150
			Phoenix	1DK 25-8747

### RML 70082



Cross Section View

Top View

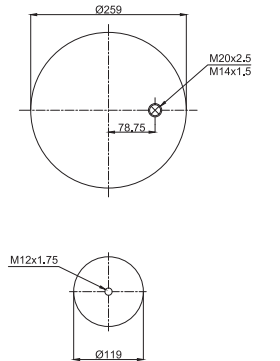
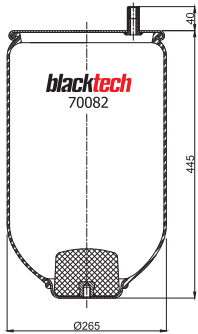

- Bolt or Stud
- Threaded hole
- ⊗ Combination Stud
- ⊗ Air Inlet

OEM PART NUMBER	MODEL NO	CROSS REFERENCES
Hendrickson		

### RML 70082 C



Cross Section View

Top View

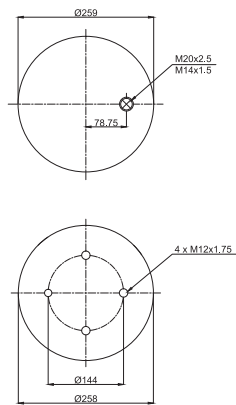
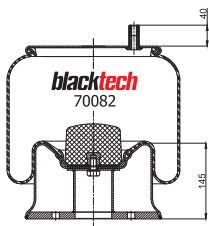

- Bolt or Stud
- Threaded hole
- ⊗ Combination Stud
- ⊗ Air Inlet

OEM PART NUMBER	MODEL NO	CROSS REFERENCES
Hendrickson		

### RML 70195 C



Cross Section View

Top View

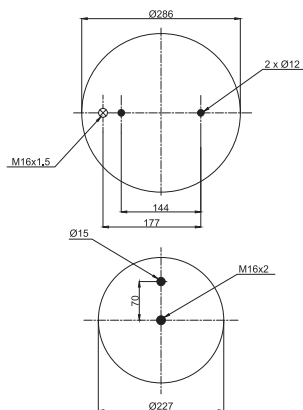
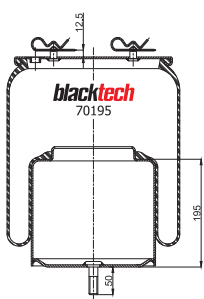

- Bolt or Stud
- Threaded hole
- ⊗ Combination Stud
- ⊗ Air Inlet

OEM PART NUMBER	MODEL NO	CROSS REFERENCES
Scania	1510195	Conlitech 0195 NP01

**RML 70301 C**



Cross Section View

Top View

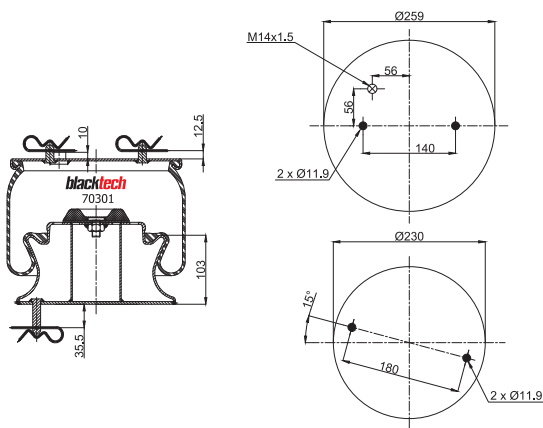

- Bolt or Stud
- Threaded hole
- ⊗ Combination Stud
- ⊗ Air Inlet

OEM PART NUMBER	MODEL NO	CROSS REFERENCES		
Scania Bussar	1440301	Bus	Firestone Style	1T15 VR-3
			Firestone No.	W01 M58 8192
			Goodyear	1R13 746
			Phoenix	1 DF23 B-1

**RML 70302 C**



Cross Section View

Top View

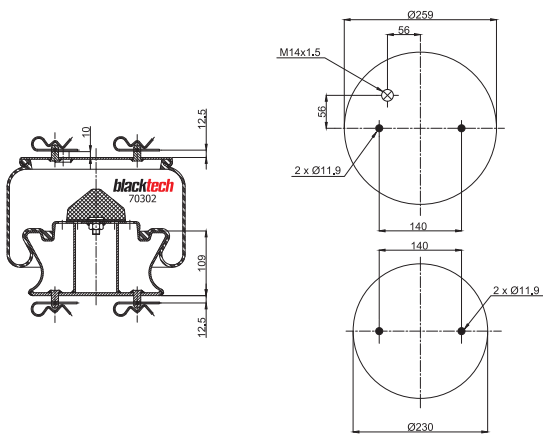

- Bolt or Stud
- Threaded hole
- ⊗ Combination Stud
- ⊗ Air Inlet

OEM PART NUMBER	MODEL NO	CROSS REFERENCES		
Scania Bussar	1440302	Bus	Firestone Style	1T15VPR-3
			Firestone No.	W01 M58 8193
			Goodyear	1R12 809
			Phoenix	1 DF 23 A-1

**RML 70303**



Cross Section View

Top View

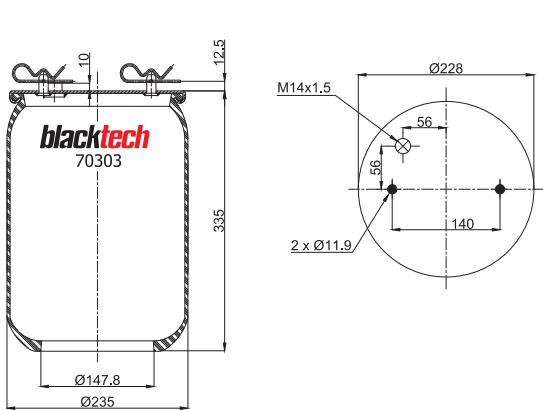

- Bolt or Stud
- Threaded hole
- ⊗ Combination Stud
- ⊗ Air Inlet

OEM PART NUMBER	MODEL NO	CROSS REFERENCES		
Scania Bussar				

### RML 70303 C



Cross Section View

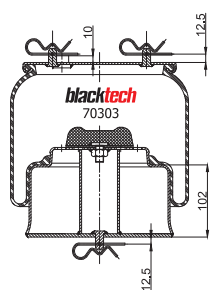

Top View

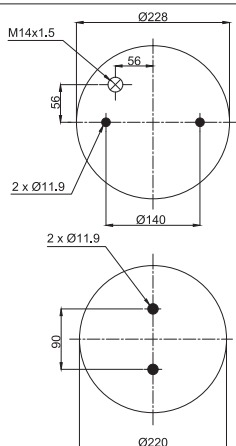

- Bolt or Stud
- Threaded hole
- ⊗ Combination Stud
- ⊗ Air Inlet

OEM PART NUMBER		MODEL NO	CROSS REFERENCES	
Scania Bussar	1440303	Bus	Goodyear	1R11 833
Scania Bussar	1521114	Bus	Phoenix	1DF 20 C-1

### RML 70303 C1



Cross Section View

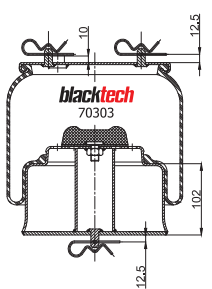

Top View

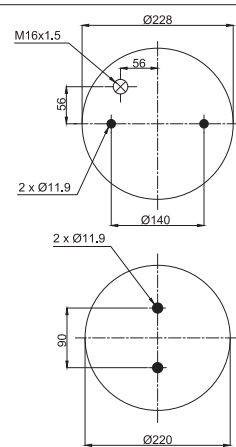

- Bolt or Stud
- Threaded hole
- ⊗ Combination Stud
- ⊗ Air Inlet

OEM PART NUMBER		MODEL NO	CROSS REFERENCES	
Scania Bussar	1726239		Goodyear	1R11 837
Scania	1726257		Phoenix	1DF 20 C-2

### RML 70304



Cross Section View

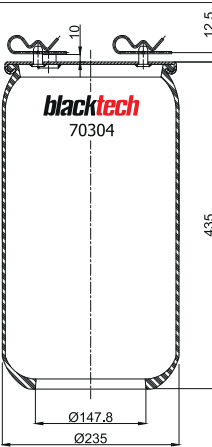

Top View

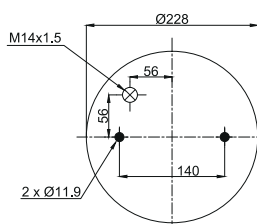

- Bolt or Stud
- Threaded hole
- ⊗ Combination Stud
- ⊗ Air Inlet

OEM PART NUMBER		MODEL NO	CROSS REFERENCES	
Scania Bussar		Bus		

**RML 70304 C**



Cross Section View

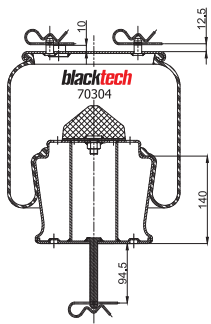

Top View

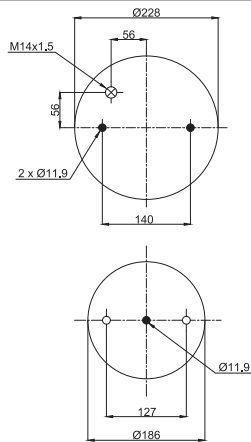

- Bolt or Stud
- Threaded hole
- ⊗ Combination Stud
- ⊗ Air Inlet

OEM PART NUMBER	MODEL NO	CROSS REFERENCES	
Scania Bussar	1440304	Goodyear	1R11 829
		Phoenix	1DF 20 A-3

**RML 70305 C**



Cross Section View

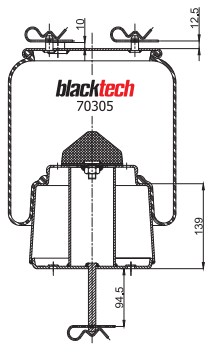

Top View

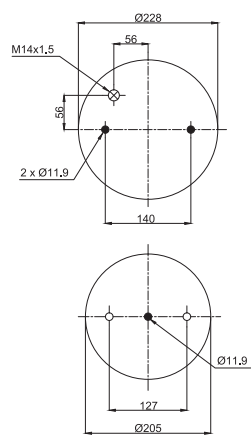

- Bolt or Stud
- Threaded hole
- ⊗ Combination Stud
- ⊗ Air Inlet

OEM PART NUMBER	MODEL NO	CROSS REFERENCES	
Scania Bussar	1440305	Goodyear	1R11 830
		Phoenix	1DF 20 A-2

**RML 70306 C**



Cross Section View

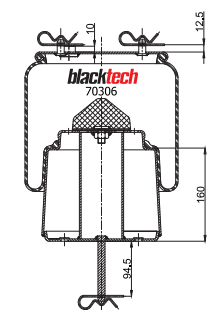

Top View

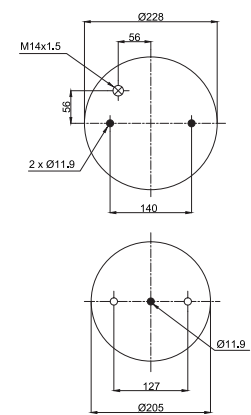

- Bolt or Stud
- Threaded hole
- ⊗ Combination Stud
- ⊗ Air Inlet

OEM PART NUMBER	MODEL NO	CROSS REFERENCES	
Scania Bussar	1440306	Goodyear	1R11 831
		Phoenix	1DF 20 A-1



### RML 70307 C



Cross Section View

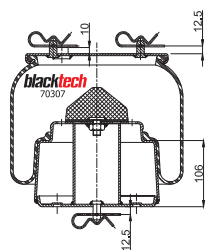

Top View

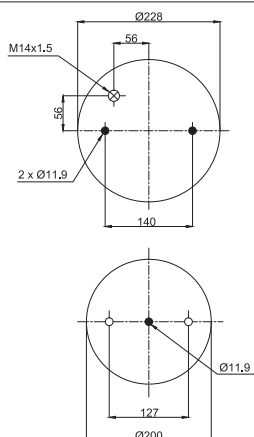

- Bolt or Stud
- Threaded hole
- ⊗ Combination Stud
- ⊗ Air Inlet

OEM PART NUMBER		MODEL NO	CROSS REFERENCES	
Scania Bussar	1440306		Goodyear	1R11 845

### RML 70310 C



Cross Section View

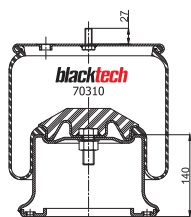

Top View

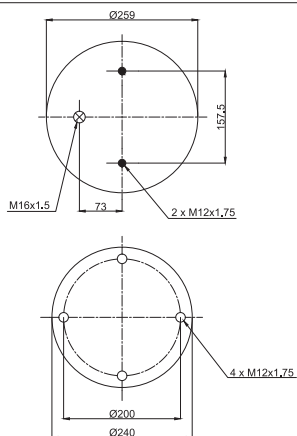

- Bolt or Stud
- Threaded hole
- ⊗ Combination Stud
- ⊗ Air Inlet

OEM PART NUMBER		MODEL NO	CROSS REFERENCES	
Hendrickson	HA 100310		Goodyear	1R11 740

### RML 70462



Cross Section View

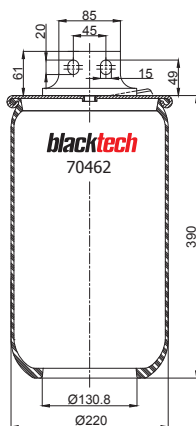

Top View

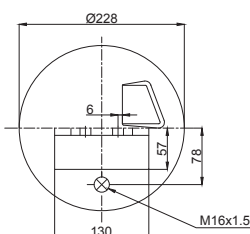

- Bolt or Stud
- Threaded hole
- ⊗ Combination Stud
- ⊗ Air Inlet

OEM PART NUMBER		MODEL NO	CROSS REFERENCES	
Iveco	42559765	Stralis 400/440E FP	CF Gomma Ref.	1TS 270-23
			CF Gomma No.	207172

**RML 70462 CP**



Cross Section View

Top View

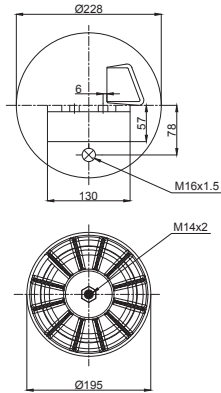
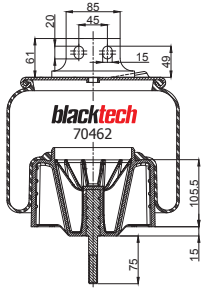

- Bolt or Stud
- Threaded hole
- ⊗ Combination Stud
- ⊗ Air Inlet

OEM PART NUMBER		MODEL NO	CROSS REFERENCES	
Iveco	41270462	STRALIS 400/440 Front	CF Gomma Ref.	1TS 270-23
			CF Gomma No.	206886

**RML 70463**



Cross Section View

Top View

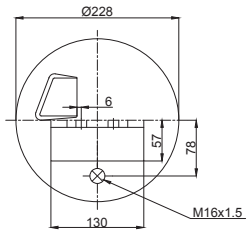
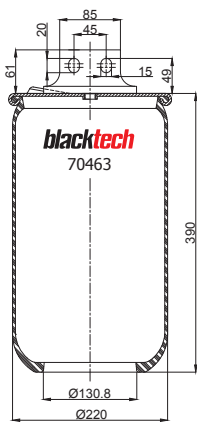

- Bolt or Stud
- Threaded hole
- ⊗ Combination Stud
- ⊗ Air Inlet

OEM PART NUMBER		MODEL NO	CROSS REFERENCES	
Iveco	42559766	STRALIS 400/440E FP	CF Gomma Ref.	1TS 270-23
			CF Gomma No.	207173

**RML 70463 CP**



Cross Section View

Top View

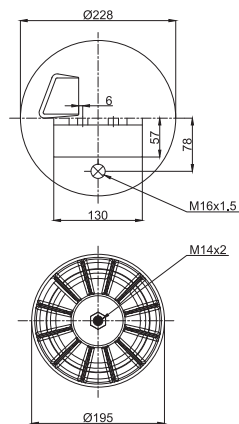
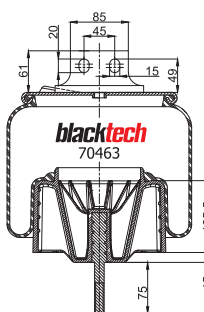

- Bolt or Stud
- Threaded hole
- ⊗ Combination Stud
- ⊗ Air Inlet

OEM PART NUMBER		MODEL NO	CROSS REFERENCES	
Iveco	41270463	STRALIS 400/440 Front	CF Gomma Ref.	1TS 270-23
			CF Gomma No.	206887

### RML 70465



Cross Section View

Top View

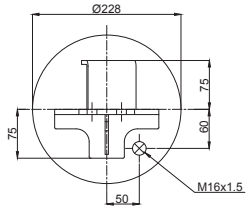
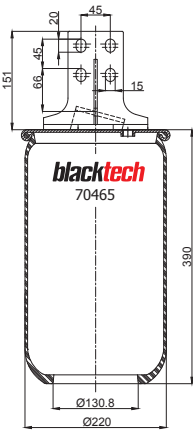

- Bolt or Stud
- Threaded hole
- ⊗ Combination Stud
- ⊗ Air Inlet

OEM PART NUMBER	MODEL NO	CROSS REFERENCES	
Iveco	42559767	STRALIS 400/440E FP	CF Gomma Ref. 1TS 270-23
			CF Gomma No. 207170

### RML 70465 CP



Cross Section View

Top View

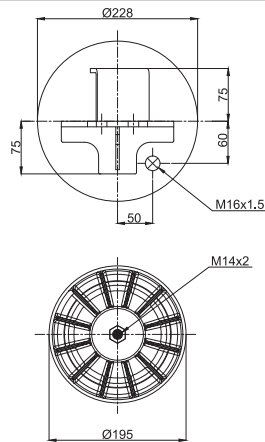
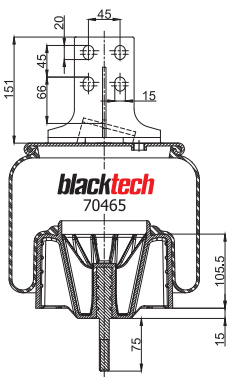

- Bolt or Stud
- Threaded hole
- ⊗ Combination Stud
- ⊗ Air Inlet

OEM PART NUMBER	MODEL NO	CROSS REFERENCES	
Iveco	41270465	STRALIS 400/440 Rear	CF Gomma Ref. 1TS 270-23
			CF Gomma No. 206884

### RML 70466



Cross Section View

Top View

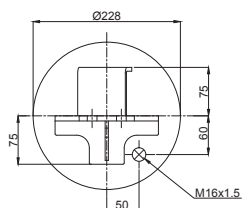
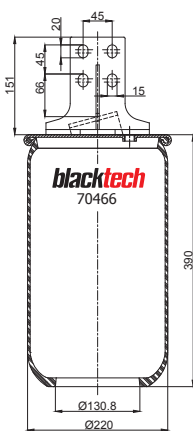

- Bolt or Stud
- Threaded hole
- ⊗ Combination Stud
- ⊗ Air Inlet

OEM PART NUMBER	MODEL NO	CROSS REFERENCES	
Iveco	42559768	STRALIS 400/440 Rear	CF Gomma Ref. 1TS 270-23
			CF Gomma No. 207171

**RML 70466 CP**



Cross Section View

Top View

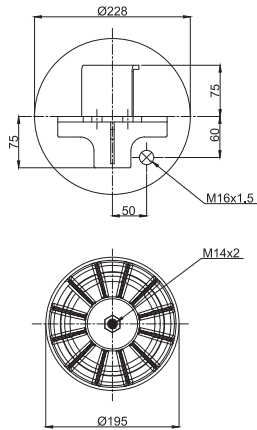
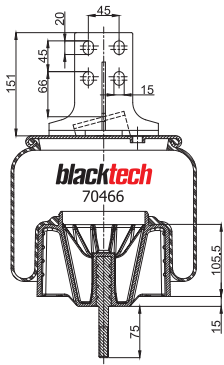

- Bolt or Stud
- Threaded hole
- ⊗ Combination Stud
- ⊗ Air Inlet

OEM PART NUMBER	MODEL NO	CROSS REFERENCES	
Iveco	41270466	STRALIS 400/440 Rear	CF Gomma Ref. 1TS 270-23
			CF Gomma No. 206885

**RML 70739 C**



Cross Section View

Top View

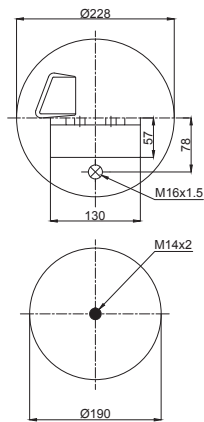
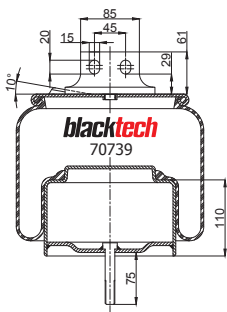

- Bolt or Stud
- Threaded hole
- ⊗ Combination Stud
- ⊗ Air Inlet

OEM PART NUMBER	MODEL NO	CROSS REFERENCES	
Iveco	41289370	Irisbus	CF Gomma Ref. 1TS 270-23
			CF Gomma No. 207536

**RML 70742**



Cross Section View

Top View

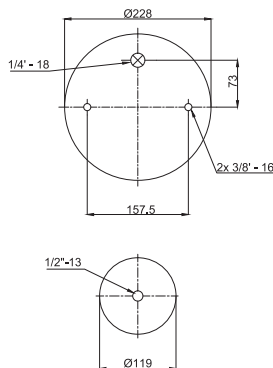
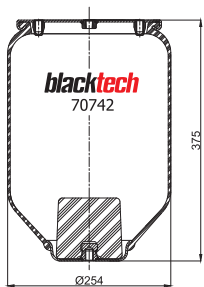

- Bolt or Stud
- Threaded hole
- ⊗ Combination Stud
- ⊗ Air Inlet

OEM PART NUMBER	MODEL NO	CROSS REFERENCES	
Austral Denning		Phoenix	10K 23 H-0742

### RML 70742 C



Cross Section View

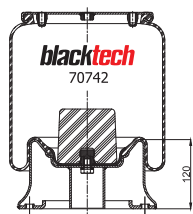

Top View

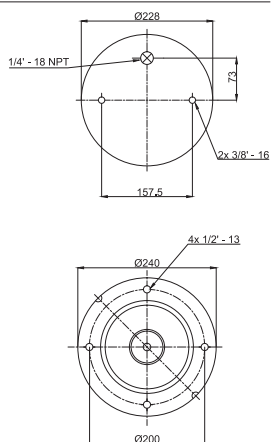

- Bolt or Stud
- Threaded hole
- ⊗ Combination Stud
- ⊗ Air Inlet

OEM PART NUMBER	MODEL NO	CROSS REFERENCES	
Austral Dening		Phoenix	1DK 23 H-0742 NP

### RML 71113



Cross Section View

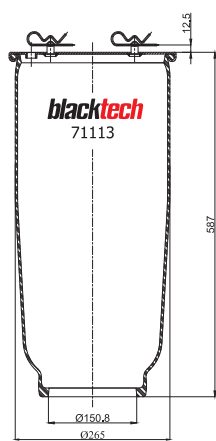

Top View

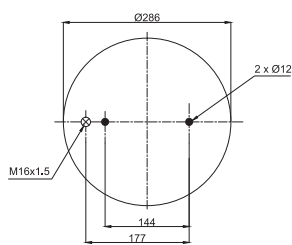

- Bolt or Stud
- Threaded hole
- ⊗ Combination Stud
- ⊗ Air Inlet

OEM PART NUMBER	MODEL NO	CROSS REFERENCES	
Scania			

### RML 71113 C



Cross Section View

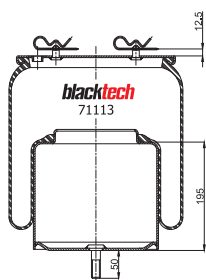

Top View

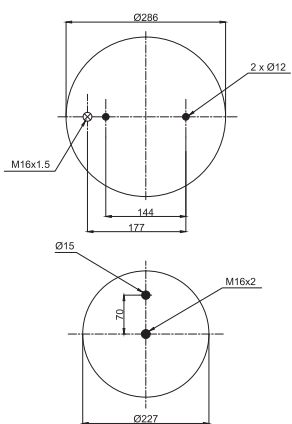

- Bolt or Stud
- Threaded hole
- ⊗ Combination Stud
- ⊗ Air Inlet

OEM PART NUMBER	MODEL NO	CROSS REFERENCES	
Scania	1731113	Conlitech	1113 N P01



### RML 71304 C1

Cross Section View

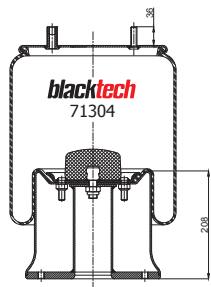

Top View

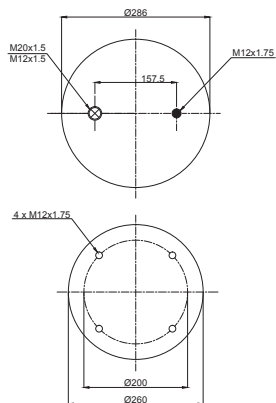

- Bolt or Stud
- Threaded hole
- ⊗ Combination Stud
- ⊗ Air Inlet

OEM PART NUMBER	MODEL NO	CROSS REFERENCES	
Zorzi 1006552		Firestone Style	1T19 L-14
SMB M001464		Firestone No.	W01 M58 8762
Fruehauf UJB0129001		Dunlop F	D13 B04
		CF Gomma Ref.	1T19 E-3
		CF Gomma No.	201840

### RML 71309 C

Cross Section View

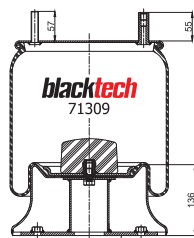

Top View

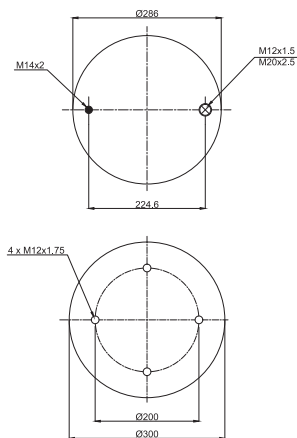

- Bolt or Stud
- Threaded hole
- ⊗ Combination Stud
- ⊗ Air Inlet

OEM PART NUMBER	MODEL NO	CROSS REFERENCES	
Kaiser F01008696		Dunlop F	D13 B09
		Goodyear	1R13-726

### RML 71314 C

Cross Section View

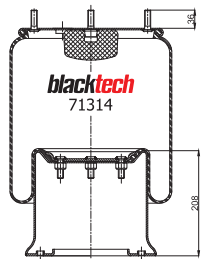

Top View

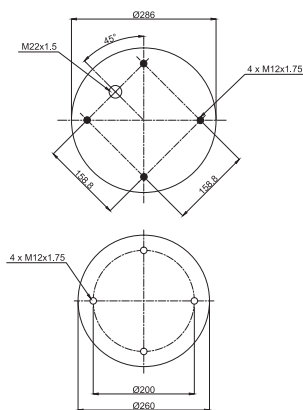

- Bolt or Stud
- Threaded hole
- ⊗ Combination Stud
- ⊗ Air Inlet

OEM PART NUMBER	MODEL NO	CROSS REFERENCES	
SMB M100152		Firestone Style	1T19 L-14
Weweler US07385F		Firestone No.	W01 M58 8766
Weweler US96681F		Dunlop F	D13 B14
		Phoenix	1028 D-2

**RML 71315 C**

Cross Section View

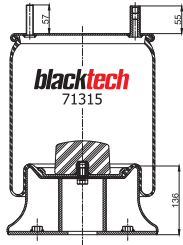

Top View

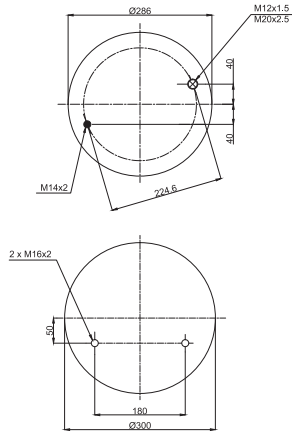

- Bolt or Stud
- Threaded hole
- ⊗ Combination Stud
- ⊗ Air Inlet

OEM PART NUMBER	MODEL NO	CROSS REFERENCES	
Kaiser	F01008697	Dunlop F	D13 B15D
		Goodyear	1R13-724

**RML 71315 C1**

Cross Section View

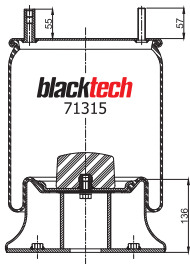

Top View

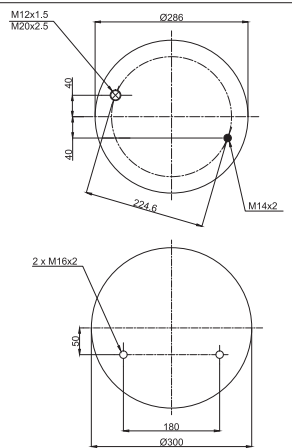

- Bolt or Stud
- Threaded hole
- ⊗ Combination Stud
- ⊗ Air Inlet

OEM PART NUMBER	MODEL NO	CROSS REFERENCES	
Kaiser	F01008697	Dunlop F	D13 B15G
		Goodyear	1R13-728

**RML 71420 C**

Cross Section View

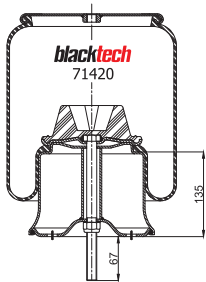

Top View

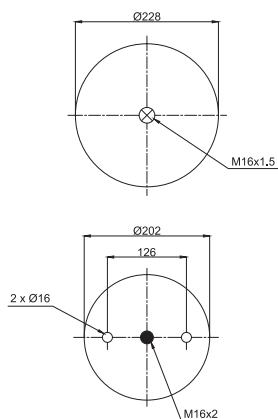

- Bolt or Stud
- Threaded hole
- ⊗ Combination Stud
- ⊗ Air Inlet

OEM PART NUMBER	MODEL NO	CROSS REFERENCES	
Austeras	99381009	Gart Ref.	D276R
		Gart No.	2761.420



### RML 71421C



Cross Section View

Top View

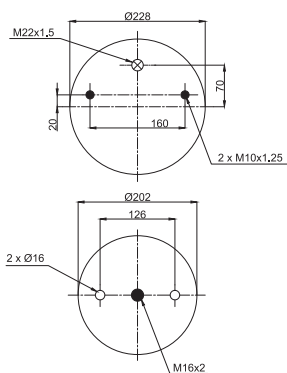
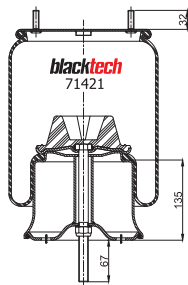

- Bolt or Stud
- Threaded hole
- ⊗ Combination Stud
- ⊗ Air Inlet

OEM PART NUMBER		MODEL NO	CROSS REFERENCES	
Battaglino	2211907		Gart Ref.	D276R
Campana	05.040.0200		Gart No.	2761.421
Tras Car	03003000070			

### RML 71480 C



Cross Section View

Top View

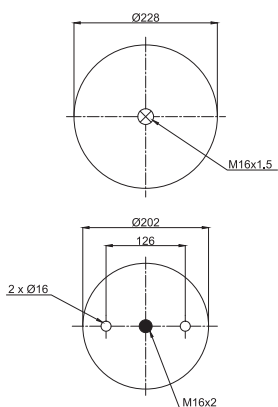
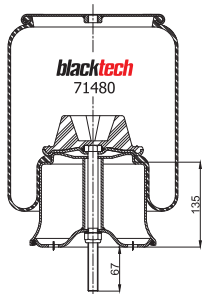

- Bolt or Stud
- Threaded hole
- ⊗ Combination Stud
- ⊗ Air Inlet

OEM PART NUMBER		MODEL NO	CROSS REFERENCES	
Austeras	99381010		Gart Ref.	D276LR
			Gart No.	2761.480

### RML 71481C



Cross Section View

Top View

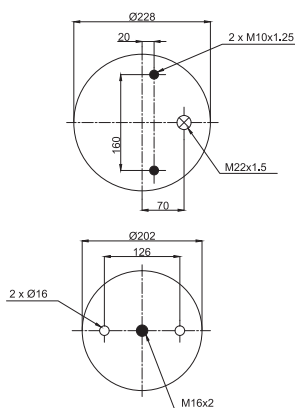
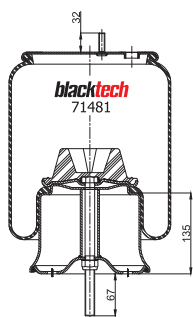

- Bolt or Stud
- Threaded hole
- ⊗ Combination Stud
- ⊗ Air Inlet

OEM PART NUMBER		MODEL NO	CROSS REFERENCES	
Tras Car	3003000060		Gart Ref.	D276LR
			Gart No.	2761.481

**RML 71501**

Cross Section View

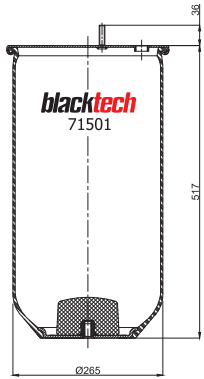

Top View

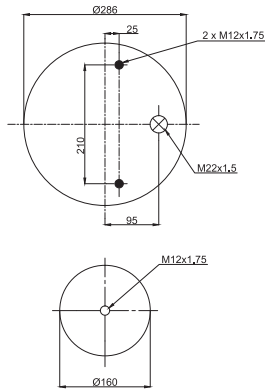

- Bolt or Stud
- Threaded hole
- ⊗ Combination Stud
- ⊗ Air Inlet

OEM PART NUMBER	MODEL NO	CROSS REFERENCES
Mercedes		

**RML 71501C**

Cross Section View

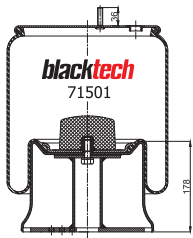

Top View

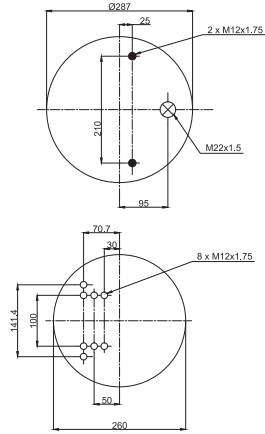

- Bolt or Stud
- Threaded hole
- ⊗ Combination Stud
- ⊗ Air Inlet

OEM PART NUMBER	MODEL NO	CROSS REFERENCES
Mercedes	A 946 328 15 01	Goodyear 1R14-823
Schmitz	S015323	Phoenix 1DK 28 F-3
Weweler	US 04030P	Gart Ref. D277/D
Weweler	US 04030G	Gart No. 277.2.520

**RML 71840 C**

Cross Section View

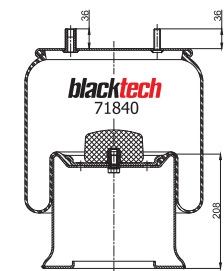

Top View

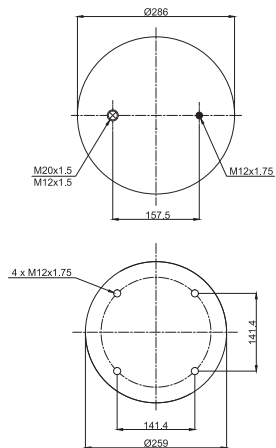

- Bolt or Stud
- Threaded hole
- ⊗ Combination Stud
- ⊗ Air Inlet

OEM PART NUMBER	MODEL NO	CROSS REFERENCES
Acerbi / Viberti	800448024	CF Gomma Ref. 1T19 E-3
Fruehauf / SMB	M001464	CF Gomma No. 201840

### RML 71901 C



Cross Section View

Top View

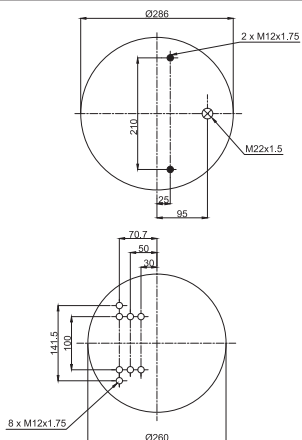
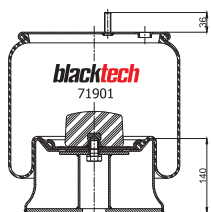

- Bolt or Stud
- Threaded hole
- ⊗ Combination Stud
- ⊗ Air Inlet

OEM PART NUMBER	MODEL NO	CROSS REFERENCES	
Daimler Tas	A 946 328 19 01	Phoenix	1D28 A-13
Weweler	US 07337RP		

### RML 72247 CP



Cross Section View

Top View

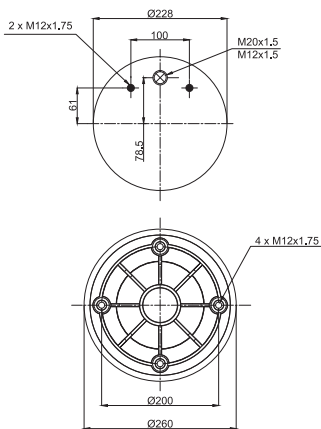
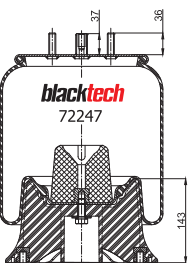

- Bolt or Stud
- Threaded hole
- ⊗ Combination Stud
- ⊗ Air Inlet

OEM PART NUMBER	MODEL NO	CROSS REFERENCES	
Volvo	20352247	Contitech	2247 M
Volvo	20386228		

### RML 72421 C



Cross Section View

Top View

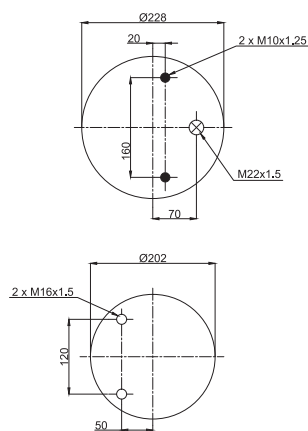
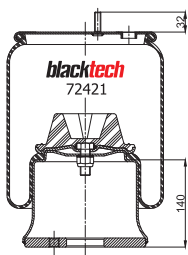

- Bolt or Stud
- Threaded hole
- ⊗ Combination Stud
- ⊗ Air Inlet

OEM PART NUMBER	MODEL NO	CROSS REFERENCES	
Battaglino	221900	Gart Ref.	D276R
		Gart No.	276.2.421

**RML 72430 C**



Cross Section View

Top View

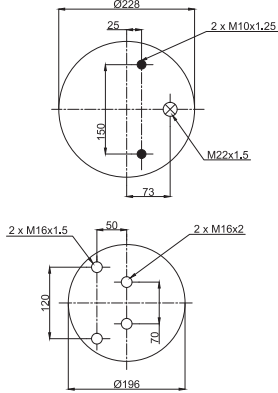
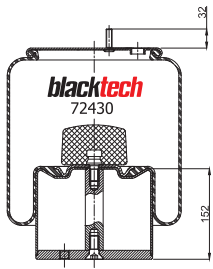

- Bolt or Stud
- Threaded hole
- ⊗ Combination Stud
- ⊗ Air Inlet

OEM PART NUMBER		MODEL NO	CROSS REFERENCES	
BPW	041.04.001.0		Gart Ref.	D278E
Campana	05.040.0100		Gart No.	278.2.430

**RML 72432 C**



Cross Section View

Top View

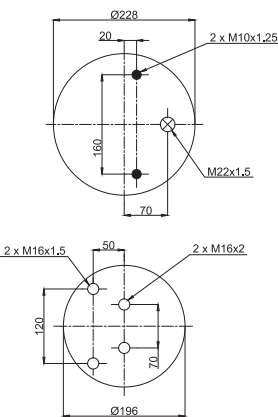
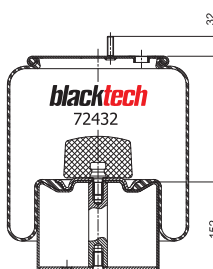

- Bolt or Stud
- Threaded hole
- ⊗ Combination Stud
- ⊗ Air Inlet

OEM PART NUMBER		MODEL NO	CROSS REFERENCES	
Tras Car	03003000080		Gart Ref.	D278E
			Gart No.	278.2.432

**RML 72478**



Cross Section View

Top View

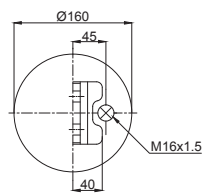
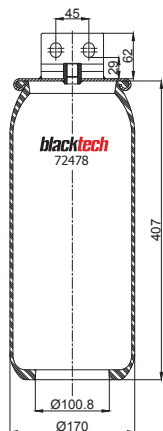

- Bolt or Stud
- Threaded hole
- ⊗ Combination Stud
- ⊗ Air Inlet

OEM PART NUMBER		MODEL NO	CROSS REFERENCES	
Iveco	42559721			

### RML 72478 C



Cross Section View

Top View

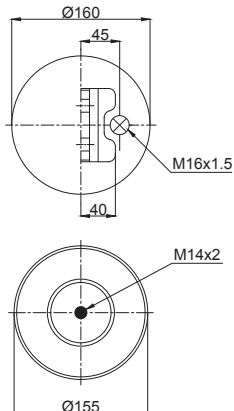
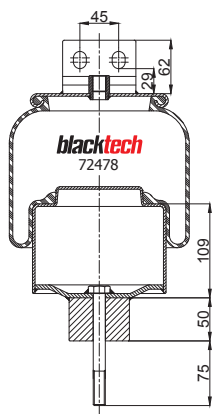

- Bolt or Stud
- Threaded hole
- ⊗ Combination Stud
- ⊗ Air Inlet

OEM PART NUMBER	MODEL NO	CROSS REFERENCES	
Iveco	41272478	Off Road 6x4 280/340	CF Gomma Ref. 1 TS 230 25 C
			CF Gomma No. 207194

### RML 72520 C



Cross Section View

Top View

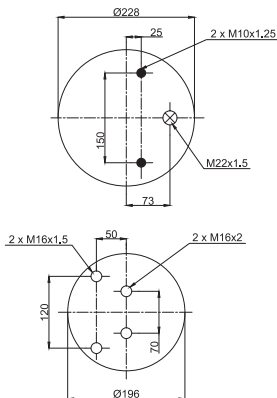
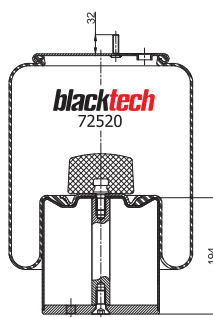

- Bolt or Stud
- Threaded hole
- ⊗ Combination Stud
- ⊗ Air Inlet

OEM PART NUMBER	MODEL NO	CROSS REFERENCES	
Austeras	99381031		Gart Ref. D278F
			Gart No. 278.2.520

### RML 72642 CP



Cross Section View

Top View

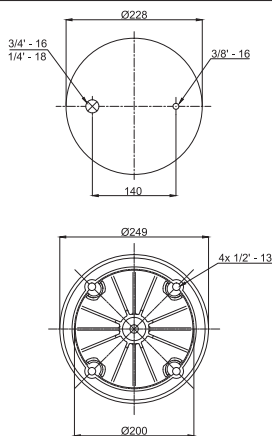
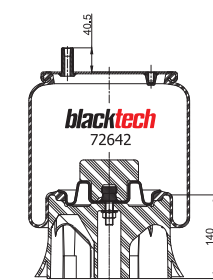

- Bolt or Stud
- Threaded hole
- ⊗ Combination Stud
- ⊗ Air Inlet

OEM PART NUMBER	MODEL NO	CROSS REFERENCES	
		Goodyear	1R12-642

**RML 72670 C**

Cross Section View

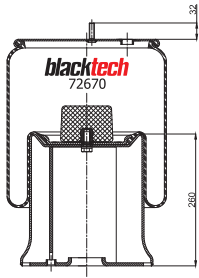

Top View

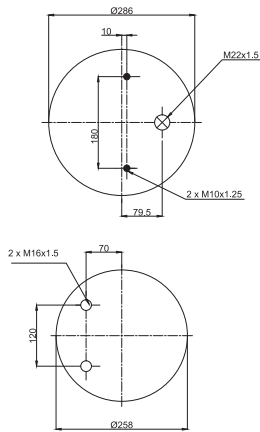

- Bolt or Stud
- Threaded hole
- ⊗ Combination Stud
- ⊗ Air Inlet

OEM PART NUMBER		MODEL NO	CROSS REFERENCES	
Omar	11815		Gart Ref.	D287D
Pezzaioli	70100027		Gart No.	2872.670
Rolfo	112010			
Zorzi	1006557			

**RML 72789**

Cross Section View

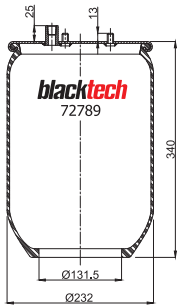

Top View

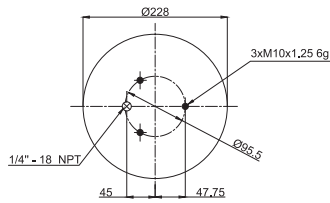

- Bolt or Stud
- Threaded hole
- ⊗ Combination Stud
- ⊗ Air Inlet

OEM PART NUMBER		MODEL NO	CROSS REFERENCES	
Mitsubishi	MK 432789	FUSO		

**RML 73042**

Cross Section View

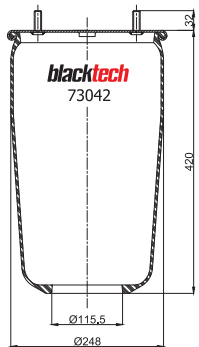

Top View

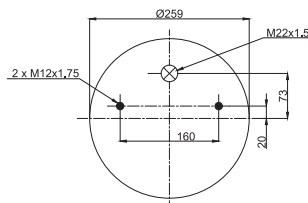

- Bolt or Stud
- Threaded hole
- ⊗ Combination Stud
- ⊗ Air Inlet

OEM PART NUMBER		MODEL NO	CROSS REFERENCES	
Gigant	247104		Conlitech	4007 N P01
Gigant	3042	724 K	Vibracoustic	V1DF21A-247104

### RML 73042 C



Cross Section View

Top View

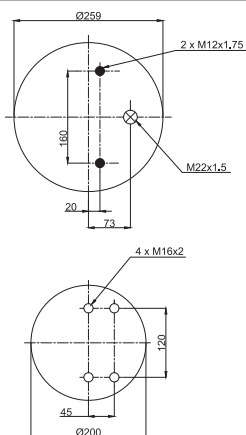
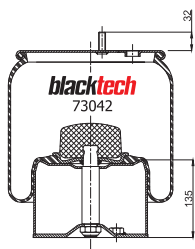

- Bolt or Stud
- Threaded hole
- ⊗ Combination Stud
- ⊗ Air Inlet

OEM PART NUMBER	MODEL NO	CROSS REFERENCES
Gigant	3042	724 K

### RML 73108



Cross Section View

Top View

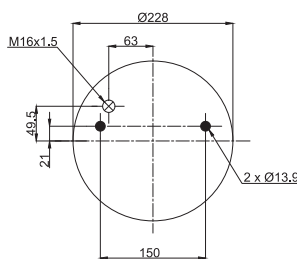
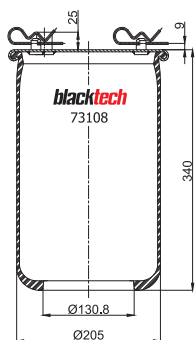

- Bolt or Stud
- Threaded hole
- ⊗ Combination Stud
- ⊗ Air Inlet

OEM PART NUMBER	MODEL NO	CROSS REFERENCES
Volvo	7321690	

### RML 73108 C



Cross Section View

Top View

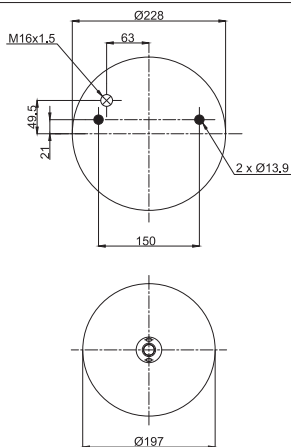
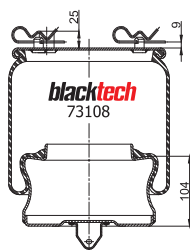

- Bolt or Stud
- Threaded hole
- ⊗ Combination Stud
- ⊗ Air Inlet

OEM PART NUMBER	MODEL NO	CROSS REFERENCES
Volvo	20 573 108	B 12 B
Volvo	70 321 692	
Volvo	70 376 919	
Volvo	70 321 690	

**RML 73311**



Cross Section View

Top View

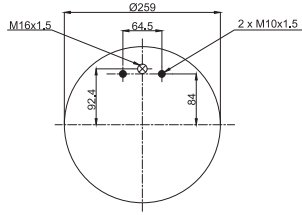
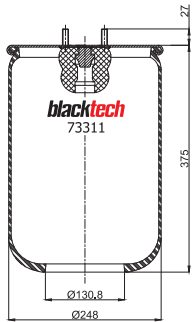

- Bolt or Stud
- Threaded hole
- ⊗ Combination Stud
- ⊗ Air Inlet

OEM PART NUMBER	MODEL NO	CROSS REFERENCES
Volvo	Bus	

**RML 73311C**



Cross Section View

Top View

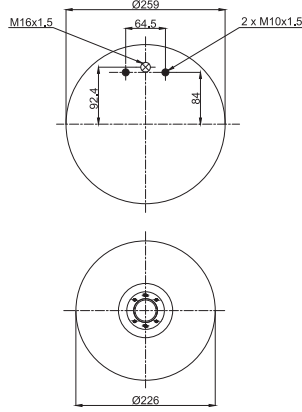
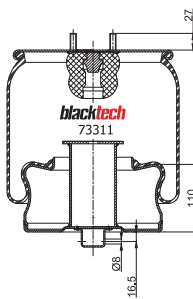

- Bolt or Stud
- Threaded hole
- ⊗ Combination Stud
- ⊗ Air Inlet

OEM PART NUMBER	MODEL NO	CROSS REFERENCES
Volvo	20 573 311	B 12 R Contitech 6603 N P02
Volvo	20 573 311	B 12 M Vibracoustic VIDF16E-1
Volvo	3 195 240	
Volvo	3 195 240	

**RML 73312**



Cross Section View

Top View

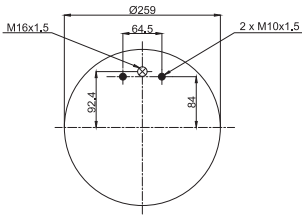
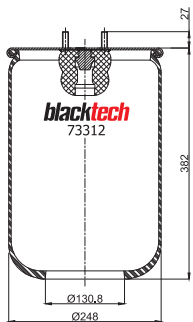

- Bolt or Stud
- Threaded hole
- ⊗ Combination Stud
- ⊗ Air Inlet

OEM PART NUMBER	MODEL NO	CROSS REFERENCES
Volvo	Bus	



### RML 73312 C



Cross Section View

Top View

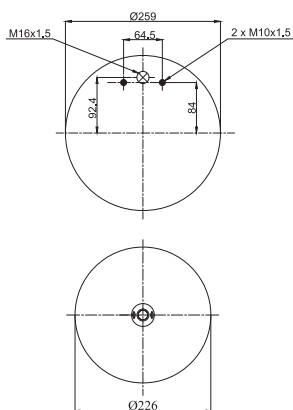
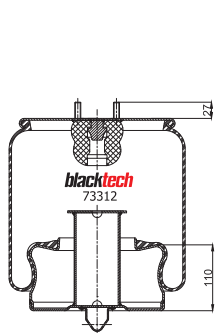

- Bolt or Stud
- Threaded hole
- ⊗ Combination Stud
- ⊗ Air Inlet

OEM PART NUMBER		MODEL NO	CROSS REFERENCES	
Volvo	20 573 312	B 12 R	Contitech	6603 N P01
Volvo	3 171 693		Goodyear	1R11-893
Volvo	3 178 706			
Volvo	3 195 240			

### RML 73608 C



Cross Section View

Top View

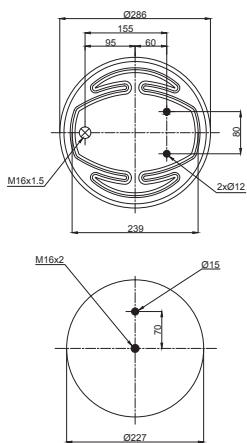
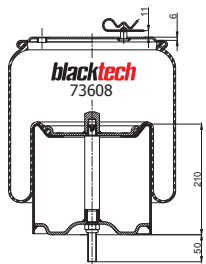

- Bolt or Stud
- Threaded hole
- ⊗ Combination Stud
- ⊗ Air Inlet

OEM PART NUMBER		MODEL NO	CROSS REFERENCES	
Scania	1903608	R-Series new generation	Contitech	6700 N P02
Scania	1944314	R-Series new generation	Firestone No.	W01-M58-8535
			Firestone No.	W01-S05-9881
			Goodyear	1R14-869

### RML 73836



Cross Section View

Top View

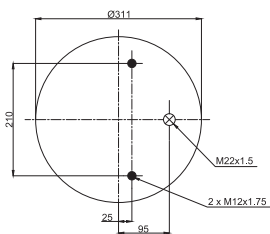
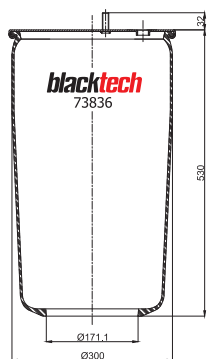

- Bolt or Stud
- Threaded hole
- ⊗ Combination Stud
- ⊗ Air Inlet

OEM PART NUMBER		MODEL NO	CROSS REFERENCES	
Gigant			Contitech	2725 N P01
			Phoenix	1DF 32

**RML 73836 C**



Cross Section View

Top View

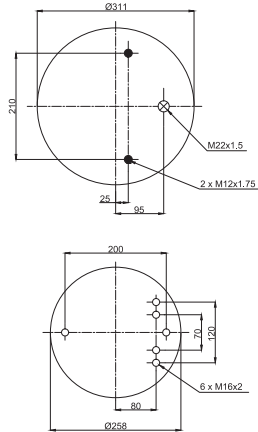
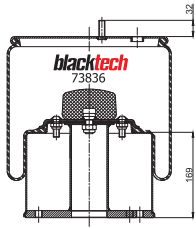

- Bolt or Stud
- Threaded hole
- ⊗ Combination Stud
- ⊗ Air Inlet

OEM PART NUMBER	MODEL NO	CROSS REFERENCES	
Tirsan			

**RML 74031 C**



Cross Section View

Top View

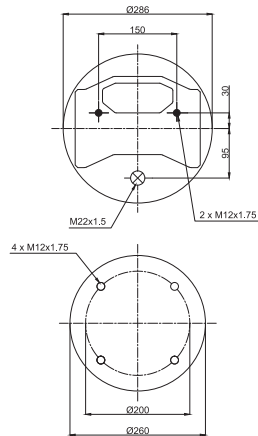
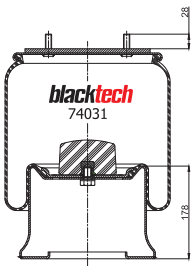

- Bolt or Stud
- Threaded hole
- ⊗ Combination Stud
- ⊗ Air Inlet

OEM PART NUMBER	MODEL NO	CROSS REFERENCES	
Weweler	USD4031	Goodyear	1R14-812
Weweler	USD4031F		
Schmitz	17685		

**RML 74283 C**



Cross Section View

Top View

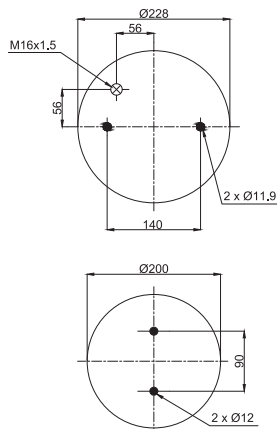
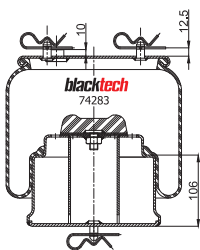

- Bolt or Stud
- Threaded hole
- ⊗ Combination Stud
- ⊗ Air Inlet

OEM PART NUMBER	MODEL NO	CROSS REFERENCES	
Scania	2024285	Axle Front	Goodyear 1R11-896
			Goodyear 1R11-879 Old Number

### RML 74287 C



Cross Section View

Top View

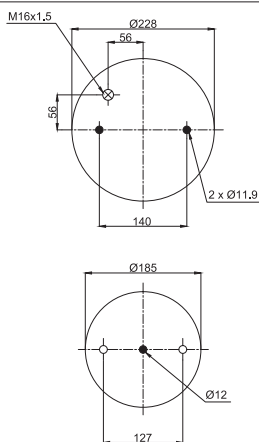
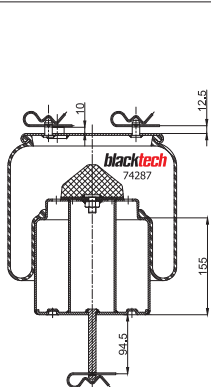

- Bolt or Stud
- Threaded hole
- ⊗ Combination Stud
- ⊗ Air Inlet

OEM PART NUMBER		MODEL NO	CROSS REFERENCES	
Scania	2024287	Axle Rear	Goodyear	1R11-867

### RML 74288 C



Cross Section View

Top View

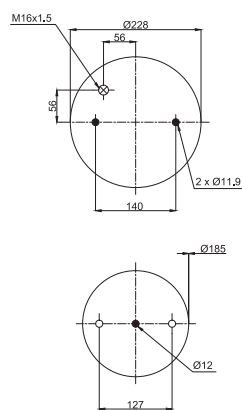
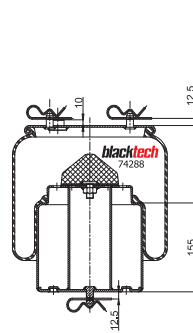

- Bolt or Stud
- Threaded hole
- ⊗ Combination Stud
- ⊗ Air Inlet

OEM PART NUMBER		MODEL NO	CROSS REFERENCES	
Scania	2024288	Rear - Center Axle	Goodyear	1R11-869

### RML 74307 C



Cross Section View

Top View

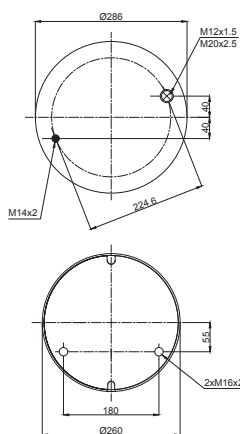
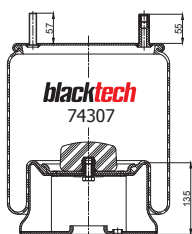

- Bolt or Stud
- Threaded hole
- ⊗ Combination Stud
- ⊗ Air Inlet

OEM PART NUMBER		MODEL NO	CROSS REFERENCES	
Kaiser	F01004307		Goodyear	1R13-730

**RML 74506 C**



Cross Section View

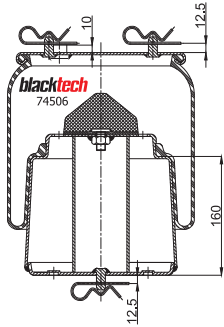

Top View

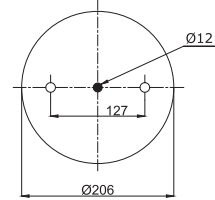
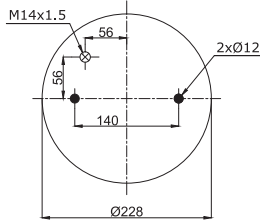

- Bolt or Stud
- Threaded hole
- ⊗ Combination Stud
- ⊗ Air Inlet

OEM PART NUMBER		MODEL NO	CROSS REFERENCES	
Scania	1434506		Goodyear	1R11-832
			Phoenix	1DF 20 A-4

**RML 74512**



Cross Section View

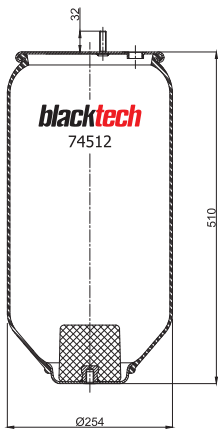

Top View

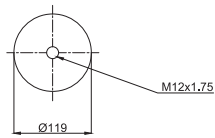
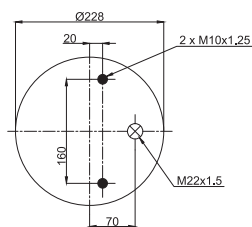

- Bolt or Stud
- Threaded hole
- ⊗ Combination Stud
- ⊗ Air Inlet

OEM PART NUMBER		MODEL NO	CROSS REFERENCES	

**RML 74512 C**



Cross Section View

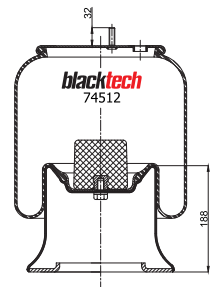

Top View

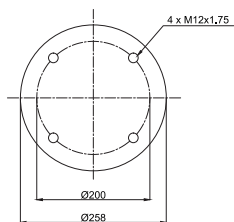
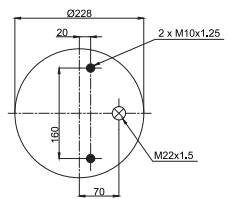

- Bolt or Stud
- Threaded hole
- ⊗ Combination Stud
- ⊗ Air Inlet

OEM PART NUMBER		MODEL NO	CROSS REFERENCES	
BPW	041.03.007.0		Gart Ref.	D278H
Campana	05.050.0100		Gart No.	278.4.512
Campana	28100002			

### RML 74514



Cross Section View

Top View

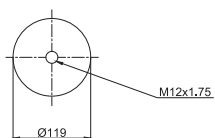
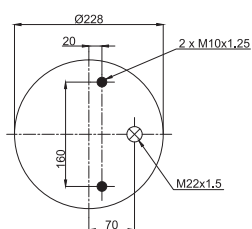
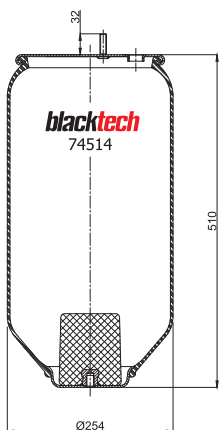

- Bolt or Stud
- Threaded hole
- ⊗ Combination Stud
- ⊗ Air Inlet

OEM PART NUMBER	MODEL NO	CROSS REFERENCES

### RML 74514 C



Cross Section View

Top View

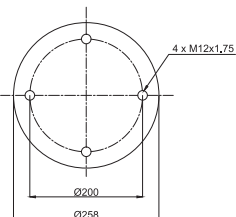
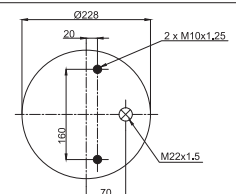
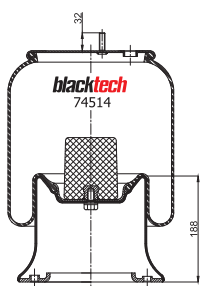

- Bolt or Stud
- Threaded hole
- ⊗ Combination Stud
- ⊗ Air Inlet

OEM PART NUMBER	MODEL NO	CROSS REFERENCES
Viberti	128147109	Gart Ref. D278H
		Gart No. 278.4.514

### RML 74520 C



Cross Section View

Top View

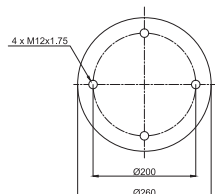
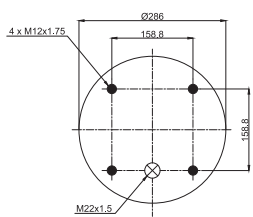
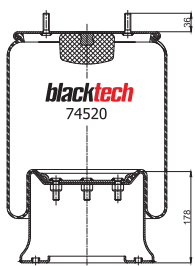

- Bolt or Stud
- Threaded hole
- ⊗ Combination Stud
- ⊗ Air Inlet

OEM PART NUMBER	MODEL NO	CROSS REFERENCES
BPW	041.03.003.0	Gart Ref. D277D
Campana	05.020.0100	Gart No. 277.4.520

**RML 74521 C**



Cross Section View

Top View

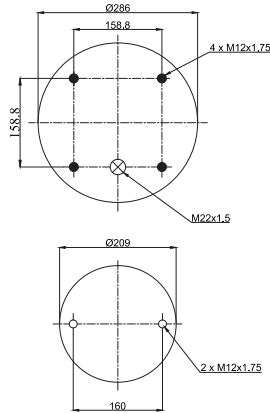
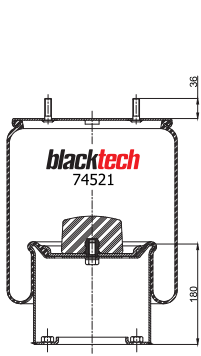

- Bolt or Stud
- Threaded hole
- ⊗ Combination Stud
- ⊗ Air Inlet

OEM PART NUMBER	MODEL NO	CROSS REFERENCES	
BPW	041.03.009.0	Gart Ref.	D277D
		Gart No.	2774.521

**RML 74523 C**



Cross Section View

Top View

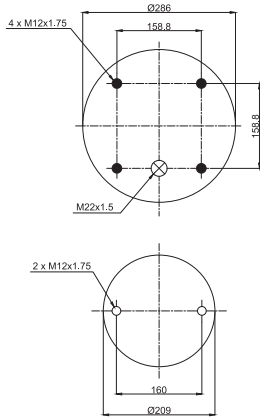
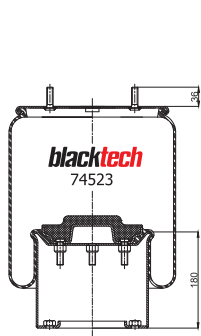

- Bolt or Stud
- Threaded hole
- ⊗ Combination Stud
- ⊗ Air Inlet

OEM PART NUMBER	MODEL NO	CROSS REFERENCES	
BPW	041.03.016.0	Gart Ref.	D277D
		Gart No.	2774.523

**RML 74543**



Cross Section View

Top View

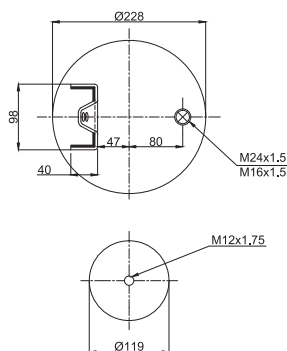
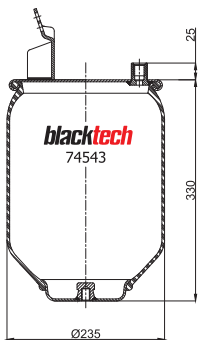

- Bolt or Stud
- Threaded hole
- ⊗ Combination Stud
- ⊗ Air Inlet

OEM PART NUMBER	MODEL NO	CROSS REFERENCES	
		Conlitech	4543 N

### RML 74543

Cross Section View

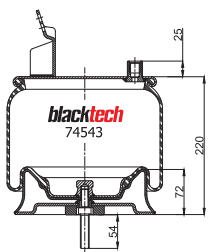

Top View

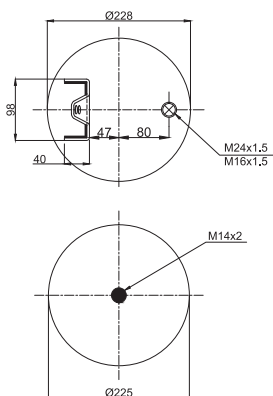

- Bolt or Stud
- Threaded hole
- ⊗ Combination Stud
- ⊗ Air Inlet

OEM PART NUMBER	MODEL NO	CROSS REFERENCES		
Volvo	20 737 947	FM / FH Xlow	Contitech	6614 NP01
Volvo	21 961 458	FM / FH Xlow		
Volvo	20 583 420	FM / FH Xlow		
Volvo	20 737 943			
Volvo	20 424 543			

### RML 74544 CP

Cross Section View

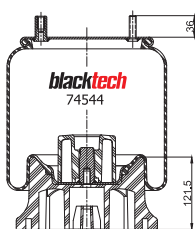

Top View

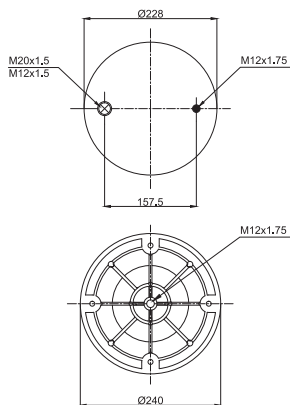

- Bolt or Stud
- Threaded hole
- ⊗ Combination Stud
- ⊗ Air Inlet

OEM PART NUMBER	MODEL NO	CROSS REFERENCES		
Fruehauf	M078580		Goodyear	1R11-733
			Vibracoustic	V1 DK 20 C2

### RML 74580

Cross Section View

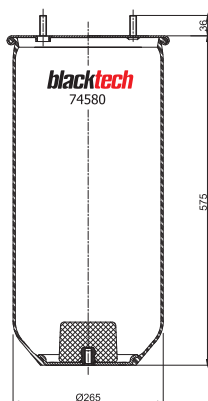

Top View

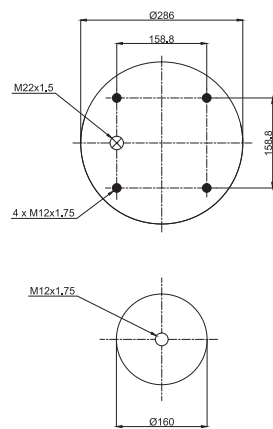

- Bolt or Stud
- Threaded hole
- ⊗ Combination Stud
- ⊗ Air Inlet

OEM PART NUMBER	MODEL NO	CROSS REFERENCES		

**RML 74580 C**



Cross Section View

Top View

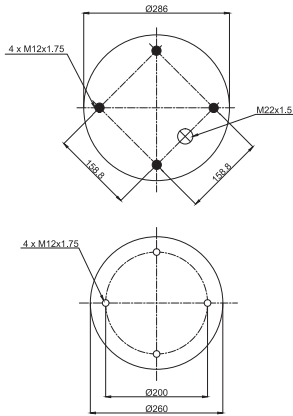
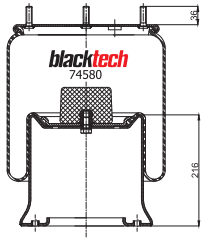

- Bolt or Stud
- Threaded hole
- ⊗ Combination Stud
- ⊗ Air Inlet

OEM PART NUMBER	MODEL NO	CROSS REFERENCES	
Fruehauf	UJB 0305	Gart Ref.	D287B
ROR Meritor	21221349	Gart No.	2874.580
Weweler	US 07380F		
Samro	H25000361		

**RML 74760 C**



Cross Section View

Top View

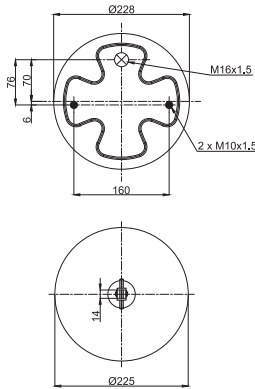
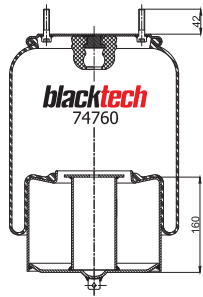

- Bolt or Stud
- Threaded hole
- ⊗ Combination Stud
- ⊗ Air Inlet

OEM PART NUMBER	MODEL NO	CROSS REFERENCES	
Volvo	20 554 760	FM / FH standard	Conlitech 6612 NP01
Volvo	20 580 705	FM / FH standard	
Volvo	21 961 472	FM / FH standard	
Volvo	20 479 800	FH standard	
Volvo	20 452 142		

**RML 74762 C**



Cross Section View

Top View

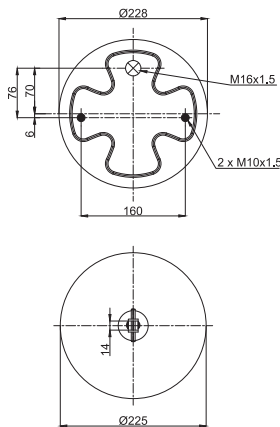
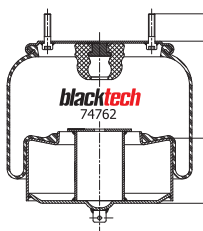

- Bolt or Stud
- Threaded hole
- ⊗ Combination Stud
- ⊗ Air Inlet

OEM PART NUMBER	MODEL NO	CROSS REFERENCES	
Volvo	20 554 762	FH low	Conlitech 6613 NP01
Volvo	21 811 323	FM / FH low, Xlow	
Volvo	21 961 475	FM / FH low, Xlow	
Volvo	20 452 144		



### RML 74770 C



Cross Section View

Top View

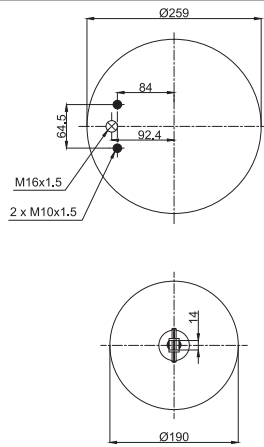
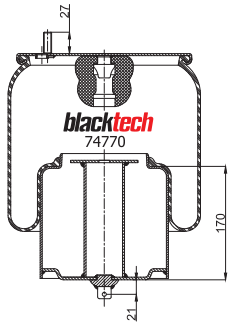

- Bolt or Stud
- Threaded hole
- ⊗ Combination Stud
- ⊗ Air Inlet

OEM PART NUMBER	MODEL NO	CROSS REFERENCES	
Volvo	20554770	Contitech	54770 M

### RML 74925



Cross Section View

Top View

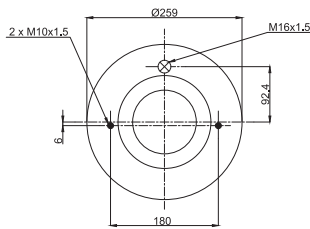
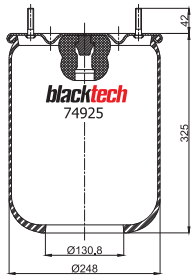

- Bolt or Stud
- Threaded hole
- ⊗ Combination Stud
- ⊗ Air Inlet

OEM PART NUMBER	MODEL NO	CROSS REFERENCES	
Volvo		Contitech	4925 N

### RML 74925 C



Cross Section View

Top View

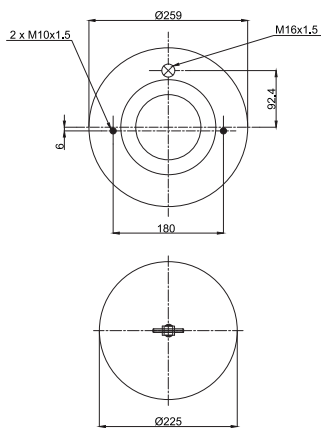
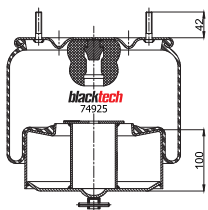

- Bolt or Stud
- Threaded hole
- ⊗ Combination Stud
- ⊗ Air Inlet

OEM PART NUMBER	MODEL NO	CROSS REFERENCES	
Volvo	1 075 365	Contitech	6609 N P01
Volvo	1 629 782		
Volvo	20 452 138		
Volvo	20 554 761		

**RML 75020 C**



Cross Section View

Top View

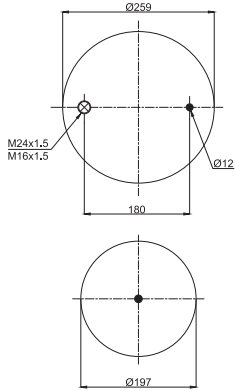
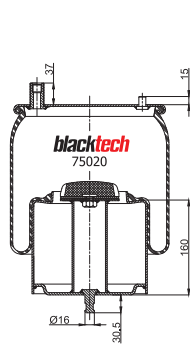

- Bolt or Stud
- Threaded hole
- ⊗ Combination Stud
- ⊗ Air Inlet

OEM PART NUMBER		MODEL NO	CROSS REFERENCES	
Renault	5.010.557.622	Premium / Magnum	Contitech	4919 NP01
Renault	5.010.630.457	FM / FH		
Volvo	21 978 490			
Volvo	20 735 220			
Renault	21 978 484	Premium / Magnum standard		

**RML 75022**



Cross Section View

Top View

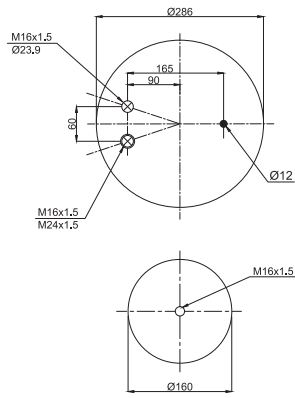
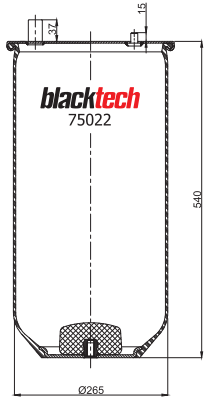

- Bolt or Stud
- Threaded hole
- ⊗ Combination Stud
- ⊗ Air Inlet

OEM PART NUMBER		MODEL NO	CROSS REFERENCES	
Renault	5.011.294.308			

**RML 75022-4**



Cross Section View

Top View

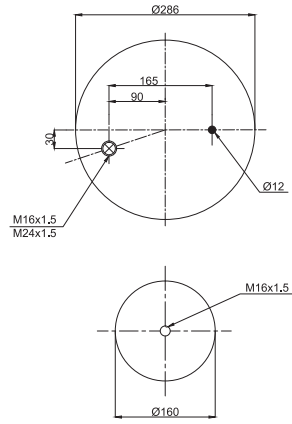
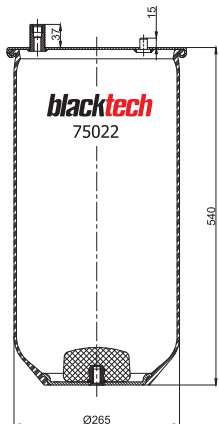

- Bolt or Stud
- Threaded hole
- ⊗ Combination Stud
- ⊗ Air Inlet

OEM PART NUMBER		MODEL NO	CROSS REFERENCES	

### RML 75022 C3



Cross Section View

Top View

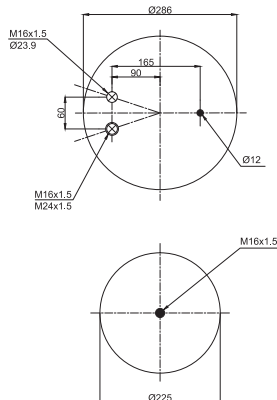
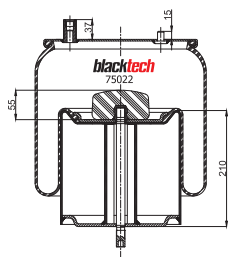

- Bolt or Stud
- Threaded hole
- ⊗ Combination Stud
- ⊗ Air Inlet

OEM PART NUMBER		MODEL NO	CROSS REFERENCES	
Renault	5.010.294.308.C	Magnum low truck	Contitech	4911 N P03
Renault	5.010.294.308.C	Premium low truck	Goodyear	1R13-739
			Goodyear	ex 1R13-714
			CF Gomma Ref.	1T19E-3
			CF Gomma No.	207770
			Dunlop F	D13B41
			Gart Ref.	D287/E
			Gart No.	2871.540

### RML 75022 C4



Cross Section View

Top View

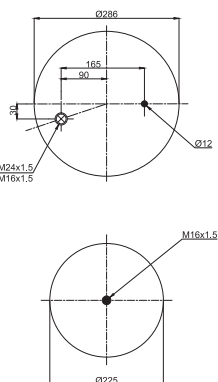
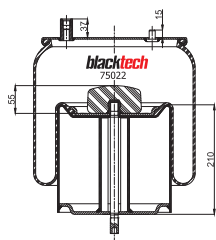

- Bolt or Stud
- Threaded hole
- ⊗ Combination Stud
- ⊗ Air Inlet

OEM PART NUMBER		MODEL NO	CROSS REFERENCES	
Renault	5.010.557.356	Magnum low truck	Contitech	4911 N P04
Renault	5.010.557.356	Premium low truck	Goodyear	1R13-755
Renault	25 364 097		CF Gomma Ref.	1T19E-3
			CF Gomma No.	207771
			Gart Ref.	D287/E
			Gart No.	2871.541

### RML 75022 C6



Cross Section View

Top View

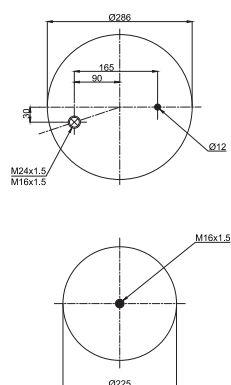
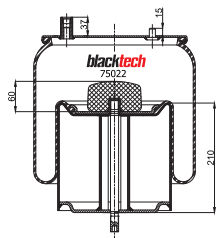

- Bolt or Stud
- Threaded hole
- ⊗ Combination Stud
- ⊗ Air Inlet

OEM PART NUMBER		MODEL NO	CROSS REFERENCES	
Renault	5.010.600.439	Premium / Magnum low	Contitech	4911 N P06
Volvo	20 726 769	FM / FH low	Gart Ref.	D287/E
Renault	5.010.305.464	FM / FH low	Gart No.	2871.542
Volvo	21 978 502	FM / FH low		
Volvo	21 978 495	Premium / Magnum low		

**RML 75023**



Cross Section View

Top View

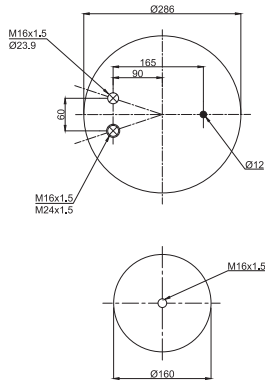
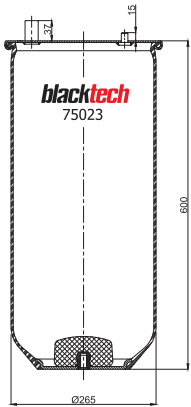

- Bolt or Stud
- Threaded hole
- ⊗ Combination Stud
- ⊗ Air Inlet

OEM PART NUMBER		MODEL NO	CROSS REFERENCES	
Renault	5.001.832.067	Magnum / Premium	Contitech	4912 N P08
			Primeride	54912 A P08
			Goodyear	1R13-713
			CF Gomma Ref.	1T19E-4
			CF Gomma No.	206780
			Dunlop F	D13U40
			Gart Ref.	D287/C
			Gart No.	2870.601

**RML 75023-10**



Cross Section View

Top View

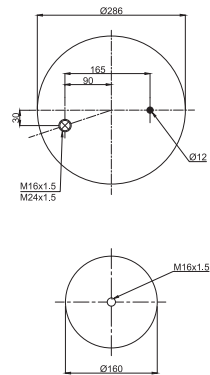
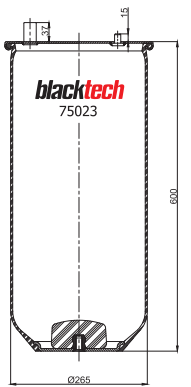

- Bolt or Stud
- Threaded hole
- ⊗ Combination Stud
- ⊗ Air Inlet

OEM PART NUMBER		MODEL NO	CROSS REFERENCES	

**RML 75023 C7**



Cross Section View

Top View

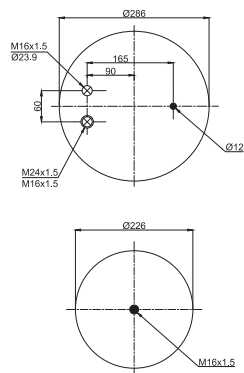
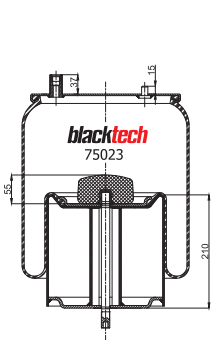

- Bolt or Stud
- Threaded hole
- ⊗ Combination Stud
- ⊗ Air Inlet

OEM PART NUMBER		MODEL NO	CROSS REFERENCES	
Renault	5.010.294.307	Magnum / Premium	Contitech	4912 N P07
			Phoenix	1DK 28 F-4
			Primeride	54912 A P07
			Firestone Style	1T19L-14
			Firestone No.	W01-M58-8786
			Goodyear	1R13-738
			Goodyear	ex 1R13-711
			Vibracoustic	V1DK28F-4
			CF Gomma Ref.	1T19E-4
			CF Gomma No.	206779
			Dunlop F	D13B40
			Dunlop F	D13B45
			Gart Ref.	D287/C
			Gart No.	2871600

### RML 75023 C10



Cross Section View

Top View

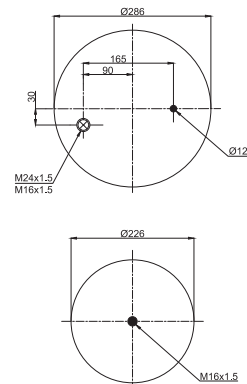
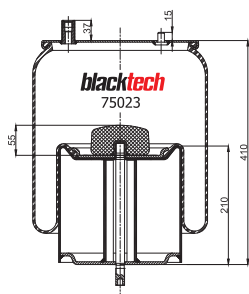

- Bolt or Stud
- Threaded hole
- ⊗ Combination Stud
- ⊗ Air Inlet

OEM PART NUMBER		MODEL NO	CROSS REFERENCES	
Renault	5.010.557.355	Magnum / Premium	Contitech	4912 NP10
Renault	5.010.557.355	Midium 18t	Phoenix	1DK 28 F-5
Volvo	20 722 412	Premium / Magnum	Firestone Style	1T19LL-14
Renault	7422025556		Firestone No.	W01-M68-5521
Volvo	22 025 568		Goodyear	1R13-753
			Vibracoustic	V1DK28F-8
			CF Gomma Ref.	1T19E-4
			CF Gomma No.	207769
			Gart Ref.	D287/C
			Gart No.	2871.603

### RML 75023 C13



Cross Section View

Top View

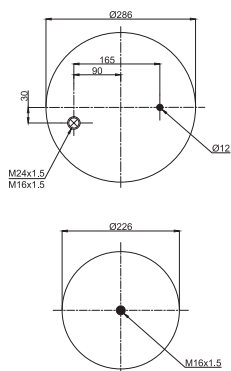
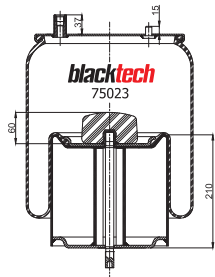

- Bolt or Stud
- Threaded hole
- ⊗ Combination Stud
- ⊗ Air Inlet

OEM PART NUMBER		MODEL NO	CROSS REFERENCES	
Renault	5.010.600.328	Premium / Magnum standard	Contitech	4912 NP13
Volvo	20 726 768	FM / FH standard	Phoenix	1DK 28 F-6
Renault	21 978 494	Premium / Magnum standard	Firestone Style	1T19LL-14
Renault	21 978 504	FM / FH standard	Firestone No.	W01-M68-5520
			Gart Ref.	D287/C
			Gart No.	2871.602

### RML 75024



Cross Section View

Top View

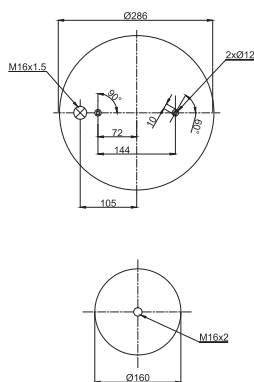
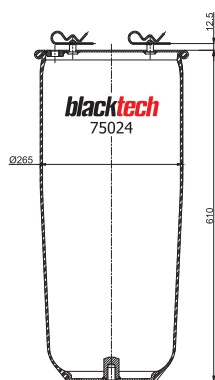

- Bolt or Stud
- Threaded hole
- ⊗ Combination Stud
- ⊗ Air Inlet

OEM PART NUMBER		MODEL NO	CROSS REFERENCES	
Scania	1379393	Series 4	Contitech	4913 NP04
			Phoenix	1D 28 H-16 NP
			Primeride	54913 A P04
			Firestone Style	1T19L-14
			Firestone No.	W01-095-0365
			Goodyear	1R14-755
			Dunlop F	D14U42
			Gart Ref.	C282/H
			Gart Ref.	D287/H
			Gart No.	282.0.601
			Gart No.	2870.603

**RML 75024 C**



Cross Section View

Top View

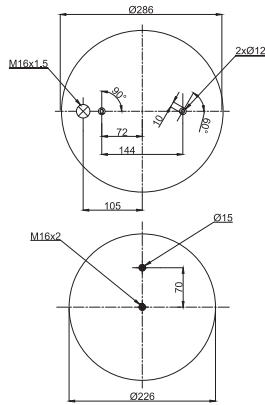
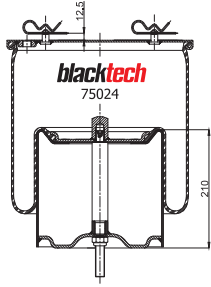

- Bolt or Stud
- Threaded hole
- ⊗ Combination Stud
- ⊗ Air Inlet

OEM PART NUMBER		MODEL NO	CROSS REFERENCES	
Scania	1379392	Series 4	Contitech	4913 N P02
Scania	1440294	Series 4	Phoenix	1D 28 H-16
			Primeride	54913 A P02
			Firestone Style	1T19LAJ-14
			Firestone Style	1T19L-14
			Firestone No.	W01-M68-9881
			Firestone No.	W01-095-0500
			Goodyear	1R14-753
			Taurus	KR625-16
			Vibracoustic	V1D28H-16
			CF Gomma Ref.	1T19E-93
			CF Gomma No.	206201
			Dunlop F	D14B42
			Dunlop UK	00937A-AP
			Gart Ref.	C282/H
			Gart Ref.	D287/H
			Gart No.	282.1600
			Gart No.	282.1606

**RML 75026**



Cross Section View

Top View

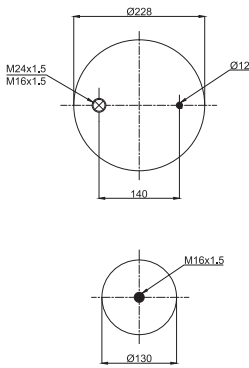
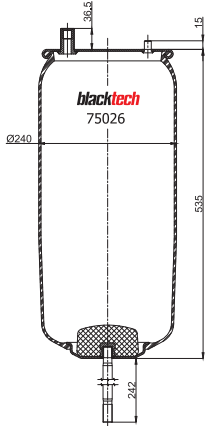

- Bolt or Stud
- Threaded hole
- ⊗ Combination Stud
- ⊗ Air Inlet

OEM PART NUMBER		MODEL NO	CROSS REFERENCES	
Renault	5.001.855.856	Magnum	Contitech	4915 N P03
			Gart Ref.	C294/C
			Gart No.	294.0.531

**RML 75026 C6**



Cross Section View

Top View

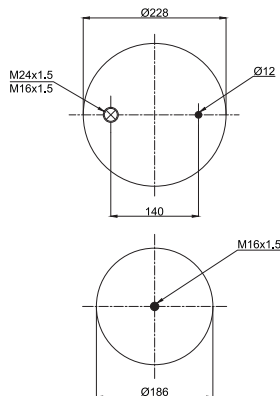
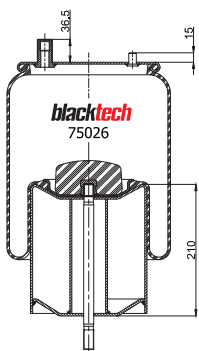

- Bolt or Stud
- Threaded hole
- ⊗ Combination Stud
- ⊗ Air Inlet

OEM PART NUMBER		MODEL NO	CROSS REFERENCES	
Renault	5.010.294.309	Premium / Magnum tag	Contitech	4915 N P06
SAMRO	H2501122		Phoenix	1DK 19-1
Renault	5.010.600.578	Premium / Magnum tag	Vibracoustic	V1DK19-1
Renault	21 978 500	Premium / Magnum tag	Gart Ref.	C294/C
Volvo	20 757 541		Gart No.	294.1.530
Renault	5.010.557.991			
Volvo	22 025 613			
Renault	22 190 563			

### RML 75027



Cross Section View

Top View

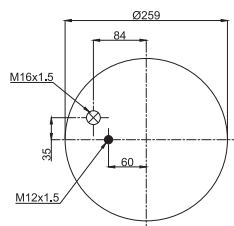
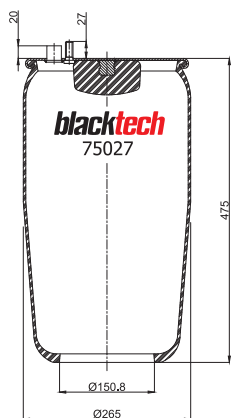

- Bolt or Stud
- Threaded hole
- ⊗ Combination Stud
- ⊗ Air Inlet

OEM PART NUMBER		MODEL NO	CROSS REFERENCES	
MAN	81.43601.0158		Contitech	4916 N1 P01

### RML 75027 C7



Cross Section View

Top View

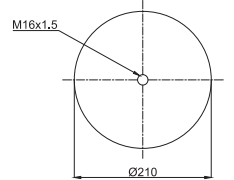
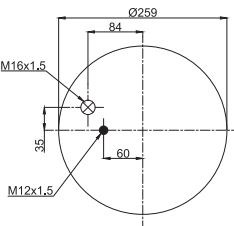
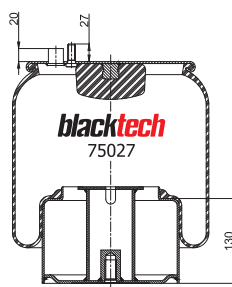

- Bolt or Stud
- Threaded hole
- ⊗ Combination Stud
- ⊗ Air Inlet

OEM PART NUMBER		MODEL NO	CROSS REFERENCES	
MAN	81.43600.6042	TGA	Contitech	4916 N1 P07

### RML 75033



Cross Section View

Top View

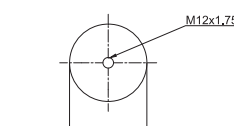
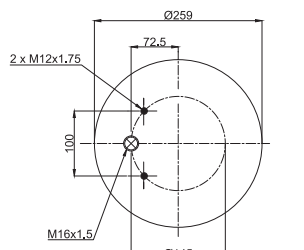
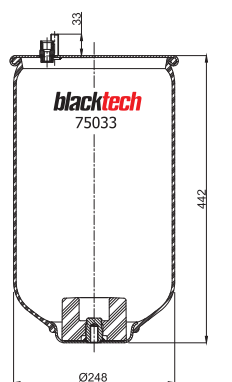

- Bolt or Stud
- Threaded hole
- ⊗ Combination Stud
- ⊗ Air Inlet

OEM PART NUMBER		MODEL NO	CROSS REFERENCES	
Renault				

**RML 75033 CP**



Cross Section View

Top View

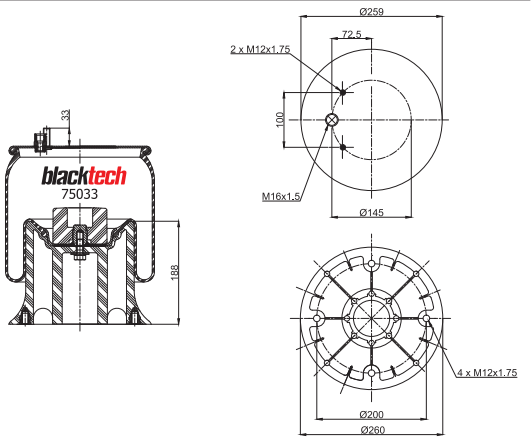

OEM PART NUMBER		MODEL NO	CROSS REFERENCES	
Renault	5 010 600 262		Contitech	4922 N P01

**RML 75051**



Cross Section View

Top View

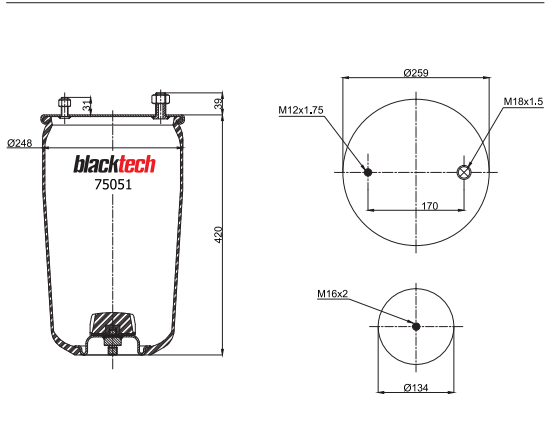

OEM PART NUMBER		MODEL NO	CROSS REFERENCES	
BPW	05.429.41.56.0	30 K	Contitech	4940 N P02
			Goodyear	1R11-799
			Dunlop F	D11U42
			Gart Ref.	C293/A
			Gart No.	293.0.413

**RML 75051 C**



Cross Section View

Top View

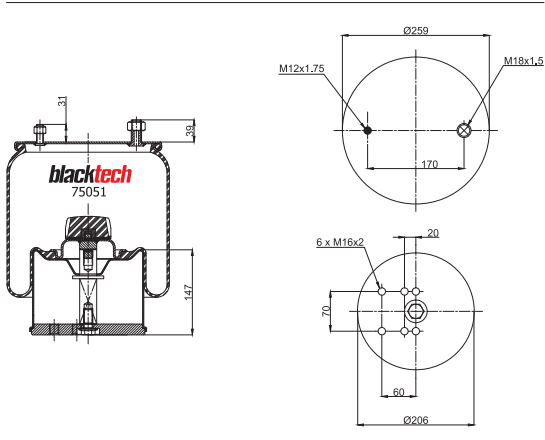

OEM PART NUMBER		MODEL NO	CROSS REFERENCES	
BPW		30 K		



### RML 75051 CP

Cross Section View

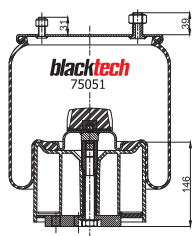

Top View

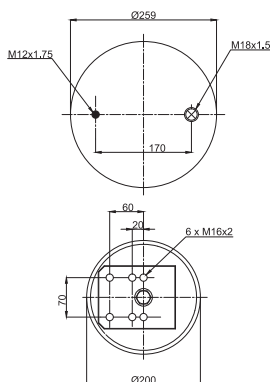

- Bolt or Stud
- Threaded hole
- ⊗ Combination Stud
- ⊗ Air Inlet

OEM PART NUMBER	MODEL NO	CROSS REFERENCES	
BPW	30 K		

### RML 75052

Cross Section View

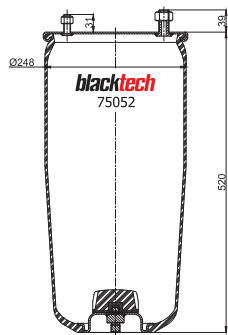

Top View

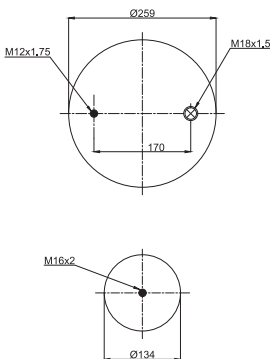

- Bolt or Stud
- Threaded hole
- ⊗ Combination Stud
- ⊗ Air Inlet

OEM PART NUMBER	MODEL NO	CROSS REFERENCES	
BPW	05.429.41.25.0	30	Contitech 4941 N P02
			Goodyear 1R11-802
			Dunlop D11 U45
			Gart Ref. C293
			Gart No. 293.0.513

### RML 75052 C

Cross Section View

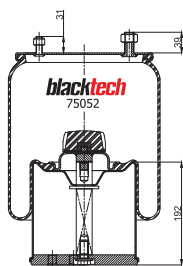

Top View

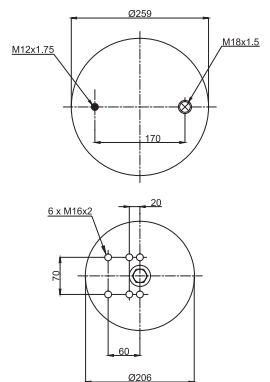

- Bolt or Stud
- Threaded hole
- ⊗ Combination Stud
- ⊗ Air Inlet

OEM PART NUMBER	MODEL NO	CROSS REFERENCES	
BPW	30	Dunlop	D11 U45

**RML 75052 CP**

Cross Section View

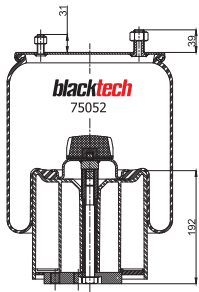

Top View

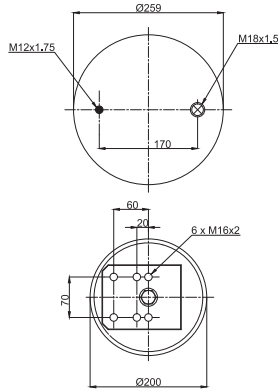

- Bolt or Stud
- Threaded hole
- ⊗ Combination Stud
- ⊗ Air Inlet

OEM PART NUMBER	MODEL NO	CROSS REFERENCES
BPW	30	

**RML 75053**

Cross Section View

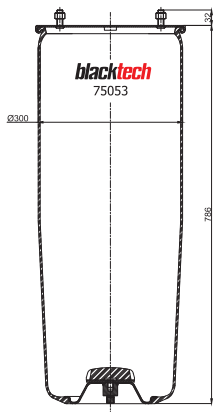

Top View

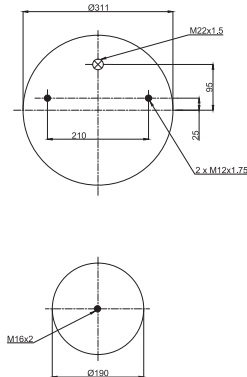

- Bolt or Stud
- Threaded hole
- ⊗ Combination Stud
- ⊗ Air Inlet

OEM PART NUMBER	MODEL NO	CROSS REFERENCES
BPW	05.429.41.09.0	36-2
		Contitech
		4942 N P02
		Gart Ref.
		C293
		Gart No.
		293.0.514

**RML 75053 C1**

Cross Section View

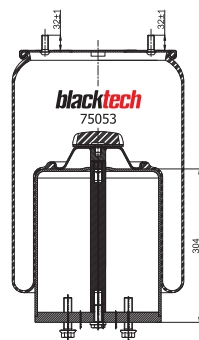

Top View

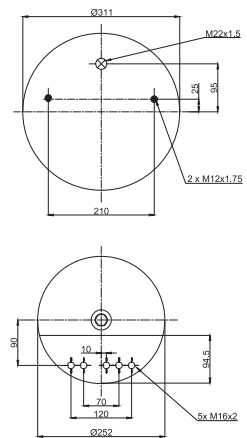

- Bolt or Stud
- Threaded hole
- ⊗ Combination Stud
- ⊗ Air Inlet

OEM PART NUMBER	MODEL NO	CROSS REFERENCES
BPW	05.429.41.86.0	36-2
		Contitech
		4942 N P04



**RML 75071 C**

Cross Section View

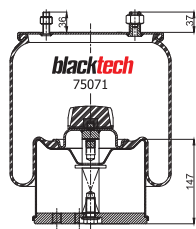

Top View

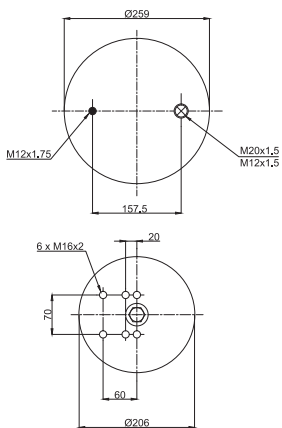

- Bolt or Stud
- Threaded hole
- ⊗ Combination Stud
- ⊗ Air Inlet

OEM PART NUMBER	MODEL NO	CROSS REFERENCES
BPW	30K	

**RML 75071 CP**

Cross Section View

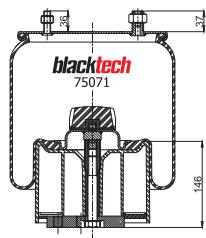

Top View

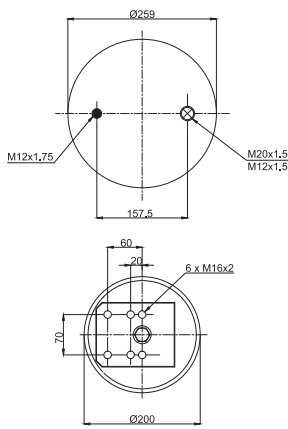

- Bolt or Stud
- Threaded hole
- ⊗ Combination Stud
- ⊗ Air Inlet

OEM PART NUMBER	MODEL NO	CROSS REFERENCES
BPW	30K	

**RML 75072**

Cross Section View

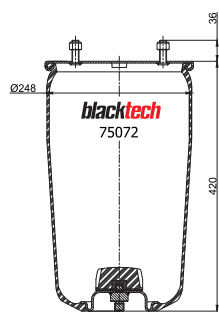

Top View

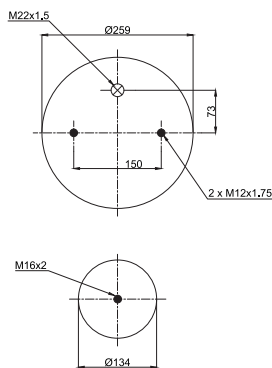

- Bolt or Stud
- Threaded hole
- ⊗ Combination Stud
- ⊗ Air Inlet

OEM PART NUMBER	MODEL NO	CROSS REFERENCES
BPW	05.429.42.04.0	30 K
		Conlitech
		4961 N P02
		Goodyear
		1R11-800
		Dunlop F
		D11U43
		Gart Ref.
		C293/A
		Gart No.
		293.0.414

### RML 75072 CP

Cross Section View

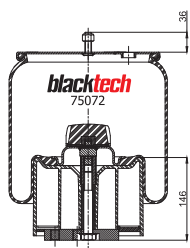

Top View

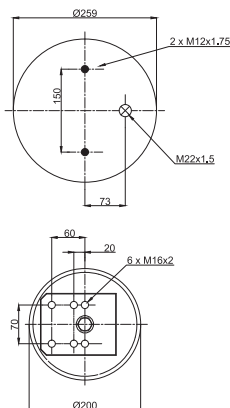

- Bolt or Stud
- Threaded hole
- ⊗ Combination Stud
- ⊗ Air Inlet

OEM PART NUMBER	MODEL NO	CROSS REFERENCES	
BPW	30K		

### RML 75073

Cross Section View

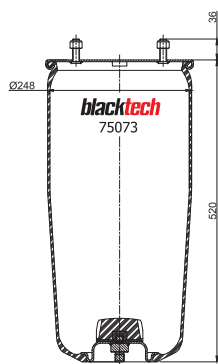

Top View

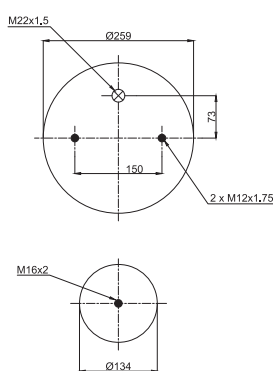

- Bolt or Stud
- Threaded hole
- ⊗ Combination Stud
- ⊗ Air Inlet

OEM PART NUMBER	MODEL NO	CROSS REFERENCES	
BPW	05.429.42.03.0	30	Contitech 4962 N P02
			Goodyear 1R11-803
			Dunlop F D11U46
			Gart Ref. C293
			Gart No. 293.0.514

### RML 75115

Cross Section View

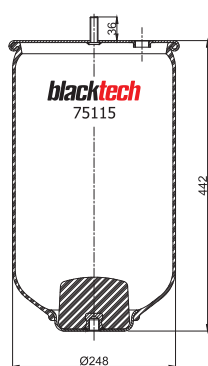

Top View

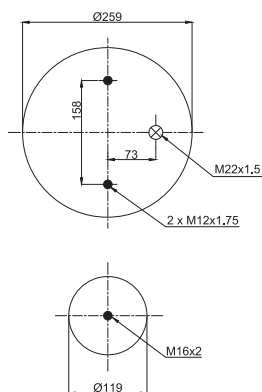

- Bolt or Stud
- Threaded hole
- ⊗ Combination Stud
- ⊗ Air Inlet

OEM PART NUMBER	MODEL NO	CROSS REFERENCES	
SAF	2618	Contitech	4004 N P02
		Phoenix	1DK 22 E-5 NP
		Primeride	54004 A P02
		Firestone Style	1T17BS-6
		Firestone No.	W01-M58-0919
		Goodyear	1R11-705
		Taurus	K505
		Vibracoustic	V1DK22E-5NP
		CF Gamma Ref.	1T300-37
		Dunlop F	D12U13
		Gart Ref.	D278/S
		Gart No.	278.0.451

**RML 75115 C**

Cross Section View

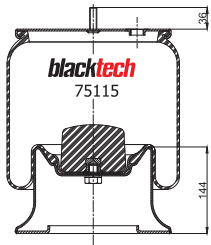

Top View

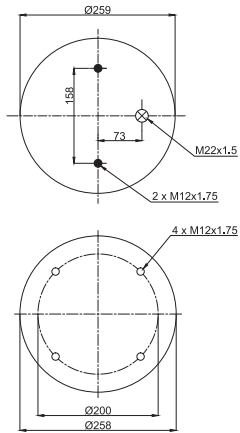

- Bolt or Stud
- Threaded hole
- ⊗ Combination Stud
- ⊗ Air Inlet

OEM PART NUMBER	MODEL NO	CROSS REFERENCES	
		Contitech	4004 N P05
		Phoenix	1DK 22 E-5
		Primeride	54004 A P05
		Firestone Style	1T17BS-6
		Goodyear	1R11-706
		Vibracoustic	V1DK22E-5
		CF Gomma Ref.	1T300-33
		CF Gomma No.	97722
		Dunlop F	D12B25
		Gart Ref.	D278/S
		Gart No.	278.4.451

**RML 75115 CP**

Cross Section View

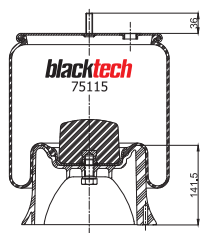

Top View

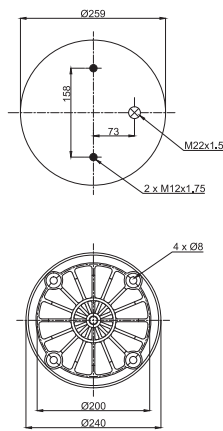

- Bolt or Stud
- Threaded hole
- ⊗ Combination Stud
- ⊗ Air Inlet

OEM PART NUMBER	MODEL NO	CROSS REFERENCES	
		Contitech	4004 N P03
		Phoenix	1DK 22 E-8
		Primeride	54004 A P03
		Firestone Style	1T17BS-6
		Firestone No.	W01-M58-6366
		Goodyear	1R11-750
		Goodyear	1R11-713
		Taurus	K505-27SM
		Vibracoustic	V1DK22E-8
		CF Gomma Ref.	1T300-37
		CF Gomma No.	203715
		Dunlop F	D12B34
		Dunlop F	D12B13
		Gart Ref.	D278/S
		Gart No.	278.4.452

**RML 75119**

Cross Section View

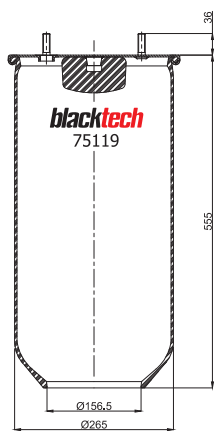

Top View

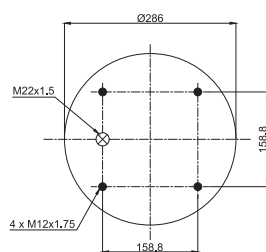

- Bolt or Stud
- Threaded hole
- ⊗ Combination Stud
- ⊗ Air Inlet

OEM PART NUMBER	MODEL NO	CROSS REFERENCES	
		Contitech	4008 N



**RML 75131 C1**



Cross Section View

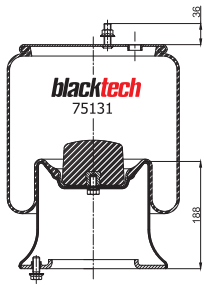

Top View

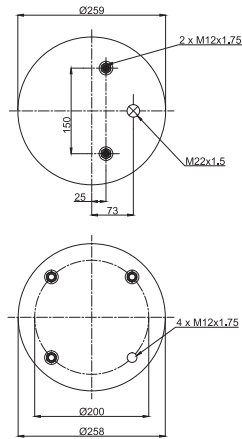

- Bolt or Stud
- Threaded hole
- ⊗ Combination Stud
- ⊗ Air Inlet

OEM PART NUMBER	MODEL NO	CROSS REFERENCES
SAF	2623 V	

**RML 75132**



Cross Section View

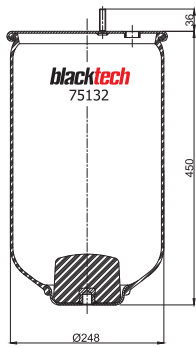

Top View

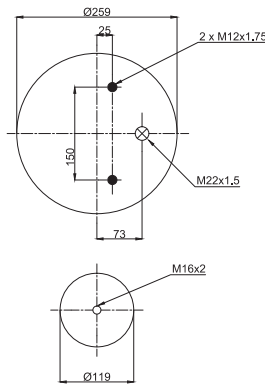

- Bolt or Stud
- Threaded hole
- ⊗ Combination Stud
- ⊗ Air Inlet

OEM PART NUMBER	MODEL NO	CROSS REFERENCES

**RML 75132 CP**



Cross Section View

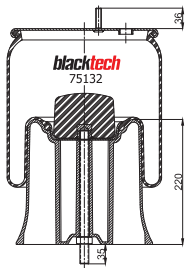

Top View

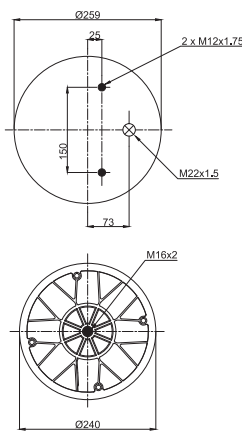

- Bolt or Stud
- Threaded hole
- ⊗ Combination Stud
- ⊗ Air Inlet

OEM PART NUMBER	MODEL NO	CROSS REFERENCES
		CF Gomma Ref. 1T 300-37
		CF Gomma No. 207722







### RML 75133 CP4

Cross Section View

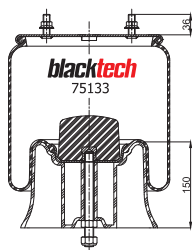

Top View

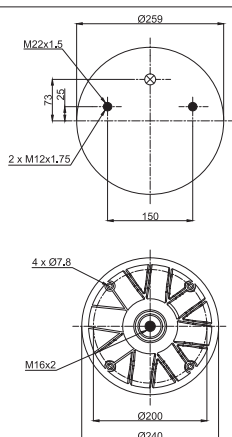

- Bolt or Stud
- Threaded hole
- ⊗ Combination Stud
- ⊗ Air Inlet

OEM PART NUMBER	MODEL NO	CROSS REFERENCES
	2619 Tirsan	

### RML 75133 CP5

Cross Section View

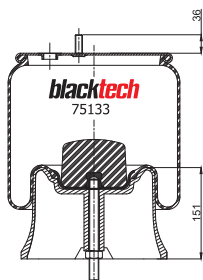

Top View

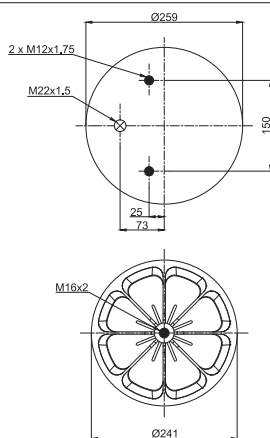

- Bolt or Stud
- Threaded hole
- ⊗ Combination Stud
- ⊗ Air Inlet

OEM PART NUMBER	MODEL NO	CROSS REFERENCES
		Contitech 4022 N P05
		Phoenix 1DK 22 E-11
		Primeride 54022 A P05
		Firestone Style 1T17BS-6
		Firestone No. W01-M58-8612
		Goodyear 1R11-781
		Vibracoustic VIDK22E-10
		CF Gomma Ref. 1T300-37
		CF Gomma No. 206585
		Dunlop F D11B41
		Gart Ref. D278/S
		Gart No. 2781.455

### RML 75134

Cross Section View

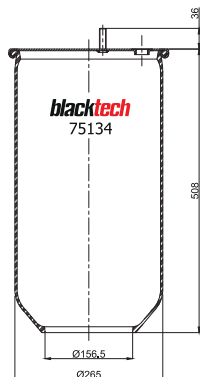

Top View

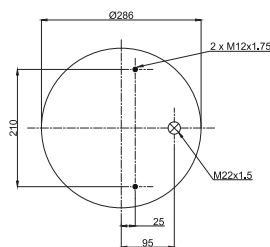

- Bolt or Stud
- Threaded hole
- ⊗ Combination Stud
- ⊗ Air Inlet

OEM PART NUMBER	MODEL NO	CROSS REFERENCES
		Contitech 4023 N P06
		Phoenix 1D 28 B-10 NP
		Firestone Style 1T19L-11
		Firestone No. W01-M58-6335

**RML 75134 C**

Cross Section View

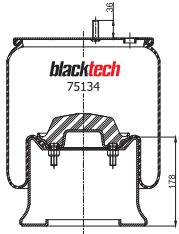

Top View

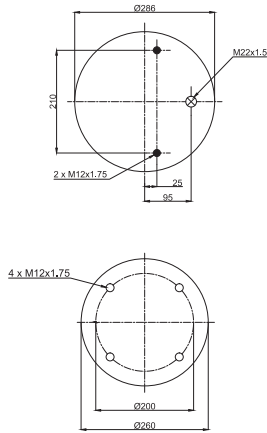

- Bolt or Stud
- Threaded hole
- ⊗ Combination Stud
- ⊗ Air Inlet

OEM PART NUMBER	MODEL NO	CROSS REFERENCES	
SAF	2923 V	Contitech	4023 N P03
		Phoenix	1D 28 B-10
		Primeride	54023 A P03
		Firestone Style	1T19L-11
		Firestone No.	W01-M58-6348
		Goodyear	1R14-729
		Taurus	KR622-18
		Vibracoustic	V1D28B-10
		CF Gomma Ref.	1T19E-2
		CF Gomma No.	204676
		Dunlop F	D13B26
		Gart Ref.	D277
		Gart No.	2774.505

**RML 75134 C1**

Cross Section View

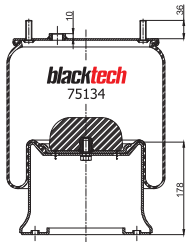

Top View

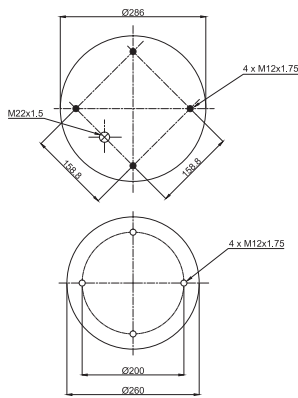

- Bolt or Stud
- Threaded hole
- ⊗ Combination Stud
- ⊗ Air Inlet

OEM PART NUMBER	MODEL NO	CROSS REFERENCES	
SAF	2618 L		

**RML 75134 C2**

Cross Section View

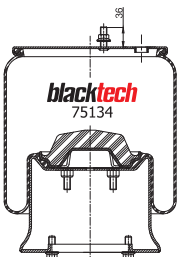

Top View

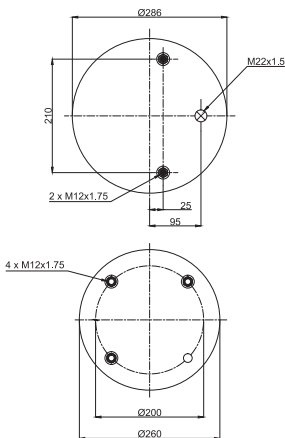

- Bolt or Stud
- Threaded hole
- ⊗ Combination Stud
- ⊗ Air Inlet

OEM PART NUMBER	MODEL NO	CROSS REFERENCES	
SAF	2923 V	Contitech	4023 N P07
		CF Gomma Ref.	1T19E-2
		CF Gomma No.	207734
		Gart Ref.	D277
		Gart No.	2774.505/2

### RML 75134 C3



Cross Section View

Top View

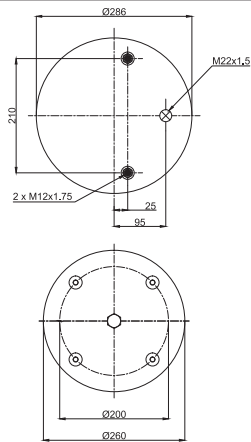
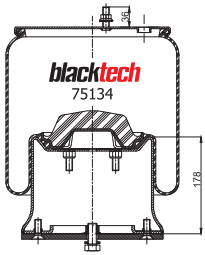

- Bolt or Stud
- Threaded hole
- ⊗ Combination Stud
- ⊗ Air Inlet

OEM PART NUMBER	MODEL NO	CROSS REFERENCES	
SAF	2923 V	Contitech	4023 N P08
		CF Gomma Ref.	1119E-2
		CF Gomma No.	207735
		Gart Ref.	D277
		Gart No.	2771505

### RML 75134 CP



Cross Section View

Top View

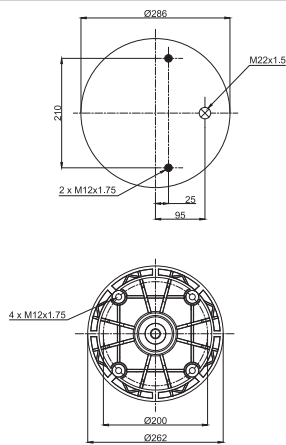
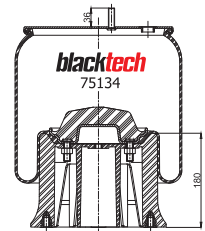

- Bolt or Stud
- Threaded hole
- ⊗ Combination Stud
- ⊗ Air Inlet

OEM PART NUMBER	MODEL NO	CROSS REFERENCES	

### RML 75134 CP1



Cross Section View

Top View

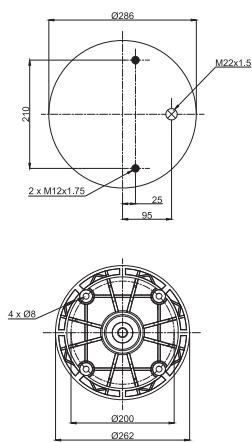
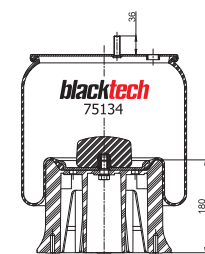

- Bolt or Stud
- Threaded hole
- ⊗ Combination Stud
- ⊗ Air Inlet

OEM PART NUMBER	MODEL NO	CROSS REFERENCES	
SAF	2923 VK		

**RML 75134 CP2**



Cross Section View

Top View

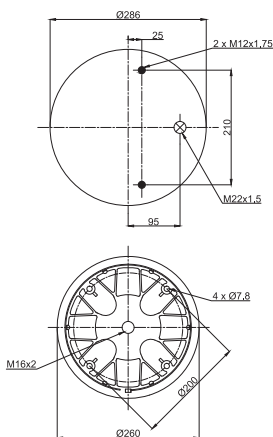
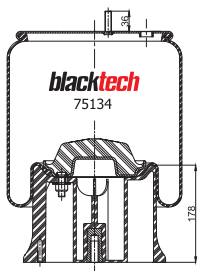

- Bolt or Stud
- Threaded hole
- ⊗ Combination Stud
- ⊗ Air Inlet

OEM PART NUMBER	MODEL NO	CROSS REFERENCES
SAF	2924 V	

**RML 75134 CP3**



Cross Section View

Top View

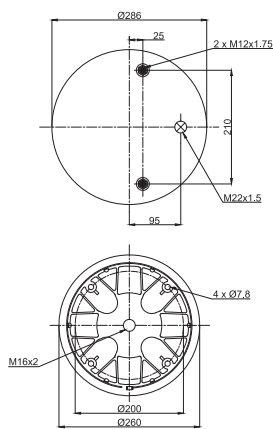
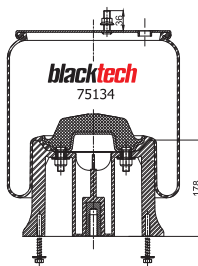

- Bolt or Stud
- Threaded hole
- ⊗ Combination Stud
- ⊗ Air Inlet

OEM PART NUMBER	MODEL NO	CROSS REFERENCES
SAF	2924 V	

**RML 75134 CP4**



Cross Section View

Top View

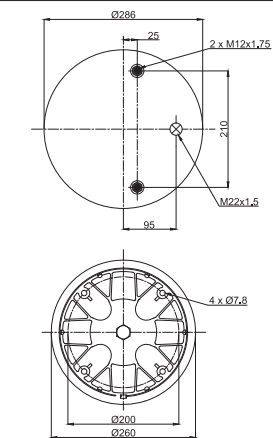
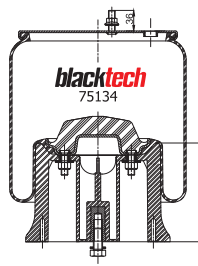

- Bolt or Stud
- Threaded hole
- ⊗ Combination Stud
- ⊗ Air Inlet

OEM PART NUMBER	MODEL NO	CROSS REFERENCES
SAF	2924 V	

### RML 75138

Cross Section View

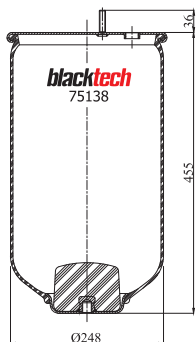

Top View

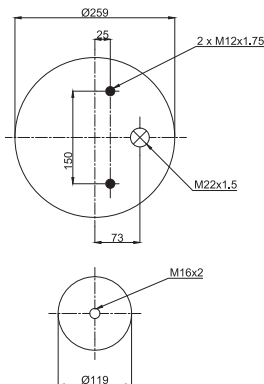

- Bolt or Stud
- Threaded hole
- ⊗ Combination Stud
- ⊗ Air Inlet

OEM PART NUMBER	MODEL NO	CROSS REFERENCES

### RML 75138 CP

Cross Section View

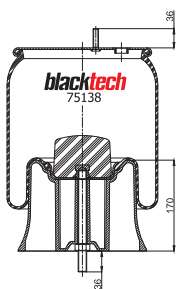

Top View

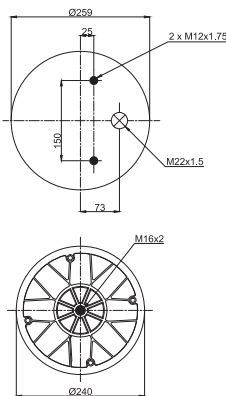

- Bolt or Stud
- Threaded hole
- ⊗ Combination Stud
- ⊗ Air Inlet

OEM PART NUMBER	MODEL NO	CROSS REFERENCES
		CF Gamma Ref. 1T 300-37
		CF Gamma No. 207719

### RML 75139

Cross Section View

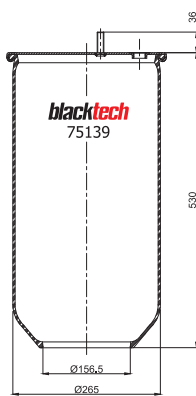

Top View

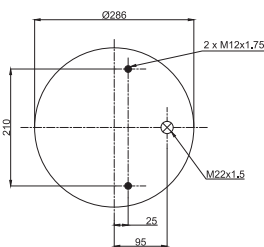

- Bolt or Stud
- Threaded hole
- ⊗ Combination Stud
- ⊗ Air Inlet

OEM PART NUMBER	MODEL NO	CROSS REFERENCES

**RML 75139 C2**

Cross Section View

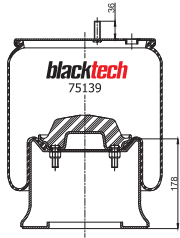

Top View

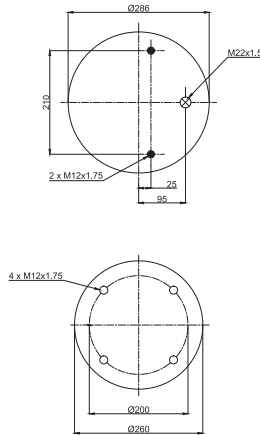

- Bolt or Stud
- Threaded hole
- ⊗ Combination Stud
- ⊗ Air Inlet

OEM PART NUMBER	MODEL NO	CROSS REFERENCES	
		Contitech	4028 N P02
		Phoenix	1D 28 F-1
		Primeride	54028 A P02
		Firestone Style	1T19L-12
		Firestone No.	W01-M58-8106
		Goodyear	1R14-782
		Vibracoustic	V1D28F-1
		Dunlop F	D14B47
		Gart Ref.	D287/E
		Gart No.	287.4.540

**RML 75139 C5**

Cross Section View

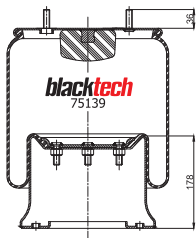

Top View

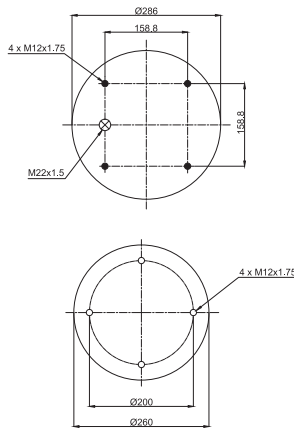

- Bolt or Stud
- Threaded hole
- ⊗ Combination Stud
- ⊗ Air Inlet

OEM PART NUMBER	MODEL NO	CROSS REFERENCES	
		Contitech	4028 N P05
		Phoenix	1D 28 B-12
		Primeride	54028 A P05
		Firestone Style	1T19L11
		Firestone No.	W01-M58-7370
		Goodyear	1R14-721
		Goodyear	1R14-710
		Vibracoustic	V1D28F-7
		Dunlop F	D14B51
		Gart Ref.	D277/D
		Gart Ref.	D287
		Gart No.	277.4.520
		Gart No.	277.4.524
		Gart No.	287.4.521

**RML 75260-1**

Cross Section View

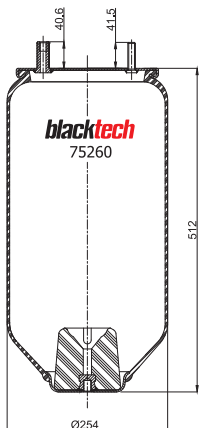

Top View

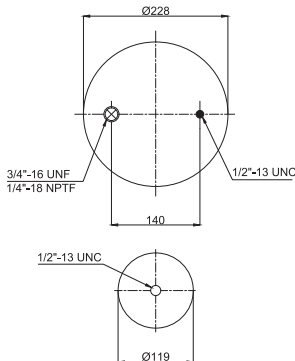

- Bolt or Stud
- Threaded hole
- ⊗ Combination Stud
- ⊗ Air Inlet

OEM PART NUMBER	MODEL NO	CROSS REFERENCES	
Hendrickson			



### RML 75260-5

Cross Section View

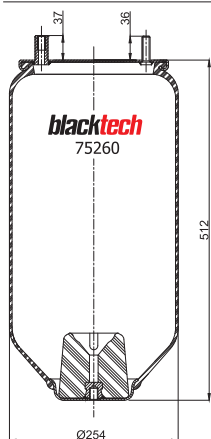

Top View

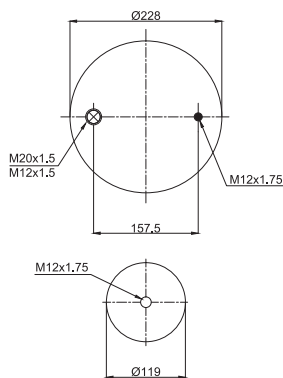

- Bolt or Stud
- Threaded hole
- ⊗ Combination Stud
- ⊗ Air Inlet

OEM PART NUMBER	MODEL NO	CROSS REFERENCES	
Fruehauf	Service Assembly	Contitech	4159 N P05
		Phoenix	1 DK 21 B-5 NP
		Primeride	54159 A P05
		Firestone Style	1T15M-9
		Firestone No.	W01-M58-0736
		Goodyear	1R12-761
		Vibracoustic	V1DK21B-5
		CF Gomma Ref.	1T323-40
		Dunlop F	D12U04
		Gart Ref.	D278/H
		Gart No.	278.0551

### RML 75260 C3

Cross Section View

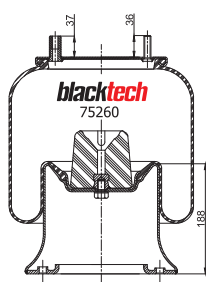

Top View

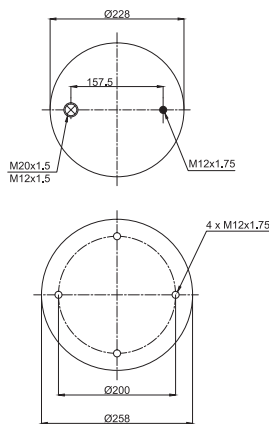

- Bolt or Stud
- Threaded hole
- ⊗ Combination Stud
- ⊗ Air Inlet

OEM PART NUMBER	MODEL NO	CROSS REFERENCES	
Fruehauf		Contitech	4159 N P03
SAMRO	H2500425	Phoenix	1 DK 23 L-27
SMB		Primeride	54159 A P03
		Firestone Style	1T15M-9
		Firestone No.	W01-M58-7548
		Firestone No.	W01-358-9130
		Goodyear	1R12-701
		Vibracoustic	V1DK23L-40
		CF Gomma Ref.	1T323-40
		CF Gomma No.	97306
		Dunlop F	D12B08
		Dunlop UK	PNP311370000
		Gart Ref.	D278/H
		Gart No.	278.451/1

### RML 75260 C4

Cross Section View

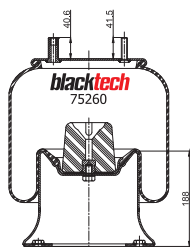

Top View

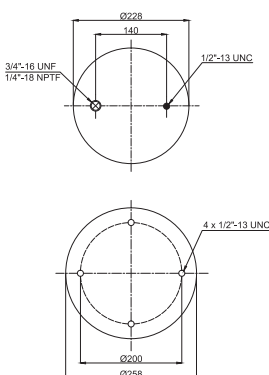

- Bolt or Stud
- Threaded hole
- ⊗ Combination Stud
- ⊗ Air Inlet

OEM PART NUMBER	MODEL NO	CROSS REFERENCES	
Neway	90557009	Contitech	4159 N P04
		Firestone Style	1T 15M-9
		Firestone No.	W01 358 9101
		Goodyear	1R12-103
		Dunlop F	D12 B34
		Taurus	KR 509-9101

**RML 75260 C6**

Cross Section View

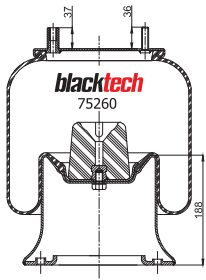

Top View

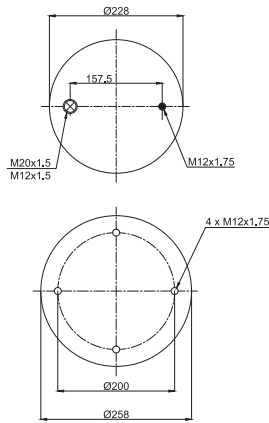

- Bolt or Stud
- Threaded hole
- ⊗ Combination Stud
- ⊗ Air Inlet



OEM PART NUMBER	MODEL NO	CROSS REFERENCES
Samro		

**RML 75260 C7**

Cross Section View

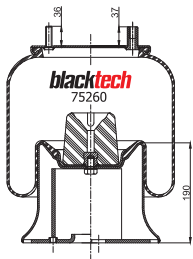

Top View

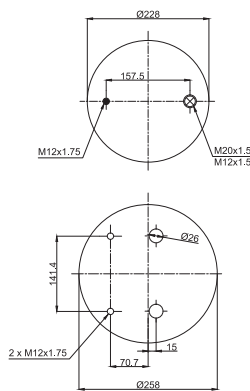

- Bolt or Stud
- Threaded hole
- ⊗ Combination Stud
- ⊗ Air Inlet



OEM PART NUMBER	MODEL NO	CROSS REFERENCES
Fruehauf	UJB 0203-001	Contitech 4159 N P07
SMB	1518779	Phoenix 1 DK 23 L-25
SMB	1520356	Primeride 54159 A P07
SMB	1524873	Firestone Style 1T15M-9
SMB	M001782	Firestone No. W01-379-9091
		Firestone No. W01-M58-8859
		Goodyear 1R12-702
		Taurus KR509-25
		Vibracoustic VIDK23B-9
		CF Gomma Ref. 1T323-40
		CF Gomma No. 202302
		Dunlop F D12B15
		Dunlop UK 00982A-AP
		Gart Ref. D278/H
		Gart No. 278.2511

**RML 75260 C8**

Cross Section View

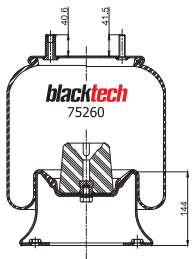

Top View

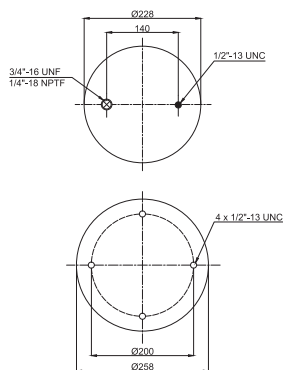

- Bolt or Stud
- Threaded hole
- ⊗ Combination Stud
- ⊗ Air Inlet



OEM PART NUMBER	MODEL NO	CROSS REFERENCES
Hendrickson		

### RML 75260 C10

Cross Section View

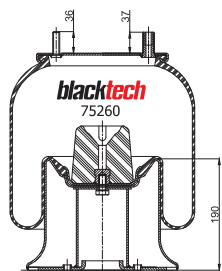

Top View

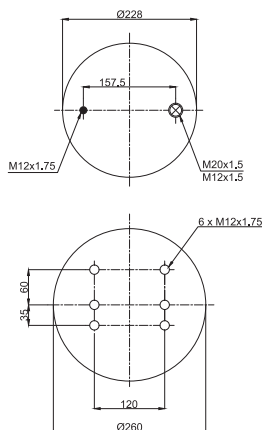

- Bolt or Stud
- Threaded hole
- ⊗ Combination Stud
- ⊗ Air Inlet

OEM PART NUMBER	MODEL NO	CROSS REFERENCES
Fruehauf		

### RML 75260 C16

Cross Section View

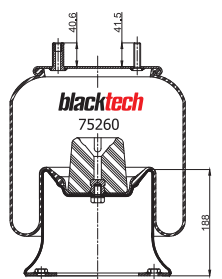

Top View

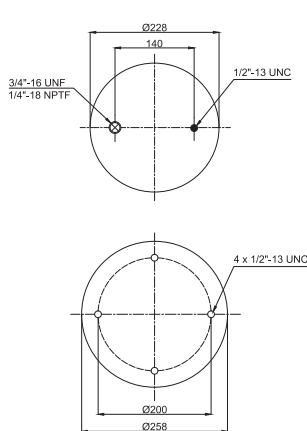

- Bolt or Stud
- Threaded hole
- ⊗ Combination Stud
- ⊗ Air Inlet

OEM PART NUMBER	MODEL NO	CROSS REFERENCES
Fruehauf		

### RML 75260 CA18

Cross Section View

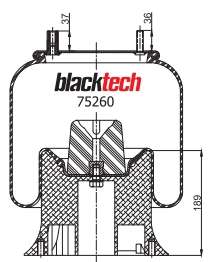

Top View

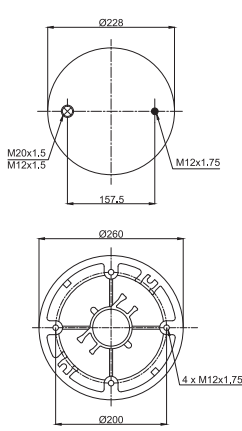

- Bolt or Stud
- Threaded hole
- ⊗ Combination Stud
- ⊗ Air Inlet

OEM PART NUMBER	MODEL NO	CROSS REFERENCES
Samro	2500425	Firestone Style 1T15 M-9 Firestone No. W01 M68 7548



### RML 75260 CP13



Cross Section View

Top View

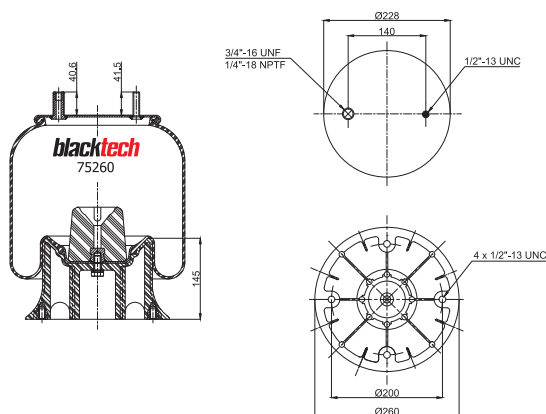

- Bolt or Stud
- Threaded hole
- ⊗ Combination Stud
- ⊗ Air Inlet

OEM PART NUMBER		MODEL NO	CROSS REFERENCES	
Hendrickson	NA 1817			

### RML 75260 CP14



Cross Section View

Top View

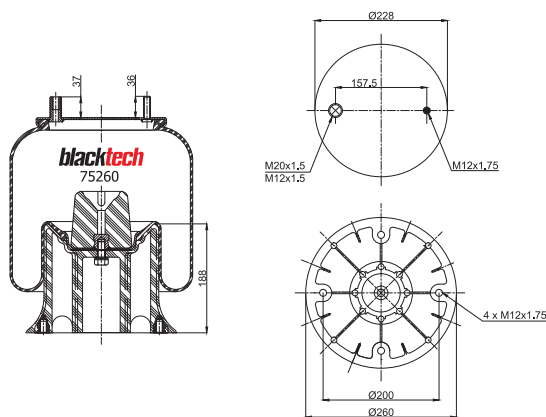

- Bolt or Stud
- Threaded hole
- ⊗ Combination Stud
- ⊗ Air Inlet

OEM PART NUMBER		MODEL NO	CROSS REFERENCES	
Fruehauf	UJA 0894-001		Contitech	4159 NP14
Montenegro			Phoenix	1DK 21B-4
ROR	2121 5762		Primeride	54159 A P14
ROR	2121 5891		Firestone Style	1T15M-9
ROR	2122 6039		Firestone No.	W01-M58-7548
			Goodyear	1R12-760
			Goodyear	1R12-834
			Vibracoustic	V10K21B-4
			CF Gomma Ref.	1T323-40
			CF Gomma No.	204124
			Dunlop F	D12B01
			Dunlop UK	PNP311370000

### RML 75265



Cross Section View

Top View

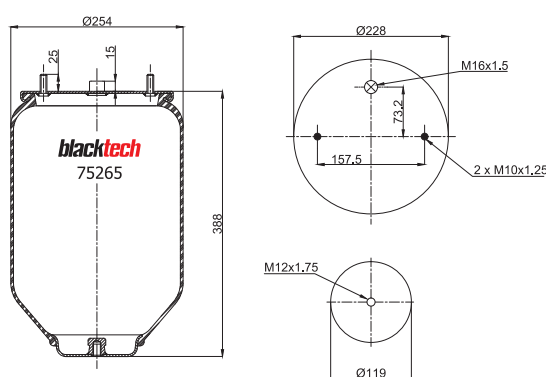

- Bolt or Stud
- Threaded hole
- ⊗ Combination Stud
- ⊗ Air Inlet

OEM PART NUMBER		MODEL NO	CROSS REFERENCES	
Renault				

**RML 75265 C5**



Cross Section View

Top View

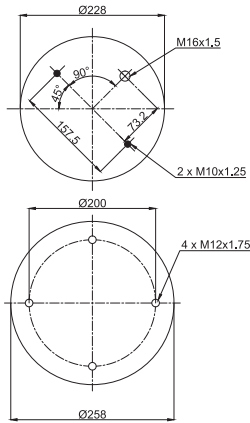
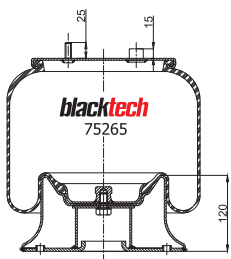

- Bolt or Stud
- Threaded hole
- ⊗ Combination Stud
- ⊗ Air Inlet

OEM PART NUMBER		MODEL NO	CROSS REFERENCES	
Renault	5.010.239.252	Premium. Magnum	Contitech	4154 N P05
Renault	5.010.488.071	Premium. Magnum	Phoenix	1DK 23F-1
			Firestone Style	1T15M-3
			Firestone No.	W01-358-8172
			Firestone No.	W01-M58-8172
			Vibracoustic	V1DK23F-1

**RML 75265 CP6**



Cross Section View

Top View

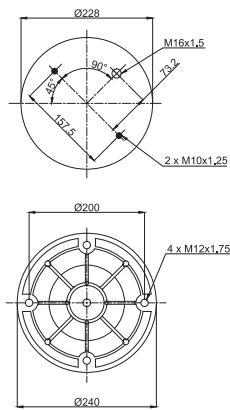
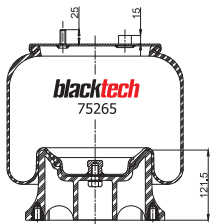

- Bolt or Stud
- Threaded hole
- ⊗ Combination Stud
- ⊗ Air Inlet

OEM PART NUMBER		MODEL NO	CROSS REFERENCES	
Renault	5.010.600.570	Premium / Magnum Lift	Contitech	4154 N P06
Volvo	20 758 818	FM / FH Lift		
Renault	5.010.305.438	FM / FH Lift		
Volvo	21 978 506	Premium / Magnum Lift		
Volvo	21 978 510	FM / FH Lift		

**RML 75266**



Cross Section View

Top View

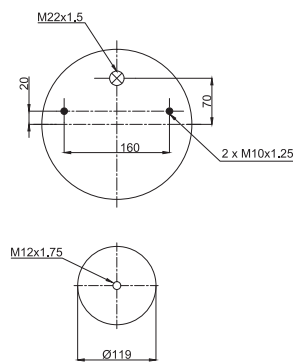
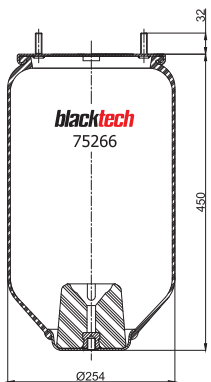

- Bolt or Stud
- Threaded hole
- ⊗ Combination Stud
- ⊗ Air Inlet

OEM PART NUMBER		MODEL NO	CROSS REFERENCES	

### RML 75266 C

Cross Section View

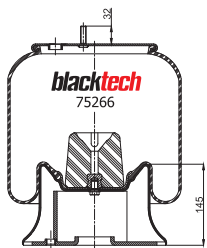

Top View

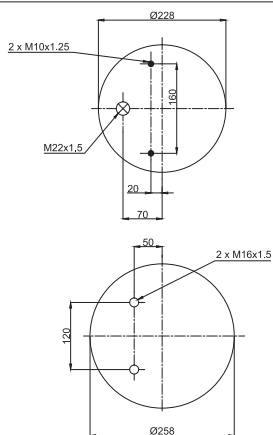

- Bolt or Stud
- Threaded hole
- ⊗ Combination Stud
- ⊗ Air Inlet

OEM PART NUMBER	MODEL NO	CROSS REFERENCES	
Zorzi	1006550	CF Gomma Ref.	1T 323-33
Bertoja	45402004	CF Gomma No.	96873
Belle Trailers	BT0319		
Cardi	58051400		
Pezzaioli	1006550		
Stefen	M04010670		
Transport	520 728		

### RML 75267-1

Cross Section View

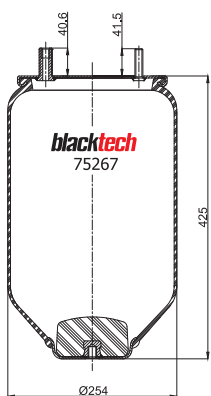

Top View

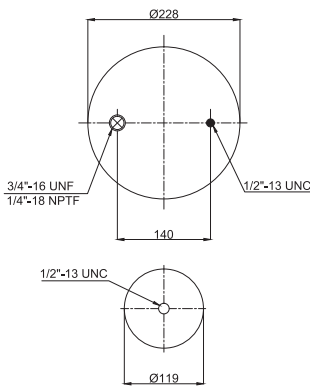

- Bolt or Stud
- Threaded hole
- ⊗ Combination Stud
- ⊗ Air Inlet

OEM PART NUMBER	MODEL NO	CROSS REFERENCES	
		Contitech	4156 N P01
		Firestone Style	1T15 M-6
		Firestone No.	W01 358 0712
		Phoenix	1DK 21 A-2
		Goodyear	1R12-093
		Taurus	KR 506-21

### RML 75267-5

Cross Section View

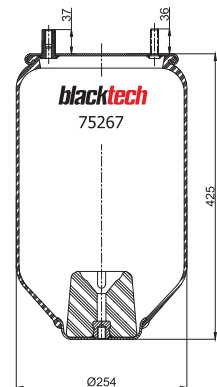

Top View

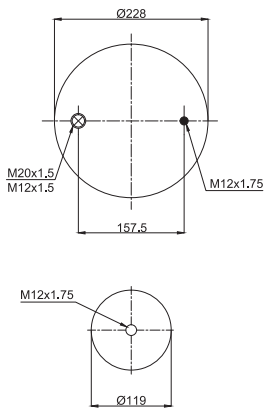

- Bolt or Stud
- Threaded hole
- ⊗ Combination Stud
- ⊗ Air Inlet

OEM PART NUMBER	MODEL NO	CROSS REFERENCES	
SMB	Service Assembly	Contitech	4156 N P05
		Primeride	54156 A P05
		Firestone Style	1T15M-6
		Firestone No.	W01-358-0734
		Goodyear	1R12-842
		Gart Ref.	D278/G
		Gart No.	278.0.421

**RML 75267-12**

Cross Section View

Top View

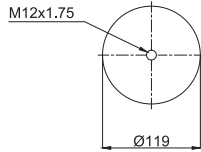
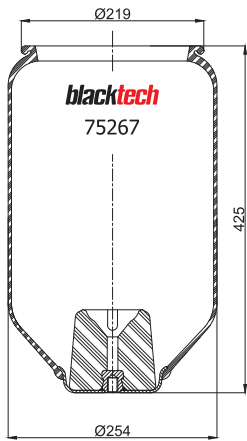

- Bolt or Stud
- Threaded hole
- ⊗ Combination Stud
- ⊗ Air Inlet

OEM PART NUMBER	MODEL NO	CROSS REFERENCES
MAN		

**RML 75267 C4**

Cross Section View

Top View

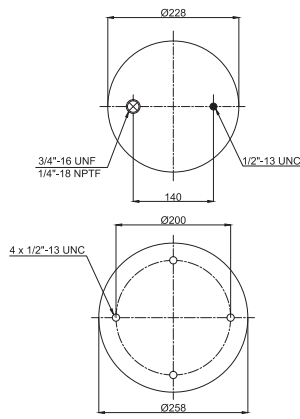
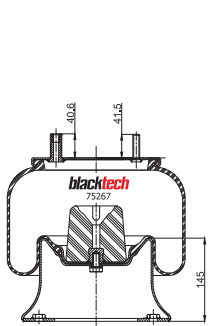

- Bolt or Stud
- Threaded hole
- ⊗ Combination Stud
- ⊗ Air Inlet

OEM PART NUMBER	MODEL NO	CROSS REFERENCES
Hendrickson B2066		Contitech 4156 N P04
		Firestone Style 1T15 M-6
		Firestone No. W01 358 9082
		Goodyear 1R12-134/092
		Taurus KR 506-9082

**RML 75267 C6**

Cross Section View

Top View

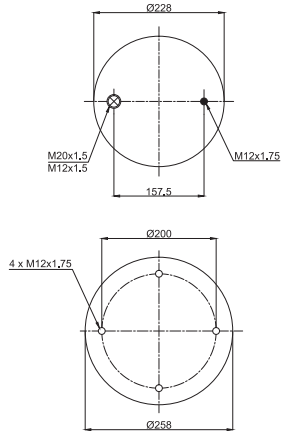
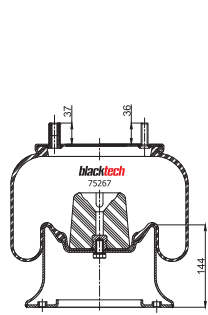

- Bolt or Stud
- Threaded hole
- ⊗ Combination Stud
- ⊗ Air Inlet

OEM PART NUMBER	MODEL NO	CROSS REFERENCES
Hendrickson HA 1000001		Firestone Style 1T15 M-6
Arvin Meritor 21215761		Firestone No. W01 358 9361
Arvin Meritor 21215762		Phoenix 1DK 23 K28
Arvin Meritor 21226046		Dunlop F D12 B19
Weweler US 35864F		Dunlop UK PNP 309580100
		Goodyear 1R12-719
		CF Gomma Ref. 1T 323-33
		CF Gomma No. 97306
		Vibracoustic V 1DK 23 K28
		Taurus KR 506-28



### RML 75267 C7

Cross Section View

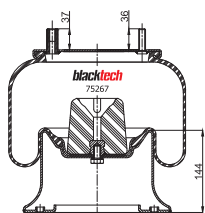

Top View

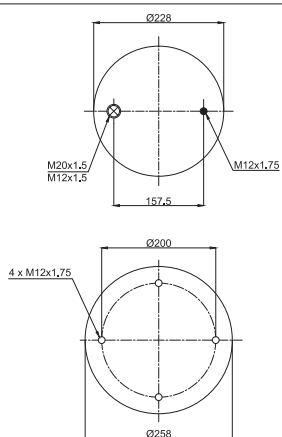

- Bolt or Stud
- Threaded hole
- ⊗ Combination Stud
- ⊗ Air Inlet

OEM PART NUMBER		MODEL NO	CROSS REFERENCES	
Fruehauf	M001472		Contitech	4156 N P07
SMB		Steel	Phoenix	1DK 23 K-28
			Primeride	54156 A P07
			Firestone Style	1T15M-6
			Firestone No.	W01-358-9361
			Goodyear	1R12-719
			Taurus	KR506-28
			Vibracoustic	V1DK23K-28
			CF Gomma Ref.	1T323-32
			Dunlop F	D12B19
			Dunlop UK	00981A-AP
			Gart Ref.	D278/G
			Gart No.	278.4.421/1

### RML 75267 C9

Cross Section View

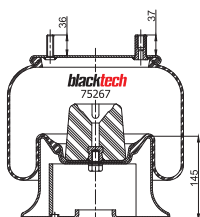

Top View

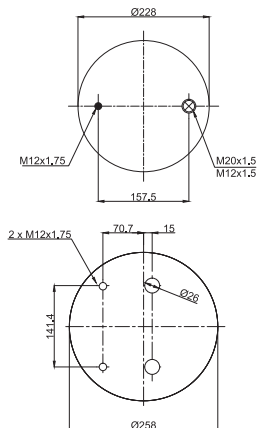

- Bolt or Stud
- Threaded hole
- ⊗ Combination Stud
- ⊗ Air Inlet

OEM PART NUMBER		MODEL NO	CROSS REFERENCES	
Bertoja	45402004		Contitech	4156 N P09
Fruehauf	UJB 0207-001		Phoenix	1DK 23 K-54
Fruehauf	UJB 0207	reinforced (offload)	Firestone Style	1T15M-6
			Firestone No.	W01-M58-9089
			Goodyear	1R12-706
			Vibracoustic	V1DK23K-54
			CF Gomma Ref.	1T323-33
			CF Gomma No.	96873
			Dunlop F	D12B16

### RML 75267 C11

Cross Section View

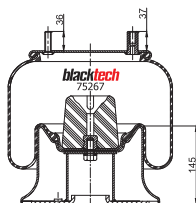

Top View

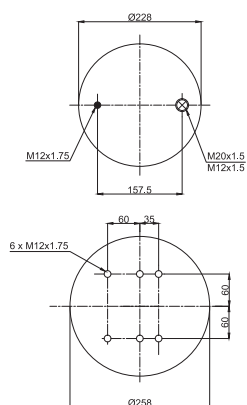

- Bolt or Stud
- Threaded hole
- ⊗ Combination Stud
- ⊗ Air Inlet

OEM PART NUMBER		MODEL NO	CROSS REFERENCES	

**RML 75267 C15**

Cross Section View

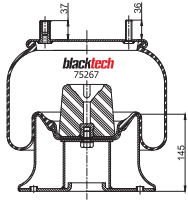

Top View

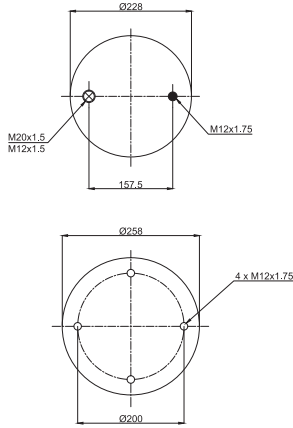

- Bolt or Stud
- Threaded hole
- ⊗ Combination Stud
- ⊗ Air Inlet

OEM PART NUMBER	MODEL NO	CROSS REFERENCES

**RML 75267 CP10**

Cross Section View

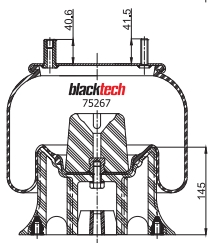

Top View

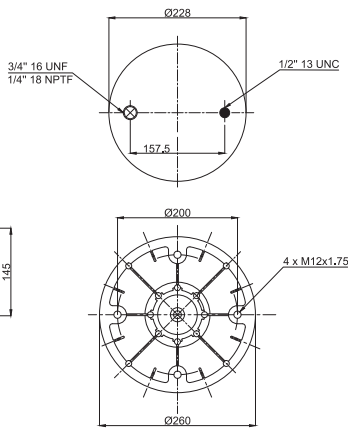

- Bolt or Stud
- Threaded hole
- ⊗ Combination Stud
- ⊗ Air Inlet

OEM PART NUMBER	MODEL NO	CROSS REFERENCES
Hendrickson HA100016		Contitech 4156 N P10
		Firestone Style 1115M-6
		Firestone No. W01-358-8929
		Goodyear 1R12-461

**RML 75267 CP13**

Cross Section View

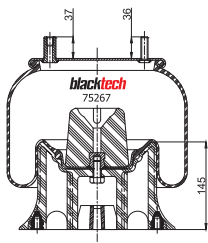

Top View

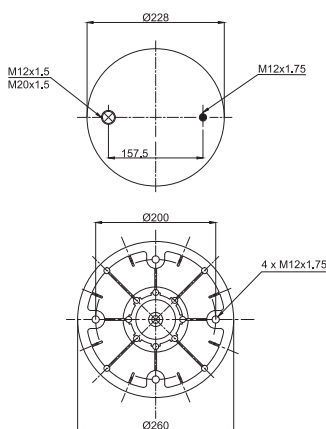

- Bolt or Stud
- Threaded hole
- ⊗ Combination Stud
- ⊗ Air Inlet

OEM PART NUMBER	MODEL NO	CROSS REFERENCES
Hendrickson		

### RML 75267 CP14

Gross Section View

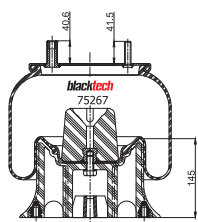

Top View

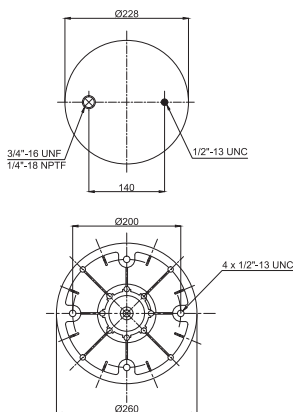

- Bolt or Stud
- Threaded hole
- ⊗ Combination Stud
- ⊗ Air Inlet

OEM PART NUMBER	MODEL NO	CROSS REFERENCES	
Fruehauf		Contitech	4156 N P14
Granning	1359	Phoenix	1 DK 23 K-9082
Granning	1528	Firestone Style	1T15M-6
Hendrickson	B 2066	T - US	Firestone No. W01-358-9082
Neway	905 570 27	AR 120	Goodyear 1R12-092
Neway	905 570 27	AR 120.US	Taurus KR506-9082
Neway	905 570 27	AR 75.9	Vibracoustic VIDK23K-9082
Neway	905 570 27	Art 500	CF Gomma Ref. 1T323-32
Neway	905 570 27	Art 505	CF Gomma No. 207767
Neway	905 570 33		Dunlop F D12B33
Neway	905 570 37		
Neway	905 570 54		
Neway	905 570 75	AR - 1057	
ROR	2120 8939		
Transport	520 728		
Weweler	US 09361F		
Weweler	US 97306		

### RML 75267 CP15

Gross Section View

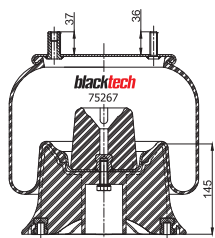

Top View

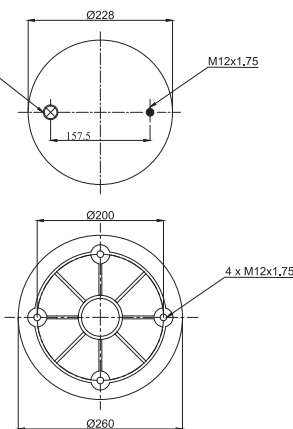

- Bolt or Stud
- Threaded hole
- ⊗ Combination Stud
- ⊗ Air Inlet

OEM PART NUMBER	MODEL NO	CROSS REFERENCES	
Fruehauf	M001472	Contitech	4156 N P15
Hendrickson	HA100001	Phoenix	1 DK 23 K-1
ROR	2121 5761	WFL 115 S	Primeride 54156 A P15
ROR	2121 5761	WFL 115 T	Firestone Style 1T15M-6
ROR	2121 5761	WFL 128	Firestone No. W01-358-9361
ROR	2121 5761	WFL 128 A	Taurus K506-22SU
ROR	2121 5761	WFL 131	CF Gomma Ref. 1T323-32
SMB			CF Gomma No. 207777
Weweler	US 35864	AC 128/131	Dunlop UK 00981B-AP
Weweler	US 35864	AC 138	

### RML 75267 CP16

Gross Section View

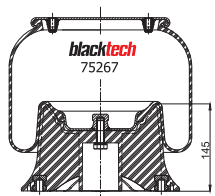

Top View

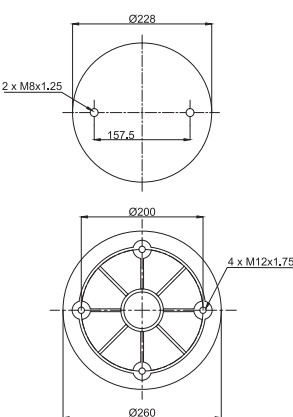

- Bolt or Stud
- Threaded hole
- ⊗ Combination Stud
- ⊗ Air Inlet

OEM PART NUMBER	MODEL NO	CROSS REFERENCES	
ROR Meritor		Contitech	4156 N P16

**RML 75268**

Cross Section View

Top View

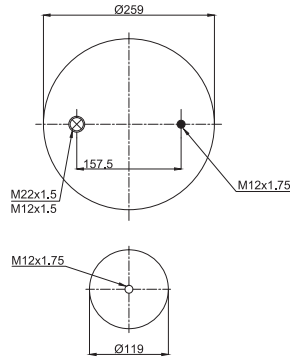
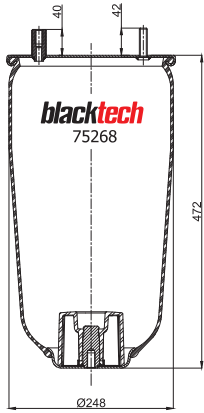

- Bolt or Stud
- Threaded hole
- ⊗ Combination Stud
- ⊗ Air Inlet

OEM PART NUMBER	MODEL NO	CROSS REFERENCES
Weweler		

**RML 75268-4**

Cross Section View

Top View

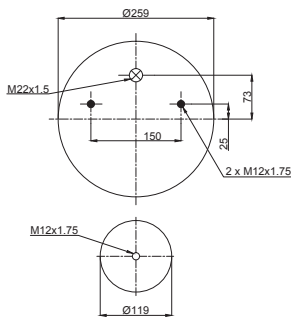
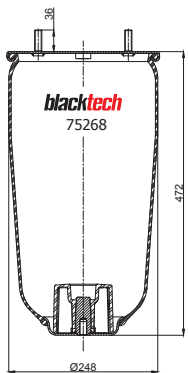

- Bolt or Stud
- Threaded hole
- ⊗ Combination Stud
- ⊗ Air Inlet

OEM PART NUMBER	MODEL NO	CROSS REFERENCES
Weweler		
ROR Meritor		
Discos		

**RML 75268-6**

Cross Section View

Top View

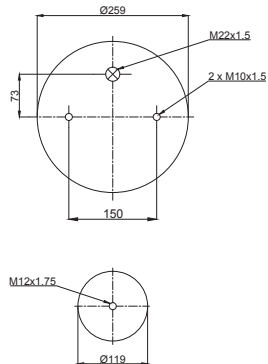
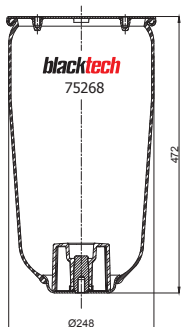

- Bolt or Stud
- Threaded hole
- ⊗ Combination Stud
- ⊗ Air Inlet

OEM PART NUMBER	MODEL NO	CROSS REFERENCES

### RML 75268 C3



Cross Section View

Top View

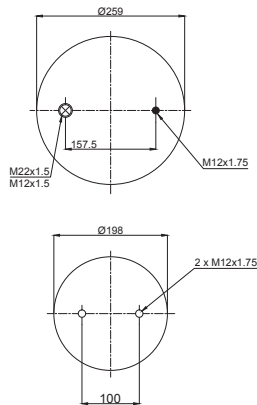
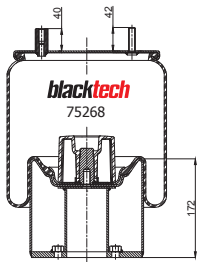

- Bolt or Stud
- Threaded hole
- ⊗ Combination Stud
- ⊗ Air Inlet

OEM PART NUMBER	MODEL NO	CROSS REFERENCES

### RML 75268 C4



Cross Section View

Top View

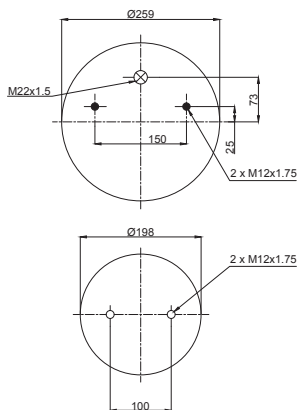
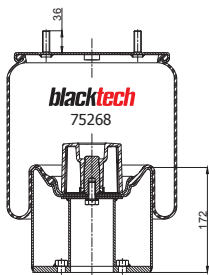

- Bolt or Stud
- Threaded hole
- ⊗ Combination Stud
- ⊗ Air Inlet

OEM PART NUMBER	MODEL NO	CROSS REFERENCES

### RML 75268 C5



Cross Section View

Top View

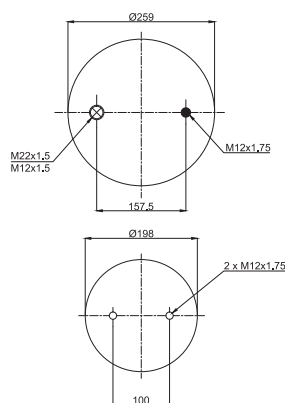
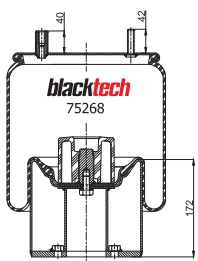

- Bolt or Stud
- Threaded hole
- ⊗ Combination Stud
- ⊗ Air Inlet

OEM PART NUMBER	MODEL NO	CROSS REFERENCES

**RML 75268 C6**



Cross Section View

Top View

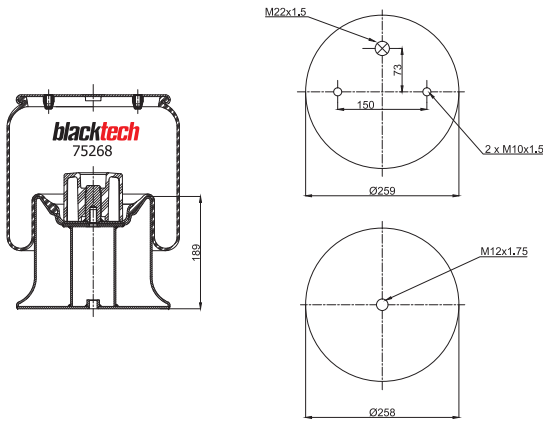

- Bolt or Stud
- Threaded hole
- ⊗ Combination Stud
- ⊗ Air Inlet

OEM PART NUMBER	MODEL NO	CROSS REFERENCES

**RML 75268 C9**



Cross Section View

Top View

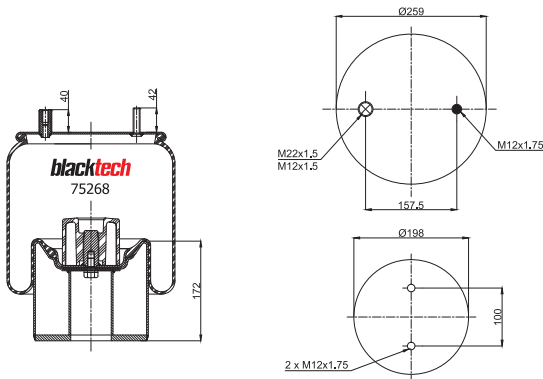

- Bolt or Stud
- Threaded hole
- ⊗ Combination Stud
- ⊗ Air Inlet

OEM PART NUMBER	MODEL NO	CROSS REFERENCES

**RML 75268 CP3**



Cross Section View

Top View

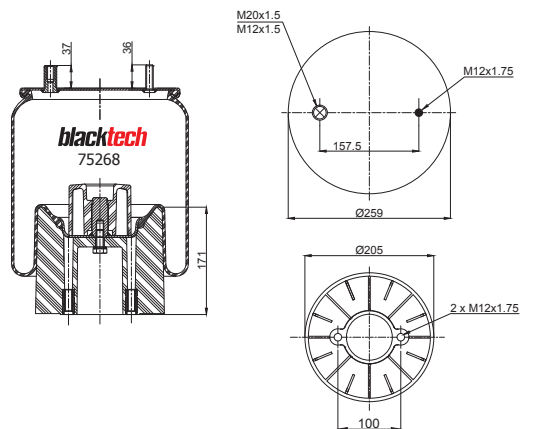

- Bolt or Stud
- Threaded hole
- ⊗ Combination Stud
- ⊗ Air Inlet

OEM PART NUMBER	MODEL NO	CROSS REFERENCES
Fruehauf		Conlitech 4157 N P03
		Goodyear 1R11-881

### RML 75268 CP4

Cross Section View

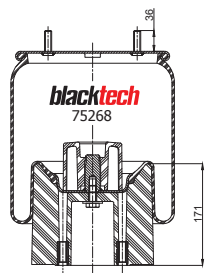

Top View

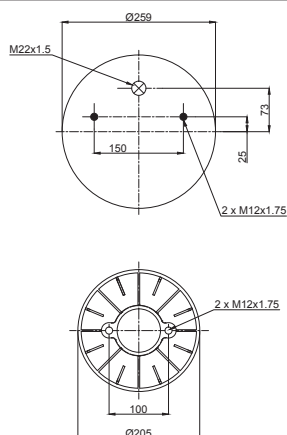

- Bolt or Stud
- Threaded hole
- ⊗ Combination Stud
- ⊗ Air Inlet

OEM PART NUMBER		MODEL NO	CROSS REFERENCES	
Mercedes	A 946 328 14 01		Contitech	4157 N P04
ROR Meritor	21221307		Firestone Style	1T15 MPW-7
Weweler	US 06287		Firestone No.	W01 M58 6297
Weweler	US 07364		Phoenix	1DK 21 A-4
			Dunlop F	D12 B18
			Goodyear	1R11-111
			Taurus	KR 915-54
			Vibracoustic	V 1DK 21 A-4

### RML 75268 CP5

Cross Section View

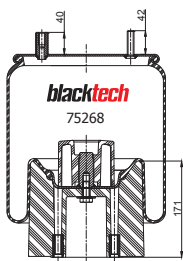

Top View

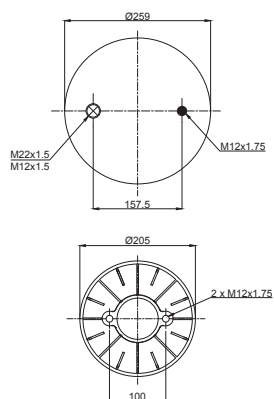

- Bolt or Stud
- Threaded hole
- ⊗ Combination Stud
- ⊗ Air Inlet

OEM PART NUMBER		MODEL NO	CROSS REFERENCES	
Weweler	US 07074C	AC 524/514	Contitech	4157 N P05
Weweler	US 07074P	AC 524/514	Phoenix	1DK 21 A-3
Weweler	US 08840	AC 524/514	Primeride	54157 A P05
			Firestone Style	1T15MPW-7
			Firestone No.	W01-M58-8840
			Goodyear	1R11-882
			Goodyear	1R11-866
			Vibracoustic	V1DK21A-3
			CF Gomma Ref.	1T323-32
			CF Gomma No.	207778
			Dunlop UK	00980B-AP
			Gart Ref.	C294
			Gart No.	294.2.450/1

### RML 75268 CP6

Cross Section View

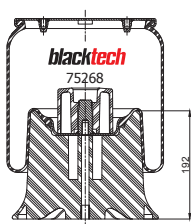

Top View

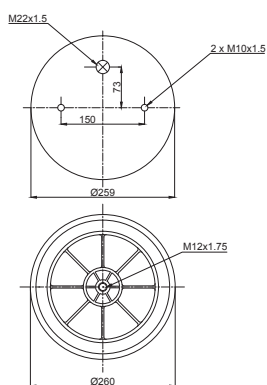

- Bolt or Stud
- Threaded hole
- ⊗ Combination Stud
- ⊗ Air Inlet

OEM PART NUMBER		MODEL NO	CROSS REFERENCES	
Schmitz	751 065		Contitech	4157 N P06
Weweler	US 06316		Phoenix	1DK 20 A-1
			Primeride	54157 A P06
			Firestone Style	1T15MPW-7
			Firestone No.	W01-968-6136
			Firestone No.	W01-968-8186
			Firestone No.	W01-M58-8194
			Goodyear	1R11-764
			Taurus	KR915-52
			Vibracoustic	V1DK20A-1
			Dunlop F	D11B37
			Gart Ref.	C294
			Gart No.	294.1.451

**RML 75268 CP8**

Cross Section View

Top View

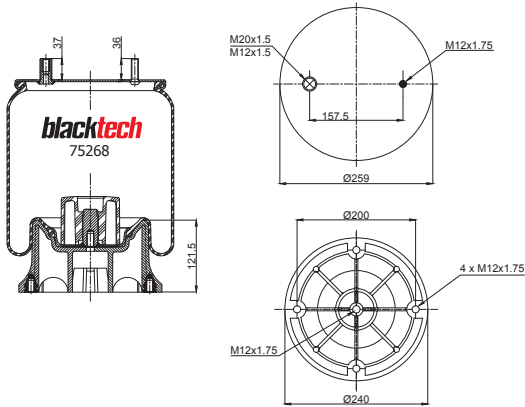

- Bolt or Stud
- Threaded hole
- ⊗ Combination Stud
- ⊗ Air Inlet

OEM PART NUMBER		MODEL NO	CROSS REFERENCES	
Neway	905 572 33		Contitech	4157 N P08
SAMRO	H2501869		Phoenix	1DK 20 C-2
SMB	M078580		Primeride	54157 A P08
			Firestone Style	1T15MPW-7
			Firestone No.	W01-M58-6317
			Goodyear	1R11-773
			Taurus	KR915-53NW
			Vibracoustic	V1DK200-2
			CF Gomma Ref.	1T300-37
			CF Gomma No.	207768
			Dunlop F	D12B30
			Gart Ref.	C294
			Gart No.	2941452

**RML 75268 CP9**

Cross Section View

Top View

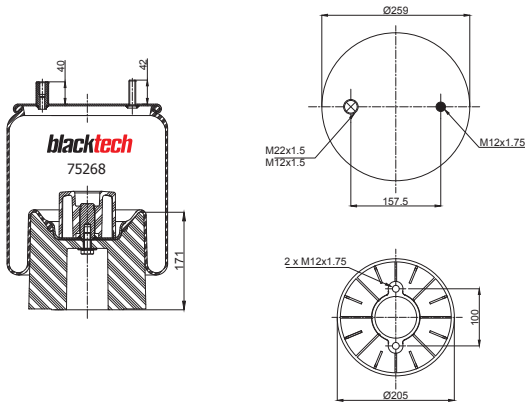

- Bolt or Stud
- Threaded hole
- ⊗ Combination Stud
- ⊗ Air Inlet

OEM PART NUMBER		MODEL NO	CROSS REFERENCES	
ROR	2122 2442		Contitech	4157 N P09
Weweler	US 07074F	AC 524/514	Phoenix	1DK 21 A-31
			Primeride	54157 A P09
			Firestone Style	1T15MPW-7
			Firestone No.	W01-M58-7074
			Goodyear	1R11-106
			Vibracoustic	V1DK21A-31
			CF Gomma Ref.	1TC300-38
			CF Gomma No.	205598
			Dunlop F	D12B17
			Gart Ref.	C294
			Gart No.	2942.450

**RML 75268 CP10**

Cross Section View

Top View

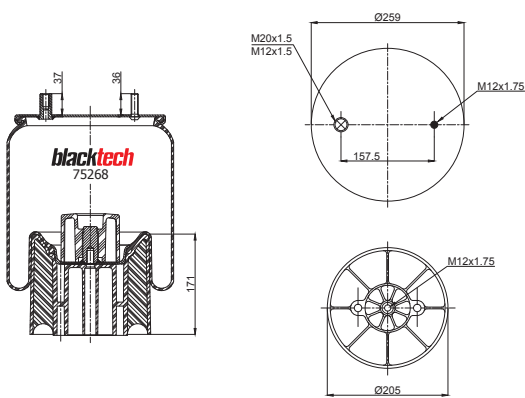

- Bolt or Stud
- Threaded hole
- ⊗ Combination Stud
- ⊗ Air Inlet

OEM PART NUMBER		MODEL NO	CROSS REFERENCES	
Acerbi	128140028		Contitech	4157 N P10
Acerbi	800449526		Phoenix	1DK 20 A-51
Fruehauf	UJB 0975		Primeride	54157 A P10
SMB	M060924		Firestone Style	1T15MPW-7
			Firestone No.	W01-M58-6315
			Goodyear	1R11-772
			Taurus	KR915-51
			Vibracoustic	V1DK20A-51
			CF Gomma Ref.	1TC300-38
			CF Gomma No.	206925
			Dunlop F	D12B29
			Gart Ref.	C294
			Gart No.	2941450



### RML 75268 CP14

Cross Section View

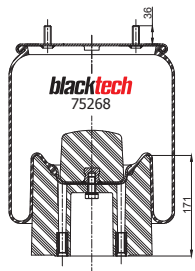

Top View

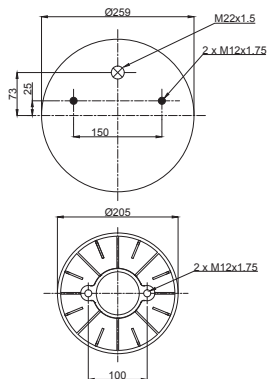

- Bolt or Stud
- Threaded hole
- ⊗ Combination Stud
- ⊗ Air Inlet

OEM PART NUMBER	MODEL NO	CROSS REFERENCES	
Daimler TAS	A 946 328 14 01	DCA; DLS	Contitech 4157 N P14
Daimler TAS	A 946 328 14 01	DCA; DLS; TE5/8	Phoenix 1 DK 21 A-4
Weweler	US 07364		Primeride 54157 A P04
			Firestone Style 1T15MPW-7
			Firestone No. W01-M58-6297
			Goodyear 1R11-111
			Vibracoustic VIDK21A-4
			Vibracoustic VIDK21A-8
			CF Gamma Ref. 1T300-40
			CF Gamma No. 207463
			Dunlop F D12B18
			Dunlop UK 00980A-AP
			Gart Ref. C294/D
			Gart No. 2942.454

### RML 75269

Cross Section View

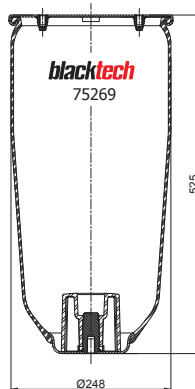

Top View

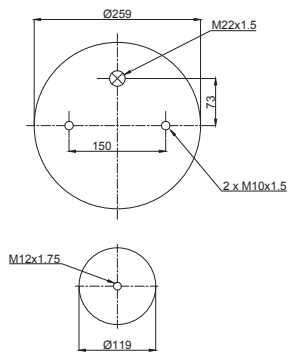

- Bolt or Stud
- Threaded hole
- ⊗ Combination Stud
- ⊗ Air Inlet

OEM PART NUMBER	MODEL NO	CROSS REFERENCES	
Schmitz	Service Assembly	Contitech	4158 N P02
		Phoenix	1 DK 20 B-1 NP
		Primeride	54158 A P02
		Firestone Style	1T15MPW-9
		Firestone No.	W01-M58-6257
		Goodyear	1R12-748
		Vibracoustic	VIDK20B-1 NP
		Dunlop F	D12U23
		Gart Ref.	D278/HS
		Gart No.	278.0531

### RML 75269 C

Cross Section View

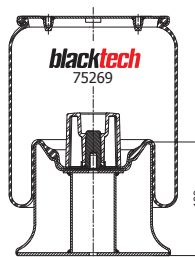

Top View

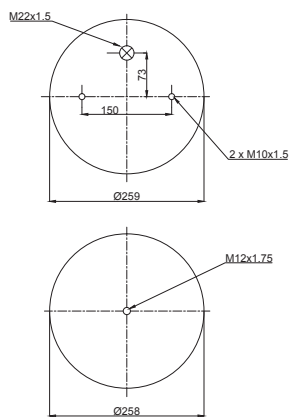

- Bolt or Stud
- Threaded hole
- ⊗ Combination Stud
- ⊗ Air Inlet

OEM PART NUMBER	MODEL NO	CROSS REFERENCES	
Schmitz	750999		
Weweler	US 06285		

**RML 75269 CP**



Cross Section View

Top View

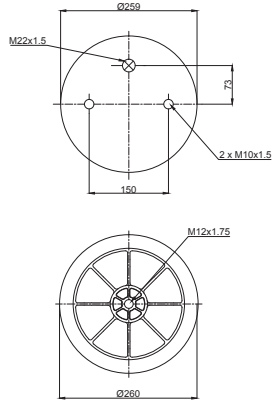
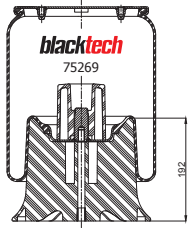

- Bolt or Stud
- Threaded hole
- ⊗ Combination Stud
- ⊗ Air Inlet

OEM PART NUMBER		MODEL NO		CROSS REFERENCES	
Schmitz	750999			Contitech	4158 N P03
Schmitz	014892			Phoenix	1DK 20 B-1
Weweler	US 06285			Primeride	54158 A P03
				Firestone Style	1T15MPW-9
				Firestone No.	W01-M58-8185
				Firestone No.	W01-M58-6285
				Goodyear	1R12-749
				Vibracoustic	V1DK20B-1
				Dunlop F	D12B22
				Gart Ref.	D278/HS
				Gart No.	2781530
				Gart No.	2781530/1

**RML 75270 C**



Cross Section View

Top View

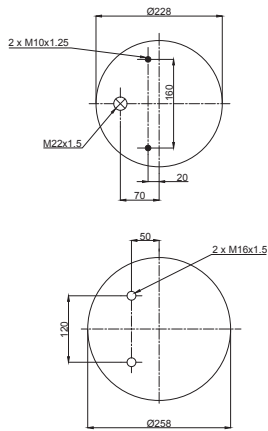
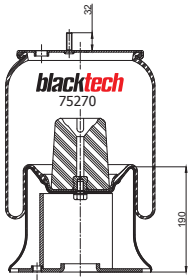

- Bolt or Stud
- Threaded hole
- ⊗ Combination Stud
- ⊗ Air Inlet

OEM PART NUMBER		MODEL NO		CROSS REFERENCES	
Cardi	58050900			Firestone Style	1T15 M-9
Omar	11808			Firestone No.	W01 M58 6289
Zorzi	1006551			Goodyear	1R12-703
				Vibracoustic	V 1D 23 E-3
				Phoenix	1D 23 E-3

**RML 75339 CP**



Cross Section View

Top View

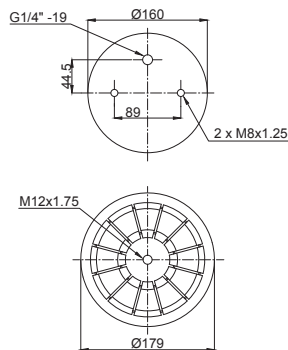
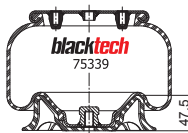

- Bolt or Stud
- Threaded hole
- ⊗ Combination Stud
- ⊗ Air Inlet

OEM PART NUMBER		MODEL NO		CROSS REFERENCES	
Goldschmitt	DLB 5339				

### RML 75339 CP1



Cross Section View

Top View

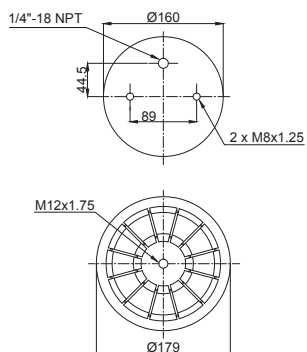
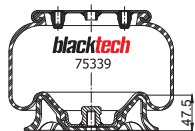

- Bolt or Stud
- Threaded hole
- ⊗ Combination Stud
- ⊗ Air Inlet

OEM PART NUMBER	MODEL NO	CROSS REFERENCES	
		Firestone Style	1T14 C-1
		Firestone No.	W01 M68 5339

### RML 75343 CA



Cross Section View

Top View

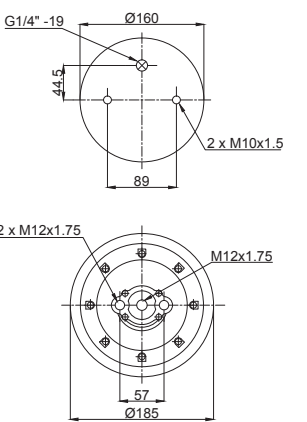
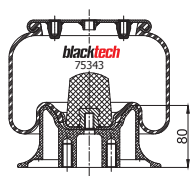

- Bolt or Stud
- Threaded hole
- ⊗ Combination Stud
- ⊗ Air Inlet

OEM PART NUMBER	MODEL NO	CROSS REFERENCES	
Goldschmitt	DLB 5343		

### RML 75343 CA1



Cross Section View

Top View

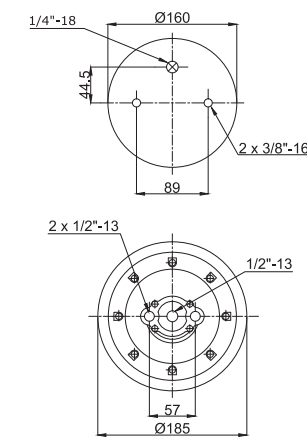
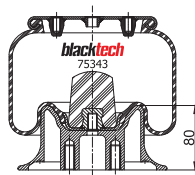

- Bolt or Stud
- Threaded hole
- ⊗ Combination Stud
- ⊗ Air Inlet

OEM PART NUMBER	MODEL NO	CROSS REFERENCES	
Iveco	504035755	Daily 35-50	Firestone Style
			Firestone No.
			1T14 C-1
			W01 358 5343

**RML 75531**



Cross Section View

Top View

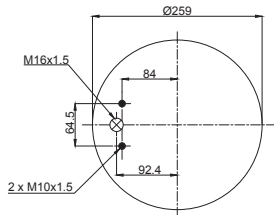
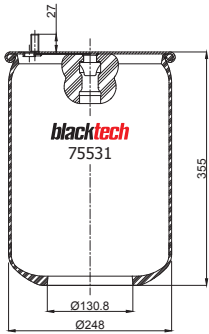

- Bolt or Stud
- Threaded hole
- ⊗ Combination Stud
- ⊗ Air Inlet

OEM PART NUMBER	MODEL NO	CROSS REFERENCES
Volvo	1076075	

**RML 75531C**



Cross Section View

Top View

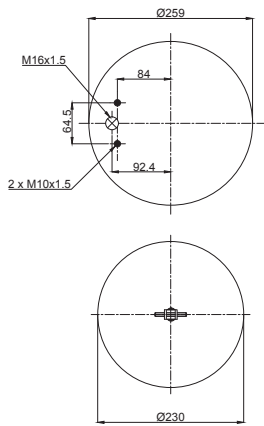
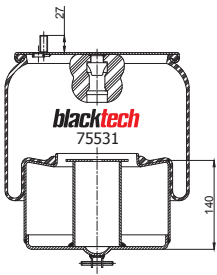

- Bolt or Stud
- Threaded hole
- ⊗ Combination Stud
- ⊗ Air Inlet

OEM PART NUMBER	MODEL NO	CROSS REFERENCES
Volvo	1 076 075	Contitech 4420 NP01
Volvo	1 076 076	Firestone Style 1117BR-8
Volvo	20 554 756	Firestone No. W01-M58-9707
		CF Gomma Ref. 1TS300-28
		CF Gomma No. 207774
		Gart Ref. D278/V1
		Gart No. 278.1.355

**RML 75580C**



Cross Section View

Top View

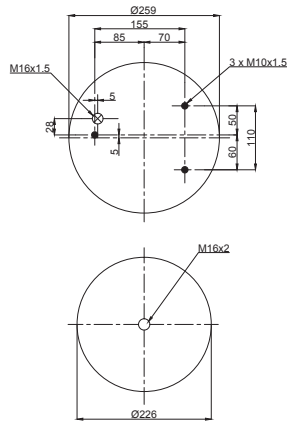
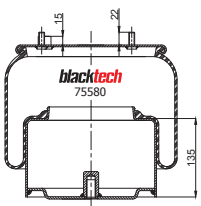

- Bolt or Stud
- Threaded hole
- ⊗ Combination Stud
- ⊗ Air Inlet

OEM PART NUMBER	MODEL NO	CROSS REFERENCES
Ford	DC46-5580-AA	Cargo Front Contitech 1850 NP01

### RML 75581 C



Cross Section View

Top View

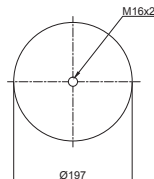
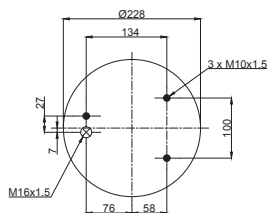
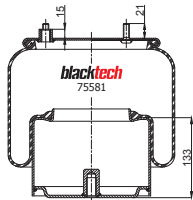

- Bolt or Stud
- Threaded hole
- ⊗ Combination Stud
- ⊗ Air Inlet

OEM PART NUMBER	MODEL NO	CROSS REFERENCES		
Ford	DC46-5580-BA	Cargo Rear	Contitech	1889 N P02

### RML 75816-1



Cross Section View

Top View

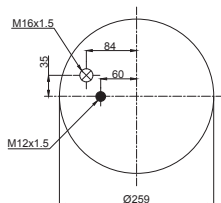
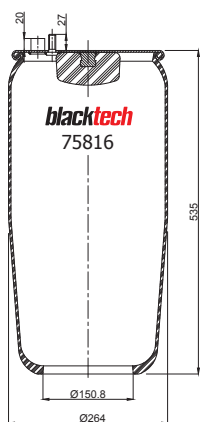

- Bolt or Stud
- Threaded hole
- ⊗ Combination Stud
- ⊗ Air Inlet

OEM PART NUMBER	MODEL NO	CROSS REFERENCES		
MAN	81.43601.0155	TGA ALV 11.5/71	Contitech	4705 N1 P01
			Goodyear	1R12-831
			Gart Ref.	C302/B
			Gart No.	302.0.521

### RML 75816 C3



Cross Section View

Top View

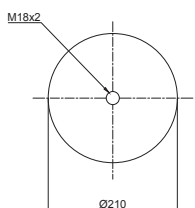
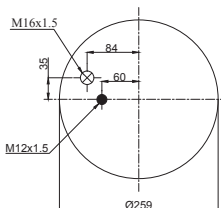
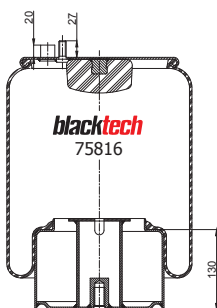

- Bolt or Stud
- Threaded hole
- ⊗ Combination Stud
- ⊗ Air Inlet

OEM PART NUMBER	MODEL NO	CROSS REFERENCES		
MAN	81.43600.6039	TGA ALV 11.5/71	Contitech	4705 N1 P03
			Gart Ref.	C302/B
			Gart No.	302.1.520

**RML 75816 C4**



Cross Section View

Top View

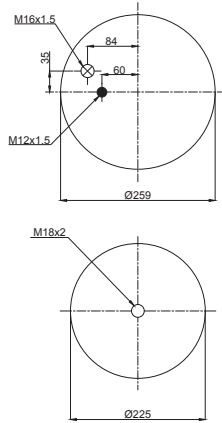
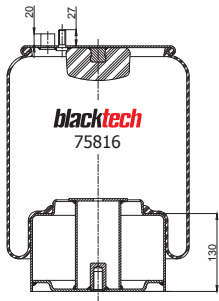

- Bolt or Stud
- Threaded hole
- ⊗ Combination Stud
- ⊗ Air Inlet

OEM PART NUMBER	MODEL NO	CROSS REFERENCES	
MAN 81.43600.6040	TGA ALV 11.5/7.5. 12/8	Contitech	4705 N1 P04
		Firestone Style	1T17AR-10.5
		Firestone No.	W01-M58-8367
		Gart Ref.	C302/B
		Gart No.	3021521

**RML 75824**



Cross Section View

Top View

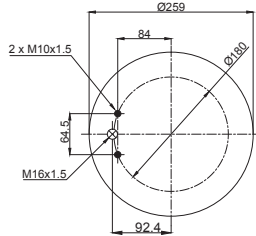
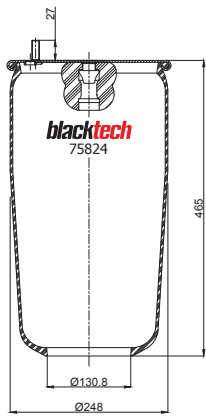

- Bolt or Stud
- Threaded hole
- ⊗ Combination Stud
- ⊗ Air Inlet

OEM PART NUMBER	MODEL NO	CROSS REFERENCES	
Volvo 1076595		Contitech	4713 N P04
		Goodyear	1R12-763
		CF Gomma Ref.	1TS300-28
		Dunlop F	D12U24
		Gart Ref.	C293/V
		Gart No.	293.0.461

**RML 75824 C**



Cross Section View

Top View

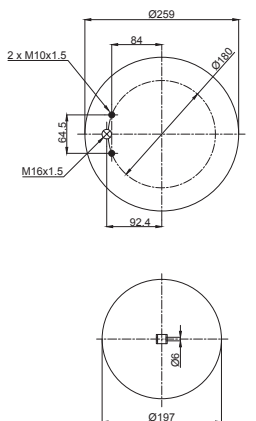
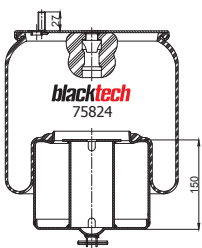

- Bolt or Stud
- Threaded hole
- ⊗ Combination Stud
- ⊗ Air Inlet

OEM PART NUMBER	MODEL NO	CROSS REFERENCES	
Volvo 1076594		Contitech	4713 N P02
Volvo 20554755		Phoenix	1DF 22 C-1
		Primeride	54713 A P02
		Firestone Style	1T17BR-8
		Firestone No.	W01-M58-9706
		Goodyear	1R12-762
		Vibracoustic	V1DF22C-1
		CF Gomma Ref.	1TS300-28
		CF Gomma No.	207775
		Dunlop F	D12B24
		Gart Ref.	C293/V
		Gart No.	2931460

### RML 75829



Cross Section View

Top View

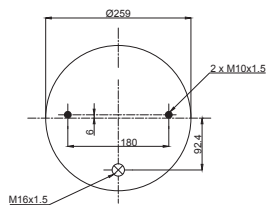
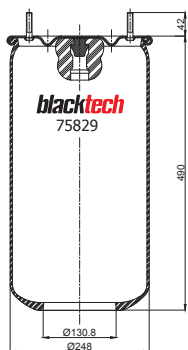

- Bolt or Stud
- Threaded hole
- ⊗ Combination Stud
- ⊗ Air Inlet

OEM PART NUMBER		MODEL NO	CROSS REFERENCES	
Volvo	1079718	lowliner	Contitech	4718 N P02
Volvo	1079718		Goodyear	1R12-841
			Gart Ref.	D278/V
			Gart No.	278.0.471

### RML 75829 C



Cross Section View

Top View

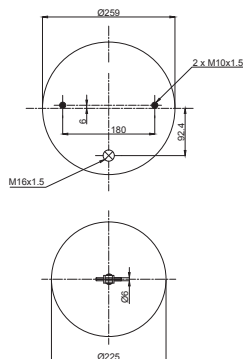
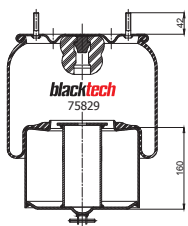

- Bolt or Stud
- Threaded hole
- ⊗ Combination Stud
- ⊗ Air Inlet

OEM PART NUMBER		MODEL NO	CROSS REFERENCES	
Volvo	1 075 363	lowliner	Contitech	4718 N P01
Volvo	20 452 136		Goodyear	1R12-821
Volvo	20 554 759		Gart Ref.	D278/V
			Gart No.	278.1.470

### RML 75921



Cross Section View

Top View

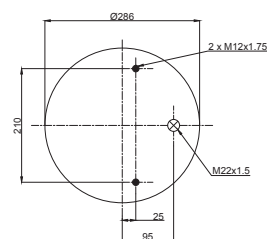
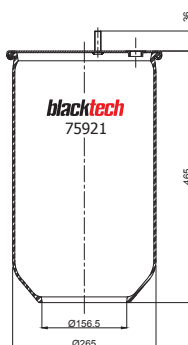

- Bolt or Stud
- Threaded hole
- ⊗ Combination Stud
- ⊗ Air Inlet

OEM PART NUMBER		MODEL NO	CROSS REFERENCES	
			Contitech	4810 N

**RML 75921 C**

Cross Section View

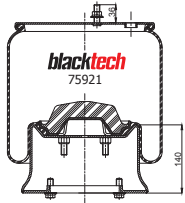

Top View

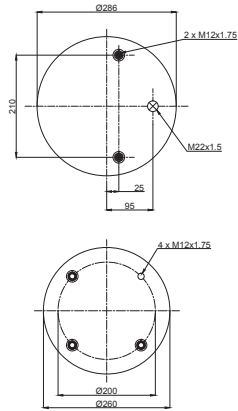

- Bolt or Stud
- Threaded hole
- ⊗ Combination Stud
- ⊗ Air Inlet

OEM PART NUMBER	MODEL NO	CROSS REFERENCES
SAF	2918 V	

**RML 75921 C1**

Cross Section View

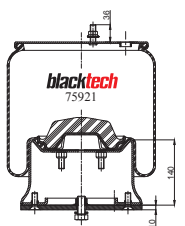

Top View

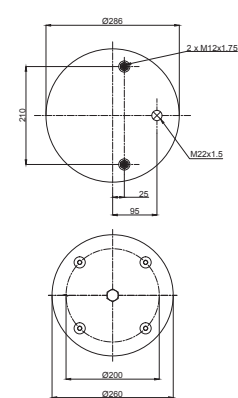

- Bolt or Stud
- Threaded hole
- ⊗ Combination Stud
- ⊗ Air Inlet

OEM PART NUMBER	MODEL NO	CROSS REFERENCES
SAF	2918 V	Contitech 4810 N P08
		CF Gomma Ref. 1119E-1
		CF Gomma No. 207733
		Gart Ref. D277/B
		Gart No. 277.4.424/1

**RML 75921 C2**

Cross Section View

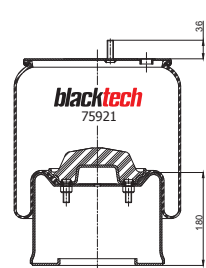

Top View

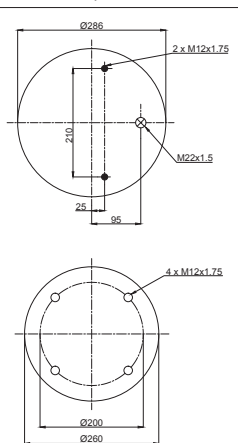

- Bolt or Stud
- Threaded hole
- ⊗ Combination Stud
- ⊗ Air Inlet

OEM PART NUMBER	MODEL NO	CROSS REFERENCES
SAF	2922 V / 250	





**RML 75921 CP1**



Cross Section View

Top View

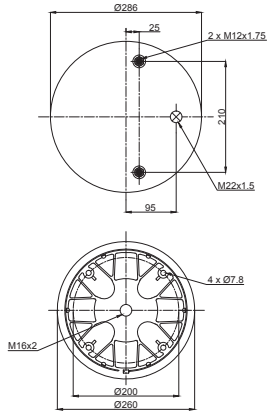
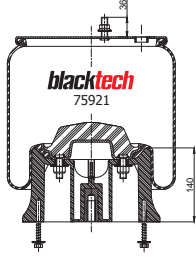

- Bolt or Stud
- Threaded hole
- ⊗ Combination Stud
- ⊗ Air Inlet

OEM PART NUMBER	MODEL NO	CROSS REFERENCES
SAF	2919 V	

**RML 75921 CP2**



Cross Section View

Top View

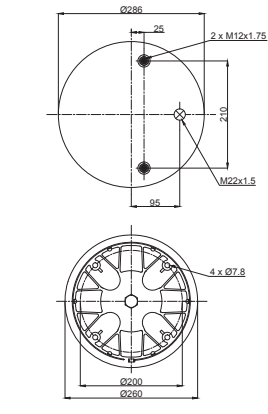
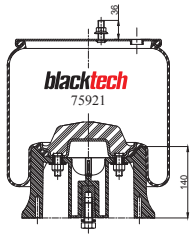

- Bolt or Stud
- Threaded hole
- ⊗ Combination Stud
- ⊗ Air Inlet

OEM PART NUMBER	MODEL NO	CROSS REFERENCES
SAF	2919 V	

**RML 75924**



Cross Section View

Top View

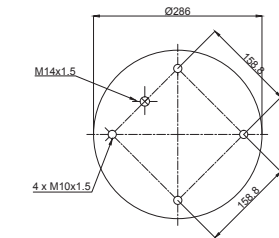
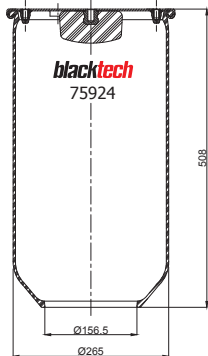

- Bolt or Stud
- Threaded hole
- ⊗ Combination Stud
- ⊗ Air Inlet

OEM PART NUMBER	MODEL NO	CROSS REFERENCES
Scania		Conlitech 4813 N

### RML 75924 C



Cross Section View

Top View

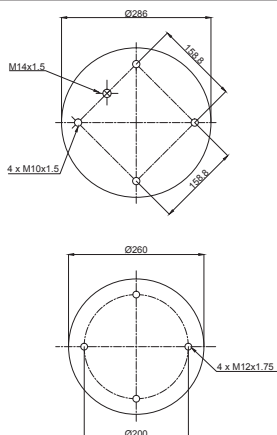
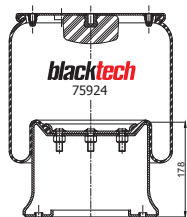

- Bolt or Stud
- Threaded hole
- ⊗ Combination Stud
- ⊗ Air Inlet

OEM PART NUMBER	MODEL NO	CROSS REFERENCES	
Scania 1107674	Series 3	Contitech	4813N P07
Scania 1314906	Series 3	Phoenix	1 D 28 B-9
Scania 1865755	Series 3	Primeride	54813 A P07
Scania 255293	Series 3	Firestone Style	1T19L-11
Scania 298568	Series 3	Firestone No.	W01-M58-7358
Scania 325748	Series 3	Goodyear	1R14-727
		Taurus	KR622-01
		Vibracoustic	VID28B-9
		CF Gamma Ref.	1T19E-2BR
		CF Gamma No.	97764
		Dunlop F	D13B10
		Dunlop F	D13B22
		Gart Ref.	D287
		Gart No.	2874.520

### RML 75924 C1



Cross Section View

Top View

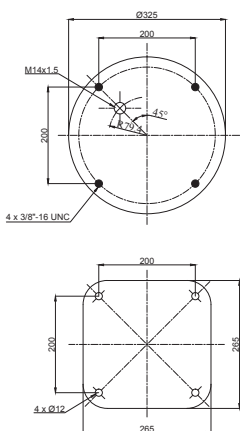
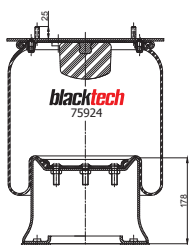

- Bolt or Stud
- Threaded hole
- ⊗ Combination Stud
- ⊗ Air Inlet

OEM PART NUMBER	MODEL NO	CROSS REFERENCES	
Lohr 29790-01			

### RML 75973



Cross Section View

Top View

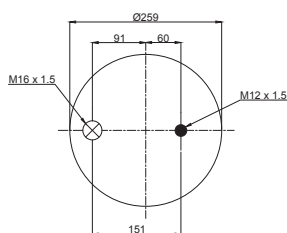
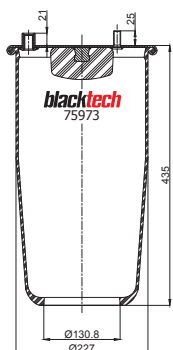

- Bolt or Stud
- Threaded hole
- ⊗ Combination Stud
- ⊗ Air Inlet

OEM PART NUMBER	MODEL NO	CROSS REFERENCES	
MAN 81.43601.0168	TG1 /TGL	Contitech	4862 N P01
		Vibracoustic	VIDF16B-1NP

**RML 75973 C2**



Cross Section View

Top View

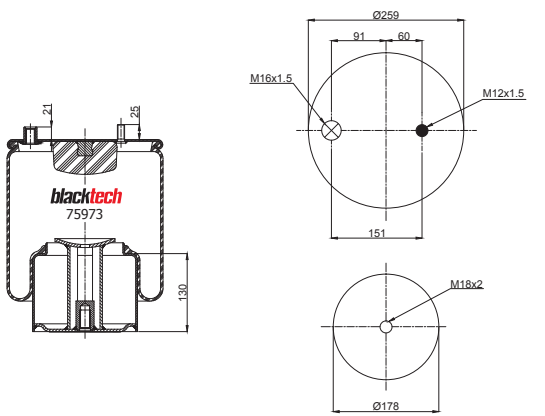

- Bolt or Stud
- Threaded hole
- ⊗ Combination Stud
- ⊗ Air Inlet

OEM PART NUMBER		MODEL NO	CROSS REFERENCES	
MAN	81.43600.6049	TG1 /TGL	Contitech	4862 N1 P02
			Vibracoustic	V1DF16B-1

**RML 75992**



Cross Section View

Top View

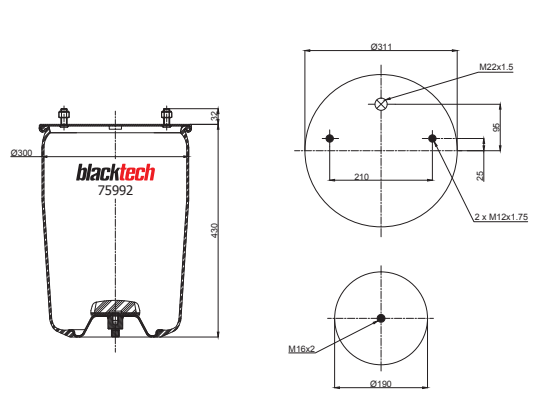

- Bolt or Stud
- Threaded hole
- ⊗ Combination Stud
- ⊗ Air Inlet

OEM PART NUMBER		MODEL NO	CROSS REFERENCES	
BPW	05.429.41.01.0	36 K	Contitech	4881 N P02
Schmitz	750 570	36 K	Phoenix	1DK 32 K
			Primeride	54881 A P02
			Firestone Style	1T66D-7
			Firestone No.	W01-M58-8601
			Goodyear	1R14-701
			Taurus	UR838-01
			Vibracoustic	V1DK32K
			CF Gomma Ref.	1TC360-40
			CF Gomma No.	205537
			Dunlop F	D14U37
			Gart Ref.	C292/A
			Gart No.	292.Q.461

**RML 75992 C**



Cross Section View

Top View

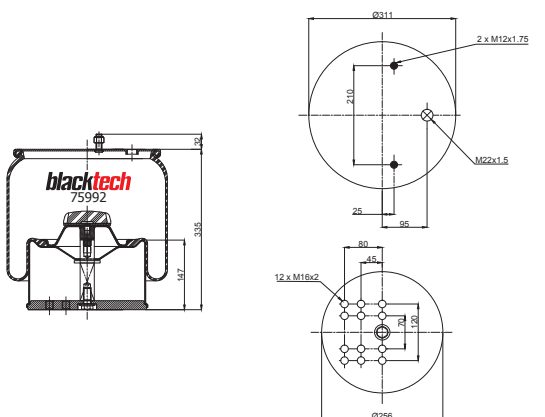

- Bolt or Stud
- Threaded hole
- ⊗ Combination Stud
- ⊗ Air Inlet

OEM PART NUMBER		MODEL NO	CROSS REFERENCES	
BPW	05.429.41.22.1	36 K		

### RML 75992 CP



Cross Section View

Top View

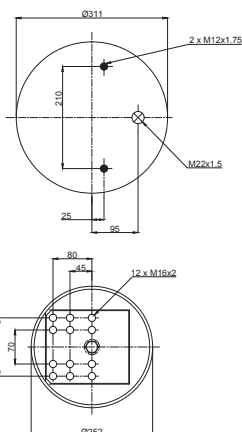
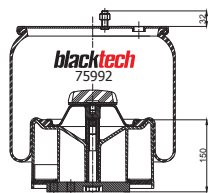

- Bolt or Stud
- Threaded hole
- ⊗ Combination Stud
- ⊗ Air Inlet

OEM PART NUMBER		MODEL NO	CROSS REFERENCES	
BPW	05.429.43.41.0	36 K	Contitech	4881 N P30
Hüferrmann	6-AB8003-0200	36 K	Phoenix	1DK 32 K-2
			Primeride	54881 A P04
			Firestone Style	1T66F-70
			Firestone No.	W01-M58-8666
			Goodyear	1R14-757
			Vibracoustic	V1DK32K Y10
			CF Gomma Ref.	1TC360-40K
			CF Gomma No.	207309
			Dunlop F	D14B44
			Gart Ref.	C292/A
			Gart No.	292.2.462

### RML 75993



Cross Section View

Top View

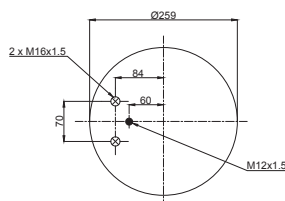
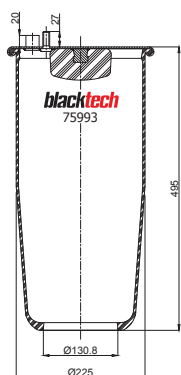

- Bolt or Stud
- Threaded hole
- ⊗ Combination Stud
- ⊗ Air Inlet

OEM PART NUMBER		MODEL NO	CROSS REFERENCES	
MAN	81.43601.0151	TGA	Contitech	4882 NI P01
MAN	81.43601.0176		Phoenix	1DF 16-2 NP
			Goodyear	1R10-702
			Vibracoustic	V1DF16-2 NP
			CF Gomma Ref.	1TS260-32
			CF Gomma No.	207760
			Dunlop F	D10U01
			Gart Ref.	C289/M
			Gart No.	289.0.512

### RML 75993 C5



Cross Section View

Top View

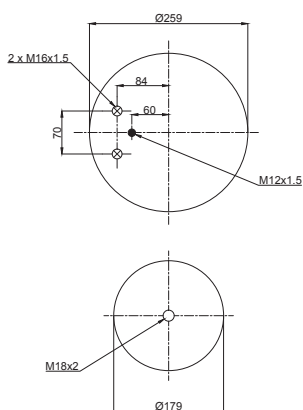
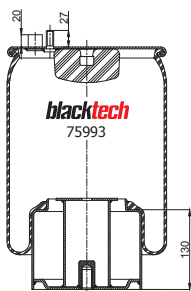

- Bolt or Stud
- Threaded hole
- ⊗ Combination Stud
- ⊗ Air Inlet

OEM PART NUMBER		MODEL NO	CROSS REFERENCES	
MAN	81.43600.6036	TGA / TGX	Contitech	4882 NI P05
MAN	81.43600.6056		Phoenix	1DF 16-2
			Firestone Style	1T17WR-8
			Firestone No.	W01-M58-9880
			Goodyear	1R10-709
			Vibracoustic	V1DF16-2
			CF Gomma Ref.	1TS260-32
			CF Gomma Ref.	1TS260-28
			CF Gomma No.	207701
			CF Gomma No.	206788
			Gart Ref.	C289/M
			Gart No.	289.1.510

**RML 75993 CP5**



Cross Section View

Top View

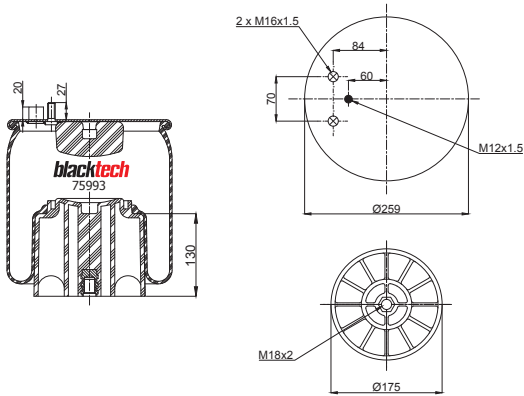

- Bolt or Stud
- Threaded hole
- ⊗ Combination Stud
- ⊗ Air Inlet

OEM PART NUMBER	MODEL NO	CROSS REFERENCES
MAN	TGA / TGX	

**RML 75994**



Cross Section View

Top View

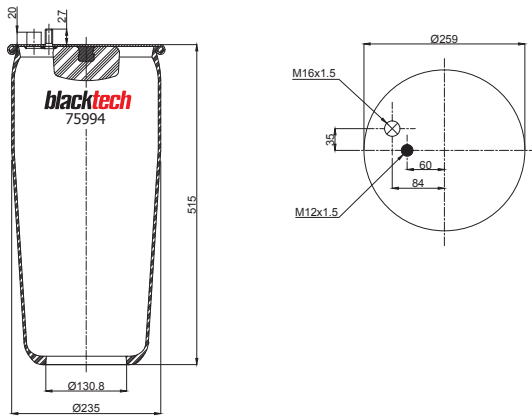

- Bolt or Stud
- Threaded hole
- ⊗ Combination Stud
- ⊗ Air Inlet

OEM PART NUMBER	MODEL NO	CROSS REFERENCES
MAN	81.43601.0153	TGA ALV 11.5/6.3
MAN	81.43601.0153	TGA ALV 13/6.5
		Contitech 4883 N1 P01
		Goodyear 1R11-804
		Vibracoustic VIDF19C-1
		CF Gomma Ref. 1TS290-30
		CF Gomma No. 207761
		Dunlop F D11U47
		Gart Ref. C304/M3
		Gart No. 304.0.513

**RML 75994 C**



Cross Section View

Top View

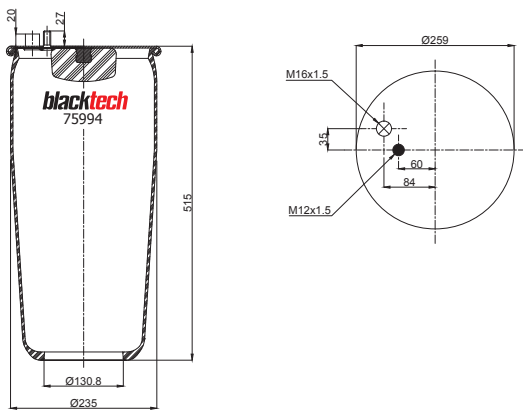

- Bolt or Stud
- Threaded hole
- ⊗ Combination Stud
- ⊗ Air Inlet

OEM PART NUMBER	MODEL NO	CROSS REFERENCES
MAN	81.43600.6037	TGA ALV 13/6.5
		Contitech 4883 N1 P06
		Goodyear 1R11-884
		Gart Ref. C304/M3
		Gart No. 304.1.513

### RML 75995



Cross Section View

Top View

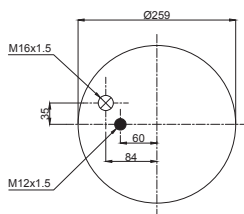
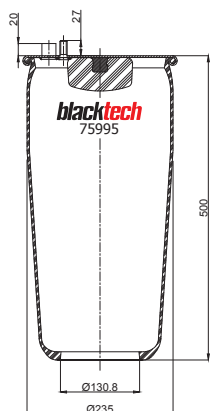

- Bolt or Stud
- Threaded hole
- ⊗ Combination Stud
- ⊗ Air Inlet

OEM PART NUMBER		MODEL NO	CROSS REFERENCES	
MAN	81.43601.0174		Contitech	4884 N1 P01
MAN	81.43601.0175		Phoenix	1DF 19 B-1 NP
			Goodyear	1R11-820
			Vibracoustic	V1DF19B-1 NP
			CF Gomma Ref.	1TS290-28
			CF Gomma No.	207759
			Dunlop F	D11U48
			Gart Ref.	C304/M4
			Gart No.	304.0511

### RML 75995-2



Cross Section View

Top View

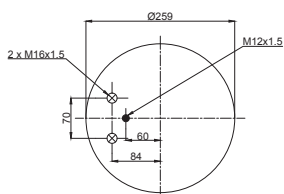
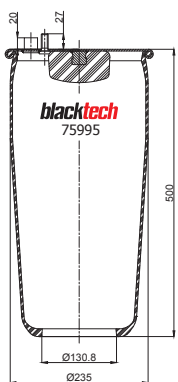

- Bolt or Stud
- Threaded hole
- ⊗ Combination Stud
- ⊗ Air Inlet

OEM PART NUMBER		MODEL NO	CROSS REFERENCES	
MAN	81.43601.0173		Contitech	4884 N1 P02

### RML 75995 C6



Cross Section View

Top View

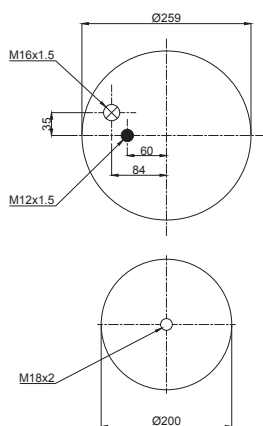
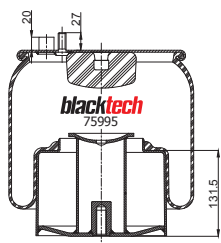

- Bolt or Stud
- Threaded hole
- ⊗ Combination Stud
- ⊗ Air Inlet

OEM PART NUMBER		MODEL NO	CROSS REFERENCES	
MAN	81.43600.6035	TGA ALV 11.56.3	Contitech	4884 N1 P06
MAN	81.43600.6055		Phoenix	1DF 19 B-1
			Firestone Style	1T17JR-72
			Firestone No.	W01-M58-9879
			Goodyear	1R11-861
			Vibracoustic	V1DF19B-1
			CF Gomma Ref.	1TS290-28
			CF Gomma No.	207702
			CF Gomma No.	206787
			Gart Ref.	C304/M4
			Gart No.	3041.510

**RML 75995 C7**



Cross Section View

Top View

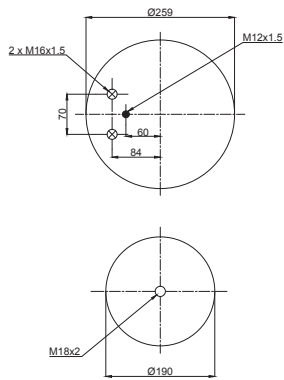
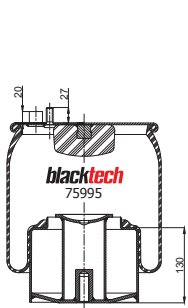

- Bolt or Stud
- Threaded hole
- ⊗ Combination Stud
- ⊗ Air Inlet

OEM PART NUMBER	MODEL NO	CROSS REFERENCES	
MAN 81.43600.6041	TGA ALV 13/6.5	Contitech	4884 N1 P07
		Goodyear	1R11-885
		Gart Ref.	C289/M
		Gart No.	289.1513

**RML 75995 CP6**



Cross Section View

Top View

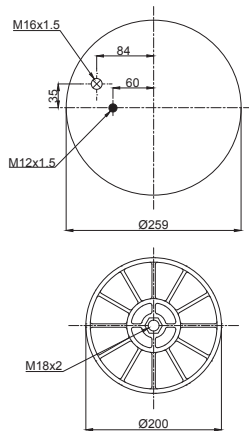
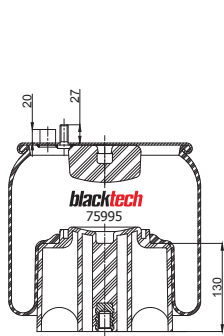

- Bolt or Stud
- Threaded hole
- ⊗ Combination Stud
- ⊗ Air Inlet

OEM PART NUMBER	MODEL NO	CROSS REFERENCES	
MAN	TGA ALV		

**RML 75996**



Cross Section View

Top View

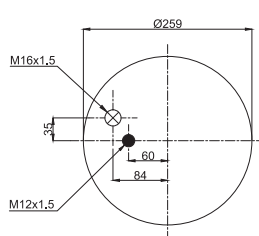
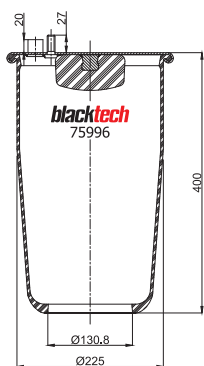

- Bolt or Stud
- Threaded hole
- ⊗ Combination Stud
- ⊗ Air Inlet

OEM PART NUMBER	MODEL NO	CROSS REFERENCES	
MAN 81.43601.0160	L2000	Contitech	4885 N1 P01
MAN 81.43601.6071	176/260	CF Gomma Ref.	1TS260-20
		CF Gomma No.	207762
		Gart Ref.	C289/M1
		Gart No.	289.0.411



### RML 75996 C2



Cross Section View

Top View

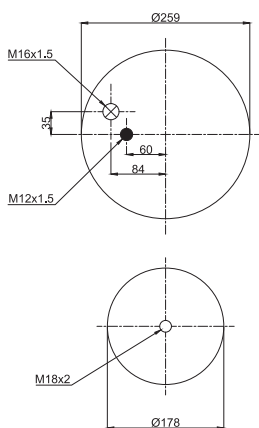
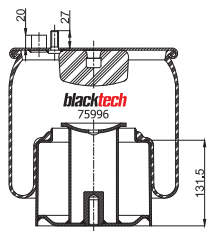

- Bolt or Stud
- Threaded hole
- ⊗ Combination Stud
- ⊗ Air Inlet

OEM PART NUMBER		MODEL NO	CROSS REFERENCES	
MAN	81.43600.6044	L2000	Contitech	4885 N1 P02
			CF Gomma Ref.	1TS260-20
			CF Gomma No.	207764
			Gart Ref.	C289/M1
			Gart No.	2891.410

### RML 75997



Cross Section View

Top View

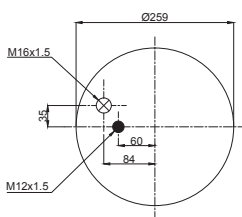
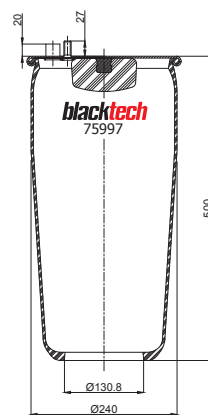

- Bolt or Stud
- Threaded hole
- ⊗ Combination Stud
- ⊗ Air Inlet

OEM PART NUMBER		MODEL NO	CROSS REFERENCES	
MAN	81.43601.0165		Contitech	4886 N P02

### RML 75997 C1



Cross Section View

Top View

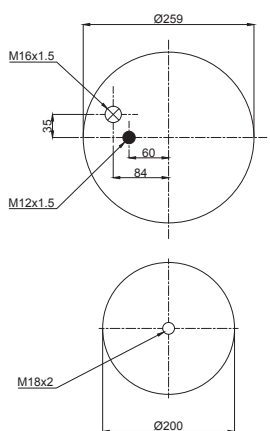
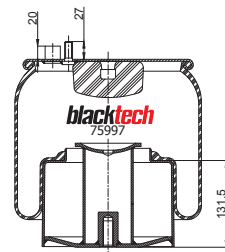

- Bolt or Stud
- Threaded hole
- ⊗ Combination Stud
- ⊗ Air Inlet

OEM PART NUMBER		MODEL NO	CROSS REFERENCES	
MAN	81.43600.6046		Contitech	4886 N P01

**RML 76113 C**



Cross Section View

Top View

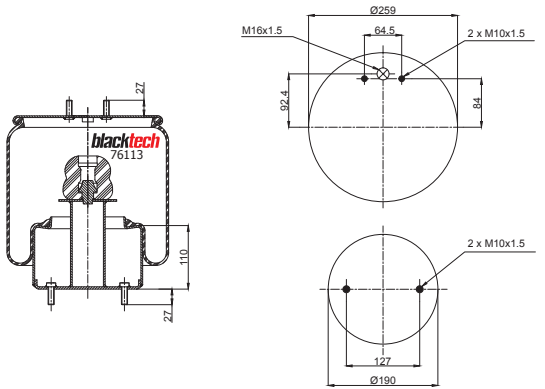

- Bolt or Stud
- Threaded hole
- ⊗ Combination Stud
- ⊗ Air Inlet

OEM PART NUMBER	MODEL NO	CROSS REFERENCES	
Volvo	20 480 202	Bus	Contitech 6602 N P01
Volvo	20 573 113		Goodyear 1R12-843
Volvo	21 041 697	B 12 B	Goodyear Flex No. 566243548
Volvo	21 041 697	B 12 BLE	
Volvo	21 097 453		
Volvo	70 313 734		
Volvo	70 397 453		
Volvo	70 321 079		

**RML 76199**



Cross Section View

Top View

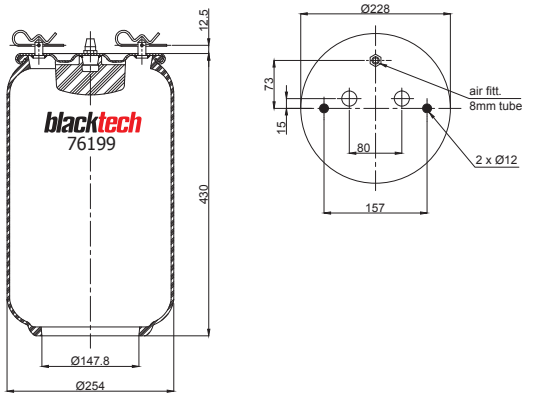

- Bolt or Stud
- Threaded hole
- ⊗ Combination Stud
- ⊗ Air Inlet

OEM PART NUMBER	MODEL NO	CROSS REFERENCES	
Scania			

**RML 76199 C**



Cross Section View

Top View

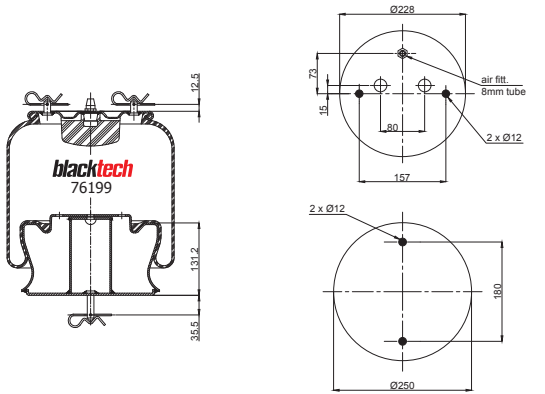

- Bolt or Stud
- Threaded hole
- ⊗ Combination Stud
- ⊗ Air Inlet

OEM PART NUMBER	MODEL NO	CROSS REFERENCES	
Scania	1386199	Phoenix	10F 23 C-1
Scania	1362145	Goodyear	1R13-744
Scania	1372146		

### RML 76200



Cross Section View

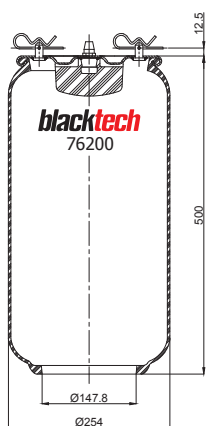

Top View

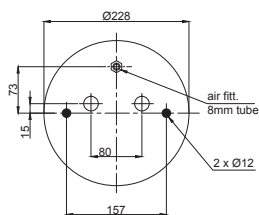

- Bolt or Stud
- Threaded hole
- ⊗ Combination Stud
- ⊗ Air Inlet

OEM PART NUMBER	MODEL NO	CROSS REFERENCES
Scania		

### RML 76200 C



Cross Section View

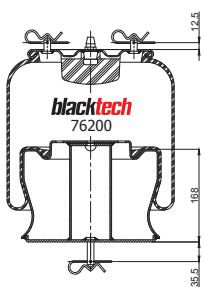

Top View

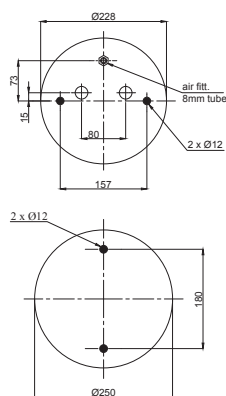

- Bolt or Stud
- Threaded hole
- ⊗ Combination Stud
- ⊗ Air Inlet

OEM PART NUMBER	MODEL NO	CROSS REFERENCES
Scania	1386200	Phoenix 1DF 23 D-1
Scania	1362147	Goodyear 1R13-745
Scania	1370744	

### RML 76200 C1



Cross Section View

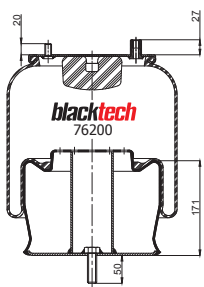

Top View

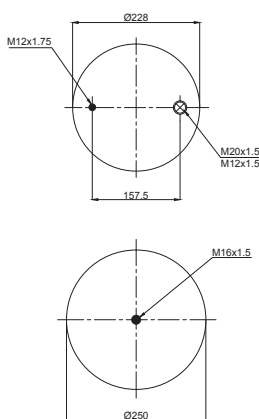

- Bolt or Stud
- Threaded hole
- ⊗ Combination Stud
- ⊗ Air Inlet

OEM PART NUMBER	MODEL NO	CROSS REFERENCES
Scania		

**RML 76237 C**



Cross Section View

Top View

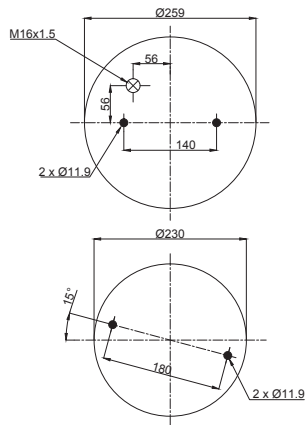
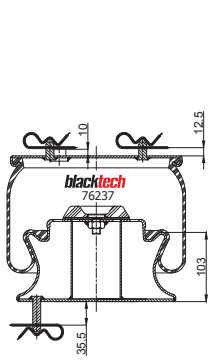

- Bolt or Stud
- Threaded hole
- ⊗ Combination Stud
- ⊗ Air Inlet

OEM PART NUMBER		MODEL NO	CROSS REFERENCES	
Scania	1726237	Bus	Phoenix	1DF 23 B-4
			Goodyear	1R13-750

**RML 76238 C**



Cross Section View

Top View

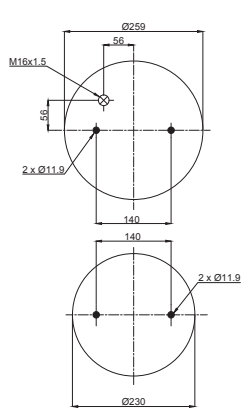
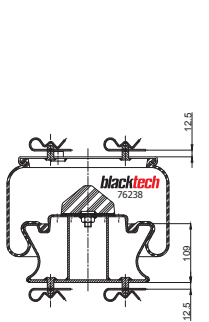

- Bolt or Stud
- Threaded hole
- ⊗ Combination Stud
- ⊗ Air Inlet

OEM PART NUMBER		MODEL NO	CROSS REFERENCES	
Scania	1726238	Bus	Phoenix	1DF 23 A-2
			Goodyear	1R12-813

**RML 76240 C**



Cross Section View

Top View

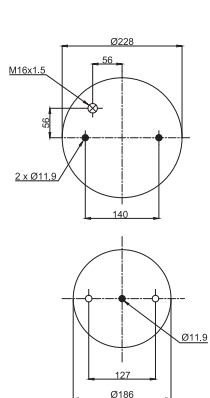
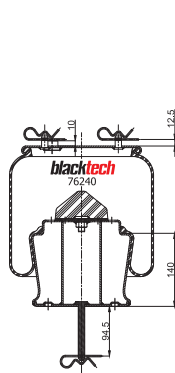

- Bolt or Stud
- Threaded hole
- ⊗ Combination Stud
- ⊗ Air Inlet

OEM PART NUMBER		MODEL NO	CROSS REFERENCES	
Scania	1726240	Bus	Phoenix	1DF 23 A-5
			Goodyear	1R11-834

### RML 76241 C



Cross Section View

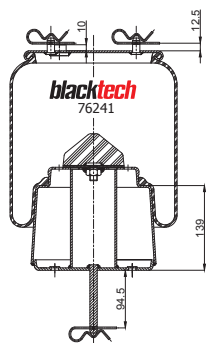

Top View

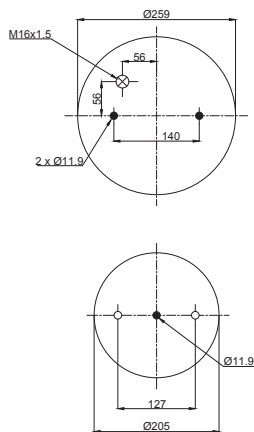

- Bolt or Stud
- Threaded hole
- ⊗ Combination Stud
- ⊗ Air Inlet

OEM PART NUMBER		MODEL NO	CROSS REFERENCES	
Scania	1726241	Bus	Phoenix	1 DF 23 A-6
			Goodyear	1R11-840

### RML 76242 C



Cross Section View

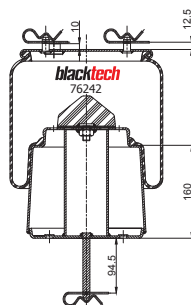

Top View

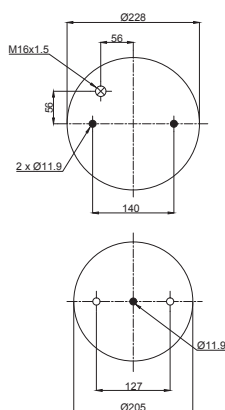

- Bolt or Stud
- Threaded hole
- ⊗ Combination Stud
- ⊗ Air Inlet

OEM PART NUMBER		MODEL NO	CROSS REFERENCES	
Scania	1726242	Bus	Phoenix	1 DF 23 A-7
			Goodyear	1R11-839

### RML 76243 C



Cross Section View

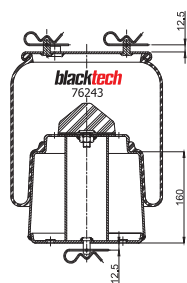

Top View

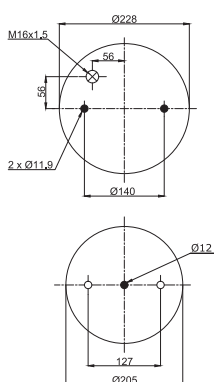

- Bolt or Stud
- Threaded hole
- ⊗ Combination Stud
- ⊗ Air Inlet

OEM PART NUMBER		MODEL NO	CROSS REFERENCES	
Scania	1726243	Bus	Phoenix	1 DF 23 A-8
			Goodyear	1R11-838

**RML 76246 C**



Cross Section View

Top View

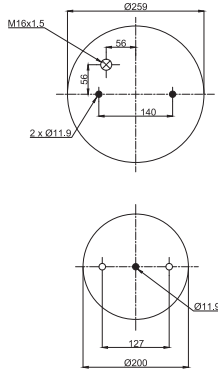
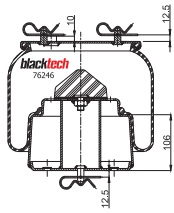

- Bolt or Stud
- Threaded hole
- ⊗ Combination Stud
- ⊗ Air Inlet

OEM PART NUMBER		MODEL NO	CROSS REFERENCES	
Scania	1726246	Bus	Phoenix	1DF 23 B-5
			Goodyear	1R11-841

**RML 76251**



Cross Section View

Top View

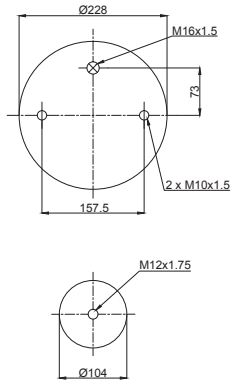
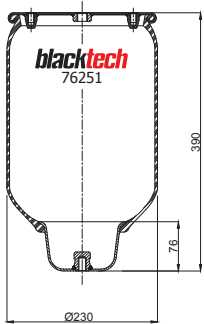

- Bolt or Stud
- Threaded hole
- ⊗ Combination Stud
- ⊗ Air Inlet

OEM PART NUMBER		MODEL NO	CROSS REFERENCES	
Scania		Series 3-4 R		

**RML 76251 C**



Cross Section View

Top View

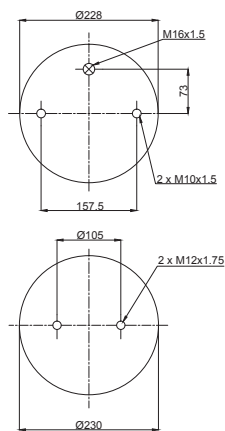
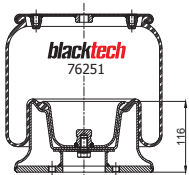

- Bolt or Stud
- Threaded hole
- ⊗ Combination Stud
- ⊗ Air Inlet

OEM PART NUMBER		MODEL NO	CROSS REFERENCES	
Scania	1394997	Series 3-4 R	Firestone Style	1T15 AA-3
Scania	1314903	Series 3-4 R	Firestone No.	W01 M68 6251
Scania	1402423	Series 3-4 R	Goodyear	1R11-826
Scania	1865759	Series 3-4 R		
Scania	1863244	Series 3-4 R		
Scania	255295	Series 3-4 R		

### RML 76251 CP



Cross Section View

Top View

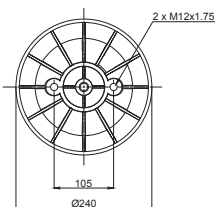
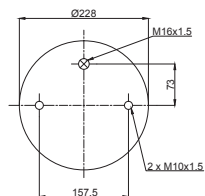
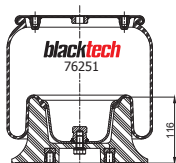

- Bolt or Stud
- Threaded hole
- ⊗ Combination Stud
- ⊗ Air Inlet

OEM PART NUMBER	MODEL NO	CROSS REFERENCES
Scania	Series 3-4 R	

### RML 76260



Cross Section View

Top View

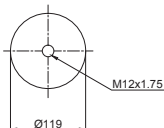
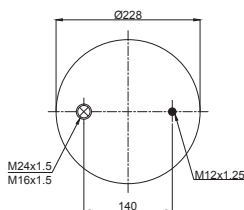
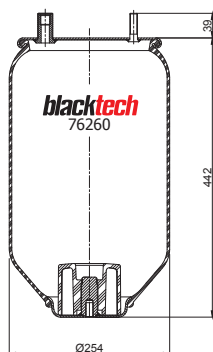

- Bolt or Stud
- Threaded hole
- ⊗ Combination Stud
- ⊗ Air Inlet

OEM PART NUMBER	MODEL NO	CROSS REFERENCES
Hendrickson		

### RML 76260 C



Cross Section View

Top View

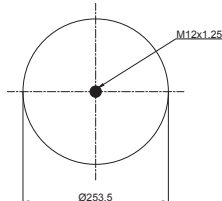
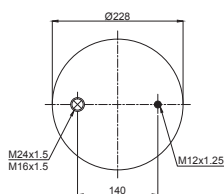
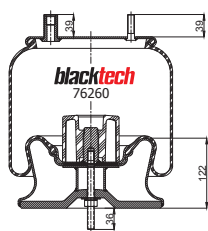

- Bolt or Stud
- Threaded hole
- ⊗ Combination Stud
- ⊗ Air Inlet

OEM PART NUMBER	MODEL NO	CROSS REFERENCES
Hendrickson		

**RML 76260 CP**

Cross Section View

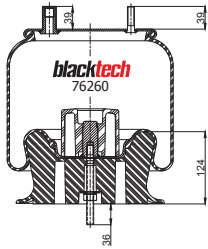

Top View

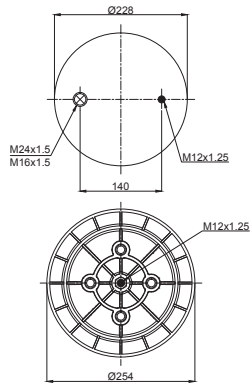

- Bolt or Stud
- Threaded hole
- ⊗ Combination Stud
- ⊗ Air Inlet

OEM PART NUMBER		MODEL NO	CROSS REFERENCES	
Hendrickson	59053-2F		Firestone Style	1T15 MPW-7
			Firestone No.	W01 M58 6260

**RML 76269**

Cross Section View

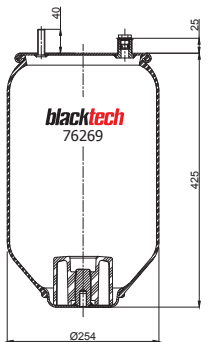

Top View

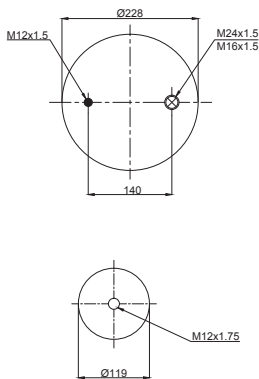

- Bolt or Stud
- Threaded hole
- ⊗ Combination Stud
- ⊗ Air Inlet

OEM PART NUMBER		MODEL NO	CROSS REFERENCES	
Hendrickson				

**RML 76269 CP**

Cross Section View

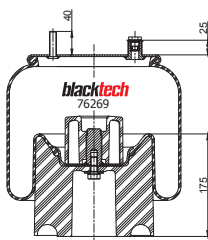

Top View

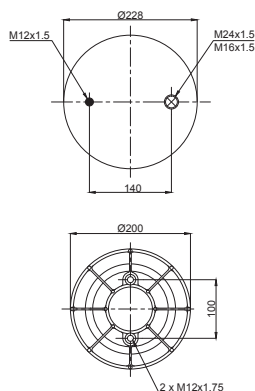

- Bolt or Stud
- Threaded hole
- ⊗ Combination Stud
- ⊗ Air Inlet

OEM PART NUMBER		MODEL NO	CROSS REFERENCES	
			Firestone Style	1T15 M-6
			Firestone No.	W01 M58 6269



### RML 76286

Cross Section View

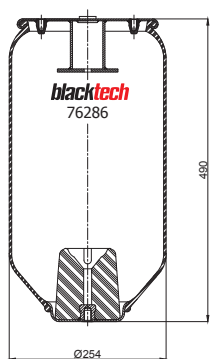

Top View

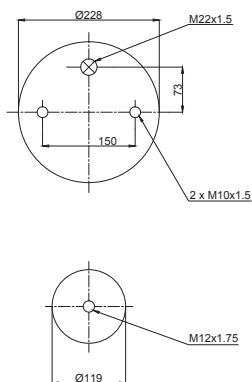

- Bolt or Stud
- Threaded hole
- ⊗ Combination Stud
- ⊗ Air Inlet

OEM PART NUMBER	MODEL NO	CROSS REFERENCES
Schmitz		
Weweler		

### RML 76286 CP

Cross Section View

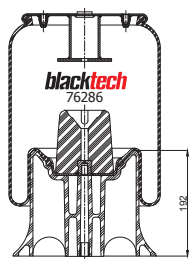

Top View

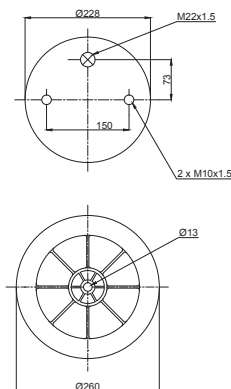

- Bolt or Stud
- Threaded hole
- ⊗ Combination Stud
- ⊗ Air Inlet

OEM PART NUMBER	MODEL NO	CROSS REFERENCES
Schmitz	751020 HP	Firestone Style 1T15 MPW-9
Weweler	US 06286 F	Firestone No. W01 M58 6286

### RML 76287 CP

Cross Section View

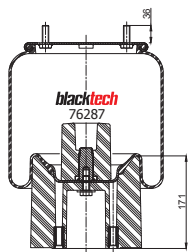

Top View

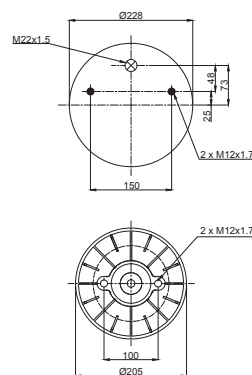

- Bolt or Stud
- Threaded hole
- ⊗ Combination Stud
- ⊗ Air Inlet

OEM PART NUMBER	MODEL NO	CROSS REFERENCES
Weweler	US06287F	Firestone Style 1T15 MPW-9
		Firestone No. W01 M58 6287

**RML 76288 CP**

Cross Section View

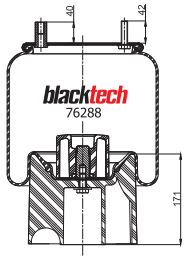

Top View

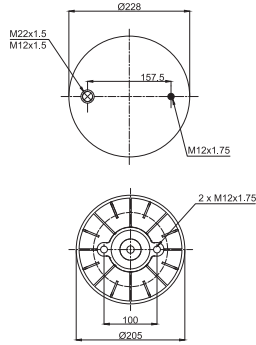

- Bolt or Stud
- Threaded hole
- ⊗ Combination Stud
- ⊗ Air Inlet

OEM PART NUMBER		MODEL NO	CROSS REFERENCES	
Weweler	US06288F		Firestone Style	1T15 MPW-9
			Firestone No.	W01 968 6238

**RML 76318**

Cross Section View

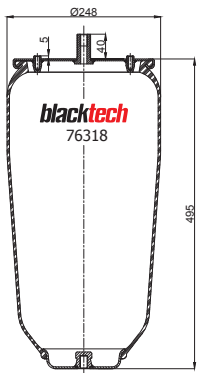

Top View

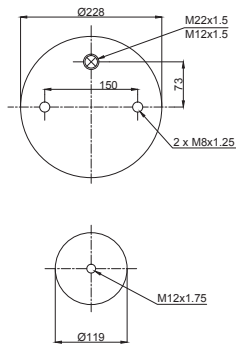

- Bolt or Stud
- Threaded hole
- ⊗ Combination Stud
- ⊗ Air Inlet

OEM PART NUMBER		MODEL NO	CROSS REFERENCES	
Weweler				
Schmitz				

**RML 76318 CP**

Cross Section View

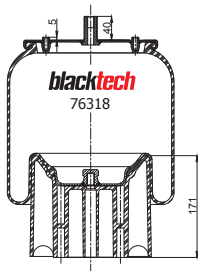

Top View

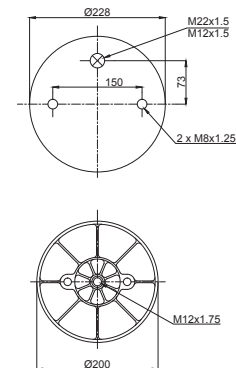

- Bolt or Stud
- Threaded hole
- ⊗ Combination Stud
- ⊗ Air Inlet

OEM PART NUMBER		MODEL NO	CROSS REFERENCES	
Weweler	US06318F		Firestone Style	1T15 MPW-9
Schmitz	016512		Firestone No.	W01 M68 6318

### RML 76420



Cross Section View

Top View

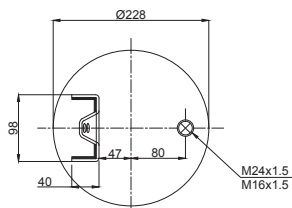
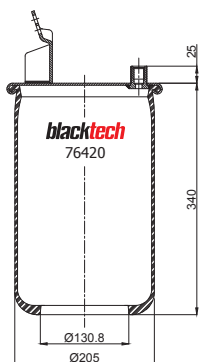

- Bolt or Stud
- Threaded hole
- ⊗ Combination Stud
- ⊗ Air Inlet

OEM PART NUMBER	MODEL NO	CROSS REFERENCES
Volvo		

### RML 76420 C



Cross Section View

Top View

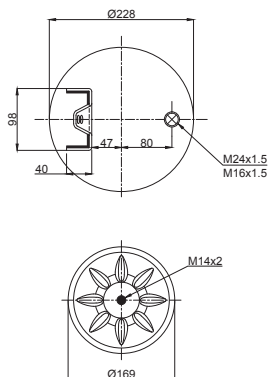
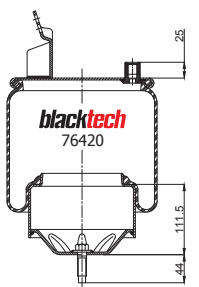

- Bolt or Stud
- Threaded hole
- ⊗ Combination Stud
- ⊗ Air Inlet

OEM PART NUMBER	MODEL NO	CROSS REFERENCES
Volvo	20 531 988	FH 12 low
Volvo	20 582 212	FM / FH low
Volvo	21 961 447	FM / FH low
Volvo	20 427 805	
Volvo	20 427 804	

### RML 76884 C



Cross Section View

Top View

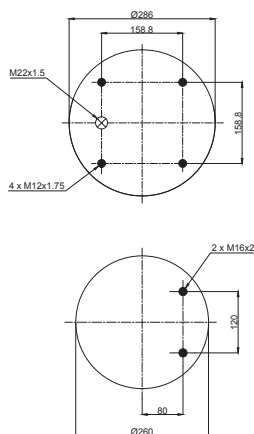
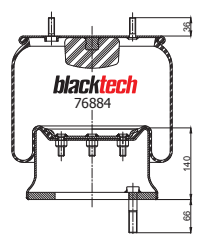

- Bolt or Stud
- Threaded hole
- ⊗ Combination Stud
- ⊗ Air Inlet

OEM PART NUMBER	MODEL NO	CROSS REFERENCES
Zorzi	1006546	Firestone Style
Bertoja	46311001	Firestone No.
Stefen	M04010495	Phoenix
Acerbis - Viberti	128147109	CF Gamma Ref.
		CF Gamma No.

**RML 76885 C**

Cross Section View

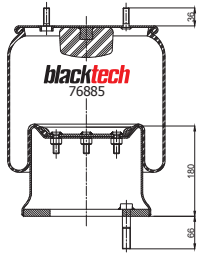

Top View

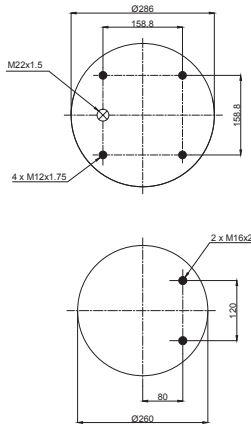

- Bolt or Stud
- Threaded hole
- ⊗ Combination Stud
- ⊗ Air Inlet



OEM PART NUMBER	MODEL NO	CROSS REFERENCES	
Zorzi 1006545		Firestone Style	1T19 L-11
		Firestone No.	W01 M58 8794
		Phoenix	1DK 28 B-8
		CF Gomma Ref.	1T19 E-2
		CF Gomma No.	96885

**RML 77179**

Cross Section View

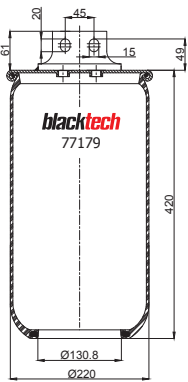

Top View

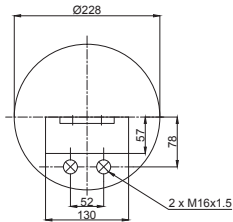

- Bolt or Stud
- Threaded hole
- ⊗ Combination Stud
- ⊗ Air Inlet



OEM PART NUMBER	MODEL NO	CROSS REFERENCES	
Iveco 42566303	Stralis Carro 6x2C	CF Gomma Ref.	1TS 270-25 C

**RML 77179 CP**

Cross Section View

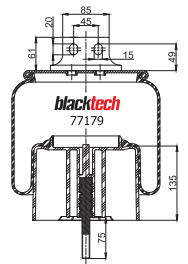

Top View

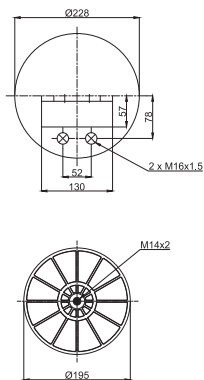

- Bolt or Stud
- Threaded hole
- ⊗ Combination Stud
- ⊗ Air Inlet



OEM PART NUMBER	MODEL NO	CROSS REFERENCES	
Iveco 41297179	Stralis Carro 6x2C	CF Gomma Ref.	1TS 270-25 C
		Firestone No.	207163

### RML 77180



Cross Section View

Top View

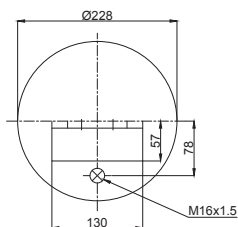
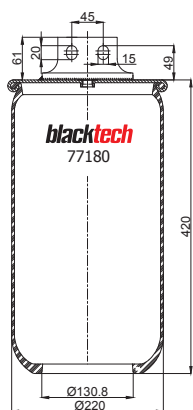

- Bolt or Stud
- Threaded hole
- ⊗ Combination Stud
- ⊗ Air Inlet

OEM PART NUMBER	MODEL NO	CROSS REFERENCES	
Iveco	42566304	Stralis Carro 6x2C	CF Gomma Ref. 1TS 270-25 C
			Firestone No. 207333

### RML 77180 CP



Cross Section View

Top View

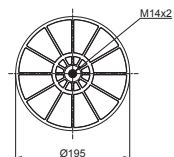
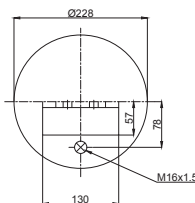
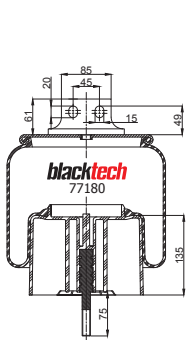

- Bolt or Stud
- Threaded hole
- ⊗ Combination Stud
- ⊗ Air Inlet

OEM PART NUMBER	MODEL NO	CROSS REFERENCES	
Iveco	41297180	Stralis Carro 6x2C	CF Gomma Ref. 1TS 270-25 C
			Firestone No. 207162

### RML 77283



Cross Section View

Top View

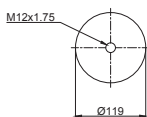
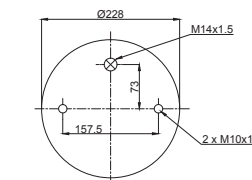
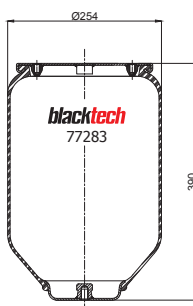

- Bolt or Stud
- Threaded hole
- ⊗ Combination Stud
- ⊗ Air Inlet

OEM PART NUMBER	MODEL NO	CROSS REFERENCES	
Scania			

**RML 77283 C**



Cross Section View

Top View

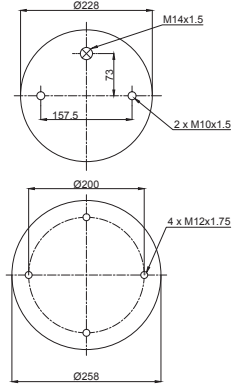
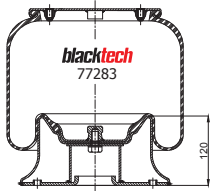

- Bolt or Stud
- Threaded hole
- ⊗ Combination Stud
- ⊗ Air Inlet

OEM PART NUMBER	MODEL NO	CROSS REFERENCES
Scania		

**RML 77283 CP**



Cross Section View

Top View

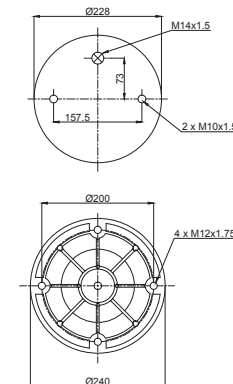
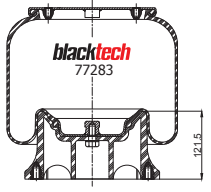

- Bolt or Stud
- Threaded hole
- ⊗ Combination Stud
- ⊗ Air Inlet

OEM PART NUMBER	MODEL NO	CROSS REFERENCES
Scania	1320151	Firestone Style 1T15 M-4 Firestone No. W01 M68 7283

**RML 77308**



Cross Section View

Top View

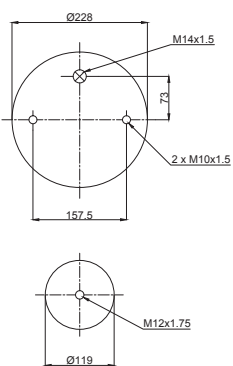
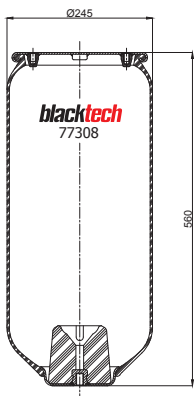

- Bolt or Stud
- Threaded hole
- ⊗ Combination Stud
- ⊗ Air Inlet

OEM PART NUMBER	MODEL NO	CROSS REFERENCES
Scania		
Weweler		

### RML 77308 C



Cross Section View

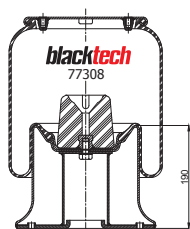

Top View

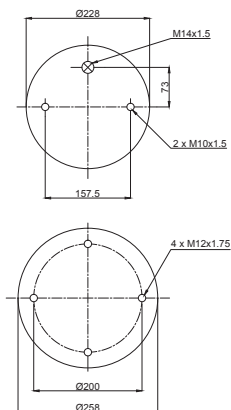

- Bolt or Stud
- Threaded hole
- ⊗ Combination Stud
- ⊗ Air Inlet

OEM PART NUMBER	MODEL NO	CROSS REFERENCES
Scania		
Weweler		

### RML 77308 CP



Cross Section View

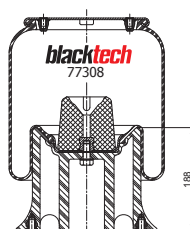

Top View

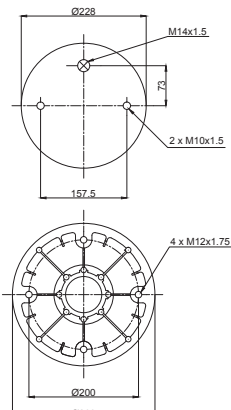

- Bolt or Stud
- Threaded hole
- ⊗ Combination Stud
- ⊗ Air Inlet

OEM PART NUMBER	MODEL NO	CROSS REFERENCES
Scania	1314905	Firestone Style 1T15 M-9
scania	1327144	Firestone No. W01 M68 7308
Scania	255294	Phoenix 1DK 23 L-7308
Scania	345879	Goodyear 1R12-713
Weweler	US07348	

### RML 77313



Cross Section View

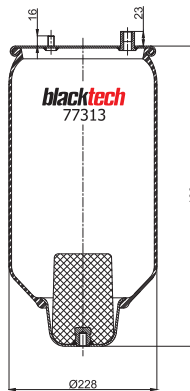

Top View

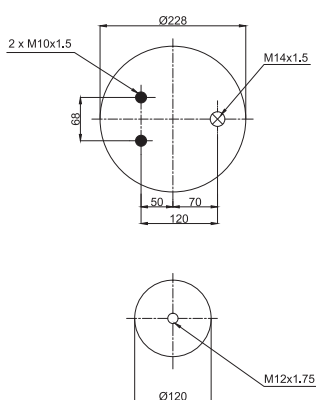

- Bolt or Stud
- Threaded hole
- ⊗ Combination Stud
- ⊗ Air Inlet

OEM PART NUMBER	MODEL NO	CROSS REFERENCES
Iveco		
Neway		

**RML 77313 CP**



Cross Section View

Top View

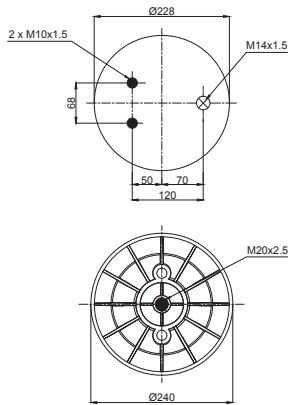
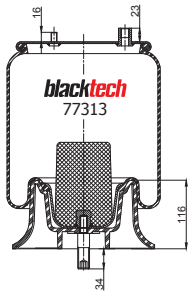

- Bolt or Stud
- Threaded hole
- ⊗ Combination Stud
- ⊗ Air Inlet

OEM PART NUMBER	MODEL NO	CROSS REFERENCES	
Iveco	99458555	Firestone Style	1T15 AA-6
Iveco	99458557	Firestone No.	W01 M58 7313
Neway	M0557019		
Neway	M0557020		
Neway	M0557030		
Neway	M0557031		

**RML 77315**



Cross Section View

Top View

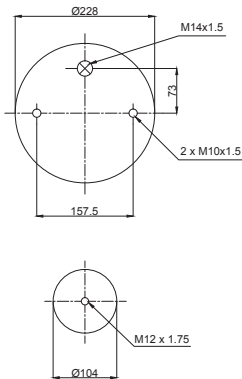
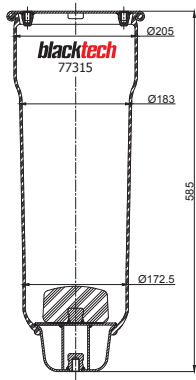

- Bolt or Stud
- Threaded hole
- ⊗ Combination Stud
- ⊗ Air Inlet

OEM PART NUMBER	MODEL NO	CROSS REFERENCES	
Scania	Series 4		

**RML 77315 C**



Cross Section View

Top View

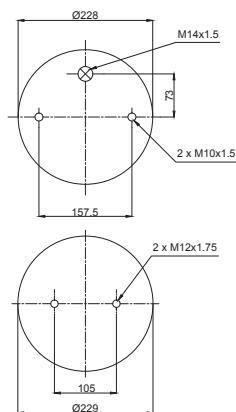
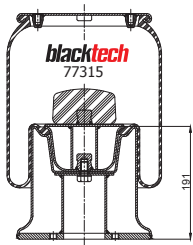

- Bolt or Stud
- Threaded hole
- ⊗ Combination Stud
- ⊗ Air Inlet

OEM PART NUMBER	MODEL NO	CROSS REFERENCES	
Scania	1314904	Series 4	Firestone Style 1T15 Lux-11
Scania	277696	Series 4	Firestone No. W01 M58 7315



### RML 77315 CP



Cross Section View

Top View

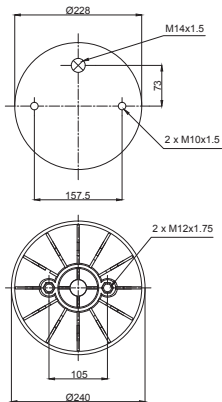
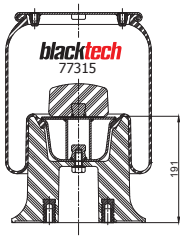

- Bolt or Stud
- Threaded hole
- ⊗ Combination Stud
- ⊗ Air Inlet

OEM PART NUMBER	MODEL NO	CROSS REFERENCES
Scania	Series 4	

### RML 77348



Cross Section View

Top View

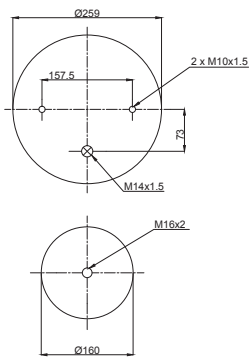
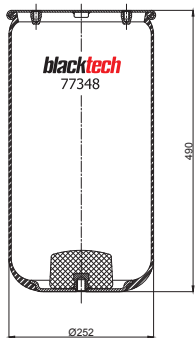

- Bolt or Stud
- Threaded hole
- ⊗ Combination Stud
- ⊗ Air Inlet

OEM PART NUMBER	MODEL NO	CROSS REFERENCES
Scania		

### RML 77348 C



Cross Section View

Top View

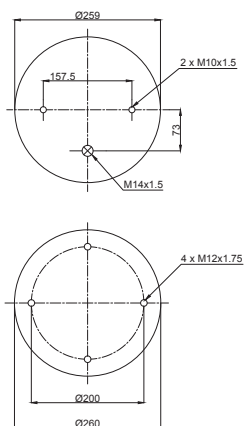
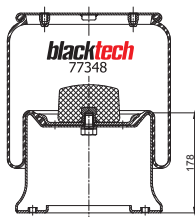

- Bolt or Stud
- Threaded hole
- ⊗ Combination Stud
- ⊗ Air Inlet

OEM PART NUMBER	MODEL NO	CROSS REFERENCES
Scania	1865757	

**RML 77415 C**



Cross Section View

Top View

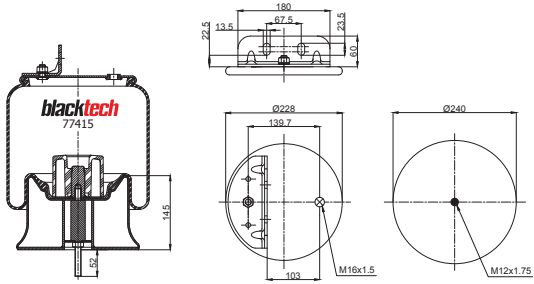

- Bolt or Stud
- Threaded hole
- ⊗ Combination Stud
- ⊗ Air Inlet

OEM PART NUMBER	MODEL NO	CROSS REFERENCES	
Iveco	504117415	Vibracoustic	V ID 23 G-5

**RML 77433**



Cross Section View

Top View

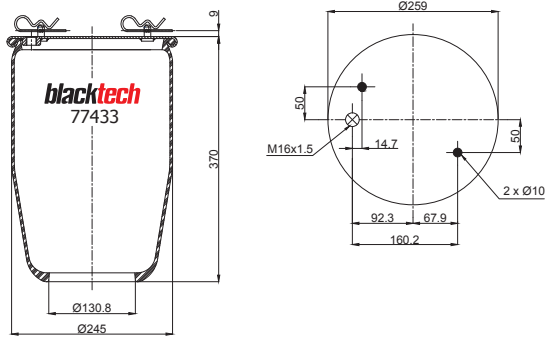

- Bolt or Stud
- Threaded hole
- ⊗ Combination Stud
- ⊗ Air Inlet

OEM PART NUMBER	MODEL NO	CROSS REFERENCES	
Volvo	20703452	Goodyear	1R12-826
Volvo	21013010		
Volvo	21513836		

**RML 77433 C**



Cross Section View

Top View

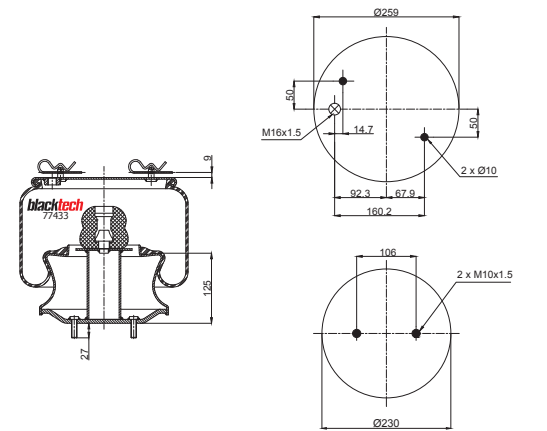

- Bolt or Stud
- Threaded hole
- ⊗ Combination Stud
- ⊗ Air Inlet

OEM PART NUMBER	MODEL NO	CROSS REFERENCES	
Volvo	21513833	Goodyear	1R12-825
Volvo	21097433		
Volvo	70311683		

### RML 77527



Cross Section View

Top View

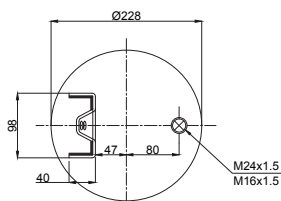
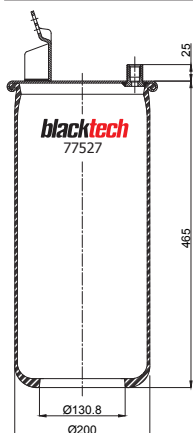

- Bolt or Stud
- Threaded hole
- ⊗ Combination Stud
- ⊗ Air Inlet

OEM PART NUMBER		MODEL NO	CROSS REFERENCES	
Volvo	1076416		Contitech	6416 N

### RML 77527 C



Cross Section View

Top View

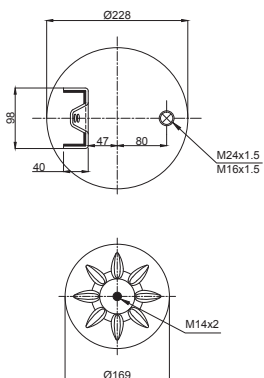
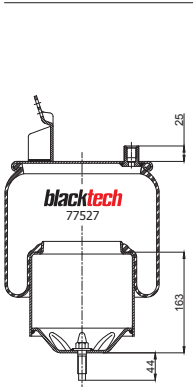

- Bolt or Stud
- Threaded hole
- ⊗ Combination Stud
- ⊗ Air Inlet

OEM PART NUMBER		MODEL NO	CROSS REFERENCES	
Volvo	1 075 891	FH 12	Contitech	6608 N P01
Volvo	1 076 416	FH 12	Phoenix	1DF 17 B-1
Volvo	20 374 510	FH 12	Primeride	56608 A P01
Volvo	20 456 152	FH 12	Firestone Style	1T15UR-9
Volvo	20 531 985	FH 12	Firestone No.	W01-M58-8474
Volvo	20 582 215	FM / FH standard	Goodyear	1R10-704
Volvo	70 321 693	FH 12	Vibracoustic	V1DF16D-1
Volvo	21 961 456	FM / FH standard	Gart. Ref.	C295/V
			Gart. No.	2951.465

### RML 77529



Cross Section View

Top View

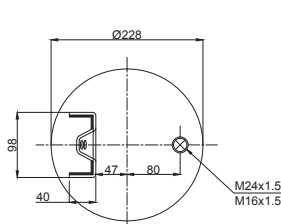
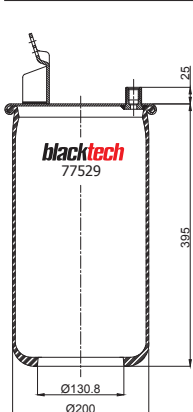

- Bolt or Stud
- Threaded hole
- ⊗ Combination Stud
- ⊗ Air Inlet

OEM PART NUMBER		MODEL NO	CROSS REFERENCES	
Volvo				

**RML 77529 C**



Cross Section View

Top View

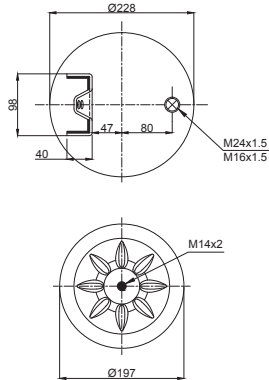
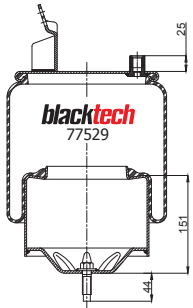

- Bolt or Stud
- Threaded hole
- ⊗ Combination Stud
- ⊗ Air Inlet

OEM PART NUMBER	MODEL NO	CROSS REFERENCES		
Volvo 1 076 418	FH medium	Contitech	6607 NP01	
Volvo 20 374 511	FH 12 medium	Phoenix	1DF 17 A-1	
Volvo 20 456 156	FH 12 medium	Primeride	56607 A P01	
Volvo 20 531 987	FH 12 medium	Firestone Style	1T15UR-6	
Volvo 20 582 214	FM / FH medium	Firestone No.	W01-M58-8473	
Volvo 3 171 695	FH medium	Goodyear	1R10-707	
Volvo 70 321 695	FH medium	Vibracoustic	V1DF16C-1	
Volvo 21 961 451	FM / FH medium	Gart Ref.	C294/VA	
		Gart No.	2951.400	

**RML 77639 C**



Cross Section View

Top View

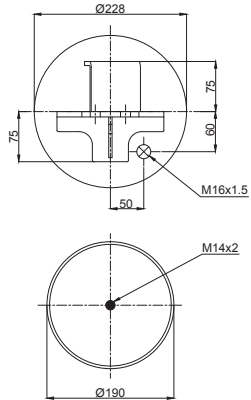
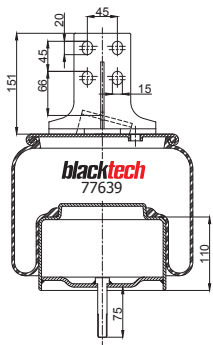

- Bolt or Stud
- Threaded hole
- ⊗ Combination Stud
- ⊗ Air Inlet

OEM PART NUMBER	MODEL NO	CROSS REFERENCES		
Iveco 41289367	Irs Bus	CF Gomma Ref.	1TS 270-23 C	
		CF Gomma No.	207537	

**RML 77639 C1**



Cross Section View

Top View

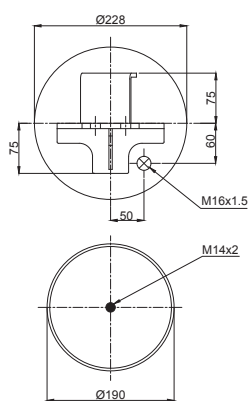
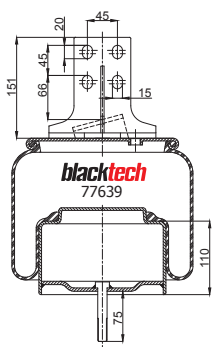

- Bolt or Stud
- Threaded hole
- ⊗ Combination Stud
- ⊗ Air Inlet

OEM PART NUMBER	MODEL NO	CROSS REFERENCES		
Iveco 41289366	Irs Bus	CF Gomma Ref.	1TS 270-23 C	
		CF Gomma No.	207538	

### RML 77685 C



Cross Section View

Top View

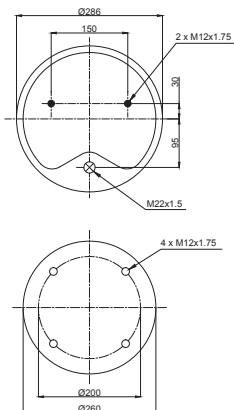
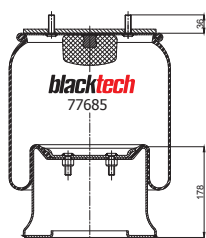

- Bolt or Stud
- Threaded hole
- ⊗ Combination Stud
- ⊗ Air Inlet

OEM PART NUMBER		MODEL NO	CROSS REFERENCES	
Schmitz	US04031		Goodyear	1R14-784
			Phoenix	1D 28 F5
			Vibracoustic	V 1D 28 F5

### RML 77804



Cross Section View

Top View

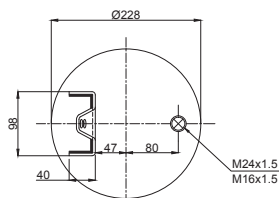
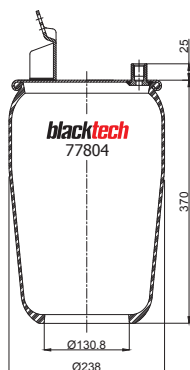

- Bolt or Stud
- Threaded hole
- ⊗ Combination Stud
- ⊗ Air Inlet

OEM PART NUMBER		MODEL NO	CROSS REFERENCES	
Volvo	20427804		Contitech	7804 N

### RML 77804 C



Cross Section View

Top View

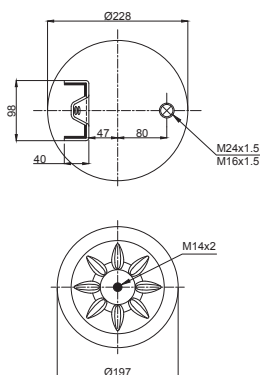
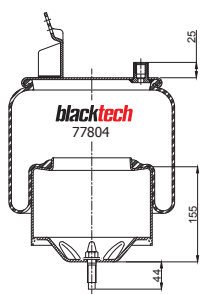

- Bolt or Stud
- Threaded hole
- ⊗ Combination Stud
- ⊗ Air Inlet

OEM PART NUMBER		MODEL NO	CROSS REFERENCES	
Volvo	20 375 227	FH 12 medium	Contitech	6606 N P01
Volvo	20 456 154	FH 12 medium	Phoenix	1DF 20 E-1
Volvo	20 531 986	FH 12 medium	Primeride	56606 A P01
Volvo	20 582 209	FM / FH medium	Firestone Style	1T15LNR-3
Volvo	3 171 694	FH medium	Firestone No.	W01-M58-8477
Volvo	70 321 694	FH medium	Goodyear	1R11-848
Volvo	20 427 801	FH 12 medium	Vibracoustic	V1DF20A-1
Volvo	21 961 443	FM / FH medium	Gart Ref.	C294/VA
Volvo	20 427 805		Gart No.	294.1.370
Volvo	20 427 804			

**RML 77805**



Cross Section View

Top View

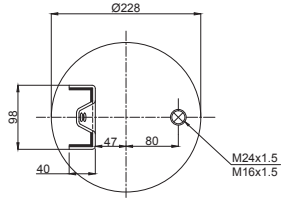
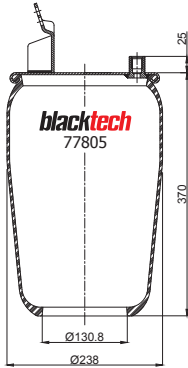

- Bolt or Stud
- Threaded hole
- ⊗ Combination Stud
- ⊗ Air Inlet

OEM PART NUMBER		MODEL NO	CROSS REFERENCES	
Volvo			Contitech	7805 N

**RML 77805 C**



Cross Section View

Top View

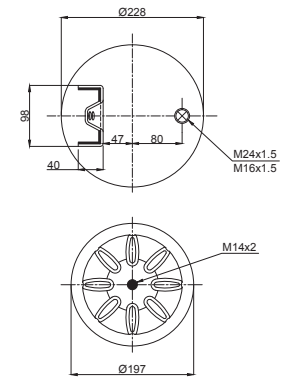
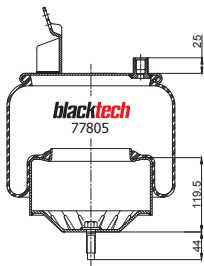

- Bolt or Stud
- Threaded hole
- ⊗ Combination Stud
- ⊗ Air Inlet

OEM PART NUMBER		MODEL NO	CROSS REFERENCES	
Volvo	20 531 988	FH 12 low	Contitech	6606 N P02
Volvo	20 582 212	FM / FH low		
Volvo	21 961 447	FM / FH low		
Volvo	20 427 805			
Volvo	20 427 804			

**RML 78188**



Cross Section View

Top View

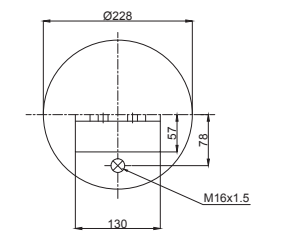
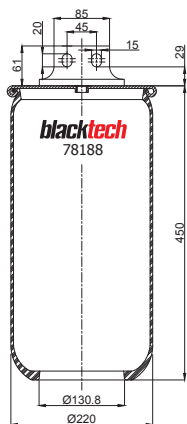

- Bolt or Stud
- Threaded hole
- ⊗ Combination Stud
- ⊗ Air Inlet

OEM PART NUMBER		MODEL NO	CROSS REFERENCES	
Iveco	42568188		CF Gomma Ref.	1TS 270-26
			CF Gomma No.	207949

### RML 78188 C



Cross Section View

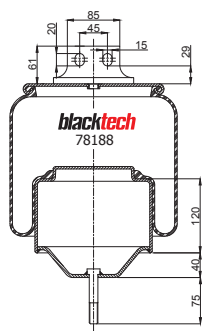

Top View

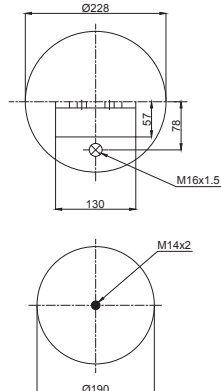

- Bolt or Stud
- Threaded hole
- ⊗ Combination Stud
- ⊗ Air Inlet

OEM PART NUMBER	MODEL NO	CROSS REFERENCES	
Iveco	41289377	CF Gomma Ref.	1TS 270-26
		CF Gomma No.	207530

### RML 78263



Cross Section View

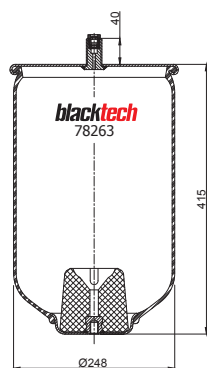

Top View

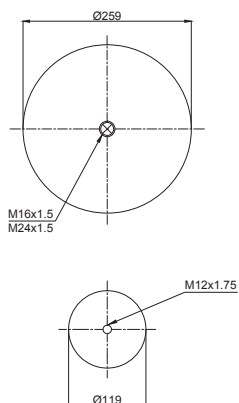

- Bolt or Stud
- Threaded hole
- ⊗ Combination Stud
- ⊗ Air Inlet

OEM PART NUMBER	MODEL NO	CROSS REFERENCES	
Hendrickson			

### RML 78263 C



Cross Section View

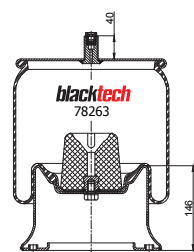

Top View

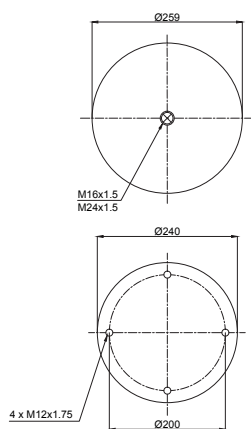

- Bolt or Stud
- Threaded hole
- ⊗ Combination Stud
- ⊗ Air Inlet

OEM PART NUMBER	MODEL NO	CROSS REFERENCES	
Hendrickson	HS508263	Goodyear	1R11-847
Mercedes	A 942 320 59 21	Vibracoustic	V 1DK 22 G-1

**RML 78385**



Cross Section View

Top View

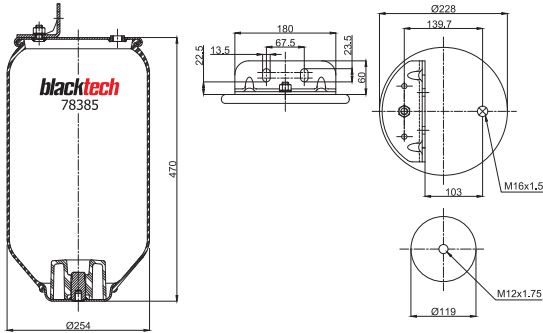

- Bolt or Stud
- Threaded hole
- ⊗ Combination Stud
- ⊗ Air Inlet

OEM PART NUMBER	MODEL NO	CROSS REFERENCES
Hendrickson		

**RML 78385 G**



Cross Section View

Top View

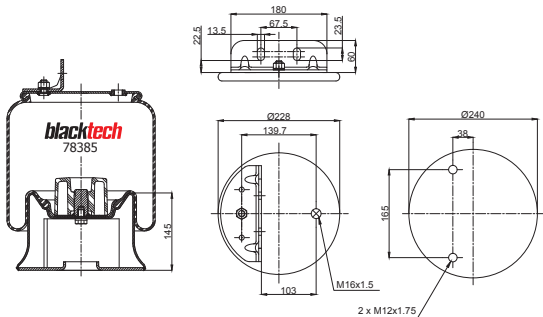

- Bolt or Stud
- Threaded hole
- ⊗ Combination Stud
- ⊗ Air Inlet

OEM PART NUMBER	MODEL NO	CROSS REFERENCES
Hendrickson	HS508385	Vibracoustic V ID 23 G-4 WB

**RML 78586**



Cross Section View

Top View

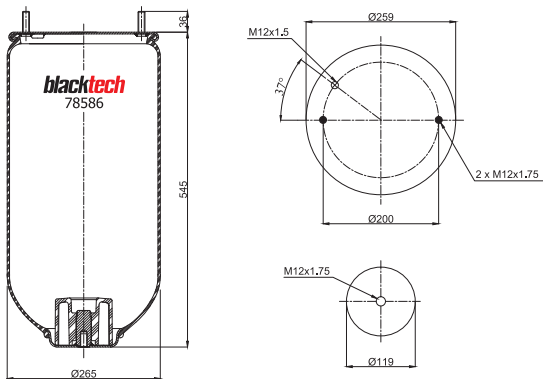

- Bolt or Stud
- Threaded hole
- ⊗ Combination Stud
- ⊗ Air Inlet

OEM PART NUMBER	MODEL NO	CROSS REFERENCES
Hendrickson		



### RML 78586 CP



Cross Section View

Top View

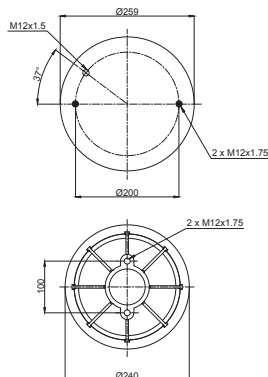
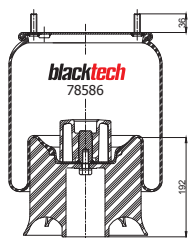

- Bolt or Stud
- Threaded hole
- ⊗ Combination Stud
- ⊗ Air Inlet

OEM PART NUMBER	MODEL NO	CROSS REFERENCES	
Hendrickson		Firestone Style	1T17 BPZ-11
		Firestone No.	W01 R88 8586

### RML 78599 CP



Cross Section View

Top View

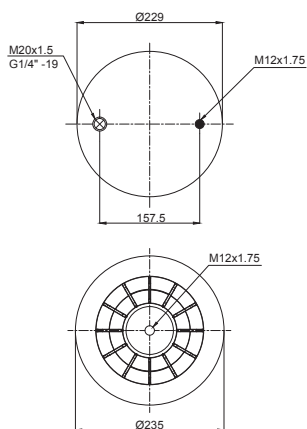
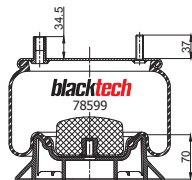

- Bolt or Stud
- Threaded hole
- ⊗ Combination Stud
- ⊗ Air Inlet

OEM PART NUMBER	MODEL NO	CROSS REFERENCES	
Goldschmitt	DLB 8599		

### RML 78608



Cross Section View

Top View

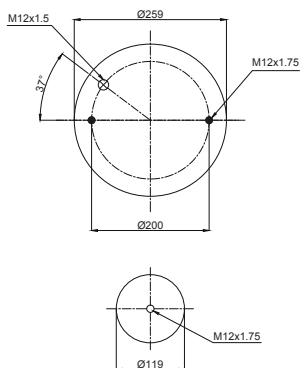
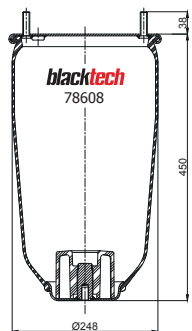

- Bolt or Stud
- Threaded hole
- ⊗ Combination Stud
- ⊗ Air Inlet

OEM PART NUMBER	MODEL NO	CROSS REFERENCES	
ROR Meritor			

**RML 78608 CP**



Cross Section View

Top View

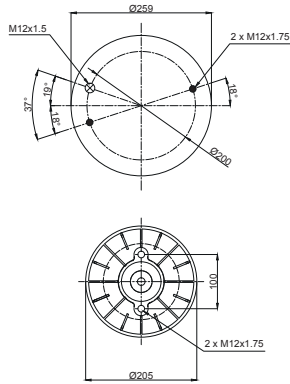
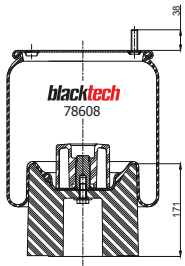

- Bolt or Stud
- Threaded hole
- ⊗ Combination Stud
- ⊗ Air Inlet

OEM PART NUMBER	MODEL NO	CROSS REFERENCES	
ROR Meritor	21229214	Firestone Style	1T17 DJ-7
		Firestone No.	W01 M58 8608

**RML 78633 C**



Cross Section View

Top View

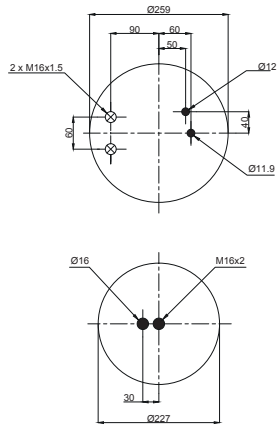
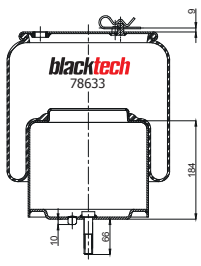

- Bolt or Stud
- Threaded hole
- ⊗ Combination Stud
- ⊗ Air Inlet

OEM PART NUMBER	MODEL NO	CROSS REFERENCES	
Scania	1434933	Firestone Style	1T17 HR
		Firestone No.	W01 M58 8633

**RML 78643**



Cross Section View

Top View

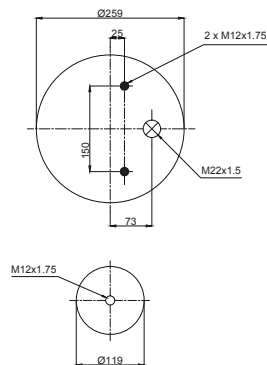
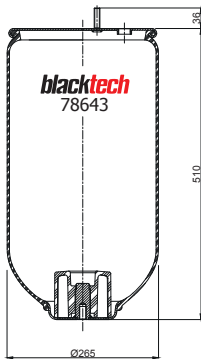

- Bolt or Stud
- Threaded hole
- ⊗ Combination Stud
- ⊗ Air Inlet

OEM PART NUMBER	MODEL NO	CROSS REFERENCES	
Hendrickson			

### RML 78643 C



Cross Section View

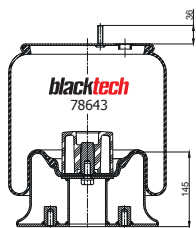

Top View

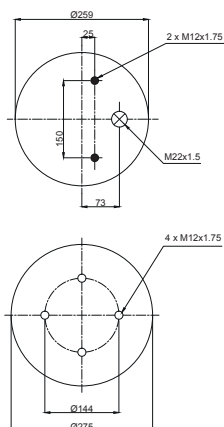

- Bolt or Stud
- Threaded hole
- ⊗ Combination Stud
- ⊗ Air Inlet

OEM PART NUMBER	MODEL NO	CROSS REFERENCES	
Hendrickson	QE 100004/F	Firestone Style	1T17 CL-9.5
		Firestone No.	W01 M58 8643
		Goodyear	1R13-167

### RML 78653 CP



Cross Section View

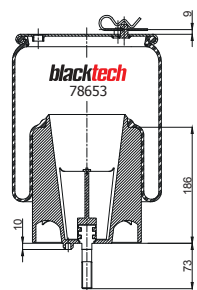

Top View

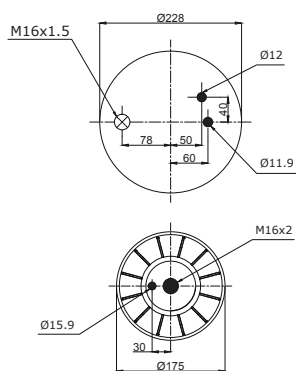

- Bolt or Stud
- Threaded hole
- ⊗ Combination Stud
- ⊗ Air Inlet

OEM PART NUMBER	MODEL NO	CROSS REFERENCES	
Scania	1434930	Firestone Style	1T15 UR-9
		Firestone No.	W01 M58 8653

### RML 78887 C



Cross Section View

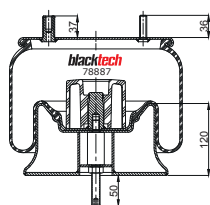

Top View

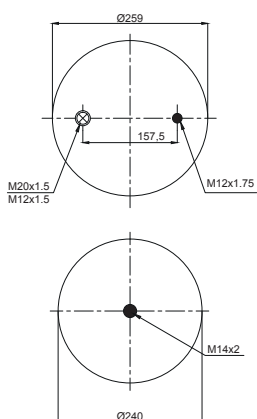

- Bolt or Stud
- Threaded hole
- ⊗ Combination Stud
- ⊗ Air Inlet

OEM PART NUMBER	MODEL NO	CROSS REFERENCES	
BMC	57RS308887	Vibracoustic	V 1DK 27 B-1
FORD		T 1835 Front	

**RML 78888 C**



Cross Section View

Top View

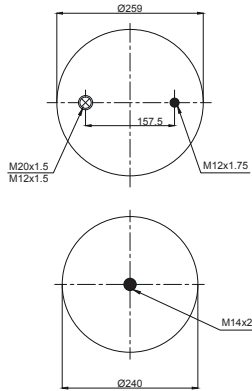
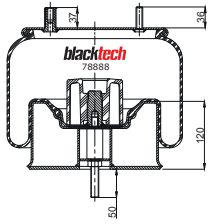

- Bolt or Stud
- Threaded hole
- ⊗ Combination Stud
- ⊗ Air Inlet

OEM PART NUMBER		MODEL NO	CROSS REFERENCES	
BMC	57RS308888		Vibracoustic	V 1DK 27 B-2
FORD		T 1835 Rear		

**RML 78914**



Cross Section View

Top View

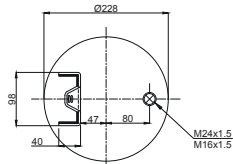
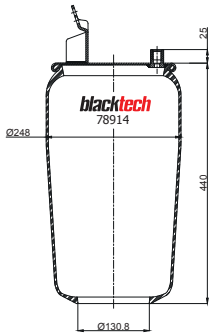

- Bolt or Stud
- Threaded hole
- ⊗ Combination Stud
- ⊗ Air Inlet

OEM PART NUMBER		MODEL NO	CROSS REFERENCES	
Volvo	20427803		Contitech	7803 N

**RML 78914 C**



Cross Section View

Top View

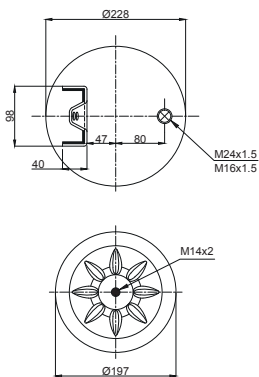
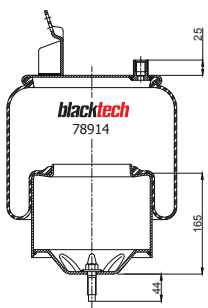

- Bolt or Stud
- Threaded hole
- ⊗ Combination Stud
- ⊗ Air Inlet

OEM PART NUMBER		MODEL NO	CROSS REFERENCES	
Volvo	1 075 890	FH standard	Contitech	6605 N P01
Volvo	1 076 415	FH 12	Phoenix	1DF 20 D-1
Volvo	20 375 226	FH standard	Primeride	56605 A P01
Volvo	20 427 800	FH standard	Firestone Style	1T15LNR-6
Volvo	20 456 150	FH standard	Firestone No.	W01-M58-8472
Volvo	20 531 984	FH standard	Goodyear	1R11-805
Volvo	20 582 206	FM / FH standard	Vibracoustic	V1DF20B-1
Volvo	21 961 374	FM / FH standard	Dunlop F	D11B42
			Gart Ref.	C294/V
			Gart No.	2941430

### RML 79002 A3

Cross Section View

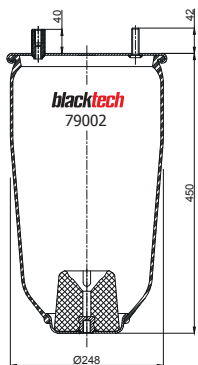

Top View

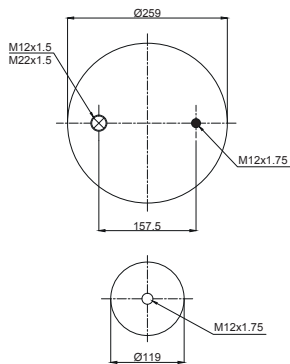

- Bolt or Stud
- Threaded hole
- ⊗ Combination Stud
- ⊗ Air Inlet

OEM PART NUMBER	MODEL NO	CROSS REFERENCES
Weweler		

### RML 79002 A3 CP

Cross Section View

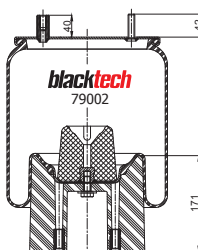

Top View

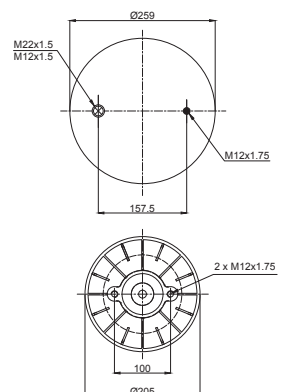

- Bolt or Stud
- Threaded hole
- ⊗ Combination Stud
- ⊗ Air Inlet

OEM PART NUMBER	MODEL NO	CROSS REFERENCES
Weweler	US 08840	AC 524/514
		Contitech 4157 N P05
		Phoenix 1 DK 21 A-3
		Primeride 54157 A P05
		Firestone Style 1T15MPW-7
		Firestone No. W01-M58-8840
		Goodyear 1R11-882
		Goodyear 1R11-866
		Vibracoustic V1DK21A-3
		CF Gomma Ref. 1T323-32
		CF Gomma No. 20778
		Dunlop UK 00980B-AP
		Gart Ref. C294
		Gart No. 294.2.450/1

### RML 79002 A3 CP1

Cross Section View

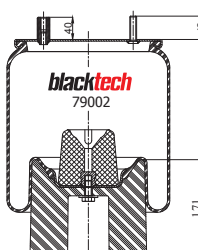

Top View

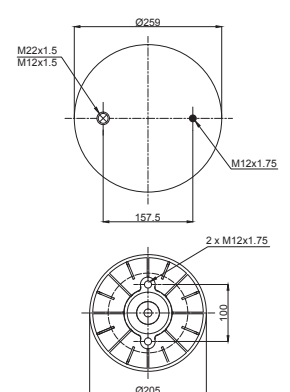

- Bolt or Stud
- Threaded hole
- ⊗ Combination Stud
- ⊗ Air Inlet

OEM PART NUMBER	MODEL NO	CROSS REFERENCES
Weweler		

**RML 79002 A8**

Cross Section View

Top View

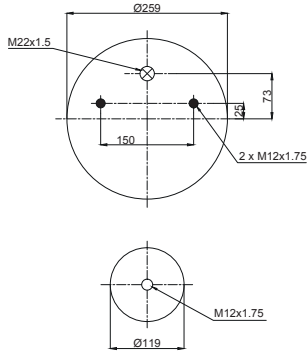
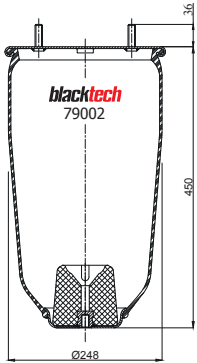

- Bolt or Stud
- Threaded hole
- ⊗ Combination Stud
- ⊗ Air Inlet

OEM PART NUMBER	MODEL NO	CROSS REFERENCES
Weweler		

**RML 79002 A8 CP**

Cross Section View

Top View

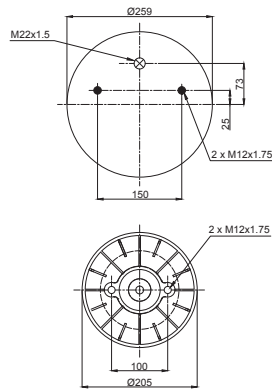
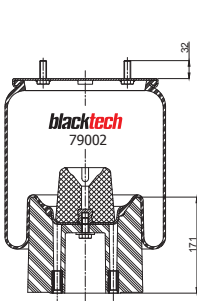

- Bolt or Stud
- Threaded hole
- ⊗ Combination Stud
- ⊗ Air Inlet

OEM PART NUMBER	MODEL NO	CROSS REFERENCES
Weweler	US87 Euro F	Contitech 4157 N P04
		Phoenix 1DK 21 A8 / A4
		Dunlop F D12 B18
		Goodyear 1R11-111
		Taurus KP 915-53 NW
		Vibracoustic V 1DK 21 A-4

**RML 79002 A8 CP1**

Cross Section View

Top View

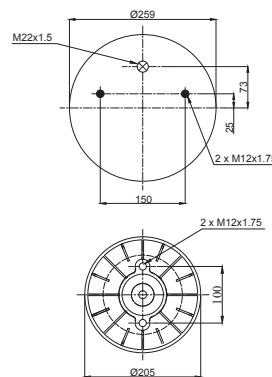
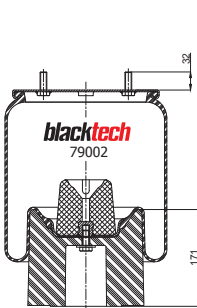

- Bolt or Stud
- Threaded hole
- ⊗ Combination Stud
- ⊗ Air Inlet

OEM PART NUMBER	MODEL NO	CROSS REFERENCES

### RML 79002 CP6



Cross Section View

Top View

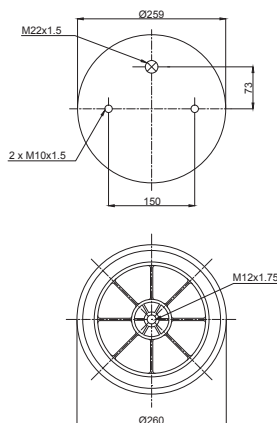
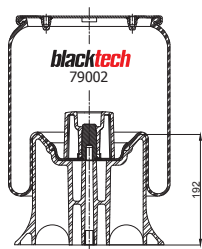

- Bolt or Stud
- Threaded hole
- ⊗ Combination Stud
- ⊗ Air Inlet

OEM PART NUMBER	MODEL NO	CROSS REFERENCES

### RML 79003 A3



Cross Section View

Top View

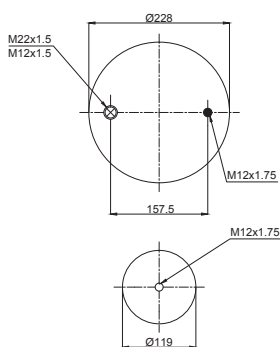
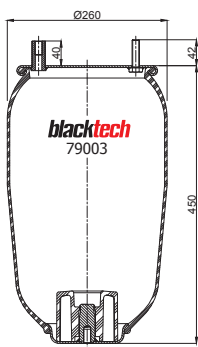

- Bolt or Stud
- Threaded hole
- ⊗ Combination Stud
- ⊗ Air Inlet

OEM PART NUMBER	MODEL NO	CROSS REFERENCES
ROR Meritor		

### RML 79003 A3 CP



Cross Section View

Top View

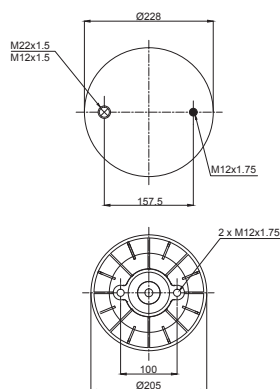
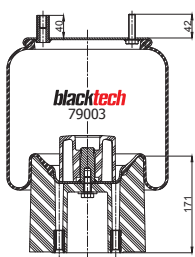

- Bolt or Stud
- Threaded hole
- ⊗ Combination Stud
- ⊗ Air Inlet

OEM PART NUMBER	MODEL NO	CROSS REFERENCES
ROR Meritor		

**RML 79003 A3 CP1**

Cross Section View

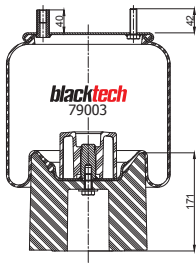

Top View

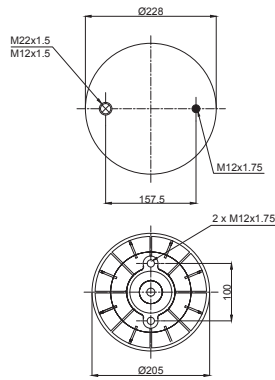

- Bolt or Stud
- Threaded hole
- ⊗ Combination Stud
- ⊗ Air Inlet

OEM PART NUMBER	MODEL NO	CROSS REFERENCES	
ROR Meritor	21222442	Firestone Style	1T15 MPW-7
Weweler	US 07074C	AC 524 / 514	Firestone No. W01 M68 7074
Weweler	US 07074P	AC 524 / 514	

**RML 79003 A8**

Cross Section View

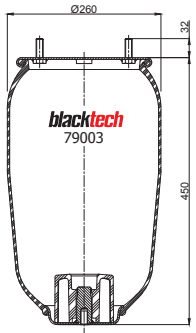

Top View

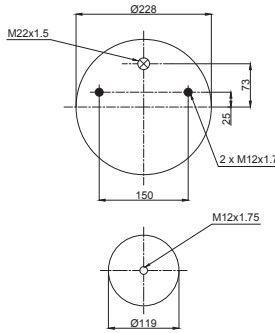

- Bolt or Stud
- Threaded hole
- ⊗ Combination Stud
- ⊗ Air Inlet

OEM PART NUMBER	MODEL NO	CROSS REFERENCES	
ROR Meritor			

**RML 79003 A8 CP**

Cross Section View

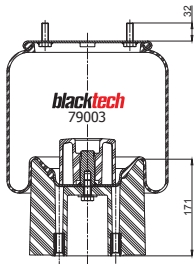

Top View

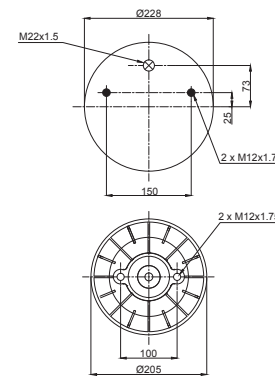

- Bolt or Stud
- Threaded hole
- ⊗ Combination Stud
- ⊗ Air Inlet

OEM PART NUMBER	MODEL NO	CROSS REFERENCES	
ROR Meritor	21221307	Firestone Style	1T15 MPW-7
		Firestone No.	W01 M68 6297



### RML 79003 A8 CP1



Cross Section View

Top View

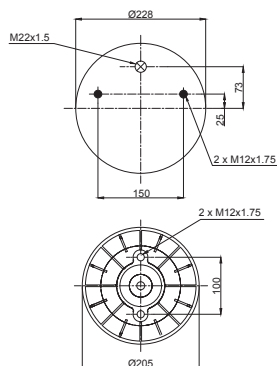
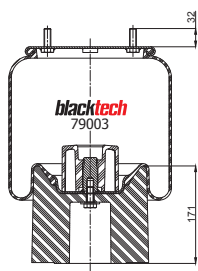

- Bolt or Stud
- Threaded hole
- ⊗ Combination Stud
- ⊗ Air Inlet

OEM PART NUMBER	MODEL NO	CROSS REFERENCES	
ROR Meritor			

### RML 79198 C



Cross Section View

Top View

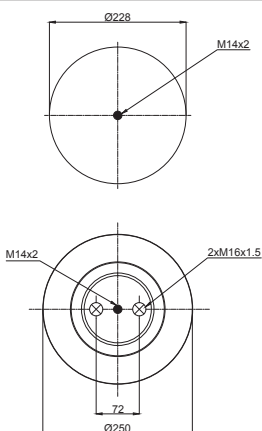
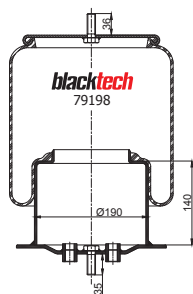

- Bolt or Stud
- Threaded hole
- ⊗ Combination Stud
- ⊗ Air Inlet

OEM PART NUMBER	MODEL NO	CROSS REFERENCES	
Iveco	41298919	CF Gomma Ref.	1TS 270-27 C
		CF Gomma No.	207405

### RML 79198 C1



Cross Section View

Top View

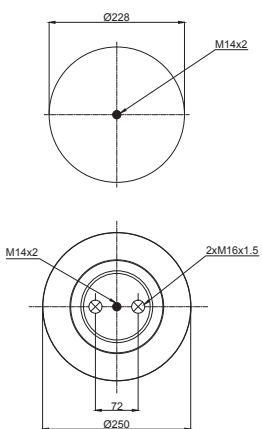
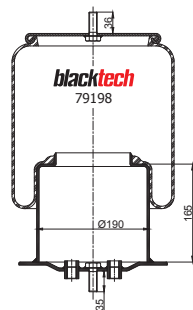

- Bolt or Stud
- Threaded hole
- ⊗ Combination Stud
- ⊗ Air Inlet

OEM PART NUMBER	MODEL NO	CROSS REFERENCES	
Iveco	41298917	CF Gomma Ref.	1TS 270-27 C
		CF Gomma No.	207406

**RML 79296**

Cross Section View

Top View

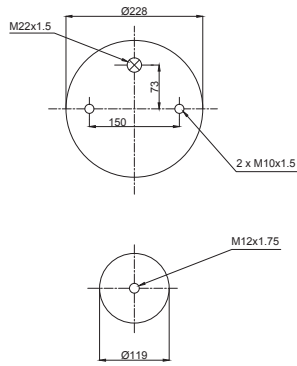
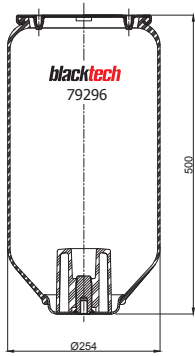

- Bolt or Stud
- Threaded hole
- ⊗ Combination Stud
- ⊗ Air Inlet

OEM PART NUMBER	MODEL NO	CROSS REFERENCES	
		Firestone Style	1T 15 MPW-9
		Firestone No.	W01 M58 6257
		Phoenix	1DK 20 B-1
		Goodyear	1R12-748
		Dunlop F	D12 U23

**RML 79296 C**

Cross Section View

Top View

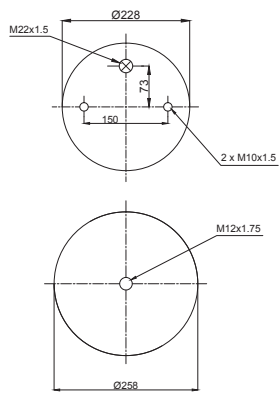
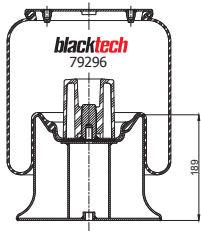

- Bolt or Stud
- Threaded hole
- ⊗ Combination Stud
- ⊗ Air Inlet

OEM PART NUMBER	MODEL NO	CROSS REFERENCES	
Neway		Firestone Style	1T 15 MPW-9
		Firestone No.	W01 M58 8185

**RML 79296 CP**

Cross Section View

Top View

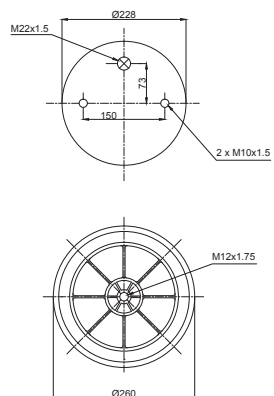
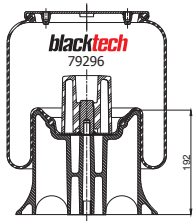

- Bolt or Stud
- Threaded hole
- ⊗ Combination Stud
- ⊗ Air Inlet

OEM PART NUMBER	MODEL NO	CROSS REFERENCES	
Schmitz	750999	Conlittech	4158 N P03
Schmitz	014892	Firestone Style	1T 15 MPW-9
Weweler	US 06285	Firestone No.	W01 M58 8185
		Goodyear	1R12-749
		Dunlop F	D12 B22

### RML 79328 C



Cross Section View

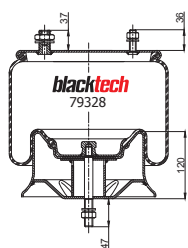

Top View

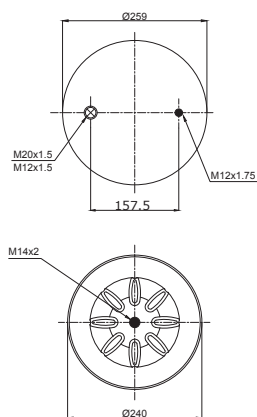

- Bolt or Stud
- Threaded hole
- ⊗ Combination Stud
- ⊗ Air Inlet

OEM PART NUMBER		MODEL NO	CROSS REFERENCES	
Hendrickson	HS 509328		Vibracoustic	V 1DK 27 B-6

### RML 79720



Cross Section View

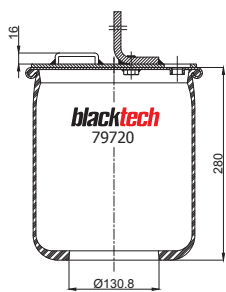

Top View

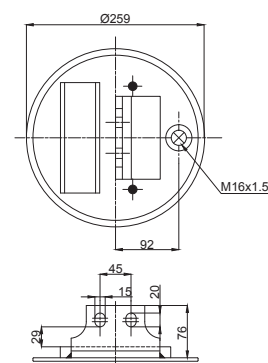

- Bolt or Stud
- Threaded hole
- ⊗ Combination Stud
- ⊗ Air Inlet

OEM PART NUMBER		MODEL NO	CROSS REFERENCES	
Iveco	42559720		CF Gomma Ref.	1TS 290-19 C
			CF Gomma No.	207617

### RML 79720 C



Cross Section View

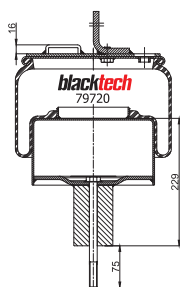

Top View

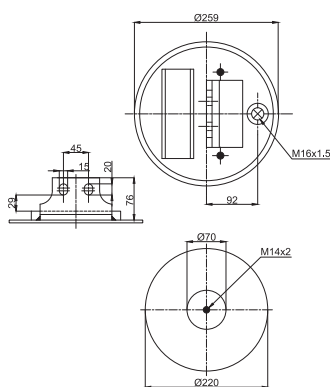

- Bolt or Stud
- Threaded hole
- ⊗ Combination Stud
- ⊗ Air Inlet

OEM PART NUMBER		MODEL NO	CROSS REFERENCES	
Iveco	41298716		CF Gomma Ref.	1TS 290-19 C
			CF Gomma No.	207410

**RML 79722-1**



Cross Section View

Top View

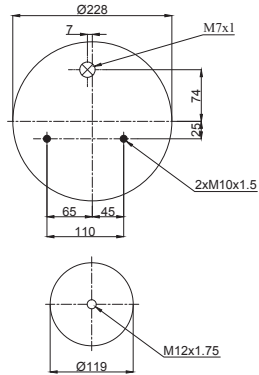
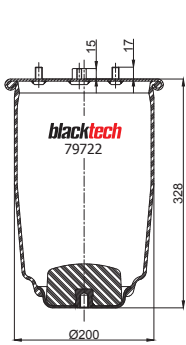

- Bolt or Stud
- Threaded hole
- ⊗ Combination Stud
- ⊗ Air Inlet

OEM PART NUMBER	MODEL NO	CROSS REFERENCES	
Iveco	42559722	CF Gomma Ref.	1T 240-20 LM
		CF Gomma No.	207619

**RML 79722-2**



Cross Section View

Top View

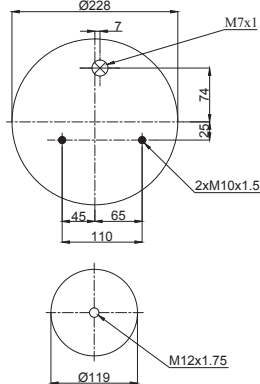
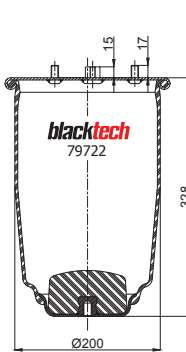

- Bolt or Stud
- Threaded hole
- ⊗ Combination Stud
- ⊗ Air Inlet

OEM PART NUMBER	MODEL NO	CROSS REFERENCES	
Iveco	42559776	CF Gomma Ref.	1T 240-20 LM
		CF Gomma No.	207620

**RML 79722 CP1**



Cross Section View

Top View

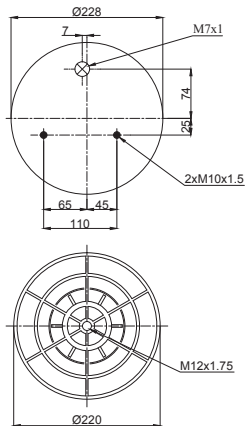
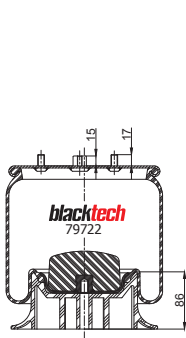

- Bolt or Stud
- Threaded hole
- ⊗ Combination Stud
- ⊗ Air Inlet

OEM PART NUMBER	MODEL NO	CROSS REFERENCES	
Iveco	504190916	CF Gomma Ref.	1T 240-20 SINISTRA
		CF Gomma No.	207113

**RML 79722 CP2**



Cross Section View

Top View

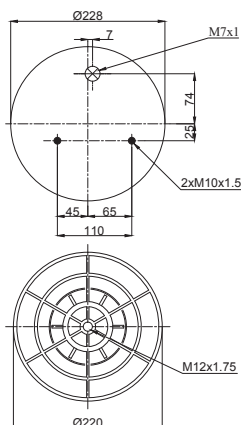
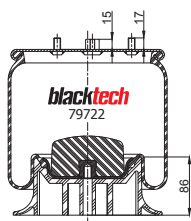

- Bolt or Stud
- Threaded hole
- ⊗ Combination Stud
- ⊗ Air Inlet

OEM PART NUMBER	MODEL NO	CROSS REFERENCES	
Iveco	504190917	CF Gamma Ref.	1T 240-20 DESTRA
		CF Gamma No.	207112

**RML 79739**



Cross Section View

Top View

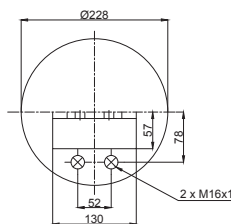
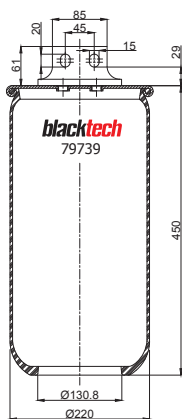

- Bolt or Stud
- Threaded hole
- ⊗ Combination Stud
- ⊗ Air Inlet

OEM PART NUMBER	MODEL NO	CROSS REFERENCES	
Iveco	42568189	CF Gamma Ref.	1TS 270- 26
		CF Gamma No.	MD11601

**RML 79739 C**



Cross Section View

Top View

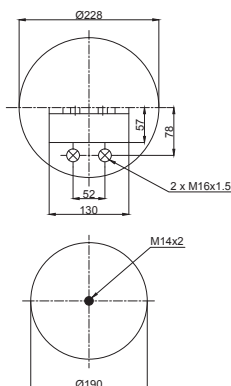
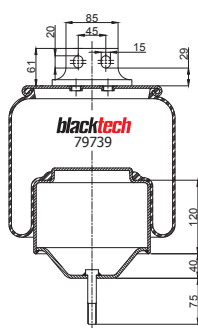

- Bolt or Stud
- Threaded hole
- ⊗ Combination Stud
- ⊗ Air Inlet

OEM PART NUMBER	MODEL NO	CROSS REFERENCES	
Iveco	41289379	CF Gamma Ref.	1TS 270- 26
		CF Gamma No.	207529

**RML 79910 C**



Cross Section View

Top View

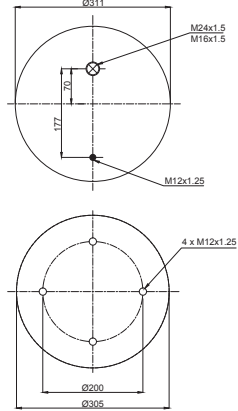
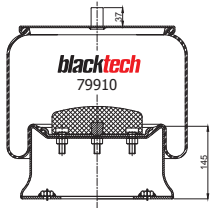

- Bolt or Stud
- Threaded hole
- ⊗ Combination Stud
- ⊗ Air Inlet

OEM PART NUMBER	MODEL NO	CROSS REFERENCES	
Neway	MQ057000G	Firestone Style	1T19 G-12
		Firestone No.	W01 M58 9910

**RML 9027 C**



Cross Section View

Top View

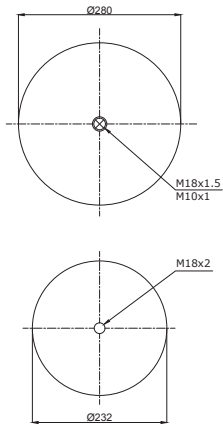
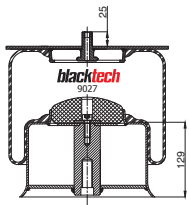

- Bolt or Stud
- Threaded hole
- ⊗ Combination Stud
- ⊗ Air Inlet

OEM PART NUMBER	MODEL NO	CROSS REFERENCES	
MAN			
Temsa			

**RML 9032 C**



Cross Section View

Top View

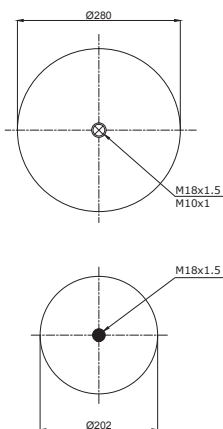
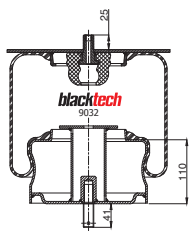

- Bolt or Stud
- Threaded hole
- ⊗ Combination Stud
- ⊗ Air Inlet

OEM PART NUMBER	MODEL NO	CROSS REFERENCES	
Temsa	Bus		

### RML 9032 C3



Cross Section View

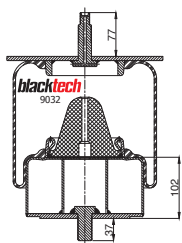

Top View

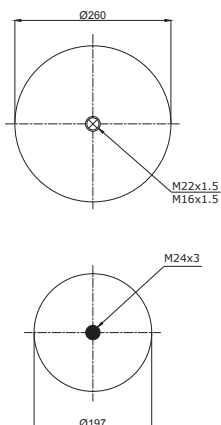

- Bolt or Stud
- Threaded hole
- ⊗ Combination Stud
- ⊗ Air Inlet

OEM PART NUMBER		MODEL NO	CROSS REFERENCES	
BMC	53RS900131	Bus		

### RML 9032 C4



Cross Section View

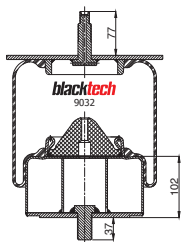

Top View

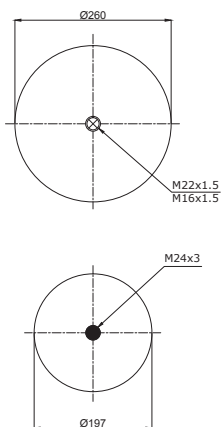

- Bolt or Stud
- Threaded hole
- ⊗ Combination Stud
- ⊗ Air Inlet

OEM PART NUMBER		MODEL NO	CROSS REFERENCES	
BMC	53RS900144	Bus		

### RML 9032 C5



Cross Section View

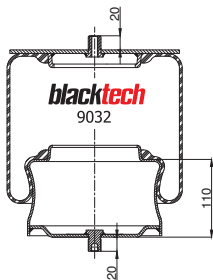

Top View

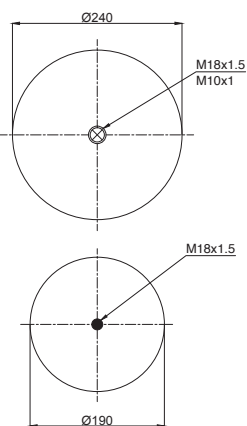

- Bolt or Stud
- Threaded hole
- ⊗ Combination Stud
- ⊗ Air Inlet

OEM PART NUMBER		MODEL NO	CROSS REFERENCES	
Iveco	5010151378	PR 100	Contitech	921 M

**RML 9755 C2**



Cross Section View

Top View

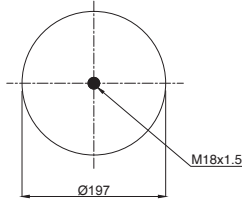
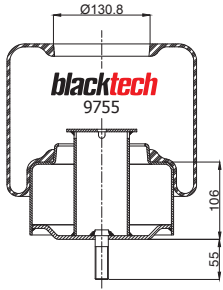

- Bolt or Stud
- Threaded hole
- ⊗ Combination Stud
- ⊗ Air Inlet

OEM PART NUMBER	MODEL NO	CROSS REFERENCES

**RML 9755 C3**



Cross Section View

Top View

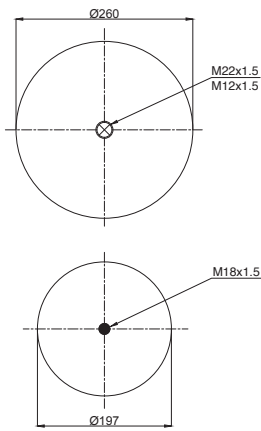
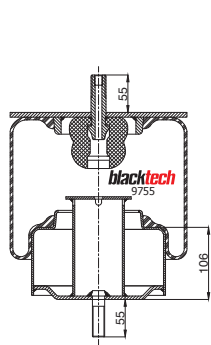

- Bolt or Stud
- Threaded hole
- ⊗ Combination Stud
- ⊗ Air Inlet

OEM PART NUMBER	MODEL NO	CROSS REFERENCES
BMC	53RS900144	Bus

**RML 9755 C4**



Cross Section View

Top View

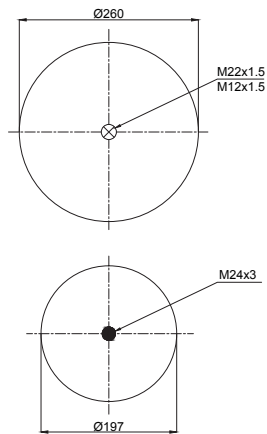
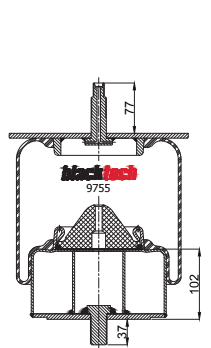

- Bolt or Stud
- Threaded hole
- ⊗ Combination Stud
- ⊗ Air Inlet

OEM PART NUMBER	MODEL NO	CROSS REFERENCES
BMC	BUS	



### RML 9772 C1



Cross Section View

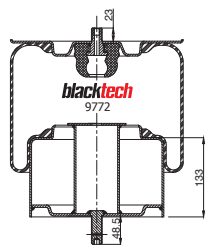

Top View

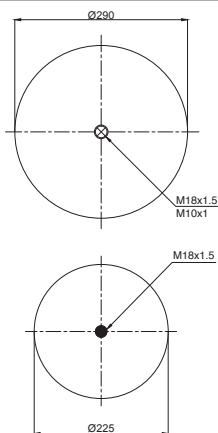

- Bolt or Stud
- Threaded hole
- ⊗

 Combination Stud
- ⊗

 Air Inlet

OEM PART NUMBER		MODEL NO	CROSS REFERENCES	
AYATS	31001569		Contitech	661 N P01
IRISBUS	5.010.073.846	R 333	Vibracoustic	VIE25-8
IRISBUS	5.010.073.846	Tracer		

### RML 9772 C2



Cross Section View

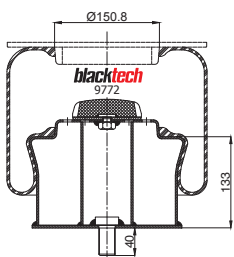

Top View

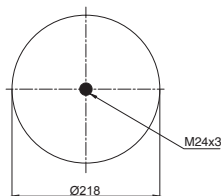

- Bolt or Stud
- Threaded hole
- ⊗

 Combination Stud
- ⊗

 Air Inlet

OEM PART NUMBER		MODEL NO	CROSS REFERENCES	

### RML 9772 C4



Cross Section View

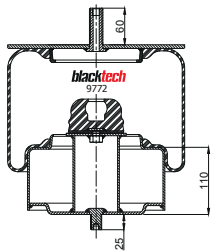

Top View

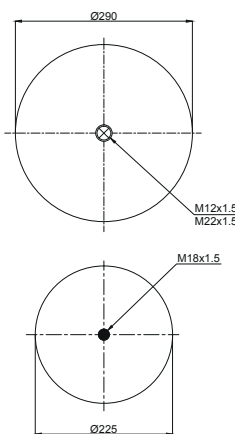

- Bolt or Stud
- Threaded hole
- ⊗

 Combination Stud
- ⊗

 Air Inlet

OEM PART NUMBER		MODEL NO	CROSS REFERENCES	
BMC	53RS900056	Bus		

**RML 9772 C6**



Cross Section View

Top View

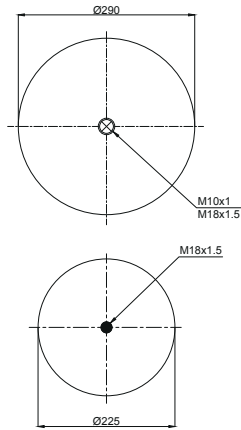
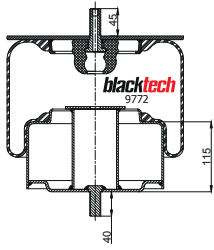

- Bolt or Stud
- Threaded hole
- ⊗ Combination Stud
- ⊗ Air Inlet

OEM PART NUMBER	MODEL NO	CROSS REFERENCES
Otokar	Bus	

**RML 9772 C7**



Cross Section View

Top View

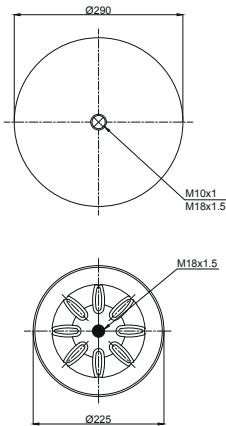
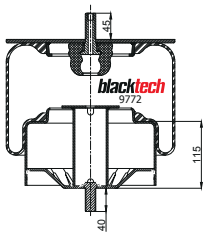

- Bolt or Stud
- Threaded hole
- ⊗ Combination Stud
- ⊗ Air Inlet

OEM PART NUMBER	MODEL NO	CROSS REFERENCES
Otokar	16N00-03650-AB Bus	

**RML 9772 C8**



Cross Section View

Top View

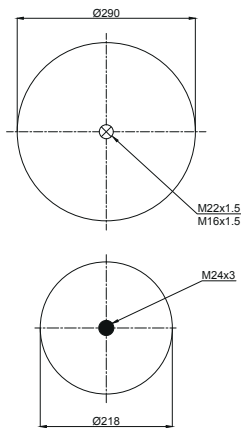
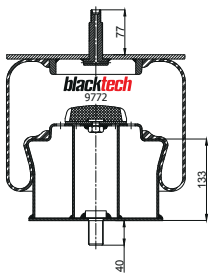

- Bolt or Stud
- Threaded hole
- ⊗ Combination Stud
- ⊗ Air Inlet

OEM PART NUMBER	MODEL NO	CROSS REFERENCES
BMC	53RS900142 Bus	

### RML 9772 C10



Cross Section View

Top View

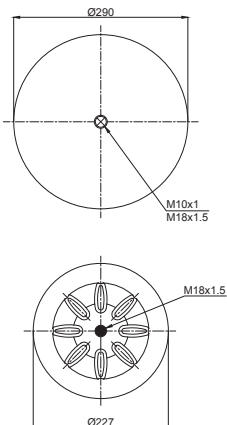
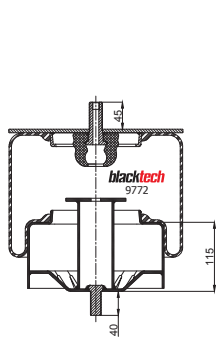

- Bolt or Stud
- Threaded hole
- ⊗ Combination Stud
- ⊗ Air Inlet

OEM PART NUMBER	MODEL NO	CROSS REFERENCES

### RML 9870 C



Cross Section View

Top View

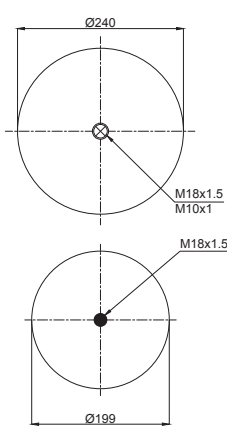
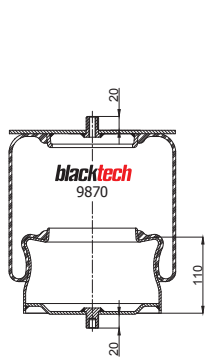

- Bolt or Stud
- Threaded hole
- ⊗ Combination Stud
- ⊗ Air Inlet

OEM PART NUMBER	MODEL NO	CROSS REFERENCES		
IRISBUS	5.000.785.792	PR 100	Contitech	769 M
SNVI	5.000.785.792		Dunlop F	260HDRD
SNVI	5.000.786.641			

### RML 9870 C1



Cross Section View

Top View

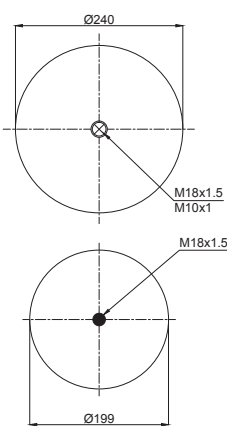
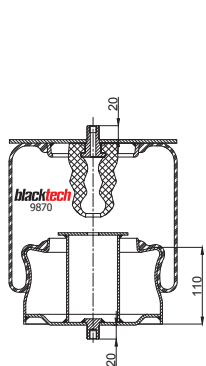

- Bolt or Stud
- Threaded hole
- ⊗ Combination Stud
- ⊗ Air Inlet

OEM PART NUMBER	MODEL NO	CROSS REFERENCES		
IRISBUS	5.000.805.999	PR 100	Contitech	769 MB
			Phoenix	1E 18-02

**RML 9873 C**



Cross Section View

Top View

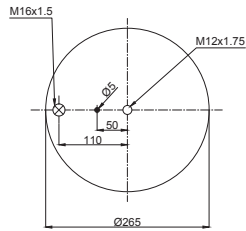
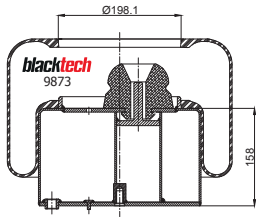

- Bolt or Stud
- Threaded hole
- ⊗ Combination Stud
- ⊗ Air Inlet

OEM PART NUMBER	MODEL NO	CROSS REFERENCES

**RML 9879 C**



Cross Section View

Top View

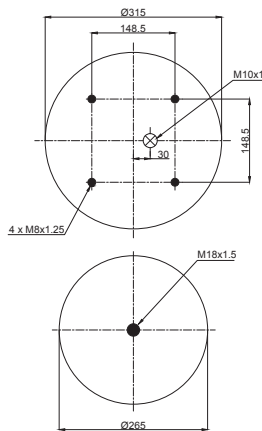
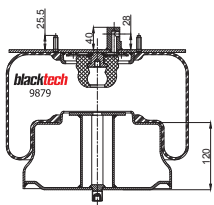

- Bolt or Stud
- Threaded hole
- ⊗ Combination Stud
- ⊗ Air Inlet

OEM PART NUMBER	MODEL NO	CROSS REFERENCES
IRISBUS 5.000.786.516	FR 1	Contitech 768 MB
Renault 5.000.869.135		
IRISBUS 5.000.786.516	FR 1	
Renault 5.000.869.135		

**RML 9886 C**



Cross Section View

Top View

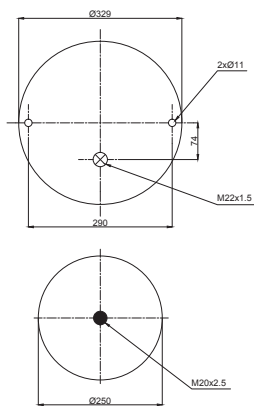
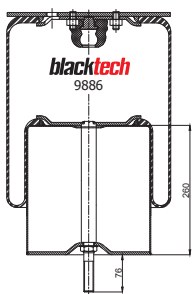

- Bolt or Stud
- Threaded hole
- ⊗ Combination Stud
- ⊗ Air Inlet

OEM PART NUMBER	MODEL NO	CROSS REFERENCES
ZF Sachs		

### RML 9893 C3



Cross Section View

Top View

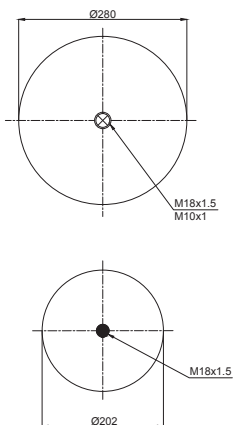
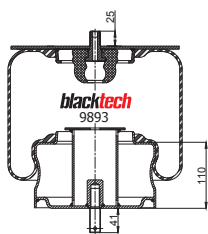

- Bolt or Stud
- Threaded hole
- ⊗ Combination Stud
- ⊗ Air Inlet

OEM PART NUMBER		MODEL NO	CROSS REFERENCES	
IRIS	5.010.190.888		Contitech	782 MB-3
ZF Sachs	0501.210.851		Vibracoustic	VIE21-23
Jonckheere	26.160.2033.00			

### RML 9893 C4



Cross Section View

Top View

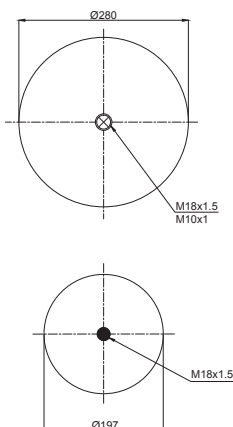
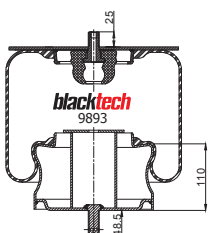

- Bolt or Stud
- Threaded hole
- ⊗ Combination Stud
- ⊗ Air Inlet

OEM PART NUMBER		MODEL NO	CROSS REFERENCES	
IVECO	5010073847		Contitech	782 N P04

### RML 9920 C



Cross Section View

Top View

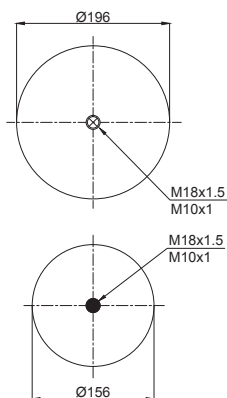
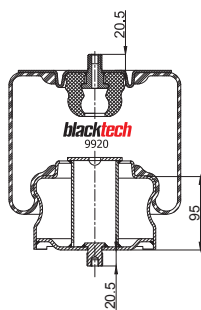

- Bolt or Stud
- Threaded hole
- ⊗ Combination Stud
- ⊗ Air Inlet

OEM PART NUMBER		MODEL NO	CROSS REFERENCES	
Mercedes	A 667 328 01 01	Vario.T0	Contitech	819 MB
Paul NFZ	A 667 328 01 01	Transporter	CF Gomma Ref.	1S 215-22
Temsa	TM260133Y	Opalin	CF Gomma No.	97297

**RML 9928 C**



Cross Section View

Top View

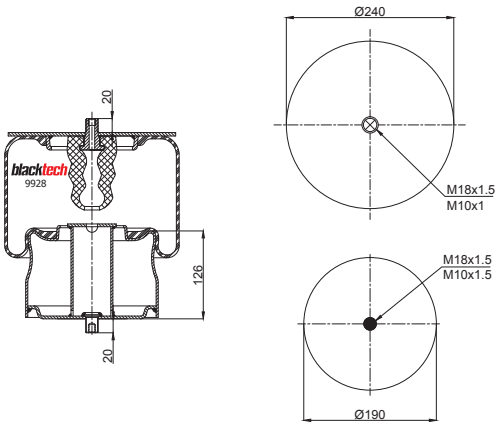

OEM PART NUMBER		MODEL NO	CROSS REFERENCES	
IRISBUS	5.000.786.641	100 V8	Contitech	817 MB
IRISBUS	5.810.111.355	A 320		
IRISBUS	5.000.786.641	100 V8		
IRISBUS	5.810.111.355	A 320		

**RML 9928 C1**



Cross Section View

Top View

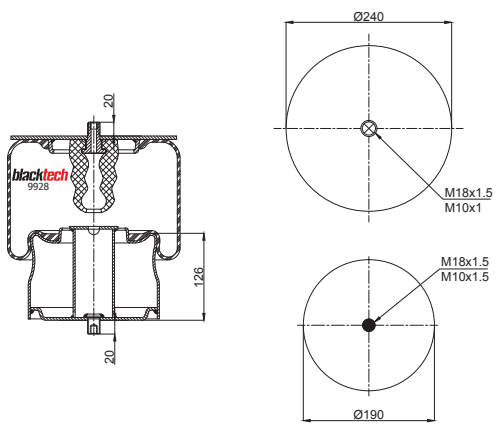

OEM PART NUMBER		MODEL NO	CROSS REFERENCES	
Otokar	99000-33889-AA			

**RML 9987 C**



Cross Section View

Top View

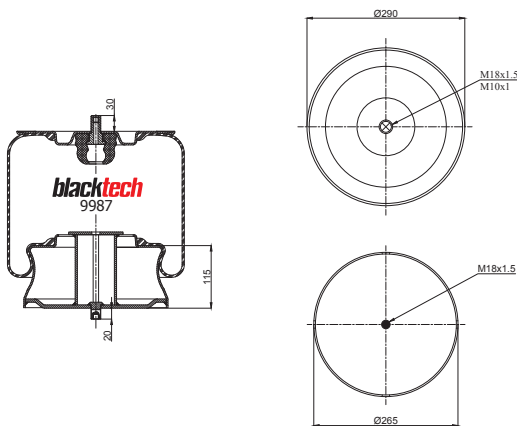

OEM PART NUMBER		MODEL NO	CROSS REFERENCES	
AYATS	30201085		Contitech	876 MB
Renault	5.000.640.399			
AYATS	30201085			
Renault	5.000.640.399			

### RML 92035 C



Cross Section View

Top View

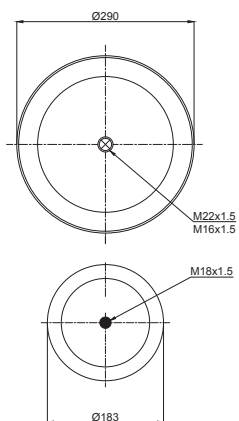
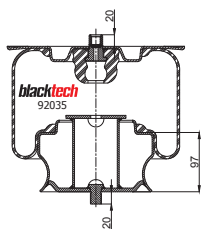

- Bolt or Stud
- Threaded hole
- ⊗ Combination Stud
- ⊗ Air Inlet

OEM PART NUMBER		MODEL NO	CROSS REFERENCES	
Iveco	5010347891	Agora < 2002	Contitech	1924 N1 P05
Heuliez	0001066001		Phoenix	2 F 18-1

### RML 92336 C



Cross Section View

Top View

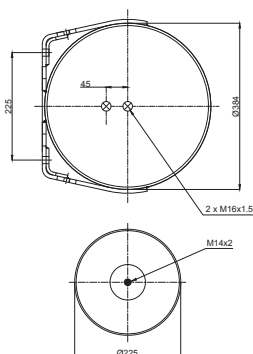
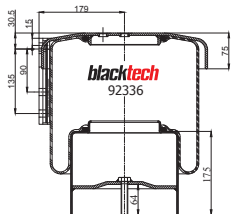

- Bolt or Stud
- Threaded hole
- ⊗ Combination Stud
- ⊗ Air Inlet

OEM PART NUMBER		MODEL NO	CROSS REFERENCES	
Iveco	41026312	Eurostar 240/260	CF Gomma Ref.	1S 323-36 C
		Eurotech 240/260/440	CF Gomma No.	204065
		Eurorider 260		
		Stralis 260		

### RML 92336 CP



Cross Section View

Top View

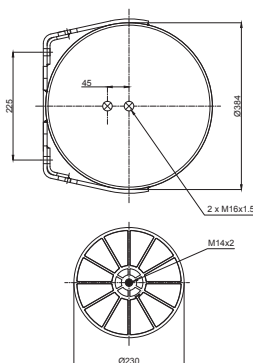
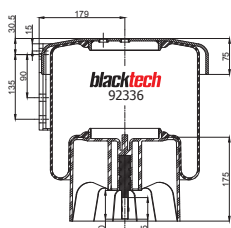

- Bolt or Stud
- Threaded hole
- ⊗ Combination Stud
- ⊗ Air Inlet

OEM PART NUMBER		MODEL NO	CROSS REFERENCES	
Iveco	41297178		CF Gomma Ref.	1S 323-36 C
			CF Gomma No.	207313





### RML 92844 C1



Cross Section View

Top View

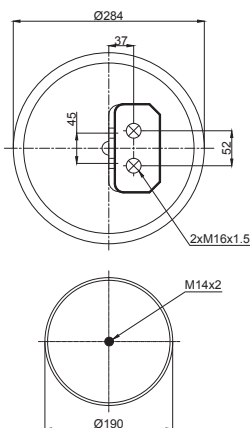
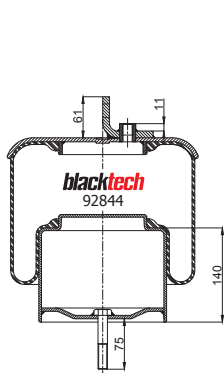

- Bolt or Stud
- Threaded hole
- ⊗ Combination Stud
- ⊗ Air Inlet

OEM PART NUMBER	MODEL NO	CROSS REFERENCES	
Iveco	41026260	Inrs Bus	CF Gomma Ref. DC 1S 270 25 C
			CF Gomma No. 204151

### RML 92996 C



Cross Section View

Top View

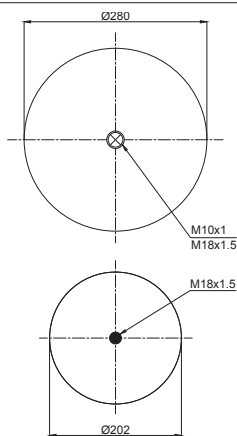
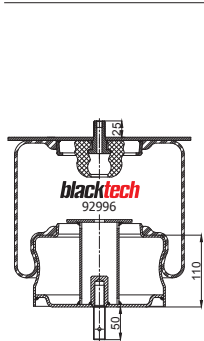

- Bolt or Stud
- Threaded hole
- ⊗ Combination Stud
- ⊗ Air Inlet

OEM PART NUMBER	MODEL NO	CROSS REFERENCES	
MAN			

### RML 93351 C



Cross Section View

Top View

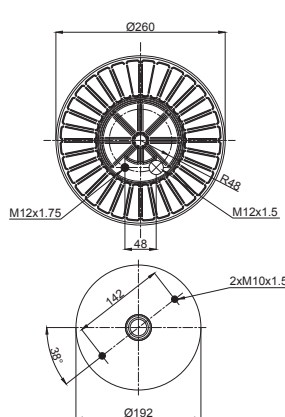
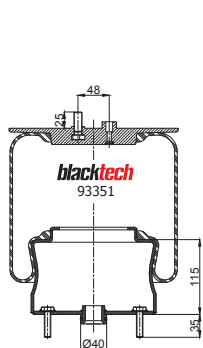

- Bolt or Stud
- Threaded hole
- ⊗ Combination Stud
- ⊗ Air Inlet

OEM PART NUMBER	MODEL NO	CROSS REFERENCES	
Iveco	5006223351	Bus 491	CF Gomma Ref. 1S 270 23 V

**RML 93351 C1**



Cross Section View

Top View

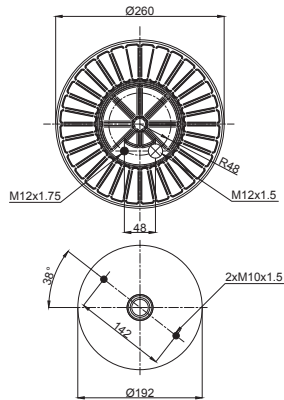
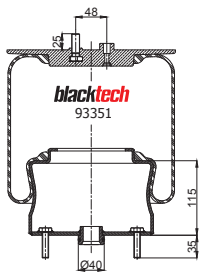

- Bolt or Stud
- Threaded hole
- ⊗ Combination Stud
- ⊗ Air Inlet

OEM PART NUMBER	MODEL NO	CROSS REFERENCES	
Iveco	5006223352	Bus 491	CF Gamma Ref. 1S 270 23 V

**RML 93856 C**



Cross Section View

Top View

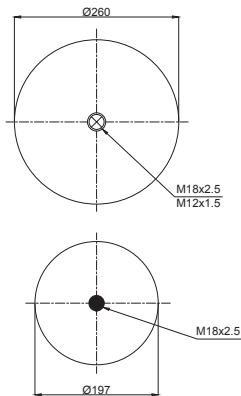
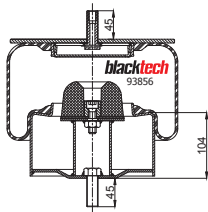

- Bolt or Stud
- Threaded hole
- ⊗ Combination Stud
- ⊗ Air Inlet

OEM PART NUMBER	MODEL NO	CROSS REFERENCES	
Voith	H68.237001		

**RML 93857 C**



Cross Section View

Top View

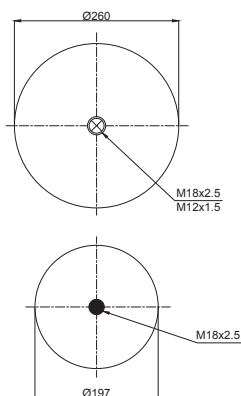
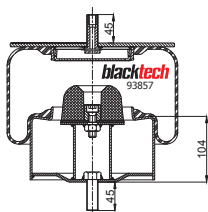

- Bolt or Stud
- Threaded hole
- ⊗ Combination Stud
- ⊗ Air Inlet

OEM PART NUMBER	MODEL NO	CROSS REFERENCES	
ISUZU			

### RML 94098 C



Cross Section View

Top View

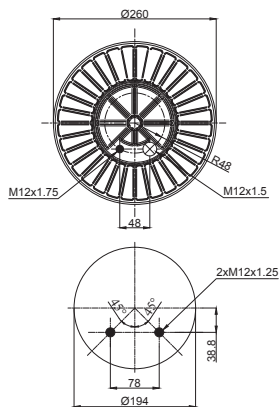
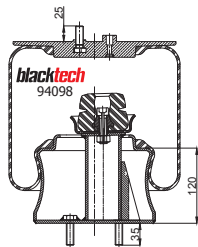

- Bolt or Stud
- Threaded hole
- ⊗ Combination Stud
- ⊗ Air Inlet

OEM PART NUMBER		MODEL NO	CROSS REFERENCES	
Iveco	5006204505	Bus 491 CityClass	CF Gomma Ref.	1S 290 23 V

### RML 95019 C



Cross Section View

Top View

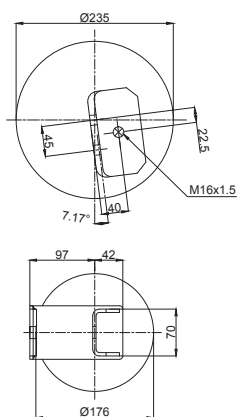
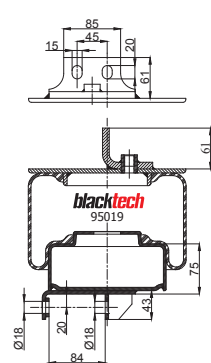

- Bolt or Stud
- Threaded hole
- ⊗ Combination Stud
- ⊗ Air Inlet

OEM PART NUMBER		MODEL NO	CROSS REFERENCES	
Iveco	500355474	Eurostar-Eurotech	CF Gomma Ref.	1SC 250-19
		190/260/440	CF Gomma No.	204660

### RML 95019 C1



Cross Section View

Top View

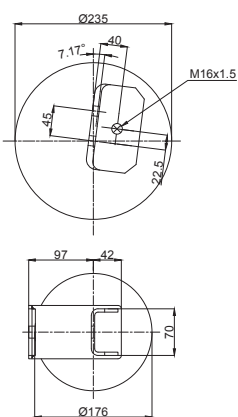
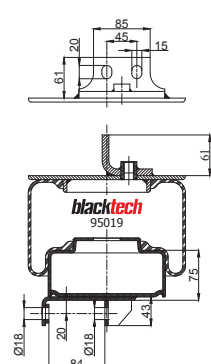

- Bolt or Stud
- Threaded hole
- ⊗ Combination Stud
- ⊗ Air Inlet

OEM PART NUMBER		MODEL NO	CROSS REFERENCES	
Iveco	500355475	Eurostar-Eurotech	CF Gomma Ref.	1SC 250-19
		190/260/440	CF Gomma No.	204886

**RML 95101 C**



Cross Section View

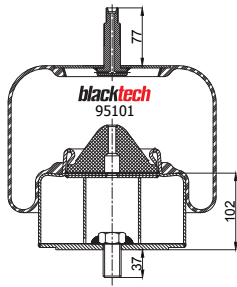

Top View

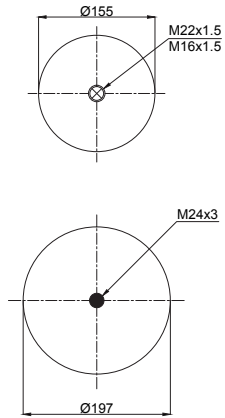

- Bolt or Stud
- Threaded hole
- ⊗ Combination Stud
- ⊗ Air Inlet

OEM PART NUMBER	MODEL NO	CROSS REFERENCES
BMC	53RS900069	

**RML 95101 C2**



Cross Section View

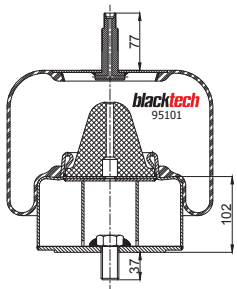

Top View

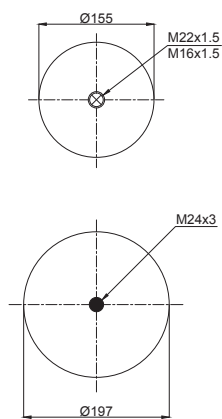

- Bolt or Stud
- Threaded hole
- ⊗ Combination Stud
- ⊗ Air Inlet

OEM PART NUMBER	MODEL NO	CROSS REFERENCES
BMC	53RS900072	

**RML 95294-1**



Cross Section View

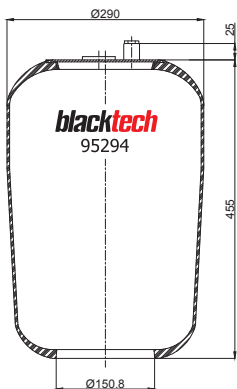

Top View

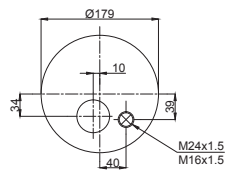

- Bolt or Stud
- Threaded hole
- ⊗ Combination Stud
- ⊗ Air Inlet

OEM PART NUMBER	MODEL NO	CROSS REFERENCES
Mercedes		Conlitech 4183 N3 ( Old 4183 N2 )
Mercedes	Actros MP2 Service Assy.	

### RML 95294-2



Cross Section View

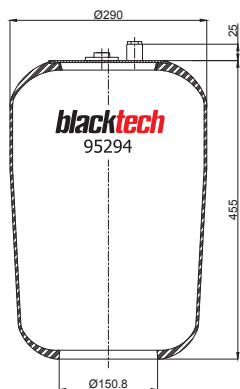

Top View

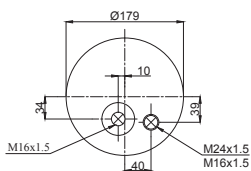

- Bolt or Stud
- Threaded hole
- ⊗ Combination Stud
- ⊗ Air Inlet

OEM PART NUMBER	MODEL NO	CROSS REFERENCES	
Mercedes		Contitech	4183 N4 ( Old 4183 N1 )
Mercedes	Actros MP2 Service Assy.		

### RML 95294 C1



Cross Section View

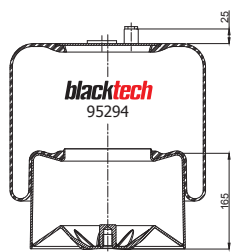

Top View

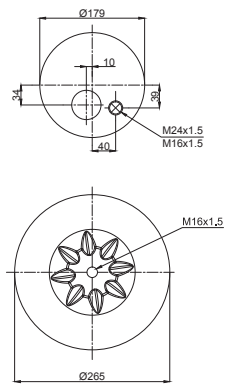

- Bolt or Stud
- Threaded hole
- ⊗ Combination Stud
- ⊗ Air Inlet

OEM PART NUMBER	MODEL NO	CROSS REFERENCES	
Mercedes	Actros MP2	Contitech	4183 NP23 ( Voss 230 )

### RML 95294 C21



Cross Section View

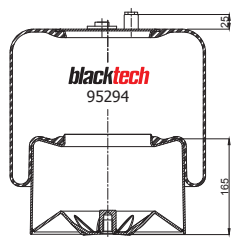

Top View

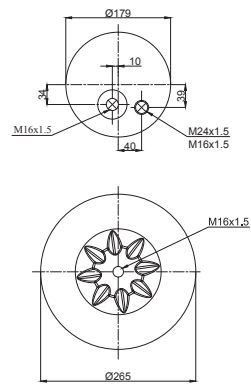

- Bolt or Stud
- Threaded hole
- ⊗ Combination Stud
- ⊗ Air Inlet

OEM PART NUMBER	MODEL NO	CROSS REFERENCES		
Mercedes	A 942 320 23 21	Actros MP2	Contitech	4183 NP24 ( Voss 230 )

**RML 95294 G23**



Cross Section View

Top View

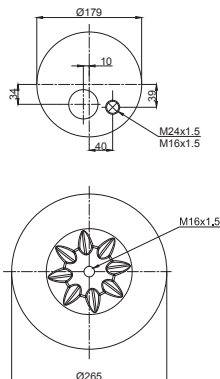
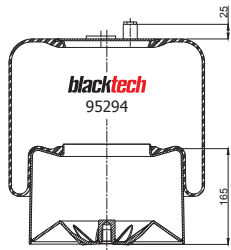

- Bolt or Stud
- Threaded hole
- ⊗ Combination Stud
- ⊗ Air Inlet

OEM PART NUMBER		MODEL NO	CROSS REFERENCES	
Mercedes	A 942 320 22 21	Actros MP2	Contitech	4183 N P25 ( Old N P23 )
Mercedes	A 942 320 68 21	Actros MP2		Voss 232

**RML 95294 G24**



Cross Section View

Top View

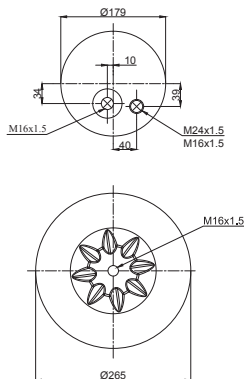
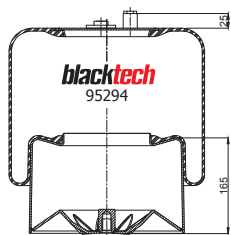

- Bolt or Stud
- Threaded hole
- ⊗ Combination Stud
- ⊗ Air Inlet

OEM PART NUMBER		MODEL NO	CROSS REFERENCES	
Mercedes	A 942 320 23 21	Actros MP2	Contitech	4183 N P26 ( Old N P24 )
Mercedes	A 942 320 69 21	Actros MP2		Voss 232

**RML 95296**



Cross Section View

Top View

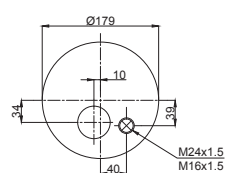
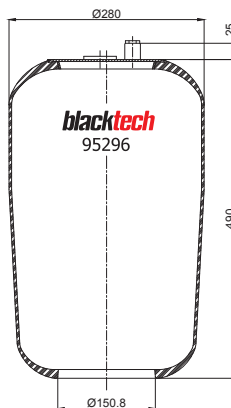

- Bolt or Stud
- Threaded hole
- ⊗ Combination Stud
- ⊗ Air Inlet

OEM PART NUMBER		MODEL NO	CROSS REFERENCES	
Mercedes	A 974 328 02 01	Atego	Contitech	4185 N

### RML 95296 C1



Cross Section View

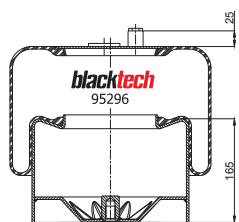

Top View

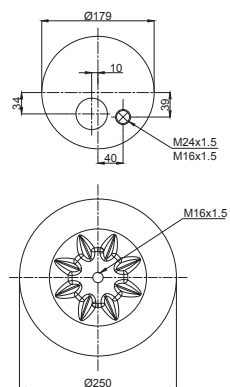

- Bolt or Stud
- Threaded hole
- ⊗ Combination Stud
- ⊗ Air Inlet

OEM PART NUMBER		MODEL NO	CROSS REFERENCES	
Mercedes	A 974 320 00 21	Atego	Contitech	4185 N P01
				Voss 230

### RML 95296 C21



Cross Section View

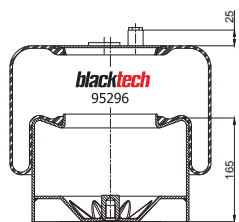

Top View

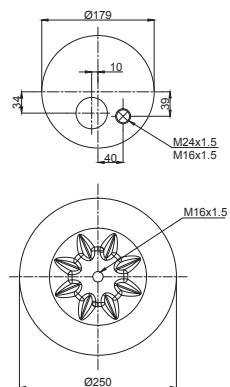

- Bolt or Stud
- Threaded hole
- ⊗ Combination Stud
- ⊗ Air Inlet

OEM PART NUMBER		MODEL NO	CROSS REFERENCES	
Mercedes	A 974 320 30 21	Atego	Contitech	4185 N P21
				Voss 232

### RML 95298-1



Cross Section View

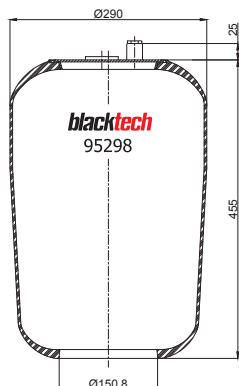

Top View

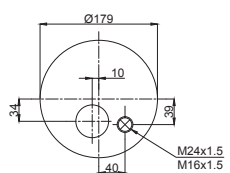

- Bolt or Stud
- Threaded hole
- ⊗ Combination Stud
- ⊗ Air Inlet

OEM PART NUMBER		MODEL NO	CROSS REFERENCES	
Mercedes			Contitech	4187 N3 ( Old 4187 N1 )
Mercedes		Actros MP2 Service Assy.		

**RML 95298-2**



Cross Section View

Top View

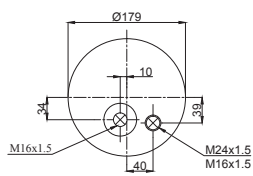
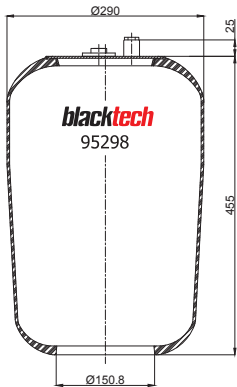

- Bolt or Stud
- Threaded hole
- ⊗ Combination Stud
- ⊗ Air Inlet

OEM PART NUMBER		MODEL NO	CROSS REFERENCES	
Mercedes			Contitech	4187 N4 ( Old 4187 N2 )
Mercedes		Actros MP2 Service Assy		

**RML 95298 C1**



Cross Section View

Top View

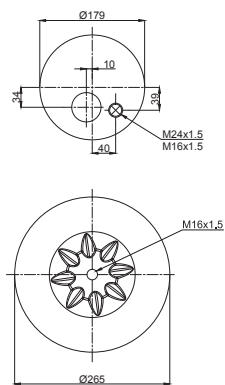
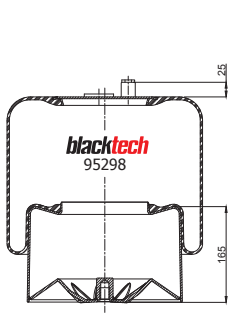

- Bolt or Stud
- Threaded hole
- ⊗ Combination Stud
- ⊗ Air Inlet

OEM PART NUMBER		MODEL NO	CROSS REFERENCES	
Mercedes	A 942 320 18 21	Actros MP 2	Contitech	4187 N P01 Voss 230

**RML 95298 C2**



Cross Section View

Top View

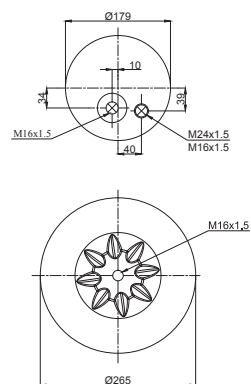
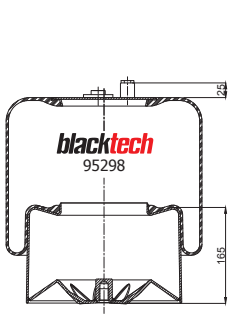

- Bolt or Stud
- Threaded hole
- ⊗ Combination Stud
- ⊗ Air Inlet

OEM PART NUMBER		MODEL NO	CROSS REFERENCES	
Mercedes	A 942 320 27 21	Actros MP2	Contitech	4187 N P22
				Voss 230



### RML 95298 G21



Cross Section View

Top View

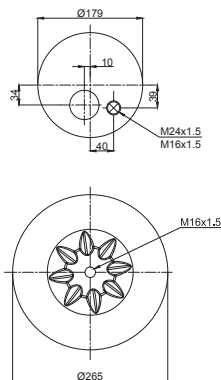
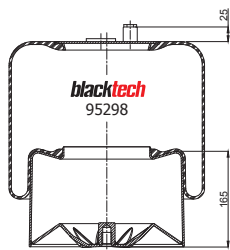

- Bolt or Stud
- Threaded hole
- ⊗ Combination Stud
- ⊗ Air Inlet

OEM PART NUMBER		MODEL NO	CROSS REFERENCES	
Mercedes	A 942 320 26 21	Actros MP2	Contitech	4187 N P23 (Old 4187 N P21)
Mercedes	A 942 320 72 21	Actros MP2		Voss 232

### RML 95298 G22



Cross Section View

Top View

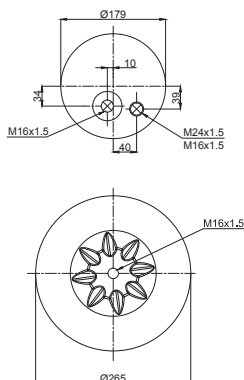
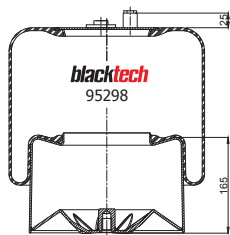

- Bolt or Stud
- Threaded hole
- ⊗ Combination Stud
- ⊗ Air Inlet

OEM PART NUMBER		MODEL NO	CROSS REFERENCES	
Mercedes	A 942 320 73 21	Actros MP2	Contitech	4187 N P24 (Old 4187 N P22)
Mercedes	A 942 320 19 21	Actros		Voss 232

### RML 95401-1



Cross Section View

Top View

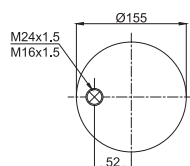
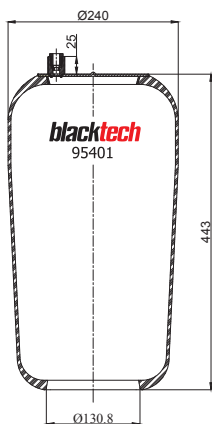

- Bolt or Stud
- Threaded hole
- ⊗ Combination Stud
- ⊗ Air Inlet

OEM PART NUMBER		MODEL NO	CROSS REFERENCES	
Mercedes	A 942 328 00 01	Actros	Contitech	4390 N1
			Phoenix	1KF 21-1 NP
			Primeride	54390 A1
			Firestone Style	1R7Z-440-290-B
			Firestone No.	W01-M58-0904
			Goodyear	9507
			Vibracoustic	V1KF21-1 NP
			CF Gomma Ref.	1VSC285-30
			CF Gomma No.	206782
			Dunlop F	D12U25
			Gart Ref.	C304
			Gart No.	304.0.440

**RML 95401-2**



Cross Section View

Top View

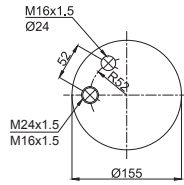
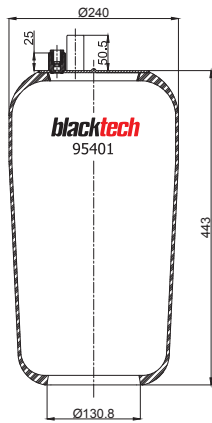

- Bolt or Stud
- Threaded hole
- ⊗ Combination Stud
- ⊗ Air Inlet

OEM PART NUMBER		MODEL NO	CROSS REFERENCES	
Mercedes	A 942 328 01 01	Actros	Contitech	4390 N2
			Phoenix	1KF 21-2 NP
			Primeride	54390 A2
			Firestone Style	1R7Z-440-290-G
			Firestone No.	W01-M58-0905
			Goodyear	9508
			Vibracoustic	V1KF21-2 NP
			CF Gomma Ref.	1VSC285-30
			CF Gomma No.	206784
			Dunlop F	D12U26
			Gart Ref.	C304
			Gart No.	304.0441

**RML 95401-3**



Cross Section View

Top View

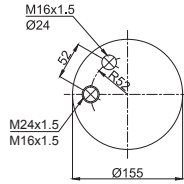
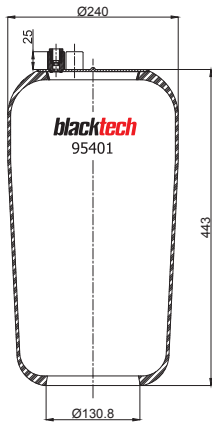

- Bolt or Stud
- Threaded hole
- ⊗ Combination Stud
- ⊗ Air Inlet

OEM PART NUMBER		MODEL NO	CROSS REFERENCES	
Mercedes		Actros		

**RML 95401C1**



Cross Section View

Top View

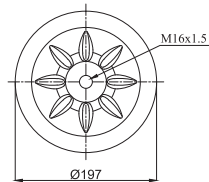
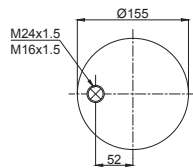
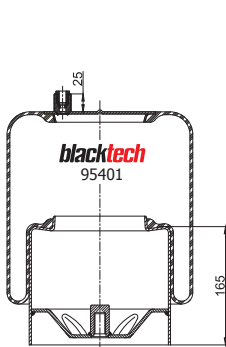

- Bolt or Stud
- Threaded hole
- ⊗ Combination Stud
- ⊗ Air Inlet

OEM PART NUMBER		MODEL NO	CROSS REFERENCES	
Mercedes	A 942 320 01 21	Actros	Contitech	4390 NP01

### RML 95401C2



Cross Section View

Top View

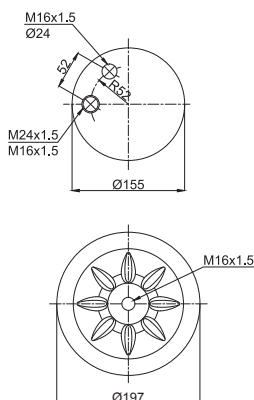
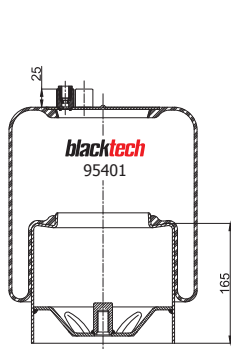

- Bolt or Stud
- Threaded hole
- Combination Stud
- Air Inlet

OEM PART NUMBER		MODEL NO	CROSS REFERENCES	
Mercedes	A 942 320 02 21	Actros	Contitech	4390 N P02

### RML 95401C3



Cross Section View

Top View

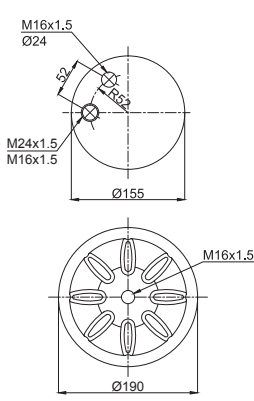
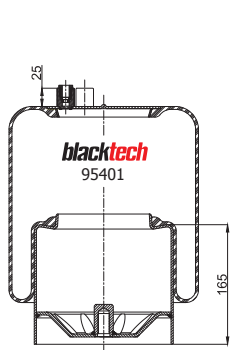

- Bolt or Stud
- Threaded hole
- Combination Stud
- Air Inlet

OEM PART NUMBER		MODEL NO	CROSS REFERENCES	
Mercedes	A 942 320 04 21	Actros	Contitech	4390 N P03

### RML 95401C4



Cross Section View

Top View

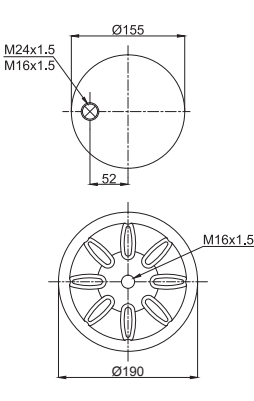
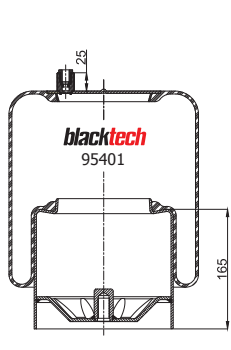

- Bolt or Stud
- Threaded hole
- Combination Stud
- Air Inlet

OEM PART NUMBER		MODEL NO	CROSS REFERENCES	
Mercedes	A 942 320 03 21	Actros	Contitech	4390 N P04

**RML 95401C5**



Cross Section View

Top View

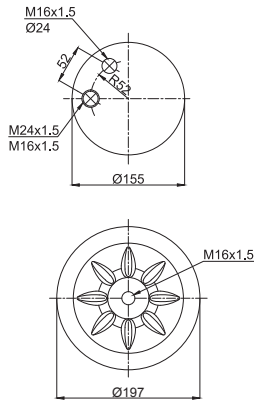
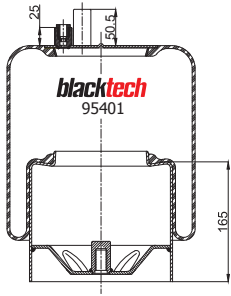

- Bolt or Stud
- Threaded hole
- ⊗ Combination Stud
- ⊗ Air Inlet

OEM PART NUMBER	MODEL NO	CROSS REFERENCES
Mercedes	Actros	

**RML 95401C21**



Cross Section View

Top View

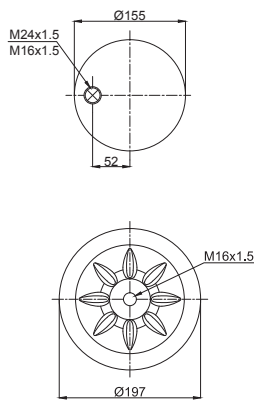
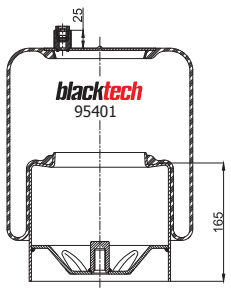

- Bolt or Stud
- Threaded hole
- ⊗ Combination Stud
- ⊗ Air Inlet

OEM PART NUMBER	MODEL NO	CROSS REFERENCES		
Mercedes	A 942 320 28 21	Actros MP2	Conlitech	4390 NP21
Mercedes	A 942 320 49 21	Actros	Phoenix	1KF 21-21
			Firestone Style	1R7Z-440-290
			Firestone No.	W01-M58-8514
			Goodyear	9505
			Vibracoustic	V1KF21-1
			CF Gomma Ref.	1VS285-30
			CF Gomma No.	207765
			Gart Ref.	C304
			Gart No.	3041440

**RML 95401C22**



Cross Section View

Top View

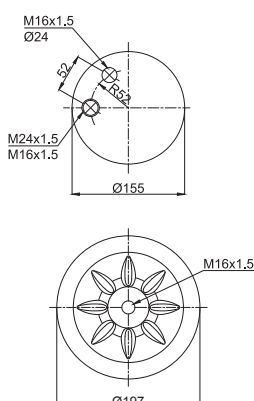
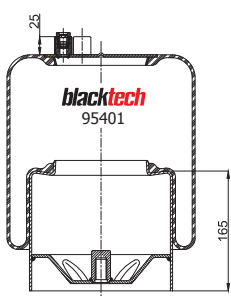

- Bolt or Stud
- Threaded hole
- ⊗ Combination Stud
- ⊗ Air Inlet

OEM PART NUMBER	MODEL NO	CROSS REFERENCES		
Mercedes	A 942 320 29 21	Actros MP2	Conlitech	4390 NP22
Mercedes	A 942 320 50 21	Actros	Phoenix	1KF 21-22
			Firestone Style	1R7Z-440-290
			Firestone No.	W01-M58-8513
			Goodyear	9506
			Vibracoustic	V1KF21-2
			CF Gomma Ref.	1VS285-30
			CF Gomma No.	207766
			Gart Ref.	C304
			Gart No.	3041441

### RML 95401C23



Cross Section View

Top View

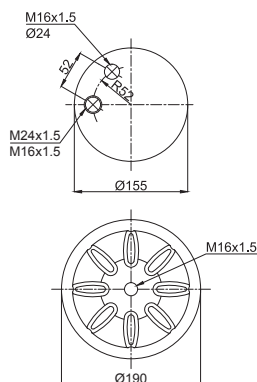
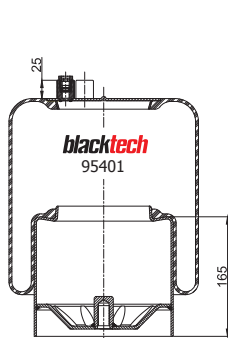

- Bolt or Stud
- Threaded hole
- Combination Stud
- Air Inlet

OEM PART NUMBER		MODEL NO	CROSS REFERENCES	
Mercedes	A 942 320 52 21	Actros	Contitech	4390 NP23
			Goodyear	9563
			Vibracoustic	V1KF21-4-232
			CF Gamma Ref.	1VSC285-30
			CF Gamma No.	206783
			Gart Ref.	C304
			Gart No.	3041.443

### RML 95401C24



Cross Section View

Top View

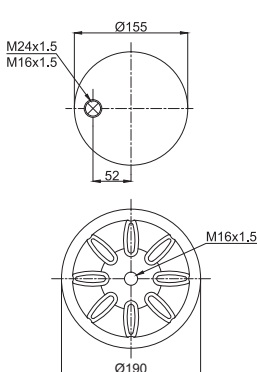
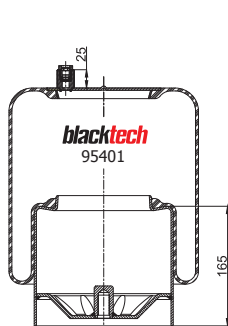

- Bolt or Stud
- Threaded hole
- Combination Stud
- Air Inlet

OEM PART NUMBER		MODEL NO	CROSS REFERENCES	
Mercedes	A 942 320 51 21	Actros	Contitech	4390 NP24
			Goodyear	9564
			Vibracoustic	V1KF21-3-232
			CF Gamma Ref.	1VSC285-30
			CF Gamma No.	206781
			Gart Ref.	C304
			Gart No.	3041.444

### RML 95402-1



Cross Section View

Top View

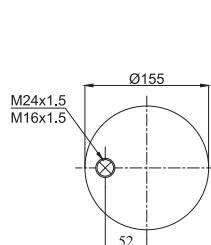
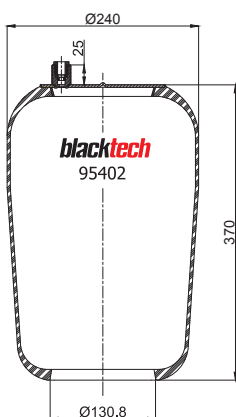

- Bolt or Stud
- Threaded hole
- Combination Stud
- Air Inlet

OEM PART NUMBER		MODEL NO	CROSS REFERENCES	
Mercedes	A 942 328 06 01	Actros Low Liner	Contitech	4391 N1

**RML 95402-2**



Cross Section View

Top View

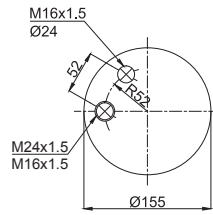
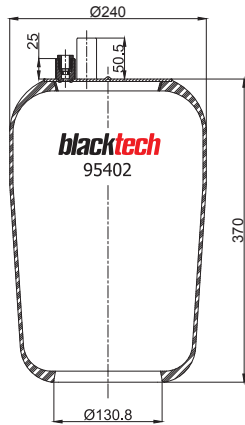

- Bolt or Stud
- Threaded hole
- ⊗ Combination Stud
- ⊗ Air Inlet

OEM PART NUMBER		MODEL NO	CROSS REFERENCES	
Mercedes	A 942 328 07 01	Actros Low Liner	Contitech	4391 N2

**RML 95402 C1**



Cross Section View

Top View

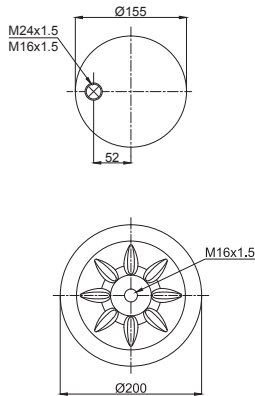
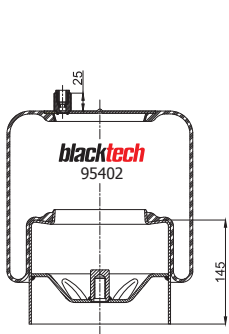

- Bolt or Stud
- Threaded hole
- ⊗ Combination Stud
- ⊗ Air Inlet

OEM PART NUMBER		MODEL NO	CROSS REFERENCES	
Mercedes	A 942 320 06 21	Actros Low Liner	Contitech	4391 N P01

**RML 95402 C2**



Cross Section View

Top View

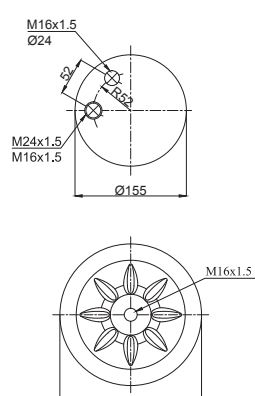
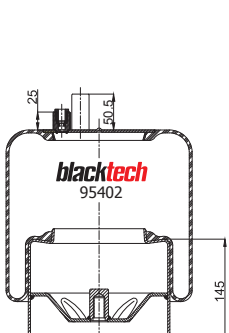

- Bolt or Stud
- Threaded hole
- ⊗ Combination Stud
- ⊗ Air Inlet

OEM PART NUMBER		MODEL NO	CROSS REFERENCES	
Mercedes	A 942 320 07 21	Actros Low Liner	Contitech	4391 N P02

### RML 95402 G21



Cross Section View

Top View

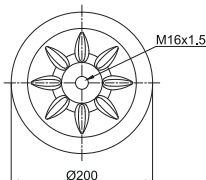
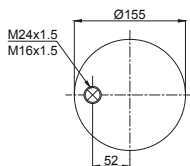
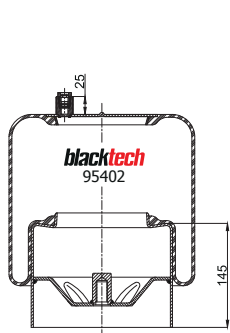

- Bolt or Stud
- Threaded hole
- ⊗ Combination Stud
- ⊗ Air Inlet

OEM PART NUMBER		MODEL NO	CROSS REFERENCES	
Mercedes	A 942 320 53 21	Actros Low Liner	Contitech	4391 N P21

### RML 95402 G22



Cross Section View

Top View

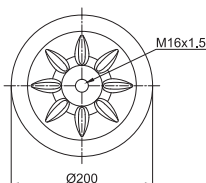
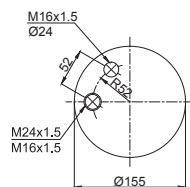
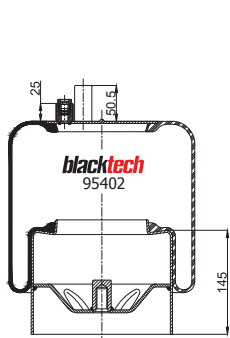

- Bolt or Stud
- Threaded hole
- ⊗ Combination Stud
- ⊗ Air Inlet

OEM PART NUMBER		MODEL NO	CROSS REFERENCES	
Mercedes	A 942 320 54 21	Actros Low Liner	Contitech	4391 N P22

### RML 95755



Cross Section View

Top View

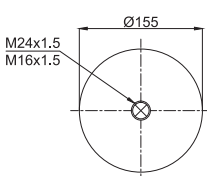
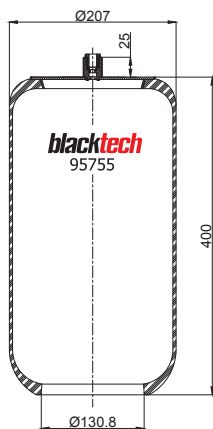

- Bolt or Stud
- Threaded hole
- ⊗ Combination Stud
- ⊗ Air Inlet

OEM PART NUMBER		MODEL NO	CROSS REFERENCES	
EvoBus	A 629 327 00 01		Contitech	4644 N
			Goodyear	9561

**RML 95755 C2**



Cross Section View

Top View

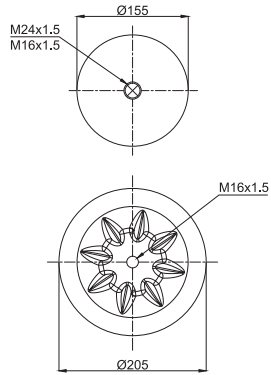
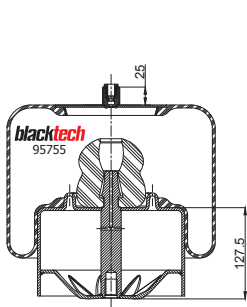

- Bolt or Stud
- Threaded hole
- ⊗ Combination Stud
- ⊗ Air Inlet

OEM PART NUMBER		MODEL NO	CROSS REFERENCES	
EvoBus	A 629 320 00 25		Contitech	4644 N P02

**RML 95755 C22**



Cross Section View

Top View

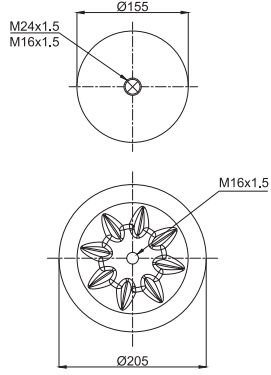
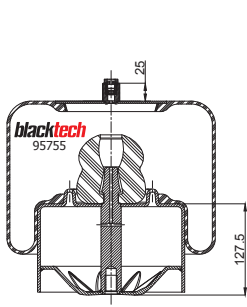

- Bolt or Stud
- Threaded hole
- ⊗ Combination Stud
- ⊗ Air Inlet

OEM PART NUMBER		MODEL NO	CROSS REFERENCES	
EvoBus	A 629 320 00 25	O 540	Contitech	4644 N P22
EvoBus	A 629 320 00 25	O 580	Vibracoustic	VIKE22-1
EvoBus	A 629 320 00 25	OC 500 IBC (≥2008)		
EvoBus	A 629 320 00 25	OC 500 IBC (<2008)		
EvoBus	A 629 320 00 25	TC 400		
EvoBus	A 629 320 00 25	Tourismo/Travego (<2008)		
EvoBus	A 629 320 00 25	Tourismo/Travego (≥2008)		

**RML 95848-1**



Cross Section View

Top View

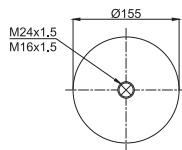
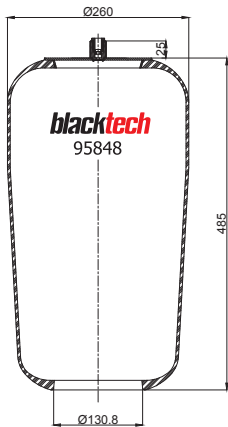

- Bolt or Stud
- Threaded hole
- ⊗ Combination Stud
- ⊗ Air Inlet

OEM PART NUMBER		MODEL NO	CROSS REFERENCES	
Mercedes		Service Assembly	Contitech	4737 N



### RML 95848 C1



Cross Section View

Top View

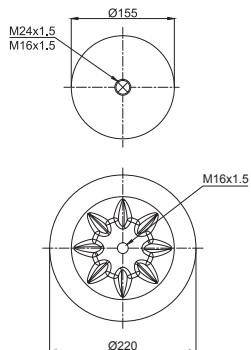
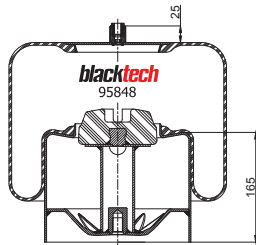

- Bolt or Stud
- Threaded hole
- ⊗ Combination Stud
- ⊗ Air Inlet

OEM PART NUMBER		MODEL NO	CROSS REFERENCES	
Mercedes	A 946 320 03 21	Atego	Contitech	4737 N P01

### RML 95848 C2



Cross Section View

Top View

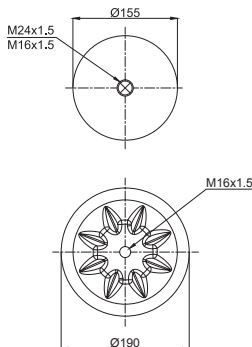
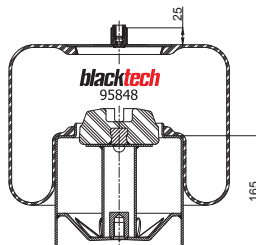

- Bolt or Stud
- Threaded hole
- ⊗ Combination Stud
- ⊗ Air Inlet

OEM PART NUMBER		MODEL NO	CROSS REFERENCES	
Mercedes	A 946 320 05 21	Atego	Contitech	4737 N P02

### RML 95848 C5



Cross Section View

Top View

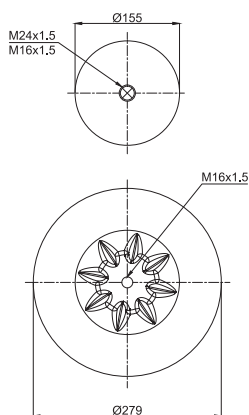
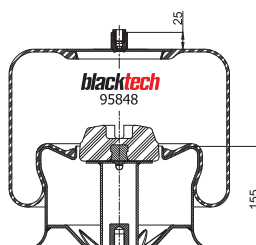

- Bolt or Stud
- Threaded hole
- ⊗ Combination Stud
- ⊗ Air Inlet

OEM PART NUMBER		MODEL NO	CROSS REFERENCES	
Mercedes	A 946 320 00 17	Atego	Contitech	4737 N P05

**RML 95848 C21**



Cross Section View

Top View

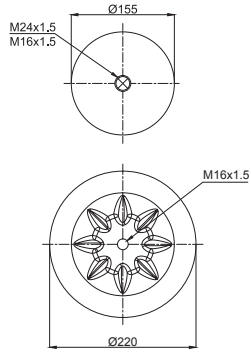
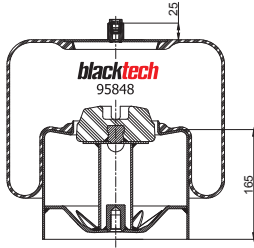

- Bolt or Stud
- Threaded hole
- ⊗ Combination Stud
- ⊗ Air Inlet

OEM PART NUMBER		MODEL NO	CROSS REFERENCES	
Mercedes	A 942 320 37 21	Atego	Contitech	4737 N P21
			Goodyear	9523

**RML 95848 C22**



Cross Section View

Top View

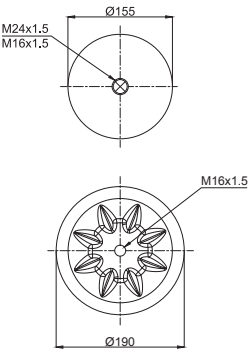
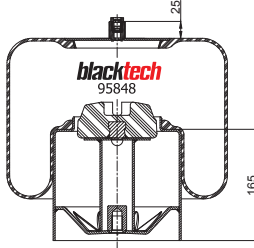

- Bolt or Stud
- Threaded hole
- ⊗ Combination Stud
- ⊗ Air Inlet

OEM PART NUMBER		MODEL NO	CROSS REFERENCES	
Mercedes	A 942 320 39 21	Atego	Contitech	4737 N P22
			Goodyear	9524

**RML 95848 C25**



Cross Section View

Top View

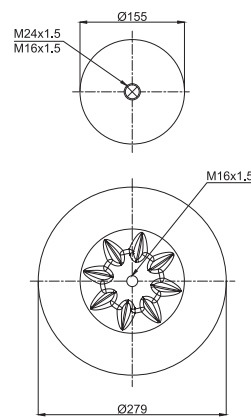
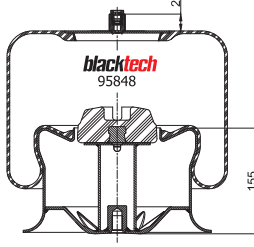

- Bolt or Stud
- Threaded hole
- ⊗ Combination Stud
- ⊗ Air Inlet

OEM PART NUMBER		MODEL NO	CROSS REFERENCES	
Mercedes	A 957 320 03 17	Atego, Econic	Contitech	4737 N P25
			Goodyear	9539

### RML 95860



Cross Section View

Top View

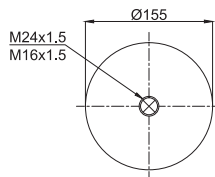
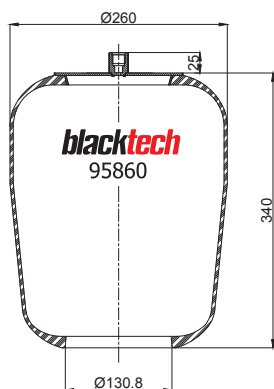

- Bolt or Stud
- Threaded hole
- ⊗ Combination Stud
- ⊗ Air Inlet

OEM PART NUMBER		MODEL NO	CROSS REFERENCES	
Mercedes	A 942 327 04 01	Actros Low Liner	Contitech	4759 N

### RML 95860 C1



Cross Section View

Top View

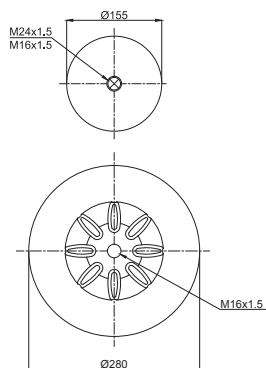
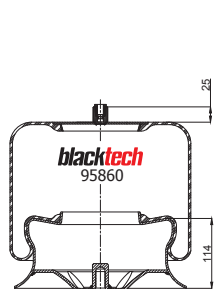

- Bolt or Stud
- Threaded hole
- ⊗ Combination Stud
- ⊗ Air Inlet

OEM PART NUMBER		MODEL NO	CROSS REFERENCES	
Mercedes	A 942 327 02 01	Actros Low Liner	Contitech	4759 N P01

### RML 95860 C21



Cross Section View

Top View

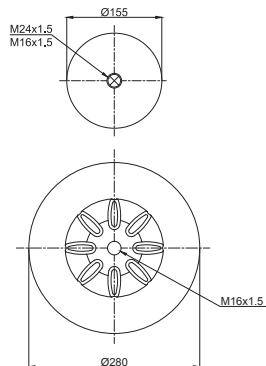
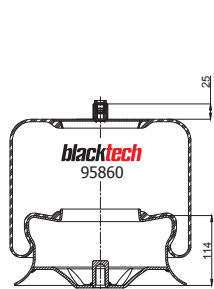

- Bolt or Stud
- Threaded hole
- ⊗ Combination Stud
- ⊗ Air Inlet

OEM PART NUMBER		MODEL NO	CROSS REFERENCES	
Mercedes	A 942 320 44 21	Actros Low Liner	Contitech	4759 N P21
Mercedes	A 942 320 02 17	Actros Low Liner		

**RML 95868-1**



Cross Section View

Top View

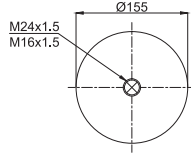
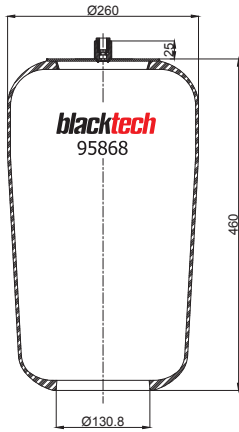

- Bolt or Stud
- Threaded hole
- ⊗ Combination Stud
- ⊗ Air Inlet

OEM PART NUMBER		MODEL NO	CROSS REFERENCES	
Mercedes	A 942 327 00 01	Actros	Contitech	4757 N1
			Phoenix	1KF 24-1 NP
			Firestone Style	1R7Z-460-305-A
			Firestone No.	W01-M68-0909
			Goodyear	9517
			Vibracoustic	V1KF24-1-230 NP
			Dunlop F	D13U42
			Gart Ref.	C299/A
			Gart No.	299.0.461

**RML 95868-2**



Cross Section View

Top View

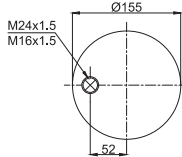
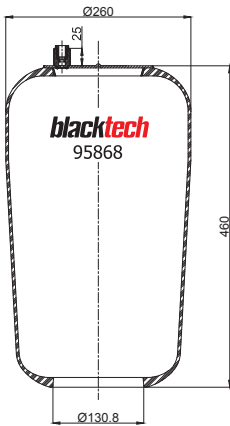

- Bolt or Stud
- Threaded hole
- ⊗ Combination Stud
- ⊗ Air Inlet

OEM PART NUMBER		MODEL NO	CROSS REFERENCES	
Mercedes	A 974 328 00 01	Atego	Contitech	4757 N2
Mercedes	A 974 328 01 01	Atego	Phoenix	1KF 24-2 NP
			Firestone Style	1R7Z-460-305-B
			Firestone No.	W01-M68-0910
			Goodyear	9518
			Vibracoustic	V1KF24-2-230 NP
			Dunlop F	D13U43
			Gart Ref.	C299/A
			Gart No.	299.0.460

**RML 95868 C1**



Cross Section View

Top View

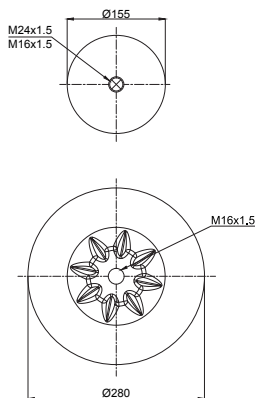
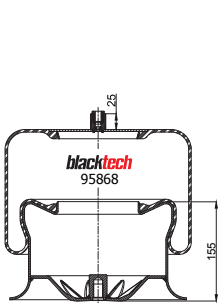

- Bolt or Stud
- Threaded hole
- ⊗ Combination Stud
- ⊗ Air Inlet

OEM PART NUMBER		MODEL NO	CROSS REFERENCES	
Mercedes	A 974 320 01 17	Atego	Contitech	4757 NP01

### RML 95868 C9



Cross Section View

Top View

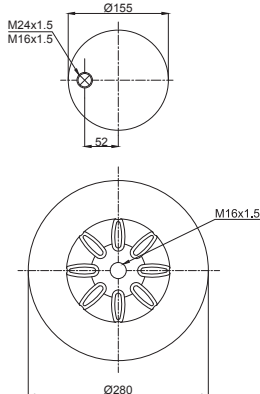
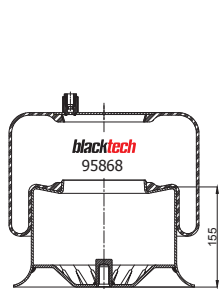

- Bolt or Stud
- Threaded hole
- ⊗ Combination Stud
- ⊗ Air Inlet

OEM PART NUMBER		MODEL NO	CROSS REFERENCES	
Mercedes	A 974 327 04 17	Atego	Contitech	4757 NP09

### RML 95868 C21



Cross Section View

Top View

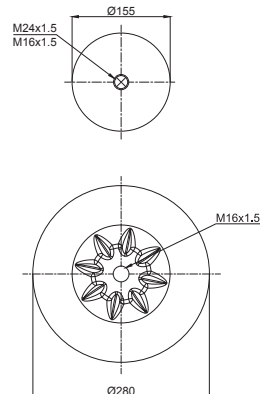
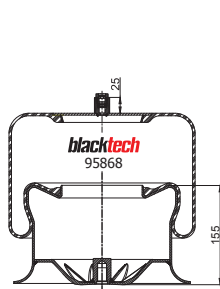

- Bolt or Stud
- Threaded hole
- ⊗ Combination Stud
- ⊗ Air Inlet

OEM PART NUMBER		MODEL NO	CROSS REFERENCES	
Mercedes	A 974 320 43 21	Atego	Contitech	4757 NP21
			Phoenix	1KF 24-21
			Firestone Style	1R7Z-460-305-A
			Firestone No.	W01-M58-8521
			Goodyear	9519
			Vibracoustic	V1KF24-1-232
			Dunlop F	D13T01
			Gart Ref.	C299/A
			Gart No.	2991.461

### RML 95868 C29



Cross Section View

Top View

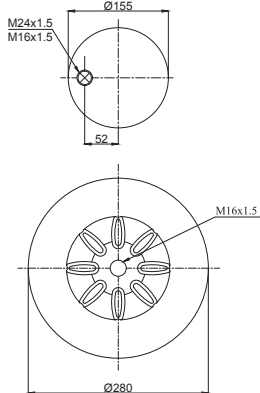
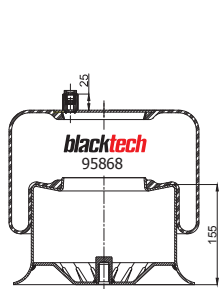

- Bolt or Stud
- Threaded hole
- ⊗ Combination Stud
- ⊗ Air Inlet

OEM PART NUMBER		MODEL NO	CROSS REFERENCES	
Mercedes	A 942 320 32 21	Actros	Contitech	4757 NP29
Mercedes	A 942 320 32 21	Atego	Phoenix	1KF 24-29
Mercedes	A 974 320 02 17	Actros, Atego	Firestone Style	1R7Z-460-305-B
			Firestone No.	W01-M58-8522
			Goodyear	9520
			Vibracoustic	V1KF24-2-232
			Dunlop F	D13T02
			Gart Ref.	C299/A
			Gart No.	2991.460

**RML 95869-1**



Cross Section View

Top View

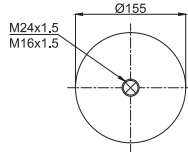
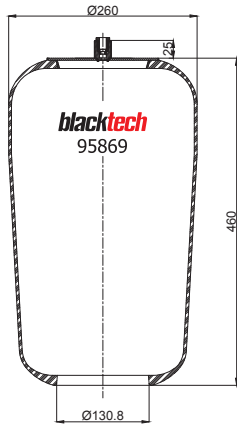

- Bolt or Stud
- Threaded hole
- Combination Stud
- Air Inlet

OEM PART NUMBER		MODEL NO	CROSS REFERENCES	
Mercedes	A 945 327 00 01	Actros	Contitech	4758 N

**RML 95869 C1**



Cross Section View

Top View

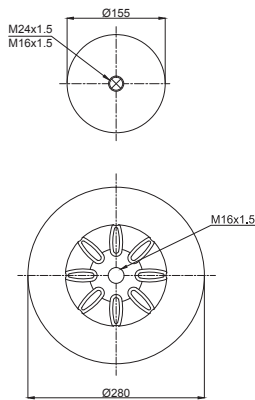
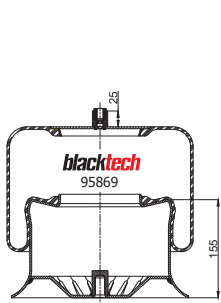

- Bolt or Stud
- Threaded hole
- Combination Stud
- Air Inlet

OEM PART NUMBER		MODEL NO	CROSS REFERENCES	
Mercedes	A 945 320 00 17	Actros	Contitech	4758 NP01

**RML 95869 C21**



Cross Section View

Top View

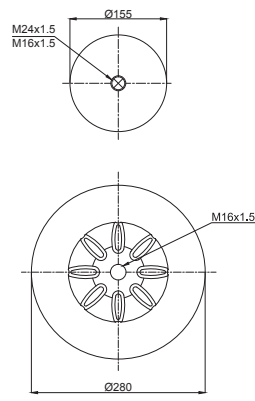
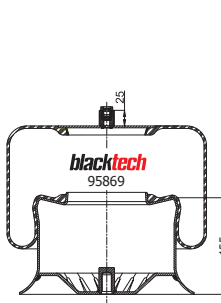

- Bolt or Stud
- Threaded hole
- Combination Stud
- Air Inlet

OEM PART NUMBER		MODEL NO	CROSS REFERENCES	
Mercedes	A 942 320 48 21	Actros	Contitech	4758 NP21

### RML 95869 C23



Cross Section View

Top View

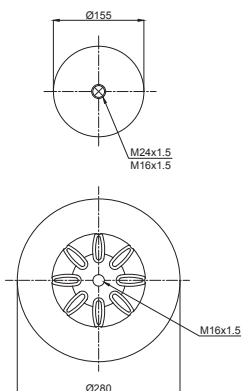
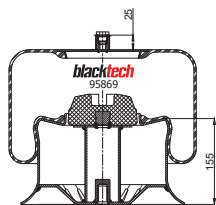

- Bolt or Stud
- Threaded hole
- ⊗ Combination Stud
- ⊗ Air Inlet

OEM PART NUMBER		MODEL NO	CROSS REFERENCES	
Mercedes	A 942 320 33 21	Actros	Contitech	4758 NP23
Mercedes	A 942 320 06 17			

### RML 95949-1



Cross Section View

Top View

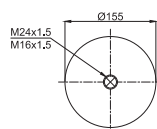
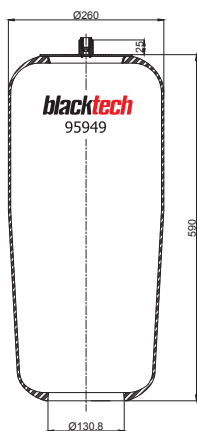

- Bolt or Stud
- Threaded hole
- ⊗ Combination Stud
- ⊗ Air Inlet

OEM PART NUMBER		MODEL NO	CROSS REFERENCES	
Mercedes	A 946 328 00 01	Actros, Atego	Contitech	4838 N

### RML 95949 C1



Cross Section View

Top View

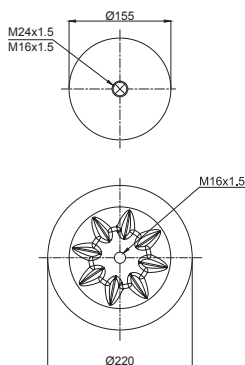
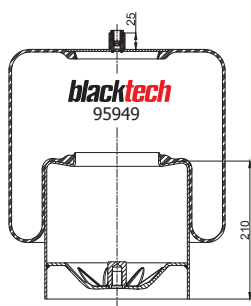

- Bolt or Stud
- Threaded hole
- ⊗ Combination Stud
- ⊗ Air Inlet

OEM PART NUMBER		MODEL NO	CROSS REFERENCES	
Mercedes	A 946 320 04 21	Actros, Atego	Contitech	4838 NP01

**RML 95949 C2**



Cross Section View

Top View

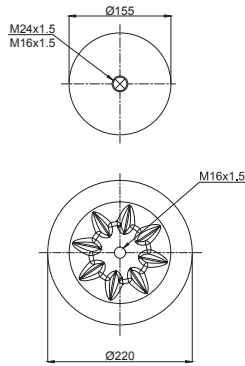
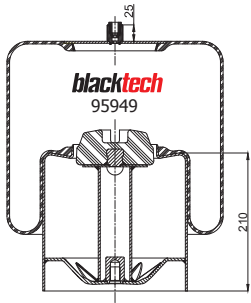

- Bolt or Stud
- Threaded hole
- ⊗ Combination Stud
- ⊗ Air Inlet

OEM PART NUMBER		MODEL NO	CROSS REFERENCES	
Mercedes	A 946 320 02 21	Actros, Atego	Contitech	4838 N P02

**RML 95949 C3**



Cross Section View

Top View

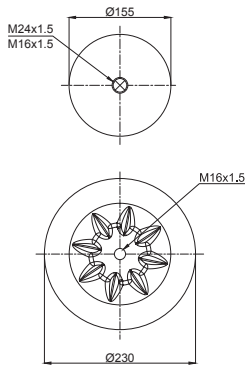
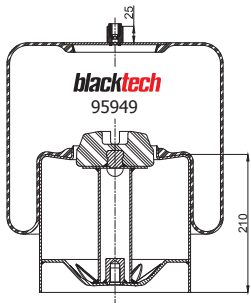

- Bolt or Stud
- Threaded hole
- ⊗ Combination Stud
- ⊗ Air Inlet

OEM PART NUMBER		MODEL NO	CROSS REFERENCES	
Mercedes	A 946 320 01 21	Actros, Atego	Contitech	4838 N P03

**RML 95949 C21**



Cross Section View

Top View

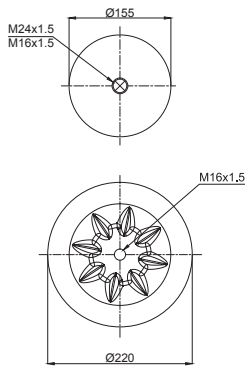
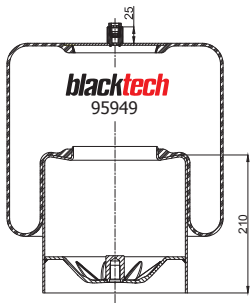

- Bolt or Stud
- Threaded hole
- ⊗ Combination Stud
- ⊗ Air Inlet

OEM PART NUMBER		MODEL NO	CROSS REFERENCES	
Mercedes	A 942 320 38 21	Actros, Atego	Contitech	4838 N P21
			Firestone Style	1R7Z-595-330-A
			Firestone No.	W01-M58-8512
			Goodyear	9521
			Vibracoustic	V1KF25-1-232



### RML 95949 C22



Cross Section View

Top View

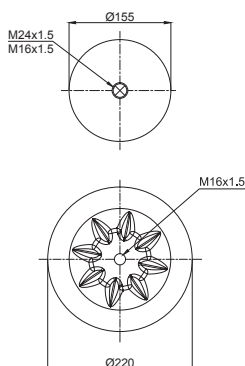
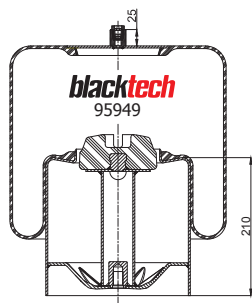

- Bolt or Stud
- Threaded hole
- ⊗ Combination Stud
- ⊗ Air Inlet

OEM PART NUMBER		MODEL NO	CROSS REFERENCES	
Mercedes	A 942 320 36 21	Actros	Contitech	4838 NP22
			Goodyear	9522
			Vibracoustic	V1KF25-2-232

### RML 95949 C23



Cross Section View

Top View

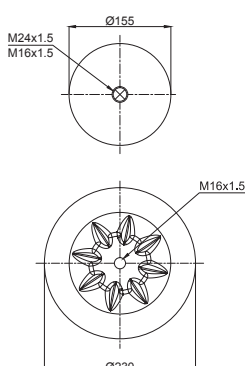
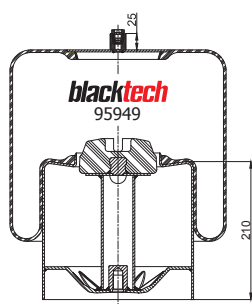

- Bolt or Stud
- Threaded hole
- ⊗ Combination Stud
- ⊗ Air Inlet

OEM PART NUMBER		MODEL NO	CROSS REFERENCES	
Mercedes	A 942 320 35 21	Actros	Contitech	4838 NP23
			Goodyear	9536
			Vibracoustic	V1KF25-3-232

### RML 96032 C



Cross Section View

Top View

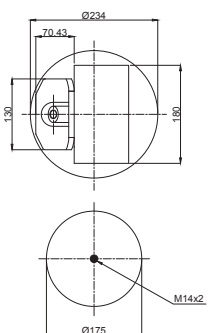
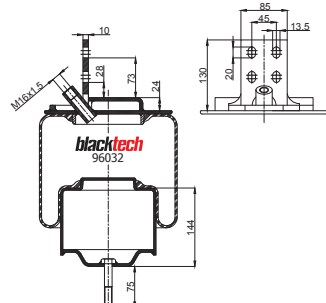

- Bolt or Stud
- Threaded hole
- ⊗ Combination Stud
- ⊗ Air Inlet

OEM PART NUMBER		MODEL NO	CROSS REFERENCES	
Iveco	98490464	Eurocarge 120 E15	CF Gomma Ref.	ISC 260-32
			Firestone No.	201408

**RML 97026 C**



Cross Section View

Top View

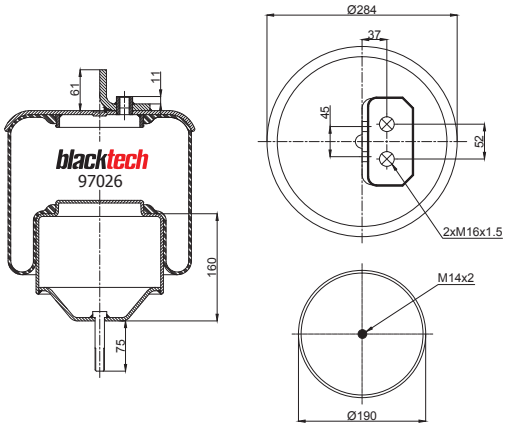

- Bolt or Stud
- Threaded hole
- ⊗ Combination Stud
- ⊗ Air Inlet

OEM PART NUMBER	MODEL NO	CROSS REFERENCES	
Iveco	500364685	Stralis 260E FS FP	CF Gamma Ref. 1S 270-26 C
			CF Gamma No. 205057

**RML 97054 C**



Cross Section View

Top View

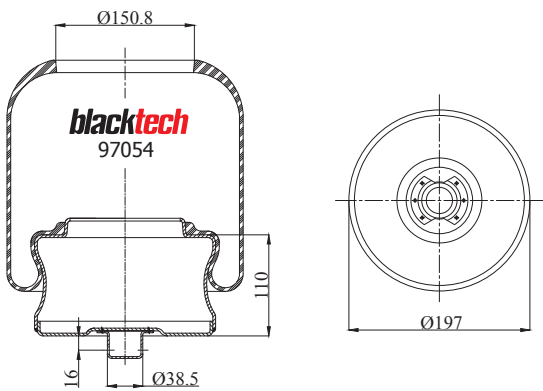

- Bolt or Stud
- Threaded hole
- ⊗ Combination Stud
- ⊗ Air Inlet

OEM PART NUMBER	MODEL NO	CROSS REFERENCES	
Volvo	70377052	B12B / B12M / B12R	

**RML 97743 C**



Cross Section View

Top View

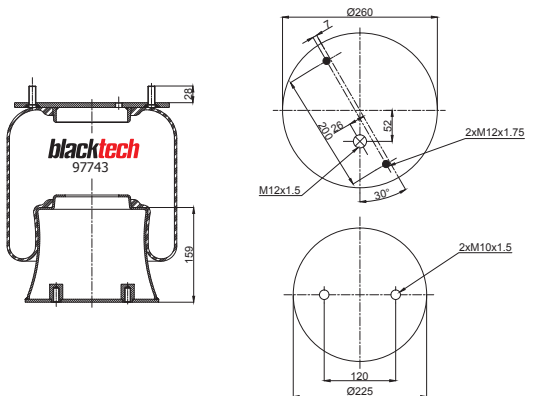

- Bolt or Stud
- Threaded hole
- ⊗ Combination Stud
- ⊗ Air Inlet

OEM PART NUMBER	MODEL NO	CROSS REFERENCES	
Iveco	93195986	Bus 380	CF Gamma Ref. 1S 285-25 C
			Firestone No. 96825

### RML 97756 C



Cross Section View

Top View

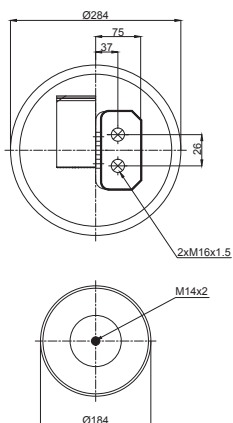
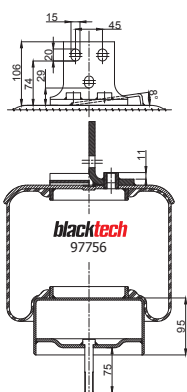

- Bolt or Stud
- Threaded hole
- ⊗ Combination Stud
- ⊗ Air Inlet

OEM PART NUMBER	MODEL NO	CROSS REFERENCES	
Iveco	41026771	Firestone Style	1S 285-23 V
		CF Gomma No.	

### RML 97756 C1



Cross Section View

Top View

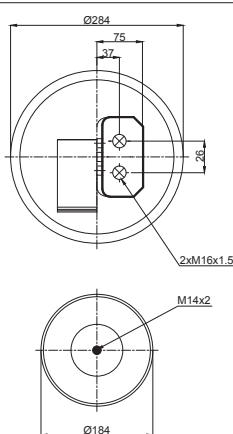
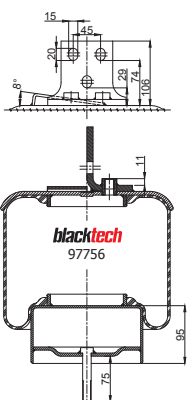

- Bolt or Stud
- Threaded hole
- ⊗ Combination Stud
- ⊗ Air Inlet

OEM PART NUMBER	MODEL NO	CROSS REFERENCES	
Iveco	41026772	CF Gomma Ref.	1S 285-23 V
		CF Gomma No.	

### RML 98183



Cross Section View

Top View

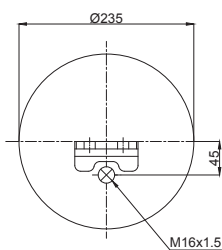
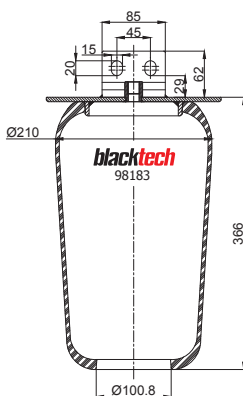

- Bolt or Stud
- Threaded hole
- ⊗ Combination Stud
- ⊗ Air Inlet

OEM PART NUMBER	MODEL NO	CROSS REFERENCES	
Iveco	42568183	Astra	ISC 230-25
		CF Gomma No.	207633

**RML 98183 C**



Cross Section View

Top View

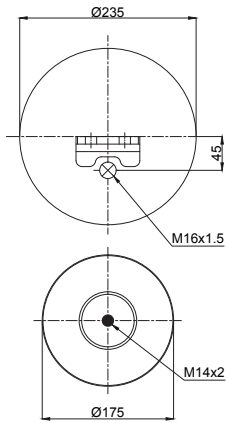
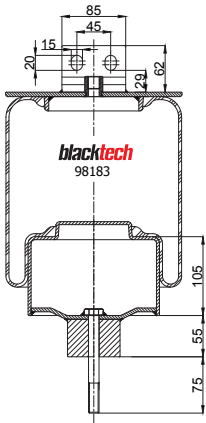

- Bolt or Stud
- Threaded hole
- ⊗ Combination Stud
- ⊗ Air Inlet

OEM PART NUMBER	MODEL NO	CROSS REFERENCES	
Iveco	41268309	Astra	CF Gomma Ref. 1SC 230-25
			CF Gomma No. 207631

**RML 98518 C**



Cross Section View

Top View

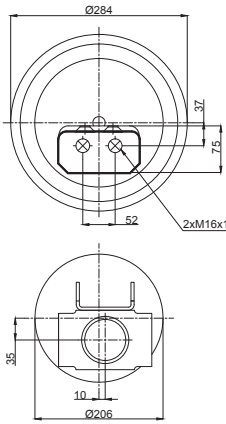
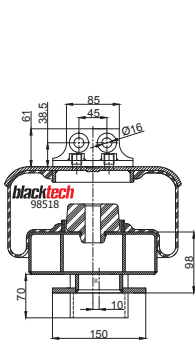

- Bolt or Stud
- Threaded hole
- ⊗ Combination Stud
- ⊗ Air Inlet

OEM PART NUMBER	MODEL NO	CROSS REFERENCES	
Iveco	41026263	Eurotech MP 400 E	CF Gomma Ref. 1S 285-18 C
			CF Gomma No. 88811

**RML 98518 C1**



Cross Section View

Top View

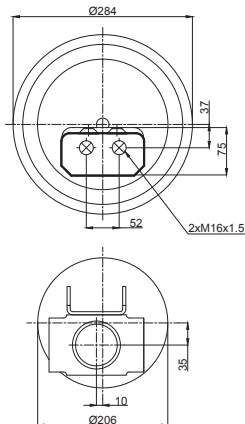
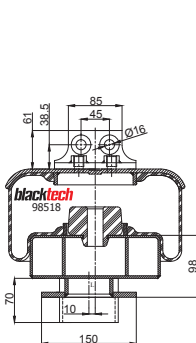

- Bolt or Stud
- Threaded hole
- ⊗ Combination Stud
- ⊗ Air Inlet

OEM PART NUMBER	MODEL NO	CROSS REFERENCES	
Iveco	41026262	Eurotech MP 400 E	CF Gomma Ref. 1S 285-18 C
			CF Gomma No. 96612

### RML 98739 C



Cross Section View

Top View

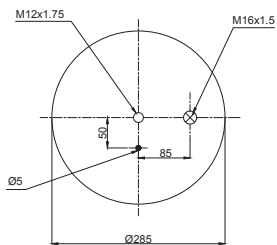
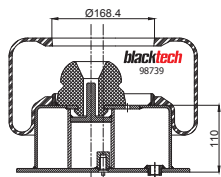

- Bolt or Stud
- Threaded hole
- ⊗ Combination Stud
- ⊗ Air Inlet

OEM PART NUMBER	MODEL NO	CROSS REFERENCES
Voith H68.219201		

### RML 98739 C1



Cross Section View

Top View

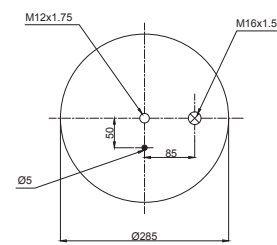
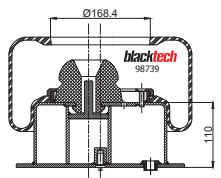

- Bolt or Stud
- Threaded hole
- ⊗ Combination Stud
- ⊗ Air Inlet

OEM PART NUMBER	MODEL NO	CROSS REFERENCES
Voith 311.00038701		

### RML 98739 C2



Cross Section View

Top View

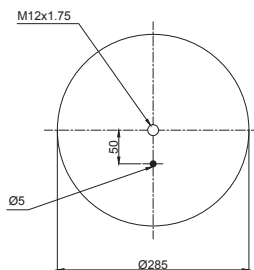
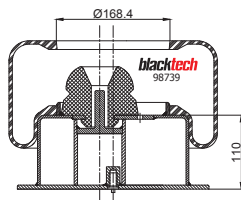

- Bolt or Stud
- Threaded hole
- ⊗ Combination Stud
- ⊗ Air Inlet

OEM PART NUMBER	MODEL NO	CROSS REFERENCES
Voith 311.00044801		

**RML 99201 C**



Cross Section View

Top View

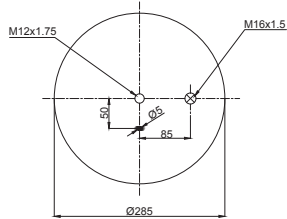
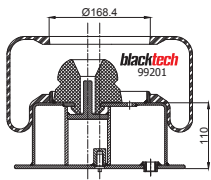

- Bolt or Stud
- Threaded hole
- ⊗ Combination Stud
- ⊗ Air Inlet

OEM PART NUMBER	MODEL NO	CROSS REFERENCES
Otokar	16H00-05484-AB	

**RML 99202 C**



Cross Section View

Top View

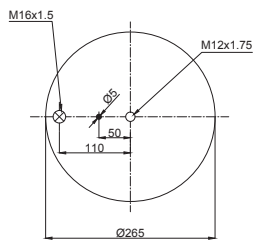
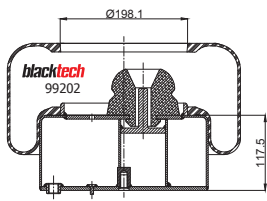

- Bolt or Stud
- Threaded hole
- ⊗ Combination Stud
- ⊗ Air Inlet

OEM PART NUMBER	MODEL NO	CROSS REFERENCES
Voith	311.00038501	

**RML 99202 C1**



Cross Section View

Top View

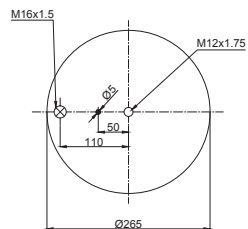
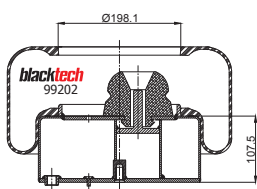

- Bolt or Stud
- Threaded hole
- ⊗ Combination Stud
- ⊗ Air Inlet

OEM PART NUMBER	MODEL NO	CROSS REFERENCES
Voith	311.00054901	

### RML 99203 C



Cross Section View

Top View

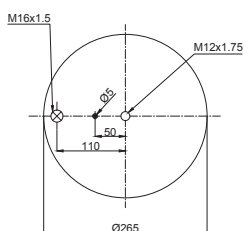
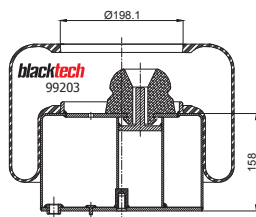

- Bolt or Stud
- Threaded hole
- ⊗ Combination Stud
- ⊗ Air Inlet

OEM PART NUMBER	MODEL NO	CROSS REFERENCES
Otokar	16M00-03652	

### RML 99205 C



Cross Section View

Top View

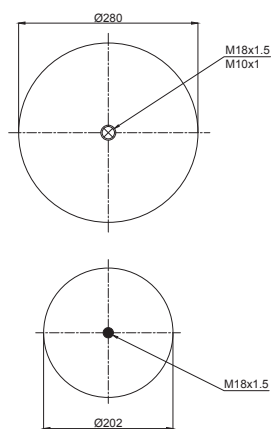
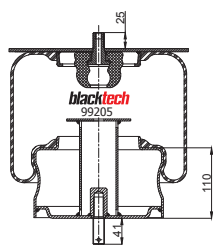

- Bolt or Stud
- Threaded hole
- ⊗ Combination Stud
- ⊗ Air Inlet

OEM PART NUMBER	MODEL NO	CROSS REFERENCES
Otokar	16F00-03652-AC	

### RML 99206 C



Cross Section View

Top View

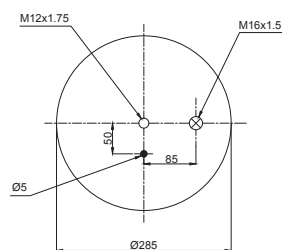
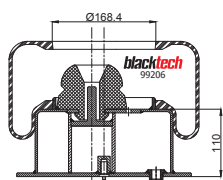

- Bolt or Stud
- Threaded hole
- ⊗ Combination Stud
- ⊗ Air Inlet

OEM PART NUMBER	MODEL NO	CROSS REFERENCES
Otokar	13H00-05484-AA	

**RML 99206 C1**



Cross Section View

Top View

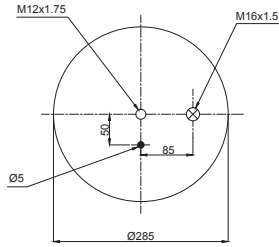
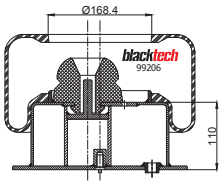

- Bolt or Stud
- Threaded hole
- ⊗ Combination Stud
- ⊗ Air Inlet

OEM PART NUMBER	MODEL NO	CROSS REFERENCES
Otokar	9900-33888-AA	

**RML 99207 C**



Cross Section View

Top View

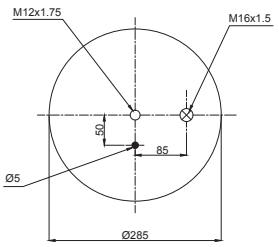
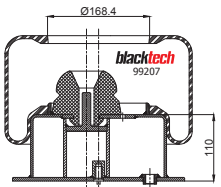

- Bolt or Stud
- Threaded hole
- ⊗ Combination Stud
- ⊗ Air Inlet

OEM PART NUMBER	MODEL NO	CROSS REFERENCES

**RML 99208 C**



Cross Section View

Top View

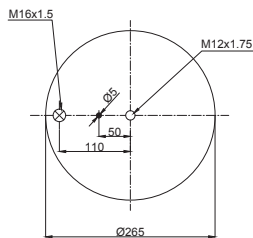
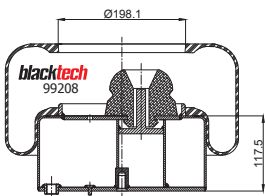

- Bolt or Stud
- Threaded hole
- ⊗ Combination Stud
- ⊗ Air Inlet

OEM PART NUMBER	MODEL NO	CROSS REFERENCES



# RML 99209 C

Gross Section View

Top View

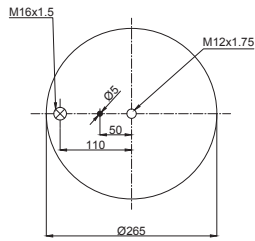
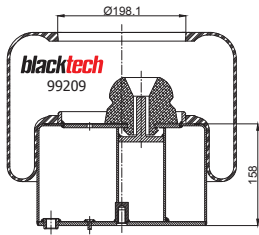

- Bolt or Stud
- Threaded hole
- ⊗ Combination Stud
- ⊗ Air Inlet

OEM PART NUMBER	MODEL NO	CROSS REFERENCES	

COMPLETE & SERVICE AIR SPRINGS CROSS LIST							
	Blacktech	ContiTech	Phoenix	Firestone Style	Firestone No.	Goodyear	CF Gomma Ref.
RML	7010 S	909 NT	1 D 23 C	1T15 L-6	W01 M58 0031		
RML	7010 SP	909 NTB	1 D 23 C-1	1T15 L-6	W01 M58 0687	1R12-709	1T 320 SP / 89753
RML	7012	901					
RML	7012 C	901 MB					
RML	7013	902					
RML	7013 C	902 MB		1T19 G-12	W01 M58 9910		
RML	7023 C1	912 N P01	1 D 28 D10	1T19 L-14	W01 M58 8502	1R14-728	1T19E-2L/1T19E-L
RML	7023 C2	912 N P02	1 D 28 D-2	1T19 L-14	W01 M58 7385 / W01 M58 8766	1R14-758	1T19E-4
RML	7023 C3						
RML	7023 C5	912 N P02					
RML	7023 CP						
RML	7023 CP1						
RML	7023 CP2						
RML	7051	940 MB	1 DK 21 K	1T17 D - 4.3	W01 M58 8613	1R11-703	1TC 300-30
RML	7051 C	940 MB	1 DK 21 K1	1T17 D - 4.3	W01 M58 8609	1R11-763	
RML	7051 C1						
RML	7051 CP	940 MB P30	1 DK 21 K-2	1T17 D - 4.3	W01 M58 8585	1R11-752	1TC300-3K
RML	7051 CP1						
RML	7052	941 MB	1 DK 21	1T17D - 8.3	W01 M58 8620	1R11-700	1TC 300-36
RML	7052 C	941 MB	1 DK 21	1T17D - 8.3	W01 M58 8619	1R11-762	1TC 300-36
RML	7052 CP	940 MB P30	1 DK 21-2	1T17D-8.3/1T17J-10.3	W01 M58 8668 / W01 M58 8618	1R11-743	1TC 300-36
RML	7053	942 MB	1 DK 32 L	1T66D13.5	W01 M58 8611	1R14-700	
RML	7053 C	942 MB		1T66F-13.5	W01 M58 8584	1R14-781	
RML	7059	948 MB					
RML	7062	951 MB		1T17D-12	W01 M58 8621	1R11-704	
RML	7062 C						
RML	7062 CP						
RML	7573						
RML	7573 C					1R12-573	
RML	7803	792 N P01					
RML	7803 CP	792 N P01					
RML	7835	724 N P01				1R11-711	
RML	7835 C1						
RML	7835 C2						
RML	7835 C3						
RML	7836	725 N P01				1R14-704	1TCS360-45
RML	7836 C2	725 N P02		1T66E-10.8	W01 M58 8969	1R14-747/1R14-813	
RML	7836 C3	725 N P03		1T66D-10.8	W01 M58 8610	1R14-814/1R14-756	
RML	7836 C4					1R14-756	
RML	7836 C5					1R14-747	
RML	7837	726 N P01					

	CF Gomma No.	Vibracoustic	Gart Ref.	Gart No.	Dunlop UK	Dunlop F	Taurus	Page
							B 151	84
	UR504-13						UR504-13	84
								84
								85
								85
								85
	207737/207736/206333	VID28D-10	D287/C	287.4.601 / 287.4.601/1		D14B52		86
	96997 / 202442	VID28D-4	D287/C	287.4.600		D 13 B14		86
								86
								87
								87
								87
								88
	205536	VIDK21K	C293/A	293.0.411		D11U31	UR 732-01	88
		VIDK21K				D11B39	KR 732-01	88
								89
	207308	VIDK21K Y4	C293/A	293.2.412	00936A-AP	D11B36		89
								89
	204466	VIDK21	C293	293.0.511		D11U30	UR730-01	90
	205170					D11B38	UR730-01	90
	206356	VIDK21 Y1	C293	293.2.512		D11B33		90
		VIDK32L						91
								91
								91
			C293/B	293.0.611				92
								92
								92
								93
								93
								93
								94
								94
								94
								95
								95
	202964	VIDF32-246149	C292/S	292.0.533		D14U38		95
		VIDF32-166252	C292/S	292.1.534		D14B40		96
		VIDF32-166252	C292/S			D14B43		96
								96
								97
		VIDF32C-166253						97

**COMPLETE & SERVICE AIR SPRINGS CROSS LIST**

Blacktech		ContiTech	Phoenix	Firestone Style	Firestone No.	Goodyear	CF Gomma Ref.
RML	7863	752 N P01					
RML	7863 C	752 N P01					
RML	7910 S	809 NT	1 D 23 B-2	1T15L-6	W01 M58 0031		1T 320 SP
RML	7910 SP	809 NTB	1 D 23 C-1	1T15L-6	W01 M58 0687	1R12-709	1T 320 SP
RML	7921		1 D 28 A-5 NP	1T19L-7	W01 M58 7237	1R14-868	
RML	7921 S	810 NT					
RML	7921 SP	810 NTB	1 DK 28 A-4	1T19L-7	W01 M58 0749	1R14-713	1T19E-1
RML	7921 C	810 MB	1 D 28 A-2	1T19L-7	W01 M58 6345 / W01 M58 8775	1R14-716	1T19E-1
RML	7921 C1						
RML	7921 C2						
RML	7921 C3						
RML	7921 CP	810 MB		1T19L-7	W01 M58 8775		
RML	7922	811 MB/O				1R14-718	1T19E-2
RML	7922-1						
RML	7922-2		1 D 28 B-2			1R14-719	
RML	7922 S	811 NT	1 D 28 B	1T19L-10	W01 M58 0028	1R14-715	
RML	7922 SP	811 NTB		1T19 L-10	W01 M58 0747	1R14-739	
RML	7922 C	811 MB				1R14-718	1T19E-2
RML	7922 C1						
RML	7922 C2						
RML	7922 C3						
RML	7922 CP2						
RML	7923						
RML	7923 C						1T19 E2
RML	7923 C1						
RML	7924	813 MB/O	1 D 28 B-5 NP	1T19L-11	W01 M58 7238	1R14-867	
RML	7924 C	813 MB	1 D 28 B-2	1T19L-11	W01 M58 6364 / W01 M58 6339	1R14-705/1R14-857	1T19E-2
RML	7924 C1						
RML	7924 C2						
RML	7924 C3						
RML	7924 C4						
RML	7924 CP						
RML	7947	836 M	1 DF 25-1 NP	1T17AR-4.5	W01 M58 0776 / W01 D08 0776	1R12-700	
RML	7947 -1	836 MB	1 DF 25-4 NP	1T17AR-4.5	W01 M58 0775	1R12-764	
RML	7947 -2	836 M2	1 DF 25-3 NP	1T17AR-4.5	W01 M58 0777 / W01 D08 0777	1R12-710	
RML	7947 -11						
RML	7947 C1	836 M K1	1 DF 25-11	1T17 AR-4.5	W01 M58 8722	1R12-712	
RML	7947-2 C1	836 M2 K1	1 DF 25-13	1T17 AR-4.5	W01 M58 8721	1R12-711	
RML	7947 C4	836 MB K4	1 DF 25-14	1T17 AR-4.5	W01 M58 8705		
RML	7947 C6	836 MB K6	1 DF 25-15	1T17 AR-4.5	W01 M58 8701	1R12-768	

	CF Gomma No.	Vibracoustic	Gart Ref.	Gart No.	Dunlop UK	Dunlop F	Taurus	Page
		V1DF32-166228						97
								98
								98
							UR 504-13	98
		V1D28A-5 NP			PNP307520000		RU621-26	99
								99
	93702				PNP311380000			99
	87413/1	V1D28A-2			00984A-AP	D13B20/D13B01	KR621-26	100
								100
								100
								101
								101
	203878		D277	277.4.506	PNP311670000	D13B34		101
								102
							KR622-31	102
						D13A02	UR622-03	102
						D14U49		103
	203878		D277	277.4.506	PNP311670000	D13B34		103
								103
			D287	287.4.522				104
			D287	287.4.522 ( UNC )				104
			D287	287.4.522				104
								105
	97730							105
			D277/2F	277.2.500				105
		V1D28B-2 NP					UR622-26	106
	87408	V1D28B-2	D277/B - D287/A	277.4.500/287.4.510	00985A-AP	D13B19/D13B02	KR622-26	106
								106
								107
								107
								107
								108
		V1DF25-1	C302	302.0.376		D13U32	UR721-01	108
		V1DF25-4				D12U27	UR721-04	108
		V1DF25-3	C302	302.0.376/2		D13U31	UR721-03	109
								109
		V1DF25-11	C302	302.1.375		D13B32	KR721-06	109
		V1DF25-13	C302	302.1.375/2		D13B31	KR721-03	110
		V1DF25-14						110
		V1DF25-15				D13B43	KR721-05	110

**COMPLETE & SERVICE AIR SPRINGS CROSS LIST**

Blacktech		ContiTech	Phoenix	Firestone Style	Firestone No.	Goodyear	CF Gomma Ref.
RML	7947 C7	836 MB K7	1 DF 25-12	1T17 AR-4.5	W01 M58 8715	1R12-723	
RML	7947 C8	836 N P05					
RML	7947 C9	836 N P06					
RML	7947 C10	836 N P10					
RML	7947 C11						
RML	7990	889 M		1T15LLR-5	W01 M58 0781	1R11-842	
RML	7990 C2	889 M K2		1T15LLR-5	W01 M58 8679	1R11-843	
RML	7992	881 MB	1 DK 32	1T66D-10.8	W01 M58 8978	1R14-708	1TC360-45
RML	7992 C	881 MB P30	1 DK 32-1	1T66F-10.8	W01 M58 8966	1R14-703	
RML	7992 CP	881 MB P30	1 DK 32-2	1T66F-10.8	W01 M58 8667	1R14-748	1TC 360-45
RML	7998	887 M		1T15LNR-3	W01 M58 0780	1R11-796	
RML	7998 C1	887 M K1		1T15LNR-3	W01 M58 8683	1R11-798	
RML	7998-2 C1	887 M K1					
RML	7998 C3	887 N P03			W01 M58 5786	1R11-888	
RML	7998 C4	887 M K4		1T15LNR-3	W01 M58 8631		
RML	7998 C6	887 N P04/887 M K6			W01 M58 5785	1R11-797	
RML	70081						
RML	70081 C		1 DK 25-8747	1T17B-11	W01 M58 8747	1R13-150	
RML	70082						
RML	70082 C						
RML	70195 C	0195 N P01					
RML	70301 C		1 DF 23 B-1	1T15VR-3	W01 M58 8192	1R13-746	
RML	70302 C		1 DF 23 A-1	1T15VPR-3	W01 M58 8193	1R12-809	
RML	70303						
RML	70303 C		1 DF 20 C-1			1R11-833	
RML	70303 C1		1 DF 20 C-2			1R11-837	
RML	70304						
RML	70304 C		1 DF 20 A-3			1R11-829	
RML	70305 C		1 DF 20 A-2			1R11-830	
RML	70306 C		1 DF 20 A-1			1R11-831	
RML	70307 C					1R11-845	
RML	70310 C					1R11-740	
RML	70462						1TS 270-23
RML	70462 CP						1TS 270-23
RML	70463						1TS 270-23
RML	70463 CP						1TS 270-23
RML	70465						1TS 270-23
RML	70465 CP						1TS 270-23
RML	70466						1TS 270-23
RML	70466 CP						1TS 270 23
RML	70739 C						1TS 270 23
RML	70742		1 DK 23 H-0742				

	CF Gomma No.	Vibracoustic	Gart Ref.	Gart No.	Dunlop UK	Dunlop F	Taurus	Page
		V1DF25-12				D13B33		111
								111
								111
								112
								112
								112
								113
	204530	V1DK32	G 292	292.0.531		D14U36	UR836-01	113
						D14B36		113
	206357	V1DK32 Y9	G 292	292.2.532		D14 B41		114
						D11U41		114
		V1DF18-2						114
								115
								115
								115
		V1DF18-3						116
								116
						D13B42		116
								117
								117
								117
								118
								118
								118
								119
								119
								119
								120
								120
								120
								121
								121
	207172							121
	206886							122
	207173							122
	206887							122
	207170							123
	206884							123
	207171							123
	206685							124
	207536							124
								124

**COMPLETE & SERVICE AIR SPRINGS CROSS LIST**

Blacktech		ContiTech	Phoenix	Firestone Style	Firestone No.	Goodyear	CF Gamma Ref.
RML	70742 C		1 DK 23 H-0742 NP				
RML	71113						
RML	71113 C	1113 N P01					
RML	71302 C						
RML	71303 C		1 D 28 C-12	1T19L-12	W01 M58 7380 / W01 M58 8765		1T19E-3
RML	71304 C			1T19L-14	W01 M58 8762		1T19E-3
RML	71304 C1			1T19L-14	W01 M58 8762		1T19E-3
RML	71309 C					1R13-726	
RML	71314 C		1 D 28 D-2	1T19L-14	W01 M58 8766		
RML	71315 C					1R13-724	
RML	71315 C1					1R13-728	
RML	71420 C						
RML	71421 C						
RML	71480 C						
RML	71481 C						
RML	71501						
1R14-823	71501 C		1 DK 28 F-3			1R14-823	
RML	71840 C						1T 19 E-3
RML	71901 C		1 D 28 A-13				
RML	72247 CP	2247 M					
RML	72421 C						
RML	72430 C						
RML	72432 C						
RML	72478						
RML	72478 C						1TS 230 25
RML	72520 C						
RML	72642 CP					1R12-642	
RML	72670 C						
RML	72789						
RML	73042	4007 N P01					
RML	73042 C	4007 N P01					
RML	73108	6604 N P01					
RML	73108 C	6604 N P01	1 DF 17-1			1R11-890	
RML	73311						
RML	73311 C	6603 N P02					
RML	73312						
RML	73312 C	6603 N P01				1R11-893	
RML	73608 C	6700 N P02			W01 M58 8535 / W01 S05 9881	1R14-869	
RML	73836	2725 N P01	1 DF 32				
RML	73836 C	2725 N P01					
RML	74031 C					1R14-812	



	CF Gomma No.	Vibracoustic	Gart Ref.	Gart No.	Dunlop UK	Dunlop F	Taurus	Page
								125
								125
								125
								126
	97343		D287/B	287.4.580		D13B03		126
	201840					D13B04		126
	201840					D13B04		127
						D13B09		127
						D13B14		127
						D13B15D		128
						D13B15G		128
			D276R	276.1.420				128
			D276R	276.1.421				129
			D276LR	276.1.480				129
			D276LR	276.1.481				129
								130
			D277/D	277.2.520				130
	201840							130
								131
								131
			D276/R	276.2.421				131
			D278E	278.2.430				132
			D278E	278.2.432				132
								132
	207194							133
			D278F	278.2.520				133
								133
			D287D	287.2.670				134
								134
		V1DF21A-247104						134
								135
								135
								135
								136
		V1DF16E-1						136
								136
								137
								137
								137
								138
								138

**COMPLETE & SERVICE AIR SPRINGS CROSS LIST**

	Blacktech	ContiTech	Phoenix	Firestone Style	Firestone No.	Goodyear	CF Gomma Ref.
RML	74283 C					1R11-896 / 1R11-896 OLD NR.	
RML	74287 C					1R11-867	
RML	74288 C					1R11-869	
RML	74307 C					1R13-730	
RML	74506 C		1 DF 20 A-4			1R11-832	
RML	74512						
RML	74512 C						
RML	74514						
RML	74514 C						
RML	74520 C						
RML	74521 C						
RML	74523 C						
RML	74543	4543 N					
RML	74543 C	6614 N P01					
RML	74544 CP					1R11-733	
RML	74580						
RML	74580 C						
RML	74760 C	6612 N P01					
RML	74762 C	6613 N P01					
RML	74770 C	54770 M					
RML	74925	4925 N					
RML	74925 C	6609 N P01					
RML	75020 C	4919 N P01					
RML	75022						
RML	75022-4						
RML	75022 C3	4911 N P03				1R13-739 / ex 1R13-714	1T19E-3
RML	75022 C4	4911 N P04				1R13-755	1T19E-3
RML	75022 C6	4911 N P06					
RML	75023	4912 N P08				1R13-713	1T19E-4
RML	75023-10						
RML	75023 C7	4912 N P07	1 DK 28 F-4	1T19L-14	W01 M58 8786	1R13-738 / ex 1R13-711	1T19E-4
RML	75023 C10	4912 N P10	1 DK 28 F-5	1T19LL-14	W01 M58 5521	1R13-753	1T19E-4
RML	75023 C13	4912 N P13	1 DK 28 F-6	1T19LL-14	W01 M58 5520		
RML	75024	4913 N P04	1 D 28 H-16 NP	1T19 L-14	W01 095 0365	1R14-755	
RML	75024 C	4913 N P02	1 D 28 H-16	1T19 L-14 / 1T19LAJ-14	W01 095 0500 / W01 M58 9881	1R14-753	1T19E-93
RML	75026	4915 N P03					
RML	75026 C6	4915 N P06	1 DK 19-1				
RML	75027	4916 N1 P01					
RML	75027 C7	4916 N1 P07					
RML	75033						
RML	75033 CP	4922 N P01					

	CF Gomma No.	Vibracoustic	Gart Ref.	Gart No.	Dunlop UK	Dunlop F	Taurus	Page
								138
								139
								139
								139
								140
								140
			D278H	278.4.512				140
								141
			D278H	278.4.514				141
			D277D	277.4.520				141
			D277D	277.4.521				142
			D277D	277.4.523				142
								142
								143
		V1DK20C2						143
								143
			278B	278.4.580				144
								144
								144
								145
								145
								145
								146
								146
								146
	207770		D 287/E	287.1.540		D13B41		147
	207771		D 287/E	287.1.541				147
			D 287/E	287.1.542				147
	206780		D 287/C	287.0.601		D13U40		148
								148
	206779	V1DK28F-4	D 287/C	287.1.600		D13B40 / D13B45		148
	207769	V1DK28F-8	D 287/C	287.1.603				149
			D 287/C	287.1.602				149
			C282/H - D287/H	282.0.601/ 287.0.603		D14U42		149
	206201		C282/H - D287/H	282.1.600 / 282.1.606	00937A-AP	D14B42	KR625-16	150
			C294/C	294.0.531				150
		V1DK19-1	C294/C	294.0.530				150
								151
								151
								151
								152

**COMPLETE & SERVICE AIR SPRINGS CROSS LIST**

Blacktech		ContiTech	Phoenix	Firestone Style	Firestone No.	Goodyear	CF Gomma Ref.
RML	75051	4940 N P02				1R11-799	
RML	75051 C						
RML	75051 CP						
RML	75052	4941 N P02				1R11-802	
RML	75052 C						
RML	75052 CP						
RML	75053	4942 N P02					
RML	75053 C1	4942 N P04					
RML	75054						
RML	75038 CP	4927 N P01					
RML	75071	4960 N P02	1 DK 21 K-3			1R11-801	1TC300-30K
RML	75071 C						
RML	75071 CP						
RML	75072	4961 N P02				1R11-800	
RML	75072 CP						
RML	75073	4962 N P02				1R11-803	
RML	75115	4004 N P02	1 DK 22 E 5 NP	1T17BS-6	W01 M58 0919	1R11-705	1T300-37
RML	75115 C	4004 N P05	1 DK 22 E-5	1T17BS-6		1R11-706	1T300-33
RML	75115 CP	4004 N P03	1 DK 22 E-8	1T17BS-6	W01 M58 6366	1R11-713 / 1R11-750	1T300-37
RML	75119	4008 N					
RML	75119 C		1 D 28 C-12	1T19L-12	W01 M58 8765		
RML	75120 C						
RML	75131 C						
RML	75131 C1						
RML	75132						
RML	75132 CP						1T300-37
RML	75133	4022 N P02	1 DK 22 E-9 NP	1T17BS-6	W01 M58 0756	1R11-709 / 1R11-850	
RML	75133-1						
RML	75133 C2						
RML	75133 C3			1T15 BS-6	W01 M58 6367	1R11-714	1T300-37
RML	75133 CP2						
RML	75133 CP3	4022 N P03	1 DK 22 E-9	1T17BS-6	W01 M58 6367	1R11-714 / 1R11-751 / 1R11-710	1T300-37
RML	75133 CP4						
RML	75133 CP5	4022 N P05	1 DK 22 E-11	1T17BS-6	W01 M58 8612	1R11-781	1T300-37
RML	75134	4023 N P06	1 D 28 B-10 NP	1T19L-11	W01 M58 6335		
RML	75134 C	4023 N P03	1 D 28 B-10	1T19L-11	W01 M58 6348	1R14-729	1T19E-2
RML	75134 C1						
RML	75134 C2	4023 N P07					1T19E-2
RML	75134 C3	4023 N P08					1T19E-2
RML	75134 CP						
RML	75134 CP1						
RML	75134 CP2						

	CF Gomma No.	Vibracoustic	Gart Ref.	Gart No.	Dunlop UK	Dunlop F	Taurus	Page
			C 293/A	293.0.413		D11U42		152
								152
								153
			C293	293.0.513		D11U45		153
						D11U45		153
								154
			C293	293.0.514				154
								154
								155
								155
	207711	VIDK21K-3	C 292/A	293.0.412		D11U44		155
								156
								156
			C293/A	293.0.414		D11U43		156
								157
			C293	293.0.514		D11U46		157
		VIDK22E-5NP	D278/S	278.0.451		D12U13	K505	157
	97722	VIDK22E-5	D278/S	278.4.451		D12B25		158
	203715	VIDK22E-8	D278/S	278.4.452		D12B34 / D12B13	K505-27SM	158
								158
		VID28C-12				D13B03		159
								159
								159
								160
								160
	207722							160
		VIDK22E-9 NP	D278/S	278.0.452		D11U40		161
								161
								161
	204677					D12B04	KR725-28	162
								162
	206340	VIDK22E-9	D278/S	278.4.454 / 278.4.453		D12B14	KR725-28	162
								163
	206585	VIDK22E-10	D278/S	278.1.455		D11B41		163
								163
	204676	VID28B-10	D277	277.4.505		D13B26	KR622-18	164
								164
	207734		D277	277.4.505/2				164
	207735		D277	277.1.505				165
								165
								165
								166

**COMPLETE & SERVICE AIR SPRINGS CROSS LIST**

Blacktech		ContiTech	Phoenix	Firestone Style	Firestone No.	Goodyear	CF Gomma Ref.
RML	75134 CP3						
RML	75134 CP4						
RML	75138						
RML	75138 CP						1T300-37
RML	75139						
RML	75139 C2	4028 N P02	1 D 28 F-1	1T19L-12	W01 M58 8106	1R14-782	
RML	75139 C5	4028 N P05	1 D 28 B-12	1T19L-11	W01 M58 7370	1R14-721 / 1R14-710	
RML	75260-1						
RML	75260-5	4159 N P05	1 DK 21 B-5 NP	1T15M-9	W01 M58 0736	1R12-761	1T323 - 40
RML	75260 C3	4159 N P03	1 DK 23 L-27	1T15M-9	W01 M58 7548 / W01 358 9130	1R12-701	1T323 - 40
RML	75260 C4	4159 N P04		1T15M-9	W01 358 9101	1R12-103	
RML	75260 C6						
RML	75260 C7	4159 N P07	1 DK 23 L-25	1T15M-9	W01 M58 8859 / W01 379 9091	1R12-702	1T323-40
RML	75260 C8						
RML	75260 C10						
RML	75260 C16						
RML	75260 CA18			1T15M-9	W01 M58 7548		
RML	75260 CP9	4159 N P09	1 DK 23 L-9131	1T15M-9	W01 M58 9131	1R12-721	1T323-40
RML	75260 CP11						
RML	75260 CP12						
RML	75260 CP13						
RML	75260 CP14	4159 N P14	1 DK 21 B-4	1T15M-9	W01 M58 7548	1R12-760 / 1R12-834	1T323-40
RML	75265						
RML	75265 C5	4154 N P05	1 DK 23 F-1	1T15M-3	W01 35 8172 / W01 M58 8172		
RML	75265 CP6	4154 N P06					
RML	75266						
RML	75266 C						1T323 - 33
RML	75267-1	4156 N P01	1 DK 21 A-2	1T15M-6	W01 358 0712	1R12-093	
RML	75267-5	4156 N P05		1T15M-6	W01 358 0734	1R12-842	
RML	75267-12						
RML	75267 C4	4156 N P04		1T15M-6	W01 358 9082	1R12-134/092	
RML	75267 C6		1 DK 23 K-28	1T15M-6	W01 358 9361	1R12-719	1T323-33
RML	75267 C7	4156 N P07	1 DK 23 K-28	1T15M-6	W01 358 9361	1R12-719	1T323-32
RML	75267 C9	4156 N P09	1 DK 23 K-54	1T15M-6	W01 M58 9089	1R12-706	1T323-33
RML	75267 C11						
RML	75267 C15						
RML	75267 CP10	4156 N P10		1T15M-6	W01 358 8929	1R12-461	
RML	75267 CP13						
RML	75267 CP14	4156 N P14	1 DK 23 K-9082	1T15M-6	W01 358 9082	1R12-092	1T323-32
RML	75267 CP15	4156 N P15	1 DK 23 K-1	1T15M-6	W01 358 9361		1T323-32

	CF Gomma No.	Vibracoustic	Gart Ref.	Gart No.	Dunlop UK	Dunlop F	Taurus	Page
								166
								166
								167
	207719							167
								167
		V1D28F-1	D287/E	287.4.540		D14B47		168
		V1D28F-7	D277/D - D287	277.4.520/277.4.524/287.4.521		D14B51		168
								168
		V1DK21B-5	D278/H	278.0.551		D12U04		169
	97306	V1DK23L-40	D278/H	278.4.511/1	PNP311370000	D12B08		169
						D12B34	KR509-9101	169
								170
	202302	V1DK23B-9	D278/H	278.2.511	00982A-AP	D12B15	KR509-25	170
								170
								171
								171
								171
	200751	V1DK23L-9131	D278/H	278.1.510		D12B04	KR509-9131	172
								172
								172
								173
	204124	V1DK21B-4			PNP311370000	D12B01		173
								173
		V1DK23F-1						174
								174
								174
	96873							175
							KR506-21	175
			D278/G	278.0.421				175
								176
							KR506-9082	176
	97306	V1DK23K-28			PNP309580100	D12B19	KR506-28	176
		V1DK23K-28	D278/G	278.4.421/1	00981A-AP	D12B19	KR506-28	177
	96873	V1DK23K-24				D12B16		177
								177
								178
								178
								178
	207767	V1DK23K-9082				D12B33	KR506-9082	179
	207777				00981B-AP		K506-22SU	179

**COMPLETE & SERVICE AIR SPRINGS CROSS LIST**

Blacktech		ContiTech	Phoenix	Firestone Style	Firestone No.	Goodyear	CF Gomma Ref.
RML	75267 CP16	4156 N P16					
RML	75268	4157 N P05					
RML	75268-4	4157 N P04					
RML	75268-6	4157 N P06					
RML	75268 C3						
RML	75268 C4						
RML	75268 C5						
RML	75268 C6						
RML	75268 C9						
RML	75268 CP3	4157 N P03				1R11-881	
RML	75268 CP4	4157 N P04	1 DK 21 A4	1T15 MPW-7	W01 M58 6297	1R11-111	
RML	75268 CP5	4157 N P05	1 DK 21 A-3	1T15 MPW-7	W01 M58 8840	1R11-882 / 1R11-886	1T 323-32
RML	75268 CP6	4157 N P06	1 DK 21 A-1	1T15 MPW-7	W01 M58 8186 / 6136	1R11-764	
RML	75268 CP8	4157 N P08	1 DK 20 C-2	1T15 MPW-7	W01 M58 6317	1R11-773	1T 323-37
RML	75268 CP9	4157 N P09	1 DK 21 A-31	1T15 MPW-7	W01 M58 7074	1R11-106	1T 300-38
RML	75268 CP10	4157 N P10	1 DK 21 A-51	1T15 MPW-7	W01 M58 6315	1R11-772	1T 300-38
RML	75268 CP14	4157 N P04	1 DK 21 A4	1T15 MPW-7	W01 M58 6297	1R11-111	1T 300-40
RML	75269	4158 N P02	1 DK 20 B1 NP	1T15 MPW-9	W01 M58 6257	1R12-748	
RML	75269 C						
RML	75269 CP	4158 N P03	1 DK 20 B-1	1T15 MPW-9	W01 M58 8185 / 6285	1R11-749	
RML	75270 C		1 D 23 E23	1T15 M-9	W01 M58 6289	1R12-703	
RML	75339 CP						
RML	75339 CP1			1T14 C-1	W01 M58 5339		
RML	75343 CA						
RML	75343 CA1			1T14 C-1	W01 358 5443		
RML	75531	6075 ( 4420 N )					
RML	75531 C	4420 N P01		1T17 BR-8	W01 M58 9707		1TS 300-28
RML	75580 C	1850 N P01					
RML	75581 C	1889 N P02					
RML	75816 - 1	4705 N1 P01				1R12-831	
RML	75816 C3	4705 N1 P03					
RML	75816 C4	4705 N1 P04		1T17 AR-10.5	W01 M58 8367		
RML	75824	4713 N P04				1R12-763	
RML	75824 C	4713 N P02	1 DF 22 C-1	1T17 BR-8	W01 M58 9706	1R12-762	1T 300-28
RML	75829	4718 N P02				1R12-841	
RML	75829 C	4718 N P01				1R12 821	
RML	75921	4810 N					
RML	75921 C						
RML	75921 C1	4810 N P08					
RML	75921 C2						
RML	75921 C5	4810 N P05	1 D28 A-10	1T19 L-7	W01 M58 6338	1R14-730	1T19 E1-E2
RML	75921 C7						



	CF Gomma No.	Vibracoustic	Gart Ref.	Gart No.	Dunlop UK	Dunlop F	Taurus	Page
								179
								180
								180
								180
								181
								181
								181
								182
								182
								182
		V1D 21A-4				D12 B18	KR 915-54	183
	207778	V1D 21A-31	C294	294.2.450/1	00980B/AP			183
		V1D 21A-1	C 294	294.1.451		D11B37	KR 915-52	183
	207768	V1DK 20 C-2	C 294	294.1.452		D12B30	KR 915-53NW	184
	205598	V1D 21A-31	C 294	294.2.450		D12B17		184
	206925	V1D 20 A-51	C 294	294.1.450		D12 B29	KR 915 - 51	184
	207463	1DK 21 A8	C 294/D	294.2.454	00980A/AP	D12 B18		185
		V1DK 20 B1 NP	D278/HS	278.0.531		D12 U23		185
								185
		V1DK 20 B1	D278/HS	278.0.531/1		D12 B22		186
		V1D 23 E23				D12 B07 / 09		186
								186
								187
								187
								187
								188
	207774		D278/V1	278.1.355				188
								188
								189
			C302/B	302.0.521				189
			C302/B	302.1.520				189
				302.1.521				190
			C293/V	293.0.461		D12U24		190
	207775	V1DF 22-C1	C293/V	293.1.460		D12B24		190
			D278/V	278.0.471				191
			D278/V	278.1.471				191
								191
								192
	1T 19E-1	207733	D277/B	277.4.424/1				192
								192
	205456 - 207732	V1D28 A-10	D277/B	277.4.523 / 277.4.505/1		D13B25	KR621-18	193
								193

**COMPLETE & SERVICE AIR SPRINGS CROSS LIST**

Blacktech		ContiTech	Phoenix	Firestone Style	Firestone No.	Goodyear	CF Gomma Ref.
RML	75921 CP						
RML	75921 CP1						
RML	75921 CP2						
RML	75924	4813 N					
RML	75924 C	4813 N P07	1 D28 B-9	1T19 L-11	W01 M58 7358	1R14-727	1T19 E2-2BR
RML	75924 C1						
RML	75973	4862 N P01					
RML	75973 C2	4862 N1 P02					
RML	75992	4881 N P02	1 DK 32 K	1T66 F-7.0	W01 M58 8601	1R14-701	1TC 360-40
RML	75992 C						
RML	75992 CP	4881 N P30	1 DK 32 K-2	1T66 F-7.0	W01 M58 8666	1R14-757	1 TC 360-40K
RML	75993	4882 N1 P01	1 DF 16-2 NP			1R10-702	1 TS 260-32
RML	75993 C5	4882 N1 P05	1 DF 16-2	1T17TWR-8	W01 M58 9880	1R10-709	1 TS 260-28
RML	75993 CP5						
RML	75994	4883 N1 P01				1R11-804	1 TS 290-30
RML	75994 C	4883 N1 P06				1R11-884	
RML	75995	4884 N1 P01	1 DF 19 B-1NP			1R11-820	1 TS 290-28
RML	75995-2	4884 N1 P02					
RML	75995 C6	4884 N1 P06	1 DF 19 B-1	1T17JR-7.2	W01 M58 9879	1R11-861	1 TS 290-28
RML	75995 C7	4884 N1 P07				1R11-885	
RML	75995 CP6						
RML	75996	4885 N1 P01					1TS 260-20
RML	75996 C2	4885 N1 P02					1TS 260-20
RML	75997	4886 N P02					
RML	75997 C1	4886 N P01					
RML	76113 C	6602 N P01				1R12-843	
RML	76199						
RML	76199 C		1 DF 23 C-1			1R13-744	
RML	76200						
RML	76200 C		1 DF 23 D-1			1R13-745	
RML	76200 C1						
RML	76237 C		1 DF 23 B-4			1R13-750	
RML	76238 C		1 DF 23 A-2			1R12-813	
RML	76240 C		1 DF 23 A-5			1R11-834	
RML	76241 C		1 DF 23 A-6			1R11-840	
RML	76242 C		1 DF 23 A-7			1R11-839	
RML	76243 C		1 DF 23 A-8			1R11-838	
RML	76246 C		1 DF 23 B-5			1R11-841	
RML	76251						
RML	76251 C			1T15 AA-3	W01 M58 6251	1R11-826	
RML	76251 CP						
RML	76260						

	CF Gomma No.	Vibracoustic	Gart Ref.	Gart No.	Dunlop UK	Dunlop F	Taurus	Page
								193
								194
								194
								194
	97764	V1D28 B-9	D287	287.4.520		D13B10 / D13B22	KR622-01	195
								195
		V1DF16 B-1 NP						195
		V1DF16 B-1						196
	205537	V1D32 K	C292/A	292.0.461		D14U37	UR838-01	196
								196
	207309	V1DK32K Y10	C292/A	292.0.462		D14B44		197
	207760	V1DF16-2 NP	C289/M	289.0.512		D10U01		197
	207701	V1DF16-2	C289/M	289.1.510				197
								198
	207761	V1DF19-C1	C304/M3	304.0.513		D11U47		198
			C304/M3	304.1.513				198
	207759	V1DF19 B-1 NP	C304/M4	304.0.511		D11U48		199
								199
	207702	V1DF19 B-1	C304/M4	304.1.510				199
			C289/M	289.1.513				200
								200
	207762		C289/M1	289.0.411				200
	207764		C289/M1	289.1.410				201
								201
								201
								202
								202
								202
								203
								203
								203
								204
								204
								204
								205
								205
								205
								206
								206
								206
								207
								207

**COMPLETE & SERVICE AIR SPRINGS CROSS LIST**

Blacktech		ContiTech	Phoenix	Firestone Style	Firestone No.	Goodyear	CF Gomma Ref.
RML	76260 C						
RML	76260 CP			1T15 MPW-7	W01 M58 6260		
RML	76269						
RML	76269 CP			1T15 M6	W01 M58 6269		
RML	76286						
RML	76286 CP			1T15 MPW-9	W01 M58 6286		
RML	76287 CP			1T15 MPW-9	W01 M58 6287		
RML	76288 CP			1T15MPW-9	W01 M58 6238		
RML	76318						
RML	76318 CP			1T15MPW-9	W01 M58 6318		
RML	76420						
RML	76420 C	6606 N P02					
RML	76884 C		1 DK 28 A-7	1T19L-7	W01 M58 8772		1T19 E-1
RML	76885 C		1 DK 28 B-8	1T19L-11	W01 M58 8794		1T19 E-2
RML	77179						1TS 270-25 C
RML	77179 CP				207163		1TS 270-25 C
RML	77180				207333		1TS 270-25 C
RML	77180 CP				207162		1TS 270-25 C
RML	77283						
RML	77283 C						
RML	77283 CP			1T15M-4	W01 M58 7283		
RML	77308						
RML	77308 C						
RML	77308 CP		1 DK 23 L-7308	1T15M-9	W01 M58 7308	1R12-713	
RML	77313						
RML	77313 CP			1T15AA-6	W01 M58 7313		
RML	77315						
RML	77315 C			1T15 Lux-11	W01 M58 7315		
RML	77315 CP						
RML	77348						
RML	77348 C						
RML	77415 C						
RML	77433					1R12-826	
RML	77433 C					1R12-825	
RML	77527	6416 N					
RML	77527 C	6608 N P01	1 DF 17 B-1	1T15UR-9	W01 M58 8474	1R10-704	
RML	77529						
RML	77529 C	6607 N P01	1 DF 17 A-1	1T15UR-6	W01 M58-8473	1R10-707	
RML	77639 C						1TS 270-23C
RML	77639 C1						1TS 270-23C
RML	77685 C		1D 28 F5			1R14-784	
RML	77804	7804 N					

	CF Gomma No.	Vibracoustic	Gart Ref.	Gart No.	Dunlop UK	Dunlop F	Taurus	Page
								207
								208
								208
								208
								209
								209
								209
								210
								210
								210
								211
								211
	96884							211
	96885							212
								212
								212
								212
								213
								213
								213
								214
								214
								214
								215
								215
								215
								216
								216
								216
								217
								217
								217
		VID23G-5						218
								218
								218
								219
		VIDF16D-1	C295/V	295.1465				219
								219
		VIDF16C-1	C294/VA	295.1400				220
	207537							220
	207538							220
		VID28F5						221
								221

COMPLETE & SERVICE AIR SPRINGS CROSS LIST							
	Blacktech	ContiTech	Phoenix	Firestone Style	Firestone No.	Goodyear	CF Gomma Ref.
RML	77804 C	6606 N P01	1 DF 20 E-1	1T15LNR-3	W01 M58 8477	1R11-848	
RML	77805	7805 N					
RML	77805 C	6606 N P02					
RML	78188						1TS 270-26
RML	78188 C						1TS 270-26
RML	78263						
RML	78263 C					1R11-847	
RML	78385						
RML	78385 C						
RML	78586						
RML	78586 CP			1T17BPZ-11	W01 R88 8586		
RML	78599 CP						
RML	78608						
RML	78608 CP			1T17DJ-7	W01 M58 8608		
RML	78633 C			1T17HR	W01 M58 8633		
RML	78643						
RML	78643 C			1T17CL-9.5	W01 M58 8643	1R13-167	
RML	78653 CP			1T15UR-9	W01 M58 8653		
RML	78887 C						
RML	78888 C						
RML	78914	7803 N					
RML	78914 C	6605 N P01	1 DF 20 D-1	1T15LNR-6	W01 M58 8472	1R11-805	
RML	79002 A3						
RML	79002 A3 CP	4157 N P05	1 DK 21 A-3	1T15MPW-7	W01 M58 8840	1R11-882/1R11-886	1T323-32
RML	79002 A3 CP1						
RML	79002 A8						
RML	79002 A8 CP	4157 N P04	1DK 21 A8/A4			1R11-111	
RML	79002 A8 CP1						
RML	79002 CP6						
RML	79003 A3						
RML	79003 A3 CP						
RML	79003 A3 CP1			1T15MPW-7	W01 M58 7074		
RML	79003 A8						
RML	79003 A8 CP			1T15MPW-7	W01 M58 6297		
RML	79003 A8 CP1						
RML	79198 C						1TS 270-27 C
RML	79198 C1						1TS 270-27 C
RML	79296		1 DK 20 B-1	1T15MPW-9	W01 M58 6257	1R12-748	
RML	79296 C			1T15MPW-9	W01 M58 8185		
RML	79296 CP	4158 N P03		1T15MPW-9	W01 M58 8185	1R12-749	
RML	79328 C						
RML	79720						1TS 290-19C

	CF Gomma No.	Vibracoustic	Gart Ref.	Gart No.	Dunlop UK	Dunlop F	Taurus	Page
		V1DF20A-1	C294/VA	294.1.370				221
								222
								222
	207949							222
	207530							223
								223
		V1DK22G-1						223
								224
		V1D23G-4WB						224
								224
								225
								225
								225
								226
								226
								226
								227
								227
		V1DK27B-1						227
		V1DK27B-2						228
								228
		V1DF20B-1	C294/V	294.1.430		D11B42		228
								229
	20778	V1DK21A-3	C294	294.2.450/1	00980B-AP			229
								229
								230
		V1DK21A-4				D12 B18	KP 915-53 NW	230
								230
								231
								231
								231
								232
								232
								232
								233
	207405							233
	207406							233
						D12 U23		234
								234
						D12 B22		234
		V1DK27B-6						235
	207617							235

**COMPLETE & SERVICE AIR SPRINGS CROSS LIST**

Blacktech		ContiTech	Phoenix	Firestone Style	Firestone No.	Goodyear	CF Gamma Ref.
RML	79720 C						1TS 290-19C
RML	79722-1						1TS 240-20LM
RML	79722-2						1TS 240-20LM
RML	79722 CP1						1T 240-20 SINISTRA
RML	79722 CP2						1T 240-20 DESTRA
RML	79739						1TS 270-26
RML	79739 C						1TS 270-26
RML	79910 C			1T19G-12	W01 M58 9910		
RML	9027 C						
RML	9032 C						
RML	9032 C3						
RML	9032 C4						
RML	9032 C5	921 M					
RML	9755 C2						
RML	9755 C3						
RML	9755 C4						
RML	9772 C1	661 N P01					
RML	9772 C2						
RML	9772 C4						
RML	9772 C6						
RML	9772 C7						
RML	9772 C8						
RML	9772 C10						
RML	9870 C	769 M					
RML	9870 C1	769 MB	1 E 18-2				
RML	9873 C						
RML	9879 C	768 MB					
RML	9886 C						
RML	9893 C3	782 MB-3					
RML	9893 C4	782 NP04					
RML	9920 C	819 MB					1S 215-22
RML	9928 C	817 MB					
RML	9928 C1						
RML	9987 C	876 MB					
RML	92035 C	1924 N1 P05	2 F 18-1				
RML	92336 C						1S 323-36 C
RML	92336 CP						1S 323-36 C
RML	92526 C	1415 N P01	1 E 23 A-1			9562	
RML	92526 C1	1415 N P02					
RML	92844 C						1S 270-25 C
RML	92844 C1						1S 270-25 C
RML	92996 C						



	CF Gomma No.	Vibracoustic	Gart Ref.	Gart No.	Dunlop UK	Dunlop F	Taurus	Page
	207410							235
	207619							236
	207620							236
	207113							236
	207112							237
	M011601							237
	207529							237
								238
								238
								238
								239
								239
								239
								240
								240
								240
		V1E25-8						241
								241
								241
								242
								242
								242
								243
						260HDD		243
								243
								244
								244
								244
		V1E21-23						245
								245
	97297							245
								246
								246
								246
								247
	204065							247
	207313							247
								248
								248
	203474							248
	204151							249
								249

**COMPLETE & SERVICE AIR SPRINGS CROSS LIST**

	Blacktech	ContiTech	Phoenix	Firestone Style	Firestone No.	Goodyear	CF Gomma Ref.
RML	93351 C						1S 270-23 V
RML	93351 C1						1S 270-23 V
RML	93856 C						
RML	93857 C						
RML	94098 C						1S 290-23 V
RML	95019 C						1 SC 250-19
RML	95019 C1						1 SC 250-19
RML	95101 C						
RML	95101 C2						
RML	95294 -1	4183 N3 ( Old Cod 4183-N2 )					
RML	95294 -2	4183 N4 ( Old Cod 4183 N1 )					
RML	95294 C1	4183 N P23					
RML	95294 C21	4183 N P24					
RML	95294 C23	4183 N P25 ( Old Cod 4183 N P23 )					
RML	95294 C24	4183 N P26 ( Old Cod 4183 N P24 )					
RML	95296	4185 N					
RML	95296 C1	4185 N P01					
RML	95296 C21	4185 N P21					
RML	95298-1	4187 N3 ( Old Cod 4187 N1 )					
RML	95298-2	4187 N4 ( Old Cod 4187 N2 )					
RML	95298 C1	4187 N P01					
RML	95298 C2	4187 N P21					
RML	95298 C21	4187 N P23 ( Old Cod N P21 )					
RML	95298 C22	4187 N P24 ( Old Cod N P22 )					
RML	95401-1	4390 N1	1 KF 21-1NP	1R7Z 440-290 B	W01 M58 0904	9507	1VSC 285-30
RML	95401-2	4390 N2	1 KF 21-2 NP	1R7Z 440-290 C	W01 M58 0905	9508	1VSC 285-30
RML	95401-3						
RML	95401 C1	4390 N P01					
RML	95401 C2	4390 N P02					
RML	95401 C3	4390 N P03					
RML	95401 C4	4390 N P04					
RML	95401 C5						
RML	95401 C21	4390 N P21	1 KF 21-21	1R7Z 440-290	W01 M58 8514	9505	1VSC 285-30
RML	95401 C22	4390 N P22	1 KF 21-22	1R7Z 440-290	W01 M58 8513	9506	1VSC 285-30
RML	95401 C23	4390 N P23				9563	1VSC 285-30
RML	95401 C24	4390 N P24				9564	1VSC 285-30
RML	95402-1	4391 N1					
RML	95402-2	4391 N2					
RML	95402 C1	4391 N P01					

	CF Gomma No.	Vibracoustic	Gart Ref.	Gart No.	Dunlop UK	Dunlop F	Taurus	Page
								249
								250
								250
								250
								251
	204660							251
	204886							251
								252
								252
								252
								253
								253
								253
								254
								254
								254
								254
								255
								255
								255
								255
								256
								256
								256
								257
								257
	206782		C304	304.0.440		D12U25		257
	206784	V 1 KF 21-1 NP	C304	304.0.441		D12U26		258
		V 1 KF 21-2 NP						258
								258
								259
								259
								259
								260
	207765		C304	304.0.440				260
	207766	V 1 KF 21-21	C304	304.0.441				260
	206783	V 1 KF 21-22	C304	304.0.443				261
	206781	V 1 KF 21-4-232	C304	304.0.444				261
		V 1 KF 21-3-232						261
								262
								262

**COMPLETE & SERVICE AIR SPRINGS CROSS LIST**

	Blacktech	ContiTech	Phoenix	Firestone Style	Firestone No.	Goodyear	CF Gomma Ref.
RML	95402 C2	4391 N P02					
RML	95402 C21	4391 N P21					
RML	95402 C22	4391 N P22					
RML	95755	4644 N				9561	
RML	95755 C2	4644 N P02					
RML	95755 C22	4644 N P22					
RML	95848-1	4737 N					
RML	95848 C1	4737 N P01					
RML	95848 C2	4737 N P02					
RML	95848 C5	4737 N P05					
RML	95848 C21	4737 N P21				9523	
RML	95848 C22	4737 N P22				9524	
RML	95848 C25	4737 N P25				9539	
RML	95860	4759 N					
RML	95860 C1	4759 N P01					
RML	95860 C21	4759 N P21					
RML	95868-1	4757 N1	1 KF 24-1 NP	1R7Z 460-305 A	W01 M58 0909	9517	
RML	95868-2	4757 N2	1 KF 24-2 NP	1R7Z 460-305 A	W01 M58 0910	9518	
RML	95868 C1	4757 N P01					
RML	95868 C9	4757 N P09					
RML	95868 C21	4757 N P21	1 KF 24-21	1R7Z 460-305 A	W01 M58 8521	9519	
RML	95868 C29	4757 N P29	1 KF 24-29	1R7Z 460-305 B	W01 M58 8522	9520	
RML	95869-1	4758 N					
RML	95869 C1	4758 N P01					
RML	95869 C21	4758 N P21					
RML	95869 C23	4758 N P23					
RML	95949-1	4838 N					
RML	95949 C1	4838 N P01				9521	
RML	95949 C2	4838 N P02					
RML	95949 C3	4838 N P03				9536	
RML	95949 C21	4838 N P21		1R7Z 595-330 A	W01 M58 8512	9521	
RML	95949 C22	4838 N P22				9522	
RML	95949 C23	4838 N P23				9536	
RML	96032 C						1 SC 260-32
RML	97026 C						1 SC 270-26
RML	97054 C						
RML	97743 C						1S 285-25 C
RML	97756 C						1S 285-23 V
RML	97756 C1						1S 285-23 V
RML	98183						1SC 230-25
RML	98183 C						1SC 230-25
RML	98518 C						1S 285-18 C

	CF Gomma No.	Vibracoustic	Gart Ref.	Gart No.	Dunlop UK	Dunlop F	Taurus	Page
								262
								263
								263
								263
								264
								264
		V1KE 22-1						264
								265
								265
								265
								266
								266
								266
								267
								267
								267
			C299/A	299.0.461		D13U42		268
		V1KF 24-1-230 NP	C299/A	299.0.460		D13U43		268
		V1KF 24-2-230 NP						268
								269
			C299/A	299.1.460		D13T01		269
		V1KF 24-1-232	C299/A	299.1.461		D13T02		269
		V1KF 24-2-232						270
								270
								270
								271
								271
								271
								272
								272
								272
		V1KF 25-1-232						273
		V1KF 25-2-232						273
	201408	V1KF 25-3-232						273
	205057							274
								274
	96825							274
								275
								275
	207633							275
	207631							276
	88811							276

**COMPLETE & SERVICE AIR SPRINGS CROSS LIST**

	Blacktech	ContiTech	Phoenix	Firestone Style	Firestone No.	Goodyear	CF Gomma Ref.
RML	98518 C1						1S 285-18 C
RML	98739 C						
RML	98739 C1						
RML	98739 C2						
RML	99201 C						
RML	99202 C						
RML	99202 C1						
RML	99203 C						
RML	99205 C						
RML	99206 C						
RML	99206 C1						
RML	99207 C						
RML	99208 C						
RML	99209 C						

	CF Gomma No.	Vibracoustic	Gart Ref.	Gart No.	Dunlop UK	Dunlop F	Taurus	Page
	96612							276
								277
								277
								277
								278
								278
								278
								279
								279
								279
								280
								280
								280
								281





# CONVOLUTED AIR SPRINGS

**blacktech**™



**Vibracoustic**  
CV Air Springs



## Components of Air Springs

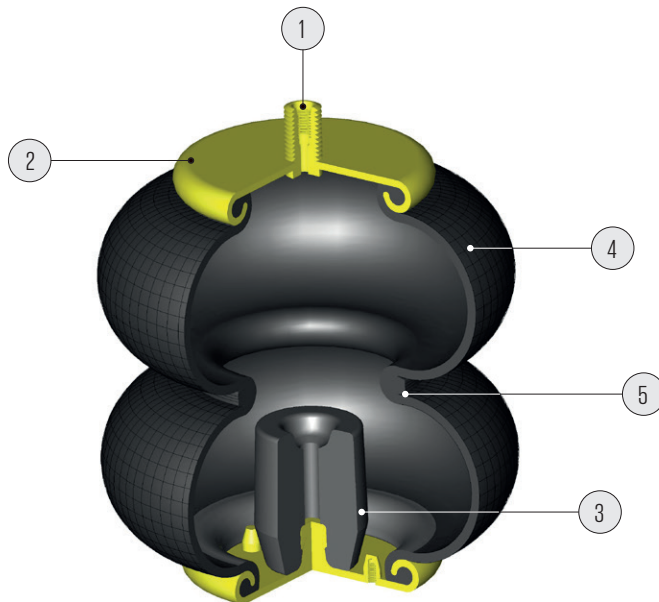

1. Combination stud / Air fitting
2. Plate
3. Bumper (Generally used in air suspension applications as fail-safe device.)
4. Rubber air spring body
5. Girdle hoop

## Product Identification / Roll Air Springs

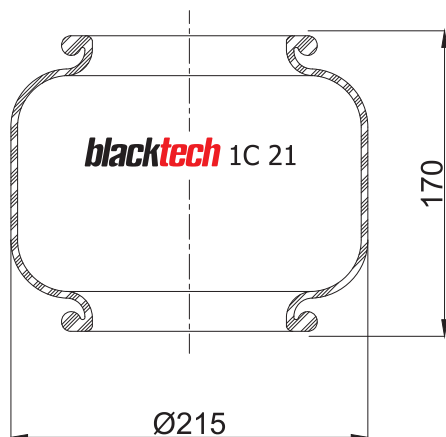

1 C1 21 - 170 S  
Rubber Bellow Only

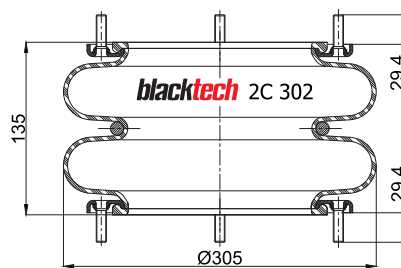

2C 302 - 135 F01  
With steel bead ring (customer's own mounting plate should be attached to the air spring)

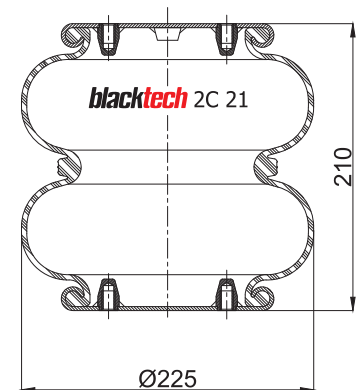

2C 21 - 210 P13  
With crimped baead plate or with steel bead ring and the mounting plate

CONVOLUTED AIR SPRINGS OEM LIST					
MANUFACTURER	OEM PART NO	PART NO	TYPE	REMARK	PAGE
AUSTERAS	99381001	1C 181-120 F01	With steel bead ring and mounting plate	(Ø 181mm)	322
BARTOLETTI	9162/110	1C 181-120 F01	With steel bead ring and mounting plate	(Ø 181mm)	322
BMC	57RS306424	3C 300-250 P01	With crimped bead plate	(Ø 305mm)	349
		3C 301-250 P03	With crimped bead plate	(Ø 305mm)	351
		3C 301-250 P04	With crimped bead plate	(Ø 305mm)	351
BMC/MERCEDES 8X2		1C 21-170 P02	With crimped bead plate	(Ø 215mm)	320
BPW	02.200.20.90.0	2C 250-170 S1	Rubber bellow only	(Ø 250mm)	337
	04.419.00.28.0	2C 250-170 F	With steel bead ring and mounting plate	(Ø 250mm)	338
	05.429.00.04.0	2C 250-170 F	With steel bead ring and mounting plate	(Ø 250mm)	338
	04.419.00.28.0	2C 250-170 F01	With steel bead ring and mounting plate	(Ø 250mm)	338
	05.429.00.04.0	2C 250-170 F01	With steel bead ring and mounting plate	(Ø 250mm)	338
	02.200.20.50.0	2C 280-175 S	Rubber bellow only	(Ø 280mm)	340
	02.200.21.90.0	2C 315-225 P04	With crimped bead plate	(Ø 315mm)	344
BPW/BATTAGLINO	22.070.00	1C 181-120 F01	With steel bead ring and mounting plate	(Ø 181mm)	322
DAF	1192 203	2C 250-170 S1	Rubber bellow only	(Ø 250mm)	337
	1307 058	2C 350-215 P02	With crimped bead plate	(Ø 350mm)	345
DAIMLER TAS	A 946 328 16 01	2C 211-220 P01	With crimped bead plate	(Ø 215mm)	336
	A 946 328 21 01	2C 211-220 P03	With crimped bead plate	(Ø 215mm)	336
DENNIS EAGLE		3C 301-250 P05	With crimped bead plate	(Ø 305mm)	351
FIULT		2C 150-140 P01	With crimped bead plate	(Ø 150mm)	331
FLOOR	13586	2C 21-210 P01	With crimped bead plate	(Ø 215mm)	326
FORD	AC46 4K273 AA	2C 570-240 S	Rubber bellow only	(Ø 570mm)	347
FRUEHAUF	F48054M 80 A04	2C 200-140 P01	With crimped bead plate	(Ø 200mm)	365
	F 48054	2C 200-140 P02	With crimped bead plate	(Ø 200mm)	335
	M 80A04	2C 200-140 P02	With crimped bead plate	(Ø 200mm)	335
	UJB 09 85/A	2C 302-135 P03	With crimped bead plate	(Ø 305mm)	342
		2C 303-270 S	Rubber bellow only	(Ø 305mm)	342
	M 07 82 46	2C 303-270 P01	With crimped bead plate	(Ø 305mm)	342
	M002297	3C 302-200 P03	With crimped bead plate	(Ø 305mm)	353
GIGANT	196 028	2C 18-195 P03	With crimped bead plate	(Ø 180mm)	325
		2C 21-210 P03	With crimped bead plate	(Ø 215mm)	327
	190130	2C 21-210 P05	With crimped bead plate	(Ø 215mm)	327
		2C 150-140 P01	With crimped bead plate	(Ø 150mm)	331
	196028	2C 200-140 P03	With crimped bead plate	(Ø 200mm)	335
	16036	2C 200-140 P03	With crimped bead plate	(Ø 200mm)	335
	196017	2C 250-170 S1	Rubber bellow only	(Ø 250mm)	337
	196034	2C 250-170 S2	Rubber bellow only	(Ø 250mm)	338
	881202	2C 302-135 P01	With crimped bead plate	(Ø 305mm)	341
	881202	2C 302-135 P02	With crimped bead plate	(Ø 305mm)	341
881204	3C 302-200 P01	With crimped bead plate	(Ø 305mm)	352	
GOLDSCHMITT	DLB 7598	1C 185-150 P01	With crimped bead plate	(Ø 185mm)	322
	DLB 6781	2C 151-150 P02	With crimped bead plate	(Ø 151mm)	332

CONVOLUTED AIR SPRINGS OEM LIST					
MANUFACTURER	OEM PART NO	PART NO	TYPE	REMARK	PAGE
GOLDSCHMITT	DLB 6784	2C 151-150 P03	With crimped bead plate	(Ø 151mm)	332
	DLB 6397	2C 151-150 P04	With crimped bead plate	(Ø 151mm)	332
	DLB 2C-170	2C 170-170 P01	With crimped bead plate	(Ø 170mm)	334
GRANNING	1371	2C 21-210 P01	With crimped bead plate	(Ø 215mm)	326
	15603	2C 21-210 P01	With crimped bead plate	(Ø 215mm)	326
	15599	2C 21-210 P22	With crimped bead plate	(Ø 215mm)	330
	15803	2C 200-140 P02	With crimped bead plate	(Ø 200mm)	335
	15670	2C 211-220 P03	With crimped bead plate	(Ø 215mm)	336
	15923	2C 280-175 S	Rubber bellow only	(Ø 280mm)	340
HENDRICKSON	NA 1827	2C 21-210 P01	With crimped bead plate	(Ø 215mm)	326
	SH 505613	2C 21-210 P15	With crimped bead plate	(Ø 215mm)	329
	NA 1816	2C 315-225 P02	With crimped bead plate	(Ø 315mm)	343
	S14795	3C 301-250 P07	With crimped bead plate	(Ø 305mm)	352
ISUZU		2C 350-215 P03	With crimped bead plate	(Ø 350mm)	346
JUNG		2C 315-225 P02	With crimped bead plate	(Ø 315mm)	343
KAISER	A 060 30 616	2C 302-135 F01	With steel bead ring and mounting plate	(Ø 305mm)	341
	A 060 30 615	2C 302-135 P03	With crimped bead plate	(Ø 305mm)	342
KÄSSBOHRER	4731003000	2C 280-175 S	Rubber bellow only	(Ø 280mm)	340
	4731024000	2C 280-175 S	Rubber bellow only	(Ø 280mm)	340
	4731034100	2C 351-350 S	Rubber bellow only	(Ø 351mm)	346
	4731034200	2C 351-350 S	Rubber bellow only	(Ø 351mm)	346
KÖGEL		1C 315-120 P01	With crimped bead plate	(Ø 315mm)	323
	32 76 68	1C 315-120 P02	With crimped bead plate	(Ø 315mm)	323
	32 76 69	1C 315-120 P02	With crimped bead plate	(Ø 315mm)	323
	6501706	2C 21-210 P22	With crimped bead plate	(Ø 215mm)	330
KRONE	550011095	2C 21-210 P05	With crimped bead plate	(Ø 215mm)	327
LOHR	A 060 30 604	2C 200-140 P01	With crimped bead plate	(Ø 200mm)	365
	A06030604	2C 200-140 P02	With crimped bead plate	(Ø 200mm)	335
	Y 0000 1737	2C 302-135 F01	With steel bead ring and mounting plate	(Ø 305mm)	341
	A 063 0601	2C 302-135 P03	With crimped bead plate	(Ø 305mm)	342
		2C 303-270 S	Rubber bellow only	(Ø 305mm)	342
	A 060 30 622	2C 303-270 P01	With crimped bead plate	(Ø 305mm)	342
	A 060 30 606	3C 302-200 P03	With crimped bead plate	(Ø 305mm)	353
MAGIRUS	0342 2652	2C 250-170 S1	Rubber bellow only	(Ø 250mm)	337
	0342 2571	2C 280-175 S	Rubber bellow only	(Ø 250mm)	340
	0342 2571	2C 280-175 S	Rubber bellow only	(Ø 280mm)	340
MAN	81436010023	2C 250-170 S1	Rubber bellow only	(Ø 250mm)	337
	88964200217	2C 280-175 S	Rubber bellow only	(Ø 280mm)	340
	81.43601.6010	3C 305-260 F01	With steel bead ring and mounting plate	(Ø 305mm)	354
MERCEDES	A 942 327 06 01	2C 21-210 P15	With crimped bead plate	(Ø 215mm)	329
MERITOR		1C 21-170 S	Rubber bellow only	(Ø 215mm)	319

CONVOLUTED AIR SPRINGS OEM LIST					
MANUFACTURER	OEM PART NO	PART NO	TYPE	REMARK	PAGE
MERITOR(ROR)	21221356	1C 21-170 P03	With crimped bead plate	(Ø 215mm)	320
	21212549	1C 181-120 F01	With steel bead ring and mounting plate	(Ø 181mm)	322
NEWAY	90557001	2C 350-215 P01	With crimped bead plate	(Ø 350mm)	345
PEGASO		2C 21-210 S	Rubber bellow only	(Ø 215mm)	325
ROLFO	112273	3C 301-250 P08	With crimped bead plate	(Ø 305mm)	352
ROR		1C 21-170 S	Rubber bellow only	(Ø 215mm)	319
	2122 1395	2C 21-210 P01	With crimped bead plate	(Ø 215mm)	326
	2122 2663	2C 21-210 P01	With crimped bead plate	(Ø 215mm)	326
	2122 1356	2C 211-220 P03	With crimped bead plate	(Ø 215mm)	336
SAMRO	H2500188	2C 200-140 P01	With crimped bead plate	(Ø 200mm)	365
	H2500188	2C 200-140 P02	With crimped bead plate	(Ø 200mm)	335
	H2500021	2C 255-170 P01	With crimped bead plate	(Ø 255mm)	339
	H2500011	3C 302-200 P03	With crimped bead plate	(Ø 305mm)	353
SCANIA	1319761	2C 21-210 P22	With crimped bead plate	(Ø 215mm)	330
	1387289	2C 21-210 P22	With crimped bead plate	(Ø 215mm)	330
SCHMITZ	016 793	2C 211-220 P01	With crimped bead plate	(Ø 215mm)	336
	016 793	2C 211-220 P01	With crimped bead plate	(Ø 215mm)	336
	016 808	2C 211-220 P03	With crimped bead plate	(Ø 215mm)	336
SMB	M 063 796	2C 302-135 P03	With crimped bead plate	(Ø 305mm)	342
		2C 303-270 S	Rubber bellow only	(Ø 305mm)	342
	M 07 82 46	2C 303-270 P01	With crimped bead plate	(Ø 305mm)	342
	M002297	3C 302-200 P03	With crimped bead plate	(Ø 305mm)	353
TOUGHLINE		3C 301-250 P05	With crimped bead plate	(Ø 305mm)	351
	17040	3C 301-250 P08	With crimped bead plate	(Ø 305mm)	352
TROUILLET	HB 10350	2C 302-135 P02	With crimped bead plate	(Ø 305mm)	341
VDL BUS	1192 203	2C 250-170 S1	Rubber bellow only	(Ø 250mm)	337
VOLVO	0 365 431	2C 21-210 S	Rubber bellow only	(Ø 215mm)	325
	0 365 461	2C 21-210 S	Rubber bellow only	(Ø 215mm)	325
	6 882 797	2C 21-210 S	Rubber bellow only	(Ø 215mm)	325
WEWELER	USN 5100 12 D	2C 150-140 P01	With crimped bead plate	(Ø 150mm)	331
	US 06910C	2C 211-220 P01	With crimped bead plate	(Ø 215mm)	336
	US 06910F	2C 211-220 P01	With crimped bead plate	(Ø 215mm)	336
	US 07394	2C 211-220 P03	With crimped bead plate	(Ø 215mm)	336
	US 07394C	2C 211-220 P03	With crimped bead plate	(Ø 215mm)	336
	US 07394F	2C 211-220 P03	With crimped bead plate	(Ø 215mm)	336
	USN 5100 11 KD	2C 302-135 P01	With crimped bead plate	(Ø 305mm)	341
	USN 5100 KD	2C 302-135 P02	With crimped bead plate	(Ø 305mm)	341
ZORZI	1006508	1C 181-120 F01	With steel bead ring and mounting plate	(Ø 181mm)	322
	1006506	3C 305-260 F01	With steel bead ring and mounting plate	(Ø 305mm)	354

### 1C 21-110 P01



Cross Section View

Top View

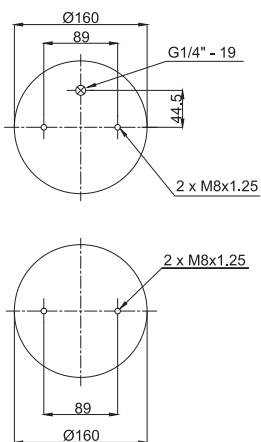
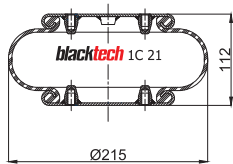

- Bolt or Stud
- Threaded hole
- ⊗ Combination Stud
- ⊗ Air Inlet

OEM PART NUMBER	MODEL NO	CROSS REFERENCES	
		Contitech	FS 200-10 1/4 M8

### 1C 21-110 P03



Cross Section View

Top View

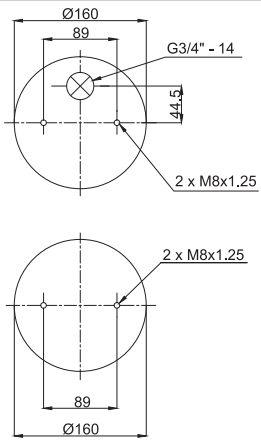
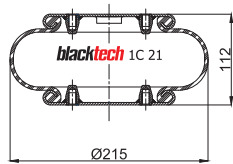

- Bolt or Stud
- Threaded hole
- ⊗ Combination Stud
- ⊗ Air Inlet

OEM PART NUMBER	MODEL NO	CROSS REFERENCES	
		Contitech	FS 200-10 3/4 M8

### 1C 21-170 S



Cross Section View

Top View

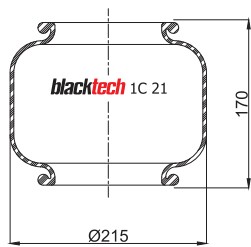

- Bolt or Stud
- Threaded hole
- ⊗ Combination Stud
- ⊗ Air Inlet

OEM PART NUMBER	MODEL NO	CROSS REFERENCES	
ROR		GART	T291/B
Meritor			

**1C 21-170 P02**



Cross Section View

Top View

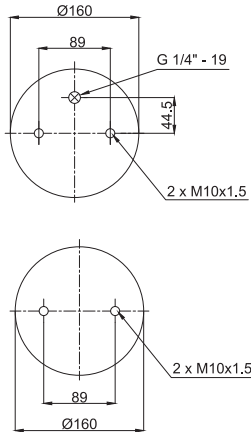
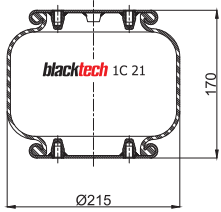

- Bolt or Stud
- Threaded hole
- ⊗ Combination Stud
- ⊗ Air Inlet

OEM PART NUMBER	MODEL NO	CROSS REFERENCES	
BMC/MERCEDES 8X2		Contitech	FS 200-16 P01

**1C 21-170 P03**



Cross Section View

Top View

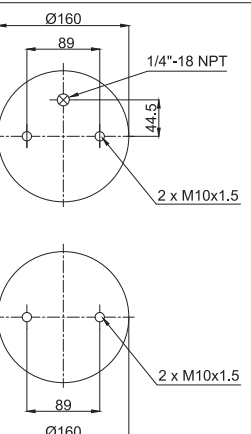
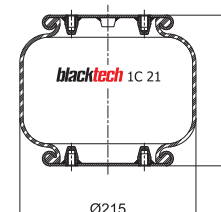

- Bolt or Stud
- Threaded hole
- ⊗ Combination Stud
- ⊗ Air Inlet

OEM PART NUMBER	MODEL NO	CROSS REFERENCES	
Meritor(ROR)	21221356	GART Ref.	T291/B
		GART No.	2911.170

**1C 21-170 P04**



Cross Section View

Top View

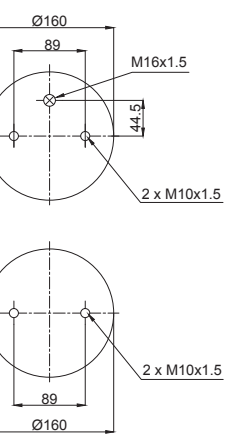
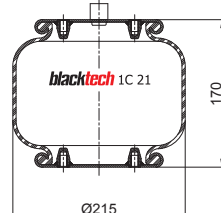

- Bolt or Stud
- Threaded hole
- ⊗ Combination Stud
- ⊗ Air Inlet

OEM PART NUMBER	MODEL NO	CROSS REFERENCES	



### 1C 21-170 P05



Cross Section View

Top View

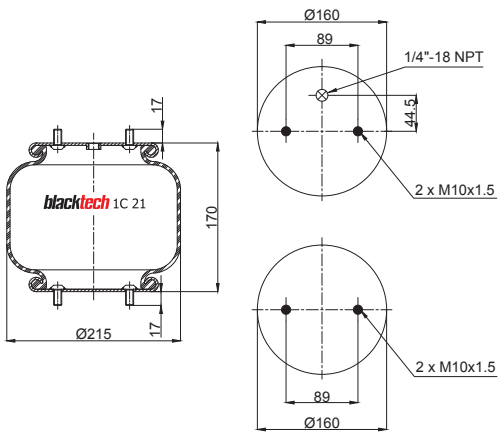

- Bolt or Stud
- Threaded hole
- ⊗ Combination Stud
- ⊗ Air Inlet

OEM PART NUMBER	MODEL NO	CROSS REFERENCES

### 1C 140-70 P01



Cross Section View

Top View

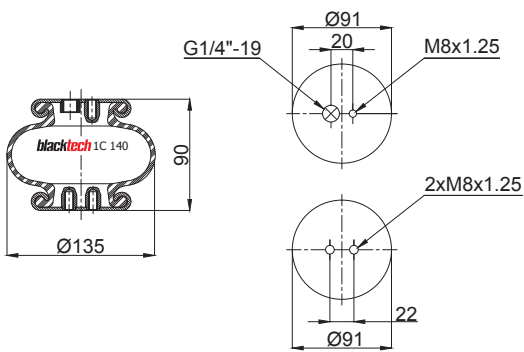

- Bolt or Stud
- Threaded hole
- ⊗ Combination Stud
- ⊗ Air Inlet

OEM PART NUMBER	MODEL NO	CROSS REFERENCES
		Phoenix SP 1B 04

### 1C 180-105 P02

Cross Section View

Top View

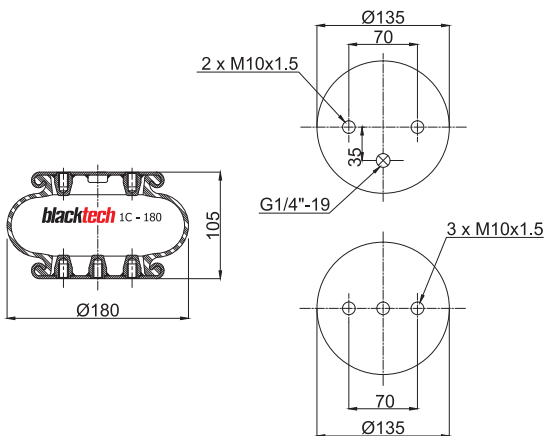

- Bolt or Stud
- Threaded hole
- ⊗ Combination Stud
- ⊗ Air Inlet

OEM PART NUMBER	MODEL NO	CROSS REFERENCES
		Contitech FS 120-9 G1/4 MID

**1C 180-105 P03**

Cross Section View

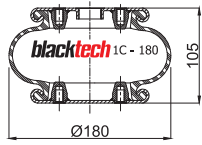

Top View

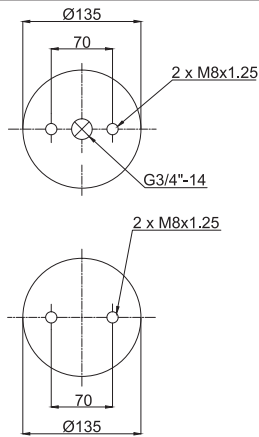

- Bolt or Stud
- Threaded hole
- ⊗ Combination Stud
- ⊗ Air Inlet

OEM PART NUMBER	MODEL NO	CROSS REFERENCES	
		Contitech	FS 120-9 G3/4 M8

**1C 181-120 F01**

Cross Section View

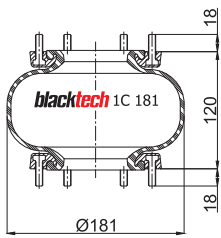

Top View

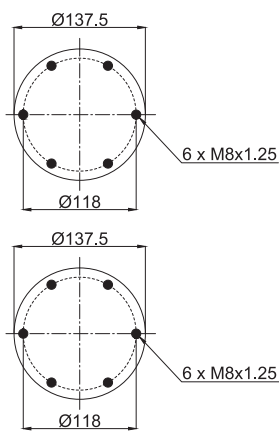

- Bolt or Stud
- Threaded hole
- ⊗ Combination Stud
- ⊗ Air Inlet

OEM PART NUMBER	MODEL NO	CROSS REFERENCES	
Austeras	99381001	Gart Ref.	T275
Bartoletti	9162/110	Gart No.	275.1120
Bpw/Battaglino	22.070.00		
Zorzi	1006508		
MERITOR(ROR)	21212549		

**1C 185-150 P01**

Cross Section View

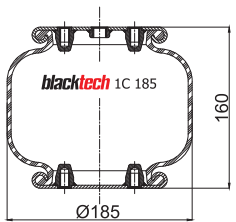

Top View

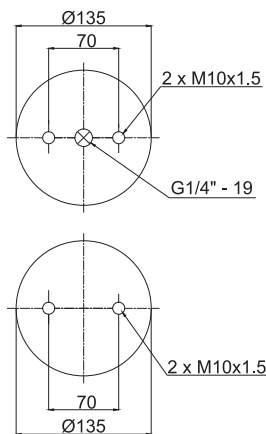

- Bolt or Stud
- Threaded hole
- ⊗ Combination Stud
- ⊗ Air Inlet

OEM PART NUMBER	MODEL NO	CROSS REFERENCES	
Goldschmitt	DLB 7598		

### 1C 185-150 P02

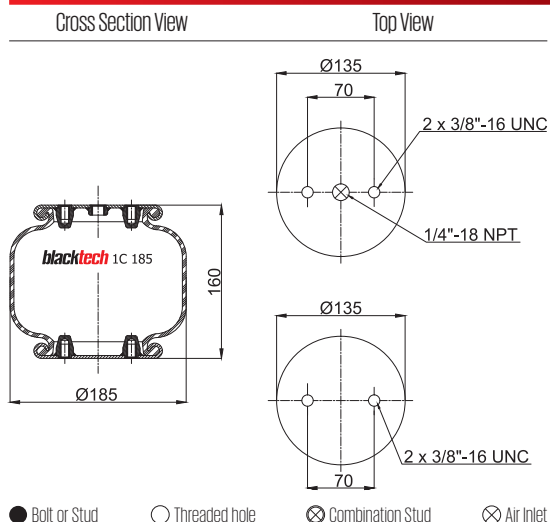

OEM PART NUMBER	MODEL NO	CROSS REFERENCES	
		Firestone Style	116-1
		Firestone Order	W01 358 7598

### 1C 315-120 P01

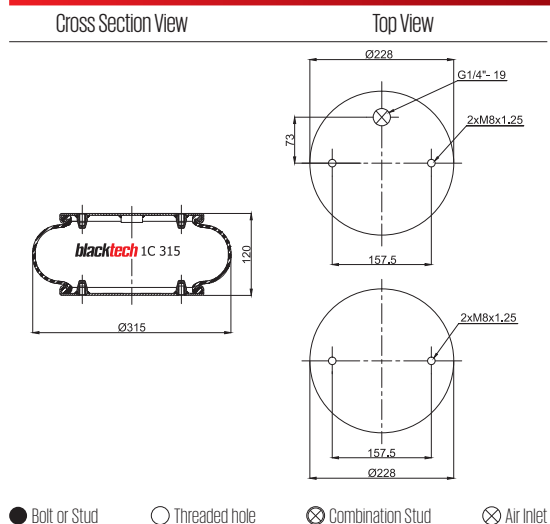

OEM PART NUMBER	MODEL NO	CROSS REFERENCES	
Kögel		Contitech	FS 330-11/4 M8

### 1C 315-120 P02

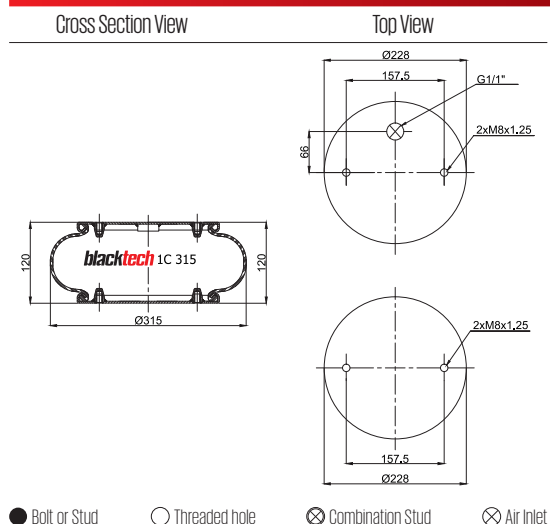

OEM PART NUMBER	MODEL NO	CROSS REFERENCES	
Kögel	32 76 68	Contitech	FS 330-11/1 M8
Kögel	32 76 69		

**2C17-170 P01**

Cross Section View

Top View

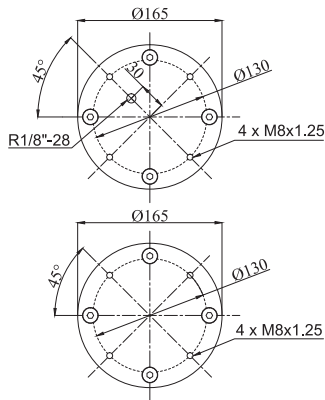
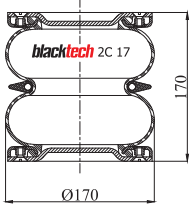

- Bolt or Stud
- Threaded hole
- ⊗ Combination Stud
- ⊗ Air Inlet

OEM PART NUMBER	MODEL NO	CROSS REFERENCES

**2C18-195 S**

Cross Section View

Top View

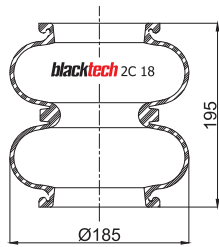

- Bolt or Stud
- Threaded hole
- ⊗ Combination Stud
- ⊗ Air Inlet

OEM PART NUMBER	MODEL NO	CROSS REFERENCES
		Contitech 603 N
		Phoenix 2 B 07 R

**2C18-195 P01**

Cross Section View

Top View

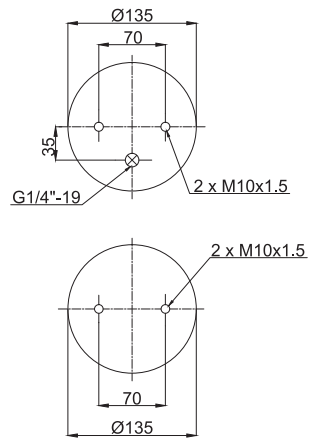
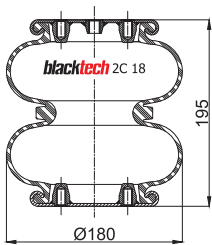

- Bolt or Stud
- Threaded hole
- ⊗ Combination Stud
- ⊗ Air Inlet

OEM PART NUMBER	MODEL NO	CROSS REFERENCES

### 2C18-195 P02



Cross Section View

Top View

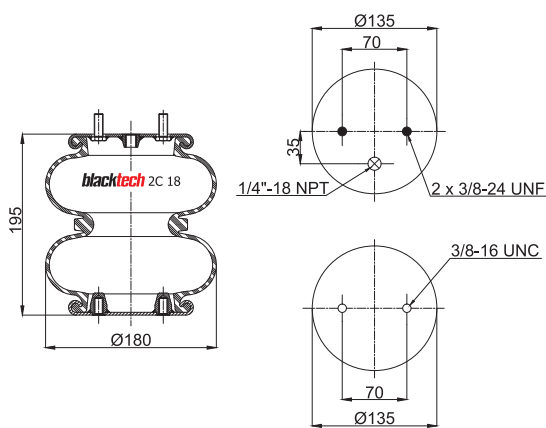

- Bolt or Stud
- Threaded hole
- ⊗ Combination Stud
- ⊗ Air Inlet

OEM PART NUMBER	MODEL NO	CROSS REFERENCES	
		Firestone No.	W21 760 7325

### 2C18-195 P03



Cross Section View

Top View

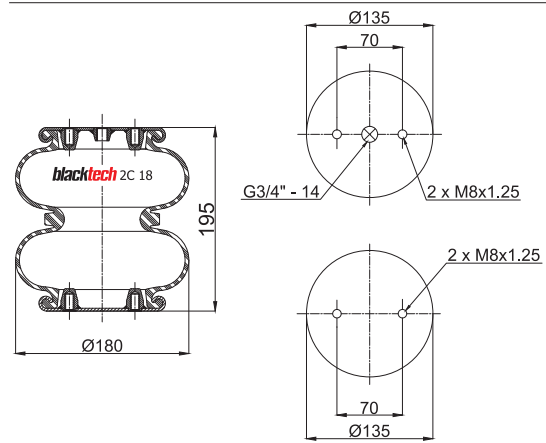

- Bolt or Stud
- Threaded hole
- ⊗ Combination Stud
- ⊗ Air Inlet

OEM PART NUMBER	MODEL NO	CROSS REFERENCES	
Gigant	196 028	Contitech	FD 120-17 3/4 M8

### 2C21-210 S



Cross Section View

Top View

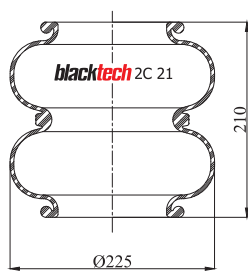

- Bolt or Stud
- Threaded hole
- ⊗ Combination Stud
- ⊗ Air Inlet

OEM PART NUMBER	MODEL NO	CROSS REFERENCES	
Pegaso	5231/5236/5266	Contitech	FD 200-19 S
Volvo	0 365 431	B 58	Phoenix
Volvo	0 365 461	B 58	Firestone Style
Volvo	6 882 797	B 58	Firestone No.
		Firestone No.	W01-095-0009
		Firestone No.	W01-358-0297
		Vibracoustic	V2B12R
		CF Gomma Ref.	20
		CF Gomma No.	86599

**2C21-210 F01**

Cross Section View

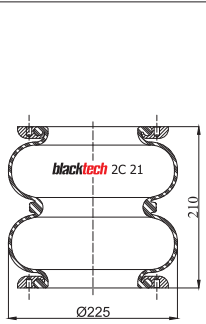

Top View

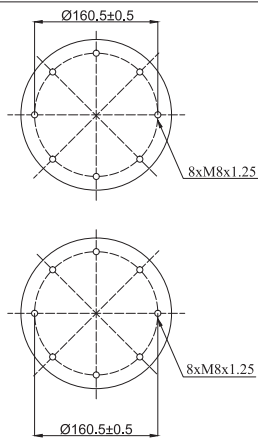

- Bolt or Stud
- Threaded hole
- ⊗ Combination Stud
- ⊗ Air Inlet

OEM PART NUMBER	MODEL NO	CROSS REFERENCES

**2C21-210 P01**

Cross Section View

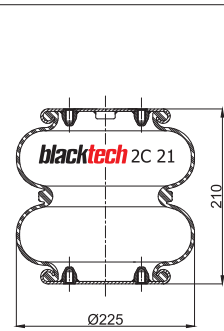

Top View

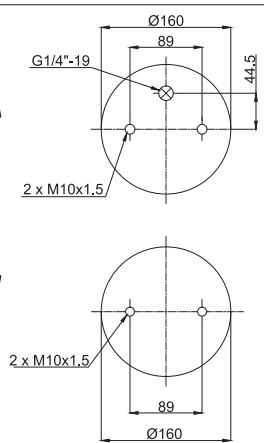

- Bolt or Stud
- Threaded hole
- ⊗ Combination Stud
- ⊗ Air Inlet

OEM PART NUMBER	MODEL NO	CROSS REFERENCES
Floor	13586	Contitech
Granning	1371	Phoenix
Granning	15603	Primeride
Hendrickson	NA 1827	Firestone Style
ROR	2122 1395	Firestone No.
ROR	2122 2663	Firestone No.
		Goodyear
		Vibracoustic
		CF Gamma Ref.
		CF Gamma No.
		Dunlop F
		Dunlop UK
		Gart Ref.
		Gart No.

**2C21-210 P02**

Cross Section View

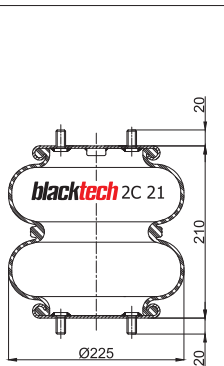

Top View

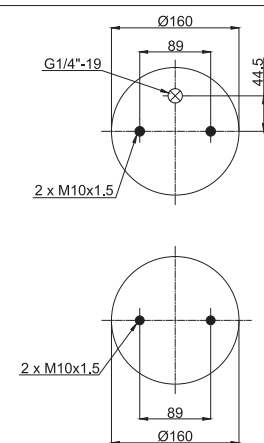

- Bolt or Stud
- Threaded hole
- ⊗ Combination Stud
- ⊗ Air Inlet

OEM PART NUMBER	MODEL NO	CROSS REFERENCES

### 2C21-210 P03

Cross Section View

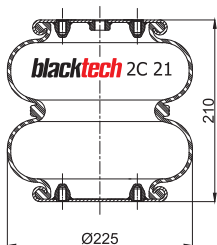

Top View

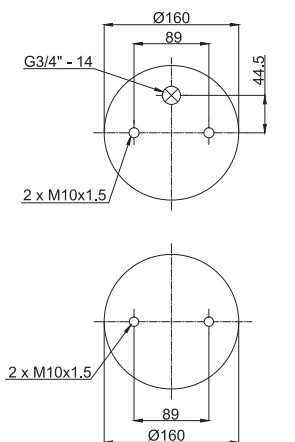

- Bolt or Stud
- Threaded hole
- ⊗ Combination Stud
- ⊗ Air Inlet

OEM PART NUMBER	MODEL NO	CROSS REFERENCES	
Gigant		Contitech	FD 200-19 3/4 M10

### 2C21-210 P04

Cross Section View

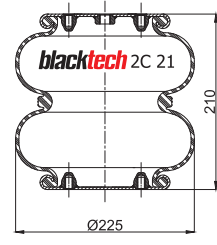

Top View

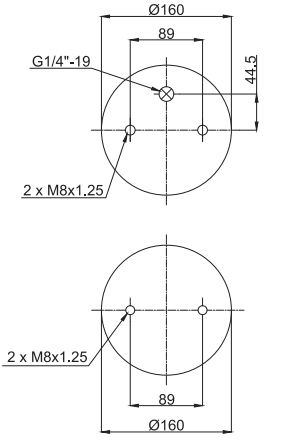

- Bolt or Stud
- Threaded hole
- ⊗ Combination Stud
- ⊗ Air Inlet

OEM PART NUMBER	MODEL NO	CROSS REFERENCES	
		Contitech	FD 200-19 1/4 M8
		Firestone Style	20
		Firestone No.	W01-M58-7679
		Firestone No.	W01-M58-6187
		Dunlop F	9"1/4 S09201
		Gart Ref.	T291/2
		Gart No.	291.2.200

### 2C21-210 P05

Cross Section View

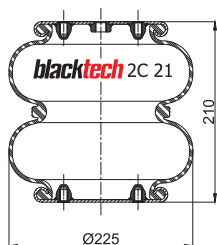

Top View

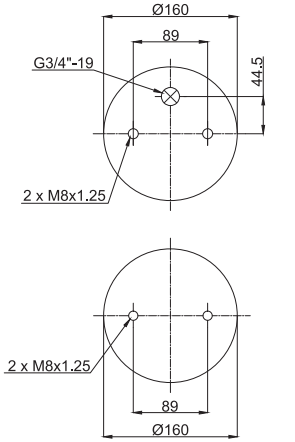

- Bolt or Stud
- Threaded hole
- ⊗ Combination Stud
- ⊗ Air Inlet

OEM PART NUMBER	MODEL NO	CROSS REFERENCES	
Gigant	190130	Contitech	FD 200-19 3/4 M8
Krone	550011095	Phoenix	SP 2 B 12 R-1
		Firestone Style	20
		Firestone No.	W01-M58-6185
		Vibracoustic	VSP2B12R-1
		Goodyear	2B9-223

**2C21-210 P06**



Cross Section View

Top View

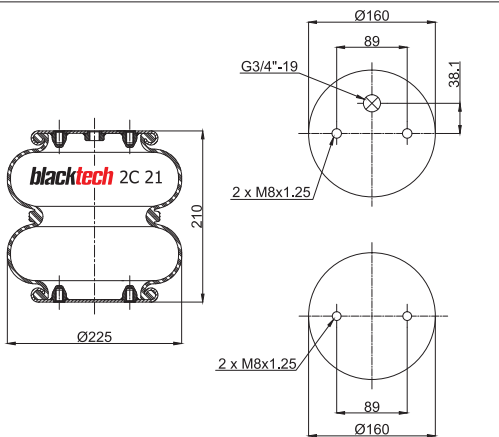

- Bolt or Stud
- Threaded hole
- ⊗ Combination Stud
- ⊗ Air Inlet

OEM PART NUMBER	MODEL NO	CROSS REFERENCES
		Contitech FD 200-22 3/4 M8

**2C21-210 P13**



Cross Section View

Top View

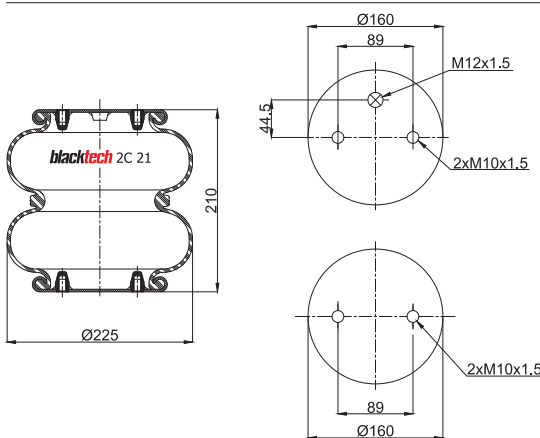

- Bolt or Stud
- Threaded hole
- ⊗ Combination Stud
- ⊗ Air Inlet

OEM PART NUMBER	MODEL NO	CROSS REFERENCES
		Phoenix SP 2B12 R A-4

**2C21-210 P14**



Cross Section View

Top View

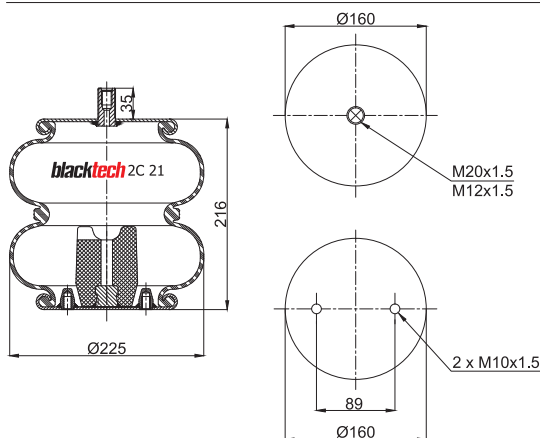

- Bolt or Stud
- Threaded hole
- ⊗ Combination Stud
- ⊗ Air Inlet

OEM PART NUMBER	MODEL NO	CROSS REFERENCES



### 2C21-210 P15



Cross Section View

Top View

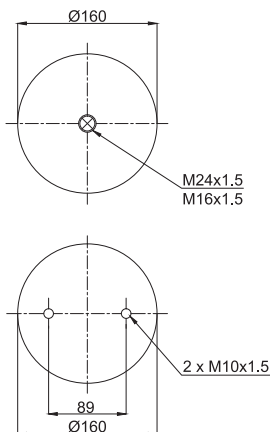
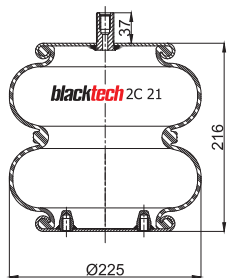

- Bolt or Stud
- Threaded hole
- ⊗ Combination Stud
- ⊗ Air Inlet

OEM PART NUMBER		MODEL NO	CROSS REFERENCES	
Hendrickson	SH 505613		Contitech	FD 200-19 P02
Mercedes	A 942 327 06 01	Hendrickson MLA1	Firestone Style	20F
			Firestone No.	W01 M58 7756
			CF Gomma Ref.	T20L
			CF Gomma No.	207065

### 2C21-210 P17



Cross Section View

Top View

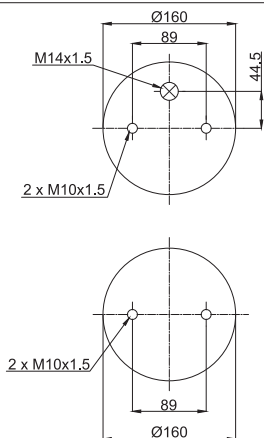
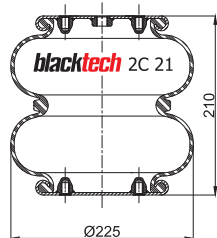

- Bolt or Stud
- Threaded hole
- ⊗ Combination Stud
- ⊗ Air Inlet

OEM PART NUMBER		MODEL NO	CROSS REFERENCES	
			Contitech	FD 200-19 M14

### 2C21-210 P20



Cross Section View

Top View

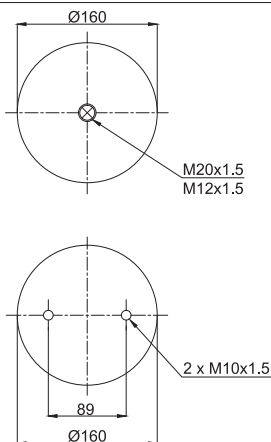
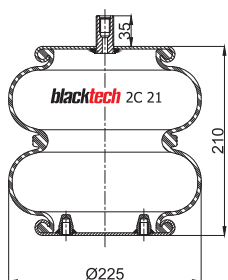

- Bolt or Stud
- Threaded hole
- ⊗ Combination Stud
- ⊗ Air Inlet

OEM PART NUMBER		MODEL NO	CROSS REFERENCES	
			Contitech	FD 200-19 M20

**2C21-210 P22**

Cross Section View

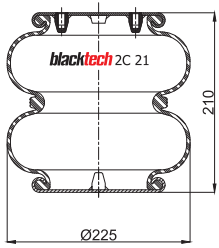

Top View

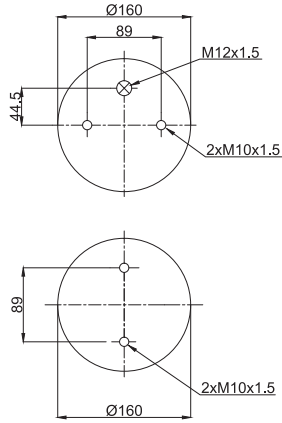

- Bolt or Stud
- Threaded hole
- ⊗ Combination Stud
- ⊗ Air Inlet

OEM PART NUMBER	MODEL NO	CROSS REFERENCES	
Granning 15599		Conlitech	FD 200-19 P04
Kögel 6501706		Phoenix	SP 2 B 12 R-5
Scania 1319761		Firestone Style	20F
Scania 1387289		Firestone No.	W01-M58-7894
		Goodyear	2B9-700
		Vibracoustic	VSP2B12R-5
		CF Gomma Ref.	2B9-700
		CF Gomma No.	207773
		Dunlop F	S09201
		Gart Ref.	T291/2
		Gart No.	291.2.203

**2C21-210 P24**

Cross Section View

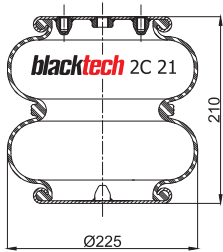

Top View

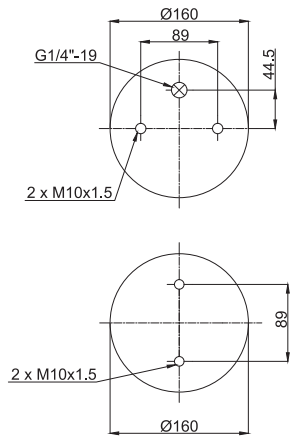

- Bolt or Stud
- Threaded hole
- ⊗ Combination Stud
- ⊗ Air Inlet

OEM PART NUMBER	MODEL NO	CROSS REFERENCES	

**2C150-140 B01**

Cross Section View

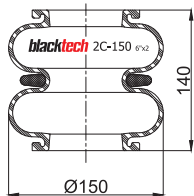

Top View

OEM PART NUMBER	MODEL NO	CROSS REFERENCES	
		Dunlop F	SP917( 6` X2 ) Plastic Ring

- Bolt or Stud
- Threaded hole
- ⊗ Combination Stud
- ⊗ Air Inlet

### 2C150-140 B02

Cross Section View

Top View

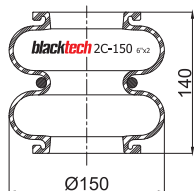

- Bolt or Stud
- Threaded hole
- ⊗ Combination Stud
- ⊗ Air Inlet

OEM PART NUMBER	MODEL NO	CROSS REFERENCES	
		Dunlop F	SP917(6" X2) Metal Ring

### 2C150-140 P01

Cross Section View

Top View

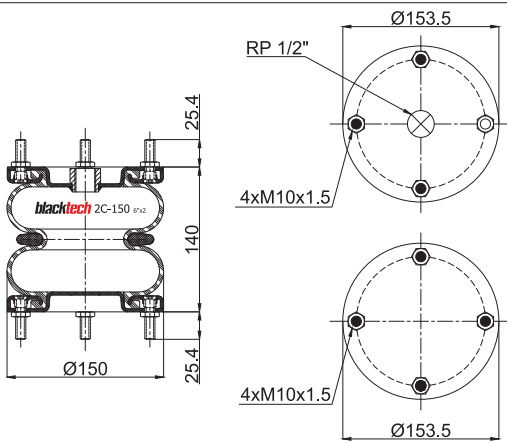

- Bolt or Stud
- Threaded hole
- ⊗ Combination Stud
- ⊗ Air Inlet

OEM PART NUMBER	MODEL NO	CROSS REFERENCES	
Weweler	USN 5100 12D	Dunlop F	SP1482 (6" X2) Plastic Ring
Gigant			
Fiult			

### 2C150-140 P02

Cross Section View

Top View

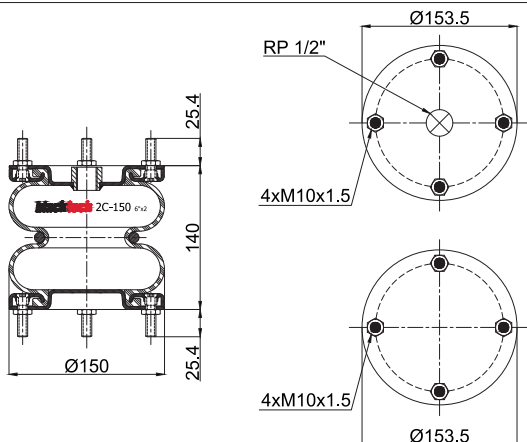

- Bolt or Stud
- Threaded hole
- ⊗ Combination Stud
- ⊗ Air Inlet

OEM PART NUMBER	MODEL NO	CROSS REFERENCES	
		Dunlop F	SP1482 (6" X2) Metal Ring

**2C151-150 P02**



Cross Section View

Top View

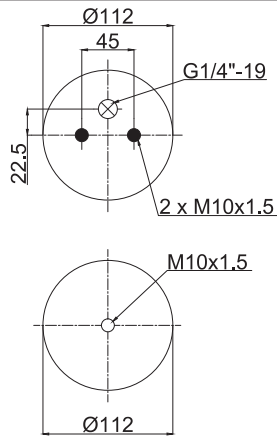
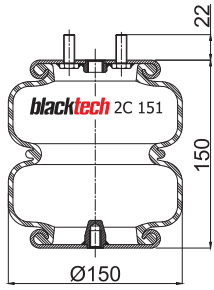

- Bolt or Stud
- Threaded hole
- ⊗ Combination Stud
- ⊗ Air Inlet

OEM PART NUMBER	MODEL NO	CROSS REFERENCES
Goldschmitt	DLB 6781	

**2C151-150 P03**



Cross Section View

Top View

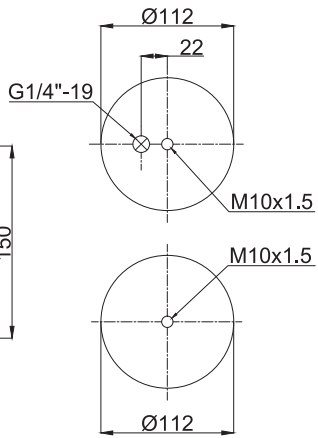
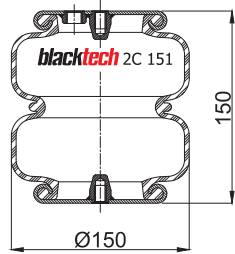

- Bolt or Stud
- Threaded hole
- ⊗ Combination Stud
- ⊗ Air Inlet

OEM PART NUMBER	MODEL NO	CROSS REFERENCES
Goldschmitt	DLB 6784	

**2C151-150 P04**



Cross Section View

Top View

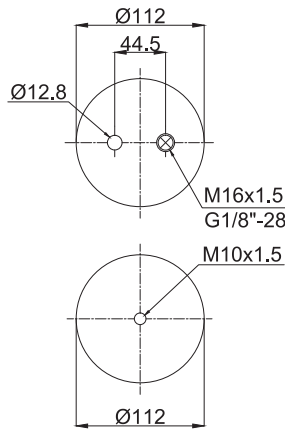
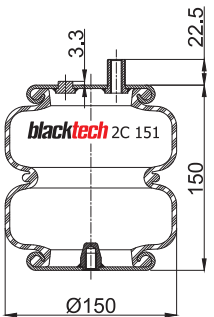

- Bolt or Stud
- Threaded hole
- ⊗ Combination Stud
- ⊗ Air Inlet

OEM PART NUMBER	MODEL NO	CROSS REFERENCES
Goldschmitt	DLB 6397	

**2C151-150 P05**



Cross Section View

Top View

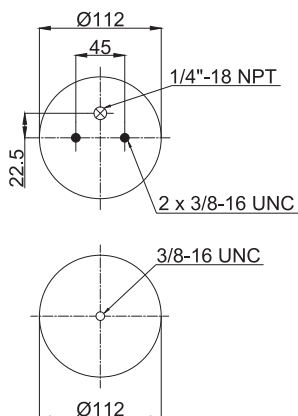
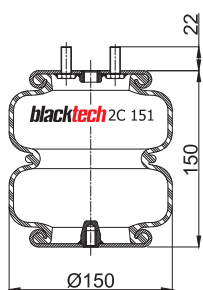

- Bolt or Stud
- Threaded hole
- ⊗ Combination Stud
- ⊗ Air Inlet

OEM PART NUMBER	MODEL NO	CROSS REFERENCES	
		Firestone Style	255 C
		Firestone No.	W21 760 6781

**2C151-150 P06**



Cross Section View

Top View

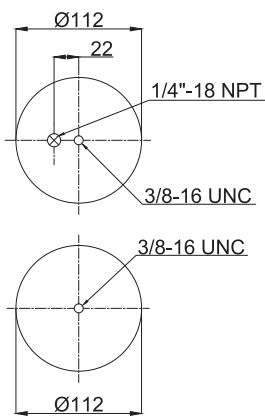
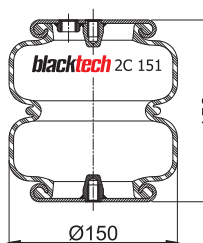

- Bolt or Stud
- Threaded hole
- ⊗ Combination Stud
- ⊗ Air Inlet

OEM PART NUMBER	MODEL NO	CROSS REFERENCES	
		Firestone Style	267 C
		Firestone No.	W21 760 6784

**2C151-150 P07**



Cross Section View

Top View

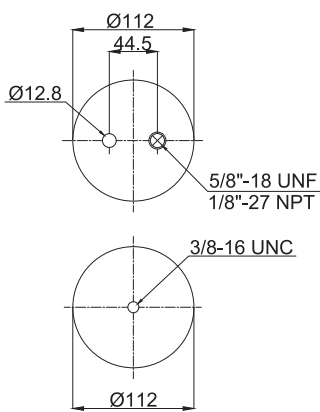
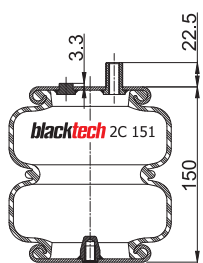

- Bolt or Stud
- Threaded hole
- ⊗ Combination Stud
- ⊗ Air Inlet

OEM PART NUMBER	MODEL NO	CROSS REFERENCES	
		Firestone Style	267 C-15
		Firestone No.	W21 760 6397

**2C170-170 P01**



Cross Section View

Top View

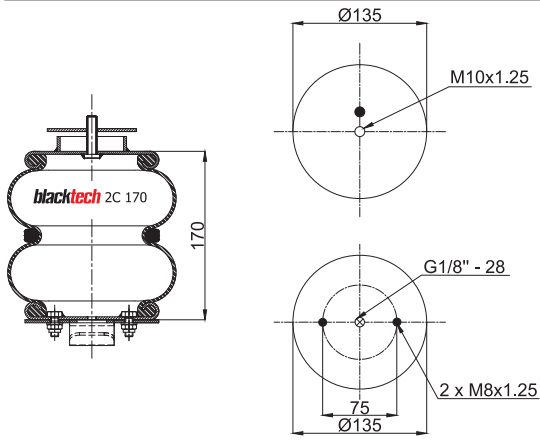

- Bolt or Stud
- Threaded hole
- ⊗ Combination Stud
- ⊗ Air Inlet

OEM PART NUMBER	MODEL NO	CROSS REFERENCES
Goldschmitt	DLB 2C-170	

**2C170-170 P02**



Cross Section View

Top View

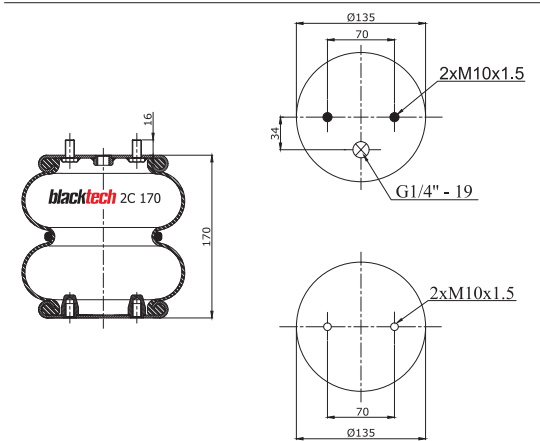

- Bolt or Stud
- Threaded hole
- ⊗ Combination Stud
- ⊗ Air Inlet

OEM PART NUMBER	MODEL NO	CROSS REFERENCES
		Firestone Style 224C
		Firestone No. W01 760 0335

**2C170-170 P03**



Cross Section View

Top View

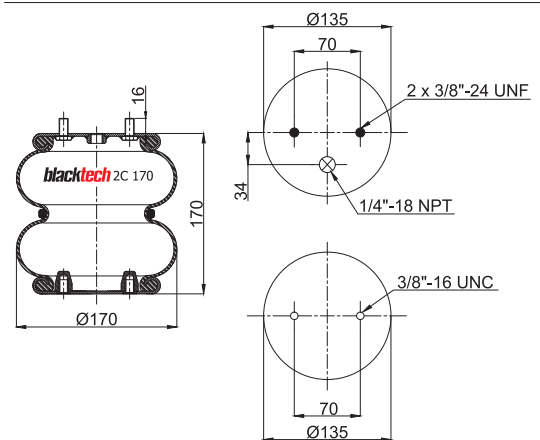

- Bolt or Stud
- Threaded hole
- ⊗ Combination Stud
- ⊗ Air Inlet

OEM PART NUMBER	MODEL NO	CROSS REFERENCES
		Firestone No. W21 760 0355

### 2C-200-140 P01

Cross Section View

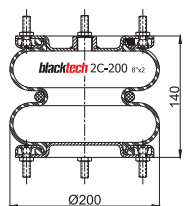

Top View

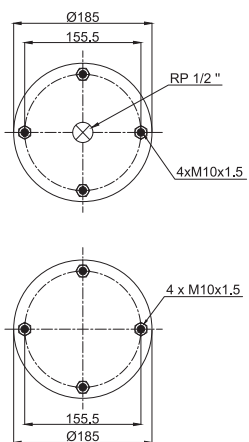

- Bolt or Stud
- Threaded hole
- ⊗ Combination Stud
- ⊗ Air Inlet

	OEM PART NUMBER	MODEL NO	CROSS REFERENCES	
Fruehauf	F48054M 80 A04		Dunlop F	SP1490
Lohr	A 060 30 604		Firestone No.	W01 R58 4055
Samro	H2500188			

### 2C-200-140 P02

Cross Section View

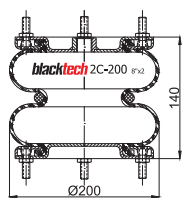

Top View

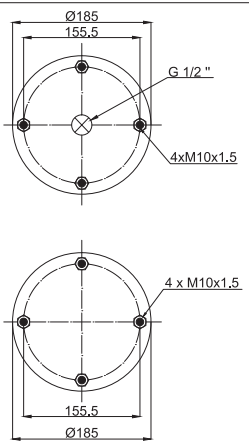

- Bolt or Stud
- Threaded hole
- ⊗ Combination Stud
- ⊗ Air Inlet

	OEM PART NUMBER	MODEL NO	CROSS REFERENCES	
Fruehauf	F 48054		Contitech	FD 138-18 1/2 M10
Fruehauf	M 80A04		Firestone Style	8x2
Granning	15803		Firestone No.	W01-R58-4055
Lohr	A06030604		Goodyear	2B8-2150
Samro	H2500188			

### 2C-200-140 P03

Cross Section View

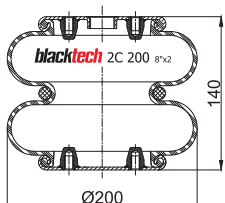

Top View

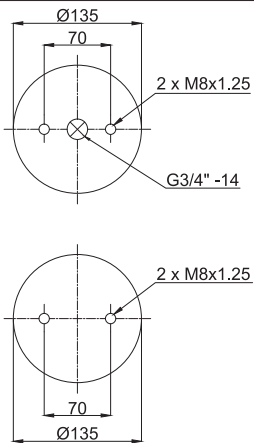

- Bolt or Stud
- Threaded hole
- ⊗ Combination Stud
- ⊗ Air Inlet

	OEM PART NUMBER	MODEL NO	CROSS REFERENCES	
Gigant	196028		Contitech	FD 120-17 3/4 M8
Gigant	16036		Firestone Style	26
			Firestone No.	W01-M58-6387
			Firestone No.	W01-358-7325
			Goodyear	2B8-2152
			Vibracoustic	VSP2B07R-2
			CF Gomma Ref.	T26
			CF Gomma No.	84181
			Dunlop F	2B8-2152

**2C211-220 P01**

Cross Section View

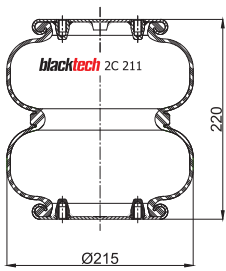

Top View

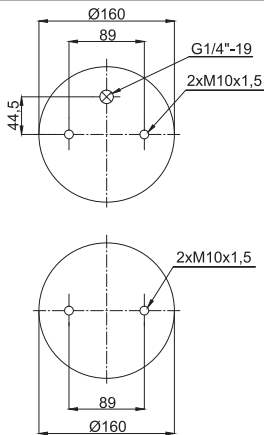

- Bolt or Stud
- Threaded hole
- ⊗ Combination Stud
- ⊗ Air Inlet

OEM PART NUMBER		MODEL NO	CROSS REFERENCES	
Schmitz	016 793		Contitech	FD 200-22 1/4 M10
Weweler	US 06910C		Firestone Style	20F
Weweler	US 06910F		Firestone No.	W01-M58-6772
Daimler TAS	A 946 328 16 01	DCA; DLS	Firestone No.	W01-M58-7888

**2C211-220 P02**

Cross Section View

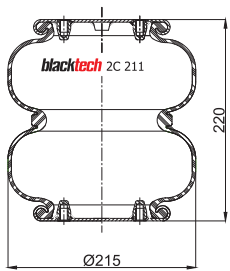

Top View

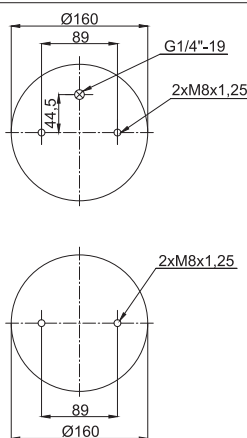

- Bolt or Stud
- Threaded hole
- ⊗ Combination Stud
- ⊗ Air Inlet

OEM PART NUMBER		MODEL NO	CROSS REFERENCES	
			Contitech	FD 200-25 174 M8
			Firestone Style	20-2
			Firestone No.	W01 M58 7394 C
			Goodyear	2B9-269

**2C211-220 P03**

Cross Section View

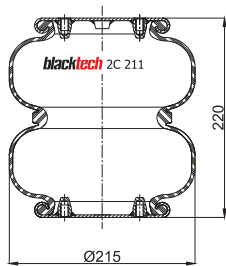

Top View

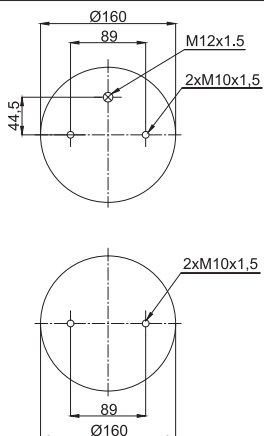

- Bolt or Stud
- Threaded hole
- ⊗ Combination Stud
- ⊗ Air Inlet

OEM PART NUMBER		MODEL NO	CROSS REFERENCES	
Granning	15670		Contitech	FD 200-25 1/4 M10
ROR	2122 1356		Phoenix	SP 2 B 12 R-A-10
Schmitz	016 808		Firestone Style	20C-2
Weweler	US 07394	AC 173	Firestone No.	W01-M58-7679
Weweler	US 07394C		Firestone No.	W01-968-6771
Weweler	US 07394F		Goodyear	2B9-269
Daimler TAS	A 946 328 21 01		Vibracoustic	VSP2B12RA-10
			CF Gomma Ref.	20L
			CF Gomma No.	207776
			Gart Ref.	T291/2B
			Gart No.	2912.260



### 2C211-220 P04



Gross Section View

Top View

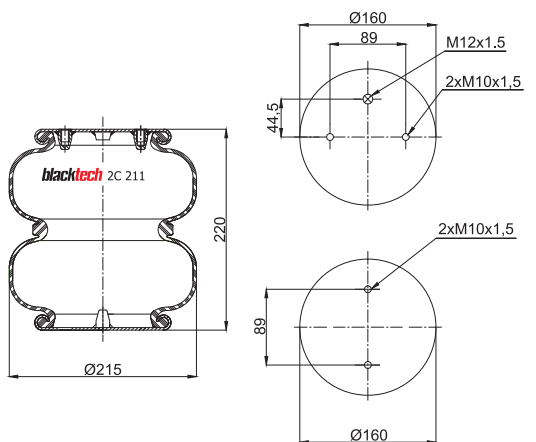

- Bolt or Stud
- Threaded hole
- ⊗ Combination Stud
- ⊗ Air Inlet

OEM PART NUMBER	MODEL NO	CROSS REFERENCES	
		Contitech	FD 200-25 P02

### 2C250-170 S



Gross Section View

Top View

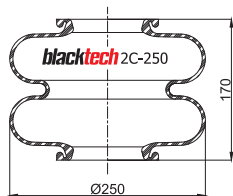

- Bolt or Stud
- Threaded hole
- ⊗ Combination Stud
- ⊗ Air Inlet

OEM PART NUMBER	MODEL NO	CROSS REFERENCES	
		Contitech	620 N 8 bar

### 2C250-170 S1



Gross Section View

Top View

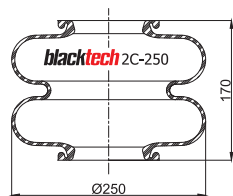

- Bolt or Stud
- Threaded hole
- ⊗ Combination Stud
- ⊗ Air Inlet

OEM PART NUMBER	MODEL NO	CROSS REFERENCES	
BPW	02.200.20.90.0	Contitech	620 N Hydro 17 bar
DAF	1 192 203	CF Gomma Ref.	245 B.V.
Gigant	196017	CF Gomma No.	92142
Magirus-Deutz	0342 2652		
MAN	81.436.010.023		
VDL Bus	1 192 203		

**2C-250-170 S2**



Cross Section View

Top View

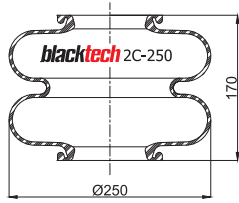

OEM PART NUMBER		MODEL NO	CROSS REFERENCES	
Gigant	196034		Contitech	620 N Hydro 34 bar

- Bolt or Stud
- Threaded hole
- Combination Stud
- Air Inlet

**2C-250-170 F**



Cross Section View

Top View

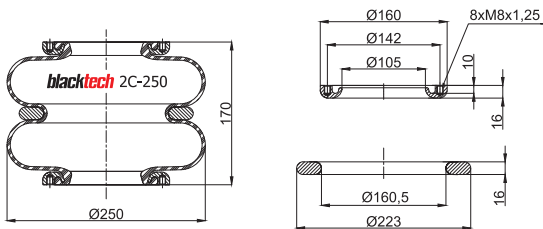

OEM PART NUMBER		MODEL NO	CROSS REFERENCES	
BPW	04.419.00.28.0		Contitech	620 M Hydro 17 bar (160 mm)
BPW	05.429.00.04.0			

- Bolt or Stud
- Threaded hole
- Combination Stud
- Air Inlet

**2C-250-170 F01**



Cross Section View

Top View

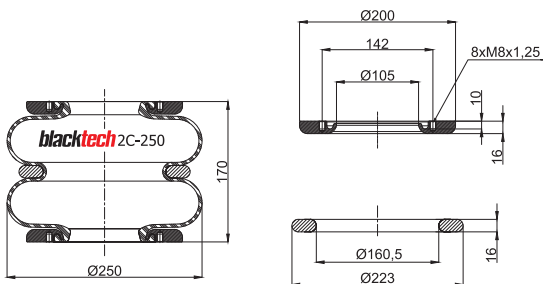

OEM PART NUMBER		MODEL NO	CROSS REFERENCES	
BPW	04.419.00.28.0		Contitech	620 M Hydro 17 bar(200 mm)
BPW	05.429.00.04.0			

- Bolt or Stud
- Threaded hole
- Combination Stud
- Air Inlet

### 2C 251-155 S



Cross Section View

Top View

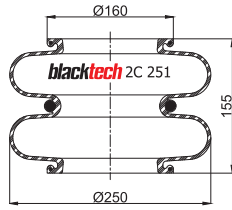

- Bolt or Stud
- Threaded hole
- ⊗ Combination Stud
- ⊗ Air Inlet

OEM PART NUMBER	MODEL NO	CROSS REFERENCES

### 2C 251-155 F01



Cross Section View

Top View

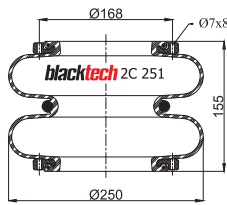

- Bolt or Stud
- Threaded hole
- ⊗ Combination Stud
- ⊗ Air Inlet

OEM PART NUMBER	MODEL NO	CROSS REFERENCES

### 2C 255-170 P01



Cross Section View

Top View

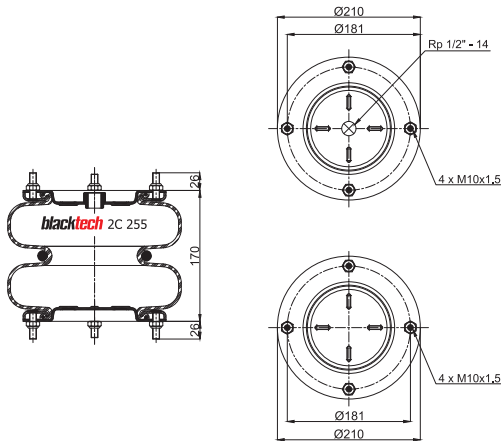

- Bolt or Stud
- Threaded hole
- ⊗ Combination Stud
- ⊗ Air Inlet

OEM PART NUMBER	MODEL NO	CROSS REFERENCES
Samro	H2500021	Contitech
		Firestone Style
		Firestone No.
		Goodyear
		Dunlop F
		Dunlop UK

**2C280-175S**



Cross Section View

Top View

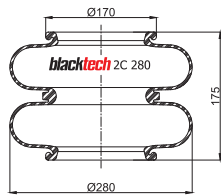

- Bolt or Stud
- Threaded hole
- ⊗ Combination Stud
- ⊗ Air Inlet

OEM PART NUMBER		MODEL NO	CROSS REFERENCES	
BPW	02.200.20.50.0		Contitech	608 N
Granning	15.923		Phoenix	2 B 20 R
Kässbohrer	4.731.003.000	SG 176	Firestone Style	20
Kässbohrer	4.731.024.000		Firestone No.	W01-R58-4088
Magirus-Deutz	0342 2571	150 L 10	Goodyear	2B12-425/300
Magirus-Deutz	0342 2571	Saturn II/II L	Vibracoustic	V2B20R
MAN	88.964.200.217			

**2C280-175F**

Cross Section View

Top View

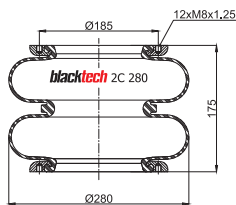

- Bolt or Stud
- Threaded hole
- ⊗ Combination Stud
- ⊗ Air Inlet

OEM PART NUMBER		MODEL NO	CROSS REFERENCES	
			Contitech	608 M

**2C301-180P02**



Cross Section View

Top View

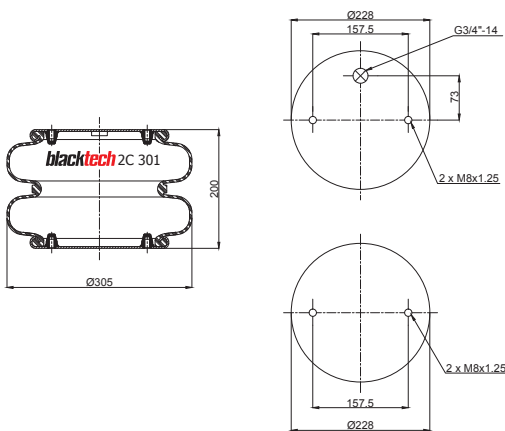

- Bolt or Stud
- Threaded hole
- ⊗ Combination Stud
- ⊗ Air Inlet

OEM PART NUMBER		MODEL NO	CROSS REFERENCES	
			Dunlop F	S 12200
			Firestone Order	W01 M68 6203

### 2C 302-135 F01

Cross Section View

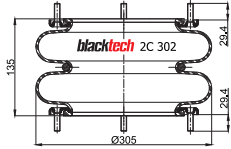

Top View

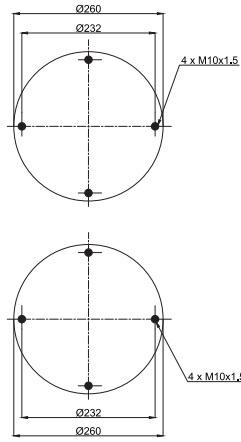

- Bolt or Stud
- Threaded hole
- ⊗ Combination Stud
- ⊗ Air Inlet

OEM PART NUMBER	MODEL NO	CROSS REFERENCES	
Kaiser	A 060 30 616	Dunlop F	SP 1025 NB (12" x 2 NB)
Lohr	Y 0000 1737		

### 2C 302-135 P01

Cross Section View

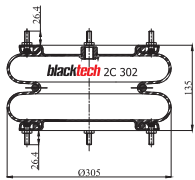

Top View

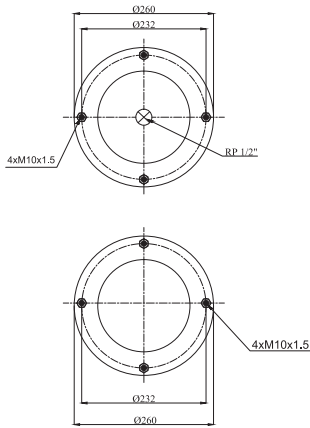

- Bolt or Stud
- Threaded hole
- ⊗ Combination Stud
- ⊗ Air Inlet

OEM PART NUMBER	MODEL NO	CROSS REFERENCES	
Gigant	881202	Dunlop F	SP 1541 NB (12" x 2 NB)
Weweler	USN 5100 11 KD		

### 2C 302-135 P02

Cross Section View

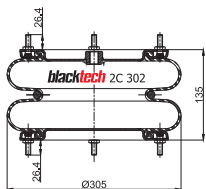

Top View

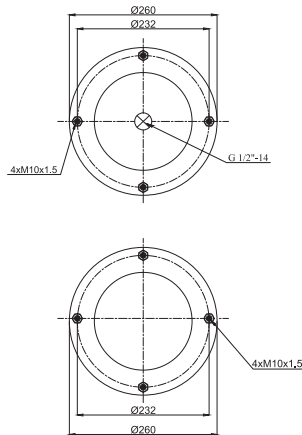

- Bolt or Stud
- Threaded hole
- ⊗ Combination Stud
- ⊗ Air Inlet

OEM PART NUMBER	MODEL NO	CROSS REFERENCES	
Gigant	881202		
Weweler	USN 5100 KD		

**2C302-135 P03**

Cross Section View

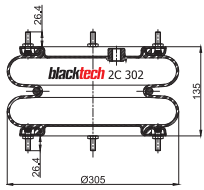

Top View

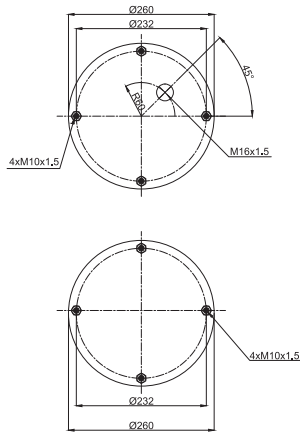

- Bolt or Stud
- Threaded hole
- ⊗ Combination Stud
- ⊗ Air Inlet

	OEM PART NUMBER	MODEL NO	CROSS REFERENCES	
Kaiser	A 060 30615		Dunlop F	SP 2665 NB(12" x 2A. NB)
Lohr	A 063 0601			
SMB	M 063 796			
TROUILLET	HB 10350			
Fruehauf	UJB 09 85/A			

**2C303-270 S**

Cross Section View

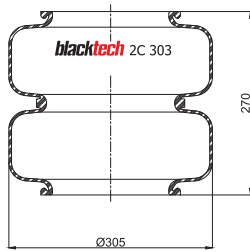

Top View

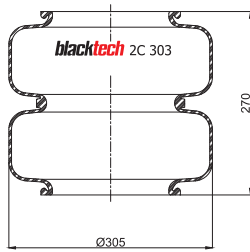

- Bolt or Stud
- Threaded hole
- ⊗ Combination Stud
- ⊗ Air Inlet

	OEM PART NUMBER	MODEL NO	CROSS REFERENCES	
SMB				
Lohr				
Fruehauf				

**2C303-270 P01**

Cross Section View

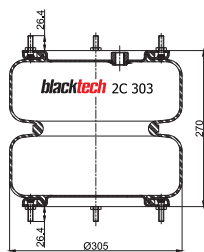

Top View

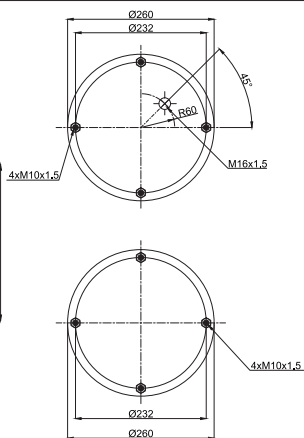

- Bolt or Stud
- Threaded hole
- ⊗ Combination Stud
- ⊗ Air Inlet

	OEM PART NUMBER	MODEL NO	CROSS REFERENCES	
SMB	M 07 82 46		Dunlop F	SP 2782 NB (12" x 2 A.NB)
Lohr	A 060 30 622			
Fruehauf	M 07 82 46			

### 2C315-225 P01

Cross Section View

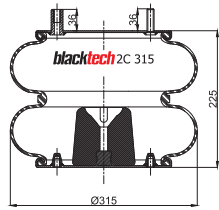

Top View

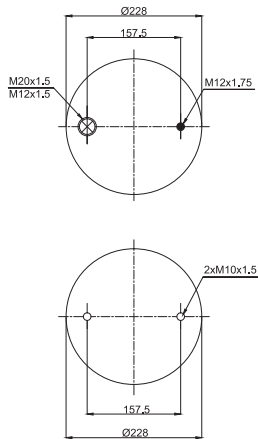

- Bolt or Stud
- Threaded hole
- ⊗ Combination Stud
- ⊗ Air Inlet

OEM PART NUMBER	MODEL NO	CROSS REFERENCES

### 2C315-225 P02

Cross Section View

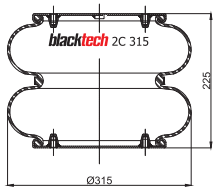

Top View

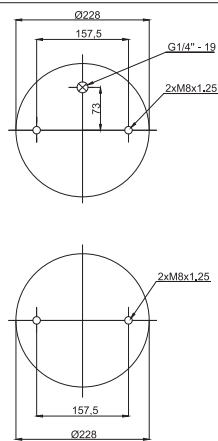

- Bolt or Stud
- Threaded hole
- ⊗ Combination Stud
- ⊗ Air Inlet

OEM PART NUMBER	MODEL NO	CROSS REFERENCES
Jung		Contitech
Hendrickson	NA 1816	FD 330-30 1/4 M8

### 2C315-225 P03

Cross Section View

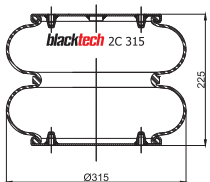

Top View

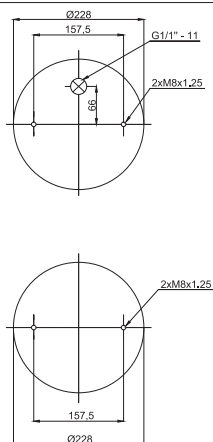

- Bolt or Stud
- Threaded hole
- ⊗ Combination Stud
- ⊗ Air Inlet

OEM PART NUMBER	MODEL NO	CROSS REFERENCES
		Contitech
		FD 330-22 1/1 M8

**2C315-225 P04**

Cross Section View

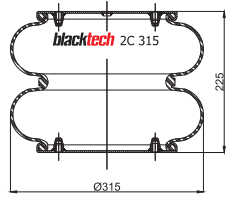

Top View

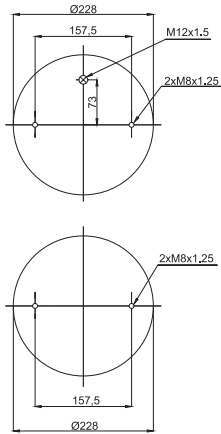

- Bolt or Stud
- Threaded hole
- ⊗ Combination Stud
- ⊗ Air Inlet

OEM PART NUMBER	MODEL NO	CROSS REFERENCES	
BPW	02.200.21.90.0	Contitech	FD 330-22 M12X1.5 M8

**2C315-225 P05**

Cross Section View

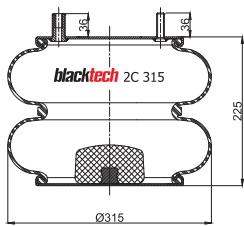

Top View

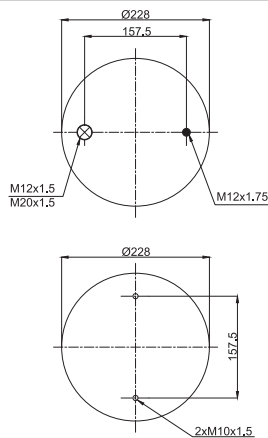

- Bolt or Stud
- Threaded hole
- ⊗ Combination Stud
- ⊗ Air Inlet

OEM PART NUMBER	MODEL NO	CROSS REFERENCES	

**2C315-225 P06**

Cross Section View

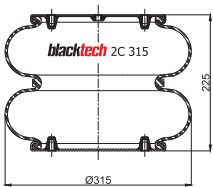

Top View

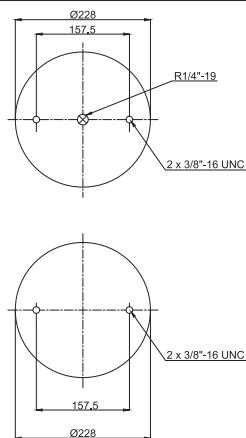

- Bolt or Stud
- Threaded hole
- ⊗ Combination Stud
- ⊗ Air Inlet

OEM PART NUMBER	MODEL NO	CROSS REFERENCES	
		Firestone Style	22-15
		Firestone Order	W01 681 7688
		Granning	1218



### 2C 315-225 P07

Cross Section View

Top View

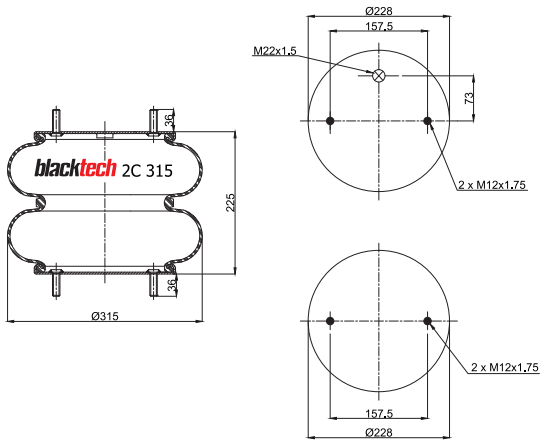

- Bolt or Stud
- Threaded hole
- ⊗ Combination Stud
- ⊗ Air Inlet

OEM PART NUMBER	MODEL NO	CROSS REFERENCES

### 2C 350-215 P01

Cross Section View

Top View

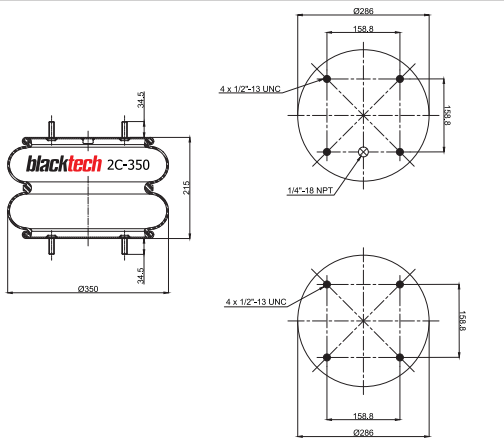

- Bolt or Stud
- Threaded hole
- ⊗ Combination Stud
- ⊗ Air Inlet

OEM PART NUMBER	MODEL NO	CROSS REFERENCES
Neway	90557001	Firestone Style 21
		Firestone Order W01 358 7135
		Goodyear 2814-360

### 2C 350-215 P02

Cross Section View

Top View

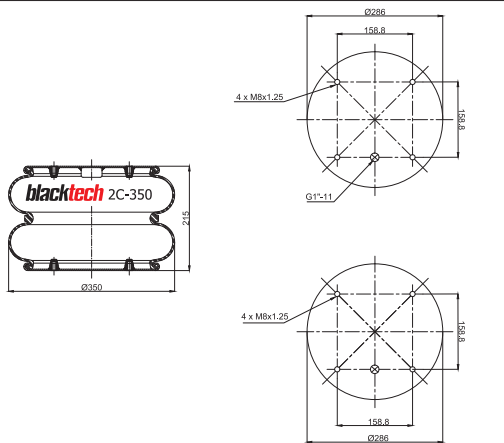

- Bolt or Stud
- Threaded hole
- ⊗ Combination Stud
- ⊗ Air Inlet

OEM PART NUMBER	MODEL NO	CROSS REFERENCES
DAF	1 307 058	Contitech FD 530-22 1/1 M8

**2C350-215 P03**

Cross Section View

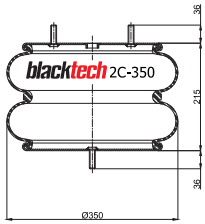

Top View

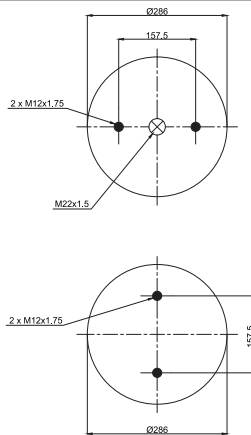

- Bolt or Stud
- Threaded hole
- ⊗ Combination Stud
- ⊗ Air Inlet

OEM PART NUMBER	MODEL NO	CROSS REFERENCES
ISUZU		

**2C351-350 S**

Cross Section View

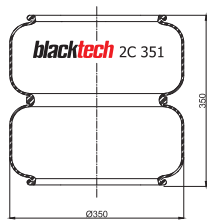

Top View

- Bolt or Stud
- Threaded hole
- ⊗ Combination Stud
- ⊗ Air Inlet

OEM PART NUMBER	MODEL NO	CROSS REFERENCES
KASSBOHRER	4.731.034.100	Phoenix
KASSBOHRER	4.731.034.200	2B 34R-b

**2C351-350 P01**

Cross Section View

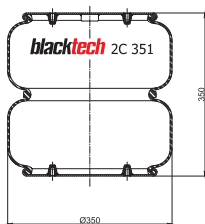

Top View

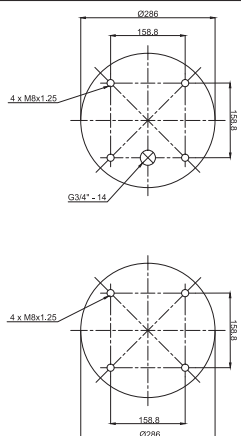

- Bolt or Stud
- Threaded hole
- ⊗ Combination Stud
- ⊗ Air Inlet

OEM PART NUMBER	MODEL NO	CROSS REFERENCES
		Phoenix
		SP 2B 34 R-b

## 2C355-190 F

Cross Section View

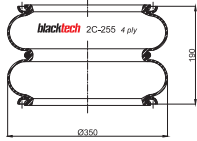

Top View

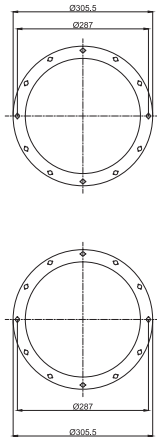

- Bolt or Stud
- Threaded hole
- ⊗ Combination Stud
- ⊗ Air Inlet

OEM PART NUMBER	MODEL NO	CROSS REFERENCES	
		Firestone Style	233
		Firestone Order	W01 M58 7710
		CF Gomma Ref.	21BR
		Cf Gomma No.	89457
		GART Ref.	T274
		GART No.	274.2.210

## 2C570-240 S

Cross Section View

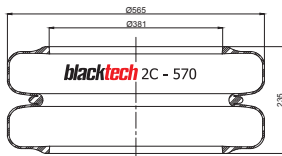

Top View

- Bolt or Stud
- Threaded hole
- ⊗ Combination Stud
- ⊗ Air Inlet

OEM PART NUMBER	MODEL NO	CROSS REFERENCES	
Ford	AC46 4K273 AA		

## 3C17-240 P01

Cross Section View

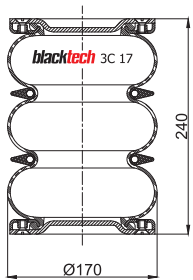

Top View

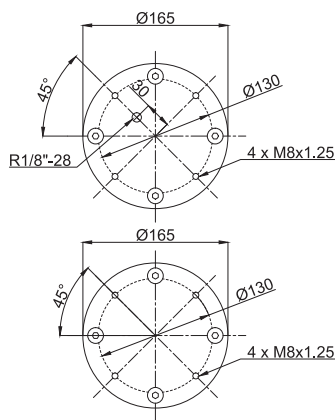

- Bolt or Stud
- Threaded hole
- ⊗ Combination Stud
- ⊗ Air Inlet

OEM PART NUMBER	MODEL NO	CROSS REFERENCES	

**3C 130-220 P01**



Cross Section View

Top View

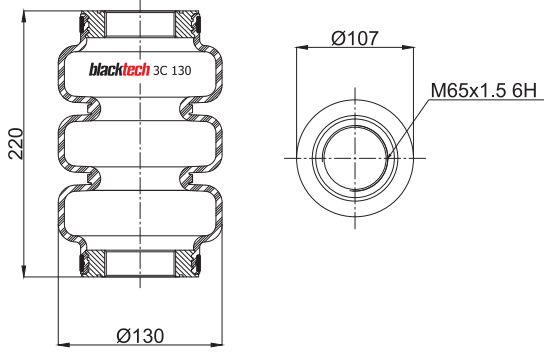

- Bolt or Stud
- Threaded hole
- ⊗ Combination Stud
- ⊗ Air Inlet

OEM PART NUMBER	MODEL NO	CROSS REFERENCES

**3C 251-230 S**

Cross Section View

Top View

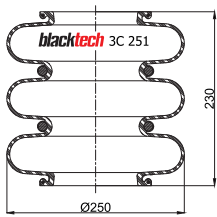

- Bolt or Stud
- Threaded hole
- ⊗ Combination Stud
- ⊗ Air Inlet

OEM PART NUMBER	MODEL NO	CROSS REFERENCES

**3C 251-230 F01**

Cross Section View

Top View

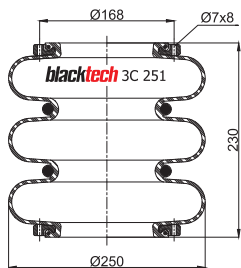

- Bolt or Stud
- Threaded hole
- ⊗ Combination Stud
- ⊗ Air Inlet

OEM PART NUMBER	MODEL NO	CROSS REFERENCES

### 3C 252-230 S

Cross Section View

Top View

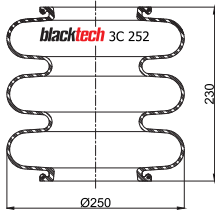

- Bolt or Stud
- Threaded hole
- ⊗ Combination Stud
- ⊗ Air Inlet

OEM PART NUMBER	MODEL NO	CROSS REFERENCES

### 3C 300-250 P01

Cross Section View

Top View

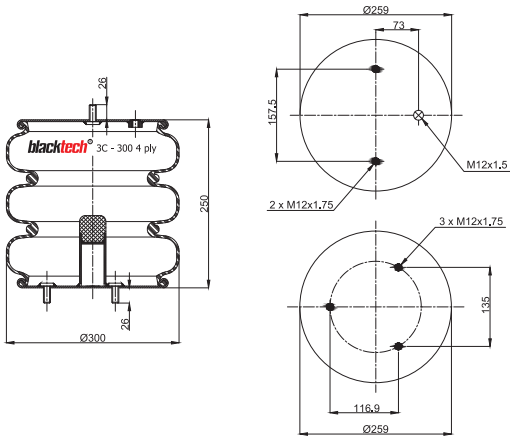

- Bolt or Stud
- Threaded hole
- ⊗ Combination Stud
- ⊗ Air Inlet

OEM PART NUMBER	MODEL NO	CROSS REFERENCES
BMC	57RS306424	

### 3C 300-250 P02

Cross Section View

Top View

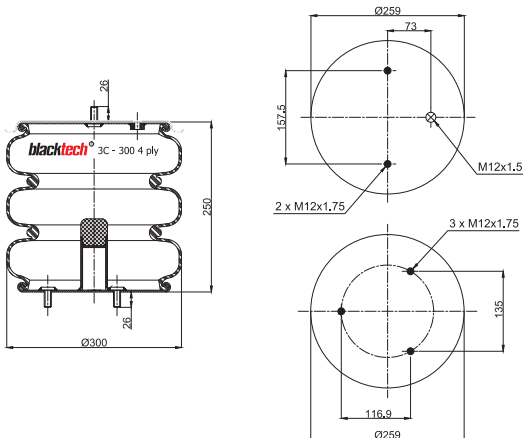

- Bolt or Stud
- Threaded hole
- ⊗ Combination Stud
- ⊗ Air Inlet

OEM PART NUMBER	MODEL NO	CROSS REFERENCES

**3C 301-250 S**

Cross Section View

Top View

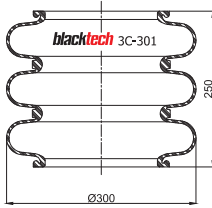

- Bolt or Stud
- Threaded hole
- ⊗ Combination Stud
- ⊗ Air Inlet

OEM PART NUMBER	MODEL NO	CROSS REFERENCES	
		Contitech	FT 330-29 S

**3C 301-250 P01**

Cross Section View

Top View

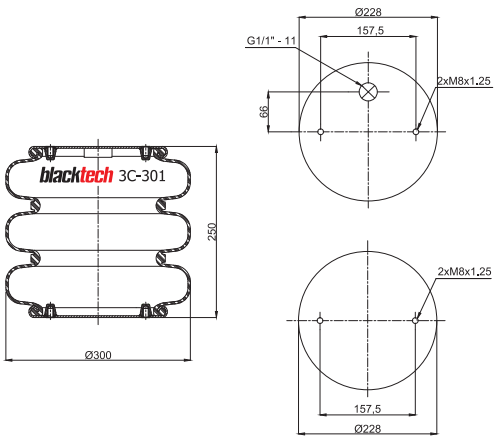

- Bolt or Stud
- Threaded hole
- ⊗ Combination Stud
- ⊗ Air Inlet

OEM PART NUMBER	MODEL NO	CROSS REFERENCES	
		Contitech	FT 330-29 1/1 M8

**3C 301-250 P02**

Cross Section View

Top View

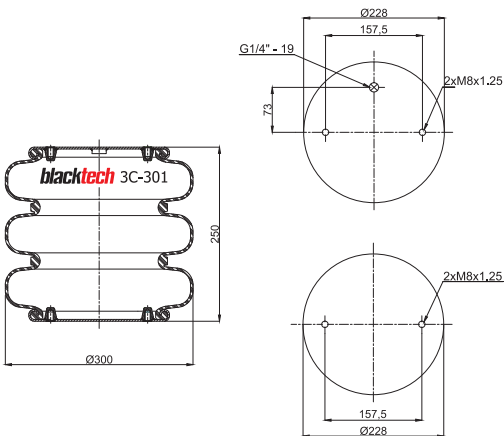

- Bolt or Stud
- Threaded hole
- ⊗ Combination Stud
- ⊗ Air Inlet

OEM PART NUMBER	MODEL NO	CROSS REFERENCES	
		Contitech	FT 330-29 1/4 M8

### 3C 301-250 P03



Cross Section View

Top View

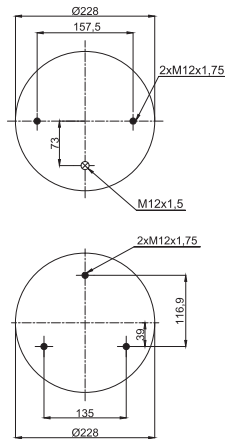
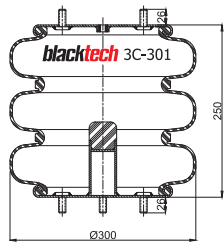

- Bolt or Stud
- Threaded hole
- ⊗ Combination Stud
- ⊗ Air Inlet

OEM PART NUMBER	MODEL NO	CROSS REFERENCES
BMC		

### 3C 301-250 P04



Cross Section View

Top View

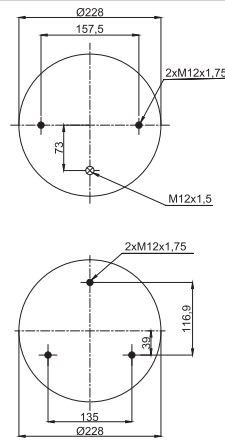
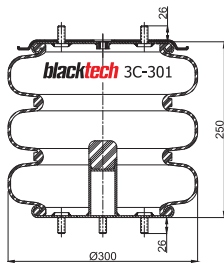

- Bolt or Stud
- Threaded hole
- ⊗ Combination Stud
- ⊗ Air Inlet

OEM PART NUMBER	MODEL NO	CROSS REFERENCES
BMC		

### 3C 301-250 P05

Cross Section View

Top View

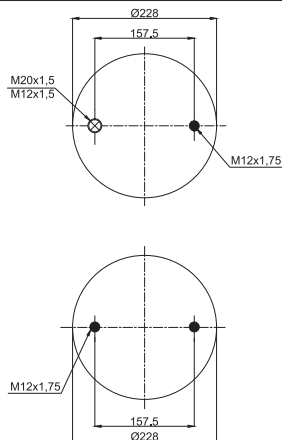
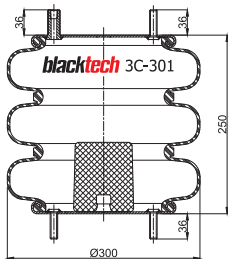

- Bolt or Stud
- Threaded hole
- ⊗ Combination Stud
- ⊗ Air Inlet

OEM PART NUMBER	MODEL NO	CROSS REFERENCES
DENNIS EAGLE		Firestone Style 38
TOUGHLINE		Firestone Order W01 358 8017
		Dunlop F S 12302(12" x 3 NB)

**3C 301-250 P07**

Cross Section View

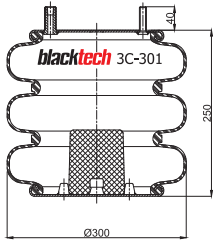

Top View

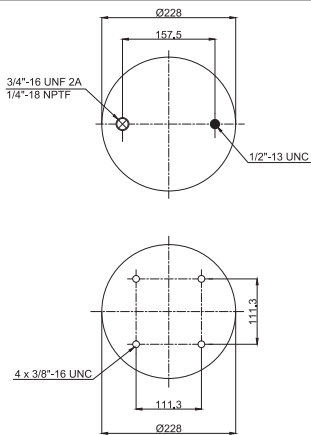

- Bolt or Stud
- Threaded hole
- ⊗ Combination Stud
- ⊗ Air Inlet

OEM PART NUMBER	MODEL NO	CROSS REFERENCES	
HENDRICKSON	S14795	Firestone Style	352
		Firestone Order	W01 358 8043

**3C 301-250 P08**

Cross Section View

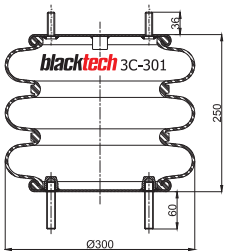

Top View

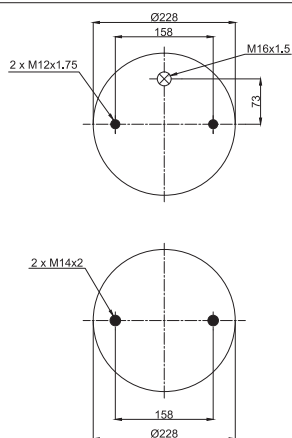

- Bolt or Stud
- Threaded hole
- ⊗ Combination Stud
- ⊗ Air Inlet

OEM PART NUMBER	MODEL NO	CROSS REFERENCES	
ROLFO	112273	Dunlop F	SP 12350
TOUGHLINE	17040	CF Gomma Ref.	322 BB
		CF Gomma No.	93410

**3C 302-200 P01**

Cross Section View

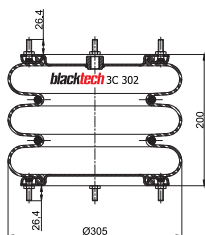

Top View

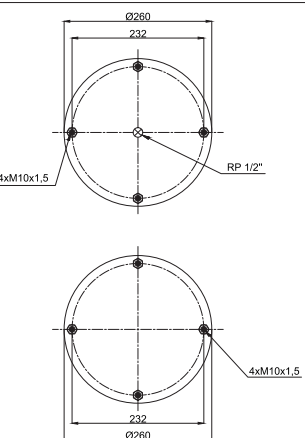

- Bolt or Stud
- Threaded hole
- ⊗ Combination Stud
- ⊗ Air Inlet

OEM PART NUMBER	MODEL NO	CROSS REFERENCES	
Gigant	881204	Dunlop F	SP 1542 NB(12" x 3 NB)
		Granning	15816



### 3C 302-200 P03

Cross Section View

Top View

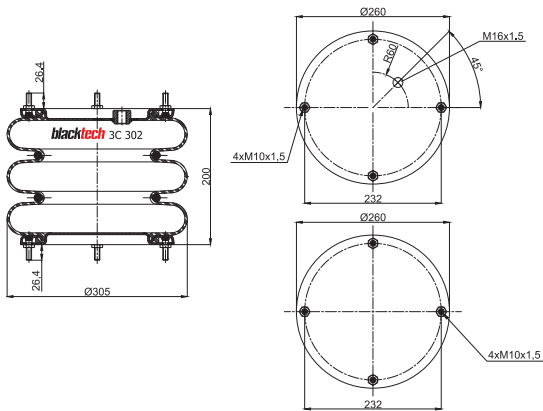

- Bolt or Stud
- Threaded hole
- ⊗ Combination Stud
- ⊗ Air Inlet

OEM PART NUMBER	MODEL NO	CROSS REFERENCES	
SMB	M002297	Dunlop F	SP 2666 NB(12" x 3 NB)
Fruehauf	M002297		
Lohr	A 060 30 606		
Samro	H2500011		

### 3C 304-200 S

Cross Section View

Top View

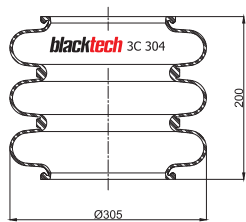

- Bolt or Stud
- Threaded hole
- ⊗ Combination Stud
- ⊗ Air Inlet

OEM PART NUMBER	MODEL NO	CROSS REFERENCES	

### 3C 304-200 F01

Cross Section View

Top View

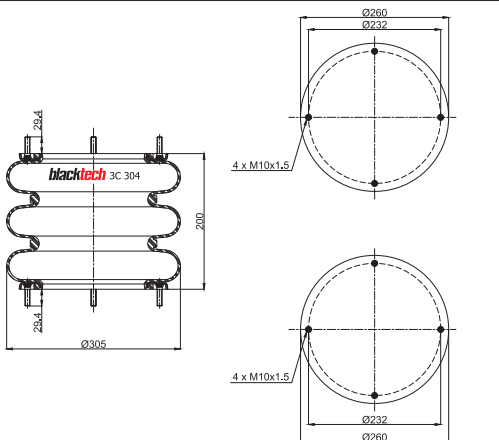

- Bolt or Stud
- Threaded hole
- ⊗ Combination Stud
- ⊗ Air Inlet

OEM PART NUMBER	MODEL NO	CROSS REFERENCES	
		Dunlop F	SP 1033 NB(12" x 3 NB)

**3C 304-200 F02**

Cross Section View

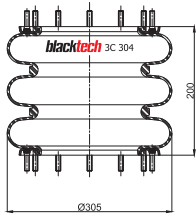

Top View

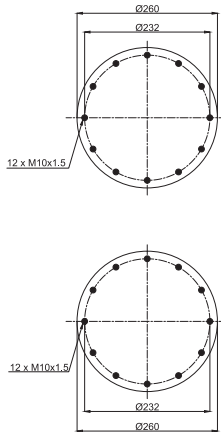

- Bolt or Stud
- Threaded hole
- ⊗ Combination Stud
- ⊗ Air Inlet

OEM PART NUMBER	MODEL NO	CROSS REFERENCES	
		Dunlop F	SP 2597 NB(12" x 3 NB)

**3C 304-200 P01**

Cross Section View

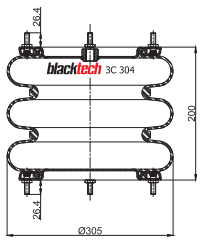

Top View

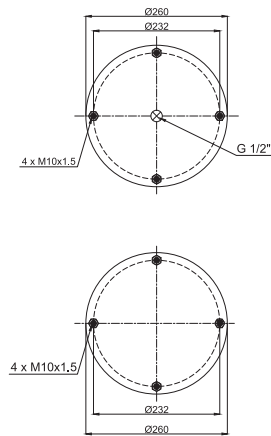

- Bolt or Stud
- Threaded hole
- ⊗ Combination Stud
- ⊗ Air Inlet

OEM PART NUMBER	MODEL NO	CROSS REFERENCES	

**3C 305-260 F01**



Cross Section View

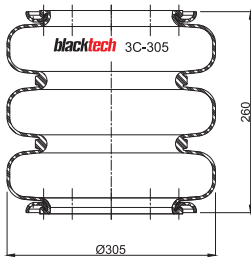

Top View

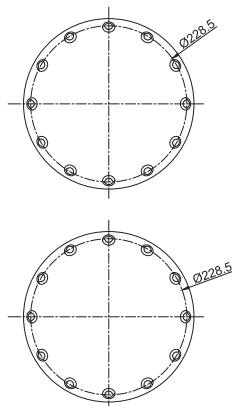

- Bolt or Stud
- Threaded hole
- ⊗ Combination Stud
- ⊗ Air Inlet

OEM PART NUMBER	MODEL NO	CROSS REFERENCES	
MAN	81.43601.6010	Firestone Style	38
Zorzi	1006506	Firestone Order	W01 M68 7992
		CF Gomma Ref.	322BR
		CF Gomma No.	89413
		GART Ref.	T271
		GART No.	271.3.293

# 3C 350-320 S

Cross Section View

Top View

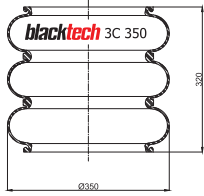

OEM PART NUMBER	MODEL NO	CROSS REFERENCES	

- Bolt or Stud
- Threaded hole
- ⊗ Combination Stud
- ⊗ Air Inlet

**CONVOLUTED AIR SPRINGS CROSS LIST**

Blacktech	ContiTech	Phoenix	Firestone Style	Firestone No.	Goodyear	CF Gomma Ref.
1C 21-110 P01	FS 200-10 1/4 M8					
1C 21-110 P03	FS 200-10 3/4 M8					
1C 21-170 S						
1C 21-170 P02	FS 200-16 P01					
1C 21-170 P03						
1C 21-170 P04						
1C 21-170 P05						
1C 140-70 P01		SP 1B 04				
1C 180-105 P02	FS 120-9 G1/4 M10					
1C 180-105 P03	FS 120-9 G3/4 M8					
1C 181-120 F01						
1C 185-150 P01 ( Metric )						
1C 185-150 P02 ( Imperial )			116-1	W01 358 7598		
1C 315-120 P01	FS 330-11 1/4 M8					
1C 315-120 P02	FS 330-11 1/1 M8					
2C 17-170 P01						
2C 18-195 S	603 N	2 B 07 R				
2C 18-195 P01 ( Metric )						
2C 18-195 P02 ( Imperial )				W21 760 7325		
2C 18-195 P03	FD 120-17 3/4 M8					
2C 21-210 S	FD 200-19 S	2 B 12 R	20	FD 200-19 S	W01 095 0009/W01-358-0297	20
2C 21-210 F01						
2C 21-210 P01	FD 200-19 1/4 M10	SP 2 B 12 R	20	FD 200-19 1/4 M10	W01-M58-6887/W01-M58-6910	2B9-223
2C 21-210 P02						
2C 21-210 P03	FD 200-19 3/4 M10					
2C 21-210 P04	FD 200-19 1/4 M8		20	FD 200-19 1/4 M8	W01-M58-7679/W01-M58-6187	
2C 21-210 P05	FD 200-19 3/4 M8	SP 2 B 12 R-1	20	FD 200-19 3/4 M8	W01-M58-6185	2B9-223
2C 21-210 P06	FD 200-22 3/4 M8					
2C 21-210 P13		SP 2B R A-4				
2C 21-210 P14						
2C 21-210 P15	FD 200-19 P02		20F	FD 200-19 P02	W01 M58 7756	T20L
2C 21-210 P17	FD 200-19 M14					
2C 21-210 P20	FD 200-19 M20					
2C 21-210 P22	FD 200-19 P04	SP 2B 12 R-5	20F	FD 200-19 P04	W01 M58 7894	2B9-700
2C 21-210 P24						
2C 150-140 B01						
2C 150-140 B02						
2C 150-140 P01						
2C 150-140 P02						
2C 151-150 P02 ( Metric )						
2C 151-150 P03 ( Metric )						
2C 151-150 P04 ( Metric )						

Part Ref.	CF Gomma No	Vibracoustic	Gart Ref.	Gart No	Dunlop UK	Dunlop F	Granning	Taurus	Page
									319
									319
			T 291/B						319
									320
			T291/B	B 291.1.170					320
									320
									321
									321
									321
									322
			T275	275.1.120					322
									322
									323
									323
									323
									324
									324
									324
									324
									325
									325
	86599	V2B12R							325
									326
	206797	VSP2B12R	T291/2	291.2.200	01128A-AP	S09201NB			326
									326
									327
			T291/2	291.2.200		9"1/4 S09201			327
		VSP2B12R-1							327
									328
									328
									328
	207065								329
									329
									329
	207773	VSP2B12R-5	T291/2	291.2.203		S09201			330
									330
						SP917( 6 " X2 ) Plastic Ring			330
						SP917( 6 " X2 ) Metal Ring			331
						SP1482 ( 6 " X2 ) Plastic Ring			331
						SP1482 ( 6 " X2 ) Metal Ring			331
									332
									332
									332

**CONVOLUTED AIR SPRINGS CROSS LIST**

Blacktech	ContiTech	Phoenix	Firestone Style	Firestone No.	Goodyear	CF Gomma Ref.
2C 151-150 P05 ( Imperial )			255 C	W21 760 6781		
2C 151-150 P06 ( Imperial )			267 C	W21 760 6784		
2C 151-150 P07 ( Imperial )			267 C-15	W21 760 6397		
2C 170-170 P01						
2C 170-170 P02			224C	W01 760 0335		
2C 170-170 P03				W21 760 0335		
2C 200-140 P01				W01 R58 4055		
2C 200-140 P02	FD 138-18 1/2 M10		8x2	W01 R58 4055	288-2150	
2C 200-140 P03	FD 120-17 3/4 M8		26	W01-M58-6387/W01-358-7325	288-2152	T26
2C 211-220 P01	FD 200-25 1/4 M10		20F	W01-M58-6772/W01-M58-7888		
2C 211-220 P02	FD 200-25 174 M8		20-2	W01 M58 7394 C	289-269	
2C 211-220 P03	FD 200-25 1/4 M10	SP 2 B 12 R-A-10	20C-2	W01-M58-7679/W01-968-6771	289-269	20L
2C 211-220 P04	FD 200-25 P02					
2C 250-170 S	620 N 8 Bar					
2C 250-170 S01	620 N Hydro 17 bar					245 B.V.
2C 250-170 S02	620 N Hydro 34 bar					
2C 250-170 F	620 M Hydro 17 bar ( 160 mm )					
2C 250-170 F01	620 M Hydro 17 bar ( 200 mm )					
2C 251-155 S						
2C 251-155 F01						
2C 255-170 P01	FD 210-22-1/2 M10		10x2	W01-R58-4058	2810-2350	
2C 280-175 S	608 N	2B 20 R	20	W01-R58-4088	2812-425/300	
2C 280-175 F	608 M					
2C 301-180 P02				W01 M58 6203		
2C 302-135 F01						
2C 302-135 P01						
2C 302-135 P02						
2C 302-135 P03						
2C 303-270 S						
2C 303-270 P01						
2C 315-225 P01						
2C 315-225 P02	FD 330-30 1/4 M8					
2C 315-225 P03	FD 330-22 1/1 M8					
2C 315-225 P04	FD 330-22 M12X1.5 M8					
2C 315-225 P05						
2C 315-225 P06			22-15	W01 681 7688		
2C 315-225 P07						
2C 350-215 P01			21	W01 358 7135	2814-360	
2C 350-215 P02	FD 530-22 1/1 M8					
2C 350-215 P03						
2C 351-350 S		2B 34 R-b				
2C 351-350 P01		SP 2B 34 R-b				

Part Ref.	CF Gomma No	Vibracoustic	Gart Ref.	Gart No	Dunlop UK	Dunlop F	Granning	Taurus	Page
									333
									333
									333
									334
									334
									334
						SP1490			335
									335
	84181	VSP2B07R-2				2B8-2152			335
									336
									336
	20776	VSP2B12RA-10	T291/2B	291.2.260					336
									337
									337
	92142								337
									338
									338
									338
									339
									339
					10x2	10"x2 SP1538			339
		V2B20R							340
									340
						S 12200			340
						SP 1025 NB ( 12 " X2 NB )			341
						SP 1541 NB ( 12 " X2 NB )			341
									341
						SP 2665 NB ( 12 " X2 A.NB )			342
									342
						SP 2782 NB ( 12 " X2 A.NB )			342
									343
									343
									343
									344
									344
							1218		344
									345
									345
									345
									346
									346
									346

**CONVOLUTED AIR SPRINGS CROSS LIST**

Blacktech	ContiTech	Phoenix	Firestone Style	Firestone No.	Goodyear	CF Gomma Ref.
2C 355-190 F			233	W01 M58 7710		21BR
2C 570-240 S						
3C 17-240 P01						
3C 130-220 P01						
3C 251-230 S						
3C 251-230 F01						
3C 252-230 S						
3C 300-250 P01						
3C 300-250 P02						
3C 301-250 S	FT 330-29 S					
3C 301-250 P01	FT 330-29 1/1 M8					
3C 301-250 P02	FT 330-29 1/4 M8					
3C 301-250 P03						
3C 301-250 P04						
3C 301-250 P05			38	W01 358 8017		
3C 301-250 P07			352	W01 358 8043		
3C 301-250 P08						322BB
3C 302-200 P01						
3C 302-200 P03						
3C 304-200 S						
3C 304-200 F01						
3C 304-200 F02						
3C 304-200 P01						
3C 305-260 F01			38	W01 M58 7992		322BR
3C 350-320 S						



Part Ref.	CF Gomma No	Vibracoustic	Gart Ref.	Gart No	Dunlop UK	Dunlop F	Granning	Taurus	Page
	89457		T274	274.2.210					347
									347
									347
									348
									348
									348
									349
									349
									349
									349
									350
									350
									350
									350
									351
									351
						S 12302 ( 12" x 3 NB )			351
									352
	93410					SP 12350			352
						SP 1542 NB ( 12" x 3 NB )	15816		352
						SP 2666 NB ( 12" x 3 NB )			353
									353
						SP 1033 NB ( 12" x 3 NB )			353
						SP 2597 NB ( 12" x 3 NB )			354
									354
	89413		T271	271.3.293					354
									355



# CABIN, SEAT AND LIFT AIR SPRINGS

**blacktech**™



**Vibracoustic**  
CV Air Springs



## Components of Air Springs

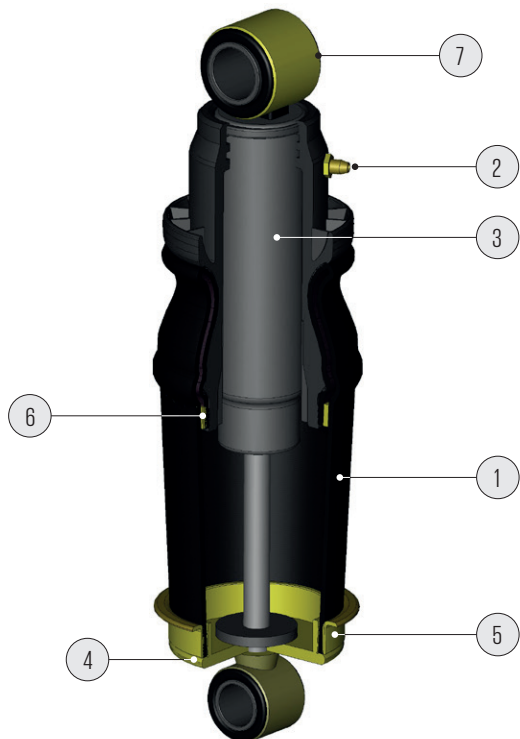

1. Sleeve
2. Air inlet
3. Piston
4. Clamping Plate
5. Clamping Ring
6. Shock Absorber

## Product Identification / Roll Air Springs

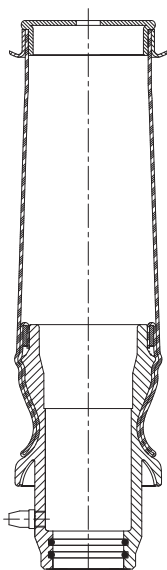

110 01 C  
Cabin air spring  
without shock  
absorber

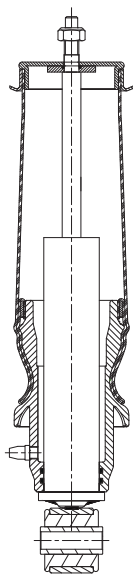

110 01 CA  
Cabin air spring  
with shock  
absorber plates

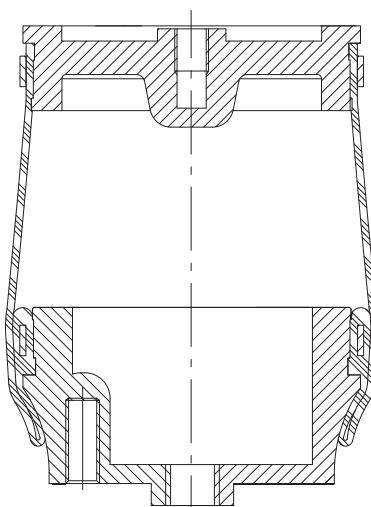

210 06 C  
Seat air springs

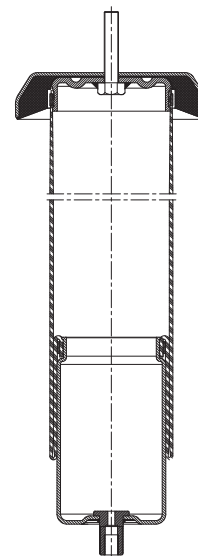

310 01 C  
Lift air springs

CABIN & SEAT & LIFT AIR SPRINGS OEM LIST					
MANUFACTURER	OEM PART NO	PART NO	TYPE	REMARK	PAGE
DEUTZ - FAHR	0442 8784	110 05 CA	With Shock Absorber		373
FREIGHTLINER	1829919000	210 12 C	Without Shock Absorber		389
		210 13 C	Without Shock Absorber		389
ISRINGHAUSEN	31396	210 28 C	Without Shock Absorber		392
SEARS / DURAFORM	S5388 / 707338	210 15 C	Without Shock Absorber		390
	S9383	210 27 C	Without Shock Absorber		392
	S20235	210 27 C	Without Shock Absorber		392
STEYR	81417226049	110 05 CA	With Shock Absorber		373
	81417226052	110 05 CA	With Shock Absorber		373
KNOEDLER	7010	210 15 C	Without Shock Absorber		390
LINK	11020022	210 14 C	Without Shock Absorber		390
	11010024	210 15 C	Without Shock Absorber		390
	11020040	210 19 C1	Without Shock Absorber		391
IVECO		110 18 C	Without Shock Absorber	Stralis front	377
	500357351	110 18 CA	With Shock Absorber	Stralis front	377
		110 19 C	Without Shock Absorber	Stralis rear	377
	504060241	110 19 CA	With Shock Absorber	Stralis rear	377
		110 26 C	Without Shock Absorber	Stralis rear	379
	500340706	110 26 CA	With Shock Absorber	Stralis rear	379
		110 29 C	Without Shock Absorber	Stralis rear	380
	504060233	110 29 CA	With Shock Absorber	Stralis rear	380
		110 30 C	Without Shock Absorber	Stralis front	381
	500340705	110 30 CA	With Shock Absorber	Stralis front	381
		110 31 C	Without Shock Absorber	Stralis rear	381
	500357352	110 31 CA	With Shock Absorber	Stralis rear	381
		110 33 C	Without Shock Absorber	EUROSTAR / EUROTECH / EUROTRAKKER rear	382
	4102 8763 4102 8764 500348793 500377878	110 33 CA	With Shock Absorber	EUROSTAR / EUROTECH / EUROTRAKKER rear	382
		110 34 C	Without Shock Absorber	EUROSTAR / EUROTECH rear	382

CABIN & SEAT & LIFT AIR SPRINGS OEM LIST					
MANUFACTURER	OEM PART NO	PART NO	TYPE	REMARK	PAGE
IVECO	500307338 500352808 500379698 9943 8514 9945 5937 9847 2734	110 34 CA	With Shock Absorber	EUROSTAR / EUROTECH rear	382
	41019150 / 8169050 410 15 530	210 03 C	Without Shock Absorber	EUROSTAR / EUROTECH / EUROTRAKKER front	388
MAN		110 04 C	Without Shock Absorber	F2000 front - rear	373
	81417226048 81417226051	110 04 CA	With Shock Absorber	F2000 front - rear	373
		110 05 C	Without Shock Absorber	F2000 / TGA rear	373
	81417226049 81417226052	110 05 CA	With Shock Absorber	F2000 / TGA rear	373
		110 22 C	Without Shock Absorber	TGA / TGS / TGX rear	378
	81417226057 85417226006 81417226012 81417226075	110 22 CA	With Shock Absorber	TGA / TGS / TGX rear	378
		110 23 C	Without Shock Absorber	TGA front	378
	81417226009 81417226015 81417226078 85417226023	110 23 CA	With Shock Absorber	TGA front	378
		110 24 C	Without Shock Absorber	TGA front	378
	81417226008 81417226014 81417226077 85417226022	110 24 CA	With Shock Absorber	TGA front	378
81417226007 81417226013 81417226058 81417226024 CLASS 0596619-1	110 47 CA	With Shock Absorber	TGA / TGL / TGS / TGX rear	385	
MERCEDES		110 06 C	Without Shock Absorber	ACTROS front	373
	A9428902919	110 06 CA	With Shock Absorber	ACTROS front	373
		110 07 C	Without Shock Absorber	ACTROS rear	374
	A9428900219 A9428906019 A9438900219 A9438906019 A9438903919	110 07 CA	With Shock Absorber	ACTROS rear	374
		110 10 C	Without Shock Absorber	ACTROS front	375
	A9428903819	110 10 CA	With Shock Absorber	ACTROS front	375

CABIN & SEAT & LIFT AIR SPRINGS OEM LIST					
MANUFACTURER	OEM PART NO	PART NO	TYPE	REMARK	PAGE
MERCEDES		110 11 C	Without Shock Absorber	ACTROS front	375
	A9428905319 A9428905919	110 11 CA	With Shock Absorber	ACTROS front	375
		110 41 C	Without Shock Absorber	ACTROS / AXOR rear	383
	A9428906119	110 41 CA	With Shock Absorber	ACTROS / AXOR rear	383
		110 42 C	Without Shock Absorber	ACTROS front	384
	A9428904919	110 42 CA	With Shock Absorber	ACTROS front	384
		110 50 C	Without Shock Absorber	ACTROS front	386
	A9428906919	110 50 CA	With Shock Absorber	ACTROS front	386
		110 56 C	Without Shock Absorber	ACTROS rear	386
	A9428907019	110 56 CA	With Shock Absorber	ACTROS rear	386
RENAULT		110 25 C	Without Shock Absorber	PREMIUM / KERAX rear	379
	5010228908 / 5010228908A 5010228908B / 5010228908C 5010316783A / 5010269674	110 25 CA	With Shock Absorber	PREMIUM / KERAX rear	379
		110 43 C	Without Shock Absorber	PREMIUM rear	384
	5010615879	110 43 CA	With Shock Absorber	PREMIUM rear	384
		110 44 C	Without Shock Absorber	MAGNUM DXI / KERAX rear	384
	5010552 241 7420898055 7482052893	110 44 CA	With Shock Absorber	MAGNUM DXI / KERAX rear	384
		110 45 C	Without Shock Absorber	MAGNUM E-TECH front	385
	5010228849	110 45 CA	With Shock Absorber	MAGNUM E-TECH front	385
	5010092916E	210 02 C	Without Shock Absorber	MANAGER / MAXTER rear	388
	5010266845A 5010313619A	210 04 C	Without Shock Absorber	MANAGER / MAXTER front	388
	5010133079D	210 05 C	Without Shock Absorber	GAMME G front	388
	5010320096A	210 09 C	Without Shock Absorber	MAGNUM E-TECH front - rear	389
	5010491301	210 17 C	Without Shock Absorber	MAGNUM DXI	390
	5010629414 / 5010130797G	210 18 C	Without Shock Absorber	PREMIUM / KERAX	390



CABIN & SEAT & LIFT AIR SPRINGS OEM LIST					
MANUFACTURER	OEM PART NO	PART NO	TYPE	REMARK	PAGE
SCANIA	1314278 / 1348121	110 01 C	Without Shock Absorber	Serie 3 front-rear	372
	370227 / 393257 550365 / 1116535 1117320 / 1117334 1331620 / 1331621 1331634 / 1331635 1348117 / 1348119 1348120 / 1177326 1331626 / 1348118 1348211 / 1348477	110 01 CA	With Shock Absorber	Serie 3 front-rear	372
	1476415 / 1381919	110 02 C	Without Shock Absorber	Serie 4 front	372
	1381904 / 1397400 1435859	110 02 CA	With Shock Absorber	Serie 4 front	372
	1476415 / 1381919	110 03 C	Without Shock Absorber	Serie 4 rear	372
	1435856 / 1382826 1391906 / 1382829	110 03 CA	With Shock Absorber	Serie 4 rear	372
	1349840	110 08 C	Without Shock Absorber	Serie 4 front	374
	1424228 / 1363122 1397396 / 1381904	110 08 CA	With Shock Absorber	Serie 4 front	374
	1349840	110 09 C	Without Shock Absorber	Serie 4 rear	374
	1382827 / 1424229 1349844	110 09 CA	With Shock Absorber	Serie 4 rear	374
	1424231	110 12 C	Without Shock Absorber	Serie 4 front - rear	376
	1505563 / 1502470 1502471 / 1502472 1502474 / 1595642	110 12 CA	With Shock Absorber	Serie 4 front - rear	376
	1502468 / 1502471	110 13 C	Without Shock Absorber	Serie 4 rear	376
	1502474	110 13 CA	With Shock Absorber	Serie 4 rear	376
		110 14 C	Without Shock Absorber	Serie 4 rear	376
	1424231	110 17 C	Without Shock Absorber	Serie 4 front	377
	1424227 / 1363120 1397386 / 1397388 1397390 / 1397392	110 17 CA	With Shock Absorber	Serie 4 front	377
		110 28 C	Without Shock Absorber	Serie 4 front	380
	1424227 / 1363120 1397396 / 1397390 1397392 / 1397386 1397388	110 28 CA	With Shock Absorber	Serie 4 front	380
		110 39 C	Without Shock Absorber	Serie 4 front	383

CABIN & SEAT & LIFT AIR SPRINGS OEM LIST					
MANUFACTURER	OEM PART NO	PART NO	TYPE	REMARK	PAGE
SCANIA	1424227 / 1363120 1397396 / 1397390 1397392 / 1397386 1397388	110 39 CA	With Shock Absorber	Serie 4 front	383
		110 40 C	Without Shock Absorber	Serie 4 rear	383
	1505563 / 1495642 1502470 / 1502471 1502472 / 1502474 1595642	110 40 CA	With Shock Absorber	Serie 4 rear	383
	1314278	110 66 C	Without Shock Absorber	FRONT - REAR	387
DAF	1265281 / 1285393 1321590 / 1353450 1353453 / 1371065 1444147 / 1622211	110 48 CA	With Shock Absorber	CF/XF/95 front	386
	1265282 / 1285394 1321591 / 1353451 1353454 / 1371066 1623477 / 299862	110 49 CA	With Shock Absorber	CF/XF/95 rear	386
VOLVO		110 27 C	Without Shock Absorber	FH12 / FH16 front	380
	1629719 1629724 3172984	110 27 CA	With Shock Absorber	FH12 / FH16 front	380
		110 32 C	Without Shock Absorber	FH12 / FH16 rear	381
	20427897 / 20721169 20889134 / 20775212 21651231 / 1076855 20721167 / 20736464 3172985 / 3198850	110 32 CA	With Shock Absorber	FH12 / FH16 rear	381
		110 35 C	Without Shock Absorber	FH12 / FH16 rear	382
	1075076 / 1075077	110 35 CA	With Shock Absorber	FH12 / FH16 rear	382
		110 46 C	Without Shock Absorber	FH12 / FH16 rear	385
	20453256 / 20399204 20453258 / 20889132 21111932 / 3198837	110 46 CA	With Shock Absorber	FH12 / FH16 rear	385
		110 63 C	Without Shock Absorber	FH12 / FH16 FRONT	387
	20453256 / 20399204 20889132 / 21111932 20452258 / 3198837	110 63 CA	With Shock Absorber	FH12 / FH16 FRONT	387
	20906196	210 18 C	Without Shock Absorber	front	390
	20534645	310 01 C	Without Shock Absorber	LIFT - AXLE SHORT VERSION	394
	1081785 / 20455245 20494458	310 02 C	Without Shock Absorber	LIFT - AXLE SHORT VERSION	394
	20534646	310 03 C	Without Shock Absorber	LIFT - AXLE SHORT VERSION	394

CABIN & SEAT & LIFT AIR SPRINGS OEM LIST					
MANUFACTURER	OEM PART NO	PART NO	TYPE	REMARK	PAGE
SEAT AIR SPRING	2014118	210 06 C	Seat Air Spring	SEDILI / C.O.B.O.	388
	1C3030	210 07 C	Seat Air Spring	Move	389
		210 08 C	Seat Air Spring	KLEPP	389
	HYA005	210 10 C	Seat Air Spring	Pilot	389
	172254-H	210 34 C	Seat Air Spring	Kab Seating	393
	174150-D	210 35 C	Seat Air Spring	Kab Seating	393
	163718	210 36 C	Seat Air Spring	Kab Seating	393
	202082	210 37 C	Seat Air Spring	Kab Seating	393
		210 38 C	Seat Air Spring	Kab Seating	393

**110 01 C**



SCANIA	3 SERIE	FRONT - REAR
Cross View Section		
OEM PART NO		
1314278 / 1348121		
MODEL NO		
3 SERIE	113E/113H/113M/143E/143H /143M/93H/93M/1113E/1113H /1143E/1143H	
CR SERIE	CR13 / CR19	
CROSS NO		
SACHS	481002	
GOODYEAR	1AS-004	
FIRESTONE	W02 M58 8000	

**110 01 CA**



SCANIA	3 SERIE	FRONT - REAR
Cross View Section		
OEM PART NO		
370227/393257/550365/1116535/1117320/ 1117334/1331620/1331621/1331634/1331636/ 1348117/1348119/1348120/1177326/1331626/ 1348118/1348211/1348477		
MODEL NO		
3 SERIE	113E/113H/113M/143E/143H /143M/93H/93M/1113E/1113H /1143E/1143H	
CR SERIE	CR13 / CR19	
CROSS NO		
SACHS	112230+105876/105846 105845+105875	
GOODYEAR	105831+481002	
FIRESTONE	1SA 036 W02 M58 8001	

**110 02 C**



SCANIA	4 SERIE	FRONT
Cross View Section		
OEM PART NO		
1476415 / 1381919		
MODEL NO		
4 SERIE	94/114/124/144/164	
CROSS NO		
MONROE	CB0030 / 717262725	
GOODYEAR	1AS-001	
FIRESTONE	W02 M58 8002	

**110 02 CA**



SCANIA	4 SERIE	FRONT
Cross View Section		
OEM PART NO		
1381904 / 1397400 / 1435859		
MODEL NO		
4 SERIE	94/114/124/144/164	
CROSS NO		
MONROE	CB0010	
GOODYEAR	1SA 006	
FIRESTONE	W02 M58 8003	

**110 03 C**



SCANIA	4 SERIE	REAR
Cross View Section		
OEM PART NO		
1476415 / 1381919		
MODEL NO		
4 SERIE	94/114/124/144/164	
CROSS NO		
MONROE	CB0030 / 717262725	
GOODYEAR	1AS-001	
FIRESTONE	W02 M58 8002	

**110 03 CA**



SCANIA	4 SERIE	REAR
Cross View Section		
OEM PART NO		
1435856 / 1382826 / 1391906 / 1382829		
MODEL NO		
4 SERIE	94/114/124/144/164	
CROSS NO		
MONROE	CB0009	
GOODYEAR	1SA 005	
FIRESTONE	W02 M58 8004	



**110 07 C**



MERCEDES	ACTROS	REAR
Cross View Section		
OEM PART NO		
MODEL NO		
CROSS NO		

**110 07 CA**



MERCEDES	ACTROS	REAR
Cross View Section		
OEM PART NO		
A942 890 02 19 / A942 890 60 19		
A943 890 02 19 / A943 890 60 19		
A943 890 39 19		
MODEL NO		
ACTROS	(1831-1835 - 1840 - 1843 - 1848 - 1853 - 1857 - 2031 - 2035 - 2040 - 2053 - 2531 - 2535 - 2540 - 2543 - 2548 - 2553 - 2631 - 2635 - 2640 - 2643 - 2648 - 2653 - 2657 - 3231 - 3235 - 3240 - 3243 - 3331 - 3335 - 3340 - 3343 - 3348 - 3353 - 3357 - 4140 - 4143 - 4148)	
ACTROS MP2-MP3	(1832 - 1836 - 1841 - 1844 - 1846 - 1848 - 1850 - 1851 - 1854 - 1858 - 2032 - 2036 - 2041 - 2044 - 2046 - 2048 - 2050 - 2532 - 2535)	
CROSS NO		
SACHS	105406 / 290997 / 311189	
GOODYEAR	ISA-AS 016	
FIRESTONE	W02 M58 8015	
PHOENIX	CD 075 123 011	
GRANNING	50512	

**110 08 C**



SCANIA	4 SERIE	FRONT
Cross View Section		
OEM PART NO		
1349840		
MODEL NO		
CR SERIE	CP14/19/28/31	
4 SERIE	94/114/124/144/164	
CROSS NO		
SACHS	557001	
FIRESTONE	W02 M58 8005	

**110 08 CA**



SCANIA	4 SERIE	FRONT
Cross View Section		
OEM PART NO		
1424228 / 1363122 / 1397396 / 1381904		
MODEL NO		
CR SERIE	CP14/19/28/31	
4 SERIE	94/114/124/144/164	
CROSS NO		
SACHS	290988 / 105872 + 557001	
FIRESTONE	290201 / 290203 + 557001	
	W02 M58 8006	

**110 09 C**



SCANIA	4 SERIE	REAR
Cross View Section		
OEM PART NO		
1349840		
MODEL NO		
CR SERIE	CP14/19/19F/28/31	
4 SERIE	94/114/124/144/164	
CROSS NO		
SACHS	557001	
FIRESTONE	W02 M58 8005	

**110 09 CA**



SCANIA	4 SERIE	REAR
Cross View Section		
OEM PART NO		
1382827 / 1424229 / 1349844		
MODEL NO		
CR SERIE	CP14/19/19F	
4 SERIE	94/114/124/144/164	
CROSS NO		
SACHS	290989 + 557001	
FIRESTONE	105873 + 557001	
	W02 M58 8007	

### 110 10 C



MERCEDES	ACTROS	FRONT
OEM PART NO		
MODEL NO		
CROSS NO		

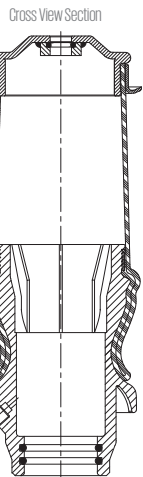

### 110 10 CA



MERCEDES	ACTROS	FRONT
OEM PART NO		
A942 890 38 19		
MODEL NO		
ACTROS	(1831 - 1835 - 1840 - 1843 - 1848 - 1853)	
1857 - 2031 - 2035 - 2040 - 2053 - 2531 - 2535 - 2540 - 2543 - 2548 - 2553		
2557 - 2631 - 2635 - 2640 - 2643 - 2648 - 2653 - 2657 - 3231 - 3235 - 3240		
3243 - 3331 - 3335 - 3340 - 3343 - 3348 - 3353 - 3357 - 4140 - 4143 - 4148		
ACTROS MP2-MP3	(1832 - 1836 - 1841 - 1844 - 1846 - 1848 - 1850)	
1851 - 1854 - 1854 - 2032 - 2036 - 2041 - 2044 - 2046 - 2048 - 2050 - 2051		
2532 - 2536 - 2541 - 2546 - 2548 - 2551 - 2555 - 2560 - 2632 - 2636 - 2641		
2644 - 2646 - 2650 - 2651 - 2654 - 2655 - 2658 - 3231 - 3232 - 3241 - 3244		
3246 - 3248 - 3331 - 3332 - 3336 - 3341 - 3344 - 3346 - 3348 - 3350 - 3351		
3354 - 3355 - 3360 - 4140 - 4144		
CROSS NO		
SACHS	290257	
FIRESTONE	W02 M58 8018	
PHOENIX	CD 075 122 013	

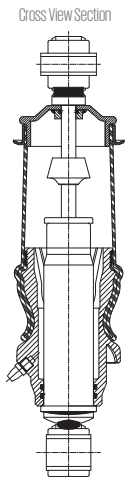

### 110 11 C



MERCEDES	ACTROS	FRONT
OEM PART NO		
MODEL NO		
CROSS NO		

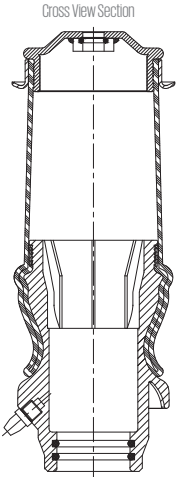

### 110 11 CA



MERCEDES	ACTROS	FRONT
OEM PART NO		
A942 890 53 19 / A942 890 59 19		
MODEL NO		
ACTROS	(1831 - 1835 - 1840 - 1843 - 1848 - 1853)	
1857 - 2031 - 2035 - 2040 - 2053 - 2531 - 2535 - 2540 - 2543 - 2548 - 2553		
2557 - 2631 - 2635 - 2640 - 2643 - 2648 - 2653 - 2657 - 3231 - 3235 - 3240		
3243 - 3331 - 3335 - 3340 - 3343 - 3348 - 3353 - 3357 - 4140 - 4143 - 4148		
ACTROS MP2-MP3	(1832 - 1836 - 1841 - 1844 - 1846 - 1848 - 1850)	
1851 - 1854 - 1854 - 2032 - 2036 - 2041 - 2044 - 2046 - 2048 - 2050 - 2051		
2532 - 2536 - 2541 - 2546 - 2548 - 2551 - 2555 - 2560 - 2632 - 2636 - 2641		
2644 - 2646 - 2650 - 2651 - 2654 - 2655 - 2658 - 3231 - 3232 - 3241 - 3244		
3246 - 3248 - 3331 - 3332 - 3336 - 3341 - 3344 - 3346 - 3348 - 3350 - 3351		
3354 - 3355 - 3360 - 4140 - 4144		
CROSS NO		
SACHS	311663	
FIRESTONE	W02 M58 8018	
PHOENIX	CD 075 122 012	

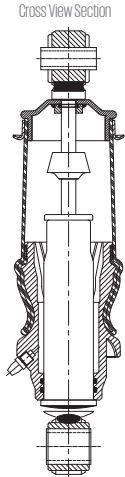

**110 12 C**



SCANIA	4 SERIE	FRONT-REAR
OEM PART NO		
1424231		
MODEL NO		
CR SERIE	CP14/16/19/28/31	
4 SERIE	94/114/124/144/164	
CROSS NO		
SACHS	310619	
GOODYEAR	IAS-005	
FIRESTONE	W02 M58 8008	

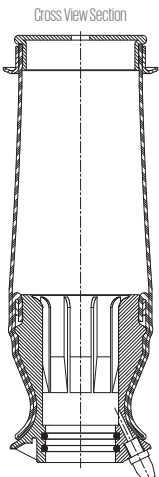

**110 12 CA**



SCANIA	4 SERIE	FRONT-REAR
OEM PART NO		
1505563 / 1502470 / 1502471 / 1502472 / 1502474 / 1596642		
MODEL NO		
CR SERIE	CP14/16/19/28/31	
4 SERIE	94/114/124/144/164	
CROSS NO		
SACHS	310619 + 319620	
FIRESTONE	W02 M58 8009	

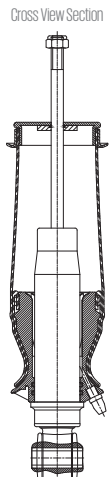

**110 13 C**



SCANIA	4 SERIE	REAR
OEM PART NO		
1502468 / 1502471		
MODEL NO		
4 SERIE	94/114/124/144/164	
R.SERIE		
P.SERIE		
CROSS NO		
MONROE	CB0074	
GOODYEAR	IAS-006	
FIRESTONE	W02 M58 8010	

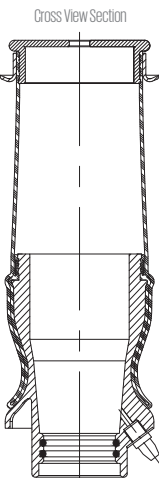

**110 13 CA**



SCANIA	4 SERIE	REAR
OEM PART NO		
1502474		
MODEL NO		
4 SERIE	94/114/124/144/164	
R.SERIE		
P.SERIE		
CROSS NO		
MONROE	CB0074/717262778	
GOODYEAR	ISA 040	

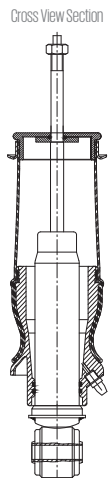

**110 14 C**



SCANIA	4 SERIE	REAR
OEM PART NO		
MODEL NO		
CROSS NO		
VIBRACOUSTIC		

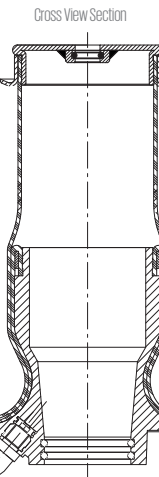



### 110 17 C



SCANIA	4 SERIE	FRONT
Cross View Section		
OEM PART NO		
1424231		
MODEL NO		
CR SERIE	CP14/16/19/28/31	
4 SERIE	94/114/124/144/164	
CP SERIE		
CROSS NO		
SACHS	310619	
GOODYEAR	IAS-005	
FIRESTONE	W02 M58 8006	

### 110 17 CA



SCANIA	4 SERIE	FRONT
Cross View Section		
OEM PART NO		
1424227 / 1363120 / 1397386 / 1397388 1397390 / 1397392		
MODEL NO		
CR SERIE	CP14/16/19/28/31	
4 SERIE	94/114/124/144/164	
CP SERIE		
CROSS NO		
SACHS	310619 + 290987	

### 110 18 C



IVECO	STRALIS	FRONT
Cross View Section		
OEM PART NO		
MODEL NO		
CROSS NO		

### 110 18 CA



IVECO	STRALIS	FRONT
Cross View Section		
OEM PART NO		
500 357 351		
MODEL NO		
AS 260S40 - AS 260S43 - AS 260S48 - AS 260S54 AS 440S40 - AS 440S43 - AS 440S48 - AS 440S54		
CROSS NO		
SACHS	310820	
FIRESTONE	W02 M58 8022	

### 110 19 C



IVECO	STRALIS	REAR
Cross View Section		
OEM PART NO		
MODEL NO		
CROSS NO		

### 110 19 CA



IVECO	STRALIS	REAR
Cross View Section		
OEM PART NO		
504 060 241		
MODEL NO		
AD 190S27 - AT 190S27 - AD 190S30 - AD 190S31 - AT 190S31 - AD 190S33 AD 190S35 - AT 190S35 - AD 190S36 - AT 190S36 - AD 190S40 - AT 190S40 AD 190S42 - AT 190S42 - AD 190S43 - AT 190S43 - AD 190S45 - AT 190S45 AD 260S27 - AT 260S27 - AD 260S27 CNG - AT 260S27 CNG - AD 260S30 AT 260S30 - AD 260S31 - AT 260S31 - AD 260S33 - AT 260S33 - AD 260S35 AT 260S35 - AD 260S36 - AT 260S36 - AD 260S40 - AT 260S40 - AD 260S42 AT 260S42 - AD 260S43 - AT 260S43 - AD 260S45 - AR 260S45 - AD 440S40 -45 AS 440S42 - 56		
CROSS NO		
SACHS	311884	
SACHS	731700000277 / 7317000002845	
FIRESTONE	W02 M58 8024	

**110 22 C**



MAN	TGA/TGS/TGX	REAR
Cross View Section		
OEM PART NO		
MODEL NO		
CROSS NO		

**110 22 CA**



MAN	TGA/TGS/TGX	REAR
Cross View Section		
OEM PART NO		
81 41722 6057 / 81 41722 6075		
85 41722 6006 / 81 41722 6012		
MODEL NO		
TGA	(18.310 - 18.390 - 18.410 - 18.480 - 18.510)	
TGS	(18.320 - 18.360 - 18.400 - 18.480 - 18.540)	
TGX	(18.360 - 18.400 - 18.480 - 18.540 - 18.680)	
CROSS NO		
SACHS	135198 (old)	
SACHS	313183	

**110 23 C**



MAN	TGA	FRONT
Cross View Section		
OEM PART NO		
MODEL NO		
CROSS NO		

**110 23 CA**



MAN	TGA	FRONT
Cross View Section		
OEM PART NO		
81 41722 6009 / 81 41722 6015		
85 41722 6023 / 81 41722 6078		
MODEL NO		
18.310 - 18.360 - 18.410 - 18.460 - 18.510		
26.310 - 26.360 - 26.410 - 26.460 - 26.510		
28.530 - 33.360 - 33.410		
CROSS NO		
SACHS	135195 / 135197 (old)	
SACHS	313182	

**110 24 C**



MAN	TGA	FRONT
Cross View Section		
OEM PART NO		
MODEL NO		
CROSS NO		

**110 24 CA**



MAN	TGA	FRONT
Cross View Section		
OEM PART NO		
81 41722 6008 / 81 41722 6014		
85 41722 6022 / 81 41722 6077		
MODEL NO		
18.310 - 18.360 - 18.410 - 18.460 - 18.480 - 18.510 - 18.530		
26.310 - 26.360 - 26.410 - 26.460 - 26.480 - 26.510 - 26.530 - 28.310 - 28.360		
28.410 - 28.460 - 28.480 - 28.510 - 28.530		
33.360 - 33.410 - 33.460 - 33.480 - 33.510 - 41.530 - 41.660		
CROSS NO		
SACHS	135194 / 135196 (old)	
SACHS	313181	



**110 27 C**



VOLVO	FH12 / FH16	FRONT
Cross View Section		
OEM PART NO		
MODEL NO		
CROSS NO		

**110 27 CA**



VOLVO	FH12 / FH16	FRONT
Cross View Section		
OEM PART NO		
3172984 / 1629719 / 1629724		
MODEL NO		
CROSS NO		
MONROE	C80003 / 717269833	
FIRESTONE	W02 M58 8036	
GOODYEAR	1SA-AS 003	

**110 28 C**



SCANIA	4 SERIE	FRONT
Cross View Section		
OEM PART NO		
MODEL NO		
CROSS NO		

**110 28 CA**



SCANIA	4 SERIE	FRONT
Cross View Section		
OEM PART NO		
1424227 / 1363120 / 1397396 / 1397390		
1397392 / 1397386 / 1397388		
MODEL NO		
4 SERIE	114C340 - 114G340 - 114L340	
	114L360 - 114L380 - 124C360	
	124C400 - 124G360 - 124G400	
	124L360 - 124L400 - 124L470	
	164C480 - 164G580 - 94D230	
CROSS NO		
SACHS	312465+209087	
SACHS	312465+105871	

**110 29 C**



IVECO	STRALIS	REAR
Cross View Section		
OEM PART NO		
MODEL NO		
CROSS NO		

**110 29 CA**



IVECO	STRALIS	REAR
Cross View Section		
OEM PART NO		
504 060 233		
MODEL NO		
CROSS NO		
ARVINMERITOR	928 323 140	
FIRESTONE	W02 M58 8027	

### 110 30 C



IVECO	STRALIS	FRONT
Cross View Section		
OEM PART NO		
MODEL NO		
CROSS NO		

### 110 30 CA



IVECO	STRALIS	FRONT
Cross View Section		
OEM PART NO		
500 340 705		
MODEL NO		
CROSS NO		
ARVINMERITOR	908 322 985	
FIRESTONE	WD2 M58 8025	

### 110 31 C



IVECO	STRALIS	REAR
Cross View Section		
OEM PART NO		
MODEL NO		
CROSS NO		

### 110 31 CA



IVECO	STRALIS	REAR
Cross View Section		
OEM PART NO		
500 357 352		
MODEL NO		
AS 260S40 - AS 260S43 - AS 260S48 - AS 260S54		
AS 440S40 - AS 440S43 - AS 440S48 - AS 440S54		
CROSS NO		
SACHS	310821	
FIRESTONE	WD2 M58 8023	

### 110 32 C



VOLVO	FH12/FH16	REAR
Cross View Section		
OEM PART NO		
MODEL NO		
CROSS NO		

### 110 32 CA



VOLVO	FH12/FH16	REAR
Cross View Section		
OEM PART NO		
20427897 / 20721169 / 20689134 / 20776212		
21651231 / 1076855 / 20721167 / 20736464		
3172985 / 3198850		
MODEL NO		
FH12	(12/340 - 12/380 - 12/420 - 12/460 - 12/500)	
FH16	(16/470 - 16/520 - 16/540 - 16/580 - 16/610)	
CROSS NO		
MONROE	C80006 / 717269647	
FIRESTONE	WD2 M58 8037	
GOODYEAR	1SA-AS 004	

**110 33 C**



IVECO	EUROSTAR/ EUROTECH/ EUROTRAKKER	REAR
Cross View Section		
OEM PART NO		
MODEL NO		
CROSS NO		

**110 33 CA**



IVECO	EUROSTAR/ EUROTECH/ EUROTRAKKER	REAR
Cross View Section		
OEM PART NO		
41028764 / 41028763 / 500377878		
500348793		
MODEL NO		
EUROSTAR	(LD 190 38P - LD 190 42P)	
EUROTECH	(MP 180 E38 - MP 180 E42)	
EUROTRAKKER	(MP 260 E 34 H - MP 260 E 34 W - MP 260 E 37 W)	
CROSS NO		
SACHS	115743	
FIRESTONE	W02 M58 8028	
GOODYEAR	1SA-AS 019	
PHOENIX	CD 075 119 012	

**110 34 C**



IVECO	EUROSTAR/ EUROTECH	REAR
Cross View Section		
OEM PART NO		
MODEL NO		
CROSS NO		

**110 34 CA**



IVECO	EUROSTAR/ EUROTECH	REAR
Cross View Section		
OEM PART NO		
500379698 / 500307338 / 99438514		
994569937 / 500352808 / 98472734		
MODEL NO		
EUROSTAR	(LD 190 E 38P - LD 240 E 52P - LD 260 E 38P LD 440 E B2 T2)	
EUROTECH	(MH 190 E 24 - MP 440 E 43 TX/P - MP 180 E 34 MP 180 E 42 MT 180 27 K)	
CROSS NO		
SACHS	115731 / 115902	
FIRESTONE	W02 M58 8029	
GOODYEAR	1SA-AS 018	
MONROE	CB0098	
PHOENIX	CD 075 119 011	

**110 35 C**



VOLVO	FH12 / FH16	REAR
Cross View Section		
OEM PART NO		
MODEL NO		
CROSS NO		

**110 35 CA**



VOLVO	FH12 / FH16	REAR
Cross View Section		
OEM PART NO		
1075076 / 1075077		
MODEL NO		
FH12	(12/340 - 12/380 - 12/420 - 12/460)	
FH16	(16/470 - 16/520)	
CROSS NO		
MONROE	CB0002 / 71726902	
FIRESTONE	W02 M58 8038	
GOODYEAR	1SA-AS 002	



**110 42 C**



MERCEDES	ACTROS	FRONT
Cross View Section		
OEM PART NO		
MODEL NO		
CROSS NO		

**110 42 CA**



MERCEDES	ACTROS	FRONT
Cross View Section		
OEM PART NO		
A942 890 49 19		
MODEL NO		
AXTROS MP2/MP3	(1846 - 1848 - 1850 - 1851 - 1854 - 1858 - 2032 2036 - 2041 - 2044 - 2051 - 2532 - 2536 - 2541 2544 - 2546 - 2636 - 2646)	
CROSS NO		
SACHS	319 950 / 72170003575	

**110 43 C**



RENAULT	PREMIUM	REAR
Cross View Section		
OEM PART NO		
MODEL NO		
CROSS NO		

**110 43 CA**



RENAULT	PREMIUM	REAR
Cross View Section		
OEM PART NO		
5010 615 679		
MODEL NO		
CROSS NO		
SACHS	313 072	

**110 44 C**



RENAULT	KERAX, MAGNUM DXI	REAR
Cross View Section		
OEM PART NO		
MODEL NO		
CROSS NO		

**110 44 CA**



RENAULT	KERAX, MAGNUM DXI	REAR
Cross View Section		
OEM PART NO		
5010 552 241 7420898055 / 7482052893		
MODEL NO		
KERAX	(370.32 - 410.18 - 410.26 - 410.32 - 450.18 450.26 - 450.32 - 460.32 - 500.32)	
MAGNUM DXI	(440.18 - 440.18 T - 460.18 T - 460.26 - 520.24 520.25 - 520.26)	
CROSS NO		
MONROE	20889055	



### 110 45 C



RENAULT	MAGNUM E-TECH	FRONT
Cross View Section		
OEM PART NO		
MODEL NO		
CROSS NO		

### 110 45 CA



RENAULT	MAGNUM E-TECH	FRONT
Cross View Section		
OEM PART NO		
5010 228 849		
MODEL NO		
400.18 - 400.18T - 400.24 - 400.26 - 440.18 440.18 T - 440.24 - 440.26 - 480.18 - 480.24 480.26		
CROSS NO		
MONROE	CB0070 / 69849	

### 110 46 C



VOLVO	FH12/FH16	FRONT
Cross View Section		
OEM PART NO		
MODEL NO		
CROSS NO		
MONROE	CB0055	

### 110 46 CA



VOLVO	FH12/FH16	FRONT
Cross View Section		
OEM PART NO		
20453256 / 20399204 / 20453258 20889132 / 2111932 / 3198837		
MODEL NO		
FH12	(12/340 - 12/380 - 12/420 - 12/460 - 12/500)	
FH16	(16/470 - 16/520 - 16/540 - 16/560 - 16/580)	
CROSS NO		
MONROE	CB0055 + CB0039	

### 110 47 CA



MAN	TGA/TGL TGS/TGX	REAR
Cross View Section		
OEM PART NO		
81 41722 6058 / 85 41722 6007 85 41722 6013 85 41722 6024 CLASS 0596 619-1		
MODEL NO		
TGA	(18.310FC - 18.320 FC - 18.360 FAK)	
TGL	(10.180 FC - 12.210 FC - 12.240 FK)	
TGS	(18.400 FAK - 18.400 FC - 18.480 FK)	
TGX	(33.680 FDLG - 35.360 FDLG)	
CROSS NO		
SACHS	135199 / 135200 / 313184	

**110 48 CA**



DAF	CF/XF/95	FRONT
<b>OEM PART NO</b>		
1285281 / 1285393 / 1321590 / 1353450 1353453 / 1371065 / 1444147 / 1622211		
<b>MODEL NO</b>		
CF	( FT 85.380 - FT 85.410 - FT 85.430 )	
XF	( FA 105.410 - FA 105.460 - FA 105.510 )	
95	( FA 95.380 - FA 95.430 - FA 95.530 )	
<b>CROSS NO</b>		
MONROE	CB0033	
GOODYEAR	ISA-AS 009	

Cross View Section

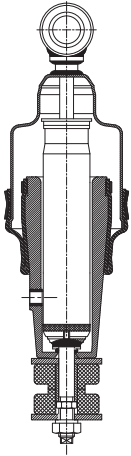

**110 49 CA**



DAF	CF/XF/95	REAR
<b>OEM PART NO</b>		
1265282 / 1265394 / 1321591 / 1353451 1353454 / 1371066 / 1623477 / 299862		
<b>MODEL NO</b>		
CF	( FT 85.380 - FT 85.410 - FT 85.430 )	
XF	( FA 105.410 - FA 105.460 - FA 105.510 )	
95	( FA 95.380 - FA 95.430 - FA 95.530 )	
<b>CROSS NO</b>		
MONROE	CB0034	
GOODYEAR	ISA-AS 010	

Cross View Section

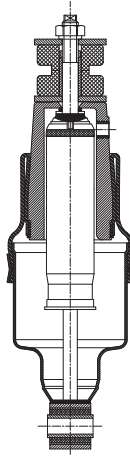

**110 50 C**



MERCEDES	ACTROS	FRONT
<b>OEM PART NO</b>		
<b>MODEL NO</b>		
<b>CROSS NO</b>		

Cross View Section

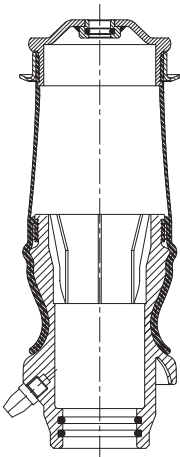

**110 50 CA**



MERCEDES	ACTROS	FRONT
<b>OEM PART NO</b>		
A 942 890 6919		
<b>MODEL NO</b>		
1831 S - 1831 L - 1831 K - 1831 AK - 1835 AK 1840 AK - 1843 S - 1848 K - 1850 AK - 1853 S 2031 - 2031 AK - 2040 AS - 2043 LS - 2548 L		
<b>CROSS NO</b>		
SACHS	731700002549	
MONROE	CB0107	

Cross View Section

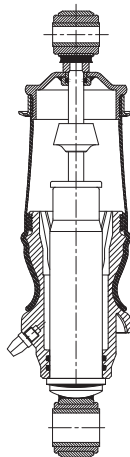

**110 56 C**



MERCEDES	ACTROS	REAR
<b>OEM PART NO</b>		
<b>MODEL NO</b>		
<b>CROSS NO</b>		

Cross View Section

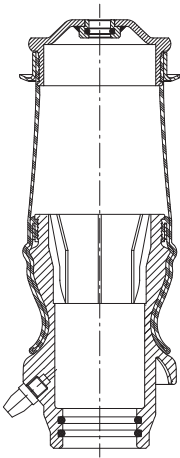

**110 56 CA**



MERCEDES	ACTROS	REAR
<b>OEM PART NO</b>		
A 942 890 7019		
<b>MODEL NO</b>		
1831 S - 1831 L - 1831 K - 1831 AK - 1835 AK 1840 AK - 1843 S - 1848 K - 1850 AK - 1853 S 2031 - 2031 AK - 2040 AS - 2043 LS - 2548 L		
<b>CROSS NO</b>		
SACHS	731700002547	
MONROE	CB0108	
PHOENIX	CD 075 122 012	

Cross View Section

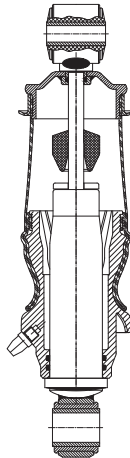

### 110 63 C



VOLVO	FH12/FH16	FRONT
OEM PART NO		
20453256 / 20399204 / 20452258		
20889132 / 2111932 / 3198837		
MODEL NO		
FH 12	( 12/340 - 12/380 - 12/420 - 12/460 - 12/500 )	
FH 16	( 16/470 - 16/520 - 16/540 - 16/550 - 16/580 )	
CROSS NO		
MONROE	CB102	

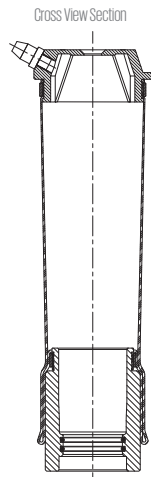

### 110 63 CA



VOLVO	FH12/FH16	FRONT
OEM PART NO		
20453256 / 20399204 / 20452258		
20889132 / 2111932 / 3198837		
MODEL NO		
FH 12	( 12/340 - 12/380 - 12/420 - 12/460 - 12/500 )	
FH 16	( 16/470 - 16/520 - 16/540 - 16/550 - 16/580 )	
CROSS NO		
MONROE	CB102 + CB0039	

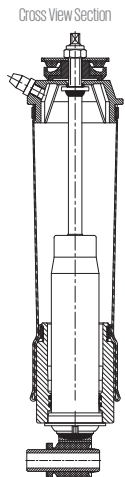

### 110 64 C



VOLVO		FRONT
OEM PART NO		
MODEL NO		
CROSS NO		

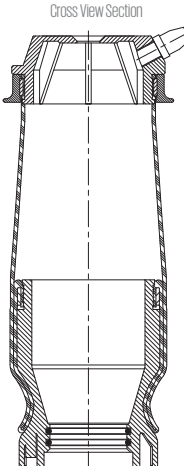

### 110 66 C



SCANIA		FRONT - REAR
OEM PART NO		
1314278		
MODEL NO		
93.113.143		
CROSS NO		
PHOENIX	1 C 39 A-245	

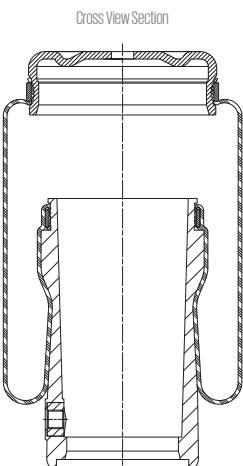



### 21007C



MOVE

SEAT

Cross View Section

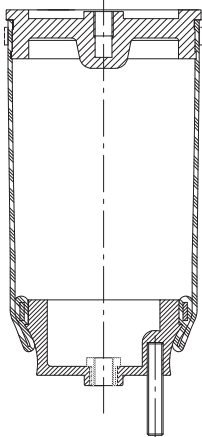

OEM PART NO	
MODEL NO	
MOVE	
CROSS NO	
CONTITECH	SZ 51-10

### 21008C



KLEPP

SEAT

Cross View Section

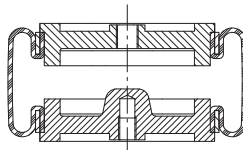

OEM PART NO	
MODEL NO	
KLEPP	
CROSS NO	
CONTITECH	SZ 51-4

### 21009C



RENAULT

FRONT - REAR

Cross View Section

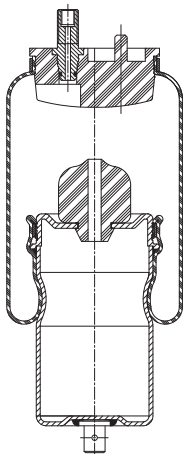

OEM PART NO	
MODEL NO	
MAGNUM E.TECH	(420 T1.18 - 420 T1.24 - 430.18 - 430.26)
MAGNUM E.TECH	(410.18 - 410.18 T - 410.24 - 440.18 T
	440.26 - 480.18 T - 480.26 - 480.26 T)
CROSS NO	
CONTITECH	816 Z
FIRESTONE	W01 M58 8033
PHOENIX	C 091340
MONROE	C80076
GOODYEAR	1AS-008

### 21010C



PILOT

SEAT

Cross View Section

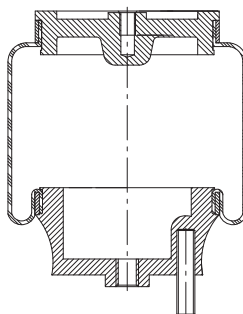

OEM PART NO	
MODEL NO	
PILOT	HYA005
CROSS NO	
CONTITECH	SZ 51-7 P01

### 21012C



FREIGHTLINER

CABIN

Cross View Section

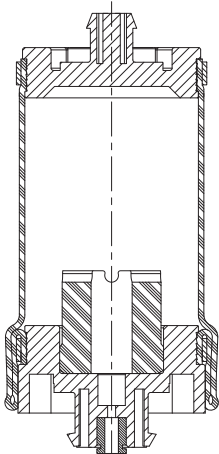

OEM PART NO	
MODEL NO	
FREIGHTLINER	
CROSS NO	
CONTITECH	SC31-W206
FIRESTONE	W02 358 7206

### 21013C



FREIGHTLINER

CABIN

Cross View Section

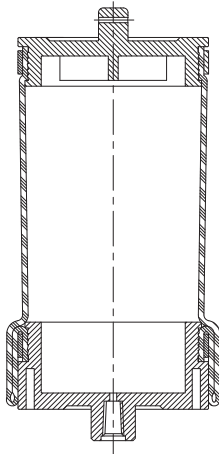

OEM PART NO	
MODEL NO	
FREIGHTLINER	
CROSS NO	
CONTITECH	SC29-W087
FIRESTONE	W02 358 7087
GOODYEAR	1S5-040

**21014 C**



LINK	
Cross View Section	1102-0022
OEM PART NO	
MODEL NO	
LINK	
CROSS NO	
CONTITECH	SC29-0046
FIRESTONE	W02 358 7046
GOODYEAR	1S4-123

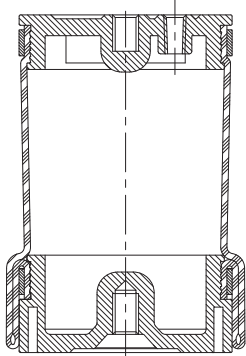

**21015 C**



SEARS		SEAT
Cross View Section	OEM PART NO	
	KNOEDLER	7010
	LINK	1101-0024
	SEARS	S-5388
	SEATS	707338
MODEL NO		
CROSS NO		
CONTITECH	SC29-0040	
FIRESTONE	W02 358 7040	
GOODYEAR	1S4-056	

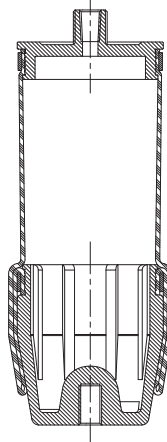

**21016 C**



LINNPEPE		TRANSPORTER / CARAVANS
Cross View Section	OEM PART NO	
MODEL NO		
LINNPEPE		
CROSS NO		
CONTITECH	SZ 55-20 P01	

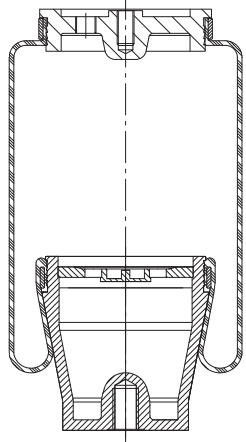

**21017 C**



RENAULT		MAGNUM DXI	DRIVER'S CAB
Cross View Section	OEM PART NO		
	5010 491 301		
MODEL NO			
12.440.18 - 12.440.24 - 12.440.26 - 12.440.26 T			
12.480.18 - 12.480.18 T - 12.480.26 - 12.480.26 T			
13.440.18 - 13.460.18 T - 13.520.26 - 13.520.26 T			
CROSS NO			
CONTITECH	SK 86-10		
PHOENIX	2 C 91-10		
MONROE	CB0135		

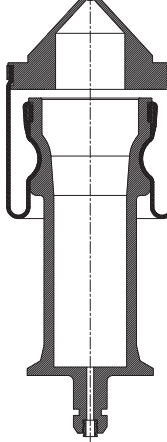

**21018 C**



RENAULT		PREMIUM / KERAX	FRONT / DRIVER'S CAB
Cross View Section	OEM PART NO		
	5 010 629 414		
	20 906 196 (VOLVO)		
	5010 130 797 G		
MODEL NO			
PREMIUM	( 250.18 D - 270.18 - 300.18 D - 320.18 320.24 D - 340.18 D - 370.18 - 400.18 D )		
KERAX	(260.18 - 270.18 - 300.18 B - 320.18 340.26 - 350.34 - 370.18 - 370.26 - 370.32)		
CROSS NO			
MONROE	CB0075		
GOODYEAR	1AS-007		
CONTITECH	SZ 50-9 P02		

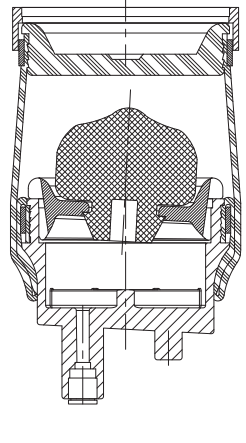

**21019 C**



RENAULT		TRANSPORTER / CARAVANS
Cross View Section	OEM PART NO	
MODEL NO		
CROSS NO		
GOLDSCHMITT	DLB7012	

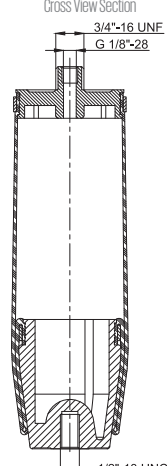

### 21019C1



LINK		DRIVER'S CAB
Cross View Section		OEM PART NO
	1102-0040	
MODEL NO		
LINK		
CROSS NO		
CONTITECH	SC29-W012	
FIRESTONE	W02 356 7012	

### 21020C

Cross View Section		OEM PART NO
MODEL NO		
CROSS NO		
CF GOMMA	1 GC 100-70	

### 21021C



Cross View Section		TRANSPORTER / CARAVANS
		OEM PART NO
MODEL NO		
CROSS NO		
GOLDSCHMITT	DLB9931	

### 21021C1



Cross View Section		TRANSPORTER / CARAVANS
		OEM PART NO
MODEL NO		
CROSS NO		
FIRESTONE	W21760 9931	

### 21022C



Cross View Section		TRANSPORTER / CARAVANS
		OEM PART NO
MODEL NO		
CROSS NO		
GOLDSCHMITT	DLB9040	

### 21022C1



Cross View Section		TRANSPORTER / CARAVANS
		OEM PART NO
MODEL NO		
CROSS NO		
RIDE-RITE		







**310 01C**

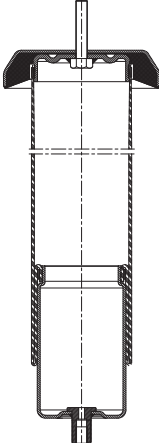

VOLVO		LIFT - AXLE SHORT VERSION	
Cross View Section 		OEM PART NO	
		2 0534 645	
		MODEL NO	
		CROSS NO	
		CONTITECH	SZ 130-25 P04

**310 02C**

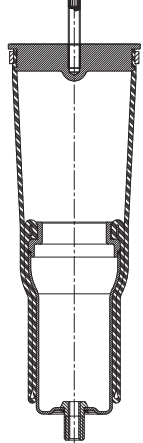

VOLVO		LIFT - AXLE SHORT VERSION	
Cross View Section 		OEM PART NO	
		1081785 / 2 0455 245 / 2 0494 458	
		MODEL NO	
		CROSS NO	
		CONTITECH	SK 95-26

**310 03C**

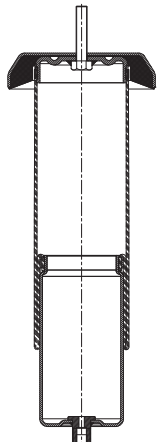

VOLVO		LIFT - AXLE SHORT VERSION	
Cross View Section 		OEM PART NO	
		2 0534 646	
		MODEL NO	
		CROSS NO	
		CONTITECH	SZ 130-25 P05



**CABIN & SEAT & LIFT AIR SPRINGS CROSS LIST**

Blacktech	ContiTech	FIRESTONE	GOODYEAR	PHOENIX	CF Gomma / Pirelli
110 01 C		W02 M58 8000	1AS004		
110 01 CA		W02M588001	1SA036		
110 02 C		W02M588002	1AS001		
110 02 CA		W02M588003	1SA006		
110 03 C		W02M588002	1AS001		
110 03 CA		W02M588004	1SA005		
110 04 C					
110 04 CA		W02M588020	1SAAS017	CD075121011	
110 05 C					
110 05 CA		W02M588021	1SAAS016	CD075120011	
110 06 C					
110 06 CA		W02M588014	1SAAS014	CD075122011	
110 07 C					
110 07 CA		W02M588015	1SAAS015	CD 075 123 011	
110 08 C		W02M588005			
110 08 CA		W02M588006			
110 09 C		W02M588005			
110 09 CA		W02M588007			
110 10 C					
110 10 CA		W02M588018		CD075122013	
110 11 C					
110 11 CA		W02M588018		CD075122012	
110 12 C		W02M588008	1AS005		
110 12 CA		W02M588009			
110 13 C		W02M588010	1AS006		
110 13 CA			1SA040		
110 14 C					
110 17 C		W02M588008	1AS005		
110 17 CA					
110 18 C					
110 18 CA		W02M588022			
110 19 C					
110 19 CA		W02M588024			
110 22 C					
110 22 CA					
110 23 C					
110 23 CA					
110 24 C					
110 24 CA					

	GOLDSCHMITT	Arvinmeritor	Granning	Sachs Complete	Sachs Spring Type	Monroe Complete	Monroe Spring Type	Page
					481 002			372
				112230+105876/105846 105845+105875 105831+481002				372
							CB0030 / 717262725	372
						CB0010		372
							CB0030 / 717262725	372
						CB0009		372
								373
			50162	105855				373
								373
			50163	105856				373
								373
			50511	105392				373
								374
			50512	105406 / 290997 / 311189				374
					557001			374
				290988 / 105872 + 557001 290201 / 290203 + 557001				374
					557001			374
				290989 + 557001 105873 + 557001				374
								375
				290257				375
								375
				311663				375
					310619			376
				310619 + 319620				376
							CB0074	376
						CB00074 / 717262778		376
								376
					310619			377
				310619 + 290987				377
								377
				310820				377
								377
				311884 731700000277 / 7317000002845				377
								378
				135198 (old) / 313183				378
								378
				135195 / 135197 (old)      313182				378
								378
				135194 / 135196 (old)      313181				378

CABIN & SEAT & LIFT AIR SPRINGS CROSS LIST					
Blacktech	ContiTech	FIRESTONE	GOODYEAR	PHOENIX	CF Gomma / Pirelli
110 25 C					
110 25 CA	SZ3610	W02M588034	1SAAS013		
110 26 C					
110 26 CA		W02M588026			
110 27 C					
110 27 CA		W02M588036	1SAAS003		
110 28 C					
110 28 CA					
110 29 C					
110 29 CA		W02M588027			
110 30 C					
110 30 CA		W02M588025			
110 31 C					
110 31 CA		W02M588023			
110 32 C					
110 32 CA		W02M588037	1SAAS004		
110 33 C					
110 33 CA		W02M588028	1SAAS019	CD075119012	
110 34 C					
110 34 CA		W02M588029	1SAAS018	CD075119011	
110 35 C					
110 35 CA		W02M588038	1SAAS002		
110 39					
110 39 CA					
110 40 C					
110 40 CA					
110 41 C					
110 41 CA					
110 42 C					
110 42 CA					
110 43 C					
110 43 CA					
110 44 C					
110 44 CA					
110 45 C					
110 45 CA					
110 46 C					
110 46 CA					
110 47 CA					
110 48 CA			1SAAS009		
110 49 CA			1SAAS010		

	GOLDSCHMITT	Arvinmeritor	Granning	Sachs Complete	Sachs Spring Type	Monroe Complete	Monroe Spring Type	Page
								379
				131041 / 310957		CB0088		379
								379
		908322986				CB0136		379
								380
				CB0003 / 717269833				380
								380
				312465+209087 312465+105871				380
								380
		928323140						380
								381
		908322985						381
								381
				310821				381
								381
						CB0006 / 717269647		381
								382
				115743				382
								382
				115731 / 115902		CB0098		382
								382
						CB0002 / 717269602		382
					312465			383
				312465 + 105871 312465 + 290987				383
					312465			383
				312465 + 310620				383
								383
				311664				383
								384
				319950 / 721700003575				384
								384
				313072				384
								384
						20889055		384
								385
						CB0070 / 69849		385
							CB0055	385
						CB0055 + CB0039		385
				135199 / 135200 / 313184				385
						CB0033		386
						CB0034		386

**CABIN & SEAT & LIFT AIR SPRINGS CROSS LIST**

Blacktech	ContiTech	FIRESTONE	GOODYEAR	PHOENIX	CF Gomma / Pirelli
110 50 C					
110 50 CA					
110 56 C					
110 56 CA				CD075122012	
110 63 C					
110 63 CA					
110 64 C					
110 66 C				1C39A245	
210 01 C	SZ50-9	W02M588035	1AS007	C075185	
210 02 C	SZ50-8	W02M588031	1AS010		
210 03 C			1AS009		IGC130-30
210 04 C	SZ50-10	W02M588030	1AS011		
210 05 C	SZ50-6	W02M588032			
210 06 C	SZ51-5				
210 07 C	SZ51-10				
210 08 C	SZ51-4				
210 09 C	816Z	W01M588033	1AS008	C091340	
210 10 C	SZ51-7P01				
210 12 C	SC31W206	W023587206			
210 13 C	SC29W087	W023587087	1S5040		
210 14 C	SC290046	W023587046	1S4123		
210 15 C	SC290040	W023587040	1S4056		
210 16 C	SZ55-20P01				
210 17 C	SK86-10			2C9110	
210 18 C	SZ50-9P02		1AS007		
210 19 C					
210 19 C1	SC29W012	W023587012			
210 20 C					1GC100-70
210 21 C					
210 21 C1		W217609931			
210 22 C					
210 22 C1		W217609002			
210 23 C					
210 23 C1		W217609000			
210 26 C	SZ140-14				
210 27 C	SC29W035	W023587035			
210 28 C	864Z / SZ60-6				
210 29 C					
210 29 C1		W217602314			
210 34 C	SZ 53-10				
210 35 C					
210 36 C					



	GOLDSCHMITT	Arvinmeritor	Granning	Sachs Complete	Sachs Spring Type	Monroe Complete	Monroe Spring Type	Page
								386
				7317000002549		CB0107		386
								386
				73 1700 002 547		CB0108		386
							CB0102	387
						CB0102 + CB0039		387
								387
								387
						CB0075		388
						CB0082		388
						CB0077		388
						CB0083		388
								388
								388
								389
								389
						CB0076		389
								389
								389
								389
								390
								390
								390
						CB0135		390
						CB0075		390
	DLB7012							390
								391
								391
	DLB9931							391
								391
	DLB9040							391
								391
	DLB9039							392
								392
								392
								392
								392
	DLB7095							392
								393
								393
								393
								393

**CABIN & SEAT & LIFT AIR SPRINGS CROSS LIST**

Blacktech	ContiTech	FIRESTONE	GOODYEAR	PHOENIX	CF Gomma / Pirelli
210 37 C	SZ 43-104 P02				
210 38 C					
310 01 C	SZ130-25P04				
310 02 C	SK 95-26				
310 03 C	SZ 130-25 P05				

	GOLDSCHMITT	Arvinmeritor	Granning	Sachs Complete	Sachs Spring Type	Monroe Complete	Monroe Spring Type	Page
								393
								393
								394
								394
								394

## DISCLAIMER

The data and information presented in this catalogue are the result of extensive research and long-term experience in the design and manufacture of air springs for truck, trailer, bus, coach and industrial applications. This catalogue is provided only for information purposes and Vibracoustic CV Air Springs GmbH does not accept liability for any loss or damage arising from typing errors or misprints that may have occurred during production. In the interest of product development Vibracoustic CV Air Springs GmbH reserves the right to make technical amendments and updates to the drawings listed in

this catalogue without prior notification. The brand names Vibracoustic CV Air Springs, Aircruise™ and Blacktech™ are protected by law and use of the trademarks by third parties is strictly prohibited without written consent from Vibracoustic CV Air Springs GmbH. Replication or copying of the data in this catalogue, even partial, is strictly prohibited without written authorisation from Vibracoustic CV Air Springs GmbH. This document is subject to Vibracoustic CV Air Springs GmbH copyright and all intellectual rights are protected by law.

A series of horizontal dotted lines spanning the width of the page, providing a guide for handwriting practice.







# VIBRACOUSTIC CV AIR SPRINGS LOCATIONS WORLDWIDE

## **GERMANY [Headquarter]**

### **Vibracoustic CV Air Springs GmbH**

Lübeckertordamm 1-3  
20099 Hamburg, Germany  
Phone: + 49 40 23 99 89-0  
Fax: + 49 40 23 99 89-140

## **CHINA**

### **Vibracoustic (Shanghai) Sales & Trading Co., Ltd.**

Lou Shan Guan Road No. 83, New Town Center  
Room 1102  
Shanghai 200336, PR China  
Phone: + 86 21 62 95 -7813  
Fax: + 86 21 62 95-7817

### **Vibracoustic CV Air Springs (Yantai) Co., Ltd.**

JIERUI Road No.11, Laishan Economic Development Zone  
City of Yantai, Shandong Province, PR China  
Postcode: 264003  
Phone: + 86 535 735 - 16 66  
Fax: + 86 535 735 - 17 00

## **HUNGARY [Sales Office]**

### **Vibracoustic CV Air Springs Magyarország Kft.**

Ráday str. 42-44, Budapest 1092, Hungary  
P.O.Box 26, 1440 Budapest, Hungary  
Phone: +36 1 456 42 96  
Fax: +36 1 456 42 95

## **HUNGARY**

### **Vibracoustic CV Air Springs Magyarország Kft.**

Derkovits u 106/A  
Nyiregyhaza 4400, Hungary  
Phone: +36 425 11 200  
Fax: +36 425 51 203

## **TURKEY**

### **Vibracoustic CV Air Springs Otomotiv Sanayi ve Ticaret A.Ş.**

Ata Mahallesi, Bursa Serbest Bölgesi, Orkide Caddesi No:25  
16600 Gemlik-Bursa, Turkey  
Phone: + 90 224 524 78 01  
Fax: +90 224 524 78 10

## **USA**

### **Vibracoustic CV Air Springs**

111 SW 5th Ave, Suite 3150, #9  
Portland, OR 97204, USA  
Phone: +1 269 615 00 12  
Fax: +1 269 637 83 15

Please visit us at [www.vibracoustic-cvas.com](http://www.vibracoustic-cvas.com)

Mail: [contact@vibracoustic-cvas.com](mailto:contact@vibracoustic-cvas.com)

