

The Original
Gabriel®

Ride the independent spirit™

2015 SHOCK & STRUT CATALOG

*Gabriel® 2015 Catalogue
d'amortisseurs et jambes
de suspension*

*Gabriel® Catalogo 2015
de amortiguadores y struts*



The secret to making great shocks? It's what's inside.

Le secret pour construire des amortisseurs efficaces?
¿El secreto para fabricar excelentes amortiguadores?

Quality and Durability - built into every one

Gabriel® has been making shocks since 1907 when we invented the first automotive shock absorber. And today, after perfecting shock absorber technology for more than 100 years, we know that it is what's on the inside that counts

Pressure Tube - D.O.M.

- Gabriel's metal forging process uses D.O.M (Drawn Over Mandrel), which removes the weld seam and imperfections from the surface
- This smoother finish surface reduces friction and leads to a longer product life
- Gabriel's finish surface roughness measures at a 3.0*, which indicates a smoother tube surface. Competitors' measure as high as 36.0*



Smooth D.O.M. inner tube surface - no seam

Chromed and Super-Finished Piston Rod

- The rod surface is chromed and super-finished, which helps prevent corrosion
- The super-finished chrome carries the proper amount of lube oil to the seal and provides a consistent wear surface and longer product life
- Competitors' rods show corrosion, Gabriel's remain clean**



Durable Piston Valve Assembly

- Gabriel's piston valve assembly design is extremely durable
- Gabriel's O-Ring provides constant pressure to the inner tube and makes the valve less susceptible to dirt, wear and fatigue leading to longer product life
- The piston seal adjusts as it wears to maintain a tight seal between the piston and pressure tube. This minimizes leak paths for a longer product life
- Many competitors' valves don't use an O-Ring and don't adjust for wear over time



Dirt Wiper Oil Seal

- Gabriel's integrated dirt wiper raises above the oil seal to help keep road debris, dirt and grit from getting inside the seal and the shock
- Many competitors' products don't contain a dirt wiper



* In Gabriel tests ** Both rods went through the same industry standard 96-hr ASTM-B117 salt spray test

Pourquoi choisir Gabriel®?

¿Por qué Gabriel®?

No matter what you drive, or where... We've got you covered.

Titre nous avons ce qu'il faut pour toutes les voitures et destinations.
No importa que vehículo maneja o del camino,
tenemos lo que necesita.

At Gabriel®, we believe there's no such thing as second best – in performance, quality or coverage. That's why we offer high-quality replacement shocks, struts and components for virtually every vehicle on the road today.

À Gabriel®, nous ne pouvons accepter des solutions de second choix quand ça vient à la performance, la qualité et la protection. C'est pourquoi nous offrons des amortisseurs, des vérins et des parties pour pratiquement tout véhicule qui sillonne présentement les routes.

En Gabriel® creemos que no hay tal cosa como segundos lugares, en rendimiento, calidad o cobertura. Esta es la razón por la ofrecemos amortiguadores, struts y componentes de reemplazo de alta calidad para prácticamente cualquier vehículo en los caminos.



MaxControl™

Premium Monotube shock absorber for superior ride and handling in any light truck or SUV.

Amortisseur Monotube de choix pour une conduite supérieure et une manipulation dans n'importe quel tour de lumière ou SUV.

Amortiguador premium monotubo para una conducción y control superiores en cualquier camioneta ligera o SUV.



ReadyMount™

Superior engineering, **G-Force™ Technology** and rigorous testing combine to give you the most durable pre-assembled strut available. Delivers OE or better ride performance, while saving up to 1½ hours during installation.

Une mécanique supérieure et des tests rigoureux contribuent à vous donner le vérin pré-assemblé le plus durable sur le marché. Offre une performance aussi bonne ou même meilleure que l'équipement d'origine, tout en vous permettant de gagner une heure et demie lors de l'installation.

Ingeniería superior y pruebas rigurosas se combinan para brindarle el strut pre-ensamblado más duradero del mercado; le proporciona un rendimiento OE o superior mientras le ahorra hasta 1½ durante la instalación.



Ultra™

Featuring **G-Force™ Technology**, Ultra™ is precision engineered for the ultimate in safety and performance.

Mettant en vedette G-Force™ Technology, Ultra™ a été conçu précisément pour la plus haute sécurité et la meilleure performance.

Con tecnología G-Force™, el Ultra™ cuenta con ingeniería de precisión para máxima seguridad y rendimiento.



ProGuard™

Engineered for comfort and control in today's trucks, vans and SUVs.

Conçus pour assurer confort et contrôle pour les camions, fourgonnettes et VUS d'aujourd'hui.

Diseñados para comodidad y control de las camionetas, furgonetas y vehículos utilitarios (SUV) de hoy.



Guardian™

Aftermarket engineered for OE-like performance.

Amortisseurs de rechange conçus pour offrir des performances dignes des pièces d'origine.

Diseñado con rendimiento como recién salido de la fábrica.

Gabriel® offers a full-line of ride control solutions including, but not limited to, commercial-duty shock and air-adjustable shock absorbers, steering stabilizers, load carriers, and accessories. For complete descriptions of all of our fine products, visit www.gabriel.com.

Gabriel® offre une gamme complète de solutions pour un meilleur contrôle de conduite, y compris, mais sans s'y limiter, des amortisseurs commerciaux et des amortisseurs à air réglables, des stabilisateurs de pilotage, des porteurs de charge et des accessoires. Pour une description complète de tous nos produits, visitez www.gabriel.com.

Gabriel® ofrece un gama completa de soluciones para control de manejo, incluyendo entre otros, amortiguadores comerciales y de uso industrial, así como amortiguadores de aire ajustables, estabilizadores de conducción, portadores de carga y otros accesorios. Para ver una descripción completa de todos nuestros productos de lujo, visite www.gabriel.com

Gabriel® ReadyMount™

Designed, tested and proven to deliver.

Conçu, testé et capable de fournir.

Diseñados, probados y comprobados para el máximo rendimiento.

Gabriel® knows strut assemblies are vital to vehicle safety. That's why we're relentless in our efforts to provide the most durable, premium pre-assembled strut available – our Gabriel ReadyMount.™

Gabriel® sait que l'assemblage des vérins est vital à la sécurité du véhicule. C'est pourquoi nous sommes inébranlables dans nos efforts à vous donner le vérin pré-assemblé de choix le plus durable sur le marché - notre Gabriel ReadyMount.®

Gabriel® reconoce que los ensambles de struts son vitales para la seguridad del vehículo. Esta es la razón por la que nunca escatimamos esfuerzos para brindarle los struts pre-ensamblados de lujo más duraderos del mercado - nuestro Gabriel ReadyMount.®

Proven Endurance

- 1,000,000-cycle validation of every new strut design
- Super-finished chromed piston rod for superior corrosion resistance

Rigorous Testing for Dependability

- More than 10 grueling component and unit tests on each new design ensure function, proper wear and durability to reduce comebacks

Superior Engineering Expertise



Precision Engineered

- Engineered with precision to the OE part specifications

Total Confidence



Fit-tested



Ride-tested

- Each new ReadyMount design is Fit- and Ride-tested on the same vehicle application for which it was designed to ensure:
 - Faster installations
 - Fewer comebacks
 - Perfect fit

Endurance démontrée

- Validation de 1,000,000 cycles pour chaque nouveau vérin
- Tige de piston chromé super-finie pour une résistance supérieure à la corrosion

Tests rigoureux de fiabilité

- Le bon fonctionnement, l'usure correcte et la durabilité sont assurés par plus de 10 tests très exigeants des composants et des unités sur chaque nouveau modèle pour réduire les retours

Expertise d'ingénierie supérieure

- Conçu avec précision aux spécifications de l'équipement d'origine

Confiance totale

- Chaque nouveau modèle ReadyMount est testé sur la même disposition de véhicule pour laquelle il a été conçu pour assurer:
 - Des installations plus rapides
 - Moins de retours
 - Un ajustement parfait

Durabilidad comprobada

- Validación de 1,000,000 de ciclos para cada nuevo diseño de struts
- Varilla de pistón con súper acabado cromado para una mayor resistencia a la corrosión

Pruebas rigurosas para confiabilidad

- Más de 10 pruebas rigurosas para los componentes y la unidad en cada nuevo diseño garantizan el funcionamiento, el desgaste adecuado y la durabilidad para reducir las devoluciones

Pericia de ingeniería superior

- Ingeniería con precisión según las especificaciones de la parte OE

Confianza total

- Se prueba la instalación y manejo de cada nuevo diseño ReadyMount en el mismo vehículo para el cual se diseñó para garantizar:
 - Instalaciones más rápidas
 - Menores devoluciones
 - Un ajuste perfecto

Table of Contents / Table des matières / Contenido

New Part Numbers / Nouveaux Numéros de Pièces / Numeracion Nueva de Partes	2
12 Year Supersedure List	3
Vehicle Model to Make Index	5
Footnote Index	14
Sales Popularity Listing / Liste des Codes de « Popularité » / Lista de Terminos mas Populares	15
New Catalog Layout and Key Descriptions	16
Application Data	
Passenger Cars & Light Trucks	17
Numerical Listing	
Steering Stabilizers	262
Steering Dampers	265
Front Load Carriers	265
Rear Load Carriers	266
Ultra Strut Cartridges	269
HiJackers	270
Ultra Spring Seats	275
Ultra Struts	279
ReadyMount Strut Assemblies	292
LTV Shocks	297
ProGuard Shocks	303
Ultra Truck Shocks	310
Ultra Shocks	320
MaxControl Monotube Shocks	324
Guardian Shocks	330
Classic Shocks	339
Suspension Mounts	343
Strut Cushions	352
Reference Section:	
A..... Air Adjustable Hose Kit Cross Reference	357
A..... <i>Ensembles de Boyaux pour HiJacker</i>	358
A..... <i>Equipos de Manguera de Aire Ajustable</i>	359
Self-leveling System Electronic Compressor Deactivation Procedure for GM Models	360
A..... <i>Procédé de Déactivation du Compresseur Électronique du Système de Nivelage des Modèles GM</i>	361
A..... <i>Compresores Electronicos con Sistema de Auto Nivelacion Procedimiento para Desactivar los Modelos GM</i>	362
B..... Strut Mount Photos	363
C..... Steering Stabilizers Boots / <i>Bottes de Stabilisation de Conduite / Zapatos Estabilizadores de la Direccion</i>	375
D..... Electronic Adjustable Suspension Conversion	376
D..... <i>Conversion de la Suspension Ajustable Électronique</i>	378
D..... <i>Conversión de la Suspensión Electronica Graduable</i>	380
E..... Left / Right Combinations	382
F..... Mounting Codes / Extended and Collapsed Length Charts	385
G..... Disposal of Old or Defective Shocks & Struts	416
G..... <i>Disposition de Vieux ou Défectueux Chocs et de Contrefiches de Gas-Pressurized</i>	417
G..... <i>Como Deshacerse de Amortiguadores y Struts Viejos o Defectuosos-sin Presurizacion con Gas</i>	418

**NEW PART NUMBERS IN THIS CATALOG
NOUVEAUX NUMÉROS DE PIÈCES DANS CE CATALOGUE
NUMERACION NUEVA DE PARTES EN ESTE CATALOGO**

14073	143343	143396	G51911	G51949	G52261	G52282	G57121	G57139
14075	143345	143419	G51912	G51953	G52262	G52283	G57122	G57140
58942	143349	143423	G51913	G51954	G52263	G52297	G57123*	G57141*
70049	143350	143425	G51914	G51955	G52264	G52298	G57124*	G57142*
70052	143357	143394*	G51915	G51960	G52265	G52314	G57125	G57144
70053	143359	143412*	G51916*	G51968	G52268	G52333	G57126	G57145
70055	143362	143418*	G51917	G51993	G52269	G52334	G57127	G57147*
70056	143366	143458*	G51918	G52123	G52270	G52335	G57128	G64071
70059	143375	G244002	G51919	G52124	G52271	G52336	G57129	G64080
70060	143377	G51898	G51920	G52175*	G52272	G52346*	G57130	G64087
70061	143378	G51899	G51921	G52176*	G52273	G52347	G57131	G64101
70068	143380	G51900	G51922	G52237	G52274	G57103	G57132	G64107
77971	143381	G51901	G51923	G52238	G52275	G57107	G57133*	
77973	143382	G51906	G51924	G52255	G52276	G57108	G57134*	
143305	143383	G51907	G51935	G52256	G52278	G57109	G57135	
143330	143390	G51908	G51936	G52257	G52279	G57118	G57136	
143337	143391	G51909	G51947	G52258	G52280	G57119	G57137	
143340	143392	G51910	G51948	G52260	G52281	G57120	G57138	

* SCHEDULED TO BE AVAILABLE 1ST QUARTER 2015

**PART NUMBERS SUPERSEDED
NUMÉROS DE PIÈCES REMPLACÉS
NUMERACION DE PARTES REEMPLAZADOS**

DELETE	THEN USE	DELETE	THEN USE	DELETE	THEN USE
143066	143059	G56815	G52124	G56755	G52238
G52071	G52073	G56756	G52237	79900	G51887
G52072	G52074	G56754	G52237	79901	G51888
G56816	G52123	G56757	G52238		

**PARTS TO BE DISCONTINUED WHEN INVENTORY IS DEPLETED
CES PIÈCES NE SERONT PLUS FABRIQUEES UNE FOIS LES STOCK EPUISES
LAS PARTES SE DESCONTINUARÁN AL AGOTAR EXISTENCIAS**

69880	142757	G44773	G44944
69885	142853	G44898	G44969
77955	G44713	G44918	G51064
142141	G44766	G44934	
142648	G44767	G44937	

**12 YEAR SUPERSEDURE LIST
LISTE DE REPLACEMENT DES 12
LISTA DE REEMPLAZOS DE 12 AÑOS**

LAST YEAR IN CATALOG	DELETE	THEN USE	LAST YEAR IN CATALOG	DELETE	THEN USE	LAST YEAR IN CATALOG	DELETE	THEN USE
2004	61514	61593	2006	142082	142844	2006	142425	142860
			2006	142083	142846	2006	142431	142862
2004	61548	61541	2006	142182	142846	2011	142435	143280
			2006	142184	142847	2006	142438	142561
2004	61577	61593	2006	142185	142803	2011	142523	143031
2004	61581	61506	2006	142188	142832 142854	2005	142533	143073 L 143074 R
2004	61585	61593	2006	142191	142855	2006	142537	142851
2004	61587	61552	2006	142192	142861	2006	142541	142857
2004	61602	61591	2011	142193	143281	2006	142544	142546
2004	61604	61500	2006	142198	142844	2006	142545	142546
2004	61628	61623	2006	142216	142839	2005	142557	142836
2004	61636	61642	2006	142218	142842	2006	142558	142559
2004	61644	61614	2006	142236	142856	2006	142560	142561
2007-2008	61652	61651	2004	142238	142240	2006	142563	142854
2004	61661	61575	2006	142243	142623	2006	142564	142847
2010	69577	69587	2006	142266	142842	2006	142565	142623
2002	69631	69996	2006	142272	142839	2006	142566	142832
2007-2008	69810	69813	2006	142299	143036 L 143037 R	2006	142732	142734
2002	69908	69407				2006	142733	142734
2013	69954	70023	2011	142303	143277	2006	142736	142827
2013	69955	70024	2011	142304	143278	2006	142742	143036
2003	69963	69462	2011	142305	143279	2006	142743	143037
2004	81457	82126	2006	142314	142840	2006	142756	142827
2002	81561	61552	2006	142315	142840	2006	142849	143067
2004	81673	81583	2006	142322	142852	2011	143066	143059
2004	81724	82066	2006	142324	142853	2010	143189	142653
2004	81822	81744	2005	142331	143062	2004	801514	801541
2004	81827	81744	2005	142332	143063	2007-2008	801617	801620
2004	81832	81744	2005	142333	143064	2007-2008	6827SE	6854SE
2004	82014	81676	2006	142394	142841	2002	G51018	G51232
2004	82073	82099	2006	142395	142841	2002	G51020	G51229
2004	82152	81091	2006	142397	142843	2002	G51045	G51249
2004	82154	81318	2006	142398	142843	2004	G51079	G51253
2005	141269	143066	2006	142400	142845	2004	G51257	G51477
2005	141274	143058	2006	142401	142845	2012	G51265	G51796
2005	141275	143060	2005	142407	143071 L 143072 R	2007-2008	G51708	G51254
2005	141551	143061				2010	G51745	G51746
2005	141577	143059	2006	142423	142858	2012	G51779	G51810
2005	141744	143057	2006	142424	142859	2012	G51780	G51811

**12 YEAR SUPERSEDURE LIST
LISTE DE REPLACEMENT DES 12
LISTA DE REEMPLAZOS DE 12 AÑOS**

LAST YEAR IN CATALOG	DELETE	THEN USE	LAST YEAR IN CATALOG	DELETE	THEN USE	LAST YEAR IN CATALOG	DELETE	THEN USE
2002	G55517	G55616	2006	G56638	G56539	2015	G52072	G52074
2005	G55595	G55847	2006	G56639	G56540	2015	G56754	G52237
2005	G55596	G55847	2005	G56737	G56719	2015	G56755	G52338
2005	G55597	G55848	2005	G56738	G56720	2015	G56756	G52237
2005	G55598	G55848	2010	G56783	G56817	2015	G56757	G52238
2004	G55613	G55518	2011	G56788	G55948	2015	G56815	G52124
2004	G55614	G55518	2011	G56789	G55949	2015	G56816	G52123
2004	G55654	G55830	2011	G56808	G56809			
2004	G55655	G55830	2011	G56811	G56810			
2002	G55659	G55999	2007-2008	G56915	G56937			
2002	G55660	G55999	2007-2008	G56922	G56952			
2002	G55677	G55914	2007-2008	G56923	G56954			
2002	G55678	G55914	2012	G56944	G57063			
2005	G55760	G55742	2012	G56944	G57063			
2004	G55779	G55891	2012	G56945	G57064			
2004	G55791	G55976	2012	G56945	G57064			
2004	G55830	G55780	2012	G56946	G57060			
2002	G55900	G55995	2012	G56946	G57060			
2007-2008	G55995	G55960	2004	G63399	G63511			
2010	G56521	G56522	2004	G63412	G63675			
2012	G56549	G56682	2004	G63435	G63506			
2013	G56549	G56682	2004	G63458	G63490			
2012	G56550	G55810	2004	G63497	G63610			
2013	G56550	G56681	2004	G63498	G63612			
2007-2008	G56564	G51712	2004	G63518	G63495			
		G56750	2004	G63519	G63610			
2007-2008	G56609	G56752	2004	G63695	G63615			
		G56754	2004	G63706	G63799			
		G56751	2004	G63774	G63678			
2007-2008	G56610	G56753	2004	G63807	G63622			
		G56755	2004	G63814	G63610			
		G56750	2004	G63861	G63860			
2007-2008	G56613	G56752	2007-2008	G63861	G63860			
		G56754	2002	G63901	G63818			
		G56756	2002	G63930	G63781			
		see applications	2002	G63933	G63782			
		G56751	2002	G63933	G63782			
		G56753	2014	79900	G51887			
2007-2008	G56614	G56755	2015	79901	G51888			
		G56757	2015	G52071	G52073			
		see applications						

VEHICLE MODEL TO MAKE INDEX

2	MAZDA	544	VOLVO	1200C	INTERNATIONAL
3	MAZDA	600	DODGE	1200D	INTERNATIONAL
5	MAZDA	604	PEUGEOT	128I	BMW
6	MAZDA	610	NISSAN	1300B	INTERNATIONAL
80	AUDI	620	NISSAN	1300C	INTERNATIONAL
88	OLDSMOBILE	626	MAZDA	1300D	INTERNATIONAL
90	AUDI	710	NISSAN	135I	BMW
93	SAAB	720	NISSAN	1500 SERIES	GMC
95	SAAB	740	VOLVO	190D	MERCEDES-BENZ
96	SAAB	745	VOLVO	190E	MERCEDES-BENZ
98	OLDSMOBILE	760	VOLVO	190SL	MERCEDES-BENZ
99	SAAB	780	VOLVO	200 QUATTRO	AUDI
100	AUDI	808	MAZDA	2000 GTX	DODGE
100	INTERNATIONAL	810	NISSAN	2000 GTX	EAGLE
122	VOLVO	850	VOLVO	200D	MERCEDES-BENZ
124	FIAT	880	DODGE	200SX	NISSAN
131	FIAT	900	SAAB	220D	MERCEDES-BENZ
142	VOLVO	924	PORSCHE	240D	MERCEDES-BENZ
144	VOLVO	929	MAZDA	240SX	NISSAN
145	VOLVO	940	VOLVO	240Z	NISSAN
150	INTERNATIONAL	944	PORSCHE	2500 SERIES	GMC
164	VOLVO	960	VOLVO	260E	MERCEDES-BENZ
200	AUDI	1010	INTERNATIONAL	260Z	NISSAN
200	CHRYSLER	1100	FIAT	280C	MERCEDES-BENZ
200	INTERNATIONAL	1110	INTERNATIONAL	280CE	MERCEDES-BENZ
210	NISSAN	1200	NISSAN	280E	MERCEDES-BENZ
220	MERCEDES-BENZ	1210	INTERNATIONAL	280S	MERCEDES-BENZ
230	MERCEDES-BENZ	1310	INTERNATIONAL	280SE	MERCEDES-BENZ
240	VOLVO	1500	FIAT	280SEL	MERCEDES-BENZ
242	VOLVO	1500	RAM	280Z	NISSAN
244	VOLVO	1600	NISSAN	280ZX	NISSAN
245	VOLVO	1800	VOLVO	3000GT	MITSUBISHI
250	MERCEDES-BENZ	1900	OPEL	300D	MERCEDES-BENZ
262	VOLVO	2000	NISSAN	300E	MERCEDES-BENZ
264	VOLVO	2500	RAM	300M	CHRYSLER
265	VOLVO	3500	RAM	300SD	MERCEDES-BENZ
280	MERCEDES-BENZ	4000	AUDI	300SDL	MERCEDES-BENZ
300	CHRYSLER	5000	AUDI	300SE	MERCEDES-BENZ
310	NISSAN	6000	PONTIAC	300SEL	MERCEDES-BENZ
323	MAZDA	9000	SAAB	300SL	MERCEDES-BENZ
325	BMW	9-3	SAAB	300TD	MERCEDES-BENZ
330	DODGE	9-5	SAAB	300ZX	NISSAN
400	DODGE	100 QUATTRO	AUDI	318I	BMW
403	PEUGEOT	1000 SERIES	GMC	318IS	BMW
404	PEUGEOT	1000B	INTERNATIONAL	318TI	BMW
410	NISSAN	1000C	INTERNATIONAL	320I	BMW
411	NISSAN	1000D	INTERNATIONAL	323CI	BMW
440	DODGE	1100B	INTERNATIONAL	323I	BMW
504	PEUGEOT	1100C	INTERNATIONAL	325CI	BMW
505	PEUGEOT	1100D	INTERNATIONAL	325E	BMW
510	NISSAN	1200B	INTERNATIONAL	325I	BMW

VEHICLE MODEL TO MAKE INDEX

325IS	BMW	908C	INTERNATIONAL	B100 VAN	DODGE
325IX	BMW	93B	SAAB	B150 VAN	DODGE
328CI	BMW	A100 SERIES	DODGE	B1500 VAN	DODGE
328I	BMW	A3	AUDI	B1600	MAZDA
330CI	BMW	A4	AUDI	B1800	MAZDA
330I	BMW	A4 QUATTRO	AUDI	B200 VAN	DODGE
350SD	MERCEDES-BENZ	A6	AUDI	B2000	MAZDA
350SDL	MERCEDES-BENZ	A6 QUATTRO	AUDI	B210	NISSAN
350SL	MERCEDES-BENZ	A8	AUDI	B2200	MAZDA
350Z	NISSAN	ACADIA	GMC	B2300	MAZDA
370Z	NISSAN	ACADIAN	PONTIAC	B250 VAN	DODGE
380SEC	MERCEDES-BENZ	ACCENT	HYUNDAI	B2500	MAZDA
380SEL	MERCEDES-BENZ	ACCLAIM	PLYMOUTH	B2500 VAN	DODGE
380SL	MERCEDES-BENZ	ACCORD	HONDA	B2600	MAZDA
380SLC	MERCEDES-BENZ	ACHIEVA	OLDSMOBILE	B300 VAN	DODGE
380SE	MERCEDES-BENZ	AERIO	SUZUKI	B3000	MAZDA
4000 QUATTRO	AUDI	AEROSTAR	FORD	B350 VAN	DODGE
400E	MERCEDES-BENZ	ALERO	OLDSMOBILE	B3500 VAN	DODGE
420SEL	MERCEDES-BENZ	ALLANTE	CADILLAC	B4000	MAZDA
450SE	MERCEDES-BENZ	ALLURE	BUICK	BAJA	SUBARU
450SEL	MERCEDES-BENZ	ALTIMA	NISSAN	BARRACUDA	PLYMOUTH
450SL	MERCEDES-BENZ	AMANTI	KIA	BEETLE	VOLKSWAGEN
450SLC	MERCEDES-BENZ	AMBASSADOR	AMERICAN MOTORS	BELAIR	CHEVROLET
4RUNNER	TOYOTA	AMERICAN	AMERICAN MOTORS	BELVEDERE	PLYMOUTH
500SEC	MERCEDES-BENZ	AMIGO	ISUZU	BERETTA	CHEVROLET
500SEL	MERCEDES-BENZ	AMX	AMERICAN MOTORS	BERMUDA	EDSEL
500SL	MERCEDES-BENZ	APOLLO	BUICK	BF300	DODGE
521 PICKUP	NISSAN	ARIES	DODGE	BF300	DODGE
524TD	BMW	ARMADA	NISSAN	BF350	DODGE
525I	BMW	ARROW	PLYMOUTH	BF350	DODGE
528E	BMW	ASCENDER	ISUZU	BISCAYNE	CHEVROLET
528I	BMW	ASPEN	CHRYSLER	BLAZER	CHEVROLET
530I	BMW	ASPEN	DODGE	BOBCAT	MERCURY
533I	BMW	ASPIRE	FORD	BONNEVILLE	PONTIAC
535I	BMW	ASTRA	SATURN	BORA	VOLKSWAGEN
535IS	BMW	ASTRE	PONTIAC	BRAT	SUBARU
540I	BMW	ASTRO	CHEVROLET	BRAVA	FIAT
560SEC	MERCEDES-BENZ	ATS	CADILLAC	BRAVADA	OLDSMOBILE
560SEL	MERCEDES-BENZ	ATTITUDE	DODGE	BREEZE	PLYMOUTH
60 SPECIAL	CADILLAC	AURA	SATURN	BREEZEWAY	MERCURY
600SL	MERCEDES-BENZ	AURORA	OLDSMOBILE	BRONCO	FORD
620 PICKUP	NISSAN	AVALANCHE 1500	CHEVROLET	BRONCO II	FORD
635CSI	BMW	AVALANCHE 2500	CHEVROLET	BROOKWOOD	CHEVROLET
735I	BMW	AVALON	TOYOTA	BROUGHAM	CADILLAC
735IL	BMW	AVANTI	STUDEBAKER	BROUGHAM	MERCURY
740I	BMW	AVENGER	DODGE	BRZ	SUBARU
740IL	BMW	AVEO	CHEVROLET	C10 SUBURBAN	CHEVROLET
750IL	BMW	AVIATOR	LINCOLN	C10 TRUCK	CHEVROLET
80 QUATTRO	AUDI	AXXESS	NISSAN	C15/C1500 PICKUP	GMC
90 QUATTRO	AUDI	AZERA	HYUNDAI	C15/C1500 SUBURBAN	GMC
908B	INTERNATIONAL	AZTEK	PONTIAC	C15/G1500 VAN	GMC

VEHICLE MODEL TO MAKE INDEX

C1500 SUBURBAN	CHEVROLET	CHEVELLE	CHEVROLET	CORRADO	VOLKSWAGEN
C1500 TRUCK	CHEVROLET	CHEVETTE	CHEVROLET	CORSAIR	EDSEL
C20 SUBURBAN	CHEVROLET	CHEVY II	CHEVROLET	CORSICA	CHEVROLET
C20 TRUCK	CHEVROLET	CHIEFTAIN	PONTIAC	CORVAIR	CHEVROLET
C220	MERCEDES-BENZ	CIERA	OLDSMOBILE	CORVETTE	CHEVROLET
C230	MERCEDES-BENZ	CIMARRON	CADILLAC	COUGAR	MERCURY
C240	MERCEDES-BENZ	CIRRUS	CHRYSLER	COUNTRY CRUISER	MERCURY
C25/C2500 PICKUP	GMC	CITATION	CHEVROLET	COUNTRY SEDAN	FORD
C25/C2500 SUBURBAN	GMC	CITATION	EDSEL	COUNTRY SQUIRE	FORD
C2500 SUBURBAN	CHEVROLET	CITATION II	CHEVROLET	COUPE	AUDI
C2500 TRUCK	CHEVROLET	CIVIC	HONDA	COUPE QUATTRO	AUDI
C280	MERCEDES-BENZ	CIVIC DEL SOL	HONDA	COURIER	FORD
C30 TRUCK	CHEVROLET	CJ3	JEEP	COURIER SEDAN DELIVERY	FORD
C320	MERCEDES-BENZ	CJ5	JEEP	CRANBROOK	PLYMOUTH
C35/C3500 PICKUP	GMC	CJ6	JEEP	CRESSIDA	TOYOTA
C350	MERCEDES-BENZ	CJ7	JEEP	CRESTLINE	FORD
C3500 TRUCK	CHEVROLET	CL	ACURA	CROSSTOUR	HONDA
C70	VOLVO	CLASSIC	AMERICAN MOTORS	CROWN	TOYOTA
CABALLERO	GMC	CLASSIC	CHEVROLET	CROWN VICTORIA	FORD
CABRIO	VOLKSWAGEN	CLK320	MERCEDES-BENZ	CRUZE	CHEVROLET
CABRIOLET	VOLKSWAGEN	CLK430	MERCEDES-BENZ	CR-V	HONDA
CADENZA	KIA	CLK500	MERCEDES-BENZ	CRX	HONDA
CALAIS	CADILLAC	CLK550	MERCEDES-BENZ	CT HYBRID	LEXUS
CALAIS	OLDSMOBILE	C-MAX	FORD	CTS	CADILLAC
CALIBER	DODGE	COBALT	CHEVROLET	CUBE	NISSAN
CAMARO	CHEVROLET	COLONY PARK	MERCURY	CUDA	PLYMOUTH
CAMBRIDGE	PLYMOUTH	COLORADO	CHEVROLET	CUSTOM	DODGE
CAMRY	TOYOTA	COLT	DODGE	CUSTOM	FORD
CANYON	GMC	COLT	PLYMOUTH	CUSTOM	MERCURY
CAPRI	MERCURY	COMANCHE	JEEP	CUSTOM	PLYMOUTH
CAPRICE	CHEVROLET	COMET	MERCURY	CUSTOM 300	FORD
CARAVAN	DODGE	COMMANDER	JEEP	CUSTOM 500	FORD
CARAVELLE	PLYMOUTH	COMMANDER	STUDEBAKER	CUSTOM CRUISER	OLDSMOBILE
CARINA	TOYOTA	COMMERCIAL CHASSIS	CADILLAC	CUSTOMLINE	FORD
CATALINA	PONTIAC	COMMERCIAL CHASSIS	CHEVROLET	CUTLASS	OLDSMOBILE
CATERA	CADILLAC	COMMUTER	MERCURY	CUTLASS CALAIS	OLDSMOBILE
CAVALIER	CHEVROLET	COMPASS	JEEP	CUTLASS CIERA	OLDSMOBILE
CB300	DODGE	CONCORD	AMERICAN MOTORS	CUTLASS CRUISER	OLDSMOBILE
CB400	DODGE	CONCORD	PLYMOUTH	CUTLASS SALON	OLDSMOBILE
CB400	DODGE	CONCORDE	CHRYSLER	CUTLASS SUPREME	OLDSMOBILE
CC	VOLKSWAGEN	CONQUEST	CHRYSLER	CX-5	MAZDA
CELEBRITY	CHEVROLET	CONQUEST	DODGE	CX-7	MAZDA
CELICA	TOYOTA	CONQUEST	PLYMOUTH	CX-9	MAZDA
CENTURION	BUICK	CONTINENTAL	LINCOLN	D100 PICKUP	DODGE
CENTURY	BUICK	CONTOUR	FORD	D150 PICKUP	DODGE
CHALLENGER	DODGE	CORDIA	MITSUBISHI	D200 PICKUP	DODGE
CHAMP	PLYMOUTH	CORDOBA	CHRYSLER	D21	NISSAN
CHAMPION	STUDEBAKER	COROLLA	TOYOTA	D250 PICKUP	DODGE
CHARADE	DAIHATSU	CORONA	TOYOTA	D300 PICKUP	DODGE
CHARGER	DODGE	CORONET	DODGE	D350 PICKUP	DODGE
CHEROKEE	JEEP	CORRADO	VOLKSWAGEN	D50	DODGE

VEHICLE MODEL TO MAKE INDEX

DAKOTA	DODGE	ENCLAVE	BUICK	FC150	JEEP
DART	DODGE	ENCORE	BUICK	FC170	JEEP
DAYTONA	CHRYSLER	ENVOY	GMC	FESTIVA	FORD
DAYTONA	DODGE	EOS	VOLKSWAGEN	FIERO	PONTIAC
DEL RAY	CHEVROLET	EQUINOX	CHEVROLET	FIESTA	FORD
DEL RIO WAGON	FORD	ES250	LEXUS	FIESTA (MEXICO VEHICLE)	OLDSMOBILE
DELMONT 88	OLDSMOBILE	ES300	LEXUS	FIFTH AVENUE	CHRYSLER
DELTA 88	OLDSMOBILE	ES330	LEXUS	FIREBIRD	PONTIAC
DELUXE	FORD	ES350	LEXUS	FIREFLY	PONTIAC
DEVILLE	CADILLAC	ESCALADE	CADILLAC	FIRENZA	OLDSMOBILE
DIAMANTE	MITSUBISHI	ESCAPE	FORD	FIT	HONDA
DIPLOMAT	DODGE	ESCORT	FORD	FJ CRUISER	TOYOTA
DISCOVERY	LAND ROVER	ESTATE WAGON	BUICK	FLEET SPECIAL	PLYMOUTH
DISPATCHER	JEEP	ESTEEM	SUZUKI	FLEETWOOD	CADILLAC
DJ5	JEEP	EXCEL	HYUNDAI	FLEX	FORD
DJ6	JEEP	EXCURSION	FORD	FOCUS	FORD
DL	SUBARU	EXECUTIVE	PONTIAC	FORD	FORD
DL	VOLVO	EXECUTIVE LIMOUSINE	CHRYSLER	FORD 300	FORD
DURANGO	DODGE	EXECUTIVE SEDAN	CHRYSLER	FORENZA	SUZUKI
DUSTER	PLYMOUTH	EXP	FORD	FORESTER	SUBARU
DYNAMIC	OLDSMOBILE	EXPEDITION	FORD	FORSA	SUZUKI
DYNASTY	CHRYSLER	EXPLORER	FORD	FORTE	KIA
DYNASTY	DODGE	EXPLORER SPORT TRAC	FORD	FOX	VOLKSWAGEN
E CLASS	CHRYSLER	EXPO	MITSUBISHI	FREESTAR	FORD
E SERIES MOTORHOME	FORD	EXPO	PLYMOUTH	FRONTIER	NISSAN
E100 VAN	FORD	EXPO LRV	MITSUBISHI	FURY	PLYMOUTH
E-150 VAN	FORD	EXPRESS 1500	CHEVROLET	FUSION	FORD
E-200 VAN	FORD	EXPRESS 2500	CHEVROLET	FX35	INFINITI
E-250 SUPER DUTY	FORD	EXPRESS 3500	CHEVROLET	FX45	INFINITI
E-250 VAN	FORD	F SERIES	FORD	G10 VAN	CHEVROLET
E300	MERCEDES-BENZ	F10	NISSAN	G1000 SERIES	GMC
E-300 VAN	FORD	F-100	FORD	G20	INFINITI
E320	MERCEDES-BENZ	F-150	FORD	G20 VAN	CHEVROLET
E-350 SUPER DUTY	FORD	F-150 HERITAGE	FORD	G25/G2500 VAN	GMC
E-350 VAN	FORD	F-250	FORD	G3	PONTIAC
E420	MERCEDES-BENZ	F-250 SUPER DUTY	FORD	G30 VAN	CHEVROLET
E430	MERCEDES-BENZ	F-350	FORD	G35	INFINITI
E-450 SUPER DUTY	FORD	F-350 SUPER DUTY	FORD	G35/G3500 VAN	GMC
E500	MERCEDES-BENZ	F-450 SUPER DUTY	FORD	G5	PONTIAC
EAGLE	AMERICAN MOTORS	F53	FORD	G6	PONTIAC
ECHO	TOYOTA	F53 SUPERDUTY CHASSIS MOTORHOME	FORD	GALANT	MITSUBISHI
ECLIPSE	MITSUBISHI	F-550 SUPER DUTY	FORD	GALAXIE	FORD
ECONOLINE	FORD	F59	FORD	GALAXIE 500	FORD
EDGE	FORD	F85	OLDSMOBILE	GL	SUBARU
EL	ACURA	FAIRLANE	FORD	GLADIATOR	JEEP
EL CAMINO	CHEVROLET	FAIRMONT	FORD	GLC	MAZDA
ELANTRA	HYUNDAI	FALCON	FORD	GLE	VOLVO
ELDORADO	CADILLAC	FALCON SEDAN DELIVERY	FORD	GOLDEN HAWK	STUDEBAKER
ELECTRA	BUICK	FASTBACK	VOLKSWAGEN	GOLF	VOLKSWAGEN
ELEMENT	HONDA			GRAN FURY	PLYMOUTH
ELR	CADILLAC			GRAN SPORT	BUICK

VEHICLE MODEL TO MAKE INDEX

GRANADA	FORD	INTEGRA	ACURA	LEBARON	CHRYSLER
GRAND AM	PONTIAC	INTREPID	CHRYSLER	LEGACY	SUBARU
GRAND CARAVAN	DODGE	INTREPID	DODGE	LEGANZA	DAEWOO
GRAND CHEROKEE	JEEP	INTRIGUE	OLDSMOBILE	LEGEND	ACURA
GRAND LEMANS	PONTIAC	INVICTA	BUICK	LEMANS	PONTIAC
GRAND MARQUIS	MERCURY	ION SERIES	SATURN	LESABRE	BUICK
GRAND MARQUIS (CANADA VEHICLE)	FORD	IS C	LEXUS	LHS	CHRYSLER
GRAND PRIX	PONTIAC	IS300	LEXUS	LIBERTY	JEEP
GRAND SAFARI	PONTIAC	J10	JEEP	LIMITED	BUICK
GRAND VITARA	SUZUKI	J20	JEEP	LN7	MERCURY
GRAND VOYAGER	CHRYSLER	J2000	PONTIAC	LOYALE	SUBARU
GRAND VOYAGER	PLYMOUTH	J2000 SUNBIRD	PONTIAC	LS SERIES	SATURN
GRAND WAGONEER	JEEP	J-2500	JEEP	LS400	LEXUS
GRANDVILLE	PONTIAC	JAVELIN	AMERICAN MOTORS	LS400	LINCOLN
GREMLIN	AMERICAN MOTORS	JEEPSTER	JEEP	LS430	LEXUS
GS	BUICK	JETFIRE	OLDSMOBILE	LSS	OLDSMOBILE
GS 350	BUICK	JETSTAR 88	OLDSMOBILE	LTD	FORD
GS 400	BUICK	JETTA	VOLKSWAGEN	LTD CROWN VICTORIA	FORD
GS 445	BUICK	JIMMY	GMC	LTD II	FORD
GS300	LEXUS	JOURNEY	DODGE	LUMINA	CHEVROLET
GS400	LEXUS	JUKE	NISSAN	LUMINA APV	CHEVROLET
GS430	LEXUS	K10 SUBURBAN	CHEVROLET	LUV	CHEVROLET
GT	ASUMA	K10 TRUCK	CHEVROLET	LUV PICKUP	CHEVROLET
GT750	SAAB	K15/K1500 SUBURBAN	GMC	LW1	SATURN
GT850	SAAB	K15/K1500 TRUCK	GMC	LW2	SATURN
GTI	VOLKSWAGEN	K1500 SUBURBAN	CHEVROLET	LW200	SATURN
GTO	PONTIAC	K1500 TRUCK	CHEVROLET	LW300	SATURN
GT-R	NISSAN	K20 SUBURBAN	CHEVROLET	LX450	LEXUS
GTX	PLYMOUTH	K20 TRUCK	CHEVROLET	LX470	LEXUS
GX	LEXUS	K25/K2500 SUBURBAN	GMC	LYNX	MERCURY
H2	HUMMER	K25/K2500 TRUCK	GMC	M SERIES VAN	INTERNATIONAL
H3	HUMMER	K2500 SUBURBAN	CHEVROLET	M1100	INTERNATIONAL
HAWK	STUDEBAKER	K2500 TRUCK	CHEVROLET	M1200	INTERNATIONAL
HHR	CHEVROLET	K30 TRUCK	CHEVROLET	M1400	INTERNATIONAL
HIGHLANDER	TOYOTA	K3500 TRUCK	CHEVROLET	M3	BMW
HOMBRE	ISUZU	K900	KIA	M300	DODGE
HORIZON	PLYMOUTH	KADETT	OPEL	M350	DODGE
HORNET	AMERICAN MOTORS	KINGSWOOD	CHEVROLET	M5	BMW
I-280	ISUZU	L100	SATURN	M800	INTERNATIONAL
I30	INFINITI	L200	SATURN	MAGENTIS	KIA
I35	INFINITI	L300	SATURN	MAGNUM	DODGE
I-350	ISUZU	LACROSSE	BUICK	MAINLINE	FORD
II	AVANTI	LANCER	DODGE	MALIBU	CHEVROLET
ILX	ACURA	LANCER	MITSUBISHI	MANTA	OPEL
I-MARK	ISUZU	LAND CRUISER	TOYOTA	MARAUDER	MERCURY
IMPALA	CHEVROLET	LANOS	DAEWOO	MARINER	MERCURY
IMPERIAL	CHRYSLER	LARK	STUDEBAKER	MARK II	TOYOTA
IMPREZA	SUBARU	LASER	CHRYSLER	MARK III	LINCOLN
IMPULSE	ISUZU	LASER	PLYMOUTH	MARK IV	LINCOLN
INSIGHT	HONDA	LAURENTIAN	PONTIAC	MARK LT	LINCOLN
		LEAF	NISSAN	MARK V	LINCOLN

VEHICLE MODEL TO MAKE INDEX

MARK VI	LINCOLN	MULTI	NISSAN	PASEO	TOYOTA
MARK VII	LINCOLN	MURANO	NISSAN	PASSAT	VOLKSWAGEN
MARLIN	AMERICAN MOTORS	MUSTANG	FORD	PASSPORT	HONDA
MARQUIS	MERCURY	MUSTANG II	FORD	PATHFINDER	NISSAN
MATADOR	AMERICAN MOTORS	MX-5	MAZDA	PATRIOT	JEEP
MATRIX	TOYOTA	MX-6	MAZDA	PB100	PLYMOUTH
MAVERICK	FORD	MYSTIQUE	MERCURY	PB1000 SERIES	GMC
MAXIMA	NISSAN	NASSAU	CHRYSLER	PB150	PLYMOUTH
MB300	DODGE	NAVAJO	MAZDA	PB200	PLYMOUTH
MB300	DODGE	NAVIGATOR	LINCOLN	PB250	PLYMOUTH
MB350	DODGE	NEON	CHRYSLER	PB300	PLYMOUTH
MB400	DODGE	NEON	DODGE	PB350	PLYMOUTH
MB400	DODGE	NEON	PLYMOUTH	PHOENIX	PONTIAC
MDX	ACURA	NEW YORKER	CHRYSLER	PICKUP	ISUZU
MEADOWBROOK	DODGE	NEWPORT	CHRYSLER	PICKUP	NISSAN
MEDALIST	MERCURY	NITRO	DODGE	PICKUP	TOYOTA
MEDALLION	EAGLE	NOVA	CHEVROLET	PILOT	HONDA
MERCURY	MERCURY	NUBIRA	DAEWOO	PINTO	FORD
METEOR	MERCURY	NX	LEXUS	PLAZA	PLYMOUTH
METRO	CHEVROLET	NX	NISSAN	POLARA	DODGE
METRO	GEO	OASIS	ISUZU	PONY	HYUNDAI
MIATA	MAZDA	ODYSSEY	HONDA	POWER HAWK	STUDEBAKER
MIGHTY MAX	MITSUBISHI	OMEGA	OLDSMOBILE	PRECIS	MITSUBISHI
MILAN	MERCURY	OMNI	DODGE	PRELUDE	HONDA
MILLENIA	MAZDA	ONE-FIFTY SERIES	CHEVROLET	PREMIER	EAGLE
MINI RAM	DODGE	OPEL	OPEL	PRESIDENT	STUDEBAKER
MIRADA	DODGE	OPTIMA	KIA	PREVIA	TOYOTA
MIRAGE	MITSUBISHI	OUTBACK	SUBARU	PRIUS	TOYOTA
MKC	LINCOLN	OUTLANDER	MITSUBISHI	PRIZM	CHEVROLET
MKS	LINCOLN	P MODELS FORWARD CONTROL	CHEVROLET	PRIZM	GEO
MKT	LINCOLN	P MODELS FORWARD CONTROL	GMC	PROBE	FORD
MKX	LINCOLN	P10 VAN	CHEVROLET	PROTÉGÉ	MAZDA
MKZ	LINCOLN	P100	DODGE	PROTEGE5	MAZDA
ML320	MERCEDES-BENZ	P-100	FORD	PT CRUISER	CHRYSLER
ML350	MERCEDES-BENZ	P15/P1500 VAN	GMC	PULSAR	NISSAN
ML430	MERCEDES-BENZ	P20 VAN	CHEVROLET	PULSAR NX	NISSAN
ML500	MERCEDES-BENZ	P200	DODGE	PURSUIT	PONTIAC
ML55 AMG	MERCEDES-BENZ	P25/P2500 VAN	GMC	PV444	VOLVO
MONACO	DODGE	P30 VAN	CHEVROLET	Q45	INFINITI
MONARCH	MERCURY	P300	DODGE	QUANTUM	VOLKSWAGEN
MONTANA	PONTIAC	P35/P3500 VAN	GMC	QUEST	NISSAN
MONTCLAIR	MERCURY	P-350	FORD	QX4	INFINITI
MONTE CARLO	CHEVROLET	P-400	FORD	QX56	INFINITI
MONTEGO	MERCURY	PACER	AMERICAN MOTORS	R10 SUBURBAN	CHEVROLET
MONTEREY	MERCURY	PACER	EDSEL	R10 TRUCK	CHEVROLET
MONTERO	MITSUBISHI	PACIFICA	CHRYSLER	R1500 SUBURBAN	CHEVROLET
MONTERO SPORT	MITSUBISHI	PARISIENNE	PONTIAC	R1500 SUBURBAN	GMC
MONZA	CHEVROLET	PARK AVENUE	BUICK	R1500 TRUCK	GMC
MOUNTAINEER	MERCURY	PARK LANE	MERCURY	R20 SUBURBAN	CHEVROLET
MPV	MAZDA	PARK LANE WAGON	FORD	R20 TRUCK	CHEVROLET
MR2	TOYOTA			R2500 SUBURBAN	CHEVROLET

VEHICLE MODEL TO MAKE INDEX

R2500 SUBURBAN	GMC	RX300	LEXUS	SERIES 61	CADILLAC
R2500 TRUCK	CHEVROLET	RX330	LEXUS	SERIES 62	CADILLAC
R2500 TRUCK	GMC	RX350	LEXUS	SERIES 70 FLEETWOOD	CADILLAC
R30 TRUCK	CHEVROLET	RX-4	MAZDA	SEVILLE	CADILLAC
R3500 TRUCK	CHEVROLET	RX400H	LEXUS	SHADOW	DODGE
R3500 TRUCK	GMC	RX-7	MAZDA	SIDEKICK	SUZUKI
RABBIT	VOLKSWAGEN	S10	CHEVROLET	SIENNA	TOYOTA
RABBIT TRUCK	VOLKSWAGEN	S10 BLAZER	CHEVROLET	SIERRA 1500	GMC
RAIDER	DODGE	S15	GMC	SIERRA 1500 HD	GMC
RAIDER	MITSUBISHI	S15 JIMMY	GMC	SIERRA 2500	GMC
RAINIER	BUICK	S2000	HONDA	SIERRA 2500 HD	GMC
RAM 1500 PICKUP	DODGE	S320	MERCEDES-BENZ	SIERRA 3500	GMC
RAM 1500 VAN	DODGE	S350	MERCEDES-BENZ	SIGMA	MITSUBISHI
RAM 2500 PICKUP	DODGE	S4	AUDI	SILHOUETTE	OLDSMOBILE
RAM 2500 VAN	DODGE	S40	VOLVO	SILVER HAWK	STUDEBAKER
RAM 3500 PICKUP	DODGE	S420	MERCEDES-BENZ	SILVERADO 1500	CHEVROLET
RAM 3500 VAN	DODGE	S500	MERCEDES-BENZ	SILVERADO 1500 HD	CHEVROLET
RAM 50	DODGE	S6	AUDI	SILVERADO 2500	CHEVROLET
RAMBLER	AMERICAN MOTORS	S60	VOLVO	SILVERADO 2500 HD	CHEVROLET
RAMCHARGER	DODGE	S600	MERCEDES-BENZ	SILVERADO 3500	CHEVROLET
RAMPAGE	DODGE	S70	VOLVO	SILVERADO 3500 HD	CHEVROLET
RANCH WAGON	FORD	S80	VOLVO	SKY HAWK	STUDEBAKER
RANCHERO	FORD	S90	VOLVO	SKYHAWK	BUICK
RANGE ROVER	LAND ROVER	SABLE	MERCURY	SKYLARK	BUICK
RANGER	EDSEL	SAFARI	GMC	SKYLINER	FORD
RANGER	FORD	SAFARI	PONTIAC	SL SERIES	SATURN
RAV4	TOYOTA	SAMURAI	SUZUKI	SL320	MERCEDES-BENZ
RC	LEXUS	SANTA FE	HYUNDAI	SL500	MERCEDES-BENZ
RD200	DODGE	SAPPORO	PLYMOUTH	SL600	MERCEDES-BENZ
RDX	ACURA	SARATOGA	CHRYSLER	SLK230	MERCEDES-BENZ
REATA	BUICK	SATELLITE	PLYMOUTH	SLK320	MERCEDES-BENZ
REGAL	BUICK	SAVANA 1500	GMC	SLX	ACURA
REGENCY	OLDSMOBILE	SAVANA 2500	GMC	SLX	ACURA
RELAY-2	SATURN	SAVANA 3500	GMC	SOLARA	TOYOTA
RELIANT	PLYMOUTH	SAVOY	PLYMOUTH	SOMERSET	BUICK
RENDEZVOUS	BUICK	SC SERIES	SATURN	SOMERSET REGAL	BUICK
RENO	SUZUKI	SC300	LEXUS	SONATA	HYUNDAI
RIDGELINE	HONDA	SC400	LEXUS	SONIC	CHEVROLET
RIO	KIA	SC430	LEXUS	SONOMA	GMC
RIVIERA	BUICK	SCAMP	PLYMOUTH	SORENTO	KIA
RL	ACURA	SCIROCCO	VOLKSWAGEN	SOUL	KIA
ROADMASTER	BUICK	SCOUPE	HYUNDAI	SPARK	CHEVROLET
ROADRUNNER	PLYMOUTH	SCOUT	INTERNATIONAL	SPECIAL	BUICK
ROCKY	DAIHATSU	SCOUT II	INTERNATIONAL	SPECTRA	KIA
RODEO	ISUZU	SCRAMBLER	JEEP	SPECTRUM	CHEVROLET
RODEO SPORT	ISUZU	SE	ASUMA	SPECTRUM	GEO
ROGUE	NISSAN	SEBRING	CHRYSLER	SPIRIT	AMERICAN MOTORS
RONDO	KIA	SEDONA	KIA	SPIRIT	DODGE
ROUNDUP	EDSEL	SENTRA	NISSAN	SPITFIRE	TRIUMPH
ROYAL MONACO	DODGE	SEPHIA	KIA	SPORT WAGON	PLYMOUTH
RSX	ACURA	SEQUOIA	TOYOTA	SPORTAGE	KIA
RX-3	MAZDA	SERIES 60 FLEETWOOD	CADILLAC		

VEHICLE MODEL TO MAKE INDEX

SPORTWAGON	BUICK	TAHOE	CHEVROLET	UPLANDER	CHEVROLET
SPRING	CHEVROLET	TALON	EAGLE	V10 TRUCK	CHEVROLET
SPRINT	GMC	TAURUS	FORD	V1500 SUBURBAN	GMC
SPRINTER	MERCEDES-BENZ	TC	SCION	V1500 TRUCK	GMC
SPRINTER 2500	DODGE	TEMPEST	PONTIAC	V20 SUBURBAN	CHEVROLET
SPRINTER 3500	DODGE	TEMPO	FORD	V20 TRUCK	CHEVROLET
SQUAREBACK	VOLKSWAGEN	TERCEL	TOYOTA	V2500 SUBURBAN	CHEVROLET
SRX	CADILLAC	TERRAIN	GMC	V2500 SUBURBAN	GMC
SSR	CHEVROLET	TERRAZA	BUICK	V2500 TRUCK	GMC
ST REGIS	CHRYSLER	THING	VOLKSWAGEN	V30 TRUCK	CHEVROLET
ST. REGIS	DODGE	THUNDERBIRD	FORD	V3500 TRUCK	CHEVROLET
STANZA	NISSAN	TIBURON	HYUNDAI	V3500 TRUCK	GMC
STAR CHIEF	PONTIAC	TIGUAN	VOLKSWAGEN	V40	VOLVO
STARFIRE	OLDSMOBILE	TITAN	NISSAN	V70	VOLVO
STARION	MITSUBISHI	TL	ACURA	V8 QUATTRO	AUDI
STARLET	TOYOTA	TOPAZ	MERCURY	V90	VOLVO
STARLINER	FORD	TORINO	FORD	VALIANT	PLYMOUTH
STEALTH	DODGE	TORNADO	CHEVROLET	VAN	MITSUBISHI
STORM	GEO	TORONADO	OLDSMOBILE	VAN	TOYOTA
STRATUS	DODGE	TORRENT	PONTIAC	VAN WAGON	TOYOTA
STREAMLINER	PONTIAC	TOUAREG	VOLKSWAGEN	VANAGON	VOLKSWAGEN
STYLELINE DELUXE	CHEVROLET	TOWN & COUNTRY	CHRYSLER	VEGA	CHEVROLET
STYLELINE SPECIAL	CHEVROLET	TOWN CAR	LINCOLN	VEHICROSS	ISUZU
STYLUS	ISUZU	TOWNSMAN	CHEVROLET	VELOSTER	HYUNDAI
S-TYPE	JAGUAR	TRACER	MERCURY	VENTURA	PONTIAC
SUBURBAN	CHEVROLET	TRACKER	CHEVROLET	VENTURE	CHEVROLET
SUBURBAN	PLYMOUTH	TRACKER	GEO	VENZA	TOYOTA
SUBURBAN 1500	CHEVROLET	TRACKER	GMC	VERANO	BUICK
SUBURBAN 2500	CHEVROLET	TRAILBLAZER	CHEVROLET	VERSA	NISSAN
SUMMIT	EAGLE	TRAILDUSTER	PLYMOUTH	VERSAILLES	LINCOLN
SUNBIRD	PONTIAC	TRANSPORTER	VOLKSWAGEN	VIBE	PONTIAC
SUNBURST	PONTIAC	TRANS SPORT	PONTIAC	VICTORIA	FORD
SUNDANCE	PLYMOUTH	TRANSIT CONNECT	FORD	VIGOR	ACURA
SUNFIRE	ASUMA	TRAVELALL	INTERNATIONAL	VILLAGER	EDSEL
SUNFIRE	PONTIAC	TRAVERSE	CHEVROLET	VILLAGER	MERCURY
SUNLINER	FORD	TRAX	CHEVROLET	VIP	PLYMOUTH
SUNRUNNER	ASUMA	TREDIA	MITSUBISHI	VISION	EAGLE
SUNRUNNER	PONTIAC	TRIBUTE	MAZDA	VISTA	EAGLE
SUPER	BUICK	TROOPER	ISUZU	VISTA CRUISER	OLDSMOBILE
SUPER 88	OLDSMOBILE	TRUCK	CHEVROLET	VITARA	SUZUKI
SUPER BEETLE	VOLKSWAGEN	TRUCK	DODGE	VOLARE	PLYMOUTH
SUPER CHIEF	PONTIAC	TRUCK	GMC	VOLT	CHEVROLET
SUPER DELUXE	FORD	TSX	ACURA	VOYAGER	CHRYSLER
SUPERBIRD	PLYMOUTH	TT	AUDI	VOYAGER	MERCURY
SUPRA	TOYOTA	TT QUATTRO	AUDI	VOYAGER	PLYMOUTH
SW1	SATURN	TUCSON	HYUNDAI	VUE	SATURN
SW3	SATURN	TUNDRA	TOYOTA	W100 PICKUP	DODGE
SWIFT	SUZUKI	TURISMO	PLYMOUTH	W150 PICKUP	DODGE
SYCLONE	GMC	TURNPIKE CRUISER	MERCURY	W200 PICKUP	DODGE
T100	TOYOTA	TWO-TEN SERIES	CHEVROLET	W250 PICKUP	DODGE
T1000	PONTIAC	TYPHOON	GMC	W300 PICKUP	DODGE
TACOMA	TOYOTA	UNIVERSAL	JEEP	W350 PICKUP	DODGE

VEHICLE MODEL TO MAKE INDEX

WAGONEER	JEEP
WAVE	PONTIAC
WILDCAT	BUICK
WINDSOR	CHRYSLER
WINDSTAR	FORD
WRANGLER	JEEP
WRX	SUBARU
X3	BMW
X5	BMW
X-5	MAZDA
X-90	SUZUKI
XC90	VOLVO
XG300	HYUNDAI
XG350	HYUNDAI
XJ12	JAGUAR
XJ6	JAGUAR
XJS	JAGUAR
XK150	JAGUAR
XKE	JAGUAR
XL-7	SUZUKI
XT	SUBARU
XTERRA	NISSAN
X-TRAIL	NISSAN
XTS	CADILLAC
XV CROSSTREK	SUBARU
YARIS	TOYOTA
YUKON	GMC
YUKON DENALI	GMC
YUKON DENALI XL	GMC
YUKON XL 1500	GMC
YUKON XL 2500	GMC
Z3	BMW
ZDX	ACURA
ZEPHYR	LINCOLN
ZEPHYR	MERCURY

FOOTNOTE INDEX

- 1 Future Part, available 3rd Quarter of 2015
- 2 Future Part, available 4th Quarter of 2015
- 3 Future Part, available 1st Quarter of 2015
- 4 Future Part, available 2nd Quarter of 2015
- 5 Use kit no. 140719 to replace O.E. hardware for lower shock absorber mounting when studs break or self-tapping screws are no longer useable.
- 6 It is recommended that when replacing shocks on vehicles with "quad shocks" option, all 4 shocks should be matched by series.
- 7 Pair Packs. Air hose kit included.
- 8 Pair Packs.
- 9 See Ref. D for procedures to replace Elec. Adj. Susp. with non-adj. product.
- 10 The Nivomat leveling shocks are on the rear only. If suspension spring contacts units, rotate suspension spring 180 degrees.
- 30 For GM Vehicles equipped with factory installed leveling systems, see Ref. A.
- 31 With Nivomat Self-Leveling Suspension replace spring with Volvo No. 1229052/4.
- 32 With Nivomat Self-Leveling Suspension replace spring with Volvo No. 1359710 or 1273977.
- 33 Also works as conventional type replacement for Nivomat suspension.
- 34 If suspension spring contacts this unit, rotate suspension spring 180 degrees.
- 35 Sight grinding of control arm opening is required to install product made before Aug. 1988.
- 36 Requires special strut installation tool.
- 37 Jounce Bumper hardware from O.E. part may need to be reused.
- 39 Conventional gas-charged strut can be used to replace O.E. air adjustable gas-charged strut. However, the self-leveling system must be deactivated. See Ref. A for instructions.
- 40 ReadyMount Strut. Complete Assembled Unit.
- 41 ReadyMount Strut. Complete Assembled Unit. See Ref. D for procedures to replace Elec. Adj. Susp. with non-adj. product.
- 42 ReadyMount Strut, does not include springs due to vehicle design.
- 43 ReadyMount Strut, does not include springs due to vehicle design. See Ref. D for procedures to replace Elec. Adj. Susp. with non-adj. product.
- 44 This strut is not gas pressurized therefore the piston rod will not extend without assistance.
- 45 Strut must be rotated to align notch with lower control arm.
- 46 Upper Mount orientation may be required.
- 50 Bellows Kit No.141242 is recommended for use to protect piston rod from potentially harmful road debris.
- 51 Strut Cushion.
- 52 See Ref. C for optional Steering Stabilizer Boots.
- 53 Strut Mount. **Hardware from O.E. Part may need to be reused.**
- 54 Kit with Mount and Bearing. **Hardware from O.E. Part may need to be reused.**
- 55 Mount Kit includes Mount, Spring Seat, Bearing & Isolator. **Hardware from O.E. Part may need to be reused.**
- 56 Mount Kit includes Mount, Bumper/Bellow & Retainers. **Hardware from O.E. Part may need to be reused.**
- 57 Mount Kit includes Lower Spring Seat with Internal Bearing & Isolator. **Hardware from O.E. Part may need to be reused.**
- 58 Mount Kit includes Suspension Bearing. **Hardware from O.E. Part may need to be reused.**
- 59 Strut Mount Contains a Plastic Bearing. **Hardware from O.E. Part may need to be reused.**
- 60 Strut Mount Contains a Metal Bearing. **Hardware from O.E. Part may need to be reused.**
- 61 Mount Kit includes Upper Spring Seat. **Hardware from O.E. Part may need to be reused.**
- 62 Mount Kit includes Lower Suspension Mount Bushing. **Hardware from O.E. Part may need to be reused.**
- 63 Mount Kit includes Isolator. **Hardware from O.E. Part may need to be reused.**
- 64 Mount Kit includes Lower Rubber Spring Seat Isolator. **Hardware from O.E. Part may need to be reused.**
- 65 Mount Kit includes Upper Spring Seat with Isolator. **Hardware from O.E. Part may need to be reused.**
- 66 Upper Spring Seat with Spacer. **Hardware from O.E. Part may need to be reused.**
- 80 Mounting bracket not required, install on O.E. Shock Mounts. See Ref. C for optional Steering Stabilizer Boots.
- 81 Mounting bracket kit is required for installation. See Numeric Listing. See Ref. C for optional Steering Stabilizer Boots.
- 82 Use kit if listed. See Ref. C for optional Steering Stabilizer Boots.
- 83 For dual system, two stabilizers and one bracket kit are to be ordered. See Ref. C for optional Steering Stabilizer Boots.
- 98 Notice: The level of difficulty to install this product is moderately high. Please review the installation instructions carefully before proceeding.
- 99 Notice: The level of difficulty to install this product is moderately high. Please review the installation instructions carefully before proceeding. Requires special strut installation tool.

**SALES POPULARITY LISTING
LISTE DES CODES DE «POPULARITÉ»
LISTA DE TERMINOS MAS POPULARES**

- A** FAST
RAPIDE
RAPIDO
- B** GOOD
BON
BUENO
- C** FAIR
PASSABLE
RAZONABLE
- D** SLOW
LENT
LENTO
- FF** NEW ITEM, AVAILABILITY TO BE ANNOUNCED
NOUVEL ITEM DISPONIBILITÉ À ÊTRE ANNONCÉE
ARTICULO NUEVO, DISPONIBILIDAD SERA ANUNCIADO
- N** NEW ITEM
NOUVEL ARTICLE
ARTICULO NUEVO
- S** SUPERSEDED - SELL UNTIL FACTORY INVENTORY IS DEPLETED,
THEN USE REPLACEMENT PART NUMBER
REPLACÉ – VENDRE JUSQU'À ÉPUISEMENT DU STOCK EN USINE,
PUIS UTILISER LE NUMÉRO DE PIÈCE DE REMPLACEMENT
REEMPLAZA – VENDERSE HASTA QUE EL INVENTARIO DE LA FABRICA
SE TERMINE, ENTONCES USE LA PARTE QUE LA REEMPLAZA
- W** EXTREMELY SLOW
TRÈS LENT
EXTREMADAMENTE LENTO
- X** DISCONTINUE WHEN CURRENT FACTORY INVENTORY IS DEPLETED -
LAST YEAR IN CATALOG
ARRÊTEZ QUAND L'INVENTAIRE DU FABRICANT EST ÉPUISÉ –
DERNIÈRE ANNÉE DANS LE CATALOGUE
DESCONTINUAR CUANDO EL INVENTARIO ACTUAL SE TERMINE –
EN EL CATALOGO DEL AÑO PASADO

**NEW CATALOG LAYOUT
NOUVELLE MISE EN PAGE DE CATALOGUE
NUEVO CATÁLOGO LAYOUT**

Gabriel's 2015 Light Vehicle catalog contains new layout updates and adjustments. The Light Vehicle application section is now categorized into Front and Rear and then broken up into the Gabriel product lines. If you have any questions, please refer them to the Gabriel Answerman at 800.999.3903.

**KEY DESCRIPTIONS IN CATALOG
DESCRIPTION DES TOUCHES DANS LE CATALOGUE
DESCRIPCIÓN DE LAS TECLAS EN EL CATÁLOGO**



$\frac{O}{O}$ Eye Ring
Eye Ring



$\frac{O}{\ominus}$ Eye Ring
Barpin



$\frac{O}{T}$ Eye Ring
Stud



$\frac{I}{T}$ Stud
Stud

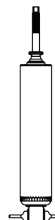

$\frac{I}{\ominus}$ Stud
Barpin



$\frac{I}{O}$ Stud
Eye Ring



$\frac{\ominus}{\ominus}$ Barpin
Barpin



$\frac{\ominus}{T}$ Barpin
Stud



$\frac{\ominus}{O}$ Barpin
Eye Ring



$\frac{O}{n}$ Eye Ring
U-Bracket







$\frac{\ominus}{n}$ Barpin
U-Bracket



$\frac{I}{n}$ Stud
U-Bracket

Images are for reference purposes only.





APPLICATION GUIDE

Year	Fitment Notes										
			Ultra	ProGuard/ Guardian/ Classic	Max Control/ LTV	Strut Cushion/ Strut Mount	Hi Jacker/ Load Carrier		Ultra	ProGuard/ Guardian/ Classic	Max Control/ LTV







ACURA

ACURA

CL

01-03	All		G55870	142230 ⁵³		G55871	142231 ⁵³
97-99	All		G55877	142230 ⁵³		G55786	142231 ⁵³ 143064 ⁵¹









EL

01-03	CAN Left		G56621		G51700	142230 ⁵³
	CAN Right		G56622		G51700	142230 ⁵³
97-00	CAN		G55909	142230 ⁵³ 143064 ⁵¹		G55910	142230 ⁵³ 143064 ⁵¹

EL READYMOUNTS

		Front	Rear
01-03	CAN Left	G57028 ⁴⁰
	CAN Right	G57029 ⁴⁰













INTEGRA

94-01	All		142230 ⁵³ 143064 ⁵¹		143064 ⁵¹
	Exc. RS & Type R Models		G55802 ⁴⁶	142230 ⁵³ 143064 ⁵¹		G55803	143064 ⁵¹
90-93	All		G55787	142230 ⁵³ 143064 ⁵¹		G55788	142230 ⁵³ 142300 ⁶² 143064 ⁵¹
86-89	All		G55731	142233 ⁵⁴		G51034	142150 ⁶² 142231 ⁵³













INTEGRA READYMOUNTS

		Front	Rear
94-01	Exc. RS & Type R Models Left	G56993 ⁴⁰	G56995 ⁴⁰
	Exc. RS & Type R Models Right	G56994 ⁴⁰	G56995 ⁴⁰

LEGEND

91-95	Left		G55958		G55952	143063 ⁵¹
	Right		G55951		G55952	143063 ⁵¹
89-90	Auto Leveling System		G55770	142230 ⁵³ 143064 ⁵¹		G55769	142150 ⁶² 142231 ⁵³ 143063 ⁵¹
87-88	Coupe		G55770	142230 ⁵³ 143064 ⁵¹		G55769	142231 ⁵³ 143063 ⁵¹
86-88	All		142230 ⁵³ 143064 ⁵¹		143063 ⁵¹
	Sedan		G55730	142230 ⁵³ 143064 ⁵¹		G55533	143063 ⁵¹

MDX

07-13	Left Exc. Active Suspension		G52249		G64080
	Right Exc. Active Suspension		G52250		G64080
03-06	Left		G52140	143315 ⁵³		G64003	61704
	Right		G52141	143315 ⁵³		G64003	61704
01-02	Left		G56759	143315 ⁵³		G64003	61704
	Right		G56758	143315 ⁵³		G64003	61704

40 ReadyMount Strut. Complete Assembled Unit.

51 Strut Cushion for use with the Strut/Cartridge/Shocks.





54 Kit with Mount and Bearing. Hardware from O.E. Part may need to be reused.

46 Upper Mount orientation may be required.

53 Strut Mount. Hardware from O.E. Part may need to be reused.

62 Mount Kit includes Lower Suspension Mount Bushing. Hardware from O.E. Part may need to be reused.

APPLICATION GUIDE

Year	Fitment Notes										
		 Ultra	ProGuard\ Guardian\ Classic	Max Control\ LTV	Strut Cushion\ Strut Mount	Hi Jacker\ Load Carrier	 Ultra	ProGuard\ Guardian\ Classic	Max Control\ LTV	Strut Cushion\ Strut Mount	Hi Jacker\ Load Carrier





ACURA

ACURA









MDX READYMOUNTS

		Front	Rear
01-02	Left	G57119⁴⁰
	Right	G57120⁴⁰









RDX

07-12	Left	 G52187	
	Right	 G52188	



RL

05-12	Left	 G51911	 G51912
	Right	 G51911	 G51913
96-04	Left	 G52057	143236 ⁵³	 G51829	143235 ⁵³
	Right	 G52058	143236 ⁵³	 G51829	143235 ⁵³













RSX

05-06	Left	 G52346	 G51914	142230 ⁵³
	Right	 G52347	 G51914	142230 ⁵³
	Type-S Left	143233 ⁶⁰
	Type-S Right	143265 ⁶⁰
02-06	Base and Type-S	143353 ⁵³
	Base and Type-S Left	143231 ⁵⁹
	Base and Type-S Right	143264 ⁵⁹
02-04	Left	 G56794	 G51830	142230 ⁵³
	Right	 G56793	 G51830	142230 ⁵³



SLX

96-99	4WD	 G63707	61607	 G63708	61608 81909
-------	-----	---	-------	------	------	------	---	----------------	------	------	------

TL

13-14	Left	 G51917	 G51919
	Right	 G51918	 G51919
09-12	Left	 G51917	142230 ⁵³	 G51919	142230 ⁵³
	Right	 G51918	142230 ⁵³	 G51919	142230 ⁵³
04-08	All	 G51737	142230 ⁵³	 G51738	142230 ⁵³
99-03	All	 G55870	142230 ⁵³	 G55871	142230 ⁵³
95-98	All	142230 ⁵³

TSX

09-14	All	 G51919
04-08	All	 G51737	 G51847





40 ReadyMount Strut. Complete Assembled Unit.

59 Strut Mount Contains a Plastic Bearing. Hardware from O.E. Part may need to be reused.

53 Strut Mount. Hardware from O.E. Part may need to be reused.



60 Strut Mount Contains a Metal Bearing. Hardware from O.E. Part may need to be reused.

APPLICATION GUIDE

Year	Fitment Notes										
		 Ultra	ProGuard/ Guardian/ Classic	Max Control/ LTV	Strut Cushion/ Strut Mount	Hi Jacker/ Load Carrier	 Ultra	ProGuard/ Guardian/ Classic	Max Control/ LTV	Strut Cushion/ Strut Mount	Hi Jacker/ Load Carrier







ACURA

VIGOR

92-94	All	 G55797	142230 ⁵³ 143064 ⁵¹	 G55796	142150 ⁶² 142231 ⁵³ 143064 ⁵¹
-------	-----	--	------	------	--	------	--	------	------	--	------





AMERICAN MOTORS

AMBASSADOR







70-74	All		82126		81340
67-69	All			82155
60-66	All			82066

AMERICAN MOTORS



AMERICAN

64-68	All		82069		82155
59-62	All			82155



AMX

78-80	All		82126		82125
70	All		82126		81340
68-69	All		82069		82155



CLASSIC

61-66	All			82066
-------	-----	--	------	------	------	------	--	-------	------	------	------

CONCORD

78-83	All		82126		82125
-------	-----	---	-------	------	------	------	---	-------	------	------	------





EAGLE

80-88	All		81491		81340
-------	-----	---	-------	------	------	------	---	-------	------	------	------





EAGLE STEERING STABILIZERS

80-88	All								Front	Rear
									6804SE ⁸⁰





GREMLIN

71-78	All		82126		82125
70	All		82126		82051





HORNET

71-77	All		82126		82125
70	All		82126		82051



JAVELIN

70-74	All		82126		81340
68-69	All		82069		82155



MARLIN

67	All			82155
65-66	All			82066

MATADOR

71-78	All		82126		81340
-------	-----	---	-------	------	------	------	---	-------	------	------	------

PACER

75-80	All		82025		81270	49105 ⁷
-------	-----	---	-------	------	------	------	---	-------	------	------	--------------------

7 Pair Packs, air hose kit included.





53 Strut Mount. Hardware from O.E. Part may need to be reused.

80 Mounting bracket not required, install on O.E. Shock Mounts. See Ref. C for optional Steering Stabilizer Boots.





51 Strut Cushion for use with the Strut/Cartridge/Shocks.

62 Mount Kit includes Lower Suspension Mount Bushing. Hardware from O.E. Part may need to be reused.

APPLICATION GUIDE



Year	Fitment Notes										
		 Ultra	ProGuard\ Guardian\ Classic	Max Control\ LTV	Strut Cushion\ Strut Mount	Hi Jacker\ Load Carrier	 Ultra	ProGuard\ Guardian\ Classic	Max Control\ LTV	Strut Cushion\ Strut Mount	Hi Jacker\ Load Carrier

AMERICAN MOTORS RAMBLER

69	All		82069		82155
59-60	All			82155

AMERICAN MOTORS







SPIRIT

79-83	All		82126		82125
-------	-----	---	-------	-------	-------	-------	---	-------	-------	-------	-------	-------





ASUNA

ASUNA





GT, SE

94	All		G44903	142296 143057		69749	81530	141974	49371
93	All		G44903 ⁹⁸	142296 ⁵³ 143057 ⁵¹		69749	81530	141974 ⁵³	49371 ⁷
92	All		G44903	142296 143057		69749	81530	141974	49371

SUNFIRE (CANADIAN VEHICLE)

93	All		G55780	142317 ⁵³ 143058 ⁵¹	
	Exc. Lotus Suspension		G55780	142317 ⁵³ 143058 ⁵¹		G55776	142334 ⁵³ 143061 ⁵¹



SUNRUNNER

94-98	All		G56518	142294		G63799	61560 81904	49613
92-93	All		G56518	142294 ⁵⁴		G63799	61560 81904	49613 ⁷





AUDI

AUDI





80

88-92	All		G44902 ⁹⁸	142195 ⁵³ 143057 ⁵¹		G51013	143061 ⁵¹
-------	-----	---	----------------------	-------	-------	--	---	--------	-------	-------	----------------------	-------





80 QUATTRO

92	All		G44902 ⁹⁸	142195 ⁵³ 143057 ⁵¹		G51064
88-91	All		G44902 ⁹⁸	142195 ⁵³ 143057 ⁵¹	







90

93-95	All		G44902 ⁹⁸	142195 ⁵³ 143057 ⁵¹		G51013	143061 ⁵¹
88-91	All		G44902 ⁹⁸	142195 ⁵³ 143057 ⁵¹		G51013	143061 ⁵¹

90 QUATTRO

93-95	All		G44902 ⁹⁸	142195 ⁵³ 143057 ⁵¹		G51064
88-91	All		G44902 ⁹⁸	142195 ⁵³ 143057 ⁵¹	

100

91-94	Mfg. Late 91		G44450 ⁹⁸	142734 ⁵⁴ 143061 ⁵¹		G51165	142521 ⁵³
89-94	All			G51165	142521 ⁵³
89-90	Mfg. Late 91		G44450 ⁹⁸	143060 ⁵¹		G51165	143061 ⁵¹ 142521 ⁵³

7 Pair Packs, air hose kit included.





53 Strut Mount. Hardware from O.E. Part may need to be reused.

98 Notice: The level of difficulty to install this product is moderately high. Please review the installation instructions carefully before proceeding.

51 Strut Cushion for use with the Strut/Cartridge/Shocks.

54 Kit with Mount and Bearing. Hardware from O.E. Part may need to be reused.



APPLICATION GUIDE

Year	Fitment Notes										
			ProGuard/ Guardian/ Classic	Max Control/ LTV	Strut Cushion/ Strut Mount	Hi Jacker/ Load Carrier		ProGuard/ Guardian/ Classic	Max Control/ LTV	Strut Cushion/ Strut Mount	Hi Jacker/ Load Carrier



AUDI

AUDI

100 QUATTRO

91-94	All		G44450 ⁹⁸
89-90	All		G44450 ⁹⁸	143057 ⁵¹



200

89-90	All		G44450 ⁹⁸	143060 ⁵¹		G51165	142521 ⁵³ 143061 ⁵¹
-------	-----	---	----------------------	------	------	----------------------	------	---	--------	------	------	--	------

200 QUATTRO

89-90	Wagon		G44450 ⁹⁸	143057 ⁵¹
-------	-------	---	----------------------	------	------	----------------------	------	------	------	------	------	------	------



4000

80-87	All		G44902 ⁹⁸	142195 ⁵³ 143057 ⁵¹		G51013	143061 ⁵¹
-------	-----	---	----------------------	------	------	--	------	---	--------	------	------	----------------------	------

4000 QUATTRO

84-87	All		G44902 ⁹⁸	142195 ⁵³ 143057 ⁵¹	143061 ⁵¹
-------	-----	---	----------------------	------	------	--	------	------	------	------	------	----------------------	------













5000

84-88	All		G44450 ⁹⁸	143060 ⁵¹		G51165
78-83	All		G44450 ⁹⁸	143060 ⁵¹









A3

06-11	All	143344 ⁵³	143345 ⁵³
-------	-----	------	------	------	------	----------------------	------	------	------	------	------	----------------------	------





A4

01-08	All		G51740	142652 ⁵⁴		69586
00	All		G51740	142652 ⁵⁴		G51100
98-99	Sport Suspension		G51099	142652 ⁵⁴		G51100	142442 ⁵³
96-99	All		142652 ⁵⁴		G51100	142442 ⁵³
	Exc. Sport Suspension		G51097	142652 ⁵⁴		G51100	142442 ⁵³
96-97	Sport Suspension		G51099	142652 ⁵⁴		G51100	142442 ⁵³

A4 QUATTRO

02-08	All			69586
	Mfg. from 11/00; Exc. Sport Suspension		G51740		69586
00-01	Mfg. from 11/00; Exc. Sport Suspension		G51740
96-00	Mfg. to 11/00; Exc. Sport Suspension		G51097	
	Sport Suspension		G51099	

A6

98-04	All		142652 ⁵⁴		69946	142653 ⁵³ 143380 ⁵³
	Exc. Sport Suspension		G51743	142652 ⁵⁴		69946	142653 ⁵³ 143380 ⁵³



51 Strut Cushion for use with the Strut/Cartridge/Shocks.

54 Kit with Mount and Bearing. Hardware from O.E. Part may need to be reused.

53 Strut Mount. Hardware from O.E. Part may need to be reused.

98 Notice: The level of difficulty to install this product is moderately high. Please review the installation instructions carefully before proceeding.



APPLICATION GUIDE

Year	Fitment Notes										
		Ultra	ProGuard/ Guardian/ Classic	Max Control/ LTV	Strut Cushion/ Strut Mount	Hi Jacker/ Load Carrier	Ultra	ProGuard/ Guardian/ Classic	Max Control/ LTV	Strut Cushion/ Strut Mount	Hi Jacker/ Load Carrier









AUDI

AUDI

A6 (cont'd)

98-00	Sport Suspension	 G51099	142652 ⁵⁴	 69946	142653 ⁵³ 143380⁵³
95-97	All	 G51165	142521 ⁵³

A6 QUATTRO

08	Exc. Air and Sport Suspension	 G51915	 G51968
05-07	All	142652 ⁵⁴
	Exc. Air and Sport Suspension	 G51915	142652 ⁵⁴	 G51968
98-04	All	 G51101	142652 ⁵⁴	 G51742
95-97	All	 G44450 ⁹⁸	142734 ⁵⁴ 143061 ⁵¹	 G51742	142521 ⁵³

A6 QUATTRO READYMOUNTS

		Front	Rear
00-04	Left	G57135⁴⁰
	Right	G57136⁴⁰



A6 READYMOUNTS

		Front	Rear
00-04	Left	G57135⁴⁰
	Right	G57136⁴⁰

A8

97-99	All	142652 ⁵⁴
-------	-----	------	------	------	----------------------	------	------	------	------	------	------

COUPE

83-87	All	 G44902 ⁹⁸	142195 ⁵³ 143057 ⁵¹	 G51013	143061 ⁵¹
-------	-----	--	------	------	--	------	--	------	------	----------------------	------

COUPE QUATTRO

90-91	All	 G44902 ⁹⁸	142195 ⁵³ 143057 ⁵¹
-------	-----	--	------	------	--	------	------	------	------	------	------

FOX

73-79	All	 G44902 ⁹⁸	142091 ⁵⁴	143059 ⁵¹
-------	-----	--	------	------	----------------------	------	------	------	------	----------------------	------

S4

00-02	All	142652 ⁵⁴	142442 ⁵³
92-94	All	 G44450 ⁹⁸



S6

95-97	All	 G44450 ⁹⁸	142734 ⁵⁴
-------	-----	--	------	------	----------------------	------	------	------	------	------	------

TT

08-09	All	143344 ⁵³	143345⁵³
00-06	All	 G56611	142651 ⁵⁴	69420	142654 ⁵³

TT QUATTRO

08-10	All	143344 ⁵³	143345⁵³
00-06	All	 G56611	142651 ⁵⁴	 69416

40 ReadyMount Strut. Complete Assembled Unit.





53 Strut Mount. Hardware from O.E. Part may need to be reused.

98 Notice: The level of difficulty to install this product is moderately high. Please review the installation instructions carefully before proceeding.

51 Strut Cushion for use with the Strut/Cartridge/Shocks.

54 Kit with Mount and Bearing. Hardware from O.E. Part may need to be reused.



APPLICATION GUIDE

Year	Fitment Notes										
			ProGuard/ Guardian/ Classic	Max Control/ LTV	Strut Cushion/ Strut Mount	Hi Jacker/ Load Carrier		ProGuard/ Guardian/ Classic	Max Control/ LTV	Strut Cushion/ Strut Mount	Hi Jacker/ Load Carrier

AUDI

AUDI



V8 QUATTRO

92-94	All		G44450 ⁹⁸	142734 ⁵⁴ 143057 ⁵¹
90-91	All		G44450 ⁹⁸	143057 ⁵¹

AVANTI

AVANTI



II

89-91	All		69600	69724
87-88	All		69600	69604



BMW

BMW





128I

08-11	Left		G52142	70045
	Right		G52143	70045



135I

08-11	Left		G52142	70045
	Right		G52143	70045



318I

92-98	Left		G56602	143061 ⁵¹	69863	142135 ⁵³
	Right		G56603	143061 ⁵¹	69863	142135 ⁵³
91	All		G44745 ⁹⁸	142217 ⁵³ 143061 ⁵¹	69725	142135 ⁵³
84-85	All		G44745 ⁹⁸	142217 ⁵³ 143061 ⁵¹	69725	142135 ⁵³

318IS

92-98	Left		G56602	143061 ⁵¹	69863	142135 ⁵³
	Right		G56603	143061 ⁵¹	69863	142135 ⁵³
91	All		G44745 ⁹⁸	142217 ⁵³ 143061 ⁵¹	69725	142135 ⁵³





318TI

95-99	Left		G56602	143057 ⁵¹	69903	142135 ⁵³
	Right		G56603	143057 ⁵¹	69903	142135 ⁵³

320I

77-83	All		G44713 ⁹⁸	G51007
-------	-----	---	----------------------	------	------	------	------	--------	------	------	------	------

323CI

00	All		69863
	Coupe		143082 ⁵³	69863
	Coupe Left Sport Suspension		G56752	69863
	Coupe Right Exc. Sport Suspension		G52238	69863



51 Strut Cushion for use with the Strut/Cartridge/Shocks.

54 Kit with Mount and Bearing. Hardware from O.E. Part may need to be reused.

53 Strut Mount. Hardware from O.E. Part may need to be reused.

98 Notice: The level of difficulty to install this product is moderately high. Please review the installation instructions carefully before proceeding.

APPLICATION GUIDE

Year	Fitment Notes										
		Ultra	ProGuard/ Guardian/ Classic	Max Control/ LTV	Strut Cushion/ Strut Mount	Hi Jacker/ Load Carrier	Ultra	ProGuard/ Guardian/ Classic	Max Control/ LTV	Strut Cushion/ Strut Mount	Hi Jacker/ Load Carrier

BMW

BMW

323Ci (cont'd)

00	Coupe Right Sport Suspension	G56753	69863
----	------------------------------	--------	-----	-----	-----	-----	-------	-----	-----	-----	-----

323i

00	Sedan Right Exc. Sport Suspension	G52238
	Wagon	14308 ⁵³	...	69863
	Wagon Left Exc. Sport Suspension	G52237
	Wagon Left Sport Suspension	G56750
	Wagon Right Sport Suspension	G56751
98-99	All	14306 ⁵¹	...	69863	142135 ⁵³	...
	E36(MfrBodyCode) Left	G56604	14306 ⁵¹	...	69863	142135 ⁵³	...
	E36(MfrBodyCode) Right	G56605	14306 ⁵¹	...	69863	142135 ⁵³	...

325

87-88	All	142217 ⁵³ 14306 ⁵¹	...	69725	142135 ⁵³	...
	Exc. Sport Suspension	G44775 ⁹⁸	142217 ⁵³ 14306 ⁵¹	...	69725	142135 ⁵³	...

325Ci

01-06	All	69863
	Left Exc. Sport Suspension	G52237	69863
	Left Sport Suspension	G56752	69863
	Right Exc. Sport Suspension	G52238	69863
	Right Sport Suspension	G56753	69863
	Sport Suspension; Exc. M-Sport Pack II	14308 ⁵³	...	69863

325E

84-87	All	142217 ⁵³ 14306 ⁵¹	...	69725	142135 ⁵³	...
	Exc. Sport Suspension	G44775 ⁹⁸	142217 ⁵³ 14306 ⁵¹	...	69725	142135 ⁵³	...

325i

06	All	70045
	Exc. Sport Suspension M-Sport Pack II	14308 ⁵³	...	70045
	Left	G52142	70045
	Right	G52143	70045
01-05	All	69863
	Exc. Sport Suspension M-Sport Pack II	14308 ⁵³	...	69863
	Mfg. from 09/01; Sport Suspension Left	G56756	69863
	Sedan Left Exc. Sport Suspension	G52237	69863





51 Strut Cushion for use with the Strut/Cartridge/Shocks.

53 Strut Mount. Hardware from O.E. Part may need to be reused.

98 Notice: The level of difficulty to install this product is moderately high. Please

review the installation instructions carefully before proceeding.



















APPLICATION GUIDE

Year	Fitment Notes										
		 Ultra	ProGuard/ Guardian/ Classic	Max Control/ LTV	Strut Cushion/ Strut Mount	Hi Jacker/ Load Carrier	 Ultra	ProGuard/ Guardian/ Classic	Max Control/ LTV	Strut Cushion/ Strut Mount	Hi Jacker/ Load Carrier







BMW

BMW

325i (cont'd)

01-05	Sedan Right Exc. Sport Suspension	 G52238	 69863
	Wagon Left Sport Suspension	 G56750	 69863
	Wagon Right Sport Suspension	 G56751	 69863
01	Sedan Left Mfg. to 9/01; Sport Suspension	 G56750	 69863
	Sedan Right Mfg. to 9/01; Sport Suspension	 G56751	 69863
92-95	All	143061 ⁵¹
	E36(MfrBodyCode) Left	 G56604	143061 ⁵¹	 69863	142135 ⁵³
	E36(MfrBodyCode) Right	 G56605	143061 ⁵¹	 69863	142135 ⁵³
92	E30(MfrBodyCode) Exc. Sport Suspension	 G44775 ⁹⁸	143061 ⁵¹	 69725
87-91	All	142217 ⁵³ 143061 ⁵¹	142135 ⁵³
	E30(MfrBodyCode) Exc. Sport Suspension	 G44775 ⁹⁸	142217 ⁵³ 143061 ⁵¹	 69725	142135 ⁵³









325IS

92	All	143061 ⁵¹	 69725	142135 ⁵³
	Exc. Sport Suspension	 G44775 ⁹⁸	143061 ⁵¹	 69725	142135 ⁵³
87-91	All	142217 ⁵³ 143061 ⁵¹	 69725	142135 ⁵³
	Exc. Sport Suspension	 G44775 ⁹⁸	142217 ⁵³ 143061 ⁵¹	 69725	142135 ⁵³









325iX

88-91	All	143061 ⁵¹	142135 ⁵³
-------	-----	------	------	------	----------------------	------	------	------	------	----------------------	------



328Ci

00	All	143082 ⁵³	 69863
	Left Sport Suspension	 G56752	143082 ⁵³	 69863
	Right Sport Suspension	 G56753	143082 ⁵³	 69863
	Coupe Left Exc. Sport Suspension	 G52237	143082 ⁵³	 69863
	Coupe Right Exc. Sport Suspension	 G52238	143082 ⁵³	 69863

328i

07-13	Left	 G52142	 70045
	Right	 G52143	 70045
99-00	All	143082 ⁵³	 69863
96-98	Left	 G56604	143061 ⁵¹	 69863	142135 ⁵³
	Right	 G56605	143061 ⁵¹	 69863	142135 ⁵³

330Ci



02-06	Left Sport Suspension	 G56752	 69863
-------	-----------------------	--	------	------	------	------	---	------	------	------	------

51 Strut Cushion for use with the Strut/Cartridge/Shocks.

53 Strut Mount. Hardware from O.E. Part may need to be reused.

98 Notice: The level of difficulty to install this product is moderately high. Please review the installation instructions carefully before proceeding.



















APPLICATION GUIDE

Year	Fitment Notes										
		Ultra	ProGuard/ Guardian/ Classic	Max Control/ LTV	Strut Cushion/ Strut Mount	Hi Jacker/ Load Carrier	Ultra	ProGuard/ Guardian/ Classic	Max Control/ LTV	Strut Cushion/ Strut Mount	Hi Jacker/ Load Carrier









BMW

BMW





330Ci (cont'd)

02-06	Right Sport Suspension	 G56753	 69863
01-06	All	 69863
	Exc. Sport Suspension M-Sport Pack II	143082 ⁵³	 69863
	Left Exc. Sport Suspension	 G52237	 69863
	Right Exc. Sport Suspension	 G52238	 69863
	Coupe Left Exc. Sport Suspension	 G56756	 69863
01	Convertible Left Sport Suspension	 G56750	 69863
	Convertible Right Sport Suspension	 G56751	 69863
	Coupe Left Mfg. from 9/01; Sport Suspension	 G56752	 69863
	Coupe Right Mfg. from 9/01; Sport Suspension	 G56753	 69863



330i

06	Left	 G52142	 70045
	Right	 G52143	 70045
01-05	All	 69863
	Sedan Left	 G56752	 69863
	Sedan Right	 G56753	 69863













335i

07-13	Left	 G52142	 70045
	Right	 G52143	 70045

524TD

86	All	 G51330
85	All	142217 ⁵³	 G51330

525i





04-08	All	 G52314	 G51900
01-03	Exc. Electronic Adjustable Suspension	143262 ⁵³
	Sedan Exc. Electronic Adjustable Suspension	 G56608	 G51216
	Wagon Exc. Electronic Adjustable Suspension	 69998
92-95	All	142217 ⁵³ 143061 ⁵¹	 G51346
	Exc. Electronic Adjustable Suspension	 G44493 ⁹⁸	142217 ⁵³ 143061 ⁵¹	 G51346	142735 ⁵³
92	Mfg. to 9/92	 G44497 ⁹⁸	142217 ⁵³ 143061 ⁵¹	 G51346
91	All	 G44497 ⁹⁸	142217 ⁵³ 143061 ⁵¹	 G51346	142735 ⁵³

51 Strut Cushion for use with the Strut/Cartridge/Shocks.

53 Strut Mount. Hardware from O.E. Part may need to be reused.

98 Notice: The level of difficulty to install this product is moderately high. Please review the installation instructions carefully before proceeding.





APPLICATION GUIDE

Year	Fitment Notes										
		 Ultra	ProGuard/ Guardian/ Classic	Max Control/ LTV	Strut Cushion/ Strut Mount	Hi Jacker/ Load Carrier	 Ultra	ProGuard/ Guardian/ Classic	Max Control/ LTV	Strut Cushion/ Strut Mount	Hi Jacker/ Load Carrier



BMW

BMW





525i (cont'd)

90	All	142217 ⁵³ 143061 ⁵¹	142735 ⁵³
	Mfg. from 8/90	 G44497 ⁹⁸	142217 ⁵³ 143061 ⁵¹	 G51346	142735 ⁵³
	Mfg. to 8/90	 G44991 ⁹⁸	142217 ⁵³ 143061 ⁵¹	142735 ⁵³
89	All	 G44991 ⁹⁸	142217 ⁵³ 143061 ⁵¹	 G51346	142735 ⁵³







528E

82-88	All	142217 ⁵³ 143061 ⁵¹
	Auto-Leveling System	 G44920 ⁹⁸	142217 ⁵³ 143061 ⁵¹	 G51330



528i

99-00	All	143082 ⁵³
	Exc. Electronic Adjustable Suspension	143082 ⁵³	143262 ⁵³
	Wagon	143082 ⁵³	 69998
97-00	Sedan	 G56608	143082 ⁵³	 G51216
97-98	All	143082 ⁵³	 G51216
	Exc. Electronic Adjustable Suspension	143082 ⁵³	 G51216	143262 ⁵³











530i

04-08	All	 G52314	 G51900
01-03	Exc. Electronic Adjustable Suspension	 G56608	 G51216	143262 ⁵³
94-95	All	143061 ⁵¹
	Sedan	 G44497 ⁹⁸	142217 ⁵³ 143061 ⁵¹	 G51346	142735 ⁵³

533i

83-84	All	142217 ⁵³ 143061 ⁵¹
	Auto-Leveling System	 G44920 ⁹⁸	142217 ⁵³ 143061 ⁵¹	 G51330

535i



90-93	Mfg. from 8/90	 G44497 ⁹⁸	142217 ⁵³ 143061 ⁵¹	 G51346	142735 ⁵³
90	Mfg. to 8/90	 G44991 ⁹⁸
89	All	 G44991 ⁹⁸	143061 ⁵¹
	Mfg. from 8/90	 G44991 ⁹⁸	142217 ⁵³ 143061 ⁵¹	 G51346	142735 ⁵³
85-88	All	143061 ⁵¹
	Auto-Leveling System	 G44920 ⁹⁸	143061 ⁵¹	 G51330
88	Exc. Auto-Leveling System	 G44991 ⁹⁸	143061 ⁵¹
	Mfg. from 8/90	142217 ⁵³ 143061 ⁵¹	142735 ⁵³
	Mfg. from 8/90; Exc. Auto-Leveling System	143061 ⁵¹	 G51346

51 Strut Cushion for use with the Strut/Cartridge/Shocks.

53 Strut Mount. Hardware from O.E. Part may need to be reused.

98 Notice: The level of difficulty to install this product is moderately high. Please review the installation instructions carefully before proceeding.

APPLICATION GUIDE

Year	Fitment Notes										
		Ultra	ProGuard/ Guardian/ Classic	Max Control/ LTV	Strut Cushion/ Strut Mount	Hi Jacker/ Load Carrier	Ultra	ProGuard/ Guardian/ Classic	Max Control/ LTV	Strut Cushion/ Strut Mount	Hi Jacker/ Load Carrier

BMW

BMW

535i (cont'd)

85-87	Mfg. from 8/90	142217 ⁵³ 143061 ⁵¹
-------	----------------	------	------	------	--	------	------	------	------	------

535IS

88	All	142217 ⁵³ 143061 ⁵¹	142735 ⁵³
	Auto-Leveling System	G44920 ⁹⁸	142217 ⁵³ 143061 ⁵¹	G51330	142735 ⁵³
	Exc. Auto-Leveling System	G44991 ⁹⁸	142217 ⁵³ 143061 ⁵¹	G51346	142735 ⁵³

540i

00-03	Wagon Exc. Electronic Adjustable Suspension	69998
97-03	Mfg. to 10/03; Exc. Electronic Adjustable Suspension	G56607	G51216	143262 ⁵³
95	Mfg. to 10/03; Exc. Electronic Adjustable Suspension	G44497 ⁹⁸	G51216	143262 ⁵³
94	Mfg. to 10/03; Exc. Electronic Adjustable Suspension	G44497 ⁹⁸

635CSI

85-89	All	143061 ⁵¹	143063 ⁵¹
	Exc. Auto-Leveling System	G44920 ⁹⁸	142217 ⁵³ 143061 ⁵¹	G51330	143063 ⁵¹

735i

91-92	All	143061 ⁵¹
88-90	All	G44969 ⁹⁸	143061 ⁵¹
86-87	All	143061 ⁵¹

735iL

88-92	All	G44969 ⁹⁸	143061 ⁵¹
-------	-----	----------------------	------	------	----------------------	------	------	------	------	------

740i

97-01	All	143263 ⁵³
	Left Exc. Electronic Adjustable Suspension	G56771	143083 ⁵³	G51744	143263 ⁵³
	Right Exc. Electronic Adjustable Suspension	G56770	143083 ⁵³	G51744	143263 ⁵³
94-95	All	143263 ⁵³
	Left Exc. Electronic Adjustable Suspension	G56771	143083 ⁵³	G51744	143263 ⁵³
	Right Exc. Electronic Adjustable Suspension	G56770	143083 ⁵³	G51744	143263 ⁵³

740iL

94-01	All	143263 ⁵³
	Left Exc. Electronic Adjustable Suspension	G56771	143083 ⁵³	G51744	143263 ⁵³
	Right Exc. Electronic Adjustable Suspension	G56770	143083 ⁵³	G51744	143263 ⁵³

750iL

97-01	Left Exc. Electronic Adjustable Suspension	G56771	143083 ⁵³
	Right Exc. Electronic Adjustable Suspension	G56770	143083 ⁵³
94-96	All	G51744





51 Strut Cushion for use with the Strut/Cartridge/Shocks.

53 Strut Mount. Hardware from O.E. Part may need to be reused.

98 Notice: The level of difficulty to install this product is moderately high. Please

review the installation instructions carefully before proceeding.





APPLICATION GUIDE

Year	Fitment Notes										
			Ultra	ProGuard/ Guardian/ Classic	Max Control/ LTV	Strut Cushion/ Strut Mount	Hi Jacker/ Load Carrier		Ultra	ProGuard/ Guardian/ Classic	Max Control/ LTV

BMW

BMW

750iL (cont'd)

94-96	Left Exc. Electronic Adjustable Suspension		G56771	143083 ⁵³		G51744
	Right Exc. Electronic Adjustable Suspension		G56770	143083 ⁵³		G51744





M3

95-99	Left		142826 ⁵³
	Right		142825 ⁵³
88-91	All		142217 ⁵³		69725	142135 ⁵³







M5

00-03	All		143263 ⁵³
91-93	All		142217 ⁵³
88	All		142217 ⁵³



X3

04-10	Left		G52199		70034
	Right		G52200		70034

X5

00-06	All			G64046	143259 ⁵³
	AWD		143084 ⁵³		G64046	143259 ⁵³
	Coil(FrontSpringType) Left		G52144		G64046	143259 ⁵³
	Coil(FrontSpringType) Right		G52145		G64046	143259 ⁵³









Z3

96-02	Left		G56761
	Right		G56760

BUICK

BUICK

ALLURE

10	FWD, Left Exc. Electronic Suspension		G52278		70059
	FWD, Right Exc. Electronic Suspension		G52279		70059
05-09	All		G55948	142524 ⁵⁸ 142525 ⁵³ 142526 ⁵⁴ 143060 ⁵¹	143061 ⁵¹
	Exc. Models with 17" or 18" Wheels		G55948	142524 ⁵⁸ 142525 ⁵³ 142526 ⁵⁴ 143060 ⁵¹		G55949	143061 ⁵¹
	Left		G55948	142524 ⁵⁸ 142525 ⁵³ 142526 ⁵⁴ 143060 ⁵¹	143073 ⁵³ 143061 ⁵¹
	Models with 17" or 18" Wheels		G55948	142524 ⁵⁸ 142525 ⁵³ 142526 ⁵⁴ 143060 ⁵¹		G52244	143061 ⁵¹
	Right		G55948	142524 ⁵⁸ 142525 ⁵³ 142526 ⁵⁴ 143060 ⁵¹	143074 ⁵³ 143061 ⁵¹





51 Strut Cushion for use with the Strut/Cartridge/Shocks.

54 Kit with Mount and Bearing. Hardware from O.E. Part may need to be reused.

53 Strut Mount. Hardware from O.E. Part may need to be reused.

58 Mount Kit includes Suspension Bearing. Hardware from O.E. Part may need to be reused.

APPLICATION GUIDE

Year	Fitment Notes										
		 Ultra	ProGuard\ Guardian\ Classic	Max Control\ LTV	Strut Cushion\ Strut Mount	Hi Jacker\ Load Carrier	 Ultra	ProGuard\ Guardian\ Classic	Max Control\ LTV	Strut Cushion\ Strut Mount	Hi Jacker\ Load Carrier









BUICK

BUICK



ALLURE READYMOUNTS

		Front	Rear
05-09	All	G57060 ⁴⁰
	Left Exc. Models with 17" or 18" Wheels	G57060 ⁴⁰	G56924 ⁴⁰
	Right Exc. Models with 17" or 18" Wheels	G57060 ⁴⁰	G56925 ⁴⁰



























APOLLO

74-75	All	 69600	81494	34051 ⁸		82093	49193 ⁷
73	All	 69600	81494	34051 ⁸	
	Exc. HD Suspension	 69600	81494	34051 ⁸		82093	49193 ⁷
	HD Suspension	 69600	81494	34051 ⁸	 69724	81514	49157 ⁷

CENTURION

71-73	All	 69675 ⁵	81446	34073 ⁸	 69724 ⁵	81514	43049 ⁸ 49131 ³⁰
-------	-----	--	-------	------	------	--------------------	--	-------	------	------	---



CENTURY

97-05	All	 G55948	142524 ⁵⁸ 142525 ⁵³ 142526 ⁵⁴ 143060 ⁵¹	 G55949	143061 ⁵¹
	Left	 G55948	142524 ⁵⁸ 142525 ⁵³ 142526 ⁵⁴ 143060 ⁵¹	 G55949	143073 ⁵³ 143061 ⁵¹
	Right	 G55948	142524 ⁵⁸ 142525 ⁵³ 142526 ⁵⁴ 143060 ⁵¹	 G55949	143074 ⁵³ 143061 ⁵¹
85-96	All	 G55514	142223 ⁵³ 142749 ⁶⁵ 143060 ⁵¹	 69723	81517	141974 ⁵³	49370 ³⁰
84	All		142223 ⁵³ 143060 ⁵¹	 69723	81517	141974 ⁵³	49370 ³⁰
	Exc. HD Suspension	 G55505	142223 ⁵³ 143060 ⁵¹	 69723	81517	141974 ⁵³	49370 ³⁰
	HD Suspension	 G55514	142223 ⁵³ 143060 ⁵¹	 69723	81517	141974 ⁵³	49370 ³⁰
82-83	All	 G55505	142223 ⁵³ 143060 ⁵¹	 69723	81517	141974 ⁵³	49370 ³⁰
78-81	All	 69600	81494	34051 ⁸	 69604	81492	43060 ⁸ 49334 ³⁰
73-77	All	 69600	81494	34051 ⁸	 69604	81492	43060 ⁸ 49152 ³⁰
58	All		81270		82156
57	All			82156
56	All		82087	

CENTURY READYMOUNTS

		Front	Rear
97-05	Left	G57060 ⁴⁰	G56924
	Right	G57060 ⁴⁰	G56925
85-96	All	G56908 ⁴⁰
84	HD Suspension	G56908 ⁴⁰

COMMERCIAL CHASSIS

92-96	All			43049 ⁸
-------	-----	--	------	------	------	------	--	------	------	------	--------------------

5 Use kit No. 140719 to replace O.E. hardware for lower shock absorber mounting when studs break or self-tapping screws are not longer useable.

8 Pair Packs.

40 ReadyMount Strut. Complete Assembled Unit.

53 Strut Mount. Hardware from O.E. Part may need to be reused.

58 Mount Kit includes Suspension Bearing. Hardware from O.E. Part may need to be reused.

7 Pair Packs, air hose kit included.



30 For GM Vehicles equipped with factory installed leveling systems, see Ref A.

51 Strut Cushion for use with the Strut/Cartridge/Shocks.

54 Kit with Mount and Bearing. Hardware from O.E. Part may need to be reused.

65 Mount Kit includes Upper Spring Seat with Isolator. Hardware from O.E. Part may need to be reused.









APPLICATION GUIDE

Year	Fitment Notes										
		Ultra	ProGuard/ Guardian/ Classic	Max Control/ LTV	Strut Cushion/ Strut Mount	Hi Jacker/ Load Carrier	Ultra	ProGuard/ Guardian/ Classic	Max Control/ LTV	Strut Cushion/ Strut Mount	Hi Jacker/ Load Carrier

BUICK

BUICK





ELECTRA

85-90	All		G56701	142225 ⁵⁴ 142227 ⁵⁸ 143061 ⁵¹	142132 ⁵³ 143060 ⁵¹
	Air(RearSpringType) Conventional Replacement for Air Assist Rear Susp. Strut Only		G56701	142225 ⁵⁴ 142227 ⁵⁸ 143061 ⁵¹	G56707 ⁹	142132 ⁵³ 143060 ⁵¹
	Air(RearSpringType) w/Air assist Rear Susp. Std. Equip. Strut Only		G56701	142225 ⁵⁴ 142227 ⁵⁸ 143061 ⁵¹	G56903	142132 ⁵³ 143060 ⁵¹
85-89	Estate Wagon		G56701	142225 ⁵⁴ 142227 ⁵⁸ 143061 ⁵¹	34073 ⁸	142132 ⁵³ 143060 ⁵¹
71-84	All		69675 ⁵	81446	34073 ⁸	69724	81514	43049 ⁸ 49131 ³⁰
65-70	All		82601	82602
61-64	All		82087	82609
59-60	Exc. Air Susp		82155

ELECTRA READYMOUNTS

		Front	Rear
85-90	All	G56914 ⁴⁰
	Air(RearSpringType) Conventional Replacement for Air Assist Rear Susp. Strut w/Upper Mount	G56914 ⁴⁰	G56726 ¹
	Air(RearSpringType) w/Air Assist Rear Susp. Std. Equip. Strut w/Upper Mount	G56914 ⁴⁰	G56906 ⁴³







ENCLAVE

12	All			G64040
08-11	All		G52125	143366 ⁵³		G64040



ENCLAVE READYMOUNTS

		Front	Rear
08-11	All	G57109



ESTATE WAGON

87	All		69675	81446		69604	81492	49152
71-83	All		69675 ⁵	81446	34073 ⁸		69604	81492	43060 ⁸ 49152 ³⁰
70	All		82601		69724	81514	49128 ³⁰





GRAN SPORT

65-67	All		82138		69604	81492	43060 ⁸ 49152 ³⁰
-------	-----	---	------	-------	------	------	------	---	-------	-------	------	------	---



GS / GS350 / GS400 / GS455

68-72	All		69600	81494		69604	81492	43060 ⁸ 49152 ³⁰
-------	-----	---	-------	-------	------	------	------	---	-------	-------	------	------	---

INVICTA

61-63	All		82087		82609
59-60	Exc. Air Susp			82155

LACROSSE

10-13	FWD, Left Exc. Electronic Suspension		G52278	70059
	FWD, Right Exc. Electronic Suspension		G52279	70059

5 Use kit No. 140719 to replace O.E. hardware for lower shock absorber mounting when studs break or self-tapping screws are not longer useable.

9 See Ref. D for procedures to replace Elec Adj Susp with non-adj product.

40 ReadyMount Strut. Complete Assembled Unit.

43 ReadyMount Strut, does not include springs due to vehicle design. See Ref. D for procedures to replace Elec Adj Susp with non-adj product.

53 Strut Mount. Hardware from O.E. Part may need to be reused.

58 Mount Kit includes Suspension Bearing. Hardware from O.E. Part may need to be reused.

8 Pair Packs.



30 For GM Vehicles equipped with factory installed leveling systems, see Ref A.

41 ReadyMount Strut. Complete Assembled Unit. See Ref. D for procedures to replace Elec Adj Susp with non-adj product.

51 Strut Cushion for use with the Strut/Cartridge/Shocks.

54 Kit with Mount and Bearing. Hardware from O.E. Part may need to be reused.

APPLICATION GUIDE

Year	Fitment Notes										
		Ultra	ProGuard/ Guardian/ Classic	Max Control/ LTV	Strut Cushion/ Strut Mount	Hi Jacker/ Load Carrier	Ultra	ProGuard/ Guardian/ Classic	Max Control/ LTV	Strut Cushion/ Strut Mount	Hi Jacker/ Load Carrier

BUICK

BUICK

LACROSSE (cont'd)

05-09	All	G55948	142524 ⁵⁸ 142525 ⁵³ 142526 ⁵⁴ 143060 ⁵¹	143061 ⁵¹
	Exc. Models with 17" or 18" Wheels	G55948	142524 ⁵⁸ 142525 ⁵³ 142526 ⁵⁴ 143060 ⁵¹	G55949	143061 ⁵¹
	Left	G55948	142524 ⁵⁸ 142525 ⁵³ 142526 ⁵⁴ 143060 ⁵¹	143073 ⁵³ 143061 ⁵¹
	Models with 17" or 18" Wheels	G55948	142524 ⁵⁸ 142525 ⁵³ 142526 ⁵⁴ 143060 ⁵¹	G52244	143061 ⁵¹
	Right	G55948	142524 ⁵⁸ 142525 ⁵³ 142526 ⁵⁴ 143060 ⁵¹	143074 ⁵³ 143061 ⁵¹

LACROSSE READYMOUNTS

		Front	Rear
05-09	All	G57060 ⁴⁰
	Left Exc. Models with 17" or 18" Wheels	G57060 ⁴⁰	G56924 ⁴⁰
	Right Exc. Models with 17" or 18" Wheels	G57060 ⁴⁰	G56925 ⁴⁰

LESABRE

05	All	G56509	142524 ⁵⁸ 142640 ⁵⁴	142647 ⁵³
	Must be used with provided air kit	G56509	142524 ⁵⁸ 142640 ⁵⁴	142647 ⁵³	49228 ³⁰
	With OE Style air fitting	G56509	142524 ⁵⁸ 142640 ⁵⁴	142647 ⁵³	49255⁷
00-04	All	G56509	142524 ⁵⁸ 142640 ⁵⁴	142647 ⁵³	49228 ³⁰
	With OE Style air fitting	G56509	142524 ⁵⁸ 142640 ⁵⁴	142647 ⁵³	49255⁷ 49228 ³⁰
97-99	All	G56718 ⁹	142524 ⁵⁸ 142530 ⁵⁴ 142751 ⁶⁵ 143060 ⁵¹	142132 ⁵³ 143060 ⁵¹
	Air(RearSpringType) Optional O.E. Hydraulic Self Leveling System	G56718 ⁹	142524 ⁵⁸ 142530 ⁵⁴ 142751 ⁶⁵ 143060 ⁵¹	G56903	142132 ⁵³ 143060 ⁵¹
	Coil(RearSpringType)	G56718 ⁹	142524 ⁵⁸ 142530 ⁵⁴ 142751 ⁶⁵ 143060 ⁵¹	G56707 ⁹	142132 ⁵³ 143060 ⁵¹
91-96	All	G56718 ⁹	142226 ⁵⁴ 142751 ⁶⁵ 143060 ⁵¹	142132 ⁵³ 143060 ⁵¹
	Air(RearSpringType) Optional O.E. Hydraulic Self Leveling System	G56718 ⁹	142226 ⁵⁴ 142751 ⁶⁵ 143060 ⁵¹	G56903	142132 ⁵³ 143060 ⁵¹
	Coil(RearSpringType)	G56718 ⁹	142226 ⁵⁴ 142751 ⁶⁵ 143060 ⁵¹	G56707 ⁹	142132 ⁵³ 143060 ⁵¹
90	All	142226 ⁵⁴ 142227 ⁵⁸ 142752 ⁶⁵	142132 ⁵³ 143060 ⁵¹
	Early Design Front Strut with Spring Guard	G56701	142225 ⁵⁴ 143061 ⁵¹ 142226 ⁵⁴ 142227 ⁵⁸ 142752 ⁶⁵	142132 ⁵³ 143060 ⁵¹

7 Pair Packs, air hose kit included.

30 For GM Vehicles equipped with factory installed leveling systems, see Ref A.

51 Strut Cushion for use with the Strut/Cartridge/Shocks.

54 Kit with Mount and Bearing. Hardware from O.E. Part may need to be reused.

65 Mount Kit includes Upper Spring Seat with Isolator. Hardware from O.E. Part may need to be reused.





9 See Ref. D for procedures to replace Elec Adj Susp with non-adj product.

40 ReadyMount Strut. Complete Assembled Unit.

53 Strut Mount. Hardware from O.E. Part may need to be reused.

58 Mount Kit includes Suspension Bearing. Hardware from O.E. Part may need to be reused.



























APPLICATION GUIDE

Year	Fitment Notes										
		 Ultra	ProGuard/ Guardian/ Classic	Max Control/ LTV	Strut Cushion/ Strut Mount	Hi Jacker/ Load Carrier	 Ultra	ProGuard/ Guardian/ Classic	Max Control/ LTV	Strut Cushion/ Strut Mount	Hi Jacker/ Load Carrier

BUICK

BUICK



LESABRE (cont'd)

90	Late Design Front Strut without Spring Guard	 G56718 ⁸	143060 ⁵¹ 142226 ⁵⁴ 142227 ⁵⁸ 142752 ⁵⁵		142132 ⁵³ 143060 ⁵¹
	Air(RearSpringType) Optional O.E. Hydraulic Self Leveling System	142226 ⁵⁴ 142227 ⁵⁸ 142752 ⁵⁵	 G56903	142132 ⁵³ 143060 ⁵¹
	Coil(RearSpringType)	142226 ⁵⁴ 142227 ⁵⁸ 142752 ⁵⁵	 G56707 ⁹	142132 ⁵³ 143060 ⁵¹
88-89	All	 G56701	142225 ⁵⁴ 142227 ⁵⁸ 142752 ⁵⁵ 143061 ⁵¹	34073 ⁸		142132 ⁵³ 143060 ⁵¹
	Air(RearSpringType) Optional O.E. Hydraulic Self Leveling System	 G56701	142225 ⁵⁴ 142227 ⁵⁸ 142752 ⁵⁵ 143061 ⁵¹	34073 ⁸	 G56903	142132 ⁵³ 143060 ⁵¹
	Coil(RearSpringType)	 G56701	142225 ⁵⁴ 142227 ⁵⁸ 142752 ⁵⁵ 143061 ⁵¹	34073 ⁸	 G56707 ⁹	142132 ⁵³ 143060 ⁵¹
86-87	All	 G56701	142225 ⁵⁴ 142227 ⁵⁸ 142752 ⁵⁵ 143061 ⁵¹		142132 ⁵³ 143060 ⁵¹
	Air(RearSpringType) Optional O.E. Hydraulic Self Leveling System	 G56701	142225 ⁵⁴ 142227 ⁵⁸ 142752 ⁵⁵ 143061 ⁵¹	 G56903	142132 ⁵³ 143060 ⁵¹
	Coil(RearSpringType)	 G56701	142225 ⁵⁴ 142227 ⁵⁸ 142752 ⁵⁵ 143061 ⁵¹	 G56707 ⁹	142132 ⁵³ 143060 ⁵¹
71-85	All	 69675 ⁵	81446	34073 ⁸	 69724	81514	43049 ⁸ 49131 ³⁰
65-70	All		82601		82602
61-64	All		82087		82609
60	All			82155
59	Exc. Air Susp			82155

LESABRE READYMOUNTS

		Front	Rear
00-05	Exc. Electronic Adjustable Suspension	G57051 ⁴⁰
91-99	All	G56909 ⁴¹
	Air(RearSpringType) Optional O.E. Hydraulic Self Leveling System	G56909 ⁴¹	G56906 ⁴³
	Coil(RearSpringType)	G56909 ⁴¹	G56726 ⁴³
90	Early Design Front Strut with Spring Guard	G56914 ⁴⁰
	Late Design Front Strut without Spring Guard	G56909 ⁴¹
	Air(RearSpringType) Optional O.E. Hydraulic Self Leveling System	G56906 ⁴³
	Coil(RearSpringType)	G56726 ⁴³
86-89	All	G56914 ⁴⁰
	Air(RearSpringType) Optional O.E. Hydraulic Self Leveling System	G56914 ⁴⁰	G56906 ⁴³
	Coil(RearSpringType)	G56914 ⁴⁰	G56726 ⁴³

LIMITED

58	All		81270		82156
----	-----	---	-------	------	------	------	---	-------	------	------	------

5 Use kit No. 140719 to replace O.E. hardware for lower shock absorber mounting when studs break or self-tapping screws are not longer useable.

9 See Ref. D for procedures to replace Elec Adj Susp with non-adj product.

40 ReadyMount Strut. Complete Assembled Unit.

43 ReadyMount Strut, does not include springs due to vehicle design. See Ref. D for procedures to replace Elec Adj Susp with non-adj product.

53 Strut Mount. Hardware from O.E. Part may need to be reused.

58 Mount Kit includes Suspension Bearing. Hardware from O.E. Part may need to be reused.

8 Pair Packs.

30 For GM Vehicles equipped with factory installed leveling systems, see Ref A.



41 ReadyMount Strut. Complete Assembled Unit. See Ref. D for procedures to replace Elec Adj Susp with non-adj product.

51 Strut Cushion for use with the Strut/Cartridge/Shocks.

54 Kit with Mount and Bearing. Hardware from O.E. Part may need to be reused.

65 Mount Kit includes Upper Spring Seat with Isolator. Hardware from O.E. Part may need to be reused.

APPLICATION GUIDE

Year	Fitment Notes										
		Ultra	ProGuard\Guardian\Classic	Max Control\LTV	Strut Cushion\Strut Mount	Hi Jacker\Load Carrier	Ultra	ProGuard\Guardian\Classic	Max Control\LTV	Strut Cushion\Strut Mount	Hi Jacker\Load Carrier

BUICK

BUICK

LUCERNE

06-11	Exc. Magnetic Ride Control Suspension	G52116
-------	---------------------------------------	--------	------	------	------	------	------	------	------	------

PARK AVENUE

98-05	All	G56508	142524 ⁵⁸ 142640 ⁵⁴ 143057 ⁵¹	142647 ⁵³	49228 ³⁰
	With OE Style air fitting	G56508	142524 ⁵⁸ 142640 ⁵⁴ 143057 ⁵¹	142647 ⁵³	49255⁷ 49228 ³⁰
97	All	G55878	142524 ⁵⁸ 142529 ⁵⁴ 143057 ⁵¹	142647 ⁵³	49228 ³⁰
	With OE Style air fitting	G55878	142524 ⁵⁸ 142529 ⁵⁴ 143057 ⁵¹	142647 ⁵³	49255⁷ 49228 ³⁰
91-96	All	G56718 ⁹	142226 ⁵⁴ 142227 ⁵⁸ 142751 ⁶⁵ 143060 ⁵¹	142132 ⁵³ 143060 ⁵¹
	Air(RearSpringType) Conventional Replacement for Air Assist Susp; Exc. Elec. Adj. Susp.	G56718 ⁹	142226 ⁵⁴ 142227 ⁵⁸ 142751 ⁶⁵ 143060 ⁵¹	G56707 ⁹	142132 ⁵³ 143060 ⁵¹
	Air(RearSpringType) Exc. Electronic Adjustable Suspension	G56718 ⁹	142226 ⁵⁴ 142227 ⁵⁸ 142751 ⁶⁵ 143060 ⁵¹	G56903 ⁹	142132 ⁵³ 143060 ⁵¹

PARK AVENUE READYMOUNTS

		Front	Rear
98-05	All	G56929 ⁴⁰
91-96	CCR Computer Command Ride	G56909 ⁴¹
	Air(RearSpringType)	G56906 ⁴³
	Air(RearSpringType) Conventional Replacement for Air Assist Susp; Exc. Elec. Adj. Susp.	G56726 ⁴²

RAINIER

04-07	All	G51718 ⁴⁵	143241 ⁵³	61717
	Coil(FrontSpringType)	G51718 ⁴⁵	143241 ⁵³	G63842	61717

RAINIER READYMOUNTS

		Front	Rear
04-07	All	G57022 ⁴⁰

REATTA

90-91	All	G56717 ⁹	142297 ⁵⁴	142405 ⁵³
88-89	All	G56717 ⁹	142298 ⁵⁴	142405 ⁵³

REGAL

97-04	All	G55948	142524 ⁵⁸ 142525 ⁵³ 142526 ⁵⁴ 143060 ⁵¹	G55949	143061 ⁵¹
	Left	G55948	142524 ⁵⁸ 142525 ⁵³ 142526 ⁵⁴ 143060 ⁵¹	G55949	143073 ⁵³ 143061 ⁵¹

7 Pair Packs, air hose kit included.

30 For GM Vehicles equipped with factory installed leveling systems, see Ref A.

41 ReadyMount Strut. Complete Assembled Unit. See Ref. D for procedures to replace Elec Adj Susp with non-adj product.

43 ReadyMount Strut, does not include springs due to vehicle design. See Ref. D for procedures to replace Elec Adj Susp with non-adj product.

51 Strut Cushion for use with the Strut/Cartridge/Shocks.

54 Kit with Mount and Bearing. Hardware from O.E. Part may need to be reused.

65 Mount Kit includes Upper Spring Seat with Isolator. Hardware from O.E. Part may need to be reused.

9 See Ref. D for procedures to replace Elec Adj Susp with non-adj product.

40 ReadyMount Strut. Complete Assembled Unit.





42 ReadyMount Strut, does not include springs due to vehicle design.

45 Strut must be rotated to align notch with lower control arm.

53 Strut Mount. Hardware from O.E. Part may need to be reused.

58 Mount Kit includes Suspension Bearing. Hardware from O.E. Part may need to be reused.















APPLICATION GUIDE

Year	Fitment Notes										
			Ultra	ProGuard/ Guardian/ Classic	Max Control/ LTV	Strut Cushion/ Strut Mount	Hi Jacker/ Load Carrier		Ultra	ProGuard/ Guardian/ Classic	Max Control/ LTV

BUICK

BUICK



REGAL (cont'd)

97-04	Right		G55948	142524 ⁵⁸ 142525 ⁵³ 142526 ⁵⁴ 143060 ⁵¹		G55949	143074 ⁵³ 143061 ⁵¹
88-96	All		G44459 ³⁵	142143 ⁵³ 143060 ⁵¹		G56708	143062 ⁵¹ 143067 ⁵³
	HD Suspension		G44459 ³⁵	142144 ⁵³ 142143 ⁵³ 143060 ⁵¹		G56708	143062 ⁵¹ 143067 ⁵³
	Left		G44459 ³⁵	143036 ⁵⁷ 142143 ⁵³ 143060 ⁵¹		G56708	143062 ⁵¹ 143067 ⁵³
	Right		G44459 ³⁵	143037 ⁵⁷ 142143 ⁵³ 143060 ⁵¹		G56708	143062 ⁵¹ 143067 ⁵³
78-87	All		69600	81494	34051 ⁸		69604	81492	43060 ⁸ 49334 ³⁰
73-77	All		69600	81494	34051 ⁸		69604	81492	43060 ⁸ 49152 ³⁰

























REGAL READYMOUNTS

		Front	Rear
97-04	Left	G57060 ⁴⁰	G56924
	Right	G57060 ⁴⁰	G56925
88-96	All	G56727 ⁴²

RENDEZVOUS

02-07	Exc. Hydraulic Self Leveling System		G55834	143091 ⁵³		G63868	61777
-------	-------------------------------------	--	--------	------	------	----------------------	------	--	--------	-------	------	------	------

RIVIERA

98-99	All		G56508	142524 ⁵⁸ 142640 ⁵⁴ 143057 ⁵¹		142647 ⁵³	49228 ³⁰
	With OE Style air fitting		G56508	142524 ⁵⁸ 142640 ⁵⁴ 143057 ⁵¹		142647 ⁵³	49255⁷ 49228 ³⁰
97	All		G55878	142411 ⁵⁴ 142751 ⁶⁵ 143057 ⁵¹		142647 ⁵³	49228 ³⁰
	With OE Style air fitting		G55878	142411 ⁵⁴ 142751 ⁶⁵ 143057 ⁵¹		142647 ⁵³	49255⁷ 49228 ³⁰
95-96	All		G56718 ⁹	142411 ⁵⁴ 142751 ⁶⁵ 143060 ⁵¹		142647 ⁵³	49228 ³⁰
	With OE Style air fitting		G56718 ⁹	142411 ⁵⁴ 142751 ⁶⁵ 143060 ⁵¹		142647 ⁵³	49255⁷ 49228 ³⁰
90-93	All		G56717 ⁹	142297 ⁵⁴		G56704 ⁹	142405 ⁵³
86-89	All		G56703	142298 ⁵⁴ 143061 ⁵¹		G56704 ⁹	142405 ⁵³
79-85	All		69706	81445		49345 ³⁰
71-78	All		69675 ⁵	81446	34073 ⁸		69724	81514	43049 ⁸ 49131 ³⁰
66-70	All		82601		82618
63-65	All		82087		82609

5 Use kit No. 140719 to replace O.E. hardware for lower shock absorber mounting when studs break or self-tapping screws are not longer useable.

8 Pair Packs.

30 For GM Vehicles equipped with factory installed leveling systems, see Ref A.

40 ReadyMount Strut. Complete Assembled Unit.

51 Strut Cushion for use with the Strut/Cartridge/Shocks.

54 Kit with Mount and Bearing. Hardware from O.E. Part may need to be reused.

58 Mount Kit includes Suspension Bearing. Hardware from O.E. Part may need to be reused.

7 Pair Packs, air hose kit included.

9 See Ref. D for procedures to replace Elec Adj Susp with non-adj product.

36 Requires special strut installation tool.

42 ReadyMount Strut, does not include springs due to vehicle design.



53 Strut Mount. Hardware from O.E. Part may need to be reused.

57 Mount Kit includes Lower Spring Seat with Internal Bearing & Isolator. Hardware from O.E. Part may need to be reused.

65 Mount Kit includes Upper Spring Seat with Isolator. Hardware from O.E. Part may need to be reused.

Bold Type - New / Future Part

APPLICATION GUIDE

Year	Fitment Notes										
		Ultra	ProGuard\ Guardian\ Classic	Max Control\ LTV	Strut Cushion\ Strut Mount	Hi Jacker\ Load Carrier	Ultra	ProGuard\ Guardian\ Classic	Max Control\ LTV	Strut Cushion\ Strut Mount	Hi Jacker\ Load Carrier

BUICK

BUICK

RIVIERA READYMOUNTS

		Front	Rear
98-99	All	G56929 ⁴⁰

RIVIERA STEERING STABILIZERS

		Front	Rear
79-85	All	14020

ROADMASTER

92-96	All	69675 ⁵	81446	34073 ⁸	69724	81514	43049 ⁸ 49131 ³⁰
	Sedan	69675 ⁵	81446	34073 ⁸	69604	81492	43060 ⁸ 49152 ³⁰
	Wagon	69675 ⁵	81446	34073 ⁸	69604	81492	43060 ⁸ 49152 ³⁰
91	All	34073 ⁸
	Wagon	69675 ⁵	81446	34073 ⁸	69604	81492	43060 ⁸ 49152 ³⁰
58	Exc. Air Susp	81270	82156
57	Exc. Air Susp	82156
56	Exc. Air Susp	82087	81147

SKYHAWK

87-89	Left	G56706	142762 ⁶⁵ 143060 ⁵¹	69749	81530	141974 ⁵³ 49371 ⁷
	Right	G56705	142762 ⁶⁵ 143060 ⁵¹	69749	81530	141974 ⁵³ 49371 ⁷
84-86	All	142762 ⁶⁵ 143060 ⁵¹	69749	81530	141974 ⁵³ 49371 ⁷
	Left Non-Rebuildable O.E. Struts	G56706	142762 ⁶⁵ 143060 ⁵¹	69749	81530	141974 ⁵³ 49371 ⁷
	Rebuildable O.E. Struts	G44451 ⁹⁸	142762 ⁶⁵ 143060 ⁵¹	69749	81530	141974 ⁵³ 49371 ⁷
	Right Non-Rebuildable O.E. Struts	G56705	142762 ⁶⁵ 143060 ⁵¹	69749	81530	141974 ⁵³ 49371 ⁷
82-83	All	G44918 ⁹⁸	142762 ⁶⁵	69749	81530	141974 ⁵³ 49371 ⁷
75-80	All	82129	81438

SKYLARK

95-98	Left	G56720 ⁹	142227 ⁵⁸ 142406 ⁵⁴ 142748 ⁶⁵ 143059 ⁵¹	69407 ⁹	81790	141974 ⁵³ 49614 ⁷
	Right	G56719	142227 ⁵⁸ 142406 ⁵⁴ 142748 ⁶⁵ 143059 ⁵¹	69407 ⁹	81790	141974 ⁵³ 49614 ⁷
92-94	All	143059 ⁵¹	69749	81530	141974 ⁵³ 49371 ⁷
	Exc. FE3 and Electronic Ride Control	142224 ⁵⁴ 142227 ⁵⁸ 142750 ⁶⁵ 143059 ⁵¹	69749	81530	141974 ⁵³ 49371 ⁷
	Left Exc. FE3 and Electronic Ride Control	G56720 ⁹	143059 ⁵¹	69749	81530	141974 ⁵³ 49371 ⁷
	Left FE3 Suspension	G56723	143059 ⁵¹	69749	81530	141974 ⁵³ 49371 ⁷
	Right Exc. FE3 and Electronic Ride Control	G56719 ⁹	143059 ⁵¹	69749	81530	141974 ⁵³ 49371 ⁷

5 Use kit No. 140719 to replace O.E. hardware for lower shock absorber mounting when studs break or self-tapping screws are not longer useable.

8 Pair Packs.

30 For GM Vehicles equipped with factory installed leveling systems, see Ref A.

51 Strut Cushion for use with the Strut/Cartridge/Shocks.

54 Kit with Mount and Bearing. Hardware from O.E. Part may need to be reused.

65 Mount Kit includes Upper Spring Seat with Isolator. Hardware from O.E. Part may need to be reused.

7 Pair Packs, air hose kit included.

9 See Ref. D for procedures to replace Elec Adj Susp with non-adj product.





40 ReadyMount Strut. Complete Assembled Unit.

53 Strut Mount. Hardware from O.E. Part may need to be reused.

58 Mount Kit includes Suspension Bearing. Hardware from O.E. Part may need to be reused.

98 Notice: The level of difficulty to install this product is moderately high. Please review the installation instructions carefully before proceeding.































APPLICATION GUIDE

Year	Fitment Notes										
			Ultra	ProGuard/ Guardian/ Classic	Max Control/ LTV	Strut Cushion/ Strut Mount	Hi Jacker/ Load Carrier		Ultra	ProGuard/ Guardian/ Classic	Max Control/ LTV

BUICK

BUICK







SKYLARK (cont'd)

92-94	Right FE3 Suspension		G56724	143059 ⁵¹		69749	81530	141974 ⁵³	49371 ⁷
86-91	All		142762 ⁵⁵ 143060 ⁵¹		69749	81530	141974 ⁵³	49371 ⁷
	Left Non-Rebuildable O.E. Struts		G56706	142762 ⁵⁵ 143060 ⁵¹		69749	81530	141974 ⁵³	49371 ⁷
	Rebuildable O.E. Struts		G44451 ⁹⁸	142762 ⁵⁵ 143060 ⁵¹		69749	81530	141974 ⁵³	49371 ⁷
	Right Non-Rebuildable O.E. Struts		G56705	142762 ⁵⁵ 143060 ⁵¹		69749	81530	141974 ⁵³	49371 ⁷
85	All		G55514	142223 ⁵³ 142749 ⁵⁵ 143060 ⁵¹		69723	81517	141974 ⁵³	49370 ³⁰
84	All		142223 ⁵³ 143060 ⁵¹		69723	81517	141974 ⁵³	49370 ³⁰
	Exc. HD Suspension		G55505	142223 ⁵³ 143060 ⁵¹		69723	81517	141974 ⁵³	49370 ³⁰
	HD Suspension		G55514	142223 ⁵³ 143060 ⁵¹		69723	81517	141974 ⁵³	49370 ³⁰
80-83	All		G55505	142223 ⁵³ 143060 ⁵¹		69723	81517	49370 ³⁰
75-79	All		69600	81494	34051 ⁸		82093	49193 ⁷
69-72	All		69600	81494	34051 ⁸		69604	81492	43060 ⁸ 49152 ³⁰
68	All		69600	81494		69604	81492	43060 ⁸ 49152 ³⁰
	HD Suspension; Exc. Sportwagon		69600	81494	34051 ⁸		69604	81492	43060 ⁸ 49152 ³⁰
64-67	Exc. HD Suspension			69724	81514	43049 ⁸ 49131 ³⁰
	HD Suspension; Exc. Sportwagon		82138		69604	81492	43060 ⁸ 49152 ³⁰
61-63	All			81495



SKYLARK READYMOUNTS

		Front	Rear
95-98	Left	G56917 ⁴⁰
	Right	G56916 ⁴⁰
92-94	Left Exc. FE3 and Electronic Ride Control	G56919 ⁴¹
	Right Exc. FE3 and Electronic Ride Control	G56918 ⁴¹
85	All	G56908 ⁴⁰
84	HD Suspension	G56908 ⁴⁰

SOMERSET / SOMERSET REGAL

85-87	All		142108 ⁵³ 142762 ⁵⁵ 143060 ⁵¹		69749	81530	141974 ⁵³	49371 ⁷
	Left Non-Rebuildable O.E. Struts		G56706	142108 ⁵³ 142762 ⁵⁵ 143060 ⁵¹		69749	81530	141974 ⁵³	49371 ⁷
	Rebuildable O.E. Struts		G44451 ⁹⁸	142108 ⁵³ 142762 ⁵⁵ 143060 ⁵¹		69749	81530	141974 ⁵³	49371 ⁷
	Right Non-Rebuildable O.E. Struts		G56705	142108 ⁵³ 142762 ⁵⁵ 143060 ⁵¹		69749	81530	141974 ⁵³	49371 ⁷

SPECIAL

68-69	All		69600	81494	34051 ⁸		69604	81492	43060 ⁸ 49152 ³⁰
-------	-----	---	-------	-------	------	------	--------------------	---	-------	-------	------	------	---

7 Pair Packs, air hose kit included.

30 For GM Vehicles equipped with factory installed leveling systems, see Ref A.

41 ReadyMount Strut. Complete Assembled Unit. See Ref. D for procedures to replace Elec Adj Susp with non-adj product.

53 Strut Mount. Hardware from O.E. Part may need to be reused.

98 Notice: The level of difficulty to install this product is moderately high. Please review the installation instructions carefully before proceeding.





8 Pair Packs.

40 ReadyMount Strut. Complete Assembled Unit.

51 Strut Cushion for use with the Strut/Cartridge/Shocks.

65 Mount Kit includes Upper Spring Seat with Isolator. Hardware from O.E. Part may need to be reused.













APPLICATION GUIDE

Year	Fitment Notes										
		 Ultra	ProGuard/ Guardian/ Classic	Max Control/ LTV	Strut Cushion/ Strut Mount	Hi Jacker/ Load Carrier	 Ultra	ProGuard/ Guardian/ Classic	Max Control/ LTV	Strut Cushion/ Strut Mount	Hi Jacker/ Load Carrier







BUICK

BUICK









SPECIAL (cont'd)

64-67	Exc. HD Suspension			69724	81514	43049 ⁸ 49131 ³⁰
	HD Suspension; Exc. Sportwagon		82138		69604	81492	43060 ⁸ 49152 ³⁰
61-63	All			81495
58	Exc. Air Susp		81270		82156
57	Exc. Air Susp			82156
56	All		82087		81147











SPORTWAGON

70-72	All		69600	81494	34051 ⁸		69604	81492	43060 ⁸ 49152 ³⁰
68-69	All		69600	81494	34051 ⁸		69606	81495	49114 ⁷
64-67	All		82138		69606	81495	49114 ⁷

SUPER

58	Exc. Air Susp		81270		82156
57	Exc. Air Susp			82156
56	All			81147
	Exc. Air Susp		82087		81147





TERRAZA

05-07	Exc. Air-Leveling Suspension		G52025	
	FWD		142526 ⁵⁴	
	FWD, Air-Leveling Suspension; Exc. Independent Rear Suspension			49230 ⁷
	FWD, Exc. Air-Leveling Suspension			G63776
05-06	AWD		G55948	

TERRAZA READYMOUNTS

		Front	Rear
05-07	FWD	G57142 ¹





WILDCAT

65-70	All		82601		82602
63-64	All		82087		82609

CADILLAC

CADILLAC

60 SPECIAL

93	All		G56718 ⁹	142226 ⁵⁴ 142227 ⁵⁸ 142751 ⁶⁵ 143060 ⁵¹		142132 ⁵³ 143060 ⁵¹
	Coil(RearSpringType) Conventional Type Replacement for Air Assist Rear Suspension		G56718 ⁹	142226 ⁵⁴ 142227 ⁵⁸ 142751 ⁶⁵ 143060 ⁵¹		G56707 ⁹	142132 ⁵³ 143060 ⁵¹

60 SPECIAL READYMOUNTS

		Front	Rear
93	All	G56909 ⁴⁰
	Air Assist Rear Suspension; Exc. Electronic Adjustable Suspension	G56909 ⁴⁰	G56906 ⁴²

1 Future Part, available 1st Quarter of 2015.

8 Pair Packs.

30 For GM Vehicles equipped with factory installed leveling systems, see Ref A.

42 ReadyMount Strut, does not include springs due to vehicle design.

53 Strut Mount. Hardware from O.E. Part may need to be reused.

58 Mount Kit includes Suspension Bearing. Hardware from O.E. Part may need to be reused.

7 Pair Packs, air hose kit included.

9 See Ref. D for procedures to replace Elec Adj Susp with non-adj product.





40 ReadyMount Strut. Complete Assembled Unit.

51 Strut Cushion for use with the Strut/Cartridge/Shocks.

54 Kit with Mount and Bearing. Hardware from O.E. Part may need to be reused.

65 Mount Kit includes Upper Spring Seat with Isolator. Hardware from O.E. Part may need to be reused.

APPLICATION GUIDE

Year	Fitment Notes										
			Ultra	ProGuard/ Guardian/ Classic	Max Control/ LTV	Strut Cushion/ Strut Mount	Hi Jacker/ Load Carrier		Ultra	ProGuard/ Guardian/ Classic	Max Control/ LTV





CADILLAC

CADILLAC





60 SPECIAL READYMOUNTS (cont'd)

		Front		Rear	
93	Coil(RearSpringType) Conventional Type Replacement for Air Assist Rear Suspension	G56909 ⁴⁰		G56726 ⁴²	

ALLANTE

89-93	All		142227 ⁵⁸
89-92	Exc. Electronic Adjustable Suspension		G56717	142297 ⁵⁴ 142227 ⁵⁸	142405 ⁵³
87-88	All		142227 ⁵⁸ 143061 ⁵¹
	Exc. Electronic Adjustable Suspension		G56703	142297 ⁵⁴ 142227 ⁵⁸ 143061 ⁵¹	142405 ⁵³







BROUGHAM

91-92	All		69675 ⁵	81446	142226 ⁵⁴ 143060 ⁵¹	34073 ⁸		69724	81514	43049 ⁹ 49131 ³⁰
87-90	All		69675 ⁵	81446	142225 ⁵⁴ 143061 ⁵¹	34073 ⁸		69724	81514	43049 ⁹ 49131 ³⁰

BROUGHAM STEERING STABILIZERS

		Front		Rear	
87-92	All		14019	















CALAIS

71-76	All		82601		82602
69-70	All		82601		82610
65-68	All		82601		82060





CATERA

97-01	All		G56769	143240 ⁵³
-------	-----	---	--------	-------	-------	----------------------	-------	-------	-------	-------	-------	-------

CIMARRON

87-88	Left		G56706	142108 ⁵³ 142762 ⁵⁵ 143060 ⁵¹		69749	81530	141974 ⁵³ 49371 ⁷
	Right		G56705	142108 ⁵³ 142762 ⁵⁵ 143060 ⁵¹		69749	81530	141974 ⁵³ 49371 ⁷
84-86	All		142762 ⁵⁵ 143060 ⁵¹		69749	81530	141974 ⁵³ 49371 ⁷
	Left Non-Rebuildable O.E. Struts		G56706	142762 ⁵⁵ 143060 ⁵¹		69749	81530	141974 ⁵³ 49371 ⁷
	Rebuildable O.E. Struts		G44451 ⁹⁸	142762 ⁵⁵ 143060 ⁵¹		69749	81530	141974 ⁵³ 49371 ⁷
	Right Non-Rebuildable O.E. Struts		G56705	142762 ⁵⁵ 143060 ⁵¹		69749	81530	141974 ⁵³ 49371 ⁷
82-83	All		G44918 ⁹⁸	142762 ⁵⁵ 143060 ⁵¹		69749	81530	49371 ⁷

COMMERCIAL CHASSIS

92-96	RWD		69675 ⁵	81446	34073 ⁸		69724	81514	43049 ⁹ 49131 ³⁰
91-93	FWD		G56718 ⁹	142226 ⁵⁴ 142227 ⁵⁸ 142751 ⁵⁵ 143060 ⁵¹	143060 ⁵¹
	FWD; Air Assist Rear Suspension; Exc. Electronic Adjustable Suspension			G56903	142132 ⁵³

5 Use kit No. 140719 to replace O.E. hardware for lower shock absorber mounting when studs break or self-tapping screws are not longer useable.

8 Pair Packs.

30 For GM Vehicles equipped with factory installed leveling systems, see Ref A.

42 ReadyMount Strut, does not include springs due to vehicle design.

53 Strut Mount. Hardware from O.E. Part may need to be reused.

58 Mount Kit includes Suspension Bearing. Hardware from O.E. Part may need to be reused.

98 Notice:The level of difficulty to install this product is moderately high. Please review the installation instructions carefully before proceeding.

7 Pair Packs, air hose kit included.

9 See Ref. D for procedures to replace Elec Adj Susp with non-adj product.



40 ReadyMount Strut. Complete Assembled Unit.

51 Strut Cushion for use with the Strut/Cartridge/Shocks.

54 Kit with Mount and Bearing. Hardware from O.E. Part may need to be reused.

65 Mount Kit includes Upper Spring Seat with Isolator. Hardware from O.E. Part may need to be reused.

APPLICATION GUIDE

Year	Fitment Notes										
		Ultra	ProGuard\Guardian\Classic	Max Control\LTV	Strut Cushion\Strut Mount	Hi Jacker\Load Carrier	Ultra	ProGuard\Guardian\Classic	Max Control\LTV	Strut Cushion\Strut Mount	Hi Jacker\Load Carrier

CADILLAC

CADILLAC

COMMERCIAL CHASSIS (cont'd)

91-93	FWD; Conventional Type Replacement for Air Assist Rear Suspension; Exc. Electronic Suspension	G56707 ⁹
85-90	All	G56701	142225 ⁵⁴ 142752 ⁶⁵ 143061 ⁵¹
	Air Assist Rear Suspension Standard Equipment	G56701	142225 ⁵⁴ 142752 ⁶⁵ 143061 ⁵¹	142132 ⁵³
	FWD	G56701	142227 ⁵⁸ 142225 ⁵⁴ 142752 ⁶⁵ 143061 ⁵¹	143060 ⁵¹
	FWD; Air Assist Rear Suspension Standard Equipment	G56701	142225 ⁵⁴ 142752 ⁶⁵ 143061 ⁵¹	G56903
	FWD; Conventional Type Replacement for Air Assist Rear Suspension; Exc. Electronic Suspension	G56701	142225 ⁵⁴ 142752 ⁶⁵ 143061 ⁵¹	G56707 ⁹
77-84	All	69675 ⁵	81446	34073 ⁸	69724	81514	43049 ⁸ 49131 ⁹⁰
75-76	All	82601	82125

COMMERCIAL CHASSIS READYMOUNTS

		Front	Rear
91-93	FWD	G56909 ⁴¹
85-90	All	G56914 ⁴⁰

COMMERCIAL CHASSIS STEERING STABILIZERS

		Front	Rear
92-96	RWD	14019
77-84	All	14019

CTS

12-13	Exc. Magnetic Ride Control Suspension	70031
09-11	All	G51901
	Exc. Magnetic Ride Control Suspension	G51901	70031
08	Exc. Magnetic Ride Control Suspension	70031
03-07	All	143092 ⁵³
	Exc. Magnetic Ride Control Suspension	G51746	143092 ⁵³	70031

DEVILLE

00-05	Exc. Electronic Adjustable Suspension	G56509	142640 ⁵⁴	142647 ⁵³	49228 ³⁰
	With OE Style air fitting Exc. Electronic Adjustable Suspension	49255 ⁷
98-99	Exc. Electronic Adjustable Suspension	142640 ⁵⁴	G56664
97-99	Electronic Ride Control	142527 ⁵⁴
94-97	Air(RearSpringType) Exc. Electronic Adjustable Suspension	G56664
97	Exc. Electronic Adjustable Suspension	142640 ⁵⁴

5 Use kit No. 140719 to replace O.E. hardware for lower shock absorber mounting when studs break or self-tapping screws are not longer useable.

8 Pair Packs.

30 For GM Vehicles equipped with factory installed leveling systems, see Ref A.

41 ReadyMount Strut. Complete Assembled Unit. See Ref. D for procedures to replace Elec Adj Susp with non-adj product.

53 Strut Mount. Hardware from O.E. Part may need to be reused.

58 Mount Kit includes Suspension Bearing. Hardware from O.E. Part may need to be reused.

7 Pair Packs, air hose kit included.

9 See Ref. D for procedures to replace Elec Adj Susp with non-adj product.





40 ReadyMount Strut. Complete Assembled Unit.

51 Strut Cushion for use with the Strut/Cartridge/Shocks.

54 Kit with Mount and Bearing. Hardware from O.E. Part may need to be reused.

65 Mount Kit includes Upper Spring Seat with Isolator. Hardware from O.E. Part may need to be reused.





























APPLICATION GUIDE

Year	Fitment Notes										
			ProGuard/ Guardian/ Classic	Max Control/ LTV	Strut Cushion/ Strut Mount	Hi Jacker/ Load Carrier		ProGuard/ Guardian/ Classic	Max Control/ LTV	Strut Cushion/ Strut Mount	Hi Jacker/ Load Carrier

CADILLAC

CADILLAC

DEVILLE (cont'd)

94-95	Left Exc. Electronic Adjustable Suspension		G56669			
	Right Exc. Electronic Adjustable Suspension		G56670			
91-93	All		142227 ⁵⁸ 142751 ⁶⁵ 143060 ⁵¹	142132 ⁵³ 143060 ⁵¹			
	Exc. Electronic Adjustable Suspension		G56718 ⁹	142226 ⁵⁴ 142227 ⁵⁸ 142751 ⁶⁵ 143060 ⁵¹	142132 ⁵³ 143060 ⁵¹			
	Air(RearSpringType) CCR Computer Command Ride		142227 ⁵⁸ 142751 ⁶⁵ 143060 ⁵¹		G56903	142132 ⁵³ 143060 ⁵¹		
	Air(RearSpringType) Conventional Type Replacement for Air Assist Rear Suspension		142227 ⁵⁸ 142751 ⁶⁵ 143060 ⁵¹		G56707 ⁹	142132 ⁵³ 143060 ⁵¹		
85-90	All		G56701	142225 ⁵⁴ 142227 ⁵⁸ 142752 ⁶⁵ 143061 ⁵¹	142132 ⁵³ 143060 ⁵¹			
	Air(RearSpringType) Air Assist Rear Suspension Standard Equipment		G56701	142225 ⁵⁴ 142227 ⁵⁸ 142752 ⁶⁵ 143061 ⁵¹		G56903	142132 ⁵³ 143060 ⁵¹		
	Air(RearSpringType) Conventional Type Replacement for Air Assist Rear Suspension		G56701	142225 ⁵⁴ 142227 ⁵⁸ 142752 ⁶⁵ 143061 ⁵¹		G56707 ⁹	142132 ⁵³ 143060 ⁵¹		
77-84	All		69675 ⁵	81446	34073 ⁸		69724	81514	43049 ⁹ 49131 ³⁰
71-76	All		82601		82602
69-70	All		82601		82610
65-68	All		82601		82060
61-64	All		82109		82125
58-60	All		82099		82125
56	All		82099		82034
55	All			82034
54	All			82066
53	All		82026		82066

DEVILLE READYMOUNTS

		Front	Rear
00-05	Exc. Electronic Adjustable Suspension	G57051 ⁴⁰
91-93	Exc. Electronic Adjustable Suspension	G56909 ⁴¹
	Air(RearSpringType) CCR Computer Command Ride	G56906 ⁴³
	Air(RearSpringType) Conventional Type Replacement for Air Assist Rear Suspension	G56726 ⁴³
85-90	All	G56914 ⁴⁰
	Air(RearSpringType) Air Assist Rear Suspension Standard Equipment	G56914 ⁴⁰	G56906 ⁴³
	Air(RearSpringType) Conventional Type Replacement for Air Assist Rear Suspension	G56914 ⁴⁰	G56726 ⁴³

DTS

06-11	Exc. Magnetic Ride Control Suspension		G52116
-------	---------------------------------------	---	--------	------	------	------	------	------	------	------	------	------

5 Use kit No. 140719 to replace O.E. hardware for lower shock absorber mounting when studs break or self-tapping screws are not longer useable.

9 See Ref. D for procedures to replace Elec Adj Susp with non-adj product.

40 ReadyMount Strut. Complete Assembled Unit.

43 ReadyMount Strut, does not include springs due to vehicle design. See Ref. D for procedures to replace Elec Adj Susp with non-adj product.

53 Strut Mount. Hardware from O.E. Part may need to be reused.

58 Mount Kit includes Suspension Bearing. Hardware from O.E. Part may need to be reused.

8 Pair Packs.

30 For GM Vehicles equipped with factory installed leveling systems, see Ref A.



41 ReadyMount Strut. Complete Assembled Unit. See Ref. D for procedures to replace Elec Adj Susp with non-adj product.

51 Strut Cushion for use with the Strut/Cartridge/Shocks.

54 Kit with Mount and Bearing. Hardware from O.E. Part may need to be reused.

65 Mount Kit includes Upper Spring Seat with Isolator. Hardware from O.E. Part may need to be reused.

APPLICATION GUIDE

Year	Fitment Notes										
		Ultra	ProGuard\Guardian\Classic	Max Control\LTV	Strut Cushion\Strut Mount	Hi Jacker\Load Carrier	Ultra	ProGuard\Guardian\Classic	Max Control\LTV	Strut Cushion\Strut Mount	Hi Jacker\Load Carrier

CADILLAC

CADILLAC

ELDORADO

97-02	Electronic Ride Control	142527 ⁵⁴ 142227 ⁵⁸ 142297 ⁵⁴
	Exc. Electronic Ride Control	142227 ⁵⁸ 142297 ⁵⁴	⊥ ○	49254 ⁸
	Left Exc. Electronic Adjustable Suspension	⊥ ○ G56775	142227 ⁵⁸ 142297 ⁵⁴
	Right Exc. Electronic Adjustable Suspension	⊥ ○ G56776	142227 ⁵⁸ 142297 ⁵⁴
94-02	All	142227 ⁵⁸ 142297 ⁵⁴
91-93	All	⊥ ○ G56717 ⁹	142227 ⁵⁸ 142297 ⁵⁴	⊥ ○ G56704 ⁹	142405 ⁵³
90	All	⊥ ○ G56717 ⁹	142297 ⁵⁴	⊥ ○ G56704 ⁹	142405 ⁵³
87-89	All	⊥ ○ G56703	142297 ⁵⁴ 143061 ⁵¹	⊥ ○ G56704 ⁹	142405 ⁵³
86	All	⊥ ○ G56703	142298 ⁵⁴ 143061 ⁵¹	⊥ ○ G56704 ⁹	142405 ⁵³
79-85	All	○ ○ 69706	81445	○ ○	49345 ³⁰
71-78	All	○ ○	82010	○ ○
68-70	Vertically Mounted	○ ○	82010	⊥ ○	82040	49122 ⁷
67	Vertically Mounted	○ ○	82010	⊥ ○	82034

ELDORADO STEERING STABILIZERS

		Front	Rear
79-85	All	14020
67-78	All	14010

ESCALADE

11	All	○ ○ G63866	
02-10	All	○ ○ G63866	58930 77953	
	Exc. Electronic Ride Control	○ ○ G63866	61675	58930 77953	
99-00	All	○ ○ G63609	61542 81726	58609 77609	○ ○ G63638	61565 81789	58638 77638	43180 ⁸ 49231 ⁷

ESCALADE ESV

03-10	Exc. Electronic Ride Control	○ ○	61675
-------	------------------------------	------	------	------	------	------	--------	-------	------	------	------

ESCALADE EXT

02-10	Exc. Electronic Ride Control	○ ○	61675
-------	------------------------------	------	------	------	------	------	--------	-------	------	------	------

FLEETWOOD

94-96	All	⊥ ○	34073 ⁸	
	RWD	⊥ ○ 69675 ⁵	81446	34073 ⁸	⊥ ○ 69724	81514	43049 ⁹ 49131 ³⁰
93	All	⊥ ○ G56718 ⁹	142226 ⁵⁴ 142227 ⁵⁸ 142751 ⁶⁵ 143060 ⁵¹	34073 ⁸	143060 ⁵¹
	Air Assist Rear Suspension; Exc. Electronic Adjustable Suspension	⊥ ○ G56718 ⁹	142226 ⁵⁴ 142227 ⁵⁸ 142751 ⁶⁵ 143060 ⁵¹	34073 ⁸	⊥ ○ G56903	143060 ⁵¹

5 Use kit No. 140719 to replace O.E. hardware for lower shock absorber mounting when studs break or self-tapping screws are not longer useable.

8 Pair Packs.

30 For GM Vehicles equipped with factory installed leveling systems, see Ref A.

53 Strut Mount. Hardware from O.E. Part may need to be reused.

58 Mount Kit includes Suspension Bearing. Hardware from O.E. Part may need to be reused.

7 Pair Packs, air hose kit included.

9 See Ref. D for procedures to replace Elec Adj Susp with non-adj product.

51 Strut Cushion for use with the Strut/Cartridge/Shocks.

54 Kit with Mount and Bearing. Hardware from O.E. Part may need to be reused.

65 Mount Kit includes Upper Spring Seat with Isolator. Hardware from O.E. Part may need to be reused.

APPLICATION GUIDE

Year	Fitment Notes										
		Ultra	ProGuard/ Guardian/ Classic	Max Control/ LTV	Strut Cushion/ Strut Mount	Hi Jacker/ Load Carrier	Ultra	ProGuard/ Guardian/ Classic	Max Control/ LTV	Strut Cushion/ Strut Mount	Hi Jacker/ Load Carrier

CADILLAC

CADILLAC

FLEETWOOD (cont'd)

93	Conventional Type Replacement for Air Assist Rear Suspension	G56718 ⁸	142226 ⁵⁴ 142227 ⁵⁸ 142751 ⁵⁵ 143060 ⁵¹	34073 ⁸	G56707 ⁹	143060 ⁵¹
	Exc. Electronic Adjustable Suspension	G56718 ⁸	142226 ⁵⁴ 142227 ⁵⁸ 142751 ⁵⁵ 143060 ⁵¹	34073 ⁸	142132 ⁵³ 143060 ⁵¹
	RWD	69675 ⁵	81446	142226 ⁵⁴ 142227 ⁵⁸ 142751 ⁵⁵ 143060 ⁵¹	34073 ⁸	69724	81514	143060 ⁵¹	43049 ⁸ 49131 ³⁰
91-92	All	G56718 ⁸	142226 ⁵⁴ 142227 ⁵⁸ 142751 ⁵⁵ 143060 ⁵¹	143060 ⁵¹
	Air Assist Rear Suspension; Exc. Electronic Adjustable Suspension	G56718 ⁸	142226 ⁵⁴ 142227 ⁵⁸ 142751 ⁵⁵ 143060 ⁵¹	G56903	143060 ⁵¹
	Conventional Type Replacement for Air Assist Rear Suspension	G56718 ⁸	142226 ⁵⁴ 142227 ⁵⁸ 142751 ⁵⁵ 143060 ⁵¹	G56707 ⁹	143060 ⁵¹
	Exc. Electronic Adjustable Suspension	G56718 ⁸	142226 ⁵⁴ 142227 ⁵⁸ 142751 ⁵⁵ 143060 ⁵¹	142132 ⁵³ 143060 ⁵¹
87-90	All	G56701	142225 ⁵⁴ 142227 ⁵⁸ 142752 ⁵⁵ 143061 ⁵¹	143060 ⁵¹
	Air Assist Rear Suspension Standard Equipment	G56701	142225 ⁵⁴ 142227 ⁵⁸ 142752 ⁵⁵ 143061 ⁵¹	G56903	142132 ⁵³ 143060 ⁵¹
	Conventional Type Replacement for Air Assist Rear Suspension	G56701	142225 ⁵⁴ 142227 ⁵⁸ 142752 ⁵⁵ 143061 ⁵¹	G56707 ⁹	143060 ⁵¹
86	All	G56701	142225 ⁵⁴ 142227 ⁵⁸ 143061 ⁵¹	143060 ⁵¹
	Air Assist Rear Suspension Standard Equipment	G56701	142225 ⁵⁴ 142227 ⁵⁸ 143061 ⁵¹	G56903	143060 ⁵¹
	Conventional Type Replacement for Air Assist Rear Suspension	G56701	142225 ⁵⁴ 142227 ⁵⁸ 143061 ⁵¹	G56707 ⁹	143060 ⁵¹
	Exc. Electronic Adjustable Suspension	G56701	142225 ⁵⁴ 142227 ⁵⁸ 143061 ⁵¹	142132 ⁵³ 143060 ⁵¹
	RWD	69675 ⁵	81446	142225 ⁵⁴ 142227 ⁵⁸ 143061 ⁵¹	34073 ⁸	69724	81514	143060 ⁵¹	43049 ⁸ 49131 ³⁰
85	All	G56701	142225 ⁵⁴ 142227 ⁵⁸ 143061 ⁵¹	143060 ⁵¹
	Air Assist Rear Suspension Standard Equipment	G56701	142225 ⁵⁴ 142227 ⁵⁸ 143061 ⁵¹	G56903	143060 ⁵¹
	Conventional Type Replacement for Air Assist Rear Suspension	G56701	142225 ⁵⁴ 142227 ⁵⁸ 143061 ⁵¹	G56707 ⁹	143060 ⁵¹
	Exc. Electronic Adjustable Suspension	G56701	142225 ⁵⁴ 142227 ⁵⁸ 143061 ⁵¹	142132 ⁵³ 143060 ⁵¹
	RWD	69675 ⁵	81446	142225 ⁵⁴ 142227 ⁵⁸ 143061 ⁵¹	34073 ⁸	69724	81514	143060 ⁵¹	43049 ⁸ 49131 ³⁰
77-84	All	34073 ⁸	

5 Use kit No. 140719 to replace O.E. hardware for lower shock absorber mounting when studs break or self-tapping screws are not longer useable.

9 See Ref. D for procedures to replace Elec Adj Susp with non-adj product.

51 Strut Cushion for use with the Strut/Cartridge/Shocks.

54 Kit with Mount and Bearing. Hardware from O.E. Part may need to be reused.

65 Mount Kit includes Upper Spring Seat with Isolator. Hardware from O.E. Part may need to be reused.



8 Pair Packs.

30 For GM Vehicles equipped with factory installed leveling systems, see Ref A.

53 Strut Mount. Hardware from O.E. Part may need to be reused.

58 Mount Kit includes Suspension Bearing. Hardware from O.E. Part may need to be reused.









APPLICATION GUIDE

Year	Fitment Notes										
		Ultra	ProGuard/ Guardian/ Classic	Max Control/ LTV	Strut Cushion/ Strut Mount	Hi Jacker/ Load Carrier	Ultra	ProGuard/ Guardian/ Classic	Max Control/ LTV	Strut Cushion/ Strut Mount	Hi Jacker/ Load Carrier















CADILLAC

CADILLAC

FLEETWOOD (cont'd)

77-84	RWD		69675 ⁵	81446	34073 ⁸		69724	81514	43049 ⁸ 49131 ³⁰
71-76	All		82601		82602
69-70	All		82601		82610
65-68	All		82601		82060

FLEETWOOD / 60 SERIES / 70 SERIES

61-64	All		82109		82125
57-60	All		82099		82125
56	All		82099		82034
55	All			82034
54	All			82066
52-53	All		82026		82066
50-51	All		82026		82060

























FLEETWOOD READYMOUNTS

		Front	Rear
91-93	All	G56909 ⁴¹
	Air Assist Rear Suspension; Exc. Electronic Adjustable Suspension	G56909 ⁴¹	G56906 ⁴³
	Conventional Type Replacement for Air Assist Rear Suspension	G56909 ⁴¹	G56726 ⁴³
85-90	All	G56914 ⁴⁰
	Air Assist Rear Suspension Standard Equipment	G56914 ⁴⁰	G56906 ⁴³
	Conventional Type Replacement for Air Assist Rear Suspension	G56914 ⁴⁰	G56726 ⁴³

FLEETWOOD STEERING STABILIZERS

		Front	Rear
85-96	RWD	14019

SEVILLE

98-04	All		142524 ⁵⁸		49228 ³⁰
	Exc. Electronic Adjustable Suspension		G56509	142640 ⁵⁴ 142524 ⁵⁸		142647 ⁵³	49228 ³⁰
	With OE Style air fitting Exc. Electronic Adjustable Suspension		142524 ⁵⁸		49255 ⁷ 49228 ³⁰
94-97	All		142227 ⁵⁸ 142527 ⁵⁴	
93	All		142227 ⁵⁸ 142527 ⁵⁴		142405 ⁵³
	SSS Speed Sensitive Suspension or CCR Computer Command Ride; Non adjustable		G56717 ⁹	142227 ⁵⁸ 142527 ⁵⁴		G56704 ⁹	142405 ⁵³
90-92	All		142227 ⁵⁸ 142297 ⁵⁴		142405 ⁵³
	SSS Speed Sensitive Suspension or CCR Computer Command Ride; Non adjustable		G56717 ⁹	142227 ⁵⁸ 142297 ⁵⁴		G56704 ⁹	142405 ⁵³
87-89	All		G56703	142227 ⁵⁸ 142297 ⁵⁴ 143061 ⁵¹		G56704 ⁹	142405 ⁵³
86	All		G56703	142298 ⁵⁴ 143061 ⁵¹		G56704 ⁹	142405 ⁵³
80-85	All		69706	81445		49345 ³⁰
76-79	All		69600	81494	34051 ⁸	

5 Use kit No. 140719 to replace O.E. hardware for lower shock absorber mounting when studs break or self-tapping screws are not longer useable.

8 Pair Packs.

30 For GM Vehicles equipped with factory installed leveling systems, see Ref A.

41 ReadyMount Strut. Complete Assembled Unit. See Ref. D for procedures to replace Elec Adj Susp with non-adj product.

51 Strut Cushion for use with the Strut/Cartridge/Shocks.

54 Kit with Mount and Bearing. Hardware from O.E. Part may need to be reused.

7 Pair Packs, air hose kit included.

9 See Ref. D for procedures to replace Elec Adj Susp with non-adj product.





40 ReadyMount Strut. Complete Assembled Unit.

43 ReadyMount Strut, does not include springs due to vehicle design. See Ref. D for procedures to replace Elec Adj Susp with non-adj product.

53 Strut Mount. Hardware from O.E. Part may need to be reused.

58 Mount Kit includes Suspension Bearing. Hardware from O.E. Part may need to be reused.

APPLICATION GUIDE

Year	Fitment Notes										
			Ultra	ProGuard/ Guardian/ Classic	Max Control/ LTV	Strut Cushion/ Strut Mount	Hi Jacker/ Load Carrier		Ultra	ProGuard/ Guardian/ Classic	Max Control/ LTV

CADILLAC

CADILLAC

SEVILLE READYMOUNTS

		Front	Rear
98-04	Exc. Electronic Adjustable Suspension	G57051 ⁴⁰









SEVILLE STEERING STABILIZERS

		Front	Rear
80-85	All	14020
76-79	All	14018







CHEVROLET

CHEVROLET

ASTRO

90-05	All			G63454	61539 81581	77454	43161 ⁸ 49215 ⁷	
	AWD		G63818	61542 81726	58609 77609		G63454	61539 81581	77454	43161 ⁸ 49215 ⁷
	RWD		G63375 ⁵	61555 81713 ⁵	77375		G63454	61539 81581	77454	43161 ⁸ 49215 ⁷
85-89	RWD		G63375 ⁵	61555 81713 ⁵	77375		G63454	61539 81581	77454	43161 ⁸ 49215 ⁷



AVALANCHE 1500

07-13	Exc. Z55 or ZW7 Ride Suspension		G51891
08-11	Exc. Electronic Ride Control		143316 ⁵³		G63866
07	Exc. Electronic Ride Control		143316 ⁵³		G63866	61675 81930	58930 77953
02-06	Exc. Electronic Ride Control		G63803	61643 81922	58803 77803		G63866	61675 81930	58930 77953





AVALANCHE 1500 READYMOUNTS

		Front	Rear
07-11	All	G57125⁴⁰

AVALANCHE 2500

02-06	Exc. Electronic Ride Control		G63817	61663 81925	58817 77817		G63866	61675 81930	58930 77953
-------	------------------------------	---	--------	----------------	----------------	------	------	---	--------	----------------	----------------	------	------





















AVEO

04-11	Left		G56886	143239 ⁵³		G51747	143375⁵³
	Right		G51921	143239 ⁵³		G51747	143375⁵³

AVEO READYMOUNTS

		Front	Rear
04-11	Left	G57130⁴⁰

BEL AIR

81	All		77375	
	Sedan		81446	77375	34073 ⁸		69724	81514	43049 ⁸ 49131 ³⁰
	Sedan Exc. Police and Taxi Models		69675 ⁵	77375	
	Sedan Police and Taxi Models		G63375 ⁵	61555	77375	
75	All		77375		69724	81514
	Sedan		81446	77375	34073 ⁸		69724	81514	43049 ⁸ 49131 ³⁰
	Sedan Exc. Police and Taxi Models		69675 ⁵	77375		69724	81514
	Sedan Police and Taxi Models		G63375 ⁵	61555	77375		69724	81514
	Wagon		81713 ⁵	77375		69724	81514
71-74	All		77375	34073 ⁸		69724	81514	43049 ⁸ 49131 ³⁰

5 Use kit No. 140719 to replace O.E. hardware for lower shock absorber mounting when studs break or self-tapping screws are not longer useable.

8 Pair Packs.

40 ReadyMount Strut. Complete Assembled Unit.



Bold Type - New / Future Part

7 Pair Packs, air hose kit included.

30 For GM Vehicles equipped with factory installed leveling systems, see Ref A.

53 Strut Mount. Hardware from O.E. Part may need to be reused.

APPLICATION GUIDE

Year	Fitment Notes										
		Ultra	ProGuard\Guardian\Classic	Max Control\LTV	Strut Cushion\Strut Mount	Hi Jacker\Load Carrier	Ultra	ProGuard\Guardian\Classic	Max Control\LTV	Strut Cushion\Strut Mount	Hi Jacker\Load Carrier

CHEVROLET

CHEVROLET

BEL AIR (cont'd)

71-74	Sedan	81446	77375	34073 ⁸	69724	81514	43049 ⁸ 49131 ³⁰
	Sedan Exc. Police and Taxi Models	69675 ⁵	77375	34073 ⁸	69724	81514	43049 ⁸ 49131 ³⁰
	Sedan Police and Taxi Models	G63375 ⁵	61555	77375	34073 ⁸	69724	81514	43049 ⁸ 49131 ³⁰
	Wagon	81713 ⁵	77375	34073 ⁸	69724	81514	43049 ⁸ 49131 ³⁰
65-70	All	69675 ⁵	81446	34073 ⁸	69724	81514	43049 ⁸ 49131 ³⁰
58-64	All	82118	82051
55-57	All	69625	82099	82066
51-54	All	82026	82155
50	All	82026
	Exc. Air Susp	82026	82155

BERETTA

95-96	Left	G56720 ⁹	142227 ⁵⁸ 142406 ⁵⁴ 142748 ⁶⁵ 143059 ⁵¹	69407 ⁹	81790	141974 ⁵³	49614 ⁷
	Right	G56719 ⁹	142227 ⁵⁸ 142406 ⁵⁴ 142748 ⁶⁵ 143059 ⁵¹	69407 ⁹	81790	141974 ⁵³	49614 ⁷
94	All	142224 ⁵⁴ 142227 ⁵⁸ 142748 ⁶⁵ 143059 ⁵¹
	Base, Left Exc. FE7 Suspension	G56720 ⁹	142224 ⁵⁴ 142227 ⁵⁸ 142748 ⁶⁵ 143059 ⁵¹	69749	81530	141974 ⁵³	49371 ⁷
	Base, Right Exc. FE7 Suspension	G56719 ⁹	142224 ⁵⁴ 142227 ⁵⁸ 142748 ⁶⁵ 143059 ⁵¹	69749	81530	141974 ⁵³	49371 ⁷
	Z26, Left FE7 Suspension	G56723	142224 ⁵⁴ 142227 ⁵⁸ 142748 ⁶⁵ 143059 ⁵¹
	Z26, Right FE7 Suspension	G56724	142224 ⁵⁴ 142227 ⁵⁸ 142748 ⁶⁵ 143059 ⁵¹
92-93	All	142224 ⁵⁴ 142227 ⁵⁸ 142750 ⁶⁵ 143059 ⁵¹
	Base, Left Exc. FE7 Suspension	G56720 ⁹	142224 ⁵⁴ 142227 ⁵⁸ 142750 ⁶⁵ 143059 ⁵¹	69749	81530	141974 ⁵³	49371 ⁷
	Base, Right Exc. FE7 Suspension	G56719 ⁹	142224 ⁵⁴ 142227 ⁵⁸ 142750 ⁶⁵ 143059 ⁵¹	69749	81530	141974 ⁵³	49371 ⁷
	GT, GTZ, Left FE7 Suspension	G56723	142224 ⁵⁴ 142227 ⁵⁸ 142750 ⁶⁵ 143059 ⁵¹
	GT, GTZ, Right FE7 Suspension	G56724	142224 ⁵⁴ 142227 ⁵⁸ 142750 ⁶⁵ 143059 ⁵¹

5 Use kit No. 140719 to replace O.E. hardware for lower shock absorber mounting when studs break or self-tapping screws are not longer useable.

8 Pair Packs.

30 For GM Vehicles equipped with factory installed leveling systems, see Ref A.

53 Strut Mount. Hardware from O.E. Part may need to be reused.

58 Mount Kit includes Suspension Bearing. Hardware from O.E. Part may need to be reused.

7 Pair Packs, air hose kit included.



9 See Ref. D for procedures to replace Elec Adj Susp with non-adj product.

51 Strut Cushion for use with the Strut/Cartridge/Shocks.

54 Kit with Mount and Bearing. Hardware from O.E. Part may need to be reused.

65 Mount Kit includes Upper Spring Seat with Isolator. Hardware from O.E. Part may need to be reused.





APPLICATION GUIDE

Year	Fitment Notes										
		Ultra	ProGuard/ Guardian/ Classic	Max Control/ LTV	Strut Cushion/ Strut Mount	Hi Jacker/ Load Carrier	Ultra	ProGuard/ Guardian/ Classic	Max Control/ LTV	Strut Cushion/ Strut Mount	Hi Jacker/ Load Carrier

CHEVROLET

CHEVROLET













BERETTA (cont'd)

87-91	Left		G56706	142148 ⁵³ 142762 ⁵⁵ 143060 ⁵¹		69749	81530	141974 ⁵³	49371 ⁷
	Right		G56705	142148 ⁵³ 142762 ⁵⁵ 143060 ⁵¹		69749	81530	141974 ⁵³	49371 ⁷























BERETTA READYMOUNTS

		Front	Rear
95-96	Left	G56917 ⁴⁰
	Right	G56916 ⁴⁰
92-94	Exc. FE7 Suspension Left	G56919 ⁴¹
94	Right Exc. FE7 Suspension	G56918 ⁴¹
92-93	Base, Right Exc. FE7 Suspension	G56918 ⁴¹
87-91	Left	G56921 ⁴⁰
	Right	G56920 ⁴⁰









BISCAYNE

71-72	All		69675 ⁵	77375	34073 ⁸		69724	81514	43049 ⁸ 49131 ³⁰
	Exc. Police and Taxi Models		69675 ⁵	81446	77375	34073 ⁸		69724	81514	43049 ⁸ 49131 ³⁰
	Police and Taxi Models		69675 ⁵	61555 81713 ⁵	77375	34073 ⁸		69724	81514	43049 ⁸ 49131 ³⁰
65-70	All		34073 ⁸		69724	81514	43049 ⁸ 49131 ³⁰
	Exc. Police and Taxi Models		81446	34073 ⁸		69724	81514	43049 ⁸ 49131 ³⁰
58-64	All		82118		82051

BLAZER 2WD

95-05	RWD; S Models, Exc. Xtreme Models		G63421	61504 81750	58423 77421	34051 ⁸		G63422	61528 81482	58422 77422	43162 ⁸ 49213 ⁷
81-84	Exc. Lift Kit			G63349	61524 81164	58349 77349	43111 ⁸
73-84	RWD		G63355	61525 81039	58355 77355	34036 ⁸	
75-80	Exc. Lift Kit			G63349	61524 81164	58349 77349	43111 ⁸ 49155 ⁷
73-74	Exc. Lift Kit			G63349	61524 81164	58349	43111 ⁸ 49155 ⁷
71-72	Coil(RearSpringType)			82003	43062 ⁸ 49107 ⁷
69-72	Leaf(RearSpringType)			82006	49162 ⁷
	RWD		G63355	61525 81039	58355 77355	34036 ⁸		G63306
	RWD, Leaf(RearSpringType)			43093 ⁸
69-70	Coil(RearSpringType)			82003	49107 ⁷
	RWD, Coil(RearSpringType)			43062 ⁸

BLAZER 4WD

95-05	4WD; S Models; Exc. ZR2		G63423	61531 81516	58423 77423		G63422	61528 81482	58422 77422	43162 ⁸ 49213 ⁷
92-94	4WD, Full Size		G63609	61542 81726	58609 77609		G63638 ⁵⁰	61565 81789	58638 77638	43180 ⁸ 49231 ⁷
87-91	4WD, Full Size; Quad Suspension Long Shock; Exc. Lift Kit		G63906 ⁸	61522 ⁸ 81496 ⁸	58906 ⁸	
	4WD, Full Size; Quad Suspension Short Shock; Exc. Lift Kit		G63908 ⁸	61516 ⁸ 81113 ⁸	58908 ⁸	

5 Use kit No. 140719 to replace O.E. hardware for lower shock absorber mounting when studs break or self-tapping screws are not longer useable.

7 Pair Packs, air hose kit included.

30 For GM Vehicles equipped with factory installed leveling systems, see Ref A.

41 ReadyMount Strut. Complete Assembled Unit. See Ref. D for procedures to replace Elec Adj Susp with non-adj product.

51 Strut Cushion for use with the Strut/Cartridge/Shocks.

65 Mount Kit includes Upper Spring Seat with Isolator. Hardware from O.E. Part may need to be reused.

6 It is recommended that when replacing shocks on vehicles with "quad shocks" all 4 shocks should be matched by series.



8 Pair Packs.

40 ReadyMount Strut. Complete Assembled Unit.

50 Bellows Kit No.141242 is recommended for use to protect piston rod from potentially harmful road debris.

53 Strut Mount. Hardware from O.E. Part may need to be reused.

APPLICATION GUIDE

Year	Fitment Notes										
		Ultra	ProGuard/ Guardian/ Classic	Max Control/ LTV	Strut Cushion/ Strut Mount	Hi Jacker/ Load Carrier	Ultra	ProGuard/ Guardian/ Classic	Max Control/ LTV	Strut Cushion/ Strut Mount	Hi Jacker/ Load Carrier

CHEVROLET

CHEVROLET

BLAZER 4WD (cont'd)

87-91	4WD; Full Size; Exc. Quad Suspension and Lift Kit	⊖	G63347	58347 ⁵⁰	43107 ⁸	⊖	G63349	61524 81164	58349 ⁵⁰ 77349	43111 ⁸ 49155 ⁷
91	4WD; Full Size; 4" Lift Kit; Exc. Quad Suspension	⊖	G63437 ⁵⁰	58437 ⁵⁰	⊖
87-90	4WD; Full Size; 4" Lift Kit; Exc. Quad Suspension	⊖	G63437 ⁵⁰	58437 ⁵⁰	⊖	G63438 ⁵⁰	58438 ⁵⁰
85-86	4WD; Exc. Quad Suspension and Lift Kit	⊖	G63347	58347 ⁵⁰	43107 ⁸	⊖	G63349	61524 81164	58349 77349	43111 ⁸ 49155 ⁷
81-86	4WD, Quad Suspension Long Shock; Exc. Lift Kit	⊖	G63906 ⁸	61522 ⁶ 81496 ⁶	58906 ⁵	⊖
	4WD, Quad Suspension Short Shock; Exc. Lift Kit	⊖	G63908 ⁸	61516 81113 ⁶	58908 ⁵	⊖
73-86	4WD; 4" Lift Kit; Exc. Quad Suspension	⊖	G63437 ⁵⁰	58437 ⁵⁰	⊖	G63438 ⁵⁰	58438 ⁵⁰
81-84	Exc. Lift Kit	⊖	⊖	G63349	61524 81164	58349 77349	43111 ⁸
	4WD; Exc. Quad Suspension and Lift Kit	⊖	G63347	58347 ⁵⁰	43107 ⁸	⊖	49155 ⁷
75-80	Exc. Lift Kit	⊖	⊖	G63349	61524 81164	58349 77349	43111 ⁸ 49155 ⁷
73-80	4WD; Exc. Quad Suspension and Lift Kit	⊖	G63347	61516 81113	58347 ⁵⁰	43107 ⁸	⊖
73-74	Exc. Lift Kit	⊖	⊖	G63349	61524 81164	58349	43111 ⁸ 49155 ⁷
	4WD, Exc. Lift Kit	⊖	⊖	77349
71-72	Coil(RearSpringType)	⊖	⊖	82003	43062 ⁸ 49107 ⁷
69-72	Leaf(RearSpringType)	⊖	⊖	82006	49162 ⁷
	4WD	⊖	61516 81113	58347 ⁵⁰	43107 ⁸	⊖	G63371
	4WD, Exc. Lift Kit	⊖	G63347	⊖
69-70	Coil(RearSpringType)	⊖	⊖	82003	49107 ⁷

BLAZER STEERING STABILIZERS 2WD

		Front	Rear
81-84	RWD, Single System without OE	6849SE ⁸²
79-84	RWD, Dual System Steering Stabilizer	6802SE ⁸⁴
75-84	RWD	14017
	RWD, Single System Steering Stabilizer	6804SE ⁸⁰
69-72	Single System Steering Stabilizer	6803SE ⁸⁴

BLAZER STEERING STABILIZERS 4WD

		Front	Rear
87-91	4WD, Full Size	14017
84-86	4WD, Single System Steering Stabilizer; without a factory mounting hole in the steering linkage.	6851SE ⁸²
79-86	4WD, Dual System Steering Stabilizer	6802SE ⁸⁴
75-86	4WD	14017
	4WD, Single System Steering Stabilizer	6804SE ⁸⁰
69-72	Single System Steering Stabilizer	6803SE ⁸⁴

BLAZER, S MODELS

88-94	4WD, Torsion Bar(FrontSpringType)	⊖	142316 ⁵³	⊖	G63422	61528 81482	58422 77422	43162 ⁸ 49213 ⁷	
83-94	All	⊖	⊖	G63422	61528 81482	58422 77422	43162 ⁸ 49213 ⁷	
	4WD	⊖	G63423	61531 81516	58423 77423	⊖	G63422	61528 81482	58422 77422	43162 ⁸ 49213 ⁷
	RWD	⊖	G63421	61504 81750	58421 77421	34051 ⁸	⊖	G63422	61528 81482	58422 77422	43162 ⁸ 49213 ⁷

6 It is recommended that when replacing shocks on vehicles with "quad shocks" all 4 shocks should be matched by series.

8 Pair Packs.

53 Strut Mount. Hardware from O.E. Part may need to be reused.

82 Use kit if listed, See Ref. C for optional Steering Stabilizer Boots.





7 Pair Packs, air hose kit included.

50 Bellows Kit No.141242 is recommended for use to protect piston rod from potentially harmful road debris.

80 Mounting bracket not required, install on O.E. Shock Mounts. See Ref. C for optional Steering Stabilizer Boots.

84 Replacement damper for vehicles with the Gabriel Aftermarket mounting kit

APPLICATION GUIDE

Year	Fitment Notes										
			Ultra	ProGuard/ Guardian/ Classic	Max Control/ LTV	Strut Cushion/ Strut Mount	Hi Jacker/ Load Carrier		Ultra	ProGuard/ Guardian/ Classic	Max Control/ LTV





CHEVROLET

CHEVROLET

























BLAZER, S MODELS STEERING STABILIZERS

		Front	Rear
83-94	Single System Steering Stabilizer; with a factory mounting hole in the steering linkage.	6801SE

BROOKWOOD

71-72	All	 69675 ⁵	81446	34073 ⁸	 69604	81492
69-70	All	 69675 ⁵	81446	34073 ⁸	 69724	81514	43049 ⁹ 49131 ³⁰



















CAMARO

10-13	3.6L V6 Left	 G52280	 G51916¹
	3.6L V6 Right	 G52281	 G51916¹
93-02	All	 G51204	142412 ⁶³	 69676	81481	75676	49203 ⁷
	Left	 G51204	142408 ⁶³ 142412 ⁶³	 69676	81481	75676	49203 ⁷
	Right	 G51204	142409 ⁶³ 142412 ⁶³	 69676	81481	75676	49203 ⁷
82-92	Left	 G56700	142146 ⁶³	 69676	81481	75676	49203 ⁷
	Right	 G56700	142145 ⁶³	 69676	81481	75676	49203 ⁷
70-81	All	 69675 ⁵	81446	34073 ⁸	 69624	81095	43084 ⁹ 49135 ³⁰
68-69	All	 69600	81494
	Leaf(RearSpringType)	 69600	81494	 69606
	Multi-Leaf Rear Spring	 69600	81494		81495
	Leaf(RearSpringType) Single Leaf Rear Springs	 69600	81494		82040	49122 ⁷
67	All	 69600	81494		82040	49122 ⁷

CAMARO READYMOUNTS

		Front	Rear
93-02	Left	G57107⁴⁰
	Right	G57108⁴⁰

CAPRICE

91-96	Exc. Police and Taxi Models	 69675 ⁵	81446	34073 ⁸
81-96	Sedan Police and Taxi Models	 G63375 ⁵	61555 81713 ⁵	77375	34073 ⁸	 69724	81514	43049 ⁹ 49131 ³⁰
77-96	Wagon	 69675 ⁵	34073 ⁸	 69604	81492	43060 ⁹ 49152 ³⁰
71-96	All	 69675 ⁵	34073 ⁸
73-90	Wagon Exc. Police and Taxi Models	 69675 ⁵	81446	34073 ⁸
75-80	Exc. Wagon	 69675 ⁵	34073 ⁸		43049 ⁹ 49131 ³⁰
80	Sedan Police and Taxi Models	 G63375 ⁵	61555 81713 ⁵	77375	34073 ⁸	 69724	81514
78-79	Sedan	 69675 ⁵	77375	34073 ⁸
	Sedan Police and Taxi Models	 G63375 ⁵	61555 81713 ⁵	34073 ⁸	 69724	81514
75-77	Sedan Police and Taxi Models	 G63375 ⁵	61555 81713 ⁵	77375	34073 ⁸	 69724	81514
71-76	Wagon	 69675 ⁵	34073 ⁸	 69604	81492	49152 ³⁰

1 Future Part, available 1st Quarter of 2015.

7 Pair Packs, air hose kit included.

30 For GM Vehicles equipped with factory installed leveling systems, see Ref A.

53 Strut Mount. Hardware from O.E. Part may need to be reused.





5 Use kit No. 140719 to replace O.E. hardware for lower shock absorber mounting when studs break or self-tapping screws are not longer useable.

8 Pair Packs.

40 ReadyMount Strut. Complete Assembled Unit.

63 Mount Kit includes Isolator. Hardware from O.E. Part may need to be reused.

















APPLICATION GUIDE

Year	Fitment Notes										
		 Ultra	ProGuard/ Guardian/ Classic	Max Control/ LTV	Strut Cushion/ Strut Mount	Hi Jacker/ Load Carrier	 Ultra	ProGuard/ Guardian/ Classic	Max Control/ LTV	Strut Cushion/ Strut Mount	Hi Jacker/ Load Carrier























CHEVROLET

CAPRICE (cont'd)

CHEVROLET

73-74	Sedan Police and Taxi Models	 G63375 ⁵	61555 81713 ⁵	77375	34073 ⁸	 69724	81514	43049 ⁸ 49131 ³⁰
71-72	Police and Taxi Models	 G63375 ⁵	61555	34073 ⁸		43049 ⁸
	Sedan; Police and Taxi Models	 69675 ⁵	77375	34073 ⁸	
	Hardtop Exc. Police and Taxi Models	 69675 ⁵	81446	34073 ⁸	
	Hardtop Police and Taxi Models	 69675 ⁵	81713 ⁵	34073 ⁸	 69724	81514	49131 ³⁰
70	All	 69675 ⁵	34073 ⁸	 69724	81514	43049 ⁸ 49131 ³⁰
	Hardtop	 69675 ⁵	81446	34073 ⁸	 69724	81514	43049 ⁸ 49131 ³⁰
66-69	All	 69675 ⁵	81446	34073 ⁸	 69724	81514	43049 ⁸ 49131 ³⁰





CAVALIER

99-05	All	 G55698	143035 ⁵⁴ 143057 ⁵¹	 G55825	142413 ⁵³
95-98	All	 G55698	142227 ⁵⁸ 142406 ⁵⁴ 143057 ⁵¹	 G55825	142413 ⁵³
92-94	Left	 G56706	142148 ⁵³ 142762 ⁶⁵ 143059 ⁵¹	 69749	81530	141974 ⁵³	49371 ⁷
	Right	 G56705	142148 ⁵³ 142762 ⁶⁵ 143059 ⁵¹	 69749	81530	141974 ⁵³	49371 ⁷
87-91	Left	 G56706	142108 ⁵³ 142762 ⁶⁵ 143059 ⁵¹	 69749	81530	141974 ⁵³	49371 ⁷
	Right	 G56705	142108 ⁵³ 142762 ⁶⁵ 143059 ⁵¹	 69749	81530	141974 ⁵³	49371 ⁷
84-86	All		142108 ⁵³ 142762 ⁶⁵ 143060 ⁵¹	 69749	81530	49371 ⁷
	Left Non-Rebuildable O.E. Struts	 G56706	142108 ⁵³ 142762 ⁶⁵ 143060 ⁵¹	 69749	81530	49371 ⁷
	Rebuildable O.E. Struts	 G44451 ⁹⁸	142108 ⁵³ 142762 ⁶⁵ 143060 ⁵¹	 69749	81530	141974 ⁵³	49371 ⁷
	Right Non-Rebuildable O.E. Struts	 G56705	142108 ⁵³ 142762 ⁶⁵ 143060 ⁵¹	 69749	81530	49371 ⁷
82-83	All	 G44918 ⁹⁸	142108 ⁵³ 142762 ⁶⁵ 143060 ⁵¹	 69749	81530	141974 ⁵³	49371 ⁷

CAVALIER READYMOUNTS

		Front	Rear
99-05	All	G56951 ⁴⁰	G56938 ⁴⁰
95-98	All	G56939 ⁴⁰	G56938 ⁴⁰
92-94	Left	G56921 ⁴⁰
	Right	G56920 ⁴⁰

CELEBRITY

85-90	All	 G55514	142223 ⁵³ 142749 ⁶⁵ 143060 ⁵¹	 69723	81517	141974 ⁵³	49370 ³⁰
84	All		142223 ⁵³ 142749 ⁶⁵ 143060 ⁵¹	 69723	81517	141974 ⁵³	49370 ³⁰

5 Use kit No. 140719 to replace O.E. hardware for lower shock absorber mounting when studs break or self-tapping screws are not longer useable.

8 Pair Packs.

40 ReadyMount Strut. Complete Assembled Unit.

53 Strut Mount. Hardware from O.E. Part may need to be reused.

58 Mount Kit includes Suspension Bearing. Hardware from O.E. Part may need to be reused.

98 Notice: The level of difficulty to install this product is moderately high. Please

review the installation instructions carefully before proceeding.

7 Pair Packs, air hose kit included.





30 For GM Vehicles equipped with factory installed leveling systems, see Ref A.

51 Strut Cushion for use with the Strut/Cartridge/Shocks.

54 Kit with Mount and Bearing. Hardware from O.E. Part may need to be reused.

65 Mount Kit includes Upper Spring Seat with Isolator. Hardware from O.E. Part may need to be reused.







APPLICATION GUIDE

Year	Fitment Notes										
			Ultra	ProGuard/ Guardian/ Classic	Max Control/ LTV	Strut Cushion/ Strut Mount	Hi Jacker/ Load Carrier		Ultra	ProGuard/ Guardian/ Classic	Max Control/ LTV

CHEVROLET

CHEVROLET









CELEBRITY (cont'd)

84	Exc. HD Suspension		G55505	142223 ⁵³ 142749 ⁶⁵ 143060 ⁵¹		69723	81517	141974 ⁵³	49370 ⁹⁰
	HD Suspension		G55514	142223 ⁵³ 142749 ⁶⁵ 143060 ⁵¹		69723	81517	141974 ⁵³	49370 ⁹⁰
82-83	All		G55505	142223 ⁵³ 143060 ⁵¹		69723	81517	141974 ⁵³	49370 ⁹⁰



CELEBRITY READYMOUNTS

		Front	Rear
85-90	All	G56908 ⁴⁰
84	HD Suspension	G56908 ⁴⁰













CHEVELLE

68-73	All		69600	81494	34051 ⁸		69604	81492	43060 ⁹ 49152 ⁹⁰
64-67	All		82138	
	Exc. HD Suspension		82138		69724	81514	43049 ⁹ 49131 ⁹⁰
	HD Suspension		82138		69604	81492	43060 ⁹ 49152 ⁹⁰









CHEVETTE

76-87	All		81322		81340
-------	-----	---	------	-------	------	------	------	---	------	-------	------	------	------

CHEVY II

68	All		69600	81494	
	Multi-Leaf Rear Spring		69600	81494		69724	81514
	Leaf(RearSpringType) Multi-Leaf Rear Spring		69600	81494		43049 ⁹ 49157 ⁷
	Leaf(RearSpringType) Single Leaf Rear Springs		69600	81494		82093
	Single-Leaf Rear Spring		69600	81494		49193 ⁷
62-67	All		82070		82074



CITATION / CITATION II

84-85	All		142223 ⁵³ 142749 ⁶⁵ 143060 ⁵¹		69723	81517	141974 ⁵³	49370 ⁹⁰
	Exc. HD Suspension		G55505	142223 ⁵³ 142749 ⁶⁵ 143060 ⁵¹		69723	81517	141974 ⁵³	49370 ⁹⁰
	HD Suspension		G55514	142223 ⁵³ 142749 ⁶⁵ 143060 ⁵¹		69723	81517	141974 ⁵³	49370 ⁹⁰
80-83	All		G55505	142223 ⁵³ 143060 ⁵¹		69723	81517	49370 ⁹⁰

CITATION / CITATION II READYMOUNTS

		Front	Rear
84-85	HD Suspension	G56908 ⁴⁰



CLASSIC

04-05	All		G55974	142531 ⁵⁴ 143060 ⁵¹		G56501	142532 ⁵³ 143057 ⁵¹
-------	-----	---	--------	------	------	--	------	---	--------	------	------	--	------

CLASSIC READYMOUNTS

		Front	Rear
04-05	All	G56927 ⁴⁰	G56928 ⁴⁰

COBALT

05-10	Exc. SS & Sport Models		G56810	143323 ⁵³		69587
-------	------------------------	---	--------	------	------	----------------------	------	---	-------	------	------	------	------

7 Pair Packs, air hose kit included.

30 For GM Vehicles equipped with factory installed leveling systems, see Ref A.

51 Strut Cushion for use with the Strut/Cartridge/Shocks.

54 Kit with Mount and Bearing. Hardware from O.E. Part may need to be reused.



8 Pair Packs.

40 ReadyMount Strut. Complete Assembled Unit.

53 Strut Mount. Hardware from O.E. Part may need to be reused.

65 Mount Kit includes Upper Spring Seat with Isolator. Hardware from O.E. Part may need to be reused.

APPLICATION GUIDE

Year	Fitment Notes										
		Ultra	ProGuard\Guardian\Classic	Max Control\LTV	Strut Cushion\Strut Mount	Hi Jacker\Load Carrier	Ultra	ProGuard\Guardian\Classic	Max Control\LTV	Strut Cushion\Strut Mount	Hi Jacker\Load Carrier

CHEVROLET

CHEVROLET

COBALT READYMOUNTS

		Front	Rear
05-10	Exc. SS & Sport Models Left	G57047 ⁴⁰
	Exc. SS & Sport Models Right	G57048 ⁴⁰

COLORADO

09-11	Torsion Bar(FrontSpringType)	G63879
04-11	RWD, Coil(FrontSpringType) Exc. Z71 Off Road Package	G51850	G63882
04-08	Torsion Bar(FrontSpringType)	G63884	G63879

CORSICA

95-96	Left	G56720 ⁹	142227 ⁵⁸ 142406 ⁵⁴ 142748 ⁶⁵ 143059 ⁵¹	G69407 ⁹	81790	141974 ⁵³	49614 ⁷
	Right	G56719	142227 ⁵⁸ 142406 ⁵⁴ 142748 ⁶⁵ 143059 ⁵¹	G69407 ⁹	81790	141974 ⁵³	49614 ⁷
94	All	142227 ⁵⁸ 142748 ⁶⁵ 143059 ⁵¹	G69749	81530	141974 ⁵³
	Base	142224 ⁵⁴ 142227 ⁵⁸ 142748 ⁶⁵ 143059 ⁵¹	G69749	81530	141974 ⁵³
	Exc. FE7 Suspension Left	G56720 ⁹	142227 ⁵⁸ 142748 ⁶⁵ 143059 ⁵¹	G69749	81530	141974 ⁵³	49371 ⁷
	Exc. FE7 Suspension Right	G56719 ⁹	142227 ⁵⁸ 142748 ⁶⁵ 143059 ⁵¹	G69749	81530	141974 ⁵³	49371 ⁷
	FE7 Suspension Left	G56723	142227 ⁵⁸ 142748 ⁶⁵ 143059 ⁵¹	G69749	81530	141974 ⁵³
	FE7 Suspension Right	G56724	142227 ⁵⁸ 142748 ⁶⁵ 143059 ⁵¹	G69749	81530	141974 ⁵³
92-93	All	142224 ⁵⁴ 142227 ⁵⁸ 142750 ⁶⁵ 143059 ⁵¹	G69749	81530	141974 ⁵³
	Exc. FE7 Suspension Left	G56720 ⁹	142224 ⁵⁴ 142227 ⁵⁸ 142750 ⁶⁵ 143059 ⁵¹	G69749	81530	141974 ⁵³	49371 ⁷
	Exc. FE7 Suspension Right	G56719 ⁹	142224 ⁵⁴ 142227 ⁵⁸ 142750 ⁶⁵ 143059 ⁵¹	G69749	81530	141974 ⁵³	49371 ⁷
	FE7 Suspension Left	G56723	142224 ⁵⁴ 142227 ⁵⁸ 142750 ⁶⁵ 143059 ⁵¹	G69749	81530	141974 ⁵³
	FE7 Suspension Right	G56724	142224 ⁵⁴ 142227 ⁵⁸ 142750 ⁶⁵ 143059 ⁵¹	G69749	81530	141974 ⁵³
87-91	Left	G56706	142148 ⁵³ 142762 ⁶⁵ 143060 ⁵¹	G69749	81530	141974 ⁵³	49371 ⁷
	Right	G56705	142148 ⁵³ 142762 ⁶⁵ 143060 ⁵¹	G69749	81530	141974 ⁵³	49371 ⁷

CORSICA READYMOUNTS

		Front	Rear
95-96	Left	G56917 ⁴⁰
	Right	G56916 ⁴⁰
92-94	Exc. FE7 Suspension Left	G56919 ⁴⁰

7 Pair Packs, air hose kit included.

40 ReadyMount Strut. Complete Assembled Unit.

53 Strut Mount. Hardware from O.E. Part may need to be reused.

58 Mount Kit includes Suspension Bearing. Hardware from O.E. Part may need to be reused.





9 See Ref. D for procedures to replace Elec Adj Susp with non-adj product.

51 Strut Cushion for use with the Strut/Cartridge/Shocks.

54 Kit with Mount and Bearing. Hardware from O.E. Part may need to be reused.

65 Mount Kit includes Upper Spring Seat with Isolator. Hardware from O.E. Part may need to be reused.

APPLICATION GUIDE

Year	Fitment Notes										
			Ultra	ProGuard/ Guardian/ Classic	Max Control/ LTV	Strut Cushion/ Strut Mount	Hi Jacker/ Load Carrier		Ultra	ProGuard/ Guardian/ Classic	Max Control/ LTV



CHEVROLET

CHEVROLET



CORSICA READYMOUNTS (cont'd)

		Front	Rear
92-94	Exc. FE7 Suspension Right	G56918 ⁴⁰
87-91	Left	G56921 ⁴⁰
	Right	G56920 ⁴⁰















CORVAIR

60-64	All		82099	
-------	-----	---	------	-------	------	------	------	---	------	------	------	------



CORVAIR TRUCK

61-64	All		82099	
-------	-----	---	------	-------	------	------	------	---	------	------	------	------









CORVETTE

97-04	Exc. Electronic Adjustable Suspension		G51904		G51871
89-96	Exc. Electronic Adjustable Suspension		69811 ⁹	81792	75811 ⁹		69795 ⁹	81791	75795
88	All		69794 ⁹		69795 ⁹	81791	75795
84-87	All		69714	75811 ⁹		69715
63-82	All		69625		69622	81880	49304 ⁷
60-62	All		82026		82155
53-59	All		82026		82039

DEL RAY

58	All		82118		82051
----	-----	---	------	-------	------	------	------	---	------	-------	------	------	------











EL CAMINO

78-87	All		61504 81750	34051 ⁸		81492	43060 ⁸ 49334 ³⁰
68-77	All		61504 81750	34051 ⁸		81492	43060 ⁸ 49152 ³⁰
64-67	All		82138		81514	43049 ⁸
59-60	All		82118		82051

EL CAMINO STEERING STABILIZERS

		Front	Rear
73-77	All	14019







EQUINOX

07-13	All			G64015	61718
07-12	Left Exc. Sport Suspension		G52127		G64015	61718
	Right Exc. Sport Suspension		G52128		G64015	61718
05-06	Left		G56773	143363 ⁵³		G64015	61718
	Right		G56774	143363 ⁵³		G64015	61718

EQUINOX READYMOUNTS

		Front	Rear
05-06	Left	G57110 ⁴⁰
	Right	G57111 ⁴⁰

HHR

11	All		143323 ⁵³		69587
	Exc. SS Models		G56810	143323 ⁵³		69587
06-10	Exc. SS Models		G56810	143323 ⁵³		69587

7 Pair Packs, air hose kit included.

9 See Ref. D for procedures to replace Elec Adj Susp with non-adj product.



40 ReadyMount Strut. Complete Assembled Unit.

8 Pair Packs.

30 For GM Vehicles equipped with factory installed leveling systems, see Ref A.

53 Strut Mount. Hardware from O.E. Part may need to be reused.

APPLICATION GUIDE

Year	Fitment Notes										
		Ultra	ProGuard/ Guardian/ Classic	Max Control/ LTV	Strut Cushion/ Strut Mount	Hi Jacker/ Load Carrier	Ultra	ProGuard/ Guardian/ Classic	Max Control/ LTV	Strut Cushion/ Strut Mount	Hi Jacker/ Load Carrier









































CHEVROLET

CHEVROLET

HHR READYMOUNTS

		Front	Rear
06-11	Exc. SS Models Left	G57047 ⁴⁰
	Exc. SS Models Right	G57048 ⁴⁰

IMPALA

04-11	Models with 17" or 18" Wheels	 G55948	142524 ⁵⁸ 142526 ⁵⁴ 143060 ⁵¹	 G52244	143061 ⁵¹
00-11	All	 G55948	142524 ⁵⁸ 142526 ⁵⁴ 143060 ⁵¹	143061 ⁵¹
	Exc. Models with 17" or 18" Wheels	 G55948	142524 ⁵⁸ 142526 ⁵⁴ 143060 ⁵¹	 G55949	143061 ⁵¹
	Left	 G55948	142524 ⁵⁸ 142526 ⁵⁴ 143060 ⁵¹	143073 ⁵³ 143061 ⁵¹
	Right	 G55948	142524 ⁵⁸ 142526 ⁵⁴ 143060 ⁵¹	143074 ⁵³ 143061 ⁵¹
	Sedan	 G55948	142525 ⁵³ 142524 ⁵⁸ 142526 ⁵⁴ 143060 ⁵¹	143061 ⁵¹
94-96	All	 69675 ⁵	34073 ⁸	 69724	81514	43049 ⁸ 49131 ³⁰
	Exc. Police and Taxi Models	 69675 ⁵	81446	34073 ⁸	 69724	81514	43049 ⁸ 49131 ³⁰
83-85	All	 69675 ⁵	34073 ⁸	 69724	81514	43049 ⁸ 49131 ³⁰
	Exc. Police and Taxi Models	 69675 ⁵	81446	34073 ⁸	 69724	81514	43049 ⁸ 49131 ³⁰
	Police and Taxi Models	 G63375 ⁵	61555 81713 ⁵	34073 ⁸	 69724	81514	43049 ⁸ 49131 ³⁰
	Sedan Police and Taxi Models	 69675 ⁵	77375	34073 ⁸	 69724	81514	43049 ⁸ 49131 ³⁰
82	Exc. Police and Taxi Models		81446
	Exc. Wagon		 69724	81514
	Sedan	 69675 ⁵	34073 ⁸
	Sedan Exc. Wagon		43049 ⁸ 49131 ³⁰
	Sedan Police and Taxi Models	 G63375 ⁵	61555 81713 ⁵	77375
	Wagon		 69604	81492
74-81	Coupe Exc. Wagon	 69675 ⁵	34073 ⁸		43049 ⁸ 49131 ³⁰
73-81	Exc. Wagon	 69675 ⁵	34073 ⁸	 69724	81514
	Sedan Exc. Wagon	 69675 ⁵	34073 ⁸		43049 ⁸ 49131 ³⁰
71-81	All	 69675 ⁵	34073 ⁸
	Exc. Police and Taxi Models	 69675 ⁵	81446	34073 ⁸
	Sedan Police and Taxi Models	 G63375 ⁵	61555 81713 ⁵	77375	34073 ⁸
	Wagon	 69675 ⁵	34073 ⁸	 69604	81492	43060 ⁸ 49152 ³⁰
73	Hardtop Exc. Wagon	 69675 ⁵	34073 ⁸		43049 ⁸ 49131 ³⁰
65-72	Sedan	69675 ⁵	34073 ⁸	69724	81514	43049 ⁸ 49131 ³⁰
70	All	69675 ⁵	34073 ⁸	69724
	Exc. Police and Taxi Models	69675 ⁵	81446	34073 ⁸	69724

5 Use kit No. 140719 to replace O.E. hardware for lower shock absorber mounting when studs break or self-tapping screws are not longer useable.

30 For GM Vehicles equipped with factory installed leveling systems, see Ref A.

51 Strut Cushion for use with the Strut/Cartridge/Shocks.

54 Kit with Mount and Bearing. Hardware from O.E. Part may need to be reused.





8 Pair Packs.

40 ReadyMount Strut. Complete Assembled Unit.

53 Strut Mount. Hardware from O.E. Part may need to be reused.







58 Mount Kit includes Suspension Bearing. Hardware from O.E. Part may need to be reused.

APPLICATION GUIDE

Year	Fitment Notes										
			ProGuard/ Guardian/ Classic	Max Control/ LTV	Strut Cushion/ Strut Mount	Hi Jacker/ Load Carrier		ProGuard/ Guardian/ Classic	Max Control/ LTV	Strut Cushion/ Strut Mount	Hi Jacker/ Load Carrier

CHEVROLET

IMPALA (cont'd)





65-69	All		69675 ⁵	34073 ⁸		69724	49131 ³⁰
	Exc. Police and Taxi Models		69675 ⁵	81446	34073 ⁸		69724	49131 ³⁰
59-64	All		82118		82051

CHEVROLET

























IMPALA READYMOUNTS

		Front	Rear
00-11	All	G57060 ⁴⁰
	Left Exc. Models with 17" or 18" Wheels	G57060 ⁴⁰	G56924 ⁴⁰
	Right Exc. Models with 17" or 18" Wheels	G57060 ⁴⁰	G56925 ⁴⁰



KINGSWOOD

71-72	All		69675 ⁵	81446	34073 ⁸		69604	81492
69-70	All		69675 ⁵	81446	34073 ⁸		69724	81514	43049 ⁵ 49131 ³⁰

LUMINA

97-01	All		G44459 ³⁶	142143 ⁵³ 143060 ⁵¹		G55831	143061 ⁵¹
	HD Suspension		G44459 ³⁶	142144 ⁵³ 142143 ⁵³ 143060 ⁵¹		G55831	143061 ⁵¹
	Left		G44459 ³⁶	143036 ⁵⁷ 142143 ⁵³ 143060 ⁵¹		G55831	143071 ⁵³ 143061 ⁵¹
	Right		G44459 ³⁶	143037 ⁵⁷ 142143 ⁵³ 143060 ⁵¹		G55831	143072 ⁵³ 143061 ⁵¹
95-96	All		G44459 ³⁶	142143 ⁵³ 143060 ⁵¹		G55817	143061 ⁵¹
	HD Suspension		G44459 ³⁶	142144 ⁵³ 142143 ⁵³ 143060 ⁵¹		G55817	143061 ⁵¹
	Left		G44459 ³⁶	143036 ⁵⁷ 142143 ⁵³ 143060 ⁵¹		G55817	143071 ⁵³ 143061 ⁵¹
	Right		G44459 ³⁶	143037 ⁵⁷ 142143 ⁵³ 143060 ⁵¹		G55817	143072 ⁵³ 143061 ⁵¹
90-94	All		G44459 ³⁶	142143 ⁵³ 143060 ⁵¹		G56708	143062 ⁵¹ 143067 ⁵³
	HD Suspension		G44459 ³⁶	142144 ⁵³ 142143 ⁵³ 143060 ⁵¹		G56708	143062 ⁵¹ 143067 ⁵³
	Left		G44459 ³⁶	143036 ⁵⁷ 142143 ⁵³ 143060 ⁵¹		G56708	143062 ⁵¹ 143067 ⁵³
	Right		G44459 ³⁶	143037 ⁵⁷ 142143 ⁵³ 143060 ⁵¹		G56708	143062 ⁵¹ 143067 ⁵³

LUMINA APV

90-96	All		G55992	142223 ⁵³ 142749 ⁵⁵ 143060 ⁵¹		G63914	61503	141974 ⁵³	49370 ³⁰
-------	-----	---	--------	------	------	--	------	---	--------	-------	------	----------------------	---------------------

LUMINA READYMOUNTS

		Front	Rear
95-96	Left	G56952 ⁴⁰
	Right	G56953 ⁴⁰
90-94	All	G56727 ⁴²

5 Use kit No. 140719 to replace O.E. hardware for lower shock absorber mounting when studs break or self-tapping screws are not longer useable.

30 For GM Vehicles equipped with factory installed leveling systems, see Ref A.

40 ReadyMount Strut. Complete Assembled Unit.

51 Strut Cushion for use with the Strut/Cartridge/Shocks.

57 Mount Kit includes Lower Spring Seat with Internal Bearing & Isolator. Hardware from O.E. Part may need to be reused.

8 Pair Packs.



36 Requires special strut installation tool.

42 ReadyMount Strut, does not include springs due to vehicle design.

53 Strut Mount. Hardware from O.E. Part may need to be reused.

65 Mount Kit includes Upper Spring Seat with Isolator. Hardware from O.E. Part may need to be reused.

APPLICATION GUIDE

Year	Fitment Notes										
		Ultra	ProGuard\Guardian\Classic	Max Control\LTV	Strut Cushion\Strut Mount	Hi Jacker\Load Carrier	Ultra	ProGuard\Guardian\Classic	Max Control\LTV	Strut Cushion\Strut Mount	Hi Jacker\Load Carrier

CHEVROLET

LUV PICKUP

CHEVROLET

81-82	All	⌋ ○	G63909	⌋ ○	G63492	61506 81318	77492	49311 ⁷
	4WD	⌋ ○	G63909	61508 81507	77909	⌋ ○	G63492	61506 81318	77492	49311 ⁷
	RWD	⌋ ○	G63902	61501 81478	77902	⌋ ○	G63492	61506 81318	77492	49311 ⁷
72-80	All	⌋ ○	G63909	61508 81507	77909	⌋ ○	G63907	61500 81147	77907	43048 ⁸ 49151 ⁷

LUV PICKUP STEERING STABILIZERS

		Front	Rear
79-82	4WD, Single System Steering Stabilizer; with a factory mounting hole in the steering linkage.	6801SE ⁸⁰

MALIBU

09-12	Exc. Classic Models Left	⌋ ○	143354 ⁵³	⌋ ○	69590
	Exc. Classic Models Right	⌋ ○	143355 ⁵³	⌋ ○	69590
04-12	Left	⌋ ○	G52028	⌋ ○
	Right	⌋ ○	G52029	⌋ ○
08	Classis Models	⌋ ○	⌋ ○	69589
	Exc. Classic Models Left	⌋ ○	143354 ⁵³	⌋ ○	69590	143425 ⁵³
	Exc. Classic Models Right	⌋ ○	143355 ⁵³	⌋ ○	69590	143425 ⁵³
04-07	Exc. Classic Models Left	⌋ ○	143354 ⁵³	⌋ ○
	Exc. Classic Models Right	⌋ ○	143355 ⁵³	⌋ ○
	Exc. Maxx Models	⌋ ○	⌋ ○	69589
	Maxx Models	⌋ ○	⌋ ○	69590	143425 ⁵³
98-03	Rear Strut Lower Mounting holes at 2.4" Apart	⌋ ○	G55974	142531 ⁵⁴ 143060 ⁵¹	⌋ ○	G56501	142532 ⁵³ 143057 ⁵¹
97-03	All	⌋ ○	G55974	142531 ⁵⁴ 143060 ⁵¹	⌋ ○	142532 ⁵³ 143057 ⁵¹
97-98	Rear Strut Lower Mounting holes at 3.2" Apart	⌋ ○	G55974	142531 ⁵⁴ 143060 ⁵¹	⌋ ○	G55975	142532 ⁵³ 143057 ⁵¹
78-83	All	⌋ ○	69600	81494	34051 ⁸	⌋ ○	69604	81492	43060 ⁸ 49334 ³⁰
73-77	All	⌋ ○	69600	81494	34051 ⁸	⌋ ○	69604	81492	43060 ⁸ 49152 ³⁰
64-67	All	⌋ ○	82138	⌋ ○
	Exc. HD Suspension	⌋ ○	82138	⌋ ○	69724	81514	43049 ⁸ 49131 ³⁰
	HD Suspension	⌋ ○	82138	⌋ ○	69604	81492	43060 ⁸ 49152 ³⁰

MALIBU READYMOUNTS

		Front	Rear
04-12	Exc. Classic; Hybrid Models & 4 cyl Left	G57069 ⁴⁰
	Exc. Classic; Hybrid Models & 4 cyl Right	G57070 ⁴⁰
08-10	4Cyl: Exc. Classic and Hybrid Models Left	G57121
	4Cyl: Exc. Classic and Hybrid Models Right	G57122
98-03	Rear Strut Lower Mounting holes at 2.4" Apart	G56927 ⁴⁰	G56928 ⁴⁰
97-03	All	G56927 ⁴⁰

METRO

98-01	Non-ABS	⌋ ○	G55891	142293 ⁵⁴ 143059 ⁵¹	⌋ ○	G55772	142295 ⁵³ 143057 ⁵¹
-------	---------	--------	--------	------	------	--	------	--------	--------	------	------	--	------

7 Pair Packs, air hose kit included.

30 For GM Vehicles equipped with factory installed leveling systems, see Ref. A.

51 Strut Cushion for use with the Strut/Cartridge/Shocks.

54 Kit with Mount and Bearing. Hardware from O.E. Part may need to be reused.





8 Pair Packs.

40 ReadyMount Strut. Complete Assembled Unit.

53 Strut Mount. Hardware from O.E. Part may need to be reused.

80 Mounting bracket not required, install on O.E. Shock Mounts. See Ref. C for optional Steering Stabilizer Boots.









































APPLICATION GUIDE

Year	Fitment Notes										
			ProGuard/ Guardian/ Classic	Max Control/ LTV	Strut Cushion/ Strut Mount	Hi Jacker/ Load Carrier		ProGuard/ Guardian/ Classic	Max Control/ LTV	Strut Cushion/ Strut Mount	Hi Jacker/ Load Carrier

CHEVROLET

MONTE CARLO

CHEVROLET

07	All		G55948	142526 ⁵⁴ 143060 ⁵¹		143059 ⁵¹
	Exc. Models with 17" or 18" Wheels		G55948	142526 ⁵⁴ 143060 ⁵¹		G55949	143059 ⁵¹
	Left		G55948	142526 ⁵⁴ 143060 ⁵¹		143073 ⁵³ 143059 ⁵¹
	Models with 17" or 18" Wheels		G55948	142526 ⁵⁴ 143060 ⁵¹		G52244	143059 ⁵¹
	Right		G55948	142526 ⁵⁴ 143060 ⁵¹		143074 ⁵³ 143059 ⁵¹
05-06	Models with 17" or 18" Wheels		G55948	142524 ⁵⁸ 142525 ⁵³ 142526 ⁵⁴ 143060 ⁵¹		G52244	143059 ⁵¹
00-06	All		G55948	142524 ⁵⁸ 142525 ⁵³ 142526 ⁵⁴ 143060 ⁵¹		143059 ⁵¹
	Exc. Models with 17" or 18" Wheels		G55948	142524 ⁵⁸ 142525 ⁵³ 142526 ⁵⁴ 143060 ⁵¹		G55949	143059 ⁵¹
	Left		G55948	142524 ⁵⁸ 142525 ⁵³ 142526 ⁵⁴ 143060 ⁵¹		143073 ⁵³ 143059 ⁵¹
	Right		G55948	142524 ⁵⁸ 142525 ⁵³ 142526 ⁵⁴ 143060 ⁵¹		143074 ⁵³ 143059 ⁵¹
97-99	All		G44459 ³⁵	143060 ⁵¹		G55831	143059 ⁵¹
	Exc. HD Suspension		G44459 ³⁵	142143 ⁵³ 143060 ⁵¹		G55831	143059 ⁵¹
	HD Suspension		G44459 ³⁵	142144 ⁵³ 143060 ⁵¹		G55831	143059 ⁵¹
	Left		G44459 ³⁵	143060 ⁵¹		G55831	143073 ⁵³ 143059 ⁵¹
	Right		G44459 ³⁵	143060 ⁵¹		G55831	143074 ⁵³ 143059 ⁵¹
95-96	All		G44459 ³⁵	143060 ⁵¹		G55817	143059 ⁵¹
	Exc. HD Suspension		G44459 ³⁵	142143 ⁵³ 143060 ⁵¹		G55817	143059 ⁵¹
	HD Suspension		G44459 ³⁵	142144 ⁵³ 143060 ⁵¹		G55817	143059 ⁵¹
	Left		G44459 ³⁵	143060 ⁵¹		G55817	143071 ⁵³ 143059 ⁵¹
	Right		G44459 ³⁵	143060 ⁵¹		G55817	143072 ⁵³ 143059 ⁵¹
73-88	All		69600	81494	34051 ⁸		69604	81492	43060 ⁹ 49334 ³⁰
70-72	All		69600	81494	34051 ⁸		69604	81492	43060 ⁹ 49152 ³⁰

MONTE CARLO READYMOUNTS

		Front	Rear
00-07	All	G57060 ⁴⁰
	Left Exc. Models with 17" or 18" Wheels	G57060 ⁴⁰	G56924 ⁴⁰
	Right Exc. Models with 17" or 18" Wheels	G57060 ⁴⁰	G56925 ⁴⁰
95-96	Left	G56954 ⁴⁰
	Right	G56955 ⁴⁰

8 Pair Packs.

36 Requires special strut installation tool.

51 Strut Cushion for use with the Strut/Cartridge/Shocks.

54 Kit with Mount and Bearing. Hardware from O.E. Part may need to be reused.



30 For GM Vehicles equipped with factory installed leveling systems, see Ref A.

40 ReadyMount Strut. Complete Assembled Unit.

53 Strut Mount. Hardware from O.E. Part may need to be reused.

58 Mount Kit includes Suspension Bearing. Hardware from O.E. Part may need to be reused.

APPLICATION GUIDE

Year	Fitment Notes										
		Ultra	ProGuard\Guardian\Classic	Max Control\LTV	Strut Cushion\Strut Mount	Hi Jacker\Load Carrier	Ultra	ProGuard\Guardian\Classic	Max Control\LTV	Strut Cushion\Strut Mount	Hi Jacker\Load Carrier

CHEVROLET

CHEVROLET

MONTE CARLO STEERING STABILIZERS

						Front	Rear			
73-77	All					14019			

MONZA

75-80	All	82129	81438
-------	-----	-------	-------	------	------	-------	-------	------	------	------

NOVA

85-88	All	G55715	142134 ⁵³ 143059 ⁵¹	G55752	142249 ⁵³ 143058 ⁵¹
74-79	All	69600	81494	34051 ⁸	69600	82093
69-73	All	69600	81494	34051 ⁸	69600
73	Exc. HD Suspension	69600	81494	34051 ⁸	69600	82093	49193 ⁷
	HD Suspension	69600	81494	34051 ⁸	69724	81514	49157 ⁷
69-72	Multi-Leaf Rear Spring	69600	81494	34051 ⁸	69724	81514	43049 ⁸ 49157 ⁷
	Single-Leaf Rear Spring	69600	81494	34051 ⁸	69600	49193 ⁷
	Leaf(RearSpringType) Single Leaf Rear Springs	69600	81494	34051 ⁸	69600	82093

ONE-FIFTY SERIES

55-57	All	69625	82099	69625	82066
53-54	All	82026	82155

OPTRA

08	All	143349 ⁵³	143350 ⁵³
06-07	Left	G56882	143349 ⁵³	G56884	143350 ⁵³
	Right	G56883	143349 ⁵³	G56885	143350 ⁵³
04-05	Left	G56882	G56884
	Right	G56883	G56885

PICKUP

60	All	82035	82086
57-58	All	82047
	3100, 3200 & 3600 Models	82047	82060
	3800 2nd Series	82047	82155
55-56	All	G63405	G63405
	3100, 3124 2nd Series	G63405	61500 81147	77405	43048 ⁸	G63405	81318
	3200	G63405	77405	G63405
	3200 & 3600 2nd Series	G63405	81147	G63405
	3800 2nd Series	G63405	61500 81147	77405	43048 ⁸	G63405	82155
55	1st Series	G63405	81270	G63405
54	All	81270	82155
50-53	3100, 3200, 3600 & 3800	81270	82066

PICKUP 1/2 TON, C10

75-86	All	G63355	61525 81039	58355 77355	34036 ⁸	G63349	61524 81164	58349 77349	43111 ⁸ 49155 ⁷
-------	-----	--------	----------------	----------------	------	--------------------	--------	----------------	----------------	------	--



7 Pair Packs, air hose kit included.

51 Strut Cushion for use with the Strut/Cartridge/Shocks.

8 Pair Packs.

53 Strut Mount. Hardware from O.E. Part may need to be reused.

APPLICATION GUIDE

Year	Fitment Notes										
		Ultra	ProGuard/ Guardian/ Classic	Max Control/ LTV	Strut Cushion/ Strut Mount	Hi Jacker/ Load Carrier	Ultra	ProGuard/ Guardian/ Classic	Max Control/ LTV	Strut Cushion/ Strut Mount	Hi Jacker/ Load Carrier

CHEVROLET

CHEVROLET

PICKUP 1/2 TON, C10 (cont'd)

73-74	All	○ ○	G63355	61525 81039	58355 77355	34036 ⁸	○ ○	61524 81164	58349 77349	43111 ⁵ 49155 ⁷
67-72	Coil(RearSpringType)	○ ○	G63355	61525 81039	58355 77355	34036 ⁸	○ ○	82003	43062 ⁹ 49107 ⁷
63-72	All	○ ○	G63355	61525 81039	58355 77355	34036 ⁸	○ ○
	Leaf(RearSpringType)	○ ○	G63355	61525 81039	58355 77355	34036 ⁸	○ ○	G63306	82006	43093 ⁹ 49162 ⁷
61-62	All	○ ○	82035	○ ○	82086

PICKUP 1/2 TON, C10 STEERING STABILIZERS

		Front	Rear
73-86	Single System Steering Stabilizer	6802SE ⁸⁴

PICKUP 1/2 TON, C15 / C1500

88-99	All	⊖ ⊕	G63489	61544 81668	58489 77489	⊖ ⊕	G63488	61543 81667	58488 77488	43163 ⁹ 49218 ⁷
-------	-----	--------	--------	----------------	----------------	------	------	--------	--------	----------------	----------------	------	--

PICKUP 1/2 TON, C15 / C1500 STEERING STABILIZERS

		Front	Rear
92-99	Exc. O.E. Steering Stabilizer	6853SE ⁸²

PICKUP 1/2 TON, K10

81-86	Exc. Lift Kit	○ ○	G63347	○ ○	G63349	61524 81164	77349	43111 ⁵
	Quad Suspension Long Shock; Exc. Lift Kit	○ ○	G63906 ⁶	61522 ⁶ 81496 ⁶	58906 ⁶	○ ○
	Quad Suspension Short Shock; Exc. Lift Kit	○ ○	G63908 ⁶	61516	58908 ⁶	○ ○
	Standard Suspension; Exc. Lift Kit	○ ○	81113	58347	43107 ⁸	○ ○	58349	49155 ⁷
76-86	4" Lift Kit; Exc. Quad Suspension	○ ○	G63437 ⁵⁰	58437 ⁵⁰	○ ○	G63438 ⁵⁰	58438
73-80	Exc. Lift Kit	○ ○	G63347	61516 81113	58347	43107 ⁸	○ ○	G63349	61524 81164	58349 77349	43111 ⁵ 49155 ⁷
73-75	4" Lift Kit; Exc. Quad Suspension	○ ○	G63437 ⁵⁰	58437 ⁵⁰	○ ○	G63438 ⁵⁰	58438 ⁵⁰
69-72	All	○ ○	G63347	○ ○	G63371
	Exc. Lift Kit	○ ○	G63347	61516 81113	58347	43107 ⁸	○ ○	G63371

PICKUP 1/2 TON, K10 STEERING STABILIZERS

		Front	Rear
73-86	All	14017
	Dual System Steering Stabilizer	6802SE ⁸⁴
	Single System Steering Stabilizer	6804SE ⁸⁰
67-72	Dual System Steering Stabilizer	6802SE ⁸⁴
61-72	Single System Steering Stabilizer	6803SE ⁸⁴

PICKUP 1/2 TON, K15 / K1500

88-99	All	⊖ ⊕	G63818	58901 77609	⊖ ⊕	G63488	61543 81667	58488 77488	43163 ⁹ 49218 ⁷
88	Quad Suspension Long Shock; Exc. Lift Kit	○ ○	G63818	61522 ⁶	58901 77609	⊖ ⊕	G63488	61543 81667	58488 77488	43163 ⁹ 49218 ⁷
	Quad Suspension Short Shock; Exc. Lift Kit	○ ○	G63818	61516 ⁶	58901 77609	⊖ ⊕	G63488	61543 81667	58488 77488	43163 ⁹ 49218 ⁷

PICKUP 1/2 TON, K15 / K1500 STEERING STABILIZERS

		Front	Rear
88-99	Single System Steering Stabilizer	6807SE ⁸⁰
92-97	Exc. O.E. Steering Stabilizer	6853SE ⁸⁰

PICKUP 1/2 TON, R10

87	All	○ ○	G63355	61525	58355 77355	34036 ⁸	○ ○	G63349	61524 81164	77349	43111 ⁵
----	-----	--------	--------	-------	----------------	------	--------------------	--------	--------	----------------	-------	------	--------------------

6 It is recommended that when replacing shocks on vehicles with "quad shocks" all 4 shocks should be matched by series.

8 Pair Packs.

80 Mounting bracket not required, install on O.E. Shock Mounts. See Ref. C for optional Steering Stabilizer Boots.



84 Replacement damper for vehicles with the Gabriel Aftermarket mounting kit

7 Pair Packs, air hose kit included.

50 Bellows Kit No. 141242 is recommended for use to protect piston rod from potentially harmful road debris.

82 Use kit if listed, See Ref. C for optional Steering Stabilizer Boots.

APPLICATION GUIDE

Year	Fitment Notes										
		Ultra	ProGuard\ Guardian\ Classic	Max Control\ LTV	Strut Cushion\ Strut Mount	Hi Jacker\ Load Carrier	Ultra	ProGuard\ Guardian\ Classic	Max Control\ LTV	Strut Cushion\ Strut Mount	Hi Jacker\ Load Carrier

CHEVROLET

CHEVROLET

PICKUP 1/2 TON, R10 (cont'd)

87	RWD	⊖	G63355	81039 61525	58355 77355	34036 ⁶	⊖	G63349	61524 81164	58349 77349	49155 ⁷ 43111 ⁸
----	-----	---	--------	----------------	----------------	------	--------------------	---	--------	----------------	----------------	------	--

PICKUP 1/2 TON, R10 STEERING STABILIZERS

87	Single System Steering Stabilizer									6802SE ⁸⁴	
----	-----------------------------------	--	--	--	--	--	--	--	--	----------------------	--	------

PICKUP 1/2 TON, SILVERADO 1500

14	All	⊖	G51949	⊖
	Exc. Classic Models and Electronic Adjustable Suspension	⊖	G51949	⊖	G63959
07-13	Exc. Classic Models and Electronic Adjustable Suspension	⊖	G51870	143316 ⁵³	⊖	G63959	61690
99-07	4WD; Classic and Old Body Style; Exc. Electronic Adjustable Suspension	⊖	G63803	61643 81922	58803 77803	⊖	G63675	61642 81921	58412 77412
	RWD; Classic Models Only; Exc. Electronic Adjustable Suspension	⊖	G63783	61641 81920	58783 77783	⊖	G63662	61600 81873	58662 77662	43181 ⁸ 49235 ⁷

PICKUP 1/2 TON, SILVERADO 1500 HD

05-07	All	⊖	G63817	61663 81925	58817 77817	⊖	G63675	61642 81921	58412 77412
01-03	All	⊖	G63817	61663 81925	58817 77817	⊖	G63675	61642 81921	58412 77412

PICKUP 1/2 TON, SILVERADO 1500 READYMOUNTS

07-13	4WD, Exc. Electronic Ride Control									G57000 ⁴⁰	
	RWD, Crew Cab Pickup Exc. Electronic Ride Control									G57000 ⁴⁰	
	RWD, Extended Cab Pickup Exc. Electronic Ride Control									G57000 ⁴⁰	
	RWD; Exc. Classic Models and Electronic Ride									G57023 ⁴⁰	

PICKUP 1/2 TON, V10

87	All	⊖	⊖	49155 ⁷
	4" Lift Kit; Exc. Quad Suspension	⊖	G63437 ⁵⁰	58437 ⁵⁰	⊖	G63438 ⁵⁰	58438 ⁵⁰	49155 ⁷
	Exc. Lift Kit	⊖	G63347	58347	43107 ⁸	⊖	G63349	61524 81164	58349 77349	43111 ⁸ 49155 ⁷
	Quad Suspension Long Shock; Exc. Lift Kit	⊖	G63906 ⁶	61522 ⁶ 81496 ⁶	58906 ⁶	⊖	49155 ⁷
	Quad Suspension Short Shock; Exc. Lift Kit	⊖	G63908 ⁶	61516 ⁶ 81113 ⁶	58908 ⁶	⊖	49155 ⁷

PICKUP 1/2 TON, V10 STEERING STABILIZERS

87	All									14017	
	Dual System Steering Stabilizer									6802SE ⁸⁴	
	Single System Steering Stabilizer									6804SE ⁸⁰	

PICKUP 3/4 TON, C20

75-86	Crew Cab Pickup	⊖	G63355	61525 81039	58355 77355	34036 ⁶	⊖	G63366	61649 81174	58366
	Standard Cab Pickup	⊖	G63355	61525 81039	58355 77355	34036 ⁶	⊖	G63349	61524 81164	58349 77349	43111 ⁸ 49155 ⁷
73-74	Crew Cab Pickup	⊖	G63355	61525 81039	58355 77355	34036 ⁶	⊖	61649 81174	58366
	Standard Cab Pickup	⊖	⊖	61524 81164	58349 77349	43111 ⁸ 49155 ⁷
67-72	All	⊖	G63355	61525 81039	58355 77355	34036 ⁶	⊖	G63306
	Coil(RearSpringType)	⊖	G63355	61525 81039	58355 77355	34036 ⁶	⊖	G63306	82003	43062 ² 49107 ⁷

6 It is recommended that when replacing shocks on vehicles with "quad shocks" all 4 shocks should be matched by series.

8 Pair Packs.

50 Bellows Kit No.141242 is recommended for use to protect piston rod from potentially harmful road debris.

80 Mounting bracket not required, install on O.E. Shock Mounts. See Ref. C for optional Steering Stabilizer Boots.



7 Pair Packs, air hose kit included.

40 ReadyMount Strut. Complete Assembled Unit.

53 Strut Mount. Hardware from O.E. Part may need to be reused.

84 Replacement damper for vehicles with the Gabriel Aftermarket mounting kit

APPLICATION GUIDE

Year	Fitment Notes										
		Ultra	ProGuard/ Guardian/ Classic	Max Control/ LTV	Strut Cushion/ Strut Mount	Hi Jacker/ Load Carrier	Ultra	ProGuard/ Guardian/ Classic	Max Control/ LTV	Strut Cushion/ Strut Mount	Hi Jacker/ Load Carrier

CHEVROLET

CHEVROLET

PICKUP 3/4 TON, C20 (cont'd)

67-72	Leaf(RearSpringType)	⊖ ⊖	G63355	61525 81039	58355 77355	34036 ⁸	⊖ ⊖	G63306	82006	43093 ⁹ 49162 ⁷
63-66	All	⊖ ⊖	G63355	61525 81039	58355 77355	34036 ⁸	⊖ ⊖	G63306	43093 ⁹ 49162 ⁷
61-62	All	⊖ ⊖	82035	⊖ ⊖	82086

PICKUP 3/4 TON, C20 STEERING STABILIZERS

		Front	Rear
63-86	Single System Steering Stabilizer	6802SE ⁸⁴

PICKUP 3/4 TON, C25 / C2500

88-00	All	⊖ ⊖	G63489	61544 81668	58489 77489	⊖ ⊖	G63488	61543 81667	58488 77488	43163 ⁹ 49218 ⁷
-------	-----	--------	--------	----------------	----------------	------	------	--------	--------	----------------	----------------	------	--

PICKUP 3/4 TON, C25 / C2500 STEERING STABILIZERS

		Front	Rear
92-99	Exc. O.E. Steering Stabilizer	6853SE ⁸²

PICKUP 3/4 TON, K20

81-86	Exc. Lift Kit	⊖ ⊖	G63347	⊖ ⊖	G63349	61524 81164	77349	43111 ⁹
	Quad Suspension Long Shock; Exc. Lift Kit	⊖ ⊖	G63906 ⁶	61522 ⁵ 81496 ⁶	58906 ⁶	⊖ ⊖
	Quad Suspension Short Shock; Exc. Lift Kit	⊖ ⊖	G63908 ⁸	61516	58908 ⁶	⊖ ⊖
	Standard Suspension; Exc. Lift Kit	⊖ ⊖	81113	58347	43107 ⁸	⊖ ⊖	58349	49155 ⁷
75-86	4" Lift Kit; Exc. Quad Suspension	⊖ ⊖	G63437 ⁵⁰	58437 ⁵⁰	⊖ ⊖	G63438 ⁵⁰	58438
75-80	Exc. Lift Kit	⊖ ⊖	G63347	61516 81113	58347	43107 ⁸	⊖ ⊖	G63349	61524 81164	58349 77349	43111 ⁹ 49155 ⁷
73-74	4" Lift Kit; Exc. Quad Suspension	⊖ ⊖	G63437 ⁵⁰	58437 ⁵⁰	⊖ ⊖	G63438 ⁵⁰	58438 ⁵⁰
	Exc. Lift Kit	⊖ ⊖	G63347	61516 81113	58347	43107 ⁸	⊖ ⊖	61524 81164	58349 77349	43111 ⁹ 49155 ⁷
71-72	All	⊖ ⊖	⊖ ⊖	G63371
	Exc. Lift Kit	⊖ ⊖	G63347	61516 81113	58347	⊖ ⊖	G63371
69-70	Exc. Lift Kit	⊖ ⊖	G63347	61516 81113	58347	⊖ ⊖

PICKUP 3/4 TON, K20 STEERING STABILIZERS

		Front	Rear
73-86	All	14017
	Dual System Steering Stabilizer	6802SE ⁸⁴
	Single System Steering Stabilizer	6804SE ⁸⁰
67-72	Dual System Steering Stabilizer	6802SE ⁸⁴
61-72	Single System Steering Stabilizer	6803SE ⁸⁴

PICKUP 3/4 TON, K25 / K2500

88-00	All	⊖ ⊖	G63609	61542 81726	58609 77609	⊖ ⊖	G63488	61543 81667	58488 77488	43163 ⁹ 49218 ⁷
-------	-----	--------	--------	----------------	----------------	------	------	--------	--------	----------------	----------------	------	--

PICKUP 3/4 TON, K25 / K2500 STEERING STABILIZERS

		Front	Rear
99-00	Exc. O.E. Steering Stabilizer	6853SE ⁸²
88-99	Single System Steering Stabilizer	6807SE ⁸⁰

PICKUP 3/4 TON, R20

88	All	⊖ ⊖	81039	⊖ ⊖
	Crew Cab Pickup	⊖ ⊖	G63355	61525 81039	58355 77355	34036 ⁸	⊖ ⊖	G63366	61649 81174	58366
87	All	⊖ ⊖	G63355	61525 81039	77355	34036 ⁸	⊖ ⊖

6 It is recommended that when replacing shocks on vehicles with "quad shocks" all 4 shocks should be matched by series.

8 Pair Packs.

80 Mounting bracket not required, install on O.E. Shock Mounts. See Ref. C for optional Steering Stabilizer Boots.



84 Replacement damper for vehicles with the Gabriel Aftermarket mounting kit

7 Pair Packs, air hose kit included.

50 Bellows Kit No.141242 is recommended for use to protect piston rod from potentially harmful road debris.

82 Use kit if listed, See Ref. C for optional Steering Stabilizer Boots.

APPLICATION GUIDE

Year	Fitment Notes										
		Ultra	ProGuard\ Guardian\ Classic	Max Control\ LTV	Strut Cushion\ Strut Mount	Hi Jacker\ Load Carrier	Ultra	ProGuard\ Guardian\ Classic	Max Control\ LTV	Strut Cushion\ Strut Mount	Hi Jacker\ Load Carrier

CHEVROLET

CHEVROLET

PICKUP 3/4 TON, R20 (cont'd)

87	Crew Cab Pickup	<input type="radio"/>	G63355	61525 81039	58355 77355	34036 ⁸	<input type="radio"/>	G63366	61649 81174	58366
	Standard Cab Pickup	<input type="radio"/>	G63355	61525 81039	58355 77355	34036 ⁸	<input type="radio"/>	G63349	61524 81164	58349 77349	43111 ⁸ 49155 ⁷

PICKUP 3/4 TON, R20 STEERING STABILIZERS

								Front	Rear	
87-88	Single System Steering Stabilizer								6802SE ⁸⁴

PICKUP 3/4 TON, R2500

89	All	<input type="radio"/>	G63355	61525	58355 77355	<input type="radio"/>
	RWD	<input type="radio"/>	G63355	81039 61525	58355 77355	34036 ⁸	<input type="radio"/>	G63366	61649 81174	58366

PICKUP 3/4 TON, R2500 STEERING STABILIZERS

								Front	Rear	
89	Single System Steering Stabilizer								6802SE ⁸⁴

PICKUP 3/4 TON, SILVERADO 2500

05-08	All	<input type="radio"/>	G63817	61663 81925	58817 77817	<input type="radio"/>	G63675	61642 81921	58412 77412
99-04	All	<input type="radio"/>	<input type="radio"/>	G63675	61642 81921	58412 77412
	4WD	<input type="radio"/>	G63817	61663 81925	58817 77817	<input type="radio"/>	G63675	61642 81921	58412 77412

PICKUP 3/4 TON, SILVERADO 2500 HD

01-10	All	<input type="radio"/>	<input type="radio"/>	G63675	61642 81921	58412 77412
	9200# GVW	<input type="radio"/>	G63817	61663 81925	58817 77817	<input type="radio"/>	G63675	61642 81921	58412 77412

PICKUP 3/4 TON, SILVERADO 2500 HD STEERING STABILIZERS

								Front	Rear	
11-13	All								14075
01-09	9200# GVW w/o O.E. Unit - 15059138 15155638								6803SE ⁸⁴
	4WD, 9200# GVW with O.E. Unit - 15059138 15155638								6853SE ⁸²

PICKUP 3/4 TON, V20

87	All	<input type="radio"/>	<input type="radio"/>	49155 ⁷
	4" Lift Kit; Exc. Quad Suspension	<input type="radio"/>	G63437 ⁵⁰	58437 ⁵⁰	<input type="radio"/>	G63438 ⁵⁰	58438 ⁵⁰	49155 ⁷
	Exc. Quad Suspension and Lift Kit	<input type="radio"/>	G63347	61516	58347	43107 ⁸	<input type="radio"/>	G63349	61524 81164	58349 77349	43111 ⁸ 49155 ⁷
	Quad Suspension Long Shock; Exc. Lift Kit	<input type="radio"/>	G63906 ⁸	61522 ⁸ 81496 ⁸	58906 ⁸	<input type="radio"/>	49155 ⁷
	Quad Suspension Short Shock; Exc. Lift Kit	<input type="radio"/>	G63908 ⁸	58908 ⁸	<input type="radio"/>	49155 ⁷

PICKUP 3/4 TON, V20 STEERING STABILIZERS

								Front	Rear	
87	All								14017
								Dual System Steering Stabilizer	6802SE ⁸⁴
								Single System Steering Stabilizer	6804SE ⁸⁰

PICKUP 1 TON, C30

75-86	All	<input type="radio"/>	G63355	61525 81039	58355 77355	34036 ⁸	<input type="radio"/>	G63366	61649 81174	58366
73-74	All	<input type="radio"/>	G63355	61525 81039	58355 77355	34036 ⁸	<input type="radio"/>	61649 81174	58366
67-72	Exc. 11,000# Rear Axle	<input type="radio"/>	G63355	61525 81039	58355 77355	34036 ⁸	<input type="radio"/>	G63306	82006	43093 ⁸ 49162 ⁷
63-72	All	<input type="radio"/>	G63355	61525 81039	58355 77355	34036 ⁸	<input type="radio"/>

6 It is recommended that when replacing shocks on vehicles with "quad shocks" all 4 shocks should be matched by series.

8 Pair Packs.

80 Mounting bracket not required, install on O.E. Shock Mounts. See Ref. C for optional Steering Stabilizer Boots.



84 Replacement damper for vehicles with the Gabriel Aftermarket mounting kit

7 Pair Packs, air hose kit included.

50 Bellows Kit No. 141242 is recommended for use to protect piston rod from potentially harmful road debris.

82 Use kit if listed, See Ref. C for optional Steering Stabilizer Boots.

APPLICATION GUIDE

Year	Fitment Notes										
		Ultra	ProGuard/ Guardian/ Classic	Max Control/ LTV	Strut Cushion/ Strut Mount	Hi Jacker/ Load Carrier	Ultra	ProGuard/ Guardian/ Classic	Max Control/ LTV	Strut Cushion/ Strut Mount	Hi Jacker/ Load Carrier

CHEVROLET

CHEVROLET

PICKUP 1 TON, C30 (cont'd)

61-62	All	○	82035
-------	-----	---	-------	-------	-------	-------	-------	-------	-------	-------	-------	-------	-------

PICKUP 1 TON, C30 STEERING STABILIZERS

		Front	Rear
73-86	Single System Steering Stabilizer; with Cooler	6802SE ⁸⁴
61-72	Single System Steering Stabilizer	6802SE ⁸⁴

PICKUP 1 TON, C35/3500



01-03	Exc. HD Straight Front Axle	⊖	77489	⊖	G63488	81667	77488	49218 ⁷
	HD Solid Front Axle	⊖	⊖	61543	58488 77488	43163 ⁹
97-03	All	⊖	⊖	77488
01-02	HD, HD Solid Front Axle	⊖	G63812	⊖	77488
98-00	Exc. HD Straight Front Axle	⊖	81668	77489	⊖	77488	49218 ⁷
	Crew Cab Pickup Exc. HD Straight Front Axle	⊖	G63489	61544	58489	⊖	G63488	77488
	Extended Cab Pickup Exc. HD Straight Front Axle	⊖	G63489	61544	58489	⊖	G63488	81667	77488
	Standard Cab Pickup Exc. HD Straight Front Axle	⊖	G63489	61544	58489	⊖	G63488	81667	77488
97-00	Cab & Chassis HD Solid Front Axle	⊖	G63812	⊖	77488
	HD Solid Front Axle	⊖	58812	⊖	61543	58488 77488	43163 ⁹
97	Exc. HD Straight Front Axle	⊖	81668	⊖	77488	49218 ⁷
	Crew Cab Pickup Exc. HD Straight Front Axle	⊖	G63489	61544	58489 77489	⊖	G63488	77488
	Extended Cab Pickup Exc. HD Straight Front Axle	⊖	G63489	61544	58489 77489	⊖	G63488	81667	77488
	Standard Cab Pickup Exc. HD Straight Front Axle	⊖	G63489	61544	58489 77489	⊖	G63488	81667	77488
96	All	⊖	⊖	77488	49218 ⁷
	Exc. HD Straight Front Axle	⊖	81668	⊖	77488	49218 ⁷
	Cab & Chassis HD Solid Front Axle	⊖	G63812	⊖	77488	49218 ⁷
	Crew Cab Pickup Exc. HD Straight Front Axle	⊖	G63489	61544	58489 77489	⊖	G63488	77488	49218 ⁷
	Extended Cab Pickup Exc. HD Straight Front Axle	⊖	G63489	61544	58489 77489	⊖	G63488	81667	77488	49218 ⁷
	HD Solid Front Axle	⊖	58812	⊖	61543	58488 77488	43163 ⁹ 49218 ⁷
	Standard Cab Pickup Exc. HD Straight Front Axle	⊖	G63489	61544	58489 77489	⊖	G63488	81667	77488	49218 ⁷
92-95	Exc. HD Straight Front Axle	⊖	81668	⊖	77488	49218 ⁷
	Crew Cab Pickup Exc. HD Straight Front Axle	⊖	G63489	61544	58489 77489	⊖	G63488	77488
	Extended Cab Pickup Exc. HD Straight Front Axle	⊖	G63489	61544	58489 77489	⊖	G63488	81667	77488
	Standard Cab Pickup Exc. HD Straight Front Axle	⊖	G63489	61544	58489 77489	⊖	G63488	81667	77488
91-95	All	⊖	⊖	77488
	Cab & Chassis HD Solid Front Axle	⊖	G63812	⊖	77488
	HD Solid Front Axle	⊖	58812	⊖	61543	58488 77488	43163 ⁹
91	Exc. HD Straight Front Axle	⊖	⊖	77488	49218 ⁷
	Cab & Chassis	⊖	61525 81039	77355	34036 ⁸	⊖	77488
	Cab & Chassis Exc. HD Solid Front Axle	⊖	G63355	58355	⊖	G63366	61649 81174	58366 77488
	Extended Cab Pickup Exc. HD Straight Front Axle	⊖	G63489	61544 81668	58489 77489	⊖	G63488	81667	77488

7 Pair Packs, air hose kit included.

8 Pair Packs.

84 Replacement damper for vehicles with the Gabriel Aftermarket mounting kit











APPLICATION GUIDE

Year	Fitment Notes										
		Ultra	ProGuard/ Guardian/ Classic	Max Control/ LTV	Strut Cushion/ Strut Mount	Hi Jacker/ Load Carrier	Ultra	ProGuard/ Guardian/ Classic	Max Control/ LTV	Strut Cushion/ Strut Mount	Hi Jacker/ Load Carrier

CHEVROLET

CHEVROLET



PICKUP 1 TON, C35/3500 (cont'd)

91	Standard Cab Pickup Exc. HD Straight Front Axle		G63489	61544 81668	58489 77489		81667	77488
88-90	Cab & Chassis		61525 81039	77355	34036 ⁸	
	Cab & Chassis Exc. HD Solid Front Axle		G63355	58355		G63366	61649 81174	58366
	Extended Cab Pickup Exc. HD Straight Front Axle		G63489	61544 81668	58489 77489		G63488	61543 81667	58488 77488	43163 ⁸ 49218 ⁷
	Standard Cab Pickup Exc. HD Straight Front Axle		G63489	61544 81668	58489 77489		G63488	61543 81667	58488 77488	43163 ⁸ 49218 ⁷

PICKUP 1 TON, C35/3500 STEERING STABILIZERS

		Front		Rear	
91-03	Single System Steering Stabilizer; HD Pickup	6807SE ⁸⁰		



PICKUP 1 TON, K30

77-86	All		G63411	58411		G63675	61642 81921	58412 77412
-------	-----	---	--------	------	-------	------	------	---	--------	----------------	----------------	------	------

PICKUP 1 TON, K30 STEERING STABILIZERS

		Front		Rear	
77-86	All	14017		
	Dual System Steering Stabilizer	6802SE ⁸⁴		
	Single System Steering Stabilizer	6804SE ⁸⁰		
73-74	All	14017		





PICKUP 1 TON, K35 / K3500

88-00	All		G63609	61542 81726	58609 77609		G63488	61543 81667	58488 77488	43163 ⁸ 49218 ⁷
-------	-----	--	--------	----------------	----------------	------	------	--	--------	----------------	----------------	------	--

PICKUP 1 TON, K35 / K3500 STEERING STABILIZERS

		Front		Rear	
95-00	Exc. O.E. Steering Stabilizer	6853SE		
88-00	Single System Steering Stabilizer	6807SE ⁸⁰		









PICKUP 1 TON, R30

87-88	All		G63355	61525	58355 77355	34036 ⁸	
	RWD		G63355	81039 61525	58355 77355	34036 ⁸		G63366	61649 81174	58366

PICKUP 1 TON, R30 STEERING STABILIZERS

		Front		Rear	
87-88	Single System Steering Stabilizer; with Cooler	6802SE ⁸⁴		



PICKUP 1 TON, R3500

90-91	All		G63411	81039	58411		G63675	61642 81921	58412 77412
89	All		81039	
	Exc. Standard Cab		G63411	81039	58411		G63675	61642 81921	58412 77412
	Standard Cab Pickup		G63355	61525 81039	58355 77355	34036 ⁸		G63366	61649 81174	58366



PICKUP 1 TON, R3500 STEERING STABILIZERS

		Front		Rear	
89-91	Single System Steering Stabilizer; with Cooler	6802SE ⁸⁴		
	RWD	14017		

PICKUP 1 TON, SILVERADO 3500

01-09	All		G63817	61663 81925	58817 77817		G63675	61642 81921	58412 77412
-------	-----	---	--------	----------------	----------------	------	------	---	--------	----------------	----------------	------	------

PICKUP 1 TON, SILVERADO 3500 HD

07-10	All		G63817	61663 81925	58817 77817		G63675	61642 81921	58412 77412
-------	-----	---	--------	----------------	----------------	------	------	---	--------	----------------	----------------	------	------





7 Pair Packs, air hose kit included.

80 Mounting bracket not required, install on O.E. Shock Mounts. See Ref. C for optional Steering Stabilizer Boots.

8 Pair Packs.

84 Replacement damper for vehicles with the Gabriel Aftermarket mounting kit

APPLICATION GUIDE

Year	Fitment Notes										
			Ultra	ProGuard/ Guardian/ Classic	Max Control/ LTV	Strut Cushion/ Strut Mount	Hi Jacker/ Load Carrier		Ultra	ProGuard/ Guardian/ Classic	Max Control/ LTV



CHEVROLET

CHEVROLET

PICKUP 1 TON, SILVERADO 3500 HD STEERING STABILIZERS

		Front	Rear
11-13	All	14075



PICKUP 1 TON, V30

87-88	All	 G63411	58411	 G63675	61642 81921	58412 77412
-------	-----	--	------	-------	------	------	--	----------------	----------------	------	------

PICKUP 1 TON, V30 STEERING STABILIZERS

		Front	Rear
87-88	All	14017

PICKUP 1 TON, V3000 / V3500

89-91	All	 G63411	58411	 G63675	61642 81921	58412 77412
-------	-----	--	------	-------	------	------	--	----------------	----------------	------	------







PICKUP 1 TON, V3000 / V3500 STEERING STABILIZERS

		Front	Rear
89-91	All	14017

PICKUP STEERING STABILIZERS

		Front	Rear
60	Truck Dana 60 Axle up to 3 1/2" O.D. or Napco axle up to 3 3/8" O.D.	6803SE ⁸⁴
57-58	Truck Dana 60 Axle up to 3 1/2" O.D. or Napco axle up to 3 3/8" O.D.	6803SE ⁸⁴
50-58	Truck Single System Steering Stabilizer; with I-Beam Axle	6802SE ⁸⁴



















PRIZM

98-02	All	 G55999	143059 ⁵¹ 143281 ⁵³		143058 ⁵¹
	Left	 G55999	143059 ⁵¹ 143281 ⁵³		G55661	142228 ⁵³ 143058 ⁵¹
	Right	 G55999	143059 ⁵¹ 143281 ⁵³		G55662	142229 ⁵³ 143058 ⁵¹

PRIZM READYMOUNTS

		Front	Rear
98-02	Left	G56948 ⁴⁰	G56949 ⁴⁰
	Right	G56948 ⁴⁰	G56950 ⁴⁰

S10

99-04	4WD; Exc. ZR2, ZR5 or Sport Chassis	 G63423	61531 81516	58423 77423	 G63422	61528 81482	58422 77422	43162 ⁵ 49213 ⁷
88-04	4WD, Torsion Bar(FrontSpringType)	142316 ⁵³
99-03	RWD; Exc. Sport Chassis or Xtreme Chassis	 G63421	61504 81750	58421 77421	34051 ⁸	 G63422	61528 81482	58422 77422	43162 ⁵ 49213 ⁷
92-98	4WD; Exc. ZR2, ZR5 or Sport Chassis	 G63423	61531 81516	58423 77423	
	Exc. ZR2, ZR5 or Sport Chassis	 G63422	61528 81482	58422 77422	43162 ⁵ 49213 ⁷
	RWD; Exc. Sport Chassis or Xtreme Chassis	 G63421	61504 81750	58421 77421	34051 ⁸	
91	4WD; Exc. ZR2, Baja & Sport Chassis	 G63423	61531 81516	58423 77423	
	Exc. ZR2, Baja & Sport Chassis	 G63422	61528 81482	58422 77422	43162 ⁵ 49213 ⁷
	RWD; Exc. ZR2, Baja & Sport Chassis	 G63421	61504 81750	58421 77421	34051 ⁸	
83-90	4WD; Exc. ZR2, ZR5 or Sport Chassis	 G63423	61531 81516	58423 77423	
82-90	Exc. ZR2, ZR5 or Sport Chassis	 G63422	61528 81482	58422 77422	43162 ⁵ 49213 ⁷
	RWD; Exc. Sport Chassis or Xtreme Chassis	 G63421	61504 81750	58421 77421	34051 ⁸	

S10 STEERING STABILIZERS

		Front	Rear
83-04	4WD, Single System Steering Stabilizer; with a factory mounting hole in the steering linkage.	6801SE
	4WD, Single System Steering Stabilizer; without a factory mounting hole in the steering linkage.	6851SE
82-03	RWD, Single System Steering Stabilizer	6802SE ⁸⁴

7 Pair Packs, air hose kit included.

40 ReadyMount Strut. Complete Assembled Unit.



53 Strut Mount. Hardware from O.E. Part may need to be reused.

8 Pair Packs.

51 Strut Cushion for use with the Strut/Cartridge/Shocks.

84 Replacement damper for vehicles with the Gabriel Aftermarket mounting kit

APPLICATION GUIDE

Year	Fitment Notes										
		Ultra	ProGuard/ Guardian/ Classic	Max Control/ LTV	Strut Cushion/ Strut Mount	Hi Jacker/ Load Carrier	Ultra	ProGuard/ Guardian/ Classic	Max Control/ LTV	Strut Cushion/ Strut Mount	Hi Jacker/ Load Carrier



CHEVROLET

CHEVROLET







S10 STEERING STABILIZERS (cont'd)

						Front	Rear
82-03	RWD, Single System Steering Stabilizer; without OE Steering Stabilizer					6849SE ⁸²



SPECTRUM

85-88	All		G55719	143058 ⁵¹		81558
-------	-----	---	--------	------	------	----------------------	------	---	------	-------	------	------	------



SPRINT

89-91	All		G55891	142293 ⁵⁴ 143059 ⁵¹		G55772	142295 ⁵³ 143057 ⁵¹
87-88	All		G55749		81562
85-86	All		G55749		81557



SSR

03-06	All		G51718 ⁴⁵	143241 ⁵³		G63842
-------	-----	---	----------------------	------	------	----------------------	------	---	--------	------	------	------	------























STYLELINE DELUXE

49-52	All		82026		82155
-------	-----	---	------	-------	------	------	------	---	------	-------	------	------	------

STYLELINE SPECIAL

49-52	All		82026		82155
-------	-----	---	------	-------	------	------	------	---	------	-------	------	------	------

SUBURBAN 1/2 TON, 1500

12-14	All			G64101 ¹
	Exc. Z55 or ZW7 Ride Suspension		G51891		G64101 ¹
09-11	Exc. Electronic Adjustable Suspension		143316 ⁵³	
	Exc. Z55 or ZW7 Ride Suspension		G51891		G63866	61675 81930	58930 77953
07-08	Exc. Z55 or ZW7 Ride Suspension		G51891	143316 ⁵³		G63866	61675 81930	58930 77953
00-06	Exc. Z55 Auto Ride Suspension		G63803	61643 81922	58803 77803		G63866	61675 81930	58930 77953
67	All		G63355	61525 81039	77355		43062 ⁸
	Coil(RearSpringType)		G63355	61525 81039	77355		82003	49107 ⁷ 43062 ⁸
	Coil(FrontSpringType)		G63355	61525 81039	58355 77355	34036 ⁶		43062 ⁸
63-66	All		G63355	61525 81039	58355 77355	34036 ⁶		G63306	82006	43093 ⁸ 49162 ⁷
61-62	All		82035		82086







SUBURBAN 1/2 TON, 1500 READYMOUNTS

						Front	Rear	
07-11	All						G57125 ¹⁰

SUBURBAN 1/2 TON, 1500 STEERING STABILIZERS

						Front	Rear
00-05	4WD, Exc. O.E. Steering Stabilizer					6853SE ⁸²

SUBURBAN 1/2 TON, C10

73-86	All		G63355	61525 81039	58355 77355	34036 ⁶		G63349	61524 81164	58349 77349	43111 ⁸ 49155 ⁷
68-72	All		G63355	61525 81039	58355 77355	34036 ⁶		82003	43062 ⁸ 49107 ⁷
67	All		G63355	61525 81039	58355 77355	34036 ⁶		43062 ⁸

1 Future Part, available 1st Quarter of 2015.

8 Pair Packs.

45 Strut must be rotated to align notch with lower control arm.

53 Strut Mount. Hardware from O.E. Part may need to be reused.

82 Use kit if listed, See Ref. C for optional Steering Stabilizer Boots.



7 Pair Packs, air hose kit included.

40 ReadyMount Strut. Complete Assembled Unit.

51 Strut Cushion for use with the Strut/Cartridge/Shocks.

54 Kit with Mount and Bearing. Hardware from O.E. Part may need to be reused.

APPLICATION GUIDE

Year	Fitment Notes										
		Ultra	ProGuard/ Guardian/ Classic	Max Control/ LTV	Strut Cushion/ Strut Mount	Hi Jacker/ Load Carrier	Ultra	ProGuard/ Guardian/ Classic	Max Control/ LTV	Strut Cushion/ Strut Mount	Hi Jacker/ Load Carrier

CHEVROLET

CHEVROLET

SUBURBAN 1/2 TON, C10 (cont'd)

63-66	All	⊙	G63355	61525 81039	58355 77355	34036 ⁸	⊙
60-62	All	⊙	⊙	82086

SUBURBAN 1/2 TON, C10 STEERING STABILIZERS

										Front	Rear
68-86	Single System Steering Stabilizer									6802SE ⁸⁴

SUBURBAN 1/2 TON, C15 / C1500

92-99	All	⊙	G63489	61544 81668	58489 77489	⊙	G63896	61565 81789	58638 77638	43180 ⁹ 49231 ⁷
-------	-----	---	--------	----------------	----------------	------	------	---	--------	----------------	----------------	------	--

SUBURBAN 1/2 TON, C15 / C1500 STEERING STABILIZERS

										Front	Rear
92-99	RWD									6852SE ⁸²

SUBURBAN 1/2 TON, K10

81-86	Exc. Lift Kit	⊙	G63347	77355	⊙	G63349	61524 81164	77349	43111 ⁹
	Quad Suspension Long Shock; Exc. Lift Kit	⊙	G63906 ⁶	61522 ⁶ 81496 ⁶	58906 ⁶ 77355	⊙
	Quad Suspension Short Shock; Exc. Lift Kit	⊙	G63908 ⁶	61516	58909 ⁶ 77355	⊙
	Standard Suspension; Exc. Lift Kit	⊙	81113	58347 77355	43107 ⁸	⊙	58349	49155 ⁷
73-86	All	⊙	77355	⊙
	4" Lift Kit; Exc. Quad Suspension	⊙	G63437 ⁵⁰	58437 ⁵⁰ 77355	⊙	G63438 ⁵⁰	58438
75-80	Exc. Lift Kit	⊙	G63347	61516 81113	58347 77355	43107 ⁸	⊙	G63349	61524 81164	58349 77349	43111 ⁹ 49155 ⁷
73-74	Exc. Lift Kit	⊙	G63347	61516 81113	58347 77355	43107 ⁸	⊙	G63349	61524	58349 77349	43111 ⁹ 49155 ⁷
71-72	All	⊙	77355	⊙	G63371
	Exc. Lift Kit	⊙	G63347	61516 81113	58347 77355	43107 ⁸	⊙	G63371
69-70	Exc. Lift Kit	⊙	G63347	61516 81113	58347 77355	43107 ⁸	⊙
68-70	All	⊙	77355	⊙

SUBURBAN 1/2 TON, K10 STEERING STABILIZERS

										Front	Rear
73-86	All									14017
	Dual System Steering Stabilizer									6802SE ⁸⁴
	Single System Steering Stabilizer									6804SE ⁸⁰
68-72	Dual System Steering Stabilizer									6802SE ⁸⁴
	Single System Steering Stabilizer									6803SE ⁸⁴

SUBURBAN 1/2 TON, K15 / K1500

92-99	All	⊙	G63609	61542 81726	58609 77609	⊙	G63638	61565 81789	58638 77638	43180 ⁹ 49231 ⁷
-------	-----	---	--------	----------------	----------------	------	------	---	--------	----------------	----------------	------	--

SUBURBAN 1/2 TON, K15 / K1500 STEERING STABILIZERS

										Front	Rear
92-97	Single System Steering Stabilizer									6807SE ⁸⁰

SUBURBAN 1/2 TON, R10

87-88	All	⊙	G63355	61525	58355 77355	34036 ⁸	⊙	G63349	61524 81164	77349	43111 ⁹
	RWD	⊙	G63355	81039 61525	58355 77355	34036 ⁸	⊙	G63349	61524 81164	58349 77349	49155 ⁷ 43111 ⁹
	RWD, Exc. Quad Suspension and Lift Kit	⊙	G63355	61525	58355 77355	43107 ⁸ 34036 ⁸	⊙	G63349	61524 81164	77349	43111 ⁹

6 It is recommended that when replacing shocks on vehicles with "quad shocks" all 4 shocks should be matched by series.

8 Pair Packs.

80 Mounting bracket not required, install on O.E. Shock Mounts. See Ref. C for optional Steering Stabilizer Boots.



84 Replacement damper for vehicles with the Gabriel Aftermarket mounting kit

7 Pair Packs, air hose kit included.

50 Bellows Kit No.141242 is recommended for use to protect piston rod from potentially harmful road debris.

82 Use kit if listed, See Ref. C for optional Steering Stabilizer Boots.

APPLICATION GUIDE

Year	Fitment Notes										
		Ultra	ProGuard\ Guardian\ Classic	Max Control\ LTV	Strut Cushion\ Strut Mount	Hi Jacker\ Load Carrier	Ultra	ProGuard\ Guardian\ Classic	Max Control\ LTV	Strut Cushion\ Strut Mount	Hi Jacker\ Load Carrier





CHEVROLET

CHEVROLET

SUBURBAN 1/2 TON, R10 STEERING STABILIZERS

		Front	Rear
87-88	Dual System Steering Stabilizer	6802SE ⁸⁴
	Single System Steering Stabilizer	6804SE ⁸⁰
	RWD	14017





SUBURBAN 1/2 TON, R1500

89-91	All	 G63355	61525	58355 77355	34036 ⁶	 G63349	61524 81164	77349	43111 ⁸
	RWD	 G63355	81039 61525	58355 77355	34036 ⁶	 G63349	61524 81164	58349 77349	49155 ⁷ 43111 ⁸











SUBURBAN 1/2 TON, R1500 STEERING STABILIZERS

		Front	Rear
89-91	Single System Steering Stabilizer	6802SE ⁸⁴



SUBURBAN 1/2 TON, V10

87-88	Exc. Lift Kit		58349
	Quad Suspension Long Shock; Exc. Lift Kit		61522 ⁶ 81496 ⁶	
	Quad Suspension Short Shock; Exc. Lift Kit		61516 ⁶ 81113 ⁶	

SUBURBAN 1/2 TON, V1500

89-91	All		49155 ⁷
	Exc. Lift Kit	 G63349	61524 81164	58349 77349	43111 ⁸ 49155 ⁷
	Exc. Quad Suspension and Lift Kit		61516		49155 ⁷
	Quad Suspension Long Shock; Exc. Lift Kit	 G63906 ⁶		49155 ⁷
	Quad Suspension Short Shock; Exc. Lift Kit	 G63908 ⁶		49155 ⁷
	4WD, 4" Lift Kit; Exc. Quad Suspension	 G63437 ⁵⁰	58437 ⁵⁰		49155 ⁷









SUBURBAN 3/4 TON, 2500

00-11	Exc. Z55 Auto Ride Suspension and QuadraSteer	 G63817	61663 81925	58817 77817	 G63866	61675 81930	58930 77953
-------	---	--	----------------	----------------	------	------	--	----------------	----------------	------	------

SUBURBAN 3/4 TON, 2500 STEERING STABILIZERS

		Front	Rear
00-05	4WD, Exc. O.E. Steering Stabilizer	6853SE ⁸²



SUBURBAN 3/4 TON, C20

73-86	All	 G63355	61525 81039	58355 77355	34036 ⁶	 G63349	61524 81164	58349 77349	43111 ⁸ 49155 ⁷
68-72	All	 G63355	61525 81039	58355 77355	34036 ⁶		82003	43062 ⁸ 49107 ⁷
67	All		61525	34036 ⁶	
65-66	All		34036 ⁶	

SUBURBAN 3/4 TON, C20 STEERING STABILIZERS

		Front	Rear
68-86	Single System Steering Stabilizer	6802SE ⁸⁴

SUBURBAN 3/4 TON, C25 / C2500

92-99	All	 G63489	61544 81668	58489 77489	 G63896	61565 81789	58638 77638	43180 ⁶ 49231 ⁷
-------	-----	--	----------------	----------------	------	------	--	----------------	----------------	------	--

SUBURBAN 3/4 TON, C25 / C2500 STEERING STABILIZERS

		Front	Rear
92-99	RWD	6852SE ⁸²

6 It is recommended that when replacing shocks on vehicles with "quad shocks" all 4 shocks should be matched by series.

8 Pair Packs.



80 Mounting bracket not required, install on O.E. Shock Mounts. See Ref. C for optional Steering Stabilizer Boots.

7 Pair Packs, air hose kit included.

50 Bellows Kit No. 141242 is recommended for use to protect piston rod from potentially harmful road debris.

82 Use kit if listed, See Ref. C for optional Steering Stabilizer Boots.

APPLICATION GUIDE

Year	Fitment Notes										
		Ultra	ProGuard/ Guardian/ Classic	Max Control/ LTV	Strut Cushion/ Strut Mount	Hi Jacker/ Load Carrier	Ultra	ProGuard/ Guardian/ Classic	Max Control/ LTV	Strut Cushion/ Strut Mount	Hi Jacker/ Load Carrier

CHEVROLET

CHEVROLET

SUBURBAN 3/4 TON, K20

81-86	Exc. Lift Kit	○	G63347	77355	○	G63349	61524 81164	77349	43111 ⁸
	Quad Suspension Long Shock; Exc. Lift Kit	○	G63906 ⁶	61522 ⁶ 81496 ⁶	58906 ⁶
	Quad Suspension Short Shock; Exc. Lift Kit	○	G63908 ⁶	61516	58908 ⁶
	Standard Suspension; Exc. Lift Kit	○	81113	58347	○	58349	49155 ⁷
73-86	4" Lift Kit; Exc. Quad Suspension	○	G63437 ⁵⁰	58437 ⁵⁰	○	G63438 ⁵⁰	58438
73-80	Exc. Lift Kit	○	G63347	61516 81113	58347 77355	○	G63349	61524 81164	58349 77349	43111 ⁸ 49155 ⁷
71-72	Exc. Lift Kit	○	G63347	61516 81113	58347 77355	○	G63371
69-70	Exc. Lift Kit	○	G63347	61516 81113	58347 77355
68	Exc. Lift Kit	○	77355

SUBURBAN 3/4 TON, K20 STEERING STABILIZERS

		Front	Rear
73-86	All	14017
	Dual System Steering Stabilizer	6802SE ⁸⁴
	Single System Steering Stabilizer	6804SE ⁸⁰
68-72	Dual System Steering Stabilizer	6802SE ⁸⁴
	Single System Steering Stabilizer	6803SE ⁸⁴

SUBURBAN 3/4 TON, K25 / K2500

92-99	All	○	G63609	61542 81726	58609 77609	○	G63638	61565 81789	58638 77638	43180 ⁸ 49231 ⁷
-------	-----	---	--------	----------------	----------------	------	------	---	--------	----------------	----------------	------	--

SUBURBAN 3/4 TON, K25 / K2500 STEERING STABILIZERS

		Front	Rear
95-99	Exc. O.E. Steering Stabilizer	6853SE ⁸²
92-97	Single System Steering Stabilizer	6807SE ⁸⁰

SUBURBAN 3/4 TON, R20

87-88	All	○	G63355	61525 81039	58355 77355	34036 ⁸	○	G63349	61524 81164	77349	43111 ⁸
	RWD	○	G63355	61525 81039	58355 77355	34036 ⁸	○	G63349	61524 81164	58349 77349	49155 ⁷ 43111 ⁸

SUBURBAN 3/4 TON, R20 STEERING STABILIZERS

		Front	Rear
87-88	Single System Steering Stabilizer	6802SE ⁸⁴

SUBURBAN 3/4 TON, R2500

89-91	All	○	G63355	61525	58355 77355	34036 ⁸	○	G63349	61524 81164	77349	43111 ⁸
	RWD	○	G63355	81039 61525	58355 77355	34036 ⁸	○	G63349	61524 81164	58349 77349	49155 ⁷ 43111 ⁸

SUBURBAN 3/4 TON, R2500 STEERING STABILIZERS

		Front	Rear
89-91	Single System Steering Stabilizer	6802SE ⁸⁴

SUBURBAN 3/4 TON, V20

87-88	All	○	○	49155 ⁷
	4" Lift Kit; Exc. Quad Suspension	○	G63437 ⁵⁰	58437 ⁵⁰	○	G63438 ⁵⁰	58438 ⁵⁰	49155 ⁷
	Exc. Quad Suspension and Lift Kit	○	G63347	58347	○	G63349	61524 81164	58349 77349	43111 ⁸ 49155 ⁷
	Quad Suspension Long Shock; Exc. Lift Kit	○	G63906 ⁶	61522 ⁶ 81496 ⁶	58906 ⁶	○	49155 ⁷
	Quad Suspension Short Shock; Exc. Lift Kit	○	G63908 ⁶	61516 81113 ³	58908 ⁶	○	49155 ⁷

6 It is recommended that when replacing shocks on vehicles with "quad shocks" all 4 shocks should be matched by series.

8 Pair Packs.

80 Mounting bracket not required, install on O.E. Shock Mounts. See Ref. C for optional Steering Stabilizer Boots.



84 Replacement damper for vehicles with the Gabriel Aftermarket mounting kit

7 Pair Packs, air hose kit included.

50 Bellows Kit No. 141242 is recommended for use to protect piston rod from potentially harmful road debris.

82 Use kit if listed, See Ref. C for optional Steering Stabilizer Boots.

APPLICATION GUIDE

Year	Fitment Notes										
		Ultra	ProGuard\ Guardian\ Classic	Max Control\ LTV	Strut Cushion\ Strut Mount	Hi Jacker\ Load Carrier	Ultra	ProGuard\ Guardian\ Classic	Max Control\ LTV	Strut Cushion\ Strut Mount	Hi Jacker\ Load Carrier

CHEVROLET

CHEVROLET

SUBURBAN 3/4 TON, V20 STEERING STABILIZERS

		Front	Rear
87-88	All	14017
	Dual System Steering Stabilizer	6802SE ⁸⁴
	Single System Steering Stabilizer	6804SE ⁸⁰

SUBURBAN 3/4 TON, V2500

89-91	All	49155 ⁷		
	4" Lift Kit; Exc. Quad Suspension	G63437 ⁵⁰	58437 ⁵⁰	G63438 ⁵⁰	58438 ⁵⁰	49155 ⁷
	Exc. Lift Kit	G63347	58347	G63349	61524 81164	58349 77349	43111 ⁸ 49155 ⁷
	Quad Suspension Long Shock; Exc. Lift Kit	G63906 ⁶	61522 ⁶ 81496 ⁶	58906 ⁵	49155 ⁷
	Quad Suspension Short Shock; Exc. Lift Kit	G63908 ⁶	61516 81113 ⁶	58908 ⁵	49155 ⁷

SUBURBAN 3/4 TON, V2500 STEERING STABILIZERS

		Front	Rear
89-91	All	14017
	Dual System Steering Stabilizer	6802SE ⁸⁴
	Single System Steering Stabilizer	6804SE ⁸⁰

TAHOE

15	All	G51960	G64107
12-14	All	G64101 ¹
	Exc. Z55 or ZW7 Ride Suspension	G51891	G64101 ¹
07-11	Exc. Z55 or ZW7 Ride Suspension	G51891	143316 ⁵³	G63866	61675 81930	58930 77953
02-06	Exc. Z55 Auto Ride Suspension	G63803	61643 81922	58803 77803	G63866	61675 81930	58930 77953
00-01	New Body Style; Exc. Z55 Auto Ride Suspension	G63803	61643 81922	58803 77803	G63866	61675 81930	58930 77953
95-00	Old Body Style	61565 81789	58638 77638	43180 ⁸ 49231 ⁷
	4WD, Old Body Style	G63609	61542 81726	58901 77609	G63638
	RWD, Old Body Style	G63489	61544 81668	58489 77489	G63896

TAHOE READYMOUNTS

		Front	Rear
07-11	All	G57125 ⁴⁰

TAHOE STEERING STABILIZERS

		Front	Rear
01-05	4WD, New Body Style; Exc. Z55 Auto Ride Suspension	6853SE ⁸²
95-00	4WD, Old Body Style	6853SE ⁸²
95-99	RWD	6852SE ⁸²

TORNADO

04-08	All	G63875
-------	-----	------	------	------	------	------	------	--------	------	------	------	------

TOWNSMAN

71-72	All	69675 ⁵	81446	34073 ⁸	69604	81492
69-70	All	69675 ⁵	81446	34073 ⁸	69724	81514	43049 ⁸ 49131 ³⁰

1 Future Part, available 1st Quarter of 2015.

6 It is recommended that when replacing shocks on vehicles with "quad shocks" all 4 shocks should be matched by series.

8 Pair Packs.

40 ReadyMount Strut. Complete Assembled Unit.

53 Strut Mount. Hardware from O.E. Part may need to be reused.

82 Use kit if listed, See Ref. C for optional Steering Stabilizer Boots.

5 Use kit No. 140719 to replace O.E. hardware for lower shock absorber mounting when studs break or self-tapping screws are not longer useable.

7 Pair Packs, air hose kit included.



30 For GM Vehicles equipped with factory installed leveling systems, see Ref A.

50 Bellows Kit No.141242 is recommended for use to protect piston rod from potentially harmful road debris.

80 Mounting bracket not required, install on O.E. Shock Mounts. See Ref. C for optional Steering Stabilizer Boots.

84 Replacement damper for vehicles with the Gabriel Aftermarket mounting kit

APPLICATION GUIDE

Year	Fitment Notes										
		Ultra	ProGuard\ Guardian\ Classic	Max Control\ LTV	Strut Cushion\ Strut Mount	Hi Jacker\ Load Carrier	Ultra	ProGuard\ Guardian\ Classic	Max Control\ LTV	Strut Cushion\ Strut Mount	Hi Jacker\ Load Carrier

CHEVROLET TRACKER

99-04	All	143204 ⁵³
04	Non-ABS	G56518	143204 ⁵³	G63799	61560 81904	49613 ⁷
99-03	Non-ABS	G56518	142294 ⁵⁴ 143204 ⁵³	G63799	61560 81904	49613 ⁷
98	Non-ABS	G56518	142294 ⁵⁴	G63799	61560 81904	49613 ⁷

CHEVROLET

TRAILBLAZER

05-09	Coil (RearSpringType)	G51718 ⁴⁵	143241 ⁵³	77971
	Coil(RearSpringType)	G51718 ⁴⁵	143241 ⁵³	G63842
02-09	All	G51718 ⁴⁵	143241 ⁵³
	Air(RearSpringType)	G51718 ⁴⁵	143241 ⁵³	G64014	61717
02-04	Coil (RearSpringType)	G51718 ⁴⁵	143241 ⁵³	G63842	77971

TRAILBLAZER EXT

02-06	All	77971
-------	-----	-------	-------	-------	-------	-------	-------	-------	-------	-------

TRAILBLAZER READYMOUNTS

02-09	All						Front	Rear
							G57022 ⁴⁰

TRAVERSE

12	All	G52125	G64040
09-11	All	G52125	143366 ⁵³	G64040

TRAVERSE READYMOUNTS

09-11	All						Front	Rear
							G57109

TWO-TEN SERIES

55-57	All	69625	82099	82066
53-54	All	82026	82155

UPLANDER

05-09	Exc. Air-Leveling Suspension	G52025
09	FWD, Exc. Air-Leveling Suspension	142526 ⁵⁴
05-08	FWD, Air-Leveling Suspension; Exc. Independent Rear Suspension	49230 ⁷
	FWD, Exc. Air-Leveling Suspension	142526 ⁵⁴	G63776

UPLANDER READYMOUNTS

05-09	FWD						Front	Rear
							G57142 ¹

VAN 1/2 TON, G / EXPRESS

07-11	RWD, Coil(FrontSpringType)	G63894	G63896	61686 81789	58638 77638	43180 ⁸ 49231 ⁷
	Torsion Bar (FrontSpringType)	G63893	G63896	61686 81789	58638 77638	43180 ⁸ 49231 ⁷
03-11	All	G63896	61686 81789	58638 77638	43180 ⁸ 49231 ⁷

1 Future Part, available 1st Quarter of 2015.

8 Pair Packs.

45 Strut must be rotated to align notch with lower control arm.

54 Kit with Mount and Bearing. Hardware from O.E. Part may need to be reused.



Bold Type - New / Future Part

7 Pair Packs, air hose kit included.

40 ReadyMount Strut. Complete Assembled Unit.

53 Strut Mount. Hardware from O.E. Part may need to be reused.

APPLICATION GUIDE

Year	Fitment Notes										
		Ultra	ProGuard\Guardian\Classic	Max Control\LTV	Strut Cushion\Strut Mount	Hi Jacker\Load Carrier	Ultra	ProGuard\Guardian\Classic	Max Control\LTV	Strut Cushion\Strut Mount	Hi Jacker\Load Carrier

CHEVROLET

CHEVROLET

VAN 1/2 TON, G / EXPRESS (cont'd)

03-06	RWD, Coil(FrontSpringType)	⊕	G63894	61684	⊕	G63896	61686 81789	58638 77638	43180 ⁸ 49231 ⁷
	Torsion Bar (FrontSpringType)	⊕	G63893	61683	⊕	G63896	61686 81789	58638 77638	43180 ⁸ 49231 ⁷
96-02	All	⊕	G63375 ⁵	61555 81713 ⁵	77375	⊕	G63896	61565 81789	58638 77638	43180 ⁸ 49231 ⁷
78-95	All	⊕	G63357 ⁵	61517 81108	58357 77357	⊕	G63413	61522 81496	58413 77413	49212 ⁷
71-77	All	⊕	G63357 ⁵	61517 81108	58357 77357	⊕	G63306	82006	43093 ⁸ 49162 ⁷
70	All	⊕	⊕	G63306	82006	43093 ⁸ 49162 ⁷
	Independent Front Suspension	⊕	G63357 ⁵	61517 81108	58357 77357	⊕	G63306	82006	43093 ⁸ 49162 ⁷
	Solid Front Axle	⊕	82062	⊕	G63306	82006	43093 ⁸ 49162 ⁷
67-69	All	⊕	82062	⊕	G63306	82006	43093 ⁸ 49162 ⁷
64-66	All	⊕	82062	⊕	82003

VAN 1/2 TON, G / EXPRESS STEERING STABILIZERS

		Front	Rear
70-95	Single System Steering Stabilizer	6802SE ⁸⁴

VAN 1/2 TON, P SERIES

74-80	All	⊕	G63355	61525 81039	58355 77355	34036 ⁸	⊕	G63366	61649 81174	58366 77662
73	All	⊕	G63355	61525 81039	58355 77355	34036 ⁸	⊕	G63349	61524 81164	58349 77349	43111 ⁸ 49155 ⁷
67-72	All	⊕	G63355	61525 81039	58355 77355	34036 ⁸	⊕	82003	43062 ⁸ 49107 ⁷
63-66	All	⊕	G63355	61525 81039	58355 77355	34036 ⁸	⊕	G63306	82006	43093 ⁸ 49162 ⁷
62	All	⊕	82035	⊕	82086

VAN 3/4 TON, G / EXPRESS





10-12	All	⊕	⊕	G63897	61687	77638
	Coil(FrontSpringType)	⊕	G63895	61685	⊕	G63897	61687	77638
	Torsion Bar (FrontSpringType)	⊕	G63893	61683	⊕	G63897	61687	77638
07-09	All	⊕	⊕	G63897	61687 81789	58638 77638
	Coil(FrontSpringType)	⊕	G63895	61685	⊕	G63897	61687 81789	58638 77638
	Torsion Bar (FrontSpringType)	⊕	G63893	61683	⊕	G63897	61687 81789	58638 77638
03-06	All	⊕	⊕	G63897	61687	77638
	Coil(FrontSpringType)	⊕	G63895	61685	⊕	G63897	61687	77638
	Torsion Bar (FrontSpringType)	⊕	G63893	61683	⊕	G63897	61687	77638
96-02	Exc. 8600# GVW	⊕	G63375 ⁵	61555 81713 ⁵	77375	⊕	G63638	61565 81789	58638 77638	43180 ⁸ 49231 ⁷
78-95	All	⊕	G63357 ⁵	⊕
	Exc. 8600# GVW	⊕	G63357 ⁵	61517 81108	58357 77357	⊕	G63413	61522 81496	58413 77413	49212 ⁷
71-77	All	⊕	G63357 ⁵	61517 81108	58357 77357	⊕	G63306	82006	43093 ⁸ 49162 ⁷
70	All	⊕	58357	⊕	G63306	82006	43093 ⁸ 49162 ⁷
	Independent Front Suspension	⊕	G63357 ⁵	61517 81108	77357 58357	⊕	G63306	82006	43093 ⁸ 49162 ⁷
	Solid Front Axle	⊕	82062	58357	⊕	G63306	82006	43093 ⁸ 49162 ⁷
67-69	All	⊕	82062	⊕	G63306	82006	43093 ⁸ 49162 ⁷

5 Use kit No. 140719 to replace O.E. hardware for lower shock absorber mounting when studs break or self-tapping screws are not longer useable.

7 Pair Packs, air hose kit included.

84 Replacement damper for vehicles with the Gabriel Aftermarket mounting kit

APPLICATION GUIDE

Year	Fitment Notes										
			Ultra	ProGuard/ Guardian/ Classic	Max Control/ LTV	Strut Cushion/ Strut Mount	Hi Jacker/ Load Carrier		Ultra	ProGuard/ Guardian/ Classic	Max Control/ LTV











CHEVROLET

CHEVROLET























































VAN 3/4 TON, G / EXPRESS STEERING STABILIZERS

		Front	Rear
78-95	Single System Steering Stabilizer	6802SE ⁸⁴
75-77	All	6802SE ⁸⁴
70-74	Single System Steering Stabilizer	6802SE ⁸⁴

VAN 3/4 TON, P SERIES

79-89	All		G63355	61525 81039	58355 77355	34036 ⁸		G63366	61649 81174	58366 77662
73-78	All		G63355	61525 81039	58355 77355	34036 ⁸		G63349	61524 81164	58349 77349	43111 ⁸ 49155 ⁷
68-72	All		G63355	61525 81039	58355 77355	34036 ⁸		G63306	82006	43093 ⁸ 49162 ⁷
63-67	All		82047	
61-62	All		82047		82155

VAN 1 TON, G / EXPRESS



10-12	All			81789	58638 77638
	Single Rear Wheels			G63897	61687 81789	58638 77638
	Torsion Bar (FrontSpringType)		G63893		81789	58638 77638
	Coil(FrontSpringType)		G63895	61685		81789	58638 77638
07-09	All			77638
	Single Rear Wheels			G63897	61687	77638
	Torsion Bar (FrontSpringType)		G63893		77638
	Coil(FrontSpringType)		G63895	61685		77638
03-06	All			81789	58638 77638
	Dual Rear Wheels			G63898	61688 81789	58638 77638
	Single Rear Wheels			G63897	61687 81789	58638 77638
	Torsion Bar (FrontSpringType)		G63893		81789	58638 77638
	Coil(FrontSpringType)		G63895	61685		81789	58638 77638
97-02	All		G63375 ⁵	61555 81713 ³	77375		61565 81789	43180 ⁸ 49231 ⁷
	Exc. 8600# GVW		G63375 ⁵	61555 81713 ³	77375		G63638	61565 81789	43180 ⁸ 49231 ⁷
96	All		61517 81108	58357 77357		43180 ⁸ 49231 ⁷
	Chassis Cab		61517 81108	58357 77357		58671	43180 ⁸ 49231 ⁷
	Exc. 8600# GVW		61517 81108	58357 77357		61565	43180 ⁸ 49231 ⁷
	Cutaway Van		61517 81108	58357 77357		G63671	43180 ⁸ 49231 ⁷
	Exc. 8600# GVW		61517 81108	77375 58357 77357		43180 ⁸ 49231 ⁷
	Exc. 8600# GVW		61517 81108	77375 58357 77357		43180 ⁸ 49231 ⁷
92-95	9200# GVW		G63357	61517 81108	58357 77357		77403
	Chassis Cab		G63357	61517 81108	58357 77357		58671
	Cutaway Van		G63357	61517 81108	58357 77357		G63671	81496	58403	49212 ⁷
	Exc. Cutaway Van		G63357	61517 81108	58357 77357		G63413
78-95	All		G63357	61517 81108	58357 77357	
79-91	9200# GVW		G63357	61517 81108	58357 77357		G63403	77403

5 Use kit No. 140719 to replace O.E. hardware for lower shock absorber mounting when studs break or self-tapping screws are not longer useable.
8 Pair Packs.

7 Pair Packs, air hose kit included.

84 Replacement damper for vehicles with the Gabriel Aftermarket mounting kit

APPLICATION GUIDE

Year	Fitment Notes										
		Ultra	ProGuard/ Guardian/ Classic	Max Control/ LTV	Strut Cushion/ Strut Mount	Hi Jacker/ Load Carrier	Ultra	ProGuard/ Guardian/ Classic	Max Control/ LTV	Strut Cushion/ Strut Mount	Hi Jacker/ Load Carrier

CHEVROLET

CHEVROLET

VAN 1 TON, G / EXPRESS (cont'd)

79-91	Cutaway Van	○	G63357	61517 81108	58357 77357	○	61522 81496	58403	49212 ⁷
78-91	Exc. Chassis Cab	○	G63357	61517 81108	58357 77357	○	77413
	Exc. Cutaway Van	○	G63357	61517 81108	58357 77357	○	G63413	58413
78	Cutaway Van	○	G63357	61517 81108	58357 77357	○	61522 81496	49212 ⁷
76-77	All	○	G63357	81108	○	G63306	82006	43093 ⁸ 49162 ⁷
75	110.0(WheelBase)	○	○	G63306	82006	43093 ⁸ 49162 ⁷
	125.0(WheelBase)	○	○	G63306	82006	43093 ⁸ 49162 ⁷
	146.0(WheelBase)	○	G63357	61517 81108	58357 77357	○
71-74	All	○	G63357	61517 81108	58357 77357	○	G63306	82006	43093 ⁸ 49162 ⁷

VAN 1 TON, G / EXPRESS STEERING STABILIZERS

		Front	Rear
94-95	Single System Steering Stabilizer; HD with Straight Front Axle & Tilt Hood	6804SE ⁸⁰
71-95	Single System Steering Stabilizer	6802SE ⁸⁴

VAN 1 TON, P SERIES

86-99	Motorhome Chassis with I-Beam Front Suspension	○	G63625	58625	○	G63366	61649 81174	58366
85-99	Motorhome Chassis with Independent Front Suspension	○	G63394	58394	○	G63366	61649 81174	58366
73-99	All	○	○	G63366	61649 81174	58366
73-90	Exc. Motorhome Chassis	○	G63355	61525 81039	58355 77355	34036 ⁸	○	G63366	61649 81174	58366
85	Motorhome Chassis with I-Beam Front Suspension	○	G63403	58403 77403	○	G63366	61649 81174	58366
74-84	Motorhome Chassis	○	G63394	58394	○	G63366	61649 81174	58366
68-72	All	○	58355 77355	34036 ⁸	○
	Exc. 11,000# Rear Axle	○	58355 77355	34036 ⁸	○	G63306	82006	43093 ⁸ 49162 ⁷
	Exc. Motorhome Chassis	○	G63355	61525 81039	58355 77355	34036 ⁸	○
63-67	All	○	82047	○
61-62	All	○	82047	○	82155

VAN 1 TON, P SERIES STEERING STABILIZERS

		Front	Rear
85-93	Single System Steering Stabilizer; with I-Beam Front Suspension	6804SE ⁸⁰
75-93	Motorhome Chassis	6805SE ⁸⁰

VEGA

72-77	All	⊕	82129	⊕	81438
71	All	⊕	82129	⊕

VENTURE

02-05	All	⊕	G55948	142524 ⁵⁸ 142525 ⁵³ 142526 ⁵⁴ 143060 ⁵¹	⊕	G63776	61659 81924
	FWD	⊕	G55948	142524 ⁵⁸ 142525 ⁵³ 142526 ⁵⁴ 143060 ⁵¹	⊕	G63776	61659 81924	49230 ⁷

7 Pair Packs, air hose kit included.

51 Strut Cushion for use with the Strut/Cartridge/Shocks.

54 Kit with Mount and Bearing. Hardware from O.E. Part may need to be reused.

80 Mounting bracket not required, install on O.E. Shock Mounts. See Ref. C for optional Steering Stabilizer Boots.





8 Pair Packs.

53 Strut Mount. Hardware from O.E. Part may need to be reused.

58 Mount Kit includes Suspension Bearing. Hardware from O.E. Part may need to be reused.

84 Replacement damper for vehicles with the Gabriel Aftermarket mounting kit



APPLICATION GUIDE

Year	Fitment Notes										
			Ultra	ProGuard/ Guardian/ Classic	Max Control/ LTV	Strut Cushion/ Strut Mount	Hi Jacker/ Load Carrier		Ultra	ProGuard/ Guardian/ Classic	Max Control/ LTV

CHEVROLET

CHEVROLET

VENTURE (cont'd)

97-01	FWD		G55948	142524 ⁵⁸ 142525 ⁵³ 142526 ⁵⁴ 143060 ⁵¹		G63776	61659 81924	49230 ⁷
-------	-----	---	--------	------	------	--	------	---	--------	----------------	------	------	--------------------

















VENTURE READYMOUNTS

		Front	Rear
02-05	All	G57060 ⁴⁰
97-01	FWD	G57060 ⁴⁰



















CHRYSLER

CHRYSLER

200

12-13	All		143336 ⁵³	
	Left Standard Suspension		G52117	143336 ⁵³	
	Right Standard Suspension		G52118	143336 ⁵³	
	Standard Suspension		143336 ⁵³		G51863
11	All		143336 ⁵³		143337 ⁵³
	Left Standard Suspension		G52117	143336 ⁵³		143337 ⁵³
	Right Standard Suspension		G52118	143336 ⁵³		143337 ⁵³
	Standard Suspension		143336 ⁵³		G51863	143337 ⁵³





300

05-10	All			143335 ⁵³
	RWD, Left		G51761		143335 ⁵³
	RWD, Left Performance Suspension		G51947		143335 ⁵³
	RWD, Right		G51760		143335 ⁵³
10	RWD		143369 ⁵³		143335 ⁵³
	05-09	RWD		143369 ⁵³		G51721	143335 ⁵³
70-71	All		82011		43067 ⁸ 49149 ⁷
65-69	All		82011		82131	43096 ⁸ 49106 ⁷
57-64	All		82072		81469	49110 ⁷

300 READYMOUNTS

		Front	Rear
05-10	RWD, Left	G57071 ⁴⁰
	RWD, Right	G57072 ⁴⁰

300M

99-04	Left		G55663	142827 ⁵⁵ 143057 ⁵¹		G55856	142828 ⁵³ 143058 ⁵¹
	Right		G55664	142827 ⁵⁵ 143057 ⁵¹		G55856	142828 ⁵³ 143058 ⁵¹

7 Pair Packs, air hose kit included.

40 ReadyMount Strut. Complete Assembled Unit.

53 Strut Mount. Hardware from O.E. Part may need to be reused.

55 Mount Kit includes Mount, Spring Seat, Bearing & Isolator. Hardware from O.E. Part may need to be reused.

63 Mount Kit includes Isolator. Hardware from O.E. Part may need to be reused.

8 Pair Packs.



51 Strut Cushion for use with the Strut/Cartridge/Shocks.

54 Kit with Mount and Bearing. Hardware from O.E. Part may need to be reused.

58 Mount Kit includes Suspension Bearing. Hardware from O.E. Part may need to be reused.

Bold Type - New / Future Part

APPLICATION GUIDE

Year	Fitment Notes										
		Ultra	ProGuard\ Guardian\ Classic	Max Control\ LTV	Strut Cushion\ Strut Mount	Hi Jacker\ Load Carrier	Ultra	ProGuard\ Guardian\ Classic	Max Control\ LTV	Strut Cushion\ Strut Mount	Hi Jacker\ Load Carrier

CHRYSLER

CHRYSLER

300M READYMOUNTS

		Front	Rear
99-04	Left	G56962 ⁴⁰	G56964 ⁴⁰
	Right	G56963 ⁴⁰	G56964 ⁴⁰

ASPEN

08	All
07	All	G64016	61720

CIRRUS

99-00	All	143030 ⁵³ 143064 ⁵¹	G51268	142396 ⁵³ 143063 ⁵¹ 143328 ⁶³
	J2(MfrBodyCode)	G51267	143030 ⁵³ 143064 ⁵¹	G51268	142396 ⁵³ 143063 ⁵¹ 143328 ⁶³
97-98	All	143030 ⁵³ 143064 ⁵¹	G51078	142396 ⁵³ 143063 ⁵¹
	JA(MfrBodyCode)	G51796	143030 ⁵³ 143064 ⁵¹	G51078	142396 ⁵³ 143063 ⁵¹
95-96	All	G55818	143030 ⁵³ 143064 ⁵¹	G51078	142396 ⁵³ 143063 ⁵¹

CIRRUS READYMOUNTS

		Front	Rear
99-00	All	G57025 ⁴⁰

CONCORDE

98-04	Left	G55663	142827 ⁵⁵ 143057 ⁵¹	G55856	142828 ⁵³ 143058 ⁵¹
	Right	G55664	142827 ⁵⁵ 143057 ⁵¹	G55856	142828 ⁵³ 143058 ⁵¹
93-97	Left	G55663	142755 ⁶¹ 142842 ⁵⁴ 143057 ⁵¹	G55665	142292 ⁵³
	Right	G55664	142755 ⁶¹ 142842 ⁵⁴ 143057 ⁵¹	G55665	142292 ⁵³

CONCORDE READYMOUNTS

		Front	Rear
98-04	Left	G56962 ⁴⁰	G56964 ⁴⁰
	Right	G56963 ⁴⁰	G56964 ⁴⁰
93-97	Left	G56958 ⁴⁰	G56960 ⁴⁰
	Right	G56959 ⁴⁰	G56960 ⁴⁰

CONQUEST

87-89	Exc. Electronic Adjustable Suspension	G44937 ⁹⁸	143058 ⁵¹	143057 ⁵¹
-------	---------------------------------------	----------------------	-------	-------	----------------------	-------	-------	-------	-------	----------------------	-------

CORDOBA

80-83	All	69704	81406	69703	81338	43138 ⁸
77-79	All	81153	69703	81338	43138 ⁸
75-76	All	81153	82131	43096 ⁸ 49106 ⁷

CROSSFIRE

04-08	All	69956	69957
-------	-----	-------	-------	-------	-------	-------	-------	-------	-------	-------	-------

7 Pair Packs, air hose kit included.

40 ReadyMount Strut. Complete Assembled Unit.

53 Strut Mount. Hardware from O.E. Part may need to be reused.

55 Mount Kit includes Mount, Spring Seat, Bearing & Isolator. Hardware from O.E.

Part may need to be reused.

63 Mount Kit includes Isolator. Hardware from O.E. Part may need to be reused.

8 Pair Packs.





51 Strut Cushion for use with the Strut/Cartridge/Shocks.

54 Kit with Mount and Bearing. Hardware from O.E. Part may need to be reused.

61 Mount Kit includes Upper Spring Seat. Hardware from O.E. Part may need to be reused.





98 Notice: The level of difficulty to install this product is moderately high. Please review the installation instructions carefully before proceeding.

APPLICATION GUIDE

Year	Fitment Notes										
			Ultra	ProGuard/ Guardian/ Classic	Max Control/ LTV	Strut Cushion/ Strut Mount	Hi Jacker/ Load Carrier		Ultra	ProGuard/ Guardian/ Classic	Max Control/ LTV



CHRYSLER

DAYTONA





86-93	CAN		G55526	142567 ⁵¹ 142568 ⁵⁴ 142880 ⁵⁴ 142933 ⁵⁶ 142940 ⁵⁶ 143059 ⁵¹		69632	81459	49369 ⁷
84-85	CAN		G55511	141580 ⁵⁴ 143060 ⁵¹		69632	81459	49369 ⁷

CHRYSLER



DYNASTY

88-93	CAN		142880 ⁵⁴ 142933 ⁵⁶ 143059 ⁵¹
	CAN Exc. Hydraulic Self Leveling System		G55526	142567 ⁵¹ 142568 ⁵⁴ 142940 ⁵⁶
	CAN Hydraulic Self Leveling System			69808	81793





E CLASS

84	All		G55511	141580 ⁵⁴ 143060 ⁵¹		69632	81459	49369 ⁷
83	All		G55507	143057 ⁵¹		69632	81459	49369 ⁷



EXECUTIVE LIMOUSINE

85	All		G55511	141580 ⁵⁴ 143060 ⁵¹		69632	81459	49369 ⁷
----	-----	--	--------	------	------	--	------	--	-------	-------	------	------	--------------------













EXECUTIVE SEDAN

84	All		G55511	141580 ⁵⁴ 143060 ⁵¹		69632	81459	49369 ⁷
83	All		G55507	143057 ⁵¹		69632	81459	49369 ⁷

FIFTH AVENUE

83-89	All		69704	81406		69703	81338	43138 ⁸ 49346 ⁷
-------	-----	---	-------	-------	------	------	------	---	-------	-------	------	------	--

IMPERIAL

90-93	All		142880 ⁵⁴ 142933 ⁵⁶ 143059 ⁵¹
	Exc. Hydraulic Self Leveling System		G55526	142567 ⁵¹ 142568 ⁵⁴ 142940 ⁵⁶ 142880 ⁵⁴ 142933 ⁵⁶ 143059 ⁵¹		69632	81459	49369 ⁷
81-83	All		69704	81406		69703	81338	43138 ⁸ 49346 ⁷
74-75	All		69704	81406		82131	43096 ⁸ 49106 ⁷
67-73	All		82011		81091	43067 ⁸ 49149 ⁷
57-66	All		82072		81469
55	All			81469

IMPERIAL READYMOUNTS

		Front	Rear
90-93	Exc. Hydraulic Self Leveling System	G56985 ⁴⁰

7 Pair Packs, air hose kit included.

40 ReadyMount Strut. Complete Assembled Unit.

54 Kit with Mount and Bearing. Hardware from O.E. Part may need to be reused.

61 Mount Kit includes Upper Spring Seat. Hardware from O.E. Part may need to be reused.

66 Upper Spring Seat with Spacer. Hardware from O.E. Part may need to be reused.



8 Pair Packs.

51 Strut Cushion for use with the Strut/Cartridge/Shocks.

56 Includes Mount, Bumper/Bellow & Retainers. Hardware from O.E. Part may need to be reused.

64 Mount Kit includes Lower Rubber Spring Seat Isolator. Hardware from O.E. Part may need to be reused.









APPLICATION GUIDE

Year	Fitment Notes										
		Ultra	ProGuard\Guardian\Classic	Max Control\LTV	Strut Cushion\Strut Mount	Hi Jacker\Load Carrier	Ultra	ProGuard\Guardian\Classic	Max Control\LTV	Strut Cushion\Strut Mount	Hi Jacker\Load Carrier

CHRYSLER

CHRYSLER







INTREPID

98-04	CAN Left		G55663	142827 ⁵⁵ 143057 ⁵¹		G55856	142828 ⁵³ 143058 ⁵¹
	CAN Right		G55664	142827 ⁵⁵ 143057 ⁵¹		G55856	142828 ⁵³ 143058 ⁵¹
93-97	CAN Left		G55663	142842 ⁵⁴ 143057 ⁵¹		G55665	142292 ⁵³
	CAN Right		G55664	142842 ⁵⁴ 143057 ⁵¹		G55665	142292 ⁵³





















INTREPID READYMOUNTS

		Front	Rear
98-04	CAN Left	G56962 ⁴⁰
	CAN Right	G56963 ⁴⁰

LASER

86	All		G55526	142567 ⁶¹ 142568 ⁶⁴ 142880 ⁵⁴ 142933 ⁵⁶ 143060 ⁵¹		69632	81459	49369 ⁷
	Mfg. from 1/2/86		G55526	142940 ⁶⁶ 142567 ⁶¹ 142568 ⁶⁴ 142880 ⁵⁴ 142933 ⁵⁶ 143060 ⁵¹		69632	81459	49369 ⁷
84-85	All		G55511	141580 ⁵⁴ 143060 ⁵¹		69632	81459	49369 ⁷

LEBARON

87-95	All		G55526	142567 ⁶¹ 142568 ⁶⁴ 142880 ⁵⁴ 142933 ⁵⁶ 142940 ⁶⁶ 143059 ⁵¹		69632	81459	49369 ⁷
86	All		G55526	142567 ⁶¹ 142568 ⁶⁴ 142880 ⁵⁴ 142933 ⁵⁶ 143059 ⁵¹		69632	81459	49369 ⁷
	Mfg. from 1/2/86		G55526	142940 ⁶⁶ 142567 ⁶¹ 142568 ⁶⁴ 142880 ⁵⁴ 142933 ⁵⁶ 143059 ⁵¹		69632	81459	49369 ⁷
84-85	All		G55511	141580 ⁵⁴ 143060 ⁵¹		69632	81459	49369 ⁷
82-83	All		G55507	141578 ⁵⁴ 143057 ⁵¹		69632	81459	49369 ⁷
81	All		69704	81406	141578 ⁵⁴ 143057 ⁵¹		69632	43138 ⁸
	Exc. M Body		69704	81406	141578 ⁵⁴ 143057 ⁵¹		69632	81459	49369 ⁷ 43138 ⁸
	M Body		69704	81406	141578 ⁵⁴ 143057 ⁵¹		69632	81338	49346 ⁷ 43138 ⁸
77-80	All		69704	81406		69703	81338	43138 ⁸
	M Body		69704	81406		69703	81338	49346 ⁷ 43138 ⁸

LEBARON READYMOUNTS

		Front	Rear
89-94	All	G56985 ⁴⁰

7 Pair Packs, air hose kit included.

40 ReadyMount Strut. Complete Assembled Unit.

53 Strut Mount. Hardware from O.E. Part may need to be reused.

55 Mount Kit includes Mount, Spring Seat, Bearing & Isolator. Hardware from O.E. Part may need to be reused.

61 Mount Kit includes Upper Spring Seat. Hardware from O.E. Part may need to be reused.

66 Upper Spring Seat with Spacer. Hardware from O.E. Part may need to be reused.

8 Pair Packs.





51 Strut Cushion for use with the Strut/Cartridge/Shocks.

54 Kit with Mount and Bearing. Hardware from O.E. Part may need to be reused.

56 Includes Mount, Bumper/Bellow & Retainers. Hardware from O.E. Part may need to be reused.









64 Mount Kit includes Lower Rubber Spring Seat Isolator. Hardware from O.E. Part may need to be reused.

APPLICATION GUIDE

Year	Fitment Notes										
			Ultra	ProGuard/ Guardian/ Classic	Max Control/ LTV	Strut Cushion/ Strut Mount	Hi Jacker/ Load Carrier		Ultra	ProGuard/ Guardian/ Classic	Max Control/ LTV

CHRYSLER LHS



CHRYSLER

99-01	Left		G55663	142827 ⁵⁵ 143057 ⁵¹		G55856	142828 ⁵³ 143058 ⁵¹
	Right		G55664	142827 ⁵⁵ 143057 ⁵¹		G55856	142828 ⁵³ 143058 ⁵¹
94-97	Left		G55663	142755 ⁵¹ 142842 ⁵⁴ 143057 ⁵¹		G55665	142292 ⁵³ 143058 ⁵¹
	Right		G55664	142755 ⁵¹ 142842 ⁵⁴ 143057 ⁵¹		G55665	142292 ⁵³ 143058 ⁵¹





LHS READYMOUNTS

		Front	Rear
99-01	Left	G56962 ⁴⁰	G56964 ⁴⁰
	Right	G56963 ⁴⁰	G56964 ⁴⁰
94-97	Left	G56958 ⁴⁰
	Right	G56959 ⁴⁰

NASSAU

55-56	All			81469	49110 ⁷
-------	-----	---	------	------	------	------	---	------	-------	------	------	--------------------















NEON

00-02	Left		G55892	142932 ⁵⁵ 143060 ⁵¹		G55894	143057 ⁵¹ 143256 ⁵³
	Right		G55892	142932 ⁵⁵ 143060 ⁵¹		G55893	143057 ⁵¹ 143256 ⁵³

NEON READYMOUNTS

		Front	Rear
00-02	Left	G56975 ⁴⁰	G56973 ⁴⁰
	Right	G56975 ⁴⁰	G56974 ⁴⁰

NEW YORKER

94-96	Left		G55663	142755 ⁵¹ 142842 ⁵⁴ 143057 ⁵¹		G55665	142292 ⁵³
	Right		G55664	142755 ⁵¹ 142842 ⁵⁴ 143057 ⁵¹		G55665	142292 ⁵³
88-93	All		G55526	142567 ⁵¹ 142568 ⁵⁴ 142880 ⁵⁴ 142933 ⁵⁶ 142940 ⁵⁶ 143060 ⁵¹	
	Exc. Hydraulic Self Leveling System		G55526	142567 ⁵¹ 142568 ⁵⁴ 142880 ⁵⁴ 142933 ⁵⁶ 142940 ⁵⁶ 143060 ⁵¹		69632	81459	49369 ⁷
87	All		G55526	142567 ⁵¹ 142568 ⁵⁴ 142880 ⁵⁴ 142933 ⁵⁶ 142940 ⁵⁶ 143060 ⁵¹		69632	81459	49369 ⁷
86	All		G55526	142567 ⁵¹ 142568 ⁵⁴ 142880 ⁵⁴ 142933 ⁵⁶ 143060 ⁵¹		69632	81459	49369 ⁷
	Mfg. from 1/2/86		G55526	142940 ⁵⁶ 142567 ⁵¹ 142568 ⁵⁴ 142880 ⁵⁴ 142933 ⁵⁶ 143060 ⁵¹		69632	81459	49369 ⁷

7 Pair Packs, air hose kit included.

51 Strut Cushion for use with the Strut/Cartridge/Shocks.

54 Kit with Mount and Bearing. Hardware from O.E. Part may need to be reused.

56 Includes Mount, Bumper/Bellow & Retainers. Hardware from O.E. Part may need to be reused.

64 Mount Kit includes Lower Rubber Spring Seat Isolator. Hardware from O.E. Part may need to be reused.

40 ReadyMount Strut. Complete Assembled Unit.





53 Strut Mount. Hardware from O.E. Part may need to be reused.

55 Mount Kit includes Mount, Spring Seat, Bearing & Isolator. Hardware from O.E. Part may need to be reused.

61 Mount Kit includes Upper Spring Seat. Hardware from O.E. Part may need to be reused.

66 Upper Spring Seat with Spacer. Hardware from O.E. Part may need to be reused.

















APPLICATION GUIDE

Year	Fitment Notes										
		 Ultra	ProGuard\ Guardian\ Classic	Max Control\ LTV	Strut Cushion\ Strut Mount	Hi Jacker\ Load Carrier	 Ultra	ProGuard\ Guardian\ Classic	Max Control\ LTV	Strut Cushion\ Strut Mount	Hi Jacker\ Load Carrier

CHRYSLER

CHRYSLER













NEW YORKER (cont'd)

84-85	All	 G55511	141580 ⁵⁴ 143060 ⁵¹	 69632	81459	49369 ⁷
83	All	 G55507	143057 ⁵¹	 69632	81459	49369 ⁷
79-82	All	 69704	81406	 69703	81338	43138 ⁸
74-78	All	 69704	81406		82131	43096 ⁸ 49106 ⁷
70-73	All		82011		81091	43067 ⁸ 49149 ⁷
65-69	All		82011		82131	43096 ⁸ 49106 ⁷
57-64	All		82072		81469	49110 ⁷
51-56	All			81469	49110 ⁷



NEW YORKER READYMOUNTS

		Front	Rear
94-96	Left	G56958 ⁴⁰
	Right	G56959 ⁴⁰
90-93	Exc. Hydraulic Self Leveling System	G56985 ⁴⁰

NEWPORT

79-81	All		81153	 69703	81338	43138 ⁸
74-78	All	 69704	81406		82131	43096 ⁸ 49106 ⁷
70-73	All		82011		81091	43067 ⁸ 49149 ⁷
65-69	All		82011		82131	43096 ⁸ 49106 ⁷
57-64	All		82072		81469	49110 ⁷
51-56	All			81469	49110 ⁷



PACIFICA

04-06	All	 G56772	142931 ⁵⁴	
-------	-----	--	------	------	----------------------	------	---	------	------	------	------

PACIFICA READYMOUNTS

		Front	Rear
04-06	Left	G57112 ⁴⁰
	Right	G57113 ⁴⁰





PT CRUISER

01-10	All	 G55896	142932 ⁵⁵ 143060 ⁵¹	 69473	143057 ⁵¹
-------	-----	--	------	------	--	------	---	------	------	----------------------	------





PT CRUISER READYMOUNTS

		Front	Rear
01-10	All	G56965 ⁴⁰

SARATOGA

57-60	All		82072		81469	49110 ⁷
51-52	All			81469	49110 ⁷

SEBRING

08-10	Left	 G52117	143336 ⁵³	 G51863	143337⁵³
	Right	 G52118	143336 ⁵³	 G51863	143337⁵³

7 Pair Packs, air hose kit included.

40 ReadyMount Strut. Complete Assembled Unit.

53 Strut Mount. Hardware from O.E. Part may need to be reused.

55 Mount Kit includes Mount, Spring Seat, Bearing & Isolator. Hardware from O.E.





Part may need to be reused.

8 Pair Packs.

51 Strut Cushion for use with the Strut/Cartridge/Shocks.

54 Kit with Mount and Bearing. Hardware from O.E. Part may need to be reused.



















APPLICATION GUIDE

Year	Fitment Notes										
			ProGuard/ Guardian/ Classic	Max Control/ LTV	Strut Cushion/ Strut Mount	Hi Jacker/ Load Carrier		Ultra	ProGuard/ Guardian/ Classic	Max Control/ LTV	Strut Cushion/ Strut Mount

CHRYSLER

CHRYSLER

SEBRING (cont'd)

07	All	143336 ⁵³		G51863	143337 ⁵³		
03-06	Sedan and Convertible; JR (MfrBodyCode)		G51267	143423 ⁷⁰		G51268	143423 ⁷⁰	
01-06	Sedan, JR(MfrBodyCode)	143321 ⁵³		
01-05	Coupe, ST(MfrBodyCode) Left		G56552	143087 ⁵³		G51254	142419 ⁵³	
	Coupe, ST(MfrBodyCode) Right		G56551	143087 ⁵³		G51254	142419 ⁵³	
01-02	Sedan and Convertible; JR (MfrBodyCode)		G51267	143423 ⁷⁰		G51268	
99-00	Convertible	143030 ⁵³	143064 ⁵¹	143063 ⁵¹	143320 ⁵³	
	Sedan and Convertible; JR (MfrBodyCode)		G51267		G51268	
96-00	Coupe		G55820	142419 ⁵³	143057 ⁵¹		G51254	142419 ⁵³	143057 ⁵¹	
97-98	Convertible		G51796	143030 ⁵³	143064 ⁵¹		G51078	143063 ⁵¹	
96	Convertible		G55818	143030 ⁵³	143064 ⁵¹		G51078	142396 ⁵³	143063 ⁵¹
95	All	142419 ⁵³	143057 ⁵¹	142419 ⁵³	143057 ⁵¹	
	Coupe		G55820	142419 ⁵³	143057 ⁵¹		G51254	142419 ⁵³	143057 ⁵¹













SEBRING READYMOUNTS

		Front	Rear
01-06	Sedan, JR(MfrBodyCode)	G57026 ⁴⁰
01-05	Coupe, ST(MfrBodyCode) Left	G57073 ⁴⁰	G57075 ⁴⁰
	Coupe, ST(MfrBodyCode) Right	G57074 ⁴⁰	G57075 ⁴⁰

ST REGIS

55-56	All		81469	49110 ⁷
-------	-----	------	------	------	------	---	------	-------	------	------	------	--------------------

TOWN & COUNTRY

08-12	Exc. Self-Leveling Suspension		G52131		G64042	
01-07	All		G56620	142931 ⁵⁴		61605 ³⁴	81878	49236 ⁷	
	Exc. Hydraulic Self Leveling System		G56620	142931 ⁵⁴		G63690 ¹⁰	61605 ³⁴	81878	49236 ⁷	
96-00	All		G55697	142753 ⁵¹	142841 ⁵⁴	143059 ⁵¹	61605 ³⁴	81878	49236 ⁷	
	Exc. Hydraulic Self Leveling System		G55697	142753 ⁵¹	142841 ⁵⁴	143059 ⁵¹		G63690 ¹⁰	61605 ³⁴	81878	49236 ⁷
90-95	All		G55525	142567 ⁵¹	142568 ⁵⁴	142880 ⁵⁴		G63426	61538	81529
86-88	All		G55526	142567 ⁵¹	142568 ⁵⁴	142880 ⁵⁴		69632	81459	49369 ⁷

7 Pair Packs, air hose kit included.

34 If suspension spring contacts this unit, rotate suspension spring 180 degrees.

51 Strut Cushion for use with the Strut/Cartridge/Shocks.

54 Kit with Mount and Bearing. Hardware from O.E. Part may need to be reused.

61 Mount Kit includes Upper Spring Seat. Hardware from O.E. Part may need to be reused.

66 Upper Spring Seat with Spacer. Hardware from O.E. Part may need to be reused.

10 The Nivomat leveling shocks are on the rear only. If suspension spring contacts units, rotate suspension spring 180 degrees.

40 ReadyMount Strut. Complete Assembled Unit.

53 Strut Mount. Hardware from O.E. Part may need to be reused.



56 Includes Mount, Bumper/Bellow & Retainers. Hardware from O.E. Part may need to be reused.

64 Mount Kit includes Lower Rubber Spring Seat Isolator. Hardware from O.E. Part may need to be reused.

70 Bushing and sleeve kit. Hardware from O.E. Part may need to be reused.

Bold Type - New / Future Part

APPLICATION GUIDE

Year	Fitment Notes										
		Ultra	ProGuard\ Guardian\ Classic	Max Control\ LTV	Strut Cushion\ Strut Mount	Hi Jacker\ Load Carrier	Ultra	ProGuard\ Guardian\ Classic	Max Control\ LTV	Strut Cushion\ Strut Mount	Hi Jacker\ Load Carrier

CHRYSLER

CHRYSLER

TOWN & COUNTRY (cont'd)

79-81	All	81153	69703	81338	43138 ⁸
74-78	All	69704	81406	82131	43096 ⁸ 49106 ⁷
71-73	All	82011	81091	43067 ⁸ 49149 ⁷
65-70	All	82011	82131	43096 ⁸ 49106 ⁷
57-64	All	82072	81469	49110 ⁷
51-56	All	81469	49110 ⁷

TOWN & COUNTRY READYMOUNTS

		Front	Rear
01-07	Left	G56956 ⁴⁰
	Right	G56957 ⁴⁰
96-00	All	G56910 ⁴⁰
90-95	All	G56907 ⁴⁰

VOYAGER / GRAND VOYAGER

01-07	All	G56620	142931 ⁵⁴ 143059 ⁵¹
01-03	Non-ABS Exc. Hydraulic Self Leveling System	G56620	142931 ⁵⁴ 143059 ⁵¹	G63690 ¹⁰
03	Exc. Hydraulic Self Leveling System	G56620	142931 ⁵⁴ 143059 ⁵¹	61605 ³⁴ 81878	49236 ⁷
01-02	Exc. Hydraulic Self Leveling System	G56620	142931 ⁵⁴ 143059 ⁵¹	G63690	61605 ³⁴ 81878	49236 ⁷
00	All	G55697	142753 ⁶¹ 142841 ⁵⁴ 143059 ⁵¹	61605 ³⁴ 81878	49236 ⁷
	Exc. Hydraulic Self Leveling System	G55697	142753 ⁶¹ 142841 ⁵⁴ 143059 ⁵¹	G63690	61605 ³⁴ 81878	49236 ⁷
	Non-ABS	G55697	142753 ⁶¹ 142841 ⁵⁴ 143059 ⁵¹	81878 61605 ³⁴	49236 ⁷
	Non-ABS Exc. Hydraulic Self Leveling System	G55697	142753 ⁶¹ 142841 ⁵⁴ 143059 ⁵¹	G63690 ¹⁰	61605 ³⁴ 81878	49236 ⁷

VOYAGER / GRAND VOYAGER READYMOUNTS

		Front	Rear
01-07	Left	G56956 ⁴⁰
	Right	G56957 ⁴⁰
00	All	G56910 ⁴⁰
	Exc. Hydraulic Self Leveling System	G56910 ⁴⁰

WINDSOR

57-61	All	82072	81469	49110 ⁷
51-56	All	81469	49110 ⁷

DAEWOO

DAEWOO

LANOS

99-02	All	G44903 ⁹⁸	69749
-------	-----	----------------------	-------	-------	-------	-------	-------	-------	-------	-------	-------

LEGANZA

99-02	Left	G56762	G56764
-------	------	--------	-------	-------	-------	-------	--------	-------	-------	-------	-------

7 Pair Packs, air hose kit included.

10 The Nivomat leveling shocks are on the rear only. If suspension spring contacts units, rotate suspension spring 180 degrees.

40 ReadyMount Strut. Complete Assembled Unit.

54 Kit with Mount and Bearing. Hardware from O.E. Part may need to be reused.

98 Notice: The level of difficulty to install this product is moderately high. Please

review the installation instructions carefully before proceeding.





8 Pair Packs.

34 If suspension spring contacts this unit, rotate suspension spring 180 degrees.

51 Strut Cushion for use with the Strut/Cartridge/Shocks.

61 Mount Kit includes Upper Spring Seat. Hardware from O.E. Part may need to be reused.



APPLICATION GUIDE

Year	Fitment Notes										
			Ultra	ProGuard/ Guardian/ Classic	Max Control/ LTV	Strut Cushion/ Strut Mount	Hi Jacker/ Load Carrier		Ultra	ProGuard/ Guardian/ Classic	Max Control/ LTV





DAEWOO

DAEWOO

LEGANZA (cont'd)

99-02	Right		G56762		G56763
-------	-------	---	--------	------	------	------	------	---	--------	------	------	------	------

NUBIRA

99-02	Non-ABS Left		G56766		G56768
	Non-ABS Right		G56765		G56767



DAIHATSU

DAIHATSU

CHARADE

88-92	All		142626 ⁵³
-------	-----	--	------	------	------	------	------	--	------	------	------	----------------------	------



ROCKY

90-92	All		G63611	81872		81270
-------	-----	---	--------	-------	------	------	------	---	------	-------	------	------	------



DODGE

DODGE



330

63-64	All		82090		82131	49106 ⁷
-------	-----	---	------	-------	------	------	------	---	------	-------	------	------	--------------------













400

82-83	All		G55507	141578 ⁵⁴ 143057 ⁵¹		69632	81459	49369 ⁷
-------	-----	--	--------	------	------	--	------	--	-------	-------	------	------	--------------------

440

63-64	All		82090		82131	49106 ⁷
-------	-----	---	------	-------	------	------	------	---	------	-------	------	------	--------------------

600

88	All		G55526	142567 ⁵¹ 142568 ⁵⁴ 142880 ⁵⁴ 142933 ⁵⁶ 142940 ⁵⁶ 143060 ⁵¹		69632	81459	49369 ⁷
	87	All		G55526	142567 ⁵¹ 142568 ⁵⁴ 142880 ⁵⁴ 142933 ⁵⁶ 143060 ⁵¹		69632	81459
86		Mfg. from 1/2/86		G55526	142940 ⁵⁶ 142567 ⁵¹ 142568 ⁵⁴ 142880 ⁵⁴ 142933 ⁵⁶ 143060 ⁵¹		69632	81459
	All		G55526	142567 ⁵¹ 142568 ⁵⁴ 142880 ⁵⁴ 142933 ⁵⁶ 143060 ⁵¹		69632	49369 ⁷
	Mfg. from 1/2/86		G55526	142940 ⁵⁶ 142567 ⁵¹ 142568 ⁵⁴ 142880 ⁵⁴ 142933 ⁵⁶ 143060 ⁵¹		69632	49369 ⁷
84-85	All		G55526	142567 ⁵¹ 142568 ⁵⁴ 142880 ⁵⁴ 142933 ⁵⁶ 143060 ⁵¹		69632	81459	49369 ⁷

7 Pair Packs, air hose kit included.

53 Strut Mount. Hardware from O.E. Part may need to be reused.

56 Includes Mount, Bumper/Bellow & Retainers. Hardware from O.E. Part may need to be reused.

64 Mount Kit includes Lower Rubber Spring Seat Isolator. Hardware from O.E. Part may need to be reused.



51 Strut Cushion for use with the Strut/Cartridge/Shocks.

54 Kit with Mount and Bearing. Hardware from O.E. Part may need to be reused.

61 Mount Kit includes Upper Spring Seat. Hardware from O.E. Part may need to be reused.

66 Upper Spring Seat with Spacer. Hardware from O.E. Part may need to be reused.



APPLICATION GUIDE

Year	Fitment Notes										
		Ultra	ProGuard/ Guardian/ Classic	Max Control/ LTV	Strut Cushion/ Strut Mount	Hi Jacker/ Load Carrier	Ultra	ProGuard/ Guardian/ Classic	Max Control/ LTV	Strut Cushion/ Strut Mount	Hi Jacker/ Load Carrier



DODGE

DODGE





600 (cont'd)

83	All	 G55507	143057 ⁵¹	 69632	81459	49369 ⁷
----	-----	--	------	------	----------------------	------	---	-------	------	------	--------------------

880

63-64	All		82072		81469	49110 ⁷
-------	-----	--	-------	------	------	------	--	-------	------	------	--------------------

2000 GTX

90	CAN	 G55945	 G51046
	CAN Exc. Auto-Leveling System	142219 ⁵³
89	CAN	 G55945	142301 ⁵³	 G51046	143064 ⁵¹
	CAN Exc. Auto-Leveling System	142219 ⁵³	142419 ⁵³







A100 TRUCK

64-70	All		81469
-------	-----	------	------	------	------	------	--	-------	------	------	------



A100 TRUCK STEERING STABILIZERS

		Front	Rear
70	Dual System Steering Stabilizer; with I-Beam Axle	6802SE ⁸⁴
	Single System Steering Stabilizer; with I-Beam Axle	6803SE ⁸⁴
64-69	Dual System	6802SE ⁸⁴





ARIES

86-89	All	 G55526	142567 ⁶¹ 142568 ⁶⁴ 142880 ⁵⁴ 142933 ⁵⁶ 142940 ⁶⁶ 143060 ⁵¹	 69632	81459	49369 ⁷
84-85	All	 G55511	141580 ⁵⁴ 143060 ⁵¹	 69632	81459	49369 ⁷
81-83	All	 G55507	141578 ⁵⁴ 143057 ⁵¹	 69632	81459	49369 ⁷











ASPEN

76-80	All	 69704	81406	 69703	81338	43138 ⁸ 49346 ⁷
-------	-----	---	-------	------	------	------	---	-------	------	------	--

ATTITUDE

06-11	Left	 G52154	 70036
	Right	 G52155	 70036

AVENGER

13	Left	 G52117	143336 ⁵³	 G51863
	Right	 G52118	143336 ⁵³	 G51863
08-12	Left	 G52117	143336 ⁵³	 G51863	143337 ⁵³
	Right	 G52118	143336 ⁵³	 G51863	143337 ⁵³
95-00	All	 G55820	142419 ⁵³	 G51254	142419 ⁵³

CALIBER

12	All	143337 ⁵³
----	-----	------	------	------	------	------	------	------	------	----------------------	------

7 Pair Packs, air hose kit included.

51 Strut Cushion for use with the Strut/Cartridge/Shocks.

54 Kit with Mount and Bearing. Hardware from O.E. Part may need to be reused.

61 Mount Kit includes Upper Spring Seat. Hardware from O.E. Part may need to be reused.

66 Upper Spring Seat with Spacer. Hardware from O.E. Part may need to be reused.

8 Pair Packs.





53 Strut Mount. Hardware from O.E. Part may need to be reused.

56 Includes Mount, Bumper/Bellow & Retainers. Hardware from O.E. Part may need to be reused.

64 Mount Kit includes Lower Rubber Spring Seat Isolator. Hardware from O.E. Part may need to be reused.

84 Replacement damper for vehicles with the Gabriel Aftermarket mounting kit





APPLICATION GUIDE

Year	Fitment Notes										
			Ultra	ProGuard/ Guardian/ Classic	Max Control/ LTV	Strut Cushion/ Strut Mount	Hi Jacker/ Load Carrier		Ultra	ProGuard/ Guardian/ Classic	Max Control/ LTV





























DODGE

DODGE

CALIBER (cont'd)

07-11	Left		G52081		G51842	143337 ⁵³
	Right		G52082		G51842	143337 ⁵³

CARAVAN / GRAND CARAVAN

08-12	Exc. Self-Leveling Suspension		G52131		G64042
06-07	All		G56620	142931 ⁵⁴	
01-07	Exc. Hydraulic Self Leveling System		G56620	142931 ⁵⁴		G63690 ¹⁰	61605 ⁵⁴ 81878	49236 ⁷
05	All		G56620	142931 ⁵⁴		G63690 ¹⁰
01-04	All		G56620	142931 ⁵⁴	
96-00	All		142753 ⁵¹ 143059 ⁵¹	
	Exc. Hydraulic Self Leveling System		G55697	142753 ⁵¹ 142841 ⁵⁴ 143059 ⁵¹		G63690 ¹⁰	61605 ⁵⁴ 81878	49236 ⁷
89-95	Mfg. from 1/86		G55525	142568 ⁵⁴ 142567 ⁵¹ 142880 ⁵⁴ 142933 ⁵⁶ 142940 ⁵⁶ 143059 ⁵¹		G63426	61538 81529
87-95	All		G55525	142567 ⁵¹ 142568 ⁵⁴ 142880 ⁵⁴ 142933 ⁵⁶ 142940 ⁵⁶ 143059 ⁵¹		G63426	61538 81529
90	Mfg. from 1/2/86		G55525	142940 ⁵⁶ 142567 ⁵¹ 142568 ⁵⁴ 142880 ⁵⁴ 142933 ⁵⁶ 142940 ⁵⁶ 143059 ⁵¹		G63426	61538 81529
86	All		142567 ⁵¹ 142568 ⁵⁴ 142880 ⁵⁴ 142933 ⁵⁶ 142940 ⁵⁶ 143059 ⁵¹		G63426	61538 81529
	Mfg. from 1/86		G55525	142567 ⁵¹ 142568 ⁵⁴ 142880 ⁵⁴ 142933 ⁵⁶ 142940 ⁵⁶ 143059 ⁵¹		G63426	61538 81529
	Mfg. to 2/86		G55509	142567 ⁵¹ 142568 ⁵⁴ 142880 ⁵⁴ 142933 ⁵⁶ 142940 ⁵⁶ 143059 ⁵¹		G63426	61538 81529
84-85	All		G55509	141580 ⁵⁴ 143059 ⁵¹		G63426	61538 81529

CARAVAN / GRAND CARAVAN READYMOUNTS

		Front	Rear
01-07	Left	G56956 ⁴⁰
	Right	G56957 ⁴⁰
96-00	Exc. Hydraulic Self Leveling System	G56910 ⁴⁰

7 Pair Packs, air hose kit included.

34 If suspension spring contacts this unit, rotate suspension spring 180 degrees.

51 Strut Cushion for use with the Strut/Cartridge/Shocks.

54 Kit with Mount and Bearing. Hardware from O.E. Part may need to be reused.

61 Mount Kit includes Upper Spring Seat. Hardware from O.E. Part may need to be reused.

66 Upper Spring Seat with Spacer. Hardware from O.E. Part may need to be reused.

10 The Nivomat leveling shocks are on the rear only. If suspension spring contacts units, rotate suspension spring 180 degrees.





40 ReadyMount Strut. Complete Assembled Unit.

53 Strut Mount. Hardware from O.E. Part may need to be reused.

56 Includes Mount, Bumper/Bellow & Retainers. Hardware from O.E. Part may need to be reused.

64 Mount Kit includes Lower Rubber Spring Seat Isolator. Hardware from O.E. Part may need to be reused.

APPLICATION GUIDE

Year	Fitment Notes										
		 Ultra	ProGuard/ Guardian/ Classic	Max Control/ LTV	Strut Cushion/ Strut Mount	Hi Jacker/ Load Carrier	 Ultra	ProGuard/ Guardian/ Classic	Max Control/ LTV	Strut Cushion/ Strut Mount	Hi Jacker/ Load Carrier



DODGE

DODGE













CARAVAN / GRAND CARAVAN READYMOUNTS (cont'd)

		Front	Rear
00	All	G56910 ⁴⁰
96-99	Exc. Hydraulic Self Leveling System	G56910 ⁴⁰
87-95	All	G56907 ⁴⁰
86	Mfg. from 1/86	G56907 ⁴⁰

CHALLENGER

08-10	All	143369 ⁶³	143335 ⁶³	
78-83	All	143059 ⁶¹	
70-74	All		82090		82131	43096 ⁸ 49106 ⁷

















CHARGER

06-10	All	143335 ⁶³	
	RWD	143369 ⁶³	143335 ⁶³	
	RWD, Left	 G51761	143335 ⁶³	
	RWD, Left Police	 G51947	143335 ⁶³	
	RWD, Right	 G51760	143335 ⁶³	
	RWD, Right Police	 G51948	143335 ⁶³	
06-09	Exc. Police Package	 G51721	143335 ⁶³
83-87	All	 G55507	141578 ⁵⁴ 143057 ⁵¹	 G51047	142173 ⁵³
77-78	All		81153	 69703	81338	43138 ⁸
73-76	All		81153		82131	43096 ⁸ 49106 ⁷
66-72	All		82090		82131	43096 ⁸ 49106 ⁷

CHARGER READYMOUNTS

		Front	Rear
06-10	RWD, Left	G57071 ⁴⁰
	RWD, Right	G57072 ⁴⁰

COLT

93-95	All	 G55911	142329 ⁶³	 G51063	142419 ⁶³ 143064 ⁵¹
	Exc. Wagon	 G55911	143057 ⁵¹ 142329 ⁶³	 G51063	142419 ⁶³ 143064 ⁵¹
92	All	142240 ⁵⁴	142419 ⁶³ 143064 ⁵¹
	Exc. Wagon	143057 ⁵¹ 142240 ⁵⁴	142419 ⁶³ 143064 ⁵¹
	Hatchback	 G55592	142240 ⁵⁴	 G51249	81555	142419 ⁶³ 143064 ⁵¹
90-91	Exc. Wagon	143057 ⁵¹
	Hatchback	 G55592	142240 ⁵⁴	 G51249	81555	142419 ⁶³ 143064 ⁵¹
86-91	Vista, 4WD, Wagon	 G55546		81739
85-91	Vista, FWD, Wagon	 G55531	143059 ⁶¹	 69689	81464
89	Hatchback	 G55592	142240 ⁵⁴ 143060 ⁵¹	 G51249	81555	142419 ⁶³ 143064 ⁵¹
87-88	Hatchback	 G55561	143060 ⁵¹		81555

7 Pair Packs, air hose kit included.

40 ReadyMount Strut. Complete Assembled Unit.

53 Strut Mount. Hardware from O.E. Part may need to be reused.





86 Mount Kit includes Isolator. Hardware from O.E. Part may need to be reused.

8 Pair Packs.

51 Strut Cushion for use with the Strut/Cartridge/Shocks.

54 Kit with Mount and Bearing. Hardware from O.E. Part may need to be reused.





















APPLICATION GUIDE

Year	Fitment Notes										
			Ultra	ProGuard/ Guardian/ Classic	Max Control/ LTV	Strut Cushion/ Strut Mount	Hi Jacker/ Load Carrier		Ultra	ProGuard/ Guardian/ Classic	Max Control/ LTV



DODGE

DODGE









COLT (cont'd)

87-88	Sedan		G55561	143060 ⁵¹		81555
85-86	Hatchback		G55716	143060 ⁵¹		81555
	Sedan		G55716	143060 ⁵¹		81555
84	Vista, FWD, Wagon		G55531		69689	81464
	Wagon		143059 ⁵¹	
79-83	Hatchback			69689	81464
75-80	Wagon		143059 ⁵¹		82156	43048 ⁸ 49151 ⁷
77-79	Exc. Wagon & Hatchback			81676
71-74	All			82156	43048 ⁸ 49151 ⁷
	Wagon		143059 ⁵¹		82156	43048 ⁸ 49151 ⁷







CONQUEST

84-86	All			143058 ⁵¹
-------	-----	---	------	------	------	------	------	---	------	------	------	------	----------------------	------





CORONET

73-76	All		81153		82131	43096 ⁸ 49106 ⁷
65-72	All		82090		82131	43096 ⁸ 49106 ⁷
57-59	All		82072		81469	49110 ⁷
51-56	All			81469	49110 ⁷

CUSTOM

65	All		82011		82131	43096 ⁸ 49106 ⁷
57-64	All		82072		81469	49110 ⁷
54-56	All			81469	49110 ⁷



















D50

79-82	RWD		G63950	61556 81714		G63907	61500 81147	77907	43048 ⁸ 49310 ⁷
82	4WD		G63418	61529	77418		G63419	61532 81538

D50 STEERING STABILIZERS

		Front	Rear
79-82	RWD, Single System Steering Stabilizer	6802SE ⁸⁴

DAKOTA

10	4WD			G63891
	RWD			G63890
05-09	All		G51815	
	4WD		G51815		G63891
	RWD		G51815		G63890
97-04	All			G63403	61658 81923	58403 77403
	4WD		G63905	61601 81836	77905		G63403	61658 81923	58403 77403
	RWD		G63915	61512 81559	77915		G63403	61658 81923	58403 77403
87-96	4WD		G63881	61679 81902	77958		G63499	61584 81837



7 Pair Packs, air hose kit included.

51 Strut Cushion for use with the Strut/Cartridge/Shocks.

8 Pair Packs.

84 Replacement damper for vehicles with the Gabriel Aftermarket mounting kit





APPLICATION GUIDE

Year	Fitment Notes										
		Ultra	ProGuard\ Guardian\ Classic	Max Control\ LTV	Strut Cushion\ Strut Mount	Hi Jacker\ Load Carrier	Ultra	ProGuard\ Guardian\ Classic	Max Control\ LTV	Strut Cushion\ Strut Mount	Hi Jacker\ Load Carrier

DODGE

DODGE













DAKOTA (cont'd)

87-96	RWD	 	G63915	61512 81559	77915	 	G63460	61511 81560
-------	-----	---	--------	----------------	-------	------	------	---	--------	----------------	------	------	------





































DAKOTA STEERING STABILIZERS

87-94	4WD, Single System Steering Stabilizer								Front		Rear		
									6804SE ⁸⁰			





DART

63-76	All	 	82090	 	81469	49110 ⁷
62	All	 	82090	 	82131	49106 ⁷
60-61	All	 	82072	 	81469	49110 ⁷





















DAYTONA

89-93	All	 	 
	Exc. Shelby & Base Models	 	G55526	 	69632	81459	49369 ⁷
87-88	All	 	 
	Exc. Shelby & Base Models	 	G55526	 	69632	81459	49369 ⁷
	Pacifica	 	 
86	All	 	G55526	 
	Exc. Shelby & Base Models	 	G55526	 	69632	81459	49369 ⁷
84-85	All	 	G55511	 
	Exc. Shelby & Base Models	 	G55511	 	69632	81459	49369 ⁷

DIPLOMAT

77-89	All	 	69704	81406	 	69703	81338	43138 ⁸ 49346 ⁷
-------	-----	---	-------	-------	------	------	------	---	-------	-------	------	------	--

DURANGO

04-09	All	 	G64016	61720	 	G63892
01-03	All	 	 	G63403	77403
	4WD	 	G63905	61601 81836	77905	 	G63403	77403
	4WD, RWD	 	 	G63403	61658 81923	58403 77403
	RWD	 	G63915	61512 81559	77915	 	G63403	77403

7 Pair Packs, air hose kit included.

51 Strut Cushion for use with the Strut/Cartridge/Shocks.

56 Includes Mount, Bumper/Bellow & Retainers. Hardware from O.E. Part may need to be reused.

64 Mount Kit includes Lower Rubber Spring Seat Isolator. Hardware from O.E. Part may need to be reused.

80 Mounting bracket not required, install on O.E. Shock Mounts. See Ref. C for optional Steering Stabilizer Boots.





8 Pair Packs.

54 Kit with Mount and Bearing. Hardware from O.E. Part may need to be reused.

61 Mount Kit includes Upper Spring Seat. Hardware from O.E. Part may need to be reused.

66 Upper Spring Seat with Spacer. Hardware from O.E. Part may need to be reused.







APPLICATION GUIDE

Year	Fitment Notes										
			ProGuard/ Guardian/ Classic	Max Control/ LTV	Strut Cushion/ Strut Mount	Hi Jacker/ Load Carrier		ProGuard/ Guardian/ Classic	Max Control/ LTV	Strut Cushion/ Strut Mount	Hi Jacker/ Load Carrier



DODGE

DODGE

DURANGO (cont'd)

99-00	All		G63403	61658 81923	58403 77403	
	RWD		G63915	61512 81559	77915		G63403	61658 81923	58403 77403
98-00	4WD		G63905	61601 81836	77905		G63403	61658 81923	58403 77403
98	All		G63403	58403 77403









DYNASTY

88-93	All	142880 ⁵⁴ 142933 ⁵⁶ 143059 ⁵¹
	Exc. Hydraulic Self Leveling System		G55526	142567 ⁵¹ 142568 ⁵⁴ 142940 ⁵⁶ 142880 ⁵⁴ 142933 ⁵⁶ 143059 ⁵¹
	Hydraulic Self Leveling System	142880 ⁵⁴ 142933 ⁵⁶ 143059 ⁵¹		69808	81793

DYNASTY READYMOUNTS

		Front	Rear
88-93	Exc. Hydraulic Self Leveling System	G56985 ⁴⁰





INTREPID

98-04	Left		G55663	142827 ⁵⁵ 143057 ⁵¹		G55856	142828 ⁵³ 143058 ⁵¹
	Right		G55664	142827 ⁵⁵ 143057 ⁵¹		G55856	142828 ⁵³ 143058 ⁵¹
93-97	Left		G55663	142755 ⁵¹ 142842 ⁵⁴ 143057 ⁵¹		G55665	142292 ⁵³
	Right		G55664	142755 ⁵¹ 142842 ⁵⁴ 143057 ⁵¹		G55665	142292 ⁵³





INTREPID READYMOUNTS

		Front	Rear
98-04	Left	G56962 ⁴⁰	G56964 ⁴⁰
	Right	G56963 ⁴⁰	G56964 ⁴⁰
93-97	Left	G56958 ⁴⁰	G56960 ⁴⁰
	Right	G56959 ⁴⁰	G56960 ⁴⁰

JOURNEY

09-13	Left		G52148		G51848
	Right		G52149		G51848

LANCER

87-89	All		G55526	142567 ⁵¹ 142568 ⁵⁴ 142880 ⁵⁴ 142933 ⁵⁶ 142940 ⁵⁶ 143060 ⁵¹		69632	81459	49369 ⁷
86	All		G55526	142567 ⁵¹ 142568 ⁵⁴ 142880 ⁵⁴ 142933 ⁵⁶ 143060 ⁵¹		69632	81459	49369 ⁷

7 Pair Packs, air hose kit included.

51 Strut Cushion for use with the Strut/Cartridge/Shocks.

54 Kit with Mount and Bearing. Hardware from O.E. Part may need to be reused.

56 Includes Mount, Bumper/Bellow & Retainers. Hardware from O.E. Part may need to be reused.

64 Mount Kit includes Lower Rubber Spring Seat Isolator. Hardware from O.E. Part may need to be reused.

40 ReadyMount Strut. Complete Assembled Unit.





53 Strut Mount. Hardware from O.E. Part may need to be reused.

55 Mount Kit includes Mount, Spring Seat, Bearing & Isolator. Hardware from O.E. Part may need to be reused.

61 Mount Kit includes Upper Spring Seat. Hardware from O.E. Part may need to be reused.

66 Upper Spring Seat with Spacer. Hardware from O.E. Part may need to be reused.







APPLICATION GUIDE

Year	Fitment Notes										
		 Ultra	ProGuard/ Guardian/ Classic	Max Control/ LTV	Strut Cushion/ Strut Mount	Hi Jacker/ Load Carrier	 Ultra	ProGuard/ Guardian/ Classic	Max Control/ LTV	Strut Cushion/ Strut Mount	Hi Jacker/ Load Carrier





DODGE

DODGE





LANCER (cont'd)

86	Mfg. from 1/2/86		G55526	142940 ⁶⁶ 142567 ⁶¹ 142568 ⁶⁴ 142880 ⁶⁴ 142933 ⁶⁶ 143060 ⁶¹		69632	81459	49369 ⁷
85	All		G55511	141580 ⁶⁴ 143060 ⁶¹		69632	81459	49369 ⁷
61-62	All		82090		81469	49110 ⁷















M300

74	All		G63605		G63183
	H3, M3, M-375 H4, M4		G63605		G63183	82065

M350

74	All		G63605	
	H3, M3, M-375 H4, M4		G63605		82065



MAGNUM

05-08	All			G51721	143335 ⁶³
	RWD		143369 ⁶³		G51721	143335 ⁶³
	RWD, Left		G51761		G51721	143335 ⁶³
	RWD, Left Performance Suspension		G51947		G51721	143335 ⁶³
	RWD, Right		G51760		G51721	143335 ⁶³
	RWD, Right Performance Suspension		G51948		G51721	143335 ⁶³
78-79	All		81153		69703	81338	43138 ⁸



MAGNUM READYMOUNTS

				Front		Rear	
05-08	RWD, Left			G57071 ⁴⁰		
	RWD, Right			G57072 ⁴⁰		



MEADOWBROOK

51-54	All			81469	49110 ⁷
-------	-----	---	------	------	------	------	------	---	------	-------	------	------	--------------------







MINI RAM

84-88	All		G63359 ³⁵	61523 ³⁵ 81096 ³⁵	58359 ³⁵ 77359 ³⁵	34052 ⁹		G63413 ³⁵	61522 ⁹ 81496	58413 77413	43085 ⁸ 49212 ⁷
-------	-----	---	----------------------	--	--	------	--------------------	---	----------------------	-----------------------------	----------------	------	--

MIRADA

80-83	All		69704	81406		69703	81338	43138 ⁸ 49346 ⁷
-------	-----	---	-------	-------	------	------	------	---	-------	-------	------	------	--

MONACO

90-92	All			81741
77-78	All		81153		69703	81338 82131	49106 ⁷
	Exc. Police Package		81153		69703	81338 82131	43138 ⁸ 49106 ⁷

6 It is recommended that when replacing shocks on vehicles with "quad shocks" all 4 shocks should be matched by series.

8 Pair Packs.

40 ReadyMount Strut. Complete Assembled Unit.

53 Strut Mount. Hardware from O.E. Part may need to be reused.

56 Includes Mount, Bumper/Bellow & Retainers. Hardware from O.E. Part may need to be reused.

63 Mount Kit includes Isolator. Hardware from O.E. Part may need to be reused.

66 Upper Spring Seat with Spacer. Hardware from O.E. Part may need to be reused.

7 Pair Packs, air hose kit included.

35 Sight grinding of control arm opening is required to install product made before Aug 1988.





51 Strut Cushion for use with the Strut/Cartridge/Shocks.

54 Kit with Mount and Bearing. Hardware from O.E. Part may need to be reused.

61 Mount Kit includes Upper Spring Seat. Hardware from O.E. Part may need to be reused.

64 Mount Kit includes Lower Rubber Spring Seat Isolator. Hardware from O.E. Part may need to be reused.

















APPLICATION GUIDE

Year	Fitment Notes										
			Ultra	ProGuard/ Guardian/ Classic	Max Control/ LTV	Strut Cushion/ Strut Mount	Hi Jacker/ Load Carrier		Ultra	ProGuard/ Guardian/ Classic	Max Control/ LTV









DODGE

DODGE

MONACO (cont'd)

77-78	Police Package		81153		69703	81338 82131	43096 ⁸ 49106 ⁷
74-76	All		69704	81406		82131	43096 ⁸ 49106 ⁷
73	All		82011		81091 82131	43096 ⁸
	Exc. Wagon		82011		81091 82131	49106 ⁷ 43096 ⁸
	Wagon		82011		81091 82131	49149 ⁷ 43096 ⁸
72	All		82011		82131	43096 ⁸ 49106 ⁷
71	All		82011		81091	43067 ⁸ 49149 ⁷
65-70	All		82011		82131	43096 ⁸ 49106 ⁷





NEON

00-05	All		142932 ⁵⁵ 143060 ⁵¹		143057 ⁵¹ 143256 ⁵³
	Exc. SRT4 Left		G55892	142932 ⁵⁵ 143060 ⁵¹		G55894	143057 ⁵¹ 143256 ⁵³
	Exc. SRT4 Right		G55892	142932 ⁵⁵ 143060 ⁵¹		G55893	143057 ⁵¹ 143256 ⁵³
95-99	All		G55679	142754 ⁶¹ 142840 ⁵⁴ 143057 ⁵¹		G55680	142393 ⁵³ 143059 ⁵¹

NEON READYMOUNTS

		Front	Rear
00-05	Exc. SRT4 Left	G56975 ⁴¹	G56973 ⁴⁰
	Exc. SRT4 Right	G56975 ⁴¹	G56974 ⁴⁰
95-99	All	G56966 ⁴⁰	G56967 ⁴⁰







NITRO

09-11	All		G51728	
07-08	All		G51728		G63844







NITRO READYMOUNTS

		Front	Rear
07-11	Left	G57007 ⁴⁰
	Right	G57008 ⁴⁰

OMNI

90	All		G55594	141578 ⁵⁴ 143059 ⁵¹		G51047	142173 ⁵³
81-89	All		G55507	141578 ⁵⁴ 143057 ⁵¹		G51047	142173 ⁵³
78-80	All		G55507	141578 ⁵⁴ 143057 ⁵¹		G51027	142173 ⁵³

PICKUP 1/2 TON, D100 SERIES

72-93	All		G63359	61523 ³⁵ 81096 ³⁵	58359 ³⁵ 77359 ³⁵	34052 ⁸		G63353	61526 81091	58353	43067 ⁸ 49149 ⁷
61-71	All		82046		82054
60	All		82065		82054

7 Pair Packs, air hose kit included.

35 Sight grinding of control arm opening is required to install product made before Aug 1988.

41 ReadyMount Strut. Complete Assembled Unit. See Ref. D for procedures to replace Elec Adj Susp with non-adj product.

53 Strut Mount. Hardware from O.E. Part may need to be reused.

55 Mount Kit includes Mount, Spring Seat, Bearing & Isolator. Hardware from O.E. Part may need to be reused.

8 Pair Packs.



40 ReadyMount Strut. Complete Assembled Unit.

51 Strut Cushion for use with the Strut/Cartridge/Shocks.

54 Kit with Mount and Bearing. Hardware from O.E. Part may need to be reused.

61 Mount Kit includes Upper Spring Seat. Hardware from O.E. Part may need to be reused.

APPLICATION GUIDE

Year	Fitment Notes										
		Ultra	ProGuard/ Guardian/ Classic	Max Control/ LTV	Strut Cushion/ Strut Mount	Hi Jacker/ Load Carrier	Ultra	ProGuard/ Guardian/ Classic	Max Control/ LTV	Strut Cushion/ Strut Mount	Hi Jacker/ Load Carrier

DODGE

DODGE

PICKUP 1/2 TON, D100 SERIES STEERING STABILIZERS

		Front	Rear
86-89	Single System Steering Stabilizer	6802SE ⁸⁴
72-79	Single System Steering Stabilizer	6802SE ⁸⁴
60-71	Single System Steering Stabilizer; with I-Beam Axle	6802SE ⁸⁴

PICKUP 1/2 TON, W100 SERIES

81-93	Exc. Lift Kit	G63389	61633 81342	58389 77389
72-80	All	G63389	61633 81342	58389 77389
61-71	All	G63183	61632 81825	58183 77183
60	All	82065

PICKUP 1/2 TON, W100 SERIES STEERING STABILIZERS

		Front	Rear
90-93	Single System Steering Stabilizer	6802SE ⁸⁴
60-89	Single System Steering Stabilizer	6803SE ⁸⁴
60-86	Dual System Steering Stabilizer; Exc. Vacuum Servo Mounted on Drivers Side of Axle	6802SE ⁸⁴

PICKUP 3/4 TON, D200 SERIES

90-93	All	G63353	61526 81091	58353	43067 ⁸ 49149 ⁷
	HD Package	G63360 ³⁵	61650 81834	58360	G63353	61526 81091	58353	43067 ⁸ 49149 ⁷
82-93	Exc. HD Package	G63359 ³⁵	61523 ³⁵ 81096 ³⁵	58359 ³⁵ 77359 ³⁵	34052 ⁸	G63353	61526 81091	58353	43067 ⁸ 49149 ⁷
82-89	All	77359 ³⁵	G63353	61526 81091	58353	43067 ⁸ 49149 ⁷
	HD Package	G63360 ³⁵	61650 81834	58360 77359 ³⁵	G63353	61526 81091	58353	43067 ⁸ 49149 ⁷
81	All	G63353	61526 81091	58353	43067 ⁸
	Exc. HD Package	G63359 ³⁵	61523 ³⁵ 81096 ³⁵	58359 ³⁵ 77359 ³⁵	34052 ⁸	G63353	61526 81091	58353	49149 ⁷ 43067 ⁸
	HD Package	G63360 ³⁵	G63353	61526 81091	58353	43067 ⁸
	165.0(WheelBase) HD Package	61650 81834	58360	G63353	61526 81091	58353	43067 ⁸
77-80	HD Package	G63360 ³⁵	61650	58360	G63353	61526 81091	58353	43067 ⁸ 49149 ⁷
	165.0(WheelBase) HD Package	81834	G63353	61526 81091	58353	43067 ⁸ 49149 ⁷
72-80	All	G63353	61526 81091	58353	43067 ⁸ 49149 ⁷
	Exc. HD Package	G63359 ³⁵	61523 ³⁵ 81096 ³⁵	58359 ³⁵ 77359 ³⁵	34052 ⁸	G63353	61526 81091	58353	43067 ⁸ 49149 ⁷
75-76	HD Package	G63360 ³⁵	G63353	61526 81091	58353	43067 ⁸ 49149 ⁷
	165.0(WheelBase) HD Package	61650 81834	58360	G63353	61526 81091	58353	43067 ⁸ 49149 ⁷
72-74	HD Package	G63360 ³⁵	61650 81834	58360	G63353	61526 81091	58353	43067 ⁸ 49149 ⁷
61-71	All	82046	82054
60	All	82065	82054

PICKUP 3/4 TON, D200 SERIES STEERING STABILIZERS

		Front	Rear
73-93	Single System Steering Stabilizer	6802SE ⁸⁴
60-71	Single System Steering Stabilizer; with I-Beam Axle	6802SE ⁸⁴

PICKUP 3/4 TON, W200 SERIES

81-93	Standard Cab Pickup Exc. Lift Kit	G63389	61633 81342	58389 77389
-------	-----------------------------------	--------	----------------	----------------	------	------

7 Pair Packs, air hose kit included.

35 Sight grinding of control arm opening is required to install product made before

8 Pair Packs.

84 Replacement damper for vehicles with the Gabriel Aftermarket mounting kit

APPLICATION GUIDE

Year	Fitment Notes										
		Ultra	ProGuard/ Guardian/ Classic	Max Control/ LTV	Strut Cushion/ Strut Mount	Hi Jacker/ Load Carrier	Ultra	ProGuard/ Guardian/ Classic	Max Control/ LTV	Strut Cushion/ Strut Mount	Hi Jacker/ Load Carrier

DODGE

DODGE

PICKUP 3/4 TON, W200 SERIES (cont'd)

72-80	All	O O	G63183	61632 81825	58183 77183	O O	G63389	61633 81342	58389 77389
69-71	All	O O	G63183	61632 81825	58183 77183	O O	82054
61-67	All	O O	G63183	61632 81825	58183 77183	O O	82054
60	All	O O	82065	O O	82054

PICKUP 3/4 TON, W200 SERIES STEERING STABILIZERS

								Front	Rear
90-93	Single System Steering Stabilizer							6802SE ⁸⁴
69-89	Single System Steering Stabilizer							6803SE ⁸⁴
60-86	Dual System Steering Stabilizer; Exc. Vacuum Servo Mounted on Drivers Side of Axle							6802SE ⁸⁴
60-67	Single System Steering Stabilizer							6803SE ⁸⁴

PICKUP 1 TON, D300 SERIES

72-93	All	I E	58360	O O	G63353	61526 81091	58353	43067 ⁸ 49149 ⁷
	HD Package	I E	G63360	61650 81834	58360	O O	G63353	61526 81091	58353	43067 ⁸ 49149 ⁷
61-71	All	O O	82046	O O	82065

PICKUP 1 TON, D300 SERIES STEERING STABILIZERS

								Front	Rear
75-93	Single System Steering Stabilizer							6802SE ⁸⁴
72-74	Single System Steering Stabilizer; with Coil Spring Front Suspension							6802SE ⁸⁴
60-71	Single System Steering Stabilizer; with I-Beam Axle							6802SE ⁸⁴

PICKUP 1 TON, W300 SERIES

81-93	Exc. Quad Suspension and Lift Kit	O O	G63183	61632 81825	58183 77183	O O	G63389	61633 81342	58389 77389
72-80	All	O O	G63183	61632 81825	58183 77183	O O	G63389	61633 81342	58389 77389
61-71	All	O O	G63183	61632 81825	58183 77183	O O	G63183	61632 81825	58183 77183

PICKUP 1 TON, W300 SERIES STEERING STABILIZERS

								Front	Rear
90-93	Single System Steering Stabilizer							6802SE ⁸⁴
60-89	Single System Steering Stabilizer							6803SE ⁸⁴
60-86	Dual System Steering Stabilizer; Exc. Vacuum Servo Mounted on Drivers Side of Axle							6802SE ⁸⁴

PICKUP 1/2 TON, RAM 1500 (SEE RAM 1500)

09-10	All	I E	O O	G64044
	4WD	I E	G51856	O O	G64044
	RWD	I E	G64043	O O	G64044
06-08	4WD, Mega Cab	I E	G64009	61712	O O
	4WD; Exc. Mega Cab	I E	G51758	143324 ⁵³	O O	G63961	61691 81931
	RWD; Exc. Mega Cab	I E	G63958	81933	77954	O O	G63962	61692
06-07	Exc. Mega Cab	I E	O O	58412 77412
02-05	All	I E	O O	G63675	58412 77412
	4WD	I E	G63848	81932	77947	O O	G63675	61691 81931	58412 77412
	RWD	I E	G63958	81933	77954	O O	G63675	61692	58412 77412
94-01	All	I E	O O	G63662	61600 81873	58662 77662	43181 ⁸ 49235 ⁷
	4WD	I E	G63673	61634 81919	58673 77673	O O	G63662	61600 81873	58662 77662	43181 ⁸ 49235 ⁷

7 Pair Packs, air hose kit included.

53 Strut Mount. Hardware from O.E. Part may need to be reused.

8 Pair Packs.

84 Replacement damper for vehicles with the Gabriel Aftermarket mounting kit

APPLICATION GUIDE

Year	Fitment Notes										
		Ultra	ProGuard\ Guardian\ Classic	Max Control\ LTV	Strut Cushion\ Strut Mount	Hi Jacker\ Load Carrier	Ultra	ProGuard\ Guardian\ Classic	Max Control\ LTV	Strut Cushion\ Strut Mount	Hi Jacker\ Load Carrier

DODGE

DODGE

PICKUP 1/2 TON, RAM 1500 (SEE RAM 1500) (cont'd)

94-01	RWD		O	G63661	61599 81928	58661 77661	O	O	G63662	61600 81873	58662 77662	43181 ⁸ 49235 ⁷
-------	-----	--	---	--------	----------------	----------------	------	------	---	---	--------	----------------	----------------	------	--

PICKUP 1/2 TON, RAM 1500 (SEE RAM 1500) READYMOUNTS

												Front	Rear		
09-10	All											G57147¹			
06-08	4WD; Exc. Mega Cab											G57053 ⁴⁰			

PICKUP 1/2 TON, RAM 1500 (SEE RAM 1500) STEERING STABILIZERS

												Front	Rear		
00-07	4WD, With OEM # 52106909AB, AC, AD											6847SE ⁸²			
94-01	RWD, GAS Coil Spring Suspension Steering Stabilizer											6859SE ⁸²			
97-99	4WD, With OEM 52039280											6846SE ⁸²			
94-97	4WD, With OEM 52038276											6804SE ⁸⁰			

PICKUP 3/4 TON, RAM 2500 (SEE RAM 2500)

09-10	4WD		O	77948	O	O	61716	77950
07-10	RWD, Standard Cab Pickup										G63970		77950		
03-10	All												77950		
	4WD, 8800# GVW										G64013		77950		
	RWD		O										77950		
05-08	4WD		O	G64011	61714	77948						61716	77950		
03-06	RWD, Crew Cab Pickup										G63971	61710	77950		
	RWD, Standard Cab Pickup										G63970	61709	77950		
03-04	4WD		O									61716	77950		
03	4WD, GAS Exc. 8800# GVW										G63662	61600 81873	77950		
99-02	4WD, Exc. 8800# GVW		O		81919										
94-02	4WD, 8800# GVW												77675		
	4WD, DIESEL 8800# GVW		O	G63674	61635	58674 77674					G63675	61642 81921	58675		
	4WD, GAS Exc. 8800# GVW		O	G63673	61634	58673 77673					G63662	61600 81873	58662 77662		49235 ⁷
	RWD		O	G63661	61599 81928	58661 77661					G63662	61600 81873	58662 77662		43181 ⁸ 49235 ⁷
95-96	4WD, CNG Exc. 8800# GVW		O	G63673	61634	58673					G63662	61600 81873	58662 77662		49235 ⁷
94-95	4WD, Exc. 8800# GVW		O		81919										

PICKUP 3/4 TON, RAM 2500 (SEE RAM 2500) STEERING STABILIZERS

												Front	Rear		
00-07	4WD, With OEM # 52106909AB, AC, AD											6847SE ⁸²			
94-02	RWD, GAS Coil Spring Suspension Steering Stabilizer											6859SE ⁸²			
97-99	4WD, With OEM 52039280											6846SE ⁸²			
94-97	4WD, With OEM 52038276											6804SE ⁸⁰			

PICKUP 1 TON, RAM 3500 (SEE RAM 3500)

03-10	All		O	O	O	77950
	4WD		O										77950		
	RWD		O										77950		
03-07	RWD, Crew Cab Pickup										G63971	61710	77950		

1 Future Part, available 1st Quarter of 2015.

8 Pair Packs.



80 Mounting bracket not required, install on O.E. Shock Mounts. See Ref. C for optional Steering Stabilizer Boots.

7 Pair Packs, air hose kit included.

40 ReadyMount Strut. Complete Assembled Unit.

82 Use kit if listed, See Ref. C for optional Steering Stabilizer Boots.

APPLICATION GUIDE

Year	Fitment Notes										
		Ultra	ProGuard/ Guardian/ Classic	Max Control/ LTV	Strut Cushion/ Strut Mount	Hi Jacker/ Load Carrier	Ultra	ProGuard/ Guardian/ Classic	Max Control/ LTV	Strut Cushion/ Strut Mount	Hi Jacker/ Load Carrier

DODGE

DODGE

PICKUP 1 TON, RAM 3500 (SEE RAM 3500) (cont'd)

03-06	RWD, Standard Cab Pickup	G63970	61709	77950
94-02	4WD	I O	G63674	61635	58674 77674	G63675	61642 81921	58675 77675
	RWD, Exc. Solid Front Axle	I O	G63661	61599 81928	58661 77661	G63662	61600 81873	58662 77662	43181 ⁸ 49235 ⁷
	RWD, Solid Front Axle	I O	G63674	61635	58674 77674	G63675	61642 81921	58675 77675

PICKUP 1 TON, RAM 3500 (SEE RAM 3500) STEERING STABILIZERS

		Front	Rear
00-07	4WD, With OEM # 52106909AB, AC, AD	6847SE ⁸²
	RWD, With OEM # 52106909AB, AC, AD and Solid Front Axle	6847SE ⁸²
94-02	RWD, GAS Coil Spring Suspension Steering Stabilizer	6859SE ⁸²
97-99	4WD, With OEM 52039280	6846SE ⁸²
94-97	4WD, With OEM 52038276	6804SE ⁸⁰

PICKUP, RAM 50

87-93	4WD	I O	61529	77418	G63419	61532 81538
	RWD	I O	G63950	61556 81714	G63907	61500 81147	77907	43048 ⁸ 49310 ⁷
83-86	All	I O	61556 81714	G63907	61500	77907	43048 ⁸ 49310 ⁷
	4WD	I O	G63418	61556 81714	G63907	61500	77907	43048 ⁸ 49310 ⁷
	RWD	I O	G63950	61556 81714	G63907	81147 61500	77907	43048 ⁸ 49310 ⁷

PICKUP, RAM 50 STEERING STABILIZERS

		Front	Rear
83-93	RWD, Single System Steering Stabilizer	6802SE ⁸⁴

POLARA

73	All	I O	82011	81091
	Exc. Wagon	I O	82011	82131 81091	43096 ⁸ 49106 ⁷
	Wagon	I O	82011	81091	43067 ⁸ 49149 ⁷
72	All	I O	82011	82131	43096 ⁸ 49106 ⁷
71	All	I O	82011	81091	43067 ⁸ 49149 ⁷
65-70	All	I O	82011	82131	43096 ⁸ 49106 ⁷
62-64	All	I O	82090	82131	43096 ⁸ 49106 ⁷
60-61	All	I O	82072	81469	49110 ⁷

RAIDER

87-89	All	I O	G63418	61529	77418
	Exc. Sport Utility	I O	G63418	61529	77418	G63492	81318	77492
	2.6L 4Cyl L	I O	G63418	61529	77418	61506
89	3.0L 6 Cyl V	I O	G63418	61529	77418	61568
	Sport Utility	I O	G63418	61529	77418	G63604

RAIDER STEERING STABILIZERS

		Front	Rear
87-89	Single System Steering Stabilizer	6802SE ⁸⁴

RAMCHARGER

76-93	4WD	O O	G63183	61632 81825	58183	G63389	61633 81342	58389
-------	-----	--------	--------	----------------	-------	-------	--------	----------------	-------	-------	-------

7 Pair Packs, air hose kit included.













80 Mounting bracket not required, install on O.E. Shock Mounts. See Ref. C for optional Steering Stabilizer Boots.

84 Replacement damper for vehicles with the Gabriel Aftermarket mounting kit

8 Pair Packs.

82 Use kit if listed, See Ref. C for optional Steering Stabilizer Boots.













APPLICATION GUIDE

Year	Fitment Notes										
		 Ultra	 ProGuard/ Guardian/ Classic	 Max Control/ LTV	 Strut Cushion/ Strut Mount	 Hi Jacker/ Load Carrier	 Ultra	 ProGuard/ Guardian/ Classic	 Max Control/ LTV	 Strut Cushion/ Strut Mount	 Hi Jacker/ Load Carrier

DODGE

DODGE



RAMCHARGER (cont'd)

76-93	RWD		G63359 ³⁵	61523 ³⁵ 81096 ³⁵	58359 ³⁵ 77359 ³⁵	34052 ⁸		G63353	61526 81091	58353	43067 ⁶ 49149 ⁷
75	All			61526	58353	43067 ⁶ 49149 ⁷
	4WD		G63183	61632 81825	58183		61526	58353	43067 ⁶ 49149 ⁷
	RWD		G63359 ³⁵	61523 ³⁵ 81096 ³⁵	58359 ³⁵ 77359 ³⁵	34052 ⁸		G63353	81091 61526	58353	43067 ⁶ 49149 ⁷
74	All		81825		G63353	61526	58353	43067 ⁶ 49149 ⁷
	4WD		G63183	61632 81825	58183		G63353	61526	58353	43067 ⁶ 49149 ⁷
	RWD		81825		G63353	81091 61526	58353	43067 ⁶ 49149 ⁷



RAMCHARGER STEERING STABILIZERS

		Front	Rear
87-93	RWD, Single System Steering Stabilizer	6802SE ⁶⁴
75-93	4WD, Single System Steering Stabilizer	6803SE ⁶⁴
74-86	Dual System Steering Stabilizer; Exc. Vacuum Servo Mounted on Drivers Side of Axle	6802SE ⁶⁴
74	Single System Steering Stabilizer	6803SE ⁶⁴



RAMPAGE

82-84	All		G55507	143057 ⁶¹	
-------	-----	---	--------	------	------	----------------------	------	---	------	------	------	------



RD200

78-80	All		G63183	81825		81342
-------	-----	--	--------	-------	------	------	------	--	------	-------	------	------	------

ROYAL MONACO

75-77	All		69704	81406		82131	43096 ⁶ 49106 ⁷
-------	-----	---	-------	-------	------	------	------	---	------	-------	------	------	--



SHADOW

87-94	All		G55526	142567 ⁶¹ 142568 ⁶⁴ 142880 ⁶⁴ 142933 ⁶⁶ 142940 ⁶⁶ 143059 ⁶¹		69632	81459	49369 ⁷
-------	-----	---	--------	------	------	--	------	---	-------	-------	------	------	--------------------

SHADOW READYMOUNTS

		Front	Rear
89-94	Exc. Hydraulic Self Leveling System	G56985 ⁴⁰





SPIRIT

89-95	All		G55526	142567 ⁶¹ 142568 ⁶⁴ 142880 ⁶⁴ 142933 ⁶⁶ 142940 ⁶⁶ 143059 ⁶¹		69632	81459	49369 ⁷
-------	-----	---	--------	------	------	--	------	---	-------	-------	------	------	--------------------

SPIRIT READYMOUNTS

		Front	Rear
89-95	Exc. Hydraulic Self Leveling System	G56985 ⁴⁰

SPRINTER 2500

03-06	All		G56778	
	Exc. Dual Rear Wheels		G56778		G63918

7 Pair Packs, air hose kit included.

35 Sight grinding of control arm opening is required to install product made before Aug 1988.

51 Strut Cushion for use with the Strut/Cartridge/Shocks.

56 Includes Mount, Bumper/Bellow & Retainers. Hardware from O.E. Part may need to be reused.

64 Mount Kit includes Lower Rubber Spring Seat Isolator. Hardware from O.E. Part may need to be reused.

84 Replacement damper for vehicles with the Gabriel Aftermarket mounting kit

8 Pair Packs.





40 ReadyMount Strut. Complete Assembled Unit.

54 Kit with Mount and Bearing. Hardware from O.E. Part may need to be reused.

61 Mount Kit includes Upper Spring Seat. Hardware from O.E. Part may need to be reused.



66 Upper Spring Seat with Spacer. Hardware from O.E. Part may need to be reused.

APPLICATION GUIDE

Year	Fitment Notes										
			Ultra	ProGuard/ Guardian/ Classic	Max Control/ LTV	Strut Cushion/ Strut Mount	Hi Jacker/ Load Carrier		Ultra	ProGuard/ Guardian/ Classic	Max Control/ LTV

DODGE

SPRINTER 3500

03-06	All		G56778
	Dual Rear Wheels		G56778
	Exc. Dual Rear Wheels		G56778

DODGE







ST. REGIS

79-81	All		81153
-------	-----	---	------	-------	------	------	------	------	------	------	------	------





STEALTH

91-96	All		142419 ⁵³
-------	-----	---	------	------	------	------	------	------	------	------	------	----------------------



STRATUS

01-06	Sedan		G51267	143423 ⁷⁰	G51268	143321 ⁵³ 143423 ⁷⁰
01-05	Coupe, ST(MfrBodyCode) Left		G56552	143087 ⁵³	G51254	142419 ⁵³
	Coupe, ST(MfrBodyCode) Right		G56551	143087 ⁵³	G51254	142419 ⁵³
99-00	All		143064 ⁵¹	142396 ⁵³ 143063 ⁵¹ 143328 ⁵³ 143423 ⁷⁰
	Sedan		G51267	143064 ⁵¹	G51268	142396 ⁵³ 143063 ⁵¹ 143328 ⁵³ 143423 ⁷⁰
97-98	All		G51796	143030 ⁵³ 143064 ⁵¹	G51078	142396 ⁵³ 143063 ⁵¹
95-96	All		G55818	143030 ⁵³ 143064 ⁵¹	G51078	142396 ⁵³ 143063 ⁵¹







STRATUS READYMOUNTS

				Front	Rear
01-06	Sedan		G57026 ⁴⁰
01-05	Coupe Left		G57073 ⁴⁰	G57075 ⁴⁰
	Coupe Right		G57074 ⁴⁰	G57075 ⁴⁰
99-00	All		G57025 ⁴⁰

TRUCK

59-60	All		82065
53-58	All		82065

VAN 1/2 TON, A / B SERIES / RAM

99-03	109.3(WheelBase) Exc. 7000# GVW		G63359 ³⁵	61523 ³⁵ 81096 ³⁵	58359 ³⁵ 77359 ³⁵	34052 ⁸	G63413	61522 ⁶ 81496	58413 77413	43085 ⁵ 49212 ⁷
82-98	109.6(WheelBase) Exc. 7000# GVW		G63359 ³⁵	61523 ³⁵ 81096 ³⁵	58359 ³⁵ 77359 ³⁵	34052 ⁸	G63413	61522 ⁶ 81496	58413 77413	43085 ⁵ 49212 ⁷
81	109.6(WheelBase) Exc. 7000# GVW		G63359 ³⁵	61523 ³⁵ 81096 ³⁵	58359 ³⁵ 77359 ³⁵	G63413	61522 ⁶ 81496	58413 77413	43085 ⁵
71-80	All		61523 ³⁵ 81096 ³⁵	58359 ³⁵ 77359 ³⁵	34052 ⁸	G63413	61522 ⁶ 81496	58413 77413	43085 ⁵ 49212 ⁷
	Exc. 4000# Front Axle		G63359 ³⁵	61523 ³⁵ 81096 ³⁵	58359 ³⁵ 77359 ³⁵	34052 ⁸	G63413	61522 ⁶ 81496	58413 77413	43085 ⁵ 49212 ⁷
64-70	All		81469
	Van		82065 81469

6 It is recommended that when replacing shocks on vehicles with "quad shocks" all 4 shocks should be matched by series.

8 Pair Packs.

40 ReadyMount Strut. Complete Assembled Unit.

53 Strut Mount. Hardware from O.E. Part may need to be reused.

70 Bushing and sleeve kit. Hardware from O.E. Part may need to be reused.

7 Pair Packs, air hose kit included.



35 Sight grinding of control arm opening is required to install product made before Aug 1988.

51 Strut Cushion for use with the Strut/Cartridge/Shocks.

63 Mount Kit includes Isolator. Hardware from O.E. Part may need to be reused.

Bold Type - New / Future Part

APPLICATION GUIDE

Year	Fitment Notes										
		Ultra	ProGuard\ Guardian\ Classic	Max Control\ LTV	Strut Cushion\ Strut Mount	Hi Jacker\ Load Carrier	Ultra	ProGuard\ Guardian\ Classic	Max Control\ LTV	Strut Cushion\ Strut Mount	Hi Jacker\ Load Carrier

DODGE

DODGE







VAN 1/2 TON, A / B SERIES / RAM STEERING STABILIZERS

		Front	Rear
71-87	Single System Steering Stabilizer	6803SE ⁸⁴
71	Single System Steering Stabilizer; with I-Beam Axle	6802SE ⁸⁴

VAN 1/2 TON, P SERIES

68	All	82046
62-64	All	82046

VAN 3/4 TON, A / B SERIES / RAM

81-03	All	 G63359 ³⁵	61523 ³⁵ 81096 ³⁵	58359 ³⁵ 77359 ³⁵	34052 ⁸	 G63413	61522 ⁵ 81496	58413 77413	43085 ⁸ 49212 ⁷
71-80	All		61523 ³⁵ 81096 ³⁵	58359 ³⁵ 77359 ³⁵	34052 ⁸	 G63413	61522 ⁵ 81496	58413 77413	43085 ⁸ 49212 ⁷
	Exc. 4000# Front Axle	 G63359 ³⁵	61523 ³⁵ 81096 ³⁵	58359 ³⁵ 77359 ³⁵	34052 ⁸	 G63413	61522 ⁵ 81496	58413 77413	43085 ⁸ 49212 ⁷













VAN 3/4 TON, A / B SERIES / RAM STEERING STABILIZERS

		Front	Rear
80-87	Single System Steering Stabilizer	6803SE ⁸⁴
78-79	Van Charger Special	6803SE ⁸⁴
71-77	Single System Steering Stabilizer	6803SE ⁸⁴
71	Single System Steering Stabilizer; with I-Beam Axle	6802SE ⁸⁴

VAN 3/4 TON, P SERIES

69-72	All	82054
-------	-----	------	------	------	------	------	-------	------	------	------

VAN 1 TON, A / B SERIES / RAM

99-03	All	 G63359 ³⁵	61523 ³⁵ 81096 ³⁵	58359 ³⁵ 77359 ³⁵	34052 ⁸	 G63413	61522 ⁵ 81496	58413 77413	43085 ⁸ 49212 ⁷
95-98	Exc. 4000# Front Axle	 G63359 ³⁵	61523 ³⁵ 81096 ³⁵	58359 ³⁵ 77359 ³⁵	34052 ⁸	 G63413	61522 ⁵ 81496	58413 77413	43085 ⁸ 49212 ⁷
94	All		61522 ⁵ 81496	58413	43085 ⁸ 49212 ⁷
	Exc. 4000# Front Axle	 G63359 ³⁵	61523 ³⁵ 81096 ³⁵	58359 ³⁵ 77359 ³⁵	34052 ⁸	 G63413	61522 ⁵ 81496	77413 58413	43085 ⁸ 49212 ⁷
71-93	All	 G63413	61522 ⁵ 81496	58413 77413	43085 ⁸ 49212 ⁷
	4000# Front Axle	 G63360	61650 81834	58360	 G63413	61522 ⁵ 81496	58413 77413	43085 ⁸ 49212 ⁷
	Exc. 4000# Front Axle	 G63359 ³⁵	61523 ³⁵ 81096 ³⁵	58359 ³⁵ 77359 ³⁵	34052 ⁸	 G63413	61522 ⁵ 81496	58413 77413	43085 ⁸ 49212 ⁷







VAN 1 TON, A / B SERIES / RAM STEERING STABILIZERS

		Front	Rear
71-87	Single System Steering Stabilizer	6803SE ⁸⁴
71	Single System Steering Stabilizer; with I-Beam Axle	6802SE ⁸⁴

VAN 1 TON, P SERIES

66-72	All	82065
61-64	All	82065

VAN, CB300

78-80	All	 G63413	61522 ⁵ 81496	58413	43085 ⁸ 49212 ⁷
	4000# Front Axle	 G63360	61650 81834	 G63413	61522 ⁵ 81496	58413	43085 ⁸ 49212 ⁷
	Exc. 4000# Front Axle	 G63359 ³⁵	61523 ³⁵ 81096 ³⁵	58359 ³⁵ 77359 ³⁵	34052 ⁸	 G63413	61522 ⁵ 81496	58413	43085 ⁸ 49212 ⁷
	Over 8300# GVW		58360	 G63413	61522 ⁵ 81496	77413 58413	43085 ⁸ 49212 ⁷

6 It is recommended that when replacing shocks on vehicles with "quad shocks" all 4 shocks should be matched by series.





8 Pair Packs.

98 84 Replacement damper for vehicles with the Gabriel Aftermarket mounting kit

7 Pair Packs, air hose kit included.

35 Sight grinding of control arm opening is required to install product made before Aug 1988.































APPLICATION GUIDE

Year	Fitment Notes										
			Ultra	ProGuard/ Guardian/ Classic	Max Control/ LTV	Strut Cushion/ Strut Mount	Hi Jacker/ Load Carrier		Ultra	ProGuard/ Guardian/ Classic	Max Control/ LTV

DODGE

DODGE





VAN, CB300 (cont'd)

77	All			G63413	61522 ⁶ 81496	58413	43085 ⁵
	4000# Front Axle		G63360	61650 81834		G63413	61522 ⁶ 81496	58413	43085 ⁵
	Exc. 4000# Front Axle		G63359 ³⁵	61523 ³⁵ 81096 ³⁵	77359 ³⁵		G63413	61522 ⁶ 81496	58413	43085 ⁵
	Over 8300# GVW		58360		G63413	61522 ⁶ 81496	77413 58413	49212 ⁷ 43085 ⁵
	Up through 8300# GVW		58359 ³⁵	34052 ⁸		G63413	61522 ⁶ 81496	58413	43085 ⁵
75-76	All			G63413	61522 ⁶ 81496	58413	43085 ⁵ 49212 ⁷
	4000# Front Axle		G63360	61650 81834		G63413	61522 ⁶ 81496	58413	43085 ⁵ 49212 ⁷
	Exc. 4000# Front Axle		G63359 ³⁵	61523 ³⁵ 81096 ³⁵	77359 ³⁵		G63413	61522 ⁶ 81496	58413	43085 ⁵ 49212 ⁷
	Over 8300# GVW		58360		G63413	61522 ⁶ 81496	77413 58413	43085 ⁵ 49212 ⁷
	Up through 8300# GVW		58359 ³⁵	34052 ⁸		G63413	61522 ⁶ 81496	58413	43085 ⁵ 49212 ⁷
74	All			G63413	61522 ⁶ 81496	58413	43085 ⁵
	4000# Front Axle		G63360	61650 81834		G63413	61522 ⁶ 81496	58413	43085 ⁵
	Exc. 4000# Front Axle		G63359 ³⁵	61523 ³⁵ 81096 ³⁵	77359 ³⁵		G63413	61522 ⁶ 81496	58413	43085 ⁵
	Over 8300# GVW		58360		G63413	61522 ⁶ 81496	77413 58413	49212 ⁷ 43085 ⁵
	Up through 8300# GVW		58359 ³⁵	34052 ⁸		G63413	61522 ⁶ 81496	58413	43085 ⁵



EAGLE

EAGLE



2000 GTX

91-93	CAN		G55945	143057 ⁵¹		G51046	142419 ⁵³ 143064 ⁵¹
	CAN Exc. Auto-Leveling System		G55605		G51424



















MEDALLION

88-89	All			81741
-------	-----	---	------	------	------	------	------	---	------	-------	------	------	------

PREMIER

88-92	All			81741
-------	-----	---	------	------	------	------	------	---	------	-------	------	------	------

SUMMIT

93-96	All		143057 ⁵¹		142419 ⁵³
	Coupe		G55911	142329 ⁵³ 143057 ⁵¹		G51063	142419 ⁵³
	Sedan		G55911	142329 ⁵³ 143057 ⁵¹		G51063	142419 ⁵³
91-92	Wagon		G55605	142301 ⁵³ 143057 ⁵¹		69462	142419 ⁵³
	Sedan		G55592	142240 ⁵⁴ 143057 ⁵¹		G51249	142419 ⁵³ 143064 ⁵¹
92	All		143057 ⁵¹	
	Hatchback		143057 ⁵¹		G51249
	Wagon		G55605	142301 ⁵³ 143057 ⁵¹		69462	142419 ⁵³
91	All		143057 ⁵¹		G51249	143064 ⁵¹

6 It is recommended that when replacing shocks on vehicles with "quad shocks" all 4 shocks should be matched by series.

8 Pair Packs.

51 Strut Cushion for use with the Strut/Cartridge/Shocks.



54 Kit with Mount and Bearing. Hardware from O.E. Part may need to be reused.

7 Pair Packs, air hose kit included.

53 Sight grinding of control arm opening is required to install product made before Aug 1988.

53 Strut Mount. Hardware from O.E. Part may need to be reused.





APPLICATION GUIDE

Year	Fitment Notes										
		Ultra	ProGuard\ Guardian\ Classic	Max Control\ LTV	Strut Cushion\ Strut Mount	Hi Jacker\ Load Carrier	Ultra	ProGuard\ Guardian\ Classic	Max Control\ LTV	Strut Cushion\ Strut Mount	Hi Jacker\ Load Carrier













EAGLE

EAGLE





SUMMIT (cont'd)

89-90	All	 G55592	142240 ⁵⁴ 143057 ⁵¹	 G51249	143064 ⁵¹
	Sedan	 G55592	142240 ⁵⁴ 143057 ⁵¹	 G51249	142419 ⁵³ 143064 ⁵¹

TALON

95-98	All	 G55819	142419 ⁵³	142419 ⁵³
	AWD	 G55819	142419 ⁵³	 G51712	142419 ⁵³
	FWD	 G55819	142419 ⁵³	 G51254	142419 ⁵³
91-94	All	 G55605	142219 ⁵³ 143057 ⁵¹	142419 ⁵³ 143064 ⁵¹
	AWD, Auto-Leveling System	 G55605	142219 ⁵³ 143057 ⁵¹	 G51046	142419 ⁵³ 143064 ⁵¹
	FWD	 G55605	142219 ⁵³ 143057 ⁵¹	 G51184	142419 ⁵³ 143064 ⁵¹
90	All	142219 ⁵³ 143057 ⁵¹	142419 ⁵³ 143064 ⁵¹
	AWD, Auto-Leveling System	142219 ⁵³ 143057 ⁵¹	 G51046	142419 ⁵³ 143064 ⁵¹
	AWD, FWD	 G55587	142219 ⁵³ 143057 ⁵¹	142419 ⁵³ 143064 ⁵¹
	FWD	142219 ⁵³ 143057 ⁵¹	 G51184	142419 ⁵³ 143064 ⁵¹







VISION

93-97	Left	 G55663	142755 ⁶¹ 142842 ⁵⁴ 143057 ⁵¹	 G55665	142292 ⁵³
	Right	 G55664	142755 ⁶¹ 142842 ⁵⁴ 143057 ⁵¹	 G55665	142292 ⁵³

VISION READYMOUNTS

		Front	Rear
93-97	Left	G56958 ⁴⁰	G56960 ⁴⁰
	Right	G56959 ⁴⁰	G56960 ⁴⁰

VISTA

89-92	Exc. Wagon	 G55561	143060 ⁵¹		81555
89-91	4WD, CAN, Wagon	 G55546		81739
	CAN, Wagon	143059 ⁵¹	 69689
	FWD, CAN, Wagon	 G55531		81464
91	CAN, Sedan	143060 ⁵¹

EDSEL

EDSEL



BERMUDA

58	All		82099
----	-----	--	-------	------	------	------	------	------	------	------	------

CITATION

58	All		82099
----	-----	--	-------	------	------	------	------	------	------	------	------

CORSAIR

58-59	All		82099		82076
-------	-----	--	-------	------	------	------	--	-------	------	------	------

40 ReadyMount Strut. Complete Assembled Unit.





53 Strut Mount. Hardware from O.E. Part may need to be reused.

61 Mount Kit includes Upper Spring Seat. Hardware from O.E. Part may need to be

51 Strut Cushion for use with the Strut/Cartridge/Shocks.

54 Kit with Mount and Bearing. Hardware from O.E. Part may need to be reused.



APPLICATION GUIDE

Year	Fitment Notes										
		 Ultra	ProGuard/ Guardian/ Classic	Max Control/ LTV	Strut Cushion/ Strut Mount	Hi Jacker/ Load Carrier	 Ultra	ProGuard/ Guardian/ Classic	Max Control/ LTV	Strut Cushion/ Strut Mount	Hi Jacker/ Load Carrier



EDSEL

EDSEL





CORSAIR (cont'd)

58-59	Exc. Wagon		82099		81469 82076
-------	------------	---	-------	-------	-------	-------	-------	---	-------	----------------	-------	-------	-------



PACER

58	All		82099	
----	-----	---	-------	-------	-------	-------	-------	---	-------	-------	-------	-------	-------





RANGER

58-60	All		82099		82076
58-59	Exc. Wagon		82099		81469 82076

ROUNDUP

58	All		82099	
----	-----	---	-------	-------	-------	-------	-------	---	-------	-------	-------	-------	-------











VILLAGER

58-60	All		82099		82076
58-59	Exc. Wagon		82099		81469 82076



FIAT

FIAT





124

75-79	Built after Serial #066.059		82614		82608
76	Wagon			82156
67-75	All		82614	
	Wagon		82614		82156
68-74	Exc. Wagon		82614		82608





131

75-78	All			82608
-------	-----	---	-------	-------	-------	-------	-------	---	-------	-------	-------	-------	-------



1100

66-67	Exc. Wagon			82155
	Wagon			82156

1500

64-67	Exc. Wagon			82155
	Wagon			82156











BRAVA

78-81	Sedan			82608
-------	-------	---	-------	-------	-------	-------	-------	---	-------	-------	-------	-------	-------



FORD

FORD

AEROSTAR

90-97	All			G63502	61557 81727	49221 ⁷
	4WD, AWD		G63621	61569 81826		G63502	61557 81727	49221 ⁷
	RWD		G63457	61540 81582		G63502	61557 81727	49221 ⁷
89	RWD		G63457	61540 81582		G63502	61557 81727	49221 ⁷
86-88	RWD		G63457	61540 81582		G63490	61541 81583

ASPIRE

94-97	Non-ABS		G55615	142847 ⁵⁴ 143057 ⁵¹		G51039	142738 ⁵³
-------	---------	---	--------	-------	-------	--	-------	---	--------	-------	-------	----------------------	-------



7 Pair Packs, air hose kit included.

53 Strut Mount. Hardware from O.E. Part may need to be reused.

51 Strut Cushion for use with the Strut/Cartridge/Shocks.

54 Kit with Mount and Bearing. Hardware from O.E. Part may need to be reused.

APPLICATION GUIDE

Year	Fitment Notes										
		Ultra	ProGuard/ Guardian/ Classic	Max Control/ LTV	Strut Cushion/ Strut Mount	Hi Jacker/ Load Carrier	Ultra	ProGuard/ Guardian/ Classic	Max Control/ LTV	Strut Cushion/ Strut Mount	Hi Jacker/ Load Carrier

FORD

FORD

BRONCO

80-96	Exc. Lift Kit	○ G63409	61554 81710	58409 77409 ⁶	43142 ⁶ 49197 ⁷
	Quad & Non Quad Suspensions Rearward of Front Axle; Exc. Lift Kit	○ G63414 ⁶	61520 ⁶ 81490	58414 ⁶ 77414 ⁶	34057 ⁸
	Quad Suspension; Forward of Front Axle; Exc. Lift Kit	○ G63410 ⁶	61546 ⁶	58410 ⁶ 77410 ⁶
80-88	3-4" Lift Kit	○ G63441 ⁵⁰
80-86	3-4" Lift Kit; Quad Suspension Forward of Front Axle	○ G63446 ⁶
	3-4" Lift Kit; Quad Suspension Rearward of Front Axle	○ G63445 ⁶
78-79	3 1/2-4" Lift Kit; Exc. Quad Suspension	○ G63441 ⁵⁰
	Exc. Lift Kit	○ G63377	61519 81484	58377 77377	43058 ⁸ 49127 ⁷
	Left 3 1/2-4" Lift Kit; Exc. Quad Suspension	○ G63447
	Quad Suspension Long Shock; Exc. Lift Kit	○ G63511 ⁶
	Quad Suspension; Forward of Front Axle; Exc. Lift Kit	○	61551 ⁶
	Quad Suspension; Rearward of Front Axle; Exc. Lift Kit	○ G63396 ⁶	61521 ⁶ 81394
	Right 3 1/2-4" Lift Kit; Exc. Quad Suspension	○ G63445 ⁶
67-77	From Serial #830001; Exc. Lift Kit	○ G63386	61521 ⁶ 81394	58386	34058 ⁸	○ G63377	61519 81484	58377 77377	43058 ⁸ 49127 ⁷
66-77	4-5" Lift Kit	○ G63445 ⁶	○ G63441 ⁵⁰
66	Exc. Lift Kit	○ G63386	81394
	From Serial #830001; Exc. Lift Kit	○	61521 ⁶	58386	34058 ⁸	○ G63377	61519 81484	58377 77377	43058 ⁸
	Thru Serial #830000	○ G63350	61518 81242	58350	43099 ⁸ 49173 ⁷

BRONCO II

90	All	○ G63614	61561 81744	58929 77614	○ G63525	61559 81730	77525	49223 ⁷
89	Mfg. from 2/89; Vehicles with 12mm bolt in rear lower mount	○	77414 ⁶	○ G63525	61559 81730	77525	49223 ⁷
	Mfg. to 2/89; Vehicles with 10mm & 12mm bolt in rear lower mount	○ G63414	61520 ⁶ 81490	34057 ⁸	○ G63427	61533 81539	43165 ⁸ 49207 ⁷
84-88	With 10mm Bolt In Rear Lower Mount	○ G63414	61520 ⁶ 81490	77414 ⁶	34057 ⁸	○ G63427	61533 81539	43165 ⁸ 49207 ⁷

BRONCO II STEERING STABILIZERS

		Front	Rear
84-90	Single System Steering Stabilizer	6802SE ⁸⁴

BRONCO STEERING STABILIZERS

		Front	Rear
92-96	Single System Steering Stabilizer	6802SE ⁸⁴
80-91	All	6802SE ⁸⁴
78-79	Dual System Steering Stabilizer; Exc. Sway Bar	6802SE ⁸⁴
71-79	All	14016
	Single System Steering Stabilizer	6803SE ⁸⁴
70	Single System Steering Stabilizer	6803SE ⁸⁴
68-69	Single System Steering Stabilizer	6804SE ⁸⁰
67	All	14016
	Single System Steering Stabilizer	6804SE ⁸⁰
66	Single System Steering Stabilizer	6804SE ⁸⁰

6 It is recommended that when replacing shocks on vehicles with "quad shocks" all 4 shocks should be matched by series.

8 Pair Packs.





80 Mounting bracket not required, install on O.E. Shock Mounts. See Ref. C for

7 Pair Packs, air hose kit included.

50 Bellows Kit No. 141242 is recommended for use to protect piston rod from potentially harmful road debris.

84 Replacement damper for vehicles with the Gabriel Aftermarket mounting kit







APPLICATION GUIDE

Year	Fitment Notes										
			Ultra	ProGuard\ Guardian\ Classic	Max Control\ LTV	Strut Cushion\ Strut Mount	Hi Jacker\ Load Carrier		Ultra	ProGuard\ Guardian\ Classic	Max Control\ LTV

FORD

CONTOUR











FORD

97-00	Mfg. from 3/97		G56520	142843 ⁵⁴ 143061 ⁵¹		G55693	142402 ⁵³ 143058 ⁵¹
95-00	All		142843 ⁵⁴ 143061 ⁵¹		G55693	142402 ⁵³ 143058 ⁵¹
95-97	Mfg. to 3/97		G55692	142843 ⁵⁴ 143061 ⁵¹		G55693	142402 ⁵³ 143058 ⁵¹













CONTOUR READYMOUNTS

		Front	Rear
99-00	Base, LX, Power, SE	G57052 ⁴⁰
96-98	Base, GL, LX, Power, SE, Sport	G57052 ⁴⁰
95	GL, LX, SE	G57052 ⁴⁰



COUNTRY SEDAN

65-74	All		69675 ⁵	81446	34073 ⁸		69606	81495	43140 ⁹ 49205 ⁷
60-64	All		82099		82076
57-59	All		82099		81270	49105 ⁷
52-56	All		82026		81270	49105 ⁷
50-51	All		82026		82156







COUNTRY SQUIRE

87-91	All		69675 ⁵	81446	34073 ⁸		69606	81495	43140 ⁹ 49205 ⁷
65-74	All		69675 ⁵	81446	34073 ⁸		69606	81495	43140 ⁹ 49205 ⁷
59-64	All		82099		82076
57-58	All		82099	
52-56	All		82026		81270	49105 ⁷
50-51	All		82026		82060





COURIER

72-82	All		G63421	61504 81750	58421 77421		61502 82125
-------	-----	---	--------	----------------	----------------	------	------	---	------	----------------	------	------	------











COURIER SEDAN DELIVERY

59-60	All		82099		82076
57-58	All		82099	
54-56	All		82026		81270	49105 ⁷

CRESTLINE

52-54	All		82026		81270	49105 ⁷
50-51	All		82026		82156

CROWN VICTORIA

07-11	All		143356 ⁵³ 143357⁵⁸	
	Exc. Police and Taxi Models		G51887	143356 ⁵³ 143357⁵⁸		69575
	Police Interceptor		G51888	143356 ⁵³ 143357⁵⁸	
07-10	Police and Taxi Models		143356 ⁵³ 143357⁵⁸		69574	77955
03-06	All		143356 ⁵³	

5 Use kit No. 140719 to replace O.E. hardware for lower shock absorber mounting when studs break or self-tapping screws are not longer useable.

8 Pair Packs.

51 Strut Cushion for use with the Strut/Cartridge/Shocks.

54 Kit with Mount and Bearing. Hardware from O.E. Part may need to be reused.

Bold Type - New / Future Part



7 Pair Packs, air hose kit included.

40 ReadyMount Strut. Complete Assembled Unit.

53 Strut Mount. Hardware from O.E. Part may need to be reused.

68 Mount Hardware Kit. Hardware from O.E. Part may need to be reused.

APPLICATION GUIDE

Year	Fitment Notes										
		Ultra	ProGuard/ Guardian/ Classic	Max Control/ LTV	Strut Cushion/ Strut Mount	Hi Jacker/ Load Carrier	Ultra	ProGuard/ Guardian/ Classic	Max Control/ LTV	Strut Cushion/ Strut Mount	Hi Jacker/ Load Carrier

FORD

FORD

CROWN VICTORIA (cont'd)

03-06	Exc. Police and Taxi Models	↓ G51887	143357⁶⁸ 143356 ⁵³	↓ 69575
	Police and Taxi Models	↓	143356 ⁵³	↓ 69574	77955
	Police Interceptor	↓ G51888	143356 ⁵³	↓
94-02	All	↓ 69675 ⁵	↓ 69606	81495	43140 ⁶ 49205 ⁷
	Exc. Hydraulic Self Leveling System	↓ 69675 ⁵	34073 ⁸	↓ 69606	81495	43140 ⁶ 49205 ⁷
	Exc. Police and Taxi Models	↓ 69675 ⁵	81446	↓ 69606	81495	43140 ⁶ 49205 ⁷
	Police and Taxi Models	↓ G63375 ⁵	61555 81713 ⁵	77375	↓ 69606	81495	43140 ⁶ 49205 ⁷
93	All	↓ 69675 ⁵	↓ 69606	81495	49205 ⁷
	Exc. Hydraulic Self Leveling System	↓ 69675 ⁵	34073 ⁸	↓ 69606	81495	43140 ⁶ 49205 ⁷
	Exc. Police and Taxi Models	↓ 69675 ⁵	81446	↓ 69606	81495	49205 ⁷
	Police and Taxi Models	↓ G63375 ⁵	61555 81713 ⁵	77375	↓ 69606	81495	49205 ⁷
92	All	↓ 69675 ⁵	↓ 69606	81495	43140 ⁶ 49205 ⁷
	Exc. Hydraulic Self Leveling System	↓ 69675 ⁵	34073 ⁸	↓ 69606	81495	43140 ⁶ 49205 ⁷
	Exc. Police and Taxi Models	↓ 69675 ⁵	81446	↓ 69606	81495	43140 ⁶ 49205 ⁷

CROWN VICTORIA READYMOUNTS

		Front		Rear	
03-11	Exc. Police and Taxi Models	G57080 ⁴⁰		

CUSTOM

65-72	All	↓ 69675 ⁵	81446	34073 ⁸	↓ 69606	81495	43140 ⁶ 49205 ⁷
64	All	↓	82099	↓	82076
57	All	↓	82099	↓	81270	49105 ⁷
52	All	↓	82026	↓	81270	49105 ⁷
50-51	All	↓	82026	↓	82156

CUSTOM 300

60	All	↓	82099	↓	82076
59	All	↓	82099	↓
58	All	↓	82099	↓	81270	49105 ⁷

CUSTOM 500

68-77	All	↓ 69675 ⁵	81446	34073 ⁸	↓ 69606	81495	43140 ⁶ 49205 ⁷
-------	-----	-------------------------	-------	------	------	--------------------	------------	-------	------	------	--

CUSTOMLINE

52-56	All	↓	82026	↓	81270	49105 ⁷
-------	-----	-----------	-------	------	------	------	-----------	-------	------	------	--------------------

DEL RIO WAGON

57-58	All	↓	82099	↓
-------	-----	-----------	-------	------	------	------	-----------	------	------	------	------

DELUXE

49-51	All	↓	82026	↓	82156
47-48	Direct Acting Shocks	↓	82007	↓	82156

5 Use kit No. 140719 to replace O.E. hardware for lower shock absorber mounting when studs break or self-tapping screws are not longer useable.

8 Pair Packs.





53 Strut Mount. Hardware from O.E. Part may need to be reused.

7 Pair Packs, air hose kit included.

40 ReadyMount Strut. Complete Assembled Unit.

68 Mount Hardware Kit. Hardware from O.E. Part may need to be reused.

APPLICATION GUIDE

Year	Fitment Notes										
			Ultra	ProGuard/ Guardian/ Classic	Max Control/ LTV	Strut Cushion/ Strut Mount	Hi Jacker/ Load Carrier		Ultra	ProGuard/ Guardian/ Classic	Max Control/ LTV

FORD

FORD



E-550 ECONOLINE SUPER DUTY

02	All		61655
----	-----	-------	-------	-------	-------	-------	---	-------	-------	-------	-------	-------

E-550 SUPER DUTY

03	All		61655
----	-----	-------	-------	-------	-------	-------	---	-------	-------	-------	-------	-------





ECONOLINE

61-67	All		G63492	61506 81318	77492		G63299	82007
-------	-----	---	--------	----------------	-------	-------	-------	---	--------	-------	-------	-------	-------

















ECONOLINE VAN STEERING STABILIZERS

61-67	Van								Front	Rear
									6802SE ⁸⁴

EDGE

07-10	Left		G56840		G64037
	Right		G56841		G64037

















ESCAPE

12	Left		G56601	
	Right		G56568	
09-11	Left		G56601	143253 ⁵³		G64047
	Right		G56568	143253 ⁵³		G64047
08	Left		G56601	143253 ⁵³		69900 G64047
	Right		G56568	143253 ⁵³		69900 G64047
01-07	Left		G56601	143253 ⁵³		69900 G63862
	Right		G56568	143253 ⁵³		69900 G63862

ESCAPE READYMOUNTS

01-11	Left								Front	Rear
	Right								G57045 ⁴⁰
									G57046 ⁴⁰

ESCORT

98-03	Hot & Cool Coupe; Non-ABS		G56801	142744 ⁵⁵ 142832 ⁵⁴ 143061 ⁵¹		G55848	142190 ⁵³ 143060 ⁵¹
97-03	All		142744 ⁵⁵ 142832 ⁵⁴ 143061 ⁵¹		G55848	142190 ⁵³ 143060 ⁵¹
97-02	Exc. Hot & Cool Coupe		G56515	142744 ⁵⁵ 142832 ⁵⁴ 143061 ⁵¹		G55848	142190 ⁵³ 143060 ⁵¹
91-96	All		G55847	142744 ⁵⁵ 142854 ⁵⁴ 143057 ⁵¹		G55848	142190 ⁵³ 143058 ⁵¹
85-90	All		142844 ⁵⁴ 143057 ⁵¹		G55705	142221 ⁵³ 143059 ⁵¹
	Mfg. from 3/85		G55714	142844 ⁵⁴ 143057 ⁵¹		G55705	142221 ⁵³ 143059 ⁵¹
85	Mfg. from 2/83 thru 3/85		G55712	142844 ⁵⁴ 143057 ⁵¹		G55705	142221 ⁵³ 143059 ⁵¹
83-84	Mfg. from 2/83 thru 3/85		G55712	143057 ⁵¹		G55705	142221 ⁵³ 143059 ⁵¹

40 ReadyMount Strut. Complete Assembled Unit.

53 Strut Mount. Hardware from O.E. Part may need to be reused.



65 Mount Kit includes Upper Spring Seat with Isolator. Hardware from O.E. Part may need to be reused.

51 Strut Cushion for use with the Strut/Cartridge/Shocks.

54 Kit with Mount and Bearing. Hardware from O.E. Part may need to be reused.

84 Replacement damper for vehicles with the Gabriel Aftermarket mounting kit

APPLICATION GUIDE

Year	Fitment Notes										
		Ultra	ProGuard/ Guardian/ Classic	Max Control/ LTV	Strut Cushion/ Strut Mount	Hi Jacker/ Load Carrier	Ultra	ProGuard/ Guardian/ Classic	Max Control/ LTV	Strut Cushion/ Strut Mount	Hi Jacker/ Load Carrier

FORD

FORD

ESCORT (cont'd)

81-84	All	143057 ⁵¹	G55705	142221 ⁵³ 143059 ⁵¹
81-83	Mfg. to 2/83	G55704	143057 ⁵¹	G55705	142221 ⁵³ 143059 ⁵¹

ESCORT READYMOUNTS

		Front		Rear	
97-03	All	G56940 ⁴⁰
97-02	Exc. Hot & Cool Coupe	G56926 ⁴⁰	G56940 ⁴⁰
91-96	All	G56911 ⁴⁰	G56940 ⁴⁰

EXCURSION

00-05	4WD	G63809	77809	G63837	77837
	RWD	G63614	77614	G63607	77607

EXCURSION STEERING STABILIZERS

		Front		Rear	
00-05	4WD, With O.E. Unit	6854SE ⁴⁰

EXP

85-88	All	142844 ⁵⁴ 143057 ⁵¹	G55705	142221 ⁵³ 143059 ⁵¹
	Mfg. from 3/85	G55714	142844 ⁵⁴ 143057 ⁵¹	G55705	142221 ⁵³ 143059 ⁵¹
85	Mfg. from 2/83 thru 3/85	G55712	142844 ⁵⁴ 143057 ⁵¹	G55705	142221 ⁵³ 143059 ⁵¹
84	All	143057 ⁵¹	G55705	142221 ⁵³ 143059 ⁵¹
	Mfg. from 2/83 thru 3/85	G55712	143057 ⁵¹	G55705	142221 ⁵³ 143059 ⁵¹
82-83	All	143057 ⁵¹	142221 ⁵³ 143059 ⁵¹
	Mfg. to 2/83	G55704	143057 ⁵¹	G55705	142221 ⁵³ 143059 ⁵¹
83	Mfg. from 2/83 thru 3/85	G55712	143057 ⁵¹	142221 ⁵³ 143059 ⁵¹

EXPEDITION

07-12	Coil(RearSpringType) Exc. Air Suspension	G51860	G51861
03-06	All	G51729	143317 ⁵³
	Exc. Adjustable Suspension	143244 ⁵³	G51729	143317 ⁵³
	4WD	G51720	G51729	143317 ⁵³
	RWD	G51719	G51729	143317 ⁵³
97-02	All	G63717	61614	58717 77717
	4WD, Exc. Front Air- Leveling	G63716	61613 81914	58716 77716	G63717	61614	58717 77717
	RWD, Exc. Front Air- Leveling	G63714	61611 81912	58714 77714	G63717	61614	58717 77717

EXPEDITION READYMOUNTS

		Front		Rear	
03-06	All	G57016 ⁴⁰
	4WD	G57015 ⁴⁰	G57016 ⁴⁰

EXPEDITION STEERING STABILIZERS

		Front		Rear	
97-02	4WD, Torsion Bar(FrontSpringType)	6861SE ⁴²

40 ReadyMount Strut. Complete Assembled Unit.

53 Strut Mount. Hardware from O.E. Part may need to be reused.





80 Mounting bracket not required, install on O.E. Shock Mounts. See Ref. C for

51 Strut Cushion for use with the Strut/Cartridge/Shocks.

54 Kit with Mount and Bearing. Hardware from O.E. Part may need to be reused.

82 Use kit if listed, See Ref. C for optional Steering Stabilizer Boots.













APPLICATION GUIDE

Year	Fitment Notes										
			Ultra	ProGuard/ Guardian/ Classic	Max Control/ LTV	Strut Cushion/ Strut Mount	Hi Jacker/ Load Carrier		Ultra	ProGuard/ Guardian/ Classic	Max Control/ LTV

FORD

FORD





EXPLORER

06-10	All		G56838	143330 ⁷⁰ 143360 ⁵³		G56839	143361 ⁵³ 143362 ⁷⁰
04-05	Exc. All Sport & Sport Trac Models		G51723	143318 ⁵³		G51724	143319 ⁵³
02-05	All		143318 ⁵³	143319 ⁵³
02-03	Exc. All Sport & Sport Trac Models		G51722	143318 ⁵³		G51724	143319 ⁵³
95-01	Exc. Adjustable Suspension		G63678	61623	77678		G63679	61624 81890	77679
	Exc. Electronic Adjustable Suspension		81893		43171 ⁸ 49232 ⁷
91-94	All		G63608	61591 81744	58929 77608	34076 ⁸		G63607	61590 81823	77607	43172 ⁸ 49225 ⁷

EXPLORER READYMOUNTS

		Front	Rear
06-10	All	G57095 ⁴⁰	G57096 ⁴⁰
04-05	Exc. All Sport & Sport Trac Models	G57019 ⁴⁰	G57018 ⁴⁰
02-03	Exc. All Sport & Sport Trac Models	G57017 ⁴⁰	G57018 ⁴⁰















EXPLORER SPORT TRAC

07-10	All		G52205		G52206
01-05	All		G63678	61623 81893	77678		G63679	61624 81890	77679	43171 ⁸ 49232 ⁷

EXPLORER STEERING STABILIZERS

		Front	Rear
91-94	All	6802SE ⁸⁴

F SERIES

57-59	All		81270	
	F-100, F-250		81270		82123
55	All		G63299	
	F-100		G63299		G63405	61500 81147	77405	43048 ⁸ 49310 ⁷
	F250		G63299		81676
53-54	All		G63299		81676
48-52	F-1, F-2 & F-3		G63405	61500 81147	77405	43048 ⁸		G63299	81676

F SERIES STEERING STABILIZERS

		Front	Rear
57-59	Single System Steering Stabilizer; with I-Beam Axle	6802SE ⁸⁴
59	Single System Steering Stabilizer; F-250, F-350; Exc. Power Steering	6803SE ⁸⁴
50-55	Single System Steering Stabilizer; with I-Beam Axle	6802SE ⁸⁴











F-550

10-12	All	58942
-------	-----	------	------	------	------	------	------	------	------	-------	------	------

F59 STEERING STABILIZERS

		Front	Rear
89-91	Single System Steering Stabilizer; Superduty Motorhome	6802SE ⁸⁴

FAIRLANE

66-70	All		82126		81270	49105 ⁷
	Wagon		82126		69606	81270	49105 ⁷
62-65	All		82075		81270	49105 ⁷
60-61	All		82099		82076
59	All		82099	

7 Pair Packs, air hose kit included.

40 ReadyMount Strut. Complete Assembled Unit.

70 Bushing and sleeve kit. Hardware from O.E. Part may need to be reused.



Bold Type - New / Future Part

8 Pair Packs.

53 Strut Mount. Hardware from O.E. Part may need to be reused.

84 Replacement damper for vehicles with the Gabriel Aftermarket mounting kit

APPLICATION GUIDE

Year	Fitment Notes										
		Ultra	ProGuard/ Guardian/ Classic	Max Control/ LTV	Strut Cushion/ Strut Mount	Hi Jacker/ Load Carrier	Ultra	ProGuard/ Guardian/ Classic	Max Control/ LTV	Strut Cushion/ Strut Mount	Hi Jacker/ Load Carrier

FORD

FORD

FAIRLANE (cont'd)

57-58	All	⌋	82099	⌋	81270	49105 ⁷
55-56	All	⌋	82026	⌋	81270	49105 ⁷

FAIRMONT

78-83	All	⌋	G56504 ⁹	142197 ⁵³ 143059 ⁵¹	⌋	69633	81460	43143 ⁸ 49199 ⁷
-------	-----	---	---------------------	------	------	--	------	---	-------	-------	------	------	--

FALCON

66-70	All	⌋	82126	⌋
	Exc. Wagon	⌋	82126	⌋	81270
	Wagon	⌋	82126	⌋	69606
	Exc. Wagon	⌋	82126	⌋	49105 ⁷
	Wagon	⌋	82126	⌋	81495
60-65	All	⌋	82126	⌋	81270	49105 ⁷

FESTIVA

88-93	All	⌋	G55615	142847 ⁵⁴ 143059 ⁵¹	⌋	G51039	142738 ⁵³ 143063 ⁵¹
-------	-----	---	--------	------	------	--	------	---	--------	------	------	--	------

FIESTA

13-14	All	⌋	⌋	70052
11-13	Left	⌋	G52255	⌋	70052
11-12	Right	⌋	G52256	⌋	70052

FIVE HUNDRED

05-07	AWD, Left	⌋	G52136	⌋	G51849
	AWD, Right	⌋	G52137	⌋	G51849
	FWD, Left	⌋	G52138	⌋	G51875	143390⁵³
	FWD, Right	⌋	G52139	⌋	G51876	143391

FOCUS

08-11	Left	⌋	G56836	142930 ⁵³	⌋	69464 ³⁷	81935	142992 ⁵³
	Right	⌋	G56837	142930 ⁵³	⌋	69464 ³⁷	81935	142992 ⁵³
06-07	Left	⌋	G56836	142930 ⁵³	⌋
	Right	⌋	G56837	142930 ⁵³	⌋
	Hatchback	⌋	⌋	69464 ³⁷	81935	142992 ⁵³
	Sedan	⌋	⌋	69464 ³⁷	81935	142992 ⁵³
00-07	Wagon	⌋	⌋	69465
00-05	Left	⌋	G56516	142930 ⁵³	⌋
	Right	⌋	G56517	142930 ⁵³	⌋
	Hatchback	⌋	143057 ⁵¹	⌋	69464 ³⁷	81935	142992 ⁵³
	Sedan	⌋	143057 ⁵¹	⌋	69464 ³⁷	81935	142992 ⁵³

7 Pair Packs, air hose kit included.

9 See Ref. D for procedures to replace Elec Adj Susp with non-adj product.

51 Strut Cushion for use with the Strut/Cartridge/Shocks.





54 Kit with Mount and Bearing. Hardware from O.E. Part may need to be reused.

8 Pair Packs.

37 Jounce Bumper hardware from O.E. part may need to be reused.

53 Strut Mount. Hardware from O.E. Part may need to be reused.

APPLICATION GUIDE



Year	Fitment Notes										
			Ultra	ProGuard/ Guardian/ Classic	Max Control/ LTV	Strut Cushion/ Strut Mount	Hi Jacker/ Load Carrier		Ultra	ProGuard/ Guardian/ Classic	Max Control/ LTV

FORD



FORD

FOCUS READYMOUNTS			Front	Rear
06-11	Left		G57081 ⁴⁰
	Right		G57082 ⁴⁰
00-05	Left		G57063 ⁴⁰
	Right		G57064 ⁴⁰



FORD

49	All		82026		82060
----	-----	---	------	-------	------	------	------	---	------	-------	------	------	------











FORD 300

63	All		82099		82076
----	-----	---	------	-------	------	------	------	---	------	-------	------	------	------











FREESTAR

04-07	All		G56655	143246 ⁵³		G63873
-------	-----	---	--------	------	------	----------------------	------	---	--------	------	------	------	------







FREESTYLE

05-07	Left		G52110	143341 ⁵³	
	Right		G52111	143341 ⁵³	
	AWD			G51857
	FWD, Left			G51889
	FWD, Right			G51890



FUSION

10-12	Left		G51896	143392 ⁵³	
	Right		G51897	143392 ⁵³	
10-11	FWD			69591
06-09	All		G51859	143392 ⁵³	
	FWD		G51859	143392 ⁵³		69591





GALAXIE

65-67	All		69675 ⁵	81446	34073 ⁸		69606	81495	43140 ⁹ 49205 ⁷
60-64	All		82099		82076
59	All		82099	



GALAXIE 500

68-74	All		69675 ⁵	81446	34073 ⁸		69606	81495	43140 ⁹ 49205 ⁷
-------	-----	---	--------------------	-------	------	------	--------------------	---	-------	-------	------	------	--

GRANADA

81-82	All		G56504 ⁹	142197 ⁵³ 143059 ⁵¹		69633	81460	43143 ⁹ 49199 ⁷
75-80	All		81491		82130

GRAND MARQUIS

03-04	All			69575
-------	-----	---	------	------	------	------	------	---	-------	------	------	------	------

5 Use kit No. 140719 to replace O.E. hardware for lower shock absorber mounting when studs break or self-tapping screws are not longer useable.

8 Pair Packs.

40 ReadyMount Strut. Complete Assembled Unit.

53 Strut Mount. Hardware from O.E. Part may need to be reused.



Bold Type - New / Future Part

7 Pair Packs, air hose kit included.

9 See Ref. D for procedures to replace Elec Adj Susp with non-adj product.

51 Strut Cushion for use with the Strut/Cartridge/Shocks.

APPLICATION GUIDE

Year	Fitment Notes										
		Ultra	ProGuard\Guardian\Classic	Max Control\ LTV	Strut Cushion\ Strut Mount	Hi Jacker\ Load Carrier	Ultra	ProGuard\Guardian\ Classic	Max Control\ LTV	Strut Cushion\ Strut Mount	Hi Jacker\ Load Carrier

FORD

FORD

GRAND MARQUIS (cont'd)

01-02	All	⊕ ⊖	69675 ⁵	81446	34073 ⁸	⊕ ⊖	69606	81495	43140 ⁸ 49205 ⁷
-------	-----	--------	--------------------	-------	------	------	--------------------	--------	-------	-------	------	------	--

LTD / COUNTRY SEDAN / COUNTRY SQUIRE / CROWN VICTORIA

87-91	All	⊕ ⊖	69675 ⁵	81446	34073 ⁸	⊕ ⊖	69606	81495	43140 ⁸ 49205 ⁷
85-86	Police and Taxi Models	⊕ ⊖	G56504 ⁹	81446	142197 ⁵³ 143059 ⁵¹	⊕ ⊖	69633	81460	43143 ⁸ 49199 ⁷
83-86	All	⊕ ⊖	G56504 ⁹	142197 ⁵³ 143059 ⁵¹	⊕ ⊖	69633	81460	43143 ⁸ 49199 ⁷
67-82	All	⊕ ⊖	69675 ⁵	81446	34073 ⁸	⊕ ⊖	69606	81495	43140 ⁸ 49205 ⁷

LTD II

77-79	All	⊕ ⊖	69675 ⁵	81446	34073 ⁸	⊕ ⊖	69606	81495	43140 ⁸ 49205 ⁷
-------	-----	--------	--------------------	-------	------	------	--------------------	--------	-------	-------	------	------	--

MAINLINE

52-56	All	⊕ ⊖	82026	⊕ ⊖	81270	49105 ⁷
-------	-----	--------	------	-------	------	------	------	--------	------	-------	------	------	--------------------

MAVERICK

69-77	All	⊕ ⊖	81076	⊕ ⊖	82130
-------	-----	--------	------	-------	------	------	------	--------	------	-------	------	------	------

MOTORHOME CHASSIS / F53 STEERING STABILIZERS

		Front		Rear	
89-91	Single System Steering Stabilizer; Motorhome	6802SE ⁸⁴		

MUSTANG / MUSTANG II

11-13	Convertible	⊕ ⊖	⊕ ⊖	69593
	Coupe	⊕ ⊖	⊕ ⊖	69592
05-10	All	⊕ ⊖	G56817	143341 ⁵³	⊕ ⊖
	Convertible	⊕ ⊖	G56817	143341 ⁵³	⊕ ⊖	69593
	Coupe	⊕ ⊖	G56817	143341 ⁵³	⊕ ⊖	69592
03-04	SVT Cobra	⊕ ⊖	G56790	142197 ⁵³ 143060 ⁵¹	⊕ ⊖
94-04	All	⊕ ⊖	142197 ⁵³ 143060 ⁵¹	⊕ ⊖
	Base, March & GT Models Only	⊕ ⊖	G55681	142197 ⁵³ 143060 ⁵¹	⊕ ⊖	69898	81794	75898	49234 ⁷
01	SVT Cobra	⊕ ⊖	G56790	142197 ⁵³ 143060 ⁵¹	⊕ ⊖
00	SVT Cobra R	⊕ ⊖	G56790	142197 ⁵³ 143060 ⁵¹	⊕ ⊖
96-99	SVT Cobra	⊕ ⊖	G56790	142197 ⁵³ 143060 ⁵¹	⊕ ⊖
95	SVT Cobra, SVT Cobra R	⊕ ⊖	G56790	142197 ⁵³ 143060 ⁵¹	⊕ ⊖
94	SVT Cobra	⊕ ⊖	G56790	142197 ⁵³ 143060 ⁵¹	⊕ ⊖
87-93	2.3L 4 Cyl L	⊕ ⊖	142197 ⁵³ 143059 ⁵¹	⊕ ⊖	81460
	5.0l 8 Cyl V	⊕ ⊖	142197 ⁵³ 143059 ⁵¹	⊕ ⊖	81674
	LX	⊕ ⊖	G56504 ⁹	142197 ⁵³ 143059 ⁵¹	⊕ ⊖	69633	75755	43143 ⁸ 49199 ⁷
84-93	All	⊕ ⊖	142197 ⁵³ 143059 ⁵¹	⊕ ⊖

5 Use kit No. 140719 to replace O.E. hardware for lower shock absorber mounting when studs break or self-tapping screws are not longer useable.

8 Pair Packs.





51 Strut Cushion for use with the Strut/Cartridge/Shocks.

7 Pair Packs, air hose kit included.

9 See Ref. D for procedures to replace Elec Adj Susp with non-adj product.

53 Strut Mount. Hardware from O.E. Part may need to be reused.

































APPLICATION GUIDE

Year	Fitment Notes										
			Ultra	ProGuard/ Guardian/ Classic	Max Control/ LTV	Strut Cushion/ Strut Mount	Hi Jacker/ Load Carrier		Ultra	ProGuard/ Guardian/ Classic	Max Control/ LTV

FORD

FORD



MUSTANG / MUSTANG II (cont'd)

84-93	GT		G55551	142197 ⁵³ 143059 ⁵¹		69755	81674	75755
84-86	LX		G56504 ⁹	142197 ⁵³ 143059 ⁵¹		69633	81460	43143 ⁸ 49199 ⁷
	LX Exc. 5.0L		142197 ⁵³ 143059 ⁵¹		49199 ⁷
	SVO		G44947 ⁹⁸	142197 ⁵³ 143059 ⁵¹		69755	81674	75755
84	L		142197 ⁵³ 143059 ⁵¹		69633	81460	43143 ⁸
82-83	All		G56504 ⁹	142197 ⁵³ 143059 ⁵¹	
	GL, GLX		G56504 ⁹	142197 ⁵³ 143059 ⁵¹		69633	81460	43143 ⁸ 49199 ⁷
	GT		G56504 ⁹	142197 ⁵³ 143059 ⁵¹		69755	81674	75755
83	L		G56504 ⁹	142197 ⁵³ 143059 ⁵¹		81460	43143 ⁸ 49199 ⁷
82	Ghia, L		G56504 ⁹	142197 ⁵³ 143059 ⁵¹		81460	43143 ⁸ 49199 ⁷
79-81	All		G56504 ⁹	143059 ⁵¹		69633	81460	43143 ⁸ 49199 ⁷
78	All			82002
74-77	All		82128		82002
71-73	All		81491		81270	49105 ⁷
67-70	All		81076		81270	49105 ⁷
65-66	All		82104		81270	49105 ⁷







MUSTANG / MUSTANG II STEERING STABILIZERS

		Front	Rear
84-04	All	14039

PARK LANE WAGON

56	All		82026		81270
----	-----	---	------	-------	------	------	------	---	------	-------	------	------	------









PICKUP 1/2 TON, F SUPERDUTY

93-97	Mfg. from 2/93		G63692		G63409	61554 81710	58409 77409 ⁶
90-97	All			G63409	61554 81710	58409 77409 ⁶
90-93	Mfg. to 2/93		G63617	58617		G63409	61554 81710	58409 77409 ⁶

PICKUP 1/2 TON, F SUPERDUTY STEERING STABILIZERS

		Front	Rear
93-97	With O.E. Unit	6857SE ⁸²
90-92	All	6802SE ⁸⁴

PICKUP 1/2 TON, F-100

80-83	RWD		G63414	61520 81490	58414 77414	34057 ⁸		G63409	61554 81710	58409 77409	43142 ⁸ 49199 ⁷
77-79	3-4" Lift Kit; Exc. Quad Suspension		G63445 ⁹⁰	
	4WD; 3-4" Lift Kit; Exc. Quad Suspension			G63447 ⁹⁰
76-79	Exc. Lift Kit		G63386	

6 It is recommended that when replacing shocks on vehicles with "quad shocks" all 4 shocks should be matched by series.

8 Pair Packs.

50 Bellows Kit No.141242 is recommended for use to protect piston rod from potentially harmful road debris.

53 Strut Mount. Hardware from O.E. Part may need to be reused.

84 Replacement damper for vehicles with the Gabriel Aftermarket mounting kit

7 Pair Packs, air hose kit included.

9 See Ref. D for procedures to replace Elec Adj Susp with non-adj product.

51 Strut Cushion for use with the Strut/Cartridge/Shocks.

82 Use kit if listed, See Ref. C for optional Steering Stabilizer Boots.

98 Notice: The level of difficulty to install this product is moderately high. Please review the installation instructions carefully before proceeding.

APPLICATION GUIDE

Year	Fitment Notes										
			Ultra	ProGuard/ Guardian/ Classic	Max Control/ LTV	Strut Cushion/ Strut Mount	Hi Jacker/ Load Carrier		Ultra	ProGuard/ Guardian/ Classic	Max Control/ LTV

FORD

FORD





PICKUP 1/2 TON, F-100 (cont'd)

75-79	RWD	 ○	61521 ⁶ 81394	58386	34058 ⁸	 ○	G63350	61518 81242	58350	43099 ⁸ 49173 ⁷
75-76	3 1/2-4" Lift Kit	 ○	 ○	G63447 ⁵⁰
	4WD, Exc. Lift Kit	 ○	82033	 ○	G63387	81285	49178 ⁷
75	RWD	 ○	G63386	 ○
74	All	 ○	G63386	 ○
	Exc. Lift Kit	 ○	G63386	 ○	49178 ⁷
	Exc. Supercab	 ○	G63386	 ○	43099 ⁸
	Lift Kit	 ○	G63386	 ○	49173 ⁷
	RWD	 ○	G63386	 ○	58350
	4WD, Exc. Lift Kit	 ○	G63386	82033	 ○	G63387	81285
	4WD, Lift Kit	 ○	G63386	 ○	G63447 ⁵⁰
	RWD	 ○	G63386	61521 ⁶ 81394	58386	34058 ⁸	 ○	G63350	61518 81242
73	All	 ○	G63386	 ○	58350
	Exc. Lift Kit	 ○	G63386	 ○	58350	49178 ⁷
	Exc. Supercab	 ○	G63386	 ○	58350	43099 ⁸
	Lift Kit	 ○	G63386	 ○	58350	49173 ⁷
	4WD, Exc. Lift Kit	 ○	G63386	82033	 ○	G63387	81285	58350
	4WD, Lift Kit	 ○	G63386	 ○	G63447 ⁵⁰	58350
	RWD	 ○	G63386	61521 ⁶ 81394	58386	34058 ⁸	 ○	G63350	61518 81242	58350
71-72	4WD, Exc. Lift Kit	 ○	G63386	82033	 ○	G63387	81285
70-72	All	 ○	G63386	 ○
	4WD; Lift Kit	 ○	G63386	 ○	G63447 ⁵⁰
	Exc. Lift Kit	 ○	G63386	 ○	49178 ⁷
	Exc. Supercab	 ○	G63386	 ○	43099 ⁸
	Lift Kit	 ○	G63386	 ○	49173 ⁷
	RWD	 ○	G63386	61521 ⁶ 81394	58386	34058 ⁸	 ○	G63350	61518 81242	58350
70	4WD, Exc. Lift Kit	 ○	G63386	82033	 ○	G63387
66-69	RWD	 ○	G63386	61521 ⁶ 81394	58386	34058 ⁸	 ○	G63377	61519 81484 82147	58377 77377	43058 ⁸ 49127 ⁷
	4WD	 ○	82033	 ○
65	All	 ○	 ○	43058 ⁸
	4WD; With Front Leaf Springs	 ○	 ○	81147	43058 ⁸
	Early 1965	 ○	82034	 ○	43058 ⁸
	RWD	 ○	G63386	61521 ⁶ 81394	58386	34058 ⁸	 ○	49127 ⁷ 43058 ⁸
	With Front Coil Springs	 ○	 ○	81484 82147	43058 ⁸
	With Front Coil Springs; Late 1965	 ○	82033	 ○	43058 ⁸
	4WD; With Front Leaf Springs	 ○	G63187	61500	 ○	43058 ⁸
	RWD; With Front Coil Springs	 ○	 ○	G63377	61519	58377 77377	43058 ⁸
61-64	All	 ○	 ○	G63405	61500 81147	77405	43048 ⁸ 49310 ⁷

6 It is recommended that when replacing shocks on vehicles with "quad shocks" all 4 shocks should be matched by series.

7 Pair Packs, air hose kit included.
50 Bellows Kit No. 141242 is recommended for use to protect piston rod from potentially harmful road debris.

APPLICATION GUIDE

Year	Fitment Notes										
		 Ultra	ProGuard/ Guardian/ Classic	Max Control/ LTV	Strut Cushion/ Strut Mount	Hi Jacker/ Load Carrier	 Ultra	ProGuard/ Guardian/ Classic	Max Control/ LTV	Strut Cushion/ Strut Mount	Hi Jacker/ Load Carrier

FORD

FORD

PICKUP 1/2 TON, F-100 (cont'd)

61-64	RWD	I I	82038	O O	G63405	61500 81147	77405	43048 ⁶ 49310 ⁷
60	All	I I	81270	O O	82123
53-55	Exc. Heavy Duty	I I	O O	81676

PICKUP 1/2 TON, F-100 STEERING STABILIZERS

								Front	Rear
80-83	Single System Steering Stabilizer	I I	82038	6802SE ⁸⁴
77-79	Single System Steering Stabilizer; with Twin I-Beam Axle	I I	81270	6802SE ⁸⁴
75-79	4WD; Single System Steering Stabilizer	I I	81270	6803SE ⁸⁴
79	Dual System Steering Stabilizer; Exc. Sway Bar	I I	6802SE ⁸⁴
	4WD; Single System	I I	14016
77-78	4WD; Dual System Steering Stabilizer; Exc. Sway Bar	I I	6802SE ⁸⁴
75-78	4WD	I I	14016
75-76	4WD, Dual System Steering Stabilizer; Exc. Sway Bar	I I	6802SE ⁸⁴
	RWD, Single System Steering Stabilizer; with Twin I-Beam Axle	I I	6802SE ⁸⁴
65-74	RWD; Single System Steering Stabilizer; with Twin I-Beam Axle	I I	6802SE ⁸⁴
60-74	4WD; Single System Steering Stabilizer	I I	6803SE ⁸⁴
61-64	RWD; Single System Steering Stabilizer; with Beam Axle	I I	6802SE ⁸⁴
60	RWD; Single System Steering Stabilizer; with I-Beam Axle	I I	6802SE ⁸⁴

PICKUP 1/2 TON, F-150

14	4WD	I I	O O	G64079
09-13	4WD	I I	G51864	O O	G64079
	RWD	I I	G51865	O O
05-08	RWD; Exc. Lightning Model	I I	G51703	143248 ⁵³	O O	G63870
04-08	All	I I	143248 ⁵³	O O
	4WD	I I	G51704	143248 ⁵³	O O	G63867
04	4WD, Exc. 7700# GVW	I I	G63716	61613 81914	58716 77716	143248 ⁵³	O O	G63715	61612 81913	58715 77715
	RWD	I I	G63714	61611 81912	58714 77714	143248 ⁵³	O O	61638 81892	58778 77778	49237 ⁷
	RWD; Exc. Lightning Model	I I	G51703	143248 ⁵³	O O	G63778 G63870
97-03	4WD	I I	G63716	61613 81914	58716 77716	O O	58715
	4WD, Exc. 7700# GVW	I I	O O	G63715	61612 81913	77715
	RWD	I I	61611 81912	58714 77714	O O
	RWD; Exc. Lightning Model	I I	G63714	O O	G63778	61638 81892	58778 77778	49237 ⁷
85-96	RWD	I I	G63414	61520 ⁶ 81490	58414 ⁶ 77414 ⁶	34057 ⁸	O O	G63406	61547 81082	58406 77406	43167 ⁶ 49214 ⁷
80-96	4WD, Exc. Lift Kit	I I	O O	G63461	61530 81510	58461 77461	49217 ⁷
	4WD, Quad & Non Quad Suspensions Rearward of Front Axle; Exc. Lift Kit	I I	G63414 ⁶	61520 ⁶ 81490	58414 ⁶ 77414 ⁶	34057 ⁸	O O
	4WD, Quad Suspension; Forward of Front Axle; Exc. Lift Kit	I I	G63410 ⁶	61546 ⁶	58410 ⁶ 77410 ⁶	O O
80-86	3-4" Lift Kit	I I	G63445 ⁵⁰	O O	G63439 ⁵⁰
	4WD, Quad Suspension with 3-4" Lift Kit Forward of Front Axle	I I	G63446 ⁶	O O
80-84	RWD	I I	G63414	61520 ⁶ 81490	58414 ⁶ 77414 ⁶	34057 ⁸	O O	G63409	61554 81710	58409 77409 ⁶	43142 ⁶ 49197 ⁷

6 It is recommended that when replacing shocks on vehicles with "quad shocks" all 4 shocks should be matched by series.

8 Pair Packs.



53 Strut Mount. Hardware from O.E. Part may need to be reused.

7 Pair Packs, air hose kit included.

50 Bellows Kit No. 141242 is recommended for use to protect piston rod from potentially harmful road debris.

84 Replacement damper for vehicles with the Gabriel Aftermarket mounting kit

APPLICATION GUIDE

Year	Fitment Notes										
		Ultra	ProGuard\Guardian\Classic	Max Control\LTV	Strut Cushion\Strut Mount	Hi Jacker\Load Carrier	Ultra	ProGuard\Guardian\Classic	Max Control\LTV	Strut Cushion\Strut Mount	Hi Jacker\Load Carrier

FORD

FORD

PICKUP 1/2 TON, F-150 (cont'd)

78-79	4WD, Extended Cab Pickup Exc. Lift Kit	⌋ ⌋	G63398	
	4WD; Quad Suspension Long Shock; Exc. Lift Kit and Ranger XLT Model	⌋ ⊖	G63511 ⁶	61551 ⁶	
77-79	4WD, Rearward of Front Axle	⌋ ⊖	G63396	
	4WD; 3-4" Lift Kit; Exc. Quad Suspension and Extended Cab	⌋ ⊖	G63445 ⁵⁰	
	4WD; Exc. Lift Kit	⌋ ⊖	G63387	61647 81285	58387	49178 ⁷
75-79	RWD	⌋ ⊖	G63386	61521 ⁶ 81394	58386	34058 ⁸	G63350	61518 81242	58350	49173 ⁷
	RWD, Standard Cab Pickup	⌋ ⊖	43099 ⁸
75-76	4WD; Exc. Lift Kit	⊖ ⊖	82033	G63387	61647 81285	58387	49178 ⁷
	4WD; Lift Kit	⌋ ⊖	G63447 ⁵⁰

PICKUP 1/2 TON, F-150 READYMOUNTS

		Front	Rear
12-13	RWD; Exc. Standard Cab	G57132
09-11	4WD; Extended Cab; Exc. FX4: Spring S and U	G57103¹
	RWD; Exc. Standard Cab	G57132¹⁰
11	4WD, Standard Cab Pickup	G57103¹
04-08	4WD	G57020 ¹⁰
	RWD	G57021 ¹⁰

PICKUP 1/2 TON, F-150 STEERING STABILIZERS

		Front	Rear
97-03	4WD	6861SE ⁸²
	RWD, Coil(FrontSpringType)	6860SE ⁸²
94-96	4WD, Single System Steering Stabilizer; with Twin Traction Beam	6802SE ⁸⁴
90-93	Single System Steering Stabilizer	6802SE ⁸⁴
80-89	All	6802SE ⁸⁴
77-79	Dual System Steering Stabilizer; Exc. Sway Bar	6802SE ⁸⁴
76-79	4WD	14016
	4WD, Single System Steering Stabilizer	6803SE ⁸⁴
75-76	RWD	6802SE ⁸⁴
75	4WD	14016

PICKUP 3/4 TON, F-250 / SUPERDUTY

13	4WD	⌋ ⊖	G63886	⊖ ⊖	G63888
	RWD	⌋ ⊖	G63622	⊖ ⊖	G64010
05-12	4WD	⌋ ⊖	G63886	61680	77951	⊖ ⊖	G63888	61682	77952
	RWD	⌋ ⊖	G63622	58807 77807	⊖ ⊖	G64010	61713
99-04	4WD	⊖ ⊖	G63809	61655	58809 77809	⊖ ⊖	G63810	61656	58810 77810
	RWD	⌋ ⊖	G63622	58807 77807	⊖ ⊖	G63808	61654	58808 77808
97-99	4WD, Up through 8500# GVW; Exc. Superduty	⌋ ⊖	G63716	61613 81914	58716 77716	⌋ ⊖	G63715	61612 81913	58715 77715
	RWD, Up through 8500# GVW	⌋ ⊖	G63714	61611 81912	58714 77714	⌋ ⊖	G63778	61638 81892	58778 77778	49237 ⁷
98	4WD, Over 8500# GVW	⊖ ⊖	G63455	77455	⊖ ⊖
97	4WD, Over 8500# GVW	⊖ ⊖	G63455	61614 81821	58455 77455	⊖ ⊖	G63461	61530 81510	58461 77461	49241 ⁷

1 Future Part, available 1st Quarter of 2015.

7 Pair Packs, air hose kit included.

40 ReadyMount Strut. Complete Assembled Unit.

82 Use kit if listed, See Ref. C for optional Steering Stabilizer Boots.



6 It is recommended that when replacing shocks on vehicles with "quad shocks" all 4 shocks should be matched by series.

8 Pair Packs.

50 Bellows Kit No.141242 is recommended for use to protect piston rod from potentially harmful road debris.

84 Replacement damper for vehicles with the Gabriel Aftermarket mounting kit

APPLICATION GUIDE

Year	Fitment Notes										
		Ultra	ProGuard/ Guardian/ Classic	Max Control/ LTV	Strut Cushion/ Strut Mount	Hi Jacker/ Load Carrier	Ultra	ProGuard/ Guardian/ Classic	Max Control/ LTV	Strut Cushion/ Strut Mount	Hi Jacker/ Load Carrier

FORD

FORD

PICKUP 3/4 TON, F-250 / SUPERDUTY (cont'd)

97	RWD, Over 8500# GVW	 O	G63414	61520 ⁶ 81490	58414 ⁶ 77414 ⁶	 O	G63406	61547 81082	58406 77406	43167 ⁸ 49214 ⁷
87-96	4WD	 O	G63455	61614 81821	58455 77455	 O	G63461	61530 81510	58461 77461	49241 ⁷
80-96	RWD	 O	G63414	61520 ⁶ 81490	58414 ⁶ 77414 ⁶	34057 ⁸	 O	G63406	61547 81082	58406 77406	43167 ⁸ 49214 ⁷
96	RWD, Up through 8500# GVW	 E	61611	58714 77714	 E
86	4WD	 O	 O	G63461	81510	58461	49217 ⁷
	4WD, Clevis Type Lower Front Mount; Exc. Dual Rear Wheels or Lift Kit	 O	G63416	58416	 O	61530	77461
83-85	4WD, Clevis Type Lower Front Mount; Exc. Dual Rear Wheels or Lift Kit	 O	G63416	58416	 O	G63461	61530 81510	58461 77461	49217 ⁷
80-82	4WD, Extended Cab Pickup	 O	G63416	58416	 O
	4WD, Standard Cab Pickup	 O	G63410	58410	 O
82	4WD	 O	61546 ⁶	77410 ⁶	 O
	4WD, Clevis Type Lower Front Mount; Exc. Dual Rear Wheels or Lift Kit	 O	 O	G63461	61530 81510	58461 77461	49217 ⁷
80-81	4WD	 O	61546 ⁶	77410 ⁶	 O	G63461	61530 81510	58461 77461	49217 ⁷
77-79	4WD; Standard Cab, Cab & Chassis; All From Serial No. Y20001	 T	G63398	 O	G63387	81285	58387	49178 ⁷
75-79	RWD, Cab & Chassis	 O	 O	G63350	61518 81242	58350	43058 ⁸ 49127 ⁷
	RWD, Extended Cab Pickup	 O	 O	G63377	61519 81484	58377	43058 ⁸ 49127 ⁷
	RWD, Standard Cab Pickup	 O	 O	G63350	61518 81242	58350	43099 ⁸ 49173 ⁷
73-79	RWD	 O	G63386	61521 ⁶ 81394	58386	34058 ⁸	 O	77377
70-77	4WD, Up through Serial No. Y20000	 T	G63187	82034	 O	82147
73-74	RWD, Supercab	 O	 O	G63377	61519 81484	58377	43058 ⁸
71-74	RWD, Exc. Extended Cab & Chassis Cab	 O	 O	49173 ⁷
70-74	RWD, Exc. Supercab	 O	 O	G63350	61518 81242	58350
	RWD, Standard Cab Pickup	 O	 O	43099 ⁸
70-72	RWD	 O	G63386	61521 ⁶ 81394	58386	34058 ⁸	 O	61519	77377
	RWD, Supercab	 O	 O	G63377	81484	58377	43058 ⁸
68-69	All	 O	 O	43058 ⁸
	Supercab	 O	 O	49127 ⁷ 43058 ⁸
	4WD, Up through Serial No. Y20000	 T	G63187	82034	 O	82147	43058 ⁸
	RWD	 O	G63386	61521 ⁶ 81394	58386	 O	61519	58377 77377	43058 ⁸
	RWD, Supercab	 O	 O	G63377	81484	43058 ⁸
67	All	 O	 O	43058 ⁸ 49127 ⁷
	4WD, Up through Serial No. Y20000	 T	G63187	82034	 O	82147	43058 ⁸ 49127 ⁷
	RWD	 O	G63386	61521 ⁶ 81394	58386	 O	61519	58377 77377	43058 ⁸ 49127 ⁷
	RWD, Supercab	 O	 O	G63377	81484	43058 ⁸ 49127 ⁷
65-66	All	 O	58386	 O	43058 ⁸	

6 It is recommended that when replacing shocks on vehicles with "quad shocks" all 4 shocks 7 Pair Packs, air hose kit included. should be matched by series.
8 Pair Packs.

APPLICATION GUIDE

Year	Fitment Notes										
		Ultra	ProGuard/ Guardian/ Classic	Max Control/ LTV	Strut Cushion/ Strut Mount	Hi Jacker/ Load Carrier	Ultra	ProGuard/ Guardian/ Classic	Max Control/ LTV	Strut Cushion/ Strut Mount	Hi Jacker/ Load Carrier

FORD

FORD

PICKUP 3/4 TON, F-250 / SUPERDUTY (cont'd)

65-66	Supercab		58386	49127 ⁷ 43058 ⁸
	RWD		G63386	61521 ⁶ 81394	58386	61519	58377 77377	43058 ⁸
	RWD, Supercab		58386		G63377	81484	43058 ⁸
66	4WD, Up through Serial No. Y20000		G63187	82034	58386	82147	43058 ⁸
			G63187	82034	58386	43058 ⁸
61-64	All			G63405	61500 81147	77405	43048 ⁸ 49310 ⁷
			G63187	82034		G63405	61500 81147	77405	43048 ⁸ 49310 ⁷
61-62	RWD		82038		G63405	61500 81147	77405	43048 ⁸ 49310 ⁷
			81270	82123
53-55	Exc. Heavy Duty		81676

PICKUP 3/4 TON, F-250 / SUPERDUTY STEERING STABILIZERS

		Front	Rear
05-07	4WD, Exc. O.E. Steering Stabilizer	6856SE ⁸²
05-06	Exc. O.E. Steering Stabilizer	6856SE ⁸²
99-04	4WD, Exc. O.E. Unit	6850SE ⁸²
	4WD, Replacement Kit	6855SE ⁸²
99-03	4WD, With O.E. Unit	6854SE ⁸⁰
	RWD	6828SE ⁸⁰
97-99	4WD, Torsion Bar(FrontSpringType)	6861SE ⁸²
	RWD, Coil(FrontSpringType)	6860SE ⁸²
97-98	4WD, Over 8600# GVW and HD	6862SE ⁸²
92-97	RWD, O.E. Replacement Stabilizer Single System	6807SE ⁸⁰
80-96	4WD, Single System Steering Stabilizer	6802SE ⁸⁴
77-79	4WD, Power Steering Single System Steering Stabilizer	6805SE ⁸⁰
73-79	RWD, Single System Steering Stabilizer	6802SE ⁸⁴
75-77	4WD, Manual Steering Single System Steering Stabilizer	6803SE ⁸⁴
73-74	4WD, Single System Steering Stabilizer	6803SE ⁸⁴
60-72	Single System Steering Stabilizer	6803SE ⁸⁴

PICKUP 1 TON, F-350 / SUPERDUTY

05-12	4WD		G63886	61680	77951
	4WD; Single Rear Wheels; Exc. Cab & Chassis			G63888	61682	77952
	RWD		G63622	58807 77807		G64010	61713
05-07	4WD; Dual Rear Wheels; Exc. Cab & Chassis			G63887	61681
				G63964
99-04	4WD		G63809	61655	58809 77809		G63810	61656	58810 77810
			G63622	58807 77807		G63808	61654	58808 77808
86-97	4WD		G63455	61614 81821	58455 77455
	4WD, Dual Rear Wheels			G63461	61530 81510	58461 77461
	4WD, Exc. Dual Rear Wheels			G63456	58456 77456
80-97	RWD		G63414	61520 ⁸ 81490	58414 ⁸ 77414 ⁸	34057 ⁸	
	RWD, Dual Rear Wheels			G63409	61554 81710	58409 77409 ⁸

6 It is recommended that when replacing shocks on vehicles with "quad shocks" all 4 shocks should be matched by series.
8 Pair Packs.

7 Pair Packs, air hose kit included.

80 Mounting bracket not required, install on O.E. Shock Mounts. See Ref. C for optional Steering Stabilizer Boots.

84 Replacement damper for vehicles with the Gabriel Aftermarket mounting kit

APPLICATION GUIDE

Year	Fitment Notes										
		Ultra	ProGuard/ Guardian/ Classic	Max Control/ LTV	Strut Cushion/ Strut Mount	Hi Jacker/ Load Carrier	Ultra	ProGuard/ Guardian/ Classic	Max Control/ LTV	Strut Cushion/ Strut Mount	Hi Jacker/ Load Carrier

FORD

FORD

PICKUP 1 TON, F-350 / SUPERDUTY (cont'd)

80-97	RWD, Exc. Dual Rear Wheels	I O	O O	G63406	61547 81082	58406 77406	43167 ⁸
82-85	4WD, Clevis Type Lower Front Mount; Exc. Dual Rear Wheels or Lift Kit	I O	G63416	58416	O O	G63461	61530 81510	58461 77461	49217 ⁷
80-81	4WD	I O	G63410	61546 ⁶	58410 77410 ⁶	O O	G63461	61530 81510	77461	49217 ⁷
	4WD, Dual Rear Wheels	I O	O O	58461
75-79	RWD	I O	61521 ⁶	58386	34058 ⁸	I O
	RWD, Cab & Chassis	I O	I O	43099 ⁸ 49173 ⁷
	RWD, Extended Cab Pickup	I O	G63396	I O	58350	43099 ⁸ 49173 ⁷
	RWD, Standard Cab Pickup	I O	G63386	O O	G63377	61519 81484	58377 77377	43058 ⁸
	RWD; Supercab	I O	I O	81242
74-79	RWD; Extended Cab Pickup	I O	I O	G63350	61518
73-79	RWD	I O	81394	I O
	RWD; Standard Cab Pickup	I O	O O	49127 ⁷
79	4WD	I I	G63398	I O	G63387	61647 81285	58387	49178 ⁷
73-74	RWD; Supercab	I O	O O	43058 ⁸
74	RWD, Extended Cab & Chassis Cab	I O	I O	49173 ⁷
	RWD; Exc. Supercab	I O	G63386	61521 ⁶	58386	34058 ⁸	O O	G63377	61519 81484	58350 77377	43099 ⁸
73	RWD; Exc. Supercab	I O	G63386	61521 ⁶	58386	34058 ⁸	O O	G63377	61519 81484	77377
67-72	RWD, Exc. Supercab	I O	G63386	I O
61-66	All	I O	O O	G63405	61500 81147	77405	43048 ⁸ 49310 ⁷
60	All	I I	81270	I O
53-55	Exc. Heavy Duty	I O	O O	81676

PICKUP 1 TON, F-350 / SUPERDUTY STEERING STABILIZERS

		Front	Rear
99-06	RWD	6828SE ⁸⁰
99-04	4WD, Exc. O.E. Unit	6850SE ⁸²
	4WD, Replacement Kit	6855SE ⁸²
99-03	4WD, With O.E. Unit	6854SE ⁸⁰
95-97	4WD	6826SE ⁸⁰
92-97	RWD, O.E. Replacement Stabilizer Single System	6807SE ⁸⁰
92-96	RWD, Dual System Steering Stabilizer	6802SE ⁸⁴
89-91	RWD, Single System Steering Stabilizer	6802SE ⁸⁴
82-88	Single System Steering Stabilizer; Exc. Anti-Sway Bar	6802SE ⁸⁴
79-81	RWD, Dual System Steering Stabilizer	6802SE ⁸⁴
79	4WD, Power Steering Single System Steering Stabilizer	6805SE ⁸⁰
75-78	Dual System Steering Stabilizer	6802SE ⁸⁴
75-77	Manual Steering Single System Steering Stabilizer	6803SE ⁸⁴
65-74	Single System Steering Stabilizer; with Twin I-Beam Axle	6802SE ⁸⁴
63-74	Single System Steering Stabilizer	6803SE ⁸⁴
60-64	Single System Steering Stabilizer; with I-Beam Axle	6802SE ⁸⁴
62	Single System Steering Stabilizer; Manual Steering	6803SE ⁸⁴
60-61	Single System Steering Stabilizer	6803SE ⁸⁴

6 It is recommended that when replacing shocks on vehicles with "quad shocks" all 4 shocks should be matched by series.

8 Pair Packs.



82 Use kit if listed, See Ref. C for optional Steering Stabilizer Boots.

7 Pair Packs, air hose kit included.

80 Mounting bracket not required, install on O.E. Shock Mounts. See Ref. C for optional Steering Stabilizer Boots.

84 Replacement damper for vehicles with the Gabriel Aftermarket mounting kit

APPLICATION GUIDE

Year	Fitment Notes										
		Ultra	ProGuard\Guardian\Classic	Max Control\LTV	Strut Cushion\Strut Mount	Hi Jacker\Load Carrier	Ultra	ProGuard\Guardian\Classic	Max Control\LTV	Strut Cushion\Strut Mount	Hi Jacker\Load Carrier

FORD

FORD

PICKUP P100 STEERING STABILIZERS

		Front	Rear
65-67	Single System Steering Stabilizer	6802SE ⁸⁴

PICKUP P350

76	All	61500
	Up through 8000# GVW	G63405	61500	77405	43048 ⁸
68-75	All	82123
	Up through 8000# GVW	G63405	61500 81147	77405	43048 ⁸	82123

PICKUP P350 STEERING STABILIZERS

		Front	Rear
68-73	Single System Steering Stabilizer	6802SE ⁸⁴

PICKUP P400

75-76	All	82123
	Up through 8000# GVW	G63405	61500 81147	77405	43048 ⁸	82123

PICKUP, F-450 SUPERDUTY

09-12	Cab & Chassis	58942
07-08	All	G63969	77967
	Cab & Chassis	G63969	77967	58942
07	4WD	G63969	77967	77969
	RWD	G63969	77967	77968
05-06	All	G63969	77967	G63963
	4WD	G63969	77967	G63963	77969
	RWD	G63969	77967	G63963	77968
99-04	All	G63809	61655	58809 77809	G63811	61657	58811 77461
97	All	G63692	G63409	61554	58409 77409 ⁸

PICKUP, F-450 SUPERDUTY STEERING STABILIZERS

		Front	Rear
99-04	4WD, With O.E. Unit	6854SE ⁸⁰

PICKUP, F-550 SUPERDUTY

07	All	G63969	77967
	4WD	G63969	77967	77969
	RWD	G63969	77967	77968
05-06	All	G63969	77967	G63963
	4WD	G63969	77967	G63963	77969
	RWD	G63969	77967	G63963	77968
99-04	All	G63809	61655	58809 77809	G63811	61657	58811 77461

PICKUP, F-550 SUPERDUTY STEERING STABILIZERS

		Front	Rear
99-04	4WD, With O.E. Unit	6854SE ⁸⁰

PINTO

74-80	Exc. Wagon & Hatchback	82128	82004
71-73	Sedan	82128	82004





6 It is recommended that when replacing shocks on vehicles with "quad shocks" all 4 shocks should be matched by series.

80 Mounting bracket not required, install on O.E. Shock Mounts. See Ref. C for

8 Pair Packs.

84 Replacement damper for vehicles with the Gabriel Aftermarket mounting kit





















APPLICATION GUIDE

Year	Fitment Notes										
			Ultra	ProGuard/ Guardian/ Classic	Max Control/ LTV	Strut Cushion/ Strut Mount	Hi Jacker/ Load Carrier		Ultra	ProGuard/ Guardian/ Classic	Max Control/ LTV











FORD

PROBE









FORD

93-97	All		142571 ⁵¹ 142856 ⁵⁴		G55672	143057 ⁵¹
	Left		G55671	142571 ⁵¹ 142856 ⁵⁴		G55672	142403 ⁵³ 143057 ⁵¹
	Right		G55670	142571 ⁵¹ 142856 ⁵⁴		G55672	142404 ⁵³ 143057 ⁵¹
91-92	Base, GL, GT, Automatic		G55600 ⁹	142562 ⁵⁸ 142569 ⁵¹ 142852 ⁵⁴ 143057 ⁵¹		G55601 ⁹	142196 ⁵³
90-92	Exc. GL, Base & GT Models		G55600 ⁹	142570 ⁵¹ 142852 ⁵⁴ 143057 ⁵¹		G55601 ⁹	142196 ⁵³
89-92	All		G55600 ⁹	142852 ⁵⁴ 143057 ⁵¹		G55601 ⁹	142196 ⁵³
	Exc. Electronic Adjustable Suspension or 4 Wheel Steer		G55600 ⁹	142803 ⁵⁴ 142852 ⁵⁴ 143057 ⁵¹		G55601 ⁹	142196 ⁵³
90	GL, GT, Automatic		G55600 ⁹	142562 ⁵⁸ 142569 ⁵¹ 142852 ⁵⁴ 143057 ⁵¹		G55601 ⁹	142196 ⁵³
89	GL, LX, Automatic		G55600 ⁹	142562 ⁵⁸ 142852 ⁵⁴ 143057 ⁵¹		G55601 ⁹	142196 ⁵³
	GT		G55600 ⁹	142569 ⁵¹ 142852 ⁵⁴ 143057 ⁵¹		G55601 ⁹	142196 ⁵³

















RANCH WAGON

65-74	All		69675 ⁵	81446 82126	34073 ⁸		69606	81495	43140 ⁹ 49205 ⁷
59-64	All		82099		82076
57-58	All		82099	
52-56	All		82026		81270	49105 ⁷
50-51	All		82026		82060

RANCHERO

72-79	All		81446	34073 ⁸		69606	81495	43140 ⁹ 49205 ⁷
66-71	All		82126		69606	81495
60-65	All		82126		81270	49105 ⁷
59	All		82099		82076

RANGER

07-11	RWD, Coil(FrontSpringType)		G63772	61626 81916	77772		G63773	61627 81917	77525	43167 ⁹
06-11	4WD		G63678	61623 81893	77678		G63775	61629 81918	77524
	RWD, Torsion Bar(FrontSpringType)		G63678	61623 81893	77678		G63775	61629 81918	77524
06	RWD, Coil(FrontSpringType)		G63772	61626 81916	77772		G63773	61627 81917	77525	43167 ⁹ 49223 ⁷
01-05	Edge, 4WD, RWD		G63678	61623 81893	77678		G63775	61629 81918	77524
98-05	Exc. Edge, EV, Splash & Sport Models		G63772	61626	77772		G63773	61627	77525
	RWD			43167 ⁹ 49223 ⁷
05	STX, XL, XLT, RWD, Exc. Edge, EV, Splash & Sport Models		81916		81917

5 Use kit No. 140719 to replace O.E. hardware for lower shock absorber mounting when studs break or self-tapping screws are not longer useable.

8 Pair Packs.

51 Strut Cushion for use with the Strut/Cartridge/Shocks.

54 Kit with Mount and Bearing. Hardware from O.E. Part may need to be reused.

61 Mount Kit includes Upper Spring Seat. Hardware from O.E. Part may need to be reused.

7 Pair Packs, air hose kit included.

9 See Ref. D for procedures to replace Elec Adj Susp with non-adj product.

53 Strut Mount. Hardware from O.E. Part may need to be reused.

58 Mount Kit includes Suspension Bearing. Hardware from O.E. Part may need to be reused.

APPLICATION GUIDE

Year	Fitment Notes										
		Ultra	ProGuard/ Guardian/ Classic	Max Control/ LTV	Strut Cushion/ Strut Mount	Hi Jacker/ Load Carrier	Ultra	ProGuard/ Guardian/ Classic	Max Control/ LTV	Strut Cushion/ Strut Mount	Hi Jacker/ Load Carrier

FORD

FORD

RANGER (cont'd)

04	Tremor, XL, XLT, RWD, Exc. Edge, EV, Splash & Sport Models		⊖	81916		⊖	81917
98-03	XL, XLT, RWD, Exc. Edge, EV, Splash & Sport Models		⊖	81916		⊖	81917
98-00	4WD		⊖	G63678	61623 81893	77678		⊖	G63775	61629 81918	77524
90-97	All		⊖	G63614	61561 81744	58929 77614		⊖
	4WD		⊖	G63614	61561 81744	58929 77614		⊖	G63524	61573 81905	77524
	RWD		⊖	G63614	61561 81744	58929 77614		⊖	G63525	61559 81730	77525	43167 ⁸ 49223 ⁷
87-89	Exc. High Ryder Option		⊖	G63414	61520 ⁶ 81490	77414 ⁶	34057 ⁸		⊖
89	4WD		⊖		⊖	G63524	61534 81540
	4WD, High Ryder Option		⊖	G63603		⊖	61573
	4WD, Mfg. from 2/89; Vehicles with 12mm bolt in rear lower mount		⊖		⊖	81905	77524
	RWD, Mfg. from 2/89; Vehicles with 12mm bolt in rear lower mount		⊖		⊖	G63525	61559 81730	77525	49223 ⁷
	RWD, Mfg. to 2/89; Vehicles with 10mm bolt in rear lower mount		⊖		⊖	G63427	61533 81539	43165 ⁸ 49207 ⁷
87-88	4WD		⊖		⊖	G63420	61534 81540
	4WD, High Ryder Option		⊖	G63603		⊖
	RWD		⊖		⊖	G63427	61533 81539	43165 ⁸ 49207 ⁷
83-86	All		⊖	G63414	61520 ⁶ 81490	77414 ⁶	34057 ⁸		⊖
	4WD		⊖	G63414	61520 ⁶ 81490	77414 ⁶	34057 ⁸		⊖	G63420	61534 81540
	RWD		⊖	G63414	61520 ⁶ 81490	77414 ⁶	34057 ⁸		⊖	G63427	61533 81539	43165 ⁸ 49207 ⁷

RANGER STEERING STABILIZERS

RANGER STEERING STABILIZERS											Front	Rear	
83-97	Single System Steering Stabilizer											6802SE ⁸⁴

SKYLINER

59	All		⊖	82099		⊖	82076
57-58	All		⊖	82099		⊖
54-56	All		⊖	82026		⊖	81270	49105 ⁷

STARLINER

60	All		⊖	82099		⊖	82076
----	-----	--	---	------	-------	------	------	------	--	---	------	-------	------	------	------

SUNLINER

62-64	All		⊖	82099		⊖	82076
60	All		⊖	82099		⊖	82076
59	All		⊖	82099		⊖
57-58	All		⊖	82099		⊖	81270	49105 ⁷
52-56	All		⊖	82026		⊖	81270	49105 ⁷

SUPER DELUXE

47-48	Direct Acting Shocks		⊖	82007		⊖	82156
-------	----------------------	--	---	------	-------	------	------	------	--	---	------	-------	------	------	------

TAURUS





08-09	FWD, Left		⊖	G52129		⊖
-------	-----------	--	---	--------	------	------	------	------	--	---	------	------	------	------	------

6 It is recommended that when replacing shocks on vehicles with "quad shocks" all 4 shocks should be matched by series.

7 Pair Packs, air hose kit included.

84 Replacement damper for vehicles with the Gabriel Aftermarket mounting kit























APPLICATION GUIDE

Year	Fitment Notes										
			Ultra	ProGuard/ Guardian/ Classic	Max Control/ LTV	Strut Cushion/ Strut Mount	Hi Jacker/ Load Carrier		Ultra	ProGuard/ Guardian/ Classic	Max Control/ LTV

FORD

FORD



TAURUS (cont'd)

08-09	FWD, Right		G52130
07-09	FWD; Mfg. from 06/07 Left		G51875
	FWD; Mfg. from 06/07 Right		G51876
96-07	Left		G55978	142747 ⁵¹ 142845 ⁵⁴ 143059 ⁵¹
	Right		G55960	142747 ⁵¹ 142845 ⁵⁴ 143059 ⁵¹
	Sedan		G55901	142254 ⁵³ 143057 ⁵¹
96-05	Wagon		69962	81927	142639 ⁵³
94-95	All		G55616	142746 ⁵¹ 142846 ⁵⁴ 143059 ⁵¹
	Sedan		G55616	142746 ⁵¹ 142846 ⁵⁴ 143059 ⁵¹	G55901	142254 ⁵³ 143057 ⁵¹
	Wagon		G55616	142746 ⁵¹ 142846 ⁵⁴ 143059 ⁵¹		69756	81693	142639 ⁵³
91-93	All		G55616	142746 ⁵¹ 142846 ⁵⁴
	Sedan		G55616	142746 ⁵¹ 142846 ⁵⁴	G55518	142254 ⁵³ 143059 ⁵¹
	Wagon		G55616	143059 ⁵¹ 142746 ⁵¹ 142846 ⁵⁴		69756	81693	142639 ⁵³
89-90	GL, L, LX, Sedan		G55616	142746 ⁵¹ 142846 ⁵⁴	142103 ⁵³ 142648 ⁵¹
	Sedan		G55616	142746 ⁵¹ 142846 ⁵⁴	G55518	143059 ⁵¹ 142648 ⁵¹
	SHO, Sedan		G55616	142746 ⁵¹ 142846 ⁵⁴	142254 ⁵³ 142648 ⁵¹
86-90	All		G55616	142746 ⁵¹ 142846 ⁵⁴	142648 ⁵¹
	Wagon		G55616	143059 ⁵¹ 142746 ⁵¹ 142846 ⁵⁴		69756	81693	142639 ⁵³ 142648 ⁵¹
86-88	Sedan		G55616	142746 ⁵¹ 142846 ⁵⁴	G55518	142103 ⁵³ 143059 ⁵¹ 142648 ⁵¹

TAURUS READYMOUNTS

		Front	Rear
96-07	Left	G56934 ⁴⁰
	Right	G56937 ⁴⁰
	Sedan	G56936 ⁴⁰
94-95	Sedan	G56912 ⁴⁰	G56936 ⁴⁰
86-95	All	G56912 ⁴⁰
86-93	Sedan	G56912 ⁴⁰	G56913 ⁴⁰

TAURUS X

08-09	AWD		G51857
	FWD, Left		G51889
	FWD, Right		G51890

7 Pair Packs, air hose kit included.

51 Strut Cushion for use with the Strut/Cartridge/Shocks.



54 Kit with Mount and Bearing. Hardware from O.E. Part may need to be reused.

40 ReadyMount Strut. Complete Assembled Unit.

53 Strut Mount. Hardware from O.E. Part may need to be reused.

61 Mount Kit includes Upper Spring Seat. Hardware from O.E. Part may need to be reused.











APPLICATION GUIDE

Year	Fitment Notes										
		Ultra	ProGuard\ Guardian\ Classic	Max Control\ LTV	Strut Cushion\ Strut Mount	Hi Jacker\ Load Carrier	Ultra	ProGuard\ Guardian\ Classic	Max Control\ LTV	Strut Cushion\ Strut Mount	Hi Jacker\ Load Carrier





















FORD

TEMPO

FORD

87-94	All		G55714	142844 ⁵⁴	142133 ⁵³ 142745 ⁶³ 143059 ⁵¹	
	FWD		G55714	142844 ⁵⁴		G55733	142133 ⁵³ 142745 ⁶³ 143059 ⁵¹
87-91	AWD		G55714	142844 ⁵⁴		G55722	142133 ⁵³ 142745 ⁶³ 143059 ⁵¹
86	All		142844 ⁵⁴	142133 ⁵³ 142745 ⁶³ 143059 ⁵¹
	FWD		142844 ⁵⁴		G55733	142133 ⁵³ 142745 ⁶³ 143059 ⁵¹
	FWD, Mfg. from 3/85		G55714	142844 ⁵⁴	142133 ⁵³ 142745 ⁶³ 143059 ⁵¹
84-85	All		142844 ⁵⁴ 143057 ⁵¹	142133 ⁵³ 142745 ⁶³ 143059 ⁵¹
	FWD		142844 ⁵⁴ 143057 ⁵¹		G55733	142133 ⁵³ 142745 ⁶³ 143059 ⁵¹
	FWD, Mfg. to 3/85		G55708	142844 ⁵⁴ 143057 ⁵¹	142133 ⁵³ 142745 ⁶³ 143059 ⁵¹
85	FWD, Mfg. from 3/85		G55714	142844 ⁵⁴ 143057 ⁵¹	142133 ⁵³ 142745 ⁶³ 143059 ⁵¹



THUNDERBIRD

02-05	All		G51770	143242 ⁵³		G51771	143242 ⁵³
92-97	Exc. Electronic Adjustable Suspension		G55579	142222 ⁵³		69845	81795
89-91	Exc. Electronic Adjustable Suspension		G55579	142222 ⁵³		69820	81881
87-88	Non-ABS		G56504 ⁹		49196 ⁷
	Non-ABS, Naturally Aspirated(Eng Asp)		142220 ⁵⁴ 143059 ⁵¹		69709 ⁹	81461
80-86	All		G56503 ³⁹	142220 ⁵⁴ 143059 ⁵¹		69709 ⁹	81461	49196 ⁷
77-79	All		69675 ⁵	81446	34073 ⁸		69606	81495	43140 ⁸ 49205 ⁷
73-76	All		69675 ⁵	81446	34073 ⁸		82603
67-72	All		69675 ⁵	81446	34073 ⁸		69606	81495	43140 ⁸ 49205 ⁷
64-66	All			82617
59-60	All		82099
55-57	All		82026		81270	49105 ⁷

THUNDERBIRD READYMOUNTS

		Front	Rear
89-97	Left Exc. Electronic Adjustable Suspension	G56976 ⁴⁰
	Right Exc. Electronic Adjustable Suspension	G56977 ⁴⁰

TORINO

74-76	Wagon		69675 ⁵	81446	34073 ⁸		69606	81495	43140 ⁸ 49205 ⁷
-------	-------	---	--------------------	-------	------	------	--------------------	---	-------	-------	------	------	--

5 Use kit No. 140719 to replace O.E. hardware for lower shock absorber mounting when studs break or self-tapping screws are not longer useable.

8 Pair Packs.

39 Conventional gas-charged strut can be used to replace O.E. air adjustable gas-charged strut. However, the self-leveling system must be deactivated. See Ref. A for instructions.

51 Strut Cushion for use with the Strut/Cartridge/Shocks.

7 Pair Packs, air hose kit included.



9 See Ref. D for procedures to replace Elec Adj Susp with non-adj product.

40 ReadyMount Strut. Complete Assembled Unit.

53 Strut Mount. Hardware from O.E. Part may need to be reused.

63 Mount Kit includes Isolator. Hardware from O.E. Part may need to be reused.

APPLICATION GUIDE

Year	Fitment Notes										
		Ultra	ProGuard\ Guardian\ Classic	Max Control\ LTV	Strut Cushion\ Strut Mount	Hi Jacker\ Load Carrier	Ultra	ProGuard\ Guardian\ Classic	Max Control\ LTV	Strut Cushion\ Strut Mount	Hi Jacker\ Load Carrier

FORD

FORD

TORINO (cont'd)

72-76	All	I O	69675 ⁵	81446	34073 ⁸	I O	69606	43140 ⁸ 49205 ⁷
68-71	All	I O	82126	I O	69606	49105 ⁷
71	Wagon	I O	82126	I O	69606	81495	49105 ⁷
68-70	Exc. Wagon	I O	82126	I O	69606	81270	49105 ⁷

VAN 1/2 TON, ECONOLINE / CLUB WAGON

08-11	All	I O	G63622	61591 81744	58929 77608	I O	G63623	61595	58624	49178 ⁷
92-07	All	I O	G63929	61591 81744	58929 77608	I O	G63624	61595 81833	58624	49178 ⁷
75-91	All	I O	G63500	61553 81694	58500	I O	G63350	61518 81242	58350	43099 ⁸ 49173 ⁷
69-74	All	I O	82012	I O	G63377	61519 81484	77377	43058 ⁸ 49127 ⁷
68	Late 1968	I O	82012	I O	G63377	61519 81484 82007	77377	43058 ⁸ 49127 ⁷
	Mfg. to 7/68	I O	G63492	61506 81318	77492	I O

VAN 1/2 TON, ECONOLINE / CLUB WAGON STEERING STABILIZERS

		Front	Rear
95-01	Aftermarket Kit	6858SE
69-74	Single System Steering Stabilizer; with Twin I-Beam Axle	6802SE ⁸⁴
68	Single System Steering Stabilizer; with I-Beam Axle	6802SE ⁸⁴

VAN 3/4 TON, ECONOLINE / CLUB WAGON / SUPERDUTY

06-11	All	I O	G63622	81744	58622 77614	I O	G63623	61646 81828	58623 77623	49178 ⁷
04-05	All	I O	G63622	61591 81744	58622 77614	I O	G63623	61646 81828	58623 77623	49178 ⁷
03	All	I O	G63622	81744	58622 77614	I O	G63623	61646 81828	58623 77623	49178 ⁷
92-02	All	I O	G63622	61591 81744	58622 77614	I O	G63623	61646 81828	58623 77623	49178 ⁷
75-91	All	I O	G63386	61521 ⁶ 81394	58386	34058 ⁸	I O	G63387	61647 81285	58387	49178 ⁷
69-74	All	I O	82012	I O	G63377	61519 81484	77377	43058 ⁸ 49127 ⁷
68	Late 1968	I O	82012	I O	G63377	61519 81484	77377	43058 ⁸ 49127 ⁷

VAN 3/4 TON, ECONOLINE / CLUB WAGON / SUPERDUTY STEERING STABILIZERS

		Front	Rear
95-01	Aftermarket Kit	6858SE
74-79	QuadraVan Special	6803SE ⁸⁴
69-74	Single System Steering Stabilizer; with Twin I-Beam Axle	6802SE ⁸⁴
68	Single System Steering Stabilizer; with I-Beam Axle	6802SE ⁸⁴

VAN 1 TON, ECONOLINE / CLUB WAGON / SUPERDUTY

08-11	Exc. Ambulance & Handling Package	I O	G63622	61591 81744	58622 77614	I O	G63623	61646 81828	58623 77623	49178 ⁷
11	All	I O	G63622	61591 81744	I O	49178 ⁷
09-10	All	I O	G63622	61591 81744	77614	I O	49178 ⁷
08	All	I O	G63622	61591 81744	77614	I O	77623	49178 ⁷
	Motorhome Conversion	I O	G63622	61591 81744	58622 77614	I O	58623 77623	49178 ⁷
07	All	I O	61591	77614	I O	77623	49178 ⁷

5 Use kit No. 140719 to replace O.E. hardware for lower shock absorber mounting when studs break or self-tapping screws are not longer useable.



7 Pair Packs, air hose kit included.

84 Replacement damper for vehicles with the Gabriel Aftermarket mounting kit

6 It is recommended that when replacing shocks on vehicles with "quad shocks" all 4 shocks should be matched by series.

8 Pair Packs.

APPLICATION GUIDE

Year	Fitment Notes										
		Ultra	ProGuard\ Guardian\ Classic	Max Control\ LTV	Strut Cushion\ Strut Mount	Hi Jacker\ Load Carrier	Ultra	ProGuard\ Guardian\ Classic	Max Control\ LTV	Strut Cushion\ Strut Mount	Hi Jacker\ Load Carrier

FORD

FORD

VAN 1 TON, ECONOLINE / CLUB WAGON / SUPERDUTY (cont'd)

07	Exc. Ambulance & Handling Package	⊕	G63622	81744 61591	58622 77614	⊕	G63623	61646 81828	58623 77623	49178 ⁷
	Motorhome Conversion	⊕	61591	58622 77614	⊕	58623 77623	49178 ⁷
04-06	Exc. Ambulance & Handling Package	⊕	G63622	61591 81744	58622 77614	⊕	G63623	61646 81828	58623 77623	49178 ⁷
06	All	⊕	G63622	61591 81744	77614	⊕	49178 ⁷
04-05	All	⊕	G63622	61591 81744	77614	⊕	61646 81828	49178 ⁷
92-05	Motorhome Conversion	⊕	G63622	61591 81744	58622 77614	⊕	G63623	61646 81828	58623 77623	49178 ⁷
03	All	⊕	61591 81744	77614	⊕	61646 81828	49178 ⁷
	Exc. Ambulance & Handling Package	⊕	61591 81744	77614	⊕	61646 81828	77623	49178 ⁷
92-02	All	⊕	61591 81744	⊕	61646 81828	49178 ⁷
77-91	All	⊕	58386	34058 ⁸	⊕	58387	49178 ⁷
	Motorhome Conversion	⊕	G63386	58386	34058 ⁸	⊕	G63387	58387	49178 ⁷
75-91	Exc. Motorhome Conversion	⊕	61521 ⁶ 81394	58386	34058 ⁸	⊕	61647 81285	58387	49178 ⁷
75-76	Motorhome Conversion	⊕	G63386	⊕	G63387
69-74	All	⊕	82012	⊕	G63377	61519 81484	77377	43058 ⁸ 49127 ⁷
68	Late 1968	⊕	82012	⊕	G63377	61519 81484	77377	43058 ⁸ 49127 ⁷

VAN 1 TON, ECONOLINE / CLUB WAGON / SUPERDUTY STEERING STABILIZERS

		Front	Rear
95-02	Aftermarket Kit	6858SE

VICTORIA

62-64	All	⊕	82099	⊕	82076
60	All	⊕	82099	⊕	82076
59	All	⊕	82099	⊕
57-58	All	⊕	82099	⊕	81270	49105 ⁷
52-56	All	⊕	82026	⊕	81270	49105 ⁷
51	All	⊕	82026	⊕	82156

WINDSTAR

95-03	All	⊕	G55685	142399 ⁵⁴ 143059 ⁵¹	⊕
	Coil(RearSpringType)	⊕	G55685	142399 ⁵⁴ 143059 ⁵¹	⊕	G63676	61625 81882	43173 ⁸ 49233 ⁷

WINDSTAR READYMOUNTS

		Front	Rear
95-03	All	G56935 ⁴⁰

GEO

GEO

METRO

89-97	Non-ABS	⊕	G55891	142293 ⁵⁴ 143059 ⁵¹	⊕	G55772	142295 ⁵³ 143057 ⁵¹
-------	---------	---	--------	------	------	--	------	---	--------	------	------	--	------

PRIZM

93-97	All	⊕	G55999	143059 ⁵¹ 143281 ⁵³	⊕	143058 ⁵¹
-------	-----	---	--------	------	------	--	------	---	------	------	------	----------------------	------

6 It is recommended that when replacing shocks on vehicles with "quad shocks" all 4 shocks should be matched by series.

8 Pair Packs.





51 Strut Cushion for use with the Strut/Cartridge/Shocks.

7 Pair Packs, air hose kit included.

40 ReadyMount Strut. Complete Assembled Unit.

53 Strut Mount. Hardware from O.E. Part may need to be reused.











APPLICATION GUIDE

Year	Fitment Notes										
			Ultra	ProGuard/ Guardian/ Classic	Max Control/ LTV	Strut Cushion/ Strut Mount	Hi Jacker/ Load Carrier		Ultra	ProGuard/ Guardian/ Classic	Max Control/ LTV

GEO

GEO



PRIZM (cont'd)

93-97	Left		G55999	143059 ⁵¹ 143281 ⁵³		G55661	142228 ⁵³ 143058 ⁵¹
	Right		G55999	143059 ⁵¹ 143281 ⁵³		G55662	142229 ⁵³ 143058 ⁵¹
89-92	All		G55591	143059 ⁵¹ 143281 ⁵³		G55557	143061 ⁵¹
	Left		G55591	143059 ⁵¹ 143281 ⁵³		G55557	142228 ⁵³ 143061 ⁵¹
	Right		G55591	143059 ⁵¹ 143281 ⁵³		G55557	142229 ⁵³ 143061 ⁵¹



PRIZM READYMOUNTS

		Front		Rear	
93-97	Left	G56947 ⁴⁰		G56949 ⁴⁰	
	Right	G56947 ⁴⁰		G56950 ⁴⁰	



SPECTRUM

89	All		G55719	143058 ⁵¹		81558
----	-----	---	--------	------	------	----------------------	------	---	------	-------	------	------	------

STORM

90-93	Non-ABS		G55780	142317 ⁵³ 143058 ⁵¹		G55776	142334 ⁵³ 143061 ⁵¹
-------	---------	---	--------	------	------	--	------	---	--------	------	------	--	------





TRACKER

89-97	All		G56518	142294 ⁵⁴		G63799	61560 81904	49613 ⁷
-------	-----	--	--------	------	------	----------------------	------	--	--------	----------------	------	------	--------------------

GMC

GMC







ACADIA

12	All		G52125		G64040
07-11	All		G52125	143366 ⁵³		G64040







ACADIA READYMOUNTS

		Front		Rear	
07-11	All	G57109		

CANYON

09-11	Torsion Bar(FrontSpringType)			G63879
04-11	RWD, Coil(FrontSpringType) Exc. Z71 Off Road Package		G51850		G63882
04-08	Torsion Bar(FrontSpringType)		G63884		G63879

ENVOY

02-09	All		G51718 ⁴⁵	143241 ⁵³		61717
	Coil(RearSpringType)		G51718 ⁴⁵	143241 ⁵³		G63842	61717	77971
03-06	Air(RearSpringType)		G51718 ⁴⁵	143241 ⁵³		G64014	61717

ENVOY READYMOUNTS

		Front		Rear	
02-09	All	G57022 ⁴⁰		

ENVOY XL

02-06	All	77971
-------	-----	------	------	------	------	------	------	------	------	-------	------	------	------

ENVOY XUV

04-05	All	77971
-------	-----	------	------	------	------	------	------	------	------	-------	------	------	------

7 Pair Packs, air hose kit included.

45 Strut must be rotated to align notch with lower control arm.

53 Strut Mount. Hardware from O.E. Part may need to be reused.

Bold Type - New / Future Part

40 ReadyMount Strut. Complete Assembled Unit.

51 Strut Cushion for use with the Strut/Cartridge/Shocks.

54 Kit with Mount and Bearing. Hardware from O.E. Part may need to be reused.

APPLICATION GUIDE

Year	Fitment Notes										
		Ultra	ProGuard/ Guardian/ Classic	Max Control/ LTV	Strut Cushion/ Strut Mount	Hi Jacker/ Load Carrier	Ultra	ProGuard/ Guardian/ Classic	Max Control/ LTV	Strut Cushion/ Strut Mount	Hi Jacker/ Load Carrier

GMC

GMC

JIMMY

05	4WD	⊖	G63423	61531 81516	58423 ⁵⁰ 77423	142316 ⁵³	⊖	G63422	61528 81482	58422 77422	43162 ⁸ 49213 ⁷
92-04	All	⊖	142316 ⁵³	⊖	G63422	61528 81482	58422 77422	43162 ⁸ 49213 ⁷
	4WD	⊖	G63423	61531 81516	58423 ⁵⁰ 77423	142316 ⁵³	⊖	G63422	61528 81482	58422 77422	43162 ⁸ 49213 ⁷
	RWD	⊖	G63421	61504 81750	58421 77421	142316 ⁵³	34051 ⁸	⊖	G63422	61528 81482	58422 77422	43162 ⁸ 49213 ⁷
87-91	Exc. Lift Kit	⊖	⊖	G63349	61524 81164	77349	43111 ⁸
	Exc. Quad Suspension and Lift Kit	⊖	⊖	49155 ⁷
73-91	4WD with 4" Lift Kit; Exc. Quad Suspension	⊖	G63437 ⁵⁰	58437 ⁵⁰	⊖	G63438 ⁵⁰	58438 ⁵⁰
	4WD; Exc. Lift Kit	⊖	G63347 ⁵⁰	⊖	58349
	4WD; Quad Suspension Long Shock; Exc. Lift Kit	⊖	G63906 ⁸	61522 ⁸ 81496 ⁸	58906 ⁸	⊖
	4WD; Quad Suspension Short Shock; Exc. Lift Kit	⊖	G63908 ⁸	58908 ⁸	⊖
70-91	4WD; Exc. Quad Suspension and Lift Kit	⊖	61516 81113	58347	43107 ⁸	⊖
73-86	Exc. Lift Kit	⊖	⊖	G63349	61524 81164	77349	43111 ⁸ 49155 ⁷
73-84	RWD	⊖	G63355	61525 81039	58355 77355	34036 ⁸	⊖
70-72	4WD	⊖	⊖	G63371	43062 ⁸ 49107 ⁷
	4WD; Exc. Lift Kit	⊖	G63347 ⁵⁰	⊖
	RWD	⊖	G63355	61525 81039	58355 77355	34036 ⁸	⊖	G63306	82003	43093 ⁸ 49162 ⁷

JIMMY STEERING STABILIZERS

			Front	Rear
84-04	4WD, Power Steering Single System Steering Stabilizer; without a factory mounting hole in the steering linkage.		6851SE
73-91	Heavy Duty replacement damper for vehicles with OE stabilizer		6804SE ⁸⁰
	Replacement damper for vehicles with OE stabilizer		14017
	Replacement damper for vehicles with the Gabriel aftermarket mounting kit		6802SE ⁸⁴
	Without OE Steering Stabilizer		6849SE ⁸²
70-72	4WD; K-5 Single System Steering Stabilizer		6803SE ⁸⁴
	4WD; K5 Dual System Steering Stabilizer		6802SE ⁸⁴
	RWD; Steering Stabilizer		6802SE ⁸⁴

PICKUP

55-59	All	⊖	82047	⊖
	Series 100, 150	⊖	82047	⊖	82060
	Series 250	⊖	82047	⊖	82123
53-54	All	⊖	81270	⊖
	1/2 and 3/4 Ton	⊖	81270	⊖	82155

PICKUP 1/2 TON, C15 / C1500

88-99	All	⊖	G63489	61544 81668	58489 77489	⊖	G63488	61543 81667	58488 77488	43163 ⁸ 49218 ⁷
73-86	All	⊖	G63355	61525 81039	58355 77355	34036 ⁸	⊖	G63349	61524 81164	58349 77349	43111 ⁸ 49155 ⁷
67-72	All	⊖	G63355	61525 81039	58355 77355	34036 ⁸	⊖
	Coil(RearSpringType)	⊖	G63355	61525 81039	58355 77355	34036 ⁸	⊖	82003	43062 ⁸ 49107 ⁷
	Leaf(RearSpringType)	⊖	G63355	61525 81039	58355 77355	34036 ⁸	⊖	82006	43093 ⁸ 49162 ⁷

6 It is recommended that when replacing shocks on vehicles with "quad shocks" all 4 shocks should be matched by series.

8 Pair Packs.

53 Strut Mount. Hardware from O.E. Part may need to be reused.

82 Use kit if listed, See Ref. C for optional Steering Stabilizer Boots.

7 Pair Packs, air hose kit included.

50 Bellows Kit No. 141242 is recommended for use to protect piston rod from potentially harmful road debris.

80 Mounting bracket not required, install on O.E. Shock Mounts. See Ref. C for optional Steering Stabilizer Boots.

84 Replacement damper for vehicles with the Gabriel Aftermarket mounting kit

APPLICATION GUIDE

Year	Fitment Notes										
		Ultra	ProGuard/ Guardian/ Classic	Max Control/ LTV	Strut Cushion/ Strut Mount	Hi Jacker/ Load Carrier	Ultra	ProGuard/ Guardian/ Classic	Max Control/ LTV	Strut Cushion/ Strut Mount	Hi Jacker/ Load Carrier

GMC

GMC

PICKUP 1/2 TON, C15 / C1500 (cont'd)

67-72	RWD; Leaf(RearSpringType)	⊖ ⊖	G63355	61525 81039	58355 77355	34036 ⁸	⊖ ⊖	G63306
-------	---------------------------	--------	--------	----------------	----------------	------	--------------------	--------	--------	------	------	------	------

PICKUP 1/2 TON, C15 / C1500 STEERING STABILIZERS

		Front	Rear
88-99	RWD	6852SE ⁸²
73-86	Single System Steering Stabilizer	6802SE ⁸⁴

PICKUP 1/2 TON, K15 / K1500

88-99	All	⊖ ⊖	G63818	58901 77609	⊖ ⊖	G63488	61543 81667	58488 ⁵⁰ 77488	43163 ⁸ 49218 ⁷
81-86	Quad Suspension Long Shock; Exc. Lift Kit	⊖ ⊖	G63906 ⁶	61522 ² 81496 ⁶	58906 ⁶	⊖ ⊖
	Quad Suspension Short Shock; Exc. Lift Kit	⊖ ⊖	G63908 ⁶	58908 ⁶	⊖ ⊖
79-86	Exc. Lift Kit	⊖ ⊖	⊖ ⊖	G63349	61524 81164	58349 77349	43111 ⁸
	Exc. Quad Suspension and Lift Kit	⊖ ⊖	G63347	61516 81113	58347	43107 ⁸	⊖ ⊖	49155 ⁷
73-86	4" Lift Kit; Exc. Quad Suspension	⊖ ⊖	G63437 ⁵⁰	58437 ⁵⁰	⊖ ⊖	G63438 ⁵⁰	58438 ⁵⁰
78	Exc. Lift Kit	⊖ ⊖	⊖ ⊖	G63349	61524 81164	58349 77349
	Exc. Quad Suspension and Lift Kit	⊖ ⊖	G63347	61516 81113	58347	43107 ⁸	⊖ ⊖	43111 ⁸ 49155 ⁷
75-77	Exc. Lift Kit	⊖ ⊖	⊖ ⊖	G63349	61524 81164	58349 77349	43111 ⁸
73-77	Exc. Quad Suspension and Lift Kit	⊖ ⊖	G63347	61516 81113	58347	43107 ⁸	⊖ ⊖	49155 ⁷
73-74	Exc. Lift Kit	⊖ ⊖	⊖ ⊖	G63349	61524 81164	58349 77349
71-72	All	⊖ ⊖	43107 ⁸	⊖ ⊖	G63371
	Exc. Quad Suspension and Lift Kit	⊖ ⊖	G63347	61516 81113	58347	43107 ⁸	⊖ ⊖	G63371
69-70	All	⊖ ⊖	43107 ⁸	⊖ ⊖
	Exc. Quad Suspension and Lift Kit	⊖ ⊖	G63347	61516 81113	58347	43107 ⁸	⊖ ⊖

PICKUP 1/2 TON, K15 / K1500 STEERING STABILIZERS

		Front	Rear
88-99	Single System Steering Stabilizer	6807SE ⁸⁰
73-86	All	14017
	Dual System Steering Stabilizer	6802SE ⁸⁴
	Single System Steering Stabilizer	6804SE ⁸⁰
69-72	Dual System Steering Stabilizer	6802SE ⁸⁴
	Single System Steering Stabilizer	6803SE ⁸⁴

PICKUP 1/2 TON, R1500

87	All	⊖ ⊖	G63355	61525 81039	58355 77355	34036 ⁸	⊖ ⊖	G63349	61524 81164	58349 77349	43111 ⁸ 49155 ⁷
----	-----	--------	--------	----------------	----------------	------	--------------------	--------	--------	----------------	----------------	------	--

PICKUP 1/2 TON, R1500 STEERING STABILIZERS

		Front	Rear
87	Single System Steering Stabilizer	6802SE ⁸⁴

PICKUP 1/2 TON, V1500

87	4" Lift Kit; Exc. Quad Suspension	⊖ ⊖	G63437 ⁵⁰	58437 ⁵⁰	⊖ ⊖	G63438 ⁵⁰	58438 ⁵⁰
	Exc. Lift Kit	⊖ ⊖	G63347	43107 ⁸	⊖ ⊖	G63349	61524 81164	58349 77349	43111 ⁸
	Exc. Quad Suspension and Lift Kit	⊖ ⊖	58347	⊖ ⊖
	Quad Suspension Long Shock; Exc. Lift Kit	⊖ ⊖	G63906 ⁶	61522 ² 81496 ⁶	58906 ⁶	⊖ ⊖

6 It is recommended that when replacing shocks on vehicles with "quad shocks" all 4 shocks should be matched by series.

8 Pair Packs.

80 Mounting bracket not required, install on O.E. Shock Mounts. See Ref. C for optional Steering Stabilizer Boots.

84 Replacement damper for vehicles with the Gabriel Aftermarket mounting kit

7 Pair Packs, air hose kit included.

50 Bellows Kit No. 141242 is recommended for use to protect piston rod from potentially harmful road debris.

82 Use kit if listed, See Ref. C for optional Steering Stabilizer Boots.

APPLICATION GUIDE

Year	Fitment Notes										
		Ultra	ProGuard/ Guardian/ Classic	Max Control/ LTV	Strut Cushion/ Strut Mount	Hi Jacker/ Load Carrier	Ultra	ProGuard/ Guardian/ Classic	Max Control/ LTV	Strut Cushion/ Strut Mount	Hi Jacker/ Load Carrier

GMC

GMC

PICKUP 1/2 TON, V1500 (cont'd)

87	Quad Suspension Short Shock; Exc. Lift Kit	⊖	G63908 ⁸	61516 81113 ⁸	58908 ⁸
	Quad Suspension; Exc. Lift Kit	⊖	49155 ⁷

PICKUP 1/2 TON, V1500 STEERING STABILIZERS

		Front		Rear	
87	All	14017		
	Dual System Steering Stabilizer	6802SE ⁸⁴		
	Single System Steering Stabilizer	6804SE ⁸⁰		

PICKUP 3/4 TON, C25 / C2500

88-00	All	⊖	G63489	61544 81668	58489 77489	⊖	G63488	61543 81667	58488 77488	43163 ⁸ 49218 ⁷
85-86	Crew Cab Pickup	⊖	⊖	G63366	61649 81174	58366
83-86	Cab & Chassis	⊖	⊖	G63349	61524 81164	58349 77349	43111 ⁸ 49155 ⁷
79-86	Exc. Extended Cab	⊖	G63355	61525 81039	58355 77355	34036 ⁸	⊖
	Standard Cab Pickup	⊖	⊖	G63349	61524 81164	58349 77349	43111 ⁸ 49155 ⁷
75-83	Crew Cab Pickup	⊖	⊖	G63366	61649 81174	58366
82	Cab & Chassis	⊖	77355	⊖	G63349	61524 81164	58349 77349	43111 ⁸ 49155 ⁷
79-81	Cab & Chassis	⊖	⊖	G63349	61524 81164	58349 77349	43111 ⁸ 49155 ⁷
75-78	Cab & Chassis	⊖	⊖	61524 81164	58349 77349	43111 ⁸ 49155 ⁷
	Exc. Extended Cab	⊖	G63355	61525 81039	58355 77355	34036 ⁸	⊖	G63349
	Standard Cab Pickup	⊖	⊖	61524 81164	58349 77349	43111 ⁸ 49155 ⁷
73-74	All	⊖	G63355	61525 81039	58355 77355	34036 ⁸	⊖	43111 ⁸ 49155 ⁷
	Crew Cab Pickup	⊖	G63355	61525 81039	58355 77355	34036 ⁸	⊖	G63366	61649	43111 ⁸ 49155 ⁷
	Exc. Crew Cab & Bonus Cab	⊖	G63355	61525 81039	58355 77355	34036 ⁸	⊖	G63349	61524	58349 77349	43111 ⁸ 49155 ⁷
67-72	All	⊖	G63355	61525 81039	58355 77355	34036 ⁸	⊖
	Coil(RearSpringType)	⊖	G63355	61525 81039	58355 77355	34036 ⁸	⊖	82003	43062 ⁸ 49107 ⁷
	Leaf(RearSpringType)	⊖	G63355	61525 81039	58355 77355	34036 ⁸	⊖	82006	43093 ⁸ 49162 ⁷
	RWD; Leaf(RearSpringType)	⊖	G63355	61525 81039	58355 77355	34036 ⁸	⊖	G63306

PICKUP 3/4 TON, C25 / C2500 STEERING STABILIZERS

		Front		Rear	
92-99	RWD, Exc. O.E. Steering Stabilizer	6852SE ⁸²		
88-91	RWD	6852SE ⁸²		
67-86	Single System Steering Stabilizer	6802SE ⁸⁴		

PICKUP 3/4 TON, K25 / K2500

88-00	All	⊖	G63609	61542 81726	58609 77609	⊖	G63488	61543 81667	58488 77488	43163 ⁸ 49218 ⁷
81-86	Quad Suspension Long Shock; Exc. Lift Kit	⊖	G63906 ⁸	61522 ⁸ 81496 ⁸	58906 ⁸	⊖
	Quad Suspension Short Shock; Exc. Lift Kit	⊖	G63908 ⁸	58908 ⁸	⊖
74-86	Exc. Lift Kit	⊖	⊖	G63349	61524 81164	58349 77349	43111 ⁸
	Exc. Quad Suspension and Lift Kit	⊖	G63347	61516 81113	58347	43107 ⁸	⊖	49155 ⁷

6 It is recommended that when replacing shocks on vehicles with "quad shocks" all 4 shocks should be matched by series.
8 Pair Packs.

7 Pair Packs, air hose kit included.

80 Mounting bracket not required, install on O.E. Shock Mounts. See Ref. C for optional Steering Stabilizer Boots.

APPLICATION GUIDE

Year	Fitment Notes										
		Ultra	ProGuard/ Guardian/ Classic	Max Control/ LTV	Strut Cushion/ Strut Mount	Hi Jacker/ Load Carrier	Ultra	ProGuard/ Guardian/ Classic	Max Control/ LTV	Strut Cushion/ Strut Mount	Hi Jacker/ Load Carrier

GMC

GMC

PICKUP 3/4 TON, K25 / K2500 (cont'd)

73-86	4" Lift Kit; Exc. Quad Suspension	<input type="radio"/>	G63437 ⁵⁰	58437 ⁵⁰	<input type="radio"/>	G63438 ⁵⁰	58438 ⁵⁰
73	Exc. Lift Kit	<input type="radio"/>	<input type="radio"/>	G63349	61524 81164	77349	43111 ⁸
	Exc. Quad Suspension and Lift Kit	<input type="radio"/>	G63347	61516 81113	58347	43107 ⁸	<input type="radio"/>	58349	49155 ⁷
71-72	All	<input type="radio"/>	<input type="radio"/>	G63371
	Exc. Quad Suspension and Lift Kit	<input type="radio"/>	G63347	61516 81113	58347	43107 ⁸	<input type="radio"/>	G63371
69-70	Exc. Quad Suspension and Lift Kit	<input type="radio"/>	G63347	61516 81113	58347	43107 ⁸	<input type="radio"/>

PICKUP 3/4 TON, K25 / K2500 STEERING STABILIZERS

								Front	Rear
99-00	4WD, 9200# GVW with O.E. Unit - 15059138 15155638	<input type="radio"/>						6853SE ⁸²
88-99	Single System Steering Stabilizer	<input type="radio"/>						6807SE ⁸⁰
73-86	All	<input type="radio"/>						14017
	Dual System Steering Stabilizer	<input type="radio"/>						6802SE ⁸⁴
	Single System Steering Stabilizer	<input type="radio"/>						6804SE ⁸⁰
67-72	Dual System Steering Stabilizer	<input type="radio"/>						6802SE ⁸⁴
	Single System Steering Stabilizer	<input type="radio"/>						6803SE ⁸⁴

PICKUP 3/4 TON, R2500

87-89	Crew Cab Pickup	<input type="radio"/>	<input type="radio"/>	G63366	61649 81174	58366
	Exc. Crew Cab & Bonus Cab	<input type="radio"/>	G63355	61525 81039	58355 77355	34036 ⁸	<input type="radio"/>	G63349	61524 81164	58349 77349	43111 ⁸ 49155 ⁷

PICKUP 3/4 TON, R2500 STEERING STABILIZERS

								Front	Rear
87-89	Single System Steering Stabilizer	<input type="radio"/>						6802SE ⁸⁴

PICKUP 3/4 TON, V2500

87	4" Lift Kit; Exc. Quad Suspension	<input type="radio"/>	G63437 ⁵⁰	58437 ⁵⁰	<input type="radio"/>	G63438 ⁵⁰	58438 ⁵⁰
	Exc. Lift Kit	<input type="radio"/>	G63347	43107 ⁸	<input type="radio"/>	G63349	61524 81164	58349 77349	43111 ⁸ 49155 ⁷
	Exc. Quad Suspension and Lift Kit	<input type="radio"/>	58347	<input type="radio"/>
	Quad Suspension Long Shock; Exc. Lift Kit	<input type="radio"/>	G63906 ⁶	61522 ⁶ 81496 ⁶	58906 ⁶	<input type="radio"/>
	Quad Suspension Short Shock; Exc. Lift Kit	<input type="radio"/>	G63908 ⁶	61516 81113 ⁶	58908 ⁶	<input type="radio"/>

PICKUP 3/4 TON, V2500 STEERING STABILIZERS

								Front	Rear
87	All	<input type="radio"/>						14017
	AN49	<input type="radio"/>						6802SE ⁸⁴
	Single System Steering Stabilizer	<input type="radio"/>						6804SE ⁸⁰

PICKUP 1 TON, C35/3500

99-00	Exc. HD Straight Front Axle	<input type="radio"/>	<input type="radio"/>	77488	49218 ⁷
92-00	Exc. HD Straight Front Axle	<input type="radio"/>	81668	<input type="radio"/>	77488
	Cab & Chassis HD Solid Front Axle	<input type="radio"/>	G63812	<input type="radio"/>	77488
	Crew Cab Pickup Exc. HD Straight Front Axle	<input type="radio"/>	G63489	61544	58489 77489	<input type="radio"/>	G63488	77488
	HD Solid Front Axle	<input type="radio"/>	58812	<input type="radio"/>	61543	58488 77488	43163 ⁹
91-00	All	<input type="radio"/>	<input type="radio"/>	77488
	Extended Cab Pickup Exc. HD Straight Front Axle	<input type="radio"/>	G63489	61544	58489 77489	<input type="radio"/>	G63488	81667	77488
	Standard Cab Pickup Exc. HD Straight Front Axle	<input type="radio"/>	G63489	61544	58489 77489	<input type="radio"/>	G63488	81667	77488

6 It is recommended that when replacing shocks on vehicles with "quad shocks" all 4 shocks should be matched by series.

8 Pair Packs.

80 Mounting bracket not required, install on O.E. Shock Mounts. See Ref. C for optional Steering Stabilizer Boots.



84 Replacement damper for vehicles with the Gabriel Aftermarket mounting kit

7 Pair Packs, air hose kit included.

50 Bellows Kit No.141242 is recommended for use to protect piston rod from potentially harmful road debris.

82 Use kit if listed, See Ref. C for optional Steering Stabilizer Boots.

APPLICATION GUIDE

Year	Fitment Notes										
		Ultra	ProGuard/ Guardian/ Classic	Max Control/ LTV	Strut Cushion/ Strut Mount	Hi Jacker/ Load Carrier	Ultra	ProGuard/ Guardian/ Classic	Max Control/ LTV	Strut Cushion/ Strut Mount	Hi Jacker/ Load Carrier

GMC

GMC

PICKUP 1 TON, C35/3500 (cont'd)

92-98	Cab & Chassis Exc. HD Straight Front Axle		77488	49218 ⁷	
91	Exc. HD Straight Front Axle	⊖	81668	77488	49218 ⁷	
	Cab & Chassis	⊖	81039	77355	77488	
	Cab & Chassis Exc. HD Solid Front Axle	⊖	G63366	61649 81174	77488	
	Cab & Chassis HD Solid Front Axle	⊖	G63812	77488	
	Exc. HD Solid Front Axle	⊖	58366 77488	
	HD Solid Front Axle	⊖	61525	58812	61543	58488 77488	43163 ⁸
89-90	Extended Cab Pickup Exc. HD Straight Front Axle	⊖	G63489	61544	58489 77489	G63488	81667	77488	43163 ⁸
88-90	Exc. HD Straight Front Axle	⊖	81668	61543	49218 ⁷
	Cab & Chassis	⊖	81039	77355	34036 ⁶
	Cab & Chassis Exc. HD Solid Front Axle	⊖	G63355	G63366	61649 81174
	Exc. HD Solid Front Axle	⊖	58366
	HD Solid Front Axle	⊖	61525	58355	58488
	Standard Cab Pickup Exc. HD Straight Front Axle	⊖	G63489	61544	58489 77489	G63488	81667	77488	43163 ⁸
88	Extended Cab Pickup Exc. HD Straight Front Axle	⊖	G63489	61544	58489 77489	G63488	77488	43163 ⁸
73-78	All	⊖	G63355	61525 81039	58355 77355	34036 ⁶	G63366	61649 81174	58366
67-72	All	⊖	G63355	61525 81039	58355 77355	34036 ⁶
	Exc. 11,000# Rear Axle	⊖	G63355	61525 81039	58355 77355	34036 ⁶	G63306	82006	43093 ⁸ 49162 ⁷

PICKUP 1 TON, C35/3500 STEERING STABILIZERS

		Front	Rear
91-93	Single System Steering Stabilizer; HD Pickup	6807SE ⁸⁰
75-86	Crew Cab Pickup	6802SE ⁸⁴
72-74	All	6802SE ⁸⁴

PICKUP 1 TON, K35 / K3500

88-00	All	⊖	G63609	61542 81726	58609 77609	⊖	G63488	61543 81667	58488 77488	43163 ⁸ 49218 ⁷
77-86	All	⊖	G63411	58411	⊖	G63675	61642 81921	58412 77412

PICKUP 1 TON, K35 / K3500 STEERING STABILIZERS

		Front	Rear
88-99	Single System Steering Stabilizer	6807SE ⁸⁰
77-86	All	14017
73-74	All	14017

PICKUP 1 TON, R3500

87-91	All	⊖	G63355	61525 81039	58355 77355	34036 ⁶	⊖	G63366	61649 81174	58366
-------	-----	---	--------	----------------	----------------	------	--------------------	---	--------	----------------	-------	------	------

PICKUP 1 TON, V3000 / V3500

87-91	All	⊖	G63411	58411	⊖	G63675	61642 81921	58412 77412
87-88	Quad Suspension Long Shock; Exc. Lift Kit	⊖	G63411	81496 ⁶	58411	⊖	G63675	61642 81921	58412 77412

PICKUP 1 TON, V3000 / V3500 STEERING STABILIZERS





		Front	Rear
87-91	All	14017

6 It is recommended that when replacing shocks on vehicles with "quad shocks" all 4 shocks should be matched by series.
8 Pair Packs.

7 Pair Packs, air hose kit included.

80 Mounting bracket not required, install on O.E. Shock Mounts. See Ref. C for optional Steering Stabilizer Boots.





APPLICATION GUIDE

Year	Fitment Notes										
			Ultra	ProGuard/ Guardian/ Classic	Max Control/ LTV	Strut Cushion/ Strut Mount	Hi Jacker/ Load Carrier		Ultra	ProGuard/ Guardian/ Classic	Max Control/ LTV





GMC

GMC



PICKUP 1000 SERIES

63-65	All		G63355	61525 81039	58355	34036 ⁸		G63306	82006	43093 ⁸ 49162 ⁷
61-62	All		82035		82086

PICKUP 1500 SERIES

63-65	All		G63355	61525 81039	58355 77355	34036 ⁸		G63306	82006	43093 ⁸ 49162 ⁷
61-62	All		82035		82086







PICKUP 2500 SERIES

61-62	All		82035	
-------	-----	---	------	-------	------	------	------	---	------	------	------	------	------

PICKUP STEERING STABILIZERS

		Front		Rear	
57-59	Single System Steering Stabilizer; with I-Beam Axle	6802SE ⁸⁴		
53-56	Truck Single System Steering Stabilizer; with I-Beam Axle	6802SE ⁸⁴		









S15 JIMMY

83-91	All		142316 ⁵³		G63422	61528 81482	58422 77422	43162 ⁸ 49213 ⁷
	4WD		G63423	61531 81516	58423 77423	142316 ⁵³		G63422	61528 81482	58422 77422	43162 ⁸ 49213 ⁷
	RWD		G63421	61504 81750	58421 77421	142316 ⁵³	34051 ⁸		G63422	61528 81482	58422 77422	43162 ⁸ 49213 ⁷











S15 JIMMY STEERING STABILIZERS

		Front		Rear	
83-91	Single System Steering Stabilizer; with a factory mounting hole in the steering linkage.	6801SE		





SAFARI

90-05	All			G63454	61539 81581	77454	43161 ⁸ 49215 ⁷
	AWD		G63818	61542 81726	58609 77609		G63454	61539 81581	77454	43161 ⁸ 49215 ⁷
	RWD		G63375 ⁵	61555 81713 ⁵	77375		G63454	61539 81581	77454	43161 ⁸ 49215 ⁷
85-89	RWD		G63375 ⁵	61555 81713 ⁵	77375		G63454	61539 81581	77454	43161 ⁸ 49215 ⁷

SIERRA 1500

14	All		G51949	
	Exc. Classic Models and Electronic Adjustable Suspension		G51949		G63959
07-13	Exc. Classic Models and Electronic Adjustable Suspension		G51870	143316 ⁵³		G63959	61690
99-07	4WD; Classic and Old Body Style; Exc. Electronic Adjustable Suspension		G63803	61643 81922	58803 77803		G63675	61642 81921	58412 77412
	RWD; Classic Models Only; Exc. Electronic Adjustable Suspension		G63783	61641 81920	58783 77783		G63662	61600 81873	58662 77662	43181 ⁸ 49235 ⁷

SIERRA 1500 HD

05-07	All		G63817	61663 81925	58817 77817		G63675	61642 81921	58412 77412
01-03	All		G63817	61663 81925	58817 77817		G63675	61642 81921	58412 77412

SIERRA 1500 READYMOUNTS

		Front		Rear	
07-13	4WD, Exc. Electronic Ride Control	G57000 ⁴⁰		
	RWD, Crew Cab Pickup Exc. Electronic Ride Control	G57000 ⁴⁰		
	RWD, Extended Cab Pickup Exc. Electronic Ride Control	G57000 ⁴⁰		
	RWD; Exc. Classic Models and Electronic Ride	G57023 ⁴⁰		

5 Use kit No. 140719 to replace O.E. hardware for lower shock absorber mounting when studs break or self-tapping screws are not longer useable.

8 Pair Packs.



53 Strut Mount. Hardware from O.E. Part may need to be reused.

7 Pair Packs, air hose kit included.

40 ReadyMount Strut. Complete Assembled Unit.

84 Replacement damper for vehicles with the Gabriel Aftermarket mounting kit

APPLICATION GUIDE

Year	Fitment Notes										
		Ultra	ProGuard\Guardian\Classic	Max Control\LTV	Strut Cushion\Strut Mount	Hi Jacker\Load Carrier	Ultra	ProGuard\Guardian\Classic	Max Control\LTV	Strut Cushion\Strut Mount	Hi Jacker\Load Carrier

GMC

GMC

SIERRA 1500 STEERING STABILIZERS

		Front	Rear
99-05	4WD, Exc. O.E. Steering Stabilizer	6853SE ⁸²

SIERRA 2500

99-04	All	58817	G63675	61642 81921	58412 77412
	4WD	G63817	61663 81925	77817 58817	G63675	61642 81921	58412 77412

SIERRA 2500 HD

10	All	G63817	61663	58817	G63675	61642 81921	58412 77412
01-09	All	G63817	61663 81925	58817 77817	G63675	61642 81921	58412 77412

SIERRA 2500 HD STEERING STABILIZERS

		Front	Rear
11-13	All	14075
01-09	4WD, 9200# GVW with O.E. Unit - 15059138 15155638	6853SE ⁸²

SIERRA 2500 STEERING STABILIZERS

		Front	Rear
99-04	4WD, Up through 8600# GVW; Exc. O.E. Steering Stabilizer	6853SE ⁸²

SIERRA 3500

01-07	All	G63817	61663 81925	58817 77817	G63675	61642 81921	58412 77412
-------	-----	--------	----------------	----------------	------	------	--------	----------------	----------------	------	------

SIERRA 3500 HD

07-10	All	G63675	61642 81921	58412 77412
	Torsion Bar(FrontSpringType)	G63817	61663 81925	58817 77817	G63675	61642 81921	58412 77412

SIERRA 3500 HD STEERING STABILIZERS

		Front	Rear
11-13	All	14075

SONOMA / S15 2WD

83-04	All	G63422	61528 81482	58422 77422	43162 ⁸ 49213 ⁷
04	RWD	G63421	61504 81750	58421 77421	34051 ⁸	G63422	61528 81482	58422 77422	43162 ⁸ 49213 ⁷
91-03	RWD	81750	G63422	61528 81482	58422 77422	43162 ⁸ 49213 ⁷
	RWD	G63421	61504	58421 77421	34051 ⁸	G63422	61528 81482	58422 77422	43162 ⁸ 49213 ⁷
83-90	RWD	G63421	61504 81750	58421 77421	G63422	61528 81482	58422 77422	43162 ⁸ 49213 ⁷
	RWD	34051 ⁸	G63422	61528 81482	58422 77422	43162 ⁸ 49213 ⁷
82	All	34051 ⁸	G63422	61528 81482	58422 77422	43162 ⁸ 49213 ⁷
	RWD	G63421	61504 81750	58421 77421	34051 ⁸	G63422	61528 81482	58422 77422	43162 ⁸ 49213 ⁷

SONOMA / S15 4WD

83-04	All	G63422	61528 81482	58422 77422	43162 ⁸ 49213 ⁷
	4WD	G63423	61531 81516	58423 77423	G63422	61528 81482	58422 77422	43162 ⁸ 49213 ⁷
04	RWD	G63421	61504 81750	58421 77421	34051 ⁸	G63422	61528 81482	58422 77422	43162 ⁸ 49213 ⁷
88-94	4WD, Torsion Bar(FrontSpringType)	142316 ⁵³	G63422	61528 81482	58422 77422	43162 ⁸ 49213 ⁷
82	All	34051 ⁸	G63422	61528 81482	58422 77422	43162 ⁸ 49213 ⁷

SONOMA / S15 STEERING STABILIZERS 2WD

		Front	Rear
91-93	Single System Steering Stabilizer; with a factory mounting hole in the steering linkage.	6801SE ⁸⁰

7 Pair Packs, air hose kit included.



53 Strut Mount. Hardware from O.E. Part may need to be reused.

132 82 Use kit if listed, See Ref. C for optional Steering Stabilizer Boots.

8 Pair Packs.

80 Mounting bracket not required, install on O.E. Shock Mounts. See Ref. C for optional Steering Stabilizer Boots.

APPLICATION GUIDE

Year	Fitment Notes										
		Ultra	ProGuard/ Guardian/ Classic	Max Control/ LTV	Strut Cushion/ Strut Mount	Hi Jacker/ Load Carrier	Ultra	ProGuard/ Guardian/ Classic	Max Control/ LTV	Strut Cushion/ Strut Mount	Hi Jacker/ Load Carrier

GMC

GMC

SONOMA / S15 STEERING STABILIZERS 2WD (cont'd)

		Front	Rear
82-93	RWD, Single System Steering Stabilizer	6802SE ⁸⁴
82-90	RWD	6849SE ⁸²
	RWD, Single System Steering Stabilizer; with a factory mounting hole in the steering linkage.	6801SE

SONOMA / S15 STEERING STABILIZERS 4WD

		Front	Rear
91-93	Single System Steering Stabilizer; with a factory mounting hole in the steering linkage.	6801SE ⁸⁰
83-90	4WD, Power Steering Single System Steering Stabilizer; without a factory mounting hole in the steering linkage.	6851SE

SPRINT / CABALLERO

78-87	All	I E	61504	34051 ⁸
	RWD	I E	G63421	81750 61504	58421 77421	34051 ⁸	81492	43060 ⁹ 49334 ³⁰
71-77	All	I E	G63421	61504 81750	58421 77421	81492	43060 ⁹ 49152 ³⁰
	RWD	I E	G63421	61504 81750	58421 77421	34051 ⁸	81492	43060 ⁹ 49152 ³⁰

SPRINT / CABALLERO STEERING STABILIZERS

		Front	Rear
73-77	All	14019

SUBURBAN 1/2 TON, C15 / C1500

93-99	All	I E	G63489	61544 81668	58489 77489	E O	G63896	61565 81789	58638 77638	43180 ⁹ 49231 ⁷
92	All	I E	G63489	61544 81668	58489 77489	E O	61565 81789	58638 77638	43180 ⁹ 49231 ⁷
	Old Body Style	I E	G63489	61544 81668	58489 77489	E O	G63896	61565 81789	58638 77638	43180 ⁹ 49231 ⁷
75-86	All	O O	G63355	61525 81039	58355 77355	34036 ⁸	O O	G63349	61524 81164	58349 77349	43111 ⁸ 49155 ⁷
73-74	All	O O	G63355	81039	58355 77355	34036 ⁸	O O	G63349	61524 81164	58349 77349	43111 ⁸ 49155 ⁷
	Coil (FrontSpringType)	O O	G63355	61525 81039	58355 77355	34036 ⁸	O O	G63349	61524 81164	58349 77349	43111 ⁸ 49155 ⁷
68-72	All	O O	G63355	58355 77355	34036 ⁸	O O	43062 ⁸
	Coil (FrontSpringType)	O O	G63355	61525 81039	58355 77355	34036 ⁸	O O	43062 ⁸
	Coil (RearSpringType)	O O	G63355	58355 77355	34036 ⁸	O O	82003	49107 ⁷ 43062 ⁹

SUBURBAN 1/2 TON, C15 / C1500 STEERING STABILIZERS

		Front	Rear
92-99	RWD, Exc. O.E. Steering Stabilizer	6852SE ⁸²
68-86	Single System Steering Stabilizer	6802SE ⁸⁴

SUBURBAN 1/2 TON, K15 / K1500

92-99	All	O O	G63609	61542 81726	58609 ⁵⁰ 77609	E O	G63638	61565 81789	58638 ⁵⁰ 77638	43180 ⁹ 49231 ⁷
81-86	Quad Suspension Long Shock; Exc. Lift Kit	O O	G63906 ⁶	61522 ⁶ 81496 ⁶	58906 ⁶
	Quad Suspension Short Shock; Exc. Lift Kit	O O	G63908 ⁶	58908 ⁶
73-86	4" Lift Kit; Exc. Quad Suspension	O O	G63437 ⁵⁰	58437 ⁵⁰	O O	G63438 ⁵⁰	58438 ⁵⁰
	Exc. Lift Kit		O O	G63349	61524 81164	58349 77349	43111 ⁸
	Exc. Quad Suspension and Lift Kit	O O	G63347	61516 81113	58347	43107 ⁸	O O	49155 ⁷
71-72	All		O O	G63371
	Exc. Quad Suspension and Lift Kit	O O	G63347	61516 81113	58347	43107 ⁸	O O	G63371

6 It is recommended that when replacing shocks on vehicles with "quad shocks" all 4 shocks should be matched by series.

8 Pair Packs.

50 Bellows Kit No. 141242 is recommended for use to protect piston rod from potentially harmful road debris.

82 Use kit if listed, See Ref. C for optional Steering Stabilizer Boots.

7 Pair Packs, air hose kit included.

30 For GM Vehicles equipped with factory installed leveling systems, see Ref. A.

80 Mounting bracket not required, install on O.E. Shock Mounts. See Ref. C for optional Steering Stabilizer Boots.

84 Replacement damper for vehicles with the Gabriel Aftermarket mounting kit

APPLICATION GUIDE

Year	Fitment Notes										
		Ultra	ProGuard/ Guardian/ Classic	Max Control/ LTV	Strut Cushion/ Strut Mount	Hi Jacker/ Load Carrier	Ultra	ProGuard/ Guardian/ Classic	Max Control/ LTV	Strut Cushion/ Strut Mount	Hi Jacker/ Load Carrier

GMC

GMC

SUBURBAN 1/2 TON, K15 / K1500 (cont'd)

69-70	Exc. Quad Suspension and Lift Kit	G63347	61516 81113	58347	43107 ⁶
-------	-----------------------------------	--------	----------------	-------	------	--------------------	------	------	------	------

SUBURBAN 1/2 TON, K15 / K1500 STEERING STABILIZERS

		Front	Rear
92-95	Single System Steering Stabilizer	6807SE ⁵⁰
73-86	All	14017
	Dual System Steering Stabilizer	6802SE ⁸⁴
	Single System Steering Stabilizer	6804SE ⁵⁰
68-72	Dual System Steering Stabilizer	6802SE ⁸⁴
	Single System Steering Stabilizer	6803SE ⁸⁴

SUBURBAN 1/2 TON, R1500

87-91	All	G63355	61525 81039	58355 77355	34036 ⁶	G63349	61524 81164	58349 77349	43111 ⁸ 49155 ⁷
-------	-----	--------	----------------	----------------	------	--------------------	--------	----------------	----------------	------	--

SUBURBAN 1/2 TON, R1500 STEERING STABILIZERS

		Front	Rear
87-91	Single System Steering Stabilizer	6802SE ⁸⁴

SUBURBAN 1/2 TON, V1500

87-91	4" Lift Kit; Exc. Quad Suspension	G63437 ⁵⁰	58437 ⁵⁰	G63438 ⁵⁰	58438 ⁵⁰
	Exc. Lift Kit	G63347	43107 ⁶	G63349	61524 81164	58349 77349	43111 ⁸ 49155 ⁷
	Exc. Quad Suspension and Lift Kit	58347
	Quad Suspension Long Shock; Exc. Lift Kit	G63906 ⁶	61522 ⁶ 81496 ⁶	58906 ⁶
	Quad Suspension Short Shock; Exc. Lift Kit	G63908 ⁶	61516 81113 ⁶	58908 ⁶

SUBURBAN 1/2 TON, V1500 STEERING STABILIZERS

		Front	Rear
87-91	All	14017
	Dual System Steering Stabilizer	6802SE ⁸⁴
	Single System Steering Stabilizer	6804SE ⁵⁰

SUBURBAN 3/4 TON, C25 / C2500

92-99	All	G63489	61544 81668	58489 77489	G63896	61565 81789	58638 77638	43180 ⁸ 49231 ⁷
		G63355	61525 81039	58355 77355	34036 ⁶	G63349	61524 81164	58349 77349	43111 ⁸ 49155 ⁷
73-74	All	G63355	61525 81039	58355 77355	34036 ⁶	58349	43111 ⁸ 49155 ⁷
		G63355	61525 81039	58355 77355	34036 ⁶	G63349	61524 81164	77349 58349	43111 ⁸ 49155 ⁷
68-72	All	G63355	61525 81039	58355 77355	34036 ⁶	82003	49107 ⁷
		G63355	61525 81039	58355 77355	34036 ⁶	82003	43062 ⁶ 49107 ⁷

SUBURBAN 3/4 TON, C25 / C2500 STEERING STABILIZERS

		Front	Rear
68-86	Single System Steering Stabilizer	6802SE ⁸⁴

SUBURBAN 3/4 TON, K25 / K2500

92-99	All	G63609	61542 81726	58609 77609	G63638	61565 81789	58638 77638	43180 ⁸ 49231 ⁷
		G63437 ⁵⁰	58437 ⁵⁰	G63438 ⁵⁰	58438 ⁵⁰
81-86	Quad Suspension Long Shock; Exc. Lift Kit	G63906 ⁶	61522 ⁶ 81496 ⁶	58906 ⁶
		G63908 ⁶	58908 ⁶

6 It is recommended that when replacing shocks on vehicles with "quad shocks" all 4 shocks should be matched by series.

8 Pair Packs.





80 Mounting bracket not required, install on O.E. Shock Mounts. See Ref. C for

7 Pair Packs, air hose kit included.

50 Bellows Kit No. 141242 is recommended for use to protect piston rod from potentially harmful road debris.

84 Replacement damper for vehicles with the Gabriel Aftermarket mounting kit

APPLICATION GUIDE

Year	Fitment Notes										
			ProGuard/ Guardian/ Classic	Max Control/ LTV	Strut Cushion/ Strut Mount	Hi Jacker/ Load Carrier		ProGuard/ Guardian/ Classic	Max Control/ LTV	Strut Cushion/ Strut Mount	Hi Jacker/ Load Carrier

GMC

GMC

SUBURBAN 3/4 TON, K25 / K2500 (cont'd)

73-86	Exc. Lift Kit	○	G63349	61524 81164	58349 77349	43111 ⁸
	Exc. Quad Suspension and Lift Kit	○	G63347	61516 81113	58347	43107 ⁸	○	49155 ⁷
83	4" Lift Kit ⁴ Lift Kit; Exc. Quad Suspension	○	58438 ⁵⁰
	4" Lift Kit; Exc. Quad Suspension	○	G63437 ⁵⁰	58437 ⁵⁰	○	G63438 ⁵⁰
73-82	4" Lift Kit; Exc. Quad Suspension	○	G63437 ⁵⁰	58437 ⁵⁰	○	G63438 ⁵⁰	58438 ⁵⁰
71-72	All	○	G63371
	Exc. Quad Suspension and Lift Kit	○	G63347	61516 81113	58347	43107 ⁸	○	G63371
69-70	Exc. Quad Suspension and Lift Kit	○	G63347	61516 81113	58347	43107 ⁸	○

SUBURBAN 3/4 TON, K25 / K2500 STEERING STABILIZERS

		Front		Rear	
92-97	Single System Steering Stabilizer	6807SE ⁸⁰		
73-86	All	14017		
	Dual System Steering Stabilizer	6802SE ⁸⁴		
	Single System Steering Stabilizer	6804SE ⁸⁰		
68-72	Dual System Steering Stabilizer	6802SE ⁸⁴		
	Single System Steering Stabilizer	6803SE ⁸⁴		

SUBURBAN 3/4 TON, R2500

87-91	All	○	G63355	61525 81039	58355 77355	34036 ⁸	○	G63349	61524 81164	58349 77349	43111 ⁸ 49155 ⁷
-------	-----	---	--------	----------------	----------------	-------	--------------------	---	--------	----------------	----------------	-------	--

SUBURBAN 3/4 TON, R2500 STEERING STABILIZERS

		Front		Rear	
87-91	Single System Steering Stabilizer	6802SE ⁸⁴		

SUBURBAN 3/4 TON, V2500

87-91	4" Lift Kit; Exc. Quad Suspension	○	G63437 ⁵⁰	58437 ⁵⁰	○	G63438 ⁵⁰	58438 ⁵⁰
	Exc. Lift Kit	○	G63347	43107 ⁸	○	G63349	61524 81164	58349 77349	43111 ⁸ 49155 ⁷
	Exc. Quad Suspension and Lift Kit	○	58347	○
	Quad Suspension Long Shock; Exc. Lift Kit	○	G63906 ⁶	61522 ⁶ 81496 ⁶	58906 ⁶	○
	Quad Suspension Short Shock; Exc. Lift Kit	○	G63908 ⁶	61516 81113 ⁶	58908 ⁶	○

SUBURBAN 3/4 TON, V2500 STEERING STABILIZERS

		Front		Rear	
87-91	All	14017		
	Dual System Steering Stabilizer	6802SE ⁸⁴		
	Single System Steering Stabilizer	6804SE ⁸⁰		

SYCLONE

91	All	○	G63423	61531 81516	58423 77423	○	G63422	61528 81482	58422 77422	43162 ⁸ 49213 ⁷
	Torsion Bar(FrontSpringType)	○	G63423	61531 81516	58423 77423	142316 ⁵³	○	G63422	61528 81482	58422 77422

SYCLONE STEERING STABILIZERS

		Front		Rear	
91	Single System Steering Stabilizer; with a factory mounting hole in the steering linkage.	6801SE ⁸⁰		

TERRAIN

13	All	○	G64015	61718
10-12	Left	↓	G52127	○	G64015	61718

6 It is recommended that when replacing shocks on vehicles with "quad shocks" all 4 shocks should be matched by series.

8 Pair Packs.

53 Strut Mount. Hardware from O.E. Part may need to be reused.





84 Replacement damper for vehicles with the Gabriel Aftermarket mounting kit

7 Pair Packs, air hose kit included.

50 Bellows Kit No. 141242 is recommended for use to protect piston rod from potentially harmful road debris.

80 Mounting bracket not required, install on O.E. Shock Mounts. See Ref. C for optional Steering Stabilizer Boots.

APPLICATION GUIDE

Year	Fitment Notes										
		 Ultra	ProGuard/ Guardian/ Classic	Max Control/ LTV	Strut Cushion/ Strut Mount	Hi Jacker/ Load Carrier	 Ultra	ProGuard/ Guardian/ Classic	Max Control/ LTV	Strut Cushion/ Strut Mount	Hi Jacker/ Load Carrier

GMC

GMC



TERRAIN (cont'd)

10-12	Right	 G652128	 G64015	61718
-------	-------	---	------	------	------	------	--	-------	------	------	------

TRACKER

89-91	All		81904
-------	-----	------	------	------	------	------	---	-------	------	------	------





























TYPHOON

92-93	All	 G63423	61531 81516	58423 77423	142316 ⁵³	 G63422	61528 81482	58422 77422	43162 ⁸ 49213 ⁷
-------	-----	--	----------------	----------------	----------------------	------	--	----------------	----------------	------	--

TYPHOON STEERING STABILIZERS

								Front	Rear
92-93	Single System Steering Stabilizer; without a factory mounting hole in the steering linkage.							6851SE





VAN 1/2 TON, G / SAVANNA

08-11	All	 G63896	61686	58638	43180 ⁸ 49231 ⁷
	RWD	 G63896	81789 61686	77638 58638	43180 ⁸ 49231 ⁷
	RWD, Coil(FrontSpringType)	 G63894	 G63896	61686	58638	43180 ⁸ 49231 ⁷
	Torsion Bar (FrontSpringType)	 G63893	 G63896	61686	58638	43180 ⁸ 49231 ⁷
07	All	 G63896	61686	43180 ⁸ 49231 ⁷
	RWD	 G63896	81789 61686	77638	43180 ⁸ 49231 ⁷
	RWD, Coil(FrontSpringType)	 G63894	 G63896	61686	43180 ⁸ 49231 ⁷
	Torsion Bar (FrontSpringType)	 G63893	 G63896	61686	43180 ⁸ 49231 ⁷
03-06	All	 G63896	61686	58638	43180 ⁸ 49231 ⁷
	RWD	 G63896	81789 61686	77638 58638	43180 ⁸ 49231 ⁷
	RWD, Coil(FrontSpringType)	 G63894	61684	 G63896	61686	58638	43180 ⁸ 49231 ⁷
	Torsion Bar (FrontSpringType)	 G63893	61683	 G63896	61686	58638	43180 ⁸ 49231 ⁷
96-02	All		61555	 G63896	61565	58638	43180 ⁸ 49231 ⁷
	RWD	 G63375 ⁵	81713 ⁵ 61555	77375	 G63896	81789 61565	77638 58638	43180 ⁸ 49231 ⁷
78-95	All	 G63357	61517 81108	58357 77357	 G63413	61522 81496	58413 77413	49212 ⁷
71-77	All	 G63357	61517 81108	58357 77357	 G63306	82006	43093 ⁸ 49162 ⁷
70	All		58357	 G63306	82006	43093 ⁸ 49162 ⁷
	I-Beam Front Axle		82062	58357	 G63306	82006	43093 ⁸ 49162 ⁷
	Independent Front Suspension	 G63357	61517 81108	77357 58357	 G63306	82006	43093 ⁸ 49162 ⁷
67-69	All		82062	 G63306	82006	43093 ⁸ 49162 ⁷
64-66	All		82062		82003

VAN 1/2 TON, G / SAVANNA STEERING STABILIZERS

								Front	Rear
70-95	Single System Steering Stabilizer							6802SE ⁸⁴

VAN 1/2 TON, P SERIES

74-80	All	 G63355	61525 81039	58355 77355	34036 ⁸	 G63366	61649 81174	58366 77662
73	All	 G63355	61525 81039	58355 77355	34036 ⁸	 G63349	61524 81164	58349 77349	43111 ⁸ 49155 ⁷



5 Use kit No. 140719 to replace O.E. hardware for lower shock absorber mounting when studs break or self-tapping screws are not longer useable.

8 Pair Packs.

7 Pair Packs, air hose kit included.

53 Strut Mount. Hardware from O.E. Part may need to be reused.

APPLICATION GUIDE

Year	Fitment Notes										
		Ultra	ProGuard/ Guardian/ Classic	Max Control/ LTV	Strut Cushion/ Strut Mount	Hi Jacker/ Load Carrier	Ultra	ProGuard/ Guardian/ Classic	Max Control/ LTV	Strut Cushion/ Strut Mount	Hi Jacker/ Load Carrier

GMC

GMC

VAN 1/2 TON, P SERIES (cont'd)

68-72	All	G63355	61525 81039	58355 77355	34036 ⁸	82003	43062 ⁹
	Coil(RearSpringType)	G63355	61525 81039	58355 77355	34036 ⁸	82003	49107 ⁷ 43062 ⁹
67	All	G63355	61525 81039	58355 77355	34036 ⁸	G63306	82006	43093 ⁹ 49162 ⁷

VAN 3/4 TON, G / SAVANNA

03-12	All	G63897	61687	77638
	Coil(FrontSpringType)	G63895	61685	G63897	61687	77638
	Torsion Bar (FrontSpringType)	G63893	61683	G63897	61687	77638
96-02	Exc. 8600# GVW	G63375 ⁵	61555 81713 ⁵	77375	G63638	61565 81789	58638 77638	43180 ⁹ 49231 ⁷
78-95	Exc. 8600# GVW	G63357	61517 81108	58357 77357	G63413	61522 81496	58413 77413	49212 ⁷
71-77	All	G63357	61517 81108	58357 77357	G63306	82006	43093 ⁹ 49162 ⁷
70	All	G63306	82006	43093 ⁹ 49162 ⁷
	I-Beam Front Axle	82062	G63306	82006	43093 ⁹ 49162 ⁷
	Independent Front Suspension	G63357	61517 81108	58357 77357	G63306	82006	43093 ⁹ 49162 ⁷
67-69	All	82062	G63306	82006	43093 ⁹ 49162 ⁷

VAN 3/4 TON, G / SAVANNA STEERING STABILIZERS

		Front	Rear
70-95	Single System Steering Stabilizer	6802SE ⁸⁴

VAN 3/4 TON, P SERIES

79-89	All	G63355	61525 81039	58355 77355	34036 ⁸	G63366	61649 81174	58366
73-78	All	G63355	61525 81039	58355 77355	34036 ⁸	G63349	61524 81164	58349 77349	43111 ⁹ 49155 ⁷
68-72	All	G63355	61525 81039	58355 77355	34036 ⁸	G63306	82006	43093 ⁹ 49162 ⁷
67	All	82047

VAN 1 TON, G / SAVANNA

04-12	All	77638
	Single Rear Wheels	G63897	61687	77638
	Torsion Bar (FrontSpringType)	G63893	77638
	Coil(FrontSpringType)	G63895	61685	77638
04-06	Dual Rear Wheels	G63898	61688	77638
03	Dual Rear Wheels	G63898	61688
	Single Rear Wheels	G63897	61687
	Torsion Bar (FrontSpringType)	G63893
	Coil(FrontSpringType)	G63895	61685
97-02	All	G63375 ⁵	61555 81713 ⁵	77375	81789	43180 ⁹ 49231 ⁷
	Exc. 8600# GVW	G63375 ⁵	61555 81713 ⁵	77375	G63638	61565 81789	58638 77638	43180 ⁹ 49231 ⁷
96	All	G63375 ⁵	61555 81713 ⁵	58357 77375	43180 ⁹ 49231 ⁷
	7100, 7400 and 8600# GVW	G63375 ⁵	61555 81713 ⁵	58357 77375	77638	43180 ⁹ 49231 ⁷
	Chassis Cab	G63375 ⁵	61555 81713 ⁵	58357 77375	58671	43180 ⁹ 49231 ⁷



5 Use kit No. 140719 to replace O.E. hardware for lower shock absorber mounting when studs break or self-tapping screws are not longer useable.

8 Pair Packs.

7 Pair Packs, air hose kit included.

84 Replacement damper for vehicles with the Gabriel Aftermarket mounting kit

APPLICATION GUIDE

Year	Fitment Notes										
		Ultra	ProGuard/ Guardian/ Classic	Max Control/ LTV	Strut Cushion/ Strut Mount	Hi Jacker/ Load Carrier	Ultra	ProGuard/ Guardian/ Classic	Max Control/ LTV	Strut Cushion/ Strut Mount	Hi Jacker/ Load Carrier

GMC

GMC

VAN 1 TON, G / SAVANNA (cont'd)

96	Exc. 8600# GVW	⊖	G63375 ⁵	61555 81713 ⁵	58357 77375	⊖	G63638	61565	58638 77638	43180 ⁶ 49231 ⁷
	Cutaway Van	⊖	G63375 ⁵	61555 81713 ⁵	58357 77375	⊖	G63671	43180 ⁶ 49231 ⁷
	Cutaway Van 9200# GVW	⊖	G63375 ⁵	61555 81713 ⁵	58357 77375	⊖	G63403	43180 ⁶ 49231 ⁷
	Exc. Cutaway Van	⊖	G63375 ⁵	61555 81713 ⁵	58357 77375	⊖	G63413	61522 ⁵ 81496	58413	49212 ⁷ 43180 ⁶ 49231 ⁷
93-95	Cutaway Van 9200# GVW	⊖	G63357	61517 81108	58357 77357	⊖	G63403	77403
92-95	Chassis Cab	⊖	G63357	61517 81108	58357 77357	⊖	58671
	Cutaway Van	⊖	G63357	61517 81108	58357 77357	⊖	G63671	58403
79-95	Exc. Cutaway Van	⊖	G63357	61517 81108	58357 77357	⊖	G63413	61522 ⁵ 81496	58413	49212 ⁷
78-95	All	⊖	G63357	61517 81108	58357 77357	⊖
92	Cutaway Van 9200# GVW	⊖	G63357	61517 81108	58357 77357	⊖	77403
79-91	Cutaway Van	⊖	G63357	61517 81108	58357 77357	⊖	58403
	Cutaway Van 9200# GVW	⊖	G63357	61517 81108	58357 77357	⊖	G63403	77403
78	Cutaway Van	⊖	G63357	61517 81108	58357 77357	⊖	G63413	61522 ⁵ 81496	58413	49212 ⁷
76-77	All	⊖	G63357	61517 81108	58357 77357	⊖	G63306	82006	43093 ⁸ 49162 ⁷
75	All	⊖	77357	⊖
	110.0(WheelBase)	⊖	61517	58357 77357	⊖	G63306	82006	43093 ⁸ 49162 ⁷
	125.0(WheelBase)	⊖	61517	58357 77357	⊖	G63306	82006	43093 ⁸ 49162 ⁷
	146.0(WheelBase)	⊖	G63357	81108	77357	⊖
71-74	All	⊖	G63357	61517 81108	58357 77357	⊖	G63306	82006
	Exc. 146" Wheelbase	⊖	G63357	61517 81108	58357 77357	⊖	G63306	82006	43093 ⁸ 49162 ⁷

VAN 1 TON, G / SAVANNA STEERING STABILIZERS

		Front	Rear
94-95	Single System Steering Stabilizer; HD with Straight Front Axle & Tilt Hood	6804SE ⁸⁰
71-95	Single System Steering Stabilizer	6802SE ⁸⁴

VAN 1 TON, P SERIES

86-99	Motorhome Chassis with I-Beam Front Suspension	⊖	G63625	58625	⊖	G63366	61649 81174	58366 77662
85-99	Motorhome Chassis with Independent Front Suspension	⊖	G63394	58394	⊖	G63366	61649 81174	58366 77662
75-99	All	⊖	⊖	G63366	61649 81174	58366 77662
75-90	Exc. Motorhome Chassis	⊖	G63355	61525 81039	58355 77355	34036 ⁸	⊖	G63366	61649 81174	58366 77662
85	Motorhome Chassis with I-Beam Front Suspension	⊖	G63403	58403 77403	⊖	G63366	61649 81174	58366 77662
75-84	Motorhome Chassis	⊖	G63394	58394	⊖	G63366	61649 81174	58366 77662
74	All	⊖	⊖	G63366	61649 81174	58366
	Exc. Motorhome Chassis	⊖	58355	34036 ⁸	⊖	G63366	61649 81174	58366
	Base, Exc. Motorhome Chassis	⊖	G63355	61525 81039	77355	⊖	G63366	61649 81174	77662 58366
	Motor Home	⊖	G63394	⊖	G63366	61649 81174	77662 58366

5 Use kit No. 140719 to replace O.E. hardware for lower shock absorber mounting when studs break or self-tapping screws are not longer useable.

7 Pair Packs, air hose kit included.



80 Mounting bracket not required, install on O.E. Shock Mounts. See Ref. C for

6 It is recommended that when replacing shocks on vehicles with "quad shocks" all 4 shocks should be matched by series.

8 Pair Packs.

84 Replacement damper for vehicles with the Gabriel Aftermarket mounting kit

APPLICATION GUIDE

Year	Fitment Notes										
		Ultra	ProGuard/ Guardian/ Classic	Max Control/ LTV	Strut Cushion/ Strut Mount	Hi Jacker/ Load Carrier	Ultra	ProGuard/ Guardian/ Classic	Max Control/ LTV	Strut Cushion/ Strut Mount	Hi Jacker/ Load Carrier

GMC

GMC

VAN 1 TON, P SERIES (cont'd)

74	Motor Home, Motorhome Chassis	○	58394	○	G63366	61649 81174	58366
73	All	○	○	G63366	61649
	Base, Exc. Motorhome Chassis	○	G63355	61525 81039	58355 77355	34036 ⁸	○	G63366	81174 61649	58366 77662
68-72	All	○	G63355	61525 81039	58355 77355	34036 ⁸	○
	Exc. 11,000# Rear Axle	○	G63355	61525 81039	58355 77355	34036 ⁸	○	G63306	82006	43093 ⁸ 49162 ⁷
67	All	○	82047	○

VAN 1 TON, P SERIES STEERING STABILIZERS

		Front	Rear
79-93	Step Van Forward Control & Motorhome	6805SE ⁸⁰
75-78	Motorhome Chassis	6805SE ⁸⁰

VAN, PB 1000 SERIES

63-65	All	○	G63355	61525 81039	58355 77355	34036 ⁸	○	G63306	82006	43093 ⁸ 49162 ⁷
-------	-----	---	--------	----------------	----------------	------	--------------------	---	--------	-------	------	------	--

YUKON

15	All	↓	G51960	○	G64107
12-14	All	↓	○	G64101 ¹
	Exc. Z55 or ZW7 Ride Suspension	↓	G51891	○	G64101 ¹
07-11	Exc. Electronic Adjustable Suspension	↓	143316 ⁵³	○
	Exc. Z55 or ZW7 Ride Suspension	↓	G51891	○
10	Exc. Z55 Auto Ride Suspension	↓	○	G63866
07-09	Exc. Z55 Auto Ride Suspension	↓	○	G63866	61675 81930	58930 77953
00-06	Exc. Z55 Auto Ride Suspension	↓	G63803	61643 81922	58803 77803	○	G63866	61675 81930	58930 77953
00	Denali	↓	○	G63896
92-99	All	↓	○	G63896	61565 81789	58638 77638	43180 ⁸ 49231 ⁷
	4WD	↓	G63609	61542 81726	58901 77609	○	G63896	61565 81789	58638 77638	43180 ⁸ 49231 ⁷
	RWD	↓	G63489	61544 81668	58489 77489	○	G63896	61565 81789	58638 77638	43180 ⁸ 49231 ⁷

YUKON READYMOUNTS

		Front	Rear
07-11	All	G57125 ⁴⁰

YUKON STEERING STABILIZERS

		Front	Rear
99-05	4WD	6853SE ⁸²
95-99	RWD	6852SE ⁸²

YUKON XL

15	All	↓	G51960	○	G64107
----	-----	---	--------	------	------	------	------	---	--------	------	------	------	------

YUKON XL 1/2 TON

12-14	All	↓	○	G64101 ¹
	Exc. Z55 or ZW7 Ride Suspension	↓	G51891	○	G64101 ¹
08-11	Exc. Z55 Auto Ride Suspension	↓	143316 ⁵³	○	G63866

1 Future Part, available 1st Quarter of 2015.

8 Pair Packs.

53 Strut Mount. Hardware from O.E. Part may need to be reused.

82 Use kit if listed, See Ref. C for optional Steering Stabilizer Boots.













Bold Type - New / Future Part

7 Pair Packs, air hose kit included.

40 ReadyMount Strut. Complete Assembled Unit.

80 Mounting bracket not required, install on O.E. Shock Mounts. See Ref. C for optional Steering Stabilizer Boots.







APPLICATION GUIDE

Year	Fitment Notes										
		 Ultra	 ProGuard/ Guardian/ Classic	 Max Control/ LTV	 Strut Cushion/ Strut Mount	 Hi Jacker/ Load Carrier	 Ultra	 ProGuard/ Guardian/ Classic	 Max Control/ LTV	 Strut Cushion/ Strut Mount	 Hi Jacker/ Load Carrier

GMC

GMC







YUKON XL 1/2 TON (cont'd)

07-11	Exc. Z55 or ZW7 Ride Suspension	 G51891	
07	Exc. Z55 Auto Ride Suspension		143316 ⁵³	 G63866	77953
00-06	Exc. Z55 Auto Ride Suspension	 G63803	61643 81922	58803 77803	 G63866	61675 81930	58930 77953

YUKON XL 1/2 TON READYMOUNTS

							Front	Rear
07-11	All						G57125⁴⁰























YUKON XL 3/4 TON

07	Exc. Hydraulic Self Leveling System			77953
00-06	Exc. Hydraulic Self Leveling System	 G63817	61663 81925	58817 77817	 G63866	61675 81930	58930 77953
	Exc. Z55 Auto Ride Suspension		81922	

HONDA

HONDA





ACCORD

08-12	Left	 G51877	 G51892
	Right	 G51878	 G51892
	Exc. Hybrid		142230 ⁵³		142230 ⁵³
03-07	Exc. Hybrid	 G51737	142230 ⁵³	 G51738	142230 ⁵³
98-02	All	 G55870	142230 ⁵³ 143064 ⁵¹	 G55871	142230 ⁵³ 142300 ⁶² 143063 ⁵¹
94-97	All	 G55877	142230 ⁵³ 143064 ⁵¹	 G55786	142150 ⁶² 142231 ⁵³ 143063 ⁵¹
90-93	All	 G55774	142230 ⁵³ 143064 ⁵¹	 G55786	142150 ⁶² 142231 ⁵³ 143063 ⁵¹
86-89	All	 G55742	142230 ⁵³	 G55743	142150 ⁶² 142231 ⁵³ 143064 ⁵¹
82-85	All	 G55515	142850 ⁵⁴	 G55516	142231 ⁵³ 143059 ⁵¹
79-81	All		143059 ⁵¹		142231 ⁵³
76-78	All		143059 ⁵¹	

ACCORD READYMOUNTS

							Front	Rear
03-07	All						G57056 ⁴⁰
	Exc. Hybrid Left						G57054 ⁴⁰	G57056 ⁴⁰
	Exc. Hybrid Right						G57055 ⁴⁰	G57056 ⁴⁰
98-02	Left						G56991 ⁴⁰	G56943 ⁴⁰
	Right						G56992 ⁴⁰	G56943 ⁴⁰
94-97	Left						G56961 ⁴⁰	G56968 ⁴⁰
	Right						G56961 ⁴⁰	G56969 ⁴⁰
90-93	Left						G56981 ⁴⁰	G56968 ⁴⁰
	Right						G56981 ⁴⁰	G56969 ⁴⁰

CITY

10-12	Left	 G52152	 G51905
	Right	 G52153	 G51905

40 ReadyMount Strut. Complete Assembled Unit.





53 Strut Mount. Hardware from O.E. Part may need to be reused.

62 Mount Kit includes Lower Suspension Mount Bushing. Hardware from O.E. Part may need to be reused.

51 Strut Cushion for use with the Strut/Cartridge/Shocks.

54 Kit with Mount and Bearing. Hardware from O.E. Part may need to be reused.













APPLICATION GUIDE

Year	Fitment Notes										
			Ultra	ProGuard/ Guardian/ Classic	Max Control/ LTV	Strut Cushion/ Strut Mount	Hi Jacker/ Load Carrier		Ultra	ProGuard/ Guardian/ Classic	Max Control/ LTV

HONDA

CIVIC

HONDA

06-11	All		G51807
	Exc. SI and GX Left		G52038	G51807
	Exc. SI and GX Right		G52039	G51807
03-05	All		G51716	142230 ⁵³
	Exc. Hatchback Left	143233 ⁶⁰	G51716	142230 ⁵³
	Exc. Hatchback Right	143265 ⁶⁰	G51716	142230 ⁵³
	Exc. Hybrid Left		G56677	G51716	142230 ⁵³
	Exc. Hybrid Right		G56678	G51716	142230 ⁵³
	Hatchback	143353 ⁵³	G51716	142230 ⁵³
	Hatchback Left	143231 ⁵⁹	G51716	142230 ⁵³
	Hatchback Right	143264 ⁵⁹	G51716	142230 ⁵³
03-04	Hatchback; Exc. Hybrid & SI models Left		G56621	G51716	142230 ⁵³
	Hatchback; Exc. Hybrid & SI models Right		G56622	G51716	142230 ⁵³
03	Coupe Left	143233 ⁶⁰	G51716	142230 ⁵³
02	All		G51700	142230 ⁵³
	Exc. Hatchback Left	143233 ⁶⁰	G51700	142230 ⁵³
	Exc. Hatchback Right	143265 ⁶⁰	G51700	142230 ⁵³
	Hatchback	143353 ⁵³	G51700	142230 ⁵³
	Hatchback Left	143231 ⁵⁹	G51700	142230 ⁵³
	Hatchback Right	143264 ⁵⁹	G51700	142230 ⁵³
	Hatchback; Exc. Hybrid & SI models Left		G56621	G51700	142230 ⁵³
	Hatchback; Exc. Hybrid & SI models Right		G56622	G51700	142230 ⁵³
01	All	143353 ⁵³	G51700	142230 ⁵³
	Left	143231 ⁵⁹ 143353 ⁵³	G51700	142230 ⁵³
	Right	143264 ⁵⁹ 143353 ⁵³	G51700	142230 ⁵³
96-00	All		G55909	142230 ⁵³	G55910	142230 ⁵³ 143064 ⁵¹
92-95	All		G55802 ⁴⁵	142230 ⁵³	G55803	142230 ⁵³ 142300 ⁶² 143064 ⁵¹
89-91	All	142230 ⁵³	142230 ⁵³ 142300 ⁶²

46 Upper Mount orientation may be required.

53 Strut Mount. Hardware from O.E. Part may need to be reused.



60 Strut Mount Contains a Metal Bearing. Hardware from O.E. Part may need to be reused.

51 Strut Cushion for use with the Strut/Cartridge/Shocks.

59 Strut Mount Contains a Plastic Bearing. Hardware from O.E. Part may need to be reused.

62 Mount Kit includes Lower Suspension Mount Bushing. Hardware from O.E. Part may need to be reused.

























APPLICATION GUIDE

Year	Fitment Notes										
		Ultra	ProGuard/ Guardian/ Classic	Max Control/ LTV	Strut Cushion/ Strut Mount	Hi Jacker/ Load Carrier	Ultra	ProGuard/ Guardian/ Classic	Max Control/ LTV	Strut Cushion/ Strut Mount	Hi Jacker/ Load Carrier



HONDA

HONDA

CIVIC (cont'd)

89-91	Hatchback		G55773	142230 ⁵³		G55771	143064 ⁵¹ 142230 ⁵³ 142300 ⁶²
	Sedan		G55773	142230 ⁵³		G55771	143064 ⁵¹ 142230 ⁵³ 142300 ⁶²
	Wagon		G55781	142230 ⁵³		G55782	142230 ⁵³ 142300 ⁶²
88	Hatchback		G55763	142230 ⁵³		G55766	142230 ⁵³
	Sedan		G55763	142230 ⁵³		G55766	142230 ⁵³
85-87	All		142231 ⁵³
	4WD, Wagon		G55728	143057 ⁵¹	142231 ⁵³
84-87	FWD, Wagon		G55732		G51170	142150 ⁶² 142231 ⁵³
	Hatchback		G55725	142233 ⁵⁴		G51170	142231 ⁵³
	Sedan		G55725	142233 ⁵⁴		G51170	142231 ⁵³
84	All				G51170	142231 ⁵³
80-83	All		G55706	142231 ⁵³
	Exc. Wagon		G55706		G55707	142231 ⁵³
	Wagon		G55706		G55707	142231 ⁵³
75-79	Wagon			G55707	142231 ⁵³	







CIVIC DEL SOL

93-97	All		G55802 ⁴⁶	142230 ⁵³		G55803	142230 ⁵³ 142300 ⁶² 143064 ⁵¹
-------	-----	---	----------------------	------	------	----------------------	------	---	--------	------	------	--	------

CIVIC READYMOUNTS

		Front	Rear
03-05	Left	G57061 ⁴⁰
	Right	G57062 ⁴⁰
01-05	Exc. Hatchback Left	G57049 ⁴⁰
	Exc. Hatchback Right	G57050 ⁴⁰
02-04	Hatchback; Exc. Hybrid & SI models Left	G57028 ⁴⁰
	Hatchback; Exc. Hybrid & SI models Right	G57029 ⁴⁰
01-02	Left	G57032 ⁴⁰
	Right	G57033 ⁴⁰
96-00	Left	G56996 ⁴⁰	G56998 ⁴⁰
	Right	G56997 ⁴⁰	G56998 ⁴⁰
92-95	Left	G56993 ⁴⁰	G56995 ⁴⁰
	Right	G56994 ⁴⁰	G56995 ⁴⁰

CR-V

13-14	All			G51879	
07-12	Left		G52187		G51879	142230 ⁵³
	Right		G52188		G51879	142230 ⁵³
03-06	All		143353 ⁵³		G51286	142230 ⁵³

40 ReadyMount Strut. Complete Assembled Unit.

51 Strut Cushion for use with the Strut/Cartridge/Shocks.





54 Kit with Mount and Bearing. Hardware from O.E. Part may need to be reused.

46 Upper Mount orientation may be required.

53 Strut Mount. Hardware from O.E. Part may need to be reused.

62 Mount Kit includes Lower Suspension Mount Bushing. Hardware from O.E. Part may need to be reused.













APPLICATION GUIDE

Year	Fitment Notes										
			Ultra	ProGuard/ Guardian/ Classic	Max Control/ LTV	Strut Cushion/ Strut Mount	Hi Jacker/ Load Carrier		Ultra	ProGuard/ Guardian/ Classic	Max Control/ LTV

HONDA

HONDA





CR-V (cont'd)

03-06	Left		G56800	143231 ⁵⁹ 143353 ⁵³		G51286	142230 ⁵³
	Right		G56799	143264 ⁵⁹ 143353 ⁵³		G51286	142230 ⁵³
02	All		143353 ⁵³		G51286
	Left		G56800	143231 ⁵⁹ 143353 ⁵³		G51286
	Right		G56799	143264 ⁵⁹ 143353 ⁵³		G51286
97-01	All		G51255	142230 ⁵³ 143064 ⁵¹		G51256	142230 ⁵³ 143064 ⁵¹















CR-V READYMOUNTS

				Front	Rear
02-06	Left			G57086 ⁴⁰
	Right			G57087 ⁴⁰
	Automatic Left			G57084 ⁴⁰
	Automatic Right			G57085 ⁴⁰
97-01	Left			G57116 ⁴⁰	G57104 ⁴⁰
	Right			G57117 ⁴⁰	G57104 ⁴⁰









CRX

89-91	All		G55787	142230 ⁵³ 143064 ⁵¹		G55803	142230 ⁵³
88	All		G55763	142230 ⁵³		G55766	142230 ⁵³ 143064 ⁵¹









ELEMENT

07-11	All			142230 ⁵³
	Exc. SC Model			G51858	142230 ⁵³
03-06	All		143353 ⁵³		142230 ⁵³
	Left		143231 ⁵⁹ 143353 ⁵³		142230 ⁵³
	Right		143264 ⁵⁹ 143353 ⁵³		142230 ⁵³
	Exc. SC Model Left		G52112	143353 ⁵³		G51858	142230 ⁵³
	Exc. SC Model Right		G52113	143353 ⁵³		G51858	142230 ⁵³

FIT

09-12	Left		G52152		G51905
	Right		G52153		G51905
07-08	Left		G52282		70060
	Right		G52283		70060

ODYSSEY

08-10	Left		G52253	143305		70010
	Right		G52254	143305		70010
05-07	Left		G52030	143305		70010
	Right		G52031	143305		70010



40 ReadyMount Strut. Complete Assembled Unit.

53 Strut Mount. Hardware from O.E. Part may need to be reused.

51 Strut Cushion for use with the Strut/Cartridge/Shocks.

59 Strut Mount Contains a Plastic Bearing. Hardware from O.E. Part may need to be reused.









APPLICATION GUIDE

Year	Fitment Notes										
		Ultra	ProGuard\ Guardian\ Classic	Max Control\ LTV	Strut Cushion\ Strut Mount	Hi Jacker\ Load Carrier	Ultra	ProGuard\ Guardian\ Classic	Max Control\ LTV	Strut Cushion\ Strut Mount	Hi Jacker\ Load Carrier

HONDA

HONDA





ODYSSEY (cont'd)

99-04	Left	 G56559	143061 ⁵¹ 143315 ⁵³	 69909  G63877
	Right	 G56558	143061 ⁵¹ 143315 ⁵³	 69909  G63877
95-98	All	 G55877	142230 ⁵³ 143064 ⁵¹	 G55821	142230 ⁵³ 143063 ⁵¹





ODYSSEY READYMOUNTS

		Front	Rear
05-07	Left	G57137
	Right	G57138
99-04	Left	G57011 ⁴⁰
	Right	G57012 ⁴⁰

PASSPORT

98-02	All	 G63611	61593 81872	 G63710	61610 81911
94-97	All	 G63611	61593 81872	 G63610	61592 81937











PILOT

03-08	Left	 G56759	143315 ⁵³	 G64003	61704
	Right	 G56758	143315 ⁵³	 G64003	61704







PILOT READYMOUNTS

		Front	Rear
03-08	AWD, Right	G57120⁴⁰
08	AWD, Left	G57119⁴⁰
07	AWD, Left	G57119⁴¹
03-06	AWD, Left	G57119⁴⁰

PRELUDE

97-01	All	 G51264	142230 ⁵³ 143064 ⁵¹	 G55805	142231 ⁵³ 142572 ⁶⁵ 143064 ⁵¹
92-96	All	 G55795	142230 ⁵³ 143064 ⁵¹	 G55805	142231 ⁵³ 142572 ⁶⁵ 143064 ⁵¹
88-91	All	 G55742	142230 ⁵³ 143064 ⁵¹	 G55757
83-87	All	 G55723	142230 ⁵³ 143059 ⁵¹	142231 ⁵³ 143059 ⁵¹
	Rebuildable Rear Struts	 G55723	142230 ⁵³ 143059 ⁵¹	 G44773 ⁹⁸	142231 ⁵³ 143059 ⁵¹
	Sealed Rear Struts	 G55723	142230 ⁵³ 143059 ⁵¹	 G55516	142231 ⁵³ 143059 ⁵¹
79-82	All	143059 ⁵¹	142231 ⁵³

RIDGELINE

12	All	142230 ⁵³
11	Left	 G52150	142230 ⁵³
	Right	 G52151	142230 ⁵³
06-10	Left	 G52150	 G51880	142230 ⁵³
	Right	 G52151	 G51880	142230 ⁵³

40 ReadyMount Strut. Complete Assembled Unit.

51 Strut Cushion for use with the Strut/Cartridge/Shocks.



65 Mount Kit includes Upper Spring Seat with Isolator. Hardware from O.E. Part may need to be reused.

41 ReadyMount Strut. Complete Assembled Unit. See Ref. D for procedures to replace Elec Adj Susp with non-adj product.

53 Strut Mount. Hardware from O.E. Part may need to be reused.

98 Notice: The level of difficulty to install this product is moderately high. Please review the installation instructions carefully before proceeding.

APPLICATION GUIDE

Year	Fitment Notes										
		Ultra	ProGuard\ Guardian\ Classic	Max Control\ LTV	Strut Cushion\ Strut Mount	Hi Jacker\ Load Carrier	Ultra	ProGuard\ Guardian\ Classic	Max Control\ LTV	Strut Cushion\ Strut Mount	Hi Jacker\ Load Carrier

HONDA

HONDA



S2000

08-09	All	142230 ⁵³	...
00-07	All	142230 ⁵³	142230 ⁵³	...



HUMMER

HUMMER

H2

03-06	All		G63817	61663	77817		G64000
-------	-----	---	--------	-------	-------	-----	-----	---	--------	-----	-----	-----	-----































H3

06-10	All		G64001		G63965
-------	-----	---	--------	-----	-----	-----	-----	---	--------	-----	-----	-----	-----



HYUNDAI

HYUNDAI





ACCENT

06-11	Left		G52154		70036		
	Right		G52155		70036		
00-05	All		G56522	142935 ⁵³	143059 ⁵¹	142626 ⁵³	143060 ⁵¹	...		
	Left Gas Charged Unit		G56522	142935 ⁵³	143059 ⁵¹	...		G52333	142626 ⁵³	143060 ⁵¹	
	Left Non-Gas Charged Unit		G56522	142935 ⁵³	143059 ⁵¹	...		G56524 ⁴⁴	142626 ⁵³	143060 ⁵¹	
	Right Gas Charged Unit		G56522	142935 ⁵³	143059 ⁵¹	...		G52334	142626 ⁵³	143060 ⁵¹	
	Right Non-Gas Charged Unit		G56522	142935 ⁵³	143059 ⁵¹	...		G56523 ⁴⁴	142626 ⁵³	143060 ⁵¹	
98-99	All		G55849	142415 ⁵³	143059 ⁵¹	...		G55890	142626 ⁵³	143060 ⁵¹	
	Left		G55849	142415 ⁵³	143059 ⁵¹	...		G52333	G55890	142626 ⁵³	143060 ⁵¹
	Right		G55849	142415 ⁵³	143059 ⁵¹	...		G52334	G55890	142626 ⁵³	143060 ⁵¹
97	All		G55849	142415 ⁵³	142626 ⁵³	...		
	Left		G55849	142415 ⁵³		G52333	142626 ⁵³	...	
	Mfg. from 6/97		G55849	142415 ⁵³		G55890	143060 ⁵¹	142626 ⁵³	
	Mfg. to 6/97		G55849	142415 ⁵³		G55850	143059 ⁵¹	142626 ⁵³	
	Right		G55849	142415 ⁵³		G52334	142626 ⁵³	...	
95-96	All		G55849	142415 ⁵³	143059 ⁵¹	...		G55850	142626 ⁵³	143059 ⁵¹	

AZERA

12-13	All	70068
11	All	143342 ⁵³		70013
06-10	All		G51806	143342 ⁵³	...		70013

ELANTRA



07-10	Left		G52156		70037
	Right		G52157		70037

44 This strut is not gas pressurized therefore the piston rod will not extend without assistance.

51 Strut Cushion for use with the Strut/Cartridge/Shocks.

53 Strut Mount. Hardware from O.E. Part may need to be reused.



















APPLICATION GUIDE

Year	Fitment Notes										
		Ultra	ProGuard\ Guardian\ Classic	Max Control\ LTV	Strut Cushion\ Strut Mount	Hi Jacker\ Load Carrier	Ultra	ProGuard\ Guardian\ Classic	Max Control\ LTV	Strut Cushion\ Strut Mount	Hi Jacker\ Load Carrier

HYUNDAI

HYUNDAI





ELANTRA (cont'd)

01-06	Left		G56539	142625 ⁵³		G56640	142535 ⁵³	
	Right		G56540	142625 ⁵³		G56641	142536 ⁵³	
96-00	All		142625 ⁵³	
	Left Gas Charged Unit		142625 ⁵³		G52335	
	Right Gas Charged Unit		142625 ⁵³		G52336	
00	Left		142625 ⁵³	142535 ⁵³	
	Left Mfg. from 5/00		G56539	142625 ⁵³		G56640	
	Left Mfg. to 5/00		G56526	142625 ⁵³	
	Left Mfg. to 5/00; Non-Gas Charged Unit		142625 ⁵³		G56528 ⁴⁴	
	Right		142625 ⁵³	142536 ⁵³	
	Right Mfg. from 5/00		G56540	142625 ⁵³		G56641
	Right Mfg. to 5/00		G56525	142625 ⁵³	
96-99	Left		G56526	142625 ⁵³	142535 ⁵³	
	Left Non-Gas Charged Unit		142625 ⁵³		G56528 ⁴⁴	
	Right		G56525	142625 ⁵³	142536 ⁵³	
	Right Non-Gas Charged Unit		142625 ⁵³		G56527 ⁴⁴	
92-95	Non-ABS		G55592	142240 ⁵⁴ 143057 ⁵¹		G51249	142419 ⁵³	





ELANTRA READYMOUNTS

		Front	Rear
00-06	Automatic Left	G57088 ⁴⁰
	Automatic Right	G57089 ⁴⁰

ENTOURAGE

07-08	Left		G52257		G64071
	Right		G52258		G64071



EXCEL

90-94	All		G55586	142234 ⁵⁴ 143057 ⁵¹		G69689	81464
86-89	All		143059 ⁵¹		G69689	81464
	Rebuildable O.E. Front Struts		G44944 ⁹⁸	143059 ⁵¹		G69689	81464

PONY

84-87	All			G69689	81464
-------	-----	--	------	------	------	------	------	---	--------	-------	------	------	------

SANTA FE

07-09	Left		G52158		G64048
-------	------	---	--------	------	------	------	------	---	--------	------	------	------	------

40 ReadyMount Strut. Complete Assembled Unit.

51 Strut Cushion for use with the Strut/Cartridge/Shocks.





54 Kit with Mount and Bearing. Hardware from O.E. Part may need to be reused.

44 This strut is not gas pressurized therefore the piston rod will not extend without assistance.

53 Strut Mount. Hardware from O.E. Part may need to be reused.

98 Notice: The level of difficulty to install this product is moderately high. Please review the installation instructions carefully before proceeding.







APPLICATION GUIDE

Year	Fitment Notes										
			ProGuard/ Guardian/ Classic	Max Control/ LTV	Strut Cushion/ Strut Mount	Hi Jacker/ Load Carrier		ProGuard/ Guardian/ Classic	Max Control/ LTV	Strut Cushion/ Strut Mount	Hi Jacker/ Load Carrier

HYUNDAI

HYUNDAI



SANTA FE (cont'd)

07-09	Right		G52159		G64048
01-06	Left		G56562	143087 ⁵³		69907 G51705
	Right		G56561	143087 ⁵³		69907 G51705





















SANTA FE READYMOUNTS

		Front	Rear
01-06	Left	G57139 ⁴⁰
	Right	G57140 ⁴⁰

SCOUPÉ

91-95	All		G55586	142234 ⁵⁴		69689	81464
-------	-----	---	--------	------	------	----------------------	------	---	-------	-------	------	------	------















SONATA

11-14	All			70068
06-10	All		G51806	143342 ⁵³		70013
01-05	All		G51714	142419 ⁵³		G51713	142419 ⁵³
00	All		G56565	142419 ⁵³		142419 ⁵³
	Mfg. from 4/00		G56565	142419 ⁵³		G51713	142419 ⁵³
	Mfg. from 8/00		G51714	142419 ⁵³		142419 ⁵³
	Mfg. to 4/00		G56565	142419 ⁵³		G56566	142419 ⁵³
99	All		G56565		G56566
95-98	All		G56577		G51290	142321 ⁵³
89-94	All		G5673	142301 ⁵³		G51186	142321 ⁵³ 143057 ⁵¹





SONATA READYMOUNTS

		Front	Rear
00-05	Left	G57059 ⁴⁰	G57090 ⁴⁰
	Right	G57059 ⁴⁰	G57091 ⁴⁰

TIBURON

03-08	Left		G56642		G56644	142535 ⁵³
	Right		G56643		G56645	142536 ⁵³
97-01	All		142625 ⁵³	
	Left		G56526	142625 ⁵³		142535 ⁵³
	Left Non-Gas Charged Unit		142625 ⁵³		G56528 ⁴⁴
	Right		G56525	142625 ⁵³		142536 ⁵³
	Right Non-Gas Charged Unit		142625 ⁵³		G56527 ⁴⁴

TUCSON

11-12	Left			142535 ⁵³
	Right			142536 ⁵³

40 ReadyMount Strut. Complete Assembled Unit.

51 Strut Cushion for use with the Strut/Cartridge/Shocks.



54 Kit with Mount and Bearing. Hardware from O.E. Part may need to be reused.

Bold Type - New / Future Part

44 This strut is not gas pressurized therefore the piston rod will not extend without assistance.

53 Strut Mount. Hardware from O.E. Part may need to be reused.





APPLICATION GUIDE

Year	Fitment Notes										
		Ultra	ProGuard/ Guardian/ Classic	Max Control/ LTV	Strut Cushion/ Strut Mount	Hi Jacker/ Load Carrier	Ultra	ProGuard/ Guardian/ Classic	Max Control/ LTV	Strut Cushion/ Strut Mount	Hi Jacker/ Load Carrier



HYUNDAI

HYUNDAI



TUCSON (cont'd)

05-10	Left		G56819	143087 ⁵³		G56822	142535 ⁵³
	Right		G56820	143087 ⁵³		G56821	142536 ⁵³



VERACRUZ

07-12	All			G64048
-------	-----	---	------	------	------	------	------	---	--------	------	------	------	------

XG300

01	All		G51899		G51713	142419 ⁵³
----	-----	---	--------	------	------	------	------	---	--------	------	------	----------------------	------





XG350

02-05	All		G51899		G51713	142419 ⁵³
-------	-----	---	--------	------	------	------	------	---	--------	------	------	----------------------	------





INFINITI

INFINITI





FX35

03-08	Left		G52061		G51831
	Right		G52062		G51831









FX45

03-08	Left		G52061		G51831
	Right		G52062		G51831









G20

91-96	Left		G56591	142547 ⁵³ 143057 ⁵¹		G56512
	Right		G56591	142547 ⁵³ 143057 ⁵¹		G56513

G35

03-07	Coupe Left Sport Suspension		G51813	
	Coupe Right Sport Suspension		G51814	
03-06	Exc. Sport Suspension			G51764
	Coupe Sport Suspension			G51812



I30

00-01	Left		G56683	142937 ⁵³		G51727
	Right		G56684	142937 ⁵³		G51727
96-99	Left		G55913	142546 ⁵⁴		G51087	142547 ⁵³
	Right		G55912	142546 ⁵⁴		G51087	142547 ⁵³

I30 READYMOUNTS

		Front	Rear
96-99	Left	G56970 ⁴⁰	G57057 ⁴⁰
	Right	G56971 ⁴⁰	G57058 ⁴⁰





I35

02-04	Left		G56685	142937 ⁵³		G51727
-------	------	---	--------	------	------	----------------------	------	---	--------	------	------	------	------

40 ReadyMount Strut. Complete Assembled Unit.

51 Strut Cushion for use with the Strut/Cartridge/Shocks.



APPLICATION GUIDE

Year	Fitment Notes										
			Ultra	ProGuard\ Guardian\ Classic	Max Control\ LTV	Strut Cushion\ Strut Mount	Hi Jacker\ Load Carrier		Ultra	ProGuard\ Guardian\ Classic	Max Control\ LTV

INFINITI

INFINITI















I35 (cont'd)

02-04	Right		G56686	142937 ⁵³		G51727
-------	-------	---	--------	------	------	----------------------	------	---	--------	------	------	------	------

Q45

97-01	Exc. Active Suspension		143210 ⁵³
-------	------------------------	--	------	------	------	----------------------	------	--	------	------	------	------	------





QX4

02-03	Left		G56687	142938 ⁵³
	Right		G56688	142938 ⁵³
99-03	Mfg. from 12/98		142938 ⁵³		G63845
98-03	All		142938 ⁵³
99-01	Left Mfg. from 12/98		G56615	142938 ⁵³
	Right Mfg. from 12/98		G56616	142938 ⁵³
98-99	Left Mfg. to 12/98		G56739	142938 ⁵³
	Right Mfg. to 12/98		G56736	142938 ⁵³
99	Mfg. to 12/98		142938 ⁵³		61609
97-98	Mfg. to 12/98		142938 ⁵³		G63712	61609 81910
97	All		142938 ⁵³		G63712	81910
	Left		G56739	142938 ⁵³		G63712	81910
	Right		G56736	142938 ⁵³		G63712	81910

QX4 READYMOUNTS

							Front	Rear					
02-03	Left						G57144 ⁴⁰					
	Right						G57145 ⁴⁰					
97-99	Mfg. to 11/98 Left						G57037 ⁴⁰					
	Mfg. to 11/98 Right						G57038 ⁴⁰					

QX56

08-10	All		G51715	143358 ⁵³ 143359 ⁷⁰
05-07	All		G51715	143358 ⁵³ 143359 ⁷⁰		G63875
04	All		G51715	143358 ⁵³ 143359 ⁷⁰

QX56 READYMOUNTS

							Front	Rear					
04-10	4WD						G57092 ⁴⁰					

INTERNATIONAL

INTERNATIONAL

100

74	All			82030
----	-----	--	------	------	------	------	------	---	------	-------	------	------	------

100 STEERING STABILIZERS

							Front	Rear					
74	All						6802SE ⁸⁴					

150

75	RWD			82030
----	-----	--	------	------	------	------	------	---	------	-------	------	------	------

40 ReadyMount Strut. Complete Assembled Unit.



70 Bushing and sleeve kit. Hardware from O.E. Part may need to be reused.

53 Strut Mount. Hardware from O.E. Part may need to be reused.

84 Replacement damper for vehicles with the Gabriel Aftermarket mounting kit

Bold Type - New / Future Part

APPLICATION GUIDE

Year	Fitment Notes										
		Ultra	ProGuard\Guardian\Classic	Max Control\LTV	Strut Cushion\Strut Mount	Hi Jacker\Load Carrier	Ultra	ProGuard\Guardian\Classic	Max Control\LTV	Strut Cushion\Strut Mount	Hi Jacker\Load Carrier

INTERNATIONAL

INTERNATIONAL

150 STEERING STABILIZERS

							Front	Rear
75	All						6802SE ⁸⁴

200

74-75	All	○ ○	82030	○ ○	82030
-------	-----	--------	------	-------	------	------	------	--------	------	-------	------	------	------

200 STEERING STABILIZERS

							Front	Rear
74-75	All						6802SE ⁸⁴

908B

68	All	○ ○	82007	○ ○	G63405	61500 81147	77405	43048 ⁸ 49310 ⁷
----	-----	--------	------	-------	------	------	------	--------	--------	----------------	-------	------	--

908B STEERING STABILIZERS

							Front	Rear
68-69	Single System Steering Stabilizer; 1/2 Ton, 3/4 Ton & Travelall						6802SE ⁸⁴

908C

68	All	○ ○	82007	○ ○	G63405	61500 81147	77405	43048 ⁸ 49310 ⁷
----	-----	--------	------	-------	------	------	------	--------	--------	----------------	-------	------	--

908C STEERING STABILIZERS

							Front	Rear
68-69	Single System Steering Stabilizer; 1/2 Ton, 3/4 Ton & Travelall						6802SE ⁸⁴

1000B

68	All	I I	82049	○ ○	61500 81147	77405	43048 ⁸ 49310 ⁷
	Exc. Travelette with 166" Wheelbase	I I	82049	○ ○	G63405	61500 81147	77405	43048 ⁸ 49310 ⁷

1000B STEERING STABILIZERS

							Front	Rear
68-69	Single System Steering Stabilizer; 1/2 Ton, 3/4 Ton & Travelall						6802SE ⁸⁴

1000C

68	All	I I	82049	○ ○	61500 81147	43048 ⁸ 49310 ⁷
	Exc. Travelette with 166" Wheelbase	I I	82049	○ ○	G63405	61500 81147	77405	43048 ⁸ 49310 ⁷

1000C STEERING STABILIZERS

							Front	Rear
68-69	Single System Steering Stabilizer; 1/2 Ton, 3/4 Ton & Travelall						6802SE ⁸⁴

1000D

69-70	Before Chassis #H-205000	I I	82049	○ ○	82030
-------	--------------------------	--------	------	-------	------	------	------	--------	------	-------	------	------	------

1000D STEERING STABILIZERS

							Front	Rear
69-70	Single System Steering Stabilizer; 1/2 Ton, 3/4 Ton & Travelall						6802SE ⁸⁴

1010

71-73	All	I I	82049	○ ○
71-72	Before Chassis #H-205000	I I	82049	○ ○	82030

1010 STEERING STABILIZERS

							Front	Rear
71-73	Single System Steering Stabilizer; 1/2 Ton, 3/4 Ton & Travelall						6802SE ⁸⁴

1100B

68	All	○ ○	82007	○ ○
	Exc. Travelette with 166" Wheelbase	○ ○	G63405	61500 81147 82007	77405	43048 ⁸	○ ○	G63405	61500 81147	77405	43048 ⁸ 49310 ⁷

1100B STEERING STABILIZERS





							Front	Rear
68-69	Single System Steering Stabilizer; 1/2 Ton, 3/4 Ton & Travelall						6802SE ⁸⁴

7 Pair Packs, air hose kit included.

8 Pair Packs.





150 84 Replacement damper for vehicles with the Gabriel Aftermarket mounting kit

APPLICATION GUIDE

Year	Fitment Notes										
			Ultra	ProGuard\ Guardian\ Classic	Max Control\ LTV	Strut Cushion\ Strut Mount	Hi Jacker\ Load Carrier		Ultra	ProGuard\ Guardian\ Classic	Max Control\ LTV

INTERNATIONAL



1100C

68	All		82007	
	Exc. Travelette with 166" Wheelbase		G63405	61500 81147 82007	77405	43048 ⁸		G63405	61500 81147	77405

1100C STEERING STABILIZERS

								Front		Rear		
68-69	Single System Steering Stabilizer; 1/2 Ton, 3/4 Ton & Travelall								6802SE ⁸⁴		



1100D

69-70	All		82030		82030
-------	-----	---	------	-------	------	------	------	---	------	-------	------	------	------

1100D STEERING STABILIZERS

								Front		Rear		
69-70	Single System Steering Stabilizer; 1/2 Ton, 3/4 Ton & Travelall								6802SE ⁸⁴		





1110

71-73	All		82030		82030
-------	-----	---	------	-------	------	------	------	---	------	-------	------	------	------

1110 STEERING STABILIZERS

								Front		Rear		
71-73	Single System Steering Stabilizer; 1/2 Ton, 3/4 Ton & Travelall								6802SE ⁸⁴		





1200B

68	Exc. Travelette with 166" Wheelbase		G63405	61500 81147 82007	77405	43048 ⁸		G63405	61500 81147	77405	43048 ⁸ 49310 ⁷
													

1200B STEERING STABILIZERS

								Front		Rear		
68-69	Single System Steering Stabilizer; 1/2 Ton, 3/4 Ton & Travelall								6802SE ⁸⁴		



1200C

68	Exc. Travelette with 166" Wheelbase		G63405	61500 81147 82007	77405	43048 ⁸		G63405	61500 81147	77405	43048 ⁸ 49310 ⁷
													

1200C STEERING STABILIZERS

								Front		Rear		
68-69	Single System Steering Stabilizer; 1/2 Ton, 3/4 Ton & Travelall								6802SE ⁸⁴		



1200D

69-70	All		82030		82030
-------	-----	---	------	-------	------	------	------	---	------	-------	------	------	------

1200D STEERING STABILIZERS

								Front		Rear		
69-70	Single System Steering Stabilizer; 1/2 Ton, 3/4 Ton & Travelall								6802SE ⁸⁴		





1210

71-73	All		82030		82030
-------	-----	---	------	-------	------	------	------	---	------	-------	------	------	------

1210 STEERING STABILIZERS

								Front		Rear		
71-73	Single System Steering Stabilizer; 1/2 Ton, 3/4 Ton & Travelall								6802SE ⁸⁴		





1300B

68	Exc. Travelette with 166" Wheelbase		G63405	61500 81147 82007	77405	43048 ⁸		G63405	61500 81147	77405	43048 ⁸ 49310 ⁷
													

1300B STEERING STABILIZERS

								Front		Rear		
68-69	Single System Steering Stabilizer; 1/2 Ton, 3/4 Ton & Travelall								6802SE ⁸⁴		

1300C

68	Exc. Travelette with 166" Wheelbase		G63405	61500 81147 82007	77405	43048 ⁸		G63405	61500 81147	77405	43048 ⁸ 49310 ⁷
													

1300C STEERING STABILIZERS



								Front		Rear		
68-69	Single System Steering Stabilizer; 1/2 Ton, 3/4 Ton & Travelall								6802SE ⁸⁴		

7 Pair Packs, air hose kit included.

8 Pair Packs.

84 Replacement damper for vehicles with the Gabriel Aftermarket mounting kit

APPLICATION GUIDE

Year	Fitment Notes										
		Ultra	ProGuard\ Guardian\ Classic	Max Control\ LTV	Strut Cushion\ Strut Mount	Hi Jacker\ Load Carrier	Ultra	ProGuard\ Guardian\ Classic	Max Control\ LTV	Strut Cushion\ Strut Mount	Hi Jacker\ Load Carrier

INTERNATIONAL

1300D

69-70	All	<input type="radio"/>	82030	<input type="radio"/>	82030
-------	-----	-----------------------------	-------	-------	-------	-------	-----------------------------	-------	-------	-------	-------

1300D STEERING STABILIZERS

69-70	Single System Steering Stabilizer; 1/2 Ton, 3/4 Ton & Travelall						Front	Rear
							6802SE ⁸⁴

1310

71-73	All	<input type="radio"/>	82030	<input type="radio"/>	82030
-------	-----	-----------------------------	-------	-------	-------	-------	-----------------------------	-------	-------	-------	-------

1310 STEERING STABILIZERS

71-73	Single System Steering Stabilizer; 1/2 Ton, 3/4 Ton & Travelall						Front	Rear
							6802SE ⁸⁴

M SERIES VAN

65-67	All	<input type="radio"/>	81318 82007	<input type="radio"/> G63405	61500 81147	77405	43048 ⁸ 49310 ⁷
-------	-----	-----------------------------	----------------	-------	-------	-------	------------------------------	----------------	-------	-------	--

M800 STEERING STABILIZERS

68-71	Single System Steering Stabilizer; 1/2 and 3/4 Ton I-Beam Axle						Front	Rear
							6802SE ⁸⁴

M1100 / M1200

68-72	All	<input type="radio"/>	81318 82007	<input type="radio"/> G63405	61500 81147	77405	43048 ⁸ 49310 ⁷
-------	-----	-----------------------------	----------------	-------	-------	-------	------------------------------	----------------	-------	-------	--

M1100 / M1200 STEERING STABILIZERS

68-72	Single System Steering Stabilizer; 1/2 and 3/4 Ton I-Beam Axle						Front	Rear
							6802SE ⁸⁴

M1400

69	All	<input type="radio"/>	82007	<input type="radio"/> G63405	61500 81147	77405	43048 ⁸ 49310 ⁷
----	-----	-----------------------------	-------	-------	-------	-------	------------------------------	----------------	-------	-------	--

M1400 STEERING STABILIZERS

69	Single System Steering Stabilizer; 1/2 and 3/4 Ton I-Beam Axle						Front	Rear
							6802SE ⁸⁴

SCOUT

61-71	All	<input type="radio"/>	82007	<input type="radio"/>	82039
-------	-----	-----------------------------	-------	-------	-------	-------	-----------------------------	-------	-------	-------	-------

SCOUT II

71-80	All	<input type="radio"/> G63350	61518 81242	58350	43099 ⁸	<input type="radio"/>	82030
-------	-----	------------------------------	----------------	-------	-------	--------------------	-----------------------------	-------	-------	-------	-------

SCOUT II STEERING STABILIZERS

71-80	Single System Steering Stabilizer						Front	Rear
							6803SE ⁸⁴

SCOUT STEERING STABILIZERS

69-71	Single System Steering Stabilizer						Front	Rear
							6803SE ⁸⁴

61-68	Single System Steering Stabilizer; 4WD; Scout 80, 800						Front	Rear
							6802SE ⁸⁴

TRAVELALL

75	All	<input type="radio"/>	82030	<input type="radio"/>
----	-----	-----------------------------	-------	-------	-------	-------	-----------------------------	-------	-------	-------	-------

TRAVELALL STEERING STABILIZERS

75	4WD, Single System Steering Stabilizer						Front	Rear
							6803SE ⁸⁴

	RWD						Front	Rear
							6802SE ⁸⁴

ISUZU

AMIGO

98-00	All	<input type="radio"/> G63611	61593 81872	<input type="radio"/> G63710	61610 81911
-------	-----	------------------------------	----------------	-------	-------	-------	------------------------------	----------------	-------	-------	-------





89-94	All	<input type="radio"/> G63909	61508 81507	77909	<input type="radio"/> G63928	61506 81318	49311 ⁷
-------	-----	------------------------------	----------------	-------	-------	-------	------------------------------	----------------	-------	-------	--------------------

ISUZU

7 Pair Packs, air hose kit included.

8 Pair Packs.



APPLICATION GUIDE

Year	Fitment Notes										
			ProGuard/ Guardian/ Classic	Max Control/ LTV	Strut Cushion/ Strut Mount	Hi Jacker/ Load Carrier		ProGuard/ Guardian/ Classic	Max Control/ LTV	Strut Cushion/ Strut Mount	Hi Jacker/ Load Carrier

ISUZU

ISUZU

























ASCENDER

03-08	All		G51718 ⁴⁵	143241 ⁵³	
	Coil(RearSpringType)		G51718 ⁴⁵	143241 ⁵³		G63842	61717





ASCENDER READYMOUNTS

		Front		Rear	
03-08	All	G57022 ⁴⁰		





HOMBRE

99-00	4WD		G63423	61531 81516	77423		G63422	61528 81482	58422 77422	43162 ⁸ 49213 ⁷	
00	All			G63422	61528 81482	58422 77422	43162 ⁸ 49213 ⁷	
	Sport Chassis		58423		G63422	61528 81482	58422 77422	43162 ⁸ 49213 ⁷	
	RWD, Exc. Sport Chassis		G63421	61504 81750	58421 77421	34051 ⁸		G63422	61528 81482	58422 77422	43162 ⁸ 49213 ⁷
99	All		G63423		G63422	61528 81482	58422 77422	43162 ⁸ 49213 ⁷	
	Sport Chassis		G63423	58423		G63422	61528 81482	58422 77422	43162 ⁸ 49213 ⁷	
	RWD, Exc. Sport Chassis		G63421	61504 81750	58421 77421	34051 ⁸		G63422	61528 81482	58422 77422	43162 ⁸ 49213 ⁷
96-98	All			G63422	61528 81482	58422 77422	43162 ⁸ 49213 ⁷	
	Sport Chassis		G63423	61531 81516	58423 77423		G63422	61528 81482	58422 77422	43162 ⁸ 49213 ⁷	
98	RWD, Exc. Sport Chassis		G63421	61504 81750	58421 77421	34051 ⁸		G63422	61528 81482	58422 77422	43162 ⁸ 49213 ⁷
96-97	RWD, Exc. Sport Chassis		G63421	61504 81750	58421 77421		G63422	61528 81482	58422 77422	43162 ⁸ 49213 ⁷	
	RWD; Exc. Sport Chassis		34051 ⁸		G63422	61528 81482	58422 77422	43162 ⁸ 49213 ⁷	



I-280

06	Coil(FrontSpringType)			G63882
	RWD, Coil(FrontSpringType) Exc. Z71 Off Road Package		G51850	





I-290

07-08	Coil(FrontSpringType)			G63882
	RWD, Coil(FrontSpringType) Exc. Z71 Off Road Package		G51850	









I-350

06	Torsion Bar(FrontSpringType)		G63884		G63879
----	------------------------------	---	--------	------	------	------	------	---	--------	------	------	------	------

I-370

08	Coil(FrontSpringType)			G63882
	RWD, Coil(FrontSpringType) Exc. Z71 Off Road Package		G51850	

I-MARK

88-89	All		G55719	
	XS		G55719		81558
85-87	All		G55719		81558
81-84	All		81322	

7 Pair Packs, air hose kit included.





40 ReadyMount Strut. Complete Assembled Unit.

53 Strut Mount. Hardware from O.E. Part may need to be reused.

8 Pair Packs.

45 Strut must be rotated to align notch with lower control arm.









APPLICATION GUIDE

Year	Fitment Notes										
		 Ultra	ProGuard/ Guardian/ Classic	Max Control/ LTV	Strut Cushion/ Strut Mount	Hi Jacker/ Load Carrier	 Ultra	ProGuard/ Guardian/ Classic	Max Control/ LTV	Strut Cushion/ Strut Mount	Hi Jacker/ Load Carrier



ISUZU

ISUZU









IMPULSE

90-92	All		G55780	143058 ⁵¹		143061 ⁵¹
	Exc. Lotus Suspension		G55780	142317 ⁵³ 143058 ⁵¹		142334 ⁵³ 143061 ⁵¹
	FWD		G55780	143058 ⁵¹		G55776	143061 ⁵¹
83-89	All		81322		81340





OASIS

96-99	All		G55877	142230 ⁵³ 143064 ⁵¹		G55821	142230 ⁵³ 143063 ⁵¹
-------	-----	---	--------	------	------	--	------	---	--------	------	------	------	--	------





PICKUP

81-95	All		77492		61506 81318
	4WD		G63909	61508 81507	77909 77492		G63928	61506 81318
	4WD, RWD		77492		61506 81318	49311 ⁷
	RWD		G63902	61501 81478	77902 77492		G63492	61506 81318











RODEO

98-04	All		G63611	61593 81872		G63710	61610 81911
91-97	All		G63611	61593 81872		G63610	61592 81937

STYLUS

91-93	All		G55780	143058 ⁵¹		G55776	143061 ⁵¹
	Exc. Lotus Suspension		G55780	142317 ⁵³ 143058 ⁵¹		G55776	142334 ⁵³ 143061 ⁵¹



TROOPER

00-02	All		G63707	61607		G63708	61608 81909
92-99	4WD		G63707	61607		G63708	61608 81909
89-91	4WD		G63495	61593 81553	77904		61586
87-88	4WD		G63495	61593 81553	77904		61558 82066
84-86	4WD		G63909	61508 81507	77909		G63928	61506 81318	49311 ⁷

TROOPER STEERING STABILIZERS

				Front	Rear
84-91	4WD, Single System Steering Stabilizer			6802SE ⁸⁴







VEHICROSS

99-01	All		G63707	61607		G63708	61608 81909
-------	-----	---	--------	-------	------	------	------	---	--------	----------------	------	------	------	------



JAGUAR

JAGUAR

S TYPE

00-06	Exc. Computer Active Technology Suspension		143242 ⁵³		143242 ⁵³
03-05	Mfg. to 6/02 Exc. Computer Active Technology Suspension			G51773
00-02	Mfg. to 6/02 Exc. Computer Active Technology Suspension		G51769		G51773

X-TYPE

02-08	Exc. CATS Computer Active Technology Suspension		G52276	
-------	---	---	--------	------	------	------	------	---	------	------	------	------	------	------





7 Pair Packs, air hose kit included.

51 Strut Cushion for use with the Strut/Cartridge/Shocks.

154 53 Strut Mount. Hardware from O.E. Part may need to be reused.



84 Replacement damper for vehicles with the Gabriel Aftermarket mounting kit

APPLICATION GUIDE

Year	Fitment Notes										
			Ultra	ProGuard/ Guardian/ Classic	Max Control/ LTV	Strut Cushion/ Strut Mount	Hi Jacker/ Load Carrier		Ultra	ProGuard/ Guardian/ Classic	Max Control/ LTV





JAGUAR

XJ6

87-94	Exc. Auto-Leveling System		G51711
72-86	All		69677
	4 units required		69677	G51161

JAGUAR

XJ12

94	Exc. Auto-Leveling System		G51711
81-92	All		69677
	4 units required		69677	G51161
73-79	All		69677
	4 units required		69677	G51161

XJS

76-96	All		69677	G51161
-------	-----	---	-------	------	------	------	------	------	------	--------	------	------

XK150

58-61	All		82123
-------	-----	--	------	------	------	------	------	------	------	------	-------	------







XKE

62-64	All		81270
-------	-----	---	------	------	------	------	------	------	------	------	-------	------

JEEP

JEEP





CHEROKEE

84-01	All		G63424	61535 81548	77424		G63425	61536 81549	77425	49226 ⁷
76-83	All		G63377	61519 81484	58377 77377	43058 ⁸		G63377	61519 81484	58377 77377	43058 ⁸ 49127 ⁷
75	All		G63377	61519 81484	58377 77377	43058 ⁸
74	All		G63377	61519 81484	58377 77377	43058 ⁸		81676









CHEROKEE STEERING STABILIZERS

		Front	Rear
84-01	All	14040
84-00	Single System Steering Stabilizer; with a factory mounting hole in the steering linkage.	6801SE ⁸⁰
75-83	4WD, Single System Steering Stabilizer	6804SE ⁸⁰
74	Single System Steering Stabilizer	6804SE ⁸⁰

CJ3

61-66	Exc. 5 Leaf Front Springs & Lift Kit		82007
65	2-4" Lift Kit			G63440 ⁵⁰
	Exc. Lift Kit			G63405

CJ5

82-83	2 - 4" Lift Kit		G63441 ⁵⁰			
	2" Lift Kit			G63443 ⁵⁰			
	3-4" Lift Kit			G63440 ⁵⁰			
	Exc. Lift Kit		G63377	61519 81484	77377		G63405	61500 81147	77405	43048 ⁸ 49310 ⁷
72-81	2-4" Lift Kit		G63443 ⁵⁰		G63440 ⁵⁰





7 Pair Packs, air hose kit included.

50 Bellows Kit No.141242 is recommended for use to protect piston rod from potentially harmful road debris.

8 Pair Packs.

80 Mounting bracket not required, install on O.E. Shock Mounts. See Ref. C for optional Steering Stabilizer Boots.



















APPLICATION GUIDE

Year	Fitment Notes										
		 Ultra	ProGuard/ Guardian/ Classic	Max Control/ LTV	Strut Cushion/ Strut Mount	Hi Jacker/ Load Carrier	 Ultra	ProGuard/ Guardian/ Classic	Max Control/ LTV	Strut Cushion/ Strut Mount	Hi Jacker/ Load Carrier

JEEP

JEEP



















CJ5 (cont'd)

72-81	Exc. Lift Kit		G63299	82007		G63405	61500 81147	77405	43048 ⁸ 49310 ⁷
66-71	All			61500	43048 ⁸ 49310 ⁷
	2-4" Lift Kit		G63443 ⁵⁰		G63440 ⁵⁰	61500	43048 ⁸ 49310 ⁷
	5 Leaf Front Springs; Exc. Lift Kit		81676		81676 61500	43048 ⁸ 49310 ⁷
	Exc. 5 Leaf Front Springs & Lift Kit		82007		81147 61500	43048 ⁸ 49310 ⁷
	Exc. Lift Kit			G63405	61500	77405	43048 ⁸ 49310 ⁷
61-65	Exc. 5 Leaf Front Springs & Lift Kit		82007	
65	2-4" Lift Kit			G63440 ⁵⁰
	Exc. Lift Kit			G63405

CJ5 STEERING STABILIZERS

		Front	Rear
66-83	Single System Steering Stabilizer	6802SE ⁸⁴
59-60	Single System Steering Stabilizer	6802SE ⁸⁴















CJ6

72-75	2-4" Lift Kit		G63443 ⁵⁰		G63440 ⁵⁰
	Exc. Lift Kit		G63299	82007		G63405	61500 81147	77405	43048 ⁸ 49310 ⁷
66-71	All			61500	43048 ⁸ 49310 ⁷
	2-4" Lift Kit		G63443 ⁵⁰		G63440 ⁵⁰	61500	43048 ⁸ 49310 ⁷
	5 Leaf Front Springs; Exc. Lift Kit		81676		81676 61500	43048 ⁸ 49310 ⁷
	Exc. 5 Leaf Front Springs & Lift Kit		82007		61500	43048 ⁸ 49310 ⁷
	Exc. Lift Kit			G63405	81147 61500	77405	43048 ⁸ 49310 ⁷
65	2-4" Lift Kit			G63440 ⁵⁰
	Exc. Lift Kit			G63405

CJ6 STEERING STABILIZERS

		Front	Rear
66-75	Single System Steering Stabilizer	6802SE ⁸⁴
59-60	Single System Steering Stabilizer	6802SE ⁸⁴



CJ7

83-86	2 - 4" Lift Kit		G63441 ⁵⁰	
82-86	2" Lift Kit			G63443 ⁵⁰
	3-4" Lift Kit			G63440 ⁵⁰
	Exc. Lift Kit		G63377	61519 81484	77377		G63405	61500 81147	77405	43048 ⁸ 49310 ⁷
82	2 - 4" Lift Kit		G63441	
76-81	2-4" Lift Kit		G63443 ⁵⁰		G63440 ⁵⁰
	Exc. Lift Kit		G63299	82007		G63405	61500 81147	77405	43048 ⁸ 49310 ⁷

CJ7 STEERING STABILIZERS

		Front	Rear
76-86	Single System Steering Stabilizer	6802SE ⁸⁴

COMANCHE

86-92	All		G63424	61535 81548	77424		G63492	61506 81318	77492
-------	-----	---	--------	----------------	-------	------	------	---	--------	----------------	-------	------	------





7 Pair Packs, air hose kit included.

50 Bellows Kit No.141242 is recommended for use to protect piston rod from

8 Pair Packs.

84 Replacement damper for vehicles with the Gabriel Aftermarket mounting kit

APPLICATION GUIDE

Year	Fitment Notes										
			Ultra	ProGuard\ Guardian\ Classic	Max Control\ LTV	Strut Cushion\ Strut Mount	Hi Jacker\ Load Carrier		Ultra	ProGuard\ Guardian\ Classic	Max Control\ LTV



JEEP

JEEP





COMANCHE STEERING STABILIZERS

		Front	Rear
86-92	All	14040
Single System Steering Stabilizer; with a factory mounting hole in the steering linkage.		6801SE ⁸⁰



COMMANDER

06-10	All		G56807	143364		G64012	61715
-------	-----	---	--------	------	------	--------	------	---	--------	-------	------	------	------





COMPASS

11-12	All	143337 ⁵³	
07-10	Left		G52081		G51842	143337 ⁵³
	Right		G52082		G51842	143337 ⁵³







DISPATCHER

61-67	All		81676		81676
-------	-----	---	------	-------	------	------	------	---	------	-------	------	------	------





DJ5

66-74	2-4" Lift Kit		G63443 ⁵⁰		G63440 ⁵⁰
	Exc. Lift Kit		G63299	82007		G63405	61500 81147	77405	43048 ⁸ 49310 ⁷



DJ6

66-68	All		82007		61500 81147	43048 ⁸ 49310 ⁷
	2-4" Lift Kit		G63443 ⁵⁰	82007		G63440 ⁵⁰	61500 81147	43048 ⁸ 49310 ⁷
	Exc. Lift Kit		82007		G63405	61500 81147	77405	43048 ⁸ 49310 ⁷













FC150

61-65	All		82007		81676	
57-60	All		82007		G63405	61500 81147	77405	43048 ⁸ 49310 ⁷

FC170

63-65	All		G63405	61500 81147	77405	43048 ⁸		G63405	61500 81147	77405	43048 ⁸ 49310 ⁷
-------	-----	---	--------	----------------	-------	------	------	--------------------	---	--------	----------------	-------	------	------	--





GLADIATOR

67	All		81318		61519 81484	43058 ⁸ 49127 ⁷
66	All		81318		81147	49310 ⁷
	Independent Front Suspension		81318		G63405	61500 81147	77405	43048 ⁸ 49310 ⁷
64-65	All			81147	49310 ⁷
	Exc. Independent Front Suspension		81318		81147	49310 ⁷
63-65	Independent Front Suspension			G63405	61500 81147	77405	43048 ⁸ 49310 ⁷

GLADIATOR STEERING STABILIZERS

		Front	Rear
63-67	Single System Steering Stabilizer	6803SE ⁸⁴

GRAND CHEROKEE

05-10	All		G56807	143364		G64012	61715
99-04	All		81869		G63829	61676 81926	77829

7 Pair Packs, air hose kit included.

50 Bellows Kit No.141242 is recommended for use to protect piston rod from potentially harmful road debris.

80 Mounting bracket not required, install on O.E. Shock Mounts. See Ref. C for optional Steering Stabilizer Boots.





Bold Type - New / Future Part

8 Pair Packs.

53 Strut Mount. Hardware from O.E. Part may need to be reused.

84 Replacement damper for vehicles with the Gabriel Aftermarket mounting kit







APPLICATION GUIDE

Year	Fitment Notes										
		 Ultra	ProGuard\ Guardian\ Classic	Max Control\ LTV	Strut Cushion\ Strut Mount	Hi Jacker\ Load Carrier	 Ultra	ProGuard\ Guardian\ Classic	Max Control\ LTV	Strut Cushion\ Strut Mount	Hi Jacker\ Load Carrier

JEEP

JEEP

GRAND CHEROKEE (cont'd)

99-04	Exc. Up Country Suspension		G63847	61664 81869	77847		G63829	61676 81926	77829
95-98	All		G63424	61535 81548	77424		G63683	61575 81891	77683
93-94	All		G63424	61535 81548	77424		G63626	61575 81891	77683



GRAND CHEROKEE READYMOUNTS

		Front	Rear
05-10	V8 Models	G57083 ⁴⁰

GRAND CHEROKEE STEERING STABILIZERS

		Front	Rear
99-04	Single System Steering Damper	14071
93-98	All	6853SE ⁸²



GRAND WAGONEER

84-91	All		G63377	61519 81484	58377 77377	43058 ⁸		G63377	61519 81484	58377 77377	43058 ⁸ 49127 ⁷
-------	-----	---	--------	----------------	----------------	------	--------------------	---	--------	----------------	----------------	------	--

GRAND WAGONEER STEERING STABILIZERS

		Front	Rear
84-91	Single System Steering Stabilizer	6804SE ⁸⁰



J10 PICKUP

74-88	All		G63377	61519 81484	77377	43058 ⁸		G63377	61519 81484	77377	43058 ⁸ 49127 ⁷
-------	-----	---	--------	----------------	-------	------	--------------------	---	--------	----------------	-------	------	--

J10 PICKUP STEERING STABILIZERS

		Front	Rear
74-88	Single System Steering Stabilizer	6804SE ⁸⁰



J20 PICKUP

74-88	All		G63377	61519 81484	77377	43058 ⁸		G63377	61519 81484	77377	43058 ⁸ 49127 ⁷
-------	-----	---	--------	----------------	-------	------	--------------------	---	--------	----------------	-------	------	--





J20 PICKUP STEERING STABILIZERS

		Front	Rear
74-88	Single System Steering Stabilizer	6804SE ⁸⁰

J2500 PICKUP

68-73	All		81318		61519 81484	43058 ⁸ 49127 ⁷
-------	-----	---	------	-------	------	------	------	---	------	----------------	------	------	--







JEEPSTER

70-73	All		82007		G63405	61500 81147	77405	43048 ⁸ 49310 ⁷
67-69	All		82007		82007

JEEPSTER STEERING STABILIZERS

		Front	Rear
66-73	Single System Steering Stabilizer	6802SE ⁸⁴

LIBERTY

12	All		G51728		G63844
02-11	Left		G51728	143255 ⁵³		G63844
	Right		G51728	143266 ⁵³		G63844

LIBERTY READYMOUNTS

		Front	Rear
02-12	Left	G57007 ⁴⁰
	Right	G57008 ⁴⁰

7 Pair Packs, air hose kit included.

40 ReadyMount Strut. Complete Assembled Unit.



80 Mounting bracket not required, install on O.E. Shock Mounts. See Ref. C for optional Steering Stabilizer Boots.

8 Pair Packs.

53 Strut Mount. Hardware from O.E. Part may need to be reused.

82 Use kit if listed, See Ref. C for optional Steering Stabilizer Boots.

APPLICATION GUIDE

Year	Fitment Notes										
		Ultra	ProGuard/ Guardian/ Classic	Max Control/ LTV	Strut Cushion/ Strut Mount	Hi Jacker/ Load Carrier	Ultra	ProGuard/ Guardian/ Classic	Max Control/ LTV	Strut Cushion/ Strut Mount	Hi Jacker/ Load Carrier

JEEP

JEEP

PATRIOT

Year	Fitment	Ultra	ProGuard/ Guardian/ Classic	Max Control/ LTV	Strut Cushion/ Strut Mount	Hi Jacker/ Load Carrier	Ultra	ProGuard/ Guardian/ Classic	Max Control/ LTV	Strut Cushion/ Strut Mount	Hi Jacker/ Load Carrier
11-12	All
07-10	Left	G52081	G51842	143337 ⁸³
	Right	G52082	G51842	143337 ⁸³

SCRAMBLER / CJ8

Year	Fitment	Ultra	ProGuard/ Guardian/ Classic	Max Control/ LTV	Strut Cushion/ Strut Mount	Hi Jacker/ Load Carrier	Ultra	ProGuard/ Guardian/ Classic	Max Control/ LTV	Strut Cushion/ Strut Mount	Hi Jacker/ Load Carrier
82-85	All	G63377	61519 81484	77377	G63405	61500 81147	77405	43048 ⁸ 49310 ⁷
81	All	G63299	82007	G63405	61500 81147	77405	43048 ⁸ 49310 ⁷

SCRAMBLER / CJ8 STEERING STABILIZERS

Year	Fitment	Front	Rear
81-85	Single System Steering Stabilizer	6802SE ⁸⁴

UNIVERSAL

Year	Fitment	Ultra	ProGuard/ Guardian/ Classic	Max Control/ LTV	Strut Cushion/ Strut Mount	Hi Jacker/ Load Carrier	Ultra	ProGuard/ Guardian/ Classic	Max Control/ LTV	Strut Cushion/ Strut Mount	Hi Jacker/ Load Carrier
66-67	All	82007	61500	43048 ⁸ 49310 ⁷
	2-4" Lift Kit	G63443 ⁵⁰	82007	G63440 ⁵⁰	61500	43048 ⁸ 49310 ⁷
	5 Leaf Front Springs; Exc. Lift Kit	81676 82007	81676 61500	43048 ⁸ 49310 ⁷
	Exc. CJ-3B	82007	81147 61500	43048 ⁸ 49310 ⁷
65-67	Exc. Lift Kit	82007	G63405	61500	77405	43048 ⁸ 49310 ⁷
65	All	82007	61500	77405	43048 ⁸ 49310 ⁷
	2-4" Lift Kit	G63443 ⁵⁰	82007	G63440 ⁵⁰	61500	77405	43048 ⁸ 49310 ⁷
	5 Leaf Front Springs; Exc. Lift Kit	81676 82007	81676 61500	77405	43048 ⁸ 49310 ⁷
	Exc. CJ-3B	82007	81147 61500	77405	43048 ⁸ 49310 ⁷
61-64	All	82007	G63405	61500	77405	43048 ⁸ 49310 ⁷
	5 Leaf Front Springs; Exc. Lift Kit	81676 82007	G63405	81676 61500	77405	43048 ⁸ 49310 ⁷
	Exc. CJ-3B	82007	G63405	81147 61500	77405	43048 ⁸ 49310 ⁷

UNIVERSAL STEERING STABILIZERS

Year	Fitment	Front	Rear
61-67	Single System Steering Stabilizer	6802SE ⁸⁴

WAGONEER

Year	Fitment	Ultra	ProGuard/ Guardian/ Classic	Max Control/ LTV	Strut Cushion/ Strut Mount	Hi Jacker/ Load Carrier	Ultra	ProGuard/ Guardian/ Classic	Max Control/ LTV	Strut Cushion/ Strut Mount	Hi Jacker/ Load Carrier
84-90	All	G63424	61535 81548	77424	G63425	61536 81549	77425	49226 ⁷
76-83	All	G63377	61519 81484	58377 77377	43058 ⁸	G63377	61519 81484	58377 77377	43058 ⁸ 49127 ⁷
75	All	G63377	61519 81484	58377 77377	43058 ⁸
74	All	G63377	61519 81484	58377 77377	43058 ⁸	G63299	81676
71-73	All	G63492	81318	77492	G63299	81676
68-70	All	G63492	81318	77492	81676
66-67	All	G63492	81318	77492	G63299	81676
63-65	All	G63299	81676
	Exc. Independent Front Suspension	G63492	81318	77492	G63299	81676
	Independent Front Suspension	81676	G63299	81676

7 Pair Packs, air hose kit included.

50 Bellows Kit No.141242 is recommended for use to protect piston rod from potentially harmful road debris.



84 Replacement damper for vehicles with the Gabriel Aftermarket mounting kit

Bold Type - New / Future Part

8 Pair Packs.

53 Strut Mount. Hardware from O.E. Part may need to be reused.

APPLICATION GUIDE

Year	Fitment Notes										
		Ultra	ProGuard\Guardian\Classic	Max Control\LTV	Strut Cushion\Strut Mount	Hi Jacker\Load Carrier	Ultra	ProGuard\Guardian\Classic	Max Control\LTV	Strut Cushion\Strut Mount	Hi Jacker\Load Carrier

JEEP

JEEP

WAGONEER STEERING STABILIZERS

		Front	Rear
63-67	Exc. Independent Front Suspension	6802SE ⁸⁴

WRANGLER

14	Unlimited Sahara, 4WD	77973
13	All	G64008	G63966
	Unlimited Sahara, 4WD	G64008	G63966	77973
07-12	All	G64008	61711
	17" Wheels	G64008	61711	G63967	61697
	Exc. 17" Wheels	G64008	61711	G63966	61696
12	Unlimited Sahara, 4WD	G64008	61711	77973
07-11	Unlimited Sahara, Unlimited X, 4WD	G64008	61711	77973
	X	G64008	61711	77973
97-06	TJ(MfrBodyCode)	G63721	61615 81936	G63722	61616 81929
87-95	YJ(MfrBodyCode)	G63511	61551 ⁶ 81691	G63490	61541 81583

WRANGLER STEERING STABILIZERS

		Front	Rear
97-06	TJ(MfrBodyCode) Single System Steering Stabilizer; with a factory mounting hole in the steering linkage.	6801SE ⁸⁰
94-95	YJ(MfrBodyCode) Single System Steering Stabilizer; with a factory mounting hole in the steering linkage.	6801SE ⁸⁰
87-92	YJ(MfrBodyCode) Single System Steering Stabilizer; with a factory mounting hole in the steering linkage.	6801SE ⁸⁰

KIA

KIA

AMANTI

07-09	All	143342 ⁵³
04-06	All	G51774	143419 ⁵³	G51825	143419 ⁵³

CADENZA

14	All	70068
----	-----	------	------	------	------	------	------	-------	------	------

MAGENTIS

07-10	Left	G52247	143381	70049
	Right	G52248	143382	70049
01-06	CAN	G51714	G51713	142419 ⁵³
06	Left	143381
	Right	143382

MAGENTIS READYMOUNTS

		Front	Rear
01-06	Left	G57090 ⁴⁰
	Right	G57091 ⁴⁰

OPTIMA

11	All	70068
07-10	Left	G52247	143381	70049
	Right	G52248	143382	70049
06	Left	143381	142419 ⁵³

6 It is recommended that when replacing shocks on vehicles with "quad shocks" all 4 shocks should be matched by series.

40 ReadyMount Strut. Complete Assembled Unit.





80 Mounting bracket not required, install on O.E. Shock Mounts. See Ref. C for optional Steering Stabilizer Boots.

7 Pair Packs, air hose kit included.

53 Strut Mount. Hardware from O.E. Part may need to be reused.

84 Replacement damper for vehicles with the Gabriel Aftermarket mounting kit



APPLICATION GUIDE

Year	Fitment Notes										
			Ultra	ProGuard\ Guardian\ Classic	Max Control\ LTV	Strut Cushion\ Strut Mount	Hi Jacker\ Load Carrier		Ultra	ProGuard\ Guardian\ Classic	Max Control\ LTV

KIA

KIA













OPTIMA (cont'd)

06	Right		143382	142419 ⁵³	
01-05	All		G51714		G51713	142419 ⁵³





OPTIMA READYMOUNTS

								Front	Rear
01-06	Left							G57090 ⁴⁰
	Right							G57091 ⁴⁰









RIO

06-11	Left		G52154		70036
	Right		G52155		70036
04-05	Left		G52015		70001
	Right		G52016		70001
01-03	Left		G56782	143227 ⁵³		69585 G63880
	Right		G56781	143227 ⁵³		69585 G63880











RONDO

07-11	Left		G52247		70049
	Right		G52248		70049

SEDONA

06-11	Left		G52257		G64071
	Right		G52258		G64071
02-05	Left		G52034	143458¹		70000
	Right		G52035	143458¹		70000

SEPHIA

01	Left Mfg. to 6/01			G56534
	Right Mfg. to 6/01			G56533
00	All		142856 ⁵⁴
	Left Mfg. to 6/01		142856 ⁵⁴		G56534	142642 ⁵³
	Right Mfg. to 6/01		142856 ⁵⁴		G56533	142641 ⁵³
	Non-ABS Left Mfg. to 6/01		G56532	142856 ⁵⁴
	Non-ABS Right Mfg. to 6/01		G56531	142856 ⁵⁴
98-99	Left		142856 ⁵⁴		G56534	142642 ⁵³
	Right		142856 ⁵⁴		G56533	142641 ⁵³
	Non-ABS Left		G56532
	Non-ABS Right		G56531

1 Future Part, available 1st Quarter of 2015.



53 Strut Mount. Hardware from O.E. Part may need to be reused.

Bold Type - New / Future Part

40 ReadyMount Strut. Complete Assembled Unit.

54 Kit with Mount and Bearing. Hardware from O.E. Part may need to be reused.





APPLICATION GUIDE

Year	Fitment Notes										
		Ultra	ProGuard/ Guardian/ Classic	Max Control/ LTV	Strut Cushion/ Strut Mount	Hi Jacker/ Load Carrier	Ultra	ProGuard/ Guardian/ Classic	Max Control/ LTV	Strut Cushion/ Strut Mount	Hi Jacker/ Load Carrier





KIA

KIA



SEPHIA (cont'd)

94-97	Left	 G56570	142643 ⁵³	 G56637	142642 ⁵³
	Right	 G56569	142643 ⁵³	 G56571	142641 ⁵³











SORENTO

03-06	Left	 G52036	143226 ⁵³	 G64032
	Right	 G52037	143226 ⁵³	 G64032

SPECTRA

04-09	Left	 G52160	 G52162	142535 ⁵³
	Right	 G52161	 G52163	142536 ⁵³
02-03	Left	 G56892	 G52017
	Right	 G56893	 G52018
00-01	Left	 G52063
	Left Mfg. to 6/01	 G56534
	Right	 G52064
	Right Mfg. to 6/01	 G56533



SPORTAGE

05-10	Left	 G56819	 G56822	142535 ⁵³
	Right	 G56820	 G56821	142536 ⁵³
00-02	Left	 G56787	143228 ⁶⁷	 G63720
	Right	 G56786	143228 ⁶⁷	 G63720
95-99	All	 G51227	143064 ⁵¹ 143228 ⁶⁷	 G63720









LAND ROVER

LAND ROVER

DISCOVERY

94-99	All	 G63506	 G63694
-------	-----	--	------	------	------	------	--	------	------	------	------





RANGE ROVER

94-95	All	 G63615
	Air(RearSpringType)	 G63615	 G63694
95	County Classic, Coil FrontSpringType & RearSpringType, Exc. Air-Leveling Suspension	 G63506
	County Classic, Exc. Air-Leveling Suspension	 G63615	 G63434
94	Coil(RearSpringType)	 G63615	 G63434
	County, Coil(RearSpringType)	 G63506

⁵¹ Strut Cushion for use with the Strut/Cartridge/Shocks.

⁵³ Strut Mount. Hardware from O.E. Part may need to be reused.



APPLICATION GUIDE

Year	Fitment Notes										
		 Ultra	ProGuard\ Guardian\ Classic	Max Control\ LTV	Strut Cushion\ Strut Mount	Hi Jacker\ Load Carrier	 Ultra	ProGuard\ Guardian\ Classic	Max Control\ LTV	Strut Cushion\ Strut Mount	Hi Jacker\ Load Carrier



















LEXUS

LEXUS

ES250

90-91	All	 G55590	143061 ⁵¹ 143281 ⁵³	 G55589	142250 ⁵³ 143061 ⁵¹
-------	-----	--	------	------	--	------	--	------	------	--	------





ES300

03	Exc. Electronic Adjustable Suspension	143202 ⁵³
	Left	 G56673
	Left Exc. Electronic Adjustable Suspension	 G56675
	Right	 G56674
	Right Exc. Electronic Adjustable Suspension	 G56676
97-02	All	143057 ⁵¹	143057 ⁵¹
02	Exc. Electronic Adjustable Suspension	143202 ⁵³ 143057 ⁵¹	142837 ⁵³ 143057 ⁵¹
	Left	 G56673	143057 ⁵¹	143057 ⁵¹
	Left Exc. Electronic Adjustable Suspension	143057 ⁵¹	 G55675	143057 ⁵¹
	Right	 G56674	143057 ⁵¹	143057 ⁵¹
	Right Exc. Electronic Adjustable Suspension	143057 ⁵¹	 G55676	143057 ⁵¹
97-01	Left Exc. Electronic Adjustable Suspension	 G56506	142650 ⁵⁴ 143057 ⁵¹	 G55675	142837 ⁵³ 143057 ⁵¹
	Right Exc. Electronic Adjustable Suspension	 G56514	142649 ⁵⁴ 143057 ⁵¹	 G55676	142837 ⁵³ 143057 ⁵¹
95-96	Left	 G56502	142836 ⁵⁴ 143057 ⁵¹	 G55675	143057 ⁵¹
	Right	 G56502	142836 ⁵⁴ 143057 ⁵¹	 G55676	143057 ⁵¹
92-94	All	142561 ⁵⁴ 143057 ⁵¹	143057 ⁵¹
	Left Sealed O.E. Struts	142561 ⁵⁴ 143057 ⁵¹	 G55675	143057 ⁵¹
	Right Sealed O.E. Struts	142561 ⁵⁴ 143057 ⁵¹	 G55676	143057 ⁵¹
	Sealed O.E. Struts	 G55914	142834 ⁵⁴ 142561 ⁵⁴ 143057 ⁵¹	143057 ⁵¹

ES300 READYMOUNTS

		Front	Rear
02	Left Exc. Electronic Adjustable Suspension	G56932 ⁴⁰
	Right Exc. Electronic Adjustable Suspension	G56933 ⁴⁰
97-01	Left Exc. Electronic Adjustable Suspension	G56930 ⁴⁰	G56932 ⁴⁰
	Right Exc. Electronic Adjustable Suspension	G56931 ⁴⁰	G56933 ⁴⁰
92-96	Left Exc. Electronic Adjustable Suspension	G56932 ⁴⁰
	Right Exc. Electronic Adjustable Suspension	G56933 ⁴⁰

ES330

04-06	Left Exc. Adaptive Variable Suspension	 G56721	143202 ⁵³	 G56728
	Right Exc. Adaptive Variable Suspension	 G56722	143202 ⁵³	 G56729

ES330 READYMOUNTS

		Front	Rear
04-06	Left	G57078 ⁴⁰
	Right	G57079 ⁴⁰





40 ReadyMount Strut. Complete Assembled Unit.

53 Strut Mount. Hardware from O.E. Part may need to be reused.

51 Strut Cushion for use with the Strut/Cartridge/Shocks.

54 Kit with Mount and Bearing. Hardware from O.E. Part may need to be reused.









APPLICATION GUIDE

Year	Fitment Notes										
		 Ultra	ProGuard/ Guardian/ Classic	Max Control/ LTV	Strut Cushion/ Strut Mount	Hi Jacker/ Load Carrier	 Ultra	ProGuard/ Guardian/ Classic	Max Control/ LTV	Strut Cushion/ Strut Mount	Hi Jacker/ Load Carrier





LEXUS

LEXUS



ES350

10-12	Left			G52103
	Right			G52104
07-09	Left		G56888		G52103
	Right		G56889		G52104



GS300

98-05	All		G56598	143200 ⁵³		G56599
93-97	All		G56594	143200 ⁵³		G56595





GS400

98-00	All		G56598	143200 ⁵³		G56599
-------	-----	---	--------	------	------	----------------------	------	---	--------	------	------	------	------

GS430

01-05	All		G56598	143200 ⁵³		G56599
-------	-----	---	--------	------	------	----------------------	------	---	--------	------	------	------	------



IS250

06-11	All			G51922
	Left		G51920		G51922









IS250 READYMOUNTS

								Front	Rear
06-11	Right							G57131⁴⁰



IS300

01-04	All		G51834		G51835
-------	-----	---	--------	------	------	------	------	---	--------	------	------	------	------



LS400

95-00	Exc. Auto-Leveling System			143198 ⁵³
	Coil(RearSpringType)		G56592		G56600
90-94	Exc. Auto-Leveling System		143199 ⁵³		143197 ⁵³
	Coil(RearSpringType)		G56592		G56593



LS430

01-06	All		G51832		G51833
-------	-----	---	--------	------	------	------	------	---	--------	------	------	------	------







LX450

96-97	All		G63615		G63616
-------	-----	---	--------	------	------	------	------	---	--------	------	------	------	------

LX470

98-06	Torsion Bar(FrontSpringType)		G63832		G63828
-------	------------------------------	---	--------	------	------	------	------	---	--------	------	------	------	------

RX300





99-03	Left		G56548	142650 ⁵⁴		142837 ⁵³
	Right		G56547	142649 ⁵⁴		142837 ⁵³
	AWD, Left			G56681

40 ReadyMount Strut. Complete Assembled Unit.

54 Kit with Mount and Bearing. Hardware from O.E. Part may need to be reused.

53 Strut Mount. Hardware from O.E. Part may need to be reused.

APPLICATION GUIDE

Year	Fitment Notes										
		 Ultra	ProGuard/ Guardian/ Classic	Max Control/ LTV	Strut Cushion/ Strut Mount	Hi Jacker/ Load Carrier	 Ultra	ProGuard/ Guardian/ Classic	Max Control/ LTV	Strut Cushion/ Strut Mount	Hi Jacker/ Load Carrier







LEXUS

LEXUS







RX300 (cont'd)

99-03	AWD, Right	 G56682
	FWD, Left	 G56554
	FWD, Right	 G56553

RX330

04-06	Left	 G56730	143202 ⁵³
	Right	 G56731	143202 ⁵³
	AWD, Left	 G56732
	AWD, Right	 G56733
	FWD, Left	 G56734
	FWD, Right	 G56735



RX350

07-09	Left	 G56730
	Right	 G56731
	AWD, Left	 G56732
	AWD, Right	 G56733
	FWD, Left	 G56734
	FWD, Right	 G56735



RX400H

06-07	All	143202 ⁵³
-------	-----	-------	-------	-------	----------------------	-------	-------	-------	-------	-------	-------

SC300

92-00	All	 G51709	 G51710	143196 ⁵³
-------	-----	--	-------	-------	-------	-------	--	-------	-------	----------------------	-------

SC400

92-00	All	 G51709	 G51710	143196 ⁵³
-------	-----	--	-------	-------	-------	-------	--	-------	-------	----------------------	-------



SC430

02-07	All	 G56598	143200 ⁵³
-------	-----	--	-------	-------	----------------------	-------	-------	-------	-------	-------	-------



LINCOLN

LINCOLN

AVIATOR

03-05	All	 G51836	 G51837
-------	-----	--	-------	-------	-------	-------	--	-------	-------	-------	-------

CONTINENTAL

82-87	All	 G55510 ³⁹	142220 ⁵⁴ 143059 ⁵¹	 69709 ⁹	81461	49196 ⁷
-------	-----	--	-------	-------	--	-------	--	-------	-------	-------	--------------------

7 Pair Packs, air hose kit included.

39 Conventional gas-charged strut can be used to replace O.E. air adjustable gas-charged strut. However, the self-leveling system must be deactivated. See Ref. A for instructions.





53 Strut Mount. Hardware from O.E. Part may need to be reused.

9 See Ref. D for procedures to replace Elec Adj Susp with non-adj product.

51 Strut Cushion for use with the Strut/Cartridge/Shocks.

54 Kit with Mount and Bearing. Hardware from O.E. Part may need to be reused.







APPLICATION GUIDE

Year	Fitment Notes										
		 Ultra	ProGuard\Guardian\Classic	Max Control\LTV	Strut Cushion\Strut Mount	Hi Jacker\Load Carrier	 Ultra	ProGuard\Guardian\Classic	Max Control\LTV	Strut Cushion\Strut Mount	Hi Jacker\Load Carrier





LINCOLN

LINCOLN



CONTINENTAL (cont'd)

70-80	All	 69675 ⁵	81446	34073 ⁸	 69606	81495	43140 ⁸ 49205 ⁷
64-69	All		82615		82067
61-63	All		82615	





LS

05-06	All		143242 ⁵³	 G51757	143242 ⁵³
00-04	All	 G51756	143242 ⁵³	 G51757	143242 ⁵³









MARK III

68-71	All	 69675 ⁵	81446	34073 ⁸	 69606	81495	43140 ⁸ 49205 ⁷
-------	-----	--	-------	------	------	--------------------	---	-------	------	------	--

MARK IV

73-76	All	 69675 ⁵	81446	34073 ⁸		82603
72	All	 69675 ⁵	81446	34073 ⁸	 69606	81495	43140 ⁸ 49205 ⁷



MARK LT

10-12	All	 G51864	 G64079
06-08	All		143248 ⁵³	
	4WD	 G51704	143248 ⁵³	 G63867
	RWD	 G51703	143248 ⁵³	 G63870



MARK LT READYMOUNTS

		Front	Rear
06-08	4WD	G57020 ⁴⁰
	RWD	G57021 ⁴⁰



MARK V

77-79	All	 69675 ⁵	81446	34073 ⁸		82603
-------	-----	--	-------	------	------	--------------------	--	-------	------	------	------









MARK VI

80-83	All	 69675 ⁵	81446	34073 ⁸	 69606	81495	43140 ⁸ 49205 ⁷
-------	-----	--	-------	------	------	--------------------	---	-------	------	------	--

MARK VII

84-92	All	 G55510 ³⁹	142220 ⁵⁴ 143059 ⁵¹	 69709 ⁹	81461
-------	-----	--	------	------	--	------	--	-------	------	------	------

MKX

10	Left	 G56840	
	Right	 G56841	
07-09	Left	 G56840	 G64037
	Right	 G56841	 G64037

5 Use kit No. 140719 to replace O.E. hardware for lower shock absorber mounting when studs break or self-tapping screws are not longer useable.

8 Pair Packs.

39 Conventional gas-charged strut can be used to replace O.E. air adjustable gas-charged strut. However, the self-leveling system must be deactivated. See Ref. A for instructions.

51 Strut Cushion for use with the Strut/Cartridge/Shocks.



7 Pair Packs, air hose kit included.

9 See Ref. D for procedures to replace Elec Adj Susp with non-adj product.

40 ReadyMount Strut. Complete Assembled Unit.





53 Strut Mount. Hardware from O.E. Part may need to be reused.

APPLICATION GUIDE

Year	Fitment Notes										
		Ultra	ProGuard\ Guardian\ Classic	Max Control\ LTV	Strut Cushion\ Strut Mount	Hi Jacker\ Load Carrier	Ultra	ProGuard\ Guardian\ Classic	Max Control\ LTV	Strut Cushion\ Strut Mount	Hi Jacker\ Load Carrier







LINCOLN

MKZ













10-12	Left		G51896	143392 ⁵³
	Right		G51897	143392 ⁵³
	FWD		69591
07-09	All		G51859	143392 ⁵³
	FWD		G51859	143392 ⁵³	69591

LINCOLN



NAVIGATOR

07-12	All		G51860		G51861
03-05	All		143244 ⁵³
98-02	4WD, Air(RearSpringType)			G64002	61703
	Coil(FrontSpringType)		61611
	RWD		G63714	81912	58714 77714		G63717	61614	77717
	RWD, Coil(FrontSpringType)			58717



TOWN CAR

07-11	All			69575
	Exc. Limo		143356 ⁵³ 143357 ⁵⁸		69575
04-06	All		G51887		69575
	Exc. Limo		G51887	143356 ⁵³ 143357 ⁵⁸		69575
03	All			69575
	Exc. Limo		143356 ⁵³ 143357 ⁵⁸		69575
	Mfg. to 12/05		G51887		69575
81-02	All		69675 ⁵	81446		69606	81495	43140 ⁶ 49205 ⁷

VERSAILLES



77-80	All		81491		82130
-------	-----	---	------	-------	------	------	------	---	------	-------	------	------	------

ZEPHYR



06	All		G51859	143392 ⁵³		69591
----	-----	---	--------	------	------	-----------------------------	------	---	-------	------	------	------	------

MAZDA

2

12-14	All			70052
11	Left		G52255		70052
	Right		G52256		70052

3

10-12	Exc. Mazdaspeed Left		G52005
	Exc. Mazdaspeed Right		G52006

5 Use kit No. 140719 to replace O.E. hardware for lower shock absorber mounting when studs break or self-tapping screws are not longer useable.

8 Pair Packs.





68 Mount Hardware Kit. Hardware from O.E. Part may need to be reused.

Bold Type - New / Future Part

7 Pair Packs, air hose kit included.

53 Strut Mount. Hardware from O.E. Part may need to be reused.







APPLICATION GUIDE

Year	Fitment Notes										
		 Ultra	ProGuard/ Guardian/ Classic	Max Control/ LTV	Strut Cushion/ Strut Mount	Hi Jacker/ Load Carrier	 Ultra	ProGuard/ Guardian/ Classic	Max Control/ LTV	Strut Cushion/ Strut Mount	Hi Jacker/ Load Carrier

MAZDA

MAZDA





3 (cont'd)

04-09	Exc. Mazdaspeed Left		G52005	143365 ⁵³		70003
	Exc. Mazdaspeed Right		G52006	143365 ⁵³		70003
04-06	All			70003

3 READYMOUNTS

		Front	Rear
04-12	Exc. Mazdaspeed Left	G57093 ⁴⁰
	Exc. Mazdaspeed Right	G57094 ⁴⁰









5

06-10	Left		G52005		70003
	Right		G52006		70003









5 READYMOUNTS

		Front	Rear
06-10	Left	G57093 ⁴⁰
	Right	G57094 ⁴⁰

6

05-08	Left		G51810	143392 ⁵³		69591
	Right		G51811	143392 ⁵³		69591
03-04	Left		G51810	143224 ⁵³		69591
	Right		G51811	143224 ⁵³		69591













323

90-94	All		G55847	142854 ⁵⁴ 143057 ⁵¹		G55848	142190 ⁵³
86-89	Exc. Electronic Adjustable Suspension		142183 ⁵³		142189 ⁵³
	FWD		143058 ⁵¹		143058 ⁵¹
	FWD, Exc. Electronic Adjustable Suspension		G55710		G55544

323 READYMOUNTS

		Front	Rear
95	All	G56940 ⁴⁰
91-94	All	G56911 ⁴⁰	G56940 ⁴⁰
90	All	G56911 ⁴⁰

626

98-02	Left		G56689	143218 ⁵³		G56691	143113 ⁵³
	Right		G56690	143218 ⁵³		G56691	143112 ⁵³
93-97	All		142571 ⁶¹ 142856 ⁵⁴		G55672	143057 ⁵¹
	Left		G55671	142571 ⁶¹ 142856 ⁵⁴		G55672	142403 ⁵³ 143057 ⁵¹
	Right		G55670	142571 ⁶¹ 142856 ⁵⁴		G55672	142404 ⁵³ 143057 ⁵¹
89-92	Automatic Exc. Electronic Adjustable Suspension or 4 Wheel Steer		142562 ⁵⁸ 142569 ⁶¹ 142852 ⁵⁴	

40 ReadyMount Strut. Complete Assembled Unit.

53 Strut Mount. Hardware from O.E. Part may need to be reused.



58 Mount Kit includes Suspension Bearing. Hardware from O.E. Part may need to be reused.

51 Strut Cushion for use with the Strut/Cartridge/Shocks.

54 Kit with Mount and Bearing. Hardware from O.E. Part may need to be reused.

61 Mount Kit includes Upper Spring Seat. Hardware from O.E. Part may need to be reused.







APPLICATION GUIDE

Year	Fitment Notes										
		Ultra	ProGuard/ Guardian/ Classic	Max Control/ LTV	Strut Cushion/ Strut Mount	Hi Jacker/ Load Carrier	Ultra	ProGuard/ Guardian/ Classic	Max Control/ LTV	Strut Cushion/ Strut Mount	Hi Jacker/ Load Carrier

MAZDA

MAZDA





626 (cont'd)

88-92	Exc. Electronic Adjustable Suspension or 4 Wheel Steer		G55600 ⁹	143060 ⁵¹		G55601 ⁹	142196 ⁵³ 143057 ⁵¹
	Standard Exc. Electronic Adjustable Suspension or 4 Wheel Steer		142570 ⁵¹ 142803 ⁵⁴
88	Automatic		142569 ⁵¹
	Automatic Exc. Electronic Adjustable Suspension or 4 Wheel Steer		142562 ⁵⁸ 142852 ⁵⁴
86-87	Exc. Electronic Adjustable Suspension		G55727		G55729
	Automatic Exc. Electronic Adjustable Suspension		143057 ⁵¹	143057 ⁵¹
	Standard Exc. Electronic Adjustable Suspension		142855 ⁵⁴
83-85	All		143057 ⁵¹	143057 ⁵¹
	Exc. Electronic Adjustable Suspension		G55727	142855 ⁵⁴ 143057 ⁵¹		G55729	143057 ⁵¹
79-82	From Chassis # CB2MS-543879			69880



808

72-77	Wagon Exc. Vehicles with Tokico O.E. Struts			81270
-------	---	--	------	------	------	------	------	---	------	-------	------	------	------



929

90-91	Exc. Electronic Adjustable Suspension		G56716		G51192 ⁹
88-89	Exc. Electronic Adjustable Suspension		G56713	142562 ⁵⁸ 142853 ⁵⁴		G51192 ⁹





B1600

72-76	All		G63421	61504 81750	58421 77421		61502 82125
-------	-----	---	--------	----------------	----------------	------	------	---	------	----------------	------	------	------





B1800

77-78	All		G63421	61504 81750	58421 77421		61502 82125
-------	-----	---	--------	----------------	----------------	------	------	---	------	----------------	------	------	------







B2000

86-87	RWD		G63495	61593 81553		G63907	61500 81147	77907	43048 ⁸ 49310 ⁷
79-84	All		G63421	61504 81750	58421 77421		61502 82125



B2200

87-93	RWD		G63495	61593 81553		G63907	61500 81147	77907	43048 ⁸ 49310 ⁷
82-84	All		G63421	61504 81750	58421 77421		61502 82125

B2300

01-06	RWD		G63772	61626 81916	77772		G63773	61627	77525
94-97	All		G63614	61561 81744	58929 77614
	RWD		G63614	61561 81744	58929 77614		G63525	61559 81730	77525	49223 ⁷
95-96	4WD		G63614	61561 81744	58929 77614		G63524	61573 81905	77524

B2500

98-01	All			81917
	RWD		G63772	61626 81916	77772		G63773	61627 81917	77525

7 Pair Packs, air hose kit included.

9 See Ref. D for procedures to replace Elec Adj Susp with non-adj product.

53 Strut Mount. Hardware from O.E. Part may need to be reused.

58 Mount Kit includes Suspension Bearing. Hardware from O.E. Part may need to be reused.





8 Pair Packs.

51 Strut Cushion for use with the Strut/Cartridge/Shocks.

54 Kit with Mount and Bearing. Hardware from O.E. Part may need to be reused.

61 Mount Kit includes Upper Spring Seat. Hardware from O.E. Part may need to be reused.





APPLICATION GUIDE

Year	Fitment Notes										
		 Ultra	ProGuard/ Guardian/ Classic	Max Control/ LTV	Strut Cushion/ Strut Mount	Hi Jacker/ Load Carrier	 Ultra	ProGuard/ Guardian/ Classic	Max Control/ LTV	Strut Cushion/ Strut Mount	Hi Jacker/ Load Carrier





















MAZDA

MAZDA

















B2600

87-93	4WD		G63635	61596		G63639	61597 81907
	RWD		G63495	61593 81553		G63907	61500 81147	77907	43048 ⁸ 49310 ⁷





B3000

98-06	4WD		G63678	61623 81893	77678		G63775	61629 81918	77524
	RWD		G63772	61626 81916	77772		G63773	61627 81917	77525
94-97	All		G63614	61561	
	4WD		G63614	61561		G63524	81905
97	RWD		G63614	61561	77614		G63525	61559	77525
96	4WD, RWD		G63614	81744 61561	
	RWD		G63614	61561	77614		G63525	61559 81730	77525
95	RWD		G63614	81744 61561	77614		G63525	61559	77525
94	4WD, RWD		G63614	81744 61561	
	RWD		G63614	61561	77614		G63525	61559 81730	77525





B4000

05-06	4WD		G63678	61623 81893	77678		G63775	61629	77524
	RWD		G63772	61626	77772		G63773	61627	77525
98-04	4WD		G63678	61623 81893	77678		G63775	61629 81918	77524
	RWD		G63772	61626 81916	77772		G63773	61627 81917	77525
95-97	RWD		G63614	61561 81744	77614		G63525	77525
94-97	All		G63614	81744	
	4WD		G63614	81744		G63524	81905
94	RWD		G63614	61561 81744	77614		G63525	61559	77525











CX-7

07-10	Left		G52209		G64056
	Right		G52210		G64056

CX-9

07-13	Left		G52260	
	Right		G52261	

GLC

84-85	All		G55710		143057 ⁵¹
	Hatchback		G55710	142183 ⁵³ 143059 ⁵¹		G55544	142189 ⁵³ 143057 ⁵¹
81-85	Sedan		G55710	142183 ⁵³ 143059 ⁵¹		G55544	142189 ⁵³ 143057 ⁵¹
79-83	Wagon			81270	49105 ⁷
83	Hatchback		142183 ⁵³ 143059 ⁵¹		G55544	142189 ⁵³ 143057 ⁵¹





7 Pair Packs, air hose kit included.

8 Pair Packs.

170 51 Strut Cushion for use with the Strut/Cartridge/Shocks.

53 Strut Mount. Hardware from O.E. Part may need to be reused.



APPLICATION GUIDE

Year	Fitment Notes										
		 Ultra	ProGuard/ Guardian/ Classic	Max Control/ LTV	Strut Cushion/ Strut Mount	Hi Jacker/ Load Carrier	 Ultra	ProGuard/ Guardian/ Classic	Max Control/ LTV	Strut Cushion/ Strut Mount	Hi Jacker/ Load Carrier











MAZDA

MAZDA





GLC (cont'd)

81-82	Hatchback	 G55710	142183 ⁵³ 143059 ⁵¹	 G55544	142189 ⁵³ 143057 ⁵¹
78	All	81270	49105 ⁷





















MIATA

04-05	Base, LS	 G56596	 G56597
03-05	Exc. Sport Package	142738 ⁵³	142738 ⁵³
03	Base, LS, SE	 G56596	 G56597
99-02	All	 G56596	 G56597
	Exc. Sport Package	 G56596	142738 ⁵³	 G56597	142738 ⁵³
90-97	Non-ABS	 G51195	142237 ⁵⁴	 G51196	142237 ⁵⁴ 143064 ⁵¹
90	All	143064 ⁵¹



MILLENNIA

95-02	Left	 G51827	 G51826	143116 ⁵³
	Right	 G51828	 G51826	143116 ⁵³

MPV

01-06	Left	 G56625	142562 ⁵⁸ 143061 ⁵¹ 143267 ⁵³	 69782 G63864
	Right	 G56624	142562 ⁵⁸ 143061 ⁵¹ 143267 ⁵³	 69782 G63864
00	All	142562 ⁵⁸ 143061 ⁵¹ 143267 ⁵³	 69782 G63864
	Left Mfg. from 8/00	 G56625	142562 ⁵⁸ 143061 ⁵¹ 143267 ⁵³	 69782 G63864
	Left Mfg. to 8/00	 G56589	142562 ⁵⁸ 143061 ⁵¹ 143267 ⁵³	 69782 G63864
	Right Mfg. from 8/00	 G56624	142562 ⁵⁸ 143061 ⁵¹ 143267 ⁵³	 69782 G63864
	Right Mfg. to 8/00	 G56588	142562 ⁵⁸ 143061 ⁵¹ 143267 ⁵³	 69782 G63864
	95-98	4WD	 G56715	 G63640	61598
	RWD	 G56714	 G63606	61589	49229 ⁷
89-94	All	142325 ⁵³
	4WD	142325 ⁵³	 G63640	61598
	4WD, Exc. Hydraulic Self Leveling System	 G56715	142325 ⁵³
	RWD	 G56714	142325 ⁵³	 G63606	61589	49229 ⁷

MX-5

06-08	All	 G51906	 G51907
-------	-----	--	------	------	------	------	--	------	------	------	------

7 Pair Packs, air hose kit included.



53 Strut Mount. Hardware from O.E. Part may need to be reused.

58 Mount Kit includes Suspension Bearing. Hardware from O.E. Part may need to be reused.

51 Strut Cushion for use with the Strut/Cartridge/Shocks.

54 Kit with Mount and Bearing. Hardware from O.E. Part may need to be reused.



APPLICATION GUIDE

Year	Fitment Notes										
		Ultra	ProGuard/ Guardian/ Classic	Max Control/ LTV	Strut Cushion/ Strut Mount	Hi Jacker/ Load Carrier	Ultra	ProGuard/ Guardian/ Classic	Max Control/ LTV	Strut Cushion/ Strut Mount	Hi Jacker/ Load Carrier









MAZDA

MAZDA



MX-5 MIATA

06-08	All		G51906	143412 ¹		G51907	143412 ¹
-------	-----	---	--------	------	------	---------------------	------	---	--------	------	------	---------------------	------

MX6

93-97	All	142571 ⁶¹ 142856 ⁵⁴		G55672	143057 ⁵¹	
	Exc. Electronic Adjustable Suspension or 4 Wheel Steer	143060 ⁵¹ 142571 ⁶¹ 142856 ⁵⁴		G55672	143057 ⁵¹	
	Left		G55671	142571 ⁶¹ 142856 ⁵⁴		G55672	142403 ⁵³ 143057 ⁵¹
	Right		G55670	142571 ⁶¹ 142856 ⁵⁴		G55672	142404 ⁵³ 143057 ⁵¹
89-92	Automatic	142569 ⁶¹	143057 ⁵¹	
	Standard Exc. Electronic Adjustable Suspension or 4 Wheel Steer	142570 ⁶¹ 142803 ⁵⁴	143057 ⁵¹	
88-92	All	143057 ⁵¹	
	Exc. Electronic Adjustable Suspension or 4 Wheel Steer		G55600 ⁹	143060 ⁵¹		G55601 ⁹	142196 ⁵³ 143057 ⁵¹
	Automatic Exc. Electronic Adjustable Suspension or 4 Wheel Steer	142562 ⁵⁸ 142852 ⁵⁴	143057 ⁵¹	
88	Standard Exc. Electronic Adjustable Suspension or 4 Wheel Steer	142803 ⁵⁴	143057 ⁵¹	

NAVAJO

91-94	All		G63608	61591 81744	58929 77608	34076 ⁸		G63607	61590 81823	77607	43172 ⁸ 49225 ⁷
-------	-----	---	--------	----------------	----------------	------	--------------------	---	--------	----------------	-------	------	--











NAVAJO STEERING STABILIZERS

91-94	All									Front	Rear		
-------	-----	--	--	--	--	--	--	--	--	-------	------	--	--

6802SE⁸⁴

....

PROTÉGÉ / PROTÉGÉS

03	All	143057 ⁵¹		143058 ⁵¹	
	Left	143057 ⁵¹		G56538	143221 ⁵³ 143058 ⁵¹	
	Left Mfg. from 10/00		G56634	143057 ⁵¹	143058 ⁵¹	
	Right	143057 ⁵¹		G56537	143223 ⁵³ 143058 ⁵¹	
	Right Mfg. from 10/00		G56633	143057 ⁵¹	143058 ⁵¹	
	DX, ES, LX, SE, Left	143219 ⁵³ 143057 ⁵¹	143221 ⁵³ 143058 ⁵¹	
	DX, ES, LX, SE, Right	143219 ⁵³ 143057 ⁵¹	143223 ⁵³ 143058 ⁵¹	
	Exc. MP3 and Mazdaspeed Models Left	143057 ⁵¹		G56538	143058 ⁵¹
	Exc. MP3 and Mazdaspeed Models Right	143057 ⁵¹		G56537	143058 ⁵¹
01-02	Exc. MP3 and Mazdaspeed Models Left	143057 ⁵¹ 143219 ⁵³		G56538	143058 ⁵¹	
	Exc. MP3 and Mazdaspeed Models Right	143057 ⁵¹ 143219 ⁵³		G56537	143058 ⁵¹	
00-02	Left Mfg. from 10/00		G56634	143057 ⁵¹ 143219 ⁵³	143058 ⁵¹	

1 Future Part, available 1st Quarter of 2015.

8 Pair Packs.

51 Strut Cushion for use with the Strut/Cartridge/Shocks.

54 Kit with Mount and Bearing. Hardware from O.E. Part may need to be reused.

61 Mount Kit includes Upper Spring Seat. Hardware from O.E. Part may need to be reused.

7 Pair Packs, air hose kit included.



9 See Ref. D for procedures to replace Elec Adj Susp with non-adj product.

53 Strut Mount. Hardware from O.E. Part may need to be reused.

58 Mount Kit includes Suspension Bearing. Hardware from O.E. Part may need to be reused.

84 Replacement damper for vehicles with the Gabriel Aftermarket mounting kit

















APPLICATION GUIDE

Year	Fitment Notes										
		Ultra	ProGuard/ Guardian/ Classic	Max Control/ LTV	Strut Cushion/ Strut Mount	Hi Jacker/ Load Carrier	Ultra	ProGuard/ Guardian/ Classic	Max Control/ LTV	Strut Cushion/ Strut Mount	Hi Jacker/ Load Carrier

MAZDA

MAZDA





PROTÉGÉ / PROTÉGÉS (cont'd)

00-02	Right Mfg. from 10/00		G56633	143057 ⁵¹ 143219 ⁵³	143058 ⁵¹	
99-02	All		143057 ⁵¹ 143219 ⁵³	143058 ⁵¹	
02	Left		143057 ⁵¹ 143219 ⁵³		G56538	143221 ⁵³ 143058 ⁵¹
	Right		143057 ⁵¹ 143219 ⁵³		G56537	143223 ⁵³ 143058 ⁵¹
01	Left		143057 ⁵¹ 143219 ⁵³	143221 ⁵³ 143058 ⁵¹
	Right		143057 ⁵¹ 143219 ⁵³	143223 ⁵³ 143058 ⁵¹
99-00	Left		143057 ⁵¹ 143219 ⁵³		G56538	143221 ⁵³ 143058 ⁵¹
	Left Mfg. to 10/00		G56536	143057 ⁵¹ 143219 ⁵³	143058 ⁵¹
	Right		143057 ⁵¹ 143219 ⁵³		G56537	143223 ⁵³ 143058 ⁵¹
	Right Mfg. to 10/00		G56535	143057 ⁵¹ 143219 ⁵³	143058 ⁵¹
95-98	All		142851 ⁵⁴ 143057 ⁵¹	143058 ⁵¹
	Left		G55882	142851 ⁵⁴ 143057 ⁵¹		G55884	143220 ⁵³ 143058 ⁵¹
	Right		G55881	142851 ⁵⁴ 143057 ⁵¹		G55883	143222 ⁵³ 143058 ⁵¹
92-94	All		143057 ⁵¹		143058 ⁵¹
	FWD, Non-ABS		G55847	142854 ⁵⁴ 143057 ⁵¹		G55848	142190 ⁵³ 143058 ⁵¹
90-91	All		142854 ⁵⁴ 143057 ⁵¹
	FWD		142854 ⁵⁴ 143057 ⁵¹	143058 ⁵¹
	FWD, Non-ABS		G55847	142854 ⁵⁴ 143057 ⁵¹		G55848	142190 ⁵³

PROTÉGÉ / PROTÉGÉS READYMOUNTS

		Front	Rear
90-94	All	G56911 ⁴⁰	G56940 ⁴⁰





RX3

75-76	Wagon			81270
	Wagon Exc. Models with Tokico O.E. Struts			49105 ⁷
74	All			49105 ⁷
	Wagon			81270	49105 ⁷
72-73	All			81270	49105 ⁷

RX4

74-78	All			81270	49105 ⁷
-------	-----	--	------	------	------	------	------	---	-------	------	------	--------------------

RX7

86-91	All		143059 ⁵¹	143063 ⁵¹
	Exc. Electronic Adjustable Suspension		G55542 ⁹	143059 ⁵¹		G51031 ⁹	143063 ⁵¹
81-85	GS, S		G44735 ⁹⁸		69674
79-85	All			69674

7 Pair Packs, air hose kit included.

40 ReadyMount Strut. Complete Assembled Unit.

53 Strut Mount. Hardware from O.E. Part may need to be reused.



98 Notice: The level of difficulty to install this product is moderately high. Please review the installation instructions carefully before proceeding.

9 See Ref. D for procedures to replace Elec Adj Susp with non-adj product.

51 Strut Cushion for use with the Strut/Cartridge/Shocks.

54 Kit with Mount and Bearing. Hardware from O.E. Part may need to be reused.



APPLICATION GUIDE

Year	Fitment Notes										
		Ultra	ProGuard\ Guardian\ Classic	Max Control\ LTV	Strut Cushion\ Strut Mount	Hi Jacker\ Load Carrier	Ultra	ProGuard\ Guardian\ Classic	Max Control\ LTV	Strut Cushion\ Strut Mount	Hi Jacker\ Load Carrier















MAZDA

MAZDA

RX8

04-08	All	 G51923	 G51924
-------	-----	--	------	------	------	------	--	------	------	------	------

TRIBUTE

10-11	Left	 G56601	 G64047
	Right	 G56568	 G64047
08-09	Left	 G56601	143253 ⁵³	 G64047
	Right	 G56568	143253 ⁵³	 G64047
01-06	Left	 G56601	143253 ⁵³	 69900  G63862
	Right	 G56568	143253 ⁵³	 69900  G63862



TRIBUTE READYMOUNTS

		Front	Rear
08-11	Left	G57045 ⁴⁰
	Right	G57046 ⁴⁰
01-06	Left	G57045 ⁴⁰
	Right	G57046 ⁴⁰



MERCEDES-BENZ

MERCEDES-BENZ

190D

84-89	All	 G55527	142326 ⁵³	 69995
-------	-----	--	------	------	----------------------	------	---	------	------	------	------



190E

84-93	All	 G55527	142326 ⁵³	 69995
-------	-----	--	------	------	----------------------	------	---	------	------	------	------





190SL

62-63	All	 82069
-------	-----	------	------	------	------	------	---	------	------	------	------









200D

69-73	All	 69766
68	All	 69661	 69766





220 / 220D

69-73	All	 69766
	W115	 69661	 69766
68	All	 69661	 69766





230

77-78	Exc. W115	 69996	 69766
74-78	All	 69766
74-76	W115	 69661	 69766
68-69	All	 69766
69	W115	 69661	 69766

240D

76-83	W123	 69996	 69766
74-83	All	 69766
74-76	W115	 69661	 69766

APPLICATION GUIDE

Year	Fitment Notes										
		 Ultra	ProGuard/ Guardian/ Classic	Max Control/ LTV	Strut Cushion/ Strut Mount	Hi Jacker/ Load Carrier	 Ultra	ProGuard/ Guardian/ Classic	Max Control/ LTV	Strut Cushion/ Strut Mount	Hi Jacker/ Load Carrier





MERCEDES-BENZ

MERCEDES-BENZ



250

68-70	All	 69766
-------	-----	-------	-------	-------	-------	-------	---	-------	-------	-------	-------





260E

87-89	4 Matic	 69995
	Exc. 4 Matic 4x4	 G55527	142326 ⁵³
	Exc. Hydromat Suspension	 69996	 69766









280

76	All	 69996	 69766
----	-----	---	-------	-------	-------	-------	---	-------	-------	-------	-------











280C

73-76	All	 69766
	W115	 69661	 69766
76	Exc. W115	 69996	 69766



280CE / 280E / 280S / 280SE / 280SEL

77-81	All	 69996	 69766
75-80	Exc. Hydromat Suspension	 69996	 69766
73	Exc. Hydromat Suspension	 69996	 69766
72	Mfg. from 9/72; Exc. Hydromat Suspension	 69996	 69766





300D

90-93	Exc. 4 Matic 4x4	 G55527	142326 ⁵³
	W115 4 Matic	 69995
87	Exc. 4 Matic 4x4	 G55527
	W115 4 Matic	 69995
84-85	W115 4 Matic	 69995
76-84	W123	 69766
	W123	 69996
76	W115	 69661
75	All	 69661
	W123	 69661	 69766



300E

86-93	All	 69995
	Exc. 4 Matic 4x4	 G55527	142326 ⁵³	 69995



300SD / 300SDL / 300SE / 300SEL / 300TD / 350SD / 350SDL / 350SL / 380SE / 380SEC / 380SEL

78-91	Exc. Hydromat Suspension	 69996	 69766
79-85	All	 69996
72	All	 69661	 69766



380SL / 380SLC

85	All	 69766
81-84	All	 69661	 69766

400E / 400SE / 400SEL / 420SEL / 450SE / 450SEL

92-93	All	 G55527	142326 ⁵³	 69807
-------	-----	--	-------	-------	----------------------	-------	---	-------	-------	-------	-------

APPLICATION GUIDE

Year	Fitment Notes										
		Ultra	ProGuard\ Guardian\ Classic	Max Control\ LTV	Strut Cushion\ Strut Mount	Hi Jacker\ Load Carrier	Ultra	ProGuard\ Guardian\ Classic	Max Control\ LTV	Strut Cushion\ Strut Mount	Hi Jacker\ Load Carrier

MERCEDES-BENZ

MERCEDES-BENZ

400E / 400SE / 400SEL / 420SEL / 450SE / 450SEL (cont'd)

86-91	Exc. Hydromat Suspension	69996	69766
73-80	Exc. Hydromat Suspension	69996	69766

450SL / 450SLC

74-80	All	69661	69766
-------	-----	-------	-----	-----	-----	-----	-------	-----	-----	-----	-----

500SEC / 500SEL / 500SEC / 560SEC / 560SEL

84-91	Exc. Hydromat Suspension	69996	69766
-------	--------------------------	-------	-----	-----	-----	-----	-------	-----	-----	-----	-----

500SL

90-93	All	142326 ⁵³
-------	-----	-----	-----	-----	----------------------	-----	-----	-----	-----	-----	-----

600SL

93	All	142326 ⁵³
----	-----	-----	-----	-----	----------------------	-----	-----	-----	-----	-----	-----

C220

94-96	All	69877	69878
-------	-----	-------	-----	-----	-----	-----	-------	-----	-----	-----	-----

C230

06-07	Exc. Sport Suspension	G56791	70033
	Sport Suspension	G56792	70033
02-07	All	70033
02-05	Coupe Exc. Sport Suspension	G56791	70033
	Coupe Sport Suspension	G56792	70033
97-00	All	69877	69878

C240

01-05	Exc. Sport Suspension	G56791
	Sport Suspension	G56792
	RWD	70033

C250

12	CGI(FuelDelSubType), Sedan	G52172	70038
10-11	All	G52172	70038

C280

08-09	All	G52172	70038
06-07	Exc. Sport Suspension	G56791
	Sport Suspension	G56792
	RWD	70033
94-00	All	69877	69878





C300

08-11	All	G52172	70038
-------	-----	--------	-----	-----	-----	-----	-------	-----	-----	-----	-----

C320



01-05	Sport Suspension	G56792
-------	------------------	--------	-----	-----	-----	-----	-----	-----	-----	-----	-----

APPLICATION GUIDE







Year	Fitment Notes										
		 Ultra	ProGuard/ Guardian/ Classic	Max Control/ LTV	Strut Cushion/ Strut Mount	Hi Jacker/ Load Carrier	 Ultra	ProGuard/ Guardian/ Classic	Max Control/ LTV	Strut Cushion/ Strut Mount	Hi Jacker/ Load Carrier

MERCEDES-BENZ











C320 (cont'd)

01-05	RWD	 70033
	Sedan Exc. Sport Suspension	 G56791
02-04	Wagon Exc. Sport Suspension	 G56791





C350

12	CGI(FuelDelSubType)	 G52172	 70038
08-11	All	 G52172	 70038
06-07	Exc. Sport Suspension	 G56791
	Sport Suspension	 G56792
	RWD	 70033















CLK320

03-05	All	 70033
	Exc. Sport Suspension	 G56791	 70033
	Sport Suspension	 G56792	 70033
98-02	All	 69950	 69951
02	Exc. Sport Suspension	 G56791	 69951
	Sport Suspension	 G56792	 69951





CLK350

06-09	All	 70033
	Exc. Sport Suspension	 G56791	 70033
	Sport Suspension	 G56792	 70033



CLK430

03	All	 70033
	Exc. Sport Suspension	 G56791	 70033
	Sport Suspension	 G56792	 70033
02	All	 69950
	Exc. Sport Suspension	 G56791
	Mfg. from 4/02	 69950	 70033
	Mfg. to 4/02	 69950	 69951
	Sport Suspension	 G56792
99-01	All	 69950	 69951

CLK500

03-06	All	 70033
	Exc. Sport Suspension	 G56791	 70033
	Sport Suspension	 G56792	 70033

APPLICATION GUIDE

Year	Fitment Notes										
		Ultra	ProGuard/ Guardian/ Classic	Max Control/ LTV	Strut Cushion/ Strut Mount	Hi Jacker/ Load Carrier	Ultra	ProGuard/ Guardian/ Classic	Max Control/ LTV	Strut Cushion/ Strut Mount	Hi Jacker/ Load Carrier

MERCEDES-BENZ

CLK550

07-09	All	70033
	Coupe Exc. Sport Suspension	G56791	70033

E300

99	Exc. 4 Matic	69952	69966
96-98	All	69952	69966
95	All	G55527	142326 ⁵³	69807

E320

96-06	Exc. 4 Matic	143086 ⁵³
96-02	Sedan	69952	69966
94-95	All	G55527	142326 ⁵³	69807

E420

97	All	69952	69966
	Exc. 4 Matic	69952	143086 ⁵³	69966
94-95	All	G55527	142326 ⁵³	69807

E430

98-02	All	69952	69966
	Exc. 4 Matic	69952	143086 ⁵³	69966

E500

94	All	G55527	142326 ⁵³	69807
----	-----	--------	-------	-------	----------------------	-------	-------	-------	-------	-------	-------

ML55 AMG

00-03	All	G64049
-------	-----	--------	-------	-------	-------	-------	-------	-------	-------	-------	-------

ML320

98-03	All	G64049
-------	-----	--------	-------	-------	-------	-------	-------	-------	-------	-------	-------

ML350

03-05	All	G64049
-------	-----	--------	-------	-------	-------	-------	-------	-------	-------	-------	-------

ML430

99-01	All	G64049
-------	-----	--------	-------	-------	-------	-------	-------	-------	-------	-------	-------

ML500

02-05	All	G64049
-------	-----	--------	-------	-------	-------	-------	-------	-------	-------	-------	-------

S320 / S350 / S420 / S500 / S600

94-99	Exc. Electronic Ride Control	70023	70024
-------	------------------------------	-------	-------	-------	-------	-------	-------	-------	-------	-------	-------

SL320 / SL500 / SL600

94-02	All	142326 ⁵³
-------	-----	-------	-------	-------	----------------------	-------	-------	-------	-------	-------	-------





SLK230

98-04	All	69956	69957
-------	-----	-------	-------	-------	-------	-------	-------	-------	-------	-------	-------





SLK320

01-04	All	69956	69957
-------	-----	-------	-------	-------	-------	-------	-------	-------	-------	-------	-------

APPLICATION GUIDE



Year	Fitment Notes										
		 Ultra	ProGuard/ Guardian/ Classic	Max Control/ LTV	Strut Cushion/ Strut Mount	Hi Jacker/ Load Carrier	 Ultra	ProGuard/ Guardian/ Classic	Max Control/ LTV	Strut Cushion/ Strut Mount	Hi Jacker/ Load Carrier

MERCEDES-BENZ SPRINTER

04-06	All	 G56778
	Dual Rear Wheels	 G56778	 G63919
	Exc. Dual Rear Wheels	 G56778	 G63918

MERCEDES-BENZ



MERCURY

75-80	All		82128
	Sedan		82128		82004



MERCURY

BOBCAT





BREEZEWAY

65-66	All	 69675 ⁵	81446	34073 ⁸	 69606	81495	43140 ⁹ 49205 ⁷
-------	-----	--	-------	------	------	--------------------	---	-------	------	------	--











BROUGHAM

67	All	 69675 ⁵	81446	34073 ⁸	 69606	81495	43140 ⁹ 49205 ⁷
----	-----	--	-------	------	------	--------------------	---	-------	------	------	--













CAPRI

91-93	All	 G55602	143057 ⁵¹	 G55603	142189 ⁵³ 143059 ⁵¹
79-86	All	 G56504 ⁹	142197 ⁵³ 143059 ⁵¹	 69633	81460	43143 ⁹ 49199 ⁷











COLONY PARK

87-91	All	 69675 ⁵	81446	34073 ⁸	 69606	81495	43140 ⁹ 49205 ⁷
65-74	All	 69675 ⁵	81446	34073 ⁸	 69606	81495	43140 ⁹ 49205 ⁷
61-64	All		82099		82076
59-60	All		82099		81270	49105 ⁷
57-58	All		82099	

COMET

71-77	All		81076		82130
68-69	All		82126		81270	49105 ⁷
66-67	All		82126	
	Exc. Wagon		82126		81270	49105 ⁷
	Wagon		82126	 69606	81495
60-65	All		82126		81270	49105 ⁷

COMMUTER

65-68	All	 69675 ⁵	81446	34073 ⁸	 69606	81495	43140 ⁹ 49205 ⁷
64	All		82099		82076
61-62	All		82099		82076
59-60	All		82099		81270	49105 ⁷
57-58	All		82099	

5 Use kit No. 140719 to replace O.E. hardware for lower shock absorber mounting when studs break or self-tapping screws are not longer useable.

8 Pair Packs.



51 Strut Cushion for use with the Strut/Cartridge/Shocks.

7 Pair Packs, air hose kit included.

9 See Ref. D for procedures to replace Elec Adj Susp with non-adj product.























53 Strut Mount. Hardware from O.E. Part may need to be reused.

APPLICATION GUIDE

Year	Fitment Notes										
		Ultra	ProGuard\ Guardian\ Classic	Max Control\ LTV	Strut Cushion\ Strut Mount	Hi Jacker\ Load Carrier	Ultra	ProGuard\ Guardian\ Classic	Max Control\ LTV	Strut Cushion\ Strut Mount	Hi Jacker\ Load Carrier

MERCURY COUGAR





MERCURY

01-02	All		G56520	142843 ⁵⁴ 143061 ⁵¹		G55693	143058 ⁵¹
99-00	All		G56520	142843 ⁵⁴ 143061 ⁵¹		G55693	142402 ⁵³ 143058 ⁵¹
92-97	Exc. Electronic Adjustable Suspension		G55579	142222 ⁵³		69845	81795
89-91	Exc. Electronic Adjustable Suspension		G55579	142222 ⁵³		69820	81881
87-88	All		G56504 ⁹	142220 ⁵⁴ 143059 ⁵¹		69709 ⁹	81461	49196 ⁷
83-86	All		G56503 ³⁹	142220 ⁵⁴ 143059 ⁵¹		69709 ⁹	81461	49196 ⁷
81-82	Base, GS & LS Models		G56504 ⁹	142197 ⁵³ 143059 ⁵¹		69633	81460	43143 ⁸ 49199 ⁷
80-82	All		143059 ⁵¹
	XR-7		G56503 ³⁹	142220 ⁵⁴ 143059 ⁵¹		69709 ⁹	81461	49196 ⁷
74-79	All		69675 ⁵	81446	34073 ⁸		69606	81495	43140 ⁸ 49205 ⁷
71-73	All		81491		81270	49105 ⁷
67-70	All		81076		81270	49105 ⁷



COUGAR READYMOUNTS

		Front	Rear
99-01	All	G57052 ⁴⁰
89-97	Left Exc. Electronic Adjustable Suspension	G56976 ⁴⁰
	Right Exc. Electronic Adjustable Suspension	G56977 ⁴⁰









COUNTRY CRUISER

63	All		82099		82076
59-60	All		82099		81270	49105 ⁷

CUSTOM

52-56	All		82026	
-------	-----	---	------	-------	------	------	------	---	------	------	------	------	------



GRAND MARQUIS

07-11	All		143356 ⁵³ 143357 ⁶⁸
03-06	All		143356 ⁵³ 143357 ⁶⁸		69575
	CAN		G51887	143356 ⁵³ 143357 ⁶⁸		69575
92-02	All		69675 ⁵	81446		69606	81495	43140 ⁸ 49205 ⁷
	Exc. Hydraulic Self Leveling System		69675 ⁵	81446	34073 ⁸		69606	81495	43140 ⁸ 49205 ⁷
75-91	All		69675 ⁵	81446	34073 ⁸		69606	81495	43140 ⁸ 49205 ⁷

GRAND MARQUIS READYMOUNTS

		Front	Rear
03-06	All	G57080 ⁴⁰

LN7

82-83	All		143057 ⁵¹		G55705	142221 ⁵³ 143059 ⁵¹
-------	-----	---	------	------	------	----------------------	------	---	--------	------	------	--	------

5 Use kit No. 140719 to replace O.E. hardware for lower shock absorber mounting when studs break or self-tapping screws are not longer useable.
8 Pair Packs.

39 Conventional gas-charged strut can be used to replace O.E. air adjustable gas-charged strut. However, the self-leveling system must be deactivated. See Ref. A for instructions.

51 Strut Cushion for use with the Strut/Cartridge/Shocks.

54 Kit with Mount and Bearing. Hardware from O.E. Part may need to be reused.

7 Pair Packs, air hose kit included.





9 See Ref. D for procedures to replace Elec Adj Susp with non-adj product.

40 ReadyMount Strut. Complete Assembled Unit.

53 Strut Mount. Hardware from O.E. Part may need to be reused.





68 Mount Hardware Kit. Hardware from O.E. Part may need to be reused.

APPLICATION GUIDE

Year	Fitment Notes										
			Ultra	ProGuard/ Guardian/ Classic	Max Control/ LTV	Strut Cushion/ Strut Mount	Hi Jacker/ Load Carrier		Ultra	ProGuard/ Guardian/ Classic	Max Control/ LTV













MERCURY

LN7 (cont'd)









82-83	Mfg. to 2/83		G55704	143057 ⁵¹		G55705	142221 ⁵³ 143059 ⁵¹
83	Mfg. from 2/83		G55712	143057 ⁵¹		G55705	142221 ⁵³ 143059 ⁵¹

MERCURY















LYNX

85-87	All		142844 ⁵⁴ 143057 ⁵¹		G55705	142221 ⁵³ 143059 ⁵¹
	Mfg. from 3/85		G55714	142844 ⁵⁴ 143057 ⁵¹		G55705	142221 ⁵³ 143059 ⁵¹
85	Mfg. from 2/83 thru 3/85		G55712	142844 ⁵⁴ 143057 ⁵¹		G55705	142221 ⁵³ 143059 ⁵¹
83-84	Mfg. from 2/83 thru 3/85		G55712	143057 ⁵¹		G55705	142221 ⁵³ 143059 ⁵¹
81-84	All		143057 ⁵¹		G55705	142221 ⁵³ 143059 ⁵¹
81-83	Mfg. to 2/83		G55704	143057 ⁵¹		G55705	142221 ⁵³ 143059 ⁵¹

MARAUDER

03-04	All		G51888		69575
69-70	All		69675 ⁵	81446	34073 ⁸		69606	81495	43140 ⁸ 49205 ⁷
65-67	All		69675 ⁵	81446	34073 ⁸		69606	81495	43140 ⁸ 49205 ⁷
63-64	All		82099		82076





MARINER

11	All			G64047
	FWD		143253 ⁵³		G64047
08-10	Left		G56601		G64047
	Right		G56568		G64047
05-10	FWD		143253 ⁵³	
05-07	Left		G56601		G63862
	Right		G56568		G63862





MARINER READYMOUNTS

		Front	Rear
05-10	Left	G57045 ⁴⁰
	Right	G57046 ⁴⁰



MARQUIS

83-86	All		G56504 ⁹	142197 ⁵³ 143059 ⁵¹		69633	81460	43143 ⁸ 49199 ⁷
67-82	All		69675 ⁵	81446	34073 ⁸		69606	81495	43140 ⁸ 49205 ⁷

MEDALIST

58	All		82099	
56	All		82026	

MERCURY

49-51	All		82026		81318
-------	-----	---	------	-------	------	------	------	---	------	-------	------	------	------

5 Use kit No. 140719 to replace O.E. hardware for lower shock absorber mounting when studs break or self-tapping screws are not longer useable.

8 Pair Packs.

40 ReadyMount Strut. Complete Assembled Unit.

53 Strut Mount. Hardware from O.E. Part may need to be reused.





7 Pair Packs, air hose kit included.

9 See Ref. D for procedures to replace Elec Adj Susp with non-adj product.

51 Strut Cushion for use with the Strut/Cartridge/Shocks.

54 Kit with Mount and Bearing. Hardware from O.E. Part may need to be reused.



APPLICATION GUIDE

Year	Fitment Notes										
		 Ultra	ProGuard\ Guardian\ Classic	Max Control\ LTV	Strut Cushion\ Strut Mount	Hi Jacker\ Load Carrier	 Ultra	ProGuard\ Guardian\ Classic	Max Control\ LTV	Strut Cushion\ Strut Mount	Hi Jacker\ Load Carrier











MERCURY

MERCURY



METEOR

62-63	All		82075		81270	49105 ⁷
-------	-----	---	------	-------	------	------	------	---	------	-------	------	------	------	--------------------











MILAN

10-11	Left		G51896	143392⁵³	
	Right		G51897	143392⁵³	
	FWD			69591
06-09	All		G51859	143392⁵³	
	FWD		G51859	143392⁵³		69591





















MONARCH

75-80	All		81491		82130
-------	-----	---	------	-------	------	------	------	---	------	-------	------	------	------	------















MONTCLAIR

65-68	All		69675 ⁵	81446	34073 ⁸		69606	81495	43140 ⁸ 49205 ⁷
64	All		82099		82076
59-60	All		82099		81270	49105 ⁷
57-58	All		82099	
55-56	All		82026	

MONTEGO

05-07	Left		143341⁵³		143390⁵³
	Right		143341⁵³		143391
	AWD			G51849
	FWD, Left		G52138		G51875
	FWD, Right		G52139		G51876
72-76	All		69675 ⁵	81446	34073 ⁸		69606	43140 ⁸ 49205 ⁷
	Wagon		69675 ⁵	81446	34073 ⁸		69606	81495	43140 ⁸ 49205 ⁷
68-71	All		82126		69606
	Exc. Wagon		82126		69606	81270	49105 ⁷
	Wagon		82126		69606	81495

MONTEREY

04-07	Mini Passenger Van		G56655	143246 ⁵³		G63873
65-74	All		69675 ⁵	81446	34073 ⁸		69606	81495	43140 ⁸ 49205 ⁷
61-64	All		82099		82076
59-60	All		82099		81270	49105 ⁷
57-58	All		82099	
52-56	All		82026	
50-51	All		82026		81318





5 Use kit No. 140719 to replace O.E. hardware for lower shock absorber mounting when studs break or self-tapping screws are not longer useable.

8 Pair Packs.

7 Pair Packs, air hose kit included.

53 Strut Mount. Hardware from O.E. Part may need to be reused.









APPLICATION GUIDE

Year	Fitment Notes										
			Ultra	ProGuard/ Guardian/ Classic	Max Control/ LTV	Strut Cushion/ Strut Mount	Hi Jacker/ Load Carrier		Ultra	ProGuard/ Guardian/ Classic	Max Control/ LTV

MERCURY

MOUNTAINEER







MERCURY

06-10	All		G56838	143330 ⁷⁰ 143360 ⁵³		G56839	143361 ⁵³ 143362 ⁷⁰
04-05	All		G51723	143318 ⁵³		G51724	143319 ⁵³
02-03	All		G51722	143318 ⁵³		G51724	143319 ⁵³
97-01	Exc. Electronic Adjustable Suspension		G63678	61623 81893	77678		G63679	61624 81890	77679	43171 ⁵ 49232 ⁷

MOUNTAINEER READYMOUNTS

		Front	Rear
06-10	All	G57095 ⁴⁰	G57096 ⁴⁰
04-05	All	G57019 ⁴⁰	G57018 ⁴⁰
02-03	All	G57017 ⁴⁰	G57018 ⁴⁰









MYSTIQUE

97-00	Mfg. from 3/97		G56520	142843 ⁵⁴		G55693	142402 ⁵³
95-00	All		142843 ⁵⁴		G55693	142402 ⁵³
95-97	Mfg. to 3/97		G55692	142843 ⁵⁴		G55693	142402 ⁵³





















MYSTIQUE READYMOUNTS

		Front	Rear
95-00	All	G57052 ⁴⁰

PARKLANE

65-68	All		69675 ⁵	81446	34073 ⁸		69606	81495	43140 ⁹ 49205 ⁷
64	All		82099		82076
59-60	All		82099		81270	49105 ⁷
58	All		82099	

SABLE

96-05	Left		G55978	142747 ⁵¹ 142845 ⁵⁴ 143059 ⁵¹	
	Right		G55960	142747 ⁵¹ 142845 ⁵⁴ 143059 ⁵¹	
	Sedan			G55901	142254 ⁵³ 143057 ⁵¹
	Wagon			69962	81927	142639 ⁵³
94-95	Sedan		G55616	142746 ⁵¹ 142846 ⁵⁴ 143059 ⁵¹		G55901	142254 ⁵³ 143057 ⁵¹
91-95	All		G55616	142846 ⁵⁴ 143059 ⁵¹	
	Wagon		G55616	142846 ⁵⁴ 143059 ⁵¹		69756	81693	142639 ⁵³	49216 ⁷
91-93	Sedan		G55616	142746 ⁵¹ 142846 ⁵⁴ 143059 ⁵¹		G55518	142254 ⁵³
86-90	All		G55616	142746 ⁵¹ 142846 ⁵⁴ 143059 ⁵¹	
	Sedan		G55616	142746 ⁵¹ 142846 ⁵⁴ 143059 ⁵¹		G55518	142103 ⁵³ 142648 ⁵¹

5 Use kit No. 140719 to replace O.E. hardware for lower shock absorber mounting when studs break or self-tapping screws are not longer useable.

8 Pair Packs.

51 Strut Cushion for use with the Strut/Cartridge/Shocks.

54 Kit with Mount and Bearing. Hardware from O.E. Part may need to be reused.

70 Bushing and sleeve kit. Hardware from O.E. Part may need to be reused.

7 Pair Packs, air hose kit included.



40 ReadyMount Strut. Complete Assembled Unit.

53 Strut Mount. Hardware from O.E. Part may need to be reused.

61 Mount Kit includes Upper Spring Seat. Hardware from O.E. Part may need to be reused.

Bold Type - New / Future Part



APPLICATION GUIDE

Year	Fitment Notes										
		Ultra	ProGuard\ Guardian\ Classic	Max Control\ LTV	Strut Cushion\ Strut Mount	Hi Jacker\ Load Carrier	Ultra	ProGuard\ Guardian\ Classic	Max Control\ LTV	Strut Cushion\ Strut Mount	Hi Jacker\ Load Carrier

MERCURY

SABLE (cont'd)











MERCURY

86-90	Wagon		G55616	142746 ⁵¹ 142846 ⁵⁴ 143059 ⁵¹		69756	81693	142639 ⁵³	49216 ⁷
-------	-------	---	--------	------	------	--	------	---	-------	-------	------	----------------------	--------------------







SABLE READYMOUNTS

		Front	Rear
96-05	Left	G56934 ⁴⁰
	Right	G56937 ⁴⁰
	Sedan	G56936 ⁴⁰
94-95	Sedan	G56912 ⁴⁰	G56936 ⁴⁰
86-95	All	G56912 ⁴⁰
86-93	Sedan	G56912 ⁴⁰	G56913 ⁴⁰

TOPAZ

92-94	All	142844 ⁵⁴	142133 ⁵³ 142745 ⁶³ 143059 ⁵¹	
	FWD	142844 ⁵⁴		G55733	142133 ⁵³ 142745 ⁶³ 143059 ⁵¹
	FWD, Mfg. from 3/85		G55714	142844 ⁵⁴	142133 ⁵³ 142745 ⁶³ 143059 ⁵¹
87-91	All	142844 ⁵⁴ 143059 ⁵¹	142133 ⁵³ 142745 ⁶³ 143059 ⁵¹
	Mfg. from 3/85		G55714	142844 ⁵⁴ 143059 ⁵¹	142133 ⁵³ 142745 ⁶³ 143059 ⁵¹
	AWD	142844 ⁵⁴ 143059 ⁵¹		G55722	142133 ⁵³ 142745 ⁶³ 143059 ⁵¹
	FWD	142844 ⁵⁴ 143059 ⁵¹		G55733	142133 ⁵³ 142745 ⁶³ 143059 ⁵¹
86	All	142844 ⁵⁴	142133 ⁵³ 142745 ⁶³ 143059 ⁵¹
	FWD	142844 ⁵⁴		G55733	142133 ⁵³ 142745 ⁶³ 143059 ⁵¹
	FWD, Mfg. from 3/85		G55714	142844 ⁵⁴	142133 ⁵³ 142745 ⁶³ 143059 ⁵¹
84-85	All	142844 ⁵⁴ 143057 ⁵¹	142133 ⁵³ 142745 ⁶³ 143059 ⁵¹
	FWD	142844 ⁵⁴ 143057 ⁵¹		G55733	142133 ⁵³ 142745 ⁶³ 143059 ⁵¹
	FWD, Mfg. to 3/85		G55708	142844 ⁵⁴ 143057 ⁵¹	142133 ⁵³ 142745 ⁶³ 143059 ⁵¹
85	FWD, Mfg. from 3/85		G55714	142844 ⁵⁴ 143057 ⁵¹	142133 ⁵³ 142745 ⁶³ 143059 ⁵¹

TRACER

97-99	FWD		G56515	142744 ⁶⁵ 142832 ⁵⁴ 143061 ⁵¹		G55848	142190 ⁵³ 143060 ⁵¹
91-96	FWD		G55847	142744 ⁶⁵ 142854 ⁵⁴ 143057 ⁵¹		G55848	142190 ⁵³ 143058 ⁵¹
87-89	FWD		G55710	142183 ⁵³		G55544	142189 ⁵³ 143058 ⁵¹

TRACER READYMOUNTS

		Front	Rear
97-99	FWD	G56926 ⁴⁰	G56940 ⁴⁰

7 Pair Packs, air hose kit included.

51 Strut Cushion for use with the Strut/Cartridge/Shocks.

54 Kit with Mount and Bearing. Hardware from O.E. Part may need to be reused.

63 Mount Kit includes Isolator. Hardware from O.E. Part may need to be reused.





40 ReadyMount Strut. Complete Assembled Unit.

53 Strut Mount. Hardware from O.E. Part may need to be reused.

61 Mount Kit includes Upper Spring Seat. Hardware from O.E. Part may need to be reused.

65 Mount Kit includes Upper Spring Seat with Isolator. Hardware from O.E. Part may need to be reused.

APPLICATION GUIDE

Year	Fitment Notes										
			ProGuard/ Guardian/ Classic	Max Control/ LTV	Strut Cushion/ Strut Mount	Hi Jacker/ Load Carrier		ProGuard/ Guardian/ Classic	Max Control/ LTV	Strut Cushion/ Strut Mount	Hi Jacker/ Load Carrier

MERCURY

MERCURY













TRACER READYMOUNTS (cont'd)

		Front	Rear
91-96	FWD	G56911 ⁴⁰	G56940 ⁴⁰

TURNPIKE CRUISER

57	All		82099
----	-----	---	-------	-------	-------	-------	-------	-------	-------	-------







VILLAGER

97-02	Non-ABS			G63299	61637
02	Left		G56785
	Right		G56784
99-01	Left		G56785	142860 ⁵⁴	
	Right		G56784	142860 ⁵⁴	
93-98	Left		G55920	142860 ⁵⁴ 143057 ⁵¹	
	Right		G55921	142860 ⁵⁴ 143057 ⁵¹	
93-96	4-Wheel ABS			G63299	61637
65-67	All		69675 ⁵	81446		69606	81495	43140 ⁸ 49205 ⁷
62-64	All		82099		82076



VILLAGER READYMOUNTS

		Front	Rear
93-98	Left	G56989 ⁴⁰
	Right	G56990 ⁴⁰

VOYAGER

66-67	All		69675 ⁵	81446	34073 ⁸		69606	81495	43140 ⁸ 49205 ⁷
59	All		82099		81270
57-58	All		82099	





ZEPHYR

78-83	All		G56504 ⁹	142197 ⁵³ 143059 ⁵¹		69633	81460	43143 ⁸ 49199 ⁷
-------	-----	---	---------------------	-------	-------	--	-------	---	-------	-------	-------	-------	--

MINI

MINI

COOPER

07-12	Left		G52297
	Right		G52298
02-06	Left		G52164		G51881
	Right		G52165		G51881



MITSUBISHI

MITSUBISHI

3000GT

91-99	All		142419 ⁵³
-------	-----	--	-------	-------	-------	-------	-------	--	-------	-------	-------	----------------------	-------

CORDIA

83-88	All		G55531	143059 ⁵¹		69689	81464
-------	-----	---	--------	-------	-------	----------------------	-------	---	-------	-------	-------	-------	-------

5 Use kit No. 140719 to replace O.E. hardware for lower shock absorber mounting when studs break or self-tapping screws are not longer useable.

8 Pair Packs.

40 ReadyMount Strut. Complete Assembled Unit.

53 Strut Mount. Hardware from O.E. Part may need to be reused.





7 Pair Packs, air hose kit included.

9 See Ref. D for procedures to replace Elec Adj Susp with non-adj product.

51 Strut Cushion for use with the Strut/Cartridge/Shocks.

54 Kit with Mount and Bearing. Hardware from O.E. Part may need to be reused.





APPLICATION GUIDE

Year	Fitment Notes										
		 Ultra	ProGuard/ Guardian/ Classic	Max Control/ LTV	Strut Cushion/ Strut Mount	Hi Jacker/ Load Carrier	 Ultra	ProGuard/ Guardian/ Classic	Max Control/ LTV	Strut Cushion/ Strut Mount	Hi Jacker/ Load Carrier























MITSUBISHI

DIAMANTE



MITSUBISHI

04	All	143087 ⁵³	142419 ⁵³
97-03	Left	 G52227	143087 ⁵³	 G51772	142419 ⁵³
	Right	 G52228	143087 ⁵³	 G51772	142419 ⁵³



















ECLIPSE

06-10	Left	 G52166	 G51882
	Right	 G52167	 G51882
00-05	Left	 G56552	143059 ⁵¹ 143087 ⁵³	 G51712	142419 ⁵³ 143059 ⁵¹
	Right	 G56551	143059 ⁵¹ 143087 ⁵³	 G51712	142419 ⁵³ 143059 ⁵¹
95-99	All	 G55819	142419 ⁵³ 143059 ⁵¹	142419 ⁵³ 143059 ⁵¹
	AWD	 G55819	142419 ⁵³ 143059 ⁵¹	 G51712	142419 ⁵³ 143059 ⁵¹
	FWD	 G55819	142419 ⁵³ 143059 ⁵¹	 G51254	142419 ⁵³ 143059 ⁵¹
91-94	All	 G55605	142219 ⁵³ 143057 ⁵¹	142419 ⁵³ 143064 ⁵¹
	AWD	 G55605	142219 ⁵³ 143057 ⁵¹	 G51046	142419 ⁵³ 143064 ⁵¹
	FWD	 G55605	142219 ⁵³ 143057 ⁵¹	 G51184	142419 ⁵³ 143064 ⁵¹
90	All	 G55587	142219 ⁵³ 143057 ⁵¹	142419 ⁵³ 143064 ⁵¹
	AWD	 G55587	142219 ⁵³ 143057 ⁵¹	 G51046	142419 ⁵³ 143064 ⁵¹
	FWD	 G55587	142219 ⁵³ 143057 ⁵¹	 G51184	142419 ⁵³ 143064 ⁵¹





EXPO

92-95	All	 G55945	142301 ⁵³ 143057 ⁵¹	 69462	142419 ⁵³
-------	-----	--	------	------	--	------	---	------	------	----------------------	------

GALANT







08-11	Exc. GT, LS, Sport, Ralliart Models Left	 G52168	 G51883
	Exc. GT, LS, Sport, Ralliart Models Right	 G52169	 G51883
04-07	All	142419 ⁵³
	Exc. GT, LS, Sport, Ralliart Models Left	 G52168	 G51883	142419 ⁵³
	Exc. GT, LS, Sport, Ralliart Models Right	 G52169	 G51883	142419 ⁵³
99-03	Left	 G56636	143087 ⁵³	 G51254	142419 ⁵³
	Right	 G56635	143087 ⁵³	 G51254	142419 ⁵³
94-98	All	 G55820	142419 ⁵³ 143057 ⁵¹	 G51253	142419 ⁵³ 143057 ⁵¹
93	All	142543 ⁵³ 143057 ⁵¹	142419 ⁵³ 143063 ⁵¹
	FWD	 G55609	142543 ⁵³ 143057 ⁵¹	 G51424	142419 ⁵³ 143063 ⁵¹
90-92	All	142543 ⁵³ 143057 ⁵¹	142419 ⁵³
	AWD	 G55605	142543 ⁵³ 143057 ⁵¹	 G51046	143063 ⁵¹ 142419 ⁵³

APPLICATION GUIDE

Year	Fitment Notes										
			Ultra	ProGuard/ Guardian/ Classic	Max Control/ LTV	Strut Cushion/ Strut Mount	Hi Jacker/ Load Carrier		Ultra	ProGuard/ Guardian/ Classic	Max Control/ LTV

MITSUBISHI

GALANT (cont'd)







90-92	FWD		G55609	142543 ⁵³ 143057 ⁵¹		G51424	142419 ⁵³ 143063 ⁵¹
89	All		143057 ⁵¹	142419 ⁵³ 143063 ⁵¹
	FWD		G55609	142543 ⁵³ 143057 ⁵¹		G51424	142419 ⁵³ 143063 ⁵¹
85-88	All		143060 ⁵¹	143064 ⁵¹
	Exc. Electronic Adjustable Suspension		G55531	143060 ⁵¹		G51424	142419 ⁵³ 143064 ⁵¹

MITSUBISHI







GALANT READYMOUNTS

							Front	Rear
99-03	GTZ						G57075 ⁴⁰

LANCER

11	DE, ES			G51908
08-10	All		143394 ¹
	DE, ES, Left		G52262		G51908	143394 ¹
	DE, ES, Right		G52263		G51908	143394 ¹
02-07	All		143088 ⁵³	143394 ¹
	Exc. ES & Evolution Series		G56894	143088 ⁵³		G51794	143394 ¹

















MIGHTY MAX

95-96	All			G63907	61500 81147	77907	43048 ⁸ 49310 ⁷
	RWD		G63950	61556 81714	77418		G63907	61500 81147	77907	43048 ⁸ 49310 ⁷
83-94	4WD		G63418	61529	77418		G63419	61532 81538
	RWD		G63950	61556 81714		G63907	61500 81147	77907	43048 ⁸ 49310 ⁷

MIGHTY MAX STEERING STABILIZERS

							Front	Rear
95-96	Single System Steering Stabilizer						6802SE ⁸⁴
83-94	RWD, Single System Steering Stabilizer						6802SE ⁸⁴

MIRAGE

97-02	All		142857 ⁵⁴ 143059 ⁵¹		G51063	142419 ⁵³ 143064 ⁵¹
	Mfg. from 4/97; with 6" or 7" Spring Left		G56530	142857 ⁵⁴ 143059 ⁵¹		G51063	142419 ⁵³ 143064 ⁵¹
	Mfg. from 4/97; with 6" or 7" Spring Right		G56529	142857 ⁵⁴ 143059 ⁵¹		G51063	142419 ⁵³ 143064 ⁵¹
96	All		143057 ⁵¹	143064 ⁵¹
	Mfg. to 5/96		G55911	142329 ⁵³ 143057 ⁵¹		G51063	142419 ⁵³ 143064 ⁵¹
95	All		G55911	143057 ⁵¹		G51063	143064 ⁵¹
	Sedan		G55911	142329 ⁵³ 143057 ⁵¹		G51063	142419 ⁵³ 143064 ⁵¹
93-94	All		G55911	142329 ⁵³ 143057 ⁵¹		G51063	142419 ⁵³ 143064 ⁵¹
89-92	All		G55592	142240 ⁵⁴ 143057 ⁵¹		G51249	142419 ⁵³ 143064 ⁵¹
87-88	All		G55561	143060 ⁵¹		81555

1 Future Part, available 1st Quarter of 2015.

8 Pair Packs.

51 Strut Cushion for use with the Strut/Cartridge/Shocks.

54 Kit with Mount and Bearing. Hardware from O.E. Part may need to be reused.

Bold Type - New / Future Part



7 Pair Packs, air hose kit included.

40 ReadyMount Strut. Complete Assembled Unit.

53 Strut Mount. Hardware from O.E. Part may need to be reused.



84 Replacement damper for vehicles with the Gabriel Aftermarket mounting kit

APPLICATION GUIDE



















Year	Fitment Notes										
		Ultra	ProGuard\ Guardian\ Classic	Max Control\ LTV	Strut Cushion\ Strut Mount	Hi Jacker\ Load Carrier	Ultra	ProGuard\ Guardian\ Classic	Max Control\ LTV	Strut Cushion\ Strut Mount	Hi Jacker\ Load Carrier

MITSUBISHI





MIRAGE (cont'd)

85-86	All	 G55716 ⁹	142240 ⁵⁴ 143060 ⁵¹		81555
-------	-----	---	------	------	--	------	---	-------	------	------	------

MONTERO

01-04	Exc. Sport	 G51839	 G64036
92-00	All	 G63782 ⁹	77782 ⁹	 G63781 ⁹	77781 ⁹
90-91	All	 G63418	61529	77418		61568
	3.0L 6 Cyl V	 G63418	61529	77418	 G63604	61568
89	All	 G63418	61529	77418		61568 81318	77492	49311 ⁷
	2.6L 4Cyl L	 G63418	61529	77418	 G63492	61568 81318	77492	49311 ⁷
	3.0L 6 Cyl V	 G63418	61529	77418	 G63604	61568 81318	77492	49311 ⁷
83-88	All	 G63418	61529	77418		81318	77492	49311 ⁷
	2.6L 4Cyl L	 G63418	61529	77418	 G63492	61506 81318	77492	49311 ⁷



MONTERO SPORT

00-04	All	 G64027	 G64028
97-99	All	 G63782 ⁹	77782 ⁹	 G63492	61506	77492	49311 ⁷





MONTERO STEERING STABILIZERS

86-95	Single System Steering Stabilizer							Front	Rear
								6802SE ⁸⁴

OUTLANDER

07-11	All	143394 ¹
05-06	All	 G52065	143088 ⁵³	143394 ¹
03-04	All	 G52065	143088 ⁵³	 G51838	143394 ¹



PRECIS

90-94	All	 G55586	142234 ⁵⁴ 143057 ⁵¹	 69689	81464
87-89	All	143059 ⁵¹
	Rebuildable O.E. Front Struts	 G44944 ⁹⁸	143059 ⁵¹	 69689

RAIDER

06-09	All	 G51815
	4WD	 G51815	 G63891
	RWD	 G51815	 G63890

SIGMA

89-90	Non-ABS	143060 ⁵¹	143064 ⁵¹
	Non-ABS Exc. Auto-Leveling System	 G55531	 G51424	142419 ⁵³

STARION

87-89	All	143057 ⁵¹	143058 ⁵¹
-------	-----	------	------	------	----------------------	------	------	------	------	----------------------	------

1 Future Part, available 1st Quarter of 2015.

9 See Ref. D for procedures to replace Elec Adj Susp with non-adj product.

53 Strut Mount. Hardware from O.E. Part may need to be reused.

84 Replacement damper for vehicles with the Gabriel Aftermarket mounting kit





7 Pair Packs, air hose kit included.

51 Strut Cushion for use with the Strut/Cartridge/Shocks.

54 Kit with Mount and Bearing. Hardware from O.E. Part may need to be reused.

98 Notice: The level of difficulty to install this product is moderately high. Please review the installation instructions carefully before proceeding.

APPLICATION GUIDE

Year	Fitment Notes										
		 Ultra	ProGuard/ Guardian/ Classic	Max Control/ LTV	Strut Cushion/ Strut Mount	Hi Jacker/ Load Carrier	 Ultra	ProGuard/ Guardian/ Classic	Max Control/ LTV	Strut Cushion/ Strut Mount	Hi Jacker/ Load Carrier



MITSUBISHI

STARION (cont'd)



87-89	Exc. Electronic Adjustable Suspension	 G44937 ⁹⁸	143057 ⁵¹	143058 ⁵¹
86	LE	143058 ⁵¹	143058 ⁵¹
84-85	LE, LS	143058 ⁵¹	143058 ⁵¹
83	All	143058 ⁵¹	143058 ⁵¹

MITSUBISHI

TREDIA











83-88	All	 G55531	143059 ⁵¹	 69689	81464
-------	-----	--	------	------	----------------------	------	---	-------	------	------	------

VAN



87-90	All	 G63904	61593 81872	77904	 G63907	61500 81147	77907	43048 ⁹ 49310 ⁷
-------	-----	--	----------------	-------	------	------	--	----------------	-------	------	--

NISSAN





200SX

95-98	All	142623 ⁵⁴ 143057 ⁵¹	142646 ⁵³
	Left B14 Solid Rear Axle	 G55970	142623 ⁵⁴ 143057 ⁵¹	 G51230	142646 ⁵³
	Right B14 Solid Rear Axle	 G55971	142623 ⁵⁴ 143057 ⁵¹	 G51230	142646 ⁵³
85-88	All	 G44934 ⁹⁸	142858 ⁵⁴ 143059 ⁵¹	 I O	81671
84	All	142858 ⁵⁴ 143059 ⁵¹
	Solid Rear Axle	 G44934 ⁹⁸	142858 ⁵⁴ 143059 ⁵¹	 I O	81501
80-83	All	 G44752 ⁹⁸	143059 ⁵¹	 I O	81501
77-79	All	 I O	81501



210

79-82	All	 G44752 ⁹⁸	143059 ⁵¹	 I O	81501
-------	-----	--	------	------	----------------------	------	--	-------	------	------	------







240SX

89-94	All	143059 ⁵¹	143064 ⁵¹
	Left Exc. Active Suspension	 G55903	142430 ⁵³ 143059 ⁵¹	 G51191	142646 ⁵³ 143064 ⁵¹
	Right Exc. Active Suspension	 G55904	142430 ⁵³ 143059 ⁵¹	 G51191	142646 ⁵³ 143064 ⁵¹

240Z

70-73	All	 G44869 ⁹⁸	142241 ⁵⁸	 G44868 ⁹⁸	143059 ⁵¹
-------	-----	--	------	------	----------------------	------	--	------	------	----------------------	------

260Z

74-75	All	 G44869 ⁹⁸	143059 ⁵¹
	2+2	 G44869 ⁹⁸	 G44867 ⁹⁸	143059 ⁵¹
74	Mfg. 9/74	 G44869 ⁹⁸	142241 ⁵⁸	143059 ⁵¹
	Base	 G44869 ⁹⁸	 G44868 ⁹⁸	143059 ⁵¹

7 Pair Packs, air hose kit included.

51 Strut Cushion for use with the Strut/Cartridge/Shocks.

54 Kit with Mount and Bearing. Hardware from O.E. Part may need to be reused.





98 Notice: The level of difficulty to install this product is moderately high. Please review the installation instructions carefully before proceeding.

8 Pair Packs.

53 Strut Mount. Hardware from O.E. Part may need to be reused.

58 Mount Kit includes Suspension Bearing. Hardware from O.E. Part may need to be reused.



APPLICATION GUIDE

Year	Fitment Notes										
		 Ultra	ProGuard\ Guardian\ Classic	Max Control\ LTV	Strut Cushion\ Strut Mount	Hi Jacker\ Load Carrier	 Ultra	ProGuard\ Guardian\ Classic	Max Control\ LTV	Strut Cushion\ Strut Mount	Hi Jacker\ Load Carrier





NISSAN

NISSAN















280Z

75-78	All	 G44869 ⁹⁸	142241 ⁵⁸	 G44867 ⁹⁸	143059 ⁵¹
-------	-----	--	------	------	----------------------	------	--	------	------	----------------------	------

280ZX

83	All	 G44869 ⁹⁸	142241 ⁵⁸ 143059 ⁵¹	 G51232
79-82	All	 G44869 ⁹⁸	142241 ⁵⁸ 143059 ⁵¹	 G51229









300ZX

94-96	2+2, Left Exc. model spec VG30DETT	 G51188	 G51190
	2+2, Right Exc. model spec VG30DETT	 G51189	 G51190
90-96	2+2	142741 ⁵³ 143057 ⁵¹	142646 ⁵³ 143064 ⁵¹
93	2+2, Exc. model spec VG30DETT	 G51190
	2+2, Left	 G51188
	2+2, Right Exc. model spec VG30DETT	 G51189
90-92	2+2, Left Exc. model spec VG30DETT	 G51188	 G51190
	2+2, Right Exc. model spec VG30DETT	 G51189	 G51190
87-89	All	 G44968 ⁹⁸	142241 ⁵⁸ 142859 ⁵⁴ 143060 ⁵¹	 69757	142429 ⁵³
84-86	All	 G44936 ⁹⁸	142241 ⁵⁸ 142859 ⁵⁴ 143057 ⁵¹	 69757	142429 ⁵³



310

79-82	All	143059 ⁵¹
-------	-----	------	------	------	----------------------	------	------	------	------	------	------



350Z

06-09	Left	 G51953	 G51955
	Right	 G51954	 G51955
03-06	Coupe Exc. Sport Suspension	 G51764
03-05	Left	 G51813
	Right	 G51814
	Sport Suspension	 G51812



410

64-65	All	 69600	81494	 82155
-------	-----	---	-------	------	------	------	---	------	------	------	------

411

64-67	All	 69600	81494	 82155
-------	-----	---	-------	------	------	------	---	------	------	------	------

510

78-81	All	 G44752 ⁹⁸	143059 ⁵¹
	Hatchback	 G44752 ⁹⁸	143059 ⁵¹	 81501

51 Strut Cushion for use with the Strut/Cartridge/Shocks.





54 Kit with Mount and Bearing. Hardware from O.E. Part may need to be reused.

98 Notice: The level of difficulty to install this product is moderately high. Please

53 Strut Mount. Hardware from O.E. Part may need to be reused.

58 Mount Kit includes Suspension Bearing. Hardware from O.E. Part may need to be reused.













APPLICATION GUIDE

Year	Fitment Notes										
			Ultra	ProGuard/ Guardian/ Classic	Max Control/ LTV	Strut Cushion/ Strut Mount	Hi Jacker/ Load Carrier		Ultra	ProGuard/ Guardian/ Classic	Max Control/ LTV



NISSAN

NISSAN











510 (cont'd)

78-81	Sedan		G44752 ⁹⁸	143059 ⁵¹		81501
	Wagon		G44752 ⁹⁸	143059 ⁵¹		82156	49310 ⁷
73	Exc. Wagon			82124
72	All			81340
	Exc. Wagon			82124 81340
68-71	Exc. Wagon			82124



521 PICKUP

69-72	All		G63902	61501 81478	77902		G63491	61505 81097	49309 ⁷
-------	-----	---	--------	----------------	-------	------	------	---	--------	----------------	------	------	--------------------





610

75-76	All		142241 ⁵⁸	
	Coupe		142241 ⁵⁸		82124
	Wagon		142241 ⁵⁸		69604	81492	49152 ⁷
73-74	All		142241 ⁵⁸		69604	82124	49152 ⁷
	Wagon		142241 ⁵⁸		69604	81492 82124	49152 ⁷













620 PICKUP

72-79	All		G63902	61501 81478	77902		G63491	61505 81097	49309 ⁷
-------	-----	---	--------	----------------	-------	------	------	---	--------	----------------	------	------	--------------------

710

74-77	Exc. Wagon			81340
	Wagon			69604	81492	43060 ⁸ 49152 ⁷











720 PICKUP

82-86	All		G63902	61501 81478	77902	
	4WD		G63902	61501 81478	77902		G63492	61506 81318	77492	49311 ⁷
86	RWD		G63902	61501 81478	77902		49309 ⁷
	RWD, Mfg. to 8/86		G63902	61501 81478	77902		G63491	61505 81097
82-85	RWD		G63902	61501 81478	77902		G63491	61505 81097	49309 ⁷
80-81	All		G63902	61501 81478	77902		G63491	61505 81097	49309 ⁷

720 PICKUP STEERING STABILIZERS

		Front	Rear
82	Single System Steering Stabilizer	6802SE ⁸⁴

810

81	All		G44869 ⁹⁸	142241 ⁵⁸ 143059 ⁵¹	
	Sedan		G44869 ⁹⁸	142241 ⁵⁸ 143059 ⁵¹		G51229
	Wagon		G44869 ⁹⁸	142241 ⁵⁸ 143059 ⁵¹		69885
79-80	Hardtop		142241 ⁵⁸		G51229
78-80	Wagon		142241 ⁵⁸		69604	81492	43060 ⁸ 49152 ⁷

7 Pair Packs, air hose kit included.

51 Strut Cushion for use with the Strut/Cartridge/Shocks.



84 Replacement damper for vehicles with the Gabriel Aftermarket mounting kit

8 Pair Packs.

58 Mount Kit includes Suspension Bearing. Hardware from O.E. Part may need to be reused.

98 Notice: The level of difficulty to install this product is moderately high. Please review the installation instructions carefully before proceeding.

APPLICATION GUIDE

Year	Fitment Notes										
		Ultra	ProGuard/ Guardian/ Classic	Max Control/ LTV	Strut Cushion/ Strut Mount	Hi Jacker/ Load Carrier	Ultra	ProGuard/ Guardian/ Classic	Max Control/ LTV	Strut Cushion/ Strut Mount	Hi Jacker/ Load Carrier

NISSAN

NISSAN

810 (cont'd)

77-80	All	142241 ⁵⁸
	Sedan	142241 ⁵⁸	G51229
77	Wagon	142241 ⁵⁸	81492

1200

71-73	All	81501 82020
-------	-----	------	------	------	------	------	------	----------------	------	------

1600

66-70	All	69704	82130
-------	-----	-------	------	------	------	------	------	-------	------	------

2000

68-70	All	69704	82130
-------	-----	-------	------	------	------	------	------	-------	------	------

ALTIMA

08-12	Left	G52121	G51874
	Right	G52122	G51874
07	Left	G52121	G51874	143214 ⁵³
	Right	G52122	G51874	143214 ⁵³
02-06	Left	G56671	142937 ⁵³	G51725	143214 ⁵³
	Right	G56672	142937 ⁵³	G51725	143214 ⁵³
00-01	Left	G55832	142939 ⁵³ 143057 ⁵¹	G55669	142428 ⁵³ 143059 ⁵¹
	Right	G55833	142939 ⁵³ 143057 ⁵¹	G55668	142428 ⁵³ 143059 ⁵¹
98-99	Left	G55832	143277 ⁵³	G55669	142428 ⁵³ 143060 ⁵¹
	Right	G55833	143277 ⁵³	G55668	142428 ⁵³ 143060 ⁵¹
93-97	Left	G55667	143277 ⁵³	G55669	142428 ⁵³ 143060 ⁵¹
	Right	G55666	143277 ⁵³	G55668	142428 ⁵³ 143060 ⁵¹

ALTIMA READYMOUNTS

		Front	Rear
02-06	Left	G57030 ⁴⁰
	Right	G57031 ⁴⁰
00-01	Left	G57003 ⁴⁰
	Right	G57004 ⁴⁰
93-99	Left	G57001 ⁴⁰	G57003 ⁴⁰
	Right	G57002 ⁴⁰	G57004 ⁴⁰

ARMADA

12-13	Exc. Auto-Leveling System	G51715	G63875
05-11	All	143358 ⁵³ 143359 ⁷⁰
	Exc. Auto-Leveling System	G51715	143358 ⁵³ 143359 ⁷⁰	G63875

40 ReadyMount Strut. Complete Assembled Unit.



53 Strut Mount. Hardware from O.E. Part may need to be reused.

70 Bushing and sleeve kit. Hardware from O.E. Part may need to be reused.

51 Strut Cushion for use with the Strut/Cartridge/Shocks.

58 Mount Kit includes Suspension Bearing. Hardware from O.E. Part may need to be reused.

APPLICATION GUIDE

Year	Fitment Notes										
		Ultra	ProGuard/ Guardian/ Classic	Max Control/ LTV	Strut Cushion/ Strut Mount	Hi Jacker/ Load Carrier	Ultra	ProGuard/ Guardian/ Classic	Max Control/ LTV	Strut Cushion/ Strut Mount	Hi Jacker/ Load Carrier







NISSAN

NISSAN











ARMADA READYMOUNTS

		Front	Rear
05-11	4WD	G57092 ⁴⁰



AXCESS

91-94	All	142241 ⁵⁸ 142862 ⁵⁴ 143059 ⁵¹	 G44776 ⁹⁸	143059 ⁵¹
	Left	142241 ⁵⁸ 142862 ⁵⁴ 143059 ⁵¹	 G44776 ⁹⁸	142426 ⁵³ 143059 ⁵¹
	Right	142241 ⁵⁸ 142862 ⁵⁴ 143059 ⁵¹	 G44776 ⁹⁸	142427 ⁵³ 143059 ⁵¹
90-94	FWD, Left	 G55607 ⁹¹	142241 ⁵⁸ 142862 ⁵⁴ 143059 ⁵¹	 G44776 ⁹⁸	143059 ⁵¹
	FWD, Right	 G55608 ⁹¹	142241 ⁵⁸ 142862 ⁵⁴ 143059 ⁵¹	 G44776 ⁹⁸	143059 ⁵¹
90	All	142241 ⁵⁸ 142862 ⁵⁴ 143059 ⁵¹	143059 ⁵¹
	Left	142241 ⁵⁸ 142862 ⁵⁴ 143059 ⁵¹	142426 ⁵³ 143059 ⁵¹
	Right	142241 ⁵⁸ 142862 ⁵⁴ 143059 ⁵¹	142427 ⁵³ 143059 ⁵¹

B210

76-78	All	 G44752 ⁹⁸	143059 ⁵¹		81501
	Hatchback	 G44752 ⁹⁸	143059 ⁵¹		82020 81501
75	All	 G44752 ⁹⁸	143059 ⁵¹		81501 82020
74	All	 G44752 ⁹⁸	143059 ⁵¹		81501
	Hatchback	 G44752 ⁹⁸	143059 ⁵¹		82020 81501









CUBE

09-14	Left	 G52193
	Right	 G52194

F10

76-78	All	143059 ⁵¹
	Wagon	143059 ⁵¹		82125

FRONTIER

05-13	Exc. Nismo Off-Road	 G64031
	Mfg. to 12/12; Exc. Nismo Off-Road	 G51766
98-04	4WD	 G63813	61662	 G63492	61506 81318	77492	49311 ⁷
	RWD, Exc. Desert Runner	 G63909	61508 81507	77909	 G63907	61500 81147	77907	43048 ⁸ 49310 ⁷
	RWD; Crew Cab with Desert Runner	 G63813	61662	 G63492	61506 81318	77492	49311 ⁷

7 Pair Packs, air hose kit included.

9 See Ref. D for procedures to replace Elec Adj Susp with non-adj product.

51 Strut Cushion for use with the Strut/Cartridge/Shocks.

54 Kit with Mount and Bearing. Hardware from O.E. Part may need to be reused.

98 Notice: The level of difficulty to install this product is moderately high. Please review the installation instructions carefully before proceeding.



8 Pair Packs.

40 ReadyMount Strut. Complete Assembled Unit.

53 Strut Mount. Hardware from O.E. Part may need to be reused.

58 Mount Kit includes Suspension Bearing. Hardware from O.E. Part may need to be reused.

APPLICATION GUIDE

Year	Fitment Notes										
		Ultra	ProGuard\Guardian\Classic	Max Control\LTV	Strut Cushion\Strut Mount	Hi Jacker\Load Carrier	Ultra	ProGuard\Guardian\Classic	Max Control\LTV	Strut Cushion\Strut Mount	Hi Jacker\Load Carrier



































NISSAN

NISSAN

FRONTIER STEERING STABILIZERS

		Front	Rear
98	4WD	6863SE ⁸²



MAXIMA

04-08	Left	 G56671	142937 ⁵³	 G51802	143214 ⁵³
	Right	 G56672	142937 ⁵³	 G51802	143214 ⁵³
02-03	Left	 G56685	142937 ⁵³	 G51727	142949 ⁵³
	Right	 G56686	142937 ⁵³	 G51727	142949 ⁵³
00-01	Left	 G56683	142937 ⁵³	 G51727	142949 ⁵³
	Right	 G56684	142937 ⁵³	 G51727	142949 ⁵³
95-99	Left	 G55913	142546 ⁵⁴	 G51087	142547 ⁵³
	Right	 G55912	142546 ⁵⁴	 G51087	142547 ⁵³
89-94	All	143059 ⁵¹	143057 ⁵¹
	Left Exc. Electronic Adjustable Suspension	 G55607 ⁹	142241 ⁵⁸ 142862 ⁵⁴ 143059 ⁵¹	 G44990 ⁹⁸	142426 ⁵³ 143057 ⁵¹
	Right Exc. Electronic Adjustable Suspension	 G55608 ⁹	142241 ⁵⁸ 142862 ⁵⁴ 143059 ⁵¹	 G44990 ⁹⁸	142427 ⁵³ 143057 ⁵¹
86-88	Sedan	143060 ⁵¹	143059 ⁵¹
	Sedan Left Exc. Electronic Adjustable Suspension	 G55521	142242 ⁵³	 G44776 ⁹⁸	142426 ⁵³
	Sedan Right Exc. Electronic Adjustable Suspension	 G55521	142242 ⁵³	 G44776 ⁹⁸	142427 ⁵³
85	All	143060 ⁵¹	143059 ⁵¹
	Left Exc. Electronic Adjustable Suspension	 G55534	142242 ⁵³ 143060 ⁵¹	 G44776 ⁹⁸	142426 ⁵³ 143059 ⁵¹
	Right Exc. Electronic Adjustable Suspension	 G55534	142242 ⁵³ 143060 ⁵¹	 G44776 ⁹⁸	142427 ⁵³ 143059 ⁵¹
83-84	Wagon	 G44869 ⁹⁸	142241 ⁵⁸ 143059 ⁵¹	 G44869 ⁹⁸	82156	49310 ⁷
82-84	All	 G44869 ⁹⁸	142241 ⁵⁸ 143059 ⁵¹
	Sedan	 G44869 ⁹⁸	142241 ⁵⁸ 143059 ⁵¹	 G51229
82	Wagon	 G44869 ⁹⁸	142241 ⁵⁸ 143059 ⁵¹	 G69885

MAXIMA READYMOUNTS

		Front	Rear
04-08	Left	G57030 ⁴⁰
	Right	G57031 ⁴⁰
95-99	Left	G56970 ⁴⁰	G57057 ⁴⁰
	Right	G56971 ⁴⁰	G57058 ⁴⁰

MULTI

87-88	CAN	 G44776 ⁹⁸	142242 ⁵³ 142861 ⁵⁴ 143060 ⁵¹	 G44776 ⁹⁸	81554	143057 ⁵¹
-------	-----	--	------	------	--	------	--	-------	------	----------------------	------

7 Pair Packs, air hose kit included.

40 ReadyMount Strut. Complete Assembled Unit.

53 Strut Mount. Hardware from O.E. Part may need to be reused.

58 Mount Kit includes Suspension Bearing. Hardware from O.E. Part may need to be reused.

98 Notice: The level of difficulty to install this product is moderately high. Please





9 See Ref. D for procedures to replace Elec Adj Susp with non-adj product.

51 Strut Cushion for use with the Strut/Cartridge/Shocks.

54 Kit with Mount and Bearing. Hardware from O.E. Part may need to be reused.

82 Use kit if listed, See Ref. C for optional Steering Stabilizer Boots.







APPLICATION GUIDE

Year	Fitment Notes										
			Ultra	ProGuard/ Guardian/ Classic	Max Control/ LTV	Strut Cushion/ Strut Mount	Hi Jacker/ Load Carrier		Ultra	ProGuard/ Guardian/ Classic	Max Control/ LTV











NISSAN

NISSAN





MULTI (cont'd)

87-88	CAN Left		G44767 ⁹⁸		G44776 ⁹⁸	81554	142426 ⁵³
	CAN Right		G44767 ⁹⁸		G44776 ⁹⁸	81554	142427 ⁵³
86	CAN		G44767 ⁹⁸		G44766 ⁹⁸	81554	142429 ⁵³



































MURANO

08-13	Mfg. to 12/12 Left		G52170		G51884
	Mfg. to 12/12 Right		G52171		G51884
08-12	All			G51884
03-07	Left		G52008	142937 ⁵³		G51798	143396 ⁵⁷
	Right		G52009	142937 ⁵³		G51798	143396 ⁵⁷

NX

91-93	Left		G55745	142623 ⁵⁴ 143057 ⁵¹		G55977	142302 ⁵³
	Right		G55745	142623 ⁵⁴ 143057 ⁵¹		G55976	142302 ⁵³

PATHFINDER

05-13	Mfg. to 12/12		G51765		G64033
04	All			G63845
	Left With OE 543034W925 or 543034W926		G56687		G63845
	Right With OE 543034W925 or 543034W926		G56688		G63845
02-03	All		142938 ⁵³		G63845
	Left With OE 543034W925 or 543034W926		G56687	142938 ⁵³		G63845
	Right With OE 543034W925 or 543034W926		G56688	142938 ⁵³		G63845
99-01	Left Mfg. from 12/98; with OE543034W985		G56615	142938 ⁵³	
	Mfg. from 12/98		142938 ⁵³		G63845
	Right Mfg. from 12/98; with OE543034W985		G56616	142938 ⁵³	
96-01	All		142938 ⁵³	
01	Left With OE 543034W925 or 543034W926		G56687	142938 ⁵³	
	Right With OE 543034W925 or 543034W926		G56688	142938 ⁵³	
96-99	Mfg. to 12/98		142938 ⁵³		G63712	61609 81910
	Mfg. to 12/98 Left		G56739	142938 ⁵³	
	Mfg. to 12/98 Right		G56736	142938 ⁵³	
87-95	All		81872	

51 Strut Cushion for use with the Strut/Cartridge/Shocks.

54 Kit with Mount and Bearing. Hardware from O.E. Part may need to be reused.



98 Notice: The level of difficulty to install this product is moderately high. Please review the installation instructions carefully before proceeding.

Bold Type - New / Future Part

53 Strut Mount. Hardware from O.E. Part may need to be reused.

67 Strut Mount Kit. Hardware from O.E. Part may need to be reused.



APPLICATION GUIDE

Year	Fitment Notes										
		Ultra	ProGuard\ Guardian\ Classic	Max Control\ LTV	Strut Cushion\ Strut Mount	Hi Jacker\ Load Carrier	Ultra	ProGuard\ Guardian\ Classic	Max Control\ LTV	Strut Cushion\ Strut Mount	Hi Jacker\ Load Carrier

NISSAN

NISSAN

PATHFINDER (cont'd)

87-95	Exc. Electronic Adjustable Suspension		G63904 ⁹	61593 ⁹ 81872	77904 ⁹		G63492 ⁹	61506 ⁹ 81318 ⁹	77492 ⁹	49311 ⁷
-------	---------------------------------------	---	---------------------	-----------------------------	--------------------	------	------	---	---------------------	--	--------------------	------	--------------------









PATHFINDER READYMOUNTS

		Front	Rear
05-11	4WD	G57118¹
02-04	Left	G57144⁴⁰
	Right	G57145⁴⁰
96-99	Mfg. to 11/98 Left	G57037 ⁴⁰
	Mfg. to 11/98 Right	G57038 ⁴⁰

PATHFINDER STEERING STABILIZERS

		Front	Rear
87-95	4WD	6848SE ⁸²











PICKUP

87-97	4WD		G63902	61501 81478	77902		G63492	61506 81318	77492	49311 ⁷
	RWD		G63909	61508 81507	77909		G63907	61500 81147	77907	43048 ⁸ 49310 ⁷
86	4WD, Mfg. from 8/86		G63902	61501 81478	77902		G63492	61506 81318	77492	49311 ⁷
	RWD, Mfg. from 8/86		G63909	61508 81507	77909		G63907	61500 81147	77907	43048 ⁸ 49310 ⁷













PICKUP STEERING STABILIZERS

		Front	Rear
95-97	4WD	6848SE ⁸²

PULSAR / PULSAR NX

87-90	All		G55745	142861 ⁵⁴ 143057 ⁵¹		G55746	143059 ⁵¹
86	All		142861 ⁵⁴ 143057 ⁵¹		143059 ⁵¹
	Mfg. from 1/86		G55745	142861 ⁵⁴ 143057 ⁵¹		G55746	81508	143059 ⁵¹
	Mfg. to 1/86		G55713 ⁹	142861 ⁵⁴ 143057 ⁵¹		143059 ⁵¹
83-85	All		G55713 ⁹	142241 ⁵⁸ 143057 ⁵¹		81508

QUEST

04-09	Left		G52032	142937 ⁵³		G51803	143396⁶⁷
	Right		G52033	142937 ⁵³		G51803	143396⁶⁷
99-02	Left		G56785	142241 ⁵⁸ 142860 ⁵⁴		G63299	61637
	Right		G56784	142241 ⁵⁸ 142860 ⁵⁴		G63299	61637
93-98	Left		G55920	142241 ⁵⁸ 142860 ⁵⁴ 143057 ⁵¹		G63299	61637
	Right		G55921	142241 ⁵⁸ 142860 ⁵⁴ 143057 ⁵¹		G63299	61637

QUEST READYMOUNTS

		Front	Rear
93-98	Left	G56989 ⁴⁰
	Right	G56990 ⁴⁰

1 Future Part, available 1st Quarter of 2015.

8 Pair Packs.

40 ReadyMount Strut. Complete Assembled Unit.

53 Strut Mount. Hardware from O.E. Part may need to be reused.

58 Mount Kit includes Suspension Bearing. Hardware from O.E. Part may need to be reused.

82 Use kit if listed, See Ref. C for optional Steering Stabilizer Boots.

7 Pair Packs, air hose kit included.



9 See Ref. D for procedures to replace Elec Adj Susp with non-adj product.

51 Strut Cushion for use with the Strut/Cartridge/Shocks.

54 Kit with Mount and Bearing. Hardware from O.E. Part may need to be reused.

67 Strut Mount Kit. Hardware from O.E. Part may need to be reused.

APPLICATION GUIDE

Year	Fitment Notes										
		Ultra	ProGuard\Guardian\Classic	Max Control\LTV	Strut Cushion\Strut Mount	Hi Jacker\Load Carrier	Ultra	ProGuard\Guardian\Classic	Max Control\LTV	Strut Cushion\Strut Mount	Hi Jacker\Load Carrier

NISSAN

NISSAN

SENTRA (cont'd)

91-92	Non-ABS Left B13 Independent Rear Suspension	143057 ⁵¹	...	G55977
	Non-ABS Right B13 Independent Rear Suspension	143057 ⁵¹	...	G55976
87-90	FWD	G55745	142861 ⁵⁴ 143057 ⁵¹	...	G55746
82-86	All	G55713 ⁹	143057 ⁵¹	81508

SENTRA READYMOUNTS

		Front	Rear
02-06	Left	G57034 ⁴⁰	G57036 ⁴⁰
	Right	G57035 ⁴⁰	G57036 ⁴⁰

STANZA

90-92	All	143059 ⁵¹ 143277 ⁵³	...	G44990 ⁹	143060 ⁵¹	...
	Left	G55610	143059 ⁵¹ 143277 ⁵³	...	G44990 ⁹	142426 ⁵³ 143060 ⁵¹	...
	Right	G55611	143059 ⁵¹ 143277 ⁵³	...	G44990 ⁹	142427 ⁵³ 143060 ⁵¹	...
87-89	Sedan	G55521	142242 ⁵³ 142861 ⁵⁴ 143060 ⁵¹	...	G44776 ⁹⁸	143057 ⁵¹	...
	Sedan Left	G55521	142242 ⁵³ 142861 ⁵⁴ 143060 ⁵¹	...	G44776 ⁹⁸	142426 ⁵³	...
	Sedan Right	G55521	142242 ⁵³ 142861 ⁵⁴ 143060 ⁵¹	...	G44776 ⁹⁸	142427 ⁵³	...
87-88	FWD, Wagon	G55539	81554
85-86	Sedan	G44767 ⁹⁸	142861 ⁵⁴ 143058 ⁵¹	...	G44766 ⁹⁸	142429 ⁵³	...
86	All	G44767 ⁹⁸	G44766 ⁹⁸	142429 ⁵³	...
	FWD, Wagon	G55539	143060 ⁵¹	...	G44766 ⁹⁸	81554	...	142429 ⁵³	...
82-85	All	G44767 ⁹⁸	143058 ⁵¹	...	G44766 ⁹⁸	142429 ⁵³	...

TITAN

12-13	All	G51715
04-11	All	G51715	143358 ⁵³ 143359 ⁷⁰
	4WD	G51715	143358 ⁵³ 143359 ⁷⁰	...	G63878
	RWD	G51715	143358 ⁵³ 143359 ⁷⁰	...	G63883

TITAN READYMOUNTS

		Front	Rear
04-15	4WD, Exc. Offroad Package	G57092 ⁴⁰	...

VERSA

07-12	Models S and SL Left	G52193	70041
	Models S and SL Right	G52194	70041

9 See Ref. D for procedures to replace Elec Adj Susp with non-adj product.

51 Strut Cushion for use with the Strut/Cartridge/Shocks.

54 Kit with Mount and Bearing. Hardware from O.E. Part may need to be reused.





98 Notice: The level of difficulty to install this product is moderately high. Please review the installation instructions carefully before proceeding.

40 ReadyMount Strut. Complete Assembled Unit.

53 Strut Mount. Hardware from O.E. Part may need to be reused.

70 Bushing and sleeve kit. Hardware from O.E. Part may need to be reused.













APPLICATION GUIDE

Year	Fitment Notes										
			Ultra	ProGuard/ Guardian/ Classic	Max Control/ LTV	Strut Cushion/ Strut Mount	Hi Jacker/ Load Carrier		Ultra	ProGuard/ Guardian/ Classic	Max Control/ LTV









NISSAN

NISSAN

X-TRAIL

10-12	Left		G52173		G64050
	Right		G52174		G64050
08	Left		G52173		G64050
	Right		G52174		G64050
02-07	Left		G52000	143346		G52002
	Right		G52001	143346		G52003





















XTERRA

05-13	4WD; Mfg. to 12/12			G69594
	Mfg. to 12/12		G51765	
	RWD; Mfg. to 12/12			G69595
00-04	All		G63813	61662		G63492	61506	77492

OLDSMOBILE

OLDSMOBILE

88 SERIES

97-99	All		G56718 ⁹	142524 ⁵⁸ 142530 ⁵⁴ 142751 ⁶⁵ 143060 ⁵¹		142132 ²³ 143060 ⁵¹
	Conventional Type Replacement for Air Assist Rear Suspension		G56718 ⁹	142524 ⁵⁸ 142530 ⁵⁴ 142751 ⁶⁵ 143060 ⁵¹		G56707 ⁹	142132 ²³ 143060 ⁵¹
	Coil(RearSpringType), Coil(FrontSpringType) Optional O.E. Hydraulic Self Leveling System; Exc. Electronic Adjustable Suspension		G56718 ⁹	142524 ⁵⁸ 142530 ⁵⁴ 142751 ⁶⁵ 143060 ⁵¹		G56903 ⁹	142132 ²³ 143060 ⁵¹
94-96	All		G56718 ⁹	142226 ⁵⁴ 142227 ⁵⁸ 142751 ⁶⁵ 143060 ⁵¹		142132 ²³ 143060 ⁵¹
	Conventional Type Replacement for Air Assist Rear Suspension		G56718 ⁹	142226 ⁵⁴ 142227 ⁵⁸ 142751 ⁶⁵ 143060 ⁵¹		G56707 ⁹	142132 ²³ 143060 ⁵¹
	Coil(RearSpringType), Coil(FrontSpringType) Optional O.E. Hydraulic Self Leveling System; Exc. Electronic Adjustable Suspension		G56718 ⁹	142226 ⁵⁴ 142227 ⁵⁸ 142751 ⁶⁵ 143060 ⁵¹		G56903 ⁹	142132 ²³ 143060 ⁵¹
92-93	All		G56718 ⁹	142226 ⁵⁴ 142227 ⁵⁸ 142751 ⁶⁵ 143060 ⁵¹		142132 ²³
	Conventional Type Replacement for Air Assist Rear Suspension		G56718 ⁹	142226 ⁵⁴ 142227 ⁵⁸ 142751 ⁶⁵ 143060 ⁵¹		G56707 ⁹	142132 ²³
	Air(RearSpringType), Coil(FrontSpringType) Optional O.E. Hydraulic Self Leveling System; Exc. Electronic Adjustable Suspension		G56718 ⁹	142226 ⁵⁴ 142227 ⁵⁸ 142751 ⁶⁵ 143060 ⁵¹		G56903 ⁹	142132 ²³
90-91	All		142226 ⁵⁴ 142227 ⁵⁸ 142751 ⁶⁵ 143060 ⁵¹		143060 ⁵¹

9 See Ref. D for procedures to replace Elec Adj Susp with non-adj product.

53 Strut Mount. Hardware from O.E. Part may need to be reused.





58 Mount Kit includes Suspension Bearing. Hardware from O.E. Part may need to be reused.

51 Strut Cushion for use with the Strut/Cartridge/Shocks.

54 Kit with Mount and Bearing. Hardware from O.E. Part may need to be reused.

65 Mount Kit includes Upper Spring Seat with Isolator. Hardware from O.E. Part may need to be reused.



















APPLICATION GUIDE

Year	Fitment Notes										
		 Ultra	ProGuard/ Guardian/ Classic	Max Control/ LTV	Strut Cushion/ Strut Mount	Hi Jacker/ Load Carrier	 Ultra	ProGuard/ Guardian/ Classic	Max Control/ LTV	Strut Cushion/ Strut Mount	Hi Jacker/ Load Carrier

OLDSMOBILE

88 SERIES (cont'd)

OLDSMOBILE

90-91	Late Design Front Strut without Spring Guard		G56718 ⁹	142226 ⁵⁴ 142227 ⁵⁸ 142751 ⁶⁵ 143060 ⁵¹	143060 ⁵¹		
	Optional O.E. Hydraulic Self Leveling System		142226 ⁵⁴ 142227 ⁵⁸ 142751 ⁶⁵ 143060 ⁵¹	142132 ⁵³ 143060 ⁵¹		
	Air(RearSpringType) Optional O.E. Hydraulic Self Leveling System		142226 ⁵⁴ 142227 ⁵⁸ 142751 ⁶⁵ 143060 ⁵¹		G56903	143060 ⁵¹	
	Coil(RearSpringType)		142226 ⁵⁴ 142227 ⁵⁸ 142751 ⁶⁵ 143060 ⁵¹		G56707 ⁹	143060 ⁵¹	
90	Early Design Front Strut with Spring Guard		G56701	142225 ⁵⁴ 143061 ⁵¹ 142226 ⁵⁴ 142227 ⁵⁸ 142751 ⁶⁵ 143060 ⁵¹	143060 ⁵¹		
86-89	All		142225 ⁵⁴ 142227 ⁵⁸ 142752 ⁶⁵		
	Early Design Front Strut with Spring Guard		G56701	143061 ⁵¹ 142225 ⁵⁴ 142227 ⁵⁸ 142752 ⁶⁵		
	Optional O.E. Hydraulic Self Leveling System		142225 ⁵⁴ 142227 ⁵⁸ 142752 ⁶⁵	142132 ⁵³		
	Air(RearSpringType) Optional O.E. Hydraulic Self Leveling System		142225 ⁵⁴ 142227 ⁵⁸ 142752 ⁶⁵		G56903	
	Coil(RearSpringType)		142225 ⁵⁴ 142227 ⁵⁸ 142752 ⁶⁵		G56707 ⁹	
71-85	All		69675 ⁵	81446	34073 ⁸		69724	81514	43049 ⁸ 49131 ³⁰
65-70	All		82110		69724	81514	43049 ⁸ 49128 ³⁰
63-64	All		82079		82089
59-62	All		82079	
58	Exc. '58 Air Suspension		82079	
57	All		82079	

88 SERIES READYMOUNTS

		Front	Rear
94-99	Coil(RearSpringType) Optional O.E. Hydraulic Self Leveling System; Exc. Electronic Adjustable Suspension	G56909 ⁴¹	G56906 ⁴³
92-99	All	G56909 ⁴¹
	Coil(RearSpringType) Exc. Electronic Adjustable Suspension	G56909 ⁴¹	G56726 ⁴³
92-93	Air(RearSpringType) Optional O.E. Hydraulic Self Leveling System; Exc. Electronic Adjustable Suspension	G56909 ⁴¹	G56906 ⁴³
90-91	Late Design Front Strut without Spring Guard	G56909 ⁴¹
86-91	Coil(RearSpringType)	G56726 ⁴³
91	Air(RearSpringType) Optional O.E. Hydraulic Self Leveling System; Exc. Electronic Adjustable Suspension	G56906 ⁴³
86-90	Early Design Front Strut with Spring Guard	G56914 ⁴⁰
	Air(RearSpringType) Optional O.E. Hydraulic Self Leveling System	G56906 ⁴³

98

91-96	All	142226 ⁵⁴ 143060 ⁵¹	142132 ⁵³ 143060 ⁵¹
-------	-----	------	------	------	--	------	------	------	--	------

5 Use kit No. 140719 to replace O.E. hardware for lower shock absorber mounting when studs break or self-tapping screws are not longer useable.

9 See Ref. D for procedures to replace Elec Adj Susp with non-adj product.

40 ReadyMount Strut. Complete Assembled Unit.

43 ReadyMount Strut, does not include springs due to vehicle design. See Ref. D for procedures to replace Elec Adj Susp with non-adj product.

53 Strut Mount. Hardware from O.E. Part may need to be reused.

58 Mount Kit includes Suspension Bearing. Hardware from O.E. Part may need to be reused.

8 Pair Packs.

30 For GM Vehicles equipped with factory installed leveling systems, see Ref A.





41 ReadyMount Strut. Complete Assembled Unit. See Ref. D for procedures to replace Elec Adj Susp with non-adj product.

51 Strut Cushion for use with the Strut/Cartridge/Shocks.

54 Kit with Mount and Bearing. Hardware from O.E. Part may need to be reused.























65 Mount Kit includes Upper Spring Seat with Isolator. Hardware from O.E. Part may need to be reused.

APPLICATION GUIDE

Year	Fitment Notes										
			ProGuard/ Guardian/ Classic	Max Control/ LTV	Strut Cushion/ Strut Mount	Hi Jacker/ Load Carrier		ProGuard/ Guardian/ Classic	Max Control/ LTV	Strut Cushion/ Strut Mount	Hi Jacker/ Load Carrier

OLDSMOBILE

98 (cont'd)







91-96	CCR Computer Command Ride		G56718 ⁸	142226 ⁵⁴ 143060 ⁵¹	142132 ⁵³ 143060 ⁵¹			
	Exc. Soft Ride Susp (FE1) and Elec. Ride & Handling (FW1)		142227 ⁵⁸ 142751 ⁵⁵ 142226 ⁵⁴ 143060 ⁵¹	142132 ⁵³ 143060 ⁵¹			
	Air(RearSpringType) CCR Computer Command Ride		142226 ⁵⁴ 143060 ⁵¹		G56903	142132 ⁵³ 143060 ⁵¹		
	Air(RearSpringType) Conventional Type Replacement		142226 ⁵⁴ 143060 ⁵¹		G56707 ⁹	142132 ⁵³ 143060 ⁵¹		
	Air(RearSpringType), Coil(FrontSpringType) Standard Equipment; Exc. Electronic Adjustable Suspension		142751 ⁵⁵ 142226 ⁵⁴ 143060 ⁵¹	142132 ⁵³ 143060 ⁵¹		
85-90	All		G56701	142225 ⁵⁴ 142227 ⁵⁸ 142752 ⁵⁵ 143061 ⁵¹	142132 ⁵³			
	Air(RearSpringType)		G56701	142225 ⁵⁴ 142227 ⁵⁸ 142752 ⁵⁵ 143061 ⁵¹		G56903	142132 ⁵³		
	Air(RearSpringType) Conventional Type Replacement		G56701	142225 ⁵⁴ 142227 ⁵⁸ 142752 ⁵⁵ 143061 ⁵¹		G56707 ⁹	142132 ⁵³		
71-84	All		69675 ⁵	81446	34073 ⁸		69724	81514	43049 ⁶ 49131 ³⁰
65-70	All		82110		69724	81514	49128 ³⁰
63-64	All		82079		82089
59-62	All		82079	
58	Exc. '58 Air Suspension		82079	
56	All			82156
55	All		82026		82156
51-54	All			82156

OLDSMOBILE

98 READYMOUNTS

		Front	Rear
91-96	All	G56909 ⁴¹
	Air(RearSpringType) CCR Computer Command Ride	G56909 ⁴¹	G56906 ⁴³
	Air(RearSpringType) Conventional Type Replacement	G56909 ⁴¹	G56726 ⁴³
85-90	All	G56914 ⁴⁰
	Air(RearSpringType)	G56914 ⁴⁰	G56906 ⁴³
	Air(RearSpringType) Conventional Type Replacement	G56914 ⁴⁰	G56726 ⁴³

ACHIEVA

95-98	All	143059 ⁵¹			
	Left Exc. Electronic Adjustable Suspension		G56720	142227 ⁵⁸ 142406 ⁵⁴ 142748 ⁵⁵ 143059 ⁵¹		69407 ⁹	81790	141974 ⁵³	49614 ⁷
	Right Exc. Electronic Adjustable Suspension		G56719	142227 ⁵⁸ 142406 ⁵⁴ 142748 ⁵⁵ 143059 ⁵¹		69407 ⁹	81790	141974 ⁵³	49614 ⁷
92-94	All		143059 ⁵¹		49371 ⁷

5 Use kit No. 140719 to replace O.E. hardware for lower shock absorber mounting when studs break or self-tapping screws are not longer useable.

8 Pair Packs.

30 For GM Vehicles equipped with factory installed leveling systems, see Ref A.

41 ReadyMount Strut. Complete Assembled Unit. See Ref. D for procedures to replace Elec Adj Susp with non-adj product.

51 Strut Cushion for use with the Strut/Cartridge/Shocks.

54 Kit with Mount and Bearing. Hardware from O.E. Part may need to be reused.

65 Mount Kit includes Upper Spring Seat with Isolator. Hardware from O.E. Part may need to be reused.

7 Pair Packs, air hose kit included.

9 See Ref. D for procedures to replace Elec Adj Susp with non-adj product.



40 ReadyMount Strut. Complete Assembled Unit.

43 ReadyMount Strut, does not include springs due to vehicle design. See Ref. D for procedures to replace Elec Adj Susp with non-adj product.

53 Strut Mount. Hardware from O.E. Part may need to be reused.

58 Mount Kit includes Suspension Bearing. Hardware from O.E. Part may need to be reused.

APPLICATION GUIDE

Year	Fitment Notes										
		Ultra	ProGuard\Guardian\Classic	Max Control\LTV	Strut Cushion\Strut Mount	Hi Jacker\Load Carrier	Ultra	ProGuard\Guardian\Classic	Max Control\LTV	Strut Cushion\Strut Mount	Hi Jacker\Load Carrier

OLDSMOBILE

OLDSMOBILE

ACHIEVA (cont'd)

92-94	Exc. Electronic Adjustable Suspension	143059 ⁵¹	141974 ⁵³	49371 ⁷
	Exc. FE3 and Electronic Ride Control	142224 ⁵⁴ 142750 ⁶⁵ 143059 ⁵¹	69749	81530	49371 ⁷
	FE3 Suspension	142227 ⁵⁸ 143059 ⁵¹	49371 ⁷
	Left Exc. FE3 and Electronic Ride Control	G56720	143059 ⁵¹	49371 ⁷
	Left FE3 Suspension	G56723	143059 ⁵¹	49371 ⁷
	Right Exc. FE3 and Electronic Ride Control	G56719	143059 ⁵¹	49371 ⁷
	Right FE3 Suspension	G56724	143059 ⁵¹	49371 ⁷

ACHIEVA READYMOUNTS

		Front	Rear
97-98	Left Exc. Electronic Adjustable Suspension	G56917 ⁴⁰
	Right Exc. Electronic Adjustable Suspension	G56916 ⁴⁰
95-96	Left	G56917 ⁴⁰
	Right	G56916 ⁴⁰
92-94	Left Exc. FE3 and Electronic Ride Control	G56919 ⁴⁰
	Right Exc. FE3 and Electronic Ride Control	G56918 ⁴¹

ALERO

99-04	All	G55974	142531 ⁵⁴ 143060 ⁵¹	G56501	142532 ⁵³ 143057 ⁵¹
-------	-----	--------	------	------	--	------	--------	------	------	--	------

ALERO READYMOUNTS

		Front	Rear
99-04	All	G56927 ⁴⁰	G56928 ⁴⁰

AURORA

01-03	All	G56509	142640 ⁵⁴	142647 ⁵³	49228 ³⁰
	With OE Style air fitting	G56509	142640 ⁵⁴	142647 ⁵³	49255⁷ 49228 ³⁰
98-99	All	G56509	142640 ⁵⁴	142647 ⁵³	49228 ³⁰
	With OE Style air fitting	G56509	142640 ⁵⁴	142647 ⁵³	49255⁷ 49228 ³⁰
97	All	G55878	142524 ⁵⁸ 142529 ⁵⁴	142647 ⁵³	49228 ³⁰
	With OE Style air fitting	G55878	142524 ⁵⁸ 142529 ⁵⁴	142647 ⁵³	49255⁷ 49228 ³⁰
95-96	All	G56718 ⁹	142227 ⁵⁸ 142411 ⁵⁴ 142751 ⁶⁵ 143060 ⁵¹	142647 ⁵³	49228 ³⁰
	With OE Style air fitting	G56718 ⁹	142227 ⁵⁸ 142411 ⁵⁴ 142751 ⁶⁵ 143060 ⁵¹	142647 ⁵³	49255⁷ 49228 ³⁰

AURORA READYMOUNTS

		Front	Rear
01-03	Exc. Electronic Adjustable Suspension	G57051 ⁴⁰
98-99	Exc. Electronic Adjustable Suspension	G57051 ⁴⁰

7 Pair Packs, air hose kit included.

30 For GM Vehicles equipped with factory installed leveling systems, see Ref. A.

41 ReadyMount Strut. Complete Assembled Unit. See Ref. D for procedures to replace Elec Adj Susp with non-adj product.

53 Strut Mount. Hardware from O.E. Part may need to be reused.

58 Mount Kit includes Suspension Bearing. Hardware from O.E. Part may need to be reused.

9 See Ref. D for procedures to replace Elec Adj Susp with non-adj product.





40 ReadyMount Strut. Complete Assembled Unit.

51 Strut Cushion for use with the Strut/Cartridge/Shocks.

54 Kit with Mount and Bearing. Hardware from O.E. Part may need to be reused.











65 Mount Kit includes Upper Spring Seat with Isolator. Hardware from O.E. Part may need to be reused.

APPLICATION GUIDE

Year	Fitment Notes										
			ProGuard/ Guardian/ Classic	Max Control/ LTV	Strut Cushion/ Strut Mount	Hi Jacker/ Load Carrier		ProGuard/ Guardian/ Classic	Max Control/ LTV	Strut Cushion/ Strut Mount	Hi Jacker/ Load Carrier

OLDSMOBILE

BRAVADA













02-04	All		G51718 ⁴⁵	143241 ⁵³		61717
	Coil(RearSpringType)		G51718 ⁴⁵	143241 ⁵³		G63842	61717
96-01	All		G63423	61531 81516	58423 77423		G63422	61528 81482	58422 77422	43162 ⁸ 49213 ⁷
91-94	All		G63423	61531 81516	58423 77423		G63422	61528 81482	58422 77422	43162 ⁸ 49213 ⁷
	Torsion Bar(FrontSpringType)		G63423	61531 81516	58423 77423	142316 ⁵³		G63422	61528 81482	58422 77422	43162 ⁸ 49213 ⁷

OLDSMOBILE

















BRAVADA READYMOUNTS

		Front	Rear
02-04	All	G57022 ⁴⁰

CALAIS

87	Left		G56706	142108 ⁵³ 142762 ⁵⁵ 143060 ⁵¹		69749	81530	141974 ⁵³	49371 ⁷
	Right		G56705	142108 ⁵³ 142762 ⁵⁵ 143060 ⁵¹		69749	81530	141974 ⁵³	49371 ⁷
85-86	All		142762 ⁵⁵ 143060 ⁵¹		69749	81530	141974 ⁵³	49371 ⁷
	Left Non-Rebuildable O.E. Struts		G56706	142762 ⁵⁵ 143060 ⁵¹		69749	81530	141974 ⁵³	49371 ⁷
	Rebuildable O.E. Struts		G44451 ⁹⁸	142108 ⁵³ 142762 ⁵⁵ 143060 ⁵¹		69749	81530	141974 ⁵³	49371 ⁷
	Right Non-Rebuildable O.E. Struts		G56705	142762 ⁵⁵ 143060 ⁵¹		69749	81530	141974 ⁵³	49371 ⁷



CIERA / CUTLASS CIERA

85-96	All		142749 ⁶⁵ 143060 ⁵¹	
	Exc. Electronic Adjustable Suspension		G55514	142223 ⁵³ 142749 ⁶⁵ 143060 ⁵¹		69723 ⁹	81517	141974 ⁵³	49370 ³⁰
84	All		142223 ⁵³ 142749 ⁶⁵ 143060 ⁵¹		141974 ⁵³	49370 ³⁰
	Exc. Electronic Adjustable Suspension		142223 ⁵³ 142749 ⁶⁵ 143060 ⁵¹		69723 ⁹	81517	141974 ⁵³	49370 ³⁰
	Exc. HD Suspension		G55505	142223 ⁵³ 142749 ⁶⁵ 143060 ⁵¹		141974 ⁵³	49370 ³⁰
	HD Suspension		G55514	142223 ⁵³ 142749 ⁶⁵ 143060 ⁵¹		141974 ⁵³	49370 ³⁰
82-83	All		G55505	142223 ⁵³ 142749 ⁶⁵ 143060 ⁵¹		49370 ³⁰
	Exc. Electronic Adjustable Suspension		G55505	142223 ⁵³ 142749 ⁶⁵ 143060 ⁵¹		69723 ⁹	81517	49370 ³⁰

CIERA / CUTLASS CIERA READYMOUNTS

		Front	Rear
85-96	Exc. Electronic Adjustable Suspension	G56908 ⁴⁰
84	HD Suspension	G56908 ⁴⁰

CUSTOM CRUISER

77-92	All		69675 ⁵	81446	34073 ⁸		69604	81492	43060 ⁸ 49152 ³⁰
-------	-----	---	--------------------	-------	------	------	--------------------	---	-------	-------	------	------	---

5 Use kit No. 140719 to replace O.E. hardware for lower shock absorber mounting when studs break or self-tapping screws are not longer useable.

8 Pair Packs.

30 For GM Vehicles equipped with factory installed leveling systems, see Ref A.

45 Strut must be rotated to align notch with lower control arm.

53 Strut Mount. Hardware from O.E. Part may need to be reused.

98 Notice:The level of difficulty to install this product is moderately high. Please review the installation instructions carefully before proceeding.

7 Pair Packs, air hose kit included.



9 See Ref. D for procedures to replace Elec Adj Susp with non-adj product.

40 ReadyMount Strut. Complete Assembled Unit.

51 Strut Cushion for use with the Strut/Cartridge/Shocks.

65 Mount Kit includes Upper Spring Seat with Isolator. Hardware from O.E. Part may need to be reused.



APPLICATION GUIDE

Year	Fitment Notes										
		Ultra	ProGuard/ Guardian/ Classic	Max Control/ LTV	Strut Cushion/ Strut Mount	Hi Jacker/ Load Carrier	Ultra	ProGuard/ Guardian/ Classic	Max Control/ LTV	Strut Cushion/ Strut Mount	Hi Jacker/ Load Carrier







































OLDSMOBILE

OLDSMOBILE

CUSTOM CRUISER (cont'd)

71-76	All	 69675 ⁵	81446	34073 ⁸	 69604	81492
-------	-----	--	-------	------	------	--------------------	---	-------	------	------	------

CUTLASS / CUTLASS SUPREME

99	All	 G55974	142531 ⁵⁴ 143060 ⁵¹	 G56501	142532 ⁵³ 143057 ⁵¹
98	All	143060 ⁵¹	142532 ⁵³ 143057 ⁵¹
	First Design with Rear Strut Lower Mounting Holes at 3.2" Apart	143060 ⁵¹	 G55975	142532 ⁵³ 143057 ⁵¹
	Rear Strut Lower Mounting Holes at 2.4" & 3.2" Apart	 G55974	142531 ⁵⁴ 143060 ⁵¹	142532 ⁵³ 143057 ⁵¹
	Second Design with Rear Strut Lower Mounting holes at 2.4" apart	143060 ⁵¹	 G56501	142532 ⁵³ 143057 ⁵¹
97	All	 G44459 ³⁶	142143 ⁵³ 142531 ⁵⁴ 143060 ⁵¹	142532 ⁵³ 143057 ⁵¹ 143062 ⁵¹ 143067 ⁵³
	Exc. Rear Strut Lower Mounting holes at 3.2" apart	 G44459 ³⁶	142143 ⁵³ 142531 ⁵⁴ 143060 ⁵¹	 G56708	142532 ⁵³ 143057 ⁵¹ 143062 ⁵¹ 143067 ⁵³
	First Design with Rear Strut Lower Mounting Holes at 3.2" Apart	 G44459 ³⁶	142143 ⁵³ 142531 ⁵⁴ 143060 ⁵¹	 G55975	142532 ⁵³ 143057 ⁵¹ 143062 ⁵¹ 143067 ⁵³
	HD Suspension	 G44459 ³⁶	142144 ⁵³ 142143 ⁵³ 142531 ⁵⁴ 143060 ⁵¹	142532 ⁵³ 143057 ⁵¹ 143062 ⁵¹ 143067 ⁵³
	Left	 G44459 ³⁶	143036 ⁵⁷ 142143 ⁵³ 142531 ⁵⁴ 143060 ⁵¹	142532 ⁵³ 143057 ⁵¹ 143062 ⁵¹ 143067 ⁵³
	Right	 G44459 ³⁶	143037 ⁵⁷ 142143 ⁵³ 142531 ⁵⁴ 143060 ⁵¹	142532 ⁵³ 143057 ⁵¹ 143062 ⁵¹ 143067 ⁵³
88-96	All	 G44459 ³⁶	142143 ⁵³ 143060 ⁵¹	 G56708	143062 ⁵¹ 143067 ⁵³
	HD Suspension	 G44459 ³⁶	142144 ⁵³ 142143 ⁵³ 143060 ⁵¹	 G56708	143062 ⁵¹ 143067 ⁵³
	Left	 G44459 ³⁶	143036 ⁵⁷ 142143 ⁵³ 143060 ⁵¹	 G56708	143062 ⁵¹ 143067 ⁵³
	Right	 G44459 ³⁶	143037 ⁵⁷ 142143 ⁵³ 143060 ⁵¹	 G56708	143062 ⁵¹ 143067 ⁵³
82-87	All	 69600	81494	34051 ⁸	 69604	81492	43060 ⁸ 49334 ³⁰
80-81	All	 69600	81494	34051 ⁸	 69604	81492	43060 ⁸ 49152 ³⁰ 49334 ³⁰
78-79	Vista Cruiser	 69600	81494	34051 ⁸	 69604	81492	49334 ³⁰ 43060 ⁸
79	All	 69600	81494	34051 ⁸	 69604	81492	43060 ⁸ 49334 ³⁰
76-78	All	 69600	81494	34051 ⁸	 69604	81492	43060 ⁸
76-77	Coupe	 69600	81494	34051 ⁸	 69604	81492	49152 ³⁰ 43060 ⁸
	Sedan	 69600	81494	34051 ⁸	 69604	81492	49152 ³⁰ 43060 ⁸
	Wagon	 69600	81494	34051 ⁸	 69604	81492	49334 ³⁰ 43060 ⁸
73-75	All	 69600	81494	34051 ⁸	 69604	81492	43060 ⁸ 49152 ³⁰

5 Use kit No. 140719 to replace O.E. hardware for lower shock absorber mounting when studs break or self-tapping screws are not longer useable.

30 For GM Vehicles equipped with factory installed leveling systems, see Ref A.

51 Strut Cushion for use with the Strut/Cartridge/Shocks.

204 54 Kit with Mount and Bearing. Hardware from O.E. Part may need to be reused.



8 Pair Packs.

36 Requires special strut installation tool.

53 Strut Mount. Hardware from O.E. Part may need to be reused.

57 Mount Kit includes Lower Spring Seat with Internal Bearing & Isolator. Hardware from O.E. Part may need to be reused.

APPLICATION GUIDE

Year	Fitment Notes										
		Ultra	ProGuard/ Guardian/ Classic	Max Control/ LTV	Strut Cushion/ Strut Mount	Hi Jacker/ Load Carrier	Ultra	ProGuard/ Guardian/ Classic	Max Control/ LTV	Strut Cushion/ Strut Mount	Hi Jacker/ Load Carrier

OLDSMOBILE

OLDSMOBILE

CUTLASS / CUTLASS SUPREME (cont'd)

71-72	All	69600	81494	34051 ⁸	69604	81492	43060 ⁹
68-72	HD Suspension	69600	81494	34051 ⁸	69604	81492	43060 ⁹
72	Base, S	69600	81494	34051 ⁸	69604	81492	49152 ³⁰ 43060 ⁹
	Cruiser	69600	81494	34051 ⁸	69604	81492	49114 ⁷ 43060 ⁹
	Exc. Cruiser	69600	81494	34051 ⁸	69604	81492	43060 ⁹
71	Exc. Vista Cruiser	69600	81494	34051 ⁸	69604	81492	49152 ³⁰ 43060 ⁹
68-70	All	69600	81494	34051 ⁸	81492	43060 ⁹
	Exc. Vista Cruiser	69600	81494	34051 ⁸	81492	49152 ³⁰ 43060 ⁹
66-67	Exc. HD Suspension	69724	81514	43049 ⁹
	Base, Exc. HD Suspension	49131 ³⁰
64-67	HD Suspension; Exc. Vista Cruiser	49152 ³⁰
	Base, Holiday	82138
67	HD Suspension	81492	43060 ⁹
	Turnpike Cruiser	82110	49128 ⁷
64-66	HD Suspension	69604	81492	43060 ⁹
64-65	Exc. HD Suspension	69724	81514	43049 ⁹ 49131 ³⁰

CUTLASS / CUTLASS SUPREME READYMOUNTS

		Front	Rear
98-99	All	G56927 ⁴⁰
97	All	G56927 ⁴⁰	G56727 ⁴²
88-96	All	G56727 ⁴²

CUTLASS CALAIS

88-91	Left	G56706	142108 ⁵³ 142762 ⁵⁵ 143060 ⁵¹	69749	81530	141974 ⁴³	49371 ⁷
	Right	G56705	142108 ⁵³ 142762 ⁵⁵ 143060 ⁵¹	69749	81530	141974 ⁴³	49371 ⁷

CUTLASS CLASSIC / CUTLASS CRUISER

87-94	All	142749 ⁶⁵ 143060 ⁵¹
	Exc. Electronic Adjustable Suspension	G55514	142223 ⁵³ 142749 ⁶⁵ 143060 ⁵¹	69723 ⁹	81517	141974 ⁴³	49370 ³⁰
80-83	All	69600	81494	34051 ⁸	69604	81492	43060 ⁹ 49334 ³⁰

CUTLASS CLASSIC / CUTLASS CRUISER READYMOUNTS

		Front	Rear
87-94	Exc. Electronic Adjustable Suspension	G56908 ⁴⁰

F85

68-72	All	69600	81494	69604	81492	43060 ⁹ 49152 ³⁰
64-67	All	82138
	Exc. HD Suspension	82138	69724	81514	43049 ⁹ 49131 ³⁰
	HD Suspension	82138	69604	81492	43060 ⁹ 49152 ³⁰

7 Pair Packs, air hose kit included.

9 See Ref. D for procedures to replace Elec Adj Susp with non-adj product.

40 ReadyMount Strut. Complete Assembled Unit.

51 Strut Cushion for use with the Strut/Cartridge/Shocks.

65 Mount Kit includes Upper Spring Seat with Isolator. Hardware from O.E. Part may need to be reused.





8 Pair Packs.

30 For GM Vehicles equipped with factory installed leveling systems, see Ref A.

42 ReadyMount Strut, does not include springs due to vehicle design.









53 Strut Mount. Hardware from O.E. Part may need to be reused.

APPLICATION GUIDE



















Year	Fitment Notes										
		 Ultra	ProGuard\ Guardian\ Classic	Max Control\ LTV	Strut Cushion\ Strut Mount	Hi Jacker\ Load Carrier	 Ultra	ProGuard\ Guardian\ Classic	Max Control\ LTV	Strut Cushion\ Strut Mount	Hi Jacker\ Load Carrier

OLDSMOBILE FIESTA







OLDSMOBILE

63	All		82079		82089
59-62	All		82079	
58	Exc. '58 Air Suspension		82079	
57	All		82079	

FIRENZA

88	Left		G56706	142108 ⁵³ 143060 ⁵¹		69749	81530	141974 ⁵³	49371 ⁷
	Right		G56705	142108 ⁵³ 143060 ⁵¹		69749	81530	141974 ⁵³	49371 ⁷
87	Left		G56706	142108 ⁵³ 142762 ⁶⁵ 143060 ⁵¹		69749	81530	141974 ⁵³	49371 ⁷
	Right		G56705	142108 ⁵³ 142762 ⁶⁵ 143060 ⁵¹		69749	81530	141974 ⁵³	49371 ⁷
84-86	All		142108 ⁵³ 142762 ⁶⁵ 143060 ⁵¹		141974 ⁵³
	Left Non-Rebuildable O.E. Struts		G56706	142108 ⁵³ 142762 ⁶⁵ 143060 ⁵¹		141974 ⁵³
	Rebuildable O.E. Struts		G44451 ⁹⁸	142108 ⁵³ 142762 ⁶⁵ 143060 ⁵¹		69749	81530	141974 ⁵³	49371 ⁷
	Right Non-Rebuildable O.E. Struts		G56705	142108 ⁵³ 142762 ⁶⁵ 143060 ⁵¹		141974 ⁵³
82-83	All		G44918 ⁹⁸	142108 ⁵³ 142762 ⁶⁵ 143060 ⁵¹		69749	81530	49371 ⁷





INTRIGUE

98-02	All		G55948	142524 ⁵⁸ 142525 ⁵³ 142526 ⁵⁴ 143060 ⁵¹		G55949	143061 ⁵¹
	Left		G55948	142524 ⁵⁸ 142525 ⁵³ 142526 ⁵⁴ 143060 ⁵¹		G55949	143073 ⁵³ 143061 ⁵¹
	Right		G55948	142524 ⁵⁸ 142525 ⁵³ 142526 ⁵⁴ 143060 ⁵¹		G55949	143074 ⁵³ 143061 ⁵¹





INTRIGUE READYMOUNTS

		Front	Rear
98-02	Left	G57060 ⁴⁰	G56924
	Right	G57060 ⁴⁰	G56925

JETFIRE

63	All		82079		82089
62	All		82079	

LSS

96-99	All		G56718 ⁹	142524 ⁵⁸ 142530 ⁵⁴ 142751 ⁶⁵ 143060 ⁵¹		142132 ⁵³ 143060 ⁵¹
	Air(RearSpringType)		G56718 ⁹	142524 ⁵⁸ 142530 ⁵⁴ 142751 ⁶⁵ 143060 ⁵¹		G56903	142132 ⁵³ 143060 ⁵¹

7 Pair Packs, air hose kit included.

40 ReadyMount Strut. Complete Assembled Unit.

53 Strut Mount. Hardware from O.E. Part may need to be reused.

58 Mount Kit includes Suspension Bearing. Hardware from O.E. Part may need to be reused.

98 Notice: The level of difficulty to install this product is moderately high. Please



9 See Ref. D for procedures to replace Elec Adj Susp with non-adj product.

51 Strut Cushion for use with the Strut/Cartridge/Shocks.

54 Kit with Mount and Bearing. Hardware from O.E. Part may need to be reused.

65 Mount Kit includes Upper Spring Seat with Isolator. Hardware from O.E. Part may need to be reused.

APPLICATION GUIDE

Year	Fitment Notes										
		Ultra	ProGuard/ Guardian/ Classic	Max Control/ LTV	Strut Cushion/ Strut Mount	Hi Jacker/ Load Carrier	Ultra	ProGuard/ Guardian/ Classic	Max Control/ LTV	Strut Cushion/ Strut Mount	Hi Jacker/ Load Carrier

OLDSMOBILE

LSS (cont'd)

96-99	Coil(RearSpringType) Conventional Type Replacement for Air Assist Rear Suspension	G56718 ⁹	142524 ⁵⁸ 142530 ⁵⁴ 142751 ⁶⁵ 143060 ⁵¹	G56707 ⁹	142132 ⁵³ 143060 ⁵¹
-------	---	---------------------	------	------	--	------	---------------------	------	------	--	------

OLDSMOBILE

LSS READYMOUNTS

		Front	Rear
96-99	All	G56909 ⁴¹
	Air(RearSpringType)	G56909 ⁴¹	G56906 ⁴³
	Coil(RearSpringType) Conventional Type Replacement for Air Assist Rear Suspension	G56909 ⁴¹	G56726 ⁴³

OMEGA

84	All	143060 ⁵¹	69723	81517	49370 ³⁰
	Exc. HD Suspension	G55505	143060 ⁵¹	69723	81517	49370 ³⁰
	HD Suspension	G55514	143060 ⁵¹	69723	81517	49370 ³⁰
80-83	All	G55505	143060 ⁵¹	69723	81517	49370 ³⁰
78-79	All	69600	81494	82093
74-77	All	69600	81494	82093	49193 ⁷
73	Exc. HD Suspension	69600	81494	82093	49193 ⁷

OMEGA READYMOUNTS

		Front	Rear
84	HD Suspension	G56908 ⁴⁰

REGENCY

97-98	All	G56718 ⁹	142524 ⁵⁸ 142530 ⁵⁴ 142751 ⁶⁵ 143060 ⁵¹	142132 ⁵³ 143060 ⁵¹
	Air(RearSpringType) Optional O.E. Hydraulic Self Leveling System	G56718 ⁹	142524 ⁵⁸ 142530 ⁵⁴ 142751 ⁶⁵ 143060 ⁵¹	G56903	142132 ⁵³ 143060 ⁵¹
	Coil(RearSpringType)	G56718 ⁹	142524 ⁵⁸ 142530 ⁵⁴ 142751 ⁶⁵ 143060 ⁵¹	G56707 ⁹	142132 ⁵³ 143060 ⁵¹

REGENCY READYMOUNTS

		Front	Rear
97-98	All	G56909 ⁴¹
	Air(RearSpringType) Optional O.E. Hydraulic Self Leveling System	G56909 ⁴¹	G56906 ⁴³
	Coil(RearSpringType)	G56909 ⁴¹	G56726 ⁴³

SILHOUETTE

02-04	AWD, FWD	G55948	142524 ⁵⁸ 142525 ⁵³ 142526 ⁵⁴ 143060 ⁵¹	G63776	61659 81924
	FWD	G55948	142524 ⁵⁸ 142525 ⁵³ 142526 ⁵⁴ 143060 ⁵¹	49230 ⁷
97-04	All	G55948	142524 ⁵⁸ 142525 ⁵³ 142526 ⁵⁴ 143060 ⁵¹
97-01	FWD	G55948	142524 ⁵⁸ 142525 ⁵³ 142526 ⁵⁴ 143060 ⁵¹	G63776	61659 81924	49230 ⁷

7 Pair Packs, air hose kit included.

9 See Ref. D for procedures to replace Elec Adj Susp with non-adj product.

40 ReadyMount Strut. Complete Assembled Unit.

43 ReadyMount Strut, does not include springs due to vehicle design. See Ref. D for procedures to replace Elec Adj Susp with non-adj product.

53 Strut Mount. Hardware from O.E. Part may need to be reused.

58 Mount Kit includes Suspension Bearing. Hardware from O.E. Part may need to be reused.

8 Pair Packs.

30 For GM Vehicles equipped with factory installed leveling systems, see Ref A.



41 ReadyMount Strut. Complete Assembled Unit. See Ref. D for procedures to replace Elec Adj Susp with non-adj product.

51 Strut Cushion for use with the Strut/Cartridge/Shocks.

54 Kit with Mount and Bearing. Hardware from O.E. Part may need to be reused.

65 Mount Kit includes Upper Spring Seat with Isolator. Hardware from O.E. Part may need to be reused.



APPLICATION GUIDE

Year	Fitment Notes										
		Ultra	ProGuard\ Guardian\ Classic	Max Control\ LTV	Strut Cushion\ Strut Mount	Hi Jacker\ Load Carrier	Ultra	ProGuard\ Guardian\ Classic	Max Control\ LTV	Strut Cushion\ Strut Mount	Hi Jacker\ Load Carrier

OLDSMOBILE

OLDSMOBILE











SILHOUETTE (cont'd)

90-96	All	 G55992	142223 ⁵³ 142749 ⁵⁵ 143060 ⁵¹	 G63914	61503	141974 ⁵³	49370 ³⁰
-------	-----	--	------	------	--	------	--	-------	------	----------------------	---------------------













SILHOUETTE READYMOUNTS

								Front	Rear		
97-04	All									G57060 ⁴⁰

STARFIRE

75-80	All		82129		81438
65-66	All		82110	 69724	81514	43049 ⁸ 49128 ³⁰
63-64	All		82079		82089
61-62	All		82079	
57	All		82079	











TORONADO

90-92	All	 G56717 ⁹	142227 ⁵⁸ 142297 ⁵⁴	 G56704 ⁹	142405 ⁵³
86-89	All	 G56703	142298 ⁵⁴	 G56704 ⁹	142405 ⁵³
79-85	All	 69706	81445		49345 ³⁰
71-78	All		82010	 69604	81492	43060 ⁸ 49152 ³⁰
67-70	Vertically Mounted		82010		82034
66	Vertically Mounted		82010		82040	49122 ⁷

TORONADO STEERING STABILIZERS

								Front	Rear		
79-85	All									14020
71-78	All									14010
66	All									14010



VISTA CRUISER

73-75	All	 69600	
68-72	All	 69600	 69606	49114 ⁷
	Stud Upper Mount	 69600	 69606	81495	49114 ⁷
64-67	All		 69606	49114 ⁷
	Stud Upper Mount		 69606	81495	49114 ⁷



OPEL

OPEL



1900

71-75	All		82614	
-------	-----	--	-------	------	------	------	--	------	------	------	------



KADETT

68-72	All			82123
-------	-----	--	------	------	------	------	--	-------	------	------	------

MANTA

71-75	All		82614	
-------	-----	--	-------	------	------	------	--	------	------	------	------

OPEL

69-73	All			82039
-------	-----	--	------	------	------	------	--	-------	------	------	------

7 Pair Packs, air hose kit included.

9 See Ref. D for procedures to replace Elec Adj Susp with non-adj product.

40 ReadyMount Strut. Complete Assembled Unit.

53 Strut Mount. Hardware from O.E. Part may need to be reused.

58 Mount Kit includes Suspension Bearing. Hardware from O.E. Part may need to be reused.

8 Pair Packs.





30 For GM Vehicles equipped with factory installed leveling systems, see Ref A.

51 Strut Cushion for use with the Strut/Cartridge/Shocks.

54 Kit with Mount and Bearing. Hardware from O.E. Part may need to be reused.

65 Mount Kit includes Upper Spring Seat with Isolator. Hardware from O.E. Part may need to be reused.

APPLICATION GUIDE

Year	Fitment Notes										
			Ultra	ProGuard/ Guardian/ Classic	Max Control/ LTV	Strut Cushion/ Strut Mount	Hi Jacker/ Load Carrier		Ultra	ProGuard/ Guardian/ Classic	Max Control/ LTV

PEUGEOT 403

PEUGEOT

59-66	All	82125
-------	-----	-------	-------	-------	-------	-------	-------	-------	-------	-------	-------	-------

404

61-67	All	82125
-------	-----	-------	-------	-------	-------	-------	-------	-------	-------	-------	-------	-------

504 / 505 / 604

91	All	143061 ⁵¹
86-90	Sedan	143061 ⁵¹

PLYMOUTH

PLYMOUTH

ACCLAIM

89-95	All	G55526	142567 ⁵¹ 142568 ⁵⁴ 142880 ⁵⁴ 142933 ⁵⁶ 142940 ⁵⁶ 143059 ⁵¹	69632	81459	49369 ⁷
-------	-----	--------	-------	-------	--	-------	-------	-------	-------	-------	-------	--------------------

ACCLAIM READYMOUNTS

								Front		Rear		
89-95	Exc. Hydraulic Self Leveling System							G56985 ⁴⁰			

ARROW

76-80	All	143059 ⁵¹	81676
-------	-----	-------	-------	-------	----------------------	-------	-------	-------	-------	-------	-------	-------

BARRACUDA

70-74	All	82090	82131
64-69	All	82090	81469	49110 ⁷

BELVEDERE

62-70	All	82090	82131	43096 ⁸ 49106 ⁷
57-61	All	82072	81469	49110 ⁷
53-56	All	81469	49110 ⁷

BREEZE

00	All	143064 ⁵¹	G51268	143063 ⁵¹ 143328 ⁵³
	Exc. JA Mfr Body Code	G51267	143064 ⁵¹	G51268	143063 ⁵¹ 143328 ⁵³
99	All	143030 ⁵³ 143064 ⁵¹	G51268	143063 ⁵¹ 143328 ⁵³
	Exc. JA Mfr Body Code	G51267	143030 ⁵³ 143064 ⁵¹	G51268	143063 ⁵¹ 143328 ⁵³
97-98	All	143030 ⁵³ 143064 ⁵¹	G51078	142396 ⁵³ 143063 ⁵¹
	JA(MfrBodyCode)	G51796	143030 ⁵³ 143064 ⁵¹	G51078	142396 ⁵³ 143063 ⁵¹
96	All	143030 ⁵³ 143064 ⁵¹	G51078	142396 ⁵³ 143063 ⁵¹
	JA(MfrBodyCode)	G51796	143030 ⁵³ 143064 ⁵¹	G51078	142396 ⁵³ 143063 ⁵¹

BREEZE READYMOUNTS

								Front		Rear		
99-00	All								G57025 ⁴⁰		

7 Pair Packs, air hose kit included.

40 ReadyMount Strut. Complete Assembled Unit.

53 Strut Mount. Hardware from O.E. Part may need to be reused.

56 Includes Mount, Bumper/Bellow & Retainers. Hardware from O.E. Part may need to be reused.

63 Mount Kit includes Isolator. Hardware from O.E. Part may need to be reused.

66 Upper Spring Seat with Spacer. Hardware from O.E. Part may need to be reused.

8 Pair Packs.



51 Strut Cushion for use with the Strut/Cartridge/Shocks.

54 Kit with Mount and Bearing. Hardware from O.E. Part may need to be reused.

61 Mount Kit includes Upper Spring Seat. Hardware from O.E. Part may need to be reused.

64 Mount Kit includes Lower Rubber Spring Seat Isolator. Hardware from O.E. Part may need to be reused.

APPLICATION GUIDE

Year	Fitment Notes										
		Ultra	ProGuard/ Guardian/ Classic	Max Control/ LTV	Strut Cushion/ Strut Mount	Hi Jacker/ Load Carrier	Ultra	ProGuard/ Guardian/ Classic	Max Control/ LTV	Strut Cushion/ Strut Mount	Hi Jacker/ Load Carrier

PLYMOUTH

CAMBRIDGE

PLYMOUTH

51-53	All	○	81469	49110 ⁷
-------	-----	-------	-------	-------	-------	-------	---	-------	-------	-------	-------	-------	--------------------

CARAVELLE

89	All	81406	○
	RWD	69704	81406	○	69703	81338	49346 ⁷
88	All	G55526	81406	142567 ⁶¹ 142568 ⁶⁴ 142880 ⁵⁴ 142933 ⁵⁶ 142940 ⁶⁶ 143060 ⁵¹	○
	FWD	G55526	81406	142567 ⁶¹ 142568 ⁶⁴ 142880 ⁵⁴ 142933 ⁵⁶ 142940 ⁶⁶ 143060 ⁵¹	○	69632	81459	49369 ⁷
	RWD	69704	81406	142567 ⁶¹ 142568 ⁶⁴ 142880 ⁵⁴ 142933 ⁵⁶ 142940 ⁶⁶ 143060 ⁵¹	○	69703	81338	49346 ⁷
87	All	G55526	81406	142567 ⁶¹ 142568 ⁶⁴ 142880 ⁵⁴ 142933 ⁵⁶ 142940 ⁶⁶ 143060 ⁵¹	○	69632	81459	49369 ⁷
86	All	G55526	81406	142567 ⁶¹ 142568 ⁶⁴ 142880 ⁵⁴ 142933 ⁵⁶ 143060 ⁵¹	○	69632	81459	49369 ⁷
	Mfg. from 1/2/86	G55526	81406	142940 ⁶⁶ 142567 ⁶¹ 142568 ⁶⁴ 142880 ⁵⁴ 142933 ⁵⁶ 143060 ⁵¹	○	69632	81459	49369 ⁷
85	All	G55511	81406	141580 ⁵⁴ 143060 ⁵¹	○	69632	81459	49369 ⁷
84	All	G55511	141580 ⁵⁴ 143060 ⁵¹	○	69632	81459	49369 ⁷
83	All	G55507	143060 ⁵¹	○	69632	81459	49369 ⁷
78-81	RWD	69704	81406	○	69703	81338	49346 ⁷

CHAMP

79-82	All	143059 ⁵¹	○	69689	81464
-------	-----	-------	-------	-------	----------------------	-------	---	-------	-------	-------	-------	-------	-------

COLT

94	All	○	142419 ⁵³
	Sedan	G55911	142329 ⁵³	○	69689 G51063	81464	142419 ⁵³
	Wagon	G55605	142301 ⁵³	○	69462	142419 ⁵³
92-93	All	143057 ⁵¹	○	142419 ⁵³
	Wagon	G55605	142301 ⁵³ 143057 ⁵¹	○	69462	142419 ⁵³
93	Sedan	G55911	142329 ⁵³ 143057 ⁵¹	○	69689 G51063	81464	142419 ⁵³
92	FWD, Hatchback	143057 ⁵¹	○	81464	142419 ⁵³

7 Pair Packs, air hose kit included.

53 Strut Mount. Hardware from O.E. Part may need to be reused.

56 Includes Mount, Bumper/Bellow & Retainers. Hardware from O.E. Part may need to be reused.

64 Mount Kit includes Lower Rubber Spring Seat Isolator. Hardware from O.E. Part may need to be reused.





51 Strut Cushion for use with the Strut/Cartridge/Shocks.

54 Kit with Mount and Bearing. Hardware from O.E. Part may need to be reused.

61 Mount Kit includes Upper Spring Seat. Hardware from O.E. Part may need to be reused.

66 Upper Spring Seat with Spacer. Hardware from O.E. Part may need to be reused.

APPLICATION GUIDE

Year	Fitment Notes										
		 Ultra	ProGuard/ Guardian/ Classic	Max Control/ LTV	Strut Cushion/ Strut Mount	Hi Jacker/ Load Carrier	 Ultra	ProGuard/ Guardian/ Classic	Max Control/ LTV	Strut Cushion/ Strut Mount	Hi Jacker/ Load Carrier

PLYMOUTH COLT (cont'd)

PLYMOUTH

92	Hatchback	143057 ⁵¹	 69689	142419 ⁵³
	Sedan	143057 ⁵¹	 69689	81464	142419 ⁵³
90-91	FWD, Hatchback	142240 ⁵⁴ 143057 ⁵¹	 G51249 69689	142419 ⁵³
	Hatchback	 G55592	 69689	142419 ⁵³
89-91	All	 69689	142419 ⁵³
	Vista, 4WD	 G55546	 69689	142419 ⁵³
	Vista, 4WD, Wagon	 69689	81739	142419 ⁵³
	Vista, Wagon	143059 ⁵¹	 69689	142419 ⁵³
91	Vista, FWD, Wagon	 G55531	 69689	81464	142419 ⁵³
89-90	DL, Wagon	 G55561	 69689	142419 ⁵³
	Exc. Vista Model	143060 ⁵¹	 69689	142419 ⁵³
	Vista, FWD, Wagon	 69689	81464	142419 ⁵³
89	FWD, Hatchback	143057 ⁵¹	 69689	142419 ⁵³
	Hatchback	 G55592	142240 ⁵⁴	 G51249 69689	142419 ⁵³
85-88	All	 69689
	Vista, 4WD	 G55546	 69689
	Vista, FWD, Wagon	 G55531	 69689	81464
	Vista, Wagon	143059 ⁵¹	 69689
88	DL, Wagon	 G55561	 69689
	Hatchback	143060 ⁵¹	 69689	81555
	Sedan	143060 ⁵¹	 69689	81555
87	Hatchback	 G55561	143060 ⁵¹	 69689	81555
	Sedan	 G55561	143060 ⁵¹	 69689	81555
85-86	DL, E, Premier	143060 ⁵¹	 69689
	FWD, Hatchback	 G55716 ⁹	 69689
	Hatchback	 69689	81555
85	FWD, Sedan	 G55716 ⁹	 69689
84	Hatchback	 69689
	Vista, FWD, Wagon	 G55531		81464
	Vista, Wagon	143059 ⁵¹	
81-83	Hatchback	143059 ⁵¹	 69689	81464
80	All		82156	43048 ⁸ 49151 ⁷
	Hatchback	143059 ⁵¹	 69689	81464 82156	43048 ⁸ 49151 ⁷
76-79	All	81676 82156	43048 ⁸ 49151 ⁷

7 Pair Packs, air hose kit included.

9 See Ref. D for procedures to replace Elec Adj Susp with non-adj product.



53 Strut Mount. Hardware from O.E. Part may need to be reused.

8 Pair Packs.

51 Strut Cushion for use with the Strut/Cartridge/Shocks.

54 Kit with Mount and Bearing. Hardware from O.E. Part may need to be reused.

APPLICATION GUIDE

Year	Fitment Notes										
		Ultra	ProGuard\Guardian\Classic	Max Control\LTV	Strut Cushion\Strut Mount	Hi Jacker\Load Carrier	Ultra	ProGuard\Guardian\Classic	Max Control\LTV	Strut Cushion\Strut Mount	Hi Jacker\Load Carrier

PLYMOUTH

COLT (cont'd)

76-79	Sedan	143059 ⁵¹	81676 82156	43048 ⁸ 49151 ⁷
	Wagon	143059 ⁵¹	81676 82156	43048 ⁸ 49151 ⁷

PLYMOUTH

CONCORD

51-52	All	81469	49110 ⁷
-------	-----	-----	-----	-----	-----	-----	-----	-------	-----	-----	--------------------

CRANBROOK

51-53	All	81469	49110 ⁷
-------	-----	-----	-----	-----	-----	-----	-----	-------	-----	-----	--------------------

CUSTOM

58-61	All	...	82072	81469	49110 ⁷
-------	-----	-----	-------	-----	-----	-----	-----	-------	-----	-----	--------------------

DUSTER

70-76	All	...	82090	81469	49110 ⁷
-------	-----	-----	-------	-----	-----	-----	-----	-------	-----	-----	--------------------

EXPO

87-89	All	G55507	141578 ⁵⁴ 143057 ⁵¹	...	G51047	142173 ⁵³ 143059 ⁵¹	...
-------	-----	--------	-----	-----	--	-----	--------	-----	-----	--	-----

FLEET SPECIAL

62-63	All	...	82090	82131	49106 ⁷
60-61	All	...	82072	81469	49110 ⁷

FURY

77-78	All	...	81153	69703	81338
	Exc. Police Package	...	81153	69703	81338	...	43138 ⁸
	Police Package	...	81153	69703	82131 81338	...	43096 ⁸ 49106 ⁷
75-76	All	...	81153	82131	43096 ⁸ 49106 ⁷
74	All	69704	82131	43096 ⁸ 49106 ⁷
73	All	...	82011	81091
	Exc. Wagon	...	82011	81091
	Exc. Wagon	...	82011	81091	49149 ⁷
	Wagon	...	82011	82131 81091	49106 ⁸ 43096 ⁸
70-72	All	...	82011	81091	49149 ⁷
65-69	All	...	82011	82131	43096 ⁸ 49106 ⁷
62-64	All	...	82090	82131	49106 ⁷
57-61	All	...	82072	81469	49110 ⁷
56	All	81469	49110 ⁷

GRAN FURY

82-89	All	69704	81406	69703	81338	...	43138 ⁸ 49346 ⁷
80-81	All	69704	81153	69703	81338	...	43138 ⁸
74-77	All	69704	81406	82131	43096 ⁸ 49106 ⁷
73	All	...	82011
	Hardtop	...	82011	81091	43067 ⁸ 49149 ⁷
	Wagon	...	82011	82131	49106 ⁷ 43096 ⁸





7 Pair Packs, air hose kit included.

51 Strut Cushion for use with the Strut/Cartridge/Shocks.

8 Pair Packs.

53 Strut Mount. Hardware from O.E. Part may need to be reused.



APPLICATION GUIDE

Year	Fitment Notes										
			ProGuard/ Guardian/ Classic	Max Control/ LTV	Strut Cushion/ Strut Mount	Hi Jacker/ Load Carrier		ProGuard/ Guardian/ Classic	Max Control/ LTV	Strut Cushion/ Strut Mount	Hi Jacker/ Load Carrier



PLYMOUTH

PLYMOUTH









GRAN FURY (cont'd)

72	All		82011		81091	49149 ⁷
----	-----	---	-------	-------	-------	-------	-------	---	-------	-------	-------	-------	--------------------







GTX

67	All		82090		82131	43096 ⁸ 49106 ⁷
----	-----	---	-------	-------	-------	-------	-------	---	-------	-------	-------	-------	--







HORIZON

90	All		G55594	141578 ⁵⁴		G51047	142173 ⁵³
	Hatchback		G55594	143059 ⁵¹ 141578 ⁵⁴		G51047	142173 ⁵³
81-89	All		G55507	141578 ⁵⁴ 143057 ⁵¹		G51047	142173 ⁵³
78-80	All		G55507	141578 ⁵⁴ 143057 ⁵¹		G51027	142173 ⁵³

LASER

92-94	AWD		G55605	142219 ⁵³ 143057 ⁵¹		G51046	142419 ⁵³ 143064 ⁵¹
90-94	All		142219 ⁵³ 143057 ⁵¹		142419 ⁵³ 143064 ⁵¹
	FWD		G55587	142219 ⁵³ 143057 ⁵¹		G51184	142419 ⁵³ 143064 ⁵¹



NEON

00-01	Left		G55892	142932 ⁵⁵		G55894	143256 ⁵³
	Right		G55892	142932 ⁵⁵		G55893	143256 ⁵³
95-99	All		G55679	142754 ⁵¹ 142840 ⁵⁴ 143057 ⁵¹		G55680	142393 ⁵³ 143059 ⁵¹

NEON READYMOUNTS

		Front	Rear
00-01	Left	G56975 ⁴⁰	G56973 ⁴⁰
	Right	G56975 ⁴⁰	G56974 ⁴⁰
95-99	All	G56966 ⁴⁰	G56967 ⁴⁰





PICKUP

79-82	All		G63950	61556 81714		G63907	61500 81147	77907	43048 ⁸ 49310 ⁷
-------	-----	---	--------	----------------	-------	-------	-------	---	--------	----------------	-------	-------	--





PICKUP STEERING STABILIZERS

		Front	Rear
79-82	All	6802SE ⁸⁴

PLAZA

57-58	All		82072		81469	49110 ⁷
54-56	All			81469	49110 ⁷

RELIANT

86-89	All		G55526	142567 ⁵¹ 142568 ⁵⁴ 142880 ⁵⁴ 142933 ⁵⁶ 142940 ⁵⁶ 143060 ⁵¹		69632	81459	49369 ⁷
	84-85	All		G55511	141580 ⁵⁴ 143060 ⁵¹		69632	81459

7 Pair Packs, air hose kit included.

40 ReadyMount Strut. Complete Assembled Unit.

53 Strut Mount. Hardware from O.E. Part may need to be reused.

55 Mount Kit includes Mount, Spring Seat, Bearing & Isolator. Hardware from O.E. Part may need to be reused.

61 Mount Kit includes Upper Spring Seat. Hardware from O.E. Part may need to be reused.

66 Upper Spring Seat with Spacer. Hardware from O.E. Part may need to be reused.

8 Pair Packs.

51 Strut Cushion for use with the Strut/Cartridge/Shocks.



54 Kit with Mount and Bearing. Hardware from O.E. Part may need to be reused.

56 Includes Mount, Bumper/Bellow & Retainers. Hardware from O.E. Part may need to be reused.

64 Mount Kit includes Lower Rubber Spring Seat Isolator. Hardware from O.E. Part may need to be reused.





84 Replacement damper for vehicles with the Gabriel Aftermarket mounting kit

APPLICATION GUIDE

Year	Fitment Notes										
		Ultra	ProGuard\ Guardian\ Classic	Max Control\ LTV	Strut Cushion\ Strut Mount	Hi Jacker\ Load Carrier	Ultra	ProGuard\ Guardian\ Classic	Max Control\ LTV	Strut Cushion\ Strut Mount	Hi Jacker\ Load Carrier







PLYMOUTH

RELIANT (cont'd)

83	All	 G55507	143057 ⁵¹	 69632	81459	49369 ⁷
81-82	All	 G55507	141578 ⁵⁴ 143057 ⁵¹	 69632	81459	49369 ⁷

PLYMOUTH







ROADRUNNER

73-75	All		81153		82131	43096 ⁸ 49106 ⁷
71-72	All		82090		82131	49106 ⁷
68-70	All		82090		82131	43096 ⁸ 49106 ⁷







SAPORO

78-83	All	143059 ⁵¹
-------	-----	------	------	------	----------------------	------	------	------	------	------	------



SATELLITE

73-74	All		81153		82131	43096 ⁸ 49106 ⁷
71-72	All		82090		82131	49106 ⁷
65-70	All		82090		82131	43096 ⁸ 49106 ⁷



SAVOY

62-64	All		82090		82131	49106 ⁷
57-61	All		82072		81469	49110 ⁷
53-56	All			81469	49110 ⁷



SCAMP

83	All	143057 ⁵¹
71-76	All		82090		81469	49110 ⁷



SPORT WAGON

60-61	All		82072		81469	49110 ⁷
-------	-----	--	-------	------	------	------	--	-------	------	------	--------------------

SUBURBAN

57-61	All		82072		81469	49110 ⁷
51-56	All		81469	49110 ⁷



SUNDANCE

87-94	All	 G55526	142567 ⁶¹ 142568 ⁶⁴ 142880 ⁵⁴ 142933 ⁵⁶ 142940 ⁶⁶ 143060 ⁵¹	 69632	81459	49369 ⁷
-------	-----	--	------	------	--	------	---	-------	------	------	--------------------



SUNDANCE READYMOUNTS

							Front	Rear
89-94	Exc. Hydraulic Self Leveling System						G56985 ⁴⁰

SUPERBIRD

70	All		82090		82131	43096 ⁸ 49106 ⁷
----	-----	--	-------	------	------	------	--	-------	------	------	--

TRAILDUSTER

81	All		77359 ³⁵	34052 ⁸		43067 ⁸ 49149 ⁷
----	-----	--	------	---------------------	------	--------------------	--	------	------	------	--

7 Pair Packs, air hose kit included.

35 Sight grinding of control arm opening is required to install product made before Aug 1988.

51 Strut Cushion for use with the Strut/Cartridge/Shocks.

56 Includes Mount, Bumper/Bellow & Retainers. Hardware from O.E.Part may need to be reused.

64 Mount Kit includes Lower Rubber Spring Seat Isolator. Hardware from O.E.Part may need to be reused.

8 Pair Packs.





40 ReadyMount Strut. Complete Assembled Unit.

54 Kit with Mount and Bearing. Hardware from O.E. Part may need to be reused.

61 Mount Kit includes Upper Spring Seat. Hardware from O.E. Part may need to be reused.

66 Upper Spring Seat with Spacer. Hardware from O.E. Part may need to be reused.



















APPLICATION GUIDE

Year	Fitment Notes										
			Ultra	ProGuard/ Guardian/ Classic	Max Control/ LTV	Strut Cushion/ Strut Mount	Hi Jacker/ Load Carrier		Ultra	ProGuard/ Guardian/ Classic	Max Control/ LTV

PLYMOUTH

PLYMOUTH





TRAILDUSTER (cont'd)

81	4WD		G63183	61632 81825	58183 77359 ³⁵	34052 ⁸		G63389	61633 81342	58389 77389	43067 ⁸ 49149 ⁷
	RWD		G63359 ³⁵	61523 ³⁵ 81096 ³⁵	58359 ³⁵ 77359 ³⁵	34052 ⁸		G63353	61526 81091	58353	43067 ⁸ 49149 ⁷
76-80	All			43067 ⁸ 49149 ⁷
	4WD		G63183	61632 81825	58183		G63389	61633 81342	58389 77389	43067 ⁸ 49149 ⁷
	RWD		G63359 ³⁵	61523 ³⁵ 81096 ³⁵	58359 ³⁵ 77359 ³⁵	34052 ⁸		G63353	61526 81091	58353	43067 ⁸ 49149 ⁷
75	All			G63353	61526	43067 ⁸ 49149 ⁷
	4WD		G63183	61632 81825	58183		G63353	61526	43067 ⁸ 49149 ⁷
	RWD		G63359 ³⁵	61523 ³⁵ 81096 ³⁵	58359 ³⁵ 77359 ³⁵	34052 ⁸		G63353	81091 61526	58353	43067 ⁸ 49149 ⁷
74	All		G63183	61632 81825	58183		G63353	61526 81091	58353	43067 ⁸ 49149 ⁷



TRAILDUSTER STEERING STABILIZERS

		Front	Rear
75-81	4WD, Single System Steering Stabilizer	6803SE ⁸⁴
74-81	Dual System Steering Stabilizer; Exc. Vacuum Servo Mounted on Drivers Side of Axle	6802SE ⁸⁴
74	Single System Steering Stabilizer	6803SE ⁸⁴



TURISMO

85	All		G55507	141578 ⁵⁴ 143057 ⁵¹		G51047	142173 ⁵³
83	All		G55507	141578 ⁵⁴ 143057 ⁵¹		G51047	142173 ⁵³



VALIANT

60-76	All		82090		81469	49110 ⁷
-------	-----	---	------	-------	------	------	------	---	------	-------	------	------	--------------------







VAN 1/2 TON, PB SERIES

74-83	All		G63359 ³⁵	61523 ³⁵ 81096 ³⁵	58359 ³⁵ 77359 ³⁵	34052 ⁸		G63413	61522 ⁶ 81496	58413 77413	43085 ⁸ 49212 ⁷
-------	-----	---	----------------------	--	--	------	--------------------	---	--------	-----------------------------	----------------	------	--



VAN 3/4 TON, PB SERIES

74-83	All		G63359 ³⁵	61523 ³⁵ 81096 ³⁵	58359 ³⁵ 77359 ³⁵	34052 ⁸		G63413	61522 ⁶ 81496	58413 77413	43085 ⁸ 49212 ⁷
-------	-----	---	----------------------	--	--	------	--------------------	---	--------	-----------------------------	----------------	------	--



VAN 1 TON, PB SERIES

74-83	All			G63413	61522 ⁶ 81496	58413 77413	43085 ⁸ 49212 ⁷
	4000# Front Axle		G63360 ³⁵	61650 81834	58360		G63413	61522 ⁶ 81496	58413 77413	43085 ⁸ 49212 ⁷
	Exc. 4000# Front Axle		G63359 ³⁵	61523 ³⁵ 81096 ³⁵	58359 ³⁵ 77359 ³⁵	34052 ⁸		G63413	61522 ⁶ 81496	58413 77413	43085 ⁸ 49212 ⁷





VIP

67	All		82011		82131	43096 ⁸ 49106 ⁷
----	-----	---	------	-------	------	------	------	---	------	-------	------	------	--

VOLARE

76-80	All		69704	81406		69703	81338	43138 ⁸ 49346 ⁷
-------	-----	---	-------	-------	------	------	------	---	-------	-------	------	------	--

VOYAGER / GRAND VOYAGER

96-00	All		G55697	143059 ⁵¹		61605 ³⁴ 81878
	Exc. Hydraulic Self Leveling System		G55697	143059 ⁵¹		G63690 ¹⁰	61605 ³⁴ 81878

6 It is recommended that when replacing shocks on vehicles with "quad shocks" all 4 shocks should be matched by series.

8 Pair Packs.

34 If suspension spring contacts this unit, rotate suspension spring 180 degrees.

51 Strut Cushion for use with the Strut/Cartridge/Shocks.

54 Kit with Mount and Bearing. Hardware from O.E. Part may need to be reused.

7 Pair Packs, air hose kit included.



10 The Nivomat leveling shocks are on the rear only. If suspension spring contacts units, rotate suspension spring 180 degrees.

35 Sight grinding of control arm opening is required to install product made before Aug 1988.

53 Strut Mount. Hardware from O.E. Part may need to be reused.

84 Replacement damper for vehicles with the Gabriel Aftermarket mounting kit

APPLICATION GUIDE

Year	Fitment Notes										
		Ultra	ProGuard\ Guardian\ Classic	Max Control\ LTV	Strut Cushion\ Strut Mount	Hi Jacker\ Load Carrier	Ultra	ProGuard\ Guardian\ Classic	Max Control\ LTV	Strut Cushion\ Strut Mount	Hi Jacker\ Load Carrier

PLYMOUTH

PLYMOUTH

VOYAGER / GRAND VOYAGER (cont'd)

96-00	Exc. Nivomat Self- Leveling Option	G55697	142753 ⁶¹ 142841 ⁵⁴ 143059 ⁵¹	○	61605 ³⁴ 81878
	Non-ABS	G55697	143059 ⁵¹	○	61605 ³⁴ 81878	49236 ⁷
87-95	All	G55525	142567 ⁶¹ 142568 ⁶⁴ 142880 ⁵⁴ 142933 ⁵⁶ 143059 ⁵¹	○	G63426	61538 81529
86	All	142567 ⁶¹ 142568 ⁶⁴ 142880 ⁵⁴ 142933 ⁵⁶ 143059 ⁵¹	○	G63426	61538 81529
	Mfg. from 1/86	G55525	142567 ⁶¹ 142568 ⁶⁴ 142880 ⁵⁴ 142933 ⁵⁶ 143059 ⁵¹	○	G63426	61538 81529
	Mfg. to 2/86	G55509	142567 ⁶¹ 142568 ⁶⁴ 142880 ⁵⁴ 142933 ⁵⁶ 143059 ⁵¹	○	G63426	61538 81529
84-85	All	G55509	141580 ⁵⁴ 143059 ⁵¹	○	G63426	61538 81529

VOYAGER / GRAND VOYAGER READYMOUNTS

		Front	Rear
96-00	All	G56910 ⁴⁰
96	Exc. Hydraulic Self Leveling System	G56910 ⁴⁰
87-95	All	G56907 ⁴⁰
86	Mfg. from 1/86	G56907 ⁴⁰

PONTIAC

PONTIAC

6000

91	FWD	142223 ⁵³ 142749 ⁶⁵ 143060 ⁵¹	○	69723	81517	141974 ⁵³	49370 ³⁰
	FWD, HD Suspension	G55514	○
89-90	All	142223 ⁵³ 142749 ⁶⁵ 143060 ⁵¹	○
	HD Suspension	G55514	142223 ⁵³ 142749 ⁶⁵ 143060 ⁵¹	○
	FWD	142223 ⁵³ 142749 ⁶⁵ 143060 ⁵¹	○	69723	81517	141974 ⁵³	49370 ³⁰
84-88	All	142223 ⁵³ 142749 ⁶⁵ 143060 ⁵¹	○	69723	81517	141974 ⁵³	49370 ³⁰
	HD Suspension	G55514	142223 ⁵³ 142749 ⁶⁵ 143060 ⁵¹	○	69723	81517	141974 ⁵³	49370 ³⁰
84	Exc. HD Suspension	G55505	142223 ⁵³ 142749 ⁶⁵ 143060 ⁵¹	○	69723	81517	141974 ⁵³	49370 ³⁰
82-83	All	G55505	142223 ⁵³ 143060 ⁵¹	○	69723	81517	49370 ³⁰

6000 READYMOUNTS

		Front	Rear
91	FWD	G56908 ⁴⁰

7 Pair Packs, air hose kit included.

34 If suspension spring contacts this unit, rotate suspension spring 180 degrees.

51 Strut Cushion for use with the Strut/Cartridge/Shocks.

54 Kit with Mount and Bearing. Hardware from O.E. Part may need to be reused.

61 Mount Kit includes Upper Spring Seat. Hardware from O.E. Part may need to be reused.

65 Mount Kit includes Upper Spring Seat with Isolator. Hardware from O.E. Part may

30 For GM Vehicles equipped with factory installed leveling systems, see Ref A.





40 ReadyMount Strut. Complete Assembled Unit.

53 Strut Mount. Hardware from O.E. Part may need to be reused.

56 Includes Mount, Bumper/Bellow & Retainers. Hardware from O.E. Part may need to be reused.

64 Mount Kit includes Lower Rubber Spring Seat Isolator. Hardware from O.E. Part may need to be reused.

APPLICATION GUIDE

Year	Fitment Notes										
			Ultra	ProGuard/ Guardian/ Classic	Max Control/ LTV	Strut Cushion/ Strut Mount	Hi Jacker/ Load Carrier		Ultra	ProGuard/ Guardian/ Classic	Max Control/ LTV



PONTIAC

PONTIAC



6000 READYMOUNTS (cont'd)

		Front	Rear
84-90	All	G56908 ⁴⁰







ACADIAN

76-87	CAN		81322		81340
-------	-----	---	------	-------	------	------	------	---	------	-------	------	------	------































ASTRE

75-77	All		82129		81438
-------	-----	---	------	-------	------	------	------	---	------	-------	------	------	------

AZTEK

01-05	All		G55834	142526 ⁵⁴	
	AWD		G55834	142526 ⁵⁴		G63868	61777
	FWD		G55834	142526 ⁵⁴		G63869

BONNEVILLE

05	All		G56509	142640 ⁵⁴		142647 ⁵³
00-04	All		G56509	142640 ⁵⁴		142647 ⁵³	49228 ⁹⁰
	With OE Style air fitting		G56509	142640 ⁵⁴		142647 ⁵³	49255 ⁷ 49228 ⁹⁰
98-99	Air(RearSpringType) CCR Computer Command Ride		142226 ⁵⁴ 142530 ⁵⁴ 142751 ⁵⁵ 143060 ⁵¹		142132 ⁵³ 143060 ⁵¹
97-99	All		142530 ⁵⁴ 142751 ⁵⁵ 143060 ⁵¹		142132 ⁵³ 143060 ⁵¹
	Exc. CCR Computer Command Ride		G56718 ⁹	142530 ⁵⁴ 142751 ⁵⁵ 143060 ⁵¹		142132 ⁵³ 143060 ⁵¹
	Air(RearSpringType) Optional O.E. Hydraulic Self Leveling System; Exc. Electronic Adjustable Suspension		142530 ⁵⁴ 142751 ⁵⁵ 143060 ⁵¹		G56903	142132 ⁵³ 143060 ⁵¹
	Coil(RearSpringType) Exc. Electronic Adjustable Suspension		142530 ⁵⁴ 142751 ⁵⁵ 143060 ⁵¹		G56707 ⁹	142132 ⁵³ 143060 ⁵¹
94-96	All		142227 ⁵⁸ 142751 ⁵⁵ 143060 ⁵¹		142132 ⁵³ 143060 ⁵¹
	CCR Computer Command Ride		142226 ⁵⁴ 142227 ⁵⁸ 142751 ⁵⁵ 143060 ⁵¹		142132 ⁵³ 143060 ⁵¹
	Exc. CCR Computer Command Ride		G56718 ⁹	142227 ⁵⁸ 142751 ⁵⁵ 143060 ⁵¹		142132 ⁵³ 143060 ⁵¹
	Air(RearSpringType) Optional O.E. Hydraulic Self Leveling System; Exc. Electronic Adjustable Suspension		142227 ⁵⁸ 142751 ⁵⁵ 143060 ⁵¹		G56903	142132 ⁵³ 143060 ⁵¹
	Coil(RearSpringType) Exc. Electronic Adjustable Suspension		142227 ⁵⁸ 142751 ⁵⁵ 143060 ⁵¹		G56707 ⁹	142132 ⁵³ 143060 ⁵¹
91-93	All		G56718 ⁹	142226 ⁵⁴ 142227 ⁵⁸ 142751 ⁵⁵ 143060 ⁵¹		142132 ⁵³ 143060 ⁵¹
	Air(RearSpringType) Optional O.E. Hydraulic Self Leveling System; Exc. Electronic Adjustable Suspension		G56718 ⁹	142226 ⁵⁴ 142227 ⁵⁸ 142751 ⁵⁵ 143060 ⁵¹		G56903	142132 ⁵³ 143060 ⁵¹

7 Pair Packs, air hose kit included.

30 For GM Vehicles equipped with factory installed leveling systems, see Ref A.

51 Strut Cushion for use with the Strut/Cartridge/Shocks.

54 Kit with Mount and Bearing. Hardware from O.E. Part may need to be reused.

65 Mount Kit includes Upper Spring Seat with Isolator. Hardware from O.E. Part may need to be reused.

9 See Ref. D for procedures to replace Elec Adj Susp with non-adj product.



40 ReadyMount Strut. Complete Assembled Unit.

53 Strut Mount. Hardware from O.E. Part may need to be reused.

58 Mount Kit includes Suspension Bearing. Hardware from O.E. Part may need to be reused.

Bold Type - New / Future Part

APPLICATION GUIDE

Year	Fitment Notes										
		Ultra	ProGuard/ Guardian/ Classic	Max Control/ LTV	Strut Cushion/ Strut Mount	Hi Jacker/ Load Carrier	Ultra	ProGuard/ Guardian/ Classic	Max Control/ LTV	Strut Cushion/ Strut Mount	Hi Jacker/ Load Carrier

PONTIAC

PONTIAC

BONNEVILLE (cont'd)

91-93	Coil(RearSpringType) Exc. Electronic Adjustable Suspension	G56718 ⁹	142226 ⁵⁴ 142227 ⁵⁸ 142751 ⁶⁵ 143060 ⁵¹	G56707 ⁹	142132 ⁵³ 143060 ⁵¹
90	All	142227 ⁵⁸ 142751 ⁶⁵ 143060 ⁵¹	142132 ⁵³ 143060 ⁵¹
	Early Design Front Strut with Spring Guard	G56701	142225 ⁵⁴ 142227 ⁵⁸ 142751 ⁶⁵ 143060 ⁵¹	142132 ⁵³ 143060 ⁵¹
	Late Design Front Strut without Spring Guard	G56718 ⁹	142226 ⁵⁴ 142227 ⁵⁸ 142751 ⁶⁵ 143060 ⁵¹	142132 ⁵³ 143060 ⁵¹
	Air(RearSpringType) Optional O.E. Hydraulic Self Leveling System	142227 ⁵⁸ 142751 ⁶⁵ 143060 ⁵¹	G56903	142132 ⁵³ 143060 ⁵¹
	Coil(RearSpringType)	142227 ⁵⁸ 142751 ⁶⁵ 143060 ⁵¹	G56707 ⁹	142132 ⁵³ 143060 ⁵¹
88-89	Air(RearSpringType) Optional O.E. Hydraulic Self Leveling System	142227 ⁵⁸ 142752 ⁶⁵ 143061 ⁵¹	G56903	142132 ⁵³ 143060 ⁵¹
87-89	All	142227 ⁵⁸ 142752 ⁶⁵ 143061 ⁵¹	142132 ⁵³ 143060 ⁵¹
	Early Design Front Strut with Spring Guard	G56701	142225 ⁵⁴ 142227 ⁵⁸ 142752 ⁶⁵ 143061 ⁵¹	142132 ⁵³ 143060 ⁵¹
	Coil(RearSpringType)	142227 ⁵⁸ 142752 ⁶⁵ 143061 ⁵¹	G56707 ⁹	142132 ⁵³ 143060 ⁵¹
87	Optional O.E. Hydraulic Self Leveling System	142227 ⁵⁸ 142752 ⁶⁵ 143061 ⁵¹	G56903	142132 ⁵³ 143060 ⁵¹
82-86	All	69600	81494	34051 ⁸	69604	81492	43060 ⁸ 49334 ³⁰
71-81	All	69675 ⁵	81446	34073 ⁸	69724	81514	43049 ⁸ 49131 ³⁰
65-70	All	82110	69724	81514	43049 ⁸ 49128 ³⁰
63-64	All	82099	69724	81514	43049 ⁸ 49128 ³⁰
61-62	All	82099
58-60	All	82099	81318 82156
57	All	82026	81318 82156

BONNEVILLE READYMOUNTS

		Front	Rear
00-05	Exc. Electronic Adjustable Suspension	G57051 ⁴⁰
94-99	Air(RearSpringType) Exc. CCR Computer Command Ride	G56909 ⁴¹
	Air(RearSpringType) Optional O.E. Hydraulic Self Leveling System; Exc. Electronic Adjustable Suspension	G56906 ⁴³
	Coil(RearSpringType) Exc. Electronic Adjustable Suspension	G56726 ⁴³
91-93	All	G56909 ⁴¹
	Air(RearSpringType) Optional O.E. Hydraulic Self Leveling System; Exc. Electronic Adjustable Suspension	G56909 ⁴¹	G56906 ⁴³
	Coil(RearSpringType) Exc. Electronic Adjustable Suspension	G56909 ⁴¹	G56726 ⁴³
88-90	Air(RearSpringType) Optional O.E. Hydraulic Self Leveling System	G56906 ⁴³
87-90	Early Design Front Strut with Spring Guard	G56914 ⁴⁰
	Coil(RearSpringType)	G56726 ⁴³

5 Use kit No. 140719 to replace O.E. hardware for lower shock absorber mounting when studs break or self-tapping screws are not longer useable.

9 See Ref. D for procedures to replace Elec Adj Susp with non-adj product.

40 ReadyMount Strut. Complete Assembled Unit.

43 ReadyMount Strut, does not include springs due to vehicle design. See Ref. D for procedures to replace Elec Adj Susp with non-adj product.

53 Strut Mount. Hardware from O.E. Part may need to be reused.

58 Mount Kit includes Suspension Bearing. Hardware from O.E. Part may need to be reused.

8 Pair Packs.

30 For GM Vehicles equipped with factory installed leveling systems, see Ref A.





41 ReadyMount Strut. Complete Assembled Unit. See Ref. D for procedures to replace Elec Adj Susp with non-adj product.

51 Strut Cushion for use with the Strut/Cartridge/Shocks.

54 Kit with Mount and Bearing. Hardware from O.E. Part may need to be reused.

65 Mount Kit includes Upper Spring Seat with Isolator. Hardware from O.E. Part may need to be reused.

APPLICATION GUIDE

Year	Fitment Notes										
			Ultra	ProGuard/ Guardian/ Classic	Max Control/ LTV	Strut Cushion/ Strut Mount	Hi Jacker/ Load Carrier		Ultra	ProGuard/ Guardian/ Classic	Max Control/ LTV























PONTIAC

PONTIAC





BONNEVILLE READYMOUNTS (cont'd)

		Front	Rear
90	Late Design Front Strut without Spring Guard	G56909 ⁴¹
87	Optional O.E. Hydraulic Self Leveling System	G56906 ⁴³



CATALINA

77-81	Wagon		69675 ⁵	81446	34073 ⁸		69604	81492	49152 ³⁰
71-81	All		69675 ⁵	81446	34073 ⁸	
	Exc. Wagon		69675 ⁵	81446	34073 ⁸		69724	81514	43049 ⁸ 49131 ³⁰
74-75	Wagon		69675 ⁵	81446	34073 ⁸		69604	81492	49152 ³⁰
71-73	Wagon		69675 ⁵	81446	34073 ⁸		69604	81492
	Wagon Wagon		69675 ⁵	81446	34073 ⁸		49152 ³⁰
65-70	All		82110		69724	81514	43049 ⁸ 49128 ³⁰
63-64	All		82099		69724	81514	43049 ⁸ 49128 ³⁰
61-62	All		82099	
58-60	All		82099		81318 82156
50-57	All		82026		82156





CHIEFTAIN

58	All		82099		81318 82156
49-57	All		82026		82156

















EXECUTIVE

67-70	All		82110		69724	81514	43049 ⁸ 49128 ³⁰
-------	-----	---	------	-------	------	------	------	---	-------	-------	------	------	---

FIERO

88	All		81670		G55593	143059 ⁵¹
84-87	All		69727		G55512	143059 ⁵¹

FIREBIRD

93-02	All		G51204	142412 ⁵³		69676	81481	75676	49203 ⁷
	Left		G51204	142408 ⁵³ 142412 ⁵³		69676	81481	75676	49203 ⁷
	Right		G51204	142409 ⁵³ 142412 ⁵³		69676	81481	75676	49203 ⁷
82-92	Left		G56700	142146 ⁵³		69676	81481	75676	49203 ⁷
	Right		G56700	142145 ⁵³		69676	81481	75676	49203 ⁷
70-81	All		69675 ⁵	81446	34073 ⁸		69624	81095	43084 ⁸ 49135 ³⁰
68-69	All		69600	81494		69606	81495
67	All		69600	81494		82040	49122 ⁷

FIREBIRD READYMOUNTS

		Front	Rear
93-02	Left	G57107 ⁴⁰

5 Use kit No. 140719 to replace O.E. hardware for lower shock absorber mounting when studs break or self-tapping screws are not longer useable.

8 Pair Packs.

40 ReadyMount Strut. Complete Assembled Unit.

43 ReadyMount Strut, does not include springs due to vehicle design. See Ref. D for procedures to replace Elec Adj Susp with non-adj product.

53 Strut Mount. Hardware from O.E. Part may need to be reused.

7 Pair Packs, air hose kit included.

30 For GM Vehicles equipped with factory installed leveling systems, see Ref A.



41 ReadyMount Strut. Complete Assembled Unit. See Ref. D for procedures to replace Elec Adj Susp with non-adj product.

51 Strut Cushion for use with the Strut/Cartridge/Shocks.

63 Mount Kit includes Isolator. Hardware from O.E. Part may need to be reused.

Bold Type - New / Future Part

APPLICATION GUIDE

Year	Fitment Notes										
		Ultra	ProGuard\ Guardian\ Classic	Max Control\ LTV	Strut Cushion\ Strut Mount	Hi Jacker\ Load Carrier	Ultra	ProGuard\ Guardian\ Classic	Max Control\ LTV	Strut Cushion\ Strut Mount	Hi Jacker\ Load Carrier

PONTIAC

PONTIAC

FIREBIRD READYMOUNTS (cont'd)

		Front					Rear				
93-02	Right	G57108⁴⁰								

FIREFLY

95-99	CAN	143059 ⁵¹	143057 ⁵¹
	Non-ABS, CAN	G55891	G55772
94	CAN	G55891	142293 ⁵⁴ 143059 ⁵¹	G55772	142295 ⁵³ 143057 ⁵¹
89-91	CAN	G55891	142293 ⁵⁴ 143059 ⁵¹	G55772	142295 ⁵³ 143057 ⁵¹
87-88	CAN	G55749	81562
85-86	CAN	G55749	81557

G3

07-09	Left	G56886	143375⁵³
09	Right	G51921	143375⁵³
07-08	Right	G56887	143375⁵³

G3 READYMOUNTS

		Front					Rear				
09	Left	G57130⁴⁰								

G5

07-09	All	G56810	143323 ⁵³	G69587
-------	-----	--------	------	------	----------------------	------	--------	------	------	------	------

G5 READYMOUNTS

		Front					Rear				
07-09	Left	G57047 ⁴⁰								
	Right	G57048 ⁴⁰								

G6

05-10	Left	G52028	143354 ⁵³	G69590	143425⁵³
	Right	G52029	143355 ⁵³	G69590	143425⁵³

G6 READYMOUNTS

		Front					Rear				
06-10	Left	G57121								
	Right	G57122								
05-10	Exc. Convertible and 4 cyl Left	G57069 ⁴⁰								
	Exc. Convertible and 4 cyl Right	G57070 ⁴⁰								

GRAND AM

99-05	All	G55974	142531 ⁵⁴ 143060 ⁵¹	G56501	142532 ⁵³ 143057 ⁵¹
96-98	Right Exc. Electronic Adjustable Suspension	G56719 ⁹	142227 ⁵⁸ 142406 ⁵⁴ 142748 ⁶⁵ 143059 ⁵¹	G69407 ⁹	81790	141974 ⁵³	49614 ⁷
95-98	Left Exc. Electronic Adjustable Suspension	G56720 ⁹	142227 ⁵⁸ 142406 ⁵⁴ 142748 ⁶⁵ 143059 ⁵¹	G69407 ⁹	81790	141974 ⁵³	49614 ⁷
95	SE, Right Exc. Electronic Adjustable Suspension	G56719 ⁹	142227 ⁵⁸ 142406 ⁵⁴ 142748 ⁶⁵ 143059 ⁵¹	G69407 ⁹	81790	141974 ⁵³	49614 ⁷

7 Pair Packs, air hose kit included.

40 ReadyMount Strut. Complete Assembled Unit.

53 Strut Mount. Hardware from O.E. Part may need to be reused.

58 Mount Kit includes Suspension Bearing. Hardware from O.E. Part may need to be reused.





9 See Ref. D for procedures to replace Elec Adj Susp with non-adj product.

51 Strut Cushion for use with the Strut/Cartridge/Shocks.

54 Kit with Mount and Bearing. Hardware from O.E. Part may need to be reused.

65 Mount Kit includes Upper Spring Seat with Isolator. Hardware from O.E. Part may need to be reused.

































APPLICATION GUIDE

Year	Fitment Notes										
			Ultra	ProGuard/ Guardian/ Classic	Max Control/ LTV	Strut Cushion/ Strut Mount	Hi Jacker/ Load Carrier		Ultra	ProGuard/ Guardian/ Classic	Max Control/ LTV

PONTIAC

PONTIAC





GRAND AM (cont'd)

92-94	All			69749	81530	141974 ⁵³	49371 ³⁰
	Exc. Electronic Adjustable Suspension		142224 ⁵⁴ 142750 ⁵⁵ 143059 ⁵¹		69749	81530	141974 ⁵³	49371 ³⁰
	GT, Left FE3 Suspension		G56723		69749	81530	141974 ⁵³	49371 ³⁰
	GT, Right FE3 Suspension		G56724		69749	81530	141974 ⁵³	49371 ³⁰
	SE, Left Exc. FE3 and Electronic Ride Control		G56720 ⁹	142227 ⁵⁸		69749	81530	141974 ⁵³	49371 ³⁰
	SE, Right Exc. FE3 and Electronic Ride Control		G56719 ⁹	142227 ⁵⁸		69749	81530	141974 ⁵³	49371 ³⁰
87-91	Left		G56706	142108 ⁵³ 143060 ⁵¹		69749	81530	141974 ⁵³	49371 ³⁰
	Right		G56705	142108 ⁵³ 143060 ⁵¹		69749	81530	141974 ⁵³	49371 ³⁰
	Standard Suspension		142762 ⁵⁵	
85-86	All		142108 ⁵³ 143060 ⁵¹		69749	81530	141974 ⁵³	49371 ³⁰
	Left Non-Rebuildable O.E. Struts		G56706	142108 ⁵³ 143060 ⁵¹		69749	81530	141974 ⁵³	49371 ³⁰
	Rebuildable O.E. Struts		G44451 ⁹⁸	142108 ⁵³ 143060 ⁵¹		69749	81530	141974 ⁵³	49371 ³⁰
	Right Non-Rebuildable O.E. Struts		G56705	142108 ⁵³ 143060 ⁵¹		69749	81530	141974 ⁵³	49371 ³⁰
	Standard Suspension		142762 ⁵⁵ 142108 ⁵³ 143060 ⁵¹		69749	81530	141974 ⁵³	49371 ³⁰
78-80	All		69600	81494	34051 ⁸		69604	81492	43060 ⁸ 49334 ³⁰
73-75	All		69600	81494	34051 ⁸		69604	81492	43060 ⁸ 49152 ³⁰







GRAND AM READYMOUNTS

							Front	Rear
99-05	All						G56927 ⁴⁰	G56928 ⁴⁰
96-98	Left Exc. Electronic Adjustable Suspension						G56917 ⁴⁰
	Right Exc. Electronic Adjustable Suspension						G56916 ⁴⁰
95	Left Exc. Electronic Adjustable Suspension						G56917 ⁴¹
	Right Exc. Electronic Adjustable Suspension						G56916 ⁴¹
92-94	SE, Left Exc. FE3 and Electronic Ride Control						G56919 ⁴⁰
	SE, Right Exc. FE3 and Electronic Ride Control						G56918 ⁴¹

GRAND LEMANS

78-83	All		69600	81494	34051 ⁸		69604	81492	43060 ⁸ 49334 ³⁰
75-77	All		69600	81494	34051 ⁸		69604	81492	43060 ⁸ 49152 ³⁰

GRAND PRIX

04-08	All		G56812	142524 ⁵⁸ 142525 ⁵³ 142526 ⁵⁴	
	Exc. Models with 17" or 18" Wheels		G56812	142524 ⁵⁸ 142525 ⁵³ 142526 ⁵⁴		G55949
	Left		G56812	142524 ⁵⁸ 142525 ⁵³ 142526 ⁵⁴		143073 ⁵³

8 Pair Packs.

30 For GM Vehicles equipped with factory installed leveling systems, see Ref A.

41 ReadyMount Strut. Complete Assembled Unit. See Ref. D for procedures to replace Elec Adj Susp with non-adj product.

53 Strut Mount. Hardware from O.E. Part may need to be reused.

58 Mount Kit includes Suspension Bearing. Hardware from O.E. Part may need to be reused.

98 Notice: The level of difficulty to install this product is moderately high. Please review the installation instructions carefully before proceeding.

9 See Ref. D for procedures to replace Elec Adj Susp with non-adj product.



40 ReadyMount Strut. Complete Assembled Unit.

51 Strut Cushion for use with the Strut/Cartridge/Shocks.

54 Kit with Mount and Bearing. Hardware from O.E. Part may need to be reused.

65 Mount Kit includes Upper Spring Seat with Isolator. Hardware from O.E. Part may need to be reused.





































APPLICATION GUIDE

Year	Fitment Notes										
		Ultra	ProGuard\ Guardian\ Classic	Max Control\ LTV	Strut Cushion\ Strut Mount	Hi Jacker\ Load Carrier	Ultra	ProGuard\ Guardian\ Classic	Max Control\ LTV	Strut Cushion\ Strut Mount	Hi Jacker\ Load Carrier

PONTIAC

PONTIAC

GRAND PRIX (cont'd)

04-08	Models with 17" or 18" Wheels		G56812	142524 ⁵⁸ 142525 ⁵³ 142526 ⁵⁴		G52244
	Right		G56812	142524 ⁵⁸ 142525 ⁵³ 142526 ⁵⁴		143074 ⁵³
97-03	All		G55948	142524 ⁵⁸ 142525 ⁵³ 142526 ⁵⁴ 143060 ⁵¹	
	Exc. Models with 17" or 18" Wheels		G55948	142524 ⁵⁸ 142525 ⁵³ 142526 ⁵⁴ 143060 ⁵¹		G55949
	Left		G55948	142524 ⁵⁸ 142525 ⁵³ 142526 ⁵⁴ 143060 ⁵¹		143073 ⁵³
	Right		G55948	142524 ⁵⁸ 142525 ⁵³ 142526 ⁵⁴ 143060 ⁵¹		143074 ⁵³
90-96	All		G44459 ³⁶	142143 ⁵³ 143060 ⁵¹		G56708	143062 ⁵¹ 143067 ⁵³
	HD Suspension		G44459 ³⁶	142144 ⁵³ 142143 ⁵³ 143060 ⁵¹		G56708	143062 ⁵¹ 143067 ⁵³
	Left		G44459 ³⁶	143036 ⁵⁷ 142143 ⁵³ 143060 ⁵¹		G56708	143062 ⁵¹ 143067 ⁵³
	Right		G44459 ³⁶	143037 ⁵⁷ 142143 ⁵³ 143060 ⁵¹		G56708	143062 ⁵¹ 143067 ⁵³
88-89	All		G44459 ³⁶	142141 ⁵³ 143060 ⁵¹		G56708	143062 ⁵¹ 143067 ⁵³
	HD Suspension		G44459 ³⁶	142142 ⁵³ 142141 ⁵³ 143060 ⁵¹		G56708	143062 ⁵¹ 143067 ⁵³
	Left		G44459 ³⁶	143036 ⁵⁷ 142141 ⁵³ 143060 ⁵¹		G56708	143062 ⁵¹ 143067 ⁵³
	Right		G44459 ³⁶	143037 ⁵⁷ 142141 ⁵³ 143060 ⁵¹		G56708	143062 ⁵¹ 143067 ⁵³
69-87	All		69600	81494	34051 ⁸		69604	81492	43060 ⁸ 49334 ³⁰
65-68	All		82110		69724	81514	49128 ³⁰
63-64	All		82099		69724	81514	49128 ³⁰
62	All		82099	

GRAND PRIX READYMOUNTS

		Front	Rear
04-08	All	G57141 ¹
	Left Exc. Models with 17" or 18" Wheels	G57141 ¹	G56924 ⁴⁰
	Right Exc. Models with 17" or 18" Wheels	G57141 ¹	G56925 ⁴⁰
97-03	All	G57060 ⁴⁰
	Left Exc. Models with 17" or 18" Wheels	G57060 ⁴⁰	G56924 ⁴⁰
	Right Exc. Models with 17" or 18" Wheels	G57060 ⁴⁰	G56925 ⁴⁰
88-96	All	G56727 ⁴²

1 Future Part, available 1st Quarter of 2015.

30 For GM Vehicles equipped with factory installed leveling systems, see Ref A.

40 ReadyMount Strut. Complete Assembled Unit.

51 Strut Cushion for use with the Strut/Cartridge/Shocks.

54 Kit with Mount and Bearing. Hardware from O.E. Part may need to be reused.

58 Mount Kit includes Suspension Bearing. Hardware from O.E. Part may need to be reused.

8 Pair Packs.





36 Requires special strut installation tool.

42 ReadyMount Strut, does not include springs due to vehicle design.

53 Strut Mount. Hardware from O.E. Part may need to be reused.

57 Mount Kit includes Lower Spring Seat with Internal Bearing & Isolator. Hardware from O.E. Part may need to be reused.



APPLICATION GUIDE

Year	Fitment Notes										
			Ultra	ProGuard/ Guardian/ Classic	Max Control/ LTV	Strut Cushion/ Strut Mount	Hi Jacker/ Load Carrier		Ultra	ProGuard/ Guardian/ Classic	Max Control/ LTV



PONTIAC

PONTIAC













GRAND SAFARI

71-78	All		69675 ⁵	81446	34073 ⁸		69604	81492	43060 ⁹ 49152 ³⁰
-------	-----	---	--------------------	-------	------	------	--------------------	---	-------	-------	------	------	---



















GRANDVILLE

71-75	All		69600	81494	34051 ⁸		69604	81492	43060 ⁹ 49152 ³⁰
-------	-----	---	-------	-------	------	------	--------------------	---	-------	-------	------	------	---



GTO

04-06	Left		G52123		70032
	Right		G52124		70032
68-73	All		69600	81494		69604	81492	43060 ⁹ 49152 ³⁰
64-67	All		82138	
	Exc. HD Suspension		82138		69724	81514	43049 ⁹ 49131 ³⁰
	HD Suspension		82138		69604	81492	43060 ⁹ 49152 ³⁰













J2000 / SUNBIRD

85	All		143060 ⁵¹		69749	81530	141974 ⁵³	49371 ³⁰
	Left Non-Rebuildable O.E. Struts		G56706	143060 ⁵¹		69749	81530	141974 ⁵³	49371 ³⁰
	Rebuildable O.E. Struts		G44451 ⁹⁸	143060 ⁵¹		69749	81530	141974 ⁵³	49371 ³⁰
	Right Non-Rebuildable O.E. Struts		G56705	143060 ⁵¹		69749	81530	141974 ⁵³	49371 ³⁰
84	All		142762 ⁵⁵ 143060 ⁵¹		69749	81530	141974 ⁵³	49371 ³⁰
	Left Non-Rebuildable O.E. Struts		G56706	142762 ⁵⁵ 143060 ⁵¹		69749	81530	141974 ⁵³	49371 ³⁰
	Rebuildable O.E. Struts		G44451 ⁹⁸	142762 ⁵⁵ 143060 ⁵¹		69749	81530	141974 ⁵³	49371 ³⁰
	Right Non-Rebuildable O.E. Struts		G56705	142762 ⁵⁵ 143060 ⁵¹		69749	81530	141974 ⁵³	49371 ³⁰
82-83	All		G44918 ⁹⁸	142762 ⁵⁵ 143060 ⁵¹		69749	81530	49371 ³⁰





LAURENTIAN

76-81	CAN		69675 ⁵	81446	34073 ⁸		69724	81514	43049 ⁹ 49131 ³⁰
-------	-----	---	--------------------	-------	------	------	--------------------	---	-------	-------	------	------	---

LEMANS

88-93	All		G44903 ⁹⁸	142296 ⁵³ 143057 ⁵¹		81742
68-81	All		69600	81494	34051 ⁸		69604	81492	43060 ⁹ 49334 ³⁰
64-67	All		82138	
	Exc. HD Suspension		82138		69724	81514	43049 ⁹ 49131 ³⁰
	HD Suspension		82138		69604	81492	43060 ⁹ 49152 ³⁰
63	All		82129	

MONTANA

06-09	All		142526 ⁵⁴	
	SV6, Exc. Self-Leveling Suspension		G52025	142526 ⁵⁴	

5 Use kit No. 140719 to replace O.E. hardware for lower shock absorber mounting when studs break or self-tapping screws are not longer useable.

30 For GM Vehicles equipped with factory installed leveling systems, see Ref A.

53 Strut Mount. Hardware from O.E. Part may need to be reused.

65 Mount Kit includes Upper Spring Seat with Isolator. Hardware from O.E. Part may need to be reused.



8 Pair Packs.

51 Strut Cushion for use with the Strut/Cartridge/Shocks.

54 Kit with Mount and Bearing. Hardware from O.E. Part may need to be reused.

98 Notice: The level of difficulty to install this product is moderately high. Please review the installation instructions carefully before proceeding.

APPLICATION GUIDE

Year	Fitment Notes										
		Ultra	ProGuard/ Guardian/ Classic	Max Control/ LTV	Strut Cushion/ Strut Mount	Hi Jacker/ Load Carrier	Ultra	ProGuard/ Guardian/ Classic	Max Control/ LTV	Strut Cushion/ Strut Mount	Hi Jacker/ Load Carrier

PONTIAC

PONTIAC

MONTANA (cont'd)

06	FWD, Exc. Air-Leveling Suspension	142526 ⁵⁴	G63776
04-05	All	142524 ⁵⁸ 142525 ⁵³ 142526 ⁵⁴ 143060 ⁵¹	61659 81924
	Exc. Air-Leveling Suspension	142524 ⁵⁸ 142525 ⁵³ 142526 ⁵⁴ 143060 ⁵¹	G63776	61659 81924
	Base	G55948	142524 ⁵⁸ 142525 ⁵³ 142526 ⁵⁴ 143060 ⁵¹	61659 81924
	FWD, Air-Leveling Suspension; Exc. Independent Rear Suspension	142524 ⁵⁸ 142525 ⁵³ 142526 ⁵⁴ 143060 ⁵¹	61659 81924	49230 ⁷
05	SV6, Exc. Self-Leveling Suspension	G52025	142524 ⁵⁸ 142525 ⁵³ 142526 ⁵⁴ 143060 ⁵¹	61659 81924
02-03	All	142525 ⁵³ 142526 ⁵⁴ 143060 ⁵¹	61659 81924
	Exc. Air-Leveling Suspension	142525 ⁵³ 142526 ⁵⁴ 143060 ⁵¹	G63776	61659 81924
	Base	G55948	142525 ⁵³ 142526 ⁵⁴ 143060 ⁵¹	61659 81924
	FWD, Air-Leveling Suspension; Exc. Independent Rear Suspension	142525 ⁵³ 142526 ⁵⁴ 143060 ⁵¹	61659 81924	49230 ⁷
	Mini Passenger Van	142524 ⁵⁸ 142525 ⁵³ 142526 ⁵⁴ 143060 ⁵¹	61659 81924
99-01	All	142524 ⁵⁸ 142525 ⁵³ 142526 ⁵⁴ 143060 ⁵¹	61659 81924
	Exc. Air-Leveling Suspension	142524 ⁵⁸ 142525 ⁵³ 142526 ⁵⁴ 143060 ⁵¹	G63776	61659 81924
	Base	G55948	142524 ⁵⁸ 142525 ⁵³ 142526 ⁵⁴ 143060 ⁵¹	61659 81924
	FWD, Air-Leveling Suspension; Exc. Independent Rear Suspension	142524 ⁵⁸ 142525 ⁵³ 142526 ⁵⁴ 143060 ⁵¹	61659 81924	49230 ⁷

MONTANA READYMOUNTS

		Front	Rear
06-09	SV6, FWD	G57142¹
99-05	All	G57060 ⁴⁰
05	SV6, FWD	G57142¹

PARISIENNE

76-86	All	⊕ 69675 ⁵	81446	34073 ⁸	
	Sedan	⊕ 69675 ⁵	81446	34073 ⁸	⊕ 69724	81514	43049 ⁸ 49131 ³⁰
	Wagon	⊕ 69675 ⁵	81446	34073 ⁸	⊕ 69604	81492	43060 ⁸ 49152 ³⁰

1 Future Part, available 1st Quarter of 2015.

7 Pair Packs, air hose kit included.

30 For GM Vehicles equipped with factory installed leveling systems, see Ref A.

51 Strut Cushion for use with the Strut/Cartridge/Shocks.

54 Kit with Mount and Bearing. Hardware from O.E. Part may need to be reused.

5 Use kit No. 140719 to replace O.E. hardware for lower shock absorber mounting when studs break or self-tapping screws are not longer useable.





8 Pair Packs.

40 ReadyMount Strut. Complete Assembled Unit.

53 Strut Mount. Hardware from O.E. Part may need to be reused.











58 Mount Kit includes Suspension Bearing. Hardware from O.E. Part may need to be reused.

APPLICATION GUIDE

Year	Fitment Notes										
		 Ultra	ProGuard/ Guardian/ Classic	Max Control/ LTV	Strut Cushion/ Strut Mount	Hi Jacker/ Load Carrier	 Ultra	ProGuard/ Guardian/ Classic	Max Control/ LTV	Strut Cushion/ Strut Mount	Hi Jacker/ Load Carrier

PONTIAC

PHOENIX



84	All		142223 ⁵³ 142749 ⁵⁵ 143060 ⁵¹		69723	81517	141974 ⁵³	49370 ³⁰
	Exc. HD Suspension		G55505	142223 ⁵³ 142749 ⁵⁵ 143060 ⁵¹		69723	81517	141974 ⁵³	49370 ³⁰
	HD Suspension		G55514	142223 ⁵³ 142749 ⁵⁵ 143060 ⁵¹		69723	81517	141974 ⁵³	49370 ³⁰
80-83	All		G55505	142223 ⁵³ 143060 ⁵¹		69723	81517	49370 ³⁰
77-79	All		69600	81494		82093	49193 ⁷

PONTIAC

PHOENIX READYMOUNTS

		Front	Rear
84	HD Suspension	G56908 ⁴⁰











PURSUIT

05-06	All		G56810	143323 ⁵³		69587
-------	-----	---	--------	------	------	----------------------	------	---	-------	------	------	------	------



PURSUIT READYMOUNTS

		Front	Rear
05-06	Left	G57047 ⁴⁰
	Right	G57048 ⁴⁰











SAFARI

87-89	All		69675 ⁵	81446	34073 ⁸		69604	81492	43060 ⁸ 49152 ³⁰
68-70	All		82110		69724	81514	49128 ³⁰
65	All		82110		69724	81514	49128 ³⁰
63-64	All		82099		69724	81514	49128 ³⁰
61-62	All		82099	



SOLSTICE

06-09	All		G51935		G51936
-------	-----	---	--------	------	------	------	------	------	---	--------	------	------	------	------







STAR CHIEF

65-66	All		82110		69724	81514	49128 ³⁰
63-64	All		82099		69724	81514	49128 ³⁰
61-62	All		82099	
58-60	All		82099		81318 82156
54-57	All		82026		82156

STREAMLINER

49-52	All		82026		82156
-------	-----	---	------	-------	------	------	------	------	---	------	-------	------	------	------

SUNBIRD

94	Left		G56706	142148 ⁵³ 142762 ⁵⁵ 143060 ⁵¹		69749	81530	141974 ⁵³	49371 ³⁰
	Right		G56705	142148 ⁵³ 142762 ⁵⁵ 143060 ⁵¹		69749	81530	141974 ⁵³	49371 ³⁰
91-93	Left		G56706	142148 ⁵³ 142762 ⁵⁵ 143060 ⁵¹		69749	81530	49371 ³⁰

5 Use kit No. 140719 to replace O.E. hardware for lower shock absorber mounting when studs break or self-tapping screws are not longer useable.

8 Pair Packs.

40 ReadyMount Strut. Complete Assembled Unit.

53 Strut Mount. Hardware from O.E. Part may need to be reused.



7 Pair Packs, air hose kit included.

30 For GM Vehicles equipped with factory installed leveling systems, see Ref A.

51 Strut Cushion for use with the Strut/Cartridge/Shocks.

65 Mount Kit includes Upper Spring Seat with Isolator. Hardware from O.E. Part may need to be reused.















APPLICATION GUIDE

Year	Fitment Notes										
		Ultra	ProGuard\Guardian\Classic	Max Control\LTV	Strut Cushion\Strut Mount	Hi Jacker\Load Carrier	Ultra	ProGuard\Guardian\Classic	Max Control\LTV	Strut Cushion\Strut Mount	Hi Jacker\Load Carrier

PONTIAC

SUNBIRD (cont'd)



PONTIAC

91-93	Right	 G56705	142148 ⁵³ 142762 ⁶⁵ 143060 ⁵¹	 69749	81530	49371 ³⁰
	Sport Suspension	142108 ⁵³	141974 ⁵³
88-90	Left	 G56706	142148 ⁵³ 142762 ⁶⁵ 143060 ⁵¹	 69749	81530	141974 ⁵³	49371 ³⁰
	Right	 G56705	142148 ⁵³ 142762 ⁶⁵ 143060 ⁵¹	 69749	81530	141974 ⁵³	49371 ³⁰
	Sport Suspension	142108 ⁵³
86-87	All	142762 ⁶⁵ 143060 ⁵¹	 69749	81530	141974 ⁵³	49371 ³⁰
	Left Non-Rebuildable O.E. Struts	 G56706	142762 ⁶⁵ 143060 ⁵¹	 69749	81530	141974 ⁵³	49371 ³⁰
	Rebuildable O.E. Struts	 G44451 ⁹⁸	142762 ⁶⁵ 143060 ⁵¹	 69749	81530	141974 ⁵³	49371 ³⁰
	Right Non-Rebuildable O.E. Struts	 G56705	142762 ⁶⁵ 143060 ⁵¹	 69749	81530	141974 ⁵³	49371 ³⁰
76-80	All		82129		81438





SUNBIRD READYMOUNTS

		Front	Rear
92-94	Left	G56921 ⁴⁰
	Right	G56920 ⁴⁰

SUNBURST

85-88	CAN	 G55719	143058 ⁵¹		81558
-------	-----	--	------	------	----------------------	------	---	-------	------	------	------



SUNFIRE

99-05	All	 G55698	143035 ⁵⁴ 143057 ⁵¹	 G55825	142413 ⁵³
95-98	All	 G55698	142227 ⁹⁸ 142406 ⁵⁴ 143057 ⁵¹	 G55825	142413 ⁵³





SUNFIRE READYMOUNTS

		Front	Rear
99-05	All	G56951 ⁴⁰	G56938 ⁴⁰
95-98	All	G56939 ⁴⁰	G56938 ⁴⁰



SUNRUNNER

94-97	CAN	 G56518	142294 ⁵⁴	 G63799	61560 81904	49613 ⁷
-------	-----	--	------	------	----------------------	------	--	----------------	------	------	--------------------





SUPER CHIEF

58	All		82099		81318 82156
57	All		82026		82156

T1000

81-87	All		81322		81340
-------	-----	---	-------	------	------	------	---	-------	------	------	------

TEMPEST

87-91	All	143060 ⁵¹
	CAN Left	 G56706	143060 ⁵¹	 69749	81530	141974 ⁵³	49371 ³⁰
	CAN Right	 G56705	143060 ⁵¹	 69749	81530	141974 ⁵³	49371 ³⁰

7 Pair Packs, air hose kit included.

40 ReadyMount Strut. Complete Assembled Unit.

53 Strut Mount. Hardware from O.E. Part may need to be reused.

58 Mount Kit includes Suspension Bearing. Hardware from O.E. Part may need to be reused.

98 Notice: The level of difficulty to install this product is moderately high. Please





30 For GM Vehicles equipped with factory installed leveling systems, see Ref A.

51 Strut Cushion for use with the Strut/Cartridge/Shocks.

54 Kit with Mount and Bearing. Hardware from O.E. Part may need to be reused.

65 Mount Kit includes Upper Spring Seat with Isolator. Hardware from O.E. Part may need to be reused.











APPLICATION GUIDE

Year	Fitment Notes										
			Ultra	ProGuard/ Guardian/ Classic	Max Control/ LTV	Strut Cushion/ Strut Mount	Hi Jacker/ Load Carrier		Ultra	ProGuard/ Guardian/ Classic	Max Control/ LTV

PONTIAC

PONTIAC











TEMPEST (cont'd)

68-70	All		69600	81494		69604	81492	43060 ⁸ 49152 ³⁰
64-67	All		82138	
	Exc. HD Suspension		82138		69724	81514	43049 ⁸ 49131 ³⁰
	HD Suspension		82138		69604	81492	43060 ⁸ 49152 ³⁰
61-63	All		82129	

TEMPEST READYMOUNTS

		Front	Rear
87-91	Left	G56921 ⁴⁰
	Right	G56920 ⁴⁰





TORRENT

07-09	All			G64015	61718
	Left Exc. Sport Suspension		G52127		G64015	61718
	Right Exc. Sport Suspension		G52128		G64015	61718
06	Left		G56773	143363 ⁵³		G64015	61718
	Right		G56774	143363 ⁵³		G64015	61718

TORRENT READYMOUNTS

		Front	Rear
06	Left	G57110 ⁴⁰
	Right	G57111 ⁴⁰























TRANS SPORT

97-98	All		G55948	142524 ⁵⁸ 142525 ⁵³ 142526 ⁵⁴ 143060 ⁵¹		G63776	61659 81924	49230 ⁷
90-96	All		G55992	142223 ⁵³ 142749 ⁵⁵ 143060 ⁵¹		G63914	61503	141974 ⁵³	49370 ³⁰

TRANS SPORT READYMOUNTS

		Front	Rear
97-98	All	G57060 ⁴⁰

VENTURA

74-77	All		69600	81494	34051 ⁸		82093	49193 ⁷
73	All		69600	81494	34051 ⁸		82093
	Exc. HD Suspension		69600	81494	34051 ⁸		82093	49193 ⁷
	HD Suspension		69600	81494	34051 ⁸		69724	81514 82093	49157 ⁷
71-72	All		69600	81494	
	Leaf(RearSpringType)		69600	81494		69724	81514
	Leaf(RearSpringType)		69600	81494		82093	43049 ⁸
	Leaf(RearSpringType) Multi-Leaf Rear Spring		69600	81494		49157 ⁷
	Leaf(RearSpringType) Single-Leaf Rear Spring		69600	81494		49193 ⁷
61	All		82099	
60	All		82099		81318 82156

7 Pair Packs, air hose kit included.

30 For GM Vehicles equipped with factory installed leveling systems, see Ref A.

51 Strut Cushion for use with the Strut/Cartridge/Shocks.

54 Kit with Mount and Bearing. Hardware from O.E. Part may need to be reused.

65 Mount Kit includes Upper Spring Seat with Isolator. Hardware from O.E. Part may need to be reused.





8 Pair Packs.

40 ReadyMount Strut. Complete Assembled Unit.

53 Strut Mount. Hardware from O.E. Part may need to be reused.











58 Mount Kit includes Suspension Bearing. Hardware from O.E. Part may need to be reused.

APPLICATION GUIDE



Year	Fitment Notes										
		 Ultra	ProGuard\ Guardian\ Classic	Max Control\ LTV	Strut Cushion\ Strut Mount	Hi Jacker\ Load Carrier	 Ultra	ProGuard\ Guardian\ Classic	Max Control\ LTV	Strut Cushion\ Strut Mount	Hi Jacker\ Load Carrier

PONTIAC VIBE

PONTIAC

09-10	Left	 G52245		
	Right	 G52246		
	FWD	 G51898	
03-08	Left	 G52013	143093 ⁵³		143094 ⁵³
	Right	 G52014	143093 ⁵³		143094 ⁵³
	FWD	 G51736
03-06	AWD	 G51768

WAVE





05-08	Left	 G56886	143239 ⁵³	 G51747	143375 ⁵³
	Right	G51921	143239 ⁵³	 G51747	143375 ⁵³

WAVE READYMOUNTS





		Front		Rear	
05-08	Left	G57130 ⁹⁰		

PORSCHE 924

PORSCHE

87-88	All	 G44850 ⁹⁸	143058 ⁵¹	 69760
77-82	All	 G44850 ⁹⁸	143058 ⁵¹	 69616





944

89-91	All	 69760
86-88	All	 G44850 ⁹⁸	143058 ⁵¹	 69760
83-85	All	 G44850 ⁹⁸	143058 ⁵¹	 69616

RAM

RAM





1500 (SEE DODGE RAM 1500)

11-12	All	 G64044
	4WD	 G51856	 G64044
	RWD	 G64043	 G64044

1500 (SEE DODGE RAM 1500) READYMOUNTS

		Front		Rear	
11	All	G57147 ¹		

2500 (SEE DODGE RAM 2500)

11-12	All	77950
	4WD	 61716	77948	 61716	77950
	4WD, 8800# GVW	 G64013	77950
	RWD	 77949	77949		77950

1 Future Part, available 1st Quarter of 2015.





51 Strut Cushion for use with the Strut/Cartridge/Shocks.

98 Notice: The level of difficulty to install this product is moderately high. Please review the installation instructions carefully before proceeding.

40 ReadyMount Strut. Complete Assembled Unit.

53 Strut Mount. Hardware from O.E. Part may need to be reused.

APPLICATION GUIDE

Year	Fitment Notes										
			Ultra	ProGuard/ Guardian/ Classic	Max Control/ LTV	Strut Cushion/ Strut Mount	Hi Jacker/ Load Carrier		Ultra	ProGuard/ Guardian/ Classic	Max Control/ LTV







RAM

RAM

2500 (SEE DODGE RAM 2500) (cont'd)

11-12	RWD, Standard Cab Pickup		G63970	77950
-------	--------------------------	-------	-------	-------	-------	-------	---	--------	-------	-------	-------	-------

















3500 (SEE DODGE RAM 3500)

11-12	All			77950
	4WD		77948		77950
	RWD		77949		77950







SAAB

SAAB



9-3

09-11	All			70039
04-08	Left		G52175¹		70039
	Right		G52176¹		70039
03	All		G244002		70039
	Left		G52175¹		70039
	Right		G52176¹		70039
99-02	All		G244002⁹⁸	
	Exc. Viggen		G244002⁹⁸	143206 ⁵³		70020

9-5

07	All		143208 ⁵³	
02-06	All		G52066	143208 ⁵³		G51885
99-01	All		143208 ⁵³		G51885



9-7X

05-09	All		G51718 ⁴⁵	143241 ⁵³		G63842	61717
-------	-----	---	----------------------	-------	-------	----------------------	---	--------	-------	-------	-------	-------



9-7X READYMOUNTS

05-09	All									Front	Rear
										G57022 ⁴⁰



93

56-57	All		82607		81676
-------	-----	---	-------	-------	-------	-------	---	-------	-------	-------	-------	-------



93B

58-59	All		82607		81676
-------	-----	---	-------	-------	-------	-------	---	-------	-------	-------	-------	-------





95

59-73	All		82607	
-------	-----	---	-------	-------	-------	-------	---	-------	-------	-------	-------	-------

96

61-73	All		82607	
-------	-----	---	-------	-------	-------	-------	---	-------	-------	-------	-------	-------

99

79-80	All		82607		69671
69-78	All		82607		81270	49105 ⁷

1 Future Part, available 1st Quarter of 2015.

40 ReadyMount Strut. Complete Assembled Unit.

53 Strut Mount. Hardware from O.E. Part may need to be reused.

7 Pair Packs, air hose kit included.

45 Strut must be rotated to align notch with lower control arm.

98 Notice: The level of difficulty to install this product is moderately high. Please review the installation instructions carefully before proceeding.

APPLICATION GUIDE

Year	Fitment Notes										
		Ultra	ProGuard/ Guardian/ Classic	Max Control/ LTV	Strut Cushion/ Strut Mount	Hi Jacker/ Load Carrier	Ultra	ProGuard/ Guardian/ Classic	Max Control/ LTV	Strut Cushion/ Strut Mount	Hi Jacker/ Load Carrier

SAAB

SAAB

900

94-98	All	○	143057 ⁵¹	○	69891
	Naturally Aspirated(Eng Asp)	↓	G44495 ⁹⁸	143057 ⁵¹	↓	69891
	Turbocharged(Eng Asp)	↓	G44461 ⁹⁸	143057 ⁵¹	↓	69891
93	All	○	69670	143057 ⁵¹	○
	Mfg. from 6/30/93	○	69670	143057 ⁵¹	○	69891
	Mfg. to 7/93	○	69670	143057 ⁵¹	○	69671
	Naturally Aspirated(Eng Asp) Mfg. from 6/30/93	↓	G44495 ⁹⁸	143057 ⁵¹	↓
	Turbocharged(Eng Asp) Mfg. from 6/30/93	↓	G44461 ⁹⁸	143057 ⁵¹	↓
80-92	All	○	69670	○	69671
79	All	○	69670	○

9000

88-98	All	○	143061 ⁵¹	○
	Exc. Hydraulic Self Leveling System	↓	G55584	143061 ⁵¹	↓
	Hydraulic Self Leveling System	○	143061 ⁵¹	○	69773
86-87	All	○	143058 ⁵¹	○
	Hydraulic Self Leveling System	○	143058 ⁵¹	○	69773

GT750

60-62	All	○	82607	○
58-59	All	○	82607	○	81676

GT850

63	All	○	82607	○	81676
----	-----	---	------	-------	------	------	------	---	------	-------	------	------	------

SATURN

SATURN

ASTRA

08-09	All	○	○	69587
-------	-----	---	------	------	------	------	------	---	-------	------	------	------	------

AURA

07-09	Left	↓	G52028	143354 ⁵³	○
	Right	↓	G52029	143355 ⁵³	↓
	Exc. Hybrid	○	○	69590	143425 ⁵³

AURA READYMOUNTS

		Front	Rear
07-09	4Cyl: Exc. Hybrid Models Left	G57121
	4Cyl: Exc. Hybrid Models Right	G57122
	Exc. Hybrid Models & 4 cyl Left	G57069 ⁴⁰
	Exc. Hybrid Models & 4 cyl Right	G57070 ⁴⁰





ION

04-07	All	↓	G56809	143089 ⁵³	○	69587
-------	-----	---	--------	------	------	----------------------	------	---	-------	------	------	------	------

40 ReadyMount Strut. Complete Assembled Unit.
53 Strut Mount. Hardware from O.E. Part may need to be reused.

51 Strut Cushion for use with the Strut/Cartridge/Shocks.
98 Notice: The level of difficulty to install this product is moderately high. Please review the installation instructions carefully before proceeding.



APPLICATION GUIDE

Year	Fitment Notes										
			Ultra	ProGuard\Guardian\Classic	Max Control\LTV	Strut Cushion\Strut Mount	Hi Jacker\Load Carrier		Ultra	ProGuard\Guardian\Classic	Max Control\LTV

SATURN

ION (cont'd)













SATURN

03	All		G56809	143089 ⁵⁴		69587
----	-----	---	--------	------	------	----------------------	------	---	-------	------	------	------	------





ION READYMOUNTS

										Front	Rear		
04-07	Left											G57099 ⁴⁰
	Right											G57100 ⁴⁰

L / LS / LW SERIES

03-05	Left		G56796	143090 ⁵³		G51759	142942 ⁵³
	Right		G56795	143090 ⁵³		G51759	142942 ⁵³
01-02	Left		G56796	142943 ⁵³		G51759	142942 ⁵³
	Right		G56795	142943 ⁵³		G51759	142942 ⁵³
00	Left		G56796		G51759
	Right		G56795		G51759









OUTLOOK

10	All		G52125		G64040
07-09	All		G52125	143366 ⁵³		G64040

OUTLOOK READYMOUNTS

										Front	Rear		
07-10	All											G57109



RELAY

05-07	Air-Leveling Suspension, Exc. Independent Rear Suspension			49230 ⁷
	Exc. Air-Leveling Suspension		G52025	
	FWD		142526 ⁵⁴	
	FWD, Exc. Air-Leveling Suspension			G63776

RELAY READYMOUNTS

										Front	Rear		
07	1, 2, 3, FWD											G57142 ¹
05-06	2, 3, FWD											G57142 ¹











SC / SL / SW SERIES

91-02	All		G55801	142244 ⁵⁴ 143057 ⁵¹		G55800	142245 ⁵³ 143059 ⁵¹
-------	-----	---	--------	------	------	--	------	---	--------	------	------	--	------

SC / SL / SW SERIES READYMOUNTS

										Front	Rear		
91-02	All											G57013 ⁴⁰	G57014 ⁴⁰

VUE

08-10	Left		G52127		G63872
	Right		G52128		G63872
02-07	All		143035 ⁵⁴		G63872
	Left		G52026	143035 ⁵⁴		G63872
	Replaces Mount in GM Service Kit 15269823		143368 ⁵³ 143035 ⁵⁴		G63872

¹ Future Part, available 1st Quarter of 2015.

⁴⁰ ReadyMount Strut. Complete Assembled Unit.

⁵³ Strut Mount. Hardware from O.E. Part may need to be reused.





Bold Type - New / Future Part

⁷ Pair Packs, air hose kit included.

⁵¹ Strut Cushion for use with the Strut/Cartridge/Shocks.

⁵⁴ Kit with Mount and Bearing. Hardware from O.E. Part may need to be reused.



APPLICATION GUIDE

Year	Fitment Notes										
		 Ultra	ProGuard\ Guardian\ Classic	Max Control\ LTV	Strut Cushion\ Strut Mount	Hi Jacker\ Load Carrier	 Ultra	ProGuard\ Guardian\ Classic	Max Control\ LTV	Strut Cushion\ Strut Mount	Hi Jacker\ Load Carrier

SATURN

SATURN

VUE (cont'd)

02-07	Right		G52027	143035 ⁵⁴		G63872
-------	-------	---	--------	------	------	----------------------	------	---	--------	------	------	------	------









VUE READYMOUNTS

		Front		Rear	
02-07	Left	G57101 ⁴⁰		
	Right	G57102 ⁴⁰		



SCION

SCION







TC

08-10	Left		G52096		G51852
	Right		G52097		G51852
05-07	Left		G52096		G51852	143094 ⁵³
	Right		G52097		G51852	143094 ⁵³









XA

04-06	All		G52098		70028
-------	-----	---	--------	------	------	------	------	---	-------	------	------	------	------

XB

08-12	Left		G52264		70053
	Right		G52265		70053
04-06	All		G52098		70028



XD

11-14	Left		G52268	
	Right		G52269	
08-10	Left		G52268		70055
	Right		G52269		70055



STUDEBAKER

STUDEBAKER



AVANTI

63-64	All		82087		82103
-------	-----	---	------	-------	------	------	------	---	------	-------	------	------	------



CHAMPION

57-58	All		82087		82151
-------	-----	---	------	-------	------	------	------	---	------	-------	------	------	------



COMMANDER

57-58	All		82087		82151
-------	-----	---	------	-------	------	------	------	---	------	-------	------	------	------



GOLDEN HAWK

57-58	All		82087		82151
-------	-----	---	------	-------	------	------	------	---	------	-------	------	------	------

HAWK

60-62	All		82087		82151
-------	-----	---	------	-------	------	------	------	---	------	-------	------	------	------





LARK

59-62	All		82087		82151
-------	-----	---	------	-------	------	------	------	---	------	-------	------	------	------

40 ReadyMount Strut. Complete Assembled Unit.

53 Strut Mount. Hardware from O.E. Part may need to be reused.



APPLICATION GUIDE

Year	Fitment Notes										
			Ultra	ProGuard/ Guardian/ Classic	Max Control/ LTV	Strut Cushion/ Strut Mount	Hi Jacker/ Load Carrier		Ultra	ProGuard/ Guardian/ Classic	Max Control/ LTV





STUDEBAKER

STUDEBAKER





POWER HAWK

56	All		82026		82060
----	-----	---	-------	-------	-------	-------	-------	---	-------	-------	-------	-------	-------



PRESIDENT

57-58	All		82087		82151
55-56	All		82026		82060



R / E SERIES 1/2 / 3/4 TON

55-60	All		61500		81147
49-54	All		61500 81147		61500 81147

SILVER HAWK

57-59	All		82087		82151
-------	-----	---	-------	-------	-------	-------	-------	---	-------	-------	-------	-------	-------





SKY HAWK

56	All		82026		82060
----	-----	---	-------	-------	-------	-------	-------	---	-------	-------	-------	-------	-------



SUBARU

SUBARU





B9 TRIBECA

06-07	Left		G52270		G51909
	Right		G52271		G51909



























BAJA

03-06	All			G51767	143140 ⁵³
-------	-----	---	-------	-------	-------	-------	-------	---	--------	-------	-------	----------------------	-------





BRAT

82-87	All		G55726	143061 ⁵¹		69733	81450
80-81	All		143061 ⁵¹		69733	81450

DL

87-89	4WD, Coupe		142335 ⁵³ 143061 ⁵¹		G51182
	4WD, Sedan		142335 ⁵³ 143061 ⁵¹		G51181
	4WD; Exc. Hatchback, Sedan and Exc. Air Suspension Left		G55785	142335 ⁵³ 143061 ⁵¹	
	4WD; Exc. Hatchback, Sedan and Exc. Air Suspension Right		G55784	142335 ⁵³ 143061 ⁵¹	
86-89	Coupe Exc. Air Suspension		142335 ⁵³ 143061 ⁵¹		142757 ⁵³
85-89	All		142335 ⁵³ 143061 ⁵¹	
	FWD, Sedan Left Exc. Air Suspension		G55738	142335 ⁵³ 143061 ⁵¹		G51173
	FWD, Sedan Right Exc. Air Suspension		G55737	142335 ⁵³ 143061 ⁵¹		G51173
	FWD, Wagon Exc. Air Suspension		142335 ⁵³ 143061 ⁵¹		G51183
	Sedan Exc. Air Suspension		142335 ⁵³ 143061 ⁵¹		142763 ⁵³
83-84	FWD		G55724		69733	81450
82-84	4WD		G55726		69733	81450
80-84	All			69733	81450





















APPLICATION GUIDE

Year	Fitment Notes										
		 Ultra	ProGuard/ Guardian/ Classic	Max Control/ LTV	Strut Cushion/ Strut Mount	Hi Jacker/ Load Carrier	 Ultra	ProGuard/ Guardian/ Classic	Max Control/ LTV	Strut Cushion/ Strut Mount	Hi Jacker/ Load Carrier



















SUBARU

SUBARU

FORESTER

07-08	Left	 G52180	 G52182
	Right	 G52181	 G52183
06	Left	 G52180	 G52182	143205 ⁵³
	Right	 G52181	 G52183	143205 ⁵³
04-05	Left	 G52067	 G52178	143205 ⁵³
	Right	 G52068	 G52179	143205 ⁵³
03	Left	 G52069	 G52178	143205 ⁵³
	Right	 G52070	 G52179	143205 ⁵³
98-02	All	142330 ⁵³ 143057 ⁵¹	143057 ⁵¹
	Left	 G56544	142330 ⁵³ 143057 ⁵¹	143057 ⁵¹
	Left Exc. Hydraulic Self Leveling System	142330 ⁵³ 143057 ⁵¹	 G56546	143057 ⁵¹
	Right	 G56543	142330 ⁵³ 143057 ⁵¹	143057 ⁵¹
	Right Exc. Hydraulic Self Leveling System	142330 ⁵³ 143057 ⁵¹	 G56545	143057 ⁵¹

GL

87-89	4WD, Coupe	142335 ⁵³	 G51182
	4WD, Sedan	142335 ⁵³	 G51181
	4WD; Exc. Hatchback, Sedan and Exc. Air Suspension Left	 G55785	142335 ⁵³
	4WD; Exc. Hatchback, Sedan and Exc. Air Suspension Right	 G55784	142335 ⁵³
86-89	Coupe Exc. Air Suspension	142335 ⁵³	142757 ⁵³
85-89	All	142335 ⁵³
	4WD, Hatchback	 G55726	142335 ⁵³
	FWD, Hatchback	 G55724	142335 ⁵³
	FWD, Sedan Left Exc. Air Suspension	 G55738	142335 ⁵³	 G51173
	FWD, Sedan Right Exc. Air Suspension	 G55737	142335 ⁵³	 G51173
	Hatchback	143061 ⁵¹ 142335 ⁵³	 69733	81450
	Sedan Exc. Air Suspension	142335 ⁵³	142763 ⁵³
89	FWD, Wagon Exc. Air Suspension	142335 ⁵³	 G51183
85-87	FWD, Wagon Exc. Air Suspension	142335 ⁵³	 G51183
83-84	FWD	 G55724	 69733	81450
82-84	4WD	 G55726	 69733	81450
80-84	All	 69733	81450

APPLICATION GUIDE

Year	Fitment Notes										
			Ultra	ProGuard/ Guardian/ Classic	Max Control/ LTV	Strut Cushion/ Strut Mount	Hi Jacker/ Load Carrier		Ultra	ProGuard/ Guardian/ Classic	Max Control/ LTV



SUBARU

SUBARU

IMPREZA

07	AWD, Wagon Left		G52085	
	AWD, Wagon Right		G52086	
	Sedan Left		G52087	
	Sedan Right		G52088	
	Wagon Left		G52083	
	Wagon Right		G52084	
04-06	All	143205 ⁵³
	AWD, Wagon Left		G52085	143205 ⁵³
	AWD, Wagon Right		G52086	143205 ⁵³
	Sedan Left		G52087	143205 ⁵³
	Sedan Right		G52088	143205 ⁵³
	Wagon Left		G52083	143205 ⁵³
04	AWD, Sedan Left		G52089	143205 ⁵³
	AWD, Sedan Right		G52090	143205 ⁵³
02-03	RS, Sedan Left		G56804	G52073	
	RS, Sedan Right		G56803	G52074	
	TS, Left		G52073	
	TS, Right		G52074	
00-01	Outback, Right		G56541	
	Outback, AWD, Left Non-ABS		G56542	
98-01	L, AWD, Non-ABS Left		G55930	
	L, AWD, Non-ABS Right		G55929	
93-01	Non-ABS Left		G55926	142330 ⁵³	142550 ⁵³	
	Non-ABS Right		G55925	142330 ⁵³	142550 ⁵³	
95-99	Outback, AWD, Non-ABS Left		G56542	
	Outback, Non-ABS Right		G56541	
96-97	Brighton, L, AWD, Non-ABS Left		G55930	
	Brighton, L, AWD, Non-ABS Right		G55929	
93-95	FWD, Non-ABS Left		G55934	

APPLICATION GUIDE

Year	Fitment Notes										
		Ultra	ProGuard/ Guardian/ Classic	Max Control/ LTV	Strut Cushion/ Strut Mount	Hi Jacker/ Load Carrier	Ultra	ProGuard/ Guardian/ Classic	Max Control/ LTV	Strut Cushion/ Strut Mount	Hi Jacker/ Load Carrier

SUBARU

SUBARU





IMPREZA (cont'd)

93-95	FWD, Non-ABS Right	G55933
95	Base, L, AWD, Non-ABS Left	G55930
	Base, L, AWD, Non-ABS Right	G55929
93-94	AWD, Non-ABS Left	G55930
	AWD, Non-ABS Right	G55929

LEGACY

08-09	Left	G52023	G51886
	Right	G52024	G51886
05-07	Left	G52023	G51886	143140 ⁵³
	Right	G52024	G51886	143140 ⁵³
00-04	All	142330 ⁵³	G56557	143140 ⁵³
	Right	G56555	142330 ⁵³	G56557	143140 ⁵³
95-99	Brighton, AWD, Left	142330 ⁵³ 143057 ⁵¹	G55860	143057 ⁵¹
	Brighton, AWD, Right	142330 ⁵³ 143057 ⁵¹	G55859	143057 ⁵¹
	Exc. Outback Left	G55858
	Exc. Outback Right	G55857
99	Outback, Outback Limited, Left	G55866	G55868
	Outback, Outback Limited, Right	G55865	G55867
98	Outback, Left	G55866	G55868
	Outback, Right	G55865	G55867
97	Outback, Outback Limited, Left	G55866	G55868
	Outback, Outback Limited, Right	G55865	G55867
95-96	L, FWD, Left	G56580
	L, FWD, Right	G56579
	Outback, Left	G55866	G55868
	Outback, Right	G55865	G55867
92-94	AWD	142330 ⁵³ 143061 ⁵¹	142550 ⁵³ 143058 ⁵¹
	AWD, Coil(RearSpringType) Left	142330 ⁵³ 143061 ⁵¹	G55930	143058 ⁵¹
	AWD, Coil(RearSpringType) Right	142330 ⁵³ 143061 ⁵¹	G55929	143058 ⁵¹
	Coil(RearSpringType) Left	G55926	142330 ⁵³ 143061 ⁵¹	143058 ⁵¹













APPLICATION GUIDE

Year	Fitment Notes										
			ProGuard/ Guardian/ Classic	Max Control/ LTV	Strut Cushion/ Strut Mount	Hi Jacker/ Load Carrier		ProGuard/ Guardian/ Classic	Max Control/ LTV	Strut Cushion/ Strut Mount	Hi Jacker/ Load Carrier











SUBARU

SUBARU



LEGACY (cont'd)

92-94	Coil(RearSpringType) Right		G55925	142330 ⁵³ 143061 ⁵¹	143058 ⁵¹
90-94	All	142330 ⁵³ 143061 ⁵¹	143058 ⁵¹
94	FWD	142330 ⁵³ 143061 ⁵¹	143139 ⁵³ 143058 ⁵¹
	FWD, Coil(RearSpringType) Left	142330 ⁵³ 143061 ⁵¹		G55934	143058 ⁵¹
	FWD, Coil(RearSpringType) Right	142330 ⁵³ 143061 ⁵¹		G55933	143058 ⁵¹
92-93	FWD, Coil(RearSpringType) Left	142330 ⁵³ 143061 ⁵¹		G55934	143139 ⁵³ 143058 ⁵¹
	FWD, Coil(RearSpringType) Right	142330 ⁵³ 143061 ⁵¹		G55933	143139 ⁵³ 143058 ⁵¹
90-91	Coil(FrontSpringType) Left		G55924	142330 ⁵³ 143061 ⁵¹	143058 ⁵¹
	Coil(FrontSpringType) Right		G55923	142330 ⁵³ 143061 ⁵¹	143058 ⁵¹
	FWD, Coil(RearSpringType) Left	142330 ⁵³ 143061 ⁵¹		G55932	143058 ⁵¹
	FWD, Coil(RearSpringType) Right	142330 ⁵³ 143061 ⁵¹		G55931	143058 ⁵¹
91	AWD, Coil(RearSpringType) Left	142330 ⁵³ 143061 ⁵¹		G55928	143058 ⁵¹
	AWD, Coil(RearSpringType) Right	142330 ⁵³ 143061 ⁵¹		G55927	143058 ⁵¹
90	AWD, Left Exc. Air Suspension	142330 ⁵³ 143061 ⁵¹		G55928	143058 ⁵¹
	AWD, Right Exc. Air Suspension	142330 ⁵³ 143061 ⁵¹		G55927	143058 ⁵¹



LOYALE

90-94	All	142335 ⁵³ 143061 ⁵¹	143064 ⁵¹
94	Exc. Air Suspension	142335 ⁵³ 143061 ⁵¹		G51183	143064 ⁵¹
90-93	4WD, Left Exc. Air Suspension		G55785	142335 ⁵³ 143061 ⁵¹	143064 ⁵¹
	4WD, Right Exc. Air Suspension		G55784	142335 ⁵³ 143061 ⁵¹	143064 ⁵¹
	4WD, Sedan	142335 ⁵³ 143061 ⁵¹		G51181	143064 ⁵¹
	FWD, Left Exc. Air Suspension		G55738	142335 ⁵³ 143061 ⁵¹	143064 ⁵¹
	FWD, Right Exc. Air Suspension		G55737	142335 ⁵³ 143061 ⁵¹	143064 ⁵¹
	FWD, Sedan Exc. Air Suspension	142335 ⁵³ 143061 ⁵¹		G51173	143064 ⁵¹
	Sedan Exc. Air Suspension	142335 ⁵³ 143061 ⁵¹	142763 ⁵³ 143064 ⁵¹
	Wagon Exc. Air Suspension	142335 ⁵³ 143061 ⁵¹		G51183	143064 ⁵¹
90	4WD, Coupe	142335 ⁵³ 143061 ⁵¹		G51182	143064 ⁵¹
	FWD, Coupe Exc. Air Suspension	142335 ⁵³ 143061 ⁵¹		G51173	143064 ⁵¹

OUTBACK

10-12	Left		G52272
	Right		G52273













APPLICATION GUIDE

Year	Fitment Notes										
		Ultra	ProGuard/ Guardian/ Classic	Max Control/ LTV	Strut Cushion/ Strut Mount	Hi Jacker/ Load Carrier	Ultra	ProGuard/ Guardian/ Classic	Max Control/ LTV	Strut Cushion/ Strut Mount	Hi Jacker/ Load Carrier







SUBARU

SUBARU



OUTBACK (cont'd)

06-09	Left	 G52272	 G51910
	Right	 G52273	 G51910
05	Left	 G52272	 G51910	143140 ⁵³
	Right	 G52273	 G51910	143140 ⁵³
00-04	AWD, Left	 G56813	 G51767	143140 ⁵³
	AWD, Right	 G56814	 G51767	143140 ⁵³

TRIBECA

14	Left	 G52270
	Right	 G52271
08-13	Left	 G52270	 G51909
	Right	 G52271	 G51909









XT

89-91	All	142335 ⁵³	143064 ⁵¹
	FWD, Coil(RearSpringType) Exc. Air Suspension	142335 ⁵³	 G51173	143064 ⁵¹
85-88	FWD	142335 ⁵³
	FWD, Coil(RearSpringType)	143064 ⁵¹
	FWD, Coil(RearSpringType) Exc. Air Suspension	 G51173





SUZUKI

SUZUKI









AERIO

04-07	Left	 G52075	 G52021	143418 ¹
	Right	 G52076	 G52022	143418 ¹
02-03	Left	 G52019	 G52021	143418 ¹
	Right	 G52020	 G52022	143418 ¹

ESTEEM

95-02	Left	 G56627	143057 ⁵¹	 G56629	143057 ⁵¹
	Right	 G56626	143057 ⁵¹	 G56628	143057 ⁵¹

FORENZA





06-08	Left	 G56882	143349 ⁵³	 G56884	143350 ⁵³
	Right	 G56883	143349 ⁵³	 G56885	143350 ⁵³
04-05	Left	 G56882	 G56884
	Right	 G56883	 G56885

1 Future Part, available 1st Quarter of 2015.

53 Strut Mount. Hardware from O.E. Part may need to be reused.

51 Strut Cushion for use with the Strut/Cartridge/Shocks.

APPLICATION GUIDE

Year	Fitment Notes										
			Ultra	ProGuard\ Guardian\ Classic	Max Control\ LTV	Strut Cushion\ Strut Mount	Hi Jacker\ Load Carrier		Ultra	ProGuard\ Guardian\ Classic	Max Control\ LTV



SUZUKI

SUZUKI







FORENZA READYMOUNTS

		Front	Rear
04-08	Left	G57126 ⁴⁰	G57128 ⁴⁰
	Right	G57127 ⁴⁰	G57129 ⁴⁰









FORSA

85-88	CAN		G55749		81562
-------	-----	---	--------	------	------	------	------	---	------	-------	------	------	------

GRAND VITARA

06-12	Left		G52184		G64052
	Right		G52185		G64052
99-05	All		G56518	143204 ⁵³		G63799	61560 81904	49613 ⁷



RENO

06-08	Left		G56882	143349 ⁵³		G56884	143350 ⁵³
	Right		G56883	143349 ⁵³		G56885	143350 ⁵³
05	Left		G56882		G56884
	Right		G56883		G56885

RENO READYMOUNTS

		Front	Rear
05-08	Left	G57126 ⁴⁰	G57128 ⁴⁰
	Right	G57127 ⁴⁰	G57129 ⁴⁰









SAMURAI

86-95	All		G63798	61549 81675		G63949	61550 81676
-------	-----	---	--------	----------------	------	------	------	---	--------	----------------	------	------	------







SAMURAI STEERING STABILIZERS

		Front	Rear
86-95	Single System Steering Stabilizer	6802SE ⁸⁴

SIDEKICK

96-98	All			G63799	61560 81904	49613 ⁷
	Non-ABS		G56518	142294 ⁵⁴		G63799	61560 81904	49613 ⁷
89-95	All			G63799	61560	49613 ⁷
	Non-ABS		G56518	142294 ⁵⁴		G63799	81904 61560	49613 ⁷



SWIFT

04-09	Left		G56886		143375 ⁵³
	Right		G51921		143375 ⁵³
89-01	All		G55891	142293 ⁵⁴ 143059 ⁵¹		G55772	142295 ⁵³ 143057 ⁵¹

SWIFT READYMOUNTS

		Front	Rear
04-09	Left	G57130 ⁴⁰

VITARA

99-04	All		G56518	143204 ⁵³		G63799	61560 81904	49613 ⁷
-------	-----	---	--------	------	------	----------------------	------	---	--------	----------------	------	------	--------------------

7 Pair Packs, air hose kit included.

51 Strut Cushion for use with the Strut/Cartridge/Shocks.

54 Kit with Mount and Bearing. Hardware from O.E. Part may need to be reused.



Bold Type - New / Future Part

40 ReadyMount Strut. Complete Assembled Unit.

53 Strut Mount. Hardware from O.E. Part may need to be reused.

84 Replacement damper for vehicles with the Gabriel Aftermarket mounting kit

APPLICATION GUIDE

Year	Fitment Notes										
		Ultra	ProGuard\ Guardian\ Classic	Max Control\ LTV	Strut Cushion\ Strut Mount	Hi Jacker\ Load Carrier	Ultra	ProGuard\ Guardian\ Classic	Max Control\ LTV	Strut Cushion\ Strut Mount	Hi Jacker\ Load Carrier

SUZUKI

SUZUKI

X-90

96-98	All	1	G63799	61560 81904	49613 ⁷
-------	-----	------	------	------	------	------	---	--------	----------------	------	------	------	--------------------

XL-7

07-09	Left	↓	G52127	↓
	Right	↓	G52128	↓
02-06	All	↓	G56518	143204 ⁵³	↓

TOYOTA

TOYOTA

4RUNNER

03-12	All	↓	143383 ⁵³	↓
12	Exc. X-REAS Suspension; Exc. Sport Models	↓	G51739	143383 ⁵³	↓
03-11	Exc. X-REAS Suspension; Exc. Sport Models	↓	G51739	143383 ⁵³	↓	G63885
96-02	All	↓	G51077	↓	G63726	77726	49387 ⁷
	Exc. HD	↓	G51077	142838 ⁵³	↓	G63726	77726	49387 ⁷
	HD	↓	G51077	143325 ⁵³	↓	G63726	77726	49387 ⁷
90-95	All	↓	G63547	61552 81870	77479	↓	G63548	61588 81906	77726	49388 ⁷
	Exc. HD	↓	G63547	61552 81870	77479	142838 ⁵³	↓	G63548	61588 81906	77726	49388 ⁷
86-89	All	↓	G63479	61552 81870	77479	↓	G63494	61510 81871	77494
84-85	All	↓	G63404	↓	G63494	61510 81871	77494

4RUNNER READYMOUNTS

		Front	Rear
03-12	Left	G57133¹
	Right	G57134¹
96-02	Left	G57065 ⁴⁰
	Right	G57066 ⁴⁰

4RUNNER STEERING STABILIZERS

		Front	Rear
84-85	Single System Steering Stabilizer	6803SE ⁸⁴

AVALON

07-11	Left	↓	G56888	↓
	Left Mfg. from 01/06	↓	↓	G52103
	Right	↓	G56889	↓
	Right Mfg. from 01/06	↓	↓	G52104
06	Left Mfg. from 01/06	↓	G56888	↓	G52103
	Right Mfg. from 01/06	↓	G56889	↓	G52104
04	All	↓	142556 ⁵⁸	↓	142837 ⁵³
	Left	↓	142650 ⁵⁴ 142556 ⁵⁸	↓	142837 ⁵³

1 Future Part, available 1st Quarter of 2015.

40 ReadyMount Strut. Complete Assembled Unit.

54 Kit with Mount and Bearing. Hardware from O.E. Part may need to be reused.





84 Replacement damper for vehicles with the Gabriel Aftermarket mounting kit

7 Pair Packs, air hose kit included.

53 Strut Mount. Hardware from O.E. Part may need to be reused.

58 Mount Kit includes Suspension Bearing. Hardware from O.E. Part may need to be reused.







APPLICATION GUIDE

Year	Fitment Notes										
			Ultra	ProGuard/ Guardian/ Classic	Max Control/ LTV	Strut Cushion/ Strut Mount	Hi Jacker/ Load Carrier		Ultra	ProGuard/ Guardian/ Classic	Max Control/ LTV

TOYOTA

TOYOTA























AVALON (cont'd)

04	Right		142649 ⁵⁴ 142556 ⁵⁸	142837 ⁵³
97-03	All		142556 ⁵⁸ 143057 ⁵¹	142837 ⁵³ 143057 ⁵¹
	Left		G56506	142650 ⁵⁴ 142556 ⁵⁸ 143057 ⁵¹	G56575	142837 ⁵³ 143057 ⁵¹
	Right		G56514	142649 ⁵⁴ 142556 ⁵⁸ 143057 ⁵¹	G56576	142837 ⁵³ 143057 ⁵¹
95-96	All		G56502	142556 ⁵⁸ 142836 ⁵⁴ 143057 ⁵¹	142439 ⁵³ 143057 ⁵¹
	Left		G56502	142556 ⁵⁸ 142836 ⁵⁴ 143057 ⁵¹	G56575	142439 ⁵³ 143057 ⁵¹
	Rebuildable O.E. Struts		G44783 ⁹⁸	142556 ⁵⁸ 142836 ⁵⁴ 143057 ⁵¹	142439 ⁵³ 143057 ⁵¹
	Right		G56502	142556 ⁵⁸ 142836 ⁵⁴ 143057 ⁵¹	G56576	142439 ⁵³ 143057 ⁵¹

AVALON READYMOUNTS

		Front	Rear
97-03	Left	G56930 ⁴⁰	G56932 ⁴⁰
	Right	G56931 ⁴⁰	G56933 ⁴⁰
95-96	Left	G56932 ⁴⁰
	Right	G56933 ⁴⁰

CAMRY

07-11	Left		G56888		G52103
	Right		G56889		G52104
04-06	Left		G56721	143202 ⁵³		G56728
	Right		G56722	143202 ⁵³		G56729
02-03	Left		G56673	143202 ⁵³		G56675	142837 ⁵³
	Right		G56674	143202 ⁵³		G56676	142837 ⁵³
97-01	All		142556 ⁵⁸ 143057 ⁵¹	142837 ⁵³ 143057 ⁵¹
	Left		G56506	142650 ⁵⁴ 142556 ⁵⁸ 143057 ⁵¹		G56575	142837 ⁵³ 143057 ⁵¹
	Right		G56514	142649 ⁵⁴ 142556 ⁵⁸ 143057 ⁵¹		G56576	142837 ⁵³ 143057 ⁵¹
95-96	All		G56502	142556 ⁵⁸ 142836 ⁵⁴ 143057 ⁵¹	142439 ⁵³ 143057 ⁵¹
	Left		G56502	142556 ⁵⁸ 142836 ⁵⁴ 143057 ⁵¹		G56575	142439 ⁵³ 143057 ⁵¹
	Rebuildable O.E. Struts		G44783 ⁹⁸	142556 ⁵⁸ 142836 ⁵⁴ 143057 ⁵¹	142439 ⁵³ 143057 ⁵¹
	Right		G56502	142556 ⁵⁸ 142836 ⁵⁴ 143057 ⁵¹		G56576	142439 ⁵³ 143057 ⁵¹
92-94	All		142561 ⁵⁴ 143057 ⁵¹	142439 ⁵³ 143057 ⁵¹
	Left Sealed O.E. Struts		142561 ⁵⁴ 143057 ⁵¹		G56575	142439 ⁵³ 143057 ⁵¹

40 ReadyMount Strut. Complete Assembled Unit.

53 Strut Mount. Hardware from O.E. Part may need to be reused.



58 Mount Kit includes Suspension Bearing. Hardware from O.E. Part may need to be reused.

51 Strut Cushion for use with the Strut/Cartridge/Shocks.

54 Kit with Mount and Bearing. Hardware from O.E. Part may need to be reused.

98 Notice: The level of difficulty to install this product is moderately high. Please review the installation instructions carefully before proceeding.

APPLICATION GUIDE

Year	Fitment Notes										
		Ultra	ProGuard/ Guardian/ Classic	Max Control/ LTV	Strut Cushion/ Strut Mount	Hi Jacker/ Load Carrier	Ultra	ProGuard/ Guardian/ Classic	Max Control/ LTV	Strut Cushion/ Strut Mount	Hi Jacker/ Load Carrier

TOYOTA

TOYOTA

CAMRY (cont'd)

92-94	Right Sealed O.E. Struts	142561 ⁵⁴ 143057 ⁵¹	G55676	142439 ⁵³ 143057 ⁵¹
	Sealed O.E. Struts	G55914	142834 ⁵⁴ 142561 ⁵⁴ 143057 ⁵¹	142439 ⁵³ 143057 ⁵¹
	FWD, Rebuildable O.E. Struts	G44999 ⁹⁸	142561 ⁵⁴ 143057 ⁵¹	G44477 ⁹⁸	142439 ⁵³ 143057 ⁵¹
87-91	All	G55590	143057 ⁵¹ 143278 ⁵³	143057 ⁵¹
	Rebuildable O.E. Front Struts	G44982 ⁹⁸	143057 ⁵¹ 143278 ⁵³	143057 ⁵¹
	FWD	G55590	143057 ⁵¹ 143278 ⁵³	G55589	142250 ⁵³ 143057 ⁵¹
	Wagon	G55590	143057 ⁵¹ 143278 ⁵³	G55588	143057 ⁵¹
83-86	All	G44940 ⁹⁸	142134 ⁵³ 143058 ⁵¹

CAMRY READYMOUNTS

		Front	Rear
04-06	Left	G57078 ⁴⁰
	Right	G57079 ⁴⁰
	4 Cyl Left	G57076 ⁴⁰
	4 Cyl Right	G57077 ⁴⁰
02-03	Left	G57041 ⁴⁰	G57043 ⁴⁰
	Right	G57042 ⁴⁰	G57044 ⁴⁰
97-01	Left	G56930 ⁴⁰	G56932 ⁴⁰
	Right	G56931 ⁴⁰	G56933 ⁴⁰
95-96	Left	G56942 ⁴⁰	G56932 ⁴⁰
	Right	G56942 ⁴⁰	G56933 ⁴⁰
92-94	Left Sealed O.E. Struts	G56932 ⁴⁰
	Right Sealed O.E. Struts	G56933 ⁴⁰

CARINA

72-73	All	143059 ⁵¹	82124
-------	-----	------	------	------	----------------------	------	-------	------	------	------

CELICA

00-05	Left	G56586	143201 ⁵³	G56587	143094 ⁵³
	Right	G56585	143201 ⁵³	G56587	143094 ⁵³
94-99	Left	G56573	142556 ⁵⁸ 142559 ⁵⁴	G56575
	Right	G56576	142556 ⁵⁸ 142559 ⁵⁴	G56574
92-93	All	143057 ⁵¹
	FWD	G55606	143057 ⁵¹
	GT, GTS, ST	G44995 ⁹⁸	143059 ⁵¹ 143279 ⁵³	143057 ⁵¹
90-91	All	G44995 ⁹⁸	143279 ⁵³
	AWD	G44995 ⁹⁸	143059 ⁵¹ 143279 ⁵³	143059 ⁵¹
	FWD	G44995 ⁹⁸	143279 ⁵³	G55606
88-89	All	143059 ⁵¹ 143279 ⁵³	G55580

40 ReadyMount Strut. Complete Assembled Unit.

53 Strut Mount. Hardware from O.E. Part may need to be reused.





58 Mount Kit includes Suspension Bearing. Hardware from O.E. Part may need to be reused.

51 Strut Cushion for use with the Strut/Cartridge/Shocks.

54 Kit with Mount and Bearing. Hardware from O.E. Part may need to be reused.

98 Notice: The level of difficulty to install this product is moderately high. Please review the installation instructions carefully before proceeding.





























APPLICATION GUIDE

Year	Fitment Notes										
			Ultra	ProGuard/ Guardian/ Classic	Max Control/ LTV	Strut Cushion/ Strut Mount	Hi Jacker/ Load Carrier		Ultra	ProGuard/ Guardian/ Classic	Max Control/ LTV







































TOYOTA

TOYOTA

CELICA (cont'd)

88-89	AWD		G44939 ⁹⁸	143059 ⁵¹ 143279 ⁵³		G55580
	FWD; Exc. All-Trac		G44982 ⁹⁸	143059 ⁵¹ 143279 ⁵³		G55580
	GT, GTS, ST		143059 ⁵¹ 143279 ⁵³		G55580	142249 ⁵³
86-87	All		143059 ⁵¹ 143279 ⁵³		G55529	142249 ⁵³
	Exc. All-Trac		G44939 ⁹⁸	143059 ⁵¹ 143279 ⁵³		G55529	142249 ⁵³
82-85	All		G44938 ⁹⁸	142311 ⁵³ 143057 ⁵¹		69713	81416
78-81	All		G44938 ⁹⁸	142311 ⁵³ 143057 ⁵¹		81416
76-77	All		G44938 ⁹⁸	142311 ⁵³ 143057 ⁵¹		82124
75	All		143057 ⁵¹	
	Mfg. from 10/75		G44938 ⁹⁸	142311 ⁵³ 143057 ⁵¹	
	Mfg. to 10/75		143057 ⁵¹		82124
74	All			82124
73	Mfg. to 7/73			82124
72	Mfg. from 8/72			82124

COROLLA



09-13	Left		G52245		G51898
	Right		G52246		G51898
03-08	Left		G56661	143201 ⁵³		G51736	143094 ⁵³
	Right		G56660	143201 ⁵³		G51736	143094 ⁵³
97-02	LE		143281 ⁵³	
93-02	Left		G55999	143059 ⁵¹		G55661	143057 ⁵¹
	Right		G55999	143059 ⁵¹		G55662	143057 ⁵¹
	Exc. Wagon Left			142228 ⁵³
	Exc. Wagon Right			142229 ⁵³
93-97	Exc. LE Model		143280 ⁵³	
93-95	LE		143281 ⁵³	
89-92	All		143059 ⁵¹	
	Exc. Wagon Left		G55591	143059 ⁵¹		G55557	142228 ⁵³
	Exc. Wagon Right		G55591	143059 ⁵¹		G55557	142229 ⁵³
	FWD		143059 ⁵¹		143058 ⁵¹
92	DLX, DLX All Trac, LE, SR5		143281 ⁵³ 143059 ⁵¹	
89-91	DLX, DLX All Trac, GTS, LE, SR5		143281 ⁵³ 143059 ⁵¹	
	Wagon		G44994 ⁹⁸	143059 ⁵¹		81498
88	DLX All Trac		143281 ⁵³	
	DLX, GTS, LE, SR5		143059 ⁵¹ 143281 ⁵³

51 Strut Cushion for use with the Strut/Cartridge/Shocks.

53 Strut Mount. Hardware from O.E. Part may need to be reused.

98 Notice: The level of difficulty to install this product is moderately high. Please review the installation instructions carefully before proceeding.

APPLICATION GUIDE

Year	Fitment Notes										
		Ultra	ProGuard/ Guardian/ Classic	Max Control/ LTV	Strut Cushion/ Strut Mount	Hi Jacker/ Load Carrier	Ultra	ProGuard/ Guardian/ Classic	Max Control/ LTV	Strut Cushion/ Strut Mount	Hi Jacker/ Load Carrier

TOYOTA

TOYOTA

COROLLA (cont'd)

88	Exc. Wagon Left	↓	G55591	↓	G55557	142228 ⁵³
	Exc. Wagon Right	↓	G55591	↓	G55557	142229 ⁵³
	FWD	↓	↓	143058 ⁵¹
	FWD, Sealed Front Struts	↓	G55715	↓
	FX Models only	↓	142134 ⁵³	↓
	FX, FX16	↓	143057 ⁵¹	↓
	FX16, Rebuildable Front Struts	↓	G44939 ⁹⁸	↓
	Wagon	↓	G44994 ⁹⁸	↓	○	81498
87	All	↓	142134 ⁵³ 143057 ⁵¹	↓	142249 ⁵³
	Coupe	↓	142134 ⁵³ 143057 ⁵¹	↓	○	81498	142249 ⁵³
	Exc. FX16 Rebuildable Front Struts	↓	G44747 ⁹⁸	142134 ⁵³ 143057 ⁵¹	↓	142249 ⁵³
	FWD	↓	142134 ⁵³ 143057 ⁵¹	↓	G55752	143058 ⁵¹ 142249 ⁵³
	FWD, Sealed Front Struts	↓	G55715	142134 ⁵³ 143057 ⁵¹	↓	142249 ⁵³
	FX16, Rebuildable Front Struts	↓	G44939 ⁹⁸	142134 ⁵³ 143057 ⁵¹	↓	142249 ⁵³
	Rack(SteeringType), Coupe, Standard	↓	G44938 ⁹⁸	142134 ⁵³ 143057 ⁵¹	↓	142249 ⁵³
84-86	All	↓	143057 ⁵¹	↓	142249 ⁵³
	Coupe	↓	143057 ⁵¹	↓	○	81498	142249 ⁵³
	Rack(SteeringType), Coupe, Standard	↓	G44938 ⁹⁸	143057 ⁵¹	↓	142249 ⁵³
86	FWD	↓	143057 ⁵¹	↓	G55752	143058 ⁵¹ 142249 ⁵³
	FWD, Rebuildable Front Struts	↓	G44747 ⁹⁸	143057 ⁵¹	↓	142249 ⁵³
	FWD, Sealed Front Struts	↓	G55715	143057 ⁵¹	↓	142249 ⁵³
84-85	FWD	↓	143057 ⁵¹	↓	143058 ⁵¹ 142249 ⁵³
	FWD, DIESEL	↓	G44939 ⁹⁸	143057 ⁵¹	↓	142249 ⁵³
	FWD, GAS	↓	143057 ⁵¹	↓	G55752	142249 ⁵³
	FWD, GAS Rebuildable Front Struts	↓	G44747 ⁹⁸	143057 ⁵¹	↓	142249 ⁵³
	FWD, GAS Sealed Front Struts	↓	G55715	143057 ⁵¹	↓	142249 ⁵³
80-83	All	↓	G44938 ⁹⁸	143057 ⁵¹	↓
	Coupe	↓	G44938 ⁹⁸	143057 ⁵¹	↓	○	81498
	Hatchback	↓	G44938 ⁹⁸	143057 ⁵¹	↓	○	81498
	Sedan	↓	G44938 ⁹⁸	143057 ⁵¹	↓	○	81498
	Wagon	↓	G44938 ⁹⁸	143057 ⁵¹	↓	○	81416
83	Hardtop	↓	G44938 ⁹⁸	143057 ⁵¹	↓	○	81498





51 Strut Cushion for use with the Strut/Cartridge/Shocks.

53 Strut Mount. Hardware from O.E. Part may need to be reused.

98 Notice: The level of difficulty to install this product is moderately high. Please

244 review the installation instructions carefully before proceeding.



















APPLICATION GUIDE

Year	Fitment Notes										
		 Ultra	ProGuard/ Guardian/ Classic	Max Control/ LTV	Strut Cushion/ Strut Mount	Hi Jacker/ Load Carrier	 Ultra	ProGuard/ Guardian/ Classic	Max Control/ LTV	Strut Cushion/ Strut Mount	Hi Jacker/ Load Carrier

TOYOTA

TOYOTA

































COROLLA (cont'd)

76-79	Coupe	 G44938 ⁹⁸		81340
75-79	All	 G44938 ⁹⁸	
	Sedan	 G44938 ⁹⁸		81340
	Wagon	 G44938 ⁹⁸	143057 ⁵¹		81416
75-78	Hardtop	 G44938 ⁹⁸		81340
72-74	Sedan		81340
74	Mfg. from 8/74	 G44938 ⁹⁸	143057 ⁵¹	
	Mfg. from 8/74; Wagon		81416
	Coupe 1200		81340
	Mfg to 07/74 Wagon		82020
72-73	Coupe		81340
71-73	Wagon		82020

COROLLA READYMOUNTS

		Front	Rear
03-08	Left	G57114 ⁴⁰	G57067 ⁴⁰
	Right	G57115 ⁴⁰	G57068 ⁴⁰
98-02	Left	G56948 ⁴⁰	G56949 ⁴⁰
	Right	G56948 ⁴⁰	G56950 ⁴⁰
93-97	Left	G56947 ⁴⁰	G56949 ⁴⁰
	Right	G56947 ⁴⁰	G56950 ⁴⁰

CORONA

80-82	All	 G44898 ⁹⁸	142311 ⁵³ 143059 ⁵¹	
	Exc. Wagon	 G44898 ⁹⁸	142311 ⁵³ 143059 ⁵¹		81416
80-81	Wagon	 G44898 ⁹⁸	142311 ⁵³ 143059 ⁵¹		81340
79	All	 G44898 ⁹⁸	143059 ⁵¹	
	Exc. Wagon	 G44898 ⁹⁸	143059 ⁵¹		81416
	Wagon	 G44898 ⁹⁸	143059 ⁵¹		81340
78	All	 69600	81494	
	Hardtop Mfg. from 8/73	 69600	81494		82124
	Sedan Mfg. from 8/73	 69600	81494		82124
	Wagon	 69600	81494		82156	49310 ⁷
75-77	Hardtop Mfg. from 8/73		81494		82124
	Sedan Mfg. from 8/73		81494		82124
73-77	Mfg. from 8/73	 69600	81494	
69-77	All		81494	
77	Wagon		81494		82156	49310 ⁷
75-76	Wagon		81494		82156

7 Pair Packs, air hose kit included.





51 Strut Cushion for use with the Strut/Cartridge/Shocks.

98 Notice: The level of difficulty to install this product is moderately high. Please review the installation instructions carefully before proceeding.

40 ReadyMount Strut. Complete Assembled Unit.

53 Strut Mount. Hardware from O.E. Part may need to be reused.

























APPLICATION GUIDE

Year	Fitment Notes										
		 Ultra	ProGuard/ Guardian/ Classic	Max Control/ LTV	Strut Cushion/ Strut Mount	Hi Jacker/ Load Carrier	 Ultra	ProGuard/ Guardian/ Classic	Max Control/ LTV	Strut Cushion/ Strut Mount	Hi Jacker/ Load Carrier

























TOYOTA

TOYOTA







CORONA (cont'd)

74-76	Exc. Wagon		81494		81340	49151 ⁷
74	Wagon Mfg. from 8/73		81494		82124
	Wagon Wagon		81494		82156
73	Exc. Wagon		81494		81340 82155	49151 ⁷
	Sedan Mfg. from 8/73		81494		82124
	Wagon Mfg. from 8/73		81494		82156
69-72	Mark II		69600	81494	
72	Exc. Wagon		81494		81340 82155
69-71	Exc. Wagon		81494		82155 82156
	Mark II, Sedan		81494		49151 ⁷
	Mark II, Wagon		81494		49309 ⁷
68	Exc. Wagon			82155







CRESSIDA

89-92	Exc. Electronic Adjustable Suspension		G44926 ⁹⁸	142437 ⁵³ 143059 ⁵¹		G51060
81-92	All		143059 ⁵¹	
85-88	Exc. Electronic Adjustable Suspension		G44926 ⁹⁸	142437 ⁵³ 143059 ⁵¹	
	Sedan Exc. Electronic Adjustable Suspension		143059 ⁵¹		81440
81-87	Wagon		143059 ⁵¹		81416
83-84	Exc. Electronic Adjustable Suspension		G44926 ⁹⁸	143059 ⁵¹	
	Sedan		143059 ⁵¹		81440
81-82	Exc. Electronic Adjustable Suspension		G44926 ⁹⁸	142242 ⁵³ 143059 ⁵¹	
	Sedan Exc. Electronic Adjustable Suspension		143059 ⁵¹		81440
78-80	All		G44898 ⁹⁸	142242 ⁵³ 143059 ⁵¹	
	Sedan		G44898 ⁹⁸	142242 ⁵³ 143059 ⁵¹		81440
	Wagon		G44898 ⁹⁸	142242 ⁵³ 143059 ⁵¹		81340

CROWN

67	Mfg. to 9/67		82099	
65-66	All		82099	
	Wagon Wagon		82099		82156

ECHO

00-05	All		G56572		69450
	Only fits O.E. P/N 48609-52021		G56572	143195 ⁵³		69450
	Only fits O.E. P/N's 48609-52011 & 48609-52050		G56572	143194 ⁵³		69450





7 Pair Packs, air hose kit included.

53 Strut Mount. Hardware from O.E. Part may need to be reused.

51 Strut Cushion for use with the Strut/Cartridge/Shocks.

98 Notice: The level of difficulty to install this product is moderately high. Please review the installation instructions carefully before proceeding.







APPLICATION GUIDE

Year	Fitment Notes										
			Ultra	ProGuard/ Guardian/ Classic	Max Control/ LTV	Strut Cushion/ Strut Mount	Hi Jacker/ Load Carrier		Ultra	ProGuard/ Guardian/ Classic	Max Control/ LTV

TOYOTA

TOYOTA

















FJ CRUISER

11-12	4WD		G51739	143383⁵³		G64030
07-12	All		G51739	143383⁵³
	RWD		G51739	143383⁵³		G64029
07-09	4WD		G51739	143383⁵³		G64030













FJ CRUISER READYMOUNTS

		Front	Rear
07-11	Left	G57133¹
	Right	G57134¹

HIGHLANDER

08-13	Left		G52201	
	Right		G52202	
	FWD, Left			G52203
	FWD, Right			G52204
04-07	Left		G56730	143202⁵³	
	Right		G56731	143202⁵³	
	AWD, Left			G56732
	AWD, Right			G56733
	FWD, Left			G56734
	FWD, Right			G56735
01-03	Left		G56679	143202⁵³	
	Right		G56680	143202⁵³	
	AWD, Left			G56681
	AWD, Right			G56682
	FWD, Left			G56667
	FWD, Right			G56668

LAND CRUISER

98-07	All		G63832		G63828
93-97	All		G63615		G63616
91-92	All		G63615	
	FJ80(MfrBodyCode)		G63615		G63616
88-90	All		G63432	61507		G63510
84-87	All			49311 ⁷	
81-87	Sport Utility, FJ60(MfrBodyCode)		G63432	61507		G63492	61506 81318	77492	49311 ⁷





1 Future Part, available 1st Quarter of 2015.

7 Pair Packs, air hose kit included.

53 Strut Mount. Hardware from O.E. Part may need to be reused.

Bold Type - New / Future Part





APPLICATION GUIDE

Year	Fitment Notes										
		 Ultra	ProGuard/ Guardian/ Classic	Max Control/ LTV	Strut Cushion/ Strut Mount	Hi Jacker/ Load Carrier	 Ultra	ProGuard/ Guardian/ Classic	Max Control/ LTV	Strut Cushion/ Strut Mount	Hi Jacker/ Load Carrier





TOYOTA

TOYOTA





















MR2 (cont'd)

87-89	All	 G44802 ⁹⁸	143059 ⁵¹	 G44943 ⁹⁸
85-86	All	 G44802 ⁹⁸	143059 ⁵¹	 G44803 ⁹⁸

PASEO

95-99	All	 G55879	142307 ⁵³ 143059 ⁵¹	 G51252	142436 ⁵³ 143064 ⁵¹
92-94	All	 G55828	142307 ⁵³ 143059 ⁵¹	 G55804	142306 ⁵³ 143064 ⁵¹





PICKUP

93-95	RWD, Exc. 1 Ton	 G63903	61509 81541	77903	 G63907	61500 81147	77907	49310 ⁷
86-95	4WD, Exc. Lift Kit	 G63479	61552 81870	77479	 G63494	61510 81871	77494
85-95	RWD	43048 ⁹
85-92	RWD, 1 Ton	 G63903	61509	 G63492	61506 81318	77492	49311 ⁷
	RWD, Exc. 1 Ton	 G63903	81541	77903	 G63907	61500 81147	77907	49310 ⁷
84-85	4WD, Exc. Lift Kit	 G63404	 G63494	61510 81871	77494
84	RWD	 G63903	61509 81541	77903	77907	43048 ⁹ 49310 ⁷
	RWD, Exc. 1 Ton	81147
	RWD; Mojave	 G63907	61500
80-83	4WD, 2-3" Lift Kit	 G63444 ⁵⁰	 G63440 ⁵⁰
	4WD, Exc. Lift Kit	 G63404	 G63492	61506 81318	77492	49311 ⁷
73-83	RWD; Mojave	 G63907	61504 81750	 G63907	61500 81147	77907	43048 ⁹ 49151 ⁷
70-72	RWD	43048 ⁹ 49151 ⁷
	RWD; Mojave	 G63907	61504 81750	 G63907	61500 81147	77907







PICKUP STEERING STABILIZERS

		Front	Rear
86-95	Single System Steering Stabilizer	6802SE ⁸⁴
	4WD, Single System Steering Stabilizer; with OE Stock Mounts	6804SE ⁸⁰
80-85	4WD, Single System Steering Stabilizer; with OE Stock Mounts	6803SE ⁸⁴
79-85	RWD, Single System Steering Stabilizer	6802SE ⁸⁴

PREVIA

91-97	Left	 G55652	143061 ⁵¹ 143278 ⁵³	 G63620	61594
	Right	 G55653	143061 ⁵¹ 143278 ⁵³	 G63620	61594

PRIUS

10-13	All	70053
04-09	Left	 G56890	143201 ⁵³	 G51795	143094 ⁵³
	Right	 G56891	143201 ⁵³	 G51795	143094 ⁵³
01-03	Left	 G52077	143193 ⁵³	 G51840	143094 ⁵³

7 Pair Packs, air hose kit included.

50 Bellows Kit No.141242 is recommended for use to protect piston rod from potentially harmful road debris.

53 Strut Mount. Hardware from O.E. Part may need to be reused.

84 Replacement damper for vehicles with the Gabriel Aftermarket mounting kit



8 Pair Packs.

51 Strut Cushion for use with the Strut/Cartridge/Shocks.

80 Mounting bracket not required, install on O.E. Shock Mounts. See Ref. C for optional Steering Stabilizer Boots.

98 Notice: The level of difficulty to install this product is moderately high. Please review the installation instructions carefully before proceeding.



APPLICATION GUIDE

Year	Fitment Notes										
		Ultra	ProGuard\ Guardian\ Classic	Max Control\ LTV	Strut Cushion\ Strut Mount	Hi Jacker\ Load Carrier	Ultra	ProGuard\ Guardian\ Classic	Max Control\ LTV	Strut Cushion\ Strut Mount	Hi Jacker\ Load Carrier

TOYOTA

TOYOTA





























PRIUS (cont'd)

01-03	Right		G52078	143193 ⁵³		G51840	143094 ⁵³
-------	-------	---	--------	------	------	----------------------	------	---	--------	------	------	----------------------	------

PRIUS C

12-14	All			70055
-------	-----	--	------	------	------	------	------	--	-------	------	------	------	------



RAV4

12	Left		G52004		G64026
	Right		G52007		G64026
06-11	Left		G52004	143343		G64026
	Right		G52007	143343		G64026
01-05	Left		G56582	143367		G69813 G63860
	Right		G56581	143367		G69813 G63860
00	All		143367		G63860
	Left Mfg. from 5/00		G56582	143367		G63860
	Left Mfg. to 5/00; Sealed Struts		G56631	143367		G63860
	Mfg. from 5/00		143367		G69813 G63860
	Mfg. to 5/00		143367		G63860	61651
	Right Mfg. from 5/00		G56581	143367		G63860
	Right Mfg. to 5/00; Sealed Struts		G56632	143367		G63860
96-99	All		143367		G63860	61651
	Left Sealed Struts		G56631	143367		G63860	61651
	Right Sealed Struts		G56632	143367		G63860	61651

RAV4 READYMOUNTS

		Front	Rear
00-05	AWD, Automatic Left Mfg. from 5/00	G57105 ⁴⁰
	AWD, Automatic Right Mfg. from 5/00	G57106 ⁴⁰







SEQUOIA

08-11	All		143339 ⁵³	143340⁵³
01-07	All		G51477	143325 ⁵³		G64087

SEQUOIA READYMOUNTS

		Front	Rear
01-07	All	G57027 ⁴⁰

SIENNA



09-10	All		143338 ⁶⁷
	AWD, Left		G52105		G51805	143338 ⁶⁷
	AWD, Right		G52106		G51805	143338 ⁶⁷
	FWD, 7 Passenger			G51804	143338 ⁶⁷
	FWD, 8 Passenger			G51805	143338 ⁶⁷

40 ReadyMount Strut. Complete Assembled Unit.

53 Strut Mount. Hardware from O.E. Part may need to be reused.

67 Strut Mount Kit. Hardware from O.E. Part may need to be reused.

APPLICATION GUIDE

Year	Fitment Notes										
		Ultra	ProGuard\ Guardian\ Classic	Max Control\ LTV	Strut Cushion\ Strut Mount	Hi Jacker\ Load Carrier	Ultra	ProGuard\ Guardian\ Classic	Max Control\ LTV	Strut Cushion\ Strut Mount	Hi Jacker\ Load Carrier

TOYOTA

TOYOTA

SOLARA (cont'd)

99-03	All	143057 ⁵¹	142837 ⁵³
	Left	G56506	142650 ⁵⁴ 143057 ⁵¹	G55675	142837 ⁵³
	Right	G56514	142649 ⁵⁴ 143057 ⁵¹	G55676	142837 ⁵³

SOLARA READYMOUNTS

		Front	Rear
04-06	Left	G57076 ⁴⁰	G57078 ⁴⁰
	Right	G57077 ⁴⁰	G57079 ⁴⁰
99-03	Left	G56930 ⁴⁰	G56932 ⁴⁰
	Right	G56931 ⁴⁰	G56933 ⁴⁰

STARLET

81-84	All	G44724 ⁹⁸	143059 ⁵¹	81440
-------	-----	----------------------	------	------	----------------------	------	-------	------	------	------

SUPRA

94-98	All	143196 ⁵³
87-91	All	143057 ⁵¹
	Exc. Electronic Adjustable Suspension	G51197 ⁹	G51193 ⁹	143057 ⁵¹
86	All	143057 ⁵¹	143057 ⁵¹
	Exc. Electronic Adjustable Suspension	G51197 ⁹	143057 ⁵¹	143057 ⁵¹
	Mfg. from 3/86; Exc. Electronic Adjustable Suspension	143057 ⁵¹	G51193 ⁹	143057 ⁵¹
	Mfg. to 3/86	G44938 ⁹⁸	142437 ⁵³ 143057 ⁵¹	69713	143057 ⁵¹

T100

93-98	4WD	G63479	61552 81870	77479	G63660	61582	77660
	RWD	G63903	61509 81541	77903	G63173	61506	77492

TACOMA

13	4WD	G51739
	Base, RWD	G63889
05-12	All	143383 ⁵³
	Base, RWD	143383 ⁵³	G63889
12	Pre Runner, 4WD, RWD	G51739	143383 ⁵³
05-11	4WD	143383 ⁵³	G64006
	Pre Runner	143383 ⁵³	G64007
	X-Runner, Left	G51739	143383 ⁵³	G64004
	X-Runner, Right	G51739	143383 ⁵³	G64005
05-09	Base and X-Runner Models Left	G51853	143383 ⁵³
	Base and X-Runner Models Right	G51854	143383 ⁵³
01-04	S-Runner	G63937	G63689	61510
	S-Runner, Exc. Offroad Package	61606 81908	77937

9 See Ref. D for procedures to replace Elec Adj Susp with non-adj product.

51 Strut Cushion for use with the Strut/Cartridge/Shocks.





54 Kit with Mount and Bearing. Hardware from O.E. Part may need to be reused.

40 ReadyMount Strut. Complete Assembled Unit.

53 Strut Mount. Hardware from O.E. Part may need to be reused.

98 Notice: The level of difficulty to install this product is moderately high. Please review the installation instructions carefully before proceeding.



















APPLICATION GUIDE

Year	Fitment Notes										
			ProGuard/ Guardian/ Classic	Max Control/ LTV	Strut Cushion/ Strut Mount	Hi Jacker/ Load Carrier		ProGuard/ Guardian/ Classic	Max Control/ LTV	Strut Cushion/ Strut Mount	Hi Jacker/ Load Carrier

TOYOTA

TOYOTA



































TACOMA (cont'd)

98-04	4WD	143325 ⁵³
	Pre Runner, Left	61699
	Pre Runner, Right	61700
	Pre Runner, 4WD, RWD, Exc. HD Upgrade	 G63494
04	Base	61510
	Base, 4WD	77494
	Base, RWD	  G63937	 G63689	61500
	Base, RWD, Exc. Offroad Package	 	61606 81908	77937
	Pre Runner, 4WD, RWD	  G51077	81871
	Pre Runner, RWD	77494
01-03	DLX	61510
98-03	Pre Runner, 4WD, RWD	  G51077	81871	77494
95-03	DLX, RWD	  G63937	 G63689	61500
	DLX, RWD, Exc. Offroad Package	 	61606 81908	77937
98-00	DLX, Limited	61510
	SR5, 4WD	61500
95-97	4WD	  G51077	143325 ⁵³	81871	77494
	4WD, Exc. HD Upgrade	 G63494
	DLX	61510

TACOMA READYMOUNTS

		Front	Rear
05-12	Left	G57133 ¹
	Right	G57134 ¹
98-04	Pre Runner, 4WD, RWD	G57010 ⁴⁰
95-97	4WD	G57010 ⁴⁰

TERCEL

95-99	All	  G55879	142307 ⁵³ 143059 ⁵¹	  G51252	142436 ⁵³ 143064 ⁵¹
91-94	All	  G55828	142307 ⁵³ 143059 ⁵¹	  G55804	142306 ⁵³ 143064 ⁵¹
89-90	All	  G44743 ⁹⁸	143059 ⁵¹	142306 ⁵³
	Hatchback	  G44743 ⁹⁸	142248 ⁵³ 143059 ⁵¹	  G51180	143064 ⁵¹ 142306 ⁵³
	Sedan	  G44743 ⁹⁸	142248 ⁵³ 143059 ⁵¹	  G51180	143064 ⁵¹ 142306 ⁵³
87-88	All	143059 ⁵¹
	4WD, Wagon	  G44800 ⁹⁸	143059 ⁵¹	 	81498
	Hatchback	  G44743 ⁹⁸	142248 ⁵³ 143059 ⁵¹	  G51180	142306 ⁵³ 143064 ⁵¹
88	Sedan	  G44743 ⁹⁸	142248 ⁵³ 143059 ⁵¹	  G51180	142306 ⁵³ 143064 ⁵¹
	Wagon	142247 ⁵³ 143059 ⁵¹	143057 ⁵¹
87	FWD, Wagon	  G44748 ⁹⁸	143059 ⁵¹	  G55752
	Wagon	142247 ⁵³ 143059 ⁵¹	142249 ⁵³ 143057 ⁵¹

1 Future Part, available 1st Quarter of 2015.

51 Strut Cushion for use with the Strut/Cartridge/Shocks.



98 Notice: The level of difficulty to install this product is moderately high. Please review the installation instructions carefully before proceeding.

Bold Type - New / Future Part

40 ReadyMount Strut. Complete Assembled Unit.

53 Strut Mount. Hardware from O.E. Part may need to be reused.

APPLICATION GUIDE

Year	Fitment Notes										
		Ultra	ProGuard\ Guardian\ Classic	Max Control\ LTV	Strut Cushion\ Strut Mount	Hi Jacker\ Load Carrier	Ultra	ProGuard\ Guardian\ Classic	Max Control\ LTV	Strut Cushion\ Strut Mount	Hi Jacker\ Load Carrier

TOYOTA

TOYOTA

TERCEL (cont'd)

83-86	All	143059 ⁵¹	G55752	142249 ⁵³
	4WD, Wagon	G44800 ⁹⁸	143059 ⁵¹	G55752	81498	142249 ⁵³
	FWD	G44748 ⁹⁸	143059 ⁵¹	G55752	142249 ⁵³
	Wagon	142247 ⁵³ 143059 ⁵¹	G55752	143057 ⁵¹ 142249 ⁵³
80-82	All	143059 ⁵¹
	AL1 (MfrBodyCode)	143059 ⁵¹	82013

TUNDRA

13	All	G51855	G64038
12	All	G51855	143339 ⁵³	G64038
07-11	All	G51855	143339 ⁵³	G64038	143340 ⁵³
00-06	All	G51477	143325 ⁵³	G63815	77815

TUNDRA READYMOUNTS

		Front	Rear
07-11	RWD; Exc. Extended Cab; Offroad and Long bed Left	G57123 ¹
	RWD; Exc. Extended Cab; Offroad and Long bed Right	G57124 ¹
00-06	All	G57027 ⁴⁰

VAN

87-89	4WD	G63612	61545	
	Coil(RearSpringType)	81542	
	RWD	G63900	61529	
	RWD; Coil(RearSpringType)	G63484	61513	
87-88	Leaf(RearSpringType)	G63907	61500 81147	77907	43048 ⁸ 49310 ⁷
84-86	All	G63900	61529	
	Coil(RearSpringType)	G63900	61529	81542	
	Leaf(RearSpringType)	G63900	61529	G63907	61500 81147	77907	43048 ⁸ 49310 ⁷
	RWD; Coil(RearSpringType)	G63900	61529	G63484	61513	

VAN WAGON

88	4WD	G63612	
	Leaf(RearSpringType)	61500	
	Coil(RearSpringType), Coil(FrontSpringType)	81542	
	Leaf(RearSpringType)	G63907	77907	
	Leaf(RearSpringType), Leaf(FrontSpringType)	81147	43048 ⁸ 49310 ⁷
	RWD	G63900	61529	
	RWD; Coil(RearSpringType)	G63484	61513	

YARIS

12-14	All	70055
-------	-----	------	------	------	------	------	-------	------	------	------

1 Future Part, available 1st Quarter of 2015.

8 Pair Packs.

51 Strut Cushion for use with the Strut/Cartridge/Shocks.





98 Notice: The level of difficulty to install this product is moderately high. Please review the installation instructions carefully before proceeding.

7 Pair Packs, air hose kit included.

40 ReadyMount Strut. Complete Assembled Unit.

53 Strut Mount. Hardware from O.E. Part may need to be reused.



APPLICATION GUIDE

Year	Fitment Notes										
			Ultra	ProGuard/ Guardian/ Classic	Max Control/ LTV	Strut Cushion/ Strut Mount	Hi Jacker/ Load Carrier		Ultra	ProGuard/ Guardian/ Classic	Max Control/ LTV

TOYOTA

TOYOTA

YARIS (cont'd)

07-11	Left		G56842	70055 G51783
	Right		G56843	70055 G51783
06	All		70055

TRIUMPH

TRIUMPH













SPITFIRE

63-80	All			82139
-------	-----	--	------	------	------	------	------	---	-------	------	------	------

VOLKSWAGEN

VOLKSWAGEN

BEETLE

98-10	All		G56606	142651 ⁵⁴		69945	81934	142654 ⁵³
67-77	All		82005		82001	49307 ⁷
66	All			82001	49307 ⁷
	1200		82001		82001	49307 ⁷
	1300 and 1500		82005		82001	49307 ⁷
52-65	All		82001		82001	49307 ⁷



BEETLE READYMOUNTS

				Front	Rear
98-08	GAS			G57039 ⁴⁰

BEETLE STEERING STABILIZERS

				Front	Rear
59-77	All			14004



BORA

06-09	All		G56899		G51799
-------	-----	---	--------	------	------	------	------	---	--------	------	------	------	------

CABRIO

95-02	All		G55989
-------	-----	---	--------	------	------	------	------	--	------	------	------	------	------





CABRIOLET

85-93	All		G44763 ⁹⁸	142091 ⁵⁴ 143058 ⁵¹		G51006	142252 ⁵³
-------	-----	---	----------------------	------	------	--	------	---	--------	------	------	----------------------	------

CC

09-12	All		143344 ⁵³	143345 ⁵³
-------	-----	--	------	------	------	----------------------	------	--	------	------	------	----------------------	------

CORRADO

93-94	VR6		G55989	142444 ⁵⁴
90-92	All		143061 ⁵¹	143063 ⁵¹
	Rebuildable Front Struts		G44774 ⁹⁸	142092 ⁵³ 143061 ⁵¹	142252 ⁵³ 143063 ⁵¹
92	VR6		G55989	142444 ⁵⁴ 143061 ⁵¹	143063 ⁵¹

EOS

12-13	Exc. Electronic Suspension			70061
07-11	All		143344 ⁵³	143345 ⁵³
	Exc. Electronic Suspension		143344 ⁵³		70061	143345 ⁵³

7 Pair Packs, air hose kit included.

51 Strut Cushion for use with the Strut/Cartridge/Shocks.





54 Kit with Mount and Bearing. Hardware from O.E. Part may need to be reused.

40 ReadyMount Strut. Complete Assembled Unit.

53 Strut Mount. Hardware from O.E. Part may need to be reused.



98 Notice: The level of difficulty to install this product is moderately high. Please review the installation instructions carefully before proceeding.

APPLICATION GUIDE



Year	Fitment Notes										
		 Ultra	ProGuard/ Guardian/ Classic	Max Control/ LTV	Strut Cushion/ Strut Mount	Hi Jacker/ Load Carrier	 Ultra	ProGuard/ Guardian/ Classic	Max Control/ LTV	Strut Cushion/ Strut Mount	Hi Jacker/ Load Carrier

VOLKSWAGEN FASTBACK

























VOLKSWAGEN

69-73	All		82001	82001	49307 ⁷
66-68	All		82001	82001

FOX

87-93	All		G44902 ⁹⁸	142136 ⁵³ 143057 ⁵¹		G51030 ⁵⁰	143063 ⁵¹
-------	-----	---	----------------------	------	------	--	------	------	---	----------------------	------	------	----------------------	------



GOLF

10-11	All		143344 ⁵³		143345 ⁵³
99-06	A4(MfrBodyCode)		G56606	142651 ⁵⁴		69945	81934	142654 ⁵³
97-98	All		142444 ⁵⁴ 143058 ⁵¹		G51022	142252 ⁵³ 142573 ⁶¹ 143063 ⁵¹
	VR6 from Chassis # 08774		G55991	142444 ⁵⁴ 143058 ⁵¹		G51022	142252 ⁵³ 142573 ⁶¹ 143063 ⁵¹
	VR6 from Chassis # 08774; w/o 2.0L 4Cyl. L		G55989	142444 ⁵⁴ 143058 ⁵¹		G51022	142252 ⁵³ 142573 ⁶¹ 143063 ⁵¹
95-96	VR6 from Chassis # 08774; w/o 2.0L 4Cyl. L		G55989	142092 ⁵³ 142444 ⁵⁴ 143058 ⁵¹		G51022	142252 ⁵³ 142573 ⁶¹ 143063 ⁵¹
93-96	All		142092 ⁵³ 142444 ⁵⁴ 143058 ⁵¹		G51022	142252 ⁵³ 142573 ⁶¹ 143063 ⁵¹
	Up to Chassis # 08773		G55990	142092 ⁵³ 142444 ⁵⁴ 143058 ⁵¹		G51022	142252 ⁵³ 142573 ⁶¹ 143063 ⁵¹
	VR6 from Chassis # 08774		G55991	142092 ⁵³ 142444 ⁵⁴ 143058 ⁵¹		G51022	142252 ⁵³ 142573 ⁶¹ 143063 ⁵¹
85-92	All		142092 ⁵³ 143058 ⁵¹		142252 ⁵³ 142573 ⁶¹ 143063 ⁵¹
	Rebuildable Front Struts		G44774 ⁹⁸	142092 ⁵³ 143058 ⁵¹		G51022	142252 ⁵³ 142573 ⁶¹ 143063 ⁵¹
	Sealed Struts		G55990	142092 ⁵³ 143058 ⁵¹		142252 ⁵³ 142573 ⁶¹ 143063 ⁵¹











GOLF READYMOUNTS

		Front	Rear
99-06	GAS	G57039 ⁴⁰
97-98	All	G57006 ⁴⁰	G57024 ⁴⁰
85-96	All	G57005 ⁴⁰	G57024 ⁴⁰

GTI

06-11	All		G56899	143344 ⁵³		G51799	143345 ⁵³
-------	-----	---	--------	------	------	----------------------	------	------	---	--------	------	------	----------------------	------

JETTA

13	All		G56899	
10-12	All		G56899	143344 ⁵³		143345 ⁵³
06-09	All		G56899	143344 ⁵³		G51799	143345 ⁵³
01-05	Sedan		G56606	142651 ⁵⁴		69945	81934	142654 ⁵³
99-00	All		G56606	142651 ⁵⁴		69945	142654 ⁵³

7 Pair Packs, air hose kit included.

50 Bellows Kit No.141242 is recommended for use to protect piston rod from potentially harmful road debris.

53 Strut Mount. Hardware from O.E. Part may need to be reused.

61 Mount Kit includes Upper Spring Seat. Hardware from O.E. Part may need to be reused.





40 ReadyMount Strut. Complete Assembled Unit.

51 Strut Cushion for use with the Strut/Cartridge/Shocks.

54 Kit with Mount and Bearing. Hardware from O.E. Part may need to be reused.























98 Notice:The level of difficulty to install this product is moderately high. Please review the installation instructions carefully before proceeding.

APPLICATION GUIDE

Year	Fitment Notes										
			ProGuard/ Guardian/ Classic	Max Control/ LTV	Strut Cushion/ Strut Mount	Hi Jacker/ Load Carrier		ProGuard/ Guardian/ Classic	Max Control/ LTV	Strut Cushion/ Strut Mount	Hi Jacker/ Load Carrier

VOLKSWAGEN















JETTA (cont'd)

96-98	All	142444 ⁵⁴ 143058 ⁵¹		G51022	142252 ⁵³ 142573 ⁵¹ 143063 ⁵¹	
	VR6 from Chassis # 08774		G55991	142444 ⁵⁴ 143058 ⁵¹		G51022	142252 ⁵³ 142573 ⁵¹ 143063 ⁵¹
	VR6 from Chassis # 08774		G55989	142444 ⁵⁴ 143058 ⁵¹		G51022	142252 ⁵³ 142573 ⁵¹ 143063 ⁵¹
	VR6 up to Chassis # 08773		G55990	142444 ⁵⁴ 143058 ⁵¹		G51022	142252 ⁵³ 142573 ⁵¹ 143063 ⁵¹
94-95	All	142092 ⁵³ 142444 ⁵⁴ 143058 ⁵¹		G51022	142252 ⁵³ 142573 ⁵¹ 143063 ⁵¹	
	VR6 from Chassis # 08774		G55991	142092 ⁵³ 142444 ⁵⁴ 143058 ⁵¹		G51022	142252 ⁵³ 142573 ⁵¹ 143063 ⁵¹
	VR6 up to Chassis # 08773		G55990	142092 ⁵³ 142444 ⁵⁴ 143058 ⁵¹		G51022	142252 ⁵³ 142573 ⁵¹ 143063 ⁵¹
85-93	All	142092 ⁵³ 143058 ⁵¹		G51022	142252 ⁵³ 142573 ⁵¹ 143063 ⁵¹	
93	VR6 from Chassis # 08774		G55991	142092 ⁵³ 143058 ⁵¹		G51022	142252 ⁵³ 142573 ⁵¹ 143063 ⁵¹
	VR6 up to Chassis # 08773		G55990	142092 ⁵³ 143058 ⁵¹		G51022	142252 ⁵³ 142573 ⁵¹ 143063 ⁵¹
85-92	Rebuildable Front Struts		G44774 ⁹⁸	142092 ⁵³ 143058 ⁵¹		G51022	142252 ⁵³ 142573 ⁵¹ 143063 ⁵¹
	Sealed Struts		G55990	142092 ⁵³ 143058 ⁵¹		G51022	142252 ⁵³ 142573 ⁵¹ 143063 ⁵¹
80-84	All		G44763 ⁹⁸	142091 ⁵⁴ 143058 ⁵¹		G51006	142252 ⁵³

JETTA READYMOUNTS

		Front	Rear
99-05	GAS	G57039 ⁴⁰
97-98	All	G57006 ⁴⁰	G57024 ⁴⁰
85-96	All	G57005 ⁴⁰	G57024 ⁴⁰

PASSAT

10	All	143344 ⁵³		143345⁵³	
06-09	All		G56899	142652 ⁵⁴ 143344 ⁵³		G51799	143345⁵³
02-05	All	142652 ⁵⁴		
	Exc. VIN# 3B300001 through VIN# 3B300000		G51743	142652 ⁵⁴		
	AWD, Exc. VIN# 3B300001 through VIN# 3B300000	142652 ⁵⁴		G51742	
	FWD	142652 ⁵⁴		143380⁵³	
98-01	All	142652 ⁵⁴ 143058 ⁵¹		142653 ⁵³ 143063 ⁵¹	
	FWD, From VIN# 3B300001 through VIN# 3B300000		G51097	142652 ⁵⁴ 143058 ⁵¹		69946	142653 ⁵³ 143063 ⁵¹	
01	Exc. VIN# 3B300001 through VIN# 3B300000		G51743	142652 ⁵⁴ 143058 ⁵¹		142653 ⁵³ 143063 ⁵¹	
	AWD, Exc. VIN# 3B300001 through VIN# 3B300000	142652 ⁵⁴ 143058 ⁵¹		G51742	142653 ⁵³ 143063 ⁵¹	

40 ReadyMount Strut. Complete Assembled Unit.

53 Strut Mount. Hardware from O.E. Part may need to be reused.



61 Mount Kit includes Upper Spring Seat. Hardware from O.E. Part may need to be reused.

51 Strut Cushion for use with the Strut/Cartridge/Shocks.

54 Kit with Mount and Bearing. Hardware from O.E. Part may need to be reused.

98 Notice: The level of difficulty to install this product is moderately high. Please review the installation instructions carefully before proceeding.

APPLICATION GUIDE

Year	Fitment Notes										
		Ultra	ProGuard\ Guardian\ Classic	Max Control\ LTV	Strut Cushion\ Strut Mount	Hi Jacker\ Load Carrier	Ultra	ProGuard\ Guardian\ Classic	Max Control\ LTV	Strut Cushion\ Strut Mount	Hi Jacker\ Load Carrier

VOLKSWAGEN

PASSAT (cont'd)

98-00	FWD, Exc. VIN# 3B300001 through VIN# 3B300000	142652 ⁵⁴ 143058 ⁵¹	G51742	142653 ⁵³ 143063 ⁵¹
90-97	All	142444 ⁵⁴ 143058 ⁵¹
	Rebuildable O.E. Front Struts	G44986 ⁹⁸	142444 ⁵⁴ 143058 ⁵¹	G51033
90-96	Exc. VR Suspension	142092 ⁵³ 142444 ⁵⁴ 143058 ⁵¹

VOLKSWAGEN

PASSAT READYMOUNTS

		Front	Rear
01-05	Left	G57135 ⁴⁰
	Right	G57136 ⁴⁰

QUANTUM

82-88	All	G44902 ⁹⁸	142195 ⁵³ 143057 ⁵¹	142442 ⁵³ 143063 ⁵¹
-------	-----	----------------------	------	------	--	------	------	------	--	------

R32

08	All	143344 ⁵³	143345 ⁵³
----	-----	------	------	------	----------------------	------	------	------	----------------------	------

RABBIT

06-09	All	G56899	143344 ⁵³	G51799	143345 ⁵³
75-84	All	G44763 ⁹⁸	142091 ⁵⁴ 143058 ⁵¹	G51006	142252 ⁵³

RABBIT PICKUP

80-83	All	G44763 ⁹⁸	143058 ⁵¹
-------	-----	----------------------	------	------	----------------------	------	------	------	------	------

ROUTAN

09-11	Exc. Self-Leveling Suspension	G52131	G64042
11	All	G64042

SCIROCCO

75-89	All	G44763 ⁹⁸	142091 ⁵⁴ 143058 ⁵¹	G51006	142252 ⁵³ 143063 ⁵¹
-------	-----	----------------------	------	------	--	------	--------	------	------	--	------

SQUAREBACK

66-73	All	82001	82001	49307 ⁷
-------	-----	------	-------	------	------	------	------	-------	------	------	--------------------

SUPER BEETLE

74-79	All	G44850 ⁹⁸	82005	142251 ⁵³ 143057 ⁵¹	82001	49307 ⁷
73	All	82005	143057 ⁵¹
	2 Bolt Flange-Type Lower Mount	G44850 ⁹⁸	82005	143057 ⁵¹
	2 Bolt Lower Mount	82005	142251 ⁵³ 143057 ⁵¹
	3 Bolt Flange-Type Lower Mount	G44862 ⁹⁸	82005	143057 ⁵¹	82001	49307 ⁷
71-72	All	143057 ⁵¹
	3 Bolt Flange-Type Lower Mount	G44862 ⁹⁸	143057 ⁵¹	82001	49307 ⁷

SUPER BEETLE STEERING STABILIZERS

		Front	Rear
71-75	All	14005

7 Pair Packs, air hose kit included.

51 Strut Cushion for use with the Strut/Cartridge/Shocks.





54 Kit with Mount and Bearing. Hardware from O.E. Part may need to be reused.

40 ReadyMount Strut. Complete Assembled Unit.



53 Strut Mount. Hardware from O.E. Part may need to be reused.

98 Notice: The level of difficulty to install this product is moderately high. Please review the installation instructions carefully before proceeding.

APPLICATION GUIDE

Year	Fitment Notes										
			Ultra	ProGuard/ Guardian/ Classic	Max Control/ LTV	Strut Cushion/ Strut Mount	Hi Jacker/ Load Carrier		Ultra	ProGuard/ Guardian/ Classic	Max Control/ LTV

VOLKSWAGEN THING

73-74	All		82005		82001	49307 ⁷
-------	-----	---	------	-------	------	------	------	---	------	-------	------	------	------	--------------------







THING STEERING STABILIZERS

73-74	All											Front	Rear
												14004





TIGUAN

11	All		143344 ⁵³		G51993
09-10	All		143344 ⁵³		G51993	143345 ⁵³

TRANSPORTER



70-79	All		82031		82032
68-69	All		82001		82032
56-67	All		82001		82001

VANAGON





80-91	RWD		69861		69858
86-89	4WD			G63454	61539 81581	49215 ⁷

VOLVO





122

59-68	All		82026		81270	49105 ⁷
-------	-----	--	------	-------	------	------	------	--	------	-------	------	------	------	--------------------



142 / 144 / 145 / 164

75	All		69600	81494		69787 ³¹
68-74	All		69600	81494	



240 / 242 / 244 / 245 / 262 / 264 / 265

75-93	All		G44856 ⁹⁸	143057 ⁵¹		69787 ³¹
	Exc. O.E. Gas Struts & Nivomat Rear Susp.		G44856 ⁹⁸	142194 ⁵³ 143057 ⁵¹		69787 ³¹



544

59-65	All			82123
-------	-----	---	------	------	------	------	------	---	------	-------	------	------	------	------

740 / 745 / 760 / 780

84-92	All		142440 ⁵⁴ 143058 ⁵¹
	Mfg. from 5/84; Exc. Hydraulic Self Leveling System		G44941 ⁹⁸	142440 ⁵⁴ 143058 ⁵¹		69805 ³²
89	Exc. Hydraulic Self Leveling System		G44941 ⁹⁸	142440 ⁵⁴ 143058 ⁵¹
83	All		142440 ⁵⁴

850

93-97	Exc. Hydraulic Self Leveling System		G56612	143191 ⁵³		69901	142941 ⁵³
-------	-------------------------------------	---	--------	------	------	----------------------	------	---	-------	------	------	------	----------------------	------

850 READYMOUNTS

93-97	Exc. Hydraulic Self Leveling System											Front	Rear
												G57040 ⁴⁰

940

91-95	Exc. Hydraulic Self Leveling System		G44941 ⁹⁸
-------	-------------------------------------	---	----------------------	------	------	------	------	--	------	------	------	------	------	------

7 Pair Packs, air hose kit included.

32 With Nivomat Self-Leveling Suspension replace spring with Volvo No. 1359710 or 1273977.

51 Strut Cushion for use with the Strut/Cartridge/Shocks.

54 Kit with Mount and Bearing. Hardware from O.E. Part may need to be reused.

Bold Type - New / Future Part





31 With Nivomat Self-Leveling Suspension replace spring with Volvo No. 1229052/4.

40 ReadyMount Strut. Complete Assembled Unit.

53 Strut Mount. Hardware from O.E. Part may need to be reused.

98 Notice: The level of difficulty to install this product is moderately high. Please review the installation instructions carefully before proceeding.

APPLICATION GUIDE

Year	Fitment Notes										
		 Ultra	ProGuard/ Guardian/ Classic	Max Control/ LTV	Strut Cushion/ Strut Mount	Hi Jacker/ Load Carrier	 Ultra	ProGuard/ Guardian/ Classic	Max Control/ LTV	Strut Cushion/ Strut Mount	Hi Jacker/ Load Carrier





VOLVO

VOLVO

940 (cont'd)

91-95	Exc. Hydraulic Self Leveling System	142440 ⁵⁴ 143058 ⁵¹	 69805 ³²
-------	-------------------------------------	------	------	------	--	------	---	------	------	------	------





960

96-97	All	142440 ⁵⁴
	Mfg. from 10/94; Exc. Hydraulic Self Leveling System	142440 ⁵⁴	 69417 ³²
94-95	Mfg. from 10/94; Exc. Hydraulic Self Leveling System	142440 ⁵⁴ 143058 ⁵¹	 69417 ³²
92-95	All	142440 ⁵⁴ 143058 ⁵¹
95	Mfg. to 10/94; Exc. Hydraulic Self Leveling System	 G44941 ⁹⁸	142440 ⁵⁴ 143058 ⁵¹
92-94	Mfg. to 10/94; Exc. Hydraulic Self Leveling System	 G44941 ⁹⁸	142440 ⁵⁴ 143058 ⁵¹	 69805 ³²





1800

61-73	All		82026
-------	-----	---	-------	------	------	------	------	------	------	------	------

C30

07-13	Left	 G52274	 70056
	Right	 G52275	 70056



C70

08-13	Left	 G52274
	Right	 G52275
06-07	All	143191 ⁵³
98-04	All	 G56612	143191 ⁵³	 69901	142941 ⁵³



C70 READYMOUNTS

							Front	Rear			
98-04	All						G57040 ⁴⁰			



DL

84	Exc. Hydraulic Self Leveling System	 G44856 ⁹⁸	142194 ⁵³	 69787 ³¹
----	-------------------------------------	--	------	------	----------------------	------	---	------	------	------	------









GLE

84	Exc. Hydraulic Self Leveling System	 G44856 ⁹⁸	142194 ⁵³	 69787 ³¹
----	-------------------------------------	--	------	------	----------------------	------	---	------	------	------	------

PV 444

49	All			82123
----	-----	---	------	------	------	------	---	-------	------	------	------

S40

04-12	Left	 G52274	 70056
	Right	 G52275	 70056
00-04	Mfg. from 04/00 Left	 G52079	 G51841
	Mfg. from 04/00 Right	 G52080	 G51841

31 With Nivomat Self-Leveling Suspension replace spring with Volvo No. 1229052/4.
40 ReadyMount Strut. Complete Assembled Unit.

53 Strut Mount. Hardware from O.E. Part may need to be reused.



98 Notice: The level of difficulty to install this product is moderately high. Please

32 With Nivomat Self-Leveling Suspension replace spring with Volvo No. 1359710 or 1273977.

51 Strut Cushion for use with the Strut/Cartridge/Shocks.





54 Kit with Mount and Bearing. Hardware from O.E. Part may need to be reused.

APPLICATION GUIDE



Year	Fitment Notes										
		Ultra	ProGuard\ Guardian\ Classic	Max Control\ LTV	Strut Cushion\ Strut Mount	Hi Jacker\ Load Carrier	Ultra	ProGuard\ Guardian\ Classic	Max Control\ LTV	Strut Cushion\ Strut Mount	Hi Jacker\ Load Carrier

VOLVO

S60

08-09	All		G56802		70040
01-07	All		G56802	143191 ⁵³		70040





S70

98-00	All		G56612	143191 ⁵³		69901	142941 ⁵³
-------	-----	---	--------	------	------	----------------------	------	---	-------	------	------	----------------------	------





S70 READYMOUNTS

		Front	Rear
98-00	All	G57040 ⁴⁰





S80

99-06	All		G56802	
	Exc. Nivomat Rear Suspension		G56802	143191 ⁵³	





S90

97-98	All		142440 ⁵⁴	
	Mfg. from 5/97; Exc. Hydraulic Self Leveling System		142440 ⁵⁴		69417 ³²













V40

00-04	Mfg. from 04/00 Left		G52079		G51841
	Mfg. from 04/00 Right		G52080		G51841

V50

05-11	Left		G52274		70056
	Right		G52275		70056



V70

01-07	All			70040
	Exc. XC70, XC Cross Country and Exc. Auto-Leveling System		143191 ⁵³		70040
01-06	Mfg. from 3/00 and Exc. XC70, XC Cross Country and Auto Leveling		G56802		70040
98-00	Exc. XC70, XC Cross Country and Exc. Auto-Leveling System		143191 ⁵³		142941 ⁵³
	Mfg. to 3/00 and Exc. XC70, XC Cross Country		G56612		69901
00	Mfg. from 3/00 and Exc. XC70, XC Cross Country and Auto Leveling		G56802	





V70 READYMOUNTS

		Front	Rear
98-00	Mfg. to 3/00 and Exc. XC70, XC Cross Country	G57040 ⁴⁰

V90

97-98	Mfg. from 5/97; Exc. Hydraulic Self Leveling System		142440 ⁵⁴		69417 ³²
-------	---	---	------	------	------	----------------------	------	---	---------------------	------	------	------	------

XC90

04-06	All		143191 ⁵³	
03	AWD		143191 ⁵³	

32 With Nivomat Self-Leveling Suspension replace spring with Volvo No. 1359710 or 1273977.

53 Strut Mount. Hardware from O.E. Part may need to be reused.

40 ReadyMount Strut. Complete Assembled Unit.

54 Kit with Mount and Bearing. Hardware from O.E. Part may need to be reused.

Numerical listing

Shock	POP	Alternative No.	MTG Acc. Supplied
Pos.	Year	Application	

Steering Stabilizer

Shock	POP	Alternative No.	MTG Acc. Supplied
Pos.	Year	Application	
6801SE A			
F	83-94	CHEVROLET BLAZER, S MODELS All Single System Steering Stabilizer; with a factory mounting hole in the steering linkage.	
F	79-82	LUV PICKUP 4WD Single System Steering Stabilizer; with a factory mounting hole in the steering linkage.	
F	83-04	S10 4WD Single System Steering Stabilizer; with a factory mounting hole in the steering linkage.	
F	83-91	GMC S15 JIMMY All Single System Steering Stabilizer; with a factory mounting hole in the steering linkage.	
F	91-93	SONOMA / S15 All Single System Steering Stabilizer; with a factory mounting hole in the steering linkage.	
F	82-90	SONOMA / S15 RWD Single System Steering Stabilizer; with a factory mounting hole in the steering linkage.	
F	91	SYCLONE All Single System Steering Stabilizer; with a factory mounting hole in the steering linkage.	
F	84-00	JEEP CHEROKEE All Single System Steering Stabilizer; with a factory mounting hole in the steering linkage.	
F	86-92	COMANCHE All Single System Steering Stabilizer; with a factory mounting hole in the steering linkage.	
F	97-06	WRANGLER TJ (MfrBodyCode) Single System Steering Stabilizer; with a factory mounting hole in the steering linkage.	
F	94-95	WRANGLER YJ (MfrBodyCode) Single System Steering Stabilizer; with a factory mounting hole in the steering linkage.	
F	87-92	WRANGLER YJ (MfrBodyCode) Single System Steering Stabilizer; with a factory mounting hole in the steering linkage.	
6802SE B			
F	79-86	CHEVROLET BLAZER 4WD Dual System Steering Stabilizer	
F	79-84	BLAZER RWD Dual System Steering Stabilizer	
F	50-58	PICKUP Truck Single System Steering Stabilizer; with I-Beam Axle	
F	73-86	PICKUP 1/2 TON, C10 All Single System Steering Stabilizer	
F	67-86	PICKUP 1/2 TON, K10 All Dual System Steering Stabilizer	
F	87	PICKUP 1/2 TON, R10 All Single System Steering Stabilizer	
F	87	PICKUP 1/2 TON, V10 All Dual System Steering Stabilizer	
F	82-86	PICKUP 1 TON, C30 6.2L 8Cyl V (379) Single System Steering Stabilizer; with Cooler	
F	73-86	PICKUP 1 TON, C30 4.8L 6Cyl L (292) Single System Steering Stabilizer; with Cooler	
F	73-86	PICKUP 1 TON, C30 5.7L 8Cyl V (350) Single System Steering Stabilizer; with Cooler	
F	86	PICKUP 1 TON, C30 5.0L 8Cyl V (305) Single System Steering Stabilizer; with Cooler	
F	78-80	PICKUP 1 TON, C30 4.1L 6Cyl L (250) Single System Steering Stabilizer; with Cooler	
F	78-79	PICKUP 1 TON, C30 5.0L 8Cyl V (305) Single System Steering Stabilizer; with Cooler	
F	76-79	PICKUP 1 TON, C30 6.6L 8Cyl V (400) Single System Steering Stabilizer; with Cooler	
F	73-75	PICKUP 1 TON, C30 4.1L 6Cyl L (250) Single System Steering Stabilizer; with Cooler	
F	73	PICKUP 1 TON, C30 5.0L 8Cyl V (307) Single System Steering Stabilizer; with Cooler	
F	61-72	PICKUP 1 TON, C30 All Single System Steering Stabilizer	

Steering Stabilizer

Shock	POP	Alternative No.	MTG Acc. Supplied
Pos.	Year	Application	

6802SE B -continued			
F	77-86	PICKUP 1 TON, K30 All Dual System Steering Stabilizer	
F	87-88	PICKUP 1 TON, R30 4.8L 6Cyl L (292) Single System Steering Stabilizer; with Cooler	
F	87-88	PICKUP 1 TON, R30 5.7L 8Cyl V (350) Single System Steering Stabilizer; with Cooler	
F	87-88	PICKUP 1 TON, R30 6.2L 8Cyl V (379) Single System Steering Stabilizer; with Cooler	
F	89-91	PICKUP 1 TON, R3500 5.7L 8Cyl V (350) Single System Steering Stabilizer; with Cooler	
F	63-86	PICKUP 3/4 TON, C20 All Single System Steering Stabilizer	
F	67-86	PICKUP 3/4 TON, K20 All Dual System Steering Stabilizer	
F	87-88	PICKUP 3/4 TON, R20 All Single System Steering Stabilizer	
F	89	PICKUP 3/4 TON, R2500 All Single System Steering Stabilizer	
F	87	PICKUP 3/4 TON, V20 All Dual System Steering Stabilizer	
F	82-03	S10 RWD Single System Steering Stabilizer	
F	68-86	SUBURBAN 1/2 TON, C10 All Single System Steering Stabilizer	
F	68-86	SUBURBAN 1/2 TON, K10 All Dual System Steering Stabilizer	
F	87-88	SUBURBAN 1/2 TON, R10 All Dual System Steering Stabilizer	
F	89-91	SUBURBAN 1/2 TON, R1500 All Single System Steering Stabilizer	
F	68-86	SUBURBAN 3/4 TON, C20 All Single System Steering Stabilizer	
F	68-86	SUBURBAN 3/4 TON, K20 All Dual System Steering Stabilizer	
F	87-88	SUBURBAN 3/4 TON, R20 All Single System Steering Stabilizer	
F	89-91	SUBURBAN 3/4 TON, R2500 All Single System Steering Stabilizer	
F	87-88	SUBURBAN 3/4 TON, V20 All Dual System Steering Stabilizer	
F	89-91	SUBURBAN 3/4 TON, V2500 All Dual System Steering Stabilizer	
F	70-95	VAN 1/2 TON, G / EXPRESS All Single System Steering Stabilizer	
F	71-95	VAN 1 TON, G / EXPRESS All Single System Steering Stabilizer	
F	78-95	VAN 3/4 TON, G / EXPRESS All Single System Steering Stabilizer	
F	75-77	VAN 3/4 TON, G / EXPRESS All	
F	70-74	VAN 3/4 TON, G / EXPRESS All Single System Steering Stabilizer	
F	70	DODGE A100 TRUCK All Dual System Steering Stabilizer; with I-Beam Axle	
F	64-69	A100 TRUCK All Dual System	
F	79-82	D50 RWD Single System Steering Stabilizer	
F	86-89	PICKUP 1/2 TON, D100 SERIES All Single System Steering Stabilizer	
F	72-79	PICKUP 1/2 TON, D100 SERIES All Single System Steering Stabilizer	
F	60-71	PICKUP 1/2 TON, D100 SERIES All Single System Steering Stabilizer; with I-Beam Axle	
F	90-93	PICKUP 1/2 TON, W100 SERIES All Single System Steering Stabilizer	
F	60-86	PICKUP 1/2 TON, W100 SERIES All Dual System Steering Stabilizer; Exc. Vacuum Servo Mounted on Drivers Side of Axle	
F	75-93	PICKUP 1 TON, D300 SERIES All Single System Steering Stabilizer	
F	72-74	PICKUP 1 TON, D300 SERIES All Single System Steering Stabilizer; with Coil Spring Front Suspension	
F	60-71	PICKUP 1 TON, D300 SERIES All Single System Steering Stabilizer; with I-Beam Axle	
F	90-93	PICKUP 1 TON, W300 SERIES All Single System Steering Stabilizer	
F	60-86	PICKUP 1 TON, W300 SERIES All Dual System Steering Stabilizer; Exc. Vacuum Servo Mounted on Drivers Side of Axle	
F	73-93	PICKUP 3/4 TON, D200 SERIES All Single System Steering Stabilizer	
F	60-71	PICKUP 3/4 TON, D200 SERIES All Single System Steering Stabilizer; with I-Beam Axle	

Numerical listing

Shock	POP	Alternative No.	MTG Acc. Supplied
Pos.	Year	Application	

6802SE B -continued			
F	90-93	PICKUP 3/4 TON, W200 SERIES All Single System Steering Stabilizer	
F	60-86	PICKUP 3/4 TON, W200 SERIES All Dual System Steering Stabilizer; Exc. Vacuum Servo Mounted on Drivers Side of Axle	
F	83-93	PICKUP, RAM 50 RWD Single System Steering Stabilizer	
F	87-89	RAIDER All Single System Steering Stabilizer	
F	87-93	RAMCHARGER RWD Single System Steering Stabilizer	
F	74-86	RAMCHARGER All Dual System Steering Stabilizer; Exc. Vacuum Servo Mounted on Drivers Side of Axle	
F	71	VAN 1/2 TON, A / B SERIES / RAM All Single System Steering Stabilizer; with I-Beam Axle	
F	71	VAN 1 TON, A / B SERIES / RAM All Single System Steering Stabilizer; with I-Beam Axle	
F	71	VAN 3/4 TON, A / B SERIES / RAM All Single System Steering Stabilizer; with I-Beam Axle	
F	92-96	FORD BRONCO All Single System Steering Stabilizer	
F	80-91	BRONCO All	
F	78-79	BRONCO All Dual System Steering Stabilizer; Exc. Sway Bar	
F	84-90	BRONCO II All Single System Steering Stabilizer	
F	61-67	ECONOLINE VAN Van	
F	91-94	EXPLORER All	
F	89-91	F59 All Single System Steering Stabilizer; Superduty Motorhome	
F	57-59	F SERIES All Single System Steering Stabilizer; with I-Beam Axle	
F	50-55	F SERIES All Single System Steering Stabilizer; with I-Beam Axle	
F	89-91	MOTORHOME CHASSIS / F53 All Single System Steering Stabilizer; Motorhome	
F	80-83	PICKUP 1/2 TON, F-100 All Single System Steering Stabilizer	
F	77-79	PICKUP 1/2 TON, F-100 All Single System Steering Stabilizer; with Twin I-Beam Axle	
F	79	PICKUP 1/2 TON, F-100 All Dual System Steering Stabilizer; Exc. Sway Bar	
F	78	PICKUP 1/2 TON, F-100 All 4WD; Dual System Steering Stabilizer; Exc. Sway Bar	
F	77	PICKUP 1/2 TON, F-100 All Dual System Steering Stabilizer; Exc. Sway Bar	
F	75-76	PICKUP 1/2 TON, F-100 4WD Dual System Steering Stabilizer; Exc. Sway Bar	
F	74-76	PICKUP 1/2 TON, F-100 RWD Single System Steering Stabilizer; with Twin I-Beam Axle	
F	73	PICKUP 1/2 TON, F-100 All Single System Steering Stabilizer; with Twin I-Beam Axle	
F	65-72	PICKUP 1/2 TON, F-100 All RWD; Single System Steering Stabilizer; with Twin I-Beam Axle	
F	61-64	PICKUP 1/2 TON, F-100 All RWD; Single System Steering Stabilizer; with I Beam Axle	
F	60	PICKUP 1/2 TON, F-100 All RWD; Single System Steering Stabilizer; with I-Beam Axle	
F	94-96	PICKUP 1/2 TON, F-150 4WD Single System Steering Stabilizer; with Twin Tractor Beam	
F	90-93	PICKUP 1/2 TON, F-150 All Single System Steering Stabilizer	
F	80-89	PICKUP 1/2 TON, F-150 All	
F	77-79	PICKUP 1/2 TON, F-150 All Dual System Steering Stabilizer; Exc. Sway Bar	
F	75-76	PICKUP 1/2 TON, F-150 RWD	
F	90-92	PICKUP 1/2 TON, F SUPERDUTY All	
F	92-96	PICKUP 1 TON, F-350 / SUPERDUTY RWD Dual System Steering Stabilizer	
F	89-91	PICKUP 1 TON, F-350 / SUPERDUTY RWD Single System Steering Stabilizer	

Numerical listing

Shock	POP	Alternative No.	MTG Acc. Supplied
Pos.	Year	Application	
6802SE	B	-continued	
F	82-88	PICKUP 1 TON, F-350 / SUPERDUTY All Single System Steering Stabilizer; Exc. Anti-Sway Bar	
F	79-81	PICKUP 1 TON, F-350 / SUPERDUTY RWD Dual System Steering Stabilizer	
F	75-78	PICKUP 1 TON, F-350 / SUPERDUTY All Dual System Steering Stabilizer	
F	65-74	PICKUP 1 TON, F-350 / SUPERDUTY All Single System Steering Stabilizer; with Twin I-Beam Axle	
F	60-64	PICKUP 1 TON, F-350 / SUPERDUTY All Single System Steering Stabilizer; with I-Beam Axle	
F	80-96	PICKUP 3/4 TON, F-250 / SUPERDUTY 4WD Single System Steering Stabilizer	
F	73-79	PICKUP 3/4 TON, F-250 / SUPERDUTY RWD Single System Steering Stabilizer	
F	65-67	PICKUP P100 All Single System Steering Stabilizer	
F	68-73	PICKUP P350 All Single System Steering Stabilizer	
F	83-97	RANGER All Single System Steering Stabilizer	
F	69-74	VAN 1/2 TON, ECONOLINE / CLUB WAGON All Single System Steering Stabilizer; with Twin I-Beam Axle	
F	68	VAN 1/2 TON, ECONOLINE / CLUB WAGON All Single System Steering Stabilizer; with I-Beam Axle	
F	69-74	VAN 3/4 TON, ECONOLINE / CLUB WAGON / SUPERDUTY All Single System Steering Stabilizer; with Twin I-Beam Axle	
F	68	VAN 3/4 TON, ECONOLINE / CLUB WAGON / SUPERDUTY All Single System Steering Stabilizer; with I-Beam Axle	
F	73-91	GMC JIMMY All Replacement damper for vehicles with the Gabriel aftermarket mounting kit	
F	70-72	JIMMY 4WD K5 Dual System Steering Stabilizer	
F	70-72	JIMMY RWD	
F	57-59	PICKUP All Single System Steering Stabilizer; with I-Beam Axle	
F	53-56	PICKUP Truck Single System Steering Stabilizer; with I-Beam Axle	
F	73-86	PICKUP 1/2 TON, C15 / C1500 All Single System Steering Stabilizer	
F	69-86	PICKUP 1/2 TON, K15 / K1500 All Dual System Steering Stabilizer	
F	87	PICKUP 1/2 TON, R1500 All Single System Steering Stabilizer	
F	87	PICKUP 1/2 TON, V1500 All Dual System Steering Stabilizer	
F	75-86	PICKUP 1 TON, C35/3500 Crew Cab Pickup	
F	72-74	PICKUP 1 TON, C35/3500 All	
F	67-86	PICKUP 3/4 TON, C25 / C2500 All Single System Steering Stabilizer	
F	67-86	PICKUP 3/4 TON, K25 / K2500 All Dual System Steering Stabilizer	
F	87-89	PICKUP 3/4 TON, R2500 All Single System Steering Stabilizer	
F	87	PICKUP 3/4 TON, V2500 All AN49	
F	82-93	SONOMA / S15 RWD Single System Steering Stabilizer	
F	68-86	SUBURBAN 1/2 TON, C15 / C1500 All Single System Steering Stabilizer	
F	68-86	SUBURBAN 1/2 TON, K15 / K1500 All Dual System Steering Stabilizer	
F	87-91	SUBURBAN 1/2 TON, R1500 All Single System Steering Stabilizer	
F	87-91	SUBURBAN 1/2 TON, V1500 All Dual System Steering Stabilizer	
F	68-86	SUBURBAN 3/4 TON, C25 / C2500 All Single System Steering Stabilizer	
F	68-86	SUBURBAN 3/4 TON, K25 / K2500 All Dual System Steering Stabilizer	
F	87-91	SUBURBAN 3/4 TON, R2500 All Single System Steering Stabilizer	
F	87-91	SUBURBAN 3/4 TON, V2500 All Dual System Steering Stabilizer	
F	70-95	VAN 1/2 TON, G / SAVANNA All Single System Steering Stabilizer	
F	71-95	VAN 1 TON, G / SAVANNA All Single System Steering Stabilizer	

Steering Stabilizer

Shock	POP	Alternative No.	MTG Acc. Supplied
Pos.	Year	Application	
6802SE	B	-continued	
F	70-95	VAN 3/4 TON, G / SAVANNA All Single System Steering Stabilizer	
F	74	INTERNATIONAL 100 All	
F	75	150 All	
F	74-75	200 All	
F	68-69	908B All Single System Steering Stabilizer; 1/2 Ton, 3/4 Ton & Travelall	
F	68-69	908C All Single System Steering Stabilizer; 1/2 Ton, 3/4 Ton & Travelall	
F	68-69	1000B All Single System Steering Stabilizer; 1/2 Ton, 3/4 Ton & Travelall	
F	68-69	1000C All Single System Steering Stabilizer; 1/2 Ton, 3/4 Ton & Travelall	
F	69-70	1000D All Single System Steering Stabilizer; 1/2 Ton, 3/4 Ton & Travelall	
F	71-73	1010 All Single System Steering Stabilizer; 1/2 Ton, 3/4 Ton & Travelall	
F	68-69	1100B All Single System Steering Stabilizer; 1/2 Ton, 3/4 Ton & Travelall	
F	68-69	1100C All Single System Steering Stabilizer; 1/2 Ton, 3/4 Ton & Travelall	
F	69-70	1100D All Single System Steering Stabilizer; 1/2 Ton, 3/4 Ton & Travelall	
F	71-73	1110 All Single System Steering Stabilizer; 1/2 Ton, 3/4 Ton & Travelall	
F	68-69	1200B All Single System Steering Stabilizer; 1/2 Ton, 3/4 Ton & Travelall	
F	68-69	1200C All Single System Steering Stabilizer; 1/2 Ton, 3/4 Ton & Travelall	
F	69-70	1200D All Single System Steering Stabilizer; 1/2 Ton, 3/4 Ton & Travelall	
F	71-73	1210 All Single System Steering Stabilizer; 1/2 Ton, 3/4 Ton & Travelall	
F	68-69	1300B All Single System Steering Stabilizer; 1/2 Ton, 3/4 Ton & Travelall	
F	68-69	1300C All Single System Steering Stabilizer; 1/2 Ton, 3/4 Ton & Travelall	
F	69-70	1300D All Single System Steering Stabilizer; 1/2 Ton, 3/4 Ton & Travelall	
F	71-73	1310 All Single System Steering Stabilizer; 1/2 Ton, 3/4 Ton & Travelall	
F	68-71	M800 All Single System Steering Stabilizer; 1/2 and 3/4 Ton I-Beam Axle	
F	68-72	M1100 / M1200 All Single System Steering Stabilizer; 1/2 and 3/4 Ton I-Beam Axle	
F	69	M1400 All Single System Steering Stabilizer; 1/2 and 3/4 Ton I-Beam Axle	
F	61-68	SCOUT All Single System Steering Stabilizer; 4WD; Scout 80, 800	
F	75	TRAVELALL RWD	
F	84-91	ISUZU TROOPER 4WD Single System Steering Stabilizer	
F	66-83	JEEP CJ5 All Single System Steering Stabilizer	
F	59-60	CJ5 All Single System Steering Stabilizer	
F	66-75	CJ6 All Single System Steering Stabilizer	
F	59-60	CJ6 All Single System Steering Stabilizer	
F	76-86	CJ7 All Single System Steering Stabilizer	
F	66-73	JEEPSTER All Single System Steering Stabilizer	
F	81-85	SCRAMBLER / CJ8 All Single System Steering Stabilizer	
F	61-67	UNIVERSAL All Single System Steering Stabilizer	
F	63-67	WAGONEER All Exc. Independent Front Suspension	
F	91-94	MAZDA NAVAJA All	
F	95-96	MINI COOPER All Single System Steering Stabilizer	

Numerical listing

Shock	POP	Alternative No.	MTG Acc. Supplied
Pos.	Year	Application	
6802SE	B	-continued	
F	83-94	MIGHTY MAX RWD Single System Steering Stabilizer	
F	86-95	MONTERO All Single System Steering Stabilizer	
F	82	NISSAN 720 PICKUP All Single System Steering Stabilizer	
F	79-82	PLYMOUTH PICKUP All	
F	74-81	TRAILDUSTER All Dual System Steering Stabilizer; Exc. Vacuum Servo Mounted on Drivers Side of Axle	
F	86-95	SUZUKI SAMURAI All Single System Steering Stabilizer	
F	86-95	TOYOTA PICKUP All Single System Steering Stabilizer	
F	79-85	PICKUP RWD Single System Steering Stabilizer	
6803SE	C		
F	69-72	CHEVROLET BLAZER All Single System Steering Stabilizer	
F	60	PICKUP Truck Dana 60 Axle up to 3 1/2" O.D. or Napco axle up to 3 3/8" O.D.	
F	57-58	PICKUP Truck Dana 60 Axle up to 3 1/2" O.D. or Napco axle up to 3 3/8" O.D.	
F	61-72	PICKUP 1/2 TON, K10 All Single System Steering Stabilizer	
F	61-72	PICKUP 3/4 TON, K20 All Single System Steering Stabilizer	
F	01-09	PICKUP 3/4 TON, SILVERADO 2500 HD All 9200# GVW w/o O.E. Unit - 15059138 15155638	
F	68-72	SUBURBAN 1/2 TON, K10 All Single System Steering Stabilizer	
F	68-72	SUBURBAN 3/4 TON, K20 All Single System Steering Stabilizer	
F	70	DODGE A100 TRUCK All Single System Steering Stabilizer; with I-Beam Axle	
F	60-89	PICKUP 1/2 TON, W100 SERIES All Single System Steering Stabilizer	
F	60-89	PICKUP 1 TON, W300 SERIES All Single System Steering Stabilizer	
F	69-89	PICKUP 3/4 TON, W200 SERIES All Single System Steering Stabilizer	
F	60-67	PICKUP 3/4 TON, W200 SERIES All Single System Steering Stabilizer	
F	75-93	RAMCHARGER 4WD Single System Steering Stabilizer	
F	74	RAMCHARGER All Single System Steering Stabilizer	
F	71-87	VAN 1/2 TON, A / B SERIES / RAM All Single System Steering Stabilizer	
F	71-87	VAN 1 TON, A / B SERIES / RAM All Single System Steering Stabilizer	
F	80-87	VAN 3/4 TON, A / B SERIES / RAM All Single System Steering Stabilizer	
F	78-79	VAN 3/4 TON, A / B SERIES / RAM All Van Charger Special	
F	71-77	VAN 3/4 TON, A / B SERIES / RAM All Single System Steering Stabilizer	
F	70-79	FORD BRONCO All Single System Steering Stabilizer	
F	59	F SERIES All Single System Steering Stabilizer; F-250, F-350; Exc. Power Steering	
F	77-79	PICKUP 1/2 TON, F-100 All 4WD; Single System Steering Stabilizer	
F	73-76	PICKUP 1/2 TON, F-100 4WD Single System Steering Stabilizer	
F	60-72	PICKUP 1/2 TON, F-100 All 4WD; Single System Steering Stabilizer	
F	76-79	PICKUP 1/2 TON, F-150 4WD Single System Steering Stabilizer	
F	75	PICKUP 1/2 TON, F-150 All 4WD	
F	75-77	PICKUP 1 TON, F-350 / SUPERDUTY Manual Steering Single System Steering Stabilizer	
F	63-74	PICKUP 1 TON, F-350 / SUPERDUTY All Single System Steering Stabilizer	
F	62	PICKUP 1 TON, F-350 / SUPERDUTY All Single System Steering Stabilizer; Manual Steering	
F	60-61	PICKUP 1 TON, F-350 / SUPERDUTY All Single System Steering Stabilizer	
F	75-77	PICKUP 3/4 TON, F-250 / SUPERDUTY 4WD, Manual Steering Single System Steering Stabilizer	

Numerical listing

Shock	POP	Alternative No.	MTG Acc. Supplied
Pos.	Year	Application	
6803SE C -continued			
F	73-74	PICKUP 3/4 TON, F-250 / SUPERDUTY 4WD Single System Steering Stabilizer	
F	60-72	PICKUP 3/4 TON, F-250 / SUPERDUTY All Single System Steering Stabilizer	
F	74-79	VAN 3/4 TON, ECONOLINE / CLUB WAGON / SUPERDUTY All QuadraVan Special	
F	70-72	GMC JIMMY 4WD K-5 Single System Steering Stabilizer	
F	69-72	PICKUP 1/2 TON, K15 / K1500 All Single System Steering Stabilizer	
F	67-72	PICKUP 3/4 TON, K25 / K2500 All Single System Steering Stabilizer	
F	68-72	SUBURBAN 1/2 TON, K15 / K1500 All Single System Steering Stabilizer	
F	68-72	SUBURBAN 3/4 TON, K25 / K2500 All Single System Steering Stabilizer	
F	69-71	INTERNATIONAL SCOUT All Single System Steering Stabilizer	
F	71-80	SCOUT II All Single System Steering Stabilizer	
F	75	TRAVELALL 4WD Single System Steering Stabilizer	
F	63-67	JEEP GLADIATOR All Single System Steering Stabilizer	
F	75-81	PLYMOUTH TRAILDUSTER 4WD Single System Steering Stabilizer	
F	74	TRAILDUSTER All Single System Steering Stabilizer	
F	84-85	TOYOTA 4RUNNER All Single System Steering Stabilizer	
F	80-85	PICKUP 4WD Single System Steering Stabilizer; with OE Stock Mounts	
6804SE A			
F	80-88	AMERICAN MOTORS EAGLE All System Steering Stabilizer	
F	75-86	CHEVROLET BLAZER 4WD Single System Steering Stabilizer	
F	75-84	BLAZER RWD Single System Steering Stabilizer	
F	73-86	PICKUP 1/2 TON, K10 All Single System Steering Stabilizer	
F	87	PICKUP 1/2 TON, V10 All Single System Steering Stabilizer	
F	77-86	PICKUP 1 TON, K30 All Single System Steering Stabilizer	
F	73-86	PICKUP 3/4 TON, K20 All Single System Steering Stabilizer	
F	87	PICKUP 3/4 TON, V20 All Single System Steering Stabilizer	
F	73-86	SUBURBAN 1/2 TON, K10 All Single System Steering Stabilizer	
F	87-88	SUBURBAN 1/2 TON, R10 All Single System Steering Stabilizer	
F	73-86	SUBURBAN 3/4 TON, K20 All Single System Steering Stabilizer	
F	87-88	SUBURBAN 3/4 TON, V20 All Single System Steering Stabilizer	
F	89-91	SUBURBAN 3/4 TON, V2500 All Single System Steering Stabilizer	
F	94-95	VAN 1 TON, G / EXPRESS All Single System Steering Stabilizer; HD with Straight Front Axle & Tilt Hood	
F	85-93	VAN 1 TON, P SERIES All Single System Steering Stabilizer; with I-Beam Front Suspension	
F	87-94	DODGE DAKOTA 4WD Single System Steering Stabilizer	
F	94-97	PICKUP 1/2 TON, RAM 1500 (SEE RAM 1500) 4WD With OEM 52038276	
F	94-97	PICKUP 1 TON, RAM 3500 (SEE RAM 3500) 4WD With OEM 52038276	
F	94-97	PICKUP 3/4 TON, RAM 2500 (SEE RAM 2500) 4WD With OEM 52038276	
F	66-69	FORD BRONCO All Single System Steering Stabilizer	
F	73-91	GMC JIMMY All Heavy Duty replacement damper for vehicles with OE stabilizer	
F	73-86	PICKUP 1/2 TON, K15 / K1500 All Single System Steering Stabilizer	
F	87	PICKUP 1/2 TON, V1500 All Single System Steering Stabilizer	
F	73-86	PICKUP 3/4 TON, K25 / K2500 All Single System Steering Stabilizer	
F	87	PICKUP 3/4 TON, V2500 All Single System Steering Stabilizer	

Steering Stabilizer

Shock	POP	Alternative No.	MTG Acc. Supplied
Pos.	Year	Application	
6804SE A -continued			
F	73-86	SUBURBAN 1/2 TON, K15 / K1500 All Single System Steering Stabilizer	
F	87-91	SUBURBAN 1/2 TON, V1500 All Single System Steering Stabilizer	
F	73-86	SUBURBAN 3/4 TON, K25 / K2500 All Single System Steering Stabilizer	
F	87-91	SUBURBAN 3/4 TON, V2500 All Single System Steering Stabilizer	
F	94-95	VAN 1 TON, G / SAVANNA All Single System Steering Stabilizer; HD with Straight Front Axle & Tilt Hood	
F	75-83	JEEP CHEROKEE 4WD Single System Steering Stabilizer	
F	74	CHEROKEE All Single System Steering Stabilizer	
F	84-91	GRAND WAGONEER All Single System Steering Stabilizer	
F	74-88	J10 PICKUP All Single System Steering Stabilizer	
F	74-88	J20 PICKUP All Single System Steering Stabilizer	
F	86-95	TOYOTA PICKUP 4WD Single System Steering Stabilizer; with OE Stock Mounts	
6805SE W			
F	75-93	CHEVROLET VAN 1 TON, P SERIES All Motorhome Chassis	
F	79	FORD PICKUP 1 TON, F-350 / SUPERDUTY 4WD, Power Steering Single System Steering Stabilizer	
F	77-79	PICKUP 3/4 TON, F-250 / SUPERDUTY 4WD, Power Steering Single System Steering Stabilizer	
F	79-93	GMC VAN 1 TON, P SERIES All Step Van Forward Control & Motorhome	
F	75-78	VAN 1 TON, P SERIES All Motorhome Chassis	
6807SE D			
F	88-99	CHEVROLET PICKUP 1/2 TON, K15 / K1500 All Single System Steering Stabilizer	
F	91-03	PICKUP 1 TON, C35/3500 All Single System Steering Stabilizer; HD Pickup	
F	88-00	PICKUP 1 TON, K35 / K3500 All Single System Steering Stabilizer	
F	88-99	PICKUP 3/4 TON, K25 / K2500 All Single System Steering Stabilizer	
F	92-97	SUBURBAN 1/2 TON, K15 / K1500 All Single System Steering Stabilizer	
F	92-97	SUBURBAN 3/4 TON, K25 / K2500 All Single System Steering Stabilizer	
F	92-97	FORD PICKUP 1 TON, F-350 / SUPERDUTY RWD O.E. Replacement Stabilizer Single System	
F	92-97	PICKUP 3/4 TON, F-250 / SUPERDUTY RWD O.E. Replacement Stabilizer Single System	
F	88-99	GMC PICKUP 1/2 TON, K15 / K1500 All Single System Steering Stabilizer	
F	91-93	PICKUP 1 TON, C35/3500 All Single System Steering Stabilizer; HD Pickup	
F	88-99	PICKUP 1 TON, K35 / K3500 All Single System Steering Stabilizer	
F	88-99	PICKUP 3/4 TON, K25 / K2500 All Single System Steering Stabilizer	
F	92-95	SUBURBAN 1/2 TON, K15 / K1500 All Single System Steering Stabilizer	
F	92-97	SUBURBAN 3/4 TON, K25 / K2500 All Single System Steering Stabilizer	
6826SE W			
F	95-97	FORD PICKUP 1 TON, F-350 / SUPERDUTY 4WD	
6828SE W			
F	99-06	FORD PICKUP 1 TON, F-350 / SUPERDUTY RWD	
F	99-03	PICKUP 3/4 TON, F-250 / SUPERDUTY RWD	
6846SE C			
F	97-99	DODGE PICKUP 1/2 TON, RAM 1500 (SEE RAM 1500) 4WD With OEM 52039280	
F	97-99	PICKUP 1 TON, RAM 3500 (SEE RAM 3500) 4WD With OEM 52039280	

Numerical listing

Shock	POP	Alternative No.	MTG Acc. Supplied
Pos.	Year	Application	
6846SE C -continued			
F	97-99	PICKUP 3/4 TON, RAM 2500 (SEE RAM 2500) 4WD With OEM 52039280	
6847SE A			
F	00-07	DODGE PICKUP 1/2 TON, RAM 1500 (SEE RAM 1500) 4WD With OEM # 52106909AB, AC, AD	
F	00-07	PICKUP 1 TON, RAM 3500 (SEE RAM 3500) 4WD With OEM # 52106909AB, AC, AD	
F	00-07	PICKUP 1 TON, RAM 3500 (SEE RAM 3500) RWD With OEM # 52106909AB, AC, AD and Solid Front Axle	
F	00-07	PICKUP 3/4 TON, RAM 2500 (SEE RAM 2500) 4WD With OEM # 52106909AB, AC, AD	
6848SE W			
F	87-95	NISSAN PATHFINDER 4WD	
F	95-97	PICKUP 4WD	
6849SE W			
F	81-84	CHEVROLET BLAZER RWD Single System without OE	
F	82-03	S10 RWD Single System Steering Stabilizer; without OE Steering Stabilizer	
F	73-91	GMC JIMMY All Without OE Steering Stabilizer	
F	82-90	SONOMA / S15 RWD	
6850SE D			
F	99-04	FORD PICKUP 1 TON, F-350 / SUPERDUTY 4WD Exc. O.E. Unit	
F	99-04	PICKUP 3/4 TON, F-250 / SUPERDUTY 4WD Exc. O.E. Unit	
6851SE W			
F	84-86	CHEVROLET BLAZER 4WD Single System Steering Stabilizer; without a factory mounting hole in the steering linkage.	
F	83-04	S10 4WD Single System Steering Stabilizer; without a factory mounting hole in the steering linkage.	
F	84-04	GMC JIMMY 4WD, Power Steering Single System Steering Stabilizer; without a factory mounting hole in the steering linkage.	
F	83-90	SONOMA / S15 4WD, Power Steering Single System Steering Stabilizer; without a factory mounting hole in the steering linkage.	
F	92-93	TYPHOON All Single System Steering Stabilizer; without a factory mounting hole in the steering linkage.	
6852SE W			
F	92-99	CHEVROLET SUBURBAN 1/2 TON, C15 / C1500 RWD	
F	92-99	SUBURBAN 3/4 TON, C25 / C2500 RWD	
F	95-99	TAHOE RWD	
F	88-99	GMC PICKUP 1/2 TON, C15 / C1500 RWD	
F	92-99	PICKUP 3/4 TON, C25 / C2500 RWD Exc. O.E. Steering Stabilizer	
F	88-91	PICKUP 3/4 TON, C25 / C2500 RWD	
F	92-99	SUBURBAN 1/2 TON, C15 / C1500 RWD Exc. O.E. Steering Stabilizer	
F	95-99	YUKON RWD	
6853SE A			
F	92-99	CHEVROLET PICKUP 1/2 TON, C15 / C1500 All Exc. O.E. Steering Stabilizer	
F	92-97	PICKUP 1/2 TON, K15 / K1500 All Exc. O.E. Steering Stabilizer	
F	95-00	PICKUP 1 TON, K35 / K3500 All Exc. O.E. Steering Stabilizer	
F	92-99	PICKUP 3/4 TON, C25 / C2500 All Exc. O.E. Steering Stabilizer	
F	99-00	PICKUP 3/4 TON, K25 / K2500 All Exc. O.E. Steering Stabilizer	
F	01-09	PICKUP 3/4 TON, SILVERADO 2500 HD 4WD 9200# GVW with O.E. Unit - 15059138 15155638	
F	00-05	SUBURBAN 1/2 TON, 1500 4WD Exc. O.E. Steering Stabilizer	
F	00-05	SUBURBAN 3/4 TON, 2500 4WD Exc. O.E. Steering Stabilizer	

Numerical listing

Steering Stabilizer, Steering Dampers, Front Load Carrier

Numerical listing

Shock	POP	Alternative No.	MTG Acc. Supplied
Pos.	Year	Application	
6853SE A -continued			
F	95-99	SUBURBAN 3/4 TON, K25 / K2500 All Exc. O.E. Steering Stabilizer	
F	01-05	TAHOE 4WD New Body Style; Exc. Z55 Auto Ride Suspension	
F	95-00	TAHOE 4WD Old Body Style	
F	99-00	GMC PICKUP 3/4 TON, K25 / K2500 4WD 9200# GVW with O.E. Unit - 15059138 15155638	
F	99-05	SIERRA 1500 4WD Exc. O.E. Steering Stabilizer	
F	99-04	SIERRA 2500 4WD Up through 8600# GVW; Exc. O.E. Steering Stabilizer	
F	01-09	SIERRA 2500 HD 4WD 9200# GVW with O.E. Unit - 15059138 15155638	
F	99-05	YUKON 4WD	
F	93-98	JEEP GRAND CHEROKEE All	
6854SE A			
F	00-05	FORD EXCURSION 4WD With O.E. Unit	
F	99-03	PICKUP 1 TON, F-350 / SUPERDUTY 4WD With O.E. Unit	
F	99-03	PICKUP 3/4 TON, F-250 / SUPERDUTY 4WD With O.E. Unit	
F	99-04	PICKUP, F-450 SUPERDUTY 4WD With O.E. Unit	
F	99-04	PICKUP, F-550 SUPERDUTY 4WD With O.E. Unit	
6855SE C			
F	99-04	FORD PICKUP 1 TON, F-350 / SUPERDUTY 4WD Replacement Kit	
F	99-04	PICKUP 3/4 TON, F-250 / SUPERDUTY 4WD Replacement Kit	
6856SE D			
F	05-07	FORD PICKUP 3/4 TON, F-250 / SUPERDUTY 4WD Exc. O.E. Steering Stabilizer	
F	05-06	PICKUP 3/4 TON, F-250 / SUPERDUTY All Exc. O.E. Steering Stabilizer	
6857SE W			
F	93-97	FORD PICKUP 1/2 TON, F SUPERDUTY All With O.E. Unit	
6858SE W			
F	95-01	FORD VAN 1/2 TON, ECONOLINE / CLUB WAGON All Aftermarket Kit	
F	95-02	VAN 1 TON, ECONOLINE / CLUB WAGON / SUPERDUTY All Aftermarket Kit	
F	95-01	VAN 3/4 TON, ECONOLINE / CLUB WAGON / SUPERDUTY All Aftermarket Kit	
6859SE W			
F	94-01	DODGE PICKUP 1/2 TON, RAM 1500 (SEE RAM 1500) RWD, GAS Coil Spring Suspension Steering Stabilizer	
F	94-02	PICKUP 1 TON, RAM 3500 (SEE RAM 3500) RWD, GAS Coil Spring Suspension Steering Stabilizer	
F	94-02	PICKUP 3/4 TON, RAM 2500 (SEE RAM 2500) RWD, GAS Coil Spring Suspension Steering Stabilizer	
6860SE W			
F	97-03	FORD PICKUP 1/2 TON, F-150 RWD, Coil (FrontSpringType)	
F	97-99	PICKUP 3/4 TON, F-250 / SUPERDUTY RWD, Coil (FrontSpringType)	
6861SE W			
F	97-02	FORD EXPEDITION 4WD, Torsion Bar (FrontSpringType)	
F	97-03	PICKUP 1/2 TON, F-150 4WD	
F	97-99	PICKUP 3/4 TON, F-250 / SUPERDUTY 4WD, Torsion Bar (FrontSpringType)	
6862SE W			
F	97-98	FORD PICKUP 3/4 TON, F-250 / SUPERDUTY 4WD Over 8600# GVW and HD	
6863SE W			
F	98	NISSAN FRONTIER 4WD	

Shock	POP	Alternative No.	MTG Acc. Supplied
Pos.	Year	Application	
Steering Dampers			
14004 C			
F	59-77	VOLKSWAGEN BEETLE All	
F	73-74	THING All	
14005 D			
F	71-75	VOLKSWAGEN SUPER BEETLE All	
14010 W			
F	67-78	CADILLAC ELDORADO All	
F	71-78	OLDSMOBILE TORONADO All	
F	66	TORONADO All	
14016 W			
F	71-79	FORD BRONCO All	
F	67	BRONCO All	
F	79	PICKUP 1/2 TON, F-100 All 4WD; Single System	
F	77-78	PICKUP 1/2 TON, F-100 All 4WD	
F	75-76	PICKUP 1/2 TON, F-100 4WD	
F	76-79	PICKUP 1/2 TON, F-150 4WD 4WD	
F	75	PICKUP 1/2 TON, F-150 All 4WD	
14017 B			
F	87-91	CHEVROLET BLAZER 4WD Full Size	
F	75-86	BLAZER 4WD	
F	75-84	BLAZER RWD	
F	73-86	PICKUP 1/2 TON, K10 All	
F	87	PICKUP 1/2 TON, V10 All	
F	77-86	PICKUP 1 TON, K30 All	
F	73-74	PICKUP 1 TON, K30 All	
F	89-91	PICKUP 1 TON, R3500 RWD	
F	87-88	PICKUP 1 TON, V30 All	
F	89-91	PICKUP 1 TON, V3000 / V3500 All	
F	73-86	PICKUP 3/4 TON, K20 All	
F	87	PICKUP 3/4 TON, V20 All	
F	73-86	SUBURBAN 1/2 TON, K10 All	
F	87-88	SUBURBAN 1/2 TON, R10 RWD	
F	73-86	SUBURBAN 3/4 TON, K20 All	
F	87-88	SUBURBAN 3/4 TON, V20 All	
F	89-91	SUBURBAN 3/4 TON, V2500 All	
F	73-91	GMC JIMMY All Replacement damper for vehicles with OE stabilizer	
F	73-86	PICKUP 1/2 TON, K15 / K1500 All	
F	87	PICKUP 1/2 TON, V1500 All	
F	77-86	PICKUP 1 TON, K35 / K3500 All	
F	73-74	PICKUP 1 TON, K35 / K3500 All	
F	87-91	PICKUP 1 TON, V3000 / V3500 All	
F	73-86	PICKUP 3/4 TON, K25 / K2500 All	
F	87	PICKUP 3/4 TON, V2500 All	
F	73-86	SUBURBAN 1/2 TON, K15 / K1500 All	
F	87-91	SUBURBAN 1/2 TON, V1500 All	
F	73-86	SUBURBAN 3/4 TON, K25 / K2500 All	
F	87-91	SUBURBAN 3/4 TON, V2500 All	
14018 W			
F	76-79	CADILLAC SEVILLE All	
14019 W			
F	87-92	CADILLAC BROUGHAM All	
F	92-96	COMMERCIAL CHASSIS RWD	
F	77-84	COMMERCIAL CHASSIS All	
F	93-96	FLEETWOOD RWD RWD	
F	87-92	FLEETWOOD All RWD	
F	85-86	FLEETWOOD RWD RWD	
F	73-77	CHEVROLET EL CAMINO All	
F	73-77	MONTE CARLO All	
F	73-77	GMC SPRINT / CABALLERO All	
14020 W			
F	79-85	BUICK RIVIERA All	
F	79-85	CADILLAC ELDORADO All	
F	80-85	SEVILLE All	
F	79-85	OLDSMOBILE TORONADO All	
14039 B			
F	84-04	FORD MUSTANG / MUSTANG II All	
14040 A			
F	84-01	JEEP CHEROKEE All	
F	86-92	COMANCHE All	
14071 A			
F	99-04	JEEP GRAND CHEROKEE All Single System Steering Damper	
14073 N			
F	80-95	TOYOTA LAND CRUISER All	

Shock	POP	Alternative No.	MTG Acc. Supplied
Pos.	Year	Application	
14075 N			
F	11-13	CHEVROLET PICKUP 1 TON, SILVERADO 3500 HD All	
F	11-13	PICKUP 3/4 TON, SILVERADO 2500 HD All	
F	11-13	GMC SIERRA 2500 HD All	
F	11-13	SIERRA 3500 HD All	
Front Load Carrier			
34036 C			
F	69-84	CHEVROLET BLAZER RWD	
F	63-86	PICKUP 1/2 TON, C10 All	
F	87	PICKUP 1/2 TON, R10 All	
F	63-86	PICKUP 1 TON, C30 All	
F	88-91	PICKUP 1 TON, C35/3500 Cab & Chassis	
F	87-88	PICKUP 1 TON, R30 All	
F	89	PICKUP 1 TON, R3500 Standard Cab Pickup	
F	75-86	PICKUP 3/4 TON, C20 Crew Cab Pickup	
F	75-86	PICKUP 3/4 TON, C20 Standard Cab Pickup	
F	63-74	PICKUP 3/4 TON, C20 All	
F	88	PICKUP 3/4 TON, R20 Crew Cab Pickup	
F	87	PICKUP 3/4 TON, R20 All	
F	89	PICKUP 3/4 TON, R2500 RWD	
F	67	SUBURBAN 1/2 TON, 1500 Coil (FrontSpringType)	
F	63-66	SUBURBAN 1/2 TON, 1500 All	
F	63-86	SUBURBAN 1/2 TON, C10 All	
F	87-88	SUBURBAN 1/2 TON, R10 All	
F	89-91	SUBURBAN 1/2 TON, R1500 All	
F	65-86	SUBURBAN 3/4 TON, C20 All	
F	87-88	SUBURBAN 3/4 TON, R20 All	
F	89-91	SUBURBAN 3/4 TON, R2500 All	
F	63-80	VAN 1/2 TON, P SERIES All	
F	73-90	VAN 1 TON, P SERIES All Exc. Motorhome Chassis	
F	68-72	VAN 1 TON, P SERIES All	
F	68-89	VAN 3/4 TON, P SERIES All	
F	70-84	GMC JIMMY RWD	
F	67-86	PICKUP 1/2 TON, C15 / C1500 All	
F	87	PICKUP 1/2 TON, R1500 All	
F	91	PICKUP 1 TON, C35/3500 Cab & Chassis HD Solid Front Axle	
F	88-90	PICKUP 1 TON, C35/3500 Cab & Chassis	
F	67-78	PICKUP 1 TON, C35/3500 All	
F	87-91	PICKUP 1 TON, R3500 All	
F	75-86	PICKUP 3/4 TON, C25 / C2500 Cab & Chassis	
F	75-86	PICKUP 3/4 TON, C25 / C2500 Crew Cab Pickup	
F	75-86	PICKUP 3/4 TON, C25 / C2500 Standard Cab Pickup	
F	67-74	PICKUP 3/4 TON, C25 / C2500 All	
F	87-89	PICKUP 3/4 TON, R2500 All Exc. Crew Cab & Bonus Cab	
F	63-65	PICKUP 1000 SERIES All	
F	63-65	PICKUP 1500 SERIES All	
F	68-86	SUBURBAN 1/2 TON, C15 / C1500 All	
F	87-91	SUBURBAN 1/2 TON, R1500 All	
F	68-86	SUBURBAN 3/4 TON, C25 / C2500 All	
F	87-91	SUBURBAN 3/4 TON, R2500 All	
F	67-80	VAN 1/2 TON, P SERIES All	
F	74-90	VAN 1 TON, P SERIES All Exc. Motorhome Chassis	
F	73	VAN 1 TON, P SERIES Base Exc. Motorhome Chassis	
F	68-72	VAN 1 TON, P SERIES All	
F	68-89	VAN 3/4 TON, P SERIES All	
F	63-65	VAN, PB 1000 SERIES All	
34051 A			
F	73-75	BUICK APOLLO All	
F	73-81	CENTURY All	
F	73-87	REGAL All	
F	75-79	SKYLARK All	
F	69-72	SKYLARK All	
F	68	SKYLARK All HD Suspension; Exc. Sportwagon	
F	68-69	SPECIAL All	
F	68-72	SPORTWAGON All	
F	76-79	CADILLAC SEVILLE All	
F	05	CHEVROLET BLAZER Base, RWD	
F	96-04	BLAZER LS, RWD	
F	95-02	BLAZER LT, RWD	
F	95-99	BLAZER Base, RWD	
F	95-97	BLAZER Deluxe, RWD	
F	83-94	BLAZER, S MODELS RWD	
F	68-73	CHEVELLE All	

Numerical listing

Shock	POP	Alternative No.	MTG Acc. Supplied
Pos.	Year	Application	
34051 A -continued			
F	68-87	EL CAMINO All	
F	73-83	MALIBU All	
F	70-88	MONTE CARLO All	
F	69-79	NOVA All	
F	94-03	S10 LS, RWD	
F	83-03	S10 Base, RWD	
F	92-93	S10 EL, RWD	
F	83-92	S10 Tahoe, RWD	
F	88-90	S10 Durango, RWD	
F	83-86	S10 Durango, RWD	
F	82	S10 Base	
F	82	S10 Durango	
F	92-04	GMC JIMMY RWD	
F	83-91	S15 JIMMY RWD	
F	04	SONOMA / S15 All RWD	
F	83-03	SONOMA / S15 RWD	
F	82	SONOMA / S15 All	
F	71-87	SPRINT / CABALLERO All	
F	98-00	ISUZU HOMBRE RWD Exc. Sport Chassis	
F	96-97	HOMBRE All Exc. Sport Chassis	
F	68-87	OLDSMOBILE CUTLASS / CUTLASS SUPREME All	
F	80-83	CUTLASS CLASSIC / CUTLASS CRUISER All	
F	78-79	OMEGA All	
F	82-86	PONTIAC BONNEVILLE All	
F	78-80	GRAND AM All	
F	73-75	GRAND AM All	
F	75-83	GRAND LEMANS All	
F	69-87	GRAND PRIX All	
F	71-75	GRANDVILLE All	
F	68-81	LEMANS All	
F	77-79	PHOENIX All	
F	73-77	VENTURA All	
34052 D			
F	84-88	DODGE MINI RAM All	
F	72-93	PICKUP 1/2 TON, D100 SERIES All	
F	72-93	PICKUP 3/4 TON, D200 SERIES All Exc. HD Package	
F	75-93	RAMCHARGER RWD	
F	99-03	VAN 1/2 TON, A / B SERIES / RAM 109.3 (WheelBase) Exc. 7000# GVW	
F	82-98	VAN 1/2 TON, A / B SERIES / RAM 109.6 (WheelBase) Exc. 7000# GVW	
F	71-80	VAN 1/2 TON, A / B SERIES / RAM All	
F	99-03	VAN 1 TON, A / B SERIES / RAM All	
F	71-98	VAN 1 TON, A / B SERIES / RAM All Exc. 4000# Front Axle	
F	71-03	VAN 3/4 TON, A / B SERIES / RAM All	
F	78-80	VAN, CB300 All Exc. 4000# Front Axle	
F	74-77	VAN, CB300 All Up through 8300# GVW	
F	81	PLYMOUTH TRAILDUSTER All	
F	75-80	TRAILDUSTER RWD	
F	74-83	VAN 1/2 TON, PB SERIES All	
F	74-83	VAN 1 TON, PB SERIES All Exc. 4000# Front Axle	
F	74-83	VAN 3/4 TON, PB SERIES All	
34057 B			
F	80-96	FORD BRONCO All Quad & Non Quad Suspensions Rearward of Front Axle; Exc. Lift Kit	
F	89	BRONCO II All Mfg. to 2/89; Vehicles with 10mm & 12mm bolt in rear lower mount	
F	84-88	BRONCO II All With 10mm Bolt In Rear Lower Mount	
F	80-83	PICKUP 1/2 TON, F-100 RWD	
F	80-96	PICKUP 1/2 TON, F-150 4WD Quad & Non Quad Suspensions Rearward of Front Axle; Exc. Lift Kit	
F	80-96	PICKUP 1/2 TON, F-150 RWD	
F	80-97	PICKUP 1 TON, F-350 / SUPERDUTY RWD	
F	80-96	PICKUP 3/4 TON, F-250 / SUPERDUTY RWD	
F	87-89	RANGER All Exc. High Ryder Option	
F	83-86	RANGER All	
34058 W			
F	66-77	FORD BRONCO All From Serial #830001; Exc. Lift Kit	
F	73-79	PICKUP 1/2 TON, F-100 RWD	
F	65-72	PICKUP 1/2 TON, F-100 All RWD	
F	75-79	PICKUP 1/2 TON, F-150 RWD	

Front Load Carrier, Rear Load Carrier

Shock	POP	Alternative No.	MTG Acc. Supplied
Pos.	Year	Application	
34058 W -continued			
F	75-79	PICKUP 1 TON, F-350 / SUPERDUTY RWD	
F	73-74	PICKUP 1 TON, F-350 / SUPERDUTY All RWD; Exc. Supercab	
F	70-79	PICKUP 3/4 TON, F-250 / SUPERDUTY RWD	
F	77-91	VAN 1 TON, ECONOLINE / CLUB WAGON / SUPERDUTY All	
F	75-91	VAN 1 TON, ECONOLINE / CLUB WAGON / SUPERDUTY All Exc. Motorhome Conversion	
F	75-91	VAN 3/4 TON, ECONOLINE / CLUB WAGON / SUPERDUTY All	
34073 A			
F	71-73	BUICK CENTURION All	
F	85-89	ELECTRA Estate Wagon	
F	71-84	ELECTRA All	
F	71-83	ESTATE WAGON All	
F	88-89	LESABRE All	
F	71-85	LESABRE All	
F	71-78	RIVIERA All	
F	91-96	ROADMASTER All	
F	87-92	CADILLAC BROUGHAM All	
F	92-96	COMMERCIAL CHASSIS RWD	
F	77-84	COMMERCIAL CHASSIS All	
F	77-84	DEVILLE All	
F	93-96	FLEETWOOD All	
F	85-86	FLEETWOOD RWD	
F	77-84	FLEETWOOD All	
F	81	CHEVROLET BEL AIR Sedan	
F	75	BEL AIR Sedan	
F	65-74	BEL AIR All	
F	65-72	BISCAYNE All	
F	69-72	BROOKWOOD All	
F	70-81	CAMARO All	
F	66-96	CAPRICE All	
F	94-96	IMPALA All	
F	83-85	IMPALA All	
F	82	IMPALA Sedan	
F	65-81	IMPALA All	
F	69-72	KINGSWOOD All	
F	69-72	TOWNSMAN All	
F	65-74	FORD COUNTRY SEDAN All	
F	87-91	COUNTRY SQUIRE All	
F	65-74	COUNTRY SQUIRE All	
F	92-02	CROWN VICTORIA All Exc. Hydraulic Self Leveling System	
F	65-72	CUSTOM All	
F	68-77	CUSTOM 500 All	
F	65-67	GALAXIE All	
F	68-74	GALAXIE 500 All	
F	01-02	GRAND MARQUIS All	
F	87-91	LTD / COUNTRY SEDAN / COUNTRY SQUIRE / CROWN VICTORIA All	
F	67-82	LTD / COUNTRY SEDAN / COUNTRY SQUIRE / CROWN VICTORIA All	
F	77-79	LTD II All	
F	72-79	RANCHERO All	
F	65-74	RANCH WAGON All	
F	67-79	THUNDERBIRD All	
F	72-76	TORINO All	
F	70-80	LINCOLN CONTINENTAL All	
F	68-71	MARK III All	
F	72-76	MARK IV All	
F	77-79	MARK V All	
F	80-83	MARK VI All	
F	81-02	TOWN CAR All	
F	65-66	MERCURY BREEZEWAY All	
F	67	BROUGHAM All	
F	87-91	COLONY PARK All	
F	65-74	COLONY PARK All	
F	65-68	COMMUTER All	
F	74-79	COUGAR All	
F	92-02	GRAND MARQUIS All Exc. Hydraulic Self Leveling System	
F	75-91	GRAND MARQUIS All	
F	69-70	MARAUDER All	
F	65-67	MARAUDER All	
F	67-82	MARQUIS All	
F	65-68	MONTCLAIR All	
F	72-76	MONTEGO All	
F	65-74	MONTEREY All	
F	65-68	PARKLANE All	
F	65-67	VILLAGER All	
F	66-67	VOYAGER All	
F	71-85	OLDSMOBILE 88 SERIES All	
F	71-84	98 All	
F	71-92	CUSTOM CRUISER All	
F	71-81	PONTIAC BONNEVILLE All	
F	71-81	CATALINA All	

Numerical listing

Shock	POP	Alternative No.	MTG Acc. Supplied
Pos.	Year	Application	
34073 A -continued			
F	70-81	FIREBIRD All	
F	71-78	GRAND SAFARI All	
F	76-81	LAURENTIAN CAN	
F	76-86	PARISIENNE All	
F	87-89	SAFARI All	
34076 W			
F	91-94	FORD EXPLORER All	
F	91-94	MAZDA NAVAJA All	
43107 W			
F	87-91	CHEVROLET BLAZER 4WD Full Size; Exc. Quad Suspension and Lift Kit	
F	76-86	BLAZER 4WD Exc. Quad Suspension and Lift Kit	
F	73-75	BLAZER 4WD Exc. Lift Kit	
F	69-72	BLAZER 4WD	
F	81-86	PICKUP 1/2 TON, K10 All Standard Suspension; Exc. Lift Kit	
F	69-80	PICKUP 1/2 TON, K10 All Exc. Lift Kit	
F	87	PICKUP 1/2 TON, V10 All Exc. Lift Kit	
F	81-86	PICKUP 3/4 TON, K20 All Standard Suspension; Exc. Lift Kit	
F	73-80	PICKUP 3/4 TON, K20 All Exc. Lift Kit	
F	87	PICKUP 3/4 TON, V20 All Exc. Quad Suspension and Lift Kit	
F	81-86	SUBURBAN 1/2 TON, K10 All Standard Suspension; Exc. Lift Kit	
F	69-80	SUBURBAN 1/2 TON, K10 All Exc. Lift Kit	
F	87-88	SUBURBAN 1/2 TON, R10 RWD Exc. Quad Suspension and Lift Kit	
F	70-91	Gmc JIMMY 4WD Exc. Quad Suspension and Lift Kit	
F	73-86	PICKUP 1/2 TON, K15 / K1500 All Exc. Quad Suspension and Lift Kit	
F	69-72	PICKUP 1/2 TON, K15 / K1500 All	
F	87	PICKUP 1/2 TON, V1500 All Exc. Lift Kit	
F	69-86	PICKUP 3/4 TON, K25 / K2500 All Exc. Quad Suspension and Lift Kit	
F	87	PICKUP 3/4 TON, V2500 All Exc. Lift Kit	
F	69-86	SUBURBAN 1/2 TON, K15 / K1500 All Exc. Quad Suspension and Lift Kit	
F	87-91	SUBURBAN 1/2 TON, V1500 All Exc. Lift Kit	
F	69-86	SUBURBAN 3/4 TON, K25 / K2500 All Exc. Quad Suspension and Lift Kit	
F	87-91	SUBURBAN 3/4 TON, V2500 All Exc. Lift Kit	
Rear Load Carrier			
43048 A			
R	75-80	CHEVROLET LUV PICKUP All	
R	72-74	LUV PICKUP All	
F	55-56	PICKUP 3100	
F	55-56	PICKUP 3800	
R	75-80	DODGE COLT Wagon	
R	71-74	COLT All	
R	79-82	D50 RWD	
R	87-93	PICKUP, RAM 50 RWD	
R	83-86	PICKUP, RAM 50 All	
R	55	FORD F SERIES All F-100	
F	48-52	F SERIES All F-1, F-2 & F-3	
R	61-64	PICKUP 1/2 TON, F-100 All	
R	61-66	PICKUP 1 TON, F-350 / SUPERDUTY All	
R	61-64	PICKUP 3/4 TON, F-250 / SUPERDUTY All	
F	68-76	PICKUP P350 All Up through 8000# GVW	
F	75-76	PICKUP P400 All Up through 8000# GVW	
R	68	INTERNATIONAL 908B All	
R	68	908C All	
R	68	1000B All	
R	68	1000C All	
F	68	1100B All Exc. Travelette with 166" Wheelbase	
R	68	1100B All Exc. Travelette with 166" Wheelbase	
F	68	1100C All Exc. Travelette with 166" Wheelbase	
R	68	1100C All Exc. Travelette with 166" Wheelbase	
F	68	1200B All Exc. Travelette with 166" Wheelbase	

Numerical listing

Shock	POP	Alternative No.	MTG Acc. Supplied
Pos.	Year	Application	
43048 A -continued			
R	68	1200B All Exc.	Travelette with 166" Wheelbase
F	68	1200C All Exc.	Travelette with 166" Wheelbase
R	68	1200C All Exc.	Travelette with 166" Wheelbase
F	68	1300B All Exc.	Travelette with 166" Wheelbase
R	68	1300B All Exc.	Travelette with 166" Wheelbase
F	68	1300C All Exc.	Travelette with 166" Wheelbase
R	68	1300C All Exc.	Travelette with 166" Wheelbase
R	68-72	M1100 / M1200 All	
R	69	M1400 All	
R	65-67	M SERIES VAN All	
R	72-83	JEEP CJ5 All Exc.	Lift Kit
R	66-71	CJ5 All	
R	72-75	CJ6 All Exc.	Lift Kit
R	66-71	CJ6 All	
R	76-86	CJ7 All Exc.	Lift Kit
R	66-74	DJ5 All Exc.	Lift Kit
R	66-68	DJ6 All	
R	57-60	FC150 All	
F	63-65	FC170 All	
R	63-65	FC170 All	
R	63-66	GLADIATOR All Independent Front Suspension	
R	70-73	JEEPSTER All	
R	81-85	SCRAMBLER / CJ8 All	
R	61-67	UNIVERSAL All	
R	86-87	MAZDA B2000 RWD	
R	87-93	B2200 RWD	
R	87-93	B2600 RWD	
R	95-96	MITSUBISHI MIGHTY MAX All	
R	83-94	MIGHTY MAX RWD	
R	87-90	VAN All	
R	98-04	NISSAN FRONTIER RWD Exc.	Desert Runner
R	87-97	PICKUP RWD	
R	86	PICKUP RWD Mfg. from 8/86	
R	76-80	PLYMOUTH COLT All	
R	79-82	PICKUP All	
R	84-95	TOYOTA PICKUP RWD	
R	75-83	PICKUP RWD Mojave	
R	73-74	PICKUP All RWD; Mojave	
R	70-72	PICKUP RWD	
R	84-88	VAN Leaf (RearSpringType)	
R	88	VAN WAGON Leaf (FrontSpringType), Leaf (RearSpringType)	
43049 C			
R	71-73	BUICK CENTURION All	
R	92-96	COMMERCIAL CHASSIS All	
R	71-84	ELECTRA All	
R	71-85	LESABRE All	
R	71-78	RIVIERA All	
R	92-96	ROADMASTER Sedan	
R	64-67	SKYLARK All Exc.	HD Suspension
R	64-67	SPECIAL All Exc.	HD Suspension
R	87-92	CADILLAC BROUGHAM All	
R	92-96	COMMERCIAL CHASSIS RWD	
R	77-84	COMMERCIAL CHASSIS All	
R	77-84	DEVILLE All	
R	93-96	FLEETWOOD RWD	
R	77-86	FLEETWOOD RWD	
R	81	CHEVROLET BEL AIR Sedan	
R	75	BEL AIR Sedan	
R	65-74	BEL AIR All	
R	65-72	BISCAYNE All	
R	69-70	BROOKWOOD All	
R	81-96	CAPRICE Sedan Police and Taxi Models	
R	76-80	CAPRICE Sedan Exc. Wagon	
R	75-80	CAPRICE Coupe Exc. Wagon	
R	75	CAPRICE Convertible Exc. Wagon	
R	75	CAPRICE Sedan	
R	73-74	CAPRICE Sedan Police and Taxi Models	
R	71-72	CAPRICE All Police and Taxi Models	
R	66-70	CAPRICE All	
R	64-67	CHEVELLE All Exc.	HD Suspension
R	68	CHEVY II Leaf (RearSpringType) Multi-Leaf Rear Spring	
R	64-67	EL CAMINO All	
R	94-96	IMPALA All	
R	83-85	IMPALA All	
R	73-82	IMPALA Sedan Exc. Wagon	
R	74-81	IMPALA Coupe Exc. Wagon	
R	73	IMPALA Hardtop Exc. Wagon	
R	65-72	IMPALA Sedan	
R	69-70	KINGSWOOD All	

Rear Load Carrier

Shock	POP	Alternative No.	MTG Acc. Supplied
Pos.	Year	Application	
43049 C -continued			
R	64-67	MALIBU All Exc.	HD Suspension
R	69-72	NOVA All Multi-Leaf Rear Spring	
R	69-70	TOWNSMAN All	
R	65-85	OLDSMOBILE 88 SERIES All	
R	71-84	98 All	
R	64-67	CUTLASS / CUTLASS SUPREME All Exc.	HD Suspension
R	64-67	F85 All Exc.	HD Suspension
R	65-66	STARFIRE All	
R	63-81	PONTIAC BONNEVILLE All	
R	75-81	CATALINA Coupe	
R	71-81	CATALINA Sedan	
R	71-74	CATALINA Hardtop	
R	63-70	CATALINA All	
R	67-70	EXECUTIVE All	
R	64-67	GTO All Exc.	HD Suspension
R	76-81	LAURENTIAN CAN	
R	64-67	LEMANS All Exc.	HD Suspension
R	76-86	PARISIENNE Sedan	
R	64-67	TEMPEST All Exc.	HD Suspension
R	71-72	VENTURA Leaf (RearSpringType)	
43058 D			
R	78-79	FORD BRONCO All Exc.	Lift Kit
R	66-77	BRONCO All From Serial #830001; Exc. Lift Kit	
R	66-69	PICKUP 1/2 TON, F-100 All RWD	
R	65	PICKUP 1/2 TON, F-100 All	
R	75-79	PICKUP 1 TON, F-350 / SUPERDUTY Standard Cab Pickup, RWD	
R	73-74	PICKUP 1 TON, F-350 / SUPERDUTY All Supercab	
R	75-79	PICKUP 3/4 TON, F-250 / SUPERDUTY Cab & Chassis, RWD	
R	75-79	PICKUP 3/4 TON, F-250 / SUPERDUTY Extended Cab Pickup, RWD	
R	70-74	PICKUP 3/4 TON, F-250 / SUPERDUTY RWD Supercab	
R	65-69	PICKUP 3/4 TON, F-250 / SUPERDUTY All	
R	69-74	VAN 1/2 TON, ECONOLINE / CLUB WAGON All	
R	68	VAN 1/2 TON, ECONOLINE / CLUB WAGON All Late 1968	
R	69-74	VAN 1 TON, ECONOLINE / CLUB WAGON / SUPERDUTY All	
R	68	VAN 1 TON, ECONOLINE / CLUB WAGON / SUPERDUTY All Late 1968	
R	69-74	VAN 3/4 TON, ECONOLINE / CLUB WAGON / SUPERDUTY All	
R	68	VAN 3/4 TON, ECONOLINE / CLUB WAGON / SUPERDUTY All Late 1968	
R	76-83	JEEP CHEROKEE All	
F	74-83	CHEROKEE All	
R	67	GLADIATOR All	
F	84-91	GRAND WAGONEER All	
R	84-91	GRAND WAGONEER All	
F	74-88	J10 PICKUP All	
R	74-88	J10 PICKUP All	
F	74-88	J20 PICKUP All	
R	74-88	J20 PICKUP All	
R	68-73	J2500 PICKUP All	
R	76-83	WAGONEER All	
F	74-83	WAGONEER All	
43060 A			
R	73-81	BUICK CENTURY All	
R	71-83	ESTATE WAGON All	
R	65-67	GRAN SPORT All	
R	68-72	GS / GS350 / GS400 / GS455 All	
R	73-87	REGAL All	
R	91-96	ROADMASTER Wagon	
R	68-72	SKYLARK All	
R	64-67	SKYLARK All HD Suspension; Exc. Sportwagon	
R	68-69	SPECIAL All	
R	64-67	SPECIAL All HD Suspension; Exc. Sportwagon	
R	70-72	SPORTWAGON All	
R	77-96	CHEVROLET CAPRICE Wagon	
R	68-73	CHEVELLE All	
R	64-67	CHEVELLE All HD Suspension	
R	68-87	EL CAMINO All	
R	71-82	IMPALA Wagon	
R	73-83	MALIBU All	
R	64-67	MALIBU All HD Suspension	
R	70-88	MONTE CARLO All	
R	78-87	GMC SPRINT / CABALLERO RWD	
R	71-77	SPRINT / CABALLERO All	
R	74-77	NISSAN 710 Wagon	

Numerical listing

Shock	POP	Alternative No.	MTG Acc. Supplied
Pos.	Year	Application	
43060 A -continued			
R	78-80	810 Wagon	
R	77-92	OLDSMOBILE CUSTOM CRUISER All	
R	68-87	CUTLASS / CUTLASS SUPREME All	
R	64-67	CUTLASS / CUTLASS SUPREME All HD Suspension	
R	80-83	CUTLASS CLASSIC / CUTLASS CRUISER All	
R	68-72	F85 All	
R	64-67	F85 All HD Suspension	
R	71-78	TORONADO All	
R	82-86	PONTIAC BONNEVILLE All	
R	78-80	GRAND AM All	
R	73-75	GRAND AM All	
R	75-83	GRAND LEMANS All	
R	69-87	GRAND PRIX All	
R	71-78	GRAND SAFARI All	
R	71-75	GRANDVILLE All	
R	68-73	GTO All	
R	64-67	GTO All HD Suspension	
R	68-81	LEMANS All	
R	64-67	LEMANS All HD Suspension	
R	80-86	PARISIENNE Wagon	
R	76-79	PARISIENNE All Wagon	
R	87-89	SAFARI All	
R	68-70	TEMPEST All	
R	64-67	TEMPEST All HD Suspension	
43062 W			
R	71-72	CHEVROLET BLAZER All Coil(RearSpringType)	
R	69-70	BLAZER RWD Coil(RearSpringType)	
R	67-72	PICKUP 1/2 TON, C10 All Coil(RearSpringType)	
R	67-72	PICKUP 3/4 TON, C20 All Coil(RearSpringType)	
R	67	SUBURBAN 1/2 TON, 1500 All	
R	67-72	SUBURBAN 1/2 TON, C10 All	
R	68-72	SUBURBAN 3/4 TON, C20 All	
R	67-72	VAN 1/2 TON, P SERIES All	
R	70-72	GMC JIMMY 4WD	
R	67-72	PICKUP 1/2 TON, C15 / C1500 All Coil(RearSpringType)	
R	67-72	PICKUP 3/4 TON, C25 / C2500 All Coil(RearSpringType)	
R	68-72	SUBURBAN 1/2 TON, C15 / C1500 All	
R	68-72	SUBURBAN 3/4 TON, C25 / C2500 All Coil(RearSpringType)	
R	68-72	VAN 1/2 TON, P SERIES All	
43067 D			
R	70-71	CHRYSLER 300 All	
R	67-73	IMPERIAL All	
R	70-73	NEWPORT All	
R	70-73	NEW YORKER All	
R	71-73	TOWN & COUNTRY All	
R	71	DODGE MONACO All	
R	72-93	PICKUP 1/2 TON, D100 SERIES All	
R	72-93	PICKUP 1 TON, D300 SERIES All	
R	72-93	PICKUP 3/4 TON, D200 SERIES All	
R	73	POLARA Wagon	
R	71	POLARA All	
R	76-93	RAMCHARGER RWD	
R	74-75	RAMCHARGER All	
R	73	PLYMOUTH GRAN FURY Hardtop	
R	74-81	TRAILDUSTER All	
43084 W			
R	70-81	CHEVROLET CAMARO All	
R	70-81	PONTIAC FIREBIRD All	
43085 W			
R	84-88	DODGE MINI RAM All	
R	99-03	VAN 1/2 TON, A / B SERIES / RAM 109.3 (WheelBase) Exc. 7000# GVV	
R	81-98	VAN 1/2 TON, A / B SERIES / RAM 109.6 (WheelBase) Exc. 7000# GVV	
R	71-80	VAN 1/2 TON, A / B SERIES / RAM All	
R	99-03	VAN 1 TON, A / B SERIES / RAM All	
R	95-98	VAN 1 TON, A / B SERIES / RAM All Exc. 4000# Front Axle	
R	71-94	VAN 1 TON, A / B SERIES / RAM All	
R	71-03	VAN 3/4 TON, A / B SERIES / RAM All	
R	74-80	VAN, CB300 All	
R	74-83	PLYMOUTH VAN 1/2 TON, PB SERIES All	
R	74-83	VAN 1 TON, PB SERIES All	
R	74-83	VAN 3/4 TON, PB SERIES All	

Numerical listing

Shock	POP	Alternative No.	MTG Acc. Supplied
Pos.	Year	Application	
43093	W		
R	69-72	CHEVROLET BLAZER RWD Leaf(RearSpringType)	
R	63-72	PICKUP 1/2 TON, C10 All Leaf(RearSpringType)	
R	67-72	PICKUP 1 TON, C30 All Exc. 11,000# Rear Axle	
R	67-72	PICKUP 3/4 TON, C20 All Leaf(RearSpringType)	
R	63-66	PICKUP 3/4 TON, C20 All	
R	63-66	SUBURBAN 1/2 TON, 1500 All	
R	67-77	VAN 1/2 TON, G / EXPRESS All	
R	63-66	VAN 1/2 TON, P SERIES All	
R	76-77	VAN 1 TON, G / EXPRESS All	
R	75	VAN 1 TON, G / EXPRESS 110.0 (WheelBase)	
R	75	VAN 1 TON, G / EXPRESS 125.0 (WheelBase)	
R	71-74	VAN 1 TON, G / EXPRESS All	
R	68-72	VAN 1 TON, P SERIES All Exc. 11,000# Rear Axle	
R	67-77	VAN 3/4 TON, G / EXPRESS All	
R	68-72	VAN 3/4 TON, P SERIES All	
R	70-72	GMC JIMMY RWD	
R	67-72	PICKUP 1/2 TON, C15 / C1500 All Leaf(RearSpringType)	
R	67-72	PICKUP 1 TON, C35/3500 All Exc. 11,000# Rear Axle	
R	67-72	PICKUP 3/4 TON, C25 / C2500 All Leaf(RearSpringType)	
R	63-65	PICKUP 1000 SERIES All	
R	63-65	PICKUP 1500 SERIES All	
R	67-77	VAN 1/2 TON, G / SAVANNA All	
R	67	VAN 1/2 TON, P SERIES All	
R	76-77	VAN 1 TON, G / SAVANNA All	
R	75	VAN 1 TON, G / SAVANNA 110.0 (WheelBase)	
R	75	VAN 1 TON, G / SAVANNA 125.0 (WheelBase)	
R	71-74	VAN 1 TON, G / SAVANNA All Exc. 146" Wheelbase	
R	68-72	VAN 1 TON, P SERIES All Exc. 11,000# Rear Axle	
R	67-77	VAN 3/4 TON, G / SAVANNA All	
R	68-72	VAN 3/4 TON, P SERIES All	
R	63-65	VAN, PB 1000 SERIES All	
43096	D		
R	65-69	CHRYSLER 300 All	
R	75-76	CORDOBA All	
R	74-75	IMPERIAL All	
R	74-78	NEWPORT All	
R	65-69	NEWPORT All	
R	74-78	NEW YORKER All	
R	65-69	NEW YORKER All	
R	74-78	TOWN & COUNTRY All	
R	65-70	TOWN & COUNTRY All	
R	70-74	DODGE CHALLENGER All	
R	66-76	CHARGER All	
R	65-76	CORONET All	
R	65	CUSTOM All	
R	77-78	MONACO All Police Package	
R	72-76	MONACO All	
R	65-70	MONACO All	
R	73	POLARA All Exc. Wagon	
R	72	POLARA All	
R	62-70	POLARA All	
R	75-77	ROYAL MONACO All	
R	62-70	PLYMOUTH BELVEDERE All	
R	77-78	FURY All Police Package	
R	74-76	FURY All	
R	73	FURY Wagon	
R	65-69	FURY All	
R	74-77	GRAN FURY All	
R	73	GRAN FURY Wagon	
R	67	GTX All	
R	73-75	ROADRUNNER All	
R	68-70	ROADRUNNER All	
R	73-74	SATELLITE All	
R	65-70	SATELLITE All	
R	70	SUPERBIRD All	
R	67	VIP All	
43099	C		
R	66	FORD BRONCO All Thru Serial #830000	
R	75-79	PICKUP 1/2 TON, F-100 RWD	
R	70-74	PICKUP 1/2 TON, F-100 All Exc. Supercab	
R	75-79	PICKUP 1/2 TON, F-150 Standard Cab Pickup, RWD	
R	75-79	PICKUP 1 TON, F-350 / SUPERDUTY Cab & Chassis, RWD	

Rear Load Carrier

Shock	POP	Alternative No.	MTG Acc. Supplied
Pos.	Year	Application	
43099	C	-continued	
R	75-79	PICKUP 1 TON, F-350 / SUPERDUTY Extended Cab Pickup, RWD	
R	74	PICKUP 1 TON, F-350 / SUPERDUTY All RWD; Exc. Supercab	
R	70-79	PICKUP 3/4 TON, F-250 / SUPERDUTY Standard Cab Pickup, RWD	
R	75-91	VAN 1/2 TON, ECONOLINE / CLUB WAGON All	
F	71-80	INTERNATIONAL SCOUT II All	
43111	C		
R	87-91	CHEVROLET BLAZER 4WD Full Size; Exc. Lift Kit	
R	85-86	BLAZER 4WD Exc. Lift Kit	
R	73-84	BLAZER All Exc. Lift Kit	
R	73-86	PICKUP 1/2 TON, C10 All	
R	73-86	PICKUP 1/2 TON, K10 All Exc. Lift Kit	
R	87	PICKUP 1/2 TON, R10 All	
R	87	PICKUP 1/2 TON, V10 All Exc. Lift Kit	
R	75-86	PICKUP 3/4 TON, C20 Standard Cab Pickup	
R	73-74	PICKUP 3/4 TON, C20 All Standard Cab Pickup	
R	73-86	PICKUP 3/4 TON, K20 All Exc. Lift Kit	
R	87	PICKUP 3/4 TON, R20 Standard Cab Pickup	
R	87	PICKUP 3/4 TON, V20 All Exc. Quad Suspension and Lift Kit	
R	73-86	SUBURBAN 1/2 TON, C10 All	
R	73-86	SUBURBAN 1/2 TON, K10 All Exc. Lift Kit	
R	87-88	SUBURBAN 1/2 TON, R10 All	
R	89-91	SUBURBAN 1/2 TON, R1500 All	
R	89-91	SUBURBAN 1/2 TON, V1500 All Exc. Lift Kit	
R	73-86	SUBURBAN 3/4 TON, C20 All	
R	73-86	SUBURBAN 3/4 TON, K20 All Exc. Lift Kit	
R	87-88	SUBURBAN 3/4 TON, R20 All	
R	89-91	SUBURBAN 3/4 TON, R2500 All	
R	87-88	SUBURBAN 3/4 TON, V20 All Exc. Quad Suspension and Lift Kit	
R	89-91	SUBURBAN 3/4 TON, V2500 All Exc. Lift Kit	
R	73	VAN 1/2 TON, P SERIES All	
R	73-78	VAN 3/4 TON, P SERIES All	
R	73-91	GMC JIMMY All Exc. Lift Kit	
R	73-86	PICKUP 1/2 TON, C15 / C1500 All	
R	79-86	PICKUP 1/2 TON, K15 / K1500 All Exc. Lift Kit	
R	75-77	PICKUP 1/2 TON, K15 / K1500 All Exc. Lift Kit	
R	87	PICKUP 1/2 TON, R1500 All	
R	87	PICKUP 1/2 TON, V1500 All Exc. Lift Kit	
R	75-86	PICKUP 3/4 TON, C25 / C2500 Cab & Chassis	
R	75-86	PICKUP 3/4 TON, C25 / C2500 Standard Cab Pickup	
R	73-74	PICKUP 3/4 TON, C25 / C2500 All	
R	73-86	PICKUP 3/4 TON, K25 / K2500 All Exc. Lift Kit	
R	88-89	PICKUP 3/4 TON, R2500 All Exc. Crew Cab & Bonus Cab	
R	87	PICKUP 3/4 TON, R2500 Cab & Chassis Exc. Crew Cab & Bonus Cab	
R	87	PICKUP 3/4 TON, R2500 Standard Cab Pickup Exc. Crew Cab & Bonus Cab	
R	87	PICKUP 3/4 TON, V2500 All Exc. Lift Kit	
R	73-86	SUBURBAN 1/2 TON, C15 / C1500 All	
R	73-86	SUBURBAN 1/2 TON, K15 / K1500 All Exc. Lift Kit	
R	87-91	SUBURBAN 1/2 TON, R1500 All	
R	87-91	SUBURBAN 1/2 TON, V1500 All Exc. Lift Kit	
R	73-86	SUBURBAN 3/4 TON, C25 / C2500 All	
R	73-86	SUBURBAN 3/4 TON, K25 / K2500 All Exc. Lift Kit	
R	87-91	SUBURBAN 3/4 TON, R2500 All	
R	87-91	SUBURBAN 3/4 TON, V2500 All Exc. Lift Kit	

Numerical listing

Shock	POP	Alternative No.	MTG Acc. Supplied
Pos.	Year	Application	
43111	C	-continued	
R	73	VAN 1/2 TON, P SERIES All	
R	73-78	VAN 3/4 TON, P SERIES All	
43138	W		
R	77-83	CHRYSLER CORDOBA All	
R	83-89	FIFTH AVENUE All	
R	81-83	IMPERIAL All	
R	77-81	LEBARON All	
R	79-81	NEWPORT All	
R	79-82	NEW YORKER All	
R	79-81	TOWN & COUNTRY All	
R	76-80	DODGE ASPEN All	
R	77-78	CHARGER All	
R	77-89	DIPLOMAT All	
R	78-79	MAGNUM All	
R	80-83	MIRADA All	
R	77-78	MONACO All Exc. Police Package	
R	79-81	ST. REGIS All	
R	77-78	PLYMOUTH FURY All Exc. Police Package	
R	80-89	GRAN FURY All	
R	76-80	VOLARE All	
43140	A		
R	65-74	FORD COUNTRY SEDAN All	
R	87-91	COUNTRY SQUIRE All	
R	65-74	COUNTRY SQUIRE All	
R	94-02	CROWN VICTORIA All	
R	93	CROWN VICTORIA All Exc. Hydraulic Self Leveling System	
R	92	CROWN VICTORIA All	
R	65-72	CUSTOM All	
R	68-77	CUSTOM 500 All	
R	65-67	GALAXIE All	
R	68-74	GALAXIE 500 All	
R	01-02	GRAND MARQUIS All	
R	87-91	LTD / COUNTRY SEDAN / COUNTRY SQUIRE / CROWN VICTORIA All	
R	67-82	LTD / COUNTRY SEDAN / COUNTRY SQUIRE / CROWN VICTORIA All	
R	77-79	LTD II All	
R	72-79	RANCHERO All	
R	65-74	RANCH WAGON All	
R	77-79	THUNDERBIRD All	
R	67-72	THUNDERBIRD All	
R	72-76	TORINO All	
R	70-80	LINCOLN CONTINENTAL All	
R	68-71	MARK III All	
R	72	MARK IV All	
R	80-83	MARK VI All	
R	81-02	TOWN CAR All	
R	65-66	MERCURY BREEZEWAY All	
R	67	BROUGHAM All	
R	87-91	COLONY PARK All	
R	65-74	COLONY PARK All	
R	65-68	COMMUTER All	
R	74-79	COUGAR All	
R	75-02	GRAND MARQUIS All	
R	69-70	MARAUDER All	
R	65-67	MARAUDER All	
R	67-82	MARQUIS All	
R	65-68	MONTCLAIR All	
R	72-76	MONTEGO All	
R	65-74	MONTEREY All	
R	65-68	PARKLANE All	
R	65-67	VILLAGER All	
R	66-67	VOYAGER All	
43142	D		
R	80-96	FORD BRONCO All Exc. Lift Kit	
R	80-83	PICKUP 1/2 TON, F-100 RWD	
R	80-84	PICKUP 1/2 TON, F-150 RWD	
43143	W		
R	78-83	FORD FAIRMONT All	
R	81-82	GRANADA All	
R	83-86	LTD / COUNTRY SEDAN / COUNTRY SQUIRE / CROWN VICTORIA All	
R	87-93	MUSTANG / MUSTANG II LX, 2.3L 4Cyl L (140)	
R	84-86	MUSTANG / MUSTANG II LX	
R	82-84	MUSTANG / MUSTANG II L	
R	82-83	MUSTANG / MUSTANG II GL	
R	82-83	MUSTANG / MUSTANG II GLX	
R	82	MUSTANG / MUSTANG II Ghia	
R	79-81	MUSTANG / MUSTANG II All	
R	79-86	MERCURY CAPRI All	
R	81-82	COUGAR Base	
R	82	COUGAR GS	
R	82	COUGAR LS	
R	83-86	MARQUIS All	
R	78-83	ZEPHYR All	

Numerical listing

Shock	POP	Alternative No.	MTG Acc. Supplied
Pos.	Year	Application	
43161 B			
R	90-05	CHEVROLET	ASTRO All
R	85-89	ASTRO	RWD
R	90-05	GMC	SAFARI All
R	85-89	SAFARI	RWD
43162 A			
R	05	CHEVROLET	BLAZER Base, 4WD
R	05	BLAZER Base,	RWD
R	96-04	BLAZER LS,	4WD
R	96-04	BLAZER LS,	RWD
R	95-02	BLAZER LT,	RWD
R	95-01	BLAZER LT,	4WD
R	95-99	BLAZER Base,	4WD
R	95-99	BLAZER Base,	RWD
R	95-97	BLAZER Deluxe,	RWD
R	83-94	BLAZER, S	MODELS All
R	99-04	S10 LS,	4WD
R	99-03	S10 Base,	4WD
R	99-03	S10 Base,	RWD
R	99-03	S10 LS,	RWD
R	94-98	S10 LS	
R	82-98	S10 Base	
R	92-93	S10 EL	
R	83-92	S10 Tahoe	
R	88-90	S10 Durango	
R	82-86	S10 Durango	
R	05	GMC	JIMMY 4WD
R	92-04	JIMMY	All
R	83-91	S15 JIMMY	All
R	82-04	SONOMA / S15	All
R	91	SYCLONE	All
R	92-93	TYPHOON	All
R	96-00	ISUZU	HOMBRE All
R	96-01	OLDSMOBILE	BRAVADA All
R	91-94	BRAVADA	All
43163 A			
R	88-99	CHEVROLET	PICKUP 1/2 TON, C15 / C1500 All
R	88-99	PICKUP 1/2 TON,	K15 / K1500 All
R	01-03	PICKUP 1 TON,	C35/3500 HD HD Solid Front Axle
R	91-00	PICKUP 1 TON,	C35/3500 All HD Solid Front Axle
R	88-90	PICKUP 1 TON,	C35/3500 Extended Cab Pickup Exc. HD Straight Front Axle
R	88-90	PICKUP 1 TON,	C35/3500 Standard Cab Pickup Exc. HD Straight Front Axle
R	88-00	PICKUP 1 TON,	K35 / K3500 All
R	88-00	PICKUP 3/4 TON,	C25 / C2500 All
R	88-00	PICKUP 3/4 TON,	K25 / K2500 All
R	88-99	GMC	PICKUP 1/2 TON, C15 / C1500 All
R	88-99	PICKUP 1/2 TON,	K15 / K1500 All
R	91-00	PICKUP 1 TON,	C35/3500 All HD Solid Front Axle
R	88-90	PICKUP 1 TON,	C35/3500 Extended Cab Pickup Exc. HD Straight Front Axle
R	88-90	PICKUP 1 TON,	C35/3500 Standard Cab Pickup Exc. HD Straight Front Axle
R	88-00	PICKUP 1 TON,	K35 / K3500 All
R	88-00	PICKUP 3/4 TON,	C25 / C2500 All
R	88-00	PICKUP 3/4 TON,	K25 / K2500 All
43165 W			
R	89	FORD	BRONCO II All Mfg. to 2/89; Vehicles with 10mm & 12mm bolt in rear lower mount
R	84-88	BRONCO II	All With 10mm Bolt In Rear Lower Mount
R	89	RANGER	RWD Mfg. to 2/89; Vehicles with 10mm bolt in rear lower mount
R	83-88	RANGER	RWD
43167 A			
R	85-96	FORD	PICKUP 1/2 TON, F-150 RWD
R	80-97	PICKUP 1 TON,	F-350 / SUPERDUTY RWD Exc. Dual Rear Wheels
R	97	PICKUP 3/4 TON,	F-250 / SUPERDUTY RWD Over 8500# GVW
R	80-96	PICKUP 3/4 TON,	F-250 / SUPERDUTY RWD
R	06-11	RANGER	RWD, Coil (FrontSpringType)
R	90-05	RANGER	RWD

Rear Load Carrier, Ultra Cartridge

Shock	POP	Alternative No.	MTG Acc. Supplied
Pos.	Year	Application	
43171 D			
R	95-01	FORD	EXPLORER All Exc. Electronic Adjustable Suspension
R	01-05	EXPLORER	SPORT TRAC All
R	97-01	MERCURY	MOUNTAINEER All Exc. Electronic Adjustable Suspension
43172 W			
R	91-94	FORD	EXPLORER All
R	91-94	MAZDA	NAVAJO All
43173 W			
R	95-03	FORD	WINDSTAR Coil (RearSpringType)
43180 B			
R	99-00	CADILLAC	ESCALADE All
R	92-94	CHEVROLET	BLAZER 4WD Full Size
R	92-99	SUBURBAN	1/2 TON, C15 / C1500 All
R	92-99	SUBURBAN	1/2 TON, K15 / K1500 All
R	92-99	SUBURBAN	3/4 TON, C25 / C2500 All
R	92-99	SUBURBAN	3/4 TON, K25 / K2500 All
R	95-00	TAHOE	All Old Body Style
R	96-11	VAN 1/2 TON,	G / EXPRESS All
R	96-02	VAN 1 TON,	G / EXPRESS All
R	96-02	VAN 3/4 TON,	G / EXPRESS All Exc. 8600# GVW
R	92-99	GMC	SUBURBAN 1/2 TON, C15 / C1500 All
R	92-99	SUBURBAN	1/2 TON, K15 / K1500 All
R	92-99	SUBURBAN	3/4 TON, C25 / C2500 All
R	92-99	SUBURBAN	3/4 TON, K25 / K2500 All
R	96-11	VAN 1/2 TON,	G / SAVANNA All
R	96-02	VAN 1 TON,	G / SAVANNA All
R	96-02	VAN 3/4 TON,	G / SAVANNA All Exc. 8600# GVW
R	92-99	YUKON	All
43181 A			
R	07	CHEVROLET	PICKUP 1/2 TON, SILVERADO 1500 Classic Hybrid, RWD Exc. Electronic Adjustable Suspension
R	07	PICKUP 1/2 TON,	SILVERADO 1500 Classic LS, RWD Exc. Electronic Adjustable Suspension
R	07	PICKUP 1/2 TON,	SILVERADO 1500 Classic LT, RWD Exc. Electronic Adjustable Suspension
R	07	PICKUP 1/2 TON,	SILVERADO 1500 Classic SS, RWD Exc. Electronic Adjustable Suspension
R	07	PICKUP 1/2 TON,	SILVERADO 1500 Classic WT, RWD Exc. Electronic Adjustable Suspension
R	99-06	PICKUP 1/2 TON,	SILVERADO 1500 RWD Exc. Electronic Adjustable Suspension
R	94-01	DODGE	PICKUP 1/2 TON, RAM 1500 (SEE RAM 1500) All
R	94-02	PICKUP 1 TON,	RAM 3500 (SEE RAM 3500) RWD Exc. Solid Front Axle
R	94-02	PICKUP 3/4 TON,	RAM 2500 (SEE RAM 2500) RWD
R	07	GMC	SIERRA 1500 Classic Hybrid, RWD Exc. Electronic Adjustable Suspension
R	07	SIERRA 1500	Classic SL, RWD Exc. Electronic Adjustable Suspension
R	07	SIERRA 1500	Classic SLE, RWD Exc. Electronic Adjustable Suspension
R	07	SIERRA 1500	Classic SLT, RWD Exc. Electronic Adjustable Suspension
R	07	SIERRA 1500	Classic WT, RWD Exc. Electronic Adjustable Suspension
R	99-06	SIERRA 1500	RWD Exc. Electronic Adjustable Suspension
Ultra Cartridge			
G44450 B			
F	92-94	AUDI	100 All

Numerical listing

Shock	POP	Alternative No.	MTG Acc. Supplied
Pos.	Year	Application	
G44450 B -continued			
F	91	100	All Mfg. Late 91
F	89-90	100	QUATTRO All
F	89-94	100	QUATTRO All
F	89-90	200	All
F	89-90	200	QUATTRO Wagon
F	78-88	5000	All
F	95-97	A6	QUATTRO All
F	92-94	S4	All
F	95-97	S6	All
F	90-94	V8	QUATTRO All
G44451 W			
F	84-86	BUICK	SKYHAWK All Rebuildable O.E. Struts
F	86-91	SKYLARK	All Rebuildable O.E. Struts
F	85-87	SOMERSET /	SOMERSET REGAL All Rebuildable O.E. Struts
F	84-86	CADILLAC	CIMARRON All Rebuildable O.E. Struts
F	84-86	CHEVROLET	CAVALIER All Rebuildable O.E. Struts
F	85-86	OLDSMOBILE	CALAIS All Rebuildable O.E. Struts
F	84-86	FIRENZA	All Rebuildable O.E. Struts
F	85-86	PONTIAC	GRAND AM All Rebuildable O.E. Struts
F	84-85	J2000 /	SUNBIRD All Rebuildable O.E. Struts
F	86-87	SUNBIRD	All Rebuildable O.E. Struts
G44459 A			
F	88-96	BUICK	REGAL All
F	90-01	CHEVROLET	LUMINA All
F	95-99	MONTE	CARLO All
F	88-97	OLDSMOBILE	CUTLASS / CUTLASS SUPREME All
F	88-96	PONTIAC	GRAND PRIX All
G44461 D			
F	94-98	SAAB	900 Turbocharged (Eng Asp)
F	93	900	Turbocharged (Eng Asp) Mfg. from 6/30/93
G44477 D			
R	92-94	TOYOTA	CAMRY FWD Rebuildable O.E. Struts
G44493 C			
F	92-95	BMW	525i All Exc. Electronic Adjustable Suspension
G44495 C			
F	94-98	SAAB	900 Naturally Aspirated (Eng Asp)
F	93	900	Naturally Aspirated (Eng Asp) Mfg. from 6/30/93
G44497 D			
F	92	BMW	525i All Mfg. to 9/92
F	91	525i	All
F	90	525i	All Mfg. from 8/90
F	94-95	530i	Sedan
F	91-93	535i	All
F	90	535i	All Mfg. from 8/90
F	94-95	540i	All
G44713 X			
F	77-83	BMW	320i All
G44724 C			
F	81-84	TOYOTA	STARLET All
G44735 W			
F	81-85	MAZDA	RX7 GS
F	81-85	RX7	S
G44743 A			
F	89-90	TOYOTA	TERCEL All
F	87-88	TERCEL	Hatchback
F	87-88	TERCEL	Sedan
G44745 D			
F	91	BMW	318i All
F	84-85	318i	All
F	91	318iS	All
G44747 W			
F	87	TOYOTA	COROLLA DLX, FWD Exc. FX16 Rebuildable Front Struts
F	87	COROLLA	LE Rebuildable Front Struts
F	87	COROLLA	Sport DLX Rebuildable Front Struts

Numerical listing

Shock	POP	Alternative No.	MTG Acc. Supplied
Pos.	Year	Application	
G44747	W	-continued	
F 87	COROLLA	Sport GTS Rebuildable Front Struts	
F 86	COROLLA	FWD Rebuildable Front Struts	
F 84-85	COROLLA	FWD, GAS Rebuildable Front Struts	
G44748	B		
F 87	TOYOTA	TERCEL Wagon, FWD	
F 83-86	TERCEL	FWD	
G44752	B		
F 80-83	NISSAN	200SX All	
F 79-82	210	All	
F 78-81	510	All	
F 74-78	B210	All	
G44763	A		
F 85-93	VOLKSWAGEN	CABRIOLET All	
F 80-84	JETTA	All	
F 75-84	RABBIT	All	
F 80-83	RABBIT	PICKUP All	
F 75-89	SCIROCCO	All	
G44766	X		
R 86	NISSAN	MULTI CAN	
R 82-86	STANZA	All	
G44767	X		
F 86-88	NISSAN	MULTI CAN	
F 82-86	STANZA	All	
G44773	X		
R 83-87	HONDA	PRELUDE All Rebuildable Rear Struts	
G44774	B		
F 90-92	VOLKSWAGEN	CORRADO 1.8L 4Cyl L (1780) Rebuildable Front Struts	
F 85-92	GOLF	All Rebuildable Front Struts	
F 85-92	JETTA	All Rebuildable Front Struts	
G44775	A		
F 87-88	BMW	325 All Exc. Sport Suspension	
F 84-87	325E	All Exc. Sport Suspension	
F 87-92	325i	E30 (MfrBodyCode) Exc. Sport Suspension	
F 87-92	325iS	All Exc. Sport Suspension	
G44776	C		
R 91-94	NISSAN	AXXESS All	
R 90	AXXESS	FWD	
R 86-88	MAXIMA	Sedan Exc. Electronic Adjustable Suspension	
R 85	MAXIMA	All Exc. Electronic Adjustable Suspension	
R 87-88	MULTI	CAN	
R 87-89	STANZA	Sedan	
G44783	W		
F 95-96	TOYOTA	AVALON All Rebuildable O.E. Struts	
F 95-96	CAMRY	All Rebuildable O.E. Struts	
G44800	B		
F 83-88	TOYOTA	TERCEL Wagon, 4WD	
G44802	W		
F 85-89	TOYOTA	MR2 All	
G44803	D		
R 85-86	TOYOTA	MR2 All	
G44850	B		
F 87-88	PORSCHE	924 All	
F 77-82	924	All	
F 83-88	944	All	
F 74-79	VOLKSWAGEN	SUPER BEETLE All	
F 73	SUPER BEETLE	All 2 Bolt Flange-Type Lower Mount	
G44856	B		
F 75-93	VOLVO	240 / 242 / 244 / 245 / 262 / 264 / 265 All	
F 84	DL	All Exc. Hydraulic Self Leveling System	
F 84	GLE	All Exc. Hydraulic Self Leveling System	
G44862	B		
F 71-73	VOLKSWAGEN	SUPER BEETLE All 3 Bolt Flange-Type Lower Mount	

Ultra Cartridge, Hi Jackers

Shock	POP	Alternative No.	MTG Acc. Supplied
Pos.	Year	Application	
G44867	C		
R 74-75	NISSAN	260Z 2+2	
R 75-78	280Z	All	
G44868	W		
R 70-73	NISSAN	240Z All	
R 74	260Z	Base	
G44869	A		
F 70-73	NISSAN	240Z All	
F 74-75	260Z	All	
F 75-78	280Z	All	
F 79-83	280ZX	All	
F 81	810	All	
F 82-84	MAXIMA	All	
G44898	X		
F 79-82	TOYOTA	CORONA All	
F 78-80	CRESSIDA	All	
G44902	W		
F 88-92	AUDI	80 All	
F 88-92	80	QUATTRO All	
F 93-95	90	All	
F 88-91	90	All	
F 93-95	90	QUATTRO All	
F 88-91	90	QUATTRO All	
F 80-87	4000	All	
F 84-87	4000	QUATTRO All	
F 83-87	COUPE	All	
F 90-91	COUPE	QUATTRO All	
F 73-79	FOX	All	
F 87-93	VOLKSWAGEN	FOX All	
F 82-88	QUANTUM	All	
G44903	A		
F 94	ASUNA	GT	
F 92	GT		
F 93	GT, SE	All	
F 94	SE		
F 92	SE		
F 99-02	DAEWOO	LANOS All	
F 88-93	PONTIAC	LEMANS All	
G44918	X		
F 82-83	BUICK	SKYHAWK All	
F 82-83	CADILLAC	CIMARRON All	
F 82-83	CHEVROLET	CAVALIER All	
F 82-83	OLDSMOBILE	FIRENZA All	
F 82-83	PONTIAC	J2000 / SUNBIRD All	
G44920	W		
F 82-88	BMW	528E All Auto-Leveling System	
F 83-84	533i	All Auto-Leveling System	
F 85-88	535i	All Auto-Leveling System	
F 88	535iS	All Auto-Leveling System	
F 85-89	635CSI	All Exc. Auto-Leveling System	
G44926	C		
F 81-92	TOYOTA	CRESSIDA All Exc. Electronic Adjustable Suspension	
G44934	X		
F 85-88	NISSAN	200SX All	
F 84	200SX	All Solid Rear Axle	
G44936	C		
F 84-86	NISSAN	300ZX All	
G44937	X		
F 87-89	CHRYSLER	CONQUEST All Exc. Electronic Adjustable Suspension	
F 87-89	MITSUBISHI	STARION All Exc. Electronic Adjustable Suspension	
G44938	A		
F 76-85	TOYOTA	CELICA All	
F 75	CELICA	All Mfg. from 10/75	
F 84-87	COROLLA	Coupe, Standard, Rack (SteeringType)	
F 75-83	COROLLA	All	
F 74	COROLLA	All Mfg. from 8/74	
F 86	SUPRA	All Mfg. to 3/86	
G44939	C		
F 88-89	TOYOTA	CELICA AWD	
F 86-87	CELICA	All Exc. All-Trac	
F 87-88	COROLLA	FX16 Rebuildable Front Struts	
F 84-85	COROLLA	FWD, DIESEL	
G44940	D		
F 83-86	TOYOTA	CAMRY All	

Numerical listing

Shock	POP	Alternative No.	MTG Acc. Supplied
Pos.	Year	Application	
G44941	A		
F 84-92	VOLVO	740 / 745 / 760 / 780 All Mfg. from 5/84; Exc. Hydraulic Self Leveling System	
F 89	740 / 745 / 760 / 780	All Exc. Hydraulic Self Leveling System	
F 91-95	940	All Exc. Hydraulic Self Leveling System	
F 92-95	960	All Mfg. to 10/94; Exc. Hydraulic Self Leveling System	
G44943	D		
R 87-89	TOYOTA	MR2 All	
G44944	X		
F 86-89	HYUNDAI	EXCEL All Rebuildable O.E. Front Struts	
F 87-89	MITSUBISHI	PRECIS All Rebuildable O.E. Front Struts	
G44947	D		
F 84-86	FORD	MUSTANG / MUSTANG II SVO	
G44968	W		
F 87-89	NISSAN	300ZX All	
G44969	X		
F 88-90	BMW	735i All	
F 88-92	735iL	All	
G44982	A		
F 87-91	TOYOTA	CAMRY All Rebuildable O.E. Front Struts	
F 88-89	CELICA	GT Exc. All-Trac	
F 88-89	CELICA	GTS Exc. All-Trac	
F 88-89	CELICA	ST Exc. All-Trac	
G44986	W		
F 90-97	VOLKSWAGEN	PASSAT All Rebuildable O.E. Front Struts	
G44990	B		
R 89-94	NISSAN	MAXIMA All Exc. Electronic Adjustable Suspension	
R 90-92	STANZA	All	
G44991	D		
F 90	BMW	525i All Mfg. to 8/90	
F 89	525i	All	
F 90	535i	All Mfg. to 8/90	
F 89	535i	All	
F 88	535i	All Exc. Auto-Leveling System	
F 88	535iS	All Exc. Auto-Leveling System	
G44994	W		
F 88-91	TOYOTA	COROLLA Wagon	
G44995	A		
F 92-93	TOYOTA	CELICA GT	
F 92-93	CELICA	GTS	
F 92-93	CELICA	ST	
F 90-91	CELICA	All	
G44997	W		
R 92-95	TOYOTA	MR2 All	
G44998	D		
F 92-95	TOYOTA	MR2 All	
G44999	C		
F 92-94	TOYOTA	CAMRY FWD Rebuildable O.E. Struts	
G244002	N		
F 99-03	SAAB	9-3 All	
Hi Jackers			
49105	A		
R 75-80	AMERICAN MOTORS	PACER All	
R 52-59	FORD	COUNTRY SEDAN All	
R 52-56	COUNTRY	SQUIRE All	
R 54-56	COURIER	SEDAN DELIVERY All	
R 52-54	CRESTLINE	All	
R 57	CUSTOM	All	
R 52	CUSTOM	All	
R 58	CUSTOM	300 All	
R 52-56	CUSTOMLINE	All	
R 62-70	FAIRLANE	All	
R 55-58	FAIRLANE	All	
R 60-70	FALCON	All	
R 52-56	MAINLINE	All	
R 65-73	MUSTANG / MUSTANG II	All	
R 60-65	RANCHERO	All	
R 52-56	RANCH WAGON	All	
R 54-56	SKYLINER	All	

Numerical listing

Shock	POP	Alternative No.	MTG Acc. Supplied
Pos.	Year	Application	
49105 A -continued			
R	52-58	SUNLINER All	
R	55-57	THUNDERBIRD All	
R	68-71	TORINO All	
R	52-58	VICTORIA All	
R	62-64	JAGUAR XKE All	
R	79-83	MAZDA GLC Wagon	
R	78	GLC All	
R	75-76	RX3 Wagon Exc. Models with Tokico O.E. Struts	
R	72-74	RX3 All	
R	74-78	RX4 All	
R	59-60	MERCURY COLONY PARK All	
R	68-69	COMET All	
R	66-67	COMET Convertible	
R	66-67	COMET Hardtop	
R	66-67	COMET Sedan	
R	60-65	COMET All	
R	59-60	COMMUTER All	
R	67-73	COUGAR All	
R	59-60	COUNTRY CRUISER All	
R	62-63	METEOR All	
R	59-60	MONTCLAIR All	
R	68-71	MONTEGO All	
R	59-60	MONTEREY All	
R	59-60	PARKLANE All	
R	69-78	SAAB 99 All	
R	59-68	VOLVO 122 All	
49106 C			
R	65-69	CHRYSLER 300 All	
R	75-76	CORDOBA All	
R	74-75	IMPERIAL All	
R	74-78	NEWPORT All	
R	65-69	NEWPORT All	
R	74-78	NEW YORKER All	
R	65-69	NEW YORKER All	
R	74-78	TOWN & COUNTRY All	
R	65-70	TOWN & COUNTRY All	
R	63-64	DODGE 330 All	
R	63-64	440 All	
R	70-74	CHALLENGER All	
R	66-76	CHARGER All	
R	65-76	CORONET All	
R	65	CUSTOM All	
R	62	DART All	
R	74-78	MONACO All	
R	73	MONACO All Exc. Wagon	
R	72	MONACO All	
R	65-70	MONACO All	
R	73	POLARA All Exc. Wagon	
R	72	POLARA All	
R	62-70	POLARA All	
R	75-77	ROYAL MONACO All	
R	62-70	PLYMOUTH BELVEDERE All	
R	62-63	FLEET SPECIAL All	
R	77-78	FURY All Police Package	
R	74-76	FURY All	
R	73	FURY Wagon	
R	62-69	FURY All	
R	74-77	GRAN FURY All	
R	73	GRAN FURY Wagon	
R	67	GTX All	
R	68-75	ROADRUNNER All	
R	65-74	SATELLITE All	
R	62-64	SAVOY All	
R	70	SUPERBIRD All	
R	67	VIP All	
49107 W			
R	69-72	CHEVROLET BLAZER All Coil(RearSpringType)	
R	67-72	PICKUP 1/2 TON, C10 All Coil(RearSpringType)	
R	67-72	PICKUP 3/4 TON, C20 All Coil(RearSpringType)	
R	67	SUBURBAN 1/2 TON, 1500 All Coil(RearSpringType)	
R	68-72	SUBURBAN 1/2 TON, C10 All	
R	68-72	SUBURBAN 3/4 TON, C20 All	
R	67-72	VAN 1/2 TON, P SERIES All	
R	70-72	GMC JIMMY 4WD	
R	67-72	PICKUP 1/2 TON, C15 / C1500 All Coil(RearSpringType)	
R	67-72	PICKUP 3/4 TON, C25 / C2500 All Coil(RearSpringType)	
R	68-72	SUBURBAN 1/2 TON, C15 / C1500 All Coil(RearSpringType)	
R	68-72	SUBURBAN 3/4 TON, C25 / C2500 All	
R	68-72	VAN 1/2 TON, P SERIES All Coil(RearSpringType)	
49110 C			
R	57-64	CHRYSLER 300 All	

Hi Jackers

Shock	POP	Alternative No.	MTG Acc. Supplied
Pos.	Year	Application	
49110 C -continued			
R	55-56	NASSAU All	
R	51-64	NEWPORT All	
R	51-64	NEW YORKER All	
R	57-60	SARATOGA All	
R	51-52	SARATOGA All	
R	55-56	ST REGIS All	
R	51-64	TOWN & COUNTRY All	
R	51-61	WINDSOR All	
R	63-64	DODGE 880 All	
R	51-59	CORONET All	
R	54-64	CUSTOM All	
R	63-76	DART All	
R	60-61	DART All	
R	61-62	LANCER All	
R	51-54	MEADOWBROOK All	
R	60-61	POLARA All	
R	64-69	PLYMOUTH BARRACUDA All	
R	53-61	BELVEDERE All	
R	51-53	CAMBRIDGE All	
R	51-52	CONCORD All	
R	51-53	CRANBROOK All	
R	58-61	CUSTOM All	
R	70-76	DUSTER All	
R	60-61	FLEET SPECIAL All	
R	56-61	FURY All	
R	54-58	PLAZA All	
R	53-61	SAVOY All	
R	71-76	SCAMP All	
R	60-61	SPORT WAGON All	
R	51-61	SUBURBAN All	
R	60-76	VALIANT All	
49114 W			
R	64-69	BUICK SPORTWAGON All	
R	72	OLDSMOBILE CUTLASS / CUTLASS SUPREME Cruiser	
R	64-72	VISTA CRUISER All	
49122 D			
R	68-70	CADILLAC ELDORADO All Vertically Mounted	
R	68-69	CHEVROLET CAMARO Leaf (RearSpringType) Single Leaf Rear Springs	
R	67	CAMARO All	
R	66	OLDSMOBILE TORONADO All Vertically Mounted	
R	67	PONTIAC FIREBIRD All	
49127 W			
R	78-79	FORD BRONCO All Exc. Lift Kit	
R	67-77	BRONCO All From Serial #830001; Exc. Lift Kit	
R	65-69	PICKUP 1/2 TON, F-100 All RWD	
R	75-79	PICKUP 1 TON, F-350 / SUPERDUTY Standard Cab Pickup, RWD	
R	74	PICKUP 1 TON, F-350 / SUPERDUTY All Standard Cab Pickup	
R	73	PICKUP 1 TON, F-350 / SUPERDUTY All RWD; Standard Cab Pickup	
R	75-79	PICKUP 3/4 TON, F-250 / SUPERDUTY Cab & Chassis, RWD	
R	75-79	PICKUP 3/4 TON, F-250 / SUPERDUTY Extended Cab Pickup, RWD	
R	68-69	PICKUP 3/4 TON, F-250 / SUPERDUTY All Supercab	
R	67	PICKUP 3/4 TON, F-250 / SUPERDUTY All	
R	65-66	PICKUP 3/4 TON, F-250 / SUPERDUTY All Supercab	
R	69-74	VAN 1/2 TON, ECONOLINE / CLUB WAGON All	
R	68	VAN 1/2 TON, ECONOLINE / CLUB WAGON All Late 1968	
R	69-74	VAN 1 TON, ECONOLINE / CLUB WAGON / SUPERDUTY All	
R	68	VAN 1 TON, ECONOLINE / CLUB WAGON / SUPERDUTY All Late 1968	
R	69-74	VAN 3/4 TON, ECONOLINE / CLUB WAGON / SUPERDUTY All	
R	68	VAN 3/4 TON, ECONOLINE / CLUB WAGON / SUPERDUTY All Late 1968	
R	76-83	JEEP CHEROKEE All	
R	67	GLADIATOR All	
R	84-91	GRAND WAGONEER All	
R	74-88	J10 PICKUP All	
R	74-88	J20 PICKUP All	
R	68-73	J2500 PICKUP All	

Numerical listing

Shock	POP	Alternative No.	MTG Acc. Supplied
Pos.	Year	Application	
49127 W -continued			
R	76-83	WAGONEER All	
49128 D			
R	70	BUICK ESTATE WAGON All	
R	65-70	OLDSMOBILE 88 SERIES All	
R	65-70	98 All	
R	67	CUTLASS / CUTLASS SUPREME Turnpike Cruiser	
R	65-66	STARFIRE All	
R	63-70	PONTIAC BONNEVILLE All	
R	63-70	CATALINA All	
R	67-70	EXECUTIVE All	
R	63-68	GRAND PRIX All	
R	68-70	SAFARI All	
R	63-65	SAFARI All	
R	63-66	STAR CHIEF All	
49131 A			
R	71-73	BUICK CENTURION All	
R	71-84	ELECTRA All	
R	71-85	LESABRE All	
R	71-78	RIVIERA All	
R	92-96	ROADMASTER Sedan	
R	64-67	SKYLARK All Exc. HD Suspension	
R	64-67	SPECIAL All Exc. HD Suspension	
R	87-92	CADILLAC BROUGHAM All	
R	92-96	COMMERCIAL CHASSIS RWD	
R	77-84	COMMERCIAL CHASSIS All	
R	77-84	DEVILLE All	
R	93-96	FLEETWOOD RWD	
R	77-86	FLEETWOOD RWD	
R	81	CHEVROLET BEL AIR Sedan	
R	75	BEL AIR Sedan	
R	65-74	BEL AIR All	
R	65-72	BISCAYNE All	
R	69-70	BROOKWOOD All	
R	81-96	CAPRICE Sedan Police and Taxi Models	
R	75-80	CAPRICE Coupe	
R	75-80	CAPRICE Sedan	
R	75	CAPRICE Convertible	
R	73-74	CAPRICE Sedan Police and Taxi Models	
R	71-72	CAPRICE Hardtop Police and Taxi Models	
R	66-70	CAPRICE All	
R	64-67	CHEVELLE All Exc. HD Suspension	
R	94-96	IMPALA All	
R	83-85	IMPALA All	
R	73-82	IMPALA Sedan Exc. Wagon	
R	74-81	IMPALA Coupe Exc. Wagon	
R	73	IMPALA Hardtop Exc. Wagon	
R	70-72	IMPALA Sedan	
R	65-69	IMPALA All	
R	69-70	KINGSWOOD All	
R	64-67	MALIBU All Exc. HD Suspension	
R	69-70	TOWNSMAN All	
R	71-85	OLDSMOBILE 88 SERIES All	
R	71-84	98 All	
R	66-67	CUTLASS / CUTLASS SUPREME Base Exc. HD Suspension	
R	64-65	CUTLASS / CUTLASS SUPREME All Exc. HD Suspension	
R	64-67	F85 All Exc. HD Suspension	
R	71-81	PONTIAC BONNEVILLE All	
R	75-81	CATALINA Coupe	
R	71-81	CATALINA Sedan	
R	72-74	CATALINA Hardtop	
R	64-67	GTO All Exc. HD Suspension	
R	76-81	LAURENTIAN CAN	
R	64-67	LEMANS All Exc. HD Suspension	
R	76-86	PARISIENNE Sedan	
R	64-67	TEMPEST All Exc. HD Suspension	
49135 B			
R	70-81	CHEVROLET CAMARO All	
R	70-81	PONTIAC FIREBIRD All	
49149 D			
R	70-71	CHRYSLER 300 All	
R	67-73	IMPERIAL All	
R	70-73	NEWPORT All	
R	70-73	NEW YORKER All	
R	71-73	TOWN & COUNTRY All	
R	73	DODGE MONACO Wagon	
R	71	MONACO All	
R	72-93	PICKUP 1/2 TON, D100 SERIES All	
R	72-93	PICKUP 1 TON, D300 SERIES All	
R	82-93	PICKUP 3/4 TON, D200 SERIES All	
R	81	PICKUP 3/4 TON, D200 SERIES All Exc. HD Package	
R	72-80	PICKUP 3/4 TON, D200 SERIES All	
R	73	POLARA Wagon	
R	71	POLARA All	
R	76-93	RAMCHARGER RWD	

Numerical listing

Shock	POP	Alternative No.	MTG Acc. Supplied
Pos.	Year	Application	
49149 D -continued			
R	74-75	RAMCHARGER All	
R	73	PLYMOUTH FURY All Exc. Wagon	
R	70-72	FURY All	
R	73	GRAN FURY Hardtop	
R	72	GRAN FURY All	
R	74-81	TRAILDUSTER All	
49151 W			
R	75-80	CHEVROLET LUV PICKUP All	
R	72-74	LUV PICKUP All	
R	75-80	DODGE COLT Wagon	
R	71-74	COLT All	
R	76-80	PLYMOUTH COLT All	
R	74-76	TOYOTA CORONA Sedan	
R	73-76	CORONA Hardtop	
R	73	CORONA Sedan Mfg. from 8/73	
R	69-71	CORONA Mark II, Sedan	
R	73-83	PICKUP RWD Mojave	
R	70-72	PICKUP RWD	
49152 A			
R	73-77	BUICK CENTURY All	
R	87	ESTATE WAGON	
R	71-83	ESTATE WAGON All	
R	65-67	GRAN SPORT All	
R	68-72	GS / GS350 / GS400 / GS455 All	
R	73-77	REGAL All	
R	91-96	ROADMASTER Wagon	
R	68-72	SKYLARK All	
R	64-67	SKYLARK All HD Suspension; Exc. Sportwagon	
R	68-69	SPECIAL All	
R	64-67	SPECIAL All HD Suspension; Exc. Sportwagon	
R	70-72	SPORTWAGON All	
R	71-96	CHEVROLET CAPRICE Wagon	
R	68-73	CHEVELLE All	
R	64-67	CHEVELLE All HD Suspension	
R	68-77	EL CAMINO All	
R	71-82	IMPALA Wagon	
R	73-77	MALIBU All	
R	64-67	MALIBU All HD Suspension	
R	70-72	MONTE CARLO All	
R	71-77	GMC SPRINT / CABALLERO All	
R	75-76	NISSAN 610 Wagon	
R	73-74	610 All	
R	74-77	710 Wagon	
R	78-80	810 Wagon	
R	77-92	OLDSMOBILE CUSTOM CRUISER All	
R	80-81	CUTLASS / CUTLASS SUPREME All	
R	76-77	CUTLASS / CUTLASS SUPREME Coupe	
R	76-77	CUTLASS / CUTLASS SUPREME Sedan	
R	73-75	CUTLASS / CUTLASS SUPREME All	
R	72	CUTLASS / CUTLASS SUPREME Base	
R	72	CUTLASS / CUTLASS SUPREME S	
R	68-71	CUTLASS / CUTLASS SUPREME All Exc. Vista Cruiser	
R	64-67	CUTLASS / CUTLASS SUPREME All HD Suspension; Exc. Vista Cruiser	
R	68-72	F85 All	
R	64-67	F85 All HD Suspension	
R	71-78	TORONADO All	
R	77-81	PONTIAC CATALINA Wagon	
R	74-75	CATALINA Wagon	
R	71-73	CATALINA Wagon Wagon	
R	73-75	GRAND AM All	
R	75-77	GRAND LEMANS All	
R	71-78	GRAND SAFARI All	
R	71-75	GRANDVILLE All	
R	68-73	GTO All	
R	64-67	GTO All HD Suspension	
R	64-67	LEMANS All HD Suspension	
R	80-86	PARISIENNE Wagon	
R	76-79	PARISIENNE All Wagon	
R	87-89	SAFARI All	
R	68-70	TEMPEST All	
R	64-67	TEMPEST All HD Suspension	
49155 C			
R	87-91	CHEVROLET BLAZER 4WD Full Size; Exc. Quad Suspension and Lift Kit	
R	81-86	BLAZER 4WD Exc. Lift Kit	
R	73-80	BLAZER All Exc. Lift Kit	
R	73-86	PICKUP 1/2 TON, C10 All	
R	81-86	PICKUP 1/2 TON, K10 All Standard Suspension; Exc. Lift Kit	

Hi Jackers

Shock	POP	Alternative No.	MTG Acc. Supplied
Pos.	Year	Application	
49155 C -continued			
R	73-80	PICKUP 1/2 TON, K10 All Exc. Lift Kit	
R	87	PICKUP 1/2 TON, R10 RWD	
R	87	PICKUP 1/2 TON, V10 All	
R	75-86	PICKUP 3/4 TON, C20 Standard Cab Pickup	
R	73-74	PICKUP 3/4 TON, C20 All Standard Cab Pickup	
R	81-86	PICKUP 3/4 TON, K20 All Standard Suspension; Exc. Lift Kit	
R	73-80	PICKUP 3/4 TON, K20 All Exc. Lift Kit	
R	87	PICKUP 3/4 TON, R20 Standard Cab Pickup	
R	87	PICKUP 3/4 TON, V20 All	
R	73-86	SUBURBAN 1/2 TON, C10 All	
R	81-86	SUBURBAN 1/2 TON, K10 All Standard Suspension; Exc. Lift Kit	
R	73-80	SUBURBAN 1/2 TON, K10 All Exc. Lift Kit	
R	87-88	SUBURBAN 1/2 TON, R10 RWD	
R	89-91	SUBURBAN 1/2 TON, R1500 RWD	
R	89-91	SUBURBAN 1/2 TON, V1500 All	
R	73-86	SUBURBAN 3/4 TON, C20 All	
R	81-86	SUBURBAN 3/4 TON, K20 All Standard Suspension; Exc. Lift Kit	
R	73-80	SUBURBAN 3/4 TON, K20 All Exc. Lift Kit	
R	87-88	SUBURBAN 3/4 TON, R20 RWD	
R	89-91	SUBURBAN 3/4 TON, R2500 RWD	
R	87-88	SUBURBAN 3/4 TON, V20 All	
R	89-91	SUBURBAN 3/4 TON, V2500 All	
R	73	VAN 1/2 TON, P SERIES All	
R	73-78	VAN 3/4 TON, P SERIES All	
R	87-91	GMC JIMMY All Exc. Quad Suspension and Lift Kit	
R	73-86	JIMMY All Exc. Lift Kit	
R	73-86	PICKUP 1/2 TON, C15 / C1500 All	
R	73-86	PICKUP 1/2 TON, K15 / K1500 All Exc. Quad Suspension and Lift Kit	
R	87	PICKUP 1/2 TON, R1500 All	
R	87	PICKUP 1/2 TON, V1500 All Quad Suspension; Exc. Lift Kit	
R	75-86	PICKUP 3/4 TON, C25 / C2500 Cab & Chassis	
R	75-86	PICKUP 3/4 TON, C25 / C2500 Standard Cab Pickup	
R	73-74	PICKUP 3/4 TON, C25 / C2500 All	
R	73-86	PICKUP 3/4 TON, K25 / K2500 All Exc. Quad Suspension and Lift Kit	
R	88-89	PICKUP 3/4 TON, R2500 All Exc. Crew Cab & Bonus Cab	
R	87	PICKUP 3/4 TON, R2500 Cab & Chassis Exc. Crew Cab & Bonus Cab	
R	87	PICKUP 3/4 TON, R2500 Standard Cab Pickup Exc. Crew Cab & Bonus Cab	
R	87	PICKUP 3/4 TON, V2500 All Exc. Lift Kit	
R	73-86	SUBURBAN 1/2 TON, C15 / C1500 All	
R	73-86	SUBURBAN 1/2 TON, K15 / K1500 All Exc. Quad Suspension and Lift Kit	
R	87-91	SUBURBAN 1/2 TON, R1500 All	
R	87-91	SUBURBAN 1/2 TON, V1500 All Exc. Lift Kit	
R	73-86	SUBURBAN 3/4 TON, C25 / C2500 All	
R	73-86	SUBURBAN 3/4 TON, K25 / K2500 All Exc. Quad Suspension and Lift Kit	
R	87-91	SUBURBAN 3/4 TON, R2500 All	
R	87-91	SUBURBAN 3/4 TON, V2500 All Exc. Lift Kit	
R	73	VAN 1/2 TON, P SERIES All	
R	73-78	VAN 3/4 TON, P SERIES All	
49157 W			
R	73	BUICK APOLLO All HD Suspension	
R	68	CHEVROLET CHEVY II Leaf (RearSpringType) Multi-Leaf Rear Spring	
R	73	NOVA All HD Suspension	
R	69-72	NOVA All Multi-Leaf Rear Spring	
R	73	PONTIAC VENTURA All HD Suspension	
R	71-72	VENTURA Leaf (RearSpringType) Multi-Leaf Rear Spring	
49162 W			
R	69-72	CHEVROLET BLAZER All Leaf(RearSpringType)	

Numerical listing

Shock	POP	Alternative No.	MTG Acc. Supplied
Pos.	Year	Application	
49162 W -continued			
R	63-72	PICKUP 1/2 TON, C10 All Leaf(RearSpringType)	
R	67-72	PICKUP 1 TON, C30 All Exc. 11,000# Rear Axle	
R	67-72	PICKUP 3/4 TON, C20 All Leaf(RearSpringType)	
R	63-66	PICKUP 3/4 TON, C20 All	
R	63-66	SUBURBAN 1/2 TON, 1500 All	
R	67-77	VAN 1/2 TON, G / EXPRESS All	
R	63-66	VAN 1/2 TON, P SERIES All	
R	76-77	VAN 1 TON, G / EXPRESS All	
R	75	VAN 1 TON, G / EXPRESS 110.0 (WheelBase)	
R	75	VAN 1 TON, G / EXPRESS 125.0 (WheelBase)	
R	71-74	VAN 1 TON, G / EXPRESS All	
R	68-72	VAN 1 TON, P SERIES All Exc. 11,000# Rear Axle	
R	67-77	VAN 3/4 TON, G / EXPRESS All	
R	68-72	VAN 3/4 TON, P SERIES All	
R	70-72	GMC JIMMY RWD	
R	67-72	PICKUP 1/2 TON, C15 / C1500 All Leaf(RearSpringType)	
R	67-72	PICKUP 1 TON, C35/3500 All Exc. 11,000# Rear Axle	
R	67-72	PICKUP 3/4 TON, C25 / C2500 All Leaf(RearSpringType)	
R	63-65	PICKUP 1000 SERIES All	
R	63-65	PICKUP 1500 SERIES All	
R	67-77	VAN 1/2 TON, G / SAVANNA All	
R	67	VAN 1/2 TON, P SERIES All	
R	76-77	VAN 1 TON, G / SAVANNA All	
R	75	VAN 1 TON, G / SAVANNA 110.0 (WheelBase)	
R	75	VAN 1 TON, G / SAVANNA 125.0 (WheelBase)	
R	71-74	VAN 1 TON, G / SAVANNA All Exc. 146" Wheelbase	
R	68-72	VAN 1 TON, P SERIES All Exc. 11,000# Rear Axle	
R	67-77	VAN 3/4 TON, G / SAVANNA All	
R	68-72	VAN 3/4 TON, P SERIES All	
R	63-65	VAN, PB 1000 SERIES All	
49173 W			
R	66	FORD BRONCO All Thru Serial #830000	
R	75-79	PICKUP 1/2 TON, F-100 RWD	
R	70-74	PICKUP 1/2 TON, F-100 All Lift Kit	
R	75-79	PICKUP 1/2 TON, F-150 RWD	
R	75-79	PICKUP 1 TON, F-350 / SUPERDUTY Cab & Chassis, RWD	
R	75-79	PICKUP 1 TON, F-350 / SUPERDUTY Extended Cab Pickup, RWD	
R	74	PICKUP 1 TON, F-350 / SUPERDUTY RWD Extended Cab & Chassis Cab	
R	75-79	PICKUP 3/4 TON, F-250 / SUPERDUTY Standard Cab Pickup, RWD	
R	71-74	PICKUP 3/4 TON, F-250 / SUPERDUTY RWD Exc. Extended Cab & Chassis Cab	
R	75-91	VAN 1/2 TON, ECONOLINE / CLUB WAGON All	
49178 C			
R	75-76	FORD PICKUP 1/2 TON, F-100 4WD Exc. Lift Kit	
R	70-74	PICKUP 1/2 TON, F-100 All Exc. Lift Kit	
R	76-79	PICKUP 1/2 TON, F-150 4WD Exc. Lift Kit	
R	75	PICKUP 1/2 TON, F-150 All 4WD; Exc. Lift Kit	
R	79	PICKUP 1 TON, F-350 / SUPERDUTY 4WD	
R	77-79	PICKUP 3/4 TON, F-250 / SUPERDUTY Cab & Chassis, 4WD All From Serial No. Y20001	
R	77-79	PICKUP 3/4 TON, F-250 / SUPERDUTY Standard Cab Pickup, 4WD All From Serial No. Y20001	
R	92-11	VAN 1/2 TON, ECONOLINE / CLUB WAGON All	
R	77-11	VAN 1 TON, ECONOLINE / CLUB WAGON / SUPERDUTY All	
R	07	VAN 1 TON, ECONOLINE / CLUB WAGON / SUPERDUTY All Exc. Ambulance & Handling Package	
R	75-91	VAN 1 TON, ECONOLINE / CLUB WAGON / SUPERDUTY All Exc. Motorhome Conversion	

Numerical listing

Shock	POP	Alternative No.	MTG Acc. Supplied
Pos.	Year	Application	
49178	C	-continued	
R	75-11	VAN 3/4 TON, ECONOLINE / CLUB WAGON / SUPERDUTY All	
49193	W		
R	74-75	BUICK APOLLO All	
R	73	APOLLO All Exc. HD Suspension	
R	75-79	SKYLARK All	
R	68	CHEVROLET CHEVY II Leaf (RearSpringType) Single-Leaf Rear Spring	
R	73	NOVA All Exc. HD Suspension	
R	69-72	NOVA All Single-Leaf Rear Spring	
R	74-77	OLDSMOBILE OMEGA All	
R	73	OMEGA All Exc. HD Suspension	
R	77-79	PONTIAC PHOENIX All	
R	74-77	VENTURA All	
R	73	VENTURA All Exc. HD Suspension	
R	71-72	VENTURA Leaf (RearSpringType) Single-Leaf Rear Spring	
49196	W		
R	87-88	FORD THUNDERBIRD Non-ABS	
R	80-86	THUNDERBIRD All	
R	82-87	LINCOLN CONTINENTAL All	
R	83-88	MERCURY COUGAR All	
R	80-82	COUGAR XR-7	
49197	W		
R	80-96	FORD BRONCO All Exc. Lift Kit	
R	80-83	PICKUP 1/2 TON, F-100 RWD	
R	80-84	PICKUP 1/2 TON, F-150 RWD	
49199	W		
R	78-83	FORD FAIRMONT All	
R	81-82	GRANADA All	
R	83-86	LTD / COUNTRY SEDAN / COUNTRY SQUIRE / CROWN VICTORIA All	
R	84-93	MUSTANG / MUSTANG II LX, 2.3L 4Cyl L (140)	
R	84-86	MUSTANG / MUSTANG II LX, 3.8L 6Cyl V (232)	
R	82-83	MUSTANG / MUSTANG II GL	
R	82-83	MUSTANG / MUSTANG II GLX	
R	82-83	MUSTANG / MUSTANG II L	
R	82	MUSTANG / MUSTANG II Ghia	
R	79-81	MUSTANG / MUSTANG II All	
R	79-86	MERCURY CAPRI All	
R	81-82	COUGAR Base	
R	82	COUGAR GS	
R	82	COUGAR LS	
R	83-86	MARQUIS All	
R	78-83	ZEPHYR All	
49203	C		
R	82-02	CHEVROLET CAMARO All	
R	82-02	PONTIAC FIREBIRD All	
49205	A		
R	65-74	FORD COUNTRY SEDAN All	
R	87-91	COUNTRY SQUIRE All	
R	65-74	COUNTRY SQUIRE All	
R	92-02	CROWN VICTORIA All	
R	65-72	CUSTOM All	
R	68-77	CUSTOM 500 All	
R	65-67	GALAXIE All	
R	68-74	GALAXIE 500 All	
R	01-02	GRAND MARQUIS All	
R	87-91	LTD / COUNTRY SEDAN / COUNTRY SQUIRE / CROWN VICTORIA All	
R	67-82	LTD / COUNTRY SEDAN / COUNTRY SQUIRE / CROWN VICTORIA All	
R	77-79	LTD II All	
R	72-79	RANCHERO All	
R	65-74	RANCH WAGON All	
R	77-79	THUNDERBIRD All	
R	67-72	THUNDERBIRD All	
R	72-76	TORINO All	
R	70-80	LINCOLN CONTINENTAL All	
R	68-71	MARK III All	
R	72	MARK IV All	
R	80-83	MARK VI All	
R	81-02	TOWN CAR All	
R	65-66	MERCURY BREEZEWAY All	
R	67	BROUGHAM All	
R	87-91	COLONY PARK All	
R	65-74	COLONY PARK All	
R	65-68	COMMUTER All	
R	74-79	COUGAR All	
R	75-02	GRAND MARQUIS All	
R	69-70	MARAUDER All	
R	65-67	MARAUDER All	
R	67-82	MARQUIS All	

Hi Jackers

Shock	POP	Alternative No.	MTG Acc. Supplied
Pos.	Year	Application	
49205	A	-continued	
R	65-68	MONTCLAIR All	
R	72-76	MONTEGO All	
R	65-74	MONTEREY All	
R	65-68	PARKLANE All	
R	65-67	VILLAGER All	
R	66-67	VOYAGER All	
49207	W		
R	89	FORD BRONCO II All Mfg. to 2/89; Vehicles with 10mm & 12mm bolt in rear lower mount	
R	84-88	BRONCO II All With 10mm Bolt In Rear Lower Mount	
R	89	RANGER RWD Mfg. to 2/89; Vehicles with 10mm bolt in rear lower mount	
R	83-88	RANGER RWD	
49212	D		
R	78-95	CHEVROLET VAN 1/2 TON, G / EXPRESS All	
R	78-95	VAN 1 TON, G / EXPRESS Cutaway Van	
R	78-95	VAN 3/4 TON, G / EXPRESS All Exc. 8600# GVW	
R	84-88	DODGE MINI RAM All	
R	99-03	VAN 1/2 TON, A / B SERIES / RAM 109.3 (WheelBase) Exc. 7000# GVW	
R	82-98	VAN 1/2 TON, A / B SERIES / RAM 109.6 (WheelBase) Exc. 7000# GVW	
R	71-80	VAN 1/2 TON, A / B SERIES / RAM All	
R	99-03	VAN 1 TON, A / B SERIES / RAM All	
R	95-98	VAN 1 TON, A / B SERIES / RAM All Exc. 4000# Front Axle	
R	71-94	VAN 1 TON, A / B SERIES / RAM All	
R	71-03	VAN 3/4 TON, A / B SERIES / RAM All	
R	78-80	VAN, CB300 All	
R	77	VAN, CB300 All Over 8300# GVW	
R	75-76	VAN, CB300 All	
R	74	VAN, CB300 All Over 8300# GVW	
R	78-95	GMC VAN 1/2 TON, G / SAVANNA All	
R	85-96	VAN 1 TON, G / SAVANNA Extended Cargo Van	
R	85-96	VAN 1 TON, G / SAVANNA Extended Passenger Van	
R	79-96	VAN 1 TON, G / SAVANNA Standard Cargo Van	
R	79-96	VAN 1 TON, G / SAVANNA Standard Passenger Van	
R	78	VAN 1 TON, G / SAVANNA Cutaway Van	
R	78-95	VAN 3/4 TON, G / SAVANNA All Exc. 8600# GVW	
R	74-83	PLYMOUTH VAN 1/2 TON, PB SERIES All	
R	74-83	VAN 1 TON, PB SERIES All	
R	74-83	VAN 3/4 TON, PB SERIES All	
49213	B		
R	05	CHEVROLET BLAZER Base, 4WD	
R	05	BLAZER Base, RWD	
R	96-04	BLAZER LS, 4WD	
R	96-04	BLAZER LS, RWD	
R	95-02	BLAZER LT, RWD	
R	95-01	BLAZER LT, 4WD	
R	95-99	BLAZER Base, 4WD	
R	95-99	BLAZER Base, RWD	
R	95-97	BLAZER Deluxe, RWD	
R	83-94	BLAZER, S MODELS All	
R	99-04	S10 LS, 4WD	
R	99-03	S10 Base, 4WD	
R	99-03	S10 Base, RWD	
R	99-03	S10 LS, RWD	
R	94-98	S10 LS	
R	82-98	S10 Base	
R	92-93	S10 EL	
R	83-92	S10 Tahoe	
R	88-90	S10 Durango	
R	82-86	S10 Durango	
R	05	GMC JIMMY 4WD	
R	92-04	JIMMY All	
R	83-91	S15 JIMMY All	
R	82-04	SONOMA / S15 All	
R	91	SYCLONE All	
R	92-93	TYPHOON All	
R	96-00	ISUZU HOMBRE All	
R	96-01	OLDSMOBILE BRAVADA All	
R	91-94	BRAVADA All	

Numerical listing

Shock	POP	Alternative No.	MTG Acc. Supplied
Pos.	Year	Application	
49214	D		
R	85-96	FORD PICKUP 1/2 TON, F-150 RWD	
R	97	PICKUP 3/4 TON, F-250 / SUPERDUTY RWD Over 8500# GVW	
R	80-96	PICKUP 3/4 TON, F-250 / SUPERDUTY RWD	
49215	B		
R	90-05	CHEVROLET ASTRO All	
R	85-89	ASTRO RWD	
R	90-05	GMC SAFARI All	
R	85-89	SAFARI RWD	
R	86-89	VOLKSWAGEN VANAGON 4WD	
49216	W		
R	86-95	FORD TAURUS Wagon	
R	86-95	MERCURY SABLE Wagon	
49217	W		
R	80-96	FORD PICKUP 1/2 TON, F-150 4WD Exc. Lift Kit	
R	82-85	PICKUP 1 TON, F-350 / SUPERDUTY 4WD Clevis Type Lower Front Mount; Exc. Dual Rear Wheels or Lift Kit	
R	80-81	PICKUP 1 TON, F-350 / SUPERDUTY 4WD	
R	86	PICKUP 3/4 TON, F-250 / SUPERDUTY 4WD	
R	82-85	PICKUP 3/4 TON, F-250 / SUPERDUTY 4WD Clevis Type Lower Front Mount; Exc. Dual Rear Wheels or Lift Kit	
R	80-81	PICKUP 3/4 TON, F-250 / SUPERDUTY 4WD	
49218	A		
R	88-99	CHEVROLET PICKUP 1/2 TON, C15 / C1500 All	
R	88-99	PICKUP 1/2 TON, K15 / K1500 All	
R	01-03	PICKUP 1 TON, C35/3500 Base Exc. HD Straight Front Axle	
R	97-00	PICKUP 1 TON, C35/3500 All Exc. HD Straight Front Axle	
R	96	PICKUP 1 TON, C35/3500 All	
R	91-95	PICKUP 1 TON, C35/3500 All Exc. HD Straight Front Axle	
R	88-90	PICKUP 1 TON, C35/3500 Extended Cab Pickup Exc. HD Straight Front Axle	
R	88-90	PICKUP 1 TON, C35/3500 Standard Cab Pickup Exc. HD Straight Front Axle	
R	88-00	PICKUP 1 TON, K35 / K3500 All	
R	88-00	PICKUP 3/4 TON, C25 / C2500 All	
R	88-00	PICKUP 3/4 TON, K25 / K2500 All	
R	88-99	GMC PICKUP 1/2 TON, C15 / C1500 All	
R	88-99	PICKUP 1/2 TON, K15 / K1500 All	
R	92-00	PICKUP 1 TON, C35/3500 Cab & Chassis Exc. HD Straight Front Axle	
R	88-91	PICKUP 1 TON, C35/3500 All Exc. HD Straight Front Axle	
R	88-00	PICKUP 1 TON, K35 / K3500 All	
R	88-00	PICKUP 3/4 TON, C25 / C2500 All	
R	88-00	PICKUP 3/4 TON, K25 / K2500 All	
49221	W		
R	90-97	FORD AEROSTAR All	
R	89	AEROSTAR RWD	
49222	W		
R	87-95	JEEP WRANGLER YJ (MfrBodyCode)	
49223	C		
R	90	FORD BRONCO II All	
R	89	BRONCO II All Mfg. from 2/89; Vehicles with 12mm bolt in rear lower mount	
R	06	RANGER RWD, Coil (FrontSpringType)	
R	90-05	RANGER RWD	
R	89	RANGER RWD Mfg. from 2/89; Vehicles with 12mm bolt in rear lower mount	
R	94-97	MAZDA B2300 RWD	
49225	W		
R	91-94	FORD EXPLORER All	
R	91-94	MAZDA NAVAJA All	
49226	C		
R	84-01	JEEP CHEROKEE All	

Numerical listing

Shock	POP	Alternative No.	MTG Acc. Supplied
Pos.	Year	Application	
49226	C	-continued	
R	84-90	WAGONEER All	
49228	A		
R	05	BUICK LESABRE All Must be used with provided air kit	
R	00-04	LESABRE All	
R	97-05	PARK AVENUE All	
R	95-99	RIVIERA All	
R	00-05	CADILLAC DEVILLE All Exc. Electronic Adjustable Suspension	
R	98-04	SEVILLE All	
R	01-03	OLDSMOBILE AURORA All	
R	95-99	AURORA All	
R	00-04	PONTIAC BONNEVILLE All	
49229	W		
R	89-98	MAZDA MPV RWD	
49230	A		
R	05-07	BUICK TERRAZA FWD Air-Leveling Suspension; Exc. Independent Rear Suspension	
R	05-08	CHEVROLET UPLANDER FWD Air-Leveling Suspension; Exc. Independent Rear Suspension	
R	97-05	VENTURE FWD	
R	97-04	OLDSMOBILE SILHOUETTE FWD	
R	99-05	PONTIAC MONTANA FWD Air-Leveling Suspension; Exc. Independent Rear Suspension	
R	97-98	TRANS SPORT All	
R	05-07	SATURN RELAY All Air-Leveling Suspension, Exc. Independent Rear Suspension	
49231	B		
R	99-00	CADILLAC ESCALADE All	
R	92-94	CHEVROLET BLAZER 4WD Full Size	
R	92-99	SUBURBAN 1/2 TON, C15 / C1500 All	
R	92-99	SUBURBAN 1/2 TON, K15 / K1500 All	
R	92-99	SUBURBAN 3/4 TON, C25 / C2500 All	
R	92-99	SUBURBAN 3/4 TON, K25 / K2500 All	
R	95-00	TAHOE All Old Body Style	
R	96-11	VAN 1/2 TON, G / EXPRESS All	
R	96-02	VAN 1 TON, G / EXPRESS All	
R	96-02	VAN 3/4 TON, G / EXPRESS All Exc. 8600# GVW	
R	92-99	GMC SUBURBAN 1/2 TON, C15 / C1500 All	
R	92-99	SUBURBAN 1/2 TON, K15 / K1500 All	
R	92-99	SUBURBAN 3/4 TON, C25 / C2500 All	
R	92-99	SUBURBAN 3/4 TON, K25 / K2500 All	
R	96-11	VAN 1/2 TON, G / SAVANNA All	
R	96-02	VAN 1 TON, G / SAVANNA All	
R	96-02	VAN 3/4 TON, G / SAVANNA All Exc. 8600# GVW	
R	92-99	YUKON All	
49232	D		
R	95-01	FORD EXPLORER All Exc. Electronic Adjustable Suspension	
R	01-05	EXPLORER SPORT TRAC All	
R	97-01	MERCURY MOUNTAINEER All Exc. Electronic Adjustable Suspension	
49233	W		
R	95-03	FORD WINDSTAR Coil (RearSpringType)	
49234	D		
R	03-04	FORD MUSTANG / MUSTANG II Mach I	
R	94-04	MUSTANG / MUSTANG II Base	
R	94-04	MUSTANG / MUSTANG II GT	
R	04	MUSTANG / MUSTANG II GT Base	
R	04	MUSTANG / MUSTANG II GT Equipado	
R	01	MUSTANG / MUSTANG II GT Bullitt	
R	95	MUSTANG / MUSTANG II GTS	
49235	A		
R	07	CHEVROLET PICKUP 1/2 TON, SILVERADO 1500 Classic Hybrid, RWD Exc. Electronic Adjustable Suspension	

Hi Jackers

Shock	POP	Alternative No.	MTG Acc. Supplied
Pos.	Year	Application	
49235	A	-continued	
R	07	PICKUP 1/2 TON, SILVERADO 1500 Classic LS, RWD Exc. Electronic Adjustable Suspension	
R	07	PICKUP 1/2 TON, SILVERADO 1500 Classic LT, RWD Exc. Electronic Adjustable Suspension	
R	07	PICKUP 1/2 TON, SILVERADO 1500 Classic SS, RWD Exc. Electronic Adjustable Suspension	
R	07	PICKUP 1/2 TON, SILVERADO 1500 Classic WT, RWD Exc. Electronic Adjustable Suspension	
R	99-06	PICKUP 1/2 TON, SILVERADO 1500 RWD Exc. Electronic Adjustable Suspension	
R	94-01	DODGE PICKUP 1/2 TON, RAM 1500 (SEE RAM 1500) All	
R	94-02	PICKUP 1 TON, RAM 3500 (SEE RAM 3500) RWD Exc. Solid Front Axle	
R	94-02	PICKUP 3/4 TON, RAM 2500 (SEE RAM 2500) 4WD, GAS Exc. 8800# GVW	
R	94-02	PICKUP 3/4 TON, RAM 2500 (SEE RAM 2500) RWD	
R	95-96	PICKUP 3/4 TON, RAM 2500 (SEE RAM 2500) 4WD, CNG Exc. 8800# GVW	
R	07	GMC SIERRA 1500 Classic Hybrid, RWD Exc. Electronic Adjustable Suspension	
R	07	SIERRA 1500 Classic SL, RWD Exc. Electronic Adjustable Suspension	
R	07	SIERRA 1500 Classic SLE, RWD Exc. Electronic Adjustable Suspension	
R	07	SIERRA 1500 Classic SLT, RWD Exc. Electronic Adjustable Suspension	
R	07	SIERRA 1500 Classic WT, RWD Exc. Electronic Adjustable Suspension	
R	99-06	SIERRA 1500 RWD Exc. Electronic Adjustable Suspension	
49236	A		
R	96-07	CHRYSLER TOWN & COUNTRY All	
R	01-03	VOYAGER / GRAND VOYAGER All Exc. Hydraulic Self Leveling System	
R	00	VOYAGER / GRAND VOYAGER All	
R	96-07	DODGE CARAVAN / GRAND CARAVAN All Exc. Hydraulic Self Leveling System	
R	96-00	PLYMOUTH VOYAGER / GRAND VOYAGER Non-ABS	
49237	B		
R	04	FORD PICKUP 1/2 TON, F-150 RWD	
R	00-03	PICKUP 1/2 TON, F-150 Harley-Davidson Edition, RWD	
R	99-03	PICKUP 1/2 TON, F-150 Lariat, RWD	
R	99-03	PICKUP 1/2 TON, F-150 XL, RWD	
R	99-03	PICKUP 1/2 TON, F-150 XLT, RWD	
R	00	PICKUP 1/2 TON, F-150 Base, RWD	
R	97-98	PICKUP 1/2 TON, F-150 RWD	
R	97-99	PICKUP 3/4 TON, F-250 / SUPERDUTY RWD Up through 8500# GVW	
49241	W		
R	97	FORD PICKUP 3/4 TON, F-250 / SUPERDUTY 4WD Over 8500# GVW	
R	87-96	PICKUP 3/4 TON, F-250 / SUPERDUTY 4WD	
49254	D		
R	97-02	CADILLAC ELDORADO All Exc. Electronic Ride Control	
49255	N		
R	00-05	BUICK LESABRE All With OE Style air fitting	
R	97-05	PARK AVENUE All With OE Style air fitting	
R	95-99	RIVIERA All With OE Style air fitting	
R	00-05	CADILLAC DEVILLE All With OE Style air fitting Exc. Electronic Adjustable Suspension	

Numerical listing

Shock	POP	Alternative No.	MTG Acc. Supplied
Pos.	Year	Application	
49255	N	-continued	
R	98-04	SEVILLE All With OE Style air fitting Exc. Electronic Adjustable Suspension	
R	01-03	OLDSMOBILE AURORA All With OE Style air fitting	
R	95-99	AURORA All With OE Style air fitting	
R	00-04	PONTIAC BONNEVILLE All With OE Style air fitting	
49304	C		
R	63-82	CHEVROLET CORVETTE All	
49307	C		
R	52-77	VOLKSWAGEN BEETLE All	
R	69-73	FASTBACK All	
R	66-73	SQUAREBACK All	
R	74-79	SUPER BEETLE All	
R	71-73	SUPER BEETLE All 3 Bolt Flange-Type Lower Mount	
R	73-74	THING All	
49309	W		
R	69-72	NISSAN 521 PICKUP All	
R	72-79	620 PICKUP All	
R	82-86	720 PICKUP RWD	
R	80-81	720 PICKUP All	
R	69-71	TOYOTA CORONA Mark II, Wagon	
49310	B		
R	79-82	DODGE D50 RWD	
R	87-93	PICKUP, RAM 50 RWD	
R	83-86	PICKUP, RAM 50 All	
R	55	FORD F SERIES All F-100	
R	61-64	PICKUP 1/2 TON, F-100 All	
R	61-66	PICKUP 1 TON, F-350 / SUPERDUTY All	
R	61-64	PICKUP 3/4 TON, F-250 / SUPERDUTY All	
R	68	INTERNATIONAL 908B All	
R	68	908C All	
R	68	1000B All	
R	68	1000C All	
R	68	1100B All Exc. Travelette with 166" Wheelbase	
R	68	1100C All Exc. Travelette with 166" Wheelbase	
R	68	1200B All Exc. Travelette with 166" Wheelbase	
R	68	1200C All Exc. Travelette with 166" Wheelbase	
R	68	1300B All Exc. Travelette with 166" Wheelbase	
R	68	1300C All Exc. Travelette with 166" Wheelbase	
R	68-72	M1100 / M1200 All	
R	69	M1400 All	
R	65-67	M SERIES VAN All	
R	72-83	JEEP CJ5 All Exc. Lift Kit	
R	66-71	CJ5 All	
R	72-75	CJ6 All Exc. Lift Kit	
R	66-71	CJ6 All	
R	76-86	CJ7 All Exc. Lift Kit	
R	66-74	DJ5 All Exc. Lift Kit	
R	66-68	DJ6 All	
R	57-60	FC150 All	
R	63-65	FC170 All	
R	64-66	GLADIATOR All	
R	63	GLADIATOR All Independent Front Suspension	
R	70-73	JEEPSTER All	
R	81-85	SCRAMBLER / CJ8 All	
R	61-67	UNIVERSAL All	
R	86-87	MAZDA B2000 RWD	
R	87-93	B2200 RWD	
R	87-93	B2600 RWD	
R	95-96	MITSUBISHI MIGHTY MAX All	
R	83-94	MIGHTY MAX RWD	
R	87-90	VAN All	
R	78-81	NISSAN 510 Wagon	
R	98-04	FRONTIER RWD Exc. Desert Runner	
R	83-84	MAXIMA Wagon	
R	87-97	PICKUP RWD	
R	86	PICKUP RWD Mfg. from 8/86	
R	79-82	PLYMOUTH PICKUP All	
R	77-78	TOYOTA CORONA Wagon	
R	69-74	LAND CRUISER All Exc. Wagon	
R	67-68	LAND CRUISER All	
R	85-95	PICKUP RWD Exc. 1 Ton	
R	84	PICKUP RWD	
R	84-88	VAN Leaf (RearSpringType)	
R	88	VAN WAGON Leaf (FrontSpringType), Leaf (RearSpringType)	

Numerical listing

Shock	POP	Alternative No.	MTG Acc. Supplied
Pos.	Year	Application	
49311 C			
R	81-82	CHEVROLET	LUV PICKUP All
R	89-94	ISUZU	AMIGO All
R	81-95		PICKUP 4WD
R	81-95		PICKUP RWD
R	84-86		TROOPER 4WD
R	83-89	MINI	MONTERO All
R	97-99		MONTERO SPORT All
R	82-86	NISSAN	720 PICKUP 4WD
R	00-04		FRONTIER Crew Cab Pickup, RWD with Desert Runner
R	98-04		FRONTIER 4WD
R	98-99		FRONTIER RWD Crew Cab with Desert Runner
R	87-95		PATHFINDER All Exc. Electronic Adjustable Suspension
R	87-97		PICKUP 4WD
R	86		PICKUP 4WD Mfg. from 8/86
R	76-87	TOYOTA	LAND CRUISER All
R	75		LAND CRUISER All Mfg. from 1/75
R	69-74		LAND CRUISER All Wagon
R	85-92		PICKUP RWD 1 Ton
R	80-83		PICKUP 4WD Exc. Lift Kit
49334 A			
R	78-81	BUICK	CENTURY All
R	78-87		REGAL All
R	78-87	CHEVROLET	EL CAMINO All
R	78-83		MALIBU All
R	73-88		MONTE CARLO All
R	78-87	GMC	SPRINT / CABALLERO RWD
R	79-87	OLDSMOBILE	CUTLASS / CUTLASS SUPREME All
R	78-79		CUTLASS / CUTLASS SUPREME Vista Cruiser
R	76-77		CUTLASS / CUTLASS SUPREME Wagon
R	80-83		CUTLASS CLASSIC / CUTLASS CRUISER All
R	82-86	PONTIAC	BONNEVILLE All
R	78-80		GRAND AM All
R	78-83		GRAND LEMANS All
R	69-87		GRAND PRIX All
R	68-81		LEMANS All
49345 W			
R	79-85	BUICK	RIVIERA All
R	79-85	CADILLAC	ELDORADO All
R	80-85		SEVILLE All
R	79-85	OLDSMOBILE	TORONADO All
49346 W			
R	83-89	CHRYSLER	FIFTH AVENUE All
R	81-83		IMPERIAL All
R	77-81		LEBARON All M Body
R	76-80	DODGE	ASPEN All
R	77-89		DIPLOMAT All
R	80-83		MIRADA All
R	88-89	PLYMOUTH	CARAVELLE RWD
R	78-81		CARAVELLE RWD
R	82-89		GRAN FURY All
R	76-80		VOLARE All
49369 D			
R	84-93	CHRYSLER	DAYTONA CAN
R	83-84		E CLASS All
R	85		EXECUTIVE LIMOUSINE All
R	83-84		EXECUTIVE SEDAN All
R	90-93		IMPERIAL All Exc. Hydraulic Self Leveling System
R	84-86		LASER All
R	82-95		LEBARON All
R	81		LEBARON All Exc. M Body
R	88-93		NEW YORKER All Exc. Hydraulic Self Leveling System
R	83-87		NEW YORKER All
R	86-88		TOWN & COUNTRY All
R	82-83	DODGE	400 All
R	83-88		600 All
R	81-89		ARIES All
R	89-93		DAYTONA ES
R	89-90		DAYTONA ES Turbo
R	87-88		DAYTONA Pacifica
R	86		DAYTONA Turbo Z
R	84-85		DAYTONA Turbo
R	85-89		LANCER All
R	87-94		SHADOW All
R	89-95		SPIRIT All
R	89-95	PLYMOUTH	ACCLAIM All
R	88		CARAVELLE FWD
R	83-87		CARAVELLE All
R	81-89		RELIANT All
R	87-94		SUNDANCE All
49370 W			
R	82-96	BUICK	CENTURY All

Hi Jackers, Ultra Spring Seat

Shock	POP	Alternative No.	MTG Acc. Supplied
Pos.	Year	Application	
49370 W -continued			
R	80-85		SKYLARK All
R	82-90	CHEVROLET	CELEBRITY All
R	80-85		CITATION / CITATION II All
R	90-96		LUMINA APV All
R	85-96	OLDSMOBILE	CIERA / CUTLASS CIERA All Exc. Electronic Adjustable Suspension
R	82-84		CIERA / CUTLASS CIERA All
R	87-94		CUTLASS CLASSIC / CUTLASS CRUISER All Exc. Electronic Adjustable Suspension
R	80-84		OMEGA All
R	90-96		SILHOUETTE All
R	89-91	PONTIAC	6000 FWD
R	82-88		6000 All
R	80-84		PHOENIX All
R	90-96		TRANS SPORT All
49371 W			
R	94	ASUNA	GT
R	92		GT
R	93		GT, SE All
R	94		SE
R	92		SE
R	82-89	BUICK	SKYHAWK All
R	86-94		SKYLARK All
R	85-87		SOMERSET / SOMERSET REGAL All
R	82-88	CADILLAC	CIMARRON All
R	92-94	CHEVROLET	BERETTA Base Exc. FE7 Suspension
R	87-91		BERETTA All
R	82-94		CAVALIER All
R	94		CORSICA Base Exc. FE7 Suspension
R	92-93		CORSICA All Exc. FE7 Suspension
R	87-91		CORSICA All
R	92-94	OLDSMOBILE	ACHIEVA All
R	85-87		CALAIS All
R	88-91		CUTLASS CALAIS All
R	87-88		FIRENZA All
R	84-86		FIRENZA All Rebuildable O.E. Struts
R	82-83		FIRENZA All
R	85-94	PONTIAC	GRAND AM All
R	82-85		J2000 / SUNBIRD All
R	86-94		SUNBIRD All
R	87-91		TEMPEST CAN
49387 W			
R	96-02	TOYOTA	4RUNNER All
49388 W			
R	90-95	TOYOTA	4RUNNER All
49613 W			
R	94-98	ASUNA	SUNRUNNER
R	92-93		SUNRUNNER All
R	98-04	CHEVROLET	TRACKER Non-ABS
R	89-97	GEO	TRACKER All
R	94-97	PONTIAC	SUNRUNNER CAN
R	99-05	SUZUKI	GRAND VITARA All
R	89-98		SIDEKICK All
R	99-04		VITARA All
R	96-98		X-90 All
49614 W			
R	95-98	BUICK	SKYLARK All
R	95-96	CHEVROLET	BERETTA All
R	95-96		CORSICA All
R	95-98	OLDSMOBILE	ACHIEVA All Exc. Electronic Adjustable Suspension
R	95-98	PONTIAC	GRAND AM All Exc. Electronic Adjustable Suspension
Ultra Spring Seat			
G51006 W			
R	85-93	VOLKSWAGEN	CABRIOLET All
R	80-84		JETTA All
R	75-84		RABBIT All
R	75-89		SCIROCCO All
G51007 W			
R	77-83	BMW	320i All
G51013 W			
R	88-92	AUDI	80 All
R	93-95		90 All
R	88-91		90 All
R	80-87		4000 All
R	83-87		COUPE All
G51022 B			
R	93-98	VOLKSWAGEN	GOLF 2.0L 4Cyl L (121)

Numerical listing

Shock	POP	Alternative No.	MTG Acc. Supplied
Pos.	Year	Application	
G51022 B -continued			
R	85-92	GOLF	All Rebuildable Front Struts
R	95-98	JETTA	1.9L 4Cyl L (116)
R	94-98	JETTA	2.0L 4Cyl L (121)
R	95	JETTA	1.8L 4Cyl L (109)
R	85-93		JETTA All
G51027 W			
R	78-80	DODGE	OMNI All
R	78-80	PLYMOUTH	HORIZON All
G51030 W			
R	87-93	VOLKSWAGEN	FOX All
G51031 W			
R	86-91	MAZDA	RX7 All Exc. Electronic Adjustable Suspension
G51033 W			
R	90-97	VOLKSWAGEN	PASSAT All Rebuildable O.E. Front Struts
G51034 W			
R	86-89	ACURA	INTEGRA All
G51039 C			
R	94-97	FORD	ASPIRE Non-ABS
R	88-93		FESTIVA All
G51046 W			
R	89-90	DODGE	2000 GTX CAN
R	91-93	EAGLE	2000 GTX CAN
R	90-94		TALON AWD Auto-Leveling System
R	90-94	MITSUBISHI	ECLIPSE AWD
R	90-92		GALANT AWD
R	92-94	PLYMOUTH	LASER AWD
G51047 W			
R	83-87	DODGE	CHARGER All
R	81-90		OMNI All
R	87-89	PLYMOUTH	EXPO All
R	81-90		HORIZON All
R	85		TURISMO All
R	83		TURISMO All
G51060 W			
R	89-92	TOYOTA	CRESSIDA All Exc. Electronic Adjustable Suspension
G51063 B			
R	93-95	DODGE	COLT All
R	93-96	EAGLE	SUMMIT Coupe
R	93-96		SUMMIT Sedan
R	97-02	MITSUBISHI	MIRAGE All
R	96		MIRAGE All Mfg. to 5/96
R	93-95		MIRAGE All
R	93-94	PLYMOUTH	COLT Sedan
G51064 X			
R	92	AUDI	80 QUATTRO All
R	93-95		90 QUATTRO All
G51077 A			
F	96-02	TOYOTA	4RUNNER All
F	98-04	TACOMA	Pre Runner, RWD
F	95-04		TACOMA 4WD
G51078 W			
R	95-98	CHRYSLER	CIRRUS All
R	96-98		SEBRING Convertible
R	95-98	DODGE	STRATUS All
R	96-98	PLYMOUTH	BREEZE All
G51087 A			
R	96-99	INFINITI	I30 All
R	95-99	NISSAN	MAXIMA All
G51097 W			
F	96-99	AUDI	A4 Base Exc. Sport Suspension
F	96-00		A4 QUATTRO Base Mfg. to 11/00; Exc. Sport Suspension
F	98-01	VOLKSWAGEN	PASSAT FWD From VIN# 3B300001 through VIN# 3B300000
G51099 W			
F	98-99	AUDI	A4 Avant Sport Suspension
F	96-97		A4 All Sport Suspension
F	98-00		A4 QUATTRO Avant Sport Suspension
F	96-97		A4 QUATTRO All Sport Suspension
F	99-00		A6 Avant Sport Suspension
F	98		A6 Base Sport Suspension
G51100 W			
R	96-00	AUDI	A4 All

Numerical listing

Shock	POP	Alternative No.	MTG Acc. Supplied
Pos.	Year	Application	
G51101	W		
R	98-04	AUDI A6 QUATTRO	All
G51161	W		
R	72-86	JAGUAR XJ6	All 4 units required
R	81-92	XJ12	All 4 units required
R	73-79	XJ12	All 4 units required
R	76-96	XJS	All
G51165	W		
R	89-94	AUDI 100	All
R	89-90	200	All
R	84-88	5000	All
R	95-97	A6	All
G51170	W		
R	85-87	HONDA CIVIC	Hatchback
R	85-87	CIVIC	Sedan
R	85-87	CIVIC	Wagon, FWD
R	84	CIVIC	All
G51173	W		
R	85-89	SUBARU DL	Sedan, FWD Exc. Air Suspension
R	85-89	GL	Sedan, FWD Exc. Air Suspension
R	90-93	LOYALE	Sedan, FWD Exc. Air Suspension
R	90	LOYALE	Coupe, FWD Exc. Air Suspension
R	85-91	XT	FWD, Coil (RearSpringType) Exc. Air Suspension
G51180	W		
R	87-90	TOYOTA TERCEL	Hatchback
R	87-90	TERCEL	Sedan
G51181	W		
R	87-89	SUBARU DL	Sedan, 4WD
R	87-89	GL	Sedan, 4WD
R	90-93	LOYALE	Sedan, 4WD
G51182	W		
R	87-89	SUBARU DL	Coupe, 4WD
R	87-89	GL	Coupe, 4WD
R	90	LOYALE	Coupe, 4WD
G51183	W		
R	85-89	SUBARU DL	Wagon, FWD Exc. Air Suspension
R	89	GL	Wagon, FWD Exc. Air Suspension
R	85-87	GL	Wagon, FWD Exc. Air Suspension
R	94	LOYALE	All Exc. Air Suspension
R	90-93	LOYALE	Wagon Exc. Air Suspension
G51184	W		
R	90-94	EAGLE TALON	FWD
R	90-94	MINIBISHI ECLIPSE	FWD
R	90-94	PLYMOUTH LASER	FWD
G51186	W		
R	89-94	HYUNDAI SONATA	All
G51188	W		
F	94-96	NISSAN 300ZX	2+2 Left Exc. model spec VG30DETT
F	93	300ZX	2+2 Left
F	90-92	300ZX	2+2 Left Exc. model spec VG30DETT
G51189	W		
F	90-96	NISSAN 300ZX	2+2 Right Exc. model spec VG30DETT
G51190	W		
R	90-96	NISSAN 300ZX	2+2 Exc. model spec VG30DETT
G51191	W		
R	89-94	NISSAN 240SX	All Exc. Active Suspension
G51192	W		
R	88-91	MAZDA 929	All Exc. Electronic Adjustable Suspension
G51193	W		
R	87-91	TOYOTA SUPRA	All Exc. Electronic Adjustable Suspension
R	86	SUPRA	All Mfg. from 3/86; Exc. Electronic Adjustable Suspension
G51195	D		
F	90-97	MAZDA MIATA	Non-ABS

Ultra Spring Seat

Shock	POP	Alternative No.	MTG Acc. Supplied
Pos.	Year	Application	
G51196	D		
R	90-97	MAZDA MIATA	Non-ABS
G51197	W		
F	86-91	TOYOTA SUPRA	All Exc. Electronic Adjustable Suspension
G51204	B		
F	93-02	CHEVROLET CAMARO	All
F	93-02	PONTIAC FIREBIRD	All
G51216	W		
R	01-03	BMW 525i	Sedan Exc. Electronic Adjustable Suspension
R	99-00	528i	Sedan
R	97-98	528i	All
R	01-03	530i	All Exc. Electronic Adjustable Suspension
R	97-03	540i	Sedan Exc. Electronic Adjustable Suspension
R	95	540i	Sedan Exc. Electronic Adjustable Suspension
G51227	W		
F	95-99	KIA SPORTAGE	All
G51229	W		
R	79-82	NISSAN 280ZX	All
R	77-81	810	Sedan
R	79-80	810	Hardtop
R	82-84	MAXIMA	Sedan
G51230	B		
R	95-98	NISSAN 200SX	All B14 Solid Rear Axle
R	95-99	SENTRA	All B14 Solid Rear Axle
G51232	W		
R	83	NISSAN 280ZX	All
G51249	W		
R	89-92	DODGE COLT	Hatchback
R	92	EAGLE SUMMIT	Hatchback
R	92	SUMMIT	Sedan
R	89-91	SUMMIT	All
R	92-95	HYUNDAI ELANTRA	Non-ABS
R	89-92	MINIBISHI MIRAGE	All
R	90-91	PLYMOUTH COLT	Hatchback, FWD
R	89	COLT	Hatchback
G51252	D		
R	95-99	TOYOTA PASEO	All
R	95-99	TERCEL	All
G51253	D		
R	94-98	MINIBISHI GALANT	All
G51254	A		
R	01-05	CHRYSLER SEBRING ST	(MfrBodyCode), Coupe
R	95-00	SEBRING	Coupe
R	95-00	DODGE AVENGER	All
R	01-05	STRATUS ST	(MfrBodyCode), Coupe
R	95-98	EAGLE TALON	FWD
R	95-99	MINIBISHI ECLIPSE	FWD
R	99-03	GALANT	All
G51255	B		
F	97-01	HONDA CR-V	All
G51256	C		
R	97-01	HONDA CR-V	All
G51264	D		
F	97-01	HONDA PRELUDE	All
G51267	A		
F	99-00	CHRYSLER CIRRUS	J2 (MfrBodyCode)
F	01-06	SEBRING JR	(MfrBodyCode), Convertible
F	01-05	SEBRING JR	(MfrBodyCode), Sedan
F	99-00	SEBRING	Convertible
F	99-06	DODGE STRATUS	Sedan
F	99-00	PLYMOUTH BREEZE	All Exc. JA Mfr Body Code
G51268	A		
R	99-00	CHRYSLER CIRRUS	All
R	01-06	SEBRING JR	(MfrBodyCode), Convertible
R	01-06	SEBRING JR	(MfrBodyCode), Sedan
R	99-00	SEBRING	Convertible

Numerical listing

Shock	POP	Alternative No.	MTG Acc. Supplied
Pos.	Year	Application	
G51268	A	-continued	
R	99-06	DODGE STRATUS	Sedan
R	99-00	PLYMOUTH BREEZE	All
G51279	A		
R	00-06	NISSAN SENTRA	All
G51286	B		
R	02-06	HONDA CR-V	All
G51290	W		
R	95-98	HYUNDAI SONATA	All
G51330	W		
R	85-86	BMW 524TD	All
R	82-88	528E	All Auto-Leveling System
R	83-84	533i	All Auto-Leveling System
R	85-88	535i	All Auto-Leveling System
R	88	535iS	All Auto-Leveling System
R	85-89	635CSi	All Exc. Auto-Leveling System
G51346	W		
R	91-95	BMW 525i	All
R	90	525i	All Mfg. from 8/90
R	89	525i	All
R	94-95	530i	Sedan
R	91-93	535i	All
R	90	535i	All Mfg. from 8/90
R	89	535i	All
R	88	535i	All Exc. Auto-Leveling System
R	88	535iS	All Exc. Auto-Leveling System
G51424	W		
R	91-93	EAGLE 2000 GTX	CAN Exc. Auto-Leveling System
R	89-93	MINIBISHI GALANT	FWD
R	85-88	GALANT	All Exc. Electronic Adjustable Suspension
R	89-90	SIGMA	Non-ABS Exc. Auto-Leveling System
G51477	A		
F	01-07	TOYOTA SEQUOIA	All
F	00-06	TUNDRA	All
G51700	B		
R	01-03	ACURA EL	CAN
R	01-02	HONDA CIVIC	All
G51703	A		
F	05-08	FORD PICKUP	1/2 TON, F-150 RWD
F	04	PICKUP	1/2 TON, F-150 Lariat, RWD
F	04	PICKUP	1/2 TON, F-150 STX, RWD
F	04	PICKUP	1/2 TON, F-150 XL, RWD
F	04	PICKUP	1/2 TON, F-150 XLT, RWD
F	06-08	LINCOLN MARK LT	RWD
G51704	B		
F	04-08	FORD PICKUP	1/2 TON, F-150 4WD
F	06-08	LINCOLN MARK LT	4WD
G51705	W		
R	01-06	HYUNDAI SANTA FE	All
G51709	W		
F	92-00	LEXUS SC300	All
F	92-00	SC400	All
G51710	W		
R	92-00	LEXUS SC300	All
R	92-00	SC400	All
G51711	W		
F	87-94	JAGUAR XJ6	All Exc. Auto-Leveling System
F	94	XJ12	All Exc. Auto-Leveling System
G51712	C		
R	95-98	EAGLE TALON	AWD
R	00-05	MINIBISHI ECLIPSE	All
R	95-99	ECLIPSE	AWD
G51713	A		
R	01-05	HYUNDAI SONATA	All
R	00	SONATA	All Mfg. from 4/00
R	01	XG300	All
R	02-05	XG350	All
R	01-06	KIA MAGENTIS	CAN
R	01-05	OPTIMA	All
G51714	B		
F	01-05	HYUNDAI SONATA	All

Numerical listing

Shock	POP	Alternative No.	MTG Acc. Supplied
Pos.	Year	Application	
G51714	B	-continued	
F	00	SONATA All Mfg. from 8/00	
F	01-06	KIA MAGENTIS CAN	
F	01-05	OPTIMA All	
G51715	A		
F	04-10	INFINITI QX56 All	
F	05-13	NISSAN ARMADA All Exc. Auto-Leveling System	
F	04-13	TITAN All	
G51716	C		
R	03-05	HONDA CIVIC All	
G51718	A		
F	04-07	BUICK RAINIER All	
F	03-06	CHEVROLET SSR All	
F	02-09	TRAILBLAZER All	
F	02-09	GMC ENVOY All	
F	03-08	ISUZU ASCENDER All	
F	02-04	OLDSMOBILE BRAVADA All	
F	05-09	SAAB 9-7X All	
G51719	B		
F	03-06	FORD EXPEDITION RWD	
G51720	W		
F	03-06	FORD EXPEDITION 4WD	
G51721	A		
R	05-09	CHRYSLER 300 RWD	
R	06-09	DODGE CHARGER All Exc. Police Package	
R	05-08	MAGNUM All	
G51722	B		
F	02-03	FORD EXPLORER Eddie Bauer Exc. All Sport & Sport Trac Models	
F	02-03	EXPLORER Limited Exc. All Sport & Sport Trac Models	
F	02-03	EXPLORER Postal Exc. All Sport & Sport Trac Models	
F	02-03	MERCURY MOUNTAINEER All	
G51723	D		
F	04-05	FORD EXPLORER Eddie Bauer Exc. All Sport & Sport Trac Models	
F	04-05	EXPLORER Limited Exc. All Sport & Sport Trac Models	
F	04-05	MERCURY MOUNTAINEER All	
G51724	D		
R	02-05	FORD EXPLORER Eddie Bauer Exc. All Sport & Sport Trac Models	
R	02-05	EXPLORER Limited Exc. All Sport & Sport Trac Models	
R	02-03	EXPLORER Postal Exc. All Sport & Sport Trac Models	
R	02-05	MERCURY MOUNTAINEER All	
G51725	A		
R	02-06	NISSAN ALTIMA All	
G51727	A		
R	00-01	INFINITI I30 All	
R	02-04	I35 All	
R	00-03	NISSAN MAXIMA All	
G51728	A		
F	07-11	DODGE NITRO All	
F	02-12	JEEP LIBERTY All	
G51729	C		
R	03-06	FORD EXPEDITION All	
G51736	A		
R	03-08	PONTIAC VIBE FWD	
R	03-08	TOYOTA COROLLA All	
R	03-08	MATRIX FWD	
G51737	A		
F	04-08	ACURA TL All	
F	04-08	TSX All	
F	06-07	HONDA ACCORD Value Package	
F	03-07	ACCORD EX	
F	03-07	ACCORD LX	
F	03-05	ACCORD DX	
F	05	ACCORD SE	
F	03	ACCORD Coupe	
G51738	A		
R	04-08	ACURA TL All	
R	06-07	HONDA ACCORD Value Package	
R	03-07	ACCORD EX	
R	03-07	ACCORD LX	
R	03-05	ACCORD DX	
R	05	ACCORD SE	

Ultra Spring Seat

Shock	POP	Alternative No.	MTG Acc. Supplied
Pos.	Year	Application	
G51738	A	-continued	
R	03	ACCORD Coupe	
G51739	A		
F	12	TOYOTA 4RUNNER All Exc. X-REAS Suspension; Exc. Sport Models	
F	10-11	4RUNNER Trail Exc. X-REAS Suspension	
F	03-11	4RUNNER Limited Exc. X-REAS Suspension	
F	03-11	4RUNNER SR5 Exc. X-REAS Suspension	
F	07-12	FJ CRUISER All	
F	05-13	TACOMA 4WD	
F	05-12	TACOMA Pre Runner, RWD	
G51740	W		
F	00-08	AUDI A4 All	
F	05-08	A4 QUATTRO Elite Mfg. from 11/00; Exc. Sport Suspension	
F	04-08	A4 QUATTRO Cabriolet Mfg. from 11/00; Exc. Sport Suspension	
F	00-08	A4 QUATTRO Base Mfg. from 11/00; Exc. Sport Suspension	
F	08	A4 QUATTRO S Line Mfg. from 11/00; Exc. Sport Suspension	
F	08	A4 QUATTRO Trendy Mfg. from 11/00; Exc. Sport Suspension	
F	06-07	A4 QUATTRO DTM Mfg. from 11/00; Exc. Sport Suspension	
F	05-06	A4 QUATTRO S Line Mfg. from 11/00; Exc. Sport Suspension	
F	06	A4 QUATTRO Vanguard Mfg. from 11/00; Exc. Sport Suspension	
F	02-05	A4 QUATTRO Luxury Mfg. from 11/00; Exc. Sport Suspension	
F	01	A4 QUATTRO Confort Mfg. from 11/00; Exc. Sport Suspension	
G51742	W		
R	95-04	AUDI A6 QUATTRO All	
R	01-05	VOLKSWAGEN PASSAT AWD Exc. VIN# 3B300001 through VIN# 3B300000	
R	98-00	PASSAT FWD Exc. VIN# 3B300001 through VIN# 3B300000	
G51743	D		
F	03-04	AUDI A6 Confort Exc. Sport Suspension	
F	02-04	A6 Luxury Exc. Sport Suspension	
F	98-04	A6 Base Exc. Sport Suspension	
F	02	A6 Premium Exc. Sport Suspension	
F	01-05	VOLKSWAGEN PASSAT All Exc. VIN# 3B300001 through VIN# 3B300000	
G51744	W		
R	97-01	BMW 740I All Exc. Electronic Adjustable Suspension	
R	94-95	740I All Exc. Electronic Adjustable Suspension	
R	94-01	740IL All Exc. Electronic Adjustable Suspension	
R	94-96	750IL All	
G51746	B		
F	03-07	CADILLAC CTS All Exc. Magnetic Ride Control Suspension	
G51747	A		
R	04-11	CHEVROLET AVEO All	
R	05-08	PONTIAC WAVE All	
G51756	B		
F	00-04	LINCOLN LS All	
G51757	C		
R	00-06	LINCOLN LS All	
G51758	B		
F	06-08	DODGE PICKUP 1/2 TON, RAM 1500 (SEE RAM 1500) 4WD Exc. Mega Cab	
G51759	B		
R	00-05	SATURN L / LS / LW SERIES All	
G51760	A		
F	05-10	CHRYSLER 300 RWD Right	
F	06-10	DODGE CHARGER RWD Right	
F	05-08	MAGNUM RWD Right	
G51761	A		
F	05-10	CHRYSLER 300 RWD Left	
F	06-10	DODGE CHARGER RWD Left	

Numerical listing

Shock	POP	Alternative No.	MTG Acc. Supplied
Pos.	Year	Application	
G51761	A	-continued	
F	05-08	MAGNUM RWD Left	
G51764	W		
R	03-06	INFINITI G35 All Exc. Sport Suspension	
R	03-06	NISSAN 350Z Coupe Exc. Sport Suspension	
G51765	B		
F	13	NISSAN PATHFINDER All	
F	12	PATHFINDER All Mfg. to 12/12	
F	05-11	PATHFINDER All	
F	13	XTERRA All	
F	12	XTERRA All Mfg. to 12/12	
F	05-11	XTERRA All	
G51766	B		
F	11-13	NISSAN FRONTIER S	
F	13	FRONTIER LE	
F	13	FRONTIER PRO-4X	
F	13	FRONTIER SL	
F	13	FRONTIER SV	
F	12	FRONTIER LE Mfg. to 12/12	
F	12	FRONTIER PRO-4X Mfg. to 12/12	
F	12	FRONTIER SL Mfg. to 12/12	
F	09-11	FRONTIER PRO-4X	
F	05-11	FRONTIER LE	
F	11	FRONTIER SL	
F	05-10	FRONTIER SE	
F	05-06	FRONTIER XE	
G51767	C		
R	03-06	SUBARU BAJA All	
R	00-04	OUTBACK All	
G51768	W		
R	03-06	PONTIAC VIBE AWD	
R	03-06	TOYOTA MATRIX AWD	
G51769	W		
F	00-02	JAGUAR S TYPE All Mfg. to 6/02 Exc. Computer Active Technology Suspension	
G51770	W		
F	02-05	FORD THUNDERBIRD All	
G51771	W		
R	02-05	FORD THUNDERBIRD All	
G51772	C		
R	97-03	MITSUBISHI DIAMANTE All	
G51773	W		
R	00-05	JAGUAR S TYPE All Mfg. to 6/02 Exc. Computer Active Technology Suspension	
G51774	D		
F	04-06	KIA AMANTI All	
G51783	B		
R	07-11	TOYOTA YARIS All	
G51794	D		
R	02-07	MITSUBISHI LANCER LS	
R	07	LANCER LS Diamond	
R	04-06	LANCER Ralliart	
R	02-06	LANCER OZ Rally	
R	06	LANCER DE	
R	06	LANCER SE	
R	04	LANCER DE	
R	04	LANCER Sportback	
G51795	D		
R	04-09	TOYOTA PRIUS All	
G51796	D		
F	97-98	CHRYSLER CIRRUS JA (MfrBodyCode)	
F	97-98	SEBRING Convertible	
F	97-98	DODGE STRATUS All	
F	96-98	PLYMOUTH BREEZE JA (MfrBodyCode)	
G51798	B		
R	03-07	NISSAN MURANO All	
G51799	C		
R	06-09	VOLKSWAGEN BORA All	
R	06-11	GTI All	
R	06-09	JETTA All	
R	06-09	PASSAT All	
R	06-09	RABBIT All	
G51802	A		
R	04-08	NISSAN MAXIMA All	

Numerical listing

Shock	POP	Alternative No.	MTG Acc. Supplied
Pos.	Year	Application	
G51803	B		
R	04-09	NISSAN QUEST All	
G51804	D		
R	04-10	TOYOTA SIENNA FWD 7 Passenger	
G51805	A		
R	04-10	TOYOTA SIENNA AWD	
R	04-10	SIENNA FWD 8 Passenger	
G51806	A		
F	06-10	HYUNDAI AZERA All	
F	06-10	SONATA All	
G51807	A		
R	06-11	HONDA CIVIC All	
G51810	C		
F	03-08	MAZDA 6 All Left	
G51811	B		
F	03-08	MAZDA 6 All Right	
G51812	D		
R	03-06	INFINITI G35 Coupe Sport Suspension	
R	03-05	NISSAN 350Z All Sport Suspension	
G51813	D		
F	03-07	INFINITI G35 Coupe Left Sport Suspension	
F	03-05	NISSAN 350Z All Left	
G51814	D		
F	03-07	INFINITI G35 Coupe Right Sport Suspension	
F	03-05	NISSAN 350Z All Right	
G51815	A		
F	05-09	DODGE DAKOTA All	
F	06-09	MITSUBISHI RAIDER All	
G51825	W		
R	04-06	KIA AMANTI All	
G51826	B		
R	95-02	MAZDA MILLENIA All	
G51827	D		
F	95-02	MAZDA MILLENIA All Left	
G51828	D		
F	95-02	MAZDA MILLENIA All Right	
G51829	W		
R	96-04	ACURA RL All	
G51830	N		
R	02-04	ACURA RSX All	
G51831	W		
R	03-08	INFINITI FX35 All	
R	03-08	FX45 All	
G51832	W		
F	01-06	LEXUS LS430 All	
G51833	W		
R	01-06	LEXUS LS430 All	
G51834	D		
F	01-04	LEXUS IS300 All	
G51835	W		
R	01-04	LEXUS IS300 All	
G51836	W		
F	03-05	LINCOLN AVIATOR All	
G51837	W		
R	03-05	LINCOLN AVIATOR All	
G51838	D		
R	03-04	MITSUBISHI OUTLANDER All	
G51839	W		
F	01-04	MITSUBISHI MONTERO All Exc. Sport	
G51840	W		
R	01-03	TOYOTA PRIUS All	
G51841	W		
R	01-04	VOLVO S40 All	
R	00	S40 All Mfg. from 04/00	
R	01-04	V40 All	
R	00	V40 All Mfg. from 04/00	

Ultra Spring Seat

Shock	POP	Alternative No.	MTG Acc. Supplied
Pos.	Year	Application	
G51842	A		
R	07-11	DODGE CALIBER All	
R	07-10	JEEP COMPASS All	
R	07-10	Patriot All	
G51847	W		
R	04-08	ACURA TSX All	
G51848	C		
R	09-13	DODGE JOURNEY All	
G51849	W		
R	05-07	FORD FIVE HUNDRED AWD	
R	05-07	MERCURY MONTEGO AWD	
G51850	C		
F	04-11	CHEVROLET COLORADO RWD, Coil (FrontSpringType) Exc. Z71 Off Road Package	
F	04-11	GMC CANYON RWD, Coil (FrontSpringType) Exc. Z71 Off Road Package	
F	06	ISUZU I-280 RWD, Coil (FrontSpringType) Exc. Z71 Off Road Package	
F	07-08	I-290 RWD, Coil (FrontSpringType) Exc. Z71 Off Road Package	
F	08	I-370 RWD, Coil (FrontSpringType) Exc. Z71 Off Road Package	
G51852	C		
R	05-10	SCION TC All	
G51853	C		
F	05-09	TOYOTA TACOMA Base, RWD Left	
F	05-09	TACOMA X-Runner Left	
G51854	C		
F	05-09	TOYOTA TACOMA Base, RWD Right	
F	05-09	TACOMA X-Runner Right	
G51855	D		
F	07-13	TOYOTA TUNDRA All	
G51856	D		
F	09-10	DODGE PICKUP 1/2 TON, RAM 1500 (SEE RAM 1500) 4WD	
F	11-12	RAM 1500 (SEE DODGE RAM 1500) 4WD	
G51857	W		
R	05-07	FORD FREESTYLE AWD	
R	08-09	TAURUS X AWD	
G51858	B		
R	04-11	HONDA ELEMENT LX	
R	03-11	ELEMENT EX	
R	03-04	ELEMENT DX	
G51859	A		
F	06-09	FORD FUSION All	
F	07-09	LINCOLN MKZ All	
F	06	ZEPHYR All	
F	06-09	MERCURY MILAN All	
G51860	W		
F	07-12	FORD EXPEDITION Coil (RearSpringType) Exc. Air Suspension	
F	07-12	LINCOLN NAVIGATOR All	
G51861	C		
R	07-12	FORD EXPEDITION Coil (RearSpringType) Exc. Air Suspension	
R	07-12	LINCOLN NAVIGATOR All	
G51863	B		
R	11-13	CHRYSLER 200 All Standard Suspension	
R	07-10	SEBRING All	
R	08-13	DODGE AVENGER All	
G51864	C		
F	09-13	FORD PICKUP 1/2 TON, F-150 4WD	
F	10-12	LINCOLN MARK LT All	
G51865	D		
F	09-13	FORD PICKUP 1/2 TON, F-150 RWD	
G51870	A		
F	08-13	CHEVROLET PICKUP 1/2 TON, SILVERADO 1500 All Exc. Electronic Adjustable Suspension	

Numerical listing

Shock	POP	Alternative No.	MTG Acc. Supplied
Pos.	Year	Application	
G51870	A		-continued
F	07	PICKUP 1/2 TON, SILVERADO 1500 Base Exc. Electronic Adjustable Suspension	
F	07	PICKUP 1/2 TON, SILVERADO 1500 LS Exc. Electronic Adjustable Suspension	
F	07	PICKUP 1/2 TON, SILVERADO 1500 LT Exc. Electronic Adjustable Suspension	
F	07	PICKUP 1/2 TON, SILVERADO 1500 LTZ Exc. Electronic Adjustable Suspension	
F	07	PICKUP 1/2 TON, SILVERADO 1500 WT Exc. Electronic Adjustable Suspension	
F	08-13	GMC SIERRA 1500 All Exc. Electronic Adjustable Suspension	
F	07	SIERRA 1500 SLE Exc. Electronic Adjustable Suspension	
F	07	SIERRA 1500 SLT Exc. Electronic Adjustable Suspension	
F	07	SIERRA 1500 WT Exc. Electronic Adjustable Suspension	
G51871	W		
R	97-04	CHEVROLET CORVETTE All Exc. Electronic Adjustable Suspension	
G51874	B		
R	07-12	NISSAN ALTIMA All	
G51875	W		
R	05-07	FORD FIVE HUNDRED FWD Left	
R	08-09	TAURUS FWD Left	
R	07	TAURUS All Left Mfg. from 06/07	
R	05-07	MERCURY MONTEGO FWD Left	
G51876	W		
R	05-07	FORD FIVE HUNDRED FWD Right	
R	08-09	TAURUS FWD Right	
R	07	TAURUS All Right Mfg. from 06/07	
R	05-07	MERCURY MONTEGO FWD Right	
G51877	W		
F	08-12	HONDA ACCORD All Left	
G51878	D		
F	08-12	HONDA ACCORD All Right	
G51879	C		
R	07-14	HONDA CR-V All	
G51880	D		
R	06-10	HONDA RIDGELINE All	
G51881	W		
R	02-06	MINI COOPER All	
G51882	W		
R	06-10	MITSUBISHI ECLIPSE All	
G51883	W		
R	10-11	MITSUBISHI GALANT SE	
R	04-11	GALANT ES	
R	04-08	GALANT DE	
R	05-07	GALANT SE	
G51884	W		
R	08-13	NISSAN MURANO All	
G51885	W		
R	99-06	SAAB 9-5 All	
G51886	W		
R	05-09	SUBARU LEGACY All	
G51887	B		
F	10-11	FORD CROWN VICTORIA Base	
F	07-11	CROWN VICTORIA LX	
F	03-08	CROWN VICTORIA Base	
F	04-06	CROWN VICTORIA LX Sport	
F	05	CROWN VICTORIA Special Edition	
F	03	CROWN VICTORIA LWB	
F	03	CROWN VICTORIA S	
F	03-06	LINCOLN TOWN CAR All	
F	03-06	MERCURY GRAND MARQUIS CAN	
G51888	D		
F	03-11	FORD CROWN VICTORIA Police Interceptor	
F	03-04	MERCURY MARAUDER All	
G51889	W		
R	05-07	FORD FREESTYLE FWD Left	
R	08-09	TAURUS X FWD Left	

Numerical listing

Shock	POP	Alternative No.	MTG Acc. Supplied
Pos.	Year	Application	
G51890 W			
R	05-07	FORD FREESTYLE FWD Right	
R	08-09	TAURUS X FWD Right	
G51891 A			
F	07-13	CHEVROLET AVALANCHE 1500 All Exc. Z55 or ZW7 Ride Suspension	
F	07-14	SUBURBAN 1/2 TON, 1500 All Exc. Z55 or ZW7 Ride Suspension	
F	07-14	TAHOE All Exc. Z55 or ZW7 Ride Suspension	
F	07-14	GMC YUKON All Exc. Z55 or ZW7 Ride Suspension	
F	07-14	YUKON XL 1/2 TON All Exc. Z55 or ZW7 Ride Suspension	
G51892 W			
R	08-12	HONDA ACCORD All	
G51896 C			
F	10-12	FORD FUSION All Left	
F	10-12	LINCOLN MKZ All Left	
F	10-11	MERCURY MILAN All Left	
G51897 C			
F	10-12	FORD FUSION All Right	
F	10-12	LINCOLN MKZ All Right	
F	10-11	MERCURY MILAN All Right	
G51898 N			
R	09-10	PONTIAC VIBE FWD	
R	09-13	TOYOTA COROLLA All	
R	09-13	MATRIX FWD	
G51899 N			
F	01	HYUNDAI XG300 All	
F	02-05	XG350 All	
G51900 N			
R	04-08	BMW 525i All	
R	04-08	530i All	
G51901 N			
F	09-11	CADILLAC CTS All	
G51904 W			
F	97-04	CHEVROLET CORVETTE All Exc. Electronic Adjustable Suspension	
G51905 W			
R	10-12	HONDA CITY All	
R	09-12	FIT All	
G51906 N			
F	06-08	MAZDA MX-5 All	
F	06-08	MX-5 MIATA All	
G51907 N			
R	06-08	MAZDA MX-5 All	
R	06-08	MX-5 MIATA All	
G51908 N			
R	08-11	MINI COOPER All	
R	08-11	LANCER ES	
G51909 N			
R	06-07	SUBARU B9 TRIBECA All	
R	08-13	TRIBECA All	
G51910 N			
R	05-09	SUBARU OUTBACK All	
G51911 N			
F	05-12	ACURA RL All	
G51912 N			
R	05-12	ACURA RL All Left	
G51913 N			
R	05-12	ACURA RL All Right	
G51914 N			
R	05-06	ACURA RSX All	
G51915 N			
F	05-08	AUDI A6 QUATTRO All Exc. Air and Sport Suspension	
G51916 FF			
R	10-13	CHEVROLET CAMARO 3.6L 6Cyl V (217)	
G51917 N			
F	09-14	ACURA TL All Left	
G51918 N			
F	09-14	ACURA TL All Right	

Ultra Spring Seat, Ultra Struts

Shock	POP	Alternative No.	MTG Acc. Supplied
Pos.	Year	Application	
G51919 N			
R	09-14	ACURA TL All	
R	09-14	TSX All	
G51920 N			
F	06-11	LEXUS IS250 All Left	
G51921 N			
F	06-11	CHEVROLET AVEO All Right	
F	04-11	AVEO All Right	
F	09	PONTIAC G3 All Right	
F	05-08	WAVE All Right	
F	04-09	SUZUKI SWIFT All Right	
G51922 N			
R	06-11	LEXUS IS250 All	
G51923 N			
F	04-08	MAZDA RX8 All	
G51924 N			
R	04-08	MAZDA RX8 All	
G51935 N			
F	06-09	PONTIAC SOLSTICE All	
G51936 N			
R	06-09	PONTIAC SOLSTICE All	
G51947 N			
F	05-10	CHRYSLER 300 RWD Left Performance Suspension	
F	06-10	DODGE CHARGER RWD Left Police	
F	05-08	MAGNUM RWD Left Performance Suspension	
G51948 N			
F	05-10	CHRYSLER 300 RWD Right Performance Suspension	
F	06-10	DODGE CHARGER RWD Right Police	
F	05-08	MAGNUM RWD Right Performance Suspension	
G51949 N			
F	14	CHEVROLET PICKUP 1/2 TON, SILVERADO 1500 All	
F	14	GMC SIERRA 1500 All	
G51953 N			
F	06-09	NISSAN 350Z All Left	
G51954 N			
F	06-09	NISSAN 350Z All Right	
G51955 N			
R	06-09	NISSAN 350Z All	
G51960 N			
F	15	CHEVROLET TAHOE All	
F	15	GMC YUKON All	
F	15	YUKON XL All	
G51968 N			
R	05-08	AUDI A6 QUATTRO All Exc. Air and Sport Suspension	
G51993 N			
R	09-11	VOLKSWAGEN TIGUAN All	
Ultra Struts			
G52000 W			
F	02-07	NISSAN X-TRAIL All Left	
G52001 W			
F	02-07	NISSAN X-TRAIL All Right	
G52002 W			
R	02-07	NISSAN X-TRAIL All Left	
G52003 W			
R	02-07	NISSAN X-TRAIL All Right	
G52004 C			
F	06-12	TOYOTA RAV4 All Left	
G52005 A			
F	08-12	MAZDA 3 GS Left	
F	08-12	3 GT Left	
F	08-12	3 GX Left	
F	07-12	3 i Left	
F	07-12	3 S Left	
F	12	3 GS-SKY Left	
F	11	3 Sport GS Left	
F	11	3 Sport GT Left	
F	11	3 Sport GX Left	
F	04-06	3 All Left	

Numerical listing

Shock	POP	Alternative No.	MTG Acc. Supplied
Pos.	Year	Application	
G52005 A -continued			
F	06-10	5 All Left	
G52006 A			
F	08-12	MAZDA 3 GS Right	
F	08-12	3 GT Right	
F	08-12	3 GX Right	
F	07-12	3 i Right	
F	07-12	3 S Right	
F	12	3 GS-SKY Right	
F	11	3 Sport GS Right	
F	11	3 Sport GT Right	
F	11	3 Sport GX Right	
F	04-06	3 All Right	
F	06-10	5 All Right	
G52007 C			
F	06-12	TOYOTA RAV4 All Right	
G52008 A			
F	03-07	NISSAN MURANO All Left	
G52009 A			
F	03-07	NISSAN MURANO All Right	
G52013 B			
F	03-08	PONTIAC VIBE All Left	
F	03-08	TOYOTA MATRIX All Left	
G52014 B			
F	03-08	PONTIAC VIBE All Right	
F	03-08	TOYOTA MATRIX All Right	
G52015 W			
F	04-05	KIA RIO All Left	
G52016 W			
F	04-05	KIA RIO All Right	
G52017 W			
R	02-03	KIA SPECTRA All Left	
G52018 W			
R	02-03	KIA SPECTRA All Right	
G52019 W			
F	02-03	SUZUKI AERIO All Left	
G52020 W			
F	02-03	SUZUKI AERIO All Right	
G52021 W			
R	02-07	SUZUKI AERIO All Left	
G52022 W			
R	02-07	SUZUKI AERIO All Right	
G52023 W			
F	05-09	SUBARU LEGACY All Left	
G52024 W			
F	05-09	SUBARU LEGACY All Right	
G52025 B			
F	05-07	BUICK TERRAZA All Exc. Air-Leveling Suspension	
F	05-09	CHEVROLET UPLANDER All Exc. Air-Leveling Suspension	
F	05-09	PONTIAC MONTANA SV6 Exc. Self-Leveling Suspension	
F	05-07	SATURN RELAY All Exc. Air-Leveling Suspension	
G52026 B			
F	02-07	SATURN VUE All Left	
G52027 B			
F	02-07	SATURN VUE All Right	
G52028 A			
F	04-12	CHEVROLET MALIBU All Left	
F	05-10	PONTIAC G6 All Left	
F	07-09	SATURN AURA All Left	
G52029 A			
F	04-12	CHEVROLET MALIBU All Right	
F	05-10	PONTIAC G6 All Right	
F	07-09	SATURN AURA All Right	
G52030 C			
F	05-07	HONDA ODYSSEY All Left	
G52031 C			
F	05-07	HONDA ODYSSEY All Right	
G52032 B			
F	04-09	NISSAN QUEST All Left	

Numerical listing

Shock	POP	Alternative No.	MTG Acc. Supplied
Pos.	Year	Application	
G52033	B		
F	04-09	NISSAN QUEST All Right	
G52034	C		
F	02-05	KIA SEDONA All Left	
G52035	C		
F	02-05	KIA SEDONA All Right	
G52036	W		
F	03-06	KIA SORENTO All Left	
G52037	W		
F	03-06	KIA SORENTO All Right	
G52038	B		
F	10-11	HONDA CIVIC EX-L Left	
F	10-11	CIVIC LX-S Left	
F	08-11	CIVIC DX-G Left	
F	06-11	CIVIC DX Left	
F	06-11	CIVIC EX Left	
F	06-11	CIVIC Hybrid Left	
F	06-11	CIVIC LX Left	
F	11	CIVIC Base Left	
F	09-10	CIVIC Sport Left	
F	08	CIVIC EX-L Left	
F	06-07	CIVIC EXS Left	
F	06-07	CIVIC LXS Left	
G52039	B		
F	10-11	HONDA CIVIC EX-L Right	
F	10-11	CIVIC Hybrid-L Right	
F	10-11	CIVIC LX-S Right	
F	08-11	CIVIC DX-G Right	
F	06-11	CIVIC DX Right	
F	06-11	CIVIC EX Right	
F	06-11	CIVIC Hybrid Right	
F	06-11	CIVIC LX Right	
F	11	CIVIC Base Right	
F	09-10	CIVIC Sport Right	
F	08	CIVIC EX-L Right	
F	06-07	CIVIC EXS Right	
F	06-07	CIVIC LXS Right	
G52055	W		
F	02-06	NISSAN SENTRA SE-R Left	
F	02-06	SENTRA SE-R Spec V Left	
G52056	W		
F	02-06	NISSAN SENTRA SE-R Right	
F	02-06	SENTRA SE-R Spec V Right	
G52057	W		
F	96-04	ACURA RL All Left	
G52058	W		
F	96-04	ACURA RL All Right	
G52061	W		
F	03-08	INFINITI FX35 All Left	
F	03-08	FX45 All Left	
G52062	W		
F	03-08	INFINITI FX35 All Right	
F	03-08	FX45 All Right	
G52063	W		
F	00-01	KIA SPECTRA All Left	
G52064	W		
F	00-01	KIA SPECTRA All Right	
G52065	D		
F	03-06	MITSUBISHI OUTLANDER All	
G52066	W		
F	02-06	SAAB 9-5 All	
G52067	W		
F	04-05	SUBARU FORESTER All Left	
G52068	W		
F	04-05	SUBARU FORESTER All Right	
G52069	W		
F	03	SUBARU FORESTER All Left	
G52070	W		
F	03	SUBARU FORESTER All Right	
G52071	S		G52073
R	02-03	SUBARU IMPREZA TS, Wagon Left	
G52072	S		G52074
R	02-03	SUBARU IMPREZA TS, Wagon Right	

Ultra Struts

Shock	POP	Alternative No.	MTG Acc. Supplied
Pos.	Year	Application	
G52073	W		
R	02-03	SUBARU IMPREZA RS, Sedan Left	
R	02-03	IMPREZA TS Left	
G52074	W		
R	02-03	SUBARU IMPREZA RS, Sedan Right	
R	02-03	IMPREZA TS Right	
G52075	W		
F	04-07	SUZUKI AERIO All Left	
G52076	W		
F	04-07	SUZUKI AERIO All Right	
G52077	W		
F	01-03	TOYOTA PRIUS All Left	
G52078	W		
F	01-03	TOYOTA PRIUS All Right	
G52079	W		
F	01-04	VOLVO S40 All Left	
F	00	S40 All Left Mfg. from 04/00	
F	01-04	V40 All Left	
F	00	V40 All Left Mfg. from 04/00	
G52080	W		
F	01-04	VOLVO S40 All Right	
F	00	S40 All Right Mfg. from 04/00	
F	01-04	V40 All Right	
F	00	V40 All Right Mfg. from 04/00	
G52081	A		
F	07-11	DODGE CALIBER All Left	
F	07-10	JEEP COMPASS All Left	
F	07-10	PATRIOT All Left	
G52082	A		
F	07-11	DODGE CALIBER All Right	
F	07-10	JEEP COMPASS All Right	
F	07-10	PATRIOT All Right	
G52083	W		
F	04-07	SUBARU IMPREZA Wagon Left	
G52084	W		
F	04-07	SUBARU IMPREZA Wagon Right	
G52085	W		
R	04-07	SUBARU IMPREZA Wagon, AWD Left	
G52086	W		
R	04-07	SUBARU IMPREZA Wagon, AWD Right	
G52087	W		
F	04-07	SUBARU IMPREZA Sedan Left	
G52088	W		
F	04-07	SUBARU IMPREZA Sedan Right	
G52089	W		
R	04	SUBARU IMPREZA Sedan, AWD Left	
G52090	W		
R	04	SUBARU IMPREZA Sedan, AWD Right	
G52094	A		
F	07-12	NISSAN SENTRA Base Left	
F	07-12	SENTRA S Left	
F	07-12	SENTRA SL Left	
G52095	A		
F	07-12	NISSAN SENTRA Base Right	
F	07-12	SENTRA S Right	
F	07-12	SENTRA SL Right	
G52096	D		
F	05-10	SCION TC All Left	
G52097	D		
F	05-10	SCION TC All Right	
G52098	D		
F	04-06	SCION XA All	
F	04-06	XB All	
G52103	A		
R	07-12	LEXUS ES350 All Left	
R	06-11	TOYOTA AVALON All Left Mfg. from 01/06	
R	07-11	CAMRY All Left	

Numerical listing

Shock	POP	Alternative No.	MTG Acc. Supplied
Pos.	Year	Application	
G52104	A		
R	07-12	LEXUS ES350 All Right	
R	06-11	TOYOTA AVALON All Right Mfg. from 01/06	
R	07-11	CAMRY All Right	
G52105	W		
F	06-10	TOYOTA SIENNA AWD Left	
F	06-10	SIENNA FWD Left 8 Passenger	
F	05	SIENNA AWD Left Mfg. from 7/05	
F	05	SIENNA FWD Left Mfg. from 7/05; 8 Passenger	
G52106	W		
F	06-10	TOYOTA SIENNA AWD Right	
F	06-10	SIENNA FWD Right 8 Passenger	
F	05	SIENNA AWD Right Mfg. from 7/05	
F	05	SIENNA FWD Right Mfg. from 7/05; 8 Passenger	
G52107	W		
F	05-10	TOYOTA SIENNA FWD Left Mfg. from 7/05; 7 Passenger	
G52108	W		
F	05-10	TOYOTA SIENNA FWD Right Mfg. from 7/05; 7 Passenger	
G52110	D		
F	05-07	FORD FREESTYLE All Left	
G52111	D		
F	05-07	FORD FREESTYLE All Right	
G52112	D		
F	04-06	HONDA ELEMENT LX Left	
F	03-06	ELEMENT EX Left	
F	03-04	ELEMENT DX Left	
G52113	D		
F	05-06	HONDA ELEMENT EX Right	
F	04-06	ELEMENT LX Right	
F	03-04	ELEMENT DX Right	
G52116	C		
F	06-11	BUICK LUCERNE All Exc. Magnetic Ride Control Suspension	
F	06-11	CADILLAC DTS All Exc. Magnetic Ride Control Suspension	
G52117	C		
F	11-13	CHRYSLER 200 All Left Standard Suspension	
F	08-10	SEBRING All Left	
F	08-13	DODGE AVENGER All Left	
G52118	C		
F	11-13	CHRYSLER 200 All Right Standard Suspension	
F	08-10	SEBRING All Right	
F	08-13	DODGE AVENGER All Right	
G52121	A		
F	07-12	NISSAN ALTIMA All Left	
G52122	A		
F	07-12	NISSAN ALTIMA All Right	
G52123	N		
F	04-06	PONTIAC GTO All Left	
G52124	N		
F	04-06	PONTIAC GTO All Right	
G52125	A		
F	08-11	BUICK ENCLAVE All	
F	09-12	CHEVROLET TRAVERSE All	
F	07-12	GMC ACADIA All	
F	07-10	SATURN OUTLOOK All	
G52127	C		
F	07-12	CHEVROLET EQUINOX All Left Exc. Sport Suspension	
F	10-12	GMC TERRAIN All Left	
F	07-09	PONTIAC TORRENT All Left Exc. Sport Suspension	
F	08-10	SATURN VUE All Left	
F	07-09	SUZUKI XL-7 All Left	
G52128	C		
F	07-12	CHEVROLET EQUINOX All Right Exc. Sport Suspension	
F	10-12	GMC TERRAIN All Right	
F	07-09	PONTIAC TORRENT All Right Exc. Sport Suspension	
F	08-10	SATURN VUE All Right	
F	07-09	SUZUKI XL-7 All Right	

Numerical listing

Shock	POP	Alternative No.	MTG Acc. Supplied
Pos.	Year	Application	
G52129	W		
F	08-09	FORD TAURUS FWD Left	
G52130	W		
F	08-09	FORD TAURUS FWD Right	
G52131	B		
F	08-12	CHRYSLER TOWN & COUNTRY All Exc. Self-Leveling Suspension	
F	08-12	DODGE CARAVAN / GRAND CARAVAN All Exc. Self-Leveling Suspension	
F	09-11	VOLKSWAGEN ROUTAN All Exc. Self-Leveling Suspension	
G52136	W		
F	05-07	FORD FIVE HUNDRED AWD Left	
G52137	W		
F	05-07	FORD FIVE HUNDRED AWD Right	
G52138	C		
F	05-07	FORD FIVE HUNDRED FWD Left	
F	05-07	MERCURY MONTEGO FWD Left	
G52139	C		
F	05-07	FORD FIVE HUNDRED FWD Right	
F	05-07	MERCURY MONTEGO FWD Right	
G52140	W		
F	03-06	ACURA MDX All Left	
G52141	W		
F	03-06	ACURA MDX All Right	
G52142	W		
F	08-11	BMW 128i All Left	
F	08-11	135i All Left	
F	06	325i All Left	
F	07-13	328i All Left	
F	06	330i All Left	
F	07-13	335i All Left	
G52143	W		
F	08-11	BMW 128i All Right	
F	08-11	135i All Right	
F	06	325i All Right	
F	07-13	328i All Right	
F	06	330i All Right	
F	07-13	335i All Right	
G52144	W		
F	00-06	BMW X5 Coil (FrontSpringType) Left	
G52145	W		
F	00-06	BMW X5 Coil (FrontSpringType) Right	
G52148	D		
F	09-13	DODGE JOURNEY All Left	
G52149	W		
F	09-13	DODGE JOURNEY All Right	
G52150	D		
F	06-11	HONDA RIDGELINE All Left	
G52151	D		
F	06-11	HONDA RIDGELINE All Right	
G52152	W		
F	10-12	HONDA CITY All Left	
F	09-12	FIT All Left	
G52153	W		
F	10-12	HONDA CITY All Right	
F	09-12	FIT All Right	
G52154	D		
F	06-11	DODGE ATTITUDE All Left	
F	06-11	HYUNDAI ACCENT All Left	
F	06-11	KIA RIO All Left	
F	06-11	RIO All Left	
G52155	D		
F	06-11	DODGE ATTITUDE All Right	
F	06-11	HYUNDAI ACCENT All Right	
F	06-11	KIA RIO All Right	
F	06-11	RIO All Right	
G52156	D		
F	07-10	HYUNDAI ELANTRA All Left	
G52157	D		
F	07-10	HYUNDAI ELANTRA All Right	

Ultra Struts

Shock	POP	Alternative No.	MTG Acc. Supplied
Pos.	Year	Application	
G52158	D		
F	07-09	HYUNDAI SANTA FE All Left	
G52159	D		
F	07-09	HYUNDAI SANTA FE All Right	
G52160	D		
F	04-09	KIA SPECTRA All Left	
G52161	D		
F	04-09	KIA SPECTRA All Right	
G52162	W		
R	04-09	KIA SPECTRA All Left	
G52163	W		
R	04-09	KIA SPECTRA All Right	
G52164	W		
F	02-06	MINI COOPER All Left	
G52165	W		
F	02-06	MINI COOPER All Right	
G52166	W		
F	06-10	MITSUBISHI ECLIPSE All Left	
G52167	W		
F	06-10	MITSUBISHI ECLIPSE All Right	
G52168	W		
F	10-11	MITSUBISHI GALANT SE Left	
F	04-11	GALANT ES Left	
F	04-08	GALANT DE Left	
F	05-07	GALANT SE Left	
G52169	W		
F	10-11	MITSUBISHI GALANT SE Right	
F	04-11	GALANT ES Right	
F	04-08	GALANT DE Right	
F	05-07	GALANT SE Right	
G52170	W		
F	13	NISSAN MURANO All Left	
F	12	MURANO All Left Mfg. to 12/12	
F	08-11	MURANO All Left	
G52171	W		
F	13	NISSAN MURANO All Right	
F	12	MURANO All Right Mfg. to 12/12	
F	08-11	MURANO All Right	
G52172	W		
F	12	MERCEDES-BENZ C250 Sedan, CGI (FuelDelSubType)	
F	10-11	C250 All	
F	08-09	C280 All	
F	08-11	C300 All	
F	12	C350 CGI (FuelDelSubType)	
F	08-11	C350 All	
G52173	W		
F	08-12	NISSAN ROGUE All Left With OE# E4303JM00A	
F	10-12	X-TRAIL All Left	
F	08	X-TRAIL All Left	
G52174	W		
F	08-12	NISSAN ROGUE All Right With OE# E4302JM00A	
F	10-12	X-TRAIL All Right	
F	08	X-TRAIL All Right	
G52175	FF		
F	03-08	SAAB 9-3 All Left	
G52176	FF		
F	03-08	SAAB 9-3 All Right	
G52178	W		
R	03-05	SUBARU FORESTER All Left	
G52179	W		
R	03-05	SUBARU FORESTER All Right	
G52180	W		
F	06-08	SUBARU FORESTER All Left	
G52181	W		
F	06-08	SUBARU FORESTER All Right	
G52182	W		
R	06-08	SUBARU FORESTER All Left	
G52183	W		
R	06-08	SUBARU FORESTER All Right	
G52184	W		
F	06-12	SUZUKI GRAND VITARA All Left	

Numerical listing

Shock	POP	Alternative No.	MTG Acc. Supplied
Pos.	Year	Application	
G52185	W		
F	06-12	SUZUKI GRAND VITARA All Right	
G52187	W		
F	07-12	ACURA RDX All Left	
F	07-12	HONDA CR-V All Left	
G52188	W		
F	07-12	ACURA RDX All Right	
F	07-12	HONDA CR-V All Right	
G52193	D		
F	09-14	NISSAN CUBE All Left	
F	12	VERSA All Left Models S and SL	
F	07-11	VERSA S Left	
F	07-11	VERSA SL Left	
G52194	D		
F	09-14	NISSAN CUBE All Right	
F	12	VERSA All Right	
F	07-11	VERSA S Right	
F	07-11	VERSA SL Right	
G52199	W		
F	04-10	BMW X3 All Left	
G52200	W		
F	04-10	BMW X3 All Right	
G52201	W		
F	08-13	TOYOTA HIGHLANDER All Left	
G52202	W		
F	08-13	TOYOTA HIGHLANDER All Right	
G52203	W		
R	08-13	TOYOTA HIGHLANDER FWD Left	
G52204	W		
R	08-13	TOYOTA HIGHLANDER FWD Right	
G52205	W		
F	07-10	FORD EXPLORER SPORT TRAC All	
G52206	W		
R	07-10	FORD EXPLORER SPORT TRAC All	
G52209	W		
F	07-10	MAZDA CX-7 All Left	
G52210	W		
F	07-10	MAZDA CX-7 All Right	
G52227	W		
F	97-03	MITSUBISHI DIAMANTE All Left	
G52228	W		
F	97-03	MITSUBISHI DIAMANTE All Right	
G52237	N		
F	00	BMW 323i Wagon Left Exc. Sport Suspension	
F	01-06	325Ci All Left Exc. Sport Suspension	
F	01-05	325i Sedan Left Exc. Sport Suspension	
F	00	328Ci Coupe Left Exc. Sport Suspension	
F	01-06	330Ci All Left Exc. Sport Suspension	
G52238	N		
F	00	BMW 323Ci Coupe Right Exc. Sport Suspension	
F	00	323i Sedan Right Exc. Sport Suspension	
F	01-06	325Ci All Right Exc. Sport Suspension	
F	01-05	325i Sedan Right Exc. Sport Suspension	
F	00	328Ci Coupe Right Exc. Sport Suspension	
F	01-06	330Ci All Right Exc. Sport Suspension	
G52244	W		
R	05-09	BUICK ALLURE All Models with 17" or 18" Wheels	
R	05-09	LACROSSE All Models with 17" or 18" Wheels	
R	04-11	CHEVROLET IMPALA All Models with 17" or 18" Wheels	
R	05-07	MONTE CARLO All Models with 17" or 18" Wheels	
R	04-08	PONTIAC GRAND PRIX All Models with 17" or 18" Wheels	

Numerical listing

Shock	POP	Alternative No.	MTG Acc. Supplied
Pos.	Year	Application	
G52245	C		
F	09-10	PONTIAC VIBE	All Left
F	09-13	TOYOTA COROLLA	All Left
F	09-13	MATRIX	All Left
G52246	W		
F	09-10	PONTIAC VIBE	All Right
F	09-13	TOYOTA COROLLA	All Right
F	09-13	MATRIX	All Right
G52247	W		
F	07-10	KIA MAGENTIS	All Left
F	07-10	OPTIMA	All Left
F	07-11	RONDO	All Left
G52248	W		
F	07-10	KIA MAGENTIS	All Right
F	07-10	OPTIMA	All Right
F	07-11	RONDO	All Right
G52249	W		
F	07-13	ACURA MDX	All Left Exc. Active Suspension
G52250	W		
F	07-13	ACURA MDX	All Right Exc. Active Suspension
G52253	N		
F	08-10	HONDA ODYSSEY	All Left
G52254	N		
F	08-10	HONDA ODYSSEY	All Right
G52255	N		
F	11-13	FORD FIESTA	All Left
F	11	MAZDA 2	All Left
G52256	N		
F	11-12	FORD FIESTA	All Right
F	11	MAZDA 2	All Right
G52257	N		
F	07-08	HYUNDAI ENTOURAGE	All Left
F	06-11	KIA SEDONA	All Left
G52258	N		
F	07-08	HYUNDAI ENTOURAGE	All Right
F	06-11	KIA SEDONA	All Right
G52260	N		
F	07-13	MAZDA CX-9	All Left
G52261	N		
F	07-13	MAZDA CX-9	All Right
G52262	N		
F	08-10	MINISUBISHI LANCER	DE Left
F	08-10	LANCER	ES Left
G52263	N		
F	08-10	MINISUBISHI LANCER	DE Right
F	08-10	LANCER	ES Right
G52264	N		
F	08-12	SCION XB	All Left
G52265	N		
F	08-12	SCION XB	All Right
G52268	N		
F	08-14	SCION XD	All Left
G52269	N		
F	08-14	SCION XD	All Right
G52270	N		
F	06-07	SUBARU B9 TRIBECA	All Left
F	08-14	TRIBECA	All Left
G52271	N		
F	06-07	SUBARU B9 TRIBECA	All Right
F	08-14	TRIBECA	All Right
G52272	N		
F	05-12	SUBARU OUTBACK	All Left
G52273	N		
F	05-12	SUBARU OUTBACK	All Right
G52274	N		
F	07-13	VOLVO C30	All Left
F	08-13	C70	All Left
F	04-12	S40	All Left
F	05-11	V50	All Left
G52275	N		
F	07-13	VOLVO C30	All Right
F	08-13	C70	All Right

Ultra Struts

Shock	POP	Alternative No.	MTG Acc. Supplied
Pos.	Year	Application	
G52275	N	-continued	
F	04-12	S40	All Right
F	05-11	V50	All Right
G52276	N		
F	02-08	JAGUAR X-TYPE	All Exc. CATS Computer Active Technology Suspension
G52278	N		
F	10	BUICK ALLURE	FWD Left Exc. Electronic Suspension
F	10-13	LACROSSE	FWD Left Exc. Electronic Suspension
G52279	N		
F	10	BUICK ALLURE	FWD Right Exc. Electronic Suspension
F	10-13	LACROSSE	FWD Right Exc. Electronic Suspension
G52280	N		
F	10-13	CHEVROLET CAMARO	3.6L 6Cyl V (217) Left
G52281	N		
F	10-13	CHEVROLET CAMARO	3.6L 6Cyl V (217) Right
G52282	N		
F	07-08	HONDA FIT	All Left
G52283	N		
F	07-08	HONDA FIT	All Right
G52297	N		
F	07-12	MINI COOPER	All Left
G52298	N		
F	07-12	MINI COOPER	All Right
G52314	N		
F	04-08	BMW 525i	All
F	04-08	530i	All
G52333	N		
R	00-05	HYUNDAI ACCENT	All Left Gas Charged Unit
R	97-99	ACCENT	All Left
G52334	N		
R	00-05	HYUNDAI ACCENT	All Right Gas Charged Unit
R	97-99	ACCENT	All Right
G52335	N		
R	96-00	HYUNDAI ELANTRA	All Left Gas Charged Unit
G52336	N		
R	96-00	HYUNDAI ELANTRA	All Right Gas Charged Unit
G52346	FF		
F	05-06	ACURA RSX	All Left
G52347	N		
F	05-06	ACURA RSX	All Right
G55505	W		
F	84	BUICK CENTURY	All Exc. HD Suspension
F	82-83	CENTURY	All
F	84	SKYLARK	All Exc. HD Suspension
F	80-83	SKYLARK	All
F	84	CHEVROLET CELEBRITY	All Exc. HD Suspension
F	82-83	CELEBRITY	All
F	84-85	CITATION / CITATION II	All Exc. HD Suspension
F	80-83	CITATION / CITATION II	All
F	84	OLDSMOBILE CIERA / CUTLASS	CIERA All Exc. HD Suspension
F	82-83	CIERA / CUTLASS	CIERA All
F	84	OMEGA	All Exc. HD Suspension
F	80-83	OMEGA	All
F	84	PONTIAC 6000	All Exc. HD Suspension
F	82-83	6000	All
F	84	PHOENIX	All Exc. HD Suspension
F	80-83	PHOENIX	All
G55507	W		
F	83	CHRYSLER E CLASS	All
F	83	EXECUTIVE SEDAN	All
F	81-83	LEBARON	All
F	83	NEW YORKER	All
F	82-83	DODGE 400	All

Numerical listing

Shock	POP	Alternative No.	MTG Acc. Supplied
Pos.	Year	Application	
G55507	W	-continued	
F	83	600	All
F	81-83	ARIES	All
F	83-87	CHARGER	All
F	78-89	OMNI	All
F	82-84	RAMPAGE	All
F	83	PLYMOUTH CARAVELLE	All
F	87-89	EXPO	All
F	78-89	HORIZON	All
F	81-83	RELIANT	All
F	85	TURISMO	All
F	83	TURISMO	All
G55509	W		
F	86	DODGE CARAVAN / GRAND	CARAVAN All Mfg. to 2/86
F	84-85	CARAVAN / GRAND CARAVAN	All
F	86	PLYMOUTH VOYAGER / GRAND	VOYAGER All Mfg. to 2/86
F	84-85	VOYAGER / GRAND VOYAGER	All
G55510	W		
F	82-87	LINCOLN CONTINENTAL	All
F	84-92	MARK VII	All
G55511	W		
F	84-85	CHRYSLER DAYTONA	CAN
F	84	E CLASS	All
F	85	EXECUTIVE LIMOUSINE	All
F	84	EXECUTIVE SEDAN	All
F	84-85	LASER	All
F	84-85	LEBARON	All
F	84-85	NEW YORKER	All
F	84-85	DODGE 600	All
F	84-85	ARIES	All
F	84-85	DAYTONA	All
F	85	LANCER	All
F	84-85	PLYMOUTH CARAVELLE	All
F	84-85	RELIANT	All
G55512	W		
R	84-87	PONTIAC FIERO	All
G55514	D		
F	85-96	BUICK CENTURY	All
F	84	CENTURY	All HD Suspension
F	85	SKYLARK	All
F	84	SKYLARK	All HD Suspension
F	85-90	CHEVROLET CELEBRITY	All
F	84	CELEBRITY	All HD Suspension
F	84-85	CITATION / CITATION II	All HD Suspension
F	85-96	OLDSMOBILE CIERA / CUTLASS	CIERA All Exc. Electronic Adjustable Suspension
F	84	CIERA / CUTLASS	CIERA All HD Suspension
F	87-94	CUTLASS CLASSIC / CUTLASS	CRUISER All Exc. Electronic Adjustable Suspension
F	84	OMEGA	All HD Suspension
F	91	PONTIAC 6000	FWD HD Suspension
F	84-90	6000	All HD Suspension
F	84	PHOENIX	All HD Suspension
G55515	W		
F	82-85	HONDA ACCORD	All
G55516	W		
R	82-85	HONDA ACCORD	All
R	83-87	PRELUDE	All Sealed Rear Struts
G55518	D		
R	86-93	FORD TAURUS	Sedan
R	86-93	MERCURY SABLE	Sedan
G55521	W		
F	86-88	NISSAN MAXIMA	Sedan Exc. Electronic Adjustable Suspension
F	87-89	STANZA	Sedan
G55525	B		
F	90-95	CHRYSLER TOWN & COUNTRY	All
F	87-95	DODGE CARAVAN / GRAND	CARAVAN All
F	86	CARAVAN / GRAND CARAVAN	All Mfg. from 1/86
F	87-95	PLYMOUTH VOYAGER / GRAND	VOYAGER All
F	86	VOYAGER / GRAND VOYAGER	All Mfg. from 1/86
G55526	C		
F	86-93	CHRYSLER DAYTONA	CAN

Numerical listing

Shock	POP	Alternative No.	MTG Acc. Supplied
Pos.	Year	Application	
G55526 C -continued			
F	88-93	DYNASTY CAN Exc. Hydraulic Self Leveling System	
F	90-93	IMPERIAL All Exc. Hydraulic Self Leveling System	
F	86	LASER All	
F	86-95	LEBARON All	
F	86-93	NEW YORKER All	
F	86-88	TOWN & COUNTRY All	
F	86-88	DODGE 600 All	
F	86-89	ARIES All	
F	89-93	DAYTONA ES	
F	87-88	DAYTONA Pacifica	
F	86	DAYTONA All	
F	88-93	DYNASTY All Exc. Hydraulic Self Leveling System	
F	86-89	LANCER All	
F	87-94	SHADOW All	
F	89-95	SPIRIT All	
F	89-95	PLYMOUTH ACCLAIM All	
F	86-88	CARAVELLE All	
F	86-89	RELIANT All	
F	87-94	SUNDANCE All	
G55527 D			
F	84-89	MERCEDES-BENZ 190D All	
F	84-93	190E All	
F	87-89	260E All Exc. 4 Matic 4x4	
F	90-93	300D All Exc. 4 Matic 4x4	
F	87	300D All Exc. 4 Matic 4x4	
F	86-93	300E All Exc. 4 Matic 4x4	
F	92-93	400E / 400SE / 400SEL / 420SEL / 450SE / 450SEL All	
F	95	E300 All	
F	94-95	E320 All	
F	94-95	E420 All	
F	94	E500 All	
G55529 W			
R	86-87	TOYOTA CELICA All	
G55531 W			
F	84-91	DODGE COLT Vista, Wagon, FWD	
F	89-91	EAGLE VISTA Wagon, FWD, CAN	
F	83-88	MITSUBISHI CORDIA All	
F	85-88	GALANT All Exc. Electronic Adjustable Suspension	
F	89-90	SIGMA Non-ABS Exc. Auto-Leveling System	
F	83-88	TREDIA All	
F	91	PLYMOUTH COLT Vista, Wagon, FWD	
F	84-88	COLT Vista, Wagon, FWD	
G55533 W			
R	86-88	ACURA LEGEND Sedan	
G55534 W			
F	85	NISSAN MAXIMA All Exc. Electronic Adjustable Suspension	
G55539 W			
F	86-88	NISSAN MULTI CAN	
F	86-88	STANZA Wagon, FWD	
G55542 W			
F	86-91	MAZDA RX7 All Exc. Electronic Adjustable Suspension	
G55544 W			
R	86-89	MAZDA 323 FWD Exc. Electronic Adjustable Suspension	
R	81-85	GLC Hatchback	
R	81-85	GLC Sedan	
R	87-89	MERCURY TRACER FWD	
G55546 W			
F	86-91	DODGE COLT Vista, Wagon, 4WD	
F	89-91	EAGLE VISTA Wagon, 4WD, CAN	
F	85-91	PLYMOUTH COLT Vista, 4WD	
G55551 A			
F	84-93	FORD MUSTANG / MUSTANG II GT, 5.0L 8Cyl V (302)	
G55557 A			
R	89-92	GEO PRIZM All	
R	88-92	TOYOTA COROLLA FWD	
G55561 W			
F	87-88	DODGE COLT Hatchback	
F	87-88	COLT Sedan	
F	89-92	EAGLE VISTA Sedan, CAN	
F	90-91	VISTA Hatchback, CAN	
F	89	VISTA Hatchback	
F	87-88	MITSUBISHI MIRAGE All	
F	88-90	PLYMOUTH COLT DL, Wagon	

Ultra Struts

Shock	POP	Alternative No.	MTG Acc. Supplied
Pos.	Year	Application	
G55561 W -continued			
F	87	COLT Hatchback	
F	87	COLT Sedan	
G55579 C			
F	89-97	FORD THUNDERBIRD All Exc. Electronic Adjustable Suspension	
F	89-97	MERCURY COUGAR All Exc. Electronic Adjustable Suspension	
G55580 W			
R	88-89	TOYOTA CELICA All	
G55584 W			
F	88-98	SAAB 9000 All Exc. Hydraulic Self Leveling System	
G55586 D			
F	90-94	HYUNDAI EXCEL All	
F	91-95	SCOUPE All	
F	90-94	MITSUBISHI PRECIS All	
G55587 W			
F	90	EAGLE TALON AWD	
F	90	TALON FWD	
F	90	MITSUBISHI ECLIPSE All	
F	90-94	PLYMOUTH LASER FWD	
G55588 W			
R	87-91	TOYOTA CAMRY Wagon	
G55589 B			
R	90-91	LEXUS ES250 All	
R	88-91	TOYOTA CAMRY Sedan, FWD	
R	87	CAMRY Sedan	
G55590 B			
F	90-91	LEXUS ES250 All	
F	87-91	TOYOTA CAMRY All	
G55591 A			
F	89-92	GEO PRIZM All	
F	88-92	TOYOTA COROLLA FWD	
G55592 W			
F	89-92	DODGE COLT Hatchback	
F	91-92	EAGLE SUMMIT Sedan	
F	89-90	SUMMIT All	
F	92-95	HYUNDAI ELANTRA Non-ABS	
F	89-92	MITSUBISHI MIRAGE All	
F	89-91	PLYMOUTH COLT Hatchback	
G55593 W			
R	88	PONTIAC FIERO All	
G55594 W			
F	90	DODGE OMNI All	
F	90	PLYMOUTH HORIZON All	
G55600 W			
F	89-92	FORD PROBE All	
F	88-92	MAZDA 626 All Exc. Electronic Adjustable Suspension or 4 Wheel Steer	
F	88-92	MX6 All Exc. Electronic Adjustable Suspension or 4 Wheel Steer	
G55601 W			
R	89-92	FORD PROBE All	
R	88-92	MAZDA 626 All Exc. Electronic Adjustable Suspension or 4 Wheel Steer	
R	88-92	MX6 All Exc. Electronic Adjustable Suspension or 4 Wheel Steer	
G55602 W			
F	91-93	MERCURY CAPRI All	
G55603 W			
R	91-93	MERCURY CAPRI All	
G55605 W			
F	91-93	EAGLE 2000 GTX CAN Exc. Auto-Leveling System	
F	92-96	SUMMIT Wagon	
F	91-94	TALON All	
F	91-94	MITSUBISHI ECLIPSE All	
F	90-92	GALANT AWD	
F	92-94	PLYMOUTH COLT Wagon	
F	92-94	LASER AWD	
G55606 W			
R	90-93	TOYOTA CELICA FWD	
G55607 D			
F	90-94	NISSAN AXXESS FWD Left	
F	89-94	MAXIMA All Left Exc. Electronic Adjustable Suspension	

Numerical listing

Shock	POP	Alternative No.	MTG Acc. Supplied
Pos.	Year	Application	
G55608 D			
F	90-94	NISSAN AXXESS FWD Right	
F	89-94	MAXIMA All Right Exc. Electronic Adjustable Suspension	
G55609 W			
F	89-93	MITSUBISHI GALANT FWD	
G55610 W			
F	90-92	NISSAN STANZA All Left	
G55611 W			
F	90-92	NISSAN STANZA All Right	
G55615 D			
F	94-97	FORD ASPIRE Non-ABS	
F	88-93	FESTIVA All	
G55616 D			
F	86-95	FORD TAURUS All	
F	86-95	MERCURY SABLE All	
G55652 D			
F	91-97	TOYOTA PREVIA All Left	
G55653 C			
F	91-97	TOYOTA PREVIA All Right	
G55657 C			
F	93-94	NISSAN SENTRA All Left B13 Independent Rear Suspension	
G55658 C			
F	93-94	NISSAN SENTRA All Right B13 Independent Rear Suspension	
G55661 A			
R	98-02	CHEVROLET PRIZM All Left	
R	93-97	GEO PRIZM All Left	
R	93-02	TOYOTA COROLLA All Left	
G55662 A			
R	98-02	CHEVROLET PRIZM All Right	
R	93-97	GEO PRIZM All Right	
R	93-02	TOYOTA COROLLA All Right	
G55663 B			
F	99-04	CHRYSLER 300M All Left	
F	93-04	CONCORDE All Left	
F	93-04	INTREPID CAN Left	
F	99-01	LHS All Left	
F	94-97	LHS All Left	
F	94-96	NEW YORKER All Left	
F	93-04	DODGE INTREPID All Left	
F	93-97	EAGLE VISION All Left	
G55664 B			
F	99-04	CHRYSLER 300M All Right	
F	93-04	CONCORDE All Right	
F	93-04	INTREPID CAN Right	
F	99-01	LHS All Right	
F	94-97	LHS All Right	
F	94-96	NEW YORKER All Right	
F	93-04	DODGE INTREPID All Right	
F	93-97	EAGLE VISION All Right	
G55665 W			
R	93-97	CHRYSLER CONCORDE All	
R	93-97	INTREPID CAN	
R	94-97	LHS All	
R	94-96	NEW YORKER All	
R	93-97	DODGE INTREPID All	
R	93-97	EAGLE VISION All	
G55666 B			
F	93-97	NISSAN ALTIMA All Right	
G55667 C			
F	93-97	NISSAN ALTIMA All Left	
G55668 C			
R	93-01	NISSAN ALTIMA All Right	
G55669 C			
R	93-01	NISSAN ALTIMA All Left	
G55670 D			
F	93-97	FORD PROBE All Right	
F	93-97	MAZDA 626 All Right	
F	93-97	MX6 All Right	
G55671 W			
F	93-97	FORD PROBE All Left	
F	93-97	MAZDA 626 All Left	
F	93-97	MX6 All Left	
G55672 D			
R	93-97	FORD PROBE All	

Numerical listing

Shock	POP	Alternative No.	MTG Acc. Supplied
Pos.	Year	Application	
G55672	D	-continued	
R	93-97	MAZDA	626 All
R	93-97	MX6 All	
G55673	W		
F	89-94	HYUNDAI	SONATA All
G55675	A		
R	97-02	LEXUS	ES300 All Left Exc. Electronic Adjustable Suspension
R	95-96	ES300 All Left	
R	92-94	ES300 All Left Sealed O.E. Struts	
R	95-03	TOYOTA	AVALON All Left
R	95-01	CAMRY All Left	
R	92-94	CAMRY All Left Sealed O.E. Struts	
R	99-03	SOLARA All Left	
G55676	A		
R	97-02	LEXUS	ES300 All Right Exc. Electronic Adjustable Suspension
R	95-96	ES300 All Right	
R	92-94	ES300 All Right Sealed O.E. Struts	
R	95-03	TOYOTA	AVALON All Right
R	95-01	CAMRY All Right	
R	92-94	CAMRY All Right Sealed O.E. Struts	
R	99-03	SOLARA All Right	
G55679	C		
F	95-99	DODGE	NEON All
F	95-99	PLYMOUTH NEON All	
G55680	A		
R	95-99	DODGE	NEON All
R	95-99	PLYMOUTH NEON All	
G55681	A		
F	03-04	FORD	MUSTANG / MUSTANG II Mach I
F	94-04	MUSTANG / MUSTANG II Base	
F	94-04	MUSTANG / MUSTANG II GT	
F	04	MUSTANG / MUSTANG II GT Base	
F	04	MUSTANG / MUSTANG II GT Equipado	
F	01	MUSTANG / MUSTANG II GT Bullitt	
F	95	MUSTANG / MUSTANG II GTS	
G55685	A		
F	95-03	FORD	WINDSTAR All
G55692	W		
F	95-97	FORD	CONTOUR All Mfg. to 3/97
F	95-97	MERCURY	MYSTIQUE All Mfg. to 3/97
G55693	A		
R	95-00	FORD	CONTOUR All
R	99-02	MERCURY	COUGAR All
R	95-00	MYSTIQUE All	
G55697	A		
F	96-00	CHRYSLER	TOWN & COUNTRY All
F	00	VOYAGER / GRAND VOYAGER All	
F	00	VOYAGER / GRAND VOYAGER Non-ABS	
F	96-00	DODGE	CARAVAN / GRAND CARAVAN All Exc. Hydraulic Self Leveling System
F	96-00	PLYMOUTH	VOYAGER / GRAND VOYAGER All
G55698	A		
F	95-05	CHEVROLET	CAVALIER All
F	95-05	PONTIAC SUNFIRE All	
G55704	W		
F	81-83	FORD	ESCORT All Mfg. to 2/83
F	82-83	EXP All Mfg. to 2/83	
F	82-83	MERCURY	LN7 All Mfg. to 2/83
F	81-83	LYNX All Mfg. to 2/83	
G55705	W		
R	81-90	FORD	ESCORT All
R	84-88	EXP All	
R	82-83	EXP All Mfg. to 2/83	
R	82-83	MERCURY	LN7 All
R	81-87	LYNX All	
G55706	W		
F	80-83	HONDA	CIVIC All
G55707	W		
R	81-83	HONDA	CIVIC Sedan
R	80-83	CIVIC Hatchback	
G55708	W		
F	84-85	FORD	TEMPO FWD Mfg. to 3/85

Ultra Struts

Shock	POP	Alternative No.	MTG Acc. Supplied
Pos.	Year	Application	
G55708	W	-continued	
F	84-85	MERCURY	TOPAZ FWD Mfg. to 3/85
G55710	W		
F	86-89	MAZDA	323 FWD Exc. Electronic Adjustable Suspension
F	84-85	GLC All	
F	81-83	GLC Sedan	
F	81-82	GLC Hatchback	
F	87-89	MERCURY	TRACER FWD
G55712	W		
F	83-85	FORD	ESCORT All Mfg. from 2/83 thru 3/85
F	83-85	EXP All Mfg. from 2/83 thru 3/85	
F	83	MERCURY	LN7 All Mfg. from 2/83
F	83-85	LYNX All Mfg. from 2/83 thru 3/85	
G55713	W		
F	86	NISSAN	PULSAR / PULSAR NX All Mfg. to 1/86
F	83-85	PULSAR / PULSAR NX All	
F	82-86	SENTRA All	
G55714	W		
F	85-90	FORD	ESCORT All Mfg. from 3/85
F	85-88	EXP All Mfg. from 3/85	
F	87-94	TEMPO All	
F	85-86	TEMPO FWD Mfg. from 3/85	
F	85-87	MERCURY LYNX All Mfg. from 3/85	
F	92-94	TOPAZ FWD Mfg. from 3/85	
F	87-91	TOPAZ All Mfg. from 3/85	
F	85-86	TOPAZ FWD Mfg. from 3/85	
G55715	D		
F	85-88	CHEVROLET	NOVA All
F	86-88	TOYOTA	COROLLA FWD Sealed Front Struts
F	84-85	COROLLA FWD, GAS Sealed Front Struts	
G55716	W		
F	85-86	DODGE	COLT Hatchback
F	85-86	COLT Sedan	
F	85-86	MITSUBISHI MIRAGE All	
F	85-86	PLYMOUTH COLT Hatchback, FWD	
F	85	COLT Sedan, FWD	
G55719	W		
F	85-88	CHEVROLET	SPECTRUM All
F	89	GEO SPECTRUM All	
F	85-89	ISUZU I-MARK All	
F	85-88	PONTIAC SUNBURST CAN	
G55722	W		
R	87-91	FORD	TEMPO AWD
R	87-91	MERCURY	TOPAZ AWD
G55723	W		
F	83-87	HONDA	PRELUDE All
G55724	W		
F	83-84	SUBARU	DL FWD
F	85-89	GL Hatchback, FWD	
F	83-84	GL FWD	
G55725	W		
F	84-87	HONDA	CIVIC Hatchback
F	84-87	CIVIC Sedan	
G55726	W		
F	82-87	SUBARU	BRAT All
F	82-84	DL 4WD	
F	85-89	GL Hatchback, 4WD	
F	82-84	GL 4WD	
G55727	W		
F	83-87	MAZDA	626 All Exc. Electronic Adjustable Suspension
G55728	W		
F	85-87	HONDA	CIVIC Wagon, 4WD
G55729	W		
R	83-87	MAZDA	626 All Exc. Electronic Adjustable Suspension
G55730	W		
F	86-88	ACURA	LEGEND Sedan
G55731	W		
F	86-89	ACURA	INTEGRA All
G55732	W		
F	84-87	HONDA	CIVIC Wagon, FWD

Numerical listing

Shock	POP	Alternative No.	MTG Acc. Supplied
Pos.	Year	Application	
G55733	W		
R	84-94	FORD	TEMPO FWD
R	84-94	MERCURY TOPAZ FWD	
G55737	W		
F	85-89	SUBARU	DL Sedan, FWD Right Exc. Air Suspension
F	85-89	GL Sedan, FWD Right Exc. Air Suspension	
F	90-93	LOYALE FWD Right Exc. Air Suspension	
G55738	W		
F	85-89	SUBARU	DL Sedan, FWD Left Exc. Air Suspension
F	85-89	GL Sedan, FWD Left Exc. Air Suspension	
F	90-93	LOYALE FWD Left Exc. Air Suspension	
G55742	D		
F	86-89	HONDA	ACCORD All
F	88-91	PRELUDE All	
G55743	D		
R	86-89	HONDA	ACCORD All
G55745	C		
F	91-93	NISSAN	NX All
F	87-90	PULSAR / PULSAR NX All	
F	86	PULSAR / PULSAR NX All Mfg. from 1/86	
F	91-92	SENTRA Non-ABS	
F	87-90	SENTRA FWD	
G55746	W		
R	87-90	NISSAN	PULSAR / PULSAR NX All
R	86	PULSAR / PULSAR NX All Mfg. from 1/86	
R	87-92	SENTRA FWD	
G55749	W		
F	85-88	CHEVROLET	SPRINT All
F	85-88	PONTIAC FIREFLY CAN	
F	85-88	SUZUKI FORSA CAN	
G55752	C		
R	85-88	CHEVROLET	NOVA All
R	86-87	TOYOTA COROLLA FWD	
R	84-85	COROLLA FWD, GAS	
R	87	TERCEL Wagon, FWD	
R	83-86	TERCEL All	
G55757	W		
R	88-91	HONDA	PRELUDE All
G55763	W		
F	88	HONDA	CIVIC Hatchback
F	88	CIVIC Sedan	
F	88	CRX All	
G55766	W		
R	88	HONDA	CIVIC Hatchback
R	88	CIVIC Sedan	
R	88	CRX All	
G55769	W		
R	89-90	ACURA	LEGEND All Auto Leveling System
R	87-88	LEGEND Coupe	
G55770	W		
F	89-90	ACURA	LEGEND All Auto Leveling System
F	87-88	LEGEND Coupe	
G55771	D		
R	89-91	HONDA	CIVIC Hatchback
R	89-91	CIVIC Sedan	
G55772	B		
R	98-01	CHEVROLET	METRO Non-ABS
R	89-91	SPRINT All	
R	89-97	GEO METRO Non-ABS	
R	95-99	PONTIAC FIREFLY Non-ABS, CAN	
R	94	FIREFLY CAN	
R	89-91	FIREFLY CAN	
R	89-01	SUZUKI SWIFT All	
G55773	D		
F	89-91	HONDA	CIVIC Hatchback
F	89-91	CIVIC Sedan	
G55774	B		
F	90-93	HONDA	ACCORD All

Numerical listing

Shock	POP	Alternative No.	MTG Acc. Supplied
Pos.	Year	Application	
G55776 W			
R	93	ASUNA SUNFIRE (CANADIAN VEHICLE) All Exc. Lotus Suspension	
R	90-93	GEO STORM Non-ABS	
R	90-92	ISUZU IMPULSE FWD	
R	91-93	STYLUS All	
G55780 W			
F	93	ASUNA SUNFIRE (CANADIAN VEHICLE) All	
F	90-93	GEO STORM Non-ABS	
F	90-92	ISUZU IMPULSE All	
F	91-93	STYLUS All	
G55781 W			
F	89-91	HONDA CIVIC Wagon	
G55782 W			
R	89-91	HONDA CIVIC Wagon	
G55784 W			
F	87-89	SUBARU DL Coupe, 4WD Right Exc. Air Suspension	
F	87-89	DL Wagon, 4WD Right Exc. Air Suspension	
F	87-89	GL Coupe, 4WD Right Exc. Air Suspension	
F	87-89	GL Wagon, 4WD Right Exc. Air Suspension	
F	90-93	LOYALE 4WD Right Exc. Air Suspension	
G55785 W			
F	87-89	SUBARU DL Coupe, 4WD Left Exc. Air Suspension	
F	87-89	DL Wagon, 4WD Left Exc. Air Suspension	
F	87-89	GL Coupe, 4WD Left Exc. Air Suspension	
F	87-89	GL Wagon, 4WD Left Exc. Air Suspension	
F	90-93	LOYALE 4WD Left Exc. Air Suspension	
G55786 A			
R	97-99	ACURA CL All	
R	90-97	HONDA ACCORD All	
G55787 D			
F	90-93	ACURA INTEGRA All	
F	89-91	HONDA CRX All	
G55788 D			
R	90-93	ACURA INTEGRA All	
G55795 W			
F	92-96	HONDA PRELUDE All	
G55796 W			
R	92-94	ACURA VIGOR All	
G55797 W			
F	92-94	ACURA VIGOR All	
G55800 B			
R	91-02	SATURN SC / SL / SW SERIES All	
G55801 B			
F	91-02	SATURN SC / SL / SW SERIES All	
G55802 A			
F	97-01	ACURA INTEGRA GS	
F	94-01	INTEGRA GS-R	
F	94-01	INTEGRA LS	
F	95-96	INTEGRA Special Edition	
F	92-95	HONDA CIVIC All	
F	93-97	CIVIC DEL SOL All	
G55803 A			
R	97-01	ACURA INTEGRA GS	
R	94-01	INTEGRA GS-R	
R	94-01	INTEGRA LS	
R	95-96	INTEGRA Special Edition	
R	92-95	HONDA CIVIC All	
R	93-97	CIVIC DEL SOL All	
R	89-91	CRX All	
G55804 B			
R	92-94	TOYOTA PASEO All	
R	91-94	TERCEL All	
G55805 D			
R	92-01	HONDA PRELUDE All	
G55817 C			
R	95-96	CHEVROLET LUMINA All	
R	95-96	MONTE CARLO All	

Ultra Struts

Shock	POP	Alternative No.	MTG Acc. Supplied
Pos.	Year	Application	
G55818 W			
F	95-96	CHRYSLER CIRRUS All	
F	96	SEBRING Convertible	
F	95-96	DODGE STRATUS All	
F	96	PLYMOUTH BREEZE All	
G55819 W			
F	95-98	EAGLE TALON All	
F	95-99	MIITSUBISHI ECLIPSE All	
G55820 D			
F	95-00	CHRYSLER SEBRING Coupe	
F	95-00	DODGE AVENGER All	
F	94-98	MIITSUBISHI GALANT All	
G55821 C			
R	95-98	HONDA ODYSSEY All	
R	96-99	ISUZU OASIS All	
G55825 A			
R	95-05	CHEVROLET CAVALIER All	
R	95-05	PONTIAC SUNFIRE All	
G55828 C			
F	92-94	TOYOTA PASEO All	
F	91-94	TERCEL All	
G55831 B			
R	97-01	CHEVROLET LUMINA All	
R	97-99	MONTE CARLO All	
G55832 D			
F	98-01	NISSAN ALTIMA All Left	
G55833 D			
F	98-01	NISSAN ALTIMA All Right	
G55834 B			
F	02-07	BUICK RENDEZVOUS All Exc. Hydraulic Self Leveling System	
F	01-05	PONTIAC AZTEK All	
G55847 C			
F	91-96	FORD ESCORT All	
F	90-94	MAZDA 323 All	
F	90-94	PROTÉGÉ / PROTÉGÉ5 FWD, Non-ABS	
F	91-96	MERCURY TRACER FWD	
G55848 A			
R	91-03	FORD ESCORT All	
R	90-94	MAZDA 323 All	
R	90-94	PROTÉGÉ / PROTÉGÉ5 FWD, Non-ABS	
R	91-99	MERCURY TRACER FWD	
G55849 D			
F	95-99	HYUNDAI ACCENT All	
G55850 W			
R	97	HYUNDAI ACCENT All Mfg. to 6/97	
R	95-96	ACCENT All	
G55856 B			
R	99-04	CHRYSLER 300M All	
R	98-04	CONCORDE All	
R	98-04	INTREPID CAN	
R	99-01	LHS All	
R	98-04	DODGE INTREPID All	
G55857 W			
F	96-99	SUBARU LEGACY Brighton, AWD Right	
F	96-99	LEGACY GT, AWD Right	
F	95-99	LEGACY L, AWD Right	
F	95-98	LEGACY Postal, AWD Right	
F	98	LEGACY GT Limited, AWD Right	
F	95-97	LEGACY LSi, AWD Right	
F	95-96	LEGACY LS, AWD Right	
G55858 W			
F	96-99	SUBARU LEGACY Brighton, AWD Left	
F	96-99	LEGACY GT, AWD Left	
F	95-99	LEGACY L, AWD Left	
F	95-98	LEGACY Postal, AWD Left	
F	98	LEGACY GT Limited, AWD Left	
F	95-97	LEGACY LSi, AWD Left	
F	95-96	LEGACY LS, AWD Left	
G55859 W			
R	95-99	SUBARU LEGACY Brighton, AWD Right	
G55860 W			
R	95-99	SUBARU LEGACY Brighton, AWD Left	

Numerical listing

Shock	POP	Alternative No.	MTG Acc. Supplied
Pos.	Year	Application	
G55865 W			
F	95-99	SUBARU LEGACY Outback Right	
F	99	LEGACY Outback Limited Right	
F	97	LEGACY Outback Limited Right	
G55866 W			
F	95-99	SUBARU LEGACY Outback Left	
F	99	LEGACY Outback Limited Left	
F	97	LEGACY Outback Limited Left	
G55867 W			
R	95-99	SUBARU LEGACY Outback Right	
R	99	LEGACY Outback Limited Right	
R	97	LEGACY Outback Limited Right	
G55868 W			
R	95-99	SUBARU LEGACY Outback Left	
R	99	LEGACY Outback Limited Left	
R	97	LEGACY Outback Limited Left	
G55870 A			
F	01-03	ACURA CL All	
F	99-03	TL All	
F	98-02	HONDA ACCORD All	
G55871 A			
R	01-03	ACURA CL All	
R	99-03	TL All	
R	98-02	HONDA ACCORD All	
G55877 A			
F	97-99	ACURA CL All	
F	94-97	HONDA ACCORD All	
F	95-98	ODYSSEY All	
F	96-99	ISUZU OASIS All	
G55878 D			
F	97	BUICK PARK AVENUE All	
F	97	RIVIERA All	
F	97	OLDSMOBILE AURORA All	
G55879 C			
F	95-99	TOYOTA PASEO All	
F	95-99	TERCEL All	
G55881 D			
F	95-98	MAZDA PROTÉGÉ / PROTÉGÉ5 All Right	
G55882 D			
F	95-98	MAZDA PROTÉGÉ / PROTÉGÉ5 All Left	
G55883 W			
R	95-98	MAZDA PROTÉGÉ / PROTÉGÉ5 All Right	
G55884 W			
R	95-98	MAZDA PROTÉGÉ / PROTÉGÉ5 All Left	
G55890 W			
R	98-99	HYUNDAI ACCENT All	
R	97	ACCENT All Mfg. from 6/97	
G55891 B			
F	98-01	CHEVROLET METRO Non-ABS	
F	89-91	SPRINT All	
F	89-97	GEO METRO Non-ABS	
F	95-99	PONTIAC FIREFLY Non-ABS, CAN	
F	94	FIREFLY CAN	
F	89-91	FIREFLY CAN	
F	89-01	SUZUKI SWIFT All	
G55892 A			
F	00-02	CHRYSLER NEON All	
F	03-05	DODGE NEON SXT	
F	00-05	NEON SE	
F	01-04	NEON R/T	
F	00-03	NEON LE	
F	01-02	NEON ACR	
F	01-02	NEON Base	
F	00-02	NEON ES	
F	00-02	NEON LX	
F	00	NEON High Line	
F	00-01	PLYMOUTH NEON All	
G55893 A			
R	00-02	CHRYSLER NEON All Right	
R	03-05	DODGE NEON SXT Right	
R	00-05	NEON SE Right	
R	01-04	NEON R/T Right	
R	00-03	NEON LE Right	
R	01-02	NEON ACR Right	
R	01-02	NEON Base Right	
R	00-02	NEON ES Right	
R	00-02	NEON LX Right	

Numerical listing

Shock	POP	Alternative No.	MTG Acc. Supplied
Pos.	Year	Application	
G55893	A	-continued	
R 00	NEON	High Line Right	
R 00-01	PLYMOUTH NEON	All Right	
G55894	A		
R 00-02	CHRYSLER NEON	All Left	
R 03-05	DODGE NEON SXT	Left	
R 00-05	NEON	SE Left	
R 01-04	NEON	R/T Left	
R 00-03	NEON	LE Left	
R 01-02	NEON	ACR Left	
R 01-02	NEON	Base Left	
R 00-02	NEON	ES Left	
R 00-02	NEON	LX Left	
R 00	NEON	High Line Left	
R 00-01	PLYMOUTH NEON	All Left	
G55896	A		
F 01-10	CHRYSLER PT CRUISER	All	
G55901	A		
R 94-07	FORD TAURUS	Sedan	
R 94-05	MERCURY SABLE	Sedan	
G55903	W		
F 89-94	NISSAN 240SX	All Left Exc. Active Suspension	
G55904	W		
F 89-94	NISSAN 240SX	All Right Exc. Active Suspension	
G55909	A		
F 97-00	ACURA EL	CAN	
F 96-00	HONDA CIVIC	All	
G55910	A		
R 97-00	ACURA EL	CAN	
R 96-00	HONDA CIVIC	All	
G55911	D		
F 93-95	DODGE COLT	All	
F 93-96	EAGLE SUMMIT	Coupe	
F 93-96	SUMMIT	Sedan	
F 96	MITSUBISHI MIRAGE	All Mfg. to 5/96	
F 93-95	MIRAGE	All	
F 93-94	PLYMOUTH COLT	Sedan	
G55912	A		
F 96-99	INFINITI I30	All Right	
F 95-99	NISSAN MAXIMA	All Right	
G55913	A		
F 96-99	INFINITI I30	All Left	
F 95-99	NISSAN MAXIMA	All Left	
G55914	A		
F 92-94	LEXUS ES300	All Sealed O.E. Struts	
F 92-94	TOYOTA CAMRY	All Sealed O.E. Struts	
G55920	B		
F 93-98	MERCURY VILLAGER	All Left	
F 93-98	NISSAN QUEST	All Left	
G55921	B		
F 93-98	MERCURY VILLAGER	All Right	
F 93-98	NISSAN QUEST	All Right	
G55923	W		
F 90-91	SUBARU LEGACY	Coil (FrontSpringType) Right	
G55924	W		
F 90-91	SUBARU LEGACY	Coil (FrontSpringType) Left	
G55925	W		
F 93-01	SUBARU IMPREZA	Non-ABS Right	
F 92-94	LEGACY	Coil (RearSpringType) Right	
G55926	W		
F 93-01	SUBARU IMPREZA	Non-ABS Left	
F 92-94	LEGACY	Coil (RearSpringType) Left	
G55927	W		
R 91	SUBARU LEGACY	AWD, Coil (RearSpringType) Right	
R 90	LEGACY	AWD Right Exc. Air Suspension	
G55928	W		
R 91	SUBARU LEGACY	AWD, Coil (RearSpringType) Left	

Ultra Struts

Shock	POP	Alternative No.	MTG Acc. Supplied
Pos.	Year	Application	
G55928	W	-continued	
R 90	LEGACY	AWD Left Exc. Air Suspension	
G55929	W		
R 95-01	SUBARU IMPREZA	L, AWD, Non-ABS Right	
R 96-97	IMPREZA	Brighton, AWD, Non-ABS Right	
R 95	IMPREZA	Base, AWD, Non-ABS Right	
R 93-94	IMPREZA	AWD, Non-ABS Right	
R 92-94	LEGACY	AWD, Coil (RearSpringType) Right	
G55930	W		
R 95-01	SUBARU IMPREZA	L, AWD, Non-ABS Left	
R 96-97	IMPREZA	Brighton, AWD, Non-ABS Left	
R 95	IMPREZA	Base, AWD, Non-ABS Left	
R 93-94	IMPREZA	AWD, Non-ABS Left	
R 92-94	LEGACY	AWD, Coil (RearSpringType) Left	
G55931	W		
R 90-91	SUBARU LEGACY	FWD, Coil (RearSpringType) Right	
G55932	W		
R 90-91	SUBARU LEGACY	FWD, Coil (RearSpringType) Left	
G55933	W		
R 93-95	SUBARU IMPREZA	FWD, Non-ABS Right	
R 92-94	LEGACY	FWD, Coil (RearSpringType) Right	
G55934	W		
R 93-95	SUBARU IMPREZA	FWD, Non-ABS Left	
R 92-94	LEGACY	FWD, Coil (RearSpringType) Left	
G55945	W		
F 89-90	DODGE 2000 GTX	CAN	
F 91-93	EAGLE 2000 GTX	CAN	
F 92-95	MITSUBISHI EXPO	All	
G55948	A		
F 05-09	BUICK ALLURE	All	
F 97-05	CENTURY	All	
F 05-09	LACROSSE	All	
F 97-04	REGAL	All	
F 05-06	TERRAZA	AWD	
F 00-11	CHEVROLET IMPALA	All	
F 00-07	MONTE CARLO	All	
F 02-05	VENTURE	All	
F 97-01	VENTURE	FWD	
F 98-02	OLDSMOBILE INTRIGUE	All	
F 97-04	SILHOUETTE	All	
F 97-03	PONTIAC GRAND PRIX	All	
F 99-05	MONTANA	Base	
F 97-98	TRANS SPORT	All	
G55949	A		
R 05-09	BUICK ALLURE	All Exc. Models with 17" or 18" Wheels	
R 97-05	CENTURY	All	
R 05-09	LACROSSE	All Exc. Models with 17" or 18" Wheels	
R 97-04	REGAL	All	
R 00-11	CHEVROLET IMPALA	All Exc. Models with 17" or 18" Wheels	
R 00-07	MONTE CARLO	All Exc. Models with 17" or 18" Wheels	
R 98-02	OLDSMOBILE INTRIGUE	All	
R 97-08	PONTIAC GRAND PRIX	All Exc. Models with 17" or 18" Wheels	
G55951	W		
F 91-95	ACURA LEGEND	All Right	
G55952	W		
R 91-95	ACURA LEGEND	All	
G55958	W		
F 91-95	ACURA LEGEND	All Left	
G55960	A		
F 96-07	FORD TAURUS	All Right	
F 96-05	MERCURY SABLE	All Right	

Numerical listing

Shock	POP	Alternative No.	MTG Acc. Supplied
Pos.	Year	Application	
G55970	B		
F 95-98	NISSAN 200SX	All Left B14 Solid Rear Axle	
F 95-99	SENTRA	All Left B14 Solid Rear Axle	
G55971	B		
F 95-98	NISSAN 200SX	All Right B14 Solid Rear Axle	
F 95-99	SENTRA	All Right B14 Solid Rear Axle	
G55974	A		
F 04-05	CHEVROLET CLASSIC	All	
F 97-03	MALIBU	All	
F 99-04	OLDSMOBILE ALERO	All	
F 99	CUTLASS / CUTLASS SUPREME	All	
F 98	CUTLASS / CUTLASS SUPREME	All Rear Strut Lower Mounting Holes at 2.4" & 3.2" Apart	
F 97	CUTLASS / CUTLASS SUPREME	All	
F 99-05	PONTIAC GRAND AM	All	
G55975	D		
R 97-98	CHEVROLET MALIBU	All Rear Strut Lower Mounting holes at 3.2" Apart	
R 97-98	OLDSMOBILE CUTLASS / CUTLASS SUPREME	All First Design with Rear Strut Lower Mounting Holes at 3.2" Apart	
G55976	D		
R 91-93	NISSAN NX	All Right	
R 91-94	SENTRA	Non-ABS Left B13 Independent Rear Suspension	
G55977	D		
R 91-93	NISSAN NX	All Left	
R 91-94	SENTRA	Non-ABS Left B13 Independent Rear Suspension	
G55978	A		
F 96-07	FORD TAURUS	All Left	
F 96-05	MERCURY SABLE	All Left	
G55989	W		
F 95-02	VOLKSWAGEN CABRIO	All	
F 92-94	CORRADO	VR6	
F 98	GOLF 1.9L 4Cyl L (116)	VR6 from Chassis # 08774	
F 95-97	GOLF 1.8L 4Cyl L (109)	VR6 from Chassis # 08774	
F 97	GOLF 2.8L 6Cyl V (2792)	VR6 from Chassis # 08774	
F 96-98	JETTA	VR6 2.0L & 1.9L from Chassis # 08774	
G55990	W		
F 93-96	VOLKSWAGEN GOLF	All Up to Chassis # 08773	
F 85-92	GOLF	All Sealed Struts	
F 94-98	JETTA	VR6 VR6; Up to Chassis # 08773	
F 93	JETTA	All VR6; Up to Chassis # 08773	
F 85-92	JETTA	All Sealed Struts	
G55991	B		
F 93-98	VOLKSWAGEN GOLF	2.0L 4Cyl L (121) VR6 from Chassis # 08774	
F 96-98	JETTA	2.8L 6Cyl V (2792) VR6 from Chassis # 08774	
F 93-95	JETTA	2.0L 4Cyl L (121) VR6 from Chassis # 08774	
G55992	W		
F 90-96	CHEVROLET LUMINA APV	All	
F 90-96	OLDSMOBILE SILHOUETTE	All	
F 90-96	PONTIAC TRANS SPORT	All	
G55993	D		
F 98-03	TOYOTA SIENNA	All Left	
G55994	D		
F 98-03	TOYOTA SIENNA	All Right	
G55999	A		
F 98-02	CHEVROLET PRIZM	All	
F 93-97	GEO PRIZM	All	
F 93-02	TOYOTA COROLLA	All	
G56501	A		
R 04-05	CHEVROLET CLASSIC	All	

Numerical listing

Shock	POP	Alternative No.	MTG Acc. Supplied
Pos.	Year	Application	
G56501 A -continued			
R	98-03	MALIBU	All Rear Strut Lower Mounting holes at 2.4" Apart
R	99-04	OLDSMOBILE ALERO	All
R	99	CUTLASS / CUTLASS SUPREME	All
R	98	CUTLASS / CUTLASS SUPREME	All Second Design with Rear Strut Lower Mounting holes at 2.4" apart
R	99-05	PONTIAC GRAND AM	All
G56502 A			
F	95-96	LEXUS ES300	All
F	95-96	TOYOTA AVALON	All
F	95-96	CAMRY	All
G56503 W			
F	80-86	FORD THUNDERBIRD	All
F	83-86	MERCURY COUGAR	All
F	80-82	COUGAR XR-7	
G56504 C			
F	78-83	FORD FAIRMONT	All
F	81-82	GRANADA	All
F	83-86	LTD / COUNTRY SEDAN / COUNTRY SQUIRE / CROWN VICTORIA	All
F	84-93	MUSTANG / MUSTANG II LX, 2.3L 4Cyl L (140)	
F	84-86	MUSTANG / MUSTANG II LX, 5.0L 8Cyl V (302)	
F	82-83	MUSTANG / MUSTANG II 5.0L 8Cyl V (302)	
F	79-83	MUSTANG / MUSTANG II 2.3L 4Cyl L (140)	
F	80	MUSTANG / MUSTANG II 4.2L 8Cyl V (255)	
F	79	MUSTANG / MUSTANG II 5.0L 8Cyl V (302)	
F	87-88	THUNDERBIRD Non-ABS	
F	79-86	MERCURY CAPRI	All
F	87-88	COUGAR	All
F	81-82	COUGAR Base	
F	82	COUGAR GS	
F	82	COUGAR LS	
F	83-86	MARQUIS	All
F	78-83	ZEPHYR	All
G56506 A			
F	97-01	LEXUS ES300	All Left Exc. Electronic Adjustable Suspension
F	97-03	TOYOTA AVALON	All Left
F	97-01	CAMRY	All Left
F	99-03	SOLARA	All Left
G56508 C			
F	98-05	BUICK PARK AVENUE	All
F	98-99	RIVIERA	All
G56509 A			
F	00-05	BUICK LESABRE	All
F	00-05	CADILLAC DEVILLE	All Exc. Electronic Adjustable Suspension
F	98-04	SEVILLE	All Exc. Electronic Adjustable Suspension
F	01-03	OLDSMOBILE AURORA	All
F	98-99	AURORA	All
F	00-05	PONTIAC BONNEVILLE	All
G56512 W			
R	91-96	INFINITI G20	All Left
G56513 W			
R	91-96	INFINITI G20	All Right
G56514 A			
F	97-01	LEXUS ES300	All Right Exc. Electronic Adjustable Suspension
F	97-03	TOYOTA AVALON	All Right
F	97-01	CAMRY	All Right
F	99-03	SOLARA	All Right
G56515 B			
F	01-02	FORD ESCORT SE	Exc. Hot & Cool Coupe
F	00-02	ESCORT ZX2	Exc. Hot & Cool Coupe
F	00	ESCORT LX	Exc. Hot & Cool Coupe
F	00	ESCORT ZX2 S/R	Exc. Hot & Cool Coupe
F	98-99	ESCORT LX	
F	98-99	ESCORT SE	
F	98-99	ESCORT SE	Equi
F	98-99	ESCORT ZX2	Equi
F	99	ESCORT ZX2 S/R	

Ultra Struts

Shock	POP	Alternative No.	MTG Acc. Supplied
Pos.	Year	Application	
G56515 B -continued			
F	99	ESCORT ZX2	Tipico
F	97	ESCORT	All
F	97-99	MERCURY TRACER	FWD
G56516 A			
F	00-05	FORD FOCUS	All Left
G56517 A			
F	00-05	FORD FOCUS	All Right
G56518 A			
F	94-98	ASUNA SUNRUNNER	
F	92-93	SUNRUNNER	All
F	98-04	CHEVROLET TRACKER	Non-ABS
F	89-97	GEO TRACKER	All
F	94-97	PONTIAC SUNRUNNER	CAN
F	99-05	SUZUKI GRAND VITARA	All
F	89-98	SIDEKICK	Non-ABS
F	99-04	VITARA	All
F	02-06	XL-7	All
G56520 W			
F	97-00	FORD CONTOUR	All Mfg. from 3/97
F	99-02	MERCURY COUGAR	All
F	97-00	MYSTIQUE	All Mfg. from 3/97
G56522 A			
F	00-05	HYUNDAI ACCENT	All
G56523 C			
R	00-05	HYUNDAI ACCENT	All Right Non-Gas Charged Unit
G56524 D			
R	00-05	HYUNDAI ACCENT	All Left Non-Gas Charged Unit
G56525 W			
F	00	HYUNDAI ELANTRA	All Right Mfg. to 5/00
F	96-99	ELANTRA	All Right
F	97-01	TIBURON	All Right
G56526 W			
F	00	HYUNDAI ELANTRA	All Left Mfg. to 5/00
F	96-99	ELANTRA	All Left
F	97-01	TIBURON	All Left
G56527 D			
R	00	HYUNDAI ELANTRA	All Right Mfg. to 5/00; Non-Gas Charged Unit
R	96-99	ELANTRA	All Right Non-Gas Charged Unit
R	97-01	TIBURON	All Right Non-Gas Charged Unit
G56528 D			
R	00	HYUNDAI ELANTRA	All Left Mfg. to 5/00; Non-Gas Charged Unit
R	96-99	ELANTRA	All Left Non-Gas Charged Unit
R	97-01	TIBURON	All Left Non-Gas Charged Unit
G56529 W			
F	98-02	MINI COOPER	1.8L 4Cyl L (112) Right With 6" or 7" Spring
F	97	MIRAGE	1.8L 4Cyl L (112) Right Mfg. from 4/97; with 6" or 7" Spring
G56530 W			
F	98-02	MINI COOPER	1.8L 4Cyl L (112) Left With 6" or 7" Spring
F	97	MIRAGE	1.8L 4Cyl L (112) Left Mfg. from 4/97; with 6" or 7" Spring
G56531 W			
F	00	KIA SEPHIA	Non-ABS Right Mfg. to 6/01
F	98-99	SEPHIA	Non-ABS Right
G56532 W			
F	00	KIA SEPHIA	Non-ABS Left Mfg. to 6/01
F	98-99	SEPHIA	Non-ABS Left
G56533 W			
R	00-01	KIA SEPHIA	All Right Mfg. to 6/01
R	98-99	SEPHIA	All Right
R	00-01	SPECTRA	All Right Mfg. to 6/01
G56534 W			
R	00-01	KIA SEPHIA	All Left Mfg. to 6/01
R	98-99	SEPHIA	All Left

Numerical listing

Shock	POP	Alternative No.	MTG Acc. Supplied
Pos.	Year	Application	
G56534 W -continued			
R	00-01	SPECTRA	All Left Mfg. to 6/01
G56535 W			
F	99-00	MAZDA PROTÉGÉ / PROTÉGÉ5	All Right Mfg. to 10/00
G56536 W			
F	99-00	MAZDA PROTÉGÉ / PROTÉGÉ5	All Left Mfg. to 10/00
G56537 A			
R	02-03	MAZDA PROTÉGÉ / PROTÉGÉ5	All Right
R	02-03	PROTÉGÉ / PROTÉGÉ5	SE Right
R	01-03	PROTÉGÉ / PROTÉGÉ5	DX Right
R	01-03	PROTÉGÉ / PROTÉGÉ5	ES Right
R	01-03	PROTÉGÉ / PROTÉGÉ5	LX Right
R	99-00	PROTÉGÉ / PROTÉGÉ5	All Right
G56538 A			
R	02-03	MAZDA PROTÉGÉ / PROTÉGÉ5	All Left
R	02-03	PROTÉGÉ / PROTÉGÉ5	SE Left
R	01-03	PROTÉGÉ / PROTÉGÉ5	DX Left
R	01-03	PROTÉGÉ / PROTÉGÉ5	ES Left
R	01-03	PROTÉGÉ / PROTÉGÉ5	LX Left
R	99-00	PROTÉGÉ / PROTÉGÉ5	All Left
G56539 B			
F	01-06	HYUNDAI ELANTRA	All Left
F	00	ELANTRA	All Left Mfg. from 5/00
G56540 A			
F	01-06	HYUNDAI ELANTRA	All Right
F	00	ELANTRA	All Right Mfg. from 5/00
G56541 W			
R	00-01	SUBARU IMPREZA	Outback Right
R	95-99	IMPREZA	Outback, Non-ABS Right
G56542 W			
R	00-01	SUBARU IMPREZA	Outback, AWD Left Non-ABS
R	95-99	IMPREZA	Outback, AWD, Non-ABS Left
G56543 W			
F	98-02	SUBARU FORESTER	All Right
G56544 W			
F	98-02	SUBARU FORESTER	All Left
G56545 D			
R	98-02	SUBARU FORESTER	All Right Exc. Hydraulic Self Leveling System
G56546 D			
R	98-02	SUBARU FORESTER	All Left Exc. Hydraulic Self Leveling System
G56547 D			
F	99-03	LEXUS RX300	All Right
G56548 D			
F	99-03	LEXUS RX300	All Left
G56551 C			
F	01-05	CHRYSLER SEBRING	ST (MfrBodyCode), Coupe Right
F	01-05	DODGE STRATUS	ST (MfrBodyCode), Coupe Right
F	00-05	MITSUBISHI ECLIPSE	All Right
G56552 D			
F	01-05	CHRYSLER SEBRING	ST (MfrBodyCode), Coupe Left
F	01-05	DODGE STRATUS	ST (MfrBodyCode), Coupe Left
F	00-05	MITSUBISHI ECLIPSE	All Left
G56553 W			
R	99-03	LEXUS RX300	FWD Right
G56554 W			
R	99-03	LEXUS RX300	FWD Left
G56555 W			
F	00-04	SUBARU LEGACY	All Right
G56556 S			
F	00-04	SUBARU LEGACY	All Left
G56557 W			
R	00-04	SUBARU LEGACY	All
G56558 B			
F	99-04	HONDA ODYSSEY	All Right

Numerical listing

Shock	POP	Alternative No.	MTG Acc. Supplied
Pos.	Year	Application	
G56559	C		
F	99-04	HONDA ODYSSEY All Left	
G56561	B		
F	01-06	HYUNDAI SANTA FE All Right	
G56562	B		
F	01-06	HYUNDAI SANTA FE All Left	
G56565	W		
F	99-00	HYUNDAI SONATA All	
G56566	W		
R	00	HYUNDAI SONATA All Mfg. to 4/00	
R	99	SONATA All	
G56568	A		
F	01-12	FORD ESCAPE All Right	
F	08-11	MAZDA TRIBUTE All Right	
F	01-06	TRIBUTE All Right	
F	05-10	MERCURY MARINER All Right	
G56569	W		
F	94-97	KIA SEPHIA All Right	
G56570	W		
F	94-97	KIA SEPHIA All Left	
G56571	W		
R	94-97	KIA SEPHIA All Right	
G56572	C		
F	00-05	TOYOTA ECHO All	
G56573	W		
F	94-99	TOYOTA CELICA All Left	
G56574	W		
R	94-99	TOYOTA CELICA All Right	
G56575	W		
R	94-99	TOYOTA CELICA All Left	
G56576	W		
F	94-99	TOYOTA CELICA All Right	
G56577	W		
F	95-98	HYUNDAI SONATA All	
G56579	W		
R	95-96	SUBARU LEGACY L , FWD Right	
G56580	W		
R	95-96	SUBARU LEGACY L , FWD Left	
G56581	B		
F	01-05	TOYOTA RAV4 All Right	
F	00	RAV4 All Right Mfg. from 5/00	
G56582	C		
F	01-05	TOYOTA RAV4 All Left	
F	00	RAV4 All Left Mfg. from 5/00	
G56585	W		
F	00-05	TOYOTA CELICA All Right	
G56586	D		
F	00-05	TOYOTA CELICA All Left	
G56587	D		
R	00-05	TOYOTA CELICA All	
G56588	W		
F	00	MAZDA MPV All Right Mfg. to 8/00	
G56589	W		
F	00	MAZDA MPV All Left Mfg. to 8/00	
G56591	D		
F	91-96	INFINITI G20 All	
G56592	W		
F	90-00	LEXUS LS400 Coil (RearSpringType)	
G56593	W		
R	90-94	LEXUS LS400 Coil (RearSpringType)	
G56594	W		
F	93-97	LEXUS GS300 All	
G56595	W		
R	93-97	LEXUS GS300 All	
G56596	W		
F	03-05	MAZDA MIATA Base	
F	03-05	MIATA LS	
F	03	MIATA SE	

Ultra Struts

Shock	POP	Alternative No.	MTG Acc. Supplied
Pos.	Year	Application	
G56596	W	-continued	
F	99-02	MIATA All	
G56597	W		
R	03-05	MAZDA MIATA Base	
R	03-05	MIATA LS	
R	03	MIATA SE	
R	99-02	MIATA All	
G56598	C		
F	98-05	LEXUS GS300 All	
F	98-00	GS400 All	
F	01-05	GS430 All	
F	02-07	SC430 All	
G56599	D		
R	98-05	LEXUS GS300 All	
R	98-00	GS400 All	
R	01-05	GS430 All	
G56600	W		
R	95-00	LEXUS LS400 Coil (RearSpringType)	
G56601	A		
F	01-12	FORD ESCAPE All Left	
F	08-11	MAZDA TRIBUTE All Left	
F	01-06	TRIBUTE All Left	
F	05-10	MERCURY MARINER All Left	
G56602	W		
F	92-98	BMW 318i All Left	
F	92-98	318iS All Left	
F	95-99	318Ti All Left	
G56603	W		
F	92-98	BMW 318i All Right	
F	92-98	318iS All Right	
F	95-99	318Ti All Right	
G56604	W		
F	98-99	BMW 323i E36 (MfrBodyCode) Left	
F	92-95	325i E36 (MfrBodyCode) Left	
F	96-98	328i All Left	
G56605	W		
F	98-99	BMW 323i E36 (MfrBodyCode) Right	
F	92-95	325i E36 (MfrBodyCode) Right	
F	96-98	328i All Right	
G56606	A		
F	98-10	VOLKSWAGEN BEETLE All	
F	99-06	GOLF A4 (MfrBodyCode)	
F	01-05	JETTA Sedan	
F	99-00	JETTA All	
G56607	W		
F	03	BMW 540i All Mfg. to 10/03; Exc. Electronic Adjustable Suspension	
F	97-02	540i All Exc. Electronic Adjustable Suspension	
F	95	540i All Exc. Electronic Adjustable Suspension	
G56608	D		
F	01-03	BMW 525i Sedan Exc. Electronic Adjustable Suspension	
F	97-00	528i Sedan	
F	01-03	530i All Exc. Electronic Adjustable Suspension	
G56611	W		
F	00-06	AUDI TT All	
F	00-06	TT QUATTRO All	
G56612	W		
F	93-97	VOLVO 850 All Exc. Hydraulic Self Leveling System	
F	98-04	C70 All	
F	98-00	S70 All	
F	98-00	V70 GLT Mfg. to 3/00 and Exc. XC70, XC Cross Country	
F	00	V70 GLT SE Mfg. to 3/00 and Exc. XC70, XC Cross Country	
F	98-99	V70 Base Mfg. to 3/00 and Exc. XC70, XC Cross Country	
F	98-99	V70 T5 Mfg. to 3/00 and Exc. XC70, XC Cross Country	
F	98	V70 R Mfg. to 3/00 and Exc. XC70, XC Cross Country	
G56615	C		
F	99-01	INFINITI QX4 All Left Mfg. from 12/98	
F	99-01	NISSAN PATHFINDER All Left Mfg. from 12/98; with OE543034W985	

Numerical listing

Shock	POP	Alternative No.	MTG Acc. Supplied
Pos.	Year	Application	
G56616	C		
F	99-01	INFINITI QX4 All Right Mfg. from 12/98	
F	99-01	NISSAN PATHFINDER All Right Mfg. from 12/98; with OE543034W985	
G56618	C		
F	00-01	NISSAN SENTRA All Left	
G56619	C		
F	00-01	NISSAN SENTRA All Right	
G56620	A		
F	01-07	CHRYSLER TOWN & COUNTRY All	
F	01-07	VOYAGER / GRAND VOYAGER All	
F	01-07	DODGE CARAVAN / GRAND CARAVAN All	
G56621	A		
F	01-03	ACURA EL CAN Left	
F	03-04	HONDA CIVIC SiR, Hatchback Left	
F	02	CIVIC SiR, Hatchback Left Hatchback; Exc. Hybrid & Si Models	
G56622	A		
F	01-03	ACURA EL CAN Right	
F	02-04	HONDA CIVIC SiR, Hatchback Right	
G56624	C		
F	01-06	MAZDA MPV All Right	
F	00	MPV All Right Mfg. from 8/00	
G56625	D		
F	01-06	MAZDA MPV All Left	
F	00	MPV All Left Mfg. from 8/00	
G56626	W		
F	95-02	SUZUKI ESTEEM All Right	
G56627	W		
F	95-02	SUZUKI ESTEEM All Left	
G56628	W		
R	95-02	SUZUKI ESTEEM All Right	
G56629	W		
R	95-02	SUZUKI ESTEEM All Left	
G56631	C		
F	00	TOYOTA RAV4 All Left Mfg. to 5/00; Sealed Struts	
F	96-99	RAV4 All Left Sealed Struts	
G56632	C		
F	00	TOYOTA RAV4 All Right Mfg. to 5/00; Sealed Struts	
F	96-99	RAV4 All Right Sealed Struts	
G56633	C		
F	00-03	MAZDA PROTÉGÉ / PROTÉGÉS All Right Mfg. from 10/00	
G56634	D		
F	00-03	MAZDA PROTÉGÉ / PROTÉGÉS All Left Mfg. from 10/00	
G56635	C		
F	99-03	MITSUBISHI GALANT All Right	
G56636	C		
F	99-03	MITSUBISHI GALANT All Left	
G56637	W		
R	94-97	KIA SEPHIA All Left	
G56640	B		
R	01-06	HYUNDAI ELANTRA All Left	
R	00	ELANTRA All Left Mfg. from 5/00	
G56641	B		
R	01-06	HYUNDAI ELANTRA All Right	
R	00	ELANTRA All Right Mfg. from 5/00	
G56642	C		
F	03-08	HYUNDAI TIBURON All Left	
G56643	C		
F	03-08	HYUNDAI TIBURON All Right	
G56644	C		
R	03-08	HYUNDAI TIBURON All Left	
G56645	C		
R	03-08	HYUNDAI TIBURON All Right	

Numerical listing

Shock	POP	Alternative No.	MTG Acc. Supplied
Pos.	Year	Application	
G56655 D			
F	04-07	FORD FREESTAR All	
F	04-07	MERCURY MONTEREY Mini Passenger Van	
G56660 A			
F	03-08	TOYOTA COROLLA All Right	
G56661 A			
F	03-08	TOYOTA COROLLA All Left	
G56664 B			
R	98-99	CADILLAC DEVILLE All Exc. Electronic Adjustable Suspension	
R	94-97	DEVILLE Air (RearSpringType) Exc. Electronic Adjustable Suspension	
G56667 W			
R	01-03	TOYOTA HIGHLANDER FWD Left	
G56668 W			
R	01-03	TOYOTA HIGHLANDER FWD Right	
G56669 W			
F	94-95	CADILLAC DEVILLE All Left Exc. Electronic Adjustable Suspension	
G56670 W			
F	94-95	CADILLAC DEVILLE All Right Exc. Electronic Adjustable Suspension	
G56671 A			
F	02-06	NISSAN ALTIMA All Left	
F	04-08	MAXIMA All Left	
G56672 A			
F	02-06	NISSAN ALTIMA All Right	
F	04-08	MAXIMA All Right	
G56673 C			
F	02-03	LEXUS ES300 All Left	
F	02-03	TOYOTA CAMRY All Left	
G56674 C			
F	02-03	LEXUS ES300 All Right	
F	02-03	TOYOTA CAMRY All Right	
G56675 C			
R	03	LEXUS ES300 All Left Exc. Electronic Adjustable Suspension	
R	02-03	TOYOTA CAMRY All Left	
G56676 C			
R	03	LEXUS ES300 All Right Exc. Electronic Adjustable Suspension	
R	02-03	TOYOTA CAMRY All Right	
G56677 C			
F	04-05	HONDA CIVIC Value Package Left	
F	03-05	CIVIC DX Left	
F	03-05	CIVIC EX Left	
F	03-05	CIVIC GX Left	
F	03-05	CIVIC HX Left	
F	03-05	CIVIC LX Left	
F	03-05	CIVIC Si Left	
F	03-04	CIVIC SiR Left	
G56678 C			
F	04-05	HONDA CIVIC Value Package Right	
F	03-05	CIVIC DX Right	
F	03-05	CIVIC EX Right	
F	03-05	CIVIC GX Right	
F	03-05	CIVIC HX Right	
F	03-05	CIVIC LX Right	
F	03-05	CIVIC Si Right	
F	03-04	CIVIC SiR Right	
G56679 W			
F	01-03	TOYOTA HIGHLANDER All Left	
G56680 D			
F	01-03	TOYOTA HIGHLANDER All Right	
G56681 D			
R	99-03	LEXUS RX300 AWD Left	
R	01-03	TOYOTA HIGHLANDER AWD Left	
G56682 D			
R	99-03	LEXUS RX300 AWD Right	
R	01-03	TOYOTA HIGHLANDER AWD Right	
G56683 B			
F	00-01	INFINITI I30 All Left	
F	00-01	NISSAN MAXIMA All Left	

Ultra Struts

Shock	POP	Alternative No.	MTG Acc. Supplied
Pos.	Year	Application	
G56684 A			
F	00-01	INFINITI I30 All Right	
F	00-01	NISSAN MAXIMA All Right	
G56685 C			
F	02-04	INFINITI I35 All Left	
F	02-03	NISSAN MAXIMA All Left	
G56686 C			
F	02-04	INFINITI I35 All Right	
F	02-03	NISSAN MAXIMA All Right	
G56687 D			
F	02-03	INFINITI QX4 All Left	
F	01-04	NISSAN PATHFINDER All Left With OE 543034W925 or 543034W926	
G56688 D			
F	02-03	INFINITI QX4 All Right	
F	01-04	NISSAN PATHFINDER All Right With OE 543034W925 or 543034W926	
G56689 W			
F	98-02	MAZDA 626 All Left	
G56690 W			
F	98-02	MAZDA 626 All Right	
G56691 C			
R	98-02	MAZDA 626 All	
G56700 B			
F	82-92	CHEVROLET CAMARO All	
F	82-92	PONTIAC FIREBIRD All	
G56701 C			
F	85-90	BUICK ELECTRA All	
F	90	LESABRE All Early Design Front Strut with Spring Guard	
F	86-89	LESABRE All	
F	85-90	CADILLAC COMMERCIAL CHASSIS All	
F	85-90	DEVILLE All	
F	85-90	FLEETWOOD All	
F	86-90	OLDSMOBILE 88 SERIES All Early Design Front Strut with Spring Guard	
F	85-90	98 All	
F	87-90	PONTIAC BONNEVILLE All Early Design Front Strut with Spring Guard	
G56703 W			
F	86-89	BUICK RIVIERA All	
F	87-88	CADILLAC ALLANTE All Exc. Electronic Adjustable Suspension	
F	86-89	ELDORADO All	
F	86-89	SEVILLE All	
F	86-89	OLDSMOBILE TORONADO All	
G56704 W			
R	86-93	BUICK RIVIERA All	
R	86-93	CADILLAC ELDORADO All	
R	90-93	SEVILLE All SSS Speed Sensitive Suspension or CCR Computer Command Ride; Non adjustable	
R	86-89	SEVILLE All	
R	86-92	OLDSMOBILE TORONADO All	
G56705 C			
F	87-89	BUICK SKYHAWK All Right	
F	84-86	SKYHAWK All Right Non-Rebuildable O.E. Struts	
F	86-91	SKYLARK All Right Non-Rebuildable O.E. Struts	
F	85-87	SOMERSET / SOMERSET REGAL All Right Non-Rebuildable O.E. Struts	
F	87-88	CADILLAC CIMARRON All Right	
F	84-86	CIMARRON All Right Non-Rebuildable O.E. Struts	
F	87-91	CHEVROLET BERETTA All Right	
F	87-94	CAVALIER All Right	
F	84-86	CAVALIER All Right Non-Rebuildable O.E. Struts	
F	87-91	CORSSICA All Right	
F	87	OLDSMOBILE CALAIS All Right	
F	85-86	CALAIS All Right Non-Rebuildable O.E. Struts	
F	88-91	CUTLASS CALAIS All Right	
F	87-88	FIRENZA All Right	
F	84-86	FIRENZA All Right Non-Rebuildable O.E. Struts	
F	87-91	PONTIAC GRAND AM All Right	
F	85-86	GRAND AM All Right Non-Rebuildable O.E. Struts	
F	84-85	J2000 / SUNBIRD All Right Non-Rebuildable O.E. Struts	

Numerical listing

Shock	POP	Alternative No.	MTG Acc. Supplied
Pos.	Year	Application	
G56705 C -continued			
F	88-94	SUNBIRD All Right	
F	86-87	SUNBIRD All Right Non-Rebuildable O.E. Struts	
F	87-91	TEMPEST CAN Right	
G56706 C			
F	87-89	BUICK SKYHAWK All Left	
F	84-86	SKYHAWK All Left Non-Rebuildable O.E. Struts	
F	86-91	SKYLARK All Left Non-Rebuildable O.E. Struts	
F	85-87	SOMERSET / SOMERSET REGAL All Left Non-Rebuildable O.E. Struts	
F	87-88	CADILLAC CIMARRON All Left	
F	84-86	CIMARRON All Left Non-Rebuildable O.E. Struts	
F	87-91	CHEVROLET BERETTA All Left	
F	87-94	CAVALIER All Left	
F	84-86	CAVALIER All Left Non-Rebuildable O.E. Struts	
F	87-91	CORSSICA All Left	
F	87	OLDSMOBILE CALAIS All Left	
F	85-86	CALAIS All Left Non-Rebuildable O.E. Struts	
F	88-91	CUTLASS CALAIS All Left	
F	87-88	FIRENZA All Left	
F	84-86	FIRENZA All Left Non-Rebuildable O.E. Struts	
F	87-91	PONTIAC GRAND AM All Left	
F	85-86	GRAND AM All Left Non-Rebuildable O.E. Struts	
F	84-85	J2000 / SUNBIRD All Left Non-Rebuildable O.E. Struts	
F	88-94	SUNBIRD All Left	
F	86-87	SUNBIRD All Left Non-Rebuildable O.E. Struts	
F	87-91	TEMPEST CAN Left	
G56707 A			
R	85-90	BUICK ELECTRA Air (RearSpringType) Conventional Replacement for Air Assist Rear Susp. Strut Only	
R	86-99	LESABRE Coil (RearSpringType)	
R	91-96	PARK AVENUE Air (RearSpringType) Conventional Replacement for Air Assist Susp; Exc. Elec. Adj. Susp.	
R	93	CADILLAC 60 SPECIAL Coil (RearSpringType) Conventional Type Replacement for Air Assist Rear Suspension	
R	92-93	COMMERCIAL CHASSIS FWD Conventional Type Replacement for Air Assist Rear Suspension; Exc. Electronic Suspension	
R	85-91	COMMERCIAL CHASSIS All Conventional Type Replacement for Air Assist Rear Suspension; Exc. Electronic Suspension	
R	85-93	DEVILLE Air (RearSpringType) Conventional Type Replacement for Air Assist Rear Suspension	
R	85-93	FLEETWOOD All Conventional Type Replacement for Air Assist Rear Suspension	
R	92-99	OLDSMOBILE 88 SERIES All Conventional Type Replacement for Air Assist Rear Suspension	
R	86-91	88 SERIES Coil (RearSpringType)	
R	85-96	98 Air (RearSpringType) Conventional Type Replacement LSS Coil (RearSpringType)	
R	96-99	CONVENTIONAL Type Replacement for Air Assist Rear Suspension	
R	97-98	REGENCY Coil (RearSpringType)	
R	91-99	PONTIAC BONNEVILLE Coil (RearSpringType) Exc. Electronic Adjustable Suspension	
R	87-90	BONNEVILLE Coil (RearSpringType)	
G56708 A			
R	88-96	BUICK REGAL All	
R	90-94	CHEVROLET LUMINA All	
R	97	OLDSMOBILE CUTLASS / CUTLASS SUPREME All Exc. Rear Strut Lower Mounting holes at 3.2" apart	
R	88-96	CUTLASS / CUTLASS SUPREME All	
R	88-96	PONTIAC GRAND PRIX All	

Numerical listing

Shock	POP	Alternative No.	MTG Acc. Supplied
Pos.	Year	Application	
G56713	W		
F	88-89	MAZDA 929 All Exc. Electronic Adjustable Suspension	
G56714	W		
F	89-98	MAZDA MPV RWD	
G56715	W		
F	95-98	MAZDA MPV 4WD	
F	89-94	MPV 4WD Exc. Hydraulic Self Leveling System	
G56716	W		
F	90-91	MAZDA 929 All Exc. Electronic Adjustable Suspension	
G56717	D		
F	88-91	BUICK REATTA All	
F	90-93	RIVIERA All	
F	89-92	CADILLAC ALLANTE All Exc. Electronic Adjustable Suspension	
F	90-93	ELDORADO All	
F	90-93	SEVILLE All SSS Speed Sensitive Suspension or CCR Computer Command Ride; Non adjustable	
F	90-92	OLDSMOBILE TORONADO All	
G56718	A		
F	91-99	BUICK LESABRE All	
F	90	LESABRE All Late Design Front Strut without Spring Guard	
F	91-96	PARK AVENUE All	
F	95-96	RIVIERA All	
F	93	CADILLAC 60 SPECIAL All	
F	92-93	COMMERCIAL CHASSIS FWD	
F	91	COMMERCIAL CHASSIS All	
F	91-93	DEVILLE All Exc. Electronic Adjustable Suspension	
F	91-93	FLEETWOOD All	
F	92-99	OLDSMOBILE 88 SERIES All	
F	90-91	88 SERIES All Late Design Front Strut without Spring Guard	
F	91-96	98 All CCR Computer Command Ride	
F	95-96	AURORA All	
F	96-99	LSS All	
F	97-98	REGENCY All	
F	94-99	PONTIAC BONNEVILLE All Exc. CCR Computer Command Ride	
F	91-93	BONNEVILLE All	
F	90	BONNEVILLE All Late Design Front Strut without Spring Guard	
G56719	W		
F	95-98	BUICK SKYLARK All Right	
F	92-94	SKYLARK All Right Exc. FE3 and Electronic Ride Control	
F	95-96	CHEVROLET BERETTA All Right	
F	92-94	BERETTA Base Right Exc. FE7 Suspension	
F	95-96	CORSICA All Right	
F	94	CORSICA Base Right Exc. FE7 Suspension	
F	93	CORSICA All Right Exc. FE7 Suspension	
F	92	CORSICA LT Right Exc. FE7 Suspension	
F	95-98	OLDSMOBILE ACHIEVA All Right Exc. Electronic Adjustable Suspension	
F	92-94	ACHIEVA All Right Exc. FE3 and Electronic Ride Control	
F	96-98	PONTIAC GRAND AM All Right Exc. Electronic Adjustable Suspension	
F	95	GRAND AM SE Right Exc. Electronic Adjustable Suspension	
F	92-94	GRAND AM SE Right Exc. FE3 and Electronic Ride Control	
G56720	W		
F	95-98	BUICK SKYLARK All Left	
F	92-94	SKYLARK All Left Exc. FE3 and Electronic Ride Control	
F	95-96	CHEVROLET BERETTA All Left	
F	92-94	BERETTA Base Left Exc. FE7 Suspension	
F	95-96	CORSICA All Left	
F	94	CORSICA Base Left Exc. FE7 Suspension	
F	93	CORSICA All Left Exc. FE7 Suspension	
F	92	CORSICA LT Left Exc. FE7 Suspension	

Ultra Struts

Shock	POP	Alternative No.	MTG Acc. Supplied
Pos.	Year	Application	
G56720	W	-continued	
F	95-98	OLDSMOBILE ACHIEVA All Left Exc. Electronic Adjustable Suspension	
F	92-94	ACHIEVA All Left Exc. FE3 and Electronic Ride Control	
F	95-98	PONTIAC GRAND AM All Left Exc. Electronic Adjustable Suspension	
F	92-94	GRAND AM SE Left Exc. FE3 and Electronic Ride Control	
G56721	B		
F	04-06	LEXUS ES330 All Left Exc. Adaptive Variable Suspension	
F	04-06	TOYOTA CAMRY All Left	
F	04-06	SOLARA All Left	
G56722	B		
F	04-06	LEXUS ES330 All Right Exc. Adaptive Variable Suspension	
F	04-06	TOYOTA CAMRY All Right	
F	04-06	SOLARA All Right	
G56723	W		
F	92-94	BUICK SKYLARK All Left FE3 Suspension	
F	94	CHEVROLET BERETTA Z26 Left FE7 Suspension	
F	92-93	BERETTA GT Left FE7 Suspension	
F	92-93	BERETTA GTZ Left FE7 Suspension	
F	94	CORSICA Base Left FE7 Suspension	
F	93	CORSICA All Left FE7 Suspension	
F	92	CORSICA LTZ Left FE7 Suspension	
F	92-94	OLDSMOBILE ACHIEVA All Left FE3 Suspension	
F	92-94	PONTIAC GRAND AM GT Left FE3 Suspension	
G56724	W		
F	92-94	BUICK SKYLARK All Right FE3 Suspension	
F	94	CHEVROLET BERETTA Z26 Right FE7 Suspension	
F	92-93	BERETTA GT Right FE7 Suspension	
F	92-93	BERETTA GTZ Right FE7 Suspension	
F	94	CORSICA Base Right FE7 Suspension	
F	93	CORSICA All Right FE7 Suspension	
F	92	CORSICA LTZ Right FE7 Suspension	
F	92-94	OLDSMOBILE ACHIEVA All Right FE3 Suspension	
F	92-94	PONTIAC GRAND AM GT Right FE3 Suspension	
G56728	C		
R	04-06	LEXUS ES330 All Left Exc. Adaptive Variable Suspension	
R	04-06	TOYOTA CAMRY All Left	
R	04-06	SOLARA All Left	
G56729	C		
R	04-06	LEXUS ES330 All Right Exc. Adaptive Variable Suspension	
R	04-06	TOYOTA CAMRY All Right	
R	04-06	SOLARA All Right	
G56730	C		
F	04-06	LEXUS RX330 All Left	
F	07-09	RX350 All Left	
F	04-07	TOYOTA HIGHLANDER All Left	
G56731	C		
F	04-06	LEXUS RX330 All Right	
F	07-09	RX350 All Right	
F	04-07	TOYOTA HIGHLANDER All Right	
G56732	W		
R	04-06	LEXUS RX330 AWD Left	
R	07-09	RX350 AWD Left	
R	04-07	TOYOTA HIGHLANDER AWD Left	
G56733	W		
R	04-06	LEXUS RX330 AWD Right	
R	07-09	RX350 AWD Right	
R	04-07	TOYOTA HIGHLANDER AWD Right	
G56734	W		
R	04-06	LEXUS RX330 FWD Left	
R	07-09	RX350 FWD Left	
R	04-07	TOYOTA HIGHLANDER FWD Left	

Numerical listing

Shock	POP	Alternative No.	MTG Acc. Supplied
Pos.	Year	Application	
G56735	W		
R	04-06	LEXUS RX330 FWD Right	
R	07-09	RX350 FWD Right	
R	04-07	TOYOTA HIGHLANDER FWD Right	
G56736	C		
F	98-99	INFINITI QX4 All Right Mfg. to 12/98	
F	97	QX4 All Right	
F	99	NISSAN PATHFINDER All Right	
F	98	PATHFINDER All Right Mfg. to 12/98	
F	96-97	PATHFINDER All Right	
G56739	C		
F	98-99	INFINITI QX4 All Left Mfg. to 12/98	
F	97	QX4 All Left	
F	99	NISSAN PATHFINDER All Left	
F	98	PATHFINDER All Left Mfg. to 12/98	
F	96-97	PATHFINDER All Left	
G56750	W		
F	00	BMW 323i Wagon Left Sport Suspension	
F	01-05	325i Wagon Left Sport Suspension	
F	01	325i Sedan Left Mfg. to 9/01; Sport Suspension	
F	01	330Ci Convertible Left Sport Suspension	
G56751	W		
F	00	BMW 323i Wagon Right Sport Suspension	
F	01-05	325i Wagon Right Sport Suspension	
F	01	325i Sedan Right Mfg. to 9/01; Sport Suspension	
F	01	330Ci Convertible Right Sport Suspension	
G56752	W		
F	00	BMW 323Ci Coupe Left Sport Suspension	
F	01-06	325Ci All Left Sport Suspension	
F	00	328Ci All Left Sport Suspension	
F	02-06	330Ci All Left Sport Suspension	
F	01	330Ci Coupe Left Mfg. from 9/01; Sport Suspension	
F	01-05	330i Sedan Left	
G56753	W		
F	00	BMW 323Ci Coupe Right Sport Suspension	
F	01-06	325Ci All Right Sport Suspension	
F	00	328Ci All Right Sport Suspension	
F	02-06	330Ci All Right Sport Suspension	
F	01	330Ci Coupe Right Mfg. from 9/01; Sport Suspension	
F	01-05	330i Sedan Right	
G56754	S		G52237
F	00	BMW 323Ci Coupe Left Exc. Sport Suspension	
F	00	323i Wagon Left Exc. Sport Suspension	
F	01-06	325Ci All Left Exc. Sport Suspension	
F	02-05	325i Sedan Left Exc. Sport Suspension	
F	01	325i Sedan Left Mfg. from 09/01; Exc. Sport Suspension	
F	00	328Ci All Left Exc. Sport Suspension	
F	01-06	330Ci Convertible Left Exc. Sport Suspension	
G56755	S		G52238
F	00	BMW 323Ci Coupe Right Exc. Sport Suspension	
F	00	323i Wagon Right Exc. Sport Suspension	
F	01-06	325Ci All Right Exc. Sport Suspension	
F	02-05	325i Sedan Right Exc. Sport Suspension	
F	01	325i Sedan Right Mfg. from 11/01; Exc. Sport Suspension	
F	00	328Ci All Right Exc. Sport Suspension	
F	01-06	330Ci Convertible Right Exc. Sport Suspension	
G56756	W		G52237
F	02-05	BMW 325i Sedan Left Sport Suspension	
F	01	325i Sedan Left Mfg. from 9/01; Sport Suspension	

Numerical listing

Shock	POP	Alternative No.	MTG Acc. Supplied
Pos.	Year	Application	
G56756	W	-continued	G52237
F	01-06	330CI Coupe Left Exc. Sport Suspension	
G56757	S		G52238
F	02-05	BMW 325i Sedan Right Sport Suspension	
F	01	325i Sedan Right Mfg. from 9/01; Sport Suspension	
F	01-06	330CI Coupe Right Exc. Sport Suspension	
G56758	A		
F	01-02	ACURA MDX All Right	
F	03-08	HONDA PILOT All Right	
G56759	A		
F	01-02	ACURA MDX All Left	
F	03-08	HONDA PILOT All Left	
G56760	W		
F	96-02	BMW Z3 All Right	
G56761	W		
F	96-02	BMW Z3 All Left	
G56762	W		
F	99-02	DAEWOO LEGANZA All	
G56763	W		
R	99-02	DAEWOO LEGANZA All Right	
G56764	W		
R	99-02	DAEWOO LEGANZA All Left	
G56765	W		
F	99-02	DAEWOO NUBIRA Non-ABS Right	
G56766	W		
F	99-02	DAEWOO NUBIRA Non-ABS Left	
G56767	W		
R	99-02	DAEWOO NUBIRA Non-ABS Right	
G56768	W		
R	99-02	DAEWOO NUBIRA Non-ABS Left	
G56769	W		
F	97-01	CADILLAC CATERA All	
G56770	W		
F	97-01	BMW 740i All Right Exc. Electronic Adjustable Suspension	
F	94-95	740i All Right Exc. Electronic Adjustable Suspension	
F	94-01	740iL All Right Exc. Electronic Adjustable Suspension	
F	94-01	750iL All Right Exc. Electronic Adjustable Suspension	
G56771	W		
F	97-01	BMW 740i All Left Exc. Electronic Adjustable Suspension	
F	94-95	740i All Left Exc. Electronic Adjustable Suspension	
F	94-01	740iL All Left Exc. Electronic Adjustable Suspension	
F	94-01	750iL All Left Exc. Electronic Adjustable Suspension	
G56772	A		
F	04-06	CHRYSLER PACIFICA All	
G56773	A		
F	05-06	CHEVROLET EQUINOX All Left	
F	06	PONTIAC TORRENT All Left	
G56774	A		
F	05-06	CHEVROLET EQUINOX All Right	
F	06	PONTIAC TORRENT All Right	
G56775	W		
F	97-02	CADILLAC ELDORADO All Left Exc. Electronic Adjustable Suspension	
G56776	W		
F	97-02	CADILLAC ELDORADO All Right Exc. Electronic Adjustable Suspension	
G56778	C		
F	03-06	DODGE SPRINTER 2500 All	
F	03-06	SPRINTER 3500 All	
F	04-06	MERCEDES-BENZ SPRINTER All	
G56781	C		
F	01-03	KIA RIO All Right	

Ultra Struts

Shock	POP	Alternative No.	MTG Acc. Supplied
Pos.	Year	Application	
G56782	D		
F	01-03	KIA RIO All Left	
G56784	C		
F	99-02	MERCURY VILLAGER All Right	
F	99-02	NISSAN QUEST All Right	
G56785	C		
F	99-02	MERCURY VILLAGER All Left	
F	99-02	NISSAN QUEST All Left	
G56786	C		
F	00-02	KIA SPORTAGE All Right	
G56787	C		
F	00-02	KIA SPORTAGE All Left	
G56790	D		
F	03-04	FORD MUSTANG / MUSTANG II SVT Cobra	
F	01	MUSTANG / MUSTANG II SVT Cobra	
F	00	MUSTANG / MUSTANG II SVT Cobra R	
F	94-99	MUSTANG / MUSTANG II SVT Cobra	
F	95	MUSTANG / MUSTANG II SVT Cobra R	
G56791	D		
F	06-07	MERCEDES-BENZ C230 All Exc. Sport Suspension	
F	02-05	C230 Coupe Exc. Sport Suspension	
F	01-05	C240 All Exc. Sport Suspension	
F	06-07	C280 All Exc. Sport Suspension	
F	01-05	C320 Sedan Exc. Sport Suspension	
F	02-04	C320 Wagon Exc. Sport Suspension	
F	06-07	C350 All Exc. Sport Suspension	
F	02-05	CLK320 All Exc. Sport Suspension	
F	06-09	CLK350 All Exc. Sport Suspension	
F	02-03	CLK430 All Exc. Sport Suspension	
F	03-06	CLK500 All Exc. Sport Suspension	
F	07-09	CLK550 Coupe Exc. Sport Suspension	
G56792	W		
F	06-07	MERCEDES-BENZ C230 All Sport Suspension	
F	02-05	C230 Coupe Sport Suspension	
F	01-05	C240 All Sport Suspension	
F	06-07	C280 All Sport Suspension	
F	01-05	C320 All Sport Suspension	
F	06-07	C350 All Sport Suspension	
F	02-05	CLK320 All Sport Suspension	
F	06-09	CLK350 All Sport Suspension	
F	02-03	CLK430 All Sport Suspension	
F	03-06	CLK500 All Sport Suspension	
G56793	W		
F	02-04	ACURA RSX All Right	
G56794	W		
F	02-04	ACURA RSX All Left	
G56795	C		
F	00-05	SATURN L / LS / LW SERIES All Right	
G56796	C		
F	00-05	SATURN L / LS / LW SERIES All Left	
G56797	D		
F	05	TOYOTA SIENNA FWD Right Mfg. to 6/05; 7 Passenger	
F	04	SIENNA FWD Right 7 Passenger	
G56798	D		
F	05	TOYOTA SIENNA FWD Left Mfg. to 6/05; 7 Passenger	
F	04	SIENNA FWD Left 7 Passenger	
G56799	B		
F	02-06	HONDA CR-V All Right	
G56800	B		
F	02-06	HONDA CR-V All Left	
G56801	D		
F	00-03	FORD ESCORT ZX2, Coupe, Non-ABS Hot & Cool Coupe; Non-ABS	
F	98-99	ESCORT ZX2 Cool Coupe, Non-ABS	
F	98-99	ESCORT ZX2 Hot Coupe, Non-ABS	

Numerical listing

Shock	POP	Alternative No.	MTG Acc. Supplied
Pos.	Year	Application	
G56802	A		
F	01-09	VOLVO S60 All	
F	99-06	S80 All	
F	05-06	V70 R Mfg. from 3/00 and Exc. XC70, XC Cross Country and Auto Leveling	
F	04-06	V70 2.4 Mfg. from 3/00 and Exc. XC70, XC Cross Country and Auto Leveling	
F	04-06	V70 2.5T Mfg. from 3/00 and Exc. XC70, XC Cross Country and Auto Leveling	
F	00-05	V70 T5 Mfg. from 3/00 and Exc. XC70, XC Cross Country and Auto Leveling	
F	04	V70 2.5T AWD Mfg. from 3/00 and Exc. XC70, XC Cross Country and Auto Leveling	
F	00-03	V70 2.4T Mfg. from 3/00 and Exc. XC70, XC Cross Country and Auto Leveling	
F	00-03	V70 Base Mfg. from 3/00 and Exc. XC70, XC Cross Country and Auto Leveling	
F	00	V70 2.4T SE Mfg. from 3/00 and Exc. XC70, XC Cross Country and Auto Leveling	
F	00	V70 GLT Mfg. from 3/00 and Exc. XC70, XC Cross Country and Auto Leveling	
F	00	V70 GLT SE Mfg. from 3/00 and Exc. XC70, XC Cross Country and Auto Leveling	
G56803	W		
F	02-03	SUBARU IMPREZA RS, Sedan Right	
G56804	W		
F	02-03	SUBARU IMPREZA RS, Sedan Left	
G56805	A		
F	02-06	NISSAN SENTRA GXE Right	
F	02-06	SENTRA GXE Sport Right	
F	02-06	SENTRA XE Right	
F	03-04	SENTRA LE Right	
F	02	SENTRA CA Right	
G56806	A		
F	02-06	NISSAN SENTRA GXE Left	
F	02-06	SENTRA GXE Sport Left	
F	02-06	SENTRA XE Left	
F	03-04	SENTRA LE Left	
F	02	SENTRA CA Left	
G56807	A		
F	06-10	JEEP COMMANDER All	
F	05-10	GRAND CHEROKEE All	
G56809	A		
F	03-07	SATURN ION All	
G56810	A		
F	05-10	CHEVROLET COBALT LS	
F	05-10	COBALT LT	
F	10	COBALT Base	
F	10	COBALT LT Team Canada	
F	06-07	COBALT LTZ	
F	05	COBALT Base	
F	11	HHR All	
F	08-10	HHR LS Panel	
F	08-10	HHR LT Panel	
F	06-10	HHR LS	
F	06-10	HHR LT	
F	06-08	HHR Comfort LT	
F	06-08	HHR Elegance LT	
F	07	HHR Edicion Especial	
F	07-09	PONTIAC G5 All	
F	05-06	PURSUIT All	
G56812	A		
F	04-08	PONTIAC GRAND PRIX All	
G56813	W		
F	00-04	SUBARU OUTBACK AWD Left	
G56814	W		
F	00-04	SUBARU OUTBACK AWD Right	
G56815	S		G52124
F	04-06	PONTIAC GTO All Right	
G56816	S		G52123
F	04-06	PONTIAC GTO All Left	
G56817	A		
F	05-10	FORD MUSTANG / MUSTANG II All	

Numerical listing

Shock	POP	Alternative No.	MTG Acc. Supplied
Pos.	Year	Application	
G56819	C		
F	05-10	HYUNDAI	TUCSON All Left
F	05-10	KIA	SPORTAGE All Left
G56820	C		
F	05-10	HYUNDAI	TUCSON All Right
F	05-10	KIA	SPORTAGE All Right
G56821	C		
R	05-10	HYUNDAI	TUCSON All Right
R	05-10	KIA	SPORTAGE All Right
G56822	C		
R	05-10	HYUNDAI	TUCSON All Left
R	05-10	KIA	SPORTAGE All Left
G56836	A		
F	06-11	FORD	FOCUS All Left
G56837	A		
F	06-11	FORD	FOCUS All Right
G56838	W		
F	06-10	FORD	EXPLORER All
F	06-10	MERCURY	MOUNTAINEER All
G56839	C		
R	06-10	FORD	EXPLORER All
R	06-10	MERCURY	MOUNTAINEER All
G56840	W		
F	07-10	FORD	EDGE All Left
F	07-10	LINCOLN	MKX All Left
G56841	D		
F	07-10	FORD	EDGE All Right
F	07-10	LINCOLN	MKX All Right
G56842	W		
F	07-11	TOYOTA	YARIS All Left
G56843	W		
F	07-11	TOYOTA	YARIS All Right
G56882	B		
F	04-07	CHEVROLET	OPTRA All Left
F	04-08	SUZUKI	FORENZA All Left
F	05-08	RENO	All Left
G56883	B		
F	04-07	CHEVROLET	OPTRA All Right
F	04-08	SUZUKI	FORENZA All Right
F	05-08	RENO	All Right
G56884	C		
R	04-07	CHEVROLET	OPTRA All Left
R	04-08	SUZUKI	FORENZA All Left
R	05-08	RENO	All Left
G56885	C		
R	04-07	CHEVROLET	OPTRA All Right
R	04-08	SUZUKI	FORENZA All Right
R	05-08	RENO	All Right
G56886	A		
F	04-11	CHEVROLET	AVEO All Left
F	07-09	PONTIAC	G3 All Left
F	05-08	WAVE	All Left
F	04-09	SUZUKI	SWIFT All Left
G56887	B		
F	04-11	CHEVROLET	AVEO All Right
F	07-09	PONTIAC	G3 All Right
F	05-08	WAVE	All Right
F	04-09	SUZUKI	SWIFT All Right
G56888	A		
F	07-09	LEXUS	ES350 All Left
F	07-11	TOYOTA	AVALON All Left
F	06	AVALON	All Left Mfg. from 01/06
F	07-11	CAMRY	All Left
G56889	A		
F	07-09	LEXUS	ES350 All Right
F	07-11	TOYOTA	AVALON All Right
F	06	AVALON	All Right Mfg. from 01/06
F	07-11	CAMRY	All Right
G56890	D		
F	04-09	TOYOTA	PRIUS All Left
G56891	D		
F	04-09	TOYOTA	PRIUS All Right
G56892	W		
F	02-03	KIA	SPECTRA All Left

Ultra Struts, ReadyMount Assembly

Shock	POP	Alternative No.	MTG Acc. Supplied
Pos.	Year	Application	
G56893	W		
F	02-03	KIA	SPECTRA All Right
G56894	A		
F	02-07	MITSUBISHI	LANCER LS
F	07	LANCER	LS Diamond
F	04-06	LANCER	Ralliart
F	02-06	LANCER	OZ Rally
F	06	LANCER	DE
F	06	LANCER	SE
F	04	LANCER	DE
F	04	LANCER	Sportback
G56899	C		
F	06-09	VOLKSWAGEN	BORA All
F	06-11	GTI	All
F	06-13	JETTA	All
F	06-09	PASSAT	All
F	06-09	RABBIT	All
G56903	B		
R	85-90	BUICK	ELECTRA Air (RearSpringType) w/Air assist Rear Susp. Std. Equip. Strut Only
R	86-99	LESABRE	Air (RearSpringType) Optional O.E. Hydraulic Self Leveling System
R	91-96	PARK AVENUE	Air (RearSpringType) Exc. Electronic Adjustable Suspension
R	92-93	CADILLAC	COMMERCIAL CHASSIS FWD Air Assist Rear Suspension; Exc. Electronic Adjustable Suspension
R	91	COMMERCIAL	CHASSIS All Air Assist Rear Suspension; Exc. Electronic Adjustable Suspension
R	85-90	COMMERCIAL	CHASSIS All Air Assist Rear Suspension Standard Equipment
R	91-93	DEVILLE	Air (RearSpringType) CCR Computer Command Ride
R	85-90	DEVILLE	Air (RearSpringType) Air Assist Rear Suspension Standard Equipment
R	91-93	FLEETWOOD	All Air Assist Rear Suspension; Exc. Electronic Adjustable Suspension
R	85-90	FLEETWOOD	All Air Assist Rear Suspension Standard Equipment
R	94-99	OLDSMOBILE	88 SERIES Coil (FrontSpringType), Coil (RearSpringType) Optional O.E. Hydraulic Self Leveling System; Exc. Electronic Adjustable Suspension
R	92-93	88 SERIES	Coil (FrontSpringType), Air (RearSpringType) Optional O.E. Hydraulic Self Leveling System; Exc. Electronic Adjustable Suspension
R	86-91	88 SERIES	Air (RearSpringType) Optional O.E. Hydraulic Self Leveling System
R	91-96	98 Air	(RearSpringType) CCR Computer Command Ride
R	85-90	98 Air	(RearSpringType)
R	96-99	LSS Air	(RearSpringType)
R	97-98	REGENCY	Air (RearSpringType) Optional O.E. Hydraulic Self Leveling System
R	91-99	PONTIAC	BONNEVILLE Air (RearSpringType) Optional O.E. Hydraulic Self Leveling System; Exc. Electronic Adjustable Suspension
R	88-90	BONNEVILLE	Air (RearSpringType) Optional O.E. Hydraulic Self Leveling System
R	87	BONNEVILLE	All Optional O.E. Hydraulic Self Leveling System
ReadyMount Assembly			
G56726	W		
R	85-90	BUICK	ELECTRA Air (RearSpringType) Conventional Replacement for Air Assist Rear Susp. Strut w/Upper Mount
R	86-99	LESABRE	Coil (RearSpringType)
R	91-96	PARK AVENUE	Air (RearSpringType) Conventional Replacement for Air Assist Susp.; Exc. Elec. Adj. Susp.
R	93	CADILLAC	60 SPECIAL Coil (RearSpringType) Conventional Type Replacement for Air Assist Rear Suspension

Numerical listing

Shock	POP	Alternative No.	MTG Acc. Supplied
Pos.	Year	Application	
G56726	W	-continued	
R	85-93	DEVILLE	Air (RearSpringType) Conventional Type Replacement for Air Assist Rear Suspension
R	85-93	FLEETWOOD	All Conventional Type Replacement for Air Assist Rear Suspension
R	92-99	OLDSMOBILE	88 SERIES Coil (RearSpringType) Exc. Electronic Adjustable Suspension
R	86-91	88 SERIES	Coil (RearSpringType)
R	85-96	98 Air	(RearSpringType) Conventional Type Replacement
R	96-99	LSS	Coil (RearSpringType) Conventional Type Replacement for Air Assist Rear Suspension
R	97-98	REGENCY	Coil (RearSpringType)
R	91-99	PONTIAC	BONNEVILLE Coil (RearSpringType) Exc. Electronic Adjustable Suspension
R	87-90	BONNEVILLE	Coil (RearSpringType)
G56727	W		
R	88-96	BUICK	REGAL All
R	90-94	CHEVROLET	LUMINA All
R	88-97	OLDSMOBILE	CUTLASS / CUTLASS SUPREME All
R	88-96	PONTIAC	GRAND PRIX All
G56906	D		
R	85-90	BUICK	ELECTRA Air (RearSpringType) w/Air Assist Rear Susp. Std. Equip. Strut w/Upper Mount
R	86-99	LESABRE	Air (RearSpringType) Optional O.E. Hydraulic Self Leveling System
R	91-96	PARK AVENUE	Air (RearSpringType)
R	93	CADILLAC	60 SPECIAL All Air Assist Rear Suspension; Exc. Electronic Adjustable Suspension
R	91-93	DEVILLE	Air (RearSpringType) CCR Computer Command Ride
R	85-90	DEVILLE	Air (RearSpringType) Air Assist Rear Suspension Standard Equipment
R	91-93	FLEETWOOD	All Air Assist Rear Suspension; Exc. Electronic Adjustable Suspension
R	85-90	FLEETWOOD	All Air Assist Rear Suspension Standard Equipment
R	94-99	OLDSMOBILE	All Air Assist Rear Suspension Standard Equipment
R	85-90	FLEETWOOD	All Air Assist Rear Suspension Standard Equipment
R	91-93	88 SERIES	Coil (FrontSpringType), Coil (RearSpringType) Optional O.E. Hydraulic Self Leveling System; Exc. Electronic Adjustable Suspension
R	91-93	88 SERIES	Coil (FrontSpringType), Air (RearSpringType) Optional O.E. Hydraulic Self Leveling System; Exc. Electronic Adjustable Suspension
R	91-93	88 SERIES	Air (RearSpringType) Optional O.E. Hydraulic Self Leveling System; Exc. Electronic Adjustable Suspension
R	86-90	88 SERIES	Air (RearSpringType) Optional O.E. Hydraulic Self Leveling System
R	91-96	98 Air	(RearSpringType) CCR Computer Command Ride
R	85-90	98 Air	(RearSpringType)
R	96-99	LSS	Air (RearSpringType)
R	97-98	REGENCY	Air (RearSpringType) Optional O.E. Hydraulic Self Leveling System
R	91-99	PONTIAC	BONNEVILLE Air (RearSpringType) Optional O.E. Hydraulic Self Leveling System; Exc. Electronic Adjustable Suspension
R	88-90	BONNEVILLE	Air (RearSpringType) Optional O.E. Hydraulic Self Leveling System
R	88-90	BONNEVILLE	Air (RearSpringType) Optional O.E. Hydraulic Self Leveling System
R	87	BONNEVILLE	All Optional O.E. Hydraulic Self Leveling System
G56907	W		
F	90-95	CHRYSLER	TOWN & COUNTRY All
F	87-95	DODGE	CARAVAN / GRAND CARAVAN All
F	86	CARAVAN	/ GRAND CARAVAN All Mfg. from 1/86
F	87-95	PLYMOUTH	VOYAGER / GRAND VOYAGER All
F	86	VOYAGER	/ GRAND VOYAGER All Mfg. from 1/86
G56908	W		
F	85-96	BUICK	CENTURY All
F	84	CENTURY	All HD Suspension

Numerical listing

Shock	POP	Alternative No.	MTG Acc. Supplied
Pos.	Year	Application	
G56908 W -continued			
F	85	SKYLARK All	
F	84	SKYLARK All HD Suspension	
F	85-90	CHEVROLET CELEBRITY All	
F	84	CELEBRITY All HD Suspension	
F	84-85	CITATION / CITATION II All HD Suspension	
F	85-96	OLDSMOBILE CIERA / CUTLASS CIERA All Exc. Electronic Adjustable Suspension	
F	84	CIERA / CUTLASS CIERA All HD Suspension	
F	87-94	CUTLASS CLASSIC / CUTLASS CRUISER All Exc. Electronic Adjustable Suspension	
F	84	OMEGA All HD Suspension	
F	91	PONTIAC 6000 FWD	
F	84-90	6000 All	
F	84	PHOENIX All HD Suspension	
G56909 A			
F	91-99	BUICK LESABRE All	
F	90	LESABRE All Late Design Front Strut without Spring Guard	
F	91-96	PARK AVENUE All CCR Computer Command Ride	
F	93	CADILLAC 60 SPECIAL All	
F	92-93	COMMERCIAL CHASSIS FWD	
F	91	COMMERCIAL CHASSIS All	
F	91-93	DEVILLE All Exc. Electronic Adjustable Suspension	
F	91-93	FLEETWOOD All	
F	92-99	OLDSMOBILE 88 SERIES All	
F	90-91	88 SERIES All Late Design Front Strut without Spring Guard	
F	91-96	98 All	
F	96-99	LSS All	
F	97-98	REGENCY All	
F	94-99	PONTIAC BONNEVILLE Air (RearSpringType) Exc. CCR Computer Command Ride	
F	91-93	BONNEVILLE All	
F	90	BONNEVILLE All Late Design Front Strut without Spring Guard	
G56910 C			
F	96-00	CHRYSLER TOWN & COUNTRY All	
F	00	VOYAGER / GRAND VOYAGER All	
F	00	VOYAGER / GRAND VOYAGER All Exc. Hydraulic Self Leveling System	
F	96-00	DODGE CARAVAN / GRAND CARAVAN All Exc. Hydraulic Self Leveling System	
F	00	CARAVAN / GRAND CARAVAN All	
F	96-00	PLYMOUTH VOYAGER / GRAND VOYAGER All	
F	96	VOYAGER / GRAND VOYAGER All Exc. Hydraulic Self Leveling System	
G56911 W			
F	91-96	FORD ESCORT All	
F	90-94	MAZDA 323 All	
F	90-94	PROTÉGÉ / PROTÉGÉ5 All	
F	91-96	MERCURY TRACER FWD	
G56912 W			
F	86-95	FORD TAURUS All	
F	86-95	MERCURY SABLE All	
G56913 W			
R	86-93	FORD TAURUS Sedan	
R	86-93	MERCURY SABLE Sedan	
G56914 W			
F	85-90	BUICK ELECTRA All	
F	90	LESABRE All Early Design Front Strut with Spring Guard	
F	86-89	LESABRE All	
F	85-90	CADILLAC COMMERCIAL CHASSIS All	
F	85-90	DEVILLE All	
F	85-90	FLEETWOOD All	
F	86-90	OLDSMOBILE 88 SERIES All Early Design Front Strut with Spring Guard	
F	85-90	98 All	
F	87-90	PONTIAC BONNEVILLE All Early Design Front Strut with Spring Guard	
G56916 W			
F	95-98	BUICK SKYLARK All Right	
F	95-96	CHEVROLET BERETTA All Right	
F	95-96	CORSICA All Right	
F	97-98	OLDSMOBILE ACHIEVA All Right Exc. Electronic Adjustable Suspension	

ReadyMount Assembly

Shock	POP	Alternative No.	MTG Acc. Supplied
Pos.	Year	Application	
G56916 W -continued			
F	95-96	ACHIEVA All Right	
F	95-98	PONTIAC GRAND AM All Right Exc. Electronic Adjustable Suspension	
G56917 W			
F	95-98	BUICK SKYLARK All Left	
F	95-96	CHEVROLET BERETTA All Left	
F	95-96	CORSICA All Left	
F	97-98	OLDSMOBILE ACHIEVA All Left Exc. Electronic Adjustable Suspension	
F	95-96	ACHIEVA All Left	
F	95-98	PONTIAC GRAND AM All Left Exc. Electronic Adjustable Suspension	
G56918 W			
F	92-94	BUICK SKYLARK All Right Exc. FE3 and Electronic Ride Control	
F	94	CHEVROLET BERETTA All Right Exc. FE7 Suspension	
F	92-93	BERETTA Base Right Exc. FE7 Suspension	
F	94	CORSICA Base Right Exc. FE7 Suspension	
F	93	CORSICA All Right Exc. FE7 Suspension	
F	92	CORSICA LT Right Exc. FE7 Suspension	
F	92-94	OLDSMOBILE ACHIEVA All Right Exc. FE3 and Electronic Ride Control	
F	92-94	PONTIAC GRAND AM SE Right Exc. FE3 and Electronic Ride Control	
G56919 W			
F	92-94	BUICK SKYLARK All Left Exc. FE3 and Electronic Ride Control	
F	94	CHEVROLET BERETTA All Left Exc. FE7 Suspension	
F	92-93	BERETTA Base Left Exc. FE7 Suspension	
F	94	CORSICA Base Left Exc. FE7 Suspension	
F	93	CORSICA All Left Exc. FE7 Suspension	
F	92	CORSICA LT Left Exc. FE7 Suspension	
F	92-94	OLDSMOBILE ACHIEVA All Left Exc. FE3 and Electronic Ride Control	
F	92-94	PONTIAC GRAND AM SE Left Exc. FE3 and Electronic Ride Control	
G56920 W			
F	87-91	CHEVROLET BERETTA All Right	
F	92-94	CAVALIER All Right	
F	87-91	CORSICA All Right	
F	92-94	PONTIAC SUNBIRD All Right	
F	87-91	TEMPEST All Right	
G56921 W			
F	87-91	CHEVROLET BERETTA All Left	
F	92-94	CAVALIER All Left	
F	87-91	CORSICA All Left	
F	92-94	PONTIAC SUNBIRD All Left	
F	87-91	TEMPEST All Left	
G56924 A			
R	05-09	BUICK ALLURE All Left Exc. Models with 17" or 18" Wheels	
R	97-05	CENTURY All Left	
R	05-09	LACROSSE All Left Exc. Models with 17" or 18" Wheels	
R	97-04	REGAL All Left	
R	00-11	CHEVROLET IMPALA All Left Exc. Models with 17" or 18" Wheels	
R	00-07	MONTE CARLO All Left Exc. Models with 17" or 18" Wheels	
R	98-02	OLDSMOBILE INTRIGUE All Left	
R	97-08	PONTIAC GRAND PRIX All Left Exc. Models with 17" or 18" Wheels	
G56925 A			
R	05-09	BUICK ALLURE All Right Exc. Models with 17" or 18" Wheels	
R	97-05	CENTURY All Right	
R	05-09	LACROSSE All Right Exc. Models with 17" or 18" Wheels	
R	97-04	REGAL All Right	
R	00-11	CHEVROLET IMPALA All Right Exc. Models with 17" or 18" Wheels	
R	00-07	MONTE CARLO All Right Exc. Models with 17" or 18" Wheels	

Numerical listing

Shock	POP	Alternative No.	MTG Acc. Supplied
Pos.	Year	Application	
G56925 A -continued			
R	98-02	OLDSMOBILE INTRIGUE All Right	
R	97-08	PONTIAC GRAND PRIX All Right Exc. Models with 17" or 18" Wheels	
G56926 B			
F	01-02	FORD ESCORT SE	
F	00-02	ESCORT ZX2	
F	99-00	ESCORT ZX2 S/R	
F	98-00	ESCORT LX	
F	98-99	ESCORT SE	
F	98-99	ESCORT SE Equi	
F	98-99	ESCORT ZX2 Equi	
F	99	ESCORT ZX2 Tipico	
F	97	ESCORT All	
F	97-99	MERCURY TRACER FWD	
G56927 A			
F	04-05	CHEVROLET CLASSIC All	
F	97-03	MALIBU All	
F	99-04	OLDSMOBILE ALERO All	
F	97-99	CUTLASS / CUTLASS SUPREME All	
F	99-05	PONTIAC GRAND AM All	
G56928 A			
R	04-05	CHEVROLET CLASSIC All	
R	98-03	MALIBU All Rear Strut Lower Mounting holes at 2.4" Apart	
R	99-04	OLDSMOBILE ALERO All	
R	99-05	PONTIAC GRAND AM All	
G56929 C			
F	98-05	BUICK PARK AVENUE All	
F	98-99	RIVIERA All	
G56930 A			
F	97-01	LEXUS ES300 All Left Exc. Electronic Adjustable Suspension	
F	97-03	TOYOTA AVALON All Left	
F	97-01	CAMRY All Left	
F	99-03	SOLARA All Left	
G56931 A			
F	97-01	LEXUS ES300 All Right Exc. Electronic Adjustable Suspension	
F	97-03	TOYOTA AVALON All Right	
F	97-01	CAMRY All Right	
F	99-03	SOLARA All Right	
G56932 A			
R	92-02	LEXUS ES300 All Left Exc. Electronic Adjustable Suspension	
R	95-03	TOYOTA AVALON All Left	
R	95-01	CAMRY All Left	
R	92-94	CAMRY All Left Sealed O.E. Struts	
R	99-03	SOLARA All Left	
G56933 A			
R	92-02	LEXUS ES300 All Right Exc. Electronic Adjustable Suspension	
R	95-03	TOYOTA AVALON All Right	
R	95-01	CAMRY All Right	
R	92-94	CAMRY All Right Sealed O.E. Struts	
R	99-03	SOLARA All Right	
G56934 A			
F	96-07	FORD TAURUS All Left	
F	96-05	MERCURY SABLE All Left	
G56935 B			
F	95-03	FORD WINDSTAR All	
G56936 A			
R	94-07	FORD TAURUS Sedan	
R	94-05	MERCURY SABLE Sedan	
G56937 A			
F	96-07	FORD TAURUS All Right	
F	96-05	MERCURY SABLE All Right	
G56938 B			
R	95-05	CHEVROLET CAVALIER All	
R	95-05	PONTIAC SUNFIRE All	
G56939 W			
F	95-98	CHEVROLET CAVALIER All	
F	95-98	PONTIAC SUNFIRE All	
G56940 B			
R	91-03	FORD ESCORT All	
R	91-95	MAZDA 323 All	
R	90-94	PROTÉGÉ / PROTÉGÉ5 All	
R	91-99	MERCURY TRACER FWD	
G56942 W			
F	95-96	TOYOTA CAMRY All	

Numerical listing

Shock	POP	Alternative No.	MTG Acc. Supplied
Pos.	Year	Application	
G56943	D		
R	98-02	HONDA ACCORD All	
G56947	C		
F	93-97	GEO PRIZM All	
F	93-97	TOYOTA COROLLA All	
G56948	B		
F	98-02	CHEVROLET PRIZM All	
F	98-02	TOYOTA COROLLA All	
G56949	C		
R	98-02	CHEVROLET PRIZM All Left	
R	93-97	GEO PRIZM All Left	
R	93-02	TOYOTA COROLLA All Left	
G56950	C		
R	98-02	CHEVROLET PRIZM All Right	
R	93-97	GEO PRIZM All Right	
R	93-02	TOYOTA COROLLA All Right	
G56951	A		
F	99-05	CHEVROLET CAVALIER All	
F	99-05	PONTIAC SUNFIRE All	
G56952	W		
R	95-96	CHEVROLET LUMINA All Left	
G56953	W		
R	95-96	CHEVROLET LUMINA All Right	
G56954	W		
R	95-96	CHEVROLET MONTE CARLO All Left	
G56955	W		
R	95-96	CHEVROLET MONTE CARLO All Right	
G56956	A		
F	01-07	CHRYSLER TOWN & COUNTRY All Left	
F	01-07	VOYAGER / GRAND VOYAGER All Left	
F	01-07	DODGE CARAVAN / GRAND CARAVAN All Left	
G56957	A		
F	01-07	CHRYSLER TOWN & COUNTRY All Right	
F	01-07	VOYAGER / GRAND VOYAGER All Right	
F	01-07	DODGE CARAVAN / GRAND CARAVAN All Right	
G56958	W		
F	93-97	CHRYSLER CONCORDE All Left	
F	94-97	LHS All Left	
F	94-96	NEW YORKER All Left	
F	93-97	DODGE INTREPID All Left	
F	93-97	EAGLE VISION All Left	
G56959	W		
F	93-97	CHRYSLER CONCORDE All Right	
F	94-97	LHS All Right	
F	94-96	NEW YORKER All Right	
F	93-97	DODGE INTREPID All Right	
F	93-97	EAGLE VISION All Right	
G56960	W		
R	93-97	CHRYSLER CONCORDE All	
R	93-97	DODGE INTREPID All	
R	93-97	EAGLE VISION All	
G56961	W		
F	94-97	HONDA ACCORD All	
G56962	B		
F	99-04	CHRYSLER 300M All Left	
F	98-04	CONCORDE All Left	
F	98-04	INTREPID CAN Left	
F	99-01	LHS All Left	
F	98-04	DODGE INTREPID All Left	
G56963	B		
F	99-04	CHRYSLER 300M All Right	
F	98-04	CONCORDE All Right	
F	98-04	INTREPID CAN Right	
F	99-01	LHS All Right	
F	98-04	DODGE INTREPID All Right	
G56964	D		
R	99-04	CHRYSLER 300M All	
R	98-04	CONCORDE All	
R	99-01	LHS All	
R	98-04	DODGE INTREPID All	

ReadyMount Assembly

Shock	POP	Alternative No.	MTG Acc. Supplied
Pos.	Year	Application	
G56965	A		
F	01-10	CHRYSLER PT CRUISER All	
G56966	W		
F	95-99	DODGE NEON All	
F	95-99	PLYMOUTH NEON All	
G56967	D		
R	95-99	DODGE NEON All	
R	95-99	PLYMOUTH NEON All	
G56968	W		
R	90-97	HONDA ACCORD All Left	
G56969	W		
R	90-97	HONDA ACCORD All Right	
G56970	D		
F	96-99	INFINITI I30 All Left	
F	95-99	NISSAN MAXIMA All Left	
G56971	D		
F	96-99	INFINITI I30 All Right	
F	95-99	NISSAN MAXIMA All Right	
G56973	D		
R	00-02	CHRYSLER NEON All Left	
R	03-05	DODGE NEON SXT Left	
R	00-05	NEON SE Left	
R	01-04	NEON R/T Left	
R	00-03	NEON LE Left	
R	01-02	NEON ACR Left	
R	01-02	NEON Base Left	
R	00-02	NEON ES Left	
R	00-02	NEON LX Left	
R	00	NEON High Line Left	
R	00-01	PLYMOUTH NEON All Left	
G56974	D		
R	00-02	CHRYSLER NEON All Right	
R	03-05	DODGE NEON SXT Right	
R	00-05	NEON SE Right	
R	01-04	NEON R/T Right	
R	00-03	NEON LE Right	
R	01-02	NEON ACR Right	
R	01-02	NEON Base Right	
R	00-02	NEON ES Right	
R	00-02	NEON LX Right	
R	00	NEON High Line Right	
R	00-01	PLYMOUTH NEON All Right	
G56975	W		
F	00-02	CHRYSLER NEON All	
F	03-05	DODGE NEON SXT	
F	00-05	NEON SE	
F	01-04	NEON R/T	
F	00-03	NEON LE	
F	01-02	NEON ACR	
F	01-02	NEON Base	
F	00-02	NEON ES	
F	00-02	NEON LX	
F	00	NEON High Line	
F	00-01	PLYMOUTH NEON All	
G56976	W		
F	89-97	FORD THUNDERBIRD All Left Exc. Electronic Adjustable Suspension	
F	89-97	MERCURY COUGAR All Left Exc. Electronic Adjustable Suspension	
G56977	W		
F	89-97	FORD THUNDERBIRD All Right Exc. Electronic Adjustable Suspension	
F	89-97	MERCURY COUGAR All Right Exc. Electronic Adjustable Suspension	
G56981	W		
F	90-93	HONDA ACCORD All	
G56985	W		
F	90-93	CHRYSLER IMPERIAL All Exc. Hydraulic Self Leveling System	
F	89-94	LEBARON All	
F	90-93	NEW YORKER All Exc. Hydraulic Self Leveling System	
F	88-93	DODGE DYNASTY All Exc. Hydraulic Self Leveling System	
F	89-94	SHADOW All Exc. Hydraulic Self Leveling System	
F	89-95	SPIRIT All Exc. Hydraulic Self Leveling System	
F	89-95	PLYMOUTH ACCLAIM All Exc. Hydraulic Self Leveling System	
F	89-94	SUNDANCE All Exc. Hydraulic Self Leveling System	

Numerical listing

Shock	POP	Alternative No.	MTG Acc. Supplied
Pos.	Year	Application	
G56989	W		
F	93-98	MERCURY VILLAGER All Left	
F	93-98	NISSAN QUEST All Left	
G56990	W		
F	93-98	MERCURY VILLAGER All Right	
F	93-98	NISSAN QUEST All Right	
G56991	B		
F	98-02	HONDA ACCORD 2.3L 4Cyl L (2254) Left	
G56992	C		
F	98-02	HONDA ACCORD 2.3L 4Cyl L (2254) Right	
G56993	C		
F	97-01	ACURA INTEGRA GS Left	
F	94-01	INTEGRA GS-R Left	
F	94-01	INTEGRA LS Left	
F	95-96	INTEGRA Special Edition Left	
F	92-95	HONDA CIVIC All Left	
G56994	C		
F	97-01	ACURA INTEGRA GS Right	
F	94-01	INTEGRA GS-R Right	
F	94-01	INTEGRA LS Right	
F	95-96	INTEGRA Special Edition Right	
F	92-95	HONDA CIVIC All Right	
G56995	D		
R	97-01	ACURA INTEGRA GS	
R	94-01	INTEGRA GS-R	
R	94-01	INTEGRA LS	
R	95-96	INTEGRA Special Edition	
R	92-95	HONDA CIVIC All	
G56996	D		
F	96-00	HONDA CIVIC All Left	
G56997	W		
F	96-00	HONDA CIVIC All Right	
G56998	C		
R	96-00	HONDA CIVIC All	
G57000	D		
F	07-13	CHEVROLET PICKUP 1/2 TON, SILVERADO 1500 4WD Exc. Electronic Ride Control	
F	07-13	PICKUP 1/2 TON, SILVERADO 1500 Crew Cab Pickup, RWD Exc. Electronic Ride Control	
F	07-13	PICKUP 1/2 TON, SILVERADO 1500 Extended Cab Pickup, RWD Exc. Electronic Ride Control	
F	07-13	GMC SIERRA 1500 4WD Exc. Electronic Ride Control	
F	07-13	SIERRA 1500 Crew Cab Pickup, RWD Exc. Electronic Ride Control	
F	07-13	SIERRA 1500 Extended Cab Pickup, RWD Exc. Electronic Ride Control	
G57001	W		
F	93-99	NISSAN ALTIMA All Left	
G57002	W		
F	93-99	NISSAN ALTIMA All Right	
G57003	W		
R	93-01	NISSAN ALTIMA All Left	
G57004	W		
R	93-01	NISSAN ALTIMA All Right	
G57005	W		
F	85-96	VOLKSWAGEN GOLF All	
F	85-96	JETTA All	
G57006	W		
F	97-98	VOLKSWAGEN GOLF 2.0L 4Cyl L (121)	
F	97-98	JETTA 2.0L 4Cyl L (121)	
G57007	C		
F	07-11	DODGE NITRO All Left	
F	02-12	JEEP LIBERTY All Left	
G57008	C		
F	07-11	DODGE NITRO All Right	
F	02-12	JEEP LIBERTY All Right	
G57010	C		
F	98-04	TOYOTA TACOMA Pre Runner, RWD	
F	95-04	TACOMA 4WD	

Numerical listing

Shock	POP	Alternative No.	MTG Acc. Supplied
Pos.	Year	Application	
G57011	B		
F	99-04	HONDA ODYSSEY All Left	
G57012	B		
F	99-04	HONDA ODYSSEY All Right	
G57013	C		
F	91-02	SATURN SC / SL / SW SERIES All	
G57014	W		
R	91-02	SATURN SC / SL / SW SERIES All	
G57015	W		
F	03-06	FORD EXPEDITION 4WD	
G57016	W		
R	03-06	FORD EXPEDITION All	
G57017	C		
F	02-03	FORD EXPLORER Eddie Bauer Exc. All Sport & Sport Trac Models	
F	02-03	EXPLORER Limited Exc. All Sport & Sport Trac Models	
F	02-03	EXPLORER Postal Exc. All Sport & Sport Trac Models	
F	02-03	MERCURY MOUNTAINEER All	
G57018	A		
R	02-05	FORD EXPLORER Eddie Bauer Exc. All Sport & Sport Trac Models	
R	02-05	EXPLORER Limited Exc. All Sport & Sport Trac Models	
R	02-03	EXPLORER Postal Exc. All Sport & Sport Trac Models	
R	02-05	MERCURY MOUNTAINEER All	
G57019	C		
F	04-05	FORD EXPLORER Eddie Bauer Exc. All Sport & Sport Trac Models	
F	04-05	EXPLORER Limited Exc. All Sport & Sport Trac Models	
F	04-05	MERCURY MOUNTAINEER All	
G57020	A		
F	04-08	FORD PICKUP 1/2 TON, F-150 4WD	
F	06-08	LINCOLN MARK LT 4WD	
G57021	A		
F	04-08	FORD PICKUP 1/2 TON, F-150 RWD	
F	06-08	LINCOLN MARK LT RWD	
G57022	A		
F	04-07	BUICK RAINIER All	
F	02-09	CHEVROLET TRAILBLAZER All	
F	02-09	GMC ENVOY All	
F	03-08	ISUZU ASCENDER All	
F	02-04	OLDSMOBILE BRAVADA All	
F	05-09	SAAB 9-7X All	
G57023	W		
F	10-13	CHEVROLET PICKUP 1/2 TON, SILVERADO 1500 Base, Standard Cab Pickup, RWD Exc. Classic Models and Electronic Ride	
F	07-13	PICKUP 1/2 TON, SILVERADO 1500 WT, Standard Cab Pickup, RWD Exc. Classic Models and Electronic Ride	
F	09	PICKUP 1/2 TON, SILVERADO 1500 LT, Standard Cab Pickup, RWD Exc. Classic Models and Electronic Ride	
F	07-08	PICKUP 1/2 TON, SILVERADO 1500 Base, Standard Cab Pickup, RWD Exc. Classic Models and Electronic Ride	
F	07	PICKUP 1/2 TON, SILVERADO 1500 LTZ, Standard Cab Pickup, RWD Exc. Classic Models and Electronic Ride	
F	07-13	GMC SIERRA 1500 SLE, Standard Cab Pickup, RWD Exc. Classic Models and Electronic Ride	
F	07-13	SIERRA 1500 WT, Standard Cab Pickup, RWD Exc. Classic Models and Electronic Ride	
G57024	W		
R	85-98	VOLKSWAGEN GOLF All	
R	94-98	JETTA 1.8L 4Cyl L (109)	
R	94-98	JETTA 1.9L 4Cyl L (116)	
R	94-98	JETTA 2.0L 4Cyl L (121)	
R	85-93	JETTA All	

ReadyMount Assembly

Shock	POP	Alternative No.	MTG Acc. Supplied
Pos.	Year	Application	
G57025	A		
R	99-00	CHRYSLER CIRRUS All	
R	99-00	DODGE STRATUS All	
R	99-00	PLYMOUTH BREEZE All	
G57026	A		
R	01-06	CHRYSLER SEBRING JR (MfrBodyCode), Sedan	
R	01-06	DODGE STRATUS Sedan	
G57027	A		
F	01-07	TOYOTA SEQUOIA All	
F	00-06	TUNDRA All	
G57028	D		
F	01-03	ACURA EL CAN Left	
F	02-04	HONDA CIVIC SiR, Hatchback Left	
G57029	D		
F	01-03	ACURA EL CAN Right	
F	02-04	HONDA CIVIC SiR, Hatchback Right	
G57030	A		
F	02-06	NISSAN ALTIMA All Left	
F	04-08	MAXIMA All Left	
G57031	A		
F	02-06	NISSAN ALTIMA All Right	
F	04-08	MAXIMA All Right	
G57032	W		
R	01-02	HONDA CIVIC All Left	
G57033	W		
R	01-02	HONDA CIVIC All Right	
G57034	C		
F	02-06	NISSAN SENTRA All Left	
G57035	C		
F	02-06	NISSAN SENTRA All Right	
G57036	A		
R	02-06	NISSAN SENTRA All	
G57037	C		
F	99	INFINITI QX4 All Left	
F	98	QX4 All Left Mfg. to 11/98	
F	97	QX4 All Left	
F	99	NISSAN PATHFINDER All Left	
F	98	PATHFINDER All Left Mfg. to 11/98	
F	96-97	PATHFINDER All Left	
G57038	C		
F	99	INFINITI QX4 All Right	
F	98	QX4 All Right Mfg. to 11/98	
F	97	QX4 All Right	
F	99	NISSAN PATHFINDER All Right	
F	98	PATHFINDER All Right Mfg. to 11/98	
F	96-97	PATHFINDER All Right	
G57039	A		
F	98-08	VOLKSWAGEN BEETLE GAS	
F	99-06	GOLF GAS	
F	99-05	JETTA GAS	
G57040	A		
F	93-97	VOLVO 850 All Exc. Hydraulic Self Leveling System	
F	98-04	C70 All	
F	98-00	S70 All	
F	99-00	V70 R AWD Mfg. to 3/00 and Exc. XC70, XC Cross Country	
F	98-00	V70 Base Mfg. to 3/00 and Exc. XC70, XC Cross Country	
F	98-00	V70 GLT Mfg. to 3/00 and Exc. XC70, XC Cross Country	
F	98-00	V70 T5 Mfg. to 3/00 and Exc. XC70, XC Cross Country	
F	00	V70 2.4T Mfg. to 3/00 and Exc. XC70, XC Cross Country	
F	00	V70 GLT SE Mfg. to 3/00 and Exc. XC70, XC Cross Country	
F	98-99	V70 AWD Mfg. to 3/00 and Exc. XC70, XC Cross Country	
F	98	V70 R Mfg. to 3/00 and Exc. XC70, XC Cross Country	
G57041	C		
F	02-03	TOYOTA CAMRY All Left	
G57042	C		
F	02-03	TOYOTA CAMRY All Right	
G57043	C		
R	02-03	TOYOTA CAMRY All Left	

Numerical listing

Shock	POP	Alternative No.	MTG Acc. Supplied
Pos.	Year	Application	
G57044	C		
R	02-03	TOYOTA CAMRY All Right	
G57045	C		
F	01-11	FORD ESCAPE All Left	
F	08-11	MAZDA TRIBUTE All Left	
F	01-06	TRIBUTE All Left	
F	05-10	MERCURY MARINER All Left	
G57046	C		
F	01-11	FORD ESCAPE All Right	
F	08-11	MAZDA TRIBUTE All Right	
F	01-06	TRIBUTE All Right	
F	05-10	MERCURY MARINER All Right	
G57047	A		
F	05-10	CHEVROLET COBALT LS Left	
F	05-10	COBALT LT Left	
F	10	COBALT Base Left	
F	10	COBALT LT Team Canada Left	
F	06-07	COBALT LTZ Left	
F	05	COBALT Base Left	
F	11	HHR All Left	
F	08-10	HHR LS Panel Left	
F	08-10	HHR LT Panel Left	
F	06-10	HHR LS Left	
F	06-10	HHR LT Left	
F	06-08	HHR Comfort LT Left	
F	06-08	HHR Elegance LT Left	
F	07	HHR Edicion Especial Left	
F	07-09	PONTIAC G5 All Left	
F	05-06	PURSUIT All Left	
G57048	A		
F	05-10	CHEVROLET COBALT LS Right	
F	05-10	COBALT LT Right	
F	10	COBALT Base Right	
F	10	COBALT LT Team Canada Right	
F	06-07	COBALT LTZ Right	
F	05	COBALT Base Right	
F	11	HHR All Right	
F	08-10	HHR LS Panel Right	
F	08-10	HHR LT Panel Right	
F	06-10	HHR LS Right	
F	06-10	HHR LT Right	
F	06-08	HHR Comfort LT Right	
F	06-08	HHR Elegance LT Right	
F	07	HHR Edicion Especial Right	
F	07-09	PONTIAC G5 All Right	
F	05-06	PURSUIT All Right	
G57049	A		
F	01-05	HONDA CIVIC Coupe Left	
F	01-05	CIVIC Sedan Left	
G57050	A		
F	01-05	HONDA CIVIC Coupe Right	
F	01-05	CIVIC Sedan Right	
G57051	A		
F	00-05	BUICK LESABRE All Exc. Electronic Adjustable Suspension	
F	00-05	CADILLAC DEVILLE All Exc. Electronic Adjustable Suspension	
F	98-04	SEVILLE All Exc. Electronic Adjustable Suspension	
F	01-03	OLDSMOBILE AURORA All Exc. Electronic Adjustable Suspension	
F	98-99	AURORA All Exc. Electronic Adjustable Suspension	
F	00-05	PONTIAC BONNEVILLE All Exc. Electronic Adjustable Suspension	
G57052	B		
R	96-00	FORD CONTOUR Base	
R	96-00	CONTOUR Power	
R	95-00	CONTOUR LX	
R	95-00	CONTOUR SE	
R	96-98	CONTOUR Sport	
R	95-98	CONTOUR GL	
R	99-01	MERCURY COUGAR All	
R	95-00	MYSTIQUE All	
G57053	A		
F	06-08	DODGE PICKUP 1/2 TON, RAM 1500 (SEE RAM 1500) 4WD Exc. Mega Cab	
G57054	W		
F	04-07	HONDA ACCORD 2.4L 4Cyl L (144) Left	
F	03-07	ACCORD 2.4L 4Cyl L (2354) Left	
G57055	W		
F	04-07	HONDA ACCORD 2.4L 4Cyl L (144) Right	
F	03-07	ACCORD 2.4L 4Cyl L (2354) Right	

Numerical listing

Shock	POP	Alternative No.	MTG Acc. Supplied
Pos.	Year	Application	
G57056	W		
R	03-07	HONDA ACCORD All	
G57057	D		
R	96-99	INFINITI I30 All Left	
R	95-99	NISSAN MAXIMA All Left	
G57058	D		
R	96-99	INFINITI I30 All Right	
R	95-99	NISSAN MAXIMA All Right	
G57059	C		
F	00-05	HYUNDAI SONATA All	
G57060	A		
F	05-09	BUICK ALLURE All	
F	97-05	CENTURY All	
F	05-09	LACROSSE All	
F	97-04	REGAL All	
F	00-11	CHEVROLET IMPALA All	
F	00-07	MONTE CARLO All	
F	02-05	VENTURE All	
F	97-01	VENTURE FWD	
F	98-02	OLDSMOBILE INTRIGUE All	
F	97-04	SILHOUETTE All	
F	97-03	PONTIAC GRAND PRIX All	
F	99-05	MONTANA All	
F	97-98	TRANS SPORT All	
G57061	W		
R	03-05	HONDA CIVIC All Left	
G57062	D		
R	03-05	HONDA CIVIC All Right	
G57063	A		
F	00-05	FORD FOCUS All Left	
G57064	A		
F	00-05	FORD FOCUS All Right	
G57065	D		
F	96-02	TOYOTA 4RUNNER All Left	
G57066	D		
F	96-02	TOYOTA 4RUNNER All Right	
G57067	C		
R	03-08	TOYOTA COROLLA All Left	
R	03-08	MATRIX FWD Left	
G57068	C		
R	03-08	TOYOTA COROLLA All Right	
R	03-08	MATRIX FWD Right	
G57069	B		
F	08-12	CHEVROLET MALIBU LT, 3.6L 6Cyl V (217) Left	
F	08-12	MALIBU LTZ, 3.6L 6Cyl V (217) Left	
F	07-10	MALIBU LS, 3.5L 6Cyl V (213) Left	
F	09	MALIBU LT, 3.5L 6Cyl V (213) Left	
F	06-08	MALIBU Base, 3.5L 6Cyl V (213) Left	
F	06-07	MALIBU LTZ, 3.5L 6Cyl V (213) Left	
F	04-07	MALIBU LT, 3.5L 6Cyl V (213) Left	
F	04-05	MALIBU LS, 3.5L 6Cyl V (213) Left	
F	05-10	PONTIAC G6 Sedan, 3.5L 6Cyl V (213) Left	
F	07-09	G6 Coupe, 3.5L 6Cyl V (213) Left	
F	07-09	G6 Coupe, 3.6L 6Cyl V (217) Left	
F	07-09	G6 Sedan, 3.6L 6Cyl V (217) Left	
F	06-09	G6 Coupe, 3.9L 6Cyl V (237) Left	
F	06	G6 Coupe, 3.5L 6Cyl V (214) Left	
F	06	G6 Sedan, 3.5L 6Cyl V (214) Left	
F	05	G6 Sedan, 3.5L 6Cyl V (211) Left	
F	07-09	SATURN AURA XR, 3.6L 6Cyl V (217) Left	
F	07-08	AURA XE, 3.5L 6Cyl V (213) Left	
G57070	B		
F	08-12	CHEVROLET MALIBU LT, 3.6L 6Cyl V (217) Right	
F	08-12	MALIBU LTZ, 3.6L 6Cyl V (217) Right	
F	07-10	MALIBU LS, 3.5L 6Cyl V (213) Right	
F	09	MALIBU LT, 3.5L 6Cyl V (213) Right	
F	06-08	MALIBU Base, 3.5L 6Cyl V (213) Right	
F	06-07	MALIBU LTZ, 3.5L 6Cyl V (213) Right	
F	04-07	MALIBU LT, 3.5L 6Cyl V (213) Right	
F	04-05	MALIBU LS, 3.5L 6Cyl V (213) Right	
F	05-10	PONTIAC G6 Sedan, 3.5L 6Cyl V (213) Right	
F	07-09	G6 Coupe, 3.5L 6Cyl V (213) Right	
F	07-09	G6 Coupe, 3.6L 6Cyl V (217) Right	
F	07-09	G6 Sedan, 3.6L 6Cyl V (217) Right	

ReadyMount Assembly

Shock	POP	Alternative No.	MTG Acc. Supplied
Pos.	Year	Application	
G57070	B	-continued	
F	06-09	G6 Coupe, 3.9L 6Cyl V (237) Right	
F	06	G6 Coupe, 3.5L 6Cyl V (214) Right	
F	06	G6 Sedan, 3.5L 6Cyl V (214) Right	
F	05	G6 Sedan, 3.5L 6Cyl V (211) Right	
F	07-09	SATURN AURA XR, 3.6L 6Cyl V (217) Right	
F	07-08	AURA XE, 3.5L 6Cyl V (213) Right	
G57071	D		
F	05-10	CHRYSLER 300 RWD, 5.7L 8Cyl V (345) Left	
F	06-10	DODGE CHARGER RWD, 5.7L 8Cyl V (345) Left	
F	05-08	MAGNUM RWD, 5.7L 8Cyl V (345) Left	
G57072	D		
F	05-10	CHRYSLER 300 RWD, 5.7L 8Cyl V (345) Right	
F	06-10	DODGE CHARGER RWD, 5.7L 8Cyl V (345) Right	
F	05-08	MAGNUM RWD, 5.7L 8Cyl V (345) Right	
G57073	D		
F	01-05	CHRYSLER SEBRING ST (MfrBodyCode), Coupe Left	
F	01-05	DODGE STRATUS Coupe Left	
G57074	W		
F	01-05	CHRYSLER SEBRING ST (MfrBodyCode), Coupe Right	
F	01-05	DODGE STRATUS Coupe Right	
G57075	C		
R	01-05	CHRYSLER SEBRING ST (MfrBodyCode), Coupe	
R	01-05	DODGE STRATUS Coupe	
R	99-03	MITSUBISHI GALANT GTZ	
G57076	D		
F	04-06	TOYOTA CAMRY 2.4L 4Cyl L (2362) Left	
F	04-05	CAMRY 2.4L 4Cyl L (144) Left	
F	04-06	SOLARA 2.4L 4Cyl L (2362) Left	
G57077	W		
F	04-06	TOYOTA CAMRY 2.4L 4Cyl L (2362) Right	
F	04-05	CAMRY 2.4L 4Cyl L (144) Right	
F	04-06	SOLARA 2.4L 4Cyl L (2362) Right	
G57078	D		
R	04-06	LEXUS ES330 All Left	
R	04-06	TOYOTA CAMRY All Left	
R	04-06	SOLARA All Left	
G57079	D		
R	04-06	LEXUS ES330 All Right	
R	04-06	TOYOTA CAMRY All Right	
R	04-06	SOLARA All Right	
G57080	C		
F	10-11	FORD CROWN VICTORIA Base	
F	03-11	CROWN VICTORIA LX	
F	03-08	CROWN VICTORIA Base	
F	06	CROWN VICTORIA LX Sport	
F	05	CROWN VICTORIA S	
F	03	CROWN VICTORIA LWB	
F	03	CROWN VICTORIA S	
F	03-06	MERCURY GRAND MARQUIS All	
G57081	B		
F	06-11	FORD FOCUS All Left	
G57082	A		
F	06-11	FORD FOCUS All Right	
G57083	D		
F	06-10	JEEP GRAND CHEROKEE 4WD, 6.1L 8Cyl V (370)	
F	05-10	GRAND CHEROKEE 4WD, 4.7L 8Cyl V (285)	
F	05-10	GRAND CHEROKEE 4WD, 5.7L 8Cyl V (345)	
G57084	D		
F	02-06	HONDA CR-V Automatic Left	
G57085	C		
F	02-06	HONDA CR-V Automatic Right	
G57086	C		
R	02-06	HONDA CR-V All Left	

Numerical listing

Shock	POP	Alternative No.	MTG Acc. Supplied
Pos.	Year	Application	
G57087	W		
R	02-06	HONDA CR-V All Right	
G57088	B		
F	00-06	HYUNDAI ELANTRA Automatic Left	
G57089	B		
F	00-06	HYUNDAI ELANTRA Automatic Right	
G57090	C		
R	00-05	HYUNDAI SONATA All Left	
R	01-06	KIA MAGENTIS All Left	
R	01-06	OPTIMA All Left	
G57091	B		
R	00-05	HYUNDAI SONATA All Right	
R	01-06	KIA MAGENTIS All Right	
R	01-06	OPTIMA All Right	
G57092	D		
F	04-10	INFINITI QX56 4WD	
F	05-11	NISSAN ARMADA 4WD	
F	04-15	TITAN 4WD Exc. Offroad Package	
G57093	A		
F	10-12	MAZDA 3 Grand Touring Left	
F	10-12	3 I Touring Left	
F	08-12	3 GS Left	
F	08-12	3 GT Left	
F	08-12	3 GX Left	
F	04-12	3 i Left	
F	04-12	3 S Left	
F	11	3 Sport GS Left	
F	11	3 Sport GT Left	
F	11	3 Sport GX Left	
F	05	3 SP23 Left	
F	06-10	5 All Left	
G57094	B		
F	10-12	MAZDA 3 I Touring Right	
F	08-12	3 GS Right	
F	08-12	3 GT Right	
F	08-12	3 GX Right	
F	04-12	3 i Right	
F	04-12	3 S Right	
F	11	3 Sport GS Right	
F	11	3 Sport GT Right	
F	05	3 SP23 Right	
F	06-10	5 All Right	
G57095	W		
F	06-10	FORD EXPLORER All	
F	06-10	MERCURY MOUNTAINEER All	
G57096	D		
R	06-10	FORD EXPLORER All	
R	06-10	MERCURY MOUNTAINEER All	
G57097	C		
F	03	TOYOTA SIENNA All Left	
F	02	SIENNA All Right Mfg. to 12/02	
F	98-01	SIENNA All Left	
G57098	C		
F	03	TOYOTA SIENNA All Right	
F	02	SIENNA All Right Mfg. to 12/02	
F	98-01	SIENNA All Right	
G57099	C		
F	04-07	SATURN ION All Left	
G57100	C		
F	04-07	SATURN ION All Right	
G57101	A		
F	02-07	SATURN VUE All Left	
G57102	A		
F	02-07	SATURN VUE All Right	
G57103	N		
F	11	FORD PICKUP 1/2 TON, F-150 Lariat, Extended Cab Pickup, 4WD, 3.5L 6Cyl V (213)	
F	11	PICKUP 1/2 TON, F-150 Lariat, Extended Cab Pickup, 4WD, 5.0L 8Cyl V (302)	
F	11	PICKUP 1/2 TON, F-150 Standard Cab Pickup, 4WD, 5.0L 8Cyl V (302)	
F	11	PICKUP 1/2 TON, F-150 STX, Extended Cab Pickup, 4WD, 5.0L 8Cyl V (302)	
F	11	PICKUP 1/2 TON, F-150 XL, Extended Cab Pickup, 4WD, 3.5L 6Cyl V (213)	

Numerical listing

Shock	POP	Alternative No.	MTG Acc. Supplied
Pos.	Year	Application	
G57103	N	-continued	
F 11	PICKUP 1/2 TON, F-150 XL, Extended Cab Pickup, 4WD, 5.0L 8Cyl V (302)		
F 11	PICKUP 1/2 TON, F-150 XLT, Extended Cab Pickup, 4WD, 3.5L 6Cyl V (213)		
F 11	PICKUP 1/2 TON, F-150 XLT, Extended Cab Pickup, 4WD, 5.0L 8Cyl V (302)		
F 09-10	PICKUP 1/2 TON, F-150 Lariat, Extended Cab Pickup, 4WD		
F 09-10	PICKUP 1/2 TON, F-150 STX, Extended Cab Pickup, 4WD		
F 09-10	PICKUP 1/2 TON, F-150 XL, Extended Cab Pickup, 4WD		
F 09-10	PICKUP 1/2 TON, F-150 XLT, Extended Cab Pickup, 4WD		
G57104	B		
R 97-01	HONDA CR-V All		
G57105	D		
F 00-05	TOYOTA RAV4 AWD, Automatic Left Mfg. from 5/00		
G57106	D		
F 00-05	TOYOTA RAV4 AWD, Automatic Right Mfg. from 5/00		
G57107	N		
F 93-02	CHEVROLET CAMARO All Left		
F 93-02	PONTIAC FIREBIRD All Left		
G57108	N		
F 93-02	CHEVROLET CAMARO All Right		
F 93-02	PONTIAC FIREBIRD All Right		
G57109	N		
F 08-11	BUICK ENCLAVE All		
F 09-11	CHEVROLET TRAVERSE All		
F 07-11	GMC ACADIA All		
F 07-10	SATURN OUTLOOK All		
G57110	B		
F 05-06	CHEVROLET EQUINOX All Left		
F 06	PONTIAC TORRENT All Left		
G57111	B		
F 05-06	CHEVROLET EQUINOX All Right		
F 06	PONTIAC TORRENT All Right		
G57112	A		
F 04-06	CHRYSLER PACIFICA All Left		
G57113	B		
F 04-06	CHRYSLER PACIFICA All Right		
G57114	B		
F 03-08	TOYOTA COROLLA All Left		
G57115	B		
F 03-08	TOYOTA COROLLA All Right		
G57116	A		
F 97-01	HONDA CR-V All Left		
G57117	B		
F 97-01	HONDA CR-V All Right		
G57118	N		
F 05-11	NISSAN PATHFINDER 4WD, 4.0L 6Cyl V (3954)		
G57119	N		
F 01-02	ACURA MDX All Left		
F 03-08	HONDA PILOT AWD Left		
G57120	N		
F 01-02	ACURA MDX All Right		
F 03-08	HONDA PILOT AWD Right		
G57121	N		
F 08-10	CHEVROLET MALIBU LS, 2.4L 4Cyl L (145) Left		
F 08-10	MALIBU LT, 2.4L 4Cyl L (145) Left		
F 08-10	MALIBU LTZ, 2.4L 4Cyl L (145) Left		
F 06-10	PONTIAC G6 2.4L 4Cyl L (145) Left		
F 08-09	SATURN AURA XE, 2.4L 4Cyl L (145) Left		
F 09	AURA XR, 2.4L 4Cyl L (145) Left		
F 07-08	AURA Green Line Left		
G57122	N		
F 08-10	CHEVROLET MALIBU LS, 2.4L 4Cyl L (145) Right		
F 08-10	MALIBU LT, 2.4L 4Cyl L (145) Right		

ReadyMount Assembly, LTV

Shock	POP	Alternative No.	MTG Acc. Supplied
Pos.	Year	Application	
G57122	N	-continued	
F 08-10	MALIBU LTZ, 2.4L 4Cyl L (145) Right		
F 06-10	PONTIAC G6 2.4L 4Cyl L (145) Right		
F 08-09	SATURN AURA XE, 2.4L 4Cyl L (145) Right		
F 09	AURA XR, 2.4L 4Cyl L (145) Right		
F 07-08	AURA Green Line Right		
G57123	FF		
F 07-11	TOYOTA TUNDRA Crew Cab Pickup, RWD Left Exc. Offroad and Long bed		
F 07-11	TUNDRA Standard Cab Pickup, RWD Left Exc. Offroad and Long bed		
G57124	FF		
F 07-11	TOYOTA TUNDRA Crew Cab Pickup, RWD Right Exc. Offroad and Long bed		
F 07-11	TUNDRA Standard Cab Pickup, RWD Right Exc. Offroad and Long bed		
G57125	N		
F 07-11	CHEVROLET AVALANCHE 1500 All		
F 07-11	SUBURBAN 1/2 TON, 1500 All		
F 07-11	TAHOE All		
F 07-11	GMC YUKON All		
F 07-11	YUKON XL 1/2 TON All		
G57126	N		
F 04-08	SUZUKI FORENZA All Left		
F 05-08	RENO All Left		
G57127	N		
F 04-08	SUZUKI FORENZA All Right		
F 05-08	RENO All Right		
G57128	N		
R 04-08	SUZUKI FORENZA All Left		
R 05-08	RENO All Left		
G57129	N		
R 04-08	SUZUKI FORENZA All Right		
R 05-08	RENO All Right		
G57130	N		
F 06-11	CHEVROLET AVEO All Left		
F 04-11	AVEO All Left		
F 09	PONTIAC G3 All Left		
F 05-08	WAVE All Left		
F 04-09	SUZUKI SWIFT All Left		
G57131	N		
F 06-11	LEXUS IS250 All Right		
G57132	N		
F 11-13	FORD PICKUP 1/2 TON, F-150 Extended Cab Pickup, RWD		
F 09-13	PICKUP 1/2 TON, F-150 Crew Cab Pickup, RWD		
F 09-10	PICKUP 1/2 TON, F-150 Extended Cab Pickup, RWD, 4.6L 8Cyl V (281)		
G57133	FF		
F 03-12	TOYOTA 4RUNNER All Left		
F 07-11	FJ CRUISER All Left		
F 05-12	TACOMA All Left		
G57134	FF		
F 03-12	TOYOTA 4RUNNER All Right		
F 07-11	FJ CRUISER All Right		
F 05-12	TACOMA All Right		
G57135	N		
F 00-04	AUDI A6 All Left		
F 00-04	A6 QUATTRO All Left		
F 01-05	VOLKSWAGEN PASSAT All Left		
G57136	N		
F 00-04	AUDI A6 All Right		
F 00-04	A6 QUATTRO All Right		
F 01-05	VOLKSWAGEN PASSAT All Right		
G57137	N		
F 05-07	HONDA ODYSSEY All Left		
G57138	N		
F 05-07	HONDA ODYSSEY All Right		
G57139	N		
F 01-06	HYUNDAI SANTA FE All Left		
G57140	N		
F 01-06	HYUNDAI SANTA FE All Right		

Numerical listing

Shock	POP	Alternative No.	MTG Acc. Supplied
Pos.	Year	Application	
G57141	FF		
F 04-08	PONTIAC GRAND PRIX All		
G57142	FF		
F 05-07	BUICK TERRAZA FWD		
F 05-09	CHEVROLET UPLANDER FWD		
F 05-09	PONTIAC MONTANA SV6, FWD		
F 05-07	SATURN RELAY 2, FWD		
F 05-07	RELAY 3, FWD		
F 07	RELAY 1, FWD		
G57144	N		
F 02-03	INFINITI QX4 All Left		
F 02-04	NISSAN PATHFINDER All Left		
G57145	N		
F 02-03	INFINITI QX4 All Right		
F 02-04	NISSAN PATHFINDER All Right		
G57147	FF		
F 09-10	DODGE PICKUP 1/2 TON, RAM 1500 (SEE RAM 1500) All		
F 11	RAM 1500 (SEE DODGE RAM 1500) All		
LTV			
58183	W		
F 81-93	DODGE PICKUP 1/2 TON, W100 SERIES All Exc. Lift Kit		
F 61-80	PICKUP 1/2 TON, W100 SERIES All		
F 81-93	PICKUP 1 TON, W300 SERIES All Exc. Quad Suspension and Lift Kit		
F 61-80	PICKUP 1 TON, W300 SERIES All		
R 61-71	PICKUP 1 TON, W300 SERIES All		
F 81-93	PICKUP 3/4 TON, W200 SERIES Standard Cab Pickup Exc. Lift Kit		
F 69-80	PICKUP 3/4 TON, W200 SERIES All		
F 61-67	PICKUP 3/4 TON, W200 SERIES All		
F 75-93	RAMCHARGER 4WD		
F 74	RAMCHARGER All 4WD		
F 75-81	PLYMOUTH TRAILDUSTER 4WD		
F 74	TRAILDUSTER All		
58347	C		
F 87-91	CHEVROLET BLAZER 4WD Full Size; Exc. Quad Suspension and Lift Kit		
F 75-86	BLAZER 4WD Exc. Quad Suspension and Lift Kit		
F 73-74	BLAZER 4WD Exc. Lift Kit		
F 69-72	BLAZER 4WD		
F 81-86	PICKUP 1/2 TON, K10 All Standard Suspension; Exc. Lift Kit		
F 69-80	PICKUP 1/2 TON, K10 All Exc. Lift Kit		
F 87	PICKUP 1/2 TON, V10 All Exc. Lift Kit		
F 81-86	PICKUP 3/4 TON, K20 All Standard Suspension; Exc. Lift Kit		
F 69-80	PICKUP 3/4 TON, K20 All Exc. Lift Kit		
F 87	PICKUP 3/4 TON, V20 All Exc. Quad Suspension and Lift Kit		
F 81-86	SUBURBAN 1/2 TON, K10 All Standard Suspension; Exc. Lift Kit		
F 69-80	SUBURBAN 1/2 TON, K10 All Exc. Lift Kit		
F 81-86	SUBURBAN 3/4 TON, K20 All Standard Suspension; Exc. Lift Kit		
F 69-80	SUBURBAN 3/4 TON, K20 All Exc. Lift Kit		
F 87-88	SUBURBAN 3/4 TON, V20 All Exc. Quad Suspension and Lift Kit		
F 89-91	SUBURBAN 3/4 TON, V2500 All Exc. Lift Kit		
F 70-91	GMC JIMMY 4WD Exc. Quad Suspension and Lift Kit		
F 69-86	PICKUP 1/2 TON, K15 / K1500 All Exc. Quad Suspension and Lift Kit		
F 87	PICKUP 1/2 TON, V1500 All Exc. Quad Suspension and Lift Kit		
F 69-86	PICKUP 3/4 TON, K25 / K2500 All Exc. Quad Suspension and Lift Kit		
F 87	PICKUP 3/4 TON, V2500 All Exc. Quad Suspension and Lift Kit		
F 69-86	SUBURBAN 1/2 TON, K15 / K1500 All Exc. Quad Suspension and Lift Kit		
F 87-91	SUBURBAN 1/2 TON, V1500 All Exc. Quad Suspension and Lift Kit		
F 69-86	SUBURBAN 3/4 TON, K25 / K2500 All Exc. Quad Suspension and Lift Kit		
F 87-91	SUBURBAN 3/4 TON, V2500 All Exc. Quad Suspension and Lift Kit		

Numerical listing

Shock	POP	Alternative No.	MTG Acc. Supplied
Pos.	Year	Application	
58349	W		
R	87-91	CHEVROLET	BLAZER 4WD Full Size; Exc. Lift Kit
R	85-86		BLAZER 4WD Exc. Lift Kit
R	73-84		BLAZER All Exc. Lift Kit
R	73-86		PICKUP 1/2 TON, C10 All
R	81-86		PICKUP 1/2 TON, K10 All Standard Suspension; Exc. Lift Kit
R	73-80		PICKUP 1/2 TON, K10 All Exc. Lift Kit
R	87		PICKUP 1/2 TON, R10 RWD
R	87		PICKUP 1/2 TON, V10 All Exc. Lift Kit
R	75-86		PICKUP 3/4 TON, C20 Standard Cab Pickup
R	73-74		PICKUP 3/4 TON, C20 All Standard Cab Pickup
R	81-86		PICKUP 3/4 TON, K20 All Standard Suspension; Exc. Lift Kit
R	73-80		PICKUP 3/4 TON, K20 All Exc. Lift Kit
R	87		PICKUP 3/4 TON, R20 Standard Cab Pickup
R	87		PICKUP 3/4 TON, V20 All Exc. Quad Suspension and Lift Kit
R	73-86		SUBURBAN 1/2 TON, C10 All
R	81-86		SUBURBAN 1/2 TON, K10 All Standard Suspension; Exc. Lift Kit
R	73-80		SUBURBAN 1/2 TON, K10 All Exc. Lift Kit
R	87-88		SUBURBAN 1/2 TON, R10 RWD
R	89-91		SUBURBAN 1/2 TON, R1500 RWD
R	87-88		SUBURBAN 1/2 TON, V10 All Exc. Lift Kit
R	89-91		SUBURBAN 1/2 TON, V1500 All Exc. Lift Kit
R	73-86		SUBURBAN 3/4 TON, C20 All
R	81-86		SUBURBAN 3/4 TON, K20 All Standard Suspension; Exc. Lift Kit
R	73-80		SUBURBAN 3/4 TON, K20 All Exc. Lift Kit
R	87-88		SUBURBAN 3/4 TON, R20 RWD
R	89-91		SUBURBAN 3/4 TON, R2500 RWD
R	87-88		SUBURBAN 3/4 TON, V20 All Exc. Quad Suspension and Lift Kit
R	89-91		SUBURBAN 3/4 TON, V2500 All Exc. Lift Kit
R	73		VAN 1/2 TON, P SERIES All
R	73-78		VAN 3/4 TON, P SERIES All
R	73-91		GMC JIMMY All Exc. Lift Kit
R	73-86		PICKUP 1/2 TON, C15 / C1500 All
R	73-86		PICKUP 1/2 TON, K15 / K1500 All Exc. Lift Kit
R	87		PICKUP 1/2 TON, R1500 All
R	87		PICKUP 1/2 TON, V1500 All Exc. Lift Kit
R	75-86		PICKUP 3/4 TON, C25 / C2500 Cab & Chassis
R	75-86		PICKUP 3/4 TON, C25 / C2500 Standard Cab Pickup
R	73-74		PICKUP 3/4 TON, C25 / C2500 All Exc. Crew Cab & Bonus Cab
R	74-86		PICKUP 3/4 TON, K25 / K2500 All Exc. Lift Kit
R	73		PICKUP 3/4 TON, K25 / K2500 All Exc. Quad Suspension and Lift Kit
R	88-89		PICKUP 3/4 TON, R2500 All Exc. Crew Cab & Bonus Cab
R	87		PICKUP 3/4 TON, R2500 Cab & Chassis Exc. Crew Cab & Bonus Cab
R	87		PICKUP 3/4 TON, R2500 Standard Cab Pickup Exc. Crew Cab & Bonus Cab
R	87		PICKUP 3/4 TON, V2500 All Exc. Lift Kit
R	73-86		SUBURBAN 1/2 TON, C15 / C1500 All
R	73-86		SUBURBAN 1/2 TON, K15 / K1500 All Exc. Lift Kit
R	87-91		SUBURBAN 1/2 TON, R1500 All
R	87-91		SUBURBAN 1/2 TON, V1500 All Exc. Lift Kit
R	73-86		SUBURBAN 3/4 TON, C25 / C2500 All
R	73-86		SUBURBAN 3/4 TON, K25 / K2500 All Exc. Lift Kit
R	87-91		SUBURBAN 3/4 TON, R2500 All
R	87-91		SUBURBAN 3/4 TON, V2500 All Exc. Lift Kit
R	73		VAN 1/2 TON, P SERIES All
R	73-78		VAN 3/4 TON, P SERIES All

LTV

Shock	POP	Alternative No.	MTG Acc. Supplied
Pos.	Year	Application	
58350	B		
R	66	FORD	BRONCO All Thru Serial #830000
R	75-79		PICKUP 1/2 TON, F-100 RWD
R	74		PICKUP 1/2 TON, F-100 All RWD
R	73		PICKUP 1/2 TON, F-100 All
R	70-72		PICKUP 1/2 TON, F-100 All RWD
R	75-79		PICKUP 1/2 TON, F-150 RWD
R	75-79		PICKUP 1 TON, F-350 / SUPERDUTY Extended Cab Pickup, RWD
R	74		PICKUP 1 TON, F-350 / SUPERDUTY All RWD; Exc. Supercab
R	75-79		PICKUP 3/4 TON, F-250 / SUPERDUTY Cab & Chassis, RWD
R	75-79		PICKUP 3/4 TON, F-250 / SUPERDUTY Standard Cab Pickup, RWD
R	70-74		PICKUP 3/4 TON, F-250 / SUPERDUTY RWD Exc. Supercab
R	75-91		VAN 1/2 TON, ECONOLINE / CLUB WAGON All
F	71-80		INTERNATIONAL SCOUT II All
58353	W		
R	72-93	DODGE	PICKUP 1/2 TON, D100 SERIES All
R	72-93		PICKUP 1 TON, D300 SERIES All
R	72-93		PICKUP 3/4 TON, D200 SERIES All
R	76-93		RAMCHARGER RWD
R	74-75		RAMCHARGER All
R	75-81		PLYMOUTH TRAILDUSTER RWD
R	74		TRAILDUSTER All
58355	D		
F	69-84	CHEVROLET	BLAZER RWD
F	63-86		PICKUP 1/2 TON, C10 All
F	87		PICKUP 1/2 TON, R10 All
F	63-86		PICKUP 1 TON, C30 All
F	88-91		PICKUP 1 TON, C35/3500 Cab & Chassis Exc. HD Solid Front Axle
F	87-88		PICKUP 1 TON, R30 All
F	89		PICKUP 1 TON, R3500 Standard Cab Pickup
F	75-86		PICKUP 3/4 TON, C20 Crew Cab Pickup
F	75-86		PICKUP 3/4 TON, C20 Standard Cab Pickup
F	63-74		PICKUP 3/4 TON, C20 All
F	87-88		PICKUP 3/4 TON, R20 Crew Cab Pickup
F	87		PICKUP 3/4 TON, R20 Standard Cab Pickup
F	89		PICKUP 3/4 TON, R2500 All
F	67		SUBURBAN 1/2 TON, 1500 Coil (FrontSpringType)
F	63-66		SUBURBAN 1/2 TON, 1500 All
F	63-86		SUBURBAN 1/2 TON, C10 All
F	87-88		SUBURBAN 1/2 TON, R10 All
F	89-91		SUBURBAN 1/2 TON, R1500 All
F	68-86		SUBURBAN 3/4 TON, C20 All
F	87-88		SUBURBAN 3/4 TON, R20 All
F	89-91		SUBURBAN 3/4 TON, R2500 All
F	63-80		VAN 1/2 TON, P SERIES All
F	73-90		VAN 1 TON, P SERIES All Exc. Motorhome Chassis
F	68-72		VAN 1 TON, P SERIES All
F	68-89		VAN 3/4 TON, P SERIES All
F	70-84		GMC JIMMY RWD
F	67-86		PICKUP 1/2 TON, C15 / C1500 All
F	87		PICKUP 1/2 TON, R1500 All
F	88-90		PICKUP 1 TON, C35/3500 Cab & Chassis HD Solid Front Axle
F	67-78		PICKUP 1 TON, C35/3500 All
F	87-91		PICKUP 1 TON, R3500 All
F	85-86		PICKUP 3/4 TON, C25 / C2500 Crew Cab Pickup
F	75-86		PICKUP 3/4 TON, C25 / C2500 Cab & Chassis
F	75-86		PICKUP 3/4 TON, C25 / C2500 Standard Cab Pickup
F	75-83		PICKUP 3/4 TON, C25 / C2500 Crew Cab Pickup
F	67-74		PICKUP 3/4 TON, C25 / C2500 All
F	87-89		PICKUP 3/4 TON, R2500 All Exc. Crew Cab & Bonus Cab
F	63-65		PICKUP 1000 SERIES All
F	63-65		PICKUP 1500 SERIES All
F	68-86		SUBURBAN 1/2 TON, C15 / C1500 All
F	87-91		SUBURBAN 1/2 TON, R1500 All
F	68-86		SUBURBAN 3/4 TON, C25 / C2500 All
F	87-91		SUBURBAN 3/4 TON, R2500 All

Numerical listing

Shock	POP	Alternative No.	MTG Acc. Supplied
Pos.	Year	Application	
58355	D	-continued	
F	67-80		VAN 1/2 TON, P SERIES All
F	74-90		VAN 1 TON, P SERIES All Exc. Motorhome Chassis
F	73		VAN 1 TON, P SERIES Base Exc. Motorhome Chassis
F	68-72		VAN 1 TON, P SERIES All
F	68-89		VAN 3/4 TON, P SERIES All
F	63-65		VAN, PB 1000 SERIES All
58357	C		
F	71-95	CHEVROLET	VAN 1/2 TON, G / EXPRESS All
F	70		VAN 1/2 TON, G / EXPRESS All Independent Front Suspension
F	78-96		VAN 1 TON, G / EXPRESS All
F	96		VAN 1 TON, G / EXPRESS Cutaway Van
F	75		VAN 1 TON, G / EXPRESS 146.0 (WheelBase)
F	71-74		VAN 1 TON, G / EXPRESS All
F	78-95		VAN 3/4 TON, G / EXPRESS All Exc. 8600# GVW
F	70-77		VAN 3/4 TON, G / EXPRESS All
F	70-95		GMC VAN 1/2 TON, G / SAVANNA All
F	76-96		VAN 1 TON, G / SAVANNA All
F	75		VAN 1 TON, G / SAVANNA 110.0 (WheelBase)
F	75		VAN 1 TON, G / SAVANNA 125.0 (WheelBase)
F	71-74		VAN 1 TON, G / SAVANNA All
F	78-95		VAN 3/4 TON, G / SAVANNA All Exc. 8600# GVW
F	71-77		VAN 3/4 TON, G / SAVANNA All
F	70		VAN 3/4 TON, G / SAVANNA All Independent Front Suspension
58359	B		
F	84-88	DODGE	MINI RAM All
F	72-93		PICKUP 1/2 TON, D100 SERIES All
F	72-93		PICKUP 3/4 TON, D200 SERIES All Exc. HD Package
F	75-93		RAMCHARGER RWD
F	99-03		VAN 1/2 TON, A / B SERIES / RAM 109.3 (WheelBase) Exc. 7000# GVW
F	81-98		VAN 1/2 TON, A / B SERIES / RAM 109.6 (WheelBase) Exc. 7000# GVW
F	71-80		VAN 1/2 TON, A / B SERIES / RAM All
F	99-03		VAN 1 TON, A / B SERIES / RAM All
F	71-98		VAN 1 TON, A / B SERIES / RAM All Exc. 4000# Front Axle
F	71-03		VAN 3/4 TON, A / B SERIES / RAM All
F	78-80		VAN, CB300 All Exc. 4000# Front Axle
F	74-77		VAN, CB300 All Up through 8300# GVW
F	75-81		PLYMOUTH TRAILDUSTER RWD
F	74-83		VAN 1/2 TON, PB SERIES All
F	74-83		VAN 1 TON, PB SERIES All Exc. 4000# Front Axle
F	74-83		VAN 3/4 TON, PB SERIES All
58360	W		
F	72-93	DODGE	PICKUP 1 TON, D300 SERIES All
F	82-93		PICKUP 3/4 TON, D200 SERIES All HD Package
F	81		PICKUP 3/4 TON, D200 SERIES 165.0 (WheelBase) HD Package
F	77-80		PICKUP 3/4 TON, D200 SERIES All HD Package
F	75-76		PICKUP 3/4 TON, D200 SERIES 165.0 (WheelBase) HD Package
F	72-74		PICKUP 3/4 TON, D200 SERIES All HD Package
F	71-93		VAN 1 TON, A / B SERIES / RAM All 4000# Front Axle
F	74-80		VAN, CB300 All Over 8300# GVW
F	74-83		PLYMOUTH VAN 1 TON, PB SERIES All 4000# Front Axle
58366	D		
R	73-86	CHEVROLET	PICKUP 1 TON, C30 All
R	88-91		PICKUP 1 TON, C35/3500 Cab & Chassis Exc. HD Solid Front Axle
R	87-88		PICKUP 1 TON, R30 RWD
R	89		PICKUP 1 TON, R3500 Standard Cab Pickup
R	75-86		PICKUP 3/4 TON, C20 Crew Cab Pickup

Numerical listing

Shock	POP	Alternative No.	MTG Acc. Supplied
Pos.	Year	Application	
58366 D -continued			
R	73-74	PICKUP 3/4 TON, C20 All Crew Cab Pickup	
R	87-88	PICKUP 3/4 TON, R20 Crew Cab Pickup	
R	89	PICKUP 3/4 TON, R2500 RWD	
R	74-80	VAN 1/2 TON, P SERIES All	
R	73-99	VAN 1 TON, P SERIES All	
R	79-89	VAN 3/4 TON, P SERIES All	
R	88-91	GMC PICKUP 1 TON, C35/3500 Cab & Chassis Exc. HD Solid Front Axle	
R	73-78	PICKUP 1 TON, C35/3500 All	
R	87-91	PICKUP 1 TON, R3500 All	
R	85-86	PICKUP 3/4 TON, C25 / C2500 Crew Cab Pickup	
R	75-83	PICKUP 3/4 TON, C25 / C2500 Crew Cab Pickup	
R	87-89	PICKUP 3/4 TON, R2500 Crew Cab Pickup	
R	74-80	VAN 1/2 TON, P SERIES All	
R	74-99	VAN 1 TON, P SERIES All	
R	73	VAN 1 TON, P SERIES Base Exc. Motorhome Chassis	
R	79-89	VAN 3/4 TON, P SERIES All	
58377 W			
R	78-79	FORD BRONCO All Exc. Lift Kit	
R	66-77	BRONCO All From Serial #830001; Exc. Lift Kit	
R	66-69	PICKUP 1/2 TON, F-100 All RWD	
R	65	PICKUP 1/2 TON, F-100 All	
R	75-79	PICKUP 1 TON, F-350 / SUPERDUTY Standard Cab Pickup, RWD	
R	75-79	PICKUP 3/4 TON, F-250 / SUPERDUTY Extended Cab Pickup, RWD	
R	70-74	PICKUP 3/4 TON, F-250 / SUPERDUTY RWD Supercab	
R	65-69	PICKUP 3/4 TON, F-250 / SUPERDUTY RWD	
R	76-83	JEEP CHEROKEE All	
F	74-83	CHEROKEE All	
F	84-91	GRAND WAGONEER All	
R	84-91	GRAND WAGONEER All	
R	76-83	WAGONEER All	
F	74-83	WAGONEER All	
58386 W			
F	66-77	FORD BRONCO All From Serial #830001; Exc. Lift Kit	
F	73-79	PICKUP 1/2 TON, F-100 RWD	
F	65-72	PICKUP 1/2 TON, F-100 All RWD	
F	75-79	PICKUP 1/2 TON, F-150 RWD	
F	75-79	PICKUP 1 TON, F-350 / SUPERDUTY RWD	
F	73-74	PICKUP 1 TON, F-350 / SUPERDUTY All RWD; Exc. Supercab	
F	67-79	PICKUP 3/4 TON, F-250 / SUPERDUTY RWD	
F	65-66	PICKUP 3/4 TON, F-250 / SUPERDUTY All	
F	77-91	VAN 1 TON, ECONOLINE / CLUB WAGON / SUPERDUTY All	
F	75-91	VAN 1 TON, ECONOLINE / CLUB WAGON / SUPERDUTY All Exc. Motorhome Conversion	
F	75-91	VAN 3/4 TON, ECONOLINE / CLUB WAGON / SUPERDUTY All	
58387 W			
R	76-79	FORD PICKUP 1/2 TON, F-150 4WD Exc. Lift Kit	
R	75	PICKUP 1/2 TON, F-150 All 4WD; Exc. Lift Kit	
R	79	PICKUP 1 TON, F-350 / SUPERDUTY 4WD	
R	77-79	PICKUP 3/4 TON, F-250 / SUPERDUTY Cab & Chassis, 4WD All From Serial No. Y20001	
R	77-79	PICKUP 3/4 TON, F-250 / SUPERDUTY Standard Cab Pickup, 4WD All From Serial No. Y20001	
R	77-91	VAN 1 TON, ECONOLINE / CLUB WAGON / SUPERDUTY All	
R	75-91	VAN 1 TON, ECONOLINE / CLUB WAGON / SUPERDUTY All Exc. Motorhome Conversion	
R	75-91	VAN 3/4 TON, ECONOLINE / CLUB WAGON / SUPERDUTY All	
58389 W			
R	81-93	DODGE PICKUP 1/2 TON, W100 SERIES All Exc. Lift Kit	

LTV

Shock	POP	Alternative No.	MTG Acc. Supplied
Pos.	Year	Application	
58389 W -continued			
R	72-80	PICKUP 1/2 TON, W100 SERIES All	
R	81-93	PICKUP 1 TON, W300 SERIES All Exc. Quad Suspension and Lift Kit	
R	72-80	PICKUP 1 TON, W300 SERIES All	
R	81-93	PICKUP 3/4 TON, W200 SERIES Standard Cab Pickup Exc. Lift Kit	
R	72-80	PICKUP 3/4 TON, W200 SERIES All	
R	76-93	RAMCHARGER 4WD	
R	76-81	PLYMOUTH TRAILDUSTER 4WD	
58394 C			
F	85-99	CHEVROLET VAN 1 TON, P SERIES All Motorhome Chassis with Independent Front Suspension	
F	74-84	VAN 1 TON, P SERIES All Motorhome Chassis	
F	85-99	GMC VAN 1 TON, P SERIES All Motorhome Chassis with Independent Front Suspension	
F	75-84	VAN 1 TON, P SERIES All Motorhome Chassis	
F	74	VAN 1 TON, P SERIES Motor Home Motorhome Chassis	
58403 B			
R	79-95	CHEVROLET VAN 1 TON, G / EXPRESS Cutaway Van	
F	85	VAN 1 TON, P SERIES All Motorhome Chassis with I-Beam Front Suspension	
R	97-04	DODGE DAKOTA All	
R	01-03	DURANGO 4WD	
R	01-03	DURANGO RWD	
R	98-00	DURANGO All	
R	79-95	GMC VAN 1 TON, G / SAVANNA Cutaway Van	
F	85	VAN 1 TON, P SERIES All Motorhome Chassis with I-Beam Front Suspension	
58406 W			
R	85-96	FORD PICKUP 1/2 TON, F-150 RWD	
R	80-97	PICKUP 1 TON, F-350 / SUPERDUTY RWD Exc. Dual Rear Wheels	
R	97	PICKUP 3/4 TON, F-250 / SUPERDUTY RWD Over 8500# GVW	
R	80-96	PICKUP 3/4 TON, F-250 / SUPERDUTY RWD	
58409 B			
R	80-96	FORD BRONCO All Exc. Lift Kit	
R	80-83	PICKUP 1/2 TON, F-100 RWD	
R	80-84	PICKUP 1/2 TON, F-150 RWD	
R	90-97	PICKUP 1/2 TON, F SUPERDUTY All	
R	80-97	PICKUP 1 TON, F-350 / SUPERDUTY RWD Dual Rear Wheels	
R	97	PICKUP, F-450 SUPERDUTY All	
58410 C			
F	80-96	FORD BRONCO All Quad Suspension; Forward of Front Axle; Exc. Lift Kit	
F	80-96	PICKUP 1/2 TON, F-150 4WD Quad Suspension; Forward of Front Axle; Exc. Lift Kit	
F	80-81	PICKUP 1 TON, F-350 / SUPERDUTY 4WD	
F	80-82	PICKUP 3/4 TON, F-250 / SUPERDUTY Standard Cab Pickup, 4WD	
58411 C			
F	77-86	CHEVROLET PICKUP 1 TON, K30 All	
F	90-91	PICKUP 1 TON, R3500 All	
F	89	PICKUP 1 TON, R3500 Cab & Chassis	
F	89	PICKUP 1 TON, R3500 Crew Cab Pickup	
F	87-88	PICKUP 1 TON, V30 All	
F	89-91	PICKUP 1 TON, V3000 / V3500 All	
F	77-86	GMC PICKUP 1 TON, K35 / K3500 All	
F	87-91	PICKUP 1 TON, V3000 / V3500 All	

Numerical listing

Shock	POP	Alternative No.	MTG Acc. Supplied
Pos.	Year	Application	
58412 A			
R	07	CHEVROLET PICKUP 1/2 TON, SILVERADO 1500 Classic Hybrid, 4WD Classic and Old Body Style; Exc. Electronic Adjustable Suspension	
R	07	PICKUP 1/2 TON, SILVERADO 1500 Classic LS, 4WD Classic and Old Body Style; Exc. Electronic Adjustable Suspension	
R	07	PICKUP 1/2 TON, SILVERADO 1500 Classic LT, 4WD Classic and Old Body Style; Exc. Electronic Adjustable Suspension	
R	07	PICKUP 1/2 TON, SILVERADO 1500 Classic WT, 4WD Classic and Old Body Style; Exc. Electronic Adjustable Suspension	
R	99-06	PICKUP 1/2 TON, SILVERADO 1500 4WD Classic and Old Body Style; Exc. Electronic Adjustable Suspension	
R	05-07	PICKUP 1/2 TON, SILVERADO 1500 HD All	
R	01-03	PICKUP 1/2 TON, SILVERADO 1500 HD All	
R	77-86	PICKUP 1 TON, K30 All	
R	90-91	PICKUP 1 TON, R3500 All	
R	89	PICKUP 1 TON, R3500 Cab & Chassis	
R	89	PICKUP 1 TON, R3500 Crew Cab Pickup	
R	01-09	PICKUP 1 TON, SILVERADO 3500 All	
R	07-10	PICKUP 1 TON, SILVERADO 3500 HD All	
R	87-88	PICKUP 1 TON, V30 All	
R	89-91	PICKUP 1 TON, V3000 / V3500 All	
R	99-08	PICKUP 3/4 TON, SILVERADO 2500 All	
R	01-10	PICKUP 3/4 TON, SILVERADO 2500 HD All	
R	06-07	DODGE PICKUP 1/2 TON, RAM 1500 (SEE RAM 1500) All Exc. Mega Cab	
R	02-05	PICKUP 1/2 TON, RAM 1500 (SEE RAM 1500) All	
R	77-86	GMC PICKUP 1 TON, K35 / K3500 All	
R	87-91	PICKUP 1 TON, V3000 / V3500 All	
R	07	SIERRA 1500 Classic Hybrid, 4WD Classic and Old Body Style; Exc. Electronic Adjustable Suspension	
R	07	SIERRA 1500 Classic SL, 4WD Classic and Old Body Style; Exc. Electronic Adjustable Suspension	
R	07	SIERRA 1500 Classic SLE, 4WD Classic and Old Body Style; Exc. Electronic Adjustable Suspension	
R	07	SIERRA 1500 Classic SLT, 4WD Classic and Old Body Style; Exc. Electronic Adjustable Suspension	
R	07	SIERRA 1500 Classic WT, 4WD Classic and Old Body Style; Exc. Electronic Adjustable Suspension	
R	99-06	SIERRA 1500 4WD Classic and Old Body Style; Exc. Electronic Adjustable Suspension	
R	05-07	SIERRA 1500 HD All	
R	01-03	SIERRA 1500 HD All	
R	99-04	SIERRA 2500 All	
R	01-10	SIERRA 2500 HD All	
R	01-07	SIERRA 3500 All	
R	07-10	SIERRA 3500 HD All	
58413 B			
R	78-95	CHEVROLET VAN 1/2 TON, G / EXPRESS All	
R	78-91	VAN 1 TON, G / EXPRESS Standard Cargo Van	
R	78-91	VAN 1 TON, G / EXPRESS Standard Passenger Van	
R	78-95	VAN 3/4 TON, G / EXPRESS All Exc. 8600# GVW	
R	84-88	DODGE MINI RAM All	
R	99-03	VAN 1/2 TON, A / B SERIES / RAM 109.3 (WheelBase) Exc. 7000# GVW	
R	81-98	VAN 1/2 TON, A / B SERIES / RAM 109.6 (WheelBase) Exc. 7000# GVW	
R	71-80	VAN 1/2 TON, A / B SERIES / RAM All	
R	99-03	VAN 1 TON, A / B SERIES / RAM All	

Numerical listing

Shock	POP	Alternative No.	MTG Acc. Supplied
Pos.	Year	Application	
58413 B -continued			
R	95-98	VAN 1 TON, A / B SERIES / RAM All Exc. 4000# Front Axle	
R	71-94	VAN 1 TON, A / B SERIES / RAM All	
R	71-03	VAN 3/4 TON, A / B SERIES / RAM All	
R	74-80	VAN, CB300 All	
R	78-95	GMC VAN 1/2 TON, G / SAVANNA All	
R	85-96	VAN 1 TON, G / SAVANNA Extended Cargo Van	
R	85-96	VAN 1 TON, G / SAVANNA Extended Passenger Van	
R	79-96	VAN 1 TON, G / SAVANNA Standard Cargo Van	
R	79-96	VAN 1 TON, G / SAVANNA Standard Passenger Van	
R	78	VAN 1 TON, G / SAVANNA Cutaway Van	
R	78-95	VAN 3/4 TON, G / SAVANNA All Exc. 8600# GVW	
R	74-83	PLYMOUTH VAN 1/2 TON, PB SERIES All	
R	74-83	VAN 1 TON, PB SERIES All	
R	74-83	VAN 3/4 TON, PB SERIES All	
58414 B			
F	80-96	FORD BRONCO All Quad & Non Quad Suspensions Rearward of Front Axle; Exc. Lift Kit	
F	80-83	PICKUP 1/2 TON, F-100 RWD	
F	80-96	PICKUP 1/2 TON, F-150 4WD Quad & Non Quad Suspensions Rearward of Front Axle; Exc. Lift Kit	
F	80-96	PICKUP 1/2 TON, F-150 RWD	
F	80-97	PICKUP 1 TON, F-350 / SUPERDUTY RWD	
F	97	PICKUP 3/4 TON, F-250 / SUPERDUTY RWD Over 8500# GVW	
F	80-96	PICKUP 3/4 TON, F-250 / SUPERDUTY RWD	
58416 C			
F	82-85	FORD PICKUP 1 TON, F-350 / SUPERDUTY 4WD Clevis Type Lower Front Mount; Exc. Dual Rear Wheels or Lift Kit	
F	83-86	PICKUP 3/4 TON, F-250 / SUPERDUTY 4WD Clevis Type Lower Front Mount; Exc. Dual Rear Wheels or Lift Kit	
F	80-82	PICKUP 3/4 TON, F-250 / SUPERDUTY Extended Cab Pickup, 4WD	
58421 D			
F	05	CHEVROLET BLAZER Base, RWD	
F	96-04	BLAZER LS, RWD	
F	95-02	BLAZER LT, RWD	
F	95-99	BLAZER Base, RWD	
F	95-97	BLAZER Deluxe, RWD	
F	83-94	BLAZER, S MODELS RWD	
F	94-03	S10 LS, RWD	
F	82-03	S10 Base, RWD	
F	92-93	S10 EL, RWD	
F	83-92	S10 Tahoe, RWD	
F	88-90	S10 Durango, RWD	
F	82-86	S10 Durango, RWD	
F	72-82	FORD COURIER All	
F	92-04	GMC JIMMY RWD	
F	83-91	S15 JIMMY RWD	
F	04	SONOMA / S15 All RWD	
F	82-03	SONOMA / S15 RWD	
F	78-87	SPRINT / CABALLERO RWD	
F	71-77	SPRINT / CABALLERO All	
F	96-00	ISUZU HOMBRE RWD Exc. Sport Chassis	
F	72-76	MAZDA B1600 All	
F	77-78	B1800 All	
F	79-84	B2000 All	
F	82-84	B2200 All	
58422 A			
R	05	CHEVROLET BLAZER Base, 4WD	
R	05	BLAZER Base, RWD	
R	96-04	BLAZER LS, 4WD	
R	96-04	BLAZER LS, RWD	
R	95-02	BLAZER LT, RWD	
R	95-01	BLAZER LT, 4WD	
R	95-99	BLAZER Base, 4WD	
R	95-99	BLAZER Base, RWD	
R	95-97	BLAZER Deluxe, RWD	
R	83-94	BLAZER, S MODELS All	
R	99-04	S10 LS, 4WD	
R	99-03	S10 Base, 4WD	

LTV

Shock	POP	Alternative No.	MTG Acc. Supplied
Pos.	Year	Application	
58422 A -continued			
R	99-03	S10 Base, RWD	
R	99-03	S10 LS, RWD	
R	94-98	S10 LS	
R	82-98	S10 Base	
R	92-93	S10 EL	
R	83-92	S10 Tahoe	
R	88-90	S10 Durango	
R	82-86	S10 Durango	
R	05	GMC JIMMY 4WD	
R	92-04	JIMMY All	
R	83-91	S15 JIMMY All	
R	82-04	SONOMA / S15 All	
R	91	SYCLONE All	
R	92-93	TYPHOON All	
R	96-00	ISUZU HOMBRE All	
R	96-01	OLDSMOBILE BRAVADA All	
R	91-94	BRAVADA All	
58423 A			
F	05	CHEVROLET BLAZER Base, 4WD	
F	96-04	BLAZER LS, 4WD	
F	95-01	BLAZER LT, 4WD	
F	95-99	BLAZER Base, 4WD	
F	83-94	BLAZER, S MODELS 4WD	
F	94-04	S10 LS, 4WD	
F	83-03	S10 Base, 4WD	
F	92-93	S10 EL, 4WD	
F	83-92	S10 Tahoe, 4WD	
F	88-90	S10 Durango, 4WD	
F	88	S10 Sport, 4WD	
F	83-86	S10 Durango, 4WD	
F	92-05	GMC JIMMY 4WD	
F	83-91	S15 JIMMY 4WD	
F	83-04	SONOMA / S15 4WD	
F	91	SYCLONE All	
F	92-93	TYPHOON All	
F	96-00	ISUZU HOMBRE All Sport Chassis	
F	96-01	OLDSMOBILE BRAVADA All	
F	91-94	BRAVADA All	
58437 C			
F	87-91	CHEVROLET BLAZER 4WD Full Size; 4" Lift Kit; Exc. Quad Suspension	
F	73-86	BLAZER 4WD 4" Lift Kit; Exc. Quad Suspension	
F	73-86	PICKUP 1/2 TON, K10 All 4" Lift Kit; Exc. Quad Suspension	
F	87	PICKUP 1/2 TON, V10 All 4" Lift Kit; Exc. Quad Suspension	
F	73-86	PICKUP 3/4 TON, K20 All 4" Lift Kit; Exc. Quad Suspension	
F	87	PICKUP 3/4 TON, V20 All 4" Lift Kit; Exc. Quad Suspension	
F	73-86	SUBURBAN 1/2 TON, K10 All 4" Lift Kit; Exc. Quad Suspension	
F	89-91	SUBURBAN 1/2 TON, V1500 4WD 4" Lift Kit; Exc. Quad Suspension	
F	73-86	SUBURBAN 3/4 TON, K20 All 4" Lift Kit; Exc. Quad Suspension	
F	87-88	SUBURBAN 3/4 TON, V20 All 4" Lift Kit; Exc. Quad Suspension	
F	89-91	SUBURBAN 3/4 TON, V2500 All 4" Lift Kit; Exc. Quad Suspension	
F	75-91	GMC JIMMY 4WD 4" Lift Kit; Exc. Quad Suspension	
F	73-74	JIMMY All 4" Lift Kit; Exc. Quad Suspension	
F	73-86	PICKUP 1/2 TON, K15 / K1500 All 4" Lift Kit; Exc. Quad Suspension	
F	87	PICKUP 1/2 TON, V1500 All 4" Lift Kit; Exc. Quad Suspension	
F	73-86	PICKUP 3/4 TON, K25 / K2500 All 4" Lift Kit; Exc. Quad Suspension	
F	87	PICKUP 3/4 TON, V2500 All 4" Lift Kit; Exc. Quad Suspension	
F	73-86	SUBURBAN 1/2 TON, K15 / K1500 All 4" Lift Kit; Exc. Quad Suspension	
F	87-91	SUBURBAN 1/2 TON, V1500 All 4" Lift Kit; Exc. Quad Suspension	
F	73-86	SUBURBAN 3/4 TON, K25 / K2500 All 4" Lift Kit; Exc. Quad Suspension	
F	87-91	SUBURBAN 3/4 TON, V2500 All 4" Lift Kit; Exc. Quad Suspension	
58438 W			
R	87-90	CHEVROLET BLAZER 4WD Full Size; 4" Lift Kit; Exc. Quad Suspension	
R	74-86	BLAZER 4WD 4" Lift Kit; Exc. Quad Suspension	
R	73	BLAZER 4WD Full Size; 4" Lift Kit; Exc. Quad Suspension	

Numerical listing

Shock	POP	Alternative No.	MTG Acc. Supplied
Pos.	Year	Application	
58438 W -continued			
R	73-86	PICKUP 1/2 TON, K10 All 4" Lift Kit; Exc. Quad Suspension	
R	87	PICKUP 1/2 TON, V10 All 4" Lift Kit; Exc. Quad Suspension	
R	73-86	PICKUP 3/4 TON, K20 All 4" Lift Kit; Exc. Quad Suspension	
R	87	PICKUP 3/4 TON, V20 All 4" Lift Kit; Exc. Quad Suspension	
R	73-86	SUBURBAN 1/2 TON, K10 All 4" Lift Kit; Exc. Quad Suspension	
R	73-86	SUBURBAN 3/4 TON, K20 All 4" Lift Kit; Exc. Quad Suspension	
R	87-88	SUBURBAN 3/4 TON, V20 All 4" Lift Kit; Exc. Quad Suspension	
R	89-91	SUBURBAN 3/4 TON, V2500 All 4" Lift Kit; Exc. Quad Suspension	
R	85-91	GMC JIMMY All 4" Lift Kit	
R	75-84	JIMMY 4WD 4" Lift Kit	
R	73-74	JIMMY All 4WD with 4" Lift Kit	
R	73-86	PICKUP 1/2 TON, K15 / K1500 All 4" Lift Kit; Exc. Quad Suspension	
R	87	PICKUP 1/2 TON, V1500 All 4" Lift Kit; Exc. Quad Suspension	
R	73-86	PICKUP 3/4 TON, K25 / K2500 All 4" Lift Kit; Exc. Quad Suspension	
R	87	PICKUP 3/4 TON, V2500 All 4" Lift Kit; Exc. Quad Suspension	
R	73-86	SUBURBAN 1/2 TON, K15 / K1500 All 4" Lift Kit; Exc. Quad Suspension	
R	87-91	SUBURBAN 1/2 TON, V1500 All 4" Lift Kit; Exc. Quad Suspension	
R	84-86	SUBURBAN 3/4 TON, K25 / K2500 All 4" Lift Kit; Exc. Quad Suspension	
R	83	SUBURBAN 3/4 TON, K25 / K2500 All 4" Lift Kit; Exc. Quad Suspension	
R	73-82	SUBURBAN 3/4 TON, K25 / K2500 All 4" Lift Kit; Exc. Quad Suspension	
R	87-91	SUBURBAN 3/4 TON, V2500 All 4" Lift Kit; Exc. Quad Suspension	
58455 W			
F	86-97	FORD PICKUP 1 TON, F-350 / SUPERDUTY 4WD	
F	97	PICKUP 3/4 TON, F-250 / SUPERDUTY 4WD Over 8500# GVW	
F	87-96	PICKUP 3/4 TON, F-250 / SUPERDUTY 4WD	
58456 W			
R	86-97	FORD PICKUP 1 TON, F-350 / SUPERDUTY 4WD Exc. Dual Rear Wheels	
58461 C			
R	80-96	FORD PICKUP 1/2 TON, F-150 4WD Exc. Lift Kit	
R	86-97	PICKUP 1 TON, F-350 / SUPERDUTY 4WD Dual Rear Wheels	
R	82-85	PICKUP 1 TON, F-350 / SUPERDUTY 4WD Clevis Type Lower Front Mount; Exc. Dual Rear Wheels or Lift Kit	
R	80-81	PICKUP 1 TON, F-350 / SUPERDUTY 4WD Dual Rear Wheels	
R	97	PICKUP 3/4 TON, F-250 / SUPERDUTY 4WD Over 8500# GVW	
R	86-96	PICKUP 3/4 TON, F-250 / SUPERDUTY 4WD	
R	82-85	PICKUP 3/4 TON, F-250 / SUPERDUTY 4WD Clevis Type Lower Front Mount; Exc. Dual Rear Wheels or Lift Kit	
R	80-81	PICKUP 3/4 TON, F-250 / SUPERDUTY 4WD	
58488 A			
R	88-99	CHEVROLET PICKUP 1/2 TON, C15 / C1500 All	
R	88-99	PICKUP 1/2 TON, K15 / K1500 All	
R	01-03	PICKUP 1 TON, C35/3500 HD, Standard Cab Pickup HD Solid Front Axle	
R	91-00	PICKUP 1 TON, C35/3500 Standard Cab Pickup HD Solid Front Axle	
R	88-90	PICKUP 1 TON, C35/3500 Extended Cab Pickup Exc. HD Straight Front Axle	
R	88-90	PICKUP 1 TON, C35/3500 Standard Cab Pickup Exc. HD Straight Front Axle	

Numerical listing

Shock	POP	Alternative No.	MTG Acc. Supplied
Pos.	Year	Application	
58488 A -continued			
R	88-00	PICKUP 1 TON, K35 / K3500 All	
R	88-00	PICKUP 3/4 TON, C25 / C2500 All	
R	88-00	PICKUP 3/4 TON, K25 / K2500 All	
R	88-99	GMC PICKUP 1/2 TON, C15 / C1500 All	
R	88-99	PICKUP 1/2 TON, K15 / K1500 All	
R	98-00	PICKUP 1 TON, C35/3500 Cab & Chassis HD Solid Front Axle	
R	88-97	PICKUP 1 TON, C35/3500 All HD Solid Front Axle	
R	88-00	PICKUP 1 TON, K35 / K3500 All	
R	88-00	PICKUP 3/4 TON, C25 / C2500 All	
R	88-00	PICKUP 3/4 TON, K25 / K2500 All	
58489 A			
F	88-99	CHEVROLET PICKUP 1/2 TON, C15 / C1500 All	
F	92-00	PICKUP 1 TON, C35/3500 Crew Cab Pickup Exc. HD Straight Front Axle	
F	88-00	PICKUP 1 TON, C35/3500 Extended Cab Pickup Exc. HD Straight Front Axle	
F	88-00	PICKUP 1 TON, C35/3500 Standard Cab Pickup Exc. HD Straight Front Axle	
F	88-00	PICKUP 3/4 TON, C25 / C2500 All	
F	92-99	SUBURBAN 1/2 TON, C15 / C1500 All	
F	92-99	SUBURBAN 3/4 TON, C25 / C2500 All	
F	95-00	TAHOE RWD Old Body Style	
F	88-99	GMC PICKUP 1/2 TON, C15 / C1500 All	
F	92-00	PICKUP 1 TON, C35/3500 Crew Cab Pickup Exc. HD Straight Front Axle	
F	88-00	PICKUP 1 TON, C35/3500 Extended Cab Pickup Exc. HD Straight Front Axle	
F	88-00	PICKUP 1 TON, C35/3500 Standard Cab Pickup Exc. HD Straight Front Axle	
F	88-00	PICKUP 3/4 TON, C25 / C2500 All	
F	92-99	SUBURBAN 1/2 TON, C15 / C1500 All	
F	92-99	SUBURBAN 3/4 TON, C25 / C2500 All	
F	92-99	YUKON RWD	
58500 W			
F	75-91	FORD VAN 1/2 TON, ECONOLINE / CLUB WAGON All	
58609 B			
F	99-00	CADILLAC ESCALADE All	
F	90-05	CHEVROLET ASTRO AWD	
F	92-94	BLAZER 4WD Full Size	
F	88-00	PICKUP 1 TON, K35 / K3500 All	
F	88-00	PICKUP 3/4 TON, K25 / K2500 All	
F	92-99	SUBURBAN 1/2 TON, K15 / K1500 All	
F	92-99	SUBURBAN 3/4 TON, K25 / K2500 All	
F	88-00	GMC PICKUP 1 TON, K35 / K3500 All	
F	88-00	PICKUP 3/4 TON, K25 / K2500 All	
F	90-05	SAFARI AWD	
F	92-99	SUBURBAN 1/2 TON, K15 / K1500 All	
F	92-99	SUBURBAN 3/4 TON, K25 / K2500 All	
58617 C			
F	90-93	FORD PICKUP 1/2 TON, F SUPERDUTY All Mfg. to 2/93	
58622 A			
F	04-11	FORD VAN 1 TON, ECONOLINE / CLUB WAGON / SUPERDUTY All Exc. Ambulance & Handling Package	
F	07-08	VAN 1 TON, ECONOLINE / CLUB WAGON / SUPERDUTY All Motorhome Conversion	
F	92-05	VAN 1 TON, ECONOLINE / CLUB WAGON / SUPERDUTY All Motorhome Conversion	
F	92-11	VAN 3/4 TON, ECONOLINE / CLUB WAGON / SUPERDUTY All	

LTV

Shock	POP	Alternative No.	MTG Acc. Supplied
Pos.	Year	Application	
58623 B			
R	04-11	FORD VAN 1 TON, ECONOLINE / CLUB WAGON / SUPERDUTY All Exc. Ambulance & Handling Package	
R	07-08	VAN 1 TON, ECONOLINE / CLUB WAGON / SUPERDUTY All Motorhome Conversion	
R	92-05	VAN 1 TON, ECONOLINE / CLUB WAGON / SUPERDUTY All Motorhome Conversion	
R	92-11	VAN 3/4 TON, ECONOLINE / CLUB WAGON / SUPERDUTY All	
58624 D			
R	92-11	FORD VAN 1/2 TON, ECONOLINE / CLUB WAGON All	
58625 W			
F	86-99	CHEVROLET VAN 1 TON, P SERIES All Motorhome Chassis with I-Beam Front Suspension	
F	86-99	GMC VAN 1 TON, P SERIES All Motorhome Chassis with I-Beam Front Suspension	
58638 A			
R	99-00	CADILLAC ESCALADE All	
R	92-94	CHEVROLET BLAZER 4WD Full Size	
R	92-99	SUBURBAN 1/2 TON, C15 / C1500 All	
R	92-99	SUBURBAN 1/2 TON, K15 / K1500 All	
R	92-99	SUBURBAN 3/4 TON, C25 / C2500 All	
R	92-99	SUBURBAN 3/4 TON, K25 / K2500 All	
R	95-00	TAHOE All Old Body Style	
R	96-11	VAN 1/2 TON, G / EXPRESS All	
R	10-12	VAN 1 TON, G / EXPRESS All	
R	03-06	VAN 1 TON, G / EXPRESS All	
R	07-09	VAN 3/4 TON, G / EXPRESS All	
R	96-02	VAN 3/4 TON, G / EXPRESS All Exc. 8600# GVW	
R	92-99	GMC SUBURBAN 1/2 TON, C15 / C1500 All	
R	92-99	SUBURBAN 1/2 TON, K15 / K1500 All	
R	92-99	SUBURBAN 3/4 TON, C25 / C2500 All	
R	92-99	SUBURBAN 3/4 TON, K25 / K2500 All	
R	08-11	VAN 1/2 TON, G / SAVANNA All	
R	96-06	VAN 1/2 TON, G / SAVANNA All	
R	96-02	VAN 1 TON, G / SAVANNA All Exc. 8600# GVW	
R	96-02	VAN 3/4 TON, G / SAVANNA All Exc. 8600# GVW	
R	92-99	YUKON All	
58661 C			
F	94-01	DODGE PICKUP 1/2 TON, RAM 1500 (SEE RAM 1500) RWD	
F	94-02	PICKUP 1 TON, RAM 3500 (SEE RAM 3500) RWD Exc. Solid Front Axle	
F	94-02	PICKUP 3/4 TON, RAM 2500 (SEE RAM 2500) RWD	
58662 A			
R	07	CHEVROLET PICKUP 1/2 TON, SILVERADO 1500 Classic Hybrid, RWD	
R	07	PICKUP 1/2 TON, SILVERADO 1500 Classic LS, RWD	
R	07	PICKUP 1/2 TON, SILVERADO 1500 Classic LT, RWD	
R	07	PICKUP 1/2 TON, SILVERADO 1500 Classic SS, RWD	
R	07	PICKUP 1/2 TON, SILVERADO 1500 Classic WT, RWD	
R	99-06	PICKUP 1/2 TON, SILVERADO 1500 RWD Exc. Electronic Adjustable Suspension	
R	94-01	DODGE PICKUP 1/2 TON, RAM 1500 (SEE RAM 1500) All	
R	94-02	PICKUP 1 TON, RAM 3500 (SEE RAM 3500) RWD Exc. Solid Front Axle	
R	94-02	PICKUP 3/4 TON, RAM 2500 (SEE RAM 2500) 4WD, GAS Exc. 8800# GVW	
R	94-02	PICKUP 3/4 TON, RAM 2500 (SEE RAM 2500) RWD	

Numerical listing

Shock	POP	Alternative No.	MTG Acc. Supplied
Pos.	Year	Application	
58662 A -continued			
R	95-96	PICKUP 3/4 TON, RAM 2500 (SEE RAM 2500) 4WD, CNG Exc. 8800# GVW	
R	07	GMC SIERRA 1500 Classic Hybrid, RWD Exc. Electronic Adjustable Suspension	
R	07	SIERRA 1500 Classic SL, RWD Exc. Electronic Adjustable Suspension	
R	07	SIERRA 1500 Classic SLE, RWD Exc. Electronic Adjustable Suspension	
R	07	SIERRA 1500 Classic SLT, RWD Exc. Electronic Adjustable Suspension	
R	07	SIERRA 1500 Classic WT, RWD Exc. Electronic Adjustable Suspension	
R	99-06	SIERRA 1500 RWD Exc. Electronic Adjustable Suspension	
58671 C			
R	92-96	CHEVROLET VAN 1 TON, G / EXPRESS All Chassis Cab	
R	92-96	GMC VAN 1 TON, G / SAVANNA All Chassis Cab	
58673 D			
F	94-01	DODGE PICKUP 1/2 TON, RAM 1500 (SEE RAM 1500) 4WD	
F	94-02	PICKUP 3/4 TON, RAM 2500 (SEE RAM 2500) 4WD, GAS Exc. 8800# GVW	
F	95-96	PICKUP 3/4 TON, RAM 2500 (SEE RAM 2500) 4WD, CNG Exc. 8800# GVW	
58674 B			
F	94-02	DODGE PICKUP 1 TON, RAM 3500 (SEE RAM 3500) 4WD	
F	94-02	PICKUP 1 TON, RAM 3500 (SEE RAM 3500) RWD Solid Front Axle	
F	94-02	PICKUP 3/4 TON, RAM 2500 (SEE RAM 2500) 4WD, DIESEL 8800# GVW	
58675 C			
R	94-02	DODGE PICKUP 1 TON, RAM 3500 (SEE RAM 3500) 4WD	
R	94-02	PICKUP 1 TON, RAM 3500 (SEE RAM 3500) RWD Solid Front Axle	
R	94-02	PICKUP 3/4 TON, RAM 2500 (SEE RAM 2500) 4WD, DIESEL 8800# GVW	
58714 B			
F	97-02	FORD EXPEDITION RWD Exc. Front Air- Leveling	
F	97-04	PICKUP 1/2 TON, F-150 RWD	
F	96-99	PICKUP 3/4 TON, F-250 / SUPERDUTY RWD Up through 8500# GVW	
F	98-02	LINCOLN NAVIGATOR RWD	
58715 B			
R	04	FORD PICKUP 1/2 TON, F-150 4WD Exc. 7700# GVW	
R	97-03	PICKUP 1/2 TON, F-150 4WD	
R	97-99	PICKUP 3/4 TON, F-250 / SUPERDUTY 4WD Up through 8500# GVW; Exc. Superduty	
58716 B			
F	97-02	FORD EXPEDITION 4WD Exc. Front Air- Leveling	
F	04	PICKUP 1/2 TON, F-150 4WD Exc. 7700# GVW	
F	97-03	PICKUP 1/2 TON, F-150 4WD	
F	97-99	PICKUP 3/4 TON, F-250 / SUPERDUTY 4WD Up through 8500# GVW; Exc. Superduty	
58717 D			
R	97-02	FORD EXPEDITION All	
R	98-02	LINCOLN NAVIGATOR RWD, Coil (FrontSpringType)	
58778 C			
R	04	FORD PICKUP 1/2 TON, F-150 RWD	
R	00-03	PICKUP 1/2 TON, F-150 Harley-Davidson Edition, RWD	
R	99-03	PICKUP 1/2 TON, F-150 Lariat, RWD	
R	99-03	PICKUP 1/2 TON, F-150 XL, RWD	

Numerical listing

Shock	POP	Alternative No.	MTG Acc. Supplied
Pos.	Year	Application	
58778 C -continued			
R	99-03	PICKUP 1/2 TON, F-150 XLT, RWD	
R	00	PICKUP 1/2 TON, F-150 Base, RWD	
R	97-98	PICKUP 1/2 TON, F-150 RWD	
R	97-99	PICKUP 3/4 TON, F-250 / SUPERDUTY RWD Up through 8500# GVW	
58783 B			
F	07	CHEVROLET PICKUP 1/2 TON, SILVERADO 1500 Classic Hybrid, RWD	
F	07	PICKUP 1/2 TON, SILVERADO 1500 Classic LS, RWD	
F	07	PICKUP 1/2 TON, SILVERADO 1500 Classic LT, RWD	
F	07	PICKUP 1/2 TON, SILVERADO 1500 Classic SS, RWD	
F	07	PICKUP 1/2 TON, SILVERADO 1500 Classic WT, RWD	
F	99-06	PICKUP 1/2 TON, SILVERADO 1500 RWD Electronic Adjustable Suspension	
F	07	GMC SIERRA 1500 Classic Hybrid, RWD Exc. Electronic Adjustable Suspension	
F	07	SIERRA 1500 Classic SL, RWD Exc. Electronic Adjustable Suspension	
F	07	SIERRA 1500 Classic SLE, RWD Exc. Electronic Adjustable Suspension	
F	07	SIERRA 1500 Classic SLT, RWD Exc. Electronic Adjustable Suspension	
F	07	SIERRA 1500 Classic WT, RWD Exc. Electronic Adjustable Suspension	
F	99-06	SIERRA 1500 RWD Exc. Electronic Adjustable Suspension	
58803 A			
F	02-06	CHEVROLET AVALANCHE 1500 All Exc. Electronic Ride Control	
F	07	PICKUP 1/2 TON, SILVERADO 1500 Classic Hybrid, 4WD Classic and Old Body Style; Exc. Electronic Adjustable Suspension	
F	07	PICKUP 1/2 TON, SILVERADO 1500 Classic LS, 4WD Classic and Old Body Style; Exc. Electronic Adjustable Suspension	
F	07	PICKUP 1/2 TON, SILVERADO 1500 Classic LT, 4WD Classic and Old Body Style; Exc. Electronic Adjustable Suspension	
F	07	PICKUP 1/2 TON, SILVERADO 1500 Classic WT, 4WD Classic and Old Body Style; Exc. Electronic Adjustable Suspension	
F	99-06	PICKUP 1/2 TON, SILVERADO 1500 4WD Classic and Old Body Style; Exc. Electronic Adjustable Suspension	
F	00-06	SUBURBAN 1/2 TON, 1500 All Exc. Z55 Auto Ride Suspension	
F	02-06	TAHOE All Exc. Z55 Auto Ride Suspension	
F	00-01	TAHOE All New Body Style; Exc. Z55 Auto Ride Suspension	
F	07	GMC SIERRA 1500 Classic Hybrid, 4WD Classic and Old Body Style; Exc. Electronic Adjustable Suspension	
F	07	SIERRA 1500 Classic SL, 4WD Classic and Old Body Style; Exc. Electronic Adjustable Suspension	
F	07	SIERRA 1500 Classic SLE, 4WD Classic and Old Body Style; Exc. Electronic Adjustable Suspension	
F	07	SIERRA 1500 Classic SLT, 4WD Classic and Old Body Style; Exc. Electronic Adjustable Suspension	
F	07	SIERRA 1500 Classic WT, 4WD Classic and Old Body Style; Exc. Electronic Adjustable Suspension	
F	99-06	SIERRA 1500 4WD Classic and Old Body Style; Exc. Electronic Adjustable Suspension	
F	00-06	YUKON All Exc. Z55 Auto Ride Suspension	
F	00-06	YUKON XL 1/2 TON All Exc. Z55 Auto Ride Suspension	

LTV

Shock	POP	Alternative No.	MTG Acc. Supplied
Pos.	Year	Application	
58807 B			
F	99-12	FORD PICKUP 1 TON, F-350 / SUPERDUTY RWD	
F	99-12	PICKUP 3/4 TON, F-250 / SUPERDUTY RWD	
58808 C			
R	99-04	FORD PICKUP 1 TON, F-350 / SUPERDUTY RWD	
R	99-04	PICKUP 3/4 TON, F-250 / SUPERDUTY RWD	
58809 A			
F	99-04	FORD PICKUP 1 TON, F-350 / SUPERDUTY 4WD	
F	99-04	PICKUP 3/4 TON, F-250 / SUPERDUTY 4WD	
F	99-04	PICKUP, F-450 SUPERDUTY All	
F	99-04	PICKUP, F-550 SUPERDUTY All	
58810 A			
R	99-04	FORD PICKUP 1 TON, F-350 / SUPERDUTY 4WD	
R	99-04	PICKUP 3/4 TON, F-250 / SUPERDUTY 4WD	
58811 W			
R	99-04	FORD PICKUP, F-450 SUPERDUTY All	
R	99-04	PICKUP, F-550 SUPERDUTY All	
58812 B			
F	91-00	CHEVROLET PICKUP 1 TON, C35/3500 Cab & Chassis HD Solid Front Axle	
F	91-00	GMC PICKUP 1 TON, C35/3500 Cab & Chassis HD Solid Front Axle	
58817 A			
F	02-06	CHEVROLET AVALANCHE 2500 All Exc. Electronic Ride Control	
F	05-07	PICKUP 1/2 TON, SILVERADO 1500 HD All	
F	01-03	PICKUP 1/2 TON, SILVERADO 1500 HD All	
F	01-09	PICKUP 1 TON, SILVERADO 3500 All	
F	07-10	PICKUP 1 TON, SILVERADO 3500 HD All	
F	05-08	PICKUP 3/4 TON, SILVERADO 2500 All	
F	99-04	PICKUP 3/4 TON, SILVERADO 2500 4WD	
F	01-10	PICKUP 3/4 TON, SILVERADO 2500 HD All 9200# GVW	
F	00-11	SUBURBAN 3/4 TON, 2500 All Exc. Z55 Auto Ride Suspension and Quadrasteer	
F	05-07	GMC SIERRA 1500 HD All	
F	01-03	SIERRA 1500 HD All	
F	99-04	SIERRA 2500 All	
F	01-10	SIERRA 2500 HD All	
F	01-07	SIERRA 3500 All	
F	07-10	SIERRA 3500 HD Torsion Bar (FrontSpringType)	
F	00-06	YUKON XL 3/4 TON All Exc. Hydraulic Self Leveling System	
58901 A			
F	88-99	CHEVROLET PICKUP 1/2 TON, K15 / K1500 All	
F	95-00	TAHOE 4WD Old Body Style	
F	88-99	GMC PICKUP 1/2 TON, K15 / K1500 All	
F	92-99	YUKON 4WD	
58906 W			
F	87-91	CHEVROLET BLAZER 4WD Full Size; Quad Suspension Long Shock; Exc. Lift Kit	
F	81-86	BLAZER 4WD Quad Suspension Long Shock; Exc. Lift Kit	
F	81-86	PICKUP 1/2 TON, K10 All Quad Suspension Long Shock; Exc. Lift Kit	
F	87	PICKUP 1/2 TON, V10 All Quad Suspension Long Shock; Exc. Lift Kit	
F	81-86	PICKUP 3/4 TON, K20 All Quad Suspension Long Shock; Exc. Lift Kit	
F	87	PICKUP 3/4 TON, V20 All Quad Suspension Long Shock; Exc. Lift Kit	
F	81-86	SUBURBAN 1/2 TON, K10 All Quad Suspension Long Shock; Exc. Lift Kit	
F	81-86	SUBURBAN 3/4 TON, K20 All Quad Suspension Long Shock; Exc. Lift Kit	
F	87-88	SUBURBAN 3/4 TON, V20 All Quad Suspension Long Shock; Exc. Lift Kit	

Numerical listing

Shock	POP	Alternative No.	MTG Acc. Supplied
Pos.	Year	Application	
58906 W -continued			
F	89-91	SUBURBAN 3/4 TON, V2500 All Quad Suspension Long Shock; Exc. Lift Kit	
F	73-91	GMC JIMMY 4WD Quad Suspension Long Shock; Exc. Lift Kit	
F	81-86	PICKUP 1/2 TON, K15 / K1500 All Quad Suspension Long Shock; Exc. Lift Kit	
F	87	PICKUP 1/2 TON, V1500 All Quad Suspension Long Shock; Exc. Lift Kit	
F	81-86	PICKUP 3/4 TON, K25 / K2500 All Quad Suspension Long Shock; Exc. Lift Kit	
F	87	PICKUP 3/4 TON, V2500 All Quad Suspension Long Shock; Exc. Lift Kit	
F	81-86	SUBURBAN 1/2 TON, K15 / K1500 All Quad Suspension Long Shock; Exc. Lift Kit	
F	87-91	SUBURBAN 1/2 TON, V1500 All Quad Suspension Long Shock; Exc. Lift Kit	
F	81-86	SUBURBAN 3/4 TON, K25 / K2500 All Quad Suspension Long Shock; Exc. Lift Kit	
F	87-91	SUBURBAN 3/4 TON, V2500 All Quad Suspension Long Shock; Exc. Lift Kit	
58908 W			
F	87-91	CHEVROLET BLAZER 4WD Full Size; Quad Suspension Short Shock; Exc. Lift Kit	
F	81-86	BLAZER 4WD Quad Suspension Short Shock; Exc. Lift Kit	
F	81-86	PICKUP 1/2 TON, K10 All Quad Suspension Short Shock; Exc. Lift Kit	
F	87	PICKUP 1/2 TON, V10 All Quad Suspension Short Shock; Exc. Lift Kit	
F	81-86	PICKUP 3/4 TON, K20 All Quad Suspension Short Shock; Exc. Lift Kit	
F	87	PICKUP 3/4 TON, V20 All Quad Suspension Short Shock; Exc. Lift Kit	
F	81-86	SUBURBAN 1/2 TON, K10 All Quad Suspension Short Shock; Exc. Lift Kit	
F	81-86	SUBURBAN 3/4 TON, K20 All Quad Suspension Short Shock; Exc. Lift Kit	
F	87-88	SUBURBAN 3/4 TON, V20 All Quad Suspension Short Shock; Exc. Lift Kit	
F	89-91	SUBURBAN 3/4 TON, V2500 All Quad Suspension Short Shock; Exc. Lift Kit	
F	73-91	GMC JIMMY 4WD Quad Suspension Short Shock; Exc. Lift Kit	
F	81-86	PICKUP 1/2 TON, K15 / K1500 All Quad Suspension Short Shock; Exc. Lift Kit	
F	87	PICKUP 1/2 TON, V1500 All Quad Suspension Short Shock; Exc. Lift Kit	
F	81-86	PICKUP 3/4 TON, K25 / K2500 All Quad Suspension Short Shock; Exc. Lift Kit	
F	87	PICKUP 3/4 TON, V2500 All Quad Suspension Short Shock; Exc. Lift Kit	
F	81-86	SUBURBAN 1/2 TON, K15 / K1500 All Quad Suspension Short Shock; Exc. Lift Kit	
F	87-91	SUBURBAN 1/2 TON, V1500 All Quad Suspension Short Shock; Exc. Lift Kit	
F	81-86	SUBURBAN 3/4 TON, K25 / K2500 All Quad Suspension Short Shock; Exc. Lift Kit	
F	87-91	SUBURBAN 3/4 TON, V2500 All Quad Suspension Short Shock; Exc. Lift Kit	
58929 C			
F	90	FORD BRONCO II All	
F	91-94	EXPLORER All	
F	90-97	RANGER All	
F	92-11	VAN 1/2 TON, ECONOLINE / CLUB WAGON All	
F	94-97	MAZDA B2300 All	
F	91-94	NAVAJO All	

Numerical listing

Shock	POP	Alternative No.	MTG Acc. Supplied
Pos.	Year	Application	
58930 A			
R	02-10	CADILLAC	ESCALADE All
R	02-07	CHEVROLET	AVALANCHE 1500 All Exc. Electronic Ride Control
R	02-06	AVALANCHE	2500 All Exc. Electronic Ride Control
R	07-11	SUBURBAN 1/2 TON,	1500 All Exc. Z55 or ZW7 Ride Suspension
R	00-06	SUBURBAN 1/2 TON,	1500 All Exc. Z55 Auto Ride Suspension
R	00-11	SUBURBAN 3/4 TON,	2500 All Exc. Z55 Auto Ride Suspension and QuadraSteer
R	07-11	TAHOE All Exc. Z55 or ZW7	Ride Suspension
R	02-06	TAHOE All Exc. Z55 Auto Ride	Suspension
R	00-01	TAHOE All New Body Style;	Exc. Z55 Auto Ride Suspension
R	00-09	GMC YUKON All Exc. Z55 Auto	Ride Suspension
R	00-06	YUKON XL 1/2 TON All Exc. Z55	Auto Ride Suspension
R	00-06	YUKON XL 3/4 TON All Exc.	Hydraulic Self Leveling System

58942 N			
R	10-12	FORD	F-550 All
R	07-12	PICKUP, F-450	SUPERDUTY Cab & Chassis

ProGuard

61500 A			
R	75-80	CHEVROLET	LUV PICKUP All
R	72-74	LUV PICKUP	All
F	55-56	PICKUP	3100
F	55-56	PICKUP	3800
R	79-82	DODGE	D50 RWD
R	87-93	PICKUP, RAM	50 RWD
R	83-86	PICKUP, RAM	50 All
R	55	FORD	F SERIES All F-100
F	48-52	F SERIES All F-1, F-2 & F-3	
F	65	PICKUP 1/2 TON, F-100 All	4WD; With Front Leaf Springs
R	61-64	PICKUP 1/2 TON, F-100 All	
R	61-66	PICKUP 1 TON, F-350 /	SUPERDUTY All
R	61-64	PICKUP 3/4 TON, F-250 /	SUPERDUTY All
F	76	PICKUP P350 All	
F	68-75	PICKUP P350 All Up through	8000# GVW
F	75-76	PICKUP P400 All Up through	8000# GVW
R	68	INTERNATIONAL	908B All
R	68	908C All	
R	68	1000B All	
R	68	1000C All	
F	68	1100B All Exc. Travelette	with 166" Wheelbase
R	68	1100B All Exc. Travelette	with 166" Wheelbase
F	68	1100C All Exc. Travelette	with 166" Wheelbase
R	68	1100C All Exc. Travelette	with 166" Wheelbase
F	68	1200B All Exc. Travelette	with 166" Wheelbase
R	68	1200B All Exc. Travelette	with 166" Wheelbase
F	68	1200C All Exc. Travelette	with 166" Wheelbase
R	68	1200C All Exc. Travelette	with 166" Wheelbase
F	68	1300B All Exc. Travelette	with 166" Wheelbase
R	68	1300B All Exc. Travelette	with 166" Wheelbase
F	68	1300C All Exc. Travelette	with 166" Wheelbase
R	68	1300C All Exc. Travelette	with 166" Wheelbase
R	68-72	M1100 / M1200 All	
R	69	M1400 All	
R	65-67	M SERIES VAN All	
R	72-83	JEEP CJ5 All Exc. Lift	Kit
R	66-71	CJ5 All	
R	72-75	CJ6 All Exc. Lift	Kit
R	66-71	CJ6 All	
R	76-86	CJ7 All Exc. Lift	Kit
R	66-74	DJ5 All Exc. Lift	Kit
R	66-68	DJ6 All	
R	57-60	FC150 All	
F	63-65	FC170 All	
R	63-65	FC170 All	

LTV, ProGuard

Shock	POP	Alternative No.	MTG Acc. Supplied
Pos.	Year	Application	
61500 A -continued			
R	63-66	GLADIATOR	All Independent Front Suspension
R	70-73	JEEPSTER	All
R	81-85	SCRAMBLER / CJ8 All	
R	61-67	UNIVERSAL All	
R	86-87	MAZDA	B2000 RWD
R	87-93	B2200 RWD	
R	87-93	B2600 RWD	
R	95-96	MITSUBISHI	MIGHTY MAX All
R	83-94	MIGHTY MAX RWD	
R	87-90	VAN All	
R	98-04	NISSAN	FRONTIER RWD Exc. Desert Runner
R	87-97	PICKUP RWD	
R	86	PICKUP RWD Mfg. from	8/86
R	79-82	PLYMOUTH	PICKUP All
F	49-60	STUDEBAKER	R / E SERIES 1/2 / 3/4 TON
R	49-54	R / E SERIES 1/2 / 3/4 TON	
R	69-74	TOYOTA	LAND CRUISER All Exc. Wagon
R	67-68	LAND CRUISER All	
R	85-95	PICKUP RWD Exc. 1 Ton	
R	84	PICKUP RWD	
R	75-83	PICKUP RWD Mojave	
R	70-74	PICKUP All RWD: Mojave	
R	04	TACOMA Base, RWD	
R	95-03	TACOMA DLX, RWD	
R	98-00	TACOMA SR5, 4WD	
R	84-88	VAN Leaf (RearSpringType)	
R	88	VAN WAGON All	Leaf(RearSpringType)

61501 W			
F	81-82	CHEVROLET	LUV PICKUP RWD
F	81-95	ISUZU	PICKUP RWD
F	69-72	NISSAN	521 PICKUP All
F	72-79	620 PICKUP All	
F	80-86	720 PICKUP All	
F	87-97	PICKUP 4WD	
F	86	PICKUP 4WD Mfg. from	8/86

61502 W			
R	72-82	FORD	COURIER All
R	72-76	MAZDA	B1600 All
R	77-78	B1800 All	
R	79-84	B2000 All	
R	82-84	B2200 All	

61503 W			
R	90-96	CHEVROLET	LUMINA APV All
R	90-96	OLDSMOBILE	SILHOUETTE All
R	90-96	PONTIAC	TRANS SPORT All

61504 A			
F	05	CHEVROLET	BLAZER Base, RWD
F	96-04	BLAZER LS, RWD	
F	95-02	BLAZER LT, RWD	
F	95-99	BLAZER Base, RWD	
F	95-97	BLAZER Deluxe, RWD	
F	83-94	BLAZER, S MODELS RWD	
F	68-87	EL CAMINO All	
F	94-03	S10 LS, RWD	
F	82-03	S10 Base, RWD	
F	92-93	S10 EL, RWD	
F	83-92	S10 Tahoe, RWD	
F	88-90	S10 Durango, RWD	
F	82-86	S10 Durango, RWD	
F	72-82	FORD	COURIER All
F	92-04	GMC	JIMMY RWD
F	83-91	S15 JIMMY RWD	
F	04	SONOMA / S15 All RWD	
F	82-03	SONOMA / S15 RWD	
F	71-87	SPRINT / CABALLERO All	
F	96-00	ISUZU	HOMBRE RWD Exc. Sport Chassis
F	72-76	MAZDA	B1600 All
F	77-78	B1800 All	
F	79-84	B2000 All	
F	82-84	B2200 All	
F	75-83	TOYOTA	PICKUP RWD Mojave
F	70-74	PICKUP All RWD; Mojave	

61505 W			
R	69-72	NISSAN	521 PICKUP All
R	72-79	620 PICKUP All	
R	86	720 PICKUP RWD Mfg. to	8/86
R	82-85	720 PICKUP RWD	
R	80-81	720 PICKUP All	

61506 A			
R	81-82	CHEVROLET	LUV PICKUP All
R	87-89	DODGE	RAIDER 2.6L 4Cyl L (156)
F	61-67	FORD	ECONOLINE All

Numerical listing

Shock	POP	Alternative No.	MTG Acc. Supplied
Pos.	Year	Application	
61506 A -continued			
F	68	VAN 1/2 TON, ECONOLINE / CLUB	WAGON All Mfg. to 7/68
R	89-94	ISUZU	AMIGO All
R	81-95	PICKUP All	
R	84-86	TROOPER 4WD	
R	86-92	JEEP	COMANCHE All
R	83-88	MITSUBISHI	MONTERO 2.6L 4Cyl L (156)
R	97-99	MONTERO SPORT All	
R	82-86	NISSAN	720 PICKUP 4WD
R	00-04	FRONTIER Crew Cab Pickup, RWD	with Desert Runner
R	98-04	FRONTIER 4WD	
R	98-99	FRONTIER RWD Crew Cab with	Desert Runner
R	87-95	PATHFINDER All Exc. Electronic	Adjustable Suspension
R	87-97	PICKUP 4WD	
R	86	PICKUP 4WD Mfg. from	8/86
R	00-04	XTERRA All	
R	84-87	TOYOTA	LAND CRUISER FJ60 (MfrBodyCode), Sport Utility
R	80-83	LAND CRUISER All	
R	79	LAND CRUISER FJ40	(MfrBodyCode)
R	79	LAND CRUISER FJ55	(MfrBodyCode), Sport Utility
R	76-78	LAND CRUISER All	
R	75	LAND CRUISER FJ40	(MfrBodyCode) Mfg. from 1/75
R	75	LAND CRUISER FJ55	(MfrBodyCode), Sport Utility Mfg. from 1/75
R	85-92	PICKUP RWD 1 Ton	
R	80-83	PICKUP 4WD Exc. Lift	Kit
R	93-98	T100 RWD	

61507 W			
F	88-90	TOYOTA	LAND CRUISER All
F	81-87	LAND CRUISER FJ60	(MfrBodyCode), Sport Utility
F	80	LAND CRUISER All	

61508 C			
F	81-82	CHEVROLET	LUV PICKUP 4WD
F	75-80	LUV PICKUP All	
F	72-74	LUV PICKUP All	
F	89-94	ISUZU	AMIGO All
F	81-95	PICKUP 4WD	
F	84-86	TROOPER 4WD	
F	98-04	NISSAN	FRONTIER RWD Exc. Desert Runner
F	87-97	PICKUP RWD	
F	86	PICKUP RWD Mfg. from	8/86

61509 D			
F	93-95	TOYOTA	PICKUP RWD Exc. 1 Ton
F	85-92	PICKUP RWD 1 Ton	
F	84	PICKUP RWD	
F	93-98	T100 RWD	

61510 C			
R	84-89	TOYOTA	4RUNNER All
R	84-95	PICKUP 4WD Exc. Lift	Kit
R	01-04	TACOMA S-Runner	
R	04	TACOMA Base	
R	95-03	TACOMA DLX	
R	98-00	TACOMA Limited	

61511 W			
R	87-96	DODGE	DAKOTA RWD

61512 A			
F	87-04	DODGE	DAKOTA RWD
F	99-03	DURANGO RWD	

61513 W			
R	87-89	TOYOTA	VAN RWD, Coil (RearSpringType)
R	84-86	VAN Coil (RearSpringType)	
R	88	VAN WAGON RWD	Coil(RearSpringType)

61516 W			
F	87-91	CHEVROLET	BLAZER 4WD Full Size; Quad Suspension Short Shock; Exc. Lift Kit
F	81-86	BLAZER 4WD Quad Suspension	Short Shock; Exc. Lift Kit
F	75-80	BLAZER 4WD Exc. Quad	Suspension and Lift Kit
F	73-74	BLAZER 4WD Exc. Lift	Kit
F	69-72	BLAZER 4WD	

Numerical listing

Shock	POP	Alternative No.	MTG Acc. Supplied
Pos.	Year	Application	
61516 W -continued			
F	81-86	PICKUP 1/2 TON, K10 All Quad Suspension Short Shock; Exc. Lift Kit	
F	69-80	PICKUP 1/2 TON, K10 All Exc. Lift Kit	
F	88	PICKUP 1/2 TON, K15 / K1500 All Quad Suspension Short Shock; Exc. Lift Kit	
F	87	PICKUP 1/2 TON, V10 All Quad Suspension Short Shock; Exc. Lift Kit	
F	81-86	PICKUP 3/4 TON, K20 All Quad Suspension Short Shock; Exc. Lift Kit	
F	69-80	PICKUP 3/4 TON, K20 All Exc. Lift Kit	
F	87	PICKUP 3/4 TON, V20 All Exc. Quad Suspension and Lift Kit	
F	81-86	SUBURBAN 1/2 TON, K10 All Quad Suspension Short Shock; Exc. Lift Kit	
F	69-80	SUBURBAN 1/2 TON, K10 All Exc. Lift Kit	
F	87-88	SUBURBAN 1/2 TON, V10 All Quad Suspension Short Shock; Exc. Lift Kit	
F	89-91	SUBURBAN 1/2 TON, V1500 All Exc. Quad Suspension and Lift Kit	
F	81-86	SUBURBAN 3/4 TON, K20 All Quad Suspension Short Shock; Exc. Lift Kit	
F	69-80	SUBURBAN 3/4 TON, K20 All Exc. Lift Kit	
F	87-88	SUBURBAN 3/4 TON, V20 All Quad Suspension Short Shock; Exc. Lift Kit	
F	89-91	SUBURBAN 3/4 TON, V2500 All Quad Suspension Short Shock; Exc. Lift Kit	
F	70-91	GMC JIMMY 4WD Exc. Quad Suspension and Lift Kit	
F	69-86	PICKUP 1/2 TON, K15 / K1500 All Exc. Quad Suspension and Lift Kit	
F	87	PICKUP 1/2 TON, V1500 All Quad Suspension Short Shock; Exc. Lift Kit	
F	69-86	PICKUP 3/4 TON, K25 / K2500 All Exc. Quad Suspension and Lift Kit	
F	87	PICKUP 3/4 TON, V2500 All Quad Suspension Short Shock; Exc. Lift Kit	
F	69-86	SUBURBAN 1/2 TON, K15 / K1500 All Exc. Quad Suspension and Lift Kit	
F	87-91	SUBURBAN 1/2 TON, V1500 All Quad Suspension Short Shock; Exc. Lift Kit	
F	69-86	SUBURBAN 3/4 TON, K25 / K2500 All Exc. Quad Suspension and Lift Kit	
F	87-91	SUBURBAN 3/4 TON, V2500 All Quad Suspension Short Shock; Exc. Lift Kit	
61517 W			
F	71-95	CHEVROLET VAN 1/2 TON, G / EXPRESS All	
F	70	VAN 1/2 TON, G / EXPRESS All Independent Front Suspension	
F	78-96	VAN 1 TON, G / EXPRESS All	
F	75	VAN 1 TON, G / EXPRESS 146.0 (WheelBase)	
F	71-74	VAN 1 TON, G / EXPRESS All	
F	78-95	VAN 3/4 TON, G / EXPRESS All Exc. 8600# GVW	
F	71-77	VAN 3/4 TON, G / EXPRESS All	
F	70	VAN 3/4 TON, G / EXPRESS All Independent Front Suspension	
F	71-95	GMC VAN 1/2 TON, G / SAVANNA All	
F	70	VAN 1/2 TON, G / SAVANNA All Independent Front Suspension	
F	76-95	VAN 1 TON, G / SAVANNA All	
F	75	VAN 1 TON, G / SAVANNA 110.0 (WheelBase)	
F	75	VAN 1 TON, G / SAVANNA 125.0 (WheelBase)	
F	71-74	VAN 1 TON, G / SAVANNA All	
F	78-95	VAN 3/4 TON, G / SAVANNA All Exc. 8600# GVW	
F	71-77	VAN 3/4 TON, G / SAVANNA All	
F	70	VAN 3/4 TON, G / SAVANNA All Independent Front Suspension	

ProGuard

Shock	POP	Alternative No.	MTG Acc. Supplied
Pos.	Year	Application	
61518 W			
R	66	FORD BRONCO All Thru Serial #830000	
R	73-79	PICKUP 1/2 TON, F-100 RWD	
R	70-72	PICKUP 1/2 TON, F-100 All RWD	
R	75-79	PICKUP 1/2 TON, F-150 RWD	
R	75-79	PICKUP 1 TON, F-350 / SUPERDUTY Extended Cab Pickup, RWD	
R	74	PICKUP 1 TON, F-350 / SUPERDUTY All RWD; Extended Cab Pickup	
R	75-79	PICKUP 3/4 TON, F-250 / SUPERDUTY Cab & Chassis, RWD	
R	75-79	PICKUP 3/4 TON, F-250 / SUPERDUTY Standard Cab Pickup, RWD	
R	70-74	PICKUP 3/4 TON, F-250 / SUPERDUTY RWD Exc. Supercab	
R	75-91	VAN 1/2 TON, ECONOLINE / CLUB WAGON All	
F	71-80	INTERNATIONAL SCOUT II All	
61519 W			
R	78-79	FORD BRONCO All Exc. Lift Kit	
R	66-77	BRONCO All From Serial #830001; Exc. Lift Kit	
R	66-69	PICKUP 1/2 TON, F-100 All RWD	
R	65	PICKUP 1/2 TON, F-100 All RWD; With Front Coil Springs	
R	75-79	PICKUP 1 TON, F-350 / SUPERDUTY Standard Cab Pickup, RWD	
R	73-74	PICKUP 1 TON, F-350 / SUPERDUTY All RWD; Exc. Supercab	
R	75-79	PICKUP 3/4 TON, F-250 / SUPERDUTY Extended Cab Pickup, RWD	
R	73-74	PICKUP 3/4 TON, F-250 / SUPERDUTY RWD Supercab	
R	65-72	PICKUP 3/4 TON, F-250 / SUPERDUTY RWD	
R	69-74	VAN 1/2 TON, ECONOLINE / CLUB WAGON All	
R	68	VAN 1/2 TON, ECONOLINE / CLUB WAGON All Late 1968	
R	69-74	VAN 1 TON, ECONOLINE / CLUB WAGON / SUPERDUTY All	
R	68	VAN 1 TON, ECONOLINE / CLUB WAGON / SUPERDUTY All Late 1968	
R	69-74	VAN 3/4 TON, ECONOLINE / CLUB WAGON / SUPERDUTY All	
R	68	VAN 3/4 TON, ECONOLINE / CLUB WAGON / SUPERDUTY All Late 1968	
R	76-83	JEEP CHEROKEE All	
F	74-83	CHEROKEE All	
F	82-83	CJ5 All Exc. Lift Kit	
F	82-86	CJ7 All Exc. Lift Kit	
F	67	GLADIATOR All	
F	84-91	GRAND WAGONEER All	
F	84-91	GRAND WAGONEER All	
F	74-88	J10 PICKUP All	
F	74-88	J10 PICKUP All	
F	74-88	J20 PICKUP All	
R	74-88	J20 PICKUP All	
R	68-73	J2500 PICKUP All	
F	82-85	SCRAMBLER / CJ8 All	
R	76-83	WAGONEER All	
F	74-83	WAGONEER All	
61520 A			
F	80-96	FORD BRONCO All Quad & Non Quad Suspensions Rearward of Front Axle; Exc. Lift Kit	
F	89	BRONCO II All Mfg. to 2/89; Vehicles with 10mm & 12mm bolt in rear lower mount	
F	84-88	BRONCO II All With 10mm Bolt In Rear Lower Mount	
F	80-83	PICKUP 1/2 TON, F-100 RWD	
F	80-96	PICKUP 1/2 TON, F-150 4WD Quad & Non Quad Suspensions Rearward of Front Axle; Exc. Lift Kit	
F	80-96	PICKUP 1/2 TON, F-150 RWD	
F	80-97	PICKUP 1 TON, F-350 / SUPERDUTY RWD	
F	97	PICKUP 3/4 TON, F-250 / SUPERDUTY RWD Over 8500# GVW	
F	80-96	PICKUP 3/4 TON, F-250 / SUPERDUTY RWD	

Numerical listing

Shock	POP	Alternative No.	MTG Acc. Supplied
Pos.	Year	Application	
61520 A -continued			
F	87-89	RANGER All Exc. High Ryder Option	
F	83-86	RANGER All	
61521 D			
F	78-79	FORD BRONCO All Quad Suspension; Rearward of Front Axle; Exc. Lift Kit	
F	66-77	BRONCO All From Serial #830001; Exc. Lift Kit	
F	73-79	PICKUP 1/2 TON, F-100 RWD	
F	65-72	PICKUP 1/2 TON, F-100 All RWD	
F	75-79	PICKUP 1/2 TON, F-150 RWD	
F	75-79	PICKUP 1 TON, F-350 / SUPERDUTY RWD	
F	74	PICKUP 1 TON, F-350 / SUPERDUTY All RWD; Exc. Supercab	
F	73	PICKUP 1 TON, F-350 / SUPERDUTY All	
F	65-79	PICKUP 3/4 TON, F-250 / SUPERDUTY RWD	
F	75-91	VAN 1 TON, ECONOLINE / CLUB WAGON / SUPERDUTY All Exc. Motorhome Conversion	
F	75-91	VAN 3/4 TON, ECONOLINE / CLUB WAGON / SUPERDUTY All	
61522 D			
F	87-91	CHEVROLET BLAZER 4WD Full Size; Quad Suspension Long Shock; Exc. Lift Kit	
F	81-86	BLAZER 4WD Quad Suspension Long Shock; Exc. Lift Kit	
F	81-86	PICKUP 1/2 TON, K10 All Quad Suspension Long Shock; Exc. Lift Kit	
F	88	PICKUP 1/2 TON, K15 / K1500 All Quad Suspension Long Shock; Exc. Lift Kit	
F	87	PICKUP 1/2 TON, V10 All Quad Suspension Long Shock; Exc. Lift Kit	
F	81-86	PICKUP 3/4 TON, K20 All Quad Suspension Long Shock; Exc. Lift Kit	
F	87	PICKUP 3/4 TON, V20 All Quad Suspension Long Shock; Exc. Lift Kit	
F	81-86	SUBURBAN 1/2 TON, K10 All Quad Suspension Long Shock; Exc. Lift Kit	
F	87-88	SUBURBAN 1/2 TON, V10 All Quad Suspension Long Shock; Exc. Lift Kit	
F	81-86	SUBURBAN 3/4 TON, K20 All Quad Suspension Long Shock; Exc. Lift Kit	
F	87-88	SUBURBAN 3/4 TON, V20 All Quad Suspension Long Shock; Exc. Lift Kit	
F	89-91	SUBURBAN 3/4 TON, V2500 All Quad Suspension Long Shock; Exc. Lift Kit	
R	78-95	VAN 1/2 TON, G / EXPRESS All	
R	78-91	VAN 1 TON, G / EXPRESS Cutaway Van	
R	78-95	VAN 3/4 TON, G / EXPRESS All Exc. 8600# GVW	
R	84-88	DODGE MINI RAM All	
R	99-03	VAN 1/2 TON, A / B SERIES / RAM 109.3 (WheelBase) Exc. 7000# GVW	
R	81-98	VAN 1/2 TON, A / B SERIES / RAM 109.6 (WheelBase) Exc. 7000# GVW	
R	71-80	VAN 1/2 TON, A / B SERIES / RAM All	
R	99-03	VAN 1 TON, A / B SERIES / RAM All	
R	95-98	VAN 1 TON, A / B SERIES / RAM All Exc. 4000# Front Axle	
R	71-94	VAN 1 TON, A / B SERIES / RAM All	
R	71-03	VAN 3/4 TON, A / B SERIES / RAM All	
R	74-80	VAN, CB300 All	
F	73-91	GMC JIMMY 4WD Quad Suspension Long Shock; Exc. Lift Kit	
F	81-86	PICKUP 1/2 TON, K15 / K1500 All Quad Suspension Long Shock; Exc. Lift Kit	
F	87	PICKUP 1/2 TON, V1500 All Quad Suspension Long Shock; Exc. Lift Kit	
F	81-86	PICKUP 3/4 TON, K25 / K2500 All Quad Suspension Long Shock; Exc. Lift Kit	
F	87	PICKUP 3/4 TON, V2500 All Quad Suspension Long Shock; Exc. Lift Kit	
F	81-86	SUBURBAN 1/2 TON, K15 / K1500 All Quad Suspension Long Shock; Exc. Lift Kit	

Numerical listing

Shock	POP	Alternative No.	MTG Acc. Supplied
Pos.	Year	Application	
61522 D -continued			
F	87-91	SUBURBAN 1/2 TON, V1500 All Quad Suspension Long Shock; Exc. Lift Kit	
F	81-86	SUBURBAN 3/4 TON, K25 / K2500 All Quad Suspension Long Shock; Exc. Lift Kit	
F	87-91	SUBURBAN 3/4 TON, V2500 All Quad Suspension Long Shock; Exc. Lift Kit	
R	78-95	VAN 1/2 TON, G / SAVANNA All	
R	85-96	VAN 1 TON, G / SAVANNA Extended Cargo Van	
R	85-96	VAN 1 TON, G / SAVANNA Extended Passenger Van	
R	79-96	VAN 1 TON, G / SAVANNA Standard Cargo Van	
R	79-96	VAN 1 TON, G / SAVANNA Standard Passenger Van	
R	78	VAN 1 TON, G / SAVANNA Cutaway Van	
R	78-95	VAN 3/4 TON, G / SAVANNA All Exc. 8600# GVW	
R	74-83	PLYMOUTH VAN 1/2 TON, PB SERIES All	
R	74-83	VAN 1 TON, PB SERIES All	
R	74-83	VAN 3/4 TON, PB SERIES All	
61523 D			
F	84-88	DODGE MINI RAM All	
F	72-93	PICKUP 1/2 TON, D100 SERIES All	
F	72-93	PICKUP 3/4 TON, D200 SERIES All Exc. HD Package	
F	75-93	RAMCHARGER RWD	
F	99-03	VAN 1/2 TON, A / B SERIES / RAM 109.3 (WheelBase) Exc. 7000# GVW	
F	81-98	VAN 1/2 TON, A / B SERIES / RAM 109.6 (WheelBase) Exc. 7000# GVW	
F	71-80	VAN 1/2 TON, A / B SERIES / RAM All	
F	99-03	VAN 1 TON, A / B SERIES / RAM All	
F	71-98	VAN 1 TON, A / B SERIES / RAM All Exc. 4000# Front Axle	
F	71-03	VAN 3/4 TON, A / B SERIES / RAM All	
F	74-80	VAN, CB300 All Exc. 4000# Front Axle	
F	75-81	PLYMOUTH TRAILDUSTER RWD	
F	74-83	VAN 1/2 TON, PB SERIES All	
F	74-83	VAN 1 TON, PB SERIES All Exc. 4000# Front Axle	
F	74-83	VAN 3/4 TON, PB SERIES All	
61524 D			
R	87-91	CHEVROLET BLAZER 4WD Full Size; Exc. Lift Kit	
R	85-86	BLAZER 4WD Exc. Lift Kit	
R	73-84	BLAZER All Exc. Lift Kit	
R	73-86	PICKUP 1/2 TON, C10 All	
R	73-86	PICKUP 1/2 TON, K10 All Exc. Lift Kit	
R	87	PICKUP 1/2 TON, R10 All	
R	87	PICKUP 1/2 TON, V10 All Exc. Lift Kit	
R	75-86	PICKUP 3/4 TON, C20 Standard Cab Pickup	
R	73-74	PICKUP 3/4 TON, C20 All Standard Cab Pickup	
R	73-86	PICKUP 3/4 TON, K20 All Exc. Lift Kit	
R	87	PICKUP 3/4 TON, R20 Standard Cab Pickup	
R	87	PICKUP 3/4 TON, V20 All Exc. Quad Suspension and Lift Kit	
R	73-86	SUBURBAN 1/2 TON, C10 All	
R	73-86	SUBURBAN 1/2 TON, K10 All Exc. Lift Kit	
R	87-88	SUBURBAN 1/2 TON, R10 All	
R	89-91	SUBURBAN 1/2 TON, R1500 All	
R	89-91	SUBURBAN 1/2 TON, V1500 All Exc. Lift Kit	
R	73-86	SUBURBAN 3/4 TON, C20 All	
R	73-86	SUBURBAN 3/4 TON, K20 All Exc. Lift Kit	
R	87-88	SUBURBAN 3/4 TON, R20 All	
R	89-91	SUBURBAN 3/4 TON, R2500 All	
R	87-88	SUBURBAN 3/4 TON, V20 All Exc. Quad Suspension and Lift Kit	
R	89-91	SUBURBAN 3/4 TON, V2500 All Exc. Lift Kit	
R	73	VAN 1/2 TON, P SERIES All	
R	73-78	VAN 3/4 TON, P SERIES All	
R	73-91	GMC JIMMY All Exc. Lift Kit	

ProGuard

Shock	POP	Alternative No.	MTG Acc. Supplied
Pos.	Year	Application	
61524 D -continued			
R	73-86	PICKUP 1/2 TON, C15 / C1500 All	
R	73-86	PICKUP 1/2 TON, K15 / K1500 All Exc. Lift Kit	
R	87	PICKUP 1/2 TON, R1500 All	
R	87	PICKUP 1/2 TON, V1500 All Exc. Lift Kit	
R	75-86	PICKUP 3/4 TON, C25 / C2500 Cab & Chassis	
R	75-86	PICKUP 3/4 TON, C25 / C2500 Standard Cab Pickup	
R	73-74	PICKUP 3/4 TON, C25 / C2500 All Exc. Crew Cab & Bonus Cab	
R	73-86	PICKUP 3/4 TON, K25 / K2500 All Exc. Lift Kit	
R	88-89	PICKUP 3/4 TON, R2500 All Exc. Crew Cab & Bonus Cab	
R	87	PICKUP 3/4 TON, R2500 Cab & Chassis Exc. Crew Cab & Bonus Cab	
R	87	PICKUP 3/4 TON, R2500 Standard Cab Pickup Exc. Crew Cab & Bonus Cab	
R	87	PICKUP 3/4 TON, V2500 All Exc. Lift Kit	
R	73-86	SUBURBAN 1/2 TON, C15 / C1500 All	
R	73-86	SUBURBAN 1/2 TON, K15 / K1500 All Exc. Lift Kit	
R	87-91	SUBURBAN 1/2 TON, R1500 All	
R	87-91	SUBURBAN 1/2 TON, V1500 All Exc. Lift Kit	
R	75-86	SUBURBAN 3/4 TON, C25 / C2500 All	
R	73-74	SUBURBAN 3/4 TON, C25 / C2500 All Exc. Crew Cab & Bonus Cab	
R	73-86	SUBURBAN 3/4 TON, K25 / K2500 All Exc. Lift Kit	
R	87-91	SUBURBAN 3/4 TON, R2500 All	
R	87-91	SUBURBAN 3/4 TON, V2500 All Exc. Lift Kit	
R	73	VAN 1/2 TON, P SERIES All	
R	73-78	VAN 3/4 TON, P SERIES All	
61525 C			
F	69-84	CHEVROLET BLAZER RWD	
F	63-86	PICKUP 1/2 TON, C10 All	
F	87	PICKUP 1/2 TON, R10 All	
F	63-86	PICKUP 1 TON, C30 All	
F	88-91	PICKUP 1 TON, C35/3500 Cab & Chassis	
F	87-88	PICKUP 1 TON, R30 All	
F	89	PICKUP 1 TON, R3500 Standard Cab Pickup	
F	75-86	PICKUP 3/4 TON, C20 Crew Cab Pickup	
F	75-86	PICKUP 3/4 TON, C20 Standard Cab Pickup	
F	63-74	PICKUP 3/4 TON, C20 All	
F	88	PICKUP 3/4 TON, R20 Crew Cab Pickup	
F	87	PICKUP 3/4 TON, R20 All	
F	89	PICKUP 3/4 TON, R2500 All	
F	63-67	SUBURBAN 1/2 TON, 1500 All	
F	63-86	SUBURBAN 1/2 TON, C10 All	
F	87-88	SUBURBAN 1/2 TON, R10 All	
F	89-91	SUBURBAN 1/2 TON, R1500 All	
F	67-86	SUBURBAN 3/4 TON, C20 All	
F	87-88	SUBURBAN 3/4 TON, R20 All	
F	89-91	SUBURBAN 3/4 TON, R2500 All	
F	63-80	VAN 1/2 TON, P SERIES All	
F	68-90	VAN 1 TON, P SERIES All Exc. Motorhome Chassis	
F	68-89	VAN 3/4 TON, P SERIES All	
F	75-84	GMC JIMMY RWD	
F	70-74	JIMMY All RWD	
F	67-86	PICKUP 1/2 TON, C15 / C1500 All	
F	87	PICKUP 1/2 TON, R1500 All	
F	88-91	PICKUP 1 TON, C35/3500 Cab & Chassis HD Solid Front Axle	
F	67-78	PICKUP 1 TON, C35/3500 All	
F	87-91	PICKUP 1 TON, R3500 All	
F	85-86	PICKUP 3/4 TON, C25 / C2500 Crew Cab Pickup	
F	75-86	PICKUP 3/4 TON, C25 / C2500 Cab & Chassis	
F	75-86	PICKUP 3/4 TON, C25 / C2500 Standard Cab Pickup	
F	75-83	PICKUP 3/4 TON, C25 / C2500 Crew Cab Pickup	
F	67-74	PICKUP 3/4 TON, C25 / C2500 All	
F	87-89	PICKUP 3/4 TON, R2500 All Exc. Crew Cab & Bonus Cab	
F	63-65	PICKUP 1000 SERIES All	
F	63-65	PICKUP 1500 SERIES All	

Numerical listing

Shock	POP	Alternative No.	MTG Acc. Supplied
Pos.	Year	Application	
61525 C -continued			
F	75-86	SUBURBAN 1/2 TON, C15 / C1500 All	
F	68-74	SUBURBAN 1/2 TON, C15 / C1500 All Coil (FrontSpringType)	
F	87-91	SUBURBAN 1/2 TON, R1500 All	
F	68-86	SUBURBAN 3/4 TON, C25 / C2500 All	
F	87-91	SUBURBAN 3/4 TON, R2500 All	
F	67-80	VAN 1/2 TON, P SERIES All	
F	75-90	VAN 1 TON, P SERIES All Exc. Motorhome Chassis	
F	73-74	VAN 1 TON, P SERIES Base Exc. Motorhome Chassis	
F	68-72	VAN 1 TON, P SERIES All	
F	68-89	VAN 3/4 TON, P SERIES All	
F	63-65	VAN, PB 1000 SERIES All	
61526 W			
R	72-93	DODGE PICKUP 1/2 TON, D100 SERIES All	
R	72-93	PICKUP 1 TON, D300 SERIES All	
R	72-93	PICKUP 3/4 TON, D200 SERIES All	
R	76-93	RAMCHARGER RWD	
R	74-75	RAMCHARGER All	
R	76-81	PLYMOUTH TRAILDUSTER RWD	
R	74-75	TRAILDUSTER All	
61528 A			
R	05	CHEVROLET BLAZER Base, 4WD	
R	05	BLAZER Base, RWD	
R	96-04	BLAZER LS, 4WD	
R	96-04	BLAZER LS, RWD	
R	95-02	BLAZER LT, RWD	
R	95-01	BLAZER LT, 4WD	
R	95-99	BLAZER Base, 4WD	
R	95-99	BLAZER Base, RWD	
R	95-97	BLAZER Deluxe, RWD	
R	83-94	BLAZER, S MODELS All	
R	99-04	S10 LS, 4WD	
R	99-03	S10 Base, 4WD	
R	99-03	S10 Base, RWD	
R	99-03	S10 LS, RWD	
R	94-98	S10 LS	
R	82-98	S10 Base	
R	92-93	S10 EL	
R	83-92	S10 Tahoe	
R	88-90	S10 Durango	
R	82-86	S10 Durango	
R	05	GMC JIMMY 4WD	
R	92-04	JIMMY All	
R	83-91	S15 JIMMY All	
R	82-04	SONOMA / S15 All	
R	91	SYCLONE All	
R	92-93	TYPHOON All	
R	96-00	ISUZU HOMBRE All	
R	96-01	OLDSMOBILE BRAVADA All	
R	91-94	BRAVADA All	
61529 W			
F	82	DODGE D50 4WD	
F	87-93	PICKUP, RAM 50 4WD	
F	87-89	RAIDER All	
F	83-94	MITSUBISHI MIGHTY MAX 4WD	
F	83-91	MONTERO All	
F	87-89	TOYOTA VAN RWD	
F	84-86	VAN All	
F	88	VAN WAGON RWD	
61530 D			
R	80-96	FORD PICKUP 1/2 TON, F-150 4WD Exc. Lift Kit	
R	86-97	PICKUP 1 TON, F-350 / SUPERDUTY 4WD Dual Rear Wheels	
R	82-85	PICKUP 1 TON, F-350 / SUPERDUTY 4WD Clevis Type Lower Front Mount; Exc. Dual Rear Wheels or Lift Kit	
R	80-81	PICKUP 1 TON, F-350 / SUPERDUTY 4WD	
R	97	PICKUP 3/4 TON, F-250 / SUPERDUTY 4WD Over 8500# GVW	
R	87-96	PICKUP 3/4 TON, F-250 / SUPERDUTY 4WD	
R	82-86	PICKUP 3/4 TON, F-250 / SUPERDUTY 4WD Clevis Type Lower Front Mount; Exc. Dual Rear Wheels or Lift Kit	
R	80-81	PICKUP 3/4 TON, F-250 / SUPERDUTY 4WD	
61531 A			
F	05	CHEVROLET BLAZER Base, 4WD	
F	96-04	BLAZER LS, 4WD	

Numerical listing

Shock	POP	Alternative No.	MTG Acc. Supplied
Pos.	Year	Application	
61531 A -continued			
F	95-01	BLAZER LT, 4WD	
F	95-99	BLAZER Base, 4WD	
F	83-94	BLAZER, S MODELS 4WD	
F	94-04	S10 LS, 4WD	
F	83-03	S10 Base, 4WD	
F	92-93	S10 EL, 4WD	
F	83-92	S10 Tahoe, 4WD	
F	88-90	S10 Durango, 4WD	
F	83-86	S10 Durango, 4WD	
F	92-05	GMC JIMMY 4WD	
F	83-91	S15 JIMMY 4WD	
F	83-04	SONOMA / S15 4WD	
F	91	SYCLONE All	
F	92-93	TYPHOON All	
F	99-00	ISUZU HOMBRE 4WD	
F	96-98	HOMBRE All Sport Chassis	
F	96-01	OLDSMOBILE BRAVADA All	
F	91-94	BRAVADA All	
61532 W			
R	82	DODGE D50 4WD	
R	87-93	PICKUP, RAM 50 4WD	
R	83-94	MITSUBISHI MIGHTY MAX 4WD	
61533 W			
R	89	FORD BRONCO II All Mfg. to 2/89; Vehicles with 10mm & 12mm bolt in rear lower mount	
R	84-88	BRONCO II All With 10mm Bolt In Rear Lower Mount	
R	89	RANGER RWD Mfg. to 2/89; Vehicles with 10mm bolt in rear lower mount	
R	83-88	RANGER RWD	
61534 W			
R	83-89	FORD RANGER 4WD	
61535 A			
F	84-01	JEEP CHEROKEE All	
F	86-92	COMANCHE All	
F	93-98	GRAND CHEROKEE All	
F	84-90	WAGONEER All	
61536 A			
R	84-01	JEEP CHEROKEE All	
R	84-90	WAGONEER All	
61538 D			
R	90-95	CHRYSLER TOWN & COUNTRY All	
R	84-95	DODGE CARAVAN / GRAND CARAVAN All	
R	84-95	PLYMOUTH VOYAGER / GRAND VOYAGER All	
61539 C			
R	90-05	CHEVROLET ASTRO All	
R	85-89	ASTRO RWD	
R	90-05	GMC SAFARI All	
R	85-89	SAFARI RWD	
R	86-89	VOLKSWAGEN VANAGON 4WD	
61540 W			
F	86-97	FORD AEROSTAR RWD	
61541 W			
R	86-88	FORD AEROSTAR RWD	
R	87-95	JEEP WRANGLER YJ (MfrBodyCode)	
61542 A			
F	99-00	CADILLAC ESCALADE All	
F	90-05	CHEVROLET ASTRO AWD	
F	92-94	BLAZER 4WD Full Size	
F	88-00	PICKUP 1 TON, K35 / K3500 All	
F	88-00	PICKUP 3/4 TON, K25 / K2500 All	
F	92-99	SUBURBAN 1/2 TON, K15 / K1500 All	
F	92-99	SUBURBAN 3/4 TON, K25 / K2500 All	
F	95-00	TAHOE 4WD Old Body Style	
F	88-00	GMC PICKUP 1 TON, K35 / K3500 All	
F	88-00	PICKUP 3/4 TON, K25 / K2500 All	
F	90-05	SAFARI AWD	
F	92-99	SUBURBAN 1/2 TON, K15 / K1500 All	
F	92-99	SUBURBAN 3/4 TON, K25 / K2500 All	
F	92-99	YUKON 4WD	
61543 A			
R	88-99	CHEVROLET PICKUP 1/2 TON, C15 / C1500 All	
R	88-99	PICKUP 1/2 TON, K15 / K1500 All	

ProGuard

Shock	POP	Alternative No.	MTG Acc. Supplied
Pos.	Year	Application	
61543 A -continued			
R	91-03	PICKUP 1 TON, C35/3500 All HD Solid Front Axle	
R	88-90	PICKUP 1 TON, C35/3500 Extended Cab Pickup Exc. HD Straight Front Axle	
R	88-90	PICKUP 1 TON, C35/3500 Standard Cab Pickup Exc. HD Straight Front Axle	
R	88-00	PICKUP 1 TON, K35 / K3500 All	
R	88-00	PICKUP 3/4 TON, C25 / C2500 All	
R	88-00	PICKUP 3/4 TON, K25 / K2500 All	
R	88-99	GMC PICKUP 1/2 TON, C15 / C1500 All	
R	88-99	PICKUP 1/2 TON, K15 / K1500 All	
R	91-00	PICKUP 1 TON, C35/3500 All HD Solid Front Axle	
R	88-90	PICKUP 1 TON, C35/3500 All Exc. HD Straight Front Axle	
R	88-00	PICKUP 1 TON, K35 / K3500 All	
R	88-00	PICKUP 3/4 TON, C25 / C2500 All	
R	88-00	PICKUP 3/4 TON, K25 / K2500 All	
61544 A			
F	88-99	CHEVROLET PICKUP 1/2 TON, C15 / C1500 All	
F	92-00	PICKUP 1 TON, C35/3500 Crew Cab Pickup Exc. HD Straight Front Axle	
F	88-00	PICKUP 1 TON, C35/3500 Extended Cab Pickup Exc. HD Straight Front Axle	
F	88-00	PICKUP 1 TON, C35/3500 Standard Cab Pickup Exc. HD Straight Front Axle	
F	88-00	PICKUP 3/4 TON, C25 / C2500 All	
F	92-99	SUBURBAN 1/2 TON, C15 / C1500 All	
F	92-99	SUBURBAN 3/4 TON, C25 / C2500 All	
F	95-00	TAHOE RWD Old Body Style	
F	88-99	GMC PICKUP 1/2 TON, C15 / C1500 All	
F	92-00	PICKUP 1 TON, C35/3500 Crew Cab Pickup Exc. HD Straight Front Axle	
F	88-00	PICKUP 1 TON, C35/3500 Extended Cab Pickup Exc. HD Straight Front Axle	
F	88-00	PICKUP 1 TON, C35/3500 Standard Cab Pickup Exc. HD Straight Front Axle	
F	88-00	PICKUP 3/4 TON, C25 / C2500 All	
F	92-99	SUBURBAN 1/2 TON, C15 / C1500 All	
F	92-99	SUBURBAN 3/4 TON, C25 / C2500 All	
F	92-99	YUKON RWD	
61545 W			
F	87-89	TOYOTA VAN 4WD	
61546 W			
F	80-96	FORD BRONCO All Quad Suspension; Forward of Front Axle; Exc. Lift Kit	
F	80-96	PICKUP 1/2 TON, F-150 4WD Quad Suspension; Forward of Front Axle; Exc. Lift Kit	
F	80-81	PICKUP 1 TON, F-350 / SUPERDUTY 4WD	
F	80-82	PICKUP 3/4 TON, F-250 / SUPERDUTY 4WD	
61547 D			
R	85-96	FORD PICKUP 1/2 TON, F-150 RWD	
R	80-97	PICKUP 1 TON, F-350 / SUPERDUTY RWD Exc. Dual Rear Wheels	
R	97	PICKUP 3/4 TON, F-250 / SUPERDUTY RWD Over 8500# GVW	
R	80-96	PICKUP 3/4 TON, F-250 / SUPERDUTY RWD	
61549 W			
F	86-95	SUZUKI SAMURAI All	
61550 W			
R	86-95	SUZUKI SAMURAI All	
61551 W			
F	78-79	FORD BRONCO All Quad Suspension; Forward of Front Axle; Exc. Lift Kit	

Numerical listing

Shock	POP	Alternative No.	MTG Acc. Supplied
Pos.	Year	Application	
61551 W -continued			
F	78-79	PICKUP 1/2 TON, F-150 Ranger Lariat, 4WD Quad Suspension Long Shock; Exc. Lift Kit	
F	78-79	PICKUP 1/2 TON, F-150 Ranger, 4WD Quad Suspension Long Shock; Exc. Lift Kit	
F	79	PICKUP 1/2 TON, F-150 Custom, 4WD Quad Suspension; Forward of Front Axle; Exc. Lift Kit	
F	78	PICKUP 1/2 TON, F-150 Base, 4WD Quad Suspension Long Shock; Exc. Lift Kit	
F	78	PICKUP 1/2 TON, F-150 Custom, 4WD Quad Suspension Long Shock; Exc. Lift Kit	
F	78	PICKUP 1/2 TON, F-150 Northland, 4WD Quad Suspension Long Shock; Exc. Lift Kit	
F	87-95	JEEP WRANGLER YJ (MfrBodyCode)	
61552 C			
F	86-95	TOYOTA 4RUNNER All	
F	86-95	PICKUP 4WD Exc. Lift Kit	
F	93-98	T100 4WD	
61553 W			
F	75-91	FORD VAN 1/2 TON, ECONOLINE / CLUB WAGON All	
61554 W			
R	80-96	FORD BRONCO All Exc. Lift Kit	
R	80-83	PICKUP 1/2 TON, F-100 RWD	
R	80-84	PICKUP 1/2 TON, F-150 RWD	
R	90-97	PICKUP 1/2 TON, F SUPERDUTY All	
R	80-97	PICKUP 1 TON, F-350 / SUPERDUTY RWD Dual Rear Wheels	
R	97	PICKUP, F-450 SUPERDUTY All	
61555 A			
F	85-05	CHEVROLET ASTRO RWD	
F	81	BEL AIR Sedan Police and Taxi Models	
F	71-75	BEL AIR Sedan Police and Taxi Models	
F	71-72	BISCAYNE All Police and Taxi Models	
F	73-96	CAPRICE Sedan Police and Taxi Models	
F	71-72	CAPRICE All Police and Taxi Models	
F	83-85	IMPALA All Police and Taxi Models	
F	71-82	IMPALA Sedan Police and Taxi Models	
F	96-02	VAN 1/2 TON, G / EXPRESS All	
F	97-02	VAN 1 TON, G / EXPRESS All	
F	96-02	VAN 3/4 TON, G / EXPRESS All Exc. 8600# GVW	
F	93-02	FORD CROWN VICTORIA Police Interceptor Police and Taxi Models	
F	85-05	GMC SAFARI RWD	
F	96-02	VAN 1/2 TON, G / SAVANNA All	
F	96-02	VAN 1 TON, G / SAVANNA All	
F	96-02	VAN 3/4 TON, G / SAVANNA All Exc. 8600# GVW	
61556 W			
F	79-82	DODGE D50 RWD	
F	87-93	PICKUP, RAM 50 RWD	
F	83-86	PICKUP, RAM 50 All	
F	83-96	MITSUBISHI MIGHTY MAX RWD	
F	79-82	PLYMOUTH PICKUP All	
61557 W			
R	90-97	FORD AEROSTAR All	
R	89	AEROSTAR RWD	
61558 W			
R	87-88	ISUZU TROOPER 4WD	
61559 C			
R	90	FORD BRONCO II All	
R	89	BRONCO II All Mfg. from 2/89; Vehicles with 12mm bolt in rear lower mount	
R	90-97	RANGER RWD	
R	89	RANGER RWD Mfg. from 2/89; Vehicles with 12mm bolt in rear lower mount	
R	94-97	MAZDA B2300 RWD	
R	94-97	B3000 RWD	
R	94	B4000 RWD	

Numerical listing

Shock	POP	Alternative No.	MTG Acc. Supplied
Pos.	Year	Application	
61560 D			
R	94-98	ASUNA SUNRUNNER	
R	92-93	SUNRUNNER All	
R	98-04	CHEVROLET TRACKER Non-ABS	
R	89-97	GEO TRACKER All	
R	94-97	PONTIAC SUNRUNNER CAN	
R	99-05	SUZUKI GRAND VITARA All	
R	89-98	SIDEKICK All	
R	99-04	VITARA All	
R	96-98	X-90 All	
61561 C			
F	90	FORD BRONCO II All	
F	90-97	RANGER All	
F	94-97	MAZDA B2300 All	
F	94-97	B3000 All	
F	94-97	B4000 RWD	
61565 B			
R	99-00	CADILLAC ESCALADE All	
R	92-94	CHEVROLET BLAZER 4WD Full Size	
R	92-99	SUBURBAN 1/2 TON, C15 / C1500 All	
R	92-99	SUBURBAN 1/2 TON, K15 / K1500 All	
R	92-99	SUBURBAN 3/4 TON, C25 / C2500 All	
R	92-99	SUBURBAN 3/4 TON, K25 / K2500 All	
R	95-00	TAHOE All Old Body Style	
R	96-02	VAN 1/2 TON, G / EXPRESS All	
R	97-02	VAN 1 TON, G / EXPRESS All	
R	96	VAN 1 TON, G / EXPRESS All Exc. 8600# GVW	
R	96-02	VAN 3/4 TON, G / EXPRESS All Exc. 8600# GVW	
R	92-99	GMC SUBURBAN 1/2 TON, C15 / C1500 All	
R	92-99	SUBURBAN 1/2 TON, K15 / K1500 All	
R	92-99	SUBURBAN 3/4 TON, C25 / C2500 All	
R	92-99	SUBURBAN 3/4 TON, K25 / K2500 All	
R	96-02	VAN 1/2 TON, G / SAVANNA All	
R	96-02	VAN 1 TON, G / SAVANNA All Exc. 8600# GVW	
R	96-02	VAN 3/4 TON, G / SAVANNA All Exc. 8600# GVW	
R	92-99	YUKON All	
61568 W			
R	89	DODGE RAIDER 3.0L 6Cyl V (181)	
R	89-91	MINI MONTERO 3.0L 6Cyl V (181)	
61569 W			
F	90-97	FORD AEROSTAR 4WD	
F	90-97	AEROSTAR AWD	
61573 W			
R	90-97	FORD RANGER 4WD	
R	89	RANGER 4WD High Ryder Option	
R	95-96	MAZDA B2300 4WD	
61575 C			
R	93-98	JEEP GRAND CHEROKEE All	
61582 W			
R	93-98	TOYOTA T100 4WD	
61584 W			
R	87-96	DODGE DAKOTA 4WD	
61586 W			
R	89-91	ISUZU TROOPER 4WD	
61588 W			
R	90-95	TOYOTA 4RUNNER All	
61589 W			
R	89-98	MAZDA MPV RWD	
61590 W			
R	91-94	FORD EXPLORER All	
R	91-94	MAZDA NAVAJO All	
61591 A			
F	91-94	FORD EXPLORER All	
F	92-11	VAN 1/2 TON, ECONOLINE / CLUB WAGON All	
F	92-11	VAN 1 TON, ECONOLINE / CLUB WAGON / SUPERDUTY All	
F	04-05	VAN 3/4 TON, ECONOLINE / CLUB WAGON / SUPERDUTY All	

ProGuard

Shock	POP	Alternative No.	MTG Acc. Supplied
Pos.	Year	Application	
61591 A -continued			
F	92-02	VAN 3/4 TON, ECONOLINE / CLUB WAGON / SUPERDUTY All	
F	91-94	MAZDA NAVAJO All	
61592 B			
R	94-97	HONDA PASSPORT All	
R	91-97	ISUZU RODEO All	
R	98-03	TOYOTA SIENNA All	
61593 B			
F	94-02	HONDA PASSPORT All	
F	98-00	ISUZU AMIGO All	
F	91-04	RODEO All	
F	87-91	TROOPER 4WD	
F	86-87	MAZDA B2000 RWD	
F	87-93	B2200 RWD	
F	87-93	B2600 RWD	
F	87-90	MINI VAN All	
F	87-95	NISSAN PATHFINDER All Exc. Electronic Adjustable Suspension	
61594 W			
R	91-97	TOYOTA PREVIA All	
61595 W			
R	92-11	FORD VAN 1/2 TON, ECONOLINE / CLUB WAGON All	
61596 W			
F	87-93	MAZDA B2600 4WD	
61597 W			
R	87-93	MAZDA B2600 4WD	
61598 W			
R	89-98	MAZDA MPV 4WD	
61599 A			
F	94-01	DODGE PICKUP 1/2 TON, RAM 1500 (SEE RAM 1500) RWD	
F	94-02	PICKUP 1 TON, RAM 3500 (SEE RAM 3500) RWD Exc. Solid Front Axle	
F	94-02	PICKUP 3/4 TON, RAM 2500 (SEE RAM 2500) RWD	
61600 A			
R	07	CHEVROLET PICKUP 1/2 TON, SILVERADO 1500 Classic Hybrid, RWD Exc. Electronic Adjustable Suspension	
R	07	PICKUP 1/2 TON, SILVERADO 1500 Classic LS, RWD Exc. Electronic Adjustable Suspension	
R	07	PICKUP 1/2 TON, SILVERADO 1500 Classic LT, RWD Exc. Electronic Adjustable Suspension	
R	07	PICKUP 1/2 TON, SILVERADO 1500 Classic SS, RWD Exc. Electronic Adjustable Suspension	
R	07	PICKUP 1/2 TON, SILVERADO 1500 Classic WT, RWD Exc. Electronic Adjustable Suspension	
R	99-06	PICKUP 1/2 TON, SILVERADO 1500 RWD Exc. Electronic Adjustable Suspension	
R	94-01	DODGE PICKUP 1/2 TON, RAM 1500 (SEE RAM 1500) All	
R	94-02	PICKUP 1 TON, RAM 3500 (SEE RAM 3500) RWD Exc. Solid Front Axle	
R	94-03	PICKUP 3/4 TON, RAM 2500 (SEE RAM 2500) 4WD, GAS Exc. 8800# GVW	
R	94-02	PICKUP 3/4 TON, RAM 2500 (SEE RAM 2500) RWD	
R	95-96	PICKUP 3/4 TON, RAM 2500 (SEE RAM 2500) 4WD, CNG Exc. 8800# GVW	
R	07	GMC SIERRA 1500 Classic Hybrid, RWD Exc. Electronic Adjustable Suspension	
R	07	SIERRA 1500 Classic SL, RWD Exc. Electronic Adjustable Suspension	
R	07	SIERRA 1500 Classic SLE, RWD Exc. Electronic Adjustable Suspension	
R	07	SIERRA 1500 Classic SLT, RWD Exc. Electronic Adjustable Suspension	
R	07	SIERRA 1500 Classic WT, RWD Exc. Electronic Adjustable Suspension	

Numerical listing

Shock	POP	Alternative No.	MTG Acc. Supplied
Pos.	Year	Application	
61600 A -continued			
R	99-06	SIERRA 1500 RWD Exc. Electronic Adjustable Suspension	
61601 A			
F	97-04	DODGE DAKOTA 4WD	
F	98-03	DURANGO 4WD	
61605 A			
R	96-07	CHRYSLER TOWN & COUNTRY All	
R	01-03	VOYAGER / GRAND VOYAGER All Exc. Hydraulic Self Leveling System	
R	00	VOYAGER / GRAND VOYAGER All	
R	00	VOYAGER / GRAND VOYAGER Non-ABS Exc. Hydraulic Self Leveling System	
R	96-07	DODGE CARAVAN / GRAND CARAVAN All Exc. Hydraulic Self Leveling System	
R	96-00	PLYMOUTH VOYAGER / GRAND VOYAGER All	
61606 C			
F	01-04	TOYOTA TACOMA S-Runner Exc. Offroad Package	
F	04	TACOMA Base, RWD Exc. Offroad Package	
F	95-03	TACOMA DLX, RWD Exc. Offroad Package	
61607 W			
F	96-99	ACURA SLX 4WD	
F	00-02	ISUZU TROOPER All	
F	92-99	TROOPER 4WD	
F	99-01	VEHICROSS All	
61608 W			
R	96-99	ACURA SLX 4WD	
R	00-02	ISUZU TROOPER All	
R	92-99	TROOPER 4WD	
R	99-01	VEHICROSS All	
61609 D			
R	97-99	INFINITI QX4 All Mfg. to 12/98	
R	96-99	NISSAN PATHFINDER All Mfg. to 12/98	
61610 D			
R	98-02	HONDA PASSPORT All	
R	98-00	ISUZU AMIGO All	
R	98-04	RODEO All	
61611 A			
F	97-02	FORD EXPEDITION RWD Exc. Front Air- Leveling	
F	97-04	PICKUP 1/2 TON, F-150 RWD	
F	96-99	PICKUP 3/4 TON, F-250 / SUPERDUTY RWD Up through 8500# GVW	
F	98-02	LINCOLN NAVIGATOR Coil (FrontSpringType)	
61612 C			
R	97-04	FORD PICKUP 1/2 TON, F-150 4WD Exc. 7700# GVW	
R	97-99	PICKUP 3/4 TON, F-250 / SUPERDUTY 4WD Up through 8500# GVW; Exc. Superduty	
61613 A			
F	97-02	FORD EXPEDITION 4WD Exc. Front Air- Leveling	
F	04	PICKUP 1/2 TON, F-150 4WD Exc. 7700# GVW	
F	97-03	PICKUP 1/2 TON, F-150 4WD	
F	97-99	PICKUP 3/4 TON, F-250 / SUPERDUTY 4WD Up through 8500# GVW; Exc. Superduty	
61614 A			
R	97-02	FORD EXPEDITION All	
F	86-97	PICKUP 1 TON, F-350 / SUPERDUTY 4WD	
F	97	PICKUP 3/4 TON, F-250 / SUPERDUTY 4WD Over 8500# GVW	
F	87-96	PICKUP 3/4 TON, F-250 / SUPERDUTY 4WD	
R	98-02	LINCOLN NAVIGATOR RWD	
61615 C			
F	97-06	JEEP WRANGLER TJ (MfrBodyCode)	

Numerical listing

Shock	POP	Alternative No.	MTG Acc. Supplied
Pos.	Year	Application	
61616	C		
R	97-06	JEEP WRANGLER TJ (MfrBodyCode)	
61623	A		
F	95-01	FORD EXPLORER All Exc. Adjustable Suspension	
F	01-05	EXPLORER SPORT TRAC All	
F	06-11	RANGER RWD, Torsion Bar (FrontSpringType)	
F	98-11	RANGER 4WD	
F	01-05	RANGER Edge, RWD	
F	03-06	MAZDA B3000 All 4WD	
F	98-02	B3000 4WD	
F	98-06	B4000 4WD	
F	97-01	MERCURY MOUNTAINEER All Exc. Electronic Adjustable Suspension	
61624	A		
R	95-01	FORD EXPLORER All Exc. Adjustable Suspension	
R	01-05	EXPLORER SPORT TRAC All	
R	97-01	MERCURY MOUNTAINEER All Exc. Electronic Adjustable Suspension	
61625	B		
R	95-03	FORD WINDSTAR Coil (RearSpringType)	
61626	A		
F	06-11	FORD RANGER RWD, Coil (FrontSpringType)	
F	98-05	RANGER XL, RWD	
F	98-05	RANGER XLT, RWD	
F	05	RANGER STX, RWD	
F	04	RANGER Tremor, RWD	
F	01-06	MAZDA B2300 RWD	
F	98-01	B2500 RWD	
F	98-06	B3000 RWD	
F	98-06	B4000 RWD	
61627	A		
R	06-11	FORD RANGER RWD, Coil (FrontSpringType)	
R	98-05	RANGER XL, RWD	
R	98-05	RANGER XLT, RWD	
R	05	RANGER STX, RWD	
R	04	RANGER Tremor, RWD	
R	01-06	MAZDA B2300 RWD	
R	98-01	B2500 RWD	
R	98-06	B3000 RWD	
R	98-06	B4000 RWD	
61629	B		
R	06-11	FORD RANGER RWD, Torsion Bar (FrontSpringType)	
R	98-11	RANGER 4WD	
R	01-05	RANGER Edge, RWD	
R	03-06	MAZDA B3000 All 4WD	
R	98-02	B3000 4WD	
R	98-06	B4000 4WD	
61632	W		
F	81-93	DODGE PICKUP 1/2 TON, W100 SERIES All Exc. Lift Kit	
F	61-80	PICKUP 1/2 TON, W100 SERIES All	
F	81-93	PICKUP 1 TON, W300 SERIES All Exc. Quad Suspension and Lift Kit	
F	61-80	PICKUP 1 TON, W300 SERIES All	
R	61-71	PICKUP 1 TON, W300 SERIES All	
F	81-93	PICKUP 3/4 TON, W200 SERIES Standard Cab Pickup Exc. Lift Kit	
F	69-80	PICKUP 3/4 TON, W200 SERIES All	
F	61-67	PICKUP 3/4 TON, W200 SERIES All	
F	75-93	RAMCHARGER 4WD	
F	74	RAMCHARGER All 4WD	
F	75-81	PLYMOUTH TRAILDUSTER 4WD	
F	74	TRAILDUSTER All	
61633	W		
R	81-93	DODGE PICKUP 1/2 TON, W100 SERIES All Exc. Lift Kit	
R	72-80	PICKUP 1/2 TON, W100 SERIES All	
R	81-93	PICKUP 1 TON, W300 SERIES All Exc. Quad Suspension and Lift Kit	
R	72-80	PICKUP 1 TON, W300 SERIES All	
R	81-93	PICKUP 3/4 TON, W200 SERIES Standard Cab Pickup Exc. Lift Kit	
R	72-80	PICKUP 3/4 TON, W200 SERIES All	
R	76-93	RAMCHARGER 4WD	
R	76-81	PLYMOUTH TRAILDUSTER 4WD	

ProGuard

Shock	POP	Alternative No.	MTG Acc. Supplied
Pos.	Year	Application	
61634	C		
F	94-01	DODGE PICKUP 1/2 TON, RAM 1500 (SEE RAM 1500) 4WD	
F	94-02	PICKUP 3/4 TON, RAM 2500 (SEE RAM 2500) 4WD, GAS Exc. 8800# GVW	
F	95-96	PICKUP 3/4 TON, RAM 2500 (SEE RAM 2500) 4WD, CNG Exc. 8800# GVW	
61635	W		
F	94-02	DODGE PICKUP 1 TON, RAM 3500 (SEE RAM 3500) 4WD	
F	94-02	PICKUP 1 TON, RAM 3500 (SEE RAM 3500) RWD Solid Front Axle	
F	94-02	PICKUP 3/4 TON, RAM 2500 (SEE RAM 2500) 4WD, DIESEL 8800# GVW	
61637	W		
R	97-02	MERCURY VILLAGER Non-ABS	
R	93-96	VILLAGER 4-Wheel ABS	
R	93-02	NISSAN QUEST All	
61638	B		
R	04	FORD PICKUP 1/2 TON, F-150 RWD	
R	00-03	PICKUP 1/2 TON, F-150 Harley-Davidson Edition, RWD	
R	99-03	PICKUP 1/2 TON, F-150 Lariat, RWD	
R	99-03	PICKUP 1/2 TON, F-150 XL, RWD	
R	99-03	PICKUP 1/2 TON, F-150 XLT, RWD	
R	00	PICKUP 1/2 TON, F-150 Base, RWD	
R	97-98	PICKUP 1/2 TON, F-150 RWD	
R	97-99	PICKUP 3/4 TON, F-250 / SUPERDUTY RWD Up through 8500# GVW	
61641	A		
F	07	CHEVROLET PICKUP 1/2 TON, SILVERADO 1500 Classic Hybrid, RWD Exc. Electronic Adjustable Suspension	
F	07	PICKUP 1/2 TON, SILVERADO 1500 Classic LS, RWD Exc. Electronic Adjustable Suspension	
F	07	PICKUP 1/2 TON, SILVERADO 1500 Classic LT, RWD Exc. Electronic Adjustable Suspension	
F	07	PICKUP 1/2 TON, SILVERADO 1500 Classic SS, RWD Exc. Electronic Adjustable Suspension	
F	07	PICKUP 1/2 TON, SILVERADO 1500 Classic WT, RWD Exc. Electronic Adjustable Suspension	
F	99-06	PICKUP 1/2 TON, SILVERADO 1500 RWD Exc. Electronic Adjustable Suspension	
F	07	GMC SIERRA 1500 Classic Hybrid, RWD Exc. Electronic Adjustable Suspension	
F	07	SIERRA 1500 Classic SL, RWD Exc. Electronic Adjustable Suspension	
F	07	SIERRA 1500 Classic SLE, RWD Exc. Electronic Adjustable Suspension	
F	07	SIERRA 1500 Classic SLT, RWD Exc. Electronic Adjustable Suspension	
F	07	SIERRA 1500 Classic WT, RWD Exc. Electronic Adjustable Suspension	
F	99-06	SIERRA 1500 RWD Exc. Electronic Adjustable Suspension	
61642	A		
R	07	CHEVROLET PICKUP 1/2 TON, SILVERADO 1500 Classic Hybrid, 4WD Classic and Old Body Style; Exc. Electronic Adjustable Suspension	
R	07	PICKUP 1/2 TON, SILVERADO 1500 Classic LS, 4WD Classic and Old Body Style; Exc. Electronic Adjustable Suspension	
R	07	PICKUP 1/2 TON, SILVERADO 1500 Classic LT, 4WD Classic and Old Body Style; Exc. Electronic Adjustable Suspension	
R	07	PICKUP 1/2 TON, SILVERADO 1500 Classic WT, 4WD Classic and Old Body Style; Exc. Electronic Adjustable Suspension	

Numerical listing

Shock	POP	Alternative No.	MTG Acc. Supplied
Pos.	Year	Application	
61642	A	-continued	
R	99-06	PICKUP 1/2 TON, SILVERADO 1500 4WD Classic and Old Body Style; Exc. Electronic Adjustable Suspension	
R	05-07	PICKUP 1/2 TON, SILVERADO 1500 HD All	
R	01-03	PICKUP 1/2 TON, SILVERADO 1500 HD All	
R	77-86	PICKUP 1 TON, K30 All	
R	90-91	PICKUP 1 TON, R3500 All	
R	89	PICKUP 1 TON, R3500 Cab & Chassis, RWD	
R	89	PICKUP 1 TON, R3500 Crew Cab Pickup, RWD	
R	01-09	PICKUP 1 TON, SILVERADO 3500 All	
R	07-10	PICKUP 1 TON, SILVERADO 3500 HD All	
R	87-88	PICKUP 1 TON, V30 All	
R	89-91	PICKUP 1 TON, V3000 / V3500 All	
R	99-08	PICKUP 3/4 TON, SILVERADO 2500 All	
R	01-10	PICKUP 3/4 TON, SILVERADO 2500 HD All	
R	94-02	DODGE PICKUP 1 TON, RAM 3500 (SEE RAM 3500) 4WD	
R	94-02	PICKUP 1 TON, RAM 3500 (SEE RAM 3500) RWD Solid Front Axle	
R	94-02	PICKUP 3/4 TON, RAM 2500 (SEE RAM 2500) 4WD, DIESEL 8800# GVW	
R	77-86	GMC PICKUP 1 TON, K35 / K3500 All	
R	87-91	PICKUP 1 TON, V3000 / V3500 All	
R	07	SIERRA 1500 Classic Hybrid, 4WD Classic and Old Body Style; Exc. Electronic Adjustable Suspension	
R	07	SIERRA 1500 Classic SL, 4WD Classic and Old Body Style; Exc. Electronic Adjustable Suspension	
R	07	SIERRA 1500 Classic SLE, 4WD Classic and Old Body Style; Exc. Electronic Adjustable Suspension	
R	07	SIERRA 1500 Classic SLT, 4WD Classic and Old Body Style; Exc. Electronic Adjustable Suspension	
R	07	SIERRA 1500 Classic WT, 4WD Classic and Old Body Style; Exc. Electronic Adjustable Suspension	
R	99-06	SIERRA 1500 4WD Classic and Old Body Style; Exc. Electronic Adjustable Suspension	
R	05-07	SIERRA 1500 HD All	
R	01-03	SIERRA 1500 HD All	
R	99-04	SIERRA 2500 All	
R	01-10	SIERRA 2500 HD All	
R	01-07	SIERRA 3500 All	
R	07-10	SIERRA 3500 HD All	
61643	A		
F	02-06	CHEVROLET AVALANCHE 1500 All Exc. Electronic Ride Control	
F	07	PICKUP 1/2 TON, SILVERADO 1500 Classic Hybrid, 4WD Classic and Old Body Style; Exc. Electronic Adjustable Suspension	
F	07	PICKUP 1/2 TON, SILVERADO 1500 Classic LS, 4WD Classic and Old Body Style; Exc. Electronic Adjustable Suspension	
F	07	PICKUP 1/2 TON, SILVERADO 1500 Classic LT, 4WD Classic and Old Body Style; Exc. Electronic Adjustable Suspension	
F	07	PICKUP 1/2 TON, SILVERADO 1500 Classic WT, 4WD Classic and Old Body Style; Exc. Electronic Adjustable Suspension	
F	07	SUBURBAN 1/2 TON, 1500 All Exc. Z55 Auto Ride Suspension	
F	02-06	TAHOE All Exc. Z55 Auto Ride Suspension	
F	00-01	TAHOE All New Body Style; Exc. Z55 Auto Ride Suspension	
F	07	GMC SIERRA 1500 Classic Hybrid, 4WD Classic and Old Body Style; Exc. Electronic Adjustable Suspension	

Numerical listing

Shock	POP	Alternative No.	MTG Acc. Supplied
Pos.	Year	Application	
61643	A	-continued	
F 07	SIERRA 1500 Classic SL, 4WD Classic and Old Body Style; Exc. Electronic Adjustable Suspension		
F 07	SIERRA 1500 Classic SLE, 4WD Classic and Old Body Style; Exc. Electronic Adjustable Suspension		
F 07	SIERRA 1500 Classic SLT, 4WD Classic and Old Body Style; Exc. Electronic Adjustable Suspension		
F 07	SIERRA 1500 Classic WT, 4WD Classic and Old Body Style; Exc. Electronic Adjustable Suspension		
F 99-06	SIERRA 1500 4WD Classic and Old Body Style; Exc. Electronic Adjustable Suspension		
F 00-06	YUKON All Exc. Z55 Auto Ride Suspension		
F 00-06	YUKON XL 1/2 TON All Exc. Z55 Auto Ride Suspension		
61646	D		
R 04-11	FORD VAN 1 TON, ECONOLINE / CLUB WAGON / SUPERDUTY All Exc. Ambulance & Handling Package		
R 92-05	VAN 1 TON, ECONOLINE / CLUB WAGON / SUPERDUTY All		
R 92-11	VAN 3/4 TON, ECONOLINE / CLUB WAGON / SUPERDUTY All		
61647	W		
R 76-79	FORD PICKUP 1/2 TON, F-150 4WD Exc. Lift Kit		
R 75	PICKUP 1/2 TON, F-150 All 4WD; Exc. Lift Kit		
R 79	PICKUP 1 TON, F-350 / SUPERDUTY 4WD		
R 75-91	VAN 1 TON, ECONOLINE / CLUB WAGON / SUPERDUTY All Exc. Motorhome Conversion		
R 75-91	VAN 3/4 TON, ECONOLINE / CLUB WAGON / SUPERDUTY All		
61649	W		
R 73-86	CHEVROLET PICKUP 1 TON, C30 All		
R 88-91	PICKUP 1 TON, C35/3500 Cab & Chassis Exc. HD Solid Front Axle		
R 87-88	PICKUP 1 TON, R30 RWD		
R 89	PICKUP 1 TON, R3500 Standard Cab Pickup		
R 75-86	PICKUP 3/4 TON, C20 Crew Cab Pickup		
R 73-74	PICKUP 3/4 TON, C20 All Crew Cab Pickup		
R 87-88	PICKUP 3/4 TON, R20 Crew Cab Pickup		
R 89	PICKUP 3/4 TON, R2500 RWD		
R 74-80	VAN 1/2 TON, P SERIES All		
R 73-99	VAN 1 TON, P SERIES All		
R 79-89	VAN 3/4 TON, P SERIES All		
R 88-91	GMC PICKUP 1 TON, C35/3500 Cab & Chassis Exc. HD Solid Front Axle		
R 73-78	PICKUP 1 TON, C35/3500 All		
R 87-91	PICKUP 1 TON, R3500 All		
R 85-86	PICKUP 3/4 TON, C25 / C2500 Crew Cab Pickup		
R 75-83	PICKUP 3/4 TON, C25 / C2500 Crew Cab Pickup		
R 73-74	PICKUP 3/4 TON, C25 / C2500 All Crew Cab Pickup		
R 87-89	PICKUP 3/4 TON, R2500 Crew Cab Pickup		
R 74-80	VAN 1/2 TON, P SERIES All		
R 73-99	VAN 1 TON, P SERIES All		
R 79-89	VAN 3/4 TON, P SERIES All		
61650	W		
F 72-93	DODGE PICKUP 1 TON, D300 SERIES All HD Package		
F 82-93	PICKUP 3/4 TON, D200 SERIES All HD Package		
F 81	PICKUP 3/4 TON, D200 SERIES 165.0 (WheelBase) HD Package		
F 77-80	PICKUP 3/4 TON, D200 SERIES All HD Package		
F 75-76	PICKUP 3/4 TON, D200 SERIES 165.0 (WheelBase) HD Package		
F 72-74	PICKUP 3/4 TON, D200 SERIES All HD Package		
F 71-93	VAN 1 TON, A / B SERIES / RAM All 4000# Front Axle		
F 74-80	VAN, CB300 All 4000# Front Axle		

ProGuard

Shock	POP	Alternative No.	MTG Acc. Supplied
Pos.	Year	Application	
61650	W	-continued	
F 74-83	PLYMOUTH VAN 1 TON, PB SERIES All 4000# Front Axle		
61651	W		
R 00	TOYOTA RAV4 All Mfg. to 5/00		
R 96-99	RAV4 All		
61654	W		
R 99-04	FORD PICKUP 1 TON, F-350 / SUPERDUTY RWD		
R 99-04	PICKUP 3/4 TON, F-250 / SUPERDUTY RWD		
61655	C		
R 02	FORD E-550 ECONOLINE SUPER DUTY All		
R 03	E-550 SUPER DUTY All		
F 99-04	PICKUP 1 TON, F-350 / SUPERDUTY 4WD		
F 99-04	PICKUP 3/4 TON, F-250 / SUPERDUTY 4WD		
F 99-04	PICKUP, F-450 SUPERDUTY All		
F 99-04	PICKUP, F-550 SUPERDUTY All		
61656	D		
R 99-04	FORD PICKUP 1 TON, F-350 / SUPERDUTY 4WD		
R 99-04	PICKUP 3/4 TON, F-250 / SUPERDUTY 4WD		
61657	W		
R 99-04	FORD PICKUP, F-450 SUPERDUTY All		
R 99-04	PICKUP, F-550 SUPERDUTY All		
61658	A		
R 97-04	DODGE DAKOTA All		
R 01-03	DURANGO 4WD		
R 01-03	DURANGO RWD		
R 99-00	DURANGO All		
R 98	DURANGO 4WD		
61659	B		
R 02-05	CHEVROLET VENTURE All		
R 97-01	VENTURE FWD		
R 02-04	OLDSMOBILE SILHOUETTE AWD		
R 97-04	SILHOUETTE FWD		
R 99-05	PONTIAC MONTANA All		
R 97-98	TRANS SPORT All		
61662	B		
F 00-04	NISSAN FRONTIER Crew Cab Pickup, RWD with Desert Runner		
F 98-04	FRONTIER 4WD		
F 98-99	FRONTIER RWD Crew Cab with Desert Runner		
F 00-04	XTERRA All		
61663	B		
F 02-06	CHEVROLET AVALANCHE 2500 All Exc. Electronic Ride Control		
F 05-07	PICKUP 1/2 TON, SILVERADO 1500 HD All		
F 01-03	PICKUP 1/2 TON, SILVERADO 1500 HD All		
F 01-09	PICKUP 1 TON, SILVERADO 3500 All		
F 07-10	PICKUP 1 TON, SILVERADO 3500 HD All		
F 05-08	PICKUP 3/4 TON, SILVERADO 2500 All		
F 99-04	PICKUP 3/4 TON, SILVERADO 2500 4WD		
F 01-10	PICKUP 3/4 TON, SILVERADO 2500 HD All 9200# GVW		
F 00-11	SUBURBAN 3/4 TON, 2500 All Exc. Z55 Auto Ride Suspension and Quadrateer		
F 05-07	GMC SIERRA 1500 HD All		
F 01-03	SIERRA 1500 HD All		
F 99-04	SIERRA 2500 4WD		
F 01-10	SIERRA 2500 HD All		
F 01-07	SIERRA 3500 All		
F 07-10	SIERRA 3500 HD Torsion Bar (FrontSpringType)		
F 00-06	YUKON XL 3/4 TON All Exc. Hydraulic Self Leveling System		
F 03-06	HUMMER H2 All		
61664	A		
F 99-04	JEEP GRAND CHEROKEE All Exc. Up Country Suspension		
61675	A		
R 02-10	CADILLAC ESCALADE All Exc. Electronic Ride Control		

Numerical listing

Shock	POP	Alternative No.	MTG Acc. Supplied
Pos.	Year	Application	
61675	A	-continued	
R 03-10	ESCALADE ESV All Exc. Electronic Ride Control		
R 02-10	ESCALADE EXT All Exc. Electronic Ride Control		
R 02-07	CHEVROLET AVALANCHE 1500 All Exc. Electronic Ride Control		
R 02-06	AVALANCHE 2500 All Exc. Electronic Ride Control		
R 07-11	SUBURBAN 1/2 TON, 1500 All Exc. Z55 or ZW7 Ride Suspension		
R 00-06	SUBURBAN 1/2 TON, 1500 All Exc. Z55 Auto Ride Suspension		
R 00-11	SUBURBAN 3/4 TON, 2500 All Exc. Z55 Auto Ride Suspension and Quadrateer		
R 07-11	TAHOE All Exc. Z55 or ZW7 Ride Suspension		
R 02-06	TAHOE All Exc. Z55 Auto Ride Suspension		
R 00-01	TAHOE All New Body Style; Exc. Z55 Auto Ride Suspension		
R 00-09	GMC YUKON All Exc. Z55 Auto Ride Suspension		
R 00-06	YUKON XL 1/2 TON All Exc. Z55 Auto Ride Suspension		
R 00-06	YUKON XL 3/4 TON All Exc. Hydraulic Self Leveling System		
61676	A		
R 99-04	JEEP GRAND CHEROKEE All		
61679	W		
F 87-96	DODGE DAKOTA 4WD		
61680	W		
F 05-12	FORD PICKUP 1 TON, F-350 / SUPERDUTY 4WD		
F 05-12	PICKUP 3/4 TON, F-250 / SUPERDUTY 4WD		
61681	W		
R 05-07	FORD PICKUP 1 TON, F-350 / SUPERDUTY Crew Cab Pickup, 4WD Dual Rear Wheels		
R 05-07	PICKUP 1 TON, F-350 / SUPERDUTY Extended Cab Pickup, 4WD Dual Rear Wheels		
R 05-07	PICKUP 1 TON, F-350 / SUPERDUTY Standard Cab Pickup, 4WD Dual Rear Wheels		
61682	W		
R 05-12	FORD PICKUP 1 TON, F-350 / SUPERDUTY Crew Cab Pickup, 4WD Single Rear Wheels		
R 05-12	PICKUP 1 TON, F-350 / SUPERDUTY Extended Cab Pickup, 4WD Single Rear Wheels		
R 05-12	PICKUP 1 TON, F-350 / SUPERDUTY Standard Cab Pickup, 4WD Single Rear Wheels		
R 05-12	PICKUP 3/4 TON, F-250 / SUPERDUTY 4WD		
61683	W		
F 03-06	CHEVROLET VAN 1/2 TON, G / EXPRESS Torsion Bar (FrontSpringType)		
F 06-12	VAN 3/4 TON, G / EXPRESS All Torsion Bar (FrontSpringType)		
F 03-05	VAN 3/4 TON, G / EXPRESS Torsion Bar (FrontSpringType)		
F 04-06	GMC VAN 1/2 TON, G / SAVANNA Torsion Bar (FrontSpringType)		
F 03	VAN 1/2 TON, G / SAVANNA Torsion Bar (FrontSpringType)		
F 06-12	VAN 3/4 TON, G / SAVANNA All Torsion Bar (FrontSpringType)		
F 03-05	VAN 3/4 TON, G / SAVANNA Torsion Bar (FrontSpringType)		
61684	W		
F 03-06	CHEVROLET VAN 1/2 TON, G / EXPRESS RWD, Coil (FrontSpringType)		
F 03-06	GMC VAN 1/2 TON, G / SAVANNA RWD, Coil (FrontSpringType)		
61685	D		
F 03-12	CHEVROLET VAN 1 TON, G / EXPRESS Coil (FrontSpringType)		
F 03-12	VAN 3/4 TON, G / EXPRESS Coil (FrontSpringType)		

Numerical listing

Shock	POP	Alternative No.	MTG Acc. Supplied
Pos.	Year	Application	
61685	D	-continued	
F	03-12	GMC VAN 1 TON, G / SAVANNA Coil (FrontSpringType)	
F	03-12	VAN 3/4 TON, G / SAVANNA Coil (FrontSpringType)	
61686	W		
R	03-11	CHEVROLET VAN 1/2 TON, G / EXPRESS All	
R	03-11	GMC VAN 1/2 TON, G / SAVANNA All	
61687	W		
R	03-12	CHEVROLET VAN 1 TON, G / EXPRESS All Single Rear Wheels	
R	03-12	VAN 3/4 TON, G / EXPRESS All	
R	03-12	GMC VAN 1 TON, G / SAVANNA All Single Rear Wheels	
R	03-12	VAN 3/4 TON, G / SAVANNA All	
61688	W		
R	03-06	CHEVROLET VAN 1 TON, G / EXPRESS All Dual Rear Wheels	
R	03-06	GMC VAN 1 TON, G / SAVANNA All Dual Rear Wheels	
61690	D		
R	08-13	CHEVROLET PICKUP 1/2 TON, SILVERADO 1500 All Exc. Electronic Adjustable Suspension	
R	07	PICKUP 1/2 TON, SILVERADO 1500 Base Exc. Electronic Adjustable Suspension	
R	07	PICKUP 1/2 TON, SILVERADO 1500 LS Exc. Electronic Adjustable Suspension	
R	07	PICKUP 1/2 TON, SILVERADO 1500 LT Exc. Electronic Adjustable Suspension	
R	07	PICKUP 1/2 TON, SILVERADO 1500 LTZ Exc. Electronic Adjustable Suspension	
R	07	PICKUP 1/2 TON, SILVERADO 1500 WT Exc. Electronic Adjustable Suspension	
R	08-13	GMC SIERRA 1500 All Exc. Electronic Adjustable Suspension	
R	07	SIERRA 1500 Denali Exc. Electronic Adjustable Suspension	
R	07	SIERRA 1500 SLE Exc. Electronic Adjustable Suspension	
R	07	SIERRA 1500 SLT Exc. Electronic Adjustable Suspension	
R	07	SIERRA 1500 WT Exc. Electronic Adjustable Suspension	
61691	W		
R	06-08	DODGE PICKUP 1/2 TON, RAM 1500 (SEE RAM 1500) Crew Cab Pickup, 4WD	
R	06-08	PICKUP 1/2 TON, RAM 1500 (SEE RAM 1500) Standard Cab Pickup, 4WD	
R	02-05	PICKUP 1/2 TON, RAM 1500 (SEE RAM 1500) 4WD	
61692	W		
R	06-08	DODGE PICKUP 1/2 TON, RAM 1500 (SEE RAM 1500) Crew Cab Pickup, RWD	
R	06-08	PICKUP 1/2 TON, RAM 1500 (SEE RAM 1500) Standard Cab Pickup, RWD	
R	02-05	PICKUP 1/2 TON, RAM 1500 (SEE RAM 1500) RWD	
61696	W		
R	07-12	JEEP WRANGLER All Exc. 17" Wheels	
61697	W		
R	07-12	JEEP WRANGLER All 17" Wheels	
61699	W		
R	98-04	TOYOTA TACOMA Pre Runner Left	
61700	W		
R	98-04	TOYOTA TACOMA Pre Runner Right	
61703	W		
R	98-02	LINCOLN NAVIGATOR 4WD, Air (RearSpringType)	
61704	W		
R	01-06	ACURA MDX All	
R	03-08	HONDA PILOT All	

ProGuard, Ultra Truck Shock

Shock	POP	Alternative No.	MTG Acc. Supplied
Pos.	Year	Application	
61709	W		
R	03-06	DODGE PICKUP 1 TON, RAM 3500 (SEE RAM 3500) Standard Cab Pickup, RWD	
R	03-06	PICKUP 3/4 TON, RAM 2500 (SEE RAM 2500) Standard Cab Pickup, RWD	
61710	W		
R	03-07	DODGE PICKUP 1 TON, RAM 3500 (SEE RAM 3500) Crew Cab Pickup, RWD	
R	03-06	PICKUP 3/4 TON, RAM 2500 (SEE RAM 2500) Crew Cab Pickup, RWD	
61711	W		
F	07-12	JEEP WRANGLER All	
61712	W		
F	06-08	DODGE PICKUP 1/2 TON, RAM 1500 (SEE RAM 1500) 4WD Mega Cab	
61713	W		
R	05-12	FORD PICKUP 1 TON, F-350 / SUPERDUTY RWD	
R	05-12	PICKUP 3/4 TON, F-250 / SUPERDUTY RWD	
61714	W		
F	05-08	DODGE PICKUP 3/4 TON, RAM 2500 (SEE RAM 2500) 4WD	
61715	W		
R	06-10	JEEP COMMANDER All	
R	05-10	GRAND CHEROKEE All	
61716	W		
R	03-10	DODGE PICKUP 3/4 TON, RAM 2500 (SEE RAM 2500) 4WD	
R	11-12	RAM 2500 (SEE DODGE RAM 2500) 4WD	
61717	B		
R	04-07	BUICK RAINIER All	
R	06-09	CHEVROLET TRAILBLAZER Air (RearSpringType)	
R	02-05	TRAILBLAZER All Air (RearSpringType)	
R	02-09	GMC ENVOY All	
R	03-08	ISUZU ASCENDER Coil (RearSpringType)	
R	02-04	OLDSMOBILE BRAVADA All	
R	05-09	SAAB 9-7X All	
61718	W		
R	05-13	CHEVROLET EQUINOX All	
R	10-13	GMC TERRAIN All	
R	06-09	PONTIAC TORRENT All	
61720	W		
F	07	CHRYSLER ASPEN All	
F	04-09	DODGE DURANGO All	
61777	C		
R	02-07	BUICK RENDEZVOUS All Exc. Hydraulic Self Leveling System	
R	01-05	PONTIAC AZTEK AWD	
Ultra Truck Shock			
G63173	C		
R	93-98	TOYOTA T100 RWD	
G63183	W		
R	74	DODGE M300 All	
F	81-93	PICKUP 1/2 TON, W100 SERIES All Exc. Lift Kit	
F	61-80	PICKUP 1/2 TON, W100 SERIES All	
F	81-93	PICKUP 1 TON, W300 SERIES All Exc. Quad Suspension and Lift Kit	
F	61-80	PICKUP 1 TON, W300 SERIES All	
F	61-71	PICKUP 1 TON, W300 SERIES All	
F	81-93	PICKUP 3/4 TON, W200 SERIES Standard Cab Pickup Exc. Lift Kit	
F	69-80	PICKUP 3/4 TON, W200 SERIES All	
F	61-67	PICKUP 3/4 TON, W200 SERIES All	
F	75-93	RAMCHARGER 4WD	
F	74	RAMCHARGER All 4WD	
F	78-80	RD200 All	
F	75-81	PLYMOUTH TRAILDUSTER 4WD	
F	74	TRAILDUSTER All	
G63187	W		
F	65	FORD PICKUP 1/2 TON, F-100 4WD With Front Leaf Springs	

Numerical listing

Shock	POP	Alternative No.	MTG Acc. Supplied
Pos.	Year	Application	
G63187	W	-continued	
F	66-77	PICKUP 3/4 TON, F-250 / SUPERDUTY 4WD Up through Serial No. Y20000	
F	61-65	PICKUP 3/4 TON, F-250 / SUPERDUTY 4WD	
G63299	C		
R	61-67	FORD ECONOLINE All	
F	53-55	F SERIES All	
R	48-52	F SERIES All F-1, F-2 & F-3	
F	72-81	JEEP CJ5 All Exc. Lift Kit	
F	72-75	CJ6 All Exc. Lift Kit	
F	76-81	CJ7 All Exc. Lift Kit	
F	66-74	DJ5 All Exc. Lift Kit	
F	81	SCRAMBLER / CJ8 All	
R	71-74	WAGONEER All	
R	63-67	WAGONEER All	
R	97-02	MERCURY VILLAGER Non-ABS	
R	93-96	VILLAGER 4-Wheel ABS	
R	93-02	NISSAN QUEST All	
F	76-83	TOYOTA LAND CRUISER FJ40 (MfrBodyCode)	
F	75	LAND CRUISER FJ40 (MfrBodyCode) Mfg. to 2/75	
F	67-74	LAND CRUISER All	
G63306	W		
R	69-72	CHEVROLET BLAZER RWD	
R	63-72	PICKUP 1/2 TON, C10 All Leaf(RearSpringType)	
R	67-72	PICKUP 1 TON, C30 All Exc. 11,000# Rear Axle	
R	63-72	PICKUP 3/4 TON, C20 All	
R	63-66	SUBURBAN 1/2 TON, 1500 All	
R	67-77	VAN 1/2 TON, G / EXPRESS All	
R	63-66	VAN 1/2 TON, P SERIES All	
R	76-77	VAN 1 TON, G / EXPRESS All	
R	75	VAN 1 TON, G / EXPRESS 110.0 (WheelBase)	
R	75	VAN 1 TON, G / EXPRESS 125.0 (WheelBase)	
R	71-74	VAN 1 TON, G / EXPRESS All	
R	68-72	VAN 1 TON, P SERIES All Exc. 11,000# Rear Axle	
R	67-77	VAN 3/4 TON, G / EXPRESS All	
R	68-72	VAN 3/4 TON, P SERIES All	
R	70-72	GMC JIMMY All RWD	
R	67-72	PICKUP 1/2 TON, C15 / C1500 All RWD	
R	67-72	PICKUP 1 TON, C35/3500 All Exc. 11,000# Rear Axle	
R	67-72	PICKUP 3/4 TON, C25 / C2500 All RWD	
R	63-65	PICKUP 1000 SERIES All	
R	63-65	PICKUP 1500 SERIES All	
R	67-77	VAN 1/2 TON, G / SAVANNA All	
R	67	VAN 1/2 TON, P SERIES All	
R	76-77	VAN 1 TON, G / SAVANNA All	
R	75	VAN 1 TON, G / SAVANNA 110.0 (WheelBase)	
R	75	VAN 1 TON, G / SAVANNA 125.0 (WheelBase)	
R	71-74	VAN 1 TON, G / SAVANNA All	
R	68-72	VAN 1 TON, P SERIES All Exc. 11,000# Rear Axle	
R	67-77	VAN 3/4 TON, G / SAVANNA All	
R	68-72	VAN 3/4 TON, P SERIES All	
R	63-65	VAN, PB 1000 SERIES All	
G63347	D		
F	87-91	CHEVROLET BLAZER 4WD Full Size; Exc. Quad Suspension and Lift Kit	
F	81-86	BLAZER 4WD Exc. Quad Suspension and Lift Kit	
F	79-80	BLAZER 4WD Exc. Lift Kit	
F	78	BLAZER 4WD 4WD; Exc. Quad Suspension and Lift Kit	
F	75-77	BLAZER 4WD Exc. Lift Kit	
F	73-74	BLAZER 4WD Exc. Quad Suspension and Lift Kit	
F	69-72	BLAZER 4WD Exc. Lift Kit	
F	73-86	PICKUP 1/2 TON, K10 All Exc. Lift Kit	
F	69-72	PICKUP 1/2 TON, K10 All	
F	87	PICKUP 1/2 TON, V10 All Exc. Lift Kit	
F	69-86	PICKUP 3/4 TON, K20 All Exc. Lift Kit	
F	87	PICKUP 3/4 TON, V20 All Exc. Quad Suspension and Lift Kit	
F	69-86	SUBURBAN 1/2 TON, K10 All Exc. Lift Kit	

Numerical listing

Shock	POP	Alternative No.	MTG Acc. Supplied
Pos.	Year	Application	
G63347 D -continued			
F	69-86	SUBURBAN 3/4 TON, K20 All Exc. Lift Kit	
F	87-88	SUBURBAN 3/4 TON, V20 All Exc. Quad Suspension and Lift Kit	
F	89-91	SUBURBAN 3/4 TON, V2500 All Exc. Lift Kit	
F	75-91	GMC JIMMY 4WD Exc. Lift Kit	
F	70-74	JIMMY All 4WD; Exc. Lift Kit	
F	69-86	PICKUP 1/2 TON, K15 / K1500 All Exc. Quad Suspension and Lift Kit	
F	87	PICKUP 1/2 TON, V1500 All Exc. Lift Kit	
F	69-86	PICKUP 3/4 TON, K25 / K2500 All Exc. Quad Suspension and Lift Kit	
F	87	PICKUP 3/4 TON, V2500 All Exc. Lift Kit	
F	69-86	SUBURBAN 1/2 TON, K15 / K1500 All Exc. Quad Suspension and Lift Kit	
F	87-91	SUBURBAN 1/2 TON, V1500 All Exc. Lift Kit	
F	69-86	SUBURBAN 3/4 TON, K25 / K2500 All Exc. Quad Suspension and Lift Kit	
F	87-91	SUBURBAN 3/4 TON, V2500 All Exc. Lift Kit	
G63349 B			
R	87-91	CHEVROLET BLAZER 4WD Full Size; Exc. Lift Kit	
R	85-86	BLAZER 4WD Exc. Lift Kit	
R	73-84	BLAZER All Exc. Lift Kit	
R	75-86	PICKUP 1/2 TON, C10 All	
R	73-86	PICKUP 1/2 TON, K10 All Exc. Lift Kit	
R	87	PICKUP 1/2 TON, R10 All	
R	87	PICKUP 1/2 TON, V10 All Exc. Lift Kit	
R	75-86	PICKUP 3/4 TON, C20 Standard Cab Pickup	
R	75-86	PICKUP 3/4 TON, K20 All Exc. Lift Kit	
R	87	PICKUP 3/4 TON, R20 Standard Cab Pickup	
R	87	PICKUP 3/4 TON, V20 All Exc. Quad Suspension and Lift Kit	
R	73-86	SUBURBAN 1/2 TON, C10 All	
R	73-86	SUBURBAN 1/2 TON, K10 All Exc. Lift Kit	
R	87-88	SUBURBAN 1/2 TON, R10 All	
R	89-91	SUBURBAN 1/2 TON, R1500 All	
R	89-91	SUBURBAN 1/2 TON, V1500 All Exc. Lift Kit	
R	73-86	SUBURBAN 3/4 TON, C20 All	
R	73-86	SUBURBAN 3/4 TON, K20 All Exc. Lift Kit	
R	87-88	SUBURBAN 3/4 TON, R20 All	
R	89-91	SUBURBAN 3/4 TON, R2500 All	
R	87-88	SUBURBAN 3/4 TON, V20 All Exc. Quad Suspension and Lift Kit	
R	89-91	SUBURBAN 3/4 TON, V2500 All Exc. Lift Kit	
R	73	VAN 1/2 TON, P SERIES All	
R	73-78	VAN 3/4 TON, P SERIES All	
R	73-91	GMC JIMMY All Exc. Lift Kit	
R	73-86	PICKUP 1/2 TON, C15 / C1500 All	
R	73-86	PICKUP 1/2 TON, K15 / K1500 All Exc. Lift Kit	
R	87	PICKUP 1/2 TON, R1500 All	
R	87	PICKUP 1/2 TON, V1500 All Exc. Lift Kit	
R	75-86	PICKUP 3/4 TON, C25 / C2500 Cab & Chassis	
R	75-86	PICKUP 3/4 TON, C25 / C2500 Standard Cab Pickup	
R	73-74	PICKUP 3/4 TON, C25 / C2500 All Exc. Crew Cab & Bonus Cab	
R	73-86	PICKUP 3/4 TON, K25 / K2500 All Exc. Lift Kit	
R	88-89	PICKUP 3/4 TON, R2500 All Exc. Crew Cab & Bonus Cab	
R	87	PICKUP 3/4 TON, R2500 Cab & Chassis Exc. Crew Cab & Bonus Cab	
R	87	PICKUP 3/4 TON, R2500 Standard Cab Pickup Exc. Crew Cab & Bonus Cab	
R	87	PICKUP 3/4 TON, V2500 All Exc. Lift Kit	
R	73-86	SUBURBAN 1/2 TON, C15 / C1500 All	
R	73-86	SUBURBAN 1/2 TON, K15 / K1500 All Exc. Lift Kit	
R	87-91	SUBURBAN 1/2 TON, R1500 All	

Ultra Truck Shock

Shock	POP	Alternative No.	MTG Acc. Supplied
Pos.	Year	Application	
G63349 B -continued			
R	87-91	SUBURBAN 1/2 TON, V1500 All Exc. Lift Kit	
R	75-86	SUBURBAN 3/4 TON, C25 / C2500 All	
R	73-74	SUBURBAN 3/4 TON, C25 / C2500 All Exc. Crew Cab & Bonus Cab	
R	73-86	SUBURBAN 3/4 TON, K25 / K2500 All Exc. Lift Kit	
R	87-91	SUBURBAN 3/4 TON, R2500 All	
R	87-91	SUBURBAN 3/4 TON, V2500 All Exc. Lift Kit	
R	73	VAN 1/2 TON, P SERIES All	
R	73-78	VAN 3/4 TON, P SERIES All	
G63350 W			
R	66	FORD BRONCO All Thru Serial #830000	
R	73-79	PICKUP 1/2 TON, F-100 RWD	
R	70-72	PICKUP 1/2 TON, F-100 All RWD	
R	75-79	PICKUP 1/2 TON, F-150 RWD	
R	75-79	PICKUP 1 TON, F-350 / SUPERDUTY Extended Cab Pickup, RWD	
R	74	PICKUP 1 TON, F-350 / SUPERDUTY Extended Cab Pickup RWD	
R	75-79	PICKUP 3/4 TON, F-250 / SUPERDUTY Cab & Chassis, RWD	
R	75-79	PICKUP 3/4 TON, F-250 / SUPERDUTY Standard Cab Pickup, RWD	
R	70-74	PICKUP 3/4 TON, F-250 / SUPERDUTY RWD Exc. Supercab	
R	75-91	VAN 1/2 TON, ECONOLINE / CLUB WAGON All	
F	71-80	INTERNATIONAL SCOUT II All	
G63353 W			
R	72-93	DODGE PICKUP 1/2 TON, D100 SERIES All	
R	72-93	PICKUP 1 TON, D300 SERIES All	
R	72-93	PICKUP 3/4 TON, D200 SERIES All	
R	75-93	RAMCHARGER RWD	
R	74	RAMCHARGER All	
R	76-81	PLYMOUTH TRAILDUSTER RWD	
R	74-75	TRAILDUSTER All	
G63355 A			
F	69-84	CHEVROLET BLAZER RWD	
F	63-86	PICKUP 1/2 TON, C10 All	
F	87	PICKUP 1/2 TON, R10 All	
F	63-86	PICKUP 1 TON, C30 All	
F	88-91	PICKUP 1 TON, C35/3500 Cab & Chassis Exc. HD Solid Front Axle	
F	87-88	PICKUP 1 TON, R30 All	
F	89	PICKUP 1 TON, R3500 Standard Cab Pickup	
F	75-86	PICKUP 3/4 TON, C20 Crew Cab Pickup	
F	75-86	PICKUP 3/4 TON, C20 Standard Cab Pickup	
F	63-74	PICKUP 3/4 TON, C20 All	
F	88	PICKUP 3/4 TON, R20 Crew Cab Pickup	
F	87	PICKUP 3/4 TON, R20 All	
F	89	PICKUP 3/4 TON, R2500 All	
F	63-67	SUBURBAN 1/2 TON, 1500 All	
F	63-86	SUBURBAN 1/2 TON, C10 All	
F	87-88	SUBURBAN 1/2 TON, R10 All	
F	89-91	SUBURBAN 1/2 TON, R1500 All	
F	68-86	SUBURBAN 3/4 TON, C20 All	
F	87-88	SUBURBAN 3/4 TON, R20 All	
F	89-91	SUBURBAN 3/4 TON, R2500 All	
F	63-80	VAN 1/2 TON, P SERIES All	
F	68-90	VAN 1 TON, P SERIES All Exc. Motorhome Chassis	
F	68-89	VAN 3/4 TON, P SERIES All	
F	75-84	GMC JIMMY RWD	
F	70-74	JIMMY All RWD	
F	67-86	PICKUP 1/2 TON, C15 / C1500 All	
F	87	PICKUP 1/2 TON, R1500 All	
F	88-90	PICKUP 1 TON, C35/3500 Cab & Chassis Exc. HD Solid Front Axle	
F	67-78	PICKUP 1 TON, C35/3500 All	
F	87-91	PICKUP 1 TON, R3500 All	
F	85-86	PICKUP 3/4 TON, C25 / C2500 Crew Cab Pickup	
F	75-86	PICKUP 3/4 TON, C25 / C2500 Cab & Chassis	
F	75-86	PICKUP 3/4 TON, C25 / C2500 Standard Cab Pickup	
F	75-83	PICKUP 3/4 TON, C25 / C2500 Crew Cab Pickup	
F	67-74	PICKUP 3/4 TON, C25 / C2500 All	

Numerical listing

Shock	POP	Alternative No.	MTG Acc. Supplied
Pos.	Year	Application	
G63355 A -continued			
F	87-89	PICKUP 3/4 TON, R2500 All Exc. Crew Cab & Bonus Cab	
F	63-65	PICKUP 1000 SERIES All	
F	63-65	PICKUP 1500 SERIES All	
F	68-86	SUBURBAN 1/2 TON, C15 / C1500 All	
F	87-91	SUBURBAN 1/2 TON, R1500 All	
F	68-86	SUBURBAN 3/4 TON, C25 / C2500 All	
F	87-91	SUBURBAN 3/4 TON, R2500 All	
F	67-80	VAN 1/2 TON, P SERIES All	
F	75-90	VAN 1 TON, P SERIES All Exc. Motorhome Chassis	
F	73-74	VAN 1 TON, P SERIES Base Exc. Motorhome Chassis	
F	68-72	VAN 1 TON, P SERIES All	
F	68-89	VAN 3/4 TON, P SERIES All	
F	63-65	VAN, PB 1000 SERIES All	
G63357 D			
F	71-95	CHEVROLET VAN 1/2 TON, G / EXPRESS All	
F	70	VAN 1/2 TON, G / EXPRESS All Independent Front Suspension	
F	76-95	VAN 1 TON, G / EXPRESS All	
F	75	VAN 1 TON, G / EXPRESS 146.0 (WheelBase)	
F	71-74	VAN 1 TON, G / EXPRESS All	
F	71-95	VAN 3/4 TON, G / EXPRESS All	
F	70	VAN 3/4 TON, G / EXPRESS All Independent Front Suspension	
F	71-95	GMC VAN 1/2 TON, G / SAVANNA All	
F	70	VAN 1/2 TON, G / SAVANNA All Independent Front Suspension	
F	76-95	VAN 1 TON, G / SAVANNA All	
F	75	VAN 1 TON, G / SAVANNA 146.0 (WheelBase)	
F	71-74	VAN 1 TON, G / SAVANNA All	
F	78-95	VAN 3/4 TON, G / SAVANNA All Exc. 8600# GVW	
F	71-77	VAN 3/4 TON, G / SAVANNA All	
F	70	VAN 3/4 TON, G / SAVANNA All Independent Front Suspension	
G63359 C			
F	84-88	DODGE MINI RAM All	
F	72-93	PICKUP 1/2 TON, D100 SERIES All	
F	72-93	PICKUP 3/4 TON, D200 SERIES All Exc. HD Package	
F	75-93	RAMCHARGER RWD	
F	99-03	VAN 1/2 TON, A / B SERIES / RAM 109.3 (WheelBase) Exc. 7000# GVW	
F	81-98	VAN 1/2 TON, A / B SERIES / RAM 109.6 (WheelBase) Exc. 7000# GVW	
F	71-80	VAN 1/2 TON, A / B SERIES / RAM All Exc. 4000# Front Axle	
F	99-03	VAN 1 TON, A / B SERIES / RAM All	
F	71-98	VAN 1 TON, A / B SERIES / RAM All Exc. 4000# Front Axle	
F	81-03	VAN 3/4 TON, A / B SERIES / RAM All	
F	71-80	VAN 3/4 TON, A / B SERIES / RAM All Exc. 4000# Front Axle	
F	74-80	VAN, CB300 All Exc. 4000# Front Axle	
F	75-81	PLYMOUTH TRAILDUSTER RWD	
F	74-83	VAN 1/2 TON, PB SERIES All	
F	74-83	VAN 1 TON, PB SERIES All Exc. 4000# Front Axle	
F	74-83	VAN 3/4 TON, PB SERIES All	
G63360 W			
F	72-93	DODGE PICKUP 1 TON, D300 SERIES All HD Package	
F	72-93	PICKUP 3/4 TON, D200 SERIES All HD Package	
F	71-93	VAN 1 TON, A / B SERIES / RAM All 4000# Front Axle	
F	74-80	VAN, CB300 All 4000# Front Axle	
F	74-83	PLYMOUTH VAN 1 TON, PB SERIES All 4000# Front Axle	
G63366 D			
R	75-86	CHEVROLET PICKUP 1 TON, C30 All	
R	88-91	PICKUP 1 TON, C35/3500 Cab & Chassis Exc. HD Solid Front Axle	
R	87-88	PICKUP 1 TON, R30 RWD	
R	89	PICKUP 1 TON, R3500 Standard Cab Pickup	
R	75-86	PICKUP 3/4 TON, C20 Crew Cab Pickup	

Numerical listing

Shock	POP	Alternative No.	MTG Acc. Supplied
Pos.	Year	Application	
G63366	D	-continued	
R	87-88	PICKUP 3/4 TON, R20 Crew Cab Pickup	
R	89	PICKUP 3/4 TON, R2500 RWD	
R	74-80	VAN 1/2 TON, P SERIES All	
R	73-99	VAN 1 TON, P SERIES All	
R	79-89	VAN 3/4 TON, P SERIES All	
R	88-91	GMC PICKUP 1 TON, C35/3500 Cab & Chassis Exc. HD Solid Front Axle	
R	73-78	PICKUP 1 TON, C35/3500 All	
R	87-91	PICKUP 1 TON, R3500 All	
R	85-86	PICKUP 3/4 TON, C25 / C2500 Crew Cab Pickup	
R	73-83	PICKUP 3/4 TON, C25 / C2500 Crew Cab Pickup	
R	87-89	PICKUP 3/4 TON, R2500 Crew Cab Pickup	
R	74-80	VAN 1/2 TON, P SERIES All	
R	73-99	VAN 1 TON, P SERIES All	
R	79-89	VAN 3/4 TON, P SERIES All	
G63371	W		
R	69-72	CHEVROLET BLAZER 4WD	
R	69-72	PICKUP 1/2 TON, K10 All	
R	71-72	PICKUP 3/4 TON, K20 All	
R	71-72	SUBURBAN 1/2 TON, K10 All	
R	71-72	SUBURBAN 3/4 TON, K20 All Exc. Lift Kit	
R	70-72	GMC JIMMY 4WD	
R	71-72	PICKUP 1/2 TON, K15 / K1500 All	
R	71-72	PICKUP 3/4 TON, K25 / K2500 All	
R	71-72	SUBURBAN 1/2 TON, K15 / K1500 All	
R	71-72	SUBURBAN 3/4 TON, K25 / K2500 All	
G63375	A		
F	85-05	CHEVROLET ASTRO RWD	
F	81	BEL AIR Sedan Police and Taxi Models	
F	71-75	BEL AIR Sedan Police and Taxi Models	
F	71-72	BISCAYNE All	
F	73-96	CAPRICE Sedan Police and Taxi Models	
F	71-72	CAPRICE All Police and Taxi Models	
F	83-85	IMPALA All Police and Taxi Models	
F	71-82	IMPALA Sedan Police and Taxi Models	
F	96-02	VAN 1/2 TON, G / EXPRESS All	
F	97-02	VAN 1 TON, G / EXPRESS All	
F	96-02	VAN 3/4 TON, G / EXPRESS All Exc. 8600# GVW	
F	93-02	FORD CROWN VICTORIA Police Interceptor Police and Taxi Models	
F	85-05	GMC SAFARI RWD	
F	96-02	VAN 1/2 TON, G / SAVANNA RWD	
F	96-02	VAN 1 TON, G / SAVANNA All	
F	96-02	VAN 3/4 TON, G / SAVANNA All Exc. 8600# GVW	
G63377	W		
R	78-79	FORD BRONCO All Exc. Lift Kit	
R	66-77	BRONCO All From Serial #830001; Exc. Lift Kit	
R	66-69	PICKUP 1/2 TON, F-100 All RWD	
R	65	PICKUP 1/2 TON, F-100 Leaf (FrontSpringType) Late 1965	
R	75-79	PICKUP 1 TON, F-350 / SUPERDUTY Standard Cab Pickup, RWD	
R	73-74	PICKUP 1 TON, F-350 / SUPERDUTY All RWD; Exc. Supercab	
R	75-79	PICKUP 3/4 TON, F-250 / SUPERDUTY Extended Cab Pickup, RWD	
R	65-74	PICKUP 3/4 TON, F-250 / SUPERDUTY RWD Supercab	
R	69-74	VAN 1/2 TON, ECONOLINE / CLUB WAGON All	
R	68	VAN 1/2 TON, ECONOLINE / CLUB WAGON All Late 1968	
R	69-74	VAN 1 TON, ECONOLINE / CLUB WAGON / SUPERDUTY All	
R	68	VAN 1 TON, ECONOLINE / CLUB WAGON / SUPERDUTY All Late 1968	
R	69-74	VAN 3/4 TON, ECONOLINE / CLUB WAGON / SUPERDUTY All	
R	68	VAN 3/4 TON, ECONOLINE / CLUB WAGON / SUPERDUTY All Late 1968	
R	76-83	JEEP CHEROKEE All	

Ultra Truck Shock

Shock	POP	Alternative No.	MTG Acc. Supplied
Pos.	Year	Application	
G63377	W	-continued	
F	74-83	CHEROKEE All	
F	82-83	CJ5 All Exc. Lift Kit	
F	82-86	CJ7 All Exc. Lift Kit	
F	84-91	GRAND WAGONEER All	
R	84-91	GRAND WAGONEER All	
F	74-88	J10 PICKUP All	
R	74-88	J10 PICKUP All	
F	74-88	J20 PICKUP All	
R	74-88	J20 PICKUP All	
F	82-85	SCRAMBLER / CJ8 All	
R	76-83	WAGONEER All	
F	74-83	WAGONEER All	
G63386	W		
F	67-77	FORD BRONCO All From Serial #830001; Exc. Lift Kit	
F	66	BRONCO All Exc. Lift Kit	
F	76-79	PICKUP 1/2 TON, F-100 All Exc. Lift Kit	
F	75	PICKUP 1/2 TON, F-100 All RWD	
F	70-74	PICKUP 1/2 TON, F-100 All	
F	65-69	PICKUP 1/2 TON, F-100 All RWD	
F	75-79	PICKUP 1/2 TON, F-150 RWD	
F	75-79	PICKUP 1 TON, F-350 / SUPERDUTY Standard Cab Pickup, RWD	
F	67-74	PICKUP 1 TON, F-350 / SUPERDUTY RWD Exc. Supercab	
F	65-79	PICKUP 3/4 TON, F-250 / SUPERDUTY RWD	
F	75-91	VAN 1 TON, ECONOLINE / CLUB WAGON / SUPERDUTY All Motorhome Conversion	
F	75-91	VAN 3/4 TON, ECONOLINE / CLUB WAGON / SUPERDUTY All	
G63387	W		
R	70-76	FORD PICKUP 1/2 TON, F-100 4WD Exc. Lift Kit	
R	76-79	PICKUP 1/2 TON, F-150 4WD Exc. Lift Kit	
R	75	PICKUP 1/2 TON, F-150 All 4WD; Exc. Lift Kit	
R	79	PICKUP 1 TON, F-350 / SUPERDUTY 4WD	
R	77-79	PICKUP 3/4 TON, F-250 / SUPERDUTY Cab & Chassis, 4WD All From Serial No. Y20001	
R	77-79	PICKUP 3/4 TON, F-250 / SUPERDUTY Standard Cab Pickup, 4WD All From Serial No. Y20001	
R	75-91	VAN 1 TON, ECONOLINE / CLUB WAGON / SUPERDUTY All Motorhome Conversion	
R	75-91	VAN 3/4 TON, ECONOLINE / CLUB WAGON / SUPERDUTY All	
G63389	W		
R	81-93	DODGE PICKUP 1/2 TON, W100 SERIES All Exc. Lift Kit	
R	72-80	PICKUP 1/2 TON, W100 SERIES All	
R	81-93	PICKUP 1 TON, W300 SERIES All Exc. Quad Suspension and Lift Kit	
R	72-80	PICKUP 1 TON, W300 SERIES All	
R	81-93	PICKUP 3/4 TON, W200 SERIES Standard Cab Pickup Exc. Lift Kit	
R	72-80	PICKUP 3/4 TON, W200 SERIES All	
R	76-93	RAMCHARGER 4WD	
R	76-81	PLYMOUTH TRAILDUSTER 4WD	
G63394	W		
F	85-99	CHEVROLET VAN 1 TON, P SERIES All Motorhome Chassis with Independent Front Suspension	
F	74-84	VAN 1 TON, P SERIES All Motorhome Chassis	
F	85-99	GMC VAN 1 TON, P SERIES All Motorhome Chassis with Independent Front Suspension	
F	75-84	VAN 1 TON, P SERIES All Motorhome Chassis	
F	74	VAN 1 TON, P SERIES Motor Home	
G63396	W		
F	78-79	FORD BRONCO All Quad Suspension; Rearward of Front Axle; Exc. Lift Kit	
F	77-79	PICKUP 1/2 TON, F-150 4WD Rearward of Front Axle	
F	75-79	PICKUP 1 TON, F-350 / SUPERDUTY Extended Cab Pickup, RWD	

Numerical listing

Shock	POP	Alternative No.	MTG Acc. Supplied
Pos.	Year	Application	
G63398	W		
F	78-79	FORD PICKUP 1/2 TON, F-150 Extended Cab Pickup, 4WD Exc. Lift Kit	
F	79	PICKUP 1 TON, F-350 / SUPERDUTY 4WD	
F	77-79	PICKUP 3/4 TON, F-250 / SUPERDUTY Cab & Chassis, 4WD All From Serial No. Y20001	
F	77-79	PICKUP 3/4 TON, F-250 / SUPERDUTY Standard Cab Pickup, 4WD All From Serial No. Y20001	
G63403	A		
R	79-91	CHEVROLET VAN 1 TON, G / EXPRESS All 9200# GVW	
F	85	VAN 1 TON, P SERIES All Motorhome Chassis with I-Beam Front Suspension	
R	97-04	DODGE DAKOTA All	
R	98-03	DURANGO All	
R	93-96	GMC VAN 1 TON, G / SAVANNA Cutaway Van 9200# GVW	
R	79-91	VAN 1 TON, G / SAVANNA Cutaway Van 9200# GVW	
F	85	VAN 1 TON, P SERIES All Motorhome Chassis with I-Beam Front Suspension	
G63404	W		
F	84-85	TOYOTA 4RUNNER All	
F	80-85	PICKUP 4WD Exc. Lift Kit	
G63405	D		
F	55-56	CHEVROLET PICKUP All	
R	55	FORD F SERIES All F-100	
F	48-52	F SERIES All F-1, F-2 & F-3	
R	61-64	PICKUP 1/2 TON, F-100 All	
R	61-66	PICKUP 1 TON, F-350 / SUPERDUTY All	
R	61-64	PICKUP 3/4 TON, F-250 / SUPERDUTY All	
F	68-76	PICKUP P350 All Up through 8000# GVW	
F	75-76	PICKUP P400 All Up through 8000# GVW	
R	68	INTERNATIONAL 908B All	
R	68	908C All	
R	68	1000B All Exc. Travelette with 166" Wheelbase	
R	68	1000C All Exc. Travelette with 166" Wheelbase	
F	68	1100B All Exc. Travelette with 166" Wheelbase	
R	68	1100B All Exc. Travelette with 166" Wheelbase	
F	68	1100C All Exc. Travelette with 166" Wheelbase	
R	68	1100C All Exc. Travelette with 166" Wheelbase	
R	68	1100C All Exc. Travelette with 166" Wheelbase	
F	68	1200B All Exc. Travelette with 166" Wheelbase	
R	68	1200B All Exc. Travelette with 166" Wheelbase	
F	68	1200C All Exc. Travelette with 166" Wheelbase	
R	68	1200C All Exc. Travelette with 166" Wheelbase	
F	68	1300B All Exc. Travelette with 166" Wheelbase	
R	68	1300B All Exc. Travelette with 166" Wheelbase	
F	68	1300C All Exc. Travelette with 166" Wheelbase	
R	68	1300C All Exc. Travelette with 166" Wheelbase	
R	68-72	M1100 / M1200 All	
R	69	M1400 All	
R	65-67	M SERIES VAN All	
R	65	JEEP CJ3 All Exc. Lift Kit	
R	65-83	CJ5 All Exc. Lift Kit	
R	65-75	CJ6 All Exc. Lift Kit	
R	76-86	CJ7 All Exc. Lift Kit	
R	66-74	DJ5 All Exc. Lift Kit	
R	66-68	DJ6 All Exc. Lift Kit	
R	57-60	FC150 All	
F	63-65	FC170 All	
R	63-65	FC170 All	
R	63-66	GLADIATOR All Independent Front Suspension	
R	70-73	JEEP STER All	
R	81-85	SCRAMBLER / CJ8 All	
R	65-67	UNIVERSAL All Exc. Lift Kit	
R	61-64	UNIVERSAL All	

Numerical listing

Shock	POP	Alternative No.	MTG Acc. Supplied
Pos.	Year	Application	
G63406 B			
R	85-96	FORD PICKUP 1/2 TON, F-150 RWD	
R	80-97	PICKUP 1 TON, F-350 / SUPERDUTY RWD Exc. Dual Rear Wheels	
R	97	PICKUP 3/4 TON, F-250 / SUPERDUTY RWD Over 8500# GVW	
R	80-96	PICKUP 3/4 TON, F-250 / SUPERDUTY RWD	
G63409 C			
R	80-96	FORD BRONCO All Exc. Lift Kit	
R	80-83	PICKUP 1/2 TON, F-100 RWD	
R	80-84	PICKUP 1/2 TON, F-150 RWD	
R	90-97	PICKUP 1/2 TON, F SUPERDUTY All	
R	80-97	PICKUP 1 TON, F-350 / SUPERDUTY RWD Dual Rear Wheels	
R	97	PICKUP, F-450 SUPERDUTY All	
G63410 C			
F	80-96	FORD BRONCO All Quad Suspension; Forward of Front Axle; Exc. Lift Kit	
F	80-96	PICKUP 1/2 TON, F-150 4WD Quad Suspension; Forward of Front Axle; Exc. Lift Kit	
F	80-81	PICKUP 1 TON, F-350 / SUPERDUTY 4WD	
F	80-82	PICKUP 3/4 TON, F-250 / SUPERDUTY Standard Cab Pickup, 4WD	
G63411 W			
F	77-86	CHEVROLET PICKUP 1 TON, K30 All	
F	90-91	PICKUP 1 TON, R3500 All	
F	89	PICKUP 1 TON, R3500 Cab & Chassis	
F	89	PICKUP 1 TON, R3500 Crew Cab Pickup	
F	87-88	PICKUP 1 TON, V30 All	
F	89-91	PICKUP 1 TON, V3000 / V3500 All	
F	77-86	GMC PICKUP 1 TON, K35 / K3500 All	
F	87-91	PICKUP 1 TON, V3000 / V3500 All	
G63413 D			
R	78-95	CHEVROLET VAN 1/2 TON, G / EXPRESS All	
R	85-95	VAN 1 TON, G / EXPRESS Extended Cargo Van	
R	85-95	VAN 1 TON, G / EXPRESS Extended Passenger Van	
R	78-95	VAN 1 TON, G / EXPRESS Standard Cargo Van	
R	78-95	VAN 1 TON, G / EXPRESS Standard Passenger Van	
R	78	VAN 1 TON, G / EXPRESS Extended Cargo Van	
R	78-95	VAN 3/4 TON, G / EXPRESS All Exc. 8600# GVW	
R	84-88	DODGE MINI RAM All	
R	99-03	VAN 1/2 TON, A / B SERIES / RAM 109.3 (WheelBase) Exc. 7000# GVW	
R	81-98	VAN 1/2 TON, A / B SERIES / RAM 109.6 (WheelBase) Exc. 7000# GVW	
R	71-80	VAN 1/2 TON, A / B SERIES / RAM All	
R	99-03	VAN 1 TON, A / B SERIES / RAM All	
R	94-98	VAN 1 TON, A / B SERIES / RAM All Exc. 4000# Front Axle	
R	71-93	VAN 1 TON, A / B SERIES / RAM All	
R	71-03	VAN 3/4 TON, A / B SERIES / RAM All	
R	74-80	VAN, CB300 All	
R	78-95	GMC VAN 1/2 TON, G / SAVANNA All	
R	85-96	VAN 1 TON, G / SAVANNA Extended Cargo Van	
R	85-96	VAN 1 TON, G / SAVANNA Extended Passenger Van	
R	79-96	VAN 1 TON, G / SAVANNA Standard Cargo Van	
R	79-96	VAN 1 TON, G / SAVANNA Standard Passenger Van	
R	78	VAN 1 TON, G / SAVANNA Cutaway Van	
R	78-95	VAN 3/4 TON, G / SAVANNA All Exc. 8600# GVW	

Ultra Truck Shock

Shock	POP	Alternative No.	MTG Acc. Supplied
Pos.	Year	Application	
G63413 D -continued			
R	74-83	PLYMOUTH VAN 1/2 TON, PB SERIES All	
R	74-83	VAN 1 TON, PB SERIES All	
R	74-83	VAN 3/4 TON, PB SERIES All	
G63414 A			
F	80-96	FORD BRONCO All Quad & Non Quad Suspensions Rearward of Front Axle; Exc. Lift Kit	
F	89	BRONCO II All Mfg. to 2/89; Vehicles with 10mm & 12mm bolt in rear lower mount	
F	84-88	BRONCO II All With 10mm Bolt In Rear Lower Mount	
F	80-83	PICKUP 1/2 TON, F-100 RWD	
F	80-96	PICKUP 1/2 TON, F-150 4WD Quad & Non Quad Suspensions Rearward of Front Axle; Exc. Lift Kit	
F	80-96	PICKUP 1/2 TON, F-150 RWD	
F	80-97	PICKUP 1 TON, F-350 / SUPERDUTY RWD	
F	97	PICKUP 3/4 TON, F-250 / SUPERDUTY RWD Over 8500# GVW	
F	80-96	PICKUP 3/4 TON, F-250 / SUPERDUTY RWD	
F	87-89	RANGER All Exc. High Ryder Option	
F	83-86	RANGER All	
G63416 W			
F	82-85	FORD PICKUP 1 TON, F-350 / SUPERDUTY 4WD Clevis Type Lower Front Mount; Exc. Dual Rear Wheels or Lift Kit	
F	83-86	PICKUP 3/4 TON, F-250 / SUPERDUTY 4WD Clevis Type Lower Front Mount; Exc. Dual Rear Wheels or Lift Kit	
F	80-82	PICKUP 3/4 TON, F-250 / SUPERDUTY Extended Cab Pickup, 4WD	
G63418 W			
F	82	DODGE D50 4WD	
F	83-86	PICKUP, RAM 50 4WD	
F	87-89	RAIDER All	
F	83-94	MITSUBISHI MIGHTY MAX 4WD	
F	83-91	MONTERO All	
G63419 W			
R	82	DODGE D50 4WD	
R	87-93	PICKUP, RAM 50 4WD	
R	83-94	MITSUBISHI MIGHTY MAX 4WD	
G63420 W			
R	83-88	FORD RANGER 4WD	
G63421 A			
F	05	CHEVROLET BLAZER Base, RWD	
F	96-04	BLAZER LS, RWD	
F	95-02	BLAZER LT, RWD	
F	95-99	BLAZER Base, RWD	
F	95-97	BLAZER Deluxe, RWD	
F	83-94	BLAZER, S MODELS RWD	
F	94-03	S10 LS, RWD	
F	82-03	S10 Base, RWD	
F	99	S10 Xtreme, RWD	
F	92-93	S10 EL, RWD	
F	83-92	S10 Tahoe, RWD	
F	88-90	S10 Durango, RWD	
F	82-86	S10 Durango, RWD	
F	72-82	FORD COURIER All	
F	92-04	GMC JIMMY RWD	
F	83-91	S15 JIMMY RWD	
F	04	SONOMA / S15 All RWD	
F	82-03	SONOMA / S15 RWD	
F	78-87	SPRINT / CABALLERO RWD	
F	71-77	SPRINT / CABALLERO All	
F	96-00	ISUZU HOMBRE RWD Exc. Sport Chassis	
F	72-76	MAZDA B1600 All	
F	77-78	B1800 All	
F	79-84	B2000 All	
F	82-84	B2200 All	
G63422 A			
R	05	CHEVROLET BLAZER Base, 4WD	
R	05	BLAZER Base, RWD	
R	96-04	BLAZER LS, 4WD	
R	96-04	BLAZER LS, RWD	
R	95-02	BLAZER LT, RWD	
R	95-01	BLAZER LT, 4WD	
R	95-99	BLAZER Base, 4WD	
R	95-99	BLAZER Base, RWD	

Numerical listing

Shock	POP	Alternative No.	MTG Acc. Supplied
Pos.	Year	Application	
G63422 A -continued			
R	95-97	BLAZER Deluxe, RWD	
R	83-94	BLAZER, S MODELS All	
R	99-04	S10 LS, 4WD	
R	99-03	S10 Base, 4WD	
R	99-03	S10 Base, RWD	
R	99-03	S10 LS, RWD	
R	94-98	S10 LS	
R	82-98	S10 Base	
R	92-93	S10 EL	
R	83-92	S10 Tahoe	
R	88-90	S10 Durango	
R	82-86	S10 Durango	
R	05	GMC JIMMY 4WD	
R	92-04	JIMMY All	
R	83-91	S15 JIMMY All	
R	82-04	SONOMA / S15 All	
R	91	SYCLONE All	
R	92-93	TYPHOON All	
R	96-00	ISUZU HOMBRE All	
R	96-01	OLDSMOBILE BRAVADA All	
R	91-94	BRAVADA All	
G63423 A			
F	05	CHEVROLET BLAZER Base, 4WD	
F	96-04	BLAZER LS, 4WD	
F	95-01	BLAZER LT, 4WD	
F	95-99	BLAZER Base, 4WD	
F	83-94	BLAZER, S MODELS 4WD	
F	94-04	S10 LS, 4WD	
F	83-03	S10 Base, 4WD	
F	92-93	S10 EL, 4WD	
F	83-92	S10 Tahoe, 4WD	
F	88-90	S10 Durango, 4WD	
F	83-86	S10 Durango, 4WD	
F	92-05	GMC JIMMY 4WD	
F	83-91	S15 JIMMY 4WD	
F	83-04	SONOMA / S15 4WD	
F	91	SYCLONE All	
F	92-93	TYPHOON All	
F	00	ISUZU HOMBRE 4WD	
F	99	HOMBRE All	
F	96-98	HOMBRE All Sport Chassis	
F	96-01	OLDSMOBILE BRAVADA All	
F	91-94	BRAVADA All	
G63424 A			
F	84-01	JEEP CHEROKEE All	
F	86-92	COMANCHE All	
F	93-98	GRAND CHEROKEE All	
F	84-90	WAGONEER All	
G63425 B			
R	84-01	JEEP CHEROKEE All	
R	84-90	WAGONEER All	
G63426 W			
R	90-95	CHRYSLER TOWN & COUNTRY All	
R	84-95	DODGE CARAVAN / GRAND CARAVAN All	
R	84-95	PLYMOUTH VOYAGER / GRAND VOYAGER All	
G63427 W			
R	89	FORD BRONCO II All Mfg. to 2/89; Vehicles with 10mm & 12mm bolt in rear lower mount	
R	84-88	BRONCO II All With 10mm Bolt In Rear Lower Mount	
R	89	RANGER RWD Mfg. to 2/89; Vehicles with 10mm bolt in rear lower mount	
R	83-88	RANGER RWD	
G63432 W			
F	88-90	TOYOTA LAND CRUISER All	
F	81-87	LAND CRUISER FJ60 (MfrBodyCode), Sport Utility	
G63434 W			
R	95	LAND ROVER RANGE ROVER County Classic Exc. Air-Leveling Suspension	
R	94	RANGE ROVER Coil (RearSpringType)	
G63437 W			
F	87-91	CHEVROLET BLAZER 4WD Full Size; 4" Lift Kit; Exc. Quad Suspension	
F	73-86	BLAZER 4WD 4" Lift Kit; Exc. Quad Suspension	
F	73-86	PICKUP 1/2 TON, K10 All 4" Lift Kit; Exc. Quad Suspension	

Numerical listing

Shock	POP	Alternative No.	MTG Acc. Supplied
Pos.	Year	Application	
G63437 W -continued			
F	87	PICKUP 1/2 TON, V10 All 4" Lift Kit; Exc. Quad Suspension	
F	73-86	PICKUP 3/4 TON, K20 All 4" Lift Kit; Exc. Quad Suspension	
F	87	PICKUP 3/4 TON, V20 All 4" Lift Kit; Exc. Quad Suspension	
F	73-86	SUBURBAN 1/2 TON, K10 All 4" Lift Kit; Exc. Quad Suspension	
F	89-91	SUBURBAN 1/2 TON, V1500 4WD 4" Lift Kit; Exc. Quad Suspension	
F	73-86	SUBURBAN 3/4 TON, K20 All 4" Lift Kit; Exc. Quad Suspension	
F	87-88	SUBURBAN 3/4 TON, V20 All 4" Lift Kit; Exc. Quad Suspension	
F	89-91	SUBURBAN 3/4 TON, V2500 All 4" Lift Kit; Exc. Quad Suspension	
F	75-91	GMC JIMMY 4WD 4" Lift Kit; Exc. Quad Suspension	
F	73-74	JIMMY All 4" Lift Kit; Exc. Quad Suspension	
F	73-86	PICKUP 1/2 TON, K15 / K1500 All 4" Lift Kit; Exc. Quad Suspension	
F	87	PICKUP 1/2 TON, V1500 All 4" Lift Kit; Exc. Quad Suspension	
F	73-86	PICKUP 3/4 TON, K25 / K2500 All 4" Lift Kit; Exc. Quad Suspension	
F	87	PICKUP 3/4 TON, V2500 All 4" Lift Kit; Exc. Quad Suspension	
F	73-86	SUBURBAN 1/2 TON, K15 / K1500 All 4" Lift Kit; Exc. Quad Suspension	
F	87-91	SUBURBAN 1/2 TON, V1500 All 4" Lift Kit; Exc. Quad Suspension	
F	73-86	SUBURBAN 3/4 TON, K25 / K2500 All 4" Lift Kit; Exc. Quad Suspension	
F	87-91	SUBURBAN 3/4 TON, V2500 All 4" Lift Kit; Exc. Quad Suspension	
G63438 D			
R	87-90	CHEVROLET BLAZER 4WD Full Size; 4" Lift Kit; Exc. Quad Suspension	
R	73-86	BLAZER 4WD 4" Lift Kit; Exc. Quad Suspension	
R	73-86	PICKUP 1/2 TON, K10 All 4" Lift Kit; Exc. Quad Suspension	
R	87	PICKUP 1/2 TON, V10 All 4" Lift Kit; Exc. Quad Suspension	
R	73-86	PICKUP 3/4 TON, K20 All 4" Lift Kit; Exc. Quad Suspension	
R	87	PICKUP 3/4 TON, V20 All 4" Lift Kit; Exc. Quad Suspension	
R	73-86	SUBURBAN 1/2 TON, K10 All 4" Lift Kit; Exc. Quad Suspension	
R	73-86	SUBURBAN 3/4 TON, K20 All 4" Lift Kit; Exc. Quad Suspension	
R	87-88	SUBURBAN 3/4 TON, V20 All 4" Lift Kit; Exc. Quad Suspension	
R	89-91	SUBURBAN 3/4 TON, V2500 All 4" Lift Kit; Exc. Quad Suspension	
R	73-91	GMC JIMMY All 4" Lift Kit; Exc. Quad Suspension	
R	73-86	PICKUP 1/2 TON, K15 / K1500 All 4" Lift Kit; Exc. Quad Suspension	
R	87	PICKUP 1/2 TON, V1500 All 4" Lift Kit; Exc. Quad Suspension	
R	73-86	PICKUP 3/4 TON, K25 / K2500 All 4" Lift Kit; Exc. Quad Suspension	
R	87	PICKUP 3/4 TON, V2500 All 4" Lift Kit; Exc. Quad Suspension	
R	73-86	SUBURBAN 1/2 TON, K15 / K1500 All 4" Lift Kit; Exc. Quad Suspension	
R	87-91	SUBURBAN 1/2 TON, V1500 All 4" Lift Kit; Exc. Quad Suspension	
R	73-86	SUBURBAN 3/4 TON, K25 / K2500 All 4" Lift Kit; Exc. Quad Suspension	
R	87-91	SUBURBAN 3/4 TON, V2500 All 4" Lift Kit; Exc. Quad Suspension	
G63439 W			
R	80-86	FORD PICKUP 1/2 TON, F-150 All 3-4" Lift Kit	
G63440 W			
R	65	JEEP CJ3 All 2-4" Lift Kit	
R	82-83	CJ5 All 3-4" Lift Kit	
R	65-81	CJ5 All 2-4" Lift Kit	
R	65-75	CJ6 All 2-4" Lift Kit	
R	82-86	CJ7 All 3-4" Lift Kit	
R	76-81	CJ7 All 2-4" Lift Kit	
R	66-74	DJ5 All 2-4" Lift Kit	
R	66-68	DJ6 All 2-4" Lift Kit	
R	65-67	UNIVERSAL All 2-4" Lift Kit	
R	80-83	TOYOTA PICKUP 4WD 2-3" Lift Kit	

Ultra Truck Shock

Shock	POP	Alternative No.	MTG Acc. Supplied
Pos.	Year	Application	
G63441 W			
R	80-88	FORD BRONCO All 3-4" Lift Kit	
R	78-79	BRONCO All 3 1/2-4" Lift Kit; Exc. Quad Suspension	
R	66-77	BRONCO All 4-5" Lift Kit	
F	82-83	JEEP CJ5 All 2 - 4" Lift Kit	
F	82-86	CJ7 All 2 - 4" Lift Kit	
G63443 W			
R	82-83	JEEP CJ5 All 2" Lift Kit	
F	66-81	CJ5 All 2-4" Lift Kit	
F	66-75	CJ6 All 2-4" Lift Kit	
R	82-86	CJ7 All 2" Lift Kit	
F	76-81	CJ7 All 2-4" Lift Kit	
F	66-74	DJ5 All 2-4" Lift Kit	
F	66-68	DJ6 All 2-4" Lift Kit	
F	65-67	UNIVERSAL All 2-4" Lift Kit	
G63444 W			
F	80-83	TOYOTA PICKUP 4WD 2-3" Lift Kit	
G63445 W			
F	80-86	FORD BRONCO All 3-4" Lift Kit; Quad Suspension Rearward of Front Axle	
F	78-79	BRONCO All Right 3 1/2-4" Lift Kit; Exc. Quad Suspension	
F	66-77	BRONCO All 4-5" Lift Kit	
F	77-79	PICKUP 1/2 TON, F-100 All 3-4" Lift Kit; Exc. Quad Suspension	
F	80-86	PICKUP 1/2 TON, F-150 All 3-4" Lift Kit	
F	77-79	PICKUP 1/2 TON, F-150 Cab & Chassis, 4WD 3-4" Lift Kit; Exc. Quad Suspension	
F	77-79	PICKUP 1/2 TON, F-150 Standard Cab Pickup, 4WD 3-4" Lift Kit; Exc. Quad Suspension	
G63446 W			
F	80-86	FORD BRONCO All 3-4" Lift Kit; Quad Suspension Forward of Front Axle	
F	80-86	PICKUP 1/2 TON, F-150 4WD Quad Suspension with 3-4" Lift Kit Forward of Front Axle	
G63447 W			
F	78-79	FORD BRONCO All Left 3 1/2-4" Lift Kit; Exc. Quad Suspension	
R	77-79	PICKUP 1/2 TON, F-100 All 4WD; 3-4" Lift Kit; Exc. Quad Suspension	
R	75-76	PICKUP 1/2 TON, F-100 4WD 3 1/2-4" Lift Kit	
R	73-74	PICKUP 1/2 TON, F-100 4WD Lift Kit	
R	70-72	PICKUP 1/2 TON, F-100 All 4WD; Lift Kit	
R	77-79	PICKUP 1/2 TON, F-150 Cab & Chassis, 4WD 3-4" Lift Kit; Exc. Quad Suspension	
R	77-79	PICKUP 1/2 TON, F-150 Standard Cab Pickup, 4WD 3-4" Lift Kit; Exc. Quad Suspension	
R	76	PICKUP 1/2 TON, F-150 Cab & Chassis, 4WD Lift Kit	
R	76	PICKUP 1/2 TON, F-150 Standard Cab Pickup, 4WD Lift Kit	
R	75	PICKUP 1/2 TON, F-150 Cab & Chassis 4WD; Lift Kit	
R	75	PICKUP 1/2 TON, F-150 Standard Cab Pickup 4WD; Lift Kit	
G63454 B			
R	90-05	CHEVROLET ASTRO All	
R	85-89	ASTRO RWD	
R	90-05	GMC SAFARI All	
R	85-89	SAFARI RWD	
R	86-89	VOLKSWAGEN VANAGON 4WD	
G63455 C			
F	86-97	FORD PICKUP 1 TON, F-350 / SUPERDUTY 4WD	
F	97-98	PICKUP 3/4 TON, F-250 / SUPERDUTY 4WD Over 8500# GVW	
F	87-96	PICKUP 3/4 TON, F-250 / SUPERDUTY 4WD	
G63456 W			
R	86-97	FORD PICKUP 1 TON, F-350 / SUPERDUTY 4WD Exc. Dual Rear Wheels	
G63457 W			
F	86-97	FORD AEROSTAR RWD	

Numerical listing

Shock	POP	Alternative No.	MTG Acc. Supplied
Pos.	Year	Application	
G63460 W			
R	87-96	DODGE DAKOTA RWD	
G63461 D			
R	80-96	FORD PICKUP 1/2 TON, F-150 4WD Exc. Lift Kit	
R	86-97	PICKUP 1 TON, F-350 / SUPERDUTY 4WD Dual Rear Wheels	
R	82-85	PICKUP 1 TON, F-350 / SUPERDUTY 4WD Clevis Type Lower Front Mount; Exc. Dual Rear Wheels or Lift Kit	
R	80-81	PICKUP 1 TON, F-350 / SUPERDUTY 4WD	
R	97	PICKUP 3/4 TON, F-250 / SUPERDUTY 4WD Over 8500# GVW	
R	86-96	PICKUP 3/4 TON, F-250 / SUPERDUTY 4WD	
R	82-85	PICKUP 3/4 TON, F-250 / SUPERDUTY 4WD Clevis Type Lower Front Mount; Exc. Dual Rear Wheels or Lift Kit	
R	80-81	PICKUP 3/4 TON, F-250 / SUPERDUTY 4WD	
G63479 D			
F	86-89	TOYOTA 4RUNNER All	
F	86-95	PICKUP 4WD Exc. Lift Kit	
F	93-98	T100 4WD	
G63484 W			
R	84-89	TOYOTA VAN Coil (RearSpringType)	
R	88	VAN WAGON Coil (FrontSpringType), Coil (RearSpringType)	
G63488 A			
R	88-99	CHEVROLET PICKUP 1/2 TON, C15 / C1500 All	
R	88-99	PICKUP 1/2 TON, K15 / K1500 All	
R	01-03	PICKUP 1 TON, C35/3500 Base Exc. HD Straight Front Axle	
R	92-00	PICKUP 1 TON, C35/3500 Crew Cab Pickup Exc. HD Straight Front Axle	
R	92-00	PICKUP 1 TON, C35/3500 Standard Cab Pickup Exc. HD Straight Front Axle	
R	88-00	PICKUP 1 TON, C35/3500 Extended Cab Pickup Exc. HD Straight Front Axle	
R	88-90	PICKUP 1 TON, C35/3500 Standard Cab Pickup Exc. HD Straight Front Axle	
R	88-00	PICKUP 1 TON, K35 / K3500 All	
R	88-00	PICKUP 3/4 TON, C25 / C2500 All	
R	88-00	PICKUP 3/4 TON, K25 / K2500 All	
R	88-99	GMC PICKUP 1/2 TON, C15 / C1500 All	
R	88-99	PICKUP 1/2 TON, K15 / K1500 All	
R	92-00	PICKUP 1 TON, C35/3500 Crew Cab Pickup Exc. HD Straight Front Axle	
R	88-00	PICKUP 1 TON, C35/3500 Extended Cab Pickup Exc. HD Straight Front Axle	
R	88-00	PICKUP 1 TON, C35/3500 Standard Cab Pickup Exc. HD Straight Front Axle	
R	88-00	PICKUP 1 TON, K35 / K3500 All	
R	88-00	PICKUP 3/4 TON, C25 / C2500 All	
R	88-00	PICKUP 3/4 TON, K25 / K2500 All	
G63489 A			
F	88-99	CHEVROLET PICKUP 1/2 TON, C15 / C1500 All	
F	92-00	PICKUP 1 TON, C35/3500 Crew Cab Pickup Exc. HD Straight Front Axle	
F	88-00	PICKUP 1 TON, C35/3500 Extended Cab Pickup Exc. HD Straight Front Axle	
F	88-00	PICKUP 1 TON, C35/3500 Standard Cab Pickup Exc. HD Straight Front Axle	
F	88-00	PICKUP 3/4 TON, C25 / C2500 All	
F	92-99	SUBURBAN 1/2 TON, C15 / C1500 All	
F	92-99	SUBURBAN 3/4 TON, C25 / C2500 All	
F	95-00	TAHOE RWD Old Body Style	
F	88-99	GMC PICKUP 1/2 TON, C15 / C1500 All	

Numerical listing

Shock	POP	Alternative No.	MTG Acc. Supplied
Pos.	Year	Application	
G63489 A -continued			
F	92-00	PICKUP 1 TON, C35/3500 Crew Cab Pickup Exc. HD Straight Front Axle	
F	88-00	PICKUP 1 TON, C35/3500 Extended Cab Pickup Exc. HD Straight Front Axle	
F	88-00	PICKUP 1 TON, C35/3500 Standard Cab Pickup Exc. HD Straight Front Axle	
F	88-00	PICKUP 3/4 TON, C25 / C2500 All	
F	92-99	SUBURBAN 1/2 TON, C15 / C1500 All	
F	92-99	SUBURBAN 3/4 TON, C25 / C2500 All	
F	92-99	YUKON RWD	
G63490 W			
R	86-88	FORD AEROSTAR RWD	
R	87-95	JEEP WRANGLER YJ (MfrBodyCode)	
G63491 W			
R	69-72	NISSAN 521 PICKUP All	
R	72-79	620 PICKUP All	
R	86	720 PICKUP RWD Mfg. to 8/86	
R	82-85	720 PICKUP RWD	
R	80-81	720 PICKUP All	
G63492 A			
R	81-82	CHEVROLET LUV PICKUP All	
R	87-89	DODGE RAIDER 2.6L 4Cyl L (156) Exc. Sport Utility	
F	61-67	FORD ECONOLINE All	
F	68	VAN 1/2 TON, ECONOLINE / CLUB WAGON All Mfg. to 7/68	
R	81-95	ISUZU PICKUP RWD	
R	86-92	JEEP COMANCHE All	
F	66-73	WAGONEER All	
F	63-65	WAGONEER All Exc. Independent Front Suspension	
R	83-89	MITSUBISHI MONTERO 2.6L 4Cyl L (156)	
R	97-99	MONTERO SPORT All	
R	82-86	NISSAN 720 PICKUP 4WD	
R	00-04	FRONTIER Crew Cab Pickup, RWD with Desert Runner	
R	98-04	FRONTIER 4WD	
R	98-99	FRONTIER RWD Crew Cab with Desert Runner	
R	87-95	PATHFINDER All Exc. Electronic Adjustable Suspension	
R	87-97	PICKUP 4WD	
R	86	PICKUP 4WD Mfg. from 8/86	
R	00-04	XTERRA All	
R	84-87	TOYOTA LAND CRUISER FJ60 (MfrBodyCode), Sport Utility	
R	76-83	LAND CRUISER All	
R	75	LAND CRUISER All Mfg. from 1/75	
R	69-74	LAND CRUISER All	
R	85-92	PICKUP RWD 1 Ton	
R	80-83	PICKUP 4WD Exc. Lift Kit	
G63494 A			
R	84-89	TOYOTA 4RUNNER All	
R	84-95	PICKUP 4WD Exc. Lift Kit	
R	98-04	TACOMA Pre Runner, RWD Exc. HD Upgrade	
R	95-04	TACOMA 4WD Exc. HD Upgrade	
G63495 W			
F	87-91	ISUZU TROOPER 4WD	
F	86-87	MAZDA B2000 RWD	
F	87-93	B2200 RWD	
F	87-93	B2600 RWD	
G63499 W			
R	87-96	DODGE DAKOTA 4WD	
G63500 W			
F	75-91	FORD VAN 1/2 TON, ECONOLINE / CLUB WAGON All	
G63502 W			
R	90-97	FORD AEROSTAR All	
R	89	AEROSTAR RWD	
G63506 W			
F	94-99	LAND ROVER DISCOVERY All	
F	95	RANGE ROVER County Classic Coil FrontSpringType & RearSpringType, Exc. Air-Leveling Suspension	
F	94	RANGE ROVER County, Coil (RearSpringType)	

Ultra Truck Shock

Shock	POP	Alternative No.	MTG Acc. Supplied
Pos.	Year	Application	
G63510 W			
R	88-90	TOYOTA LAND CRUISER All	
G63511 W			
F	78-79	FORD BRONCO All Quad Suspension Long Shock; Exc. Lift Kit	
F	78-79	PICKUP 1/2 TON, F-150 Custom, 4WD Quad Suspension Long Shock; Exc. Lift Kit	
F	78-79	PICKUP 1/2 TON, F-150 Ranger Lariat, 4WD Quad Suspension Long Shock; Exc. Lift Kit	
F	78-79	PICKUP 1/2 TON, F-150 Ranger, 4WD Quad Suspension Long Shock; Exc. Lift Kit	
F	78	PICKUP 1/2 TON, F-150 Base, 4WD Quad Suspension Long Shock; Exc. Lift Kit	
F	78	PICKUP 1/2 TON, F-150 Northland, 4WD Quad Suspension Long Shock; Exc. Lift Kit	
F	87-95	JEEP WRANGLER YJ (MfrBodyCode)	
G63524 W			
R	89-97	FORD RANGER 4WD	
R	95-96	MAZDA B2300 4WD	
R	94-97	B3000 4WD	
R	94-97	B4000 4WD	
G63525 D			
R	90	FORD BRONCO II All	
R	89	BRONCO II All Mfg. from 2/89; Vehicles with 12mm bolt in rear lower mount	
R	90-97	RANGER RWD	
R	89	RANGER RWD Mfg. from 2/89; Vehicles with 12mm bolt in rear lower mount	
R	94-97	MAZDA B2300 RWD	
R	94-97	B3000 RWD	
R	94-97	B4000 RWD	
G63547 C			
F	90-95	TOYOTA 4RUNNER All	
G63548 C			
R	90-95	TOYOTA 4RUNNER All	
G63603 W			
F	87-89	FORD RANGER 4WD High Ryder Option	
G63604 W			
R	89	DODGE RAIDER Sport Utility, 3.0L 6Cyl V (181)	
R	89-91	MITSUBISHI MONTERO 3.0L 6Cyl V (181)	
G63605 W			
F	74	DODGE M300 All	
F	74	M350 All	
G63606 W			
R	89-98	MAZDA MPV RWD	
G63607 W			
R	00-05	FORD EXCURSION RWD	
R	91-94	EXPLORER All	
R	91-94	MAZDA NAVAJO All	
G63608 W			
F	91-94	FORD EXPLORER All	
F	91-94	MAZDA NAVAJO All	
G63609 A			
F	99-00	CADILLAC ESCALADE All	
F	92-94	CHEVROLET BLAZER 4WD Full Size	
F	88-00	PICKUP 1 TON, K35 / K3500 All	
F	88-00	PICKUP 3/4 TON, K25 / K2500 All	
F	92-99	SUBURBAN 1/2 TON, K15 / K1500 All	
F	92-99	SUBURBAN 3/4 TON, K25 / K2500 All	
F	95-00	TAHOE 4WD Old Body Style	
F	88-00	GMC PICKUP 1 TON, K35 / K3500 All	
F	88-00	PICKUP 3/4 TON, K25 / K2500 All	
F	92-99	SUBURBAN 1/2 TON, K15 / K1500 All	
F	92-99	SUBURBAN 3/4 TON, K25 / K2500 All	
F	92-99	YUKON 4WD	
G63610 C			
R	94-97	HONDA PASSPORT All	

Numerical listing

Shock	POP	Alternative No.	MTG Acc. Supplied
Pos.	Year	Application	
G63610 C -continued			
R	91-97	ISUZU RODEO All	
R	98-03	TOYOTA SIENNA All	
G63611 C			
F	90-92	DAIHATSU ROCKY All	
F	94-02	HONDA PASSPORT All	
F	98-00	ISUZU AMIGO All	
F	91-04	RODEO All	
G63612 W			
F	87-89	TOYOTA VAN 4WD	
F	88	VAN WAGON All 4WD	
G63614 C			
F	90	FORD BRONCO II All	
F	00-05	EXCURSION RWD	
F	90-97	RANGER All	
F	94-97	MAZDA B2300 All	
F	94-97	B3000 All	
F	94-97	B4000 All	
G63615 W			
F	94-95	LAND ROVER RANGE ROVER All	
F	96-97	LEXUS LX450 All	
F	91-97	TOYOTA LAND CRUISER All	
G63616 C			
R	96-97	LEXUS LX450 All	
R	93-97	TOYOTA LAND CRUISER All	
R	91-92	LAND CRUISER FJ80 (MfrBodyCode)	
G63617 W			
F	90-93	FORD PICKUP 1/2 TON, F SUPERDUTY All Mfg. to 2/93	
G63620 D			
R	91-97	TOYOTA PREVIA All	
G63621 W			
F	90-97	FORD AEROSTAR 4WD	
F	90-97	AEROSTAR AWD	
G63622 A			
F	99-12	FORD PICKUP 1 TON, F-350 / SUPERDUTY RWD	
F	99-13	PICKUP 3/4 TON, F-250 / SUPERDUTY RWD	
F	08-11	VAN 1/2 TON, ECONOLINE / CLUB WAGON All	
F	08-11	VAN 1 TON, ECONOLINE / CLUB WAGON / SUPERDUTY All	
F	07	VAN 1 TON, ECONOLINE / CLUB WAGON / SUPERDUTY All Exc. Ambulance & Handling Package	
F	04-06	VAN 1 TON, ECONOLINE / CLUB WAGON / SUPERDUTY All	
F	92-05	VAN 1 TON, ECONOLINE / CLUB WAGON / SUPERDUTY All	
F	92-11	VAN 3/4 TON, ECONOLINE / CLUB WAGON / SUPERDUTY All	
G63623 A			
R	08-11	FORD VAN 1/2 TON, ECONOLINE / CLUB WAGON All	
R	04-11	VAN 1 TON, ECONOLINE / CLUB WAGON / SUPERDUTY All Exc. Ambulance & Handling Package	
R	92-05	VAN 1 TON, ECONOLINE / CLUB WAGON / SUPERDUTY All	
R	92-11	VAN 3/4 TON, ECONOLINE / CLUB WAGON / SUPERDUTY All	
G63624 C			
R	92-07	FORD VAN 1/2 TON, ECONOLINE / CLUB WAGON All	
G63625 W			
F	86-99	CHEVROLET VAN 1 TON, P SERIES All Motorhome Chassis with I-Beam Front Suspension	
F	86-99	GMC VAN 1 TON, P SERIES All Motorhome Chassis with I-Beam Front Suspension	
G63626 W			
R	93-94	JEEP GRAND CHEROKEE All	
G63635 W			
F	87-93	MAZDA B2600 4WD	
G63638 C			
R	99-00	CADILLAC ESCALADE All	

Numerical listing

Shock	POP	Alternative No.	MTG Acc. Supplied
Pos.	Year	Application	
G63638 C -continued			
R	92-94	CHEVROLET BLAZER 4WD Full Size	
R	92-99	SUBURBAN 1/2 TON, K15 / K1500 All	
R	92-99	SUBURBAN 3/4 TON, K25 / K2500 All	
R	95-00	TAHOE 4WD Old Body Style	
R	97-02	VAN 1 TON, G / EXPRESS All Exc. 8600# GVW	
R	96-02	VAN 3/4 TON, G / EXPRESS All Exc. 8600# GVW	
R	92-99	GMC SUBURBAN 1/2 TON, K15 / K1500 All	
R	92-99	SUBURBAN 3/4 TON, K25 / K2500 All	
R	96-02	VAN 1 TON, G / SAVANNA All Exc. 8600# GVW	
R	96-02	VAN 3/4 TON, G / SAVANNA All Exc. 8600# GVW	
G63639 W			
R	87-93	MAZDA B2600 4WD	
G63640 W			
R	89-98	MAZDA MPV 4WD	
G63660 W			
R	93-98	TOYOTA T100 4WD	
G63661 A			
F	94-01	DODGE PICKUP 1/2 TON, RAM 1500 (SEE RAM 1500) RWD	
F	94-02	PICKUP 1 TON, RAM 3500 (SEE RAM 3500) RWD Exc. Solid Front Axle	
F	94-02	PICKUP 3/4 TON, RAM 2500 (SEE RAM 2500) RWD	
G63662 A			
R	07	CHEVROLET PICKUP 1/2 TON, SILVERADO 1500 Classic Hybrid, RWD Exc. Electronic Adjustable Suspension	
R	07	PICKUP 1/2 TON, SILVERADO 1500 Classic LS, RWD Exc. Electronic Adjustable Suspension	
R	07	PICKUP 1/2 TON, SILVERADO 1500 Classic LT, RWD Exc. Electronic Adjustable Suspension	
R	07	PICKUP 1/2 TON, SILVERADO 1500 Classic SS, RWD Exc. Electronic Adjustable Suspension	
R	07	PICKUP 1/2 TON, SILVERADO 1500 Classic WT, RWD Exc. Electronic Adjustable Suspension	
R	99-06	PICKUP 1/2 TON, SILVERADO 1500 RWD Exc. Electronic Adjustable Suspension	
R	94-01	DODGE PICKUP 1/2 TON, RAM 1500 (SEE RAM 1500) All	
R	94-02	PICKUP 1 TON, RAM 3500 (SEE RAM 3500) RWD Exc. Solid Front Axle	
R	94-03	PICKUP 3/4 TON, RAM 2500 (SEE RAM 2500) 4WD, GAS Exc. 8800# GVW	
R	94-02	PICKUP 3/4 TON, RAM 2500 (SEE RAM 2500) RWD	
R	95-96	PICKUP 3/4 TON, RAM 2500 (SEE RAM 2500) 4WD, CNG Exc. 8800# GVW	
R	07	GMC SIERRA 1500 Classic Hybrid, RWD Exc. Electronic Adjustable Suspension	
R	07	SIERRA 1500 Classic SL, RWD Exc. Electronic Adjustable Suspension	
R	07	SIERRA 1500 Classic SLE, RWD Exc. Electronic Adjustable Suspension	
R	07	SIERRA 1500 Classic SLT, RWD Exc. Electronic Adjustable Suspension	
R	07	SIERRA 1500 Classic WT, RWD Exc. Electronic Adjustable Suspension	
R	01-06	SIERRA 1500 RWD Exc. Electronic Adjustable Suspension	
R	00	SIERRA 1500 RWD Classic and Old Body Style; Exc. Electronic Adjustable Suspension	
R	99	SIERRA 1500 RWD Exc. Electronic Adjustable Suspension	

Ultra Truck Shock

Shock	POP	Alternative No.	MTG Acc. Supplied
Pos.	Year	Application	
G63671 W			
R	92-96	CHEVROLET VAN 1 TON, G / EXPRESS Cutaway Van	
R	92-96	GMC VAN 1 TON, G / SAVANNA Cutaway Van	
G63673 B			
F	94-01	DODGE PICKUP 1/2 TON, RAM 1500 (SEE RAM 1500) 4WD	
F	94-02	PICKUP 3/4 TON, RAM 2500 (SEE RAM 2500) 4WD, GAS Exc. 8800# GVW	
F	95-96	PICKUP 3/4 TON, RAM 2500 (SEE RAM 2500) 4WD, CNG Exc. 8800# GVW	
G63674 B			
F	94-02	DODGE PICKUP 1 TON, RAM 3500 (SEE RAM 3500) 4WD	
F	94-02	PICKUP 1 TON, RAM 3500 (SEE RAM 3500) RWD Solid Front Axle	
F	94-02	PICKUP 3/4 TON, RAM 2500 (SEE RAM 2500) 4WD, DIESEL 8800# GVW	
G63675 A			
R	07	CHEVROLET PICKUP 1/2 TON, SILVERADO 1500 Classic Hybrid, 4WD Classic and Old Body Style; Exc. Electronic Adjustable Suspension	
R	07	PICKUP 1/2 TON, SILVERADO 1500 Classic LS, 4WD Classic and Old Body Style; Exc. Electronic Adjustable Suspension	
R	07	PICKUP 1/2 TON, SILVERADO 1500 Classic LT, 4WD Classic and Old Body Style; Exc. Electronic Adjustable Suspension	
R	07	PICKUP 1/2 TON, SILVERADO 1500 Classic WT, 4WD Classic and Old Body Style; Exc. Electronic Adjustable Suspension	
R	99-06	PICKUP 1/2 TON, SILVERADO 1500 4WD Classic and Old Body Style; Exc. Electronic Adjustable Suspension	
R	05-07	PICKUP 1/2 TON, SILVERADO 1500 HD All	
R	01-03	PICKUP 1/2 TON, SILVERADO 1500 HD All	
R	77-86	PICKUP 1 TON, K30 All	
R	90-91	PICKUP 1 TON, R3500 All	
R	89	PICKUP 1 TON, R3500 Cab & Chassis, RWD	
R	89	PICKUP 1 TON, R3500 Crew Cab Pickup, RWD	
R	01-09	PICKUP 1 TON, SILVERADO 3500 All	
R	07-10	PICKUP 1 TON, SILVERADO 3500 HD All	
R	87-88	PICKUP 1 TON, V30 All	
R	89-91	PICKUP 1 TON, V3000 / V3500 All	
R	99-08	PICKUP 3/4 TON, SILVERADO 2500 All	
R	01-10	PICKUP 3/4 TON, SILVERADO 2500 HD All	
R	02-05	DODGE PICKUP 1/2 TON, RAM 1500 (SEE RAM 1500) All	
R	94-02	PICKUP 1 TON, RAM 3500 (SEE RAM 3500) 4WD	
R	94-02	PICKUP 1 TON, RAM 3500 (SEE RAM 3500) RWD Solid Front Axle	
R	94-02	PICKUP 3/4 TON, RAM 2500 (SEE RAM 2500) 4WD, DIESEL 8800# GVW	
R	77-86	GMC PICKUP 1 TON, K35 / K3500 All	
R	87-91	PICKUP 1 TON, V3000 / V3500 All	
R	07	SIERRA 1500 Classic Hybrid, 4WD Classic and Old Body Style; Exc. Electronic Adjustable Suspension	
R	07	SIERRA 1500 Classic SL, 4WD Classic and Old Body Style; Exc. Electronic Adjustable Suspension	
R	07	SIERRA 1500 Classic SLE, 4WD Classic and Old Body Style; Exc. Electronic Adjustable Suspension	
R	07	SIERRA 1500 Classic SLT, 4WD Classic and Old Body Style; Exc. Electronic Adjustable Suspension	
R	07	SIERRA 1500 Classic WT, 4WD Classic and Old Body Style; Exc. Electronic Adjustable Suspension	
R	07	SIERRA 1500 RWD Classic and Old Body Style; Exc. Electronic Adjustable Suspension	
R	07	SIERRA 1500 RWD Exc. Electronic Adjustable Suspension	

Numerical listing

Shock	POP	Alternative No.	MTG Acc. Supplied
Pos.	Year	Application	
G63675 A -continued			
R	99-06	SIERRA 1500 4WD Classic and Old Body Style; Exc. Electronic Adjustable Suspension	
R	05-07	SIERRA 1500 HD All	
R	01-03	SIERRA 1500 HD All	
R	99-04	SIERRA 2500 All	
R	01-10	SIERRA 2500 HD All	
R	01-07	SIERRA 3500 All	
R	07-10	SIERRA 3500 HD All	
G63676 C			
R	95-03	FORD WINDSTAR Coil (RearSpringType)	
G63678 A			
F	95-01	FORD EXPLORER All Exc. Adjustable Suspension	
F	01-05	EXPLORER SPORT TRAC All	
F	06-11	RANGER RWD, Torsion Bar (FrontSpringType)	
F	98-11	RANGER 4WD	
F	01-05	RANGER Edge, RWD	
F	03-06	MAZDA B3000 All 4WD	
F	98-02	B3000 4WD	
F	98-06	B4000 4WD	
F	97-01	MERCURY MOUNTAINEER All Exc. Electronic Adjustable Suspension	
G63679 A			
R	95-01	FORD EXPLORER All Exc. Adjustable Suspension	
R	01-05	EXPLORER SPORT TRAC All	
R	97-01	MERCURY MOUNTAINEER All Exc. Electronic Adjustable Suspension	
G63683 C			
R	95-98	JEEP GRAND CHEROKEE All	
G63689 B			
R	01-04	TOYOTA TACOMA S-Runner	
R	04	TACOMA Base, RWD	
R	95-03	TACOMA DLX, RWD	
G63690 A			
R	96-07	CHRYSLER TOWN & COUNTRY All Exc. Hydraulic Self Leveling System	
R	00-03	VOYAGER / GRAND VOYAGER Non-ABS Exc. Hydraulic Self Leveling System	
R	00-02	VOYAGER / GRAND VOYAGER All Exc. Hydraulic Self Leveling System	
R	96-07	DODGE CARAVAN / GRAND CARAVAN All Exc. Hydraulic Self Leveling System	
R	05	CARAVAN / GRAND CARAVAN All	
R	96-00	PLYMOUTH VOYAGER / GRAND VOYAGER All Exc. Hydraulic Self Leveling System	
G63692 W			
F	93-97	FORD PICKUP 1/2 TON, F SUPERDUTY All Mfg. from 2/93	
F	97	PICKUP, F-450 SUPERDUTY All	
G63694 W			
R	94-99	LAND ROVER DISCOVERY All	
R	94-95	RANGE ROVER Air (RearSpringType)	
G63707 W			
F	96-99	ACURA SLX 4WD	
F	00-02	ISUZU TROOPER All	
F	92-99	TROOPER 4WD	
F	99-01	VEHICROSS All	
G63708 W			
R	96-99	ACURA SLX 4WD	
R	00-02	ISUZU TROOPER All	
R	92-99	TROOPER 4WD	
R	99-01	VEHICROSS All	
G63710 W			
R	98-02	HONDA PASSPORT All	
R	98-00	ISUZU AMIGO All	
R	98-04	RODEO All	
G63712 D			
R	98	INFINITI QX4 All Mfg. to 12/98	
R	97	QX4 All	
R	96-99	NISSAN PATHFINDER All Mfg. to 12/98	

Numerical listing

Shock	POP	Alternative No.	MTG Acc. Supplied
Pos.	Year	Application	
G63714 A			
F	97-02	FORD EXPEDITION RWD Exc. Front Air- Leveling	
F	04	PICKUP 1/2 TON, F-150 RWD	
F	00-03	PICKUP 1/2 TON, F-150 Harley-Davidson Edition, RWD	
F	99-03	PICKUP 1/2 TON, F-150 Lariat, RWD	
F	99-03	PICKUP 1/2 TON, F-150 XL, RWD	
F	99-03	PICKUP 1/2 TON, F-150 XLT, RWD	
F	00	PICKUP 1/2 TON, F-150 Base, RWD	
F	97-98	PICKUP 1/2 TON, F-150 RWD	
F	97-99	PICKUP 3/4 TON, F-250 / SUPERDUTY RWD Up through 8500# GVW	
F	98-02	LINCOLN NAVIGATOR RWD	
G63715 A			
R	97-04	FORD PICKUP 1/2 TON, F-150 4WD Exc. 7700# GVW	
R	97-99	PICKUP 3/4 TON, F-250 / SUPERDUTY 4WD Up through 8500# GVW; Exc. Superduty	
G63716 A			
F	97-02	FORD EXPEDITION 4WD Exc. Front Air- Leveling	
F	04	PICKUP 1/2 TON, F-150 4WD Exc. 7700# GVW	
F	97-03	PICKUP 1/2 TON, F-150 4WD	
F	97-99	PICKUP 3/4 TON, F-250 / SUPERDUTY 4WD Up through 8500# GVW; Exc. Superduty	
G63717 B			
R	97-02	FORD EXPEDITION All	
R	98-02	LINCOLN NAVIGATOR RWD	
G63720 D			
R	95-02	KIA SPORTAGE All	
G63721 C			
F	97-06	JEEP WRANGLER TJ (MfrBodyCode)	
G63722 B			
R	97-06	JEEP WRANGLER TJ (MfrBodyCode)	
G63726 A			
R	96-02	TOYOTA 4RUNNER All	
G63772 A			
F	06-11	FORD RANGER RWD, Coil (FrontSpringType)	
F	98-05	RANGER XL, RWD	
F	98-05	RANGER XLT, RWD	
F	05	RANGER STX, RWD	
F	04	RANGER Tremor, RWD	
F	01-06	MAZDA B2300 RWD	
F	98-01	B2500 RWD	
F	98-06	B3000 RWD	
F	98-06	B4000 RWD	
G63773 B			
R	06-11	FORD RANGER RWD, Coil (FrontSpringType)	
R	98-05	RANGER XL, RWD	
R	98-05	RANGER XLT, RWD	
R	05	RANGER STX, RWD	
R	04	RANGER Tremor, RWD	
R	01-06	MAZDA B2300 RWD	
R	98-01	B2500 RWD	
R	98-06	B3000 RWD	
R	98-06	B4000 RWD	
G63775 D			
R	06-11	FORD RANGER RWD, Torsion Bar (FrontSpringType)	
R	98-11	RANGER 4WD	
R	01-05	RANGER Edge, RWD	
R	03-06	MAZDA B3000 All 4WD	
R	98-02	B3000 4WD	
R	98-06	B4000 4WD	
G63776 A			
R	05-07	BUICK TERRAZA FWD Exc. Air-Leveling Suspension	
R	05-08	CHEVROLET UPLANDER FWD Exc. Air-Leveling Suspension	
R	02-05	VENTURE All	
R	97-01	VENTURE FWD	
R	02-04	OLDSMOBILE SILHOUETTE AWD	
R	97-04	SILHOUETTE FWD	
R	06	PONTIAC MONTANA FWD Exc. Air-Leveling Suspension	

Ultra Truck Shock

Shock	POP	Alternative No.	MTG Acc. Supplied
Pos.	Year	Application	
G63776 A -continued			
R	99-05	MONTANA All Exc. Air-Leveling Suspension	
R	97-98	TRANS SPORT All	
R	05-07	SATURN RELAY FWD Exc. Air-Leveling Suspension	
G63778 A			
R	04	FORD PICKUP 1/2 TON, F-150 RWD	
R	00-03	PICKUP 1/2 TON, F-150 Harley-Davidson Edition, RWD	
R	99-03	PICKUP 1/2 TON, F-150 Lariat, RWD	
R	99-03	PICKUP 1/2 TON, F-150 XL, RWD	
R	99-03	PICKUP 1/2 TON, F-150 XLT, RWD	
R	00	PICKUP 1/2 TON, F-150 Base, RWD	
R	97-98	PICKUP 1/2 TON, F-150 RWD	
R	97-99	PICKUP 3/4 TON, F-250 / SUPERDUTY RWD Up through 8500# GVW	
G63781 W			
R	92-00	MITSUBISHI MONTERO All	
G63782 C			
F	92-00	MITSUBISHI MONTERO All	
F	97-99	MONTERO SPORT All	
G63783 A			
F	07	CHEVROLET PICKUP 1/2 TON, SILVERADO 1500 Classic Hybrid, RWD	
F	07	PICKUP 1/2 TON, SILVERADO 1500 Classic LS, RWD	
F	07	PICKUP 1/2 TON, SILVERADO 1500 Classic LT, RWD	
F	07	PICKUP 1/2 TON, SILVERADO 1500 Classic SS, RWD	
F	07	PICKUP 1/2 TON, SILVERADO 1500 Classic WT, RWD	
F	99-06	PICKUP 1/2 TON, SILVERADO 1500 RWD Exc. Electronic Adjustable Suspension	
F	07	GMC SIERRA 1500 Classic Hybrid, RWD Exc. Electronic Adjustable Suspension	
F	07	SIERRA 1500 Classic SL, RWD Exc. Electronic Adjustable Suspension	
F	07	SIERRA 1500 Classic SLE, RWD Exc. Electronic Adjustable Suspension	
F	07	SIERRA 1500 Classic SLT, RWD Exc. Electronic Adjustable Suspension	
F	07	SIERRA 1500 Classic WT, RWD Exc. Electronic Adjustable Suspension	
F	04-06	SIERRA 1500 RWD Exc. Electronic Adjustable Suspension	
F	03	SIERRA 1500 RWD Classic and Old Body Style; Exc. Electronic Adjustable Suspension	
F	01-02	SIERRA 1500 RWD Exc. Electronic Adjustable Suspension	
F	00	SIERRA 1500 RWD Classic and Old Body Style; Exc. Electronic Adjustable Suspension	
F	99	SIERRA 1500 RWD Exc. Electronic Adjustable Suspension	
G63798 W			
F	86-95	SUZUKI SAMURAI All	
G63799 W			
R	94-98	ASUNA SUNRUNNER	
R	92-93	SUNRUNNER All	
R	98-04	CHEVROLET TRACKER Non-ABS	
R	89-97	GEO TRACKER All	
R	94-97	PONTIAC SUNRUNNER CAN	
R	99-05	SUZUKI GRAND VITARA All	
R	89-98	SIDEKICK All	
R	99-04	VITARA All	
R	96-98	X-90 All	
G63803 A			
F	02-06	CHEVROLET AVALANCHE 1500 All Exc. Electronic Ride Control	
F	07	PICKUP 1/2 TON, SILVERADO 1500 Classic Hybrid, 4WD Classic and Old Body Style; Exc. Electronic Adjustable Suspension	

Numerical listing

Shock	POP	Alternative No.	MTG Acc. Supplied
Pos.	Year	Application	
G63803 A -continued			
F	07	PICKUP 1/2 TON, SILVERADO 1500 Classic LS, 4WD Classic and Old Body Style; Exc. Electronic Adjustable Suspension	
F	07	PICKUP 1/2 TON, SILVERADO 1500 Classic LT, 4WD Classic and Old Body Style; Exc. Electronic Adjustable Suspension	
F	07	PICKUP 1/2 TON, SILVERADO 1500 Classic WT, 4WD Classic and Old Body Style; Exc. Electronic Adjustable Suspension	
F	99-06	PICKUP 1/2 TON, SILVERADO 1500 4WD Classic and Old Body Style; Exc. Electronic Adjustable Suspension	
F	00-06	SUBURBAN 1/2 TON, 1500 All Exc. Z55 Auto Ride Suspension	
F	02-06	TAHOE All Exc. Z55 Auto Ride Suspension	
F	00-01	TAHOE All New Body Style; Exc. Z55 Auto Ride Suspension	
F	07	GMC SIERRA 1500 Classic Hybrid, 4WD Classic and Old Body Style; Exc. Electronic Adjustable Suspension	
F	07	SIERRA 1500 Classic SL, 4WD Classic and Old Body Style; Exc. Electronic Adjustable Suspension	
F	07	SIERRA 1500 Classic SLE, 4WD Classic and Old Body Style; Exc. Electronic Adjustable Suspension	
F	07	SIERRA 1500 Classic SLT, 4WD Classic and Old Body Style; Exc. Electronic Adjustable Suspension	
F	07	SIERRA 1500 Classic WT, 4WD Classic and Old Body Style; Exc. Electronic Adjustable Suspension	
F	99-06	SIERRA 1500 4WD Classic and Old Body Style; Exc. Electronic Adjustable Suspension	
F	00-06	YUKON All Exc. Z55 Auto Ride Suspension	
F	00-06	YUKON XL 1/2 TON All Exc. Z55 Auto Ride Suspension	
G63808 D			
R	99-04	FORD PICKUP 1 TON, F-350 / SUPERDUTY RWD	
R	99-04	PICKUP 3/4 TON, F-250 / SUPERDUTY RWD	
G63809 A			
F	00-05	FORD EXCURSION 4WD	
F	99-04	PICKUP 1 TON, F-350 / SUPERDUTY 4WD	
F	99-04	PICKUP 3/4 TON, F-250 / SUPERDUTY 4WD	
F	99-04	PICKUP, F-450 SUPERDUTY All	
F	99-04	PICKUP, F-550 SUPERDUTY All	
G63810 A			
R	99-04	FORD PICKUP 1 TON, F-350 / SUPERDUTY 4WD	
R	99-04	PICKUP 3/4 TON, F-250 / SUPERDUTY 4WD	
G63811 W			
R	99-04	FORD PICKUP , F-450 SUPERDUTY All	
R	99-04	PICKUP, F-550 SUPERDUTY All	
G63812 W			
F	01-02	CHEVROLET PICKUP 1 TON, C35/3500 HD HD Solid Front Axle	
F	91-00	PICKUP 1 TON, C35/3500 Cab & Chassis HD Solid Front Axle	
F	91-00	GMC PICKUP 1 TON, C35/3500 Cab & Chassis HD Solid Front Axle	
G63813 A			
F	00-04	NISSAN FRONTIER Crew Cab Pickup, RWD with Desert Runner	
F	98-04	FRONTIER 4WD	
F	98-99	FRONTIER RWD Crew Cab with Desert Runner	
F	00-04	XTERRA All	
G63815 A			
R	00-06	TOYOTA TUNDRA All	
G63817 A			
F	02-06	CHEVROLET AVALANCHE 2500 All Exc. Electronic Ride Control	

Numerical listing

Shock	POP	Alternative No.	MTG Acc. Supplied
Pos.	Year	Application	
G63817	A	-continued	
F	05-07	PICKUP 1/2 TON, SILVERADO 1500 HD All	
F	01-03	PICKUP 1/2 TON, SILVERADO 1500 HD All	
F	01-09	PICKUP 1 TON, SILVERADO 3500 All	
F	07-10	PICKUP 1 TON, SILVERADO 3500 HD All	
F	05-08	PICKUP 3/4 TON, SILVERADO 2500 All	
F	99-04	PICKUP 3/4 TON, SILVERADO 2500 4WD	
F	01-10	PICKUP 3/4 TON, SILVERADO 2500 HD All 9200# GVW	
F	00-11	SUBURBAN 3/4 TON, 2500 All Exc. Z55 Auto Ride Suspension and QuadraSteer	
F	05-07	GMC SIERRA 1500 HD All	
F	01-03	SIERRA 1500 HD All	
F	99-04	SIERRA 2500 4WD	
F	01-10	SIERRA 2500 HD All	
F	01-07	SIERRA 3500 All	
F	07-10	SIERRA 3500 HD Torsion Bar (FrontSpringType)	
F	00-06	YUKON XL 3/4 TON All Exc. Hydraulic Self Leveling System	
F	03-06	HUMMER H2 All	
G63818	A		
F	90-05	CHEVROLET ASTRO AWD	
F	88-99	PICKUP 1/2 TON, K15 / K1500 All	
F	88-99	GMC PICKUP 1/2 TON, K15 / K1500 All	
F	90-05	SAFARI AWD	
G63828	B		
R	98-06	LEXUS LX470 Torsion Bar (FrontSpringType)	
R	98-07	TOYOTA LAND CRUISER All	
G63829	A		
R	99-04	JEEP GRAND CHEROKEE All	
G63832	B		
F	98-06	LEXUS LX470 Torsion Bar (FrontSpringType)	
F	98-07	TOYOTA LAND CRUISER All	
G63837	W		
R	00-05	FORD EXCURSION 4WD	
G63842	A		
R	04-07	BUICK RAINIER Coil (FrontSpringType)	
R	03-06	CHEVROLET SSR All	
R	02-09	TRAILBLAZER Coil (RearSpringType)	
R	02-09	GMC ENVOY Coil (RearSpringType)	
R	03-08	ISUZU ASCENDER Coil (RearSpringType)	
R	02-04	OLDSMOBILE BRAVADA Coil (RearSpringType)	
R	05-09	SAAB 9-7X All	
G63844	A		
R	07-08	DODGE NITRO All	
R	02-12	JEEP LIBERTY All	
G63845	B		
R	99-03	INFINITI QX4 All Mfg. from 12/98	
R	02-04	NISSAN PATHFINDER All	
R	99-01	PATHFINDER All Mfg. from 12/98	
G63847	A		
F	99-04	JEEP GRAND CHEROKEE All Exc. Up Country Suspension	
G63848	A		
F	02-05	DODGE PICKUP 1/2 TON, RAM 1500 (SEE RAM 1500) 4WD	
G63860	C		
R	96-05	TOYOTA RAV4 All	
G63862	B		
R	01-07	FORD ESCAPE All	
R	01-06	MAZDA TRIBUTE All	
R	05-07	MERCURY MARINER All	
G63864	D		
R	00-06	MAZDA MPV All	
G63866	A		
R	02-11	CADILLAC ESCALADE All	
R	02-11	CHEVROLET AVALANCHE 1500 All Exc. Electronic Ride Control	

Ultra Truck Shock

Shock	POP	Alternative No.	MTG Acc. Supplied
Pos.	Year	Application	
G63866	A	-continued	
R	02-06	AVALANCHE 2500 All Exc. Electronic Ride Control	
R	07-11	SUBURBAN 1/2 TON, 1500 All Exc. Z55 or ZW7 Ride Suspension	
R	00-06	SUBURBAN 1/2 TON, 1500 All Exc. Z55 Auto Ride Suspension	
R	00-11	SUBURBAN 3/4 TON, 2500 All Exc. Z55 Auto Ride Suspension and QuadraSteer	
R	07-11	TAHOE All Exc. Z55 or ZW7 Ride Suspension	
R	02-06	TAHOE All Exc. Z55 Auto Ride Suspension	
R	00-01	TAHOE All New Body Style; Exc. Z55 Auto Ride Suspension	
R	00-10	GMC YUKON All Exc. Z55 Auto Ride Suspension	
R	00-11	YUKON XL 1/2 TON All Exc. Z55 Auto Ride Suspension	
R	00-06	YUKON XL 3/4 TON All Exc. Hydraulic Self Leveling System	
G63867	A		
R	04-08	FORD PICKUP 1/2 TON, F-150 4WD	
R	06-08	LINCOLN MARK LT 4WD	
G63868	D		
R	02-07	BUICK RENDEZVOUS All Exc. Hydraulic Self Leveling System	
R	01-05	PONTIAC AZTEK AWD	
G63869	W		
R	01-05	PONTIAC AZTEK FWD	
G63870	A		
R	05-08	FORD PICKUP 1/2 TON, F-150 RWD	
R	04	PICKUP 1/2 TON, F-150 Lariat, RWD	
R	04	PICKUP 1/2 TON, F-150 STX, RWD	
R	04	PICKUP 1/2 TON, F-150 XL, RWD	
R	04	PICKUP 1/2 TON, F-150 XLT, RWD	
R	06-08	LINCOLN MARK LT RWD	
G63872	A		
R	02-10	SATURN VUE All	
G63873	D		
R	04-07	FORD FREESTAR All	
R	04-07	MERCURY MONTEREY Mini Passenger Van	
G63875	D		
R	04-08	CHEVROLET TORNADO All	
R	05-07	INFINITI QX56 All	
R	05-13	NISSAN ARMADA All Exc. Auto-Leveling System	
G63877	W		
R	99-04	HONDA ODYSSEY All	
G63878	D		
R	04-11	NISSAN TITAN 4WD	
G63879	A		
R	04-11	CHEVROLET COLORADO Torsion Bar (FrontSpringType)	
R	04-11	GMC CANYON Torsion Bar (FrontSpringType)	
R	06	ISUZU I-350 Torsion Bar (FrontSpringType)	
G63880	W		
R	01-03	KIA RIO All	
G63881	W		
F	87-96	DODGE DAKOTA 4WD	
G63882	D		
R	04-11	CHEVROLET COLORADO RWD, Coil (FrontSpringType) Exc. Z71 Off Road Package	
R	04-11	GMC CANYON RWD, Coil (FrontSpringType) Exc. Z71 Off Road Package	
R	06	ISUZU I-280 Coil (FrontSpringType)	
R	07-08	I-290 Coil (FrontSpringType)	
R	08	I-370 Coil (FrontSpringType)	
G63883	C		
R	04-11	NISSAN TITAN RWD	
G63884	A		
F	04-08	CHEVROLET COLORADO Torsion Bar (FrontSpringType)	

Numerical listing

Shock	POP	Alternative No.	MTG Acc. Supplied
Pos.	Year	Application	
G63884	A	-continued	
F	04-08	GMC CANYON Torsion Bar (FrontSpringType)	
F	06	ISUZU I-350 Torsion Bar (FrontSpringType)	
G63885	C		
R	10-11	TOYOTA 4RUNNER Trail	
R	03-11	4RUNNER Limited	
R	03-11	4RUNNER SR5	
G63886	A		
F	05-12	FORD PICKUP 1 TON, F-350 / SUPERDUTY 4WD	
F	05-13	PICKUP 3/4 TON, F-250 / SUPERDUTY 4WD	
G63887	W		
R	05-07	FORD PICKUP 1 TON, F-350 / SUPERDUTY Crew Cab Pickup, 4WD Dual Rear Wheels	
R	05-07	PICKUP 1 TON, F-350 / SUPERDUTY Extended Cab Pickup, 4WD Dual Rear Wheels	
R	05-07	PICKUP 1 TON, F-350 / SUPERDUTY Standard Cab Pickup, 4WD Dual Rear Wheels	
G63888	B		
R	05-12	FORD PICKUP 1 TON, F-350 / SUPERDUTY Crew Cab Pickup, 4WD Single Rear Wheels	
R	05-12	PICKUP 1 TON, F-350 / SUPERDUTY Extended Cab Pickup, 4WD Single Rear Wheels	
R	05-12	PICKUP 1 TON, F-350 / SUPERDUTY Standard Cab Pickup, 4WD Single Rear Wheels	
R	05-13	PICKUP 3/4 TON, F-250 / SUPERDUTY 4WD	
G63889	W		
R	05-13	TOYOTA TACOMA Base, RWD	
G63890	C		
R	05-10	DODGE DAKOTA RWD	
R	06-09	MITSUBISHI RAIDER RWD	
G63891	C		
R	05-10	DODGE DAKOTA 4WD	
R	06-09	MITSUBISHI RAIDER 4WD	
G63892	A		
R	07-08	CHRYSLER ASPEN All	
R	04-09	DODGE DURANGO All	
G63893	W		
F	03-11	CHEVROLET VAN 1/2 TON, G / EXPRESS Torsion Bar (FrontSpringType)	
F	03-12	VAN 1 TON, G / EXPRESS All Torsion Bar (FrontSpringType)	
F	06-12	VAN 3/4 TON, G / EXPRESS All Torsion Bar (FrontSpringType)	
F	03-05	VAN 3/4 TON, G / EXPRESS Torsion Bar (FrontSpringType)	
F	03-11	GMC VAN 1/2 TON, G / SAVANNA Torsion Bar (FrontSpringType)	
F	03-12	VAN 1 TON, G / SAVANNA All Torsion Bar (FrontSpringType)	
F	04-12	VAN 3/4 TON, G / SAVANNA All Torsion Bar (FrontSpringType)	
F	03	VAN 3/4 TON, G / SAVANNA Torsion Bar (FrontSpringType)	
G63894	A		
F	03-11	CHEVROLET VAN 1/2 TON, G / EXPRESS RWD, Coil (FrontSpringType)	
F	03-11	GMC VAN 1/2 TON, G / SAVANNA RWD, Coil (FrontSpringType)	
G63895	A		
F	03-12	CHEVROLET VAN 1 TON, G / EXPRESS Coil (FrontSpringType)	
F	03-12	VAN 3/4 TON, G / EXPRESS Coil (FrontSpringType)	
F	03-12	GMC VAN 1 TON, G / SAVANNA Coil (FrontSpringType)	
F	03-12	VAN 3/4 TON, G / SAVANNA Coil (FrontSpringType)	
G63896	B		
R	92-99	CHEVROLET SUBURBAN 1/2 TON, C15 / C1500 All	
R	92-99	SUBURBAN 3/4 TON, C25 / C2500 All	

Numerical listing

Shock	POP	Alternative No.	MTG Acc. Supplied
Pos.	Year	Application	
G63896 B -continued			
R	95-00	TAHOE RWD Old Body Style	
R	96-11	VAN 1/2 TON, G / EXPRESS All	
R	93-99	GMC SUBURBAN 1/2 TON, C15 / C1500 All	
R	92	SUBURBAN 1/2 TON, C15 / C1500 All Old Body Style	
R	92-99	SUBURBAN 3/4 TON, C25 / C2500 All	
R	96-11	VAN 1/2 TON, G / SAVANNA All	
R	00	YUKON Denali	
R	92-99	YUKON All	
G63897 A			
R	03-12	CHEVROLET VAN 1 TON, G / EXPRESS All Single Rear Wheels	
R	03-12	VAN 3/4 TON, G / EXPRESS All	
R	03-12	GMC VAN 1 TON, G / SAVANNA All Single Rear Wheels	
R	03-12	VAN 3/4 TON, G / SAVANNA All	
G63898 W			
R	03-06	CHEVROLET VAN 1 TON, G / EXPRESS All Dual Rear Wheels	
R	03-06	GMC VAN 1 TON, G / SAVANNA All Dual Rear Wheels	
G63900 W			
F	87-89	TOYOTA VAN RWD	
F	84-86	VAN All	
F	88	VAN WAGON RWD	
G63902 W			
F	81-82	CHEVROLET LUV PICKUP RWD	
F	81-95	ISUZU PICKUP RWD	
F	69-72	NISSAN 521 PICKUP All	
F	72-79	620 PICKUP All	
F	80-86	720 PICKUP All	
F	87-97	PICKUP 4WD	
F	86	PICKUP 4WD Mfg. from 8/86	
G63903 C			
F	85-95	TOYOTA PICKUP RWD Exc. 1 Ton	
F	84	PICKUP RWD	
F	93-98	T100 RWD	
G63904 C			
F	87-90	MITSUBISHI VAN All	
F	87-95	NISSAN PATHFINDER All Exc. Electronic Adjustable Suspension	
G63905 A			
F	97-04	DODGE DAKOTA 4WD	
F	98-03	DURANGO 4WD	
G63906 W			
F	87-91	CHEVROLET BLAZER 4WD Full Size; Quad Suspension Long Shock; Exc. Lift Kit	
F	81-86	BLAZER 4WD Quad Suspension Long Shock; Exc. Lift Kit	
F	81-86	PICKUP 1/2 TON, K10 All Quad Suspension Long Shock; Exc. Lift Kit	
F	87	PICKUP 1/2 TON, V10 All Quad Suspension Long Shock; Exc. Lift Kit	
F	81-86	PICKUP 3/4 TON, K20 All Quad Suspension Long Shock; Exc. Lift Kit	
F	87	PICKUP 3/4 TON, V20 All Quad Suspension Long Shock; Exc. Lift Kit	
F	81-86	SUBURBAN 1/2 TON, K10 All Quad Suspension Long Shock; Exc. Lift Kit	
F	89-91	SUBURBAN 1/2 TON, V1500 All Quad Suspension Long Shock; Exc. Lift Kit	
F	81-86	SUBURBAN 3/4 TON, K20 All Quad Suspension Long Shock; Exc. Lift Kit	
F	87-88	SUBURBAN 3/4 TON, V20 All Quad Suspension Long Shock; Exc. Lift Kit	
F	89-91	SUBURBAN 3/4 TON, V2500 All Quad Suspension Long Shock; Exc. Lift Kit	
F	73-91	GMC JIMMY 4WD Quad Suspension Long Shock; Exc. Lift Kit	
F	81-86	PICKUP 1/2 TON, K15 / K1500 All Quad Suspension Long Shock; Exc. Lift Kit	
F	87	PICKUP 1/2 TON, V1500 All Quad Suspension Long Shock; Exc. Lift Kit	
F	81-86	PICKUP 3/4 TON, K25 / K2500 All Quad Suspension Long Shock; Exc. Lift Kit	
F	87	PICKUP 3/4 TON, V2500 All Quad Suspension Long Shock; Exc. Lift Kit	
F	81-86	SUBURBAN 1/2 TON, K15 / K1500 All Quad Suspension Long Shock; Exc. Lift Kit	

Ultra Truck Shock

Shock	POP	Alternative No.	MTG Acc. Supplied
Pos.	Year	Application	
G63906 W -continued			
F	87-91	SUBURBAN 1/2 TON, V1500 All Quad Suspension Long Shock; Exc. Lift Kit	
F	81-86	SUBURBAN 3/4 TON, K25 / K2500 All Quad Suspension Long Shock; Exc. Lift Kit	
F	87-91	SUBURBAN 3/4 TON, V2500 All Quad Suspension Long Shock; Exc. Lift Kit	
G63907 B			
R	75-80	CHEVROLET LUV PICKUP All	
R	72-74	LUV PICKUP All	
R	79-82	DODGE D50 RWD	
R	87-93	PICKUP, RAM 50 RWD	
R	83-86	PICKUP, RAM 50 All	
R	86-87	MAZDA B2000 RWD	
R	87-93	B2200 RWD	
R	87-93	B2600 RWD	
R	95-96	MITSUBISHI MIGHTY MAX All	
R	83-94	MIGHTY MAX RWD	
R	87-90	VAN All	
R	98-04	NISSAN FRONTIER RWD Exc. Desert Runner	
R	87-97	PICKUP RWD	
R	86	PICKUP RWD Mfg. from 8/86	
R	79-82	PLYMOUTH PICKUP All	
R	85-95	TOYOTA PICKUP RWD Exc. 1 Ton	
R	75-84	PICKUP RWD Mojave	
R	70-74	PICKUP All RWD; Mojave	
R	84-88	VAN Leaf (RearSpringType)	
R	88	VAN WAGON Leaf (RearSpringType)	
G63908 W			
F	87-91	CHEVROLET BLAZER 4WD Full Size; Quad Suspension Short Shock; Exc. Lift Kit	
F	81-86	BLAZER 4WD Quad Suspension Short Shock; Exc. Lift Kit	
F	81-86	PICKUP 1/2 TON, K10 All Quad Suspension Short Shock; Exc. Lift Kit	
F	87	PICKUP 1/2 TON, V10 All Quad Suspension Short Shock; Exc. Lift Kit	
F	81-86	PICKUP 3/4 TON, K20 All Quad Suspension Short Shock; Exc. Lift Kit	
F	87	PICKUP 3/4 TON, V20 All Quad Suspension Short Shock; Exc. Lift Kit	
F	81-86	SUBURBAN 1/2 TON, K10 All Quad Suspension Short Shock; Exc. Lift Kit	
F	89-91	SUBURBAN 1/2 TON, V1500 All Quad Suspension Short Shock; Exc. Lift Kit	
F	81-86	SUBURBAN 3/4 TON, K20 All Quad Suspension Short Shock; Exc. Lift Kit	
F	87-88	SUBURBAN 3/4 TON, V20 All Quad Suspension Short Shock; Exc. Lift Kit	
F	89-91	SUBURBAN 3/4 TON, V2500 All Quad Suspension Short Shock; Exc. Lift Kit	
F	73-91	GMC JIMMY 4WD Quad Suspension Short Shock; Exc. Lift Kit	
F	81-86	PICKUP 1/2 TON, K15 / K1500 All Quad Suspension Short Shock; Exc. Lift Kit	
F	87	PICKUP 1/2 TON, V1500 All Quad Suspension Short Shock; Exc. Lift Kit	
F	81-86	PICKUP 3/4 TON, K25 / K2500 All Quad Suspension Short Shock; Exc. Lift Kit	
F	87	PICKUP 3/4 TON, V2500 All Quad Suspension Short Shock; Exc. Lift Kit	
F	81-86	SUBURBAN 1/2 TON, K15 / K1500 All Quad Suspension Short Shock; Exc. Lift Kit	
F	87-91	SUBURBAN 1/2 TON, V1500 All Quad Suspension Short Shock; Exc. Lift Kit	
F	81-86	SUBURBAN 3/4 TON, K25 / K2500 All Quad Suspension Short Shock; Exc. Lift Kit	
F	87-91	SUBURBAN 3/4 TON, V2500 All Quad Suspension Short Shock; Exc. Lift Kit	

Numerical listing

Shock	POP	Alternative No.	MTG Acc. Supplied
Pos.	Year	Application	
G63909 A			
F	75-82	CHEVROLET LUV PICKUP All	
F	72-74	LUV PICKUP All	
F	89-94	ISUZU AMIGO All	
F	81-95	PICKUP 4WD	
F	84-86	TROOPER 4WD	
F	98-04	NISSAN FRONTIER RWD Exc. Desert Runner	
F	87-97	PICKUP RWD	
F	86	PICKUP RWD Mfg. from 8/86	
G63914 W			
R	90-96	CHEVROLET LUMINA APV All	
R	90-96	OLDSMOBILE SILHOUETTE All	
R	90-96	PONTIAC TRANS SPORT All	
G63915 B			
F	87-04	DODGE DAKOTA RWD	
F	99-03	DURANGO RWD	
G63918 W			
R	03-06	DODGE SPRINTER 2500 All Exc. Dual Rear Wheels	
R	03-06	SPRINTER 3500 All Exc. Dual Rear Wheels	
R	04-06	MERCEDES-BENZ SPRINTER All Exc. Dual Rear Wheels	
G63919 W			
R	03-06	DODGE SPRINTER 3500 All Dual Rear Wheels	
R	04-06	MERCEDES-BENZ SPRINTER All Dual Rear Wheels	
G63928 W			
R	89-94	ISUZU AMIGO All	
R	81-95	PICKUP 4WD	
R	84-86	TROOPER 4WD	
G63929 C			
F	92-07	FORD VAN 1/2 TON, ECONOLINE / CLUB WAGON All	
G63937 B			
F	01-04	TOYOTA TACOMA S-Runner	
F	04	TACOMA Base, RWD	
F	95-03	TACOMA DLX, RWD	
G63949 W			
R	86-95	SUZUKI SAMURAI All	
G63950 W			
F	79-82	DODGE D50 RWD	
F	83-93	PICKUP, RAM 50 RWD	
F	83-96	MITSUBISHI MIGHTY MAX RWD	
F	79-82	PLYMOUTH PICKUP All	
G63958 A			
F	06-08	DODGE PICKUP 1/2 TON, RAM 1500 (SEE RAM 1500) Crew Cab Pickup, RWD	
F	06-08	PICKUP 1/2 TON, RAM 1500 (SEE RAM 1500) Standard Cab Pickup, RWD	
F	02-05	PICKUP 1/2 TON, RAM 1500 (SEE RAM 1500) RWD	
G63959 A			
R	08-14	CHEVROLET PICKUP 1/2 TON, SILVERADO 1500 All Exc. Electronic Adjustable Suspension	
R	07	PICKUP 1/2 TON, SILVERADO 1500 Base Exc. Electronic Adjustable Suspension	
R	07	PICKUP 1/2 TON, SILVERADO 1500 LS Exc. Electronic Adjustable Suspension	
R	07	PICKUP 1/2 TON, SILVERADO 1500 LT Exc. Electronic Adjustable Suspension	
R	07	PICKUP 1/2 TON, SILVERADO 1500 LTZ Exc. Electronic Adjustable Suspension	
R	07	PICKUP 1/2 TON, SILVERADO 1500 WT Exc. Electronic Adjustable Suspension	
R	08-14	GMC SIERRA 1500 All Exc. Electronic Adjustable Suspension	
R	07	SIERRA 1500 SLE Exc. Electronic Adjustable Suspension	
R	07	SIERRA 1500 SLT Exc. Electronic Adjustable Suspension	
R	07	SIERRA 1500 WT Exc. Electronic Adjustable Suspension	

Numerical listing

Shock	POP	Alternative No.	MTG Acc. Supplied
Pos.	Year	Application	
G63961	C		
R	06-08	DODGE PICKUP 1/2 TON, RAM 1500 (SEE RAM 1500) 4WD Exc. Mega Cab	
G63962	C		
R	06-08	DODGE PICKUP 1/2 TON, RAM 1500 (SEE RAM 1500) RWD Exc. Mega Cab	
G63963	W		
R	05-06	FORD PICKUP, F-450 SUPERDUTY All	
R	05-06	PICKUP, F-550 SUPERDUTY All	
G63964	W		
R	05-06	FORD PICKUP 1 TON, F-350 / SUPERDUTY Cab & Chassis, 4WD	
G63965	D		
R	06-10	HUMMER H3 All	
G63966	W		
R	13	JEEP WRANGLER All	
R	07-12	WRANGLER All Exc. 17" Wheels	
G63967	D		
R	07-12	JEEP WRANGLER All 17" Wheels	
G63969	W		
F	05-08	FORD PICKUP, F-450 SUPERDUTY All	
F	05-07	PICKUP, F-550 SUPERDUTY All	
G63970	W		
R	03-06	DODGE PICKUP 1 TON, RAM 3500 (SEE RAM 3500) Standard Cab Pickup, RWD	
R	03-10	PICKUP 3/4 TON, RAM 2500 (SEE RAM 2500) Standard Cab Pickup, RWD	
R	11-12	RAM 2500 (SEE DODGE RAM 2500) Standard Cab Pickup, RWD	
G63971	W		
R	03-07	DODGE PICKUP 1 TON, RAM 3500 (SEE RAM 3500) Crew Cab Pickup, RWD	
R	03-06	PICKUP 3/4 TON, RAM 2500 (SEE RAM 2500) Crew Cab Pickup, RWD	
G64000	W		
R	03-06	HUMMER H2 All	
G64001	D		
F	06-10	HUMMER H3 All	
G64002	D		
R	98-02	LINCOLN NAVIGATOR 4WD, Air (RearSpringType)	
G64003	A		
R	01-06	ACURA MDX All	
R	03-08	HONDA PILOT All	
G64004	W		
R	05-11	TOYOTA TACOMA X-Runner Left	
G64005	W		
R	05-11	TOYOTA TACOMA X-Runner Right	
G64006	C		
R	05-11	TOYOTA TACOMA 4WD	
G64007	D		
R	05-11	TOYOTA TACOMA Pre Runner	
G64008	B		
F	07-13	JEEP WRANGLER All	
G64009	W		
F	06-08	DODGE PICKUP 1/2 TON, RAM 1500 (SEE RAM 1500) 4WD Mega Cab	
G64010	D		
R	05-12	FORD PICKUP 1 TON, F-350 / SUPERDUTY RWD	
R	05-13	PICKUP 3/4 TON, F-250 / SUPERDUTY RWD	
G64011	W		
F	05-08	DODGE PICKUP 3/4 TON, RAM 2500 (SEE RAM 2500) 4WD	
G64012	B		
R	06-10	JEEP COMMANDER All	
R	05-10	GRAND CHEROKEE All	

Ultra Truck Shock, Ultra Shock

Shock	POP	Alternative No.	MTG Acc. Supplied
Pos.	Year	Application	
G64013	W		
R	03-10	DODGE PICKUP 3/4 TON, RAM 2500 (SEE RAM 2500) 4WD 8800# GVW	
R	11-12	RAM 2500 (SEE DODGE RAM 2500) 4WD 8800# GVW	
G64014	W		
R	06-09	CHEVROLET TRAILBLAZER Air (RearSpringType)	
R	02-05	TRAILBLAZER All Air(RearSpringType)	
R	03-06	GMC ENVOY Air (RearSpringType)	
G64015	B		
R	05-13	CHEVROLET EQUINOX All	
R	10-13	GMC TERRAIN All	
R	06-09	PONTIAC TORRENT All	
G64016	A		
F	07	CHRYSLER ASPEN All	
F	04-09	DODGE DURANGO All	
G64026	C		
R	06-12	TOYOTA RAV4 All	
G64027	C		
F	00-04	MITSUBISHI MONTERO SPORT All	
G64028	C		
R	00-04	MITSUBISHI MONTERO SPORT All	
G64029	W		
R	07-12	TOYOTA FJ CRUISER RWD	
G64030	W		
R	11-12	TOYOTA FJ CRUISER 4WD	
R	07-09	FJ CRUISER 4WD	
G64031	D		
R	09-13	NISSAN FRONTIER All Exc. Nismo Off-Road	
R	05-08	FRONTIER LE	
R	05-08	FRONTIER SE	
R	05-08	FRONTIER XE	
G64032	D		
R	03-06	KIA SORENTO All	
G64033	C		
R	13	NISSAN PATHFINDER All	
R	12	PATHFINDER All Mfg. to 12/12	
R	05-11	PATHFINDER All	
G64036	W		
R	01-04	MITSUBISHI MONTERO All Exc. Sport	
G64037	W		
R	07-10	FORD EDGE All	
R	07-09	LINCOLN MKX All	
G64038	W		
R	07-13	TOYOTA TUNDRA All	
G64040	C		
R	08-12	BUICK ENCLAVE All	
R	09-12	CHEVROLET TRAVERSE All	
R	07-12	GMC ACADIA All	
R	07-10	SATURN OUTLOOK All	
G64042	C		
R	08-12	CHRYSLER TOWN & COUNTRY All Exc. Self-Leveling Suspension	
R	08-12	DODGE CARAVAN / GRAND CARAVAN All Exc. Self-Leveling Suspension	
R	11	VOLKSWAGEN ROUTAN All	
R	09-10	ROUTAN All Exc. Self-Leveling Suspension	
G64043	W		
F	09-10	DODGE PICKUP 1/2 TON, RAM 1500 (SEE RAM 1500) RWD	
F	11-12	RAM 1500 (SEE DODGE RAM 1500) RWD	
G64044	W		
R	09-10	DODGE PICKUP 1/2 TON, RAM 1500 (SEE RAM 1500) All	
R	11-12	RAM 1500 (SEE DODGE RAM 1500) All	
G64046	W		
R	00-06	BMW X5 All	
G64047	D		
R	08-11	FORD ESCAPE All	

Numerical listing

Shock	POP	Alternative No.	MTG Acc. Supplied
Pos.	Year	Application	
G64047	D	-continued	
R	08-11	MAZDA TRIBUTE All	
R	08-11	MERCURY MARINER All	
G64048	W		
R	07-09	HYUNDAI SANTA FE All	
R	07-12	VERACRUZ All	
G64049	W		
F	00-03	MERCEDES-BENZ ML55 AMG All	
F	98-03	ML320 All	
F	03-05	ML350 All	
F	99-01	ML430 All	
F	02-05	ML500 All	
G64050	D		
R	08-12	NISSAN ROGUE All	
R	10-12	X-TRAIL All	
R	08	X-TRAIL All	
G64052	W		
R	06-12	SUZUKI GRAND VITARA All	
G64056	W		
R	07-10	MAZDA CX-7 All	
G64071	N		
R	07-08	HYUNDAI ENTOURAGE All	
R	06-11	KIA SEDONA All	
G64079	C		
R	09-14	FORD PICKUP 1/2 TON, F-150 4WD	
R	10-12	LINCOLN MARK LT All	
G64080	N		
R	07-13	ACURA MDX All Exc. Active Suspension	
G64087	N		
R	01-07	TOYOTA SEQUOIA All	
G64101	N		
R	12-14	CHEVROLET SUBURBAN 1/2 TON, 1500 All	
R	12-14	TAHOE All	
R	12-14	GMC YUKON All	
R	12-14	YUKON XL 1/2 TON All	
G64107	N		
R	15	CHEVROLET TAHOE All	
R	15	GMC YUKON All	
R	15	YUKON XL All	
Ultra Shock			
69407	W		
R	95-98	BUICK SKYLARK All	
R	95-96	CHEVROLET BERETTA All	
R	95-96	CORSIKA All	
R	95-98	OLDSMOBILE ACHIEVA All Exc. Electronic Adjustable Suspension	
R	95-98	PONTIAC GRAND AM All Exc. Electronic Adjustable Suspension	
69416	W		
R	00-06	AUDI TT QUATTRO All	
69417	W		
R	94-97	VOLVO 960 All Mfg. from 10/94; Exc. Hydraulic Self Leveling System	
R	97-98	S90 All Mfg. from 5/97; Exc. Hydraulic Self Leveling System	
R	97-98	V90 All Mfg. from 5/97; Exc. Hydraulic Self Leveling System	
69420	W		
R	00-06	AUDI TT All	
69450	B		
R	00-05	TOYOTA ECHO All	
69462	W		
R	92-96	EAGLE SUMMIT Wagon	
R	92-95	MITSUBISHI EXPO All	
R	92-94	PLYMOUTH COLT Wagon	
69464	A		
R	08-11	FORD FOCUS All	
R	00-07	FOCUS Hatchback	
R	00-07	FOCUS Sedan	
69465	D		
R	00-07	FORD FOCUS Wagon	
69473	A		
R	01-10	CHRYSLER PT CRUISER All	

Numerical listing

Shock	POP	Alternative No.	MTG Acc. Supplied
Pos.	Year	Application	
69574	C		
R	03-10	FORD CROWN VICTORIA Police Interceptor Police and Taxi Models	
69575	A		
R	10-11	FORD CROWN VICTORIA Base Exc. Police and Taxi Models	
R	03-11	CROWN VICTORIA LX Exc. Police and Taxi Models	
R	03-08	CROWN VICTORIA Base Exc. Police and Taxi Models	
R	04-06	CROWN VICTORIA LX Sport Exc. Police and Taxi Models	
R	05	CROWN VICTORIA S Exc. Police and Taxi Models	
R	05	CROWN VICTORIA Special Edition Exc. Police and Taxi Models	
R	03	CROWN VICTORIA LWB Exc. Police and Taxi Models	
R	03	CROWN VICTORIA S Exc. Police and Taxi Models	
R	03-04	GRAND MARQUIS All	
R	03-11	LINCOLN TOWN CAR All	
R	03-06	MERCURY GRAND MARQUIS All	
R	03-04	MARAUDER All	
69585	C		
R	01-03	KIA RIO All	
69586	W		
R	01-08	AUDI A4 All	
R	02-08	A4 QUATTRO All	
69587	A		
R	05-10	CHEVROLET COBALT LS	
R	05-10	COBALT LT	
R	10	COBALT Base	
R	10	COBALT LT Team Canada	
R	06-07	COBALT LTZ	
R	05	COBALT Base	
R	11	HHR All	
R	08-10	HHR LS Panel	
R	08-10	HHR LT Panel	
R	06-10	HHR LS	
R	06-10	HHR LT	
R	06-08	HHR Comfort LT	
R	06-08	HHR Elegance LT	
R	07	HHR Edicion Especial	
R	07-09	PONTIAC G5 All	
R	05-06	PURSUIT All	
R	08-09	SATURN ASTRA All	
R	03-07	ION All	
69589	A		
R	08	CHEVROLET MALIBU Classic LS	
R	08	MALIBU Classic LT	
R	06-07	MALIBU LTZ	
R	06-07	MALIBU SS	
R	04-07	MALIBU LS	
R	04-07	MALIBU LT	
R	04-05	MALIBU Base	
69590	A		
R	09-12	CHEVROLET MALIBU All	
R	08	MALIBU Base	
R	08	MALIBU Hybrid	
R	08	MALIBU LS	
R	08	MALIBU LT	
R	08	MALIBU LTZ	
R	04-07	MALIBU Maxx LS	
R	04-07	MALIBU Maxx LT	
R	04	MALIBU Maxx	
R	05-10	PONTIAC G6 All	
R	07-09	SATURN AURA XE	
R	07-09	AURA XR	
69591	B		
R	06-11	FORD FUSION FWD	
R	07-12	LINCOLN MKZ FWD	
R	06	ZEPHYR All	
R	03-08	MAZDA 6 All	
R	06-11	MERCURY MILAN FWD	
69592	B		
R	05-13	FORD MUSTANG / MUSTANG II Coupe	
69593	W		
R	05-13	FORD MUSTANG / MUSTANG II Convertible	
69594	D		
R	13	NISSAN XTERRA 4WD	
R	12	XTERRA 4WD Mfg. to 12/12	
R	05-11	XTERRA 4WD	

Ultra Shock

Shock	POP	Alternative No.	MTG Acc. Supplied
Pos.	Year	Application	
69595	D		
R	13	NISSAN XTERRA RWD	
R	12	XTERRA RWD Mfg. to 12/12	
R	05-11	XTERRA RWD	
69600	B		
F	87-91	AVANTI II All	
F	73-75	BUICK APOLLO All	
F	73-81	CENTURY All	
F	68-72	GS / GS350 / GS400 / GS455 All	
F	73-87	REGAL All	
F	75-79	SKYLARK All	
F	68-72	SKYLARK All	
F	68-69	SPECIAL All	
F	68-72	SPORTWAGON All	
F	76-79	CADILLAC SEVILLE All	
F	67-69	CHEVROLET CAMARO All	
F	68-73	CHEVELLE All	
F	68	CHEVY II All	
F	73-83	MALIBU All	
F	70-88	MONTE CARLO All	
F	69-79	NOVA All	
F	64-65	NISSAN 410 All	
F	64-67	411 All	
F	68-87	OLDSMOBILE CUTLASS / CUTLASS SUPREME All	
F	80-83	CUTLASS CLASSIC / CUTLASS CRUISER All	
F	68-72	F85 All	
F	74-79	OMEGA All	
F	73	OMEGA All Exc. HD Suspension	
F	68-75	VISTA CRUISER All	
F	82-86	PONTIAC BONNEVILLE All	
F	67-69	FIREBIRD All	
F	78-80	GRAND AM All	
F	73-75	GRAND AM All	
F	75-83	GRAND LEMANS All	
F	69-87	GRAND PRIX All	
F	71-75	GRANDVILLE All	
F	68-73	GTO All	
F	68-81	LEMANS All	
F	77-79	PHOENIX All	
F	68-70	TEMPEST All	
F	71-77	VENTURA All	
F	78	TOYOTA CORONA All	
F	73-77	CORONA All Mfg. from 8/73	
F	69-72	CORONA Mark II	
F	68-75	VOLVO 142 / 144 / 145 / 164 All	
69604	C		
R	87-88	AVANTI II All	
R	73-81	BUICK CENTURY All	
R	87	ESTATE WAGON All	
R	71-83	ESTATE WAGON All	
R	65-67	GRAND SPORT All	
R	68-72	GS / GS350 / GS400 / GS455 All	
R	73-87	REGAL All	
R	91-96	ROADMASTER Wagon	
R	68-72	SKYLARK All	
R	64-67	SKYLARK All HD Suspension; Exc. Sportwagon	
R	68-69	SPECIAL All	
R	64-67	SPECIAL All HD Suspension; Exc. Sportwagon	
R	70-72	SPORTWAGON All	
R	71-72	CHEVROLET BROOKWOOD All	
R	71-96	CAPRICE Wagon	
R	68-73	CHEVELLE All	
R	64-67	CHEVELLE All HD Suspension	
R	71-82	IMPALA Wagon	
R	71-72	KINGSWOOD All	
R	73-83	MALIBU All	
R	64-67	MALIBU All HD Suspension	
R	70-88	MONTE CARLO All	
R	71-72	TOWNSMAN All	
R	75-76	NISSAN 610 Wagon	
R	73-74	610 All	
R	74-77	710 Wagon	
R	78-80	810 Wagon	
R	71-92	OLDSMOBILE CUSTOM CRUISER All	
R	71-87	CUTLASS / CUTLASS SUPREME All	
R	68-72	CUTLASS / CUTLASS SUPREME All HD Suspension	
R	64-66	CUTLASS / CUTLASS SUPREME All HD Suspension	
R	80-83	CUTLASS CLASSIC / CUTLASS CRUISER All	
R	68-72	F85 All	
R	64-67	F85 All HD Suspension	
R	71-78	TORONADO All	
R	82-86	PONTIAC BONNEVILLE All	
R	77-81	CATALINA Wagon	
R	71-75	CATALINA Wagon	

Numerical listing

Shock	POP	Alternative No.	MTG Acc. Supplied
Pos.	Year	Application	
69604	C -continued		
R	78-80	GRAND AM All	
R	73-75	GRAND AM All	
R	75-83	GRAND LEMANS All	
R	69-87	GRAND PRIX All	
R	71-78	GRAND SAFARI All	
R	71-75	GRANDVILLE All	
R	68-73	GTO All	
R	64-67	GTO All HD Suspension	
R	68-81	LEMANS All	
R	64-67	LEMANS All HD Suspension	
R	80-86	PARISIENNE Wagon	
R	76-79	PARISIENNE All Wagon	
R	87-89	SAFARI All	
R	68-70	TEMPEST All	
R	64-67	TEMPEST All HD Suspension	
69606	A		
R	64-69	BUICK SPORTWAGON All	
R	68-69	CHEVROLET CAMARO All Leaf(RearSpringType)	
R	65-74	FORD COUNTRY SEDAN All	
R	87-91	COUNTRY SQUIRE All	
R	65-74	COUNTRY SQUIRE All	
R	92-02	CROWN VICTORIA All	
R	65-72	CUSTOM All	
R	68-77	CUSTOM 500 All	
R	66-70	FAIRLANE All Wagon	
R	66-70	FALCON All Wagon	
R	65-67	GALAXIE All	
R	68-74	GALAXIE 500 All	
R	01-02	GRAND MARQUIS All	
R	87-91	LTD / COUNTRY SEDAN / COUNTRY SQUIRE / CROWN VICTORIA All	
R	67-82	LTD / COUNTRY SEDAN / COUNTRY SQUIRE / CROWN VICTORIA All	
R	77-79	LTD II All	
R	66-79	RANCHERO All	
R	65-74	RANCH WAGON All	
R	77-79	THUNDERBIRD All	
R	67-72	THUNDERBIRD All	
R	68-76	TORINO All	
R	70-80	LINCOLN CONTINENTAL All	
R	68-71	MARK III All	
R	72	MARK IV All	
R	80-83	MARK VI All	
R	81-02	TOWN CAR All	
R	65-66	MERCURY BREEZEWAY All	
R	67	BROUGHAM All	
R	87-91	COLONY PARK All	
R	65-74	COLONY PARK All	
R	66-67	COMET Wagon	
R	65-68	COMMUTER All	
R	74-79	COUGAR All	
R	75-02	GRAND MARQUIS All	
R	69-70	MARAUDER All	
R	65-67	MARAUDER All	
R	67-82	MARQUIS All	
R	65-68	MONTCLAIR All	
R	68-76	MONTGO All	
R	65-74	MONTEREY All	
R	65-68	PARKLANE All	
R	65-67	VILLAGER All	
R	66-67	VOYAGER All	
R	64-72	OLDSMOBILE VISTA CRUISER All	
R	68-69	PONTIAC FIREBIRD All	
69616	W		
R	77-82	PORSCHE 924 All	
R	83-85	944 All	
69622	C		
R	63-82	CHEVROLET CORVETTE All	
69624	C		
R	70-81	CHEVROLET CAMARO All	
R	70-81	PONTIAC FIREBIRD All	
69625	C		
F	55-57	CHEVROLET BEL AIR All	
F	63-82	CORVETTE All	
F	55-57	ONE-FIFTY SERIES All	
F	55-57	TWO-TEN SERIES All	
69632	W		
R	84-93	CHRYSLER DAYTONA CAN	
R	83-84	E CLASS All	
R	85	EXECUTIVE LIMOUSINE All	
R	83-84	EXECUTIVE SEDAN All	
R	90-93	IMPERIAL All Exc. Hydraulic Self Leveling System	
R	84-86	LASER All	
R	81-95	LEBARON All	

Numerical listing

Shock	POP	Alternative No.	MTG Acc. Supplied
Pos.	Year	Application	
69632 W -continued			
R	88-93	NEW YORKER All Exc. Hydraulic Self Leveling System	
R	83-87	NEW YORKER All	
R	86-88	TOWN & COUNTRY All	
R	82-83	DODGE 400 All	
R	83-88	600 All	
R	81-89	ARIES All	
R	92-93	DAYTONA Iroc R/T	
R	91-93	DAYTONA Iroc	
R	89-93	DAYTONA ES	
R	89-90	DAYTONA ES Turbo	
R	87-88	DAYTONA Pacifica	
R	86	DAYTONA Turbo Z	
R	84-85	DAYTONA Turbo	
R	85-89	LANCER All	
R	87-94	SHADOW All	
R	89-95	SPIRIT All	
R	89-95	PLYMOUTH ACCLAIM All	
R	88	CARAVELLE FWD	
R	83-87	CARAVELLE All	
R	81-89	RELIANT All	
R	87-94	SUNDANCE All	
69633 D			
R	78-83	FORD FAIRMONT All	
R	81-82	GRANADA All	
R	83-86	LTD / COUNTRY SEDAN / COUNTRY SQUIRE / CROWN VICTORIA All	
R	84-93	MUSTANG / MUSTANG II LX	
R	84	MUSTANG / MUSTANG II L	
R	82-83	MUSTANG / MUSTANG II GL	
R	82-83	MUSTANG / MUSTANG II GLX	
R	79-81	MUSTANG / MUSTANG II All	
R	79-86	MERCURY CAPRI All	
R	81-82	COUGAR Base	
R	82	COUGAR GS	
R	82	COUGAR LS	
R	83-86	MARQUIS All	
R	78-83	ZEPHYR All	
69661 W			
F	68	MERCEDES-BENZ 200D All	
F	69-73	220 / 220D All W115	
F	68	220 / 220D All	
F	74-76	230 All W115	
F	69	230 All W115	
F	74-76	240D All W115	
F	73-76	280C All W115	
F	76	300D All W115	
F	75	300D All	
F	72	300SD / 300SDL / 300SE / 300SEL / 300TD / 350SD / 350SDL / 350SL / 380SE / 380SEC / 380SEL All	
F	81-84	380SL / 380SLC All	
F	74-80	450SL / 450SLC All	
69670 W			
F	79-93	SAAB 900 All	
69671 W			
R	79-80	SAAB 99 All	
R	93	900 All Mfg. to 7/93	
R	80-92	900 All	
69674 W			
R	79-85	MAZDA RX7 All	
69675 A			
F	71-73	BUICK CENTURION All	
F	71-84	ELECTRA All	
F	87	ESTATE WAGON	
F	71-83	ESTATE WAGON All	
F	71-85	LESABRE All	
F	71-78	RIVIERA All	
F	92-96	ROADMASTER All	
F	91	ROADMASTER Wagon	
F	87-92	CADILLAC BROUGHAM All	
F	92-96	COMMERCIAL CHASSIS RWD	
F	77-84	COMMERCIAL CHASSIS All	
F	77-84	DEVILLE All	
F	93-96	FLEETWOOD RWD	
F	77-86	FLEETWOOD RWD	
F	81	CHEVROLET BEL AIR Sedan Exc. Police and Taxi Models	
F	71-75	BEL AIR Sedan Exc. Police and Taxi Models	
F	65-70	BEL AIR All	
F	71-72	BISCAYNE All	
F	69-72	BROOKWOOD All	
F	70-81	CAMARO All	
F	66-96	CAPRICE All	
F	94-96	IMPALA All	
F	83-85	IMPALA All	
F	82	IMPALA Sedan	

Ultra Shock

Shock	POP	Alternative No.	MTG Acc. Supplied
Pos.	Year	Application	
69675 A -continued			
F	65-81	IMPALA All	
F	69-72	KINGSWOOD All	
F	69-72	TOWNSMAN All	
F	65-74	FORD COUNTRY SEDAN All	
F	87-91	COUNTRY SQUIRE All	
F	65-74	COUNTRY SQUIRE All	
F	92-02	CROWN VICTORIA All	
F	65-72	CUSTOM All	
F	68-77	CUSTOM 500 All	
F	65-67	GALAXIE All	
F	68-74	GALAXIE 500 All	
F	01-02	GRAND MARQUIS All	
F	87-91	LTD / COUNTRY SEDAN / COUNTRY SQUIRE / CROWN VICTORIA All	
F	67-82	LTD / COUNTRY SEDAN / COUNTRY SQUIRE / CROWN VICTORIA All	
F	77-79	LTD II All	
F	65-74	RANCH WAGON All	
F	67-79	THUNDERBIRD All	
F	72-76	TORINO All	
F	70-80	LINCOLN CONTINENTAL All	
F	68-71	MARK III All	
F	72-76	MARK IV All	
F	77-79	MARK V All	
F	80-83	MARK VI All	
F	81-02	TOWN CAR All	
F	65-66	MERCURY BREEZEWAY All	
F	67	BROUGHAM All	
F	87-91	COLONY PARK All	
F	65-74	COLONY PARK All	
F	65-68	COMMUTER All	
F	74-79	COUGAR All	
F	75-02	GRAND MARQUIS All	
F	69-70	MARAUDER All	
F	65-67	MARAUDER All	
F	67-82	MARQUIS All	
F	65-68	MONTECLAIR All	
F	72-76	MONTEGO All	
F	65-74	MONTEREY All	
F	65-68	PARKLANE All	
F	65-67	VILLAGER All	
F	66-67	VOYAGER All	
F	71-85	OLDSMOBILE 88 SERIES All	
F	71-84	98 All	
F	71-92	CUSTOM CRUISER All	
F	71-81	PONTIAC BONNEVILLE All	
F	71-81	CATALINA All	
F	70-81	FIREBIRD All	
F	71-78	GRAND SAFARI All	
F	76-81	LAURENTIAN CAN	
F	76-86	PARISIENNE All	
F	87-89	SAFARI All	
69676 A			
R	82-02	CHEVROLET CAMARO All	
R	82-02	PONTIAC FIREBIRD All	
69677 W			
F	72-86	JAGUAR XJ6 All	
F	81-92	XJ12 All	
F	73-79	XJ12 All	
F	76-96	XJS All	
69689 W			
R	84-91	DODGE COLT Vista, Wagon, FWD	
R	79-83	COLT Hatchback	
R	89-91	EAGLE VISTA Wagon, CAN	
R	86-94	HYUNDAI EXCEL All	
R	84-87	PONY All	
R	91-95	SCOUPE All	
R	83-88	MITSUBISHI CORDIA All	
R	90-94	PRECIS All	
R	87-89	PRECIS All Rebuildable O.E. Front Struts	
R	83-88	TREDIA All	
R	79-82	PLYMOUTH CHAMP All	
R	92-94	COLT Sedan	
R	92	COLT Hatchback	
R	85-91	COLT All	
R	80-84	COLT Hatchback	
69703 W			
R	77-83	CHRYSLER CORDOBA All	
R	83-89	FIFTH AVENUE All	
R	81-83	IMPERIAL All	
R	77-80	LEBARON All	
R	79-81	NEWPORT All	
R	79-82	NEW YORKER All	
R	79-81	TOWN & COUNTRY All	
R	76-80	DODGE ASPEN All	
R	77-78	CHARGER All	
R	77-89	DIPLOMAT All	
R	78-79	MAGNUM All	

Numerical listing

Shock	POP	Alternative No.	MTG Acc. Supplied
Pos.	Year	Application	
69703 W -continued			
R	80-83	MIRADA All	
R	77-78	MONACO All	
R	79-81	ST. REGIS All	
R	88-89	PLYMOUTH CARAVELLE RWD	
R	78-81	CARAVELLE RWD	
R	77-78	FURY All	
R	80-89	GRAN FURY All	
R	76-80	VOLARE All	
69704 W			
F	80-83	CHRYSLER CORDOBA All	
F	83-89	FIFTH AVENUE All	
F	81-83	IMPERIAL All	
F	74-75	IMPERIAL All	
F	77-81	LEBARON All	
F	74-78	NEWPORT All	
F	74-82	NEW YORKER All	
F	74-78	TOWN & COUNTRY All	
F	76-80	DODGE ASPEN All	
F	77-89	DIPLOMAT All	
F	80-83	MIRADA All	
F	74-76	MONACO All	
F	75-77	ROYAL MONACO All	
F	66-70	NISSAN 1600 All	
F	68-70	2000 All	
F	88-89	PLYMOUTH CARAVELLE RWD	
F	78-81	CARAVELLE RWD	
F	74	FURY All	
F	80-89	GRAN FURY All	
F	74-77	GRAN FURY All	
F	76-80	VOLARE All	
69706 W			
F	79-85	BUICK RIVIERA All	
F	79-85	CADILLAC ELDORADO All	
F	80-85	SEVILLE All	
F	79-85	OLDSMOBILE TORONADO All	
69709 W			
R	87-88	FORD THUNDERBIRD Naturally Aspirated (Eng Asp), Non-ABS	
R	80-86	THUNDERBIRD All	
R	82-87	LINCOLN CONTINENTAL All	
R	84-92	MARK VII All	
R	83-88	MERCURY COUGAR All	
R	80-82	COUGAR XR-7	
69713 W			
R	82-85	TOYOTA CELICA All	
R	86	SUPRA All Mfg. to 3/86	
69714 W			
F	84-87	CHEVROLET CORVETTE All	
69715 W			
R	84-87	CHEVROLET CORVETTE All	
69723 W			
R	82-96	BUICK CENTURY All	
R	80-85	SKYLARK All	
R	82-90	CHEVROLET CELEBRITY All	
R	80-85	CITATION / CITATION II All	
R	82-96	OLDSMOBILE CIERA / CUTLASS CIERA All Exc. Electronic Adjustable Suspension	
R	87-94	CUTLASS CLASSIC / CUTLASS CRUISER All Exc. Electronic Adjustable Suspension	
R	80-84	OMEGA All	
R	89-91	PONTIAC 6000 FWD	
R	82-88	6000 All	
R	80-84	PHOENIX All	
69724 C			
R	89-91	AVANTI II All	
R	73	BUICK APOLLO All HD Suspension	
R	71-73	CENTURION All	
R	71-84	ELECTRA All	
R	70	ESTATE WAGON All	
R	71-85	LESABRE All	
R	71-78	RIVIERA All	
R	92-96	ROADMASTER Sedan	
R	64-67	SKYLARK All Exc. HD Suspension	
R	64-67	SPECIAL All Exc. HD Suspension	
R	87-92	CADILLAC BROUGHAM All	
R	92-96	COMMERCIAL CHASSIS RWD	
R	77-84	COMMERCIAL CHASSIS All	
R	77-84	DEVILLE All	
R	93-96	FLEETWOOD RWD	
R	77-86	FLEETWOOD RWD	
R	81	CHEVROLET BEL AIR Sedan	
R	65-75	BEL AIR All	
R	65-72	BISCAYNE All	
R	69-70	BROOKWOOD All	

Numerical listing

Shock	POP	Alternative No.	MTG Acc. Supplied
Pos.	Year	Application	
69724	C	-continued	
R	73-96	CAPRICE Sedan Police and Taxi Models	
R	71-72	CAPRICE Hardtop Police and Taxi Models	
R	66-70	CAPRICE All	
R	64-67	CHEVELLE All Exc. HD Suspension	
R	68	CHEVY II All Multi-Leaf Rear Spring	
R	94-96	IMPALA All	
R	83-85	IMPALA All	
R	81-82	IMPALA Sedan	
R	81	IMPALA Coupe	
R	74-80	IMPALA Coupe Exc. Wagon	
R	74-80	IMPALA Sedan Exc. Wagon	
R	71-73	IMPALA Sedan	
R	73	IMPALA Hardtop	
R	65-70	IMPALA All	
R	69-70	KINGSWOOD All	
R	64-67	MALIBU All Exc. HD Suspension	
R	73	NOVA All HD Suspension	
R	69-72	NOVA All Multi-Leaf Rear Spring	
R	69-70	TOWNSMAN All	
R	65-85	OLDSMOBILE 88 SERIES All	
R	65-84	98 All	
R	64-67	CUTLASS / CUTLASS SUPREME All Exc. HD Suspension	
R	64-67	F85 All Exc. HD Suspension	
R	65-66	STARFIRE All	
R	63-81	PONTIAC BONNEVILLE All	
R	75-81	CATALINA Coupe	
R	71-81	CATALINA Sedan	
R	71-74	CATALINA Hardtop	
R	63-70	CATALINA All	
R	67-70	EXECUTIVE All	
R	63-68	GRAND PRIX All	
R	64-67	GTO All Exc. HD Suspension	
R	76-81	LAURENTIAN CAN	
R	64-67	LEMANS All Exc. HD Suspension	
R	76-86	PARISIENNE Sedan	
R	68-70	SAFARI All	
R	63-65	SAFARI All	
R	63-66	STAR CHIEF All	
R	64-67	TEMPEST All Exc. HD Suspension	
R	73	VENTURA All HD Suspension	
R	71-72	VENTURA All Leaf(RearSpringType)	
69725	W		
R	91	BMW 318i All	
R	84-85	318i All	
R	91	318iS All	
R	87-88	325 All	
R	84-87	325E All	
R	87-92	325i E30 (MfrBodyCode) Exc. Sport Suspension	
R	87-92	325iS All	
R	88-91	M3 All	
69727	W		
F	84-87	PONTIAC FIERO All	
69733	W		
R	80-87	SUBARU BRAT All	
R	80-84	DL All	
R	85-89	GL Hatchback	
R	80-84	GL All	
69749	W		
R	94	ASUNA GT	
R	92	GT	
R	93	GT, SE All	
R	94	SE	
R	92	SE	
R	82-89	BUICK SKYHAWK All	
R	86-94	SKYLARK All	
R	85-87	SOMERSET / SOMERSET REGAL All	
R	82-88	CADILLAC CIMARRON All	
R	92-94	CHEVROLET BERETTA Base Exc. FE7 Suspension	
R	87-91	BERETTA All	
R	82-94	CAVALIER All	
R	87-94	CORSICA All	
R	99-02	DAEWOO LANOS All	
R	92-94	OLDSMOBILE ACHIEVA All Exc. FE3 and Electronic Ride Control	
R	85-87	CALAIS All	
R	88-91	CUTLASS CALAIS All	
R	87-88	FIRENZA All	
R	84-86	FIRENZA All Rebuildable O.E. Struts	
R	82-83	FIRENZA All	
R	85-94	PONTIAC GRAND AM All	
R	82-85	J2000 / SUNBIRD All	
R	86-94	SUNBIRD All	
R	87-91	TEMPEST CAN	

Ultra Shock

Shock	POP	Alternative No.	MTG Acc. Supplied
Pos.	Year	Application	
69755	C		
R	87-93	FORD MUSTANG / MUSTANG II GT, 5.0L 8Cyl V (302)	
R	84-86	MUSTANG / MUSTANG II SVO	
R	82-86	MUSTANG / MUSTANG II GT	
69756	W		
R	86-95	FORD TAURUS Wagon	
R	86-95	MERCURY SABLE Wagon	
69757	W		
R	84-89	NISSAN 300ZX All	
69760	W		
R	87-88	PORSCHE 924 All	
R	86-91	944 All	
69766	C		
R	68-73	MERCEDES-BENZ 200D All	
R	68-73	220 / 220D All	
R	74-78	230 All	
R	68-69	230 All	
R	74-83	240D All	
R	68-70	250 All	
R	87-89	260E All Exc. Hydromat Suspension	
R	76	280 All	
R	73-76	280C All	
R	77-81	280CE / 280E / 280S / 280SE / 280SEL All	
R	75-80	280CE / 280E / 280S / 280SE / 280SEL All Exc. Hydromat Suspension	
R	73	280CE / 280E / 280S / 280SE / 280SEL All Exc. Hydromat Suspension	
R	72	280CE / 280E / 280S / 280SE / 280SEL All Mfg. from 9/72; Exc. Hydromat Suspension	
R	75-84	300D All W123	
R	78-91	300SD / 300SDL / 300SE / 300SEL / 300TD / 350SD / 350SDL / 350SL / 380SE / 380SEC / 380SEL All Exc. Hydromat Suspension	
R	72	300SD / 300SDL / 300SE / 300SEL / 300TD / 350SD / 350SDL / 350SL / 380SE / 380SEC / 380SEL All	
R	81-85	380SL / 380SLC All	
R	86-91	400E / 400SE / 400SEL / 420SEL / 450SE / 450SEL All Exc. Hydromat Suspension	
R	73-80	400E / 400SE / 400SEL / 420SEL / 450SE / 450SEL All Exc. Hydromat Suspension	
R	74-80	450SL / 450SLC All	
R	84-91	500SEC / 500SEL / 500SEC / 560SEC / 560SEL All Exc. Hydromat Suspension	
69773	W		
R	86-98	SAAB 9000 All Hydraulic Self Leveling System	
69782	W		
R	00-06	MAZDA MPV All	
69787	W		
R	75	VOLVO 142 / 144 / 145 / 164 All	
R	75-93	240 / 242 / 244 / 245 / 262 / 264 / 265 All	
R	84	DL All Exc. Hydraulic Self Leveling System	
R	84	GLE All Exc. Hydraulic Self Leveling System	
69794	W		
F	88	CHEVROLET CORVETTE All	
69795	W		
R	89-96	CHEVROLET CORVETTE All Exc. Electronic Adjustable Suspension	
R	88	CORVETTE All	
69805	W		
R	84-92	VOLVO 740 / 745 / 760 / 780 All Mfg. from 5/84; Exc. Hydraulic Self Leveling System	
R	91-95	940 All Exc. Hydraulic Self Leveling System	
R	92-94	960 All Mfg. to 10/94; Exc. Hydraulic Self Leveling System	
69807	W		
R	92-93	MERCEDES-BENZ 400E / 400SE / 400SEL / 420SEL / 450SE / 450SEL All	
R	95	E300 All	
R	94-95	E320 All	

Numerical listing

Shock	POP	Alternative No.	MTG Acc. Supplied
Pos.	Year	Application	
69807	W	-continued	
R	94-95	E420 All	
R	94	E500 All	
69808	W		
R	88-93	CHRYSLER DYNASTY CAN Hydraulic Self Leveling System	
R	88-93	DODGE DYNASTY All Hydraulic Self Leveling System	
69811	W		
F	89-96	CHEVROLET CORVETTE All Exc. Electronic Adjustable Suspension	
69813	W		
R	01-05	TOYOTA RAV4 All	
R	00	RAV4 All Mfg. from 5/00	
69820	W		
R	89-91	FORD THUNDERBIRD All Exc. Electronic Adjustable Suspension	
R	89-91	MERCURY COUGAR All Exc. Electronic Adjustable Suspension	
69845	W		
R	92-97	FORD THUNDERBIRD All Exc. Electronic Adjustable Suspension	
R	92-97	MERCURY COUGAR All Exc. Electronic Adjustable Suspension	
69858	W		
R	80-91	VOLKSWAGEN VANAGON RWD	
69861	W		
F	80-91	VOLKSWAGEN VANAGON RWD	
69863	A		
R	92-98	BMW 318i All	
R	92-98	318iS All	
R	00	323CI All	
R	00	323i Wagon	
R	98-99	323i All	
R	01-06	325CI All	
R	01-05	325i All	
R	92-95	325i E36 (MfrBodyCode)	
R	00	328CI All	
R	96-00	328i All	
R	01-06	330CI All	
R	01-05	330i All	
69877	W		
F	94-96	MERCEDES-BENZ C220 All	
F	97-00	C230 All	
F	94-00	C280 All	
69878	W		
R	94-96	MERCEDES-BENZ C220 All	
R	97-00	C230 All	
R	94-00	C280 All	
69880	X		
R	79-82	MAZDA 626 All From Chassis # CB2MS-543879	
69884	W		
R	75-83	HONDA CIVIC Wagon	
69885	X		
R	81	NISSAN 810 Wagon	
R	82	MAXIMA Wagon	
69891	W		
R	94-98	SAAB 900 All	
R	93	900 All Mfg. from 6/30/93	
69898	A		
R	03-04	FORD MUSTANG / MUSTANG II Mach I	
R	94-04	MUSTANG / MUSTANG II Base	
R	94-04	MUSTANG / MUSTANG II GT	
R	04	MUSTANG / MUSTANG II GT Base	
R	04	MUSTANG / MUSTANG II GT Equipado	
R	01	MUSTANG / MUSTANG II GT Bullitt	
R	95	MUSTANG / MUSTANG II GTS	
69900	A		
R	01-08	FORD ESCAPE All	
R	01-06	MAZDA TRIBUTE All	
69901	D		
R	93-97	VOLVO 850 All Exc. Hydraulic Self Leveling System	
R	98-04	C70 All	
R	98-00	S70 All	
R	98-00	V70 All Mfg. to 3/00 and Exc. XC70, XC Cross Country	

Numerical listing

Shock	POP	Alternative No.	MTG Acc. Supplied
Pos.	Year	Application	
69903	W		
R	95-99	BMW 318TI All	
69907	B		
R	01-06	HYUNDAI SANTA FE All	
69909	A		
R	99-04	HONDA ODYSSEY All	
69945	B		
R	98-10	VOLKSWAGEN BEETLE All	
R	99-06	GOLF A4 (MfrBodyCode)	
R	01-05	JETTA Sedan	
R	99-00	JETTA All	
69946	W		
R	98-04	AUDI A6 All	
R	98-05	VOLKSWAGEN PASSAT FWD From VIN# 3B300001 through VIN# 3B300000	
69950	W		
F	98-02	MERCEDES-BENZ CLK320 All	
F	99-02	CLK430 All	
69951	W		
R	98-02	MERCEDES-BENZ CLK320 All	
R	02	CLK430 All Mfg. to 4/02	
R	99-01	CLK430 All	
69952	D		
F	99	MERCEDES-BENZ E300 All Exc. 4 Matic	
F	96-98	E300 All	
F	96-02	E320 Sedan	
F	97	E420 All	
F	98-02	E430 All	
69956	W		
F	04-08	CHRYSLER CROSSFIRE All	
F	98-04	MERCEDES-BENZ SLK230 All	
F	01-04	SLK320 All	
69957	W		
R	04-08	CHRYSLER CROSSFIRE All	
R	98-04	MERCEDES-BENZ SLK230 All	
R	01-04	SLK320 All	
69962	C		
R	96-05	FORD TAURUS Wagon	
R	96-05	MERCURY SABLE Wagon	
69966	W		
R	99	MERCEDES-BENZ E300 All Exc. 4 Matic	
R	96-98	E300 All	
R	96-02	E320 Sedan	
R	97	E420 All	
R	98-02	E430 All	
69995	W		
R	84-89	MERCEDES-BENZ 190D All	
R	84-93	190E All	
R	87-89	260E All 4 Matic	
R	90-93	300D All W115 4 Matic	
R	87	300D All W115 4 Matic	
R	84-85	300D All W115 4 Matic	
R	86-93	300E All	
69996	W		
F	77-78	MERCEDES-BENZ 230 All Exc. W115	
F	76-83	240D All W123	
F	87-89	260E All Exc. Hydromat Suspension	
F	76	280 All	
F	76	280C All Exc. W115	
F	77-81	280CE / 280E / 280S / 280SE / 280SEL All	
F	75-80	280CE / 280E / 280S / 280SE / 280SEL All Exc. Hydromat Suspension	
F	73	280CE / 280E / 280S / 280SE / 280SEL All Exc. Hydromat Suspension	
F	72	280CE / 280E / 280S / 280SE / 280SEL All Mfg. from 9/72; Exc. Hydromat Suspension	
F	77-84	300D All	
F	76	300D All W123	
F	78-91	300SD / 300SDL / 300SE / 300SEL / 300TD / 350SD / 350SDL / 350SL / 380SE / 380SEC / 380SEL All Exc. Hydromat Suspension	
F	79-85	300SD / 300SDL / 300SE / 300SEL / 300TD / 350SD / 350SDL / 350SL / 380SE / 380SEC / 380SEL All	

Ultra Shock, Max Control

Shock	POP	Alternative No.	MTG Acc. Supplied
Pos.	Year	Application	
69996	W	-continued	
F	86-91	400E / 400SE / 400SEL / 420SEL / 450SE / 450SEL All Exc. Hydromat Suspension	
F	73-80	400E / 400SE / 400SEL / 420SEL / 450SE / 450SEL All Exc. Hydromat Suspension	
F	84-91	500SEC / 500SEL / 500SEC / 560SEC / 560SEL All Exc. Hydromat Suspension	
69998	W		
R	01-03	BMW 525I Wagon Exc. Electronic Adjustable Suspension	
R	99-00	528I Wagon	
R	00-03	540I Wagon Exc. Electronic Adjustable Suspension	
70000	A		
R	02-05	KIA SEDONA All	
70001	W		
R	04-05	KIA RIO All	
70003	A		
R	08-09	MAZDA 3 GS	
R	08-09	3 GT	
R	08-09	3 GX	
R	07-09	3 i	
R	07-09	3 S	
R	04-06	3 All	
R	06-10	5 All	
70010	B		
R	05-10	HONDA ODYSSEY All	
70013	C		
R	06-11	HYUNDAI AZERA All	
R	06-10	SONATA All	
70020	W		
R	01-02	SAAB 9-3 Turbo	
R	99-02	9-3 SE	
R	99-01	9-3 Base	
70023	W		
F	94-99	MERCEDES-BENZ S320 / S350 / S420 / S500 / S600 All Exc. Electronic Ride Control	
70024	W		
R	94-99	MERCEDES-BENZ S320 / S350 / S420 / S500 / S600 All Exc. Electronic Ride Control	
70027	A		
R	07-12	NISSAN SENTRA Base	
R	07-12	SENTRA S	
R	07-12	SENTRA SL	
70028	D		
R	04-06	SCION XA All	
R	04-06	XB All	
70031	D		
R	03-13	CADILLAC CTS All Exc. Magnetic Ride Control Suspension	
70032	W		
R	04-06	PONTIAC GTO All	
70033	D		
R	02-07	MERCEDES-BENZ C230 All	
R	03-05	C240 RWD	
R	01-02	C240 All	
R	06-07	C280 RWD	
R	03-05	C320 RWD	
R	01-02	C320 All	
R	06-07	C350 RWD	
R	03-05	CLK320 All	
R	06-09	CLK350 All	
R	03	CLK430 All	
R	02	CLK430 All Mfg. from 4/02	
R	03-06	CLK500 All	
R	07-09	CLK550 All	
70034	W		
R	04-10	BMW X3 All	
70036	D		
R	06-11	DODGE ATTITUDE All	
R	06-11	HYUNDAI ACCENT All	
R	06-11	KIA RIO All	
R	06-11	RIO All	
70037	D		
R	07-10	HYUNDAI ELANTRA All	

Numerical listing

Shock	POP	Alternative No.	MTG Acc. Supplied
Pos.	Year	Application	
70038	C		
R	12	MERCEDES-BENZ C250 Sedan, CGI (FuelDelSubType)	
R	10-11	C250 All	
R	08-09	C280 All	
R	08-11	C300 All	
R	12	C350 CGI (FuelDelSubType)	
R	08-11	C350 All	
70039	D		
R	03-11	SAAB 9-3 All	
70040	D		
R	01-09	VOLVO S60 All	
R	01-07	V70 All	
70041	C		
R	12	NISSAN VERSA All	
R	07-11	VERSA S	
R	07-11	VERSA SL	
70045	D		
R	08-11	BMW 128I All	
R	08-11	135I All	
R	06	325I All	
R	07-13	328I All	
R	06	330I All	
R	07-13	335I All	
70049	N		
R	07-10	KIA MAGENTIS All	
R	07-10	OPTIMA All	
R	07-11	RONDO All	
70052	N		
R	11-14	FORD FIESTA All	
R	11-14	MAZDA 2 All	
70053	N		
R	08-12	SCION XB All	
R	10-13	TOYOTA PRIUS All	
70055	N		
R	08-10	SCION XD All	
R	12-14	TOYOTA PRIUS C All	
R	06-14	YARIS All	
70056	N		
R	07-13	VOLVO C30 All	
R	04-12	S40 All	
R	05-11	V50 All	
70059	N		
R	10	BUICK ALLURE FWD Exc. Electronic Suspension	
R	13	LACROSSE All Exc. Electronic Suspension	
R	10-12	LACROSSE FWD Exc. Electronic Suspension	
70060	N		
R	07-08	HONDA FIT All	
70061	N		
R	07-13	VOLKSWAGEN EOS All Exc. Electronic Suspension	
70068	N		
R	12-13	HYUNDAI AZERA All	
R	11-14	SONATA All	
R	14	KIA CADENZA All	
R	11	OPTIMA All	
Max Control			
75676	D		
R	82-02	CHEVROLET CAMARO All	
R	82-02	PONTIAC FIREBIRD All	
75755	W		
R	87-93	FORD MUSTANG / MUSTANG II GT, 5.0L 8Cyl V (302)	
R	87-93	MUSTANG / MUSTANG II LX, 5.0L 8Cyl V (302)	
R	84-86	MUSTANG / MUSTANG II SVO	
R	82-86	MUSTANG / MUSTANG II GT	
75795	W		
R	89-96	CHEVROLET CORVETTE All Exc. Electronic Adjustable Suspension	
R	88	CORVETTE All	
75811	W		
F	89-96	CHEVROLET CORVETTE All Exc. Electronic Adjustable Suspension	
F	84-87	CORVETTE All	

Numerical listing

Shock	POP	Alternative No.	MTG Acc. Supplied
Pos.	Year	Application	
75898 W			
R	03-04	FORD MUSTANG / MUSTANG II Mach I	
R	94-04	MUSTANG / MUSTANG II Base	
R	94-04	MUSTANG / MUSTANG II GT	
R	04	MUSTANG / MUSTANG II GT Base	
R	04	MUSTANG / MUSTANG II GT Equipado	
R	01	MUSTANG / MUSTANG II GT Bullitt	
R	95	MUSTANG / MUSTANG II GTS	
77183 W			
F	81-93	DODGE PICKUP 1/2 TON, W100 SERIES All Exc. Lift Kit	
F	61-80	PICKUP 1/2 TON, W100 SERIES All	
F	81-93	PICKUP 1 TON, W300 SERIES All Exc. Quad Suspension and Lift Kit	
F	61-80	PICKUP 1 TON, W300 SERIES All	
R	61-71	PICKUP 1 TON, W300 SERIES All	
F	81-93	PICKUP 3/4 TON, W200 SERIES Standard Cab Pickup Exc. Lift Kit	
F	69-80	PICKUP 3/4 TON, W200 SERIES All	
F	61-67	PICKUP 3/4 TON, W200 SERIES All	
77349 W			
R	87-91	CHEVROLET BLAZER 4WD Full Size; Exc. Quad Suspension and Lift Kit	
R	85-86	BLAZER 4WD Exc. Lift Kit	
R	75-84	BLAZER All Exc. Lift Kit	
R	73-74	BLAZER 4WD Exc. Lift Kit	
R	73-86	PICKUP 1/2 TON, C10 All	
R	73-86	PICKUP 1/2 TON, K10 All Exc. Lift Kit	
R	87	PICKUP 1/2 TON, R10 All	
R	87	PICKUP 1/2 TON, V10 All Exc. Lift Kit	
R	75-86	PICKUP 3/4 TON, C20 Standard Cab Pickup	
R	73-74	PICKUP 3/4 TON, C20 All Standard Cab Pickup	
R	73-86	PICKUP 3/4 TON, K20 All Exc. Lift Kit	
R	87	PICKUP 3/4 TON, R20 Standard Cab Pickup	
R	87	PICKUP 3/4 TON, V20 All Exc. Quad Suspension and Lift Kit	
R	73-86	SUBURBAN 1/2 TON, C10 All	
R	73-86	SUBURBAN 1/2 TON, K10 All Exc. Lift Kit	
R	87-88	SUBURBAN 1/2 TON, R10 All	
R	89-91	SUBURBAN 1/2 TON, R1500 All	
R	89-91	SUBURBAN 1/2 TON, V1500 All Exc. Lift Kit	
R	73-86	SUBURBAN 3/4 TON, C20 All	
R	73-86	SUBURBAN 3/4 TON, K20 All Exc. Lift Kit	
R	87-88	SUBURBAN 3/4 TON, R20 All	
R	89-91	SUBURBAN 3/4 TON, R2500 All	
R	87-88	SUBURBAN 3/4 TON, V20 All Exc. Quad Suspension and Lift Kit	
R	89-91	SUBURBAN 3/4 TON, V2500 All Exc. Lift Kit	
R	73	VAN 1/2 TON, P SERIES All	
R	73-78	VAN 3/4 TON, P SERIES All	
R	73-91	GMC JIMMY All Exc. Lift Kit	
R	73-86	PICKUP 1/2 TON, C15 / C1500 All	
R	73-86	PICKUP 1/2 TON, K15 / K1500 All Exc. Lift Kit	
R	87	PICKUP 1/2 TON, R1500 All	
R	87	PICKUP 1/2 TON, V1500 All Exc. Lift Kit	
R	75-86	PICKUP 3/4 TON, C25 / C2500 Cab & Chassis	
R	75-86	PICKUP 3/4 TON, C25 / C2500 Standard Cab Pickup	
R	73-74	PICKUP 3/4 TON, C25 / C2500 All Exc. Crew Cab & Bonus Cab	
R	73-86	PICKUP 3/4 TON, K25 / K2500 All Exc. Lift Kit	
R	88-89	PICKUP 3/4 TON, R2500 All Exc. Crew Cab & Bonus Cab	
R	87	PICKUP 3/4 TON, R2500 Cab & Chassis Exc. Crew Cab & Bonus Cab	
R	87	PICKUP 3/4 TON, R2500 Standard Cab Pickup Exc. Crew Cab & Bonus Cab	
R	87	PICKUP 3/4 TON, V2500 All Exc. Lift Kit	
R	73-86	SUBURBAN 1/2 TON, C15 / C1500 All	
R	73-86	SUBURBAN 1/2 TON, K15 / K1500 All Exc. Lift Kit	
R	87-91	SUBURBAN 1/2 TON, R1500 All	

Max Control

Shock	POP	Alternative No.	MTG Acc. Supplied
Pos.	Year	Application	
77349 W -continued			
R	87-91	SUBURBAN 1/2 TON, V1500 All Exc. Lift Kit	
R	75-86	SUBURBAN 3/4 TON, C25 / C2500 All	
R	73-74	SUBURBAN 3/4 TON, C25 / C2500 All Exc. Crew Cab & Bonus Cab	
R	73-86	SUBURBAN 3/4 TON, K25 / K2500 All Exc. Lift Kit	
R	87-91	SUBURBAN 3/4 TON, R2500 All	
R	87-91	SUBURBAN 3/4 TON, V2500 All Exc. Lift Kit	
R	73	VAN 1/2 TON, P SERIES All	
R	73-78	VAN 3/4 TON, P SERIES All	
77355 W			
F	69-84	CHEVROLET BLAZER RWD	
F	63-86	PICKUP 1/2 TON, C10 All	
F	87	PICKUP 1/2 TON, R10 All	
F	63-86	PICKUP 1 TON, C30 All	
F	88-91	PICKUP 1 TON, C35/3500 Cab & Chassis	
F	87-88	PICKUP 1 TON, R30 All	
F	89	PICKUP 1 TON, R3500 Standard Cab Pickup	
F	75-86	PICKUP 3/4 TON, C20 Crew Cab Pickup	
F	75-86	PICKUP 3/4 TON, C20 Standard Cab Pickup	
F	63-74	PICKUP 3/4 TON, C20 All	
F	88	PICKUP 3/4 TON, R20 Crew Cab Pickup	
F	87	PICKUP 3/4 TON, R20 All	
F	89	PICKUP 3/4 TON, R2500 All	
F	63-67	SUBURBAN 1/2 TON, 1500 All	
F	63-86	SUBURBAN 1/2 TON, C10 All	
F	68-86	SUBURBAN 1/2 TON, K10 All	
F	87-88	SUBURBAN 1/2 TON, R10 All	
F	89-91	SUBURBAN 1/2 TON, R1500 All	
F	68-86	SUBURBAN 3/4 TON, C20 All	
F	68-86	SUBURBAN 3/4 TON, K20 All Exc. Lift Kit	
F	87-88	SUBURBAN 3/4 TON, R20 All	
F	89-91	SUBURBAN 3/4 TON, R2500 All	
F	63-80	VAN 1/2 TON, P SERIES All	
F	73-90	VAN 1 TON, P SERIES All Exc. Motorhome Chassis	
F	68-72	VAN 1 TON, P SERIES All	
F	68-89	VAN 3/4 TON, P SERIES All	
F	75-84	GMC JIMMY RWD	
F	70-74	JIMMY All RWD	
F	67-86	PICKUP 1/2 TON, C15 / C1500 All	
F	87	PICKUP 1/2 TON, R1500 All	
F	88-91	PICKUP 1 TON, C35/3500 Cab & Chassis	
F	67-78	PICKUP 1 TON, C35/3500 All	
F	87-91	PICKUP 1 TON, R3500 All	
F	85-86	PICKUP 3/4 TON, C25 / C2500 Crew Cab Pickup	
F	75-86	PICKUP 3/4 TON, C25 / C2500 Cab & Chassis	
F	75-86	PICKUP 3/4 TON, C25 / C2500 Standard Cab Pickup	
F	75-83	PICKUP 3/4 TON, C25 / C2500 Crew Cab Pickup	
F	67-74	PICKUP 3/4 TON, C25 / C2500 All	
F	87-89	PICKUP 3/4 TON, R2500 All Exc. Crew Cab & Bonus Cab	
F	63-65	PICKUP 1500 SERIES All	
F	68-86	SUBURBAN 1/2 TON, C15 / C1500 All	
F	87-91	SUBURBAN 1/2 TON, R1500 All	
F	68-86	SUBURBAN 3/4 TON, C25 / C2500 All	
F	87-91	SUBURBAN 3/4 TON, R2500 All	
F	67-80	VAN 1/2 TON, P SERIES All	
F	75-90	VAN 1 TON, P SERIES All Exc. Motorhome Chassis	
F	73-74	VAN 1 TON, P SERIES Base Exc. Motorhome Chassis	
F	68-72	VAN 1 TON, P SERIES All	
F	68-89	VAN 3/4 TON, P SERIES All	
F	63-65	VAN, PB 1000 SERIES All	
77357 W			
F	71-95	CHEVROLET VAN 1/2 TON, G / EXPRESS All	
F	70	VAN 1/2 TON, G / EXPRESS All Independent Front Suspension	
F	78-96	VAN 1 TON, G / EXPRESS All	
F	75	VAN 1 TON, G / EXPRESS 146.0 (WheelBase)	
F	71-74	VAN 1 TON, G / EXPRESS All	
F	78-95	VAN 3/4 TON, G / EXPRESS All Exc. 8600# GVW	

Numerical listing

Shock	POP	Alternative No.	MTG Acc. Supplied
Pos.	Year	Application	
77357 W -continued			
F	71-77	VAN 3/4 TON, G / EXPRESS All	
F	70	VAN 3/4 TON, G / EXPRESS All Independent Front Suspension	
F	71-95	GMC VAN 1/2 TON, G / SAVANNA All	
F	70	VAN 1/2 TON, G / SAVANNA All Independent Front Suspension	
F	71-95	VAN 1 TON, G / SAVANNA All	
F	78-95	VAN 3/4 TON, G / SAVANNA All Exc. 8600# GVW	
F	71-77	VAN 3/4 TON, G / SAVANNA All	
F	70	VAN 3/4 TON, G / SAVANNA All Independent Front Suspension	
77359 W			
F	84-88	DODGE MINI RAM All	
F	72-93	PICKUP 1/2 TON, D100 SERIES All	
F	90-93	PICKUP 3/4 TON, D200 SERIES All Exc. HD Package	
F	82-89	PICKUP 3/4 TON, D200 SERIES All	
F	72-81	PICKUP 3/4 TON, D200 SERIES All Exc. HD Package	
F	75-93	RAMCHARGER RWD	
F	99-03	VAN 1/2 TON, A / B SERIES / RAM 109.3 (WheelBase) Exc. 7000# GVW	
F	81-98	VAN 1/2 TON, A / B SERIES / RAM 109.6 (WheelBase) Exc. 7000# GVW	
F	71-80	VAN 1/2 TON, A / B SERIES / RAM All	
F	99-03	VAN 1 TON, A / B SERIES / RAM All	
F	71-98	VAN 1 TON, A / B SERIES / RAM All Exc. 4000# Front Axle	
F	71-03	VAN 3/4 TON, A / B SERIES / RAM All	
F	74-80	VAN, CB300 All Exc. 4000# Front Axle	
F	81	PLYMOUTH TRAILDUSTER All	
F	75-80	TRAILDUSTER RWD	
F	74-83	VAN 1 TON, PB SERIES All Exc. 4000# Front Axle	
F	74-83	VAN 3/4 TON, PB SERIES All	
77375 C			
F	85-05	CHEVROLET ASTRO RWD	
F	81	BEL AIR All	
F	71-75	BEL AIR All	
F	71-72	BISCAYNE All	
F	80-96	CAPRICE Sedan Police and Taxi Models	
F	78-79	CAPRICE Sedan	
F	73-77	CAPRICE Sedan Police and Taxi Models	
F	71-72	CAPRICE All Sedan; Police and Taxi Models	
F	71-85	IMPALA Sedan Police and Taxi Models	
F	96-02	VAN 1/2 TON, G / EXPRESS All	
F	97-02	VAN 1 TON, G / EXPRESS All	
F	96	VAN 1 TON, G / EXPRESS All Exc. 8600# GVW	
F	96-02	VAN 3/4 TON, G / EXPRESS All Exc. 8600# GVW	
F	93-02	FORD CROWN VICTORIA Police Interceptor Police and Taxi Models	
F	85-05	GMC SAFARI RWD	
F	96-02	VAN 1/2 TON, G / SAVANNA RWD	
F	96-02	VAN 1 TON, G / SAVANNA All	
F	96-02	VAN 3/4 TON, G / SAVANNA All Exc. 8600# GVW	
77377 W			
R	78-79	FORD BRONCO All Exc. Lift Kit	
R	66-77	BRONCO All From Serial #830001; Exc. Lift Kit	
R	66-69	PICKUP 1/2 TON, F-100 All RWD	
R	65	PICKUP 1/2 TON, F-100 All RWD; With Front Coil Springs	
R	75-79	PICKUP 1 TON, F-350 / SUPERDUTY Standard Cab Pickup, RWD	
R	73-74	PICKUP 1 TON, F-350 / SUPERDUTY All	
R	65-79	PICKUP 3/4 TON, F-250 / SUPERDUTY RWD	
R	69-74	VAN 1/2 TON, ECONOLINE / CLUB WAGON All	
R	68	VAN 1/2 TON, ECONOLINE / CLUB WAGON All Late 1968	
R	69-74	VAN 1 TON, ECONOLINE / CLUB WAGON / SUPERDUTY All	

Numerical listing

Shock	POP	Alternative No.	MTG Acc. Supplied
Pos.	Year	Application	
77377 W -continued			
R	68	VAN 1 TON, ECONOLINE / CLUB WAGON / SUPERDUTY All Late 1968	
R	69-74	VAN 3/4 TON, ECONOLINE / CLUB WAGON / SUPERDUTY All	
R	68	VAN 3/4 TON, ECONOLINE / CLUB WAGON / SUPERDUTY All Late 1968	
R	76-83	JEEP CHEROKEE All	
F	74-83	CHEROKEE All	
F	82-83	CJ5 All Exc. Lift Kit	
F	82-86	CJ7 All Exc. Lift Kit	
F	84-91	GRAND WAGONEER All	
R	84-91	GRAND WAGONEER All	
F	74-88	J10 PICKUP All	
R	74-88	J10 PICKUP All	
F	74-88	J20 PICKUP All	
R	74-88	J20 PICKUP All	
F	82-85	SCRAMBLER / CJ8 All	
R	76-83	WAGONEER All	
F	74-83	WAGONEER All	
77389 W			
R	81-93	DODGE PICKUP 1/2 TON, W100 SERIES All Exc. Lift Kit	
R	72-80	PICKUP 1/2 TON, W100 SERIES All	
R	81-93	PICKUP 1 TON, W300 SERIES All Exc. Quad Suspension and Lift Kit	
R	72-80	PICKUP 1 TON, W300 SERIES All	
R	81-93	PICKUP 3/4 TON, W200 SERIES Standard Cab Pickup Exc. Lift Kit	
R	72-80	PICKUP 3/4 TON, W200 SERIES All	
R	76-81	PLYMOUTH TRAILDUSTER 4WD	
77403 C			
R	79-95	CHEVROLET VAN 1 TON, G / EXPRESS All 9200# GVW	
F	85	VAN 1 TON, P SERIES All Motorhome Chassis with I-Beam Front Suspension	
R	97-04	DODGE DAKOTA All	
R	98-03	DURANGO All	
R	79-95	GMC VAN 1 TON, G / SAVANNA Cutaway Van 9200# GVW	
F	85	VAN 1 TON, P SERIES All Motorhome Chassis with I-Beam Front Suspension	
77405 W			
F	55-56	CHEVROLET PICKUP 3100	
F	55-56	PICKUP 3200	
F	55-56	PICKUP 3800	
R	55	FORD F SERIES All F-100	
R	48-52	F SERIES All F-1, F-2 & F-3	
R	61-64	PICKUP 1/2 TON, F-100 All	
R	61-66	PICKUP 1 TON, F-350 / SUPERDUTY All	
R	61-64	PICKUP 3/4 TON, F-250 / SUPERDUTY All	
F	68-76	PICKUP P350 All Up through 8000# GVW	
F	75-76	PICKUP P400 All Up through 8000# GVW	
R	68	INTERNATIONAL 908B All	
R	68	908C All	
R	68	1000B All	
R	68	1000C All Exc. Travelette with 166" Wheelbase	
F	68	1100B All Exc. Travelette with 166" Wheelbase	
R	68	1100B All Exc. Travelette with 166" Wheelbase	
F	68	1100C All Exc. Travelette with 166" Wheelbase	
R	68	1100C All Exc. Travelette with 166" Wheelbase	
F	68	1200B All Exc. Travelette with 166" Wheelbase	
R	68	1200B All Exc. Travelette with 166" Wheelbase	
F	68	1200C All Exc. Travelette with 166" Wheelbase	
R	68	1200C All Exc. Travelette with 166" Wheelbase	
F	68	1300B All Exc. Travelette with 166" Wheelbase	
R	68	1300B All Exc. Travelette with 166" Wheelbase	
F	68	1300C All Exc. Travelette with 166" Wheelbase	
R	68	1300C All Exc. Travelette with 166" Wheelbase	
R	68-72	M1100 / M1200 All	
R	69	M1400 All	

Max Control

Shock	POP	Alternative No.	MTG Acc. Supplied
Pos.	Year	Application	
77405 W -continued			
R	65-67	M SERIES VAN All	
R	66-83	JEEP CJ5 All Exc. Lift Kit	
R	66-75	CJ6 All Exc. Lift Kit	
R	76-86	CJ7 All Exc. Lift Kit	
R	66-74	DJ5 All Exc. Lift Kit	
R	66-68	DJ6 All Exc. Lift Kit	
R	57-60	FC150 All	
F	63-65	FC170 All	
R	63-65	FC170 All	
R	63-66	GLADIATOR All Independent Front Suspension	
R	70-73	JEEPSTER All	
R	81-85	SCRAMBLER / CJ8 All	
R	66-67	UNIVERSAL All Exc. Lift Kit	
R	61-65	UNIVERSAL All	
77406 W			
R	85-96	FORD PICKUP 1/2 TON, F-150 RWD	
R	80-97	PICKUP 1 TON, F-350 / SUPERDUTY RWD Exc. Dual Rear Wheels	
R	97	PICKUP 3/4 TON, F-250 / SUPERDUTY RWD Over 8500# GVW	
R	80-96	PICKUP 3/4 TON, F-250 / SUPERDUTY RWD	
77409 W			
R	80-96	FORD BRONCO All Exc. Lift Kit	
R	80-83	PICKUP 1/2 TON, F-100 RWD	
R	80-84	PICKUP 1/2 TON, F-150 RWD	
R	90-97	PICKUP 1/2 TON, F SUPERDUTY All	
R	80-97	PICKUP 1 TON, F-350 / SUPERDUTY RWD Dual Rear Wheels	
R	97	PICKUP, F-450 SUPERDUTY All	
77410 W			
F	80-96	FORD BRONCO All Quad Suspension; Forward of Front Axle; Exc. Lift Kit	
F	80-96	PICKUP 1/2 TON, F-150 4WD Quad Suspension; Forward of Front Axle; Exc. Lift Kit	
F	80-81	PICKUP 1 TON, F-350 / SUPERDUTY 4WD	
F	80-82	PICKUP 3/4 TON, F-250 / SUPERDUTY 4WD	
77412 A			
R	07	CHEVROLET PICKUP 1/2 TON, SILVERADO 1500 Classic Hybrid, 4WD Classic and Old Body Style; Exc. Electronic Adjustable Suspension	
R	07	PICKUP 1/2 TON, SILVERADO 1500 Classic LS, 4WD Classic and Old Body Style; Exc. Electronic Adjustable Suspension	
R	07	PICKUP 1/2 TON, SILVERADO 1500 Classic LT, 4WD Classic and Old Body Style; Exc. Electronic Adjustable Suspension	
R	07	PICKUP 1/2 TON, SILVERADO 1500 Classic WT, 4WD Classic and Old Body Style; Exc. Electronic Adjustable Suspension	
R	99-06	PICKUP 1/2 TON, SILVERADO 1500 4WD Classic and Old Body Style; Exc. Electronic Adjustable Suspension	
R	05-07	PICKUP 1/2 TON, SILVERADO 1500 HD All	
R	01-03	PICKUP 1/2 TON, SILVERADO 1500 HD All	
R	77-86	PICKUP 1 TON, K30 All	
R	90-91	PICKUP 1 TON, R3500 All	
R	89	PICKUP 1 TON, R3500 Cab & Chassis, RWD	
R	89	PICKUP 1 TON, R3500 Crew Cab Pickup, RWD	
R	01-09	PICKUP 1 TON, SILVERADO 3500 All	
R	07-10	PICKUP 1 TON, SILVERADO 3500 HD All	
R	87-88	PICKUP 1 TON, V30 All	
R	89-91	PICKUP 1 TON, V3000 / V3500 All	
R	99-08	PICKUP 3/4 TON, SILVERADO 2500 All	
R	01-10	PICKUP 3/4 TON, SILVERADO 2500 HD All	

Numerical listing

Shock	POP	Alternative No.	MTG Acc. Supplied
Pos.	Year	Application	
77412 A -continued			
R	06-07	DODGE PICKUP 1/2 TON, RAM 1500 (SEE RAM 1500) All Exc. Mega Cab	
R	02-05	PICKUP 1/2 TON, RAM 1500 (SEE RAM 1500) All	
R	77-86	GMC PICKUP 1 TON, K35 / K3500 All	
R	87-91	PICKUP 1 TON, V3000 / V3500 All	
R	07	SIERRA 1500 Classic Hybrid, 4WD Classic and Old Body Style; Exc. Electronic Adjustable Suspension	
R	07	SIERRA 1500 Classic SL, 4WD Classic and Old Body Style; Exc. Electronic Adjustable Suspension	
R	07	SIERRA 1500 Classic SLE, 4WD Classic and Old Body Style; Exc. Electronic Adjustable Suspension	
R	07	SIERRA 1500 Classic SLT, 4WD Classic and Old Body Style; Exc. Electronic Adjustable Suspension	
R	07	SIERRA 1500 Classic WT, 4WD Classic and Old Body Style; Exc. Electronic Adjustable Suspension	
R	99-06	SIERRA 1500 4WD Classic and Old Body Style; Exc. Electronic Adjustable Suspension	
R	05-07	SIERRA 1500 HD All	
R	01-03	SIERRA 1500 HD All	
R	99-04	SIERRA 2500 All	
R	01-10	SIERRA 2500 HD All	
R	01-07	SIERRA 3500 All	
R	07-10	SIERRA 3500 HD All	
77413 W			
R	78-95	CHEVROLET VAN 1/2 TON, G / EXPRESS All	
R	85-91	VAN 1 TON, G / EXPRESS Extended Cargo Van	
R	85-91	VAN 1 TON, G / EXPRESS Extended Passenger Van	
R	78-91	VAN 1 TON, G / EXPRESS Standard Cargo Van	
R	78-91	VAN 1 TON, G / EXPRESS Standard Passenger Van	
R	78-95	VAN 3/4 TON, G / EXPRESS All Exc. 8600# GVW	
R	84-88	DODGE MINI RAM All	
R	99-03	VAN 1/2 TON, A / B SERIES / RAM 109.3 (WheelBase) Exc. 7000# GVW	
R	81-98	VAN 1/2 TON, A / B SERIES / RAM 109.6 (WheelBase) Exc. 7000# GVW	
R	71-80	VAN 1/2 TON, A / B SERIES / RAM All	
R	99-03	VAN 1 TON, A / B SERIES / RAM All	
R	94-98	VAN 1 TON, A / B SERIES / RAM All Exc. 4000# Front Axle	
R	71-93	VAN 1 TON, A / B SERIES / RAM All	
R	71-03	VAN 3/4 TON, A / B SERIES / RAM All	
R	74-80	VAN, CB300 All Over 8300# GVW	
R	78-95	GMC VAN 1/2 TON, G / SAVANNA All	
R	78-95	VAN 3/4 TON, G / SAVANNA All Exc. 8600# GVW	
R	74-83	PLYMOUTH VAN 1/2 TON, PB SERIES All	
R	74-83	VAN 1 TON, PB SERIES All	
R	74-83	VAN 3/4 TON, PB SERIES All	
77414 C			
F	80-96	FORD BRONCO All Quad & Non Quad Suspensions Rearward of Front Axle; Exc. Lift Kit	
F	89	BRONCO II All Mfg. from 2/89; Vehicles with 12mm bolt in rear lower mount	
F	84-88	BRONCO II All With 10mm Bolt In Rear Lower Mount	
F	80-83	PICKUP 1/2 TON, F-100 RWD	
F	80-96	PICKUP 1/2 TON, F-150 4WD Quad & Non Quad Suspensions Rearward of Front Axle; Exc. Lift Kit	
F	80-96	PICKUP 1/2 TON, F-150 RWD	
F	80-97	PICKUP 1 TON, F-350 / SUPERDUTY RWD	
F	97	PICKUP 3/4 TON, F-250 / SUPERDUTY RWD Over 8500# GVW	
F	80-96	PICKUP 3/4 TON, F-250 / SUPERDUTY RWD	
F	87-89	RANGER All Exc. High Ryder Option	

Numerical listing

Shock	POP	Alternative No.	MTG Acc. Supplied
Pos.	Year	Application	
77414 C -continued			
F	83-86	RANGER All	
77418 W			
F	82	DODGE D50 4WD	
F	87-93	PICKUP, RAM 50 4WD	
F	87-89	RAIDER All	
F	95-96	MITSUBISHI MIGHTY MAX RWD	
F	83-94	MIGHTY MAX 4WD	
F	83-91	MONTERO All	
77421 D			
F	05	CHEVROLET BLAZER Base, RWD	
F	96-04	BLAZER LS, RWD	
F	95-02	BLAZER LT, RWD	
F	95-99	BLAZER Base, RWD	
F	95-97	BLAZER Deluxe, RWD	
F	83-94	BLAZER, S MODELS RWD	
F	94-03	S10 LS, RWD	
F	82-03	S10 Base, RWD	
F	92-93	S10 EL, RWD	
F	83-92	S10 Tahoe, RWD	
F	88-90	S10 Durango, RWD	
F	82-86	S10 Durango, RWD	
F	72-82	FORD COURIER All	
F	92-04	GMC JIMMY RWD	
F	83-91	S15 JIMMY RWD	
F	04	SONOMA / S15 All RWD	
F	82-03	SONOMA / S15 RWD	
F	78-87	SPRINT / CABALLERO RWD	
F	71-77	SPRINT / CABALLERO All	
F	96-00	ISUZU HOMBRE RWD Exc. Sport Chassis	
F	72-76	MAZDA B1600 All	
F	77-78	B1800 All	
F	79-84	B2000 All	
F	82-84	B2200 All	
77422 C			
R	05	CHEVROLET BLAZER Base, 4WD	
R	05	BLAZER Base, RWD	
R	96-04	BLAZER LS, 4WD	
R	96-04	BLAZER LS, RWD	
R	95-02	BLAZER LT, RWD	
R	95-01	BLAZER LT, 4WD	
R	95-99	BLAZER Base, 4WD	
R	95-99	BLAZER Base, RWD	
R	95-97	BLAZER Deluxe, RWD	
R	83-94	BLAZER, S MODELS All	
R	99-04	S10 LS, 4WD	
R	99-03	S10 Base, 4WD	
R	99-03	S10 Base, RWD	
R	99-03	S10 LS, RWD	
R	94-98	S10 LS	
R	82-98	S10 Base	
R	92-93	S10 EL	
R	83-92	S10 Tahoe	
R	88-90	S10 Durango	
R	82-86	S10 Durango	
R	05	GMC JIMMY 4WD	
R	92-04	JIMMY All	
R	83-91	S15 JIMMY All	
R	82-04	SONOMA / S15 All	
R	91	SYCLONE All	
R	92-93	TYPHOON All	
R	96-00	ISUZU HOMBRE All	
R	96-01	OLDSMOBILE BRAVADA All	
R	91-94	BRAVADA All	
77423 C			
F	05	CHEVROLET BLAZER Base, 4WD	
F	96-04	BLAZER LS, 4WD	
F	95-01	BLAZER LT, 4WD	
F	95-99	BLAZER Base, 4WD	
F	83-94	BLAZER, S MODELS 4WD	
F	94-04	S10 LS, 4WD	
F	83-03	S10 Base, 4WD	
F	92-93	S10 EL, 4WD	
F	83-92	S10 Tahoe, 4WD	
F	88-90	S10 Durango, 4WD	
F	83-86	S10 Durango, 4WD	
F	92-05	GMC JIMMY 4WD	
F	83-91	S15 JIMMY 4WD	
F	83-04	SONOMA / S15 4WD	
F	91	SYCLONE All	
F	92-93	TYPHOON All	
F	99-00	ISUZU HOMBRE 4WD	
F	96-98	HOMBRE All Sport Chassis	
F	96-01	OLDSMOBILE BRAVADA All	
F	91-94	BRAVADA All	
77424 W			
F	84-01	JEEP CHEROKEE All	
F	86-92	COMANCHE All	
F	93-98	GRAND CHEROKEE All	
F	84-90	WAGONEER All	

Max Control

Shock	POP	Alternative No.	MTG Acc. Supplied
Pos.	Year	Application	
77425 W			
R	84-01	JEEP CHEROKEE All	
R	84-90	WAGONEER All	
77454 D			
R	90-05	CHEVROLET ASTRO All	
R	85-89	ASTRO RWD	
R	90-05	GMC SAFARI All	
R	85-89	SAFARI RWD	
77455 W			
F	86-97	FORD PICKUP 1 TON, F-350 / SUPERDUTY 4WD	
F	97-98	PICKUP 3/4 TON, F-250 / SUPERDUTY 4WD Over 8500# GVW	
F	87-96	PICKUP 3/4 TON, F-250 / SUPERDUTY 4WD	
77456 W			
R	86-97	FORD PICKUP 1 TON, F-350 / SUPERDUTY 4WD Exc. Dual Rear Wheels	
77461 D			
R	80-96	FORD PICKUP 1/2 TON, F-150 4WD Exc. Lift Kit	
R	86-97	PICKUP 1 TON, F-350 / SUPERDUTY 4WD Dual Rear Wheels	
R	82-85	PICKUP 1 TON, F-350 / SUPERDUTY 4WD Clevis Type Lower Front Mount; Exc. Dual Rear Wheels or Lift Kit	
R	80-81	PICKUP 1 TON, F-350 / SUPERDUTY 4WD	
R	97	PICKUP 3/4 TON, F-250 / SUPERDUTY 4WD Over 8500# GVW	
R	87-96	PICKUP 3/4 TON, F-250 / SUPERDUTY 4WD	
R	82-86	PICKUP 3/4 TON, F-250 / SUPERDUTY 4WD Clevis Type Lower Front Mount; Exc. Dual Rear Wheels or Lift Kit	
R	80-81	PICKUP 3/4 TON, F-250 / SUPERDUTY 4WD	
R	99-04	PICKUP, F-450 SUPERDUTY All	
R	99-04	PICKUP, F-550 SUPERDUTY All	
77479 W			
F	86-95	TOYOTA 4RUNNER All	
F	86-95	PICKUP 4WD Exc. Lift Kit	
F	93-98	T100 4WD	
77488 A			
R	88-99	CHEVROLET PICKUP 1/2 TON, C15 / C1500 All	
R	88-99	PICKUP 1/2 TON, K15 / K1500 All	
R	91-03	PICKUP 1 TON, C35/3500 All	
R	88-90	PICKUP 1 TON, C35/3500 Extended Cab Pickup Exc. HD Straight Front Axle	
R	88-90	PICKUP 1 TON, C35/3500 Standard Cab Pickup Exc. HD Straight Front Axle	
R	88-00	PICKUP 1 TON, K35 / K3500 All	
R	88-00	PICKUP 3/4 TON, C25 / C2500 All	
R	88-00	PICKUP 3/4 TON, K25 / K2500 All	
R	88-99	GMC PICKUP 1/2 TON, C15 / C1500 All	
R	88-99	PICKUP 1/2 TON, K15 / K1500 All	
R	91-00	PICKUP 1 TON, C35/3500 All	
R	88-90	PICKUP 1 TON, C35/3500 Extended Cab Pickup Exc. HD Straight Front Axle	
R	88-90	PICKUP 1 TON, C35/3500 Standard Cab Pickup Exc. HD Straight Front Axle	
R	88-00	PICKUP 1 TON, K35 / K3500 All	
R	88-00	PICKUP 3/4 TON, C25 / C2500 All	
R	88-00	PICKUP 3/4 TON, K25 / K2500 All	
77489 B			
F	88-99	CHEVROLET PICKUP 1/2 TON, C15 / C1500 All	
F	01-03	PICKUP 1 TON, C35/3500 Base Exc. HD Straight Front Axle	
F	98-00	PICKUP 1 TON, C35/3500 All Exc. HD Straight Front Axle	
F	92-97	PICKUP 1 TON, C35/3500 Crew Cab Pickup Exc. HD Straight Front Axle	
F	88-97	PICKUP 1 TON, C35/3500 Extended Cab Pickup Exc. HD Straight Front Axle	

Numerical listing

Shock	POP	Alternative No.	MTG Acc. Supplied
Pos.	Year	Application	
77489 B -continued			
F	88-97	PICKUP 1 TON, C35/3500 Standard Cab Pickup Exc. HD Straight Front Axle	
F	88-00	PICKUP 3/4 TON, C25 / C2500 All	
F	92-99	SUBURBAN 1/2 TON, C15 / C1500 All	
F	92-99	SUBURBAN 3/4 TON, C25 / C2500 All	
F	95-00	TAHOE RWD Old Body Style	
F	88-99	GMC PICKUP 1/2 TON, C15 / C1500 All	
F	92-00	PICKUP 1 TON, C35/3500 Crew Cab Pickup Exc. HD Straight Front Axle	
F	88-00	PICKUP 1 TON, C35/3500 Extended Cab Pickup Exc. HD Straight Front Axle	
F	88-00	PICKUP 1 TON, C35/3500 Standard Cab Pickup Exc. HD Straight Front Axle	
F	88-00	PICKUP 3/4 TON, C25 / C2500 All	
F	92-99	SUBURBAN 1/2 TON, C15 / C1500 All	
F	92-99	SUBURBAN 3/4 TON, C25 / C2500 All	
F	92-99	YUKON RWD	
77492 D			
R	81-82	CHEVROLET LUV PICKUP All	
R	87-89	DODGE RAIDER 2.6L 4Cyl L (156) Exc. Sport Utility	
F	61-67	FORD ECONOLINE All	
F	68	VAN 1/2 TON, ECONOLINE / CLUB WAGON All Mfg. to 7/68	
F	81-95	ISUZU PICKUP All	
R	86-92	JEEP COMANCHE All	
F	66-73	WAGONEER All	
F	63-65	WAGONEER All Exc. Independent Front Suspension	
R	83-89	MITSUBISHI MONTERO 2.6L 4Cyl L (156)	
R	97-99	MONTERO SPORT All	
R	82-86	NISSAN 720 PICKUP 4WD	
R	00-04	FRONTIER Crew Cab Pickup, RWD with Desert Runner	
R	98-04	FRONTIER 4WD	
R	98-99	FRONTIER RWD Crew Cab with Desert Runner	
R	87-95	PATHFINDER All Exc. Electronic Adjustable Suspension	
R	87-97	PICKUP 4WD	
R	86	PICKUP 4WD Mfg. from 8/86	
R	00-04	XTERRA All	
R	84-87	TOYOTA LAND CRUISER FJ60 (MfrBodyCode), Sport Utility	
R	76-83	LAND CRUISER All	
R	75	LAND CRUISER All Mfg. to 2/75	
R	69-74	LAND CRUISER All	
R	85-92	PICKUP RWD 1 Ton	
R	80-83	PICKUP 4WD Exc. Lift Kit	
R	93-98	T100 RWD	
77494 C			
R	84-89	TOYOTA 4RUNNER All	
R	84-95	PICKUP 4WD Exc. Lift Kit	
R	98-04	TACOMA Pre Runner, RWD	
R	04	TACOMA Base, 4WD	
R	95-03	TACOMA 4WD	
77524 D			
R	06-11	FORD RANGER RWD, Torsion Bar (FrontSpringType)	
R	90-11	RANGER 4WD	
R	01-05	RANGER Edge, RWD	
R	89	RANGER 4WD Mfg. from 2/89; Vehicles with 12mm bolt in rear lower mount	
R	95-96	MAZDA B2300 4WD	
R	03-06	B3000 All 4WD	
R	98-02	B3000 4WD	
R	98-06	B4000 4WD	
77525 D			
R	90	FORD BRONCO II All	
R	89	BRONCO II All Mfg. from 2/89; Vehicles with 12mm bolt in rear lower mount	
R	06-11	RANGER RWD, Coil (FrontSpringType)	
R	98-05	RANGER XL, RWD	
R	98-05	RANGER XLT, RWD	
R	05	RANGER STX, RWD	
R	04	RANGER Tremor, RWD	
R	90-97	RANGER RWD	

Numerical listing

Shock	POP	Alternative No.	MTG Acc. Supplied
Pos.	Year	Application	
77525	D	-continued	
R	89	RANGER RWD Mfg. from 2/89; Vehicles with 12mm bolt in rear lower mount	
R	01-06	MAZDA B2300 RWD	
R	94-97	B2300 RWD	
R	98-01	B2500 RWD	
R	94-06	B3000 RWD	
R	94-06	B4000 RWD	
77607	W		
R	00-05	FORD EXCURSION RWD	
R	91-94	EXPLORER All	
R	91-94	MAZDA NAVAJO All	
77608	W		
F	91-94	FORD EXPLORER All	
F	92-11	VAN 1/2 TON, ECONOLINE / CLUB WAGON All	
F	91-94	MAZDA NAVAJO All	
77609	A		
F	99-00	CADILLAC ESCALADE All	
F	90-05	CHEVROLET ASTRO AWD	
F	92-94	BLAZER 4WD Full Size	
F	88-99	PICKUP 1/2 TON, K15 / K1500 All	
F	88-00	PICKUP 1 TON, K35 / K3500 All	
F	88-00	PICKUP 3/4 TON, K25 / K2500 All	
F	92-99	SUBURBAN 1/2 TON, K15 / K1500 All	
F	92-99	SUBURBAN 3/4 TON, K25 / K2500 All	
F	95-00	TAHOE 4WD Old Body Style	
F	88-99	GMC PICKUP 1/2 TON, K15 / K1500 All	
F	88-00	PICKUP 1 TON, K35 / K3500 All	
F	88-00	PICKUP 3/4 TON, K25 / K2500 All	
F	90-05	SAFARI AWD	
F	92-99	SUBURBAN 1/2 TON, K15 / K1500 All	
F	92-99	SUBURBAN 3/4 TON, K25 / K2500 All	
F	92-99	YUKON 4WD	
77614	A		
F	90	FORD BRONCO II All	
F	00-05	EXCURSION RWD	
F	90-97	RANGER All	
F	07-11	VAN 1 TON, ECONOLINE / CLUB WAGON / SUPERDUTY All Exc. Ambulance & Handling Package	
F	03-10	VAN 1 TON, ECONOLINE / CLUB WAGON / SUPERDUTY All	
F	92-05	VAN 1 TON, ECONOLINE / CLUB WAGON / SUPERDUTY All Motorhome Conversion	
F	92-11	VAN 3/4 TON, ECONOLINE / CLUB WAGON / SUPERDUTY All	
F	94-97	MAZDA B2300 All	
F	94-97	B3000 RWD	
F	94-97	B4000 RWD	
77623	D		
R	03-11	FORD VAN 1 TON, ECONOLINE / CLUB WAGON / SUPERDUTY All Exc. Ambulance & Handling Package	
R	07-08	VAN 1 TON, ECONOLINE / CLUB WAGON / SUPERDUTY All	
R	92-05	VAN 1 TON, ECONOLINE / CLUB WAGON / SUPERDUTY All Motorhome Conversion	
R	92-11	VAN 3/4 TON, ECONOLINE / CLUB WAGON / SUPERDUTY All	
77638	A		
R	99-00	CADILLAC ESCALADE All	
R	92-94	CHEVROLET BLAZER 4WD Full Size	
R	92-99	SUBURBAN 1/2 TON, C15 / C1500 All	
R	92-99	SUBURBAN 1/2 TON, K15 / K1500 All	
R	92-99	SUBURBAN 3/4 TON, C25 / C2500 All	
R	92-99	SUBURBAN 3/4 TON, K25 / K2500 All	
R	95-00	TAHOE All Old Body Style	
R	96-11	VAN 1/2 TON, G / EXPRESS All	
R	03-12	VAN 1 TON, G / EXPRESS All	
R	03-12	VAN 3/4 TON, G / EXPRESS All	
R	96-02	VAN 3/4 TON, G / EXPRESS All Exc. 8600# GVW	
R	92-99	GMC SUBURBAN 1/2 TON, C15 / C1500 All	

Max Control

Shock	POP	Alternative No.	MTG Acc. Supplied
Pos.	Year	Application	
77638	A	-continued	
R	92-99	SUBURBAN 1/2 TON, K15 / K1500 All	
R	92-99	SUBURBAN 3/4 TON, C25 / C2500 All	
R	92-99	SUBURBAN 3/4 TON, K25 / K2500 All	
R	96-11	VAN 1/2 TON, G / SAVANNA RWD	
R	04-12	VAN 1 TON, G / SAVANNA All	
R	96-02	VAN 1 TON, G / SAVANNA All Exc. 8600# GVW	
R	96	VAN 1 TON, G / SAVANNA All 7100, 7400 and 8600# GVW	
R	03-12	VAN 3/4 TON, G / SAVANNA All	
R	96-02	VAN 3/4 TON, G / SAVANNA All Exc. 8600# GVW	
R	92-99	YUKON All	
77660	W		
R	93-98	TOYOTA T100 4WD	
77661	C		
F	94-01	DODGE PICKUP 1/2 TON, RAM 1500 (SEE RAM 1500) RWD	
F	94-02	PICKUP 1 TON, RAM 3500 (SEE RAM 3500) RWD Exc. Solid Front Axle	
F	94-02	PICKUP 3/4 TON, RAM 2500 (SEE RAM 2500) RWD	
77662	A		
R	07	CHEVROLET PICKUP 1/2 TON, SILVERADO 1500 Classic Hybrid, RWD	
R	07	PICKUP 1/2 TON, SILVERADO 1500 Classic LS, RWD	
R	07	PICKUP 1/2 TON, SILVERADO 1500 Classic LT, RWD	
R	07	PICKUP 1/2 TON, SILVERADO 1500 Classic SS, RWD	
R	07	PICKUP 1/2 TON, SILVERADO 1500 Classic WT, RWD	
R	99-06	PICKUP 1/2 TON, SILVERADO 1500 RWD Exc. Electronic Adjustable Suspension	
R	74-80	VAN 1/2 TON, P SERIES All	
R	79-89	VAN 3/4 TON, P SERIES All	
R	94-01	DODGE PICKUP 1/2 TON, RAM 1500 (SEE RAM 1500) All	
R	94-02	PICKUP 1 TON, RAM 3500 (SEE RAM 3500) RWD Exc. Solid Front Axle	
R	94-02	PICKUP 3/4 TON, RAM 2500 (SEE RAM 2500) 4WD, GAS Exc. 8800# GVW	
R	94-02	PICKUP 3/4 TON, RAM 2500 (SEE RAM 2500) RWD	
R	95-96	PICKUP 3/4 TON, RAM 2500 (SEE RAM 2500) 4WD, CNG Exc. 8800# GVW	
R	07	GMC SIERRA 1500 Classic Hybrid, RWD Exc. Electronic Adjustable Suspension	
R	07	SIERRA 1500 Classic SL, RWD Exc. Electronic Adjustable Suspension	
R	07	SIERRA 1500 Classic SLE, RWD Exc. Electronic Adjustable Suspension	
R	07	SIERRA 1500 Classic SLT, RWD Exc. Electronic Adjustable Suspension	
R	07	SIERRA 1500 Classic WT, RWD Exc. Electronic Adjustable Suspension	
R	99-06	SIERRA 1500 RWD Exc. Electronic Adjustable Suspension	
R	74-80	VAN 1/2 TON, P SERIES All	
R	75-99	VAN 1 TON, P SERIES All	
R	73-74	VAN 1 TON, P SERIES Base Exc. Motorhome Chassis	
R	74	VAN 1 TON, P SERIES Motor Home	
77673	D		
F	94-01	DODGE PICKUP 1/2 TON, RAM 1500 (SEE RAM 1500) 4WD	
F	94-02	PICKUP 3/4 TON, RAM 2500 (SEE RAM 2500) 4WD, GAS Exc. 8800# GVW	
77674	D		
F	94-02	DODGE PICKUP 1 TON, RAM 3500 (SEE RAM 3500) 4WD	
F	94-02	PICKUP 1 TON, RAM 3500 (SEE RAM 3500) RWD Solid Front Axle	

Numerical listing

Shock	POP	Alternative No.	MTG Acc. Supplied
Pos.	Year	Application	
77674	D	-continued	
F	94-02	PICKUP 3/4 TON, RAM 2500 (SEE RAM 2500) 4WD, DIESEL 8800# GVW	
77675	C		
R	94-02	DODGE PICKUP 1 TON, RAM 3500 (SEE RAM 3500) 4WD	
R	94-02	PICKUP 1 TON, RAM 3500 (SEE RAM 3500) RWD Solid Front Axle	
R	94-02	PICKUP 3/4 TON, RAM 2500 (SEE RAM 2500) 4WD 8800# GVW	
77678	C		
F	95-01	FORD EXPLORER All Exc. Adjustable Suspension	
F	01-05	EXPLORER SPORT TRAC All	
F	06-11	RANGER RWD, Torsion Bar (FrontSpringType)	
F	98-11	RANGER 4WD	
F	01-05	RANGER Edge, RWD	
F	03-06	MAZDA B3000 All 4WD	
F	98-02	B3000 4WD	
F	98-06	B4000 4WD	
F	97-01	MERCURY MOUNTAINEER All Exc. Electronic Adjustable Suspension	
77679	W		
R	95-01	FORD EXPLORER All Exc. Adjustable Suspension	
R	01-05	EXPLORER SPORT TRAC All	
R	97-01	MERCURY MOUNTAINEER All Exc. Electronic Adjustable Suspension	
77683	W		
R	93-98	JEEP GRAND CHEROKEE All	
77714	B		
F	97-02	FORD EXPEDITION RWD Exc. Front Air- Leveling	
F	97-04	PICKUP 1/2 TON, F-150 RWD	
F	96-99	PICKUP 3/4 TON, F-250 / SUPERDUTY RWD Up through 8500# GVW	
F	98-02	LINCOLN NAVIGATOR RWD	
77715	C		
R	97-04	FORD PICKUP 1/2 TON, F-150 4WD Exc. 7700# GVW	
R	97-99	PICKUP 3/4 TON, F-250 / SUPERDUTY 4WD Up through 8500# GVW; Exc. Superduty	
77716	B		
F	97-02	FORD EXPEDITION 4WD Exc. Front Air- Leveling	
F	04	PICKUP 1/2 TON, F-150 4WD Exc. 7700# GVW	
F	97-03	PICKUP 1/2 TON, F-150 4WD	
F	97-99	PICKUP 3/4 TON, F-250 / SUPERDUTY 4WD Up through 8500# GVW; Exc. Superduty	
77717	C		
R	97-02	FORD EXPEDITION All	
R	98-02	LINCOLN NAVIGATOR RWD	
77726	C		
R	90-02	TOYOTA 4RUNNER All	
77772	W		
F	06-11	FORD RANGER RWD, Coil (FrontSpringType)	
F	98-05	RANGER XL, RWD	
F	98-05	RANGER XLT, RWD	
F	05	RANGER STX, RWD	
F	04	RANGER Tremor, RWD	
F	01-06	MAZDA B2300 RWD	
F	98-01	B2500 RWD	
F	98-06	B3000 RWD	
F	98-06	B4000 RWD	
77778	B		
R	04	FORD PICKUP 1/2 TON, F-150 RWD	
R	00-03	PICKUP 1/2 TON, F-150 Harley-Davidson Edition, RWD	
R	99-03	PICKUP 1/2 TON, F-150 Lariat, RWD	
R	99-03	PICKUP 1/2 TON, F-150 XL, RWD	
R	99-03	PICKUP 1/2 TON, F-150 XLT, RWD	
R	00	PICKUP 1/2 TON, F-150 Base, RWD	
R	97-98	PICKUP 1/2 TON, F-150 RWD	

Numerical listing

Shock	POP	Alternative No.	MTG Acc. Supplied
Pos.	Year	Application	
77778	B	-continued	
R	97-99	PICKUP 3/4 TON, F-250 / SUPERDUTY RWD Up through 8500# GVW	
77781	W		
R	92-00	MITSUBISHI MONTERO All	
77782	W		
F	92-00	MITSUBISHI MONTERO All	
F	97-99	MONTERO SPORT All	
77783	A		
F	07	CHEVROLET PICKUP 1/2 TON, SILVERADO 1500 Classic Hybrid, RWD Exc. Electronic Adjustable Suspension	
F	07	PICKUP 1/2 TON, SILVERADO 1500 Classic LS, RWD Exc. Electronic Adjustable Suspension	
F	07	PICKUP 1/2 TON, SILVERADO 1500 Classic LT, RWD Exc. Electronic Adjustable Suspension	
F	07	PICKUP 1/2 TON, SILVERADO 1500 Classic SS, RWD Exc. Electronic Adjustable Suspension	
F	07	PICKUP 1/2 TON, SILVERADO 1500 Classic WT, RWD Exc. Electronic Adjustable Suspension	
F	99-06	PICKUP 1/2 TON, SILVERADO 1500 RWD Exc. Electronic Adjustable Suspension	
F	07	GMC SIERRA 1500 Classic Hybrid, RWD Exc. Electronic Adjustable Suspension	
F	07	SIERRA 1500 Classic SL, RWD Exc. Electronic Adjustable Suspension	
F	07	SIERRA 1500 Classic SLE, RWD Exc. Electronic Adjustable Suspension	
F	07	SIERRA 1500 Classic SLT, RWD Exc. Electronic Adjustable Suspension	
F	07	SIERRA 1500 Classic WT, RWD Exc. Electronic Adjustable Suspension	
F	99-06	SIERRA 1500 RWD Exc. Electronic Adjustable Suspension	
77803	A		
F	02-06	CHEVROLET AVALANCHE 1500 All Exc. Electronic Ride Control	
F	07	PICKUP 1/2 TON, SILVERADO 1500 Classic Hybrid, 4WD Classic and Old Body Style; Exc. Electronic Adjustable Suspension	
F	07	PICKUP 1/2 TON, SILVERADO 1500 Classic LS, 4WD Classic and Old Body Style; Exc. Electronic Adjustable Suspension	
F	07	PICKUP 1/2 TON, SILVERADO 1500 Classic LT, 4WD Classic and Old Body Style; Exc. Electronic Adjustable Suspension	
F	07	PICKUP 1/2 TON, SILVERADO 1500 Classic LT, 4WD Classic and Old Body Style; Exc. Electronic Adjustable Suspension	
F	07	PICKUP 1/2 TON, SILVERADO 1500 Classic WT, 4WD Classic and Old Body Style; Exc. Electronic Adjustable Suspension	
F	99-06	PICKUP 1/2 TON, SILVERADO 1500 4WD Classic and Old Body Style; Exc. Electronic Adjustable Suspension	
F	00-06	SUBURBAN 1/2 TON, 1500 All Exc. Z55 Auto Ride Suspension	
F	02-06	TAHOE All Exc. Z55 Auto Ride Suspension	
F	00-01	TAHOE All New Body Style; Exc. Z55 Auto Ride Suspension	
F	07	GMC SIERRA 1500 Classic Hybrid, 4WD Classic and Old Body Style; Exc. Electronic Adjustable Suspension	
F	07	SIERRA 1500 Classic SL, 4WD Classic and Old Body Style; Exc. Electronic Adjustable Suspension	
F	07	SIERRA 1500 Classic SLE, 4WD Classic and Old Body Style; Exc. Electronic Adjustable Suspension	
F	07	SIERRA 1500 Classic SLT, 4WD Classic and Old Body Style; Exc. Electronic Adjustable Suspension	
F	07	SIERRA 1500 Classic WT, 4WD Classic and Old Body Style; Exc. Electronic Adjustable Suspension	

Max Control

Shock	POP	Alternative No.	MTG Acc. Supplied
Pos.	Year	Application	
77803	A	-continued	
F	99-06	SIERRA 1500 4WD Classic and Old Body Style; Exc. Electronic Adjustable Suspension	
F	00-06	YUKON All Exc. Z55 Auto Ride Suspension	
F	00-06	YUKON XL 1/2 TON All Exc. Z55 Auto Ride Suspension	
77807	A		
F	99-12	FORD PICKUP 1 TON, F-350 / SUPERDUTY RWD	
F	99-12	PICKUP 3/4 TON, F-250 / SUPERDUTY RWD	
77808	C		
R	99-04	FORD PICKUP 1 TON, F-350 / SUPERDUTY RWD	
R	99-04	PICKUP 3/4 TON, F-250 / SUPERDUTY RWD	
77809	A		
F	00-05	FORD EXCURSION 4WD	
F	99-04	PICKUP 1 TON, F-350 / SUPERDUTY 4WD	
F	99-04	PICKUP 3/4 TON, F-250 / SUPERDUTY 4WD	
F	99-04	PICKUP, F-450 SUPERDUTY All	
F	99-04	PICKUP, F-550 SUPERDUTY All	
77810	A		
R	99-04	FORD PICKUP 1 TON, F-350 / SUPERDUTY 4WD	
R	99-04	PICKUP 3/4 TON, F-250 / SUPERDUTY 4WD	
77815	B		
R	00-06	TOYOTA TUNDRA All	
77817	A		
F	02-06	CHEVROLET AVALANCHE 2500 All Exc. Electronic Ride Control	
F	05-07	PICKUP 1/2 TON, SILVERADO 1500 HD All	
F	01-03	PICKUP 1/2 TON, SILVERADO 1500 HD All	
F	01-09	PICKUP 1 TON, SILVERADO 3500 All	
F	07-10	PICKUP 1 TON, SILVERADO 3500 HD All	
F	05-08	PICKUP 3/4 TON, SILVERADO 2500 All	
F	99-04	PICKUP 3/4 TON, SILVERADO 2500 4WD	
F	01-10	PICKUP 3/4 TON, SILVERADO 2500 HD All 9200# GVW	
F	00-11	SUBURBAN 3/4 TON, 2500 All Exc. Z55 Auto Ride Suspension and Quadrateer	
F	05-07	GMC SIERRA 1500 HD All	
F	01-03	SIERRA 1500 HD All	
F	99-04	SIERRA 2500 4WD	
F	01-09	SIERRA 2500 HD All	
F	01-07	SIERRA 3500 All	
F	07-10	SIERRA 3500 HD Torsion Bar (FrontSpringType)	
F	00-06	YUKON XL 3/4 TON All Exc. Hydraulic Self Leveling System	
F	03-06	HUMMER H2 All	
77829	C		
R	99-04	JEEP GRAND CHEROKEE All	
77837	W		
R	00-05	FORD EXCURSION 4WD	
77847	D		
F	99-04	JEEP GRAND CHEROKEE All Exc. Up Country Suspension	
77902	W		
F	81-82	CHEVROLET LUV PICKUP RWD	
F	81-95	ISUZU PICKUP RWD	
F	69-72	NISSAN 521 PICKUP All	
F	72-79	620 PICKUP All	
F	80-86	720 PICKUP All	
F	87-97	PICKUP 4WD	
F	86	PICKUP 4WD Mfg. from 8/86	
77903	W		
F	85-95	TOYOTA PICKUP RWD Exc. 1 Ton	
F	84	PICKUP RWD	
F	93-98	T100 RWD	
77904	W		
F	87-91	ISUZU TROOPER 4WD	
F	87-90	MITSUBISHI VAN All	

Numerical listing

Shock	POP	Alternative No.	MTG Acc. Supplied
Pos.	Year	Application	
77904	W	-continued	
F	87-95	NISSAN PATHFINDER All Exc. Electronic Adjustable Suspension	
77905	B		
F	97-04	DODGE DAKOTA 4WD	
F	98-03	DURANGO 4WD	
77907	W		
R	75-80	CHEVROLET LUV PICKUP All	
R	72-74	LUV PICKUP All	
R	79-82	DODGE D50 RWD	
R	87-93	PICKUP, RAM 50 RWD	
R	83-86	PICKUP, RAM 50 All	
R	86-87	MAZDA B2000 RWD	
R	87-93	B2200 RWD	
R	87-93	B2600 RWD	
R	95-96	MITSUBISHI MIGHTY MAX All	
R	83-94	MIGHTY MAX RWD	
R	87-90	VAN All	
R	98-04	NISSAN FRONTIER RWD Exc. Desert Runner	
R	87-97	PICKUP RWD	
R	86	PICKUP RWD Mfg. from 8/86	
R	79-82	PLYMOUTH PICKUP All	
R	85-95	TOYOTA PICKUP RWD Exc. 1 Ton	
R	84	PICKUP RWD	
R	75-83	PICKUP RWD Mojave	
R	70-74	PICKUP All RWD; Mojave	
R	84-88	VAN Leaf (RearSpringType)	
R	88	VAN WAGON Leaf (RearSpringType)	
77909	W		
F	81-82	CHEVROLET LUV PICKUP 4WD	
F	75-80	LUV PICKUP All	
F	72-74	LUV PICKUP All	
F	89-94	ISUZU AMIGO All	
F	81-95	PICKUP 4WD	
F	84-86	TROOPER 4WD	
F	98-04	NISSAN FRONTIER RWD Exc. Desert Runner	
F	87-97	PICKUP RWD	
F	86	PICKUP RWD Mfg. from 8/86	
77915	W		
F	87-04	DODGE DAKOTA RWD	
F	99-03	DURANGO RWD	
77937	W		
F	01-04	TOYOTA TACOMA S-Runner Exc. Offroad Package	
F	04	TACOMA Base, RWD Exc. Offroad Package	
F	95-03	TACOMA DLX, RWD Exc. Offroad Package	
77947	C		
F	02-05	DODGE PICKUP 1/2 TON, RAM 1500 (SEE RAM 1500) 4WD	
77948	A		
F	03-10	DODGE PICKUP 1 TON, RAM 3500 (SEE RAM 3500) 4WD	
F	03-10	PICKUP 3/4 TON, RAM 2500 (SEE RAM 2500) 4WD	
F	11-12	RAM 2500 (SEE DODGE RAM 2500) 4WD	
F	11-12	3500 (SEE DODGE RAM 3500) 4WD	
77949	A		
F	03-10	DODGE PICKUP 1 TON, RAM 3500 (SEE RAM 3500) RWD	
F	03-10	PICKUP 3/4 TON, RAM 2500 (SEE RAM 2500) RWD	
F	11-12	RAM 2500 (SEE DODGE RAM 2500) RWD	
F	11-12	3500 (SEE DODGE RAM 3500) RWD	
77950	A		
R	03-10	DODGE PICKUP 1 TON, RAM 3500 (SEE RAM 3500) All	
R	03-10	PICKUP 3/4 TON, RAM 2500 (SEE RAM 2500) All	
R	11-12	RAM 2500 (SEE DODGE RAM 2500) All	
R	11-12	3500 (SEE DODGE RAM 3500) All	
77951	A		
F	05-12	FORD PICKUP 1 TON, F-350 / SUPERDUTY 4WD	
F	05-12	PICKUP 3/4 TON, F-250 / SUPERDUTY 4WD	

Numerical listing

Shock	POP	Alternative No.	MTG Acc. Supplied
Pos.	Year	Application	
77952	B		
R	05-12	FORD	PICKUP 1 TON, F-350 / SUPERDUTY Crew Cab Pickup, 4WD Single Rear Wheels
R	05-12		PICKUP 1 TON, F-350 / SUPERDUTY Extended Cab Pickup, 4WD Single Rear Wheels
R	05-12		PICKUP 1 TON, F-350 / SUPERDUTY Standard Cab Pickup, 4WD Single Rear Wheels
R	05-12		PICKUP 3/4 TON, F-250 / SUPERDUTY 4WD
77953	A		
R	02-10	CADILLAC	ESCALADE All
R	02-07	CHEVROLET	AVALANCHE 1500 All Exc. Electronic Ride Control
R	02-06		AVALANCHE 2500 All Exc. Electronic Ride Control
R	07-11		SUBURBAN 1/2 TON, 1500 All Exc. Z55 or ZW7 Ride Suspension
R	00-06		SUBURBAN 1/2 TON, 1500 All Exc. Z55 Auto Ride Suspension
R	00-11		SUBURBAN 3/4 TON, 2500 All Exc. Z55 Auto Ride Suspension and Quadrateer
R	07-11		TAHOE All Exc. Z55 or ZW7 Ride Suspension
R	02-06		TAHOE All Exc. Z55 Auto Ride Suspension
R	00-01		TAHOE All New Body Style; Exc. Z55 Auto Ride Suspension
R	00-09	GMC	YUKON All Exc. Z55 Auto Ride Suspension
R	00-07		YUKON XL 1/2 TON All Exc. Z55 Auto Ride Suspension
R	00-07		YUKON XL 3/4 TON All Exc. Hydraulic Self Leveling System
77954	B		
F	06-08	DODGE	PICKUP 1/2 TON, RAM 1500 (SEE RAM 1500) Crew Cab Pickup, RWD
F	06-08		PICKUP 1/2 TON, RAM 1500 (SEE RAM 1500) Standard Cab Pickup, RWD
F	02-05		PICKUP 1/2 TON, RAM 1500 (SEE RAM 1500) RWD
77955	X		
R	03-10	FORD	CROWN VICTORIA Police Interceptor Police and Taxi Models
77958	W		
F	87-96	DODGE	DAKOTA 4WD
77967	W		
F	05-08	FORD	PICKUP, F-450 SUPERDUTY All
F	05-07		PICKUP, F-550 SUPERDUTY All
77968	W		
R	05-07	FORD	PICKUP, F-450 SUPERDUTY RWD
R	05-07		PICKUP, F-550 SUPERDUTY RWD
77969	W		
R	05-07	FORD	PICKUP, F-450 SUPERDUTY 4WD
R	05-07		PICKUP, F-550 SUPERDUTY 4WD
77971	N		
R	02-09	CHEVROLET	TRAILBLAZER Coil (RearSpringType)
R	02-06		TRAILBLAZER EXT All
R	02-09	GMC	ENVOY Coil (RearSpringType)
R	02-06		ENVOY XL All
R	04-05		ENVOY XUV All
77973	N		
R	07-14	JEEP	WRANGLER Unlimited Sahara, 4WD
R	07-11		WRANGLER Unlimited X, 4WD
R	07-11		WRANGLER X
79900	S		141727
F	10-11	FORD	CROWN VICTORIA Base
F	06-11		CROWN VICTORIA LX
F	06-08		CROWN VICTORIA Base
F	06		CROWN VICTORIA LX Sport
F	05		CROWN VICTORIA Base Mfg. to 12/05
F	05		CROWN VICTORIA LX Mfg. to 12/05
F	05		CROWN VICTORIA LX Sport Mfg. to 12/05

Max Control, Guardian Shock

Shock	POP	Alternative No.	MTG Acc. Supplied
Pos.	Year	Application	
79900	S	-continued	141727
F	05		CROWN VICTORIA S Mfg. to 12/05
F	05		CROWN VICTORIA Special Edition Mfg. to 12/05
F	03-04		CROWN VICTORIA Base
F	03-04		CROWN VICTORIA LX
F	04		CROWN VICTORIA LX Sport Exc. Police and Taxi Models
F	03		CROWN VICTORIA LWB
F	03		CROWN VICTORIA S
F	03-04		GRAND MARQUIS All
F	06		LINCOLN TOWN CAR All
F	05		TOWN CAR All Mfg. to 12/05
F	03-04		TOWN CAR All
F	06		MERCURY GRAND MARQUIS All
F	05		GRAND MARQUIS All Mfg. to 12/05
F	03-04		GRAND MARQUIS All
79901	S		141727
F	06-11	FORD	CROWN VICTORIA Police Interceptor
F	05		CROWN VICTORIA Police Interceptor Mfg. to 12/05
F	03-04		CROWN VICTORIA Police Interceptor
F	03-04	MERCURY	MARAUDER All
Guardian Shock			
81039	A		
F	69-84	CHEVROLET	BLAZER RWD
F	63-86		PICKUP 1/2 TON, C10 All
F	87		PICKUP 1/2 TON, R10 RWD
F	63-86		PICKUP 1 TON, C30 All
F	88-91		PICKUP 1 TON, C35/3500 Cab & Chassis
F	87-88		PICKUP 1 TON, R30 RWD
F	89-91		PICKUP 1 TON, R3500 All
F	75-86		PICKUP 3/4 TON, C20 Crew Cab Pickup
F	75-86		PICKUP 3/4 TON, C20 Standard Cab Pickup
F	63-74		PICKUP 3/4 TON, C20 All
F	87-88		PICKUP 3/4 TON, R20 All
F	89		PICKUP 3/4 TON, R2500 RWD
F	63-67		SUBURBAN 1/2 TON, 1500 All
F	63-86		SUBURBAN 1/2 TON, C10 All
F	87-88		SUBURBAN 1/2 TON, R10 RWD
F	89-91		SUBURBAN 1/2 TON, R1500 RWD
F	68-86		SUBURBAN 3/4 TON, C20 All
F	87-88		SUBURBAN 3/4 TON, R20 All
F	89-91		SUBURBAN 3/4 TON, R2500 RWD
F	63-80		VAN 1/2 TON, P SERIES All
F	68-90		VAN 1 TON, P SERIES All Exc. Motorhome Chassis
F	68-89		VAN 3/4 TON, P SERIES All
F	75-84	GMC	JIMMY RWD
F	70-74		JIMMY All RWD
F	67-86		PICKUP 1/2 TON, C15 / C1500 All
F	87		PICKUP 1/2 TON, R1500 All
F	88-91		PICKUP 1 TON, C35/3500 Cab & Chassis
F	67-78		PICKUP 1 TON, C35/3500 All
F	87-91		PICKUP 1 TON, R3500 All
F	75-86		PICKUP 3/4 TON, C25 / C2500 Cab & Chassis
F	75-86		PICKUP 3/4 TON, C25 / C2500 Crew Cab Pickup
F	75-86		PICKUP 3/4 TON, C25 / C2500 Standard Cab Pickup
F	67-74		PICKUP 3/4 TON, C25 / C2500 All
F	87-89		PICKUP 3/4 TON, R2500 All Exc. Crew Cab & Bonus Cab
F	63-65		PICKUP 1000 SERIES All
F	63-65		PICKUP 1500 SERIES All
F	73-86		SUBURBAN 1/2 TON, C15 / C1500 All
F	68-72		SUBURBAN 1/2 TON, C15 / C1500 All Coil (FrontSpringType)
F	87-91		SUBURBAN 1/2 TON, R1500 All
F	68-86		SUBURBAN 3/4 TON, C25 / C2500 All
F	87-91		SUBURBAN 3/4 TON, R2500 All
F	67-80		VAN 1/2 TON, P SERIES All
F	75-90		VAN 1 TON, P SERIES All Exc. Motorhome Chassis
F	73-74		VAN 1 TON, P SERIES Base Exc. Motorhome Chassis
F	68-72		VAN 1 TON, P SERIES All
F	68-89		VAN 3/4 TON, P SERIES All
F	63-65		VAN, PB 1000 SERIES All
81076	C		
F	69-77	FORD	MAVERICK All
F	67-70		MUSTANG / MUSTANG II All
F	71-77	MERCURY	COMET All

Numerical listing

Shock	POP	Alternative No.	MTG Acc. Supplied
Pos.	Year	Application	
81076	C	-continued	
F	67-70		COUGAR All
81082	C		
R	85-96	FORD	PICKUP 1/2 TON, F-150 RWD
R	80-97		PICKUP 1 TON, F-350 / SUPERDUTY RWD Exc. Dual Rear Wheels
R	97		PICKUP 3/4 TON, F-250 / SUPERDUTY RWD Over 8500# GVW
R	80-96		PICKUP 3/4 TON, F-250 / SUPERDUTY RWD
81091	W		
R	67-73	CHRYSLER	IMPERIAL All
R	70-73		NEWPORT All
R	70-73		NEW YORKER All
R	71-73		TOWN & COUNTRY All
R	73	DODGE	MONACO All
R	71		MONACO All
R	72-93		PICKUP 1/2 TON, D100 SERIES All
R	72-93		PICKUP 1 TON, D300 SERIES All
R	72-93		PICKUP 3/4 TON, D200 SERIES All
R	73		POLARA All
R	71		POLARA All
R	74-93		RAMCHARGER RWD
R	70-73	PLYMOUTH	FURY All
R	73		FURY All Exc. Wagon
R	73		GRAN FURY Hardtop
R	72		GRAN FURY All
R	75-81		TRAILDUSTER RWD
R	74		TRAILDUSTER All
81095	W		
R	70-81	CHEVROLET	CAMARO All
R	70-81	PONTIAC	FIREBIRD All
81096	B		
F	84-88	DODGE	MINI RAM All
F	72-93		PICKUP 1/2 TON, D100 SERIES All
F	72-93		PICKUP 3/4 TON, D200 SERIES All Exc. HD Package
F	75-93		RAMCHARGER RWD
F	99-03		VAN 1/2 TON, A / B SERIES / RAM 109.3 (WheelBase) Exc. 7000# GVW
F	81-98		VAN 1/2 TON, A / B SERIES / RAM 109.6 (WheelBase) Exc. 7000# GVW
F	71-80		VAN 1/2 TON, A / B SERIES / RAM All
F	99-03		VAN 1 TON, A / B SERIES / RAM All
F	71-98		VAN 1 TON, A / B SERIES / RAM All Exc. 4000# Front Axle
F	71-03		VAN 3/4 TON, A / B SERIES / RAM All
F	74-80		VAN, CB300 All Exc. 4000# Front Axle
F	75-81	PLYMOUTH	TRAILDUSTER RWD
F	74-83		VAN 1/2 TON, PB SERIES All
F	74-83		VAN 1 TON, PB SERIES All Exc. 4000# Front Axle
F	74-83		VAN 3/4 TON, PB SERIES All
81097	W		
R	69-72	NISSAN	521 PICKUP All
R	72-79		620 PICKUP All
R	86		720 PICKUP RWD Mfg. to 8/86
R	82-85		720 PICKUP RWD
R	80-81		720 PICKUP All
81108	W		
F	71-95	CHEVROLET	VAN 1/2 TON, G / EXPRESS All
F	70		VAN 1/2 TON, G / EXPRESS All Independent Front Suspension
F	76-96		VAN 1 TON, G / EXPRESS All
F	75		VAN 1 TON, G / EXPRESS 146.0 (WheelBase)
F	71-74		VAN 1 TON, G / EXPRESS All
F	78-95		VAN 3/4 TON, G / EXPRESS All Exc. 8600# GVW
F	71-77		VAN 3/4 TON, G / EXPRESS All
F	70		VAN 3/4 TON, G / EXPRESS All Independent Front Suspension
F	71-95	GMC	VAN 1/2 TON, G / SAVANNA All
F	70		VAN 1/2 TON, G / SAVANNA All Independent Front Suspension
F	76-95		VAN 1 TON, G / SAVANNA All
F	75		VAN 1 TON, G / SAVANNA 146.0 (WheelBase)
F	71-74		VAN 1 TON, G / SAVANNA All

Numerical listing

Shock	POP	Alternative No.	MTG Acc. Supplied
Pos.	Year	Application	
81108	W	-continued	
F	78-95	VAN 3/4 TON, G / SAVANNA All Exc. 8600# GVW	
F	71-77	VAN 3/4 TON, G / SAVANNA All	
F	70	VAN 3/4 TON, G / SAVANNA All Independent Front Suspension	
81113	W	-continued	
F	87-91	CHEVROLET BLAZER 4WD Full Size; Quad Suspension Short Shock; Exc. Lift Kit	
F	81-86	BLAZER 4WD Quad Suspension Short Shock; Exc. Lift Kit	
F	75-80	BLAZER 4WD Exc. Quad Suspension and Lift Kit	
F	73-74	BLAZER 4WD Exc. Lift Kit	
F	69-72	BLAZER 4WD	
F	81-86	PICKUP 1/2 TON, K10 All Standard Suspension; Exc. Lift Kit	
F	69-80	PICKUP 1/2 TON, K10 All Exc. Lift Kit	
F	87	PICKUP 1/2 TON, V10 All Quad Suspension Short Shock; Exc. Lift Kit	
F	81-86	PICKUP 3/4 TON, K20 All Standard Suspension; Exc. Lift Kit	
F	69-80	PICKUP 3/4 TON, K20 All Exc. Lift Kit	
F	81-86	SUBURBAN 1/2 TON, K10 All Standard Suspension; Exc. Lift Kit	
F	69-80	SUBURBAN 1/2 TON, K10 All Exc. Lift Kit	
F	87-88	SUBURBAN 1/2 TON, V10 All Quad Suspension Short Shock; Exc. Lift Kit	
F	81-86	SUBURBAN 3/4 TON, K20 All Standard Suspension; Exc. Lift Kit	
F	69-80	SUBURBAN 3/4 TON, K20 All Exc. Lift Kit	
F	87-88	SUBURBAN 3/4 TON, V20 All Quad Suspension Short Shock; Exc. Lift Kit	
F	89-91	SUBURBAN 3/4 TON, V2500 All Quad Suspension Short Shock; Exc. Lift Kit	
F	70-91	GMC JIMMY 4WD Exc. Quad Suspension and Lift Kit	
F	69-86	PICKUP 1/2 TON, K15 / K1500 All Exc. Quad Suspension and Lift Kit	
F	87	PICKUP 1/2 TON, V1500 All Quad Suspension Short Shock; Exc. Lift Kit	
F	69-86	PICKUP 3/4 TON, K25 / K2500 All Exc. Quad Suspension and Lift Kit	
F	87	PICKUP 3/4 TON, V2500 All Quad Suspension Short Shock; Exc. Lift Kit	
F	69-86	SUBURBAN 1/2 TON, K15 / K1500 All Exc. Quad Suspension and Lift Kit	
F	87-91	SUBURBAN 1/2 TON, V1500 All Quad Suspension Short Shock; Exc. Lift Kit	
F	69-86	SUBURBAN 3/4 TON, K25 / K2500 All Exc. Quad Suspension and Lift Kit	
F	87-91	SUBURBAN 3/4 TON, V2500 All Quad Suspension Short Shock; Exc. Lift Kit	
81147	A	-continued	
R	56	BUICK ROADMASTER All Exc. Air Susp	
R	56	SPECIAL All	
R	56	SUPER All	
R	75-80	CHEVROLET LUV PICKUP All	
R	72-74	LUV PICKUP All	
F	55-56	PICKUP 3100	
F	55-56	PICKUP 3200	
F	55-56	PICKUP 3600	
F	55-56	PICKUP 3800	
R	79-82	DODGE D50 RWD	
R	83-93	PICKUP, RAM 50 RWD	
R	55	FORD F SERIES All F-100	
F	48-52	F SERIES All F-1, F-2 & F-3	
R	65	PICKUP 1/2 TON, F-100 All 4WD; With Front Leaf Springs	
R	61-64	PICKUP 1/2 TON, F-100 All	
R	61-66	PICKUP 1 TON, F-350 / SUPERDUTY All	
R	61-64	PICKUP 3/4 TON, F-250 / SUPERDUTY All	
F	68-75	PICKUP P350 All Up through 8000# GVW	

Guardian Shock

Shock	POP	Alternative No.	MTG Acc. Supplied
Pos.	Year	Application	
81147	A	-continued	
F	75-76	PICKUP P400 All Up through 8000# GVW	
R	68	INTERNATIONAL 908B All	
R	68	908C All	
R	68	1000B All	
R	68	1000C All	
F	68	1100B All Exc. Travelette with 166" Wheelbase	
R	68	1100B All Exc. Travelette with 166" Wheelbase	
F	68	1100C All Exc. Travelette with 166" Wheelbase	
R	68	1100C All Exc. Travelette with 166" Wheelbase	
F	68	1200B All Exc. Travelette with 166" Wheelbase	
R	68	1200B All Exc. Travelette with 166" Wheelbase	
F	68	1200C All Exc. Travelette with 166" Wheelbase	
R	68	1200C All Exc. Travelette with 166" Wheelbase	
F	68	1300B All Exc. Travelette with 166" Wheelbase	
R	68	1300B All Exc. Travelette with 166" Wheelbase	
F	68	1300C All Exc. Travelette with 166" Wheelbase	
R	68	1300C All Exc. Travelette with 166" Wheelbase	
R	68-72	M1100 / M1200 All	
R	69	M1400 All	
R	65-67	M SERIES VAN All	
R	72-83	JEEP CJ5 All Exc. Lift Kit	
R	66-71	CJ5 All Exc. 5 Leaf Front Springs & Lift Kit	
R	66-75	CJ6 All Exc. Lift Kit	
R	76-86	CJ7 All Exc. Lift Kit	
R	66-74	DJ5 All Exc. Lift Kit	
R	66-68	DJ6 All	
R	57-60	FC150 All	
F	63-65	FC170 All	
R	63-65	FC170 All	
R	64-66	GLADIATOR All	
R	63	GLADIATOR All Independent Front Suspension	
R	70-73	JEEP STER All	
R	81-85	SCRAMBLER / CJ8 All	
R	61-67	UNIVERSAL All Exc. CJ-3B	
R	86-87	MAZDA B2000 RWD	
R	87-93	B2200 RWD	
R	87-93	B2600 RWD	
R	95-96	MITSUBISHI MIGHTY MAX All	
R	83-94	MIGHTY MAX RWD	
R	87-90	VAN All	
R	98-04	NISSAN FRONTIER RWD Exc. Desert Runner	
R	87-97	PICKUP RWD	
R	86	PICKUP RWD Mfg. from 8/86	
R	79-82	PLYMOUTH PICKUP All	
R	49-60	STUDEBAKER R / E SERIES 1/2 / 3/4 TON	
F	49-54	R / E SERIES 1/2 / 3/4 TON	
R	67-68	TOYOTA LAND CRUISER All	
R	84-95	PICKUP RWD Exc. 1 Ton	
R	75-83	PICKUP RWD Mojave	
R	70-74	PICKUP All RWD; Mojave	
R	84-88	VAN Leaf (RearSpringType)	
R	88	VAN WAGON Leaf (FrontSpringType), Leaf (RearSpringType)	
81153	W	-continued	
F	75-79	CHRYSLER CORDOBA All	
F	79-81	NEWPORT All	
F	79-81	TOWN & COUNTRY All	
F	73-78	DODGE CHARGER All	
F	73-76	CORONET All	
F	78-79	MAGNUM All	
F	77-78	MONACO All	
F	79-81	ST. REGIS All	
F	75-78	PLYMOUTH FURY All	
F	80-81	GRAN FURY All	
F	73-75	ROADRUNNER All	
F	73-74	SATELLITE All	
81164	C	-continued	
R	87-91	CHEVROLET BLAZER 4WD Full Size; Exc. Quad Suspension and Lift Kit	
R	85-86	BLAZER 4WD Exc. Lift Kit	
R	73-84	BLAZER All Exc. Lift Kit	
R	73-86	PICKUP 1/2 TON, C10 All	

Numerical listing

Shock	POP	Alternative No.	MTG Acc. Supplied
Pos.	Year	Application	
81164	C	-continued	
R	73-86	PICKUP 1/2 TON, K10 All Exc. Lift Kit	
R	87	PICKUP 1/2 TON, R10 All	
R	87	PICKUP 1/2 TON, V10 All Exc. Lift Kit	
R	75-86	PICKUP 3/4 TON, C20 Standard Cab Pickup	
R	73-74	PICKUP 3/4 TON, C20 All Standard Cab Pickup	
R	73-86	PICKUP 3/4 TON, K20 All Exc. Lift Kit	
R	87	PICKUP 3/4 TON, R20 Standard Cab Pickup	
R	87	PICKUP 3/4 TON, V20 All Exc. Quad Suspension and Lift Kit	
R	73-86	SUBURBAN 1/2 TON, C10 All	
R	75-86	SUBURBAN 1/2 TON, K10 All Exc. Lift Kit	
R	87-88	SUBURBAN 1/2 TON, R10 All	
R	89-91	SUBURBAN 1/2 TON, R1500 All	
R	89-91	SUBURBAN 1/2 TON, V1500 All Exc. Lift Kit	
R	73-86	SUBURBAN 3/4 TON, C20 All	
R	73-86	SUBURBAN 3/4 TON, K20 All Exc. Lift Kit	
R	87-88	SUBURBAN 3/4 TON, R20 All	
R	89-91	SUBURBAN 3/4 TON, R2500 All	
R	87-88	SUBURBAN 3/4 TON, V20 All Exc. Quad Suspension and Lift Kit	
R	89-91	SUBURBAN 3/4 TON, V2500 All Exc. Lift Kit	
R	73	VAN 1/2 TON, P SERIES All	
R	73-78	VAN 3/4 TON, P SERIES All	
R	73-91	GMC JIMMY All Exc. Lift Kit	
R	73-86	PICKUP 1/2 TON, C15 / C1500 All	
R	73-86	PICKUP 1/2 TON, K15 / K1500 All Exc. Lift Kit	
R	87	PICKUP 1/2 TON, R1500 All	
R	87	PICKUP 1/2 TON, V1500 All Exc. Lift Kit	
R	75-86	PICKUP 3/4 TON, C25 / C2500 Cab & Chassis	
R	75-86	PICKUP 3/4 TON, C25 / C2500 Standard Cab Pickup	
R	73-86	PICKUP 3/4 TON, K25 / K2500 All Exc. Lift Kit	
R	88-89	PICKUP 3/4 TON, R2500 All Exc. Crew Cab & Bonus Cab	
R	87	PICKUP 3/4 TON, R2500 Cab & Chassis Exc. Crew Cab & Bonus Cab	
R	87	PICKUP 3/4 TON, R2500 Standard Cab Pickup Exc. Crew Cab & Bonus Cab	
R	87	PICKUP 3/4 TON, V2500 All Exc. Lift Kit	
R	73-86	SUBURBAN 1/2 TON, C15 / C1500 All	
R	73-86	SUBURBAN 1/2 TON, K15 / K1500 All Exc. Lift Kit	
R	87-91	SUBURBAN 1/2 TON, R1500 All	
R	87-91	SUBURBAN 1/2 TON, V1500 All Exc. Lift Kit	
R	75-86	SUBURBAN 3/4 TON, C25 / C2500 All	
R	73-74	SUBURBAN 3/4 TON, C25 / C2500 All Exc. Crew Cab & Bonus Cab	
R	73-86	SUBURBAN 3/4 TON, K25 / K2500 All Exc. Lift Kit	
R	87-91	SUBURBAN 3/4 TON, R2500 All	
R	87-91	SUBURBAN 3/4 TON, V2500 All Exc. Lift Kit	
R	73	VAN 1/2 TON, P SERIES All	
R	73-78	VAN 3/4 TON, P SERIES All	
81174	W	-continued	
R	73-86	CHEVROLET PICKUP 1 TON, C30 All	
R	88-91	PICKUP 1 TON, C35/3500 Cab & Chassis Exc. HD Solid Front Axle	
R	87-88	PICKUP 1 TON, R30 RWD	
R	89	PICKUP 1 TON, R3500 Standard Cab Pickup	
R	75-86	PICKUP 3/4 TON, C20 Crew Cab Pickup	
R	73-74	PICKUP 3/4 TON, C20 All Crew Cab Pickup	
R	87-88	PICKUP 3/4 TON, R20 Crew Cab Pickup	
R	89	PICKUP 3/4 TON, R2500 RWD	
R	74-80	VAN 1/2 TON, P SERIES All	
R	73-99	VAN 1 TON, P SERIES All	
R	79-89	VAN 3/4 TON, P SERIES All	

Numerical listing

Shock	POP	Alternative No.	MTG Acc. Supplied
Pos.	Year	Application	
81174 W -continued			
R	88-91	GMC PICKUP 1 TON, C35/3500 Cab & Chassis Exc. HD Solid Front Axle	
R	73-78	PICKUP 1 TON, C35/3500 All	
R	87-91	PICKUP 1 TON, R3500 All	
R	85-86	PICKUP 3/4 TON, C25 / C2500 Crew Cab Pickup	
R	75-83	PICKUP 3/4 TON, C25 / C2500 Crew Cab Pickup	
R	87-89	PICKUP 3/4 TON, R2500 Crew Cab Pickup	
R	74-80	VAN 1/2 TON, P SERIES All	
R	74-99	VAN 1 TON, P SERIES All	
R	73	VAN 1 TON, P SERIES Base Exc. Motorhome Chassis	
R	79-89	VAN 3/4 TON, P SERIES All	
81242 C			
R	66	FORD BRONCO All Thru Serial #830000	
R	73-79	PICKUP 1/2 TON, F-100 RWD	
R	70-72	PICKUP 1/2 TON, F-100 All RWD	
R	75-79	PICKUP 1/2 TON, F-150 RWD	
R	75-79	PICKUP 1 TON, F-350 / SUPERDUTY Extended Cab Pickup, RWD	
R	75-79	PICKUP 3/4 TON, F-250 / SUPERDUTY Cab & Chassis, RWD	
R	75-79	PICKUP 3/4 TON, F-250 / SUPERDUTY Standard Cab Pickup, RWD	
R	70-74	PICKUP 3/4 TON, F-250 / SUPERDUTY RWD Exc. Supercab	
R	75-91	VAN 1/2 TON, ECONOLINE / CLUB WAGON All	
F	71-80	INTERNATIONAL SCOUT II All	
81270 A			
R	75-80	AMERICAN MOTORS PACER All	
F	58	BUICK CENTURY All	
F	58	LIMITED All	
F	58	ROADMASTER All Exc. Air Susp	
F	58	SPECIAL All Exc. Air Susp	
F	58	SUPER All Exc. Air Susp	
F	55	CHEVROLET PICKUP All 1st Series	
F	54	PICKUP All	
F	50-53	PICKUP 3100	
F	50-53	PICKUP 3600	
F	50-53	PICKUP 3800	
R	90-92	DAIHATSU ROCKY All	
R	52-59	FORD COUNTRY SEDAN All	
R	52-56	COUNTRY SQUIRE All	
R	54-56	COURIER SEDAN DELIVERY All	
R	52-54	CRESTLINE All	
R	57	CUSTOM All	
R	52	CUSTOM All	
R	58	CUSTOM 300 All	
R	52-56	CUSTOMLINE All	
R	62-70	FAIRLANE All	
R	55-58	FAIRLANE All	
R	66-70	FALCON All Exc. Wagon	
R	60-65	FALCON All	
F	57-59	F SERIES All	
R	52-56	MAINLINE All	
R	65-73	MUSTANG / MUSTANG II All	
R	56	PARK LANE WAGON All	
F	60	PICKUP 1/2 TON, F-100 All	
F	60	PICKUP 1 TON, F-350 / SUPERDUTY All	
F	60	PICKUP 3/4 TON, F-250 / SUPERDUTY All	
R	60-65	RANCHERO All	
R	52-56	RANCH WAGON All	
R	54-56	SKYLINER All	
R	52-58	SUNLINER All	
R	55-57	THUNDERBIRD All	
R	68-70	TORINO All Exc. Wagon	
R	52-58	VICTORIA All	
F	53-54	GMC PICKUP All	
R	62-64	JAGUAR XKE All	
R	72-77	MAZDA 808 Wagon Exc. Vehicles with Tokico O.E. Struts	
R	79-83	GLC Wagon	
R	78	GLC All	
R	74-76	RX3 Wagon	
R	72-73	RX3 All	
R	74-78	RX4 All	
R	59-60	MERCURY COLONY PARK All	
R	68-69	COMET All	
R	66-67	COMET Convertible	
R	66-67	COMET Hardtop	
R	66-67	COMET Sedan	
R	60-65	COMET All	
R	59-60	COMMUTER All	

Guardian Shock

Shock	POP	Alternative No.	MTG Acc. Supplied
Pos.	Year	Application	
81270 A -continued			
R	67-73	COUGAR All	
R	59-60	COUNTRY CRUISER All	
R	62-63	METEOR All	
R	59-60	MONTECLAIR All	
R	68-71	MONTEGO Convertible	
R	68-71	MONTEGO Hardtop	
R	68-71	MONTEGO Sedan	
R	59-60	MONTEREY All	
R	59-60	PARKLANE All	
R	59	VOYAGER All	
R	69-78	SAAB 99 All	
R	59-68	VOLVO 122 All	
81285 D			
R	71-76	FORD PICKUP 1/2 TON, F-100 4WD Exc. Lift Kit	
R	76-79	PICKUP 1/2 TON, F-150 4WD Exc. Lift Kit	
R	75	PICKUP 1/2 TON, F-150 All 4WD; Exc. Lift Kit	
R	79	PICKUP 1 TON, F-350 / SUPERDUTY 4WD	
R	77-79	PICKUP 3/4 TON, F-250 / SUPERDUTY Cab & Chassis, 4WD All From Serial No. Y20001	
R	77-79	PICKUP 3/4 TON, F-250 / SUPERDUTY Standard Cab Pickup, 4WD All From Serial No. Y20001	
R	75-91	VAN 1 TON, ECONOLINE / CLUB WAGON / SUPERDUTY All Exc. Motorhome Conversion	
R	75-91	VAN 3/4 TON, ECONOLINE / CLUB WAGON / SUPERDUTY All	
81318 C			
R	81-82	CHEVROLET LUV PICKUP All	
R	55-56	PICKUP 3100	
R	87-89	DODGE RAIDER 2.6L 4Cyl L (156) Exc. Sport Utility	
F	61-67	FORD ECONOLINE All	
F	68	VAN 1/2 TON, ECONOLINE / CLUB WAGON All Mfg. to 7/68	
F	68-72	INTERNATIONAL M1100 / M1200 All	
F	65-67	M SERIES VAN All	
R	89-94	ISUZU AMIGO All	
R	81-95	PICKUP All	
R	84-86	TROOPER 4WD	
R	86-92	JEEP COMANCHE All	
F	66-67	GLADIATOR All	
F	64-65	GLADIATOR All Exc. Independent Front Suspension	
F	68-73	J2500 PICKUP All	
F	66-73	WAGONEER All	
F	63-65	WAGONEER All Exc. Independent Front Suspension	
R	49-51	MERCURY MERCURY All	
R	50-51	MONTEREY All	
R	83-89	MITSUBISHI MONTERO 2.6L 4Cyl L (156)	
R	82-86	NISSAN 720 PICKUP 4WD	
R	00-04	FRONTIER Crew Cab Pickup, RWD with Desert Runner	
R	98-04	FRONTIER 4WD	
R	98-99	FRONTIER RWD Crew Cab with Desert Runner	
R	87-95	PATHFINDER All Exc. Electronic Adjustable Suspension	
R	87-97	PICKUP 4WD	
R	86	PICKUP 4WD Mfg. from 8/86	
R	57-60	PONTIAC BONNEVILLE All	
R	58-60	CATALINA All	
R	58	CHIEFTAIN All	
R	58-60	STAR CHIEF All	
R	58	SUPER CHIEF All	
R	60	VENTURA All	
R	84-87	TOYOTA LAND CRUISER FJ60 (MfrBodyCode), Sport Utility	
R	75-83	LAND CRUISER All	
R	69-74	LAND CRUISER All Wagon	
R	85-92	PICKUP RWD 1 Ton	
R	80-83	PICKUP 4WD Exc. Lift Kit	
81322 W			
F	76-87	CHEVROLET CHEVETTE All	
F	81-84	ISUZU I-MARK All	
F	83-89	IMPULSE All	
F	76-87	PONTIAC ACADIAN CAN	
F	81-87	T1000 All	
81338 W			
R	77-83	CHRYSLER CORDOBA All	
R	83-89	FIFTH AVENUE All	
R	81-83	IMPERIAL All	
R	81	LEBARON All M Body	

Numerical listing

Shock	POP	Alternative No.	MTG Acc. Supplied
Pos.	Year	Application	
81338 W -continued			
R	77-80	LEBARON All	
R	79-81	NEWPORT All	
R	79-82	NEW YORKER All	
R	79-81	TOWN & COUNTRY All	
R	76-80	DODGE ASPEN All	
R	77-78	CHARGER All	
R	77-89	DIPLOMAT All	
R	78-79	MAGNUM All	
R	80-83	MIRADA All	
R	77-78	MONACO All	
R	79-81	ST. REGIS All	
R	88-89	PLYMOUTH CARAVELLE RWD	
R	78-81	CARAVELLE RWD	
R	77-78	FURY All	
R	80-89	GRAN FURY All	
R	76-80	VOLARE All	
81340 D			
R	70-74	AMERICAN MOTORS AMBASSADOR All	
R	70	AMX All	
R	80-88	EAGLE All	
R	70-74	JAVELIN All	
R	71-78	MATADOR All	
R	76-87	CHEVROLET CHEVETTE All	
R	83-89	ISUZU IMPULSE All	
R	72	NISSAN 510 All	
R	74-77	710 Hardtop	
R	74-77	710 Sedan	
R	76-87	PONTIAC ACADIAN CAN	
R	81-87	T1000 All	
R	76-79	TOYOTA COROLLA Coupe	
R	72-79	COROLLA Sedan	
R	75-78	COROLLA Hardtop	
R	74	COROLLA Coupe 1200	
R	72-73	COROLLA Coupe	
R	79-81	CORONA Wagon	
R	73-76	CORONA Sedan	
R	73-74	CORONA Hardtop	
R	72	CORONA Mark II Exc. Wagon	
R	78-80	CRESSIDA Wagon	
F	75-79	LAND CRUISER FJ55 (MfrBodyCode), Sport Utility	
F	69-74	LAND CRUISER All	
81342 W			
R	81-93	DODGE PICKUP 1/2 TON, W100 SERIES All Exc. Lift Kit	
R	72-80	PICKUP 1/2 TON, W100 SERIES All	
R	81-93	PICKUP 1 TON, W300 SERIES All Exc. Quad Suspension and Lift Kit	
R	72-80	PICKUP 1 TON, W300 SERIES All	
R	81-93	PICKUP 3/4 TON, W200 SERIES Standard Cab Pickup Exc. Lift Kit	
R	72-80	PICKUP 3/4 TON, W200 SERIES All	
R	76-93	RAMCHARGER 4WD	
R	78-80	RD200 All	
R	76-81	PLYMOUTH TRAILDUSTER 4WD	
81394 C			
F	78-79	FORD BRONCO All Quad Suspension; Rearward of Front Axle; Exc. Lift Kit	
F	67-77	BRONCO All From Serial #830001; Exc. Lift Kit	
F	66	BRONCO All Exc. Lift Kit	
F	73-79	PICKUP 1/2 TON, F-100 RWD	
F	65-72	PICKUP 1/2 TON, F-100 All RWD	
F	75-79	PICKUP 1/2 TON, F-150 RWD	
F	75-79	PICKUP 1 TON, F-350 / SUPERDUTY RWD	
F	73-74	PICKUP 1 TON, F-350 / SUPERDUTY All	
F	65-79	PICKUP 3/4 TON, F-250 / SUPERDUTY RWD	
F	75-91	VAN 1 TON, ECONOLINE / CLUB WAGON / SUPERDUTY All Exc. Motorhome Conversion	
F	75-91	VAN 3/4 TON, ECONOLINE / CLUB WAGON / SUPERDUTY All	
81406 W			
F	80-83	CHRYSLER CORDOBA All	
F	83-89	FIFTH AVENUE All	
F	81-83	IMPERIAL All	
F	74-75	IMPERIAL All	
F	77-81	LEBARON All	
F	74-78	NEWPORT All	
F	74-82	NEW YORKER All	
F	74-78	TOWN & COUNTRY All	
F	76-80	DODGE ASPEN All	
F	77-89	DIPLOMAT All	
F	80-83	MIRADA All	
F	74-76	MONACO All	
F	75-77	ROYAL MONACO All	

Numerical listing

Shock	POP	Alternative No.	MTG Acc. Supplied
Pos.	Year	Application	
81406 W -continued			
F	85-89	PLYMOUTH CARAVELLE All	
F	78-81	CARAVELLE RWD	
F	82-89	GRAN FURY All	
F	74-77	GRAN FURY All	
F	76-80	VOLARE All	
81416 W			
R	78-85	TOYOTA CELICA All	
R	75-83	COROLLA Wagon	
R	74	COROLLA All Mfg. from 8/74; Wagon	
R	79-82	CORONA Hatchback	
R	79-82	CORONA Sedan	
R	81-87	CRESSIDA Wagon	
81438 W			
R	75-80	BUICK SKYHAWK All	
R	75-80	CHEVROLET MONZA All	
R	72-77	VEGA All	
R	75-80	OLDSMOBILE STARFIRE All	
R	75-77	PONTIAC ASTRE All	
R	76-80	SUNBIRD All	
81440 W			
R	85-88	TOYOTA CRESSIDA Sedan Exc. Electronic Adjustable Suspension	
R	83-84	CRESSIDA Sedan	
R	81-82	CRESSIDA Sedan Exc. Electronic Adjustable Suspension	
R	78-80	CRESSIDA Sedan	
R	81-84	STARLET All	
81445 W			
F	79-85	BUICK RIVIERA All	
F	79-85	CADILLAC ELDORADO All	
F	80-85	SEVILLE All	
F	79-85	OLDSMOBILE TORONADO All	
81446 A			
F	71-73	BUICK CENTURION All	
F	71-84	ELECTRA All	
F	87	ESTATE WAGON	
F	71-83	ESTATE WAGON All	
F	71-85	LESABRE All	
F	71-78	RIVIERA All	
F	92-96	ROADMASTER All	
F	91	ROADMASTER Wagon	
F	87-92	CADILLAC BROUGHAM All	
F	92-96	COMMERCIAL CHASSIS RWD	
F	77-84	COMMERCIAL CHASSIS All	
F	77-84	DEVILLE All	
F	93-96	FLEETWOOD RWD	
F	77-86	FLEETWOOD RWD	
F	81	CHEVROLET BEL AIR Sedan	
F	71-75	BEL AIR Sedan	
F	65-70	BEL AIR All	
F	65-72	BISCAYNE All Exc. Police and Taxi Models	
F	69-72	BROOKWOOD All	
F	70-81	CAMARO All	
F	91-96	CAPRICE All Exc. Police and Taxi Models	
F	73-90	CAPRICE Wagon Exc. Police and Taxi Models	
F	71-72	CAPRICE Hardtop Exc. Police and Taxi Models	
F	70	CAPRICE Hardtop	
F	66-69	CAPRICE All	
F	94-96	IMPALA All Exc. Police and Taxi Models	
F	65-85	IMPALA All Exc. Police and Taxi Models	
F	69-72	KINGSWOOD All	
F	69-72	TOWNSMAN All	
F	65-74	FORD COUNTRY SEDAN All	
F	87-91	COUNTRY SQUIRE All	
F	65-74	COUNTRY SQUIRE All	
F	93-02	CROWN VICTORIA Base Exc. Police and Taxi Models	
F	93-02	CROWN VICTORIA LX Exc. Police and Taxi Models	
F	93-02	CROWN VICTORIA S Exc. Police and Taxi Models	
F	02	CROWN VICTORIA LWB Exc. Police and Taxi Models	
F	92	CROWN VICTORIA All Exc. Police and Taxi Models	
F	65-72	CUSTOM All	
F	68-77	CUSTOM 500 All	
F	65-67	GALAXIE All	
F	68-74	GALAXIE 500 All	
F	01-02	GRAND MARQUIS All	
F	87-91	LTD / COUNTRY SEDAN / COUNTRY SQUIRE / CROWN VICTORIA All	

Guardian Shock

Shock	POP	Alternative No.	MTG Acc. Supplied
Pos.	Year	Application	
81446 A -continued			
F	85-86	LTD / COUNTRY SEDAN / COUNTRY SQUIRE / CROWN VICTORIA Crown Victoria	
F	67-82	LTD / COUNTRY SEDAN / COUNTRY SQUIRE / CROWN VICTORIA All	
F	77-79	LTD II All	
F	72-79	RANCHERO All	
F	65-74	RANCH WAGON All	
F	67-79	THUNDERBIRD All	
F	72-76	TORINO All	
F	70-80	LINCOLN CONTINENTAL All	
F	68-71	MARK III All	
F	72-76	MARK IV All	
F	77-79	MARK V All	
F	80-83	MARK VI All	
F	81-02	TOWN CAR All	
F	65-66	MERCURY BREEZEWAY All	
F	67	BROUGHAM All	
F	87-91	COLONY PARK All	
F	65-74	COLONY PARK All	
F	65-68	COMMUTER All	
F	74-79	COUGAR All	
F	75-02	GRAND MARQUIS All	
F	69-70	MARAUDER All	
F	65-67	MARAUDER All	
F	67-82	MARQUIS All	
F	65-68	MONTECLAIR All	
F	72-76	MONTEGO All	
F	65-74	MONTEREY All	
F	65-68	PARKLANE All	
F	65-67	VILLAGER All	
F	66-67	VOYAGER All	
F	71-85	OLDSMOBILE 88 SERIES All	
F	71-84	98 All	
F	71-92	CUSTOM CRUISER All	
F	71-81	PONTIAC BONNEVILLE All	
F	71-81	CATALINA All	
F	70-81	FIREBIRD All	
F	71-78	GRAND SAFARI All	
F	76-81	LAURENTIAN CAN	
F	76-86	PARISIENNE All	
F	87-89	SAFARI All	
81450 W			
R	80-87	SUBARU BRAT All	
R	80-84	DL All	
R	85-89	GL Hatchback	
R	80-84	GL All	
81459 C			
R	84-93	CHRYSLER DAYTONA CAN	
R	83-84	E CLASS All	
R	85	EXECUTIVE LIMOUSINE All	
R	83-84	EXECUTIVE SEDAN All	
R	90-93	IMPERIAL All Exc. Hydraulic Self Leveling System	
R	84-86	LASER All	
R	82-95	LEBARON All	
R	81	LEBARON All Exc. M Body	
R	88-93	NEW YORKER All Exc. Hydraulic Self Leveling System	
R	83-87	NEW YORKER All	
R	86-88	TOWN & COUNTRY All	
R	82-83	DODGE 400 All	
R	87-88	600 All	
R	86	600 All Mfg. to 2/86	
R	83-85	600 All	
R	81-89	ARIES All	
R	92-93	DAYTONA Iroc R/T	
R	91-93	DAYTONA Iroc	
R	89-93	DAYTONA ES	
R	89-90	DAYTONA ES Turbo	
R	87-88	DAYTONA Pacifica	
R	86	DAYTONA Turbo Z	
R	84-85	DAYTONA Turbo	
R	85-89	LANCER All	
R	87-94	SHADOW All	
R	89-95	SPIRIT All	
R	89-95	PLYMOUTH ACCLAIM All	
R	88	CARAVELLE FWD	
R	83-87	CARAVELLE All	
R	81-89	RELIANT All	
R	87-94	SUNDANCE All	
81460 W			
R	78-83	FORD FAIRMONT All	
R	81-82	GRANADA All	
R	83-86	LTD / COUNTRY SEDAN / COUNTRY SQUIRE / CROWN VICTORIA All	
R	87-93	MUSTANG / MUSTANG II LX, 2.3L 4Cyl L (140)	
R	84-86	MUSTANG / MUSTANG II LX	

Numerical listing

Shock	POP	Alternative No.	MTG Acc. Supplied
Pos.	Year	Application	
81460 W -continued			
R	82-84	MUSTANG / MUSTANG II L	
R	82-83	MUSTANG / MUSTANG II GL	
R	82-83	MUSTANG / MUSTANG II GLX	
R	82	MUSTANG / MUSTANG II Ghia	
R	79-81	MUSTANG / MUSTANG II All	
R	79-86	MERCURY CAPRI All	
R	81-82	COUGAR Base	
R	82	COUGAR GS	
R	82	COUGAR LS	
R	83-86	MARQUIS All	
R	78-83	ZEPHYR All	
81461 W			
R	87-88	FORD THUNDERBIRD Naturally Aspirated (Eng Asp), Non-ABS	
R	80-86	THUNDERBIRD All	
R	82-87	LINCOLN CONTINENTAL All	
R	84-92	MARK VII All	
R	83-88	MERCURY COUGAR All	
R	80-82	COUGAR XR-7	
81464 W			
R	84-91	DODGE COLT Vista, Wagon, FWD	
R	79-83	COLT Hatchback	
R	89-91	EAGLE VISTA Wagon, FWD, CAN	
R	86-94	HYUNDAI EXCEL All	
R	84-87	PONY All	
R	91-95	SCOUPE All	
R	83-88	MITSUBISHI CORDIA All	
R	90-94	PRECIS All	
R	83-88	TREDIA All	
R	79-82	PLYMOUTH CHAMP All	
R	92-94	COLT Sedan	
R	92	COLT Hatchback, FWD	
R	84-91	COLT Vista, Wagon, FWD	
R	80-83	COLT Hatchback	
81469 C			
R	57-64	CHRYSLER 300 All	
R	57-66	IMPERIAL All	
R	55	IMPERIAL All	
R	55-56	NASSAU All	
R	51-64	NEWPORT All	
R	51-64	NEW YORKER All	
R	57-60	SARATOGA All	
R	51-52	SARATOGA All	
R	55-56	ST REGIS All	
R	51-64	TOWN & COUNTRY All	
R	51-61	WINDSOR All	
R	63-64	DODGE 880 All	
R	64-70	A100 TRUCK All	
R	51-59	CORONET All	
R	54-64	CUSTOM All	
R	63-76	DART All	
R	60-61	DART All	
R	61-62	LANCER All	
R	51-54	MEADOWBROOK All	
R	60-61	POLARA All	
R	64-70	VAN 1/2 TON, A / B SERIES / RAM All	
R	58-59	EDSEL CORSAIR All Exc. Wagon	
R	58-59	RANGER All Exc. Wagon	
R	58-59	VILLAGER All Exc. Wagon	
R	64-69	PLYMOUTH BARRACUDA All	
R	53-61	BELVEDERE All	
R	51-53	CAMBRIDGE All	
R	51-52	CONCORD All	
R	51-53	CRANBROOK All	
R	58-61	CUSTOM All	
R	70-76	DUSTER All	
R	60-61	FLEET SPECIAL All	
R	56-61	FURY All	
R	54-58	PLAZA All	
R	53-61	SAVOY All	
R	71-76	SCAMP All	
R	60-61	SPORT WAGON All	
R	51-61	SUBURBAN All	
R	60-76	VALIANT All	
81478 D			
F	81-82	CHEVROLET LUV PICKUP RWD	
F	81-95	ISUZU PICKUP RWD	
F	69-72	NISSAN 521 PICKUP All	
F	72-79	620 PICKUP All	
F	80-86	720 PICKUP All	
F	87-97	PICKUP 4WD	
F	86	PICKUP 4WD Mfg. from 8/86	
81481 C			
R	82-02	CHEVROLET CAMARO All	
R	82-02	PONTIAC FIREBIRD All	
81482 A			
R	05	CHEVROLET BLAZER Base, 4WD	
R	05	BLAZER Base, RWD	

Numerical listing

Shock	POP	Alternative No.	MTG Acc. Supplied
Pos.	Year	Application	
81482 A -continued			
R	96-04	BLAZER LS, 4WD	
R	96-04	BLAZER LS, RWD	
R	95-02	BLAZER LT, RWD	
R	95-01	BLAZER LT, 4WD	
R	95-99	BLAZER Base, 4WD	
R	95-99	BLAZER Base, RWD	
R	95-97	BLAZER Deluxe, RWD	
R	83-94	BLAZER, S MODELS All	
R	98-04	S10 LS, 4WD	
R	99-03	S10 Base, 4WD	
R	99-03	S10 LS, RWD	
R	98-03	S10 Base, RWD	
R	94-97	S10 LS	
R	82-97	S10 Base	
R	92-93	S10 EL	
R	83-92	S10 Tahoe	
R	88-90	S10 Durango	
R	82-86	S10 Durango	
R	05	GMC JIMMY 4WD	
R	92-04	JIMMY All	
R	83-91	S15 JIMMY All	
R	82-04	SONOMA / S15 All	
R	91	SYCLONE All	
R	92-93	TYPHOON All	
R	96-00	ISUZU HOMBRE All	
R	96-01	OLDSMOBILE BRAVADA All	
R	91-94	BRAVADA All	
81484 C			
R	78-79	FORD BRONCO All Exc. Lift Kit	
R	66-77	BRONCO All From Serial #830001; Exc. Lift Kit	
R	66-69	PICKUP 1/2 TON, F-100 All RWD	
R	65	PICKUP 1/2 TON, F-100 All With Front Coil Springs	
R	75-79	PICKUP 1 TON, F-350 / SUPERDUTY Standard Cab Pickup, RWD	
R	73-74	PICKUP 1 TON, F-350 / SUPERDUTY All	
R	75-79	PICKUP 3/4 TON, F-250 / SUPERDUTY Extended Cab Pickup, RWD	
R	65-74	PICKUP 3/4 TON, F-250 / SUPERDUTY RWD Supercab	
R	69-74	VAN 1/2 TON, ECONOLINE / CLUB WAGON All	
R	68	VAN 1/2 TON, ECONOLINE / CLUB WAGON All Late 1968	
R	69-74	VAN 1 TON, ECONOLINE / CLUB WAGON / SUPERDUTY All	
R	68	VAN 1 TON, ECONOLINE / CLUB WAGON / SUPERDUTY All Late 1968	
R	69-74	VAN 3/4 TON, ECONOLINE / CLUB WAGON / SUPERDUTY All	
R	68	VAN 3/4 TON, ECONOLINE / CLUB WAGON / SUPERDUTY All Late 1968	
R	76-83	JEEP CHEROKEE All	
F	74-83	CHEROKEE All	
F	82-83	CJ5 All Exc. Lift Kit	
F	82-86	CJ7 All Exc. Lift Kit	
R	67	GLADIATOR All	
F	84-91	GRAND WAGONEER All	
R	84-91	GRAND WAGONEER All	
F	74-88	J10 PICKUP All	
R	74-88	J10 PICKUP All	
F	74-88	J20 PICKUP All	
R	74-88	J20 PICKUP All	
R	68-73	J2500 PICKUP All	
F	82-85	SCRAMBLER / CJ8 All	
R	76-83	WAGONEER All	
F	74-83	WAGONEER All	
81490 A			
F	80-96	FORD BRONCO All Quad & Non Quad Suspensions Rearward of Front Axle; Exc. Lift Kit	
F	89	BRONCO II All Mfg. to 2/89; Vehicles with 10mm & 12mm bolt in rear lower mount	
F	84-88	BRONCO II All With 10mm Bolt In Rear Lower Mount	
F	80-83	PICKUP 1/2 TON, F-100 RWD	
F	80-96	PICKUP 1/2 TON, F-150 4WD Quad & Non Quad Suspensions Rearward of Front Axle; Exc. Lift Kit	
F	80-96	PICKUP 1/2 TON, F-150 RWD	
F	80-97	PICKUP 1 TON, F-350 / SUPERDUTY RWD	
F	97	PICKUP 3/4 TON, F-250 / SUPERDUTY RWD Over 8500# GVW	

Guardian Shock

Shock	POP	Alternative No.	MTG Acc. Supplied
Pos.	Year	Application	
81490 A -continued			
F	80-96	PICKUP 3/4 TON, F-250 / SUPERDUTY RWD	
F	87-89	RANGER All Exc. High Ryder Option	
F	83-86	RANGER All	
81491 W			
F	80-88	AMERICAN MOTORS EAGLE All	
F	75-80	FORD GRANADA All	
F	71-73	MUSTANG / MUSTANG II All	
F	77-80	LINCOLN VERSAILLES All	
F	71-73	MERCURY COUGAR All	
F	75-80	MONARCH All	
81492 A			
R	73-81	BUICK CENTURY All	
R	87	ESTATE WAGON	
R	71-83	ESTATE WAGON All	
R	65-67	GRAN SPORT All	
R	68-72	GS / GS350 / GS400 / GS455 All	
R	73-87	REGAL All	
R	91-96	ROADMASTER Wagon	
R	68-72	SKYLARK All	
R	64-67	SKYLARK All HD Suspension; Exc. Sportwagon	
R	68-69	SPECIAL All	
R	64-67	SPECIAL All HD Suspension; Exc. Sportwagon	
R	70-72	SPORTWAGON All	
R	71-72	CHEVROLET BROOKWOOD All	
R	71-96	CAPRICE Wagon	
R	68-73	CHEVELLE All	
R	64-67	CHEVELLE All HD Suspension	
R	68-87	EL CAMINO All	
R	71-82	IMPALA Wagon	
R	71-72	KINGSWOOD All	
R	73-83	MALIBU All	
R	64-67	MALIBU All HD Suspension	
R	70-88	MONTE CARLO All	
R	71-72	TOWNSMAN All	
R	78-87	GMC SPRINT / CABALLERO RWD	
R	71-77	SPRINT / CABALLERO All	
R	73-76	NISSAN 610 Wagon	
R	74-77	710 Wagon	
R	77-80	810 Wagon	
R	71-92	OLDSMOBILE CUSTOM CRUISER All	
R	68-87	CUTLASS / CUTLASS SUPREME All	
R	72	CUTLASS / CUTLASS SUPREME Base	
R	72	CUTLASS / CUTLASS SUPREME S	
R	64-67	CUTLASS / CUTLASS SUPREME All HD Suspension	
R	80-83	CUTLASS CLASSIC / CUTLASS CRUISER All	
R	68-72	F85 All	
R	64-67	F85 All HD Suspension	
R	71-78	TORONADO All	
R	82-86	PONTIAC BONNEVILLE All	
R	77-81	CATALINA Wagon	
R	71-75	CATALINA Wagon	
R	78-80	GRAND AM All	
R	73-75	GRAND AM All	
R	75-83	GRAND LEMANS All	
R	69-87	GRAND PRIX All	
R	71-78	GRAND SAFARI All	
R	71-75	GRANDVILLE All	
R	68-73	GTO All	
R	64-67	GTO All HD Suspension	
R	68-81	LEMANS All	
R	64-67	LEMANS All HD Suspension	
R	80-86	PARISIENNE Wagon	
R	76-79	PARISIENNE All Wagon	
R	87-89	SAFARI All	
R	68-70	TEMPEST All	
R	64-67	TEMPEST All HD Suspension	
81494 A			
F	73-75	BUICK APOLLO All	
F	73-81	CENTURY All	
F	68-72	GS / GS350 / GS400 / GS455 All	
F	73-87	REGAL All	
F	75-79	SKYLARK All	
F	68-72	SKYLARK All	
F	68-69	SPECIAL All	
F	68-72	SPORTWAGON All	
F	76-79	CADILLAC SEVILLE All	
F	67-69	CHEVROLET CAMARO All	
F	68-73	CHEVELLE All	
F	68	CHEVY II All	
F	73-83	MALIBU All	
F	70-88	MONTE CARLO All	
F	69-79	NOVA All	

Numerical listing

Shock	POP	Alternative No.	MTG Acc. Supplied
Pos.	Year	Application	
81494 A -continued			
F	64-65	NISSAN 410 All	
F	64-67	411 All	
F	68-87	OLDSMOBILE CUTLASS / CUTLASS SUPREME All	
F	80-83	CUTLASS CLASSIC / CUTLASS CRUISER All	
F	68-72	F85 All	
F	74-79	OMEGA All	
F	73	OMEGA All Exc. HD Suspension	
F	82-86	PONTIAC BONNEVILLE All	
F	67-69	FIREBIRD All	
F	78-80	GRAND AM All	
F	73-75	GRAND AM All	
F	75-83	GRAND LEMANS All	
F	69-87	GRAND PRIX All	
F	71-75	GRANDVILLE All	
F	68-73	GTO All	
F	68-81	LEMANS All	
F	77-79	PHOENIX All	
F	68-70	TEMPEST All	
F	71-77	VENTURA All	
F	69-78	TOYOTA CORONA All	
F	68-75	VOLVO 142 / 144 / 145 / 164 All	
81495 A			
R	61-63	BUICK SKYLARK All	
R	61-63	SPECIAL All	
R	64-69	SPORTWAGON All	
R	68-69	CHEVROLET CAMARO All Multi-Leaf Rear Spring	
R	65-74	FORD COUNTRY SEDAN All	
R	87-91	COUNTRY SQUIRE All	
R	65-74	COUNTRY SQUIRE All	
R	92-02	CROWN VICTORIA All	
R	65-72	CUSTOM All	
R	68-77	CUSTOM 500 All	
R	66-70	FALCON All Wagon	
R	65-67	GALAXIE All	
R	68-74	GALAXIE 500 All	
R	01-02	GRAND MARQUIS All	
R	87-91	LTD / COUNTRY SEDAN / COUNTRY SQUIRE / CROWN VICTORIA All	
R	67-82	LTD / COUNTRY SEDAN / COUNTRY SQUIRE / CROWN VICTORIA All	
R	77-79	LTD II All	
R	66-79	RANCHERO All	
R	65-74	RANCH WAGON All	
R	77-79	THUNDERBIRD All	
R	67-72	THUNDERBIRD All	
R	74-76	TORINO Wagon	
R	71	TORINO Wagon	
R	70-80	LINCOLN CONTINENTAL All	
R	68-71	MARK III All	
R	72	MARK IV All	
R	80-83	MARK VI All	
R	81-02	TOWN CAR All	
R	65-66	MERCURY BREEZEWAY All	
R	67	BROUGHAM All	
R	87-91	COLONY PARK All	
R	65-74	COLONY PARK All	
R	66-67	COMET Wagon	
R	65-68	COMMUTER All	
R	74-79	COUGAR All	
R	75-02	GRAND MARQUIS All	
R	69-70	MARAUDER All	
R	65-67	MARAUDER All	
R	67-82	MARQUIS All	
R	65-68	MONTCLAIR All	
R	68-76	MONTEGO Wagon	
R	65-74	MONTEREY All	
R	65-68	PARKLANE All	
R	65-67	VILLAGER All	
R	66-67	VOYAGER All	
R	64-72	OLDSMOBILE VISTA CRUISER All Stud Upper Mount	
R	68-69	PONTIAC FIREBIRD All	
81496 D			
F	87-91	CHEVROLET BLAZER 4WD Full Size; Quad Suspension Long Shock; Exc. Lift Kit	
F	81-86	BLAZER 4WD Quad Suspension Long Shock; Exc. Lift Kit	
F	81-86	PICKUP 1/2 TON, K10 All Quad Suspension Long Shock; Exc. Lift Kit	
F	87	PICKUP 1/2 TON, V10 All Quad Suspension Long Shock; Exc. Lift Kit	
F	81-86	PICKUP 3/4 TON, K20 All Quad Suspension Long Shock; Exc. Lift Kit	
F	87	PICKUP 3/4 TON, V20 All Quad Suspension Long Shock; Exc. Lift Kit	

Numerical listing

Shock	POP	Alternative No.	MTG Acc. Supplied
Pos.	Year	Application	
81496	D -continued		
F	81-86	SUBURBAN 1/2 TON, K10 All Quad Suspension Long Shock; Exc. Lift Kit	
F	87-88	SUBURBAN 1/2 TON, V10 All Quad Suspension Long Shock; Exc. Lift Kit	
F	81-86	SUBURBAN 3/4 TON, K20 All Quad Suspension Long Shock; Exc. Lift Kit	
F	87-88	SUBURBAN 3/4 TON, V20 All Quad Suspension Long Shock; Exc. Lift Kit	
F	89-91	SUBURBAN 3/4 TON, V2500 All Quad Suspension Long Shock; Exc. Lift Kit	
R	78-95	VAN 1/2 TON, G / EXPRESS All	
R	78-95	VAN 1/2 TON, G / EXPRESS Cutaway Van	
R	78-95	VAN 3/4 TON, G / EXPRESS All Exc. 8600# GVW	
R	84-88	DODGE MINI RAM All	
R	99-03	VAN 1/2 TON, A / B SERIES / RAM 109.3 (WheelBase) Exc. 7000# GVW	
R	81-98	VAN 1/2 TON, A / B SERIES / RAM 109.6 (WheelBase) Exc. 7000# GVW	
R	71-80	VAN 1/2 TON, A / B SERIES / RAM All	
R	99-03	VAN 1 TON, A / B SERIES / RAM All	
R	95-98	VAN 1 TON, A / B SERIES / RAM All Exc. 4000# Front Axle	
R	71-94	VAN 1 TON, A / B SERIES / RAM All	
R	71-03	VAN 3/4 TON, A / B SERIES / RAM All	
R	74-80	VAN, CB300 All	
F	73-91	GMC JIMMY 4WD Quad Suspension Long Shock; Exc. Lift Kit	
F	81-86	PICKUP 1/2 TON, K15 / K1500 All Quad Suspension Long Shock; Exc. Lift Kit	
F	87	PICKUP 1/2 TON, V1500 All Quad Suspension Long Shock; Exc. Lift Kit	
F	87-88	PICKUP 1 TON, V3000 / V3500 All Quad Suspension Long Shock; Exc. Lift Kit	
F	81-86	PICKUP 3/4 TON, K25 / K2500 All Quad Suspension Long Shock; Exc. Lift Kit	
F	87	PICKUP 3/4 TON, V2500 All Quad Suspension Long Shock; Exc. Lift Kit	
F	81-86	SUBURBAN 1/2 TON, K15 / K1500 All Quad Suspension Long Shock; Exc. Lift Kit	
F	87-91	SUBURBAN 1/2 TON, V1500 All Quad Suspension Long Shock; Exc. Lift Kit	
F	81-86	SUBURBAN 3/4 TON, K25 / K2500 All Quad Suspension Long Shock; Exc. Lift Kit	
F	87-91	SUBURBAN 3/4 TON, V2500 All Quad Suspension Long Shock; Exc. Lift Kit	
R	78-95	VAN 1/2 TON, G / SAVANNA All	
R	85-96	VAN 1 TON, G / SAVANNA Extended Cargo Van	
R	85-96	VAN 1 TON, G / SAVANNA Extended Passenger Van	
R	79-96	VAN 1 TON, G / SAVANNA Standard Cargo Van	
R	79-96	VAN 1 TON, G / SAVANNA Standard Passenger Van	
R	78	VAN 1 TON, G / SAVANNA Cutaway Van	
R	78-95	VAN 3/4 TON, G / SAVANNA All Exc. 8600# GVW	
R	74-83	PLYMOUTH VAN 1/2 TON, PB SERIES All	
R	74-83	VAN 1 TON, PB SERIES All	
R	74-83	VAN 3/4 TON, PB SERIES All	
81498	W		
R	88-91	TOYOTA COROLLA Wagon	
R	80-87	COROLLA Coupe	
R	80-83	COROLLA Hatchback	
R	80-83	COROLLA Sedan	
R	83	COROLLA Hardtop	
R	83-88	TERCEL Wagon, 4WD	
81501	W		
R	84	NISSAN 200SX All Solid Rear Axle	
R	77-83	200SX All	
R	79-82	210 All	
R	78-81	510 Hatchback	
R	78-81	510 Sedan	
R	71-73	1200 All	
R	74-78	B210 All	

Guardian Shock

Shock	POP	Alternative No.	MTG Acc. Supplied
Pos.	Year	Application	
81507	A		
F	81-82	CHEVROLET LUV PICKUP 4WD	
F	75-80	LUV PICKUP All	
F	72-74	LUV PICKUP All	
F	89-94	ISUZU AMIGO All	
F	81-95	PICKUP 4WD	
F	84-86	TROOPER 4WD	
F	98-04	NISSAN FRONTIER RWD Exc. Desert Runner	
F	87-97	PICKUP RWD	
F	86	PICKUP RWD Mfg. from 8/86	
81508	W		
R	86	NISSAN PULSAR / PULSAR NX All Mfg. from 1/86	
R	83-85	PULSAR / PULSAR NX All	
R	82-86	SENTRA All	
81510	C		
R	80-96	FORD PICKUP 1/2 TON, F-150 4WD Exc. Lift Kit	
R	86-97	PICKUP 1 TON, F-350 / SUPERDUTY 4WD Dual Rear Wheels	
R	82-85	PICKUP 1 TON, F-350 / SUPERDUTY 4WD Clevis Type Lower Front Mount; Exc. Dual Rear Wheels or Lift Kit	
R	80-81	PICKUP 1 TON, F-350 / SUPERDUTY 4WD	
R	97	PICKUP 3/4 TON, F-250 / SUPERDUTY 4WD Over 8500# GVW	
R	86-96	PICKUP 3/4 TON, F-250 / SUPERDUTY 4WD	
R	82-85	PICKUP 3/4 TON, F-250 / SUPERDUTY 4WD Clevis Type Lower Front Mount; Exc. Dual Rear Wheels or Lift Kit	
R	80-81	PICKUP 3/4 TON, F-250 / SUPERDUTY 4WD	
81514	C		
R	73	BUICK APOLLO All HD Suspension	
R	71-73	CENTURION All	
R	71-84	ELECTRA All	
R	70	ESTATE WAGON All	
R	71-85	LESABRE All	
R	71-78	RIVIERA All	
R	92-96	ROADMASTER Sedan	
R	64-67	SKYLARK All Exc. HD Suspension	
R	64-67	SPECIAL All Exc. HD Suspension	
R	87-92	CADILLAC BROUGHAM All	
R	92-96	COMMERCIAL CHASSIS RWD	
R	77-84	COMMERCIAL CHASSIS All	
R	77-84	DEVILLE All	
R	93-96	FLEETWOOD RWD	
R	77-86	FLEETWOOD RWD	
R	81	CHEVROLET BEL AIR Sedan	
R	65-75	BEL AIR All	
R	65-72	BISCAYNE All	
R	69-70	BROOKWOOD All	
R	73-96	CAPRICE Sedan Police and Taxi Models	
R	71-72	CAPRICE Hardtop Police and Taxi Models	
R	66-70	CAPRICE All	
R	64-67	CHEVELLE All Exc. HD Suspension	
R	68	CHEVY II All Multi-Leaf Rear Spring	
R	64-67	EL CAMINO All	
R	94-96	IMPALA All	
R	83-85	IMPALA All	
R	65-82	IMPALA Sedan	
R	74-81	IMPALA Coupe	
R	73	IMPALA Hardtop	
R	69-70	KINGSWOOD All	
R	64-67	MALIBU All Exc. HD Suspension	
R	73	NOVA All HD Suspension	
R	69-72	NOVA All Multi-Leaf Rear Spring	
R	69-70	TOWNSMAN All	
R	65-85	OLDSMOBILE 88 SERIES All	
R	65-84	98 All	
R	64-67	CUTLASS / CUTLASS SUPREME All Exc. HD Suspension	
R	64-67	F85 All Exc. HD Suspension	
R	65-66	STARFIRE All	
R	63-81	PONTIAC BONNEVILLE All	
R	75-81	CATALINA Coupe	
R	71-81	CATALINA Sedan	
R	71-74	CATALINA Hardtop	
R	63-70	CATALINA All	
R	67-70	EXECUTIVE All	
R	63-68	GRAND PRIX All	
R	64-67	GTO All Exc. HD Suspension	
R	76-81	LAURENTIAN CAN	

Numerical listing

Shock	POP	Alternative No.	MTG Acc. Supplied
Pos.	Year	Application	
81514	C -continued		
R	64-67	LEMANS All Exc. HD Suspension	
R	76-86	PARISIENNE Sedan	
R	68-70	SAFARI All	
R	63-65	SAFARI All	
R	63-66	STAR CHIEF All	
R	64-67	TEMPEST All Exc. HD Suspension	
R	73	VENTURA All HD Suspension	
R	71-72	VENTURA All HD Suspension Leaf(RearSpringType)	
81516	A		
F	05	CHEVROLET BLAZER Base, 4WD	
F	96-04	BLAZER LS, 4WD	
F	95-01	BLAZER LT, 4WD	
F	95-99	BLAZER Base, 4WD	
F	83-94	BLAZER, S MODELS 4WD	
F	94-04	S10 LS, 4WD	
F	83-03	S10 Base, 4WD	
F	92-93	S10 EL, 4WD	
F	83-92	S10 Tahoe, 4WD	
F	88-90	S10 Durango, 4WD	
F	83-86	S10 Durango, 4WD	
F	92-05	GMC JIMMY 4WD	
F	83-91	S15 JIMMY 4WD	
F	83-04	SONOMA / S15 4WD	
F	91	SYCLONE All	
F	92-93	TYPHOON All	
F	99-00	ISUZU HOMBRE 4WD	
F	96-98	HOMBRE All Sport Chassis	
F	96-01	OLDSMOBILE BRAVADA All	
F	91-94	BRAVADA All	
81517	D		
R	82-96	BUICK CENTURY All	
R	80-85	SKYLARK All	
R	82-90	CHEVROLET CELEBRITY All	
R	80-85	CITATION / CITATION II All	
R	82-96	OLDSMOBILE CIERA / CUTLASS CIERA All Exc. Electronic Adjustable Suspension	
R	87-94	CUTLASS CLASSIC / CUTLASS CRUISER All Exc. Electronic Adjustable Suspension	
R	80-84	OMEGA All	
R	89-91	PONTIAC 6000 FWD	
R	82-88	6000 All	
R	80-84	PHOENIX All	
81529	W		
R	90-95	CHRYSLER TOWN & COUNTRY All	
R	84-95	DODGE CARAVAN / GRAND CARAVAN All	
R	84-95	PLYMOUTH VOYAGER / GRAND VOYAGER All	
81530	W		
R	94	ASUNA GT	
R	92	GT	
R	93	GT, SE All	
R	94	SE	
R	92	SE	
R	82-89	BUICK SKYHAWK All	
R	86-94	SKYLARK All	
R	85-87	SOMERSET / SOMERSET REGAL All	
R	82-88	CADILLAC CIMARRON All	
R	92-94	CHEVROLET BERETTA Base Exc. FE7 Suspension	
R	87-91	BERETTA All	
R	82-94	CAVALIER All	
R	87-94	CORSIKA All	
R	92-94	OLDSMOBILE ACHIEVA All Exc. FE3 and Electronic Ride Control	
R	85-87	CALAIS All	
R	88-91	CUTLASS CALAIS All	
R	87-88	FIRENZA All	
R	84-86	FIRENZA All Rebuildable O.E. Struts	
R	82-83	FIRENZA All	
R	85-94	PONTIAC GRAND AM All	
R	82-85	J2000 / SUNBIRD All	
R	86-94	SUNBIRD All	
R	87-91	TEMPEST CAN	
81538	W		
R	82	DODGE D50 4WD	
R	87-93	PICKUP, RAM 50 4WD	
R	83-94	MITSUBISHI MIGHTY MAX 4WD	
81539	W		
R	89	FORD BRONCO II All Mfg. to 2/89; Vehicles with 10mm & 12mm bolt in rear lower mount	

Numerical listing

Shock	POP	Alternative No.	MTG Acc. Supplied
Pos.	Year	Application	
81539	W	-continued	
R	84-88	BRONCO II All With 10mm Bolt In Rear Lower Mount	
R	89	RANGER RWD Mfg. to 2/89; Vehicles with 10mm bolt in rear lower mount	
R	83-88	RANGER RWD	
81540	W		
R	83-89	FORD RANGER 4WD	
81541	C		
F	85-95	TOYOTA PICKUP RWD Exc. 1 Ton	
F	84	PICKUP RWD	
F	93-98	T100 RWD	
81542	W		
R	84-89	TOYOTA VAN Coil (RearSpringType)	
R	88	VAN WAGON Coil (FrontSpringType), Coil (RearSpringType)	
81548	A		
F	84-01	JEEP CHEROKEE All	
F	86-92	COMANCHE All	
F	93-98	GRAND CHEROKEE All	
F	84-90	WAGONEER All	
81549	A		
R	84-01	JEEP CHEROKEE All	
R	84-90	WAGONEER All	
81553	W		
F	87-91	ISUZU TROOPER 4WD	
F	86-87	MAZDA B2000 RWD	
F	87-93	B2200 RWD	
F	87-93	B2600 RWD	
81554	W		
R	86-88	NISSAN MULTI CAN	
R	86-88	STANZA Wagon, FWD	
81555	W		
R	85-92	DODGE COLT Hatchback	
R	85-88	COLT Sedan	
R	90-92	EAGLE VISTA Sedan, CAN	
R	89-92	VISTA Hatchback, CAN	
R	89	VISTA Sedan	
R	85-88	MITSUBISHI MIRAGE All	
R	87-88	PLYMOUTH COLT Sedan	
R	85-88	COLT Hatchback	
81557	W		
R	85-86	CHEVROLET SPRINT All	
R	85-86	PONTIAC FIREFLY CAN	
81558	W		
R	85-88	CHEVROLET SPECTRUM All	
R	89	GEO SPECTRUM All	
R	88-89	ISUZU I-MARK XS	
R	85-87	I-MARK All	
R	85-88	PONTIAC SUNBURST CAN	
81559	A		
F	87-04	DODGE DAKOTA RWD	
F	99-03	DURANGO RWD	
81560	D		
R	87-96	DODGE DAKOTA RWD	
81562	W		
R	87-88	CHEVROLET SPRINT All	
R	87-88	PONTIAC FIREFLY CAN	
R	85-88	SUZUKI FORSA CAN	
81581	C		
R	90-05	CHEVROLET ASTRO All	
R	85-89	ASTRO RWD	
R	90-05	GMC SAFARI All	
R	85-89	SAFARI RWD	
R	86-89	VOLKSWAGEN VANAGON 4WD	
81582	W		
F	86-97	FORD AEROSTAR RWD	
81583	D		
R	86-88	FORD AEROSTAR RWD	
R	87-95	JEEP WRANGLER YJ (MfrBodyCode)	
81667	A		
R	88-99	CHEVROLET PICKUP 1/2 TON, C15 / C1500 All	
R	88-99	PICKUP 1/2 TON, K15 / K1500 All	
R	01-03	PICKUP 1 TON, C35/3500 Base Exc. HD Straight Front Axle	

Guardian Shock

Shock	POP	Alternative No.	MTG Acc. Supplied
Pos.	Year	Application	
81667	A	-continued	
R	88-00	PICKUP 1 TON, C35/3500 Extended Cab Pickup Exc. HD Straight Front Axle	
R	88-00	PICKUP 1 TON, C35/3500 Standard Cab Pickup Exc. HD Straight Front Axle	
R	88-00	PICKUP 1 TON, K35 / K3500 All	
R	88-00	PICKUP 3/4 TON, C25 / C2500 All	
R	88-00	PICKUP 3/4 TON, K25 / K2500 All	
R	88-99	GMC PICKUP 1/2 TON, C15 / C1500 All	
R	88-99	PICKUP 1/2 TON, K15 / K1500 All	
R	89-00	PICKUP 1 TON, C35/3500 Extended Cab Pickup Exc. HD Straight Front Axle	
R	88-00	PICKUP 1 TON, C35/3500 Standard Cab Pickup Exc. HD Straight Front Axle	
R	88-00	PICKUP 1 TON, K35 / K3500 All	
R	88-00	PICKUP 3/4 TON, C25 / C2500 All	
R	88-00	PICKUP 3/4 TON, K25 / K2500 All	
81668	A		
F	88-99	CHEVROLET PICKUP 1/2 TON, C15 / C1500 All	
F	92-00	PICKUP 1 TON, C35/3500 All Exc. HD Straight Front Axle	
F	88-91	PICKUP 1 TON, C35/3500 Extended Cab Pickup Exc. HD Straight Front Axle	
F	88-91	PICKUP 1 TON, C35/3500 Standard Cab Pickup Exc. HD Straight Front Axle	
F	88-00	PICKUP 3/4 TON, C25 / C2500 All	
F	92-99	SUBURBAN 1/2 TON, C15 / C1500 All	
F	92-99	SUBURBAN 3/4 TON, C25 / C2500 All	
F	95-00	TAHOE RWD Old Body Style	
F	88-99	GMC PICKUP 1/2 TON, C15 / C1500 All	
F	88-00	PICKUP 1 TON, C35/3500 All Exc. HD Straight Front Axle	
F	88-00	PICKUP 3/4 TON, C25 / C2500 All	
F	92-99	SUBURBAN 1/2 TON, C15 / C1500 All	
F	92-99	SUBURBAN 3/4 TON, C25 / C2500 All	
F	92-99	YUKON RWD	
81670	W		
F	88	PONTIAC FIERO All	
81671	W		
R	85-88	NISSAN 200SX All	
81674	W		
R	87-93	FORD MUSTANG / MUSTANG II GT, 5.0L 8Cyl V (302)	
R	87-93	MUSTANG / MUSTANG II LX, 5.0L 8Cyl V (302)	
R	84-86	MUSTANG / MUSTANG II SVO	
R	82-86	MUSTANG / MUSTANG II GT	
81675	W		
F	86-95	SUZUKI SAMURAI All	
81676	D		
R	77-79	DODGE COLT Coupe	
R	77-79	COLT Sedan	
R	77	COLT Hardtop	
R	55	FORD F SERIES All F250	
R	53-54	F SERIES All	
R	48-52	F SERIES All F-1, F-2 & F-3	
R	53-55	PICKUP 1/2 TON, F-100 All Exc. Heavy Duty	
R	53-55	PICKUP 1 TON, F-350 / SUPERDUTY All Exc. Heavy Duty	
R	53-55	PICKUP 3/4 TON, F-250 / SUPERDUTY All Exc. Heavy Duty	
R	74	JEEP CHEROKEE All	
F	66-71	CJ5 All 5 Leaf Front Springs; Exc. Lift Kit	
R	66-71	CJ5 All 5 Leaf Front Springs; Exc. Lift Kit	
F	66-71	CJ6 All 5 Leaf Front Springs; Exc. Lift Kit	
R	66-71	CJ6 All 5 Leaf Front Springs; Exc. Lift Kit	
F	61-67	DISPATCHER All	
R	61-67	DISPATCHER All	
R	61-65	FC150 All	
F	61-67	UNIVERSAL All 5 Leaf Front Springs; Exc. Lift Kit	

Numerical listing

Shock	POP	Alternative No.	MTG Acc. Supplied
Pos.	Year	Application	
81676	D	-continued	
R	61-67	UNIVERSAL All 5 Leaf Front Springs; Exc. Lift Kit	
R	63-74	WAGONEER All	
F	63-65	WAGONEER All Independent Front Suspension	
R	76-80	PLYMOUTH ARROW All	
R	76-79	COLT All	
R	56-57	SAAB 93 All	
R	58-59	93B All	
R	58-59	GT750 All	
R	63	GT850 All	
R	86-95	SUZUKI SAMURAI All	
81691	D		
F	87-95	JEEP WRANGLER YJ (MfrBodyCode)	
81693	W		
R	86-95	FORD TAURUS Wagon	
R	86-95	MERCURY SABLE Wagon	
81694	D		
F	75-91	FORD VAN 1/2 TON, ECONOLINE / CLUB WAGON All	
81710	W		
R	80-96	FORD BRONCO All Exc. Lift Kit	
R	80-83	PICKUP 1/2 TON, F-100 RWD	
R	80-84	PICKUP 1/2 TON, F-150 RWD	
R	90-97	PICKUP 1/2 TON, F SUPERDUTY All	
R	80-97	PICKUP 1 TON, F-350 / SUPERDUTY RWD Dual Rear Wheels	
81713	A		
F	85-05	CHEVROLET ASTRO RWD	
F	71-75	BEL AIR Wagon	
F	71-72	BISCAYNE All Police and Taxi Models	
F	73-96	CAPRICE Sedan Police and Taxi Models	
F	71-72	CAPRICE Hardtop Police and Taxi Models	
F	83-85	IMPALA All Police and Taxi Models	
F	71-82	IMPALA Sedan Police and Taxi Models	
F	96-02	VAN 1/2 TON, G / EXPRESS All	
F	97-02	VAN 1 TON, G / EXPRESS All	
F	96-02	VAN 3/4 TON, G / EXPRESS All Exc. 8600# GVW	
F	93-02	FORD CROWN VICTORIA Police Interceptor Police and Taxi Models	
F	85-05	GMC SAFARI RWD	
F	96-02	VAN 1/2 TON, G / SAVANNA RWD	
F	96-02	VAN 1 TON, G / SAVANNA All	
F	96-02	VAN 3/4 TON, G / SAVANNA All Exc. 8600# GVW	
81714	W		
F	79-82	DODGE D50 RWD	
F	87-93	PICKUP, RAM 50 RWD	
F	83-86	PICKUP, RAM 50 All	
F	83-96	MITSUBISHI MIGHTY MAX RWD	
F	79-82	PLYMOUTH PICKUP All	
81726	B		
F	99-00	CADILLAC ESCALADE All	
F	90-05	CHEVROLET ASTRO AWD	
F	92-94	BLAZER 4WD Full Size	
F	88-00	PICKUP 1 TON, K35 / K3500 All	
F	88-00	PICKUP 3/4 TON, K25 / K2500 All	
F	92-99	SUBURBAN 1/2 TON, K15 / K1500 All	
F	92-99	SUBURBAN 3/4 TON, K25 / K2500 All	
F	95-00	TAHOE 4WD Old Body Style	
F	88-00	GMC PICKUP 1 TON, K35 / K3500 All	
F	88-00	PICKUP 3/4 TON, K25 / K2500 All	
F	90-05	SAFARI AWD	
F	92-99	SUBURBAN 1/2 TON, K15 / K1500 All	
F	92-99	SUBURBAN 3/4 TON, K25 / K2500 All	
F	92-99	YUKON 4WD	
81727	W		
R	90-97	FORD AEROSTAR All	
R	89	AEROSTAR RWD	
81730	A		
R	90	FORD BRONCO II All	

Numerical listing

Shock	POP	Alternative No.	MTG Acc. Supplied
Pos.	Year	Application	
81730	A	-continued	
R	89	BRONCO II All Mfg. from 2/89; Vehicles with 12mm bolt in rear lower mount	
R	90-97	RANGER RWD	
R	89	RANGER RWD Mfg. from 2/89; Vehicles with 12mm bolt in rear lower mount	
R	94-97	MAZDA B2300 RWD	
R	96	B3000 RWD	
R	94	B3000 RWD	
81739	W		
R	86-91	DODGE COLT Vista, Wagon, 4WD	
R	89-91	EAGLE VISTA Wagon, 4WD, CAN	
R	89-91	PLYMOUTH COLT Vista, Wagon, 4WD	
81741	W		
R	90-92	DODGE MONACO All	
R	88-89	EAGLE MEDALLION All	
R	88-92	PREMIER All	
81742	W		
R	88-93	PONTIAC LEMANS All	
81744	A		
F	90	FORD BRONCO II All	
F	91-94	EXPLORER All	
F	90-97	RANGER All	
F	92-11	VAN 1/2 TON, ECONOLINE / CLUB WAGON All	
F	08-11	VAN 1 TON, ECONOLINE / CLUB WAGON / SUPERDUTY All	
F	07	VAN 1 TON, ECONOLINE / CLUB WAGON / SUPERDUTY All Exc. Ambulance & Handling Package	
F	92-06	VAN 1 TON, ECONOLINE / CLUB WAGON / SUPERDUTY All	
F	92-11	VAN 3/4 TON, ECONOLINE / CLUB WAGON / SUPERDUTY All	
F	94-97	MAZDA B2300 All	
F	94-96	B3000 RWD	
F	96	B3000 4WD	
F	94	B3000 4WD	
F	94-97	B4000 All	
F	91-94	NAVAJO All	
81750	A		
F	05	CHEVROLET BLAZER Base, RWD	
F	96-04	BLAZER LS, RWD	
F	95-02	BLAZER LT, RWD	
F	95-99	BLAZER Base, RWD	
F	95-97	BLAZER Deluxe, RWD	
F	83-94	BLAZER, S MODELS RWD	
F	68-87	EL CAMINO All	
F	94-03	S10 LS, RWD	
F	82-03	S10 Base, RWD	
F	92-93	S10 EL, RWD	
F	83-92	S10 Tahoe, RWD	
F	88-90	S10 Durango, RWD	
F	82-86	S10 Durango, RWD	
F	72-82	FORD COURIER All	
F	92-04	GMC JIMMY RWD	
F	83-91	S15 JIMMY RWD	
F	04	SONOMA / S15 All RWD	
F	82-03	SONOMA / S15 RWD	
F	78-87	SPRINT / CABALLERO RWD	
F	71-77	SPRINT / CABALLERO All	
F	96-00	ISUZU HOMBRE RWD Exc. Sport Chassis	
F	72-76	MAZDA B1600 All	
F	77-78	B1800 All	
F	79-84	B2000 All	
F	82-84	B2200 All	
F	75-83	TOYOTA PICKUP RWD Mojave	
F	70-74	PICKUP All RWD; Mojave	
81789	B		
R	99-00	CADILLAC ESCALADE All	
R	92-94	CHEVROLET BLAZER 4WD Full Size	
R	92-99	SUBURBAN 1/2 TON, C15 / C1500 All	
R	92-99	SUBURBAN 1/2 TON, K15 / K1500 All	
R	92-99	SUBURBAN 3/4 TON, C25 / C2500 All	
R	92-99	SUBURBAN 3/4 TON, K25 / K2500 All	
R	95-00	TAHOE All Old Body Style	
R	96-11	VAN 1/2 TON, G / EXPRESS All	
R	10-12	VAN 1 TON, G / EXPRESS All	
R	97-06	VAN 1 TON, G / EXPRESS All	
R	07-09	VAN 3/4 TON, G / EXPRESS All	

Guardian Shock

Shock	POP	Alternative No.	MTG Acc. Supplied
Pos.	Year	Application	
81789	B	-continued	
R	96-02	VAN 3/4 TON, G / EXPRESS All Exc. 8600# GVW	
R	92-99	GMC SUBURBAN 1/2 TON, C15 / C1500 All	
R	92-99	SUBURBAN 1/2 TON, K15 / K1500 All	
R	92-99	SUBURBAN 3/4 TON, C25 / C2500 All	
R	92-99	SUBURBAN 3/4 TON, K25 / K2500 All	
R	96-11	VAN 1/2 TON, G / SAVANNA RWD	
R	97-02	VAN 1 TON, G / SAVANNA All	
R	96-02	VAN 3/4 TON, G / SAVANNA All Exc. 8600# GVW	
R	92-99	YUKON All	
81790	W		
R	95-98	BUICK SKYLARK All	
R	95-96	CHEVROLET BERETTA All	
R	95-96	CORSIKA All	
R	95-98	OLDSMOBILE ACHIEVA All Exc. Electronic Adjustable Suspension	
R	95-98	PONTIAC GRAND AM All Exc. Electronic Adjustable Suspension	
81791	W		
R	89-96	CHEVROLET CORVETTE All Exc. Electronic Adjustable Suspension	
R	88	CORVETTE All	
81792	W		
F	89-96	CHEVROLET CORVETTE All Exc. Electronic Adjustable Suspension	
81793	W		
R	88-93	CHRYSLER DYNASTY CAN Hydraulic Self Leveling System	
R	88-93	DODGE DYNASTY All Hydraulic Self Leveling System	
81794	B		
R	03-04	FORD MUSTANG / MUSTANG II Mach I	
R	94-04	MUSTANG / MUSTANG II Base	
R	94-04	MUSTANG / MUSTANG II GT	
R	04	MUSTANG / MUSTANG II GT Base	
R	04	MUSTANG / MUSTANG II GT Equipado	
R	01	MUSTANG / MUSTANG II GT Bullitt	
R	95	MUSTANG / MUSTANG II GTS	
81795	D		
R	92-97	FORD THUNDERBIRD All Exc. Electronic Adjustable Suspension	
R	92-97	MERCURY COUGAR All Exc. Electronic Adjustable Suspension	
81821	W		
F	86-97	FORD PICKUP 1 TON, F-350 / SUPERDUTY 4WD	
F	97	PICKUP 3/4 TON, F-250 / SUPERDUTY 4WD Over 8500# GVW	
F	87-96	PICKUP 3/4 TON, F-250 / SUPERDUTY 4WD	
81823	W		
R	91-94	FORD EXPLORER All	
R	91-94	MAZDA NAVAJO All	
81825	W		
F	81-93	DODGE PICKUP 1/2 TON, W100 SERIES All Exc. Lift Kit	
F	61-80	PICKUP 1/2 TON, W100 SERIES All	
F	81-93	PICKUP 1 TON, W300 SERIES All Exc. Quad Suspension and Lift Kit	
F	61-80	PICKUP 1 TON, W300 SERIES All	
R	61-71	PICKUP 1 TON, W300 SERIES All	
F	81-93	PICKUP 3/4 TON, W200 SERIES Standard Cab Pickup Exc. Lift Kit	
F	69-80	PICKUP 3/4 TON, W200 SERIES All	
F	61-67	PICKUP 3/4 TON, W200 SERIES All	
F	75-93	RAMCHARGER 4WD	
F	74	RAMCHARGER All	
F	78-80	RD200 All	
F	75-81	PLYMOUTH TRAILDUSTER 4WD	
F	74	TRAILDUSTER All	
81826	W		
F	90-97	FORD AEROSTAR 4WD	
F	90-97	AEROSTAR AWD	

Numerical listing

Shock	POP	Alternative No.	MTG Acc. Supplied
Pos.	Year	Application	
81828	D		
R	04-11	FORD VAN 1 TON, ECONOLINE / CLUB WAGON / SUPERDUTY All Exc. Ambulance & Handling Package	
R	92-05	VAN 1 TON, ECONOLINE / CLUB WAGON / SUPERDUTY All	
R	92-11	VAN 3/4 TON, ECONOLINE / CLUB WAGON / SUPERDUTY All	
81833	W		
R	92-07	FORD VAN 1/2 TON, ECONOLINE / CLUB WAGON All	
81834	W		
F	72-93	DODGE PICKUP 1 TON, D300 SERIES All HD Package	
F	82-93	PICKUP 3/4 TON, D200 SERIES All HD Package	
F	75-81	PICKUP 3/4 TON, D200 SERIES 165.0 (WheelBase) HD Package	
F	72-74	PICKUP 3/4 TON, D200 SERIES All HD Package	
F	71-93	VAN 1 TON, A / B SERIES / RAM All 4000# Front Axle	
F	74-80	VAN, CB300 All 4000# Front Axle	
F	74-83	PLYMOUTH VAN 1 TON, PB SERIES All 4000# Front Axle	
81836	A		
F	97-04	DODGE DAKOTA 4WD	
F	98-03	DURANGO 4WD	
81837	W		
R	87-96	DODGE DAKOTA 4WD	
81869	A		
F	99-04	JEEP GRAND CHEROKEE All	
81870	C		
F	86-95	TOYOTA 4RUNNER All	
F	86-95	PICKUP 4WD Exc. Lift Kit	
F	93-98	T100 4WD	
81871	C		
R	84-89	TOYOTA 4RUNNER All	
R	84-95	PICKUP 4WD Exc. Lift Kit	
R	98-04	TACOMA Pre Runner, RWD	
R	95-04	TACOMA 4WD	
81872	B		
F	90-92	DAIHATSU ROCKY All	
F	94-02	HONDA PASSPORT All	
F	98-00	ISUZU AMIGO All	
F	91-04	RODEO All	
F	87-90	MITSUBISHI VAN All	
F	87-95	NISSAN PATHFINDER All	
81873	A		
R	07	CHEVROLET PICKUP 1/2 TON, SILVERADO 1500 Classic Hybrid, RWD Exc. Electronic Adjustable Suspension	
R	07	PICKUP 1/2 TON, SILVERADO 1500 Classic LS, RWD Exc. Electronic Adjustable Suspension	
R	07	PICKUP 1/2 TON, SILVERADO 1500 Classic LT, RWD Exc. Electronic Adjustable Suspension	
R	07	PICKUP 1/2 TON, SILVERADO 1500 Classic SS, RWD Exc. Electronic Adjustable Suspension	
R	07	PICKUP 1/2 TON, SILVERADO 1500 Classic WT, RWD Exc. Electronic Adjustable Suspension	
R	99-06	PICKUP 1/2 TON, SILVERADO 1500 RWD Exc. Electronic Adjustable Suspension	
R	94-01	DODGE PICKUP 1/2 TON, RAM 1500 (SEE RAM 1500) All	
R	94-02	PICKUP 1 TON, RAM 3500 (SEE RAM 3500) RWD Exc. Solid Front Axle	
R	94-03	PICKUP 3/4 TON, RAM 2500 (SEE RAM 2500) 4WD, GAS Exc. 8800# GVW	
R	94-02	PICKUP 3/4 TON, RAM 2500 (SEE RAM 2500) RWD	
R	95-96	PICKUP 3/4 TON, RAM 2500 (SEE RAM 2500) 4WD, CNG Exc. 8800# GVW	
R	07	GMC SIERRA 1500 Classic Hybrid, RWD Classic and Old Body Style; Exc. Electronic Adjustable Suspension	

Numerical listing

Shock	POP	Alternative No.	MTG Acc. Supplied
Pos.	Year	Application	
81873		A -continued	
R	07	SIERRA 1500 Classic SL, RWD	Exc. Electronic Adjustable Suspension
R	07	SIERRA 1500 Classic SLE, RWD	Exc. Electronic Adjustable Suspension
R	07	SIERRA 1500 Classic SLT, RWD	Exc. Electronic Adjustable Suspension
R	07	SIERRA 1500 Classic WT, RWD	Exc. Electronic Adjustable Suspension
R	99-06	SIERRA 1500 RWD Exc. Electronic Adjustable Suspension	
81878		A	
R	96-07	CHRYSLER TOWN & COUNTRY All	
R	01-03	VOYAGER / GRAND VOYAGER All	Exc. Hydraulic Self Leveling System
R	00	VOYAGER / GRAND VOYAGER All	
R	00	VOYAGER / GRAND VOYAGER	Non-ABS
R	96-07	DODGE CARAVAN / GRAND CARAVAN All	Exc. Hydraulic Self Leveling System
R	96-00	PLYMOUTH VOYAGER / GRAND VOYAGER All	
81880		W	
R	63-82	CHEVROLET CORVETTE All	
81881		W	
R	89-91	FORD THUNDERBIRD All	Exc. Electronic Adjustable Suspension
R	89-91	MERCURY COUGAR All	Exc. Electronic Adjustable Suspension
81882		B	
R	95-03	FORD WINDSTAR Coil	(RearSpringType)
81890		A	
R	95-01	FORD EXPLORER All	Exc. Adjustable Suspension
R	01-05	EXPLORER SPORT TRAC All	
R	97-01	MERCURY MOUNTAINEER All	Exc. Electronic Adjustable Suspension
81891		C	
R	93-98	JEEP GRAND CHEROKEE All	
81892		B	
R	04	FORD PICKUP 1/2 TON, F-150 RWD	
R	00-03	PICKUP 1/2 TON, F-150 Harley-Davidson Edition, RWD	
R	99-03	PICKUP 1/2 TON, F-150 Lariat, RWD	
R	99-03	PICKUP 1/2 TON, F-150 XL, RWD	
R	99-03	PICKUP 1/2 TON, F-150 XLT, RWD	
R	00	PICKUP 1/2 TON, F-150 Base, RWD	
R	97-98	PICKUP 1/2 TON, F-150 RWD	
R	97-99	PICKUP 3/4 TON, F-250 / SUPERDUTY RWD Up through 8500# GVW	
81893		A	
F	95-01	FORD EXPLORER All	Exc. Electronic Adjustable Suspension
F	01-05	EXPLORER SPORT TRAC All	
F	06-11	RANGER RWD, Torsion Bar	(FrontSpringType)
F	98-11	RANGER 4WD	
F	01-05	RANGER Edge, RWD	
F	03-06	MAZDA B3000 All	4WD
F	98-02	B3000 4WD	
F	98-06	B4000 4WD	
F	97-01	MERCURY MOUNTAINEER All	Exc. Electronic Adjustable Suspension
81902		W	
F	87-96	DODGE DAKOTA 4WD	
81904		D	
R	94-98	ASUNA SUNRUNNER	
R	92-93	SUNRUNNER All	
R	98-04	CHEVROLET TRACKER Non-ABS	
R	89-97	GEO TRACKER All	
R	89-91	GMC TRACKER All	
R	94-97	PONTIAC SUNRUNNER CAN	
R	99-05	SUZUKI GRAND VITARA All	
R	96-98	SIDEKICK All	

Guardian Shock

Shock	POP	Alternative No.	MTG Acc. Supplied
Pos.	Year	Application	
81904		D -continued	
R	89-95	SIDEKICK Non-ABS	
R	99-04	VITARA All	
R	96-98	X-90 All	
81905		W	
R	90-97	FORD RANGER 4WD	
R	89	RANGER 4WD Mfg. from 2/89;	Vehicles with 12mm bolt in rear lower mount
R	95-96	MAZDA B2300 4WD	
R	94-97	B3000 4WD	
R	94-97	B4000 4WD	
81906		W	
R	90-95	TOYOTA 4RUNNER All	
81907		W	
R	87-93	MAZDA B2600 4WD	
81908		W	
F	01-04	TOYOTA TACOMA S-Runner	Exc. Offroad Package
F	04	TACOMA Base, RWD	Exc. Offroad Package
F	95-03	TACOMA DLX, RWD	Exc. Offroad Package
81909		W	
R	96-99	ACURA SLX 4WD	
R	00-02	ISUZU TROOPER All	
R	92-99	TROOPER 4WD	
R	99-01	VEHICROSS All	
81910		W	
R	98	INFINITI QX4 All	Mfg. to 12/98
R	97	QX4 All	
R	96-99	NISSAN PATHFINDER All	Mfg. to 12/98
81911		W	
R	98-02	HONDA PASSPORT All	
R	98-00	ISUZU AMIGO All	
R	98-04	RODEO All	
81912		B	
F	97-02	FORD EXPEDITION RWD	Exc. Front Air- Leveling
F	97-04	PICKUP 1/2 TON, F-150 RWD	
F	97-99	PICKUP 3/4 TON, F-250 / SUPERDUTY RWD Up through 8500# GVW	
F	98-02	LINCOLN NAVIGATOR RWD	
81913		D	
R	97-04	FORD PICKUP 1/2 TON, F-150 4WD	Exc. 7700# GVW
R	97-99	PICKUP 3/4 TON, F-250 / SUPERDUTY 4WD Up through 8500# GVW; Exc. Superduty	
81914		D	
F	97-02	FORD EXPEDITION 4WD	Exc. Front Air- Leveling
F	04	PICKUP 1/2 TON, F-150 4WD	Exc. 7700# GVW
F	97-03	PICKUP 1/2 TON, F-150 4WD	
F	97-99	PICKUP 3/4 TON, F-250 / SUPERDUTY 4WD Up through 8500# GVW; Exc. Superduty	
81916		A	
F	06-11	FORD RANGER RWD, Coil	(FrontSpringType)
F	98-05	RANGER XL, RWD	Exc. Edge, EV, Splash & Sport Models
F	98-05	RANGER XLT, RWD	Exc. Edge, EV, Splash & Sport Models
F	05	RANGER STX, RWD	Exc. Edge, EV, Splash & Sport Models
F	04	RANGER Tremor, RWD	Exc. Edge, EV, Splash & Sport Models
F	01-06	MAZDA B2300 RWD	
F	98-01	B2500 RWD	
F	98-06	B3000 RWD	
F	98-04	B4000 RWD	
81917		D	
R	06-11	FORD RANGER RWD, Coil	(FrontSpringType)
R	98-05	RANGER XL, RWD	Exc. Edge, EV, Splash & Sport Models
R	98-05	RANGER XLT, RWD	Exc. Edge, EV, Splash & Sport Models
R	05	RANGER STX, RWD	Exc. Edge, EV, Splash & Sport Models

Numerical listing

Shock	POP	Alternative No.	MTG Acc. Supplied
Pos.	Year	Application	
81917		D -continued	
R	04	RANGER Tremor, RWD	Exc. Edge, EV, Splash & Sport Models
R	98-01	MAZDA B2500 All	
R	98-06	B3000 RWD	
R	98-04	B4000 RWD	
81918		D	
R	06-11	FORD RANGER RWD, Torsion Bar	(FrontSpringType)
R	98-11	RANGER 4WD	
R	01-05	RANGER Edge, RWD	
R	03-06	MAZDA B3000 All	4WD
R	98-02	B3000 4WD	
R	98-04	B4000 4WD	
81919		D	
F	94-01	DODGE PICKUP 1/2 TON, RAM 1500	(SEE RAM 1500) 4WD
F	99-02	PICKUP 3/4 TON, RAM 2500	(SEE RAM 2500) 4WD Exc. 8800# GVW
F	94-95	PICKUP 3/4 TON, RAM 2500	(SEE RAM 2500) 4WD Exc. 8800# GVW
81920		A	
F	07	CHEVROLET PICKUP 1/2 TON, SILVERADO 1500 Classic Hybrid,	RWD Exc. Electronic Adjustable Suspension
F	07	PICKUP 1/2 TON, SILVERADO 1500 Classic LS, RWD	Exc. Electronic Adjustable Suspension
F	07	PICKUP 1/2 TON, SILVERADO 1500 Classic LT, RWD	Exc. Electronic Adjustable Suspension
F	07	PICKUP 1/2 TON, SILVERADO 1500 Classic SS, RWD	Exc. Electronic Adjustable Suspension
F	07	PICKUP 1/2 TON, SILVERADO 1500 Classic WT, RWD	Exc. Electronic Adjustable Suspension
F	99-06	PICKUP 1/2 TON, SILVERADO 1500 RWD	Exc. Electronic Adjustable Suspension
F	07	GMC SIERRA 1500 Classic Hybrid,	RWD Exc. Electronic Adjustable Suspension
F	07	SIERRA 1500 Classic SL, RWD	Exc. Electronic Adjustable Suspension
F	07	SIERRA 1500 Classic SLE, RWD	Exc. Electronic Adjustable Suspension
F	07	SIERRA 1500 Classic SLT, RWD	Exc. Electronic Adjustable Suspension
F	07	SIERRA 1500 Classic WT, RWD	Exc. Electronic Adjustable Suspension
F	99-06	SIERRA 1500 RWD	Exc. Electronic Adjustable Suspension
81921		B	
R	07	CHEVROLET PICKUP 1/2 TON, SILVERADO 1500 Classic Hybrid,	4WD Classic and Old Body Style; Exc. Electronic Adjustable Suspension
R	07	PICKUP 1/2 TON, SILVERADO 1500 Classic LS, 4WD	Classic and Old Body Style; Exc. Electronic Adjustable Suspension
R	07	PICKUP 1/2 TON, SILVERADO 1500 Classic LT, 4WD	Classic and Old Body Style; Exc. Electronic Adjustable Suspension
R	07	PICKUP 1/2 TON, SILVERADO 1500 Classic WT, 4WD	Classic and Old Body Style; Exc. Electronic Adjustable Suspension
R	99-06	PICKUP 1/2 TON, SILVERADO 1500 4WD	Classic and Old Body Style; Exc. Electronic Adjustable Suspension
R	05-07	PICKUP 1/2 TON, SILVERADO 1500 HD All	
R	01-03	PICKUP 1/2 TON, SILVERADO 1500 HD All	
R	77-86	PICKUP 1 TON, K30 All	
R	90-91	PICKUP 1 TON, R3500 All	
R	89	PICKUP 1 TON, R3500 Cab & Chassis, RWD	
R	89	PICKUP 1 TON, R3500 Crew Cab	Pickup, RWD
R	01-09	PICKUP 1 TON, SILVERADO 3500 All	

Numerical listing

Shock	POP	Alternative No.	MTG Acc. Supplied
Pos.	Year	Application	
81921	B	-continued	
R	07-10	PICKUP 1 TON, SILVERADO 3500 HD All	
R	87-88	PICKUP 1 TON, V30 All	
R	89-91	PICKUP 1 TON, V3000 / V3500 All	
R	99-08	PICKUP 3/4 TON, SILVERADO 2500 All	
R	01-10	PICKUP 3/4 TON, SILVERADO 2500 HD All	
R	94-02	DODGE PICKUP 1 TON, RAM 3500 (SEE RAM 3500) 4WD	
R	94-02	PICKUP 1 TON, RAM 3500 (SEE RAM 3500) RWD Solid Front Axle	
R	94-02	PICKUP 3/4 TON, RAM 2500 (SEE RAM 2500) 4WD, DIESEL 8800# GVW	
R	77-86	GMC PICKUP 1 TON, K35 / K3500 All	
R	87-91	PICKUP 1 TON, V3000 / V3500 All	
R	07	SIERRA 1500 Classic Hybrid, 4WD Classic and Old Body Style; Exc. Electronic Adjustable Suspension	
R	07	SIERRA 1500 Classic SL, 4WD Classic and Old Body Style; Exc. Electronic Adjustable Suspension	
R	07	SIERRA 1500 Classic SLE, 4WD Classic and Old Body Style; Exc. Electronic Adjustable Suspension	
R	07	SIERRA 1500 Classic SLT, 4WD Classic and Old Body Style; Exc. Electronic Adjustable Suspension	
R	07	SIERRA 1500 Classic WT, 4WD Classic and Old Body Style; Exc. Electronic Adjustable Suspension	
R	99-06	SIERRA 1500 4WD Classic and Old Body Style; Exc. Electronic Adjustable Suspension	
R	05-07	SIERRA 1500 HD All	
R	01-03	SIERRA 1500 HD All	
R	99-04	SIERRA 2500 All	
R	01-10	SIERRA 2500 HD All	
R	01-07	SIERRA 3500 All	
R	07-10	SIERRA 3500 HD All	
81922	A		
F	02-06	CHEVROLET AVALANCHE 1500 All Exc. Electronic Ride Control	
F	07	PICKUP 1/2 TON, SILVERADO 1500 Classic Hybrid, 4WD Classic and Old Body Style; Exc. Electronic Adjustable Suspension	
F	07	PICKUP 1/2 TON, SILVERADO 1500 Classic LS, 4WD Classic and Old Body Style; Exc. Electronic Adjustable Suspension	
F	07	PICKUP 1/2 TON, SILVERADO 1500 Classic LT, 4WD Classic and Old Body Style; Exc. Electronic Adjustable Suspension	
F	07	PICKUP 1/2 TON, SILVERADO 1500 Classic WT, 4WD Classic and Old Body Style; Exc. Electronic Adjustable Suspension	
F	99-06	PICKUP 1/2 TON, SILVERADO 1500 4WD Classic and Old Body Style; Exc. Electronic Adjustable Suspension	
F	00-06	SUBURBAN 1/2 TON, 1500 All Exc. Z55 Auto Ride Suspension	
F	02-06	TAHOE All Exc. Z55 Auto Ride Suspension	
F	00-01	TAHOE All New Body Style; Exc. Z55 Auto Ride Suspension	
F	07	GMC SIERRA 1500 Classic Hybrid, 4WD Classic and Old Body Style; Exc. Electronic Adjustable Suspension	
F	07	SIERRA 1500 Classic SL, 4WD Classic and Old Body Style; Exc. Electronic Adjustable Suspension	
F	07	SIERRA 1500 Classic SLE, 4WD Classic and Old Body Style; Exc. Electronic Adjustable Suspension	
F	07	SIERRA 1500 Classic SLT, 4WD Classic and Old Body Style; Exc. Electronic Adjustable Suspension	
F	07	SIERRA 1500 Classic WT, 4WD Classic and Old Body Style; Exc. Electronic Adjustable Suspension	
F	99-06	SIERRA 1500 4WD Classic and Old Body Style; Exc. Electronic Adjustable Suspension	
F	00-06	YUKON All Exc. Z55 Auto Ride Suspension	

Guardian Shock, Classic Shock Absorbers

Shock	POP	Alternative No.	MTG Acc. Supplied
Pos.	Year	Application	
81922	A	-continued	
F	00-06	YUKON XL 1/2 TON All Exc. Z55 Auto Ride Suspension	
F	00-06	YUKON XL 3/4 TON All Exc. Z55 Auto Ride Suspension	
81923	C		
R	97-04	DODGE DAKOTA All	
R	01-03	DURANGO 4WD	
R	01-03	DURANGO RWD	
R	99-00	DURANGO All	
R	98	DURANGO 4WD	
81924	D		
R	02-05	CHEVROLET VENTURE All	
R	97-01	VENTURE FWD	
R	02-04	OLDSMOBILE SILHOUETTE AWD	
R	97-04	SILHOUETTE FWD	
R	99-05	PONTIAC MONTANA All	
R	97-98	TRANS SPORT All	
81925	W		
F	02-06	CHEVROLET AVALANCHE 2500 All Exc. Electronic Ride Control	
F	05-07	PICKUP 1/2 TON, SILVERADO 1500 HD All	
F	01-03	PICKUP 1/2 TON, SILVERADO 1500 HD All	
F	01-09	PICKUP 1 TON, SILVERADO 3500 All	
F	07-10	PICKUP 1 TON, SILVERADO 3500 HD All	
F	05-08	PICKUP 3/4 TON, SILVERADO 2500 All	
F	99-04	PICKUP 3/4 TON, SILVERADO 2500 4WD	
F	01-10	PICKUP 3/4 TON, SILVERADO 2500 HD All 9200# GVW	
F	00-11	SUBURBAN 3/4 TON, 2500 All Exc. Z55 Auto Ride Suspension and QuadraSteer	
F	05-07	GMC SIERRA 1500 HD All	
F	01-03	SIERRA 1500 HD All	
F	99-04	SIERRA 2500 4WD	
F	01-09	SIERRA 2500 HD All	
F	01-07	SIERRA 3500 All	
F	07-10	SIERRA 3500 HD Torsion Bar (FrontSpringType)	
F	00-06	YUKON XL 3/4 TON All Exc. Hydraulic Self Leveling System	
81926	C		
R	99-04	JEEP GRAND CHEROKEE All	
81927	W		
R	96-05	FORD TAURUS Wagon	
R	96-05	MERCURY SABLE Wagon	
81928	B		
F	94-01	DODGE PICKUP 1/2 TON, RAM 1500 (SEE RAM 1500) RWD	
F	94-02	PICKUP 1 TON, RAM 3500 (SEE RAM 3500) RWD Exc. Solid Front Axle	
F	94-02	PICKUP 3/4 TON, RAM 2500 (SEE RAM 2500) RWD	
81929	W		
R	97-06	JEEP WRANGLER TJ (MfrBodyCode)	
81930	B		
R	02-07	CHEVROLET AVALANCHE 1500 All Exc. Electronic Ride Control	
R	02-06	AVALANCHE 2500 All Exc. Electronic Ride Control	
R	07-11	SUBURBAN 1/2 TON, 1500 All Exc. Z55 or ZW7 Ride Suspension	
R	00-06	SUBURBAN 1/2 TON, 1500 All Exc. Z55 Auto Ride Suspension	
R	00-11	SUBURBAN 3/4 TON, 2500 All Exc. Z55 Auto Ride Suspension and QuadraSteer	
R	07-11	TAHOE All Exc. Z55 or ZW7 Ride Suspension	
R	02-06	TAHOE All Exc. Z55 Auto Ride Suspension	
R	00-01	TAHOE All New Body Style; Exc. Z55 Auto Ride Suspension	
R	00-09	GMC YUKON All Exc. Z55 Auto Ride Suspension	
R	00-06	YUKON XL 1/2 TON All Exc. Z55 Auto Ride Suspension	
R	00-06	YUKON XL 3/4 TON All Exc. Hydraulic Self Leveling System	

Numerical listing

Shock	POP	Alternative No.	MTG Acc. Supplied
Pos.	Year	Application	
81931	W		
R	06-08	DODGE PICKUP 1/2 TON, RAM 1500 (SEE RAM 1500) Crew Cab Pickup, 4WD	
R	06-08	PICKUP 1/2 TON, RAM 1500 (SEE RAM 1500) Standard Cab Pickup, 4WD	
R	02-05	PICKUP 1/2 TON, RAM 1500 (SEE RAM 1500) 4WD	
81932	W		
F	02-05	DODGE PICKUP 1/2 TON, RAM 1500 (SEE RAM 1500) 4WD	
81933	A		
F	06-08	DODGE PICKUP 1/2 TON, RAM 1500 (SEE RAM 1500) Crew Cab Pickup, RWD	
F	06-08	PICKUP 1/2 TON, RAM 1500 (SEE RAM 1500) Standard Cab Pickup, RWD	
F	02-05	PICKUP 1/2 TON, RAM 1500 (SEE RAM 1500) RWD	
81934	A		
R	98-10	VOLKSWAGEN BEETLE All	
R	99-06	GOLF A4 (MfrBodyCode)	
R	01-05	JETTA Sedan	
81935	B		
R	08-11	FORD FOCUS All	
R	00-07	FOCUS Hatchback	
R	00-07	FOCUS Sedan	
81936	W		
F	97-06	JEEP WRANGLER TJ (MfrBodyCode)	
81937	W		
R	94-97	HONDA PASSPORT All	
R	91-97	ISUZU RODEO All	
R	98-03	TOYOTA SIENNA All	
Classic Shock Absorbers			
82001	A		
R	52-77	VOLKSWAGEN BEETLE All	
F	66	BEETLE All 1200	
F	52-65	BEETLE All	
F	66-73	FASTBACK All	
R	66-73	FASTBACK All	
F	66-73	SQUAREBACK All	
R	66-73	SQUAREBACK All	
R	74-79	SUPER BEETLE All	
R	71-73	SUPER BEETLE All 3 Bolt Flange-Type Lower Mount	
R	73-74	THING All	
F	56-69	TRANSPORTER All	
R	56-67	TRANSPORTER All	
82002	W		
R	74-78	FORD MUSTANG / MUSTANG II All	
82003	A		
R	69-72	CHEVROLET BLAZER All Coil(RearSpringType)	
R	67-72	PICKUP 1/2 TON, C10 All Coil(RearSpringType)	
R	67-72	PICKUP 3/4 TON, C20 All Coil(RearSpringType)	
R	67	SUBURBAN 1/2 TON, 1500 All Coil(RearSpringType)	
R	68-72	SUBURBAN 1/2 TON, C10 All	
R	68-72	SUBURBAN 3/4 TON, C20 All	
R	64-66	VAN 1/2 TON, G / EXPRESS All	
R	67-72	VAN 1/2 TON, P SERIES All	
R	70-72	GMC JIMMY All RWD	
R	67-72	PICKUP 1/2 TON, C15 / C1500 All Coil(RearSpringType)	
R	67-72	PICKUP 3/4 TON, C25 / C2500 All Coil(RearSpringType)	
R	68-72	SUBURBAN 1/2 TON, C15 / C1500 All Coil(RearSpringType)	
R	68-72	SUBURBAN 3/4 TON, C25 / C2500 All	
R	64-66	VAN 1/2 TON, G / SAVANNA All	
R	68-72	VAN 1/2 TON, P SERIES All	
82004	A		
R	71-80	FORD PINTO Sedan	
R	75-80	MERCURY BOBCAT Sedan	
82005	A		
F	67-77	VOLKSWAGEN BEETLE All	
F	66	BEETLE All 1300 and 1500	
F	73-79	SUPER BEETLE All	
F	73-74	THING All	

Numerical listing

Shock	POP	Alternative No.	MTG Acc. Supplied
Pos.	Year	Application	
82006 C			
R	69-72	CHEVROLET BLAZER All Leaf(RearSpringType)	
R	63-72	PICKUP 1/2 TON, C10 All Leaf(RearSpringType)	
R	67-72	PICKUP 1 TON, C30 All Exc. 11,000# Rear Axle	
R	67-72	PICKUP 3/4 TON, C20 All Leaf(RearSpringType)	
R	63-66	SUBURBAN 1/2 TON, 1500 All	
R	67-77	VAN 1/2 TON, G / EXPRESS All	
R	63-66	VAN 1/2 TON, P SERIES All	
R	76-77	VAN 1 TON, G / EXPRESS All	
R	75	VAN 1 TON, G / EXPRESS 110.0 (WheelBase)	
R	75	VAN 1 TON, G / EXPRESS 125.0 (WheelBase)	
R	71-74	VAN 1 TON, G / EXPRESS All	
R	68-72	VAN 1 TON, P SERIES All Exc. 11,000# Rear Axle	
R	67-77	VAN 3/4 TON, G / EXPRESS All	
R	68-72	VAN 3/4 TON, P SERIES All	
R	67-72	GMC PICKUP 1/2 TON, C15 / C1500 All Leaf(RearSpringType)	
R	67-72	PICKUP 1 TON, C35/3500 All Exc. 11,000# Rear Axle	
R	67-72	PICKUP 3/4 TON, C25 / C2500 All Leaf(RearSpringType)	
R	63-65	PICKUP 1000 SERIES All	
R	63-65	PICKUP 1500 SERIES All	
R	67-77	VAN 1/2 TON, G / SAVANNA All	
R	67	VAN 1/2 TON, P SERIES All	
R	76-77	VAN 1 TON, G / SAVANNA All	
R	75	VAN 1 TON, G / SAVANNA 110.0 (WheelBase)	
R	75	VAN 1 TON, G / SAVANNA 125.0 (WheelBase)	
R	71-74	VAN 1 TON, G / SAVANNA All	
R	68-72	VAN 1 TON, P SERIES All Exc. 11,000# Rear Axle	
R	67-77	VAN 3/4 TON, G / SAVANNA All	
R	68-72	VAN 3/4 TON, P SERIES All	
R	63-65	VAN, PB 1000 SERIES All	
82007 A			
F	47-48	FORD DELUXE All Direct Acting Shocks	
R	61-67	ECONOLINE All	
F	47-48	SUPER DELUXE All Direct Acting Shocks	
R	68	VAN 1/2 TON, ECONOLINE / CLUB WAGON All Late 1968	
F	68	INTERNATIONAL 908B All	
F	68	908C All	
F	68	1100B All	
F	68	1100C All	
F	68	1200B All Exc. Travelette with 166" Wheelbase	
F	68	1200C All Exc. Travelette with 166" Wheelbase	
F	68	1300B All Exc. Travelette with 166" Wheelbase	
F	68	1300C All Exc. Travelette with 166" Wheelbase	
F	68-72	M1100 / M1200 All	
F	69	M1400 All	
F	65-67	M SERIES VAN All	
F	61-71	SCOUT All	
F	61-66	JEEP CJ3 All Exc. 5 Leaf Front Springs & Lift Kit	
F	72-81	CJ5 All Exc. Lift Kit	
F	61-71	CJ5 All Exc. 5 Leaf Front Springs & Lift Kit	
F	72-75	CJ6 All Exc. Lift Kit	
F	66-71	CJ6 All Exc. 5 Leaf Front Springs & Lift Kit	
F	76-81	CJ7 All Exc. Lift Kit	
F	66-74	DJ5 All Exc. Lift Kit	
F	66-68	DJ6 All	
F	57-65	FC150 All	
F	67-73	JEEPSTER All	
R	67-69	JEEPSTER All	
F	81	SCRAMBLER / CJ8 All	
F	61-67	UNIVERSAL All	
F	76-83	TOYOTA LAND CRUISER FJ40 (MfrBodyCode)	
F	75	LAND CRUISER FJ40 (MfrBodyCode) Mfg. to 2/75	
F	67-74	LAND CRUISER All	
82010 D			
F	71-78	CADILLAC ELDORADO All	
F	67-70	ELDORADO All Vertically Mounted	
F	71-78	OLDSMOBILE TORONADO All	
F	66-70	TORONADO All Vertically Mounted	

Classic Shock Absorbers

Shock	POP	Alternative No.	MTG Acc. Supplied
Pos.	Year	Application	
82011 C			
F	65-71	CHRYSLER 300 All	
F	67-73	IMPERIAL All	
F	65-73	NEWPORT All	
F	65-73	NEW YORKER All	
F	65-73	TOWN & COUNTRY All	
F	65	DODGE CUSTOM All	
F	65-73	MONACO All	
F	65-73	POLARA All	
F	65-73	PLYMOUTH FURY All	
F	72-73	GRAN FURY All	
F	67	VIP All	
82012 W			
F	69-74	FORD VAN 1/2 TON, ECONOLINE / CLUB WAGON All	
F	68	VAN 1/2 TON, ECONOLINE / CLUB WAGON All Late 1968	
F	69-74	VAN 1 TON, ECONOLINE / CLUB WAGON / SUPERDUTY All	
F	68	VAN 1 TON, ECONOLINE / CLUB WAGON / SUPERDUTY All Late 1968	
F	69-74	VAN 3/4 TON, ECONOLINE / CLUB WAGON / SUPERDUTY All	
F	68	VAN 3/4 TON, ECONOLINE / CLUB WAGON / SUPERDUTY All Late 1968	
82013 W			
R	80-82	TOYOTA TERCEL AL1 (MfrBodyCode)	
82020 W			
R	71-73	NISSAN 1200 All	
R	76-78	B210 All Hatchback	
R	75	B210 All	
R	74	B210 All Hatchback	
R	74	TOYOTA COROLLA Wagon Mfg to 7/74	
R	71-73	COROLLA Wagon	
82025 W			
F	75-80	AMERICAN MOTORS PACER All	
82026 A			
F	53	CADILLAC DEVILLE All	
F	50-53	FLEETWOOD / 60 SERIES / 70 SERIES All	
F	50-54	CHEVROLET BEL AIR All	
F	53-62	CORVETTE All	
F	53-54	ONE-FIFTY SERIES All	
F	49-52	STYLELINE DELUXE All	
F	49-52	STYLELINE SPECIAL All	
F	53-54	TWO-TEN SERIES All	
F	50-56	FORD COUNTRY SEDAN All	
F	50-56	COUNTRY SQUIRE All	
F	54-56	COURIER SEDAN DELIVERY All	
F	50-54	CRESTLINE All	
F	50-52	CUSTOM All	
F	52-56	CUSTOMLINE All	
F	49-51	DELUXE All	
F	55-56	FAIRLANE All	
F	49	FORD All	
F	52-56	MAINLINE All	
F	56	PARK LANE WAGON All	
F	50-56	RANCH WAGON All	
F	54-56	SKYLINER All	
F	52-56	SUNLINER All	
F	55-57	THUNDERBIRD All	
F	51-56	VICTORIA All	
F	52-56	MERCURY CUSTOM All	
F	56	MEDALIST All	
F	49-51	MERCURY All	
F	55-56	MONTECLAIR All	
F	50-56	MONTEREY All	
F	55	OLDSMOBILE 98 All	
F	57	PONTIAC BONNEVILLE All	
F	50-57	CATALINA All	
F	49-57	CHIEFTAIN All	
F	54-57	STAR CHIEF All	
F	49-52	STREAMLINER All	
F	57	SUPER CHIEF All	
F	56	STUDEBAKER POWER HAWK All	
F	55-56	PRESIDENT All	
F	56	SKY HAWK All	
F	59-68	VOLVO 122 All	
F	61-73	1800 All	
82030 D			
R	74	INTERNATIONAL 100 All	
R	75	150 RWD	
R	74-75	200 All	
R	74-75	200 All	
R	69-70	1000D All Before Chassis #H-205000	

Numerical listing

Shock	POP	Alternative No.	MTG Acc. Supplied
Pos.	Year	Application	
82030 D -continued			
R	71-72	1010 All Before Chassis #H-205000	
F	69-70	1100D All	
R	69-70	1100D All	
F	71-73	1110 All	
R	71-73	1110 All	
F	69-70	1200D All	
R	69-70	1200D All	
F	71-73	1210 All	
R	71-73	1210 All	
F	69-70	1300D All	
R	69-70	1300D All	
F	71-73	1310 All	
R	71-73	1310 All	
R	71-80	SCOUT II All	
F	75	TRAVELALL All	
82031 W			
F	70-79	VOLKSWAGEN TRANSPORTER All	
82032 W			
R	68-79	VOLKSWAGEN TRANSPORTER All	
82033 W			
F	70-76	FORD PICKUP 1/2 TON, F-100 4WD Exc. Lift Kit	
F	66-69	PICKUP 1/2 TON, F-100 4WD	
F	65	PICKUP 1/2 TON, F-100 All With Front Coil Springs; Late 1965	
F	76	PICKUP 1/2 TON, F-150 4WD Exc. Lift Kit	
F	75	PICKUP 1/2 TON, F-150 All 4WD; Exc. Lift Kit	
82034 C			
R	55-56	CADILLAC DEVILLE All	
R	67	ELDORADO All Vertically Mounted	
R	55-56	FLEETWOOD / 60 SERIES / 70 SERIES All	
F	65	FORD PICKUP 1/2 TON, F-100 All Early 1965	
F	66-77	PICKUP 3/4 TON, F-250 / SUPERDUTY 4WD Up through Serial No. Y20000	
F	61-65	PICKUP 3/4 TON, F-250 / SUPERDUTY 4WD	
R	67-70	OLDSMOBILE TORONADO All Vertically Mounted	
82035 D			
F	60	CHEVROLET PICKUP All	
F	61-62	PICKUP 1/2 TON, C10 All	
F	61-62	PICKUP 1 TON, C30 All	
F	61-62	PICKUP 3/4 TON, F-100 All, C20 All	
F	61-62	SUBURBAN 1/2 TON, 1500 All	
F	62	VAN 1/2 TON, P SERIES All	
F	61-62	GMC PICKUP 1000 SERIES All	
F	61-62	PICKUP 1500 SERIES All	
F	61-62	PICKUP 2500 SERIES All	
82038 W			
F	61-64	FORD PICKUP 1/2 TON, F-100 RWD	
F	61-62	PICKUP 3/4 TON, F-250 / SUPERDUTY RWD	
82039 B			
R	53-59	CHEVROLET CORVETTE All	
R	61-71	INTERNATIONAL SCOUT All	
R	69-73	OPEL OPEL All	
82040 D			
R	68-70	CADILLAC ELDORADO All Vertically Mounted	
R	68-69	CHEVROLET CAMARO Leaf (RearSpringType) Single Leaf Rear Springs	
R	67	CAMARO All	
R	66	OLDSMOBILE TORONADO All Vertically Mounted	
R	67	PONTIAC FIREBIRD All	
82046 W			
F	61-71	DODGE PICKUP 1/2 TON, D100 SERIES All	
F	61-71	PICKUP 1 TON, D300 SERIES All	
F	61-71	PICKUP 3/4 TON, D200 SERIES All	
R	68	VAN 1/2 TON, P SERIES All	
R	62-64	VAN 1/2 TON, P SERIES All	
82047 C			
F	57-58	CHEVROLET PICKUP All	
F	61-67	VAN 1 TON, P SERIES All	
F	61-67	VAN 3/4 TON, P SERIES All	

Numerical listing

Shock	POP	Alternative No.	MTG Acc. Supplied
Pos.	Year	Application	
82047	C -continued		
F	55-59	GMC PICKUP All	
F	67	VAN 1 TON, P SERIES All	
F	67	VAN 3/4 TON, P SERIES All	
82049	W		
F	68	INTERNATIONAL 1000B All	
F	68	1000C All	
F	69-70	1000D All Before Chassis #H-205000	
F	71-73	1010 All	
82051	A		
R	70	AMERICAN MOTORS GREMLIN All	
R	70	HORNET All	
R	58-64	CHEVROLET BEL AIR All	
R	58-64	BISCAYNE All	
R	58	DEL RAY All	
R	59-60	EL CAMINO All	
R	59-64	IMPALA All	
82054	W		
R	60-71	DODGE PICKUP 1/2 TON, D100 SERIES All	
R	60-71	PICKUP 1/2 TON, W100 SERIES All	
R	60-71	PICKUP 3/4 TON, D200 SERIES All	
R	69-71	PICKUP 3/4 TON, W200 SERIES All	
R	60-67	PICKUP 3/4 TON, W200 SERIES All	
R	59-60	TRUCK All	
R	69-72	VAN 3/4 TON, P SERIES All	
82060	A		
R	65-68	CADILLAC CALAIS All	
R	65-68	DEVILLE All	
R	65-68	FLEETWOOD All	
R	50-51	FLEETWOOD / 60 SERIES / 70 SERIES All	
R	57-58	CHEVROLET PICKUP Truck, 3100	
R	57-58	PICKUP Truck, 3200	
R	57-58	PICKUP Truck, 3600	
R	50-51	FORD COUNTRY SQUIRE All	
R	49	FORD All	
R	50-51	RANCH WAGON All	
R	55-59	GMC PICKUP All Series 100, 150	
R	56	STUDEBAKER POWER HAWK All	
R	55-56	PRESIDENT All	
R	56	SKY HAWK All	
82062	W		
F	70	CHEVROLET VAN 1/2 TON, G / EXPRESS All Solid Front Axle	
F	64-69	VAN 1/2 TON, G / EXPRESS All	
F	70	VAN 3/4 TON, G / EXPRESS All Solid Front Axle	
F	67-69	VAN 3/4 TON, G / EXPRESS All	
F	70	GMC VAN 1/2 TON, G / SAVANNA All I-Beam Front Axle	
F	64-69	VAN 1/2 TON, G / SAVANNA All	
F	70	VAN 3/4 TON, G / SAVANNA All I-Beam Front Axle	
F	67-69	VAN 3/4 TON, G / SAVANNA All	
82065	W		
R	74	DODGE M300 All H3, M3, M-375 H4, M4	
R	74	M350 All H3, M3, M-375 H4, M4	
F	60	PICKUP 1/2 TON, D100 SERIES All	
F	60	PICKUP 1/2 TON, W100 SERIES All	
R	61-71	PICKUP 1 TON, D300 SERIES All	
F	60	PICKUP 3/4 TON, D200 SERIES All	
F	60	PICKUP 3/4 TON, W200 SERIES All	
F	53-60	TRUCK All	
R	53-58	TRUCK All	
R	64-70	VAN 1/2 TON, A / B SERIES / RAM Van	
R	66-72	VAN 1 TON, P SERIES All	
R	61-64	VAN 1 TON, P SERIES All	
82066	A		
R	60-66	AMERICAN MOTORS AMBASSADOR All	
R	61-66	CLASSIC All	
R	65-66	MARLIN All	
R	53-54	CADILLAC DEVILLE All	
R	52-54	FLEETWOOD / 60 SERIES / 70 SERIES All	
R	55-57	CHEVROLET BEL AIR All	
R	55-57	ONE-FIFTY SERIES All	
R	50-53	PICKUP Truck, 3100	
R	50-53	PICKUP Truck, 3600	
R	50-53	PICKUP Truck, 3800	
R	55-57	TWO-TEN SERIES All	
R	87-88	ISUZU TROOPER 4WD	

Classic Shock Absorbers

Shock	POP	Alternative No.	MTG Acc. Supplied
Pos.	Year	Application	
82067	W		
R	64-69	LINCOLN CONTINENTAL All	
82069	C		
F	64-68	AMERICAN MOTORS AMERICAN All	
F	68-69	AMX All	
F	68-69	JAVELIN All	
F	69	RAMBLER All	
R	62-63	MERCEDES-BENZ 190SL All	
82070	D		
F	62-67	CHEVROLET CHEVY II All	
82072	B		
F	57-64	CHRYSLER 300 All	
F	57-66	IMPERIAL All	
F	57-64	NEWPORT All	
F	57-64	NEW YORKER All	
F	57-60	SARATOGA All	
F	57-64	TOWN & COUNTRY All	
F	57-61	WINDSOR All	
F	63-64	DODGE 880 All	
F	57-59	CORONET All	
F	57-64	CUSTOM All	
F	60-61	DART All	
F	60-61	POLARA All	
F	57-61	PLYMOUTH BELVEDERE All	
F	58-61	CUSTOM All	
F	60-61	FLEET SPECIAL All	
F	57-61	FURY All	
F	57-58	PLAZA All	
F	57-61	SAVOY All	
F	60-61	SPORT WAGON All	
F	57-61	SUBURBAN All	
82074	W		
R	62-67	CHEVROLET CHEVY II All	
82075	B		
F	62-65	FORD FAIRLANE All	
F	62-63	MERCURY METEOR All	
82076	C		
R	58-59	EDSEL CORSAIR All	
R	58-60	RANGER All	
R	58-60	VILLAGER All	
R	60-64	FORD COUNTRY SEDAN All	
R	59-64	COUNTRY SQUIRE All	
R	59-60	COURIER SEDAN DELIVERY All	
R	64	CUSTOM All	
R	60	CUSTOM 300 All	
R	60-61	FAIRLANE All	
R	63	FORD 300 All	
R	60-64	GALAXIE All	
R	59	RANCHERO All	
R	59-64	RANCH WAGON All	
R	59	SKYLINER All	
R	60	STARLINER All	
R	62-64	SUNLINER All	
R	60	SUNLINER All	
R	62-64	VICTORIA All	
R	60	VICTORIA All	
R	61-64	MERCURY COLONY PARK All	
R	64	COMMUTER All	
R	61-62	COMMUTER All	
R	63	COUNTRY CRUISER All	
R	63-64	MARAUDER All	
R	64	MONTCLAIR All	
R	61-64	MONTEREY All	
R	64	PARKLANE All	
R	62-64	VILLAGER All	
82079	B		
F	59-64	OLDSMOBILE 88 SERIES All	
F	58	88 SERIES All Exc. '58 Air Suspension	
F	57	88 SERIES All	
F	59-64	98 All	
F	58	98 All Exc. '58 Air Suspension	
F	59-63	FIESTA All	
F	58	FIESTA All Exc. '58 Air Suspension	
F	57	FIESTA All	
F	62-63	JETFIRE All	
F	61-64	STARFIRE All	
F	57	STARFIRE All	
82086	C		
R	60	CHEVROLET PICKUP All	
R	61-62	PICKUP 1/2 TON, C10 All	
R	61-62	PICKUP 3/4 TON, C20 All	
R	61-62	SUBURBAN 1/2 TON, 1500 All	
R	60-62	SUBURBAN 1/2 TON, C10 All	
R	62	VAN 1/2 TON, P SERIES All	
R	61-62	GMC PICKUP 1000 SERIES All	
R	61-62	PICKUP 1500 SERIES All	

Numerical listing

Shock	POP	Alternative No.	MTG Acc. Supplied
Pos.	Year	Application	
82087	A		
F	56	BUICK CENTURY All	
F	61-64	ELECTRA All	
F	61-63	INVICTA All	
F	61-64	LESABRE All	
F	63-65	RIVIERA All	
F	56	ROADMASTER All Exc. Air Susp	
F	56	SPECIAL All	
F	56	SUPER All Exc. Air Susp	
F	63-64	WILDCAT All	
F	63-64	STUDEBAKER AVANTI All	
F	57-58	CHAMPION All	
F	57-58	COMMANDER All	
F	57-58	GOLDEN HAWK All	
F	60-62	HAWK All	
F	59-62	LARK All	
F	57-58	PRESIDENT All	
F	57-59	SILVER HAWK All	
82089	W		
R	63-64	OLDSMOBILE 88 SERIES All	
R	63-64	98 All	
R	63	FIESTA All	
R	63	JETFIRE All	
R	63-64	STARFIRE All	
82090	A		
F	63-64	DODGE 330 All	
F	63-64	440 All	
F	70-74	CHALLENGER All	
F	66-72	CHARGER All	
F	65-72	CORONET All	
F	62-76	DART All	
F	61-62	LANCER All	
F	62-64	POLARA All	
F	64-74	PLYMOUTH BARRACUDA All	
F	62-70	BELVEDERE All	
F	70-76	DUSTER All	
F	62-63	FLEET SPECIAL All	
F	62-64	FURY All	
F	67	GTX All	
F	68-72	ROADRUNNER All	
F	65-72	SATELLITE All	
F	62-64	SAVOY All	
F	71-76	SCAMP All	
F	70	SUPERBIRD All	
F	60-76	VALIANT All	
82093	B		
R	74-75	BUICK APOLLO All	
R	73	APOLLO All Exc. HD Suspension	
R	75-79	SKYLARK All	
R	68	CHEVROLET CHEVY II Leaf (RearSpringType) Single Leaf Rear Springs	
R	74-79	NOVA All	
R	73	NOVA All Exc. HD Suspension	
R	69-72	NOVA Leaf (RearSpringType) Single Leaf Rear Springs	
R	74-79	OLDSMOBILE OMEGA All	
R	73	OMEGA All Exc. HD Suspension	
R	77-79	PONTIAC PHOENIX All	
R	73-77	VENTURA All	
R	71-72	VENTURA Leaf (RearSpringType)	
82099	A		
F	58-60	CADILLAC DEVILLE All	
F	56	DEVILLE All	
F	56-60	FLEETWOOD / 60 SERIES / 70 SERIES All	
F	55-57	CHEVROLET BEL AIR All	
F	60-64	CORVAIR All	
F	61-64	CORVAIR TRUCK All	
F	55-57	ONE-FIFTY SERIES All	
F	55-57	TWO-TEN SERIES All	
F	58	EDSEL BERMUDA All	
F	58	CITATION All	
F	58-59	CORSAIR All	
F	58	PACER All	
F	58-60	RANGER All	
F	58	ROUNDUP All	
F	58-60	VILLAGER All	
F	57-64	FORD COUNTRY SEDAN All	
F	57-64	COUNTRY SQUIRE All	
F	57-60	COURIER SEDAN DELIVERY All	
F	64	CUSTOM All	
F	57	CUSTOM All	
F	58-60	CUSTOM 300 All	
F	57-58	DEL RIO WAGON All	
F	57-61	FAIRLANE All	
F	63	FORD 300 All	
F	59-64	GALAXIE All	
F	59	RANCHERO All	
F	57-64	RANCH WAGON All	
F	57-59	SKYLINER All	
F	60	STARLINER All	

Numerical listing

Shock	POP	Alternative No.	MTG Acc. Supplied
Pos.	Year	Application	
82099	A -continued		
F	62-64	SUNLINER All	
F	57-60	SUNLINER All	
F	59-60	THUNDERBIRD All	
F	62-64	VICTORIA All	
F	57-60	VICTORIA All	
F	57-64	MERCURY COLONY PARK All	
F	64	COMMUTER All	
F	57-62	COMMUTER All	
F	63	COUNTRY CRUISER All	
F	59-60	COUNTRY CRUISER All	
F	63-64	MARAUDER All	
F	58	MEDALIST All	
F	64	MONTCLAIR All	
F	57-60	MONTCLAIR All	
F	57-64	MONTEREY All	
F	64	PARKLANE All	
F	58-60	PARKLANE All	
F	57	TURNPIKE CRUISER All	
F	62-64	VILLAGER All	
F	57-59	VOYAGER All	
F	58-64	PONTIAC BONNEVILLE All	
F	58-64	CATALINA All	
F	58	CHIEFTAIN All	
F	62-64	GRAND PRIX All	
F	61-64	SAFARI All	
F	58-64	STAR CHIEF All	
F	58	SUPER CHIEF All	
F	60-61	VENTURA All	
F	67	TOYOTA CROWN All Mfg. to 9/67	
F	65-66	CROWN All	
82103	C		
R	63-64	STUDEBAKER AVANTI All	
82104	A		
F	65-66	FORD MUSTANG / MUSTANG II All	
82109	C		
F	61-64	CADILLAC DEVILLE All	
F	61-64	FLEETWOOD / 60 SERIES / 70 SERIES All	
82110	D		
F	65-70	OLDSMOBILE 88 SERIES All	
F	65-70	98 All	
F	67	CUTLASS / CUTLASS SUPREME Turnpike Cruiser	
F	65-66	STARFIRE All	
F	65-70	PONTIAC BONNEVILLE All	
F	65-70	CATALINA All	
F	67-70	EXECUTIVE All	
F	65-68	GRAND PRIX All	
F	68-70	SAFARI All	
F	65	SAFARI All	
F	65-66	STAR CHIEF All	
82118	A		
F	58-64	CHEVROLET BEL AIR All	
F	58-64	BISCAYNE All	
F	58	DEL RAY All	
F	59-60	EL CAMINO All	
F	59-64	IMPALA All	
82123	W		
R	57-59	FORD F SERIES All F-100, F-250	
R	60	PICKUP 1/2 TON, F-100 All	
R	60	PICKUP 3/4 TON, F-250 / SUPERDUTY All	
R	68-75	PICKUP P350 All	
R	75-76	PICKUP P400 All	
R	55-59	GMC PICKUP All Series 250	
R	58-61	JAGUAR XK150 All	
R	68-72	OPEL KADETT All	
R	59-65	VOLVO 544 All	
R	49	PV 444 All	
82124	W		
R	68-73	NISSAN 510 All Exc. Wagon	
R	75-76	610 Coupe	
R	73-74	610 All	
R	72-73	TOYOTA CARINA All	
R	76-77	CELICA All	
R	75	CELICA All Mfg. to 10/75	
R	74	CELICA All	
R	73	CELICA All Mfg. to 7/73	
R	72	CELICA All Mfg. from 8/72	
R	75-78	CORONA Hardtop Mfg. from 8/73	
R	75-78	CORONA Sedan Mfg. from 8/73	
R	74	CORONA Wagon Mfg. from 8/73	
R	73	CORONA Sedan Mfg. from 8/73	
82125	B		
R	78-80	AMERICAN MOTORS AMX All	
R	78-83	CONCORD All	
R	71-78	GREMLIN All	

Classic Shock Absorbers

Shock	POP	Alternative No.	MTG Acc. Supplied
Pos.	Year	Application	
82125	B -continued		
R	71-77	HORNET All	
R	79-83	SPIRIT All	
R	75-76	CADILLAC COMMERCIAL CHASSIS All	
R	58-64	DEVILLE All	
R	57-64	FLEETWOOD / 60 SERIES / 70 SERIES All	
R	72-82	FORD COURIER All	
R	72-76	MAZDA B1600 All	
R	77-78	B1800 All	
R	79-84	B2000 All	
R	82-84	B2200 All	
R	76-78	NISSAN F10 Wagon	
R	59-66	PEUGEOT 403 All	
R	61-67	404 All	
82126	A		
F	70-74	AMERICAN MOTORS AMBASSADOR All	
F	78-80	AMX All	
F	70	AMX All	
F	78-83	CONCORD All	
F	70-78	GREMLIN All	
F	70-77	HORNET All	
F	70-74	JAVELIN All	
F	71-78	MATADOR All	
F	79-83	SPIRIT All	
F	66-70	FORD FAIRLANE All	
F	60-70	FALCON All	
F	60-71	RANCHERO All	
F	65-74	RANCH WAGON All	
F	68-71	TORINO All	
F	60-69	MERCURY COMET All	
F	68-71	MONTEGO All	
82128	C		
F	74-77	FORD MUSTANG / MUSTANG II All	
F	71-80	PINTO Sedan	
F	75-80	MERCURY BOBCAT All	
82129	W		
F	75-80	BUICK SKYHAWK All	
F	75-80	CHEVROLET MONZA All	
F	71-77	VEGA All	
F	75-80	OLDSMOBILE STARFIRE All	
F	75-77	PONTIAC ASTRE All	
F	63	LEMANS All	
F	76-80	SUNBIRD All	
F	61-63	TEMPEST All	
82130	B		
R	75-80	FORD GRANADA All	
R	69-77	MAVERICK All	
R	77-80	LINCOLN VERSAILLES All	
R	71-77	MERCURY COMET All	
R	75-80	MONARCH All	
R	66-70	NISSAN 1600 All	
R	68-70	2000 All	
82131	A		
R	65-69	CHRYSLER 300 All	
R	75-76	CORDOBA All	
R	74-75	IMPERIAL All	
R	74-78	NEWPORT All	
R	65-69	NEWPORT All	
R	74-78	NEW YORKER All	
R	65-69	NEW YORKER All	
R	74-78	TOWN & COUNTRY All	
R	65-70	TOWN & COUNTRY All	
R	63-64	DODGE 330 All	
R	63-64	440 All	
R	70-74	CHALLENGER All	
R	66-76	CHARGER All	
R	65-76	CORONET All	
R	65	CUSTOM All	
R	62	DART All	
R	72-78	MONACO All	
R	65-70	MONACO All	
R	73	POLARA All Exc. Wagon	
R	72	POLARA All	
R	62-70	POLARA All	
R	75-77	ROYAL MONACO All	
R	70-74	PLYMOUTH BARRACUDA All	
R	62-70	BELVEDERE All	
R	62-63	FLEET SPECIAL All	
R	77-78	FURY All Police Package	
R	73-76	FURY All	
R	73	FURY Wagon	
R	62-69	FURY All	
R	74-77	GRAN FURY All	
R	73	GRAN FURY Wagon	
R	67	GTX All	
R	68-75	ROADRUNNER All	
R	65-74	SATELLITE All	
R	62-64	SAVOY All	

Numerical listing

Shock	POP	Alternative No.	MTG Acc. Supplied
Pos.	Year	Application	
82131	A -continued		
R	70	SUPERBIRD All	
R	67	VIP All	
82138	A		
F	65-67	BUICK GRAN SPORT All	
F	64-67	SKYLARK All HD Suspension; Exc. Sportwagon	
F	64-67	SPECIAL All HD Suspension; Exc. Sportwagon	
F	64-67	SPORTWAGON All	
F	64-67	CHEVROLET CHEVELLE All	
F	64-67	EL CAMINO All	
F	64-67	MALIBU All	
F	64-67	OLDSMOBILE CUTLASS / CUTLASS SUPREME Base	
F	64-67	CUTLASS / CUTLASS SUPREME Holiday	
F	64-67	F85 All	
F	64-67	PONTIAC GTO All	
F	64-67	LEMANS All	
F	64-67	TEMPEST All	
82139	D		
R	63-80	TRIUMPH SPITFIRE All	
82147	D		
R	66-69	FORD PICKUP 1/2 TON, F-100 All RWD	
R	65	PICKUP 1/2 TON, F-100 All With Front Coil Springs	
R	66-77	PICKUP 3/4 TON, F-250 / SUPERDUTY 4WD Up through Serial No. Y20000	
82151	C		
R	57-58	STUDEBAKER CHAMPION All	
R	57-58	COMMANDER All	
R	57-58	GOLDEN HAWK All	
R	60-62	HAWK All	
R	59-62	LARK All	
R	57-58	PRESIDENT All	
R	57-59	SILVER HAWK All	
82155	C		
R	67-69	AMERICAN MOTORS AMBASSADOR All	
R	64-68	AMERICAN All	
R	59-62	AMERICAN All	
R	68-69	AMX All	
R	68-69	JAVELIN All	
R	67	MARLIN All	
R	69	RAMBLER All	
R	59-60	RAMBLER All	
R	59-60	BUICK ELECTRA All Exc. Air Susp	
R	59-60	INVICTA All Exc. Air Susp	
R	60	LESABRE All	
R	59	LESABRE All Exc. Air Susp	
R	51-54	CHEVROLET BEL AIR All	
R	50	BEL AIR All Exc. Air Susp	
R	60-62	CORVETTE All	
R	53-54	ONE-FIFTY SERIES All	
R	55-58	PICKUP 3800	
R	54	PICKUP All	
R	49-52	STYLELINE DELUXE All	
R	49-52	STYLELINE SPECIAL All	
R	53-54	TWO-TEN SERIES All	
R	61-62	VAN 1 TON, P SERIES All	
R	61-62	VAN 3/4 TON, P SERIES All	
R	66-67	FIAT 1100 All Exc. Wagon	
R	64-67	1500 All Exc. Wagon	
R	53-54	GMC PICKUP All 1/2 and 3/4 Ton	
R	64-65	NISSAN 410 All	
R	64-67	411 All	
R	68-73	TOYOTA CORONA Base, Hardtop	
R	68-73	CORONA Base, Sedan	
82156	A		
R	57-58	BUICK CENTURY All	
R	58	LIMITED All	
R	57-58	ROADMASTER All Exc. Air Susp	
R	57-58	SPECIAL All Exc. Air Susp	
R	57-58	SUPER All Exc. Air Susp	
R	75-80	DODGE COLT Wagon	
R	71-74	COLT All	
R	75-76	FIAT 124 All Wagon	
R	67-74	124 Wagon Wagon	
R	66-67	1100 All Wagon	
R	64-67	1500 All Wagon	
R	50-51	FORD COUNTRY SEDAN All	
R	50-51	CRESTLINE All	
R	50-51	CUSTOM All	
R	49-51	DELUXE All	
R	47-48	DELUXE All Direct Acting Shocks	
R	47-48	SUPER DELUXE All Direct Acting Shocks	

Numerical listing

Shock	POP	Alternative No.	MTG Acc. Supplied
Pos.	Year	Application	
82156 A -continued			
R	51	VICTORIA All	
R	78-81	NISSAN 510 Wagon	
R	83-84	MAXIMA Wagon	
R	51-56	OLDSMOBILE 98 All	
R	76-80	PLYMOUTH COLT All	
R	57-60	PONTIAC BONNEVILLE All	
R	50-60	CATALINA All	
R	49-58	CHIEFTAIN All	
R	54-60	STAR CHIEF All	
R	49-52	STREAMLINER All	
R	57-58	SUPER CHIEF All	
R	60	VENTURA All	
R	75-78	TOYOTA CORONA Wagon	
R	74	CORONA Wagon Wagon	
R	73	CORONA Wagon Mfg. from 8/73	
R	71	CORONA Mark II, Hardtop Exc. Wagon	
R	71	CORONA Mark II, Sedan Exc. Wagon	
R	69-70	CORONA Mark II, Hardtop	
R	69-70	CORONA Mark II, Sedan	
R	65-66	CROWN Wagon Wagon	
82601 B			
F	65-70	BUICK ELECTRA All	
F	70	ESTATE WAGON All	
F	65-70	LESABRE All	
F	66-70	RIVIERA All	
F	65-70	WILDCAT All	
F	65-76	CADILLAC CALAIS All	
F	75-76	COMMERCIAL CHASSIS All	
F	65-76	DEVILLE All	
F	65-76	FLEETWOOD All	
82602 D			
R	65-70	BUICK ELECTRA All	
R	65-70	LESABRE All	
R	65-70	WILDCAT All	
R	71-76	CADILLAC CALAIS All	
R	71-76	DEVILLE All	
R	71-76	FLEETWOOD All	
82603 W			
R	73-76	FORD THUNDERBIRD All	
R	73-76	LINCOLN MARK IV All	
R	77-79	MARK V All	
82607 D			
F	56-57	SAAB 93 All	
F	58-59	93B All	
F	59-73	95 All	
F	61-73	96 All	
F	69-80	99 All	
F	58-62	GT750 All	
F	63	GT850 All	
82608 W			
R	75-79	FIAT 124 All Built after Serial #066.059	
R	68-74	124 Convertible	
R	68-74	124 Coupe	
R	68-74	124 Sedan	
R	75-78	131 All	
R	78-81	BRAVA Sedan	
82609 D			
R	61-64	BUICK ELECTRA All	
R	61-63	INVICTA All	
R	61-64	LESABRE All	
R	63-65	RIVIERA All	
R	63-64	WILDCAT All	
82610 W			
R	69-70	CADILLAC CALAIS All	
R	69-70	DEVILLE All	
R	69-70	FLEETWOOD All	
82614 W			
F	76-79	FIAT 124 All Built after Serial #066.059	
F	67-75	124 All	
F	71-75	OPEL 1900 All	
F	71-75	MANTA All	
82615 W			
F	61-69	LINCOLN CONTINENTAL All	
82617 D			
R	64-66	FORD THUNDERBIRD All	
82618 D			
R	66-70	BUICK RIVIERA All	

Classic Shock Absorbers, Suspension Mounts

Shock	POP	Alternative No.	MTG Acc. Supplied
Pos.	Year	Application	
Suspension Mounts			
141578 W			
F	81-83	CHRYSLER LEBARON All	
F	82-83	DODGE 400 All	
F	81-83	ARIES All	
F	83-87	CHARGER All	
F	78-90	OMNI All	
F	87-89	PLYMOUTH EXPO All	
F	78-90	HORIZON All	
F	81-82	RELIANT All	
F	85	TURISMO All	
F	83	TURISMO All	
141580 W			
F	84-85	CHRYSLER DAYTONA CAN	
F	84	E CLASS All	
F	85	EXECUTIVE LIMOUSINE All	
F	84	EXECUTIVE SEDAN All	
F	84-85	LASER All	
F	84-85	LEBARON All	
F	84-85	NEW YORKER All	
F	84-85	DODGE 600 All	
F	84-85	ARIES All	
F	84-85	CARAVAN / GRAND CARAVAN All	
F	84-85	DAYTONA All	
F	85	LANCER All	
F	84-85	PLYMOUTH CARAVELLE All	
F	84-85	RELIANT All	
F	84-85	VOYAGER / GRAND VOYAGER All	
141974 B			
R	94	ASUNA GT	
R	92	GT	
R	93	GT, SE All	
R	94	SE	
R	92	SE	
R	82-96	BUICK CENTURY All	
R	82-89	SKYHAWK All	
R	84-98	SKYLARK All	
R	85-87	SOMERSET / SOMERSET REGAL All	
R	84-88	CADILLAC CIMARRON All	
R	95-96	CHEVROLET BERETTA All	
R	92-94	BERETTA Base Exc. FE7 Suspension	
R	87-91	BERETTA All	
R	87-94	CAVALIER All	
R	84-86	CAVALIER All Rebuildable O.E. Struts	
R	82-83	CAVALIER All	
R	82-90	CELEBRITY All	
R	84-85	CITATION / CITATION II All	
R	87-96	CORSICA All	
R	90-96	LUMINA APV All	
R	92-98	OLDSMOBILE ACHIEVA All Exc. Electronic Adjustable Suspension	
R	85-87	CALAIS All	
R	85-96	CIERA / CUTLASS CIERA All Exc. Electronic Adjustable Suspension	
R	84	CIERA / CUTLASS CIERA All	
R	88-91	CUTLASS CALAIS All	
R	87-94	CUTLASS CLASSIC / CUTLASS CRUISER All Exc. Electronic Adjustable Suspension	
R	84-88	FIRENZA All	
R	90-96	SILHOUETTE All	
R	89-91	PONTIAC 6000 FWD	
R	84-88	6000 All	
R	95-98	GRAND AM All Exc. Electronic Adjustable Suspension	
R	85-94	GRAND AM All	
R	84-85	J2000 / SUNBIRD All	
R	84	PHOENIX All	
R	94	SUNBIRD All	
R	91-93	SUNBIRD All Sport Suspension	
R	86-90	SUNBIRD All	
R	87-91	TEMPEST CAN	
R	90-96	TRANS SPORT All	
142091 W			
F	73-79	AUDI FOX All	
F	85-93	VOLKSWAGEN CABRIOLET All	
F	80-84	JETTA All	
F	75-84	RABBIT All	
F	75-89	SCIROCCO All	
142092 D			
F	90-92	VOLKSWAGEN CORRADO All Rebuildable Front Struts	
F	93-96	GOLF 2.0L 4Cyl L (121)	
F	85-92	GOLF All	
F	94-95	JETTA 2.0L 4Cyl L (121)	
F	94	JETTA 1.8L 4Cyl L (109)	
F	85-93	JETTA All	

Numerical listing

Shock	POP	Alternative No.	MTG Acc. Supplied
Pos.	Year	Application	
142092 D -continued			
F	95-96	PASSAT 2.0L 4Cyl L (121) Exc. VR Suspension	
F	94	PASSAT 2.0L 4Cyl L (1984) Exc. VR Suspension	
F	93	PASSAT 2.0L 4Cyl L (121) Exc. VR Suspension	
F	90-92	PASSAT All Exc. VR Suspension	
142103 W			
R	89-90	FORD TAURUS GL, Sedan	
R	89-90	TAURUS L, Sedan	
R	89-90	TAURUS LX, Sedan	
R	86-88	TAURUS Sedan	
R	86-90	MERCURY SABLE Sedan	
142108 W			
F	85-87	BUICK SOMERSET / SOMERSET REGAL All	
F	87-88	CADILLAC CIMARRON All	
F	82-91	CHEVROLET CAVALIER All	
F	87	OLDSMOBILE CALAIS All	
F	85-86	CALAIS All Rebuildable O.E. Struts	
F	88-91	CUTLASS CALAIS All	
F	82-88	FIRENZA All	
F	85-91	PONTIAC GRAND AM All	
F	88-93	SUNBIRD All Sport Suspension	
142132 C			
R	85-90	BUICK ELECTRA All	
R	86-99	LESABRE All	
R	91-96	PARK AVENUE All	
R	93	CADILLAC 60 SPECIAL All	
R	92-93	COMMERCIAL CHASSIS FWD Air Assist Rear Suspension; Exc. Electronic Adjustable Suspension	
R	91	COMMERCIAL CHASSIS All Air Assist Rear Suspension; Exc. Electronic Adjustable Suspension	
R	85-90	COMMERCIAL CHASSIS All Air Assist Rear Suspension Standard Equipment	
R	85-93	DEVILLE All	
R	91-93	FLEETWOOD All Exc. Electronic Adjustable Suspension	
R	87-90	FLEETWOOD All Air Assist Rear Suspension Standard Equipment	
R	85-86	FLEETWOOD All Exc. Electronic Adjustable Suspension	
R	92-99	OLDSMOBILE 88 SERIES All	
R	86-91	88 SERIES All Leveling O.E. Hydraulic Self Leveling System	
R	85-96	98 All	
R	96-99	LSS All	
R	97-98	REGENCY All	
R	87-99	PONTIAC BONNEVILLE All	
142133 W			
R	84-94	FORD TEMPO All	
R	84-94	MERCURY TOPAZ All	
142134 W			
F	85-88	CHEVROLET NOVA All	
F	83-86	TOYOTA CAMRY All	
F	88	COROLLA FX	
F	88	COROLLA FX16	
F	87	COROLLA All	
142135 C			
R	91-98	BMW 318i All	
R	84-85	318i All	
R	91-98	318iS All	
R	95-99	318Ti All	
R	98-99	323i All	
R	87-88	325 All	
R	84-87	325E All	
R	92-95	325i E36 (MfrBodyCode)	
R	87-91	325i All	
R	87-92	325iS All	
R	88-91	325iX All	
R	96-98	328i All	
R	88-91	M3 All	
142136 W			
F	87-93	VOLKSWAGEN FOX All	
142141 X			
F	88-89	PONTIAC GRAND PRIX All	
142142 W			
F	88-89	PONTIAC GRAND PRIX All HD Suspension	
142143 C			
F	88-96	BUICK REGAL All	
F	90-01	CHEVROLET LUMINA All	

Numerical listing

Shock	POP	Alternative No.	MTG Acc. Supplied
Pos.	Year	Application	
142143	C	-continued	
F	95-99	MONTE CARLO	All Exc. HD Suspension
F	88-97	OLDSMOBILE CUTLASS / CUTLASS SUPREME	All
F	90-96	PONTIAC GRAND PRIX	All
142144	W		
F	88-96	BUICK REGAL	All HD Suspension
F	90-01	CHEVROLET LUMINA	All HD Suspension
F	95-99	MONTE CARLO	All HD Suspension
F	88-97	OLDSMOBILE CUTLASS / CUTLASS SUPREME	All HD Suspension
F	90-96	PONTIAC GRAND PRIX	All HD Suspension
142145	W		
F	82-92	CHEVROLET CAMARO	All Right
F	82-92	PONTIAC FIREBIRD	All Right
142146	W		
F	82-92	CHEVROLET CAMARO	All Left
F	82-92	PONTIAC FIREBIRD	All Left
142148	W		
F	87-91	CHEVROLET BERETTA	All
F	92-94	CAVALIER	All
F	87-91	CORSICA	All
F	88-94	PONTIAC SUNBIRD	All
142150	D		
R	86-89	ACURA INTEGRA	All
R	89-90	LEGEND	All Auto Leveling System
R	92-94	VIGOR	All
R	86-97	HONDA ACCORD	All
R	84-87	CIVIC	Wagon, FWD
142173	W		
R	83-87	DODGE CHARGER	All
R	78-90	OMNI	All
R	87-89	PLYMOUTH EXPO	All
R	78-90	HORIZON	All
R	85	TURISMO	All
R	83	TURISMO	All
142183	W		
F	86-89	MAZDA 323	All Exc. Electronic Adjustable Suspension
F	81-85	GLC Hatchback	
F	81-85	GLC Sedan	
F	87-89	MERCURY TRACER	FWD
142189	W		
R	86-89	MAZDA 323	All Exc. Electronic Adjustable Suspension
R	81-85	GLC Hatchback	
R	81-85	GLC Sedan	
R	91-93	MERCURY CAPRI	All
R	87-89	TRACER	FWD
142190	C		
R	91-03	FORD ESCORT	All
R	90-94	MAZDA 323	All
R	90-94	PROTÉGÉ / PROTÉGÉ5	FWD, Non-ABS
R	91-99	MERCURY TRACER	FWD
142194	W		
F	75-93	VOLVO 240 / 242 / 244 / 245 / 262 / 264 / 265	All Exc. O.E. Gas Struts & Nivomat Rear Susp.
F	84	DL	All Exc. Hydraulic Self Leveling System
F	84	GLE	All Exc. Hydraulic Self Leveling System
142195	W		
F	88-92	AUDI 80	All
F	88-92	80 QUATTRO	All
F	93-95	90 All	
F	88-91	90 All	
F	93-95	90 QUATTRO	All
F	88-91	90 QUATTRO	All
F	80-87	4000 All	
F	84-87	4000 QUATTRO	All
F	83-87	COUPE	All
F	90-91	COUPE QUATTRO	All
F	82-88	VOLKSWAGEN QUANTUM	All
142196	W		
R	89-92	FORD PROBE	All
R	88-92	MAZDA 626	All Exc. Electronic Adjustable Suspension or 4 Wheel Steer

Suspension Mounts

Shock	POP	Alternative No.	MTG Acc. Supplied
Pos.	Year	Application	
142196	W	-continued	
R	88-92	MX6	All Exc. Electronic Adjustable Suspension or 4 Wheel Steer
142197	A		
F	78-83	FORD FAIRMONT	All
F	81-82	GRANADA	All
F	83-86	LTD / COUNTRY SEDAN / COUNTRY SQUIRE / CROWN VICTORIA	All
F	82-04	MUSTANG / MUSTANG II	All
F	79-86	MERCURY CAPRI	All
F	81-82	COUGAR Base	
F	82	COUGAR GS	
F	82	COUGAR LS	
F	83-86	MARQUIS	All
F	78-83	ZEPHYR	All
142217	W		
F	91	BMW 318i	All
F	84-85	318i	All
F	91	318iS	All
F	87-88	325 All	
F	84-87	325E All	
F	87-91	325i All	
F	87-91	325iS All	
F	85	524TD All	
F	89-95	525i All	
F	82-88	528E All	
F	94-95	530i Sedan	
F	83-84	533i All	
F	91-93	535i All	
F	90	535i All Mfg. from 8/90	
F	85-89	535i All	
F	88	535iS All	
F	85-89	635CSI	All Exc. Auto-Leveling System
F	88-91	M3	All
F	91-93	M5	All
F	88	M5	All
142219	W		
F	89-90	DODGE 2000 GTX	CAN Exc. Auto-Leveling System
F	90-94	EAGLE TALON	All
F	90-94	MITSUBISHI ECLIPSE	All
F	90-94	PLYMOUTH LASER	All
142220	W		
F	87-88	FORD THUNDERBIRD	Naturally Aspirated (Eng Asp), Non-ABS
F	80-86	THUNDERBIRD	All
F	82-87	LINCOLN CONTINENTAL	All
F	84-92	MARK VII	All
F	83-88	MERCURY COUGAR	All
F	80-82	COUGAR XR-7	
142221	W		
R	81-90	FORD ESCORT	All
R	82-88	EXP	All
R	82-83	MERCURY LN7	All
R	81-87	LYNX	All
142222	W		
F	89-97	FORD THUNDERBIRD	All Exc. Electronic Adjustable Suspension
F	89-97	MERCURY COUGAR	All Exc. Electronic Adjustable Suspension
142223	W		
F	82-96	BUICK CENTURY	All
F	80-85	SKYLARK	All
F	82-90	CHEVROLET CELEBRITY	All
F	80-85	CITATION / CITATION II	All
F	90-96	LUMINA APV	All
F	85-96	OLDSMOBILE CIERA / CUTLASS CIERA	All Exc. Electronic Adjustable Suspension
F	82-84	CIERA / CUTLASS CIERA	All
F	87-94	CUTLASS CLASSIC / CUTLASS CRUISER	All Exc. Electronic Adjustable Suspension
F	90-96	SILHOUETTE	All
F	91	PONTIAC 6000	FWD
F	82-90	6000 All	
F	80-84	PHOENIX	All
F	90-96	TRANS SPORT	All
142224	W		
F	92-94	BUICK SKYLARK	All Exc. FE3 and Electronic Ride Control
F	92-94	CHEVROLET BERETTA	All
F	94	CORSICA	Base
F	92-93	CORSICA	All
F	92-94	OLDSMOBILE ACHIEVA	All Exc. FE3 and Electronic Ride Control

Numerical listing

Shock	POP	Alternative No.	MTG Acc. Supplied
Pos.	Year	Application	
142224	W	-continued	
F	92-94	PONTIAC GRAND AM	All Exc. Electronic Adjustable Suspension
142225	W		
F	85-90	BUICK ELECTRA	All
F	90	LESABRE	All Early Design Front Strut with Spring Guard
F	86-89	LESABRE	All
F	87-90	CADILLAC BROUGHAM	All
F	85-90	COMMERCIAL CHASSIS	All
F	85-90	DEVILLE	All
F	85-90	FLEETWOOD	All
F	90	OLDSMOBILE 88 SERIES	All Early Design Front Strut with Spring Guard
F	86-89	88 SERIES	All
F	85-90	98 All	
F	87-90	PONTIAC BONNEVILLE	All Early Design Front Strut with Spring Guard
142226	B		
F	90-96	BUICK LESABRE	All
F	91-96	PARK AVENUE	All
F	93	CADILLAC 60 SPECIAL	All
F	91-92	BROUGHAM	All
F	92-93	COMMERCIAL CHASSIS FWD	
F	91	COMMERCIAL CHASSIS	All
F	91-93	DEVILLE	All Exc. Electronic Adjustable Suspension
F	91-93	FLEETWOOD	All
F	90-96	OLDSMOBILE 88 SERIES	All
F	91-96	98 All	
F	98-99	PONTIAC BONNEVILLE	Air (RearSpringType) CCR Computer Command Ride
F	94-96	BONNEVILLE	All CCR Computer Command Ride
F	91-93	BONNEVILLE	All
F	90	BONNEVILLE	All Late Design Front Strut without Spring Guard
142227	W		
F	85-90	BUICK ELECTRA	All
F	86-90	LESABRE	All
F	91-96	PARK AVENUE	All
F	95-98	SKYLARK	All
F	92-94	SKYLARK	All Exc. FE3 and Electronic Ride Control
F	93	CADILLAC 60 SPECIAL	All
F	87-93	ALLANTE	All
F	92-93	COMMERCIAL CHASSIS FWD	
F	85-91	COMMERCIAL CHASSIS	All
F	85-93	DEVILLE	All
F	91-02	ELDORADO	All
F	85-93	FLEETWOOD	All
F	87-97	SEVILLE	All
F	92-96	CHEVROLET BERETTA	All
F	95-98	CAVALIER	All
F	92-96	CORSICA	All
F	86-96	OLDSMOBILE 88 SERIES	All
F	91-96	98 All Exc. Soft Ride Susp (FE1) and Elec. Ride & Handling (FW1)	
F	85-90	98 All	
F	95-98	ACHIEVA	All Exc. Electronic Adjustable Suspension
F	92-94	ACHIEVA	All FE3 Suspension
F	95-96	AURORA	All
F	90-92	TORONADO	All
F	87-96	PONTIAC BONNEVILLE	All
F	95-98	GRAND AM	All Exc. Electronic Adjustable Suspension
F	92-94	GRAND AM SE	All Exc. FE3 and Electronic Ride Control
F	95-98	SUNFIRE	All
142228	D		
R	98-02	CHEVROLET PRIZM	All Left
R	89-97	GEO PRIZM	All Left
R	88-02	TOYOTA COROLLA	FWD Left
142229	D		
R	98-02	CHEVROLET PRIZM	All Right
R	89-97	GEO PRIZM	All Right
R	88-02	TOYOTA COROLLA	FWD Right
142230	A		
F	01-03	ACURA CL	All
F	97-99	CL	All
R	97-03	EL CAN	
F	97-00	EL CAN	
F	90-01	INTEGRA	All
R	90-93	INTEGRA	All
F	89-90	LEGEND	All Auto Leveling System
F	86-88	LEGEND	All
R	02-06	RSX	All
R	99-12	TL	All

Numerical listing

Shock	POP	Alternative No.	MTG Acc. Supplied
Pos.	Year	Application	
142230 A -continued			
F	95-12	TL All	
F	92-94	VIGOR All	
F	08-12	HONDA ACCORD All	
R	98-12	ACCORD All	
F	03-07	ACCORD 2.4L 4Cyl L (2354)	
F	86-02	ACCORD All	
R	89-05	CIVIC All	
F	89-00	CIVIC All	
F	88	CIVIC Hatchback	
R	88	CIVIC Hatchback	
F	88	CIVIC Sedan	
R	88	CIVIC Sedan	
F	93-97	CIVIC DEL SOL All	
R	93-97	CIVIC DEL SOL All	
R	03-12	CR-V All	
F	97-01	CR-V All	
R	97-01	CR-V All	
F	88-91	CRX All	
R	88-91	CRX All	
R	03-11	ELEMENT All	
F	95-98	ODYSSEY All	
R	95-98	ODYSSEY All	
F	83-01	PRELUDE All	
R	06-12	RIDGELINE All	
R	00-09	S2000 All	
F	00-07	S2000 All	
F	96-99	ISUZU OASIS All	
R	96-99	OASIS All	
142231 W			
R	01-03	ACURA CL All	
R	97-99	CL All	
R	86-89	INTEGRA All	
R	89-90	LEGEND All Auto Leveling System	
R	87-88	LEGEND Coupe	
R	92-94	VIGOR All	
R	79-97	HONDA ACCORD All	
R	80-87	CIVIC All	
R	92-01	PRELUDE All	
R	79-87	PRELUDE All	
142233 W			
F	86-89	ACURA INTEGRA All	
F	84-87	HONDA CIVIC Hatchback	
F	84-87	CIVIC Sedan	
142234 W			
F	90-94	HYUNDAI EXCEL All	
F	91-95	SCOUPE All	
F	90-94	MINI COOPER All	
142237 W			
F	90-97	MAZDA MIATA Non-ABS	
R	90-97	MIATA Non-ABS	
142240 W			
F	92	DODGE COLT All	
F	89-91	COLT Hatchback	
F	91-92	EAGLE SUMMIT Sedan	
F	89-90	SUMMIT All	
F	92-95	HYUNDAI ELANTRA Non-ABS	
F	89-92	MINI COOPER All	
F	85-86	MIRAGE All	
F	90-91	PLYMOUTH COLT Hatchback, FWD	
F	89	COLT Hatchback	
142241 W			
F	70-73	NISSAN 240Z All	
F	74	260Z All Mfg. 9/74	
F	75-78	280Z All	
F	79-83	280ZX All	
F	84-89	300ZX All	
F	73-76	610 All	
F	77-81	810 All	
F	90-94	AXXESS All	
F	89-94	MAXIMA All Exc. Electronic Adjustable Suspension	
F	82-84	MAXIMA All	
F	83-85	PULSAR / PULSAR NX All	
F	93-02	QUEST All	
142242 W			
F	86-88	NISSAN MAXIMA Sedan Exc. Electronic Adjustable Suspension	
F	85	MAXIMA All Exc. Electronic Adjustable Suspension	
F	87-88	MULTI CAN	
F	87-89	STANZA Sedan	
F	81-82	TOYOTA CRESSIDA All Exc. Electronic Adjustable Suspension	
F	78-80	CRESSIDA All	
142244 W			
F	91-02	SATURN SC / SL / SW SERIES All	

Suspension Mounts

Shock	POP	Alternative No.	MTG Acc. Supplied
Pos.	Year	Application	
142245 W			
R	91-02	SATURN SC / SL / SW SERIES All	
142247 W			
F	83-88	TOYOTA TERCEL Wagon	
142248 W			
F	87-90	TOYOTA TERCEL Hatchback	
F	87-90	TERCEL Sedan	
142249 W			
R	85-88	CHEVROLET NOVA All	
R	88-89	TOYOTA CELICA GT	
R	88-89	CELICA GTS	
R	88-89	CELICA ST	
R	86-87	CELICA All	
R	84-87	COROLLA All	
R	87	TERCEL Wagon	
R	83-86	TERCEL All	
142250 W			
R	90-91	LEXUS ES250 All	
R	87-91	TOYOTA CAMRY FWD	
142251 W			
F	74-79	VOLKSWAGEN SUPER BEETLE All	
F	73	SUPER BEETLE All 2 Bolt Lower Mount	
142252 D			
R	85-93	VOLKSWAGEN CABRIOLET All	
R	90-92	CORRADO All Rebuildable Front Struts	
R	85-98	GOLF All	
R	80-98	JETTA All	
R	75-84	RABBIT All	
R	75-89	SCIROCCO All	
142254 D			
R	91-07	FORD TAURUS Sedan	
R	89-90	TAURUS SHO, Sedan	
R	91-05	MERCURY SABLE Sedan	
142292 W			
R	93-97	CHRYSLER CONCORDE All	
R	93-97	INTREPID CAN	
R	94-97	LHS All	
R	94-96	NEW YORKER All	
R	93-97	DODGE INTREPID All	
R	93-97	EAGLE VISION All	
142293 W			
F	98-01	CHEVROLET METRO Non-ABS	
F	89-91	SPRINT All	
F	89-97	GEO METRO Non-ABS	
F	94	PONTIAC FIREFLY CAN	
F	89-91	FIREFLY CAN	
F	89-01	SUZUKI SWIFT All	
142294 W			
F	94-98	ASUNA SUNRUNNER	
F	92-93	SUNRUNNER All	
F	98-03	CHEVROLET TRACKER Non-ABS	
F	89-97	GEO TRACKER All	
F	94-97	PONTIAC SUNRUNNER CAN	
F	89-98	SUZUKI SIDEKICK Non-ABS	
142295 W			
R	98-01	CHEVROLET METRO Non-ABS	
R	89-91	SPRINT All	
R	89-97	GEO METRO Non-ABS	
R	94	PONTIAC FIREFLY CAN	
R	89-91	FIREFLY CAN	
R	89-01	SUZUKI SWIFT All	
142296 W			
F	94	ASUNA GT	
F	92	GT	
F	93	GT, SE All	
F	94	SE	
F	92	SE	
F	88-93	PONTIAC LEMANS All	
142297 W			
F	90-91	BUICK REATTA All	
F	90-93	RIVIERA All	
F	87-92	CADILLAC ALLANTE All Exc. Electronic Adjustable Suspension	
F	87-02	ELDORADO All	
F	87-92	SEVILLE All	
F	90-92	OLDSMOBILE TORONADO All	
142298 W			
F	88-89	BUICK REATTA All	
F	86-89	RIVIERA All	
F	86	CADILLAC ELDORADO All	

Numerical listing

Shock	POP	Alternative No.	MTG Acc. Supplied
Pos.	Year	Application	
142298 W -continued			
F	86	SEVILLE All	
F	86-89	OLDSMOBILE TORONADO All	
142300 W			
R	90-93	ACURA INTEGRA All	
R	98-02	HONDA ACCORD All	
R	89-95	CIVIC All	
R	93-97	CIVIC DEL SOL All	
142301 W			
F	89	DODGE 2000 GTX CAN	
F	92-96	EAGLE SUMMIT Wagon	
F	89-94	HYUNDAI SONATA All	
F	92-95	MINI COOPER All	
F	92-94	PLYMOUTH COLT Wagon	
142302 W			
R	91-93	NISSAN NX All	
R	93-94	SENTRA All	
R	91-92	SENTRA Non-ABS	
142306 W			
R	92-94	TOYOTA PASEO All	
R	89-94	TERCEL All	
R	87-88	TERCEL Hatchback	
R	87-88	TERCEL Sedan	
142307 D			
F	92-99	TOYOTA PASEO All	
F	91-99	TERCEL All	
142311 W			
F	76-85	TOYOTA CELICA All	
F	75	CELICA All Mfg. from 10/75	
F	80-82	CORONA All	
142316 W			
F	88-94	CHEVROLET BLAZER, S MODELS 4WD, Torsion Bar (FrontSpringType)	
F	88-04	S10 4WD, Torsion Bar (FrontSpringType)	
F	05	GMC JIMMY 4WD	
F	92-04	JIMMY All	
F	83-91	S15 JIMMY All	
F	88-94	SONOMA / S15 4WD, Torsion Bar (FrontSpringType)	
F	91	SYCLONE Torsion Bar (FrontSpringType)	
F	92-93	TYPHOON All	
F	91-94	OLDSMOBILE BRAVADA Torsion Bar (FrontSpringType)	
142317 W			
F	93	ASUNA SUNFIRE (CANADIAN VEHICLE) All	
F	90-93	GEO STORM Non-ABS	
F	90-92	ISUZU IMPULSE All Exc. Lotus Suspension	
F	91-93	STYLUS All Exc. Lotus Suspension	
142321 W			
R	89-98	HYUNDAI SONATA All	
142325 W			
F	89-94	MAZDA MPV All	
142326 W			
F	84-89	MERCEDES-BENZ 190D All	
F	84-93	190E All	
F	87-89	260E All Exc. 4 Matic 4x4	
F	90-93	300D All Exc. 4 Matic 4x4	
F	86-93	300E All Exc. 4 Matic 4x4	
F	92-93	400E / 400SE / 400SEL / 420SEL / 450SE / 450SEL All	
F	90-93	500SL All	
F	93	600SL All	
F	95	E300 All	
F	94-95	E320 All	
F	94-95	E420 All	
F	94	E500 All	
F	94-02	SL320 / SL500 / SL600 All	
142329 W			
F	93-95	DODGE COLT All	
F	93-96	EAGLE SUMMIT Coupe	
F	93-96	SUMMIT Sedan	
F	96	MINI COOPER All Mfg. to 5/96	
F	95	MIRAGE Sedan	
F	93-94	MIRAGE All	
F	93-94	PLYMOUTH COLT Sedan	
142330 D			
F	98-02	SUBARU FORESTER All	
F	93-01	IMPREZA Non-ABS	
F	90-04	LEGACY All	

Numerical listing

Shock	POP	Alternative No.	MTG Acc. Supplied
Pos.	Year	Application	
142334 W			
R	93	ASUNA SUNFIRE (CANADIAN VEHICLE) All Exc. Lotus Suspension	
R	90-93	GEO STORM Non-ABS	
R	90-92	ISUZU IMPULSE All Exc. Lotus Suspension	
R	91-93	STYLUS All Exc. Lotus Suspension	
142335 W			
F	85-89	SUBARU DL All	
F	85-89	GL All	
F	90-94	LOYALE All	
F	89-91	XT All	
F	85-88	XT FWD	
142393 W			
R	95-99	DODGE NEON All	
R	95-99	PLYMOUTH NEON All	
142396 C			
R	95-00	CHRYSLER CIRRUS All	
R	96	SEBRING Convertible	
R	95-00	DODGE STRATUS All	
R	96-98	PLYMOUTH BREEZE All	
142399 D			
F	95-03	FORD WINDSTAR All	
142402 W			
R	95-00	FORD CONTOUR All	
R	99-00	MERCURY COUGAR All	
R	95-00	MYSTIQUE All	
142403 W			
R	93-97	FORD PROBE All Left	
R	93-97	MAZDA 626 All Left	
R	93-97	MX6 All Left	
142404 W			
R	93-97	FORD PROBE All Right	
R	93-97	MAZDA 626 All Right	
R	93-97	MX6 All Right	
142405 W			
R	88-91	BUICK REATTA All	
R	86-93	RIVIERA All	
R	87-92	CADILLAC ALLANTE All Exc. Electronic Adjustable Suspension	
R	86-93	ELDORADO All	
R	86-93	SEVILLE All	
R	86-92	OLDSMOBILE TORONADO All	
142406 W			
F	95-98	BUICK SKYLARK All	
F	95-96	CHEVROLET BERETTA All	
F	95-98	CAVALIER All	
F	95-96	CORSICA All	
F	95-98	OLDSMOBILE ACHIEVA All Exc. Electronic Adjustable Suspension	
F	95-98	PONTIAC GRAND AM All Exc. Electronic Adjustable Suspension	
F	95-98	SUNFIRE All	
142408 B			
F	93-02	CHEVROLET CAMARO All Left	
F	93-02	PONTIAC FIREBIRD All Left	
142409 B			
F	93-02	CHEVROLET CAMARO All Right	
F	93-02	PONTIAC FIREBIRD All Right	
142411 W			
F	95-97	BUICK RIVIERA All	
F	95-96	OLDSMOBILE AURORA All	
142412 D			
F	93-02	CHEVROLET CAMARO All	
F	93-02	PONTIAC FIREBIRD All	
142413 C			
R	95-05	CHEVROLET CAVALIER All	
R	95-05	PONTIAC SUNFIRE All	
142415 W			
F	95-99	HYUNDAI ACCENT All	
142419 A			
R	01-05	CHRYSLER SEBRING ST (MfrBodyCode), Coupe	
F	96-00	SEBRING Coupe	
R	96-00	SEBRING Coupe	
F	95	SEBRING All	
R	95	SEBRING All	
R	89	DODGE 2000 GTX CAN Exc. Auto-Leveling System	
F	95-00	AVENGER All	
R	95-00	AVENGER All	

Suspension Mounts

Shock	POP	Alternative No.	MTG Acc. Supplied
Pos.	Year	Application	
142419 A -continued			
R	92-95	COLT All	
R	89-91	COLT Hatchback	
R	91-96	STEALTH All	
R	01-05	STRATUS ST (MfrBodyCode), Coupe	
R	91-93	EAGLE 2000 GTX CAN	
R	93-96	SUMMIT All	
R	89-92	SUMMIT Sedan	
R	92	SUMMIT Wagon	
F	95-98	TALON All	
R	90-98	TALON All	
R	92-95	HYUNDAI ELANTRA Non-ABS	
F	00-05	SONATA All	
R	00-05	SONATA All	
R	01	XG300 All	
R	02-05	XG350 All	
R	01-06	KIA MAGENTIS CAN	
R	01-06	OPTIMA All	
R	91-99	MITSUBISHI 3000GT All	
R	97-04	DIAMANTE All	
R	90-05	ECLIPSE All	
F	95-99	ECLIPSE All	
R	92-95	EXPO All	
R	89-07	GALANT All	
F	94-98	GALANT All	
R	85-88	GALANT All Exc. Electronic Adjustable Suspension	
R	97-02	MIRAGE All	
R	96	MIRAGE All Mfg. to 5/96	
R	95	MIRAGE Sedan	
R	89-94	MIRAGE All	
R	89-90	SIGMA Non-ABS Exc. Auto-Leveling System	
R	89-94	PLYMOUTH COLT All	
R	90-94	LASER All	
142426 W			
R	90-94	NISSAN AXCESS All Left	
R	89-94	MAXIMA All Left Exc. Electronic Adjustable Suspension	
R	86-88	MAXIMA Sedan Left Exc. Electronic Adjustable Suspension	
R	85	MAXIMA All Left Exc. Electronic Adjustable Suspension	
R	87-88	MULTI CAN Left	
R	90-92	STANZA All Left	
R	87-89	STANZA Sedan Left	
142427 W			
R	90-94	NISSAN AXCESS All Right	
R	89-94	MAXIMA All Right Exc. Electronic Adjustable Suspension	
R	86-88	MAXIMA Sedan Right Exc. Electronic Adjustable Suspension	
R	85	MAXIMA All Right Exc. Electronic Adjustable Suspension	
R	87-88	MULTI CAN Right	
R	90-92	STANZA All Right	
R	87-89	STANZA Sedan Right	
142428 W			
R	93-01	NISSAN ALTIMA All	
142429 W			
R	84-89	NISSAN 300ZX All	
R	86	MULTI CAN	
R	82-86	STANZA All	
142430 W			
F	89-94	NISSAN 240SX All Exc. Active Suspension	
142436 W			
R	95-99	TOYOTA PASEO All	
R	95-99	TERCEL All	
142437 W			
F	85-92	TOYOTA CRESSIDA All Exc. Electronic Adjustable Suspension	
F	86	SUPRA All Mfg. to 3/86	
142439 C			
R	95-96	TOYOTA AVALON All	
R	92-96	CAMRY All	
142440 W			
F	83-92	VOLVO 740 / 745 / 760 / 780 All	
F	91-95	940 All Exc. Hydraulic Self Leveling System	
F	92-97	960 All	
F	97-98	S90 All	
F	97-98	V90 All Mfg. from 5/97; Exc. Hydraulic Self Leveling System	

Numerical listing

Shock	POP	Alternative No.	MTG Acc. Supplied
Pos.	Year	Application	
142442 W			
R	96-99	AUDI A4 All	
R	00-02	S4 All	
R	82-88	VOLKSWAGEN QUANTUM All	
142444 W			
F	92-94	VOLKSWAGEN CORRADO VR6	
F	93-98	GOLF All	
F	94-98	JETTA 2.8L 6Cyl V (2792)	
F	90-97	PASSAT All	
142521 W			
R	89-94	AUDI 100 All	
R	89-90	200 All	
R	95-97	A6 All	
R	95-97	A6 QUATTRO All	
142524 D			
F	05-09	BUICK ALLURE All	
F	97-05	CENTURY All	
F	05-09	LACROSSE All	
F	97-05	LESABRE All	
F	97-05	PARK AVENUE All	
F	97-04	REGAL All	
F	98-99	RIVIERA All	
F	98-04	CADILLAC SEVILLE All	
F	00-11	CHEVROLET IMPALA All	
F	00-06	MONTE CARLO All	
F	02-05	VENTURE All	
F	97-01	VENTURE FWD	
F	97-99	OLDSMOBILE 88 SERIES All	
F	97	AURORA All	
F	98-02	INTRIGUE All	
F	96-99	LSS All	
F	97-98	REGENCY All	
F	97-04	SILHOUETTE All	
F	97-08	PONTIAC GRAND PRIX All	
F	04-05	MONTANA All	
F	02-03	MONTANA Mini Passenger Van	
F	99-01	MONTANA All	
F	97-98	TRANS SPORT All	
142525 W			
F	05-09	BUICK ALLURE All	
F	97-05	CENTURY All	
F	05-09	LACROSSE All	
F	97-04	REGAL All	
F	00-11	CHEVROLET IMPALA Sedan	
F	00-06	MONTE CARLO All	
F	02-05	VENTURE All	
F	97-01	VENTURE FWD	
F	98-02	OLDSMOBILE INTRIGUE All	
F	97-04	SILHOUETTE All	
F	97-08	PONTIAC GRAND PRIX All	
F	99-05	MONTANA All	
F	97-98	TRANS SPORT All	
142526 A			
F	05-09	BUICK ALLURE All	
F	97-05	CENTURY All	
F	05-09	LACROSSE All	
F	97-04	REGAL All	
F	05-07	TERRAZA FWD	
F	00-11	CHEVROLET IMPALA All	
F	00-07	MONTE CARLO All	
F	05-09	UPLANDER FWD Exc. Air-Leveling Suspension	
F	02-05	VENTURE All	
F	97-01	VENTURE FWD	
F	98-02	OLDSMOBILE INTRIGUE All	
F	97-04	SILHOUETTE All	
F	01-05	PONTIAC AZTEK All	
F	97-08	GRAND PRIX All	
F	99-09	MONTANA All	
F	97-98	TRANS SPORT All	
F	05-07	SATURN RELAY FWD	
142527 D			
F	97-99	CADILLAC DEVILLE All Electronic Ride Control	
F	97-02	ELDORADO All Electronic Ride Control	
F	93-97	SEVILLE All	
142529 W			
F	97	BUICK PARK AVENUE All	
F	97	OLDSMOBILE AURORA All	
142530 C			
F	97-99	BUICK LESABRE All	
F	97-99	OLDSMOBILE 88 SERIES All	
F	96-99	LSS All	
F	97-98	REGENCY All	
F	97-99	PONTIAC BONNEVILLE All	

Numerical listing

Shock	POP	Alternative No.	MTG Acc. Supplied
Pos.	Year	Application	
142531 A			
F	04-05	CHEVROLET	CLASSIC All
F	97-03	MALIBU	All
F	99-04	OLDSMOBILE	ALERO All
F	99	CUTLASS / CUTLASS SUPREME	All
F	98	CUTLASS / CUTLASS SUPREME	All Rear Strut Lower Mounting Holes at 2.4" & 3.2" Apart
F	97	CUTLASS / CUTLASS SUPREME	All
F	99-05	PONTIAC	GRAND AM All
142532 A			
R	04-05	CHEVROLET	CLASSIC All
R	97-03	MALIBU	All
R	99-04	OLDSMOBILE	ALERO All
R	97-99	CUTLASS / CUTLASS SUPREME	All
R	99-05	PONTIAC	GRAND AM All
142535 C			
R	96-06	HYUNDAI	ELANTRA All Left
R	03-08	TIBURON	All Left
R	97-01	TIBURON	All Left
R	05-12	TUCSON	All Left
R	05-09	KIA SPECTRA	All Left
R	04-09	SPECTRA	All Left
R	05-10	SPORTAGE	All Left
142536 C			
R	96-06	HYUNDAI	ELANTRA All Right
R	03-08	TIBURON	All Right
R	97-01	TIBURON	All Right
R	05-12	TUCSON	All Right
R	05-09	KIA SPECTRA	All Right
R	04-09	SPECTRA	All Right
R	05-10	SPORTAGE	All Right
142543 W			
F	90-93	MINI	GALANT All
F	89	GALANT	FWD
142546 A			
F	96-99	INFINITI	I30 All
F	95-99	NISSAN	MAXIMA All
142547 W			
F	91-96	INFINITI	G20 All
R	96-99	I30	All
R	95-99	NISSAN	MAXIMA All
142550 W			
R	93-01	SUBARU	IMPENZA Non-ABS
R	92-94	LEGACY	AWD
142556 W			
F	95-04	TOYOTA	AVALON All
F	95-01	CAMRY	All
F	94-99	CELICA	All
142559 W			
F	94-99	TOYOTA	CELICA All
142561 C			
F	92-94	LEXUS	ES300 All
F	92-94	TOYOTA	CAMRY All
142562 W			
F	91-92	FORD PROBE	Base, 2.2L 4Cyl L (133), Automatic
F	90-92	PROBE	GT, 2.2L 4Cyl L (133), Automatic
F	89-92	PROBE	GL, 2.2L 4Cyl L (133), Automatic
F	89	PROBE	LX, 2.2L 4Cyl L (133), Automatic
F	88-92	MAZDA	626 Automatic Exc. Electronic Adjustable Suspension or 4 Wheel Steer
F	88-89	929 All Exc.	Electronic Adjustable Suspension
F	00-06	MPV	All
F	88-92	MX6	Automatic Exc. Electronic Adjustable Suspension or 4 Wheel Steer
142567 W			
F	86-93	CHRYSLER	DAYTONA CAN
F	88-93	DYNASTY	CAN Exc. Hydraulic Self Leveling System
F	90-93	IMPERIAL	All Exc. Hydraulic Self Leveling System
F	86	LASER	All
F	86-95	LEBARON	All
F	86-93	NEW YORKER	All
F	90-95	TOWN & COUNTRY	All

Suspension Mounts

Shock	POP	Alternative No.	MTG Acc. Supplied
Pos.	Year	Application	
142567 W -continued			
F	86-88	TOWN & COUNTRY	All
F	86-88	DODGE	600 All
F	86-89	ARIES	All
F	86-95	CARAVAN / GRAND CARAVAN	All
F	86-93	DAYTONA	All
F	88-93	DYNASTY	All Exc. Hydraulic Self Leveling System
F	86-89	LANCER	All
F	87-94	SHADOW	All
F	89-95	SPIRIT	All
F	89-95	PLYMOUTH	ACCLAIM All
F	86-88	CARAVELLE	All
F	86-89	RELIANT	All
F	87-94	SUNDANCE	All
F	86-95	VOYAGER / GRAND VOYAGER	All
142568 W			
F	86-93	CHRYSLER	DAYTONA CAN
F	88-93	DYNASTY	CAN Exc. Hydraulic Self Leveling System
F	90-93	IMPERIAL	All Exc. Hydraulic Self Leveling System
F	86	LASER	All
F	86-95	LEBARON	All
F	86-93	NEW YORKER	All
F	90-95	TOWN & COUNTRY	All
F	86-88	TOWN & COUNTRY	All
F	86-88	DODGE	600 All
F	86-89	ARIES	All
F	89-95	CARAVAN / GRAND CARAVAN	Mfg. from 1/86
F	86-95	CARAVAN / GRAND CARAVAN	All
F	89-93	DAYTONA	All
F	87-88	DAYTONA	Pacifica
F	86	DAYTONA	All
F	88-93	DYNASTY	All Exc. Hydraulic Self Leveling System
F	86-89	LANCER	All
F	87-94	SHADOW	All
F	89-95	SPIRIT	All
F	89-95	PLYMOUTH	ACCLAIM All
F	86-88	CARAVELLE	All
F	86-89	RELIANT	All
F	87-94	SUNDANCE	All
F	86-95	VOYAGER / GRAND VOYAGER	All
142569 W			
F	90-92	FORD PROBE	GT, 2.2L 4Cyl L (133), Automatic
F	89	PROBE	GT, 2.2L 4Cyl L (133)
F	89-92	MAZDA	626 Automatic Exc. Electronic Adjustable Suspension or 4 Wheel Steer
F	88	626	Automatic
F	89-92	MX6	Automatic
142570 W			
F	91-92	FORD PROBE	SE
F	90-92	PROBE	LX
F	88-92	MAZDA	626 Standard Exc. Electronic Adjustable Suspension or 4 Wheel Steer
F	89-92	MX6	Standard Exc. Electronic Adjustable Suspension or 4 Wheel Steer
142571 W			
F	93-97	FORD PROBE	All
F	93-97	MAZDA	626 All
F	93-97	MX6	All
142572 W			
R	92-01	HONDA	PRELUDE All
142573 W			
R	85-98	VOLKSWAGEN	GOLF All
R	85-98	JETTA	All
142623 D			
F	95-98	NISSAN	200SX All
F	91-93	NX	All
F	93-99	SENTRA	All
F	91-92	SENTRA	Non-ABS
142625 A			
F	96-06	HYUNDAI	ELANTRA All
F	97-01	TIBURON	All
142626 W			
R	88-92	DAIHATSU	CHARADE All
R	95-05	HYUNDAI	ACCENT All
142639 W			
R	86-05	FORD	TAURUS Wagon
R	86-05	MERCURY	SABLE Wagon

Numerical listing

Shock	POP	Alternative No.	MTG Acc. Supplied
Pos.	Year	Application	
142640 A			
F	00-05	BUICK	LESABRE All
F	98-05	PARK AVENUE	All
F	98-99	RIVIERA	All
F	97-05	CADILLAC	DEVILLE All Exc. Electronic Adjustable Suspension
F	98-04	SEVILLE	All Exc. Electronic Adjustable Suspension
F	01-03	OLDSMOBILE	AURORA All
F	98-99	AURORA	All
F	00-05	PONTIAC	BONNEVILLE All
142641 W			
R	00	KIA	SEPHIA All Right Mfg. to 6/01
R	94-99	SEPHIA	All Right
142642 W			
R	00	KIA	SEPHIA All Left Mfg. to 6/01
R	94-99	SEPHIA	All Left
142643 W			
F	94-97	KIA	SEPHIA All
142646 W			
R	95-98	NISSAN	200SX All
R	89-94	240SX	All Exc. Active Suspension
R	90-96	300ZX	2+2
R	96-99	SENTRA	All
R	95	SENTRA	All B14 Solid Rear Axle
142647 A			
R	00-05	BUICK	LESABRE All
R	97-05	PARK AVENUE	All
R	95-99	RIVIERA	All
R	00-05	CADILLAC	DEVILLE All Exc. Electronic Adjustable Suspension
R	98-04	SEVILLE	All Exc. Electronic Adjustable Suspension
R	01-03	OLDSMOBILE	AURORA All
R	95-99	AURORA	All
R	00-05	PONTIAC	BONNEVILLE All
142648 X			
R	86-90	FORD	TAURUS All
R	86-90	MERCURY	SABLE Sedan
142649 A			
F	97-01	LEXUS	ES300 All Right Exc. Electronic Adjustable Suspension
F	99-03	RX300	All Right
F	97-04	TOYOTA	AVALON All Right
F	97-01	CAMRY	All Right
F	03	SIENNA	All Right
F	02	SIENNA	All Right Mfg. to 12/02
F	98-01	SIENNA	All Right
F	99-03	SOLARA	All Right
142650 A			
F	97-01	LEXUS	ES300 All Left Exc. Electronic Adjustable Suspension
F	99-03	RX300	All Left
F	97-04	TOYOTA	AVALON All Left
F	97-01	CAMRY	All Left
F	98-03	SIENNA	All Left
F	99-03	SOLARA	All Left
142651 A			
F	00-06	AUDI	TT All
F	00-06	TT	QUATTRO All
F	98-10	VOLKSWAGEN	BEETLE All
F	99-06	GOLF	A4 (MfrBodyCode)
F	01-05	JETTA	Sedan
F	99-00	JETTA	All
142652 B			
F	96-08	AUDI	A4 All
F	98-04	A6	All
F	98-07	A6	QUATTRO All
F	97-99	A8	All
F	00-02	S4	All
F	98-09	VOLKSWAGEN	PASSAT All
142653 W			
R	98-04	AUDI	A6 All
R	98-01	VOLKSWAGEN	PASSAT All
142654 B			
R	00-06	AUDI	TT All
R	98-10	VOLKSWAGEN	BEETLE All
R	99-06	GOLF	A4 (MfrBodyCode)
R	01-05	JETTA	Sedan
R	99-00	JETTA	All
142734 W			
F	91-94	AUDI	100 All Mfg. Late 91
F	95-97	A6	QUATTRO All
F	95-97	S6	All

Numerical listing

Shock	POP	Alternative No.	MTG Acc. Supplied
Pos.	Year	Application	
142734	W	-continued	
F	92-94	V8 QUATTRO All	
142735	W		
R	92-95	BMW 525i All Exc. Electronic Adjustable Suspension	
R	89-91	525i All	
R	94-95	530i Sedan	
R	88-93	535i All	
R	88	535iS All	
142738	W		
R	94-97	FORD ASPIRE Non-ABS	
R	88-93	FESTIVA All	
F	99-05	MAZDA MIATA All Exc. Sport Package	
R	99-05	MIATA All Exc. Sport Package	
142741	W		
F	90-96	NISSAN 300ZX 2+2	
142744	W		
F	91-03	FORD ESCORT All	
F	91-99	MERCURY TRACER FWD	
142745	W		
R	84-94	FORD TEMPO All	
R	84-94	MERCURY TOPAZ All	
142746	W		
F	86-95	FORD TAURUS All	
F	91-95	MERCURY SABLE Sedan	
F	86-90	SABLE All	
142747	D		
F	96-07	FORD TAURUS All	
F	96-05	MERCURY SABLE All	
142748	W		
F	95-98	BUICK SKYLARK All	
F	94-96	CHEVROLET BERETTA All	
F	94-96	CORSIKA All	
F	95-98	OLDSMOBILE ACHIEVA All Exc. Electronic Adjustable Suspension	
F	95-98	PONTIAC GRAND AM All Exc. Electronic Adjustable Suspension	
142749	W		
F	85-96	BUICK CENTURY All	
F	85	SKYLARK All	
F	84-90	CHEVROLET CELEBRITY All	
F	84-85	CITATION / CITATION II All	
F	90-96	LUMINA APV All	
F	82-96	OLDSMOBILE CIERA / CUTLASS CIERA All	
F	87-94	CUTLASS CLASSIC / CUTLASS CRUISER All	
F	90-96	SILHOUETTE All	
F	91	PONTIAC 6000 FWD	
F	84-90	6000 All	
F	84	PHOENIX All	
F	90-96	TRANS SPORT All	
142750	W		
F	92-94	BUICK SKYLARK All Exc. FE3 and Electronic Ride Control	
F	92-93	CHEVROLET BERETTA All	
F	92-93	CORSIKA All	
F	92-94	OLDSMOBILE ACHIEVA All Exc. FE3 and Electronic Ride Control	
F	92-94	PONTIAC GRAND AM All Exc. Electronic Adjustable Suspension	
142751	W		
F	91-99	BUICK LESABRE All	
F	91-96	PARK AVENUE All	
F	95-97	RIVIERA All	
F	93	CADILLAC 60 SPECIAL All	
F	92-93	COMMERCIAL CHASSIS FWD	
F	91	COMMERCIAL CHASSIS All	
F	91-93	DEVILLE All	
F	91-93	FLEETWOOD All	
F	90-99	OLDSMOBILE 88 SERIES All	
F	91-96	98 All Exc. Soft Ride Susp (FE1) and Elec. Ride & Handling (FW1)	
F	91-96	98 Coil (FrontSpringType), Air (RearSpringType) Standard Equipment; Exc. Electronic Adjustable Suspension	
F	95-96	AURORA All	
F	96-99	LSS All	
F	97-98	REGENCY All	
F	90-99	PONTIAC BONNEVILLE All	
142752	W		
F	86-90	BUICK LESABRE All	

Suspension Mounts

Shock	POP	Alternative No.	MTG Acc. Supplied
Pos.	Year	Application	
142752	W	-continued	
F	85-90	CADILLAC COMMERCIAL CHASSIS All	
F	85-90	DEVILLE All	
F	87-90	FLEETWOOD All	
F	86-89	OLDSMOBILE 88 SERIES All	
F	85-90	98 All	
F	87-89	PONTIAC BONNEVILLE All	
142753	D		
F	96-00	CHRYSLER TOWN & COUNTRY All	
F	00	VOYAGER / GRAND VOYAGER All	
F	96-00	DODGE CARAVAN / GRAND CARAVAN All	
F	96-00	CARAVAN / GRAND CARAVAN All Exc. Hydraulic Self Leveling System	
F	96-00	PLYMOUTH VOYAGER / GRAND VOYAGER All Exc. Nivomat Self-Leveling Option	
142754	W		
F	95-99	DODGE NEON All	
F	95-99	PLYMOUTH NEON All	
142755	W		
F	93-97	CHRYSLER CONCORDE All	
F	94-97	LHS All	
F	94-96	NEW YORKER All	
F	93-97	DODGE INTREPID All	
F	93-97	EAGLE VISION All	
142757	X		
R	86-89	SUBARU DL Coupe Exc. Air Suspension	
R	86-89	GL Coupe Exc. Air Suspension	
142762	W		
F	82-89	BUICK SKYHAWK All	
F	86-91	SKYLARK All	
F	85-87	SOMERSET / SOMERSET REGAL All	
F	82-88	CADILLAC CIMARRON All	
F	87-91	CHEVROLET BERETTA All	
F	82-94	CAVALIER All	
F	87-91	CORSIKA All	
F	85-87	OLDSMOBILE CALAIS All	
F	88-91	CUTLASS CALAIS All	
F	82-87	FIRENZA All	
F	85-91	PONTIAC GRAND AM All Standard Suspension	
F	82-84	J2000 / SUNBIRD All	
F	86-94	SUNBIRD All	
142763	W		
R	85-89	SUBARU DL Sedan Exc. Air Suspension	
R	85-89	GL Sedan Exc. Air Suspension	
R	90-93	LOYALE Sedan Exc. Air Suspension	
142803	W		
F	91-92	FORD PROBE 3.0L 6Cyl V (182) Exc. Electronic Adjustable Suspension or 4 Wheel Steer	
F	89-90	PROBE All Exc. Electronic Adjustable Suspension or 4 Wheel Steer	
F	88-92	MAZDA 626 Standard Exc. Electronic Adjustable Suspension or 4 Wheel Steer	
F	88-92	MX6 Standard Exc. Electronic Adjustable Suspension or 4 Wheel Steer	
142825	W		
F	95-99	BMW M3 All Right	
142826	W		
F	95-99	BMW M3 All Left	
142827	B		
F	99-04	CHRYSLER 300M All	
F	98-04	CONCORDE All	
F	98-04	INTREPID CAN	
F	99-01	LHS All	
F	98-04	DODGE INTREPID All	
142828	W		
R	99-04	CHRYSLER 300M All	
R	98-04	CONCORDE All	
R	98-04	INTREPID CAN	
R	99-01	LHS All	
R	98-04	DODGE INTREPID All	
142832	C		
F	97-03	FORD ESCORT All	

Numerical listing

Shock	POP	Alternative No.	MTG Acc. Supplied
Pos.	Year	Application	
142832	C	-continued	
F	97-99	MERCURY TRACER FWD	
142834	W		
F	92-94	LEXUS ES300 All Sealed O.E. Struts	
F	92-94	TOYOTA CAMRY All Sealed O.E. Struts	
142836	C		
F	95-96	LEXUS ES300 All	
F	95-96	TOYOTA AVALON All	
F	95-96	CAMRY All	
142837	A		
R	97-02	LEXUS ES300 All Exc. Electronic Adjustable Suspension	
R	99-03	RX300 All	
R	97-04	TOYOTA AVALON All	
R	97-03	CAMRY All	
R	99-03	SOLARA All	
142838	D		
F	90-02	TOYOTA 4RUNNER All Exc. HD	
142840	W		
F	95-99	DODGE NEON All	
F	95-99	PLYMOUTH NEON All	
142841	W		
F	96-00	CHRYSLER TOWN & COUNTRY All	
F	00	VOYAGER / GRAND VOYAGER All	
F	96-00	DODGE CARAVAN / GRAND CARAVAN All Exc. Hydraulic Self Leveling System	
F	96-00	PLYMOUTH VOYAGER / GRAND VOYAGER All Exc. Nivomat Self-Leveling Option	
142842	W		
F	93-97	CHRYSLER CONCORDE All	
F	93-97	INTREPID CAN	
F	94-97	LHS All	
F	94-96	NEW YORKER All	
F	93-97	DODGE INTREPID All	
F	93-97	EAGLE VISION All	
142843	C		
F	95-00	FORD CONTOUR All	
F	99-02	MERCURY COUGAR All	
F	95-00	MYSTIQUE All	
142844	W		
F	85-90	FORD ESCORT All	
F	85-88	EXP All	
F	84-94	TEMPO All	
F	85-87	MERCURY LYNX All	
F	84-94	TOPAZ All	
142845	A		
F	96-07	FORD TAURUS All	
F	96-05	MERCURY SABLE All	
142846	D		
F	86-95	FORD TAURUS All	
F	86-95	MERCURY SABLE All	
142847	W		
F	94-97	FORD ASPIRE Non-ABS	
F	88-93	FESTIVA All	
142850	W		
F	82-85	HONDA ACCORD All	
142851	D		
F	95-98	MAZDA PROTÉGÉ / PROTÉGÉS All	
142852	W		
F	89-92	FORD PROBE All	
F	88-92	MAZDA 626 Automatic Exc. Electronic Adjustable Suspension or 4 Wheel Steer	
F	88-92	MX6 Automatic Exc. Electronic Adjustable Suspension or 4 Wheel Steer	
142853	X		
F	88-89	MAZDA 929 All Exc. Electronic Adjustable Suspension	
142854	D		
F	91-96	FORD ESCORT All	
F	90-94	MAZDA 323 All	
F	92-94	PROTÉGÉ / PROTÉGÉS FWD, Non-ABS	
F	90-91	PROTÉGÉ / PROTÉGÉS All	

Numerical listing

Shock	POP	Alternative No.	MTG Acc. Supplied
Pos.	Year	Application	
142854	D	-continued	
F	91-96	MERCURY TRACER FWD	
142855	W		
F	86-87	MAZDA 626 Standard Exc. Electronic Adjustable Suspension	
F	83-85	626 All Exc. Electronic Adjustable Suspension	
142856	W		
F	93-97	FORD PROBE All	
F	98-00	KIA SEPHIA All	
F	93-97	MAZDA 626 All	
F	93-97	MX6 All	
142857	D		
F	97-02	MITSUBISHI MIRAGE All	
142858	W		
F	84-88	NISSAN 200SX All	
142859	W		
F	84-89	NISSAN 300ZX All	
142860	W		
F	93-01	MERCURY VILLAGER All	
F	93-02	NISSAN QUEST All	
142861	W		
F	86-88	NISSAN MULTI CAN	
F	86-90	PULSAR / PULSAR NX All	
F	91-92	SENTRA Classic, FWD	
F	87-90	SENTRA FWD	
F	85-89	STANZA Sedan	
142862	W		
F	90-94	NISSAN AXXESS All	
F	89-94	MAXIMA All Exc. Electronic Adjustable Suspension	
142880	C		
F	86-93	CHRYSLER DAYTONA CAN	
F	88-93	DYNASTY CAN	
F	90-93	IMPERIAL All	
F	86	LASER All	
F	86-95	LEBARON All	
F	86-93	NEW YORKER All	
F	90-95	TOWN & COUNTRY All	
F	86-88	TOWN & COUNTRY All	
F	86-88	DODGE 600 All	
F	86-89	ARIES All	
F	86-95	CARAVAN / GRAND CARAVAN All	
F	89-93	DAYTONA All	
F	87-88	DAYTONA Pacifica	
F	86	DAYTONA All	
F	88-93	DYNASTY All	
F	86-89	LANCER All	
F	87-94	SHADOW All	
F	89-95	SPIRIT All	
F	89-95	PLYMOUTH ACCLAIM All	
F	86-88	CARAVELLE All	
F	86-89	RELIANT All	
F	87-94	SUNDANCE All	
F	86-95	VOYAGER / GRAND VOYAGER All	
142930	A		
F	00-11	FORD FOCUS All	
142931	A		
F	04-06	CHRYSLER PACIFICA All	
F	01-07	TOWN & COUNTRY All	
F	01-07	VOYAGER / GRAND VOYAGER All	
F	01-07	DODGE CARAVAN / GRAND CARAVAN All	
142932	C		
F	00-02	CHRYSLER NEON All	
F	01-10	PT CRUISER All	
F	00-05	DODGE NEON All	
F	00-01	PLYMOUTH NEON All	
142933	W		
F	86-93	CHRYSLER DAYTONA CAN	
F	88-93	DYNASTY CAN	
F	90-93	IMPERIAL All	
F	86	LASER All	
F	86-95	LEBARON All	
F	86-93	NEW YORKER All	
F	90-95	TOWN & COUNTRY All	
F	86-88	DODGE 600 All	
F	86-89	ARIES All	
F	86-95	CARAVAN / GRAND CARAVAN All	
F	89-93	DAYTONA All	
F	87-88	DAYTONA Pacifica	
F	86	DAYTONA All	
F	88-93	DYNASTY All	
F	86-89	LANCER All	

Suspension Mounts

Shock	POP	Alternative No.	MTG Acc. Supplied
Pos.	Year	Application	
142933	W	-continued	
F	87-94	SHADOW All	
F	89-95	SPIRIT All	
F	89-95	PLYMOUTH ACCLAIM All	
F	86-88	CARAVELLE All	
F	86-89	RELIANT All	
F	87-94	SUNDANCE All	
F	86-95	VOYAGER / GRAND VOYAGER All	
142935	C		
F	00-05	HYUNDAI ACCENT All	
142936	D		
F	00-01	NISSAN SENTRA All	
142937	A		
F	00-01	INFINITI I30 All	
F	02-04	I35 All	
F	02-06	NISSAN ALTIMA All	
F	00-08	MAXIMA All	
F	03-07	MURANO All	
F	04-09	QUEST All	
142938	B		
F	97-03	INFINITI QX4 All	
F	96-03	NISSAN PATHFINDER All	
142939	D		
F	00-01	NISSAN ALTIMA All	
142940	W		
F	86-93	CHRYSLER DAYTONA CAN	
F	88-93	DYNASTY CAN Exc. Hydraulic Self Leveling System	
F	90-93	IMPERIAL All Exc. Hydraulic Self Leveling System	
F	86	LASER All Mfg. from 1/2/86	
F	87-95	LEBARON All	
F	86	LEBARON All Mfg. from 1/2/86	
F	87-93	NEW YORKER All	
F	86	NEW YORKER All Mfg. from 1/2/86	
F	90-95	TOWN & COUNTRY All	
F	88	DODGE 600 All	
F	86-87	600 All Mfg. from 1/2/86	
F	86-89	ARIES All	
F	86-95	CARAVAN / GRAND CARAVAN All	
F	90	CARAVAN / GRAND CARAVAN All Mfg. from 1/2/86	
F	89-93	DAYTONA ES	
F	89-90	DAYTONA ES Turbo	
F	87-88	DAYTONA Pacifica	
F	86	DAYTONA All	
F	88-93	DYNASTY All Exc. Hydraulic Self Leveling System	
F	87-89	LANCER All	
F	86	LANCER All Mfg. from 1/2/86	
F	87-94	SHADOW All	
F	89-95	SPIRIT All	
F	89-95	PLYMOUTH ACCLAIM All	
F	87-88	CARAVELLE All	
F	86	CARAVELLE All Mfg. from 1/2/86	
F	86-89	RELIANT All	
F	87-94	SUNDANCE All	
142941	W		
R	93-97	VOLVO 850 All Exc. Hydraulic Self Leveling System	
R	98-04	C70 All	
R	98-00	S70 All	
R	99-00	V70 R AWD Exc. Auto Rear Leveling	
R	98-00	V70 Base Exc. Auto Rear Leveling	
R	98-00	V70 GLT Exc. Auto Rear Leveling	
R	98-00	V70 T5 Exc. Auto Rear Leveling	
R	00	V70 2.4T Exc. Auto Rear Leveling	
R	00	V70 GLT SE Exc. Auto Rear Leveling	
R	98-99	V70 AWD Exc. Auto Rear Leveling	
R	98	V70 R Exc. Auto Rear Leveling	
142942	W		
R	01-05	SATURN L / LS / LW SERIES All	
142943	C		
F	01-02	SATURN L / LS / LW SERIES All	
142949	C		
R	00-03	NISSAN MAXIMA All	
142992	B		
R	08-11	FORD FOCUS All	
R	00-07	FOCUS Hatchback	
R	00-07	FOCUS Sedan	
143030	B		
F	95-00	CHRYSLER CIRRUS All	
F	96-00	SEBRING Convertible	

Numerical listing

Shock	POP	Alternative No.	MTG Acc. Supplied
Pos.	Year	Application	
143030	B	-continued	
F	95-98	DODGE STRATUS All	
F	96-99	PLYMOUTH BREEZE All	
143035	B		
F	99-05	CHEVROLET CAVALIER All	
F	99-05	PONTIAC SUNFIRE All	
F	02-07	SATURN VUE All	
143036	W		
F	88-96	BUICK REGAL All Left	
F	90-01	CHEVROLET LUMINA All Left	
F	88-97	OLDSMOBILE CUTLASS / CUTLASS SUPREME All Left	
F	88-96	PONTIAC GRAND PRIX All Left	
143037	W		
F	88-96	BUICK REGAL All Right	
F	90-01	CHEVROLET LUMINA All Right	
F	88-97	OLDSMOBILE CUTLASS / CUTLASS SUPREME All Right	
F	88-96	PONTIAC GRAND PRIX All Right	
143067	D		
R	88-96	BUICK REGAL All	
R	90-94	CHEVROLET LUMINA All	
R	88-97	OLDSMOBILE CUTLASS / CUTLASS SUPREME All	
R	88-96	PONTIAC GRAND PRIX All	
143071	W		
R	95-01	CHEVROLET LUMINA All Left	
R	95-96	MONTE CARLO All Left	
143072	W		
R	95-01	CHEVROLET LUMINA All Right	
R	95-96	MONTE CARLO All Right	
143073	A		
R	05-09	BUICK ALLURE All Left	
R	97-05	CENTURY All Left	
R	05-09	LACROSSE All Left	
R	97-04	REGAL All Left	
R	00-11	CHEVROLET IMPALA All Left	
R	97-07	MONTE CARLO All Left	
R	98-02	OLDSMOBILE INTRIGUE All Left	
R	97-08	PONTIAC GRAND PRIX All Left	
143074	A		
R	05-09	BUICK ALLURE All Right	
R	97-05	CENTURY All Right	
R	05-09	LACROSSE All Right	
R	97-04	REGAL All Right	
R	00-11	CHEVROLET IMPALA All Right	
R	97-07	MONTE CARLO All Right	
R	98-02	OLDSMOBILE INTRIGUE All Right	
R	97-08	PONTIAC GRAND PRIX All Right	
143082	C		
F	00	BMW 323Ci Coupe	
F	00	323i Wagon	
F	01-06	325Ci All Sport Suspension; Exc. M-Sport Pack II	
F	01-06	325i All Exc. Sport Suspension M-Sport Pack II	
F	00	328Ci All	
F	99-00	328i All	
F	01-06	330Ci All Exc. Sport Suspension M-Sport Pack II	
F	97-00	528i All	
143083	W		
F	97-01	BMW 740i All Exc. Electronic Adjustable Suspension	
F	94-95	740i All Exc. Electronic Adjustable Suspension	
F	94-01	740iL All Exc. Electronic Adjustable Suspension	
F	94-01	750iL All Exc. Electronic Adjustable Suspension	
143084	W		
F	00-06	BMW X5 AWD	
143086	W		
F	96-06	MERCEDES-BENZ E320 All Exc. 4 Matic	
F	97	E420 All Exc. 4 Matic	
F	98-02	E430 All Exc. 4 Matic	
143087	A		
F	01-05	CHRYSLER SEBRING ST (MfrBodyCode), Coupe	
F	01-05	DODGE STRATUS ST (MfrBodyCode), Coupe	
F	01-06	HYUNDAI SANTA FE All	
F	05-10	TUCSON All	

Numerical listing

Shock	POP	Alternative No.	MTG Acc. Supplied
Pos.	Year	Application	
143087	A	-continued	
F	97-04	MITSUBISHI	DIAMANTE All
F	00-05	ECLIPSE	All
F	99-03	GALANT	All
143088	C		
F	02-07	MITSUBISHI	LANCER All
F	03-06	OUTLANDER	All
143089	A		
F	03-07	SATURN	ION All
143090	W		
F	03-05	SATURN	L / LS / LW SERIES All
143091	D		
F	02-07	BUICK	RENDEZVOUS All Exc. Hydraulic Self Leveling System
143092	B		
F	03-07	CADILLAC	CTS All
143093	C		
F	03-08	PONTIAC	VIBE All
F	03-08	TOYOTA	MATRIX All
143094	B		
R	03-08	PONTIAC	VIBE All
R	05-07	SCION	TC All
R	00-05	TOYOTA	CELICA All
R	03-08	COROLLA	All
R	03-08	MATRIX	All
R	01-09	PRIUS	All
143112	W		
R	98-02	MAZDA	626 All Right
143113	W		
R	98-02	MAZDA	626 All Left
143116	W		
R	95-02	MAZDA	MILLENNIA All
143139	W		
R	94	SUBARU	LEGACY FWD
R	92-93	LEGACY	FWD, Coil (RearSpringType)
143140	W		
R	03-06	SUBARU	BAJA All
R	00-07	LEGACY	All
R	00-05	OUTBACK	All
143191	A		
F	94-97	VOLVO	850 Wagon Exc. Hydraulic Self Leveling System
F	93-97	850	Sedan Exc. Hydraulic Self Leveling System
F	06-07	C70	All
F	98-04	C70	All
F	01-07	S60	All
F	98-00	S70	All
F	99-06	S80	All Exc. Nivomat Rear Suspension
F	06-07	V70	R, AWD
F	04-05	V70	2.4
F	04-05	V70	2.5T
F	04-05	V70	R
F	01-05	V70	T5
F	04	V70	2.5T AWD
F	01-03	V70	2.4T
F	01-03	V70	Base
F	02	V70	AWD
F	99-00	V70	R AWD Exc. Auto Rear Leveling
F	98-00	V70	Base Exc. Auto Rear Leveling
F	98-00	V70	GLT Exc. Auto Rear Leveling
F	98-00	V70	T5 Exc. Auto Rear Leveling
F	00	V70	2.4T Exc. Auto Rear Leveling
F	00	V70	GLT SE Exc. Auto Rear Leveling
F	98-99	V70	AWD Exc. Auto Rear Leveling
F	98	V70	R Exc. Auto Rear Leveling
F	04-06	XC90	All
F	03	XC90	AWD
143193	W		
F	01-03	TOYOTA	PRIUS All
143194	W		
F	00-05	TOYOTA	ECHO All Only fits O.E. P/N's 48609-52011 & 48609-52050
143195	W		
F	00-05	TOYOTA	ECHO All Only fits O.E. P/N 48609-52021

Suspension Mounts

Shock	POP	Alternative No.	MTG Acc. Supplied
Pos.	Year	Application	
143196	W		
R	92-00	LEXUS	SC300 All
R	92-00	SC400	All
R	94-98	TOYOTA	SUPRA All
143197	W		
R	90-94	LEXUS	LS400 All Exc. Auto-Leveling System
143198	W		
R	95-00	LEXUS	LS400 All Exc. Auto-Leveling System
143199	W		
F	90-94	LEXUS	LS400 All Exc. Auto-Leveling System
143200	W		
F	93-05	LEXUS	GS300 All
F	98-00	GS400	All
F	01-05	GS430	All
F	02-07	SC430	All
143201	B		
F	00-05	TOYOTA	CELICA All
F	03-08	COROLLA	All
F	04-09	PRIUS	All
143202	A		
F	02-03	LEXUS	ES300 All Exc. Electronic Adjustable Suspension
F	04-06	ES330	All Exc. Adaptive Variable Suspension
F	04-06	RX330	All
F	06-07	RX400H	All
F	02-06	TOYOTA	CAMRY All
F	01-07	HIGHLANDER	All
F	04-08	SIENNA	All
F	04-07	SOLARA	All
143204	D		
F	03-04	CHEVROLET	TRACKER All
F	01-02	TRACKER	2.5L 6Cyl V (2500)
F	99-02	TRACKER	2.0L 4Cyl L (122)
F	99-05	SUZUKI	GRAND VITARA 2.5L 6Cyl V (2500)
F	04	VITARA	2.5L 6Cyl V (2500)
F	99-03	VITARA	2.0L 4Cyl L (2000)
F	02-06	XL-7	All
143205	C		
R	03-06	SUBARU	FORESTER All
R	04-06	IMPREZA	All
143206	D		
F	01-02	SAAB	9-3 Turbo
F	99-02	9-3	SE
F	99-01	9-3	Base
143207	W		
F	94-98	SAAB	900 All
143208	W		
F	99-07	SAAB	9-5 All
143209	D		
R	00-06	NISSAN	SENTRA All
143210	W		
F	97-01	INFINITI	Q45 All Exc. Active Suspension
143214	C		
R	02-07	NISSAN	ALTIMA All
R	04-08	MAXIMA	All
143218	D		
F	98-02	MAZDA	626 All
143219	C		
F	03	MAZDA	PROTÉGÉ / PROTÉGÉ5 DX
F	03	PROTÉGÉ	/ PROTÉGÉ5 ES
F	03	PROTÉGÉ	/ PROTÉGÉ5 LX
F	03	PROTÉGÉ	/ PROTÉGÉ5 SE
F	99-02	PROTÉGÉ	/ PROTÉGÉ5 All
143220	W		
R	95-98	MAZDA	PROTÉGÉ / PROTÉGÉ5 All Left
143221	C		
R	99-03	MAZDA	PROTÉGÉ / PROTÉGÉ5 All Left
R	03	PROTÉGÉ	/ PROTÉGÉ5 DX Left
R	03	PROTÉGÉ	/ PROTÉGÉ5 ES Left
R	03	PROTÉGÉ	/ PROTÉGÉ5 LX Left
R	03	PROTÉGÉ	/ PROTÉGÉ5 SE Left

Numerical listing

Shock	POP	Alternative No.	MTG Acc. Supplied
Pos.	Year	Application	
143222	W		
R	95-98	MAZDA	PROTÉGÉ / PROTÉGÉ5 All Right
143223	B		
R	99-03	MAZDA	PROTÉGÉ / PROTÉGÉ5 All Right
R	03	PROTÉGÉ	/ PROTÉGÉ5 DX Right
R	03	PROTÉGÉ	/ PROTÉGÉ5 ES Right
R	03	PROTÉGÉ	/ PROTÉGÉ5 LX Right
R	03	PROTÉGÉ	/ PROTÉGÉ5 SE Right
143224	W		
F	03-04	MAZDA	6 All
143226	W		
F	03-06	KIA	SORENTO All
143227	W		
F	01-03	KIA	RIO All
143228	W		
F	95-02	KIA	SPORTAGE All
143231	W		
F	02-06	ACURA	RSX Base Left
F	02-04	RSX	Type-S Left
F	02-05	HONDA	CIVIC Hatchback Left
F	01	CIVIC	All Left
F	02-06	CR-V	All Left
F	03-06	ELEMENT	All Left
143233	B		
F	05-06	ACURA	RSX Type-S Left
F	02-05	HONDA	CIVIC Coupe Left
F	02-05	CIVIC	Sedan Left
143235	W		
R	96-04	ACURA	RL All
143236	W		
F	96-04	ACURA	RL All
143239	A		
F	06-11	CHEVROLET	AVEO All
F	04-11	AVEO	All
F	05-08	PONTIAC	WAVE All
143240	W		
F	97-01	CADILLAC	CATERA All
143241	B		
F	04-07	BUICK	RAINIER All
F	03-06	CHEVROLET	SSR All
F	02-09	TRAILBLAZER	All
F	02-09	GMC	ENVOY All
F	03-08	ISUZU	ASCENDER All
F	02-04	OLDSMOBILE	BRAVADA All
F	05-09	SAAB	9-7X All
143242	D		
F	02-05	FORD	THUNDERBIRD All
R	02-05	THUNDERBIRD	All
F	00-06	JAGUAR	S TYPE All Exc. Computer Active Technology Suspension
R	00-06	S TYPE	All Exc. Computer Active Technology Suspension
F	00-06	LINCOLN	LS All
R	00-06	LS	All
143244	W		
F	03-06	FORD	EXPEDITION All Exc. Adjustable Suspension
F	03-05	LINCOLN	NAVIGATOR All
143246	W		
F	04-07	FORD	FREESTAR All
F	04-07	MERCURY	MONTEREY Mini Passenger Van
143248	W		
F	04-08	FORD	PICKUP 1/2 TON, F-150 All
F	06-08	LINCOLN	MARK LT All
143253	A		
F	01-11	FORD	ESCAPE All
F	08-09	MAZDA	TRIBUTE All
F	01-06	TRIBUTE	All
F	05-11	MERCURY	MARINER FWD
143255	W		
F	02-11	JEEP	LIBERTY All Left
143256	B		
R	00-02	CHRYSLER	NEON All
R	00-05	DODGE	NEON All
R	00-01	PLYMOUTH	NEON All

Numerical listing

Shock	POP	Alternative No.	MTG Acc. Supplied
Pos.	Year	Application	
143259	W		
R	00-06	BMW X5 All	
143262	W		
R	01-03	BMW 525i All Exc. Electronic Adjustable Suspension	
R	97-00	528i All Exc. Electronic Adjustable Suspension	
R	01-03	530i All Exc. Electronic Adjustable Suspension	
R	97-03	540i All Exc. Electronic Adjustable Suspension	
R	95	540i All Exc. Electronic Adjustable Suspension	
143263	W		
R	97-01	BMW 740i All	
R	94-95	740i All	
R	94-01	740iL All	
R	00-03	M5 All	
143264	W		
F	02-06	ACURA RSX Base Right	
F	02-04	RSX Type-S Right	
F	02-05	HONDA CIVIC Hatchback Right	
F	01	CIVIC All Right	
F	02-06	CR-V All Right	
F	03-06	ELEMENT All Right	
143265	A		
F	05-06	ACURA RSX Type-S Right	
F	02-05	HONDA CIVIC Coupe Right	
F	02-05	CIVIC Sedan Right	
143266	W		
F	02-11	JEEP LIBERTY All Right	
143267	D		
F	00-06	MAZDA MPV All	
143277	C		
F	93-99	NISSAN ALTIMA All	
F	90-92	STANZA All	
143278	B		
F	87-91	TOYOTA CAMRY All	
F	91-97	PREVIA All	
143279	W		
F	92-93	TOYOTA CELICA GT	
F	92-93	CELICA GTS	
F	92-93	CELICA ST	
F	86-91	CELICA All	
143280	A		
F	93-97	TOYOTA COROLLA Base Exc. LE Model	
F	93-97	COROLLA DX Exc. LE Model	
F	93	COROLLA All Trac Exc. LE Model	
143281	A		
F	98-02	CHEVROLET PRIZM All	
F	89-97	GEO PRIZM All	
F	90-91	LEXUS ES250 All	
F	97-02	TOYOTA COROLLA LE	
F	88-95	COROLLA LE	
F	88-92	COROLLA DLX	
F	88-92	COROLLA DLX All Trac	
F	88-92	COROLLA SR5	
F	88-91	COROLLA GTS	
143305	N		
F	05-10	HONDA ODYSSEY All	
143315	A		
F	01-06	ACURA MDX All	
F	99-04	HONDA ODYSSEY All	
F	03-08	PILOT All	
143316	D		
F	07-11	CHEVROLET AVALANCHE 1500 All Exc. Electronic Ride Control	
F	07-13	PICKUP 1/2 TON, SILVERADO 1500 All Exc. Electronic Adjustable Suspension	
F	09-11	SUBURBAN 1/2 TON, 1500 All Exc. Electronic Adjustable Suspension	
F	07-08	SUBURBAN 1/2 TON, 1500 All Exc. Z55 or ZW7 Ride Suspension	
F	07-11	TAHOE All Exc. Z55 or ZW7 Ride Suspension	
F	12-13	GMC SIERRA 1500 All Exc. Electronic Adjustable Suspension	
F	07-11	SIERRA 1500 All Exc. Electronic Adjustable Suspension	
F	07-11	YUKON All Exc. Electronic Adjustable Suspension	

Suspension Mounts

Shock	POP	Alternative No.	MTG Acc. Supplied
Pos.	Year	Application	
143316	D -continued		
F	07-11	YUKON XL 1/2 TON All Exc. Z55 Auto Ride Suspension	
143317	D		
R	03-06	FORD EXPEDITION All	
143318	D		
F	02-05	FORD EXPLORER All	
F	02-05	MERCURY MOUNTAINEER All	
143319	D		
R	02-05	FORD EXPLORER All	
R	02-05	MERCURY MOUNTAINEER All	
143320	W		
R	99-00	CHRYSLER SEBRING Convertible	
143321	A		
R	01-06	CHRYSLER SEBRING JR (MfrBodyCode), Sedan	
R	01-06	DODGE STRATUS Sedan	
143322	A		
F	02-06	NISSAN SENTRA All	
143323	A		
F	05-10	CHEVROLET COBALT LS	
F	05-10	COBALT LT	
F	10	COBALT Base	
F	10	COBALT LT Team Canada	
F	06-07	COBALT LTZ	
F	05	COBALT Base	
F	11	HHR All	
F	08-10	HHR LS Panel	
F	08-10	HHR LT Panel	
F	06-10	HHR LS	
F	06-10	HHR LT	
F	06-08	HHR Comfort LT	
F	06-08	HHR Elegance LT	
F	07	HHR Edicion Especial	
F	07-09	PONTIAC G5 All	
F	05-06	PURSUIT All	
143324	D		
F	06-08	DODGE PICKUP 1/2 TON, RAM 1500 (SEE RAM 1500) 4WD Exc. Mega Cab	
143325	A		
F	96-02	TOYOTA 4RUNNER 4WD	
F	01-07	SEQUOIA All	
F	95-04	TACOMA 4WD	
F	00-06	TUNDRA All	
143328	W		
R	99-00	CHRYSLER CIRRUS All	
R	99-00	DODGE STRATUS All	
R	99-00	PLYMOUTH BREEZE All	
143330	N		
F	06-10	FORD EXPLORER All	
F	06-10	MERCURY MOUNTAINEER All	
143335	C		
R	05-10	CHRYSLER 300 All	
R	08-10	DODGE CHALLENGER All	
R	06-10	CHARGER All	
R	05-08	MAGNUM All	
143336	D		
F	11-13	CHRYSLER 200 All	
F	07-10	SEBRING All	
F	08-13	DODGE AVENGER All	
143337	N		
R	11	CHRYSLER 200 All	
R	07-10	SEBRING All	
R	08-12	DODGE AVENGER All	
R	07-12	CALIBER All	
R	07-12	JEEP COMPASS All	
R	07-12	PATRIOT All	
143338	W		
R	04-10	TOYOTA SIENNA All	
143339	C		
F	08-11	TOYOTA SEQUOIA All	
F	07-12	TUNDRA All	
143340	N		
R	08-11	TOYOTA SEQUOIA All	
R	07-11	TUNDRA All	
143341	A		
F	05-07	FORD FREESTYLE All	
F	05-10	MUSTANG / MUSTANG II All	
F	05-07	MERCURY MONTEGO All	

Numerical listing

Shock	POP	Alternative No.	MTG Acc. Supplied
Pos.	Year	Application	
143342	B		
F	06-11	HYUNDAI AZERA All	
F	06-10	SONATA All	
F	07-09	KIA AMANTI All	
143343	N		
F	06-11	TOYOTA RAV4 All	
143344	W		
F	06-11	AUDI A3 All	
F	08-09	TT All	
F	08-10	TT QUATTRO All	
F	09-12	VOLKSWAGEN CC All	
F	07-11	EOS All	
F	10-11	GOLF All	
F	06-11	GTI All	
F	06-12	JETTA All	
F	09-10	PASSAT All	
F	06-09	PASSAT All	
F	08	R32 All	
F	06-09	RABBIT All	
F	09-11	TIGUAN All	
143345	N		
R	06-11	AUDI A3 All	
R	08-09	TT All	
R	08-10	TT QUATTRO All	
R	09-12	VOLKSWAGEN CC All	
R	07-11	EOS All	
R	10-11	GOLF All	
R	06-11	GTI All	
R	06-12	JETTA All	
R	09-10	PASSAT All	
R	06-09	PASSAT All	
R	08	R32 All	
R	06-09	RABBIT All	
R	09-10	TIGUAN All	
143346	W		
F	02-07	NISSAN X-TRAIL All	
143349	N		
F	06-08	CHEVROLET OPTRA All	
F	06-08	SUZUKI FORENZA All	
F	06-08	RENO All	
143350	N		
R	06-08	CHEVROLET OPTRA All	
R	06-08	SUZUKI FORENZA All	
R	06-08	RENO All	
143353	A		
F	02-06	ACURA RSX Base	
F	02-06	RSX Type-S	
F	02-05	HONDA CIVIC Hatchback	
F	01	CIVIC All	
F	02-06	CR-V All	
F	03-06	ELEMENT All	
143354	C		
F	04-12	CHEVROLET MALIBU All Left	
F	05-10	PONTIAC G6 All Left	
F	07-09	SATURN AURA All Left	
143355	C		
F	04-12	CHEVROLET MALIBU All Right	
F	05-10	PONTIAC G6 All Right	
F	07-09	SATURN AURA All Right	
143356	W		
F	03-11	FORD CROWN VICTORIA All	
F	03-11	LINCOLN TOWN CAR All Exc. Limo	
F	03-11	MERCURY GRAND MARQUIS All	
143357	N		
F	07-11	FORD CROWN VICTORIA All	
F	03-06	CROWN VICTORIA Base	
F	03-06	CROWN VICTORIA LX	
F	04-05	CROWN VICTORIA LX Sport	
F	05	CROWN VICTORIA S	
F	05	CROWN VICTORIA Special Edition	
F	03	CROWN VICTORIA LWB	
F	03	CROWN VICTORIA S	
F	03-11	LINCOLN TOWN CAR Executive	
F	03-11	MERCURY GRAND MARQUIS All	
143358	W		
F	04-10	INFINITI QX56 All	
F	05-11	NISSAN ARMADA All	
F	04-11	TITAN All	
143359	N		
F	04-10	INFINITI QX56 All	
F	05-11	NISSAN ARMADA All	
F	04-11	TITAN All	

Numerical listing

Shock	POP	Alternative No.	MTG Acc. Supplied
Pos.	Year	Application	
143360	W		
F	06-10	FORD EXPLORER All	
F	06-10	MERCURY MOUNTAINEER All	
143361	W		
R	06-10	FORD EXPLORER All	
R	06-10	MERCURY MOUNTAINEER All	
143362	N		
R	06-10	FORD EXPLORER All	
R	06-10	MERCURY MOUNTAINEER All	
143363	A		
F	05-06	CHEVROLET EQUINOX All	
F	06	PONTIAC TORRENT All	
143364	C		
F	06-10	JEEP COMMANDER All	
F	05-10	GRAND CHEROKEE All	
143365	C		
F	08-09	MAZDA 3 GS	
F	08-09	3 GT	
F	08-09	3 S	
F	04-09	3 i	
F	08	3 GX	
F	05	3 SP23	
143366	N		
F	08-11	BUICK ENCLAVE All	
F	09-11	CHEVROLET TRAVERSE All	
F	07-11	GMC ACADIA All	
F	07-09	SATURN OUTLOOK All	
143367	C		
F	96-05	TOYOTA RAV4 All	
143368	C		
F	02-07	SATURN VUE All Replaces Mount in GM Service Kit 15269823	
143369	A		
F	05-10	CHRYSLER 300 RWD	
F	08-10	DODGE CHALLENGER All	
F	06-10	CHARGER RWD	
F	05-08	MAGNUM RWD	
143375	N		
R	06-11	CHEVROLET AVEO All	
R	04-11	AVEO All	
R	07-09	PONTIAC G3 All	
R	05-08	WAVE All	
R	04-09	SUZUKI SWIFT All	
143377	N		
F	07-10	NISSAN SENTRA All Left	
143378	N		
F	07-10	NISSAN SENTRA All Right	
143380	N		
R	98-04	AUDI A6 All	
R	02-05	VOLKSWAGEN PASSAT FWD	
143381	N		
F	06-10	KIA MAGENTIS All Left	
F	06-10	OPTIMA All Left	
143382	N		
F	06-10	KIA MAGENTIS All Right	
F	06-10	OPTIMA All Right	
143383	N		
F	03-12	TOYOTA 4RUNNER All	
F	07-12	FJ CRUISER All	
F	05-12	TACOMA All	
143390	N		
R	05-07	FORD FIVE HUNDRED FWD Left	
R	05-07	MERCURY MONTEGO All Left	
143391	N		
R	05-07	FORD FIVE HUNDRED FWD Right	
R	05-07	MERCURY MONTEGO All Right	
143392	N		
F	06-12	FORD FUSION All	
F	07-12	LINCOLN MKZ All	
F	06	ZEPHYR All	
F	05-08	MAZDA 6 All	
F	06-11	MERCURY MILAN All	
143394	FF		
R	02-10	MITSUBISHI LANCER All	
R	03-11	OUTLANDER All	
143396	N		
R	03-07	NISSAN MURANO All	

Suspension Mounts, Strut Cushion

Shock	POP	Alternative No.	MTG Acc. Supplied
Pos.	Year	Application	
143396	N	-continued	
R	04-09	QUEST All	
143412	FF		
F	06-08	MAZDA MX-5 MIATA All	
R	06-08	MX-5 MIATA All	
143418	FF		
R	02-07	SUZUKI AERIO All	
143419	N		
F	04-06	KIA AMANTI All	
R	04-06	AMANTI All	
143423	N		
R	03-06	CHRYSLER SEBRING JR (MfrBodyCode), Convertible	
R	03-06	SEBRING JR (MfrBodyCode), Sedan	
F	01-06	SEBRING JR (MfrBodyCode), Convertible	
F	01-06	SEBRING JR (MfrBodyCode), Sedan	
F	01-06	DODGE STRATUS Sedan	
R	01-06	STRATUS Sedan	
R	99-00	STRATUS All	
143425	N		
R	08	CHEVROLET MALIBU Base	
R	08	MALIBU Hybrid	
R	08	MALIBU LS	
R	08	MALIBU LT	
R	08	MALIBU LTZ	
R	04-07	MALIBU Maxx LS	
R	04-07	MALIBU Maxx LT	
R	04	MALIBU Maxx	
R	05-10	PONTIAC G6 All	
R	07-09	SATURN AURA XE	
R	07-09	AURA XR	
R	07-08	AURA Green Line	
143458	FF		
F	02-05	KIA SEDONA All	
Strut Cushion			
143057	A		
F	94	ASUNA GT	
F	92	GT	
F	93	GT, SE All	
F	94	SE	
F	92	SE	
F	88-92	AUDI 80 All	
F	88-92	80 QUATTRO All	
F	93-95	90 All	
F	88-91	90 All	
F	93-95	90 QUATTRO All	
F	88-91	90 QUATTRO All	
F	89-90	100 QUATTRO All	
F	89-90	200 QUATTRO Wagon	
F	80-87	4000 All	
F	84-87	4000 QUATTRO All	
F	83-87	COUPE All	
F	90-91	COUPE QUATTRO All	
F	90-94	V8 QUATTRO All	
F	95-99	BMW 318TI All	
F	97-05	BUICK PARK AVENUE All	
F	97-99	RIVIERA All	
F	95-05	CHEVROLET CAVALIER All	
R	04-05	CLASSIC All	
R	97-03	MALIBU All	
R	98-01	METRO Non-ABS	
R	89-91	SPRINT All	
F	99-04	CHRYSLER 300M All	
F	93-04	CONCORDE All	
R	87-89	CONQUEST All Exc. Electronic Adjustable Suspension	
F	83	E CLASS All	
F	83	EXECUTIVE SEDAN All	
F	93-04	INTREPID CAN	
F	81-83	LEBARON All	
F	99-01	LHS All	
F	94-97	LHS All	
R	00-02	NEON All	
F	94-96	NEW YORKER All	
F	83	NEW YORKER All	
R	01-10	PT CRUISER All	
F	96-00	SEBRING Coupe	
R	96-00	SEBRING Coupe	
F	95	SEBRING All	
R	95	SEBRING All	
F	82-83	DODGE 400 All	
F	83	600 All	
F	81-83	ARIES All	
F	83-87	CHARGER All	
F	90-95	COLT Sedan	

Numerical listing

Shock	POP	Alternative No.	MTG Acc. Supplied
Pos.	Year	Application	
143057	A	-continued	
F	90-94	COLT Hatchback	
F	93-04	INTREPID All	
R	00-05	NEON All	
F	95-99	NEON All	
F	78-89	OMNI All	
F	82-84	RAMPAGE All	
F	91-93	EAGLE 2000 GTX CAN	
F	89-96	SUMMIT All	
F	90-94	TALON All	
F	93-97	VISION All	
F	94-97	FORD ASPIRE Non-ABS	
F	81-96	ESCORT All	
F	82-88	EXP All	
F	00-05	FOCUS Hatchback	
F	00-05	FOCUS Sedan	
R	93-97	PROBE All	
F	89-92	PROBE All	
R	94-07	TAURUS Sedan	
F	84-85	TEMPO All	
R	89-97	GEO METRO Non-ABS	
F	85-87	HONDA CIVIC Wagon, 4WD	
F	92-95	HYUNDAI ELANTRA Non-ABS	
F	90-94	EXCEL All	
F	89-94	SONATA All	
F	91-96	INFINITI G20 All	
F	92-02	LEXUS ES300 All	
F	92-02	ES300 All	
F	90-94	MAZDA 323 All	
R	93-97	626 All	
R	88-92	626 All Exc. Electronic Adjustable Suspension or 4 Wheel Steer	
F	86-87	626 Automatic Exc. Electronic Adjustable Suspension	
R	86-87	626 Automatic Exc. Electronic Adjustable Suspension	
F	83-85	626 All	
R	83-85	626 All	
R	84-85	GLC All	
R	81-83	GLC Hatchback	
R	81-83	GLC Sedan	
R	88-97	MX6 All	
F	90-03	PROTÉGÉ / PROTÉGÉ5 All	
F	91-93	MERCURY CAPRI All	
F	82-83	LN7 All	
F	81-87	LYNX All	
R	94-05	SABLE Sedan	
F	84-85	TOPAZ All	
F	91-96	TRACER FWD	
F	93-98	VILLAGER All	
F	90-94	MITSUBISHI ECLIPSE All	
F	92-95	EXPO All	
R	94-98	GALANT All	
F	89-98	GALANT All	
F	89-96	MIRAGE All	
F	90-94	PRECIS All	
F	87-89	STARION All	
F	95-98	NISSAN 200SX All	
F	90-96	300ZX 2+2	
F	84-86	300ZX All	
F	00-01	ALTIMA All	
R	89-94	MAXIMA All	
F	87-88	MULTI CAN	
F	91-93	NX All	
F	83-90	PULSAR / PULSAR NX All	
F	93-98	QUEST All	
F	91-99	SENTRA All	
F	87-90	SENTRA FWD	
F	82-86	SENTRA All	
R	87-89	STANZA Sedan	
R	99-04	OLDSMOBILE ALERO All	
R	97-99	CUTLASS / CUTLASS SUPREME All	
F	92-93	PLYMOUTH COLT All	
F	89-91	COLT Hatchback, FWD	
F	87-89	EXPO All	
F	78-89	HORIZON All	
F	90-94	LASER All	
F	95-99	NEON All	
F	81-83	RELIANT All	
F	83	SCAMP All	
F	85	TURISMO All	
F	83	TURISMO All	
R	94-99	PONTIAC FIREFLY CAN	
R	89-91	FIREFLY CAN	
R	99-05	GRAND AM All	
F	88-93	LEMANS All	
F	95-05	SUNFIRE All	
F	93-98	SAAB 900 All	
F	91-02	SATURN SC / SL / SW SERIES All	
F	98-02	SUBARU FORESTER All	
R	98-02	FORESTER All	
F	95-99	LEGACY All	
R	95-99	LEGACY All	
F	95-02	SUZUKI ESTEEM All	

Numerical listing

Shock	POP	Alternative No.	MTG Acc. Supplied
Pos.	Year	Application	

143057 A -continued			
R	95-02	ESTEEM All	
R	89-01	SWIFT All	
F	95-03	TOYOTA AVALON All	
R	95-03	AVALON All	
F	87-01	CAMRY All	
R	87-01	CAMRY All	
R	92-93	CELICA All	
F	75-85	CELICA All	
R	93-02	COROLLA All	
F	88	COROLLA FX	
F	88	COROLLA FX16	
F	80-87	COROLLA All	
F	75-79	COROLLA Wagon	
F	74	COROLLA All Mfg. from 8/74	
F	99-03	SOLARA All	
R	86-91	SUPRA All	
F	86	SUPRA All	
R	83-88	TERCEL Wagon	
F	87-93	VOLKSWAGEN FOX All	
F	82-88	QUANTUM All	
F	71-79	SUPER BEETLE All	
F	75-93	VOLVO 240 / 242 / 244 / 245 / 262 / 264 / 265 All	

143058 C			
F	93	ASUNA SUNFIRE (CANADIAN VEHICLE) All	
R	85-88	CHEVROLET NOVA All	
R	98-02	PRIZM All	
F	85-88	SPECTRUM All	
R	99-04	CHRYSLER 300M All	
R	98-04	CONCORDE All	
F	87-89	CONQUEST All Exc. Electronic Adjustable Suspension	
R	98-04	INTREPID CAN	
R	99-01	LHS All	
R	94-97	LHS All	
R	84-86	DODGE CONQUEST All	
R	98-04	INTREPID All	
R	95-00	FORD CONTOUR All	
R	91-96	ESCORT All	
R	93-97	GEO PRIZM All	
F	89	SPECTRUM All	
F	90-93	STORM Non-ABS	
F	90-92	ISUZU IMPULSE All	
F	91-93	STYLUS All	
F	86-89	MAZDA 323 FWD	
R	86-89	323 FWD	
R	92-03	PROTÉGÉ / PROTÉGÉS All	
R	90-91	PROTÉGÉ / PROTÉGÉS FWD	
R	99-02	MERCURY COUGAR All	
R	91-96	TRACER FWD	
R	87-89	TRACER FWD	
R	87-89	MITSUBISHI STARION All	
F	84-86	STARION LE	
R	84-86	STARION LE	
F	84-85	STARION LS	
R	84-85	STARION LS	
F	83	STARION All	
R	83	STARION All	
F	86	NISSAN STANZA Sedan	
F	82-85	STANZA All	
F	85-88	PONTIAC SUNBURST CAN	
F	87-88	PORSCHE 924 All	
F	77-82	924 All	
F	83-88	944 All	
F	86-87	SAAB 9000 All	
R	90-94	SUBARU LEGACY All	
F	83-86	TOYOTA CAMRY All	
R	84-92	COROLLA FWD	
F	85-93	VOLKSWAGEN CABRIOLET All	
F	85-98	GOLF All	
F	80-98	JETTA All	
F	90-01	PASSAT All	
F	75-84	RABBIT All	
F	80-83	RABBIT PICKUP All	
F	75-89	SCIROCCO All	
F	84-92	VOLVO 740 / 745 / 760 / 780 All	
F	91-95	940 All Exc. Hydraulic Self Leveling System	
F	92-95	960 All	

143059 A			
R	73-79	AUDI FOX All	
F	92-98	BUICK SKYLARK All	
F	92-96	CHEVROLET BERETTA All	
F	87-94	CAVALIER All	
F	92-96	CORSICA All	
F	98-01	METRO Non-ABS	
R	95-07	MONTE CARLO All	
F	85-88	NOVA All	
F	98-02	PRIZM All	
F	89-91	SPRINT All	
F	86-93	CHRYSLER DAYTONA CAN	

Strut Cushion

Shock	POP	Alternative No.	MTG Acc. Supplied
Pos.	Year	Application	

143059 A -continued			
F	88-93	DYNASTY CAN	
F	90-93	IMPERIAL All	
F	86-95	LEBARON All	
F	90-00	TOWN & COUNTRY All	
F	00-07	VOYAGER / GRAND VOYAGER All	
F	84-00	DODGE CARAVAN / GRAND CARAVAN All	
F	78-83	CHALLENGER All	
F	85-91	COLT Vista, Wagon, FWD	
F	84	COLT Wagon	
F	71-80	COLT Wagon	
F	86-93	DAYTONA All	
F	88-93	DYNASTY All	
R	95-99	NEON All	
F	90	OMNI All	
F	87-94	SHADOW All	
F	89-95	SPIRIT All	
F	89-91	EAGLE VISTA Wagon, CAN	
R	81-90	FORD ESCORT All	
R	82-88	EXP All	
F	78-83	FAIRMONT All	
F	88-93	FESTIVA All	
F	81-82	GRANADA All	
F	83-86	LTD / COUNTRY SEDAN / COUNTRY SQUIRE / CROWN VICTORIA All	
F	79-93	MUSTANG / MUSTANG II All	
F	94-07	TAURUS All	
R	86-93	TAURUS Sedan	
R	86-93	TAURUS Wagon	
R	84-94	TEMPO All	
F	87-88	THUNDERBIRD Naturally Aspirated (Eng Asp), Non-ABS	
F	80-86	THUNDERBIRD All	
F	95-03	WINDSTAR All	
F	89-97	GEO METRO Non-ABS	
F	89-97	PRIZM All	
R	82-85	HONDA ACCORD All	
F	76-81	ACCORD All	
R	83-87	PRELUDE All	
F	79-87	PRELUDE All	
F	98-05	HYUNDAI ACCENT All	
R	97	ACCENT All Mfg. to 6/97	
F	95-96	ACCENT All	
F	95-96	ACCENT All	
F	86-89	EXCEL All	
F	82-87	LINCOLN CONTINENTAL All	
F	84-92	MARK VII All	
F	81-85	MAZDA GLC Hatchback	
F	81-85	GLC Sedan	
F	86-91	RX7 All	
R	91-93	MERCURY CAPRI All	
F	79-86	CAPRI All	
F	80-88	COUGAR All	
R	82-83	LN7 All	
R	81-87	LYNX All	
F	83-86	MARQUIS All	
F	86-05	SABLE All	
R	84-94	TOPAZ All	
F	87-91	TOPAZ All	
F	78-83	ZEPHYR All	
F	83-88	MITSUBISHI CORDIA All	
F	95-05	ECLIPSE All	
R	95-05	ECLIPSE All	
F	97-02	MIRAGE All	
F	87-89	PRECIS All	
F	83-88	TREDIA All	
F	80-88	NISSAN 200SX All	
F	79-82	210 All	
F	89-94	240SX All	
R	70-73	240Z All	
R	74-75	260Z All	
R	75-78	280Z All	
F	79-83	280ZX All	
F	79-82	310 All	
F	78-81	510 All	
F	81	810 All	
R	00-01	ALTIMA All	
F	90-94	AXXESS All	
F	90-94	AXXESS All	
F	74-78	B210 All	
F	76-78	F10 All	
F	89-94	MAXIMA All	
R	86-88	MAXIMA Sedan	
R	85	MAXIMA All	
F	82-84	MAXIMA All	
F	86-90	PULSAR / PULSAR NX All	
F	90-92	STANZA All	
F	92-98	OLDSMOBILE ACHIEVA All	
F	89-95	PLYMOUTH ACCLAIM All	
F	76-80	ARROW All	
F	79-82	CHAMP All	
F	84-91	COLT Vista, Wagon	
F	80-83	COLT Hatchback	

Numerical listing

Shock	POP	Alternative No.	MTG Acc. Supplied
Pos.	Year	Application	

143059 A -continued			
F	76-79	COLT Sedan	
F	76-79	COLT Wagon	
R	87-89	EXPO All	
F	90	HORIZON Hatchback	
R	95-99	NEON All	
F	78-83	SAPPORO All	
F	96-00	VOYAGER / GRAND VOYAGER Non-ABS	
F	84-00	VOYAGER / GRAND VOYAGER All	
R	84-88	PONTIAC FIERO All	
F	94-99	FIREFLY CAN	
F	89-91	FIREFLY CAN	
F	92-98	GRAND AM All Exc. Electronic Adjustable Suspension	
R	91-02	SATURN SC / SL / SW SERIES All	
F	89-01	SUZUKI SWIFT All	
F	72-73	TOYOTA CARINA All	
F	92-93	CELICA GT	
F	92-93	CELICA GTS	
F	92-93	CELICA ST	
F	90-91	CELICA AWD	
R	90-91	CELICA AWD	
F	86-89	CELICA All	
F	89-02	COROLLA All	
F	88	COROLLA DLX	
F	88	COROLLA GTS	
F	88	COROLLA LE	
F	88	COROLLA SR5	
F	79-82	CORONA All	
F	78-92	CRESSIDA All	
F	92-95	MR2 All	
F	85-89	MR2 All	
F	92-99	PASEO All	
F	81-84	STARLET All	
F	80-99	TERCEL All	

143060 D			
F	89-90	AUDI 100 All	
F	89-90	200 All	
F	78-88	5000 All	
F	05-09	BUICK ALLURE All	
F	82-05	CENTURY All	
R	85-90	ELECTRA All	
F	05-09	LACROSSE All	
F	91-99	LESABRE All	
R	86-99	LESABRE All	
F	90	LESABRE All Late Design Front Strut without Spring Guard	
F	91-96	PARK AVENUE All	
R	91-96	PARK AVENUE All	
F	88-04	REGAL All	
F	95-96	RIVIERA All	
F	84-89	SKYHAWK All	
F	80-91	SKYLARK All	
F	85-87	SOMERSET / SOMERSET REGAL All	
F	93	CADILLAC 60 SPECIAL All	
R	93	60 SPECIAL All	
F	91-92	BROUGHAM All	
F	82-88	CIMARRON All	
F	92-93	COMMERCIAL CHASSIS FWD	
R	92-93	COMMERCIAL CHASSIS FWD	
R	85-91	COMMERCIAL CHASSIS All	
F	91	COMMERCIAL CHASSIS All	
F	91-93	DEVILLE All	
R	85-93	DEVILLE All	
F	91-93	FLEETWOOD All	
R	85-93	FLEETWOOD All	
F	87-91	CHEVROLET BERETTA All	
F	82-86	CAVALIER All	
F	82-90	CELEBRITY All	
F	80-85	CITATION / CITATION II All	
F	04-05	CLASSIC All	
F	87-91	CORSICA All	
F	00-11	IMPALA All	
F	90-01	LUMINA All	
F	90-96	LUMINA APV All	
F	97-03	MALIBU All	
F	95-07	MONTE CARLO All	
F	02-05	VENTURE All	
F	97-01	VENTURE FWD	
F	84-85	CHRYSLER DAYTONA CAN	
F	84	E CLASS All	
F	85	EXECUTIVE LIMOUSINE All	
F	84	EXECUTIVE SEDAN All	
F	84-86	LASER All	
F	84-85	LEBARON All	
F	00-02	NEON All	
F	84-93	NEW YORKER All	
F	01-10	PT CRUISER All	
F	84-88	DODGE 600 All	
F	84-89	ARIES All	
F	85-89	COLT Hatchback	
F	85-88	COLT Sedan	

Numerical listing

Shock	POP	Alternative No.	MTG Acc. Supplied
Pos.	Year	Application	

Shock	POP	Alternative No.	MTG Acc. Supplied
Pos.	Year	Application	
	143060	D	-continued
F	84-85	DAYTONA	All
F	85-89	LANCER	All
F	00-05	NEON	All
F	89-92	EAGLE VISTA	Sedan, CAN
F	90-91	VISTA	Hatchback, CAN
F	89	VISTA	Hatchback
R	97-03	FORD ESCORT	All
F	94-04	MUSTANG / MUSTANG II	All
R	98-05	HYUNDAI ACCENT	All
R	97	ACCENT	All Mfg. from 6/97
F	88-92	MAZDA 626	All Exc. Electronic Adjustable Suspension or 4 Wheel Steer
F	88-97	MX6	All Exc. Electronic Adjustable Suspension or 4 Wheel Steer
R	97-99	MERCURY TRACER	FWD
F	85-88	MITSUBISHI GALANT	All
F	85-88	MIRAGE	All
F	89-90	SIGMA	Non-ABS
F	87-89	NISSAN 300ZX	All
R	93-99	ALTIMA	All
F	86-88	MAXIMA	Sedan
F	85	MAXIMA	All
F	86-88	MULTI	CAN
R	90-92	STANZA	All
F	87-89	STANZA	Sedan
F	86	STANZA	Wagon, FWD
R	94-99	OLDSMOBILE 88 SERIES	All
F	90-99	88 SERIES	All
R	90-91	88 SERIES	All
F	91-96	98	All
R	91-96	98	All
F	99-04	ALERO	All
F	95-96	AURORA	All
F	85-87	CALAIS	All
F	82-96	CIERA / CUTLASS CIERA	All
F	88-99	CUTLASS / CUTLASS SUPREME	All
F	88-91	CUTLASS CALAIS	All
F	87-94	CUTLASS CLASSIC / CUTLASS CRUISER	All
F	82-88	FIRENZA	All
F	98-02	INTRIGUE	All
F	96-99	LSS	All
R	96-99	LSS	All
F	80-84	OMEGA	All
F	97-98	REGENCY	All
R	97-98	REGENCY	All
F	90-04	SILHOUETTE	All
F	83-88	PLYMOUTH CARAVELLE	All
F	89-90	COLT DL, Wagon	
F	90	COLT	Base, Wagon
F	87-88	COLT	Hatchback
F	87-88	COLT	Sedan
F	85-86	COLT DL	
F	85-86	COLT E	
F	85-86	COLT Premier	
F	84-89	RELIANT	All
F	87-94	SUNDANCE	All
F	91	PONTIAC 6000	FWD
F	82-90	6000	All
F	90-99	BONNEVILLE	All
R	87-99	BONNEVILLE	All
F	99-05	GRAND AM	All
F	85-91	GRAND AM	All
F	88-03	GRAND PRIX	All
F	82-85	J2000 / SUNBIRD	All
F	99-05	MONTANA	All
F	80-84	PHOENIX	All
F	86-94	SUNBIRD	All
F	87-91	TEMPEST	All
F	90-98	TRANS SPORT	All

Shock	POP	Alternative No.	MTG Acc. Supplied
Pos.	Year	Application	
	143061	W	
R	93	ASUNA SUNFIRE	(CANADIAN VEHICLE) All Exc. Lotus Suspension
R	88-92	AUDI 80	All
R	93-95	90	All
R	88-91	90	All
F	91-94	100	All Mfg. Late 91
R	89-90	100	All
R	89-90	200	All
R	80-87	4000	All
R	84-87	4000 QUATTRO	All
F	95-97	A6 QUATTRO	All
R	83-87	COUPE	All
F	91-98	BMW 318i	All
F	84-85	318i	All
F	91-98	318iS	All
F	98-99	323i	All
F	87-88	325	All
F	84-87	325E	All
F	87-95	325i	All
F	87-92	325iS	All

Strut Cushion

Shock	POP	Alternative No.	MTG Acc. Supplied
Pos.	Year	Application	

Shock	POP	Alternative No.	MTG Acc. Supplied
Pos.	Year	Application	
	143061	W	-continued
F	88-91	325IX	All
F	96-98	328i	All
F	89-95	525i	All
F	82-88	528E	All
F	94-95	530i	All
F	83-84	533i	All
F	91-93	535i	All
F	90	535i	All Mfg. from 8/90
F	85-89	535i	All
F	88	535iS	All
F	85-89	635CSI	All
F	86-92	735i	All
F	88-92	735iL	All
R	05-09	BUICK ALLURE	All
R	97-05	CENTURY	All
F	85-90	ELECTRA	All
R	05-09	LACROSSE	All
F	90	LESABRE	All Early Design Front Strut with Spring Guard
F	86-89	LESABRE	All
R	97-04	REGAL	All
F	86-89	RIVIERA	All
F	87-88	CADILLAC ALLANTE	All
F	87-90	BROUGHAM	All
F	85-90	COMMERCIAL CHASSIS	All
F	85-90	DEVILLE	All
F	86-89	ELDORADO	All
F	85-90	FLEETWOOD	All
F	86-89	SEVILLE	All
R	00-11	CHEVROLET IMPALA	All
R	95-01	LUMINA	All
F	95-00	FORD CONTOUR	All
F	97-03	ESCORT	All
R	89-92	GEO PRIZM	All
R	90-93	STORM	Non-ABS
F	99-04	HONDA ODYSSEY	All
R	90-92	ISUZU IMPULSE	All
R	91-93	STYLUS	All
F	90-91	LEXUS ES250	All
R	90-91	ES250	All
F	00-06	MAZDA MPV	All
F	99-02	MERCURY COUGAR	All
F	97-99	TRACER	FWD
F	86-90	OLDSMOBILE 88 SERIES	All Early Design Front Strut with Spring Guard
F	85-90	98	All
R	98-02	INTRIGUE	All
F	91	PEUGEOT 504 / 505 / 604	All
F	86-90	504 / 505 / 604	Sedan
F	87-89	PONTIAC BONNEVILLE	All
F	88-98	SAAB 9000	All
F	80-87	SUBARU BRAT	All
F	85-89	DL	All
F	85-89	GL	Hatchback
F	90-94	LEGACY	All
F	90-94	LOYALE	All
F	91-97	TOYOTA PREVIA	All
F	90-92	VOLKSWAGEN CORRADO	All

Shock	POP	Alternative No.	MTG Acc. Supplied
Pos.	Year	Application	
	143062	W	
R	88-96	BUICK REGAL	All
R	90-94	CHEVROLET LUMINA	All
R	88-97	OLDSMOBILE CUTLASS / CUTLASS SUPREME	All
R	88-96	PONTIAC GRAND PRIX	All

Shock	POP	Alternative No.	MTG Acc. Supplied
Pos.	Year	Application	
	143063	W	
R	91-95	ACURA LEGEND	All
R	89-90	LEGEND	All Auto Leveling System
R	86-88	LEGEND	All
R	85-89	BMW 635CSI	All
R	95-00	CHRYSLER CIRRUS	All
R	96-00	SEBRING	Convertible
R	95-00	DODGE STRATUS	All
R	88-93	FORD FESTIVA	All
R	90-02	HONDA ACCORD	All
R	95-98	ODYSSEY	All
R	96-99	ISUZU OASIS	All
R	86-91	MAZDA RX7	All
R	93	MITSUBISHI GALANT	All
R	90-92	GALANT	AWD
R	89	GALANT	All
R	96-00	PLYMOUTH BREEZE	All
R	90-92	VOLKSWAGEN CORRADO	All
R	87-93	FOX	All
R	85-98	GOLF	All
R	85-98	JETTA	All
R	98-01	PASSAT	All
R	82-88	QUANTUM	All
R	75-89	SCIROCCO	All

Shock	POP	Alternative No.	MTG Acc. Supplied
Pos.	Year	Application	
	143064	B	
R	97-99	ACURA CL	All
F	97-00	EL CAN	

Numerical listing

Shock	POP	Alternative No.	MTG Acc. Supplied
Pos.	Year	Application	

Shock	POP	Alternative No.	MTG Acc. Supplied
Pos.	Year	Application	
	143064	B	-continued
R	97-00	EL CAN	
F	90-01	INTEGRA	All
R	90-01	INTEGRA	All
F	89-90	LEGEND	All Auto Leveling System
F	86-88	LEGEND	All
F	92-94	VIGOR	All
R	92-94	VIGOR	All
F	95-00	CHRYSLER CIRRUS	All
F	96-00	SEBRING	Convertible
R	89	DODGE 2000 GTX	CAN
R	92-95	COLT	All
R	89-91	COLT	Hatchback
F	95-00	STRATUS	All
R	91-93	EAGLE 2000 GTX	CAN
R	92	SUMMIT	Sedan
R	89-91	SUMMIT	All
R	90-94	TALON	All
F	90-02	HONDA ACCORD	All
R	86-89	ACCORD	All
R	92-00	CIVIC	All
R	89-91	CIVIC	Hatchback
R	89-91	CIVIC	Sedan
R	93-97	CIVIC DEL SOL	All
F	97-01	CR-V	All
R	97-01	CR-V	All
F	89-91	CRX	All
R	88	CRX	All
F	95-98	ODYSSEY	All
R	92-01	PRELUDE	All
F	88-01	PRELUDE	All
F	96-99	ISUZU OASIS	All
F	95-99	KIA SPORTAGE	All
R	91-97	MAZDA MIATA	Non-ABS
R	90	MIATA	All
R	90-94	MITSUBISHI ECLIPSE	All
R	85-88	GALANT	All
R	89-02	MIRAGE	All
R	89-90	SIGMA	Non-ABS
R	89-94	NISSAN 240SX	All
R	90-96	300ZX	2+2
F	96-00	PLYMOUTH BREEZE	All
R	90-94	LASER	All
R	90-94	SUBARU LOYALE	All
R	89-91	XT	All
R	85-88	XT	FWD, Coil (RearSpringType)
R	92-99	TOYOTA PASEO	All
R	91-99	TERCEL	All
R	87-90	TERCEL	Hatchback
R	87-90	TERCEL	Sedan



Reference A

(Air Adjustable Hose Kits)
(Self-Leveling System Electronic Compressor
Deactivation Procedure for GM Models)

Reference B

(Strut Mounts)

Reference C

(Steering Stabilizer Boots)

Reference D

(Electronic Adjustable Suspension Conversion)

Reference E

(Left/Right Combinations)

Reference F

(Explanation of Specifications)
(Specifications by Part Number)

Reference G

(Disposal of Shocks)

The
Original
Gabriel[®]
Ride the independent spirit™

AIR ADJUSTABLE HOSE KITS

Hose kit **141099** is packaged with all Air Adjustable Shocks listed in this catalog. For those vehicles equipped with G.M. Self-Leveling Systems, it may be necessary to purchase adapter kit **141248**. Hose kit **140656** with separate fill valves can be installed on vehicles to allow Air Adjustable Shocks to be filled individually.

REPLACEMENT AIR FITTINGS KITS

Each kit packaged in individual plastic bags.

KIT PART NUMBER	CONTENTS OF KIT	
140701 Replacement Air Fill Valve.	1 Tee Valve 1 Cap 1 Metal Washer	1 Rubber Washer 2 Nuts 1 Air Pressure Warning Circle
140721 Necessary hardware to accomplish one complete installation; excluding hose assemblies.	1 Brass Fill Valve 1 Cap 1 Metal Washer	1 Rubber Washer 1 Nut 1 Air Pressure Warning Circle
141122 Replacement Hose and fittings.	2 Tube Nuts 2 Tube Clamps 6 'O' rings	1 Tube 3 Tubing Clips

G.M. SELF-LEVELING SYSTEM / HOSE KIT CROSS REFERENCE

General Motors vehicles equipped with factory installed G.M. Self-Leveling Systems require an adapter hose kit to operate with our Air Adjustable Shocks. See chart below for the correct application for your vehicle.

Use of conventional shock absorbers on these applications would require deactivation of the air compressor.

APPLICATION	AIR ADJUSTABLE NO.	HOSE KIT(S) REQUIRED
1979-85 Buick Riviera	49345	141099 or 141248*
1979-85 Cadillac Eldorado	49345	141099 or 141248*
1980-85 Cadillac Seville	49345	141099 or 141248*
1979-85 Oldsmobile Toronado	49345	141099 or 141248*
G.M. vehicles with electrically operated self-leveling system or vacuum operated self-leveling system (except above listings)	Listed with Vehicle	141099 and 141248**

* 141099 and 141248 are packaged with the Air Adjustable shocks. Shown for reference if replacement is required.

** 141099 is packaged with the Air Adjustable shocks. 141248 must be purchased separately and used with hose kit packaged with shocks.

No. 141099 Kit Contains:

- 4 - Tube Nuts
- 4 - Tube Clamps
- 10 - Packing 'O' Rings
- 1 - Tube
- 1 - Tee Block Air Valve Fitting
- 1 - Valve Core
- 6 - Tubing Clips
- 1 - Valve Cap
- 1 - Washer
- 2 - Hex Nuts
- 1 - Seal
- 1 - Warning Tag
- 1 - Instruction Sheet

No. 141248*** Kit Contains:

- 3 - Tube Nuts
- 3 - Tube Clamps
- 8 - Packing 'O' Rings
- 2 - Tubing Clips
- 1 - Valve stem adapter & seal sub-assy
- 1 - Valve stem adapter
- 1 - Self-tapping screw
- 1 - Coupling (brass)
- 1 - Compression Spring
- 1 - Valve core
- 1 - Tee clip
- 1 - Valve cap
- 1 - Instruction sheet

*** Used in conjunction with Hose Kit #141099.

ENSEMBLES DE BOYAUX POUR HI JACKER

Kit de tuyau 141099 est emballé avec tous les amortisseurs réglables à Air répertoriés dans ce catalogue.
 Pour les véhicules équipés de systèmes de Self-Leveling de G.M., il peut être nécessaire d'acheter la trousse 141248.
 Kit de tuyau 140656 avec les robinets de remplissage séparé peut être installé sur les véhicules afin de permettre un réglage uniforme de chacun des amortisseurs à Air.

ENSEMBLES DE QUINCAILLERIE DE REMPLACEMENT POUR SYSTEME DE COMPRESSION

Chaque ensemble est emballé individuellement dans des sachets plastiques.

NUMÉRO DE PIÈCE	CONTENU DE L'ENSEMBLE	
140701 Soupape de remplissage d'air de remplacement.	1 Valve en "T" 1 Capuchon 1 Rondelle de métal	1 Rondelle de métal 2 Écrous 1 Anneau indicateur de
140721 Quincaillerie nécessaire pour une installation complète, boyaux non inclus.	1 Écrou 1 Capuchon 1 Rondelle de métal	1 Valve de remplissage cuivre 1 Rondelle de caoutchouc 1 Anneau indicateur de
141122 Boyaux et raccords de remplacement.	1 Tuyau 3 Brides de tuyau 6 Joints toriques	2 Colliers de serrage pour tuyau 2 Écrous pour tuyau

LISTE DE RENVOIS POUR ENSEMBLES DE BOYAUX "SELF LEVELING SYSTEM" DE GM

Les véhicules General Motors équipé d'un "Self Leveling System" installé en usine requièrent un ensemble d'adaptateurs de boyaux pour fonctionner avec notre système Hi Jacker. Consultez le tableau ci-dessous pour l'application appropriée à votre véhicule.

Pour utiliser des amortisseurs conventionnels avec ces applications, on doit désactiver le compresseur d'air.

APPLICATION	NUMÉRO AIR RÉGLABLE	ENSEMBLE DE TUYAU REQUIS
1979-85 Buick Riviera	49345	141099 ou 141248*
1979-85 Cadillac Eldorado	49345	141099 ou 141248*
1980-85 Cadillac Seville	49345	141099 ou 141248*
1979-85 Oldsmobile Toronado	49345	141099 ou 141248*
G.M. avec système Auto Réglage électrique ou avec système Auto Réglage a air (sauf la liste au dessus)	En vente avec un véhicule	141099 et 141248**

* 141099 et 141248 sont emballés avec les amortisseurs d'Air réglable.
 Voir les références si le remplacement est nécessaire.

** 141099 est emballé avec les Amortisseurs d'Air réglable.
 141248 doit être acheté séparément et utilisé avec l'ensemble de tuyau emballé avec les Amortisseurs.

No 141099 Ensemble:

- 4 - Écrous pour tuyau
- 4 - Colliers de serrage pour tuyau
- 10 - Joints toriques
- 1 - Tuyau
- 1 - Raccord de soupape en "T"
- 1 - Noyau de valve
- 6 - Brides pour tuyau
- 1 - Capuchon de soupape
- 1 - Rondelle
- 2 - Écrous à hexagonaux
- 1 - Joint d'étanchéité
- 1 - Étiquette de prévention
- 1 - Feuille d'instructions

No 141248 Ensemble:***

- 3 - Écrous pour tuyau
- 3 - Colliers de serrage pour tuyau
- 8 - Joints toriques
- 2 - Brides de tuyau
- 1 - Sous-ensemble d'adaptateurs de corps de valve et de joint d'étanchéité
- 1 - Adaptateur de corps de valve
- 1 - Vis à tôle autotaraudeuse
- 1 - Raccord en cuivre
- 1 - Ressort de compression
- 1 - Obus de valve
- 1 - Bride en "T"
- 1 - Bouchon de valve
- 1 - Feuille d'instructions

EQUIPOS DE MANGUERA DE AIRE AJUSTABLE

El paquete de manguera **141099** viene con todos los Amortiguadores de Aire Ajustables en este catalogo. Para los autos equipados con Sistema de Auto Nivelación G.M., puede ser necesario comprar el paquete con adaptador **141248**. El paquete de manguera **140656** con válvulas separadas puede ser instalado en el auto para permitir que los amortiguadores de Aire Ajustable puedan ser cargados individualmente.

PAQUETES PARA REEMPLAZAR EQUIPOS DE AIRE

Cada paquete esta empacado en bolsas plásticas.

NUMERO DE PARTE	CONTENIDO	
140701 Válvula de aire para reemplazo.	1 Válvula de arriba 1 Tapa 1 Arandela de metal	1 Arandela de caucho 2 Tuercas 1 Anillo de alerta de presión de aire
140721 Herramienta necesaria para una instalación completa; excluyendo el ensamblaje de la manguera.	1 Válvula de latón 1 Tapa 1 Arandela de metal	1 Arandela de caucho 1 Tuerca 1 Anillo de alerta de presión de aire
141122 Reemplazo de manguera y equipos.	2 Tuercas de tubo 2 Ganchos de tubo 6 'O' anillos	1 Tubo 3 Agarraderas para tubo

SYSTEMA G.M. AUTO NIVELACION / PAQUETE DE MANGUERA PARA REMISION

Los autos de General Motors con equipos de fábrica de Sistema de Auto-Nivelación G.M. requieren un adaptador de manguera para operar con nuestro Aire Ajustable. Vea la lista de abajo para la aplicación correcta para su auto.

El uso del amortiguador convencional en esta instalación requerirá la desactivación del compresor del aire.

APLICACION	AIR- AJUSTABLE NO.	PAQUETE(S) DE MANGUERA EQUERIDO
1979-85 Buick Riviera	49345	141099 o 141248*
1979-85 Cadillac Eldorado	49345	141099 o 141248*
1980-85 Cadillac Seville	49345	141099 o 141248*
1979-85 Oldsmobile Toronado	49345	141099 o 141248*
Los autos G.M. con sistema de auto-nivelación operados electrónicamente o los operados con sistema de auto nivelación al vacío (excepto los de la lista de arriba)	Información viene en el manual	141099 y 141248**

* 141099 y 141248 están empacados con amortiguadores de Aire Ajustable. En lista como referencia, si es necesario reemplazarlos.

** 141099 esta empacado con los amortiguadores de Aire Ajustable. 141248 deben comprarse separadamente y usarlos con el paquete de manguera empacados con amortiguadores.

No. 141099 Empaque contiene:

- 4 - Tuercas de tubo
- 4 - Ganchos de tubo
- 10 - Empaque de 'O' anillos
- 1 - Tubo
- 1 - Equipo de válvula de aire de bloqueo de arriba
- 1 - Válvula central
- 6 - Agarraderas para tubo
- 1 - Tapa de válvula
- 1 - Arandela
- 2 - Tuercas hexagonales
- 1 - Sello
- 1 - Tiquete de advertencia
- 1 - Hoja de instrucciones

*** Use junto con el paquete de manguera # 141099.

No. 141248*** Empaque contiene:

- 3 - Tuercas de tubo
- 3 - Ganchos de tubo
- 8 - Empaque de 'O' anillos
- 2 - Agarraderas para tubo
- 1 - Válvula con adaptador de tubo & sellado subalterno
- 1 - Válvula con adaptador de tubo
- 1 - Tornillo auto-golpes
- 1 - Combinación (latón)
- 1 - Resorte de compresión
- 1 - Válvula central
- 1 - Agarradera de arriba
- 1 - Tapa de válvula
- 1 - Hoja de instrucciones

SELF LEVELING SYSTEM ELECTRONIC COMPRESSOR DEACTIVATION PROCEDURE FOR GM MODELS

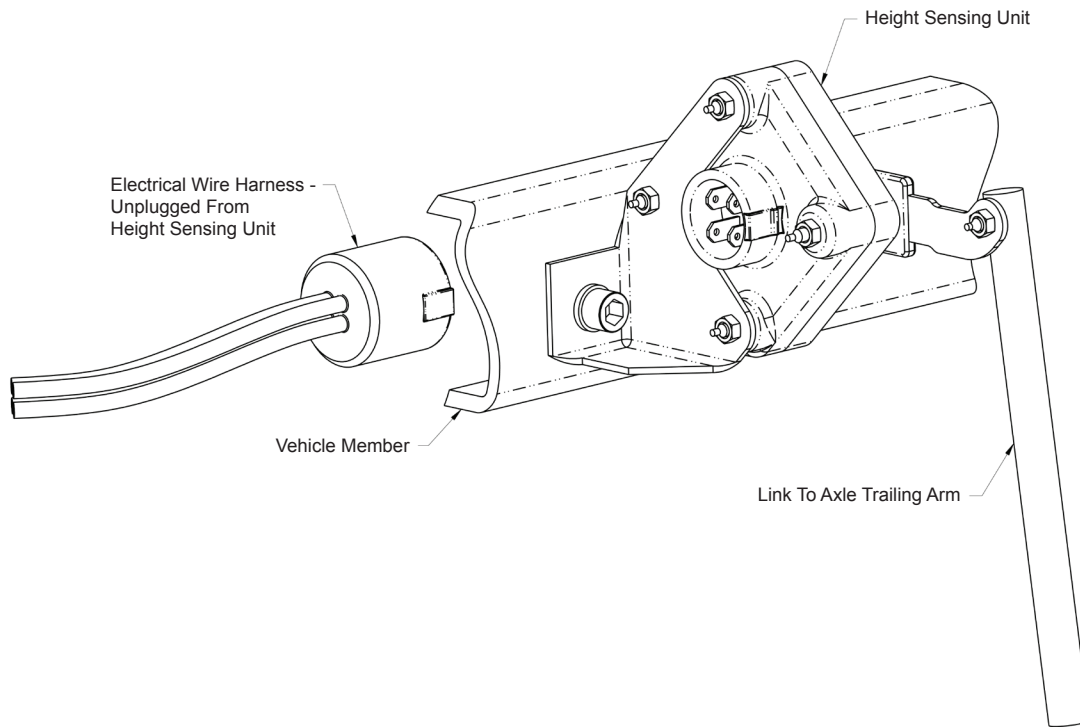

When installing conventional struts/shock absorbers on GM models equipped with self leveling rear suspension that uses an electronic compressor the following procedure should be used:

1. Locate height sensing unit on under body of vehicle approximately above the independent suspension/rear axle. Locate a small link connected to the independent suspension control arm/rear axle trailing arm. The upper end of this link will be connected to the electronic height sensing unit.
2. Unplug electrical wire harness from the height sensing unit. System is now deactivated.
3. Cover exposed electrical connector with tape or other suitable material and secure to underside of vehicle.
4. It is NOT necessary to disconnect link to suspension control/axle trailing arm.

PROCÉDÉ DE DÉACTIVATION DU COMPRESSEUR ÉLECTRONIQUE DU SYSTÈME DE NIVELAGE DES MODÈLES GM

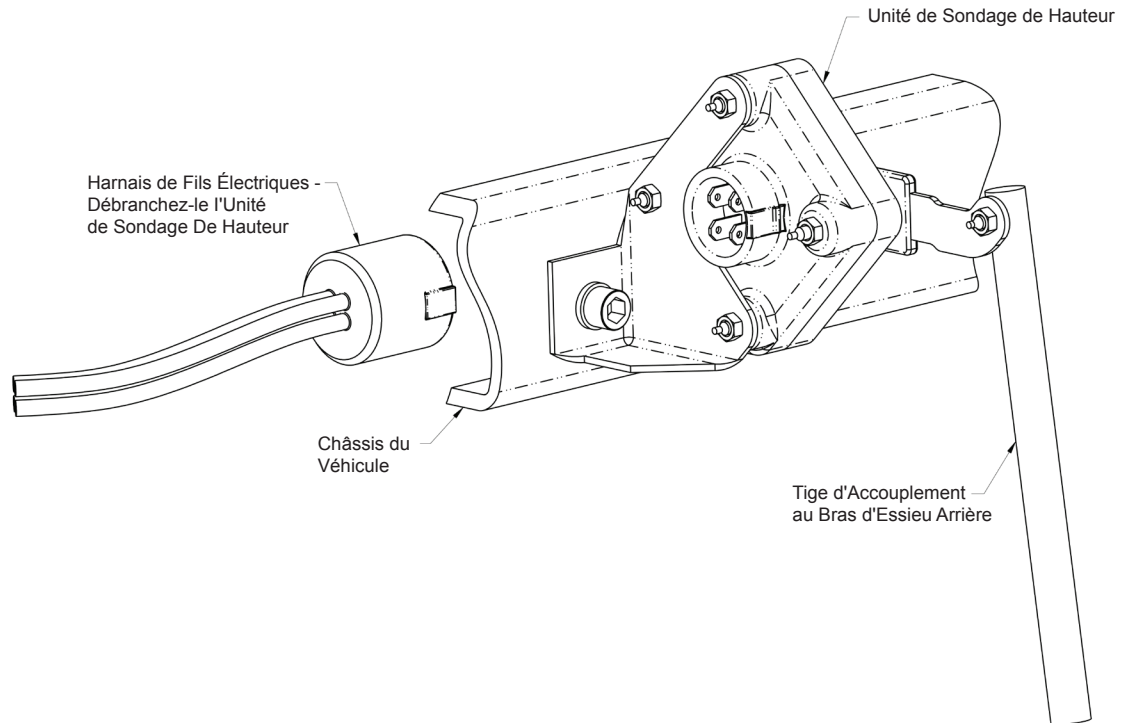

Lors de l'installation d'amortisseurs conventionnels sur les modèles GM doté d'une suspension arrière auto-niveleuse utilisant un compresseur électronique, le procédé suivant doit être utilisé:

1. Retrouvez l'unité de sondage de hauteur sous le chassis du véhicule environ au-dessus de l'essieu arrière. Retrouvez la petite tige d'accouplement au bras d'essieu arrière. Le bout supérieur de cette tige sera raccordé à l'unité électronique de sondage de hauteur.
2. Débranchez le harnais de fils électriques de l'unité de sondage de hauteur. Le système est maintenant désactivé.
3. Recouvrez le raccord électrique exposé avec du ruban ou tout autre matériau convenable et fixez-le sous le véhicule.
4. Il N'EST PAS nécessaire de désaccoupler la tige d'accouplement du bras d'essieu arrière.

COMPRESORES ELECTRONICOS CON SISTEMA DE AUTO NIVELACION PROCEDIMIENTO PARA DESACTIVAR LOS MODELOS GM

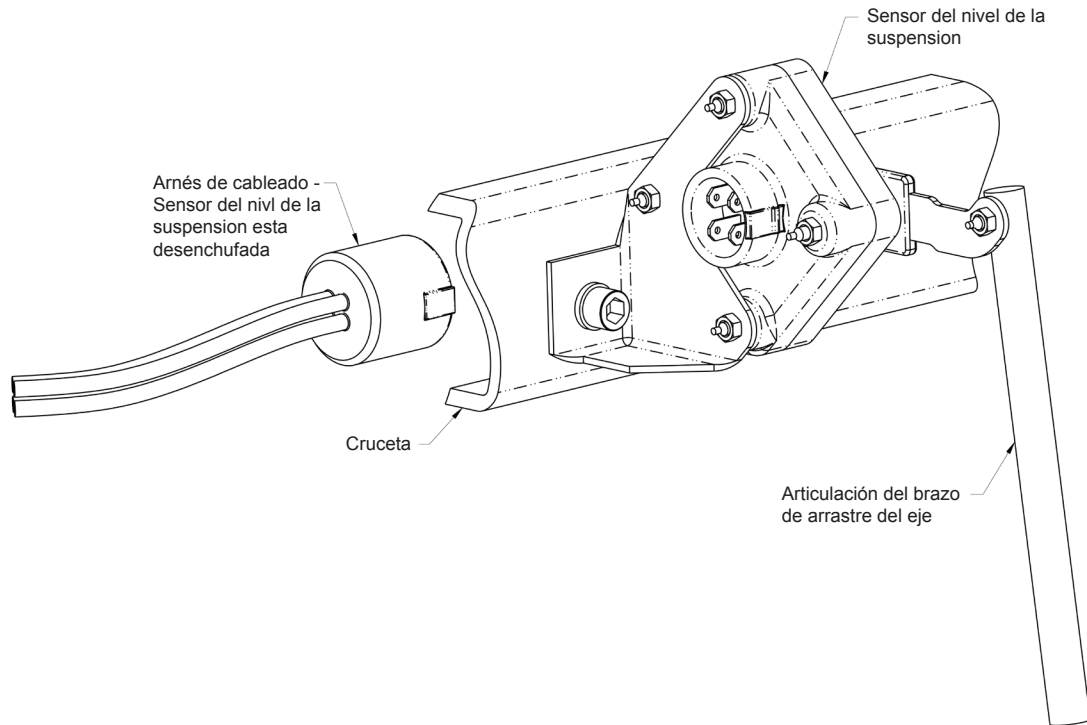

Cuando instale struts convencionales/amortiguadores de absorción en los modelos GM equipados con auto nivelación en la suspensión trasera, que usa un compresor electrónico se debe hacer lo siguiente:

1. Ubique la unidad sensora debajo del la carrocería del auto que esta encima de la suspensión independiente/ eje trasero. Ubique una pequeña conexión pegada al control/eje trasero del remolque. La parte superior de esta unidad estará conectada a la unidad sensora electrónica.
2. Desconecte los cables eléctricos del control de la unidad sensora. El sistema está ahora desactivado.
3. Cubra el conector que esta expuesto con cinta u otro material apropiado y asegúrelo por debajo del auto.
4. NO es necesario desconectar la conexión del control de la suspensión/eje trasero del remolque.

STRUT MOUNTS

 <p>141578</p>	 <p>141580</p>	 <p>141974</p>	 <p>142091</p>	 <p>142092</p>
 <p>142103</p>	 <p>142108</p>	 <p>142132</p>	 <p>142133</p>	 <p>142134</p>
 <p>142135</p>	 <p>142136</p>	 <p>142141</p>	 <p>142142</p>	 <p>142143</p>
 <p>142144</p>	 <p>142145</p>	 <p>142146</p>	 <p>142148</p>	 <p>142150</p>
 <p>142173</p>	 <p>142183</p>	 <p>142189</p>	 <p>142190</p>	 <p>142194</p>
 <p>142195</p>	 <p>142196</p>	 <p>142197</p>	 <p>142217</p>	 <p>142219</p>

STRUT MOUNTS

 <p>142220</p>	 <p>142221</p>	 <p>142222</p>	 <p>142223</p>	 <p>142224</p>
 <p>142225</p>	 <p>142226</p>	 <p>142227</p>	 <p>142228</p>	 <p>142229</p>
 <p>142230</p>	 <p>142231</p>	 <p>142233</p>	 <p>142234</p>	 <p>142237</p>
 <p>142240</p>	 <p>142241</p>	 <p>142242</p>	 <p>142244</p>	 <p>142245</p>
 <p>142247</p>	 <p>142248</p>	 <p>142249</p>	 <p>142250</p>	 <p>142251</p>
 <p>142252</p>	 <p>142254</p>	 <p>142292</p>	 <p>142293</p>	 <p>142294</p>











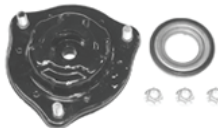







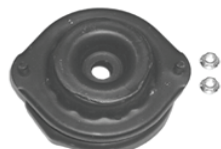
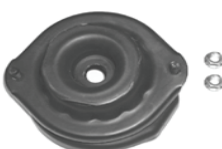

STRUT MOUNTS

 <p>142295</p>	 <p>142296</p>	 <p>142297</p>	 <p>142298</p>	 <p>142300</p>
 <p>142301</p>	 <p>142302</p>	 <p>142306</p>	 <p>142307</p>	 <p>142311</p>
 <p>142316</p>	 <p>142317</p>	 <p>142321</p>	 <p>142325</p>	 <p>142326</p>
 <p>142329</p>	 <p>142330</p>	 <p>142334</p>	 <p>142335</p>	 <p>142393</p>
 <p>142396</p>	 <p>142399</p>	 <p>142402</p>	 <p>142403</p>	 <p>142404</p>
 <p>142405</p>	 <p>142406</p>	 <p>142408</p>	 <p>142409</p>	 <p>142411</p>

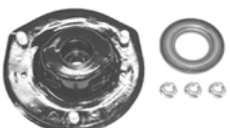
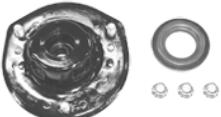









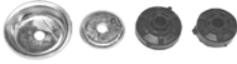















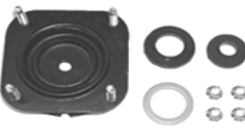
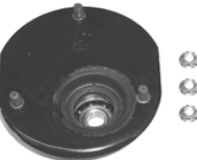

STRUT MOUNTS

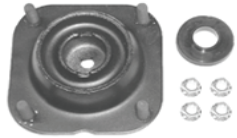
 <p>142412</p>	 <p>142413</p>	 <p>142415</p>	 <p>142419</p>	 <p>142426</p>
 <p>142427</p>	 <p>142428</p>	 <p>142429</p>	 <p>142430</p>	 <p>142436</p>
 <p>142437</p>	 <p>142439</p>	 <p>142440</p>	 <p>142442</p>	 <p>142444</p>
 <p>142521</p>	 <p>142524</p>	 <p>142525</p>	 <p>142526</p>	 <p>142527</p>
 <p>142529</p>	 <p>142530</p>	 <p>142531</p>	 <p>142532</p>	 <p>142535</p>
 <p>142536</p>	 <p>142543</p>	 <p>142546</p>	 <p>142547</p>	 <p>142550</p>

STRUT MOUNTS

 <p>142556</p>	 <p>142559</p>	 <p>142561</p>	 <p>142562</p>	 <p>142567</p>
 <p>142568</p>	 <p>142569</p>	 <p>142570</p>	 <p>142571</p>	 <p>142572</p>
 <p>142573</p>	 <p>142623</p>	 <p>142625</p>	 <p>142626</p>	 <p>142639</p>
 <p>142640</p>	 <p>142641</p>	 <p>142642</p>	 <p>142643</p>	 <p>142646</p>
 <p>142647</p>	 <p>142648</p>	 <p>142649</p>	 <p>142650</p>	 <p>142651</p>
 <p>142652</p>	 <p>142653</p>	 <p>142654</p>	 <p>142734</p>	 <p>142735</p>

STRUT MOUNTS

 <p>142738</p>	 <p>142741</p>	 <p>142744</p>	 <p>142745</p>	 <p>142746</p>
 <p>142747</p>	 <p>142748</p>	 <p>142749</p>	 <p>142750</p>	 <p>142751</p>
 <p>142752</p>	 <p>142753</p>	 <p>142754</p>	 <p>142755</p>	 <p>142757</p>
 <p>142762</p>	 <p>142763</p>	 <p>142803</p>	 <p>142825</p>	 <p>142826</p>
 <p>142827</p>	 <p>142828</p>	 <p>142832</p>	 <p>142834</p>	 <p>142836</p>
 <p>142837</p>	 <p>142838</p>	 <p>142840</p>	 <p>142841</p>	 <p>142842</p>

STRUT MOUNTS

 <p>142843</p>	 <p>142844</p>	 <p>142845</p>	 <p>142846</p>	 <p>142847</p>
 <p>142850</p>	 <p>142851</p>	 <p>142852</p>	 <p>142853</p>	 <p>142854</p>
 <p>142855</p>	 <p>142856</p>	 <p>142857</p>	 <p>142858</p>	 <p>142859</p>
 <p>142860</p>	 <p>142861</p>	 <p>142862</p>	 <p>142880</p>	 <p>142930</p>
 <p>142931</p>	 <p>142932</p>	 <p>142933</p>	 <p>142935</p>	 <p>142936</p>
 <p>142937</p>	 <p>142938</p>	 <p>142939</p>	 <p>142940</p>	 <p>142941</p>

STRUT MOUNTS

 142942	 142943	 142949	 142992	 143030
 143035	 143036	 143037	 143067	 143071
 143072	 143073	 143074	 143082	 143083
 143084	 143086	 143087	 143088	 143089
 143090	 143091	 143092	 143093	 143094
 143112	 143113	 143116	 143139	 143140

STRUT MOUNTS

 <p>143191</p>	 <p>143193</p>	 <p>143194</p>	 <p>143195</p>	 <p>143196</p>
 <p>143197</p>	 <p>143198</p>	 <p>143199</p>	 <p>143200</p>	 <p>143201</p>
 <p>143202</p>	 <p>143204</p>	 <p>143205</p>	 <p>143206</p>	 <p>143207</p>
 <p>143208</p>	 <p>143209</p>	 <p>143210</p>	 <p>143214</p>	 <p>143218</p>
 <p>143219</p>	 <p>143220</p>	 <p>143221</p>	 <p>143222</p>	 <p>143223</p>
 <p>143224</p>	 <p>143226</p>	 <p>143227</p>	 <p>143228</p>	 <p>1432231</p>

STRUT MOUNTS

 <p>143233</p>	 <p>143235</p>	 <p>143236</p>	 <p>143239</p>	 <p>143240</p>
 <p>143241</p>	 <p>143242</p>	 <p>143244</p>	 <p>143246</p>	 <p>143248</p>
 <p>143253</p>	 <p>143255</p>	 <p>143256</p>	 <p>143259</p>	 <p>143262</p>
 <p>143263</p>	 <p>143264</p>	 <p>143265</p>	 <p>143266</p>	 <p>143267</p>
 <p>143277</p>	 <p>143278</p>	 <p>143279</p>	 <p>143280</p>	 <p>143281</p>
 <p>143305</p>	 <p>143315</p>	 <p>143316</p>	 <p>143317</p>	 <p>143318</p>

STRUT MOUNTS

 <p>143319</p>	 <p>143320</p>	 <p>143321</p>	 <p>143322</p>	 <p>143323</p>
 <p>143324</p>	 <p>143325</p>	 <p>143328</p>	 <p>143330</p>	 <p>143335</p>
 <p>143336</p>	 <p>143337</p>	 <p>143338</p>	 <p>143339</p>	 <p>143340</p>
 <p>143341</p>	 <p>143342</p>	 <p>143344</p>	 <p>143353</p>	 <p>143354</p>
 <p>143355</p>	 <p>143356</p>	 <p>143357</p>	 <p>143358</p>	 <p>143359</p>
 <p>143360</p>	 <p>143361</p>	 <p>143362</p>	 <p>143363</p>	 <p>143364</p>

STRUT MOUNTS

 143365	 143367	 143368	 143369	 143375
 143378	 143381	 143382	 143390	 143391
 143392	 143396	 143419	 143425	

STEERING STABILIZER BOOTS

COLOR	BOOTS	PART NUMBER
RED		142001
BLACK		142005
DARK BLUE		142008

BOTTES DE STABILISATION DE CONDUITE

COULEUR	BOTTES	NUMÉRO DE PIÈCE
ROUGE		142001
NOIR		142005
BLEU FONÇÉ		142008

ZAPATOS ESTABILIZADORES DE LA DIRECCION

COLOR	ZAPATOS	NUMERO
ROJO		142001
NEGRO		142005
AZUL OSCURO		142008

ELECTRONIC ADJUSTABLE SUSPENSION CONVERSION

Some vehicles equipped with Electronically Adjustable Suspension can have a non-adjustable strut/shock replacement. The following is a list of those vehicles and the procedures for replacement.

BUICK PARK AVENUE 1993-96 with CCR (Computer Command Ride)

- Remove the strut actuators
- Remove the CCR. It is located under the driver's seat.
 - Reference GM Document VSS20000025
- Remove struts and install G56718 front and one of the following rears: G56707, G56726, G56903, G56906

BUICK SKYLARK 1992-94 with CCR (Computer Command Ride)

- Remove the shock and strut actuators
- Remove the CCR. It is located behind the sound insulator panel, right side.
 - Reference GM Document VSS20000025
- Remove the shocks and struts and install G56719, G56720 front and 69749 rear.

CADILLAC DEVILLE 1991-93 with CCR (Computer Command Ride)

- Remove the strut actuators
 - Reference GM Document VSS20000025 and GM Service Manual for system adjustment.
- Remove struts and install G56718 front and one of the following rears: G56707, G56726, G56903, G56906

CADILLAC ELDORADO 1991-92 with CCR (Computer Command Ride) or SSS (Speed Sensitive Suspension)

- Remove the strut actuators
 - Reference GM Document VSS20000025 and GM Service Manual for system adjustment.
- Remove struts and install G56717 front and G56704 rear.

CADILLAC SEVILLE 1991-92 with CCR (Computer Command Ride) or SSS (Speed Sensitive Suspension)

- Remove the strut actuators
 - Reference GM Document VSS20000025 and GM Service Manual for system adjustment.
- Remove struts and install G56717 front and G56704 rear.

CHEVROLET CORVETTE 1990-96 with ERC (Electronic Ride Control)

- Remove the shock actuators.
- Unplug the ERC module. It is located in the rear cargo area.
- Remove the shocks and install 69811 or 75811 front and 69795 or 75795 rear.

FORD PROBE 1989-92 with PRC (Programmed Ride Control)

- Remove the strut actuators.
- Unplug the PRC module. It is located under the front passenger seat.
- Remove the struts and install G55600 front and G55601 rear.

FORD THUNDERBIRD TURBO COUPE 1987-88 with PRC (Programmed Ride Control)

- Remove the strut and shock actuators.
- Unplug the PRC module. It is located in the rear cargo area.
- Remove the struts and shocks and install G56504 front and 69709 rear.

MAZDA MX6 GT 1988-92 with AAS (Auto Adjust Suspension)

- Remove the strut actuators.
- Unplug the AAS module. It is located in the rear cargo area.
- Remove the struts and install G55600 front and G55601 rear.

MAZDA RX7 TURBO 1989-90 and MAZDA RX7 GXL 1986-88 with AAS (Auto Adjust Suspension)

- Remove the strut and shock actuators.
- Unplug the AAS module. It is located in the rear cargo area.
- Remove the struts and install G55542 front and G51031 rear.

ELECTRONIC ADJUSTABLE SUSPENSION CONVERSION

MAZDA 626 1988-92 with AAS (Auto Adjust Suspension)

- Remove the strut actuators.
- Unplug the AAS module. It is located in the rear cargo area.
- Remove the struts and install G55600 front and G55601 rear.

MAZDA 929 1988-89 with AAS (Auto Adjust Suspension)

- Remove the strut and shock actuators.
- Unplug the AAS module. It is located in the rear cargo area.
- Remove the struts and install G55713 front and G51192 rear.

MAZDA 929 1990-91 with AAS (Auto Adjust Suspension)

- Remove the strut and shock actuators.
- Unplug the AAS module. It is located in the rear cargo area.
- Remove the struts and install G55716 front and G51192 rear.

MERCURY COUGAR XR7 1987-88 with PRC (Programmed Ride Control)

- Remove the strut and shock actuators.
- Unplug the PRC module. It is located in the rear cargo area.
- Remove the struts and shocks and install G56504 front and 69709 rear.

MITSUBISHI MONTERO 1992-96 with VSA (Variable Shock Absorbers)

- Remove the shock actuators.
- Unplug the module. It is located behind the left rear trim panel.
- Remove the shocks and install G63782 or 77782 front and G63781 or 77781 rear.

NISSAN MAXIMA 1989-94 with NSS (Nissan Sonar Suspension) II

- Remove the strut actuators.
- Unplug the NSS module. It is located in the console.
- Remove the struts and install G55607, G55608 front and G44990 rear.

NISSAN PATHFINDER 1987-95 with ASA (Adjustable Shock Absorber)

- Remove the shock actuators.
- Unplug the control switch. It is located in the console.
- Remove the shocks and install G63904 or 77904 front and G63492 or 77492 rear.

OLDSMOBILE ACHIEVA 1992-94 with CCR (Computer Command Ride)

- Remove the shocks and strut actuators
- Remove the CCR. It is located behind the sound insulator panel, right side.
- Reference GM Document VSS2000025
- Remove the shocks and struts and install G56719, G56720 front and 69749 rear.

OLDSMOBILE NINETY EIGHT 1991-96 with CCR (Computer Command Ride)

- Remove the strut actuators.
- Remove the CCR. It is located under the driver's seat.
- Remove struts and install G56718 front and one of the following rears: G56707, G56726, G56903, G56906

PONTIAC BONNEVILLE 1994-99 with CCR (Computer Command Ride)

- Remove the strut actuators.
- Remove the CCR. It is located under the driver's seat.
- Remove struts and install G56718 front and one of the following rears: G56707, G56726, G56903, G56906

TOYOTA SUPRA from MARCH 1986-95 with TEMS (Toyota Electronic Modulated Systems)

- Remove the shock actuators.
- Unplug the TEMS module. It is located under the dash.
- Remove the shocks and install G51197 front and G51193 rear.

CONVERSION DE LA SUSPENSION AJUSTABLE ÉLECTRONIQUE

Certain véhicules équipés d'une Suspension ajustable électronique peuvent avoir un changement d'amortisseur/de plaquette non ajustable. La liste suivante est une liste de ces véhicules et des procédures pour le remplacement.

BUICK PARK AVENUE 1993-1996 avec SCO (Suspension contrôlée par ordinateur)

- Retirez les actionnaires de plaquette
- Retirez le SCO. Elle est située sous le siège du chauffeur.
 - Document Référence GM VSS20000025
- Retirez les actionnaires et installez G56718 Avant et un des Arrières suivant: G56707, G56726, G56903 ou G56906

BUICK SKYLARK 1992-1994 avec SCO (Suspension contrôlée par ordinateur)

- Retirez les amortisseurs et les actionneurs de plaquette.
- Retirez le SCO. Elle est située derrière le panneau d'isolation de son, sur le côté droit.
 - Document Référence GM VSS20000025
- Retirez les amortisseurs et les actionnaires. Installez G56719, G56720 avant et 69749 arrière.

CADILLAC DEVILLE 1991-1993 avec SCO (Suspension contrôlée par ordinateur)

- Retirez les actionneurs de plaquette
 - Document Référence GM VSS20000025 et Manuel d'entretien GM pour le système d'ajustement.
- Retirez les actionneurs et installez G56718 avant et un des Arrières suivant: G56707, G56726, G56903 ou G56906

CADILLAC ELDORADO 1991-1992 avec SCO (Suspension contrôlée par ordinateur) ou SSV (Suspension sensible à la vitesse)

- Retirez les actionneurs de plaquette
 - Document Référence GM VSS20000025 et Manuel d'entretien GM pour le système d'ajustement.
- Retirez les actionneurs de plaquette et installez G56717 Avant et G56704 Arrière.

CADILLAC SEVILLE 1991-1992 avec SCO (Suspension contrôlée par ordinateur) ou SSV (Suspension sensible à la vitesse)

- Retirez les actionneurs de plaquette
 - Document Référence GM VSS20000025 et Manuel d'entretien GM pour le système d'ajustement.
- Retirez les actionneurs de plaquette et installez G56717 Avant et G56704 Arrière

CHEVROLET CORVETTE 1990-1996 avec ERC (Contrôle électronique de la suspension)

- Retirez les actionneurs d'amortisseur
- Débranchez le module ERC. Il est situé près de la région cargo.
- Retirez les amortisseurs et installez 69811 ou 75811 Avant 69795 ou 75795 Arrière.

FORD PROBE 1989-1992 avec PRC (Suspension contrôlée par ordinateur)

- Retirez les actionneurs de plaquette.
- Débranchez le module PRC. Il est situé sous le siège avant du passager.
- Retirez les plaquettes et installez G55600 Avant et G55601 Arrière.

FORD THUNDERBIRD TURBO COUPE 1987-1988 avec PRC (Suspension contrôlée par ordinateur)

- Retirez les actionneurs de plaquette et d'amortisseur.
- Débranchez le module PRC. Il est situé près de la région cargo.
- Retirez les plaquettes et les amortisseurs et installez G56504 Avant et 69709 Arrière.

MAZDA MX6 GT 1988-1992 avec RAS (Réglage automatique de la suspension)

- Retirez les actionneurs de plaquette.
- Débranchez le module RAS. Il est situé près de la région cargo.
- Retirez les plaquettes et installez G55600 Avant et G55601 Arrière.

CONVERSION DE LA SUSPENSION AJUSTABLE ÉLECTRONIQUE

MAZDA RX7 TURBO 1989-1990 et MAZDA RX7 GXL 1986-1988 avec RAS (Réglage automatique de la suspension)

- Retirez les actionneurs de plaquette et d'amortisseur.
- Débranchez le module RAS. Il est situé près de la région cargo.
- Retirez les plaquettes et installez G55542 Avant et G51031 Arrière.

MAZDA 626 1988-1992 avec AAS (Réglage automatique de la suspension)

- Retirez les actionneurs de plaquette.
- Débranchez le module AAS. Il est situé près de la région cargo.
- Retirez les plaquettes et installez G55600 Avant et G55601 Arrière.

MAZDA 929 1988-1989 avec AAS (Réglage automatique de la suspension)

- Retirez les actionneurs de plaquette et d'amortisseur.
- Débranchez le module AAS. Il est situé près de la région cargo.
- Retirez les plaquettes et installez G55713 Avant et G51192 Arrière.

MAZDA 929 1990-1991 avec AAS (Réglage automatique de la suspension)

- Retirez les actionneurs de plaquette et d'amortisseur.
- Débranchez le module AAS. Il est situé près de la région cargo.
- Retirez les plaquettes et installez G55716 Avant et G51192 Arrière.

MERCURY COUGAR XR7 1987-1988 avec PRC (Suspension contrôlée par ordinateur)

- Retirez les actionneurs de plaquette et d'amortisseur.
- Débranchez le module PRC. Il est situé près de la région cargo.
- Retirez les plaquettes et les amortisseurs et installez G56504 Avant et 69709 Arrière.

MITSUBISHI MONTERO 1992-1996 avec AAS (Réglage automatique de la suspension)

- Retirez les actionneurs d'amortisseurs.
- Débranchez le module. Il est situé près du panneau arrière gauche.
- Retirez les amortisseurs et installez G63782 ou 77782 Avant et G63781 ou 77781 Arrière.

NISSAN MAXIMA 1989-1994 avec SSN (Suspension sonar Nissan) II

- Retirez les actionneurs de plaquette.
- Débranchez le module SSN. Il est situé dans la console.
- Retirez les plaquettes et installez G55607, G55608 Avant et G44990 Arrière.

NISSAN PATHFINDER 1987-1995 avec AAS (Réglage automatique de la suspension)

- Retirez les actionneurs de plaquette.
- Débranchez l'interrupteur de contrôle. Il est situé dans la console.
- Retirez les amortisseurs et installez G63904 ou 77904 Avant et G63492 ou 77492 Arrière.

OLDSMOBILE ACHIEVA 1992-1994 avec SCO (Suspension contrôlée par ordinateur)

- Retirez les actionneurs de plaquette et d'amortisseurs.
- Retirez le SCO. Il est situé derrière le panneau d'isolation de son, sur le côté droit.
- Document Référence GM VSS20000025
- Retirez les amortisseurs et les plaquettes et installez G56719, G56720 Avant et 69749 Arrière.

OLDSMOBILE NINETY EIGHT 1991-1996 avec SCO (Suspension contrôlée par ordinateur)

- Retirez les actionneurs de plaquette
- Retirez le SCO. Il est situé sous le siège du chauffeur.
- Retirez les plaquettes et installez G56718 Avant et un des Arrières suivant: G56707, G56726, G56903 ou G56906

PONTIAC BONNEVILLE 1994-1999 avec SCO (Suspension contrôlée par ordinateur)

- Retirez les actionneurs de plaquette
- Retirez le SCO. Il est situé sous le siège du chauffeur.
- Retirez les plaquettes et installez G56718 Avant et un des Arrières suivant: G56707, G56726, G56903 ou G56906

TOYOTA SUPRA du mois de mars 1986-1995 avec SMET (Systèmes modulés électroniques Toyota)

- Retirez les actionneurs d'amortisseur.
- Débranchez le module SMET. Il est situé sous le tableau de bord.
- Retirez les amortisseurs et installez G51197 Avant et G51193 Arrière.

CONVERSION DE LA SUSPENSION ELECTRONICA GRADUABLE

A algunos autos equipados con Suspensión Graduable Electrónica se les puede reemplazar con un strut/amortiguador que no sea ajustable. La siguiente es una lista de esos autos y el proceso para reemplazarlo.

BUICK PARK AVENUE 1993-96 con CCR (Viaje Dirigido por Computador)

- Remueva los actuadores del strut.
- Remueva el CCR. Está debajo del asiento del chofer.
 - Referencia GM Documento VSS20000025
- Remueva los struts e instale G56718 delantero y uno de los siguientes traseros: G56707, G56726, G56903, G56906

BUICK SKYLARK 1992-94 con CCR (Viaje Dirigido por Computador)

- Remueva los actuadores del amortiguador y del strut
- Remueva el CCR. Esta detrás del compartimiento del insulador del sonido, al lado derecho.
 - Referencia GM Documento VSS20000025
- Remueva los amortiguadores y los struts e instale G56719, G56720 delantero y el 69749 trasero.

CADILLAC DEVILLE 1991-93 con CCR (Viaje Dirigido por Computador)

- Remueva los actuadores del strut
 - Referencia GM Documento VSS20000025 y el Manual de Servicio de GM para el ajuste del sistema.
- Remueva los struts e instale G56718 delantero y uno de los siguientes traseros: G56707, G56726, G56903, G56906

CADILLAC ELDORADO 1991-92 con CCR (Viaje Dirigido por Computador)

o SSS (Suspensión con Velocidad Sensitiva)

- Remueva los actuadores del strut
 - Referencia GM Documento VSS20000025 y el Manual de Servicio de GM para el ajuste del sistema.
- Remueva los struts e instale G56717 delantero y el G56704 trasero.

CADILLAC SEVILLE 1991-92 con CCR (Viaje Dirigido por Computador)

o SSS (Suspensión con Velocidad Sensitiva)

- Remueva los actuadores del strut
 - Referencia GM Documento VSS20000025 y el Manual de Servicio para el ajuste del sistema.
- Remueva los struts e instale G56717 delantero y el G56704 trasero.

CHEVROLET CORVETTE 1990-96 con ERC (Control Electronico)

- Remueva los actuadores de los amortiguadores.
- Desconecte al módulo ERC. Está en el baúl.
- Remueva los amortiguadores e instale 69811 o 75811 delantero y el 69795 o el 75795 trasero.

FORD PROBE 1989-92 con PRC (Control Programado)

- Remueva los actuadores del strut.
- Desconecte el modulo PRC. Esta debajo del asiento del chofer.
- Remueva los struts e instale G55600 delantero y el G55601 trasero.

FORD THUNDERBIRD TURBO COUPE 1987-88 con PRC (Control Programado)

- Remueva los actuadores del amortiguador.
- Desconecte del modulo PRC. Está en el baúl.
- Remueva los struts y los amortiguadores e instale G56504 delantero y el 69709 trasero.

MAZDA MX6 GT 1988-92 con AAS (Suspensión Ajustable Automática)

- Remueva los actuadores del strut.
- Desconecte el modulo AAS. Está en el baúl.
- Remueva los struts e instale G55600 delantero y el G55601 trasero.

MAZDA RX7 TURBO 1989-90 y MAZDA RX7 GXL 1986-88 con AAS (Suspensión Ajustable Automática)

- Remueva los actuadores del strut y de los amortiguadores.
- Desconecte el modulo AAS. Está en el baúl.
- Remueva los struts e instale G55542 delantero y el G51031 trasero.

CONVERSION DE LA SUSPENSION ELECTRONICA GRADUABLE

MAZDA 626 1988-92 con AAS (Suspensión Ajustable Automática)

- Remueva los actuadores del strut
- Desconecte el modulo AAS. Está en el baúl
- Remueva los struts e instale G55600 delantero y el G55601 trasero.

MAZDA 929 1988-89 con AAS (Suspensión Ajustable Automática)

- Remueva los actuadores del strut y de los amortiguadores.
- Desconecte el modulo AAS. Está en el baúl.
- Remueva los struts e instale G55713 delantero y el G51192 trasero.

MAZDA 929 1990-91 con AAS (Suspensión Ajustable Automática)

- Remueva los actuadores del strut y de los amortiguadores
- Desconecte el modulo AAS. Está en el baúl.
- Remueva los struts e instale G55716 delanteros y el G51192 trasero.

MERCURY COUGAR XR7 1987-88 con PRC (Control Programado)

- Remueva los actuadores del strut y de los amortiguadores.
- Desconecte el modulo AAS. Está en el baúl.
- Remueva los struts y amortiguadores e instale G56504 delantero y el 69709.

MITSUBISHI MONTERO 1992-96 con VSA (Amortiguadores Variables)

- Remueva los actuadores del amortiguador.
- Desconecte al modulo VSA. Esta detrás del compartimiento izquierdo.
- Remueva los amortiguadores e instale G63782 o 77782 delanteros y el G63781 o 77781 traseros.

NISSAN MAXIMA 1989-94 con NSS (Suspensión Sonar de Nissan) II

- Remueva los actuadores del strut.
- Desconecte al modulo NSS. Está en la consola.
- Remueva los struts e instale G55607, G55608 delantero y el G44990 trasero.

NISSAN PATHFINDER 1987-95 con ASA (Amortiguadores Ajustables)

- Remueva los actuadores del amortiguador.
- Desconecte el botón de control. Está en la consola.
- Remueva los amortiguadores e instale G63904 o 77904 delanteros y el G63492 o 77492 traseros.

OLDSMOBILE ACHIEVA 1992-94 con CCR (Viaje Dirigido por Computador)

- Remueva los actuadores de los amortiguadores y el strut.
- Remueva el CCR. Esta detrás del compartimiento del insulador del sonido, al lado derecho.
- Referencia GM Documento VSS20000025
- Remueva los amortiguadores y los struts e instale G56719, G56720 delantero y el 69749 trasero.

OLDSMOBILE NINETY EIGHT 1991-96 con CCR (Viaje Dirigido por Computador)

- Remueva los actuadores del strut.
- Remueva el CCR. Esta debajo del asiento del chofer.
- Remueva los struts e instale G56718 delantero y uno de los siguientes traseros: G56707, G56726, G56903, G56906

PONTIAC BONNEVILLE 1994-99 con CCR (Viaje Dirigido por Computador)

- Remueva los actuadores del strut.
- Remueva el CCR. Esta debajo del asiento del chofer.
- Remueva los struts e instale G56718 delantero y uno de los siguientes traseros: G56707, G56726, G56903, G56906

TOYOTA SUPRA de MARZO 1986-95 con TEMS (Sistema Modulado Electronico Toyota)

- Remueva los actuadores del amortiguador.
- Desconecte el modulo TEMS. Esta debajo del tablero.
- Remueva los amortiguadores e instale G51197 delantero y el G51193 trasero.

LEFT/RIGHT COMBINATIONS

ProGuard				Ultra Struts				Ultra Struts (Cont'd)			
61699	RL	61700	RR	G52000	FL	G52001	FR	G52110	FL	G52111	FR
Suspension Mounts				G52002	RL	G52003	RR	G52112	FL	G52113	FR
142146	FL	142145	FR	G52004	FL	G52007	FR	G52117	FL	G52118	FR
142228	RL	142229	RR	G52005	FL	G52006	FR	G52121	FL	G52122	FR
142403	RL	142404	RR	G52008	FL	G52009	FR	G52123	FL	G52124	FR
142408	FL	142409	FR	G52013	FL	G52014	FR	G52127	FL	G52128	FR
142426	RL	142427	RR	G52015	FL	G52016	FR	G52129	FL	G52130	FR
142535	RL	142536	RR	G52017	RL	G52018	RR	G52136	FL	G52137	FR
142642	RL	142641	RR	G52019	FL	G52020	FR	G52138	FL	G52139	FR
142650	FL	142649	FR	G52021	RL	G52022	RR	G52140	FL	G52141	FR
142826	FL	142825	FR	G52023	FL	G52024	FR	G52142	FL	G52143	FR
143036	FL	143037	FR	G52026	FL	G52027	FR	G52144	FL	G52145	FR
143071	RL	143072	RR	G52028	FL	G52029	FR	G52148	FL	G52149	FR
143073	RL	143074	RR	G52030	FL	G52031	FR	G52150	FL	G52151	FR
143113	RL	143112	RR	G52032	FL	G52033	FR	G52152	FL	G52153	FR
143220	RL	143222	RR	G52033	FR	G52032	FL	G52154	FL	G52155	FR
143221	RL	143223	RR	G52034	FL	G52035	FR	G52156	FL	G52157	FR
143231	FL	143264	FR	G52036	FL	G52037	FR	G52158	FL	G52159	FR
143233	FL	143265	FR	G52038	FL	G52039	FR	G52160	FL	G52161	FR
143255	FL	143266	FR	G52055	FL	G52056	FR	G52162	RL	G52163	RR
143354	FL	143355	FR	G52057	FL	G52058	FR	G52164	FL	G52165	FR
143377	FL	143378	FR	G52061	FL	G52062	FR	G52166	FL	G52167	FR
143381	FL	143382	FR	G52063	FL	G52064	FR	G52168	FL	G52169	FR
143390	RL	143391	RR	G52067	FL	G52068	FR	G52170	FL	G52171	FR
Ultra Spring Seat				G52069	FL	G52070	FR	G52173	FL	G52174	FR
G51188	FL	G51189	FR	G52071	RL	G52072	RR	G52175	FL	G52176	FR
G51761	FL	G51760	FR	G52073	RL	G52074	RR	G52178	RL	G52179	RR
G51810	FL	G51811	FR	G52075	FL	G52076	FR	G52180	FL	G52181	FR
G51813	FL	G51814	FR	G52077	FL	G52078	FR	G52182	RL	G52183	RR
G51827	FL	G51828	FR	G52079	FL	G52080	FR	G52184	FL	G52185	FR
G51853	FL	G51854	FR	G52081	FL	G52082	FR	G52187	FL	G52188	FR
G51875	RL	G51876	RR	G52083	FL	G52084	FR	G52193	FL	G52194	FR
G51877	FL	G51878	FR	G52085	RL	G52086	RR	G52199	FL	G52200	FR
G51889	RL	G51890	RR	G52087	FL	G52088	FR	G52201	FL	G52202	FR
G51896	FL	G51897	FR	G52089	RL	G52090	RR	G52203	RL	G52204	RR
G51912	RL	G51913	FR	G52094	FL	G52095	FR	G52209	FL	G52210	FR
G51917	FL	G51918	FR	G52096	FL	G52097	FR	G52227	FL	G52228	FR
G51920	FL	G51921	FR	G52103	RL	G52104	RR	G52237	FL	G52238	FR
G51947	FL	G51948	FR	G52105	FL	G52106	FR	G52245	FL	G52246	FR
G51953	FL	G51954	FR	G52107	FL	G52108	FR	G52247	FL	G52248	FR

LEFT/RIGHT COMBINATIONS

Ultra Struts (Cont'd)				Ultra Struts (Cont'd)				Ultra Struts (Cont'd)			
G52249	FL	G52250	FR	G55920	FL	G55921	FR	G56589	FL	G56588	FR
G52253	FL	G52254	FR	G55924	FL	G55923	FR	G56601	FL	G56568	FR
G52255	FL	G52256	FR	G55926	FL	G55925	FR	G56602	FL	G56603	FR
G52257	FL	G52258	FR	G55928	RL	G55927	RR	G56604	FL	G56605	FR
G52260	FL	G52261	FR	G55930	RL	G55929	RR	G56615	FL	G56616	FR
G52262	FL	G52263	FR	G55932	RL	G55931	RR	G56618	FL	G56619	FR
G52264	FL	G52265	FR	G55934	RL	G55933	RR	G56621	FL	G56622	FR
G52268	FL	G52269	FR	G55958	FL	G56758	FR	G56625	FL	G56624	FR
G52270	FL	G52271	FR	G55958	FL	G55951	FR	G56627	FL	G56626	FR
G52272	FL	G52273	FR	G55970	FL	G55971	FR	G56629	RL	G56628	RR
G52274	FL	G52275	FR	G55977	RL	G55976	RR	G56631	FL	G56632	FR
G52278	FL	G52279	FR	G55978	FL	G55960	FR	G56634	FL	G56633	FR
G52280	FL	G52281	FR	G55993	FL	G55994	FR	G56636	FL	G56635	FR
G52282	FL	G52283	FR	G56506	FL	G56514	FR	G56637	RL	G56571	RR
G52297	FL	G52298	FR	G56512	RL	G56513	RR	G56640	RL	G56641	RR
G52327	FL	G52328	FR	G56516	FL	G56517	FR	G56642	FL	G56643	FR
G52333	RL	G52334	RR	G56524	RL	G56523	RR	G56644	RL	G56645	RR
G52335	RL	G52336	RR	G56526	FL	G56525	FR	G56661	FL	G56660	FR
G52346	FL	G52347	FR	G56528	RL	G56527	RR	G56667	RL	G56668	RR
G55607	FL	G55608	FR	G56530	FL	G56529	FR	G56669	FL	G56670	FR
G55610	FL	G55611	FR	G56532	FL	G56531	FR	G56671	FL	G56672	FR
G55652	FL	G55653	FR	G56534	RL	G56533	RR	G56673	FL	G56674	FR
G55657	FL	G55658	FR	G56536	FL	G56535	FR	G56675	RL	G56676	RR
G55661	RL	G55662	RR	G56538	RL	G56537	RR	G56677	FL	G56678	FR
G55663	FL	G55664	FR	G56539	FL	G56540	FR	G56679	FL	G56680	FR
G55667	FL	G55666	FR	G56542	RL	G56541	RR	G56681	RL	G56682	RR
G55669	RL	G55668	RR	G56544	FL	G56543	FR	G56683	FL	G56684	FR
G55671	FL	G55670	FR	G56546	RL	G56545	RR	G56685	FL	G56686	FR
G55675	RL	G55676	RR	G56548	FL	G56547	FR	G56687	FL	G56688	FR
G55738	FL	G55737	FR	G56552	FL	G56551	FR	G56689	FL	G56690	FR
G55785	FL	G55784	FR	G56554	RL	G56553	RR	G56706	FL	G56705	FR
G55832	FL	G55833	FR	G56556	FL	G56555	FR	G56720	FL	G56719	FR
G55858	FL	G55857	FR	G56559	FL	G56558	FR	G56721	FL	G56722	FR
G55860	RL	G55859	RR	G56561	FR	G56562	FL	G56723	FL	G56724	FR
G55866	FL	G55865	FR	G56562	FL	G56561	FR	G56728	RL	G56729	RR
G55868	RL	G55867	RR	G56570	FL	G56569	FR	G56730	FL	G56731	FR
G55882	FL	G55881	FR	G56573	FL	G56576	FR	G56732	RL	G56733	RR
G55884	RL	G55883	RR	G56575	RL	G56574	RR	G56734	RL	G56735	RR
G55894	RL	G55893	RR	G56580	RL	G56579	RR	G56739	FL	G56736	FR
G55903	FL	G55904	FR	G56582	FL	G56581	FR	G56750	FL	G56751	FR
G55913	FL	G55912	FR	G56586	FL	G56585	FR	G56752	FL	G56753	FR

LEFT/RIGHT COMBINATIONS

Ultra Struts (Cont'd)				ReadyMount Assembly (Cont'd)				ReadyMount Assembly (Cont'd)			
G56754	FL	G56755	FR	G56934	FL	G56937	FR	G57084	FL	G57085	FR
G56756	FL	G56757	FR	G56949	RL	G56950	RR	G57086	RL	G57087	RR
G56759	FL	G56758	FR	G56952	RL	G56953	RR	G57088	FL	G57089	FR
G56761	FL	G56760	FR	G56954	RL	G56955	RR	G57090	RL	G57091	RR
G56764	RL	G56763	RR	G56956	FL	G56957	FR	G57093	FL	G57094	FR
G56766	FL	G56765	FR	G56958	FL	G56959	FR	G57097	FL	G57098	FR
G56768	RL	G56767	RR	G56962	FL	G56963	FR	G57099	FL	G57100	FR
G56771	FL	G56770	FR	G56968	RL	G56969	RR	G57101	FL	G57102	FR
G56773	FL	G56774	FR	G56970	FL	G56971	FR	G57105	FL	G57106	FR
G56775	FL	G56776	FR	G56973	RL	G56974	RR	G57107	FL	G57108	FR
G56782	FL	G56781	FR	G56976	FL	G56977	FR	G57110	FL	G57111	FR
G56785	FL	G56784	FR	G56989	FL	G56990	FR	G57112	FL	G57113	FR
G56787	FL	G56786	FR	G56991	FL	G56992	FR	G57114	FL	G57115	FR
G56794	FL	G56793	FR	G56993	FL	G56994	FR	G57116	FL	G57117	FR
G56796	FL	G56795	FR	G56996	FL	G56997	FR	G57119	FL	G57120	FR
G56798	FL	G56797	FR	G57001	FL	G57002	FR	G57121	FL	G57122	FR
G56800	FL	G56799	FR	G57003	RL	G57004	RR	G57123	FL	G57124	FR
G56804	FL	G56803	FR	G57007	FL	G57008	FR	G57126	FL	G57127	FR
G56806	FL	G56805	FR	G57011	FL	G57012	FR	G57128	RL	G57129	RR
G56813	FL	G56814	FR	G57028	FL	G57029	FR	G57130	FL	G57131	FR
G56816	FL	G56815	FR	G57030	FL	G57031	FR	G57133	FL	G57134	FR
G56819	FL	G56820	FR	G57032	RL	G57033	RR	G57135	FL	G57136	FR
G56822	RL	G56821	RR	G57034	FL	G57035	FR	G57137	FL	G57138	FR
G56836	FL	G56837	FR	G57037	FL	G57038	FR	G57139	FL	G57140	FR
G56840	FL	G56841	FR	G57041	FL	G57042	FR	G57144	FL	G57145	FR
G56842	FL	G56843	FR	G57043	RL	G57044	RR	Ultra Truck Shock			
G56882	FL	G56883	FR	G57045	FL	G57046	FR	G64004	RL	G64005	RR
G56884	RL	G56885	RR	G57047	FL	G57048	FR				
G56886	FL	G56887	FR	G57049	FL	G57050	FR				
G56888	FL	G56889	FR	G57054	FL	G57055	FR				
G56889	FR	G56888	FL	G57057	RL	G57058	RR				
G56890	FL	G56891	FR	G57061	RL	G57062	RR				
G56891	FR	G56890	FL	G57063	FL	G57064	FR				
G56892	FL	G56893	FR	G57065	FL	G57066	FR				
ReadyMount Assembly				G57067	RL	G57068	RR				
G56917	FL	G56916	FR	G57069	FL	G57070	FR				
G56919	FL	G56918	FR	G57071	FL	G57072	FR				
G56921	FL	G56920	FR	G57073	FL	G57074	FR				
G56924	RL	G56925	RR	G57076	FL	G57077	FR				
G56930	FL	G56931	FR	G57078	RL	G57079	RR				
G56932	RL	G56933	RR	G57081	FL	G57082	FR				

EXPLANATION OF SPECIFICATIONS

Part Number:	The catalog number for the individual shock absorber.
Extended Length*:	The length of the shock absorber when it is fully extended. See "How to Measure" instructions.
Collapsed Length*:	The length of the shock absorber when it is fully collapsed. See "How to Measure" instructions.
Stroke:	This is the approximate length of the stroke of the individual shock absorber being described.
Mounting Codes:	Indicates the type of mounting ends for the upper and lower end of each shock absorber. They are listed as follows: <ul style="list-style-type: none"> Stud type mounts ("S" & "DS") Eye ring and bushing mounts ("EB") Eye ring and bushing with sleeve mounts ("ES") Eye ring and bushing with bar pin mounts ("BP") Special mounting codes ("SP")

CONVERSION CHART

Fraction (Inches)	Decimal (Inches)	Metric (MM)	Fraction (Inches)	Decimal (Inches)	Metric (MM)
1/64	0.016	0.397	33/64	0.516	13.097
1/32	0.031	0.794	17/32	0.531	13.494
3/64	0.047	1.191	35/64	0.547	13.891
1/16	0.063	1.588	9/16	0.563	14.288
5/64	0.078	1.984	37/64	0.578	14.684
3/32	0.094	2.381	19/32	0.594	15.081
7/64	0.109	2.778	39/64	0.609	15.478
1/8	0.125	3.175	5/8	0.625	15.875
9/64	0.141	3.572	41/64	0.641	16.272
5/32	0.156	3.969	21/32	0.656	16.669
11/64	0.172	4.366	43/64	0.672	17.066
3/16	0.188	4.763	11/16	0.688	17.463
13/64	0.203	5.159	45/64	0.703	17.859
7/32	0.219	5.556	23/32	0.719	18.256
15/64	0.234	5.953	47/64	0.734	18.653
1/4	0.250	6.350	3/4	0.750	19.050
17/64	0.266	6.747	49/64	0.766	19.447
9/32	0.281	7.144	25/32	0.781	19.844
19/64	0.297	7.541	51/64	0.797	20.241
5/16	0.313	7.938	13/16	0.813	20.638
21/64	0.328	8.334	53/64	0.828	21.034
11/32	0.344	8.731	27/32	0.844	21.431
23/64	0.359	9.128	55/64	0.859	21.828
3/8	0.375	9.525	7/8	0.875	22.225
25/64	0.391	9.922	57/64	0.891	22.622
13/32	0.406	10.319	29/32	0.906	23.019
27/64	0.422	10.716	59/64	0.922	23.416
7/16	0.438	11.113	15/16	0.938	23.813
29/64	0.453	11.509	61/64	0.953	24.209
15/32	0.469	11.906	31/32	0.969	24.606
31/64	0.484	12.303	63/64	0.984	25.003
1/2	0.500	12.700	1	1.000	25.400

METRIC CONVERSION CHART

MILLIMETERS	INCHES	MILLIMETERS	INCHES	MILLIMETERS	INCHES
1	0.03937	10	0.39370	19	0.74803
2	0.07874	11	0.43307	20	0.78740
3	0.11811	12	0.47244	21	0.82677
4	0.15748	13	0.51181	22	0.86614
5	0.19685	14	0.55118	23	0.90551
6	0.23622	15	0.59055	24	0.94488
7	0.27559	16	0.62992	25	0.98425
8	0.31496	17	0.66929		
9	0.35433	18	0.70866		

HOW TO MEASURE EXTENDED & COLLAPSED LENGTHS OF SHOCK ABSORBERS

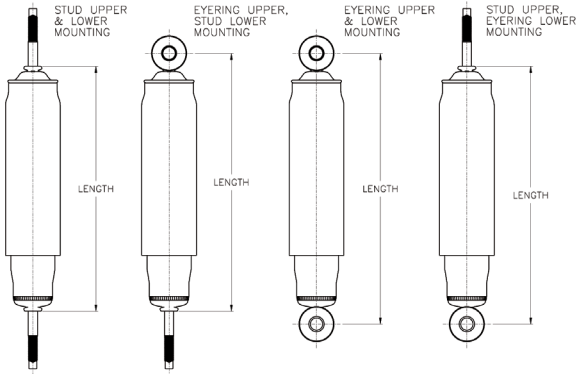

Instructions

1. Using the proper measuring points as shown above find the nearest replacement shock absorber from the listing increments of extended length.
2. Identify the proper mounting form the mounting codes and match these requirements by carefully measuring the mounting dimensions (top and bottom) of the shock absorber to be replaced.
3. Carefully take note of the following requirements:
 - a. **Mounting Accessories** - Contents and descriptions of parts are shown in this manual.
 - b. **Dust tubes** - This requirement should be noted in comparison with the shock absorber to be replaced. Shock absorber environment in its application makes this requirement necessary for piston rod protection and extended shock absorber life.
 - c. **Recoil Cutoff and Compression Bumper** - Carefully note these specifications- deviation of length requirements should not exceed $\pm\frac{1}{2}$ ". These shock absorber designs are footnoted for easy identification.
 - d. **Limited Environment Application** - Most conventional shock absorbers are offered in "straight" construction to fit limited environment applications. These shock absorber designs are footnoted.

SHOCK ABSORBER DIAMETERS

Shown below are measuring points for diameters by type of shock absorber. Refer to the chart below which lists diameters for the various bore sizes available for each type.

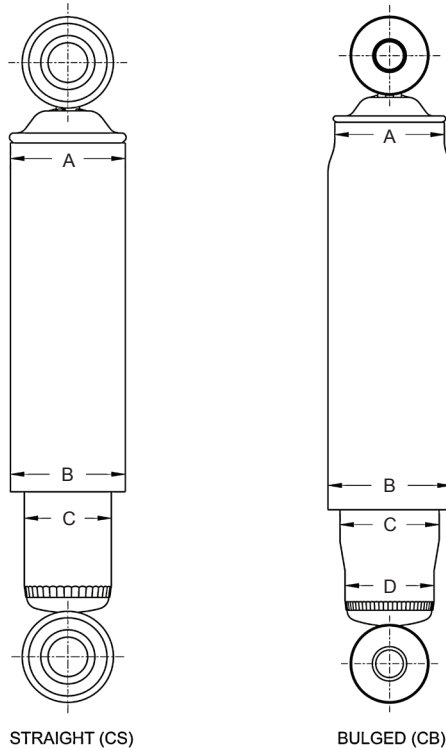

BORE SIZE	SHOCK ABSORBERS	TYPE (Shown Above)	Diameters			
			A	B	C	D
1 3/16"	Classic, Guardian, Ultra Pass. Car	CS	2.06	2.00	1.63	NA
1 3/16"	Classic, Guardian, Ultra Pass. Car	CB	2.06	2.19	1.81	1.63
1 3/8"	Ultra Truck	CS	NA	2.37	2.00	NA
1 3/8"	Ultra Truck	CB	2.37	2.50	2.19	2.00

MOUNTING CODE "ES" EYE RING AND BUSHING WITH STEEL SLEEVE

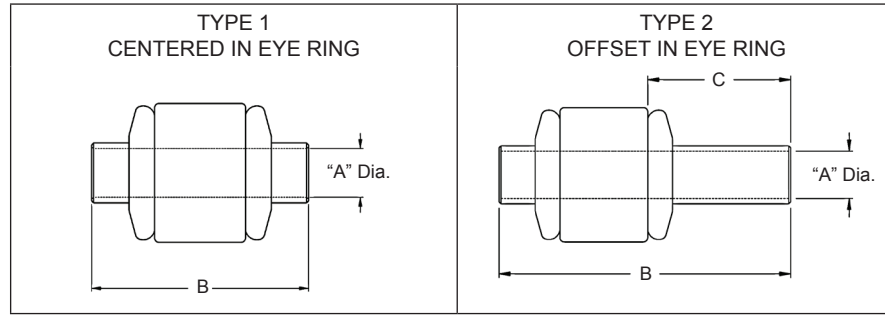

MOUNTING CODE	TYPE	DIMENSION			MOUNTING CODE	TYPE	DIMENSION			MOUNTING CODE	TYPE	DIMENSION		
		A	B	C			A	B	C			A	B	C
ES1	1	10MM	1.25	--	ES56	1	14MM	1.58	--	ES121	1	3/4	2.06	--
ES2	1	10MM	1.42	--	ES57	1	10MM	1.03	--	ES123	1	16MM	1.57	--
ES3	1	10MM	1.56	--	ES58	1	14MM	2.13	--	ES126	1	1/2	2.44	--
ES4	2	1/2	2.20	0.77	ES59	1	15MM	1.56	--	ES128	1	1/2	1.66	--
ES5	1	10MM	2.07	--	ES60	1	14MM	1.26	--	ES130	1	1/2	1.56	--
ES6	1	10MM	2.35	--	ES61	1	12MM	1.76	--	ES133	1	12MM	1.93	--
ES7	1	9/16	1.25	--	ES62	1	12MM	0.98	--	ES136	1	5/8	1.75	--
ES8	1	7/16	1.25	--	ES63	1	15MM	2.28	--	ES137	1	1/2	1.73	--
ES9	1	7/16	1.31	--	ES64	1	16MM	1.25	--	ES138	1	5/8	1.70	--
ES10	1	7/16	1.38	--	ES65	1	12MM	1.38	--	ES139	1	12MM	1.35	--
ES11	1	7/16	1.50	--	ES66	1	16MM	1.38	--	ES141	1	12MM	1.61	--
ES12	1	7/16	1.62	--	ES67	1	16MM	1.56	--	ES142	1	16MM	1.43	--
ES13	1	9/16	1.89	--	ES68	1	9/16	1.35	--	ES143	1	9/16	1.60	--
ES14	1	7/16	1.88	--	ES69	1	12MM	1.58	--	ES145	1	7/16	2.25	--
ES15	1	9/16	2.79	--	ES70	2	7/16	1.88	0.70	ES146	1	12MM	1.37	--
ES16	1	7/16	3.15	--	ES71	1	15MM	2.15	--	ES147	1	12MM	1.97	--
ES17	1	12MM	1.25	--	ES72	1	16MM	1.65	--	ES149	1	1/2	2.36	--
ES18	1	12MM	1.65	--	ES73	1	16MM	1.74	--	ES150	1	3/4	2.24	--
ES19	1	12MM	1.88	--	ES74	1	16MM	1.93	--	ES152	1	20MM	1.69	--
ES20	1	12MM	1.95	--	ES75	1	16MM	2.04	--	ES153	1	14MM	1.55	--
ES21	1	12MM	2.28	--	ES76	1	17/32	1.49	--	ES157	2	1/2	2.05	0.95
ES22	1	1/2	1.25	--	ES77	1	20MM	2.35	--	ES158	1	3/4	3.80	--
ES23	1	1/2	1.31	--	ES78	1	10MM	1.92	--	ES159	2	3/4	3.21	1.03
ES24	1	1/2	1.38	--	ES79	1	21/32	1.58	--	ES160	1	1.00	2.01	--
ES25	1	1/2	1.50	--	ES80	2	25/32	1.69	0.07	ES161	1	16MM	3.95	--
ES26	1	1/2	1.56	--	ES81	1	31/64	1.26	--	ES162	1	16MM	2.60	--
ES27	1	1/2	1.62	--	ES82	1	31/64	1.53	--	ES163	1	7/16	2.50	--
ES28	1	9/16	3.15	--	ES83	1	12MM	1.48	--	ES164	1	1/2	2.26	--
ES29	1	10MM	2.95	--	ES84	1	10MM	1.62	--	ES165	1	1/2	1.75	--
ES30	1	12MM	2.57	--	ES85	1	12MM	2.36	--	ES166	1	5/8	2.97	--
ES31	2	1/2	2.25	1.00	ES86	1	14MM	2.44	--	ES167	1	14MM	2.31	--
ES32	1	1/2	3.34	--	ES87	1	31/64	1.65	--	ES168	1	14MM	2.62	--
ES33	1	12MM	3.15	--	ES88	1	12MM	1.81	--	ES169	1	14MM	1.91	--
ES34	1	9/16	1.66	--	ES89	1	39/64	2.16	--	ES171	1	1/2	1.88	--
ES35	1	5/8	1.38	--	ES90	1	5/8	2.00	--	ES172	1	1/2	2.72	--
ES36	1	3/4	1.75	--	ES91	1	1/2	2.10	--	ES173	1	7/8	2.28	--
ES37	1	12MM	1.01	--	ES92	2	39/64	2.20	0.88	ES174	1	5/8	3.25	--
ES38	1	7/16	2.18	--	ES93	2	39/64	2.57	0.79	ES175	1	16MM	1.96	--
ES39	1	10MM	1.31	--	ES94	1	1/2	2.15	--	ES176	1	16MM	3.72	--
ES40	1	7/16	3.38	--	ES95	1	41/64	2	--	ES177	1	16MM	3.55	--
ES41	1	12MM	3.48	--	ES96	1	45/64	1.57	--	ES178	1	3/4	1.96	--
ES42	1	12MM	3.77	--	ES99	1	14MM	1.42	--	ES179	1	20MM	1.75	--
ES43	1	13MM	1.31	--	ES102	1	10MM	1.77	--	ES181	1	7/16	1.98	--
ES44	1	10MM	2.28	--	ES104	1	20MM	1.58	--	ES182	1	20MM	1.96	--
ES45	1	13MM	1.68	--	ES106	1	10MM	1.48	--	ES183	1	20MM	3.80	--
ES46	1	13MM	1.73	--	ES107	1	12MM	2.15	--	ES184	1	20MM	2.44	--
ES47	1	13MM	2.50	--	ES109	1	10MM	0.95	--	ES185	1	12MM	2.44	--
ES48	1	14MM	1.42	--	ES110	1	16MM	1.61	--	ES187	1	1.00	1.75	--
ES49	1	14MM	1.66	--	ES111	1	9MM	1.78	--	ES188	1	16MM	1.81	--
ES50	1	14MM	1.81	--	ES112	1	12MM	1.08	--	ES190	1	22MM	1.75	--
ES51	1	14MM	1.89	--	ES113	1	16MM	1.49	--	ES191	1	1.00	2.44	--
ES52	1	14MM	1.96	--	ES114	1	12MM	2.04	--	ES192	1	24MM	2.44	--
ES53	1	10MM	1.38	--	ES115	1	10MM	2.02	--	ES193	1	24MM	2.28	--
ES54	1	12MM	2.91	--	ES118	1	12MM	1.31	--	ES194	1	7/8	2.28	--
ES55	1	14MM	2	--	ES120	1	3/4	2.76	--					

MOUNTING CODE “DS” & “S” STUD MOUNTS

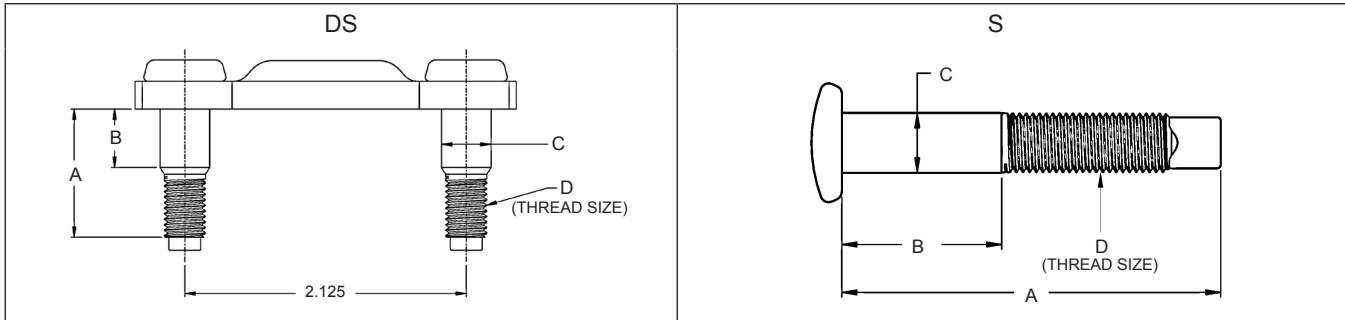

MOUNTING CODE	A	B	C	D
DS1	1.27	0.66	3/8	5/16-24
S1	2.37	1.00	3/8	3/8-24
S2	2.06	1.00	3/8	3/8-24
S3	2.67	1.37	10MM	3/8-16
S4	1.85	1.00	3/8	3/8-24
S5	1.29	1.14	13MM	3/8-24
S6	2.47	1.47	7/16	3/8-24
S7	1.97	1.00	3/8	3/8-24
S8	1.75	1.00	10MM	3/8-24
S9	1.84	1.05	7/16	3/8-24
S10	2.37	1.33	7/16	3/8-24
S11	3.00	1.12	3/8	3/8-24
S12	2.37	1.15	7/16	3/8-24
S13	2.06	1.35	3/8	3/8-24
S14	2.25	1.33	7/16	3/8-24
S15	3.29	1.98	3/8	3/8-24
S16	2.95	1.45	16MM	16MM
S17	2.15	1.03	7/16	3/8-24
S18	2.67	1.81	10MM	M10x1.25
S19	1.34	0.41	7/16	M10x1
S20	1.34	0.41	10MM	M10x1
S21	3.28	1.75	5/8	5/8-18
S22	0.75	0.35	10MM	M10x1
S23	1.84	1.05	3/8	3/8-24
S24	1.22	0.31	11MM	M10x1
S25	1.81	1.50	3/8	M10x1
S26	2.02	0.82	12MM	M10x1
S27	2.36	1.14	10MM	M10x1
S28	2.44	1.37	12MM	M10x1
S29	2.99	1.87	3/8	3/8-24
S30	2.59	1.41	10MM	M10x1
S31	0.79	0.40	17MM	10MM
S32	2.31	1.38	14MM	12MM
S33	3.44	2.17	10MM	M10x1
S34	1.06	0.59	5/16	M8x1.25
S35	2.60	1.12	7/16	3/8-24

MOUNTING CODE	A	B	C	D
S36	2.49	1.33	7/16	3/8-24
S37	3.18	1.41	12MM	M10x1
S38	2.75	1.70	14MM	12MM
S39	2.20	1.31	10MM	10MM
S40	2.52	1.33	7/16	3/8-24
S41	3.48	2.32	5/8	1/2-20
S42	3.50	2.00	5/8	5/8-18
S43	2.75	1.25	5/8	5/8-18
S44	1.57	0.39	10MM	M10x1.25
S45	2.36	1.00	10MM	M10x1.25
S46	1.57	1.18	10MM	M10x1.25
S47	2.20	1.31	10MM	M10x1.25
S48	2.55	1.51	10MM	M10x1.25
S49	2.67	1.29	10MM	M10x1.25
S50	2.95	1.57	10MM	M10x1.25
S51	3.00	1.65	10MM	M10x1.25
S52	1.18	0.74	10MM	M10x1.5
S53	2.16	1.89	10MM	M10x1.5
S54	2.42	1.28	15MM	M10x1.5
S55	2.51	1.39	10MM	M10x1.5
S56	2.67	1.53	11MM	M10x1.5
S57	2.95	1.40	27/64	M10x1.5
S58	2.98	1.68	10MM	M10x1.5
S59	2.98	1.68	12MM	M10x1.5
S60	3.46	1.96	9/16	M10x1.5
S61	3.11	1.45	14MM	M12x1.25
S62	3.24	1.70	9/16	M12x1.25
S63	3.54	2.24	17MM	M12x1.25
S64	2.36	1.18	12MM	M12x1.5
S65	2.89	1.65	12MM	M12x1.5
S66	1.39	0.15	12MM	M12x1.75
S67	2.40	1.53	9/16	M14x1.5
S68	2.95	1.45	5/8	M16x1.5
S69	1.32	1.37	39/64	M16x2
S70	1.88	0.90	7/16	M8x1.25

MOUNTING CODE "BP" EYE RING AND BUSHING WITH BAR PIN

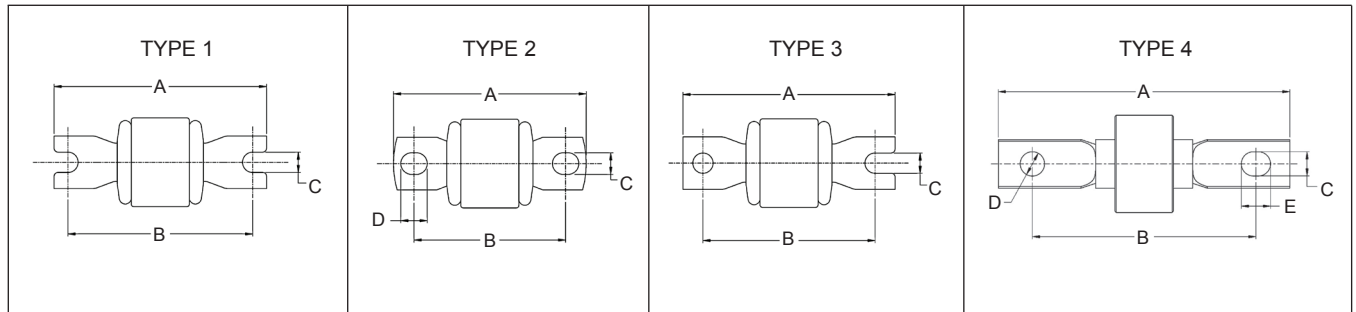

MOUNTING CODE	TYPE	A	B	C	D	E
BP1	1	2.72	2.20	0.33	--	--
BP2	1	3.59	3.12	0.32	--	--
BP3	1	2.82	2.38	0.33	--	--
BP4	1	3.19	2.38	0.33	--	--
BP5	1	3.19	2.75	0.33	--	--
BP6	1	4.25	3.62	0.33	--	--
BP7	2	3.13	2.50	0.35	0.42	--
BP8	2	3.50	2.87	0.35	0.42	--
BP9	1	3.38	2.60	0.35	0.57	--
BP10	2	3.5	2.74	0.50	0.50	--
BP11	1	2.96	2.52	0.33	--	--
BP12	1	3.75	3.14	0.33	--	--
BP13	1	3.45	3.00	0.33	--	--
BP14	2	3.43	2.87	0.45	--	--
BP15	4	4.56	3.62	0.39	0.47	0.39

MOUNTING CODE	TYPE	A	B	C	D	E
BP17	1	3.11	2.61	0.33	--	--
BP18	1	3.75	3.14	0.39	--	--
BP19	1	3.19	2.62	0.33	--	--
BP20	1	3.59	3.12	0.33	--	--
BP26	3	3.06	2.37	0.26	--	--
BP27	2	4.00	2.95	0.52	0.50	--
BP29	2	4.00	2.95	0.37	0.49	--
BP30	1	3.00	2.25	0.34	--	--
BP31	3	3.50	2.87	0.35	--	--
BP32	2	3.45	2.83	0.42	--	--
BP33	2	4.44	3.62	0.39	0.47	--
BP34	1	3.81	2.99	0.41	--	--
BP35	2	3.53	2.73	0.38	0.38	--
BP36	2	4.72	3.38	0.52	0.52	--

MOUNTING CODE "SP" SPECIAL MOUNTS

Part numbers with "SP" mounting codes are unique to the application. Please reference the specific OE or Gabriel part for dimensions. If you have any further questions or concerns, contact the Gabriel® Answerman at 1.800.999.3903.

MOUNTING CODE "EB" EYE RING AND BUSHING

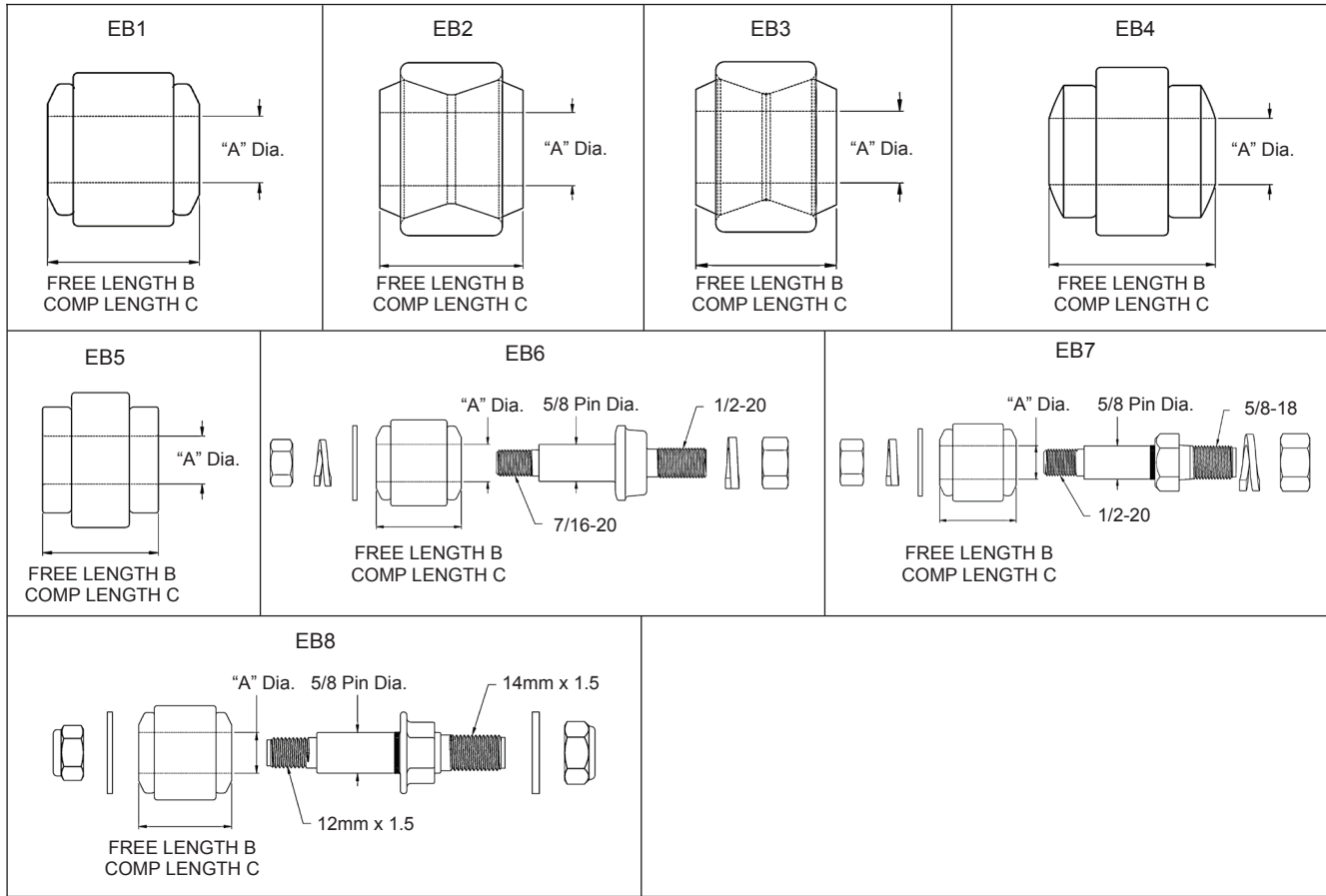

MOUNTING CODE	A DIAMETER	B FREE LENGTH	C COMP. LENGTH	VEHICLE MOUNTING PIN DIAMETER
EB1	5/8	1.44	1.31	5/8
EB2	3/4	1.75	1.50	3/4
EB3	1.00	1.91	1.75	1.00
EB4	11/16	1.72	1.55	11/16
EB5	5/8	1.51	1.25	5/8
EB6	5/8	1.44	1.31	Mounting pin furnished with shock absorber for 1/2 dia. vehicle mounting hole.
EB7	5/8	1.44	1.31	Mounting pin furnished with shock absorber for 5/8 dia. vehicle mounting hole.
EB8	5/8	1.44	1.31	Mounting pin furnished with shock absorber for 14MM dia. vehicle mounting hole.
EB9	1	1.75	--	1
EB10	1.00	1.00	--	1.00
EB11	3/8	0.83	--	3/8
EB12	10MM	1.18	--	10MM
EB13	12MM	1.03	--	12MM
EB14	15MM	1.41	--	15MM
EB15	15MM	1.76	--	15MM
EB16	16MM	1.5	--	16MM
EB17	17MM	1.18	--	17MM
EB18	19MM	1.65	--	19MM
EB19	20MM	1.75	--	20MM
EB20	45/64	1.05	--	45/64
EB21	45/64	1.39	--	45/64

SPECIFICATIONS BY PART NUMBER

STEERING DAMPERS

CATALOG PART NO.	EXTENDED LENGTH	COLLAPSED LENGTH	STROKE	UPPER MTG CODE	LOWER MTG CODE
14004	17.48	11.28	6.20		
14005	14.49	9.41	5.08		
14010	16.77	10.45	6.32	ES35	ES35
14016	21.4	12.33	9.07	S1	S1
14017	24.04	14.43	9.61	EB1	EB1
14018	21.37	12.8	8.57	ES35	EB1
14019	26.87	15.55	11.32	ES35	EB1

CATALOG PART NO.	EXTENDED LENGTH	COLLAPSED LENGTH	STROKE	UPPER MTG CODE	LOWER MTG CODE
14020	19.75	12.05	7.70	EB1	ES39
14039	15.73	12.12	3.51	ES41	ES41
14040	19.73	12.12	7.61	EB1	ES24
14071	20.7	12.79	7.91	ES53	ES65
14072					
14073	25.63	16.61	9.02		
14075					

FRONT LOAD CARRIERS

CATALOG PART NO.	EXTENDED LENGTH	COLLAPSED LENGTH	STROKE	UPPER MTG CODE	LOWER MTG CODE
34036	14.16	9.53	4.63	EB1	ES24
34051	13.28	8.67	4.61	S1	BP30
34052	13.62	9	4.62	S1	BP13
34057	15.01	10.14	4.87	S12	ES41

CATALOG PART NO.	EXTENDED LENGTH	COLLAPSED LENGTH	STROKE	UPPER MTG CODE	LOWER MTG CODE
34058	17.13	11.01	6.12	S12	ES3
34073	14.29	9.37	4.92	S1	BP7
34076	14.59	9.87	4.72	S36	EB1
43107	17.95	11.37	6.58	ES31	ES24

REAR LOAD CARRIERS

CATALOG PART NO.	EXTENDED LENGTH	COLLAPSED LENGTH	STROKE	UPPER MTG CODE	LOWER MTG CODE
43048	20.45	12.62	7.83	EB1	EB1
43049	21.86	13.28	8.58	BP31	EB1
43058	19.95	12.37	7.58	EB1	ES25
43060	20.2	12.55	7.65	EB1	BP31
43062	18.95	11.87	7.08	ES24	ES24
43067	24.61	14.78	9.83	ES27	EB4
43084	21.42	12.84	8.58	BP14	S1
43085	20.61	12.78	7.83	EB4	ES27
43093	20.2	12.62	7.58	ES24	ES24
43096	22.61	13.78	8.83	ES27	EB4
43099	19.17	11.77	7.40	S1	ES25
43111	22.9	13.82	9.08	ES34	ES34
43138	18.18	11.1	7.08	ES27	S12

CATALOG PART NO.	EXTENDED LENGTH	COLLAPSED LENGTH	STROKE	UPPER MTG CODE	LOWER MTG CODE
43140	20.92	12.84	8.08	S1	EB1
43142	21.45	13.12	8.33	ES185	ES185
43143	20.42	12.34	8.08	S1	ES91
43161	22.3	13.69	8.61	ES18	ES18
43162	22.99	14.38	8.61	BP14	ES34
43163	25.05	15.69	9.36	BP14	ES34
43165	22.99	13.88	9.11	ES106	ES106
43167	22.99	13.88	9.11	ES185	ES185
43171	24.74	15.38	9.36	BP14	ES185
43172	25.55	16.19	9.36	BP14	ES185
43173	15.39	10.38	5.01	ES69	ES69
43180	23.55	14.19	9.36	BP8	ES34
43181	24.24	14.88	9.36	ES34	ES34

HIJACKERS

CATALOG PART NO.	EXTENDED LENGTH	COLLAPSED LENGTH	STROKE	UPPER MTG CODE	LOWER MTG CODE
49105	18.21	11.23	6.98	S1	S1
49106	22.43	13.95	8.48	ES26	EB4
49107	19.27	12.29	6.98	ES24	ES24
49110	22.08	13.85	8.23	EB4	EB4
49114	20.24	12.51	7.73	S1	EB1
49122	21.62	13.14	8.48	S1	ES10
49127	19.87	12.63	7.24	EB1	ES25
49128	22.77	14.04	8.73	BP14	EB1
49131	22.15	13.67	8.48	BP31	EB1

CATALOG PART NO.	EXTENDED LENGTH	COLLAPSED LENGTH	STROKE	UPPER MTG CODE	LOWER MTG CODE
49135	21.62	13.14	8.48	BP14	S1
49149	24.93	15.64	9.29	ES27	EB4
49151	20.35	12.83	7.52	EB1	EB1
49152	20.27	13.04	7.23	BP31	EB1
49155	23.27	14.29	8.98	EB1	ES34
49157	21.37	13.29	8.08	BP14	EB1
49162	20.02	12.79	7.23	ES24	ES24
49173	19.24	12.01	7.23	S1	ES25
49178	23.12	13.89	9.23	S1	ES25

SPECIFICATIONS BY PART NUMBER

HIJACKERS (CONT'D)

CATALOG PART NO.	EXTENDED LENGTH	COLLAPSED LENGTH	STROKE	UPPER MTG CODE	LOWER MTG CODE
49193	21.27	13.29	7.98	BP14	ES10
49196	23.74	14.26	9.48	S1	ES185
49197	21.27	13.29	7.98	EB1	ES185
49199	20.68	12.7	7.98	S1	ES91
49203	20.24	12.51	7.73	S1	EB1
49205	21.12	13.13	7.99	S1	EB1
49207	22.81	14.06	8.75	EB1	ES106
49212	21.02	13.29	7.73	ES27	ES27
49213	24.27	14.79	9.48	BP14	ES34
49214	23.27	14.29	8.98	EB1	ES41
49215	23.02	14.16	8.86	ES18	ES18
49216	20.74	12.76	7.98	S12	BP7
49217	25.27	15.29	9.98	EB1	ES185
49218	26.34	16.36	9.98	BP14	ES34
49221	18.36	11.88	6.48	ES141	ES25
49222	18.77	12.04	6.73	EB1	ES25
49223	23.27	14.29	8.98	EB1	ES41
49225	25.77	15.54	10.23	BP14	ES185
49226	20.77	13.04	7.73	BP20	EB1
49228	24.47	14.74	9.73	S15	BP14
49229	23.99	15.11	8.88	ES152	ES153
49230	20.27	12.79	7.48	ES185	ES185
49231	24.27	14.79	9.48	BP14	ES34
49232	25.09	15.16	9.93	BP14	ES185

CATALOG PART NO.	EXTENDED LENGTH	COLLAPSED LENGTH	STROKE	UPPER MTG CODE	LOWER MTG CODE
49233	15.67	10.79	4.88	ES69	ES69
49234	19.77	13.98	5.79	S1	ES185
49235	24.77	15.04	9.73	ES34	ES34
49236	17.77	11.54	6.23	ES18	ES18
49237	24.18	14.45	9.73	S12	ES171
49241	25.77	15.54	10.23	EB1	ES185
49254	17.86	12.45	5.41	S69	ES15
49255	24.54	14.66	9.87		
49304	14.35	9.75	4.60	ES10	EB1
49307	16.35	10.75	5.60	ES17	ES17
49309	18.52	11.5	7.02	EB1	S1
49310	20.35	12.75	7.60	EB1	EB1
49311	22.44	14	8.44	EB1	EB1
49334	20.7	13.05	7.65	BP31	EB1
49345	22.6	15.16	7.44	ES18	ES21
49346	18.08	11.48	6.60	ES27	S12
49369	21.86	13.51	8.35	ES84	ES84
49370	21.6	15.04	6.56	S29	ES84
49371	22.55	13.7	8.85	S29	ES53
49387	21.14	13.03	8.11	S12	EB2
49388	21.79	13.39	8.40	S12	EB2
49613	19.12	11.97	7.15	S1	ES185
49614	19.04	11.94	7.10	S29	ES24

LTV

CATALOG PART NO.	EXTENDED LENGTH	COLLAPSED LENGTH	STROKE	UPPER MTG CODE	LOWER MTG CODE
58183	21.18	13.3	7.88	EB4	EB4
58347	17.87	11.49	6.38	ES31	ES24
58349	23.18	14.3	8.88	EB1	ES34
58350	18.6	11.65	6.95	S1	ES25
58353	24.52	14.9	9.62	ES27	EB4
58355	14.87	10.11	4.76	EB11	ES24
58357	14.68	10.06	4.62	ES24	ES24
58359	13.92	9.14	4.78	S1	BP13
58360	15.42	9.89	5.53	S1	BP13
58366	23.18	14.3	8.88	ES34	ES34
58377	19.87	12.49	7.38	EB1	ES25
58386	16.04	10.66	5.38	S36	ES25
58387	23.15	14.03	9.12	S1	ES25
58389	29.02	17.15	11.87	ES27	ES27
58394	15.68	10.56	5.12	ES24	EB1
58403	24.48	14.95	9.53	ES26	ES26

CATALOG PART NO.	EXTENDED LENGTH	COLLAPSED LENGTH	STROKE	UPPER MTG CODE	LOWER MTG CODE
58406	22.87	13.99	8.88	EB1	ES185
58409	21.37	13.24	8.13	EB1	ES185
58410	18.62	11.75	6.87	S12	EB1
58411	18.68	12.06	6.62	ES31	ES26
58412	26.68	16.18	10.50	ES34	ES34
58413	20.68	13.06	7.62	ES27	ES27
58414	15.04	10.16	4.88	S36	ES41
58416	18.42	11.8	6.62	S12	ES25
58421	13.42	8.89	4.53	S1	BP30
58422	23.87	14.49	9.38	BP14	ES34
58423	16.45	10.67	5.78	ES26	ES26
58437	22.99	14.09	8.90	ES31	ES24
58438	29.68	17.55	12.13	EB1	ES34
58455	22.87	13.99	8.88	ES41	ES41
58456	26.68	16.06	10.62	ES25	ES25
58461	25.37	15.24	10.13	ES185	ES185

SPECIFICATIONS BY PART NUMBER

LTV (CONT'D)

CATALOG PART NO.	EXTENDED LENGTH	COLLAPSED LENGTH	STROKE	UPPER MTG CODE	LOWER MTG CODE
58488	26.68	16.05	10.63	BP14	ES34
58489	14.64	9.61	5.03	S29	BP11
58500	15.04	10.16	4.88	S36	ES185
58609	16.49	11.05	5.44	ES126	ES45
58617	27.37	16.24	11.13	ES83	ES83
58622	15.04	10.16	4.88	S36	EB1
58623	22.54	13.91	8.63	S36	ES185
58624	20.04	12.66	7.38	S36	ES185
58625	22.36	13.83	8.53	EB1	EB20
58638	23.87	14.49	9.38	BP14	ES34
58661	14.22	9.59	4.63	S38	ES34
58662	24.68	15.36	9.32	ES34	ES34
58671	22.2	13.67	8.53	ES26	ES26
58673	22.72	13.84	8.88	S38	ES34
58674	23.22	14.09	9.13	S38	ES34
58675	26.13	15.87	10.26	ES34	ES34
58714	15.26	9.98	5.28	S62	BP7
58715	28.34	16.46	11.88	S12	ES171

CATALOG PART NO.	EXTENDED LENGTH	COLLAPSED LENGTH	STROKE	UPPER MTG CODE	LOWER MTG CODE
58716	15.74	10.37	5.37	S62	ES26
58717	22.87	13.99	8.88	ES25	ES25
58778	24.34	14.46	9.88	S12	ES171
58783	14.59	10.21	4.38	S12	BP11
58803	15.24	10.37	4.87	S12	U Bracket
58807	15.24	10.11	5.13	S36	EB1
58808	28.38	16.75	11.63	ES41	ES41
58809	23.65	14.53	9.12	EB1	ES185
58810	31.42	18.42	13.00	EB1	ES185
58811	25.36	15.23	10.13	EB1	ES185
58812	22.45	14.07	8.38	ES86	EB20
58817	15.59	10.96	4.63	S12	ES60
58901	16.49	10.87	5.62	ES126	ES34
58906	19.98	12.7	7.28	ES27	ES27
58908	18.2	11.67	6.53	ES31	ES24
58929	14.54	9.76	4.78	S36	EB1
58930	22.81	14.06	8.75	ES34	ES34

PROGUARD

CATALOG PART NO.	EXTENDED LENGTH	COLLAPSED LENGTH	STROKE	UPPER MTG CODE	LOWER MTG CODE
61500	20.23	12.37	7.86	EB1	EB1
61501	12.6	8.59	4.01	S1	ES64
61502	20.67	12.06	8.61	S8	S1
61503	21.12	16.31	4.81	S29	ES84
61504	13.7	8.92	4.78	S1	BP30
61505	18.95	11.67	7.28	EB1	S1
61506	21.86	13.58	8.28	EB1	EB1
61507	21.11	12.83	8.28	S1	EB2
61508	14.11	9	5.11	S1	ES64
61509	14.7	9.34	5.36	S1	BP14
61510	22.29	13.76	8.53	EB2	EB2
61511	23.16	14.13	9.03	BP13	ES27
61512	13.2	8.59	4.61	S1	BP7
61513	19.95	12.42	7.53	S8	EB1
61516	18.23	11.37	6.86	ES31	ES24
61517	14.98	9.95	5.03	ES24	ES24
61518	18.73	11.7	7.03	S1	ES25
61519	19.98	12.45	7.53	EB1	ES25
61520	15.34	10.31	5.03	S36	ES41
61521	16.45	10.67	5.78	S12	ES25
61522	20.49	12.63	7.86	ES27	ES27
61523	13.7	8.92	4.78	S1	BP13

CATALOG PART NO.	EXTENDED LENGTH	COLLAPSED LENGTH	STROKE	UPPER MTG CODE	LOWER MTG CODE
61524	23.26	14.23	9.03	EB1	ES34
61525	15.01	9.95	5.06	EB1	ES24
61526	24.64	14.86	9.78	ES27	EB4
61528	23.98	14.45	9.53	BP14	ES34
61529	14.1	9.34	4.76	S1	BP4
61530	25.48	15.2	10.28	EB1	ES185
61531	16.73	10.7	6.03	ES26	ES26
61532	23.98	14.45	9.53	EB1	EB1
61533	22.98	13.95	9.03	EB1	ES106
61534	26.98	15.95	11.03	EB1	ES106
61535	20.45	12.67	7.78	S1	BP7
61536	19.98	12.45	7.53	BP20	EB1
61538	17.98	11.45	6.53	ES18	ES18
61539	22.79	14.01	8.78	ES141	ES141
61540	13.7	8.92	4.78	S1	BP4
61541	18.14	11.61	6.53	EB5	ES25
61542	16.73	10.95	5.78	ES126	ES128
61543	26.76	16.23	10.53	BP14	ES34
61544	14.54	9.75	4.79	S29	BP11
61545	14.45	9.67	4.78	S1	ES64
61546	18.45	11.67	6.78	S1	ES64
61547	23.01	14.07	8.94	ES185	ES185

SPECIFICATIONS BY PART NUMBER

PROGUARD (CONT'D)

CATALOG PART NO.	EXTENDED LENGTH	COLLAPSED LENGTH	STROKE	UPPER MTG CODE	LOWER MTG CODE	CATALOG PART NO.	EXTENDED LENGTH	COLLAPSED LENGTH	STROKE	UPPER MTG CODE	LOWER MTG CODE
61549	15.89	10.11	5.78	S1	EB1	61615	20.3	12.27	8.03	S12	BP11
61550	17.73	11.12	6.61	EB1	EB1	61616	19.39	12.23	7.16	BP20	ES24
61551	22.45	13.42	9.03	S1	ES25	61623	18.04	13.51	4.53	S36	BP7
61552	13.95	9.17	4.78	S1	ES113	61624	24.98	14.95	10.03	BP14	ES185
61553	15.09	10.06	5.03	S36	ES25	61625	15.48	10.45	5.03	ES69	ES69
61554	21.48	13.2	8.28	ES185	ES185	61626	13.73	9.45	4.28	S36	BP10
61555	14.14	9.11	5.03	S12	BP7	61627	22.98	13.95	9.03	ES185	ES185
61556	14.2	9.09	5.11	S1	BP7	61629	26.98	15.95	11.03	ES185	ES185
61557	18.42	11.88	6.54	ES141	ES25	61632	20.79	13.01	7.78	EB4	EB4
61558	22.45	13.42	9.03	S1	EB1	61633	28.64	16.86	11.78	ES27	EB4
61559	22.98	13.95	9.03	EB1	ES185	61634	22.3	13.77	8.53	S38	ES34
61560	18.45	11.67	6.78	S1	ES185	61635	23.27	14.24	9.03	S38	ES34
61561	15.09	10.06	5.03	S36	EB1	61637	17.98	11.45	6.53	EB1	EB1
61565	24.26	14.73	9.53	BP14	ES34	61638	24.45	14.42	10.03	S12	ES171
61568	19.64	12.36	7.28	EB1	ES142	61641	14.7	10.17	4.53	S12	BP11
61569	16.33	10.8	5.53	S12	BP7	61642	26.76	15.98	10.78	ES34	ES34
61573	26.98	15.95	11.03	EB1	ES185	61643	15.36	10.33	5.03	S12	U Bracket
61575	21.14	13.36	7.78	EB5	ES24	61646	22.57	14.29	8.28	S36	ES185
61582	24.98	14.95	10.03	EB1	EB1	61647	23.23	13.95	9.28	S1	ES25
61584	25.48	15.2	10.28	BP13	ES26	61649	23.26	14.23	9.03	ES34	ES34
61586	22.95	13.67	9.28	S1	EB1	61650	15.7	9.92	5.78	S1	BP13
61588	21.11	13.08	8.03	S12	EB2	61651	24.4	14.64	9.76	S47	EB1
61589	21.29	13.51	7.78	ES152	ES153	61654	28.76	16.98	11.78	ES185	ES185
61590	25.48	15.2	10.28	BP14	ES185	61655	23.01	14.07	8.94	ES185	ES185
61591	14.47	9.71	4.76	S36	EB1	61656	31.51	18.48	13.03	ES185	ES185
61592	21.45	13.17	8.28	S47	EB1	61657	25.48	15.2	10.28	ES185	ES185
61593	14.95	9.67	5.28	S1	ES64	61658	24.48	14.7	9.78	ES26	ES26
61594	19.45	12.17	7.28	EB1	S17	61659	20.76	12.98	7.78	ES185	ES185
61595	20.07	12.54	7.53	S36	ES185	61662	12.23	8.45	3.78	S47	ES64
61596	14.45	9.42	5.03	S1	ES69	61663	15.7	10.92	4.78	S12	ES60
61597	24.14	14.61	9.53	ES104	ES69	61664	20.45	12.67	7.78	S1	BP7
61598	23.79	15.01	8.78	ES152	ES153	61675	22.81	14.12	8.69	ES34	ES34
61599	13.8	9.52	4.28	S38	ES34	61676	21.25	13.31	7.94	ES88	ES65
61600	24.51	14.98	9.53	ES34	ES34	61679	14.71	9.49	5.22	S1	ES25
61601	14.71	9.49	5.22	S1	ES83	61680	20.83	13.39	7.44	S38	ES34
61605	17.98	11.45	6.53	ES18	ES18	61681	29.71	17.77	11.94	EB1	ES41
61606	14.7	9.34	5.36	S1	BP19	61682	31.36	18.67	12.69	EB1	ES41
61607	15.89	10.11	5.78	S12	ES64	61683	15.07	10.44	4.63	S11	U Bracket
61608	19.64	12.36	7.28	ES99	ES48	61684	12.82	8.88	3.94	S11	BP9
61609	22.48	13.7	8.78	ES110	ES19	61685	14.12	9.68	4.44	S11	BP9
61610	19.04	11.76	7.28	S1	ES153	61686	22.36	13.92	8.44	BP14	ES34
61611	15.48	9.95	5.53	S62	BP7	61687	23.87	14.68	9.19	BP14	ES34
61612	28.39	16.36	12.03	S12	ES171	61688	25.19	15.31	9.88	BP14	ES34
61613	15.48	9.95	5.53	S62	ES26	61690	24.78	15.84	8.94	EB20	EB20
61614	22.98	13.95	9.03	ES41	ES41	61691	26.51	16.12	10.39	ES34	ES34

SPECIFICATIONS BY PART NUMBER

PROGUARD (CONT'D)

CATALOG PART NO.	EXTENDED LENGTH	COLLAPSED LENGTH	STROKE	UPPER MTG CODE	LOWER MTG CODE
61692	26.05	15.87	10.18	ES34	ES34
61696	22.45	14.5	7.95	BP18	ES26
61697	22.62	14.43	8.19	BP18	ES26
61699	19.41	12.65	6.76	EB2	EB2
61700	20.37	13.11	7.26	EB2	EB2
61703	20.15	13.96	6.19	ES83	ES83
61704	16.84	11.28	5.56	ES69	ES69
61709	27.58	17.14	10.44	ES34	ES34
61710	27.58	17.14	10.44	ES34	ES34
61711	21.8	13.61	8.19	S36	ES26

CATALOG PART NO.	EXTENDED LENGTH	COLLAPSED LENGTH	STROKE	UPPER MTG CODE	LOWER MTG CODE
61712	23.3	14.26	9.04	S38	ES34
61713	26.94	16	10.94	EB1	ES83
61714	23.36	14.22	9.14	S62	ES77
61715	24.12	15.18	8.94	ES88	ES69
61716	26.5	16.33	10.17	ES34	ES34
61717	22.75	14.56	8.19	ES47	ES26
61718	21.33	13.64	7.69	ES128	ES45
61720	15.92	11.23	4.69	ES17	ES19
61777	15.62	10.68	4.94	ES164	ES68

STEERING STABILIZERS

CATALOG PART NO.	EXTENDED LENGTH	COLLAPSED LENGTH	STROKE	UPPER MTG CODE	LOWER MTG CODE
6801SE	19.33	12.16	7.17	EB1	EB1
6802SE	20.02	12.11	7.91	S1	S1
6803SE	22.52	13.36	9.16	S1	S1
6804SE	24.08	14.67	9.41	EB1	EB1
6805SE	21.2	12.59	8.61	S1	EB1
6807SE	19.73	12.12	7.61	EB1	EB1
6826SE	21.17	12.31	8.86	S1	S1
6828SE	21.23	12.87	8.36	EB1	EB1
6846SE	22.6	13.68	8.92	ES65	ES65
6847SE	23	13.83	9.17	EB1	ES65
6848SE	18.04	11.18	6.86	ES62	ES109
6849SE	20.17	11.81	8.36	S1	S1
6850SE	23.3	13.77	9.53	EB1	S1

CATALOG PART NO.	EXTENDED LENGTH	COLLAPSED LENGTH	STROKE	UPPER MTG CODE	LOWER MTG CODE
6851SE	21.27	12.49	8.78	S1	S1
6852SE	20.27	11.99	8.28	S1	S1
6853SE	19.33	12.05	7.28	EB1	ES24
6854SE	23.03	14.27	8.76	EB1	EB1
6855SE	23.83	14.3	9.53	EB1	EB1
6856SE	27.3	15.77	11.53	S1	EB1
6857SE	21.27	12.49	8.78	S1	S1
6858SE	21.27	12.49	8.78	S1	S1
6859SE	20.27	11.99	8.28	S1	S1
6860SE	20.27	11.99	8.28	S1	S1
6861SE	20.27	11.99	8.28	S1	S1
6862SE	20.27	11.99	8.28	S1	S1
6863SE	20.27	11.99	8.28	S1	S1

ULTRA SHOCKS

CATALOG PART NO.	EXTENDED LENGTH	COLLAPSED LENGTH	STROKE	UPPER MTG CODE	LOWER MTG CODE
69407	18.92	11.56	7.36	S29	ES24
69416	20.15	13.45	6.70	ES3	ES56
69417	18.25	11.99	6.26	ES71	ES121
69420	22.81	14.68	8.13	S1	EB3
69450	26.25	16	10.25	S48	EB5
69462	24.11	15.01	9.10	S50	ES80
69464	24.2	15.93	8.27	384557-1	ES41
69465	17.94	12.78	5.16	ES162	ES65
69473	18.29	11.43	6.86	ES85	ES30
69574	20.26	12.5	7.76	S36	ES7
69575	20.16	12.4	7.76	S36	ES162
69585	22.5	13.99	8.51	BP18	ES18
69586	23.5	15.62	7.88	S20	ES89
69587	15.9	10.64	5.26	ES19	ES56

CATALOG PART NO.	EXTENDED LENGTH	COLLAPSED LENGTH	STROKE	UPPER MTG CODE	LOWER MTG CODE
69589	17.54	11.53	6.01	ES19	ES59
69590	17.82	11.21	6.61	S58	ES59
69591	17.73	11.72	6.01	ES185	ES185
69592	20.07	12.56	7.51	S1	ES107
69593	20.07	12.56	7.51	S1	ES107
69594	19.42	12.41	7.01	EB1	ES34
69595	20.34	12.83	7.51	EB1	ES34
69600	13.61	8.75	4.86	S1	BP30
69604	20.64	12.78	7.86	BP31	EB1
69606	20.2	12.34	7.86	S1	EB1
69616	16.63	10.87	5.76	ES18	ES19
69622	14.73	9.62	5.11	ES10	EB1
69624	21.7	12.84	8.86	BP14	S1
69625	14.11	9	5.11	S1	BP19

SPECIFICATIONS BY PART NUMBER

ULTRA SHOCKS (CONT'D)

CATALOG PART NO.	EXTENDED LENGTH	COLLAPSED LENGTH	STROKE	UPPER MTG CODE	LOWER MTG CODE	CATALOG PART NO.	EXTENDED LENGTH	COLLAPSED LENGTH	STROKE	UPPER MTG CODE	LOWER MTG CODE
69632	21.78	13.42	8.36	ES84	ES84	69878	20.94	14.76	6.18	S30	ES3
69633	20.7	12.34	8.36	S1	ES91	69880	21.1	12.84	8.26	S1	EB1
69661	20.1	15.04	5.06	S36	ES137	69884	16.73	10.62	6.11	EB1	EB1
69670	14.1	9.34	4.76	S1	EB1	69885	17.63	11.37	6.26	ES43	ES43
69671	18.1	11.34	6.76	S1	ES133	69891	21.61	13.1	8.51	S12	ES10
69674	21.2	12.84	8.36	S1	ES64	69898	19.85	14.19	5.66	S1	ES185
69675	14.61	9.25	5.36	S1	BP7	69900	24.91	14.8	10.11	S1	ES67
69676	19.7	11.84	7.86	S1	EB1	69901	16.69	10.51	6.18	S52	ES143
69677	18.45	11.34	7.11	S1	ES8	69903	21.69	12.99	8.70	S27	ES18
69689	15.63	10.37	5.26	ES85	ES85	69907	23.35	15.16	8.19	S50	ES113
69703	17.95	11.09	6.86	ES27	S12	69909	16.63	10.88	5.75	ES69	ES69
69704	10.67	7.06	3.61	S1	S12	69945	26.35	16.45	9.90	S19	ES84
69706	13.46	9.95	3.51	ES86	ES34	69946	24.04	14.33	9.71	S25	ES6
69709	23.7	13.84	9.86	S1	ES185	69950	18.62	17.62	1.00	S30	ES3
69713	23.85	14.59	9.26	S17	EB1	69951	19.6	14.72	4.88	S30	ES3
69714	14.1	9.94	4.16	S1	BP17	69952	21.45	18.38	3.07	S33	ES3
69715	13.98	9.37	4.61	ES18	ES110	69956	18.62	17.55	1.07	S30	ES3
69723	21.12	16.31	4.81	S29	ES84	69957	18.22	16.18	2.04	S30	ES3
69724	22.14	13.28	8.86	BP31	EB1	69962	21.11	15.1	6.01	S36	U Bracket
69725	21.6	13.09	8.51	S1	ES69	69966	17.62	11.27	6.35	S33	ES3
69727	13.13	9.12	4.01	BP14	ES53	69995	22.57	13.91	8.66		
69733	17.88	12.72	5.16	BP27	ES137	69996	19.1	15.04	4.06	S36	ES169
69749	21.92	13.06	8.86	S29	ES53	69998	17.91	14.09	3.82	S67	ES92
69755	20.45	12.34	8.11	S1	ES185	70000	19.57	12.09	7.48	S64	ES113
69756	20.45	12.34	8.11	S12	BP7	70001	22.52	13.94	8.58	BP34	ES72
69757	24.6	17.54	7.06	S1	ES85	70003	26.55	18.62	7.93	S34	ES147
69760	16.26	12.6	3.66	ES18	ES79	70010	22.56	14.09	8.47	BP15	ES69
69766	17.48	10.95	6.53	S36	EB21	70013	22.95	14.88	8.07	S44	ES113
69773	22.44	17.38	5.06	S33	ES69	70020	21.89	13.14	8.75	S60	ES53
69782	15.1	10.34	4.76	ES67	ES61	70023	21.81	15.94	5.87		
69787	17.79	11.53	6.26	ES27	ES19	70024	23.39	19.48	3.9		
69794	14.6	10.69	3.91	S36	BP14	70027	17.83	12.95	4.88		
69795	15.2	9.59	5.61	S12	ES110	70028	25.39	16.42	8.98		
69805	18.19	11.93	6.26	ES71	ES71	70031	21.89	14.41	7.48		
69807	19.84	15.43	4.41	S28	ES3	70032	26.18	15.31	10.87		
69808	22.74	13.63	9.11	ES84	ES84	70033	22.44	15.51	6.93		
69811	13.6	9.69	3.91	S36	BP14	70034	22.95	17.39	5.55		
69813	24.26	14.15	10.11	S1	EB1	70036	23.86	14.49	9.37		
69820	19.1	11.84	7.26	S36	ES143	70037	21.34	13.7	7.64		
69845	19.2	13.94	5.26	S36	ES143	70038	23.11	15.67	7.44		
69858	21.23	12.87	8.36	ES18	ES18	70039	16.69	10.51	6.18		
69861	15.51	10.23	5.28	S39	ES28	70040	18.03	11.38	6.65		
69863	24.43	14.91	9.52	S27	ES18	70041	21.38	14.8	6.57		
69877	20.94	14.76	6.18	S26	ES3	70045	20.51	14.37	6.14		

SPECIFICATIONS BY PART NUMBER

ULTRA SHOCKS (CONT'D)

CATALOG PART NO.	EXTENDED LENGTH	COLLAPSED LENGTH	STROKE	UPPER MTG CODE	LOWER MTG CODE
70049	21.57	15.08	6.5		
70052	26.41	16.18	10.23		
70053	23.81	14.52	9.28		
70055	23.89	14.84	9.05		
70056	27.67	18.54	9.13		

CATALOG PART NO.	EXTENDED LENGTH	COLLAPSED LENGTH	STROKE	UPPER MTG CODE	LOWER MTG CODE
70059	22.20	13.77	8.43		
70060	20.78	17.28	3.5		
70061	22.24	14.09	8.14		
70067					
70068	22.51	14.88	7.63		

MAXCONTROL

CATALOG PART NO.	EXTENDED LENGTH	COLLAPSED LENGTH	STROKE	UPPER MTG CODE	LOWER MTG CODE
75676	19.66	11.83	7.83	S1	EB1
75755	20.34	12.59	7.75	S1	ES83
75795	15.24	9.66	5.58	S12	ES110
75811	13.55	9.67	3.88	S36	BP14
75898	19.85	14.18	5.67	S12	ES83
77183	20.86	13.01	7.85	EB1	EB1
77349	23.32	14.29	9.03	EB1	ES34
77355	14.85	9.86	4.99	EB1	ES24
77357	14.85	9.86	4.99	ES24	ES24
77359	13.55	8.84	4.71	S1	BP13
77375	14.14	9.04	5.10	S12	BP7
77377	19.87	12.23	7.64	EB1	ES25
77389	28.73	16.92	11.81	EB1	ES27
77403	24.31	14.78	9.53	ES26	ES26
77405	19.87	12.23	7.64	EB1	EB1
77406	22.92	13.9	9.02	EB1	ES83
77409	21.54	13.11	8.43	EB1	ES83
77410	18.47	11.71	6.76	S12	EB1
77412	26.77	16.26	10.51	ES34	ES34
77413	20.86	13.01	7.85	ES27	ES27
77414	15.33	10.34	4.99	S36	ES83
77418	14.14	9.04	5.10	S1	BP11
77421	13.55	8.84	4.71	S1	BP30
77422	23.92	14.39	9.53	BP14	ES34
77423	16.8	10.83	5.97	ES128	ES128
77424	20.34	12.59	7.75	S1	BP7
77425	19.87	12.23	7.64	EB1	BP20
77454	22.77	14	8.77	ES141	ES141
77455	22.92	13.9	9.02	ES83	ES83
77456	26.73	15.94	10.79	EB1	ES83
77461	25.39	15.18	10.21	EB1	ES83
77479	14.14	9.04	5.10	S1	ES113
77488	26.77	16.26	10.51	BP14	ES34
77489	14.36	9.55	4.81	S29	BP11
77492	22.33	13.6	8.73	EB1	EB1

CATALOG PART NO.	EXTENDED LENGTH	COLLAPSED LENGTH	STROKE	UPPER MTG CODE	LOWER MTG CODE
77494	21.78	13.52	8.26	EB2	EB2
77524	26.87	15.87	11.00	EB1	ES83
77525	22.9	14	8.90	EB1	ES83
77607	25.39	15.18	10.21	BP14	ES83
77608	14.45	9.64	4.81	S36	EB1
77609	16.43	10.95	5.48	ES126	ES128
77614	15.04	10.05	4.99	S36	EB1
77623	22.38	13.84	8.54	S38	ES83
77638	24.31	14.78	9.53	BP14	ES34
77660	24.9	14.88	10.02	EB1	EB1
77661	13.72	9.5	4.22	S12	ES34
77662	24.31	14.78	9.53	ES34	ES34
77673	22.38	13.84	8.54	S38	ES34
77674	23.27	14.27	9.00	S38	ES34
77675	26.25	15.74	10.51	ES34	ES34
77678	18.01	13.51	4.50	S36	BP7
77679	24.9	14.88	10.02	BP14	ES83
77683	21.11	13.27	7.84	EB5	ES24
77714	15.34	9.84	5.50	S38	BP7
77715	28.32	16.33	11.99	S12	ES171
77716	15.32	9.84	5.48	S38	ES26
77717	22.92	13.9	9.02	ES25	ES25
77726	20.85	13.05	7.80	S12	EB19
77772	14.51	9.72	4.79	S36	BP10
77778	24.38	14.36	10.02	S12	ES169
77781	18.57	11.8	6.77	S1	ES113
77782	14.14	9.04	5.10	S1	ES118
77783	14.64	10.12	4.52	S12	BP11
77803	15.31	10.32	4.99	S29	U Bracket
77807	15.33	10.34	4.99	S36	EB1
77808	28.73	16.92	11.81	EB1	ES83
77809	22.92	13.9	9.02	EB1	ES83
77810	31.53	18.5	13.03	EB1	ES83
77815	21.97	13.2	8.77	S47	ES64
77817	15.73	10.94	4.79	S12	ES60

SPECIFICATIONS BY PART NUMBER

MAXCONTROL (CONT'D)

CATALOG PART NO.	EXTENDED LENGTH	COLLAPSED LENGTH	STROKE	UPPER MTG CODE	LOWER MTG CODE
77829	22.33	13.6	8.73	ES88	ES65
77837	28.73	16.92	11.81	ES83	BP14
77847	20.34	12.59	7.75	S1	BP7
77902	12.56	8.5	4.06	S1	ES64
77903	14.64	9.33	5.31	S1	BP14
77904	14.83	9.54	5.29	S1	ES64
77905	14.64	9.33	5.31	S1	ES83
77907	19.87	12.23	7.64	EB1	EB1
77909	14.14	9.04	5.10	S1	ES17
77915	13.61	8.85	4.76	S1	BP7
77937	14.93	9.35	5.58	S1	BP19
77947	15.63	10.88	4.75	S38	ES34
77948	23.5	14.75	8.75	S38	ES34

CATALOG PART NO.	EXTENDED LENGTH	COLLAPSED LENGTH	STROKE	UPPER MTG CODE	LOWER MTG CODE
77949	16.16	10.67	5.49	S38	BP27
77950	27.5	17.5	10.00	ES34	ES34
77951	20.5	13	7.50	S38	ES34
77952	29.68	17.43	12.25	EB1	ES185
77953	22.65	13.9	8.75	ES34	ES34
77954	13.83	9.08	4.75	S29	BP13
77955	22.57	13.91	8.66	S36	ES7
77958	14.51	9.35	5.16	S1	ES25
77967	20.75	13.13	7.62	S62	ES34
77968	24.71	15.09	9.62	EB1	ES185
77969	25.43	15.81	9.62	EB1	ES185
77971	23.64	14.70	8.94		
77973	22.57	14.41	8.16		

GUARDIAN SHOCKS

CATALOG PART NO.	EXTENDED LENGTH	COLLAPSED LENGTH	STROKE	UPPER MTG CODE	LOWER MTG CODE
81039	14.73	9.62	5.11	EB1	ES24
81076	14.2	9.44	4.76	BP4	DS1
81082	23.23	13.87	9.36	EB1	ES185
81091	25.14	15.28	9.86	ES27	EB4
81095	21.7	12.84	8.86	BP14	S1
81096	13.7	8.84	4.86	S1	BP13
81097	18.2	11.09	7.11	EB1	S1
81108	14.23	9.37	4.86	ES24	ES24
81113	18.23	11.37	6.86	ES31	ES24
81147	20.23	12.37	7.86	EB1	EB1
81153	11.61	7.75	3.86	S1	ES38
81164	23.23	13.87	9.36	EB1	ES34
81174	23.23	13.87	9.36	ES34	ES34
81242	19.2	11.59	7.61	S1	ES25
81270	17.67	10.56	7.11	S1	S1
81285	23.2	13.84	9.36	S1	ES25
81318	22.73	13.87	8.86	EB1	EB1
81322	15.51	10	5.51	S1	ES67
81338	17.95	11.09	6.86	ES27	S12
81340	20.7	12.34	8.36	S1	EB1
81342	28.89	16.78	12.11	ES27	EB4
81394	17.47	11.21	6.26	S36	ES25
81406	10.67	7.06	3.61	S1	S12
81416	18.6	11.59	7.01	S9	EB1
81438	20.23	12.37	7.86	BP14	ES10
81440	24.6	14.59	10.01	S17	EB1
81445	13.46	9.95	3.51	ES86	ES34
81446	14.61	9.25	5.36	S1	BP7

CATALOG PART NO.	EXTENDED LENGTH	COLLAPSED LENGTH	STROKE	UPPER MTG CODE	LOWER MTG CODE
81450	17.88	12.72	5.16	BP27	ES137
81459	21.73	13.37	8.36	ES84	ES84
81460	20.7	12.34	8.36	S1	ES91
81461	23.7	13.84	9.86	S1	ES185
81464	15.63	10.37	5.26	ES85	ES64
81469	22.54	13.68	8.86	EB4	EB4
81478	12.6	8.59	4.01	S1	ES64
81481	19.7	11.84	7.86	S1	EB1
81482	24.23	14.37	9.86	BP14	ES34
81484	20.23	12.37	7.86	EB1	ES25
81490	14.85	9.84	5.01	S12	ES41
81491	13	8.74	4.26	S12	DS1
81492	20.64	12.78	7.86	BP31	EB1
81494	13.61	8.75	4.86	S1	BP30
81495	20.2	12.34	7.86	S1	EB1
81496	20.49	12.63	7.86	ES27	ES27
81498	22.1	13.34	8.76	S17	EB1
81501	21.6	14.44	7.16	S1	ES64
81507	14.26	9.15	5.11	S1	ES64
81508	21.6	13.34	8.26	S12	ES64
81510	25.73	15.12	10.61	EB1	ES185
81514	22.14	13.28	8.86	BP31	EB1
81516	16.73	10.62	6.11	ES26	ES26
81517	21.12	16.31	4.81	S29	ES84
81529	17.73	11.12	6.61	ES18	ES18
81530	21.92	13.06	8.86	S29	ES53
81538	24.23	14.37	9.86	EB1	EB1
81539	23.23	13.87	9.36	EB1	ES106

SPECIFICATIONS BY PART NUMBER

GUARDIAN SHOCKS (CONT'D)

CATALOG PART NO.	EXTENDED LENGTH	COLLAPSED LENGTH	STROKE	UPPER MTG CODE	LOWER MTG CODE	CATALOG PART NO.	EXTENDED LENGTH	COLLAPSED LENGTH	STROKE	UPPER MTG CODE	LOWER MTG CODE
81540	25.73	15.12	10.61	EB1	ES106	81823	25.73	15.12	10.61	BP14	ES185
81541	14.7	9.34	5.36	S1	BP14	81825	21.1	12.99	8.11	EB4	EB4
81542	20.1	12.34	7.76	S8	EB1	81826	15.6	10.09	5.51	S12	BP7
81548	20.6	12.59	8.01	S1	BP7	81828	22.72	14.21	8.51	S36	ES185
81549	20.73	12.62	8.11	BP20	EB1	81833	20.21	12.45	7.76	S36	ES185
81553	15.2	9.59	5.61	S1	ES64	81834	15.7	9.84	5.86	S1	BP13
81554	18.48	11.62	6.86	ES64	EB1	81836	14.75	9.39	5.36	S1	ES83
81555	16.13	10.62	5.51	ES44	ES1	81837	26.28	15.42	10.86	BP13	ES27
81557	16.29	10.93	5.36	ES64	ES112	81869	20.6	12.59	8.01	S1	BP7
81558	19.01	12.35	6.66	S1	ES109	81870	13.86	9	4.86	S1	ES113
81559	13.2	8.59	4.61	S1	BP7	81871	22.04	13.43	8.61	EB2	EB2
81560	23.14	13.78	9.36	BP13	ES27	81872	14.95	9.59	5.36	S1	ES64
81562	19.85	15.54	4.31	S36	ES74	81873	24.74	14.88	9.86	ES34	ES34
81581	22.54	13.68	8.86	ES141	ES141	81878	17.73	11.12	6.61	ES18	ES18
81582	13.45	8.84	4.61	S1	BP4	81880	14.73	9.62	5.11	ES10	EB1
81583	18.39	11.53	6.86	EB5	ES25	81881	19.1	11.84	7.26	S36	ES143
81667	26.95	16.19	10.76	BP14	ES34	81882	15.63	10.37	5.26	ES69	ES69
81668	14.32	9.56	4.76	S29	BP11	81890	25.28	14.92	10.36	BP14	ES185
81670	11.7	7.84	3.86	S1	BP7	81891	21.09	13.33	7.76	EB5	ES24
81671	23.35	15.44	7.91	S1	ES85	81892	24.2	14.09	10.11	S12	ES171
81674	20.45	12.34	8.11	S1	ES185	81893	18.27	13.51	4.76	S36	BP7
81675	15.7	9.84	5.86	S1	EB1	81902	14.75	9.39	5.36	S1	ES76
81676	17.73	11.12	6.61	EB1	EB1	81904	18.46	11.7	6.76	S1	ES185
81691	24.2	14.09	10.11	S1	ES25	81905	26.97	15.86	11.11	EB1	ES185
81693	20.45	12.34	8.11	S12	BP7	81906	21.11	13.1	8.01	S12	EB19
81694	14.72	9.71	5.01	S36	ES25	81907	24.14	14.53	9.61	EB19	ES69
81710	21.73	13.12	8.61	EB1	ES185	81908	14.75	9.34	5.41	S1	BP19
81713	14.42	9.31	5.11	S29	BP7	81909	19.63	12.27	7.36	EB19	ES48
81714	14.2	9.09	5.11	S1	BP7	81910	22.48	13.62	8.86	ES19	ES110
81726	16.48	10.87	5.61	ES126	ES128	81911	19.04	11.68	7.36	S1	ES153
81727	18.44	11.58	6.86	ES141	ES25	81912	15.48	9.87	5.61	S62	BP7
81730	23.23	13.87	9.36	EB1	ES185	81913	28.39	16.28	12.11	S12	ES171
81739	16.23	10.87	5.36	ES85	ES64	81914	15.48	9.87	5.61	S62	ES26
81741	18.31	13.64	4.67	ES69	ES4	81916	13.72	9.46	4.26	S36	BP10
81742	22.6	13.59	9.01	S36	ES53	81917	23.03	13.92	9.11	EB1	ES185
81744	14.52	9.76	4.76	S36	EB1	81918	26.97	15.86	11.11	EB1	ES185
81750	13.61	8.75	4.86	S1	BP30	81919	22.3	13.54	8.76	S38	ES34
81789	23.73	14.12	9.61	BP14	ES34	81920	14.71	10.1	4.61	S12	BP11
81790	18.92	11.56	7.36	S29	ES24	81921	26.76	15.67	11.09	ES34	ES34
81791	15.2	9.59	5.61	S12	ES110	81922	15.35	10.24	5.11	S12	U Bracket
81792	13.6	9.69	3.91	S36	BP14	81923	24.47	14.61	9.86	ES26	ES26
81793	22.78	13.67	9.11	ES84	ES84	81924	20.78	12.67	8.11	ES185	ES185
81794	19.85	14.19	5.66	S1	ES185	81925	14.7	9.59	5.11	S12	ES7
81795	19.2	13.94	5.26	S1	ES143	81926	21.25	13.24	8.01	ES88	ES65
81821	23.23	13.87	9.36	ES41	ES41	81927	21.01	15.87	5.14	S36	

SPECIFICATIONS BY PART NUMBER

GUARDIAN SHOCKS (CONT'D)

CATALOG PART NO.	EXTENDED LENGTH	COLLAPSED LENGTH	STROKE	UPPER MTG CODE	LOWER MTG CODE
81928	13.78	9.52	4.26	S38	ES34
81929	19.49	12.13	7.36	BP20	ES24
81930	22.81	13.95	8.86	ES34	ES34
81931	26.53	16.02	10.51	ES34	ES34
81932	15.87	10.51	5.36	S38	ES34

CATALOG PART NO.	EXTENDED LENGTH	COLLAPSED LENGTH	STROKE	UPPER MTG CODE	LOWER MTG CODE
81933	13.97	9.11	4.86	S29	BP13
81934	26.14	16.45	9.69	S20	ES84
81935	24.19	15.93	8.26	S70	ES41
81936	20.3	12.19	8.11	S12	BP11
81937	21.44	13.18	8.26	S47	EB1

CLASSIC SHOCKS

CATALOG PART NO.	EXTENDED LENGTH	COLLAPSED LENGTH	STROKE	UPPER MTG CODE	LOWER MTG CODE
82001	15.98	10.37	5.61	ES64	ES64
82002	16.2	10.09	6.11	S17	ES14
82003	18.55	11.44	7.11	ES24	ES24
82004	14.17	8.81	5.36	S17	S1
82005	17.2	12.44	4.76	S1	ES64
82006	20.48	12.62	7.86	ES24	ES24
82007	18.23	11.37	6.86	EB1	EB1
82010	16.63	12.47	4.16	ES34	ES34
82011	12.11	8	4.11	S1	ES11
82012	16.04	10.53	5.51	BP6	ES25
82013	20.82	13.06	7.76	S29	BP20
82020	18.11	11	7.11	S8	ES62
82025	12.95	9.19	3.76	S36	BP17
82026	13.42	8.56	4.86	S1	S1
82030	20.23	12.37	7.86	ES43	ES43
82031	16.23	10.37	5.86	ES18	ES18
82032	22.73	13.87	8.86	ES64	ES64
82033	18.79	12.03	6.76	ES25	EB19
82034	22.17	12.81	9.36	S1	S1
82035	14.64	9.53	5.11	ES24	EB1
82038	24.67	14.06	10.61	S1	S1
82039	17.7	10.84	6.86	S1	EB1
82040	21.7	12.84	8.86	S1	ES10
82046	26.04	15.43	10.61	EB4	EB4
82047	20.23	12.37	7.86	EB1	EB1
82049	13.17	8.31	4.86	S1	S1
82051	22.14	13.28	8.86	BP8	EB1
82054	24.54	14.68	9.86	EB4	EB4
82060	23.23	13.87	9.36	EB1	EB1
82062	24.23	14.37	9.86	ES24	ES24
82065	19.04	11.93	7.11	EB4	EB4
82066	22.7	13.34	9.36	S1	EB1
82067	20.86	12.5	8.36	S1	EB4
82069	14.59	9.31	5.28	S1	S1
82070	15.75	9.99	5.76	S1	DS1

CATALOG PART NO.	EXTENDED LENGTH	COLLAPSED LENGTH	STROKE	UPPER MTG CODE	LOWER MTG CODE
82072	11.61	7.75	3.86	S1	ES8
82074	18.7	11.34	7.36	S1	ES24
82075	16.1	10.34	5.76	S1	BP10
82076	18.7	11.34	7.36	ES66	S1
82079	15.54	9.93	5.61	ES9	BP20
82086	25.54	14.93	10.61	ES35	ES35
82087	14.61	9.25	5.36	S1	BP20
82089	22.23	13.37	8.86	ES12	EB1
82090	16.11	10	6.11	S1	ES8
82093	21.23	12.87	8.36	BP31	ES10
82099	14.11	9	5.11	S1	BP19
82103	22.7	13.34	9.36	ES145	S1
82104	14.2	9.44	4.76	BP19	DS1
82109	13.64	8.74	4.90	S1	ES32
82110	14.1	8.99	5.11	S1	BP8
82118	15.31	10.06	5.25	S5	BP19
82123	18.6	11.59	7.01	S9	EB1
82124	22.1	13.34	8.76	S17	EB1
82125	20.67	12.06	8.61	S8	S1
82126	14.25	9.24	5.01	S36	DS1
82128	11.2	8.19	3.01	S36	ES40
82129	12.51	8.5	4.01	S1	BP3
82130	17.7	10.84	6.86	EB1	S36
82131	22.39	13.53	8.86	ES27	EB4
82138	15.1	9.49	5.61	S1	BP3
82139	12.98	9.97	3.01	EB1	EB1
82147	23.23	13.87	9.36	EB1	ES25
82151	23.23	13.87	9.36	ES145	ES70
82155	20.7	12.34	8.36	S1	EB1
82156	20.23	12.37	7.86	EB1	EB1
82601	13.61	8.75	4.86	S1	ES16
82602	23.23	13.87	9.36	BP8	EB1
82603	17.7	10.84	6.86	S1	EB1
82607	14.73	9.62	5.11	EB1	EB1
82608	20.85	13.94	6.91	S12	ES39

SPECIFICATIONS BY PART NUMBER

CLASSIC SHOCKS (CONT'D)

CATALOG PART NO.	EXTENDED LENGTH	COLLAPSED LENGTH	STROKE	UPPER MTG CODE	LOWER MTG CODE
82609	25.64	15.03	10.61	EB1	ES35
82610	23.23	13.87	9.36	EB1	EB1
82614	12.01	8.25	3.76	S12	ES5

CATALOG PART NO.	EXTENDED LENGTH	COLLAPSED LENGTH	STROKE	UPPER MTG CODE	LOWER MTG CODE
82615	15.69	10.43	5.26	EB4	BP11
82617	18.86	11.5	7.36	S1	EB4
82618	25.73	15.12	10.61	BP14	EB1

ULTRA CARTRIDGES

CATALOG PART NO.	EXTENDED LENGTH	COLLAPSED LENGTH	STROKE	UPPER MTG CODE	LOWER MTG CODE
G244002	20.66	14.21	6.44		
G44450	22.17	14.55	7.62		
G44451	20.35	13.92	6.43		
G44459	20.32	13.41	6.91		
G44461	20.58	14.67	5.91		
G44477	24.98	16.77	8.21		
G44493	22.8	17.92	4.88		
G44495	20.74	14.65	6.09		
G44497	22.8	17.97	4.83		
G44713	26.08	18.74	7.34		
G44724	22.68	14.95	7.73		
G44735	21.95	14.35	7.6		
G44743	19.70	13.10	6.6		
G44745	24.66	17.48	7.18		
G44747	19.46	13.57	5.89		
G44748	20.07	14.14	5.93		
G44752	24.22	17.81	6.41		
G44763	19.95	13.82	6.13		
G44766	23.9	16.12	7.78		
G44767	21.04	14.21	6.84		
G44773	22.42	15.52	6.9		
G44774	21.36	14.13	7.23		
G44775	24.55	17.48	7.08		
G44776	24.66	16.77	7.90		
G44783	20.81	13.66	7.15		
G44800	21.05	15.24	5.82		
G44802	21.78	15.17	6.61		
G44803	21.01	14.38	6.63		
G44850	22.3	15.42	6.88		
G44856	24.24	16.79	7.45		
G44862	22.98	16.78	6.2		

CATALOG PART NO.	EXTENDED LENGTH	COLLAPSED LENGTH	STROKE	UPPER MTG CODE	LOWER MTG CODE
G44867	25.16	18.73	6.43		
G44868	23.14	17.33	5.82		
G44869	21.36	15.65	5.71		
G44898	23.87	16.14	7.73		
G44902	21.78	14.37	7.41		
G44903	19.81	13.59	6.22		
G44918	20.57	14.59	5.98		
G44920	25.22	18.02	7.2		
G44926	23.6	15.77	7.83		
G44934	21.90	15.20	6.71		
G44936	21.06	14.69	6.37		
G44937	22.68	16.53	6.16		
G44938	23.49	16.28	7.21		
G44939	19.72	13.66	6.07		
G44940	20.37	14.14	6.24		
G44941	25.17	18.67	6.5		
G44943	20.64	13.91	6.73		
G44944	19.18	13.29	5.90		
G44947	23.9	16.55	7.35		
G44968	20.91	14.41	6.5		
G44969	25.61	18.00	7.61		
G44982	19.72	13.66	6.07		
G44986	21.45	14.95	6.5		
G44990	24.79	16.89	7.90		
G44991	25.24	18.24	7		
G44994	19.84	14.20	5.64		
G44995	18.77	13.21	5.56		
G44997	21.76	14.76	7		
G44998	20.17	13.86	6.31		
G44999	20.93	14.23	6.7		

SPECIFICATIONS BY PART NUMBER

ULTRA SPRING SEATS

CATALOG PART NO.	EXTENDED LENGTH	COLLAPSED LENGTH	STROKE	UPPER MTG CODE	LOWER MTG CODE	CATALOG PART NO.	EXTENDED LENGTH	COLLAPSED LENGTH	STROKE	UPPER MTG CODE	LOWER MTG CODE
G51006	21.01	13.00	8.01			G51229	21.23	14.97	6.26		
G51007	21.87	13.86	8.01			G51230	16.2	10.98	5.22		
G51013	22.47	14.46	8.01			G51232	21.73	14.97	6.76		
G51022	24.76	16.75	8.01			G51249	24.48	16.97	7.51		
G51027	20.17	12.41	7.76			G51252	18.82	12.02	6.8		
G51030	23.24	14.72	8.53			G51253	21.3	14.30	7		
G51031	22	14.50	7.5			G51254	21.3	14.30	7		
G51033	23.85	15.59	8.26			G51255	15.76	11.54	4.22		
G51034	19.31	12.41	6.91			G51256	22.66	15.45	7.22		
G51039	23.41	15.28	8.14			G51264	16.01	11.28	4.73		
G51046	22.48	15.22	7.26			G51267	14.25	10.70	3.55		
G51047	20.17	12.41	7.76			G51268	24.48	16.97	7.51		
G51060	21.81	14.44	7.37			G51279	16.37	11.07	5.3		
G51063	21.31	13.05	8.26			G51286	15.65	10.84	4.81		
G51064						G51290	19.78	13.07	6.71		
G51077	18.02	12.75	5.27			G51330	21.46	13.43	8.03		
G51078	20.79	13.69	7.1			G51346					
G51087	17.86	11.91	5.95			G51424	20.23	12.97	7.26		
G51097	22.83	18.07	4.76			G51477	18.14	13.36	4.78		
G51099	22.05	18.19	3.86			G51700	14.68	10.35	4.33		
G51100	23.62	15.9	7.72			G51703	20.6	16.65	3.95		
G51101	22.83	18.07	4.76			G51704	21.69	16.62	5.07		
G51161						G51705	23.28	14.49	8.78		
G51165	21.26	13.44	7.82			G51709	20.44	15.32	5.12		
G51170	19.31	12.41	6.9			G51710	23.08	16.02	7.06		
G51173	17.27	11.00	6.27			G51711	17.25	14.75	2.5		
G51180	18	12.00	6			G51712	21.1	14.80	6.3		
G51181	21.31	13.36	7.95			G51713	22	15.69	6.31		
G51182	16.13	10.33	5.8			G51714	16.79	11.99	4.8		
G51183	16.1	10.33	5.77			G51715	14.92	10.43	4.49		
G51184	16.85	10.70	6.15			G51716	14.68	10.35	4.33		
G51186	19.48	12.72	6.76			G51718	16.61	11.41	5.2		
G51188	24.21	14.38	9.83			G51719	19.84	15.70	4.14		
G51189	17.81	12.18	5.63			G51720	21.05	16.14	4.91		
G51190	21.38	15.35	6.03			G51721	24.88	17.95	6.94		
G51191	21.18	15.07	6.11			G51722	18.93	16.73	2.2		
G51192	24.21	14.38	9.84			G51723	18.93	16.73	2.2		
G51193	20.81	14.09	6.72			G51724	19.28	13.69	5.59		
G51195	18.12	13.42	4.70			G51725	21.12	14.62	6.5		
G51196	14.93	9.95	4.98			G51727	17.62	12.87	4.75		
G51197	20.37	15.76	4.61			G51728	13.87	9.62	4.25		
G51204	18.63	14.83	3.8			G51729	21.5	14.26	7.24		
G51216	23.23	15.35	7.88			G51736	16.5	11.50	5		
G51227	12.00	7.13	4.87			G51737	17.12	12.50	4.62		

SPECIFICATIONS BY PART NUMBER

ULTRA SPRING SEATS (CONT'D)

CATALOG PART NO.	EXTENDED LENGTH	COLLAPSED LENGTH	STROKE	UPPER MTG CODE	LOWER MTG CODE	CATALOG PART NO.	EXTENDED LENGTH	COLLAPSED LENGTH	STROKE	UPPER MTG CODE	LOWER MTG CODE
G51738	24.57	17.09	7.48			G51826	28.54	20.47	8.07		
G51739	21.36	16.79	4.57			G51827	16.61	10.67	5.94		
G51740	24.5	19	5.50	SS4		G51828	16.61	10.67	5.94		
G51742	22.12	17.37	4.75	S2		G51829	24.88	15.75	9.13		
G51743	22	18.12	3.88	SS4		G51830	14.92	10.55	4.37		
G51744	19.75	15.5	4.25			G51831					
G51746	22.12	17.37	4.75	SS2		G51832	22.13	17.48	4.65		
G51747	23.51	14.91	8.61			G51833					
G51756	20.37	17.75	2.62			G51834					
G51757	17.37	13.12	4.25			G51835					
G51758	21.5	15.34	5.85	SS6		G51836	19.53	16.69	2.83		
G51759	23.25	15.12	8.12	SS2		G51837	19.21	13.39	5.83		
G51760	25.17	19.37	5.8	SS6		G51838	19.02	12.72	6.3		
G51761	25.17	19.37	5.8	SS6		G51839	18.58	13.34	5.24		
G51764	19.69	14.36	5.33			G51840					
G51765	15.56	10.99	4.01			G51841	20.98	14.29	6.69		
G51766	15.56	10.99	4.01			G51842	19.05	12.75	6.30		
G51767	18.19	12.36	5.83			G51847	24.8	17.04	7.76		
G51768	16.87	12.12	4.75			G51848	21.41	13.66	7.75		
G51769	21.61	17.67	3.94			G51849	17.95	12.36	5.59		
G51770	20.37	17.75	2.62			G51850	16.1	11.06	5.04		
G51771	18.12	13.12	5			G51852	13.89	10.66	3.23		
G51772	26	17.37	8.63	S4		G51853	16.85	12	4.84		
G51773	18	13.5	4.50			G51854	16.85	12	4.84		
G51774	16.73	11.88	4.85			G51855	23.26	17.55	5.7		
G51783	24.41	14.45	9.96			G51856	21.18	15.11	6.07		
G51794	17.28	11.06	6.22			G51857	18.62	12.24	6.38		
G51795	18.78	12.008	6.77			G51858	15.35	11.18	4.17		
G51796	14.25	10.71	3.54			G51859	18.5	14.29	4.21		
G51798	15.35	11.1	4.25			G51860	19.96	16.29	3.67		
G51799	23.03	14.65	8.38			G51861	19.21	15.15	4.05		
G51802	20.83	14.09	6.74			G51863	20.30	12.48	7.83		
G51803	14.41	10.12	4.29			G51864	21.57	17.16	4.41		
G51804	26.18	15.83	10.35			G51865	20.86	16.45	4.41		
G51805	27.13	16.61	10.52			G51868	17.56	13.35	4.21		
G51806	15.74	11.339	4.41			G51869	18.23	13.7	4.53		
G51807	21.93	17.48	4.45			G51870	21.22	15.43			
G51810	19.17	13.27	5.90			G51871	15.7	11.77	3.93		
G51811	19.17	13.27	5.90			G51874	20.43	16.41	4.01		
G51812	19.96	13.94	6.02			G51875	18.11	12.32	5.79		
G51813	23.98	19.21	4.77			G51876	18.11	12.32	5.79		
G51814	23.98	19.21	4.77			G51877	17.67	12.91	4.76		
G51815	18.07	13.46	4.61			G51878	17.67	12.91	4.76		
G51825	22.48	16.1	6.38			G51879	15.67	10.94	4.73		

SPECIFICATIONS BY PART NUMBER

ULTRA SPRING SEATS (CONT'D)

CATALOG PART NO.	EXTENDED LENGTH	COLLAPSED LENGTH	STROKE	UPPER MTG CODE	LOWER MTG CODE
G51880	18.42	12	6.42		
G51881	16.57	11.65	4.92		
G51882	18.62	12.24	6.38		
G51883	19.52	12.48	7.04		
G51884	16.53	13.5	3.03		
G51885	24.44	15.39	9.05		
G51886	16.22	10.74	5.48		
G51887	15.55	12.08	3.47		
G51888	15.55	12.08	3.47		
G51889	19.29	12.91	6.38		
G51890	19.29	12.91	6.38		
G51891	17.8	13.54	4.26		

CATALOG PART NO.	EXTENDED LENGTH	COLLAPSED LENGTH	STROKE	UPPER MTG CODE	LOWER MTG CODE
G51892	23	15.86	7.14		
G51896	18.54	14.09	4.45		
G51897	18.54	14.09	4.45		
G51898	16.57	12.09	4.49		
G51899	17.04	11.73	5.31		
G51900	22.83	14.92	7.91		
G51901	22.4	19.32	3.07		
G51904	16.22	11.5	4.72		
G51905	23.74	17.79	5.95		
G51906	20.07	14.49	5.59		
G51907	21.34	13.74	7.6		

ULTRA STRUTS

CATALOG PART NO.	EXTENDED LENGTH	COLLAPSED LENGTH	STROKE	UPPER MTG CODE	LOWER MTG CODE
G52000	21.97	15.35	6.62		
G52001	21.97	15.35	6.62		
G52002	21.97	15.39	6.58		
G52003	21.97	15.39	6.58		
G52004	21.02	14.69	6.33		
G52005	19.02	11.81	7.21		
G52006	19.02	11.81	7.21		
G52007	21.02	14.69	6.33		
G52008	22.2	15.04	7.16		
G52009	22.2	15.04	7.16		
G52013	20.52	13.5	7.02		
G52014	20.52	13.5	7.02		
G52015	18.86	13.35	5.51		
G52016	18.86	13.35	5.51		
G52017	21.77	13.9	7.87		
G52018	21.77	13.9	7.87		
G52019	19.17	12.64	6.53		
G52020	19.17	12.64	6.53		
G52021	21.42	13.66	7.76		
G52022	21.42	13.66	7.76		
G52023	19.84	13.54	6.30		
G52024	19.84	13.54	6.30		
G52025	19.61	13.15	6.46		
G52026	22.8	14.84	7.96		
G52027	22.8	14.84	7.96		
G52028	20.47	12.68	7.79		
G52029	20.47	13.07	7.40		
G52030	24.88	17.95	6.93		

CATALOG PART NO.	EXTENDED LENGTH	COLLAPSED LENGTH	STROKE	UPPER MTG CODE	LOWER MTG CODE
G52031	24.88	17.95	6.93		
G52032	21.54	14.13	7.41		
G52033	21.54	14.13	7.41		
G52034	21.38	14.41	6.97		
G52035	21.38	14.41	6.97		
G52036	19.37	15.04	4.33		
G52037	19.37	15.04	4.33		
G52038	20.04	13.11	6.93		
G52039	20.04	13.11	6.93		
G52055	18.82	12.76	6.06		
G52056	18.82	12.76	6.06		
G52057	18.11	13.31	4.8		
G52058	18.11	13.31	4.8		
G52061					
G52062					
G52063	18.43	12.52	5.91		
G52064	21.875	14.125	7.75		
G52065	22.72	15.39	7.32		
G52066	20.7	13.62	7.08		
G52067					
G52068					
G52069	20.39	15.12	5.28		
G52070	20.39	15.12	5.28		
G52071					
G52072					
G52073					
G52074					
G52075	19.32	12.56	6.77		

SPECIFICATIONS BY PART NUMBER

ULTRA STRUTS (CONT'D)

CATALOG PART NO.	EXTENDED LENGTH	COLLAPSED LENGTH	STROKE	UPPER MTG CODE	LOWER MTG CODE	CATALOG PART NO.	EXTENDED LENGTH	COLLAPSED LENGTH	STROKE	UPPER MTG CODE	LOWER MTG CODE
G52076	19.32	12.56	6.77			G52137	17.63	11.57	6.06		
G52077						G52138	16.96	11.02	5.94		
G52078						G52139	16.96	11.02	5.94		
G52079	18.54	12.44	6.10			G52140	24.13	16.97	7.16		
G52080	18.54	12.44	6.10			G52141	24.13	16.97	7.16		
G52081	22.83	16.3	6.53			G52142	18.38	14.05	4.33		
G52082	22.83	16.3	6.53			G52143	18.38	14.05	4.33		
G52083						G52144	20.35	15.39	4.96		
G52084						G52145	20.35	15.39	4.96		
G52085						G52148	22.12	14.76	7.36		
G52086						G52149	22.12	14.76	7.36		
G52087	20.68	14.625	6.06			G52150	24.68	16.69	7.99		
G52088	24.56	14.625	9.94			G52151	24.68	16.69	7.99		
G52089						G52152	21.77	13.93	7.84		
G52090						G52153	21.77	13.93	7.84		
G52094	17.28	13.03	4.25			G52154	19.29	12.52	6.77		
G52095	17.28	13.03	4.25			G52155	19.29	12.52	6.77		
G52096	20.7	13.42	7.28			G52156	19.84	12.59	7.25		
G52097	20.7	13.42	7.28			G52157	19.84	12.59	7.25		
G52098	20.6	13.85	6.75			G52158	23	15.94	7.06		
G52103	24.13	15.82	8.31			G52159	23	15.94	7.06		
G52104	24.13	15.82	8.31			G52160	19.68	13.15	6.53		
G52105	23.3	16.57	6.73			G52161	19.68	13.15	6.53		
G52106	23.3	16.57	6.73			G52162	22.2	14.13	8.07		
G52107	23.22	16.18	7.04			G52163	22.2	14.13	8.07		
G52108	23.22	16.18	7.04			G52164	16.25	10.78	5.47		
G52110	18.14	11.96	6.19			G52165	16.25	10.78	5.47		
G52111	18.14	11.96	6.19			G52166	21.22	13.81	7.41		
G52112	21.41	14	7.41			G52167	21.22	13.81	7.41		
G52113	21.41	14	7.41			G52168	21.61	14.17	7.44		
G52116	19.29	13.07	6.22			G52169	21.61	14.17	7.44		
G52117	21.69	14.76	6.93			G52170	20.9	16.02	4.88		
G52118	21.69	14.76	6.93			G52171	20.9	16.02	4.88		
G52121	17.51	13.3	4.21			G52172	20.66	16.32	4.33		
G52122	17.51	13.3	4.21			G52173	21.61	15.23	6.38		
G52123	22.01	14.84	7.17			G52174	21.61	15.23	6.38		
G52124	22.01	14.84	7.17			G52175					
G52125	22	14.13	7.87			G52176					
G52127	23.3	15.6	7.7			G52178	25	16.57	8.43		
G52128	23.3	15.6	7.7			G52179	25	16.57	8.43		
G52129	17.82	11.49	6.34			G52180	21.85	15.11	6.74		
G52130	17.82	11.49	6.34			G52181	21.85	15.11	6.74		
G52131	22.71	15.74	6.97			G52182	25.35	16.18	9.17		
G52136	17.63	11.57	6.06			G52183	25.35	16.18	9.17		

SPECIFICATIONS BY PART NUMBER

ULTRA STRUTS (CONT'D)

CATALOG PART NO.	EXTENDED LENGTH	COLLAPSED LENGTH	STROKE	UPPER MTG CODE	LOWER MTG CODE	CATALOG PART NO.	EXTENDED LENGTH	COLLAPSED LENGTH	STROKE	UPPER MTG CODE	LOWER MTG CODE
G52184	22.75	14.96	7.79			G52273					
G52185	22.75	14.96	7.79			G52274	19.72	13.19	6.54		
G52187	23.26	14.8	8.46			G52275	19.72	13.19	6.54		
G52188	23.26	14.8	8.46			G52276	18.3	11.3	7.01		
G52193	19.09	14.29	4.8			G52278	19.45	13.5	5.94		
G52194	19.09	14.29	4.8			G52279	19.45	13.5	5.94		
G52199	19.44	14.76	4.68			G52280	19.48	12.87	6.61		
G52200	19.44	14.76	4.68			G52281	19.48	12.87	6.61		
G52201	22.51	15.94	6.57			G52282	20.83	13.86	6.97		
G52202	22.51	15.94	6.57			G52283	20.83	13.86	6.97		
G52203	26.33	17.95	8.38			G52314	20.98	16.34	4.65		
G52204	26.33	17.95	8.38			G52327					
G52205	20.47	17.67	2.8			G52328					
G52206	19.21	13.18	6.03			G52333	22.44	13.78	8.66		
G52209	19.21	13.18	6.03			G52334	22.44	13.78	8.66		
G52210	25.7	17	8.69			G52335	21.46	14.06	7.4		
G52227	19.84	13.93	5.91			G52336	21.46	14.06	7.4		
G52228	19.84	13.93	5.91			G52346	18.86	13.31	5.55		
G52237	19.64	14.92	4.72			G52347	18.86	13.31	5.55		
G52238	19.64	14.92	4.72			G55505	16.98	10.40	6.58		
G52244	23.15	15.82	7.33			G55507	20.37	14.08	6.29		
G52245	20.51	13.39	7.13			G55509	19.36	13.35	6.01		
G52246	20.51	13.39	7.13			G55510	20.67	13.55	7.12		
G52247	20.78	13.66	7.12			G55511	17.89	11.85	6.05		
G52248	20.78	13.66	7.12			G55512	16.52	9.76	6.76		
G52249	23.03	16.85	6.18			G55514	16.98	10.40	6.58		
G52250	23.03	16.85	6.18			G55515	17.45	11.24	6.22		
G52253	25.35	16.57	8.77			G55516	20.39	13.41	6.99		
G52254	25.35	16.57	8.77			G55518	22.14	13.82	8.32		
G52255						G55521	17.37	11.06	6.31		
G52256						G55525	18.97	12.97	6.01		
G52257	23.5	15.59	7.91			G55526	17.41	10.83	6.58		
G52258	23.5	15.59	7.91			G55527	23.23	16.54	6.69		
G52260	25.31	17.28	8.02			G55529	20.03	12.50	7.53		
G52261	25.31	17.28	8.02			G55531	16.66	10.10	6.56		
G52262	21.61	13.7	7.91			G55533	20.94	13.65	7.29		
G52263	21.61	13.7	7.91			G55534	16.66	10.23	6.43		
G52264	19.48	12.72	6.77			G55539	18.02	11.95	6.07		
G52265	19.48	12.72	6.77			G55542	14.7	8.27	6.44		
G52268	21.5	14.72	6.77			G55544	16.66	10.26	6.4		
G52269	21.5	14.72	6.77			G55546	17.25	11.17	6.08		
G52270	22.05	16.34	5.71			G55551	24.1	14.50	9.6		
G52271	22.05	16.34	5.71			G55557	20	12.00	8		
G52272						G55561	16.38	9.84	6.54		

SPECIFICATIONS BY PART NUMBER

ULTRA STRUTS (CONT'D)

CATALOG PART NO.	EXTENDED LENGTH	COLLAPSED LENGTH	STROKE	UPPER MTG CODE	LOWER MTG CODE	CATALOG PART NO.	EXTENDED LENGTH	COLLAPSED LENGTH	STROKE	UPPER MTG CODE	LOWER MTG CODE
G55579	20.56	16.32	4.23			G55679	15.72	10.10	5.62		
G55580	20	12.50	7.5			G55680	17	12.25	4.75		
G55584	17.87	11.05	6.83			G55681	20.69	14.36	6.34		
G55586	16.32	9.67	6.65			G55685	20.01	13.49	6.52		
G55587	15.93	10.07	5.86			G55692	19.09	12.55	6.54		
G55588	20.8	13.05	7.75			G55693	24.59	15.59	9		
G55589	20.44	12.69	7.76			G55697	19.7	13.19	6.51		
G55590	19.41	13.04	6.37			G55698	19.92	13.14	6.78		
G55591	16.94	10.76	6.18			G55704	19.26	13.97	5.29		
G55592	15.96	9.54	6.42			G55705	19.01	12.00	7.01		
G55593	17.7	12.05	5.65			G55706	18.53	12.72	5.81		
G55594	17.7	12.05	5.65			G55707	20.11	14.24	5.87		
G55600	16.09	9.60	6.49			G55708	20.54	14.00	6.54		
G55601	20	12.50	7.5			G55710	16.67	9.7	6.97		
G55602	16.68	9.69	6.99			G55712	20.52	14.00	6.52		
G55603	22.49	14.15	8.34			G55713	17.79	11.43	6.36		
G55605	15.93	10.03	5.9			G55714	20.5	14.00	6.5		
G55606	19.95	12.47	7.48			G55715	19.42	13.5	5.92		
G55607	15.22	9.41	5.81			G55716	19.38	12.38	7		
G55608	15.22	9.41	5.81			G55719	18.2	11.36	6.84		
G55609	16.34	10.65	5.69			G55722	18.53	10.71	7.82		
G55610	16.17	10.90	5.27			G55723	13.84	8.52	5.32		
G55611	16.17	10.80	5.37			G55724	17.46	12.41	5.05		
G55615	16.26	11.06	5.2			G55725	16.58	10.7	5.88		
G55616	20.19	13.73	6.46			G55726	18.06	13.19	4.87		
G55652	18.73	12.25	6.49			G55727	17.87	10.23	7.63		
G55653	18.73	12.25	6.49			G55728	19.12	13.38	5.74		
G55657	17.23	10.93	6.3			G55729	22.78	14.16	8.62		
G55658	17.23	10.93	6.3			G55730	15.65	8.92	6.73		
G55661	19.57	11.76	7.81			G55731	18.21	10.38	7.83		
G55662	19.57	11.76	7.81			G55732	18.8	12.97	5.83		
G55663	17.34	11.26	6.09			G55733	21.61	13.82	7.79		
G55664	17.34	11.26	6.09			G55737	20.68	13.15	7.53		
G55665	24.78	16.33	8.45			G55738	20.68	13.15	7.53		
G55666	16.65	10.61	6.04			G55742	14.3	8.35	5.95		
G55667	16.65	10.61	6.04			G55743	14.35	8.36	5.99		
G55668	20.34	12.83	7.51			G55745	20.47	13.27	7.2		
G55669	20.34	12.83	7.51			G55746	20.31	11.56	8.75		
G55670	15.39	9.73	5.66			G55749	15.3	9.48	5.82		
G55671	15.39	9.73	5.66			G55752	22.75	14.63	8.12		
G55672	19.05	12.57	6.48			G55757	23.06	14.81	8.25		
G55673	16.82	11.05	5.77			G55763	15.56	9.88	5.68		
G55675	20.84	12.64	8.20			G55766	18.97	12.70	6.27		
G55676	20.84	12.64	8.2			G55769	24.35	15.03	9.32		

SPECIFICATIONS BY PART NUMBER

ULTRA STRUTS (CONT'D)

CATALOG PART NO.	EXTENDED LENGTH	COLLAPSED LENGTH	STROKE	UPPER MTG CODE	LOWER MTG CODE	CATALOG PART NO.	EXTENDED LENGTH	COLLAPSED LENGTH	STROKE	UPPER MTG CODE	LOWER MTG CODE
G55770	15.65	8.92	6.73			G55866	21.7	15.63	6.08		
G55771	18.99	13.42	5.58			G55867	22.96	14.95	8.01		
G55772	20.35	13.85	6.5			G55868	22.96	14.95	8.01		
G55773	15.84	10.03	5.81			G55870	16.78	11.56	5.22		
G55774	15.24	10.55	4.7			G55871	25.31	16.56	8.75		
G55776	27.1	16.30	10.8			G55877	15.24	10.55	4.7		
G55780	17.43	11.09	6.34			G55878	18.61	11.02	7.59		
G55781	16	10.50	5.5			G55879	16.51	10.28	6.23		
G55782	18.89	13.02	5.87			G55881	16.65	10.35	6.3		
G55784	21.25	14.00	7.25			G55882	16.65	10.35	6.3		
G55785	21.25	14.00	7.25			G55883	20.47	11.81	8.66		
G55786	24.75	16.50	8.25			G55884	20.47	11.81	8.66		
G55787	16	10.25	5.75			G55890	19.33	11.52	7.81		
G55788	20.28	14.69	5.59			G55891	15.53	9.78	5.75		
G55795	18.25	11.25	7			G55892	20.19	14.09	6.9		
G55796	24.75	16.50	8.25			G55893	24.41	16.46	7.95		
G55797	17.9	11.00	6.9			G55894	24.41	16.46	7.95		
G55800	19.63	12.38	7.25			G55896	20.2	14.1	6.10		
G55801	17.25	10.25	7			G55901	20.41	13.65	6.76		
G55802	15.31	10.37	4.94			G55903	13.88	7.84	6.04		
G55803	18.92	13.23	5.69			G55904	16.61	10.47	6.14		
G55804	18.55	12.05	6.49			G55909	15.32	10.38	4.95		
G55805	24.5	18.00	6.5			G55910	19.23	13.09	6.14		
G55817	20.25	12.56	7.7			G55911	16.22	9.72	6.5		
G55818	14.41	10.71	3.7			G55912	19.32	12.31	7.02		
G55819	18	13.40	4.6			G55913	19.32	12.31	7.02		
G55820	16	11.25	4.75			G55914	17.65	11.48	6.17		
G55821	23.3	15.95	7.35			G55920	16.87	11.13	5.74		
G55825	22.88	17.33	5.55			G55921	16.87	11.13	5.74		
G55828	19	13.00	6			G55923	20.75	13.74	7.01		
G55831	23.26	15.67	7.59			G55924	20.75	13.74	7.01		
G55832	16.61	10.61	6			G55925	20.63	14.21	6.42		
G55833	16.61	10.61	6			G55926	20.63	14.21	6.42		
G55834	16.77	10.05	6.72			G55927	21.38	12.82			
G55847	18.5	12.00	6.5			G55928	21.38	12.82			
G55848	20.16	11.87	8.30			G55929	22.99	15.12	7.87		
G55849	15.71	9.86	5.85			G55930	22.99	15.12	7.87		
G55850	15.71	9.86	5.85			G55931	22.47	14.00			
G55856	23.37	14.26	9.11			G55932	18.16	11.62	6.54		
G55857	18.14	11.57	6.57			G55933	21.75	14.00			
G55858	18.14	11.57	6.57			G55934	22.48	14.00	8.48		
G55859	21.52	12.02	9.5			G55945	16.20	10.36	5.84		
G55860	21.52	12.02	9.5			G55948	16.5	10.71	5.79		
G55865	21.7	15.63	6.08			G55949	23.13	16.09	7.05		

SPECIFICATIONS BY PART NUMBER

ULTRA STRUTS (CONT'D)

CATALOG PART NO.	EXTENDED LENGTH	COLLAPSED LENGTH	STROKE	UPPER MTG CODE	LOWER MTG CODE	CATALOG PART NO.	EXTENDED LENGTH	COLLAPSED LENGTH	STROKE	UPPER MTG CODE	LOWER MTG CODE
G55951	16.26	11.53	4.74			G56533	21.87	14.12	7.75		
G55952	25.06	16.11	8.95			G56534	21.87	14.12	7.75		
G55958	16.26	11.53	4.74			G56535	20.2	12.83	7.37		
G55960	19.51	13.60	5.91			G56536	23.39	15.00	8.39		
G55970	17.63	11.90	5.73			G56537	23.39	15.00	8.39		
G55971	17.63	11.90	5.73			G56538	23.39	15.00	8.39		
G55974	18.01	11.14	6.88			G56539	19.62	13.37	6.25		
G55975	20.97	12.80	8.18			G56540	19.62	13.37	6.25		
G55976	20.23	12.12	8.11			G56541	20.59	12.48	8.11		
G55977	20.23	12.12	8.11			G56542	20.59	12.48	8.11		
G55978	19.51	13.60	5.91			G56543	21.55	15.18	6.38		
G55989	18.49	11.34	7.15			G56544	21.55	15.18	6.38		
G55990	17.93	11.32	6.61			G56545	25.12	17.5	7.62		
G55991	20.87	14.53	6.34			G56546	25.12	17.5	7.62		
G55992	16.99	10.40	6.59			G56547	19.76	12.89	6.87		
G55993	21.73	15.16	6.57			G56548	19.76	12.89	6.87		
G55994	21.73	15.16	6.57			G56551	16.6	10.42	6.18		
G55999	16.79	10.81	5.98			G56552	16.6	10.42	6.18		
G56501	20.18	12.01	8.18			G56553	22.58	14.4	8.18		
G56502	17.22	10.54	6.68			G56554	22.58	14.4	8.18		
G56503	20.01	14.25	5.76			G56555	20.77	14.25	6.53		
G56504	20.37	13.14	7.24			G56556	20.77	14.25	6.53		
G56506	17.22	10.54	6.68			G56557	13.12	10.37	2.75		
G56508	17.52	10.66	6.87			G56558	20.98	14.44	6.54		
G56509	16.82	10.66	6.17			G56559	20.98	14.44	6.54		
G56512	20.5	13.75	6.75			G56561	23	16.37	6.62		
G56513	20.5	13.75	6.75			G56562	23	16.37	6.62		
G56514	17.22	10.54	6.68			G56565	16.77	11.81	4.96		
G56515	16.15	8.44	7.71			G56566	22.68	15.31	7.37		
G56516	20.22	14.02	6.2			G56568	25	17.75	7.25		
G56517	20.22	13.94	6.28			G56569	19.12	12.25	6.87		
G56518	15.23	8.83	6.41			G56570	19.12	12.25	6.87		
G56520	18.95	12.56	6.39			G56571	22.12	14.12	8		
G56522	16.41	9.98	6.43			G56572	20.55	13.66	6.89		
G56523	22.5	14.00	8.5			G56573	19.87	13.50	6.37		
G56524	22.25	14.00	8.25			G56574	23.5	16.00	7.5		
G56525	16.91	10.48	6.43			G56575	23.5	16.00	7.5		
G56526	16.91	10.48	6.43			G56576	19.87	13.50	6.37		
G56527	19.06	11.60	7.46			G56577					
G56528	19.06	11.60	7.46			G56579	25.5	17.12	8.37		
G56529	16.9	10.55	6.35			G56580	25.5	17.12	8.37		
G56530	16.9	10.55	6.35			G56581	20.74	13.59	7.15		
G56531	18.37	12.62	5.75			G56582	20.74	13.59	7.15		
G56532	18.37	12.62	5.75			G56585	19.25	12.87	6.37		

SPECIFICATIONS BY PART NUMBER

ULTRA STRUTS (CONT'D)

CATALOG PART NO.	EXTENDED LENGTH	COLLAPSED LENGTH	STROKE	UPPER MTG CODE	LOWER MTG CODE	CATALOG PART NO.	EXTENDED LENGTH	COLLAPSED LENGTH	STROKE	UPPER MTG CODE	LOWER MTG CODE
G56586	19.25	12.87	6.37			G56640	22.12	14.37	7.75		
G56587	16	11.75	4.25			G56641	22.12	14.37	7.75		
G56588	25.37	18.00	7.37			G56642	17.3	11.14	6.16		
G56589	25.37	18.00	7.37			G56643	17.3	11.14			
G56591	17.5	12.12	5.37	SS2		G56644	19.07	12.00	7.07		
G56592	20.75	15.75	5	SS2		G56645	19.07	12.00	7.07		
G56593	25.25	17.37	7.87			G56655	20.03	13.38	6.65		
G56594	20.03	15.23	4.8			G56660	19.62	13.87	5.75		
G56595	20.03	15.23	4.81			G56661	19.62	13.87	5.75		
G56596	18.25	13.50	4.75	SS2		G56664	17.86	12.45	5.41		
G56597	14.5	9.87	4.62			G56667	20.81	13.23	7.58		
G56598	19.74	15.23	4.51			G56668	20.81	13.23	7.58		
G56599	22.28	17.20	5.08			G56669	17.65	10.57	7.09		
G56600						G56670	17.65	10.57	7.09		
G56601	25	17.75	7.25			G56671	20.5	13.62	6.87	B10	
G56602	24.06	16.93	7.13			G56672	20.5	13.61	6.87	B10	
G56603	24.06	16.93	7.13			G56673	18.89	11.48	7.41		
G56604	20.71	15.98	4.73			G56674	18.89	11.48	7.41		
G56605	20.71	15.98	4.73			G56675	20.95	12.25	8.7		
G56606	19.65	13.23	6.42			G56676	20.95	12.25	8.7		
G56607	16.14	11.81	4.33			G56677	19.87	13.37	6.5		
G56608	17.13	12.2	4.93			G56678	19.87	13.37	6.5		
G56611	19.25	12.97	6.28			G56679	21.26	15.9	5.36	B2	
G56612	20.39	14.21	6.18			G56680	21.26	15.9	5.36	B2	
G56615	22.62	16.00	6.62			G56681	23.3	15.26	8.04		
G56616	22.62	16.00	6.62			G56682	23.3	15.26	8.04		
G56618	18.75	12.87	5.88			G56683	21.12	14.37	6.75	B10	
G56619	18.75	12.87	5.88			G56684	21.12	14.37	6.75	B10	
G56620	18.6	12.14	6.47			G56685	21.12	14.37	6.75	B11	
G56621	19.12	13.00	6.12			G56686	21.12	14.37	6.75	B11	
G56622	19.12	13.00	6.12			G56687	22.56	15.98	6.58		
G56624	25.37	18.00	7.37			G56688	22.56	15.98	6.58		
G56625	25.37	18.00	7.37			G56689	19.12	13.12	6		
G56626	19.12	13	6.12			G56690	19.12	13.12	6		
G56627	19.12	13	6.12			G56691	22.5	14.75	7.75		
G56628	21.5	13.62	7.87	B2		G56700	17.19	10.57	6.62		
G56629	21.5	13.62	7.87	B2		G56701	18.49	11.34	7.15		
G56631	20.74	13.59	7.15			G56703	17.90	10.85	7.05		
G56632	20.74	13.59	7.15			G56704	17.73	11.07	6.66		
G56633	20.08	12.52	7.56			G56705	17.63	11.28	6.36		
G56634	20.08	12.52	7.56			G56706	17.63	11.28	6.36		
G56635	16.6	10.42	6.18			G56707	21.6	13.77	7.84		
G56636	16.6	10.42	6.18			G56708	18.77	10.85	7.92		
G56637	22.12	14.12	8			G56713	18.01	10.76	7.25		

SPECIFICATIONS BY PART NUMBER

ULTRA STRUTS (CONT'D)

CATALOG PART NO.	EXTENDED LENGTH	COLLAPSED LENGTH	STROKE	UPPER MTG CODE	LOWER MTG CODE	CATALOG PART NO.	EXTENDED LENGTH	COLLAPSED LENGTH	STROKE	UPPER MTG CODE	LOWER MTG CODE
G56714	18.53	10.62	7.91			G56773	20.94	12.87	8.07	B13	
G56715	17.84	9.98	7.87			G56774	20.94	12.87	8.07	B13	
G56716	17.43	10.89	6.54			G56775	16.98	9.9	7.08		
G56717	17.9	10.86	7.05			G56776	16.98	9.9	7.08		
G56718	18.63	11.07	7.57			G56778	21.37	14.37	7		
G56719	20.04	13.26	6.78			G56781	19.37	14.00	5.37		
G56720	17.63	11.28	6.36			G56782	19.37	14.00	5.37		
G56721	18.91	11.48	7.43			G56784	20.25	14.25	6		
G56722	18.91	11.48	7.43			G56785	20.25	14.25	6		
G56723	17.63	11.28	6.36			G56786	13.37	8.50	4.87		
G56724	17.63	11.28	6.36			G56787	13.37	8.50	4.87		
G56728	20.95	12.25	8.7			G56790	18.5	12.87	5.62	B7	
G56729	20.95	12.25	8.7			G56791	20.25	16.12	4.13		
G56730	23.72	16.95	6.77			G56792	19.5	16.12	3.38		
G56731	23.72	16.95	6.77			G56793	19.13	13	6.13		
G56732	22.91	15.41	7.50			G56794	19.13	13	6.13		
G56733	22.91	15.41	7.50			G56795	20.62	14.75	5.87	B11	
G56734	24.31	17.32	6.99			G56796	20.67	14.21	6.46		
G56735	24.31	17.32	6.99			G56797	23.82	16.54	7.28		
G56736	23.31	16.65	6.66			G56798	23.54	16.34	7.2		
G56739	23.31	16.65	6.66			G56799	21.1	14.53	6.57	B17	
G56750	18.74	12.76	5.98			G56800	21.1	14.53	6.57	B17	
G56751	18.74	12.76	5.98			G56801	17.25	11.75	5.5	B2	
G56752	18.74	12.76	5.98			G56802	20.75	14.12	6.63	B11	
G56753	18.74	12.76	5.98			G56803	21.43	14.98	6.45	B16	
G56754	19.45	12.76	6.69			G56804					
G56755	19.45	12.76	6.69			G56805	18.75	12.75	6.00	B10	
G56756	18.35	12.76	5.59			G56806	18.75	12.75	6.00	B10	
G56757	14.7	9.34	5.36			G56807	21	14.25	6.75		
G56758	21.75	14.50	7.25	B17		G56809	19.75	13.12	6.62		
G56759	27.75	14.50	13.25			G56810	20	13.50	6.5		
G56760	21.5	17.00	4.5			G56812	16.62	10.32	6.37		
G56761	21.5	17.00	4.5			G56813	21.73	15.75	5.98		
G56762	20.5	14.00	6.5	B9		G56814	21.73	15.75	5.98		
G56763	23.25	15.75	7.5			G56815	22	15.37	6.62		
G56764	23.25	15.75	7.5			G56816	22	15.37	6.62		
G56765	19.87	14.25	5.62			G56817	16.59	10.9	5.69		
G56766	19.87	14.25	5.62			G56819	21.35	15.18	6.16	B12	
G56767	21.75	14.37	7.37	B9		G56820	21.35	15.18	6.16	B12	
G56768	21.75	14.37	7.37	B9		G56821	23.27	15.90	7.36		
G56769	21.75	14.50	7.25			G56822	23.27	15.90	7.36		
G56770	22.25	17.12	5.12			G56836	18.84	13.12	5.72		
G56771	22.25	17.12	5.12			G56837	18.84	13.12	5.72		
G56772	20.8	13.38	7.42	B18		G56838	21.06	17.99	3.07		

SPECIFICATIONS BY PART NUMBER

ULTRA STRUTS (CONT'D)

CATALOG PART NO.	EXTENDED LENGTH	COLLAPSED LENGTH	STROKE	UPPER MTG CODE	LOWER MTG CODE
G56839	19.33	13.42	5.91		
G56840	20.51	13.63	6.88		
G56841	20.51	13.63	6.88		
G56842	19.47	13.41			
G56843	19.47	13.41			
G56882	20.44	13.69	6.75		
G56883	20.44	13.69	6.75		
G56884	22.34	14.9	7.44		
G56885	22.34	14.9	7.44		
G56886	20.09	13.79	6.30		

CATALOG PART NO.	EXTENDED LENGTH	COLLAPSED LENGTH	STROKE	UPPER MTG CODE	LOWER MTG CODE
G56887	20.09	13.79	6.30		
G56888	21.38	14.49	6.89		
G56889	21.38	14.49	6.89		
G56890	20.47	13.31	7.16		
G56891	20.47	13.31	7.16		
G56892	17.87	12.24	5.63		
G56893	17.87	12.24	5.63		
G56894	20.98	14.29	6.69		
G56899	21.1	14.8	6.30		
G56903	21.92	15.19	6.74		

ULTRA TRUCK SHOCKS

CATALOG PART NO.	EXTENDED LENGTH	COLLAPSED LENGTH	STROKE	UPPER MTG CODE	LOWER MTG CODE
G63173	21.86	13.58	8.28	EB1	EB1
G63183	20.79	13.01	7.78	EB4	EB4
G63187	22.92	13.39	9.53	S1	S1
G63299	18.08	11.55	6.53	EB1	EB1
G63306	19.85	12.57	7.28	ES24	ES24
G63347	18.08	11.55	6.53	ES31	ES35
G63349	23.33	14.3	9.03	EB1	ES34
G63350	18.82	11.79	7.03	S1	ES25
G63353	24.74	14.96	9.78	ES27	EB4
G63355	14.98	9.95	5.03	EB1	ES24
G63357	14.98	9.95	5.03	ES24	ES24
G63359	13.7	8.92	4.78	S1	BP13
G63360	15.7	9.92	5.78	S1	BP13
G63366	23.26	14.23	9.03	ES34	ES34
G63371	21.98	13.45	8.53	ES24	ES24
G63375	14.14	9.11	5.03	S12	BP7
G63377	20.08	12.55	7.53	EB1	ES25
G63386	16.11	10.58	5.53	S36	ES25
G63387	23.32	14.04	9.28	S1	ES25
G63389	28.74	16.96	11.78	ES27	EB4
G63394	16.01	10.48	5.53	EB1	ES24
G63396	16.55	10.77	5.78	S12	ES25
G63398	20.42	12.14	8.28	S1	S1
G63403	24.58	14.8	9.78	ES26	ES26
G63404	17.05	11.02	6.03	S1	ES64
G63405	20.01	12.48	7.53	EB1	EB1
G63406	22.98	13.95	9.03	EB1	ES185
G63409	21.48	13.2	8.28	EB1	ES185
G63410	18.55	11.77	6.78	S12	EB1
G63411	18.58	11.8	6.78	ES31	ES26

CATALOG PART NO.	EXTENDED LENGTH	COLLAPSED LENGTH	STROKE	UPPER MTG CODE	LOWER MTG CODE
G63413	20.76	12.98	7.78	ES27	ES27
G63414	15.09	10.06	5.03	S36	ES41
G63416	18.55	11.77	6.78	S12	ES185
G63418	13.95	9.17	4.78	S1	BP11
G63419	24.08	14.55	9.53	EB1	EB1
G63420	27.08	16.05	11.03	EB1	ES106
G63421	13.7	8.92	4.78	S1	BP30
G63422	24.01	14.48	9.53	BP14	ES34
G63423	16.76	10.73	6.03	ES26	ES26
G63424	20.45	12.67	7.78	S1	BP7
G63425	20.01	12.48	7.53	BP20	EB1
G63426	18.01	11.48	6.53	ES18	ES18
G63427	22.98	13.95	9.03	EB1	ES106
G63432	21.11	12.83	8.28	S1	EB19
G63434	22.68	13.9	8.78	EB19	S32
G63437	23.33	14.05	9.28	ES31	ES24
G63438	29.33	17.3	12.03	EB1	ES34
G63439	29.76	17.23	12.53	EB1	ES185
G63440	26.33	15.55	10.78	EB1	EB1
G63441	26.33	15.55	10.78	EB1	ES25
G63443	23.33	13.95	9.38	EB1	EB1
G63444	23.3	14.02	9.28	S1	ES64
G63445	23.09	14.06	9.03	S36	ES185
G63446	23.3	14.02	9.28	S12	EB1
G63447	30.18	17.65	12.53	S12	ES25
G63454	22.79	14.01	8.78	ES141	ES141
G63455	22.98	13.95	9.03	ES41	ES41
G63456	26.85	16.07	10.78	EB1	ES185
G63457	13.7	8.92	4.78	S1	BP4
G63460	23.16	14.13	9.03	BP13	ES27

SPECIFICATIONS BY PART NUMBER

ULTRA TRUCK SHOCKS (CONT'D)

CATALOG PART NO.	EXTENDED LENGTH	COLLAPSED LENGTH	STROKE	UPPER MTG CODE	LOWER MTG CODE	CATALOG PART NO.	EXTENDED LENGTH	COLLAPSED LENGTH	STROKE	UPPER MTG CODE	LOWER MTG CODE
G63461	25.51	15.23	10.28	EB1	ES41	G63640	23.89	15.11	8.78	ES152	ES153
G63479	13.95	9.17	4.78	S1	ES113	G63660	25.08	15.05	10.03	EB1	EB1
G63484	20.05	12.52	7.53	S8	EB1	G63661	13.8	9.52	4.28	S38	ES34
G63488	26.61	16.33	10.28	BP14	ES34	G63662	24.58	15.05	9.53	ES34	ES34
G63489	14.42	9.64	4.78	S29	BP11	G63671	22.48	13.7	8.78	ES26	ES26
G63490	19.08	12.05	7.03	EB1	ES25	G63673	22.3	13.77	8.53	S38	ES34
G63491	19.05	11.77	7.28	EB1	S1	G63674	23.39	14.36	9.03	S38	ES34
G63492	22.58	13.8	8.78	EB1	EB1	G63675	26.86	16.08	10.78	ES34	ES34
G63494	22.39	13.86	8.53	EB19	EB19	G63676	15.48	10.45	5.03	ES69	ES69
G63495	14.95	9.67	5.28	S1	ES64	G63678	18.09	13.56	4.53	S36	BP7
G63499	25.58	15.3	10.28	BP13	ES26	G63679	25.01	14.98	10.03	BP14	ES185
G63500	15.09	10.06	5.03	S36	ES25	G63683	21.14	13.36	7.78	EB5	ES24
G63502	18.51	11.98	6.53	ES25	ES141	G63689	19.08	12.05	7.03	EB1	EB1
G63506	21.4	12.64	8.76	S32	S32	G63690	18.01	11.48	6.53	ES18	ES18
G63510	21.29	13.26	8.03	EB19	EB19	G63692	27.58	16.3	11.28	EB1	EB1
G63511	22.45	13.42	9.03	S1	ES25	G63694	22.18	13.4	8.78	S38	EB20
G63524	27.08	16.05	11.03	EB1	ES185	G63707	15.89	10.11	5.78	S12	ES64
G63525	22.98	13.95	9.03	EB1	ES185	G63708	19.74	12.46	7.28	ES48	EB19
G63547	13.61	9.08	4.53	S1	ES113	G63710	18.96	11.93	7.03	S1	ES153
G63548	21.11	13.08	8.03	S12	EB19	G63712	22.48	13.7	8.78	ES110	ES19
G63603	16.12	10.59	5.53	S36	ES185	G63714	15.39	9.86	5.53	S62	BP7
G63604	19.74	12.46	7.28	EB1	ES142	G63715	28.55	16.52	12.03	S12	ES171
G63605	24.24	14.71	9.53	EB19	ES27	G63716	16.39	9.86	6.53	S62	ES26
G63606	21.29	13.51	7.78	ES152	ES153	G63717	22.98	13.95	9.03	ES41	ES41
G63607	25.58	15.3	10.28	BP14	ES185	G63720	21.39	12.86	8.53	S36	ES22
G63608	14.56	9.78	4.78	S36	EB1	G63721	20.21	12.43	7.78	S12	BP11
G63609	16.5	10.97	5.53	ES126	ES128	G63722	19.49	12.21	7.28	BP20	ES24
G63610	21.95	13.17	8.78	S47	EB1	G63726	21.05	12.77	8.28	S12	EB19
G63611	14.95	9.67	5.28	S1	ES64	G63772	13.73	9.45	4.28	S36	BP10
G63612	14.45	9.67	4.78	S1	ES64	G63773	22.98	13.95	9.03	EB1	ES185
G63614	15.09	10.06	5.03	S36	EB1	G63775	27.08	16.05	11.03	EB1	ES185
G63615	23.66	13.88	9.78	S38	S38	G63776	20.76	12.98	7.78	ES185	ES185
G63616	23.78	14.25	9.53	S38	EB19	G63778	24.55	14.52	10.03	S12	ES171
G63617	27.58	16.3	11.28	ES83	EB1	G63781	18.45	11.93	6.52	S1	ES113
G63620	19.55	12.27	7.28	EB1	S17	G63782	13.7	9.09	4.61	S1	ES118
G63621	16.46	10.93	5.53	S12	BP7	G63783	14.59	10.21	4.38	S12	BP11
G63622	15.32	10.29	5.03	S36	EB1	G63798	15.98	10.2	5.78	S1	EB1
G63623	22.57	14.29	8.28	S36	ES185	G63799	18.55	11.77	6.78	S1	ES185
G63624	20.17	12.64	7.53	S36	ES185	G63803	15.36	10.33	5.03	S12	U Bracket
G63625	22.56	13.78	8.78	EB1	ES24	G63808	28.86	17.08	11.78	EB1	ES185
G63626	21.14	13.36	7.78	EB5	ES24	G63809	22.98	13.95	9.03	EB1	ES185
G63635	14.45	9.42	5.03	S1	ES69	G63810	31.6	18.57	13.03	EB1	ES185
G63638	24.33	14.8	9.53	BP14	ES34	G63811	25.51	15.23	10.28	EB1	ES41
G63639	24.16	14.63	9.53	EB19	ES69	G63812	22.56	13.78	8.78	ES86	ES36

SPECIFICATIONS BY PART NUMBER

ULTRA TRUCK SHOCKS (CONT'D)

CATALOG PART NO.	EXTENDED LENGTH	COLLAPSED LENGTH	STROKE	UPPER MTG CODE	LOWER MTG CODE	CATALOG PART NO.	EXTENDED LENGTH	COLLAPSED LENGTH	STROKE	UPPER MTG CODE	LOWER MTG CODE
G63813	12.23	8.45	3.78	S47	ES64	G63897	23.87	14.68	9.19	BP14	ES34
G63815	21.95	13.17	8.78	S47	ES64	G63898	25.19	15.31	9.88	BP14	ES34
G63817	15.8	11.02	4.78	S12	ES60	G63900	14.1	9.34	4.76	S1	BP4
G63818	16.51	10.98	5.53	ES126	ES128	G63902	12.6	8.59	4.01	S1	ES64
G63828	23.16	15.13	8.03	S21	EB20	G63903	14.7	9.34	5.36	S1	BP14
G63829	22.52	13.74	8.78	ES88	ES65	G63904	14.95	9.95	5.00	S1	ES64
G63832	17.16	11.38	5.78	S21	ES153	G63905	14.7	9.34	5.36	S1	ES76
G63837	28.23	17.95	10.28	BP8	ES41	G63906	20.49	12.63	7.86	ES27	ES27
G63842	23.33	14.8	8.53	ES18	ES126	G63907	20.23	12.37	7.86	EB1	EB1
G63844	22.52	13.74	8.78	ES87	ES19	G63908	18.23	11.37	6.86	ES31	ES24
G63845	24.58	14.8	9.78	ES87	ES19	G63909	14.11	9	5.11	S1	ES64
G63847	20.45	12.67	7.78	S1	BP7	G63914	21.12	16.31	4.81	S29	ES84
G63848	15.87	10.59	5.28	S38	ES34	G63915	13.2	8.59	4.61	S1	BP7
G63860	24.33	14.39	9.94	S1	EB1	G63918	21.25	13.56	7.69	ES34	ES141
G63862	25.07	14.94	10.13	S1	ES67	G63919	21.25	13.56	7.69	ES58	ES153
G63864	15	10.56	4.44	ES67	ES61	G63928	22.73	13.87	8.86	EB1	EB1
G63866	22.81	14.12	8.69	ES34	ES34	G63929	14.72	9.71	5.01	S36	EB1
G63867	27.31	16.37	10.94	ES82	ES82	G63937	14.7	9.34	5.36	S1	BP19
G63868	15.61	10.67	4.94	ES164	ES68	G63949	17.73	11.12	6.61	EB1	EB1
G63869	20.26	12.82	7.44	ES41	ES41	G63950	14.2	9.09	5.11	S1	BP7
G63870	24.89	15.2	9.69	ES82	ES82	G63958	13.8	9.13	4.67	S29	BP13
G63872	21.65	13.29	8.36	ES128	ES128	G63959	24.78	15.84	8.94	ES34	ES34
G63873	15.75	10.56	5.19	ES82	ES82	G63961	26.51	16.12	10.39	ES34	ES34
G63875	17.67	11.73	5.94	ES13	ES13	G63962	26.05	15.87	10.18	ES34	ES34
G63877	16.93	11.24	5.69	ES69	ES69	G63963	24.75	15.06	9.69	EB1	ES185
G63878	24.16	14.97	9.19	ES34	ES13	G63964	25.48	15.53	9.95	EB1	ES185
G63879	23	14.31	8.69	BP10	ES34	G63965	24.14	15.2	8.94	BP14	ES34
G63880	22.5	14.06	8.44	BP18	ES18	G63966	22.45	14.5	7.95	BP18	ES26
G63881	14.71	9.49	5.22	S1	ES25	G63967	22.62	14.43	8.19	BP18	ES26
G63882	21	13.31	7.69	BP10	ES34	G63969	20.75	13.31	7.44	S62	ES34
G63883	22.82	14.38	8.44	ES34	ES13	G63970	27.58	17.14	10.44	ES34	ES34
G63884	14.72	9.78	4.94	S47	EB13	G63971	27.58	17.14	10.44	ES34	ES34
G63885	22.24	13.56	8.68	S59	ES36	G64000	27.36	17.68	9.68	ES34	ES34
G63886	20.8	13.36	7.44	S38	ES34	G64001	14.67	11.47	3.20	S11	U Bracket
G63887	29.71	17.77	11.94	EB1	ES41	G64002	20.15	13.96	6.19	ES83	ES83
G63888	31.36	18.67	12.69	EB1	ES41	G64003	16.84	11.28	5.56	ES69	ES69
G63889	20.44	12.75	7.69	S1	ES81	G64004	19.07	12.13	6.94	S1	ES81
G63890	23.97	15.28	8.69	ES87	ES87	G64005	19.75	12.31	7.44	S1	ES81
G63891	23.97	15.28	8.69	ES87	ES87	G64006	22.75	13.81	8.94	S1	ES81
G63892	23.97	15.28	8.69	ES19	ES87	G64007	22.75	13.81	8.94	S1	ES81
G63893	15.07	10.44	4.63	S11	U Bracket	G64008	21.79	13.6	8.19	S57	ES26
G63894	12.82	8.88	3.94	S11	BP9	G64009	23.29	14.25	9.04	S38	ES34
G63895	14.12	9.68	4.44	S11	BP9	G64010	26.94	16	10.94	EB1	ES83
G63896	22.36	13.92	8.44	BP14	ES34	G64011	23.36	14.21	9.15	S62	ES87

SPECIFICATIONS BY PART NUMBER

ULTRA TRUCK SHOCKS (CONT'D)

CATALOG PART NO.	EXTENDED LENGTH	COLLAPSED LENGTH	STROKE	UPPER MTG CODE	LOWER MTG CODE
G64012	24.11	15.17	8.94	ES88	ES69
G64013	26.52	16.33	10.19	ES34	ES34
G64014	22.75	14.56	8.19	ES47	ES45
G64015	21.32	13.63	7.69	ES45	ES128
G64016	15.91	11.22	4.69	ES19	ES17
G64026	16.26	11.57	4.69	ES73	ES73
G64027	13.62	8.74	4.88	S47	ES118
G64028	20.75	13.19	7.56	EB16	ES113
G64029	21.73	13.54	8.19	S38	ES36
G64030	22.56	13.86	8.70	S38	ES36
G64031	21.19	13.5	7.69	ES34	EB1
G64032	18.7	12.09	6.61	ES49	ES49
G64033	14.72	10.36	4.36	ES51	ES51
G64036	22.67	13.66	9.01	S45	ES51
G64037	26.37	15.47	10.9	S55	ES147
G64038	24.48	15.07	9.41	S63	ES69
G64040	15.9	11.1	4.8	ES42	ES50

CATALOG PART NO.	EXTENDED LENGTH	COLLAPSED LENGTH	STROKE	UPPER MTG CODE	LOWER MTG CODE
G64042	14.92	10.55	4.37	ES18	ES18
G64043	14.09	9.68	4.41	S61	
G64044	25.98	16.22	9.76	ES49	ES49
G64046	18.62	14.72	3.9	S65	ES93
G64047	25.03	15	10.03		
G64048	17.16	11.57	5.59	ES75	ES113
G64049	14.96	11.65	3.31	S51	ES55
G64050	19.55	12.91	6.65	ES30	ES137
G64052	20.86	13.11	7.75	ES83	ES83
G64056	20.51	13.11	7.4	S18	ES83
G64071					
G64079	29.37	17.32	12.05	ES83	ES83
G64080	21.57	17.72	3.85	ES69	ES33
G64087	22.63	13.78	8.85		
G64101					
G64107					

DISPOSAL OF OLD OR DEFECTIVE GAS-PRESSURIZED SHOCKS & STRUTS

STORAGE OF USED SHOCK ABSORBERS AND STRUTS

Used struts and shocks should be stored so that any oil leakage will be properly collected. Those containers used to store this product should be labeled "USED OIL".

Used struts and shocks can either be punctured to recycle the shock oil or disposed of in a manner consistent with local or state programs.

RECYCLING OF SHOCK AND STRUT OIL

1. FOR YOUR SAFETY, ALWAYS WEAR SAFETY GLASSES AND PROTECTIVE GLOVES WHEN PUNCTURING STRUTS AND SHOCKS.
2. Securely mount the strut or shock in a vice in the horizontal position. Make sure that the piston rod is fully extended prior to drilling the unit (Fig. #1).
3. Using a 1/16" or 1/8" drill bit, drill a hole in a downward direction approximately 1.0" from the bottom of the strut or shock (Fig #2). It is important to cover the area where the hole is being drilled with a towel or some type of shield to prevent spraying gas and oil upon initial penetration of the drill bit.
4. After the gas pressure is released continue drilling into the inner cylinder of the strut or shock unit, approximately 1/2" deep. Drill a second 1/2" hole near the top of the unit.
5. Remove the strut or shock from the vice and hold it over a container to collect the used oil. Hand stroke the unit to completely purge the oil from the cylinder of the unit (Fig #3).
6. Collect all used oil, **being careful not to mix this oil with any other waste or refuse**. Store in DOT approved containers labeled "USED OIL".
7. Dispose of the remaining strut or shock body and internal parts in accordance with local or state regulations (e.g., scrap metal recycler).
8. Store, dispose, and/or transport used oil in accordance with EPA regulations and your state's used oil program.

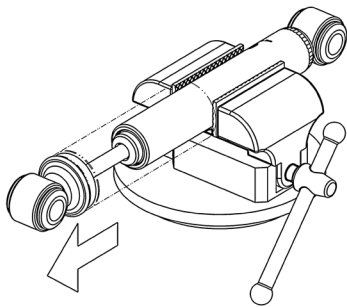

FIG. #1

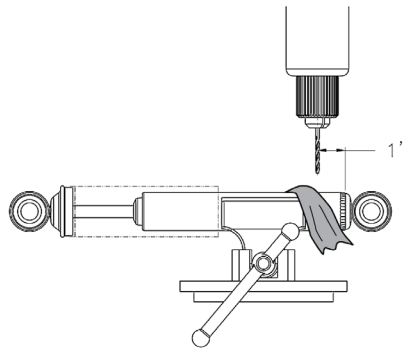

FIG. #2

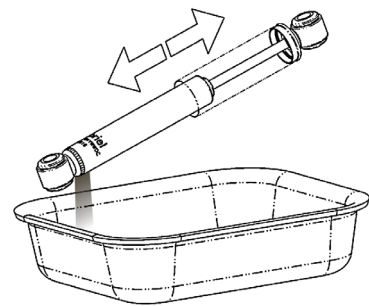

FIG. #3

DISPOSITION DE VIEUX OU DÉFECTUEUX CHOCS ET DE CONTREFICHES DE GAS-PRESSURIZED STOCKAGE DES AMORTISSEURS ET DES CONTREFICHES UTILISÉS

Des contrefiches utilisées et les chocs devraient être stockés de sorte que n'importe quelle fuite d'huile soit correctement rassemblée. Ces récipients stockaient ce produit devraient être marqués "HUILE USÉE".

Des contrefiches utilisées et les chocs peuvent se crever pour réutiliser l'huile de choc ou en quelque sorte le conformé débarassé aux programmes de gens du pays ou d'état.

RÉUTILISATION DU CHOC ET DE L'HUILE DE CONTREFICHE

1. POUR VOTRE SÛRETÉ, TOUJOURS VERRES DE SÛRETÉ D'USAGE ET GANTS PROTECTEURS EN CREVANT DES CONTREFICHES ET DES CHOCS.
2. Montez solidement la contrefiche ou la choquez dans un vice en position horizontale. Assurez-vous que la tige de piston est entièrement prolongée avant de forer l'unité (Fig. # 1).
3. Emploi d'un morceau de foret de 1/16" ou de 1/8", forez un trou dans un sens de haut en bas approximativement 1.0" du fond de la contrefiche ou le choquez (Fig. # 2). Il est important de couvrir le domaine où le trou est foré avec un essuie-main ou un certain type d'écran protecteur pour empêcher pulvériser le gas et le pétrole sur la pénétration initiale du morceau de foret.
4. Après que la pression de gaz soit libérée continuent de forer dans le cylindre intérieur de la contrefiche ou choquez l'unité, approximativement 1/2" profondément. Trou forez deuxième 1/2" près du dessus de l'unité.
5. Enlevez la contrefiche ou la choquez du vice et tenez-l'au-dessus d'un récipient pour rassembler la huile usée. Course de main l'unité pour purger complet l'huile du cylindre de l'unité (Fig. # 3).
6. Rassemblez toute la huile usée, **faisant attention à ne pas mélanger cette huile à tout autre erte ou à ne pas refuser.** Le magasin dans le POINT a reconnu des récipients marqués "HUILE USÉE."
7. Débarassez-vous de la contrefiche restante ou choquez le corps et les pièces internes selon les règlements de gens du pays ou d'état (e.g., recycleur en métal de chute).
8. Magasin, disposez, etou le transport a employé l'huile selon des règlements d'EPA et le programme de la huile usée de votre état.

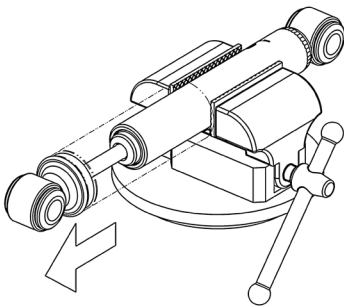

FIG. #1

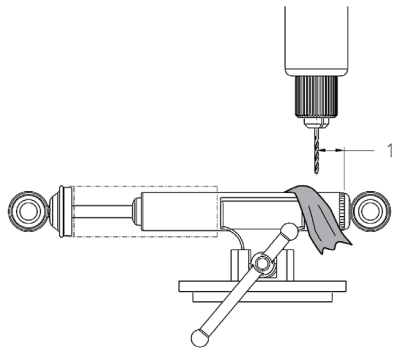

FIG. #2

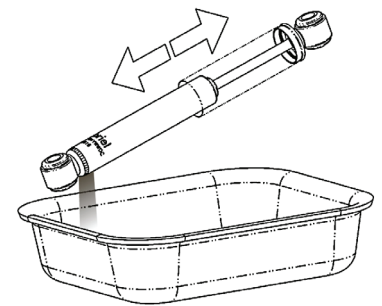

FIG. #3

COMO DESHACERSE DE AMORTIGUADORES Y STRUTS VIEJOS O DEFECTUOSOS-SIN PRESURIZACION CON GAS ALMACENAJE DE AMORTIGUADORES Y STRUTS USADOS

Los struts y amortiguadores deben almacenarse para que el aceite se pueda recoger. Los recipientes que se usen para almacenar este producto deben tener una etiqueta que diga: "ACEITE USADO".

Los struts y amortiguadores pueden ser perforados para reciclar el aceite o deshacerse de una manera constante con un programa local o del estado.

RECYCLAJE DEL ACEITE DE AMORTIGUADOR Y STRUT

1. PARA SU SEGURIDAD, SIEMPRE USE ANTEOJOS DE SEGURIDAD Y GANTES CUANDO PERFORE LOS STRUTS Y LOS AMORTIGUADORES.
2. Asegure la montura del strut o amortiguador sobre una manija horizontalmente. Asegúrese de que la varilla del pistón este totalmente extendida antes de taladrar la unidad (Fig. #1).
3. Use una broca de taladro de 1/16" o de 1/8", taladre un hueco de para abajo, aproximadamente de 1.0" en la parte de abajo del strut o amortiguador (Fig. #2). Es importante cubrir el área en que taladre con una toalla o cualquier otra manera de protección, para evitar que el gas y el aceite salten por todas partes cuando haga la primera incisión con la broca.
4. Después de que la presión del gas salga continúe taladrando dentro del cilindro interior del strut o amortiguador, aproximadamente 1/2" de profundidad. Taladre un Segundo hueco de 1/2" cerca de la parte de arriba de la unidad.
5. Remueva el strut o amortiguador del la manija y sosténgala sobre un recipiente para coleccionar el aceite usado. Sacuda la unidad para sacarle completamente el aceite del cilindro de la unidad (Fig. #3).
6. Recoja el aceite usado, **tenga cuidado de no mezclar este aceite con otro desperdicio o basura.** Almacene en recipientes aprobados por el DOT con una etiqueta que diga: "ACEITE USADO."
7. Deshágase de los sobrados del strut o amortiguador y las partes interiores de acuerdo con las regulaciones locales o del estado (por ejemplo: reciclaje para sobras de metal).
8. Almacene, deshágase, y/o lleve el aceite usado de acuerdo con las regulaciones del EPA y el programa de aceite usado.

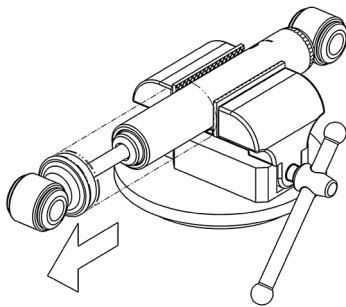

FIG. #1

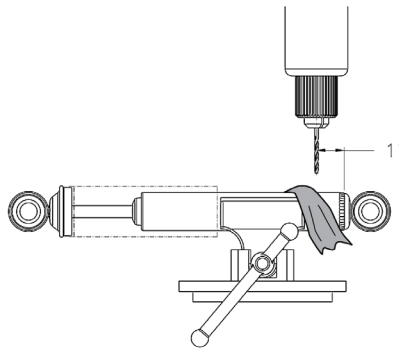

FIG. #2

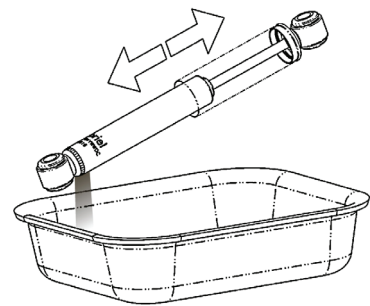

FIG. #3



100 Day Gabriel® Ride Guarantee*

Garantie Gabriel® Ride de 100 Jours*
Garantía* "Gabriel® Ride" de 100 Dias

Ride Control, LLC is so confident that your customer will be satisfied with their purchase of Ride Control Products (ReadyMount,® Ultra,™ ProGuard,™ Guardian,™ MaxControl,™ LTV,™ or Hijackers,®) that we are offering a 100 Day "Ride Control" Guarantee.

- 1) To qualify for the guarantee, purchase and install any pair or set of four Ride Control, LLC products on the same vehicle.
- 2) Retain the ride control equipment that was removed from vehicle (place aside in your shop or give to customer).
- 3) If, at any time during the next 100 days from installation, the customer is not satisfied with their new Ride Control products, Ride Control, LLC will pay for labor (\$10 per shock or \$25 per strut) to re-install the original products or new product acquired somewhere else.
- 4) Submit invoice from your supplier for Ride Control product and copy of your labor bill for credit from your supplier.
- 5) Credit for the product only will be handled in the same manner as any other warranty issue. The product would be returned to your supplier, who will then issue credit to you. Ride Control will then credit your supplier.
- 6) Once the product is returned to your supplier, they will notify the Ride Control Warranty Administrator (800.251.5932 ext. 362) to issue a check to you for the labor. The back up items mentioned above (#4 and #5) would need to be faxed to the Warranty Administrator at 615.221.7190.

*This offer does not include units improperly installed, used or substituted. Valid only on vehicles used for private, non-commercial use and may be withdrawn at any time.

Nous sommes tellement sûrs que vos clients seront satisfaits de leur achat de produits Gabriel Ride Control pour le réglage de la suspension (ReadyMount,® Ultra,™ ProGuard,™ Guardian,™ MaxControl,™ LTV,™ ou Hijackers,®) que nous offrons une garantie de 100 jours sur ces produits Gabriel, la Garantie Gabriel Ride.

- 1) Pour avoir droit à la garantie, achetez et installez n'importe quel ensemble de deux ou quatre produits Gabriel Ride Control sur le même véhicule.
- 2) Conservez le système de réglage de la suspension qui a été retiré du véhicule (mettez-le de côté dans votre garage ou donnez-le au client.)
- 3) Si, à un moment quelconque pendant les 100 jours qui suivent l'installation, le client n'est pas satisfait de ses produits Gabriel neufs, Gabriel paiera pour la main-d'oeuvre (10 \$ par amortisseur ou 25 \$ par jambe de suspension) pour réinstaller les produits d'origine ou de nouveaux produits achetés ailleurs.
- 4) Soumettez la facture de votre fournisseur pour le produit Gabriel et une copie de votre facture pour la main-d'oeuvre en vue d'obtenir un crédit de votre fournisseur.
- 5) Le crédit pour le produit seulement sera traité de la même façon que toutes les autres transactions effectuées dans le cadre de la garantie. Le produit sera renvoyé à votre fournisseur, qui vous accordera alors un crédit. Gabriel créditera ensuite votre fournisseur.
- 6) Une fois que le produit aura été renvoyé à votre fournisseur, ce dernier demandera à l'Administrateur de la Garantie Gabriel (800.251.5932, poste 362) de vous envoyer un chèque pour rembourser les frais de main-d'oeuvre. Les justificatifs mentionnés ci-dessus (no 4 et n o 5) devront être envoyés par télécopie à l'Administrateur de la Garantie au 615.221.7190.

**Cette offre ne concerne pas les produits mal installés, utilisés ou substitués. Elle n'est valide que pour les véhicules non commerciaux à usage privé et peut être retirée à tout moment.*

Ride Control, LLC esta tan seguro que sus clientes estarán completamente satisfechos con la compra de sus productos llamados: Productos Ride Control (ReadyMount,® Ultra,™ ProGuard,™ Guardian,™ MaxControl,™ LTV,™ o Hijackers,®) que les estamos ofreciendo la garantía "Ride Control" por 100 Días.

- 1) Para calificar para la garantía, compre e instale cualquier par o un juego de cuatro productos de Ride Control, LLC para el mismo auto.
- 2) Guardar el equipo que fue quitado de su auto (guardelo en su tienda o delo al cliente.)
- 3) Si, en cualquier momento durante los siguientes 100 días de la instalación, el cliente no esta satisfecho con sus productos nuevos de Ride Control; Ride Control, LLC pagará por el trabajo (\$10 por el amortiguador y \$25 por el strut) de instalar de nuevo los productos originales o nuevos productos obtenidos en otra parte.
- 4) Mostrar factura de su vendedor de productos Ride Control y copia de la cuenta por el trabajo, para darle crédito de parte de su vendedor.
- 5) El crédito por su producto será manejado de la misma manera como cualquier otra garantía. El producto será devuelto a su vendedor, el cual le dará el crédito. Ride Control le dará crédito a su vendedor.
- 6) Una vez que el producto es entregado a su vendedor, ellos le avisaran al departamento de garantías Ride Control Warranty Administrator (800.251.5932 ext. 362) para hacerle un cheque a usted por el trabajo. Los puntos mencionados anteriormente (#4 y #5) deben ser enviados por fax al: Warranty Administrator 615.221.7190.

**Esta oferta no incluye unidades instaladas inapropiadamente, usadas o sustituidas. Valida únicamente en autos de uso privados, no-comerciales, y puede ser cancelada en cualquier momento.*

THE ANSWERMAN

QUESTIONS ANSWERED.
800.999.3903 | GABRIEL.COM

With the Gabriel® Answerman, you never get automated voices – just expert answers. If you have a question for the Answerman, call toll-free or go to gabriel.com and check out our Answerman FAQs, articles, technical bulletins and in-depth videos for the answers you need to get the job done right.

RÉPONSE À VOS QUESTIONS.
800.999.3903 | gabriel.com

Avec le répondant Gabriel®, vous n'avez jamais de message vocal automatisé – simplement des réponses expertes. Si vous avez une question à poser au répondant, appelez sans frais, ou rendez vous sur gabriel.com et vérifiez nos FAQ de répondant, articles, bulletins techniques et vidéos en profondeur pour les réponses dont vous avez besoin pour faire du bon travail.

PREGUNTAS.
800.999.3903 | GABRIEL.COM

Con el servicio Gabriel® Answerman, usted nunca recibe mensajes automatizados, solamente respuestas expertas. Si tiene alguna pregunta para el Answerman, llame gratuitamente o visite el sitio web gabriel.com y revise las preguntas frecuentes al Answerman, artículos, boletines técnicos y videos detallados para obtener las respuestas que necesita para hacer el trabajo correctamente.

The Original
Gabriel®

Ride Control Answerman/Tech Line:

800.999.3903

For application, technical and product questions

Monday - Friday, 8AM - 5PM CT

Gabriel Customer Service:

800.251.5932

To place and track orders

Monday - Friday, 7AM - 5PM CT

Distributed by:

gabriel.com

Ride Control, LLC, 750 Old Hickory Boulevard, Suite 1-180
Brentwood, TN 37027, 615.221.7433

This catalog may be used only to specify and sell products of Ride Control, LLC, its subsidiaries and affiliated companies. Use to specify and sell any other products is a copyright violation.

Ce catalogue peut être utilisé uniquement pour spécifier et vendre les produits de Ride Control, LLC, ses filiales et ses sociétés affiliées. Son utilisation autre peut constituer une violation du droit d'auteur.

Este catálogo puede ser usado únicamente para especificar y vender productos de Ride Control, LLC, sus subsidiarios y sus compañías afiliadas. Si se usa para especificar o vender otros productos es una violación de los derechos de autor.



Gabriel®

2015 Shock & Strut Catalog

Form 1212952 | 2015