



FOR TRUCK TRAILER AND BUS SHOCKS



www.gabriel.com

Table of Contents

New Part Numbers / Part Numbers Superseded	2
Application and Numerical Listings	
Specialty Shocks	3
Medium Duty & Heavy Duty Trucks, Trailers & Buses Application Listing	5
Medium Duty & Heavy Duty Trucks, Trailers & Buses Numerical Listing.....	206
Fleetline / GasSLX Interchange	218
Competitive and OEM Interchange	219
How to Determine the Correct Shock for Your Truck.....	264
Specifications by End Mount	272
Specifications by Part Number.....	286
Mounting Accessory Packages and Component Parts	300
Mounting Accessory Packages - Buyer's Guide	303

**NEW PART NUMBERS IN THIS CATALOG
NOUVEAUX NUMÉROS DE PIÈCES DANS CE CATALOGUE
NUMERACION NUEVA DE PARTES EN ESTE CATALOGO**

83065	83177	83518	85122	85180	85994
83066	83178	83519	85123	85181	85995
83067	83180	85109	85124	85351	85998
83175	83389	85119	85125	85745	85999
83176	83515	85120	85126	85746	

**PART NUMBERS SUPERSEDED
NUMÉROS DE PIÈCES REMPLACÉS
NUMERACION DE PARTES REEMPLAZADOS**

DELETE	THEN USE	DELETE	THEN USE
83032	83025	85330	85379
83200	89402	85714	85715
85050	83221	85717	85715
85312	85733	85718	85732
85324	85342	89403	89401

**PARTS TO BE DISCONTINUED WHEN INVENTORY IS DEPLETED
CES PIÈCES NE SERONT PLUS FABRIQUÉES UNE FOIS LES STOCK ÉPUISÉS
LAS PARTES SE DESCONTINUARÁN AL AGOTAR EXISTENCIAS**

83014	83172	85073	85701	85730	85913	85944	85949
83043	83173	85074	85703	85731	85940	85945	85950
83046	83353	85075	85707	85905	85941	85946	85951
83115	83634	85076	85710	85907	85942	85947	89412
83165	83636	85077	85719	85912	85943	85948	89416

**12 YEAR SUPERSEDURE LIST
LISTE DE REMPLACEMENT DES 12
LISTA DE REEMPLAZOS DE 12 AÑOS**

LAST YEAR IN CATALOG	DELETE	THEN USE	LAST YEAR IN CATALOG	DELETE	THEN USE
2006	83106	83136	2006	85326	85336
2006	83121	83137	2007	85328	83136
2007	83132	83140	2006	85922	85920
2005	85044	85058	2006	87001	85734
2007	85048	83136	2006	87002	85736
2006	85049	85071	2006	87004	85735
2007	85057	85907	2006	87006	85736
2007	85325	83136	2010	632155	646155 / 646177

APPLICATION GUIDE - SPECIALITY

Year Año Année	Model Modelo Modèle	OEM #	Fleetline #
ADVANCE MIXER			
	Rear Discharge Mixers with Self - Steering Axle Shock	12111 ADV	646155
CHALLENGE			
	Cement Mixer	632147 632155	632147 646177
GRANNING SUSPENSION			
	Model L120 Self Steer Axle	701071-01	646155
HENDRICKSON TRAILER SUSPENSION SYSTEMS			
Auxiliary Liftable Steerable System (HL)			
	HLP Paralift	A-14496	646155
	HLU Paralift Ultra	A-14496	646155
INGERSALL MACHINE			
	700060-0 Axle Assy.	665472	665472
	Models with O.E.M. Number	665904	665472
KIMBLE MIXER CO			
	Rear Discharge Mixers with Self - Steering Axle Shock	OE10455	646155
LINK/HIGH-STEER			
	6000 Steering Stabilizer	632155	646177
	9000 Steering Stabilizer	1210-0007 1210-0009	665937 665937
	Models with O.E.M. Number	1210-0001 1210-0002 1210-0010 1210-0012 646168	646155 632147 646155 646155 646155
LONDON MIXER			
	Rear Discharge Mixers with Self - Steering Axle Shock	MB-37737-30	646155
MC NEILUS TRUCK & MAN.			
	Booster Axles	1170719 600-115994B	632147 632147
	Bridgmaster V models with Self - Steering Axle Shocks	600-188206	646155
	Models with O.E.M. Number	1473224 2034140 MTM 600-11599M	646155 646155 632147
	Pusher Axles	600-115994B	632147
OSHKOSH MOTORS			
	Models with O.E.M. Number	2034140	646177
PIERCE MANUFACTURING INC.			
	Models with O.E.M. Number	2034140	646177
REX MIXER			
	Rear Discharge Mixers with Self - Steering Axle Shock	102-13441-10	646155
REYCO SUSPENSION			
	L132 Steering Stabilizer	701071-01	665937
RIDEWELL CORPORATION			
	RLT-230	1310002	665937
	RSS-232	1317570B001	646155
	RSS-236/R	1310002 1310004	665937 665937
SAF HOLLAND			
	Self - Steering Axle Shocks	646201 90045331	646177 646155

APPLICATION GUIDE - SPECIALITY

Year Año Année	Model Modelo Modèle	OEM #	Fleetline #
----------------------	---------------------------	-------	-------------

SAF HOLLAND (Cont'd.)

Neway V-Steer II (Cont'd.)

	Self - Steering Axle Shocks	632155	646177
--	-----------------------------	--------	--------

SPRING VALLEY

	SS120 Steering Stabilizer	632155	646177
	SS130L Steering Stabilizer	632155	646177

SUSPENSIONS INC.

	LP11 Steerable Lift Axle	200188	646155
--	--------------------------	--------	--------

TEREX CORPORATION

	Rear Discharge Mixers with Self - Steering Axle Shock	12111	646155
--	---	-------	--------

TUTHILL TECHNOLOGIES

	Models with O.E.M. Number	66502	646155
--	---------------------------	-------	--------

VARIOUS

Steering Stabilizer

	Various Class 8 Trucks with Front Axle Rating of 10,000 lb to 20,000 lb	SC-2920	83176
--	---	---------	-------

WATSON & CHALIN MFG. INC.

Self - Steering Axle Suspension Systems

	LW5L-1100 SR	11418	646155
	Models with O.E.M. Number	17069	632147
	SL-2089 Steerable Lift Axle Suspension	11418	646155
	WCAL-1000 SST	11418	646155
	WCAL-1100 LR	11418	646155
	WCAL-1100 SR	11418	646155
	WCAL-1100 SRLP	11418	646155
	WCAL-1100 SSR	11418	646155
	WCHL-1100 FL	11418	646155
	WCHL-1100 HI-LIFT	11418	646155

WESTPORT AXLE CORP

	Self - Steering Axle Shocks	143699-0185 646124	646177 646177
--	-----------------------------	-----------------------	------------------

APPLICATION GUIDE - TRUCKS, TRAILERS, AND BUSES

Year Año Année	Model Modelo Modèle	OEM #	Front		Rear	
			Fleetline	GasSLX	Fleetline	GasSLX

ABC BUS

	Drive Axle	12J-5-10		0 -	85733	...
	T2100 Van Hool Buses with O.E.M. Number (Front & Tag Axle)	10685703	- -	695406
		624314570	- -	695406
		90-2291	- -	695406
	Models with O.E.M. Number	050134513	0 0	85732
		12L-5-88		0 -	85729	...
		6243-13790	- -	85708
		6243-14040	- -	85708
	Additional O.E.M. Interchanges	12B-5-1	0 0				85735	
		12L-5-114	- -				85727	
		12L-5-72	- -				85709	
		3166657	0 0				85700	
		680323	0 0				85700	

ACF BRILL BUS

	37R Models	0 0	83225
	C-27 and C-31 City Bus		85307	...	0 0	85307	...
	C-36 City Bus Serial #1051 and on		85307	...	0 0	85307	...
	C-37M Models		83225	...	0 0	83225	...
	C-44 City Bus and T-44 Trolley Bus		85308	...	0 0	85308	89422
	IC-41 Intercity Bus Serial #1088 and on		85308	...	0 0	85308	89422
	IC-41 Intercity Bus to Serial #1088		85307	...	0 0	85307	...
	Additional O.E.M. Interchanges	610513	0 0				85307	
		631237	0 0				85308 or 89422	
		641521	0 0				85308 or 89422	
		649648	0 0				85308 or 89422	
		659129	0 0				85303 or 89422	
		661732	0 0				83215	
		661733	0 0				83225	
		995891	0 0				85307	

ADVANCE MIXER

	Advance Mixer part number	13424 ADV	0 0	0 0	83207	89407
		13883 ADV		85334
		14626 ADV		0 0	83209	...
		23458 ADV		0 -	83112	...
	Models with O.E.M. Number	13883	0 0	85334
			680087	0 0	85334





ALLCO TRAILER

	Dump Trailers with Watson & Chalin TA-5000-DB-19 Air Suspension	727602		0 0	83122	89406
--	---	--------	--	-----	-----	-----	--------------	--------------

AM GENERAL

	Small Bus	5979484		0 0	85302	89420
	Additional O.E.M. Interchanges	3166657	0 0				85700	
		4975501	0 0				85700	
		5565748	0 0				85700	
		5957136	0 0				85700	
		5969438	0 0				85700	
		5978712	0 0				85700	
		5979574	0 0				85700	

APPLICATION GUIDE - TRUCKS, TRAILERS, AND BUSES

Year Año Année	Model Modelo Modèle	OEM #	Front		Rear	
			 Fleetline	 GasSLX	 Fleetline	 GasSLX

AM GENERAL(Cont'd.)

Additional O.E.M. Interchanges	5982537	010	85700			
--------------------------------	---------	-----	--------------	--	--	--

ARVIN MERITOR

Blue Bird Motor Home with IFS (37 Foot)	7805-N-1002	010	85329
	7805-S-1007	010	85329
Models with Manufacturing Number	085009	-10	85009				
	085014		010	85014	...
	085321		010	85321	...
	654907		010	85000	89436
	654958	010	83164				
	659016	010	83064				
	659222	010	83171
	665044	010	83209				
	665724		010	85000	89436
	665746	010	85000				
	665760		010	85045	...
	665769		010	85052	...
	665804		010	85939	...
	671091		-1-	85069	89455
	671092	010	85012	89413	
	671507		010	87015	...
	671707		010	85052	...
	680102	010	85712				
	680322	010	85704				
	680331	010	85702				
	680337	-1-	85708				
	680347	010	85718				
	680464	010	85005				
	680518	010	85700				
	680584		010	85938	...
	680671		-1-	85708	...
	695172	-1-	85707				
	695180	-1-	85705				
	695181	-1-	85707				
	695214	-1-	85722				
	695348	010	87018				
	695406	-1-	695406				
	727600	010	83200				
	727607	010	83207				
	727609	010	83209				
	727614	010	83214				
	727615	010	83215				
	727616	010	83216				
	727619	010	83219				
	727625	010	83225				
727628	-10	83301					
727630	010	83303					
727631	010	83304					
727635	010	83308					
727636	010	83309					
727639	010	83312					
727641	010	83314					

APPLICATION GUIDE - TRUCKS, TRAILERS, AND BUSES

Year Año Année	Model Modelo Modèle	OEM #	Front		Rear	
			Fleetline	GasSLX	Fleetline	GasSLX









ARVIN MERITOR(Cont'd.)

Models with Manufacturing Number	727645	- 0			83318
	727671	- -			83613
	727672	0 0			83242
	727692	0 -			83353
	728601	0 0			85001
	728603	0 0			85003
	728604	0 0			85300
	728606	0 0			85302
	728608	0 0			85304
	728609	0 0			85305
	728611	0 0			85307
	728612	0 0			85308
	728614	- -			85310
	728615	- 0			85311
	728616	0 0			85004
	728617	0 0			85005
	728618	0 0			85006
	728619	0 0			85007
	728621	- 0			85009
	728622	0 0			85010
	728623	0 0			85011
	728624	0 0			85012
	728625	0 0			85013
	728626	0 -			85312
	728627	0 0			85313
	728628	0 0			85314
	728631	0 0			85029
	728632	0 0			85030
	728635	- -			85318
	728639	0 -			85026
728640	- -			85027	
728800	- 0			85711	
728806	0 0			85736	
728811	- -			85707	
728812	- -			85705	

AUTOCAR

A42B, A42F, A64B A64F Models From Feb. 1971 Thru Jan. 1971	03-1106460	0 0				
	28R010	0 0	85005	89430
ACM, ACL Models	35901-3201		0 0	85024 89416
	37301-3201	- -	85027	89418
C65T, C70T, C70TS, C90, C75, C90T, DC74, DC75, DC102, DC104 Models	0 0	83216
DC87T, DC9364 From Feb. 1971	0 0	83122	89406
Models with Air Suspension and O.E.M. Number	8026658		0 0	85046 89434
	8071524		0 0	85024 89416
Models with O.E.M. Number	1011839	0 0	83216
	28CFG-910	0 0	83216
	37301-3202	0 -	85026	89417
	660186	0 0	83216
	849246	0 0	83216

APPLICATION GUIDE - TRUCKS, TRAILERS, AND BUSES

Year Año Année	Model Modelo Modèle	OEM #	Front		Rear	
						
						
			Fleetline	GasSLX	Fleetline	GasSLX

AUTOCAR(Cont'd.)

XPEDITOR(Cont'd.)

08 - 16	4 X 2 Models with Hendrickson Primaax EX 232 Air Suspensions Standard with 8 1/2" to 10" Ride Height	60657-003							
			010	85072	...		
08 - 16	6 X 4 Models with Hendrickson HMX 400/460 Haulmax with 16.5" Saddle	60680-004							
			01-	83143	...		
08 - 16	6 X 4 Models with Hendrickson HMX 400/460 Haulmax with 17.5" & 18.5" Saddle	60680-005							
			01-	83142	...		
08 - 16	6 X 4 Models with Hendrickson HN - 522	60680-003							
			01-	83112	...		
08 - 16	6 X 4 Models with Hendrickson Primaax EX 462 Air Suspensions Standard with 12 1/2" - 14 3/8" - 15 1/2" Ride Height	60665-011							
	Standard with 8 1/2" to 10" Ride Height	60657-003	010	85967	...		
			010	85072	...		
08 - 16	8 X 4 Models with Chalmers 800 Series - 46K Tandem Truck Suspensions (HD Shock Kit with High Mounts)	800670							
			010	85060	...		
08 - 16	8 X 4 Models with Chalmers 800 Series - 46K Tandem Truck Suspensions (HD Shock Kit with Low Mounts)	800781							
			010	85314	89425		
08 - 16	8 X 4 Models with Hendrickson Primaax EX 462 Air Suspensions Standard with 12 1/2" - 14 3/8" - 15 1/2" Ride Height	60665-011							
	Standard with 8 1/2" to 10" Ride Height	60657-003	010	85967	...		
			010	85072	...		

BECK BUS

	Deck and 1/2 Bus - Spring Suspension							
			85307	...	010	85307	...		
	Deck and 1/2 Bus - Trailing Wheel	010	85301	...		
	Deck and 1/2 Bus with Air Suspension	85304	...	010	85304	...		
	Luxury Liner Bus - Spring Suspension	85307	...	010	85307	...		
	Mainliner with Air Suspension	85304	...	010	85304	...		
	Models with O.E.M. Number	14QK-140	010	85304		
		14QK-2102		010	85304	...	

BENSON TRUCK BODIES INC.

	Models with Hendrickson Intrax Air Suspension	A-20002							
			010	85000	89436		
	Models with Neway Air Suspension	90044089							
			010	83124	89407		

BERING TRUCK CORP.





	HD80TT Models with Hendrickson HAS-400 Air Suspension	47902-24							
			010	83137	...		
	Models with Hendrickson HAS-230 Air Suspension	47902-24							
			010	83137	...		

BLUEBIRD SCHOOL BUS

All American Series (FE & RE Models)

	Buses with 13,200 lb, 2-Leaf Parabolic Springs	1658525 AMS65109								
			010	85971		
			010	85058	89431			
	Buses with 19,000 lb - 21,000 lb - 2 Stage Leaf Springs	AMS65110								
			010	85005	89430			
06 - 13	Buses with Comfort Air Suspensions	00085991								
		471700000428								
		60998-001								
		60998-003								
			010	85006	...			
			010	85006	...			
			010	85006	...			
	Buses with Hendrickson Airtex Front Air Suspension	0110808	010	83124	89407			
- 15	Buses with Hendrickson Airtex Front Air Suspension (13, 200 to 14,600 lb Capacity)	58913-011	010	85959			
98 - 15	Buses with Hendrickson Parasteer Suspensions	0015222	010	85919			
		0040015	010	85919			
		481700131438	010	85919		
		59483-000	010	85919		

APPLICATION GUIDE - TRUCKS, TRAILERS, AND BUSES

Year Año Année	Model Modelo Modèle	OEM #	Front		Rear	
						
			Fleetline	GasSLX	Fleetline	GasSLX

BLUEBIRD SCHOOL BUS(Cont'd.)

All American Series (FE & RE Models)(Cont'd.)

98 - 15	Buses with Hendrickson Parasteer Suspensions	60665-005	010	85919
		60998-002	010	85919
- 15	Buses with Hendrickson Softek Suspension (13,200 lb - 14,600 lb Capacity)	0106303	010	85106
		471700002919	010	85106
		58913-010	010	85106
05 - 13	Buses with Leaf Spring Rear Suspension	0088035		010	85090
	Buses with O.E.M. Number	0823054	010	85304
	RE (Rear Engine) Models with Ridewell RAS - 227 Steer Axle Air Suspension	1260008		010	87017
		90-2610 SP1		010	87017

D3 Series (FE & RE Models)

	Buses with Comfort Air Suspensions	00085991		010	85006	...
		471700000428		010	85006	...
		60998-001		010	85006	...
	Buses with Hendrickson Airtek Front Air Suspension	0110808	010	83124	89407	
12 - 15	Buses with Hendrickson Airtek Front Air Suspension (13, 200 to 14,600 lb Capacity)	58913-011	010	85959	
- 15	Buses with Hendrickson Softek Suspension (13,200 lb - 14,600 lb Capacity)	0106303	010	85106	
		471700002919	010	85106	
		58913-010	010	85106	
	Buses with Leaf Spring Rear Suspension	0088035		010	85090	

TC 2000 Bus, TC/2000 FE Series

	Buses with Neway Rear Air Suspension	90045050		010	85914	...
	Buses with Ridewell Front Suspension Option #4540	1004167	010	85712	
		1317767	010	85029	
		1667831	010	85029	
		300-1317767	010	85029	
		AMS65119	010	85029	
	Buses with Ridewell Rear Suspension Option #4540	1316546		010	85006	...
		1658533		010	85010	...
		305-0961284		010	85734	...
	Buses with Standard Flat Leaf Rear Springs	1746163		010	85006	
	Buses with Standard Parabolic Front Springs	1658525	010	85971	

Type A School Bus

92 - 17	MicroBird Type A School bus with Ford E350 Chassis	8C24-18045-DA	-10	83177	
		8C2Z-18124-D	-10	83177	
		ASH-1154	-10	83177	
		AT-163G	-10	83177	
		8C24-18080-DB		-10	83178	...
		8C2Z-18125-D		-10	83178	...
		ASH-1136		-10	83178	...
		AT-164G		-10	83178	...
00 - 17	MicroBird Type A School bus with Ford E450 Chassis	8C24-18045-DA	-10	83177	
		8C2Z-18124-D	-10	83177	
		ASH-1154	-10	83177	
		AT-163G	-10	83177	
		8C24-18080-DB		-10	83178	...
		8C2Z-18125-D		-10	83178	...
		ASH-1136		-10	83178	...
		AT-164G		-10	83178	...

APPLICATION GUIDE - TRUCKS, TRAILERS, AND BUSES

Year Año Année	Model Modelo Modèle	OEM #	Front		Rear	
			Fleetline	GasSLX	Fleetline	GasSLX

BLUEBIRD SCHOOL BUS(Cont'd.)









Vision Series(Cont'd.)

06 - 15	Buses with Comfort Air Suspensions	00085991		010	85006	...
		47170000428		010	85006	...
		471700131545		010	85006	...
		60998-001		010	85006	...
		60998-003		010	85006	...
	Buses with Hendrickson Airtek Front Air Suspension	00119797	010	85959
		65992-003	010	85959
06 - 10	Buses with Hendrickson Airtek Front Air Suspension	58913-007	010	85959
06 - 15	Buses with Hendrickson Airtek Front Air Suspension (10,000 lb Capacity)	0055017	010	85959
		0085990	010	85959
		47170000456	010	85959
		58913-008	010	85959
		58913-009	010	85959
12 - 15	Buses with Hendrickson Airtek Front Air Suspension (13, 200 to 14,600 lb Capacity)	58913-011	010	85959
- 15	Buses with Hendrickson Softek Suspension (13,200 lb - 14,600 lb Capacity)	0106303	010	85106
		471700002919	010	85106
		58913-010	010	85106
06 - 15	Buses with Hendrickson Softek Suspension (8,500 lb - 10,000 lb Capacity)	0055008	010	85959
		0085990	010	85959
		47170000456	010	85959
		58913-007	010	85959
		58913-007L	010	85959
		58913-009	010	85959
05 - 13	Buses with Leaf Spring Rear Suspension	0088035		010	85090	...
		47170000464		010	85090	...

Additional Applications

	Buses with 3/4" Mounting Pins	2021459		85012	...	010	85012	89413
	Buses with 35" Chassis	303-1350628	010	85712
		90-1968	010	85712
	Buses with Flat Leaf Rear Spring Suspensions (8,200 lb to 10,400 lb)	1707405		010	85005	...
	Buses with Neway Air Suspensions with O.E.M. Number	1526417		010	85052	...
		90044448		010	85051	...
		90044915		010	83127	...
		90045083		010	85910	...
	Buses with Reyco Air Suspension	1668722	010	85030	89440	
		1668730		010	85013	89414
		1722222		010	85013	89414
	City Bird Buses with 1 " Mounting Pins	300-0614966	010	85307
		300-0614974		010	85304	...
		609180		010	85304	...
		614958	010	85307
		614966	010	85307
	FE Models School Bus (Front Engine)	0014605		010	85036	89405
		0014985		010	83137	...
		59057-001		010	83137	...
		59057-002		010	85036	89405
	Low Floor Bus Models with O.E.M. Number	0075916	010	85086
		4759272		- -	...	89447

APPLICATION GUIDE - TRUCKS, TRAILERS, AND BUSES

Year Año Année	Model Modelo Modèle	OEM #	Front		Rear	
						
						
			Fleetline	GasSLX	Fleetline	GasSLX

BLUEBIRD SCHOOL BUS(Cont'd.)

Additional Applications(Cont'd.)

Low Floor Bus Models with O.E.M. Number	4760958	010	85086
	680667		- -	...	89447
Motor Home with IFS (37 Foot)	7805-N-1002	010	85329
	7805-S-1007	010	85329
RE Models School Bus (Rear Engine) with 1 " Mounting Pins	300-0614966	010	85307
	300-0614974		010	85304	...
	609180		010	85304	...
	614958	010	85307
WanderLodge Drive Axle Front with Reyco Air Suspension	1750793		010	85712	...
	90-1968-SP1	010	85712
	1722214		010	85030	89440
WanderLodge LX, LXI - Models Front Rear	90-2497-SP1	
	90-1951-SP1		010	85734	...
Models with O.E.M. Number	00119798	010	85106
	0020326		010	85976	...
	300-1316546		010	85006	...
	614974	010	85304
	65992-004	010	85106
680783	010	85304	

Additional O.E.M. Interchanges

Additional O.E.M. Interchanges	0523047	010				85736	
	1217934	010				85304	
	1962422	010				85304	
	1962430	010				83207 or 89407	
	23106-01	010				85975	
	300-0823047	010				85736	
	300-0823054	010				85304	
	300-09612284	010				85734	
	671933	010				85919	
	680102	010				85712	
	680155	010				85712	
	70317	010				89402	
	70397	010				85006	
	7805-M-1001	010				85919	
	87001-01A	010				85734	
90-1813	010				85712		
A-4890	010				85712		

BOYDSTUN EQUIPMENT MANUFACTURING

Trailers with Ridewell RAR-210 Suspensions	1253069B000		010	85005	89430
Trailers with Ridewell RAR-221AS-11-USW, RAR-221AS-11-1-USW Suspensions	1253069B000		010	85005	89430









BREDA BUS

Models with O.E.M. Number	500-403-4	
---------------------------	-----------	--	-----	-----	--	------	-----

BROCKWAY SCHOOL BUS

257T, 260S, 260T Models	010	83207	89407	
-------------------------	------	-----	--------------	--------------	--	-----	-----

APPLICATION GUIDE - TRUCKS, TRAILERS, AND BUSES

Year Año Année	Model Modelo Modèle	OEM #	Front				Rear			
										
										
		Fleetline	GasSLX	Fleetline	GasSLX					

BROCKWAY SCHOOL BUS(Cont'd.)

	300, 400, 500 Models With 1" Mounting Pins	010	85307
	With 3/4" Mounting Pins	010	85012	89413	
	55 and 61 Passenger School Bus With 1" Rear Mounting Pins	010	83216	...	010	85305	...
	With 3/4" Rear Mounting Pins	010	83216
	88WH, 128W, 154W Models	010	83216
	Less than 55 Passenger School Bus	010	83216
	Models with O.E.M. Number	14QK-281P10	010	85305
		14QK-282P1	010	83216
		14QK-282P3	010	83216
		152398	010	85304
		152412	010	83215
		508657	010	85307
		515231	010	85303	89422	
		530873	010	83207	89407	
	532397	010	85307	

BUILT RITE

	Models with Air Suspension	318-06-100		010	85006	...
--	----------------------------	------------	--	-----	-----	-----	--------------	-----

BUS & TRUCK CO.

	Silver Eagle	0100-905		85307	...	010	85307	...
		680091		85303	...	010	85303	89422
		70039		85303	...	010	85303	89422
		70041		85305	...	010	85305	...

CARPENTER BUS

	Models with O.E.M. Number	0272-SS5	010	85712
		63-0001		010	85713	...

CASCADE TRAILER

	Models with Air Suspension	120-1		010	83125	...
--	----------------------------	-------	--	-----	-----	-----	--------------	-----

CHALMERS SUSPENSION

	K800-199 Models Kit	665174		010	85060	...
	Single Axle Truck Suspension (1023-23K, 1030 -30K, 1040-40K)	665174		010	85060	...
	800 Series - 46K Tandem Truck Suspensins (HD Shock Kit with High Mounts)	800670		010	85060	...
	800 Series - 46K Tandem Truck Suspensins (HD Shock Kit with Low Mounts)	800781		010	85314	89425
	Models with O.E.M. Number	21335		010	G63355	...









CHAMPION TRANSIT

	GMC P6000 Chassis	22064230	- -	83136
		22064231		- -	85324	...

CHANCE BUS

	Models with O.E.M. Number	59039		83207	...	010	83207	89407
		665017		010	85014	...
		6892		83207	...	010	83207	89407
		6893	010	83203	89436	

APPLICATION GUIDE - TRUCKS, TRAILERS, AND BUSES

Year Año Année	Model Modelo Modèle	OEM #	Front		Rear	
						
						
			Fleetline	GasSLX	Fleetline	GasSLX

CHANCE BUS(Cont'd.)

Models with O.E.M. Number	728600		83203	...	OIO	83203	89436
	AS789B		85014	...	OIO	85014	...
Additional O.E.M. Interchanges	270-6708	OIO	85014				

CHANCE COACH

Additional Applications

Buses with 3/4" Mounting Pins	2021459		85012	...	OIO	85012	89413
-------------------------------	---------	--	--------------	-----	-----	--------------	--------------

CHEVROLET TRUCK (ALSO SEE GMC TRUCK)



4, 40, 4000 & 4500 Series

69 - 72	All - Exc. Tilt Cab	22012096		83221	...	OIO	83221	...
		3192892		83221	...	OIO	83221	...
63 - 68	C-40 , P-40, SS-40 Models	OIO	85005	89430	OIO	83221	...
60 - 62	C-40 Models	OIO	83221	...
68	Cowl - Exc. School Bus	22012096	OIO	83221
		3192892	OIO	83221
69 - 70	D-D Forward Control with 9000 & 11000 lb Axles - Exc. Tilt Cab	22012096	OIO	83221
		3192892	OIO	83221
69 - 70	D-D Forward Control with Tilt Cab	22012095	OIO	83126	89430	
		4940606	OIO	83126	89430	
67 - 72	S-40 School Bus	22012096		83221	...	OIO	83221	...
		3192892		83221	...	OIO	83221	...
67 - 68	TDM 4 Cycle Detroit Diesel with Tandem Axle - Exc. Tilt Cab	22012096		OIO	83221	...
		3192892		OIO	83221	...

5, 50, 5000 & 5500 Series

69 - 72	All - Exc. Tilt Cab	22012096		83221	...	OIO	83221	...
		3192892		83221	...	OIO	83221	...
73 - 80	C, M, S Chassis - Conventional Cab	22007750	OIO	83207	89407	
		4975467	OIO	83207	89407	
		4975494	OIO	83207	89407	
75 - 80	C, M, S Chassis - Conventional Cab	4975510	OIO	83221
76 - 89	C, M, S Chassis - Conventional Cab	22002294	OIO	83304
		22007752	OIO	83304
		22012096		OIO	83221	...
		22012169		OIO	83221	...
73 - 80	C, S Chassis - Conventional Cab and School Bus	22012096		OIO	83221	...
		3192892		OIO	83221	...
73 - 89	C, S Chassis - Conventional Cab and School Bus	22012095		OIO	83126	89430
		22012166		OIO	83126	89430
63 - 69	C-50, M-50, S-50, SE-50, T-50 Models	OIO	85005	89430	OIO	83221	...
68	Cowl - Exc. School Bus	22012096	OIO	83221
		3192892	OIO	83221
69 - 70	D-D Forward Control with 9000 & 11000 lb Axles - Exc. Tilt Cab	22012096	OIO	83221
		3192892	OIO	83221
69 - 70	D-D Forward Control with Tilt Cab	22012095	OIO	83126	89430	
		4940606	OIO	83126	89430	
69 - 72	S-50 School Bus	3192892		83221	...	OIO	83221	...
73 - 78	S-50 School Bus	22012166		OIO	83126	89430
		3192892		OIO	83221	...
67 - 68	TDM 4 Cycle Detroit Diesel with Tandem Axle - Exc. Tilt Cab	22012096		OIO	83221	...
		3192892		OIO	83221	...
71 - 72	TDM 4 Cycle Detroit Diesel with Tandem Axle - Exc. Tilt Cab	22012095		OIO	83126	89430

APPLICATION GUIDE - TRUCKS, TRAILERS, AND BUSES

Year Año Année	Model Modelo Modèle	OEM #	Front		Rear	
						
			Fleetline	GasSLX	Fleetline	GasSLX

CHEVROLET TRUCK (ALSO SEE GMC TRUCK)(Cont'd.)



5, 50, 5000 & 5500 Series(Cont'd.)

71 - 72	TDM 4 Cycle Detroit Diesel with Tandem Axle - Exc. Tilt Cab	4940606		010	83126	89430
---------	---	---------	--	-----	-----	-----	-------	-------

6, 60, 6000 & 6500 Series

69 - 72	All - Exc. Tilt Cab	22012096		83221	...	010	83221	...
		3192892		83221	...	010	83221	...
68 - 69	All with 9000 & 11000 lb Axles - Exc. Tilt Cab	22012095	010	83126	89430	
		4940606	010	83126	89430	
79 - 89	B6P042 School Bus (Axle codes F070, F070D)	22002294	010	83304
		22007752	010	83304
79 - 89	B6P042 School Bus (Axle codes F090, F120D)	22002295	010	83303
		22007753	010	83303
		22017531	010	83303
79 - 89	B6P042 School Bus w/15000 lb or 17000 lb Rear Springs	22012096		010	83221	...
		22012169		010	83221	...
79 - 89	B6P042 School Bus w/18500 or 20800 lb Rear Springs	22012095		010	83126	89430
		22012166		010	83126	89430
76 - 89	C, M Chassis - Conventional Cab	22002294	010	83304
		22007752	010	83304
75 - 80	C, M, S Chassis - Conventional Cab and School Bus	4975510	010	83221
73 - 75	C, M, S Chassis - Conventional Cab and School Bus with 5000 & 7000 lb Axle	22007750	010	83207	89407	
		4975467	010	83207	89407	
		4975494	010	83207	89407	
73 - 89	C, S Chassis - Conventional Cab and School Bus - Exc. with 20800 & 23000 lb Rear Axle	22012096		010	83221	...
		22012169		010	83221	...
		3192892		010	83221	...
73 - 89	C, S Chassis - Conventional Cab and School Bus with 20800 & 23000 lb Rear Axles	22012095		010	83126	89430
		22012166		010	83126	89430
		4940606		010	83126	89430
79 - 89	C, S Chassis - Conventional Cab and School Bus	22002295	010	83303
		22007753	010	83303
		22017530	010	83303
		22017531	010	83303
73 - 80	C, S, T Chassis - Conventional & Tilt Cab and School Bus with 5000 & 7000 lb Axle	22002293	010	83126	89430	
		22007701	010	83126	89430	
		22007751	010	83303
		22012095	010	83126	89430	
		3192890	010	83126	89430	
		4940606	010	83126	89430	
		4940662	010	83126	89430	
		4975497	010	83126	89430	
71 - 72	Conventional Cab & Tilt Cab with 9000 & 11000 lb Axles	22012095		010	83126	89430
		4940606		010	83126	89430
68	Cowl - Exc. School Bus	22012096	010	83221
		3192892	010	83221
69 - 70	D - D Forward Control with 9000 & 11000 lb Axles - Exc. Tilt Cab	22012096	010	83221
		3192892	010	83221
76 - 89	S Chassis - School Bus	22002294	010	83304
		22007702	010	83304
		22007752	010	83304

APPLICATION GUIDE - TRUCKS, TRAILERS, AND BUSES

Year Año Année	Model Modelo Modèle	OEM #	Front		Rear	
						
			Fleetline	GasSLX	Fleetline	GasSLX

CHEVROLET TRUCK (ALSO SEE GMC TRUCK)(Cont'd.)





6, 60, 6000 & 6500 Series(Cont'd.)

69 - 78	S-60	3192892		83221	...	010	83221	...
		4975510		83221	...	010	83221	...
73 - 78	S-60 w/Air Brakes	22007701		010	83126	89430
		22007751		010	83303	...
		22012095		010	83126	89430
		22012166		010	83126	89430
		3171069		010	85304	...
		4940606		010	83126	89430
73 - 75	SE, SS-60 thru Serial # 134487 (1975 1st Design)	22007700	010	83207	89407	
		22007750	010	83207	89407	
		4975467	010	83207	89407	
		4975494	010	83207	89407	
76 - 78	SE-60 From Serial # 120000 (1976 2nd Design)	22002294	010	83304
		22007752	010	83304
76 - 78	SE-60 w/Hydraulic Brakes from Serial # 120000 (1975 2nd Design)	22012169		010	83221	...
		3192892		010	83221	...
73 - 74	SG, SM-60	3192890	010	83126	89430	
73 - 74	SG, SM-61	4940606	010	83126	89430	
73 - 74	SG, SM-62	22002293	010	83126	89430	
73 - 74	SG, SM-63	22007701	010	83126	89430	
73 - 74	SG, SM-64	22007751	010	83303
60 - 62	Standard and Heavy Duty Truck and School Bus (2 Ton)	010	83221	...
71 - 72	TDM 4 Cycle Detroit Diesel with Tandem Axle	22012095		010	83126	89430
		4940606		010	83126	89430
67 - 68	TDM 4 Cycle Detroit Diesel with Tandem Axle - Exc. Tilt Cab	22012096		010	83221	...
		3192892		010	83221	...
79 - 80	W Chassis - 72" BBC Steel Tilt Cab	22002293	010	83126	89430	
		22007751	010	83303

7, 70 & 7000 Series

66 - 72	72" BBC Steel Tilt Cab with V-6 2 Cycle Diesel Engine	22012095	010	83126	89430	
		3171462	010	83126	89430	
		3192890	010	83126	89430	
66 - 72	72" BBC Steel Tilt Cab with V-6 2 Cycle Diesel Engine with 17201 and 17221 Axle	22012096		010	83221	...
		3192892		010	83221	...
66 - 72	72" BBC Steel Tilt Cab with V-6 2 Cycle Diesel Engine with 19101 and 19201 Axle	4940600		010	83209	89414
66 - 72	92" BBC Conventional Cab	3192657	010	83216
		4940614	010	83216
		4963854	010	83216
79 - 89	C, M Chassis - 97" BBC Conventional Cab	22002294	010	83304
		22002295	010	83303
		22007752	010	83304
		22007753	010	83303
		22012095		010	83126	89430
		22012166		010	83126	89430
		22017530	010	83303
22017531	010	83303		
66 - 72	Conventional Cab with Tapered 2-Leaf Softride 11000 lb Rating and F120 Axle (12000 lb)	22046483	010	85304
		22052336	010	85304

APPLICATION GUIDE - TRUCKS, TRAILERS, AND BUSES

Year Año Année	Model Modelo Modèle	OEM #	Front		Rear	
						
			Fleetline	GasSLX	Fleetline	GasSLX

CHEVROLET TRUCK (ALSO SEE GMC TRUCK)(Cont'd.)



7, 70 & 7000 Series(Cont'd.)

66 - 72	Conventional Cab with Tapered 2-Leaf Softride 11000 lb Rating and F120 Axle (12000 lb)	3171069	010	85304	
66 - 72	Conventional Cab With Tapered 2-Leaf Softride 7000 & 9000 lb Rating and F070, F090, F120 Axle (7000, 9000 & 12000 lb)	3171068	010	83216	
		3192657	010	83216	
		4940614	010	83216	
		4963853	010	83216	
		4963854	010	83216	
77 - 80	H, J Chassis - 92" BBC Conventional Cab	4963854	010	83216	
		4984526	010	83216	
73 - 80	H, J Chassis - 92" BBC Conventional Cab with V-6, V8 Diesel Engines	4940614	010	83216	
		4963854	010	83216	
73 - 80	H, J, M Chassis - 92" & 114" BBC Conventional Cab	2204683	010	85304	
		3171069	010	85304	
73 - 80	R Chassis - Rear Engine Bus	22012090	010	85308	89422	
		5552451	010	85308	89422	
		5552456		010	85307	...
		5552552		010	85303	89422
				010	83126	89430
83 - 84	S7T042 Forward Control Chassis w/17000, 18500, 21000, 23000 lb Rear Axle	22012095		010	83126	89430
		22012166		010	83126	89430
83 - 84	STT042 Forward Control Chassis	22012065	010	85304	
		3171069	010	85304	
73 - 80	T, W Chassis - 72" BBC Steel Tilt Cab (4 x 2) with V-6 Diesel Engine	22007751	010	83303	
		22012095	010	83126	89430	
		4940606	010	83126	89430	
		4975497	010	83126	89430	
73 - 80	T, W Chassis - 72" BBC Steel Tilt Cab with V-6 Gas Engine	22012091	010	85303	89422	
		5552452	010	85303	89422	

8, 80 & 8000 Series

66 - 69	72" BBC Steel Tilt Cab	5544060	010	85302	89420	
66 - 72	92" BBC Conventional Cab	3171068	010	83216	
		3192657	010	83216	
		4940614	010	83216	
		4963853	010	83216	
		4963854	010	83216	
66 - 72	92" BBC Conventional Cab with 7000 & 9000 lb Axles - Exc. 2-Leaf Softride	22046483	010	85304	
		22052336	010	85304	
		3171069	010	85304	
79 - 82	H, J Chassis - 92" BBC Conventional Cab 4 x 2 with Air Suspension	22012065		010	85304	...
		22046483		010	85304	...
		22052336		010	85304	...
		3171069		010	85304	...
73 - 81	H, J Chassis - 92" BBC Conventional Cab	4940614	010	83216	
		4963854	010	83216	
		4984526	010	83216	
73 - 86	H, J, M Chassis - 92" & 114" BBC Conventional Cab	22046483	010	85304	
		22052336	010	85304	
		3171069	010	85304	

APPLICATION GUIDE - TRUCKS, TRAILERS, AND BUSES

Year Año Année	Model Modelo Modèle	OEM #	Front		Rear	
						
			Fleetline	GasSLX	Fleetline	GasSLX

CHEVROLET TRUCK (ALSO SEE GMC TRUCK)(Cont'd.)

8, 80 & 8000 Series(Cont'd.)

73 - 80	R Chassis - Rear Engine Bus	22012090	○ ○	85308	89422	
		22012091		○ ○	85303	89422
		5552451	○ ○	85308	89422	
		5552452		○ ○	85303	89422
		5552456		○ ○	85307	...
70 - 80	T, W Chassis - 72" BBC Steel Tilt Cab with V-6 Gas Engine	22012091	○ ○	85303	89422	
		5552452	○ ○	85303	89422	

9000 Series

70 - 72	54" BBC Aluminum Tilt Cab 6 x 4	22046483		85304	...	○ ○	85304	...
		22052336		85304	...	○ ○	85304	...
		3171069		85304	...	○ ○	85304	...
70 - 72	92" & 114" BBC Conventional Cab - Exc. 6 x 4	4940614	○ ○	83216
		4963854	○ ○	83216
70 - 72	92" & 114" BBC Conventional Cab 6 x 4	22046483		85304	...	○ ○	85304	...
		22052336		85304	...	○ ○	85304	...
		3171069		85304	...	○ ○	85304	...
70 - 86	D, F Chassis - 54" BBC Aluminum Tilt Cab with Rear GM Air Ride Suspension (4 Req'd)	22012065		85304	...	○ ○	85304	...
		22046483		85304	...	○ ○	85304	...
		22052336		85304	...	○ ○	85304	...
		3171069		85304	...	○ ○	85304	...
70 - 86	H, J Chassis - 92" BBC Conventional Cab	22046483	○ ○	85304
		22052336	○ ○	85304
		3171069	○ ○	85304
77 - 86	M, N Chassis - 114" BBC Conventional & 108" BBC Aluminum Conventional Cab with Rear GM Air-Ride Suspension (4 Req'd)	22012065		85304	...	○ ○	85304	...
		22046483		85304	...	○ ○	85304	...
		22052336		85304	...	○ ○	85304	...
		3171069		85304	...	○ ○	85304	...
70 - 80	T, W Chassis - 72" BBC Steel Tilt Cab	22012091	○ ○	85303	89422	
		5552452	○ ○	85303	89422	





B - Series - School Bus

90 - 98	B6, B7 Model School Bus Chassis With 11000, 13500, 15000 lb Taperleaf Springs With 15000, 19000, 21000 lb Multileaf Springs	22064231		- -	85324	...
		15174902		- -	85071	...
		22064232		- -	85071	...
	Models with O.E.M. Number	15123676	- -	83136
		15588554	- -	83136
		22064230	- -	83136
		88982682	- -	83136

C - Series (C4500, C5500) Kodiak

90 - 09	C Chassis - Conventional Cab Front Shock with O.E.M. Number	15123676	- -	83136
		15588554	- -	83136
		15887728	- -	83136
		19152843	- -	83136
		22064230	- -	83136
		88982682	- -	83136
	With 15000, 19000, 21000 lb Multileaf Springs	15174902		- -	85071	...
		22064232		- -	85071	...
		88982686		- -	85071	...
				- -	85071	...

APPLICATION GUIDE - TRUCKS, TRAILERS, AND BUSES

Year Año Année	Model Modelo Modèle	OEM #	Front		Rear	
						
			Fleetline	GasSLX	Fleetline	GasSLX

CHEVROLET TRUCK (ALSO SEE GMC TRUCK)(Cont'd.)

C - Series (C4500, C5500) Kodiak(Cont'd.)

04 - 09	C Chassis - Conventional Cab (Non 4x4 Option) with 13,500 Multi-leaf Spring	15185644		010	83155	...
		508-89		010	83155	...
		L-12706		010	83155	...
90 -	C Chassis - Conventional Cab w/11000, 13500, 15000 lb Taperleaf Springs	22064231		-1-	85324	...
90 - 06	C Chassis - Conventional Cab w/16900 or 17850 lb Taperleaf Springs	21998392		-1-	85336	...
		22064489		-1-	85336	...
		88963409		-1-	85336	...
90 -	C Chassis - Conventional Cab w/19000, 21000, 23000 lb Taperleaf Springs (EXC Low Profile Vehicle)	22064233		-1-	83136	...
83 - 99	C Chassis - Conventional Cab with 9100 to 17500 lb Rear Axle	22064432		010	85050	...
03 - 09	C Chassis - Conventional Cab with Taperleaf Rear Suspension	15185643		010	83153	...
	Models with O.E.M. Number	88982684	-1-	83136
		88982688		-1-	85336	...

C - Series (C6500, C7500, C8500) Kodiak

04 - 08	Conventional Cab (Low Profile) with 12000, 15000, & 17000 lb Leaf Spring	15174901		-1-	85342	...
		507-22		-1-	85342	...
		88982685		-1-	85342	...
90 - 09	Conventional Cab w/ Front Shock with O.E.M. Number	15123676	-1-	83136
		15174898	-1-	83136
		15588554	-1-	83136
		15887728	-1-	83136
		19152843	-1-	83136
		22064230	-1-	83136
		88982682	-1-	83136
90 -	Conventional Cab w/11000, 13500, 15000 lb Taperleaf Springs	22064231		-1-	85324	...
90 - 09	Conventional Cab w/15000, 19000, 21000 lb Multileaf Springs	15174902		-1-	85071	...
		22064232		-1-	85071	...
		88982686		-1-	85071	...
90 - 06	Conventional Cab w/16900 or 17850 lb Taperleaf Springs	21998392		-1-	85336	...
		22064489		-1-	85336	...
		88963409		-1-	85336	...
90 -	Conventional Cab w/19000, 21000, 23000 lb Taperleaf Springs (EXC Low Profile Vehicle)	22064233		-1-	83136	...
04 - 08	Conventional Cab with 19000 lb Leaf Spring	15174903		-1-	85342	...
		507-23		-1-	85342	...
		88982687		-1-	85342	...
83 - 99	Conventional Cab with 9100 to 17500 lb Rear Axle	22064432		010	85050	...
95 - 02	Models with Hendrickson Air Suspension (Stamping number 47902-13)	12474915		010	83122	89406
		15963161		010	83122	89406
96 - 02	Models with Hendrickson Air Suspension (Stamping number 47902-29)	12474917		010	83137	...
		15740554		010	83137	...
	Models with O.E.M. Number	88982684	-1-	83136
		88982688		-1-	85336	...









P - Series

92 - 96	Motorhome Chassis	22064231		-1-	85324	...
		22064233		-1-	83136	...

T - Series (T5500, T6500, T7500, T8500)

97 -	FL1 Tilt Cab with 8100 lb Axle	22064804	-1-	83136
------	--------------------------------	----------	-----	-------	-----	--	-----	-----

APPLICATION GUIDE - TRUCKS, TRAILERS, AND BUSES

Year Año Année	Model Modelo Modèle	OEM #	Front		Rear	
						
						
			Fleetline	GasSLX	Fleetline	GasSLX

CHEVROLET TRUCK (ALSO SEE GMC TRUCK)(Cont'd.)

T - Series (T5500, T6500, T7500, T8500)(Cont'd.)

97 -	FL1 Tilt Cab with 8100 lb Axle	22064805	- -	83136
		22165187	- -	83136
		22165188	- -	83136
97 -	FL2 Tilt Cab with 5000 to 11000 lb Axle	22064807	- -	83136
		22166442	- -	83136
97 -	FL3 Tilt Cab with 14575 lb Axle	22064806	- -	83136
		22165189	- -	83136
99	Models with Hendrickson Air Suspension (Stamping number 47902-13)	12474915		0 0	83122	89406
		15963161		0 0	83122	89406
90 - 99	Tilt Cab w/11000, 13500, 15000 lb Taperleaf Springs	22064231		- -	85324	...
90 - 06	Tilt Cab w/15000, 19000, 21000 lb Multileaf Springs	15174902		- -	85071	...
		22064232		- -	85071	...
92 - 06	Tilt Cab w/16900 lb Taperleaf Springs	21998392		- -	85336	...
		22064489		- -	85336	...
		88963409		- -	85336	...
92 - 99	Tilt Cab w/19000, 21000, 23000 lb Taperleaf Springs (EXC Low Profile Veh.)	22064233		- -	83136	...
06 - 09	Tilt Cab Models with O.E.M. Number	15174901		- -	85342	...
		15174903		- -	85342	...
		507-22		- -	85342	...
		507-23		- -	85342	...
		88982685		- -	85342	...
		88982687		- -	85342	...





W - Series (Isuzu)

83 - 95	W4 Models	9-51630-666-0		0 0	85012	89413
		9-51630-666-2		0 0	85012	89413
86 - 90	W4 Models	8-94454-986-0	- 0	83515
		8-94454-987-0	- 0	83515
		9-51630-647-1	- 0	83515
89 - 90	W4 Models Flatlow	9-51630-647-1	- 0	83515
89 - 92	W4 Models Flatlow	9-51630-666-0		0 0	85012	89413
		9-51630-666-2		0 0	85012	89413
86 - 95	W4 Models with 11000 lb Suspension	97083027	- 0	83515
87 - 95	W4 Models with 13000 lb Suspension	94454987	- 0	83515
		97083029	- 0	83515
88 - 97	W5 Models	1-51630-217-0	- 0	83114
		1-51630-217-1	- 0	83114
		1-51630-219-1	- 0	83114
86 - 91	W6 Models	1-51630-168-1	- 0	83515
		1-51630-217-0	- 0	83114
		1-51630-217-1	- 0	83114
	Models with O.E.M. Number	8-94057-593-0	- 0	83114
		8-97201-960-0	- 0	83515
		94033786	- 0	83114
		94051090	- 0	83114
		94057593	- 0	83114
		97201960	- 0	83515

Additional O.E.M. Interchanges

	Models with O.E.M. Number	15642943		- -	83136	...
		22046489	0 0	85303	89422	
		22065218	0 0	G63347

APPLICATION GUIDE - TRUCKS, TRAILERS, AND BUSES





Year Año Année	Model Modelo Modèle	OEM #	Front		Rear	
						
			Fleetline	GasSLX	Fleetline	GasSLX

CHEVROLET TRUCK (ALSO SEE GMC TRUCK)(Cont'd.)

Additional O.E.M. Interchanges(Cont'd.)

Models with O.E.M. Number	22065251	010	85030	89440	
	22099889		- -	85336	...
	507-24		- -	85336	...
	508-86		- -	83136	...
	508-88		010	83153	...
	Additional O.E.M. Interchanges	22007703	010	83303			
	22012067	010	85700				
	22012079	- -	85701				
	22012082	010	85702				
	22012083	- 0	85711				
	22012114	010	85700				
	22012131	- 0	85711				
	22024062	- -	85701				
	22024673	- 0	85710				
	22045526	010	85702				
	22046481	010	85702				
	22046485	- 0	85710				
	22046499	- 0	85710				
	22052014	010	85702				
	22052424	- 0	85710				
	3171696	010	85307				
	3172948	010	85303 or 89422				
	3175509	010	85735				
	3178157	010	85700				
	3178233	010	85734				
	3178507	010	85700				
	3178995	010	85700				
	3188626	010	85300 or 89419				
	3188729	010	85303 or 89422				
	4939852	010	85308 or 89422				
	4939967	010	85308 or 89422				
	4940601	010	83216				
	4940627	010	83203 or 89436				
	4940640	010	83216				
	4940650	010	83207 or 89407				
	4940654	010	83216				
	4940660	010	83207 or 89407				
	4963844	010	85307				
	4964853	010	83217				
	4974401	010	85700				
	4975429	010	85300 or 89419				
	4975479	- -	83400				
	4975480	- -	83400				
	4975515	- -	85701				
	4975516	010	85702				
	4975518	010	85704				
	4975538	010	85700				
	4975549	010	83216				
	4975550	010	85702				
	507-3	010	85307				
	5171068	010	83216				

APPLICATION GUIDE - TRUCKS, TRAILERS, AND BUSES





Year Año Année	Model Modelo Modèle	OEM #	Front		Rear	
						
			Fleetline	GasSLX	Fleetline	GasSLX

CHEVROLET TRUCK (ALSO SEE GMC TRUCK)(Cont'd.)

Additional O.E.M. Interchanges(Cont'd.)

Additional O.E.M. Interchanges	OEM #	OEM #	Interchange #
	5316784	010	85700
	5316791	010	83219
	5316792	010	85305
	5316793	010	85305
	5321920	010	85307
	5321929	010	85307
	5348631	010	83203 or 89436
	5352858	010	85305
	5353054	010	85303 or 89422
	5355798	010	85307
	5357955	010	85300 or 89419
	5357956	010	85734
	5357959	010	85300 or 89419
	5361994	010	85734
	5374779	010	85308 or 89422
	5374999	010	85307
	5385939	010	85307
	5392387	010	85303 or 89422
	5394448	010	85305
	5394467	010	85305
	5394468	010	85735
	5455798	010	85307
	5513489	010	83216
	5513716	010	85304
	5516459	010	85305
	5522781	010	85735
	5522794	010	85308 or 89422
	5522818	010	85305
	5527001	010	85300 or 89419
	5527271	010	85700
	5527272	010	85700
	5527606	010	85305
	5531027	010	85301
	5531435	010	85307
	5531436	010	85307
	5531437	010	85307
	5532026	010	85304
	5532425	010	83207 or 89407
	5532433	010	83207 or 89407
	5532675	010	85307
	5534430	010	85303 or 89422
	5534439	010	85304
	5534447	010	85303 or 89422
	5544112	010	83216
	5544581	010	85302 or 89420
	5544716	010	85304
	5544717	010	85304
	5544812	010	83308
	5544818	010	85735
	5549899	010	83207 or 89407
	5549924	010	85700

APPLICATION GUIDE - TRUCKS, TRAILERS, AND BUSES

Year Año Année	Model Modelo Modèle	OEM #	Front		Rear	
						
			Fleetline	GasSLX	Fleetline	GasSLX

CHEVROLET TRUCK (ALSO SEE GMC TRUCK)(Cont'd.)

Additional O.E.M. Interchanges(Cont'd.)

Additional O.E.M. Interchanges	OEM #	010	85304
	5549925	010	85304
	5552111	010	85304
	5552112	010	85307
	5552114	010	83216
	5552205	010	83217
	5552206	010	83214
	5552207	010	83217
	5552208	010	83217
	5552209	010	83215
	5552210	010	85308 or 89422
	5552244	010	85308 or 89422
	5552285	010	83214
	5552286	010	83217
	5552287	010	83217
	5552288	010	83217
	5552453	010	85301
	5552527	010	85735
	5554184	010	85302 or 89420
	5554589	010	85307
	5554596	010	85303 or 89422
	5554814	010	85302 or 89420
	5554959	010	83401
	5554995	010	85305
	5559363	010	83203 or 89436
	5585939	010	85307
	684280	010	83209 or 89414
	97-2210-00153	- -	85701
	97-2210-00164	- -	85708
	97-2210-00170	01-	85733

CHEVROLET TRUCK CAB SHOCKS

Description	OEM #	010	83023
Bruin Tractors with J9 Cabs with Link Cabmate Model GMC92J9	1202-0012	010	83023
90 - Kodiak Truck Cabs with Link Cabmate Model GMC104TK	1202-0054	010	83021
- 89 Kodiak Truck Cabs with Link Cabmate Model GMC92TK	1202-0012	010	83023
Models with Link Cab Suspension	1202-0022	010	83046
Titan Cabover (Sleeper & Non-Sleeper Trucks) with Link Cabmate Model GMC-2P-A	1202-0032	010	83016

CHRYSLER

Motorhome Chassis

Year	Description	OEM #	010	G63183	...
73 - 81	M & R-300, 400, 500 Motorhome Chassis	3638112	010
63 - 72	M-300, M-375 & R-375 Motorhome Chassis	2961043	010
		3633744	010









CLARK EQUIPMENT

Description	OEM #	010	85307	...
Model 130885 (Air Suspension)	5532675	010
Ross Carrier	355778	85315	...	010
	680042	85301	...	010

CNH GLOBAL N V

Description	OEM #	010	83022
Models with O.E.M. Number	87019546	010	83022

APPLICATION GUIDE - TRUCKS, TRAILERS, AND BUSES

Year Año Année	Model Modelo Modèle	OEM #	Front		Rear	
						
						
			Fleetline	GasSLX	Fleetline	GasSLX

CNH GLOBAL N V(Cont'd.)

Models with O.E.M. Number	87268250	010	83021
---------------------------	----------	-----	--------------

COACHMEN RV

Class A MotorHomes

Year	Model	OEM #	Front	Rear		
03 - 05	Cross Country Elite & SE Series MotorHomes with Freightliner XC Chassis ADL200 Suspension w/ 20K Rear AS120 Front Suspension Rear Shock with O.E.M. Number ZF - IFS Front Suspension with 23,000 lb GVW or Greater	16-16873-000	...	010 85029		
		141700131810	010 83160	...		
		16-16737-000	010 83160	...		
		16-16874-000	010 83160	...		
		141700131809	...	010 85029		
		16-16736-000	...	010 85029		
		16-18103-000	-1- 85900	...		
		481700000493	-1- 85900	...		
		06	Cross Country Series MotorHomes with Freightliner XC Chassis ADL200 Suspension w/ 20K Rear AS120 Front Suspension Rear Shock with O.E.M. Number ZF - IFS Front Suspension with 23,000 lb GVW or Greater	16-16873-000	...	010 85029
				141700131810	010 83160	...
16-16737-000	010 83160			...		
16-16874-000	010 83160			...		
141700131809	...			010 85029		
16-16736-000	...			010 85029		
16-18103-000	-1- 85900			...		
481700000493	-1- 85900			...		

CONTINENTAL TRAILWAYS-EAGLE INT'L

Model	OEM #	Front	Rear
Buses with O.E.M. Number	01-0100-020	85307	...
	5532026	85304	...
	6-05-5	85307	...
Silver Eagle	01-0100-905	85303	85303 89422
	5394467	85305	85305 89422
	680091	85303	85303 89422
	70039	85303	85303 89422
	70041	85305	85305 89422

COUNTRY COACH

Models with O.E.M. Number	89406	010	...	89406
	89414		...	010	...	89414









CRANE CARRIER

Model	OEM #	Front	Rear
Models with O.E.M. Number	277A-1	010 85307	...
	277A-13	010 85302	89420
	277A-14	010 85304	...
	277A-8	010 85303	89422
	277A-9	010 85307	...
	680091	010 85303	89422
Additional O.E.M. Interchanges	277A-12	010	85304
	680088	010	85713

CROWN COACH

All with Steel Spring Suspension	3188729	010	85303	89422
	5532026		85304	...	010	85304

APPLICATION GUIDE - TRUCKS, TRAILERS, AND BUSES

Year Año Année	Model Modelo Modèle	OEM #	Front		Rear	
						
						
			Fleetline	GasSLX	Fleetline	GasSLX

DODGE TRUCK(Cont'd.)

LNT, LVT, NLT, VLT- Tilt Cab 6 x 4(Cont'd.)

64 - 73	LNT, LVT Models	2516009		OIO	G63183	...
---------	-----------------	---------	--	-----	-----	-----	---------------	-----

LS & LT-Steel Tilt Cab

73 - 75	LS-1000, LT-1000	2516009		OIO	G63183	...
---------	------------------	---------	--	-----	-----	-----	---------------	-----

Motorhome Chassis

73 - 81	M & R-300, 400, 500 Motorhome Chassis	3638112 3638631	OIO	OIO	G63183	...
				G63605
63 - 72	M-300, M-375 & R-375 Motorhome Chassis	2961043 3633744		OIO	G63183	...
				OIO	G63183	...
77 - 81	M-6 Motorhome Chassis	3638112 4036892	OIO	OIO	G63183	...
				G63605

P Series - Forward Control

72 - 82	P-300	OIO	G63183	...
63 - 78	P-400	OIO	G63183	...
63 - 71	PC-500 and PC-600, PD-500 and PD-600	OIO	G63183	...

School Buses

61 - 71	S-400, S-500, S-600	OIO	G63183	...
72 - 73	S-500, S-600	2516009		OIO	G63183	...
74 - 78	S-600, S-700	3633643		OIO	G63183	...

W-Series And Power Wagons

61 - 72	W-500, WT-500 Models	OIO	G63183	...
73	W-600 Models	2516009 2960707	OIO	OIO	G63183	...
				G63183
74 - 78	W-600 Models	3633643		OIO	G63183	...

DUPLEX TRUCK

	Models with O.E.M. Number	59024 7604-3371		83204	...	OIO	83204	...
				83204	...	OIO	83204	...





DURA SUSPENSION

	Models with O.E.M. Number	1080099 12866 59024 59030 665133 665267 7604-3371 A-2212		OIO	83203	89436
				OIO	83207	89407
				OIO	83204	...
				OIO	83203	89436
				OIO	83203	89436
				OIO	85029	...
				OIO	83204	...
				OIO	85029	...

EAGLE MOTOR COACH

	Buses with Rubber Torsion Suspension	6-05-5		OIO	85307	...
	Buses with Steel Spring Suspension	5532026		85304	...	OIO	85304	...
	Models with O.E.M. Number	01-0100-020 01-0100-905 014-0100-905 101364 154-0100-514 5394467 680091 70039 70041	OIO	OIO	85307	...
				85303	...	OIO	85303	89422
				85308	89422	
				85305	...	OIO	85305	...
				85314	89425	
				85305	...	OIO	85305	...
				85303	...	OIO	85303	89422
				85303	...	OIO	85303	89422
	Additional O.E.M. Interchanges	0140100-905	OIO	85308 or 89422				

APPLICATION GUIDE - TRUCKS, TRAILERS, AND BUSES

Year Año Année	Model Modelo Modèle	OEM #	Front		Rear	
						
			Fleetline	GasSLX	Fleetline	GasSLX

EAGLE MOTOR COACH(Cont'd.)

Additional O.E.M. Interchanges	12B-5-1	○ ○	85735
	12J-5-10	○ -	85733
	690060	○ ○	85713

EAST MANUFACTURING CORP.

Identification of the trailer suspension is necessary to determine what section of the catalog to refer to. Some possible options can be Chalmers, Hendrickson, Neway, Ridewell, Reyco.									
	Shocks with stamping number	A-20002							
		A-20126	○ ○	85000	89436		
			○ ○	85323	89436		
	Trailers with East Trailer part number	517-05001-18	○ ○	87015	...		
		517-05001-23	○ ○	85005	89430		
		517-05006-20	○ ○	85030	89440		
		517-05009-14	○ ○	83125	...		
		517-05010-07	○ ○	83214	...		
		517-05022-07	○ ○	83217	...		
		517-05110-20	○ ○	85000	89436		
		517-05511-14	○ ○	83128	...		
		517-05805-20	○ ○	85000	89436		
		517-05806-20	○ ○	85029	...		
		517-05808-20	○ ○	85738	...		
		517-05809-20	○ ○	...	89437		
		517-05916-14	○ ○	83124	89407		

ELDORADO NATIONAL

02 - 13	40 Foot Low Floor Buses with O.E.M	13208701	- -	85746	
		13208801	- -	85745

FLEETWOOD RV

Class A MotorHomes

02 - 06	Bounder / Discovery & Expedition MotorHomes with Freightliner XC Chassis								
	ADL200 Suspension w/ 20K Rear	16-16873-000	○ ○	85029	...		
	AS120 Front Suspension	141700131810	○ ○	83160		
		16-16737-000	○ ○	83160		
		16-16874-000	○ ○	83160		
	Rear Shock with O.E.M. Number	141700131809	○ ○	85029	...		
		16-16736-000	○ ○	85029	...		
	ZF - IFS Front Suspension with 23,000 lb GVW or Greater	16-18103-000	- -	85900		
		481700000493	- -	85900		
03 - 06	Excursion & Providence MotorHomes with Freightliner XC Chassis								
	ADL200 Suspension w/ 20K Rear	16-16873-000	○ ○	85029	...		
	AS120 Front Suspension	141700131810	○ ○	83160		
		16-16737-000	○ ○	83160		
		16-16874-000	○ ○	83160		
	Rear Shock with O.E.M. Number	141700131809	○ ○	85029	...		
		16-16736-000	○ ○	85029	...		
	ZF - IFS Front Suspension with 23,000 lb GVW or Greater	16-18103-000	- -	85900		
		481700000493	- -	85900		

FLUIDRIVE

Models T950-1200, -1400, -1700	2697								
			○ ○	85712	...		

APPLICATION GUIDE - TRUCKS, TRAILERS, AND BUSES

Year Año Année	Model Modelo Modèle	OEM #	Front		Rear	
			Fleetline	GasSLX	Fleetline	GasSLX

FLXIBLE BUS

	29 Passenger & Vista Coach		83217	...	OIO	83217	...
	2-Level Intercity Bus		85736	...	OIO	85736	...
	City Bus - 51 Passenger	6-05-1	OIO	85736
		6-05-2	OIO	85736
		6-05-3	OIO	85736
		6-05-4	OIO	85736
		6-05-5	OIO	85307
		6-05-6	OIO	85736
		6-05-7	OIO	85736
		6-05-8	OIO	85736
	City Bus - 51 Passenger with Rubber Torsion Suspension	6-05-1		85736	...	OIO	85736	...
		6-05-2		OIO	85736	...
		6-05-3		OIO	85736	...
		6-05-4		OIO	85736	...
		6-05-5		OIO	85307	...
		6-05-6		OIO	85736	...
		6-05-7		OIO	85736	...
		6-05-8		OIO	85736	...
	CNG Bus (Natural Gas)	87-2519-00002	-IO	85731
		87-2519-00004	-IO	85731
		87-2520-00002		OIO	85730	...
		87-2520-00004		OIO	85730	...
		97-2201-00008	-IO	85731
		97-2210-00010		OIO	85730	...
	Model 870 Flex Bus, Metro	22024062	-I-	85701
		22024506	-IO	85703
		22025066	-IO	85703
		4975518		OIO	85704	...
		680320	-IO	85703
		74412		OIO	85704	...
		87-2519-00001	-IO	85703
		87-2519-00003	-IO	85703
		87-2520-00001		OIO	85704	...
		87-2520-00003		OIO	85704	...
		97-2201-00003	-IO	85703
		97-2201-00005	-IO	85703
		97-2201-00006	-IO	85703
		97-2201-00007	-IO	85703
		97-2201-00009	-IO	85703
		97-2210-00001		OIO	85704	...
		97-2210-00002		OIO	85704	...
		97-2210-00003		OIO	85704	...
		97-2210-00004		OIO	85704	...
		97-2210-00005		OIO	85704	...
97-2210-00006		OIO	85704	...		
97-2210-00009		OIO	85704	...		
97-2210-00011		OIO	85704	...		
	Models with O.E.M. Number	22012067		85700	...	OIO	85700	...
		22012114		85700	...	OIO	85700	...
		22024061		OIO	85704	...
		22025067		OIO	85704	...
		22025305		OIO	85704	...





APPLICATION GUIDE - TRUCKS, TRAILERS, AND BUSES

Year Año Année	Model Modelo Modèle	OEM #	Front		Rear	
			Fleetline	GasSLX	Fleetline	GasSLX

FLXIBLE BUS(Cont'd.)

	Models with O.E.M. Number	3166657		85700	...	010	85700	...
		3192333		85700	...	010	85700	...
		6-05-13		010	85304	...
		6-05-9	010	85304
		6-367-12		85700	...	010	85700	...
		6-367-14		85700	...	010	85700	...
		6-367-16		85700	...	010	85700	...
		6-367-8		85700	...	010	85700	...
		695125		010	85704	...
		97-2201-00001	-10	85703
		97-2201-00002	-10	85703
		97-2201-00004	-10	85703
		97-2201-00151		85700	...	010	85700	...
		97-2210-00170		85733	...	01-	85733	...
		97-9999-02592	-10	85710
	Additional O.E.M. Interchanges	015813	-1-	85708				
		06-0367-00151	010	85700				
		06-0367-00156	010	85702				
		06-0367-00157	-1-	85701				
		48-1-239	010	85736				
		48-1-241	010	85712				
		6-05-10	010	85734				
		6-367-1	-10	85711				
		6-367-11	-10	85711				
		6-367-17	010	85700				
		6-367-2	010	85736				
		6-367-3	010	85304				
		6-367-4	010	83217				
		6-367-6	-10	85711				
		6-367-7	010	85305				
		6-367-9	-10	85711				
		680029	010	85301				
		680155	010	85712				
		97-2210-00153	-1-	85701				
		97-2210-00156	010	85702				
		97-2210-00157	-1-	85708				
		97-2210-00160	-1-	85705 or 89447				
		97-2210-00162	-1-	85701				
		97-2210-00164	-1-	85708				
		97-9999-00732	-1-	85707				
		97-9999-00807	010	85307				
		97-9999-02514	010	85700				
		97-9999-02515	010	85702				
		97-9999-02516	-1-	85701				
		97-9999-02519	-1-	85707				
		97-9999-02595	010	85313				
		97-9999-02632	-10	85711				
97-9999-02633	-10	85311 or 89424						
97-9999-02634	01-	85733						
97-9999-02635	010	85718						
97-9999-02636	010	85716						

APPLICATION GUIDE - TRUCKS, TRAILERS, AND BUSES

Year Año Année	Model Modelo Modèle	OEM #	Front		Rear	
						
			Fleetline	GasSLX	Fleetline	GasSLX

FLYER INDUSTRIES

	Coaches with Low Floor	15813		- -	85708	...
91 -	Coaches with Low Floor	009863	- -	85722
	Additional O.E.M. Interchanges	015915	- 0				85711	
		22012067	0 0				85700	
		22012114	0 0				85700	
		3166657	0 0				85700	
		3192333	0 0				85700	
		4975501	0 0				85700	
		4975552	- 0				85711	
		592-6568	0 0				85700	
		5979574	0 0				85700	

FORD











AeroMax (A, AT, AAT, 8500, 9500) Series

96	8000 Models with 12000 or 13000 lb Axles	F6HT-18045-LA	0 0	85376
96	8000 Models with 16000 lb. Multileaf Spring	F6HT-18045-AA	0 0	85054	89438	
96 - 97	9500 (113" & 122" BBC) Models with 10000 lb Axle and 54" Multileaf Spring	F6HT-18045-KA	0 0	83200	89402	
96 -	9500 (113" & 122" BBC) Models with 12000 or 13200 lb Axle and 54" Multileaf Spring	F6HT-18045-BC	0 0	85047	89435	
96 - 97	9500 (113" & 122" BBC) Models with 8500 or 9000 lb Axle and 54" Taperleaf Spring	F6HT-18045-HC	0 0	85054	89438	
96 -	All Models with 10000 lb or 12000 lb Axle and 54" Taperleaf Spring	F6HT-18045-AC	0 0	85054	89438	
		F6HZ-18124-A	0 0	85054	89438	
		F6HZ-18124-G	0 0	85054	89438	
96 -	All with 12000 lb, 13000 lb or 14600 lb Axle and 60" Taperleaf Spring	F6HT-18045-EB	0 0	85055	89439	
		F6HT-18045-EC	0 0	85055	89439	
		F6HZ-18124-D	0 0	85055	89439	
		F6HZ-18124-E	0 0	85055	89439	
		F6HZ-18124-F	0 0	85055	89439	
96 -	All with 13200 lb or 14600 lb Axle and 54" Taperleaf Spring	F6HT-18045-GB	0 0	85030	89440	
		F6HT-18045-GC	0 0	85030	89440	
96 -	All with 21000 lb or 23000 lb Axle and 46" Taperleaf spring	F5HZ-18125-B		0 0	85001	89410
96 -	All with 23000 lb Axle and 52" Taperleaf spring	F5HZ-18125-A		0 0	85314	89425
96 - 97	All with Hendrickson 40LH Model Tandem Axle	57241-2		0 -	83109	...
		F6HT-18080-B		0 -	83109	...
		F6HT-18080-DA		0 -	83109	...
		F6HZ-18125-B		0 -	83109	...
96 - 97	All with Hendrickson HAS-400, HA-210 or HA-230 Air Suspension	47902-28		0 0	85013	89414
		F6HZ-18080-FC		0 0	85013	89414
		F6HZ-18125-D		0 0	85013	89414
96 - 97	All with Neway AD-123 Air Suspension	90045068		- 0	...	89441
		F6HZ-18125-C		- 0	...	89441
96 - 97	All with Neway AD-246 Air Suspension	90045099		0 0	85906	89407
		90045132		0 0	85909	...

B - Series - Bus Cowl Chassis

61 - 79	B - 500, B - 600, B - 700, B - 750 Models	D2TF-18080-HA		0 0	83225	...
		D7HT-18080-BA		0 0	83225	...
70 - 79	B - 500, B - 600, B - 700, B - 750 Models	D2TF-18045-GA	0 0	83308
		D7HT-18045-GA	0 0	83308

APPLICATION GUIDE - TRUCKS, TRAILERS, AND BUSES

Year Año Année	Model Modelo Modèle	OEM #	Front				Rear			
										
										
Fleetline		GasSLX		Fleetline		GasSLX				

FORD(Cont'd.)

B - Series - Bus Cowl Chassis(Cont'd.)

61 - 69	B - 500, B - 600, B - 700, B - 750 with 4000, 4700 and 5000 lb Axle	- -	83400
61 - 69	B - 500, B - 600, B - 700, B - 750 with 6000 & 7000 lb Axle	C2TA-18045-A	o o	83216
86 - 89	B - 600, B - 700 Models with O.E.M. Number	ASH-24446		o o	83215	...
		AX-310		o o	83215	...
77 - 96	B - 600, B - 700, B - 750, B - 800, B - 7000 with 18500 lb Axle	D7HT-18080-AA		o o	83215	...
80 - 96	B - 600, B - 700, B - 800, B - 7000 Models	D7HT-18080-DA		o o	83215	...
		E0HT-18045-AA	o o	83309	89446	
		E0HT-18045-AB	o o	83309	89446	
		E0HT-18080-AA		o o	83215	...
	F1HT-18045-AA	o o	83309	89446		
77 - 79	B - 600, B - 750, with 18500 lb Axle	D7HT-18080-DA		o o	83215	...
94 - 97	B - 700, B - 800 with 14600 lb Multileaf Spring	F4HT-18045-EA	o o	83125
94 - 97	B - 700, B - 800 with 15000, 17500, 19000 lb Taperleaf Springs	F4HT-18080-AA		o o	85314	89425
		F4HT-18080-AB		o o	85314	89425
94 - 97	B - 700, B - 800 with 21000 lb Taperleaf Springs	F4HT-18080-BA		o o	85001	89410
94 - 97	B - 700, B - 800 with 52" Multileaf Spring	F4HT-18045-CB	o o	83107





C & CT Series - Tilt Cab

71 - 73	C-500, C-550, C-600, C-650, C-700, C-750 with 6000 & 7000 lb Axle	D1TF-18045-LA	o o	83312	89409	
64 - 67	C-550, C-600 with 6000 lb Axle - and Power Steering	C2TA-18045-A	o o	83216
64 - 67	C-550, C-600 with 6000 lb Axle - Exc. with Power Steering	C6PF-18077-A	o o	G63306
64 - 67	C-550, C-600, C-650, C-700, C-750 Models	C6PF-18077-F		o o	83225	...
67 - 69	C-600, C-650, C-700, C-750, C-800, C-850, C-1000 with 7000, 9000, 11000, 12000, 15000 lb Axles - Exc. with 175" Wheel Base	D2HF-18045-CA	o o	83308
67 - 71	C-600, C-650, C-700, C-750, C-800, C-850, C-1000 with 7000, 9000, 11000, 12000, 15000 lb Axles and 175" Wheel Base	C8HA-18045-A	o o	83312	89409	
80 - 90	C-600, C-700, C-7000, C-800, C-8000, CT-800, CT-8000 with 3100 lb Spring and 7000 lb Axle	D7HT-18045-JA	o o	83308
76 - 79	C-600, C-700, C-750, C-800, C-900, CT-800, CT-900 Models	D2EF-18045-AA	o o	83312	89409	
		D7KF-18045-EA	o o	83312	89409	
80 - 90	C-600, C-700, C-800, C-7000, CT-800, CT-8000 with 4040, 5040 lb Springs and 7000, 9000, 12000 lb Axles	D2EF-18045-AA	o o	83312	89409	
64 - 66	C700/1100, CT-700/1100 with 7000, 9000, 11000, 15000 lb Axles	D2HF-18045-CA	o o	83308
69 - 79	C-750, C-800, C-850, C-900, CT-750, CT-800, CT-850, CT-900, CT-950 with 9000 lb to 15000 lb Axles	C8HA-18045-A	o o	83312	89409	
		D1TF-18045-LA	o o	83312	89409	
		D2KF-18045-AA	o o	83312	89409	

CF Series (Brazilian Built)

86 - 89	CF - 600, CF - 700 Models	E5HT-18045-AA	o o	85301
		E5HT-18080-DA		o o	85315	...
		E5HT-18080-EA		o o	85315	...
96 - 97	CF-7000, CF-8000 or CFT-8000 Models with 16000 lb. Multileaf Spring	F6HT-18045-AA	o o	85054	89438	
92 - 97	CF-7000, CF-8000 or CFT-8000 Models with 9000 lb Axle	F2HT-18045-BA	o o	85376
		F2HT-18045-CA	o o	85376
		F2HZ-18124-A	o o	85376
		F6HT-18045-LA	o o	85376
86 - 97	CF-7000, CF-8000 with 12000 lb or 13000 lb Axle	o o	85302	89420
		87HU-18045-AA	o o	85301
		E5HT-18045-AA	o o	85301
		E6HZ-18124-A	o o	85301

APPLICATION GUIDE - TRUCKS, TRAILERS, AND BUSES

Year Año Année	Model Modelo Modèle	OEM #	Front		Rear	
						
			Fleetline	GasSLX	Fleetline	GasSLX

FORD(Cont'd.)

CF Series (Brazilian Built)(Cont'd.)

86 - 97	CF-7000, CF-8000 with 12000 lb or 13000 lb Axle	E7HZ-18124-A	OIO	85301
---------	---	--------------	-----	-------	-----	-----	-----









CL & CLT Series - Highway Tractor Tilt Cab

78 - 89	CL-9000, CLT-9000 Models	D7HT-18045-NA	OIO	85301
90 - 91	CL-9000, CLT-9000 with Multileaf Spring	F1HT-18045-NA	OIO	85040
78 - 89	CL-9000, CLT-9000 with Rear Tandem Axle with Neway Suspension	D7HA-18080-AA		OIO	83123 89405
78 - 89	CL-9000, CLT-9000 with Single Rear Axle Suspension	D4HA-18080-AA		OIO	83209 89414
	Models with Hendrickson Rear Air Suspension	47902-13		OIO	83122 89406

F Series - Conventional Cab

64 - 66	F-1000 Models with 11000 lb to 15000 lb Axles	C1TT-18045-D	OIO	G63406
64 - 69	F-500	C2TA-18045-A	OIO	83216
64 - 77	F-500	C7PF-18077-A		OIO	83225 ...
		D2TF-18080-HA		OIO	83225 ...
67 - 69	F-500	C8TA-18045-AA	-IO	G63386
70 - 77	F-500	D2HT-18045-GA	OIO	83308
		D2TF-18045-GA	OIO	83308
64 - 79	F-600 (2 x 4), F-650, F-700, F-750	C7PF-18077-A		OIO	83225 ...
		D2TF-18080-HA		OIO	83225 ...
		D7HT-18080-BA		OIO	83225 ...
71 - 79	F-600 (4 x 4)	D2HT-18045-GA	OIO	83308
		D2TF-18045-GA	OIO	83308
80 - 94	F-600, F-6000, F-700, F-7000, F-800, F-8000, FT-700, FT-800, FT-8000 - Exc. 9000 lb Axle with H.D. Suspension & 12000 lb Axle	E0HT-18045-AA	OIO	83309	89446
		E0HT-18045-AB	OIO	83309	89446
83 - 89	F-600, F-6000, F-700, F-7000, F-800, F-8000, FT-700, FT-800, FT-8000 with 9000 lb Axle with H.D. Suspension & 12000 lb Axle	D2HF-18045-AA	OIO	83314
		D7HT-18045-CA	OIO	83314
67 - 69	F-600, F-650, F-700, F-750 with 5500, 6000, 7000 & 9000 lb Axles	C8TA-18045-AA	-IO	G63386
70 - 79	F-600, F-650, F-700, F-750 with 5500, 6000, 7000 & 9000 lb Axles	D2HT-18045-GA	OIO	83308
		D2TF-18045-GA	OIO	83308
64 - 67	F-600, F-700, F-750	C7PF-18077-A		OIO	83225 ...
64 - 69	F-600, F-700, F-750 with 6000 & 7000 Axle	C2TA-18045-A	OIO	83216
86 - 90	F-600, F-700, F-800	ASH-24446		OIO	83215 ...
		AX-310		OIO	83215 ...
		E6HT-18080-AA		OIO	83215 ...
		E6HZ-18125-D		OIO	83215 ...
80 - 90	F-600, F-700, F-800 with 13000 & 15000 lb Rear Axle	D7HT-18080-BA		OIO	83225 ...
80 - 90	F-600, F-700, F-800 with 17000 & 18000 lb Rear Axle	D7HF-18080-AA		OIO	83215 ...
		D7HT-18080-DA		OIO	83215 ...
90	F-600, F-700, F-800, FT-800, FT-900, with Multileaf Spring	F1HT-18045-AA	OIO	83309	89446
89 - 94	F-600, F-700, LPO (Low Profile Vehicle)	E9HS-18045-AA	OIO	83309	89446
		E9HS-18080-AA		OIO	85716 ...
70 - 72	F-700 (Diesel), F-750 with 9000 lb Axle	D2HF-18045-CA	OIO	83308
73 - 79	F-700 (Diesel), F-750 with 9000 lb Axle	D2EF-18045-AA	OIO	83312	89409
		D2TF-18045-AA	OIO	83312	89409
		D7HT-18045-BA	OIO	83312	89409
90 - 97	F-700, F-800	ASH-24446		OIO	83215 ...
		AX-310		OIO	83215 ...
		E6HT-18080-AA		OIO	83215 ...

APPLICATION GUIDE - TRUCKS, TRAILERS, AND BUSES

Year Año Année	Model Modelo Modèle	OEM #	Front		Rear	
						
						
			Fleetline	GasSLX	Fleetline	GasSLX

FORD(Cont'd.)





F Series - Conventional Cab(Cont'd.)

90 - 97	F-700, F-800	E6HZ-18125-D		OIO	83215	...
94 - 98	F-700, F-800 with 15000, 17500, 19000 lb Taperleaf Springs	F4HT-18080-AA		OIO	85314	89425
		F4HT-18080-AB		OIO	85314	89425
		F5HZ-18125-A		OIO	85314	89425
94 - 97	F-700, F-800 with 21000 lb Taperleaf Springs	F4HT-18080-BA		OIO	85001	89410
94 - 97	F-700, F-800 with 52" or 54" Taperleaf Springs and with 10000 or 12000 lb Axle	F4HT-18045-DA	OIO	85063
		F5HZ-18124-C	OIO	85063
94 - 97	F-700, F-800 with Multileaf Spring and 14600 lb Axle	F4HT-18045-EA	OIO	83125
		F5HZ-18124-D	OIO	83125
94 - 97	F-700, F-800 with Multileaf Spring and with 10000, 12000 or 13200 lb Axle	F4HT-18045-CB	OIO	83107
		F5HZ-18124-B	OIO	83107
94 - 98	F-700, F-800 with Taperleaf Springs and with 6000, 7000, 8500, 9000 lb Axle	F4HT-18045-AB	OIO	83314
		F4HT-18045-AC	OIO	83314
		F5HZ-18124-A	OIO	83314
76 - 79	F-800	D2HT-18080-HA		OIO	83225	...
		D2TF-18045-GA	OIO	83308
		D7HT-18045-GA	OIO	83308
		D7HT-18080-BA		OIO	83225	...
76 - 79	F-800 with 9000 lb Axle	D2EF-18045-AA	OIO	83312	89409	
		D2TF-18045-AA	OIO	83312	89409	
		D7HT-18045-BA	OIO	83312	89409	
64 - 66	F-800, F-850-,F-900, F-950, F-1000 - Exc. Diesel with 11000 CP Axle	C1TT-18045-D	OIO	G63406
64 - 69	F-800, F-850-,F-900, F-950, F-1000 with 6000, 7000, 9000, 11000, 12000, 15000, 18000 lb Axles (Exc. Diesel with 6000 and 7000 lb Axles)	C1TT-18045-C	OIO	83312	89409	
		C6PF-18077-DL	OIO	83312	89409	
64 - 69	F-950, F-1000, F-1100 Diesel with 7000 lb Axle	C6PF-18077-DN	OIO	83314

F Series - F450, F550, F650, F750 Models

99 - 04	F-450 , F-550 Superduty with single or dual rear wheels with 165" or 201" wheel base	ASH-23486		OIO	G63461	...
		ASH-247		OIO	G63461	...
		AT-610		OIO	G63461	...
		AT-611		OIO	G63461	...
		F81A-18080-DCA		OIO	G63461	...
		F81Z-18125-DC		OIO	G63461	...
15 - 16	F-650 (22,000 lb GVW)	471700011530	OIO	85181
		ASH-24659	OIO	85181
		FC44-18045-BB	OIO	85181
		FC4Z-18124-B	OIO	85181
00 - 15	F-650 with 10,000 lb Front Suspension	3584116C1	OIO	83175
		3584116C2	OIO	83175
		4C4Z-18124-QA	OIO	83175
		AA-616	OIO	83175
00 - 15	F-650 with 12,000 & 13,200 lb Front Springs	3584118C2	OIO	85928
		4C4Z-18124-RA	OIO	85928
		AA-617	OIO	85928
15 - 16	F-650 with 13,500, 15,500 & 19,000 lb Multi-leaf Rear Springs	471700011531		OIO	85180	...
		ASH-24660		OIO	85180	...
		FC44-18080-AB		OIO	85180	...

APPLICATION GUIDE - TRUCKS, TRAILERS, AND BUSES









Year Año Année	Model Modelo Modèle	OEM #	Front		Rear	
						
			Fleetline	GasSLX	Fleetline	GasSLX

FORD(Cont'd.)

F Series - F450, F550, F650, F750 Models(Cont'd.)

15 - 16	F-650 with 13,500, 15,500 & 19,000 lb Multi-leaf Rear Springs	FC4Z-18125-A		010	85180	...
- 15	F-650 with 21,000 lb Rear Air Suspension	3578858C1		010	85926	...
		3578858C2		010	85926	...
		4C4Z-18125-DA		010	85926	...
05 - 10	F-650 with 22,000 lb Multi-leaf Rear Springs	4C4Z-18125-B		-10	83317	...
		501906C92		-10	83317	...
98 - 03	F-650 with 23,000 lb Multi-leaf Rear Springs	AT-696		010	83140	...
		F81A-18080-ZC		010	83140	...
		F81Z-18125-ZA		010	83140	...
00 - 15	F-650 with 6,000 to 8,000 lb Front Suspension	3584117C2	010	83135
		4C4Z-18124-HB	010	83135
		4C4Z-18124-P	010	83135
		AA-615	010	83135
		AT-811	010	83135
		FC4Z-18124-HB	010	83135
98 - 03	F-650 with 8500 or 9000 lb Front Axle	AA-494	010	83131
		ASH-397	010	83131
		XC35-18045-AB	010	83131
		XC35-18045-AD	010	83131
		XC35-18045-JA	010	83131
		XC3Z-18124-JA	010	83131
98 - 03	F-650 with Hendrickson HAS - 190 Rear Air Suspension	1C44-18080-AA		010	83123	89405
		60670-008		010	83123	89405
05 - 07	F-650 with O.E.M. Number	3553628C1	010	85927
		3553628C2	010	85927
15 - 16	F-750 (22,000 lb GVW)	471700011530	010	85181
		ASH-24659	010	85181
		FC44-18045-BB	010	85181
		FC4Z-18124-B	010	85181
00 - 15	F-750 with 10,000 lb Front Suspension	3584116C1	010	83175
		3584116C2	010	83175
		4C4Z-18124-QA	010	83175
		AA-616	010	83175
00 - 15	F-750 with 12,000 & 13,200 lb Front Springs	3584118C2	010	85928
		4C4Z-18124-RA	010	85928
		AA-617	010	85928
15 - 16	F-750 with 13,500, 15,500 & 19,000 lb Multi-leaf Rear Springs	471700011531		010	85180	...
		ASH-24660		010	85180	...
		FC44-18080-AB		010	85180	...
		FC4Z-18125-A		010	85180	...
- 15	F-750 with 21,000 lb Rear Air Suspension	3578858C1		010	85926	...
		3578858C2		010	85926	...
		4C4Z-18125-DA		010	85926	...
05 - 10	F-750 with 22,000 lb Rear Spring Suspension	4C4Z-18125-B		-10	83317	...
		501906C92		-10	83317	...
98 - 03	F-750 with 23000 lb Multi-leaf Rear Springs	AT-696		010	83140	...
		F81A-18080-ZC		010	83140	...
		F81Z-18125-ZA		010	83140	...
00 - 15	F-750 with 6,000 to 8,000 lb Front Suspension	3584117C2	010	83135
		4C4Z-18124-HB	010	83135
		4C4Z-18124-P	010	83135

APPLICATION GUIDE - TRUCKS, TRAILERS, AND BUSES

Year Año Année	Model Modelo Modèle	OEM #	Front		Rear	
						
						
			Fleetline	GasSLX	Fleetline	GasSLX

FORD(Cont'd.)

F Series - F450, F550, F650, F750 Models(Cont'd.)

00 - 15	F-750 with 6,000 to 8,000 lb Front Suspension	AA-615	OIO	83135	
		AT-811	OIO	83135	
		FC4Z-18124-HB	OIO	83135	
98 - 03	F-750 with 8500 or 9000 lb Front Axle	AA-494	OIO	83131	
		ASH-397	OIO	83131	
		XC35-18045-AB	OIO	83131	
		XC35-18045-AD	OIO	83131	
		XC35-18045-JA	OIO	83131	
		XC3Z-18124-JA	OIO	83131	
98 - 03	F-750 with Hendrickson HAS - 190 Rear Air Suspension	1C44-18080-AA		OIO	83123	89405
		60670-008		OIO	83123	89405
05 - 07	F-750 with O.E.M. Number	3553628C1	OIO	85927	
		3553628C2	OIO	85927	

FT Series - Conventional Cab

90 - 92	FT-900 (Low Profile Vehicle)	E9HS-18080-AA		OIO	85716	...
90 - 94	FT-900 (Low Profile Vehicle)	E9HS-18045-AA	OIO	83309	89446	
		E9HZ-18124-A	OIO	83309	89446	
94 - 97	FT-900 with 46" Taperleaf Spring and 15000, 17500 or 19000 lb Axle	F4HT-18080-AA		OIO	85314	89425
		F4HT-18080-AB		OIO	85314	89425
		F5HZ-18125-DA		OIO	85314	89425
94 - 97	FT-900 with 46" Taperleaf Springs and 21000 lb Axle	F4HT-18080-BA		OIO	85001	89410
94 - 97	FT-900 with 52 or 54" Taperleaf Springs and with 10000 or 12000 lb Axle	F4HT-18045-DA	OIO	85063
		F5HZ-18124-C	OIO	85063
90 - 94	FT-900 with 9000 lb Axle with H.D. Suspension or 10000, 11000, or 12000 lb Axles	C4HZ-18124-E	OIO	83309	89446	
		E9HS-18045-AA	OIO	83309	89446	
		F1HT-18045-AA	OIO	83309	89446	
		F1HZ-18124-A	OIO	83309	89446	
94 - 97	FT-900 with Multileaf Spring and 14600 lb Axle	F4HT-18045-EA	OIO	83125
		F5HZ-18124-D	OIO	83125
94 - 97	FT-900 with Multileaf Spring and with 10000, 12000 or 13200 lb Axle	F4HT-18045-CB	OIO	83107
		F5HZ-18124-B	OIO	83107
90 - 97	FT-900 with shock located forward of rear axle	ASH-24446		OIO	83215	...
		AX-310		OIO	83215	...
		E6HT-18080-AA		OIO	83215	...
		E6HZ-18125-D		OIO	83215	...
94 - 97	FT-900, with Taperleaf Springs and with 6000, 7000, 8500 or 9000 lb Axles	F4HT-18045-AB	OIO	83314
		F5HZ-18124-A	OIO	83314



H and HT Series - Hi Tilt Cab

61 - 63	HT-950 with 11000 lb Axle	OIO	83314
61 - 66	HT-950 with 12000 & 15000 lb Axle	OIO	83314

L, LT & LTS - Conventional Cab

73 - 90	L-800, L8000, L-900, L-9000, LT-800, LT-880, LT8000, LT-900, LT-9000 with 7000, 9000, 12000 lb Axles	D2EF-18045-AA	OIO	83312	89409	
		D2KF-18045-AA	OIO	83312	89409	
		D7HF-18045-FA	OIO	83312	89409	
		D7HT-18045-BA	OIO	83312	89409	
73 - 85	L-800, L8000, L-900, L-9000, LT-800, LT-880, LT8000, LT-900, LT-9000, LTS-8000, LTS-900, LTS-9000 with 7000, 9000, 12000, 16000 lb Axles	D2HF-18045-AA	OIO	83314

APPLICATION GUIDE - TRUCKS, TRAILERS, AND BUSES

Year Año Année	Model Modelo Modèle	OEM #	Front		Rear	
						
			Fleetline	GasSLX	Fleetline	GasSLX

FORD(Cont'd.)

L, LT & LTS - Conventional Cab(Cont'd.)

73 - 85	L-800, L8000, L-900,L-9000, LT-800, LT-880, LT8000, LT-900, LT-9000, LTS-8000, LTS-900, LTS-9000 with 7000, 9000, 12000, 16000 lb Axles	D2HT-18045-CA	010	83314
73 - 90	L-800, L850, L-900,L-9000, LT-800, LT-850, LT880, LT-900, LT-9000, LTS-800, LTS-850, LTS-900 with 7000, 9000, 12000, 16000 lb Axles	D2HF-18045-BA	010	83309	89446	
		D7HT-18045-DA	010	83309	89446	
94 - 97	L-8000, L-9000, LT-8000 or LT-9000 Models with 21000 or 23000 lb. with 46" Taperleaf Spring	F4HT-18080-BA		010	85001	89410
90 - 97	L-8000, L-9000, LT-8000, LT-9000 with 52" Taperleaf Spring	F1HT-18045-GA	010	85006	89401	
91 - 92	L-8000, L-9000, LT-8000, LT-9000 with 52" Taperleaf Spring	F1HT-18045-GB	010	...	89403	
90 - 97	L-8000, L-9000, LT-8000, LT-9000 with 58" Parabolic Taperleaf Spring	F1HT-18045-RA	010	...	89441	
		F1HT-18045-RB	010	...	89402	
	L-8000, L-9000, LT-8000, LT-9000 with Hendrickson Rear Air Suspension	47902-13		010	83122	89406
91 - 97	L-8000, L-9000, LT-8000, LT-9000 with Multleaf Spring	F1HT-18045-DA	010	83312	89409	
91 - 97	L-8000, L-9000, LT-8000, LT-9000 with 4000, 4500, 5400, 6000, 7200 lb Multileaf Springs and with 9000, 10000, 12000 or 16000 lb Axles	F1HT-18045-CB	010	83216
91 - 97	L-8000, L-9000, LT-8000, LT-9000 with 4500, 5400, 6000, 7200, 10000 lb Multileaf Springs and with 10000, 12000, 13200, 16000 lb Axles	F1HT-18045-DB	010	83308
73 - 89	LTS-800, LTS-850, LTS-900, LTS-9000 with 16000 lb Axle	D0HA-18045-E	010	83312	89409	
		D2HF-18045-DA	010	83312	89409	
		D7HT-18045-EA	010	83312	89409	

LA, LS & LST - Conventional Cab

96	LA-8000 Models with 12000 or 13000 lb Axles	F6HT-18045-LA	010	85376
96	LA-8000 Models with 16000 lb. Multileaf Spring	F6HT-18045-AA	010	85054	89438	
91 - 96	LA-8000, LA-9000 Models with 4000, 4500, 5400, 6000, or 7200 lb. Multileaf Spring	F1HT-18045-CB	010	83216
91 - 96	LA-8000, LA-9000 Models with Hendrickson Rear Air Suspension	47902-28		010	85013	89414
90 - 97	LA-8000, LA-9000, LS-8000, LST-8000 with 4500 lb to 10000 lb Multileaf Spring	F1HT-18045-CA	010	83308
90 - 97	LA-8000, LS-8000, LST-8000 with 52" Taperleaf Spring	F1HT-18045-EA	010	...	89402	
91 - 96	LA-8000, LS-8000, LST-8000 with 58" Taperleaf Spring	F1HT-18045-EB	010	...	89402	









LL, LLA, LTA, LTL, LTLA - Conventional Cab

91 - 95	LL-9000 with 4500, 5000, 6000 lb Springs and with 10000, 11000, 12000 lb Axles	F1HT-18045-DB	010	83308
91 - 96	LL-9000, LLA-9000, LTA-9000, LTLA-9000, with 4000, 4500, 5400, 6000 or 7200 lb Multileaf Springs and with 9000, 10000, 12000 or 16000 lb Axles	F1HT-18045-CB	010	83216
91 - 96	LLA-9000, LTLA-9000 with 4500, 5400, 6500 lb 58" Parabolic Taperleaf Spring	F0HT-18045-CA	010	85006	89401	
		F1HT-18045-HB	010	85006	89401	
91 - 96	LTA-9000, LLA-9000 or LTLA-9000 Models With 4500, 5400, 6000, 7200 or 10000 lb. Multileaf Spring With Hendrickson Rear Air Suspension	F1HT-18045-CA	010	83308
		47902-28		010	85013	89414
80 - 85	LTL-900, LTL-9000 with 7000, 9000, 12000 lb Axle	D2HF-18045-AA	010	83314

LN & LNT - Conventional Cab

72	LN-500, LN-550 with 11000, 13000, 15000, 17000 lb Axles	D2TF-18080-HA		010	83225	...
70 - 72	LN-500, LN-550 with 5000, 5500, 6000 & 7000 lb Axles	D2TF-18045-GA	010	83308
72 - 79	LN-600, LN-650, LN-700, LN-750 with 11000, 13000, 15000, 17000 lb Axles	D2TF-18080-HA		010	83225	...
70 - 79	LN-600, LN-650, LN-700, LN-750 with 5000, 5500, 6000 & 7000 lb Axles	D7HT-18045-GA	010	83308
76 - 79	LN-600, LN-650, LN-700, LN-800	D2EF-18045-AA	010	83312	89409	

APPLICATION GUIDE - TRUCKS, TRAILERS, AND BUSES

Year Año Année	Model Modelo Modèle	OEM #	Front		Rear	
						
						
			Fleetline	GasSLX	Fleetline	GasSLX

FORD(Cont'd.)





LN & LNT - Conventional Cab(Cont'd.)

76 - 79	LN-600, LN-650, LN-700, LN-800	D7HT-18045-BA	010	83312	89409	
80 - 89	LN-600, LN-700, LN-7000, LN-800, LN-8000, LNT-800, LNT-8000 with 3000, 3300 lb Springs and 5000, 5500, 6000, 7000 lb Axles	D7HT-18045-GA	010	83308
80 - 89	LN-600, LN-700, LN-7000, LN-800, LN-8000, LNT-800, LNT-8000 with 4400 lb Spring and 7000, 9000 lb Axles	D2EF-18045-AA	010	83312	89409	
80 - 89	LN-600, LN-700, LN-750 with 11000, 13000, 15000, 17000 lb Axles	D7HT-18080-BA		010	83225	...
70 - 75	LN-700, LN-750 Diesel with 9000 lb Axle	C1TT-18045-C	010	83312	89409	
		D2EF-18045-AA	010	83312	89409	
94 - 97	LN-7000, LN-8000, LN-9000, LNT-8000 or LNT-9000 Models with 21000 or 23000 lb. with 46" Taperleaf Spring	F4HT-18080-BA		010	85001	89410
91 - 97	LN-7000, LN-8000, LN-9000, LNT-8000 or LNT-9000 Models with 4000, 4500, 5400, 6000 or 7200 lb. Multileaf Springs and with 9000, 10000, 12000 or 16000 lb. Axles	F1HT-18045-CB	010	83216
90	LN-7000, LN-8000, LN-9000, LNT-8000, LNT-9000 with 52" Taperleaf Spring	F1HT-18045-GA	010	85006	89401	
91 - 97	LN-7000, LN-8000, LN-9000, LNT-8000, LNT-9000 with 52" Taperleaf Spring	F1HT-18045-GB	010	...	89403	
90 - 97	LN-7000, LN-8000, LN-9000, LNT-8000, LNT-9000 with 58" Parabolic Taperleaf Spring	F1HT-18045-RA	010	...	89402	
		F1HT-18045-RB	010	...	89402	
	LN-7000, LN-8000, LN-9000, LNT-8000, LNT-9000 with Hendrickson Rear Air Suspension	47902-13		010	83122	89406
		F0HT-18080-AA		010	83122	89406
		F0HZ-18125-A		010	83122	89406
90 - 97	LN-7000, LN-8000, LN-9000, LNT-8000, LNT-9000 with Multileaf Spring	F1HT-18045-DA	010	83312	89409	
91 - 97	LN-7000, LN-8000, LN-9000, LNT-8000, LNT-9000 with 4500, 5400, 6000, 7200, 10000 lb Springs and with 10000, 12000, 13200, 16000 lb Axles	F1HT-18045-DB	010	83308
76 - 77	LN-800, LN-8000, LN-900, LN-9000, LNT-800, LNT-8000, LNT-900, LNT-9000	D2KF-18045-AA	010	83312	89409	
76 - 81	LN-800, LN-8000, LN-900, LN-9000, LNT-800, LNT-8000, LNT-900, LNT-9000	D2HF-18045-AA	010	83314
		D7HT-18045-CA	010	83314
70 - 71	LN-800, LN-850, LNT-900, with 7000, 9000, 12000 lb Axles	D2TF-18045-GA	010	83308
70 - 89	LN-800, LN-850, LN-8000, LN-900, LN-9000, LNT-800, LNT-850, LNT-880, LNT-8000, LNT-900, LNT-9000 with 6000, 7000, 9000, 12000, 16000 lb Axles	D2HF-18045-BA	010	83309	89446	
		D7HT-18045-DA	010	83309	89446	

Louisville Series - Conventional Cab

96 - 97	All Models with 10000 lb or 12000 lb Axle and 54" Taperleaf Spring	F6HT-18045-AC	010	85054	89438	
		F6HZ-18124-A	010	85054	89438	
		F6HZ-18124-G	010	85054	89438	
96 - 97	All with 12000 lb, 13000 lb or 14600 lb Axle and 60" Taperleaf Spring	F6HT-18045-EB	010	85055	89439	
		F6HT-18045-EC	010	85055	89439	
		F6HZ-18124-D	010	85055	89439	
		F6HZ-18124-E	010	85055	89439	
		F6HZ-18124-F	010	85055	89439	
96 -	All with 13200 lb or 14600 lb Axle and 54" Taperleaf Spring	F6HT-18045-GB	010	85030	89440	
		F6HT-18045-GC	010	85030	89440	
96 -	All with 54" Multi-leaf Spring and 14600 or 16000 lb Axle	F6HT-18045-CC	010	85055	89439	
		F6HZ-18124-C	010	85055	89439	
	All with 54" Multileaf Spring and with 12000 or 13200 lb Axle	F6HT-18045-BC	010	85047	89435	
96 - 97	All with 54" Multileaf Spring and with 8500 or 9000 lb Axle	F6HT-18045-JB	010	83200	89402	

APPLICATION GUIDE - TRUCKS, TRAILERS, AND BUSES

Year Año Année	Model Modelo Modèle	OEM #	Front		Rear	
						
			Fleetline	GasSLX	Fleetline	GasSLX

FORD(Cont'd.)

Louisville Series - Conventional Cab(Cont'd.)

96 - 97	All with 54" Multileaf Spring and with 8500 or 9000 lb Axle	F6HT-18045-JC F6HZ-18124-J	○ ○	83200	89402
			○ ○	83200	89402
96 - 97	All with 8500 lb or 9000 lb Axle with 54" Taperleaf Spring	F6HT-18045-HB F6HT-18045-HC F6HZ-18124-H	○ ○	85054	89438
			○ ○	85054	89438
			○ ○	85054	89438
	All with Hendrickson HAS-400 Air Suspension	47902-28 F6HZ-18080-FC F6HZ-18125-D		○ ○	85013 89414
				○ ○	85013 89414
				○ ○	85013 89414
	All with Neway AD-123 Air Suspension	90045068 F6HZ-18125-C		- ○	89441
				- ○	89441
	All with Neway AD-246 Air Suspension	90045099 90045132		○ ○	85906 89407
				○ ○	85909

Motorhome Chassis

99 - 17	F53 Motorhome Chassis with 16,000 lb GVW to 22,000 lb GVW	1C34-18045-AA 1C34-18045-JA 9U94-18045-AA 9U9Z-18124-A ASH-1022 ASH-1205 ASH-1228 ASH-294 AT-620 AT-766	○ ○	83209
			○ ○	83209
			○ ○	83209
			○ ○	83209
			○ ○	83209
			○ ○	83209
			○ ○	83209
			○ ○	83209
			○ ○	83209
			○ ○	83209
99 - 17	F53 Motorhome Chassis with 20,500 lb GVW to 22,000 lb GVW	9U94-18080-AA 9U9Z-18125-A ASH-1023 ASH-1206 ASH-1230 ASH-137 AT-621		○ ○	83122
				○ ○	83122
				○ ○	83122
				○ ○	83122
				○ ○	83122
				○ ○	83122
				○ ○	83122
73 - 76	M-400 & M-500 Motorhome Chassis	○ ○	85012	89413	○ ○	83225
57 - 76	P-400 & 4000 Motorhome Chassis with H.D. Springs	○ ○	85012	89413		...





N and NT 89" BBC Conventional Cab

64 - 69	N-1100 with 11000 thru 15000 lb Axles	C6PF-18077-DN	○ ○	83314
64 - 69	N-500, N-550, N-600, N-650, N-700 with 5000, 6000, 7000 & 9000 lb Axles	D2TF-18045-GA	○ ○	83308
64 - 69	N-500, N-550, N-600, N-650, N-700, N-750	C7PF-18077-A D2TF-18080-HA		○ ○	83225
				○ ○	83225
64 - 67	N-600, N-650, N-700, N-750 with 6000 & 7000 lb Axle	C6PF-18077-DL	○ ○	83312	89409
67 - 69	N-750 with 9000 lb Axle	C1TT-18045-C	○ ○	83312	89409
64 - 69	N-800, N-850, N-900, N-950 with 6000, 7000, 9000, 11000, 12000 lb Axles	C1TT-18045-C C6PF-18077-DL	○ ○	83312	89409
			○ ○	83312	89409
67 - 69	N-850, N-900, N-950, N-1000, NT-850, NT-900, NT-950, NT-1000 with 6000, 7000, 9000, 11000, 12000, 15000, 18000 lb Axles	C1TT-18045-D	○ ○	G63406

P-Series - Parcel Delivery

57 - 76	P-400 & 4000 w/ H. D. Springs	○ ○	85012	89413
57 - 76	P500, P-5000	○ ○	85012	89413	○ ○	83225
78 - 79	P-600	D7HT-18045-HA D7HT-18080-CA	○ ○	85012	89413
				○ ○	83225

APPLICATION GUIDE - TRUCKS, TRAILERS, AND BUSES

Year Año Année	Model Modelo Modèle	OEM #	Front		Rear	
						
			Wrench	Wrench	Wrench	Wrench
			Fleetline	GasSLX	Fleetline	GasSLX

FORD(Cont'd.)

T-Series - Conventional Tandem(Cont'd.)

64 - 69	T-750, T-800, T-850, T-900, T-950 with 6000, 7000, 9000, 11000, 12000, 15000, 18000 lb Axles	C1TT-18045-D	OIO	G63406
64 - 69	T-750, T-800, T-850, T-900, T-950 with 9000 thru 15000 lb Axles	C1TT-18045-E	OIO	83314
		C6PF-18077-DN	OIO	83314





W and WT Series - Hi Tilt Cab Highway Tractor

66 - 71	W-900, W-950,W-1000, WT-900, WT-950, WT-1000 with 11000 lb Axle	D2HA-18045-E1A	OIO	85304
		D2HA-18045-E1B	OIO	85304
		D2HA-18045-E2A	OIO	85304
		D2HA-18045-E2B	OIO	85304
66 - 77	W-900, W-950,W-1000, WT-900, WT-950, WT-1000 with 12000 & 15000 lb Axle	C6TA-18045-Y	OIO	85301
		C6TA-18045-Z	OIO	85301
		C6TA-18045-Z	OIO	85301
73 - 77	W-900, WT-900 with Air Suspension	D2HZ-18080-A		OIO	83209 89414
		D4HA-18080-AA		OIO	83209 89414

Additional O.E.M. Interchanges

	HN-80 with 21000 lb or 23000 lb Axle & 52" Taper leaf Rear Suspension	F6HT-18080-JA		OIO	85305	...
	Models with O.E.M. Number	0017LA-18080-G		-IO	83161	...
		2C4Z-18124-BA	OIO	83175
		2C7Z-18125-AA		OIO	G63837	...
		2C7Z-18125-CA		OIO	G63607	...
		3U2Z-18124-BAA	OIO	G63809
		3U2Z-18124-BV	-IO	G63614
		3U2Z-18124-BW	-IO	G63614
		3U2Z-18124-EA	-IO	G63772
		3U2Z-18124-FA	-IO	G63608
		3U2Z-18124-FAA	-IO	G63809
		3U2Z-18124-JAA	-IO	G63614
		3U2Z-18124-YAA	OIO	G63809
		3U2Z-18125-AD		-IO	69575	...
		3U2Z-18125-CA		OIO	G63607	...
		3U2Z-18125-DA		OIO	G63525	...
		3U2Z-18125-EA		OIO	G63524	...
		3U2Z-18125-RA		-IO	G63623	...
		47902-8		OIO	83122	89406
		4U2Z-18V124-AA	-IO	G63678
		57365-111	OIO	85006	89401	
		5C3Z-18124-JA	-IO	G63969
		5C3Z-18125-CF		OIO	77969	...
		5C3Z-18125-DA		OIO	77968	...
		5U2Z-18V124-AA	-IO	G63714
		5U2Z-18V124-AHA	OIO	G63622
		5U2Z-18V124-AU	-IO	G63772
		5U2Z-18V124-BA	-IO	G63716
		5U2Z-18V124-CAA	OIO	G63809
		5U2Z-18V124-DB	OIO	G63455
		5U2Z-18V124-GA	-IO	G63809
5U2Z-18V124-LA	-IO	G63929		
5U2Z-18V125-AE		OIO	G63808	...		
5U2Z-18V125-AF		OIO	G63810	...		

APPLICATION GUIDE - TRUCKS, TRAILERS, AND BUSES





Year Año Année	Model Modelo Modèle	OEM #	Front		Rear	
						
			Fleetline	GasSLX	Fleetline	GasSLX

FORD(Cont'd.)

Additional O.E.M. Interchanges(Cont'd.)

Models with O.E.M. Number							
5U2Z-18V125-BDA	-10	G63623	...		
5U2Z-18V125-BGA	-10	G63778	...		
5U2Z-18V125-BS	010	G63607	...		
5U2Z-18V125-BT	010	G63525	...		
5U2Z-18V125-BU	010	G63524	...		
5U2Z-18V125-F	010	G63676	...		
5U2Z-18V125-G	010	G63837	...		
5U2Z-18V125-H	010	G63406	...		
6C2Z-18124-B	-10	G63929		
6ETZ-18124-AA	010	83145		
6ETZ-18125-A	010	83146	...		
6U2Z18V125A	010	G63837	...		
6U2Z-18V125-B	010	G63607	...		
70127	010	85006	89401		
70128	010	85006	89401		
7C34-18045-HB	-10	G63969		
7C34-18080-DCB	010	77968	...		
7W7Z-18125-B	-10	69574	...		
90044769	010	83207	89407		
90044770	010	83207	89407		
AX-267A	010	83309	89446		
B3Q-18124-A	010	83219		
B3Q-18125-A	010	83217	...		
B3TZ-18125-A	010	83217	...		
B6TZ-18124-A	010	83219		
B6TZ-18125-B	-10	83161	...		
B6TZ-18125-C	-10	83161	...		
B6TZ-18125-E	-10	83161	...		
B7C-18125-A	010	83217	...		
B7T-18124-C	010	83225		
B7TZ-18124-B	010	83216		
B7TZ-18124-C	010	83216		
B7TZ-18124-D	010	83219		
B7TZ-18124-E	010	83217		
B7TZ-18125-C	010	83217	...		
B8Q-18125-A	010	85307	...		
B8QZ-18124-A	010	83312	89409		
B8TZ-18124-A	010	83219		
B9TT-18045-C	010	83219		
B9TT-18045-D	010	83219		
B9TT-18080-B	-10	83161	...		
B9TZ-18125-B	-10	83161	...		
C0TT-18045-A	010	83219		
C0TT-18045-D	010	83216		
C0TZ-18124-A	010	83216		
C1TT-18045-G	010	83216		
C1TT-18080-B	010	83217	...		
C1TZ-18045-C	010	83312	89409		
C1TZ-18124-A	010	83217		
C1TZ-18124-B	010	83216		
C1TZ-18124-C	010	83312	89409		

APPLICATION GUIDE - TRUCKS, TRAILERS, AND BUSES





Year Año Année	Model Modelo Modèle	OEM #	Front		Rear	
						
			Fleetline	GasSLX	Fleetline	GasSLX

FORD(Cont'd.)

Additional O.E.M. Interchanges(Cont'd.)

Models with O.E.M. Number						
C1TZ-18124-D	010	83309	89446	
C1TZ-18124-E	010	83312	89409	
C1TZ-18124-F	010	83312	89409	
C1TZ-18124-N	010	83314
C1TZ-18124-P	010	83312	89409	
C1TZ-18125-B		010	83217	...
C1VT-18080-B		010	83217	...
C2TA-18045-B	010	83308
C2TZ-18124-A	010	83308
C3TA-18045-A	010	83216
C3TZ-18124-A	010	83308
C4HZ-18124-A	010	83312	89409	
C4HZ-18124-B	010	83309	89446	
C4HZ-18124-C	010	83314
C4HZ-18124-D	010	83312	89409	
C4HZ-18124-F	010	83308
C4PF-18045-H	010	83216
C4TZ-18124-AA	010	83308
C4TZ-18124-AB	010	83308
C4TZ-18124-B	010	83308
C5TZ-18124-A	010	83308
C6PF-18077-AC		-10	83161	...
C6TA-18045-U	010	85301
C6TA-18045-V	010	85301
C6TS-18080-A		010	83217	...
C6TZ-18124-D	010	85301
C6TZ-18124-E	010	85301
C6TZ-18124-H	010	85301
C6TZ-18124-J	010	85301
C7HZ-18124-A	010	83312	89409	
C7TA-18045-R	010	83216
C7TA-18045-Z	010	85301
C8PF-18045-CM	010	83216
C8PF-18045-S	-10	83161
C8PF-18045-T	-10	83161
C8TA-18080-Y		-10	83161	...
C8TA-18080-Z		-10	83161	...
C8TZ-18125-D		-10	83161	...
D0HA-18045-D	010	83309	89446	
D0HZ-18124-A	010	83309	89446	
D0HZ-18124-B	010	83312	89409	
D0HZ-18124-C	010	83314
D1TZ-18124-D	010	83308
D1TZ-18124-E	010	83216
D1TZ-18124-F	010	83312	89409	
D1TZ-18125-E		010	83217	...
D2EF-18124-AA	010	83312	89409	
D2HA-18045-EB	010	85301
D2HA-18045-F1A	010	85301
D2HA-18045-F1B	010	85301
D2HA-18045-F2A	010	85301

APPLICATION GUIDE - TRUCKS, TRAILERS, AND BUSES









Year Año Année	Model Modelo Modèle	OEM #	Front		Rear	
						
			Fleetline	GasSLX	Fleetline	GasSLX

FORD(Cont'd.)

Additional O.E.M. Interchanges(Cont'd.)

Year	Model	OEM #	Front	Rear	Front	Rear
	Models with O.E.M. Number	D2HA-18045-F2B	O10	85301
		D2HF-18045-A	O10	83314
		D2HF-18124-AA	O10	83314
		D2HT-18045-EA	O10	83312	89409	...
		D2HZ-18125-A		O10 83209 89414
		D2HZ-18125-B		O10 83209 89414
		D2KF-18124-AA	O10	83312	89409	...
		D2TA-18045-AAA	O10	83219
		D2TA-18045-ZA	O10	83219
		D2TF-18045-FA	O10	83312	89409	...
		D2TF-18080-NA		O10 83217
		D2TF-18124-F	O10	83309	89446	...
		D2TZ-18124-A	O10	83308
		D2TZ-18124-E	O10	83312	89409	...
		D2TZ-18124-F	O10	83309	89446	...
		D2TZ-18124-G	O10	83314
		D2TZ-18124-H	O10	83308
		D2TZ-18124-J	O10	83312	89409	...
		D3TA-18045-BA	O10	83219
		D3TZ-18124-B	O10	83219
		D3TZ-18125-C		O10 83217
		D3TZ-18125-D		O10 83217
		D4HA-18080-A		O10 83209 89414
		D4TF-18045-AA	O10	83312	89409	...
		D4TZ-18124-J	O10	83308
		D5TZ-18124-B	O10	83308
		D5TZ-18124-C	O10	83312	89409	...
		D7HF-18125-AA		O10 83215
		D7HT-18124-BA	O10	83312	89409	...
		D7HT-18124-CA	O10	83314
		D7HT-18124-DA	O10	83309	89446	...
		D7HT-18124-EA	O10	83312	89409	...
		D7HT-18124-FA	O10	83312	89409	...
		D7HT-18124-GA	O10	83308
		D7HT-18124-HA	O10	83219
		D7HT-18124-JA	O10	83308
		D7HT-18124-KA	O10	85301
		D7HT-18125-BA		O10 83217
		D7HT-18125-CA		O10 83217
		D7HT-18125-DA		O10 83215
		D7HT-18125-FA		O10 83123 89405
		D7HZ-18125-A		O10 83215
		D7TA-18124-GA	O10	83314
		D7TZ-18125-C		O10 83217
		D8HZ-18124-A	O10	85301
		D8HZ-18125-A		O10 83209 89414
		D8HZ-18125-B		O10 83123 89405
		E0HZ-18124-A	O10	83309	89446	...
		E1TA-18045-AA	O10	83309	89446	...
		E1TD-18045-AA	O10	83309	89446	...
		E5HT-18045-DA	O10	85301

APPLICATION GUIDE - TRUCKS, TRAILERS, AND BUSES





Year Año Année	Model Modelo Modèle	OEM #	Front		Rear	
						
						
			Fleetline	GasSLX	Fleetline	GasSLX

FORD(Cont'd.)

Additional O.E.M. Interchanges(Cont'd.)

	Models with O.E.M. Number					
	E5HT-18045-EA	010	85301
	E6HZ-18124-D	010	85301
	E6HZ-18125-E		010	85315
	E6HZ-18125-F		010	85315
	E7XZ-18124-A	-10	G63386
	E7XZ-18124-B	-10	G63500
	E7XZ-18124-C	-10	G63511
	E7XZ-18124-D	-10	G63396
	E7XZ-18124-F	-1-	G63398
	E7XZ-18124-G	-1-	G63398
	E7XZ-18125-A		-10	G63350
	E7XZ-18125-B		-10	G63387
	E7XZ-18125-C		010	G63409
	E7XZ-18125-D		010	G63406
	E7XZ-18125-E		010	G63406
	E7XZ-18125-G		010	G63811
	E7XZ-18125-J		010	G63299
	E9HZ-18125-A		010	85716
	E9HZ-18125-AA		010	85716
	F0HS-18045-AA	010	85006	89401		...
	F0HT-18045-AA	010	85006	89401		...
	F0HZ-18124-A	010	85006	89401		...
	F0HZ-18124-B	010	85006
	F1HT-18045-KB	010	85006	89401		...
	F1HT-18045-LB	010	85006	89401		...
	F1HZ-18124-AA	010	83309	89446		...
	F1HZ-18124-B	010	83308
	F1HZ-18124-C	010	...	89402		...
	F1HZ-18124-D	010	85006	89401		...
	F1HZ-18124-E	010	85006	89401		...
	F1HZ-18124-F	010	85006	89401		...
	F1HZ-18124-G	010	85006	89401		...
	F1HZ-18124-H	010	85040
	F1HZ-18124-J	010	83308
	F1HZ-18124-K	010	...	89402		...
	F2HT-18045-DA	010	85006	89401		...
	F2HT-18080-DA		010	85712
	F2HZ-18124-B	010	85301
	F2HZ-18124-C	010	85006	89401		...
	F2HZ-18125-A		010	85712
	F4TA-18045-TA	010	G63455
	F4TA-18080-PA		010	G63461
	F4TZ-18124-D	-10	G63414
	F4TZ-18124-K	010	G63455
	F4TZ-18125-E		010	G63461
	F4TZ-18125-L		010	G63406
	F57Z-18125-BB		010	G63679
	F5HZ-18124-AA	010	83314
	F5HZ-18124-C	010	85063
	F5HZ-18124-DA	010	83125
	F5HZ-18125-A		010	85314
						89425

APPLICATION GUIDE - TRUCKS, TRAILERS, AND BUSES









Year Año Année	Model Modelo Modèle	OEM #	Front		Rear	
						
			Fleetline	GasSLX	Fleetline	GasSLX

FORD(Cont'd.)

Additional O.E.M. Interchanges(Cont'd.)

Models with O.E.M. Number	OEM #	Front	Rear	Front	Rear
F5HZ-18125-AA	010	85314	89425
F5HZ-18125-B	010	85001	89410
F5HZ-18125-BA	010	85001	89410
F5TZ-18124-B	-10	G63608
F5TZ-18125-BC	010	G63607	...
F5UZ-18124-A	01-	G63622
F5UZ-18124-B	01-	G63622
F5UZ-18125-A	-10	G63623	...
F5UZ-18125-C	-10	G63624	...
F6HT-18045-KA	010	83200	89402
F6HT-18045-MA	010	85006	89401
F6HT-18080-CA	010	85314	89425
F6HT-18080-EA	010	85906	89407
F6HT-18080-FC	010	85013	89414
F6HZ-18124-B	010	83308
F6HZ-18124-KA	010	83200	89402
F6HZ-18124-MA	010	85006	89401
F6HZ-18125-A	010	85314	89425
F6HZ-18125-JA	010	85305	...
F7C2Z-18124-BR	-10	G63929
F7TA-18045-AA	-10	G63608
F7TA-18080-BA	010	G63607	...
F81Z-18124-AL	01-	G63622
F81Z-18124-BK	010	G63809
F81Z-18124-PA	010	85928
F87Z-18125-CA	010	G63773	...
F87Z-18125-RA	010	G63775	...
LA-18080	-10	83161	...
LA-18080-A	-10	83161	...
LA-18080-B	-10	83161	...
LA-18080-C	-10	83161	...
LA-18080-F	-10	83161	...
LA-18080-J	-10	83161	...
TAAH-18080-A	-10	83161	...
TAAH-18080-A2	-10	83161	...
TAAH-18080-A3	-10	83161	...
TAAK-18080-A	-10	83161	...
TAAK-18080-A1	-10	83161	...
TAAK-18080-A2	-10	83161	...
TACAA-18045-A	010	83216
TANNA-18045-A	010	83312	89409
TBAK-18080-A	-10	83161	...
TBDA-18080-A	010	83217	...
TBDA-18080-B	010	83217	...
TDAA-18080-A	-10	83161	...
TDAA-18080-B	010	83217	...
TDBA-18045-A	010	83219
TDBA-18045-B	010	83219
TDBA-18080-A	010	83217	...
TDBA-18080-B	010	83217	...
TDBA-18080-C	010	83217	...

APPLICATION GUIDE - TRUCKS, TRAILERS, AND BUSES

Year Año Année	Model Modelo Modèle	OEM #	Front		Rear	
						
						
			Fleetline	GasSLX	Fleetline	GasSLX

FORD(Cont'd.)

Additional O.E.M. Interchanges(Cont'd.)

Models with O.E.M. Number	TDBE-18045-A	010	83219	
	TFAA-18045-B	010	83219	
	TFAA-18045-C	010	83219	
	TFAA-18080-A		010	85307	...
	THAB-18045-A	010	83219	
	THAB-18045-B	010	83219	
	TQSH-18045-A	010	83309	89446	
	XC45-18045-AA	010	83216	
	XL2Z-18124-EA	-10	G63678	
	XL2Z-18125-BA		010	G63679	...
	XL2Z-18125-CA		010	G63679	...
	XL2Z-18125-EA		010	G63679	...
	YL5Z-18124-AA	-10	G63772	
Additional O.E.M. Interchanges	680029	010	85301				
	C6PF-18077-DD	010	83216				
	C6PF-18077-DE	010	83219				
	C7PF-18077-Z	010	83217				

FORD CAB SHOCKS

8500 Series

Models with 101", 113" & 122" BBC Conventional Tractors with Link Cabmate Models FH101, FH1322 & FH1322-A	1201-1043	010				83025
	1202-1043	010				83025

9500 Series

Models with 101", 113" & 122" BBC Conventional Tractors with Link Cabmate Models FH101, FH1322 & FH1322-A	1201-1043	010				83025
	1202-1043	010				83025
Models with O.E.M. Number	F6HZ-5K407-AB	010				83034
	F6HZ-5K407-BA	010				83033
	F8HT-5K407-AA	010				83033

Additional Applications

CL9000 & CLT9000 Cabover Tractors (Sleeper & Non-Sleeper) with Link Cabmate Model FCL110-2P	1202-0032	010				83016
Models with Link Cab Suspension	1202-0022	010				83046
	1202-0042	010				83025

L-Series Conventional









All with 60" Able Body Sleepers with Link Bunkmate Models FAS60-A & FAS60-AS	1201-1044	010				83025
	1202-1044	010				83025
L, LT, LN, LNT 800, 8000, 9000 Models, LTS, LS 8000, 9000 Models, & LTL, LL 9000 Models with Link Cabmate Model FN89-A	1201-0012	010				83023
	1202-0012	010				83023

FOREST RIVER INC

Class A MotorHomes

02 - 04	Reflection Series MotorHomes with Freightliner XC Chassis ADL200 Suspension w/ 20K Rear AS120 Front Suspension Rear Shock with O.E.M. Number	16-16873-000 141700131810 16-16737-000 16-16874-000 141700131809 16-16736-000						
					010	85029
			010	83160
			010	83160
			010	83160
				010	85029	...		
				010	85029	...		

APPLICATION GUIDE - TRUCKS, TRAILERS, AND BUSES

Year Año Année	Model Modelo Modèle	OEM #	Front		Rear	
						
						
			Fleetline	GasSLX	Fleetline	GasSLX

FOREST RIVER INC(Cont'd.)

Class A MotorHomes(Cont'd.)

	ZF - IFS Front Suspension with 23,000 lb GVW or Greater	16-18103-000	- -	85900
		481700000493	- -	85900
02 - 06	Tsunami Series MotorHomes with Freightliner XC Chassis							
	ADL200 Suspension w/ 20K Rear	16-16873-000		OIO	85029	...
	AS120 Front Suspension	141700131810	OIO	83160
		16-16737-000	OIO	83160
		16-16874-000	OIO	83160
	Rear Shock with O.E.M. Number	141700131809		OIO	85029	...
		16-16736-000		OIO	85029	...
	ZF - IFS Front Suspension with 23,000 lb GVW or Greater	16-18103-000	- -	85900
	481700000493	- -	85900	

FREIGHTLINER

Argosy

99 - 07	Models with 12000 lb Taperleaf Front Suspension	10-12703-000	OIO	85918	89449	
		10-13634-000	OIO	85918	89449	
		471700000449	OIO	85918	89449	
99 - 07	Models with Freightliner FAS II Rear Air Suspension	16-13957-000		OIO	85724	89443
		16-15817-000		OIO	85724	89443
		680339		OIO	85724	89443
		680611		OIO	85724	89443
99 - 07	Models with Freightliner Low Profile Rear Air Suspension (18,000 to 40,000 lb)	16-14259-000		OIO	85331	...
		16-18706-000		OIO	85331	...
		471700002992		OIO	85331	...
		680511		OIO	85331	...
99 - 07	Models with Rear 10000 lb - 15000 lb Low Profile AirLiner	16-16577-000		OIO	85335	...
		16-18711-000		OIO	85335	...
		471700002996		OIO	85335	...





Cargo - FC70 & FC80

99 - 07	FC70 & FC80 Models with 10,000 to 18,000 lb Suspension	10-13759-000	OIO	85006
		471700003009	OIO	85006
		6803230300	OIO	85006
		GBL665538	OIO	85006
99 - 07	FC70 & FC80 Models with 6000 to 9000 lb Front Axle	654654	OIO	85043
		6803230200	OIO	85043
99 - 07	FC70 & FC80 Models with FAS II Rear Air Suspension	16-13957-000		OIO	85724	89443
		16-15817-000		OIO	85724	89443
		680339		OIO	85724	89443
		680611		OIO	85724	89443

Cascadia

09 - 17	Models with 12000 to 13300 lb Taperleaf Front Suspension	10-13809-000	OIO	85958
		SDA471400003920	OIO	85958
09 - 17	Models with Hendrickson Front Airtek	471700006269	OIO	85932	89453	
		471700131331	OIO	85932	89453	
		58913-003	OIO	85932	89453	
		58913-012	OIO	85932	89453	
09 - 17	Models with FAS II (40,000 lb) Rear Air Suspension	16-15817-000		OIO	85724	89443
		16-18708-000		OIO	85724	89443
		471700002809		OIO	85724	89443
		680611		OIO	85724	89443

APPLICATION GUIDE - TRUCKS, TRAILERS, AND BUSES

Year Año Année	Model Modelo Modèle	OEM #	Front		Rear	
						
			Wrench	Wrench	Wrench	Wrench
			Fleetline	GasSLX	Fleetline	GasSLX

FREIGHTLINER(Cont'd.)

Cascadia(Cont'd.)

09 - 17	Models with FAS II (40,000 lb) Rear Air Suspension	SDA471700002809	OIO	85724	89443
---------	--	-----------------	-----	-----	-----	-------	-------

Century Class - C112, C120, CST112 & CST120

00 - 11	Models with 12000 lb Taperleaf Front Suspension	10-13021-000	OIO	85918	89449	
		10-13063-000	OIO	85918	89449	
		10-13211-000	OIO	85918	89449	
		10-13634-000	OIO	85918	89449	
		471700000449	OIO	85918	89449	
		471700000449	OIO	85918	89449	
		471700131155	OIO	85918	89449	
97 - 99	Models with 12000 lb Taperleaf Front Suspension	10-12542-000	OIO	85901
97 - 11	Models with FAS II Rear Air Suspension	16-13957-000		OIO	85724	89443
		16-15817-000		OIO	85724	89443
		16-18708-000		OIO	85724	89443
		471700002809		OIO	85724	89443
		680339		OIO	85724	89443
		680611		OIO	85724	89443
97 - 11	Models with Freightliner Low Profile Rear Air Suspension (18,000 to 40,000 lb)	SDA471700002809		OIO	85724	89443
		16-14259-000		OIO	85331	...
		16-18706-000		OIO	85331	...
		471700002992		OIO	85331	...
02 - 11	Models with Hendrickson Front Airtek	680511		OIO	85331	...
		471700131331	OIO	85932	89453	
	Models with Low Profile Front	58913-003	OIO	85932	89453	
		10-12703-000	OIO	85918	89449	









Classic/ClassicXL

03 - 11	Models with 12000 lb Taperleaf Front Suspension	10-13021-000	OIO	85918	89449	
		10-13063-000	OIO	85918	89449	
		10-13211-000	OIO	85918	89449	
		10-13634-000	OIO	85918	89449	
		471700000449	OIO	85918	89449	
		471700000449	OIO	85918	89449	
		471700131155	OIO	85918	89449	
03 - 11	Models with FAS II Rear Air Suspension	16-15817-000		OIO	85724	89443
		16-18708-000		OIO	85724	89443
		471700002809		OIO	85724	89443
		680611		OIO	85724	89443
		SDA471700002809		OIO	85724	89443
03 - 11	Models with Hendrickson Front Airtek	471700131331	OIO	85932	89453	
		58913-003	OIO	85932	89453	
	Models with O.E.M. Number	10-12032-002	OIO	85320	89429	
		10-12032-004	OIO	85320	89429	
		680009	OIO	85302	89420	
		70029	OIO	85308	89422	

Columbia

03 - 08	Models with 12000 lb Taperleaf Front Suspension	10-13021-000	OIO	85918	89449	
		10-13063-000	OIO	85918	89449	
		10-13211-000	OIO	85918	89449	
		10-13634-000	OIO	85918	89449	
		471700000449	OIO	85918	89449	
		471700131155	OIO	85918	89449	

APPLICATION GUIDE - TRUCKS, TRAILERS, AND BUSES

Year Año Année	Model Modelo Modèle	OEM #	Front		Rear	
						
						
			Fleetline	GasSLX	Fleetline	GasSLX

FREIGHTLINER(Cont'd.)

Columbia(Cont'd.)

09 - 17	Models with 12000 lb Taperleaf Front Suspension	10-13809-000 SDA471400003920	O O	85958
			O O	85958
03 - 17	Models with Hendrickson Front Airtek	471700006269 471700131331 58913-003 58913-012	O O	85932	89453	
			O O	85932	89453	
			O O	85932	89453	
			O O	85932	89453	
	Models with O.E.M. Number	10-13684-000 471700000470	O O	85918	89449	
			O O	85918	89449	
03 - 17	Models with FAS II Rear Air Suspension	16-15817-000 16-18708-000 471700002808 471700002809 680611 SDA471700002809		O O	85724	89443
				O O	85724	89443
				O O	85724	89443
				O O	85724	89443
				O O	85724	89443
				O O	85724	89443

Condor

01 - 07	Models with 14,600 to 20,000 lb Front Suspension	10-13211-000 10-13634-000 471700000449 471700131155	O O	85918	89449	
			O O	85918	89449	
			O O	85918	89449	
			O O	85918	89449	
01 - 07	Models with Chalmers 46,000 lb Rear Suspension	665174		O O	85060	...
01 - 07	Models with FAS II Rear Air Suspension	16-13957-000 16-15817-000 16-18708-000 471700002809 680339 SDA471700002809		O O	85724	89443
				O O	85724	89443
				O O	85724	89443
				O O	85724	89443
				O O	85724	89443
				O O	85724	89443
01 - 07	Models with Freightliner TufTrac Rear Air Suspension	16-15770-000 481700125969		O O	85956	...
				O O	85956	...

Coronado

10 - 17	Models with 12,000 lb to 20,000 Front Axle	10-13809-000 471700003920	O O	85958
			O O	85958
10 - 16	Models with Hendrickson Front Airtek	471700006269 471700131331 58913-003 58913-012	O O	85932	89453	
			O O	85932	89453	
			O O	85932	89453	
			O O	85932	89453	
10 - 14	Models with Chalmers 46,000 lb Rear Suspension	665174		O O	85060	...
10 - 17	Models with FAS II (40,000 lb) Rear Air Suspension	16-15817-000 16-18708-000 471700002809 680611 SDA471700002809		O O	85724	89443
				O O	85724	89443
				O O	85724	89443
				O O	85724	89443
				O O	85724	89443
10 - 17	Models with Freightliner TufTrac Rear Air Suspension	16-15770-000 481700125969		O O	85956	...
				O O	85956	...

FL50, 60, 70, 80 - Business Class

	FAS Airliner, Single / Tandem Past Production	16-11133-000		O O	85007	89412
92 - 06	FL Models with 15000 lb Rear Suspension	6803260000 GBL654725		O -	83120	...
				O -	83120	...
92 - 06	FL Models with 10,000 to 18,000 lb Suspension	10-13759-000 471700003009 6803230300 GBL665538	O O	85006
			O O	85006
			O O	85006
			O O	85006

APPLICATION GUIDE - TRUCKS, TRAILERS, AND BUSES

Year Año Année	Model Modelo Modèle	OEM #	Front		Rear	
			Fleetline	GasSLX	Fleetline	GasSLX

FREIGHTLINER(Cont'd.)

FL50, 60, 70, 80 - Business Class(Cont'd.)

92 - 06	FL Models with 6000 to 9000 lb Front axle	654654 6803230200	OIO	85043
			OIO	85043
92 - 06	FL Models with FAS II Rear Air Suspension	16-13957-000 16-15817-000 680339 680611		OIO	85724	89443
				OIO	85724	89443
				OIO	85724	89443
				OIO	85724	89443









FLA & FLB Series - COE Truck & Tractor

89 - 02	COE Models	10-12030-002 10-12032-000 10-12032-001 10-12032-002 10-12032-003 10-12032-004	OIO	85320	89429	
			OIO	85320	89429	
			OIO	85320	89429	
			OIO	85320	89429	
			OIO	85320	89429	
			OIO	85320	89429	
89 - 02	COE Models with Airliner Rolling Lobe Spring Air Suspension	16-13947-000 681-326-0400		-IO	85319	89428
				-IO	85319	89428
89 - 02	COE Models with Convoluted Spring Air Suspension	16-12117-000 16-18705-000 471700002990 665236		OIO	85007	89412
				OIO	85007	89412
				OIO	85007	89412
				OIO	85007	89412
89 - 02	COE Models with FAS II Rear Air Suspension	16-13957-000 16-15817-000 680339 680611		OIO	85724	89443
				OIO	85724	89443
				OIO	85724	89443
				OIO	85724	89443
	COE Models with Neway Tag Axle Air Suspension	90044162		OIO	83128	89436

FLC & FLD Series - 112 & 120 Conventional Truck & Tractor

00 - 11	Conventional Models with 12000 lb Taperleaf Front Suspension	10-13021-000 10-13063-000 10-13211-000 10-13634-000 471700000449 471700000449 471700131155	OIO	85918	89449	
			OIO	85918	89449	
			OIO	85918	89449	
			OIO	85918	89449	
			OIO	85918	89449	
			OIO	85918	89449	
			OIO	85918	89449	
- 94	Conventional Models with Airliner Rolling Lobe Spring Air Suspension	16-13947-000 681-326-0400		-IO	85319	89428
				-IO	85319	89428
- 08	Conventional Models with Convoluted Spring Air Suspension	16-12117-000 16-18705-000 471700002990 665236		OIO	85007	89412
				OIO	85007	89412
				OIO	85007	89412
				OIO	85007	89412
- 11	Conventional Models with FAS II Rear Air Suspension	16-13957-000 16-15817-000 16-18708-000 471700002809 680339 680611 SDA471700002809		OIO	85724	89443
				OIO	85724	89443
				OIO	85724	89443
				OIO	85724	89443
				OIO	85724	89443
				OIO	85724	89443
				OIO	85724	89443
02 - 11	Conventional Models with Hendrickson Front Airtex	471700131331 58913-003	OIO	85932	89453	
			OIO	85932	89453	
	Conventional Models with Neway Tag Axle Air Suspension	90044162		OIO	83128	89436
	Conventional Models with O.E.M. Number	10-12030-002 10-12032-000	OIO	85320	89429	
			OIO	85320	89429	

APPLICATION GUIDE - TRUCKS, TRAILERS, AND BUSES

Year Año Année	Model Modelo Modèle	OEM #	Front		Rear	
						
						
			Fleetline	GasSLX	Fleetline	GasSLX

FREIGHTLINER(Cont'd.)

FLC & FLD Series - 112 & 120 Conventional Truck & Tractor(Cont'd.)

	Conventional Models with O.E.M. Number	10-12032-001	OIO	85320	89429	
		10-12032-002	OIO	85320	89429	
		10-12032-003	OIO	85320	89429	
		10-12032-004	OIO	85320	89429	
09 - 11	Models with 12000 lb Taperleaf Front Suspension	10-13809-000	OIO	85958
		SDA471400003920	OIO	85958
08 - 11	Models with Freightliner TufTrac Rear Air Suspension	16-15770-000		OIO	85956	...
		481700125969		OIO	85956	...
		SDA481700125969		OIO	85956	...

Legacy

- 98	Models with FAS II Rear Air Suspension	16-13957-000		OIO	85724	89443
		680339		OIO	85724	89443
99 -	Models with FAS II Rear Air Suspension	16-15817-000		OIO	85724	89443
		680611		OIO	85724	89443
	Models with O.E.M. Number	681-323-0900	-IO	85009

M2 - Business Class

02 - 08	Models with 10000 to12000 lb. Taper-leaf Spring Suspension	10-12390-000	OIO	85920
05 - 08	Models with 12000 lb Taperleaf Front Suspension	10-13634-000	OIO	85918	89449	
		471700000449	OIO	85918	89449	
09 - 17	Models with 13300 lb to 20000 Front Axle	10-13809-000	OIO	85958
		471700003920	OIO	85958
02 - 08	Models with 6000 to 9000 lb Front axle	10-12388-000	OIO	85920
09 - 17	Models with 8000 to 16000 lb Front Axle and Taperleaf Spring	10-13592-000	OIO	85959
		10-13760-000	OIO	85959
		471700000440	OIO	85959
		471700002391	OIO	85959
		SDA471700002991	OIO	85959
02 - 17	Models with FAS II Rear Air Suspension	16-15817-000		OIO	85724	89443
		16-18708-000		OIO	85724	89443
		471700002809		OIO	85724	89443
		680611		OIO	85724	89443
		SDA471700002809		OIO	85724	89443
02 - 15	Models with Freightliner Low Profile Rear Air Suspension (18,000 to 40,000 lb)	16-14259-000		OIO	85331	...
		16-18706-000		OIO	85331	...
		471700002992		OIO	85331	...
		680511		OIO	85331	...
02 -	Models with Rear 10000 lb - 15000 lb Low Profile AirLiner	16-16577-000		OIO	85335	...
		16-18711-000		OIO	85335	...
		471700002996		OIO	85335	...
02 - 14	Models with Rear 52" Spring ,10000 lb - 15000 lb	16-16486-000		-IO	83134	...
		16-18710-000		-IO	83134	...
		471700002995		-IO	83134	...
02 - 14	Models with Rear 52" Spring ,18000 lb - 23000 lb	16-16442-000		-IO	83134	...
		16-18709-000		-IO	83134	...
		471700002994		-IO	83134	...
02 -	Models with Rear 60" Spring ,18000 lb - 23000 lb	16-15765-000		-IO	85921	...
		16-18707-000		-IO	85921	...
		471700002993		-IO	85921	...
- 04	Models with Taperleaf Front Suspension	10-13211-000	OIO	85918	89449	
		471700131155	OIO	85918	89449	

APPLICATION GUIDE - TRUCKS, TRAILERS, AND BUSES

Year Año Année	Model Modelo Modèle	OEM #	Front		Rear	
			Fleetline	GasSLX	Fleetline	GasSLX

FREIGHTLINER(Cont'd.)

Severe Duty Series - 108SD, 114SD & 122SD(Cont'd.)

12 - 16	All Models with 12,000 to 16,000 lb. Front Axle and Taperleaf Spring	10-13760-000 471700002991	0 0	85959
			0 0	85959
12 - 17	All Models with 18,000 lb Flat Leaf Spring	10-13684-000 471700000470	0 0	85918	89449	
			0 0	85918	89449	
12 - 17	All Models with 20,000 lb Flat Leaf Spring	10-13809-000 471700003920	0 0	85958
			0 0	85958
12 - 14	All Models with O.E.M. Number	10-13934-000 471700006929	0 -	85123
			0 -	85123
12 - 17	All Models with FAS II (40,000 lb) Rear Air Suspension	16-15817-000 16-18708-000 471700002809 680611 SDA471700002809		0 0	85724	89443
				0 0	85724	89443
				0 0	85724	89443
				0 0	85724	89443
				0 0	85724	89443
12 - 17	All Models with Freightliner TuffTrac Rear Air Suspension	16-15770-000 481700125969		0 0	85956	...
				0 0	85956	...
12 - 17	All Models with Hendrickson HMX 400/460 Haulmax - with 16.5" Saddle - with 17.5" & 18.5" Saddle	60680-004 60680-005		0 -	83143	...
				0 -	83142	...
				0 -	83142	...

Additional O.E.M. Interchanges

	Models with 7000 lb Front Suspension	10-13776-000	0 0	85005	89430	
	Models with Neway Air Suspension with shock stamping	90045083		0 0	85910	...
	Models with O.E.M. Number	10-12046-000	0 0	85320	89429	
		10-12594-000	0 0	85984
		16-10688-000		0 0	85042	...
		16-14577-000	0 0	85043
		16-14669-000	0 0	G63403
		16-14759-000	0 0	85000	89436	
		16-19138-000	0 0	85058	89431	
		3638112		0 0	G63183	...
		4036892	0 0	G63605
		471700000440	0 0	85959
		471700002991	0 0	85959
		47902-13		0 0	83122	89406
		535228	0 0	85302	89420	
		61300224	0 0	85918	89449	
		61300240	0 0	85918	89449	
		650224		0 0	83225	...
		651352		0 0	85042	...
		654875		0 0	83117	...
		654918	0 0	83118
		659060	0 0	85920
		659062		- 0	83134	...
		659063		- 0	83134	...
		659300	0 0	85005	89430	
		660235		0 0	85042	...
		665409	- 0	85009
		671908	0 0	85918	89449	
		671945	0 0	85920
671946		- 0	85921	...		
680009	0 0	85302	89420			

APPLICATION GUIDE - TRUCKS, TRAILERS, AND BUSES

Year Año Année	Model Modelo Modèle	OEM #	Front		Rear	
			Fleetline	GasSLX	Fleetline	GasSLX

FREIGHTLINER(Cont'd.)

Additional O.E.M. Interchanges(Cont'd.)

Models with O.E.M. Number	680442	010	-10	85319	89428
	680651		010	85335	...
	680782	010	85302	89420	
	6813230900	-10	85009
	6813260000		010	83634	...
	6813260200		010	85011	...
	70042	010	85302	89420	
	GBL 651356		010	83634	...
	SDA471700000440	010	85959
	Additional O.E.M. Interchanges	10-13051-001	010	85005 or 89430			
10-13205-000			85918	89449	
10-13859-000		010	85005 or 89430				
16-14667-000		010	85005 or 89430				
16-14668-000		010	83127				
16-15591-000		010	85043				
16-16765-000		010	85006				
16-17759-000		010	85919				
16-18094-000		010	85959				
471700131646		010	85918	89449	
680008		010	85300 or 89419				
680017		010	85302 or 89420				
681-323-1100		010	85301				

FREIGHTLINER CAB SHOCKS

Argosy

00 - 06	Models with O.E.M. Number	18-37813-000	010	83044
---------	---------------------------	--------------	-----	-------

Cascadia

09 - 17	Models with 72" High-Roof Sleeper	18-41762-000	010	83038
		18-60764-000	010	83038
		814903003528	010	83038

Century Class

	Day Cab Suspensions with O.E.M. Number	18-32999-001	010	83006
	Models with O.E.M. Number	18-41762-000	010	83038
	Sleeper-Cabs with O.E. Number	18-30378-000	010	83001
		18-32999-000	010	83001

Classic

	Models with O.E.M. Number	18-29846-000	010	83009
--	---------------------------	--------------	-----	-------

Columbia

	Models with O.E.M. Number	18-29846-000	010	83009
03 - 17	Models with Sleeper Cabs w/O.E.M. Numbers	18-41762-000	010	83038
		18-60764-000	010	83038
		814903003528	010	83038

Coronado

10 - 17	Models with Sleeper Cabs w/O.E.M. Numbers	18-41762-000	010	83038
		18-41762-002	010	83038
		18-60764-000	010	83038
		18-60765-002	010	83038
		814903003528	010	83038

FL 60, 70, 80 & 106 Series - Business Class Conventional

	Models with O.E.M. Number	18-30378	010	83006
--	---------------------------	----------	-----	-------

APPLICATION GUIDE - TRUCKS, TRAILERS, AND BUSES

Year Año Année	Model Modelo Modèle	OEM #	Front		Rear	
			Fleetline	GasSLX	Fleetline	GasSLX

FREIGHTLINER CAB SHOCKS(Cont'd.)

FL 60, 70, 80 & 106 Series - Business Class Conventional(Cont'd.)

91 -	Trucks with Link Cabmate Models FRT153BC-A , FRT106BC or FRT106HD-A	1201-0054	010	83021
		1202-0054	010	83021

FL112 Conventional

97 -	FL112 Business Class Day Cab Tractors with Link Cabmate Model FRT112DC	1202-1044	010	83025
------	--	-----------	-----	-------

FLA - COE Truck & Tractors

89 -	Cabover Tractors with 86", 96" & 104" Cabs with Link Cabmate Model FRT285	1202-0032	010	83016
	Models with O.E.M. Number	681-891-02-05	010	83017

FLB - COE Truck & Tractors

93 -	90", 100", & 110" Cabs with Link Cabmate Models FRT46-2P-A or FRT46-2P-B	1201-0054	010	83021
84 -	Cabover Tractors with 86", 96" & 104" Cabs with Link Cabmate Model FRT285	1202-0032	010	83016
	Cabover Tractors with the rear cab mounts having a center to center measurement of 50" or 54" & with Link Cabmate Models FRT50-2P-C	1202-0054	010	83021
84 -	Models with 86", 96" & 104" Cabs with Link Cabmate Model FRT285-A	1202-0022	010	83046

FLC - 112 & 120 Conventional Tractors

89 -	Conventional Tractors with Link Cabmate Model FRTE120-A	1201-1043	010	83025
		1202-1043	010	83025
97 -	FL112 Models Business Class Day Cab Models with Link Cabmate Model FRT112DC	1201-1044	010	83025
- 03/88	Models with Link Cabmate FRTC120-A or FRTC120-AW Air Suspension	1201-0012	010	83023
		1202-0012	010	83023

FLD 112 & 120 Conventional Truck & Tractor

	FLD Sleeper with Air Suspension	18-29846-000	010	83009
--	---------------------------------	--------------	-----	-------

FLD Series - 112 & 120 Conventional Truck & Tractor

09/93 -	64" Able Body Sleepers with Link Bunkmate Models FRTA64 or FRTAS64-A	1202-1044	010	83025
89 -	Conventional Tractors with Link Cabmate Model FRTE120-A	1202-1043	010	83025
	D2 Cab	18-41762-001	010	83047
		18-60765-001	010	83047
		814903003486	010	83047
01 - 12	FLD Sleeper with Air Suspension	18-29846-001	010	83064
	FLD112 Daycab with Air Suspension	18-31476-000	010	83020

M2 - Business Class

03 - 10	Crew Cab Models with O.E.M. Number	18-43504-000	010	83057
		18-60768-000	010	83057
		814903003484	010	83057
02 - 16	Day Cab Models with Leaf Spring Suspensions	18-47349-000	010	83039
		18-60767-000	010	83039
		814903003483	010	83039
03 - 16	M2-112 Crew Cab Models with O.E.M. Number	18-41762-000	010	83038
		18-60764-000	010	83038
		814903003528	010	83038
02 - 17	Models with Spring Suspension	18-47350-000	010	83040
		18-60766-000	010	83040
		814903003482	010	83040

Severe Duty Series - 108SD, 114SD & 122SD

12 - 17	108 SD Models with O.E.M. Number	18-60766-000	010	83040
---------	----------------------------------	--------------	-----	-------

APPLICATION GUIDE - TRUCKS, TRAILERS, AND BUSES

Year Año Année	Model Modelo Modèle	OEM #	Front		Rear	
			Fleetline	GasSLX	Fleetline	GasSLX

FREIGHTLINER CAB SHOCKS(Cont'd.)

Severe Duty Series - 108SD, 114SD & 122SD(Cont'd.)

12 - 17	108 SD Models with O.E.M. Number	814903003482	010	83040
12 - 17	114 SD Models with O.E.M. Number	18-60766-000	010	83040
		814903003482	010	83040
12 - 16	122 SD Crew Cab Models with O.E.M. Number	18-60764-000	010	83038
		814903003528	010	83038







Additional Applications

	Models with 60" Sleeper w/ Link Bunkmate Model FRTS60-A	1202-1043	010	83025
	Models with Link Cab Suspension	1202-0042	010	83025
		1202-0043	010	83032
		1202-0044	010	83025
	Models with O.E.M. Number	18-42613-000	010	83033
		18-44321-000	010	83009
		18-45067-000	010	83034
		18-60295-000	010	83006
		18-60765-000	010	83038
		18-60769-000	010	83009
		18-60772-000	010	83026
		18-60773-000	01-	83027
		654739	010	83009
		654819	010	83001
		654831	010	83006
		654841	010	83020
		654990	010	83038
		659079	010	83040
		659080	010	83039
		659125	010	83047
		659178	010	83038
		659288	010	83006
	814903003496	010	83009	
	GBL 650361	010	83017	

FREIGHTLINER CUSTOM CHASSIS

06 - 15	B2 Bus Chassis	10-13634-000	010	85918	89449	
		16-15817-000		010	85724	89443
		16-18708-000		010	85724	89443
	F65 School bus chassis with 10,000 to 18,000 lb Suspension	10-13759-000	010	85006
		471700003009	010	85006
		6803230300	010	85006
		GBL665538	010	85006
	F65 School bus chassis with Taperleaf Spring	6803260000		01-	83120	...
		GBL654725		01-	83120	...
	FB 65 Models with O.E.M. Number	10-13358-000	010	85097
	FB Shuttle bus chassis with O.E.M. Number	16-16765-000	010	85006
		471700131775	010	85006
	FedEx Trucks with O.E.M. Number	MAE16950	010	83118
		P117146	010	83118
	Fleetwood Motor Home with O.E.M. Number	GBL 651375	010	83119
		RW24285	010	83119
06 - 08	Front - Engine Diesel Chassis (FRED Chassis)	16-18095-000		01-	85092	...
		16-18455-000	010	85918	89449	
		471700000467		01-	85092	...









APPLICATION GUIDE - TRUCKS, TRAILERS, AND BUSES

Year Año Année	Model Modelo Modèle	OEM #	Front		Rear	
						
						
			Fleetline	GasSLX	Fleetline	GasSLX

FREIGHTLINER CUSTOM CHASSIS(Cont'd.)

06 - 08	Front - Engine Diesel Chassis (FRED Chassis)	471700002726	○ ○	85918	89449	
	MB55 & MT55 Models	16-17684-000	○ ○	85058	89431	
	MB55 Chassis	16-17759-000	○ ○	85919
		471700000447	○ ○	85919
	MB55 Shuttle bus w/8000 lb. flat leaf front suspension	16-15676-000	○ ○	85058	89431	
96 - 99	MC Chassis for Class A Motorhomes	654918	○ ○	83118
		P117099		○ -	83120	...
		P117146	○ ○	83118
	MC Chassis with Hendrickson Softek Front Suspension	16-18094-000	○ ○	85959
		471700000466	○ ○	85959
	MC-L Chassis with 9,000 lb Suspension	16-18455-000	○ ○	85918	89449	
		471700002726	○ ○	85918	89449	
	M-Line Walk in Van with O.E.M. Number	MAE 16949		○ -	83120	...
		MAE 16950	○ ○	83118
		P117099		○ -	83120	...
		P117146	○ ○	83118
	MP 14 and MP 19 Chassis	16-15475-000	○ ○	83164
	MP14 and 19 (UPS)	P117253	○ ○	83116
	MT135	GBL654875		○ ○	83117	...
	MT45 Step Van - Rear - w/35" Front Spring - w/38" Front Spring	16-15394-000		○ -	83120	...
		16-15473-000	○ ○	83157
		16-15474-000	○ ○	83157
		16-15089-000	○ ○	83164
	MT55 Step Van	16-15436-000		○ -	83154	...
		16-15705-000		○ -	83120	...
		16-15934-000		○ -	83120	...
		16-16262-000		○ -	83120	...
		16-16542-000		○ -	83154	...
	MT55 Step Van - w/35" Front Spring - w/38" Front Spring	16-15473-000	○ ○	83157
		16-15474-000	○ ○	83157
		16-15089-000	○ ○	83164
	MT55 Utility Van w/8000 lb. flat leaf front suspension	16-15676-000	○ ○	85058	89431	
	Oshkosh Motor Home with O.E.M. Number	1398980		83127	...	○ ○	83127	...
		GBL654875		○ ○	83117	...
	School Bus Chassis with 7,000 lb Suspension	10-13859-000	○ ○	85005	89430	
		471700005079	○ ○	85005	89430	
	Shuttle Bus Chassis	16-16082-000	○ ○	85043
	Step Van and Motorhome chassis with O.E.M. Number	16-15475-000	○ ○	83164
	Step Van Models with O.E.M. Number	16-19138-000	○ ○	85058	89431	
		471700003011	○ ○	85058	89431	
09-12	Type C School bus chassis with O.E.M. Number	16-18713-000		○ -	85122	...
		471700003070		○ -	85122	...
03 - 07	VC Chassis ADL200 Suspension w/ 20K Rear Rear Shock with O.E.M. Number ZF - IFS Front Suspension with 23,000 lb GVW or Greater	16-16873-000		○ ○	85029	...
		471700131974		○ ○	85029	...
		141700131809		○ ○	85029	...
		16-16736-000		○ ○	85029	...
		16-18103-000	- -	85900
		481700000493	- -	85900
93 - 04	VC Chassis (Up To 22000 lb GVW)	○ ○	83160

APPLICATION GUIDE - TRUCKS, TRAILERS, AND BUSES

Year Año Année	Model Modelo Modèle	OEM #	Front		Rear	
						
						
			Fleetline	GasSLX	Fleetline	GasSLX





FREIGHTLINER CUSTOM CHASSIS(Cont'd.)

	XC & XB MotorHome Chassis with Neway AS-120, 10,500 lb Front Air Suspension	14170000377	○ ○	83174
		16-18075-000	○ ○	83174
	XC & XB MotorHome Chassis with Neway AS-120, 12,000 lb Front Air Suspension	14170000378	○ ○	83160
		141700131975	○ ○	83160
		16-16874-000	○ ○	83160
		16-18076-000	○ ○	83160
03 - 07	XC Chassis							
	ADL200 Suspension w/ 20K Rear	16-16873-000		○ ○	85029	...
	AS120 Front Suspension	141700131810	○ ○	83160
		16-16737-000	○ ○	83160
		16-16874-000	○ ○	83160
	Rear Shock with O.E.M. Number	141700131809		○ ○	85029	...
		16-16736-000		○ ○	85029	...
	ZF - IFS Front Suspension with 23,000 lb GVW or Greater	16-18103-000	- -	85900
		48170000493	- -	85900
93 - 04	XC Chassis (Up To 22000 lb GVW)	○ ○	83160
	XC MotorHome Chassis with ZF- IFS, 12,000 lb Front Air Suspension	16-17144-000	- -	85900
		16-17361-000	- -	85900
		48170000477	- -	85900
		481700131919	- -	85900
00 - 02	XCS Chassis (22000 lb GVW) w/ O.E.M. Number	16-15592-000	○ -	83154
		16-15755-000	○ ○	85043
		16-16043-000	○ ○	85043
01 - 02	XCS Chassis with Freightliner Rear Air Suspension	16-16093-000	○ ○	83160
	Models with O.E.M. Number	16-14794-000		○ -	83154	...
		16-16083-000		○ ○	85331	...
		16-16836-000		○ -	83154	...
		654953	○ ○	85058	89431	
		659227	○ ○	85058	89431	
		GBL 654870	○ ○	83116
		GBL654918	○ ○	83118
	Additional O.E.M. Interchanges	16-15805-000	○ -				83120	
		1745500	○ ○				89430	
		659104	○ ○				85904	
		66554540I	○ ○				89430	
		P116168	○ ○				83117	

FRUEHAUF

	"L" Suspensions	UCD-006216-001		○ ○	83203	89436
	"T" Suspensions	UCE-1295-901		○ ○	85300	89419
	"T" Suspensions With Drop Frame (NT Construction)	UCF-8339-001		○ ○	85321	...
		UCF-8339-002		○ ○	85321	...
	All with Air Suspension and O.E.M. Number	UCE-1295-1		○ ○	85300	89419
	All with Lift Axle	UCE-9399-1		○ ○	83122	89406
	Model "T" Low Mount with 48 ft drop-deck trailer	○ ○	85327	...
	Model UCA-5431	5352858		○ ○	85305	...
	Model W24T1 Air Ride	UCE-2983-000		○ ○	85322	...
		UCE-2983-001		○ ○	85322	...
	Tractor & Trailer Lift Axle with O.E.M. Number	5116-117		○ ○	83122	89406
	Models with O.E.M. Number	144-5910		○ ○	85300	89419

APPLICATION GUIDE - TRUCKS, TRAILERS, AND BUSES

Year Año Année	Model Modelo Modèle	OEM #	Front		Rear	
						
			Wrench	Wrench	Wrench	Wrench
			Fleetline	GasSLX	Fleetline	GasSLX

FRUEHAUF(Cont'd.)

Models with O.E.M. Number	680117		010	85300	89419
	680298		010	85321	...
	UCA-01113		010	85304	...
	UCA-5431		010	85305	...
	UCD-6216-1		010	83203	89436
	UCE-2983-1		010	85322	...
	UEY 1124-001		010	85030	89440

FWD TRUCK

Models with O.E.M. Number	450739		010	85302	89420		...
---------------------------	--------	--	-----	-------	-------	--	-----









GENERAL TRAILER CO

Models with Air Suspension	120-1		010	83125	...
Additional O.E.M. Interchanges	12608		010	83125			

GILLIG BROS.

Models with Neway Air Suspension with shock stamping	90045084		010	85968	...	
Models with Neway ARD-234 Models Truck & Tractor Air Suspension (ARD-234-6)	90044046		010	83123	89405	
Phantom Models (30 Foot) with O.E.M. Number	90-2164 SP1	01-	85723	
00 - 11 Phantom Models with O.E.M. Number	90-2627		010	...	89461	
School Bus w/1" Mounting Pins	200-171		85304	...	010	85304	...	
	53-176		85304	...	010	85304	...	
School Bus w/3/4" Mounting Pins	57113	010	83219	
	57131		010	83216	...	
Transit Bus, Phantom 55, 40, TB40	53-14010		- -	85318	...	
	53-24685	01-	85723	
	695110		- -	85318	...	
	90F-1912		- -	85318	...	
Models with O.E.M. Number	1583470		010	85051	...	
	695109	01-	85723	
	82-01878		83122	...	010	83122	89406	
	90044683		010	83122	89406	
	90044769		010	83207	89407	
	90044770		010	83207	89407	
	90-1951-SP1		010	85734	...	
	90-1968	010	85712	
	90-2423	01-	85723	
	H53-02132-14005	01-	85723	
	H53-20415-006		010	85051	...	
MR6394	01-	85723		
Additional O.E.M. Interchanges	53-02132	01-	85723					
	53-02133-000	- -	85318					
	53-13952-000	- -	85722					
	53-14005-000	01-	85723					
	665568	010	85051					
	680009	010	85302 or 89420					
	680333	- -	85708					
	70034	010	85302 or 89420					
	82-21542-000	010	85716					
	82-30159-000	- -	85708					
	90-1908	01-	85723					

APPLICATION GUIDE - TRUCKS, TRAILERS, AND BUSES

Year Año Année	Model Modelo Modèle	OEM #	Front		Rear	
						
						
			Fleetline	GasSLX	Fleetline	GasSLX

GMC TRUCK

	1591501		- -	85722	...
--	---------	--	-----	-----	-----	--------------	-----

3500 & 4000 Series

60 - 62	3500, 4000, B-4000, L-4000, S-4000 with H-130, H-150 and 13800 Axles	O O	83221	...
63 - 66	Truck and School Bus	O O	85005	89430	O O	83221	...

4500 Series

66 - 72	CE-4500, CS-4500 Conventional Cab with V-8 Gas or In-line 6 Gas Engines	22012096		83221	...	O O	83221	...
		3192892		83221	...	O O	83221	...
66 - 72	EG-4500, EM-4500, ES-4500 Cab/Cowl with V-6 Gas or Diesel or In-line 6 Gas Engines	3171068	O O	83216
		3192657	O O	83216
		4940614	O O	83216
		4963853	O O	83216
		4963854	O O	83216
		22012095		O O	83126	89430
		3171462		O O	83126	89430
3192890		O O	83126	89430		
72 - 80	PS4620 P, 4650P Step Van (Walk-in) 3/4" Upper bolt	22002293	O O	83126	89430	
		22007701	O O	83126	89430	
		22012095	O O	83126	89430	
		22012166	O O	83126	89430	
		3192890	O O	83126	89430	
		4940606	O O	83126	89430	
		4975497	O O	83126	89430	
72 - 80	PS4620 P, 4650P Step Van (Walk-in) 5/8" Upper bolt	22007751	O O	83303
72 - 80	PS4620 P, 4650P Step Van (Walk-in)	22012096		O O	83221	...
		3192892		O O	83221	...



5000 Series

60 - 62	5000, B-5000, L-5000, S-5000 with 1618 or 16802 Axle	O O	83221	...
75 - 80	C Chassis - Conventional Cab	4975510	O O	83221
76 - 89	C Chassis - Conventional Cab	22002294	O O	83304
		22007752	O O	83304
		22007757	O O	83304
		22012096		O O	83221	...
		22012196		O O	83221	...
73 - 80	C, S Chassis - Conventional Cab	22007750	O O	83207	89407	
		4975467	O O	83207	89407	
		4975494	O O	83207	89407	
73 - 80	C,S Chassis - Conventional Cab and School Bus	22012096		O O	83221	...
		3192892		O O	83221	...
73 - 89	C,S Chassis - Conventional Cab and School Bus	22012095		O O	83126	89430
		22012166		O O	83126	89430
60 - 68	SP-5000, DSP-5000 School Bus	O O	85302	89420	O O	85307	...
63 - 66	Truck and School Bus	O O	85005	89430	
63 - 68	W-5000, BW-5000, DW-5000	O O	85005	89430	

5500 Series

66 - 72	CE-5500, CS-5500 Conventional Cab with V-8 Gas or In-line 6 Gas Engines	22012096		83221	...	O O	83221	...
		3192891		83221	...	O O	83221	...
		3192892		83221	...	O O	83221	...
66 - 72	CG-5500, CM-5500, T-5500 Conventional & Tilt Cab with V-6 Gas or Diesel Engines	22012095	O O	83126	89430	

APPLICATION GUIDE - TRUCKS, TRAILERS, AND BUSES

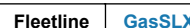
Year Año Année	Model Modelo Modèle	OEM #	Front		Rear	
						
			Wrench	Wrench	Wrench	Wrench
			Fleetline	GasSLX	Fleetline	GasSLX

GMC TRUCK(Cont'd.)









5500 Series(Cont'd.)

66 - 72	CG-5500, CM-5500, T-5500 Conventional & Tilt Cab with V-6 Gas or Diesel Engines	3192890	OIO	83126	89430		
			4940606	OIO	83126	89430	
66 - 72	EG-5500, EM-5500, ES-5500 Cab/Cowl with 6 Cyl. Engines	3171068	OIO	83216		
			3192657	OIO	83216		
			4940614	OIO	83216		
			4963853	OIO	83216		
			4963854	OIO	83216		
			22012095	OIO	OIO	83126	89430
			3171462	OIO	OIO	83126	89430
3192890	OIO	OIO	83126	89430			
60 - 68	LW-5500	OIO	85307		
67 - 68	Truck and School Bus	OIO	85005	89430	OIO	83221	...	
63 - 68	W-5500	OIO	85005	89430		

6000 Series

76 - 89	C Chassis - Conventional Cab	22002294	OIO	83304		
			22007752	OIO	83304		
			22007757	OIO	83304		
75 - 80	C, S Chassis - Conventional Cab and School Bus	4975510	OIO	83221		
79 - 89	C, S Chassis - Conventional Cab and School Bus	22002295	OIO	83303		
			22007753	OIO	83303		
			22017530	OIO	83303		
73 - 75	C, S Chassis - Conventional Cab and School Bus - Exc. with 18500, 20800 & 23000 lb Rear Axle	22007750	OIO	83207	89407		
			4975467	OIO	83207	89407	...		
			4975494	OIO	83207	89407	...		
73 - 89	C, S Chassis - Conventional Cab and School Bus - Exc. with 18500, 20800 & 23000 lb Rear Axle	22012096	OIO	OIO	83221	...	
			22012169	OIO	OIO	83221	...
			3192892	OIO	OIO	83221	...
73 - 89	C, S Chassis - Conventional Cab and School Bus with 18500, 20800 & 23000 lb Rear Axle	22012095	OIO	OIO	83126	89430	
			22012166	OIO	OIO	83126	89430
			4940606	OIO	OIO	83126	89430
73 - 80	C, S, T Chassis - Conventional & Tilt Cab and School Bus with 5000 & 7000 lb Axle	22002293	OIO	83126	89430		
			22007701	OIO	83126	89430	...		
			22007751	OIO	83303		
			22012095	OIO	83126	89430	...		
			3192890	OIO	83126	89430	...		
			4940606	OIO	83126	89430	...		
			4940662	OIO	83126	89430	...		
4975497	OIO	83126	89430	...					
63 - 68	DW - 6000	OIO	85005	89430		
60 - 68	L - 6000	OIO	85307		
79 - 89	S Chassis - School Bus	22002294	OIO	83304		
			22007702	OIO	83304		
			22007752	OIO	83304		
			22007757	OIO	83304		
79 - 80	W Chassis - 72" BBC Steel Tilt Cab	22002293	OIO	83126	89430		
			22007751	OIO	83303		

APPLICATION GUIDE - TRUCKS, TRAILERS, AND BUSES









Year Año Année	Model Modelo Modèle	OEM #	Front		Rear	
						
						
			Fleetline	GasSLX	Fleetline	GasSLX

GMC TRUCK(Cont'd.)

6500 Series(Cont'd.)

75 - 76	C, M Chassis - Conventional Cab	4975510	OIO	83221	...	OIO	83221	...
76 - 89	C, M Chassis - Conventional Cab	22002294	OIO	83304	...	OIO	83304	...
		22007752	OIO	83304	...	OIO	83304	...
		22007757	OIO	83304	...	OIO	83304	...
73 - 75	C, M Chassis - Conventional Cab with 9000 & 12000 lb Axle	22012095	OIO	83126	89430	OIO	83126	89430
		3192890	OIO	83126	89430	OIO	83126	89430
		4940606	OIO	83126	89430	OIO	83126	89430
		4940614	OIO	83216	...	OIO	83216	...
		4963854	OIO	83216	...	OIO	83216	...
		4975497	OIO	83126	89430	OIO	83126	89430
75 - 89	C, M Chassis - Conventional Cab with 9000 & 12000 lb Axle	22002295	OIO	83303	...	OIO	83303	...
		22007751	OIO	83303	...	OIO	83303	...
		22017530	OIO	83303	...	OIO	83303	...
		22017531	OIO	83303	...	OIO	83303	...
		4975511	OIO	83303	...	OIO	83303	...
73 - 75	C, M, S Chassis - Conventional Cab and School Bus	22007750	OIO	83207	89407	OIO	83207	89407
		4975467	OIO	83207	89407	OIO	83207	89407
		4975494	OIO	83207	89407	OIO	83207	89407
73 - 80	C, M, S Chassis - Conventional Cab and School Bus - Exc. with 20800 or 23000 lb Rear Axle	22012096		OIO	83221	...
		22012169		OIO	83221	...
		3192892		OIO	83221	...
73 - 80	C, M, S Chassis - Conventional Cab and School Bus with 20800 or 23000 lb Rear Axle	22012095		OIO	83126	89430
		22012166		OIO	83126	89430
		4940606		OIO	83126	89430
73 - 80	C, S, T Chassis - Conventional & Tilt Cab and School Bus	22002293	OIO	83126	89430	OIO	83126	89430
		22012095	OIO	83126	89430	OIO	83126	89430
		3192890	OIO	83126	89430	OIO	83126	89430
		4940606	OIO	83126	89430	OIO	83126	89430
		4975497	OIO	83126	89430	OIO	83126	89430
66 - 72	CE-6500, CM-6500 Conventional Cab with V-6 Diesel or V-8 Gas Engine	3192892		OIO	83221	...
66 - 72	CE-6500, ME-6500 Conventional Cab with V-8 Gas Engine - Exc. 11000 lb Axle	22012096	OIO	83221	...	OIO	83221	...
		3192891	OIO	83221	...	OIO	83221	...
		3192892	OIO	83221	...	OIO	83221	...
66 - 72	CE-6500, ME-6500 Conventional Cab with V-8 Gas Engine with 11000 lb Axle	22012095	OIO	83126	89430	OIO	83126	89430
		3192890	OIO	83126	89430	OIO	83126	89430
		4940606	OIO	83126	89430	OIO	83126	89430
66 - 72	CM-6500, TE-6500, TM-6500 Conventional Cab with V-6 Diesel or V-8 Gas Engine	22012095	OIO	83126	89430	OIO	83126	89430
		22012096		OIO	83221	...
		3192890	OIO	83126	89430	OIO	83126	89430
		4940606	OIO	83126	89430	OIO	83126	89430
66 - 72	EG-6500, DM-6500, ES-6500 Cab/Cowl with V-6 Gas or Diesel or In-line 6 Gas Engines	3171068	OIO	83216	...	OIO	83216	...
		3192657	OIO	83216	...	OIO	83216	...
		4963853	OIO	83216	...	OIO	83216	...
		22012095		OIO	83126	89430
		3171462		OIO	83126	89430
		3192890		OIO	83126	89430

APPLICATION GUIDE - TRUCKS, TRAILERS, AND BUSES

Year Año Année	Model Modelo Modèle	OEM #	Front		Rear	
						
						
			Fleetline	GasSLX	Fleetline	GasSLX

GMC TRUCK(Cont'd.)





7000 Series(Cont'd.)

79 - 89	C, M Chassis - 97" BBC Conventional Cab	22002294 22002295 22007752 22007753 22007757 22017530 22017531	O1O	83304
			O1O	83303	
			O1O	83304	
			O1O	83303	
			O1O	83304	
			O1O	83303	
			O1O	83303	
79 - 81	C, M Chassis - 97" BBC Conventional Cab - Exc. with 18500, 20800 & 23000 lb Rear Axle	22012096 2212169		O1O	83221	...
				O1O	83221	...
79 - 89	C, M Chassis - 97" BBC Conventional Cab with 18500, 20800 & 23000 lb Rear Axle	22012095 22012166		O1O	83126	89430
				O1O	83126	89430
79 - 80	W Chassis - 72" BBC Steel Tilt Cab	22002293 22007751	O1O	83126	89430	
			O1O	83303

7500 Series

66 - 69	72" BBC Tilt Cab	22012095 3171462 4940606	O1O	83126	89430	
			O1O	83126	89430	
			O1O	83126	89430	
66 - 72	72" BBC Tilt Cab with V-6 2 Cycle Diesel Engine with 17221 Axle	22012096 3192892		O1O	83221	...
				O1O	83221	...
66 - 72	72" BBC Tilt Cab with V-6 2 Cycle Diesel Engine with 19101 and 19201 Axle	4940600		O1O	83209	89414
70 - 72	72" BBC Tilt Cab with Air Brakes - Exc. Gas Engine	22012095 3171462 4940606	O1O	83126	89430	
			O1O	83126	89430	
			O1O	83126	89430	
70 - 72	72" BBC Tilt Cab with Air Brakes & Gas Engine	22012091 5552452	O1O	85303	89422	
			O1O	85303	89422	
			
66 - 72	92" BBC Conventional Cab with Tapered 2-Leaf Softride 11000 lb Rating and F120 Axle (12000 lb)	22046483 22052336 3171069	O1O	85304
			O1O	85304
			O1O	85304
66 - 72	92" BBC Conventional Cab with Tapered 2-Leaf Softride 7000 & 9000 lb Rating and F070, F090, F120 Axle (7000, 9000 & 12000 lb)	3171068 3192657 4940614 4963853 4963854	O1O	83216
			O1O	83216
			O1O	83216
			O1O	83216
			O1O	83216
77 - 80	H, J Chassis - 92" BBC Conventional Cab	4963854 4984526	O1O	83216
			O1O	83216
73 - 80	H, J, M Chassis - 92" & 114" BBC Conventional Cab	22046483 22052336 3171069	O1O	85304
			O1O	85304
			O1O	85304
73 - 80	H, J, M Chassis - 92" & 114" BBC Conventional Cab with V-6, V-8 Gas or V-6 Diesel Engines	4940614 4963854	O1O	83216
			O1O	83216
			
73 - 80	R Chassis - Rear Engine Bus	22012090 22012091 5552451 5552452 5552456	O1O	85308	89422	
				O1O	85303	89422
			O1O	85308	89422	
				O1O	85303	89422
				O1O	85307	...
73 - 80	T, W Chassis - 72" BBC Steel Tilt Cab with V-6 Diesel Engine	22007751	O1O	83303

APPLICATION GUIDE - TRUCKS, TRAILERS, AND BUSES

Year Año Année	Model Modelo Modèle	OEM #	Front		Rear	
						
					Fleetline	GasSLX

GMC TRUCK(Cont'd.)

7500 Series(Cont'd.)

73 - 80	T, W Chassis - 72" BBC Steel Tilt Cab with V-6 Diesel Engine	22012095	010	83126	89430	
		4940606	010	83126	89430	
		4975497	010	83126	89430	
73 - 80	T, W Chassis - 72" BBC Steel Tilt Cab with V-6 Gas Engine	22012091	010	85303	89422	
		5552452	010	85303	89422	

8500 Series

66 - 72	72" BBC Tilt Cab	5544060	010	85302	89420	
67	92" BBC Conventional Cab	3171068	010	83216
		3192657	010	83216
		4940614	010	83216
		4963853	010	83216
		4963854	010	83216
66 - 72	92" BBC Conventional Cab with 7000 & 9000 lb Axles	22046483	010	85304
		22052336	010	85304
		3171069	010	85304
79 - 80	D, F Chassis - 54" BBC Aluminum Tilt Cab	22046483	010	85304
		22052336	010	85304
		3171069	010	85304
79 - 82	H, J Chassis - 92" BBC Conventional Cab 4 x 2 with Air Suspension	22012065		010	85304	...
		22046483		010	85304	...
		22052336		010	85304	...
		3171069		010	85304	...
73 - 81	H, J Chassis - 92" BBC Conventional Cab with V-6, V-8 Gas Engine	4940614	010	83216
		4963854	010	83216
		4984526	010	83216
73 - 86	H, J, M Chassis - 92" & 114" BBC Conventional Cab	22046483	010	85304
		22052336	010	85304
		3171069	010	85304
73 - 80	R Chassis - Rear Engine Bus	22012090	010	85308	89422	
		22012091		010	85303	89422
		5552451	010	85308	89422	
		5552452		010	85303	89422
		5552456		010	85307	...
73 - 80	T, W Chassis - 72" BBC Steel Tilt Cab with V-6 Gas Engine	22012091	010	85303	89422	
		5552452	010	85303	89422	

9500 Series

66 - 72	48" BBC Aluminum Tilt Cab	5552454	010	85302	89420	
66 - 72	72" BBC Steel Tilt Cab	22012091	010	85303	89422	
		5552452	010	85303	89422	
67 - 72	92" & 114" BBC Conventional Cab	3171068	010	83216
		3192657	010	83216
		4940614	010	83216
		4963853	010	83216
		4963854	010	83216
73 - 89	D, F Chassis - 54" BBC Aluminum Tilt Cab with Rear GM Air Ride Suspension (4 Req'd)	22012065		85304	...	010	85304	...
		22046483		85304	...	010	85304	...
		22052336		85304	...	010	85304	...
		3171069		85304	...	010	85304	...

APPLICATION GUIDE - TRUCKS, TRAILERS, AND BUSES

Year Año Année	Model Modelo Modèle	OEM #	Front			Rear		
			Fleetline	GasSLX				

GMC TRUCK(Cont'd.)

9500 Series(Cont'd.)

73 - 89	H, J Chassis - 92" BBC Conventional Cab with Rear GM Air-Ride Suspension (4 req'd)	22012065 22046483 22052336 3171069		85304	...	0 0	85304	...
			85304	...	0 0	85304	...	
			85304	...	0 0	85304	...	
			85304	...	0 0	85304	...	
77 - 89	M, N Chassis - 114" BBC Conventional & 108" BBC Aluminum Conventional Cab with Rear GM Air-Ride Suspension (4 req'd)	22046483 22052336 3171069	85304	...	0 0	85304	...	
			85304	...	0 0	85304	...	
			85304	...	0 0	85304	...	
73 - 80	T, W Chassis - 72" BBC Steel Tilt Cab	22012091 5552452	0 0	85303	89422	
			0 0	85303	89422	

B - Series - School Bus

90 - 98	B7 Model School Bus Chassis w/11000, 13500, 15000 lb Taperleaf Springs	22064231		- -	85324	...
90 - 06	B7 Model School Bus Chassis w/15000, 19000, 21000 lb Multileaf Springs	15174902 22064232	- -	85071	...	
			- -	85071	...	
- 09	B6, B7 Models with O.E.M. Number	15123676 15588554 22064230 88982682	- -	83136
			- -	83136
			- -	83136
			- -	83136









C - Series (C4500, C5500) Topkick

04 - 09	C Chassis - Conventional Cab (Non 4x4 Option) with 13,500 Multi-leaf Spring	15185644 508-89 L-12706		0 0	83155	...
			0 0	83155	...	
			0 0	83155	...	
90 -	C Chassis - Conventional Cab with 11000, 13500, 15000 lb Taperleaf Springs	22064231	- -	85324	...	
90 - 09	C Chassis - Conventional Cab with 15000, 19000, 21000 lb Multileaf Springs	15174902 22064232 88982686	- -	85071	...	
			- -	85071	...	
			- -	85071	...	
90 - 06	C Chassis - Conventional Cab with 16900 or 17850 lb Taperleaf Springs	21998392 22064489 88963409	- -	85336	...	
			- -	85336	...	
			- -	85336	...	
90 -	C Chassis - Conventional Cab with 19000, 21000, 23000 lb Taperleaf Springs (EXC Low Profile Vehicle)	22064233	- -	83136	...	
83 - 99	C Chassis - Conventional Cab with 9100 to 17500 lb Rear Axle	22064432	0 0	85050	...	
90 - 09	C Chassis - Conventional Cab with Front Shock with O.E.M. Number	15123676 15588554 15887728 19152843 22064230 88982682	- -	83136
			- -	83136
			- -	83136
			- -	83136
			- -	83136
			- -	83136
03 - 09	C Chassis - Conventional Cab with Taperleaf Rear Suspension Models with O.E.M. Number	15185643 88982684 88982688	0 0	83153	...	
			- -	83136
			- -	85336	...	

C - Series (C6500, C7500, C8500) Topkick

90 - 09	Conventional Cab Front Shock with O.E.M. Number	15123676 15174898 15588554	- -	83136
			- -	83136
			- -	83136

APPLICATION GUIDE - TRUCKS, TRAILERS, AND BUSES

Year Año Année	Model Modelo Modèle	OEM #	Front		Rear	
						
						
			Fleetline	GasSLX	Fleetline	GasSLX

GMC TRUCK(Cont'd.)

C - Series (C6500, C7500, C8500) Topkick(Cont'd.)

90 - 09	Front Shock with O.E.M. Number With 15000, 19000, 21000 lb Multileaf Springs	15887728 19152843 22064230 88982682 15174902 22064232 88982686	- -	83136	
			- -	83136	
			- -	83136	
			- -	83136	
				- -	85071	...
				- -	85071	...
				- -	85071	...
				- -	85071	...
04 - 08	Conventional Cab (Low Profile) with 12000, 15000, & 17000 lb Leaf Spring	15174901 507-22 88982685		- -	85342	...
				- -	85342	...
				- -	85342	...
90 -	Conventional Cab w/11000, 13500, 15000 lb Taperleaf Springs	22064231		- -	85324	...
90 - 06	Conventional Cab w/16900 or 17850 lb Taperleaf Springs	21998392 22064489 88963409		- -	85336	...
				- -	85336	...
				- -	85336	...
90 -	Conventional Cab w/19000, 21000, 23000 lb Taperleaf Springs (EXC Low Profile Vehicle)	22064233		- -	83136	...
04 - 08	Conventional Cab with 19000 lb Leaf Spring	15174903 507-23 88982687		- -	85342	...
				- -	85342	...
				- -	85342	...
83 - 99	Conventional Cab with 9100 to 17500 lb Rear Axle	22064432		0 0	85050	...
95 - 02	Models with Hendrickson Air Suspension (Stamping number 47902-13)	12474915 15963161		0 0	83122	89406
				0 0	83122	89406
96 - 02	Models with Hendrickson Air Suspension (Stamping number 47902-29)	12474917 15740554		0 0	83137	...
				0 0	83137	...
	Models with O.E.M. Number	88982684 88982688	- -	83136
				- -	85336	...





Coaches

	4100, 4900 Models	3182842 3188599 3192416 4975552		85711	...	- 0	85711	...
				85711	...	- 0	85711	...
				85711	...	- 0	85711	...
				85711	...	- 0	85711	...
	4500, 5300 Models	3166657 3192333		85700	...	0 0	85700	...
				85700	...	0 0	85700	...
	Models with O.E.M. Number	3175509 3178106 3178507 3178995 3189265 5304059 5316784 5316794 5316984 5352857 5527271 5527272 5549924		85735	...	0 0	85735	...
				85700	...	0 0	85700	...
				85700	...	0 0	85700	...
				85700	...	0 0	85700	...
				85700	...	0 0	85700	...
				85700	...	0 0	85700	...
				85700	...	0 0	85700	...
				85700	...	0 0	85700	...
				85700	...	0 0	85700	...
				85700	...	0 0	85700	...
				85313	...	0 0	85313	...
				85700	...	0 0	85700	...
				85700	...	0 0	85700	...
				85700	...	0 0	85700	...

P - Series

92 - 96	Motorhome Chassis	22064231 22064233		- -	85324	...
				- -	83136	...

APPLICATION GUIDE - TRUCKS, TRAILERS, AND BUSES

Year Año Année	Model Modelo Modèle	OEM #	Front		Rear	
			 Fleetline	 GasSLX	 Fleetline	 GasSLX

GMC TRUCK(Cont'd.)









T - Series (T5500, T6500, T7500, T8500)(Cont'd.)

97 -	FL1 Tilt Cab with 8100 lb Axle	22064804	- -	83136
		22064805	- -	83136
		22165187	- -	83136
		22165188	- -	83136
97 -	FL2 Tilt Cab with 5000 to 11000 lb Axle	22064807	- -	83136
		22166442	- -	83136
97 -	FL3 Tilt Cab with 14575 lb Axle	22064806	- -	83136
		22165189	- -	83136
99	Models with Hendrickson Air Suspension (Stamping number 47902-13)	12474915		0 0	83122	89406
		15963161		0 0	83122	89406
06 - 09	Tilt Cab Models with O.E.M. Number	15174901		- -	85342	...
		15174903		- -	85342	...
		507-22		- -	85342	...
		507-23		- -	85342	...
		88982685		- -	85342	...
		88982687		- -	85342	...
90 - 99	Tilt Cab with 11000, 13500, 15000 lb Taperleaf Springs	22064231		- -	85324	...
90 - 06	Tilt Cab with 15000, 19000, 21000 lb Multileaf Springs	15174902		- -	85071	...
		22064232		- -	85071	...
92 - 06	Tilt Cab with 16900 lb Taperleaf Springs RR SUSP(GZH) Heavy Duty	21998392		- -	85336	...
		22064489		- -	85336	...
		88963409		- -	85336	...
92 - 99	Tilt Cab with 19000, 21000, 23000 lb Taperleaf Springs (EXC Low Profile Veh.)	22064233		- -	83136	...

W - Series (Isuzu)

	Models with O.E.M. Number	8-97253664-0		0 0	83159	...
		97253664		0 0	83159	...
83 - 95	W4 Models	8-51630-666-0		0 0	85012	89413
		9-51630-666-0		0 0	85012	89413
89 - 90	W4 Models Flatlow	9-51630-647-1	- 0	83515
89 - 92	W4 Models Flatlow	8-51630-666-0		0 0	85012	89413
86 - 09	W4 Models with 11000 lb & 13000 lb Suspension	8-94454-986-0	- 0	83515
		8-94454-987-0	- 0	83515
		8-97253-620-0	- 0	83515
		94454987	- 0	83515
		9-51630-647-1	- 0	83515
		97083027	- 0	83515
		97083029	- 0	83515
		97253620	- 0	83515
		98232671	- 0	83515
01 - 08	W4 Models with O.E.M. Number	97253651		0 0	83404	...
02 - 14	W4 Models with O.E.M. Number	8-97253665-0		0 0	83159	...
		898098-0580		0 0	83159	...
		898098-0581		0 0	83159	...
		898098-0590		0 0	83159	...
		97253665		0 0	83159	...
		98098058		0 0	83159	...
		98098059		0 0	83159	...
88 - 99	W5 Models	1-51630-217-0	- 0	83114
		1-51630-217-1	- 0	83114

APPLICATION GUIDE - TRUCKS, TRAILERS, AND BUSES

Year Año Année	Model Modelo Modèle	OEM #	Front		Rear	
						
						
			Fleetline	GasSLX	Fleetline	GasSLX

GMC TRUCK(Cont'd.)

W - Series (Isuzu)(Cont'd.)

88 - 99	W5 Models	1-51630-219-1	- O	83114	
03 - 09	W5 Models with 11000 lb & 13000 lb Suspension	97253620	- O	83515	
03 - 09	W5 Models with O.E.M. Number	97253665		O O	83159	
86 - 91	W6 Models	1-51630-168-1	- O	83515	
		1-51630-217-1	- O	83114	
	Models with O.E.M. Number	8-94057-593-0	- O	83114	
		8-97083-029-0	- O	83515	
		8-97201-960-0	- O	83515	
		898098-1250	- O	83515	
		898098-1270	- O	83515	
		90044769		O O	83207	89407
		90044770		O O	83207	89407
		94033786		- O	83114	...
		94051090	- O	83114
		94057593	- O	83114
		94454987	- O	83515
		9-51630-666-2		O O	85012	89413
		97201960	- O	83515
		97253616	- O	83515
		97253621	- O	83515
		97253623	- O	83515
		98098125	- O	83515
98098127	- O	83515		

WCA & WIA Series

	Models with O.E.M. Number	37301-0016	O -	85026	89417
		37301-0021	O -	85026	89417
		37301-3202	O -	85026	89417

WH Series

	WHS, WHR, WHL or WHE Models with Front Dual Shocks	3082284	- -	83400
--	--	---------	-----	-------	-----	-----	-----





Additional Applications

	1500 Models						
	Models with Rear Suspension	35901-0005		O O	83219
	Models with O.E.M. Number	35901-0001		O O	83209

Additional O.E.M. Interchanges

	Models with O.E.M. Number	15642943		- -	83136	...
		22024061		O O	85704	...
		22025067		O O	85704	...
		22025305		O O	85704	...
		22046489	O O	85303	89422
		22065218	O O	G63347
		22065251	O O	85030	89440
		22099889		- -	85336	...
		507-24		- -	85336	...
		508-88		O O	83153	...
		87-2520-00003		O O	85704	...
		U0109-014		- -	83400	...
	Additional O.E.M. Interchanges	22007703	O O	83303				
		22012067	O O	85700				
		22012079	- -	85701				
		22012082	O O	85702				
		22012083	- O	85711				

APPLICATION GUIDE - TRUCKS, TRAILERS, AND BUSES





Year Año Année	Model Modelo Modèle	OEM #	Front		Rear	
						
			Fleetline	GasSLX	Fleetline	GasSLX

GMC TRUCK(Cont'd.)

Additional O.E.M. Interchanges(Cont'd.)

Additional O.E.M. Interchanges	OEM #	Interchange	Replacement
	22012083GS	-10	85711
	22012114	010	85700
	22012131	-10	85711
	22024062	-1-	85701
	22024673	-10	85710
	22045526	010	85702
	22046481	010	85702
	22046485	-10	85710
	22046499	-10	85710
	22052014	010	85702
	22052424	-10	85710
	3171696	010	85307
	3172948	010	85303 or 89422
	3178157	010	85700
	3178233	010	85734
	3188626	010	85300 or 89419
	3188729	010	85303 or 89422
	35901-0003	010	85301
	35901-0004	010	83219
	35901-0017	010	83314
	4939852	010	85308 or 89422
	4939967	010	85308 or 89422
	4940601	010	83216
	4940627	010	83203 or 89436
	4940640	010	83216
	4940650	010	83207 or 89407
	4940654	010	83216
	4940660	010	83207 or 89407
	4963844	010	85307
	4964853	010	83217
	4974401	010	85700
	4975429	010	85300 or 89419
	4975472	-10	83161
	4975479	-1-	83400
	4975480	-1-	83400
	4975501	010	85700
	4975515	-1-	85701
	4975516	010	85702
	4975518	010	85704
	4975538	010	85700
	4975549	010	83216
	4975550	010	85702
	507-12	-1-	85701
	507-16	010	85702
	507-19	010	85700
	5171068	010	83216
	5316791	010	83219
	5316792	010	85305
	5316793	010	85305
	5321920	010	85307
	5321929	010	85307

APPLICATION GUIDE - TRUCKS, TRAILERS, AND BUSES





Year Año Année	Model Modelo Modèle	OEM #	Front		Rear	
						
			Fleetline	GasSLX	Fleetline	GasSLX

GMC TRUCK(Cont'd.)

Additional O.E.M. Interchanges(Cont'd.)

	Additional O.E.M. Interchanges	5348631	010	83203 or 89436
		5352858	010	85305
		5353054	010	85303 or 89422
		5355798	010	85307
		5357955	010	85300 or 89419
		5357956	010	85734
		5357959	010	85300 or 89419
		5361994	010	85734
		5374779	010	85308 or 89422
		5374999	010	85307
		5385939	010	85307
		5392387	010	85303 or 89422
		5394448	010	85305
		5394467	010	85305
		5394468	010	85735
		5455798	010	85307
		5513489	010	83216
		5513716	010	85304
		5516459	010	85305
		5522781	010	85735
		5522794	010	85308 or 89422
		5522818	010	85305
		5527001	010	85300 or 89419
		5527606	010	85305
		5531027	010	85301
		5531435	010	85307
		5531436	010	85307
		5531437	010	85307
		5532026	010	85304
		5532425	010	83207 or 89407
		5532433	010	83207 or 89407
		5532675	010	85307
		5533699	010	85302 or 89420
		5534430	010	85303 or 89422
		5534439	010	85304
		5534447	010	85303 or 89422
		5544112	010	83216
		5544581	010	85302 or 89420
		5544716	010	85304
		5544717	010	85304
		5544812	010	83308
		5544818	010	85735
		5549899	010	83207 or 89407
		5549925	010	85304
		5552111	010	85304
		5552112	010	85307
		5552114	010	83216
		5552205	010	83217
		5552206	010	83214
		5552207	010	83217
		5552208	010	83217

APPLICATION GUIDE - TRUCKS, TRAILERS, AND BUSES

Year Año Année	Model Modelo Modèle	OEM #	Front		Rear	
						
			Fleetline	GasSLX	Fleetline	GasSLX

GMC TRUCK(Cont'd.)

Additional O.E.M. Interchanges(Cont'd.)

	Additional O.E.M. Interchanges	5552209	010	83215
		5552210	010	85308 or 89422
		5552244	010	85308 or 89422
		5552285	010	83214
		5552286	010	83217
		5552287	010	83217
		5552288	010	83217
		5552453	010	85301
		5552527	010	85735
		5554184	010	85302 or 89420
		5554589	010	85307
		5554596	010	85303 or 89422
		5554814	010	85302 or 89420
		5554959	010	83401
		5554995	010	85305
		5559363	010	83203 or 89436
		5585939	010	85307
		684280	010	83209 or 89414
		97-2210-00153	-1-	85701
		97-2210-00156	010	85702
	97-2210-00164	-1-	85708	
	97-2210-00170	01-	85733	

GMC TRUCK CAB SHOCKS

	Astro Cabover (Sleeper & Non-Sleeper Trucks) with Link Cabmate Model GMC-2P-A	1202-0032	010	83016
	Brigadier Tractors with J9 Cabs with Link Cabmate Model GMC92J9	1202-0012	010	83023
03 -	C4500 , C5500 Models Models with Link Cabmate Model GMT560	1201-1043	010	83025
		1202-1043	010	83025
79 -	Conventional Trucks measuring 108" BBC or 116" BBC with Link Cabmate Model GMC816	1202-0012	010	83023
		Models with Link Cab Suspension	1202-0022	010
90 -	TopKick Truck Cabs with Link Cabmate Model GMC104TK	1202-0054	010	83021
- 89	TopKick Truck Cabs with Link Cabmate Model GMC92TK	1202-0012	010	83023

GRANNING SUSPENSION

	Models T950-1200, -1400, -1700	2697		010	85712	...
	Models with O.E.M. Number	1085		010	83214	...
		680162		010	85300	89419
		OE12425		010	83214	...

GREAT DANE TRAILER

Identification of the trailer suspension is necessary to determine what section of the catalog to refer to. Some possible options can be Chalmers, Hendrickson, Neway, Ridewell, Reyco.									
	Reyco Suspension 87	18163-01		010	83207	89407	
	Reyco Suspension 88	18164-01		010	83122	89406	
	Trailers with Great Dane part number	HENS-20001		010	83128	89436	
		HENS-20002		010	85000	89436	
		HENS-20126		010	85323	89436	
		HENS-21292		010	85052	...	
		HENS-23566		010	85000	89436	

APPLICATION GUIDE - TRUCKS, TRAILERS, AND BUSES

Year Año Année	Model Modelo Modèle	OEM #	Front		Rear	
			Fleetline	GasSLX	Fleetline	GasSLX

GREAT DANE TRAILER(Cont'd.)

	Trailers with Great Dane part number	HENS-23649	OIO	85064	...
		MER202447	OIO	85919	...
		REY18165-01	OIO	85006	...
	Trailers with Great Dane part number Heavy Duty Standard	HENS-24088	OIO	85000	89436
		HENS-24088	OIO	83128	89436
		Trailers with Reyco 86 AR / RS 1015, 1035, 3035 Slider Air Suspension	18165-01	OIO	85006

GREYHOUND BUS

	City Cruiser	12TA-01-013	OIO	85303	...	OIO	85303	89422
	MC5, MC7, MC8	12B-5-1	OIO	85735	...	OIO	85735	...
		3178157	OIO	85700	...	OIO	85700	...
	Additional O.E.M. Interchanges	3166657	OIO	85700				
		3178154	OIO	85735				
		3192333	OIO	85700				
		690029	OIO	85700				
		74413	OIO	85313				

GRUMMAN BUS









	Model 870 Flex Bus	22024506	-IO	85703	...	OIO
		22025066	-IO	85703	...	OIO
		22025067	OIO	OIO	85704	...
		22025305	OIO	OIO	85704	...
		97-2201-00001	-IO	85703	...	OIO
		97-2201-00002	-IO	85703	...	OIO
		97-2201-00003	-IO	85703	...	OIO
		97-2201-00004	-IO	85703	...	OIO
		97-2201-00005	-IO	85703	...	OIO
		97-2210-00001	OIO	OIO	85704	...
		97-2210-00002	OIO	OIO	85704	...
		97-2210-00003	OIO	OIO	85704	...
		97-2210-00004	OIO	OIO	85704	...
		97-2210-00005	OIO	OIO	85704	...
			Additional O.E.M. Interchanges	690029	OIO	85700		

GULF STREAM COACH

Class A MotorHomes

03 - 06	Atrium Series MotorHomes with Freightliner XC Chassis ADL200 Suspension w/ 20K Rear AS120 Front Suspension Rear Shock with O.E.M. Number ZF - IFS Front Suspension with 23,000 lb GVW or Greater	16-16873-000	OIO	OIO	85029	...
		141700131810	OIO	83160	...	OIO
		16-16737-000	OIO	83160	...	OIO
		16-16874-000	OIO	83160	...	OIO
		141700131809	OIO	OIO	85029	...
		16-16736-000	OIO	OIO	85029	...
		16-18103-000	-I-	85900	...	OIO
		481700000493	-I-	85900	...	OIO
02 - 06	Friendship & Scenic Cruiser Series MotorHomes with Freightliner XC Chassis ADL200 Suspension w/ 20K Rear AS120 Front Suspension	16-16873-000	OIO	OIO	85029	...
		141700131810	OIO	83160	...	OIO
		16-16737-000	OIO	83160	...	OIO

APPLICATION GUIDE - TRUCKS, TRAILERS, AND BUSES

Year Año Année	Model Modelo Modèle	OEM #	Front		Rear	
						
						
			Fleetline	GasSLX	Fleetline	GasSLX

GULF STREAM COACH(Cont'd.)

Class A MotorHomes(Cont'd.)

02 - 06	ADL200 Suspension w/ 20K Rear Rear Shock with O.E.M. Number	16-16874-000 141700131809 16-16736-000 ZF - IFS Front Suspension with 23,000 lb GVW or Greater 16-18103-000 481700000493	OIO	83160	...	OIO	85029	...
			OIO	85029	...	
			OIO	85029	...	
			-I-	85900	
			-I-	85900	
02	Independence Series MotorHomes with Freightliner XC Chassis ADL200 Suspension w/ 20K Rear AS120 Front Suspension Rear Shock with O.E.M. Number ZF - IFS Front Suspension with 23,000 lb GVW or Greater	16-16873-000 141700131810 16-16737-000 16-16874-000 141700131809 16-16736-000 16-18103-000 481700000493						
			OIO	OIO	85029	...
			OIO	83160	
			OIO	83160	
			OIO	83160	
				OIO	85029	...
				OIO	85029	...
			-I-	85900	
			-I-	85900	
			02 - 04	Yellowstone Series MotorHomes with Freightliner XC Chassis ADL200 Suspension w/ 20K Rear AS120 Front Suspension Rear Shock with O.E.M. Number ZF - IFS Front Suspension with 23,000 lb GVW or Greater	16-16873-000 141700131810 16-16737-000 16-16874-000 141700131809 16-16736-000 16-18103-000 481700000493			
OIO				OIO	85029	...
OIO	83160	
OIO	83160	
OIO	83160	
				OIO	85029	...
				OIO	85029	...
-I-	85900	
-I-	85900	

HARDEE MFG

Models with O.E.M. Number	8030223 AS789B	OIO	83207	89407
		OIO	85014	...

HAUSMAN





Models with O.E.M. Number	695110 695119 695198	-I-	85318	...
		OIO	85702	...
		-I-	85706	...

HENDRICKSON TRAILER SUSPENSION SYSTEMS

Intraax

AA230T & AA250T Models with O.E.M. Number	A-20002 A-20126 A-20889 B-22345	OIO	85000	89436	
		OIO	85323	89436	
		OIO	85323	89436	
		OIO	85911	...	
AAEDL Models For Models with 12" Ride Height For Models with 14" to 19" Ride Height For Models with 9" Ride Height	B-24023 B-23316 B-24579						
			OIO	85738	...
			OIO	85382	...
AAEDT 30K Models (w/14" and 15" Ride Height- High Damping) (w/14" Ride Height) (w/15", 16" & 17" Ride Height)	B-25436 B-23361 B-25515						
			OIO	85916	89430
			OIO	85911	...
AAL 23K, 25K & 30K Models Front shocks with 12" Ride Height Front shocks with 14" to 19" Ride Height	B-23566 A-2212						
			OIO	85000	89436
		OIO	85029	...	

APPLICATION GUIDE - TRUCKS, TRAILERS, AND BUSES

Year Año Année	Model Modelo Modèle	OEM #	Front		Rear	
			 Fleetline	 GasSLX	 Fleetline	 GasSLX

HENDRICKSON TRAILER SUSPENSION SYSTEMS(Cont'd.)





Intraax(Cont'd.)

	Front shocks with 6.5" to 9" Ride Height	B-23651	010	85045	...
	Rear shocks with 14" to 17" Ride Height	B-25437	010	85337	...
	Rear shocks with 6.5" to 7.5" Ride Height	B-20345	010	85345	...
	Rear shocks with 9" to 12" Ride Height	B-25436	010	85916	89430
	AANL 23K Models						
	with 12" to 17" Ride Height - High Damping	B-25515	010	85338	...
	with 6.5" to 9" Ride Height - High Damping	B-24579	010	85939	...
	with 6.5" to 9" Ride Height - Standard	B-23651	010	85045	...
	AANLS - 20K with Rear shocks with 9" Ride Height	B-23316	010	85382	...
	AANT 23K Models						
	(High Damping)	B-24023	010	85738	...
	(Hvy Duty)	B-24125	010	85323	89436
	(Limited Rebound)	B-23361	010	85911	...
	(Standard)	B-23566	010	85000	89436
	AAT 23K Models						
	(High Damping)	B-24023	010	85738	...
	(Hvy Duty)	B-24125	010	85323	89436
	(Limited Rebound)	B-23361	010	85911	...
	(Standard)	B-23566	010	85000	89436
	AAT 25K Models						
	(High Damping)	B-24023	010	85738	...
	(Hvy Duty)	B-24125	010	85323	89436
	(Limited Rebound)	B-23361	010	85911	...
	(Standard)	B-23566	010	85000	89436
	AAT 30K Models	B-24023	010	85738	...
	AAZL 23K / 46K Models						
	with 12" Ride Height - High Damping	B-24023	010	85738	...
	with 12" Ride Height - Standard	B-23566	010	85000	...
	with 6.5" to 9" Ride Height - High Damping	B-24579	010	85939	...
	with 6.5" to 9" Ride Height - Standard	B-23651	010	85045	...
	AAZNT 23K / 46K / 69K Models						
	with 12" to 17" Ride Height - High Damping	B-24023	010	85738	...
	with 12" to 17" Ride Height - Standard	B-23566	010	85000	...
	Low Ride Height Models with						
	(10.5" to 15" Ride Height)	B-23013	010	85000	89436
	(15.5" to 21" Ride Height - High Damping)	B-23316	010	85382	...
	(15.5" to 21" Ride Height - Std Damping)	B-23315	010	85029	...
	(6.5" to 8" Ride Height - High Damping)	B-22312	010	85939	...
	(6.5" to 8" Ride Height)	B-22311	010	85045	...

Top Mount Style

	HT190T (All Models)	A-20001	010	83128	89436
	HT230T						
	All except Models listed below	A-20002	010	85000	89436
	(TA14-020)	B-22345	010	85911	...
	(TA15-521, TA17-521)	B-21553	010	85738	...
	(TA15-522, TA17-522)	B-21699	010	87018	...
	(-14-020, -14-021, TA14-021)	A-2212	010	85029	...
	(-14-17, -15-17, -15-517, -17-517, TA15-517, TA15-520, TA17-517)	A-20126	010	85323	89436
	(-14-7, -14-11, -15-7, -15-11, -15-12, -15-28, TA14-7, TA15-7, TA16-7, TA17-7, TB14-33, TB15-28)	A-2160	010	85014	...
	HT250T (All Models)	A-2212	010	85029	...

APPLICATION GUIDE - TRUCKS, TRAILERS, AND BUSES

Year Año Année	Model Modelo Modèle	OEM #	Front		Rear	
						
			Fleetline	GasSLX	Fleetline	GasSLX

HENDRICKSON TRAILER SUSPENSION SYSTEMS(Cont'd.)





Top Mount Style(Cont'd.)

HT300T & N-HT300T (All except Models listed below) (-15-007, -15-011, -15-021,-17-007,-17-011, -17-012, TB19-007,TB19-020) (-15-017, -15-518, -17-518,-17-520) (TB15-027) (TB15-518)	A-20126	010	85323	89436
	A-2160	010	85014	...
	B-21553	010	85738	...
	B-24579	010	85939	...
	B-21699	010	87018	...
T-15-140, -155, -172, 244, -376	A-2218	010	85030	89440
T-15-324	A-2160	010	85014	...
T-17-141, -174, -284	A-2218	010	85030	89440
TMB-14-120	A-2213	010	85010	...
TMB-17-135	A-4084	010	85005	89430

UnderSlung Style

HT190U (-6.75-001 / -6.75-002 / -6.75-003 / -6.75-020) (U-7.5-517) (U-9-022 / UB7-021) (All except Models listed above)	A-2212	010	85029	...
	A-20002	010	85000	89436
	B-23649	010	85064	...
	A-20001	010	83128	89436
HT250U & N-HT250U (All except Models listed below) (U-6.5-030, U-6.5-031) (U-6.5-27,U-9-27 & -28,U-14-28,UB6.5-522,UB7.5-27 &-522,UB9-522,UB12-27 &-28,UB14-27 &-28) (U-6.5-517, U-7.5-17, U-7.5-517, U-9-517, U-12-517, U-14-514, UB6.5-517, UB7.5-517) (U-7.5-021, U-7.5-022) (U-9-20 & -21 & -23, U-9.5-26, U-15-22, UB9-22, UB15-22)	A-20002	010	85000	89436
	A-2160	010	85014	...
	B-21553	010	85738	...
	A-20126	010	85323	89436
	A-1667	010	85000	89436
HT250US - 5.5 to 6.5" Ride Height (High Damping)	B-23744	010	85344	...
	S-23744	010	85344	...
HT250US (Models with Angled and Frame Clearance Mount) (Standard Travel w/ 6.5", 7.5" & 14" Ride Height -High Damping) (Standard Travel w/ 6.5", 7.5" & 14" Ride Height)	B-24579	010	85939	...
	B-23651	010	85045	...
HT250US (Models with O.E.M. Number)	B-21936	010	85064	...
	B-21947	010	85052	...
	B-22862	010	85045	...
HT250US (Models with Remote Shock Mount) (Extended Rebound w/ 6.5" to 9" Ride Height -High Damping) (Extended Rebound w/ 6.5" to 9" Ride Height) (Standard Travel w/ 12" to 14" Ride Height) (Standard Travel w/ 5.5" to 6.5" Ride Height) (Standard Travel w/ 7.5" to 9" Ride Height -High Damping) (Standard Travel w/ 7.5" to 9" Ride Height)	B-23316	010	85382	...
	A-2212	010	85029	...
	A-2212	010	85029	...
	B-23650	010	85052	...
	B-23743	010	85938	...
	B-23649	010	85064	...
HT250US (Models with Standard Shock Mount) (Extended Rebound w/ 6.5" Ride Height -High Damping) (Extended Rebound w/ 6.5" Ride Height) (Standard Travel w/ 3.5" to 4" Ride Height) (Standard Travel w/ 5.5" to 6.5" Ride Height) (Standard Travel w/ 7.5" to 14" Ride Height -High Damping) (Standard Travel w/ 7.5" to 14" Ride Height)	B-24579	010	85939	...
	B-23651	010	85045	...
	B-23548	010	85079	...
	B-23650	010	85052	...
	B-23743	010	85938	...
	B-23649	010	85064	...
HT250U-Y (All Models)	A-20002	010	85000	89436

APPLICATION GUIDE - TRUCKS, TRAILERS, AND BUSES

Year Año Année	Model Modelo Modèle	OEM #	Front		Rear	
						
			Fleetline	GasSLX	Fleetline	GasSLX

HENDRICKSON TRAILER SUSPENSION SYSTEMS(Cont'd.)

UnderSlung Style(Cont'd.)

HT300U & N-HT300U (All except Models listed below) (U-7.5-519,U-9-011,U-9-519,U-12-011,U-12-015,U-14-011,U-14-015,U-17-011)	A-20126		010	85323	89436
	B-21699		010	87018	...
T-12-139	A-2213		010	85010	...
T-23-US-9-011	A-2213		010	85010	...
T30-US-9, -17	A-10348		010	85043	...
T-4-392	A-2160		010	85014	...
T-6-062, -295, -370, -422	A-1667		010	85000	89436
T-6-071	A-2212		010	85029	...
T-9-084	A-2240		010	85013	89414
T-9-106, -278, -313	A-4084		010	85005	89430
T-9-175	A-2160		010	85014	...
T-9-325	A-2218		010	85030	89440
T-9-390	A-2213		010	85010	...

Vantraax

HKA180 Heavy Duty	B-24088		010	85000	89436
	S-24088		010	85000	89436
	B-24088		010	83128	89436
	S-24088		010	83128	89436
HKA200	B-23566		010	85000	89436
	S-23566		010	85000	89436
HKA250 (Standard)	B-24023		010	85738	...
HKAL 46K Models	B-23566		010	85000	89436
HKANT 40K Heavy Duty	B-24088		010	85000	89436
	S-24088		010	85000	89436
	B-24088		010	83128	89436
	S-24088		010	83128	89436
HKANT 46K	B-23566		010	85000	89436
	S-23566		010	85000	89436
HKANT 69K23	S-23566		010	85000	89436
	S-23566		010	85000	89436
HKARL 46K Disc Brake Applications	B-25436		010	85916	89430
	S-25436		010	85916	89430
	B-23566		010	85000	89436
	S-23566		010	85000	89436
HKAT 46K	B-23566		010	85000	89436
	S-23566		010	85000	89436
HKAT 50K	B-24023		010	85738	...
	S-24023		010	85738	...
HKAT 69K	B-24023		010	85738	...
	S-24023		010	85738	...

Additional Applications

AB-32-001 Models	A-1667		010	85000	89436
HK190T (Slider Air Suspension)	A-21292		010	85052	...
HK230 (Slider Air Suspension)	A-21292		010	85052	...
HS190T (Slider Air Suspension)	A-20001		010	83128	89436

APPLICATION GUIDE - TRUCKS, TRAILERS, AND BUSES

Year Año Année	Model Modelo Modèle	OEM #	Front		Rear	
			Fleetline	GasSLX	Fleetline	GasSLX

HENDRICKSON TRAILER SUSPENSION SYSTEMS(Cont'd.)

Additional Applications(Cont'd.)

HS230 (Slider Air Suspension)	A-20002	010	85000	89436
MT-45,MTL45,MTL-50	S-1667	010	85000	89436
TDC-014	665267	010	85029	...
	A-2212	010	85029	...

Additional O.E.M. Interchanges

Models with O.E.M. Number	57905-2	010	85006	...
	60675-004	010	85006	...
	654951	010	85000	89436
	659024	010	85052	...
	665190	010	85006	...
	665246	010	85043	...
	665405	010	85030	89440
	665406	010	85010	...
	665531	010	85000	89436
	665532	010	85013	89414
	665533	010	85005	89430
	665536	010	85000	89436
	665693	010	85064	...
	665694	010	85052	...
	665698	010	85911	...
	665733	010	85045	...
	665756	010	85000	89436
	665758	010	85064	...
	665759	010	85052	...
	665760	010	85045	...
	665761	010	85911	...
	665763	010	85079	...
	665764	010	85029	...
	665765	010	83150	...
	665766	010	85000	89436
	665767	010	85045	...
	671779	010	...	89414
	671948	010	85000	89436
	680102	010	85712	...
	680341	010	85323	89436
	680463	010	...	89440
	680467	010	85323	89436
	680509	010	85738	...
	680565	010	85738	...
	680566	010	85938	...
	680568	010	85323	89436
	680570	010	...	89437
	680571	010	85738	...
	680573	010	85939	...
	680579	010	85939	...
	680614	010	85338	...
	680616	010	...	89430
	680617	010	85337	...
	680702	010	85323	89436
	680756	010	85323	89436
	680769	010	85911	...

APPLICATION GUIDE - TRUCKS, TRAILERS, AND BUSES

Year Año Année	Model Modelo Modèle	OEM #	Front		Rear	
			Fleetline	GasSLX	Fleetline	GasSLX

HENDRICKSON TRAILER SUSPENSION SYSTEMS(Cont'd.)

Additional O.E.M. Interchanges(Cont'd.)

Models with O.E.M. Number	OEM #	Fleetline	GasSLX	Fleetline	GasSLX
680776	010	85338	...
98583-019	010	85323	89436
98583-020	010	...	89414
A-10023	010	85000	89436
A-11931	010	85000	89436
A-14583	010	85000	89436
A-1668	010	85000	89436
A-20345	010	85345	...
A-20886	010	85030	89440
A-20887	010	85005	89430
A-2230	010	85005	89430
A-2232	010	85005	89430
A-2240-1	010	85043	...
A-2471	010	85006	...
A-4089	010	83209	89414
A-4890	010	85712	...
A-6156	010	85301	...
B-21832	010	85323	89436
B-21936	010	85064	...
B-21994	010	85938	...
B-21995	010	85344	...
B-22715	010	85000	89436
B-23014	010	85738	...
B-23290	010	83150	...
B-23362	010	...	89437
B-25174	010	85029	...
B-26652	010	85000	89436
B-27058	010	83128	...
B-27747	010	85911	...
B-29432	010	85323	89436
B-29678	010	85911	...
B-29826	010	85338	...
B-33312	010	85338	...
B-33313	010	85338	...
NS500699	010	85005	89430
S-10348	010	85043	...
S-14583	010	85000	89436
S-1668	010	85000	89436
S-20001	010	83128	89436
S-20002	010	85000	89436
S-20126	010	85323	89436
S-20345	010	85345	...
S-20886	010	85030	89440
S-20887	010	85005	89430
S-20889	010	85323	89436
S-21292	010	85052	...
S-21553	010	85738	...
S-2160	010	85014	...
S-21699	010	87018	...
S-21832	010	85323	89436
S-21936	010	85064	...

APPLICATION GUIDE - TRUCKS, TRAILERS, AND BUSES

Year Año Année	Model Modelo Modèle	OEM #	Front		Rear	
			Fleetline	GasSLX	Fleetline	GasSLX

HENDRICKSON TRAILER SUSPENSION SYSTEMS(Cont'd.)

Additional O.E.M. Interchanges(Cont'd.)









Models with O.E.M. Number	S-21947	010	85052	...
	S-2212	010	85029	...
	S-2213	010	85010	...
	S-2218	010	85030	89440
	S-2230	010	85005	89430
	S-22311	010	85045	...
	S-22312	010	85939	...
	S-2232	010	85005	89430
	S-22345	010	85911	...
	S-2240	010	85013	89414
	S-22715	010	85000	89436
	S-22862	010	85045	...
	S-23013	010	85000	89436
	S-23014	010	85738	...
	S-23290	010	83150	...
	S-23315	010	85029	...
	S-23316	010	85382	...
	S-23361	010	85911	...
	S-23362	010	...	89437
	S-23548	010	85079	...
	S-23649	010	85064	...
	S-23650	010	85052	...
	S-23651	010	85045	...
	S-23743	010	85938	...
	S-24023	010	85738	...
	S-24125	010	85323	89436
	S-24579	010	85939	...
	S-2471	010	85006	...
	S-25437	010	85337	...
	S-25515	010	85338	...
	S-26652	010	85000	89436
	S-29432	010	85323	89436
S-29678	010	85911	...	
S-29826	010	85338	...	
S-33312	010	85338	...	
S-33313	010	85338	...	
S-33313L	010	85338	...	
S-4084	010	85005	89430	
S-4089	010	83209	89414	
S-4890	010	85712	...	
Models with O.E.M. Number Heavy Duty Standard	S-24088	010	85000	89436
	S-24088	010	83128	89436

HENDRICKSON TRUCK SUSPENSION SYSTEMS

Airtek - Series

Airtek Front Used on BlueBird	471700000456	010	85959
	58913-007	010	85959
	58913-007L	010	85959
	58913-008	010	85959

APPLICATION GUIDE - TRUCKS, TRAILERS, AND BUSES

Year Año Année	Model Modelo Modèle	OEM #	Front		Rear	
						
						
			Fleetline	GasSLX	Fleetline	GasSLX

HENDRICKSON TRUCK SUSPENSION SYSTEMS(Cont'd.)

Airtek - Series(Cont'd.)

Used on BlueBird	58913-008L	010	85959	
	58913-009	010	85959	
	58913-009L	010	85959	
	65992-003	010	85959	
	Used on Freightliner / Western Star	471700006269	010	85932	89453	
		58913-003	010	85932	89453	
		58913-012	010	85932	89453	
	Used on International	65992-001	010	85955
		65992-002	010	85955
		65992-006	010	85986
	Used on Volvo / Mack	64838-001	010	85933	89454	
		64838-001L	010	85933	89454	
		64838-002	010	85933	89454	
		64838-002L	010	85933	89454	
		64838-003	010	85933	89454	
		64838-003L	010	85933	89454	

All American Series (FE & RE Models)

Buses with Hendrickson 14,600 lb Capacity-Left Hand Drive Steertek Axle	58913-011	010	85959
---	-----------	-----	--------------	-----	--	-----	-----





Comfort Air - Series

Conventional Hino Models with Single Axle Air Suspension	60670-013		010	83148	...
	60670-017		010	83148	...
Models with O.E.M. Number	471700131545		010	85006	...
	60998-001		010	85006	...
	60998-003		010	85006	...

Firemaax - Series

Firemaax 240 Air Suspensions Disc Brake Applications with 8 1/2" to 10" Ride Height Drum Brake Applications with 8 1/2" to 10" Ride Height Standard with 12 1/2" - 14 3/8" - 15 1/2" Ride Height Standard with 8 1/2" to 10" Ride Height	60665-014		010	85962	...
	60665-018		010	85961	...
	60665-011		010	85967	...
	60657-003		010	85072	...
					
Firemaax 270 Air Suspensions Disc Brake Applications with 8 1/2" to 10" Ride Height Drum Brake Applications with 8 1/2" to 10" Ride Height	60665-015		010	85966	...
	60665-013		010	85965	...
Firemaax 480 Air Suspensions Disc Brake Applications with 8 1/2" to 10" Ride Height Drum Brake Applications with 8 1/2" to 10" Ride Height Standard with 12 1/2" - 14 3/8" - 15 1/2" Ride Height Standard with 8 1/2" to 10" Ride Height	60665-014		010	85962	...
	60665-018		010	85961	...
	60665-011		010	85967	...
	60657-003		010	85072	...
Firemaax 540 Air Suspensions Disc Brake Applications with 8 1/2" to 10" Ride Height Drum Brake Applications with 8 1/2" to 10" Ride Height	60665-015		010	85966	...
	60665-013		010	85965	...
Firemaax EX 242 Air Suspensions Standard with 12 1/2" - 14 3/8" - 15 1/2" Ride Height Standard with 8 1/2" to 10" Ride Height	60665-011		010	85967	...
	60657-003		010	85072	...
Firemaax EX 272 Air Suspensions Disc Brake Applications with 8 1/2" to 10" Ride Height Drum Brake Applications with 8 1/2" to 10" Ride Height	60665-015		010	85966	...
	60665-013		010	85965	...
Firemaax EX 482 Air Suspensions Standard with 12 1/2" - 14 3/8" - 15 1/2" Ride Height Standard with 8 1/2" to 10" Ride Height	60665-011		010	85967	...
	60657-003		010	85072	...

APPLICATION GUIDE - TRUCKS, TRAILERS, AND BUSES

Year Año Année	Model Modelo Modèle	OEM #	Front		Rear	
						
			Wrench	Fleetline GasSLX	Wrench	Fleetline GasSLX

HENDRICKSON TRUCK SUSPENSION SYSTEMS(Cont'd.)

Firemaax - Series(Cont'd.)

Firemaax EX 542 Air Suspensions	60665-015						
Disc Brake Applications with 8 1/2" to 10" Ride Height	60665-015		010	85966	...
Drum Brake Applications with 8 1/2" to 10" Ride Height	60665-013		010	85965	...

HA - Series

HA - 180 (Used on all except Mack)	47902-13						
	47902-8		010	83122	89406
HA - 200 (Used on all except Mack)	47902-13		010	83122	89406
	47902-8		010	83122	89406
HA - 230 (Used on all except Mack)	47902-13		010	83122	89406
	47902-8		010	83122	89406
HA - 360 (Used on all except Mack)	47902-13		010	83122	89406
	47902-8		010	83122	89406
HA - 400 (Used on all except Mack)	47902-13		010	83122	89406
	47902-8		010	83122	89406
HA - 460 (Used on all except Mack)	47902-13		010	83122	89406
	47902-8		010	83122	89406
HA Series Air Suspension (All Models used on Mack)	47902-19		010	83123	89405
	47902-9		010	83123	89405
HA-360/400/460 Edge System High Torque Rise	60675-003		010	85976	...

HAS - Series

HAS - 120L	60670-010						
HAS - 150L	60670-003		010	83149	...
HAS - 190	60675-003		010	85976	...
HAS - 190 Standard	60670-005		010	83137	...
	60670-008		010	83123	89405
HAS - 190L	60670-008		010	83123	89405
HAS - 210	60675-003		010	85976	...
HAS - 210 Standard	60670-005		010	83137	...
	60670-008		010	83123	89405
HAS - 210L	60670-008		010	83123	89405
HAS - 230	60675-003		010	85976	...
HAS - 230 Standard	60670-005		010	83137	...
	60670-008		010	83123	89405
HAS - 230L	60670-008		010	83123	89405
HAS - 360	60675-003		010	85976	...
HAS - 360 Standard	60670-005		010	83137	...
	60675-003		010	85976	...
HAS - 400	60675-006		010	85909	...
	60675-006		010	85909	...
HAS - 400 Mack & Kenworth Air Suspensions Standard Standard Inboard Rear	47902-25		010	83125	...
	60670-005		010	83137	...
	60670-007		010	83144	...
HAS - 400L	60670-008		010	83123	89405
HAS - 402	60675-003		010	85976	...
	60675-006		010	85909	...
HAS - 402 Standard Standard Inboard Rear	60670-005		010	83137	...
	60670-007		010	83144	...
HAS - 402L	60670-008		010	83123	89405
HAS - 40LH	60685-001		01-	85977	...

APPLICATION GUIDE - TRUCKS, TRAILERS, AND BUSES

Year Año Année	Model Modelo Modèle	OEM #	Front		Rear	
			Fleetline	GasSLX	Fleetline	GasSLX

HENDRICKSON TRUCK SUSPENSION SYSTEMS(Cont'd.)

HAS - Series(Cont'd.)

HAS - 40LH Standard	60680-001		01-	83111	...
HAS - 460	60675-003		010	85976	...
	60675-006		010	85909	...
HAS - 460 Standard Standard Inboard Rear	60670-005		010	83137	...
	60670-007		010	83144	...
HAS - 460L	60670-008		010	83123	89405
	60670-008L		010	83123	89405
Models with O.E.M. Number	60675-014		010	85978	...
	60675-8Q		010	85976	...

HN - Series

HN - 400 Models built between Mar/96 - Sept/97 Models built between Nov/88 - Feb/96	60680-003		01-	83112	...
	60670-002		010	83207	89407
HN - 402 Models built between Apr/96 - Dec/04	57241-003		01-	83112	...
	60680-003		01-	83112	...
HN - 460 Models built between Mar/96 - Sept/97 Models built between Nov/88 - Feb/96	57241-003		01-	83112	...
	60680-003		01-	83112	...
	60670-002		010	83207	89407
HN - 462 Models built between Apr/96 - Dec/04	57241-003		01-	83112	...
	60680-003		01-	83112	...
96 - 15	HN - 522	60680-003	01-	83112	...
	HNT - 460	47902-18	010	85030	89440





HTB 400 LT - Series

HTB 400LT Rear Air Suspensions	60657-006		010	85102	...
	60657-010		010	85102	...
	60657-011		010	85102	...

Primaax - Series

230 Air Suspensions For International Models with 9" Ride Height Standard with 12 1/2" - 14 3/8" - 15 1/2" Ride Height Standard with 8 1/2" to 10" Ride Height	60657-003		010	85072	...
	60665-011		010	85967	...
	60657-003		010	85072	...
260 Air Suspensions Disc Brake Applications with 8 1/2" to 10" Ride Height Drum Brake Applications with 8 1/2" to 10" Ride Height	60665-015		010	85966	...
	60665-013		010	85965	...
460 Air Suspensions For International Models with 9" Ride Height Standard with 12 1/2" - 14 3/8" - 15 1/2" Ride Height Standard with 8 1/2" to 10" Ride Height	60657-003		010	85072	...
	60665-011		010	85967	...
	60657-003		010	85072	...
520 Air Suspensions Disc Brake Applications with 8 1/2" to 10" Ride Height Drum Brake Applications with 8 1/2" to 10" Ride Height	60665-015		010	85966	...
	60665-013		010	85965	...
690 Air Suspensions For International Models with 9" Ride Height Standard with 12 1/2" - 14 3/8" - 15 1/2" Ride Height Standard with 8 1/2" to 10" Ride Height	60657-003		010	85072	...
	60665-011		010	85967	...
	60657-003		010	85072	...

APPLICATION GUIDE - TRUCKS, TRAILERS, AND BUSES

Year Año Année	Model Modelo Modèle	OEM #	Front		Rear	
			 Fleetline	 GasSLX	 Fleetline	 GasSLX

HENDRICKSON TRUCK SUSPENSION SYSTEMS(Cont'd.)

Primaax - Series(Cont'd.)

780 Air Suspensions Disc Brake Applications with 8 1/2" to 10" Ride Height	60665-015		010	85966	...
	60665-013		010	85965	...
EX 232 Air Suspensions Standard with 12 1/2" - 14 3/8" - 15 1/2" Ride Height	60665-011		010	85967	...
	60657-003		010	85072	...
EX 262 Air Suspensions Disc Brake Applications with 8 1/2" to 10" Ride Height	60665-015		010	85966	...
	60665-013		010	85965	...
EX 462 Air Suspensions Standard with 12 1/2" - 14 3/8" - 15 1/2" Ride Height	60665-011		010	85967	...
	60657-003		010	85072	...
EX 522 Air Suspensions Disc Brake Applications with 8 1/2" to 10" Ride Height	60665-015		010	85966	...
	60665-013		010	85965	...
EX 692 Air Suspensions Standard with 12 1/2" - 14 3/8" - 15 1/2" Ride Height	60665-011		010	85967	...
	60657-003		010	85072	...
EX 782 Air Suspensions Disc Brake Applications with 8 1/2" to 10" Ride Height	60665-015		010	85966	...
	60665-013		010	85965	...
Models with O.E.M. Number	60657-005		010	85087	...

Additional Applications

Conventional Hino Models with Hendrickson Comfort Air Suspension	60670-020		010	83148	...
HAS 400 / 460 Suspensions with O.E.M. Number	60675-005		010	85980	...
Hendrickson Rear Air Suspension used on Conventional Hino Models (23,000 lb Capacity)	60670-018		010	83166	...
HMX 400/460 Haulmax with 16.5" Saddle Height	60680-004		01-	83143	...
HMX 400/460 Haulmax with 17.5" or 18.5" Saddle Height	60680-005		01-	83142	...
HTS 210 For Spartan Chassis (Type C School Bus Applications)	60665-025		010	85036	...
MaxAir / AL-405 Models	57241-006		01-	83111	...
Parasteer Suspensions Models with O.E.M. Number	59483-000	010	85919
	60665-005	010	85919
	60998-002	010	85919
RT2 & RTE2 (400 / 520) Models Air Suspension (Note: For Ride Height of 10.41" to 12.27" with 52" & 54" Beams and 8.52" to 10.37" with 60" Beams.)	57324-6		010	85904	...

Additional O.E.M. Interchanges

Models with O.E.M. Number	12738		010	83225	...
	47902-11		010	83207	89407
	47902-15		010	83137	...
	47902-20		010	85036	89405
	47902-21		010	85976	...
	47902-22		010	85916	...
	47902-24		010	83137	...
	47902-26		010	83144	...
	47902-27		010	83123	89405
	47902-28		010	85013	89414
	47902-29		010	83149	...
	47902-3		010	85005	89430

APPLICATION GUIDE - TRUCKS, TRAILERS, AND BUSES





Year Año Année	Model Modelo Modèle	OEM #	Front		Rear	
			Fleetline	GasSLX	Fleetline	GasSLX

HENDRICKSON TRUCK SUSPENSION SYSTEMS(Cont'd.)

Additional O.E.M. Interchanges(Cont'd.)

Models with O.E.M. Number	OEM #	Fleetline	GasSLX	Fleetline	GasSLX
503610C2	010	83207	89407
5554596	010	85303	89422
57241-001	01-	83111	...
57241-002	01-	83109	...
57241-004	01-	83110	...
57324-1	010	85036	89405
57324-11	010	85305	...
57324-2	010	85976	...
57324-3	010	85916	...
57324-5	010	85903	...
57905-1	010	85976	...
58623-1	010	85978	...
59048-001	010	83148	...
59057-001	010	83137	...
59057-002	010	85036	89405
59305-1	010	85979	...
59851-1	010	85976	...
59852-1	01-	85977	...
59852-2	01-	85977	...
60657-007	010	85072	...
60665-003	010	83137	...
60665-004	010	85036	89405
60665-008	010	85978	...
60665-009	010	85904	...
60665-020	010	85919	...
60665-024	010	85903	...
60670-001	010	85036	89405
60670-001	010	83123	89405
60670-004	010	83123	89405
60670-006	010	83147	...
60670-009	010	85013	89414
60670-011	010	83148	...
60670-012	010	83168	...
60670-014	010	83166	...
60670-019	010	83166	...
60670-12	010	83168	...
60675-001	010	85978	...
60675-002	010	85979	...
60680-002	01-	83109	...
60680-009	01-	85083	...
60680-012	01-	85083	...
654890	010	83207	89407
654891	010	83149	...
654894	010	83123	89405
654895	010	83137	...
654896	010	83147	...
654897	010	83144	...
654897	010	83144	...
654898	010	83123	89405
654899	010	85013	89414
654900	010	83149	...

APPLICATION GUIDE - TRUCKS, TRAILERS, AND BUSES

Year Año Année	Model Modelo Modèle	OEM #	Front		Rear	
						
			Fleetline	GasSLX	Fleetline	GasSLX

HENDRICKSON TRUCK SUSPENSION SYSTEMS(Cont'd.)

Additional O.E.M. Interchanges(Cont'd.)

Models with O.E.M. Number	654903		01-	83111	...
	654904		01-	83109	...
	654905		01-	83112	...
	659000		010	83148	...
	659004		010	83123	89405
	659048		01-	83143	...
	659049		01-	83142	...
	659155		010	83147	...
	659202		010	83148	...
	659292		010	83148	...
	665816		010	85072	...
	665892		010	85072	...
	671006		010	85036	89405
	671007		010	83137	...
	671009		010	85919	...
	671030		01-	85083	...
	671063		01-	85083	...
	671105		010	85072	...
	671603		010	85919	...
	671606		010	85955
	671611		010	85955
	671704		010	85904	...
	671764		010	85967	...
	671792		010	85965	...
	671793		010	85966	...
	671798		010	85962	...
	672009		010	85903	...
	680091		010	85303	89422
	680600		010	85305	...
	70018		010	85303	89422
	70021		010	85303	89422
	70088		010	85307	...
	98583-005		010	83168	...
	98583-006		010	83148	...
	98583-016		010	83147	...
	98583-032		010	85072	...
	AE76164-3		010	85307	...
	AE76164-4		010	83225	...
	BE76164-2		010	85303	89422
	BE76164-3		010	85307	...
	BE76164-4		010	83225	...

HIGHWAY PRODUCT









	Transit Bus with Air Suspension	010	83203	89436
	Transit Bus with Leaf Spring Suspension		83203	...	010	83203 89436
	A1-6-134			010	83207 89407
	A1-6-135		010	83203	89436

HINO

145 Series

05 - 10	Models with O.E.M. Number	48500-3710	010	83126	89430
---------	---------------------------	------------	-----	-------	-------	-----	-----

APPLICATION GUIDE - TRUCKS, TRAILERS, AND BUSES

Year Año Année	Model Modelo Modèle	OEM #	Front		Rear	
						
						
			Fleetline	GasSLX	Fleetline	GasSLX

HINO(Cont'd.)

145 Series(Cont'd.)

05 - 10	Models with O.E.M. Number	485003710A S4850-03710 48530-3280 S4853-03280	○ ○	83126	89430	
			○ ○	83126	89430	
				○ ○	G63440	...
				○ ○	G63440	...

155 Series

13 - 17	Models with O.E.M. Number	48511-37320 48511-80162	- ○	83518
			- ○	83518

165 Series

05 - 10	Models with O.E.M. Number	48500-3710 485003710A S4850-03710 48530-3280 S4853-03280	○ ○	83126	89430	
			○ ○	83126	89430	
			○ ○	83126	89430	
				○ ○	G63440	...
				○ ○	G63440	...

185 Series

05 - 10	Models with O.E.M. Number	48500-3710 485003710A 48500-3720 S4850-03710 S4850-03720 48530-3280 S4853-03280	○ ○	83126	89430	
			○ ○	83126	89430	
			○ ○	83140
			○ ○	83126	89430	
			○ ○	83140
				○ ○	G63440	...
				○ ○	G63440	...

195 Series

13 - 17	Models with O.E.M. Number	48511-37320 48511-80162 48531-37361 48531-37362	- ○	83518
			- ○	83518
				○ ○	83519	...
				○ ○	83519	...

238 Series

05 - 14	Models with O.E.M. Number	48500-3720 S4850-03720	○ ○	83140
			○ ○	83140

258 Series

08 - 17	258 LP Car Carrier Models with Hendrickson Rear Air Suspension	48530E0100 60670-014		○ ○	83166	...
				○ ○	83166	...
05 - 14	Models with O.E.M. Number	48500-3720 S4850-03720	○ ○	83140
			○ ○	83140

268, 268A Series

	Models with Hendrickson Rear Air Suspension (Shock stamping #)	60670-012		○ ○	83168	...
05 - 14	Models with O.E.M. Number	48500-3720 S4850-03720	○ ○	83140
			○ ○	83140

308 Series

07 - 10	Models with O.E.M. Number	48500-3720 S4850-03720	○ ○	83140
			○ ○	83140









338 Series

05 - 14	Models with O.E.M. Number	48500-3720 S4850-03720	○ ○	83140
			○ ○	83140

358 Series

07 - 14	Models with O.E.M. Number	48500-3720 S4850-03720	○ ○	83140
			○ ○	83140

APPLICATION GUIDE - TRUCKS, TRAILERS, AND BUSES

Year Año Année	Model Modelo Modèle	OEM #	Front		Rear	
						
						
			Fleetline	GasSLX	Fleetline	GasSLX

HINO(Cont'd.)

FA, FB Series(Cont'd.)

89 - 04	FA, FB Models Trucks with: Front Shock with O.E.M. Number	48500-1950	-10	G63610		
			-10	G63610		
			-10	G63610		
			-10	G63610		
		Rear Shock with O.E.M. Number	48500-01950	-10	G63610	
				48500-02750	-10	G63610
						010	83216	...
				48530-1910		010	83216	...
				48530-2510		010	83216	...
				S4853-01910		010	83216	...
S4853-02510		010	83216	...				
89 - 96	FA14, FB14	48500-1950	-10	G63610		
				010	83216	...		
93 - 97	FA1415 (FA15), FB1715 (FB15)	48500-1950	-10	G63610		
				010	83216	...		
92 - 96	FA15, FB15	48500-1950	-10	G63610		
				010	83216	...		
98	FA1517, FA1817, FB1817	010	G63419	...		
				010	83216	...		

FD Series

98 - 03	FD Models Trucks with O.E.M. Number	48500-1801	010	83216
				010	83362	...
86 - 87	FD16	48500-1801	010	83216
				010	83362	...
88 - 91	FD17	48500-1801	010	83216
				010	83362	...
92	FD20	48500-1801	010	83216
				010	83362	...
93 - 97	FD2218, FD2218LD (FD5H). FE5H, FF5H	48500-1801	010	83216
				010	83362	...
98	FD2220, FD2220 Lo Pro	48500-1801	010	83216











FE Series

86 - 87	FE16	48500-1801	010	83216		
				010	83104	...		
84 - 91	FE17, FE19	48530-1900		010	83104	...		
				010	83104	...		
92	FE20	48530-1900		010	83104	...		
93 - 97	FE2618 (FE5H)	48530-1900		010	83104	...		
98	FE2620	48530-1880		010	83362	...		
98 - 04	FE Models Trucks with: Front Shock with O.E.M. Number	48500-1941	010	83141		
			010	83141		
		Rear Shock with O.E.M. Number	S4850-01941		010	83104	...	
					010	83104	...	
				48530-1900		010	G63440	...
				S4853-01900		010	G63440	...

FF Series

98 - 03	FF Models Trucks with O.E.M. Number	48500-1941	010	83141
				010	83104	...
84 - 91	FF17, FF19	48530-1900		010	83104	...
				010	83104	...
92	FF20, FF23	48530-1900		010	83104	...
93 - 97	FF3018 (FF5H)	48530-1900		010	83104	...
93 - 97	FF3020 (FF4H)	48530-1900		010	83104	...

APPLICATION GUIDE - TRUCKS, TRAILERS, AND BUSES

Year Año Année	Model Modelo Modèle	OEM #	Front				Rear			
										
										
Fleetline		GasSLX		Fleetline		GasSLX				

HINO(Cont'd.)

FF Series(Cont'd.)

98	FF3320	48530-1880		OIO	83362	...
87 - 88	FFC1	48530-1900		OIO	83104	...

FG Series

84 - 85	FG19, FG22	48530-1900		OIO	83104	...
---------	------------	------------	--	-----	-----	-----	-------	-----

GC Series

90 - 91	GC17	48500-1801	OIO	83216
		48530-2050		OIO	83217	...
92	GC20	48500-1801	OIO	83216
		48530-2050		OIO	83217	...

SG Series

98 - 03	SG Models Trucks with O.E.M. Number	48500-1941	OIO	83141
		S4850-01941	OIO	83141
86 - 91	SG19	48500-1941	OIO	83141
92	SG20	48500-1941	OIO	83141
86	SG22 Straight Truck	48500-1941	OIO	83141
86	SG221 Tractor	48500-1941	OIO	83141
87 - 92	SG23 Straight Truck	48500-1941	OIO	83141
87 - 92	SG231 Tractor	48500-1941	OIO	83141
93 - 97	SG3320 (SG4H)	48500-1941	OIO	83141
93 - 97	SG3323 (SG1H) Straight Truck	48500-1941	OIO	83141
93 - 97	SG5523 (SG1HD) Tractor	48500-1941	OIO	83141

Additional Applications

	Conventional Hino Models with Hendrickson Comfort Air Suspension	60670-020		OIO	83148	...
	Conventional Hino Models with Hendrickson Comfort Air Suspension (23,000 lb Capacity)	60670-018		OIO	83166	...
	Conventional Hino Models with Hendrickson Comfort Air Suspension (19,000 lb & 21,000 lb Capacity)	60670-013		OIO	83148	...
	Conventional Hino Models with Hendrickson Rear Air Suspension	60670-014		OIO	83166	...
		60670-019		OIO	83166	...
	Models with O.E.M. Number	48500-1800	OIO	83216
		48500-1940	OIO	83141
		48530-1120		OIO	83104	...
		48530-1460		OIO	83215	...
		48530-1620		OIO	83104	...
		48530-1770		OIO	83215	...

HOBBS TRAILERS

	Models with O.E.M. Number	680117		OIO	85300	89419
--	---------------------------	--------	--	-----	-----	-----	-------	-------

HOLIDAY RAMBLER

99 - 03	Admiral, Endeavor Gas and Vacationer Models with F53 Motorhome Chassis (16,000 lb to 22,000 lb GVW)	OIO	83209	...	OIO	83122	...
90 - 97	Admiral, Endeavor Gas and Vacationer Models with F53 Motorhome Chassis (7.5 L, Gas V8)	OIO	83209	...	OIO	85097	...
99 - 03	Atlantis Models with Ford E450 Chassis	-IO	83177	...	-IO	83178	...
	Models with Mor-Ryde Suspension	U0109-007		OIO	G63183	...
	Models with Neway Trailer Air Suspension	90044794		OIO	83127	...
95 - 99	MotorHomes with Freightliner XC Chassis (22,000 to 26,000 lb GVW)	OIO	83160	...	OIO	85029	...

APPLICATION GUIDE - TRUCKS, TRAILERS, AND BUSES

Year Año Année	Model Modelo Modèle	OEM #	Front			Rear		
			Fleetline	GasSLX				

HOLLAND - BINKLEY

Air Plus Integrated Air Susp. with ProPar Parallel Spindle Axles	6898		010	83125	...
Holland ProPar NT2 Air Suspension	680298		010	85321	...

HOLLAND (SEE NEWAY)

Refer to SAF Holland Section for application information

HUTCHENS SUSPENSION

Models with O.E.M. Number	9423-00		010	83203	89436
---------------------------	---------	--	-----	-----	-----	--------------	--------------

HYSTER

Straddle Carrier	650150		83217	...	010	83217	...
	73516		83217	...	010	83217	...

IC CORPORATION

AE Series School Bus

AE Model School Buses with O.E.M. Number	3902993C2	010	83135
	3902993C3	010	83135

BE Series School Bus

- 12	BE200 Model School Buses with 7000 lb Front Axle	3605735C1	010	83156
		3605735C2	010	83156

CE Series School Bus

06 - 17	CE Model School Buses (71 Capacity) with 9,000 to 10,000 lb Front Suspension	3578105C1	010	83163
		3578105C2	010	83163
		6127088C1	010	83163
		OE13402S	010	83163
10 - 15	CE Model School Buses with 20,000 lb International IROS Air Suspension	3578858C2		010	85926
16 - 17	CE Model School Buses with 20,000 lb Rear Air Suspension	3601600C3		010	85082
05 - 13	CE Model School Buses with 22,000 lb Rear Spring Suspension	501906C91		-10	83317
		501906C92		-10	83317
		OE13424S		-10	83317
13 - 16	CE Model School Buses with 6,000 to 8,000 lb Front Axles	3533356C3	010	83169

RE Series School Bus

RE Model School Buses with 12,000 to 14,000 lb Front Axles	2200327C1	-10	85332
RE Model School Buses with Hendrickson AirTek Front Suspension	65992-006	010	85986
RE Model School Buses with O.E.M. Number	3604282C1	-10	85351
	472412C91	-1-	83456	89447	

INGERSOLL AXLES

Ingersoll part number	653511-01		010	85323	89436
	653511-02		010	85938	...
	653511-03		010	85045	...
	653511-04		010	85052	...

INTERNATIONAL (NAVISTAR)

A, B, AC and BC Conventional

A-140 (4 x 4) Models	010	83216	...
A-160, B-160, AC-160, BC-160 Models	308649C91		010	83216	...
	308650C91		010	83216	...

APPLICATION GUIDE - TRUCKS, TRAILERS, AND BUSES

Year Año Année	Model Modelo Modèle	OEM #	Front		Rear	
			Fleetline	GasSLX	Fleetline	GasSLX

INTERNATIONAL (NAVISTAR)(Cont'd.)

A, B, AC and BC Conventional(Cont'd.)

	A-160, B-160, AC-160, BC-160 Models	453567C91		OIO	83216	...
	A-170, B-170, AC-170, BC-170, A-180, B-180, AC-180, BC-180 Models	308646C91	OIO	85012	89413	
		308649C91		OIO	83216	...
		308650C91		OIO	83216	...
		453567C91		OIO	83216	...
	AB-140 Models		G63306	...	OIO	G63306	...
	AC-170 & BC-170 (4 x 4) Models	OIO	83216	...
	AC-180 & BC-180 (4 x 4) Models	OIO	83216	...
	ACF-170 & BCF-170 Models	308646C91		OIO	85012	89413
	BCF-195-D Models	OIO	83225	...
	C-150 Models	OIO	G63306
		308649C91		OIO	83216	...
		308668C91		OIO	85012	89413
		453556C91		OIO	85012	89413
		453567C91		OIO	83216	...

BE Series School Bus

- 12	BE200 Model School Bus Chassis with 7000 lb Front Axle	3605735C1	OIO	83156
		3605735C2	OIO	83156
	with 9000 lb Rear Suspension	3609400C1		-IO	83317	...
		3609400C2		-IO	83317	...





Binder

	Binder	453556C91	OIO	85012	89413	
		453571C91		OIO	83216	...
		467983C91	OIO	85012	89413	
		467985C91	OIO	85012	89413	
		471201C91	OIO	85012	89413	
	S Models Binder	472367C91	-I-	83318

Cargostar

	CO-1600, CO-1610A & B, CO-1630A & B, CO-1700, CO-1710A & B, CO-1730A & B, CO-1750, CO-1750A & B, CO-1800, CO-1810A & B, CO-1830A & B, CO-1850, and CO-1850A & B	206620R91		OIO	83216	...
		206621R92		OIO	83216	...
		294334C91		OIO	83216	...
		3085640C92		OIO	83216	...
		308646C91		OIO	85012	89413
		308649C91		OIO	83216	...
		308650C92		OIO	83216	...
		360444C91		OIO	85012	89413
		453564C91		OIO	85012	89413
		453567C91		OIO	83216	...
		453570C91		OIO	83216	...
		467983C91		OIO	85012	89413
		467984C91		OIO	83216	...
			CO-1610A & B, CO-1630A & B, CO-1710A & B, CO-1730A & B, CO-1750A & B, CO-1810A & B, CO-1830A & B, COF-1810A & B - Exc. with 9000, 10800, or 12000 lb Front Axle	453572C91	OIO	83309	89446	
	CO-1610A & B, CO-1630A & B, CO-1710A & B, CO-1730A & B, CO-1750A & B, CO-1810A & B, CO-1830A & B, COF-1810A & B - With 9000, 10800, or 12000 lb Front Axle	873619C92	OIO	83314
873619C93		OIO	83314	

APPLICATION GUIDE - TRUCKS, TRAILERS, AND BUSES

Year Año Année	Model Modelo Modèle	OEM #	Front			Rear		
								
						Fleetline	GasSLX	Fleetline

INTERNATIONAL (NAVISTAR)(Cont'd.)

Cargostar(Cont'd.)

	CO-190, VCO-190, CO-200, DCO-200, VCO-200,CO-220, VCO-220 With Air Ride Suspension After Chassis No G-387453	350425C1		010	85300	89419
		462557C91		010	85300	89419
	CO-190, VCO-190, CO-200, DCO-200, VCO-200,CO-220, VCO-220 With Air Ride Suspension before Chassis No G-387453	350426C91		010	85734	...
	CO-190, COF-190, VCO-190, VCOF-190 & CO-200, DCO-200, VCO-200 & CO-220, VCO-220 & VCO-190 (4 man cab)	204994R91	010	83225
		210534R92	010	83225
		288920C91	010	83225
		288921R92	010	83225
		308648C91	010	83225
		452566C91	010	83225
		453561C91	010	83225
		453562C91	010	83225
		453565C91	010	83225
		453569C91	010	83225
		467371C91	010	83225
		467372C91	010	83225
	CO-1910A & B, CO-1950A & B, COF-1910A& B, COF-1950A & B	453572C91	010	83309	89446	
		873619C92	010	83314
	CO-1950 , COF-1950 & COT-1950	204994R91	010	83225
		288920C91	010	83225
		288921C91	010	83225
		308648C91	010	83225
		453561C91	010	83225
		453565C91	010	83225
		453566C91	010	83225
		453569C91	010	83225
		467371C91	010	83225
		467372C91	010	83225
	CO-1950 with Air Ride Suspension After Chassis No. G-387453	350425C1		010	85300	89419
		462557C91		010	85300	89419
	CO-1950 with Air Ride Suspension Before Chassis No. G-387453	350426C1		010	85734	...









CE Series School Bus

06 - 17	CE Model School Buses (71 Capacity) with 9,000 to 10,000 lb Front Suspension	3578105C1	010	83163
		3578105C2	010	83163
		6127088C1	010	83163
		OE13402S	010	83163
10 - 15	CE Model School Buses with 20,000 lb International IROS Air Suspension	3578858C2		010	85926	...
16 - 17	CE Model School Buses with 20,000 lb International IROS Air Suspension	6127713C1		010	85926	...
05 - 13	CE Model School Buses with 22,000 lb Rear Spring Suspension	501906C92		-10	83317	...
		OE13424S		-10	83317	...
13 - 16	CE Model School Buses with 6,000 to 8,000 lb Front Axles	3533356C3	010	83169

Co-Transtar and Transtar II

	7070B, F-7070B, CO-7070B & COF-7070B Models	426744R91	010	85303	89422	
		426744R92	010	85303	89422	
		453576C91	010	85303	89422	

APPLICATION GUIDE - TRUCKS, TRAILERS, AND BUSES

Year Año Année	Model Modelo Modèle	OEM #	Front		Rear	
						
						
			Fleetline	GasSLX	Fleetline	GasSLX

INTERNATIONAL (NAVISTAR)(Cont'd.)

Co-Transtar and Transtar II(Cont'd.)

	7070B, F-7070B, CO-7070B & COF-7070B Models	453576C92 477132C1	010	85303	89422	
			010	85303	89422	
	CO-4010, COF-4010, COT-4010, COT-4010D, CO-4050, COF-4050, COT-4050, CO-4040A & B, CO-4070D, COF-4070B, COF-4070D, COT-4070D, COF-4077, COF-4077A, COF-4080D, CO-4090A, COF-4090A	426744R91 426744R92 453576C91 453576C92 477132C1	010	85303	89422	
			010	85303	89422	
			010	85303	89422	
			010	85303	89422	
			010	85303	89422	
	CO-4070A, COF-4070A, COF-4090A with Rear Suspension	462557C91		010	85300	89419

CXT Series

	CXT Models with 9,000 to 10,000 lb Front Suspension	3606770C1 3606770C2	010	83163
			010	83163

DuraStar - 1000 Series

	1300 Models	56110-T8123 56110-T8129 66400	-10	G63432
			-10	G63432
			-10	G63432

DuraStar - 4300, 4400 Series

13	Low-Profile models with O.E.M. Number	1660846C92		010	83101	...
16 - 17	Models with 11,000 lb to 14,000 lb Front axle	6127714C1	010	85928
02 - 15	Models with 12,000 lb Front axle	3533357C1 3533357C2 3533357C3	010	85957
			010	85957
			010	85957
- 15	Models with 20,000 lb International IROS Air Suspension	3578858C1 3578858C2		010	85926	...
				010	85926	...
16 - 17	Models with 20,000 lb International IROS Air Suspension	6127713C1		010	85926	...
02 - 13	Models with 22,000 lb Rear Spring Suspension	501906C91 501906C92		-10	83317	...
				-10	83317	...
- 11	Models with 40,000 lb Rear Air Suspension	3549099C2		010	85923	89458
02 - 12	Models with 6,000 to 8,000 lb Front Suspension	3533356C1 3533356C2	010	83135
			010	83135
13 - 16	Models with 6,000 to 8,000 lb Front Suspension	3533356C3	010	83169
- 15	Models with 9,000 to 10,000 lb Front Suspension	3578105C2	010	83163
16 - 17	Models with 9,000 to 10,000 lb Front Suspension	6127088C1	010	83163
- 17	Models with Hendrickson HAS - 230 or 460 Rear Air Suspension	60675-003		010	85976	...
	Models with International IROS Air Suspension	3553628C1 3553628C2 3553628C3		010	85927	...
				010	85927	...
				010	85927	...
02 - 12	School Bus models with 6,000 to 8,000 lb Front Suspension	3533356C1 3533356C2	010	83135
			010	83135

F & S Series

	1600, 1700, 1800, 1900, 2100 Models	3000070C91 453576C92	-1-	83456	89447	
			010	85303	89422	
	1600, 1700, 1800, 1900, 2100 Models with International Air Suspension	1675455C1 1690035C1 2018987C1 2018987C2 501553C91		010	85003	89411
				010	85003	89411
				010	85003	89411
				010	85003	89411
				010	85003	89411
	1600, 1700, 1800, 1900, 2100 Models with Neway ARD-234 Air Suspension	537524C91		010	83123	89405

APPLICATION GUIDE - TRUCKS, TRAILERS, AND BUSES

Year Año Année	Model Modelo Modèle	OEM #	Front			Rear		
			Fleetline	GasSLX				

INTERNATIONAL (NAVISTAR)(Cont'd.)

F & S Series(Cont'd.)

1624, 1654, 1724, 1754, 1824, 1854, 1924, F1924, 1925, 1954, F1954, 1955, 2124, 2125, F2125, 2154, 2155 Models Exc. with Rear Axle Codes 14029, 14030, 14187	501905C91		- O	83301	...
	501906C91		- O	83317	...
1624, 1654, 1724, 1754, 1824, 1854, 1924, F1924, 1925, 1954, F1954, 1955, 2124, 2125, F2125, 2154, 2155 Models with 5000, 6000 or 7500 lb Front Axle	472367C91	- -	83318
1624, 1654, 1724, 1754, 1824, 1854, 1924, F1924, 1925, 1954, F1954, 1955, 2124, 2125, F2125, 2154, 2155 Models with Rear Axle Codes 14029, 14030, 14187	501905C91		- O	83301	...
1624, 1654, 1724, 1754, 1824, 1854, 1924, F1924, 1925, 1954, F1954, 1955, 2124, 2125, F2125, 2154, 2155, 2275, F2275, 2524, F2524, 2554, F2554, 2574, F2574, 2575, F2575, F2624, F2654, F2674 Models with 9000, 10800 or 12000 lb Front Axle	472411C91	- -	83456	89447	
	472412C91	- -	83456	89447	
	586724C91	- -	83456	89447	
1924, 1954 (6 x 6) Models	472367C91	- -	83318
	472414C91	- -	83318
2275, F2275, 2524, F2524, 2554, F2554, 2574, F2574, 2575, F2575, F2624, F2654, F2674 Models with International Corporate Air Suspension	1675455C1		O O	85003	89411
	1690035C1		O O	85003	89411
	2018987C1		O O	85003	89411
	2018987C2		O O	85003	89411
	501553C91		O O	85003	89411
2275, F2275, 2524, F2524, 2554, F2554, 2574, F2574, 2575, F2575, F2624, F2654, F2674 Models with Neway ARD-125/244 Air Suspension	790335C91		O O	83209	89414
2275, F2275, 2524, F2524, 2554, F2554, 2574, F2574, 2575, F2575, F2624, F2654, F2674 Models with Neway ARD-234 Air Suspension	537524C91		O O	83123	89405
2275, F2275, 2524, F2524, 2554, F2554, 2574, F2574, 2575, F2575, F2624, F2654, F2674 Models with Ridwell Rear Suspension	534464C1		O O	85734	...









Firetruck

CO-8190	204994R91	O O	83225
	308648C91	O O	83225
	453561C91	O O	83225
	453565C91	O O	83225
	467371C91	O O	83225
Models with O.E.M. Number	210919R91		O O	85307	...

Fleetstar - Conventional

1900, F-1900, T-1900, 1950, F-1950, T-1950, 2000, 2000D, F-2000D & T-2000D Models	210535R91	O O	83225
	453568C91	O O	83225
	467372C91	O O	83225
1910A, F-1910A, 2010A, F-2010A, 2050A, F-2050A, 2070A, F-2070A, 2110A & 2150A Models	206621R92	O O	83216
	308650C92	O O	83216
	453570C91	O O	83216
	467984C91	O O	83216
2000D, 2010A, 2050A, 2070A, 2110A, 2150A with Air Ride Suspension After Chassis No G-387453	350425C1		O O	85300	89419
	462557C91		O O	85300	89419
2000D, 2010A, 2050A, 2070A, 2110A, 2150A with Air Ride Suspension Before Chassis No G-387453	350426C1		O O	85734	...
F-2010A, F-2050A, F-2000D with Air Ride Suspension	350425C1		O O	85300	89419
	462557C91		O O	85300	89419

APPLICATION GUIDE - TRUCKS, TRAILERS, AND BUSES

Year Año Année	Model Modelo Modèle	OEM #	Front		Rear	
						
						
			Fleetline	GasSLX	Fleetline	GasSLX

INTERNATIONAL (NAVISTAR)(Cont'd.)

Fleetstar - Conventional(Cont'd.)

R-185, R-190, RD-190, R-200, RD-200, RF-200, RDF-200, R-220, RD-220, R210 & RF-210	210533R91	O10	83225
	210534R92	O10	83225
	210535R91	O10	83225
	210536R91	O10	83225
	210537R91	O10	83225
	210538R91	O10	83225
	453562C91	O10	83225
	453568C91	O10	83225
	467371C91	O10	83225
	467372C91	O10	83225

Loadstar - Conventional

1600, 1600 (4x4), 1610, 1610 (4x4), 1610FC, 1700, 1700 (4x4), 1710, 1710 (4x4), F-1700, 1750, 1800, 1810, F-1800, F-1800-D, 1850, F-1850, 1890 & 1890-D with 9000, 10800 or 12000 lb Front Axle	329316C92	O10	85012	89413	
	360444C91	O10	85012	89413	
	453564C91	O10	85012	89413	
	467983C91	O10	85012	89413	
	471201C91	O10	85012	89413	
1600, 1600 (4x4), 1610, 1610 (4x4), 1610FC, 1700, 1700 (4x4), 1710, 1710 (4x4), F-1700, 1750, 1800, 1810, F-1800, F-1800-D, 1850, F-1850, 1890 & 1890-D with Axle Codes 02089, 02091	206620R91	O10	83216
	308649C91	O10	83216
	453567C91	O10	83216
1600, 1600 (4x4), 1610, 1610 (4x4), 1700, 1700 (4x4), 1710, 1710 (4x4), 1750, 1800, 1810, 1850, 1890 & 1890-D Models	206620R91		O10	83216	...
	206621R91		O10	83216	...
	308649C91		O10	83216	...
	308650C92		O10	83216	...
	329316C92		O10	85012	89413
	360444C91		O10	85012	89413
	383379C91		O10	83308	...
	453564C91		O10	85012	89413
	453567C91		O10	83216	...
	453570C91		O10	83216	...
	453575C91		O10	83308	...
	467983C91		O10	85012	89413
	467984C91		O10	83216	...
	471203C91		O10	83308	...
	474002C91		O10	83308	...
873622C91		O10	83308	...	
1600, 1600 (4x4), 1610, 1610 (4x4), 1700, 1700 (4x4), 1710, 1710 (4x4), F-1700, 1750, 1800, 1810, F-1800, F-1800-D, 1850, F-1850, 1890 & 1890-D Exc. Axle Codes 02054, 02057, 02059, 02089, 02091, 02098, 02101, 02109, 02139, 02208, 02218, 02228, 02309, 0232	308668C92	O10	85012	89413	
	453556C91	O10	85012	89413	
	467985C91	O10	85012	89413	
	874695R91	O10	85012	89413	
	874695R92	O10	85012	89413	
1600, 1610FC, 1700, 1700 (4x4), 1800, 1890, 1890D Models	384435C91		O10	83216	...
	453571C91		O10	83216	...
	462753C91		O10	83216	...

APPLICATION GUIDE - TRUCKS, TRAILERS, AND BUSES

Year Año Année	Model Modelo Modèle	OEM #	Front			Rear		
						Fleetline	GasSLX	Fleetline

INTERNATIONAL (NAVISTAR)(Cont'd.)

Loadstar - Conventional(Cont'd.)

	1700, 1750, 1800, 1850 Models with Air Ride Suspension	462557C91		OIO	85300	89419
	M1600, M1700, M1800, M1900, M2100 Models	453576C92	OIO	85303	89422	





LoneStar - Series

09 - 15	All models with 40,000 lb Rear Air Suspension	3620395C1		OIO	85931	89458
09 - 15	Day Cab models with 14,600 lb Parabolic Taperleaf Front Spring	3813341C1	OIO	85963
		3813341C2	OIO	85963
		3813341C3	OIO	85963
08 - 10	Models with 12,000 lb Mono-leaf Front Spring	3819277C1	OIO	85969
		3819279C1	OIO	85969
12 - 15	Models with 12,350 lb Front Mono Leaf Spring Suspension	3813341C2	OIO	85963
		3813341C3	OIO	85963
- 16	Models with Hendrickson HAS - 230 or 460 Rear Air Suspension	3514952C1		OIO	85976	...
		60675-003		OIO	85976	...
		H60675-003		OIO	85976	...
12 - 16	Models with International 40,000 lb Rear Air Suspension (52" Spacing- Heavy Duty Rear)	3688614C1		OIO	85923	89458
		3688616C1		OIO	85923	89458
13 -	Models with O.E.M. Number	3810581C3	OIO	85995
		3810581C4	OIO	85995
09 - 15	Sleeper Cab models with 14,000 lb Parabolic Taperleaf Front Spring	3813340C1	OIO	85964
		3813340C2	OIO	85964
		3813340C3	OIO	85964

Metro & Multi-Shop Series

	AM and AMC-160, AMC-164	308649C91	OIO	83216
		453567C91	OIO	83216
	M1600, M1700, M1800, M1900, M2100 Models	453576C92	OIO	85303	89422	
	M1600, M1700, M1800, M1900, M2100 Models - Exc. with Rear Axle Codes 14029, 14030, 14187	501905C91		-IO	83301	...
		501906C91		-IO	83317	...
	M1600, M1700, M1800, M1900, M2100 Models with 5000, 6000 or 7500 lb Front Axle	472367C91	-I-	83318
	M1600, M1700, M1800, M1900, M2100 Models with 9000, 10800 or 12000 Front Axle	472411C91	-I-	83456	89447	
	M1600, M1700, M1800, M1900, M2100 Models with Front Axle Codes 02109, 02118, 02309, 02127, 02139, 02329, 02339	472412C91	-I-	83456	89447	
		586724C91	-I-	83456	89447	
	M1600, MC1600, M1700 & MC1700	206620R91		OIO	83216	...
		308649C91		OIO	83216	...
		308668C91	OIO	85012	89413	
		308669C91	OIO	85012	89413	
		453556C91	OIO	85012	89413	
		453597C91		OIO	83216	...
		874695R91	OIO	85012	89413	
		874696R91	OIO	85012	89413	
	MA1200, M1400, M1500, MA1500	287318C91		G63306	...	OIO	G63306	...
		308649C91		OIO	83216	...
		308669C91		OIO	85012	89413
		453531C91		OIO	G63306	...
		453556C91		OIO	85012	89413
		453557C91		OIO	G63306	...
		453567C91		OIO	83216	...

APPLICATION GUIDE - TRUCKS, TRAILERS, AND BUSES

Year Año Année	Model Modelo Modèle	OEM #	Front		Rear	
						
			Fleetline	GasSLX	Fleetline	GasSLX

INTERNATIONAL (NAVISTAR)(Cont'd.)

Metro & Multi-Shop Series(Cont'd.)

	MA1200, M1400, M1500, MA1500	467980C91		G63306	...	OIO	G63306	...
66 - 72	Metro Models M1200 - Exc. Frame Code 01000.0962	OIO	G63299
66 - 72	Metro Models M1200 with 14016 Reg. Rear Springs & with 14020 Rear Axle Code		G63306	...	OIO	G63306	...
66 - 72	Metro Models M1200 with Axle Code 0208 & Frame Code 01000.0962		G63306	...	OIO	G63306	...
66 - 72	Metro Models M1200 with Code 03204 Aux. Springs	OIO	G63299	...
66 - 72	Metro Models M700, 800, 900-U, 1000, 1100,		G63306	...	OIO	G63306	...
73 - 75	Multi-Stop Models MS-1210 & 1510	OIO	G63306	...





Paystar - 5000 Series

	5010, F-5010, F-5050, F-5050SF, 5070, F-5070, F-5070SF Models	426744R91	OIO	85303	89422	
		426744R92	OIO	85303	89422	
		453576C91	OIO	85303	89422	
		453576C92	OIO	85303	89422	
		477132C1	OIO	85303	89422	
- 12	5600i Models with 16,000 lb Front axle	1667520C1	OIO	85058	89431	
		4070336C1	OIO	85058	89431	
04 - 12	5900 SB Models with 18,000 lb Front axle	1667520C1	OIO	85058	89431	
04 - 15	5900 SB Models with 46,000 lb Hendrickson Rear Air Suspension	3626571C1		OIO	85072	...
		H60657-003		OIO	85072	...
- 15	5900 SB Models with Hendrickson Primaax 230, 460 and 690 Air Suspension (8-1/2" to 10" Ride Height)	60657-003		OIO	85072	...
- 15	5900 SB Models with Hendrickson Primaax EX 232, 462 and 692 Air Suspension (8-1/2" to 10" Ride Height)	60657-003		OIO	85072	...
09 - 11	5900i Models with 12,000 lb - 14,000 lb Front axle	2015556C1	-IO	85316	89426	
04 - 12	5900i SFA Models with 16,000 lb Front axle	1667520C1	OIO	85058	89431	
04 - 09	5900i SFA Models with 46,000 lb Neway Rear Air Suspension	2029200C91		OIO	83126	89430
		90044626		OIO	83126	89430
	Models with 10,000 to 16,000 lb Front Suspension	3576465C2	OIO	85999
		3816234C1	OIO	85999
10 - 13	Models with 12,000 to 14,000 lb Front Taperleaf Suspension	3868264C1	OIO	85998
- 13	Models with Hendrickson HMX 400/460 Haulmax with 16.5" Saddle	60680-004		OIO	83143	...

ProStar - Series

09 - 15	All models with 40,000 lb Rear Air Suspension	3620395C1		OIO	85931	89458
16 -	All models with 40,000 lb Rear Air Suspension	4050340C1		OIO	85931	89458
		4050340C2		OIO	85931	89458
09 - 15	Day Cab models with 14,600 lb Parabolic Taperleaf Front Spring	3813341C3	OIO	85963
	Day Models with O.E.M. Number	3737576C1		OIO	85931	89458
13 -	Models with 113" Sleeper Cab	3806341C3	OIO	85995
		3810581C3	OIO	85995
		3810581C3	OIO	85995
		3810581C4	OIO	85995
-15	Models with Day Cab and 12,000 to 14,000 lb Taperleaf Front Spring Suspension	3606859C1	OIO	85954
		3606859C2	OIO	85954
		3606859C3	OIO	85994
		3812837C1	OIO	85954
16 -	Models with Day Cab and 14,000 lb Taperleaf Front Spring Suspension	4050444C1	OIO	85994
		4050444C2	OIO	85994

APPLICATION GUIDE - TRUCKS, TRAILERS, AND BUSES

Year Año Année	Model Modelo Modèle	OEM #	Front		Rear	
						
			Fleetline	GasSLX	Fleetline	GasSLX

INTERNATIONAL (NAVISTAR)(Cont'd.)





ProStar - Series(Cont'd.)

	Models with Day Cab and Air Suspension	3610199C1	010	85964
- 16	Models with Hendrickson HAS - 230 or 460 Rear Air Suspension	3514952C1		010	85976	...
		60675-003		010	85976	...
		H60675-003		010	85976	...
	Models with Hendrickson HTB 400LT Rear Air Suspension	60657-006		010	85102	...
		60657-010		010	85102	...
		60657-011		010	85102	...
		H60657-006		010	85102	...
		H60657-010		010	85102	...
		H60657-011		010	85102	...
	Models with O.E.M. Number	3668566C1	010	85954
		3688729C1		010	85931	89458
		3688732C1		010	85931	89458
		3821760C1		010	85931	89458
- 14	Models with Sleeper Cab and 12,350 lb Leaf Spring Suspension	3606857C1	010	85954
		3606857C2	010	85954
14 - 15	Models with Sleeper Cab and 12,350 lb Leaf Spring Suspension	3606857C3	010	85994
16 -	Models with Sleeper Cab and 12,350 lb Leaf Spring Suspension	4050443C1	010	85994
		4050443C2	010	85994
- 13	Models with Sleeper Cab and Air Suspension	3610198C1	010	85963
	Models with Sleeper Cab with O.E.M. Number	3737575C1	010	85954

S Series School Bus

	1603, 1703, 1803 & 1853	206620R91	010	010	83216	...	
		206621R91		010	83216	...	
		306444C91		010	85012	89413	
		308649C91		010	83216	...	
		308650C92		010	83216	...	
		329316C92		010	85012	89413	
		383379C91		010	83308	...	
		453564C91		010	85012	89413	
		453567C91		010	83216	...	
		453570C91		010	83216	...	
		453575C91		010	83308	...	
		467983C91		010	85012	89413	
		471201C91		010	85012	89413	
		471203C91		010	83308	...	
474002C91	010	83308	...				
873622C91	010	83308	...				
	1603, 1703, 1803 & 1853 - Exc. Axle Codes 02054, 02057, 02059, 02089, 02091, 02098, 02101, 02109, 02139, 02208, 02218, 02228, 02309, 02329, 02339	308668C92	010	85012	89413		
		453556C91	010	85012	89413		
		467985C91	010	85012	89413		
	1603, 1703, 1803 & 1853 with Axle Codes 02089, 02091	206620R91	010	83216	
		308649C91	010	83216	
		453567C91	010	83216	
		467984C91	010	83216	

APPLICATION GUIDE - TRUCKS, TRAILERS, AND BUSES

Year Año Année	Model Modelo Modèle	OEM #	Front		Rear	
						
			Fleetline	GasSLX	Fleetline	GasSLX

INTERNATIONAL (NAVISTAR)(Cont'd.)

S Series School Bus(Cont'd.)

1603, 1703, 1803 & 1853 with 9000, 10800 or 12000 lb Front Axle	320444C91	010	85012	89413	
	329316C92	010	85012	89413	
	453564C91	010	85012	89413	
	467983C91	010	85012	89413	
1723 S Models with 5000, 6000 or 7500 lb Front Axle	472367C91	-1-	83318
1723, 1823, 1853 Models with International Air Suspension	1675455C1		010	85003	89411
	1690035C1		010	85003	89411
	2018987C1		010	85003	89411
	2018987C2		010	85003	89411
	501553C91		010	85003	89411
1723, 1823, 1853 Models with Neway ARD-234 Air Suspension	537524C91		010	83123	89405
173 FC & 183 FC - Exc. Axle Codes 14149 & 14189	210918R91		010	83215	...
	453574C91		010	85307	...
173 FC & 183 FC with Axle Codes 14149 & 14189	210535R91		010	83225	...
	453568C91		010	83225	...
	467372C91		010	83225	...
173 FC, 183 FC, 183RE, 193 RE, 1853 FC & 1853 DFC	204994R91	010	83225
	308648C91	010	83225
	453561C91	010	83225
	453565C91	010	83225
	467371C91	010	83225
1823 S Models - Exc. with Rear Axle Codes 14029,14030, 14187	501906C91		-10	83317	...
1823, 1853 S Models with 9000, 10800 or 12000 lb Front Axle	472411C91	-1-	83456	89447	
	472412C91	-1-	83456	89447	
	586724C91	-1-	83456	89447	
183 RE Models with Axle Codes 14043, 14147 & 14186	210533R91		010	83225	...
	210534R92		010	83225	...
	453562C91		010	83225	...
	467371C91		010	83225	...
1853 DFC3	210920R91	010	85308	89422	
	453579C91	010	85308	89422	
1853 FC & 1853 DFC with Axle Code 14136	210919R91		010	85307	...
	308664C91		010	85307	...
	453574C91		010	85307	...
1853 FC & 1853 DFC with Axle Code 14149 with FD Serial Numbers	453567C91		010	83216	...
1853 FC & 1853 DFC with Axle Codes 14039, 14139, 14149 & 14189 - Exc. 14149 with FD Serial Numbers	210533R91		010	83225	...
	210534R92		010	83225	...
	453562C91		010	83225	...
	467371C91		010	83225	...
1853 FC & 1853 DFC with Axle Codes 14044, 14045, 14060, 14145, 14146, 14150 and 14186	208664C91		010	85307	...
	210919R91		010	85307	...
	453574C91		010	85307	...
193 RE Models	210920R91	010	85308	89422	
	453579C91	010	85308	89422	
193 RE Models - Exc. Axle Codes 14039 & 14189	210533R91		010	83225	...
	210534R92		010	83225	...
	453562C91		010	83225	...
	467371C91		010	83225	...

APPLICATION GUIDE - TRUCKS, TRAILERS, AND BUSES

Year Año Année	Model Modelo Modèle	OEM #	Front		Rear	
			Fleetline	GasSLX	Fleetline	GasSLX

INTERNATIONAL (NAVISTAR)(Cont'd.)

S Series School Bus(Cont'd.)

RE Models	3604282C1	- O	85351
Series 1000 Forward Control Chassis						
1452, 1652 Models	453576C92	O O	85303	89422		...
	472412C91	- -	83456	89447		...
	586724C91	- -	83456	89447		...
1452, 1652 Models with International Air Suspension	1675455C1		O O	85003 89411
	1690035C1		O O	85003 89411
	2018987C1		O O	85003 89411
	2018987C2		O O	85003 89411
	501553C91		O O	85003 89411
1452, 1652 Models with MOR-RYDE Rear Suspension	548532C1		- -	83103 ...
1654 LP Models (Low Profile Vehicle)	1660846C91		O O	83101 ...
	1660846C92		O O	83101 ...
	1663471C1	- -	83103
	2039565C1	O O	83100
M1400, M1600 Models	472412C91	- -	83456	89447		...
	501905C91		- O	83301 ...
	586724C91	- -	83456	89447		...

Series 2000 - Conventional Truck (Severe Service)

2554, 2574, 2654, 2674 Models with International Air Suspension	1675455C1		O O	85003 89411
	1690035C1		O O	85003 89411
	2018987C1		O O	85003 89411
	2018987C2		O O	85003 89411
	501553C91		O O	85003 89411
2554, 2574, 2654, 2674 Models with International Vari-Rate Rear Suspension	501506C91		- O	83317 ...
All 2000 Models	With 12000 lb Front Axle	472412C91	- -	83456	89447	...
	With 16000 or 18000 lb Springs	1667520C1	O O	85058	89431	...
	Without 16000 or 18000 lb Springs	2015556C1	- O	85316	89426	...

Series 3000 - School Bus Chassis

3000, 3400 Models with 10,000 to 14,000 lb Front axle	3533357C1	O O	85957
	3533357C2	O O	85957
	3533357C3	O O	85957
3000, 3400 Models with 6,000 to 8,000 lb Front axle	3533356C1	O O	83135
	3533356C2	O O	83135
3700, 3800 Models	472412C91	- -	83456	89447		...
	501905C91		- O	83301 ...
	501906C91		- O	83317 ...
	586724C91	- -	83456	89447		...
3700, 3800 Models with International Air Suspension	1675455C1		O O	85003 89411
	1690035C1		O O	85003 89411
	2018987C1		O O	85003 89411
	2018987C2		O O	85003 89411
	501553C91		O O	85003 89411
3700, 3800 Models with MOR-RYDE Rear Suspension	548532C1		- -	83103 ...
3700, 3800 Models with Neway ARD-234 Air Suspension	537524C91		O O	83123 89405
	537525C91		O O	83123 89405
3900FC Models	1677707C1	O O	85030	89440		...
	2015557C1	O O	85030	89440		...

APPLICATION GUIDE - TRUCKS, TRAILERS, AND BUSES

Year Año Année	Model Modelo Modèle	OEM #	Front				Rear			
					Fleetline	GasSLX			Fleetline	GasSLX

INTERNATIONAL (NAVISTAR)(Cont'd.)

Series 3000 - School Bus Chassis(Cont'd.)

	3900FC Models	467371C91		83225	...	OIO	83225	...
	3900FC Models (Genesis - Front Engine)	2200327C1	-IO	85332
	3900FC Models (Genesis - Rear Engine)	2039549C1	-IO	85333

Series 400, 500, 600, 700, & 900 - Medium Cabover Truck & Tractor (Nissan)

	400 Models	56101 Z5008	-IO	83114
				G63610
	500 Models	56101 Z5011	-IO	G63610
	600, 700, 900 Models	56101 Z1030	-IO	85311	89424	
				85311	89424	

Series 4000 - Short Conventional Medium Truck & Tractor

	4000 Models with Hendrickson HAS-230 Rear Air Suspension	AMS650420		OIO	85013	89414	
	4600, 4700, 4800, 4900 Models	1663606C91	-IO	85027	89418		
				85058	89431	OIO	
				83456	89447	-IO	
	4600, 4700, 4800, 4900 Models with 10000 lb Front Axle	472412C91	-IO	83456	89447		
	4600, 4700, 4800, 4900 Models with International Air Suspension (Exc. Low Profile)	1675455C1		OIO	85003	89411	
				1690035C1	OIO	85003	89411
				2018987C1	OIO	85003	89411
				2018987C2	OIO	85003	89411
				501553C91	OIO	85003	89411
	4600LP, 4700LP Models (Low Profile Vehicle) U-Haul	540395C91	-IO	83613	
				83613	...	-IO	
- 94	4600LP, 4700LP Models (Low Profile Vehicle) U-Haul	1675496C91		OIO	83636	...	
		1675496C92		OIO	83636	...	
02/95-	4600LP, 4700LP Models (Low Profile Vehicle) U-Haul	2039565C1		OIO	83100	...	
	F-4900 & 4600LP Models (Low Profile Vehicle)	501906C91		-IO	83317	...	
				501906C92	-IO	83317	...
90 - 02	F-4900 Models with 10000 lb Front Axle	472412C91	-IO	83456	89447		
90 - 02	F-4900 Models with Dual Doors	2015556C1	-IO	85316	89426		
	F-4900 Models with Hendrickson HN - 400 Models Rear suspension	60680-003		OIO	83112	...	

Series 405

	Models with O.E.M. Number	293009C91	OIO	85308	89422	
				85303	89422	
				85303	89422	
				85308	89422	

Series 417

	DCO-417 & DCOF-417	426744R91	OIO	85303	89422	
				85303	89422		OIO	...





Series 5000, 5000i - Severe Service Conventional Truck & Tractor

	6 X 4 Models with Neway AD-246-10 Air Suspension and 60" Axle Spacing										
				Heavy Duty	2029200C91		OIO	85030	89440
					AMS 600172		OIO	85030	89440
				Standard	2029200C91		OIO	83126	89430
		AMS 600172		OIO	83126	89430			

Series 7000 - Short Conventional Medium Truck & Tractor

	7000 Models School Bus with O.E.M. Number	3609400C1		-IO	83317	...
				3609400C2	-IO
	7100 Models	1663606C91	-IO	85027	89418	
				83456	89447	-IO

APPLICATION GUIDE - TRUCKS, TRAILERS, AND BUSES

Year Año Année	Model Modelo Modèle	OEM #	Front		Rear	
						
			Fleetline	GasSLX	Fleetline	GasSLX

INTERNATIONAL (NAVISTAR)(Cont'd.)

Series 7000 - Short Conventional Medium Truck & Tractor(Cont'd.)

7100 Models	586724C91	- -	83456	89447	
7100 Models with International Air Suspension	1675455C1		0 0	85003	89411
	1690035C1		0 0	85003	89411
	2018987C1		0 0	85003	89411
	2018987C2		0 0	85003	89411
	501553C91		0 0	85003	89411
7300, 7400, 7500, 7600 Models w/ IAS Suspension w/ 5.3" Ride Height	3544766C1		0 0	85930	...









Series 8000 - Conventional Heavy Duty Tractor

8100 Models - 6 X 4 & 4 X 2 Models with International Air Suspension for Lo-Profile and Carhauler	1660846C91		0 0	83101	...
	1660846C92		0 0	83101	...
8100 Models Car Hauler	1664524C1		- 0	85935	...
	472412C91	- -	83456	89447	
8100, 8200, 8300 Models	3000070C91	- -	83456	89447	
	501906C91		- 0	83317	...
8100, 8200, 8300 Models - with Hendrickson HA-460 Air Suspension with 55" & 60" axle spacing and 40000 & 46000 lb capacity	AMS 600102		0 0	85005	89430
8100, 8200, 8300 Models with 12000 - 14000 lb Suspension	1664788C2	- 0	85316	89426	
	2015556C1	- 0	85316	89426	
8100, 8200, 8300 Models with 15000 - 18000 lb Suspension	1667520C1	0 0	85058	89431	
8100, 8200, 8300 Models with Hendrickson HA-230 Rear Air Suspension	AMS 600102		0 0	85005	89430
8100, 8200, 8300 Models with International Air Suspension (Except Lo-Profile and Carhauler)	1675455C1		0 0	85003	89411
	1690035C1		0 0	85003	89411
	2018987C1		0 0	85003	89411
	2018987C2		0 0	85003	89411
	501553C91		0 0	85003	89411
07 - 08 8600 Models with Taperleaf Front Spring Suspension	3670156C1	0 0	85954
Models with Neway AD-246-10 Air Suspension and 60" Axle Spacing	Heavy Duty	2029200C91	0 0	85030	89440
		AMS 600172	0 0	85030	89440
	Standard	2029200C91	0 0	83126	89430
		AMS 600172	0 0	83126	89430

Series 9100, 9100i - Tractor & Straight Truck

6 X 4 Models with International Air Suspension For Lo-Profile	1660846C91		0 0	83101	...
	1660846C92		0 0	83101	...
6 X 4 Models with Neway AD-246-10 Air Suspension and 60" Axle Spacing	Heavy Duty	2029200C91	0 0	85030	89440
		AMS 600172	0 0	85030	89440
	Standard	2029200C91	0 0	83126	89430
		AMS 600172	0 0	83126	89430
9100 Models - with Hendrickson HA-460 Models Air Suspension	AMS 600102		0 0	85005	89430
9100 Models with 12000 - 14000 lb Suspension	1664788C2	- 0	85316	89426	
	2015556C1	- 0	85316	89426	
	2032533C1	- 0	85316	89426	
Models with International Air Suspension (Except Lo-Profile)	2018987C1		0 0	85003	89411
	2018987C2		0 0	85003	89411

APPLICATION GUIDE - TRUCKS, TRAILERS, AND BUSES

Year Año Année	Model Modelo Modèle	OEM #	Front		Rear	
						
						
			Fleetline	GasSLX	Fleetline	GasSLX

INTERNATIONAL (NAVISTAR)(Cont'd.)

Series 9200, 9200i - Tractor & Straight Truck(Cont'd.)

	4 X 2 Models with International Air Suspension	2018987C1		OIO	85003	89411
		2018987C2		OIO	85003	89411
- 08//94	4 X 2 Models with International Air Suspension	1675496C91		OIO	83636	...
		1675496C92		OIO	83636	...
	6 X 4 Models with 12,000 to 14,000 lb Front Axles	3581109C3	OIO	85924	89457	
		3581109C4	OIO	85924	89457	
	6 X 4 Models with International Air Suspension	2018987C1		OIO	85003	89411
		2018987C2		OIO	85003	89411
	6 X 4 Models with International Air Suspension For Lo-Profile Heavy Duty Standard	1660846C91		OIO	83101	...
		1660846C92		OIO	83101	...
		2029200C91		OIO	85030	89440
		AMS 600172		OIO	85030	89440
		2029200C91		OIO	83126	89430
		AMS 600172		OIO	83126	89430
	Models with 12,000 - 18,000 lb Suspension	1664788C2	-IO	85316	89426	
		2015556C1	-IO	85316	89426	
		2032533C1	-IO	85316	89426	
00 - 09	Models with 12,000 lb Front Axle	3581107C1	OIO	85924	89457	
		3581107C2	OIO	85924	89457	
		3581107C3	OIO	85924	89457	
		3584535C3	OIO	85924	89457	
04 - 09	Models with 40,000 lb Rear Air Suspension	3586883C1		OIO	85931	89458
	Models with Day Cab & Hendrickson AirTek Suspension	3613984C1	OIO	85955
		3660549C1	OIO	85955
	65992-002	OIO	85955	
	Models with Hendrickson HA-460 Models Air Suspension	AMS 600102		OIO	85005	89430
	Models with IAS Suspension w/ 9.25" or 9.5" Ride Height	3573265C1		OIO	85931	89458
	Models with International Air Suspension	1675455C1		OIO	85003	89411
		1690035C1		OIO	85003	89411
		501553C91		OIO	85003	89411
	Models with Sleeper Cab & Hendrickson AirTek Suspension	3609178C1	OIO	85955
		3660548C1	OIO	85955
		65992-001	OIO	85955

Series 9300, 9300i, 9400 & 9400i Long Hood Conventional Truck & Tractor

	6 X 4 Models with International Air Suspension Exc. Lo-Profile	2018987C1		OIO	85003	89411
		2018987C2		OIO	85003	89411
	6 X 4 Models with International Air Suspension For Lo-Profile Heavy Duty Standard	1660846C91		OIO	83101	...
		1660846C92		OIO	83101	...
		2029200C91		OIO	85030	89440
		AMS 600172		OIO	85030	89440
		2029200C91		OIO	83126	89430
		AMS 600172		OIO	83126	89430
	Models with 10,800 lb Suspension	503610C2	OIO	83207	89407	
	Models with 12,000 - 14,000 lb Suspension	1664788C2	-IO	85316	89426	
		2015556C1	-IO	85316	89426	
		2032533C1	-IO	85316	89426	
00 - 09	Models with 12,000 lb Front Axle	3581107C1	OIO	85924	89457	
		3581107C2	OIO	85924	89457	
		3581107C3	OIO	85924	89457	
		3584535C3	OIO	85924	89457	
	Models with 16,000 - 18,000 lb Suspension	1667520C1	OIO	85058	89431	

APPLICATION GUIDE - TRUCKS, TRAILERS, AND BUSES

Year Año Année	Model Modelo Modèle	OEM #	Front		Rear	
			Fleetline	GasSLX	Fleetline	GasSLX

INTERNATIONAL (NAVISTAR)(Cont'd.)

Series 9300, 9300i, 9400 & 9400i Long Hood Conventional Truck & Tractor(Cont'd.)

04 - 09	Models with 40,000 lb Rear Air Suspension	3586883C1		OIO	85931	89458
	Models with Day Cab & Hendrickson AirTek Suspension	3613984C1	OIO	85955
		3660549C1	OIO	85955
		65992-002	OIO	85955
	Models with Hendrickson HA-460 Models Air Suspension	AMS 600102		OIO	85005	89430
	Models with IAS Suspension w/ 9.25" or 9.5" Ride Height	3573265C1		OIO	85931	89458
	Models with International Air Suspension	1675455C1		OIO	85003	89411
		1690035C1		OIO	85003	89411
		501553C91		OIO	85003	89411
	Models with Neway ARD-125/244 Air Suspension	790335C91		OIO	83209	89414
	Models with Sleeper Cab & Hendrickson AirTek Suspension	3609178C1	OIO	85955
		3660548C1	OIO	85955
		65992-001	OIO	85955
	Set Back Axle Models with 16,000 lb to 18,000 lb Suspension	1664149C1	OIO	85029
	Set Forward Axle Models with 16,000 lb to 18,000 lb Suspension	507202C1	OIO	85030	89440	

Series 9600 & 9700 Premium Cabover Tractor

	9600, 9700 Models	507202C1	OIO	85030	89440	
	9600, 9700 Models Except Low Profile	1664788C2	-IO	85316	89426	
		2015556C1	-IO	85316	89426	
	9600, 9700 Models for Low Profile	503610C2	OIO	83207	89407	
	9600, 9700 Models with 16000 - 18000 lb Suspension	1667520C1	OIO	85058	89431	
	9600, 9700 Models with Hendrickson HA-460 Air Suspension with 55" or 60" axle spacing and 40000 or 46000 lb capacity	AMS 600102		OIO	85005	89430
	9600, 9700 Models with International STL Spring Suspension	503550C1		OIO	83207	89407
	9600, 9700 Models with Neway ARD-125/244 Air Suspension	790335C91		OIO	83209	89414
	9600, 9700 Models with Neway ARD-234 Air Suspension	537524C91		OIO	83123	89405
	Models with International Air Suspension	1675455C1		OIO	85003	89411
		1690035C1		OIO	85003	89411
		2018987C1		OIO	85003	89411
		2018987C2		OIO	85003	89411
		501553C91		OIO	85003	89411



Series 9800 - Premium Cabover Tractor

	6 X 4 Models with International Air Suspension	2018987C1		OIO	85003	89411
	Heavy Duty	2018987C2		OIO	85003	89411
		2029200C91		OIO	85030	89440
	Standard	AMS 600172		OIO	85030	89440
		2029200C91		OIO	83126	89430
	AMS 600172		OIO	83126	89430	
	9800 Models - with Hendrickson HA-460 Air Suspension with 55" & 60" axle spacing and 40000 & 46000 lb capacity	AMS 600102		OIO	85005	89430
	9800 Models - with Hendrickson HAS-402-60 Air Suspension	AMS 650420		OIO	85013	89414
	9800 Models - with Set Back axle	2015556C1	-IO	85316	89426	
	9800 Models - with Set Forward axle	503610C2	OIO	83207	89407	

Series 9900, 9900i, 9900ix Long Hood Conventional Truck

	6 X 4 Models with International Air Suspension Exc. Lo-Profile	2018987C1		OIO	85003	89411	
		2018987C2		OIO	85003	89411	
	6 X 4 Models with International Air Suspension For Lo-Profile	1660846C91		OIO	83101	...	
		1660846C92		OIO	83101	...	
		Heavy Duty	2029200C91		OIO	85030	89440
			AMS 600172		OIO	85030	89440
		Standard	2029200C91		OIO	83126	89430

APPLICATION GUIDE - TRUCKS, TRAILERS, AND BUSES

Year Año Année	Model Modelo Modèle	OEM #	Front		Rear	
						
			Fleetline	GasSLX	Fleetline	GasSLX

INTERNATIONAL (NAVISTAR)(Cont'd.)

Series 9900, 9900i, 9900ix Long Hood Conventional Truck(Cont'd.)

	Heavy Duty	AMS 600172		OIO	83126	89430
- 11	Day Cab Models with 12,000 lb Front Axles	3581106C1	OIO	85924	89457	
		3581106C2	OIO	85924	89457	
		3581106C3	OIO	85924	89457	
	Models with 10,800 lb - 14,600 lb Suspension	503610C2	OIO	83207	89407	
	Models with 12,000 - 14,000 lb Suspension	1664788C2	-IO	85316	89426	
		2015556C1	-IO	85316	89426	
		2032533C1	-IO	85316	89426	
04 - 09	Models with 12,000 lb Front axle	3584535C3	OIO	85924	89457	
13 -	Models with 12,000 lb Front axle	3810581C3	OIO	85995
		3810581C4	OIO	85995
	Models with 16,000 - 18,000 lb Suspension	1667520C1	OIO	85058	89431	
04 - 11	Models with 40,000 lb Rear Air Suspension	3586883C1		OIO	85931	89458
02 - 16	Models with Hendrickson HAS - 230 or 460 Rear Air Suspension	3514952C1		OIO	85976	...
		60675-003		OIO	85976	...
		H60675-003		OIO	85976	...
- 16	Models with International 40,000 lb Rear Air Suspension (52" Spacing- Heavy Duty Rear)	3688616C1		OIO	85923	89458
	Models with International Air Suspension	1675455C1		OIO	85003	89411
		1690035C1		OIO	85003	89411
		501553C91		OIO	85003	89411
	Models with Neway ARD-125/244 Air Suspension	790335C91		OIO	83209	89414
	Set Back Axle Models with 16,000 lb to 18,000 lb Suspension	1664149C1	OIO	85029
	Set Forward Axle Models with 16,000 lb to 18,000 lb Suspension	507202C1	OIO	85030	89440	

TerraStar

2014	4 WD Models with Rear Spring Suspension	3945165C1		OIO	83180	...
12	Models with 6,000 to 7,000 lb Front Axle	3902993C1	OIO	83167
		OE17103	OIO	83167
13 - 14	Models with 6,000 to 7,000 lb Front Axle	3902993C3	OIO	83135
		OE 18513	OIO	83135
	Models with International IROS Air Suspension	3892445C3		OIO	85931	89458
12	Models with O.E.M. Number	6E7Z-18125-A		OIO	83146	...

TranStar - 8500, 8600 Series

03 - 15	Models with 12,000 lb Front axle	3533357C1	OIO	85957
		3533357C2	OIO	85957
		3588209C1	OIO	85957
		3588209C2	OIO	85957
03 - 13	Models with 40,000 lb Rear Air Suspension	3549099C1		OIO	85923	89458
		3549099C2		OIO	85923	89458
- 13	Models with O.E.M. Number	3674348C1	OIO	85954

Transtar - Conventional

	4170, F-4170, 4200, F-4200, 4300 & F-4300 Models	426744R91	OIO	85303	89422	
		426744R92	OIO	85303	89422	
		453576C91	OIO	85303	89422	
		453576C92	OIO	85303	89422	
		477132C1	OIO	85303	89422	
	4170, F-4170, 4200, F-4200, 4300 & F-4300 with Air Ride Suspension	350425C1		OIO	85300	89419
		462557C91		OIO	85300	89419
	D-400, DF-400, DC-400, DCF-400 & DCF-400M - Exc. Axle Code 02136	426744R91	OIO	85303	89422	

APPLICATION GUIDE - TRUCKS, TRAILERS, AND BUSES

Year Año Année	Model Modelo Modèle	OEM #	Front		Rear	
			Fleetline	GasSLX	Fleetline	GasSLX

INTERNATIONAL (NAVISTAR)(Cont'd.)

Transtar - Conventional(Cont'd.)

	D-400, DF-400, DC-400, DCF-400 & DCF-400M - Exc. Axle Code 02136	426744R92	010	85303	89422	
			010	85303	89422	
	D-400, DF-400, DC-400, DCF-400 & DCF-400M with Axle Code 02136	293009C91	010	85308	89422	
			010	85308	89422	

Unistar

	CO7044A	426744R91		85303	...	010	85303	89422
				85303	...	010	85303	89422
				85303	...	010	85303	89422
	Additional O.E.M. Interchanges	56101 Z5008	-10	83114				
		596329C1	010	85014				





WorkStar - 7000 Series

	7300, 7400, 7500, 7600 Models with 16,000 lb to 20,000 lb Multi-leaf Spring Severe Duty Standard	3541456C1	010	85929
			010	85925
			010	85925
			010	85925
04 - 15	7400, 7500, 7600 Models with 12,000 lb Front axle	3533357C1	010	85957
			010	85957
			010	85957
- 16	7400, 7500, 7600 Models with 18,000 lb Front Axles	3576464C1	010	85957
		3576464C2	010	85957
	7400, 7500, 7600 Models with Hendrickson HAS - 400 (Standard Inboard Rear)	60670-007		010	83144	...
	Models with 10,000 to 16,000 lb Front Suspension	3576465C2	010	85999
		3816234C1	010	85999
10 - 13	Models with 12,000 to 14,000 lb Front Taperleaf Suspension	3868264C1	010	85998
02 - 16	Models with Hendrickson HAS - 230 or 460 Rear Air Suspension	3514952C1		010	85976	...
		60675-003		010	85976	...
		H60675-003		010	85976	...
- 14	Models with Hendrickson HMX 400/460 Haulmax with 16.5" Saddle	60680-004		01-	83143	...
- 15	Models with Hendrickson Primaax 230, 460 and 690 Air Suspension (8-1/2" to 10" Ride Height)	60657-003		010	85072	...
- 15	Models with Hendrickson Primaax EX 232, 462 and 692 Air Suspension (8-1/2" to 10" Ride Height)	60657-003		010	85072	...
	Models with O.E.M. Number	4070336C1	010	85058	89431	
	S7700 Models w/ Multistage Front Suspension	3588591C1	010	85953
			010	85953
			010	85953
			010	85953
	Additional O.E.M. Interchanges	453527C91	-10	85311 or 89424				
		453528C91	-10	85311 or 89424				
		462603C91	-1-	85705 or 89447				
		463926C91	-1-	85705 or 89447				

Additional O.E.M. Interchanges

	Models with Chalmers 40,000 lb Rear Suspension	800670		010	85060	...
	Models with Meritor AirLink Suspension	446-51-211		010	85739	...
	Models with O.E.M. Number	3000098C1		-10	83317	...
			-10	85316	89426	
			010	85924	89457	

APPLICATION GUIDE - TRUCKS, TRAILERS, AND BUSES

Year Año Année	Model Modelo Modèle	OEM #	Front		Rear	
						
			Fleetline	GasSLX	Fleetline	GasSLX

INTERNATIONAL (NAVISTAR)(Cont'd.)

Additional O.E.M. Interchanges(Cont'd.)

Models with O.E.M. Number	3584116C1	010	83175	
	3584116C2	010	83175	
	3584117C1	010	83135	
	3584117C2	010	83135	
	3584118C1	010	85928	
	3584118C2	010	85928	
	3584535C1	010	85924	89457	
	3584535C2	010	85924	89457	
	3586902C2		010	83146	...
	3601600C1	010	85082				
	3601600C2	010	85082				
	3601600C3	010	85082				
	47902-24		010	83137	...
	4C4Z-18124-N	010	85957	
	4C4Z-18125-DA		010	85926	...
	503610C1		010	83207	89407
	90044025		010	83209	89414
	Additional O.E.M. Interchanges	3541456C1	010	85929			
		3544768C1	010	85926			
		3549100C1	010	85926			
3558989C1		010	85925				
3558989C2		010	85925				
3571713C1		-10	85333				
3596107C1		010	85927				
3596107C2		010	85927				
70334		-10	85316 or 89426				
AMS650102		010	85001 or 89410				
AMS650107		-10	85316 or 89426				
AMS650400		-10	85033 or 89427				
AMS650402		-10	85311 or 89424				
AMS650404		-1-	85310 or 89423				
AMS650405		010	85023 or 89415				
AMS650406		010	85024 or 89416				
AMS650408		-10	85319 or 89428				

INTERNATIONAL (NAVISTAR) CAB SHOCKS

	1900A, 2000A Models - Fleetstar Conventional	480945C1	-1-	83014
		480945C2	-1-	83014
97 -	Eagle Pro-Sleeper	1202-0054	010	83021
09 - 15	LoneStar Models with 72" Hi Roof Sleeper	2595314C1	01-	83062
		2600491C91	01-	83062
	Models with Link Cab Suspension NPS90	1202-0054	010	83021
	Models with Link Cabmate Suspensions with O.E.M. Number	1201-1043	010	83025
		1201-1049	010	83025
		1201-9003	010	83052
		1201-9007	010	83054
		1201-9009	010	83054
		1201-9013	01-	83062
		1201-9014	01-	83062
		1201-9018	01-	83062
		1201-9021	01-	83062

APPLICATION GUIDE - TRUCKS, TRAILERS, AND BUSES

Year Año Année	Model Modelo Modèle	OEM #	Front		Rear	
			Fleetline	GasSLX	Fleetline	GasSLX





INTERNATIONAL (NAVISTAR) CAB SHOCKS(Cont'd.)

	Models with Link Cabmate Suspensions with O.E.M. Number	1202-0012	010	83023
		1202-0022	010	83046
		1202-0032	010	83016
		1202-0042	010	83025
		1202-0043	010	83032
		1202-0044	010	83025
		1202-0054	010	83021
		1202-1212	010	83013
		1202-1213	01-	83005
			Models with O.E.M. Number	1201-1212
1201-1213	01-			83005
2012768C1	010			83013
2012769C2	01-			83005
2023685C1	01-			83015
2025790C1	010			83013
2500013C1	010			83013
2507409C1	010			83052
2507761C1	010			83052
2507763C1	010			83052
2507948C1	010			83054
2508326C1	010			83021
2508327C1	010			83025
2590915C1	01-			83062
2590916C1	01-			83062
2597458C91	01-			83062
2601488C91	01-			83062
2602021C1	01-			83062
3557165C1	010			83053
3557166C1	010			83052
3557167C3	010			83053
3557169C1	010			83052
3557169C2	010			83052
3560649C1	010			83052
3560649C2	010			83052
3560705C2	010			83054
AMS66160	010	83052		
AMS66161	010	83053		
OE14771	01-	83062		
- 91	Navistar 60" Sleepers with Link Cabmate Model IHS60	1202-1043	010	83025
11 - 15	Pro-Star Models With 56" or 72" Hi Roof Sleeper	2593803C91	01-	83062
		2595314C1	01-	83062
	S2500, S2600, 8100, 8200, & 8300 Models Conventional Tractors with Link Cabmate Model NAV80	1202-1043	010	83025

4000 Series

	Cabover Tractors with 74", 84" or 88" cabs with Link Cabmate Model IHB-2P	1202-0032	010	83016
	Conventional Tractors with Link Cabmate Model IHC43	1201-0012	010	83023
		1202-0012	010	83023
- 17	DuraStar - 4300, 4400 Models Conventional Tractors with O.E.M. Number	2509221C91	010	83054
	HPV 4000 Models travel crew cabs with ITC 42 Link Cabmate Model	1201-9002	010	83052

APPLICATION GUIDE - TRUCKS, TRAILERS, AND BUSES

Year Año Année	Model Modelo Modèle	OEM #	Front		Rear	
						
			Fleetline	GasSLX	Fleetline	GasSLX

INTERNATIONAL (NAVISTAR) CAB SHOCKS(Cont'd.)

5000 Series(Cont'd.)

09/94 -	Paystar - SBA Conventionals with Link Cabmate Model NP50 & NP50-A built after August of 1994	1201-1044	010	83025
		1202-1044	010	83025
09/96 -	Paystar - SFA Conventionals with Link Cabmate Model NP50 & NP50-A built after August of 1996	1201-1044	010	83025
		1202-1044	010	83025

7000 Series

	7300, 7400 & 7500 Models trucks with day cab or extended cabs with Link Cabmate Model IDC734	1201-9001	010	83052
	7300, 7400 & 7500 Models trucks with day cab or extended cabs with Link Cabmate Model IDC7345	1201-9008	010	83054
	7600 Models trucks with day cab or extended cabs with Link Cabmate Model IDC76	1201-9010	010	83053
- 15	WorkStar - 7000 Models Models with O.E.M. Number	2509224C91	010	83053
- 16	WorkStar - 7000 Models Models with O.E.M. Number	2509223C91	010	83054

8000 Series

	8500 Model trucks with day cab or extended cabs with Link Cabmate Model IDC85	1201-9008	010	83054
	8600 Model trucks with day cab or extended cabs with Link Cabmate Model IDC86	1201-9011	010	83053
- 13	TranStar - 8500, 8600 Models Tractors with O.E.M. Number	2509223C91	010	83054
04 - 09	TranStar - 8500, 8600 Models Tractors with 36" Sleepers	2509222C91	010	83053

9000 Series

01/93-	48" & 60" Bentz Sleepers on 9000 Models Conventional Tractors with Link Cabmate Model IHS4860	1201-1044	010	83025
		1202-1044	010	83025
03/97 -	9100 & 9200 Models Conventionals with Link Cabmate Model ND92-A	1202-1043	010	83025
		2023684C1	01-	83015
	9300 & 9400 Conventional Tractors with Link Cabmate Model IHC93-A	1202-1043	010	83025
		2503529C1	010	83025
81 -	9670 Cabover Tractors with 89" or 110" cabs with Link Cabmate Models IH967-A or IH97110	1202-0032	010	83016
82 -	9670, 9700 & 9800 Cabovers with 89" & 110" cabs with Link Cabmate Model NAV9876	1202-0054	010	83021
89 -	9700 Cabover Tractors with 110" cabs with Link Cabmate Model IH97110	1202-0032	010	83016
89 -	9700 Cabover Tractors with 89" cabs with Link Cabmate Model IH9789	1202-0032	010	83016
04 - 09	Models With 51" Low-Roof Sleeper	1201-0154	010	83051
		2585145C1	010	83051
04 - 09	Models with 72" High-Roof Sleeper	1201-0254	010	83051
		2589922C1	010	83051

ISUZU

FTR Series

05 - 09	FTR Models with 15000, 19000, 21000 lb Multileaf Springs	15174902		- -	85071	...
		88982686		- -	85071	...
05 - 09	FTR Models with O.E.M. Number	15123676	- -	83136
		88982682	- -	83136
		8-98098-059-0		010	83159	...
		8-98098-127-0	- 0	83515
		8982326720	- 0	83515
		98098059		010	83159	...
	98098127	- 0	83515	

APPLICATION GUIDE - TRUCKS, TRAILERS, AND BUSES

Year Año Année	Model Modelo Modèle	OEM #	Front		Rear	
			Fleetline	GasSLX	Fleetline	GasSLX

ISUZU(Cont'd.)

FVR Series(Cont'd.)

90 - 09	FVR Models with 15000, 19000, 21000 lb Multileaf Springs	88982686		- -	85071	...
09	FVR Models with Hendrickson HAS suspension	12474915		0 0	83122	89406
		60670-005		0 0	83137	...
00 - 09	FVR Models with O.E.M. Number	15887728	- -	83136
		19152843	- -	83136









NPR Series

86 - 95	NPR Models (NPC & NPN)	51630666		0 0	85012	89413
		8-94454-647-1	- 0	83515
		8-94454-986-0	- 0	83515
		8-94454-987-0	- 0	83515
		8-97083-029-0	- 0	83515
		94454986	- 0	83515
		9-51630-666-0		0 0	85012	89413
		9-51630-666-2		0 0	85012	89413
89 - 90	NPR Models Flatlow	51630647	- 0	83515
		9-51630-647-1	- 0	83515
89 - 92	NPR Models Flatlow	9-51630-666-0		0 0	85012	89413
		9-51630-666-2		0 0	85012	89413
01 - 07	NPR, NPR-HD (Diesel Models)	8-97253-651-2		0 0	83404	...
		97253651		0 0	83404	...
03 - 08	NPR, NPR-HD (Gas Models)	8-97253-651-2		0 0	83404	...
		97253651		0 0	83404	...
95 - 02	NPR, NPR-HD (Gas & Diesel Models)	8-97253-664-0		0 0	83159	...
		97253664		0 0	83159	...
86 - 14	NPR, NPR-HD Models with 11000 lb & 13000 lb Suspension	8-94454-987-0	- 0	83515
		8-97083-027-0	- 0	83515
		8-97083-029-0	- 0	83515
		8-97253-620-0	- 0	83515
		8-97253-620-1	- 0	83515
		8-98098-125-0	- 0	83515
		8982326710	- 0	83515
		94454987	- 0	83515
		97083027	- 0	83515
		97083029	- 0	83515
03 - 14	NPR, NPR-HD Models with O.E.M Number	8-97253-665-0		0 0	83159	...
		8-98098-058-0		0 0	83159	...
		8-98098-058-1		0 0	83159	...
		898098-0581		0 0	83159	...
		8-98098-059-0		0 0	83159	...
		97253665		0 0	83159	...
		98098058		0 0	83159	...
		98098059		0 0	83159	...

NQR Series

02	NQR (Diesel)	8-97253-664-0		0 0	83159	...
		97253664		0 0	83159	...
95 - 97	NQR (Diesel)	8-97253-664-0		0 0	83159	...
		97253664		0 0	83159	...
03 - 12	NQR Models with O.E.M. Number	8-97253-620-0	- 0	83515

APPLICATION GUIDE - TRUCKS, TRAILERS, AND BUSES

Year Año Année	Model Modelo Modèle	OEM #	Front		Rear	
						
						
			Fleetline	GasSLX	Fleetline	GasSLX

ISUZU(Cont'd.)

NQR Series(Cont'd.)

03 - 12	NQR Models with O.E.M. Number	8-97253-665-0		OIO	83159	...
		8-98098-059-0		OIO	83159	...
		8-98098-127-0	-IO	83515
		8982326720	-IO	83515
		97253620	-IO	83515
		97253665		OIO	83159	...
		98098059		OIO	83159	...
		98098127	-IO	83515

NRR Series

88 - 99	NRR Models (All)	1-51630-217-0	-IO	83114
		1-51630-217-1	-IO	83114
		1-51630-219-1	-IO	83114
		51630217	-IO	83114
02 - 12	NRR Models with O.E.M. Number	8-97253-620-0	-IO	83515
		8-97253-665-0		OIO	83159	...
		8-98098059-0		OIO	83159	...
		8-98098-127-0	-IO	83515
		8982326720	-IO	83515
		97253620	-IO	83515
		97253665		OIO	83159	...
		98098059		OIO	83159	...
98098127	-IO	83515		

Additional Applications

95 -	FRR Models (All)	1-51630-219-1	-IO	83114
		51630219	-IO	83114
86 - 92	FSR Models	1-51630-168-1	-IO	83515
		1-51630-217-1	-IO	83114
		51630168	-IO	G63610
85	KS22 Models (All)	8-97083-027-0	-IO	83515
		9-51630-666-0		OIO	85012	89413
		9-51630-666-2		OIO	85012	89413
	Models with O.E.M. Number	8-22064-231-0		-I-	85324	...
		8-22064-232-0		-I-	85071	...
		8-22064-233-0	-I-	83136
		8-22064-489-0		-I-	85336	...
		8-22064-804-0	-I-	83136
		8-22064-805-0	-I-	83136
		8-22064-806-0	-I-	83136
		8-22064-807-0	-I-	83136
		8-51630-666-0		OIO	85012	89413
		8972019600	-IO	83515
		8-97253-616-0	-IO	83515
		8-97253-621-0	-IO	83515
		8-97253-623-0	-IO	83515
		898098-1250	-IO	83515
		898098-1270	-IO	83515
		94033786	-IO	83114

APPLICATION GUIDE - TRUCKS, TRAILERS, AND BUSES

Year Año Année	Model Modelo Modèle	OEM #	Front		Rear	
			Fleetline	GasSLX	Fleetline	GasSLX

KENWORTH

C500, C500B, C500K, C540 & C550

	All with Air Glide 100 Suspension with 8 air bags, 4 units required	K374-29		- -	85310	89423
		K374-32		- -	85310	89423
	All with Air Glide 200 with 40,000 lb Suspension with 8 air bags, 4 units required	665903		- -	85900	...
		665944		- -	85900	...
		70701		- -	85900	...
	All with Air Glide 200 with 46,000 lb Suspension with 8 air bags, 4 units required	665906		- -	85902	...
		665945		- -	85902	...
01 - 16	Models with Air Glide 380 (AG380) Rear Air Suspension	C71-1002		0 0	85067	89451
		C71-1016		0 0	85067	89451
	Models with Dual Steering Front Axle and Torsion Bar Bogey Rear Suspension	K374-28		0 0	85314	89425
		K374-4		0 0	85314	89425
- 09	Models with Multiple Leaf Springs on Front Axle	B71-1003	0 0	83312	89409	
		K374-3	0 0	83312	89409	
		K374-33	0 0	83312	89409	
	Models with Neway ADZ Rear Suspension	471700004423		0 0	85109	...
		90045605		0 0	85109	...
- 09	Models with Taper Leaf Springs on Front Axle	B71-1002	0 0	85001	89410	
		K374-16	0 0	85001	89410	
		K374-26	0 0	85001	89410	
		K374-27	0 0	85001	89410	

ICON 900

16 - 17	Models with 10,000 lb to 14,600 lb Taperleaf Springs and Set Back Front Axles	B71-6019	0 0	85989
16 - 17	Models with Air Glide 380 (AG380) Rear Air Suspension	C71-1016		0 0	85067	89451
		C71-6015		0 0	85067	89451
16 - 17	Models with Air Glide 400 (AG400) Rear Air Suspension	C71-1014		0 -	85936	89456
16 - 17	Models with Air Glide 460 (AG460) Rear Air Suspension	C71-1015		0 -	85937	...
		C71-1015 PLUS		0 -	85937	...
2016	Models with Taper Leaf Springs on Front Axle	B71-1002	0 0	85001	89410	

K100, K100E, K125

	All with Air Glide 100 Suspension with 8 air bags, 4 units required	K374-29		- -	85310	89423
		K374-32		- -	85310	89423
	All with Air Glide 200 with 40,000 lb Suspension with 8 air bags, 4 units required	665903		- -	85900	...
		665944		- -	85900	...
		70701		- -	85900	...
	All with Air Glide 200 with 46,000 lb Suspension with 8 air bags, 4 units required	665906		- -	85902	...
		665945		- -	85902	...
	Models with Dual Steering Front Axle and Torsion Bar Bogey Rear Suspension	K374-28		0 0	85314	89425
		K374-4		0 0	85314	89425
	Models with Multiple Leaf Springs on Front Axle	B71-1003	0 0	83312	89409	
		K374-3	0 0	83312	89409	
		K374-33	0 0	83312	89409	
	Models with Set Back Front Axle	665331	0 -	83353
		K374-13	0 -	83353
		K374-13-1	0 -	83353
	Models with Taper Leaf Springs on Front Axle	B71-1002	0 0	85001	89410	

APPLICATION GUIDE - TRUCKS, TRAILERS, AND BUSES

Year Año Année	Model Modelo Modèle	OEM #	Front		Rear	
			 Fleetline	 GasSLX	 Fleetline	 GasSLX

KENWORTH(Cont'd.)

K100, K100E, K125(Cont'd.)

	Models with Taper Leaf Springs on Front Axle	K374-16	○ ○	85001	89410	
		K374-26	○ ○	85001	89410	
		K374-27	○ ○	85001	89410	

K270, K370

13 - 17	Models with 21,000 to 23,000 lb Reyco Spring Suspension	19495-01		○ ○	83126	89440
		TK19679		○ ○	83126	89440
13 - 16	Models with Hendrickson HAS - 230L Rear Air Suspension	60670-008		○ ○	83123	89405
13 - 17	Models with Reyco 102 or 79KB Suspension (Drive Axle)	16725-01		○ ○	83221	...

K300, T300

	All with Air Glide 100 Suspension with 8 air bags, 4 units required	K374-29		- -	85310	89423
		K374-32		- -	85310	89423
	All with Air Glide 200 with 40,000 lb Suspension with 8 air bags, 4 units required	665903		- -	85900	...
		665944		- -	85900	...
		70701		- -	85900	...
	All with Air Glide 200 with 46,000 lb Suspension with 8 air bags, 4 units required	665906		- -	85902	...
		665945		- -	85902	...
	K300 COE Medium Duty	665565	○ ○	85007	89412	
	Models with Hendrickson Rear Air Suspension	47902-19		○ ○	83123	89405
	Models with Multiple Leaf Springs on Front Axle	B71-1003	○ ○	83312	89409	
		K374-3	○ ○	83312	89409	
		K374-33	○ ○	83312	89409	
	Models with O.E.M. Number	665617	○ ○	85031
		B71-1000	○ ○	85031
	Models with Reyco 102 or 79KB Suspension (Drive Axle)	16725-01		○ ○	83221	...
	Models with Reyco 1209 or 1212 Suspension (Steer Axle)	19495-01	○ ○	83126	89440	
	Models with Taper Leaf Springs on Front Axle	B71-1002	○ ○	85001	89410	
		K374-16	○ ○	85001	89410	
		K374-26	○ ○	85001	89410	
		K374-27	○ ○	85001	89410	
	Models with Woodhead Shock (Stamping Number ACHB 966)	ACHB966		- -	83136	...

T170

08 - 13	Models with 8,000 lb Dana Front Axle	665617	○ ○	85031
08 - 13	Models with Reyco 79KB Rear Suspension	16725-01		○ ○	83221	...

T270, T370

10 - 14	Models with 10,000 lb to 12,000 lb Front Axle	B71-6005	○ ○	85084	89460	
15 - 17	Models with 10,000 lb to 14,600 lb Taperleaf Springs and Set Back Front Axles	B71-6019	○ ○	85989
08 - 09	Models with 12,000 lb Front Axle	665617	○ ○	85031
10 - 14	Models with 13,200 lb to 14,600 lb Front Axle	B71-6006	○ ○	85084	89460	
10 - 17	Models with 21,000 to 23,000 lb Reyco Spring Suspension	19495-01		○ ○	83126	89440
		TK19679		○ ○	83126	89440
10 - 14	Models with 8,000 lb Front Axle	B71-6004	○ ○	85084	89460	
08 - 17	Models with AG210L Rear Air Suspension	C71-1011		- -	85069	89455
		C71-1017		- -	85069	89455
08 - 17	Models with Hendrickson HAS - 230L Rear Air Suspension	60670-008		○ ○	83123	89405
10 - 14	Models with Hendrickson HAS - 400 (Standard) Rear Air Suspension	60670-005		○ ○	83137	...
10 - 17	Models with Reyco 102 or 79KB Suspension (Drive Axle)	16725-01		○ ○	83221	...

APPLICATION GUIDE - TRUCKS, TRAILERS, AND BUSES

Year Año Année	Model Modelo Modèle	OEM #	Front		Rear	
			Fleetline	GasSLX	Fleetline	GasSLX

KENWORTH(Cont'd.)

T400, T400B, T450B(Cont'd.)

	All with Air Glide 100 Suspension with 8 air bags, 4 units required	K374-29		- -	85310	89423
		K374-32		- -	85310	89423
	All with Air Glide 200 with 40,000 lb Suspension with 8 air bags, 4 units required	665903		- -	85900	...
		665944		- -	85900	...
		70701		- -	85900	...
	All with Air Glide 200 with 46,000 lb Suspension with 8 air bags, 4 units required	665906		- -	85902	...
		665945		- -	85902	...
	Models with Multiple Leaf Springs on Front Axle	B71-1003	o o	83312	89409	
		K374-3	o o	83312	89409	
		K374-33	o o	83312	89409	
	Models with Taper Leaf Springs on Front Axle	B71-1002	o o	85001	89410	
		K374-16	o o	85001	89410	
		K374-26	o o	85001	89410	
		K374-27	o o	85001	89410	
	Models with Torsion Bar Bogey (2 rear axles) and KW Air Ride Suspension (with 4 air bags)	K374-28		o o	85314	89425
		K374-4		o o	85314	89425

T440

12 - 17	Models with 12,000 to 20,000 lb Taperleaf Front Suspension	665858	o o	85070	89459	
		B71-1001	o o	85070	89459	
12 - 17	Models with 21,000 to 23,000 lb Reyco Spring Suspension	19495-01		o o	83126	89440
		TK19679		o o	83126	89440
12 - 17	Models with Air Glide 380 (AG380) Rear Air Suspension	C71-1002		o o	85067	89451
		C71-1016		o o	85067	89451
		C71-6015		o o	85067	89451
12 - 17	Models with Air Glide 400 (AG400) Rear Air Suspension	671962		o -	85936	89456
		C71-1014		o -	85936	89456
12 - 17	Models with Air Glide 400L (AG400L) Rear Air Suspension	C71-1011		- -	85069	89455
		C71-1017		- -	85069	89455
12 - 17	Models with Air Glide 460 (AG460) Rear Air Suspension	671963		o -	85937	...
		C71-1015		o -	85937	...
		C71-1015 PLUS		o -	85937	...
12 - 17	Models with Chalmers 40,000 lb Rear Suspension	665174		o o	85060	...
12 - 17	Models with Hendrickson HAS - 230 Rear Air Suspension	60670-005		o o	83137	...
12 - 17	Models with Hendrickson HMX 400/460 Haulmax - with 16.5" Saddle - with 17.5" & 18.5" Saddle	60680-004		o -	83143	...
		60680-005		o -	83142	...
12 - 17	Models with Hendrickson Primaax 230, 460 and 690 Air Suspension (8-1/2" to 10" Ride Height)	60657-003		o o	85072	...
12 - 17	Models with Hendrickson Primaax EX 232, 462 and 692 Air Suspension (8-1/2" to 10" Ride Height)	60657-003		o o	85072	...
12 - 17	Models with Hendrickson Primaax EX 262S or 522S Rear Air Suspension (10" Ride Height)	60665-011		o o	85967	...
12 - 16	Models with Neway AD-123 or AD-246 Models Air Suspension with - Shock stamping	90045068		- o	...	89441
		90045099		o o	85906	89407
		90045132		o o	85909	...
12 - 17	Models with Neway ADZ Rear Suspension	471700004423		o o	85109	...
		90045605		o o	85109	...
12 - 17	Models with Reyco 102 or 79KB Suspension (Drive Axle)	16725-01		o o	83221	...

APPLICATION GUIDE - TRUCKS, TRAILERS, AND BUSES

Year Año Année	Model Modelo Modèle	OEM #	Front		Rear	
			 Fleetline	 GasSLX	 Fleetline	 GasSLX

KENWORTH(Cont'd.)





T470(Cont'd.)

10 - 17	Models with 12,000 to 20,000 lb Taperleaf Front Suspension	665858	○ ○	85070	89459	
		B71-1001	○ ○	85070	89459	
10 - 17	Models with 21,000 to 23,000 lb Reyco Spring Suspension	19495-01		○ ○	83126	89440
		TK19679		○ ○	83126	89440
10 - 16	Models with Air Glide 230 (AG230) Rear Air Suspension	671656		○ -	85985	...
		C71-1013		○ -	85985	...
10 - 17	Models with Air Glide 380 (AG380) Rear Air Suspension	C71-1002		○ ○	85067	89451
		C71-1016		○ ○	85067	89451
		C71-6015		○ ○	85067	89451
10 - 17	Models with Air Glide 400 (AG400) Rear Air Suspension	671962		○ -	85936	89456
		C71-1014		○ -	85936	89456
12 - 17	Models with Air Glide 400L (AG400L) Rear Air Suspension	C71-1011		- -	85069	89455
		C71-1017		- -	85069	89455
10 - 17	Models with Air Glide 460 (AG460) Rear Air Suspension	671963		○ -	85937	...
		C71-1015		○ -	85937	...
		C71-1015 PLUS		○ -	85937	...
10 - 16	Models with Chalmers 40,000 lb Rear Suspension	665174		○ ○	85060	...
10 - 16	Models with Hendrickson HAS - 230 Rear Air Suspension	60670-005		○ ○	83137	...
10 - 17	Models with Hendrickson HMX 400/460 Haulmax - with 16.5" Saddle - with 17.5" & 18.5" Saddle	60680-004		○ -	83143	...
		60680-005		○ -	83142	...
10 - 17	Models with Hendrickson Primaax 230, 460 and 690 Air Suspension (8-1/2" to 10" Ride Height)	60657-003		○ ○	85072	...
10 - 17	Models with Hendrickson Primaax EX 232, 462 and 692 Air Suspension (8-1/2" to 10" Ride Height)	60657-003		○ ○	85072	...
10 - 16	Models with Neway AD-123 or AD-246 Models Air Suspension with - Shock stamping	90045068		- ○	...	89441
		90045099		○ ○	85906	89407
		90045132		○ ○	85909	...
10 - 17	Models with Neway ADZ Rear Suspension	471700004423		○ ○	85109	...
		90045605		○ ○	85109	...
10 - 17	Models with Reyco 102 or 79KB Suspension (Drive Axle)	16725-01		○ ○	83221	...

T600, T600A, T600B, T602

	All with Air Glide 100 Suspension with 8 air bags, 4 units required	K374-29		- -	85310	89423
		K374-32		- -	85310	89423
	All with Air Glide 200 with 40,000 lb Suspension with 8 air bags, 4 units required	665903		- -	85900	...
		665944		- -	85900	...
		70701		- -	85900	...
	All with Air Glide 200 with 46,000 lb Suspension with 8 air bags, 4 units required	665906		- -	85902	...
		665945		- -	85902	...
06 -	Models with 13,000 lb Front Axle	665858	○ ○	85070	89459	
		B71-1001	○ ○	85070	89459	
01 - 07	Models with Air Glide 380 (AG380) Rear Air Suspension	C71-1002		○ ○	85067	89451
		C71-1016		○ ○	85067	89451
01 - 07	Models with Air Glide 400 (AG400) Rear Air Suspension	671962		○ -	85936	89456
		C71-1014		○ -	85936	89456
- 07	Models with Air Glide 460 (AG460) Rear Air Suspension	671963		○ -	85937	...
	Models with Hendrickson Rear Air Suspension	47902-19		○ ○	83123	89405
		47902-24		○ ○	83137	...

APPLICATION GUIDE - TRUCKS, TRAILERS, AND BUSES

Year Año Année	Model Modelo Modèle	OEM #	Front		Rear	
						
				Fleetline	GasSLX	Fleetline

KENWORTH(Cont'd.)

T600, T600A, T600B, T602(Cont'd.)

	Models with Multiple Leaf Springs on Front Axle	B71-1003	010	83312	89409	
		K374-3	010	83312	89409	
		K374-33	010	83312	89409	
	Models with Reyco 102 or 79KB Suspension (Drive Axle)	16725-01		010	83221	...
	Models with Reyco 1209 or 1212 Suspension (Steer Axle)	19495-01	010	83126	89440	
	Models with Taper Leaf Springs on Front Axle	B71-1002	010	85001	89410	
		K374-16	010	85001	89410	
		K374-26	010	85001	89410	
		K374-27	010	85001	89410	

T660

	Carhauler with O.E.M. Number	K374-36	010	...	89432	
06 - 17	Models with 12,000 or 13,200 lb Front Axle	665858	010	85070	89459	
		B71-1001	010	85070	89459	
08 - 17	Models with 40,000 lb Low Air leaf Suspension	C71-1011		-1-	85069	89455
		C71-1017		-1-	85069	89455
06 -	Models with Air Glide 230 (AG230) Rear Air Suspension	671656		01-	85985	...
		C71-1013		01-	85985	...
08 - 17	Models with Air Glide 380 (AG380) Rear Air Suspension	C71-1002		010	85067	89451
		C71-1016		010	85067	89451
		C71-6015		010	85067	89451
13 - 17	Models with Air Glide 400 (AG400) Rear Air Suspension	671962		01-	85936	89456
		C71-1014		01-	85936	89456
13 - 17	Models with O.E.M. Number	B71-6012	010	85119

T680

13 - 14	Models with 10,000 lb to 13,200 lb Front Axle	B71-6005	010	85084	89460	
14 - 17	Models with 10,000 lb to 14,600 lb Taperleaf Springs and Set Back Front Axles	B71-6019	010	85989
14 - 17	Models with 16,000 lb to 20,000 lb Taperleaf Springs and Set Back Front Axles	B71-6020	010	85989
13 - 17	Models with 21,000 to 23,000 lb Reyco Spring Suspension	19495-01		010	83126	89440
		TK19679		010	83126	89440
13 - 17	Models with Air Glide 380 (AG380) Rear Air Suspension	C71-1002		010	85067	89451
		C71-1016		010	85067	89451
		C71-6015		010	85067	89451
13 - 17	Models with Air Glide 400 (AG400) Rear Air Suspension	671962		01-	85936	89456
		C71-1014		01-	85936	89456
13 - 17	Models with Air Glide 400L (AG400L) Rear Air Suspension	C71-1011		-1-	85069	89455
		C71-1017		-1-	85069	89455
13 - 17	Models with Air Glide 460 (AG460) Rear Air Suspension	671963		01-	85937	...
		C71-1015		01-	85937	...
		C71-1015 PLUS		01-	85937	...
13 - 17	Models with Hendrickson HMX 400/460 Haulmax - with 16.5" Saddle - with 17.5" & 18.5" Saddle	60680-004 60680-005		01-	83143	...
				01-	83142	...
13 - 17	Models with Hendrickson Primaax EX 462 Air Suspensions Standard with 12 1/2" - 14 3/8" - 15 1/2" Ride Height Standard with 8 1/2" to 10" Ride Height	60665-011 60657-003		010	85967	...
				010	85072	...
13 - 17	Models with Neway ADZ Rear Suspension	471700004423 90045605		010	85109	...
				010	85109	...
13 - 17	Models with O.E.M. Number	B71-6012	010	85119
13 - 17	Models with Reyco 102 or 79KB Suspension (Drive Axle)	16725-01		010	83221	...

APPLICATION GUIDE - TRUCKS, TRAILERS, AND BUSES

Year Año Année	Model Modelo Modèle	OEM #	Front		Rear	
			Fleetline	GasSLX	Fleetline	GasSLX

KENWORTH(Cont'd.)









T700(Cont'd.)

11 - 17	Models with 13,000 lb Front Axle	665858 B71-1001	○ ○	85070	89459	
			○ ○	85070	89459	
11 - 16	Models with Air Glide 230 (AG230) Rear Air Suspension	671656 C71-1013		○ -	85985	...
				○ -	85985	...
11 - 17	Models with Air Glide 380 (AG380) Rear Air Suspension	C71-1002 C71-1016 C71-6015		○ ○	85067	89451
				○ ○	85067	89451
				○ ○	85067	89451
11 - 17	Models with Air Glide 400 (AG400) Rear Air Suspension	671962 C71-1014		○ -	85936	89456
				○ -	85936	89456

T800, T800B, T800B(8x4), T800SH, T800H, T800W

	All with Air Glide 100 Suspension with 8 air bags, 4 units required	K374-29 K374-32		- -	85310	89423
				- -	85310	89423
	All with Air Glide 200 with 40,000 lb Suspension with 8 air bags, 4 units required	665903 665944 70701		- -	85900	...
				- -	85900	...
				- -	85900	...
	All with Air Glide 200 with 46,000 lb Suspension with 8 air bags, 4 units required	665906 665945		- -	85902	...
				- -	85902	...
05 - 17	Models with 12,000 to 20,000 lb Front Axles	665858 B71-1001	○ ○	85070	89459	
			○ ○	85070	89459	
06 -	Models with Air Glide 230 (AG230) Rear Air Suspension	671656 C71-1013		○ -	85985	...
				○ -	85985	...
01 - 17	Models with Air Glide 380 (AG380) Rear Air Suspension	C71-1002 C71-1016 C71-6015		○ ○	85067	89451
				○ ○	85067	89451
				○ ○	85067	89451
07 - 17	Models with Air Glide 400 (AG400) Rear Air Suspension	671962 C71-1014		○ -	85936	89456
				○ -	85936	89456
14 - 17	Models with Air Glide 400L (AG400L) Rear Air Suspension	C71-1017		- -	85069	89455
07 - 17	Models with Air Glide 460 (AG460) Rear Air Suspension	671963 C71-1015 C71-1015 PLUS		○ -	85937	...
				○ -	85937	...
				○ -	85937	...
- 14	Models with Chalmers 40,000 lb Rear Suspension	665174		○ ○	85060	...
10 - 17	Models with Hendrickson Primaax EX 232, 462 and 692 Air Suspension (8-1/2" to 10" Ride Height)	60657-003		○ ○	85072	...
				○ ○	83123	89405
	Models with Hendrickson Rear Air Suspension	47902-19 47902-24		○ ○	83137	...
	Models with Multiple Leaf Springs on Front Axle	B71-1003 K374-3 K374-33	○ ○	83312	89409	
			○ ○	83312	89409	
			○ ○	83312	89409	
- 17	Models with Neway ADZ Rear Suspension	471700004423 90045605		○ ○	85109	...
				○ ○	85109	...
	Models with Neway Rear Air Suspension	90044089		○ ○	83124	89407
	Models with Neway Rear Air Suspension (AD123-, AD246-)	90045132		○ ○	85909	...
	Models with Reyco 102 or 79KB Suspension (Drive Axle)	16725-01		○ ○	83221	...
	Models with Reyco 1209 or 1212 Suspension (Steer Axle)	19495-01	○ ○	83126	89440	
	Models with Taper Leaf Springs on Front Axle	B71-1002 K374-16 K374-26 K374-27	○ ○	85001	89410	
			○ ○	85001	89410	
			○ ○	85001	89410	
			○ ○	85001	89410	
	Models with Torsion Bar Bogey (2 rear axles) and KW Air Ride Suspension (with 4 air bags)	K374-28		○ ○	85314	89425

APPLICATION GUIDE - TRUCKS, TRAILERS, AND BUSES

Year Año Année	Model Modelo Modèle	OEM #	Front		Rear	
						
						
			Fleetline	GasSLX	Fleetline	GasSLX

KENWORTH(Cont'd.)

T800, T800B, T800B(8x4), T800SH, T800H, T800W(Cont'd.)

	Models with Torsion Bar Bogey (2 rear axles) and KW Air Ride Suspension (with 4 air bags)	K374-4		0 0	85314	89425
--	---	--------	--	-----	-----	-----	--------------	--------------

T880

14 - 17	Models with 10,000 lb to 14,600 lb Taperleaf Springs and Set Back Front Axles	B71-6019	0 0	85989
14 - 17	Models with 16,000 lb to 20,000 lb Taperleaf Springs and Set Back Front Axles	B71-6020	0 0	85989
14 - 17	Models with Air Glide 400 (AG400) Rear Air Suspension	671962 C71-1014		0 -	85936	89456
14 - 17	Models with Air Glide 400L (AG400L) Rear Air Suspension	C71-1017		- -	85069	89455
14 - 17	Models with Air Glide 460 (AG460) Rear Air Suspension	671963 C71-1015 C71-1015 PLUS		0 -	85937	...
14 - 17	Models with Hendrickson HMX 400/460 Haulmax - with 16.5" Saddle - with 17.5" & 18.5" Saddle	60680-004 60680-005		0 -	83143	...
14 - 17	Models with Hendrickson Primaax EX 462 Air Suspensions Standard with 12 1/2" - 14 3/8" - 15 1/2" Ride Height Standard with 8 1/2" to 10" Ride Height	60665-011 60657-003		0 0	85967	...
14 - 17	Models with Neway ADZ Rear Suspension	471700004423 90045605		0 0	85109	...
	Models with O.E.M. Number	C71-1015A		0 -	85937	...
14 - 16	Models with O.E.M. Number	B71-6012	0 0	85119
14 - 17	Models with Reyco 102 or 79KB Suspension (Drive Axle)	16725-01		0 0	83221	...

T2000

	All with Air Glide 100 Suspension with 8 air bags, 4 units required	K374-29 K374-32		- -	85310	89423
	All with Air Glide 200 with 40,000 lb Suspension with 8 air bags, 4 units required	665903 665944 70701		- -	85900	...
	All with Air Glide 200 with 46,000 lb Suspension with 8 air bags, 4 units required	665906 665945		- -	85902	...
06 - 10	Models with 13,000 lb Front Axle	665858 B71-1001	0 0	85070	89459	
01 - 11	Models with Air Glide 380 (AG380) Rear Air Suspension	C71-1002 C71-1016		0 0	85067	89451
05 - 11	Models with Air Glide 400 (AG400) Rear Air Suspension	671962 C71-1014		0 -	85936	89456
05 - 11	Models with Air Glide 460 (AG460) Rear Air Suspension	671963		0 -	85937	...
	Models with Multiple Leaf Springs on Front Axle	B71-1003 K374-3 K374-33	0 0 0 0 0 0	83312	89409	
	Models with Taper Leaf Springs on Front Axle	B71-1002 K374-16 K374-26 K374-27	0 0 0 0 0 0 0 0	85001	89410	

W900, W900B, W900L, W900S

	All with Air Glide 100 Suspension with 8 air bags, 4 units required	K374-29 K374-32		- -	85310	89423
				- -	85310	89423

APPLICATION GUIDE - TRUCKS, TRAILERS, AND BUSES

Year Año Année	Model Modelo Modèle	OEM #	Front			Rear		
			Fleetline	GasSLX				

KENWORTH(Cont'd.)





W900, W900B, W900L, W900S(Cont'd.)

	All with Air Glide 200 with 40,000 lb Suspension with 8 air bags, 4 units required	665903		- -	85900	...
		665944		- -	85900	...
		70701		- -	85900	...
	All with Air Glide 200 with 46,000 lb Suspension with 8 air bags, 4 units required	665906		- -	85902	...
		665945		- -	85902	...
	Carhauler with O.E.M. Number	K374-36	O O	...	89432	
05 - 17	Models with 12,000 or 13,200 lb Front Axle	665858	O O	85070	89459	
		B71-1001	O O	85070	89459	
10	Models with 46,000 lb Neway Rear Air Suspension	90045132		O O	85909	...
06 -	Models with Air Glide 230 (AG230) Rear Air Suspension	671656		O -	85985	...
		C71-1013		O -	85985	...
01 - 17	Models with Air Glide 380 (AG380) Rear Air Suspension	C71-1002		O O	85067	89451
		C71-1016		O O	85067	89451
		C71-6015		O O	85067	89451
05 - 17	Models with Air Glide 400 (AG400) Rear Air Suspension	671962		O -	85936	89456
		C71-1014		O -	85936	89456
08 - 17	Models with Air Glide 400L (AG400L) Rear Air Suspension	C71-1011		- -	85069	89455
		C71-1017		- -	85069	89455
05 - 17	Models with Air Glide 460 (AG460) Rear Air Suspension	671963		O -	85937	...
		C71-1015		O -	85937	...
		C71-1015 PLUS		O -	85937	...
	Models with Hendrickson Rear Air Suspension	47902-19		O O	83123	89405
		47902-24		O O	83137	...
	Models with Multiple Leaf Springs on Front Axle	B71-1003	O O	83312	89409	
		K374-3	O O	83312	89409	
		K374-33	O O	83312	89409	
- 17	Models with Neway ADZ Rear Suspension	471700004423		O O	85109	...
		90045605		O O	85109	...
	Models with Reyco 102 or 79KB Suspension (Drive Axle)	16725-01		O O	83221	...
	Models with Reyco 1209 or 1212 Suspension (Steer Axle)	19495-01	O O	83126	89440	
- 17	Models with Taper Leaf Springs on Front Axle	B71-1002	O O	85001	89410	
		K374-16	O O	85001	89410	
		K374-26	O O	85001	89410	
		K374-27	O O	85001	89410	
	Models with Torsion Bar Bogey (2 rear axles) and KW Air Ride Suspension (with 4 air bags)	K374-28		O O	85314	89425
		K374-4		O O	85314	89425

Additional O.E.M. Interchanges

	Models with Hendrickson Primaax 260 or 520 Rear Air Suspension (10" Ride Height-Disc Brakes only)	60665-015		O O	85966	...
	Models with Hendrickson Primaax 260 or 520 Rear Air Suspension (10" Ride Height-Drum Brakes only)	60665-013		O O	85965	...
	Models with Hendrickson Primaax EX 262 or 522 Rear Air Suspension (10" Ride Height)	60665-013		O O	85965	...
	Models with Hendrickson Primaax EX 262S or 522S Rear Air Suspension (10" Ride Height)	60665-011		O O	85967	...
	OE PLUS Shock Stamping Number	02-02736PLUS	O O	85302	89420	
		02-02737PLUS	O O	85062	89408	
		02-02738PLUS	O O	85012	89413	
		02-02739PLUS	O O	85013	89414	
		03-04176PLUS		O O	85308	89422

APPLICATION GUIDE - TRUCKS, TRAILERS, AND BUSES





Year Año Année	Model Modelo Modèle	OEM #	Front		Rear	
						
			Fleetline	GasSLX	Fleetline	GasSLX

KENWORTH(Cont'd.)

Additional O.E.M. Interchanges(Cont'd.)

OE PLUS Shock Stamping Number	03-06084PLUS	-10	85033	89427		
	03-07421PLUS	-10	85311	89424		
	03-07423PLUS	-10	85033	89427		
	10-12032-002PLUS	O10	85320	89429		
	10-12542-000PLUS	O10	85901	
	16-13947-000PLUS	-10	85319	89428	
	2018987C1PLUS	O10	85003	89411	
	47902-13PLUS	O10	83122	89406	
	60670-005PLUS	O10	83137	...	
	60670-008PLUS	O10	83123	89405	
	665565PLUS	O10	85007	89412	
	671962PLUS	O1-	85936	89456	
	70701PLUS	-1-	85900	...	
	8086053PLUS	O10	85047	89435	
	90044025PLUS	O10	83209	89414		
	90044089PLUS	O10	83124	89407	
	B71-6015	O10	85012	89413		
	C71-1002PLUS	O10	85067	89451	
	C71-1011PLUS	-1-	85069	89455	
	K374-26PLUS	O10	85001	89410		
	K374-28PLUS	O10	85314	89425	
	K374-29PLUS	-1-	85310	89423	
	K374-33PLUS	O10	83312	89409		
	TruckMaster Shock Stamping Number	665632	O10	85013	89414	
		665633	-10	85033	89427
665783		O10	83123	89405	
665784		O10	83122	89406	
665785		O10	83137	...	
665844		-1-	85069	89455	
665918		-1-	85900	...	
665926		O10	85047	89435	
665927		O10	85901	
665928		O10	85062	89408		
665930		O10	85001	89410		
665931		O10	83312	89409		
665932		O10	85012	89413		
665950		-1-	85902	...	
671052		O10	85070	89459		
671654		O1-	85936	89456	
671699		O1-	85937	...	
671794		O10	85067	89451	
680237		...	85303	...	O10	85303	89422	
680239		-1-	85310	89423	
680240		O10	85302	89420	
680242		O10	85308	89422	
680253		O10	85314	89425	
680261		O10	85062	89408		
680279		O10	83209	89414		
680280		O10	85906	89407	
680281		O10	85003	89411	
680283		O1-	83353	

APPLICATION GUIDE - TRUCKS, TRAILERS, AND BUSES





Year Año Année	Model Modelo Modèle	OEM #	Front		Rear	
						
			Fleetline	GasSLX	Fleetline	GasSLX

KENWORTH(Cont'd.)

Additional O.E.M. Interchanges(Cont'd.)

	TruckMaster Shock Stamping Number	680303		010	85007	89412
		680425	010	85320	89429	
		680435		-10	85033	89427
		680473		-10	85319	89428
	All with Air Glide 100 Suspension with 8 air bags, 4 units required	K374-C7		-1-	85310	89423
	Models with Multiple Leaf Springs on Front Axle	K374-14	010	83312	89409	
		K374-5	010	83312	89409	
	Models with O.E.M. Number	665453	010	85001	89410	
		665670	010	85001	89410	
		665680	010	83312	89409	
		665788		010	85000	89436
		665828		010	85067	89451
		675041	01-	83353
		675122	010	85001	89410	
		680241		-10	85311	89424
		680475		010	85314	89425
		680476		-1-	85310	89423
		680486		-1-	85310	89423
		680586		-10	85311	89424
		B71-6000	010	85959
		B71-6002	010	85012	89413	
		B71-6003	010	85029
		B71-6007	010	85062	89408	
		B71-6008	010	83312	89409	
		B71-6010	010	85023 or 89415				
		B71-6011	010	85062	89408	
		B71-6013	010	85012	89413	
		B71-6016	010	85012	89413	
		B71-6017	010	85910
		B71-6018	010	85012	89413	
		C71-6003		-10	85988	...
		C71-6004		-10	85343	...
		C71-6005		-1-	85069	89455
		K374-15	01-	83353
		K374-7		-1-	85310	89423
		K374-9		-1-	85310	89423
		K374-C31	010	83312	89409	
		R71-6006	010	83063				
		R71-6007	010	83008				
R71-6008	010	83035						
S-20126		010	85323	89436		
	Models with Taper Leaf Springs on Front Axle	K374-11	010	85001	89410	
	Additional O.E.M. Interchanges	3166657	010	85700				
		665092	010	83312 or 89409				
		665118	010	83312 or 89409				
		K374-10	010	83362				
		K374-3-1	010	83312 or 89409				

APPLICATION GUIDE - TRUCKS, TRAILERS, AND BUSES

Year Año Année	Model Modelo Modèle	OEM #	Front		Rear	
						
			Fleetline	GasSLX	Fleetline	GasSLX

KENWORTH CAB SHOCKS

Aerocab

	Models with 38" Sleepers with Link Cabmate Models KWK1T03 or KWCSA 01-06	1202-1264	010	83031
	Models with 62" and 74" Sleepers with O.E.M. Number	1202-1164	010	83031
	Models with 72" Sleepers with Link Cabmate Models KWK1T02 or KWCSA 01-06	1202-1065	010	83002
08 - 16	Models with 86" Sleepers with O.E.M. Number	1202-1286	010	83056
		1202K286	010	83056
		T71-1003	010	83056

C-500B

	Models with Link Cabmate KWB500 Air Suspension	1202-0044	010	83025
--	--	-----------	-----	-------

COE Models

	90" and 112" E Models with Link Cabmate KWE90112-B Air Suspension	1202K064	010	83024
		R71-1005	010	83024
	Models with Link Cabmate KW1102-B Air Suspension (Does not fit Non-Sleeper cabs)	1202-0032	010	83016
	Models with Link Cabmate KWE90112-A Air Suspension	1202-0032	010	83016

ICON 900

2016	Models with 86" Sleepers with O.E.M. Number	T71-1003	010	83056
2016	Models with O.E.M. Number	T71-1002	010	83002

T400A

06/92 -	Models with Link Cabmate Air Suspension KWB689-A with rear cab support Kenworth P/N K235-1646	1202-0012	010	83023
- 05/92	Models with Link Cabmate KWB400-A Air Suspension	1202-0012	010	83023
05/92 -	Models with Link Cabmate KWB689-B or KWB689-C Air Suspension	1201-1043	010	83025
06/92 -	Models with Link Cabmate KWB689-B or KWB689-C Air Suspension	1202-1043	010	83025

T440

	Models with Link Cabmate KWB689-D and Severe service crossmembers	1201-1046	010	83049
		1202-1046	010	83049
		1202K046	010	83049
		R71-1004	010	83049

T450

06/92 -	Models with Link Cabmate Air Suspension KWB689-A with rear cab support Kenworth P/N K235-1646	1202-0012	010	83023
- 05/92	Models with Link Cabmate KWB400-A Air Suspension	1202-0012	010	83023
05/92 -	Models with Link Cabmate KWB689-B or KWB689-C Air Suspension	1201-1043	010	83025
06/92 -	Models with Link Cabmate KWB689-B or KWB689-C Air Suspension	1202-1043	010	83025
	Models with Link Cabmate KWB689-D and Severe service crossmembers	1202K046	010	83049
		R71-1004	010	83049









T600

	Models with Link Cabmate KWMC642 Air Suspension	1202-0054	010	83021
--	---	-----------	-----	-------

T600A

	Models with Link Cabmate KWB689-A Air Suspension and rear cab mount Kenworth P/N K235-1436 or K235-1488	1202-0012	010	83023
	Models with Link Cabmate KWB689-B or KWB689-C Air Suspension and rear cab mount Kenworth part # K235-1436 or K235-1488	1201-1043	010	83025
		1202-1043	010	83025
	Models with Link Cabmate KWB689-D and Severe service crossmembers	1202K046	010	83049

APPLICATION GUIDE - TRUCKS, TRAILERS, AND BUSES

Year Año Année	Model Modelo Modèle	OEM #	Front		Rear	
						
						
			Fleetline	GasSLX	Fleetline	GasSLX

KENWORTH CAB SHOCKS(Cont'd.)

T600A(Cont'd.)

Models with Link Cabmate KWB689-D and Severe service crossmembers	R71-1004	010		83049
---	----------	-----	--	-------

T660

08 - 17	Models with 86" Sleepers with O.E.M. Number	1202-1286	010		83056
		1202K286	010		83056
		T71-1003	010		83056
06 - 10	Models with Link Cab Suspension	1202-1065	010		83002

T700

11 - 16	DayCab Models with O.E.M. Number	R71-6000	010		83067
		R71-6010	010		83067
08 - 16	Models with 86" Sleepers with O.E.M. Number	1202-1286	010		83056
		1202K286	010		83056
		T71-1003	010		83056
11 - 16	Models with Extended Sleeper Cab	1202-1064	010		83024
		1202K064	010		83024
		R71-1005	010		83024

T800 / T800A

- 12	Models with Link Cab Suspension	1202-1046	010		83049
	Models with Link Cabmate KWB689-A Air Suspension and rear cab mount Kenworth P/N K235-1436 or K235-1488	1202-0012	010		83023
	Models with Link Cabmate KWB689-B or KWB689-C Air Suspension and rear cab mount Kenworth part # K235-1436 or K235-1488	1201-1043	010		83025
		1202-1043	010		83025
	Models with Link Cabmate KWB689-D and Severe service crossmembers	1202K046	010		83049
- 14	Models with Link Cabmate KWB689-D and Severe service crossmembers	R71-1004	010		83049
		Models with Link Cabmate KWMC642 Air Suspension	1202-0054	010	

W900L

06 - 17	Models with O.E.M. Number	1202K065	010		83002
		T71-1002	010		83002

T2000

97 - 10	Models with Link Cabmate KWT2000-A Air Suspension	1202-1064	010		83024
		1202K064	010		83024
		R71-1005	010		83024
07/98 -	Models with PowerPacker Cab Suspension after 6/28/98	PP2582870	010		83012
- 06/98	Models with PowerPacker Cab Suspension prior to 6/28/98	96027-10545	010		83011









W-900 / W-900B

	Models with Link Cabmate KWB689-A Air Suspension and rear cab mount Kenworth P/N K235-1436 or K235-1488	1202-0012	010		83023
	Models with Link Cabmate KWB689-B or KWB689-C Air Suspension and rear cab mount Kenworth part # K235-1436 or K235-1488	1201-1043	010		83025
		1202-1043	010		83025
	Models with Link Cabmate KWB689-D and Severe service crossmembers	1202K046	010		83049
		R71-1004	010		83049
	Models with Link Cabmate KWMC642 Air Suspension	1202-0054	010		83021

Additional Applications

	60" Sleeper with Link Cab Suspension	1202-0043	010		83032
- 82	Conventional Tractors with A-Model cabs & Link Cabmate Model KWA900	1201-0012	010		83023
		1202-0012	010		83023

APPLICATION GUIDE - TRUCKS, TRAILERS, AND BUSES

Year Año Année	Model Modelo Modèle	OEM #	Front		Rear	
						
						
			Fleetline	GasSLX	Fleetline	GasSLX

KENWORTH CAB SHOCKS(Cont'd.)

Additional Applications(Cont'd.)

86 -	Kenworth Sleepers with Link Cabmate KWS60-A Air Suspension and round cornered doors.	1201-1044	010	83025
	Models with Link Cab Suspension	1202-0022	010	83046
		1202-0042	010	83025
	Models with O.E.M. Number	1202-K065	010	83002
		1202K164	010	83031
		1202K264	010	83031
		PP1058870	010	83059
		R71-6005	010	83042
		T71-1000	010	83031
		T71-1001	010	83031

KIMBLE MIXER CO

Rear Discharge Mixers with Self - Steering Axle Shock	T91-00002-00	010	010
---	--------------	-----	-----	-----	-----	-----	-----

KING OF THE ROAD

Class A MotorHomes

04 - 06	Genesis Series MotorHomes with Freightliner XC Chassis	16-16873-000	010	...	010	85029	...
	ADL200 Suspension w/ 20K Rear	141700131810	010	83160
	AS120 Front Suspension	16-16737-000	010	83160
		16-16874-000	010	83160
	Rear Shock with O.E.M. Number	141700131809		010	85029
		16-16736-000		010	85029
	ZF - IFS Front Suspension with 23,000 lb GVW or Greater	16-18103-000	-1-	85900
		481700000493	-1-	85900

KWK-LOC (JIFFLOX)

Truck Dolly	CP-5222	010	85315
-------------	---------	-----	--------------	-----	-----	-----	-----

LEYLAND TRUCK

Models with Air Trac Suspension (38000 or 40000 lb)	1456033	010	-10	85311	89424
---	---------	-----	-----	-----	-----	--------------	--------------

LINK MANUFACTURING CAB SHOCKS

	Models with Link Cab Suspension	1202-1046	010	83049
06 - 13	Peterbilt 335 Day Cab models with Link Number	1202P055	010	83061
	Models with Link Cab Suspension	1201-0012	010	83023
		1201-0154	010	83051
		1201-0254	010	83051
		1201-1043	010	83025
		1201-1044	010	83025
		1201-1046	010	83049
		1201-1049	010	83025
		1201-1212	010	83013
		1201-1213	01-	83005
		1201-9001	010	83052
		1201-9002	010	83052
		1201-9003	010	83052
		1201-9007	010	83054
		1201-9008	010	83054
		1201-9009	010	83054

APPLICATION GUIDE - TRUCKS, TRAILERS, AND BUSES

Year Año Année	Model Modelo Modèle	OEM #	Front		Rear	
			Fleetline	GasSLX	Fleetline	GasSLX





LINK MANUFACTURING CAB SHOCKS(Cont'd.)

Models with Link Cab Suspension	1201-9010	010		83053
	1201-9011	010		83053
	1201-9013	01-		83062
	1201-9014	01-		83062
	1201-9018	01-		83062
	1201-9021	01-		83062
	1202-0012	010		83023
	1202-0022	010		83046
	1202-0032	010		83016
	1202-0042	010		83025
	1202-0043	010		83032
	1202-0044	010		83025
	1202-0052	010		83021
	1202-0054	010		83021
	1202-1042	010		83025
	1202-1043	010		83025
	1202-1044	010		83025
	1202-1064	010		83024
	1202-1065	010		83002
	1202-1164	010		83031
	1202-1212	010		83013
	1202-1213	01-		83005
	1202-1286	010		83056
	1202K065	010		83002
	1202K164	010		83031
	1202K264	010		83031
	1202K286	010		83056
	632120	010		83046
	632129	010		83023
	635705	010		83016
	654669	010		83021
	654799	010		83025
	654811	010		83024
	654833	010		83021
	654847	010		83002
	654849	010		83031
654867	010		83025	
LG40450	010		83016	
LG40470	010		83016	
R71-1004	010		83049	
R71-1005	010		83024	
T71-1000	010		83031	
T71-1001	010		83031	
T71-1002	010		83002	

LINK MANUFACTURING LTD.

(See Specialty App's Section Also)								
	Sterling Models with Link Rear Air Suspension	1210-0528		010	85904	...
	Models with O.E.M. Number	1210-0005		010	85734	...
		671093		010	85904	...

APPLICATION GUIDE - TRUCKS, TRAILERS, AND BUSES

Year Año Année	Model Modelo Modèle	OEM #	Front		Rear	
						
			Fleetline	GasSLX	Fleetline	GasSLX

LODAL, INC.

Refuse Truck	9960257	OIO	83122	89406
--------------	---------	-----	-------	-------	-----	-----

M.A.N. BUS

Americana Bus with O.E.M. Numbers	25-1700-106-654	-	- -	85708	...
	81-43701-6543		- -	85708	...
	81-43701-6572		85708
	81-43701-6573		85722
Articulating Bus - Drive Axle	81-43701-6537		- -	85709	...
Articulating Bus - Front Axle	81-43701-6538	- -	85708
Articulating Bus - Trailing Axle	81-43701-6539		- -	85708	...
Models with O.E.M. Number	134		- -	85709	...
	81-43701-6609		- -	85709	...
	9020M-1042		- -	85709	...

MAC TRAILER MFG., INC.





Identification of the trailer suspension is necessary to determine what section of the catalog to refer to. Some possible options can be Chalmers, Hendrickson, Neway, Ridewell, Reyco.

MACK

CH Series

CH Models with Hendrickson HA Series Air Suspension	14QK-410M2	OIO	OIO	83137	...
	14QK-410M3		OIO	83125	...
	25625254		OIO	83125	...
CH600 Models with 12000 lb Taperleaf Spring	14QK-392AM	OIO	85005	89430	
	14QK-392BM	OIO	85005	89430	
	14QK-392BM3	OIO	85005	89430	
	14QK-396M	OIO	85005	89430	
	25625743	OIO	85005	89430	
CH600 Models with AL Suspension	14QK-393M		OIO	85010	...
CH600 Models with ALV Hendrickson Suspension	14QK-413M5		O -	83138	...
	14QK-413M6		O -	83111	...
	25622221		O -	83111	...
	25625223		O -	83111	...
CH600 Models with HAS400 MACK Air Suspension	14QK-410M		OIO	83125	...
	25625234		OIO	83125	...
	47902-25		OIO	83125	...
CH600 Models with Hendrickson AL-405 Rear Suspension	14QK-413M7		O -	83111	...
	25625223		O -	83111	...
	57241-006		O -	83111	...
CH600 Models with Hendrickson HN-2 Series Suspension	14QK-415M		O -	83112	...
	14QK-415M7		O -	83112	...
	25624241		O -	83112	...
CH600 Models with Hendrickson Rear Air Suspension	14QK-393AM		OIO	83123	89405
	47902-9		OIO	83123	89405
CH600 Models with Neway AD Air Suspension Shock w/ extend length of 24.30"	14QK-414M2		OIO	85909	...
	25624351		OIO	85909	...
CH600 Models with ST34 Suspension	14QK-2133M	OIO	85001	89410	
	25622466	OIO	85001	89410	
CH600 Models with Steering Axle with Parabolic Taperleaf Spring	14QK-396	OIO	85005	89430	
Models with O.E.M. Number	14QK-2113P6		OIO	85007	89412
	14QK-421M	OIO	85014

APPLICATION GUIDE - TRUCKS, TRAILERS, AND BUSES

Year Año Année	Model Modelo Modèle	OEM #	Front		Rear	
						
			Fleetline	GasSLX	Fleetline	GasSLX

MACK(Cont'd.)

CHN - Series(Cont'd.)

05 - 07	CHN-613 Models w/ MACK Air Suspension	14QK-3101M		010	85066	89448
		471700000431		010	85066	89448
		SDA471700000431		010	85066	89448
05 - 07	CHN-613 Models with 12,000 lb Front Axle	14QK-3107M	010	85061	89450	
		20973993	010	85061	89450	
05 - 07	CHN-613 Models with 14,600 lb Front Axle	20998401	010	85014
05 - 07	CHN-613 Models with Camelback Rear Suspension (SS34 & 38)	25625091		010	83215	...





CHU - Pinnacle Series

08 - 17	CHU-613 Models with 12,000 lb or 14,600 lb Front Axle	14QK-434M	010	85014
		20625775	010	85014
		20998401	010	85014
		SDA471700002861	010	85014
11 - 17	CHU-613 Models with 40,000 lb Rear Air Suspensions	22202560		010	85088	...
		471700009647		010	85088	...
08 - 14	CHU-613 Models with Hendrickson 38,000 lb Rear Air Suspension	14QK-424M		010	83147	...
		20570098		010	83147	...
		60670-006		010	83147	...
- 17	CHU-613 Models with Hendrickson HAS 400 or 460 Series Rear Suspension	60675-001		010	85978	...
		8083872		010	85978	...
- 15	CHU-613 Models with O.E.M. Number	25625091		010	83215	...

CL Series

	CL600, CL700 Models with Neway AD Air Suspension Shock w/ extend length of 24.30"	14QK-414M2		010	85909	...
		25624351		010	85909	...
	CL600, CL700 Models with ALV Hendrickson Suspension	14QK-413M5		01-	83138	...
		14QK-413M6		01-	83111	...
		25622221		01-	83111	...
		25625223		01-	83111	...
	CL600, CL700 Models with HAS400 MACK Air Suspension	14QK-410M		010	83125	...
		25625234		010	83125	...
		47902-25		010	83125	...
	CL600, CL700 Models with Hendrickson HA Series Air Suspension	14QK-410M2		010	83137	...
		14QK-410M3		010	83125	...
		25625254		010	83125	...
	CL600, CL700 Models with Hendrickson HN-2 Series Suspension	14QK-415M		01-	83112	...
		14QK-415M7		01-	83112	...
		25624241		01-	83112	...
	CL600, CL700 Models with Hendrickson Rear Air Suspension	14QK-393AM		010	83123	89405
		47902-9		010	83123	89405
	CL600, CL700 Models with Multileaf Spring Suspension	14QK-392AM2	010	83123	89405	
		14QK-392BM2	010	85321
	CL600, CL700 Models with ST34 Suspension	14QK-2113	010	85001	89410	
		14QK-2133M	010	85001	89410	
		25621955	010	85001	89410	
		25622466	010	85001	89410	
		25632145	010	85001	89410	
	CL600, CL700 Models with Steering Axle & Taperleaf Spring	14QK-392AM	010	85005	89430	
		14QK-392BM	010	85005	89430	

APPLICATION GUIDE - TRUCKS, TRAILERS, AND BUSES

Year Año Année	Model Modelo Modèle	OEM #	Front		Rear	
						
			Fleetline	GasSLX	Fleetline	GasSLX

MACK(Cont'd.)

CL Series(Cont'd.)

	CL600, CL700 Models with Steering Axle & Taperleaf Spring	25625743	010	85005	89430	
--	---	----------	-----	--------------	--------------	--	-----	-----

CS, MS - Mid - Liner Series

	CS Models Mid-Liner with O.E.M Number	4103-5000447861	-10	83105
		4103-5000546892	-10	83105
		V10234121	-10	83105
		V10242320	-10	83105
	MS200, MS300 Models Mid-Liner	V10234121	-10	83105

CV - Series

02 - 07	CV-713 Models with 18,000 lb Front Axles	14QK-366	010	85036	89405	
		25625151	010	85036	89405	
02 - 07	CV-713 Models with Hendrickson HN-2 Models Suspension	14QK-415M		01-	83112	...
		14QK-415M7		01-	83112	...
		25624241		01-	83112	...





CX Series - Vision

	CX Vision Models w/ Hendrickson Air Suspension	14QK-431M		010	85061	89450
	CX Vision Models w/ Hendrickson HA Models Air Suspension	14QK-410M2		010	83137	...
		14QK-410M3		010	83125	...
		25625254		010	83125	...
	CX Vision Models w/ Hendrickson HN-2 Models Suspension	14QK-415M		01-	83112	...
		14QK-415M7		01-	83112	...
		25624241		01-	83112	...
	CX Vision Models w/ Neway AD Air Suspension Shock w/ extend length of 24.30"	14QK-414M2		010	85909	...
		25624351		010	85909	...
	CX Vision Models w/ Parabolic Spring	14QK-431M		010	85061	89450
	CX Vision Models w/ ALV Hendrickson Suspension	14QK-413M5		01-	83138	...
		14QK-413M6		01-	83111	...
		25622221		01-	83111	...
		25625223		01-	83111	...
	CX Vision Models w/ MACK Air Suspension	14QK-3101M		010	85066	89448
		471700000431		010	85066	89448
		SDA471700000431		010	85066	89448
	Models with 12000 lb Taperleaf Front Suspension	14QK-392BM3	010	85005	89430	
	Models with HAS400 MACK Air Suspension	14QK-410M		010	83125	...
		25625234		010	83125	...
		47902-25		010	83125	...
	Models with Hendrickson Air Suspension (Stamping No. 57241-4)	14QK-413M4		01-	83110	...
		25624341		01-	83110	...
	Models with MAC AL405 Suspension	14QK-413M7		01-	83111	...
		25625223		01-	83111	...
		57241-006		01-	83111	...
	Models with O.E.M. Number	141700000373	010	85061	89450	
		20513881	010	85061	89450	

CXN Series

05 - 07	CXN-613 Models w/ MACK Air Suspension	14QK-3101M		010	85066	89448
		SDA471700000431		010	85066	89448
11 - 14	CXN-613 Models with 12,000 - 14,600 lb Front Axles	141700005839	010	85098
		21436096	010	85098
	CXN-613 Models with 12,000 lb Front Axles	14QK-3114M	010	85061	89450	
		20973993	010	85061	89450	

APPLICATION GUIDE - TRUCKS, TRAILERS, AND BUSES

Year Año Année	Model Modelo Modèle	OEM #	Front		Rear	
						
			Fleetline	GasSLX	Fleetline	GasSLX

MACK(Cont'd.)

CXN Series(Cont'd.)

	CXN-613 Models with 12,000 lb Front Axles	SDA141700000380	○ ○	85061	89450	
	CXN-613 Models with 40,000 lb Rear Air Suspensions	14QK-2136M		○ ○	85061	89450
		20897198		○ ○	85061	89450
11 - 14	CXN-613 Models with 40,000 lb Rear Air Suspensions	21462382		○ ○	85088	...
		471700006039		○ ○	85088	...
	CXN-613 Models with Hendrickson AirTek Front Air Suspension	14QK-422M	○ ○	85933	89454	
		20485633	○ ○	85933	89454	
		64838-002	○ ○	85933	89454	

CXP Series

11 - 12	CXP-613 Models with 12,000 - 14,600 lb Front Axles	141700005839	○ ○	85098
		21436096	○ ○	85098
06 - 07	CXP-613 Models with 12,000 lb Front Axles	14QK-3114M	○ ○	85061	89450	
		20973993	○ ○	85061	89450	
		SDA141700000380	○ ○	85061	89450	

CXU - Pinnacle Series

11 - 17	CXU-613 Models with 12,000 - 14,600 lb Front Axles	141700005839	○ ○	85098
		21436096	○ ○	85098
08 - 10	CXU-613 Models with 12,000 lb Front Axles	141700000380	○ ○	85061	89450	
		14QK-3114M	○ ○	85061	89450	
		20973993	○ ○	85061	89450	
		SDA141700000380	○ ○	85061	89450	
08 - 10	CXU-613 Models with 40,000 lb Rear Air Suspensions	14QK-2136M		○ ○	85061	89450
		20897198		○ ○	85061	89450
		471700002626		○ ○	85061	89450
11 - 17	CXU-613 Models with 40,000 lb Rear Air Suspensions	21462382		○ ○	85088	...
		21462384		○ ○	85088	...
		22202559		○ ○	85088	...
		22202560		○ ○	85088	...
		471700006039		○ ○	85088	...
		471700009646		○ ○	85088	...
		471700009647		○ ○	85088	...

DM Series

	Models with O.E.M. Number	14QK-2100P8	○ ○	83242
		25622345	○ ○	83242





F Series

	F Models - Eastern	○ ○	83221
	F Models (exc. Eastern)	○ ○	83207	89407	○ ○	83215	...
	F Models with Standard Suspension	○ ○	85305	...
	Fire Truck		85302	...	○ ○	85302	89420
	FL Models - Western	14QK-143	○ ○	83207	89407	
		14QK-2100D-P4	○ ○	83207	89407	

Granite Series - GU-432, GU-533, GU-713, GU-813

12 - 17	GU-432 or GU-533 Models with 12,000 lb or 14,600 lb Front Axle	20998401	○ ○	85014
12 - 17	GU-432 or GU-533 Models with 14,600 lb to 18,000 lb Multi-Leaf Front Springs	21010744	○ ○	83101
12 - 17	GU-432 or GU-533 Models with Hendrickson HAS 400 or 460 Series Rear Suspension	60675-001		○ ○	85978	...
		8083872		○ ○	85978	...
	GU-713 or GU-813 Models O.E.M. Number	21687170	○ ○	85120

APPLICATION GUIDE - TRUCKS, TRAILERS, AND BUSES

Year Año Année	Model Modelo Modèle	OEM #	Front		Rear	
						
			Fleetline	GasSLX	Fleetline	GasSLX

MACK(Cont'd.)

Granite Series - GU-432, GU-533, GU-713, GU-813(Cont'd.)

08 - 17	GU-713 or GU-813 Models with 14,600 lb to 18,000 lb Multi-Leaf Front Springs	14QK-3116M	010	83101
		21010744	010	83101
08 - 10	GU-713 or GU-813 Models with 20,000 lb Front Axles	14QK-3108M	01-	85080
		14QK-427M	01-	85080
		20863239	01-	85080
		25626048	01-	85080
		47170000445	01-	85080
08 - 15	GU-713 or GU-813 Models with Hendrickson 38,000 lb Rear Air Suspension	14QK-424M		010	83147	...
		20570098		010	83147	...
		60670-006		010	83147	...
08 - 17	GU-713 or GU-813 Models with Hendrickson HAS 400 or 460 Series Rear Suspension	60675-001		010	85978	...
		8083872		010	85978	...
08 - 17	GU-713 or GU-813 Models with Hendrickson HAS Series Rear Suspension	22314111		010	85036	89405
		60675-13		010	85036	89405

LE & LEU Series

	LE & LEU 613 Models with Ridewell RD-202S HD Tandem Drive Truck Suspension	1252607B000		010	85702	...
01 - 06	LE 613 Models with O.E.M Number	14QK-366P4	010	83209	89414	
		25625187	010	83209	89414	
2009	LEU 613 Models with 18,000 lb Front Axle	14QK-372M2	010	83209	89414	
		25632561	010	83209	89414	
10 - 16	LEU 613 Models with 20,000 lb Front Axle	21002497	010	85972

MH Series

	MH Models - 4" Wide Springs	14QK-373	010	83215
		14QK-378M	010	83215
		25623321	010	83215
	MH Models with Camelback Rear Suspension (SS34 & 38)	14QK-2107P1		010	83215	...
		14QK-2107P2		010	83215	...
		25625091		010	83215	...
	MH Models with Neway ARD-234 Air Suspension	14QK-375M		010	83123	89405
	MH Models with O.E.M. Number	14QK-2113P5	010	85001	89410	
		14QK-2133M	010	85001	89410	
		14QK-2133M2	010	85001	89410	
		14QK-377M	010	83215
		14QK-392AM	010	85005	...	010	85005	89430
	MH Models with Taperleaf Rear Suspension	14QK-2113P4		010	85007	89412





MR Series

	Models with O.E.M. Number	14QK-3115M	010	85972
		21002497	010	85972

R Series

	R, RU, RD600 Models-3 1/2" Wide springs	14QK-366P1	010	85036	89405	
	R, U Models	010	83221	...	010	83215	...
	R, U, RD 600 Models	14QK-2115	010	85305
		14QK-29302	010	83207	89407	
		25632147	010	85305
	R, U, RD 600 Models/ MR600 Models with Front Taperleaf Springs	14QK-366	010	85036	89405	
		14QK-366P1	010	85036	89405	

APPLICATION GUIDE - TRUCKS, TRAILERS, AND BUSES

Year Año Année	Model Modelo Modèle	OEM #	Front		Rear	
						
			Fleetline	GasSLX	Fleetline	GasSLX

MACK(Cont'd.)

R Series(Cont'd.)

R, U, RD 600 Models/ MR600 Models with Front Taperleaf Springs	25625151	OIO	85036	89405
RB 600 Models (Drive Axle)	14QK-2107		OIO	83215
	14QK-393M		OIO	85010
RD Models with ST34 Suspension	14QK-2133M	OIO	85001	89410
	25622466	OIO	85001	89410
RD800 Models with Shock Absorbers & Taperleaf Suspension (SWT & SWTL 561)(ST-34)	14QK-2110	OIO	85305

RW Series

RW Models - 4" Wide Springs	14QK-373	OIO	83215
	14QK-378M	OIO	83215
	25623321	OIO	83215
RW Models with Camelback Rear Suspension (SS34 & 38)	14QK-2107P1		OIO	83215
	14QK-2107P2		OIO	83215
	25625091		OIO	83215
RW Models with Neway ARD-234 Air Suspension	14QK-375M		OIO	83123 89405
RW Models with O.E.M. Number	14QK-2113P5	OIO	85001	89410
	14QK-2133M	OIO	85001	89410
	14QK-2133M2	OIO	85001	89410
	14QK-377M	OIO	83215
	14QK-392AM		85005	...	OIO	85005 89430
	25622466	OIO	85001	89410
RW Models with Taperleaf Rear Suspension	14QK-2113P4		OIO	85007 89412





TD - Titan Series

08 - 10	TD-713 Models with 20,000 lb Front Axle	14QK-493M 21155033	OIO	83101
			OIO	83101
10 - 15	TD-713 Models with Hendrickson 38,000 lb Rear Air Suspension	14QK-424M 20570098 60670-006		OIO 83147
				OIO 83147
				OIO 83147
- 16	TD-713 Models with Hendrickson 40,000 lb Pimaax EX and FireMaax EX Air Suspension	20782199 60657-007		OIO 85072
				OIO 85072
- 17	TD-713 Models with Hendrickson HAS 400 or 460 Series Rear Suspension	60675-001 8083872		OIO 85978
				OIO 85978
- 17	TD-713 Models with Hendrickson HAS Series Rear Suspension	22314111 60675-13		OIO 85036 89405
				OIO 85036 89405

Additional Applications

	B Models	14QK-142		OIO 85305
	CF Fire Chassis	14QK-2102		OIO 85304
	CM 422 Tractor	14QK-390	-IO	83105
		V10242320	-IO	83105
	DM Models	OIO	83209	89414	OIO 83215
	MB Models	OIO	83221	...	OIO 83215
		14QK-2100P4	OIO	83207	89407	...
	Model 75 Bogie Axle	OIO 83215
	Models with 12000 lb Taperleaf Spring	14QK-392AM3	OIO	85005	89430	...
06 - 16	Models with Hendrickson 40,000 lb Primaax, Pimaax EX and FireMaax EX Air Suspension	60657-007		OIO 85072
	Models with Hendrickson AirTek Front Air Suspension	14QK-422M	OIO	85933	89454	...
		20469001	OIO	85933	89454	...
		20469002	OIO	85933	89454	...

APPLICATION GUIDE - TRUCKS, TRAILERS, AND BUSES

Year Año Année	Model Modelo Modèle	OEM #	Front		Rear	
						
			Fleetline	GasSLX	Fleetline	GasSLX

MACK(Cont'd.)





Additional Applications(Cont'd.)

	Models with Hendrickson AirTek Front Air Suspension	20485632	010	85933	89454	
		20485633	010	85933	89454	
		471700131921	010	85933	89454	
		64838-002	010	85933	89454	
	Models with Hendrickson HAS-40LH Air Suspension (O.E. Number 57241-4)	14QK-413M4		01-	83110	...
	Models with Inverted Camelback Spring Suspension	14QK-142P1	010	83215
	Models with MAC AL405 Suspension	14QK-413M		01-	83111	...
	Models with Meritor AirLink Suspension	14QK-3100		010	85739	...
		446-51-211		010	85739	...
	Models with Neway Rear Suspension (With O.E.Stamping 90045099)	14QK-414M		010	85906	89407
		25633154		010	85906	89407
75 - 79	W Models - Western	010	83207	89407	010	83215	...

Additional O.E.M. Interchanges

	Models with O.E.M. Number	14QK-1200P4	010	83207	89407	
		14QK-140	010	85304
		14QK-142AP1	010	83215
		14QK-145	010	85307
		14QK-2100P2	010	83209	89414	
		14QK-2100P3	010	83207	89407	
		14QK-2100P5	010	83221
		14QK-2100P6	010	85036	89405	
		14QK-2100P7	010	83221
		14QK-2105	010	83209	89414	
		14QK-2107P3	010	83215
		14QK-2108	010	83203	89436	
		14QK-2108P1	010	83203	89436	
		14QK-2113P3	010	85001	89410	
		14QK-288-P1	010	85007	89412	
		14QK-29001P2	010	85303	89422	
		14QK-29301P1	010	83207	89407	
		14QK-29301P2	010	83207	89407	
		14QK-3108	01-	85080
		14QK-366P2	010	85036	89405	
		14QK-366P3	010	85036	89405	
		14QK-372M3	010	83122	89406	
		14QK-378	010	83215
		14QK-423M		010	85978	...
		14QK-428	01-	85080
		14QK-428M	01-	85080
		25621571	010	83215
		25626149	01-	85080
		471700000451	01-	85080
		471700002861	010	85014
		57241-004		01-	83110	...
		5966-90044025	010	83209	89414	
651103	010	85036	89405			
	Additional O.E.M. Interchanges	14QK-140P1	010	83225				
		14QK-20001P2	010	85308 or 89422				
		14QK-2100	010	83221				
		14QK-2100P1	010	83221				

APPLICATION GUIDE - TRUCKS, TRAILERS, AND BUSES

Year Año Année	Model Modelo Modèle	OEM #	Front		Rear	
						
			Fleetline	GasSLX	Fleetline	GasSLX

MACK(Cont'd.)

Additional O.E.M. Interchanges(Cont'd.)

Additional O.E.M. Interchanges			
	14QK-2110P1	010	85305
	14QK-282P1	010	83216
	14QK-282P3	010	83216
	14QK-288P2	010	83217
	14QK-29302P1	010	83207 or 89407
	14QK-372M	010	83221
	14QK-392M	010	85005 or 89430
	25624365	010	83217
	4940654	010	83216
	5533699	010	85302 or 89420
	5554184	010	85302 or 89420
	650102	010	85001 or 89410
	650107	-10	85316 or 89426
	650107MT	-10	85316 or 89426
	650400MT	-10	85033 or 89427
	650402	-10	85311 or 89424
	650402MT	-10	85311 or 89424
	650404	-1-	85310 or 89423
	650404MT	-1-	85310 or 89423
	650405	010	85023 or 89415
	650405MT	010	85023 or 89415
	650406	010	85024 or 89416
	650408	-10	85319 or 89428
	650408MT	-10	85319 or 89428
	651012	010	83221
	651151	010	83209 or 89414
	70042	010	85302 or 89420

MACK CAB SHOCKS

CH Series

Models with O.E.M. Number			
	14QK-411	010	83007
	14QK-411AM	010	83007
	14QK-411M	010	83007
	25631922	010	83007

CHN - Series

05 - 07	CHN-613 Models with O.E.M. Number		
	14QK-3103M	01-	83050
	20874147	01-	83050

CHU - Pinnacle Series

- 17	CHU-613 Models with Hi - Roof Sleeper Cabs with O.E.M. Number		
	25625636	01-	83045
	21345869	010	83066
	21490486	010	83066
08 - 11	CHU-613 Models with O.E.M. Number		
	14QK-303M	01-	83050
	14QK-3103M	01-	83050
	20874147	01-	83050





CL Series

Models with O.E.M. Number			
	14QK-391AM	01-	83041
	14QK-391AM2	01-	83041

CT, CTX - Series

Models with O.E.M. Number			
	14QK-303M	01-	83050
	14QK-3103M	01-	83050

APPLICATION GUIDE - TRUCKS, TRAILERS, AND BUSES

Year Año Année	Model Modelo Modèle	OEM #	Front		Rear	
						
			Fleetline	GasSLX	Fleetline	GasSLX

MACK CAB SHOCKS(Cont'd.)

CT, CTX - Series(Cont'd.)

	Models with O.E.M. Number	20874147	0 -	83050
--	---------------------------	----------	-----	-------

CX (Vision) Series

	Models with Sleeper Cabs w/O.E.M. Numbers	14QK-399M	0 -	83045
		14QK-399M2	0 -	83045
		14QK-399M3	0 -	83045
		25625635	0 -	83045
		25625636	0 -	83045
		25625637	0 -	83045

CXN Series

05 - 06	CXN-613 Models with O.E.M. Number	14QK-3103M	0 -	83050
		20874147	0 -	83050
- 14	Models with Sleeper Cabs w/O.E.M. Numbers	25625635	0 -	83045

CXP - Series

06 - 07	CXP-613 Day Cab Models	14QK-3103M	0 -	83050
		20874147	0 -	83050
11 - 12	CXP-613 Models with Sleeper Cabs	25625636	0 -	83045

CXU - Pinnacle Series

2008 - 17	CXU-613 Models with Hi - Roof Sleeper Cabs with O.E.M. Number	25625636	0 -	83045
2011 - 16	CXU-613 Models with Mid - Roof Sleeper Cabs with O.E.M. Number	25625635	0 -	83045
	CXU-613 Models with O.E.M. Number	21345869	0 0	83066
		21490486	0 0	83066
08 - 11	CXU-613 Models with O.E.M. Number	14QK-303M	0 -	83050
		14QK-3103M	0 -	83050
		20874147	0 -	83050

Granite Series - GU-432, GU-533, GU-713, GU-813

	GU 713 and GU 813 Models with O.E.M. Number	21345869	0 0	83066
		21490486	0 0	83066
08 -	GU 713 and GU 813 Models with O.E.M. Number	14QK-432M	0 -	83050
		20873442	0 -	83050

R - Series

	R 600 Tractors with Link Cabmate Model MCR600	1201-0012	0 0	83023
		1202-0012	0 0	83023
	R, RD Models	14QK-382	0 -	83018
		14QK-382-P2	0 -	83018
	R, RD400 & 600 Models with Cab Air suspension	14QK-2111-P4	0 -	83019
	RS & Superliner Tractors with Link Cabmate Model MCRS600	1201-0012	0 0	83023
		1202-0012	0 0	83023
	RW Models	14QK-29303-P2	- -	83014

TD - Titan Series

- 17	TD - Titan Models with O.E.M. Number	14QK-440M	0 -	83058
		21154397	0 -	83058

Additional Applications

02 - 07	CV-713 Models with O.E.M number	14QK-391BM	0 -	83041
	MH Models with Air Cab	14QK-374	- 0	83003
		14QK-376	- 0	83003
	Models with Link Cab Suspension	1202-0012	0 0	83023
		1202-0022	0 0	83046
		1202-0032	0 0	83016
	Models with O.E.M. Number	14QK-2111	0 -	83019

APPLICATION GUIDE - TRUCKS, TRAILERS, AND BUSES

Year Año Année	Model Modelo Modèle	OEM #	Front		Rear	
			Fleetline	GasSLX	Fleetline	GasSLX

MACK CAB SHOCKS(Cont'd.)









Additional Applications(Cont'd.)

Models with O.E.M. Number	14QK-2111-P2	01-			83019
	14QK-391BM2	01-			83041
	14QK-391M	01-			83041
	14QK-391M2	01-			83041
	14QK-439M	01-			83050
	21154393	01-			83050
	21345868	010			83066
	25622612	01-			83041
	25622613	01-			83041
	25624837	01-			83041

MAECO

Bus with O.E.M. Number	1668722		85030	...	010	85030	89440
FedEx Trucks with O.E.M. Number	16950	010	83118
UPS Trucks with O.E.M. Number	16949		01-	83120	...
Additional O.E.M. Interchanges	1085	010				83214	
	12608	010				83125	
	12788	010				83216	
	12866	010				83207 or 89407	
	16385	010				83215	
	16720	010				83107	
	16767	010				85013	
	16768	010				83217	
	16769	010				83221	
	16770	010				83209	
	16771	010				83126 or 89430	
	16772	010				83122 or 89406	
	16773	010				85005	
	16774	010				83215	
	16775	010				83207 or 89407	
	16776	010				83122	
	16777	010				85006	
	16778	010				83203	
	16779	010				83126 or 89440	
	16780	010				83123 or 89405	
	16781	010				85006	
	16787	010				85030 or 89440	
	6025	010				83122 or 89406	
	6026	010				83204	
	70018	010				85303 or 89422	
	70021	010				85303 or 89422	
	70029	010				85308 or 89422	
	70034	010				85302 or 89420	
	70039	010				85303 or 89422	
	70041	010				85305	
	70042	010				85302 or 89420	
	70088	010				85307	
	70123	010				85716	
70127	010				85006 or 89401		
70128	010				85006 or 89401		
70162	010				85716		

APPLICATION GUIDE - TRUCKS, TRAILERS, AND BUSES

Year Año Année	Model Modelo Modèle	OEM #	Front		Rear	
						
						
			Fleetline	GasSLX	Fleetline	GasSLX

MAECO(Cont'd.)





Additional O.E.M. Interchanges	OEM #	Code	Part #
	70163	010	85302 or 89420
	70164	010	85716
	70300	010	85320 or 89429
	70312	010	85001 or 89410
	70315	010	85063
	70317	010	89432
	70331	010	85314 or 89425
	70332	010	83314
	70334	-10	85316 or 89426
	70397	010	85006
	70402	010	85305
	70642	010	85300
	70644	010	85334
	70646	010	85313
	70647	-1-	85701
	70648	010	89414
	70650	010	89440
	70651	010	85013 or 89414
	70652	010	85030 or 89440
	70663	010	85013 or 89414
	70691	010	85007
	70720	010	85934
	70721	010	83125
	74039	010	85303 or 89422
	OE10881	-10	85711
	OE10882	01-	85740
	OE10883	010	85339
	OE12425	010	83214
	SC-2920	010	83176

MANDALAY COACH

Class A MotorHomes

Year	Description	OEM #	Code	Part #	Code	Part #
04 - 06	Mandalay Series MotorHomes with Freightliner XC Chassis ADL200 Suspension w/ 20K Rear AS120 Front Suspension	16-16873-000		...	010	85029
		141700131810	010	83160		...
		16-16737-000	010	83160		...
		16-16874-000	010	83160		...
	Rear Shock with O.E.M. Number	141700131809		...	010	85029
		16-16736-000		...	010	85029
		16-18103-000	-1-	85900		...
		481700000493	-1-	85900		...
06	Presidio & Valencia Series MotorHomes with Freightliner XC Chassis AS120 Front Suspension	141700131810	010	83160		...
		16-16737-000	010	83160		...
		16-16874-000	010	83160		...
		141700131809		...	010	85029
	Rear Shock with O.E.M. Number	16-16736-000		...	010	85029
		16-18103-000	-1-	85900		...
		481700000493	-1-	85900		...

APPLICATION GUIDE - TRUCKS, TRAILERS, AND BUSES

Year Año Année	Model Modelo Modèle	OEM #	Front		Rear	
						
			Fleetline	GasSLX	Fleetline	GasSLX

MARMON

Models with O.E.M. Number	1-7001	O1O	83216
	37-1-1	O1O	83122	89406	
	51-139-28		O1O	85003	89411
	51-163-7		O1O	83123	89405
	576451	O1O	83122	89406	
	665147	O1O	83216

MARMON CAB SHOCKS

81 -	Conventional Tractors with Link Cabmate Model MARC57-B	1202-0054	O1O				83021
	Models with Link Cab Suspension	1202-0022	O1O				83046

MATSON SCHOOL BUS

Models with O.E.M. Number	5392387	O1O	85303	89422	
---------------------------	---------	-----	--------------	--------------	--	-----	-----

MC NEILUS TRUCK & MAN.

Mc Neilus part number	1139039 MTM	O1O	85334
	1139046 MTM		O1-	83112	...
	1139059 MTM		O1O	83207	89407
	1139069 MTM		O1O	83209	89414
	12405FX1 MTM		85303	...	O1O	85303	89422
	1323106 MTM		O1O	85305	...
	1333575 MTM		O1O	85072	...
	1340975 MTM		O1-	83142	...
	1340976 MTM	O1O	85919
	1340979 MTM		O1-	83143	...
	1360386 MTM		O1O	85323	89436
	1367383 MTM		O1O	83147	...
	1396513 MTM	O1O	85959
	1398980 MTM		O1O	83127	...
	1404068 MTM		O1O	85980	...
	1404068 MTM		O1O	85087	...
	1410046 MTM	O1O	85919
	1411765 MTM		O1O	83148	...
	1412744 MTM		O1O	85966	...
	1429317 MTM	O1O	85919		
	1431085 MTM		O1O	85738	...
	1432386 MTM		O1O	85965	...
	1433009 MTM		O1O	85962	...
	1468783 MTM		O1O	85345	...
	1485576 MTM		O1O	85979	...
	1491909 MTM		O1O	83128	89436
	1KK552 MTM		O1O	85967	...
	2218640 MTM	O1O	83009		
	3215395 MTM		O1-	83112	...
	3HR582 MTM		O1O	85013	89414
	3HR582 MTM		O1O	85013	89414
	3HR916 MTM		O1O	83207	89407
	4HA569 MTM	O1O	85932	89453	
	4KP398 MTM	O1O	85933	89454	
	5HA994 MTM		O1O	85916	...
	5HB645 MTM		O1-	83109	...
	5KK247 MTM		O1-	85977	...

APPLICATION GUIDE - TRUCKS, TRAILERS, AND BUSES

Year Año Année	Model Modelo Modèle	OEM #	Front		Rear		
						Fleetline	GasSLX

MC NEILUS TRUCK & MAN.(Cont'd.)

	Mc Neilus part number	64442AX MTM		OIO	83128	...
		6HA961 MTM		OIO	83123	89405
		6HB390 MTM		OIO	83137	...
		6HD720 MTM		OIO	85909	...
		6HS773 MTM		OIO	83122	89406
		6KP857 MTM		OIO	85000	89436
		7HS237 MTM		OIO	83122	89406
		7HS534 MTM		OIO	85906	89407
		8KK524 MTM		OIO	83168	...
		9HB362 MTM		OIO	85976	...
		9KK464 MTM		OIO	85079	...
		Models with O.E.M. Number	217330	OIO	85303			

MERITOR

	Air Link Suspensions with O.E.M. Number	14QK-3100		OIO	85739	...
		446-51-211		OIO	85739	...
	AL460 Air Link Suspension	700115		OIO	85712	...
	AL520 Air Link Suspension	700115		OIO	85712	...
	FlexAir 9NB Suspension with O.E.M. Number	21224745		OIO	86203	...
		21224778		OIO	86202	...
		671502		OIO	86202	...
		671503		OIO	86203	...
	FS230 Trailer Suspension (Light Duty)	A-7805P-1030		OIO	85737	...
	FS230 Trailer Suspension (Std Duty)	671507		OIO	87015	...
		A-7805L-1026		OIO	87015	...
	FS230T	21227751		OIO	87015	...
		671020		OIO	87015	...
	Meritor Kit 11210 includes washers and nuts (For Shock only)	KIT11210		OIO	87015	...
	MTA 25T / MTA 30T Trailer Air Suspension	671506		OIO	86200	...
		7805-F-1020		OIO	86200	...
		A-7805F-1020		OIO	86200	...
	RC S 9L Suspension	21228392		OIO	86201	...
		671500		OIO	86201	...
	RFS 23T / 25T / 30T Trailer Air Suspensions	21227751		OIO	87015	...
		A-7805L-1026		OIO	87015	...
	RHP11, RHP55 and RideSentry Trailer Suspension	202447		OIO	85919	...
		A-3280-M-9711		OIO	85919	...
01 -	RHP11, RHP55 and RideSentry Trailer Suspension	A-7805L-1000		OIO	85919	...
	Models with O.E.M. Number	671907		OIO	85919	...
		680705		OIO	85737	...

MITSUBISHI-FUSO

FE Series

07/86 -	FE434, FE439, FE444, FE450	MB025382					
				OIO	G63299	...
96 - 97	FE639, FE639SP, FE639HDT	MC114595		OIO	G63405	...

FF Series

86 - 87	FF415	MC813511	-I-	G63398
---------	-------	----------	-----	--------	-----	-----	-----	-----

FH Series

10/87 - 96	FH100 Suspension (All)	MC809390		-I-	83103	...
				MC826268	-IO	G63610

APPLICATION GUIDE - TRUCKS, TRAILERS, AND BUSES

Year Año Année	Model Modelo Modèle	OEM #	Front			Rear		
						Fleetline	GasSLX	Fleetline

MITSUBISHI-FUSO(Cont'd.)

FK Series(Cont'd.)

11/85-11/86	FK414	MC813511	-I-	G63398
06/88-02/91	FK455	MC814614	-IO	85009
03/91-06/93	FK457	MC814614	-IO	85009

FM Series

06/88-02/91	FM555	MC814614	-IO	85009
11/85-05/88	FM555	MC813135	-I-	83456	89447
05/89-06/93	FM557	MC814614	-IO	85009





MOHAWK

Additional O.E.M. Interchanges	01-0100-905	OIO	85303 or 89422
	020273544	OIO	83203 or 89436
	050134508	OIO	85718
	10134504	OIO	85715
	10134506	OIO	85714
	10234503	OIO	85714
	10234504	OIO	85717
	1235233	OIO	85736
	22012079	-I-	85701
	22012082	OIO	85702
	22012114	OIO	85700
	4968853	OIO	83216
	6-367-7	OIO	85305
	680323	OIO	85700
	680332	-I-	85701
	680485	OI-	85733
	695195	-I-	85707
	695196	-I-	85707
	97-2201-00007	-IO	85703
	97-2201-00011	OIO	85704
	97-9999-02320	OIO	85704
	MM-6886	OIO	83207 or 89407
	MM-6957	OIO	83225
	MM-74029	OIO	85308 or 89422

MONACO

98 - 14	All Models with W20 & W22 Workhorse Motorhome Chassis	24-186629	OIO	85125
			F4-BE5-B492-HO	OIO	85125
99 - 03	Monarch and LaPalma Models with F53 Motorhome Chassis (16,000 lb to 22,000 lb GVW)	OIO	83209	...	OIO	83122
90 - 97	Monarch and LaPalma Models with F53 Motorhome Chassis (7.5 L, Gas V8)	OIO	83209	...	OIO	85097
01 - 04	Monarch and LaPalma Models with W20 & W22 Workhorse Motorhome Chassis	24-186537		OI-	85126
		24-186629	OIO	85125
		F4-BE5-A011-HO		OI-	85126
		F4-BE5-B492-HO	OIO	85125
95 - 99	MotorHomes with Freightliner XC Chassis (22,000 to 26,000 lb GVW)	OIO	83160	...	OIO	85029

APPLICATION GUIDE - TRUCKS, TRAILERS, AND BUSES

Year Año Année	Model Modelo Modèle	OEM #	Front		Rear	
						
			Fleetline	GasSLX	Fleetline	GasSLX

MONACO(Cont'd.)

01 - 04	Vacationer Models with W20 & W22 Workhorse Motorhome Chassis	24-186537	01-	85126	...
		24-186629	85125	...	010
		F4-BE5-A011-HO	01-	85126	...
		F4-BE5-B492-HO	85125	...	010

MOR-RYDE SUSPENSION

Bus Suspension	-1-	83103	...
	U0109-006	010	G63866	...
Recreational Vehicle	U0109-014	-1-	83400	...
	U0109-018	010	G63866	...
Trailer Rear	U0109-007	010	G63183	...

MOTOR COACH INDUSTRIES





Additional Applications

Drive Axle	12J-5-2	01-	85312	...
	12J-5-4	01-	85312	...
	12L-5-71	-1-	85708	...
	T14-1081	01-	85729	...
Low Floor Bus Models with O.E.M. Number	12L-5-99	010	85339	...
MC5, MC7, MC8	12B-5-1	85735	...	010	85735	...
	3178157	85700	...	010	85700	...
	680323	85700	...	010	85700	...
RTS Bus with "V" Drive Rear	G1101590GS	010	85713	...
RTS Bus with Normal Front	695117	-1-	85701
	74410	-1-	85701
RTS Bus with Regular Rear	G1011822	010	85702	...
RTS Bus with Solid Front Axle	22024673	-10	85710
Steering - Tag Axle	12L-4-170	010	83158	...
	654789	010	83158	...
Tag Axle	12-05-6068	-1-	85727	...
	12J-5-11	010	85313	...
	12J-5-3	010	85313	...
	T14-1082	-1-	85727	...

D - Series Coaches

D 4000 Coach (Drive Axle)	12-05-1177	01-	85729	...	
	12-05-1328	01-	85729	...	
	(Front Axle)	12-05-1176	-1-	85728	
		12-05-1327	-1-	85728	
	(Trailing Axle)	12L-5-97	-1-	85728	
		12-05-1178	010	85339	...
		12-05-1194	010	85339	...
	12L-5-99	010	85339	...	
D 4005 Coach (Drive Axle)	12-05-1177	01-	85729	...	
	12-05-1328	01-	85729	...	
	(Front Axle)	12-05-1176	-1-	85728	
		12-05-1327	-1-	85728	
	(Trailing Axle)	12L-5-97	-1-	85728	
		12-05-1194	010	85339	...
		12L-5-99	010	85339	...

APPLICATION GUIDE - TRUCKS, TRAILERS, AND BUSES

Year Año Année	Model Modelo Modèle	OEM #	Front		Rear	
						
			Fleetline	GasSLX	Fleetline	GasSLX

MOTOR COACH INDUSTRIES(Cont'd.)

D - Series Coaches(Cont'd.)

D 4500 Coach (Drive Axle)	12-05-1177 12-05-1328 12L-5-88 85729		0 -	85729	...			
			0 -	85729	...			
			0 -	85729	...			
			0 -	85729	...			
			(Front Axle)	12-05-1176 12-05-1327	- -	85728
						85728
						85728
			(Trailing Axle)	12L-5-67 12-05-1179 12-05-1329 12L-5-114	- -	- -	85727	...
						- -	85727	...
						- -	85727	...
						- -	85727	...
			D 4505 Coach (Drive Axle)	12-05-1177 12-05-1328 12L-5-88		0 -	85729	...
...	...	0 -				85729	...			
...	...	0 -				85729	...			
(Front Axle)	12-05-1176 12-05-1327	- -				85728
						85728
						85728
(Trailing Axle)	12L-5-67 12-05-1179 12-05-1329 12L-5-114	- -				- -	85727	...
						- -	85727	...
						- -	85727	...
						- -	85727	...
DL3 Bus	12-05-1327 12-05-1328 12L-5-88 12L-5-89 12L-5-96 12L-5-97	- -				85728
						0 -	85729	...
			0 -	85729	...			
			0 -	85729	...			
			85728			
			85728			
DL3 Bus -Drive Axle	12J-5-10		0 -	85733	...			
DL3 Bus -Tag Axle	01-205219 12-05-1329 12L-5-100 12L-5-114 T12-1208		- -	85727	...			
			- -	85727	...			
			- -	85727	...			
			- -	85727	...			
			- -	85727	...			





E - Series Coaches

E 4500 Coach (Drive Axle)	12-05-1022 12-05-1102 12-05-1138 12-05-1148 12-05-1188		0 -	85970	...			
			0 -	85970	...			
			0 -	85970	...			
			0 -	85970	...			
			(Front Axle)	12-05-1150 12-05-1165	- 0	85711
						85711
						0 -	85341	...
			(Trailing Axle)	12-05-1139 12-05-1147 12-05-1166	- 0	0 -	85341	...
						0 -	85341	...
						0 -	85341	...

G - Series Coaches

G 4500 Coach Drive Axle	12-05-6001 12-05-6054		0 -	85740	...			
			0 -	85740	...			
			Front Axle	12-05-6000 12-05-6053	- 0	85711
						85711

APPLICATION GUIDE - TRUCKS, TRAILERS, AND BUSES

Year Año Année	Model Modelo Modèle	OEM #	Front		Rear	
						
			Fleetline	GasSLX	Fleetline	GasSLX

MOTOR COACH INDUSTRIES(Cont'd.)

G - Series Coaches(Cont'd.)

	Drive Axle	1497835	- O	85711
	Tag Axle	1498565		O O	85339	...
	Trailing Axle	12-05-6002		O O	85339	...
		12-05-6033		O O	85339	...
		12-05-6055		O O	85339	...





J - Series Coaches

	J 4500 Coach (Drive Axle)	12-05-1022		O -	85970	...	
		12-05-1138		O -	85970	...	
		12-05-1148		O -	85970	...	
		12-05-1188		O -	85970	...	
	(Front Axle with OEM Number)	12-05-1137		O -	85340
		12-05-1142		O -	85340
		12-05-1146		O -	85340
		12-05-1150		- O	85711
		12-05-1165		- O	85711
	(Trailing Axle)	12-05-1228		- O	85711
		12-05-1139			O -	85341	...
		12-05-1147			O -	85341	...
		12-05-1166			O -	85341	...

Additional O.E.M. Interchanges

	Models with O.E.M. Number	12-05-1021	O -	85340
		12-05-1023		O -	85341	...
		12-05-1101	O -	85340
		12-05-1103		O -	85341	...
		12-05-1170	O -	85340
		12-05-1199		O -	85729	...
		12-05-1242	- -	85728
		12-05-1243		O -	85729	...
		12-05-1244		- -	85727	...
		12-5-1-G	O O	85700
		12-5-1-GS	O O	85700
		12B-5-1-G	O O	85700
		12B-5-1-GS	O O	85700
		12J-5-10GS		O -	85733	...
		12L-5-58	- -	85728
		12L-5-69	O O	85700
		12L-5-98		O O	85339	...
		12T-1-13		85303	...	O O	85303	89422
		12TA-01-013		85303	...	O O	85303	89422
		1498200		O -	85740	...
		22012067	O O	85700
		22024061		O O	85704	...
		22045526		O O	85702	...
		22046485	- O	85710
		3178154		O O	85735	...
		4975515	- -	85701
		4975515GS	- -	85701
		5316984		85313	...	O O	85313	...
		63-0127GS		85303	...	O O	85303	89422
		680231		O O	85313	...

APPLICATION GUIDE - TRUCKS, TRAILERS, AND BUSES









Year Año Année	Model Modelo Modèle	OEM #	Front		Rear	
			 	 		
			Fleetline	GasSLX	Fleetline	GasSLX

MOTOR COACH INDUSTRIES(Cont'd.)

Additional O.E.M. Interchanges(Cont'd.)

Models with O.E.M. Number	680232		01-	85733	...
	680322		010	85704	...
	680323	010	85700
	680350	-10	85710
	680369		-1-	85708	...
	680374	-1-	85728
	680441		01-	85729	...
	680452		010	85339	...
	680462	-1-	85728
	680470		010	85713	...
	680482		-1-	85727	...
	680485		01-	85733	...
	680544	-10	85711
	680546		010	85339	...
	680602		010	85339	...
	680677	-1-	85728
	680680		01-	85729	...
	680681		-1-	85727	...
	695125		010	85704	...
	97-9999-02585	01-	85723
	G1101590		010	85713	...
	G1201338	-10	85710
	G1201339		010	85702	...
	G5008069	010	85700
	OE10086S		010	85702	...
	OE10881	-10	85711
	OE10882		01-	85740	...
	OE10883		010	85339	...
	T14-1029	-1-	85701
	T14-1045GS	010	85700
	T14-1048		010	85302	89420
T14-1080	-1-	85728	
Additional O.E.M. Interchanges	12G-5-1	010				85700	
	12J-5-6	010				85313	
	12J-5-7	01-				85312	
	12J-5-71	01-				85733	
	12J-5-9	010				85700	
	12L-5-70	010				85700	
	12L-5-72	010				85709	
	22012066	-1-				85707	
	22012079	-1-				85701	
	22052014	010				85702	
	6314933	-1-				85708	
	680332	-1-				85701	
	680333	-1-				85708	
	690029	010				85700	
	97-2201-00151	010				85700	
	97-2210-00164	-1-				85708	
	97-9999-02514	010				85700	
97-9999-02634	01-				85733		

APPLICATION GUIDE - TRUCKS, TRAILERS, AND BUSES

Year Año Année	Model Modelo Modèle	OEM #	Front		Rear	
						
						
			Fleetline	GasSLX	Fleetline	GasSLX

MUNCIE RECLAMATION

Additional O.E.M. Interchanges

	Models with O.E.M. Number	665459		- -	89447	...
		665568		0 0	85051	...
		H53-20415-006		0 0	85051	...
		MR6394	0 -	85723
	Additional O.E.M. Interchanges	665569	0 0				85045	
		680334	- -				85709	
		97-2210-00164	- -				85708	
		H53-21144-004	0 0				85045	
		MR1623	0 0				85700	
		MR1710	0 0				85713	
		MR1751	0 0				85713	
		MR1763	0 0				85300 or 89419	
		MR1765	0 0				85713	
		MR25767	0 0				85702	
		MR2960	0 0				85702	
		MR2961	- -				85701	
		MR2996	0 0				85704	
		MR2997	- 0				85703	
		MR3303	- -				85709	
		MR3304	- 0				85710	
		MR3304H	- -				85709	
		MR3306	- -				85705 or 89447	
		MR3307	- -				85707	
		MR3650	- -				85707	
MR6535	- -				85708			
MR6536	- -				85722			
MR7388	- 0				85710			

NATIONAL COACH CORP

Eldorado Coach RE-29	C800853	0 0	83207	89407	
----------------------	---------	-----	--------------	--------------	--	-----	-----









NAVISTAR - SEE INTERNATIONAL (NAVISTAR)

--	--	--	--	--	--	--	--

NEOPLAN BUS

Mini-Bus	24-1700-106-149		0 0	83216	...
		24-1700-999-362	- 0	85009
		BN1002002	- 0	85009
		BT1002011		0 0	83216
Model 40	25-1700-101-426		85705	...	- -	85705	89447
	DT1002002		85707	...	- -	85707	...
Model 80B	CL1002003		85705	...	- -	85705	89447
	DZ1002002		85705	...	- -	85705	89447
Models with O.E.M. Number	680307		85705	...	- -	85705	89447
	680308		85706	...	- -	85706	...
	AA1002002		85705	...	- -	85705	89447
	AA1002003		85705	...	- -	85705	89447
	AA1802002		85705	...	- -	85705	89447
	AC1002002		85705	...	- -	85705	89447
	AC1002002GS		85705	...	- -	85705	89447
	AC1002003		85705	...	- -	85705	89447

APPLICATION GUIDE - TRUCKS, TRAILERS, AND BUSES

Year Año Année	Model Modelo Modèle	OEM #	Front		Rear	
						
						
			Fleetline	GasSLX	Fleetline	GasSLX

NEWMAR CORP(Cont'd.)

Class A MotorHomes(Cont'd.)

Year	Model	OEM #	Front	Rear	
02 - 05	AS120 Front Suspension	48170000493	- - 85900	
06	Ventana Series MotorHomes with Freightliner XC Chassis AS120 Front Suspension	141700131810	0 0 83160	
		16-16737-000	0 0 83160	
		16-16874-000	0 0 83160	
	Rear Shock with O.E.M. Number	141700131809	0 0 85029
		16-16736-000	0 0 85029
	ZF - IFS Front Suspension with 23,000 lb GVW or Greater	16-18103-000	- - 85900	
		48170000493	- - 85900	

NISSAN

UD 1300 Series

Year	Model	OEM #	Front	Rear
	UD 1300 Models Steer Axle	56110-T8123	- 0 G63432
		56110-T8129	- 0 G63432
		66400	- 0 G63432

UD 1800 Series

Year	Model	OEM #	Front	Rear
11 - 13	Models with O.E.M. Number	56101-30Z01	- 0 83161
		56101-30Z02	0 - G63610
		56110-30Z01	- 0 83161
		56110-30Z02	0 - G63610
89 - 94	Models with O.E.M. Number	56101-Z5008	- 0 83114
		56110-Z5008	- 0 83114
95 - 98	Models with O.E.M. Number	56101-30Z01	- 0 83161
		56101-30Z02	0 - G63610
		56110-30Z01	- 0 83161
		56110-30Z02	0 - G63610

UD 18CS Series

Year	Model	OEM #	Front	Rear	
05 - 10	Models with O.E.M. Number	56101-30Z01	- 0 83161	
		56110-30Z01	- 0 83161	
99 - 04	Models with O.E.M. Number	56101-Z5008	- 0 83114	
		56110-Z5008	- 0 83114	
		56201-Z5001	- - 85085
		56210-Z5001	- - 85085

UD 18HD Series

Year	Model	OEM #	Front	Rear
99 - 10	Models with O.E.M. Number	56101-30Z01	- 0 83161
		56101-30Z02	0 - G63610
		56110-30Z01	- 0 83161
		56110-30Z02	0 - G63610

UD 2000 Series

Year	Model	OEM #	Front	Rear	
89 - 94	U D 2000 Models with O.E.M. Number	56110-Z5011	- 0 G63610	
		56101-Z5008	- 0 83114	
95 - 13	U D 2000 Models with O.E.M. Number	56110-Z5008	- 0 83114	
		56101-30Z01	- 0 83161	
		56101-30Z02	0 - G63610	
		56110-30Z01	- 0 83161	
89 - 13	U D 2600 Models with O.E.M. Number	56110-30Z02	0 - G63610	
		56101-Z5017	- 0 83162	
92 - 94	U D 2600 Models with O.E.M. Number	56110-Z5017	- 0 83162	
		56201-Z5001	- - 85085
89 - 94	U D 2800 Models with O.E.M. Number	56210-Z5001	- - 85085
		56101-Z5017	- 0 83162	

APPLICATION GUIDE - TRUCKS, TRAILERS, AND BUSES

Year Año Année	Model Modelo Modèle	OEM #	Front			Rear		
			Fleetline	GasSLX				

NISSAN(Cont'd.)

UD 2000 Series(Cont'd.)

89 - 94	U D 2800 Models with O.E.M. Number	56110-Z5017	- O	83162
92 - 94	U D 2800 Models with O.E.M. Number	56201-Z5001		- -	85085	...
		56210-Z5001		- -	85085	...

UD 23DH Series

95 - 13	Models with O.E.M. Number	56101-30Z01	- O	83161
		56101-30Z02	O -	G63610
		56110-30Z01	- O	83161
		56110-30Z02	O -	G63610

UD 23LP Series

95 - 13	Models with O.E.M. Number	56101-30Z01	- O	83161
		56101-30Z02	O -	G63610
		56110-30Z01	- O	83161
		56110-30Z02	O -	G63610

UD 3000 Series

89 - 91	U D 3000 Models with O.E.M. Number	56101-Z5017	- O	83162
		56110-Z5017	- O	83162
95 - 00	U D 3000 Models with O.E.M. Number	56101-Z5017	- O	83162
		56110-Z5017	- O	83162
89 - 94	U D 3300 Models with O.E.M. Number	56101-Z5017	- O	83162
		56110-Z5017	- O	83162
92 - 94	U D 3300 Models with O.E.M. Number	56201-Z5001		- -	85085	...
		56210-Z5001		- -	85085	...
99 - 13	U D 3300 Models with O.E.M. Number	56101-Z5017	- O	83162
		56110-Z5017	- O	83162
		56201-Z5001		- -	85085	...
		56210-Z5001		- -	85085	...









Additional Applications

92 - 94	30HD Models with O.E.M. Number	56101-Z5017	- O	83162
		56110-Z5017	- O	83162
		56201-Z5001		- -	85085	...
		56210-Z5001		- -	85085	...
92 - 94	30SD Models with O.E.M. Number	56101-Z5017	- O	83162
		56110-Z5017	- O	83162
		56201-Z5001		- -	85085	...
		56210-Z5001		- -	85085	...
89 - 91	500T Models with O.E.M. Number	56101-Z5017	- O	83162
		56110-Z5017	- O	83162
92 - 94	600T Models with O.E.M. Number	56101-Z5017	- O	83162
		56110-Z5017	- O	83162
		56201-Z5001		- -	85085	...
		56210-Z5001		- -	85085	...

NOVA BUS

	Classic Bus with O.E.M. Number	97-2201-00151		85700	...	O O	85700	...
	Low Floor Bus Models with O.E.M. Number	481700131250	O O	85377
		481700131252		O O	85378	...
		680480	O O	85377
		N16248	O O	85377
		N16249		O O	85378	...
		N21543		O O	85378	...
		N31830		O O	85378	...

APPLICATION GUIDE - TRUCKS, TRAILERS, AND BUSES

Year Año Année	Model Modelo Modèle	OEM #	Front		Rear	
						
						
			Fleetline	GasSLX	Fleetline	GasSLX

NOVA BUS(Cont'd.)

	Low Floor Bus Models with O.E.M. Number	N31831	010	85377
	RTS Bus	22012079	-1-	85701
		22045526			...	010	85702	...
		22052014			...	010	85702	...
		4975515		-1-	85701
		695117		-1-	85701
		74410		-1-	85701
		G1011822			...	010	85702	...
		G1203223			...	010	85702	...
		G1205763		010	87019
		G1205763-001		010	87019
		OE 10086S			...	010	85702	...
		RTS Bus with "V" Drive	G1011823	-10	85710
			G1101590			...	010	85713
	RTS Bus with Solid Front Axle	22024673	-10	85710	
	Models with O.E.M. Number	12J-5-10		01-	85733	...
		12J-5-11			...	010	85313	...
		680231			...	010	85313	...
		680232			...	01-	85733	...
		680323		010	85700
		680326		010	85700
		680470			...	010	85713	...
		680481			...	010	85378	...
		G1201338		-10	85710
		G1201339			...	010	85702	...
		G5008070		010	85700
		N22212		010	85700
		Additional O.E.M. Interchanges	97-9999-02514	010	85700			

OLE GRANNING

	Models with O.E.M. Number	1086	010	83217
--	---------------------------	------	-----	--------------	-----	--	-----	-----

ONEIDA PRODUCTS

	School Bus w/Heavy Duty Suspension		85307	...	010	85307	...
	School Bus w/Standard Suspension		83216	...	010	83216	...





OPTIMA BUS CORP

	Buses with Ridewell RAS - 227 Models Steer Axle Air Suspension w/ O.E.M. Number	1260008		010	87017	...
		90-2610-SP1		010	87017	...

ORION BUS INDUSTRIES

	Orion 1	010134505-4	010	85715
		010134509	010	85717
		010234503-4			...	010	85308	89422
		010234506			...	010	85714	...
	Orion 102	050134501-4	010	85716
		050230501			...	010	85716	...
		050231505			...	010	85716	...
		680504			...	010	85716	...
	Orion II	010134505-4	010	85715
		010234503-4			...	010	85308	89422





APPLICATION GUIDE - TRUCKS, TRAILERS, AND BUSES

Year Año Année	Model Modelo Modèle	OEM #	Front		Rear	
						
			Fleetline	GasSLX	Fleetline	GasSLX

ORION BUS INDUSTRIES(Cont'd.)

Orion II	020117504	010	85720
	020273541	010	83203	89436	
	020273541-4		010	85000	89436
	020273544	010	83203	89436	
	020273546		010	85719	...
	020273547		010	85719	...
	020273548		010	85719	...
	020273549		010	85719	...
	20117501	010	85720
	20117503	010	85720
	20117504	010	85720
	20117505	010	85720
Orion V	010134508-4	010	85718
	050134502-4	010	85718
	050134506-4	010	85718
	050134509	010	85732
	050134510	010	85732
	050134513	010	85732
	050231505		010	85716	...
	680504		010	85716	...
	695347	010	85732
Orion VI (Low Floor)	060231508	010	85717
Orion VI (M Axle) with O.E.M. Number	060131507	-10	87016
	060131508	-10	87016
Orion VII - 30 ft Rear	070231527		01-	85729	...
Orion VII with O.E.M. Number	070131502	-10	87016
	070131506	-10	87016
	070231514		01-	85729	...
Models with O.E.M. Number	665596		010	85719	...
	680271		010	85714	...
	680274		010	85716	...
	680328	010	85717
	680378	010	85720
	695327	010	85732
	695343	010	85732
	695366	010	85732
	695389	-10	87016
	695420		01-	85729	...
	695421	-10	87016
	695440		01-	85729	...
Additional O.E.M. Interchanges	010134501-4	010				85307	
	010134504-4	010				85715	
	010134506-4	010				85717	
	020273547-4	010				85719	
	050134508	010				85718	
	0501345-11	010				85718	
	050231502-4	010				85716	
	050231507	010				85716	
	680091	010				85303 or 89422	
	680102	010				85712	
	680352	-10				85711	
680501	010				85714		

APPLICATION GUIDE - TRUCKS, TRAILERS, AND BUSES

Year Año Année	Model Modelo Modèle	OEM #	Front		Rear	
						
			Wrench	Wrench	Wrench	Wrench
			Fleetline	GasSLX	Fleetline	GasSLX

OSTERLUND TRUCK

	Models with O.E.M. Number	59011	○ ○	83214
		680117	○ ○	85300	89419	
	Additional O.E.M. Interchanges	220-S5-10		○ ○	85712	...

OTTAWA TRUCK

	Yard Tractor	59009		83217	...	○ ○	83217	...
	Models with O.E.M. Number	59011	○ ○	83214
		680117	○ ○	85300	89419	
	Additional O.E.M. Interchanges	53540451	○ ○	85300 or 89419				
		90013787	- -	85310 or 89423				
		9007342	○ ○	85303 or 89422				
	Yard Tractor	90027577	○ ○	85720

PACCAR

Additional Applications

	TruckMaster Shock Stamping Number	665633		- ○	85033	89427
--	-----------------------------------	--------	--	-----	-----	-----	--------------	--------------

PACIFIC TRUCK & TRAILER

	Additional O.E.M. Interchanges	3178157C	○ ○	85735			
		507202C1	○ ○	85030 or 89440			

PAGE SUSPENSION

	Model with LM-2000 Models Lift Axle Suspension	1080099		○ ○	83203	89436
	Model with Trailmaster Air Spring Suspension	1081933		○ ○	83204	...
		A-2212		○ ○	85029	...
	Models with O.E.M. Number	665133		○ ○	83203	89436
		665267		○ ○	85029	...

PAI CORP

	Models with O.E.M. Number	HSA-5067	○ ○	85305
		HSA-5080	○ ○	83221
		HSA-5095	○ ○	83215

PEERLESS TRAILER

	Models with Air Suspension	72-61		○ ○	83125	...
	Models with O.E.M. Number	120-1		○ ○	83125	...

PETERBILT

210 Series

	Models with Reyco 79KB Rear Steel Spring Suspension	16725-01		○ ○	83221	...
--	---	----------	--	-----	-----	-----	--------------	-----





220 Series

07 - 12	Models with 12,000 lb Front Axle	02-02738	○ ○	85012	89413	
		B71-6016	○ ○	85012	89413	
07 - 16	Models with 21,000 lb Reyco Spring Suspension	19495-01		○ ○	83126	89440
07 - 16	Models with Hendrickson HAS - 210L or HAS - 230L Rear Air Suspension	60670-008		○ ○	83123	89405
07 - 16	Models with Reyco 102AR (Standard) Rear Air Suspension	12887-01		○ ○	85013	89414
		12887-02		○ ○	85013	89414
07 - 16	Models with Reyco 79KB Rear Steel Spring Suspension	16725-01		○ ○	83221	...

270 Series

	Models with Woodhead Shock (Stamping Number ACHB 966)	ACHB966		- -	83136	...
--	---	---------	--	-----	-----	-----	--------------	-----

APPLICATION GUIDE - TRUCKS, TRAILERS, AND BUSES

Year Año Année	Model Modelo Modèle	OEM #	Front		Rear	
						
			Fleetline	GasSLX	Fleetline	GasSLX

PETERBILT(Cont'd.)

320 Series(Cont'd.)

87 - 16	Models with 12,000 lb to 14,600 lb Taperleaf Spring Suspension and Set Forward Front Axle.	02-01787	010	85062	89408	
		02-02737	010	85062	89408	
		B71-6009	010	85062	89408	
01 - 17	Models with 18,000 lb to 23,000 lb Taperleaf Front Spring Suspension and Set Forward Front Axle.	02-02742	010	85062	89408	
		B71-6011	010	85062	89408	
94 - 16	Models with Air Trac Suspension (38000 or 40000 lb)	03-07421		-10	85311	89424
		C71-6002		-10	85311	89424
01 - 17	Models with Hendrickson HMX 400/460 Haulmax with 17.5" & 18.5" Saddle	60680-005		01-	83142	...

325 Series

- 16	Models with 21,000 lb Reyco Spring Suspension	19495-01		010	83126	89440
2016	Models with 8,000 lb Front Axle	B71-6004	010	85084	89460	

330 Series

16 - 17	Models with 10,000 lb to 14,600 lb Taperleaf Springs and Set Back Front Axles	B71-6019	010	85989
95 - 16	Models with 12000 lb Set Back Front Axle	02-02738	010	85012	89413	
		B71-6016	010	85012	89413	
		B71-6016A	010	85012	89413	
- 17	Models with 21,000 lb Reyco Spring Suspension	19495-01		010	83126	89440
95 - 02	Models with Peterbilt 40000 lb Low Air Leaf Suspension	03-07423		-10	85033	89427
03 - 16	Models with Peterbilt Low Air Leaf Suspension	03-08781		-1-	85069	89455
		C71-1011		-1-	85069	89455
		C71-1017		-1-	85069	89455
- 17	Models with Reyco 79KB Rear Steel Spring Suspension	16725-01		010	83221	...
	Models with O.E.M. Number	02-03020	010	85910
		B71-6017	010	85910





335 Series

05 - 10	Models with 12000 lb Set Back Front Axle	02-02738	010	85012	89413	
		02-02741	010	85012	89413	
		B71-6016	010	85012	89413	
		B71-6016A	010	85012	89413	
05 - 10	Models with Air Trac Suspension (38000 or 40000 lb)	03-07421		-10	85311	89424
05 - 10	Models with Peterbilt Low Air Leaf Suspension	03-08781		-1-	85069	89455
		C71-1011		-1-	85069	89455
		C71-1017		-1-	85069	89455

337 Series

10 - 14	Models with 10,000 lb to 12,000 lb Front Axle	B71-6005	010	85084	89460	
15 - 17	Models with 10,000 lb to 14,600 lb Taperleaf Springs and Set Back Front Axles	B71-6019	010	85989
10 - 14	Models with 13,200 lb to 14,600 lb Front Axle	B71-6006	010	85084	89460	
10 - 13	Models with Peterbilt Air Trac Suspension (38000 or 40000 lb)	03-07421		-10	85311	89424
		C71-6002		-10	85311	89424
14 - 16	Models with Peterbilt Air Trac Suspension (38000 or 40000 lb)	C71-6003		-10	85988	...
10 - 16	Models with Peterbilt Low Air Leaf Suspension (AG400L)	03-08781		-1-	85069	89455
		C71-1011		-1-	85069	89455
		C71-1017		-1-	85069	89455
10 - 16	Models with Reyco 102AR (Standard) Rear Air Suspension	12887-01		010	85013	89414
		12887-02		010	85013	89414
10 - 16	Models with Reyco 79KB Rear Steel Spring Suspension	16725-01		010	83221	...

APPLICATION GUIDE - TRUCKS, TRAILERS, AND BUSES

Year Año Année	Model Modelo Modèle	OEM #	Front		Rear	
						
			Fleetline	GasSLX	Fleetline	GasSLX

PETERBILT(Cont'd.)

340 Series(Cont'd.)

07 - 10	Models with 12000 lb Set Back Front Axle	02-02738 02-02741	010	85012	89413	
			010	85012	89413	
13 - 14	Models with 12000 lb Set Back Front Axle	B71-6016 B71-6016A	010	85012	89413	
			010	85012	89413	
07 - 10	Models with Air Trac Suspension (38000 or 40000 lb)	03-07421		-10	85311	89424

348 Series

12 - 13	Models with 10,000 lb to 12,000 lb Front Axle	B71-6005	010	85084	89460	
14 - 17	Models with 10,000 lb to 14,600 lb Taperleaf Springs and Set Back Front Axles	B71-6019	010	85989
14 - 17	Models with 20,000 lb Taperleaf Springs and Set Back Front Axles	B71-6020	010	85989
10 - 16	Models with Air Trac Suspension (38000 or 40000 lb)	03-07421 C71-6002		-10	85311	89424
				-10	85311	89424
08 - 16	Models with Hendrickson HMX 400/460 Haulmax with 17.5" & 18.5" Saddle	60680-005		01-	83142	...
15 - 16	Models with O.E.M. Number	B71-6012	010	85119
14 - 17	Models with Peterbilt Air Trac Suspension	C71-6003		-10	85988	...
- 16	Models with Reyco 102AR (Standard) Rear Air Suspension	12887-01 12887-02		010	85013	89414
				010	85013	89414
- 17	Models with Reyco 79KB Rear Steel Spring Suspension	16725-01		010	83221	...

349 Series

	349 Conventional Models with 12000 lb capacity	02-00376 02-00495 02-02736	010	85302	89420	
			010	85302	89420	
			010	85302	89420	





353 Series

	353 Conventional Models with 12000 lb capacity	02-00376 02-00495 02-02736	010	85302	89420	
			010	85302	89420	
			010	85302	89420	

357 Series

	Conventional Models with Front Air Suspension and Set Back Front Axle.	02-02739	010	85013	89414	
	Conventional Models with Front Air Suspension and without Set Back Front Axle.	02-02740	010	85036	89405	
	Conventional Models with Spring Suspension and with Set Back Front Axle.	02-02738	010	85012	89413	
		02-02741	010	85012	89413	
13 - 14	Conventional Models with Spring Suspension and with Set Back Front Axle.	B71-6016	010	85012	89413	
		B71-6016A	010	85012	89413	
	Models with 12,000 lb to 14,600 lb Taperleaf Spring Suspension and Set Forward Front Axle.	02-02737	010	85062	89408	
		B71-6007	010	85062	89408	
		B71-6009	010	85062	89408	
	Models with 18,000 lb to 23,000 lb Taperleaf Front Spring Suspension and Set Forward Front Axle.	02-02742	010	85062	89408	
	Models with 18,000 lb to 23,000 lb Taperleaf Spring Suspension and Set Forward Axles	B71-6011	010	85062	89408	
- 11/82	Models with Air Trac Suspension (38000 or 40000 lb)	03-04176		010	85308	89422
87 - 07	Models with Air Trac Suspension (38000 or 40000 lb)	03-07421		-10	85311	89424
	Models with Air Track Tandem with TRD8000 Pusher Axle	03-08350		-10	85343	...
		C71-6004		-10	85343	...
	Models with Chalmers 40,000 lb Rear Suspension	665174		010	85060	...
		800670		010	85060	...
	Models with Neway ARD 125/244-8 Models Rear Air Suspension	90044011		010	85004	...

APPLICATION GUIDE - TRUCKS, TRAILERS, AND BUSES

Year Año Année	Model Modelo Modèle	OEM #	Front		Rear	
						
			Fleetline	GasSLX	Fleetline	GasSLX

PETERBILT(Cont'd.)

357 Series(Cont'd.)

- 03	Models with Peterbilt Low Air Leaf Suspension	03-07423	-10	85033	89427
		665633	-10	85033	89427
03 -	Models with Peterbilt Low Air Leaf Suspension	03-08781	-1-	85069	89455
		C71-1017	-1-	85069	89455

359 Series

	359 Conventional Models with 12000 lb capacity	02-00376	010	85302	89420	
		02-00495	010	85302	89420	
		02-02736	010	85302	89420	









362 Series

	C.O.E. Models with 12000 lb capacity	02-02736	010	85302	89420	
	C.O.E. Models with 14600 lb Taper Leaf Springs and Set Back Front Axle	02-02740	010	85036	89405	
	C.O.E. Models with Progressive Springs	02-02738	010	85012	89413	
13 - 14	C.O.E. Models with Progressive Springs	B71-6016	010	85012	89413	
		B71-6016A	010	85012	89413	
	C.O.E. Models without Set Back Front Axle	02-00376	010	85302	89420	
		02-00495	010	85302	89420	
- 11/82	Models with Air Trac Suspension (38000 or 40000 lb)	03-04176		010	85308	89422
81 - 06	Models with Air Trac Suspension (38000 or 40000 lb)	03-07421		-10	85311	89424
	Models with Chalmers 40,000 lb Rear Suspension	665174		010	85060	...
		800670		010	85060	...
	Models with Neway ARD 125/244-8 Models Rear Air Suspension	90044011		010	85004	...
- 03	Models with Peterbilt Low Air Leaf Suspension	03-07423		-10	85033	89427
		665633		-10	85033	89427
03 -	Models with Peterbilt Low Air Leaf Suspension	03-08781		-1-	85069	89455
		C71-1017		-1-	85069	89455

365 Series

08 - 17	Models with 12,000 lb to 14,600 lb Taperleaf Spring Suspension and Set Forward Front Axle.	B71-6007	010	85062	89408	
08 - 15	Models with 12,000 lb to 16,000 lb Taperleaf Front Suspension (Set-Back Axle)	B71-6002	010	85012	89413	
		B71-6013	010	85012	89413	
08 - 17	Models with 18,000 lb to 23,000 lb Taperleaf Front Spring Suspension and Set Forward Front Axle.	02-02742	010	85062	89408	
		B71-6011	010	85062	89408	
08 - 16	Models with Air Trac Suspension (38000 or 40000 lb)	03-07421		-10	85311	89424
		C71-6002		-10	85311	89424
- 17	Models with Chalmers 40,000 lb Rear Suspension	665174		010	85060	...
		800670		010	85060	...
08 - 17	Models with FlexAir Suspension (38000 lb)	C71-1002		010	85067	89451
		C71-1016		010	85067	89451
		C71-6000		010	85067	89451
		C71-6015		010	85067	89451
08 - 17	Models with Hendrickson HMX 400/460 Haulmax with 16.5" Saddle	60680-004		01-	83143	...
08 - 17	Models with Hendrickson HMX 400/460 Haulmax with 17.5" & 18.5" Saddle	60680-005		01-	83142	...
- 16	Models with Neway ADZ Rear Suspension	471700004423		010	85109	...
		90045605		010	85109	...
14 - 17	Models with Peterbilt Air Leaf Suspension	C71-6003		-10	85988	...
08 - 17	Models with Peterbilt Low Air Leaf Suspension	03-08781		-1-	85069	89455
		C71-1011		-1-	85069	89455

APPLICATION GUIDE - TRUCKS, TRAILERS, AND BUSES

Year Año Année	Model Modelo Modèle	OEM #	Front		Rear	
						
						
			Fleetline	GasSLX	Fleetline	GasSLX

PETERBILT(Cont'd.)

365 Series(Cont'd.)

08 - 17	Models with Peterbilt Low Air Leaf Suspension	C71-1017 C71-6005	- -	85069	89455
			- -	85069	89455
08 - 12	Models with Quadraflex 4 Spring Rear Suspension	03-07420	- -	85336	...

367 Series

08 - 16	Models with 10,000 lb to 16,000 lb Taperleaf Front Spring Suspension and with Set Back Front Axle.	B71-6002 B71-6016	O O	85012	89413
			O O	85012	89413
14 - 17	Models with 12,000 lb to 14,600 lb Taperleaf Spring Suspension and Set Forward Front Axle.	B71-6009	O O	85062	89408
08 - 17	Models with 18,000 lb to 23,000 lb Taperleaf Front Spring Suspension and Set Forward Front Axle.	02-02742 B71-6007 B71-6011	O O	85062	89408
			O O	85062	89408
			O O	85062	89408
08 - 17	Models with Air Trac Suspension (38000 or 40000 lb)	03-07421 C71-6002	- O	85311	89424
			- O	85311	89424
	Models with Air Track Tri Drive Suspension	03-08350 C71-6004	- O	85343	...
			- O	85343	...
	Models with Chalmers 40,000 lb Rear Suspension	665174 800670	O O	85060	...
			O O	85060	...
08 - 17	Models with FlexAir Suspension (38000 lb)	C71-1002 C71-1016 C71-6000 C71-6015	O O	85067	89451
			O O	85067	89451
			O O	85067	89451
			O O	85067	89451
08 - 17	Models with Hendrickson HMX 400/460 Haulmax with 16.5" Saddle	60680-004	O -	83143	...
08 - 17	Models with Hendrickson HMX 400/460 Haulmax with 17.5" & 18.5" Saddle	60680-005	O -	83142	...
- 16	Models with Neway ADZ Rear Suspension	471700004423 90045605	O O	85109	...
			O O	85109	...
08 -	Models with Peterbilt Low Air Leaf Suspension	03-08781 C71-1011 C71-1017	- -	85069	89455
			- -	85069	89455
			- -	85069	89455
08 - 10	Models with Quadraflex 4 Spring Rear Suspension	03-07420	- -	85336	...





372 Series

- 93	C.O.E. Models with Front Air Suspension	02-02739	O O	85013	89414
- 93	C.O.E. Models with Front Spring Suspension	02-02738 B71-6016 B71-6016A	O O	85012	89413
			O O	85012	89413
			O O	85012	89413
- 11/82	Models with Air Trac Suspension (38000 or 40000 lb)	03-04176	O O	85308	89422
89 - 93	Models with Air Trac Suspension (38000 or 40000 lb)	03-07421	- O	85311	89424
- 93	Models with Chalmers 40,000 lb Rear Suspension	665174 800670	O O	85060	...
			O O	85060	...
- 93	Models with Neway ARD 125/244-8 Models Rear Air Suspension	90044011	O O	85004	...
- 93	Models with Peterbilt Low Air Leaf Suspension	03-07423 665633	- O	85033	89427
			- O	85033	89427

375 Series

	Conventional Models with Front Air Suspension and Set Back Front Axle.	02-02739	O O	85013	89414
	Conventional Models with Front Air Suspension and without Set Back Front Axle.	02-02740	O O	85036	89405
	Conventional Models with Spring Suspension and with Set Back Front Axle.	02-02738 02-02741	O O	85012	89413
			O O	85012	89413

APPLICATION GUIDE - TRUCKS, TRAILERS, AND BUSES

Year Año Année	Model Modelo Modèle	OEM #	Front		Rear	
						
			Fleetline	GasSLX	Fleetline	GasSLX

PETERBILT(Cont'd.)

375 Series(Cont'd.)

13 - 14	Conventional Models with Spring Suspension and with Set Back Front Axle.	B71-6016	010	85012	89413	
		B71-6016A	010	85012	89413	
	Models with 12,000 lb to 14,600 lb Taperleaf Spring Suspension and Set Forward Front Axle.	02-02737	010	85062	89408	
		B71-6007	010	85062	89408	
		B71-6009	010	85062	89408	
	Models with 18,000 lb to 23,000 lb Taperleaf Front Spring Suspension and Set Forward Front Axle.	02-02742	010	85062	89408	
	Models with 18,000 lb to 23,000 lb Taperleaf Spring Suspension and Set Forward Axles	B71-6011	010	85062	89408	
- 11/82	Models with Air Trac Suspension (38000 or 40000 lb)	03-04176		010	85308	89422
87 - 96	Models with Air Trac Suspension (38000 or 40000 lb)	03-07421		-10	85311	89424
	Models with Chalmers 40,000 lb Rear Suspension	665174		010	85060	...
		800670		010	85060	...
	Models with Neway ARD 125/244-8 Models Rear Air Suspension	90044011		010	85004	...
- 03	Models with Peterbilt Low Air Leaf Suspension	03-07423		-10	85033	89427
		665633		-10	85033	89427
03 -	Models with Peterbilt Low Air Leaf Suspension	03-08781		-1-	85069	89455
		C71-1017		-1-	85069	89455

376 Series

	Conventional Models with Front Air Suspension and Set Back Front Axle.	02-02739	010	85013	89414	
	Conventional Models with Front Air Suspension and without Set Back Front Axle.	02-02740	010	85036	89405	
	Conventional Models with Spring Suspension and with Set Back Front Axle.	02-02738	010	85012	89413	
		02-02741	010	85012	89413	
		B71-6016	010	85012	89413	
		B71-6016A	010	85012	89413	
	Models with 12,000 lb to 14,600 lb Taperleaf Spring Suspension and Set Forward Front Axle.	02-02737	010	85062	89408	
		B71-6007	010	85062	89408	
		B71-6009	010	85062	89408	
	Models with 18,000 lb to 23,000 lb Taperleaf Front Spring Suspension and Set Forward Front Axle.	02-02742	010	85062	89408	
	Models with 18,000 lb to 23,000 lb Taperleaf Spring Suspension and Set Forward Axles	B71-6011	010	85062	89408	
- 11/82	Models with Air Trac Suspension (38000 or 40000 lb)	03-04176		010	85308	89422
11/ 82 -	Models with Air Trac Suspension (38000 or 40000 lb)	03-07421		-10	85311	89424
	Models with Chalmers 40,000 lb Rear Suspension	665174		010	85060	...
		800670		010	85060	...
	Models with Neway ARD 125/244-8 Models Rear Air Suspension	90044011		010	85004	...
- 03	Models with Peterbilt Low Air Leaf Suspension	03-07423		-10	85033	89427
		665633		-10	85033	89427
03 -	Models with Peterbilt Low Air Leaf Suspension	03-08781		-1-	85069	89455
		C71-1017		-1-	85069	89455

377 Series

	Conventional Models with Front Air Suspension and Set Back Front Axle.	02-02739	010	85013	89414	
	Conventional Models with Front Air Suspension and without Set Back Front Axle.	02-02740	010	85036	89405	
	Conventional Models with Spring Suspension and with Set Back Front Axle.	02-02738	010	85012	89413	

APPLICATION GUIDE - TRUCKS, TRAILERS, AND BUSES

Year Año Année	Model Modelo Modèle	OEM #	Front		Rear	
			 Fleetline	 GasSLX	 Fleetline	 GasSLX

PETERBILT(Cont'd.)

377 Series(Cont'd.)

	Conventional Models with Spring Suspension and with Set Back Front Axle.	02-02741	010	85012	89413	
	Models with 12,000 lb to 14,600 lb Taperleaf Spring Suspension and Set Forward Front Axle.	02-02737	010	85062	89408	
		B71-6007	010	85062	89408	
		B71-6009	010	85062	89408	
	Models with 18,000 lb to 23,000 lb Taperleaf Front Spring Suspension and Set Forward Front Axle.	02-02742	010	85062	89408	
	Models with 18,000 lb to 23,000 lb Taperleaf Spring Suspension and Set Forward Axles	B71-6011	010	85062	89408	
- 11/82	Models with Air Trac Suspension (38000 or 40000 lb)	03-04176		010	85308	89422
11/ 82 -	Models with Air Trac Suspension (38000 or 40000 lb)	03-07421		-10	85311	89424
	Models with Chalmers 40,000 lb Rear Suspension	665174		010	85060	...
		800670		010	85060	...
	Models with Neway ARD 125/244-8 Models Rear Air Suspension	90044011		010	85004	...
- 03	Models with Peterbilt Low Air Leaf Suspension	03-07423		-10	85033	89427
		665633		-10	85033	89427





378 Series

	Conventional Models with Front Air Suspension and Set Back Front Axle.	02-02739	010	85013	89414	
	Conventional Models with Front Air Suspension and without Set Back Front Axle.	02-02740	010	85036	89405	
- 07	Conventional Models with Spring Suspension and with Set Back Front Axle.	02-02738	010	85012	89413	
		02-02741	010	85012	89413	
		B71-6016	010	85012	89413	
		B71-6016A	010	85012	89413	
	Models with 12,000 lb to 14,600 lb Taperleaf Spring Suspension and Set Forward Front Axle.	02-02737	010	85062	89408	
		B71-6007	010	85062	89408	
		B71-6009	010	85062	89408	
	Models with 18,000 lb to 23,000 lb Taperleaf Front Spring Suspension and Set Forward Front Axle.	02-02742	010	85062	89408	
	Models with 18,000 lb to 23,000 lb Taperleaf Spring Suspension and Set Forward Axles	B71-6011	010	85062	89408	
- 11/82	Models with Air Trac Suspension (38000 or 40000 lb)	03-04176		010	85308	89422
11/ 82 -	Models with Air Trac Suspension (38000 or 40000 lb)	03-07421		-10	85311	89424
	Models with Chalmers 40,000 lb Rear Suspension	665174		010	85060	...
		800670		010	85060	...
99 - 07	Models with FlexAir Suspension (38000 lb)	C71-1002		010	85067	89451
		C71-6000		010	85067	89451
	Models with Neway ARD 125/244-8 Models Rear Air Suspension	90044011		010	85004	...
- 03	Models with Peterbilt Low Air Leaf Suspension	03-07423		-10	85033	89427
		665633		-10	85033	89427
03 -	Models with Peterbilt Low Air Leaf Suspension	03-08781		-1-	85069	89455
		C71-1017		-1-	85069	89455

379 Series

	Conventional Models with Front Air Suspension and Set Back Front Axle.	02-02739	010	85013	89414	
	Conventional Models with Front Air Suspension and without Set Back Front Axle.	02-02740	010	85036	89405	
- 09	Conventional Models with Spring Suspension and with Set Back Front Axle.	02-02738	010	85012	89413	
		02-02741	010	85012	89413	

APPLICATION GUIDE - TRUCKS, TRAILERS, AND BUSES

Year Año Année	Model Modelo Modèle	OEM #	Front		Rear	
						
			Fleetline	GasSLX	Fleetline	GasSLX

PETERBILT(Cont'd.)

379 Series(Cont'd.)

- 09	Conventional Models with Spring Suspension and with Set Back Front Axle.	B71-6016	010	85012	89413	
		B71-6016A	010	85012	89413	
	Models with 12,000 lb to 14,600 lb Taperleaf Spring Suspension and Set Forward Front Axle.	02-02737	010	85062	89408	
		B71-6007	010	85062	89408	
		B71-6009	010	85062	89408	
	Models with 18,000 lb to 23,000 lb Taperleaf Front Spring Suspension and Set Forward Front Axle.	02-02742	010	85062	89408	
	Models with 18,000 lb to 23,000 lb Taperleaf Spring Suspension and Set Forward Axles	B71-6011	010	85062	89408	
- 11/82	Models with Air Trac Suspension (38000 or 40000 lb)	03-04176		010	85308	89422
11/ 82 -	Models with Air Trac Suspension (38000 or 40000 lb)	03-07421		-10	85311	89424
	Models with Chalmers 40,000 lb Rear Suspension	665174		010	85060	...
		800670		010	85060	...
99 - 07	Models with FlexAir Suspension (38000 lb)	C71-1002		010	85067	89451
		C71-6000		010	85067	89451
	Models with Neway ARD 125/244-8 Models Rear Air Suspension	90044011		010	85004	...
- 03	Models with Peterbilt Low Air Leaf Suspension	03-07423		-10	85033	89427
		665633		-10	85033	89427
03 -	Models with Peterbilt Low Air Leaf Suspension	03-08781		-1-	85069	89455
		C71-1017		-1-	85069	89455









382 Series

11 -	Models with 10,000 lb to 12,000 lb Front Axle	B71-6005	010	85084	89460	
11 -	Models with 12,000 lb to 14,600 lb Taperleaf Spring Suspension and Set Forward Front Axle.	02-02737	010	85062	89408	
		B71-6009	010	85062	89408	
11 - 16	Models with Air Trac Suspension (38000 or 40000 lb)	03-07421		-10	85311	89424
		C71-6002		-10	85311	89424
11 - 17	Models with FlexAir Suspension (38000 lb)	C71-1002		010	85067	89451
		C71-1016		010	85067	89451
		C71-6000		010	85067	89451
		C71-6015		010	85067	89451
11 -	Models with Peterbilt Low Air Leaf Suspension	03-08781		-1-	85069	89455
		C71-1011		-1-	85069	89455
		C71-1017		-1-	85069	89455
11 -	Models with Quadraflex 4 Spring Rear Suspension	03-07420		-1-	85336	...
11 -	Models with Reyco 102AR (Standard) Rear Air Suspension	12887-01		010	85013	89414
		12887-02		010	85013	89414
11 -	Models with Reyco 79KB Rear Steel Spring Suspension	16725-01		010	83221	...

384 Series

08 - 12	Models with 12,000 lb to 14,600 lb Taperleaf Spring Suspension and Set Forward Front Axle.	02-02737	010	85062	89408	
13 - 14	Models with 12,000 lb to 14,600 lb Taperleaf Spring Suspension and Set Forward Front Axle. (Std Duty)	B71-6009	010	83219	89408	
		B71-6009	010	85062	89408	
08 - 16	Models with Air Trac Suspension (38000 or 40000 lb)	03-07421		-10	85311	89424
		C71-6002		-10	85311	89424
09 - 17	Models with FlexAir Suspension (38000 lb)	C71-1002		010	85067	89451
		C71-1016		010	85067	89451
		C71-6000		010	85067	89451
		C71-6015		010	85067	89451

APPLICATION GUIDE - TRUCKS, TRAILERS, AND BUSES

Year Año Année	Model Modelo Modèle	OEM #	Front		Rear	
						
						
			Fleetline	GasSLX	Fleetline	GasSLX

PETERBILT(Cont'd.)

384 Series(Cont'd.)

08 -	Models with Peterbilt Low Air Leaf Suspension	03-08781 C71-1011 C71-1017		- -	85069	89455
				- -	85069	89455
				- -	85069	89455
08 -	Models with Quadraflex 4 Spring Rear Suspension	03-07420		- -	85336	...





385 Series

- 07	Conventional Models with Spring Suspension and with Set Back Front Axle.	02-02738 02-02741 B71-6016 B71-6016A	010	85012	89413	
			010	85012	89413	
			010	85012	89413	
			010	85012	89413	
- 07	Models with 12,000 lb to 14,600 lb Taperleaf Spring Suspension and Set Forward Front Axle.	02-02737 B71-6007 B71-6009	010	85062	89408	
			010	85062	89408	
			010	85062	89408	
- 07	Models with 18,000 lb to 23,000 lb Taperleaf Front Spring Suspension and Set Forward Front Axle.	02-02742 B71-6011	010	85062	89408	
			010	85062	89408	
- 11/82	Models with Air Trac Suspension	03-04176		010	85308	89422
95 - 08	Models with Air Trac Suspension	03-07421		- 0	85311	89424
				010	85060	...
95 - 08	Models with FlexAir Suspension (38000 lb)	C71-1002 C71-6000		010	85067	89451
				010	85067	89451
	Models with Neway ARD 125/244-8 Models Rear Air Suspension	90044011		010	85004	...
- 03	Models with Peterbilt Low Air Leaf Suspension	03-07423 665633		- 0	85033	89427
				- 0	85033	89427
04 - 07	Models with Peterbilt Low Air Leaf Suspension	03-08781 C71-1017		- -	85069	89455
				- -	85069	89455
	Models with Quadraflex 4 Spring Rear Suspension	03-07420		- -	85336	...

386 Series

06 -	Conventional Models with Front Air Suspension and Set Back Front Axle.	02-02739	010	85013	89414	
06 -	Conventional Models with Front Air Suspension and without Set Back Front Axle.	02-02740	010	85036	89405	
06 -	Conventional Models with Spring Suspension and with Set Back Front Axle.	02-02738 02-02741 02-04010 B71-6018	010	85012	89413	
			010	85012	89413	
			010	85012	89413	
			010	85012	89413	
13 - 14	Conventional Models with Spring Suspension and with Set Back Front Axle.	B71-6016 B71-6016A	010	85012	89413	
			010	85012	89413	
06 -	Models with 12,000 lb to 14,600 lb Taperleaf Spring Suspension and Set Forward Front Axle.	B71-6007	010	85062	89408	
06 - 12	Models with 12,000 lb to 14,600 lb Taperleaf Spring Suspension and Set Forward Front Axle.	02-02737 B71-6009	010	85062	89408	
			010	85062	89408	
06 -	Models with 18,000 lb to 23,000 lb Taperleaf Front Spring Suspension and Set Forward Front Axle.	02-02742 B71-6011	010	85062	89408	
			010	85062	89408	
06 - 17	Models with FlexAir Suspension (38000 lb)	C71-1002 C71-1016 C71-6000 C71-6015		010	85067	89451
				010	85067	89451
				010	85067	89451
				010	85067	89451

APPLICATION GUIDE - TRUCKS, TRAILERS, AND BUSES

Year Año Année	Model Modelo Modèle	OEM #	Front		Rear	
						
			Fleetline	GasSLX	Fleetline	GasSLX

PETERBILT(Cont'd.)

386 Series(Cont'd.)

06 - 16	Models with Peterbilt Air Leaf Suspension	03-07421 C71-6002		-10	85311	89424
06 -	Models with Peterbilt Low Air Leaf Suspension	03-08781 C71-1011 C71-1017		-1-	85069	89455
				-1-	85069	89455
				-1-	85069	89455





387 Series

- 09	Conventional Models with Front Air Suspension and Set Back Front Axle.	02-02739	010	85013	89414	
- 09	Conventional Models with Front Air Suspension and without Set Back Front Axle.	02-02740	010	85036	89405	
- 11	Conventional Models with Spring Suspension and with Set Back Front Axle.	02-02738	010	85012	89413	
		02-02741	010	85012	89413	
		02-04010	010	85012	89413	
		B71-6016	010	85012	89413	
		B71-6016A B71-6018	010 010	85012 85012	89413 89413	
- 11	Models with 12,000 lb to 14,600 lb Taperleaf Spring Suspension and Set Forward Front Axle.	02-02737	010	85062	89408	
		B71-6007 B71-6009	010 010	85062 85062	89408 89408	
		02-02742	010	85062	89408	
- 11	Models with 18,000 lb to 23,000 lb Taperleaf Front Spring Suspension and Set Forward Front Axle.	02-02742 B71-6011	010	85062	89408	
			010	85062	89408	
00 - 11	Models with FlexAir Suspension (38000 lb)	C71-1002 C71-6000		010	85067	89451
- 11	Models with Peterbilt Air Leaf Suspension	03-07421		-10	85311	89424
- 03	Models with Peterbilt Low Air Leaf Suspension	03-07423 665633		-10	85033	89427
				-10	85033	89427
03 - 11	Models with Peterbilt Low Air Leaf Suspension	03-08781 C71-1011 C71-1017		-1-	85069	89455
				-1-	85069	89455
				-1-	85069	89455

388 Series

08 - 16	Conventional Models with Front Air Suspension and Set Back Front Axle.	02-02739 85013A0C	010	85013	89414	
			010	85013	89414	
08 -	Conventional Models with Front Air Suspension and without Set Back Front Axle.	02-02740	010	85036	89405	
08 -	Conventional Models with Spring Suspension and with Set Back Front Axle.	02-04010 B71-6018	010	85012	89413	
			010	85012	89413	
08 - 17	Models with 12,000 lb to 14,600 lb Taperleaf Spring Suspension and Set Forward Front Axle. (Std Duty)	B71-6007 B71-6009 B71-6009	010	85062	89408	
			010	85062	89408	
			010	83219	89408	
08 - 17	Models with 18,000 lb to 23,000 lb Taperleaf Front Spring Suspension and Set Forward Front Axle.	02-02742 B71-6011	010	85062	89408	
			010	85062	89408	
08 - 17	Models with Air Trac Suspension (38000 or 40000 lb)	03-07421 C71-6002		-10	85311	89424
				-10	85311	89424
08 - 17	Models with FlexAir Suspension (38000 lb)	C71-1002 C71-1016 C71-6000 C71-6015		010	85067	89451
				010	85067	89451
				010	85067	89451
				010	85067	89451

APPLICATION GUIDE - TRUCKS, TRAILERS, AND BUSES

Year Año Année	Model Modelo Modèle	OEM #	Front			Rear		
							Fleetline	GasSLX

PETERBILT(Cont'd.)

388 Series(Cont'd.)

14 -	Models with O.E.M. Number	C71-6003		-10	85988	...
08 - 14	Models with Peterbilt Air Leaf Suspension	03-07421		-10	85311	89424
		03-07421PLUS		-10	85311	89424
08 - 17	Models with Peterbilt Low Air Leaf Suspension	03-08781		-1-	85069	89455
		C71-1011		-1-	85069	89455
		C71-1017		-1-	85069	89455





389 Series

08 -	Conventional Models with Front Air Suspension and Set Back Front Axle.	02-02739	010	85013	89414	
08 -	Conventional Models with Front Air Suspension and without Set Back Front Axle.	02-02740	010	85036	89405	
08 -	Conventional Models with Spring Suspension and with Set Back Front Axle.	02-04010	010	85012	89413	
		B71-6018	010	85012	89413	
08 -	Models with 12,000 lb to 14,600 lb Taperleaf Spring Suspension and Set Forward Front Axle.	B71-6007	010	85062	89408	
10 - 13	Models with 12,000 lb to 14,600 lb Taperleaf Spring Suspension and Set Forward Front Axle.	02-02737	010	85062	89408	
		B71-6009	010	85062	89408	
08 -	Models with 18,000 lb to 23,000 lb Taperleaf Front Spring Suspension and Set Forward Front Axle.	02-02742	010	85062	89408	
		B71-6011	010	85062	89408	
14 - 16	Models with Air Trac Suspension (38000 or 40000 lb)	C71-6002		-10	85311	89424
08 - 17	Models with FlexAir Suspension (38000 lb)	C71-1002		010	85067	89451
		C71-1016		010	85067	89451
		C71-6000		010	85067	89451
		C71-6015		010	85067	89451
14 - 16	Models with Neway ADZ Rear Suspension	471700004423		010	85109	...
		90045605		010	85109	...
08 -	Models with Peterbilt Air Leaf Suspension	03-07421		-10	85311	89424
08 -	Models with Peterbilt Low Air Leaf Suspension	03-08781		-1-	85069	89455
		C71-1011		-1-	85069	89455
		C71-1017		-1-	85069	89455

567 Series

14 - 17	Models with 10,000 lb to 14,600 lb Taperleaf Springs and Set Back Front Axles	B71-6019	010	85989
14 - 17	Models with 12,000 lb to 14,600 lb Taperleaf Spring Suspension and Set Forward Front Axle.	B71-6009	010	85062	89408	
14 - 17	Models with 18,000 lb to 23,000 lb Taperleaf Spring Suspension and Set Forward Axles	B71-6011	010	85062	89408	
14 - 17	Models with 20,000 lb Taperleaf Springs and Set Back Front Axles	B71-6020	010	85989
14 - 17	Models with Air Trac Suspension (38000 or 40000 lb)	C71-6002		-10	85311	89424
14 - 17	Models with Chalmers 40,000 lb Rear Suspension	665174		010	85060	...
		800670		010	85060	...
14 - 17	Models with FlexAir Suspension (38000 lb)	C71-1016		010	85067	89451
		C71-6015		010	85067	89451
14 - 17	Models with Hendrickson HMX 400/460 Haulmax with 16.5" Saddle	60680-004		01-	83143	...
14 - 17	Models with Hendrickson HMX 400/460 Haulmax with 17.5" & 18.5" Saddle	60680-005		01-	83142	...
14 - 17	Models with Neway ADZ Rear Suspension	471700004423		010	85109	...
		90045605		010	85109	...
14 - 17	Models with Peterbilt Air Trac Suspension (38000 or 40000 lb)	C71-6003		-10	85988	...
14 - 17	Models with Peterbilt Low Air Leaf Suspension	C71-1017		-1-	85069	89455

APPLICATION GUIDE - TRUCKS, TRAILERS, AND BUSES

Year Año Année	Model Modelo Modèle	OEM #	Front		Rear	
						
			Fleetline	GasSLX	Fleetline	GasSLX

PETERBILT(Cont'd.)

567 Series(Cont'd.)

14 - 17	Models with Peterbilt Low Air Leaf Suspension	C71-6005		- -	85069	89455
---------	---	----------	--	-----	-----	-----	-------	-------

579 Series

13 - 16	Day Cab Models with 10,000 lb to 12,000 lb Front Axle	B71-6005	O O	85084	89460	
13 - 17	Models with 10,000 lb to 14,600 lb Taperleaf Springs and Set Back Front Axles	B71-6019	O O	85989
13 -	Models with 12,000 lb to 14,600 lb Taperleaf Spring Suspension and Set Forward Front Axle.	02-02737	O O	85062	89408	
		B71-6009	O O	85062	89408	
13 - 16	Models with Air Trac Suspension (38000 or 40000 lb)	03-07421		- O	85311	89424
		C71-6002		- O	85311	89424
13 - 17	Models with FlexAir Suspension (38000 lb)	C71-1002		O O	85067	89451
		C71-1016		O O	85067	89451
		C71-6000		O O	85067	89451
		C71-6015		O O	85067	89451
13 -	Models with Peterbilt Front Air Leaf Suspension	B71-6000	O O	85959
13 - 16	Models with Peterbilt Low Air Leaf Suspension	03-08781		- -	85069	89455
		C71-1011		- -	85069	89455
		C71-1017		- -	85069	89455
13 -	Models with Reyco 102AR (Standard) Rear Air Suspension	12887-01		O O	85013	89414
		12887-02		O O	85013	89414
13 -	Models with Reyco 79KB Rear Steel Spring Suspension	16725-01		O O	83221	...









587 Series

11 - 16	Models with 12,000 lb to 14,600 lb Taperleaf Spring Suspension and Set Forward Front Axle.	02-02737	O O	85062	89408	
		B71-6009	O O	85062	89408	
11 - 16	Models with Air Trac Suspension (38000 or 40000 lb)	03-07421		- O	85311	89424
		C71-6002		- O	85311	89424
11 - 17	Models with FlexAir Suspension (38000 lb)	C71-1002		O O	85067	89451
		C71-1016		O O	85067	89451
		C71-6000		O O	85067	89451
		C71-6015		O O	85067	89451
11 - 13	Models with Peterbilt Front Air Leaf Suspension	B71-6000	O O	85959
11 - 17	Models with Peterbilt Low Air Leaf Suspension	03-08781		- -	85069	89455
		C71-1011		- -	85069	89455
		C71-1017		- -	85069	89455
11 -	Models with Quadraflex 4 Spring Rear Suspension	03-07420		- -	85336	...
11 -	Models with Reyco 102AR (Standard) Rear Air Suspension	12887-01		O O	85013	89414
		12887-02		O O	85013	89414
11 -	Models with Reyco 79KB Rear Steel Spring Suspension	16725-01		O O	83221	...

Additional Applications

	OE PLUS Shock Stamping Number	02-02736PLUS	O O	85302	89420	
		02-02737PLUS	O O	85062	89408	
		02-02738PLUS	O O	85012	89413	
		02-02739PLUS	O O	85013	89414	
		03-04176PLUS		O O	85308	89422
		03-06084PLUS		- O	85033	89427
		03-07421PLUS		- O	85311	89424
		03-07423PLUS		- O	85033	89427
		10-12032-002PLUS	O O	85320	89429	
		10-12542-000PLUS	O O	85901
		16-13947-000PLUS		- O	85319	89428
		2018987C1PLUS		O O	85003	89411

APPLICATION GUIDE - TRUCKS, TRAILERS, AND BUSES





Year Año Année	Model Modelo Modèle	OEM #	Front		Rear	
						
						
			Fleetline	GasSLX	Fleetline	GasSLX

PETERBILT(Cont'd.)

Additional Applications(Cont'd.)

OE PLUS Shock Stamping Number	47902-13PLUS		010	83122	89406
	60670-005PLUS		010	83137	...
	60670-008PLUS		010	83123	89405
	665565PLUS		010	85007	89412
	671962PLUS		01-	85936	89456
	70701PLUS		-1-	85900	...
	8086053PLUS		010	85047	89435
	90044025PLUS	010	83209	89414	
	90044089PLUS		010	83124	89407
	B71-6015	010	85012	89413	
	C71-1002PLUS		010	85067	89451
	C71-1011PLUS		-1-	85069	89455
	K374-26PLUS	010	85001	89410	
	K374-28PLUS		010	85314	89425
	K374-29PLUS		-1-	85310	89423
	K374-33PLUS	010	83312	89409	
TruckMaster Shock Stamping Number	665632	010	85013	89414	
	665783		010	83123	89405
	665784		010	83122	89406
	665785		010	83137	...
	665844		-1-	85069	89455
	665918		-1-	85900	...
	665926		010	85047	89435
	665927	010	85901
	665928	010	85062	89408	
	665930	010	85001	89410	
	665931	010	83312	89409	
	665932	010	85012	89413	
	665950		-1-	85902	...
	671052	010	85070	89459	
	671654		01-	85936	89456
	671699		01-	85937	...
	671794		010	85067	89451
	680237		010	85303	89422
	680239		-1-	85310	89423
	680240		010	85302	89420
	680242		010	85308	89422
	680253		010	85314	89425
	680261	010	85062	89408	
	680279	010	83209	89414	
	680280		010	85906	89407
	680281		010	85003	89411
	680283	01-	83353
	680303		010	85007	89412
	680425	010	85320	89429	
	680435		-10	85033	89427
	680473		-10	85319	89428
	Models with O.E.M. Number	02-01759	010	83312	89409		...
02-01890		010	85012	89413	
02-02061		010	85013	89414	
02-02142		010	85036	89405	

APPLICATION GUIDE - TRUCKS, TRAILERS, AND BUSES









Year Año Année	Model Modelo Modèle	OEM #	Front		Rear	
						
			Fleetline	GasSLX	Fleetline	GasSLX

PETERBILT(Cont'd.)

Additional Applications(Cont'd.)

Year	Model	OEM #	Front	Rear
	Models with O.E.M. Number	02-02225	010 85012 89413
		03-01635	010 85308 89422
		03-04629	-10 85311 89424
		03-05106	-10 85033 89427
		03-05384	-10 85033 89427
		03-06084	-10 85033 89427
		03-07281	-10 85311 89424
		03-07424	-10 85311 89424
		03-07424PLUS	-10 85311 89424
		23-08233	010 85308 89422
		23-10393	010 85308 89422
		23-12262	010 85012 89413
		665133	010 83203 89436
		665617	010 85031
		665655	010 85062 89408
		665656	010 85012 89413
		665657	010 85013 89414
		665658	010 85036 89405
		665660	-10 85033 89427
		665662	010 85012 89413
		665738	010 85910
		665752	010 85067 89451
		665762	010 85012 89413
		665788	010 85000 89436
		665826	-1- 85069 89455
		665858	010 85070 89459
		665876	010 85959
		665945	-1- 85902
		671091	-1- 85069 89455
		671092	010 85012 89413
		671963	01- 85937
		680026	010 85302 89420
		680027	010 85308 89422
		680185	010 85308 89422
		680241	-10 85311 89424
		680348	010 85012 89413
		680435	-10 85033 89427
		680457	010 85302 89420
		680458	-1- 85336
		680459	-10 85311 89424
		680586	-10 85311 89424
		B71-1000	010 85031
		B71-1001	010 85070 89459
		B71-1002	010 85001 89410
		B71-1003	010 83312 89409
		B71-6002	010 85012 89413
		B71-6003	010 85029
		B71-6004	010 85084 89460
		B71-6008	010 83312 89409
		C71-1013	01- 85985
		C71-1014	01- 85936 89456

APPLICATION GUIDE - TRUCKS, TRAILERS, AND BUSES

Year Año Année	Model Modelo Modèle	OEM #	Front		Rear	
						
						
			Fleetline	GasSLX	Fleetline	GasSLX

PETERBILT(Cont'd.)

Additional Applications(Cont'd.)

	Models with O.E.M. Number	C71-6005	- -	85069	89455
2013 -	Models with O.E.M. Number	B71-6010	0 0	85023 or 89415			
	Models with Quadraflex 4 spring rear suspension	03-04628	- -	85336	...

PETERBILT CAB SHOCKS

06 - 13	335 Day Cab models with O.E.M. Number	1202P055	0 0	83061
- 14	337 Day Cab models with O.E.M. Number	1202P055	0 0	83061
- 17	348 Day Cab models with O.E.M. Number	1202P055	0 0	83061
	357, 375, 376, 377 & 378 Conventional Truck & Tractors with Link Cabmate Models PBC377 & PBC377-A	1202-0054	0 0	83021
81 -	362 Cabovers with Link Cabmate Model PB-362-2P	1202-0032	0 0	83016
78 -	48" Sleepers with Link Bunkmate Model PBS48-A	1202-1044	0 0	83025
78 -	63" Sleepers with Link Bunkmate Model PBS63-A	1202-1044	0 0	83025
	Models with Link Cab Suspension	1202-0022	0 0	83046
	Models with O.E.M. Number	654782	0 0	83008
		654812	0 0	83042
		654919	0 0	83035
		R71-1004	0 0	83049
		R71-1005	0 0	83024
	Models with PowerPacker Cab Suspension	96027-1054	0 0	83011
		PP1058870	0 0	83059
		PP1059870	0 0	83060
		PP2582870	0 0	83012

359 Series

	359 Conventional Truck & Tractors with Link Cabmate Models PBC379 & PBC379-A	1202-0054	0 0	83021
	359 Models (Older Models) Conventional Tractors with Link Cabmate Model PBCAL359	1201-0012	0 0	83023
		1202-0012	0 0	83023

365 Series

08 - 17	365 Conventional Day Cab with O.E.M. Number	20-16755	0 0	83042
		R71-6005	0 0	83042

367 Series

08 - 17	367 Conventional Day Cab with O.E.M. Number	20-16755	0 0	83042
		R71-6005	0 0	83042
08 - 16	367 Models with 70" Sleepers	29-02455	0 0	83008
		R71-6007	0 0	83008

377 & 379 Series

	377 & 379 Conventional Models with Unibuilt Cab	29-02455	0 0	83008
		R71-6007	0 0	83008
	379 Conventional Truck & Tractors with Link Cabmate Models PBC379 & PBC379-A	1202-0054	0 0	83021

384 Series

08 - 16	384 Conventional Day Cab with O.E.M. Number	20-16755	0 0	83042
		R71-6005	0 0	83042









386 Series

06 - 16	386 Conventional Day Cab with O.E.M. Number	20-16755	0 0	83042
		R71-6005	0 0	83042
06 - 16	386 Models with Sleepers	29-02455	0 0	83008
		R71-6007	0 0	83008

387 Series

99 -	387 Models with 70" Sleepers	29-06032	0 0	83035
------	------------------------------	----------	-----	-------

APPLICATION GUIDE - TRUCKS, TRAILERS, AND BUSES

Year Año Année	Model Modelo Modèle	OEM #	Front		Rear	
						
						
			Fleetline	GasSLX	Fleetline	GasSLX

PETERBILT CAB SHOCKS(Cont'd.)

387 Series(Cont'd.)

99 -	387 Models with 70" Sleepers	R71-6008	010	83035
99 -	387 Models with O.E.M. Number	29-06005	010	83035
08 - 11	DayCab Models with O.E.M. Number	R71-6000	010	83067
		R71-6010	010	83067

388 Series

08 - 17	388 Conventional Day Cab with O.E.M. Number	20-16755	010	83042
		R71-6005	010	83042
08 - 16	388 Models with 70" Sleepers	29-02455	010	83008
		R71-6007	010	83008

389 Series

- 16	389 Day Cab models with O.E.M. Number	20-19140	010	83063
		R71-6006	010	83063
08 - 16	389 Models with 70" Sleepers	29-02455	010	83008
		R71-6007	010	83008

587 Series

11 - 16	587 Models with 70" Sleepers	29-06032	010	83035
		R71-6008	010	83035

PIERCE MANUFACTURING INC.

	Pierce FireTrucks with O.E.M. Number	680401	010	85307
	Additional O.E.M. Interchanges	1445910	010	85300 or 89419			
		40-0242	010	83312 or 89409			
		40-4845	010	85304			
		40-4951	010	85316 or 89426			
		40-5348	010	85058 or 89431			
		40-6967	010	85030 or 89440			





POWERPACKER CAB SHOCKS

	Models with PowerPacker Cab Suspension	PP1058870	010	83059
		PP1059870	010	83060

PREVOST

04 - 09	H3 Bus, H3 VIP Bus Drive and Tag Axle Shocks	630253	010		
		481700999386	010	85713		
		630127	010	85736		
		650407	010	85736		
		VIP with Independant Front Suspension	481700000208	010	85379	
			630251	010	85379	
			With I-Beam Front Suspension	630252	010	85329
				481700999376	010	85329
				630134	010	85329
				680422	010	85329
		Intercity Bus with O.E.M. Number	481700999427	010	85380	
			630228	010	85380	
			680583	010	85380	
		LeMirage XL 40 ft, 45 ft, & H Models Coaches with Independant Front Suspension	630136	010	85330	
LeMirage XL 40 ft, 45 ft, & H3-45 VIP Coaches with I-Beam Front Suspension	481700999376		010	85329		
		630134	010	85329		









APPLICATION GUIDE - TRUCKS, TRAILERS, AND BUSES

Year Año Année	Model Modelo Modèle	OEM #	Front		Rear	
						
			Fleetline	GasSLX	Fleetline	GasSLX

PREVOST(Cont'd.)

	Low Floor Bus Models with O.E.M. Number	N16249		010	85378	...
	X3-45 Bus			010	85713	...
	Drive and Tag Axle Shocks	630253		010	85380	...
	With I-Beam Front Suspension	48170000206	01-	85380
		630254	01-	85380
	With Independant Front Suspension	630136	01-	85330
04 - 06	XL II Bus, XL II MTH Bus			010	85713	...
	Drive and Tag Axle Shocks	630253		010	85736	...
		481700999386		010	85736	...
		630127		010	85736	...
		650407		010	85736	...
	With I-Beam Front Suspension	630252	010	85329
		481700999376	010	85329
		630134	010	85329
		680422	010	85329
	With Independant Front Suspension	48170000208	01-	85379
		630251	01-	85379
		481700999377	01-	85330
		630163	01-	85330
07 - 09	XL II MTH Bus			010	85713	...
	Drive and Tag Axle Shocks	630253		010	85713	...
	Front Suspension	630136	01-	85330
89 - 00	XL-45 Coach			010	85736	...
	Drive and Tag Axle Shocks	481700999386		010	85736	...
		630127		010	85736	...
		650407		010	85736	...
	With I-Beam Front Suspension	481700999376	010	85329
		630134	010	85329
		680422	010	85329
	Models with O.E.M. Number	12L-5-89		01-	85729	...
		12T-1-13		85303	...	010	85303	89422
		19501288		01-	85729	...
		19501289	-1-	85728
		19501547		01-	85740	...
		48170000207	010	85329
		48170000209		010	85713	...
		630103	010	85329
		630161		010	85736	...
		630234	010	85329
		630235	01-	85330
		630236	010	85329
		680510	01-	85330
		G5008070	010	85700
	Additional O.E.M. Interchanges	01-0100-905	010	85303 or 89422				
		0822045526	010	85702				
		12B-5-1	010	85735				
		19501669	010	85339				
		19502711	010	85702				
		19506846	010	85339				
		196347	-10	85710				
		196533	-1-	85708				
		3166657	010	85700				

APPLICATION GUIDE - TRUCKS, TRAILERS, AND BUSES

Year Año Année	Model Modelo Modèle	OEM #	Front		Rear	
						
						
			Fleetline	GasSLX	Fleetline	GasSLX

REYCO SUSPENSION(Cont'd.)

Additional Applications(Cont'd.)

Models with O.E.M. Number	671707	O10	O10	85052	...	
	680551		O10	85738	...	
	680552		O10	85938	...	
	680700		O10	85938	...	
	700098-01		83128	89436		
	702135-01		O10	85045	...	
	702136-01		O10	85052	...	
	702209-01		O10	85014	...	
	704672-01		O10	85938	...	

RIDEWELL CORPORATION

Bus and R.V. Air-Rides

Mobile Home & RV with Air Suspension	AS563B		O10	83203	89436
	S6009B		O10	83203	89436
RAS - 227 Models Steer Axles Air Suspension w/ O.E.M. Number	1260008		O10	87017	...
	90-2610 SP1		O10	87017	...

Trailer Air-Rides

RAR - 244 FeatherRide Light Duty Air Suspension (8,000 lb Capacity)	1270007		O10	85045	...
RAR-210 With Double Convolution Spring With Shock Absorber Bracket 2-1/2" Above Frame Rail With Shock Absorber Bracket 2-7/8" Above Lower Frame Rail With Shock Absorber Bracket 3" Above Lower Frame Rail With Shock Absorber Bracket Even With Underside of Frame	AS789B		O10	85014	...
	S5878B		O10	83207	89407
	O10	85006	...
	O10	83207	89407
	O10	85005	89430
	AS546B		O10	85006	...
RAR-210 For Trailers with 25" Drop	1253069B000		O10	85005	89430
	AS30698		O10	85005	89430
	AS3069B		O10	85005	89430
RAR-210 Tag Axle	AS563B		O10	83203	89436
	S6009B		O10	83203	89436
RAR-221 Tag Axle	AS563B		O10	83203	89436
	AS789B		O10	85014	...
	S5878B		O10	83207	89407
	S6009B		O10	83203	89436
RAR-221-11, 12, 13-USW Trailer with Shock Absorber and Hanger	AS563B		O10	83203	89436
	S6009B		O10	83203	89436
RAR-221AS-11-USW, RAR-221AS-11-1-USW Trailer	1253069B000		O10	85005	89430
	AS30698		O10	85005	89430
	AS3069B		O10	85005	89430
RAR-221AS-12-USW, RAR-221AS-12-1-USW Trailer	1250546B000		O10	85006	...
	AS546B		O10	85006	...
RAR-240, RAR-240W (Mono Pivot Trailers with HD Air Suspension) With O.E.M. Number	1270563B000		O10	85000	89436
	1270563B003		O10	85934	...
	1270789B000		O10	85014	...
			O10	85934	...
RAR-243 (Mono Pivot Trailers with HD Air Suspension)	1270563B003		O10	85934	...
RAR-260 Overslung Air Suspension (25,000 lb Capacity)	1270563B003		O10	85934	...

APPLICATION GUIDE - TRUCKS, TRAILERS, AND BUSES

Year Año Année	Model Modelo Modèle	OEM #	Front		Rear	
			Fleetline	GasSLX	Fleetline	GasSLX

RIDEWELL CORPORATION(Cont'd.)

Trailer Air-Rides(Cont'd.)

RAR-260 Underslung Air Suspension (25,000 lb and 30,000 lb Capacity)	1270563B003		010	85934	...
RideLite Trailer Air Suspension	1270563B003		010	85934	...
Models with O.E.M. Number	1275943B		010	85005	89430
	57645		010	85005	89430
	665526		010	85014	...

Truck Air-Rides

Fire Truck with Ridewell Front Suspension	AS 4025B	010	85712
Pusher w/Axle Lift	AS563B		010	83203	89436
	S6009B		010	83203	89436
RAD-221R Drive Axle	S2607B		010	85702	...
	S5477B		010	85307	...
RCA-215 Models Air Suspension (RCA-215 LM, RCA-215 MM)	1250789B000		010	85014	...
RD-202B Tandem Drive Axle	S5478B		010	85307	...
RD-202S-54-48-BS Tandem Drive Air Suspension	1252607B000		010	85702	...
RD-202S-54-52T-SR Tandem Drive Air Suspension	1252607B000		010	85702	...
RSS-236, RSS-236R Self Steering Tag/Pusher Lift Axle (For 13000 lb & 16000 lb Capacity)	1253069B000		010	85005	89430
	AS30698		010	85005	89430
	AS3069B		010	85005	89430
RUA-220B-1-, 10, 10.5, 11, 11.5, 12, 12.5, 13 (Lift Tag Axle & Trailer Lift Suspension)	1250789B000		010	85014	...
	AS789B000		010	85014	...
RUA-220B-1-, 7, 7.5, 8, 8.5, 9, 9.5, 10 (Lift Tag Axle & Trailer Lift Suspension)	1270563B000		010	85000	89436
Models with O.E.M. Number	1250563B000		010	85000	89436
	1252607B000		010	85702	...
	1253069B000		010	85005	89430
	1254190B000		010	85302	89420
	12651527B000		010	85712	...
	1266009B000		010	83130	...
	1267120B000		010	85734	...
	1267395B000		010	85302	89420
	1275813B000		010	85704	...
	665198		010	85005	89430
	665267		010	85029	...
	680101		010	85702	...
	70654		010	85000	89436
	AS575B		010	85005	89430
	S4025B		010	85712	...
	S5813B		010	85704	...
	S7120B		010	85304	...
	S7172B		010	83207	89407
S7249B		010	85307	...	
S7365B		010	85305	...	
Additional O.E.M. Interchanges	1250005	010	85901				
	1254025B000	010	85712				
	1265478B000	010	85736				
	1267249B000	010	85712				

APPLICATION GUIDE - TRUCKS, TRAILERS, AND BUSES

Year Año Année	Model Modelo Modèle	OEM #	Front		Rear	
			Fleetline	GasSLX	Fleetline	GasSLX

ROADMASTER (MONACO)





	Models with AD-123 Models Suspension (AD123-6,-8,-10,-8.75)	90045132		OIO	85909	...
	Models with O.E.M. Number	90045188		OIO	85910	...

SAF HOLLAND

Trailer Air Suspension

	AirLite 2 Model Trailer Air Suspension	90044025		OIO	83209	89414
	AR-120 Models Trailer Air Suspension (AR-120, AR-120-L, AR-120-US, AR-120-US-F) (AR-120-US-L, -1, -2, -3)	90044626 90044625		OIO	83126	89430
	AR-125 Models Trailer Air Suspension (AR-125, AR-125-L, AR-125-US, AR-125-US-F) (AR-125-US-L, -1, -2, -3)	90044626 90044625		OIO	83126	89430
	AR-165-US Models Trailer Air Suspension (AR165-US)	90044626		OIO	83126	89430
	AR-250 Models Trailer Air Suspension (AR-250-12) (AR-250-14, -15) (AR-250-16, -17)	90045054 90044642 90044089		OIO	85051	...
	AR-41 Models Trailer Air Suspension (All)	90044162		OIO	83128	89436
	AR-45 Models Trailer Air Suspension (AR-45, AR-45-1)	90044162		OIO	83128	89436
	AR-50 Models Trailer Air Suspension (AR-50-US, AR-50-US-F,-1,-2)	90044162		OIO	83128	89436
	AR-51 Models Trailer Air Suspension (AR51-US)	90044162		OIO	83128	89436
	AR-70 Models Trailer Air Suspension (AR-70-9, -14, AR-70A-9, 14)	90044626		OIO	83126	89430
	AR-75 Models Trailer Air Suspension (AR-75-12) (AR-75-6, -9, -1-12)	90044625 90044626		OIO	83125	...
	AR-80 Models Trailer Air Suspension (AR-80-6.75) (AR-80-9, -9FM) (AR-80-9-WST)	90044046 90044868 90044626		OIO	83123	89405
	AR-85-A Models Trailer Air Suspension (AR-85-A)	90044625		OIO	83125	...
	AR-90 Models Trailer Air Suspension (AR-90-14, -15, -16, -17)	90044089		OIO	83124	89407
	AR-90-1 Models Trailer Air Suspension (AR-90-1-12, -14, -17) (AR-90-1-15, -16)	90044162 90044448 90045054		OIO	83128	89436
	AR-92 Models Trailer Air Suspension (AR-92-12) (AR-92-14) (AR-92-15) (AR-92-16) (AR-92-17) (AR-92-18)	90044162 90044992 90045040 90044448 90045054 90044794 90044642 90044089 90044769		OIO	83128	89436
				OIO	85000	89436
				OIO	83130	...
				OIO	85051	...
				OIO	85051	...
				OIO	83127	...
				OIO	83127	...
				OIO	83124	89407
				OIO	83207	89407

APPLICATION GUIDE - TRUCKS, TRAILERS, AND BUSES





Year Año Année	Model Modelo Modèle	OEM #	Front		Rear	
			 Fleetline	 GasSLX	 Fleetline	 GasSLX

SAF HOLLAND(Cont'd.)

Trailer Air Suspension(Cont'd.)

AR-93 Models Trailer Air Suspension (AR-93-14)	90044448		010	85051	...	
	90045054		010	85051	...	
	(AR-93-15)	90044794		010	83127	...
	(AR-93-16)	90044642		010	83127	...
	(AR-93-17)	90044089		010	83124	89407
		90044769		010	83207	89407
AR-94 Models Trailer Air Suspension	90045028		010	85907	...	
	90045048		010	85905	...	
	90045049		010	85905	...	
AR-95 Models Trailer Air Suspension (AR-95-9, -12, -14, -17, All -HD Models, AR-95A-9, -12, -14, -17)	90044625		010	83125	...	
AR-955 Models Trailer Air Suspension (Liftaxle) (AR-955-9, -12, -14, -17) (AR-955-9HD, -12HD, -14HD, -17HD) (AR-955A-9, -12, -14, -17) (AR-955A-9HD, -12HD, -14HD, -17HD)	90044625		010	83125	...	
	90044625		010	83125	...	
	90044625		010	83125	...	
	90044625		010	83125	...	
ARA-93 Models Trailer Air Suspension (ARA-93-14)	90045054		010	85051	...	
ARL20 Models Trailer Air Suspension (ARL20-D, ARL20-D-US)	90044162		010	83128	89436	
ARS112 Models Trailer Air Suspension (ARS112-6)	90045096		010	85916	...	
ARU-92 Models Trailer Air Suspension (ARU-92-8, -9, -10, -12)	90044642		010	83127	...	
ARU-93 Models Trailer Air Suspension (ARU-93-6) (ARU-93-7, -8, -9, -10)	90045040		010	83130	...	
	90044642		010	83127	...	
ARU-98 Models Trailer Air Suspension (ARU-98-17)	90045054		010	85051	...	
CB-2300 Models Trailer Air Suspension (CB-2300-14) (CB-2300-15) (CB-2300-16, CB-2300-17)	90044868		010	85045	...	
	90045381		010	83150	...	
	90045298		010	83128	...	
CB-400/4000 Models Trailer Air Suspension (CB-400-15.5, CB-400-16.0) (CB-400-16.5, CB-400-17.0) (CB-400-18.0)	90045298		010	83128	...	
	90044162		010	83128	89436	
	90045040		010	83130	...	
CBX 23 Models Trailer Air Suspension (CBX 23-14) (CBX 23-15) (CBX 23-16, CBX 23-17)	90044868		010	85045	...	
	90045381		010	83150	...	
	90045298		010	83128	...	
CBX 23 with 245 or 317 Fusion Axle and Beam Assembly For Bracket Type #1, 3, 4, & 5 - 16.0" & 17.0" Ride Height	90045299		010	83389	89436	
CBX 25 Models Trailer Air Suspension (CBX 25-14) (CBX 25-16, CBX 25-17)	90045607		010	83150	...	
	90045040		010	83130	...	
CBX 25 with 245 Fusion Axle and Beam Assembly (16.0" & 17.0" Ride Height)	90045299		010	83389	89436	
CBX 30 with 245 Fusion Axle and Beam Assembly (16.0" & 17.0" Ride Height)	90045299		010	83389	89436	
CBX 40 Models Trailer Air Suspension (CBX 40 -16.5, CBX 40 -17.0) (CBX 40-15.5, CBX 40-16.0)	90044162		010	83128	89436	
	90045298		010	83128	...	

APPLICATION GUIDE - TRUCKS, TRAILERS, AND BUSES





Year Año Année	Model Modelo Modèle	OEM #	Front		Rear	
						
			Fleetline	GasSLX	Fleetline	GasSLX

SAF HOLLAND(Cont'd.)

Trailer Air Suspension(Cont'd.)

	(CBX 40-18.0)	90045040		010	83130	...
	CBX 46 Models Trailer Air Suspension (16.5" & 17.0" Ride Height)	90044162		010	83128	89436
	CBX 50 Models Trailer Air Suspension (16.5" & 17.0" Ride Height)	90044162		010	83128	89436
	NL-200 Models Non Steer - Auxiliary Lift Air Suspension (NL-200-1S, NL-200-2S)	90044162		010	83128	89436
	NS-190 Models Trailer Air Suspension (NS-190-16.0) (NS-190-16.5, NS-190-17.0) (NS-190-18.0)	90044162		010	83128	89436
		90045040		010	83130	...
		90045054		010	85051	...
	NS-400 Models Trailer Air Suspension (NS-400-16.0) (NS-400-16.5) (NS-400-18.0)	90045298		010	83128	...
		90044162		010	83128	89436
		90045040		010	83130	...
	NS-400 Models Trailer Air Suspension (17.0" Ride Height)	90045299		010	83389	89436
	NS-450 Models Trailer Air Suspension (NS-450-16.0) (NS-450-16.5) (NS-450-18.0)	90045298		010	83128	...
		90044162		010	83128	89436
		90045040		010	83130	...
	NS-450 Models Trailer Air Suspension (17.0" Ride Height)	90045299		010	83389	89436
	RL-196 Models Trailer Air Suspension (RL-196-12) (RL-196-14, -15) (RL-196-16, -17)	90044977		010	83115	...
		90044978		010	85059	...
		90044979		010	83113	...
	RL-196A Models Trailer Air Suspension (RL-196A-12) (RL-196A-14, -15) (RL-196A-16, -17)	90044162		010	83128	89436
		90045040		010	83130	...
		90044794		010	83127	...
	RL-228 Models Trailer Air Suspension (RL-228-12-3) (RL-228-14-3, -14-4, -15-3, -16-3) (RL-228-17-3)	90044162		010	83128	89436
		90044642		010	83127	...
		90044089		010	83124	89407
	RL-230 Models Trailer Air Suspension (RL-230-12-3) (RL-230-14-3, -15-3) (RL-230-16-3, -17-3)	90045381		010	83150	...
		90044642		010	83127	...
		90044089		010	83124	89407
	RL-230 Models Trailer Air Suspension (Hanger Mounted Shock) (RL-230-14-3, -15-4) (RL-230-16-4) (RL-230-17-4)	90045381		010	83150	...
		90045299		010	83389	89436
		90045040		010	83130	...
	RL-230 Models Trailer Air Suspension (Single Stud Air Spring) (RL-230-14-3, -15-4, -16-4) (RL-230-17-4)	90044642		010	83127	...
		90044089		010	83124	89407
	RL-250 Models Trailer Air Suspension (Shock Below Frame) (RL-250-14-3, -15-4) (RL-250-16-4, -17-4)	90045040		010	83130	...
		90045299		010	83389	89436
	RL-250 Models Trailer Air Suspension (Std Suspension) (RL-250-12) (RL-250-14.0, -15.0) (RL-250-16.0, -17.0)	90045054		010	85051	...
		90044642		010	83127	...
		90044089		010	83124	89407

APPLICATION GUIDE - TRUCKS, TRAILERS, AND BUSES





Year Año Année	Model Modelo Modèle	OEM #	Front		Rear	
						
			Fleetline	GasSLX	Fleetline	GasSLX

SAF HOLLAND(Cont'd.)

Trailer Air Suspension(Cont'd.)

RL-300 Models Trailer Air Suspension (Offset Stud Air Spring) (RL-300-13)	90045054		010	85051	...
	(RL-300-14, -15, -16, -17)	90045338	010	85060	...
RL-300 Models Trailer Air Suspension (Std Suspension) (RL-300-12, -13)	90045054		010	85051	...
	(RL-300-14, -15, -16, -17)	90045338	010	85060	...
RLSA Models Trailer Air Suspension (RLSA-4212, -4812)	90044977		010	83115	...
RLSA Models Trailer Air Suspension (RLSA-4214, -4215, -4814, -4815)	90044978		010	85059	...
RLSA Models Trailer Air Suspension (RLSA-4216, -4217, -4816, -4817)	90044979		010	83113	...
RLSA228 Models Trailer Air Suspension (RLSA-228-4214, -4215, -4216, -4814, -4815, -4816)	90044642		010	83127	...
RLSA228 Models Trailer Air Suspension (RLSA-228-4217, -4817)	90044089		010	83124	89407
RLU-228 Models Trailer Air Suspension (RLU-228-10-3)	90044089		010	83124	89407
	(RLU-228-6-3)	90045040	010	83130	...
	(RLU-228-7-3)	90044642	010	83127	...
	(RLU-228-8-3, RLU-228-9-3)	90044626	010	83126	89430
RLU-228 Models Trailer Air Suspension (Axle Mounted Shock Suspension) (RLU-228-8-3)	90044162		010	83128	89436
	(RLU-228-9-3, RLU-228-10-3, RLU-228-12-3)	90044642	010	83127	...
RLU-228 Models Trailer Air Suspension (Current Production - w/3" Axle Travel Up) (RLU-228-10-3, RLU-228-12-3)	90044642		010	83127	...
	(RLU-228-6-3)	90045298	010	83128	...
	(RLU-228-7-3)	90044162	010	83128	89436
	(RLU-228-8-3)	90045040	010	83130	...
	(RLU-228-9-3)	90045054	010	85051	...
RLU-228 Models Trailer Air Suspension (Current Production - w/4" Axle Travel Up) (RLU-228-10-4)	90044642		010	83127	...
	(RLU-228-8-4)	90044162	010	83128	89436
	(RLU-228-9-4, RLU-228-12-4)	90044626	010	83126	89430
RLU-228 Models Trailer Air Suspension (Current Production - w/4" Axle Travel Up) HVY DTY (RLU-228-8-4)	90045337		010	85911	...
RLU-250 Models Trailer Air Suspension (RLU-250-12)	90044642		010	83127	...
	(RLU-250-6.5)	90045381	010	83150	...
	(RLU-250-9)	90044162	010	83128	89436
RLU-250 Models Trailer Air Suspension (Frame Mount Suspension) (RLU-250-12-FMT)	90045054		010	85051	...
	(RLU-250-6.5-FMT)	90045381	010	83150	...
	(RLU-250-9-FMT)	90044162	010	83128	89436
RLU-300 Models Trailer Air Suspension (Std Suspension) (RLU-300-6.5)	90045471		010	83150	...
	(RLU-300-9)	90045337	010	85911	...
Trailer Air Suspension (RL196-16,-17)	90044979		010	83113	...
CBX 69 Trailer Air Suspension	90045669		010	83389	89436
Models with O.E.M. Number	665454		010	85045	...

APPLICATION GUIDE - TRUCKS, TRAILERS, AND BUSES

Year Año Année	Model Modelo Modèle	OEM #	Front		Rear	
						
			Fleetline	GasSLX	Fleetline	GasSLX

SAF HOLLAND(Cont'd.)





Trailer Air Suspension(Cont'd.)

Models with O.E.M. Number	671931	010	85916	...	
	680234	010	85906	89407	
	680268	010	85323	89436	
	90044980	010	85907	...	
	90045000	010	85906	89407	
	90045001	010	85323	89436	
	90045002	010	85906	89407	
	90045003	010	85323	89436	
	90045019	010	85913	...	
	90045080	010	85912	...	
	90045083	010	85910	...	
	90045188	010	85910	...	
	90045207	010	...	89405	
	90045433	010	85916	...	
	90045563	010	85014	...	
	90045564	010	83128	89436	
	90045572	010	85045	...	
	90045574	010	83130	...	
	90045575	010	85051	...	
	90045576	010	83150	...	
	90045665	010	85029	...	
	90045667	010	85060	...	
	XB-SPN-053-36	010	83125	...	
	Models with O.E.M. Number (Hvy Duty)	90045666	010	85051	...
	Models with O.E.M. Number (STD)	90045666	010	83130	...

Truck & Tractor Air Suspension (Tag Axle)

Models with O.E.M. Number	57639	010	85000	89436
	57643	010	85013	89414
	6025	010	83122	89406
	6026	010	83204	...
	665197	010	85051	...
	665514	010	83127	...
	665969	010	...	89430
	90044001	010	85005	89430
	90044071	010	85000	89436
	90044081	010	85000	89436
	90044086	010	85000	89436
	90044089C	010	83124	89407
	90044095	010	83203	89436
	90044679	010	83122	89406
	90044680	010	83125	...
	90044681	010	83204	...
	90044682	010	83209	89414
	90044683	010	83122	89406
	90044684	010	83124	89407
	90044685	010	83389	89439
	90044686	010	85051	...
	90044687	010	83125	...
	90044688	010	83122	89406
	90044770	010	83207	89407
	90044833	010	85052	...

APPLICATION GUIDE - TRUCKS, TRAILERS, AND BUSES

Year Año Année	Model Modelo Modèle	OEM #	Front		Rear	
						
			Fleetline	GasSLX	Fleetline	GasSLX

SAF HOLLAND(Cont'd.)





Truck & Tractor Air Suspension (Tag Axle)(Cont'd.)

Models with O.E.M. Number	90044834	010	85052	...
	90044878	01-	83635	...
	90044915	010	83127	...
	90044981	010	85000	89436
	90044982	010	85000	89436
	90044991	010	85000	89436
	90045110	010	83137	...
	90045175	010	85916	...
	90045384	010	...	89430
	AR-1008	010	85006	...
	AR-1141	010	83204	...
	AR-1141-C	010	83204	...
	AR-1202	010	85300	89419
	AR-134-C	010	85005	89430
	AR-1404	010	85301	...
	AR-1425	010	85301	...
	AR-1434	010	83203	89436
	AR-1654	010	83209	89414
	AR-1822	010	85304	...
	AR-2451	010	83203	89436
	AR-2598	010	83123	89405
	AR-718-C	010	83203	89436
	AR-718-C-HD	010	85000	89436
	AR-781	010	83203	89436
AR-958	010	83207	89407	
AR-995	010	85734	...	

Truck, Bus & Motorhome Air Suspensions

AD-123 Models Truck and Tractor Air Suspension (AD123-6,-8,-10,-8.75)	90045068	-10	...	89441
AD-123 Models Truck and Tractor Air Suspension (AD123-6,-8,-10,-8.75) Shock Mount approx. 2-1/2" above bottom of frame Shock Mount flush with bottom of frame	90045132	010	85909	...
	90045099	010	85906	89407
AD-130 Models Truck and Tractor Air Suspension (AD123-6,-8,-10,-8.75)	90045466	010	...	89406
AD-130 Models Truck and Tractor Air Suspension W/ OEM Number	90045432	010	85321	...
AD-150 Models Truck & Tractor Air Suspension	90045075	010	85911	...
AD-200 Models Truck & Tractor Air Suspension (AD-200-7, -8, -9, -11)	90045138	010	85910	...
AD-246 Models Truck & Tractor Air Suspension (AD246 -6, -8, -10, -8.75)	90045099	010	85906	89407
	90045132	010	85909	...
00 - AD-246 Models with 10" Ride Height	90045504	010	85030	...
AD-252-10 Tandem Axle	90045132	010	85909	...
00 - AD-369 Models with 10" Ride Height	90045504	010	85030	...
ADZ-123 Models Truck and Bus Air Suspension	90045605	010	85109	...
ADZ-126 Models Truck and Bus Air Suspension	90045605	010	85109	...
ADZ-246 Models Truck and Bus Air Suspension	90045605	010	85109	...
ADZ-252 Models Truck and Bus Air Suspension	90045605	010	85109	...
ADZ-369 Models Truck and Bus Air Suspension	90045605	010	85109	...
ADZ-378 Models Truck and Bus Air Suspension	90045605	010	85109	...

APPLICATION GUIDE - TRUCKS, TRAILERS, AND BUSES

Year Año Année	Model Modelo Modèle	OEM #	Front		Rear	
						
			Fleetline	GasSLX	Fleetline	GasSLX

SAF HOLLAND(Cont'd.)

Truck, Bus & Motorhome Air Suspensions(Cont'd.)

ARD-120 Models Truck & Tractor Air Suspension (ARD-120-6)	90044025	010	83209	89414
ARD-125 Models Truck & Tractor Air Suspension (ARD-125-6 use on Ford, GM, International (Navistar), Mack, White, Western Star, Freightliner) (ARD-125-8 use on Freightliner, White, Western Star) (ARD-125-8 use on Mack)	90044025 90044011 90044016	010 010 010	83209 85004 85300	89414 ... 89419
ARD-165 Models Truck & Tractor Air Suspension (ARD-165-A, ARD-165-B)	90044011	010	85004	...
ARD-190 Models Truck & Tractor Air Suspension (ARD-190-B)	90044016	010	85300	89419
ARD-234 Models Truck & Tractor Air Suspension (ARD-234-6)	90044046	010	83123	89405
ARD-238 Models Truck & Tractor Air Suspension (ARD-238-6)	90044025	010	83209	89414
ARD-238-6 Models Truck & Tractor Air Suspension	90044025	010	83209	89414
ARD-244 Models Truck & Tractor Air Suspension (ARD-244-6 use on Ford, GM, International (Navistar), Mack, White, Western Star, Freightliner) (ARD-244-8 use on Freightliner, White, Western Star) (ARD-244-8 use on Mack)	90044025 90044011 90044016	010 010 010	83209 85004 85300	89414 ... 89419
ARDAB-120 Models Truck & Tractor Air Suspension (ARDAB-120-5)	90044907	01-	83635	...
ARDAB-238-5 Models Truck & Tractor Air Suspension	90044907	01-	83635	...
ARDAB-240 Models Truck & Tractor Air Suspension (ARDAB-240-5)	90044907	01-	83635	...
ARDST-123 Models Truck & Tractor Air Suspension (ARDST-123-6, ARDSTM/L-123-6)	90044025	010	83209	89414
ARDST-244 Models Truck & Tractor Air Suspension (ARDST-244-6)	90044025	010	83209	89414
ARDST-246 Models Truck & Tractor Air Suspension (ARDST-246-6, ARDSTM/L-246-6)	90044025	010	83209	89414
ARDST-250-6 Models Truck & Tractor Air Suspension	90044025	010	83209	89414
ARDTB-125 Models Bus Air Suspension (ARDTB-125-6A)	90044448	010	85051	...
ARDTB-125 Models Bus Air Suspension (ARDTB-125-6B)	90045031	010	85968	...
ARDTB-125-6A (Note: Front shock)	90045050	010	85914
ARDTB-125-6A (Note: Rear shock)	90045053	010	85908	...
ART-500 Models Truck & Tractor Tag Axle Air Suspension (ART-500-B, ART-500-B-1) (ART-500-US, ART-500-US-A)	90044162 90044008	010 010	83128 85000	89436 89436
ART-505 Models Truck & Tractor Tag Axle Air Suspension (ART-505-B, -1, ART-505-C, -1)	90044162	010	83128	89436
ART-541 Models Truck & Tractor Tag Axle Air Suspension (ART-541B)	90044162	010	83128	89436
ART-550 Models Truck & Tractor Tag Axle Air Suspension (ART-550-US-1, -2, -3)	90044012	010	85006	...
ART-551 Models Truck & Tractor Tag Axle Air Suspension (ART-551-B-1) (ART-551-B-2, -3, ART-551-US-1, -2, -3)	90044162 90044017	010 010	83128 83204	89436 ...
ART-555 Models Truck & Tractor Tag Axle Air Suspension (ART-555-B-1, ART-555-C-1) (ART-555-B-2, -3, ART555C-2, -3)	90044162 90044642	010 010	83128 83127	89436 ...
Models with O.E.M. Number	471700000433 471700000436 471700000458 471700000459 471700000460	010 010 010 010 010	85099 85030 85014 85030 85097

APPLICATION GUIDE - TRUCKS, TRAILERS, AND BUSES

Year Año Année	Model Modelo Modèle	OEM #	Front			Rear		
					○ ○			○ ○

SAF HOLLAND(Cont'd.)

Truck, Bus & Motorhome Air Suspensions(Cont'd.)

Models with O.E.M. Number	47170000461		○ ○	...	89414
	48170000483		○ ○	85975	...
	48170000484		○ ○	85974	...
	48170000485		○ ○	85975	...
	665002		○ ○	85004	...
	665003		○ ○	85300	89419
	671921		○ ○	85916	...
	671922		○ ○	...	89405
	671923		○ ○	...	89440
	680645		○ ○	85321	...
	90045084		○ ○	85968	...
	90045277		○ ○	85030	...
	90045336		○ ○	85014	...
	90045418		○ ○	85916	...
	90045419		○ ○	...	89405
	90045420		○ ○	...	89440
	90045455		○ ○	85909	...
	90045499		○ ○	85974	...
	90045500		○ ○	85975	...
	90045503		○ ○	85975	...
	90045504		○ ○	85030	...
	90045532		○ ○	85030	...
	90045533		○ ○	85099	...
	90045534		○ ○	85014	...
	90045535		○ ○	85097	...
	90045536		○ ○	...	89414
	90045568		○ ○	85060	...

SEAGRAVE FIRE APPARATUS LLC

Models with O.E.M. Number	680117		○ ○	85300	89419
	P0025500		○ ○	85300	89419

SICARD

Models with O.E.M. Number	3166657		85700	...	○ ○	85700	...
---------------------------	---------	--	--------------	-----	-----	--------------	-----





SOUTHERN COACH

Early Model Air Suspension		85304	...	○ ○	85304	...
Late Model Air Suspension		83217	...	○ ○	83217	...
U.S. Army Coaches		83217	...	○ ○	83217	...

SPARTAN MOTORS

97 - 00	Alpine / Summit MotorHome Chassis with O.E.M. Number	0377-SS5	○ ○	85029	...
		B46-1725	○ ○	85029	...
	Buses with Hendrickson Softek Suspension with Drum and Disc Brakes	471700000456	○ ○	85959
		58913-009	○ ○	85959
	Chassis With Hendrickson HTS 210 Suspension (Type C School Bus Applications)	60665-025		○ ○	85036
	Fire Truck with O.E.M. Number	0272-SS5	○ ○	85712
86	Fire Truck with Ridewell Front Suspension	AS 4025B	○ ○	85712
97 - 00	K2 / K3/ MountainMaster with O.E.M. Number	B46-2151		○ ○	85007 89412
91 - 95	K2 / K3/ MountainMaster with Tuthill 102 AR Air Suspension	0346-SS5		○ ○	85013 89414

APPLICATION GUIDE - TRUCKS, TRAILERS, AND BUSES

Year Año Année	Model Modelo Modèle	OEM #	Front		Rear	
						
			Fleetline	GasSLX	Fleetline	GasSLX

SPARTAN MOTORS(Cont'd.)

91 - 95	K2 / K3/ MountainMaster with Tuthill 102 AR Air Suspension	B46-1594		○ ○	85013	89414
	Models with Reyco 1200 Steer Option)	21310-01	○ ○	85307
	Motorhome chassis with Ridewell Front Suspension	AS 4025B	○ ○	85712
	Models with O.E.M. Number	59011	○ ○	83214
	Additional O.E.M. Interchanges	78068	○ ○	85304				

STERLING TRUCK

A - Line 9500 Series (SilverStar)

98 -	A9513, A9522, AT9513, AT9522 (113" & 122" BBC) Models with 8500 or 9000 lb Axle and 54" Taperleaf Spring	F6HT-18045-HB	○ ○	85054	89438	
		F6HT-18045-HC	○ ○	85054	89438	
98 -	A9513, A9522, AT9513, AT9522 (113" & 122" BBC) Models with 8500, 9000 or 10000 lb Axle and 54" Multileaf Spring	F6HT-18045-KA	○ ○	83200	89402	
98 -	All Models with 10000 lb or 12000 lb Axle and 54" Taperleaf Spring	F6HT-18045-AC	○ ○	85054	89438	
98 -	All Models with 12000 lb or 13200 lb Axle and 54" Multileaf Spring	F6HT-18045-BC	○ ○	85047	89435	
98 -	All Models with 12000 lb, 13200 lb or 14600 lb Axle and 60" Taperleaf Spring	F6HT-18045-EB	○ ○	85055	89439	
		F6HT-18045-EC	○ ○	85055	89439	
98 -	All Models with 13200 lb or 14600 lb Axle and 54" Taperleaf Spring	F6HT-18045-GC	○ ○	85030	89440	
98 -	All Models with 14600 lb or 16000 lb Axle and 54" Multi-leaf Spring	F6HT-18045-CC	○ ○	85055	89439	
98 -	All Models with 23000 lb Axle and 52" Taperleaf Softride Rear Suspension	F6HT-18080-CA		○ ○	85314	89425
98 -	All Models with Hendrickson 40LH Tandem Axle	57241-2		○ -	83109	...
98 -	All Models with Hendrickson HAS Rear Air Suspension	47902-28		○ ○	85013	89414
		F6HT-18080-FC		○ ○	85013	89414
98 -	Models with FAS II Rear Air Suspension	16-15817-000		○ ○	85724	89443

ACTERRA

09 - 10	Models with 10000 to 12000 lb. Front Axle and 3" Taper-leaf Suspension	10-13592-000	○ ○	85959
		SDA471700000440	○ ○	85959
03 -	Models with 10000 to 12000 lb. Taper-leaf Spring Suspension	10-12390-000	○ ○	85920
		Models with 11000 to 12000 lb Front axle	6803230300	○ ○	85006
	Models with 15000 lb Rear Suspension	6803260000		○ -	83120	...
- 02	Models with 6000 to 9000 lb Front axle	6803230200	○ ○	85043
03 - 08	Models with 6000 to 9000 lb Front axle	10-12388-000	○ ○	85920
03 - 10	Models with FAS II Rear Air Suspension	16-15817-000		○ ○	85724	89443
		16-18708-000		○ ○	85724	89443
		471700002809		○ ○	85724	89443
		680611		○ ○	85724	89443
		SDA471700002809		○ ○	85724	89443
- 04/09	Models with Hendrickson Airtek Suspension	58913-003	○ ○	85932	89453	

Cargo Line

98	SC-7000 or SC-8000 Models with 12000 or 13000 lb. Axles	F6HT-18045-LA	○ ○	85376
98	SC-7000 or SC-8000 Models with 16000 lb. Multileaf Spring	F6HT-18045-AA	○ ○	85054	89438	





L - Line 7500 Series - Short Haul Tractor

	Models with 10000 lb Front Axle	F6HT-18045-KA	○ ○	83200	89402	
--	---------------------------------	---------------	-----	--------------	--------------	--	-----	-----

L - Line 8500 Series - Conventional Cab

98	All Models with 10000 lb or 12000 lb Axle and 54" Taperleaf Spring	F6HT-18045-AC	○ ○	85054	89438	
98 -	All Models with 12000 lb or 13200 lb Axle and 54" Multileaf Spring	F6HT-18045-BC	○ ○	85047	89435	

APPLICATION GUIDE - TRUCKS, TRAILERS, AND BUSES

Year Año Année	Model Modelo Modèle	OEM #	Front		Rear	
			 Fleetline	 GasSLX	 Fleetline	 GasSLX

STERLING TRUCK(Cont'd.)

L - Line 8500 Series - Conventional Cab(Cont'd.)

98 -	All Models with 12000 lb, 13200 lb or 14600 lb Axle and 60" Taperleaf Spring	F6HT-18045-EB	010	85055	89439	
		F6HT-18045-EC	010	85055	89439	
98 -	All Models with 13200 lb or 14600 lb Axle and 54" Taperleaf Spring	F6HT-18045-GC	010	85030	89440	
98 -	All Models with 14600 lb or 16000 lb Axle and 54" Multi-leaf Spring	F6HT-18045-CC	010	85055	89439	
98 -	All Models with 23000 lb Axle and 52" Taperleaf Softride Rear Suspension	F6HT-18080-CA		010	85314	89425
		47902-28		010	85013	89414
	All with Hendrickson HAS Rear Air Suspension	F6HT-18080-FC		010	85013	89414
98	LT-8000 Models with 12000 or 13000 lb Axles	F6HT-18045-LA	010	85376
98	LT-8000 Models with 16000 lb. Multileaf Spring	F6HT-18045-AA	010	85054	89438	
98	LT-8501 (101" BBC) Models with 8500 or 9000 lb Axle and 54" Multileaf Spring	F6HT-18045-JB	010	83200	89402	
		F6HT-18045-JC	010	83200	89402	
	LT-8501 (101" BBC) Models with 8500 or 9000 lb Axle and 54" Taperleaf Spring	F6HT-18045-HB	010	85054	89438	
		F6HT-18045-HC	010	85054	89438	
99 - 10	Models with FAS II Rear Air Suspension	16-15817-000		010	85724	89443
		680611		010	85724	89443
98	Models with Hendrickson 40LH Tandem Axle	57241-2		01-	83109	...





L - Line 9500 Series - Conventional Cab

98	All Models with 10000 lb or 12000 lb Axle and 54" Taperleaf Spring	F6HT-18045-AC	010	85054	89438	
98 -	All Models with 12000 lb or 13200 lb Axle and 54" Multileaf Spring	F6HT-18045-BC	010	85047	89435	
98 -	All Models with 12000 lb, 13200 lb or 14600 lb Axle and 60" Taperleaf Spring	F6HT-18045-EB	010	85055	89439	
		F6HT-18045-EC	010	85055	89439	
98 -	All Models with 13200 lb or 14600 lb Axle and 54" Taperleaf Spring	F6HT-18045-GC	010	85030	89440	
98 -	All Models with 14600 lb or 16000 lb Axle and 54" Multi-leaf Spring	F6HT-18045-CC	010	85055	89439	
98 -	All with 23000 lb Axle and 52" Taperleaf Softride Rear Suspension	F6HT-18080-CA		010	85314	89425
		47902-28		010	85013	89414
	All with Hendrickson HAS Rear Air Suspension	F6HT-18080-FC		010	85013	89414
98 -	LT-9501, LT-9511, LT-9513 or LT-9513 (113" & 122" BBC) Models with 8500 or 9000 lb Axle and 54" Multileaf Spring	F6HT-18045-JB	010	83200	89402	
		F6HT-18045-JC	010	83200	89402	
98 -	LT-9501, LT-9511, LT-9513 or LT-9513 (113" & 122" BBC) Models with 8500 or 9000 lb Axle and 54" Taperleaf Spring	F6HT-18045-HB	010	85054	89438	
		F6HT-18045-HC	010	85054	89438	
99 - 10	Models with FAS II Rear Air Suspension	16-13957-000		010	85724	89443
98 -	Models with Hendrickson 40LH Tandem Axle	57241-2		01-	83109	...

Additional O.E.M. Interchanges

	Models with Link Rear Air Suspension	1210-0528		010	85904	...
	Models with Neway Rear Suspension	90045099		010	85906	89407
	Models with O.E.M. Number	16-15770-000		010	85956	...
		4C4Z-18124-N	010	85957
		4C4Z-18125-DA		010	85926	...
		6E7Z-18125-A		010	83146	...
		AT-560	010	G63809
		AX-267A	010	83309	89446	
	AX-310		010	83215	...	

APPLICATION GUIDE - TRUCKS, TRAILERS, AND BUSES

Year Año Année	Model Modelo Modèle	OEM #	Front		Rear	
						
					Fleetline	GasSLX

STERLING TRUCK(Cont'd.)

Additional O.E.M. Interchanges(Cont'd.)

Year	Model	OEM #	Front	Rear
	Models with O.E.M. Number	C4HZ-18124-E	010 83309 89446
		C4TZ-18124-AB	010 83308
		D8HZ-18124-A	010 85301
		E6HZ-18124-A	010 85301
		E6HZ-18124-D	010 85301
		E6HZ-18125-D	010 83215 ...
		E7HZ-18124-A	010 85301
		E7XZ-18124-A	-10 G63386
		E7XZ-18125-B	-10 G63387 ...
		E9HZ-18124-A	010 83309 89446
		F0HZ-18124-B	010 85006
		F1HZ-18124-A	010 83309 89446
		F1HZ-18124-B	010 83308
		F1HZ-18124-D	010 85006 89401
		F1HZ-18124-E	010 85006 89401
		F1HZ-18124-H	010 85040
		F1HZ-18124-J	010 83308
		F1HZ-18124-K	010 ... 89402
		F2HZ-18124-A	010 85376
		F2HZ-18124-B	010 85301
		F4HT-18080-AB	010 85314 89425
		F4HT-18080-BA	010 85001 89410
		F5HZ-18124-A	010 83314
		F5HZ-18124-B	010 83107
		F5HZ-18124-C	010 85063
		F5HZ-18124-D	010 83125
		F5HZ-18125-A	010 85314 89425
		F5HZ-18125-B	010 85001 89410
		F6HT-18045-GB	010 85030 89440
		F6HT-18080-B	01- 83109 ...
		F6HT-18080-DA	01- 83109 ...
		F6HT-18080-EA	010 85906 89407
		F6HT-18124-JC	010 83200 89402
		F6HT-18124-KA	010 83200 89402
		F6HZ-18124-A	010 85054 89438
		F6HZ-18124-B	010 83308
		F6HZ-18124-C	010 85055 89439
		F6HZ-18124-D	010 85055 89439
		F6HZ-18124-E	010 85055 89439
		F6HZ-18124-F	010 85055 89439
		F6HZ-18124-G	010 85054 89438
		F6HZ-18124-H	010 85054 89438
		F6HZ-18124-J	010 83200 89402
		F6HZ-18125-B	01- 83109 ...
		F6HZ-18125-D	010 85013 89414
		F81A-18045-AGB	010 G63809
		XC45-18045-AA	010 83216

L - Line 9500 Series - Conventional Cab

99 - 10	Models with FAS II Rear Air Suspension	XC45-18080-BA	010 85724 89443
---------	--	---------------	-----	-----	-----------------

APPLICATION GUIDE - TRUCKS, TRAILERS, AND BUSES

Year Año Année	Model Modelo Modèle	OEM #	Front		Rear	
			Fleetline	GasSLX	Fleetline	GasSLX

STERLING TRUCK CAB SHOCKS

	8500 & 9500 Models with 113" & 122" BBC Conventional Tractors with Link Cabmate Models FH1322 & FH1322-A	1202-1043	OIO	83025
	AT-9500 Models with O.E.M. Number	F6HZ-5K407-BA	OIO	83033
		F8HT-5K407-AA	OIO	83033
	L8501 & L9501 Models with 101" BBC Conventional Tractors with Link Cabmate Model FH101	1202-1043	OIO	83025
	LT-9500 Models with O.E.M. Number	F6HZ-5K407-AB	OIO	83034
	Models with O.E.M. Number	18-45067-000	OIO	83034

ACTERRA

03 - 10	Acterra Models with O.E.M. Number	18-43504-000	OIO	83057
		18-60768-000	OIO	83057
		18-814903003484	OIO	83057

STOUGHTON TRAILERS INC.

	Trailers with Hendrickson HT190T, HT190U, & HS190T Models Air Suspension	HTA20001		OIO	83128	89436
	Trailers with Hendrickson HT230T Models Air Suspension	HTA20002		OIO	85000	89436
	Trailers with Neway AR-90-1-12, -14, -17 Models Air Suspension	NW90044162		OIO	83128	89436
	Trailers with Neway AR-90-1-15, -16 Models Air Suspension	NW90044448		OIO	85051	...
	Trailers with Neway RL-196-14, -15, Models Air Suspension	NW90044978		OIO	85059	...
	Trailers with Neway RL-196-16, -17, Models Air Suspension	NW90044979		OIO	83113	...
	Trailers with Reyco 86AR/RS1015 Air Ride Suspension	RT18165-01		OIO	85006	...
	Trailers with Reyco 86AR/RS1035 Anti-Dock Walk Air Suspension	RT18165-01		OIO	85006	...

SUSPENSYS

	FS230 Trailer Suspension (Light Duty)	218004872		OIO	85737	...
--	---------------------------------------	-----------	--	-----	-----	-----	--------------	-----





THE BINKLEY COMPANY

97	Trailers with Binkley AirLite Suspension	16965		OIO	85006	...
		6898		OIO	83125	...

THOMAS SCHOOL BUS

	Buses with Neway Tandem Air Suspension	61310232		OIO	85000	89436
	Buses with O.E.M. Number	16-19138-000	OIO	85058	89431	
	Model MVP	61310101		85736	...	OIO	85736	...
06 - 15	Models with Freightliner CC B2 Bus Chassis	10-13634-000	OIO	85918	89449	
		16-15817-000		OIO	85724	89443
		16-18708-000		OIO	85724	89443
	ROC Front, SAF-T-Liner	61300285	- -	83102
		GBL651442	- -	83102
	SAF-T-Liner HDX Models with Hendrickson Comfort Air Rear Air Suspension	471700131545		OIO	85006	...
		60998-001		OIO	85006	...
		60998-003		OIO	85006	...
	SAF-T-Liner School Bus MVP-ER & MVP-EF	61300219	OIO	85091
		61300222	OIO	85091
		61300223	OIO	85091
		70445	OIO	85091
2009	SAF-T-Liner School Bus with SAF Holland AD-246 Suspension	90045504	OIO	85030
2009	SAF-T-Liner School Bus with SAF Holland AD-369 Suspension	90045504	OIO	85030
	School Bus	300-0614966		OIO	85307	...
		614966		OIO	85307	...

APPLICATION GUIDE - TRUCKS, TRAILERS, AND BUSES

Year Año Année	Model Modelo Modèle	OEM #	Front		Rear	
						
			Fleetline	GasSLX	Fleetline	GasSLX









THOMAS SCHOOL BUS(Cont'd.)

	School Bus	614974	010	85304
		680010	010	85304
		680054		010	85307	...
07 - 12	Type C Conventional Buses (65 capacity) with 12000 lb Taperleaf Front Suspension	10-13634-000	010	85918	89449	
- 17	Type C Conventional Buses (65 capacity) with FAS II Rear Air Suspension	16-15817-000		010	85724	89443
		16-18708-000		010	85724	89443
		61310434		010	85724	89443
		61310478		010	85724	89443
2003	Type C Conventional School buses (65 capacity) with O.E.M. Number	680-323-0300	010	85006
		GBL665538	010	85006
09-12	Type C School bus chassis with O.E.M. Number	16-18713-000		01-	85122	...
		471700003070		01-	85122	...
	Models with O.E.M. Number	128745	-1-	83102
		60670-006		010	83147	...
		61300112	-1-	83613
		61300224	010	85918	89449	
		61300240	010	85918	89449	
		61310102		010	85308	89422
		61310103		010	85308	89422
		651442	-1-	83102
		659287	-1-	83102
		680-326-0000		01-	83120	...
		GBL654725		01-	83120	...
	Additional O.E.M. Interchanges	6130-0114	010				89437	
		6130029	010				85712	
		61310104	010				85713	
		63-0001	010				85713	
		680088	010				85713	
		680102	010				85712	
		728802	010				85736	
		87002	010				85736	
		A-4890	010				85712	

Type A School Bus

92 - 17	Minotour Type A School bus with Ford E350 Chassis	8C24-18045-DA	-10	83177
		8C2Z-18124-D	-10	83177
		ASH-1154	-10	83177
		AT-163G	-10	83177
		8C24-18080-DB		-10	83178	...
		8C2Z-18125-D		-10	83178	...
		ASH-1136		-10	83178	...
		AT-164G		-10	83178	...
00 - 17	Minotour Type A School bus with Ford E450 Chassis	8C24-18045-DA	-10	83177
		8C2Z-18124-D	-10	83177
		ASH-1154	-10	83177
		AT-163G	-10	83177
		8C24-18080-DB		-10	83178	...
		8C2Z-18125-D		-10	83178	...
		ASH-1136		-10	83178	...
		AT-164G		-10	83178	...

APPLICATION GUIDE - TRUCKS, TRAILERS, AND BUSES

Year Año Année	Model Modelo Modèle	OEM #	Front		Rear	
						
						
			Fleetline	GasSLX	Fleetline	GasSLX

THOR MOTOR COACH

Class A MotorHomes

06	Astoria & Tuscany Series MotorHomes with Freightliner XC Chassis ADL200 Suspension w/ 20K Rear AS120 Front Suspension Rear Shock with O.E.M. Number ZF - IFS Front Suspension with 23,000 lb GVW or Greater	16-16873-000 141700131810 16-16737-000 16-16874-000 141700131809 16-16736-000 16-18103-000 481700000493									
			010	83160	...	010	85029	...			
			010	83160			
			010	83160			
			-1-	85900			
			-1-	85900			
02 - 05	Escaper & UltraSport Series MotorHomes with Freightliner XC Chassis ADL200 Suspension w/ 20K Rear AS120 Front Suspension Rear Shock with O.E.M. Number ZF - IFS Front Suspension with 23,000 lb GVW or Greater	16-16873-000 141700131810 16-16737-000 16-16874-000 141700131809 16-16736-000 16-18103-000 481700000493									
			010	83160	...	010	85029	...			
			010	83160			
			010	83160			
			-1-	85900			
			-1-	85900			

TIMBREN INDUSTRIES

Additional O.E.M. Interchanges	665804	010	85939
--------------------------------	--------	-----	--------------





TRAIL KING INDUSTRIES

Identification of the trailer suspension is necessary to determine what section of the catalog to refer to. Some possible options can be Chalmers, Hendrickson, Neway, Ridewell, Reyco.							
---	--	--	--	--	--	--	--

TRAILMOBILE CANADA CORP.

Trailers with Granning Air Susp. T-350A	43-8-022					010	83225	...
Trailers with Hendrickson Air Susp. HT230T (23,000 lb Capacity)	43-6-118					010	85000	89436
Trailers with Hendrickson Air Susp. HT250U, HT250U-Y	A-2212					010	85029	...
Trailers with Hendrickson Air Susp. T23-RL-17	43-8-011					010	83207	89407
Trailers with Hendrickson Air Susp. T23-US-6 (Non-Liftable)	43-8-015					010	85006	...
Trailers with Hendrickson Air Susp. T23-US-9 (Liftable & Non-Liftable)	43-8-014					010	85013	89414
Trailers with Hendrickson Air Susp. T30-US-9, -12, -14, -17	43-8-013					010	85000	89436
Trailers with Neway Air Susp. AR90-1-14, AR90-1-17	90044089					010	83124	89407
Trailers with Neway Air Susp. AR90-14, -17,	90044089					010	83124	89407
Trailers with Neway Air Susp. AR92-14	90044992					010	85000	89436
Trailers with Neway Air Susp. AR92-17	90044642					010	83127	...
Trailers with Neway Air Susp. AR93-14	90045054					010	85051	...
Trailers with Neway Air Susp. AR93-17	90044089					010	83124	89407
Trailers with Neway Air Susp. AR95-9-HD, -12-HD, -14-HD, 17-HD	90044625					010	83125	...
Trailers with Neway Air Susp. RL196-12	90044977					010	83115	...
Trailers with Neway Air Susp. RL196-14, -15	90044978					010	85059	...
Trailers with Neway Air Susp. RL196-16, -17	90044979					010	83113	...
Trailers with Reyco Air Susp. Model # 21AR (25,000 LB Capacity)	43-8-002					010	83209	89414
Trailers with Reyco Air Susp. Model # 74AR (30,000 LB Capacity)	43-8-002					010	83209	89414
Trailers with Reyco Air Susp. Model # 86AR	43-8-015					010	85006	...

APPLICATION GUIDE - TRUCKS, TRAILERS, AND BUSES

Year Año Année	Model Modelo Modèle	OEM #	Front		Rear	
						
				Fleetline		GasSLX

TRAILMOBILE CANADA CORP.(Cont'd.)

Models with O.E.M. Number	43-4-235		010	85051	...
	43-4-236		010	85029	...
	43-4-237		010	85000	89436
	43-4-239		010	83207	89407
	43-4-241		010	85006	...
	43-4-277		010	85000	89436
	43-4-278		010	85059	...
	43-4-279		010	83204	...
	43-6-028		010	85000	89436
	43-6-137		010	85006	...
	43-6-158		010	85013	89414
	43-6-164		010	83207	89407
	43-8-031		010	85029	...





TRANSPORTATION MFG. CORP

City Cruiser	12TA-01-13		85303	...	010	85303	89422
Drive Axle	12J-5-10		01-	85733	...
	12J-5-2		01-	85312	...
	12J-5-4		01-	85312	...
G 4500 Coach (Front) 45 ft Coach -Tag Axle Tag Axle	12-05-6000	-10	85711
	12-05-6033		010	85339	...
	12-05-6002		010	85339	...
Low Floor Bus Models with O.E.M. Number	12L-5-99		010	85339	...
RTS Bus with "V" Drive Rear	G1101590		010	85713	...
RTS Bus with Normal Front	22012079	-1-	85701
	4975515	-1-	85701
	695117	-1-	85701
	74410	-1-	85701
RTS Bus with Regular Rear	22045526		010	85702	...
	22052014		010	85702	...
	G1011822		010	85702	...
RTS Bus with Solid Front Axle	22024673	-10	85710
	22046485	-10	85710
	680350	-10	85710
	695273	-10	85710
	695279	-10	85710
Tag Axle	12J-5-11		010	85313	...
	12J-5-3		010	85313	...
	12J-5-6		010	85313	...
	12J-5-9		010	85700	...
Models with O.E.M. Number	12B-5-1		010	85735	...
	12G-5-1	010	85700
	12T-1-13		85303	...	010	85303	89422
	680349		010	85702	...
	680470		010	85713	...
Additional O.E.M. Interchanges	12L-5-69	010			85700		
	12L-5-70	010			85700		

TRINITY TRAILER MFG., INC.

Identification of the trailer suspension is necessary to determine what section of the catalog to refer to. Some possible options can be Chalmers, Hendrickson, Neway, Ridewell, Reyco.							
---	--	--	--	--	--	--	--

APPLICATION GUIDE - TRUCKS, TRAILERS, AND BUSES

Year Año Année	Model Modelo Modèle	OEM #	Front		Rear	
						
			Fleetline	GasSLX	Fleetline	GasSLX

TWIN COACH(Cont'd.)

	Models with O.E.M. Number	90044162	○ ○	83128	89436
		AR-718-C-HD	○ ○	85000	89436
		AR-958	○ ○	83207	89407

UNITED MANUFACTURING

	Models with O.E.M. Number	K-96-41	○ ○	85304	...
--	---------------------------	---------	-----	-----	-----	--------------	-----

UNIVERSAL COACH

	Models with O.E.M. Number	12-05-1199	○ -	85729	...
		680777	○ -	85729	...

UPS TRUCK

	Models with O.E.M. Number	P117099	○ -	83120	...
		P117146	○ ○	83118

UTILITY TRAILER MANUFACTURING COMPANY

Identification of the trailer suspension is necessary to determine what section of the catalog to refer to. Some possible options can be Chalmers, Hendrickson, Neway, Ridewell, Reyco.

Flatbeds

	4000A Model Trailers with Hendrickson AANT 23K Intraax Air Ride (High Damping) (Hvy Duty) (Limited Rebound) (Standard)	B-24023	○ ○	85738	...
		B-24125	○ ○	85323	89436
		B-23361	○ ○	85911	...
		B-23566	○ ○	85000	89436
	Drop Deck Trailers with Hendrickson AANL 23K Intraax Air Ride with 12" to 17" Ride Height - High Damping with 6.5" to 9" Ride Height - High Damping with 6.5" to 9" Ride Height - Standard	B-25515	○ ○	85338	...
		B-24579	○ ○	85939	...
		B-23651	○ ○	85045	...
			○ ○		





Reefers & Dry Vans

	3000R Multi-Temp Trailers with Hendrickson HKANT 40K Vantraax Air Ride Heavy Duty	B-24088	○ ○	85000	89436
		S-24088	○ ○	85000	89436
		B-24088	○ ○	83128	89436
		S-24088	○ ○	83128	89436
	4000D Trailers with Hendrickson HKANT 40K Vantraax Air Ride Heavy Duty	B-24088	○ ○	85000	89436
		S-24088	○ ○	85000	89436
		B-24088	○ ○	83128	89436
		S-24088	○ ○	83128	89436
	4000D-X Composite Trailers with Hendrickson HKANT 40K Vantraax Air Ride Heavy Duty	B-24088	○ ○	85000	89436
		S-24088	○ ○	85000	89436
		B-24088	○ ○	83128	89436
		S-24088	○ ○	83128	89436

VAN HOOL

00 - 09	T2145 and T2150 Buses with O.E.M. Number (Front & Tag Axle)	10685703	- -	695406	...
		624314570	- -	695406	...

APPLICATION GUIDE - TRUCKS, TRAILERS, AND BUSES

Year Año Année	Model Modelo Modèle	OEM #	Front		Rear	
			 Fleetline	 GasSLX	 Fleetline	 GasSLX

VAN HOOL(Cont'd.)

00 - 09	T2145 and T2150 Buses with O.E.M. Number (Front & Tag Axle)	90-2291	- -	695406	...
	T811, T812, T813, T814 Buses	6243-14040 665563	85708	...	- -	85708	...
	T815 4D Buses	6243-14040 665563	- -	85708	...
	T940 and T945 Buses	624314570 90-2291	- -	695406	...
	TL 13/14 Buses	6243-13790 665562	85708	...	- -	85708	...
			85708	...	- -	85708	...

VOLVO

FE Series

	FE6 Models	6857668	- O	83105
		6876828	- O	83105
	FE611, FE614 Front after CH419306	6794358	O O	85040
	FE614 Tractor	6790756		O O	83215	...
		6794358	O O	85040
	FE615, FE715	6772218	O O	85040
		6775412	O O	85040
	FE7 Models up to Chassis No. 20855	1505190		- -	85722	...
	FE7 Models with over 6.5 Front Axle (Ton)	1590439	O O	83104
	FE7 Models with Rear Air Suspension (Drive Axle)	1591501		- -	85722	...
	FE715 with Rear Parabolic Spring	6790756		O O	83215	...
	Models with Rear Air Suspension and O.E.M. Number	8056892		O O	85023	89415

N Series

	N10 with 5.5 Ton Front Axle	1593843	O O	83215
	N11 Models	1-0200-32-888-1	O O	83104
		1591735	O O	83104
		1593843	O O	83215
	N12 Models	1-0200-32-888-1	O O	83104
		1591735	O O	83104
		1593843	O O	83215
	N12 with over 6.5 Ton Front Axle	1590439	O O	83104





VAH Series

	VAH 430 Models with Hendrickson HAS 400 or 460 Series Rear Suspension	60675-001		O O	85978	...
		8083872		O O	85978	...
2014	VAH 430 Models with O.E.M. Number	141700005838	O O	85098
		21436086	O O	85098

VHD - Series

08 - 17	Models with 12,000 to 22,000 lb Front Axles	20353932	O -	85081
		20414440	O -	85081
		20433426	O -	85081
		20434880	O -	85081
		471700131258	O -	85081
		SDA471700131258	O -	85081
- 17	Models with Hendrickson 40,000 lb Pimaax EX and FireMaax EX Air Suspension	20782199		O O	85072	...
		60657-007		O O	85072	...
	Models with Neway ADZ Rear Suspension	471700004423		O O	85109	...
		90045605		O O	85109	...
08 - 17	Models with T-Ride Rear Suspension	20433427		O -	85065	...

APPLICATION GUIDE - TRUCKS, TRAILERS, AND BUSES

Year Año Année	Model Modelo Modèle	OEM #	Front		Rear	
						
			Fleetline	GasSLX	Fleetline	GasSLX

VOLVO(Cont'd.)

VHD - Series(Cont'd.)

08 - 17	Models with T-Ride Rear Suspension	471700131256				01-	85065	...
---------	------------------------------------	--------------	--	--	--	-----	--------------	-----









VN Series - 2200

05/99 -	Models built after May 1999	20433425				010	85066	89448
		471700002627				010	85066	89448
		8086651				010	85066	89448
	Models with O.E.M. Number	20433424	010	85061	89450	
		20513881	010	85061	89450	
		20551628		010	85066	89448
		471700000443		010	85066	89448
		665607		010	85047	89435
		8077874		010	85047	89435
		8077874-P01		010	85047	89435
		8078195	010	85061	89450	
		8086053		010	85047	89435
		8169859		010	85047	89435

VNL Series

06 - 16	300 Models with Hendrickson 40,000 lb Pimaax EX and FireMaax EX Air Suspension	20782199				010	85072	...
		60657-007				010	85072	...
06 - 10	300, 300U Models with 12,000 - 13,200 lb Front Axles	20433424	010	85061	89450	
11 - 17	300, 300U Models with 12,000 - 13,200 lb Front Axles	141700005838	010	85098
		21436086	010	85098
06 - 11	300, 300U Models with 40,000 lb Rear Air Suspension	20433425		010	85066	89448
		20551628		010	85066	89448
		471700000443		010	85066	89448
		471700002627		010	85066	89448
11 - 17	300, 300U Models with 40,000 lb Rear Air Suspension	21462378		010	85088	...
		471700006038		010	85088	...
06 - 14	300, 300U Models with Hendrickson Airtek	20485632	010	85933	89454	
		20485633	010	85933	89454	
		21137330	010	85933	89454	
		471700003832	010	85933	89454	
		64838-003	010	85933	89454	
11 - 17	430 Models with 12,500 - 14,600 lb Front Axle	141700005838	010	85098
		21436086	010	85098
06 - 10	430 Models with 13,200 lb Front Axle	20433424	010	85061	89450	
05 - 11	430 Models with 40,000 lb Rear Air Suspension	20433425		010	85066	89448
		20551628		010	85066	89448
		471700000443		010	85066	89448
		471700002627		010	85066	89448
11 - 17	430 Models with 40,000 lb Rear Air Suspension	21462380		010	85088	...
		471700006040		010	85088	...
05 - 14	430 Models with Hendrickson Airtek	20485632	010	85933	89454	
		20485633	010	85933	89454	
		21137330	010	85933	89454	
		471700003832	010	85933	89454	
		64838-003	010	85933	89454	
11 - 17	630 & 670 Models with 12,500 - 14,600 lb Front Axle	141700005838	010	85098
		21436086	010	85098
06 - 10	630 & 670 Models with 13,200 lb Front Axle	20433424	010	85061	89450	
06 - 11	630 & 670 Models with 40,000 lb Rear Air Suspension	20551628		010	85066	89448

APPLICATION GUIDE - TRUCKS, TRAILERS, AND BUSES

Year Año Année	Model Modelo Modèle	OEM #	Front		Rear	
						
						
			Fleetline	GasSLX	Fleetline	GasSLX

VOLVO(Cont'd.)

VNL Series(Cont'd.)

06 - 11	630 & 670 Models with 40,000 lb Rear Air Suspension	47170000443		OIO	85066	89448
11 - 17	630 & 670 Models with 40,000 lb Rear Air Suspension	21462380		OIO	85088	...
		471700006040		OIO	85088	...
06 - 16	630 & 670 Models with Hendrickson Airtek	20485632	OIO	85933	89454	
		20485633	OIO	85933	89454	
		21137330	OIO	85933	89454	
		471700003832	OIO	85933	89454	
		64838-003	OIO	85933	89454	
06 - 16	64T-830 Models with Hendrickson 40,000 lb Pimaax EX and FireMaax EX Air Suspension	20782199		OIO	85072	...
06 - 16	64T-830 Models with Hendrickson 40,000 lb Primaax, Pimaax EX and FireMaax EX Air Suspension	60657-007		OIO	85072	...
11 - 17	730 & 780 Models with 12,500 - 14,600 lb Front Axle	141700005838	OIO	85098
		21436086	OIO	85098
06 - 10	730 & 780 Models with 13,200 lb Front Axle	20433424	OIO	85061	89450	
06 - 11	730 & 780 Models with 40,000 lb Rear Air Suspension	20551628		OIO	85066	89448
		47170000443		OIO	85066	89448
11 - 17	730 & 780 Models with 40,000 lb Rear Air Suspension	21462380		OIO	85088	...
		471700006040		OIO	85088	...
06 - 16	730 & 780 Models with Hendrickson Airtek	20485632	OIO	85933	89454	
		20485633	OIO	85933	89454	
		21137330	OIO	85933	89454	
		471700003832	OIO	85933	89454	
		64838-003	OIO	85933	89454	
06 - 10	All Models with 12,000 - 13,200 lb Front Axles	20433424	OIO	85061	89450	
		8071881	OIO	85061	89450	
05/99 -	Models with 38,000 lb Rear Air Suspension built after May 1999	20433425		OIO	85066	89448
		471700002627		OIO	85066	89448

VNM Series

- 17	200 Models with 12,000 lb Front Axles	21436086	OIO	85098
- 16	200 Models with 46,000 lb T-Ride Rear Suspension	20433427		OIO	85065	...
- 17	430 Models with 12,500 lb Front Axle	21436086	OIO	85098
- 17	630 Models with 12,500 lb Front Axle	21436086	OIO	85098
- 17	630 Models with 38,000 lb Rear Air Suspension	21462378		OIO	85088	...
		21462380		OIO	85088	...

VNX - Series

	Models with Neway ADZ Rear Suspension	471700004423		OIO	85109	...
		90045605		OIO	85109	...





Vocational Trucks

	Models with T-Ride Rear Suspension	20433427		OIO	85065	...
		8060026		OIO	85065	...
		8073212		OIO	85065	...
		8075257		OIO	85065	...
	WX, WXR, WG, AC Models with Hendrickson HN-402 Rear Suspension	57241-3		OIO	83112	...
	WX, WXML, WXR, WG, AC Models With Hendrickson HAS-400 Rear Air Suspension	47902-24		OIO	83137	...
		47902-24		OIO	83137	...
		57241-3		OIO	83112	...

VT Series

06 - 10	64T-830 Models with 40,000 lb Rear Air Suspension	20551628		OIO	85066	89448
		47170000443		OIO	85066	89448

APPLICATION GUIDE - TRUCKS, TRAILERS, AND BUSES

Year Año Année	Model Modelo Modèle	OEM #	Front		Rear	
						
			Fleetline	GasSLX	Fleetline	GasSLX

VOLVO(Cont'd.)

VT Series(Cont'd.)

06 - 16	64T-830 Models with Hendrickson 40,000 lb Primaax, Pimaax EX and FireMaax EX Air Suspension	60657-007	OIO	85072	...
06 - 16	64T-880 Models with Hendrickson 40,000 lb Pimaax EX and FireMaax EX Air Suspension	20782199	OIO	85072	...
06 - 10	All Models with 12,000 - 13,200 lb Front Axles	20433424	OIO	85061	89450
		8071881	OIO	85061	89450

WCA & WIA Series

95 -	All with O.E.M. Number and after V.I.N. Number 723506	8169859	OIO	85047	89435
	Models with Front Dual Shocks	02-7005976	- -	83400
		3082284	- -	83400
93 - 95	Models with O.E.M. Number and after V.I.N. Number 657841	8026658	OIO	85046	89434
- 92	Models with O.E.M. Number and up to V.I.N. Number 657250	8071524	OIO	85024	89416
	Models with O.E.M. Number	37301-0016	O -	85026	89417
		37301-0021	O -	85026	89417
		37301-3201	- -	85027	89418
		37301-3202	O -	85026	89417
		4975549	OIO	83216
		8065787	O -	85026	89417

WG Series

	Models with O.E.M. Number	35901-3201	OIO	85024	89416
		37301-3201	- -	85027	89418
		665623	OIO	85046	89434
- 92	Models with O.E.M. Number	8065787	O -	85026	89417
		8071524	OIO	85024	89416
93 - 95	Models with O.E.M. Number	8026658	OIO	85046	89434





WH Series

	WHS, WHR, WHL or WHE Models with Front Dual Shocks	02-7005976	- -	83400
		3082284	- -	83400
	WHS, WHR, WHL or WHE Models with Front Single Shocks	37301-0021	O -	85026	89417
- 92	WHS, WHR, WHL or WHE Models with O.E.M. Number	35901-3201	OIO	85024	89416
		8071524	OIO	85024	89416
93 - 95	WHS, WHR, WHL or WHE Models with O.E.M. Number	8026658	OIO	85046	89434
95 -	WHS, WHR, WHL or WHE Models with O.E.M. Number	8169859	OIO	85047	89435

Additional Applications

	1500 Models	83122	...	OIO	83122	89406
	1500 Models Models with Rear Suspension Models with Velvet Ride Suspension	35901-0005	OIO	83219	...
		530596	OIO	85308	89422
	3000, 4000 & 9000 Models - Special Unit - Four Shock Absorbers Required Per Axle	5554959	OIO	83401	
		676081	OIO	83401	
		676082	OIO	83401	
	3014, 3015, 3016, 3020 C.O.E. and 1500	OIO	83122	89406	
	9000 Models	OIO	83122	89406	
	Brigadier Models	22012065	OIO	85304	
		22046483	OIO	85304	
		22052336	OIO	85304	
	Models with Hendrickson HN - 400 Rear suspension	3971703	O -	83112	...
78 - 83	RC2	OIO	83122	89406
	Road Boss, Road Boss II, Road Commander II, Road Expedito - (Four Shocks per Axle)	3946210	- -	83103	

APPLICATION GUIDE - TRUCKS, TRAILERS, AND BUSES

Year Año Année	Model Modelo Modèle	OEM #	Front		Rear	
						
			Wrench	Wrench	Wrench	Wrench
			Fleetline	GasSLX	Fleetline	GasSLX

VOLVO(Cont'd.)





Additional Applications(Cont'd.)

	Road Boss, Road Boss II, Road Commander, Road Commander II, Road Expeditor II - (Four Shocks per Axle)	02-7005976	- -	83400
		02-7005977	- -	83400
		4975479	- -	83400
		4975480	- -	83400
	Models with Hendrickson Airtex	20469001	0 0	85933	89454	
		20469002	0 0	85933	89454	
		471700131920	0 0	85933	89454	
		471700131921	0 0	85933	89454	
		64838-001	0 0	85933	89454	
		64838-002	0 0	85933	89454	

Additional O.E.M. Interchanges

Additional O.E.M. Interchanges	03-1106460	0 0		85005 or 89430		
	20863239	0 -		85080		
	35901-0003	0 0		85301		
	35901-0004	0 0		83219		
	35901-0011	0 0		83123 or 89405		
	35901-0017	0 0		83314		
	35901-0022	0 -		83635		
	35901-3406	0 0		85305		
	35901-3409	0 0		85304		
	35901-3410	0 0		85307		
	35901-3413	0 0		85006		
	35901-3420	0 0		85303 or 89422		
	37001-5	0 0		83401		
	37301-0001	0 0		85013 or 89414		
	37301-0018	0 0		85005 or 89430		
	3953643	0 0		85040		
	4940640	0 0		83216		
	494-660	0 0		83219		
	5322338	0 0		83214		
	5513989	0 0		83216		
	5531435	0 0		85307		
	5531436	0 0		85307		
	5531437	0 0		85307		
	5534430	0 0		85303 or 89422		
	5534447	0 0		85303 or 89422		
	5549899	0 0		83207 or 89407		
	5549925	0 0		85304		
	629398	0 0		85307		
	629501	0 0		85307		
	646220	0 0		85734		
	66010-0016	0 -		85025		
	668302	0 0		83216		
6771501	0 0		85040			
6775411	0 0		85040			
1091347	0 0		83125			
1091348	0 0		83122 or 89406			
1091349	0 0		83204			
1091350	0 0		83207 or 89407			
1091351	0 0		83209 or 89414			

APPLICATION GUIDE - TRUCKS, TRAILERS, AND BUSES





Year Año Année	Model Modelo Modèle	OEM #	Front		Rear	
						
			Fleetline	GasSLX	Fleetline	GasSLX

VOLVO(Cont'd.)

Additional O.E.M. Interchanges(Cont'd.)

Additional O.E.M. Interchanges	OEM #	Interchange Code	Interchange Part #
	1091353	010	83215
	1091354	010	83216
	1091355	010	83217
	1091357	010	83219
	1091358	-1-	83456 or 89447
	1091359	010	83123 or 89405
	1091360	010	83303
	1091361	010	83304
	1091362	010	83309 or 89446
	1091363	010	83221
	1091364	010	83312 or 89409
	1091365	-1-	83400
	1091366	010	83401
	1091367	010	85000 or 89436
	1091368	010	85003 or 89411
	1091370	010	85006
	1091371	010	85300 or 89419
	1091372	010	85301
	1091373	010	85302 or 89420
	1091374	010	85303 or 89422
	1091375	010	85304
	1091376	010	85305
	1091377	010	85307
	1091378	010	85308 or 89422
	1091379	-1-	85310 or 89423
	1091384	010	85735
	1093100	-1-	85027 or 89418
	1093174	01-	83353
	1093176	010	85024 or 89416
	1093177	01-	85025
	1093178	01-	85026 or 89417
	1093180	010	85030 or 89440
	1716824	010	85304
	19501669	010	85339
	19502711	010	85702
	19506846	010	85339
	3130140	010	85315
	3171696	010	85307
	3172948	010	85303 or 89422
	3199937	-10	85316 or 89426
	3199938	010	85030 or 89432
	3199939	010	85058 or 89431
	3199940	010	85005 or 89430
	3199941	010	85006
	3199942	010	89402
	3199943	010	85012 or 89413
	3199944	010	85006
	3199945	-1-	85027 or 89418
	3199946	-10	85033 or 89427
	3199947	010	85013 or 89414
	3199948	-10	85311 or 89424

APPLICATION GUIDE - TRUCKS, TRAILERS, AND BUSES





Year Año Année	Model Modelo Modèle	OEM #	Front		Rear	
						
			Fleetline	GasSLX	Fleetline	GasSLX

VOLVO(Cont'd.)

Additional O.E.M. Interchanges(Cont'd.)

Additional O.E.M. Interchanges	OEM #	Interchange	Replacement Part
	3199949	- -	85310 or 89423
	3199950	0 0	85023 or 89415
	3199951	0 0	85024 or 89416
	3199952	0 0	85736
	3199953	- 0	85319 or 89428
	3199954	0 0	85003 or 89411
	3199955	0 0	85300 or 89419
	3199956	0 0	85036 or 89405
	3199957	0 0	83122 or 89406
	3199959	0 0	85323 or 89436
	3199960	0 0	85322
	3199961	0 0	85307
	3199962	0 0	85314 or 89425
	3199963	0 0	85315
	3199965	0 0	85736
	3199966	0 0	85303 or 89422
	3199967	0 0	85302 or 89420
	3199968	0 0	85308 or 89422
	3199970	- -	85701
	3199972	0 0	85320 or 89429
	3199973	- -	85722
	3199974	0 0	85712
	3199975	0 0	85700
	3199976	- 0	85711
	3199977	- 0	85711
	3199978	0 0	85712
	3199979	0 0	85702
	3199980	- -	85310 or 89423
	3199982	- 0	85703
	3199983	0 0	85704
	3199984	0 0	85314 or 89425
	3199985	0 -	85723
	3199986	- -	85318
	3199987	- -	85705
	3199988	- 0	85311 or 89424
	3199989	- -	85709
	3199990	0 0	85003 or 89411
	3199991	- -	85708
	3199992	0 -	85733
	3199993	0 0	85712
	3199994	0 0	85308 or 89422
	3915917	- 0	85319 or 89428
	3915947	0 0	85001 or 89410
	3915948	- 0	85311 or 89424
	3916352	0 0	85013 or 89414
	3919055	0 0	85007 or 89412
	3919056	0 0	83203 or 89436
	3919057	0 0	83225
	3919526	0 0	83314
	3919561	0 0	85314 or 89425
	3919565	- -	83103

APPLICATION GUIDE - TRUCKS, TRAILERS, AND BUSES





Year Año Année	Model Modelo Modèle	OEM #	Front		Rear	
						
			Fleetline	GasSLX	Fleetline	GasSLX

VOLVO(Cont'd.)

Additional O.E.M. Interchanges(Cont'd.)

Additional O.E.M. Interchanges	OEM #	Interchange	GasSLX
	3919567	- -	83613
	3919568	0 0	83636
	3919569	0 0	85052
	3919570	0 0	83128
	3919571	0 -	83635
	3919572	0 0	83130
	3919573	0 0	83123 or 89405
	3919574	0 0	85006 or 89401
	3919575	0 -	83120
	3919582	0 0	83215
	3919583	0 0	83100
	3919584	0 -	83353
	3919585	0 0	83209 or 89414
	3919586	0 0	83100
	3919587	- 0	83105
	3919588	0 0	83216
	3919589	0 -	85026 or 89417
	3919590	0 0	85042
	3919591	- 0	83515
	3919592	0 0	85024 or 89416
	3919593	0 0	83242
	3919594	0 0	85003 or 89411
	3919596	0 -	G63484
	3919598	0 0	83312 or 89409
	3919900	0 0	85012 or 89413
	3919901	- -	83103
	3919902	0 0	83126 or 89430
	3919903	0 0	83216
	3919904	0 0	G63183
	3919906	0 0	83308
	3919907	0 0	83309 or 89446
	3919908	0 0	83104
	3919909	0 0	G63605
	3919910	0 0	83221
	3919911	0 0	83124 or 89407
	3919912	0 0	83215
	3919913	0 0	83203 or 89436
	3919914	0 0	83209 or 89414
	3919915	0 0	83127
	3919916	0 0	83126 or 89430
	3919917	0 0	83125
	3919918	0 0	83401
	3919919	0 0	G63625
	3919920	0 0	83303
	3919921	0 0	83123 or 89405
	3919922	- -	83318
	3919923	- 0	83301
	3919924	- -	83456 or 89447
	3919925	- 0	83317
	3919926	0 0	G63403
	3919927	0 0	83101

APPLICATION GUIDE - TRUCKS, TRAILERS, AND BUSES





Year Año Année	Model Modelo Modèle	OEM #	Front		Rear	
						
			Fleetline	GasSLX	Fleetline	GasSLX

VOLVO(Cont'd.)

Additional O.E.M. Interchanges(Cont'd.)

Additional O.E.M. Interchanges			
	3919928	010	83225
	3919930	01-	83353
	3919931	010	83126 or 89430
	3919932	010	85062 or 89408
	3919933	010	85001 or 89410
	3919934	010	85320 or 89429
	3919935	01-	85026 or 89417
	3919936	010	83207 or 89407
	3919937	-10	85316 or 89426
	3919938	010	85030 or 89432
	3919939	010	85058 or 89431
	3919940	010	85005 or 89430
	3919941	010	85006
	3919942	010	89402
	3919943	010	85012 or 89413
	3919944	010	85036
	3919945	-1-	85027 or 89418
	3919946	-10	85033 or 89427
	3919947	010	85013 or 89414
	3919948	-10	85311 or 89424
	3919949	-1-	85310 or 89423
	3919950	010	83219
	3919951	010	83309 or 89416
	3919952	010	85736
	3919953	-10	85319 or 89428
	3919954	010	85003 or 89411
	3919955	010	85300 or 89419
	3919956	010	85036 or 89405
	3919957	010	83122 or 89406
	3919959	010	85000 or 89436
	3919960	010	85322
	3919961	010	85302 or 89420
	3919962	010	85700
	3919963	010	85730
	3919964	010	85304
	3919965	010	85702
	3919966	010	85736
	3919967	010	85302 or 89420
	3919968	010	85736
	3919970	-1-	85701
	3919972	010	85320 or 89429
	3919973	010	85956
	3919974	010	85712
	3919975	010	85700
	3919976	-10	85033 or 89427
	3919977	-10	85033 or 89427
	3919978	010	85702
	3919979	010	85702
	3919980	010	85702
	3919981	-1-	85701
	3919982	-10	85703

APPLICATION GUIDE - TRUCKS, TRAILERS, AND BUSES





Year Año Année	Model Modelo Modèle	OEM #	Front		Rear	
						
			Fleetline	GasSLX	Fleetline	GasSLX

VOLVO(Cont'd.)

Additional O.E.M. Interchanges(Cont'd.)

Additional O.E.M. Interchanges	OEM #	Interchange Code	GasSLX #
	3919983	010	85704
	3919984	010	85700
	3919985	01-	85723
	3919987	-1-	85706
	3919988	-10	85311 or 89424
	3919989	-1-	85709
	3919990	010	85003 or 89411
	3919991	-1-	85708
	3919992	01-	85733
	3919993	010	85712
	3919994	-1-	85310 or 89423
	3945806	01-	89417
	3945807	010	89416
	3945808	010	89407
	3945809	010	89410
	3945810	010	89420
	3945811	010	89409
	3945812	-1-	89423
	3945813	-10	89428
	3945814	-10	89424
	3945815	010	89406
	3945816	010	89430
	3945817	010	89422
	3945818	010	89415
	3945819	010	89411
	3945820	010	89413
	3945821	010	89419
	3946217	010	83125
	3946219	-1-	83400
	662211401	010	83215
	83176191	01-	83019
	83176192	01-	83041
	83176193	01-	83045
	83176194	010	83048
	83176195	-1-	83103
	83176196	01-	83110
	83176197	01-	83111
	83176198	01-	83112
	83176199	010	83123
	83176200	010	83124
	83176201	010	83125
	83176202	010	83126
	83176203	010	83127
	83176204	010	83128
	83176205	-1-	83136
	83176206	010	83148
	83176207	010	83203
	83176208	010	83209
	83176209	010	83215
	83176210	010	83216
	83176211	010	85000

APPLICATION GUIDE - TRUCKS, TRAILERS, AND BUSES





Year Año Année	Model Modelo Modèle	OEM #	Front		Rear	
						
			Fleetline	GasSLX	Fleetline	GasSLX

VOLVO(Cont'd.)

Additional O.E.M. Interchanges(Cont'd.)

Additional O.E.M. Interchanges		
	83176212	010 85001
	83176213	010 85003
	83176214	010 85005
	83176215	010 85023
	83176216	01- 85026
	83176217	-10 85033
	83176218	010 85036
	83176219	010 85045
	83176220	010 85046
	83176221	010 85047
	83176222	010 85052
	83176223	010 85061
	83176224	010 85062
	83176225	010 85066
	83176226	010 85067
	83176227	-1- 85069
	83176228	010 85070
	83176229	010 85303
	83176230	-1- 85310
	83176231	-10 85311
	83176232	010 85320
	83176233	010 85321
	83176234	010 85323
	83176235	010 85724
	83176236	-1- 85900
	83176237	010 85916
	83176238	010 85918
	83176239	010 85933
	83176240	010 646155
	85104186	010 85006
	85106580	010 85918 or 89449
	85137234	010 83125
	85137420	010 85000 or 89436
	RC SA3041	01- 83041
	RC SA3045	01- 83045
	RC SA3048	010 83048
	RC SA3103	-1- 83103
	RC SA3111	01- 83111
	RC SA3112	01- 83112
	RC SA3124	010 83124
	RC SA3125	010 83125
	RC SA3127	010 83127
	RC SA3128	010 83128 or 89436
	RC SA3136	-1- 83136
	RC SA3148	010 83148
	RC SA3203	010 83203
	RC SA3216	010 83216
	RC SA5000	010 85000
	RC SA5001	010 85001
	RC SA5003	010 85003
	RC SA5005	010 85005

APPLICATION GUIDE - TRUCKS, TRAILERS, AND BUSES

Year Año Année	Model Modelo Modèle	OEM #	Front		Rear	
						
			Fleetline	GasSLX	Fleetline	GasSLX

VOLVO(Cont'd.)

Additional O.E.M. Interchanges(Cont'd.)

Additional O.E.M. Interchanges			
	RC SA5047	010	85047
	RC SA5052	010	85052
	RC SA5061	010	85061
	RC SA5062	010	85062
	RC SA5066	010	85066
	RC SA5067	010	85067
	RC SA5070	010	85070
	RC SA5310	-1-	85310
	RC SA5320	010	85320
	RC SA5724	010	85724
	RC SA5900	-1-	85900
	RC SA5918	010	85918
	RC SA5933	010	85933
	RC SA6155	010	646155
	SA3019	01-	83019
	SA3041	01-	83041
	SA3045	01-	83045
	SA3048	010	83048
	SA3103	-1-	83103
	SA3110	01-	83110
	SA3111	01-	83111
	SA3112	01-	83112
	SA3123	010	83123
	SA3124	010	83124
	SA3125	010	83125
	SA3126	010	83126
	SA3127	010	83127
	SA3128	010	83128
	SA3136	-1-	83136
	SA3148	010	83148
	SA5000	010	85000
	SA5001	010	85001
	SA5003	010	85003
	SA5005	010	85005
	SA5023	010	85023
	SA5026	01-	85026
	SA5033	-10	85033
	SA5036	010	85036
	SA5045	010	85045
	SA5046	010	85046
	SA5047	010	85047
	SA5052	010	85052
	SA5061	010	85061
	SA5062	010	85062
	SA5066	010	85066
	SA5067	010	85067
	SA5069	-1-	85069
	SA5070	010	85070
	SA5303	010	85303
	SA5310	-1-	85310
	SA5311	-10	85311

APPLICATION GUIDE - TRUCKS, TRAILERS, AND BUSES

Year Año Année	Model Modelo Modèle	OEM #	Front		Rear	
			Fleetline	GasSLX	Fleetline	GasSLX

VOLVO CAB SHOCKS(Cont'd.)

VN Series - 2200(Cont'd.)

	VN Models - Horizontal Position	8078547	010	83029
	VN Models - Vertical Position (w/O.E.M. Number)	20496215	010	83048
		20704334	010	83048
		20721254	010	83048
		21368413	010	83048
		22662125	010	83048
		8078546	010	83028

VNL - Series

06 - 10	VNL 42T-300 Models - With O.E.M. Number	20704334	010	83048
		22662125	010	83048
13 - 16	VNL 64T-630 Models with Flat Top Sleepers	21391412	010	83048
- 13	VNL 64T-670 Models with High Rise Sleeper Cabs	21368413	010	83048
- 14	VNL 64T-780 Models with High Rise Sleeper Cabs	20721254	010	83048
		21368413	010	83048
13 - 16	VNL Models - 64T-430 with Flat Top Sleepers	21391412	010	83048
06 - 11	VNL Models - All with 60" to 77" Mid - High Roof Sleepers (w/O.E.M. Number)	20721254	010	83048





VNM - Series

- 14	VNM Models - All with 60" to 77" Mid - High Roof Sleepers (w/O.E.M. Number)	21391412	010	83048
-------------	---	----------	-----	--------------

WABASH NATIONAL

Identification of the trailer suspension is necessary to determine what section of the catalog to refer to. Some possible options can be Chalmers, Hendrickson, Neway, Ridewell, Reyco.				
97 -	RHP11, RHP55 and RideSentry Trailer Suspension	202447	010	85919
		203447	010	85919
	Trailers with Aurora part number	DANSR1VJ100	010	85078
		FLL83203-071	010	83203 89436
		FLL83207-071	010	83207 89407
		FLL85000-071	010	85000 89436
		FLL85030-071	010	85030 89440
		FRUUCE1295-1	010	85300 89419
		FRUUCE1295-901	010	85300 89419
		FRUUCE2983-1	010	85322
		FRUUCF8339-1	010	85321
		HENS-20001	010	83128 89436
		HENS-20002	010	85000 89436
		HENS-20126	010	85323 89436
		HENS-21292	010	85052
		HENS-23566	010	85000 89436
		NEW900-44-089	010	83124 89407
		NEW900-44-162	010	83128 89436
		NEW900-44-625	010	83125
		NEW900-44-626	010	83126 89430
		NEW900-44-642	010	83127
		NEW900-44-794	010	83127
		NEW900-44-868	010	85045
		NEW900-44-978	010	85059
		NEW900-44-979	010	83113
		NEW900-45-040	010	83130
		NEW900-45-054	010	85051
		NEW900-45-298	010	83128

APPLICATION GUIDE - TRUCKS, TRAILERS, AND BUSES

Year Año Année	Model Modelo Modèle	OEM #	Front		Rear	
						
			Fleetline	GasSLX	Fleetline	GasSLX

WABASH NATIONAL(Cont'd.)

	Trailers with Aurora part number	NEW900-45-299	010	85000	89436
	Trailers with Aurora part number						
	Heavy Duty	HENS-24088	010	85000	89436
	Standard	HENS-24088	010	83128	89436

WATSON & CHALIN MFG. INC.

Heavy Duty Trailer Air Suspension

	TA-2590-14, 17 HD	10148	010	83204	...
	TA-3090-14, -17, -19	10148	010	83204	...
	TA-550-17	10148	010	83204	...

Light Weight Trailer Air Suspension

	TA-3175-9	17079	010	85300	89419
	TA-751-16	10148	010	83204	...

LWSL-1100-SR Self Steer Axle Suspension

	AL-1100-SR Models	10148	010	83204	...
	HL-1100-20	10148	010	83204	...
	HL-1100-20 FL	10147	010	83203	89436
	SL-1100-LR	12128	010	85005	89430

Trailer Air Suspension

	TA-2590-12, 14, 15, & 17,	12128	010	85005	89430
	TA-2590-12-1	10147	010	83203	89436

WCAL-2200 Series Pusher or Tag Axle Assembly

	AL-2200 Models	10148	010	83204	...
--	----------------	-------	-----	-----	-----	-------	-----

WCTA Series Dump Trailer Air Suspension

	TA-1600-21	11604	010	83125	...
	TA-1900-15	10147	010	83203	89436
	TA-1900-16, -17	10148	010	83204	...
	TA-1900-18, -19	12128	010	85005	89430
	TA-5000-DB-19, -F-19	12128	010	85005	89430
	TA-5000-DB-24, -DB-30, -F-24, -F-30,	11724	010	83123	89405
	TA-525, -DB	10147	010	83203	89436

WCTA Series Trailer Air Suspension

	TA-2075-6	10148	010	83204	...
	TA-2075-9	12128	010	85005	89430
	TA-250-12	10148	010	83204	...
	TA-250-6, 7.5, 9,	10147	010	83203	89436
	TA-251-12, -12FS,	10148	010	83204	...
	TA-251-6.5, -6.5FS,	10147	010	83203	89436
	TA-251-7.5, -7.5FS	10147	010	83203	89436
	TA-251-8FS	10147	010	83203	89436
	TA-251-9.0, -9.0FS, -10,	10147	010	83203	89436
	TA-255-9	10147	010	83203	89436
	TA-280-6.5, 7.5, -9.0,	11604	010	83125	...
	TA-300-9	10147	010	83203	89436
	TA-380-9	12128	010	85005	89430





WCTA-1200 Series Trailer Air Suspension

	TA-1000	10634	010	G63357	...
	TA-1200-5	10147	010	83203	89436

WCTL-2200 Series Trailer Air Lift

	TL-1600-21	11604	010	83125	...
10/89 -	TL-2590-12,14,15, & 17	12128	010	85005	89430

APPLICATION GUIDE - TRUCKS, TRAILERS, AND BUSES

Year Año Année	Model Modelo Modèle	OEM #	Front		Rear	
						
			Fleetline	GasSLX	Fleetline	GasSLX

WATSON & CHALIN MFG. INC.(Cont'd.)

WCWB Series Trailer Air Suspension(Cont'd.)

WB-2500-6	10148	010	83204	...
WB-2500-7.5, -9,	12128	010	85005	89430
WB-251-6.5, 7.5, 9	10147	010	83203	89436
WB-280-9	11604	010	83125	...
Models with O.E.M. Number	17300	010	85052	...
	3946219	-1-	83400	...
	665727	010	85005	89430
	665769	010	85052	...

Additional O.E.M. Interchanges

Models with O.E.M. Number	10147HD	010	85000	89436
	17186	010	85323	89436
	17186-01	010	85323	89436
	17218	010	85029	...
	17297	010	85064	...
	17306	010	85938	...
	17317	010	85344	...
	17382	010	85014	...
	17430	010	85321	...
	17474	-10	85009	...
	19036	010	85934	...
	19249	010	85939	...
	19250	010	85382	...
	19603	010	85939	...
	665724	010	85000	89436
	665728	010	85060	...
	665770	010	85064	...
	665862	010	85000	89436
	680547	010	85323	89436
	680584	010	85938	...
	680714	010	85934	...
	727603	010	83203	89436
	727604	010	83204	...
	A-20345	010	85345	...
	B-23649	010	85064	...
	B-23650	010	85052	...
	B-23651	010	85045	...
	B-23743	010	85938	...





WESTERN STAR

Models with Neway ADZ Rear Suspension	471700004423	010	85109	...
	90045605	010	85109	...

3800 Series - Heritage Class

3842S, 3864S Models	37390-4401	010	85053	89442
	37390-4402	010	85053	89442
	37390-4403	010	85053	89442
With Hendrickson Rear Suspension	47902-13	010	83122	89406
	47902-24	010	83137	...
	47902-8	010	83122	89406
With Neway Rear Suspension	90044025	010	83209	89414
	90044907	01-	83635	...

APPLICATION GUIDE - TRUCKS, TRAILERS, AND BUSES

Year Año Année	Model Modelo Modèle	OEM #	Front		Rear	
						
			Fleetline	GasSLX	Fleetline	GasSLX

WESTERN STAR(Cont'd.)

4700 Series(Cont'd.)

11 - 15	Models with 20000 lb Set -Back Front Axle	10-13809-000	OIO	85958
11 - 15	Models with FAS II Rear Air Suspension	16-18708-000		OIO	85724	89443

4800 & 4900 Series - Constellation Class

	4842FX, 4864FX, 4964EX, 4964EX, 4942SX or 4964SX Constellation Class	37301-3401	OIO	85053	89442	
		37301-3404	OIO	85053	89442	
		37301-3409	OIO	85053	89442	
		37301-3412	OIO	85053	89442	
		37390-4401	OIO	85053	89442	
		37390-4402	OIO	85053	89442	
		37390-4403	OIO	85053	89442	
09 - 12	Models w/ Low Profile Rear Air Suspension	16-18706-000		OIO	85331	...
09 - 15	Models with 12000 lb Taperleaf Front Suspension	10-13809-000	OIO	85958
		SDA471700003920	OIO	85958
08 - 15	Models with Freightliner TuffTrac Rear Air Suspension	16-15770-000		OIO	85956	...
		SDA481700125969		OIO	85956	...
- 16	Models with Hendrickson Front Airtek	471700006269	OIO	85932	89453	
		471700131331	OIO	85932	89453	
		58913-003	OIO	85932	89453	
		58913-012	OIO	85932	89453	
	With Hendrickson HAS-40LH Rear Suspension	57241-1		OIO	83111	...
	With Hendrickson Rear Suspension	47902-13		OIO	83122	89406
		47902-24		OIO	83137	...
		47902-8		OIO	83122	89406
	With Neway Rear Suspension	90044025		OIO	83209	89414
		90044907		OIO	83635	...
		90045099		OIO	85906	89407

4800 & 4900 Series - Heritage Class

	4842F, 4864F, 4843S, 4864S, 4942F, 4964F, 4942S or 4964S Heritage Class	37301-3401	OIO	85053	89442	
		37301-3404	OIO	85053	89442	
		37301-3409	OIO	85053	89442	
		37301-3412	OIO	85053	89442	
		37390-4401	OIO	85053	89442	
		37390-4402	OIO	85053	89442	
		37390-4403	OIO	85053	89442	
09 - 15	Models with 12000 lb Taperleaf Front Suspension	10-13809-000	OIO	85958
		SDA471700003920	OIO	85958
08 - 15	Models with Freightliner TuffTrac Rear Air Suspension	16-15770-000		OIO	85956	...
		SDA481700125969		OIO	85956	...
- 16	Models with Hendrickson Front Airtek	471700006269	OIO	85932	89453	
		471700131331	OIO	85932	89453	
		58913-003	OIO	85932	89453	
		58913-012	OIO	85932	89453	
	With Hendrickson HAS-40LH Rear Suspension	57241-1		OIO	83111	...
	With Hendrickson Rear Suspension	47902-13		OIO	83122	89406
		47902-24		OIO	83137	...
		47902-8		OIO	83122	89406
	With Neway Rear Suspension	90044025		OIO	83209	89414
		90044907		OIO	83635	...
		90045099		OIO	85906	89407

APPLICATION GUIDE - TRUCKS, TRAILERS, AND BUSES

Year Año Année	Model Modelo Modèle	OEM #	Front		Rear	
			Fleetline	GasSLX	Fleetline	GasSLX

WESTERN STAR(Cont'd.)





5800 & 5900 Series - Constellation Class(Cont'd.)

	5842SS, 5864SS, 5942SS or 5964SS Constellation Class	37301-3401	010	85053	89442	
		37301-3404	010	85053	89442	
		37301-3409	010	85053	89442	
		37301-3412	010	85053	89442	
		37390-4401	010	85053	89442	
		37390-4402	010	85053	89442	
		37390-4403	010	85053	89442	
09 - 15	Models with 12000 lb Taperleaf Front Suspension	10-13809-000	010	85958
		SDA471700003920	010	85958
08 - 15	Models with Freightliner TufTrac Rear Air Suspension	16-15770-000		010	85956	...
		SDA481700125969		010	85956	...
		With Hendrickson Rear Suspension	47902-13		010	83122
		47902-24		010	83137	...
		47902-8		010	83122	89406
	With Neway Rear Suspension	90044025		010	83209	89414
		90044907		01-	83635	...
		90045099		010	85906	89407
		With Hendrickson Rear Suspension	57905-2		010	85006

5900 & 6900 Series - Heritage Class

	5942S, 5964S, 6964F or 6964S Heritage Class	37301-3401	010	85053	89442	
		37301-3404	010	85053	89442	
		37301-3409	010	85053	89442	
		37301-3412	010	85053	89442	
		37390-4401	010	85053	89442	
		37390-4402	010	85053	89442	
		37390-4403	010	85053	89442	
	All with 4 shock Front System	010	83401
09 - 15	Models with 12000 lb Taperleaf Front Suspension	10-13809-000	010	85958
		SDA471700003920	010	85958
08 - 15	Models with Freightliner TufTrac Rear Air Suspension	16-15770-000		010	85956	...
		SDA481700125969		010	85956	...
- 06/10	Models with Hendrickson Airtek Suspension	58913-003	010	85932	89453	
07/10 -	Models with Hendrickson Airtek Suspension	471700006269	010	85932	89453	
		58913-012	010	85932	89453	
	With Hendrickson HAS-40LH Rear Suspension	57241-1		01-	83111	...
	With Hendrickson Rear Suspension	47902-13		010	83122	89406
		47902-24		010	83137	...
		47902-8		010	83122	89406
		60675-002		010	85979	...
	With Neway Rear Suspension	90044025		010	83209	89414
		90044907		01-	83635	...
		90045099		010	85906	89407
	Models with O.E.M. Number	02-7005976	-1-	83400
		02-7005977	-1-	83400
		04-9041375		010	85315	...
		28R010	010	83216
		35066-4413		010	83122	89406
		35901-0001		010	83209	89414
		35901-4403		010	85060	...
		37301-3405	010	85053	89442	
		57252	010	85308	89422	

APPLICATION GUIDE - TRUCKS, TRAILERS, AND BUSES

Year Año Année	Model Modelo Modèle	OEM #	Front		Rear	
						
			Fleetline	GasSLX	Fleetline	GasSLX

WESTERN STAR(Cont'd.)

5900 & 6900 Series - Heritage Class(Cont'd.)

	Models with O.E.M. Number	57905-1	010	85976	...
		665682	85053	89442	
		CP-5222	010	85315	...
	With Hendrickson Rear Suspension	57905-2	010	85006	...
	Additional O.E.M. Interchanges	1011839	83216
		35901-3406				85305	
		35901-3409				85304	
		35901-3410				85307	
		35901-3413				85006	
		35901-3420				85303 or 89422	
		615016				83401	
		676081				83401	
		676082				83401	

WESTERN STAR CAB SHOCKS

	6900 Models	725470	010	83010	
01 - 15	6900 SX Models	66010-3407	010	83065	
	Constellation Day Cab Models	18-60772-000	010	83026	
		66010-3405	010	83026	
		81-4903003500	010	83026	
	Constellation Sleeper Cab Models	18-60773-000	01-	83027	
		66010-3406	01-	83027	
		814903003501	01-	83027	
86 -	Conventional Tractors with Link Cabmate Model WSC4000	1201-0012	010	83023	
		1202-0012	010	83023	
	For 4800, 4900, 6900 Heritage & Constellation Day Cab	66010-3402	010	83022	
		66010-3403	010	83022	
	Heritage Constellation models	66010-3404	010	83022	
	Models with Link Cab Suspension	1201-0022	010	83046	
		1202-0022	010	83046	
		1202-0032	010	83016	
	Models with O.E.M. Number	617547	010	83022	
		654846	01-	83027	
		GBL 654916	010	83026	

WESTERN UNIT "STABILAIR" SUSPENSION





	Model 893T Trailer Suspension	010	85307	...
	Model TDA202, 203, 206, 240, 241, 243 Truck Drive Axle Suspension	010	85735	...
	Model TDA204, 205, 242 - Truck Drive Axle Suspension	010	85307	...
	Models with O.E.M. Number	101030		010	85307	...
		101364		010	85305	...
		4939967		010	85308	89422
		80370		010	85304	...
		80600		010	85300	89419

WINNEBAGO

Class A MotorHomes

03 - 06	Journey Series MotorHomes with Freightliner XC Chassis ADL200 Suspension w/ 20K Rear AS120 Front Suspension	16-16873-000		010	85029	...
		141700131810	010	83160

APPLICATION GUIDE - TRUCKS, TRAILERS, AND BUSES

Year Año Année	Model Modelo Modèle	OEM #	Front		Rear	
			 Fleetline	 GasSLX	 Fleetline	 GasSLX

WINNEBAGO(Cont'd.)

Class A MotorHomes(Cont'd.)

03 - 06	ADL200 Suspension w/ 20K Rear Rear Shock with O.E.M. Number ZF - IFS Front Suspension with 23,000 lb GVW or Greater	16-16737-000	010	83160
		16-16874-000	010	83160
		141700131809		010	85029	...
		16-16736-000		010	85029	...
		16-18103-000	-1-	85900
		481700000493	-1-	85900
06	Tour Series MotorHomes with Freightliner XC Chassis ADL200 Suspension w/ 20K Rear AS120 Front Suspension Rear Shock with O.E.M. Number ZF - IFS Front Suspension with 23,000 lb GVW or Greater	16-16873-000		010	85029	...
		141700131810	010	83160
		16-16737-000	010	83160
		16-16874-000	010	83160
		141700131809		010	85029	...
		16-16736-000		010	85029	...
		16-18103-000	-1-	85900
		481700000493	-1-	85900
04 - 06	Vetra Series MotorHomes with Freightliner XC Chassis ADL200 Suspension w/ 20K Rear AS120 Front Suspension Rear Shock with O.E.M. Number ZF - IFS Front Suspension with 23,000 lb GVW or Greater	16-16873-000		010	85029	...
		141700131810	010	83160
		16-16737-000	010	83160
		16-16874-000	010	83160
		141700131809		010	85029	...
		16-16736-000		010	85029	...
		16-18103-000	-1-	85900
		481700000493	-1-	85900

WORKHORSE

	Models with O.E.M. Number	659223		010	G63866	...
		680672		010	85919	...
	Models with RSAS Rear Suspension	7805-X-1012		010	85919	...
	Step Van Models with O.E.M. Number	659222	010	83171
		W0007363	010	83171
		W0007365		010	G63866	...
		W8007000	010	83171
06 - 09	W16 & W18 MotorHome Chassis with O.E.M. Number	F4-BE5-F324-HO	010	85125
		W0005662	010	85125
05 - 14	W20 , W22, & W24 MotorHome Chassis with O.E.M. Number	24-153256		-1-	85124	...
		F4-BE5-F325-HO		-1-	85124	...
		W0005663		-1-	85124	...
98 - 04	W20 , W22, & W24 MotorHome Chassis with O.E.M. Number	24-186537		01-	85126	...
		F4-BE5-A011-HO		01-	85126	...
98 - 14	W20 , W22, & W24 MotorHome Chassis with O.E.M. Number	24-153249	010	85125
		24-186629	010	85125
		F4-BE5-A832-MO	010	85125
		F4-BE5-B492-HO	010	85125
		F4-BE5-F324-HO	010	85125
		W0005662	010	85125
		W0006254	010	85125

NUMERICAL LISTING LISTA NUMÉRICA LISTE NUMÉRIQUE

GABRIEL#	APPLICATION	MTG ACC PKG NO	GABRIEL#	APPLICATION	MTG ACC PKG NO	GABRIEL#	APPLICATION	MTG ACC PKG NO
Shocks for Special Applications			G63403	W FREIGHTLINER VOLVO	Not Req'd.	G63775	W FORD	Not Req'd.
83176	N VARIOUS	Not Req'd.	G63405	W MITSUBISHI-FUSO	140884	G63778	W FORD	142700
632147	W CHALLENGE LINK/HIGH-STEER MC NEILUS TRUCK & MAN. WATSON & CHALIN MFG. INC.	Not Req'd.	G63406	W FORD	Not Req'd.	G63808	W FORD	Not Req'd.
646155	A ADVANCE MIXER GRANNING SUSPENSION HENDRICKSON TRAILER SUSPENSION SYSTEMS KIMBLE MIXER CO LINK/HIGH-STEER LONDON MIXER MC NEILUS TRUCK & MAN. REX MIXER RIDEWELL CORPORATION SAF HOLLAND SUSPENSIONS INC. TEREX CORPORATION TUTHILL TECHNOLOGIES WATSON & CHALIN MFG. INC.	Not Req'd.	G63409	W FORD	Not Req'd.	G63809	W FORD STERLING TRUCK	Not Req'd.
646177	C CHALLENGE LINK/HIGH-STEER OSHKOSH MOTORS PIERCE MANUFACTURING INC. SAF HOLLAND SPRING VALLEY WESTPORT AXLE CORP	Not Req'd.	G63414	W FORD	140780	G63810	W FORD	Not Req'd.
665472	W INGERSALL MACHINE	Not Req'd.	G63419	W HINO	Not Req'd.	G63811	W FORD	Not Req'd.
665937	W LINK/HIGH-STEER REYCO SUSPENSION RIDEWELL CORPORATION	Not Req'd.	G63432	W INTERNATIONAL (NAVISTAR) NISSAN	141349 & 140169	G63837	W FORD	Not Req'd.
Gas Light Truck Applications			G63440	W HINO	Not Req'd.	G63866	W MOR-RYDE SUSPENSION WORKHORSE	Not Req'd.
G63183	W CHRYSLER DODGE TRUCK FREIGHTLINER HOLIDAY RAMBLER JOHN DEERE MOR-RYDE SUSPENSION OSHKOSH MOTORS VOLVO	Not Req'd.	G63455	W FORD	Not Req'd.	G63929	W FORD	140780
G63299	W FORD INTERNATIONAL (NAVISTAR) MITSUBISHI-FUSO	140885(1)	G63461	W FORD	Not Req'd.	G63969	W FORD	143146
G63306	W FORD INTERNATIONAL (NAVISTAR)	Not Req'd.	G63484	W VOLVO	140524	Fleetline Applications		
G63347	W CHEVROLET TRUCK (Also See GMC Truck) GMC TRUCK	Not Req'd.	G63500	W FORD	140780	83001	B FREIGHTLINER CAB SHOCKS	404702(1)
G63350	W FORD	140126	G63511	W FORD	141353	83002	C KENWORTH CAB SHOCKS LINK MANUFACTURING CAB SHOCKS	Not Req'd.
G63355	W CHALMERS SUSPENSION	140702	G63524	W FORD	Not Req'd.	83003	W MACK CAB SHOCKS	140455(1)
G63357	W WATSON & CHALIN MFG. INC.	Not Req'd.	G63525	W FORD	Not Req'd.	83004	W VOLVO CAB SHOCKS	Not Req'd.
G63386	W FORD STERLING TRUCK	140780	G63605	W DODGE TRUCK FREIGHTLINER JOHN DEERE OSHKOSH MOTORS VOLVO	140169	83005	W INTERNATIONAL (NAVISTAR) CAB SHOCKS LINK MANUFACTURING CAB SHOCKS	140455(1)
G63387	W FORD STERLING TRUCK	140126	G63607	W FORD	140719	83006	W FREIGHTLINER CAB SHOCKS	404702(1)
G63396	W FORD	140780	G63608	W FORD	140780	83007	W MACK CAB SHOCKS	404702(2) & 140702(1)
G63398	W FORD MITSUBISHI-FUSO	141138	G63610	W HINO INTERNATIONAL (NAVISTAR) ISUZU MITSUBISHI-FUSO NISSAN	142389	83008	A KENWORTH PETERBILT CAB SHOCKS	Not Req'd.
			G63614	W FORD	140780	83009	A FREIGHTLINER CAB SHOCKS MC NEILUS TRUCK & MAN. OSHKOSH MOTORS CAB SHOCKS VOLVO CAB SHOCKS	Not Req'd.
			G63622	W FORD	142617	83010	W WESTERN STAR CAB SHOCKS	Not Req'd.
			G63623	W FORD	142617	83011	W KENWORTH CAB SHOCKS PETERBILT CAB SHOCKS	404702(2)
			G63624	W FORD	140780	83012	W KENWORTH CAB SHOCKS PETERBILT CAB SHOCKS	404702(2)
			G63625	W VOLVO	140702	83013	W INTERNATIONAL (NAVISTAR) CAB SHOCKS LINK MANUFACTURING CAB SHOCKS	Not Req'd.
			G63676	W FORD	Not Req'd.	83014	X INTERNATIONAL (NAVISTAR) CAB SHOCKS MACK CAB SHOCKS	140455(2)
			G63678	W FORD	Not Req'd.	83015	W INTERNATIONAL (NAVISTAR) CAB SHOCKS	140455(1)
			G63679	W FORD	140719	83016	W CHEVROLET TRUCK CAB SHOCKS FORD CAB SHOCKS FREIGHTLINER CAB SHOCKS GMC TRUCK CAB SHOCKS INTERNATIONAL (NAVISTAR) CAB SHOCKS KENWORTH CAB SHOCKS LINK MANUFACTURING CAB SHOCKS MACK CAB SHOCKS PETERBILT CAB SHOCKS VOLVO CAB SHOCKS WESTERN STAR CAB SHOCKS	Not Req'd.
			G63714	W FORD	142731			
			G63716	W FORD	142731			
			G63772	W FORD	141665			
			G63773	W FORD	Not Req'd.			

N = New, X = Discontinued once inventory is gone

NUMERICAL LISTING LISTA NUMÉRICA LISTE NUMÉRIQUE

GABRIEL#	APPLICATION	MTG ACC PKG NO	GABRIEL#	APPLICATION	MTG ACC PKG NO	GABRIEL#	APPLICATION	MTG ACC PKG NO
83017	W FREIGHTLINER CAB SHOCKS	Not Req'd.	83039	W FREIGHTLINER CAB SHOCKS	Not Req'd.	83065	N WESTERN STAR CAB SHOCKS	Not Req'd.
83018	W MACK CAB SHOCKS	140780(1)	83040	W FREIGHTLINER CAB SHOCKS	Not Req'd.	83066	N MACK CAB SHOCKS	Not Req'd.
83019	W MACK CAB SHOCKS VOLVO	140780(1)	83041	D MACK CAB SHOCKS VOLVO	140780(1)	83067	N KENWORTH CAB SHOCKS PETERBILT CAB SHOCKS	Not Req'd.
83020	W FREIGHTLINER CAB SHOCKS	Not Req'd.	83042	W KENWORTH CAB SHOCKS PETERBILT CAB SHOCKS	Not Req'd.	83100	W INTERNATIONAL (NAVISTAR) MERCEDES BENZ VOLVO	Not Req'd.
83021	C CHEVROLET TRUCK CAB SHOCKS CNH GLOBAL N V FREIGHTLINER CAB SHOCKS GMC TRUCK CAB SHOCKS INTERNATIONAL (NAVISTAR) CAB SHOCKS KENWORTH CAB SHOCKS LINK MANUFACTURING CAB SHOCKS MARMON CAB SHOCKS OSHKOSH MOTORS CAB SHOCKS PETERBILT CAB SHOCKS	Not Req'd.	83044	W FREIGHTLINER CAB SHOCKS	Not Req'd.	83101	W INTERNATIONAL (NAVISTAR) MACK VOLVO	Not Req'd.
83022	W CNH GLOBAL N V WESTERN STAR CAB SHOCKS	Not Req'd.	83045	W MACK CAB SHOCKS VOLVO	140780(1)	83102	W THOMAS SCHOOL BUS	145089-000(2)
83023	W CHEVROLET TRUCK CAB SHOCKS FORD CAB SHOCKS FREIGHTLINER CAB SHOCKS GMC TRUCK CAB SHOCKS INTERNATIONAL (NAVISTAR) CAB SHOCKS KENWORTH CAB SHOCKS LINK MANUFACTURING CAB SHOCKS MACK CAB SHOCKS PETERBILT CAB SHOCKS VOLVO CAB SHOCKS WESTERN STAR CAB SHOCKS	Not Req'd.	83046	X CHEVROLET TRUCK CAB SHOCKS FORD CAB SHOCKS FREIGHTLINER CAB SHOCKS GMC TRUCK CAB SHOCKS INTERNATIONAL (NAVISTAR) CAB SHOCKS KENWORTH CAB SHOCKS LINK MANUFACTURING CAB SHOCKS MACK CAB SHOCKS MARMON CAB SHOCKS PETERBILT CAB SHOCKS VOLVO CAB SHOCKS WESTERN STAR CAB SHOCKS	Not Req'd.	83103	W INTERNATIONAL (NAVISTAR) MITSUBISHI-FUSO MOR-RYDE SUSPENSION VOLVO	145054(2)
83024	D KENWORTH CAB SHOCKS LINK MANUFACTURING CAB SHOCKS PETERBILT CAB SHOCKS	Not Req'd.	83047	D FREIGHTLINER CAB SHOCKS	404702(1)	83104	W GMC TRUCK HINO VOLVO	Not Req'd.
83025	C FORD CAB SHOCKS FREIGHTLINER CAB SHOCKS GMC TRUCK CAB SHOCKS INTERNATIONAL (NAVISTAR) CAB SHOCKS KENWORTH CAB SHOCKS LINK MANUFACTURING CAB SHOCKS PETERBILT CAB SHOCKS STERLING TRUCK CAB SHOCKS	Not Req'd.	83048	C VOLVO VOLVO CAB SHOCKS	Not Req'd.	83105	W MACK VOLVO	140780(1)
83026	W FREIGHTLINER CAB SHOCKS WESTERN STAR CAB SHOCKS	Not Req'd.	83049	D KENWORTH CAB SHOCKS LINK MANUFACTURING CAB SHOCKS PETERBILT CAB SHOCKS	Not Req'd.	83107	W FORD MAECO STERLING TRUCK	145080(2)
83027	D FREIGHTLINER CAB SHOCKS WESTERN STAR CAB SHOCKS	140126(1)	83050	W MACK CAB SHOCKS VOLVO CAB SHOCKS	140780(1)	83109	W FORD HENDRICKSON TRUCK SUSPENSION SYSTEMS MC NEILUS TRUCK & MAN. STERLING TRUCK	145128(1)
83028	D VOLVO CAB SHOCKS	Not Req'd.	83051	C INTERNATIONAL (NAVISTAR) CAB SHOCKS LINK MANUFACTURING CAB SHOCKS	Not Req'd.	83110	D HENDRICKSON TRUCK SUSPENSION SYSTEMS MACK VOLVO	145128(1)
83029	W VOLVO CAB SHOCKS	Not Req'd.	83052	W INTERNATIONAL (NAVISTAR) CAB SHOCKS LINK MANUFACTURING CAB SHOCKS	Not Req'd.	83111	D HENDRICKSON TRUCK SUSPENSION SYSTEMS MACK VOLVO WESTERN STAR	145128(1)
83030	W VOLVO CAB SHOCKS	Not Req'd.	83053	W INTERNATIONAL (NAVISTAR) CAB SHOCKS LINK MANUFACTURING CAB SHOCKS	Not Req'd.	83112	C ADVANCE MIXER AUTOCAR HENDRICKSON TRUCK SUSPENSION SYSTEMS INTERNATIONAL (NAVISTAR) MACK MC NEILUS TRUCK & MAN. VOLVO	Not Req'd.
83031	D KENWORTH CAB SHOCKS LINK MANUFACTURING CAB SHOCKS	Not Req'd.	83054	W INTERNATIONAL (NAVISTAR) CAB SHOCKS LINK MANUFACTURING CAB SHOCKS	Not Req'd.	83113	W SAF HOLLAND STOUGHTON TRAILERS INC. TRAILMOBILE CANADA CORP. WABASH NATIONAL	Not Req'd.
83032	S FREIGHTLINER CAB SHOCKS INTERNATIONAL (NAVISTAR) CAB SHOCKS KENWORTH CAB SHOCKS LINK MANUFACTURING CAB SHOCKS	Not Req'd.	83055	W KENWORTH CAB SHOCKS LINK MANUFACTURING CAB SHOCKS	Not Req'd.	83114	W CHEVROLET TRUCK (Also See GMC Truck) GMC TRUCK INTERNATIONAL (NAVISTAR) ISUZU NISSAN	140780(1)
83033	W FORD CAB SHOCKS FREIGHTLINER CAB SHOCKS STERLING TRUCK CAB SHOCKS	Not Req'd.	83056	W KENWORTH CAB SHOCKS LINK MANUFACTURING CAB SHOCKS	Not Req'd.	83115	X SAF HOLLAND TRAILMOBILE CANADA CORP.	Not Req'd.
83034	W FORD CAB SHOCKS FREIGHTLINER CAB SHOCKS STERLING TRUCK CAB SHOCKS	Not Req'd.	83057	W FREIGHTLINER CAB SHOCKS STERLING TRUCK CAB SHOCKS	Not Req'd.	83116	W FREIGHTLINER CUSTOM CHASSIS	Not Req'd.
83035	C KENWORTH PETERBILT CAB SHOCKS	Not Req'd.	83058	W MACK CAB SHOCKS	140780(1)	83117	W FREIGHTLINER FREIGHTLINER CUSTOM CHASSIS OSHKOSH MOTORS	404702(1)
83038	A FREIGHTLINER CAB SHOCKS	404702(1)	83059	W KENWORTH CAB SHOCKS PETERBILT CAB SHOCKS POWERPACKER CAB SHOCKS	Not Req'd.	83118	W FREIGHTLINER FREIGHTLINER CUSTOM CHASSIS MAECO OSHKOSH MOTORS UPS TRUCK	Not Req'd.
			83060	W PETERBILT CAB SHOCKS POWERPACKER CAB SHOCKS	Not Req'd.			
			83061	W LINK MANUFACTURING CAB SHOCKS PETERBILT CAB SHOCKS	Not Req'd.			
			83062	W INTERNATIONAL (NAVISTAR) CAB SHOCKS LINK MANUFACTURING CAB SHOCKS	145128(1)			
			83063	N KENWORTH PETERBILT CAB SHOCKS	Not Req'd.			
			83064	N ARVIN MERITOR FREIGHTLINER CAB SHOCKS	Not Req'd.			

N = New, S = Superseded, X = Discontinued once inventory is gone

NUMERICAL LISTING LISTA NUMÉRICA LISTE NUMÉRIQUE

GABRIEL#	APPLICATION	MTG ACC PKG NO	GABRIEL#	APPLICATION	MTG ACC PKG NO	GABRIEL#	APPLICATION	MTG ACC PKG NO
83119	W FREIGHTLINER CUSTOM CHASSIS OSHKOSH MOTORS	Not Req'd.	83126	D TUTHILL TECHNOLOGIES VOLVO WABASH NATIONAL	Not Req'd.	83143	W PETERBILT	145128(1)
83120	W FREIGHTLINER FREIGHTLINER CUSTOM CHASSIS MAECO OSHKOSH MOTORS STERLING TRUCK THOMAS SCHOOL BUS UPS TRUCK VOLVO	145089-000(1) & 145143(1)	83127	B BLUEBIRD SCHOOL BUS FREIGHTLINER FREIGHTLINER CUSTOM CHASSIS HOLIDAY RAMBLER MC NEILUS TRUCK & MAN. OSHKOSH MOTORS SAF HOLLAND TRAILMOBILE CANADA CORP. VOLVO WABASH NATIONAL	Not Req'd.	83144	W HENDRICKSON TRUCK SUSPENSION SYSTEMS INTERNATIONAL (NAVISTAR)	Not Req'd.
83122	D ALLCO TRAILER AUTOCAR CHEVROLET TRUCK (Also See GMC Truck) FORD FREIGHTLINER FRUEHAUF GILLIG BROS. GMC TRUCK GREAT DANE TRAILER HENDRICKSON TRUCK SUSPENSION SYSTEMS HOLIDAY RAMBLER ISUZU KENWORTH LODAL, INC. MACK MAECO MARMON MC NEILUS TRUCK & MAN. MONACO OSHKOSH MOTORS PETERBILT REYCO SUSPENSION SAF HOLLAND TUTHILL TECHNOLOGIES VOLVO WESTERN STAR	Not Req'd.	83128	A EAST MANUFACTURING CORP. FREIGHTLINER GREAT DANE TRAILER HENDRICKSON TRAILER SUSPENSION SYSTEMS MC NEILUS TRUCK & MAN. REYCO SUSPENSION SAF HOLLAND STOUGHTON TRAILERS INC. TWIN COACH UTILITY TRAILER MANUFACTURING COMPANY VOLVO WABASH NATIONAL	Not Req'd.	83145	W FORD INTERNATIONAL (NAVISTAR)	Not Req'd.
83123	C FORD GILLIG BROS. HENDRICKSON TRUCK SUSPENSION SYSTEMS INTERNATIONAL (NAVISTAR) KENWORTH MACK MAECO MARMON MC NEILUS TRUCK & MAN. PETERBILT REYCO SUSPENSION SAF HOLLAND TUTHILL TECHNOLOGIES VOLVO WATSON & CHALIN MFG. INC.	Not Req'd.	83130	C W RIDEWELL CORPORATION SAF HOLLAND VOLVO WABASH NATIONAL	Not Req'd.	83146	W FORD INTERNATIONAL (NAVISTAR) STERLING TRUCK	Not Req'd.
83124	C BENSON TRUCK BODIES INC. BLUEBIRD SCHOOL BUS EAST MANUFACTURING CORP. KENWORTH PETERBILT SAF HOLLAND TRAILMOBILE CANADA CORP. TWIN COACH VOLVO WABASH NATIONAL	Not Req'd.	83131	W FORD	Not Req'd.	83147	B HENDRICKSON TRUCK SUSPENSION SYSTEMS MACK MC NEILUS TRUCK & MAN. THOMAS SCHOOL BUS	Not Req'd.
83125	A CASCADE TRAILER EAST MANUFACTURING CORP. FORD GENERAL TRAILER CO HENDRICKSON TRUCK SUSPENSION SYSTEMS HOLLAND - BINKLEY MACK MAECO PEERLESS TRAILER SAF HOLLAND STERLING TRUCK THE BINKLEY COMPANY TRAILMOBILE CANADA CORP. VOLVO WABASH NATIONAL WATSON & CHALIN MFG. INC.	Not Req'd.	83134	W FREIGHTLINER	145054(1)	83148	D HENDRICKSON TRUCK SUSPENSION SYSTEMS HINO MC NEILUS TRUCK & MAN.	Not Req'd.
83126	D CHEVROLET TRUCK (Also See GMC Truck) GMC TRUCK HINO INTERNATIONAL (NAVISTAR) KENWORTH MAECO PETERBILT REYCO SUSPENSION SAF HOLLAND	Not Req'd.	83135	C FORD IC CORPORATION INTERNATIONAL (NAVISTAR)	Not Req'd.	83149	W HENDRICKSON TRUCK SUSPENSION SYSTEMS	Not Req'd.
			83136	C CHAMPION TRANSIT CHEVROLET TRUCK (Also See GMC Truck) GMC TRUCK ISUZU KENWORTH PETERBILT VOLVO	145054(2)	83150	W HENDRICKSON TRAILER SUSPENSION SYSTEMS SAF HOLLAND	Not Req'd.
			83137	C BERING TRUCK CORP. BLUEBIRD SCHOOL BUS CHEVROLET TRUCK (Also See GMC Truck) GMC TRUCK HENDRICKSON TRUCK SUSPENSION SYSTEMS INTERNATIONAL (NAVISTAR) ISUZU KENWORTH MACK MC NEILUS TRUCK & MAN. PETERBILT SAF HOLLAND VOLVO WESTERN STAR	Not Req'd.	83153	W CHEVROLET TRUCK (Also See GMC Truck) GMC TRUCK	Not Req'd.
			83138	W MACK	145128(1)	83154	W FREIGHTLINER CUSTOM CHASSIS	145089-000(1)
			83140	W FORD HINO	415010-802(2) & 145148(2)	83155	W CHEVROLET TRUCK (Also See GMC Truck) GMC TRUCK	Not Req'd.
			83141	W HINO	415010-802(2) & 145148(2)	83156	W IC CORPORATION INTERNATIONAL (NAVISTAR)	Not Req'd.
			83142	W AUTOCAR FREIGHTLINER HENDRICKSON TRUCK SUSPENSION SYSTEMS KENWORTH MC NEILUS TRUCK & MAN. PETERBILT	145128(1)	83157	W FREIGHTLINER CUSTOM CHASSIS	Not Req'd.
			83143	W AUTOCAR FREIGHTLINER HENDRICKSON TRUCK SUSPENSION SYSTEMS INTERNATIONAL (NAVISTAR) KENWORTH MC NEILUS TRUCK & MAN.	145128(1)	83158	W MOTOR COACH INDUSTRIES	Not Req'd.
						83159	W GMC TRUCK ISUZU	TR0027(4)
						83160	W COACHMEN RV FLEETWOOD RV FOREST RIVER INC FREIGHTLINER CUSTOM CHASSIS GULF STREAM COACH HOLIDAY RAMBLER ITASCA KING OF THE ROAD MANDALAY COACH MONACO NEWMAR CORP THOR MOTOR COACH WINNEBAGO	Not Req'd.
						83161	W FORD GMC TRUCK NISSAN	140524(1) & 404702(1)
						83162	W NISSAN	140780(1) & 145116 & 406422 & 415010-802(1)
						83163	W IC CORPORATION INTERNATIONAL (NAVISTAR)	Not Req'd.
						83164	W ARVIN MERITOR FREIGHTLINER CUSTOM CHASSIS	Not Req'd.
						83166	W HENDRICKSON TRUCK SUSPENSION SYSTEMS HINO	Not Req'd.
						83167	W INTERNATIONAL (NAVISTAR)	Not Req'd.
						83168	W HENDRICKSON TRUCK SUSPENSION SYSTEMS HINO	Not Req'd.

NUMERICAL LISTING LISTA NUMÉRICA LISTE NUMÉRIQUE

GABRIEL#	APPLICATION	MTG ACC PKG NO	GABRIEL#	APPLICATION	MTG ACC PKG NO	GABRIEL#	APPLICATION	MTG ACC PKG NO
83168	W MC NEILUS TRUCK & MAN.	Not Req'd.	83207	C VOLVO WABASH NATIONAL	Not Req'd.	83219	W PETERBILT VOLVO	140149(1)
83169	W IC CORPORATION INTERNATIONAL (NAVISTAR)	Not Req'd.	83209	D ADVANCE MIXER ARVIN MERITOR CHEVROLET TRUCK (Also See GMC Truck) FORD GMC TRUCK HENDRICKSON TRAILER SUSPENSION SYSTEMS HOLIDAY RAMBLER INTERNATIONAL (NAVISTAR) KENWORTH MACK MAECO MC NEILUS TRUCK & MAN. MONACO PETERBILT REYCO SUSPENSION SAF HOLLAND TRAILMOBILE CANADA CORP. TUTHILL TECHNOLOGIES VOLVO WESTERN STAR	Not Req'd.	83221	W CHEVROLET TRUCK (Also See GMC Truck) GMC TRUCK KENWORTH MACK MAECO OSHKOSH MOTORS PAI CORP PETERBILT REYCO SUSPENSION TUTHILL TECHNOLOGIES VOLVO	Not Req'd.
83171	W ARVIN MERITOR WORKHORSE	Not Req'd.	83214	W ARVIN MERITOR CHEVROLET TRUCK (Also See GMC Truck) DIAMOND-REO EAST MANUFACTURING CORP. GMC TRUCK GRANNING SUSPENSION MAECO OSTERLUND TRUCK OTTAWA TRUCK SPARTAN MOTORS TUTHILL TECHNOLOGIES VOLVO	401754(4)	83225	W ACF BRILL BUS ARVIN MERITOR FORD FREIGHTLINER HENDRICKSON TRUCK SUSPENSION SYSTEMS INTERNATIONAL (NAVISTAR) MACK MOHAWK TRAILMOBILE CANADA CORP. VOLVO	401754(4)
83174	N FREIGHTLINER CUSTOM CHASSIS	Not Req'd.	83215	W ACF BRILL BUS ARVIN MERITOR BROCKWAY SCHOOL BUS CHEVROLET TRUCK (Also See GMC Truck) FORD GMC TRUCK HINO INTERNATIONAL (NAVISTAR) MACK MAECO PAI CORP REYCO SUSPENSION STERLING TRUCK TUTHILL TECHNOLOGIES VOLVO	401754(4)	83242	W ARVIN MERITOR MACK VOLVO	Not Req'd.
83175	N FORD INTERNATIONAL (NAVISTAR)	Not Req'd.	83216	W ARVIN MERITOR AUTOCAR BROCKWAY SCHOOL BUS CHEVROLET TRUCK (Also See GMC Truck) FORD GILLIG BROS. GMC TRUCK HINO INTERNATIONAL (NAVISTAR) MACK MAECO MARMON MOHAWK NEOPLAN BUS ONEIDA PRODUCTS STERLING TRUCK VOLVO WESTERN STAR	140149(1)	83301	W ARVIN MERITOR INTERNATIONAL (NAVISTAR) VOLVO	141083(1)
83176	N MAECO	Not Req'd.	83217	W CHEVROLET TRUCK (Also See GMC Truck) DIAMOND-REO EAST MANUFACTURING CORP. FLXIBLE BUS FORD GMC TRUCK HINO HYSTER MACK MAECO OLE GRANNING OTTAWA TRUCK REYCO SUSPENSION SOUTHERN COACH TUTHILL TECHNOLOGIES VOLVO	401754(4)	83303	W ARVIN MERITOR CHEVROLET TRUCK (Also See GMC Truck) GMC TRUCK VOLVO	140702(1)
83177	N 140780(1) & 404702(1) BLUEBIRD SCHOOL BUS HOLIDAY RAMBLER THOMAS SCHOOL BUS		83218	W ARVIN MERITOR FORD STERLING TRUCK		83304	W ARVIN MERITOR CHEVROLET TRUCK (Also See GMC Truck) GMC TRUCK VOLVO	140702(1)
83178	N 142095(1) BLUEBIRD SCHOOL BUS HOLIDAY RAMBLER THOMAS SCHOOL BUS		83219	W ARVIN MERITOR CHEVROLET TRUCK (Also See GMC Truck) FORD GILLIG BROS. GMC TRUCK		83308	W ARVIN MERITOR CHEVROLET TRUCK (Also See GMC Truck) FORD GMC TRUCK INTERNATIONAL (NAVISTAR) STERLING TRUCK VOLVO	140149(1)
83180	N INTERNATIONAL (NAVISTAR)	Not Req'd.	83204	W DUPLIX TRUCK DURA SUSPENSION MAECO PAGE SUSPENSION REYCO SUSPENSION SAF HOLLAND TRAILMOBILE CANADA CORP. TUTHILL TECHNOLOGIES VOLVO WATSON & CHALIN MFG. INC.	Not Req'd.	83309	W ARVIN MERITOR FORD INTERNATIONAL (NAVISTAR) STERLING TRUCK VOLVO	140149(1)
83200	S 140149(1) ARVIN MERITOR FORD STERLING TRUCK		83207	C ADVANCE MIXER ARVIN MERITOR BLUEBIRD SCHOOL BUS BROCKWAY SCHOOL BUS CHANCE BUS CHEVROLET TRUCK (Also See GMC Truck) DURA SUSPENSION FORD GILLIG BROS. GMC TRUCK GREAT DANE TRAILER HARDEE MFG HENDRICKSON TRUCK SUSPENSION SYSTEMS HIGHWAY PRODUCT INTERNATIONAL (NAVISTAR) MACK MAECO MC NEILUS TRUCK & MAN. MOHAWK NATIONAL COACH CORP OSHKOSH MOTORS REYCO SUSPENSION RIDEWELL CORPORATION SAF HOLLAND TRAILMOBILE CANADA CORP. TUTHILL TECHNOLOGIES TWIN COACH	Not Req'd.	83312	D 140149(1) ARVIN MERITOR FORD KENWORTH OSHKOSH MOTORS PETERBILT PIERCE MANUFACTURING INC. VOLVO	
83203	A CHANCE BUS CHEVROLET TRUCK (Also See GMC Truck) DURA SUSPENSION FRUEHAUF GMC TRUCK HIGHWAY PRODUCT HUTCHENS SUSPENSION MACK MAECO MOHAWK ORION BUS INDUSTRIES PAGE SUSPENSION PETERBILT REYCO SUSPENSION RIDEWELL CORPORATION SAF HOLLAND TUTHILL TECHNOLOGIES VOLVO WABASH NATIONAL WATSON & CHALIN MFG. INC.	Not Req'd.	83209	C ADVANCE MIXER ARVIN MERITOR BLUEBIRD SCHOOL BUS BROCKWAY SCHOOL BUS CHANCE BUS CHEVROLET TRUCK (Also See GMC Truck) DURA SUSPENSION FORD GILLIG BROS. GMC TRUCK GREAT DANE TRAILER HARDEE MFG HENDRICKSON TRUCK SUSPENSION SYSTEMS HIGHWAY PRODUCT INTERNATIONAL (NAVISTAR) MACK MAECO MC NEILUS TRUCK & MAN. MOHAWK NATIONAL COACH CORP OSHKOSH MOTORS REYCO SUSPENSION RIDEWELL CORPORATION SAF HOLLAND TRAILMOBILE CANADA CORP. TUTHILL TECHNOLOGIES TWIN COACH	Not Req'd.	83314	W 140149(1) ARVIN MERITOR FORD GMC TRUCK INTERNATIONAL (NAVISTAR) MAECO STERLING TRUCK VOLVO	
83204	W DUPLIX TRUCK DURA SUSPENSION MAECO PAGE SUSPENSION REYCO SUSPENSION SAF HOLLAND TRAILMOBILE CANADA CORP. TUTHILL TECHNOLOGIES VOLVO WATSON & CHALIN MFG. INC.	Not Req'd.	83214	W ARVIN MERITOR CHEVROLET TRUCK (Also See GMC Truck) DIAMOND-REO EAST MANUFACTURING CORP. GMC TRUCK GRANNING SUSPENSION MAECO OSTERLUND TRUCK OTTAWA TRUCK SPARTAN MOTORS TUTHILL TECHNOLOGIES VOLVO	401754(4)	83317	D 141083(1) DINA BUS FORD IC CORPORATION INTERNATIONAL (NAVISTAR) VOLVO	
83207	C ADVANCE MIXER ARVIN MERITOR BLUEBIRD SCHOOL BUS BROCKWAY SCHOOL BUS CHANCE BUS CHEVROLET TRUCK (Also See GMC Truck) DURA SUSPENSION FORD GILLIG BROS. GMC TRUCK GREAT DANE TRAILER HARDEE MFG HENDRICKSON TRUCK SUSPENSION SYSTEMS HIGHWAY PRODUCT INTERNATIONAL (NAVISTAR) MACK MAECO MC NEILUS TRUCK & MAN. MOHAWK NATIONAL COACH CORP OSHKOSH MOTORS REYCO SUSPENSION RIDEWELL CORPORATION SAF HOLLAND TRAILMOBILE CANADA CORP. TUTHILL TECHNOLOGIES TWIN COACH	Not Req'd.	83215	W ACF BRILL BUS ARVIN MERITOR BROCKWAY SCHOOL BUS CHEVROLET TRUCK (Also See GMC Truck) FORD GMC TRUCK HINO INTERNATIONAL (NAVISTAR) MACK MAECO PAI CORP REYCO SUSPENSION STERLING TRUCK TUTHILL TECHNOLOGIES VOLVO	401754(4)	83318	W 141083(2) ARVIN MERITOR INTERNATIONAL (NAVISTAR) VOLVO	
83209	C VOLVO WABASH NATIONAL	Not Req'd.	83216	W ARVIN MERITOR AUTOCAR BROCKWAY SCHOOL BUS CHEVROLET TRUCK (Also See GMC Truck) FORD GILLIG BROS. GMC TRUCK HINO INTERNATIONAL (NAVISTAR) MACK MAECO MARMON MOHAWK NEOPLAN BUS ONEIDA PRODUCTS STERLING TRUCK VOLVO WESTERN STAR	140149(1)	83353	X 145099(1) ARVIN MERITOR KENWORTH PETERBILT VOLVO	

N = New, S = Superseded, X = Discontinued once inventory is gone

NUMERICAL LISTING LISTA NUMÉRICA LISTE NUMÉRIQUE

GABRIEL#	APPLICATION	MTG ACC PKG NO	GABRIEL#	APPLICATION	MTG ACC PKG NO	GABRIEL#	APPLICATION	MTG ACC PKG NO
83362	W	401754(4)	85003	A	Not Req'd.	85012	A	145080(2)
HINO KENWORTH			KENWORTH MARMON PETERBILT VOLVO			VOLVO		
83389	N	Not Req'd.	85004	W	401754(4)	85013	C	Not Req'd.
SAF HOLLAND			ARVIN MERITOR PETERBILT SAF HOLLAND			ARVIN MERITOR BLUEBIRD SCHOOL BUS FORD HENDRICKSON TRAILER SUSPENSION SYSTEMS HENDRICKSON TRUCK SUSPENSION SYSTEMS INTERNATIONAL (NAVISTAR) KENWORTH MAECO MC NEILUS TRUCK & MAN. PETERBILT REYCO SUSPENSION SAF HOLLAND SPARTAN MOTORS STERLING TRUCK TRAILMOBILE CANADA CORP. TUTHILL TECHNOLOGIES VOLVO		
83400	W	140455(2)	85005	B	Not Req'd.	85014	C	Not Req'd.
CHEVROLET TRUCK (Also See GMC Truck) FORD GMC TRUCK MOR-RYDE SUSPENSION VOLVO WATSON & CHALIN MFG. INC. WESTERN STAR			ARVIN MERITOR AUTOCAR BLUEBIRD SCHOOL BUS BOYDSTUN EQUIPMENT MANUFACTURING CHEVROLET TRUCK (Also See GMC Truck) EAST MANUFACTURING CORP. FREIGHTLINER FREIGHTLINER CUSTOM CHASSIS GMC TRUCK HENDRICKSON TRAILER SUSPENSION SYSTEMS HENDRICKSON TRUCK SUSPENSION SYSTEMS INTERNATIONAL (NAVISTAR) MACK MAECO MERCEDES BENZ REYCO SUSPENSION RIDEWELL CORPORATION SAF HOLLAND TUTHILL TECHNOLOGIES VOLVO WATSON & CHALIN MFG. INC.			ARVIN MERITOR CHANCE BUS DINA BUS HARDEE MFG HENDRICKSON TRAILER SUSPENSION SYSTEMS INTERNATIONAL (NAVISTAR) MACK REYCO SUSPENSION RIDEWELL CORPORATION SAF HOLLAND TUTHILL TECHNOLOGIES WATSON & CHALIN MFG. INC.		
83401	W	404702(2)	85006	A	Not Req'd.	85023	D	140149(1)
CHEVROLET TRUCK (Also See GMC Truck) GMC TRUCK VOLVO WESTERN STAR			ARVIN MERITOR BLUEBIRD SCHOOL BUS BUILT RITE DEXTER AXLE FORD FREIGHTLINER FREIGHTLINER CUSTOM CHASSIS GREAT DANE TRAILER HENDRICKSON TRAILER SUSPENSION SYSTEMS HENDRICKSON TRUCK SUSPENSION SYSTEMS MAECO MERCEDES BENZ RAMERIZ TRAILER REYCO SUSPENSION RIDEWELL CORPORATION SAF HOLLAND STERLING TRUCK STOUGHTON TRAILERS INC. THE BINKLEY COMPANY THOMAS SCHOOL BUS TRAILMOBILE CANADA CORP. TUTHILL TECHNOLOGIES VOLVO WESTERN STAR			INTERNATIONAL (NAVISTAR) KENWORTH MACK PETERBILT VOLVO		
83404	W	401011(4)	85007	D	401754(4)	85024	W	140149(1)
GMC TRUCK HINO INTERNATIONAL (NAVISTAR) ISUZU			ARVIN MERITOR FREIGHTLINER KENWORTH MACK MAECO PETERBILT REYCO SUSPENSION SPARTAN MOTORS TUTHILL TECHNOLOGIES VOLVO			AUTOCAR INTERNATIONAL (NAVISTAR) MACK VOLVO		
83456	C	142998(2)	85009	W	145054(1)	85025	W	140169(1) & 145054(1)
IC CORPORATION INTERNATIONAL (NAVISTAR) MITSUBISHI-FUSO VOLVO			ARVIN MERITOR FREIGHTLINER MITSUBISHI-FUSO NEOPLAN BUS WATSON & CHALIN MFG. INC.			VOLVO		
83515	N	141041(1) & TR0027(2)	85010	W	Not Req'd.	85026	W	145054(1)
CHEVROLET TRUCK (Also See GMC Truck) GMC TRUCK ISUZU VOLVO			ARVIN MERITOR BLUEBIRD SCHOOL BUS HENDRICKSON TRAILER SUSPENSION SYSTEMS HENDRICKSON TRUCK SUSPENSION SYSTEMS MACK MANDALAY COACH MONACO NEWMAR CORP PAGE SUSPENSION PETERBILT RIDEWELL CORPORATION SAF HOLLAND SPARTAN MOTORS THOR MOTOR COACH TRAILMOBILE CANADA CORP. WATSON & CHALIN MFG. INC. WINNEBAGO			ARVIN MERITOR AUTOCAR GMC TRUCK VOLVO		
83518	N	141041(1) & TR0027(2)	85011	X	Not Req'd.	85027	W	145054(2)
HINO			ARVIN MERITOR FREIGHTLINER			ARVIN MERITOR AUTOCAR INTERNATIONAL (NAVISTAR) VOLVO		
83519	N	TR0027(4)	85012	A	145080(2)	85029	B	Not Req'd.
HINO			ARVIN MERITOR BLUEBIRD SCHOOL BUS BROCKWAY SCHOOL BUS CHANCE COACH CHEVROLET TRUCK (Also See GMC Truck) FORD GMC TRUCK INTERNATIONAL (NAVISTAR) ISUZU KENWORTH PETERBILT			ARVIN MERITOR BLUEBIRD SCHOOL BUS COACHMEN RV DURA SUSPENSION EAST MANUFACTURING CORP. FLEETWOOD RV FOREST RIVER INC FREIGHTLINER CUSTOM CHASSIS GULF STREAM COACH HENDRICKSON TRAILER SUSPENSION SYSTEMS HOLIDAY RAMBLER INTERNATIONAL (NAVISTAR) ITASCA KENWORTH KING OF THE ROAD MANDALAY COACH MONACO NEWMAR CORP PAGE SUSPENSION PETERBILT RIDEWELL CORPORATION SAF HOLLAND SPARTAN MOTORS THOR MOTOR COACH TRAILMOBILE CANADA CORP. WATSON & CHALIN MFG. INC. WINNEBAGO		
83613	D	141083(2)	85013	X	Not Req'd.	85030	C	Not Req'd.
ARVIN MERITOR INTERNATIONAL (NAVISTAR) THOMAS SCHOOL BUS VOLVO			ARVIN MERITOR FREIGHTLINER			ARVIN MERITOR BLUEBIRD SCHOOL BUS CHEVROLET TRUCK (Also See GMC Truck) FORD EAST MANUFACTURING CORP. FORD FRUEHAUF GMC TRUCK		
83634	X	Not Req'd.	85014	A	Not Req'd.			
FREIGHTLINER								
83635	W	145054(1)						
SAF HOLLAND VOLVO WESTERN STAR								
83636	X	Not Req'd.						
INTERNATIONAL (NAVISTAR) VOLVO								
85000	A	Not Req'd.						
ARVIN MERITOR BENSON TRUCK BODIES INC. EAST MANUFACTURING CORP. FREIGHTLINER GREAT DANE TRAILER HENDRICKSON TRAILER SUSPENSION SYSTEMS KENWORTH MC NEILUS TRUCK & MAN. ORION BUS INDUSTRIES PETERBILT RIDEWELL CORPORATION SAF HOLLAND STOUGHTON TRAILERS INC. THOMAS SCHOOL BUS TRAILMOBILE CANADA CORP. TWIN COACH UTILITY TRAILER MANUFACTURING COMPANY VOLVO WABASH NATIONAL WATSON & CHALIN MFG. INC.								
85001	A	401754(4)						
ARVIN MERITOR FORD INTERNATIONAL (NAVISTAR) KENWORTH MACK MAECO PETERBILT REYCO SUSPENSION STERLING TRUCK TUTHILL TECHNOLOGIES VOLVO								
85003	A	Not Req'd.						
ARVIN MERITOR INTERNATIONAL (NAVISTAR)								

N = New, X = Discontinued once inventory is gone

NUMERICAL LISTING LISTA NUMÉRICA LISTE NUMÉRIQUE

GABRIEL#	APPLICATION	MTG ACC PKG NO	GABRIEL#	APPLICATION	MTG ACC PKG NO	GABRIEL#	APPLICATION	MTG ACC PKG NO
85030	C	Not Req'd.	85052	A	Not Req'd.	85078	W	Not Req'd.
HENDRICKSON TRAILER SUSPENSION SYSTEMS HENDRICKSON TRUCK SUSPENSION SYSTEMS INTERNATIONAL (NAVISTAR) MAECO OSHKOSH MOTORS PACIFIC TRUCK & TRAILER PIERCE MANUFACTURING INC. REYCO SUSPENSION SAF HOLLAND STERLING TRUCK THOMAS SCHOOL BUS TUTHILL TECHNOLOGIES VOLVO WABASH NATIONAL			VOLVO WABASH NATIONAL WATSON & CHALIN MFG. INC.			DANA WABASH NATIONAL		
85031	C	140169(1) & TR0027(2)	85053	C	145126(2)	85079	W	Not Req'd.
KENWORTH PETERBILT			WESTERN STAR			HENDRICKSON TRAILER SUSPENSION SYSTEMS MC NEILUS TRUCK & MAN.		
85033	A	145099(1)	85054	W	145080(2)	85080	W	145054(1)
INTERNATIONAL (NAVISTAR) KENWORTH MACK PACCAR PETERBILT VOLVO			FORD STERLING TRUCK			MACK VOLVO		
85036	D	Not Req'd.	85055	W	145080(2)	85081	W	145090(1)
BLUEBIRD SCHOOL BUS HENDRICKSON TRUCK SUSPENSION SYSTEMS MACK PETERBILT SPARTAN MOTORS VOLVO			FORD STERLING TRUCK			VOLVO		
85040	W	401754(4)	85058	B	Not Req'd.	85082	W	Not Req'd.
FORD STERLING TRUCK VOLVO			BLUEBIRD SCHOOL BUS FREIGHTLINER FREIGHTLINER CUSTOM CHASSIS INTERNATIONAL (NAVISTAR) OSHKOSH MOTORS PIERCE MANUFACTURING INC. THOMAS SCHOOL BUS VOLVO			IC CORPORATION INTERNATIONAL (NAVISTAR)		
85042	W	401754(4)	85059	W	Not Req'd.	85083	W	145128(1)
FREIGHTLINER VOLVO			RED LION TRAILER SAF HOLLAND STOUGHTON TRAILERS INC. TRAILMOBILE CANADA CORP. WABASH NATIONAL			HENDRICKSON TRUCK SUSPENSION SYSTEMS		
85043	C	Not Req'd.	85060	D	Not Req'd.	85084	D	Not Req'd.
FREIGHTLINER FREIGHTLINER CUSTOM CHASSIS HENDRICKSON TRAILER SUSPENSION SYSTEMS STERLING TRUCK			AUTOCAR CHALMERS SUSPENSION FREIGHTLINER INTERNATIONAL (NAVISTAR) KENWORTH PETERBILT SAF HOLLAND VOLVO WATSON & CHALIN MFG. INC. WESTERN STAR			KENWORTH PETERBILT		
85045	A	Not Req'd.	85061	A	Not Req'd.	85085	W	145054(2)
ARVIN MERITOR HENDRICKSON TRAILER SUSPENSION SYSTEMS INGERSOLL AXLES MUNCIE RECLAMATION REYCO SUSPENSION RIDEWELL CORPORATION SAF HOLLAND TUTHILL TECHNOLOGIES UTILITY TRAILER MANUFACTURING COMPANY VOLVO WABASH NATIONAL WATSON & CHALIN MFG. INC.			MACK VOLVO			NISSAN		
85046	W	140149(1)	85062	A	145080(2)	85086	W	Not Req'd.
AUTOCAR VOLVO			KENWORTH PETERBILT VOLVO			BLUEBIRD SCHOOL BUS REYCO SUSPENSION		
85047	C	140149(1)	85063	W	145080(2)	85087	W	Not Req'd.
FORD KENWORTH PETERBILT STERLING TRUCK VOLVO			FORD MAECO STERLING TRUCK			HENDRICKSON TRUCK SUSPENSION SYSTEMS MC NEILUS TRUCK & MAN.		
85050	S	Not Req'd.	85064	C	Not Req'd.	85088	B	Not Req'd.
CHEVROLET TRUCK (Also See GMC Truck) GMC TRUCK			GREAT DANE TRAILER HENDRICKSON TRAILER SUSPENSION SYSTEMS WATSON & CHALIN MFG. INC.			MACK VOLVO		
85051	D	Not Req'd.	85065	W	145128(1) & 145144(1)	85090	W	Not Req'd.
BLUEBIRD SCHOOL BUS GILLIG BROS. MUNCIE RECLAMATION OSHKOSH MOTORS REYCO SUSPENSION SAF HOLLAND STOUGHTON TRAILERS INC. TRAILMOBILE CANADA CORP. TUTHILL TECHNOLOGIES WABASH NATIONAL			VOLVO			BLUEBIRD SCHOOL BUS		
85052	A	Not Req'd.	85066	A	Not Req'd.	85091	W	Not Req'd.
ARVIN MERITOR BLUEBIRD SCHOOL BUS GREAT DANE TRAILER HENDRICKSON TRAILER SUSPENSION SYSTEMS INGERSOLL AXLES REYCO SUSPENSION SAF HOLLAND TUTHILL TECHNOLOGIES			MACK VOLVO			THOMAS SCHOOL BUS		
			85067	A	Not Req'd.	85092	W	145054(1)
			KENWORTH PETERBILT VOLVO			FREIGHTLINER CUSTOM CHASSIS		
			85069	A	145089-000(2)	85097	W	Not Req'd.
			ARVIN MERITOR KENWORTH PETERBILT VOLVO			FREIGHTLINER CUSTOM CHASSIS HOLIDAY RAMBLER MONACO SAF HOLLAND		
			85070	A	401754(2)	85098	B	Not Req'd.
			KENWORTH PETERBILT VOLVO			MACK VOLVO		
			85071	W	145054(2)	85099	W	Not Req'd.
			CHEVROLET TRUCK (Also See GMC Truck) GMC TRUCK ISUZU			SAF HOLLAND		
			85072	C	Not Req'd.	85102	W	Not Req'd.
			AUTOCAR HENDRICKSON TRUCK SUSPENSION SYSTEMS INTERNATIONAL (NAVISTAR) KENWORTH MACK MC NEILUS TRUCK & MAN. VOLVO			HENDRICKSON TRUCK SUSPENSION SYSTEMS INTERNATIONAL (NAVISTAR)		
						85106	W	Not Req'd.
						BLUEBIRD SCHOOL BUS		
						85109	N	Not Req'd.
						KENWORTH PETERBILT SAF HOLLAND VOLVO WESTERN STAR		
						85119	N	Not Req'd.
						KENWORTH PETERBILT		
						85120	N	Not Req'd.
						MACK		
						85122	N	145089-000(1)
						FREIGHTLINER CUSTOM CHASSIS THOMAS SCHOOL BUS		
						85123	N	145090(1)
						FREIGHTLINER		
						85124	N	145054(2)
						ITASCA WORKHORSE		
						85125	N	Not Req'd.
						ITASCA MONACO WORKHORSE		
						85126	N	145054(1)
						MONACO WORKHORSE		

N = New, S = Superseded

NUMERICAL LISTING LISTA NUMÉRICA LISTE NUMÉRIQUE

GABRIEL#	APPLICATION	MTG ACC PKG NO	GABRIEL#	APPLICATION	MTG ACC PKG NO	GABRIEL#	APPLICATION	MTG ACC PKG NO
85180	N	Not Req'd.	85304	W	401754(4)	85308	W	401754(4)
FORD			BLUEBIRD SCHOOL BUS			PREVOST		
85181	N	Not Req'd.	BROCKWAY SCHOOL BUS			THOMAS SCHOOL BUS		
FORD			CHEVROLET TRUCK (Also See GMC Truck)			VOLVO		
85300	C	401754(4)	CONTINENTAL TRAILWAYS-EAGLE INT'L			WESTERN STAR		
ARVIN MERITOR			CRANE CARRIER			WESTERN UNIT "STABILAIRE" SUSPENSION		
CHEVROLET TRUCK (Also See GMC Truck)			CROWN COACH			85310	A	141108(1)
FREIGHTLINER			DIAMOND-REO			ARVIN MERITOR		
FRUEHAUF			DIAMOND T			INTERNATIONAL (NAVISTAR)		
GMC TRUCK			EAGLE MOTOR COACH			KENWORTH		
GRANNING SUSPENSION			FLXIBLE BUS			MACK		
HOBBS TRAILERS			FORD			OTTAWA TRUCK		
INTERNATIONAL (NAVISTAR)			FRUEHAUF			PETERBILT		
MAECO			GILLIG BROS.			VOLVO		
MUNCIE RECLAMATION			GMC TRUCK			85311	A	141247(1)
OSHKOSH MOTORS			MACK			ARVIN MERITOR		
OSTERLUND TRUCK			OSHKOSH MOTORS			FLXIBLE BUS		
OTTAWA TRUCK			PIERCE MANUFACTURING INC.			INTERNATIONAL (NAVISTAR)		
PIERCE MANUFACTURING INC.			RIDEWELL CORPORATION			KENWORTH		
REYCO SUSPENSION			SAF HOLLAND			LEYLAND TRUCK		
SAF HOLLAND			SOUTHERN COACH			MACK		
SEAGRAVE FIRE APPARATUS LLC			SPARTAN MOTORS			PETERBILT		
TUTHILL TECHNOLOGIES			THOMAS SCHOOL BUS			VOLVO		
VOLVO			UNITED MANUFACTURING			85312	S	141247(1)
WABASH NATIONAL			VOLVO			ARVIN MERITOR		
WATSON & CHALIN MFG. INC.			WESTERN STAR			MOTOR COACH INDUSTRIES		
WESTERN UNIT "STABILAIRE" SUSPENSION			WESTERN UNIT "STABILAIRE" SUSPENSION			TRANSPORTATION MFG. CORP		
85301	W	401754(4)	85305	W	401754(4)	85313	W	401754(4)
BECK BUS			ARVIN MERITOR			ARVIN MERITOR		
CHEVROLET TRUCK (Also See GMC Truck)			BROCKWAY SCHOOL BUS			FLXIBLE BUS		
CLARK EQUIPMENT			BUS & TRUCK CO.			GMC TRUCK		
FLXIBLE BUS			CHEVROLET TRUCK (Also See GMC Truck)			GREYHOUND BUS		
FORD			CONTINENTAL TRAILWAYS-EAGLE INT'L			MAECO		
FREIGHTLINER			EAGLE MOTOR COACH			MOTOR COACH INDUSTRIES		
GMC TRUCK			FLXIBLE BUS			NOVA BUS		
HENDRICKSON TRAILER SUSPENSION SYSTEMS			FORD			REYCO SUSPENSION		
SAF HOLLAND			FRUEHAUF			TRANSPORTATION MFG. CORP		
STERLING TRUCK			GMC TRUCK			TUTHILL TECHNOLOGIES		
VOLVO			HENDRICKSON TRUCK SUSPENSION SYSTEMS			85314	W	401754(4)
85302	D	401754(4)	MACK			ARVIN MERITOR		
AM GENERAL			MC NEILUS TRUCK & MAN.			AUTOCAR		
ARVIN MERITOR			MOHAWK			CHALMERS SUSPENSION		
CHEVROLET TRUCK (Also See GMC Truck)			PAI CORP			EAGLE MOTOR COACH		
CRANE CARRIER			RIDEWELL CORPORATION			FORD		
FORD			VOLVO			KENWORTH		
FREIGHTLINER			WESTERN STAR			MAECO		
FWD TRUCK			WESTERN UNIT "STABILAIRE" SUSPENSION			PETERBILT		
GILLIG BROS.			85307	W	401754(4)	STERLING TRUCK		
GMC TRUCK			ACF BRILL BUS			VOLVO		
KENWORTH			ARVIN MERITOR			85315	W	401754(4)
MACK			BECK BUS			CLARK EQUIPMENT		
MAECO			BLUEBIRD SCHOOL BUS			CUNHA PRODUCTS OHD		
MOTOR COACH INDUSTRIES			BROCKWAY SCHOOL BUS			FORD		
PETERBILT			BUS & TRUCK CO.			JIFFLOX		
RIDEWELL CORPORATION			CHEVROLET TRUCK (Also See GMC Truck)			KWK-LOC (JIFFLOX)		
VOLVO			CLARK EQUIPMENT			VOLVO		
85303	D	401754(4)	CONTINENTAL TRAILWAYS-EAGLE INT'L			WESTERN STAR		
ACF BRILL BUS			CRANE CARRIER			85316	C	145090(1)
Beck			DIAMOND-REO			INTERNATIONAL (NAVISTAR)		
BROCKWAY SCHOOL BUS			DINA BUS			MACK		
BUS & TRUCK CO.			EAGLE MOTOR COACH			MAECO		
CHEVROLET TRUCK (Also See GMC Truck)			FLXIBLE BUS			OSHKOSH MOTORS		
CONTINENTAL TRAILWAYS-EAGLE INT'L			FORD			PIERCE MANUFACTURING INC.		
CRANE CARRIER			GMC TRUCK			VOLVO		
CROWN COACH			HENDRICKSON TRUCK SUSPENSION SYSTEMS			85318	W	145054(2)
Dina			INTERNATIONAL (NAVISTAR)			ARVIN MERITOR		
EAGLE MOTOR COACH			MACK			GILLIG BROS.		
GMC TRUCK			MAECO			HAUSMAN		
GREYHOUND BUS			ONEIDA PRODUCTS			VOLVO		
HENDRICKSON TRUCK SUSPENSION SYSTEMS			ORION BUS INDUSTRIES			85319	C	145089-000(1)
INTERNATIONAL (NAVISTAR)			PIERCE MANUFACTURING INC.			FREIGHTLINER		
KENWORTH			REYCO SUSPENSION			INTERNATIONAL (NAVISTAR)		
MACK			RIDEWELL CORPORATION			KENWORTH		
MAECO			SPARTAN MOTORS			MACK		
MATSON SCHOOL BUS			THOMAS SCHOOL BUS			PETERBILT		
MCI			VOLVO			VOLVO		
MC NEILUS TRUCK & MAN.			WESTERN STAR			85320	A	401754(4)
MOHAWK			WESTERN UNIT "STABILAIRE" SUSPENSION			FREIGHTLINER		
MOTOR COACH INDUSTRIES			85308	W	401754(4)	INTERNATIONAL (NAVISTAR)		
OISA			ACF BRILL BUS			KENWORTH		
ORION BUS INDUSTRIES			ARVIN MERITOR			MACK		
OSHKOSH MOTORS			CHEVROLET TRUCK (Also See GMC Truck)			PETERBILT		
OTTAWA TRUCK			EAGLE MOTOR COACH			VOLVO		
Peña			FREIGHTLINER			85321	D	Not Req'd.
PETERBILT			GMC TRUCK			ARVIN MERITOR		
PREVOST			HAULMARK			FRUEHAUF		
Ramírez			HINO			HOLLAND - BINKLEY		
Sultana			INTERNATIONAL (NAVISTAR)			MACK		
TRANSPORTATION MFG. CORP			KENWORTH			SAF HOLLAND		
VOLVO			MACK			VOLVO		
Volvo			MAECO			WABASH NATIONAL		
WESTERN STAR			MITSUBISHI-FUSO					
85304	W	401754(4)	MOHAWK					
ARVIN MERITOR			NISSAN					
BECK BUS			ORION BUS INDUSTRIES					
			PETERBILT					

N = New, S = Superseded

NUMERICAL LISTING LISTA NUMÉRICA LISTE NUMÉRIQUE

GABRIEL#	APPLICATION	MTG ACC PKG NO	GABRIEL#	APPLICATION	MTG ACC PKG NO	GABRIEL#	APPLICATION	MTG ACC PKG NO
85321	D WATSON & CHALIN MFG. INC.	Not Req'd.	85345	W WATSON & CHALIN MFG. INC.	Not Req'd.	85704	W MUNCIE RECLAMATION REYCO SUSPENSION RIDEWELL CORPORATION TUTHILL TECHNOLOGIES VOLVO	401754(4)
85322	W FRUEHAUF VOLVO WABASH NATIONAL	401754(2)	85346	W NEW FLYER	145090(2)	85705	W ARVIN MERITOR FLXIBLE BUS INTERNATIONAL (NAVISTAR) MUNCIE RECLAMATION NEOPLAN BUS VOLVO	145090(2)
85323	A EAST MANUFACTURING CORP. GREAT DANE TRAILER HENDRICKSON TRAILER SUSPENSION SYSTEMS INGERSOLL AXLES KENWORTH MC NEILUS TRUCK & MAN. SAF HOLLAND UTILITY TRAILER MANUFACTURING COMPANY VOLVO WABASH NATIONAL WATSON & CHALIN MFG. INC.	Not Req'd.	85347	W NEW FLYER SCANIA	145090(2)	85706	W HAUSMAN NEOPLAN BUS VOLVO	145090(2)
85324	S CHAMPION TRANSIT CHEVROLET TRUCK (Also See GMC Truck) GMC TRUCK ISUZU MERCEDES BENZ	145054(2)	85351	N IC CORPORATION INTERNATIONAL (NAVISTAR)	145090(1)	85707	X ARVIN MERITOR FLXIBLE BUS MOTOR COACH INDUSTRIES MUNCIE RECLAMATION NEOPLAN BUS	145090(2)
85327	W FRUEHAUF	401754(2)	85376	W FORD STERLING TRUCK	401754(4)	85708	C ABC BUS ARVIN MERITOR CHEVROLET TRUCK (Also See GMC Truck) FLXIBLE BUS FLYER INDUSTRIES GILLIG BROS. GMC TRUCK M.A.N. BUS MOTOR COACH INDUSTRIES MUNCIE RECLAMATION NEW FLYER PREVOST VAN HOOL VOLVO	145090(2)
85329	W ARVIN MERITOR BLUEBIRD SCHOOL BUS PREVOST	401754(4)	85377	W NOVA BUS	Not Req'd.	85709	W ABC BUS M.A.N. BUS MOTOR COACH INDUSTRIES MUNCIE RECLAMATION VOLVO	145090(2)
85330	S PREVOST	145054(1)	85378	W NOVA BUS PREVOST	Not Req'd.	85710	X CHEVROLET TRUCK (Also See GMC Truck) FLXIBLE BUS GMC TRUCK MOTOR COACH INDUSTRIES MUNCIE RECLAMATION NEW FLYER NOVA BUS PREVOST TRANSPORTATION MFG. CORP	141247(1) & 401754(2)
85331	C FREIGHTLINER FREIGHTLINER CUSTOM CHASSIS WESTERN STAR	Not Req'd.	85379	W PREVOST	145054(1)	85711	W ARVIN MERITOR CHEVROLET TRUCK (Also See GMC Truck) FLXIBLE BUS FLYER INDUSTRIES GMC TRUCK MAECO MOTOR COACH INDUSTRIES NEW FLYER ORION BUS INDUSTRIES TRANSPORTATION MFG. CORP VOLVO	141247(1) & 401754(2)
85332	W IC CORPORATION INTERNATIONAL (NAVISTAR)	145128(1)	85380	W PREVOST	145090(1) & 401754(2)	85712	D ARVIN MERITOR BLUEBIRD SCHOOL BUS CARPENTER BUS DIAMOND-REO FLUIDRIVE FLXIBLE BUS FORD GILLIG BROS. GRANNING SUSPENSION HENDRICKSON TRAILER SUSPENSION SYSTEMS MERITOR ORION BUS INDUSTRIES OSTERLUND TRUCK RAYDAN MANUFACTURING RIDEWELL CORPORATION SPARTAN MOTORS THOMAS SCHOOL BUS TUTHILL TECHNOLOGIES VOLVO	401754(4)
85333	W INTERNATIONAL (NAVISTAR)	145128(1)	85382	W HENDRICKSON TRAILER SUSPENSION SYSTEMS WATSON & CHALIN MFG. INC.	Not Req'd.	85713	W CARPENTER BUS CRANE CARRIER EAGLE MOTOR COACH MOTOR COACH INDUSTRIES	401754(4)
85334	D ADVANCE MIXER MAECO MC NEILUS TRUCK & MAN. REYCO SUSPENSION	401754(4)	85700	W ABC BUS AM GENERAL ARVIN MERITOR CHEVROLET TRUCK (Also See GMC Truck) FLXIBLE BUS FLYER INDUSTRIES GMC TRUCK GREYHOUND BUS GRUMMAN BUS JAY MADSEN KENWORTH MOHAWK MOTOR COACH INDUSTRIES MUNCIE RECLAMATION NOVA BUS ORION BUS INDUSTRIES PREVOST SICARD TRANSPORTATION MFG. CORP VOLVO	401754(4)			
85335	W FREIGHTLINER	Not Req'd.	85701	X CHEVROLET TRUCK (Also See GMC Truck) FLXIBLE BUS GMC TRUCK MAECO MOHAWK MOTOR COACH INDUSTRIES MUNCIE RECLAMATION NOVA BUS TRANSPORTATION MFG. CORP VOLVO	145054(2)			
85336	W CHEVROLET TRUCK (Also See GMC Truck) GMC TRUCK ISUZU PETERBILT	145054(2)	85702	W ARVIN MERITOR CHEVROLET TRUCK (Also See GMC Truck) FLXIBLE BUS GMC TRUCK HAUSMAN MACK MOHAWK MOTOR COACH INDUSTRIES MUNCIE RECLAMATION NOVA BUS PREVOST REYCO SUSPENSION RIDEWELL CORPORATION TRANSPORTATION MFG. CORP TUTHILL TECHNOLOGIES VOLVO	401754(4)			
85337	W HENDRICKSON TRAILER SUSPENSION SYSTEMS	Not Req'd.	85703	X FLXIBLE BUS GRUMMAN BUS MOHAWK MUNCIE RECLAMATION VOLVO	141247(1) & 401754(2)			
85338	W HENDRICKSON TRAILER SUSPENSION SYSTEMS UTILITY TRAILER MANUFACTURING COMPANY	Not Req'd.	85704	W ARVIN MERITOR CHEVROLET TRUCK (Also See GMC Truck) FLXIBLE BUS GMC TRUCK GRUMMAN BUS MOHAWK MOTOR COACH INDUSTRIES	401754(4)			
85339	W MAECO MOTOR COACH INDUSTRIES PREVOST TRANSPORTATION MFG. CORP VOLVO	401754(4)						
85340	W MOTOR COACH INDUSTRIES	145089-000(1)						
85341	W MOTOR COACH INDUSTRIES	145089-000(1)						
85342	W CHEVROLET TRUCK (Also See GMC Truck) GMC TRUCK	145054(2)						
85343	W KENWORTH PETERBILT	145089-000(1) & 401754(2)						
85344	W HENDRICKSON TRAILER SUSPENSION SYSTEMS WATSON & CHALIN MFG. INC.	Not Req'd.						
85345	W HENDRICKSON TRAILER SUSPENSION SYSTEMS MC NEILUS TRUCK & MAN.	Not Req'd.						

N = New, S = Superseded, X = Discontinued once inventory is gone

NUMERICAL LISTING LISTA NUMÉRICA LISTE NUMÉRIQUE

GABRIEL#	APPLICATION	MTG ACC PKG NO	GABRIEL#	APPLICATION	MTG ACC PKG NO	GABRIEL#	APPLICATION	MTG ACC PKG NO
85713	W MUNCIE RECLAMATION NOVA BUS PREVOST THOMAS SCHOOL BUS TRANSPORTATION MFG. CORP	401754(4)	85733	W MOHAWK MOTOR COACH INDUSTRIES NOVA BUS TRANSPORTATION MFG. CORP VOLVO	145089-000(1)	85904	W FREIGHTLINER CUSTOM CHASSIS HENDRICKSON TRUCK SUSPENSION SYSTEMS LINK MANUFACTURING LTD. STERLING TRUCK	Not Req'd.
85714	S MOHAWK ORION BUS INDUSTRIES	145093(1)	85734	W BLUEBIRD SCHOOL BUS CHEVROLET TRUCK (Also See GMC Truck) CROWN COACH FLXIBLE BUS GILLIG BROS. GMC TRUCK INTERNATIONAL (NAVISTAR) LINK MANUFACTURING LTD. OSHKOSH MOTORS RIDEWELL CORPORATION SAF HOLLAND VOLVO	401754(4)	85905	X SAF HOLLAND	401754(2)
85715	W MOHAWK ORION BUS INDUSTRIES	145093(1)	85735	W ABC BUS CHEVROLET TRUCK (Also See GMC Truck) EAGLE MOTOR COACH GMC TRUCK GREYHOUND BUS MOTOR COACH INDUSTRIES PACIFIC TRUCK & TRAILER PREVOST TRANSPORTATION MFG. CORP VOLVO WESTERN UNIT "STABILAIRE" SUSPENSION	401754(4)	85906	W FORD KENWORTH MACK MC NEILUS TRUCK & MAN. PETERBILT SAF HOLLAND STERLING TRUCK VOLVO WESTERN STAR	Not Req'd.
85716	W DINA BUS FLXIBLE BUS FORD GILLIG BROS. MAECO NEW FLYER ORION BUS INDUSTRIES	145093(1)	85736	W ARVIN MERITOR BLUEBIRD SCHOOL BUS FLXIBLE BUS MOHAWK PREVOST RIDEWELL CORPORATION THOMAS SCHOOL BUS VOLVO	401754(4)	85907	X SAF HOLLAND	Not Req'd.
85717	S MOHAWK ORION BUS INDUSTRIES REYCO SUSPENSION TUTHILL TECHNOLOGIES	145093(1)	85737	W MERITOR SUSPENSYS	Not Req'd.	85908	W SAF HOLLAND	Not Req'd.
85718	S ARVIN MERITOR FLXIBLE BUS MOHAWK NEW FLYER ORION BUS INDUSTRIES	145093(1)	85738	B EAST MANUFACTURING CORP. HENDRICKSON TRAILER SUSPENSION SYSTEMS MC NEILUS TRUCK & MAN. REYCO SUSPENSION TUTHILL TECHNOLOGIES UTILITY TRAILER MANUFACTURING COMPANY	Not Req'd.	85909	D FORD HENDRICKSON TRUCK SUSPENSION SYSTEMS KENWORTH MACK MC NEILUS TRUCK & MAN. ROADMASTER (MONACO) SAF HOLLAND	Not Req'd.
85719	X ORION BUS INDUSTRIES	145093(1)	85739	W INTERNATIONAL (NAVISTAR) MACK MERITOR RAYDAN MANUFACTURING	Not Req'd.	85910	W BLUEBIRD SCHOOL BUS FREIGHTLINER KENWORTH PETERBILT ROADMASTER (MONACO) SAF HOLLAND	Not Req'd.
85720	D NEW FLYER ORION BUS INDUSTRIES OTTAWA TRUCK	401754(4)	85740	W MAECO MOTOR COACH INDUSTRIES PREVOST	145090(1) & 401754(2)	85911	W HENDRICKSON TRAILER SUSPENSION SYSTEMS SAF HOLLAND UTILITY TRAILER MANUFACTURING COMPANY	Not Req'd.
85722	D ARVIN MERITOR FLYER INDUSTRIES GILLIG BROS. GMC TRUCK M.A.N. BUS MUNCIE RECLAMATION NEW FLYER VOLVO	145090(2)	85745	N ELDORADO NATIONAL	145090(2)	85912	X SAF HOLLAND	401754(2)
85723	W GILLIG BROS. MOTOR COACH INDUSTRIES MUNCIE RECLAMATION VOLVO	145075(1)	85746	N ELDORADO NATIONAL	145090(2)	85913	X RED LION TRAILER SAF HOLLAND	401754(2)
85724	A FREIGHTLINER FREIGHTLINER CUSTOM CHASSIS STERLING TRUCK THOMAS SCHOOL BUS VOLVO WESTERN STAR	Not Req'd.	85900	B COACHMEN RV FLEETWOOD RV FOREST RIVER INC FREIGHTLINER CUSTOM CHASSIS GULF STREAM COACH ITASCA KENWORTH KING OF THE ROAD MANDALAY COACH NEWMAR CORP PETERBILT THOR MOTOR COACH VOLVO WINNEBAGO	145054(2)	85914	W BLUEBIRD SCHOOL BUS SAF HOLLAND	Not Req'd.
85727	D ABC BUS MOTOR COACH INDUSTRIES	145176(2)	85901	C FREIGHTLINER KENWORTH PETERBILT RIDEWELL CORPORATION	401754(4)	85916	W HENDRICKSON TRAILER SUSPENSION SYSTEMS HENDRICKSON TRUCK SUSPENSION SYSTEMS MC NEILUS TRUCK & MAN. SAF HOLLAND VOLVO	Not Req'd.
85728	D MOTOR COACH INDUSTRIES PREVOST	145176(2)	85902	D KENWORTH PETERBILT	145054(2)	85918	A FREIGHTLINER FREIGHTLINER CUSTOM CHASSIS THOMAS SCHOOL BUS VOLVO	Not Req'd.
85729	D ABC BUS MOTOR COACH INDUSTRIES ORION BUS INDUSTRIES PREVOST UNIVERSAL COACH	145176(1) & 401754(2)	85903	W HENDRICKSON TRUCK SUSPENSION SYSTEMS	Not Req'd.	85919	A BLUEBIRD SCHOOL BUS FREIGHTLINER FREIGHTLINER CUSTOM CHASSIS GREAT DANE TRAILER HENDRICKSON TRUCK SUSPENSION SYSTEMS MC NEILUS TRUCK & MAN. MERITOR WABASH NATIONAL WORKHORSE	Not Req'd.
85730	X FLXIBLE BUS VOLVO	401754(4)	85920	B FREIGHTLINER STERLING TRUCK	Not Req'd.	85921	W FREIGHTLINER	145054(1)
85731	X FLXIBLE BUS	145054(1) & 401754(2)	85923	C INTERNATIONAL (NAVISTAR)	Not Req'd.	85924	B INTERNATIONAL (NAVISTAR)	Not Req'd.
85732	W ABC BUS NEW FLYER ORION BUS INDUSTRIES	145116(2)	85925	W INTERNATIONAL (NAVISTAR)	Not Req'd.	85926	C FORD IC CORPORATION	Not Req'd.
85733	W ABC BUS CHEVROLET TRUCK (Also See GMC Truck) EAGLE MOTOR COACH FLXIBLE BUS GMC TRUCK	145089-000(1)						

N = New, S = Superseded, X = Discontinued once inventory is gone

NUMERICAL LISTING LISTA NUMÉRICA LISTE NUMÉRIQUE

GABRIEL#	APPLICATION	MTG ACC PKG NO	GABRIEL#	APPLICATION	MTG ACC PKG NO	GABRIEL#	APPLICATION	MTG ACC PKG NO
85926	C INTERNATIONAL (NAVISTAR) STERLING TRUCK	Not Req'd.	85961	W HENDRICKSON TRUCK SUSPENSION SYSTEMS	Not Req'd.	85998	N INTERNATIONAL (NAVISTAR)	Not Req'd.
85927	W FORD INTERNATIONAL (NAVISTAR)	Not Req'd.	85962	W HENDRICKSON TRUCK SUSPENSION SYSTEMS MC NEILUS TRUCK & MAN.	Not Req'd.	85999	N INTERNATIONAL (NAVISTAR)	Not Req'd.
85928	D FORD INTERNATIONAL (NAVISTAR)	Not Req'd.	85963	W INTERNATIONAL (NAVISTAR)	Not Req'd.	86200	W MERITOR	Not Req'd.
85929	W INTERNATIONAL (NAVISTAR)	Not Req'd.	85964	W INTERNATIONAL (NAVISTAR)	Not Req'd.	86201	W MERITOR	Not Req'd.
85930	W INTERNATIONAL (NAVISTAR)	Not Req'd.	85965	W HENDRICKSON TRUCK SUSPENSION SYSTEMS KENWORTH MC NEILUS TRUCK & MAN.	Not Req'd.	86202	W MERITOR	Not Req'd.
85931	A INTERNATIONAL (NAVISTAR)	Not Req'd.	85966	W HENDRICKSON TRUCK SUSPENSION SYSTEMS KENWORTH MC NEILUS TRUCK & MAN.	Not Req'd.	86203	W MERITOR	Not Req'd.
85932	C FREIGHTLINER HENDRICKSON TRUCK SUSPENSION SYSTEMS MC NEILUS TRUCK & MAN. STERLING TRUCK WESTERN STAR	Not Req'd.	85967	W AUTOCAR HENDRICKSON TRUCK SUSPENSION SYSTEMS KENWORTH MC NEILUS TRUCK & MAN.	Not Req'd.	87015	W ARVIN MERITOR EAST MANUFACTURING CORP. MERITOR	Not Req'd.
85933	B HENDRICKSON TRUCK SUSPENSION SYSTEMS MACK MC NEILUS TRUCK & MAN. VOLVO	Not Req'd.	85968	W GILLIG BROS. SAF HOLLAND	401754(4)	87016	W 145116(1) & 145090(1) NEW FLYER ORION BUS INDUSTRIES	
85934	A MAECO RIDEWELL CORPORATION WATSON & CHALIN MFG. INC.	Not Req'd.	85969	W INTERNATIONAL (NAVISTAR)	Not Req'd.	87017	W BLUEBIRD SCHOOL BUS OPTIMA BUS CORP RIDEWELL CORPORATION	Not Req'd.
85935	W INTERNATIONAL (NAVISTAR)	145090(1)	85970	W MOTOR COACH INDUSTRIES	145089-000(1)	87018	W ARVIN MERITOR HENDRICKSON TRAILER SUSPENSION SYSTEMS	Not Req'd.
85936	B KENWORTH PETERBILT	145089-200(1)	85971	W BLUEBIRD SCHOOL BUS	Not Req'd.	87019	W NOVA BUS	Not Req'd.
85937	B KENWORTH PETERBILT	145089-200(1)	85972	W MACK	Not Req'd.	89402	W VOLVO	140149(1)
85938	B ARVIN MERITOR HENDRICKSON TRAILER HENDRICKSON TRAILER SUSPENSION SYSTEMS INGERSOLL AXLES REYCO SUSPENSION TUTHILL TECHNOLOGIES WATSON & CHALIN MFG. INC.	Not Req'd.	85974	W SAF HOLLAND	Not Req'd.	89414	W MAECO	Not Req'd.
85939	D ARVIN MERITOR HENDRICKSON TRAILER SUSPENSION SYSTEMS TIMBREN INDUSTRIES UTILITY TRAILER MANUFACTURING COMPANY WATSON & CHALIN MFG. INC.	Not Req'd.	85975	W BLUEBIRD SCHOOL BUS REYCO SUSPENSION SAF HOLLAND	Not Req'd.	89440	W MAECO	Not Req'd.
85953	W INTERNATIONAL (NAVISTAR)	Not Req'd.	85976	W BLUEBIRD SCHOOL BUS HENDRICKSON TRUCK SUSPENSION SYSTEMS INTERNATIONAL (NAVISTAR) MC NEILUS TRUCK & MAN. VOLVO WESTERN STAR	Not Req'd.	89447	W MUNCIE RECLAMATION	141108(1)
85954	A INTERNATIONAL (NAVISTAR)	Not Req'd.	85977	W HENDRICKSON TRUCK SUSPENSION SYSTEMS MC NEILUS TRUCK & MAN.	145128(1)	646155	A VOLVO	Not Req'd.
85955	W HENDRICKSON TRUCK SUSPENSION SYSTEMS INTERNATIONAL (NAVISTAR)	Not Req'd.	85978	D HENDRICKSON TRUCK SUSPENSION SYSTEMS MACK VOLVO	Not Req'd.	695406	W ABC BUS ARVIN MERITOR VAN HOOL	145090(2)
85956	D FREIGHTLINER STERLING TRUCK VOLVO WESTERN STAR	Not Req'd.	85979	W HENDRICKSON TRUCK SUSPENSION SYSTEMS MC NEILUS TRUCK & MAN. WESTERN STAR	Not Req'd.	89401	W FORD MAECO STERLING TRUCK VOLVO	140149(1)
85957	C INTERNATIONAL (NAVISTAR) STERLING TRUCK	Not Req'd.	85980	W HENDRICKSON TRUCK SUSPENSION SYSTEMS MC NEILUS TRUCK & MAN.	Not Req'd.	89402	W BLUEBIRD SCHOOL BUS FORD STERLING TRUCK VOLVO	140149(1)
85958	A FREIGHTLINER WESTERN STAR	Not Req'd.	85984	W FREIGHTLINER	Not Req'd.	89403	S FORD	140149(1)
85959	B BLUEBIRD SCHOOL BUS FREIGHTLINER FREIGHTLINER CUSTOM CHASSIS HENDRICKSON TRUCK SUSPENSION SYSTEMS KENWORTH MC NEILUS TRUCK & MAN. PETERBILT SPARTAN MOTORS STERLING TRUCK	Not Req'd.	85985	W KENWORTH PETERBILT	145089-200(1)	89405	W BLUEBIRD SCHOOL BUS FORD GILLIG BROS. HENDRICKSON TRUCK SUSPENSION SYSTEMS INTERNATIONAL (NAVISTAR) KENWORTH MACK MAECO MARMON MC NEILUS TRUCK & MAN. PETERBILT REYCO SUSPENSION SAF HOLLAND TUTHILL TECHNOLOGIES VOLVO WATSON & CHALIN MFG. INC.	Not Req'd.
			85986	N HENDRICKSON TRUCK SUSPENSION SYSTEMS IC CORPORATION	Not Req'd.	89406	W ALLCO TRAILER AUTOCAR CHEVROLET TRUCK (Also See GMC Truck) COUNTRY COACH FORD	Not Req'd.
			85988	N KENWORTH PETERBILT	145099(1)			
			85989	N KENWORTH PETERBILT	Not Req'd.			
			85994	N INTERNATIONAL (NAVISTAR)	Not Req'd.			
			85995	N INTERNATIONAL (NAVISTAR)	Not Req'd.			

GasSLX Applications

N = New, S = Superseded

NUMERICAL LISTING LISTA NUMÉRICA LISTE NUMÉRIQUE

GABRIEL#	APPLICATION	MTG ACC PKG NO	GABRIEL#	APPLICATION	MTG ACC PKG NO	GABRIEL#	APPLICATION	MTG ACC PKG NO
89406	W	Not Req'd.	89413	D	145080(2)	89422	W	401754(4)
FREIGHTLINER FRUEHAUF GILLIG BROS. GMC TRUCK GREAT DANE TRAILER HENDRICKSON TRUCK SUSPENSION SYSTEMS ISUZU KENWORTH LODAL, INC. MACK MAECO MARMON MC NEILUS TRUCK & MAN. OSHKOSH MOTORS PETERBILT REYCO SUSPENSION SAF HOLLAND TUTHILL TECHNOLOGIES VOLVO WESTERN STAR			ARVIN MERITOR BLUEBIRD SCHOOL BUS BROCKWAY SCHOOL BUS CHANCE COACH CHEVROLET TRUCK (Also See GMC Truck) FORD GMC TRUCK INTERNATIONAL (NAVISTAR) ISUZU KENWORTH PETERBILT VOLVO			Beck BROCKWAY SCHOOL BUS BUS & TRUCK CO. CHEVROLET TRUCK (Also See GMC Truck) CONTINENTAL TRAILWAYS-EAGLE INT'L CRANE CARRIER CROWN COACH Dina EAGLE MOTOR COACH FREIGHTLINER GMC TRUCK GREYHOUND BUS HAULMARK HENDRICKSON TRUCK SUSPENSION SYSTEMS HINO INTERNATIONAL (NAVISTAR) KENWORTH MACK MAECO MATSON SCHOOL BUS MCI MC NEILUS TRUCK & MAN. MITSUBISHI-FUSO MOHAWK MOTOR COACH INDUSTRIES NISSAN OISA ORION BUS INDUSTRIES OSHKOSH MOTORS OTTAWA TRUCK Peña PETERBILT PREVOST Ramirez Sultana THOMAS SCHOOL BUS TRANSPORTATION MFG. CORP VOLVO Volvo WESTERN STAR WESTERN UNIT "STABILAIRE" SUSPENSION		
89407	W	Not Req'd.	89414	W	Not Req'd.	89423	D	141108(1)
ADVANCE MIXER BENSON TRUCK BODIES INC. BLUEBIRD SCHOOL BUS BROCKWAY SCHOOL BUS CHANCE BUS CHEVROLET TRUCK (Also See GMC Truck) DURA SUSPENSION EAST MANUFACTURING CORP. FORD GILLIG BROS. GMC TRUCK GREAT DANE TRAILER HARDEE MFG HENDRICKSON TRUCK SUSPENSION SYSTEMS HIGHWAY PRODUCT INTERNATIONAL (NAVISTAR) KENWORTH MACK MAECO MC NEILUS TRUCK & MAN. MOHAWK NATIONAL COACH CORP OSHKOSH MOTORS PETERBILT REYCO SUSPENSION RIDEWELL CORPORATION SAF HOLLAND STERLING TRUCK TRAILMOBILE CANADA CORP. TUTHILL TECHNOLOGIES TWIN COACH VOLVO WABASH NATIONAL WESTERN STAR			BLUEBIRD SCHOOL BUS CHEVROLET TRUCK (Also See GMC Truck) COUNTRY COACH FORD GMC TRUCK HENDRICKSON TRAILER SUSPENSION SYSTEMS HENDRICKSON TRUCK SUSPENSION SYSTEMS INTERNATIONAL (NAVISTAR) KENWORTH MACK MAECO MC NEILUS TRUCK & MAN. PETERBILT REYCO SUSPENSION SAF HOLLAND SPARTAN MOTORS STERLING TRUCK TRAILMOBILE CANADA CORP. TUTHILL TECHNOLOGIES VOLVO WESTERN STAR			INTERNATIONAL (NAVISTAR) KENWORTH MACK OTTAWA TRUCK PETERBILT VOLVO		
89408	A	145080(2)	89415	W	140149(1)	89424	C	141247(1)
KENWORTH PETERBILT VOLVO			INTERNATIONAL (NAVISTAR) KENWORTH MACK PETERBILT VOLVO			FLXIBLE BUS INTERNATIONAL (NAVISTAR) KENWORTH LEYLAND TRUCK MACK PETERBILT VOLVO		
89409	W	140149(1)	89416	X	140149(1)	89425	W	401754(4)
FORD KENWORTH OSHKOSH MOTORS PETERBILT PIERCE MANUFACTURING INC. VOLVO			AUTOCAR INTERNATIONAL (NAVISTAR) MACK VOLVO			AUTOCAR CHALMERS SUSPENSION EAGLE MOTOR COACH FORD KENWORTH MAECO PETERBILT STERLING TRUCK VOLVO		
89410	C	401754(4)	89417	W	145054(1)	89426	D	145090(1)
FORD INTERNATIONAL (NAVISTAR) KENWORTH MACK MAECO PETERBILT REYCO SUSPENSION STERLING TRUCK TUTHILL TECHNOLOGIES VOLVO			AUTOCAR GMC TRUCK VOLVO			INTERNATIONAL (NAVISTAR) MACK MAECO OSHKOSH MOTORS PIERCE MANUFACTURING INC. VOLVO		
89411	D	Not Req'd.	89418	W	145054(2)	89427	C	145099(1)
INTERNATIONAL (NAVISTAR) KENWORTH MARMON PETERBILT VOLVO			AUTOCAR INTERNATIONAL (NAVISTAR) VOLVO			INTERNATIONAL (NAVISTAR) KENWORTH MACK PACCAR PETERBILT VOLVO		
89412	X	401754(4)	89419	W	401754(4)	89428	W	145089-000(1)
FREIGHTLINER KENWORTH MACK PETERBILT REYCO SUSPENSION SPARTAN MOTORS TUTHILL TECHNOLOGIES VOLVO			CHEVROLET TRUCK (Also See GMC Truck) FREIGHTLINER FRUEHAUF GMC TRUCK GRANNING SUSPENSION HOBBS TRAILERS INTERNATIONAL (NAVISTAR) MUNCIE RECLAMATION OSHKOSH MOTORS OSTERLUND TRUCK OTTAWA TRUCK PIERCE MANUFACTURING INC. REYCO SUSPENSION SAF HOLLAND SEAGRAVE FIRE APPARATUS LLC TUTHILL TECHNOLOGIES VOLVO WABASH NATIONAL WATSON & CHALIN MFG. INC. WESTERN UNIT "STABILAIRE" SUSPENSION			FREIGHTLINER INTERNATIONAL (NAVISTAR) KENWORTH MACK PETERBILT VOLVO		
			89420	W	401754(4)	89429	C	401754(4)
			AM GENERAL CHEVROLET TRUCK (Also See GMC Truck) CRANE CARRIER FORD FREIGHTLINER FWD TRUCK GILLIG BROS. GMC TRUCK KENWORTH MACK MAECO MOTOR COACH INDUSTRIES PETERBILT RIDEWELL CORPORATION VOLVO			FREIGHTLINER KENWORTH MAECO PETERBILT VOLVO		
			89422	W	401754(4)			
			ACF BRILL BUS					

NUMERICAL LISTING LISTA NUMÉRICA LISTE NUMÉRIQUE

GABRIEL#	APPLICATION	MTG ACC PKG NO	GABRIEL#	APPLICATION	MTG ACC PKG NO	GABRIEL#	APPLICATION	MTG ACC PKG NO
89430	C	Not Req'd.	89440	W	Not Req'd.	89459	C	401754(2)
AUTOCAR BLUEBIRD SCHOOL BUS BOYDSTUN EQUIPMENT MANUFACTURING CHEVROLET TRUCK (Also See GMC Truck) EAST MANUFACTURING CORP. FREIGHTLINER FREIGHTLINER CUSTOM CHASSIS GMC TRUCK HENDRICKSON TRAILER SUSPENSION SYSTEMS HENDRICKSON TRUCK SUSPENSION SYSTEMS HINO INTERNATIONAL (NAVISTAR) MACK MAECO MERCEDES BENZ OSHKOSH MOTORS REYCO SUSPENSION RIDEWELL CORPORATION SAF HOLLAND TUTHILL TECHNOLOGIES VOLVO WABASH NATIONAL WATSON & CHALIN MFG. INC.			BLUEBIRD SCHOOL BUS CHEVROLET TRUCK (Also See GMC Truck) EAST MANUFACTURING CORP. FORD FRUEHAUF GMC TRUCK HENDRICKSON TRAILER SUSPENSION SYSTEMS HENDRICKSON TRUCK SUSPENSION SYSTEMS INTERNATIONAL (NAVISTAR) KENWORTH MAECO OSHKOSH MOTORS PACIFIC TRUCK & TRAILER PETERBILT PIERCE MANUFACTURING INC. REYCO SUSPENSION SAF HOLLAND STERLING TRUCK TUTHILL TECHNOLOGIES VOLVO WABASH NATIONAL			KENWORTH PETERBILT		
89431	W	Not Req'd.	89441	W	145054(1)	89460	W	Not Req'd.
BLUEBIRD SCHOOL BUS FREIGHTLINER FREIGHTLINER CUSTOM CHASSIS INTERNATIONAL (NAVISTAR) OSHKOSH MOTORS PIERCE MANUFACTURING INC. THOMAS SCHOOL BUS VOLVO			FORD KENWORTH SAF HOLLAND			KENWORTH PETERBILT		
89432	W	Not Req'd.	89442	W	145126(2)	89461	W	Not Req'd.
KENWORTH MAECO VOLVO			WESTERN STAR			GILLIG BROS.		
89434	W	140149(1)	89443	B	Not Req'd.			
AUTOCAR VOLVO			FREIGHTLINER FREIGHTLINER CUSTOM CHASSIS STERLING TRUCK THOMAS SCHOOL BUS VOLVO WESTERN STAR					
89435	W	140149(1)	89446	W	TR0027(4)			
FORD KENWORTH PETERBILT STERLING TRUCK VOLVO			FORD INTERNATIONAL (NAVISTAR) STERLING TRUCK VOLVO					
89436	A	Not Req'd.	89447	W	141108(1)			
ARVIN MERITOR BENSON TRUCK BODIES INC. CHANCE BUS CHEVROLET TRUCK (Also See GMC Truck) DURA SUSPENSION EAST MANUFACTURING CORP. FREIGHTLINER FRUEHAUF GMC TRUCK GREAT DANE TRAILER HENDRICKSON TRAILER SUSPENSION SYSTEMS HIGHWAY PRODUCT HUTCHENS SUSPENSION INGERSOLL AXLES KENWORTH MACK MC NEILUS TRUCK & MAN. MOHAWK ORION BUS INDUSTRIES PAGE SUSPENSION PETERBILT REYCO SUSPENSION RIDEWELL CORPORATION SAF HOLLAND STOUGHTON TRAILERS INC. THOMAS SCHOOL BUS TRAILMOBILE CANADA CORP. TUTHILL TECHNOLOGIES TWIN COACH UTILITY TRAILER MANUFACTURING COMPANY VOLVO WABASH NATIONAL WATSON & CHALIN MFG. INC.			BLUEBIRD SCHOOL BUS FLXIBLE BUS IC CORPORATION INTERNATIONAL (NAVISTAR) MITSUBISHI-FUSO MUNCIE RECLAMATION NEOPLAN BUS VOLVO					
89437	W	Not Req'd.	89448	D	Not Req'd.			
EAST MANUFACTURING CORP. HENDRICKSON TRAILER SUSPENSION SYSTEMS THOMAS SCHOOL BUS			MACK VOLVO					
89438	W	145080(2)	89449	B	Not Req'd.			
FORD STERLING TRUCK			FREIGHTLINER FREIGHTLINER CUSTOM CHASSIS THOMAS SCHOOL BUS VOLVO					
89439	W	145080(2)	89450	W	Not Req'd.			
FORD SAF HOLLAND STERLING TRUCK			MACK VOLVO					
			89451	B	Not Req'd.			
			KENWORTH PETERBILT					
			89453	W	Not Req'd.			
			FREIGHTLINER HENDRICKSON TRUCK SUSPENSION SYSTEMS MC NEILUS TRUCK & MAN. STERLING TRUCK WESTERN STAR					
			89454	W	Not Req'd.			
			HENDRICKSON TRUCK SUSPENSION SYSTEMS MACK MC NEILUS TRUCK & MAN. VOLVO					
			89455	B	141108(1)			
			ARVIN MERITOR KENWORTH PETERBILT					
			89456	D	145089-200(1)			
			KENWORTH PETERBILT					
			89457	W	Not Req'd.			
			INTERNATIONAL (NAVISTAR)					
			89458	C	Not Req'd.			
			INTERNATIONAL (NAVISTAR)					



Fleetline® GasSLX® Interchange

Intercambio
Échange

Fleetline	GasSLX
83122	89406
83123	89405
83124	89407
83126	89430
83203	89436
83207	89407
83209	89414
83309	89446
83312	89409
83389	89436
83456	89447
85000	89436
85001	89410
85003	89411
85005	89430
85007	89412
85012	89413
85013	89414
85023	89415
85024	89416
85026	89417
85027	89418
85030	89440
85033	89427
85036	89405
85046	89434
85047	89435
85053	89442
85054	89438
85055	89439

Fleetline	GasSLX
85058	89431
85061	89450
85062	89408
85066	89448
85067	89451
85069	89455
85070	89459
85084	89460
85300	89419
85302	89420
85303	89422
85308	89422
85310	89423
85311	89424
85314	89425
85316	89426
85319	89428
85320	89429
85323	89436
85705	89447
85724	89443
85906	89407
85916	89430
85918	89449
85923	89458
85924	89457
85931	89458
85932	89453
85933	89454
85936	89456



IMPORTANT NOTE: Interchange must only be used for FLEETLINE to GASSLX upgrade. Interchange is **NOT REVERSABLE**.

NOTA IMPORTANTE: El intercambio se debe utilizar solamente de FLEETLINE a GASSLX mejorado. El intercambio **NO ES REVERSIBLE**.

REMARQUE IMPORTANTE: L'échange ne peut se faire que pour le surclassement du FLEETLINE au GASSLX. L'échange **N'EST PAS REVERSIBLE**.



COMPETITIVE & O.E.M. INTERCHANGE LIST
Lista de Intercambios contra Competidores y Equipo Original.
Liste d'interchange de produits compétitifs & d'équipement original (OEM)

ABC BUS

O.E.M #	Gabriel	Upgrade	O.E.M #	Gabriel	Upgrade	O.E.M #	Gabriel	Upgrade	O.E.M #	Gabriel	Upgrade
050134513	85732		12L-5-114	85727		6243-13790	85708		90-2291	695406	
10685703	695406		12L-5-72	85709		6243-14040	85708				
12B-5-1	85735		12L-5-88	85729		624314570	695406				
12J-5-10	85733		3166657	85700		680323	85700				

ACF BRILL BUS

O.E.M #	Gabriel	Upgrade	O.E.M #	Gabriel	Upgrade	O.E.M #	Gabriel	Upgrade	O.E.M #	Gabriel	Upgrade
610513	85307		641521	85308	89422	659129	85303	89422	661733	83225	
631237	85308	89422	649648	85308	89422	661732	83215		995891	85307	

ADVANCE MIXER

O.E.M #	Gabriel	Upgrade	O.E.M #	Gabriel	Upgrade	O.E.M #	Gabriel	Upgrade	O.E.M #	Gabriel	Upgrade
12111 ADV	646155		13883	85334		14626 ADV	83209		680087	85334	
13424 ADV	83207	89407	13883 ADV	85334		23458 ADV	83112				

ALLCO TRAILER

O.E.M #	Gabriel	Upgrade	O.E.M #	Gabriel	Upgrade	O.E.M #	Gabriel	Upgrade	O.E.M #	Gabriel	Upgrade
727602	83122	89406									

AM GENERAL

O.E.M #	Gabriel	Upgrade	O.E.M #	Gabriel	Upgrade	O.E.M #	Gabriel	Upgrade	O.E.M #	Gabriel	Upgrade
3166657	85700		5957136	85700		5979484	85302	89420			
4975501	85700		5969438	85700		5979574	85700				
5565748	85700		5978712	85700		5982537	85700				

ARALMEX

Aralmex	Gabriel	Upgrade	Aralmex	Gabriel	Upgrade	Aralmex	Gabriel	Upgrade	Aralmex	Gabriel	Upgrade
2AMG037	G63375		3AMG007	G63357		3AMG023	G63421		3AMG031	G63360	
3AMG001	G63355		3AMG008	G63500		3AMG026	G63455		3AMG032	G63502	
3AMG004	G63306		3AMG009	G63406		3AMG027	G63426		3AMG033	G63614	
3AMG005	G63359		3AMG021	G63409		3AMG029	G63488		3AMG034	G63608	
3AMG006	G63377		3AMG022	G63454		3AMG030	G63818		3AMG035	G63607	

ARVIN MERITOR

O.E.M #	Gabriel	Upgrade	O.E.M #	Gabriel	Upgrade	O.E.M #	Gabriel	Upgrade	O.E.M #	Gabriel	Upgrade
085009	85009		680347	85718		727631	83304		728618	85006	
085014	85014		680464	85005		727635	83308		728619	85007	
085321	85321		680518	85700		727636	83309		728621	85009	
654907	85000	89436	680584	85938		727639	83312		728622	85010	
654958	83164		680671	85708		727641	83314		728623	85011	
659016	83064		695172	85707		727645	83318		728624	85012	
659222	83171		695180	85705		727671	83613		728625	85013	
665044	83209		695181	85707		727672	83242		728626	85312	
665724	85000	89436	695214	85722		727692	83353		728627	85313	
665746	85000		695348	87018		728601	85001		728628	85314	
665760	85045		695406	695406		728603	85003		728631	85029	
665769	85052		727600	83200		728604	85300		728632	85030	
665804	85939		727607	83207		728606	85302		728635	85318	
671091	85069	89455	727609	83209		728608	85304		728639	85026	
671092	85012	89413	727614	83214		728609	85305		728640	85027	
671507	87015		727615	83215		728611	85307		728800	85711	
671707	85052		727616	83216		728612	85308		728806	85736	
680102	85712		727619	83219		728614	85310		728811	85707	
680322	85704		727625	83225		728615	85311		728812	85705	
680331	85702		727628	83301		728616	85004		7805-N-1002	85329	
680337	85708		727630	83303		728617	85005		7805-S-1007	85329	

AUTOCAR

O.E.M #	Gabriel	Upgrade	O.E.M #	Gabriel	Upgrade	O.E.M #	Gabriel	Upgrade	O.E.M #	Gabriel	Upgrade
03-1106460	85005	89430	37301-3201	85027	89418	60680-004	83143		8026658	85046	89434
1011839	83216		37301-3202	85026	89417	60680-005	83142				
28CFG-910	83216		60657-003	85072		660186	83216				
28R010	83216		60665-011	85967		800670	85060				
35901-3201	85024	89416	60680-003	83112		800781	85314	89425			

Important Note: Competitive Interchanges are to be used for stocking purposes only. Where multiple crosses are identified, please reference the applications section of this catalog. / **Remarque importante:** Les interchanges concurrentiels ne s'utilisent qu'aux fins de stocks. Dans le cas de références multiples, consulter la section des applications du catalogue. / **Nota importante:** Dans le cas de références multiples, consulter la section des applications du catalogue. / **Nota importante:** Se pueden usar intercambios competitivos para propósitos de almacenamiento solamente. Cuando se identifican intercambios múltiples, consulte la sección de aplicaciones de este catálogo.

COMPETITIVE & O.E.M. INTERCHANGE LIST

Lista de Intercambios contra Competidores y Equipo Original.

Liste d'interchange de produits compétitifs & d'équipement original (OEM)

AUTOCAR... cont'd

O.E.M #	Gabriel	Upgrade	O.E.M #	Gabriel	Upgrade	O.E.M #	Gabriel	Upgrade	O.E.M #	Gabriel	Upgrade
8071524	85024	89416	849246	83216							

BATCO

Batco	Gabriel	Upgrade	Batco	Gabriel	Upgrade	Batco	Gabriel	Upgrade	Batco	Gabriel	Upgrade
1083203	83203	89436	1083225	83225		1085005	85005	89430	1085311	85311	89424
1083204	83204		1083310	83221		1085007	85007	89412	1087001	85734	
1083207	83207	89407	1083317	83317		1085300	85300	89419	1087004	85735	
1083209	83209	89414	1085003	85003	89411	1085305	85305		1087006	85736	

BECK BUS

O.E.M #	Gabriel	Upgrade	O.E.M #	Gabriel	Upgrade	O.E.M #	Gabriel	Upgrade	O.E.M #	Gabriel	Upgrade
14QK-140	85304		14QK-2102	85304							

BENSON TRUCK BODIES INC.

O.E.M #	Gabriel	Upgrade	O.E.M #	Gabriel	Upgrade	O.E.M #	Gabriel	Upgrade	O.E.M #	Gabriel	Upgrade
90044089	83124	89407	A-20002	85000	89436						

BERING TRUCK CORP.

O.E.M #	Gabriel	Upgrade	O.E.M #	Gabriel	Upgrade	O.E.M #	Gabriel	Upgrade	O.E.M #	Gabriel	Upgrade
47902-24	83137										

BILSTEIN

Bilstein	Gabriel	Upgrade	Bilstein	Gabriel	Upgrade	Bilstein	Gabriel	Upgrade	Bilstein	Gabriel	Upgrade
B46-1594	85013	89414	B46-1725	85029		B46-2151	85007	89412			

BLUEBIRD SCHOOL BUS

O.E.M #	Gabriel	Upgrade	O.E.M #	Gabriel	Upgrade	O.E.M #	Gabriel	Upgrade	O.E.M #	Gabriel	Upgrade
00085991	85006		1668730	85013	89414	58913-007	85959		7805-N-1002	85329	
00119797	85959		1707405	85005		58913-007L	85959		7805-S-1007	85329	
00119798	85106		1722214	85030	89440	58913-008	85959		87001-01A	85734	
0014605	85036	89405	1722222	85013	89414	58913-009	85959		8C24-18045-DA	83177	
0014985	83137		1746163	85006		58913-010	85106		8C24-18080-DB	83178	
0015222	85919		1750793	85712		58913-011	85959		8C2Z-18124-D	83177	
0020326	85976		1962422	85304		59057-001	83137		8C2Z-18125-D	83178	
0040015	85919		1962430	83207	89407	59057-002	85036	89405	90-1813	85712	
0055008	85959		2021459	85012	89413	59483-000	85919		90-1951-SP1	85734	
0055017	85959		23106-01	85975		60665-005	85919		90-1968	85712	
0075916	85086		300-0614966	85307		609180	85304		90-1968-SP1	85712	
0085990	85959		300-0614974	85304		60998-001	85006		90-2610 SP1	87017	
0088035	85090		300-0823047	85736		60998-002	85919		90044448	85051	
0106303	85106		300-0823054	85304		60998-003	85006		90044915	83127	
0110808	83124	89407	300-09612284	85734		614958	85307		90045050	85914	
0523047	85736		300-1316546	85006		614966	85307		90045083	85910	
0823054	85304		300-1317767	85029		614974	85304		A-4890	85712	
1004167	85712		303-1350628	85712		65992-003	85959		AMS65109	85058	89431
1217934	85304		305-0961284	85734		65992-004	85106		AMS65110	85005	89430
1260008	87017		471700000428	85006		671933	85919		AMS65119	85029	
1316546	85006		471700000456	85959		680102	85712		ASH-1136	83178	
1317767	85029		471700000464	85090		680155	85712		ASH-1154	83177	
1526417	85052		471700002919	85106		680667		89447	AT-163G	83177	
1658525	85971		471700131545	85006		680783	85304		AT-164G	83178	
1658533	85010		4759272		89447	70317		89402			
1667831	85029		4760958	85086		70397	85006				
1668722	85030	89440	481700131438	85919		7805-M-1001	85919				

BOGE

Boge	Gabriel	Upgrade	Boge	Gabriel	Upgrade	Boge	Gabriel	Upgrade	Boge	Gabriel	Upgrade
40-A85-0	85708										

BOYDSTUN EQUIPMENT MANUFACTURING

O.E.M #	Gabriel	Upgrade	O.E.M #	Gabriel	Upgrade	O.E.M #	Gabriel	Upgrade	O.E.M #	Gabriel	Upgrade
1253069B000	85005	89430									

Important Note: Competitive Interchanges are to be used for stocking purposes only. Where multiple crosses are identified, please reference the applications section of this catalog. / **Remarque importante:** Les interchanges concurrentiels ne s'utilisent qu'aux fins de stocks. Dans le cas de références multiples, consulter la section des applications du catalogue. / **Nota importante:** Dans le cas de références multiples, consulter la section des applications du catalogue. / **Nota importante:** Se pueden usar intercambios competitivos para propósitos de almacenamiento solamente. Cuando se identifican intercambios múltiples, consulte la sección de aplicaciones de este catálogo.

COMPETITIVE & O.E.M. INTERCHANGE LIST
Lista de Intercambios contra Competidores y Equipo Original.
Liste d'interchange de produits compétitifs & d'équipement original (OEM)

BROCKWAY SCHOOL BUS

O.E.M #	Gabriel	Upgrade	O.E.M #	Gabriel	Upgrade	O.E.M #	Gabriel	Upgrade	O.E.M #	Gabriel	Upgrade
14QK-281P10	85305		152398	85304		515231	85303	89422			
14QK-282P1	83216		152412	83215		530873	83207	89407			
14QK-282P3	83216		508657	85307		532397	85307				

BUILT RITE

O.E.M #	Gabriel	Upgrade	O.E.M #	Gabriel	Upgrade	O.E.M #	Gabriel	Upgrade	O.E.M #	Gabriel	Upgrade
318-06-100	85006										

BUS & TRUCK CO.

O.E.M #	Gabriel	Upgrade	O.E.M #	Gabriel	Upgrade	O.E.M #	Gabriel	Upgrade	O.E.M #	Gabriel	Upgrade
0100-905	85307		680091	85303	89422	70039	85303	89422	70041	85305	

CARPENTER BUS

O.E.M #	Gabriel	Upgrade	O.E.M #	Gabriel	Upgrade	O.E.M #	Gabriel	Upgrade	O.E.M #	Gabriel	Upgrade
0272-SS5	85712		63-0001	85713							

CASCADE TRAILER

O.E.M #	Gabriel	Upgrade	O.E.M #	Gabriel	Upgrade	O.E.M #	Gabriel	Upgrade	O.E.M #	Gabriel	Upgrade
120-1	83125										

CHALLENGE

O.E.M #	Gabriel	Upgrade	O.E.M #	Gabriel	Upgrade	O.E.M #	Gabriel	Upgrade	O.E.M #	Gabriel	Upgrade
632147	632147		632155	646177							

CHALMERS SUSPENSION

O.E.M #	Gabriel	Upgrade	O.E.M #	Gabriel	Upgrade	O.E.M #	Gabriel	Upgrade	O.E.M #	Gabriel	Upgrade
21335	G63355		665174	85060		800670	85060		800781	85314	89425

CHAMPION TRANSIT

O.E.M #	Gabriel	Upgrade	O.E.M #	Gabriel	Upgrade	O.E.M #	Gabriel	Upgrade	O.E.M #	Gabriel	Upgrade
22064230	83136		22064231	85324							

CHANCE BUS

O.E.M #	Gabriel	Upgrade	O.E.M #	Gabriel	Upgrade	O.E.M #	Gabriel	Upgrade	O.E.M #	Gabriel	Upgrade
270-6708	85014		665017	85014		6893	83203	89436	AS789B	85014	
59039	83207	89407	6892	83207	89407	728600	83203	89436			

CHANCE COACH

O.E.M #	Gabriel	Upgrade	O.E.M #	Gabriel	Upgrade	O.E.M #	Gabriel	Upgrade	O.E.M #	Gabriel	Upgrade
2021459	85012	89413									

CHEVROLET TRUCK (Also See GMC Truck)

O.E.M #	Gabriel	Upgrade	O.E.M #	Gabriel	Upgrade	O.E.M #	Gabriel	Upgrade	O.E.M #	Gabriel	Upgrade
1-51630-168-1	83515		22007701	83126	89430	22045526	85702		22165188	83136	
1-51630-217-0	83114		22007702	83304		22046481	85702		22165189	83136	
1-51630-217-1	83114		22007703	83303		22046483	85304		22166442	83136	
1-51630-219-1	83114		22007750	83207	89407	22046485	85710		3171068	83216	
12474915	83122	89406	22007751	83303		22046489	85303	89422	3171069	85304	
12474917	83137		22007752	83304		22046499	85710		3171462	83126	89430
15123676	83136		22007753	83303		2204683	85304		3171696	85307	
15174898	83136		22012065	85304		22052014	85702		3172948	85303	89422
15174901	85342		22012067	85700		22052336	85304		3175509	85735	
15174902	85071		22012079	85701		22052424	85710		3178157	85700	
15174903	85342		22012082	85702		22064230	83136		3178233	85734	
15185643	83153		22012083	85711		22064231	85324		3178507	85700	
15185644	83155		22012090	85308	89422	22064232	85071		3178995	85700	
15588554	83136		22012091	85303	89422	22064233	83136		3188626	85300	89419
15642943	83136		22012095	83126	89430	22064432	85050		3188729	85303	89422
15740554	83137		22012096	83221		22064489	85336		3192657	83216	
15887728	83136		22012114	85700		22064804	83136		3192890	83126	89430
15963161	83122	89406	22012131	85711		22064805	83136		3192892	83221	
19152843	83136		22012166	83126	89430	22064806	83136		4939852	85308	89422
21998392	85336		22012169	83221		22064807	83136		4939967	85308	89422
22002293	83126	89430	22017530	83303		22065218	G63347				
22002294	83304		22017531	83303		22065251	85030	89440			
22002295	83303		22024062	85701		22099889	85336				
22007700	83207	89407	22024673	85710		22165187	83136				

Important Note: Competitive Interchanges are to be used for stocking purposes only. Where multiple crosses are identified, please reference the applications section of this catalog. / **Remarque importante:** Les interchanges concurrentiels ne s'utilisent qu'aux fins de stocks. Dans le cas de références multiples, consulter la section des applications du catalogue. / **Nota importante:** Dans le cas de références multiples, consulter la section des applications du catalogue. / **Nota importante:** Se pueden usar intercambios competitivos para propósitos de almacenamiento solamente. Cuando se identifican intercambios múltiples, consulte la sección de aplicaciones de este catálogo.

COMPETITIVE & O.E.M. INTERCHANGE LIST
Lista de Intercambios contra Competidores y Equipo Original.
Liste d'interchange de produits compétitifs & d'équipement original (OEM)

CHEVROLET TRUCK (Also See GMC Truck)... cont'd

O.E.M #	Gabriel	Upgrade	O.E.M #	Gabriel	Upgrade	O.E.M #	Gabriel	Upgrade	O.E.M #	Gabriel	Upgrade
4940600	83209	89414	5171068	83216		5531437	85307		5552527	85735	
4940601	83216		5316784	85700		5532026	85304		5552552	85303	89422
4940606	83126	89430	5316791	83219		5532425	83207	89407	5554184	85302	89420
4940614	83216		5316792	85305		5532433	83207	89407	5554589	85307	
4940627	83203	89436	5316793	85305		5532675	85307		5554596	85303	89422
4940640	83216		5321920	85307		5534430	85303	89422	5554814	85302	89420
4940650	83207	89407	5321929	85307		5534439	85304		5554959	83401	
4940654	83216		5348631	83203	89436	5534447	85303	89422	5554995	85305	
4940660	83207	89407	5352858	85305		5544060	85302	89420	5559363	83203	89436
4940662	83126	89430	5353054	85303	89422	5544112	83216		5585939	85307	
4963844	85307		5355798	85307		5544581	85302	89420	684280	83209	89414
4963853	83216		5357955	85300	89419	5544716	85304		8-94057-593-0	83114	
4963854	83216		5357956	85734		5544717	85304		8-94454-986-0	83515	
4964853	83217		5357959	85300	89419	5544812	83308		8-94454-987-0	83515	
4974401	85700		5361994	85734		5544818	85735		8-97201-960-0	83515	
4975429	85300	89419	5374779	85308	89422	5549899	83207	89407	88963409	85336	
4975467	83207	89407	5374999	85307		5549924	85700		88982682	83136	
4975479	83400		5385939	85307		5549925	85304		88982684	83136	
4975480	83400		5392387	85303	89422	5552111	85304		88982685	85342	
4975494	83207	89407	5394448	85305		5552112	85307		88982686	85071	
4975497	83126	89430	5394467	85305		5552114	83216		88982687	85342	
4975510	83221		5394468	85735		5552205	83217		88982688	85336	
4975515	85701		5455798	85307		5552206	83214		9-51630-647-1	83515	
4975516	85702		5513489	83216		5552207	83217		9-51630-666-0	85012	89413
4975518	85704		5513716	85304		5552208	83217		9-51630-666-2	85012	89413
4975538	85700		5516459	85305		5552209	83215		94033786	83114	
4975549	83216		5522781	85735		5552210	85308	89422	94051090	83114	
4975550	85702		5522794	85308	89422	5552244	85308	89422	94057593	83114	
4984526	83216		5522818	85305		5552285	83214		94454987	83515	
507-22	85342		5527001	85300	89419	5552286	83217		97-2210-00153	85701	
507-23	85342		5527271	85700		5552287	83217		97-2210-00164	85708	
507-24	85336		5527272	85700		5552288	83217		97-2210-00170	85733	
507-3	85307		5527606	85305		5552451	85308	89422	97083027	83515	
508-86	83136		5531027	85301		5552452	85303	89422	97083029	83515	
508-88	83153		5531435	85307		5552453	85301		97201960	83515	
508-89	83155		5531436	85307		5552456	85307		L-12706	83155	

CHEVROLET TRUCK CAB SHOCKS

O.E.M #	Gabriel	Upgrade	O.E.M #	Gabriel	Upgrade	O.E.M #	Gabriel	Upgrade	O.E.M #	Gabriel	Upgrade
1202-0012	83023		1202-0022	83046		1202-0032	83016		1202-0054	83021	

CHRYSLER

O.E.M #	Gabriel	Upgrade	O.E.M #	Gabriel	Upgrade	O.E.M #	Gabriel	Upgrade	O.E.M #	Gabriel	Upgrade
2961043	G63183		3633744	G63183		3638112	G63183				

CLARK EQUIPMENT

O.E.M #	Gabriel	Upgrade	O.E.M #	Gabriel	Upgrade	O.E.M #	Gabriel	Upgrade	O.E.M #	Gabriel	Upgrade
355778	85315		5532675	85307		680042	85301				

CNH GLOBAL N V

O.E.M #	Gabriel	Upgrade	O.E.M #	Gabriel	Upgrade	O.E.M #	Gabriel	Upgrade	O.E.M #	Gabriel	Upgrade
87019546	83022		87268250	83021							

COACHMEN RV

O.E.M #	Gabriel	Upgrade	O.E.M #	Gabriel	Upgrade	O.E.M #	Gabriel	Upgrade	O.E.M #	Gabriel	Upgrade
141700131809	85029		16-16736-000	85029		16-16873-000	85029		16-18103-000	85900	
141700131810	83160		16-16737-000	83160		16-16874-000	83160		481700000493	85900	

COFAP

Cofap	Gabriel	Upgrade	Cofap	Gabriel	Upgrade	Cofap	Gabriel	Upgrade	Cofap	Gabriel	Upgrade
45011	85702		45056	85315		45058	85941		45087	85943	
45054	85301		45058	85301		45086	85949		45089	85940	

Important Note: Competitive Interchanges are to be used for stocking purposes only. Where multiple crosses are identified, please reference the applications section of this catalog. / **Remarque importante:** Les interchanges concurrentiels ne s'utilisent qu'aux fins de stocks. Dans le cas de références multiples, consulter la section des applications du catalogue. / **Nota importante:** Dans le cas de références multiples, consulter la section des applications du catalogue. / **Nota importante:** Se pueden usar intercambios competitivos para propósitos de almacenamiento solamente. Cuando se identifican intercambios múltiples, consulte la sección de aplicaciones de este catálogo.

COMPETITIVE & O.E.M. INTERCHANGE LIST
Lista de Intercambios contra Competidores y Equipo Original.
Liste d'interchange de produits compétitifs & d'équipement original (OEM)

COFAP... cont'd

Cofap	Gabriel	Upgrade	Cofap	Gabriel	Upgrade	Cofap	Gabriel	Upgrade	Cofap	Gabriel	Upgrade
45089	85949		45160	85946		ATG-051	G63426		L-12488	85073	
45090	85942		45174	85947		ATG-081	G63502		L-12590	85074	
45091	85944		45189	85950		ATG-084	G63608		L-12601	85077	
45094	85949		45200	85941		ATG-085	G63607		L-12602	85076	
45095	85948		45235	85946		L-12039	85065		L-12687	83030	
45096	85951		45238	85949		L-12040	85073		L-12703	85071	
45117	85918	89449	45240	85981		L-12151	85075		L-12706	83155	
45137	85948		8482	85026	89417	L-12476	85074		L-12713	83136	
45139C-Y	85901		ATG-046	G63457		L-12477	85073		L-13092	85073	

CONDUMEX

Condumex	Gabriel	Upgrade	Condumex	Gabriel	Upgrade	Condumex	Gabriel	Upgrade	Condumex	Gabriel	Upgrade
43066	83309	89446	58038	85001	89410	69685	83136		69753	85031	
43136	83017		58040	85026	89417	69687	83100		78001	85314	89425
43137	83009		58041	83456		69688	85302	89420	78002	85702	
43138	83004		58047	85381		69705	83122	89406	78003	85308	89422
43139	83021		58048	83137		69711	83207	89407	78005	85310	89423
43145	83021		58049	85323	89436	69712	85013	89414	78007	85307	
53010	83136		58050	85061	89450	69713	85046	89434	78009	85303	89422
53018	83317		58055	85003	89411	69714	83215		78013	85323	89436
53019	83456		58056	83137		69715	85000	89436	78015	85724	89443
53038	85103		58057	83456	89447	69716	85024	89416	78016	85001	89410
53039	85006		58058	85031		69717	85310	89423	78020	85712	
53040	85006		58059	85005		69720	85736		78023	85705	
53041	85310	89423	58061	83122		69725	85918	89449	78025	85009	
53042	83309		58061	85916		69726	85319		78026	85706	
53043	83215		58062	85096		69728	85055	89439	78027	85314	89425
53059	85051		58065	85949		69729	85314	89425	78030	85316	89426
53062	83009		58067	85942		69732	85300	89419	78034	85920	
53063	83025		69500	83122	89406	69741	85906		78039	85311	
53065	83136		69515	83124	89407	69743	85061	89450	USA53085	83512	
53066	83124	89407	69669	83123	89405	69745	85058	89431	USA53086	83511	
53078	85940		69670	85051		69746	83137		USA53087	83506	
53079	85074		69671	85006		69747	85003		USA53088	83513	
53080	83015		69672	85043		69748	85001	89410	USA53091	83508	
58012	85314	89425	69673	83209	89414	69750	85314	89425	USA53092	83509	
58034	85013	89414	69680	83200		69752	85316	89426			

CONTINENTAL TRAILWAYS-EAGLE INT'L

O.E.M #	Gabriel	Upgrade	O.E.M #	Gabriel	Upgrade	O.E.M #	Gabriel	Upgrade	O.E.M #	Gabriel	Upgrade
01-0100-020	85307		5394467	85305		6-05-5	85307		70039	85303	89422
01-0100-905	85303	89422	5532026	85304		680091	85303	89422	70041	85305	

COUNTRY COACH

O.E.M #	Gabriel	Upgrade	O.E.M #	Gabriel	Upgrade	O.E.M #	Gabriel	Upgrade	O.E.M #	Gabriel	Upgrade
89406		89406	89414		89414						

CRANE CARRIER

O.E.M #	Gabriel	Upgrade	O.E.M #	Gabriel	Upgrade	O.E.M #	Gabriel	Upgrade	O.E.M #	Gabriel	Upgrade
277A-1	85307		277A-13	85302	89420	277A-8	85303	89422	680088	85713	
277A-12	85304		277A-14	85304		277A-9	85307		680091	85303	89422

CROWN COACH

O.E.M #	Gabriel	Upgrade	O.E.M #	Gabriel	Upgrade	O.E.M #	Gabriel	Upgrade	O.E.M #	Gabriel	Upgrade
3188729	85303	89422	5532026	85304		5532036	85734				

CUNHA PRODUCTS OHD

O.E.M #	Gabriel	Upgrade	O.E.M #	Gabriel	Upgrade	O.E.M #	Gabriel	Upgrade	O.E.M #	Gabriel	Upgrade
CP-5222	85315										

DANA

O.E.M #	Gabriel	Upgrade	O.E.M #	Gabriel	Upgrade	O.E.M #	Gabriel	Upgrade	O.E.M #	Gabriel	Upgrade
SR1VJ100	85078										

Important Note: Competitive Interchanges are to be used for stocking purposes only. Where multiple crosses are identified, please reference the applications section of this catalog. / **Remarque importante:** Les interchanges concurrentiels ne s'utilisent qu'aux fins de stocks. Dans le cas de références multiples, consulter la section des applications du catalogue. / **Nota importante:** Dans le cas de références multiples, consulter la section des applications du catalogue. / **Nota importante:** Se pueden usar intercambios competitivos para propósitos de almacenamiento solamente. Cuando se identifican intercambios múltiples, consulte la sección de aplicaciones de este catálogo.

COMPETITIVE & O.E.M. INTERCHANGE LIST
Lista de Intercambios contra Competidores y Equipo Original.
Liste d'interchange de produits compétitifs & d'équipement original (OEM)

DELCO

Delco	Gabriel	Upgrade	Delco	Gabriel	Upgrade	Delco	Gabriel	Upgrade	Delco	Gabriel	Upgrade
501-13	83318		507-8	85301		508-35	G63306		508-70	G63416	
501-74	83304		507-9	85700		508-35	G63371		508-71	83314	
501-75	83303		508-13	85012	89413	508-39	G63347		508-71	G63398	
507-1	85304		508-14	83216		508-42	G63353		508-72	G63386	
507-10	85711		508-14	85012	89413	508-42	G63389		508-74	G63511	
507-11	85308	89422	508-15	83216		508-47	G63350		508-78	83400	
507-12	85701		508-16	83308	89435	508-47	G63377		508-79	G63424	
507-13	85704		508-17	83312	89409	508-48	G63409		508-80	G63425	
507-15	85703		508-18	83309	89446	508-48	G63427		508-82	G63410	
507-16	85702		508-19	83314		508-5	G63359		508-86	83136	
507-17	85304		508-20	83207	89407	508-5	G63360		508-87	85071	
507-18	85305		508-21	83214		508-50	G63299		508-88	83153	
507-19	85700		508-22	83217		508-50	G63907		508-89	83155	
507-2	85302	89420	508-23	83217		508-52	G63405		508-9	85000	89436
507-22	85342		508-23	83225		508-52	G63419		508-90	83136	
507-23	85342		508-24	83215		508-52	G63492		550-13	85005	89430
507-24	85336		508-26	83203	89436	508-56	G63605		550-73	83303	
507-3	85307		508-26	85030	89440	508-57	83123	89405	550-73	85005	89430
507-4	85303	89422	508-28	83207	89407	508-59	G63183		550-74	83304	
507-5	85308	89422	508-29	85030	89440	508-68	83209	89414	550-75	83303	
507-6	85314	89425	508-3	83400		508-68	85006		550-77	83221	
507-7	85301		508-30	85005	89430	508-70	G63396				

DEXTER AXLE

O.E.M #	Gabriel	Upgrade	O.E.M #	Gabriel	Upgrade	O.E.M #	Gabriel	Upgrade	O.E.M #	Gabriel	Upgrade
18165-01	85006										

DIAMOND T

O.E.M #	Gabriel	Upgrade	O.E.M #	Gabriel	Upgrade	O.E.M #	Gabriel	Upgrade	O.E.M #	Gabriel	Upgrade
5549925	85304										

DIAMOND-REO

O.E.M #	Gabriel	Upgrade	O.E.M #	Gabriel	Upgrade	O.E.M #	Gabriel	Upgrade	O.E.M #	Gabriel	Upgrade
220-55-1	83214		220-55-6	83214		220-55-8	83217				
220-55-2	85304		220-55-7	85304		220-S5-10	85712				

DINA BUS

O.E.M #	Gabriel	Upgrade	O.E.M #	Gabriel	Upgrade	O.E.M #	Gabriel	Upgrade	O.E.M #	Gabriel	Upgrade
1520030010	83317		39380353-6	85716		39390340-4	85716				
152E030030	85014		39390339-6	85307							

DODGE TRUCK

O.E.M #	Gabriel	Upgrade	O.E.M #	Gabriel	Upgrade	O.E.M #	Gabriel	Upgrade	O.E.M #	Gabriel	Upgrade
2516009	G63183		2961043	G63183		3633744	G63183		3638631	G63605	
2960707	G63183		3633643	G63183		3638112	G63183		4036892	G63605	

DUPLEX TRUCK

O.E.M #	Gabriel	Upgrade	O.E.M #	Gabriel	Upgrade	O.E.M #	Gabriel	Upgrade	O.E.M #	Gabriel	Upgrade
59024	83204		7604-3371	83204							

DURA SUSPENSION

O.E.M #	Gabriel	Upgrade	O.E.M #	Gabriel	Upgrade	O.E.M #	Gabriel	Upgrade	O.E.M #	Gabriel	Upgrade
1080099	83203	89436	59024	83204		665133	83203	89436	7604-3371	83204	
12866	83207	89407	59030	83203	89436	665267	85029		A-2212	85029	

EAGLE MOTOR COACH

O.E.M #	Gabriel	Upgrade	O.E.M #	Gabriel	Upgrade	O.E.M #	Gabriel	Upgrade	O.E.M #	Gabriel	Upgrade
01-0100-020	85307		101364	85305		5394467	85305		690060	85713	
01-0100-905	85303	89422	12B-5-1	85735		5532026	85304		70039	85303	89422
014-0100-905	85308	89422	12J-5-10	85733		6-05-5	85307		70041	85305	
0140100-905	85308	89422	154-0100-514	85314	89425	680091	85303	89422			

EAST MANUFACTURING CORP.

O.E.M #	Gabriel	Upgrade	O.E.M #	Gabriel	Upgrade	O.E.M #	Gabriel	Upgrade	O.E.M #	Gabriel	Upgrade
517-05001-18	87015		517-05006-20	85030	89440						
517-05001-23	85005	89430	517-05009-14	83125							

Important Note: Competitive Interchanges are to be used for stocking purposes only. Where multiple crosses are identified, please reference the applications section of this catalog. / **Remarque importante:** Les interchanges concurrentiels ne s'utilisent qu'aux fins de stocks. Dans le cas de références multiples, consulter la section des applications du catalogue. / **Nota importante:** Dans le cas de références multiples, consulter la section des applications du catalogue. / **Nota importante:** Se pueden usar intercambios competitivos para propósitos de almacenamiento solamente. Cuando se identifican intercambios múltiples, consulte la sección de aplicaciones de este catálogo.

COMPETITIVE & O.E.M. INTERCHANGE LIST
Lista de Intercambios contra Competidores y Equipo Original.
Liste d'interchange de produits compétitifs & d'équipement original (OEM)

EAST MANUFACTURING CORP.... cont'd

O.E.M #	Gabriel	Upgrade	O.E.M #	Gabriel	Upgrade	O.E.M #	Gabriel	Upgrade	O.E.M #	Gabriel	Upgrade
517-05010-07	83214		517-05511-14	83128		517-05808-20	85738		A-20002	85000	89436
517-05022-07	83217		517-05805-20	85000	89436	517-05809-20		89437	A-20126	85323	89436
517-05110-20	85000	89436	517-05806-20	85029		517-05916-14	83124	89407			

ELDORADO NATIONAL

O.E.M #	Gabriel	Upgrade	O.E.M #	Gabriel	Upgrade	O.E.M #	Gabriel	Upgrade	O.E.M #	Gabriel	Upgrade
13208701	85746		13208801	85745							

EUCLID

Euclid	Gabriel	Upgrade	Euclid	Gabriel	Upgrade	Euclid	Gabriel	Upgrade	Euclid	Gabriel	Upgrade
E14009	85933	89454	E83219	83219		E85005	85005	89430	E85313	85313	
E14021	85955		E83221	83221		E85006	85006		E85314	85314	89425
E14022	85955		E83223	83223		E85007	85007	89412	E85318	85318	
E14037	85967		E83225	83225		E85008	85008		E85700	85700	
E14042	85965		E83242	83242		E85010	85010		E85702	85702	
E14043	85966		E83300	83300		E85011	85011		E85703	85703	
E14045	83143		E83301	83301		E85012	85012	89413	E85704	85704	
E14046	83142		E83302	83302		E85013	85013	89414	E85705	85705	
E83200	83200		E83303	83303		E85014	85014		E85706	85706	
E83201	83201		E83304	83304		E85024	85024	89416	E85709	85709	
E83202	83202		E83308	83308	89435	E85026	85026	89417	E85711	85711	
E83203	83203	89436	E83309	83309	89446	E85029	85029		E85712	85712	
E83204	83204		E83310	83221		E85030	85030	89440	E85713	85713	
E83205	83209	89414	E83311	83311		E85300	85300	89419	E87000	85711	
E83206	83206		E83312	83312	89409	E85302	85302	89420	E87001	85734	
E83207	83207	89407	E83314	83314		E85303	85303	89422	E87003	85700	
E83209	83209	89414	E83318	83318		E85304	85304		E87004	85735	
E83213	83213		E83353	83353		E85305	85305		E87006	85736	
E83214	83214		E83400	83400		E85307	85307		E87011	85707	
E83215	83215		E83401	83401		E85308	85308	89422	E87012	85705	
E83216	83216		E85000	85000	89436	E85310	85310	89423	E87013	85706	
E83217	83217		E85001	85001	89410	E85311	85311	89424			
E83218	83122	89406	E85003	85003	89411	E85312	85312				

FLEETRITE

Fleetrite	Gabriel	Upgrade	Fleetrite	Gabriel	Upgrade	Fleetrite	Gabriel	Upgrade	Fleetrite	Gabriel	Upgrade
AMS600101	85003	89411	AMS600129	83317		AMS600163	83101		AMS650113	85012	89413
AMS600102	85005	89430	AMS600130	83204		AMS600164	83613		AMS650114	85006	
AMS600103	85014		AMS600131	83318		AMS600165	83636		AMS650115	85027	89418
AMS600104	85000	89436	AMS600132	83215		AMS600166	85052		AMS650116	85303	89422
AMS600105	83304		AMS600133	83362		AMS600167	83128		AMS650118	83215	
AMS600106	83312	89409	AMS600134	83221		AMS600168	83635		AMS650119	85029	
AMS600107	83309	89446	AMS600136	83353		AMS600169	85051		AMS650120	85010	
AMS600108	83209	89414	AMS600138	83100		AMS600172	85005	89430	AMS650121	89432	
AMS600109	83217		AMS600139	83353		AMS600173	85043		AMS650122	85063	
AMS600110	83303		AMS600142	83209	89414	AMS600174	83125		AMS650123	85054	89438
AMS600111	83301		AMS600145	85040		AMS600175	83120		AMS650124	85053	89442
AMS600112	83456	89447	AMS600146	83105		AMS600202	83009		AMS650128	85031	
AMS600113	83215		AMS600147	83216		AMS650101	85062	89408	AMS650129	85701	
AMS600114	83125		AMS600148	85026	89417	AMS650102	85001	89410	AMS650130	85061	89450
AMS600116	83216		AMS600149	83217		AMS650103	85320	89429	AMS650139	85918	89449
AMS600117	83308	89435	AMS600150	85009		AMS650104	65104		AMS650400	85033	89427
AMS600118	83219		AMS600151	85024	89416	AMS650105	85026	89417	AMS650401	85013	89414
AMS600119	83314		AMS600152	83242		AMS650106	65106		AMS650402	85311	89424
AMS600120	G63605		AMS600153	85003	89411	AMS650107	85316	89426	AMS650404	85310	89423
AMS600123	G63183		AMS600154	83104		AMS650108	85030	89432	AMS650405	85023	89415
AMS600125	83123	89405	AMS600155	83103		AMS650109	85058	89431			
AMS600126	83400		AMS600156	83103		AMS650110	85005	89430			
AMS600127	83161		AMS600157	83221		AMS650111	85006				
AMS600128	83401		AMS600162	83103		AMS650112	89402				

Important Note: Competitive Interchanges are to be used for stocking purposes only. Where multiple crosses are identified, please reference the applications section of this catalog. / **Remarque importante:** Les interchanges concurrentiels ne s'utilisent qu'aux fins de stocks. Dans le cas de références multiples, consulter la section des applications du catalogue. / **Nota importante:** Dans le cas de referencias multiples, consultar la sección de aplicaciones del catálogo. / **Nota importante:** Se pueden usar intercambios competitivos para propósitos de almacenamiento solamente. Cuando se identifican intercambios múltiples, consulte la sección de aplicaciones de este catálogo.

COMPETITIVE & O.E.M. INTERCHANGE LIST
Lista de Intercambios contra Competidores y Equipo Original.
Liste d'interchange de produits compétitifs & d'équipement original (OEM)

FLEETRITE... cont'd

Fleetrite	Gabriel	Upgrade	Fleetrite	Gabriel	Upgrade	Fleetrite	Gabriel	Upgrade	Fleetrite	Gabriel	Upgrade
AMS650406	85024	89416	AMS650471	85302	89420	AMS660154	83104		AMS660233	83023	
AMS650407	85736		AMS650472	85330		AMS660155	83103		AMS660234	83013	
AMS650408	85319	89428	AMS650473	85329		AMS660157	85030	89440	AMS660236	83025	
AMS650409	85003	89411	AMS650474	85712		AMS660160	83114		AMS660237	83005	
AMS650410	85300	89419	AMS650475	85065		AMS660161	G63610		AMS660238	83101	
AMS650411	85036	89405	AMS650478	85030	89440	AMS660162	83103		AMS660244	83125	
AMS650412	83122	89406	AMS650479	83122	89406	AMS660164	83613		AMS660247	83116	
AMS650413	65413		AMS650480	83109		AMS660165	83636		AMS660247	83118	
AMS650414	65414		AMS650480	83111		AMS660166	85052		AMS660248	83117	
AMS650415	85046	89434	AMS650481	83123	89405	AMS660167	83128		AMS660502	646155	
AMS650416	85323	89436	AMS650482	85006		AMS660168	83635		AMS660504	632147	
AMS650417	85322		AMS650486	85066	89448	AMS660169	85051		AMS700101	85308	89422
AMS650418	85906	89407	AMS65107	85316	89426	AMS660170	83016		AMS700102	85303	89422
AMS650419	85000	89436	AMS65109	85058	89431	AMS660171	83017		AMS700103	85302	89420
AMS650420	85013	89414	AMS65144	85957		AMS660172	83126	89430	AMS700104	85304	
AMS650421	85916		AMS65146	85925		AMS660173	85043		AMS700105	85314	89425
AMS650422	85912		AMS65158	85954		AMS660174	83125		AMS700106	85301	
AMS650423	85907		AMS660102	85005	89430	AMS660175	83120		AMS700107	85307	
AMS650424	85905		AMS660103	85014		AMS660176	83018		AMS700108	85315	
AMS650425	89441		AMS660104	85000	89436	AMS660177	83019		AMS700111	85320	89429
AMS650426	85054	89438	AMS660105	83304		AMS660179	83162		AMS700112	85722	
AMS650427	85903		AMS660106	83312	89409	AMS660182	83004		AMS700113	85736	
AMS650428	85321		AMS660107	83309	89446	AMS660183	85012	89413	AMS700114	85701	
AMS650429	85030	89440	AMS660108	83209	89414	AMS660187	85071		AMS700115	85712	
AMS650430	85712		AMS660109	83217		AMS660188	85045		AMS700116	83136	
AMS650431	85909		AMS660110	83303		AMS660189	83136		AMS700117	85324	
AMS650432	85910		AMS660111	83301		AMS660190	83107		AMS700119	85336	
AMS650433	85910		AMS660112	83456	89447	AMS660191	83216		AMS700120	85332	
AMS650434	85012	89413	AMS660113	83215		AMS660192	85001	89410	AMS700121	83136	
AMS650435	85901		AMS660114	85006		AMS660193	83001		AMS700401	85700	
AMS650436	85900		AMS660116	83216		AMS660194	83207	89407	AMS700402	85310	89423
AMS650439	85718		AMS660117	83308	89435	AMS660195	83130		AMS700403	85702	
AMS650440	85711		AMS660118	85012	89413	AMS660196	G63610		AMS700404	85311	89424
AMS650441	85704		AMS660119	83314		AMS660197	G63866		AMS700405	85300	89419
AMS650442	85700		AMS660120	G63605		AMS660198	83007		AMS700406	85711	
AMS650443	85706		AMS660123	G63183		AMS660200	83008		AMS700407	85712	
AMS650444	85311	89424	AMS660125	83123	89405	AMS660201	83308	89435	AMS700408	85704	
AMS650445	85731		AMS660126	83400		AMS660202	83009		AMS700409	85701	
AMS650446	85730		AMS660127	83161		AMS660203	83112		AMS700410	85314	89425
AMS650447	85703		AMS660128	83401		AMS660204	83010		AMS700411	85703	
AMS650448	85700		AMS660129	83317		AMS660205	83003		AMS700413	85705	89447
AMS650449	85702		AMS660130	83204		AMS660208	G63616		AMS700414	85723	
AMS650451	85029		AMS660131	83318		AMS660209	83014		AMS700415	85318	
AMS650452	85733		AMS660132	83215		AMS660211	83110		AMS700416	85709	
AMS650453	85904		AMS660133	83362		AMS660212	83015		AMS700418	85003	89411
AMS650454	85713		AMS660134	83221		AMS660213	85009		AMS700419	85708	
AMS650455	85716		AMS660136	83353		AMS660214	83002		AMS700420	85733	
AMS650456	85376		AMS660138	83100		AMS660215	85059		AMS700421	85712	
AMS650458	85908		AMS660142	83209	89414	AMS660216	83123	89405	AMS700422	85308	89422
AMS650459	85043		AMS660145	85040		AMS660218	83137		AMS700423	85724	89443
AMS650462	85913		AMS660146	83105		AMS660219	83215		AMS700424	85333	
AMS650463	85040		AMS660147	83216		AMS660220	83109		AMS74421	85708	
AMS650464	85716		AMS660148	85026	89417	AMS660223	85055	89439	AMS85722	83400	
AMS650465	85914		AMS660149	85042		AMS660224	83111		AMS85736	G63394	
AMS650466	85047	89435	AMS660150	G63616		AMS660225	83200		AMS85768	83209	89414
AMS650468	85069	89455	AMS660153	85003	89411	AMS660232	83114		AMS85802	83216	

Important Note: Competitive Interchanges are to be used for stocking purposes only. Where multiple crosses are identified, please reference the applications section of this catalog. / **Remarque importante:** Les interchanges concurrentiels ne s'utilisent qu'aux fins de stocks. Dans le cas de références multiples, consulter la section des applications du catalogue. / **Nota importante:** Dans le cas de références multiples, consulter la section des applications du catalogue. / **Nota importante:** Se pueden usar intercambios competitivos para propósitos de almacenamiento solamente. Cuando se identifican intercambios múltiples, consulte la sección de aplicaciones de este catálogo.

COMPETITIVE & O.E.M. INTERCHANGE LIST

Lista de Intercambios contra Competidores y Equipo Original.

Liste d'interchange de produits compétitifs & d'équipement original (OEM)

FLEETRITE... cont'd

Fleetrite	Gabriel	Upgrade	Fleetrite	Gabriel	Upgrade	Fleetrite	Gabriel	Upgrade	Fleetrite	Gabriel	Upgrade
AMS85803	G63306		AMS85895	83207	89407	AMS85904	G63299		AMS85932	G63398	
AMS85821	G63406		AMS85900	G63386		AMS85905	G63405		AMS85960	G63366	
AMS85853	G63183		AMS85901	G63387		AMS85909	G63398				

FLEETWOOD RV

O.E.M #	Gabriel	Upgrade	O.E.M #	Gabriel	Upgrade	O.E.M #	Gabriel	Upgrade	O.E.M #	Gabriel	Upgrade
141700131809	85029		16-16736-000	85029		16-16873-000	85029		16-18103-000	85900	
141700131810	83160		16-16737-000	83160		16-16874-000	83160		481700000493	85900	

FLUIDRIVE

O.E.M #	Gabriel	Upgrade	O.E.M #	Gabriel	Upgrade	O.E.M #	Gabriel	Upgrade	O.E.M #	Gabriel	Upgrade
2697	85712										

FLXIBLE BUS

O.E.M #	Gabriel	Upgrade	O.E.M #	Gabriel	Upgrade	O.E.M #	Gabriel	Upgrade	O.E.M #	Gabriel	Upgrade
015813	85708		6-05-6	85736		87-2519-00003	85703		97-2210-00011	85704	
06-0367-00151	85700		6-05-7	85736		87-2519-00004	85731		97-2210-00153	85701	
06-0367-00156	85702		6-05-8	85736		87-2520-00001	85704		97-2210-00156	85702	
06-0367-00157	85701		6-05-9	85304		87-2520-00002	85730		97-2210-00157	85708	
22012067	85700		6-367-1	85711		87-2520-00003	85704		97-2210-00160	85705	89447
22012114	85700		6-367-11	85711		87-2520-00004	85730		97-2210-00162	85701	
22024061	85704		6-367-12	85700		97-2201-00001	85703		97-2210-00164	85708	
22024062	85701		6-367-14	85700		97-2201-00002	85703		97-2210-00170	85733	
22024506	85703		6-367-16	85700		97-2201-00003	85703		97-9999-00732	85707	
22025066	85703		6-367-17	85700		97-2201-00004	85703		97-9999-00807	85307	
22025067	85704		6-367-2	85736		97-2201-00005	85703		97-9999-02514	85700	
22025305	85704		6-367-3	85304		97-2201-00006	85703		97-9999-02515	85702	
3166657	85700		6-367-4	83217		97-2201-00007	85703		97-9999-02516	85701	
3192333	85700		6-367-6	85711		97-2201-00008	85731		97-9999-02519	85707	
48-1-239	85736		6-367-7	85305		97-2201-00009	85703		97-9999-02592	85710	
48-1-241	85712		6-367-8	85700		97-2201-00151	85700		97-9999-02595	85313	
4975518	85704		6-367-9	85711		97-2210-00001	85704		97-9999-02632	85711	
6-05-1	85736		680029	85301		97-2210-00002	85704		97-9999-02633	85311	89424
6-05-10	85734		680155	85712		97-2210-00003	85704		97-9999-02634	85733	
6-05-13	85304		680320	85703		97-2210-00004	85704		97-9999-02635	85718	
6-05-2	85736		695125	85704		97-2210-00005	85704		97-9999-02636	85716	
6-05-3	85736		74412	85704		97-2210-00006	85704				
6-05-4	85736		87-2519-00001	85703		97-2210-00009	85704				
6-05-5	85307		87-2519-00002	85731		97-2210-00010	85730				

FLYER INDUSTRIES

O.E.M #	Gabriel	Upgrade	O.E.M #	Gabriel	Upgrade	O.E.M #	Gabriel	Upgrade	O.E.M #	Gabriel	Upgrade
009863	85722		22012067	85700		3192333	85700		592-6568	85700	
015915	85711		22012114	85700		4975501	85700		5979574	85700	
15813	85708		3166657	85700		4975552	85711				

FORD

O.E.M #	Gabriel	Upgrade	O.E.M #	Gabriel	Upgrade	O.E.M #	Gabriel	Upgrade	O.E.M #	Gabriel	Upgrade
0017LA-18080-G	83161		3584117C2	83135		3U2Z-18125-EA	G63524		4U2Z-18V124-AA	G63678	
1C34-18045-AA	83209		3584118C2	85928		3U2Z-18125-RA	G63623		501906C92	83317	
1C34-18045-JA	83209		3U2Z-18124-BAA	G63809		471700011530	85181		57241-2	83109	
1C44-18080-AA	83123	89405	3U2Z-18124-BV	G63614		471700011531	85180		57365-111	85006	89401
2C4Z-18124-BA	83175		3U2Z-18124-BW	G63614		47902-13	83122	89406	5C3Z-18124-JA	G63969	
2C7Z-18125-AA	G63837		3U2Z-18124-EA	G63772		47902-28	85013	89414	5C3Z-18125-CF	77969	
2C7Z-18125-CA	G63607		3U2Z-18124-FA	G63608		47902-8	83122	89406	5C3Z-18125-DA	77968	
3553628C1	85927		3U2Z-18124-FAA	G63809		4C4Z-18124-HB	83135		5U2Z-18V124-AA	G63714	
3553628C2	85927		3U2Z-18124-JAA	G63614		4C4Z-18124-P	83135		5U2Z-18V124-AHA	G63622	
3578858C1	85926		3U2Z-18124-YAA	G63809		4C4Z-18124-PA	83175		5U2Z-18V124-AU	G63772	
3578858C2	85926		3U2Z-18125-AD	69575		4C4Z-18124-RA	85928		5U2Z-18V124-BA	G63716	
3584116C1	83175		3U2Z-18125-CA	G63607		4C4Z-18125-B	83317		5U2Z-18V124-CAA	G63809	
3584116C2	83175		3U2Z-18125-DA	G63525		4C4Z-18125-DA	85926		5U2Z-18V124-DB	G63455	

Important Note: Competitive Interchanges are to be used for stocking purposes only. Where multiple crosses are identified, please reference the applications section of this catalog. / **Remarque importante:** Les interchanges concurrentiels ne s'utilisent qu'aux fins de stocks. Dans le cas de références multiples, consulter la section des applications du catalogue. / **Nota importante:** Dans le cas de références multiples, consulter la section des applications du catalogue. / **Nota importante:** Se pueden usar intercambios competitivos para propósitos de almacenamiento solamente. Cuando se identifican intercambios múltiples, consulte la sección de aplicaciones de este catálogo.

COMPETITIVE & O.E.M. INTERCHANGE LIST
Lista de Intercambios contra Competidores y Equipo Original.
Liste d'interchange de produits compétitifs & d'équipement original (OEM)

FORD... cont'd

O.E.M #	Gabriel	Upgrade	O.E.M #	Gabriel	Upgrade	O.E.M #	Gabriel	Upgrade	O.E.M #	Gabriel	Upgrade
5U2Z-18V124-GA	G63809		AT-696	83140		C4PF-18045-H	83216		D2HF-18045-AA	83314	
5U2Z-18V124-LA	G63929		AT-766	83209		C4TZ-18124-AA	83308		D2HF-18045-BA	83309	89446
5U2Z-18V125-AE	G63808		AT-811	83135		C4TZ-18124-AB	83308		D2HF-18045-CA	83308	
5U2Z-18V125-AF	G63810		AX-267A	83309	89446	C4TZ-18124-B	83308		D2HF-18045-DA	83312	89409
5U2Z-18V125-BDA	G63623		AX-310	83215		C5TZ-18124-A	83308		D2HF-18124-AA	83314	
5U2Z-18V125-BGA	G63778		B3Q-18124-A	83219		C6PF-18077-A	G63306		D2HT-18045-CA	83314	
5U2Z-18V125-BS	G63607		B3Q-18125-A	83217		C6PF-18077-AC	83161		D2HT-18045-EA	83312	89409
5U2Z-18V125-BT	G63525		B3TZ-18125-A	83217		C6PF-18077-DD	83216		D2HT-18045-GA	83308	
5U2Z-18V125-BU	G63524		B6TZ-18124-A	83219		C6PF-18077-DE	83219		D2HT-18080-HA	83225	
5U2Z-18V125-F	G63676		B6TZ-18125-B	83161		C6PF-18077-DL	83312	89409	D2HZ-18080-A	83209	89414
5U2Z-18V125-G	G63837		B6TZ-18125-C	83161		C6PF-18077-DN	83314		D2HZ-18125-A	83209	89414
5U2Z-18V125-H	G63406		B6TZ-18125-E	83161		C6PF-18077-F	83225		D2HZ-18125-B	83209	89414
60670-008	83123	89405	B7C-18125-A	83217		C6TA-18045-U	85301		D2KF-18045-AA	83312	89409
680029	85301		B7T-18124-C	83225		C6TA-18045-V	85301		D2KF-18124-AA	83312	89409
6C2Z-18124-B	G63929		B7TZ-18124-B	83216		C6TA-18045-Y	85301		D2TA-18045-AAA	83219	
6ETZ-18124-AA	83145		B7TZ-18124-C	83216		C6TA-18045-Z	85301		D2TA-18045-ZA	83219	
6ETZ-18125-A	83146		B7TZ-18124-D	83219		C6TS-18080-A	83217		D2TF-18045-AA	83312	89409
6U2Z-18V125-B	G63607		B7TZ-18124-E	83217		C6TZ-18124-D	85301		D2TF-18045-FA	83312	89409
6U2Z18V125A	G63837		B7TZ-18125-C	83217		C6TZ-18124-E	85301		D2TF-18045-GA	83308	
70127	85006	89401	B8Q-18125-A	85307		C6TZ-18124-H	85301		D2TF-18080-HA	83225	
70128	85006	89401	B8QZ-18124-A	83312	89409	C6TZ-18124-J	85301		D2TF-18080-NA	83217	
7C34-18045-HB	G63969		B8TZ-18124-A	83219		C7HZ-18124-A	83312	89409	D2TF-18124-F	83309	89446
7C34-18080-DCB	77968		B9TT-18045-C	83219		C7PF-18077-A	83225		D2TZ-18124-A	83308	
7W7Z-18125-B	69574		B9TT-18045-D	83219		C7PF-18077-Z	83217		D2TZ-18124-E	83312	89409
87HU-18045-AA	85301		B9TT-18080-B	83161		C7TA-18045-R	83216		D2TZ-18124-F	83309	89446
90044769	83207	89407	B9TZ-18125-B	83161		C7TA-18045-Z	85301		D2TZ-18124-G	83314	
90044770	83207	89407	C0TT-18045-A	83219		C8HA-18045-A	83312	89409	D2TZ-18124-H	83308	
90045068		89441	C0TT-18045-D	83216		C8PF-18045-CM	83216		D2TZ-18124-J	83312	89409
90045099	85906	89407	C0TZ-18124-A	83216		C8PF-18045-S	83161		D3TA-18045-BA	83219	
90045132	85909		C1TT-18045-C	83312	89409	C8PF-18045-T	83161		D3TZ-18124-B	83219	
9U94-18045-AA	83209		C1TT-18045-D	G63406		C8TA-18045-AA	G63386		D3TZ-18125-C	83217	
9U94-18080-AA	83122		C1TT-18045-E	83314		C8TA-18080-Y	83161		D3TZ-18125-D	83217	
9U9Z-18124-A	83209		C1TT-18045-G	83216		C8TA-18080-Z	83161		D4HA-18080-A	83209	89414
9U9Z-18125-A	83122		C1TT-18080-B	83217		C8TZ-18125-D	83161		D4HA-18080-AA	83209	89414
AA-494	83131		C1TZ-18045-C	83312	89409	D0HA-18045-D	83309	89446	D4TF-18045-AA	83312	89409
AA-615	83135		C1TZ-18124-A	83217		D0HA-18045-E	83312	89409	D4TZ-18124-J	83308	
AA-616	83175		C1TZ-18124-B	83216		D0HZ-18124-A	83309	89446	D5TZ-18124-B	83308	
AA-617	85928		C1TZ-18124-C	83312	89409	D0HZ-18124-B	83312	89409	D5TZ-18124-C	83312	89409
ASH-1022	83209		C1TZ-18124-D	83309	89446	D0HZ-18124-C	83314		D7HA-18080-AA	83123	89405
ASH-1023	83122		C1TZ-18124-E	83312	89409	D1TF-18045-LA	83312	89409	D7HF-18045-FA	83312	89409
ASH-1205	83209		C1TZ-18124-F	83312	89409	D1TZ-18124-D	83308		D7HF-18080-AA	83215	
ASH-1206	83122		C1TZ-18124-N	83314		D1TZ-18124-E	83216		D7HF-18125-AA	83215	
ASH-1228	83209		C1TZ-18124-P	83312	89409	D1TZ-18124-F	83312	89409	D7HT-18045-BA	83312	89409
ASH-1230	83122		C1TZ-18125-B	83217		D1TZ-18125-E	83217		D7HT-18045-CA	83314	
ASH-137	83122		C1VT-18080-B	83217		D2EF-18045-AA	83312	89409	D7HT-18045-DA	83309	89446
ASH-23486	G63461		C2TA-18045-A	83216		D2EF-18124-AA	83312	89409	D7HT-18045-EA	83312	89409
ASH-24446	83215		C2TA-18045-B	83308		D2HA-18045-E1A	85304		D7HT-18045-GA	83308	
ASH-24659	85181		C2TZ-18124-A	83308		D2HA-18045-E1B	85304		D7HT-18045-HA	85012	89413
ASH-24660	85180		C3TA-18045-A	83216		D2HA-18045-E2A	85304		D7HT-18045-JA	83308	
ASH-247	G63461		C3TZ-18124-A	83308		D2HA-18045-E2B	85304		D7HT-18045-NA	85301	
ASH-294	83209		C4HZ-18124-A	83312	89409	D2HA-18045-EB	85301		D7HT-18080-AA	83215	
ASH-397	83131		C4HZ-18124-B	83309	89446	D2HA-18045-F1A	85301		D7HT-18080-BA	83225	
AT-610	G63461		C4HZ-18124-C	83314		D2HA-18045-F1B	85301		D7HT-18080-CA	83225	
AT-611	G63461		C4HZ-18124-D	83312	89409	D2HA-18045-F2A	85301		D7HT-18080-DA	83215	
AT-620	83209		C4HZ-18124-E	83309	89446	D2HA-18045-F2B	85301		D7HT-18124-BA	83312	89409
AT-621	83122		C4HZ-18124-F	83308		D2HF-18045-A	83314		D7HT-18124-CA	83314	

Important Note: Competitive Interchanges are to be used for stocking purposes only. Where multiple crosses are identified, please reference the applications section of this catalog. / **Remarque importante:** Les interchanges concurrentiels ne s'utilisent qu'aux fins de stocks. Dans le cas de références multiples, consulter la section des applications du catalogue. / **Nota importante:** Dans le cas de références multiples, consulter la section des applications du catalogue. / **Nota importante:** Se pueden usar intercambios competitivos para propósitos de almacenamiento solamente. Cuando se identifican intercambios múltiples, consulte la sección de aplicaciones de este catálogo.

COMPETITIVE & O.E.M. INTERCHANGE LIST
Lista de Intercambios contra Competidores y Equipo Original.
Liste d'interchange de produits compétitifs & d'équipement original (OEM)

FORD... cont'd

O.E.M #	Gabriel	Upgrade	O.E.M #	Gabriel	Upgrade	O.E.M #	Gabriel	Upgrade	O.E.M #	Gabriel	Upgrade
D7HT-18124-DA	83309	89446	F0HT-18045-CA	85006	89401	F5HZ-18124-AA	83314		F7TA-18080-BA	G63607	
D7HT-18124-EA	83312	89409	F0HT-18080-AA	83122	89406	F5HZ-18124-B	83107		F81A-18080-DCA	G63461	
D7HT-18124-FA	83312	89409	F0HZ-18124-A	85006	89401	F5HZ-18124-C	85063		F81A-18080-ZC	83140	
D7HT-18124-GA	83308		F0HZ-18124-B	85006		F5HZ-18124-D	83125		F81Z-18124-AL	G63622	
D7HT-18124-HA	83219		F0HZ-18125-A	83122	89406	F5HZ-18124-DA	83125		F81Z-18124-BK	G63809	
D7HT-18124-JA	83308		F1HT-18045-AA	83309	89446	F5HZ-18125-A	85314	89425	F81Z-18124-PA	85928	
D7HT-18124-KA	85301		F1HT-18045-CA	83308		F5HZ-18125-AA	85314	89425	F81Z-18125-DC	G63461	
D7HT-18125-BA	83217		F1HT-18045-CB	83216		F5HZ-18125-B	85001	89410	F81Z-18125-ZA	83140	
D7HT-18125-CA	83217		F1HT-18045-DA	83312	89409	F5HZ-18125-BA	85001	89410	F87Z-18125-CA	G63773	
D7HT-18125-DA	83215		F1HT-18045-DB	83308		F5HZ-18125-DA	85314	89425	F87Z-18125-RA	G63775	
D7HT-18125-FA	83123	89405	F1HT-18045-EA		89402	F5TZ-18124-B	G63608		FC44-18045-BB	85181	
D7HZ-18125-A	83215		F1HT-18045-EB		89402	F5TZ-18125-BC	G63607		FC44-18080-AB	85180	
D7KF-18045-EA	83312	89409	F1HT-18045-GA	85006	89401	F5UZ-18124-A	G63622		FC4Z-18124-B	85181	
D7TA-18124-GA	83314		F1HT-18045-GB		89403	F5UZ-18124-B	G63622		FC4Z-18124-HB	83135	
D7TZ-18125-C	83217		F1HT-18045-HB	85006	89401	F5UZ-18125-A	G63623		FC4Z-18125-A	85180	
D8HZ-18124-A	85301		F1HT-18045-KB	85006	89401	F5UZ-18125-C	G63624		LA-18080	83161	
D8HZ-18125-A	83209	89414	F1HT-18045-LB	85006	89401	F6HT-18045-AA	85054	89438	LA-18080-A	83161	
D8HZ-18125-B	83123	89405	F1HT-18045-LB	85006	89401	F6HT-18045-AC	85054	89438	LA-18080-B	83161	
E0HT-18045-AA	83309	89446	F1HT-18045-NA	85040		F6HT-18045-BC	85047	89435	LA-18080-C	83161	
E0HT-18045-AB	83309	89446	F1HT-18045-RA		89402	F6HT-18045-CC	85055	89439	LA-18080-F	83161	
E0HT-18080-AA	83215		F1HT-18045-RA		89441	F6HT-18045-CC	85055	89439	LA-18080-F	83161	
E0HT-18080-AA	83215		F1HT-18045-RB		89402	F6HT-18045-EB	85055	89439	LA-18080-J	83161	
E0HZ-18124-A	83309	89446	F1HZ-18124-A	83309	89446	F6HT-18045-EB	85055	89439	TAAH-18080-A	83161	
E1TA-18045-AA	83309	89446	F1HZ-18124-AA	83309	89446	F6HT-18045-EC	85055	89439	TAAH-18080-A2	83161	
E1TD-18045-AA	83309	89446	F1HZ-18124-AA	83309	89446	F6HT-18045-EC	85055	89439	TAAH-18080-A2	83161	
E1TD-18045-AA	83309	89446	F1HZ-18124-B	83308		F6HT-18045-GB	85030	89440	TAAH-18080-A3	83161	
E5HT-18045-AA	85301		F1HZ-18124-B	83308		F6HT-18045-GC	85030	89440	TAAH-18080-A3	83161	
E5HT-18045-DA	85301		F1HZ-18124-C		89402	F6HT-18045-HB	85054	89438	TAAG-18080-A	83161	
E5HT-18045-EA	85301		F1HZ-18124-C	85006	89401	F6HT-18045-HB	85054	89438	TAAG-18080-A	83161	
E5HT-18045-EA	85301		F1HZ-18124-D	85006	89401	F6HT-18045-HC	85054	89438	TAAG-18080-A1	83161	
E5HT-18080-DA	85315		F1HZ-18124-E	85006	89401	F6HT-18045-HC	85054	89438	TAAG-18080-A1	83161	
E5HT-18080-DA	85315		F1HZ-18124-F	85006	89401	F6HT-18045-JB	83200	89402	TAAG-18080-A2	83161	
E5HT-18080-EA	85315		F1HZ-18124-F	85006	89401	F6HT-18045-JC	83200	89402	TACAA-18045-A	83216	
E6HT-18080-AA	83215		F1HZ-18124-G	85006	89401	F6HT-18045-JC	83200	89402	TANNA-18045-A	83312	89409
E6HZ-18124-A	85301		F1HZ-18124-H	85040		F6HT-18045-KA	83200	89402	TANNA-18045-A	83312	89409
E6HZ-18124-D	85301		F1HZ-18124-H	85040		F6HT-18045-LA	85376		TBAK-18080-A	83161	
E6HZ-18125-D	83215		F1HZ-18124-J	83308		F6HT-18045-LA	85376		TBAK-18080-A	83161	
E6HZ-18125-E	85315		F1HZ-18124-K		89402	F6HT-18045-MA	85006	89401	TBDA-18080-A	83217	
E6HZ-18125-F	85315		F1HZ-18124-K		89402	F6HT-18045-MA	85006	89401	TBDA-18080-A	83217	
E7HZ-18124-A	85301		F2HT-18045-BA	85376		F6HT-18080-B	83109		TBDA-18080-B	83217	
E7XZ-18124-A	G63386		F2HT-18045-BA	85376		F6HT-18080-CA	85314	89425	TDAA-18080-A	83161	
E7XZ-18124-B	G63500		F2HT-18045-CA	85376		F6HT-18080-CA	85314	89425	TDAA-18080-A	83161	
E7XZ-18124-C	G63511		F2HT-18045-CA	85376		F6HT-18080-DA	83109		TDAA-18080-B	83217	
E7XZ-18124-D	G63396		F2HT-18045-DA	85006	89401	F6HT-18080-DA	83109		TDAA-18080-B	83217	
E7XZ-18124-E	G63398		F2HT-18080-DA	85712		F6HT-18080-EA	85906	89407	TDBA-18045-A	83219	
E7XZ-18124-F	G63398		F2HZ-18124-A	85376		F6HT-18080-FC	85013	89414	TDBA-18045-B	83219	
E7XZ-18124-G	G63398		F2HZ-18124-A	85376		F6HT-18080-FC	85013	89414	TDBA-18045-B	83219	
E7XZ-18125-A	G63350		F2HZ-18124-B	85301		F6HT-18080-JA	85305		TDBA-18080-A	83217	
E7XZ-18125-B	G63387		F2HZ-18124-B	85301		F6HT-18080-JA	85305		TDBA-18080-B	83217	
E7XZ-18125-C	G63409		F2HZ-18124-C	85006	89401	F6HZ-18080-FC	85013	89414	TDBA-18080-B	83217	
E7XZ-18125-D	G63406		F2HZ-18124-C	85006	89401	F6HZ-18124-A	85054	89438	TDBA-18080-C	83217	
E7XZ-18125-E	G63406		F2HZ-18124-C	85006	89401	F6HZ-18124-A	85054	89438	TDBA-18080-C	83217	
E7XZ-18125-G	G63811		F2HZ-18125-A	85712		F6HZ-18124-B	83308		TDBE-18045-A	83219	
E7XZ-18125-J	G63299		F2HZ-18125-A	85712		F6HZ-18124-B	83308		TDBE-18045-A	83219	
E9HS-18045-AA	83309	89446	F4HT-18045-AB	83314		F6HZ-18124-C	85055	89439	TFAA-18045-B	83219	
E9HS-18080-AA	85716		F4HT-18045-AB	83314		F6HZ-18124-C	85055	89439	TFAA-18045-B	83219	
E9HZ-18124-A	83309	89446	F4HT-18045-AC	83314		F6HZ-18124-D	85055	89439	TFAA-18045-C	83219	
E9HZ-18125-A	85716		F4HT-18045-AC	83314		F6HZ-18124-D	85055	89439	TFAA-18045-C	83219	
E9HZ-18125-AA	85716		F4HT-18045-CB	83107		F6HZ-18124-E	85055	89439	TFAA-18080-A	85307	
F0HS-18045-AA	85006	89401	F4HT-18045-CB	83107		F6HZ-18124-E	85055	89439	THAB-18045-A	83219	
F0HT-18045-AA	85006	89401	F4HT-18045-DA	85063		F6HZ-18124-F	85055	89439	THAB-18045-A	83219	
			F4HT-18045-DA	85063		F6HZ-18124-F	85055	89439	THAB-18045-B	83219	
			F4HT-18045-EA	83125		F6HZ-18124-G	85054	89438	THAB-18045-B	83219	
			F4HT-18080-AA	85314	89425	F6HZ-18124-G	85054	89438	TQSH-18045-A	83309	89446
			F4HT-18080-AA	85314	89425	F6HZ-18124-H	85054	89438	TQSH-18045-A	83309	89446
			F4HT-18080-AB	85314	89425	F6HZ-18124-H	85054	89438	TQSH-18045-A	83309	89446
			F4HT-18080-AB	85314	89425	F6HZ-18124-H	85054	89438	TQSH-18045-A	83309	89446
			F4HT-18080-BA	85001	89410	F6HZ-18124-J	83200	89402	XC35-18045-AB	83131	
			F4HT-18080-BA	85001	89410	F6HZ-18124-J	83200	89402	XC35-18045-AB	83131	
			F4TA-18045-TA	G63455		F6HZ-18124-KA	83200	89402	XC35-18045-AD	83131	
			F4TA-18045-TA	G63455		F6HZ-18124-KA	83200	89402	XC35-18045-AD	83131	
			F4TA-18080-PA	G63461		F6HZ-18124-MA	85006	89401	XC35-18045-JA	83131	
			F4TA-18080-PA	G63461		F6HZ-18124-MA	85006	89401	XC35-18045-JA	83131	
			F4TZ-18124-D	G63414		F6HZ-18125-A	85314	89425	XC3Z-18124-JA	83131	
			F4TZ-18124-D	G63414		F6HZ-18125-A	85314	89425	XC3Z-18124-JA	83131	
			F4TZ-18124-K	G63455		F6HZ-18125-B	83109		XC45-18045-AA	83216	
			F4TZ-18124-K	G63455		F6HZ-18125-B	83109		XC45-18045-AA	83216	
			F4TZ-18125-E	G63461		F6HZ-18125-C		89441	XL2Z-18124-EA	G63678	
			F4TZ-18125-E	G63461		F6HZ-18125-C		89441	XL2Z-18124-EA	G63678	
			F4TZ-18125-L	G63406		F6HZ-18125-D	85013	89414	XL2Z-18125-BA	G63679	
			F4TZ-18125-L	G63406		F6HZ-18125-D	85013	89414	XL2Z-18125-BA	G63679	
			F57Z-18125-BB	G63679		F6HZ-18125-JA	85305		XL2Z-18125-CA	G63679	
			F57Z-18125-BB	G63679		F6HZ-18125-JA	85305		XL2Z-18125-CA	G63679	
			F5HZ-18124-A	83314		F7C2Z-18124-BR	G63929		XL2Z-18125-EA	G63679	
			F5HZ-18124-A	83314		F7C2Z-18124-BR	G63929		XL2Z-18125-EA	G63679	
						F7TA-18045-AA	G63608		YL5Z-18124-AA	G63772	
						F7TA-18045-AA	G63608		YL5Z-18124-AA	G63772	

Important Note: Competitive Interchanges are to be used for stocking purposes only. Where multiple crosses are identified, please reference the applications section of this catalog. / **Remarque importante:** Les interchanges concurrentiels ne s'utilisent qu'aux fins de stocks. Dans le cas de références multiples, consulter la section des applications du catalogue. / **Nota importante:** Dans le cas de referencias multiples, consultar la seccion de aplicaciones del catalogo. / **Nota importante:** Se pueden usar intercambios competitivos para propósitos de almacenamiento solamente. Cuando se identifican intercambios múltiples, consulte la sección de aplicaciones de este catálogo.

COMPETITIVE & O.E.M. INTERCHANGE LIST

Lista de Intercambios contra Competidores y Equipo Original.

Liste d'interchange de produits compétitifs & d'équipement original (OEM)

FORD CAB SHOCKS

O.E.M #	Gabriel	Upgrade	O.E.M #	Gabriel	Upgrade	O.E.M #	Gabriel	Upgrade	O.E.M #	Gabriel	Upgrade
1201-0012	83023		1202-0012	83023		1202-0042	83025		F6HZ-5K407-AB	83034	
1201-1043	83025		1202-0022	83046		1202-1043	83025		F6HZ-5K407-BA	83033	
1201-1044	83025		1202-0032	83016		1202-1044	83025		F8HT-5K407-AA	83033	

FOREST RIVER INC

O.E.M #	Gabriel	Upgrade	O.E.M #	Gabriel	Upgrade	O.E.M #	Gabriel	Upgrade	O.E.M #	Gabriel	Upgrade
141700131809	85029		16-16736-000	85029		16-16873-000	85029		16-18103-000	85900	
141700131810	83160		16-16737-000	83160		16-16874-000	83160		481700000493	85900	

FREIGHTLINER

O.E.M #	Gabriel	Upgrade	O.E.M #	Gabriel	Upgrade	O.E.M #	Gabriel	Upgrade	O.E.M #	Gabriel	Upgrade
10-12030-002	85320	89429	16-14667-000	85005	89430	471700002993	85921		671908	85918	89449
10-12032-000	85320	89429	16-14668-000	83127		471700002994	83134		671945	85920	
10-12032-001	85320	89429	16-14669-000	G63403		471700002995	83134		671946	85921	
10-12032-002	85320	89429	16-14759-000	85000	89436	471700002996	85335		680008	85300	89419
10-12032-003	85320	89429	16-15591-000	85043		471700003009	85006		680009	85302	89420
10-12032-004	85320	89429	16-15765-000	85921		471700003920	85958		680017	85302	89420
10-12046-000	85320	89429	16-15770-000	85956		471700006269	85932	89453	6803230200	85043	
10-12388-000	85920		16-15817-000	85724	89443	471700006929	85123		6803230300	85006	
10-12390-000	85920		16-16442-000	83134		471700131155	85918	89449	6803260000	83120	
10-12542-000	85901		16-16486-000	83134		471700131331	85932	89453	680339	85724	89443
10-12594-000	85984		16-16577-000	85335		471700131646	85918	89449	680442	85319	89428
10-12703-000	85918	89449	16-16765-000	85006		47902-13	83122	89406	680511	85331	
10-13021-000	85918	89449	16-17759-000	85919		481700125969	85956		680611	85724	89443
10-13051-001	85005	89430	16-18094-000	85959		535228	85302	89420	680651	85335	
10-13063-000	85918	89449	16-18705-000	85007	89412	58913-003	85932	89453	680782	85302	89420
10-13205-000	85918	89449	16-18706-000	85331		58913-012	85932	89453	681-323-0900	85009	
10-13211-000	85918	89449	16-18707-000	85921		60680-004	83143		681-323-1100	85301	
10-13592-000	85959		16-18708-000	85724	89443	60680-005	83142		681-326-0400	85319	89428
10-13634-000	85918	89449	16-18709-000	83134		61300224	85918	89449	6813230900	85009	
10-13684-000	85918	89449	16-18710-000	83134		61300240	85918	89449	6813260000	83634	
10-13759-000	85006		16-18711-000	85335		650224	83225		6813260200	85011	
10-13760-000	85959		16-19138-000	85058	89431	651352	85042		70029	85308	89422
10-13776-000	85005	89430	3638112	G63183		654654	85043		70042	85302	89420
10-13809-000	85958		4036892	G63605		654875	83117		90044162	83128	89436
10-13859-000	85005	89430	471700000440	85959		654918	83118		90045083	85910	
10-13934-000	85123		471700000449	85918	89449	659060	85920		GBL 651356	83634	
16-10688-000	85042		471700000470	85918	89449	659062	83134		GBL654725	83120	
16-11133-000	85007	89412	471700002391	85959		659063	83134		GBL665538	85006	
16-12117-000	85007	89412	471700002808	85724	89443	659300	85005	89430	SDA471400003920	85958	
16-13947-000	85319	89428	471700002809	85724	89443	660235	85042		SDA471700000440	85959	
16-13957-000	85724	89443	471700002990	85007	89412	665174	85060		SDA471700002809	85724	89443
16-14259-000	85331		471700002991	85959		665236	85007	89412	SDA471700002991	85959	
16-14577-000	85043		471700002992	85331		665409	85009		SDA481700125969	85956	

FREIGHTLINER CAB SHOCKS

O.E.M #	Gabriel	Upgrade	O.E.M #	Gabriel	Upgrade	O.E.M #	Gabriel	Upgrade	O.E.M #	Gabriel	Upgrade
1201-0012	83023		1202-1044	83025		18-42613-000	83033		18-60767-000	83039	
1201-0054	83021		18-29846-000	83009		18-43504-000	83057		18-60768-000	83057	
1201-1043	83025		18-29846-001	83064		18-44321-000	83009		18-60769-000	83009	
1201-1044	83025		18-30378	83006		18-45067-000	83034		18-60772-000	83026	
1202-0012	83023		18-30378-000	83001		18-47349-000	83039		18-60773-000	83027	
1202-0022	83046		18-31476-000	83020		18-47350-000	83040		654739	83009	
1202-0032	83016		18-32999-000	83001		18-60295-000	83006		654819	83001	
1202-0042	83025		18-32999-001	83006		18-60764-000	83038		654831	83006	
1202-0043	83032		18-37813-000	83044		18-60765-000	83038		654841	83020	
1202-0044	83025		18-41762-000	83038		18-60765-001	83047		654990	83038	
1202-0054	83021		18-41762-001	83047		18-60765-002	83038		659079	83040	
1202-1043	83025		18-41762-002	83038		18-60766-000	83040		659080	83039	

Important Note: Competitive Interchanges are to be used for stocking purposes only. Where multiple crosses are identified, please reference the applications section of this catalog. / **Remarque importante:** Les interchanges concurrentiels ne s'utilisent qu'aux fins de stocks. Dans le cas de références multiples, consulter la section des applications du catalogue. / **Nota importante:** Dans le cas de références multiples, consulter la section des applications du catalogue. / **Nota importante:** Se pueden usar intercambios competitivos para propósitos de almacenamiento solamente. Cuando se identifican intercambios múltiples, consulte la sección de aplicaciones de este catálogo.

COMPETITIVE & O.E.M. INTERCHANGE LIST
Lista de Intercambios contra Competidores y Equipo Original.
Liste d'interchange de produits compétitifs & d'équipement original (OEM)

FREIGHTLINER CAB SHOCKS... cont'd

O.E.M #	Gabriel	Upgrade	O.E.M #	Gabriel	Upgrade	O.E.M #	Gabriel	Upgrade	O.E.M #	Gabriel	Upgrade
659125	83047		681-891-02-05	83017		814903003484	83057		814903003528	83038	
659178	83038		814903003482	83040		814903003486	83047		GBL 650361	83017	
659288	83006		814903003483	83039		814903003496	83009				

FREIGHTLINER CUSTOM CHASSIS

O.E.M #	Gabriel	Upgrade	O.E.M #	Gabriel	Upgrade	O.E.M #	Gabriel	Upgrade	O.E.M #	Gabriel	Upgrade
10-13358-000	85097		16-15805-000	83120		16-18094-000	85959		654918	83118	
10-13634-000	85918	89449	16-15817-000	85724	89443	16-18095-000	85092		654953	85058	89431
10-13759-000	85006		16-15934-000	83120		16-18103-000	85900		659104	85904	
10-13859-000	85005	89430	16-16043-000	85043		16-18455-000	85918	89449	659227	85058	89431
1398980	83127		16-16082-000	85043		16-18708-000	85724	89443	665545401		89430
141700000377	83174		16-16083-000	85331		16-18713-000	85122		6803230300	85006	
141700000378	83160		16-16093-000	83160		16-19138-000	85058	89431	6803260000	83120	
141700131809	85029		16-16262-000	83120		1745500		89430	GBL 651375	83119	
141700131810	83160		16-16542-000	83154		471700000447	85919		GBL 654870	83116	
141700131975	83160		16-16736-000	85029		471700000466	85959		GBL654725	83120	
16-14794-000	83154		16-16737-000	83160		471700000467	85092		GBL654875	83117	
16-15089-000	83164		16-16765-000	85006		471700002726	85918	89449	GBL654918	83118	
16-15394-000	83120		16-16836-000	83154		471700003009	85006		GBL665538	85006	
16-15436-000	83154		16-16873-000	85029		471700003011	85058	89431	MAE 16949	83120	
16-15473-000	83157		16-16874-000	83160		471700003070	85122		MAE 16950	83118	
16-15474-000	83157		16-17144-000	85900		471700005079	85005	89430	MAE16950	83118	
16-15475-000	83164		16-17361-000	85900		471700131775	85006		P116168	83117	
16-15592-000	83154		16-17684-000	85058	89431	471700131974	85029		P117099	83120	
16-15676-000	85058	89431	16-17759-000	85919		481700000477	85900		P117146	83118	
16-15705-000	83120		16-18075-000	83174		481700000493	85900		P117253	83116	
16-15755-000	85043		16-18076-000	83160		481700131919	85900		RW24285	83119	

FRUEHAUF

O.E.M #	Gabriel	Upgrade	O.E.M #	Gabriel	Upgrade	O.E.M #	Gabriel	Upgrade	O.E.M #	Gabriel	Upgrade
144-5910	85300	89419	UCA-01113	85304		UCE-1295-901	85300	89419	UCF-8339-001	85321	
5116-117	83122	89406	UCA-5431	85305		UCE-2983-000	85322		UCF-8339-002	85321	
5352858	85305		UCD-006216-001	83203	89436	UCE-2983-001	85322		UEY 1124-001	85030	89440
680117	85300	89419	UCD-6216-1	83203	89436	UCE-2983-1	85322				
680298	85321		UCE-1295-1	85300	89419	UCE-9399-1	83122	89406			

FWD TRUCK

O.E.M #	Gabriel	Upgrade	O.E.M #	Gabriel	Upgrade	O.E.M #	Gabriel	Upgrade	O.E.M #	Gabriel	Upgrade
450739	85302	89420									

GENERAL TRAILER CO

O.E.M #	Gabriel	Upgrade	O.E.M #	Gabriel	Upgrade	O.E.M #	Gabriel	Upgrade	O.E.M #	Gabriel	Upgrade
120-1	83125		12608	83125							

GILLIG BROS.

O.E.M #	Gabriel	Upgrade	O.E.M #	Gabriel	Upgrade	O.E.M #	Gabriel	Upgrade	O.E.M #	Gabriel	Upgrade
1583470	85051		57113	83219		82-21542-000	85716		90044683	83122	89406
200-171	85304		57131	83216		82-30159-000	85708		90044769	83207	89407
53-02132	85723		665568	85051		90-1908	85723		90044770	83207	89407
53-02133-000	85318		680009	85302	89420	90-1951-SP1	85734		90045084	85968	
53-13952-000	85722		680333	85708		90-1968	85712		90F-1912	85318	
53-14005-000	85723		695109	85723		90-2164 SP1	85723		H53-02132-14005	85723	
53-14010	85318		695110	85318		90-2423	85723		H53-20415-006	85051	
53-176	85304		70034	85302	89420	90-2627		89461	MR6394	85723	
53-24685	85723		82-01878	83122	89406	90044046	83123	89405			

GMC TRUCK

O.E.M #	Gabriel	Upgrade	O.E.M #	Gabriel	Upgrade	O.E.M #	Gabriel	Upgrade	O.E.M #	Gabriel	Upgrade
1-51630-168-1	83515		12474917	83137		15174903	85342		15740554	83137	
1-51630-217-0	83114		15123676	83136		15185643	83153				
1-51630-217-1	83114		15174898	83136		15185644	83155				
1-51630-219-1	83114		15174901	85342		15588554	83136				
12474915	83122	89406	15174902	85071		15642943	83136				

Important Note: Competitive Interchanges are to be used for stocking purposes only. Where multiple crosses are identified, please reference the applications section of this catalog. / **Remarque importante:** Les interchanges concurrentiels ne s'utilisent qu'aux fins de stocks. Dans le cas de références multiples, consulter la section des applications du catalogue. / **Nota importante:** Dans le cas de références multiples, consulter la section des applications du catalogue. / **Nota importante:** Se pueden usar intercambios competitivos para propósitos de almacenamiento solamente. Cuando se identifican intercambios múltiples, consulte la sección de aplicaciones de este catálogo.

COMPETITIVE & O.E.M. INTERCHANGE LIST
Lista de Intercambios contra Competidores y Equipo Original.
Liste d'interchange de produits compétitifs & d'équipement original (OEM)

GMC TRUCK... cont'd

O.E.M #	Gabriel	Upgrade	O.E.M #	Gabriel	Upgrade	O.E.M #	Gabriel	Upgrade	O.E.M #	Gabriel	Upgrade
15887728	83136		22064807	83136		4964853	83217		5513716	85304	
1591501	85722		22065218	G63347		4974401	85700		5516459	85305	
15963161	83122	89406	22065251	85030	89440	4975429	85300	89419	5522781	85735	
19152843	83136		22099889	85336		4975467	83207	89407	5522794	85308	89422
21998392	85336		2212169	83221		4975472	83161		5522818	85305	
22002293	83126	89430	22165187	83136		4975479	83400		5527001	85300	89419
22002294	83304		22165188	83136		4975480	83400		5527271	85700	
22002295	83303		22165189	83136		4975494	83207	89407	5527272	85700	
22007701	83126	89430	22166442	83136		4975497	83126	89430	5527606	85305	
22007702	83304		3082284	83400		4975501	85700		5531027	85301	
22007703	83303		3166657	85700		4975510	83221		5531435	85307	
22007750	83207	89407	3171068	83216		4975511	83303		5531436	85307	
22007751	83303		3171069	85304		4975515	85701		5531437	85307	
22007752	83304		3171462	83126	89430	4975516	85702		5532026	85304	
22007753	83303		3171696	85307		4975518	85704		5532425	83207	89407
22007757	83304		3172948	85303	89422	4975538	85700		5532433	83207	89407
22012065	85304		3175509	85735		4975549	83216		5532675	85307	
22012067	85700		3178106	85700		4975550	85702		5533699	85302	89420
22012079	85701		3178157	85700		4975552	85711		5534430	85303	89422
22012082	85702		3178233	85734		4984526	83216		5534439	85304	
22012083	85711		3178507	85700		507-12	85701		5534447	85303	89422
22012083GS	85711		3178995	85700		507-16	85702		5544060	85302	89420
22012090	85308	89422	3182842	85711		507-19	85700		5544112	83216	
22012091	85303	89422	3188599	85711		507-22	85342		5544581	85302	89420
22012095	83126	89430	3188626	85300	89419	507-23	85342		5544716	85304	
22012096	83221		3188729	85303	89422	507-24	85336		5544717	85304	
22012114	85700		3189265	85700		508-88	83153		5544812	83308	
22012131	85711		3192333	85700		508-89	83155		5544818	85735	
22012166	83126	89430	3192416	85711		5171068	83216		5549899	83207	89407
22012169	83221		3192657	83216		5304059	85700		5549924	85700	
22012196	83221		3192890	83126	89430	5316784	85700		5549925	85304	
22017530	83303		3192891	83221		5316791	83219		5552111	85304	
22017531	83303		3192892	83221		5316792	85305		5552112	85307	
22024061	85704		35901-0001	83209	89414	5316793	85305		5552114	83216	
22024062	85701		35901-0003	85301		5316794	85700		5552205	83217	
22024673	85710		35901-0004	83219		5316984	85313		5552206	83214	
22025067	85704		35901-0005	83219		5321920	85307		5552207	83217	
22025305	85704		35901-0017	83314		5321929	85307		5552208	83217	
22045526	85702		37301-0016	85026	89417	5348631	83203	89436	5552209	83215	
22046481	85702		37301-0021	85026	89417	5352857	85700		5552210	85308	89422
22046483	85304		37301-3202	85026	89417	5352858	85305		5552244	85308	89422
22046485	85710		4939852	85308	89422	5353054	85303	89422	5552285	83214	
22046489	85303	89422	4939967	85308	89422	5355798	85307		5552286	83217	
22046499	85710		4940600	83209	89414	5357955	85300	89419	5552287	83217	
22052014	85702		4940601	83216		5357956	85734		5552288	83217	
22052336	85304		4940606	83126	89430	5357959	85300	89419	5552451	85308	89422
22052424	85710		4940614	83216		5361994	85734		5552452	85303	89422
22064230	83136		4940627	83203	89436	5374779	85308	89422	5552453	85301	
22064231	85324		4940640	83216		5374999	85307		5552454	85302	89420
22064232	85071		4940650	83207	89407	5385939	85307		5552456	85307	
22064233	83136		4940654	83216		5392387	85303	89422	5552527	85735	
22064432	85050		4940660	83207	89407	5394448	85305		5554184	85302	89420
22064489	85336		4940662	83126	89430	5394467	85305		5554589	85307	
22064804	83136		4963844	85307		5394468	85735		5554596	85303	89422
22064805	83136		4963853	83216		5455798	85307		5554814	85302	89420
22064806	83136		4963854	83216		5513489	83216		5554959	83401	

Important Note: Competitive Interchanges are to be used for stocking purposes only. Where multiple crosses are identified, please reference the applications section of this catalog. / **Remarque importante:** Les interchanges concurrentiels ne s'utilisent qu'aux fins de stocks. Dans le cas de références multiples, consulter la section des applications du catalogue. / **Nota importante:** Dans le cas de références multiples, consulter la section des applications du catalogue. / **Nota importante:** Se pueden usar intercambios competitivos para propósitos de almacenamiento solamente. Cuando se identifican intercambios múltiples, consulte la sección de aplicaciones de este catálogo.

COMPETITIVE & O.E.M. INTERCHANGE LIST
Lista de Intercambios contra Competidores y Equipo Original.
Liste d'interchange de produits compétitifs & d'équipement original (OEM)

GMC TRUCK... cont'd

O.E.M #	Gabriel	Upgrade	O.E.M #	Gabriel	Upgrade	O.E.M #	Gabriel	Upgrade	O.E.M #	Gabriel	Upgrade
5554995	85305		88963409	85336		9-51630-666-2	85012	89413	97253616	83515	
5559363	83203	89436	88982682	83136		90044769	83207	89407	97253620	83515	
5585939	85307		88982684	83136		90044770	83207	89407	97253621	83515	
684280	83209	89414	88982685	85342		94033786	83114		97253623	83515	
8-51630-666-0	85012	89413	88982686	85071		94051090	83114		97253651	83404	
8-94057-593-0	83114		88982687	85342		94057593	83114		97253664	83159	
8-94454-986-0	83515		88982688	85336		94454987	83515		97253665	83159	
8-94454-987-0	83515		898098-0580	83159		97-2210-00153	85701		98098058	83159	
8-97083-029-0	83515		898098-0581	83159		97-2210-00156	85702		98098059	83159	
8-97201-960-0	83515		898098-0590	83159		97-2210-00164	85708		98098125	83515	
8-97253-620-0	83515		898098-1250	83515		97-2210-00170	85733		98098127	83515	
8-97253664-0	83159		898098-1270	83515		97083027	83515		98232671	83515	
8-97253665-0	83159		9-51630-647-1	83515		97083029	83515		L-12706	83155	
87-2520-00003	85704		9-51630-666-0	85012	89413	97201960	83515		U0109-014	83400	

GMC TRUCK CAB SHOCKS

O.E.M #	Gabriel	Upgrade	O.E.M #	Gabriel	Upgrade	O.E.M #	Gabriel	Upgrade	O.E.M #	Gabriel	Upgrade
1201-1043	83025		1202-0022	83046		1202-0054	83021				
1202-0012	83023		1202-0032	83016		1202-1043	83025				

GRANNING SUSPENSION

O.E.M #	Gabriel	Upgrade	O.E.M #	Gabriel	Upgrade	O.E.M #	Gabriel	Upgrade	O.E.M #	Gabriel	Upgrade
1085	83214		680162	85300	89419	OE12425	83214				
2697	85712		701071-01	646155							

GREAT DANE TRAILER

O.E.M #	Gabriel	Upgrade	O.E.M #	Gabriel	Upgrade	O.E.M #	Gabriel	Upgrade	O.E.M #	Gabriel	Upgrade
18163-01	83207	89407	HENS-20002	85000	89436	HENS-23649	85064		REY18165-01	85006	
18164-01	83122	89406	HENS-20126	85323	89436	HENS-24088	83128	89436			
18165-01	85006		HENS-21292	85052		HENS-24088	85000	89436			
HENS-20001	83128	89436	HENS-23566	85000	89436	MER202447	85919				

GREYHOUND BUS

O.E.M #	Gabriel	Upgrade	O.E.M #	Gabriel	Upgrade	O.E.M #	Gabriel	Upgrade	O.E.M #	Gabriel	Upgrade
12B-5-1	85735		3166657	85700		3178157	85700		690029	85700	
12TA-01-013	85303	89422	3178154	85735		3192333	85700		74413	85313	

GRUMMAN BUS

O.E.M #	Gabriel	Upgrade	O.E.M #	Gabriel	Upgrade	O.E.M #	Gabriel	Upgrade	O.E.M #	Gabriel	Upgrade
22024506	85703		690029	85700		97-2201-00004	85703		97-2210-00003	85704	
22025066	85703		97-2201-00001	85703		97-2201-00005	85703		97-2210-00004	85704	
22025067	85704		97-2201-00002	85703		97-2210-00001	85704		97-2210-00005	85704	
22025305	85704		97-2201-00003	85703		97-2210-00002	85704				

GULF STREAM COACH

O.E.M #	Gabriel	Upgrade	O.E.M #	Gabriel	Upgrade	O.E.M #	Gabriel	Upgrade	O.E.M #	Gabriel	Upgrade
141700131809	85029		16-16736-000	85029		16-16873-000	85029		16-18103-000	85900	
141700131810	83160		16-16737-000	83160		16-16874-000	83160		481700000493	85900	

HARDEE MFG

O.E.M #	Gabriel	Upgrade	O.E.M #	Gabriel	Upgrade	O.E.M #	Gabriel	Upgrade	O.E.M #	Gabriel	Upgrade
8030223	83207	89407	AS789B	85014							

HAUSMAN

O.E.M #	Gabriel	Upgrade	O.E.M #	Gabriel	Upgrade	O.E.M #	Gabriel	Upgrade	O.E.M #	Gabriel	Upgrade
695110	85318		695119	85702		695198	85706				

HENDRICKSON TRAILER SUSPENSION SYSTEMS

O.E.M #	Gabriel	Upgrade	O.E.M #	Gabriel	Upgrade	O.E.M #	Gabriel	Upgrade	O.E.M #	Gabriel	Upgrade
57905-2	85006		665267	85029		665536	85000	89436	665758	85064	
60675-004	85006		665405	85030	89440	665693	85064		665759	85052	
654951	85000	89436	665406	85010		665694	85052		665760	85045	
659024	85052		665531	85000	89436	665698	85911		665761	85911	
665190	85006		665532	85013	89414	665733	85045		665763	85079	
665246	85043		665533	85005	89430	665756	85000	89436	665764	85029	

Important Note: Competitive Interchanges are to be used for stocking purposes only. Where multiple crosses are identified, please reference the applications section of this catalog. / **Remarque importante:** Les interchanges concurrentiels ne s'utilisent qu'aux fins de stocks. Dans le cas de références multiples, consulter la section des applications du catalogue. / **Nota importante:** Dans le cas de références multiples, consulter la section des applications du catalogue. / **Nota importante:** Se pueden usar intercambios competitivos para propósitos de almacenamiento solamente. Cuando se identifican intercambios múltiples, consulte la sección de aplicaciones de este catálogo.

COMPETITIVE & O.E.M. INTERCHANGE LIST
Lista de Intercambios contra Competidores y Equipo Original.
Liste d'interchange de produits compétitifs & d'équipement original (OEM)

HENDRICKSON TRAILER SUSPENSION SYSTEMS... cont'd

O.E.M #	Gabriel	Upgrade	O.E.M #	Gabriel	Upgrade	O.E.M #	Gabriel	Upgrade	O.E.M #	Gabriel	Upgrade
665765	83150		A-2160	85014		B-24023	85738		S-22312	85939	
665766	85000	89436	A-2212	85029		B-24088	83128	89436	S-2232	85005	89430
665767	85045		A-2213	85010		B-24088	85000	89436	S-22345	85911	
671779		89414	A-2218	85030	89440	B-24125	85323	89436	S-2240	85013	89414
671948	85000	89436	A-2230	85005	89430	B-24579	85939		S-22715	85000	89436
680102	85712		A-2232	85005	89430	B-25174	85029		S-22862	85045	
680341	85323	89436	A-2240	85013	89414	B-25436	85916	89430	S-23013	85000	89436
680463		89440	A-2240-1	85043		B-25437	85337		S-23014	85738	
680467	85323	89436	A-2471	85006		B-25515	85338		S-23290	83150	
680509	85738		A-4084	85005	89430	B-26652	85000	89436	S-23315	85029	
680565	85738		A-4089	83209	89414	B-27058	83128		S-23316	85382	
680566	85938		A-4890	85712		B-27747	85911		S-23361	85911	
680568	85323	89436	A-6156	85301		B-29432	85323	89436	S-23362		89437
680570		89437	B-20345	85345		B-29678	85911		S-23548	85079	
680571	85738		B-21553	85738		B-29826	85338		S-23566	85000	89436
680573	85939		B-21699	87018		B-33312	85338		S-23649	85064	
680579	85939		B-21832	85323	89436	B-33313	85338		S-23650	85052	
680614	85338		B-21936	85064		NS500699	85005	89430	S-23651	85045	
680616		89430	B-21947	85052		S-10348	85043		S-23743	85938	
680617	85337		B-21994	85938		S-14583	85000	89436	S-23744	85344	
680702	85323	89436	B-21995	85344		S-1667	85000	89436	S-24023	85738	
680756	85323	89436	B-22311	85045		S-1668	85000	89436	S-24088	83128	89436
680769	85911		B-22312	85939		S-20001	83128	89436	S-24088	85000	89436
680776	85338		B-22345	85911		S-20002	85000	89436	S-24125	85323	89436
98583-019	85323	89436	B-22715	85000	89436	S-20126	85323	89436	S-24579	85939	
98583-020		89414	B-22862	85045		S-20345	85345		S-2471	85006	
A-10023	85000	89436	B-23013	85000	89436	S-20886	85030	89440	S-25436	85916	89430
A-10348	85043		B-23014	85738		S-20887	85005	89430	S-25437	85337	
A-11931	85000	89436	B-23290	83150		S-20889	85323	89436	S-25515	85338	
A-14496	646155		B-23315	85029		S-21292	85052		S-26652	85000	89436
A-14583	85000	89436	B-23316	85382		S-21553	85738		S-29432	85323	89436
A-1667	85000	89436	B-23361	85911		S-2160	85014		S-29678	85911	
A-1668	85000	89436	B-23362		89437	S-21699	87018		S-29826	85338	
A-20001	83128	89436	B-23548	85079		S-21832	85323	89436	S-33312	85338	
A-20002	85000	89436	B-23566	85000		S-21936	85064		S-33313	85338	
A-20126	85323	89436	B-23566	85000	89436	S-21947	85052		S-33313L	85338	
A-20345	85345		B-23649	85064		S-2212	85029		S-4084	85005	89430
A-20886	85030	89440	B-23650	85052		S-2213	85010		S-4089	83209	89414
A-20887	85005	89430	B-23651	85045		S-2218	85030	89440	S-4890	85712	
A-20889	85323	89436	B-23743	85938		S-2230	85005	89430			
A-21292	85052		B-23744	85344		S-22311	85045				

HENDRICKSON TRUCK SUSPENSION SYSTEMS

O.E.M #	Gabriel	Upgrade	O.E.M #	Gabriel	Upgrade	O.E.M #	Gabriel	Upgrade	O.E.M #	Gabriel	Upgrade
12738	83225		47902-26	83144		57324-1	85036	89405	58913-009L	85959	
471700000456	85959		47902-27	83123	89405	57324-11	85305		58913-011	85959	
471700006269	85932	89453	47902-28	85013	89414	57324-2	85976		58913-012	85932	89453
471700131545	85006		47902-29	83149		57324-3	85916		59048-001	83148	
47902-11	83207	89407	47902-3	85005	89430	57324-5	85903		59057-001	83137	
47902-13	83122	89406	47902-8	83122	89406	57324-6	85904		59057-002	85036	89405
47902-15	83137		47902-9	83123	89405	57905-1	85976		59305-1	85979	
47902-18	85030	89440	503610C2	83207	89407	58623-1	85978		59483-000	85919	
47902-19	83123	89405	5554596	85303	89422	58913-003	85932	89453	59851-1	85976	
47902-20	85036	89405	57241-001	83111		58913-007	85959		59852-1	85977	
47902-21	85976		57241-002	83109		58913-007L	85959				
47902-22	85916		57241-003	83112		58913-008	85959				
47902-24	83137		57241-004	83110		58913-008L	85959				
47902-25	83125		57241-006	83111		58913-009	85959				

Important Note: Competitive Interchanges are to be used for stocking purposes only. Where multiple crosses are identified, please reference the applications section of this catalog. / **Remarque importante:** Les interchanges concurrentiels ne s'utilisent qu'aux fins de stocks. Dans le cas de références multiples, consulter la section des applications du catalogue. / **Nota importante:** Dans le cas de références multiples, consulter la section des applications du catalogue. / **Nota importante:** Se pueden usar intercambios competitivos para propósitos de almacenamiento solamente. Cuando se identifican intercambios múltiples, consulte la sección de aplicaciones de este catálogo.

COMPETITIVE & O.E.M. INTERCHANGE LIST
Lista de Intercambios contra Competidores y Equipo Original.
Liste d'interchange de produits compétitifs & d'équipement original (OEM)

HENDRICKSON TRUCK SUSPENSION SYSTEMS... cont'd

O.E.M #	Gabriel	Upgrade	O.E.M #	Gabriel	Upgrade	O.E.M #	Gabriel	Upgrade	O.E.M #	Gabriel	Upgrade
59852-2	85977		60670-009	85013	89414	64838-001L	85933	89454	671006	85036	89405
60657-003	85072		60670-010	83149		64838-002	85933	89454	671007	83137	
60657-005	85087		60670-011	83148		64838-002L	85933	89454	671009	85919	
60657-006	85102		60670-012	83168		64838-003	85933	89454	671030	85083	
60657-007	85072		60670-013	83148		64838-003L	85933	89454	671063	85083	
60657-010	85102		60670-014	83166		654890	83207	89407	671105	85072	
60657-011	85102		60670-017	83148		654891	83149		671603	85919	
60665-003	83137		60670-018	83166		654894	83123	89405	671606	85955	
60665-004	85036	89405	60670-019	83166		654895	83137		671611	85955	
60665-005	85919		60670-020	83148		654896	83147		671704	85904	
60665-008	85978		60670-12	83168		654897	83144		671764	85967	
60665-009	85904		60675-001	85978		654898	83123	89405	671792	85965	
60665-011	85967		60675-002	85979		654899	85013	89414	671793	85966	
60665-013	85965		60675-003	85976		654900	83149		671798	85962	
60665-014	85962		60675-005	85980		654903	83111		672009	85903	
60665-015	85966		60675-006	85909		654904	83109		680091	85303	89422
60665-018	85961		60675-014	85978		654905	83112		680600	85305	
60665-020	85919		60675-8Q	85976		659000	83148		70018	85303	89422
60665-024	85903		60680-001	83111		659004	83123	89405	70021	85303	89422
60665-025	85036		60680-002	83109		659048	83143		70088	85307	
60670-001	83123	89405	60680-003	83112		659049	83142		98583-005	83168	
60670-001	85036	89405	60680-004	83143		659155	83147		98583-006	83148	
60670-002	83207	89407	60680-005	83142		659202	83148		98583-016	83147	
60670-003	83149		60680-009	85083		659292	83148		98583-032	85072	
60670-004	83123	89405	60680-012	85083		65992-001	85955		AE76164-3	85307	
60670-005	83137		60685-001	85977		65992-002	85955		AE76164-4	83225	
60670-006	83147		60998-001	85006		65992-003	85959		BE76164-2	85303	89422
60670-007	83144		60998-002	85919		65992-006	85986		BE76164-3	85307	
60670-008	83123	89405	60998-003	85006		665816	85072		BE76164-4	83225	
60670-008L	83123	89405	64838-001	85933	89454	665892	85072				

HIGHWAY PRODUCT

O.E.M #	Gabriel	Upgrade	O.E.M #	Gabriel	Upgrade	O.E.M #	Gabriel	Upgrade	O.E.M #	Gabriel	Upgrade
A1-6-134	83207	89407	A1-6-135	83203	89436						

HINO

O.E.M #	Gabriel	Upgrade	O.E.M #	Gabriel	Upgrade	O.E.M #	Gabriel	Upgrade	O.E.M #	Gabriel	Upgrade
34802	83216		48511-80162	83518		48530-3280	G63440		S4850-01941	83141	
48500-1800	83216		48530-1120	83104		48530E0100	83166		S4850-01950	G63610	
48500-1801	83216		48530-1460	83215		48531-37361	83519		S4850-02750	G63610	
48500-1940	83141		48530-1620	83104		48531-37362	83519		S4850-03710	83126	89430
48500-1941	83141		48530-1770	83215		60670-012	83168		S4850-03720	83140	
48500-1950	G63610		48530-1880	83362		60670-013	83148		S4853-01900	83104	
48500-2750	G63610		48530-1890	83104		60670-014	83166		S4853-01910	83216	
48500-3710	83126	89430	48530-1900	83104		60670-018	83166		S4853-02510	83216	
48500-3720	83140		48530-1910	83216		60670-019	83166		S4853-03280	G63440	
485003710A	83126	89430	48530-2050	83217		60670-020	83148				
48511-37320	83518		48530-2510	83216		66639	G63610				

HOBBS TRAILERS

O.E.M #	Gabriel	Upgrade	O.E.M #	Gabriel	Upgrade	O.E.M #	Gabriel	Upgrade	O.E.M #	Gabriel	Upgrade
680117	85300	89419									

HOLIDAY RAMBLER

O.E.M #	Gabriel	Upgrade	O.E.M #	Gabriel	Upgrade	O.E.M #	Gabriel	Upgrade	O.E.M #	Gabriel	Upgrade
90044794	83127		U0109-007	G63183							

HOLLAND - BINKLEY

O.E.M #	Gabriel	Upgrade	O.E.M #	Gabriel	Upgrade	O.E.M #	Gabriel	Upgrade	O.E.M #	Gabriel	Upgrade
680298	85321		6898	83125							

Important Note: Competitive Interchanges are to be used for stocking purposes only. Where multiple crosses are identified, please reference the applications section of this catalog. / **Remarque importante:** Les interchanges concurrentiels ne s'utilisent qu'aux fins de stocks. Dans le cas de références multiples, consulter la section des applications du catalogue. / **Nota importante:** Dans le cas de références multiples, consulter la section des applications du catalogue. / **Nota importante:** Se pueden usar intercambios competitivos para propósitos de almacenamiento solamente. Cuando se identifican intercambios múltiples, consulte la sección de aplicaciones de este catálogo.

COMPETITIVE & O.E.M. INTERCHANGE LIST
Lista de Intercambios contra Competidores y Equipo Original.
Liste d'interchange de produits compétitifs & d'équipement original (OEM)

HUTCHENS SUSPENSION

O.E.M #	Gabriel	Upgrade	O.E.M #	Gabriel	Upgrade	O.E.M #	Gabriel	Upgrade	O.E.M #	Gabriel	Upgrade
9423-00	83203	89436									

HYSTER

O.E.M #	Gabriel	Upgrade	O.E.M #	Gabriel	Upgrade	O.E.M #	Gabriel	Upgrade	O.E.M #	Gabriel	Upgrade
650150	83217		73516	83217							

IC CORPORATION

O.E.M #	Gabriel	Upgrade	O.E.M #	Gabriel	Upgrade	O.E.M #	Gabriel	Upgrade	O.E.M #	Gabriel	Upgrade
2200327C1	85332		3601600C3	85082		3902993C3	83135		65992-006	85986	
3533356C3	83169		3604282C1	85351		472412C91	83456	89447	OE13402S	83163	
3578105C1	83163		3605735C1	83156		501906C91	83317		OE13424S	83317	
3578105C2	83163		3605735C2	83156		501906C92	83317				
3578858C2	85926		3902993C2	83135		6127088C1	83163				

INGERSALL MACHINE

O.E.M #	Gabriel	Upgrade	O.E.M #	Gabriel	Upgrade	O.E.M #	Gabriel	Upgrade	O.E.M #	Gabriel	Upgrade
665472	665472		665904	665472							

INGERSOLL AXLES

O.E.M #	Gabriel	Upgrade	O.E.M #	Gabriel	Upgrade	O.E.M #	Gabriel	Upgrade	O.E.M #	Gabriel	Upgrade
653511-01	85323	89436	653511-02	85938		653511-03	85045		653511-04	85052	

INTERNATIONAL (NAVISTAR)

O.E.M #	Gabriel	Upgrade	O.E.M #	Gabriel	Upgrade	O.E.M #	Gabriel	Upgrade	O.E.M #	Gabriel	Upgrade
1660846C91	83101		288920C91	83225		3553628C3	85927		3588591C1	85953	
1660846C92	83101		288921C91	83225		3558089C1	85925		3588591C2	85953	
1663471C1	83103		288921R92	83225		3558089C2	85925		3588592C1	85953	
1663606C91	85027	89418	293009C91	85308	89422	3558089C3	85925		3588592C2	85953	
1664149C1	85029		294334C91	83216		3558989C1	85925		3596107C1	85927	
1664524C1	85935		3000070C91	83456	89447	3558989C2	85925		3596107C2	85927	
1664788C2	85316	89426	3000098C1	83317		3571711C1	85316	89426	3601600C1	85082	
1667520C1	85058	89431	306444C91	85012	89413	3571713C1	85333		3601600C2	85082	
1675455C1	85003	89411	3085640C92	83216		3573265C1	85931	89458	3601600C3	85082	
1675496C91	83636		308646C91	85012	89413	3576464C1	85957		3604282C1	85351	
1675496C92	83636		308648C91	83225		3576464C2	85957		360444C91	85012	89413
1677707C1	85030	89440	308649C91	83216		3576465C2	85999		3605735C1	83156	
1690035C1	85003	89411	308650C91	83216		3578105C1	83163		3605735C2	83156	
2015556C1	85316	89426	308650C92	83216		3578105C2	83163		3606770C1	83163	
2015557C1	85030	89440	308664C91	85307		3578858C1	85926		3606770C2	83163	
2018987C1	85003	89411	308668C91	85012	89413	3578858C2	85926		3606857C1	85954	
2018987C2	85003	89411	308668C92	85012	89413	3581106C1	85924	89457	3606857C2	85954	
2029200C91	83126	89430	308669C91	85012	89413	3581106C2	85924	89457	3606857C3	85994	
2029200C91	85030	89440	320444C91	85012	89413	3581106C3	85924	89457	3606859C1	85954	
2032533C1	85316	89426	329316C92	85012	89413	3581107C1	85924	89457	3606859C2	85954	
2039549C1	85333		350425C1	85300	89419	3581107C2	85924	89457	3606859C3	85994	
2039565C1	83100		350426C1	85734		3581107C3	85924	89457	3609178C1	85955	
204994R91	83225		350426C91	85734		3581109C1	85924	89457	3609400C1	83317	
206620R91	83216		3514952C1	85976		3581109C3	85924	89457	3609400C2	83317	
206621R91	83216		3533356C1	83135		3581109C4	85924	89457	3610198C1	85963	
206621R92	83216		3533356C2	83135		3584116C1	83175		3610199C1	85964	
208664C91	85307		3533356C3	83169		3584116C2	83175		3613984C1	85955	
210533R91	83225		3533357C1	85957		3584117C1	83135		3620395C1	85931	89458
210534R92	83225		3533357C2	85957		3584117C2	83135		3626571C1	85072	
210535R91	83225		3533357C3	85957		3584118C1	85928		3660548C1	85955	
210536R91	83225		3541456C1	85929		3584118C2	85928		3660549C1	85955	
210537R91	83225		3544766C1	85930		3584355C1	85924	89457	3668566C1	85954	
210538R91	83225		3544768C1	85926		3584355C2	85924	89457	3670156C1	85954	
210918R91	83215		3549099C1	85923	89458	3584355C3	85924	89457	3674348C1	85954	
210919R91	85307		3549099C2	85923	89458	3586883C1	85931	89458			
210920R91	85308	89422	3549100C1	85926		3586902C2	83146				
2200327C1	85332		3553628C1	85927		3588209C1	85957				
287318C91	G63306		3553628C2	85927		3588209C2	85957				

Important Note: Competitive Interchanges are to be used for stocking purposes only. Where multiple crosses are identified, please reference the applications section of this catalog. / **Remarque importante:** Les interchanges concurrentiels ne s'utilisent qu'aux fins de stocks. Dans le cas de références multiples, consulter la section des applications du catalogue. / **Nota importante:** Dans le cas de références multiples, consulter la section des applications du catalogue. / **Nota importante:** Se pueden usar intercambios competitivos para propósitos de almacenamiento solamente. Cuando se identifican intercambios múltiples, consulte la sección de aplicaciones de este catálogo.

COMPETITIVE & O.E.M. INTERCHANGE LIST
Lista de Intercambios contra Competidores y Equipo Original.
Liste d'interchange de produits compétitifs & d'équipement original (OEM)

INTERNATIONAL (NAVISTAR)... cont'd

O.E.M #	Gabriel	Upgrade	O.E.M #	Gabriel	Upgrade	O.E.M #	Gabriel	Upgrade	O.E.M #	Gabriel	Upgrade
3688614C1	85923	89458	453528C91	85311	89424	477132C1	85303	89422	65992-002	85955	
3688616C1	85923	89458	453531C91	G63306		47902-24	83137		66400	G63432	
3688729C1	85931	89458	453556C91	85012	89413	4C4Z-18124-N	85957		6E7Z-18125-A	83146	
3688732C1	85931	89458	453557C91	G63306		4C4Z-18125-DA	85926		70334	85316	89426
3737575C1	85954		453561C91	83225		501506C91	83317		790335C91	83209	89414
3737576C1	85931	89458	453562C91	83225		501553C91	85003	89411	800670	85060	
3806341C3	85995		453564C91	85012	89413	501905C91	83301		873619C92	83314	
3810581C3	85995		453565C91	83225		501906C91	83317		873619C93	83314	
3810581C4	85995		453566C91	83225		501906C92	83317		873622C91	83308	
3812837C1	85954		453567C91	83216		503550C1	83207	89407	874695R91	85012	89413
3813340C1	85964		453568C91	83225		503610C1	83207	89407	874695R92	85012	89413
3813340C2	85964		453569C91	83225		503610C2	83207	89407	874696R91	85012	89413
3813340C3	85964		453570C91	83216		507202C1	85030	89440	90044025	83209	89414
3813341C1	85963		453571C91	83216		534464C1	85734		90044626	83126	89430
3813341C2	85963		453572C91	83309	89446	537524C91	83123	89405	AMS 600102	85005	89430
3813341C3	85963		453574C91	85307		537525C91	83123	89405	AMS 600172	83126	89430
3816234C1	85999		453575C91	83308		540395C91	83613		AMS 600172	85030	89440
3819277C1	85969		453576C91	85303	89422	540395C92	83613		AMS 650420	85013	89414
3819279C1	85969		453576C92	85303	89422	548532C1	83103		AMS650102	85001	89410
3821760C1	85931	89458	453577C91	85308	89422	56101 Z1030	85311	89424	AMS650107	85316	89426
383379C91	83308		453579C91	85308	89422	56101 Z2000	85311	89424	AMS650400	85033	89427
384435C91	83216		453597C91	83216		56101 Z5008	83114		AMS650402	85311	89424
3868264C1	85998		462557C91	85300	89419	56101 Z5011	G63610		AMS650404	85310	89423
3892445C3	85931	89458	462603C91	85705	89447	56110-T8123	G63432		AMS650405	85023	89415
3902993C1	83167		462753C91	83216		56110-T8129	G63432		AMS650406	85024	89416
3902993C3	83135		463926C91	85705	89447	586724C91	83456	89447	AMS650408	85319	89428
3945165C1	83180		467371C91	83225		596329C1	85014		AMS650420	85013	89414
4050340C1	85931	89458	467372C91	83225		60657-003	85072		H60657-003	85072	
4050340C2	85931	89458	467980C91	G63306		60657-006	85102		H60657-006	85102	
4050443C1	85994		467983C91	85012	89413	60657-010	85102		H60657-010	85102	
4050443C2	85994		467984C91	83216		60657-011	85102		H60657-011	85102	
4050444C1	85994		467985C91	85012	89413	60670-007	83144		H60675-003	85976	
4050444C2	85994		471201C91	85012	89413	60675-003	85976		OE 18513	83135	
4070336C1	85058	89431	471203C91	83308		60680-003	83112		OE13402S	83163	
426744R91	85303	89422	472367C91	83318		60680-004	83143		OE13424S	83317	
426744R92	85303	89422	472411C91	83456	89447	6127088C1	83163		OE17103	83167	
446-51-211	85739		472412C91	83456	89447	6127713C1	85926				
452566C91	83225		472414C91	83318		6127714C1	85928				
453527C91	85311	89424	474002C91	83308		65992-001	85955				

INTERNATIONAL (NAVISTAR) CAB SHOCKS

O.E.M #	Gabriel	Upgrade	O.E.M #	Gabriel	Upgrade	O.E.M #	Gabriel	Upgrade	O.E.M #	Gabriel	Upgrade
1201-0012	83023		1201-9013	83062		2012769C2	83005		2585145C1	83051	
1201-0154	83051		1201-9014	83062		2023684C1	83015		2589922C1	83051	
1201-0254	83051		1201-9018	83062		2023685C1	83015		2590915C1	83062	
1201-1043	83025		1201-9021	83062		2025790C1	83013		2590916C1	83062	
1201-1044	83025		1202-0012	83023		2500013C1	83013		2593803C91	83062	
1201-1049	83025		1202-0022	83046		2503529C1	83025		2595314C1	83062	
1201-1212	83013		1202-0032	83016		2507409C1	83052		2597458C91	83062	
1201-1213	83005		1202-0042	83025		2507761C1	83052		2600491C91	83062	
1201-9001	83052		1202-0043	83032		2507763C1	83052		2601488C91	83062	
1201-9002	83052		1202-0044	83025		2507948C1	83054		2602021C1	83062	
1201-9003	83052		1202-0054	83021		2508326C1	83021		3557165C1	83053	
1201-9007	83054		1202-1043	83025		2508327C1	83025		3557166C1	83052	
1201-9008	83054		1202-1044	83025		2509221C91	83054				
1201-9009	83054		1202-1212	83013		2509222C91	83053				
1201-9010	83053		1202-1213	83005		2509223C91	83054				
1201-9011	83053		2012768C1	83013		2509224C91	83053				

Important Note: Competitive Interchanges are to be used for stocking purposes only. Where multiple crosses are identified, please reference the applications section of this catalog. / **Remarque importante:** Les interchanges concurrentiels ne s'utilisent qu'aux fins de stocks. Dans le cas de références multiples, consulter la section des applications du catalogue. / **Nota importante:** Dans le cas de références multiples, consulter la section des applications du catalogue. / **Nota importante:** Se pueden usar intercambios competitivos para propósitos de almacenamiento solamente. Cuando se identifican intercambios múltiples, consulte la sección de aplicaciones de este catálogo.

COMPETITIVE & O.E.M. INTERCHANGE LIST

Lista de Intercambios contra Competidores y Equipo Original.

Liste d'interchange de produits compétitifs & d'équipement original (OEM)

INTERNATIONAL (NAVISTAR) CAB SHOCKS... cont'd

O.E.M #	Gabriel	Upgrade	O.E.M #	Gabriel	Upgrade	O.E.M #	Gabriel	Upgrade	O.E.M #	Gabriel	Upgrade
3557167C3	83053		3560649C1	83052		480945C1	83014		AMS66161	83053	
3557169C1	83052		3560649C2	83052		480945C2	83014		OE14771	83062	
3557169C2	83052		3560705C2	83054		AMS66160	83052				

ISUZU

O.E.M #	Gabriel	Upgrade	O.E.M #	Gabriel	Upgrade	O.E.M #	Gabriel	Upgrade	O.E.M #	Gabriel	Upgrade
1-51630-168-1	83515		8-22064-233-0	83136		8-97253-651-2	83404		9-51630-647-1	83515	
1-51630-217-0	83114		8-22064-489-0	85336		8-97253-664-0	83159		9-51630-666-0	85012	89413
1-51630-217-1	83114		8-22064-804-0	83136		8-97253-665-0	83159		9-51630-666-2	85012	89413
1-51630-219-1	83114		8-22064-805-0	83136		8-98098-058-0	83159		94033786	83114	
12474915	83122	89406	8-22064-806-0	83136		8-98098-058-1	83159		94454986	83515	
15123676	83136		8-22064-807-0	83136		8-98098-059-0	83159		94454987	83515	
15174902	85071		8-51630-666-0	85012	89413	8-98098-125-0	83515		97083027	83515	
15887728	83136		8-94454-647-1	83515		8-98098-127-0	83515		97083029	83515	
19152843	83136		8-94454-986-0	83515		8-98098059-0	83159		97253620	83515	
51630168	G63610		8-94454-987-0	83515		88982682	83136		97253651	83404	
51630217	83114		8-97083-027-0	83515		88982686	85071		97253664	83159	
51630219	83114		8-97083-029-0	83515		8972019600	83515		97253665	83159	
51630647	83515		8-97253-616-0	83515		898098-0581	83159		98098058	83159	
51630666	85012	89413	8-97253-620-0	83515		898098-1250	83515		98098059	83159	
60670-005	83137		8-97253-620-1	83515		898098-1270	83515		98098125	83515	
8-22064-231-0	85324		8-97253-621-0	83515		8982326710	83515		98098127	83515	
8-22064-232-0	85071		8-97253-623-0	83515		8982326720	83515				

ITASCA

O.E.M #	Gabriel	Upgrade	O.E.M #	Gabriel	Upgrade	O.E.M #	Gabriel	Upgrade	O.E.M #	Gabriel	Upgrade
141700131809	85029		16-16873-000	85029		24-153256	85124		F4-BE5-F325-HO	85124	
141700131810	83160		16-16874-000	83160		481700000493	85900		W0005662	85125	
16-16736-000	85029		16-18103-000	85900		F4-BE5-A832-MO	85125		W0005663	85124	
16-16737-000	83160		24-153249	85125		F4-BE5-F324-HO	85125		W0006254	85125	

JAY MADSEN

O.E.M #	Gabriel	Upgrade	O.E.M #	Gabriel	Upgrade	O.E.M #	Gabriel	Upgrade	O.E.M #	Gabriel	Upgrade
3166657	85700		3192333	85700							

JIFFLOX

O.E.M #	Gabriel	Upgrade	O.E.M #	Gabriel	Upgrade	O.E.M #	Gabriel	Upgrade	O.E.M #	Gabriel	Upgrade
CP-5222	85315										

JOHN DEERE

O.E.M #	Gabriel	Upgrade	O.E.M #	Gabriel	Upgrade	O.E.M #	Gabriel	Upgrade	O.E.M #	Gabriel	Upgrade
3638112	G63183		4036892	G63605							

KENWORTH

O.E.M #	Gabriel	Upgrade	O.E.M #	Gabriel	Upgrade	O.E.M #	Gabriel	Upgrade	O.E.M #	Gabriel	Upgrade
02-02736PLUS	85302	89420	47902-24	83137		665617	85031		665930	85001	89410
02-02737PLUS	85062	89408	60657-003	85072		665632	85013	89414	665931	83312	89409
02-02738PLUS	85012	89413	60665-011	85967		665633	85033	89427	665932	85012	89413
02-02739PLUS	85013	89414	60665-013	85965		665670	85001	89410	665944	85900	
03-04176PLUS	85308	89422	60665-015	85966		665680	83312	89409	665945	85902	
03-06084PLUS	85033	89427	60670-005	83137		665783	83123	89405	665950	85902	
03-07421PLUS	85311	89424	60670-005PLUS	83137		665784	83122	89406	671052	85070	89459
03-07423PLUS	85033	89427	60670-008	83123	89405	665785	83137		671654	85936	89456
10-12032-002PLUS	85320	89429	60670-008PLUS	83123	89405	665788	85000	89436	671656	85985	
10-12542-000PLUS	85901		60680-004	83143		665788	85067	89451	671699	85937	
16-13947-000PLUS	85319	89428	60680-005	83142		665844	85069	89455	671794	85067	89451
16725-01	83221		665092	83312	89409	665858	85070	89459	671962	85936	89456
19495-01	83126	89440	665118	83312	89409	665903	85900		671962PLUS	85936	89456
2018987C1PLUS	85003	89411	665174	85060		665906	85902		671963	85937	
3166657	85700		665331	83353		665918	85900				
471700004423	85109		665453	85001	89410	665926	85047	89435			
47902-13PLUS	83122	89406	665565	85007	89412	665927	85901				
47902-19	83123	89405	665565PLUS	85007	89412	665928	85062	89408			

Important Note: Competitive Interchanges are to be used for stocking purposes only. Where multiple crosses are identified, please reference the applications section of this catalog. / **Remarque importante:** Les interchanges concurrentiels ne s'utilisent qu'aux fins de stocks. Dans le cas de références multiples, consulter la section des applications du catalogue. / **Nota importante:** Dans le cas de referencias multiples, consultar la sección de aplicaciones del catálogo. / **Nota importante:** Se pueden usar intercambios competitivos para propósitos de almacenamiento solamente. Cuando se identifican intercambios múltiples, consulte la sección de aplicaciones de este catálogo.

COMPETITIVE & O.E.M. INTERCHANGE LIST
Lista de Intercambios contra Competidores y Equipo Original.
Liste d'interchange de produits compétitifs & d'équipement original (OEM)

KENWORTH... cont'd

O.E.M #	Gabriel	Upgrade	O.E.M #	Gabriel	Upgrade	O.E.M #	Gabriel	Upgrade	O.E.M #	Gabriel	Upgrade
675041	83353		90044089	83124	89407	B71-6017	85910		K374-16	85001	89410
675122	85001	89410	90044089PLUS	83124	89407	B71-6018	85012	89413	K374-26	85001	89410
680237	85303	89422	90045068		89441	B71-6019	85989		K374-26PLUS	85001	89410
680239	85310	89423	90045099	85906	89407	B71-6020	85989		K374-27	85001	89410
680240	85302	89420	90045132	85909		C71-1002	85067	89451	K374-28	85314	89425
680241	85311	89424	90045605	85109		C71-1002PLUS	85067	89451	K374-28PLUS	85314	89425
680242	85308	89422	ACHB966	83136		C71-1011	85069	89455	K374-29	85310	89423
680253	85314	89425	B71-1000	85031		C71-1011PLUS	85069	89455	K374-29PLUS	85310	89423
680261	85062	89408	B71-1001	85070	89459	C71-1013	85985		K374-3	83312	89409
680279	83209	89414	B71-1002	85001	89410	C71-1014	85936	89456	K374-3-1	83312	89409
680280	85906	89407	B71-1003	83312	89409	C71-1015	85937		K374-32	85310	89423
680281	85003	89411	B71-6000	85959		C71-1015 PLUS	85937		K374-33	83312	89409
680283	83353		B71-6002	85012	89413	C71-1015A	85937		K374-33PLUS	83312	89409
680303	85007	89412	B71-6003	85029		C71-1016	85067	89451	K374-36		89432
680425	85320	89429	B71-6004	85084	89460	C71-1017	85069	89455	K374-4	85314	89425
680435	85033	89427	B71-6005	85084	89460	C71-6003	85988		K374-5	83312	89409
680473	85319	89428	B71-6006	85084	89460	C71-6004	85343		K374-7	85310	89423
680475	85314	89425	B71-6007	85062	89408	C71-6005	85069	89455	K374-9	85310	89423
680476	85310	89423	B71-6008	83312	89409	C71-6015	85067	89451	K374-C31	83312	89409
680486	85310	89423	B71-6010	85023	89415	K374-10	83362		K374-C7	85310	89423
680586	85311	89424	B71-6011	85062	89408	K374-11	85001	89410	R71-6006	83063	
70701	85900		B71-6012	85119		K374-13	83353		R71-6007	83008	
70701PLUS	85900		B71-6013	85012	89413	K374-13-1	83353		R71-6008	83035	
8086053PLUS	85047	89435	B71-6015	85012	89413	K374-14	83312	89409	S-20126	85323	89436
90044025PLUS	83209	89414	B71-6016	85012	89413	K374-15	83353		TK19679	83126	89440

KENWORTH CAB SHOCKS

O.E.M #	Gabriel	Upgrade	O.E.M #	Gabriel	Upgrade	O.E.M #	Gabriel	Upgrade	O.E.M #	Gabriel	Upgrade
1201-0012	83023		1202-0054	83021		1202K064	83024		R71-6000	83067	
1201-1043	83025		1202-1043	83025		1202K065	83002		R71-6005	83042	
1201-1044	83025		1202-1046	83049		1202K164	83031		R71-6010	83067	
1201-1046	83049		1202-1064	83024		1202K264	83031		T71-1000	83031	
1202-0012	83023		1202-1065	83002		1202K286	83056		T71-1001	83031	
1202-0022	83046		1202-1164	83031		96027-10545	83011		T71-1002	83002	
1202-0032	83016		1202-1264	83031		PP1058870	83059		T71-1003	83056	
1202-0042	83025		1202-1286	83056		PP2582870	83012				
1202-0043	83032		1202-K065	83002		R71-1004	83049				
1202-0044	83025		1202K046	83049		R71-1005	83024				

KIMBLE MIXER CO

O.E.M #	Gabriel	Upgrade	O.E.M #	Gabriel	Upgrade	O.E.M #	Gabriel	Upgrade	O.E.M #	Gabriel	Upgrade
OE10455	646155										

KING OF THE ROAD

O.E.M #	Gabriel	Upgrade	O.E.M #	Gabriel	Upgrade	O.E.M #	Gabriel	Upgrade	O.E.M #	Gabriel	Upgrade
141700131809	85029		16-16736-000	85029		16-16873-000	85029		16-18103-000	85900	
141700131810	83160		16-16737-000	83160		16-16874-000	83160		481700000493	85900	

KONI

Koni	Gabriel	Upgrade	Koni	Gabriel	Upgrade	Koni	Gabriel	Upgrade	Koni	Gabriel	Upgrade
090-2209-SP2	85001	89410	30-1501	G63608		80-2516	G63421		82-2345	G63413	
30-1348	G63424		30-1502	G63679		80-2517	G63422		82-2372	G63609	
30-1350	G63511		30-1565	G63707		80-2633	G63423		82-2384	G63488	
30-1351	G63490		30-1566	G63708		80-2634	G63422		8240-1029	G63386	
30-1365	G63611		30-1606	G63423		82-1952	G63347		8240-1054	G63375	
30-1366	G63610		30-1607	G63422		82-1954	G63355		8240-1055	G63454	
30-1381	G63426		30-1614	G63678		82-1955	G63349		8240-1148	G63720	
30-1421	G63547		30-1624	G63424		82-1969	G63500				
30-1422	G63548		30-1627	G63690		82-1970	G63350				
30-1456	G63782		30-1630	G63425		82-2158	G63357				
30-1457	G63781		30-1630	G63722		82-2246	G63299				

Important Note: Competitive Interchanges are to be used for stocking purposes only. Where multiple crosses are identified, please reference the applications section of this catalog. / **Remarque importante:** Les interchanges concurrentiels ne s'utilisent qu'aux fins de stocks. Dans le cas de références multiples, consulter la section des applications du catalogue. / **Nota importante:** Dans le cas de referencias multiples, consultar la sección de aplicaciones del catálogo. / **Nota importante:** Se pueden usar intercambios competitivos para propósitos de almacenamiento solamente. Cuando se identifican intercambios múltiples, consulte la sección de aplicaciones de este catálogo.

COMPETITIVE & O.E.M. INTERCHANGE LIST

Lista de Intercambios contra Competidores y Equipo Original.

Liste d'interchange de produits compétitifs & d'équipement original (OEM)

KONI... cont'd

Koni	Gabriel	Upgrade	Koni	Gabriel	Upgrade	Koni	Gabriel	Upgrade	Koni	Gabriel	Upgrade
84-1168	83130		88-1641	85029		90-1912	85318		90-2416	86202	
88-1385	83105		88-1642	83124	89407	90-1922	85900		90-2416 SP1	86202	
88-1417	83312	89409	88-1644	85000	89436	90-1943	85307		90-2433	85710	
88-1419	83136		88-1646	83613		90-1951-SP1	85734		90-2434	85702	
88-1422	85030	89440	88-1647	83317		90-1951-SP5	85712		90-2477	85900	
88-1457-SP1	83209	89414	88-5162	83209	89414	90-1965	85304		90-2478	85902	
88-1458-SP1	83122	89406	88-5163	83122	89406	90-1968	85720		90-2497SP1	85712	
88-1458-SP2	83122	89406	8805-1001	85125		90-1974	85311	89424	90-2529	85707	
88-1468	83209	89414	8805-1002	85124		90-2059	85722		90-2530	85707	
88-1476	83353		8805-1003	85126		90-2060	85722		90-2563	85006	
88-1489	85036	89405	8805-1022	85724	89443	90-2102-SP1	85708		90-2572	85329	
88-1490	83124	89407	90-1400	83104		90-2148	85304		90-2573	85329	
88-1499	85001	89410	90-1409-SP1	85722		90-2164-SP1	85723		90-2574	85330	
88-1509	85027	89418	90-1466	85707		90-2209	85308	89422	90-2575	85700	
88-1510	85708		90-1577-SP1	85310	89423	90-2251	85717		90-2576	85700	
88-1517	85040		90-1608	83104		90-2252	85714		90-2586	85728	
88-1518	85040		90-1811	85301		90-2253-SP2	85718		90-2587	85729	
88-1520	85040		90-1813-SP1	85712		90-2254	85720		90-2588	85339	
88-1525	85040		90-1813-SP3	85968		90-2255	85719		90-2589	85727	
88-1532	85708		90-1862	85708		90-2256	85718		90-2610-SP1	87017	
88-1540	85051		90-1867	85053	89442	90-2257	85716		90-2627	89461	
88-1541	85045		90-1868	85307		90-2325	85340		90-5055-SP2	85318	
88-1558	85013	89414	90-1868-SP1	85307		90-2326	85970		90-5180	85300	89419
88-1559-SP1	85036	89405	90-1896	85302	89420	90-2327	85341		9020-1042	85708	
88-1560	85062	89408	90-1897	85303	89422	90-2368	86203		90F-1235	85700	
88-1561	85012	89413	90-1898	83215		90-2368 SP1	86203		91-2368	86203	
88-1562	85003	89411	90-1907-SP1	85300	89419	90-2368 SP2	86203		91-2400	86203	
88-1616	85014		90-1908-SP1	85723		90-2404	86203		91-2527	86202	
88-1639	83130		90-1910	85704		90-2407	85709		92-1227	85722	

KWK-LOC (JIFFLOX)

O.E.M #	Gabriel	Upgrade	O.E.M #	Gabriel	Upgrade	O.E.M #	Gabriel	Upgrade	O.E.M #	Gabriel	Upgrade
CP-5222	85315										

KYB

Kyb	Gabriel	Upgrade	Kyb	Gabriel	Upgrade	Kyb	Gabriel	Upgrade	Kyb	Gabriel	Upgrade
340043	G63909		341631	646155		344049	G63414		344088	G63424	
341302	G63678		341632	83124	89407	344050	G63773		344089	G63425	
341312	G63865		341633	83215		344051	G63420		344090	G63492	
341339	G63918		343030	G63949		344054	G63444		344091	G63511	
341343	G63893		343127	G63900		344055	G63484		344092	G63490	
341374	G63884		343160	G63914		344066	G63359		344093	G63905	
341613	85062	89408	343209	G63903		344067	G63347		344094	G63915	
341614	85001	89410	343210	G63799		344068	G63355		344095	G63499	
341615	83215		343272	G63860		344069	G63500		344096	G63460	
341617	85005	89430	343353	G63880		344072	G63349		344098	G63612	
341618	85918	89449	343379	G63845		344074	G63811		344202	G63479	
341619	83136		343388	G63712		344075	G63413		344263	G63488	
341620	85033	89427	343395	G63842		344076	G63410		344264	G63387	
341621	85311	89424	343395	G64014		344077	G63406		344265	G63489	
341622	85023	89415	343403	G63660		344078	G63683		344266	G63818	
341623	85003	89411	344040	G63421		344079	G63775		344267	G63455	
341624	85036	89405	344041	G63422		344080	G63426		344268	G63614	
341625	85000	89436	344042	G63423		344081	G63375		344269	G63679	
341626	85000	89436	344043	G63813		344082	G63454		344272	G63386	
341627	85006		344044	G63907		344083	G63457				
341628	85724	89443	344045	G63492		344084	G63490				
341629	85938		344046	G63491		344085	G63306				
341630	85052		344047	G63950		344086	G63353				

Important Note: Competitive Interchanges are to be used for stocking purposes only. Where multiple crosses are identified, please reference the applications section of this catalog. / **Remarque importante:** Les interchanges concurrentiels ne s'utilisent qu'aux fins de stocks. Dans le cas de références multiples, consulter la section des applications du catalogue. / **Nota importante:** Dans le cas de références multiples, consulter la section des applications du catalogue. / **Nota importante:** Se pueden usar intercambios competitivos para propósitos de almacenamiento solamente. Cuando se identifican intercambios múltiples, consulte la sección de aplicaciones de este catálogo.

COMPETITIVE & O.E.M. INTERCHANGE LIST
Lista de Intercambios contra Competidores y Equipo Original.
Liste d'interchange de produits compétitifs & d'équipement original (OEM)

KYB... cont'd

Kyb	Gabriel	Upgrade	Kyb	Gabriel	Upgrade	Kyb	Gabriel	Upgrade	Kyb	Gabriel	Upgrade
344273	G63638		344464	G63882		553361	G63689		KG5474	G63479	
344291	G63873		344466	G63879		554347	G63886		KG5475	G63432	
344299	G63710		344481	G63894		KG4159	G63892		KG5476	G63611	
344338	G63776		344496	G64012		KG4160	G64016		KG5477	G63906	
344341	G63847		345005	G63694		KG4613A	G63909		KG5478	G63489	
344342	G63829		345022	G63832		KG4616	G63798		KG5479	G63488	
344353	G63877		345023	G63828		KG5194	G64000		KG5480	G63609	
344356	G63862		345024	G63864		KG5196	G64013		KG5482	G63675	
344359	G63720		345030	83304		KG5198A	G63606		KG5484	G63635	
344364	G63673		345030	G63394		KG5401	G63299		KG5485	G63639	
344365	G63662		345042	G63883		KG5406	G63386		KG5487	G63525	
344366	G63366		345043	G63878		KG5417	G63371		KG5488	G63403	
344367	G63714		345055	G63872		KG5420	G63366		KG5489	G63614	
344368	G63716		345601	83613		KG5421	G63387		KG5491	G63604	
344369	G63624		345602	85052		KG5422	G63183		KG5494	G63620	
344370	G63622		345604	85051		KG5424	G63187		KG5495	G63929	
344371	G63623		345605	85012	89413	KG5426	G63396		KG5496	G63624	
344372	G63661		345606	83136		KG5429	G63398		KG5497	G63622	
344373	G63675		345607	83130		KG54300	G63615		KG5498	G63623	
344374	G63778		345608	85060		KG54301	G63616		KG5499	G63621	
344375	G63715		345609	G63616		KG54302	G63782		KG5534	G63610	
344377	G63717		345611	83120		KG54303	G63781		KG5538	G63484	
344380	G63783		345613	85005	89430	KG54304	G63707		KG5555	G63914	
344381	G63803		345614	83309	89446	KG54305	G63640		KG6001A	83304	
344382	G63887		345615	83314		KG54307	G63812		KG6002A	85030	89440
344385	G63866		345616	83125		KG54308	G63708		KG6003	83309	89416
344387	G63617		345617	83203	89436	KG5431	G63511		KG6004	85320	89429
344397	G63772		345618	83126	89430	KG54317	G63726		KG6005	83216	
344398	G63958		345620	83456	89447	KG54330	G63809		KG6006	85012	89413
344399	G63848		345621	85003	89411	KG54331	G63837		KG6007	85007	89412
344401	G63970		349004	G63886		KG54333	G63810		KG6008A	83122	89406
344402	G63817		349009	G63897		KG54335	G63815		KG6009A	83303	
344404	G63844		349009	G63919		KG5438	G63492		KG6010	83308	89435
344410	G63885		349010	G64006		KG5440	G63350		KG6198	G63616	
344419	G63888		349119	89439		KG5442	G63626		KG6199	85012	89413
344426	G63299		441600	85310	89423	KG5444	G63904		KG6201	83456	89447
344427	G63904		441601	85710		KG5446	G63909		KG6403	G63605	
344428	G63494		441602	85724	89443	KG5447	G63491		KG6406	G63183	
344430	G63611		444058	83404		KG5455	G63456		KG6412	G63625	
344431	G63620		444328	85055		KG5456	G63416		KG6415	85013	89414
344435	G63721		444329	83509		KG5462	G63494		KG6416	83123	89405
344438	G63869		553360	G63937		KG5466	G63492				

LEYLAND TRUCK

O.E.M #	Gabriel	Upgrade	O.E.M #	Gabriel	Upgrade	O.E.M #	Gabriel	Upgrade	O.E.M #	Gabriel	Upgrade
1456033	85311	89424									

LINK MANUFACTURING CAB SHOCKS

O.E.M #	Gabriel	Upgrade	O.E.M #	Gabriel	Upgrade	O.E.M #	Gabriel	Upgrade	O.E.M #	Gabriel	Upgrade
1201-0012	83023		1201-9001	83052		1201-9014	83062		1202-0052	83021	
1201-0154	83051		1201-9002	83052		1201-9018	83062		1202-0054	83021	
1201-0254	83051		1201-9003	83052		1201-9021	83062		1202-1042	83025	
1201-1043	83025		1201-9007	83054		1202-0012	83023		1202-1043	83025	
1201-1044	83025		1201-9008	83054		1202-0022	83046		1202-1044	83025	
1201-1046	83049		1201-9009	83054		1202-0032	83016		1202-1046	83049	
1201-1049	83025		1201-9010	83053		1202-0042	83025		1202-1064	83024	
1201-1212	83013		1201-9011	83053		1202-0043	83032		1202-1065	83002	
1201-1213	83005		1201-9013	83062		1202-0044	83025		1202-1164	83031	

Important Note: Competitive Interchanges are to be used for stocking purposes only. Where multiple crosses are identified, please reference the applications section of this catalog. / **Remarque importante:** Les interchanges concurrentiels ne s'utilisent qu'aux fins de stocks. Dans le cas de références multiples, consulter la section des applications du catalogue. / **Nota importante:** Dans le cas de références multiples, consulter la section des applications du catalogue. / **Nota importante:** Se pueden usar intercambios competitivos para propósitos de almacenamiento solamente. Cuando se identifican intercambios múltiples, consulte la sección de aplicaciones de este catálogo.

COMPETITIVE & O.E.M. INTERCHANGE LIST

Lista de Intercambios contra Competidores y Equipo Original.

Liste d'interchange de produits compétitifs & d'équipement original (OEM)

LINK MANUFACTURING CAB SHOCKS... cont'd

O.E.M #	Gabriel	Upgrade	O.E.M #	Gabriel	Upgrade	O.E.M #	Gabriel	Upgrade	O.E.M #	Gabriel	Upgrade
1202-1212	83013		1202P055	83061		654833	83021		R71-1005	83024	
1202-1213	83005		632120	83046		654847	83002		T71-1000	83031	
1202-1286	83056		632129	83023		654849	83031		T71-1001	83031	
1202K065	83002		635705	83016		654867	83025		T71-1002	83002	
1202K164	83031		654669	83021		LG40450	83016				
1202K264	83031		654799	83025		LG40470	83016				
1202K286	83056		654811	83024		R71-1004	83049				

LINK MANUFACTURING LTD.

O.E.M #	Gabriel	Upgrade	O.E.M #	Gabriel	Upgrade	O.E.M #	Gabriel	Upgrade	O.E.M #	Gabriel	Upgrade
1210-0005	85734		1210-0528	85904		671093	85904				

LINK/HIGH-STEER

O.E.M #	Gabriel	Upgrade	O.E.M #	Gabriel	Upgrade	O.E.M #	Gabriel	Upgrade	O.E.M #	Gabriel	Upgrade
1210-0001	646155		1210-0007	665937		1210-0010	646155		632155	646177	
1210-0002	632147		1210-0009	665937		1210-0012	646155		646168	646155	

LODAL, INC.

O.E.M #	Gabriel	Upgrade	O.E.M #	Gabriel	Upgrade	O.E.M #	Gabriel	Upgrade	O.E.M #	Gabriel	Upgrade
9960257	83122	89406									

LONDON MIXER

O.E.M #	Gabriel	Upgrade	O.E.M #	Gabriel	Upgrade	O.E.M #	Gabriel	Upgrade	O.E.M #	Gabriel	Upgrade
MB-37737-30	646155										

M.A.N. BUS

O.E.M #	Gabriel	Upgrade	O.E.M #	Gabriel	Upgrade	O.E.M #	Gabriel	Upgrade	O.E.M #	Gabriel	Upgrade
134	85709		81-43701-6538	85708		81-43701-6572	85708		9020M-1042	85709	
25-1700-106-654	85708		81-43701-6539	85708		81-43701-6573	85722				
81-43701-6537	85709		81-43701-6543	85708		81-43701-6609	85709				

MACK

O.E.M #	Gabriel	Upgrade	O.E.M #	Gabriel	Upgrade	O.E.M #	Gabriel	Upgrade	O.E.M #	Gabriel	Upgrade
1252607B000	85702		14QK-2108	83203	89436	14QK-3116M	83101		14QK-413M	83111	
141700000373	85061	89450	14QK-2108P1	83203	89436	14QK-366	85036	89405	14QK-413M4	83110	
141700000380	85061	89450	14QK-2110	85305		14QK-366P1	85036	89405	14QK-413M5	83138	
141700005839	85098		14QK-2110P1	85305		14QK-366P2	85036	89405	14QK-413M6	83111	
14QK-1200P4	83207	89407	14QK-2113	85001	89410	14QK-366P3	85036	89405	14QK-413M7	83111	
14QK-140	85304		14QK-2113P3	85001	89410	14QK-366P4	83209	89414	14QK-414M	85906	89407
14QK-140P1	83225		14QK-2113P4	85007	89412	14QK-372M	83221		14QK-414M2	85909	
14QK-142	85305		14QK-2113P5	85001	89410	14QK-372M2	83209	89414	14QK-415M	83112	
14QK-142AP1	83215		14QK-2113P6	85007	89412	14QK-372M3	83122	89406	14QK-415M7	83112	
14QK-142P1	83215		14QK-2115	85305		14QK-373	83215		14QK-421M	85014	
14QK-143	83207	89407	14QK-2133M	85001	89410	14QK-375M	83123	89405	14QK-422M	85933	89454
14QK-145	85307		14QK-2133M2	85001	89410	14QK-377M	83215		14QK-423M	85978	
14QK-20001P2	85308	89422	14QK-2136M	85061	89450	14QK-378	83215		14QK-424M	83147	
14QK-2100	83221		14QK-282P1	83216		14QK-378M	83215		14QK-427M	85080	
14QK-2100D-P4	83207	89407	14QK-282P3	83216		14QK-390	83105		14QK-428	85080	
14QK-2100P1	83221		14QK-288-P1	85007	89412	14QK-392AM	85005	89430	14QK-428M	85080	
14QK-2100P2	83209	89414	14QK-288P2	83217		14QK-392AM2	83123	89405	14QK-431M	85061	89450
14QK-2100P3	83207	89407	14QK-29001P2	85303	89422	14QK-392AM3	85005	89430	14QK-434M	85014	
14QK-2100P4	83207	89407	14QK-29301P1	83207	89407	14QK-392BM	85005	89430	14QK-493M	83101	
14QK-2100P5	83221		14QK-29301P2	83207	89407	14QK-392BM2	85321		20469001	85933	89454
14QK-2100P6	85036	89405	14QK-29302	83207	89407	14QK-392BM3	85005	89430	20469002	85933	89454
14QK-2100P7	83221		14QK-29302P1	83207	89407	14QK-392M	85005	89430	20485632	85933	89454
14QK-2100P8	83242		14QK-3100	85739		14QK-393AM	83123	89405	20485633	85933	89454
14QK-2102	85304		14QK-3101M	85066	89448	14QK-393M	85010		20513881	85061	89450
14QK-2105	83209	89414	14QK-3107M	85061	89450	14QK-396	85005	89430	20570098	83147	
14QK-2107	83215		14QK-3108	85080		14QK-396M	85005	89430	20625775	85014	
14QK-2107P1	83215		14QK-3108M	85080		14QK-410M	83125		20782199	85072	
14QK-2107P2	83215		14QK-3114M	85061	89450	14QK-410M2	83137		20863239	85080	
14QK-2107P3	83215		14QK-3115M	85972		14QK-410M3	83125		20897198	85061	89450

Important Note: Competitive Interchanges are to be used for stocking purposes only. Where multiple crosses are identified, please reference the applications section of this catalog. / **Remarque importante:** Les interchanges concurrentiels ne s'utilisent qu'aux fins de stocks. Dans le cas de références multiples, consulter la section des applications du catalogue. / **Nota importante:** Dans le cas de références multiples, consulter la section des applications du catalogue. / **Nota importante:** Se pueden usar intercambios competitivos para propósitos de almacenamiento solamente. Cuando se identifican intercambios múltiples, consulte la sección de aplicaciones de este catálogo.

COMPETITIVE & O.E.M. INTERCHANGE LIST
Lista de Intercambios contra Competidores y Equipo Original.
Liste d'interchange de produits compétitifs & d'équipement original (OEM)

MACK... cont'd

O.E.M #	Gabriel	Upgrade	O.E.M #	Gabriel	Upgrade	O.E.M #	Gabriel	Upgrade	O.E.M #	Gabriel	Upgrade
20973993	85061	89450	25624365	83217		471700002861	85014		650400MT	85033	89427
20998401	85014		25625091	83215		471700006039	85088		650402	85311	89424
21002497	85972		25625151	85036	89405	471700009646	85088		650402MT	85311	89424
21010744	83101		25625187	83209	89414	471700009647	85088		650404	85310	89423
21155033	83101		25625223	83111		471700131921	85933	89454	650404MT	85310	89423
21436096	85098		25625234	83125		47902-25	83125		650405	85023	89415
21462382	85088		25625254	83125		47902-9	83123	89405	650405MT	85023	89415
21462384	85088		25625743	85005	89430	4940654	83216		650406	85024	89416
21687170	85120		25626048	85080		5533699	85302	89420	650408	85319	89428
22202559	85088		25626149	85080		5554184	85302	89420	650408MT	85319	89428
22202560	85088		25632145	85001	89410	57241-004	83110		651012	83221	
22314111	85036	89405	25632147	85305		57241-006	83111		651103	85036	89405
25621571	83215		25632561	83209	89414	5966-90044025	83209	89414	651151	83209	89414
25621955	85001	89410	25633154	85906	89407	60657-007	85072		70042	85302	89420
25622221	83111		4103-5000447861	83105		60670-006	83147		8083872	85978	
25622345	83242		4103-5000546892	83105		60675-001	85978		SDA141700000380	85061	89450
25622466	85001	89410	446-51-211	85739		60675-13	85036	89405	SDA471700000431	85066	89448
25623321	83215		471700000431	85066	89448	64838-002	85933	89454	SDA471700002861	85014	
25624241	83112		471700000445	85080		650102	85001	89410	V10234121	83105	
25624341	83110		471700000451	85080		650107	85316	89426	V10242320	83105	
25624351	85909		471700002626	85061	89450	650107MT	85316	89426			

MACK CAB SHOCKS

O.E.M #	Gabriel	Upgrade	O.E.M #	Gabriel	Upgrade	O.E.M #	Gabriel	Upgrade	O.E.M #	Gabriel	Upgrade
1201-0012	83023		14QK-376	83003		14QK-399M3	83045		21345868	83066	
1202-0012	83023		14QK-382	83018		14QK-411	83007		21345869	83066	
1202-0022	83046		14QK-382-P2	83018		14QK-411AM	83007		21490486	83066	
1202-0032	83016		14QK-391AM	83041		14QK-411M	83007		25622612	83041	
14QK-2111	83019		14QK-391AM2	83041		14QK-432M	83050		25622613	83041	
14QK-2111-P2	83019		14QK-391BM	83041		14QK-439M	83050		25624837	83041	
14QK-2111-P4	83019		14QK-391BM2	83041		14QK-440M	83058		25625635	83045	
14QK-29303-P2	83014		14QK-391M	83041		20873442	83050		25625636	83045	
14QK-303M	83050		14QK-391M2	83041		20874147	83050		25625637	83045	
14QK-3103M	83050		14QK-399M	83045		21154393	83050		25631922	83007	
14QK-374	83003		14QK-399M2	83045		21154397	83058				

MAECO

O.E.M #	Gabriel	Upgrade	O.E.M #	Gabriel	Upgrade	O.E.M #	Gabriel	Upgrade	O.E.M #	Gabriel	Upgrade
1085	83214		16777	85006		70088	85307		70644	85334	
12608	83125		16778	83203		70123	85716		70646	85313	
12788	83216		16779	83126	89440	70127	85006	89401	70647	85701	
12866	83207	89407	16780	83123	89405	70128	85006	89401	70648	89414	
16385	83215		16781	85006		70162	85716		70650	89440	
1668722	85030	89440	16787	85030	89440	70163	85302	89420	70651	85013	89414
16720	83107		16949	83120		70164	85716		70652	85030	89440
16767	85013		16950	83118		70300	85320	89429	70663	85013	89414
16768	83217		6025	83122	89406	70312	85001	89410	70691	85007	
16769	83221		6026	83204		70315	85063		70720	85934	
16770	83209		70018	85303	89422	70317		89432	70721	83125	
16771	83126	89430	70021	85303	89422	70331	85314	89425	74039	85303	89422
16772	83122	89406	70029	85308	89422	70332	83314		OE10881	85711	
16773	85005		70034	85302	89420	70334	85316	89426	OE10882	85740	
16774	83215		70039	85303	89422	70397	85006		OE10883	85339	
16775	83207	89407	70041	85305		70402	85305		OE12425	83214	
16776	83122		70042	85302	89420	70642	85300		SC-2920	83176	

MANDALAY COACH

O.E.M #	Gabriel	Upgrade	O.E.M #	Gabriel	Upgrade	O.E.M #	Gabriel	Upgrade	O.E.M #	Gabriel	Upgrade
141700131809	85029		16-16736-000	85029							
141700131810	83160		16-16737-000	83160							

Important Note: Competitive Interchanges are to be used for stocking purposes only. Where multiple crosses are identified, please reference the applications section of this catalog. / **Remarque importante:** Les interchanges concurrentiels ne s'utilisent qu'aux fins de stocks. Dans le cas de références multiples, consulter la section des applications du catalogue. / **Nota importante:** Dans le cas de références multiples, consulter la section des applications du catalogue. / **Nota importante:** Se pueden usar intercambios competitivos para propósitos de almacenamiento solamente. Cuando se identifican intercambios múltiples, consulte la sección de aplicaciones de este catálogo.

COMPETITIVE & O.E.M. INTERCHANGE LIST

Lista de Intercambios contra Competidores y Equipo Original.

Liste d'interchange de produits compétitifs & d'équipement original (OEM)

MANDALAY COACH... cont'd

O.E.M #	Gabriel	Upgrade	O.E.M #	Gabriel	Upgrade	O.E.M #	Gabriel	Upgrade	O.E.M #	Gabriel	Upgrade
16-16873-000	85029		16-16874-000	83160		16-18103-000	85900		481700000493	85900	

MARMON

O.E.M #	Gabriel	Upgrade	O.E.M #	Gabriel	Upgrade	O.E.M #	Gabriel	Upgrade	O.E.M #	Gabriel	Upgrade
1-7001	83216		51-139-28	85003	89411	576451	83122	89406			
37-1-1	83122	89406	51-163-7	83123	89405	665147	83216				

MARMON CAB SHOCKS

O.E.M #	Gabriel	Upgrade	O.E.M #	Gabriel	Upgrade	O.E.M #	Gabriel	Upgrade	O.E.M #	Gabriel	Upgrade
1202-0022	83046		1202-0054	83021							

MATSON SCHOOL BUS

O.E.M #	Gabriel	Upgrade	O.E.M #	Gabriel	Upgrade	O.E.M #	Gabriel	Upgrade	O.E.M #	Gabriel	Upgrade
5392387	85303	89422									

MC NEILUS TRUCK & MAN.

O.E.M #	Gabriel	Upgrade	O.E.M #	Gabriel	Upgrade	O.E.M #	Gabriel	Upgrade	O.E.M #	Gabriel	Upgrade
1139039 MTM	85334		1398980 MTM	83127		1KK552 MTM	85967		600-188206	646155	
1139046 MTM	83112		1404068 MTM	85087		2034140 MTM	646155		64442AX MTM	83128	
1139059 MTM	83207	89407	1404068 MTM	85980		217330	85303		6HA961 MTM	83123	89405
1139069 MTM	83209	89414	1410046 MTM	85919		2218640 MTM	83009		6HB390 MTM	83137	
1170719	632147		1411765 MTM	83148		3215395 MTM	83112		6HD720 MTM	85909	
12405FX1 MTM	85303	89422	1412744 MTM	85966		3HR582 MTM	85013	89414	6HS773 MTM	83122	89406
1323106 MTM	85305		1429317 MTM	85919		3HR916 MTM	83207	89407	6KP857 MTM	85000	89436
1333575 MTM	85072		1431085 MTM	85738		4HA569 MTM	85932	89453	7HS237 MTM	83122	89406
1340975 MTM	83142		1432386 MTM	85965		4KP398 MTM	85933	89454	7HS534 MTM	85906	89407
1340976 MTM	85919		1433009 MTM	85962		5HA994 MTM	85916		8KK524 MTM	83168	
1340979 MTM	83143		1468783 MTM	85345		5HB645 MTM	83109		9HB362 MTM	85976	
1360386 MTM	85323	89436	1473224	646155		5KK247 MTM	85977		9KK464 MTM	85079	
1367383 MTM	83147		1485576 MTM	85979		600-115994B	632147				
1396513 MTM	85959		1491909 MTM	83128	89436	600-11599M	632147				

MERITOR

O.E.M #	Gabriel	Upgrade	O.E.M #	Gabriel	Upgrade	O.E.M #	Gabriel	Upgrade	O.E.M #	Gabriel	Upgrade
14QK-3100	85739		446-51-211	85739		671507	87015		A-7805F-1020	86200	
202447	85919		671020	87015		671907	85919		A-7805L-1000	85919	
21224745	86203		671500	86201		680705	85737		A-7805L-1026	87015	
21224778	86202		671502	86202		700115	85712		A-7805P-1030	85737	
21227751	87015		671503	86203		7805-F-1020	86200		KIT11210	87015	
21228392	86201		671506	86200		A-3280-M-9711	85919				

MITSUBISHI-FUSO

O.E.M #	Gabriel	Upgrade	O.E.M #	Gabriel	Upgrade	O.E.M #	Gabriel	Upgrade	O.E.M #	Gabriel	Upgrade
MB161497	G63299		MC809390	83103		MC813511	G63398		MC826268	G63610	
MC114595	G63405		MC813135	83456	89447	MC814614	85009				

MOHAWK

O.E.M #	Gabriel	Upgrade	O.E.M #	Gabriel	Upgrade	O.E.M #	Gabriel	Upgrade	O.E.M #	Gabriel	Upgrade
01-0100-905	85303	89422	10234504	85717		6-367-7	85305		97-2201-00007	85703	
020273544	83203	89436	1235233	85736		680323	85700		97-2201-00011	85704	
050134508	85718		22012079	85701		680332	85701		97-9999-02320	85704	
10134504	85715		22012082	85702		680485	85733		MM-6886	83207	89407
10134506	85714		22012114	85700		695195	85707		MM-6957	83225	
10234503	85714		4968853	83216		695196	85707		MM-74029	85308	89422

MONACO

O.E.M #	Gabriel	Upgrade	O.E.M #	Gabriel	Upgrade	O.E.M #	Gabriel	Upgrade	O.E.M #	Gabriel	Upgrade
24-186537	85126		24-186629	85125		F4-BE5-A011-HO	85126		F4-BE5-B492-HO	85125	

MONROE

Monroe	Gabriel	Upgrade	Monroe	Gabriel	Upgrade	Monroe	Gabriel	Upgrade	Monroe	Gabriel	Upgrade
12872	83219		31029	G63798		32274	G63781		34504	G63817	
16385	83215		32066	G63900		32314	G63604				
16721	83125		32207	G63949		32341	G63675				
171322	G63679		32217	G63612		32392	G63848				
171341	G64014		32273	G63782		33049	G63610				

Important Note: Competitive Interchanges are to be used for stocking purposes only. Where multiple crosses are identified, please reference the applications section of this catalog. / **Remarque importante:** Les interchanges concurrentiels ne s'utilisent qu'aux fins de stocks. Dans le cas de références multiples, consulter la section des applications du catalogue. / **Nota importante:** Dans le cas de références multiples, consulter la section des applications du catalogue. / **Nota importante:** Se pueden usar intercambios competitivos para propósitos de almacenamiento solamente. Cuando se identifican intercambios múltiples, consulte la sección de aplicaciones de este catálogo.

COMPETITIVE & O.E.M. INTERCHANGE LIST
Lista de Intercambios contra Competidores y Equipo Original.
Liste d'interchange de produits compétitifs & d'équipement original (OEM)

MONROE... cont'd

Monroe	Gabriel	Upgrade	Monroe	Gabriel	Upgrade	Monroe	Gabriel	Upgrade	Monroe	Gabriel	Upgrade
34514	G63958		34817	G63355		37035	G63607		37111	G63937	
34515	G63675		34821	G63406		37036	G63410		37112	G63689	
34516	G63848		34822	G63371		37038	G63461		37113	G64005	
34517	G63837		34824	G63349		37040	G63347		37114	G64004	
34518	G63809		34828	G63510		37041	G63349		37120	G63511	
34519	G63837		34831	G63359		37042	G63906		37121	G63490	
34523	G63969		34832	61526		37044	G63488		37122	G63678	
34524	77968		34839	G63671		37045	G63183		37123	G63690	
34612	83017		34868	61650		37046	G63389		37128	G63929	
34617	83019		34895	83207	89407	37047	G63902		37129	G63421	
34655	G63714		34899	G63500		37048	G63492		37130	G63609	
34656	G63778		34900	G63386		37049	G63355		37131	G63714	
34657	G63716		34901	G63387		37050	G63489		37132	G63778	
34658	G63715		34904	G63299		37051	G63490		37133	G63716	
34675	G63783		34905	G63405		37052	G63406		37134	G63715	
34676	G63662		34906	G63396		37053	G63386		37135	G63722	
34677	G63803		34907	G63511		37055	G63455		37144	G63717	
34684	G63622		34909	G63187		37058	G63457		37149	G63783	
34685	G63808		34910	61516		37060	G63621		37151	G63803	
34686	G63809		34911	G63350		37061	G63502		37153	G63772	
34687	G63810		34912	83304		37062	G63818		37155	G63676	
34690	G63675		34919	G63411		37063	G63375		37156	G63869	
34721	83103		34920	G63675		37064	G63454		37157	G63726	
34722	83400		34927	G63409		37065	G63426		37158	G63712	
34729	G63414		34928	G63416		37066	G63915		37160	G63710	
34730	G63386		34929	G63403		37067	G63460		37161	G63847	
34732	G63455		34930	G63811		37068	G63905		37162	G63829	
34733	G63617		34944	61516		37069	G63499		37163	G63817	
34736	G63394		34954	G63484		37070	G63799		37164	G63675	
34741	G63489		34958	G63377		37071	G63914		37166	G63866	
34751	G63607		34959	G63432		37072	G63903		37178	G63803	
34755	G63812		34960	G63366		37073	G63907		37191	G63506	
34756	G63638		34963	G63406		37074	G63620		37198	G63694	
34759	G63624		34964	G63456		37075	G63606		37199	G63860	
34760	G63622		34972	G63610		37076	G63639		37202	G64002	
34761	G63623		34975	G63511		37077	G63909		37203	G63844	
34762	G63638		34983	G63489		37080	G63624		37204	G63845	
34763	58638		34985	61543		37082	G63626		37206	G63958	
34767	G63638		37011	G63414		37085	G63896		37217	G63862	
34768	83209	89414	37012	G63603		37086	G63897		37218	G63877	
34776	G63661		37013	G63525		37088	G63500		37231	G63720	
34777	G63662		37014	G63524		37089	G63350		37238	G63815	
34778	G63673		37015	G63614		37090	G63357		37240	G63865	
34781	G63675		37016	G63635		37091	G63413		37241	G63842	
34782	G63674		37017	G63639		37093	G63359		37242	G64014	
34787	G63615		37021	G63422		37094	G63353		37243	G63610	
34788	G63616		37022	G63495		37097	G63950		37244	G63864	
34791	G63692		37024	G63610		37099	G63423		37246	G64003	
34793	61520		37026	G63424		37100	G63904		37249	G63434	
34794	G63360		37027	G63425		37101	G63660		37803	G63306	
34796	G63929		37028	G63904		37102	G63661		38072	83043	
34797	G63406		37029	G63928		37103	G63662		39052	G63868	
34798	G63609		37030	G63547		37104	G63673		40209	83161	
34799	G63609		37031	G63404		37108	G63707		54487	85073	
34802	83216		37032	G63494		37109	G63708		54488	85074	
34803	G63306		37033	G63548		37110	G63676		550010	G63375	

Important Note: Competitive Interchanges are to be used for stocking purposes only. Where multiple crosses are identified, please reference the applications section of this catalog. / **Remarque importante:** Les interchanges concurrentiels ne s'utilisent qu'aux fins de stocks. Dans le cas de références multiples, consulter la section des applications du catalogue. / **Nota importante:** Dans le cas de références multiples, consulter la section des applications du catalogue. / **Nota importante:** Se pueden usar intercambios competitivos para propósitos de almacenamiento solamente. Cuando se identifican intercambios múltiples, consulte la sección de aplicaciones de este catálogo.

COMPETITIVE & O.E.M. INTERCHANGE LIST
Lista de Intercambios contra Competidores y Equipo Original.
Liste d'interchange de produits compétitifs & d'équipement original (OEM)

MONROE... cont'd

Monroe	Gabriel	Upgrade	Monroe	Gabriel	Upgrade	Monroe	Gabriel	Upgrade	Monroe	Gabriel	Upgrade
550011	69606		557026	83127		65162	85959		65443	85706	
550012	G63375		557027	83144		65163	85954		65444	85311	89424
550013	69724		557028	85010		65166	85090		65445	85731	
550016	G63424		557031	85010		65167	G63969		65446	85730	
550017	G63425		557032	85126		65168	77968		65447	85703	
550018	69575		557033	85900		65169	85342		65448	85700	
550019	G63918		557038	85125		65170	85969		65449	85702	
550020	G63919		557039	85959		65171	85964		65450	85701	
550051	43140		557040	85092		65172	83153		65451	85029	
551001	83125		5777	G63880		65173	85336		65452	85733	
551002	83122	89406	65101	85062	89408	65174	58942		65453	85904	
553001	79900		65102	85001	89410	65175	85084	89460	65454	85030	89440
553002	G56778		65103	85320	89429	65176	85084	89460	65455	85716	
555004	G63299		65104	85026	89417	65177	85012	89413	65456	85376	
555005	G63689		65105	85026	89417	65178	85998		65457	85909	
555006	G63173		65106	85091		65179	85995		65458	85908	
555010	77623		65107	85316	89426	65400	85033	89427	65459	85043	
555011	83119		65108	85030	89432	65401	85013	89414	65461	85059	
555012	G63183		65109	85058	89431	65402	85311	89424	65462	85913	
555019	85069	89455	65110	85005	89430	65404	85310	89423	65463	85040	
555026	83124	89407	65111	85006		65405	85023	89415	65464	85968	
555027	83124	89407	65112	89402		65406	85024	89416	65465	85939	
555028	83207	89407	65113	85012	89413	65407	85736		65466	85047	89435
555029	83144		65114	85036	89405	65408	85319	89428	65467	85054	89438
555031	83177		65115	85027	89418	65409	85003	89411	65468	85069	89455
555032	83178		65116	85329		65410	85300	89419	65469	85708	
555033	G63386		65118	85001	89410	65411	85036	89405	65470	85708	
555034	G63387		65119	85029		65412	83122	89406	65471	85302	89420
555035	G63357		65120	85010		65413	83136		65472	85330	
555036	77403		65121	85971		65414	85324		65473	85329	
555037	G63359		65122	85063		65415	85046	89434	65474	85712	
555038	G63413		65123	85054	89438	65416	85000	89436	65475	85065	
555039	G63359		65124	85053	89442	65417	85322		65476	85736	
555041	G63866		65128	85031		65418	85906	89407	65477	85702	
555043	83400		65129	85701		65419	85000	89436	65478	85058	89431
555045	G63394		65130	85061	89450	65420	85013	89414	65479	83122	89406
557001	85013	89414	65133	85935		65421	85916		65480	83111	
557002	85097		65139	85918	89449	65422	85912		65481	85036	89405
557004	G63866		65140	85918	89449	65423	85907		65482	85006	
557005	83136		65141	85091		65424	85905		65483	85978	
557006	83136		65142	83131		65425	85056	89441	65484	85976	
557007	85099		65143	83163		65426	85054	89438	65485	85972	
557008	85029		65144	85928		65427	85903		65486	85066	89448
557009	85007	89412	65145	85929		65428	85321		65487	85927	
557010	83144		65146	85925		65429	85030	89440	65488	85926	
557011	83160		65147	85924	89457	65430	85968		65489	85331	
557012	85029		65148	85918	89449	65431	85909		65490	85724	89443
557013	83127		65150	85953		65432	85910		65491	85930	
557014	83126	89430	65151	85953		65433	85910		65492	85931	89458
557015	83209	89414	65153	85921		65434	85012	89413	65493	85934	
557017	85029		65155	83175		65435	85901		65494	85061	89450
557018	83127		65157	85954		65436	85900		65495	85067	89451
557020	83123	89405	65158	85954		65439	85716		65496	83138	
557021	85051		65159	85070	89459	65440	85711		65497	85933	89454
557022	85051		65160	85080		65441	85704		65498	85964	
557023	83144		65161	83136		65442	85700		65499	85963	

Important Note: Competitive Interchanges are to be used for stocking purposes only. Where multiple crosses are identified, please reference the applications section of this catalog./ **Remarque importante:** Les interchanges concurrentiels ne s'utilisent qu'aux fins de stocks. Dans le cas de références multiples, consulter la section des applications du catalogue./ **Nota importante:** Dans le cas de références multiples, consulter la section des applications du catalogue./ **Nota importante:** Se pueden usar intercambios competitivos para propósitos de almacenamiento solamente. Cuando se identifican intercambios múltiples, consulte la sección de aplicaciones de este catálogo.

COMPETITIVE & O.E.M. INTERCHANGE LIST
Lista de Intercambios contra Competidores y Equipo Original.
Liste d'interchange de produits compétitifs & d'équipement original (OEM)

MONROE... cont'd

Monroe	Gabriel	Upgrade	Monroe	Gabriel	Upgrade	Monroe	Gabriel	Upgrade	Monroe	Gabriel	Upgrade
65500	85738		66106	83016		66407	83134		66625	83162	
65501	85323	89436	66107	83048		66408	83145		66626	85071	
65502	85938		66108	83028		66409	83146		66627	85045	
65503	85919		66109	83048		66412	83156		66628	83136	
65504	85072		66111	83016		66415	G63918		66629	83107	
65505	85006		66112	83017		66416	85085		66630	83216	
65506	83168		66113	83050		66417	G63919		66631	83140	
65507	83143		66114	83045		66418	85918	89449	66632	83006	
65508	83142		66115	83045		66419	85931	89458	66633	83127	
65509	85079		66116	83018		66422	83163		66634	83203	89436
65510	85052		66117	83019		66423	85001	89410	66636	83127	
65511	85939		66118	83001		66424	85310	89423	66637	83304	
65512	85938		66121	83047		66425	85920		66638	83123	89405
65513	85338		66122	83038		66426	85924	89457	66639	G63610	
65514	85099		66123	83004		66427	89441		66642	G63866	
65515	85097		66124	83040		66428	85033	89427	66643	83007	
65516	85013	89414	66125	83035		66429	85311	89424	66645	83008	
65517	83165		66126	83051		66430	83309	89416	66646	83308	89435
65518	85089		6613	83123	89405	66431	85066	89448	66647	83009	
65519	85060		66131	83062		66432	85319	89428	66648	83112	
65520	85121		66132	83001		66433	85918	89449	66649	83010	
65521	85014		6614	83125		66434	85069	89455	66650	83003	
65522	85082		66142	83039		66435	83219		66653	83515	
65523	85937		66143	83007		66436	85067	89451	66654	83014	
65524	85936	89456	66145	83008		66442	83150		66656	83110	
65525	87015		66147	83009		66443	83150		66657	83015	
65526	85956		66149	83022		66445	83135		66658	85009	
65527	85955		6615	83120		66447	83180		66659	83002	
65528	85069	89455	66150	83003		66486	85066	89448	66660	85059	
65529	85984		66152	83012		66502	646155		66661	83123	89405
65530	85932	89453	66154	83014		66503	646155		66664	83215	
65531	85334		66157	83015		66504	632147		66665	83109	
65532	85967		66159	83031		66506	646155		66666	G63671	
65533	85120		66160	83052		66535	85062	89408	66668	83313	89439
65534	85343		66161	83054		6658	85009		66669	83111	
65535	85954		66162	83025		66601	83114		66670	83200	
65536	85965		66169	83027		66602	83161		66671	83123	89405
65537	85962		66178	83023		66603	83103		66672	83209	89414
65538	85966		66179	83013		66604	83101		66677	83114	
65539	85961		66181	83025		66605	83613		66678	83023	
65541	85119		66182	83005		66606	83636		66679	83013	
65542	85102		66189	83041		66607	85052		66680	83317	
6603	83103		66193	83034		66608	83128		66681	83025	
6604	83101		66195	83033		66609	83635		66682	83005	
6605	83613		66196	83027		66610	83130		66683	83101	
6606	83636		66198	83158		66611	83016		66684	85007	89412
6607	85052		66199	83048		66612	83017		66686	85014	
6608	83128		66200	83066		66613	83123	89405	66691	83118	
6609	83635		66203	83067		66614	83125		66692	83120	
6610	85051		66204	83024		66615	83120		66693	83034	
66101	83042		66205	83063		66616	83018		66695	83033	
66102	83059		66400	G63432		66617	83019		66697	83164	
66102	83063		66402	83157		66618	83159		66699	83113	
66103	83046		66403	83154		66620	83162		66701	83215	
66104	83021		66405	83154		66623	83004		66707	83215	
66105	83044		66406	85920		66624	83141		66708	83100	

Important Note: Competitive Interchanges are to be used for stocking purposes only. Where multiple crosses are identified, please reference the applications section of this catalog. / **Remarque importante:** Les interchanges concurrentiels ne s'utilisent qu'aux fins de stocks. Dans le cas de références multiples, consulter la section des applications du catalogue. / **Nota importante:** Dans le cas de références multiples, consulter la section des applications du catalogue. / **Nota importante:** Se pueden usar intercambios competitivos para propósitos de almacenamiento solamente. Cuando se identifican intercambios múltiples, consulte la sección de aplicaciones de este catálogo.

COMPETITIVE & O.E.M. INTERCHANGE LIST
Lista de Intercambios contra Competidores y Equipo Original.
Liste d'interchange de produits compétitifs & d'équipement original (OEM)

MONROE... cont'd

Monroe	Gabriel	Upgrade	Monroe	Gabriel	Upgrade	Monroe	Gabriel	Upgrade	Monroe	Gabriel	Upgrade
66710	83209	89414	6720	85003	89411	70447	85949		74434	85711	
66712	83100		6721	83103		70448	85943		74435	87017	
66713	83105		6801	G63484		70449	85942		74436	85334	
66714	83216		6803	G63907		70454	85941		74437	89461	
66715	85026	89417	6811	83312	89409	70459	85948		74438	85734	
66716	85042		6817	G63355		70459	85951		74439	85728	
66717	83515		6824	G63349		70477	85949		74440	85729	
66719	83242		6828	83219		70720	85934		74441	85339	
66720	85003	89411	6829	83103		74001	85307		74442	85727	
66801	83161		6831	G63359		74003	85314	89425	74443	85377	
66811	83312	89409	6833	83126	89430	74004	85315		74444	85378	
66813	83303		6839	G63357		74006	85304		74445	85381	
66828	83159		6840	83217		74012	85736		74451	85711	
66829	83103		6841	83216		74024	85308	89422	74452	85740	
66833	83126	89430	6860	83308	89435	74025	85303	89422	74453	85339	
66841	83216		6861	83309	89446	74028	85302	89420	74454	85314	89425
66858	G63183		6863	83314		74029	85308	89422	74457	695406	
66860	83308	89435	6864	83104		74069	85301		74458	695406	
66861	83309	89446	6868	G63360		74070	85701		74461	87019	
66863	83314		6878	83221		74073	85320	89429	74462	85346	
66864	83104		6886	83124	89407	74074	85722		74463	85347	
66868	83219		6891	83215		74075	85712		74464	85318	
66871	G63605		6893	83203	89436	74076	85706		74465	85708	
66878	83221		6894	83209	89414	74077	85324		74466	85318	
66883	83314		6895	83204		74078	85027	89418	74467	85723	
66884	83125		6897	83126	89430	74079	85336		74470	89461	
66886	83124	89407	6898	83125		74080	85332		74471	85736	
66891	83215		6900	G63386		74081	85727		74472	85303	89422
66893	83203	89436	6901	G63387		74400	85700		74473	85716	
66894	83137		6902	83401		74402	85711		74475	85746	
66897	83126	89430	6903	83400		74405	85300	89419	74476	85745	
66898	83125		6910	G63413		74406	85712		74477	83165	
66902	83401		6911	G63350		74408	85702		74478	85089	
66903	83400		6912	83304		74409	85310	89423	911030	G63479	
66912	83304		6913	83303		74410	85701		911171	G63813	
66913	83303		6916	83123	89405	74411	85703		911172	G63491	
66921	83318		6920	G63411		74412	85704		911183	G63832	
66922	83301		6921	83318		74413	85313		911184	G63828	
66923	83456	89447	6922	83301		74414	85723		911222	G63970	
66924	83317		6923	83456	89447	74415	85318		911228	G63882	
66956	83101		6927	G63409		74416	85705	89447	911229	G63884	
66957	83225		6945	G63421		74417	85311	89424	911230	G63879	
66966	83353		6956	83101		74418	85709		911251	G63878	
66969	83126	89430	6957	83225		74420	85003	89411	911252	G63883	
6701	83215		6960	G63366		74421	85708		911253	G63875	
6707	83215		6969	83126	89430	74422	85733		911255	G63894	
6708	83100		6994	83122	89406	74423	85712		911256	G63893	
6710	83209	89414	70039	85303	89422	74424	85308	89422	911257	G63895	
6712	85040		70166	85301		74425	85724	89443	911258	G63872	
6713	83105		70300	85320	89429	74426	85333		911259	G64016	
6714	83216		70312	85001	89410	74427	85308	89422	911260	G63892	
6715	85026	89417	70331	85314	89425	74429	85919		911265	G64010	
6716	85042		70332	83314		74430	85340		911266	G63886	
6717	G63616		70334	85316	89426	74431	85341		911267	G63887	
6718	85024	89416	70402	85305		74432	85970		911268	G63888	
6719	83242		70447	85940		74433	85331		911270	G63885	

Important Note: Competitive Interchanges are to be used for stocking purposes only. Where multiple crosses are identified, please reference the applications section of this catalog. / **Remarque importante:** Les interchanges concurrentiels ne s'utilisent qu'aux fins de stocks. Dans le cas de références multiples, consulter la section des applications du catalogue. / **Nota importante:** Dans le cas de références multiples, consulter la section des applications du catalogue. / **Nota importante:** Se pueden usar intercambios competitivos para propósitos de almacenamiento solamente. Cuando se identifican intercambios múltiples, consulte la sección de aplicaciones de este catálogo.

COMPETITIVE & O.E.M. INTERCHANGE LIST
Lista de Intercambios contra Competidores y Equipo Original.
Liste d'interchange de produits compétitifs & d'équipement original (OEM)

MOR-RYDE SUSPENSION

O.E.M #	Gabriel	Upgrade	O.E.M #	Gabriel	Upgrade	O.E.M #	Gabriel	Upgrade	O.E.M #	Gabriel	Upgrade
U0109-006	G63866		U0109-007	G63183		U0109-014	83400		U0109-018	G63866	

MOTOR COACH INDUSTRIES

O.E.M #	Gabriel	Upgrade	O.E.M #	Gabriel	Upgrade	O.E.M #	Gabriel	Upgrade	O.E.M #	Gabriel	Upgrade
01-205219	85727		12-05-6033	85339		12L-5-99	85339		680482	85727	
12-05-1021	85340		12-05-6053	85711		12T-1-13	85303	89422	680485	85733	
12-05-1022	85970		12-05-6054	85740		12TA-01-013	85303	89422	680544	85711	
12-05-1023	85341		12-05-6055	85339		1497835	85711		680546	85339	
12-05-1101	85340		12-05-6068	85727		1498200	85740		680602	85339	
12-05-1102	85970		12-5-1-G	85700		1498565	85339		680677	85728	
12-05-1103	85341		12-5-1-GS	85700		22012066	85707		680680	85729	
12-05-1137	85340		12B-5-1	85735		22012067	85700		680681	85727	
12-05-1138	85970		12B-5-1-G	85700		22012079	85701		690029	85700	
12-05-1139	85341		12B-5-1-GS	85700		22024061	85704		695117	85701	
12-05-1142	85340		12G-5-1	85700		22024673	85710		695125	85704	
12-05-1146	85340		12J-5-10	85733		22045526	85702		74410	85701	
12-05-1147	85341		12J-5-10GS	85733		22046485	85710		85729	85729	
12-05-1148	85970		12J-5-11	85313		22052014	85702		97-2201-00151	85700	
12-05-1150	85711		12J-5-2	85312		3178154	85735		97-2210-00164	85708	
12-05-1165	85711		12J-5-3	85313		3178157	85700		97-9999-02514	85700	
12-05-1166	85341		12J-5-4	85312		4975515	85701		97-9999-02585	85723	
12-05-1170	85340		12J-5-6	85313		4975515GS	85701		97-9999-02634	85733	
12-05-1176	85728		12J-5-7	85312		5316984	85313		G1011822	85702	
12-05-1177	85729		12J-5-71	85733		63-0127GS	85303	89422	G1101590	85713	
12-05-1178	85339		12J-5-9	85700		6314933	85708		G1101590GS	85713	
12-05-1179	85727		12L-4-170	83158		654789	83158		G1201338	85710	
12-05-1188	85970		12L-5-100	85727		680231	85313		G1201339	85702	
12-05-1194	85339		12L-5-114	85727		680232	85733		G5008069	85700	
12-05-1199	85729		12L-5-58	85728		680322	85704		OE10086S	85702	
12-05-1228	85711		12L-5-67	85728		680323	85700		OE10881	85711	
12-05-1242	85728		12L-5-69	85700		680332	85701		OE10882	85740	
12-05-1243	85729		12L-5-70	85700		680333	85708		OE10883	85339	
12-05-1244	85727		12L-5-71	85708		680350	85710		T12-1208	85727	
12-05-1327	85728		12L-5-72	85709		680369	85708		T14-1029	85701	
12-05-1328	85729		12L-5-88	85729		680374	85728		T14-1045GS	85700	
12-05-1329	85727		12L-5-89	85729		680441	85729		T14-1048	85302	89420
12-05-6000	85711		12L-5-96	85728		680452	85339		T14-1080	85728	
12-05-6001	85740		12L-5-97	85728		680462	85728		T14-1081	85729	
12-05-6002	85339		12L-5-98	85339		680470	85713		T14-1082	85727	

MOTORCRAFT

Motorcraft	Gabriel	Upgrade	Motorcraft	Gabriel	Upgrade	Motorcraft	Gabriel	Upgrade	Motorcraft	Gabriel	Upgrade
AA-229	G63773		AA-617	85928		ASH-119	G63809		ASH-24492	83175	
AA-450	G63773		AS-1086	G63678		ASH-120	G63837		ASH-24659	85181	
AA-456	G63772		AS-413	G63414		ASH-1205	83209	89414	ASH-24660	85180	
AA-457	G63678		AS-433	G63406		ASH-1206	83122		ASH-25	83309	89446
AA-483	G63837		AS-485G	G63622		ASH-121	G63607		ASH-29	83314	
AA-484	G63837		AS-498G	G63608		ASH-122	G63614		ASH-294	83209	89414
AA-485	G63837		AS-500G	G63624		ASH-1228	83209	89414	ASH-32	83125	
AA-486	G63607		ASH-1022	83209	89414	ASH-1230	83122	89406	ASH-322	77969	
AA-494	83131		ASH-1023	83122	89406	ASH-132	G63614		ASH-324	77968	
AA-500	G63809		ASH-1130	G63622		ASH-137	83122	89406	ASH-335	G63969	
AA-501	G63809		ASH-1131	G63622		ASH-23454	G63614		ASH-36	85716	
AA-502	G63614		ASH-1132	G63622		ASH-23458	G63614		ASH-362	G63607	
AA-503	G63614		ASH-1135	G63623		ASH-24401	G63809		ASH-363	G63525	
AA-504	G63614		ASH-1136	83178		ASH-24402	85928		ASH-364	G63524	
AA-615	83135		ASH-1154	83177		ASH-24433	G63837		ASH-365	G63772	
AA-616	83175		ASH-1155	G63623		ASH-24434	G63607		ASH-366	G63608	

Important Note: Competitive Interchanges are to be used for stocking purposes only. Where multiple crosses are identified, please reference the applications section of this catalog. / **Remarque importante:** Les interchanges concurrentiels ne s'utilisent qu'aux fins de stocks. Dans le cas de références multiples, consulter la section des applications du catalogue. / **Nota importante:** Dans le cas de références multiples, consulter la section des applications du catalogue. / **Nota importante:** Se pueden usar intercambios competitivos para propósitos de almacenamiento solamente. Cuando se identifican intercambios múltiples, consulte la sección de aplicaciones de este catálogo.

COMPETITIVE & O.E.M. INTERCHANGE LIST
Lista de Intercambios contra Competidores y Equipo Original.
Liste d'interchange de produits compétitifs & d'équipement original (OEM)

MOTORCRAFT... cont'd

Motorcraft	Gabriel	Upgrade	Motorcraft	Gabriel	Upgrade	Motorcraft	Gabriel	Upgrade	Motorcraft	Gabriel	Upgrade
ASH-38	85314	89425	AT-685	G63679		CAT-759	G63624		CAT-960	G63366	
ASH-387	G63809		AT-696	83140		CAT-760	G63622		CAT-963	G63427	
ASH-39	85001	89410	AT-710	G63809		CAT-761	G63623		CAT-963	G63525	
ASH-391	G63809		AT-713	G63614		CAT-762	G63638		CAT-964	G63420	
ASH-394	G63614		AT-715	G63614		CAT-768	83209	89414	CAT-964	G63456	
ASH-397	83131		AT-716	G63809		CAT-776	G63661		CAT-972	G63610	
ASH-398	85928		AT-764	G63678		CAT-777	G63662		CAT-975	G63511	
ASH-407	G63809		AT-765	G63772		CAT-778	G63673		CAT-976	G63490	
ASH-408	G63809		AT-766	83209	89414	CAT-793	G63414		CAT-977	G63915	
ASH-51	G63773		AT-811	83135		CAT-802	G63419		CAT-978	G63460	
ASH-684	G63623		AX-131A	83217		CAT-802	G63492		CAT-983	G63489	
ASH-69	83175		AX-135A	G63406		CAT-802	G63928		CAT-984	G63609	
ASH-706	G63614		AX-267A	83309	89446	CAT-803	G63306		CAT-984	G63818	
ASH-707	G63614		AX-269A	83308	89435	CAT-817	G63355		CAT-985	G63488	
ASH-712	69575		AX-269A	83312	89409	CAT-824	G63349		CAT-986	G63489	
ASH-824	G63929		AX-277A	83219		CAT-826	G63187		CAT-990	G63906	
ASHV-1	G63678		AX-282A	85010		CAT-828	G63494		CAX-001	85307	
ASHV-1015	G63622		AX-310	83215		CAT-831	G63359		CAX-707	83215	
ASHV-1025	G63623		AX-327	G63773		CAT-832	G63353		CAX-707	85001	89410
ASHV-1028	G63778		AX-332	85928		CAT-839	G63357		CAX-710	83209	89414
ASHV-1046	G63772		AX-79A	83221		CAT-853	G63183		CAX-720	85003	89411
ASHV-1047	G63607		AX-79A	85030	89440	CAT-854	G63389		CAX-811	83312	89409
ASHV-1048	G63525		AX-97A	83122	89406	CAT-868	G63360		CAX-828	83207	89407
ASHV-1049	G63524		AX-97A	85005	89430	CAT-895	83207	89407	CAX-828	85012	89413
ASHV-1050	G63608		CAH-001	85307		CAT-899	G63500		CAX-833	83303	
ASHV-1051	G63837		CAH-001	85711		CAT-900	G63386		CAX-833	85005	89430
ASHV-13	G63676		CAH-003	83215		CAT-901	G63387		CAX-841	83216	
ASHV-14	G63837		CAH-006	85304		CAT-904	G63299		CAX-860	83308	89435
ASHV-3	G63714		CAH-012	85736		CAT-905	G63405		CAX-861	83309	89446
ASHV-4	G63716		CAH-025	85007	89412	CAT-906	G63396		CAX-863	83314	
ASHV-6	G63809		CAH-028	85302	89420	CAT-907	G63511		CAX-878	83221	
ASHV-864	G63929		CAH-029	85308	89422	CAT-909	G63398		CAX-886	83207	89407
ASHV-865	G63808		CAH-069	83219		CAT-910	G63413		CAX-886	85014	
ASHV-866	G63810		CAH-069	85301		CAT-911	G63350		CAX-891	83215	
ASHV-867	G63455		CAHL-400	85303	89422	CAT-912	G63625		CAX-891	85314	89425
ASHV-868	G63406		CAHL-400	85700		CAT-919	G63411		CAX-893	83203	89436
ASHV-871	G63809		CAHL-405	85300	89419	CAT-920	G63675		CAX-893	85000	89436
ASHV-879	G63455		CAHL-406	85004		CAT-926	G63410		CAX-893	85043	
AST-260	G63929		CAHL-409	85310	89423	CAT-927	G63409		CAX-894	83209	89414
AT-163G	83177		CAHL-417	85311	89424	CAT-927	G63690		CAX-894	85005	89430
AT-164G	83178		CAT-722	83400		CAT-928	G63410		CAX-894	85013	89414
AT-504G	G63679		CAT-729	G63414		CAT-929	G63403		CAX-898	83125	
AT-506G	G63679		CAT-730	G63386		CAT-930	G63461		CAX-898	85006	
AT-507G	G63607		CAT-731	G63409		CAT-932	G63398		CAX-912	83304	
AT-546	G63678		CAT-732	G63455		CAT-935	G63424		CAX-913	83303	
AT-547	G63775		CAT-733	G63617		CAT-936	G63425		CAX-916	83123	89405
AT-554	85305		CAT-736	G63394		CAT-944	G63347		CAX-916	85036	89405
AT-568	G63622		CAT-737	G63502		CAT-944	G63908		CAX-921	83318	
AT-579	G63809		CAT-739	G63603		CAT-945	G63421		CAX-923	83102	
AT-610	G63461		CAT-740	G63423		CAT-945	G63457		CAX-923	83456	89447
AT-611	G63461		CAT-741	G63489		CAT-948	G63909		CAX-924	83317	
AT-620	83209	89414	CAT-745	G63608		CAT-953	G63375		CAX-957	83217	
AT-621	83122	89406	CAT-745	G63614		CAT-953	G63900		CAX-957	83225	
AT-682	G63678		CAT-750	G63359		CAT-953	G63903		CAX-969	83221	
AT-683	G63679		CAT-751	G63607		CAT-955	G63454		CAX-969	85011	
AT-684	G63679		CAT-758	G63909		CAT-958	G63377		CAX-969	85030	89440

Important Note: Competitive Interchanges are to be used for stocking purposes only. Where multiple crosses are identified, please reference the applications section of this catalog. / **Remarque importante:** Les interchanges concurrentiels ne s'utilisent qu'aux fins de stocks. Dans le cas de références multiples, consulter la section des applications du catalogue. / **Nota importante:** Dans le cas de références multiples, consulter la section des applications du catalogue. / **Nota importante:** Se pueden usar intercambios competitivos para propósitos de almacenamiento solamente. Cuando se identifican intercambios múltiples, consulte la sección de aplicaciones de este catálogo.

COMPETITIVE & O.E.M. INTERCHANGE LIST
Lista de Intercambios contra Competidores y Equipo Original.
Liste d'interchange de produits compétitifs & d'équipement original (OEM)

MOTORCRAFT... cont'd

Motorcraft	Gabriel	Upgrade	Motorcraft	Gabriel	Upgrade	Motorcraft	Gabriel	Upgrade	Motorcraft	Gabriel	Upgrade
CLT-109	G63614		CLT-113	G63524		CLT-116	G63902		CLT-138	G63502	
CLT-112	G63525		CLT-114	G63635		CLT-124	G63610				

MUNCIE RECLAMATION

O.E.M #	Gabriel	Upgrade	O.E.M #	Gabriel	Upgrade	O.E.M #	Gabriel	Upgrade	O.E.M #	Gabriel	Upgrade
665459	89447		MR1623	85700		MR2961	85701		MR3307	85707	
665568	85051		MR1710	85713		MR2996	85704		MR3650	85707	
665569	85045		MR1751	85713		MR2997	85703		MR6394	85723	
680334	85709		MR1763	85300	89419	MR3303	85709		MR6535	85708	
97-2210-00164	85708		MR1765	85713		MR3304	85710		MR6536	85722	
H53-20415-006	85051		MR25767	85702		MR3304H	85709		MR7388	85710	
H53-21144-004	85045		MR2960	85702		MR3306	85705	89447			

NATIONAL COACH CORP

O.E.M #	Gabriel	Upgrade	O.E.M #	Gabriel	Upgrade	O.E.M #	Gabriel	Upgrade	O.E.M #	Gabriel	Upgrade
C800853	83207	89407									

NEOPLAN BUS

O.E.M #	Gabriel	Upgrade	O.E.M #	Gabriel	Upgrade	O.E.M #	Gabriel	Upgrade	O.E.M #	Gabriel	Upgrade
24-1700-106-149	83216		AA1002002	85705	89447	BN1002002	85009		DZ1002002	85705	89447
24-1700-999-362	85009		AA1002003	85705	89447	BT1002011	83216		GJ1002002	85706	
25-1700-101-426	85705	89447	AA1802002	85705	89447	CI 1002003	85705	89447	GJ1002003	85705	89447
680307	85705	89447	AC1002002	85705	89447	CL1002003	85705	89447	MM1002002	85705	89447
680308	85706		AC1002002GS	85705	89447	DT1002002	85707		MM1002003	85705	89447
97-9999-02519	85707		AC1002003	85705	89447	DT1802002	85705	89447			

NEW FLYER

O.E.M #	Gabriel	Upgrade	O.E.M #	Gabriel	Upgrade	O.E.M #	Gabriel	Upgrade	O.E.M #	Gabriel	Upgrade
009863	85722		203398	85346		68037840B	85720		69536640Y	85732	
015813	85708		204428	85347		68050440X	85716		97-2210-00164	85708	
015915	85711		68027440Y	85716		68050640Y	85718		G1011823	85710	
016415	85722		680346	85722		680671	85708				
064845	85711		68035041Y	85710		690102	85711				
152959	85708		680352	85711		69536140Y	87016				

NEWMAR CORP

O.E.M #	Gabriel	Upgrade	O.E.M #	Gabriel	Upgrade	O.E.M #	Gabriel	Upgrade	O.E.M #	Gabriel	Upgrade
141700131809	85029		16-16736-000	85029		16-16874-000	83160		481700000493	85900	
141700131810	83160		16-16737-000	83160		16-18103-000	85900				

NISSAN

O.E.M #	Gabriel	Upgrade	O.E.M #	Gabriel	Upgrade	O.E.M #	Gabriel	Upgrade	O.E.M #	Gabriel	Upgrade
56101-30Z01	83161		56110-30Z01	83161		56110-Z5008	83114		56210-Z5001	85085	
56101-30Z02	G63610		56110-30Z02	G63610		56110-Z5011	G63610		66400	G63432	
56101-Z5008	83114		56110-T8123	G63432		56110-Z5017	83162				
56101-Z5017	83162		56110-T8129	G63432		56201-Z5001	85085				

NOVA BUS

O.E.M #	Gabriel	Upgrade	O.E.M #	Gabriel	Upgrade	O.E.M #	Gabriel	Upgrade	O.E.M #	Gabriel	Upgrade
12J-5-10	85733		680231	85313		97-2201-00151	85700		G1205763-001	87019	
12J-5-11	85313		680232	85733		97-9999-02514	85700		G5008070	85700	
22012079	85701		680323	85700		G1011822	85702		N16248	85377	
22024673	85710		680326	85700		G1011823	85710		N16249	85378	
22045526	85702		680470	85713		G1101590	85713		N21543	85378	
22052014	85702		680480	85377		G1201338	85710		N22212	85700	
481700131250	85377		680481	85378		G1201339	85702		N31830	85378	
481700131252	85378		695117	85701		G1203223	85702		N31831	85377	
4975515	85701		74410	85701		G1205763	87019		OE 10086S	85702	

OLE GRANNING

O.E.M #	Gabriel	Upgrade	O.E.M #	Gabriel	Upgrade	O.E.M #	Gabriel	Upgrade	O.E.M #	Gabriel	Upgrade
1086	83217										

Important Note: Competitive Interchanges are to be used for stocking purposes only. Where multiple crosses are identified, please reference the applications section of this catalog. / **Remarque importante:** Les interchanges concurrentiels ne s'utilisent qu'aux fins de stocks. Dans le cas de références multiples, consulter la section des applications du catalogue. / **Nota importante:** Dans le cas de références multiples, consulter la section des applications du catalogue. / **Nota importante:** Se pueden usar intercambios competitivos para propósitos de almacenamiento solamente. Cuando se identifican intercambios múltiples, consulte la sección de aplicaciones de este catálogo.

COMPETITIVE & O.E.M. INTERCHANGE LIST
Lista de Intercambios contra Competidores y Equipo Original.
Liste d'interchange de produits compétitifs & d'équipement original (OEM)

OPTIMA BUS CORP

O.E.M #	Gabriel	Upgrade	O.E.M #	Gabriel	Upgrade	O.E.M #	Gabriel	Upgrade	O.E.M #	Gabriel	Upgrade
1260008	87017		90-2610-SP1	87017							

ORION BUS INDUSTRIES

O.E.M #	Gabriel	Upgrade	O.E.M #	Gabriel	Upgrade	O.E.M #	Gabriel	Upgrade	O.E.M #	Gabriel	Upgrade
010134501-4	85307		0501345-11	85718		070231514	85729		680505	85717	
010134504-4	85715		050134501-4	85716		070231527	85729		680506	85718	
010134505-4	85715		050134502-4	85718		20117501	85720		690102	85711	
010134506-4	85717		050134506-4	85718		20117503	85720		695327	85732	
010134508-4	85718		050134508	85718		20117504	85720		695343	85732	
010134509	85717		050134509	85732		20117505	85720		695347	85732	
010234503-4	85308	89422	050134510	85732		665596	85719		695366	85732	
010234506	85714		050134513	85732		680091	85303	89422	695389	87016	
020117504	85720		050230501	85716		680102	85712		695420	85729	
020273541	83203	89436	050231502-4	85716		680271	85714		695421	87016	
020273541-4	85000	89436	050231505	85716		680274	85716		695440	85729	
020273544	83203	89436	050231507	85716		680328	85717		97-9999-02635	85718	
020273546	85719		060131507	87016		680352	85711		97-9999-02636	85716	
020273547	85719		060131508	87016		680378	85720		A-4890	85712	
020273547-4	85719		060231508	85717		680501	85714		OB020570	85711	
020273548	85719		070131502	87016		680502	85715		OB020764	85716	
020273549	85719		070131506	87016		680504	85716		OB3166657	85700	

OSHKOSH MOTORS

O.E.M #	Gabriel	Upgrade	O.E.M #	Gabriel	Upgrade	O.E.M #	Gabriel	Upgrade	O.E.M #	Gabriel	Upgrade
12405F	85734		1745500		89430	40-4951	85316	89426	665060	83122	89406
12405F-1	85303	89422	2034140	646177		40-5348	85058	89431	690049	85303	89422
12405FX1	85303	89422	2173340	85303	89422	40-6967	85030	89440	90044448	85051	
1398980	83127		26228-A	83122	89406	4036892	G63605		GBL654875	83117	
1445910	85300	89419	2JD137	83119		5353054	85303	89422	GBL654918	83118	
1573270	83207	89407	3638112	G63183		5361994	85734		P117099	83120	
1573280	83221		40-0242	83312	89409	651444	83221		P117146	83118	
1583470	85051		40-4845	85304		665040	85303	89422	RW24285	83119	

OSHKOSH MOTORS CAB SHOCKS

O.E.M #	Gabriel	Upgrade	O.E.M #	Gabriel	Upgrade	O.E.M #	Gabriel	Upgrade	O.E.M #	Gabriel	Upgrade
1202-0054	83021		2218640	83009							

OSTERLUND TRUCK

O.E.M #	Gabriel	Upgrade	O.E.M #	Gabriel	Upgrade	O.E.M #	Gabriel	Upgrade	O.E.M #	Gabriel	Upgrade
220-S5-10	85712		59011	83214		680117	85300	89419			

OTTAWA TRUCK

O.E.M #	Gabriel	Upgrade	O.E.M #	Gabriel	Upgrade	O.E.M #	Gabriel	Upgrade	O.E.M #	Gabriel	Upgrade
53540451	85300	89419	59011	83214		90013787	85310	89423	9007342	85303	89422
59009	83217		680117	85300	89419	90027577	85720				

PACCAR

O.E.M #	Gabriel	Upgrade	O.E.M #	Gabriel	Upgrade	O.E.M #	Gabriel	Upgrade	O.E.M #	Gabriel	Upgrade
665633	85033	89427									

PACIFIC TRUCK & TRAILER

O.E.M #	Gabriel	Upgrade	O.E.M #	Gabriel	Upgrade	O.E.M #	Gabriel	Upgrade	O.E.M #	Gabriel	Upgrade
3178157C	85735		507202C1	85030	89440						

PAGE SUSPENSION

O.E.M #	Gabriel	Upgrade	O.E.M #	Gabriel	Upgrade	O.E.M #	Gabriel	Upgrade	O.E.M #	Gabriel	Upgrade
1080099	83203	89436	665133	83203	89436	A-2212	85029				
1081933	83204		665267	85029							

PAI CORP

O.E.M #	Gabriel	Upgrade	O.E.M #	Gabriel	Upgrade	O.E.M #	Gabriel	Upgrade	O.E.M #	Gabriel	Upgrade
HSA-5067	85305		HSA-5080	83221		HSA-5095	83215				

PEERLESS TRAILER

O.E.M #	Gabriel	Upgrade	O.E.M #	Gabriel	Upgrade	O.E.M #	Gabriel	Upgrade	O.E.M #	Gabriel	Upgrade
120-1	83125		72-61	83125							

Important Note: Competitive Interchanges are to be used for stocking purposes only. Where multiple crosses are identified, please reference the applications section of this catalog. / **Remarque importante:** Les interchanges concurrentiels ne s'utilisent qu'aux fins de stocks. Dans le cas de références multiples, consulter la section des applications du catalogue. / **Nota importante:** Dans le cas de références multiples, consulter la section des applications du catalogue. / **Nota importante:** Se pueden usar intercambios competitivos para propósitos de almacenamiento solamente. Cuando se identifican intercambios múltiples, consulte la sección de aplicaciones de este catálogo.

COMPETITIVE & O.E.M. INTERCHANGE LIST
Lista de Intercambios contra Competidores y Equipo Original.
Liste d'interchange de produits compétitifs & d'équipement original (OEM)

PEERLESS TRAILER... cont'd

PETERBILT

O.E.M #	Gabriel	Upgrade	O.E.M #	Gabriel	Upgrade	O.E.M #	Gabriel	Upgrade	O.E.M #	Gabriel	Upgrade
02-00376	85302	89420	16-13947-000PLUS	85319	89428	665945	85902		B71-1002	85001	89410
02-00495	85302	89420	16725-01	83221		665950	85902		B71-1003	83312	89409
02-01759	83312	89409	19495-01	83126	89440	671052	85070	89459	B71-6000	85959	
02-01787	85062	89408	2018987C1PLUS	85003	89411	671091	85069	89455	B71-6002	85012	89413
02-01890	85012	89413	23-08233	85308	89422	671092	85012	89413	B71-6003	85029	
02-02061	85013	89414	23-10393	85308	89422	671654	85936	89456	B71-6004	85084	89460
02-02142	85036	89405	23-12262	85012	89413	671699	85937		B71-6005	85084	89460
02-02225	85012	89413	471700004423	85109		671794	85067	89451	B71-6006	85084	89460
02-02736	85302	89420	47902-13PLUS	83122	89406	671962PLUS	85936	89456	B71-6007	85062	89408
02-02736PLUS	85302	89420	60670-005PLUS	83137		671963	85937		B71-6008	83312	89409
02-02737	85062	89408	60670-008	83123	89405	680026	85302	89420	B71-6009	83219	89408
02-02737PLUS	85062	89408	60670-008PLUS	83123	89405	680027	85308	89422	B71-6009	85062	89408
02-02738	85012	89413	60680-004	83143		680185	85308	89422	B71-6010	85023	89415
02-02738PLUS	85012	89413	60680-005	83142		680237	85303	89422	B71-6011	85062	89408
02-02739	85013	89414	665133	83203	89436	680239	85310	89423	B71-6012	85119	
02-02739PLUS	85013	89414	665174	85060		680240	85302	89420	B71-6013	85012	89413
02-02740	85036	89405	665565PLUS	85007	89412	680241	85311	89424	B71-6015	85012	89413
02-02741	85012	89413	665617	85031		680242	85308	89422	B71-6016	85012	89413
02-02742	85062	89408	665632	85013	89414	680253	85314	89425	B71-6016A	85012	89413
02-03020	85910		665633	85033	89427	680261	85062	89408	B71-6017	85910	
02-04010	85012	89413	665655	85062	89408	680279	83209	89414	B71-6018	85012	89413
03-01635	85308	89422	665656	85012	89413	680280	85906	89407	B71-6019	85989	
03-04176	85308	89422	665657	85013	89414	680281	85003	89411	B71-6020	85989	
03-04176PLUS	85308	89422	665658	85036	89405	680283	83353		C71-1002	85067	89451
03-04628	85336		665660	85033	89427	680303	85007	89412	C71-1002PLUS	85067	89451
03-04629	85311	89424	665662	85012	89413	680348	85012	89413	C71-1011	85069	89455
03-05106	85033	89427	665738	85910		680425	85320	89429	C71-1011PLUS	85069	89455
03-05384	85033	89427	665752	85067	89451	680435	85033	89427	C71-1013	85985	
03-06084	85033	89427	665762	85012	89413	680457	85302	89420	C71-1014	85936	89456
03-06084PLUS	85033	89427	665783	83123	89405	680458	85336		C71-1016	85067	89451
03-07281	85311	89424	665784	83122	89406	680459	85311	89424	C71-1017	85069	89455
03-07420	85336		665785	83137		680473	85319	89428	C71-6000	85067	89451
03-07421	85311	89424	665788	85000	89436	680586	85311	89424	C71-6002	85311	89424
03-07421PLUS	85311	89424	665826	85069	89455	70701PLUS	85900		C71-6003	85988	
03-07423	85033	89427	665844	85069	89455	800670	85060		C71-6004	85343	
03-07423PLUS	85033	89427	665858	85070	89459	8086053PLUS	85047	89435	C71-6005	85069	89455
03-07424	85311	89424	665876	85959		85013A0C	85013	89414	C71-6015	85067	89451
03-07424PLUS	85311	89424	665918	85900		90044011	85004		K374-26PLUS	85001	89410
03-08350	85343		665926	85047	89435	90044025PLUS	83209	89414	K374-28PLUS	85314	89425
03-08781	85069	89455	665927	85901		90044089PLUS	83124	89407	K374-29PLUS	85310	89423
10-12032-002PLUS	85320	89429	665928	85062	89408	90045605	85109		K374-33PLUS	83312	89409
10-12542-000PLUS	85901		665930	85001	89410	ACHB966	83136				
12887-01	85013	89414	665931	83312	89409	B71-1000	85031				
12887-02	85013	89414	665932	85012	89413	B71-1001	85070	89459			

PETERBILT CAB SHOCKS

O.E.M #	Gabriel	Upgrade	O.E.M #	Gabriel	Upgrade	O.E.M #	Gabriel	Upgrade	O.E.M #	Gabriel	Upgrade
1201-0012	83023		20-16755	83042		654919	83035		R71-6000	83067	
1202-0012	83023		20-19140	83063		96027-1054	83011		R71-6005	83042	
1202-0022	83046		29-02455	83008		PP1058870	83059		R71-6006	83063	
1202-0032	83016		29-06005	83035		PP1059870	83060		R71-6007	83008	
1202-0054	83021		29-06032	83035		PP2582870	83012		R71-6008	83035	
1202-1044	83025		654782	83008		R71-1004	83049		R71-6010	83067	
1202P055	83061		654812	83042		R71-1005	83024				

Important Note: Competitive Interchanges are to be used for stocking purposes only. Where multiple crosses are identified, please reference the applications section of this catalog. / **Remarque importante:** Les interchanges concurrentiels ne s'utilisent qu'aux fins de stocks. Dans le cas de références multiples, consulter la section des applications du catalogue. / **Nota importante:** Dans le cas de références multiples, consulter la section des applications du catalogue. / **Nota importante:** Se pueden usar intercambios competitivos para propósitos de almacenamiento solamente. Cuando se identifican intercambios múltiples, consulte la sección de aplicaciones de este catálogo.

COMPETITIVE & O.E.M. INTERCHANGE LIST
Lista de Intercambios contra Competidores y Equipo Original.
Liste d'interchange de produits compétitifs & d'équipement original (OEM)

PIERCE MANUFACTURING INC.

O.E.M #	Gabriel	Upgrade	O.E.M #	Gabriel	Upgrade	O.E.M #	Gabriel	Upgrade	O.E.M #	Gabriel	Upgrade
1445910	85300	89419	40-0242	83312	89409	40-4951	85316	89426	40-6967	85030	89440
2034140	646177		40-4845	85304		40-5348	85058	89431	680401	85307	

POWERPACKER CAB SHOCKS

O.E.M #	Gabriel	Upgrade	O.E.M #	Gabriel	Upgrade	O.E.M #	Gabriel	Upgrade	O.E.M #	Gabriel	Upgrade
PP1058870	83059		PP1059870	83060							

PREVOST

O.E.M #	Gabriel	Upgrade	O.E.M #	Gabriel	Upgrade	O.E.M #	Gabriel	Upgrade	O.E.M #	Gabriel	Upgrade
01-0100-905	85303	89422	481700000206	85380		630127	85736		680323	85700	
0822045526	85702		481700000207	85329		630134	85329		680422	85329	
12B-5-1	85735		481700000208	85379		630136	85330		680492	85713	
12L-5-89	85729		481700000209	85713		630161	85736		680510	85330	
12T-1-13	85303	89422	481700999376	85329		630163	85330		680555	85330	
19501288	85729		481700999377	85330		630228	85380		680583	85380	
19501289	85728		481700999386	85736		630234	85329		690060	85713	
19501547	85740		481700999427	85380		630235	85330		74939852	85308	89422
19501669	85339		52001	85708		630236	85329		G1011822	85702	
19502711	85702		63-1013	85329		630251	85379		N5008070	85700	
19506846	85339		630001	85713		630252	85329		N16249	85378	
196347	85710		630080	85713		630253	85713		N22212	85700	
196533	85708		630091	85736		630254	85380				
3166657	85700		630103	85329		650407	85736				

RAMERIZ TRAILER

O.E.M #	Gabriel	Upgrade	O.E.M #	Gabriel	Upgrade	O.E.M #	Gabriel	Upgrade	O.E.M #	Gabriel	Upgrade
18165-01	85006										

RAYDAN MANUFACTURING

O.E.M #	Gabriel	Upgrade	O.E.M #	Gabriel	Upgrade	O.E.M #	Gabriel	Upgrade	O.E.M #	Gabriel	Upgrade
14QK-3100	85739		446-51-211	85739		700115	85712				

RED LION TRAILER

O.E.M #	Gabriel	Upgrade	O.E.M #	Gabriel	Upgrade	O.E.M #	Gabriel	Upgrade	O.E.M #	Gabriel	Upgrade
90044978	85059		90045019	85913							

REX MIXER

O.E.M #	Gabriel	Upgrade	O.E.M #	Gabriel	Upgrade	O.E.M #	Gabriel	Upgrade	O.E.M #	Gabriel	Upgrade
102-13441-10	646155										

REYCO SUSPENSION

O.E.M #	Gabriel	Upgrade	O.E.M #	Gabriel	Upgrade	O.E.M #	Gabriel	Upgrade	O.E.M #	Gabriel	Upgrade
12885-01	85300	89419	17794-01	83215		20960-01	83204		665833	85052	
12885-03	85300	89419	18146-01	85313		21310-01	85307		671707	85052	
12886-01	85334		18163-01	83207	89407	21497-01	85005	89430	680551	85738	
12887-01	85013	89414	18164-01	83122	89406	22062-01	85007	89412	680552	85938	
12887-02	85013	89414	18165-01	85006		23106-01	85975		680700	85938	
14954-01	83217		18166-01	85704		23523-01	85086		700098-01	83128	89436
16230-01	85702		18286-01		89414	23524-01	85738		700098-03	85052	
16725-01	83221		18800-01	83203	89436	23553-01	85938		701071-01	665937	
16824-01	85006		19495-01	83126	89440	23614-01	85717		702135-01	85045	
17142-01	85001	89410	19623-01	83123	89405	24392-01	85051		702136-01	85052	
17146-01	83209	89414	19824-01	85006		665519		89414	702209-01	85014	
17358-01	83126	89430	20125-01	85030	89440	665748	85086		704672-01	85938	
17403-01	83122	89406	20126-01		89440	665813	85051				
17408-01	85005	89430	20129-01	85007	89412	665830	85045				

RIDEWELL CORPORATION

O.E.M #	Gabriel	Upgrade	O.E.M #	Gabriel	Upgrade	O.E.M #	Gabriel	Upgrade	O.E.M #	Gabriel	Upgrade
1250005	85901		1254025B000	85712		1267120B000	85734		1270789B000	85014	
1250546B000	85006		1254190B000	85302	89420	1267249B000	85712		1275813B000	85704	
1250563B000	85000	89436	1260008	87017		1267395B000	85302	89420			
1250789B000	85014		12651527B000	85712		1270007	85045				
1252607B000	85702		1265478B000	85736		1270563B000	85000	89436			
1253069B000	85005	89430	1266009B000	83130		1270563B003	85934				

Important Note: Competitive Interchanges are to be used for stocking purposes only. Where multiple crosses are identified, please reference the applications section of this catalogue. / **Remarque importante:** Les interchanges concurrentiels ne s'utilisent qu'aux fins de stocks. Dans le cas de références multiples, consulter la section des applications du catalogue. / **Nota importante:** Dans le cas de références multiples, consulter la section des applications du catalogue. / **Nota importante:** Se pueden usar intercambios competitivos para propósitos de almacenamiento solamente. Cuando se identifican intercambios múltiples, consulte la sección de aplicaciones de este catálogo.

COMPETITIVE & O.E.M. INTERCHANGE LIST
Lista de Intercambios contra Competidores y Equipo Original.
Liste d'interchange de produits compétitifs & d'équipement original (OEM)

RIDEWELL CORPORATION... cont'd

O.E.M #	Gabriel	Upgrade	O.E.M #	Gabriel	Upgrade	O.E.M #	Gabriel	Upgrade	O.E.M #	Gabriel	Upgrade
1275943B	85005	89430	680101	85702		AS575B	85005	89430	S5878B	83207	89407
1310002	665937		70654	85000	89436	AS789B	85014		S6009B	83203	89436
1310004	665937		90-2610 SP1	87017		AS789B000	85014		S7120B	85304	
1317570B001	646155		AS 4025B	85712		S2607B	85702		S7172B	83207	89407
57645	85005	89430	AS30698	85005	89430	S4025B	85712		S7249B	85307	
665198	85005	89430	AS3069B	85005	89430	S5477B	85307		S7365B	85305	
665267	85029		AS546B	85006		S5478B	85307				
665526	85014		AS563B	83203	89436	S5813B	85704				

ROADMASTER (MONACO)

O.E.M #	Gabriel	Upgrade	O.E.M #	Gabriel	Upgrade	O.E.M #	Gabriel	Upgrade	O.E.M #	Gabriel	Upgrade
90045132	85909		90045188	85910							

SABO

Sabo	Gabriel	Upgrade	Sabo	Gabriel	Upgrade	Sabo	Gabriel	Upgrade	Sabo	Gabriel	Upgrade
690459	86203		8901026	85064		8901032	85901		890165B	85121	
8901020	85300		8901027	85310		8901033	85918		890414	85323	
8901021	85320		8901028	85316		8901037	86202		890449	85300	
8901023	85066	89448	8901029	85319		8901038	86201		890612	86202	
8901024	85314		8901029	85724	89443	8901156	G63299		895315	83009	
8901025	83128	89436	8901030	85323	89436	890120	85300		895316	83002	
8901025	85000	89436	8901031	85900		890164B	85179				

SACHS

Sachs	Gabriel	Upgrade	Sachs	Gabriel	Upgrade	Sachs	Gabriel	Upgrade	Sachs	Gabriel	Upgrade
101892	85708		311634	85001	89410	315428	85380		315610	83026	
101968	85708		311635	85030	89440	315430	85099		315611	85337	
106-884	85708		311793	85975		315431	85014		315612	85006	
106282	85722		311794	85974		315432	89414		315613	85030	89440
106884	85708		312724	85311		315434	85065		315614	85097	
106885	85722		313708	85378		315435	85088		315615	83027	
112-885	85709		313709	85377		315540	83613		315616	83038	
124693	85708		315389	85090		315541	85052		315618	83160	
141700000373	85061	89450	315390	85958		315542	83122	89406	315619	83160	
141700000377	83174		315391	85956		315543	83125		315620	85080	
141700000378	83160		315392	85007	89412	315544	85014		315621	85080	
141700000380	85061	89450	315393	85331		315545	85333		315622	85081	
141700000443	85066	89448	315394	85921		315546	85005	89430	315623	85918	
141700000800	85179		315395	85724	89443	315547	85924	89457	315625	85975	
141700000901	83165		315396	85335		315548	85070	89459	315626	85933	89454
141700002626	85061	89450	315397	83120		315549	85033	89427	315656	83040	
141700005838	85098		315398	85058	89431	315550	85311	89424	315657	83039	
141700005839	85098		315399	85005	89430	315551	85310	89423	315658	83057	
141700125243	85089		315400	85006		315552	83128		315659	83047	
141700125275	83165		315403	85919		315553	85900		315660	83009	
141700131809	85029		315404	85900		315554	85006		315661	85932	89453
141700131810	83160		315406	85918	89449	315555	83038		40-A85-0	85708	
141700131975	83160		315411	83128		315556	85314	89425	410 011	83173	
170210	83104		315414	85959		315593	85029		410 038	85100	
170211	83104		315415	85933	89454	315594	85029		410010	83317	
280499	85300	89419	315416	85003	89411	315597	85959		410011	85093	
290146	85012	89413	315417	85923		315598	85933	89454	410021	83125	
290460	85005	89430	315418	83456	89447	315600	85959		410022	85006	
290465	83125		315420	85014		315601	85920		410023	85103	
290488	85040		315421	85088		315602	85092		410024	85302	89420
311229	85918	89449	315423	83127		315603	83134		410025	83215	
311230	85956		315424	85067	89451	315606	85061	89450			
311631	85906	89407	315425	85330		315607	85061	89450			
311632	85909		315426	85329		315608	85061	89450			
311633	85900		315427	85713		315609	85066	89448			

Important Note: Competitive Interchanges are to be used for stocking purposes only. Where multiple crosses are identified, please reference the applications section of this catalog. / **Remarque importante:** Les interchanges concurrentiels ne s'utilisent qu'aux fins de stocks. Dans le cas de références multiples, consulter la section des applications du catalogue. / **Nota importante:** Dans le cas de références multiples, consulter la section des applications du catalogue. / **Nota importante:** Se pueden usar intercambios competitivos para propósitos de almacenamiento solamente. Cuando se identifican intercambios múltiples, consulte la sección de aplicaciones de este catálogo.

COMPETITIVE & O.E.M. INTERCHANGE LIST
Lista de Intercambios contra Competidores y Equipo Original.
Liste d'interchange de produits compétitifs & d'équipement original (OEM)

SACHS... cont'd

Sachs	Gabriel	Upgrade	Sachs	Gabriel	Upgrade	Sachs	Gabriel	Upgrade	Sachs	Gabriel	Upgrade
410026	85918	89449	471700000443	85066	89448	471700006040	85088		481700131252	85378	
410032	85320	89429	471700000445	85080		471700006048	83165		481700131438	85919	
410035	85001		471700000447	85919		471700006269	85932	89453	481700131919	85900	
410035	85337		471700000449	85918	89449	471700009646	85088		481700999376	85329	
410036	85061	89450	471700000451	85080		471700009647	85088		481700999377	85330	
410037	85081		471700000458	85014		471700011530	85181		481700999386	85376	
410038	85100		471700000459	85030	89440	471700011531	85180		481700999427	85380	
410040	85005	89430	471700000460	85097		471700125245	85089		510001	85716	
410042	85310	89423	471700000461	89414		471700131155	85918	89449	510002	85302	89420
410043	85957		471700000464	85090		471700131256	85065		510002	85983	
410044	85031		471700000466	85959		471700131258	85081		510003	85004	
410046	83136		471700000470	85918	89449	471700131331	85932	89453	510004	85307	
410047	85071		471700000802	85121		471700131545	85006		510005	85303	
410048	83207		471700002580	83165		471700131646	85918	89449	510006	85705	
410048	83304		471700002627	85066	89448	471700131775	85006		510006	85706	
410048	85014		471700002726	85918	89449	471700131920	85933	89454	510009	85711	
410050	85121		471700002809	85724	89443	471700131921	85933	89454	510011	87020	
410051	85108		471700002861	85014		471700131974	85029		510017	85323	89436
410052	85096		471700002919	85106		481700000206	85380		510018	85724	89443
410053	85095		471700002990	85007		481700000207	85329		510019	85916	
410056	85000	89436	471700002991	85959		481700000208	85379		510023	85316	89426
410057	83137		471700002992	85331		481700000209	85713		510024	85381	
410058	83122		471700002993	85921		481700000477	85900		510039	85982	
410068	85030	89440	471700002994	83134		481700000483	85975		510040	85110	
410068	85054		471700002995	83134		481700000484	85974		814903003482	83040	
410069	83165		471700002996	85335		481700000485	85975		814903003483	83039	
410069	85094		471700003009	85006		481700000493	85900		814903003484	83057	
410070	85089		471700003011	85058		481700004271	85993		814903003486	83047	
471700000426	85014		471700003832	85933	89454	481700004476	85982		814903003496	83009	
471700000428	85006		471700003920	85958		481700005414	85179		814903003500	83026	
471700000431	85066	89448	471700004270	85117		481700008558	85347		814903003501	83027	
471700000433	85099		471700004423	85109		481700008666	87020		814903003528	83038	
471700000436	85030	89440	471700005079	85005	89430	481700125969	85956		823196420	85100	
471700000440	85959		471700006039	85088		481700131250	85377				

SAF HOLLAND

O.E.M #	Gabriel	Upgrade	O.E.M #	Gabriel	Upgrade	O.E.M #	Gabriel	Upgrade	O.E.M #	Gabriel	Upgrade
471700000433	85099		671921	85916		90044162	83128	89436	90044878	83635	
471700000436	85030		671922		89405	90044448	85051		90044907	83635	
471700000458	85014		671923		89440	90044625	83125		90044915	83127	
471700000459	85030		671931	85916		90044626	83126	89430	90044977	83115	
471700000460	85097		680234	85906	89407	90044642	83127		90044978	85059	
471700000461		89414	680268	85323	89436	90044679	83122	89406	90044979	83113	
481700000483	85975		680645	85321		90044680	83125		90044980	85907	
481700000484	85974		90044001	85005	89430	90044681	83204		90044981	85000	89436
481700000485	85975		90044008	85000	89436	90044682	83209	89414	90044982	85000	89436
57639	85000	89436	90044011	85004		90044683	83122	89406	90044991	85000	89436
57643	85013	89414	90044012	85006		90044684	83124	89407	90044992	85000	89436
6025	83122	89406	90044016	85300	89419	90044685	83389	89439	90044993	85000	89436
6026	83204		90044017	83204		90044686	85051		90045000	85906	89407
632155	646177		90044025	83209	89414	90044687	83125		90045001	85323	89436
646201	646177		90044046	83123	89405	90044688	83122	89406	90045002	85906	89407
665002	85004		90044071	85000	89436	90044769	83207	89407	90045003	85323	89436
665003	85300	89419	90044081	85000	89436	90044770	83207	89407	90045019	85913	
665197	85051		90044086	85000	89436	90044794	83127		90045028	85907	
665454	85045		90044089	83124	89407	90044833	85052				
665514	83127		90044089C	83124	89407	90044834	85052				
665969		89430	90044095	83203	89436	90044868	85045				

Important Note: Competitive Interchanges are to be used for stocking purposes only. Where multiple crosses are identified, please reference the applications section of this catalog. / **Remarque importante:** Les interchanges concurrentiels ne s'utilisent qu'aux fins de stocks. Dans le cas de références multiples, consulter la section des applications du catalogue. / **Nota importante:** Dans le cas de références multiples, consulter la section des applications du catalogue. / **Nota importante:** Se pueden usar intercambios competitivos para propósitos de almacenamiento solamente. Cuando se identifican intercambios múltiples, consulte la sección de aplicaciones de este catálogo.

COMPETITIVE & O.E.M. INTERCHANGE LIST
Lista de Intercambios contra Competidores y Equipo Original.
Liste d'interchange de produits compétitifs & d'équipement original (OEM)

SAF HOLLAND... cont'd

O.E.M #	Gabriel	Upgrade	O.E.M #	Gabriel	Upgrade	O.E.M #	Gabriel	Upgrade	O.E.M #	Gabriel	Upgrade
90045031	85968		90045277	85030		90045504	85030		AR-1008	85006	
90045040	83130		90045298	83128		90045532	85030		AR-1141	83204	
90045048	85905		90045299	83389	89436	90045533	85099		AR-1141-C	83204	
90045049	85905		90045331	646155		90045534	85014		AR-1202	85300	89419
90045050	85914		90045336	85014		90045535	85097		AR-134-C	85005	89430
90045053	85908		90045337	85911		90045536		89414	AR-1404	85301	
90045054	85051		90045338	85060		90045563	85014		AR-1425	85301	
90045068		89441	90045381	83150		90045564	83128	89436	AR-1434	83203	89436
90045075	85911		90045384		89430	90045568	85060		AR-1654	83209	89414
90045080	85912		90045418	85916		90045572	85045		AR-1822	85304	
90045083	85910		90045419		89405	90045574	83130		AR-2451	83203	89436
90045084	85968		90045420		89440	90045575	85051		AR-2598	83123	89405
90045096	85916		90045432	85321		90045576	83150		AR-718-C	83203	89436
90045099	85906	89407	90045433	85916		90045605	85109		AR-718-C-HD	85000	89436
90045110	83137		90045455	85909		90045607	83150		AR-781	83203	89436
90045132	85909		90045466		89406	90045665	85029		AR-958	83207	89407
90045138	85910		90045471	83150		90045666	83130		AR-995	85734	
90045175	85916		90045499	85974		90045666	85051		XB-SPN-053-36	83125	
90045188	85910		90045500	85975		90045667	85060				
90045207		89405	90045503	85975		90045669	83389	89436			

SEAGRAVE FIRE APPARATUS LLC

O.E.M #	Gabriel	Upgrade	O.E.M #	Gabriel	Upgrade	O.E.M #	Gabriel	Upgrade	O.E.M #	Gabriel	Upgrade
680117	85300	89419	P0025500	85300	89419						

SICARD

O.E.M #	Gabriel	Upgrade	O.E.M #	Gabriel	Upgrade	O.E.M #	Gabriel	Upgrade	O.E.M #	Gabriel	Upgrade
3166657	85700										

SPARTAN MOTORS

O.E.M #	Gabriel	Upgrade	O.E.M #	Gabriel	Upgrade	O.E.M #	Gabriel	Upgrade	O.E.M #	Gabriel	Upgrade
0272-SS5	85712		471700000456	85959		78068	85304		B46-2151	85007	89412
0346-SS5	85013	89414	58913-009	85959		AS 4025B	85712				
0377-SS5	85029		59011	83214		B46-1594	85013	89414			
21310-01	85307		60665-025	85036		B46-1725	85029				

SPRING VALLEY

O.E.M #	Gabriel	Upgrade	O.E.M #	Gabriel	Upgrade	O.E.M #	Gabriel	Upgrade	O.E.M #	Gabriel	Upgrade
632155	646177										

STERLING TRUCK

O.E.M #	Gabriel	Upgrade	O.E.M #	Gabriel	Upgrade	O.E.M #	Gabriel	Upgrade	O.E.M #	Gabriel	Upgrade
10-12388-000	85920		AT-560	G63809		F1HZ-18124-K		89402	F6HT-18045-HC	85054	89438
10-12390-000	85920		AX-267A	83309	89446	F2HZ-18124-A	85376		F6HT-18045-JB	83200	89402
10-13592-000	85959		AX-310	83215		F2HZ-18124-B	85301		F6HT-18045-JC	83200	89402
1210-0528	85904		C4HZ-18124-E	83309	89446	F4HT-18080-AB	85314	89425	F6HT-18045-KA	83200	89402
16-13957-000	85724	89443	C4TZ-18124-AB	83308		F4HT-18080-BA	85001	89410	F6HT-18045-LA	85376	
16-15770-000	85956		D8HZ-18124-A	85301		F5HZ-18124-A	83314		F6HT-18080-B	83109	
16-15817-000	85724	89443	E6HZ-18124-A	85301		F5HZ-18124-B	83107		F6HT-18080-CA	85314	89425
16-18708-000	85724	89443	E6HZ-18124-D	85301		F5HZ-18124-C	85063		F6HT-18080-DA	83109	
471700002809	85724	89443	E6HZ-18125-D	83215		F5HZ-18124-D	83125		F6HT-18080-EA	85906	89407
47902-28	85013	89414	E7HZ-18124-A	85301		F5HZ-18125-A	85314	89425	F6HT-18080-FC	85013	89414
4C4Z-18124-N	85957		E7XZ-18124-A	G63386		F5HZ-18125-B	85001	89410	F6HT-18124-JC	83200	89402
4C4Z-18125-DA	85926		E7XZ-18125-B	G63387		F6HT-18045-AA	85054	89438	F6HT-18124-KA	83200	89402
57241-2	83109		E9HZ-18124-A	83309	89446	F6HT-18045-AC	85054	89438	F6HZ-18124-A	85054	89438
58913-003	85932	89453	F0HZ-18124-B	85006		F6HT-18045-BC	85047	89435	F6HZ-18124-B	83308	
6803230200	85043		F1HZ-18124-A	83309	89446	F6HT-18045-CC	85055	89439	F6HZ-18124-C	85055	89439
6803230300	85006		F1HZ-18124-B	83308		F6HT-18045-EB	85055	89439	F6HZ-18124-D	85055	89439
6803260000	83120		F1HZ-18124-D	85006	89401	F6HT-18045-EC	85055	89439			
680611	85724	89443	F1HZ-18124-E	85006	89401	F6HT-18045-GB	85030	89440			
6E7Z-18125-A	83146		F1HZ-18124-H	85040		F6HT-18045-GC	85030	89440			
90045099	85906	89407	F1HZ-18124-J	83308		F6HT-18045-HB	85054	89438			

Important Note: Competitive Interchanges are to be used for stocking purposes only. Where multiple crosses are identified, please reference the applications section of this catalog. / **Remarque importante:** Les interchanges concurrentiels ne s'utilisent qu'aux fins de stocks. Dans le cas de références multiples, consulter la section des applications du catalogue. / **Nota importante:** Dans le cas de références multiples, consulter la section des applications du catalogue. / **Nota importante:** Se pueden usar intercambios competitivos para propósitos de almacenamiento solamente. Cuando se identifican intercambios múltiples, consulte la sección aplicaciones de este catálogo.

COMPETITIVE & O.E.M. INTERCHANGE LIST

Lista de Intercambios contra Competidores y Equipo Original.

Liste d'interchange de produits compétitifs & d'équipement original (OEM)

STERLING TRUCK... cont'd

O.E.M #	Gabriel	Upgrade	O.E.M #	Gabriel	Upgrade	O.E.M #	Gabriel	Upgrade	O.E.M #	Gabriel	Upgrade
F6HZ-18124-E	85055	89439	F6HZ-18124-H	85054	89438	F6HZ-18125-D	85013	89414	SDA471700002809	85724	89443
F6HZ-18124-F	85055	89439	F6HZ-18124-J	83200	89402	F81A-18045-AGB	G63809		XC45-18045-AA	83216	
F6HZ-18124-G	85054	89438	F6HZ-18125-B	83109		SDA471700000440	85959		XC45-18080-BA	85724	89443

STERLING TRUCK CAB SHOCKS

O.E.M #	Gabriel	Upgrade	O.E.M #	Gabriel	Upgrade	O.E.M #	Gabriel	Upgrade	O.E.M #	Gabriel	Upgrade
1202-1043	83025		18-45067-000	83034		18-814903003484	83057		F6HZ-5K407-BA	83033	
18-43504-000	83057		18-60768-000	83057		F6HZ-5K407-AB	83034		F8HT-5K407-AA	83033	

STOUGHTON TRAILERS INC.

O.E.M #	Gabriel	Upgrade	O.E.M #	Gabriel	Upgrade	O.E.M #	Gabriel	Upgrade	O.E.M #	Gabriel	Upgrade
HTA20001	83128	89436	NW90044162	83128	89436	NW90044978	85059		RT18165-01	85006	
HTA20002	85000	89436	NW90044448	85051		NW90044979	83113				

SUSPENSIONS INC.

O.E.M #	Gabriel	Upgrade	O.E.M #	Gabriel	Upgrade	O.E.M #	Gabriel	Upgrade	O.E.M #	Gabriel	Upgrade
200188	646155										

SUSPENSYS

O.E.M #	Gabriel	Upgrade	O.E.M #	Gabriel	Upgrade	O.E.M #	Gabriel	Upgrade	O.E.M #	Gabriel	Upgrade
218004872	85737										

TEREX CORPORATION

O.E.M #	Gabriel	Upgrade	O.E.M #	Gabriel	Upgrade	O.E.M #	Gabriel	Upgrade	O.E.M #	Gabriel	Upgrade
12111	646155										

THE BINKLEY COMPANY

O.E.M #	Gabriel	Upgrade	O.E.M #	Gabriel	Upgrade	O.E.M #	Gabriel	Upgrade	O.E.M #	Gabriel	Upgrade
16965	85006		6898	83125							

THOMAS SCHOOL BUS

O.E.M #	Gabriel	Upgrade	O.E.M #	Gabriel	Upgrade	O.E.M #	Gabriel	Upgrade	O.E.M #	Gabriel	Upgrade
10-13634-000	85918	89449	61300219	85091		614966	85307		8C24-18045-DA	83177	
128745	83102		61300222	85091		614974	85304		8C24-18080-DB	83178	
16-15817-000	85724	89443	61300223	85091		63-0001	85713		8C2Z-18124-D	83177	
16-18708-000	85724	89443	61300224	85918	89449	651442	83102		8C2Z-18125-D	83178	
16-18713-000	85122		61300240	85918	89449	659287	83102		90045504	85030	
16-19138-000	85058	89431	61300285	83102		680-323-0300	85006		A-4890	85712	
300-0614966	85307		6130029	85712		680-326-0000	83120		ASH-1136	83178	
471700003070	85122		61310101	85736		680010	85304		ASH-1154	83177	
471700131545	85006		61310102	85308	89422	680054	85307		AT-163G	83177	
60670-006	83147		61310103	85308	89422	680088	85713		AT-164G	83178	
60998-001	85006		61310104	85713		680102	85712		GBL651442	83102	
60998-003	85006		61310232	85000	89436	70445	85091		GBL654725	83120	
6130-0114		89437	61310434	85724	89443	728802	85736		GBL665538	85006	
61300112	83613		61310478	85724	89443	87002	85736				

THOR MOTOR COACH

O.E.M #	Gabriel	Upgrade	O.E.M #	Gabriel	Upgrade	O.E.M #	Gabriel	Upgrade	O.E.M #	Gabriel	Upgrade
141700131809	85029		16-16736-000	85029		16-16873-000	85029		16-18103-000	85900	
141700131810	83160		16-16737-000	83160		16-16874-000	83160		481700000493	85900	

TIMBREN INDUSTRIES

O.E.M #	Gabriel	Upgrade	O.E.M #	Gabriel	Upgrade	O.E.M #	Gabriel	Upgrade	O.E.M #	Gabriel	Upgrade
665804	85939										

TRAILMOBILE CANADA CORP.

O.E.M #	Gabriel	Upgrade	O.E.M #	Gabriel	Upgrade	O.E.M #	Gabriel	Upgrade	O.E.M #	Gabriel	Upgrade
43-4-235	85051		43-6-028	85000	89436	43-8-014	85013	89414	90044978	85059	
43-4-236	85029		43-6-118	85000	89436	43-8-015	85006		90044979	83113	
43-4-237	85000	89436	43-6-137	85006		43-8-022	83225		90044992	85000	89436
43-4-239	83207	89407	43-6-158	85013	89414	43-8-031	85029		90045054	85051	
43-4-241	85006		43-6-164	83207	89407	90044089	83124	89407	A-2212	85029	
43-4-277	85000	89436	43-8-002	83209	89414	90044625	83125				
43-4-278	85059		43-8-011	83207	89407	90044642	83127				
43-4-279	83204		43-8-013	85000	89436	90044977	83115				

Important Note: Competitive Interchanges are to be used for stocking purposes only. Where multiple crosses are identified, please reference the applications section of this catalog. / **Remarque importante:** Les interchanges concurrentiels ne s'utilisent qu'aux fins de stocks. Dans le cas de références multiples, consulter la section des applications du catalogue. / **Nota importante:** Dans le cas de références multiples, consulter la section des applications du catalogue. / **Nota importante:** Se pueden usar intercambios competitivos para propósitos de almacenamiento solamente. Cuando se identifican intercambios múltiples, consulte la sección de aplicaciones de este catálogo.

COMPETITIVE & O.E.M. INTERCHANGE LIST

Lista de Intercambios contra Competidores y Equipo Original.

Liste d'interchange de produits compétitifs & d'équipement original (OEM)

TRANSPORTATION MFG. CORP

O.E.M #	Gabriel	Upgrade	O.E.M #	Gabriel	Upgrade	O.E.M #	Gabriel	Upgrade	O.E.M #	Gabriel	Upgrade
12-05-6000	85711		12J-5-3	85313		12TA-01-13	85303	89422	680350	85710	
12-05-6002	85339		12J-5-4	85312		22012079	85701		680470	85713	
12-05-6033	85339		12J-5-6	85313		22024673	85710		695117	85701	
12B-5-1	85735		12J-5-9	85700		22045526	85702		695273	85710	
12G-5-1	85700		12L-5-69	85700		22046485	85710		695279	85710	
12J-5-10	85733		12L-5-70	85700		22052014	85702		74410	85701	
12J-5-11	85313		12L-5-99	85339		4975515	85701		G1011822	85702	
12J-5-2	85312		12T-1-13	85303	89422	680349	85702		G1101590	85713	

TRUCKMASTER

Truckmaster	Gabriel	Upgrade	Truckmaster	Gabriel	Upgrade	Truckmaster	Gabriel	Upgrade	Truckmaster	Gabriel	Upgrade
665632	85013	89414	665930	85001	89410	680240	85302	89420	680303	85007	89412
665633	85033	89427	665931	83312	89409	680241	85311	89424	680348	85012	89413
665783	83123	89405	665932	85012	89413	680242	85308	89422	680385	85311	89424
665784	83122	89406	665950	85902		680243	85001	89410	680425	85320	89429
665785	83137		671052	85070	89459	680253	85314	89425	680435	85033	89427
665844	85069	89455	671654	85936	89456	680261	85062	89408	680473	85319	89428
665918	85900		671699	85937		680279	83209	89414	680586	85311	89424
665926	85047	89435	671794	85067	89451	680280	85906	89407	680601	85012	89413
665927	85901		680237	85303	89422	680281	85003	89411			
665928	85062	89408	680239	85310	89423	680283	83353				

TUTHILL TECHNOLOGIES

O.E.M #	Gabriel	Upgrade	O.E.M #	Gabriel	Upgrade	O.E.M #	Gabriel	Upgrade	O.E.M #	Gabriel	Upgrade
1085	83214		17358-01	83126	89430	19495-01	83126	89440	24392-01	85051	
12885-01	85300	89419	17403-01	83122	89406	19623-01	83123	89405	2697	85712	
12885-03	85300	89419	17408-01	85005	89430	19824-01	85006		66502	646155	
12887-01	85013	89414	17794-01	83215		20125-01	85030	89440	680162	85300	89419
12887-02	85013	89414	18146-01	85313		20126-01		89440	702135-01	85045	
14954-01	83217		18163-01	83207	89407	20129-01	85007	89412	702136-01	85052	
16230-01	85702		18164-01	83122	89406	20960-01	83204		702209-01	85014	
16725-01	83221		18165-01	85006		21497-01	85005	89430	OE12425	83214	
16824-01	85006		18166-01	85704		23524-01	85738				
17142-01	85001	89410	18286-01		89414	23553-01	85938				
17146-01	83209	89414	18800-01	83203	89436	23614-01	85717				

TWIN COACH

O.E.M #	Gabriel	Upgrade	O.E.M #	Gabriel	Upgrade	O.E.M #	Gabriel	Upgrade	O.E.M #	Gabriel	Upgrade
90044089	83124	89407	90044162	83128	89436	AR-958	83207	89407			
90044089C	83124	89407	AR-718-C-HD	85000	89436						

UNITED MANUFACTURING

O.E.M #	Gabriel	Upgrade	O.E.M #	Gabriel	Upgrade	O.E.M #	Gabriel	Upgrade	O.E.M #	Gabriel	Upgrade
K-96-41	85304										

UNIVERSAL COACH

O.E.M #	Gabriel	Upgrade	O.E.M #	Gabriel	Upgrade	O.E.M #	Gabriel	Upgrade	O.E.M #	Gabriel	Upgrade
12-05-1199	85729		680777	85729							

UPS TRUCK

O.E.M #	Gabriel	Upgrade	O.E.M #	Gabriel	Upgrade	O.E.M #	Gabriel	Upgrade	O.E.M #	Gabriel	Upgrade
P117099	83120		P117146	83118							

UTILITY TRAILER MANUFACTURING COMPANY

O.E.M #	Gabriel	Upgrade	O.E.M #	Gabriel	Upgrade	O.E.M #	Gabriel	Upgrade	O.E.M #	Gabriel	Upgrade
B-23361	85911		B-24023	85738		B-24125	85323	89436	S-24088	83128	89436
B-23566	85000	89436	B-24088	83128	89436	B-24579	85939		S-24088	85000	89436
B-23651	85045		B-24088	85000	89436	B-25515	85338				

VAN HOOL

O.E.M #	Gabriel	Upgrade	O.E.M #	Gabriel	Upgrade	O.E.M #	Gabriel	Upgrade	O.E.M #	Gabriel	Upgrade
10685703	695406		6243-14040	85708		665562	85708		90-2291	695406	
6243-13790	85708		624314570	695406		665563	85708				

Important Note: Competitive Interchanges are to be used for stocking purposes only. Where multiple crosses are identified, please reference the applications section of this catalog. / **Remarque importante:** Les interchanges concurrentiels ne s'utilisent qu'aux fins de stocks. Dans le cas de références multiples, consulter la section des applications du catalogue. / **Nota importante:** Dans le cas de références multiples, consulter la section des applications du catalogue. / **Nota importante:** Se pueden usar intercambios competitivos para propósitos de almacenamiento solamente. Cuando se identifican intercambios múltiples, consulte la sección de aplicaciones de este catálogo.

COMPETITIVE & O.E.M. INTERCHANGE LIST
Lista de Intercambios contra Competidores y Equipo Original.
Liste d'interchange de produits compétitifs & d'équipement original (OEM)

VARIOUS

O.E.M #	Gabriel	Upgrade	O.E.M #	Gabriel	Upgrade	O.E.M #	Gabriel	Upgrade	O.E.M #	Gabriel	Upgrade
SC-2920	83176										

VOLVO

O.E.M #	Gabriel	Upgrade	O.E.M #	Gabriel	Upgrade	O.E.M #	Gabriel	Upgrade	O.E.M #	Gabriel	Upgrade
02-7005976	83400		20433424	85061	89450	3199968	85308	89422	3919561	85314	89425
02-7005977	83400		20433425	85066	89448	3199970	85701		3919565	83103	
03-1106460	85005	89430	20433426	85081		3199972	85320	89429	3919567	83613	
1-0200-32-888-1	83104		20433427	85065		3199973	85722		3919568	83636	
1091347	83125		20434880	85081		3199974	85712		3919569	85052	
1091348	83122	89406	20469001	85933	89454	3199975	85700		3919570	83128	
1091349	83204		20469002	85933	89454	3199976	85711		3919571	83635	
1091350	83207	89407	20485632	85933	89454	3199977	85711		3919572	83130	
1091351	83209	89414	20485633	85933	89454	3199978	85712		3919573	83123	89405
1091353	83215		20513881	85061	89450	3199979	85702		3919574	85006	89401
1091354	83216		20551628	85066	89448	3199980	85310	89423	3919575	83120	
1091355	83217		20782199	85072		3199982	85703		3919582	83215	
1091357	83219		20863239	85080		3199983	85704		3919583	83100	
1091358	83456	89447	21137330	85933	89454	3199984	85314	89425	3919584	83353	
1091359	83123	89405	21436086	85098		3199985	85723		3919585	83209	89414
1091360	83303		21462378	85088		3199986	85318		3919586	83100	
1091361	83304		21462380	85088		3199987	85705		3919587	83105	
1091362	83309	89446	22012065	85304		3199988	85311	89424	3919588	83216	
1091363	83221		22046483	85304		3199989	85709		3919589	85026	89417
1091364	83312	89409	22052336	85304		3199990	85003	89411	3919590	85042	
1091365	83400		3082284	83400		3199991	85708		3919591	83515	
1091366	83401		3092842	85061	89450	3199992	85733		3919592	85024	89416
1091367	85000	89436	3130140	85315		3199993	85712		3919593	83242	
1091368	85003	89411	3171696	85307		3199994	85308	89422	3919594	85003	89411
1091370	85006		3172948	85303	89422	35901-0001	83209	89414	3919596	G63484	
1091371	85300	89419	3199937	85316	89426	35901-0003	85301		3919598	83312	89409
1091372	85301		3199938	85303	89432	35901-0004	83219		3919900	85012	89413
1091373	85302	89420	3199939	85058	89431	35901-0005	83219		3919901	83103	
1091374	85303	89422	3199940	85005	89430	35901-0008	85060		3919902	83126	89430
1091375	85304		3199941	85006		35901-0011	83123	89405	3919903	83216	
1091376	85305		3199942		89402	35901-0017	83314		3919904	G63183	
1091377	85307		3199943	85012	89413	35901-0022	83635		3919906	83308	
1091378	85308	89422	3199944	85006		35901-3201	85024	89416	3919907	83309	89446
1091379	85310	89423	3199945	85027	89418	35901-3406	85305		3919908	83104	
1091384	85735		3199946	85033	89427	35901-3409	85304		3919909	G63605	
1093100	85027	89418	3199947	85013	89414	35901-3410	85307		3919910	83221	
1093174	83353		3199948	85311	89424	35901-3413	85006		3919911	83124	89407
1093176	85024	89416	3199949	85310	89423	35901-3420	85303	89422	3919912	83215	
1093177	85025		3199950	85023	89415	37001-5	83401		3919913	83203	89436
1093178	85026	89417	3199951	85024	89416	37301-0001	85013	89414	3919914	83209	89414
1093180	85030	89440	3199952	85736		37301-0008	83400		3919915	83127	
141700000373	85061	89450	3199953	85319	89428	37301-0016	85026	89417	3919916	83126	89430
141700005838	85098		3199954	85003	89411	37301-0018	85005	89430	3919917	83125	
1505190	85722		3199955	85300	89419	37301-0021	85026	89417	3919918	83401	
1590439	83104		3199956	85036	89405	37301-3201	85027	89418	3919919	G63625	
1591501	85722		3199957	83122	89406	37301-3202	85026	89417	3919920	83303	
1591735	83104		3199959	85323	89436	3915917	85319	89428	3919921	83123	89405
1593843	83215		3199960	85322		3915947	85001	89410	3919922	83318	
1716824	85304		3199961	85307		3915948	85311	89424	3919923	83301	
19501669	85339		3199962	85314	89425	3916352	85013	89414	3919924	83456	89447
19502711	85702		3199963	85315		3919055	85007	89412			
19506846	85339		3199965	85736		3919056	83203	89436			
20353932	85081		3199966	85303	89422	3919057	83225				
20414440	85081		3199967	85302	89420	3919526	83314				

Important Note: Competitive Interchanges are to be used for stocking purposes only. Where multiple crosses are identified, please reference the applications section of this catalog. / **Remarque importante:** Les interchanges concurrentiels ne s'utilisent qu'aux fins de stocks. Dans le cas de références multiples, consulter la section des applications du catalogue. / **Nota importante:** Dans le cas de références multiples, consulter la section des applications du catalogue. / **Nota importante:** Se pueden usar intercambios competitivos para propósitos de almacenamiento solamente. Cuando se identifican intercambios múltiples, consulte la sección de aplicaciones de este catálogo.

COMPETITIVE & O.E.M. INTERCHANGE LIST
Lista de Intercambios contra Competidores y Equipo Original.
Liste d'interchange de produits compétitifs & d'équipement original (OEM)

VOLVO... cont'd

O.E.M #	Gabriel	Upgrade	O.E.M #	Gabriel	Upgrade	O.E.M #	Gabriel	Upgrade	O.E.M #	Gabriel	Upgrade
3919925	83317		3919984	85700		5531437	85307		83176196	83110	
3919926	G63403		3919985	85723		5534430	85303	89422	83176197	83111	
3919927	83101		3919987	85706		5534447	85303	89422	83176198	83112	
3919928	83225		3919988	85311	89424	5549899	83207	89407	83176199	83123	
3919930	83353		3919989	85709		5549925	85304		83176200	83124	
3919931	83126	89430	3919990	85003	89411	5554959	83401		83176201	83125	
3919932	85062	89408	3919991	85708		57241-3	83112		83176202	83126	
3919933	85001	89410	3919992	85733		60657-007	85072		83176203	83127	
3919934	85320	89429	3919993	85712		60675-001	85978		83176204	83128	
3919935	85026	89417	3919994	85310	89423	629398	85307		83176205	83136	
3919936	83207	89407	3945806		89417	629501	85307		83176206	83148	
3919937	85316	89426	3945807		89416	646220	85734		83176207	83203	
3919938	85030	89432	3945808		89407	64838-001	85933	89454	83176208	83209	
3919939	85058	89431	3945809		89410	64838-002	85933	89454	83176209	83215	
3919940	85005	89430	3945810		89420	64838-003	85933	89454	83176210	83216	
3919941	85006		3945811		89409	66010-0016	85025		83176211	85000	
3919942	89402		3945812		89423	662211401	83215		83176212	85001	
3919943	85012	89413	3945813		89428	665410	85027	89418	83176213	85003	
3919944	85036		3945814		89424	665539	85026	89417	83176214	85005	
3919945	85027	89418	3945815		89406	665607	85047	89435	83176215	85023	
3919946	85033	89427	3945816		89430	665623	85046	89434	83176216	85026	
3919947	85013	89414	3945817		89422	665739	85047	89435	83176217	85033	
3919948	85311	89424	3945818		89415	668302	83216		83176218	85036	
3919949	85310	89423	3945819		89411	676081	83401		83176219	85045	
3919950	83219		3945820		89413	676082	83401		83176220	85046	
3919951	83309	89416	3945821		89419	6771501	85040		83176221	85047	
3919952	85736		3946210	83103		6772218	85040		83176222	85052	
3919953	85319	89428	3946217	83125		6775411	85040		83176223	85061	
3919954	85003	89411	3946219	83400		6775412	85040		83176224	85062	
3919955	85300	89419	3946239	85724	89443	6790756	83215		83176225	85066	
3919956	85036	89405	3949240	85047	89435	6794358	85040		83176226	85067	
3919957	83122	89406	3949241	85061	89450	6857668	83105		83176227	85069	
3919958	85046	89434	3953643	85040		6876828	83105		83176228	85070	
3919959	85000	89436	3971703	83112		70042	85302	89420	83176229	85303	
3919960	85322		3972662	85976		8026658	85046	89434	83176230	85310	
3919961	85302	89420	47170000443	85066	89448	8056892	85023	89415	83176231	85311	
3919962	85700		471700002627	85066	89448	8060026	85065		83176232	85320	
3919963	85730		471700003832	85933	89454	8065787	85026	89417	83176233	85321	
3919964	85304		471700004423	85109		8071524	85024	89416	83176234	85323	
3919965	85702		471700006038	85088		8071881	85061	89450	83176235	85724	
3919966	85736		471700006040	85088		8073212	85065		83176236	85900	
3919967	85302	89420	471700131256	85065		8075257	85065		83176237	85916	
3919968	85736		471700131258	85081		8075287	85065		83176238	85918	
3919970	85701		471700131920	85933	89454	8077874	85047	89435	83176239	85933	
3919972	85320	89429	471700131921	85933	89454	8077874-P01	85047	89435	83176240	646155	
3919973	85956		47902-24	83137		8078195	85061	89450	85104186	85006	
3919974	85712		494-660	83219		8083872	85978		85104221	85066	89448
3919975	85700		4940640	83216		8086053	85047	89435	85106580	85918	89449
3919976	85033	89427	4975479	83400		8086651	85066	89448	85107238	85976	
3919977	85033	89427	4975480	83400		8169859	85047	89435	85134402	85061	89450
3919978	85702		4975549	83216		8174749	85906	89407	85137234	83125	
3919979	85702		530596	85308	89422	83176191	83019		85137420	85000	89436
3919980	85702		5322338	83214		83176192	83041		90045605	85109	
3919981	85701		5513989	83216		83176193	83045		RC SA3041	83041	
3919982	85703		5531435	85307		83176194	83048		RC SA3045	83045	
3919983	85704		5531436	85307		83176195	83103		RC SA3048	83048	

Important Note: Competitive Interchanges are to be used for stocking purposes only. Where multiple crosses are identified, please reference the applications section of this catalog. / **Remarque importante:** Les interchanges concurrentiels ne s'utilisent qu'aux fins de stocks. Dans le cas de références multiples, consulter la section des applications du catalogue. / **Nota importante:** Dans le cas de références multiples, consulter la section des applications du catalogue. / **Nota importante:** Se pueden usar intercambios competitivos para propósitos de almacenamiento solamente. Cuando se identifican intercambios múltiples, consulte la sección de aplicaciones de este catálogo.

COMPETITIVE & O.E.M. INTERCHANGE LIST
Lista de Intercambios contra Competidores y Equipo Original.
Liste d'interchange de produits compétitifs & d'équipement original (OEM)

VOLVO... cont'd

O.E.M #	Gabriel	Upgrade	O.E.M #	Gabriel	Upgrade	O.E.M #	Gabriel	Upgrade	O.E.M #	Gabriel	Upgrade
RC SA3103	83103		RC SA5066	85066		SA3124	83124		SA5061	85061	
RC SA3111	83111		RC SA5067	85067		SA3125	83125		SA5062	85062	
RC SA3112	83112		RC SA5070	85070		SA3126	83126		SA5066	85066	
RC SA3124	83124		RC SA5310	85310		SA3127	83127		SA5067	85067	
RC SA3125	83125		RC SA5320	85320		SA3128	83128		SA5069	85069	
RC SA3127	83127		RC SA5724	85724		SA3136	83136		SA5070	85070	
RC SA3128	83128	89436	RC SA5900	85900		SA3148	83148		SA5303	85303	
RC SA3136	83136		RC SA5918	85918		SA5000	85000		SA5310	85310	
RC SA3148	83148		RC SA5933	85933		SA5001	85001		SA5311	85311	
RC SA3203	83203		RC SA6155	646155		SA5003	85003		SA5320	85320	
RC SA3216	83216		SA3019	83019		SA5005	85005		SA5321	85321	
RC SA5000	85000		SA3041	83041		SA5023	85023		SA5323	85323	
RC SA5001	85001		SA3045	83045		SA5026	85026		SA5724	85724	
RC SA5003	85003		SA3048	83048		SA5033	85033		SA5900	85900	
RC SA5005	85005		SA3103	83103		SA5036	85036		SA5916	85916	
RC SA5047	85047		SA3110	83110		SA5045	85045		SA5918	85918	
RC SA5052	85052		SA3111	83111		SA5046	85046		SA5933	85933	
RC SA5061	85061		SA3112	83112		SA5047	85047		SA6155	646155	
RC SA5062	85062		SA3123	83123		SA5052	85052		SDA471700131258	85081	

VOLVO CAB SHOCKS

O.E.M #	Gabriel	Upgrade	O.E.M #	Gabriel	Upgrade	O.E.M #	Gabriel	Upgrade	O.E.M #	Gabriel	Upgrade
1201-0012	83023		20704334	83048		22662224	83048		8078547	83029	
1202-0012	83023		20721254	83048		3945842	83009		8162662	83004	
1202-0022	83046		20874147	83050		635869	83004		8168617	83030	
1202-0032	83016		21368413	83048		66010-0007	83004		85107095	83009	
20496215	83048		21391412	83048		66010-0008	83004				
20496217	83029		22662125	83048		8078546	83028				

WABASH NATIONAL

O.E.M #	Gabriel	Upgrade	O.E.M #	Gabriel	Upgrade	O.E.M #	Gabriel	Upgrade	O.E.M #	Gabriel	Upgrade
202447	85919		FRUUCE1295-901	85300	89419	HENS-24088	83128	89436	NEW900-44-868	85045	
203447	85919		FRUUCE2983-1	85322		HENS-24088	85000	89436	NEW900-44-978	85059	
DANSR1VJ100	85078		FRUUCF8339-1	85321		NEW900-44-089	83124	89407	NEW900-44-979	83113	
FLL83203-071	83203	89436	HENS-20001	83128	89436	NEW900-44-162	83128	89436	NEW900-45-040	83130	
FLL83207-071	83207	89407	HENS-20002	85000	89436	NEW900-44-625	83125		NEW900-45-054	85051	
FLL85000-071	85000	89436	HENS-20126	85323	89436	NEW900-44-626	83126	89430	NEW900-45-298	83128	
FLL85030-071	85030	89440	HENS-21292	85052		NEW900-44-642	83127		NEW900-45-299	85000	89436
FRUUCE1295-1	85300	89419	HENS-23566	85000	89436	NEW900-44-794	83127				

WATSON & CHALIN MFG. INC.

O.E.M #	Gabriel	Upgrade	O.E.M #	Gabriel	Upgrade	O.E.M #	Gabriel	Upgrade	O.E.M #	Gabriel	Upgrade
10147	83203	89436	17186-01	85323	89436	19250	85382		680714	85934	
10147HD	85000	89436	17218	85029		19603	85939		727603	83203	89436
10148	83204		17297	85064		3946219	83400		727604	83204	
10634	G63357		17300	85052		665724	85000	89436	A-20345	85345	
11418	646155		17306	85938		665727	85005	89430	B-23649	85064	
11604	83125		17317	85344		665728	85060		B-23650	85052	
11724	83123	89405	17382	85014		665769	85052		B-23651	85045	
12128	85005	89430	17430	85321		665770	85064		B-23743	85938	
17069	632147		17474	85009		665862	85000	89436			
17079	85300	89419	19036	85934		680547	85323	89436			
17186	85323	89436	19249	85939		680584	85938				

WESTERN STAR

O.E.M #	Gabriel	Upgrade	O.E.M #	Gabriel	Upgrade	O.E.M #	Gabriel	Upgrade	O.E.M #	Gabriel	Upgrade
02-7005976	83400		16-15770-000	85956		35901-0001	83209	89414	35901-3420	85303	89422
02-7005977	83400		16-18706-000	85331		35901-3406	85305				
04-9041375	85315		16-18708-000	85724	89443	35901-3409	85304				
10-13809-000	85958		28R010	83216		35901-3410	85307				
1011839	83216		35066-4413	83122	89406	35901-3413	85006				

Important Note: Competitive Interchanges are to be used for stocking purposes only. Where multiple crosses are identified, please reference the applications section of this catalog. / **Remarque importante:** Les interchanges concurrentiels ne s'utilisent qu'aux fins de stocks. Dans le cas de références multiples, consulter la section des applications du catalogue. / **Nota importante:** Dans le cas de références multiples, consulter la section des applications du catalogue. / **Nota importante:** Se pueden usar intercambios competitivos para propósitos de almacenamiento solamente. Cuando se identifican intercambios múltiples, consulte la sección de aplicaciones de este catálogo.

COMPETITIVE & O.E.M. INTERCHANGE LIST
Lista de Intercambios contra Competidores y Equipo Original.
Liste d'interchange de produits compétitifs & d'équipement original (OEM)

WESTERN STAR... cont'd

O.E.M #	Gabriel	Upgrade	O.E.M #	Gabriel	Upgrade	O.E.M #	Gabriel	Upgrade	O.E.M #	Gabriel	Upgrade
35901-4403	85060		471700004423	85109		57905-2	85006		90044907	83635	
37301-3401	85053	89442	471700006269	85932	89453	58913-003	85932	89453	90045099	85906	89407
37301-3404	85053	89442	471700131331	85932	89453	58913-012	85932	89453	90045605	85109	
37301-3405	85053	89442	47902-13	83122	89406	60675-002	85979		CP-5222	85315	
37301-3409	85053	89442	47902-24	83137		615016	83401		SDA471700003920	85958	
37301-3412	85053	89442	47902-8	83122	89406	665682	85053	89442	SDA481700125969	85956	
37390-4401	85053	89442	57241-1	83111		676081	83401				
37390-4402	85053	89442	57252	85308	89422	676082	83401				
37390-4403	85053	89442	57905-1	85976		90044025	83209	89414			

WESTERN STAR CAB SHOCKS

O.E.M #	Gabriel	Upgrade	O.E.M #	Gabriel	Upgrade	O.E.M #	Gabriel	Upgrade	O.E.M #	Gabriel	Upgrade
1201-0012	83023		18-60772-000	83026		66010-3403	83022		725470	83010	
1201-0022	83046		18-60773-000	83027		66010-3404	83022		81-4903003500	83026	
1202-0012	83023		617547	83022		66010-3405	83026		814903003501	83027	
1202-0022	83046		654846	83027		66010-3406	83027		GBL 654916	83026	
1202-0032	83016		66010-3402	83022		66010-3407	83065				

WESTERN UNIT ``STABILAIR" SUSPENSION

O.E.M #	Gabriel	Upgrade	O.E.M #	Gabriel	Upgrade	O.E.M #	Gabriel	Upgrade	O.E.M #	Gabriel	Upgrade
101030	85307		4939967	85308	89422	80600	85300	89419			
101364	85305		80370	85304							

WESTPORT AXLE CORP

O.E.M #	Gabriel	Upgrade	O.E.M #	Gabriel	Upgrade	O.E.M #	Gabriel	Upgrade	O.E.M #	Gabriel	Upgrade
143699-0185	646177		646124	646177							

WINNEBAGO

O.E.M #	Gabriel	Upgrade	O.E.M #	Gabriel	Upgrade	O.E.M #	Gabriel	Upgrade	O.E.M #	Gabriel	Upgrade
141700131809	85029		16-16736-000	85029		16-16873-000	85029		16-18103-000	85900	
141700131810	83160		16-16737-000	83160		16-16874-000	83160		481700000493	85900	

WORKHORSE

O.E.M #	Gabriel	Upgrade	O.E.M #	Gabriel	Upgrade	O.E.M #	Gabriel	Upgrade	O.E.M #	Gabriel	Upgrade
24-153249	85125		659223	G63866		F4-BE5-B492-HO	85125		W0006254	85125	
24-153256	85124		680672	85919		F4-BE5-F324-HO	85125		W0007363	83171	
24-186537	85126		7805-X-1012	85919		F4-BE5-F325-HO	85124		W0007365	G63866	
24-186629	85125		F4-BE5-A011-HO	85126		W0005662	85125		W8007000	83171	
659222	83171		F4-BE5-A832-MO	85125		W0005663	85124				

Important Note: Competitive Interchanges are to be used for stocking purposes only. Where multiple crosses are identified, please reference the applications section of this catalog. / **Remarque importante:** Les interchanges concurrentiels ne s'utilisent qu'aux fins de stocks. Dans le cas de références multiples, consulter la section des applications du catalogue. / **Nota importante:** Dans le cas de références multiples, consulter la section des applications du catalogue. / **Nota importante:** Se pueden usar intercambios competitivos para propósitos de almacenamiento solamente. Cuando se identifican intercambios múltiples, consulte la sección de aplicaciones de este catálogo.

HOW TO DETERMINE THE CORRECT SHOCK FOR YOUR TRUCK

CÓMO ESCOGER EL MEJOR AMORTIGUADOR PARA SU CAMIÓN

COMMENT CHOISIR LE BON AMORTISSEUR POUR VOTRE CAMION

Part Number: The catalog number for the individual shock absorber.

Extended Length*: The length of the shock absorber when it is fully extended. See "How to Measure" instructions.

Collapsed Length*: The length of the shock absorber when it is fully collapsed. See "How to Measure" instructions

Stroke: This is the approximate length of the stroke of the individual shock absorber being described.

Mounting Codes: Indicates the type of mounting ends for the upper and lower end of each shock absorber.

They are listed as follows:

- Stud type mounts ("S" & "DS")
- Eye ring and bushing mounts ("EB")
- Eye ring and bushing with sleeve mounts ("ES")
- Eye ring and bushing with bar pin mounts ("BP")
- Special mounting codes ("SP")

Número de parte: El número de catálogo para el amortiguador individual.

Longitud extendida*: La longitud del amortiguador cuando está totalmente extendido. Consulte las instrucciones "Cómo medir".

Longitud colapsada*: La longitud del amortiguador cuando está totalmente colapsado. Consulte las instrucciones "Cómo medir".

Carrera: Esta es la longitud aproximada de la carrera del amortiguador individual que se está describiendo.

Códigos de montura: Indica el tipo de extremos de montura para el extremo superior e inferior de cada amortiguador.

Se enumeran de la siguiente manera:

- Monturas tipo perno ("S" y "DS")
- Monturas de anillo y casquillo ("EB")
- Monturas de anillo y casquillo con funda ("ES")
- Monturas de anillo y casquillo con pasador de barra ("BP")
- Códigos especiales de montura ("SP")

Numéro de pièce : Le numéro de catalogue pour l'amortisseur individuel.

Longueur en extension*: La longueur de l'amortisseur lorsqu'il est en extension complète. Voir les instructions « Comment mesurer ».

Longueur plié*: La longueur de l'amortisseur lorsqu'il est complètement plié. Voir les instructions « Comment mesurer ».

Course: Ceci est la longueur approximative de la course de l'amortisseur individuel décrit ici.

Codes de fixation: Indique le type d'extrémité de fixation pour l'extrémité supérieure et inférieure de chaque amortisseur.

Ils sont classés comme suit :

- Fixations à goujons (« S » et « DS »)
- Fixations à œillet et à douille (« EB »)
- Fixations à œillet et douille de glissement (« ES »)
- Fixations à œillet et à douille avec broche (« BP »)
- Codes de fixations spéciales (« SP »)

CONVERSION CHART | TABLA DE CONVERSIÓN | TABLEAU DE CONVERSION

Fraction Fracción	Decimal Décimal	Metric Métrico Métrique	Fraction Fracción	Decimal Décimal	Metric Métrico Métrique
(INCHES)	(INCHES)	(MM)	(INCHES)	(INCHES)	(MM)
1/64	0.016	0.397	33/64	0.516	13.097
1/32	0.031	0.794	17/32	0.531	13.494
3/64	0.047	1.191	35/64	0.547	13.891
1/16	0.063	1.588	9/16	0.563	14.288
5/64	0.078	1.984	37/64	0.578	14.684
3/32	0.094	2.381	19/32	0.594	15.081
7/64	0.109	2.778	39/64	0.609	15.478
1/8	0.125	3.175	5/8	0.625	15.875
9/64	0.141	3.572	41/64	0.641	16.272
5/32	0.156	3.969	21/32	0.656	16.669
11/64	0.172	4.366	43/64	0.672	17.066
3/16	0.188	4.763	11/16	0.688	17.463
13/64	0.203	5.159	45/64	0.703	17.859
7/32	0.219	5.556	23/32	0.719	18.256
15/64	0.234	5.953	47/64	0.734	18.653
1/4	0.250	6.350	3/4	0.750	19.050
17/64	0.266	6.747	49/64	0.766	19.447
9/32	0.281	7.144	25/32	0.781	19.844
19/64	0.297	7.541	51/64	0.797	20.241
5/16	0.313	7.938	13/16	0.813	20.638
21/64	0.328	8.334	53/64	0.828	21.034
11/32	0.344	8.731	27/32	0.844	21.431
23/64	0.359	9.128	55/64	0.859	21.828
3/8	0.375	9.525	7/8	0.875	22.225
25/64	0.391	9.922	57/64	0.891	22.622
13/32	0.406	10.319	29/32	0.906	23.019
27/64	0.422	10.716	59/64	0.922	23.416
7/16	0.438	11.113	15/16	0.938	23.813
29/64	0.453	11.509	61/64	0.953	24.209
15/32	0.469	11.906	31/32	0.969	24.606
31/64	0.484	12.303	63/64	0.984	25.003
1/2	0.500	12.700	1	1.000	25.400

METRIC CONVERSION CHART | TABLA DE CONVERSIÓN MÉTRICA | TABLEAU DE CONVERSION

(MM)	(INCHES)	(MM)	(INCHES)	(MM)	(INCHES)
1	0.03937	10	0.39370	19	0.74803
2	0.07874	11	0.43307	20	0.78740
3	0.11811	12	0.47244	21	0.82677
4	0.15748	13	0.51181	22	0.86614
5	0.19685	14	0.55118	23	0.90551
6	0.23622	15	0.59055	24	0.94488
7	0.27559	16	0.62992	25	0.98425
8	0.31496	17	0.66929		
9	0.35433	18	0.70866		

HOW TO DETERMINE THE CORRECT SHOCK FOR YOUR TRUCK

CÓMO ESCOGER EL MEJOR AMORTIGUADOR PARA SU CAMIÓN COMMENT CHOISIR LE BON AMORTISSEUR POUR VOTRE CAMION

- STEP 2:** Identify the mounting style. Measure fully extended and fully collapsed lengths at the locations indicated for mounting style.
- 2º PASO:** Identifique el tipo de montaje. Mida la longitud totalmente extendida y totalmente comprimida, en los puntos indicados para cada tipo de montaje.
- 2È ÉTAPE:** Identifiez la méthode de fixation. Mesurez la longueur en pleine extension et en pleine compression, aux endroits indiqués pour la méthode de fixation.

HOW TO MEASURE EXTENDED & COLLAPSED LENGTHS OF SHOCK ABSORBERS COMO MEDIR LAS LONGITUDES EXTENDIDA Y COMPRIMIDA DE LOS AMORTIGUADORES COMMENT MESURER LES LONGUEURS ALLONGÉ ET COMPRIMÉ DES AMORTISSEURS

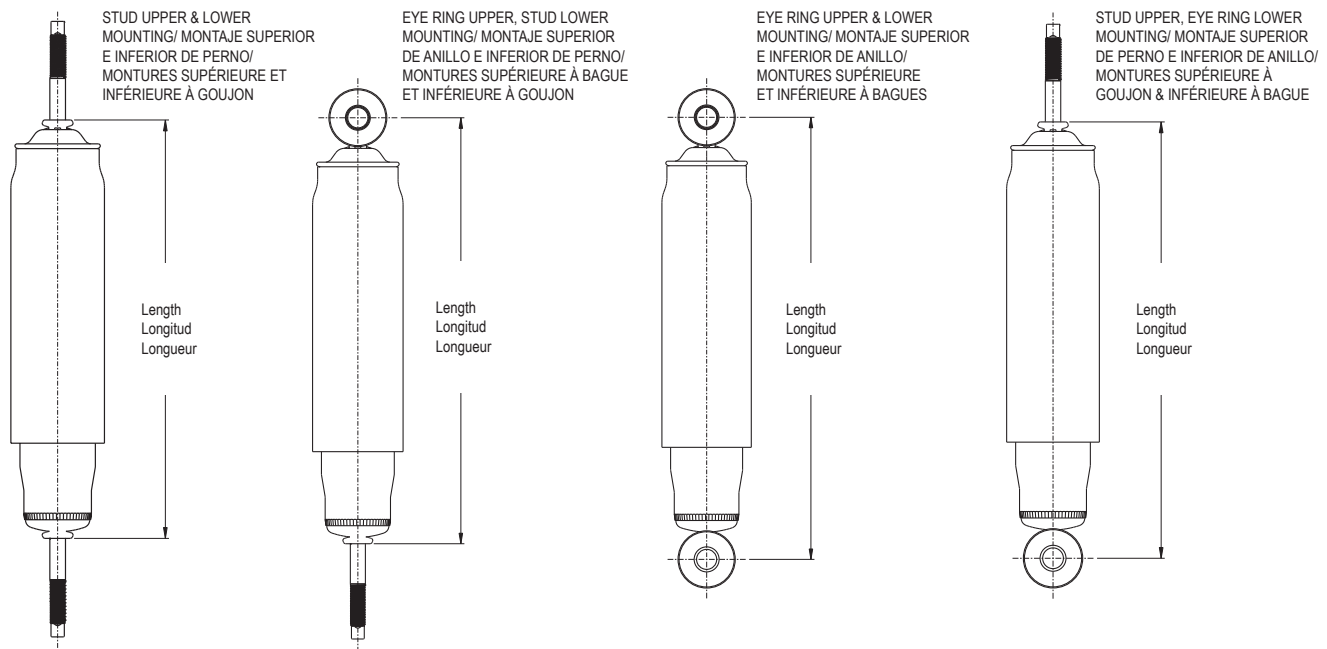

INSTRUCTIONS:

- Using the proper measuring points as shown above find the nearest replacement shock absorber from the listing by increments of extended length.
- Identify the proper mounting from the mounting codes and match these requirements by carefully measuring the mounting dimensions (top and bottom) of the shock absorber to be replaced.
- Carefully take note of the following requirements:
 - Dust tubes** - This requirement should be noted in comparison with the shock absorber to be replaced. Shock absorber environment in its application makes this requirement necessary for piston rod protection and extended shock absorber life.
 - Recoil Cutoff and Compression Bumper** - Carefully note these specifications - deviation of length requirements should not exceed $\pm 1/4$ ". These shock absorber designs are footnoted for easy identification.

Note: Shock absorbers used for installations other than those recommended in our catalog are **not subject to warranty**.

INSTRUCCIONES:

- Usando los puntos de medida adecuados como mencionado, encuentre el amortiguador más cercano en la lista por incrementos de la longitud extendida.
- Identifique la montaje adecuado por medio de los códigos de fijación y compare estas especificaciones, midiendo cuidadosamente las dimensiones de la montaje (superior e inferior) del amortiguador por reemplazar.
- Note cuidadosamente las exigencias siguientes:
 - Polvera** - Este componente debe estar presente en el amortiguador por reemplazar. El ambiente de trabajo del amortiguador hacen a la polvera necesaria para proteger la barra del pistón y extender la vida del producto.
 - Tope de retorno y tope de compresión** - Note cuidadosamente las especificaciones siguientes : las exigencias de longitud no deben de ser excedidas $\pm 1/4$ ". Estos diseños de amortiguadores están marcados para facilitar su identificación.

Nota: Los amortiguadores usados para instalaciones otras que las recomendadas en nuestro catálogo **no son garantizados**.

INSTRUCTIONS:

- En utilisant les points de mesure appropriés comme indiqués ci-dessus, trouvez l'amortisseur de rechange le plus près de cette mesure d'après la longueur allongée.
- Repérez les montures appropriées sur les codes des montures et faites correspondre ces exigences en mesurant attentivement les dimensions des montures (haut et bas) de l'amortisseur à replacer.
- Avec soin, prenez note des exigences suivantes:
 - Tubes pare-poussière** - Cette exigence devrait être notée en comparaison de l'amortisseur à remplacer. Le milieu de service rend cette exigence nécessaire pour la protection de la tige de piston et une meilleure longévité de l'amortisseur.
 - Arrêt de retour et butée de compression** - Notez avec soin ces spécifications. La déviation par rapport aux exigences de longueurs ne doit pas dépasser $\pm 1/4$ po. Ces modèles d'amortisseurs portent une note pour une identification facile.

Note: Les amortisseurs utilisés pour des installations autres que celles recommandées dans notre catalogue **ne sont pas couverts par la garantie**.

HOW TO DETERMINE THE CORRECT SHOCK FOR YOUR TRUCK

CÓMO ESCOGER EL MEJOR AMORTIGUADOR PARA SU CAMIÓN COMMENT CHOISIR LE BON AMORTISSEUR POUR VOTRE CAMION

STEP 1: Measure the diameter of the dust tube and cylinder to determine the series.

1^{ER} PASO: Mida el diámetro del tubo de polvo y del cilindro para determinar la serie.

1^{RE} ÉTAPE: Mesurez le diamètre du tube de poussière et du cylindre pour déterminer la série.

EXTERNAL DIMENSIONS DIMENSIONES EXTERNAS DIMENSIONS EXTÉRIEURES

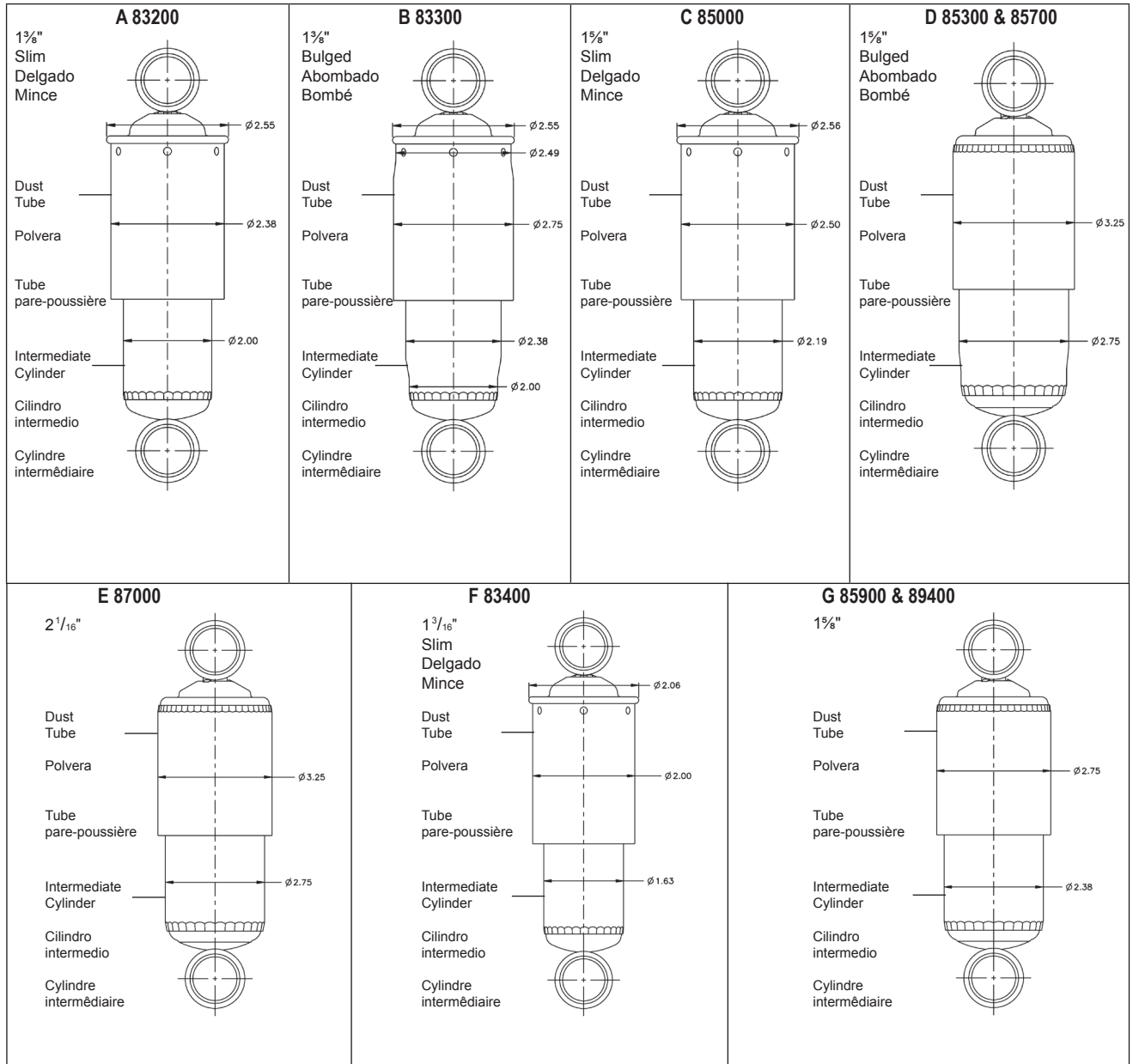

HOW TO DETERMINE THE CORRECT SHOCK FOR YOUR TRUCK

CÓMO ESCOGER EL MEJOR AMORTIGUADOR PARA SU CAMIÓN COMMENT CHOISIR LE BON AMORTISSEUR POUR VOTRE CAMION

STEP 3: Measure end mount diameters, widths, and lengths. Refer to the following end mount tables to determine the appropriate or matching mounting code.

3ER PASO: Mida las dimensiones del tubo, así como el diámetro, la anchura y la longitud de las fijaciones. Consulte las tablas siguientes de conteras para determinar el código de montaje apropiado o concorde.

3E ÉTAPE: Mesurez le diamètre, la largeur et la longueur des bagues. Consultez les tableaux d'embouts suivants afin d'établir le code de montage approprié ou concordant.

MOUNTING CODE "EB" EYE RING AND BUSHING CODIGO DE FIJACION «EB» ANILLO Y BUJE CODE DE MONTURE "EB" À BAGUE ET MANCHON

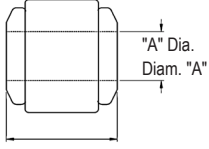
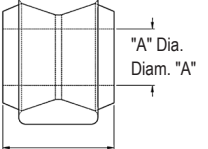
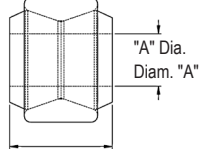
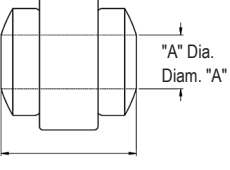
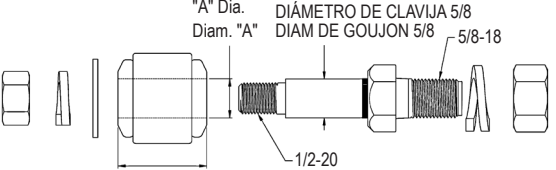
<p>EB1</p>  <p>"A" Dia. Diam. "A"</p> <p>FREE LENGTH "B" COMP LENGTH "C" LONGITUD LIBRE "B" LONGITUD COMPRIMIDA "C" LONGUEUR NON COMP "B" LONGUEUR COMP "C"</p>	<p>EB2</p>  <p>"A" Dia. Diam. "A"</p> <p>FREE LENGTH "B" COMP LENGTH "C" LONGITUD LIBRE "B" LONGITUD COMPRIMIDA "C" LONGUEUR NON COMP "B" LONGUEUR COMP "C"</p>	<p>EB3</p>  <p>"A" Dia. Diam. "A"</p> <p>FREE LENGTH "B" COMP LENGTH "C" LONGITUD LIBRE "B" LONGITUD COMPRIMIDA "C" LONGUEUR NON COMP "B" LONGUEUR COMP "C"</p>
<p>EB4</p>  <p>"A" Dia. Diam. "A"</p> <p>FREE LENGTH "B" COMP LENGTH "C" LONGITUD LIBRE "B" LONGITUD COMPRIMIDA "C" LONGUEUR NON COMP "B" LONGUEUR COMP "C"</p>	<p>EB7</p>  <p>"A" Dia. Diam. "A"</p> <p>5/8 PIN DIA DIÁMETRO DE CLAVIJA 5/8 DIAM DE GOUJON 5/8</p> <p>5/8-18</p> <p>1/2-20</p> <p>FREE LENGTH "B" COMP LENGTH "C" LONGITUD LIBRE "B" LONGITUD COMPRIMIDA "C" LONGUEUR NON COMP "B" LONGUEUR COMP "C"</p>	

MOUNTING CODE "EB" EYE RING AND BUSHING CÓDIGO DE MONTAJE «EB» ANILLO Y BUJE CODE DE MONTURE "EB" A BAGUE ET MANCHON

Mounting Code Código de montaje Code de monture	"A" Dia. Diámetro "A" Diam. "A"	B Free Length Longitud libre Long. non comp.	C Comp. Length Longitud comprimida Long. comp.	Vehicle Mounting Pin Dia. Diámetro de clavija de montaje del vehículo Diam. du goujon de montage du véhicule
EB1	5/8	1.44	1.31	5/8
EB2	3/4	1.75	1.50	3/4
EB3	1.00	1.91	1.75	1.00
EB4	11/16	1.72	1.55	11/16
EB7	5/8	1.44	1.31	Mounting pin furnished with shock absorber for 5/8" dia. vehicle mounting hole. Perno proveído con el amortiguador para orificio de montaje de 5/8" de diámetro. Goujon de montage fourni avec l'amortisseur pour trou de montage de 5/8 po de diam. sur véhicule.

HOW TO DETERMINE THE CORRECT SHOCK FOR YOUR TRUCK

CÓMO ESCOGER EL MEJOR AMORTIGUADOR PARA SU CAMIÓN

COMMENT CHOISIR LE BON AMORTISSEUR POUR VOTRE CAMION

MOUNTING CODE "ES" & "CB" EYE RING AND BUSHING WITH STEEL SLEEVE

CÓDIGO DE MONTAJE «ES» Y «CB» ANILLO Y BUJE CON CAMISA DE ACERO

CODE DE MONTURE "ES" & "CB" BAGUE ET MANCHON AVEC COLLET EN ACIER

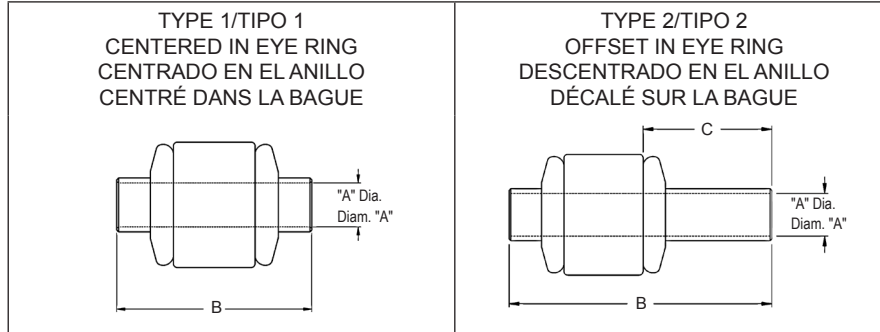

MOUNTING CODE	TYPE	DIMENSION		
		A	B	C
ES2	1	10MM	1.42	--
ES3	1	10MM	1.56	--
ES8	1	7/16	1.25	--
ES10	1	7/16	1.38	--
ES19	1	12MM	1.88	--
ES22	1	1/2	1.25	--
ES24	1	1/2	1.38	--
ES25	1	1/2	1.50	--
ES26	1	1/2	1.56	--
ES27	1	1/2	1.62	--
ES34	1	9/16	1.66	--
ES35	1	5/8	1.38	--
ES36	1	3/4	1.75	--
ES53	1	10MM	1.38	--
ES69	1	12MM	1.58	--
ES82	1	31/64	1.53	--
ES83	1	12MM	1.48	--
ES86	1	14MM	2.44	--
ES90	1	5/8	2.00	--
ES91	1	1/2	2.10	--
ES115	1	10MM	2.02	--
ES120	1	3/4	2.76	--
ES121	1	3/4	2.06	--
ES128	1	1/2	1.66	--
ES136	1	5/8	1.75	--
ES149	1	1/2	2.36	--
ES150	1	3/4	2.24	--
ES153	1	14MM	1.55	--
ES158	1	3/4	3.80	--
ES159	2	3/4	3.21	1.03
ES160	1	1.00	2.01	--

MOUNTING CODE	TYPE	DIMENSION		
		A	B	C
ES161	1	16MM	3.95	--
ES162	1	16MM	2.60	--
ES163	1	7/16	2.50	--
ES164	1	1/2	2.26	--
ES165	1	1/2	1.75	--
ES166	1	5/8	2.97	--
ES167	1	14MM	2.31	--
ES168	1	14MM	2.62	--
ES169	1	14MM	1.91	--
ES171	1	1/2	1.88	--
ES172	1	1/2	2.72	--
ES173	1	7/8	2.28	--
ES174	1	5/8	3.25	--
ES175	1	16MM	1.96	--
ES176	1	16MM	3.72	--
ES177	1	16MM	3.55	--
ES178	1	3/4	1.96	--
ES179	1	20MM	1.75	--
ES181	1	7/16	1.98	--
ES182	1	20MM	1.96	--
ES183	1	20MM	3.80	--
ES184	1	20MM	2.44	--
ES185	1	12MM	2.44	--
ES187	1	1.00	1.75	--
ES188	1	16MM	1.81	--
ES190	1	22MM	1.75	--
ES193	1	24MM	2.28	--
ES194	1	7/8	2.28	--
ES195	1	20MM	4.07	--
ES206	1	1/2	3.13	--

HOW TO DETERMINE THE CORRECT SHOCK FOR YOUR TRUCK

CÓMO ESCOGER EL MEJOR AMORTIGUADOR PARA SU CAMIÓN
COMMENT CHOISIR LE BON AMORTISSEUR POUR VOTRE CAMION

MOUNTING CODE "BP" EYE RING AND BUSHING WITH BAR PIN

CÓDIGO DE MONTAJE «BP» ANILLO Y BUJE CON CLAVIJA TIPO BARRA

CODE DE MONTURE "BP" BAGUE ET MANCHON AVEC GOUPILLE

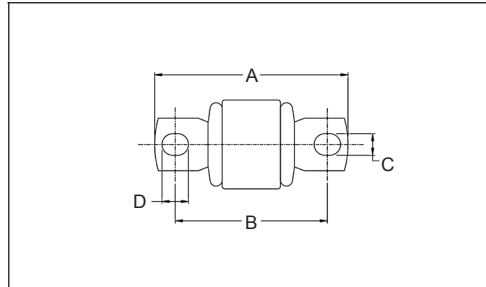

MOUNTING CODE	A	B	C	D
BP7	3.13	2.50	0.35	0.42
BP8	3.50	2.87	0.35	0.42
BP27	4.00	2.95	0.52	0.50
BP33	4.44	3.62	0.39	0.47
BP35	3.53	2.73	0.38	0.38

HOW TO DETERMINE THE CORRECT SHOCK FOR YOUR TRUCK
CÓMO ESCOGER EL MEJOR AMORTIGUADOR PARA SU CAMIÓN
COMMENT CHOISIR LE BON AMORTISSEUR POUR VOTRE CAMION

MOUNTING CODES "S" STUD MOUNT
CÓDIGOS DE MONTAJE «S» MONTAJES DE DOBLE PERNO
CODES DE MONTURE "S" À GOUJON

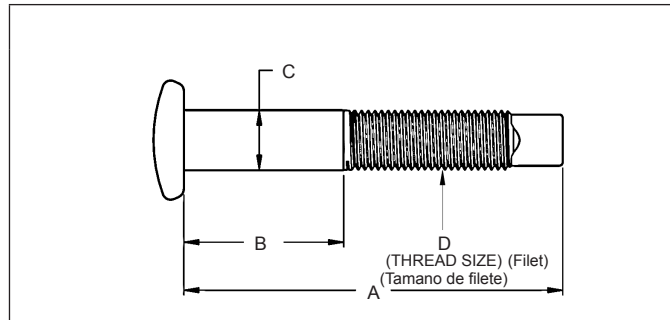

MOUNTING CODE	A	B	C	D
S1	2.37	1.00	3/8	3/8-24
S4	1.85	1.00	3/8	3/8-24
S6	2.47	1.47	7/16	3/8-24
S10	2.37	1.33	7/16	3/8-24
S12	2.37	1.15	7/16	3/8-24
S16	2.95	1.45	16MM	16MM
S21	3.28	1.75	5/8	5/8-18
S28	2.44	1.37	12MM	M10x1
S36	2.49	1.33	7/16	3/8-24
S38	2.75	1.70	14MM	12MM
S40	2.52	1.33	7/16	3/8-24
S42	3.50	2.00	5/8	5/8-18
S43	2.75	1.25	5/8	5/8-18

HOW TO DETERMINE THE CORRECT SHOCK FOR YOUR TRUCK

CÓMO ESCOGER EL MEJOR AMORTIGUADOR PARA SU CAMIÓN

COMMENT CHOISIR LE BON AMORTISSEUR POUR VOTRE CAMION

EXPLANATION OF COLUMN HEADINGS

EXPLICACIÓN DE LOS TÍTULOS DE LAS COLUMNAS

EXPLICATION DES EN-TÊTES DE COLONNES

SHOCK ABSORBER PART NUMBER: The catalog number for the individual shock absorber.	Número de parte del amortiguador: El número de catálogo para el amortiguador individual.	Numéro de pièce de l'amortisseur: Le numéro de catalogue pour l'amortisseur individuel.
EXTENDED LENGTH:* The length of the shock absorber when it is fully extended. See "How to Measure" instructions.	Longitud extendida :* La longitud del amortiguador cuando está totalmente extendido. Ver instrucciones «Cómo medir».	Longueur étirée:* La longueur de l'amortisseur entièrement étiré. Voir "Comment mesurer".
COLLAPSED LENGTH:* The length of the shock absorber when it is fully compressed. See "How to Measure" instructions.	Longitud comprimida :* La longitud del amortiguador cuando está totalmente comprimido. Ver instrucciones «Cómo medir».	Longueur comprimée:* La longueur de l'amortisseur entièrement comprimé. Voir "Comment mesurer".
STROKE: This is the approximate length of the stroke of the individual shock absorber being described.	Carrera : Es la longitud aproximada del recorrido del amortiguador descrito.	Course: C'est la longueur approximative de la course de l'amortisseur individuel décrit.
MOUNTING CODES: Indicates the type of mounting ends for the upper and lower end of each shock absorber. They are listed as follows: Stud Type Mounts ("S" & "DS") Eye Ring and Bushing Mounts ("EB") Eye Ring and Bushing with Sleeve Mounts ("ES") Eye Ring and Bushing with Bar Pin Mounts ("BP") Special Mounting Codes ("SP")	Códigos de montaje : Indica el tipo de montantes de montaje superior e inferior para cada amortiguador. Se enlistan como sigue : Montajes tipo perno («S» y «DS») Montajes anillo y buje («EB») Montajes anillo y buje con camisa («ES») Montajes anillo y buje con clavija («BP») Códigos de montajes especiales («SP»)	Codes de montage: Indique le type de montures supérieure et inférieure de chaque amortisseur. Ils sont énumérés comme suit: Montures de type goujon ("S" et "DS") Montures à bague et manchon ("EB") Montures à bague et manchon avec collet ("ES") Montures à bague et manchon avec goupille ("BP") Codes de montures spéciales ("SP")
DUST TUBE: Indicates whether the shock absorber is supplied with a dust tube.	Polvera: Indica si el amortiguador cuenta un polvera.	Tube pare-poussière: Indique que l'amortisseur est fourni avec un tube pare-poussière.
MOUNTING ACCESSORY PACKAGE NUMBER: The part number of the Mount Accessory Package supplied with the shock absorber.	Número de paquete de accesorios de montaje: El número de parte del paquete de accesorios de montaje proveído con el amortiguador.	Numéro d'emballage d'accessoires de montage: Le numéro de pièce de l'emballage d'accessoires de montage fourni avec l'amortisseur.
*NOTE: All dimensions shown are in inches	*Nota : Todas las dimensiones son en pulgadas	*Note: Toutes les dimensions indiquées sont en pouces

STEP 4: Refer to shock absorber specifications by end mount. Start first by finding the appropriate series. Next, match the extended/collapsed length and find the correct mounting codes. Refer to the far left column of the chart for the correct Gabriel shock absorber part number.

4º PASO: Consulte las especificaciones del amortiguador mostradas al final del catálogo. Encuentre primero la serie adecuada. Luego, compare las longitudes de extensión y de compresión, y encuentre los códigos de montaje correctos. Consulte la columna del extremo izquierdo de la tabla para identificar el número de parte del amortiguador Gabriel correcto.

4E ÉTAPE: Reportez-vous aux spécifications d'amortisseur énoncées à la fin du catalogue. Trouvez d'abord la série appropriée. Comparez ensuite les longueurs d'extension et de compression et trouvez les bons codes de fixation. Reportez-vous à la colonne située à la extrême gauche de tableau pour identifier le bon numéro de pièce pour un amortisseur Gabriel.

SPECIFICATIONS BY END MOUNT
ESPECIFICACIONES POR TIPO DE MONTAJE
SPÉCIFICATIONS PAR FIXATION DES EXTRÉMITÉS

Fleetline	Mounting		Bore	External Diameter Illustration	Lengths			Dust Tube	Recoil Cutoff	Controls*	
	Upper	Lower			Extended	Collapsed	Stroke			Rebound	Compression
83171		ES36	1-3/8"	A	23.98	14.51	9.47	YES	YES	513	146
630811	0	0	1-3/16"		22.45	14.1	8.35	NO	NO		
632147	0	0	1-3/16"		22.45	14.1	8.35	NO	NO		
G63969	412847	ES34	1-3/8"		20.75	13.31	7.44				
83013	BP8	BP8	1-3/16"	2" D/T	7.66	6.63†	1.7	YES	NO	646	480
G63837	BP8	ES83	1-3/8"		28.23	17.95	10.28				
G63679	BP8	ES83	1-3/8"		25	14.97	10.03	YES	NO		
83015	BP8	S1	1-3/8"	A	9.79	7.55	2.24	YES	YES	735	430
83005	BP8	S10	1-3/16"	2" D/T	7.34	5.87	1.47	YES	NO	858	216
83041	BP27	S10	1-3/8"	A	10.51†	8.34†	3.02	YES	YES	486	189
G63607	BP33	ES83	1-3/8"		25.58	15.3	10.28	YES	NO		
83060	EB	BP7	1-3/8"	A	9.76	7.98†	2.25	NO	YES	431	441
83011	EB1	EB1	1-3/8"	A	11.55†	8.43	3.62	YES	YES	738	330
83012	EB1	EB1	1-3/8"	A	11.05†	8.18	3.37	YES	YES	738	330
G63440	EB1	EB1	1-3/8"		26.33	15.55	10.78	NO	NO		
83401	EB1	EB1	1-3/16"	F	24.09	14.26	9.83	YES	NO	341	252
G63419	EB1	EB1	1-3/8"		24.08	14.55	9.53	YES	NO		
G63405	EB1	EB1	1-3/8"		20	12.47	7.53	YES	NO	572	115
83007	EB1	EB1	1-3/8"	A	18.54	11.67	6.87	NO	NO	489	343
G63299	EB1	EB1	1-3/8"		18.08	11.55	6.53	YES	NO	396	109
G63810	EB1	ES83	1-3/8"		31.51	18.48	13.03	YES	NO		
G63808	EB1	ES83	1-3/8"		28.86	17.08	11.78	YES	NO		
G63524	EB1	ES83	1-3/8"		27.08	16.05	11.03	YES	NO		
G63775	EB1	ES83	1-3/8"		27.08	16.05	11.03	YES	NO		
G63461	EB1	ES83	1-3/8"		25.5	15.22	10.28	YES	NO		
G63811	EB1	ES83	1-3/8"		25.5	15.22	10.28	YES	NO		
G63525	EB1	ES83	1-3/8"		23.08	14.05	9.03	YES	NO		
G63773	EB1	ES83	1-3/8"		23.08	14.05	9.03	YES	NO		
G63406	EB1	ES83	1-3/8"		23	13.97	9.03	YES	NO		
G63809	EB1	ES83	1-3/8"		23	13.97	9.03	YES	NO		
G63409	EB1	ES83	1-3/8"		21.58	13.3	8.28	YES	NO		
85063	EB2	EB2	1-5/8"	C	32.01	18.85	13.16	YES	NO	762	174
83107	EB2	EB2	1-3/8"	A	31.6	18.36	13.24	YES	NO	352	77
83314	EB2	EB2	1-3/8"	B	30.64	18.11	12.53	YES	YES	633	143
85024	EB2	EB2	1-5/8"	C	28.74	17.21	11.53	YES	YES	1008	539
83309	EB2	EB2	1-3/8"	B	28.64	17.11	11.53	YES	YES	589	135
89416	EB2	EB2	1-5/8"	G	28.62	17.54	11.08	YES	YES	1155‡	514
89401	EB2	EB2	1-5/8"	G	28.41	17.16	11.25	YES	NO	665‡	194
89446	EB2	EB2	1-5/8"	G	28.36	17.41	10.95	YES	YES	702‡	204
85046	EB2	EB2	1-5/8"	C	27.51	16.6	10.91	YES	YES	1008	539
89434	EB2	EB2	1-5/8"	G	27.12	16.79	10.33	YES	YES	1155‡	514
89403	EB2	EB2	1-5/8"	G	26.86	17.16	9.7	YES	YES	929‡	281

* Damping force, in pounds, to either extend or collapse the shock absorber at an average operating velocity. Fuerza de amortiguación en libras para extender o comprimir el amortiguador a una velocidad de operación promedio. La puissance d'amortissement en poids de l'amortisseur, soit comprimé, doit détendu, à une vitesse de fonctionnement moyenne.

† At bumper contact / Al contacto con el tope de goma / Au contact avec le butoir

‡ For GasSLX Series, forces are at the "Firm" (F) setting. / Para la serie GasSLX, las fuerzas están ajustadas en (F) "Firme". / Pour la série GasSLX, le réglage de la force est sur «Firme» (F).

SPECIFICATIONS BY END MOUNT
ESPECIFICACIONES POR TIPO DE MONTAJE
SPÉCIFICATIONS PAR FIXATION DES EXTRÉMITÉS

Fleetline	Mounting		Bore	External Diameter Illustration	Lengths			Dust Tube	Recoil Cutoff	Controls*	
	Upper	Lower			Extended	Collapsed	Stroke			Rebound	Compression
83312	EB2	EB2	1-3/8"	B	26.64	16.11	10.53	YES	YES	527	152
89409	EB2	EB2	1-5/8"	G	26.36	16.41	9.95	YES	YES	567‡	165
89439	EB2	EB2	1-5/8"	G	25.67	15.79	9.88	YES	NO	518‡	103
85055	EB2	EB2	1-5/8"	C	25.63	15.6	10.03	YES	NO	577	102
85047	EB2	EB2	1-5/8"	C	25.25	15.47	9.78	YES	YES	1008	539
83308	EB2	EB2	1-3/8"	B	25.14	15.36	9.78	YES	YES	445	180
89435	EB2	EB2	1-5/8"	G	24.86	15.66	9.2	YES	YES	1155‡	514
83200	EB2	EB2	1-3/8"	A	24.51	15.1	9.53	YES	NO	806	370
89402	EB2	EB2	1-5/8"	G	24.41	15.16	9.25	YES	NO	874‡	206
83519	EB2	EB2	1-3/16"		23.83	14.35	9.48	YES	NO	292	132
83216	EB2	EB2	1-3/8"	A	23.51	14.48	9.03	YES	YES	776	262
85054	EB2	EB2	1-5/8"	C	23.26	14.35	8.91	YES	NO	602	104
89438	EB2	EB2	1-5/8"	G	23.17	14.54	8.63	YES	NO	583‡	103
83404	EB2	EB2	1-3/16"	F	22.01	13.44	8.58	YES	NO	545	171
83159	EB2	EB2	1-3/8"	A	21.62	13.4	8.14	YES	NO	658	149
85012	EB2	EB2	1-5/8"	C	21	13.22	7.78	YES	NO	523	199
89413	EB2	EB2	1-5/8"	G	20.91	13.41	7.5	YES	NO	536‡	201
85023	EB2	EB2	1-5/8"	C	20.24	12.96	7.28	YES	YES	1008	539
89415	EB2	EB2	1-5/8"	G	20.12	13.29	6.83	YES	YES	1155‡	514
83219	EB2	EB2	1-3/8"	A	20.01	12.73	7.28	YES	YES	299	125
85062	EB2	EB2	1-5/8"	C	19.76	12.6	7.2	YES	NO	523	199
89408	EB2	EB2	1-5/8"	G	19.67	12.79	6.88	YES	NO	536‡	201
G63605	EB2	ES27	1-3/8"		24.24	14.71	9.53	YES	NO		
85025	EB2	S21	1-5/8"	C	23	13.97	9.03	YES	NO	1079	539
85376	EB3	EB3	1-5/8"	D	33.25	19.72	13.53	YES	NO	668	134
85301	EB3	EB3	1-5/8"	D	31.92	19.03	12.89	YES	NO	1442	455
85339	EB3	EB3	1-5/8"	D	31.68	19.02	12.66	YES	YES	804	463
85040	EB3	EB3	1-5/8"	C	30.9	18.49	12.41	YES	NO	889	114
85730	EB3	EB3	1-5/8"	D	30.75	18.72	12.03	YES	YES	1517	293
85315	EB3	EB3	1-5/8"	D	29.66	18.15	11.51	YES	NO	380	142
85901	EB3	EB3	1-5/8"	G	29.05	17.64	11.41	YES	NO	1830	418
85704	EB3	EB3	1-5/8"	D	28.75	18.72	10.03	YES	YES	1435	186
83104	EB3	EB3	1-3/8"	A	28.24	17.12	11.12	YES	NO	698	133
85305	EB3	EB3	1-5/8"	D	27.25	16.72	10.53	YES	NO	1120	225
83362	EB3	EB3	1-3/8"	B	27	16.25	10.75	YES	NO	539	202
87004	EB3	EB3	2-1/16"	E	26.76	16.76	10	YES	YES	1158	190
85735	EB3	EB3	1-5/8"	D	26.74	16.71	10.03	YES	YES	1288	227
83215	EB3	EB3	1-3/8"	A	26.64	16.36	10.28	YES	YES	697	108
85314	EB3	EB3	1-5/8"	D	26.5	16.47	10.03	YES	YES	1216	169
89425	EB3	EB3	1-5/8"	G	26.5	16.8	9.7	YES	YES	1352‡	167
89410	EB3	EB3	1-5/8"	G	26.33	16.42	9.91	YES	NO	1185‡	182
85001	EB3	EB3	1-5/8"	C	26.27	16.36	9.91	YES	NO	1202	186

* Damping force, in pounds, to either extend or collapse the shock absorber at an average operating velocity. Fuerza de amortiguación en libras para extender o comprimir el amortiguador a una velocidad de operación promedio. La puissance d'amortissement en poids de l'amortisseur, soit comprimé, doit détendu, à une vitesse de fonctionnement moyenne.

† At bumper contact / Al contacto con el tope de goma / Au contact avec le butoir

‡ For GasSLX Series, forces are at the "Firm" (F) setting. / Para la serie GasSLX, las fuerzas están ajustadas en (F) "Firme". / Pour la série GasSLX, le réglage de la force est sur «Firme» (F).

SPECIFICATIONS BY END MOUNT
ESPECIFICACIONES POR TIPO DE MONTAJE
SPÉCIFICATIONS PAR FIXATION DES EXTRÉMITÉS

Fleetline	Mounting		Bore	External Diameter Illustration	Lengths			Dust Tube	Recoil Cutoff	Controls*	
	Upper	Lower			Extended	Collapsed	Stroke			Rebound	Compression
85313	EB3	EB3	1-5/8"	D	26.26	16.35	9.91	YES	YES	717	111
87003	EB3	EB3	2-1/16"	E	26.26	16.51	9.75	YES	YES	1332	395
89429	EB3	EB3	1-5/8"	G	26.18	16.43	9.75	YES	NO	941‡	266
85320	EB3	EB3	1-5/8"	D	26.13	16.35	9.78	YES	NO	970	308
85700	EB3	EB3	1-5/8"	D	26.13	16.6	9.53	YES	YES	1446	328
83140	EB3	EB3	1-3/8"	A	25.27	15.52	9.75	YES	NO	738	88
83141	EB3	EB3	1-3/8"	A	25.27	15.52	9.75	YES	NO	408	113
83132	EB3	EB3	1-3/8"	A	25.24	15.5	9.74	YES	NO	828	150
85308	EB3	EB3	1-5/8"	D	25.13	15.85	9.28	YES	YES	764	254
85714	EB3	EB3	1-5/8"	D	25.13	15.85	9.28	YES	YES	1220	175
85715	EB3	EB3	1-5/8"	D	25.13	15.85	9.28	YES	YES	1915	200
85717	EB3	EB3	1-5/8"	D	25.13	15.85	9.28	YES	YES	1915	200
89422	EB3	EB3	1-5/8"	G	25.13	16.18	8.95	YES	YES	794‡	253
85303	EB3	EB3	1-5/8"	D	24.75	15.47	9.28	YES	NO	1019	221
85053	EB3	EB3	1-5/8"	C	24.65	15.49	9.16	YES	NO	1019	227
89442	EB3	EB3	1-5/8"	G	24.55	15.55	9	YES	NO	1055‡	224
85329	EB3	EB3	1-5/8"	D	24.5	15.47	9.03	YES	YES	1550	232
85713	EB3	EB3	1-5/8"	D	24.5	15.47	9.03	YES	YES	1157	180
89412	EB3	EB3	1-5/8"	G	24.26	15.68	8.58	YES	YES	1155‡	169
85007	EB3	EB3	1-5/8"	C	24.21	15.3	8.91	YES	YES	1008	171
83225	EB3	EB3	1-3/8"	A	24.14	15.11	9.03	YES	YES	482	159
85307	EB3	EB3	1-5/8"	D	24.01	15.1	8.91	YES	NO	1094	173
85702	EB3	EB3	1-5/8"	D	23.76	15.85	7.91	YES	YES	1093	825
87006	EB3	EB3	2-1/16"	E	23.75	15.25	8.5	YES	YES	1158	272
85736	EB3	EB3	1-5/8"	D	23.62	15.21	8.41	YES	YES	1155	352
87002	EB3	EB3	2-1/16"	E	23.5	15.41	8.09	YES	YES	879	203
89420	EB3	EB3	1-5/8"	G	22.81	14.68	8.13	YES	NO	862‡	258
83217	EB3	EB3	1-3/8"	A	22.77	14.49	8.28	YES	YES	539	202
85302	EB3	EB3	1-5/8"	D	22.75	14.66	8.09	YES	NO	836	253
85304	EB3	EB3	1-5/8"	D	22.25	14.22	8.03	YES	NO	767	325
85718	EB3	EB3	1-5/8"	D	22.13	15.04	7.09	YES	YES	2506	206
85732	EB3	EB3	2-1/16"	E	22.13	15.11	7.03	YES	YES	2632	382
85716	EB3	EB3	1-5/8"	D	22.01	14.35	7.66	YES	YES	1220	175
87001	EB3	EB3	2-1/16"	E	20.76	13.76	7	YES	YES	1158	190
85734	EB3	EB3	1-5/8"	D	20.74	13.71	7.03	YES	YES	1288	227
85004	EB3	EB3	1-5/8"	C	20.68	13.67	7.01	YES	YES	1019	219
85042	EB3	EB3	1-5/8"	C	20.64	13.61	7.03	YES	YES	333	161
85712	EB3	EB3	1-5/8"	D	20.5	13.47	7.03	YES	YES	1435	562
85720	EB3	EB3	1-5/8"	D	20.5	13.47	7.03	YES	YES	1435	562
85968	EB3	EB3	1-5/8"	G	19.87	13.39	6.48	YES	YES	1069	227
83214	EB3	EB3	1-3/8"	A	19.64	12.86	6.78	YES	YES	269	90
85300	EB3	EB3	1-5/8"	D	18	12.22	5.78	YES	YES	1435	676

* Damping force, in pounds, to either extend or collapse the shock absorber at an average operating velocity. Fuerza de amortiguación en libras para extender o comprimir el amortiguador a una velocidad de operación promedio. La puissance d'amortissement en poids de l'amortisseur, soit comprimé, doit détendu, à une vitesse de fonctionnement moyenne.

† At bumper contact / Al contacto con el tope de goma / Au contact avec le butoir

‡ For GasSLX Series, forces are at the "Firm" (F) setting. / Para la serie GasSLX, las fuerzas están ajustadas en (F) "Firme". / Pour la série GasSLX, le réglage de la force est sur «Firme» (F).

SPECIFICATIONS BY END MOUNT
ESPECIFICACIONES POR TIPO DE MONTAJE
SPÉCIFICATIONS PAR FIXATION DES EXTRÉMITÉS

Fleetline	Mounting		Bore	External Diameter Illustration	Lengths			Dust Tube	Recoil Cutoff	Controls*	
	Upper	Lower			Extended	Collapsed	Stroke			Rebound	Compression
89419	EB3	EB3	1-5/8"	G	18	12.55	5.45	YES	YES	1352‡	636
85719	EB3	EB3	1-5/8"	D	17.25	11.97	5.28	YES	YES	1517	213
85334	EB3	EB3	1-5/8"	D	14.5	10.47	4.03	YES	YES	1271	319
85912	EB3	ES36	1-5/8"	G	18.68	12.57	6.11	YES	YES	1020	219
85327	EB3	ES160	1-5/8"	D	16.01	12.1	3.91	YES	YES	764	162
85322	EB3	ES160	1-5/8"	D	15.26	11.85	3.41	YES	YES	764	162
83353	EB3	S21	1-3/8"	B	24.84	15.06	9.78	YES	NO	432	214
85740	EB3	S21	1-5/8"	D	24.7	15.15	9.55	YES	YES	848	305
85380	EB3	S21	1-5/8"	D	23.95	14.79	9.15	YES	YES	1568	227
85312	EB3	S21	1-5/8"	D	23.69	14.85	8.84	YES	YES	717	111
85733	EB3	S21	1-5/8"	D	23.57	14.73	8.84	YES	YES	717	111
85379	EB3	S21	1-5/8"	D	22.69	14.4	8.29	YES	YES	1658	176
85330	EB3	S21	1-5/8"	D	22.44	14.16	8.28	YES	YES	1140	176
85729	EB3	S21	1-5/8"	D	21.58	13.8	7.78	YES	YES	783	111
85723	EB3	S21	1-5/8"	D	19.94	12.91	7.03	YES	YES	1318	248
83117	EB4	EB1	1-3/8"	A	23.94	14.45	9.49	YES	NO	354	300
G63183	EB4	EB4	1-3/8"		20.89	13.11	7.78	YES	NO		
83119	EB4	ES165	1-3/8"	A	23.96	14.84	9.12	YES	NO	354	300
G63355	EB7	ES24	1-3/8"		15	9.97	5.03	YES	NO		
83303	EB7	ES36	1-3/8"	B	24.86	15.08	9.78	YES	YES	470	122
83304	EB7	ES36	1-3/8"	B	22.86	14.08	8.78	YES	YES	470	122
G63625	EB7	ES36	1-3/8"		22.48	13.96	8.53	YES	NO		
G63306	ES2	ES24	1-3/8"		19.86	12.58	7.28	YES	NO		
G63347	ES3	ES24	1-3/8"		18.08	11.55	6.53	YES	NO		
G63455	ES8	ES83	1-3/8"		23	13.97	9.03	YES	NO		
83002	ES10	ES10	1-3/8"	A	11.61	8.62	3	YES	YES	3112	590
83024	ES10	ES10	1-3/8"	2-1/2" D/T	11.61	8.62	2.99	YES	YES	811	320
83016	ES10	ES10	1"	1-5/8"	11.51	8.14	3.37	NO	YES	506	139
83031	ES10	ES10	1-3/8"	2-1/2" D/T	11.49	8.62	2.87	YES	YES	811	314
83051	ES10	ES10	1-3/8"	2-1/2" D/T	9.41	7.4	2.01	YES	YES	579	163
83061	ES10	ES10	1-3/8"	2-1/2" D/T	9.41	7.4	2.01	YES	YES	1030	220
83021	ES10	ES10	1-3/8"	A	9.36	7.37	1.99	YES	YES	745	315
83046	ES10	ES181	1-3/16"		9.23†	7.62†	2.73	NO	YES	514	173
83023	ES10	ES181	1"	1-5/8"	8.7	7.09†	2.14	NO	YES	484	157
83045	ES19	S10	1-3/8"	A	11.53†	8.58†	3.81	YES	NO	510	153
83050	ES19	S10	1-3/8"	A	10.43†	8.38†	2.9	YES	YES	599	321
83058	ES19	S10	1-3/8"	A	10.43†	8.38†	2.9	YES	YES	742	243
83158	ES22	ES22	1-3/8"	A	12.96	8.97	4	YES	NO	783	484
83010	ES24	ES24	1"	2" D/T	14.15†	9.33	5.07	YES	YES	188	70
G63357	ES24	ES24	1-3/8"		15	9.97	5.03	YES	NO		
83022	ES24	ES24	1"	2" D/T	14.28	9.33	4.95	YES	NO	840	152
83026	ES24	ES24	1-3/8"	A	13.11	9.12	3.99	YES	YES	602	104

* Damping force, in pounds, to either extend or collapse the shock absorber at an average operating velocity. Fuerza de amortiguación en libras para extender o comprimir el amortiguador a una velocidad de operación promedio. La puissance d'amortissement en poids de l'amortisseur, soit comprimé, doit détendu, à une vitesse de fonctionnement moyenne.

† At bumper contact / Al contacto con el tope de goma / Au contact avec le butoir

‡ For GasSLX Series, forces are at the "Firm" (F) setting. / Para la serie GasSLX, las fuerzas están ajustadas en (F) "Firme". / Pour la série GasSLX, le réglage de la force est sur «Ferme» (F).

SPECIFICATIONS BY END MOUNT
ESPECIFICACIONES POR TIPO DE MONTAJE
SPÉCIFICATIONS PAR FIXATION DES EXTRÉMITÉS

Fleetline	Mounting		Bore	External Diameter Illustration	Lengths			Dust Tube	Recoil Cutoff	Controls*	
	Upper	Lower			Extended	Collapsed	Stroke			Rebound	Compression
83018	ES24	S10	1-3/8"	A	10.3†	8.42†	3.24	YES	YES	515	174
83027	ES24	S10	1-3/8"	A	13.8	9.18	4.62	YES	YES	602	104
83019	ES24	S10	1-3/8"	A	9.42	8.16†	2.28	YES	YES	509	121
83044	ES27	ES164	1-3/8"	A	10.91	7.93	2.98	YES	YES	789	296
G63866	ES34	ES34	1-3/8"		22.81	14.12	8.69				
83153	ES34	ES34	1-3/8"	A	21.69	13.62	8.07	YES	YES	974	206
83155	ES34	ES34	1-3/8"	A	21.69	13.62	8.07	YES	YES	507	80
83059	ES35	ES35	1-3/8"	A	12.06†	8.68	3.88	YES	YES	738	350
83004	ES35	ES136	1"	2" D/T	9.36†	7.29	2.32	YES	YES	539	324
85905	ES36	EB3	1-5/8"	G	23.81	16.16	7.66	YES	YES	1020	219
85913	ES36	EB3	1-5/8"	G	22.56	15.2	7.36	YES	YES	1020	219
85057	ES36	EB3	1-5/8"	C	21.45	14.23	7.22	YES	YES	1216	115
85907	ES36	EB3	1-5/8"	G	21.43	14.2	7.23	YES	YES	1216	251
83113	ES36	EB3	1-3/8"	A	20.42	13.43	6.99	YES	YES	997	238
85059	ES36	EB3	1-5/8"	C	19.07	12.79	6.28	YES	YES	928	151
85915	ES36	EB3	1-5/8"	G	19.06	12.7	6.36	YES	YES	1020	219
83115	ES36	EB3	1-3/8"	A	16.19	13.32	4.87	YES	YES	997	238
83242	ES36	ES36	1-3/8"	A	33.73	20.98	12.75	YES	YES	721	135
85903	ES36	ES36	1-5/8"	G	31.99	19.13	12.86	YES	YES	666	113
85979	ES36	ES36	1-5/8"	G	31.17	18.66	12.52	YES	YES	582	138
85972	ES36	ES36	1-5/8"	G	30.78	18.26	12.52	YES	NO	1493	261
83121	ES36	ES36	1-3/8"	A	30.25	18.32	11.93	YES	YES	689	126
83137	ES36	ES36	1-3/8"	A	30.03	17.78	12.25	YES	YES	517	132
85976	ES36	ES36	1-5/8"	G	29.91	18.13	11.79	YES	YES	582	138
85013	ES36	ES36	1-5/8"	C	29.74	17.71	12.03	YES	YES	1019	219
83205	ES36	ES36	1-3/8"	A	29.69	17.69	12	YES	YES	660	76
83209	ES36	ES36	1-3/8"	A	29.64	17.61	12.03	YES	YES	670	78
89414	ES36	ES36	1-5/8"	G	29.62	18.04	11.58	YES	YES	1045‡	217
85337	ES36	ES36	1-5/8"	D	28.72	17.45	11.28	YES	YES	1318	374
85006	ES36	ES36	1-5/8"	C	28.5	17.09	11.41	YES	YES	1019	219
83125	ES36	ES36	1-3/8"	A	28.12	17.13	10.99	YES	YES	625	115
85097	ES36	ES36	1-5/8"	C	27.95	17.11	10.84	YES	YES	1086	109
85043	ES36	ES36	1-5/8"	C	27.63	16.85	10.78	YES	YES	628	163
85904	ES36	ES36	1-5/8"	G	27.61	16.88	10.73	YES	YES	666	113
85010	ES36	ES36	1-5/8"	C	26.74	16.21	10.53	YES	YES	1019	219
83123	ES36	ES36	1-3/8"	A	26.62	16.38	10.24	YES	YES	589	119
83176	ES36	ES36	1-3/8"	A	26.62	15.96	10.66	NO	NO	406	275
85036	ES36	ES36	1-5/8"	C	26.38	16.29	10.09	YES	YES	633	119
89405	ES36	ES36	1-5/8"	G	26.24	16.41	9.83	YES	YES	1009‡	249
85099	ES36	ES36	1-5/8"	C	26.02	15.93	10.09	YES	YES	1152	135
85974	ES36	ES36	1-5/8"	G	26.02	16.11	9.91	YES	YES	3087	230
85321	ES36	ES36	1-5/8"	D	25.36	15.58	9.78	YES	YES	1435	676

* Damping force, in pounds, to either extend or collapse the shock absorber at an average operating velocity. Fuerza de amortiguación en libras para extender o comprimir el amortiguador a una velocidad de operación promedio. La puissance d'amortissement en poids de l'amortisseur, soit comprimé, doit détendu, à une vitesse de fonctionnement moyenne.

† At bumper contact / Al contacto con el tope de goma / Au contact avec le butoir

‡ For GasSLX Series, forces are at the "Firm" (F) setting. / Para la serie GasSLX, las fuerzas están ajustadas en (F) "Firme". / Pour la série GasSLX, le réglage de la force est sur «Firme» (F).

SPECIFICATIONS BY END MOUNT
ESPECIFICACIONES POR TIPO DE MONTAJE
SPÉCIFICATIONS PAR FIXATION DES EXTRÉMITÉS

Fleetline	Mounting		Bore	External Diameter Illustration	Lengths			Dust Tube	Recoil Cutoff	Controls*	
	Upper	Lower			Extended	Collapsed	Stroke			Rebound	Compression
83149	ES36	ES36	1-3/8"	A	25.28	15.78	9.49	YES	YES	332	101
83122	ES36	ES36	1-3/8"	A	25.24	15.75	9.49	YES	YES	661	201
83218	ES36	ES36	1-3/8"	A	25.19	15.44	9.75	YES	YES	721	194
665472	ES36	ES36	1-5/8"	G	25.14	15.61	9.53	NO	NO	925	977
85005	ES36	ES36	1-5/8"	C	24.74	15.21	9.53	YES	YES	1019	219
89406	ES36	ES36	1-5/8"	G	24.74	15.66	9.08	YES	YES	658‡	125
85916	ES36	ES36	1-5/8"	G	24.61	15.51	9.11	YES	YES	1149	219
89430	ES36	ES36	1-5/8"	G	24.6	15.39	9.53	YES	YES	1462‡	279
83126	ES36	ES36	1-3/8"	A	24.37	15.25	9.12	YES	YES	625	115
85909	ES36	ES36	1-5/8"	G	24.24	15.13	9.11	YES	YES	700	255
85975	ES36	ES36	1-5/8"	G	24.24	15.15	9.09	YES	YES	1658	219
83310	ES36	ES36	1-3/8"	B	24.06	14.69	9.37	YES	NO	559	153
83221	ES36	ES36	1-3/8"	A	24.01	14.73	9.28	YES	YES	599	153
85030	ES36	ES36	1-5/8"	C	24	14.84	9.16	YES	YES	1019	219
89440	ES36	ES36	1-5/8"	G	23.86	15.16	8.7	YES	YES	1498‡	561
83144	ES36	ES36	1-3/8"	A	23.78	15.03	8.75	YES	YES	596	93
89432	ES36	ES36	1-5/8"	G	23.41	14.66	8.75	YES	NO	1507‡	561
85050	ES36	ES36	1-5/8"	C	23.28	14.5	9.03	YES	NO	525	138
665937	ES36	ES36	1-5/8"	G	22.91	16.09	6.82	YES	NO		
85044	ES36	ES36	1-5/8"	C	22.63	14.1	8.53	YES	NO	722	212
85058	ES36	ES36	1-5/8"	C	22.63	14.22	8.41	YES	YES	722	114
85971	ES36	ES36	1-5/8"	G	22.55	14.17	8.38	YES	NO	2315	451
85919	ES36	ES36	1-5/8"	G	22.48	14.25	8.23	YES	YES	1265	121
632155	ES36	ES36	1-3/16"		22.45	14.1	8.35	NO	NO		
646155	ES36	ES36	1-3/16"		22.45	14.1	8.35	YES	NO		
646177	ES36	ES36	1-3/16"		22.45	14.1	8.35	NO	NO		
89431	ES36	ES36	1-5/8"	G	22.41	14.16	8.25	YES	NO	751‡	211
85345	ES36	ES36	1-5/8"	D	21.83	13.82	8.01	YES	YES	1093	219
85014	ES36	ES36	1-5/8"	C	21.74	13.71	8.03	YES	YES	1019	219
85906	ES36	ES36	1-5/8"	G	21.73	14	7.73	YES	YES	700	255
83124	ES36	ES36	1-3/8"	A	21.65	13.75	7.87	YES	YES	750	137
83207	ES36	ES36	1-3/8"	A	21.64	13.61	8.03	YES	YES	553	143
89407	ES36	ES36	1-5/8"	G	21.62	14.04	7.58	YES	YES	652‡	218
85091	ES36	ES36	1-5/8"	C	21.38	13.56	7.82	YES	NO	1121	331
85910	ES36	ES36	1-5/8"	G	20.73	13.5	7.23	YES	YES	1074	219
85029	ES36	ES36	1-5/8"	C	20.5	13.09	7.41	YES	YES	1019	219
85382	ES36	ES36	1-5/8"	D	20.22	13.07	7.15	YES	YES	1658	420
83204	ES36	ES36	1-3/8"	A	20.14	12.86	7.28	YES	YES	451	110
83127	ES36	ES36	1-3/8"	A	20.12	13.13	6.99	YES	YES	940	218
89437	ES36	ES36	1-5/8"	G	20.12	13.29	6.83	YES	YES	1155‡	514
85060	ES36	ES36	1-5/8"	C	19.75	12.72	7.03	YES	YES	943	405
85338	ES36	ES36	1-5/8"	D	19.47	12.7	6.77	YES	YES	1664	420

* Damping force, in pounds, to either extend or collapse the shock absorber at an average operating velocity. Fuerza de amortiguación en libras para extender o comprimir el amortiguador a una velocidad de operación promedio. La puissance d'amortissement en poids de l'amortisseur, soit comprimé, doit détendu, à une vitesse de fonctionnement moyenne.

† At bumper contact / Al contacto con el tope de goma / Au contact avec le butoir

‡ For GasSLX Series, forces are at the "Firm" (F) setting. / Para la serie GasSLX, las fuerzas están ajustadas en (F) "Firme". / Pour la série GasSLX, le réglage de la force est sur «Ferme» (F).

SPECIFICATIONS BY END MOUNT
ESPECIFICACIONES POR TIPO DE MONTAJE
SPÉCIFICATIONS PAR FIXATION DES EXTRÉMITÉS

Fleetline	Mounting		Bore	External Diameter Illustration	Lengths			Dust Tube	Recoil Cutoff	Controls*	
	Upper	Lower			Extended	Collapsed	Stroke			Rebound	Compression
85051	ES36	ES36	1-5/8"	C	18.53	12.15	6.4	YES	YES	1019	139
85908	ES36	ES36	1-5/8"	G	18.48	12.25	6.23	YES	YES	1020	219
83130	ES36	ES36	1-3/8"	A	18.03	12.04	5.99	YES	YES	871	177
85934	ES36	ES36	1-5/8"	G	17.73	12	5.73	YES	YES	3511	1063
85086	ES36	ES36	1-5/8"	C	17.55	11.63	5.92	YES	YES	2027	389
85738	ES36	ES36	1-5/8"	D	17.47	11.7	5.77	YES	YES	1830	416
85323	ES36	ES36	1-5/8"	D	17.36	11.58	5.78	YES	YES	1085	163
87018	ES36	ES36	2-1/16"	E	17.36	11.71	5.65	YES	YES	2479	1000
83389	ES36	ES36	1-3/8"	A	17.32	11.57	5.75	YES	YES	1084	228
89436	ES36	ES36	1-5/8"	G	17.24	11.91	5.33	YES	YES	998‡	217
85000	ES36	ES36	1-5/8"	C	17.22	11.46	5.76	YES	YES	1019	219
83203	ES36	ES36	1-3/8"	A	17.1	11.36	5.74	YES	YES	609	114
83128	ES36	ES36	1-3/8"	A	16.87	11.51	5.37	YES	YES	940	218
85911	ES36	ES36	1-5/8"	G	16.86	11.5	5.36	YES	YES	1020	219
85938	ES36	ES36	1-5/8"	G	16.06	10.78	5.28	YES	YES	1581	432
85064	ES36	ES36	1-5/8"	C	16.03	10.76	5.27	YES	YES	1481	340
83150	ES36	ES36	1-3/8"	A	15.24	10.43	4.81	YES	YES	940	216
85078	ES36	ES36	1-5/8"	C	14.77	10.13	4.64	YES	YES	1409	282
85045	ES36	ES36	1-5/8"	C	14.51	10.1	4.41	YES	YES	1020	219
85939	ES36	ES36	1-5/8"	G	14.44	10.03	4.41	YES	YES	1719	420
85914	ES36	ES36	1-5/8"	G	14.36	10.25	4.11	YES	YES	1020	219
85052	ES36	ES36	1-5/8"	C	13.25	9.47	3.78	YES	YES	1019	139
85344	ES36	ES36	1-5/8"	D	13.22	9.45	3.77	YES	YES	1581	443
85079	ES36	ES36	1-5/8"	C	12.04	8.87	3.17	YES	YES	1494	325
83157	ES36	ES90	1-3/8"	A	26.38	15.76	10.61	YES	NO	446	303
85102	ES36	ES136	1-5/8"	C	21.53	14.94	6.59	YES	YES	1224	342
83164	ES36	ES165	1-3/8"	C	24.22	14.59	9.63	YES	NO	426	274
85072	ES36	ES176	1-5/8"	C	24.17	14.83	9.34	YES	YES	1387	305
85087	ES36	ES176	1-5/8"	C	22.79	14.71	8.08	YES	YES	1568	403
85109	ES36	ES195	1-5/8"	C	24.21	15.14	9.07	YES	YES	1123	149
83635	ES36	S21	1-3/8"	A	21.74	13.25	8.49	YES	NO	558	119
85977	ES36	S42	1-5/8"	G	26.2	15.91	10.29	YES	YES	582	138
83109	ES36	S42	1-3/8"	A	26.14	15.9	10.24	YES	YES	345	78
83111	ES36	S42	1-3/8"	A	26.14	15.9	10.24	YES	YES	560	141
83138	ES36	S42	1-3/8"	A	23.55	14.42	9.12	YES	YES	997	231
83110	ES36	S42	1-3/8"	A	22.89	14.27	8.62	YES	YES	450	143
83112	ES36	S42	1-3/8"	A	21.52	13.4	8.12	YES	YES	1064	343
83033	ES53	ES53	1-3/8"	A	13.99	10.37	3.62	YES	YES	494	312
G63676	ES69	ES69	1-3/8"		15.58	10.55	5.03	YES	YES		
G63403	ES82	ES82	1-3/8"		24.58	14.8	9.78	YES	NO		
83131	ES83	ES83	1-3/8"	A	27.8	18.18	9.62	YES	NO	212	129
83145	ES83	ES83	1-3/8"	A	19.93	12.32	7.54	YES	NO	479	153

* Damping force, in pounds, to either extend or collapse the shock absorber at an average operating velocity. Fuerza de amortiguación en libras para extender o comprimir el amortiguador a una velocidad de operación promedio. La puissance d'amortissement en poids de l'amortisseur, soit comprimé, doit détendu, à une vitesse de fonctionnement moyenne.

† At bumper contact / Al contacto con el tope de goma / Au contact avec le butoir

‡ For GasSLX Series, forces are at the "Firm" (F) setting. / Para la serie GasSLX, las fuerzas están ajustadas en (F) "Firme". / Pour la série GasSLX, le réglage de la force est sur «Firme» (F).

SPECIFICATIONS BY END MOUNT
ESPECIFICACIONES POR TIPO DE MONTAJE
SPÉCIFICATIONS PAR FIXATION DES EXTRÉMITÉS

Fleetline	Mounting		Bore	External Diameter Illustration	Lengths			Dust Tube	Recoil Cutoff	Controls*	
	Upper	Lower			Extended	Collapsed	Stroke			Rebound	Compression
83048	ES86	ES167	1-3/8"	A	9.97	8.43†	2.37	YES	YES	904	415
83028	ES86	ES167	1-3/8"	A	9.94	7.57	2.37	YES	YES	445	531
85963	ES90	ES36	1-5/8"	G	25.49	18.68	6.81	YES	YES	1490	206
85964	ES90	ES36	1-5/8"	G	25.49	18.68	6.81	YES	YES	1981	205
85995	ES90	ES36	1-5/8"	G	23.5	14.52	8.98	YES	NO	1830	173
85994	ES90	ES36	1-5/8"	G	21.21	13.4	7.81	YES	NO	1824	263
85954	ES90	ES36	1-5/8"	G	20.43	12.96	7.46	YES	NO	1812	148
85924	ES90	ES36	1-5/8"	G	20.41	12.96	7.46	YES	NO	1036	122
89457	ES90	ES36	1-5/8"	G	19.95	12.71	6.97	YES	NO	941‡	156
85969	ES90	ES36	1-5/8"	G	18.38	11.93	6.45	YES	NO	1612	125
83180	ES90	ES83	1-3/8"		30.2	21.24	8.96	YES	NO	909	204
83146	ES90	ES83	1-3/8"	A	24.02	14.68	9.33	YES	YES	479	119
85082	ES90	ES90	1-5/8"	C	28.6	20.64	7.97	YES	YES	1435	266
83636	ES90	ES90	1-3/8"	A	27.72	16.95	10.77	YES	YES	505	148
83100	ES90	ES90	1-3/8"	A	26.6	16.11	10.49	YES	YES	481	142
85926	ES90	ES90	1-5/8"	G	26.48	17.96	8.53	YES	YES	1387	279
85953	ES90	ES90	1-5/8"	G	26.13	15.86	10.27	YES	NO	2001	153
85003	ES90	ES90	1-5/8"	C	25.37	15.59	9.78	YES	YES	437	182
89411	ES90	ES90	1-5/8"	G	25.36	15.59	9.78	YES	YES	436‡	186
85927	ES90	ES90	1-5/8"	G	24.74	15.38	9.36	YES	YES	1288	388
83101	ES90	ES90	1-3/8"	A	24.6	15.11	9.49	YES	YES	481	142
85998	ES90	ES90	1-5/8"	G	22.83	14.17	8.66	YES	NO	1345	178
85925	ES90	ES90	1-5/8"	G	22.54	15.59	6.96	YES	NO	761	144
85957	ES90	ES90	1-5/8"	G	20.78	13.15	7.63	YES	NO	1583	138
85928	ES90	ES90	1-5/8"	G	20.28	13.21	7.08	YES	NO	957	229
85929	ES90	ES90	1-5/8"	G	20.28	13.21	7.08	YES	NO	2214	267
85999	ES90	ES90	1-5/8"	G	19.84	12.79	7.05	YES	NO	2214	259
83167	ES90	ES90	1-3/8"	A	19.49	12.38	7.11	YES	NO	285	90
83135	ES90	ES90	1-3/8"	A	19.48	12.36	7.12	YES	NO	519	121
83156	ES90	ES90	1-3/8"	A	18.55	11.91	6.64	YES	NO	778	135
83169	ES90	ES90	1-3/8"	A	18.55	11.91	6.64	YES	NO	599	171
83020	ES91	ES91	1-3/8"	A	9.41	7.17	2.24	YES	YES	796	255
83034	ES115	ES115	1-3/16"	1-5/8"	10.04†	7.32	2.97	NO	YES	430	129
83634	ES120	ES120	1-3/8"	A	27.48	16.23	11.25	YES	YES	779	157
85011	ES120	ES121	1-5/8"	C	27.49	16.46	11.03	YES	NO	1268	186
85122	ES120	S21	1-5/8"	C	22.22	13.78	8.44	YES	YES	926	162
83120	ES120	S21	1-3/8"	A	22.12	13.63	8.49	YES	YES	779	164
85123	ES120	S21	1-5/8"	C	21.49	13.26	8.23	YES	NO	1809	246
83154	ES120	S21	1-3/8"	A	20.78	12.72	8.06	YES	YES	599	140
83160	ES128	ES36	1-3/8"	A	24.31	14.9	9.37	YES	YES	920	161
83174	ES128	ES36	1-3/8"	A	24.31	14.9	9.37	YES	YES	795	160
83042	ES136	ES136	1-3/8"	A	9.88†	8.44†	2.38	YES	YES	954	541

* Damping force, in pounds, to either extend or collapse the shock absorber at an average operating velocity. Fuerza de amortiguación en libras para extender o comprimir el amortiguador a una velocidad de operación promedio. La puissance d'amortissement en poids de l'amortisseur, soit comprimé, doit détendu, à une vitesse de fonctionnement moyenne.

† At bumper contact / Al contacto con el tope de goma / Au contact avec le butoir

‡ For GasSLX Series, forces are at the "Firm" (F) setting. / Para la serie GasSLX, las fuerzas están ajustadas en (F) "Firme". / Pour la série GasSLX, le réglage de la force est sur «Ferme» (F).

SPECIFICATIONS BY END MOUNT
ESPECIFICACIONES POR TIPO DE MONTAJE
SPÉCIFICATIONS PAR FIXATION DES EXTRÉMITÉS

Fleetline	Mounting		Bore	External Diameter Illustration	Lengths			Dust Tube	Recoil Cutoff	Controls*	
	Upper	Lower			Extended	Collapsed	Stroke			Rebound	Compression
83030	ES136	ES136	1-3/8"	A	9.6†	7.61	2.49	YES	YES	308	87
83008	ES136	ES136	1-3/8"	A	12.98†	10.15†	3.99	YES	YES	699	307
83056	ES136	ES136	1-5/8"	C	11.53	8.63	2.89	YES	YES	3830	737
85026	ES136	S21	1-5/8"	C	23	13.97	9.03	YES	NO	1079	539
89417	ES136	S21	1-5/8"	G	22.93	14.18	8.75	YES	NO	1226‡	515
83047	ES149	EB1	1-3/8"	A	11.78†	9.74†	3	YES	YES	364	314
83001	ES149	EB1	1-3/8"	A	10.41†	8.36†	3	YES	YES	793	363
83038	ES149	EB1	1-3/8"	A	10.41†	8.36†	2.99	YES	YES	336	242
83006	ES149	EB1	1-3/8"	A	10.66	8.48†	2.77	YES	YES	525	182
83009	ES149	ES149	1-3/8"	A	10.41†	8.36†	2.99	YES	YES	793	363
83039	ES149	ES149	1-3/8"	A	10.41†	8.36†	2.99	YES	YES	876	326
83064	ES149	ES149	1-3/8"	A	10.41†	8.36†	2.99	YES	YES	635	323
83017	ES149	ES149	1-3/8"	A	10.93	8.35†	3.13	YES	YES	353	138
85090	ES150	ES36	1-5/8"	C	25.31	15.52	9.78	YES	YES	943	99
85180	ES150	ES36	1-5/8"	C	20.94	13.83	7.11	YES	YES	681	283
85181	ES150	ES150	1-5/8"	C	26.33	17.06	9.27	YES	YES	681	285
89449	ES150	ES150	1-5/8"	G	23.09	14.71	8.38	YES	NO	1519‡	324
85918	ES150	ES150	1-5/8"	G	22.96	14.55	8.41	YES	NO	1726	412
85958	ES150	ES150	1-5/8"	G	22.96	14.55	8.41	YES	YES	1926	281
85119	ES150	ES150	1-5/8"	C	21.39	13.81	7.68	YES	YES	1387	185
85920	ES150	ES150	1-5/8"	G	21.19	13.53	7.66	YES	NO	845	49
85922	ES150	ES150	1-5/8"	G	21.19	13.53	7.66	YES	NO	878	185
85959	ES150	ES150	1-5/8"	G	21.19	13.53	7.66	YES	YES	1021	123
85106	ES150	ES150	1-5/8"	C	20.03	12.89	7.14	YES	YES	1054	109
85092	ES150	S21	1-5/8"	C	21.95	15.04	6.89	YES	YES	1597	138
83066	ES153	ES153	1-3/8"	A	11.15†	9.2†	2.78	YES	YES	599	221
85984	ES158	ES150	1-5/8"	G	25.44	15.96	9.48	YES	YES	2248	1168
85125	ES158	ES159	1-5/8"	C	26.9	16.64	10.26	YES	YES	1479	183
85724	ES158	ES159	1-5/8"	D	22.78	14.5	8.28	YES	YES	1235	454
89443	ES158	ES159	1-5/8"	G	22.17	14.31	7.86	YES	YES	1206‡	466
85331	ES158	ES159	1-5/8"	D	19.66	12.88	6.78	YES	YES	1757	396
85335	ES158	ES159	1-5/8"	D	19.66	12.88	6.78	YES	YES	827	107
85126	ES158	S21	1-5/8"	C	21.76	13.63	8.13	YES	YES	1086	215
87019	ES160	ES160	2-1/16"	E	24.84	15.85	8.9	YES	YES	2972	665
87017	ES160	ES160	2-1/16"	E	23.35	15.31	8.07	YES	YES	1876	220
89461	ES160	ES160	1-5/8"	G	19.96	13.58	6.38	YES	YES	897‡	103
85088	ES161	ES162	1-5/8"	C	25.31	15.52	9.78	YES	YES	616	178
85061	ES161	ES162	1-5/8"	C	24.75	15.22	9.53	YES	YES	1216	195
85098	ES161	ES162	1-5/8"	C	24.64	15.25	9.39	YES	YES	747	158
85066	ES161	ES162	1-5/8"	C	24.63	15.22	9.41	YES	YES	812	322
89448	ES161	ES162	1-5/8"	G	24.62	15.54	9.08	YES	YES	782‡	323
89450	ES161	ES162	1-5/8"	G	24.62	15.54	9.08	YES	YES	1282‡	193

* Damping force, in pounds, to either extend or collapse the shock absorber at an average operating velocity. Fuerza de amortiguación en libras para extender o comprimir el amortiguador a una velocidad de operación promedio. La puissance d'amortissement en poids de l'amortisseur, soit comprimé, doit détendu, à une vitesse de fonctionnement moyenne.

† At bumper contact / Al contacto con el tope de goma / Au contact avec le butoir

‡ For GasSLX Series, forces are at the "Firm" (F) setting. / Para la serie GasSLX, las fuerzas están ajustadas en (F) "Firme". / Pour la série GasSLX, le réglage de la force est sur «Ferme» (F).

SPECIFICATIONS BY END MOUNT
ESPECIFICACIONES POR TIPO DE MONTAJE
SPÉCIFICATIONS PAR FIXATION DES EXTRÉMITÉS

Fleetline	Mounting		Bore	External Diameter Illustration	Lengths			Dust Tube	Recoil Cutoff	Controls*	
	Upper	Lower			Extended	Collapsed	Stroke			Rebound	Compression
85065	ES161	S21	1-5/8"	C	28.02	16.99	11.03	YES	YES	1059	300
85083	ES162	S42	1-5/8"	C	27.81	16.53	11.28	YES	YES	1429	184
83142	ES162	S42	1-3/8"	A	23.92	14.5	9.43	YES	YES	367	131
83143	ES162	S42	1-3/8"	A	21.92	13.5	8.43	YES	YES	403	137
83049	ES163	ES163	1-3/8"	A	8.02	6.53	1.48	YES	YES	2879	705
83025	ES163	ES163	1-3/8"	A	7.98	6.49	1.49	YES	YES	710	230
83032	ES163	ES163	1-3/8"	A	7.85	6.36	1.49	NO	YES	779	135
83118	ES164	ES90	1-3/8"	A	24.45	14.71	9.74	YES	NO	410	311
83116	ES164	ES165	1-3/8"	A	23.81	14.68	9.12	YES	NO	354	300
83035	ES166	ES136	1-3/8"	A	12.96†	9.33	4.13	YES	YES	320	100
83067	ES166	ES136	1-3/16"	2" D/T	12.33†	9.27†	3.56	YES	YES	424	101
83029	ES168	ES169	1-5/8"	C	10.35	7.94	2.41	YES	NO	1303	1349
83057	ES171	ES172	1-3/8"	2-1/2" D/T	10.44†	8.4†	2.99	YES	YES	364	242
83040	ES171	ES172	1-3/8"	A	10.41†	8.36†	2.99	YES	YES	876	326
87015	ES173	ES173	45MM	E	15.51	11.18	4.33	YES	YES	4950	900
85737	ES173	ES173	1-5/8"	D	15.11	10.84	4.27	YES	YES	3066	782
89459	ES174	EB3	1-5/8"	G	25.62	15.86	9.78	YES	NO	1179‡	314
85070	ES174	EB3	1-5/8"	C	25.6	15.82	9.78	YES	NO	1100	310
85067	ES174	ES136	1-5/8"	C	30.51	18.1	12.41	YES	YES	676	170
89451	ES174	ES136	1-5/8"	G	30.36	18.41	11.95	YES	YES	645‡	172
85989	ES174	ES136	1-5/8"	G	20.78	13.15	7.63	YES	NO	1812	351
85084	ES174	ES136	1-5/8"	C	20.59	13.03	7.57	YES	NO	1145	407
89460	ES174	ES136	1-5/8"	G	20.58	13.03	7.55	YES	NO	997‡	384
85985	ES174	S43	1-5/8"	G	19.04	12.31	6.73	YES	YES	2068	723
85937	ES174	S43	1-5/8"	G	18.98	12.26	6.72	YES	YES	1479	337
85936	ES174	S43	1-5/8"	G	17.23	11.38	5.85	YES	YES	1479	337
89456	ES174	S43	1-5/8"	G	17.02	11.29	5.73	YES	YES	975‡	377
83063	ES175	ES136	1-3/8"	A	10.76†	9.26†	3.01	YES	YES	954	541
85955	ES175	ES150	1-5/8"	G	21.25	13.66	7.59	YES	YES	1034	397
85986	ES175	ES150	1-5/8"	G	21.25	13.66	7.59	YES	YES	1754	221
85120	ES175	ES175	1-5/8"	C	23.67	15.06	8.61	YES	NO	2083	519
83163	ES175	ES175	1-3/8"	A	20.75	13.01	7.74	YES	NO	828	98
83175	ES175	ES175	1-3/8"	A	20.48	13.19	7.29	YES	NO	1245	156
85933	ES175	ES175	1-5/8"	G	18.23	12.71	5.52	YES	YES	1089	383
89454	ES175	ES175	1-5/8"	G	18.23	12.78	5.45	YES	YES	938‡	388
85081	ES175	S21	1-5/8"	C	23.44	14.33	9.11	YES	YES	1658	250
85080	ES175	S21	1-5/8"	C	22.51	13.78	8.74	YES	NO	447	138
85031	ES176	EB2	1-5/8"	C	25.63	15.85	9.78	YES	NO	941	257
85923	ES177	ES161	1-5/8"	G	22.48	14.5	7.98	YES	YES	1940	221
85931	ES177	ES161	1-5/8"	G	22.48	14.5	7.98	YES	YES	1435	220
89458	ES177	ES161	1-5/8"	G	22.47	14.25	7.95	YES	YES	1575‡	222
85930	ES177	ES161	1-5/8"	G	17.86	12	5.86	YES	YES	1617	342

* Damping force, in pounds, to either extend or collapse the shock absorber at an average operating velocity. Fuerza de amortiguación en libras para extender o comprimir el amortiguador a una velocidad de operación promedio. La puissance d'amortissement en poids de l'amortisseur, soit comprimé, doit détendu, à une vitesse de fonctionnement moyenne.

† At bumper contact / Al contacto con el tope de goma / Au contact avec le butoir

‡ For GasSLX Series, forces are at the "Firm" (F) setting. / Para la serie GasSLX, las fuerzas están ajustadas en (F) "Firme". / Pour la série GasSLX, le réglage de la force est sur «Ferme» (F).

SPECIFICATIONS BY END MOUNT
ESPECIFICACIONES POR TIPO DE MONTAJE
SPÉCIFICATIONS PAR FIXATION DES EXTRÉMITÉS

Fleetline	Mounting		Bore	External Diameter Illustration	Lengths			Dust Tube	Recoil Cutoff	Controls*	
	Upper	Lower			Extended	Collapsed	Stroke			Rebound	Compression
85932	ES178	ES150	1-5/8"	G	21.23	13.62	7.61	YES	YES	1102	430
89453	ES178	ES150	1-5/8"	G	21.1	13.78	7.32	YES	YES	860‡	435
85965	ES178	ES161	1-5/8"	G	24.24	15.15	9.09	YES	YES	2206	238
85966	ES178	ES161	1-5/8"	G	23.25	14.64	8.62	YES	YES	2206	238
85967	ES178	ES176	1-5/8"	G	23.93	14.86	9.07	YES	YES	2206	238
85961	ES178	ES176	1-5/8"	G	22.83	14.17	8.66	YES	YES	2206	240
85962	ES178	ES176	1-5/8"	G	21.8	13.66	8.15	YES	YES	2206	240
85980	ES179	ES179	1-5/8"	G	31.17	18.66	12.52	YES	YES	582	138
83148	ES179	ES179	1-3/8"	A	30	17.83	12.17	YES	YES	604	149
85978	ES179	ES179	1-5/8"	G	29.91	18.13	11.79	YES	YES	582	138
83147	ES179	ES179	1-3/8"	A	28.53	17.34	11.15	YES	YES	358	128
83166	ES179	ES179	1-3/8"	A	25.28	15.78	9.49	YES	YES	622	132
83168	ES179	ES179	1-3/8"	A	25.28	15.78	9.49	YES	YES	246	88
85377	ES182	ES182	1-5/8"	D	23.8	14.84	8.96	YES	YES	1937	570
85378	ES182	ES182	1-5/8"	D	23.8	14.84	8.96	YES	YES	1110	240
85956	ES183	ES184	1-5/8"	G	30.63	18.75	11.87	YES	YES	979	373
83053	ES185	ES185	1-3/8"	A	10.91	7.93	2.97	YES	YES	968	214
83054	ES185	ES185	1-3/8"	A	10.28	7.56	2.72	YES	YES	1004	184
83052	ES185	ES185	1-3/8"	2-1/2" D/T	9.41	7.19	2.23	YES	NO	1101	149
83062	ES185	S42	1-3/8"	A	12.71	9.18	3.53	YES	NO	704	153
85739	ES187	ES187	1-5/8"	D	20.73	13.54	7.19	YES	YES	3247	334
85341	ES188	S21	1-5/8"	D	30.95	18.1	12.85	YES	YES	1807	333
85970	ES188	S21	1-5/8"	G	27.19	16.4	10.78	YES	YES	1092	147
85340	ES188	S21	1-5/8"	D	26.46	15.85	10.61	YES	YES	1807	165
86203	ES193	ES193	45 MM	D	16.88	11.61	5.27	YES	YES	4238	910
86202	ES193	ES193	45 MM	D	14.52	10.43	4.09	YES	YES	4238	688
86201	ES193	ES193	45 MM	D	13.26	9.94	3.32	YES	YES	4238	688
86200	ES194	ES194	45 MM	D	14.24	10.45	3.79	YES	YES	4238	688
83065	ES206	ES171	1-5/8"	G	12.52	9.32	3.2	YES	YES	680‡	184
83003	S1	BP7	1-3/8"	A	11.76	8.95†	3.4	YES	YES	248	100
G63610	S1	EB1	1-3/8"		21.55	13.27	8.28	YES	NO		
83161	S1	EB1	1-3/8"	A	20.82	12.56	8.25	YES	NO	400	70
83518	S1	EB2	1-3/16"		24.4	14.26	10.14	YES	NO	153	82
83515	S1	EB2	1-3/16"		23.34	13.89	9.45	YES	NO	643	205
G63432	S1	EB2	1-3/8"		21.21	12.93	8.28	YES	NO		
G63387	S1	ES25	1-3/8"		23.33	14.05	9.28	YES	NO		
G63511	S1	ES25	1-3/8"		22.55	13.52	9.03	YES	NO		
G63350	S1	ES25	1-3/8"		18.83	11.8	7.03	YES	NO		
83400	S1	S1	1-3/16"	F	22.02	12.82	9.2	YES	NO	301	120
G63398	S1	S1	1-3/8"		20.52	12.24	8.28	YES	NO		
83014	S1	S1	1-3/8"	A	10.48	7.11	3.37	NO	NO	544	501
G63484	S4	EB1	1-3/8"		20.05	12.52	7.53	YES	NO		

* Damping force, in pounds, to either extend or collapse the shock absorber at an average operating velocity. Fuerza de amortiguación en libras para extender o comprimir el amortiguador a una velocidad de operación promedio. La puissance d'amortissement en poids de l'amortisseur, soit comprimé, doit détendu, à une vitesse de fonctionnement moyenne.

† At bumper contact / Al contacto con el tope de goma / Au contact avec le butoir

‡ For GasSLX Series, forces are at the "Firm" (F) setting. / Para la serie GasSLX, las fuerzas están ajustadas en (F) "Firme". / Pour la série GasSLX, le réglage de la force est sur «Firme» (F).

SPECIFICATIONS BY END MOUNT
ESPECIFICACIONES POR TIPO DE MONTAJE
SPÉCIFICATIONS PAR FIXATION DES EXTRÉMITÉS

Fleetline	Mounting		Bore	External Diameter Illustration	Lengths			Dust Tube	Recoil Cutoff	Controls*	
	Upper	Lower			Extended	Collapsed	Stroke			Rebound	Compression
G63714	S6	BP7	1-3/8"		15.54	10.01	5.53	YES	NO		
G63772	S6	BP35	1-3/8"		13.83	9.55	4.28	YES	YES		
G63396	S10	ES25	1-3/8"		16.55	10.77	5.78	YES	NO		
G63778	S12	ES25	1-3/8"		24.55	14.52	10.03	YES	NO		
G63716	S12	ES26	1-3/8"		15.54	10.01	5.53	YES	NO		
83317	S16	ES90	1-3/8"	B	27.03	16	11.34	YES	YES		
83301	S16	ES90	1-3/8"	B	24.52	14.74	9.78	YES	YES	653	86
83318	S16	S16	1-3/8"	B	22.53	13.5	9.03	YES	YES	323	77
83613	S16	S16	1-3/8"	A	21.04	12.76	8.28	YES	YES	601	242
85731	S21	EB3	1-5/8"	D	30.57	18.54	12.03	YES	YES	1517	293
85703	S21	EB3	1-5/8"	D	29.57	18.54	11.03	YES	YES	1435	186
85033	S21	EB3	1-5/8"	C	27.21	17.37	9.84	YES	YES	764	254
89427	S21	EB3	1-5/8"	G	27.2	17.5	9.7	YES	YES	794‡	253
85317	S21	EB3	1-5/8"	D	27.18	17.42	9.76	YES	YES	764	254
85711	S21	EB3	1-5/8"	D	24.57	15.29	9.28	YES	YES	1435	208
87000	S21	EB3	2-1/16"	E	24.46	15.21	9.25	YES	YES	1332	300
85311	S21	EB3	1-5/8"	D	23.95	14.79	9.16	YES	YES	764	254
85988	S21	EB3	1-5/8"	G	23.84	14.87	8.97	YES	YES	1200	138
89424	S21	EB3	1-5/8"	G	23.7	15	8.7	YES	YES	794‡	253
85710	S21	EB3	1-5/8"	D	23.45	15.1	8.34	YES	YES	994	248
85343	S21	EB3	1-5/8"	D	22.96	14.79	8.17	YES	YES	858	289
87016	S21	EB3	2-1/16"	E	21.17	13.91	7.26	YES	YES	1808	238
85009	S21	ES36	1-5/8"	C	23.52	14.36	9.16	YES	YES	857	144
83134	S21	ES36	1-3/8"	A	22.24	13.5	8.74	YES	NO	430	49
85921	S21	ES36	1-5/8"	G	22.03	13.5	8.53	YES	NO	2053	339
85316	S21	ES36	1-5/8"	D	20.61	12.85	7.76	YES	NO	943	443
85351	S21	ES36	1-5/8"	D	20.61	12.82	7.79	YES	NO	1887	259
89426	S21	ES36	1-5/8"	G	20.43	12.93	7.5	YES	NO	926‡	419
85056	S21	ES36	1-5/8"	C	20.15	12.87	7.28	YES	YES	732	114
89441	S21	ES36	1-5/8"	G	20.14	13.06	7.08	YES	YES	761‡	126
85935	S21	ES36	1-5/8"	G	18.7	11.92	6.78	YES	NO	1054	419
85319	S21	ES150	1-5/8"	D	22.2	13.92	8.28	YES	YES	988	454
89428	S21	ES150	1-5/8"	G	21.96	14.13	7.83	YES	YES	958‡	446
85709	S21	S21	1-5/8"	D	31.64	18.36	13.28	YES	YES	700	203
85727	S21	S21	1-5/8"	D	29.89	17.36	12.53	YES	YES	783	111
83106	S21	S21	1-3/8"	A	29.25	16.76	12.49	YES	NO	451	80
83136	S21	S21	1-3/8"	A	29.25	16.76	12.49	YES	NO	914	65
85048	S21	S21	1-5/8"	C	29.16	16.88	12.28	YES	NO	432	106
85318	S21	S21	1-5/8"	D	27.37	16.36	11.01	YES	YES	1372	192
85722	S21	S21	1-5/8"	D	27.15	16.43	10.72	YES	YES	1264	369
85069	S21	S21	1-5/8"	C	26.28	15.94	10.34	YES	YES	762	255
89455	S21	S21	1-5/8"	G	26.28	15.92	10.36	YES	YES	791‡	276

* Damping force, in pounds, to either extend or collapse the shock absorber at an average operating velocity. Fuerza de amortiguación en libras para extender o comprimir el amortiguador a una velocidad de operación promedio. La puissance d'amortissement en poids de l'amortisseur, soit comprimé, doit détendu, à une vitesse de fonctionnement moyenne.

† At bumper contact / Al contacto con el tope de goma / Au contact avec le butoir

‡ For GasSLX Series, forces are at the "Firm" (F) setting. / Para la serie GasSLX, las fuerzas están ajustadas en (F) "Firme". / Pour la série GasSLX, le réglage de la force est sur «Ferme» (F).

SPECIFICATIONS BY END MOUNT
ESPECIFICACIONES POR TIPO DE MONTAJE
SPÉCIFICATIONS PAR FIXATION DES EXTRÉMITÉS

Fleetline	Mounting		Bore	External Diameter Illustration	Lengths			Dust Tube	Recoil Cutoff	Controls*	
	Upper	Lower			Extended	Collapsed	Stroke			Rebound	Compression
85328	S21	S21	1-5/8"	D	25.64	15.36	10.28	YES	NO	930	383
85071	S21	S21	1-5/8"	C	25.57	15.04	10.53	YES	NO	610	107
85049	S21	S21	1-5/8"	C	25.53	15	10.53	YES	NO	597	107
85085	S21	S21	1-5/8"	C	24.95	14.67	10.23	YES	NO	970	101
85728	S21	S21	1-5/8"	D	24.39	14.86	9.53	YES	YES	1435	510
83456	S21	S21	1-3/8"	B	24.03	14.25	9.78	YES	YES	566	80
85705	S21	S21	1-5/8"	D	23.65	14.24	9.41	YES	YES	639	436
85706	S21	S21	1-5/8"	D	23.65	14.24	9.41	YES	YES	1086	696
85707	S21	S21	2-1/16"	D	23.65	14.4	9.25	YES	YES	1761	986
87011	S21	S21	2-1/16"	E	23.65	14.4	9.25	YES	YES	1750	1050
87012	S21	S21	2-1/16"	E	23.65	14.4	9.25	YES	YES	650	364
87013	S21	S21	2-1/16"	E	23.65	14.4	9.25	YES	YES	1075	585
89447	S21	S21	1-5/8"	G	23.65	14.57	9.08	YES	YES	702‡	241
85325	S21	S21	1-5/8"	D	23.64	14.36	9.28	YES	NO	1024	240
85347	S21	S21	1-5/8"	D	23.62	14.22	9.4	YES	YES	961	122
85342	S21	S21	1-5/8"	D	23.28	13.99	9.29	YES	NO	893	188
83102	S21	S21	1-3/8"	A	22.94	13.56	9.38	YES	YES	513	333
85324	S21	S21	1-5/8"	D	22.14	13.61	8.53	YES	NO	579	114
85346	S21	S21	1-5/8"	D	22.12	13.48	8.64	YES	YES	2016	285
85027	S21	S21	1-5/8"	C	21.52	12.99	8.53	YES	NO	1008	539
89418	S21	S21	1-5/8"	G	21.44	13.19	8.25	YES	NO	1266‡	515
695406	S21	S21	2-1/16"	E	21.39	13.26	8.13	YES	YES	1854	274
85124	S21	S21	1-5/8"	C	20.91	12.9	8.01	YES	YES	1086	222
85708	S21	S21	1-5/8"	D	20.64	12.86	7.78	YES	YES	914	204
85745	S21	S21	1-5/8"	D	19.88	12.34	7.54	YES	YES	3064	231
85746	S21	S21	1-5/8"	D	19.88	12.34	7.54	YES	YES	1754	167
83103	S21	S21	1-3/8"	A	19.64	11.89	7.75	YES	YES	517	301
85326	S21	S21	1-5/8"	D	19.64	12.36	7.28	YES	NO	799	142
85902	S21	S21	1-5/8"	G	19.01	12.03	6.98	YES	YES	1441	267
85336	S21	S21	1-5/8"	D	18.76	11.86	6.9	YES	NO	861	200
85310	S21	S21	1-5/8"	D	18.65	11.74	6.91	YES	YES	1379	578
89423	S21	S21	1-5/8"	G	18.65	12.07	6.58	YES	YES	1352‡	573
85900	S21	S21	1-5/8"	G	17.27	11.16	6.11	YES	YES	1467	337
87007	S21	S21	2-1/16"	E	15.65	10.4	5.25	YES	YES	879	253
85701	S21	S21	1-5/8"	D	15.64	10.36	5.28	YES	YES	914	204
G63500	S28	ES25	1-3/8"		15.09	10.06	5.03	NO	YES		
G63678	S36	BP7	1-3/8"		18.09	13.56	4.53	YES	NO		
G63622	S36	EB1	1-3/8"		15.42	10.39	5.03	YES	YES		
G63614	S36	EB1	1-3/8"		15.12	10.09	5.03	NO	YES		
G63929	S36	EB1	1-3/8"		14.72	9.71	5.01	YES	YES		
G63608	S36	EB1	1-3/8"		14.58	9.81	4.78	YES	YES		
G63386	S36	ES25	1-3/8"		17.19	11.16	6.03	NO	YES		

* Damping force, in pounds, to either extend or collapse the shock absorber at an average operating velocity. Fuerza de amortiguación en libras para extender o comprimir el amortiguador a una velocidad de operación promedio. La puissance d'amortissement en poids de l'amortisseur, soit comprimé, doit détendu, à une vitesse de fonctionnement moyenne.

† At bumper contact / Al contacto con el tope de goma / Au contact avec le butoir

‡ For GasSLX Series, forces are at the "Firm" (F) setting. / Para la serie GasSLX, las fuerzas están ajustadas en (F) "Firme". / Pour la série GasSLX, le réglage de la force est sur «Firme» (F).

SPECIFICATIONS BY END MOUNT
ESPECIFICACIONES POR TIPO DE MONTAJE
SPÉCIFICATIONS PAR FIXATION DES EXTRÉMITÉS

Fleetline	Mounting		Bore	External Diameter Illustration	Lengths			Dust Tube	Recoil Cutoff	Controls*	
	Upper	Lower			Extended	Collapsed	Stroke			Rebound	Compression
G63623	S36	ES83	1-3/8"		22.67	14.39	8.28	YES	YES		
G63624	S36	ES83	1-3/8"		20.17	12.64	7.53	YES	YES		
83178	S38	ES83	1-3/8"	A	21.95	13.26	8.69	YES	NO	690	275
83177	S40	EB1	1-3/8"	A	14.99	10.12	5.38	YES	NO	690	275
83114	S40	ES35	1-3/8"	A	23	13.76	9.24	YES	NO	450	102
83105	S40	ES179	1-3/8"	A	31.91	18.29	13.62	YES	NO	559	150
83162	S40	ES190	1-3/8"	A	24.35	14.69	9.67	YES	NO	877	52
85332	S42	ES36	1-5/8"	D	20.64	12.98	7.66	YES	YES	2351	967
85333	S42	ES36	1-5/8"	D	20.64	12.98	7.66	YES	YES	1241	534

* Damping force, in pounds, to either extend or collapse the shock absorber at an average operating velocity. Fuerza de amortiguación en libras para extender o comprimir el amortiguador a una velocidad de operación promedio. La puissance d'amortissement en poids de l'amortisseur, soit comprimé, doit détendu, à une vitesse de fonctionnement moyenne.

† At bumper contact / Al contacto con el tope de goma / Au contact avec le butoir

‡ For GasSLX Series, forces are at the "Firm" (F) setting. / Para la serie GasSLX, las fuerzas están ajustadas en (F) "Firme". / Pour la série GasSLX, le réglage de la force est sur «Firme» (F).

SPECIFICATIONS BY PART NUMBER
ESPECIFICACIONES POR NÚMERO DE PARTE
SPÉCIFICATIONS PAR NUMÉRO DE PIÈCE

Fleetline	Mounting		Bore	External Diameter Illustration	Lengths			Dust Tube	Recoil Cutoff	Controls*	
	Upper	Lower			Extended	Collapsed	Stroke			Rebound	Compression
83001	ES149	EB1	1-3/8"	A	10.41†	8.36†	3	YES	YES	793	363
83002	ES10	ES10	1-3/8"	A	11.61	8.62	3	YES	YES	3112	590
83003	S1	BP7	1-3/8"	A	11.76	8.95†	3.4	YES	YES	248	100
83004	ES35	ES136	1"	2" D/T	9.36†	7.29	2.32	YES	YES	539	324
83005	BP8	S10	1-3/16"	2" D/T	7.34	5.87	1.47	YES	NO	858	216
83006	ES149	EB1	1-3/8"	A	10.66	8.48†	2.77	YES	YES	525	182
83007	EB1	EB1	1-3/8"	A	18.54	11.67	6.87	NO	NO	489	343
83008	ES136	ES136	1-3/8"	A	12.98†	10.15†	3.99	YES	YES	699	307
83009	ES149	ES149	1-3/8"	A	10.41†	8.36†	2.99	YES	YES	793	363
83010	ES24	ES24	1"	2" D/T	14.15†	9.33	5.07	YES	YES	188	70
83011	EB1	EB1	1-3/8"	A	11.55†	8.43	3.62	YES	YES	738	330
83012	EB1	EB1	1-3/8"	A	11.05†	8.18	3.37	YES	YES	738	330
83013	BP8	BP8	1-3/16"	2" D/T	7.66	6.63†	1.7	YES	NO	646	480
83014	S1	S1	1-3/8"	A	10.48	7.11	3.37	NO	NO	544	501
83015	BP8	S1	1-3/8"	A	9.79	7.55	2.24	YES	YES	735	430
83016	ES10	ES10	1"	1-5/8"	11.51	8.14	3.37	NO	YES	506	139
83017	ES149	ES149	1-3/8"	A	10.93	8.35†	3.13	YES	YES	353	138
83018	ES24	S10	1-3/8"	A	10.3†	8.42†	3.24	YES	YES	515	174
83019	ES24	S10	1-3/8"	A	9.42	8.16†	2.28	YES	YES	509	121
83020	ES91	ES91	1-3/8"	A	9.41	7.17	2.24	YES	YES	796	255
83021	ES10	ES10	1-3/8"	A	9.36	7.37	1.99	YES	YES	745	315
83022	ES24	ES24	1"	2" D/T	14.28	9.33	4.95	YES	NO	840	152
83023	ES10	ES181	1"	1-5/8"	8.7	7.09†	2.14	NO	YES	484	157
83024	ES10	ES10	1-3/8"	2-1/2" D/T	11.61	8.62	2.99	YES	YES	811	320
83025	ES163	ES163	1-3/8"	A	7.98	6.49	1.49	YES	YES	710	230
83026	ES24	ES24	1-3/8"	A	13.11	9.12	3.99	YES	YES	602	104
83027	ES24	S10	1-3/8"	A	13.8	9.18	4.62	YES	YES	602	104
83028	ES86	ES167	1-3/8"	A	9.94	7.57	2.37	YES	YES	445	531
83029	ES168	ES169	1-5/8"	C	10.35	7.94	2.41	YES	NO	1303	1349
83030	ES136	ES136	1-3/8"	A	9.6†	7.61	2.49	YES	YES	308	87
83031	ES10	ES10	1-3/8"	2-1/2" D/T	11.49	8.62	2.87	YES	YES	811	314
83032	ES163	ES163	1-3/8"	A	7.85	6.36	1.49	NO	YES	779	135
83033	ES53	ES53	1-3/8"	A	13.99	10.37	3.62	YES	YES	494	312
83034	ES115	ES115	1-3/16"	1-5/8"	10.04†	7.32	2.97	NO	YES	430	129
83035	ES166	ES136	1-3/8"	A	12.96†	9.33	4.13	YES	YES	320	100
83038	ES149	EB1	1-3/8"	A	10.41†	8.36†	2.99	YES	YES	336	242
83039	ES149	ES149	1-3/8"	A	10.41†	8.36†	2.99	YES	YES	876	326
83040	ES171	ES172	1-3/8"	A	10.41†	8.36†	2.99	YES	YES	876	326
83041	BP27	S10	1-3/8"	A	10.51†	8.34†	3.02	YES	YES	486	189
83042	ES136	ES136	1-3/8"	A	9.88†	8.44†	2.38	YES	YES	954	541
83044	ES27	ES164	1-3/8"	A	10.91	7.93	2.98	YES	YES	789	296
83045	ES19	S10	1-3/8"	A	11.53†	8.58†	3.81	YES	NO	510	153

* Damping force, in pounds, to either extend or collapse the shock absorber at an average operating velocity. Fuerza de amortiguación en libras para extender o comprimir el amortiguador a una velocidad de operación promedio. La puissance d'amortissement en poids de l'amortisseur, soit comprimé, doit détendu, à une vitesse de fonctionnement moyenne.

† At bumper contact / Al contacto con el tope de goma / Au contact avec le butoir

‡ For GasSLX Series, forces are at the "Firm" (F) setting. / Para la serie GasSLX, las fuerzas están ajustadas en (F) "Firme". / Pour la série GasSLX, le réglage de la force est sur «Firme» (F).

SPECIFICATIONS BY PART NUMBER
ESPECIFICACIONES POR NÚMERO DE PARTE
SPÉCIFICATIONS PAR NUMÉRO DE PIÈCE

Fleetline	Mounting		Bore	External Diameter Illustration	Lengths			Dust Tube	Recoil Cutoff	Controls*	
	Upper	Lower			Extended	Collapsed	Stroke			Rebound	Compression
83046	ES10	ES181	1-3/16"		9.23†	7.62†	2.73	NO	YES	514	173
83047	ES149	EB1	1-3/8"	A	11.78†	9.74†	3	YES	YES	364	314
83048	ES86	ES167	1-3/8"	A	9.97	8.43†	2.37	YES	YES	904	415
83049	ES163	ES163	1-3/8"	A	8.02	6.53	1.48	YES	YES	2879	705
83050	ES19	S10	1-3/8"	A	10.43†	8.38†	2.9	YES	YES	599	321
83051	ES10	ES10	1-3/8"	2-1/2" D/T	9.41	7.4	2.01	YES	YES	579	163
83052	ES185	ES185	1-3/8"	2-1/2" D/T	9.41	7.19	2.23	YES	NO	1101	149
83053	ES185	ES185	1-3/8"	A	10.91	7.93	2.97	YES	YES	968	214
83054	ES185	ES185	1-3/8"	A	10.28	7.56	2.72	YES	YES	1004	184
83056	ES136	ES136	1-5/8"	C	11.53	8.63	2.89	YES	YES	3830	737
83057	ES171	ES172	1-3/8"	2-1/2" D/T	10.44†	8.4†	2.99	YES	YES	364	242
83058	ES19	S10	1-3/8"	A	10.43†	8.38†	2.9	YES	YES	742	243
83059	ES35	ES35	1-3/8"	A	12.06†	8.68	3.88	YES	YES	738	350
83060	EB	BP7	1-3/8"	A	9.76	7.98†	2.25	NO	YES	431	441
83061	ES10	ES10	1-3/8"	2-1/2" D/T	9.41	7.4	2.01	YES	YES	1030	220
83062	ES185	S42	1-3/8"	A	12.71	9.18	3.53	YES	NO	704	153
83063	ES175	ES136	1-3/8"	A	10.76†	9.26†	3.01	YES	YES	954	541
83064	ES149	ES149	1-3/8"	A	10.41†	8.36†	2.99	YES	YES	635	323
83065	ES206	ES171	1-5/8"	G	12.52	9.32	3.2	YES	YES	680‡	184
83066	ES153	ES153	1-3/8"	A	11.15†	9.2†	2.78	YES	YES	599	221
83067	ES166	ES136	1-3/16"	2" D/T	12.33†	9.27†	3.56	YES	YES	424	101
83100	ES90	ES90	1-3/8"	A	26.6	16.11	10.49	YES	YES	481	142
83101	ES90	ES90	1-3/8"	A	24.6	15.11	9.49	YES	YES	481	142
83102	S21	S21	1-3/8"	A	22.94	13.56	9.38	YES	YES	513	333
83103	S21	S21	1-3/8"	A	19.64	11.89	7.75	YES	YES	517	301
83104	EB3	EB3	1-3/8"	A	28.24	17.12	11.12	YES	NO	698	133
83105	S40	ES179	1-3/8"	A	31.91	18.29	13.62	YES	NO	559	150
83106	S21	S21	1-3/8"	A	29.25	16.76	12.49	YES	NO	451	80
83107	EB2	EB2	1-3/8"	A	31.6	18.36	13.24	YES	NO	352	77
83109	ES36	S42	1-3/8"	A	26.14	15.9	10.24	YES	YES	345	78
83110	ES36	S42	1-3/8"	A	22.89	14.27	8.62	YES	YES	450	143
83111	ES36	S42	1-3/8"	A	26.14	15.9	10.24	YES	YES	560	141
83112	ES36	S42	1-3/8"	A	21.52	13.4	8.12	YES	YES	1064	343
83113	ES36	EB3	1-3/8"	A	20.42	13.43	6.99	YES	YES	997	238
83114	S40	ES35	1-3/8"	A	23	13.76	9.24	YES	NO	450	102
83115	ES36	EB3	1-3/8"	A	16.19	13.32	4.87	YES	YES	997	238
83116	ES164	ES165	1-3/8"	A	23.81	14.68	9.12	YES	NO	354	300
83117	EB4	EB1	1-3/8"	A	23.94	14.45	9.49	YES	NO	354	300
83118	ES164	ES90	1-3/8"	A	24.45	14.71	9.74	YES	NO	410	311
83119	EB4	ES165	1-3/8"	A	23.96	14.84	9.12	YES	NO	354	300
83120	ES120	S21	1-3/8"	A	22.12	13.63	8.49	YES	YES	779	164
83121	ES36	ES36	1-3/8"	A	30.25	18.32	11.93	YES	YES	689	126

* Damping force, in pounds, to either extend or collapse the shock absorber at an average operating velocity. Fuerza de amortiguación en libras para extender o comprimir el amortiguador a una velocidad de operación promedio. La puissance d'amortissement en poids de l'amortisseur, soit comprimé, doit détendu, à une vitesse de fonctionnement moyenne.

† At bumper contact / Al contacto con el tope de goma / Au contact avec le butoir

‡ For GasSLX Series, forces are at the "Firm" (F) setting. / Para la serie GasSLX, las fuerzas están ajustadas en (F) "Firme". / Pour la série GasSLX, le réglage de la force est sur «Firme» (F).

SPECIFICATIONS BY PART NUMBER
ESPECIFICACIONES POR NÚMERO DE PARTE
SPÉCIFICATIONS PAR NUMÉRO DE PIÈCE

Fleetline	Mounting		Bore	External Diameter Illustration	Lengths			Dust Tube	Recoil Cutoff	Controls*	
	Upper	Lower			Extended	Collapsed	Stroke			Rebound	Compression
83122	ES36	ES36	1-3/8"	A	25.24	15.75	9.49	YES	YES	661	201
83123	ES36	ES36	1-3/8"	A	26.62	16.38	10.24	YES	YES	589	119
83124	ES36	ES36	1-3/8"	A	21.65	13.75	7.87	YES	YES	750	137
83125	ES36	ES36	1-3/8"	A	28.12	17.13	10.99	YES	YES	625	115
83126	ES36	ES36	1-3/8"	A	24.37	15.25	9.12	YES	YES	625	115
83127	ES36	ES36	1-3/8"	A	20.12	13.13	6.99	YES	YES	940	218
83128	ES36	ES36	1-3/8"	A	16.87	11.51	5.37	YES	YES	940	218
83130	ES36	ES36	1-3/8"	A	18.03	12.04	5.99	YES	YES	871	177
83131	ES83	ES83	1-3/8"	A	27.8	18.18	9.62	YES	NO	212	129
83132	EB3	EB3	1-3/8"	A	25.24	15.5	9.74	YES	NO	828	150
83134	S21	ES36	1-3/8"	A	22.24	13.5	8.74	YES	NO	430	49
83135	ES90	ES90	1-3/8"	A	19.48	12.36	7.12	YES	NO	519	121
83136	S21	S21	1-3/8"	A	29.25	16.76	12.49	YES	NO	914	65
83137	ES36	ES36	1-3/8"	A	30.03	17.78	12.25	YES	YES	517	132
83138	ES36	S42	1-3/8"	A	23.55	14.42	9.12	YES	YES	997	231
83140	EB3	EB3	1-3/8"	A	25.27	15.52	9.75	YES	NO	738	88
83141	EB3	EB3	1-3/8"	A	25.27	15.52	9.75	YES	NO	408	113
83142	ES162	S42	1-3/8"	A	23.92	14.5	9.43	YES	YES	367	131
83143	ES162	S42	1-3/8"	A	21.92	13.5	8.43	YES	YES	403	137
83144	ES36	ES36	1-3/8"	A	23.78	15.03	8.75	YES	YES	596	93
83145	ES83	ES83	1-3/8"	A	19.93	12.32	7.54	YES	NO	479	153
83146	ES90	ES83	1-3/8"	A	24.02	14.68	9.33	YES	YES	479	119
83147	ES179	ES179	1-3/8"	A	28.53	17.34	11.15	YES	YES	358	128
83148	ES179	ES179	1-3/8"	A	30	17.83	12.17	YES	YES	604	149
83149	ES36	ES36	1-3/8"	A	25.28	15.78	9.49	YES	YES	332	101
83150	ES36	ES36	1-3/8"	A	15.24	10.43	4.81	YES	YES	940	216
83153	ES34	ES34	1-3/8"	A	21.69	13.62	8.07	YES	YES	974	206
83154	ES120	S21	1-3/8"	A	20.78	12.72	8.06	YES	YES	599	140
83155	ES34	ES34	1-3/8"	A	21.69	13.62	8.07	YES	YES	507	80
83156	ES90	ES90	1-3/8"	A	18.55	11.91	6.64	YES	NO	778	135
83157	ES36	ES90	1-3/8"	A	26.38	15.76	10.61	YES	NO	446	303
83158	ES22	ES22	1-3/8"	A	12.96	8.97	4	YES	NO	783	484
83159	EB2	EB2	1-3/8"	A	21.62	13.4	8.14	YES	NO	658	149
83160	ES128	ES36	1-3/8"	A	24.31	14.9	9.37	YES	YES	920	161
83161	S1	EB1	1-3/8"	A	20.82	12.56	8.25	YES	NO	400	70
83162	S40	ES190	1-3/8"	A	24.35	14.69	9.67	YES	NO	877	52
83163	ES175	ES175	1-3/8"	A	20.75	13.01	7.74	YES	NO	828	98
83164	ES36	ES165	1-3/8"	C	24.22	14.59	9.63	YES	NO	426	274
83166	ES179	ES179	1-3/8"	A	25.28	15.78	9.49	YES	YES	622	132
83167	ES90	ES90	1-3/8"	A	19.49	12.38	7.11	YES	NO	285	90
83168	ES179	ES179	1-3/8"	A	25.28	15.78	9.49	YES	YES	246	88
83169	ES90	ES90	1-3/8"	A	18.55	11.91	6.64	YES	NO	599	171

* Damping force, in pounds, to either extend or collapse the shock absorber at an average operating velocity. Fuerza de amortiguación en libras para extender o comprimir el amortiguador a una velocidad de operación promedio. La puissance d'amortissement en poids de l'amortisseur, soit comprimé, doit détendu, à une vitesse de fonctionnement moyenne.

† At bumper contact / Al contacto con el tope de goma / Au contact avec le butoir

‡ For GasSLX Series, forces are at the "Firm" (F) setting. / Para la serie GasSLX, las fuerzas están ajustadas en (F) "Firme". / Pour la série GasSLX, le réglage de la force est sur «Firme» (F).

SPECIFICATIONS BY PART NUMBER
ESPECIFICACIONES POR NÚMERO DE PARTE
SPÉCIFICATIONS PAR NUMÉRO DE PIÈCE

Fleetline	Mounting		Bore	External Diameter Illustration	Lengths			Dust Tube	Recoil Cutoff	Controls*	
	Upper	Lower			Extended	Collapsed	Stroke			Rebound	Compression
83171		ES36	1-3/8"	A	23.98	14.51	9.47	YES	YES	513	146
83174	ES128	ES36	1-3/8"	A	24.31	14.9	9.37	YES	YES	795	160
83175	ES175	ES175	1-3/8"	A	20.48	13.19	7.29	YES	NO	1245	156
83176	ES36	ES36	1-3/8"	A	26.62	15.96	10.66	NO	NO	406	275
83177	S40	EB1	1-3/8"	A	14.99	10.12	5.38	YES	NO	690	275
83178	S38	ES83	1-3/8"	A	21.95	13.26	8.69	YES	NO	690	275
83180	ES90	ES83	1-3/8"		30.2	21.24	8.96	YES	NO	909	204
83200	EB2	EB2	1-3/8"	A	24.51	15.1	9.53	YES	NO	806	370
83203	ES36	ES36	1-3/8"	A	17.1	11.36	5.74	YES	YES	609	114
83204	ES36	ES36	1-3/8"	A	20.14	12.86	7.28	YES	YES	451	110
83205	ES36	ES36	1-3/8"	A	29.69	17.69	12	YES	YES	660	76
83207	ES36	ES36	1-3/8"	A	21.64	13.61	8.03	YES	YES	553	143
83209	ES36	ES36	1-3/8"	A	29.64	17.61	12.03	YES	YES	670	78
83214	EB3	EB3	1-3/8"	A	19.64	12.86	6.78	YES	YES	269	90
83215	EB3	EB3	1-3/8"	A	26.64	16.36	10.28	YES	YES	697	108
83216	EB2	EB2	1-3/8"	A	23.51	14.48	9.03	YES	YES	776	262
83217	EB3	EB3	1-3/8"	A	22.77	14.49	8.28	YES	YES	539	202
83218	ES36	ES36	1-3/8"	A	25.19	15.44	9.75	YES	YES	721	194
83219	EB2	EB2	1-3/8"	A	20.01	12.73	7.28	YES	YES	299	125
83221	ES36	ES36	1-3/8"	A	24.01	14.73	9.28	YES	YES	599	153
83225	EB3	EB3	1-3/8"	A	24.14	15.11	9.03	YES	YES	482	159
83242	ES36	ES36	1-3/8"	A	33.73	20.98	12.75	YES	YES	721	135
83301	S16	ES90	1-3/8"	B	24.52	14.74	9.78	YES	YES	653	86
83303	EB7	ES36	1-3/8"	B	24.86	15.08	9.78	YES	YES	470	122
83304	EB7	ES36	1-3/8"	B	22.86	14.08	8.78	YES	YES	470	122
83308	EB2	EB2	1-3/8"	B	25.14	15.36	9.78	YES	YES	445	180
83309	EB2	EB2	1-3/8"	B	28.64	17.11	11.53	YES	YES	589	135
83310	ES36	ES36	1-3/8"	B	24.06	14.69	9.37	YES	NO	559	153
83312	EB2	EB2	1-3/8"	B	26.64	16.11	10.53	YES	YES	527	152
83314	EB2	EB2	1-3/8"	B	30.64	18.11	12.53	YES	YES	633	143
83317	S16	ES90	1-3/8"	B	27.03	16	11.34	YES	YES		
83318	S16	S16	1-3/8"	B	22.53	13.5	9.03	YES	YES	323	77
83353	EB3	S21	1-3/8"	B	24.84	15.06	9.78	YES	NO	432	214
83362	EB3	EB3	1-3/8"	B	27	16.25	10.75	YES	NO	539	202
83389	ES36	ES36	1-3/8"	A	17.32	11.57	5.75	YES	YES	1084	228
83400	S1	S1	1-3/16"	F	22.02	12.82	9.2	YES	NO	301	120
83401	EB1	EB1	1-3/16"	F	24.09	14.26	9.83	YES	NO	341	252
83404	EB2	EB2	1-3/16"	F	22.01	13.44	8.58	YES	NO	545	171
83456	S21	S21	1-3/8"	B	24.03	14.25	9.78	YES	YES	566	80
83515	S1	EB2	1-3/16"		23.34	13.89	9.45	YES	NO	643	205
83518	S1	EB2	1-3/16"		24.4	14.26	10.14	YES	NO	153	82
83519	EB2	EB2	1-3/16"		23.83	14.35	9.48	YES	NO	292	132

* Damping force, in pounds, to either extend or collapse the shock absorber at an average operating velocity. Fuerza de amortiguación en libras para extender o comprimir el amortiguador a una velocidad de operación promedio. La puissance d'amortissement en poids de l'amortisseur, soit comprimé, doit détendu, à une vitesse de fonctionnement moyenne.

† At bumper contact / Al contacto con el tope de goma / Au contact avec le butoir

‡ For GasSLX Series, forces are at the "Firm" (F) setting. / Para la serie GasSLX, las fuerzas están ajustadas en (F) "Firme". / Pour la série GasSLX, le réglage de la force est sur «Firme» (F).

SPECIFICATIONS BY PART NUMBER
ESPECIFICACIONES POR NÚMERO DE PARTE
SPÉCIFICATIONS PAR NUMÉRO DE PIÈCE

Fleetline	Mounting		Bore	External Diameter Illustration	Lengths			Dust Tube	Recoil Cutoff	Controls*	
	Upper	Lower			Extended	Collapsed	Stroke			Rebound	Compression
83613	S16	S16	1-3/8"	A	21.04	12.76	8.28	YES	YES	601	242
83634	ES120	ES120	1-3/8"	A	27.48	16.23	11.25	YES	YES	779	157
83635	ES36	S21	1-3/8"	A	21.74	13.25	8.49	YES	NO	558	119
83636	ES90	ES90	1-3/8"	A	27.72	16.95	10.77	YES	YES	505	148
85000	ES36	ES36	1-5/8"	C	17.22	11.46	5.76	YES	YES	1019	219
85001	EB3	EB3	1-5/8"	C	26.27	16.36	9.91	YES	NO	1202	186
85003	ES90	ES90	1-5/8"	C	25.37	15.59	9.78	YES	YES	437	182
85004	EB3	EB3	1-5/8"	C	20.68	13.67	7.01	YES	YES	1019	219
85005	ES36	ES36	1-5/8"	C	24.74	15.21	9.53	YES	YES	1019	219
85006	ES36	ES36	1-5/8"	C	28.5	17.09	11.41	YES	YES	1019	219
85007	EB3	EB3	1-5/8"	C	24.21	15.3	8.91	YES	YES	1008	171
85009	S21	ES36	1-5/8"	C	23.52	14.36	9.16	YES	YES	857	144
85010	ES36	ES36	1-5/8"	C	26.74	16.21	10.53	YES	YES	1019	219
85011	ES120	ES121	1-5/8"	C	27.49	16.46	11.03	YES	NO	1268	186
85012	EB2	EB2	1-5/8"	C	21	13.22	7.78	YES	NO	523	199
85013	ES36	ES36	1-5/8"	C	29.74	17.71	12.03	YES	YES	1019	219
85014	ES36	ES36	1-5/8"	C	21.74	13.71	8.03	YES	YES	1019	219
85023	EB2	EB2	1-5/8"	C	20.24	12.96	7.28	YES	YES	1008	539
85024	EB2	EB2	1-5/8"	C	28.74	17.21	11.53	YES	YES	1008	539
85025	EB2	S21	1-5/8"	C	23	13.97	9.03	YES	NO	1079	539
85026	ES136	S21	1-5/8"	C	23	13.97	9.03	YES	NO	1079	539
85027	S21	S21	1-5/8"	C	21.52	12.99	8.53	YES	NO	1008	539
85029	ES36	ES36	1-5/8"	C	20.5	13.09	7.41	YES	YES	1019	219
85030	ES36	ES36	1-5/8"	C	24	14.84	9.16	YES	YES	1019	219
85031	ES176	EB2	1-5/8"	C	25.63	15.85	9.78	YES	NO	941	257
85033	S21	EB3	1-5/8"	C	27.21	17.37	9.84	YES	YES	764	254
85036	ES36	ES36	1-5/8"	C	26.38	16.29	10.09	YES	YES	633	119
85040	EB3	EB3	1-5/8"	C	30.9	18.49	12.41	YES	NO	889	114
85042	EB3	EB3	1-5/8"	C	20.64	13.61	7.03	YES	YES	333	161
85043	ES36	ES36	1-5/8"	C	27.63	16.85	10.78	YES	YES	628	163
85044	ES36	ES36	1-5/8"	C	22.63	14.1	8.53	YES	NO	722	212
85045	ES36	ES36	1-5/8"	C	14.51	10.1	4.41	YES	YES	1020	219
85046	EB2	EB2	1-5/8"	C	27.51	16.6	10.91	YES	YES	1008	539
85047	EB2	EB2	1-5/8"	C	25.25	15.47	9.78	YES	YES	1008	539
85048	S21	S21	1-5/8"	C	29.16	16.88	12.28	YES	NO	432	106
85049	S21	S21	1-5/8"	C	25.53	15	10.53	YES	NO	597	107
85050	ES36	ES36	1-5/8"	C	23.28	14.5	9.03	YES	NO	525	138
85051	ES36	ES36	1-5/8"	C	18.53	12.15	6.4	YES	YES	1019	139
85052	ES36	ES36	1-5/8"	C	13.25	9.47	3.78	YES	YES	1019	139
85053	EB3	EB3	1-5/8"	C	24.65	15.49	9.16	YES	NO	1019	227
85054	EB2	EB2	1-5/8"	C	23.26	14.35	8.91	YES	NO	602	104
85055	EB2	EB2	1-5/8"	C	25.63	15.6	10.03	YES	NO	577	102

* Damping force, in pounds, to either extend or collapse the shock absorber at an average operating velocity. Fuerza de amortiguación en libras para extender o comprimir el amortiguador a una velocidad de operación promedio. La puissance d'amortissement en poids de l'amortisseur, soit comprimé, doit détendu, à une vitesse de fonctionnement moyenne.

† At bumper contact / Al contacto con el tope de goma / Au contact avec le butoir

‡ For GasSLX Series, forces are at the "Firm" (F) setting. / Para la serie GasSLX, las fuerzas están ajustadas en (F) "Firme". / Pour la série GasSLX, le réglage de la force est sur «Firme» (F).

SPECIFICATIONS BY PART NUMBER
ESPECIFICACIONES POR NÚMERO DE PARTE
SPÉCIFICATIONS PAR NUMÉRO DE PIÈCE

Fleetline	Mounting		Bore	External Diameter Illustration	Lengths			Dust Tube	Recoil Cutoff	Controls*	
	Upper	Lower			Extended	Collapsed	Stroke			Rebound	Compression
85056	S21	ES36	1-5/8"	C	20.15	12.87	7.28	YES	YES	732	114
85057	ES36	EB3	1-5/8"	C	21.45	14.23	7.22	YES	YES	1216	115
85058	ES36	ES36	1-5/8"	C	22.63	14.22	8.41	YES	YES	722	114
85059	ES36	EB3	1-5/8"	C	19.07	12.79	6.28	YES	YES	928	151
85060	ES36	ES36	1-5/8"	C	19.75	12.72	7.03	YES	YES	943	405
85061	ES161	ES162	1-5/8"	C	24.75	15.22	9.53	YES	YES	1216	195
85062	EB2	EB2	1-5/8"	C	19.76	12.6	7.2	YES	NO	523	199
85063	EB2	EB2	1-5/8"	C	32.01	18.85	13.16	YES	NO	762	174
85064	ES36	ES36	1-5/8"	C	16.03	10.76	5.27	YES	YES	1481	340
85065	ES161	S21	1-5/8"	C	28.02	16.99	11.03	YES	YES	1059	300
85066	ES161	ES162	1-5/8"	C	24.63	15.22	9.41	YES	YES	812	322
85067	ES174	ES136	1-5/8"	C	30.51	18.1	12.41	YES	YES	676	170
85069	S21	S21	1-5/8"	C	26.28	15.94	10.34	YES	YES	762	255
85070	ES174	EB3	1-5/8"	C	25.6	15.82	9.78	YES	NO	1100	310
85071	S21	S21	1-5/8"	C	25.57	15.04	10.53	YES	NO	610	107
85072	ES36	ES176	1-5/8"	C	24.17	14.83	9.34	YES	YES	1387	305
85078	ES36	ES36	1-5/8"	C	14.77	10.13	4.64	YES	YES	1409	282
85079	ES36	ES36	1-5/8"	C	12.04	8.87	3.17	YES	YES	1494	325
85080	ES175	S21	1-5/8"	C	22.51	13.78	8.74	YES	NO	447	138
85081	ES175	S21	1-5/8"	C	23.44	14.33	9.11	YES	YES	1658	250
85082	ES90	ES90	1-5/8"	C	28.6	20.64	7.97	YES	YES	1435	266
85083	ES162	S42	1-5/8"	C	27.81	16.53	11.28	YES	YES	1429	184
85084	ES174	ES136	1-5/8"	C	20.59	13.03	7.57	YES	NO	1145	407
85085	S21	S21	1-5/8"	C	24.95	14.67	10.23	YES	NO	970	101
85086	ES36	ES36	1-5/8"	C	17.55	11.63	5.92	YES	YES	2027	389
85087	ES36	ES176	1-5/8"	C	22.79	14.71	8.08	YES	YES	1568	403
85088	ES161	ES162	1-5/8"	C	25.31	15.52	9.78	YES	YES	616	178
85090	ES150	ES36	1-5/8"	C	25.31	15.52	9.78	YES	YES	943	99
85091	ES36	ES36	1-5/8"	C	21.38	13.56	7.82	YES	NO	1121	331
85092	ES150	S21	1-5/8"	C	21.95	15.04	6.89	YES	YES	1597	138
85097	ES36	ES36	1-5/8"	C	27.95	17.11	10.84	YES	YES	1086	109
85098	ES161	ES162	1-5/8"	C	24.64	15.25	9.39	YES	YES	747	158
85099	ES36	ES36	1-5/8"	C	26.02	15.93	10.09	YES	YES	1152	135
85102	ES36	ES136	1-5/8"	C	21.53	14.94	6.59	YES	YES	1224	342
85106	ES150	ES150	1-5/8"	C	20.03	12.89	7.14	YES	YES	1054	109
85109	ES36	ES195	1-5/8"	C	24.21	15.14	9.07	YES	YES	1123	149
85119	ES150	ES150	1-5/8"	C	21.39	13.81	7.68	YES	YES	1387	185
85120	ES175	ES175	1-5/8"	C	23.67	15.06	8.61	YES	NO	2083	519
85122	ES120	S21	1-5/8"	C	22.22	13.78	8.44	YES	YES	926	162
85123	ES120	S21	1-5/8"	C	21.49	13.26	8.23	YES	NO	1809	246
85124	S21	S21	1-5/8"	C	20.91	12.9	8.01	YES	YES	1086	222
85125	ES158	ES159	1-5/8"	C	26.9	16.64	10.26	YES	YES	1479	183

* Damping force, in pounds, to either extend or collapse the shock absorber at an average operating velocity. Fuerza de amortiguación en libras para extender o comprimir el amortiguador a una velocidad de operación promedio. La puissance d'amortissement en poids de l'amortisseur, soit comprimé, doit détendu, à une vitesse de fonctionnement moyenne.

† At bumper contact / Al contacto con el tope de goma / Au contact avec le butoir

‡ For GasSLX Series, forces are at the "Firm" (F) setting. / Para la serie GasSLX, las fuerzas están ajustadas en (F) "Firme". / Pour la série GasSLX, le réglage de la force est sur «Firme» (F).

SPECIFICATIONS BY PART NUMBER
ESPECIFICACIONES POR NÚMERO DE PARTE
SPÉCIFICATIONS PAR NUMÉRO DE PIÈCE

Fleetline	Mounting		Bore	External Diameter Illustration	Lengths			Dust Tube	Recoil Cutoff	Controls*	
	Upper	Lower			Extended	Collapsed	Stroke			Rebound	Compression
85126	ES158	S21	1-5/8"	C	21.76	13.63	8.13	YES	YES	1086	215
85180	ES150	ES36	1-5/8"	C	20.94	13.83	7.11	YES	YES	681	283
85181	ES150	ES150	1-5/8"	C	26.33	17.06	9.27	YES	YES	681	285
85300	EB3	EB3	1-5/8"	D	18	12.22	5.78	YES	YES	1435	676
85301	EB3	EB3	1-5/8"	D	31.92	19.03	12.89	YES	NO	1442	455
85302	EB3	EB3	1-5/8"	D	22.75	14.66	8.09	YES	NO	836	253
85303	EB3	EB3	1-5/8"	D	24.75	15.47	9.28	YES	NO	1019	221
85304	EB3	EB3	1-5/8"	D	22.25	14.22	8.03	YES	NO	767	325
85305	EB3	EB3	1-5/8"	D	27.25	16.72	10.53	YES	NO	1120	225
85307	EB3	EB3	1-5/8"	D	24.01	15.1	8.91	YES	NO	1094	173
85308	EB3	EB3	1-5/8"	D	25.13	15.85	9.28	YES	YES	764	254
85310	S21	S21	1-5/8"	D	18.65	11.74	6.91	YES	YES	1379	578
85311	S21	EB3	1-5/8"	D	23.95	14.79	9.16	YES	YES	764	254
85312	EB3	S21	1-5/8"	D	23.69	14.85	8.84	YES	YES	717	111
85313	EB3	EB3	1-5/8"	D	26.26	16.35	9.91	YES	YES	717	111
85314	EB3	EB3	1-5/8"	D	26.5	16.47	10.03	YES	YES	1216	169
85315	EB3	EB3	1-5/8"	D	29.66	18.15	11.51	YES	NO	380	142
85316	S21	ES36	1-5/8"	D	20.61	12.85	7.76	YES	NO	943	443
85317	S21	EB3	1-5/8"	D	27.18	17.42	9.76	YES	YES	764	254
85318	S21	S21	1-5/8"	D	27.37	16.36	11.01	YES	YES	1372	192
85319	S21	ES150	1-5/8"	D	22.2	13.92	8.28	YES	YES	988	454
85320	EB3	EB3	1-5/8"	D	26.13	16.35	9.78	YES	NO	970	308
85321	ES36	ES36	1-5/8"	D	25.36	15.58	9.78	YES	YES	1435	676
85322	EB3	ES160	1-5/8"	D	15.26	11.85	3.41	YES	YES	764	162
85323	ES36	ES36	1-5/8"	D	17.36	11.58	5.78	YES	YES	1085	163
85324	S21	S21	1-5/8"	D	22.14	13.61	8.53	YES	NO	579	114
85325	S21	S21	1-5/8"	D	23.64	14.36	9.28	YES	NO	1024	240
85326	S21	S21	1-5/8"	D	19.64	12.36	7.28	YES	NO	799	142
85327	EB3	ES160	1-5/8"	D	16.01	12.1	3.91	YES	YES	764	162
85328	S21	S21	1-5/8"	D	25.64	15.36	10.28	YES	NO	930	383
85329	EB3	EB3	1-5/8"	D	24.5	15.47	9.03	YES	YES	1550	232
85330	EB3	S21	1-5/8"	D	22.44	14.16	8.28	YES	YES	1140	176
85331	ES158	ES159	1-5/8"	D	19.66	12.88	6.78	YES	YES	1757	396
85332	S42	ES36	1-5/8"	D	20.64	12.98	7.66	YES	YES	2351	967
85333	S42	ES36	1-5/8"	D	20.64	12.98	7.66	YES	YES	1241	534
85334	EB3	EB3	1-5/8"	D	14.5	10.47	4.03	YES	YES	1271	319
85335	ES158	ES159	1-5/8"	D	19.66	12.88	6.78	YES	YES	827	107
85336	S21	S21	1-5/8"	D	18.76	11.86	6.9	YES	NO	861	200
85337	ES36	ES36	1-5/8"	D	28.72	17.45	11.28	YES	YES	1318	374
85338	ES36	ES36	1-5/8"	D	19.47	12.7	6.77	YES	YES	1664	420
85339	EB3	EB3	1-5/8"	D	31.68	19.02	12.66	YES	YES	804	463
85340	ES188	S21	1-5/8"	D	26.46	15.85	10.61	YES	YES	1807	165

* Damping force, in pounds, to either extend or collapse the shock absorber at an average operating velocity. Fuerza de amortiguación en libras para extender o comprimir el amortiguador a una velocidad de operación promedio. La puissance d'amortissement en poids de l'amortisseur, soit comprimé, doit détendu, à une vitesse de fonctionnement moyenne.

† At bumper contact / Al contacto con el tope de goma / Au contact avec le butoir

‡ For GasSLX Series, forces are at the "Firm" (F) setting. / Para la serie GasSLX, las fuerzas están ajustadas en (F) "Firme". / Pour la série GasSLX, le réglage de la force est sur «Firme» (F).

SPECIFICATIONS BY PART NUMBER
ESPECIFICACIONES POR NÚMERO DE PARTE
SPÉCIFICATIONS PAR NUMÉRO DE PIÈCE

Fleetline	Mounting		Bore	External Diameter Illustration	Lengths			Dust Tube	Recoil Cutoff	Controls*	
	Upper	Lower			Extended	Collapsed	Stroke			Rebound	Compression
85341	ES188	S21	1-5/8"	D	30.95	18.1	12.85	YES	YES	1807	333
85342	S21	S21	1-5/8"	D	23.28	13.99	9.29	YES	NO	893	188
85343	S21	EB3	1-5/8"	D	22.96	14.79	8.17	YES	YES	858	289
85344	ES36	ES36	1-5/8"	D	13.22	9.45	3.77	YES	YES	1581	443
85345	ES36	ES36	1-5/8"	D	21.83	13.82	8.01	YES	YES	1093	219
85346	S21	S21	1-5/8"	D	22.12	13.48	8.64	YES	YES	2016	285
85347	S21	S21	1-5/8"	D	23.62	14.22	9.4	YES	YES	961	122
85351	S21	ES36	1-5/8"	D	20.61	12.82	7.79	YES	NO	1887	259
85376	EB3	EB3	1-5/8"	D	33.25	19.72	13.53	YES	NO	668	134
85377	ES182	ES182	1-5/8"	D	23.8	14.84	8.96	YES	YES	1937	570
85378	ES182	ES182	1-5/8"	D	23.8	14.84	8.96	YES	YES	1110	240
85379	EB3	S21	1-5/8"	D	22.69	14.4	8.29	YES	YES	1658	176
85380	EB3	S21	1-5/8"	D	23.95	14.79	9.15	YES	YES	1568	227
85382	ES36	ES36	1-5/8"	D	20.22	13.07	7.15	YES	YES	1658	420
85700	EB3	EB3	1-5/8"	D	26.13	16.6	9.53	YES	YES	1446	328
85701	S21	S21	1-5/8"	D	15.64	10.36	5.28	YES	YES	914	204
85702	EB3	EB3	1-5/8"	D	23.76	15.85	7.91	YES	YES	1093	825
85703	S21	EB3	1-5/8"	D	29.57	18.54	11.03	YES	YES	1435	186
85704	EB3	EB3	1-5/8"	D	28.75	18.72	10.03	YES	YES	1435	186
85705	S21	S21	1-5/8"	D	23.65	14.24	9.41	YES	YES	639	436
85706	S21	S21	1-5/8"	D	23.65	14.24	9.41	YES	YES	1086	696
85707	S21	S21	2-1/16"	D	23.65	14.4	9.25	YES	YES	1761	986
85708	S21	S21	1-5/8"	D	20.64	12.86	7.78	YES	YES	914	204
85709	S21	S21	1-5/8"	D	31.64	18.36	13.28	YES	YES	700	203
85710	S21	EB3	1-5/8"	D	23.45	15.1	8.34	YES	YES	994	248
85711	S21	EB3	1-5/8"	D	24.57	15.29	9.28	YES	YES	1435	208
85712	EB3	EB3	1-5/8"	D	20.5	13.47	7.03	YES	YES	1435	562
85713	EB3	EB3	1-5/8"	D	24.5	15.47	9.03	YES	YES	1157	180
85714	EB3	EB3	1-5/8"	D	25.13	15.85	9.28	YES	YES	1220	175
85715	EB3	EB3	1-5/8"	D	25.13	15.85	9.28	YES	YES	1915	200
85716	EB3	EB3	1-5/8"	D	22.01	14.35	7.66	YES	YES	1220	175
85717	EB3	EB3	1-5/8"	D	25.13	15.85	9.28	YES	YES	1915	200
85718	EB3	EB3	1-5/8"	D	22.13	15.04	7.09	YES	YES	2506	206
85719	EB3	EB3	1-5/8"	D	17.25	11.97	5.28	YES	YES	1517	213
85720	EB3	EB3	1-5/8"	D	20.5	13.47	7.03	YES	YES	1435	562
85722	S21	S21	1-5/8"	D	27.15	16.43	10.72	YES	YES	1264	369
85723	EB3	S21	1-5/8"	D	19.94	12.91	7.03	YES	YES	1318	248
85724	ES158	ES159	1-5/8"	D	22.78	14.5	8.28	YES	YES	1235	454
85727	S21	S21	1-5/8"	D	29.89	17.36	12.53	YES	YES	783	111
85728	S21	S21	1-5/8"	D	24.39	14.86	9.53	YES	YES	1435	510
85729	EB3	S21	1-5/8"	D	21.58	13.8	7.78	YES	YES	783	111
85730	EB3	EB3	1-5/8"	D	30.75	18.72	12.03	YES	YES	1517	293

* Damping force, in pounds, to either extend or collapse the shock absorber at an average operating velocity. Fuerza de amortiguación en libras para extender o comprimir el amortiguador a una velocidad de operación promedio. La puissance d'amortissement en poids de l'amortisseur, soit comprimé, doit détendu, à une vitesse de fonctionnement moyenne.

† At bumper contact / Al contacto con el tope de goma / Au contact avec le butoir

‡ For GasSLX Series, forces are at the "Firm" (F) setting. / Para la serie GasSLX, las fuerzas están ajustadas en (F) "Firme". / Pour la série GasSLX, le réglage de la force est sur «Firme» (F).

SPECIFICATIONS BY PART NUMBER
ESPECIFICACIONES POR NÚMERO DE PARTE
SPÉCIFICATIONS PAR NUMÉRO DE PIÈCE

Fleetline	Mounting		Bore	External Diameter Illustration	Lengths			Dust Tube	Recoil Cutoff	Controls*	
	Upper	Lower			Extended	Collapsed	Stroke			Rebound	Compression
85731	S21	EB3	1-5/8"	D	30.57	18.54	12.03	YES	YES	1517	293
85732	EB3	EB3	2-1/16"	E	22.13	15.11	7.03	YES	YES	2632	382
85733	EB3	S21	1-5/8"	D	23.57	14.73	8.84	YES	YES	717	111
85734	EB3	EB3	1-5/8"	D	20.74	13.71	7.03	YES	YES	1288	227
85735	EB3	EB3	1-5/8"	D	26.74	16.71	10.03	YES	YES	1288	227
85736	EB3	EB3	1-5/8"	D	23.62	15.21	8.41	YES	YES	1155	352
85737	ES173	ES173	1-5/8"	D	15.11	10.84	4.27	YES	YES	3066	782
85738	ES36	ES36	1-5/8"	D	17.47	11.7	5.77	YES	YES	1830	416
85739	ES187	ES187	1-5/8"	D	20.73	13.54	7.19	YES	YES	3247	334
85740	EB3	S21	1-5/8"	D	24.7	15.15	9.55	YES	YES	848	305
85745	S21	S21	1-5/8"	D	19.88	12.34	7.54	YES	YES	3064	231
85746	S21	S21	1-5/8"	D	19.88	12.34	7.54	YES	YES	1754	167
85900	S21	S21	1-5/8"	G	17.27	11.16	6.11	YES	YES	1467	337
85901	EB3	EB3	1-5/8"	G	29.05	17.64	11.41	YES	NO	1830	418
85902	S21	S21	1-5/8"	G	19.01	12.03	6.98	YES	YES	1441	267
85903	ES36	ES36	1-5/8"	G	31.99	19.13	12.86	YES	YES	666	113
85904	ES36	ES36	1-5/8"	G	27.61	16.88	10.73	YES	YES	666	113
85905	ES36	EB3	1-5/8"	G	23.81	16.16	7.66	YES	YES	1020	219
85906	ES36	ES36	1-5/8"	G	21.73	14	7.73	YES	YES	700	255
85907	ES36	EB3	1-5/8"	G	21.43	14.2	7.23	YES	YES	1216	251
85908	ES36	ES36	1-5/8"	G	18.48	12.25	6.23	YES	YES	1020	219
85909	ES36	ES36	1-5/8"	G	24.24	15.13	9.11	YES	YES	700	255
85910	ES36	ES36	1-5/8"	G	20.73	13.5	7.23	YES	YES	1074	219
85911	ES36	ES36	1-5/8"	G	16.86	11.5	5.36	YES	YES	1020	219
85912	EB3	ES36	1-5/8"	G	18.68	12.57	6.11	YES	YES	1020	219
85913	ES36	EB3	1-5/8"	G	22.56	15.2	7.36	YES	YES	1020	219
85914	ES36	ES36	1-5/8"	G	14.36	10.25	4.11	YES	YES	1020	219
85915	ES36	EB3	1-5/8"	G	19.06	12.7	6.36	YES	YES	1020	219
85916	ES36	ES36	1-5/8"	G	24.61	15.51	9.11	YES	YES	1149	219
85918	ES150	ES150	1-5/8"	G	22.96	14.55	8.41	YES	NO	1726	412
85919	ES36	ES36	1-5/8"	G	22.48	14.25	8.23	YES	YES	1265	121
85920	ES150	ES150	1-5/8"	G	21.19	13.53	7.66	YES	NO	845	49
85921	S21	ES36	1-5/8"	G	22.03	13.5	8.53	YES	NO	2053	339
85922	ES150	ES150	1-5/8"	G	21.19	13.53	7.66	YES	NO	878	185
85923	ES177	ES161	1-5/8"	G	22.48	14.5	7.98	YES	YES	1940	221
85924	ES90	ES36	1-5/8"	G	20.41	12.96	7.46	YES	NO	1036	122
85925	ES90	ES90	1-5/8"	G	22.54	15.59	6.96	YES	NO	761	144
85926	ES90	ES90	1-5/8"	G	26.48	17.96	8.53	YES	YES	1387	279
85927	ES90	ES90	1-5/8"	G	24.74	15.38	9.36	YES	YES	1288	388
85928	ES90	ES90	1-5/8"	G	20.28	13.21	7.08	YES	NO	957	229
85929	ES90	ES90	1-5/8"	G	20.28	13.21	7.08	YES	NO	2214	267
85930	ES177	ES161	1-5/8"	G	17.86	12	5.86	YES	YES	1617	342

* Damping force, in pounds, to either extend or collapse the shock absorber at an average operating velocity. Fuerza de amortiguación en libras para extender o comprimir el amortiguador a una velocidad de operación promedio. La puissance d'amortissement en poids de l'amortisseur, soit comprimé, doit détendu, à une vitesse de fonctionnement moyenne.

† At bumper contact / Al contacto con el tope de goma / Au contact avec le butoir

‡ For GasSLX Series, forces are at the "Firm" (F) setting. / Para la serie GasSLX, las fuerzas están ajustadas en (F) "Firme". / Pour la série GasSLX, le réglage de la force est sur «Firme» (F).

SPECIFICATIONS BY PART NUMBER
ESPECIFICACIONES POR NÚMERO DE PARTE
SPÉCIFICATIONS PAR NUMÉRO DE PIÈCE

Fleetline	Mounting		Bore	External Diameter Illustration	Lengths			Dust Tube	Recoil Cutoff	Controls*	
	Upper	Lower			Extended	Collapsed	Stroke			Rebound	Compression
85931	ES177	ES161	1-5/8"	G	22.48	14.5	7.98	YES	YES	1435	220
85932	ES178	ES150	1-5/8"	G	21.23	13.62	7.61	YES	YES	1102	430
85933	ES175	ES175	1-5/8"	G	18.23	12.71	5.52	YES	YES	1089	383
85934	ES36	ES36	1-5/8"	G	17.73	12	5.73	YES	YES	3511	1063
85935	S21	ES36	1-5/8"	G	18.7	11.92	6.78	YES	NO	1054	419
85936	ES174	S43	1-5/8"	G	17.23	11.38	5.85	YES	YES	1479	337
85937	ES174	S43	1-5/8"	G	18.98	12.26	6.72	YES	YES	1479	337
85938	ES36	ES36	1-5/8"	G	16.06	10.78	5.28	YES	YES	1581	432
85939	ES36	ES36	1-5/8"	G	14.44	10.03	4.41	YES	YES	1719	420
85953	ES90	ES90	1-5/8"	G	26.13	15.86	10.27	YES	NO	2001	153
85954	ES90	ES36	1-5/8"	G	20.43	12.96	7.46	YES	NO	1812	148
85955	ES175	ES150	1-5/8"	G	21.25	13.66	7.59	YES	YES	1034	397
85956	ES183	ES184	1-5/8"	G	30.63	18.75	11.87	YES	YES	979	373
85957	ES90	ES90	1-5/8"	G	20.78	13.15	7.63	YES	NO	1583	138
85958	ES150	ES150	1-5/8"	G	22.96	14.55	8.41	YES	YES	1926	281
85959	ES150	ES150	1-5/8"	G	21.19	13.53	7.66	YES	YES	1021	123
85961	ES178	ES176	1-5/8"	G	22.83	14.17	8.66	YES	YES	2206	240
85962	ES178	ES176	1-5/8"	G	21.8	13.66	8.15	YES	YES	2206	240
85963	ES90	ES36	1-5/8"	G	25.49	18.68	6.81	YES	YES	1490	206
85964	ES90	ES36	1-5/8"	G	25.49	18.68	6.81	YES	YES	1981	205
85965	ES178	ES161	1-5/8"	G	24.24	15.15	9.09	YES	YES	2206	238
85966	ES178	ES161	1-5/8"	G	23.25	14.64	8.62	YES	YES	2206	238
85967	ES178	ES176	1-5/8"	G	23.93	14.86	9.07	YES	YES	2206	238
85968	EB3	EB3	1-5/8"	G	19.87	13.39	6.48	YES	YES	1069	227
85969	ES90	ES36	1-5/8"	G	18.38	11.93	6.45	YES	NO	1612	125
85970	ES188	S21	1-5/8"	G	27.19	16.4	10.78	YES	YES	1092	147
85971	ES36	ES36	1-5/8"	G	22.55	14.17	8.38	YES	NO	2315	451
85972	ES36	ES36	1-5/8"	G	30.78	18.26	12.52	YES	NO	1493	261
85974	ES36	ES36	1-5/8"	G	26.02	16.11	9.91	YES	YES	3087	230
85975	ES36	ES36	1-5/8"	G	24.24	15.15	9.09	YES	YES	1658	219
85976	ES36	ES36	1-5/8"	G	29.91	18.13	11.79	YES	YES	582	138
85977	ES36	S42	1-5/8"	G	26.2	15.91	10.29	YES	YES	582	138
85978	ES179	ES179	1-5/8"	G	29.91	18.13	11.79	YES	YES	582	138
85979	ES36	ES36	1-5/8"	G	31.17	18.66	12.52	YES	YES	582	138
85980	ES179	ES179	1-5/8"	G	31.17	18.66	12.52	YES	YES	582	138
85984	ES158	ES150	1-5/8"	G	25.44	15.96	9.48	YES	YES	2248	1168
85985	ES174	S43	1-5/8"	G	19.04	12.31	6.73	YES	YES	2068	723
85986	ES175	ES150	1-5/8"	G	21.25	13.66	7.59	YES	YES	1754	221
85988	S21	EB3	1-5/8"	G	23.84	14.87	8.97	YES	YES	1200	138
85989	ES174	ES136	1-5/8"	G	20.78	13.15	7.63	YES	NO	1812	351
85994	ES90	ES36	1-5/8"	G	21.21	13.4	7.81	YES	NO	1824	263
85995	ES90	ES36	1-5/8"	G	23.5	14.52	8.98	YES	NO	1830	173

* Damping force, in pounds, to either extend or collapse the shock absorber at an average operating velocity. Fuerza de amortiguación en libras para extender o comprimir el amortiguador a una velocidad de operación promedio. La puissance d'amortissement en poids de l'amortisseur, soit comprimé, doit détendu, à une vitesse de fonctionnement moyenne.

† At bumper contact / Al contacto con el tope de goma / Au contact avec le butoir

‡ For GasSLX Series, forces are at the "Firm" (F) setting. / Para la serie GasSLX, las fuerzas están ajustadas en (F) "Firme". / Pour la série GasSLX, le réglage de la force est sur «Firme» (F).

SPECIFICATIONS BY PART NUMBER
ESPECIFICACIONES POR NÚMERO DE PARTE
SPÉCIFICATIONS PAR NUMÉRO DE PIÈCE

Fleetline	Mounting		Bore	External Diameter Illustration	Lengths			Dust Tube	Recoil Cutoff	Controls*	
	Upper	Lower			Extended	Collapsed	Stroke			Rebound	Compression
85998	ES90	ES90	1-5/8"	G	22.83	14.17	8.66	YES	NO	1345	178
85999	ES90	ES90	1-5/8"	G	19.84	12.79	7.05	YES	NO	2214	259
86200	ES194	ES194	45 MM	D	14.24	10.45	3.79	YES	YES	4238	688
86201	ES193	ES193	45 MM	D	13.26	9.94	3.32	YES	YES	4238	688
86202	ES193	ES193	45 MM	D	14.52	10.43	4.09	YES	YES	4238	688
86203	ES193	ES193	45 MM	D	16.88	11.61	5.27	YES	YES	4238	910
87000	S21	EB3	2-1/16"	E	24.46	15.21	9.25	YES	YES	1332	300
87001	EB3	EB3	2-1/16"	E	20.76	13.76	7	YES	YES	1158	190
87002	EB3	EB3	2-1/16"	E	23.5	15.41	8.09	YES	YES	879	203
87003	EB3	EB3	2-1/16"	E	26.26	16.51	9.75	YES	YES	1332	395
87004	EB3	EB3	2-1/16"	E	26.76	16.76	10	YES	YES	1158	190
87006	EB3	EB3	2-1/16"	E	23.75	15.25	8.5	YES	YES	1158	272
87007	S21	S21	2-1/16"	E	15.65	10.4	5.25	YES	YES	879	253
87011	S21	S21	2-1/16"	E	23.65	14.4	9.25	YES	YES	1750	1050
87012	S21	S21	2-1/16"	E	23.65	14.4	9.25	YES	YES	650	364
87013	S21	S21	2-1/16"	E	23.65	14.4	9.25	YES	YES	1075	585
87015	ES173	ES173	45MM	E	15.51	11.18	4.33	YES	YES	4950	900
87016	S21	EB3	2-1/16"	E	21.17	13.91	7.26	YES	YES	1808	238
87017	ES160	ES160	2-1/16"	E	23.35	15.31	8.07	YES	YES	1876	220
87018	ES36	ES36	2-1/16"	E	17.36	11.71	5.65	YES	YES	2479	1000
87019	ES160	ES160	2-1/16"	E	24.84	15.85	8.9	YES	YES	2972	665
89401	EB2	EB2	1-5/8"	G	28.41	17.16	11.25	YES	NO	665‡	194
89402	EB2	EB2	1-5/8"	G	24.41	15.16	9.25	YES	NO	874‡	206
89403	EB2	EB2	1-5/8"	G	26.86	17.16	9.7	YES	YES	929‡	281
89405	ES36	ES36	1-5/8"	G	26.24	16.41	9.83	YES	YES	1009‡	249
89406	ES36	ES36	1-5/8"	G	24.74	15.66	9.08	YES	YES	658‡	125
89407	ES36	ES36	1-5/8"	G	21.62	14.04	7.58	YES	YES	652‡	218
89408	EB2	EB2	1-5/8"	G	19.67	12.79	6.88	YES	NO	536‡	201
89409	EB2	EB2	1-5/8"	G	26.36	16.41	9.95	YES	YES	567‡	165
89410	EB3	EB3	1-5/8"	G	26.33	16.42	9.91	YES	NO	1185‡	182
89411	ES90	ES90	1-5/8"	G	25.36	15.59	9.78	YES	YES	436‡	186
89412	EB3	EB3	1-5/8"	G	24.26	15.68	8.58	YES	YES	1155‡	169
89413	EB2	EB2	1-5/8"	G	20.91	13.41	7.5	YES	NO	536‡	201
89414	ES36	ES36	1-5/8"	G	29.62	18.04	11.58	YES	YES	1045‡	217
89415	EB2	EB2	1-5/8"	G	20.12	13.29	6.83	YES	YES	1155‡	514
89416	EB2	EB2	1-5/8"	G	28.62	17.54	11.08	YES	YES	1155‡	514
89417	ES136	S21	1-5/8"	G	22.93	14.18	8.75	YES	NO	1226‡	515
89418	S21	S21	1-5/8"	G	21.44	13.19	8.25	YES	NO	1266‡	515
89419	EB3	EB3	1-5/8"	G	18	12.55	5.45	YES	YES	1352‡	636
89420	EB3	EB3	1-5/8"	G	22.81	14.68	8.13	YES	NO	862‡	258
89422	EB3	EB3	1-5/8"	G	25.13	16.18	8.95	YES	YES	794‡	253
89423	S21	S21	1-5/8"	G	18.65	12.07	6.58	YES	YES	1352‡	573

* Damping force, in pounds, to either extend or collapse the shock absorber at an average operating velocity. Fuerza de amortiguación en libras para extender o comprimir el amortiguador a una velocidad de operación promedio. La puissance d'amortissement en poids de l'amortisseur, soit comprimé, doit détendu, à une vitesse de fonctionnement moyenne.

† At bumper contact / Al contacto con el tope de goma / Au contact avec le butoir

‡ For GasSLX Series, forces are at the "Firm" (F) setting. / Para la serie GasSLX, las fuerzas están ajustadas en (F) "Firme". / Pour la série GasSLX, le réglage de la force est sur «Firme» (F).

SPECIFICATIONS BY PART NUMBER
ESPECIFICACIONES POR NÚMERO DE PARTE
SPÉCIFICATIONS PAR NUMÉRO DE PIÈCE

Fleetline	Mounting		Bore	External Diameter Illustration	Lengths			Dust Tube	Recoil Cutoff	Controls*	
	Upper	Lower			Extended	Collapsed	Stroke			Rebound	Compression
89424	S21	EB3	1-5/8"	G	23.7	15	8.7	YES	YES	794‡	253
89425	EB3	EB3	1-5/8"	G	26.5	16.8	9.7	YES	YES	1352‡	167
89426	S21	ES36	1-5/8"	G	20.43	12.93	7.5	YES	NO	926‡	419
89427	S21	EB3	1-5/8"	G	27.2	17.5	9.7	YES	YES	794‡	253
89428	S21	ES150	1-5/8"	G	21.96	14.13	7.83	YES	YES	958‡	446
89429	EB3	EB3	1-5/8"	G	26.18	16.43	9.75	YES	NO	941‡	266
89430	ES36	ES36	1-5/8"	G	24.6	15.39	9.53	YES	YES	1462‡	279
89431	ES36	ES36	1-5/8"	G	22.41	14.16	8.25	YES	NO	751‡	211
89432	ES36	ES36	1-5/8"	G	23.41	14.66	8.75	YES	NO	1507‡	561
89434	EB2	EB2	1-5/8"	G	27.12	16.79	10.33	YES	YES	1155‡	514
89435	EB2	EB2	1-5/8"	G	24.86	15.66	9.2	YES	YES	1155‡	514
89436	ES36	ES36	1-5/8"	G	17.24	11.91	5.33	YES	YES	998‡	217
89437	ES36	ES36	1-5/8"	G	20.12	13.29	6.83	YES	YES	1155‡	514
89438	EB2	EB2	1-5/8"	G	23.17	14.54	8.63	YES	NO	583‡	103
89439	EB2	EB2	1-5/8"	G	25.67	15.79	9.88	YES	NO	518‡	103
89440	ES36	ES36	1-5/8"	G	23.86	15.16	8.7	YES	YES	1498‡	561
89441	S21	ES36	1-5/8"	G	20.14	13.06	7.08	YES	YES	761‡	126
89442	EB3	EB3	1-5/8"	G	24.55	15.55	9	YES	NO	1055‡	224
89443	ES158	ES159	1-5/8"	G	22.17	14.31	7.86	YES	YES	1206‡	466
89446	EB2	EB2	1-5/8"	G	28.36	17.41	10.95	YES	YES	702‡	204
89447	S21	S21	1-5/8"	G	23.65	14.57	9.08	YES	YES	702‡	241
89448	ES161	ES162	1-5/8"	G	24.62	15.54	9.08	YES	YES	782‡	323
89449	ES150	ES150	1-5/8"	G	23.09	14.71	8.38	YES	NO	1519‡	324
89450	ES161	ES162	1-5/8"	G	24.62	15.54	9.08	YES	YES	1282‡	193
89451	ES174	ES136	1-5/8"	G	30.36	18.41	11.95	YES	YES	645‡	172
89453	ES178	ES150	1-5/8"	G	21.1	13.78	7.32	YES	YES	860‡	435
89454	ES175	ES175	1-5/8"	G	18.23	12.78	5.45	YES	YES	938‡	388
89455	S21	S21	1-5/8"	G	26.28	15.92	10.36	YES	YES	791‡	276
89456	ES174	S43	1-5/8"	G	17.02	11.29	5.73	YES	YES	975‡	377
89457	ES90	ES36	1-5/8"	G	19.95	12.71	6.97	YES	NO	941‡	156
89458	ES177	ES161	1-5/8"	G	22.47	14.25	7.95	YES	YES	1575‡	222
89459	ES174	EB3	1-5/8"	G	25.62	15.86	9.78	YES	NO	1179‡	314
89460	ES174	ES136	1-5/8"	G	20.58	13.03	7.55	YES	NO	997‡	384
89461	ES160	ES160	1-5/8"	G	19.96	13.58	6.38	YES	YES	897‡	103
630811	0	0	1-3/16"		22.45	14.1	8.35	NO	NO		
632147	0	0	1-3/16"		22.45	14.1	8.35	NO	NO		
632155	ES36	ES36	1-3/16"		22.45	14.1	8.35	NO	NO		
646155	ES36	ES36	1-3/16"		22.45	14.1	8.35	YES	NO		
646177	ES36	ES36	1-3/16"		22.45	14.1	8.35	NO	NO		
665472	ES36	ES36	1-5/8"	G	25.14	15.61	9.53	NO	NO	925	977
665937	ES36	ES36	1-5/8"	G	22.91	16.09	6.82	YES	NO		
695406	S21	S21	2-1/16"	E	21.39	13.26	8.13	YES	YES	1854	274

* Damping force, in pounds, to either extend or collapse the shock absorber at an average operating velocity. Fuerza de amortiguación en libras para extender o comprimir el amortiguador a una velocidad de operación promedio. La puissance d'amortissement en poids de l'amortisseur, soit comprimé, doit détendu, à une vitesse de fonctionnement moyenne.

† At bumper contact / Al contacto con el tope de goma / Au contact avec le butoir

‡ For GasSLX Series, forces are at the "Firm" (F) setting. / Para la serie GasSLX, las fuerzas están ajustadas en (F) "Firme". / Pour la série GasSLX, le réglage de la force est sur «Firme» (F).

SPECIFICATIONS BY PART NUMBER
ESPECIFICACIONES POR NÚMERO DE PARTE
SPÉCIFICATIONS PAR NUMÉRO DE PIÈCE

Fleetline	Mounting		Bore	External Diameter Illustration	Lengths			Dust Tube	Recoil Cutoff	Controls*	
	Upper	Lower			Extended	Collapsed	Stroke			Rebound	Compression
G63183	EB4	EB4	1-3/8"		20.89	13.11	7.78	YES	NO		
G63299	EB1	EB1	1-3/8"		18.08	11.55	6.53	YES	NO	396	109
G63306	ES2	ES24	1-3/8"		19.86	12.58	7.28	YES	NO		
G63347	ES3	ES24	1-3/8"		18.08	11.55	6.53	YES	NO		
G63350	S1	ES25	1-3/8"		18.83	11.8	7.03	YES	NO		
G63355	EB7	ES24	1-3/8"		15	9.97	5.03	YES	NO		
G63357	ES24	ES24	1-3/8"		15	9.97	5.03	YES	NO		
G63386	S36	ES25	1-3/8"		17.19	11.16	6.03	NO	YES		
G63387	S1	ES25	1-3/8"		23.33	14.05	9.28	YES	NO		
G63396	S10	ES25	1-3/8"		16.55	10.77	5.78	YES	NO		
G63398	S1	S1	1-3/8"		20.52	12.24	8.28	YES	NO		
G63403	ES82	ES82	1-3/8"		24.58	14.8	9.78	YES	NO		
G63405	EB1	EB1	1-3/8"		20	12.47	7.53	YES	NO	572	115
G63406	EB1	ES83	1-3/8"		23	13.97	9.03	YES	NO		
G63409	EB1	ES83	1-3/8"		21.58	13.3	8.28	YES	NO		
G63419	EB1	EB1	1-3/8"		24.08	14.55	9.53	YES	NO		
G63432	S1	EB2	1-3/8"		21.21	12.93	8.28	YES	NO		
G63440	EB1	EB1	1-3/8"		26.33	15.55	10.78	NO	NO		
G63455	ES8	ES83	1-3/8"		23	13.97	9.03	YES	NO		
G63461	EB1	ES83	1-3/8"		25.5	15.22	10.28	YES	NO		
G63484	S4	EB1	1-3/8"		20.05	12.52	7.53	YES	NO		
G63500	S28	ES25	1-3/8"		15.09	10.06	5.03	NO	YES		
G63511	S1	ES25	1-3/8"		22.55	13.52	9.03	YES	NO		
G63524	EB1	ES83	1-3/8"		27.08	16.05	11.03	YES	NO		
G63525	EB1	ES83	1-3/8"		23.08	14.05	9.03	YES	NO		
G63605	EB2	ES27	1-3/8"		24.24	14.71	9.53	YES	NO		
G63607	BP33	ES83	1-3/8"		25.58	15.3	10.28	YES	NO		
G63608	S36	EB1	1-3/8"		14.58	9.81	4.78	YES	YES		
G63610	S1	EB1	1-3/8"		21.55	13.27	8.28	YES	NO		
G63614	S36	EB1	1-3/8"		15.12	10.09	5.03	NO	YES		
G63622	S36	EB1	1-3/8"		15.42	10.39	5.03	YES	YES		
G63623	S36	ES83	1-3/8"		22.67	14.39	8.28	YES	YES		
G63624	S36	ES83	1-3/8"		20.17	12.64	7.53	YES	YES		
G63625	EB7	ES36	1-3/8"		22.48	13.96	8.53	YES	NO		
G63676	ES69	ES69	1-3/8"		15.58	10.55	5.03	YES	YES		
G63678	S36	BP7	1-3/8"		18.09	13.56	4.53	YES	NO		
G63679	BP8	ES83	1-3/8"		25	14.97	10.03	YES	NO		
G63714	S6	BP7	1-3/8"		15.54	10.01	5.53	YES	NO		
G63716	S12	ES26	1-3/8"		15.54	10.01	5.53	YES	NO		
G63772	S6	BP35	1-3/8"		13.83	9.55	4.28	YES	YES		
G63773	EB1	ES83	1-3/8"		23.08	14.05	9.03	YES	NO		
G63775	EB1	ES83	1-3/8"		27.08	16.05	11.03	YES	NO		

* Damping force, in pounds, to either extend or collapse the shock absorber at an average operating velocity. Fuerza de amortiguación en libras para extender o comprimir el amortiguador a una velocidad de operación promedio. La puissance d'amortissement en poids de l'amortisseur, soit comprimé, doit détendu, à une vitesse de fonctionnement moyenne.

† At bumper contact / Al contacto con el tope de goma / Au contact avec le butoir

‡ For GasSLX Series, forces are at the "Firm" (F) setting. / Para la serie GasSLX, las fuerzas están ajustadas en (F) "Firme". / Pour la série GasSLX, le réglage de la force est sur «Firme» (F).

SPECIFICATIONS BY PART NUMBER
ESPECIFICACIONES POR NÚMERO DE PARTE
SPÉCIFICATIONS PAR NUMÉRO DE PIÈCE

Fleetline	Mounting		Bore	External Diameter Illustration	Lengths			Dust Tube	Recoil Cutoff	Controls*	
	Upper	Lower			Extended	Collapsed	Stroke			Rebound	Compression
G63778	S12	ES25	1-3/8"		24.55	14.52	10.03	YES	NO		
G63808	EB1	ES83	1-3/8"		28.86	17.08	11.78	YES	NO		
G63809	EB1	ES83	1-3/8"		23	13.97	9.03	YES	NO		
G63810	EB1	ES83	1-3/8"		31.51	18.48	13.03	YES	NO		
G63811	EB1	ES83	1-3/8"		25.5	15.22	10.28	YES	NO		
G63837	BP8	ES83	1-3/8"		28.23	17.95	10.28				
G63866	ES34	ES34	1-3/8"		22.81	14.12	8.69				
G63929	S36	EB1	1-3/8"		14.72	9.71	5.01	YES	YES		
G63969	412847	ES34	1-3/8"		20.75	13.31	7.44				

* Damping force, in pounds, to either extend or collapse the shock absorber at an average operating velocity. Fuerza de amortiguación en libras para extender o comprimir el amortiguador a una velocidad de operación promedio. La puissance d'amortissement en poids de l'amortisseur, soit comprimé, doit détendu, à une vitesse de fonctionnement moyenne.

† At bumper contact / Al contacto con el tope de goma / Au contact avec le butoir

‡ For GasSLX Series, forces are at the "Firm" (F) setting. / Para la serie GasSLX, las fuerzas están ajustadas en (F) "Firme". / Pour la série GasSLX, le réglage de la force est sur «Firme» (F).

MOUNTING ACCESSORY PACKAGES AND COMPONENT PARTS
KITS DE ACCESORIOS Y COMPONENTES
ENSEMBLES D'ACCESSOIRES DE MONTURES ET DE PIÈCES DÉTACHÉES

140126	401383	2	Retainer (washer) / Seguro (arandela) / Arrêt (rondelle)	3/8 in. I.D. x 1-1/2 in. O.D. x .093 in. thick
	402263	2	Bushing / Buje / Bague	7/8" centering lip for 3/8" O.D. stud
	401006	1	Hex nut / Tuerca hexagonal / Écrou hexagonal	3/8" x 24 UNF thread
140149	401011	4	Bushing / Buje / Bague	EB2 style - for 1-3/4" O.D. eye ring - 3/4" diam. Stud
140169	401011	2	Bushing / Buje / Bague	EB2 style - for 1-3/4" O.D. eye ring - 3/4" diam. Stud
140455	401006	1	Hex nut / Tuerca hexagonal / Écrou hexagonal	3/8" x 24 UNF thread
	401008	2	Retainer (washer) / Seguro (arandela) / Arrêt (rondelle)	3/8 in. I.D. x 1-1/4 in. O.D. x .075 in. thick
	403489	2	Bushing / Buje / Bague	5/8" centering lip for 3/8" O.D. stud
140524	401006	1	Hex nut / Tuerca hexagonal / Écrou hexagonal	3/8" x 24 UNF thread
	401376	2	Retainer (washer) / Seguro (arandela) / Arrêt (rondelle)	3/8 in. I.D. x 1-3/8 in. O.D. x .089 in. thick
	402294	2	Bushing / Buje / Bague	5/8" lip for 3/8" dia. stud-5/8" or 7/8" holes
140702	401174	1	Hex nut / Tuerca hexagonal / Écrou hexagonal	5/8" x 18 thread
	401184	1	Lock washer / Arandela de seguridad / Rondelle-frein	7/16" Lock washer
	401193	1	Lock washer / Arandela de seguridad / Rondelle-frein	5/8" I.D. (thin)
	402844	1	Hex nut / Tuerca hexagonal / Écrou hexagonal	7/16" x 20 UNF Thread
	403878	1	Washer / Arandela / Rondelle	0.453" I.D. x 1.25" O.D. x .075" thick
	404782	1	Stud / Perno / Goujon	5/8" x 18 and 7/16" x 20
140719	402653-001	2	Lock washer / Arandela de seguridad / Rondelle-frein	5/16" I.D. (med.)
	403870-001	2	Bolt / Tornillo / Boulon	Hex Head 5/16" x 18 x 3/4 in. long
	403871-001	2	Hex nut / Tuerca hexagonal / Écrou hexagonal	5/16" x 18 thread
140780	401006	1	Hex nut / Tuerca hexagonal / Écrou hexagonal	3/8" x 24 UNF thread
	402943	1	Retainer (washer) / Seguro (arandela) / Arrêt (rondelle)	0.457" I.D. x 1.68" O.D. x .120" thick
	403298	1	Retainer (washer) / Seguro (arandela) / Arrêt (rondelle)	0.390" I.D. x 1.68" O.D. x .120" thick
	403299	2	Bushing / Buje / Bague	7/8" centering lip for 7/16" O.D. stud
140884	401267	1	Retainer (washer) / Seguro (arandela) / Arrêt (rondelle)	5/8" I.D. x 1-1/4" O.D. x .075" thick
	402662	1	Spacer / Espaciador / Entretoise	5/8" I.D. x 1-1/4" O.D. x 1/4" thick
	412016	1	Extn nut / Tuerca ext. / Écrou ext.	7/16" x 20 UNF Thread
	427030	1	Instruction sheet / Hoja de instr. / Feuillet d'instr.	
140885	401267	1	Retainer (washer) / Seguro (arandela) / Arrêt (rondelle)	5/8" I.D. x 1-1/4" O.D. x .075" thick
	402662	1	Spacer / Espaciador / Entretoise	5/8" I.D. x 1-1/4" O.D. x 1/4" thick
	403189	2	Spacer / Espaciador / Entretoise	1/2" I.D. x 1-1/4" O.D.
	411012	2	Sleeve / Camisa / Manchon	13 mm I.D. x 5/8 in. O.D. x 1-5/16 in. long
	412016	1	Extn nut / Tuerca ext. / Écrou ext.	7/16" x 20 UNF Thread
	427031	1	Instruction sheet / Hoja de instr. / Feuillet d'instr.	
141041	401006	1	Hex nut / Tuerca hexagonal / Écrou hexagonal	3/8" x 24 UNF thread
	401376	2	Retainer (washer) / Seguro (arandela) / Arrêt (rondelle)	3/8 in. I.D. x 1-3/8 in. O.D. x .089 in. thick
	404652	2	Bushing / Buje / Bague	Used with 5/8" dia. hole or 7/8" dia. Hole
141083	401193	1	Lock washer / Arandela de seguridad / Rondelle-frein	5/8" I.D. (thin)
	404451	1	Hex nut / Tuerca hexagonal / Écrou hexagonal	16 x 1.5 metric thread
	404452	2	Retainer (washer) / Seguro (arandela) / Arrêt (rondelle)	5/8" I.D. x 2-3/4" O.D. x .180" thick
	404453	1	Sleeve / Camisa / Manchon	16 mm I.D. x 1-3/16" O.D. x 1-1/2" long
	404454	2	Bushing / Buje / Bague	1-3/16" centering lip for 13/16" O.D. stud
141108	401174	2	Hex nut / Tuerca hexagonal / Écrou hexagonal	5/8" x 18 thread
	405360	4	Retainer (washer) / Seguro (arandela) / Arrêt (rondelle)	5/8" I.D. x 2-3/16" O.D. x .120" thick
	405361-000	4	Bushing / Buje / Bague	1" centering lip for 5/8" O.D. stud (1.00" thick)
141138	401006	2	Hex nut / Tuerca hexagonal / Écrou hexagonal	3/8" x 24 UNF thread
	403489	4	Bushing / Buje / Bague	5/8" centering lip for 3/8" O.D. stud
	403575	4	Retainer (washer) / Seguro (arandela) / Arrêt (rondelle)	25/64" I.D. x 1-1/4" O.D. x .12" thick
	404949	4	Washer / Arandela / Rondelle	1/2" I.D. x 1-1/2" O.D. x .04" thick

MOUNTING ACCESSORY PACKAGES AND COMPONENT PARTS
KITS DE ACCESORIOS Y COMPONENTES
ENSEMBLES D'ACCESSOIRES DE MONTURES ET DE PIÈCES DÉTACHÉES

141247	401174	1	Hex nut / Tuerca hexagonal / Écrou hexagonal	5/8" x 18 thread
	401754	2	Bushing / Buje / Bague	EB3 - style for 2.39 in. O.D. eye ring - 1" diam. Stud
	405360	2	Retainer (washer) / Seguro (arandela) / Arrêt (rondelle)	5/8" I.D. x 2-3/16" O.D. x .120" thick
	405361	2	Bushing / Buje / Bague	1" centering lip for 5/8" O.D. stud
141349	401006	1	Hex nut / Tuerca hexagonal / Écrou hexagonal	3/8" x 24 UNF thread
	401007	1	Pal nut / Tuerca de cierre / Écrou Pal	3/8" x 24 UNF thread
	401376	2	Retainer (washer) / Seguro (arandela) / Arrêt (rondelle)	3/8 in. I.D. x 1-3/8 in. O.D. x .089 in. thick
	404652	2	Bushing / Buje / Bague	Used with 5/8" dia. hole or 7/8" dia. Hole
	429680-030	1	Instruction sheet / Hoja de instr. / Feuillet d'instr.	
141353	401006	1	Hex nut / Tuerca hexagonal / Écrou hexagonal	3/8" x 24 UNF thread
	401007	1	Jam nut / Contratuerca / Contre-Écrou	3/8" x 24 UNF thread
	401383	2	Retainer (washer) / Seguro (arandela) / Arrêt (rondelle)	3/8 in. I.D. x 1-1/2 in. O.D. x .093 in. thick
	402263	2	Bushing / Buje / Bague	7/8" centering lip for 3/8" O.D. stud
141665	401006	1	Hex nut / Tuerca hexagonal / Écrou hexagonal	3/8" x 24 UNF thread
	402943	1	Retainer (washer) / Seguro (arandela) / Arrêt (rondelle)	0.457" I.D. x 1.68" O.D. x .120" thick
	403298	1	Retainer (washer) / Seguro (arandela) / Arrêt (rondelle)	0.390" I.D. x 1.68" O.D. x .120" thick
	404959	2	Bushing / Buje / Bague	3/4" centering lip for 7/16" O.D. stud
	411520	1	Jam nut / Contratuerca / Contre-Écrou	3/8" x 24 UNF thread
142095	411165	1	Lock nut / Contratuerca / Contre-Écrou	12 x 1.25 metric thread
	411447	2	Retainer (washer) / Seguro (arandela) / Arrêt (rondelle)	9/16" I.D. x 1-3/4" O.D. x .087" thick
	412103	1	Retainer (washer) / Seguro (arandela) / Arrêt (rondelle)	9/16" I.D. x 1-3/4" O.D. x 1/4" thick
	412116	2	Bushing / Buje / Bague	Flat bushing for 9/16" O.D. Stud
142389	404287	2	Retainer (washer) / Seguro (arandela) / Arrêt (rondelle)	0.453" I.D. x 1.50" O.D. x 0.090" thick
	404947	2	Bushing / Buje / Bague	For 3/8" O.D. stud- no centering lip
	411497	1	Lock nut / Contratuerca / Contre-Écrou	10 x 1.25 metric thread
142617	401006	1	Hex nut / Tuerca hexagonal / Écrou hexagonal	3/8" x 24 UNF thread
	402943	1	Retainer (washer) / Seguro (arandela) / Arrêt (rondelle)	0.457" I.D. x 1.68" O.D. x .120" thick
	403298	1	Retainer (washer) / Seguro (arandela) / Arrêt (rondelle)	0.390" I.D. x 1.68" O.D. x .120" thick
	412661	2	Bushing / Buje / Bague	0.790" centering lip for 7/16" O.D. stud
142700	401006	1	Hex nut / Tuerca hexagonal / Écrou hexagonal	3/8" x 24 UNF thread
	402943	1	Retainer (washer) / Seguro (arandela) / Arrêt (rondelle)	0.457" I.D. x 1.68" O.D. x .120" thick
	403298	1	Retainer (washer) / Seguro (arandela) / Arrêt (rondelle)	0.390" I.D. x 1.68" O.D. x .120" thick
	404959	2	Bushing / Buje / Bague	3/4" centering lip for 7/16" O.D. stud
	411520	1	Jam nut / Contratuerca / Contre-Écrou	3/8" x 24 UNF thread
	412682	1	Sleeve / Camisa / Manchon	0.479" I.D. x 0.548" O.D. x 1.48" long
	429680-008	1	Instruction sheet / Hoja de instr. / Feuillet d'instr.	
142731	411165	1	Lock nut / Contratuerca / Contre-Écrou	12 x 1.25 metric thread
	411447	1	Retainer (washer) / Seguro (arandela) / Arrêt (rondelle)	9/16" I.D. x 1-3/4" O.D. x .087" thick
	412554	1	Retainer (washer) / Seguro (arandela) / Arrêt (rondelle)	0.485" O.D. x 1.76" O.D. x .089" thick
	412675	2	Bushing / Buje / Bague	0.950" centering lip for 9/16" O.D. stud
142998	404452	2	Retainer (washer) / Seguro (arandela) / Arrêt (rondelle)	5/8" I.D. x 2-3/4" O.D. x .180" thick
	404454	2	Bushing / Buje / Bague	1-3/16" centering lip for 13/16" O.D. stud
	405862	1	Self locking nut / Tuerca de seguridad / Écrou indesserrable	5/8" x 18 thread
143146	411165	1	Lock nut / Contratuerca / Contre-Écrou	12 x 1.25 metric thread
	411447	2	Retainer (washer) / Seguro (arandela) / Arrêt (rondelle)	9/16" I.D. x 1-3/4" O.D. x .087" thick
	412675	2	Bushing / Buje / Bague	0.950" centering lip for 9/16" O.D. stud
145054	401174	1	Hex nut / Tuerca hexagonal / Écrou hexagonal	5/8 in. -18 thread
	401175	1	Lock washer / Arandela de seguridad / Rondelle-frein	
	405360	2	Retainer (washer) / Seguro (arandela) / Arrêt (rondelle)	5/8" I.D. x 2-3/16" O.D. x .120" thick
	405361-000	2	Bushing / Buje / Bague	1" centering lip for 5/8" O.D. stud (1.00" thick)

MOUNTING ACCESSORY PACKAGES AND COMPONENT PARTS
KITS DE ACCESORIOS Y COMPONENTES
ENSEMBLES D'ACCESSOIRES DE MONTURES ET DE PIÈCES DÉTACHÉES

145080	401011	2	Bushing / Buje / Bague	EB2 style - for 1-3/4" O.D. eye ring - 3/4" diam. Stud
	401429	1	Retainer (washer) / Seguro (arandela) / Arrêt (rondelle)	1/2" I.D. x 1-5/8" O.D. x .090" thick
	401430	1	Retainer (washer) / Seguro (arandela) / Arrêt (rondelle)	3/4" I.D. x 1-5/8" O.D. x .090" thick
145089-000	405360	2	Retainer (washer) / Seguro (arandela) / Arrêt (rondelle)	5/8" I.D. x 2-3/16" O.D. x .120" thick
	405361-000	2	Bushing / Buje / Bague	1" centering lip for 5/8" O.D. stud (1.00" thick)
	405862	1	Self locking nut / Tuerca de seguridad / Écrou indesserrable	5/8" x 18 thread
145089-200	405360	2	Retainer (washer) / Seguro (arandela) / Arrêt (rondelle)	5/8" I.D. x 2-3/16" O.D. x .120" thick
	405361-100	2	Bushing / Buje / Bague	1" centering lip for 5/8" O.D. stud (0.75" thick)
	415196-001	1	Nylon lock nut / Contratuerca / Contre-Écrou	5/8" x 18 thread
145090	405643	1	Sleeve / Camisa / Manchon	0.645" I.D x 0.810" O.D. x 2.00" long
	405859	2	Bushing / Buje / Bague	0.815" I.D. x 2.35" O.D x 1.05" thick with 1.15" centering lip
	405860	2	Retainer (washer) / Seguro (arandela) / Arrêt (rondelle)	0.650" I.D. x 2.75" O.D. x .180" thick
	405862	1	Self locking nut / Tuerca de seguridad / Écrou indesserrable	5/8" x 18 thread
	424276	1	Instruction sheet / Hoja de instr. / Feuillet d'instr.	
145093	401750	2	Retainer (washer) / Seguro (arandela) / Arrêt (rondelle)	3/4" I.D. x 2-3/8" O.D. x .105" thick
	401752	2	Retainer (washer) / Seguro (arandela) / Arrêt (rondelle)	1" I.D. x 2-3/8" O.D. x .105" thick
	401754	4	Bushing / Buje / Bague	EB3 - style for 2.39 in. O.D. eye ring - 1" diam. Stud
145099	401174	1	Hex nut / Tuerca hexagonal / Écrou hexagonal	5/8" x 18 thread
	401175	1	Lock washer / Arandela de seguridad / Rondelle-frein	
	401754	2	Bushing / Buje / Bague	EB3 - style for 2.39 in. O.D. eye ring - 1" diam. Stud
	405360	2	Retainer (washer) / Seguro (arandela) / Arrêt (rondelle)	5/8" I.D. x 2-3/16" O.D. x .120" thick
	405361-000	2	Bushing / Buje / Bague	1" centering lip for 5/8" O.D. stud (1.00" thick)
	424274	1	Instruction sheet / Hoja de instr. / Feuillet d'instr.	
145116	401750	1	Retainer (washer) / Seguro (arandela) / Arrêt (rondelle)	3/4" I.D. x 2-3/8" O.D. x .105" thick
	401752	1	Retainer (washer) / Seguro (arandela) / Arrêt (rondelle)	1" I.D. x 2-3/8" O.D. x .105" thick
	415169	2	Bushing / Buje / Bague (Durometer 80)	EB3 - style for 2.39 in. O.D. eye ring - 1" diam. Stud
145126	401750	2	Retainer (washer) / Seguro (arandela) / Arrêt (rondelle)	3/4" I.D. x 2-3/8" O.D. x .105" thick
	401754	2	Bushing / Buje / Bague	EB3 - style for 2.39 in. O.D. eye ring - 1" diam. Stud
	403752	1	Sleeve / Camisa / Manchon	3/4" I.D. x 15/16" O.D. x 1-3/4" long
	415277	1	Spacer / Espaciador / Entretoise	1-3/16" I.D. x 1-1/4" O.D. x .200" thick
	424281	1	Instruction sheet / Hoja de instr. / Feuillet d'instr.	
145128	405360	2	Retainer (washer) / Seguro (arandela) / Arrêt (rondelle)	5/8" I.D. x 2-3/16" O.D. x .120" thick
	405361-000	2	Bushing / Buje / Bague	1" centering lip for 5/8" O.D. stud (1.00" thick)
	415196-001	1	Nylon lock nut / Contratuerca / Contre-Écrou	5/8" x 18 thread
145143	415305-001	2	Rubber spacer / Espaciador de goma / Entretoise de caout.	0.910" I.D. x 1.58" O.D. x 0.427" long
	424284	1	Instruction sheet / Hoja de instr. / Feuillet d'instr.	
145144	415305-000	2	Rubber spacer / Espaciador de goma / Entretoise de caout.	0.910" I.D. x 1.58" O.D. x 1.1" long
	424284	1	Instruction sheet / Hoja de instr. / Feuillet d'instr.	
145148	401750	1	Retainer (washer) / Seguro (arandela) / Arrêt (rondelle)	3/4" I.D. x 2-3/8" O.D. x .105" thick
	401752	1	Retainer (washer) / Seguro (arandela) / Arrêt (rondelle)	1" I.D. x 2-3/8" O.D. x .105" thick
145176	405361-000	2	Bushing / Buje / Bague	1" centering lip for 5/8" O.D. stud (1.00" thick)
	405360	1	Retainer (washer) / Seguro (arandela) / Arrêt (rondelle)	5/8" I.D. x 2-3/16" O.D. x .120" thick
	415196-001	1	Nylon lock nut / Contratuerca / Contre-Écrou	5/8" x 18 thread
	404452	1	Retainer (washer) / Seguro (arandela) / Arrêt (rondelle)	5/8" I.D. x 2-3/8" O.D. x .180" thick
401011	1	Bushing / Buje / Bague	EB2 style - for 1-3/4" O.D. eye ring - 3/4" diam. Stud - Replaced by TR0027	
401754	1	Bushing / Buje / Bague	EB3 - style for 2.39 in. O.D. eye ring - 1" diam. Stud	
404702	1	Bushing / Buje / Bague	EB1 style - 1 pc Spool shaped bushing (5/8" I.D.)	
406422	1	Retainer (washer) / Seguro (arandela) / Arrêt (rondelle)	22 mm I.D. x 60.2 mm O.D. x 2.7 mm thick	
415010-802	1	Sleeve / Camisa / Manchon	22 mm I.D. x 1.00" O.D. x 1-3/4" long	
TR0027	1	Bushing / Buje / Bague	EB2 style - for 1-3/4" O.D. eye ring - 3/4" diam. Stud - (Replaces 401011)	

MOUNTING ACCESSORY PACKAGES - BUYER'S GUIDE
KITS DE ACCESORIOS – GUÍA DEL COMPRADOR
ENSEMBLE D'ACCESSOIRES POUR LA FIXATION - GUIDE DE L'ACHETEUR

Kit #	Gabriel #
140126	83027
	G63350
	G63387
140149	83200
	83216
	83219
	83308
	83309
	83312
	83314
	85023
	85024
	85046
	85047
	89402
140169	85025
	85031
	G63432
	G63605
140455	83003
	83005
	83014
	83015
	83400
140524	83161
	G63484
140702	83007
	83303
	83304
	G63355
	G63625
140719	G63607
	G63679
140780	83018
	83019
	83041
	83045
	83050
	83058
	83105
	83114
	83162
	83177

Kit #	Gabriel #
140780 Cont.	G63386
	G63396
	G63414
	G63500
	G63608
	G63614
	G63624
	G63929
140884	G63405
140885	G63299
141041	83515
	83518
141083	83301
	83317
	83318
	83613
141108	85310
	89447
141138	G63398
141247	85311
	85312
	85703
	85710
	85711
141349	G63432
141353	G63511
141665	G63772
142095	83178
142389	G63610
142617	G63622
	G63623
142700	G63778
142731	G63714
	G63716
142998	83456
143146	G63969
145054	83103
	83134
	83136
	83635
	85009
	85025
	85026

Kit #	Gabriel #
145054 Cont.	85027
	85071
	85080
	85085
	85092
	85124
	85126
	85318
	85324
	85330
	85336
	85342
	85379
	85701
	85731
	85900
	85902
	85921
145075	85723
145080	83107
	85012
	85054
	85055
	85062
	85063
145089-000	83102
	83120
	83154
	85069
	85122
	85319
	85340
	85341
	85343
	85733
	85970
145089-200	85936
	85937
	85985
145090	695406
	85081
	85123
	85316

MOUNTING ACCESSORY PACKAGES - BUYER'S GUIDE
KITS DE ACCESORIOS – GUÍA DEL COMPRADOR
ENSEMBLE D'ACCESSOIRES POUR LA FIXATION - GUIDE DE L'ACHETEUR

Kit #	Gabriel #
145090 Cont.	85346
	85347
	85351
	85380
	85705
	85706
	85707
	85708
	85709
	85722
	85740
	85745
	85746
	85935
	87016
145093	85714
	85715
	85716
	85717
	85718
	85719
145099	83353
	85033
	85988
145116	83162
	85732
	87016
145126	85053
145128	83062
	83109
	83110
	83111
	83112
	83138
	83142
	83143
	85065
	85083
	85332
	85333
	85977
145143	83120
145144	85065

Kit #	Gabriel #
145148	83140
	83141
145176	85727
	85728
	85729
401011	83404
401754	83214
	83215
	83217
	83225
	83362
	85001
	85004
	85007
	85040
	85042
	85070
	85300
	85301
	85302
	85303
	85304
	85305
	85307
	85308
	85313
	85314
	85315
	85320
	85322
	85327
	85329
	85334
	85339
	85343
	85376
	85380
	85700
	85702
	85703
	85704
	85710
	85711

Kit #	Gabriel #
401754 Cont.	85712
	85713
	85720
	85729
	85730
	85731
	85734
	85735
	85736
	85740
	85901
	85905
	85912
	85913
	85968
404702	83001
	83006
	83007
	83011
	83012
	83038
	83047
	83117
	83161
	83177
	83401
406422	83162
415010-802	83140
	83141
	83162
TR0027	83159
	83515
	83518
	83519
	85031