

# Japanparts



WORLDWIDE QUALITY REPLACEMENT PARTS FOR JAPANESE AND KOREAN CARS

# STEERING AND SUSPENSION PARTS



**2013**  
**2014**

# Japanparts®



WORLDWIDE QUALITY REPLACEMENT PARTS FOR JAPANESE AND KOREAN CARS





**NEW VEHICLES**  
**NUOVI VEICOLI ..... PAG. 4**

**PRODUCTS RANGE**  
**PRODUKTE IM SORTIMENT**  
**GAMME DE PRODUIT**  
**GAMA DE PRODUCTOS**  
**PRODOTTI IN GAMMA..... PAG. 6**

**MEASURES**  
**MASSNAHMEN**  
**MESURES**  
**MEDIDAS**  
**MISURE ..... PAG. 10**

**CHEVROLET ..... PAG. 12**

**CHRYSLER..... PAG. 20**

**DACIA ..... PAG. 26**

**DAEWOO-CHEVROLET ..... PAG. 30**

**DAIHATSU..... PAG. 39**

**HONDA..... PAG. 53**

**HYUNDAI ..... PAG. 88**

**ISUZU ..... PAG. 120**

**JEEP ..... PAG. 126**

**KIA ..... PAG. 130**

**LAND ROVER..... PAG. 155**

**MAHINDRA..... PAG. 166**

**MAZDA ..... PAG. 167**

**MITSUBISHI ..... PAG. 198**

**NISSAN ..... PAG. 241**

**SMART ..... PAG. 288**

**SSANGYONG ..... PAG. 291**

**SUBARU ..... PAG. 296**

**SUZUKI..... PAG. 311**

**TATA..... PAG. 333**

**TOYOTA..... PAG. 337**

**CROSS REFERENCE LIST**  
**VERGLEICHSLISTE**  
**LISTA DE REFERENCIAS CRUZADES**  
**LISTE DE COMPARAISON**  
**LISTA DI COMPARAZIONE..... PAG. 403**

**BUMP RUBBER KIT UNIVERSAL TYPE**  
**UNIVERSALE DÄMPFERKAPPEN**  
**SOUFFLET DE CARDAN**  
**FUELLES AMTORIGUADORES UNIVERSALES**  
**CUFFIE AMMORTIZZATORI UNIVERSALI..... PAG. 441**

**RUBBER PARTS LIST**  
**MOTORAUFHÄNGUNG LISTE**  
**LISTE SILENT BLOCS**  
**LISTA TAPONES DE GOMA**  
**LISTA PARTI IN GOMMA ..... PAG. 452**







## NEW VEHICLES - NUOVI VEICOLI



### CHRYSLER

300C [2005 - ]

GRAND VOYAGER IV [2007 - ]

### CHEVROLET

CRUZE [2009 - ]

SPARK [2010 - ]

### DACIA

DUSTER [2010 - ]

LOGAN [2006 - ]

SANDERO [2008 - ]

SOLENZA [2003 - ]

### HONDA

ACCORD IX [2008 - ]

CR-V [2006 - ]

INSIGHT [2009 - ]

JAZZ III [2008 - ]

### HYUNDAI

H-1 [2008 - ]

I10 [2007 - ]

I20 [2008 - ]

I30 [2007 - ]

IX35 [2010 - ]

### JEEP

GRAND CHEROKEE III [2005 - ]

### KIA

SORENTO [2009 - ]

SOUL [2009 - ]

SPORTAGE [2010 - ]

VENGA [2010 - ]

### LANDROVER

FREELANDER [2006 - ]

### MAZDA

CX-7 [2007 - ]

2 [2007 - ]

5 [2005 - ]

6 [2007 - ]

### MITSUBISHI

ASX [2010 - ]

PAJERO IV [2007 - ]

### NISSAN

JUKE [2010 - ]

PIXO [2009 - ]

TIIDA [2007 - ]

X-TRAIL (T-31) [2007 - ]

### SMART

FORTWO [2007 - ]

### SSANGYONG

KYRON [2005 - ]

### SUBARU

FORESTER [2008 - ]

LEGACY [2003 - ]

LEGACY [2009 - ]

### SUZUKI

ALTO V [2009 - ]

SPLASH [2008 - ]

### TOYOTA

4 RUNNER [1996 - ]

AURIS [2007 - ]

AVENSIS (T27) [2009 - ]

CAMRY [2006 - ]

IQ [2009 - ]

PRIUS [2000 - 2003]







PRIUS [2003 - 2008]

PRIUS [2009 - ]

URBAN CRUISER [2009 - ]

VERSO [2009 - ]

SOSPENSIONI/SUSPENSIONS LENKUNGS UND-AUFHÄNGUNGSTEILE SUSPENSION/SUSPENSIÓN		
	MM	AMMORTIZZATORI
		SHOCK ABSORBERS
		AMORTISSEURS
		STOSSDÄMPFER
		AMORTIZADORES
	KK	KIT CUSCINETTI RUOTA
		WHEELBEARING KITS
		KIT DE ROULEMENTS DE ROUES
		RADLAGERSÄTZE
		KIT COJINETES DE RUEDA
	RU	GOMMINI
		RUBBERS
		SILENT BLOCS
		MOTORAUFHÄNGUNG
		TAPONES DE GOMA
	BS	TRAPEZIO
		SUSPENSION TRIANGLE
		TRIANGLE DE SUSPENSION
		TRAPEZ
		TRAPEZIO
	CJ-ML	BRACCIO OSCILLANTE
		SUSPENSION ARMS
		BRAS OSCILLANTS
		SCHWENKARME
		BRAZO OSCILANTE
	ID	LEVE RINVIO STERZO
		STEERING RELAY
		LEVIERS DE RENVOI DE LA DIRECTION
		LENKRADHEBEL
		LEVAS DE REENVÍO DE LA DIRECCIÓN
	LB	TESTINE SOSPENSIONE
		BALL JOINT
		ROTULE (POUR SUSPENSION ET DIRECTION)
		AUFHÄNGEKÖPFE
		CABEZALES DE SUSPENSIÓN
	SA	BARRE ACCOPPIAMENTO
		COUPLING BARS
		BARRES D'ACCOUPLMENT
		PLEUELSTANGEN
		BARRAS DE ACOPLAMIENTO
	TI	TESTA BARRA D'ACCOPPIAMENTO
		TIE-ROD END
		ROTULE DE BARRE DE CONNEXION
		SPURSTANGENKOPF
		CABEZA DE BARRA DE ACOPLAMIENTO

SOSPENSIONI/SUSPENSIONS LENKUNGS UND-AUFHÄNGUNGSTEILE SUSPENSION/SUSPENSIÓN		
	CW	BRACCIO OSCILLANTE, SOSPENSIONE RUOTA
		TRACK CONTROL ARM
		BRAS DE LIAISON, SUSPENSION DE ROUE
		LENKER, RADAUFHÄNGUNG
		BRAZO OSCILANTE, SUSPENSIÓN DE RUEDA
	PI	LEVE RINVIO STERZO
		STEERING RELAY
		LEVIERS DE RENVOI DE LA DIRECTION
		LENKRADHEBEL
		LEVAS DE REENVÍO DE LA DIRECCIÓN
	RD	GIUNTO ASSIALE, ASTA TRASVERSALE
		AXIAL ROD, TIE ROD
		ROTULE DE DIRECTION INTÉRIEURE, BARRE DE CONNEXION
		AXIALGELENK, SPURSTANGE
		JUNTA AXIAL, ASTA TRANSVERSAL
	SI	STABILIZZATORE, CHASSIS
		STABILISER, CHASSIS
		STABILISATEUR, CHASSIS
		STABILISATOR, FAHRWERK
		ESTABILIZADOR, CHASIS
	CR	BARRA D'ACCOPPIAMENTO
		TIE ROD, STEERING
		BARRE DE CONNEXION SPURSTANGE
		SPURSTANGENKOPF, LENKUNG
		BARRA DE ACOPLAMIENTO
	AX	GIUNTO ASSIALE, ASTA TRASVERSALE
		AXIAL ROD, TIE ROD
		ROTULE DE DIRECTION INTÉRIEURE, BARRE DE CONNEXION
		AXIALGELENK, SPURSTANGE
		JUNTA AXIAL, ASTA TRANSVERSAL
	BJ	GIUNTO DI SUPPORTO/GUIDA
		SUPPORT/TEERING LINK
		ROTULE DE SUSPENSION
		TRAG/FÜHRUNGSGELENK
		JUNTA DE SOPORTE /GUÍA

The pictures as shown in the catalogue are not a reproduction of original drawings and are only mean for visual and identifying purposes and cannot be objected with the original parts at all, Japanparts declines any responsibility following improper uses of these pictures and possible mistakes.

I disegni riportati nel catalogo non sono riproduzioni di disegni originali e sono a solo uso visivo ed identificativo e non potranno costituire oggetto di contestazione con i pezzi originali, in ogni caso la Japanparts declina ogni responsabilità sull'uso improprio degli stessi e non risponderà di eventuali errori e/o omissioni.

Copyright by Japanparts - Verona

All rights of reproduction are reserved for Japanparts  
Les droits de reproduction sont réservés à Japanparts  
Todos los derechos de la reproducción son reservados para Japanparts  
I diritti di riproduzione sono riservati alla Japanparts

## LETTURA DEL CODICE JAPANPARTS - THE KEY TO THE JAPANPARTS' CODE

### ESEMPIO/EXAMPLE

**RU- 9 10**

IDENTIFICA IL PRODOTTO/MAIN PRODUCT GROUP

COSTRUTTORE DEL VEICOLO/CAR MANUFACTURER

PARTE NUMERICA/COUNTING POSITION

- 0 = TATA - LADA - HUMMER
- 1 = NISSAN
- 2 = TOYOTA
- 3 = MAZDA
- 4 = HONDA
- 5 = MITSUBISHI
- 6 = DAIHATSU - PIAGGIO
- 7 = SUBARU
- 8 = SUZUKI - MARUTI
- 9 = ISUZU - JEEP - OPEL - CHRYSLER

- H = HYUNDAI
- K = KIA
- L = LAND ROVER
- M = SMART
- S = SSANGYONG
- W = DAEWOO-CHEVROLET

# WORLDWIDE QUALITY





NOTICE: Were you see European flag means complete range for european cars.

NOTA: Bandiera Europea significa gamma completa per auto europea.



 <b>FILTRI - FILTERS FILTRES - FILTER FILTROS - FILTROS</b>	
	<b>FO</b> Filtri olio - Oil filters Filtres à huile - Ölfilter Filtros do óleo - Filtros de aceite
	<b>FA</b> Filtri aria - Air filters Filtres à air - Luftfilter Filtros de ar - Filtros de aire
	<b>FAA</b> Filtri abitacolo - Cabin filters Filtres d'habitacle - Oollenfilter Filtros de hanbitáculo - Filtros de purificación
	<b>FC</b> Filtri carburante - Fuel filters Filtres à carburant - Kraftstofffilter Filtros de combustível - Filtros de carburante
	<b>FO-ECO</b> Filtri olio eco - Eco oil filters Filtres à huile eco - Ölfilter eco Eco filtros do óleo - Eco filtros de aceite
	<b>FC-ECO</b> Filtri carburante eco - Eco fuel filters Filtres à carburant eco - Kraftstofffilter eco Eco filtros de combustível - Eco filtros de carburante
	<b>KT</b> Kit filtri per tagliando - Service filter kit Kit filtres entretien - Filter service satz Kit de filtros da revisão - Kit filtros para revisão
	<b>FO-GAS</b> Filtro depurazione gpl - Gpl purification filter Filtre purification gpl - ReinigungsfILTER gpl Filtro gás para a filtragem do gpl Gas filtro de purificación gpl
	<b>DH</b> Supporto filtro - Filter support Filtre d'appui - Filtre halterung Suporte do filtro - Soporte filtri

 <b>FRENANTE - BRAKES BREMS - FREINAGE TRAVÕES - FRENOS</b>	
	<b>PA</b> Pastiglie freno ant. - Brake pads front Plaquettes de frein avant - Bremsklötse vorne Pastilhas dos travões da frente - Pastillas de freno ant.
	<b>PP</b> Pastiglie freno post. - Brake pads rear Plaquettes de frein arrière - Bremsklötse hinten Pastilhas dos travões de trás - Pastillas de freno post.
	<b>DI</b> Dischi freno ant. - Brake discs front Disques de frein avant - Bremsscheiben vorne Discos dos travões da frente - Discos de freno ant.
	<b>DP</b> Dischi freno post. - Brake discs rear Disques de frein arrière - Bremsscheiben hinten Discos dos travões de trás - Discos de freno post.
	<b>GF</b> Ganasce freno - Brake shoes Machaires de frein - Bremsbacken Maxilas de travão - Zapatas de freno
	<b>TA</b> Tamburi freno - Brake drums Tambours de frein - Bremstrommel Tambores dos travões - Tambores de freno
	<b>CD</b> Cilindretti freno dx - Rear wheel cylinder right Cylindre de roue droit - Radbremszylinder, rechts Cilindro de travão de trás direito - Cilindros de freno dx
	<b>CS</b> Cilindretti freno sx - Rear wheel cylinder left Cylindre de roue gauche - Radbremszylinder, links Cilindro de travão de trás esquerdo - Cilindros de freno sx

	<b>PF</b> Pompe freno - Brake master cylinders Maitre cylindres - Hauptbremszylinder Bombas dos travões - Bombas de freno
	<b>TF</b> Tubi freno - Brake hoses Fléxibles de frein - Bremsschläuche Tubos dos travões - Tubos de freno
	<b>KC</b> Kit riparazione pompa freno Repair kit, brake master cylinder Kit de réparation, maître cylindre de frein Reparatursatz, hauptbremszylinder Kit reparação da bomba dos travões Kit reparación bomba de freno
	<b>KD-PC</b> Kit riparazione pinza freno - Brake calipers repair kit Kit de reparation etriers de frein Reparatursatz bremsattel - Kit reparação pinça travão Kit reparación pinza de freno
	<b>BC</b> Cavi freno - Brake Cable Câbles de frein - Bremskabel Cabo de aço - Cable de freno

 <b>FRIZIONI - CLUTCH KUPPLUNG - EMBRAYAGE EMBRAIAGEM - EMBRAGUE</b>	
	<b>KF</b> Kit frizione - Clutch kits Kit embrayages - Kupplungssätze Kit embraiagem - Kit embrague
	<b>KV</b> Kit frizione completo di volano - Clutch kit with flywheel Kit embrayage avec volant - Kupplungssatz mit schwungrad Kit de embraiagem com volante Kit embrague completo con volante de inercia
	<b>DF</b> Dischi frizione - Clutch discs Disques d'embrayage - Kupplungsscheiben Disco de embraiagem - Disco de embrague
	<b>SF</b> Spingidisco frizione - Clutch cover Mécanisme d'embrayage - Druckplatten kupplung Prato de pressão da embraiagem - Prensa de embrague
	<b>VL</b> Volani - Flywheels Volants - Schwungräder Volantes Bi-Massa - Volantes
	<b>CF</b> Cuscinetti frizione - Clutch bearings Butées d'embrayage - Kupplungs-ausrücklager Rolamento de embraiagem - Cojinetes de embrague
	<b>BV</b> Bullone, porta corona dentata volano Bolt, flywheel ring gear Carrier vis boulon au support du pignon pour volant d'inertie Schraube, zahnkranzträgerschwungrad Perno, soporte corona - Dentada, volante
	<b>FR</b> Pompe frizione - Clutch master cylinders Cylindre émetteur - Kupplungs-hauptzylinder Bombas embraiagem - Bomba embrague
	<b>CY</b> Cilindretti frizione - Clutch slave cylinders Cylindre récepteur - Kupplungs-nehmerzylinder Bomba secundária da embraiagem Cilindros embrague
	<b>KR</b> Kit riparazione pompa frizione Repair kit, clutch master cylinder Kit d'assemblage, cylindre émetteur d'embrayage Reparatursatz, kupplungsgeberzylinder Kit de reparação da bomba de embraiagem principal Kit reparación bomba de embrague

# GAMMA PRODOTTI

# PRODUCT RANGE



KY

Kit riparazione cilindretto frizione  
 Repair kit, clutch slave cylinder  
 Kit d'assemblage, cylindre récepteur d'embrayage  
 Reparatursatz, kupplungsnehmerzylinder  
 Kit de reparação da bomba de embraiagem secundária  
 Kit reparación cilindro embrague



## DISTRIBUZIONE - DISTRIBUTION VERTEILUNG - DISTRIBUTION DISTRIBUIÇÃO - DISTRIBUCIÓN



new

KDK

Kit distribuzione catena - Timing chain kit  
 Kit chaines de distribution - Steuerkettensatz  
 Kit da corrente de distribuição  
 Kit distribución de cadena



KDD

Kit cinghia e tendicinghia - Timing belt kit  
 Kit de distribution - Zahnriemensatz  
 Kit de distribuição de correia - Kit correa y tensor de correa



new

SKD

Pompa acqua + kit cinghie - Water pump & timing belt kit  
 Pompe à eau + kit de courroie de distribution  
 Wasserpumpe + Zahnriemensatz  
 Bomba de água + kit de correia dentada  
 Bomba de agua + kit correa distribución



BE

Cuscinetti tendicinghia - Timing belt tensioners  
 Galet tendeur - Spannrollen  
 Tensores da correia de distribuição  
 Cojinetes de tensor de correa



DD

Cinghie distribuzione - Timing belts  
 Courroies de distribution - Zahnriemen  
 Correia de distribuição - Correias de distribución



TT

Cinghia servizi - Fan belts  
 Courroie - Keilriemen  
 Correia de ventoinha - Correa de servicios



DT

Cinghia servizi bando - Fan belt bando  
 Courroie bando - Keilriemen bando  
 Correia de ventoinha bando - Correa de servicios bando



TV

Cinghie servizi scanalate - Fan belts - Courroies  
 Keilrippenriemen - Correia de ventoinha - Correa de servicios



DV

Cinghia servizi scanalata bando - Fan belt bando  
 Courroies bando - Keilrippenriemen bando  
 Correia de ventoinha bando - Correa de servicios bando



CH

Catene distribuzione - Timing chains  
 Chaines de distribution - Steuerketten  
 Correntes de distribuição - Cadenas de distribución



TS

Tenditore cinghia Poly-V - Timing belt tensioner  
 Tendeur, courroie trapézoïdale - Spannarm, Keilrippenriemen  
 Tensor, correia trapezoidal - Brazo tensor, correa Poly-V



new

RP

Galoppino/Guidacinghia, Cinghia Poly-V  
 Deflection/Guide Pulley, V-ribbed belt - Poulie courroie  
 trapézoïdale - Umlenk-/Führungsrolle, Keilrippenriemen  
 Polea correia Poly-V - Polia correia trapezoidal



new

TP

Rullo tenditore, Cinghia Poly-V - Poly-V belt tensioner  
 Poulie-tendeur, courroie trapézoïdale à nervures  
 Spannrolle, Keilrippenriemen - Rolo tensor, correia trapezoidal  
 estriada - Polea tensora, correia trapezoidal con dentado interior



new

TL

Smorzatore vibrazioni, Cinghia Poly-V  
 Vibration damper V-ribbed belt  
 Amortisseur de vibrations, courroie trapézoïdale à nervures  
 Schwingungsdämpfer, Keilrippenriemen  
 Amortecedor de vibrações, correia trapezoidal estriada  
 Amortiguador vibraciones, correa trapez. Poly-V



## RAFFREDDAMENTO - COOLING ABKÜHLUNG - REFRIGERATION ARREFECIMENTO - REFRIGERACION



PQ

Pompe acqua - Water pumps  
 Pompes à eau - Wasserpumpen  
 Bombas da água - Bombas de agua



VC

Giunti viscosi - Viscous couplings  
 Visco coupleur - Visco-kupplungen  
 Juntas viscosas - Juntas viscosas



VT

Valvole termostatiche - Thermostats  
 Thermostates - Thermostate  
 Termostatos - Válvulas termostáticas



new

VA

Valvola termostatica tama - Thermostate tama  
 Vanne thermostatique tama - Thermostatventil tama  
 Termostatos tama - Válvula termostática tama



new

RDA

Radiatore - Radiator  
 Radiateur - Kühler  
 Radiador - Radiador



KH

Tappi radiatore - Radiator caps  
 Bouchons radiateurs - Kuhler verschluss kappe  
 Tampões de radiator - Tapones radiator



new

CMP

Compressore - Compressor  
 Compresseur - Kompressor  
 Compresor - Compressor



new

CND

Condensatore - Condenser  
 Condenseur - Kondensator  
 Condensador - Condensador



new

EVP

Evaporatore - Evaporator  
 Evaporateur - Verdampfer  
 Evaporador - Evaporador



new

RSD

Riscaldatore - Heat Exchanger, interior heating  
 Système de chauffage - Heizung  
 Radiador de calefacción - Permutador de calor



new

VNT

Ventola, Raffreddamento motore - Fan, radiator  
 Ventilateur - Lüfter  
 Ventilador - Ventilador



## GIUNTI E CUFFIE - JOINTS AND BOOTS KUPPLUNGEN UND ACHSMANSCHETTEN COUPLEUR, SOUFFLET DE CARDAN - JUNTAS DE TRANSMISSÃO E FOLES - JUNTAS Y FUELLES



GI

Giunti omocineticici lato ruota  
 Costant velocity joints  
 Joint homocinétique - Antriebswellen  
 Juntas homocinéticas lado roda  
 Juntas homocinéticas de lado de rueda



KB

Kit cuffia - Boot kits  
 Soufflet de cardana - Achsmanschetten  
 Kit de foles - Kit de fuelles



JO

Crociere - Universal joints  
 Croisillons de trans - Universal gelenke  
 Cruzetas de cardan - Crucetas



## SOSPENSIONI - SUSPENSIONS LENKUNGS UND-AUFHÄNGUNGSTEILE SUSPENSION - SUSPENSÃO SUSPENSIONA





















KK

Kit cuscinetti ruota - Wheelbearing kits  
 Kit de roulements de roues - Radlagersätze  
 Jogos de rolamentos das rodas - Kit cojinetes de rueda

## GAMME DES PRODUITS

## PRODUKTELINIE

	<b>MM</b>	Ammortizzatori - Shock absorbers Amortisseurs - Stossdämpfer Amortecedores - Amortiguador
	<b>RU</b>	Gommini - Rubbers Silent blocs - Motoraufhängung Borrachas - Tapones de goma
	<b>BS</b>	Trapezio - Suspension triangle Triangle de suspension - Trapez Triângulo da suspensão - Trapecio
	<b>CJ-ML</b>	Braccio oscillante - Suspension arms Bras oscillants - Schwenkarme Braços da suspensão - Braço oscilante
	<b>ID</b>	Leve rinvio sterzo - Steering relay Leviers de renvoi de la direction - Lenkradhebel Pendural da barra de direcção Levas de reenvío de la dirección
	<b>LB</b>	Testine sospensione - Ball joint Rotule (pour suspension et direction) Aufhängeköpfe - Rotula da suspensão Cabezales de suspensión
	<b>SA</b>	Barre accoppiamento - Coupling bars Barres d'accouplement - Pleuelstangen Barras da direcção - Barras de acoplamiento
	<b>TI</b>	Testa barra d'accoppiamento - Tie-rod end Rotule de barre de connexion Spurstangenkopf - Terminal da direcção Cabeza de barra de acoplamiento
	<b>SI</b>	Stabilizzatore, chassis - Stabilizer, chassis Stabilisateur, chassis - Stabilisator, fahrwerk Estabilizador, chassi - Estabilizador, chasis
	<b>RD AX</b>	Giunto assiale, asta trasversale - Axial rod, tie rod Rotule de direction intérieure, barre de connexion Axialgelenk, spurstange - Rótula da direcção interior Junta axial, asta transversal
	<b>PI</b>	Leve rinvio sterzo - Steering relay Leviers de renvoi de la direction - Lenkradhebel Braço do pendural da direcção Levas de reenvío de la dirección
	<b>CW</b>	Braccio oscillante, sospensione ruota Track control arm Bras de liaison, suspension de roue Lenker, radaufhängung - Braço de suspensão Brazo oscilante, suspensión de rueda
	<b>CR</b>	Barra d'accoppiamento - Tie rod, steering Barre de connexion spurstange Verbindungstange - Barra de junção Barra de acoplamiento
	<b>BJ</b>	Giunto di supporto/guida Support/steering link Rotule de suspension Trag/führungsgelenk Rótula da suspensão Junta de soporte /guía
	<b>KB-A</b>	Cuffie ammortizzatori universali Universal bump rubber kit Soufflet de cardan Universale dämpferkappen Kits de foles universais dos amortecedores Fuelles amortiguadores universales



	<b>IMPIANTO ELETTRICO - ELECTRICAL PARTS ELEKTRISCHE TEILE - ÉLECTRIQUE PARTS MATERIAL ELÉCTRICO - PARTES ELÉCTRICAS</b>	
	<b>AL</b>	Alternatori - Alternators Alternateurs - Lichtmaschinen Alternadores - Alternadores
	<b>MT</b>	Motorini avviamento - Starters Démarreurs - Anlasser Motores de arranque - Arrancador
	<b>DENSO</b>	Candele - Spark plugs Bougies d'allumage - Kerzen Denso velas - Denso bujias
	<b>CE</b>	Candele - Glow plugs Bougies de pré-chauffage - Gluhkerzen Velas de incandescência - Bujias
	<b>HKT</b>	Candele hkt - Hkt glow plugs Bougies de préchauffage hkt - Gluhkerzen hkt Velas de incandescência hkt - Candelillas hkt
	<b>DENSO</b>	Candele denso - Denso glow plugs Bougies de préchauffage denso - Gluhkerzen denso Velas de incandescência denso - Candelillas denso
	<b>OO</b>	Sonde lambda - Oxigen sensors Sonde lambda - Lambda sonde Sondas lambda - Sensor oxigen
	<b>DENSO</b>	Sonde lambda denso - Oxigen sensors denso Sonde lambda denso - Lambda sonde denso Sondas lambda denso - Sondas lambda
	<b>SS-X</b>	Spazzole tergicristallo Wiper blades - Balais essuie glaces Wischerblätter - Escovas limpa vidros Escobillas
	<b>SS-F</b>	Spazzole tergicristallo universali - Universal wiper blades Balais essuie glaces universelles - Universale wischerblätter Escovas limpa vidros universais - Escobillas limpiaparabrisas universales
	<b>SS-R</b>	Spazzole tergicristallo universali posteriori - Universal Rear wiper Blades Balais d'essuie-glaces arrières universelles - Hintere universal Scheibenwischer Escovas limpa vidros traseiras universales Escobillas limpiaparabrisas traseras universales
	<b>SS-RE70C - SS-RE70C SS-RE70VL - SS-RE75BH</b>	Refill universali per spazzole normali/flat Universal refill for normal wiper blades/flat wiper blades Refill universel pour balais essuie glace norm. et balais "flat" Universal refill fuer normale/wischerblaetter Und fuer flat wischerblaetter Recargas universais para escovas flat normais Recambios universales para escobillas normales
	<b>HY</b>	Spazzola ibrida - Hybrid wiper blade - Hybrid balai d'essuie-glace Hybrid wischblatt - Und fuer flat wischerblaetter Escova hibrida de limpa-vidros - Escobilla hibrida
	<b>HY-U</b>	Spazzola Ibrida universale - Universal Hybrid wiper blade Balais d'essuie-glaces hybrid universelles - Hybrid universal Scheibenwischer Escovas limpa vidros Ibridadas universales - Escobillas limpiaparabrisas Ibridadas universales
	<b>BA</b>	Bulbi elettroventola - Temp. sensors Capteur de température - Ventilkugeln Sensores de temperatura - Sensor temperatura
	<b>PB</b>	Pompe benzina - Fuel pump Pompe a carburant - Benzinpumpen Bombas gasolina - Bombas de gasolina
	<b>RE</b>	Regolatori - Regulators Regulateur de tension - Spannungsregler Reguladores - Reguladores

## GAMA DE PRODUTOS

	<b>SR</b>	Spazzole accensione - Rotor arms Rotors d'allumeurs - Verteilerfinger Rotores - Rotor del distribuidor
	<b>XX-C</b>	Kit cavi accensione - Electric-cable ignition kit Kit câbles d'allumage - Zündkabel set Jogo de fios de vela - Kit cables de encendido
	<b>BO</b>	Bobina di accensione - Coil, ignition Bobine d'allumage - Zündspule Bobina de ignição - Bobina de encendido
	<b>CO</b>	Condensatore - Condenser, ignition Condenseur, système d'allumage Kondensator, zündanlage Condensador - Condensador
	<b>CT</b>	Kit contatti accensione - Contact breaker Distributor jeu de contacts d'allumage Kontaktsatz, zündverteiler Jogo de platinados - kit contactos de encendido
	<b>GA GN GO</b>	Gruppo universale koito - Insert, headlight koito Bloc-optique de phare koito Scheinwerfereinsatz, hauptscheinwerfer koito Óptica koito - Grupo universal koito
	<b>IS</b>	Interruttore stop - Interrupteur des feux de freins Brake light switch - Bremslichtschalter Interruptor stop - Interruptor de luces de freno
	<b>IV</b>	Interruttore temperatura, ventola radiatore Temperature switch, radiator fan Interrupteur de température, ventiateur de radiateur Temperaturschalter, kühlerlüfter Interruptor temperatura, ventoinha radiador Interruptor temperatura, ventilador radiador
	<b>PO</b>	Pressostato olio - Oil pressure switch Switch de pression d'huile - Öl druckschalter Interruptor da pressão do óleo - Interruptor presión de aceite
	<b>SP</b>	Spinterogeno - Distributor Distributeur - Verteiler Distribuidor - Distribuidor
	<b>DE</b>	Sensore massa aria - Mass sensor Capteur de masse - Sensorenmesser Sensor massa ar - Sensor masa de aire
	<b>VF</b>	Corpo farfallato elettrico - Throttle housing Boîtier de papillon - Drosselklappenstutzen Corpo de mariposa eléctrico Cuerpo de mariposa eléctrico
	<b>RA</b>	Puleggia alternatore - Freewheel Clutch, alternator Poulie roue libre, alternateur - Generatorfreilauf Rueda libre alternador - Roda livre do alternador
	<b>CA</b>	Calotte spinterogeno - Distributor caps Tête d'allumeur - Verteilekappen Tampas do distribuidor - Tapa distribuidor

**IRCO**

**MOTORE - ENGINE  
MOTOR - MOTEUR  
MOTOR - MOTOR**

	<b>AA</b>	Alberi a camme - Camshafts - Arbres a cames Nockenwellen - Árvores de cames - Árboles de levas
	<b>AB</b>	Alberi motore - Crankshafts - Vilebrequins Kurbelwellen - Cambotas - Árboles de moto
	<b>PU</b>	Puleggia albero motore - Crank shaft pulleys Poulie de vilebrequin - Motor-welle rolle Polia da cambota - Polea del eje motor

## GAMMA PRODUCTO

	<b>GP</b>	Guarnizioni coperchio valvole - Valves cover gaskets Joint de couvre culbuteur - Dichtungen des klappendeckels Juntas da cabeça - Tapa de culata de cilindro
	<b>GT</b>	Guarnizioni testata - Head gaskets Joints de culasses - Zylindercöpfe dichturg Jogo de juntas da cabeça - Juntas de culata
	<b>KG</b>	Kit guarnizioni testata - Head gaskets set Kit joints de culasses - Zylinderkopfdichtungssatze Kit guarnições cabeça - Kit juntas de culata
	<b>KI</b>	Kit pistoni - Pistons kit - Kit pistons Kolben rep. Sätze - Jogo de pistões - Kit pistones
	<b>KM</b>	Kit guarnizioni motore - Full set gasket Kit pochette joint moteur - Motor dichtungssatze Jogo de juntas completo - Kit juntas de motor
	<b>VV</b>	Valvole - Engine valves - Soupapes Ventile - Válvulas - Válvulas
	<b>XX</b>	Testate - Cylinder heads - Culasses Zylinderköpfe - Cabeças - Culata del cilindro
	<b>BI</b>	Bielle - Connecting roads - Bielle Pleuel - Bielas - Bielas
	<b>PB</b>	Boccola biella - Piston pin bushings - Bagues tête de bielle Kolben-pleuel-buchse - Casquilhos de biela - Casq. de biela
	<b>RC</b>	Fascia elastica - Piston ring Segment de piston - Kolbenring Segmento - Aros del pistón
	<b>MS</b>	Bronzina banco - Main bearings Coussinets de palier - Hauptlager Bronzes de apoio - Cojinete de bancada
	<b>CB</b>	Bronzina di biella - Big end bearings Coussinet de bielle - Pleuellager Bronzes de biela - Cojinete de biela
	<b>CC</b>	Kit canne cilindro motore - Cylinder liner kits Kit chemises - Laufbuchensätze Jogos de camisas - Kit barras de cilindro de motor
	<b>BZ</b>	Bilancieri valvole - Balances valves Valves d'équilibres - Balancen ventile - Balancoen ventile Martelos - Balancines de las válvulas
	<b>SH DB</b>	Bronzina albero a camme - Camshaft bearings Coussinets arbre à cames - Nockenwellenlager Bronzes da árvore de cames - Cojinete de árbol de levas
	<b>TW</b>	Rasamenti - Thrust washers Cales latérale - Anlaufscheibe Anilhas de folga da cambota - Enrases
	<b>BL</b>	Bulloni testata - Cylinder head bolt Boulon de culasse de cylindre - Zylinderkopfschraube Pernos da cabeça - Pernos de cabezal
	<b>XX</b>	Valvola ricircolo gas di scarico Exhaust gas recirculation valve Vanne egr ventil - Abgasrückführventil Válvula de reciclo do gás de escape Válvula de recirculación de gas de descarga
	<b>XX</b>	Pompa olio - Oil pump Pompe à huile - Ölpumpe Bomba óleo - Bomba de aceite
	<b>XX</b>	Iniettore - Injector - Injecteur Injektoren - Injector - Inyector
	<b>XX</b>	Motore completo - Complete engine Moteur complet - Motor komplett Motor completo - Motor completo
	<b>XX</b>	Turbina - Turbocharger - Turbocompresseur Turbolader - Turbo - Turbina

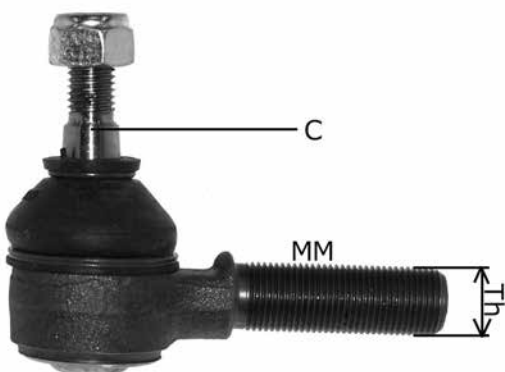
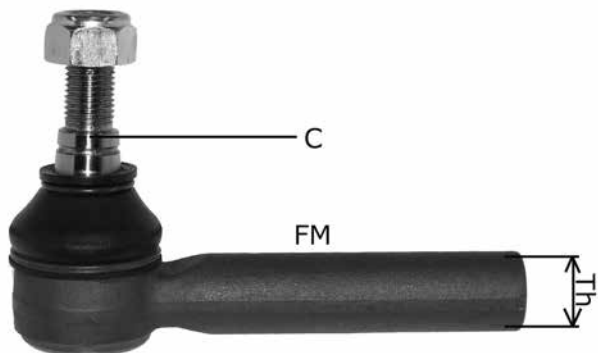

IT

L Lunghezza  
D Diametro  
C Diametro cono piccolo  
Th Caratteristiche filettatura  
FM Filettatura interna  
MM Filettatura esterna

GB

L Length  
D Diameter  
C Smallest cone diameter  
Th Thread features  
FM Internal thread  
MM External thread

D

L Länge  
D Durchmesser  
C Kleinster Konusdurchmesser  
Th Gewindeabmessung  
FM Innengewinde  
MM Aussengewinde

F

L Longueur  
D Diamètre  
C Diamètre mineur du cono  
Th Caractéristiques du filet  
FM Filetage intérieur  
MM Filetage extérieur

ESP

L Longitud  
D Diámetro  
C Diámetro más pequeño cono  
Th Características rosca  
FM Rosca interior  
MM Rosca externa

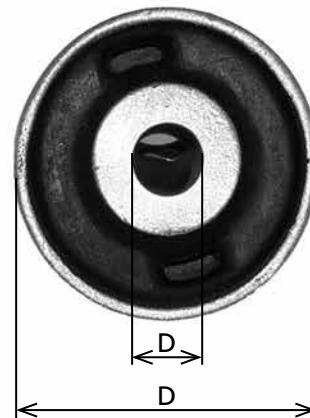

**IT**

**GB**

**D**

**F**

**ESP**

L Lunghezza	L Length	L Länge	L Longueur	L Longitud
D Diametro	D Diameter	D Durchmesser	D Diamètre	D Diámetro
C Diametro cono piccolo	C Smallest cone diameter	C Kleinster Konusdurchmesser	C Diamètre mineur du cone	C Diámetro más pequeño cono
Th Caratteristiche filettatura	Th Thread features	Th Gewindeabmessung	Th Caractéristiques du filet	Th Características rosca
FM Filettatura interna	FM Internal thread	FM Innengewinde	FM Filetage intérieur	FM Rosca interior
MM Filettatura esterna	MM External thread	MM Aussengewinde	MM Filetage extérieur	MM Rosca externa



# CHEVROLET CAPTIVA

CAPTIVA

06/2006 ->

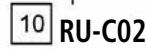
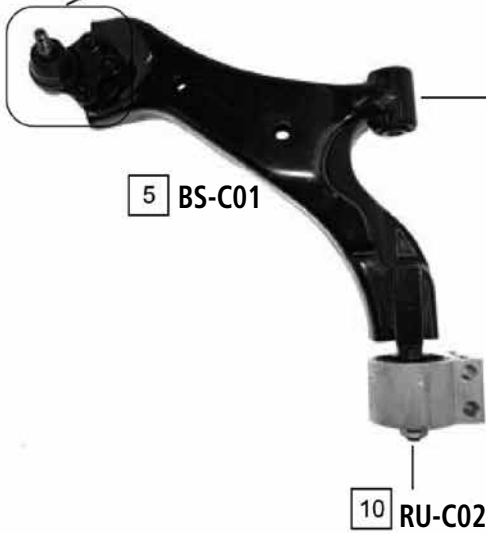
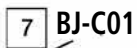
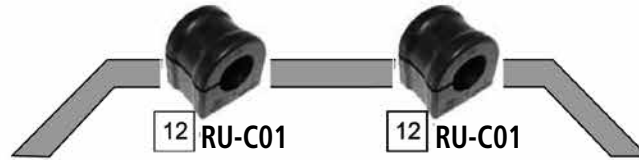

Ref.	JAPANPARTS CODE	Description	OEM	Measures	Ref.	JAPANPARTS CODE	Description	OEM	Measures
1	RD-C01	Axial Joint	Part of	-	7	BJ-C01	Ball Joint	Part of BS-C01/BS-C02	c: 15,2
2	SI-C01	Stabiliser Link Left	48 06 304	L: 286	8	TI-C01	Tie Rod End	96626667	c: 12,5 th: FM14X1.5 R
3	SI-C02	Stabiliser Link Right	48 06 305	L: 286	9	RU-C04	Silentblock For Susp.Arm	Part of BS-C01/BS-C02	d: 14,2
4	SI-C03	Stabiliser Link	96626150	L: 165	10	RU-C02	Silentblock For Susp.Arm	Part of BS-C01	d: 14,2
5	BS-C01	Tca Left Wbj	96819161	c: 15,2	11	RU-C03	Silentblock For Susp.Arm	Part of BS-C02	d: 14,2
6	BS-C02	Tca Right Wbj	48 06 301	c: 15,2	12	RU-C01	Stabiliser Mounting	96810751	d: 26

CRUZE (J300)

05/2009 ->

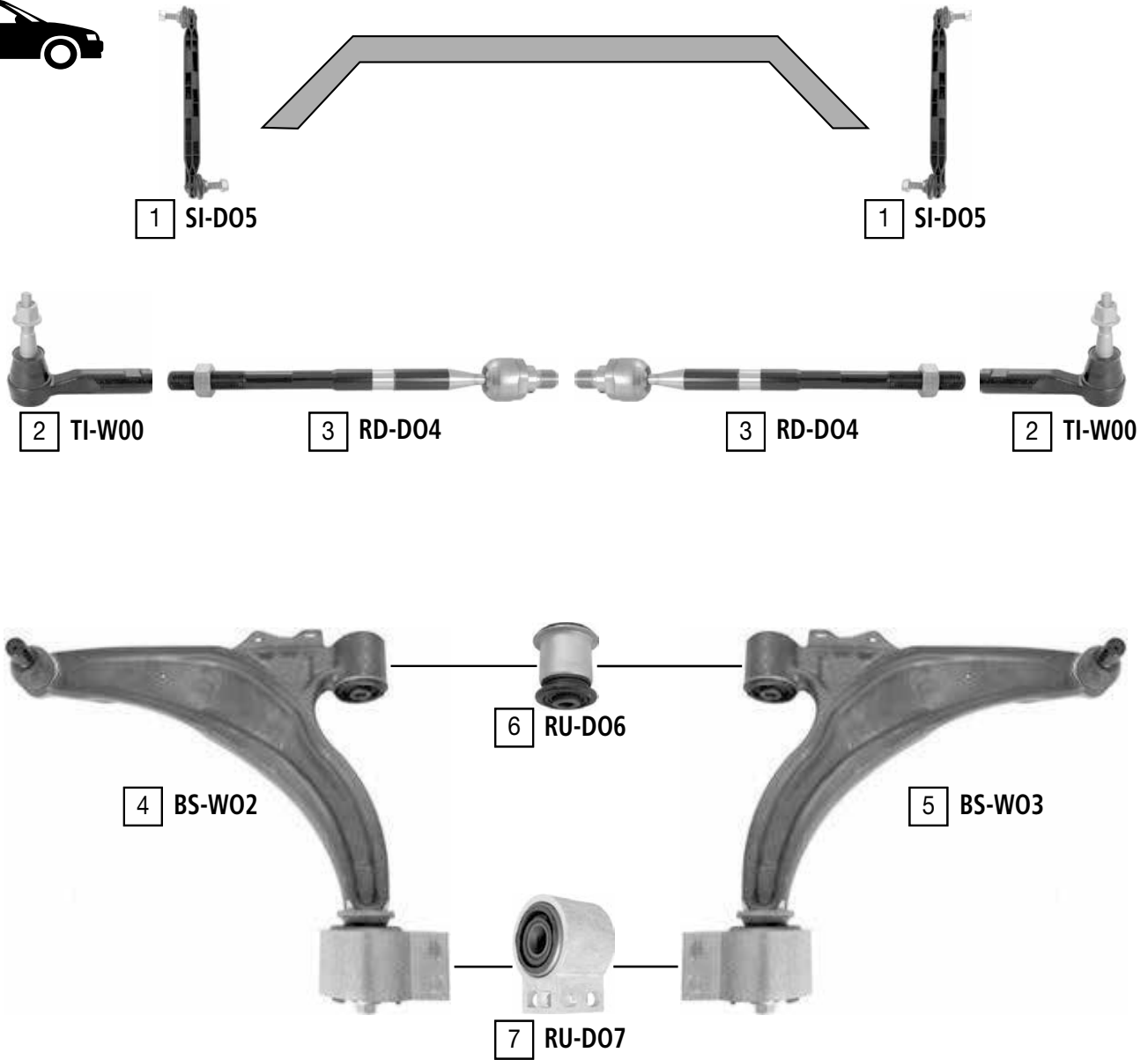

Ref.	JAPANPARTS CODE	Description	OEM	Measures	Ref.	JAPANPARTS CODE	Description	OEM	Measures
1	SI-D05	Stabiliser Link	13219141	L:304	5	BS-W03	TCA right wbj	13272606	c:20
2	TI-W00	Tie Rod End	13278359	c:13.2 th:FM16x1.5R	6	RU-D06	Silentblock for TCA	13219090	di:12.4 do:40.4
3	RD-D04	Axial Joint	13278358	th:MM16x1.5R L:293	7	RU-D07	Silentblock for TCA	13230774	di:22.3
4	BS-W02	TCA Left Wbj	13272605	c:20					

# CHEVROLET EVANDA - EPICA

EVANDA/EPICA

03/2005 ->

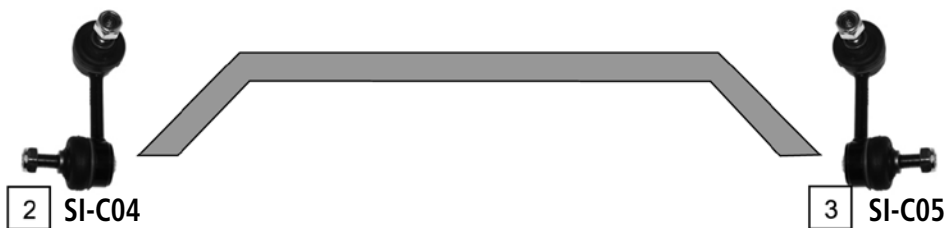

Ref.	JAPANPARTS CODE	Description	OEM	Measures	Ref.	JAPANPARTS CODE	Description	OEM	Measures
1	RD-C02	Axial Joint	93740701	th:MM16X1.5R L:358	3	SI-C05	Stabiliser Link Right	96225858	L:79
2	SI-C04	Stabiliser Link Left	96225859	L:79	4	TI-C02	Tie Rod End	93740710	c: 13.2 th:FM14X1.5R

KALOS

03/2005 ->

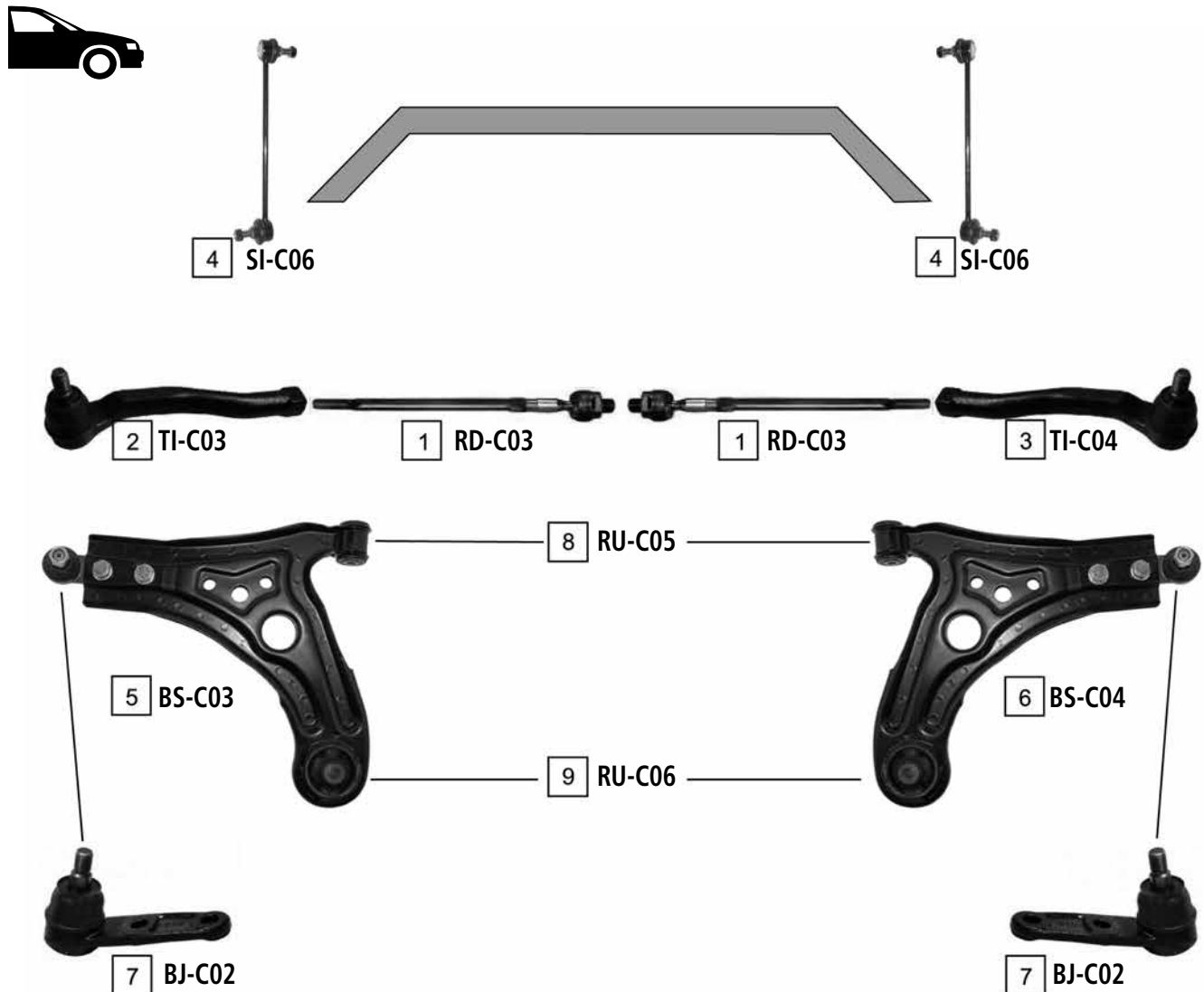

Ref.	JAPANPARTS CODE	Description	OEM	Measures	Ref.	JAPANPARTS CODE	Description	OEM	Measures
1	RD-C03	Axial Joint	No OE Ref	th: MM16X1.5R L:200	6	BS-C04	TCA Right	96535082	c: 14.8
2	TI-C03	Tie Rod End Left	9374-0722	c:13.2 th:FM12X1.5R	7	BJ-C02	Ball Joint	96535089	c: 14.8
3	TI-C04	Tie Rod End Right	9374-0723	c:13.2 th:FM12X1.5R	8	RU-C05	Silentblock For Susp.Arm	Part of BS-C03/BS-C04	d: 28
4	SI-C06	Stabiliser Link	96391875	L: 260	9	RU-C06	Silentblock For Susp.Arm	Part of BS-C03/BS-C04	d: 60
5	BS-C03	TCA Left	96535081	c: 14.8					

# CHEVROLET LACETTI - NUBIRA

LACETTI - NUBIRA

03/2005 ->

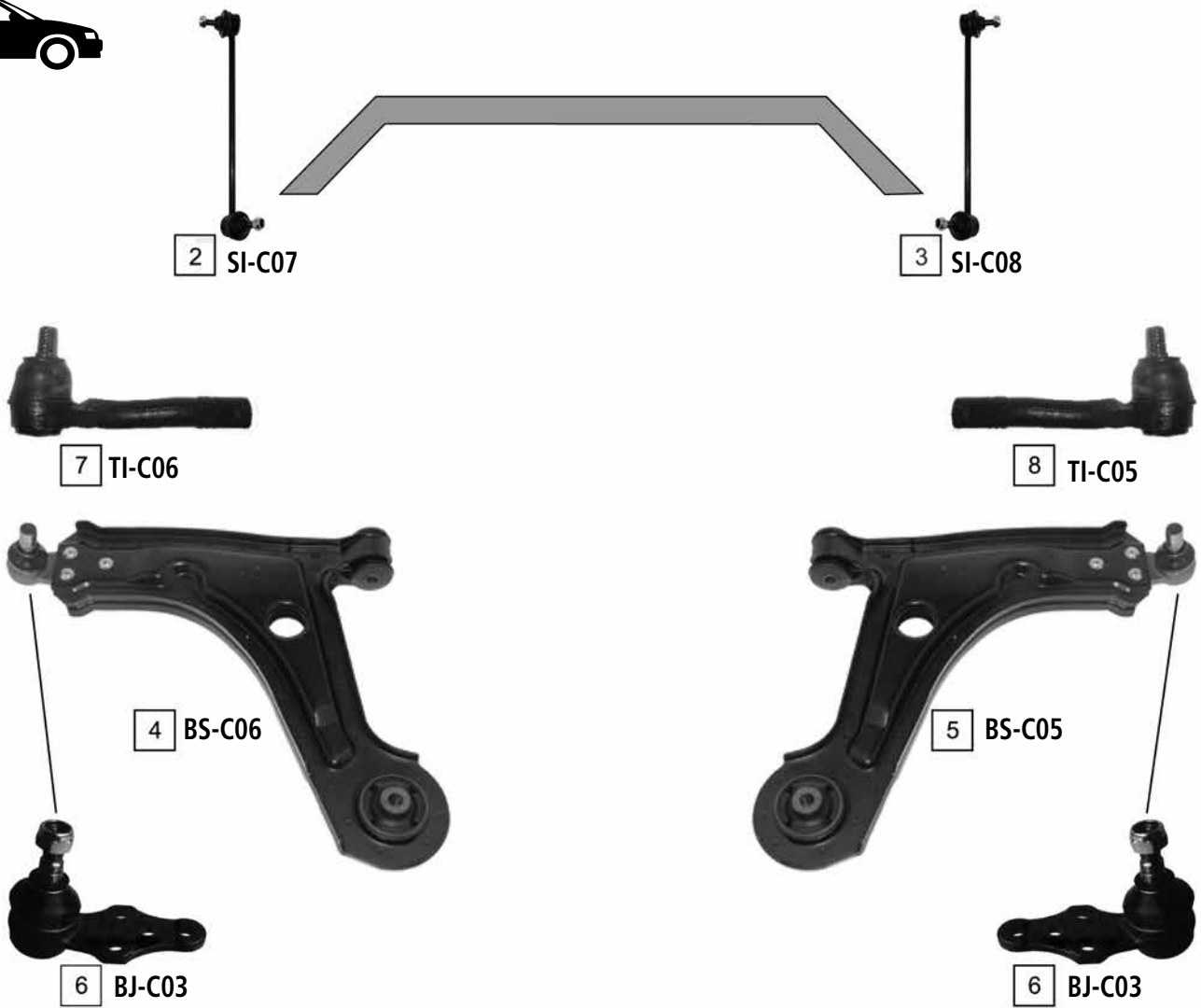

Ref.	JAPANPARTS CODE	Description	OEM	Measures	Ref.	JAPANPARTS CODE	Description	OEM	Measures
1	SI-C09	Stabiliser Link	96391876	L: 246	5	BS-C05	TCA Right	9639 1851	c: 18.2
2	SI-C07	Stabiliser Link	96403099	L: 271	6	BJ-C03	Ball Joint	9649 0218	c: 18
3	SI-C08	Stabiliser Link	96403100	L: 271	7	TI-C06	Tie Rod End Left	96407485	c:13.3 th:FM14X1.5R
4	BS-C06	TCA Left	9639 1850	c: 18.2	8	TI-C05	Tie Rod End Right	96407486	c:13.3 th:FM14X1.5R

MATIZ

03/2005 ->

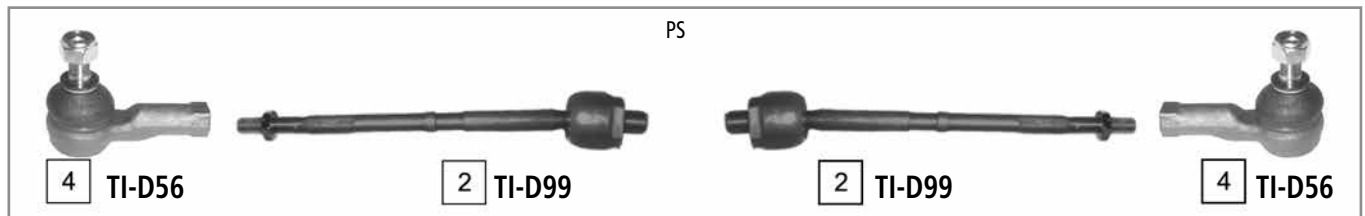
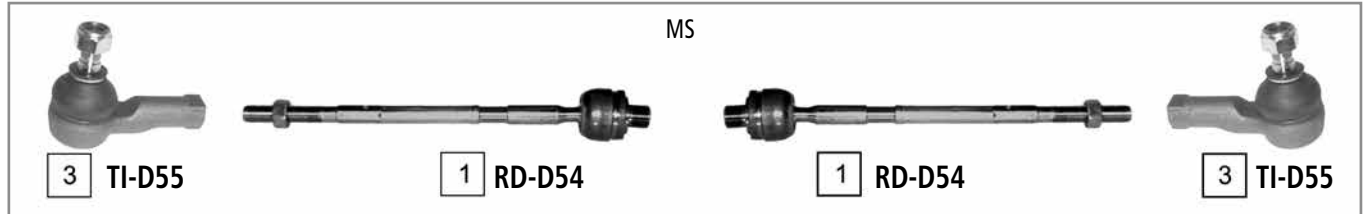

Ref.	JAPANPARTS CODE	Description	OEM	Measures	Ref.	JAPANPARTS CODE	Description	OEM	Measures
1	RD-D54	Axial Joint	9374 1074	th: MM16X1.5R L:250	4	TI-D56	Tie Rod End	KBJ 029	c: 12.5 th: FM12X1.5R
2	TI-D99	Axial Joint	9374 1092	th: MM16X1.5R L:251	5	CJ-803	TCA	9631-6765	c:15
3	TI-D55	Tie Rod End	48810-A78B00	c:12.5 th:FM12X1.5R	6	RU-C07	Silentblock For Susp.Arm	9638 0613	d: 27.5

SPARK (M300)

02/2010 ->

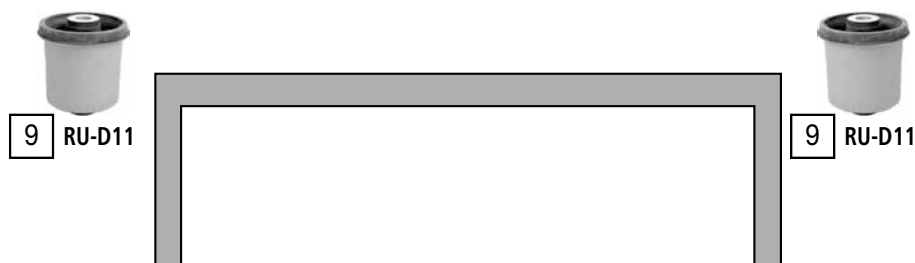
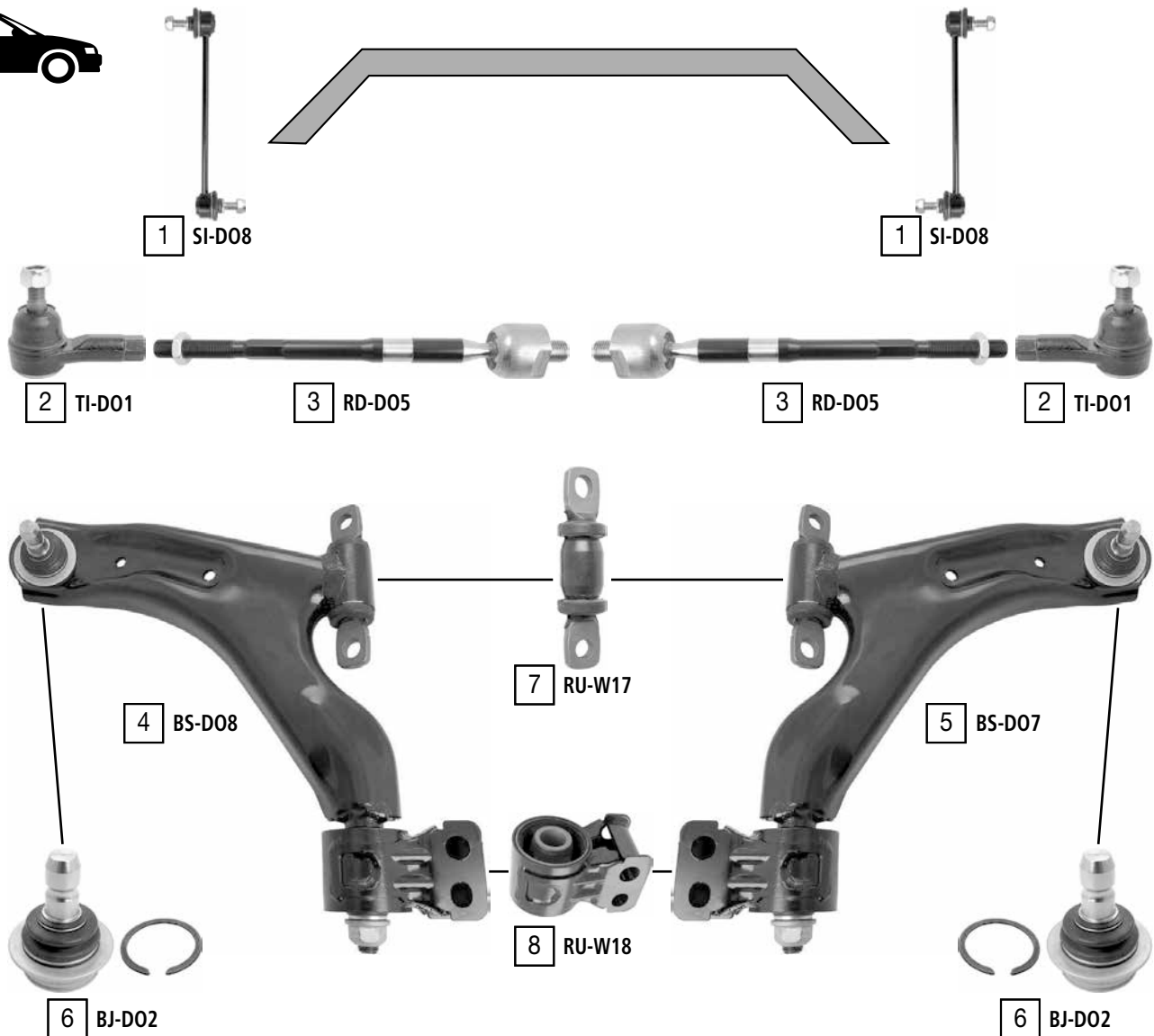

Ref.	JAPANPARTS CODE	Description	OEM	Measures	Ref.	JAPANPARTS CODE	Description	OEM	Measures
1	SI-D08	Stabiliser Link	95947829	L:235	6	BJ-D02	Ball Joint	Part of	c:16 do:42
2	TI-D01	Tie Rod End	95967285	c:13.25 th:FM12X1.25R	7	RU-W17	Silentblock For TCA	Part of	do:31
3	RD-D05	Axial Joint	95967294	th:M14X1.5R L:244	8	RU-W18	Silentblock For TCA	Part of	di:18.1 do:51
4	BS-D08	TCA left wbj	95952782	c:15.95	9	RU-D11	Mounting Axle Body	95020214	do:69.35
5	BS-D07	TCA right wbj		c:15.95					

TACUMA - REZZO

03/2005 ->

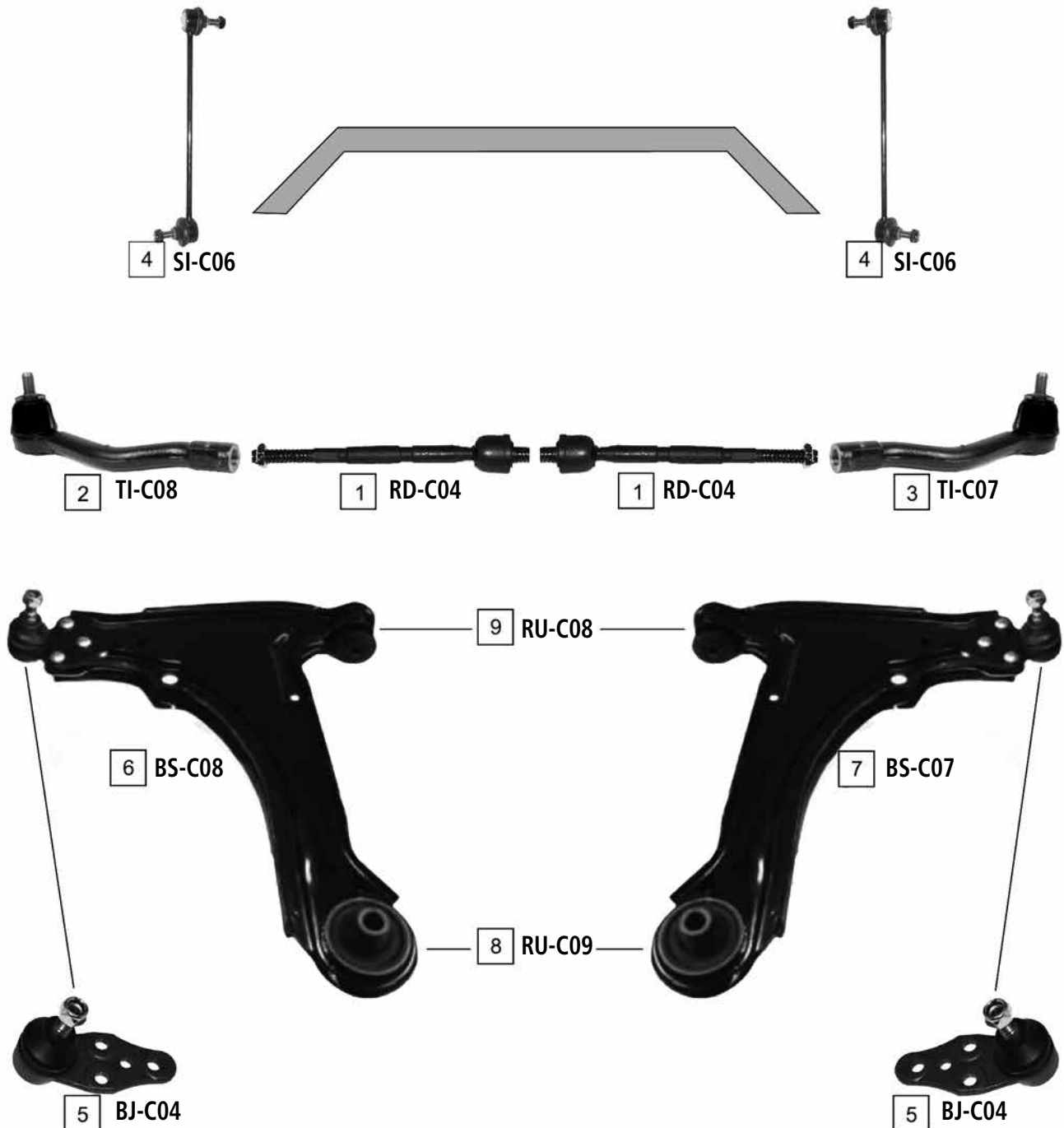

Ref.	JAPANPARTS CODE	Description	OEM	Measures	Ref.	JAPANPARTS CODE	Description	OEM	Measures
1	RD-C04	Axial Joint	521564	th: MM16X1.5R L:240	6	BS-C08	TCA Left	96378347	
2	TI-C08	Tie Rod End Left	96261378	c:13.2 th:FM14X1.5R	7	BS-C07	TCA Right	96378348	
3	TI-C07	Tie Rod End Right	96261379	c:13.2 th:FM14X1.5R	8	RU-C09	Silentblock For Susp.Arm	96261107	
4	SI-C06	Stabiliser Link	96391875	L: 260	9	RU-C08	Silentblock For Susp.Arm	96378346	
5	BJ-C04	Ball Joint	96261108	c: 16					



300 C / 300 C TOURING

09/2004 ->

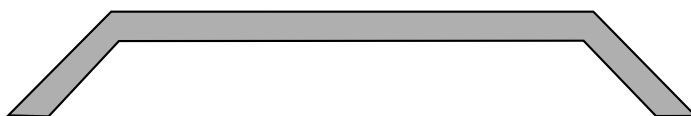

LOWER

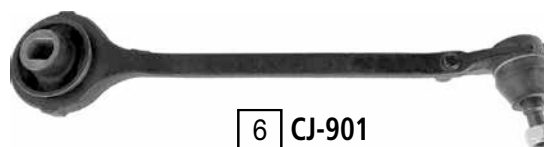
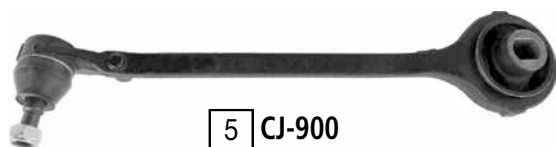

Ref.	JAPANPARTS CODE	Description	OEM	Measures	Ref.	JAPANPARTS CODE	Description	OEM	Measures
1	SI-914	stabiliser link left	4895 483AB	L:214	5	CJ-900	TCA left wbj	5180 607AB	c:16.85
2	SI-915	stabiliser link right	4895 482AB	L:214	6	CJ-901	TCA right wbj	5180 606AB	c:16.85
3	TI-916	tie rod end	52013 468AD	c:15 th:FM15x1.5R	7	CJ-902	TCA wobj	4782 561AE	c:14.3
4	RD-908	axial joint	68028 831AC	th:MM18x1.5 L:323	8	SI-917	stabiliser link rear axle	4766 866AA	L:260

PT CRUISER

06/2000 ->



1 TI-C09



1 TI-C09



2 BS-C10

4 BJ-C05



5 RU-C10



3 BS-C09

4 BJ-C05



6 RU-C11

Ref.	JAPANPARTS CODE	Description	OEM	Measures	Ref.	JAPANPARTS CODE	Description	OEM	Measures
1	TI-C09	Tie Rod End	4762861-AA	c:12.5 th:FM14X1.5R	4	BJ-C05	Ball joint	4656 010	c: 18
2	BS-C10	TCA Left Wbj	4656 731AH		5	RU-C10	Silentblock For Susp.Arm	Part of BS-C10/BS-C09	
3	BS-C09	TCA Right Wbj	4656 730AH		6	RU-C11	Silentblock For Susp.Arm	4656 012AC	

VOYAGER I (ES)

01/1984 - 01/1995



1 TI-C10



1 TI-C10



2 BS-C12

5 RU-C12



3 BS-C11

6 RU-C13



4 BJ-C06



4 BJ-C06

Ref.	JAPANPARTS CODE	Description	OEM	Measures	Ref.	JAPANPARTS CODE	Description	OEM	Measures
1	TI-C10	Tie Rod End	52744700	c:12.8 th:MM14X1.5R	4	BJ-C06	Ball Joint	4694 747	c: 18
2	BS-C12	TCA Left Wbj	4728885	c:18	5	RU-C12	Silentblock For Susp.Arm	272084	d: 39
3	BS-C11	TCA Right Wbj	4728884	c:18	6	RU-C13	Silentblock For Susp.Arm	5272098	d: 58

VOYAGER II (GS)

01/1995 - 03/2001

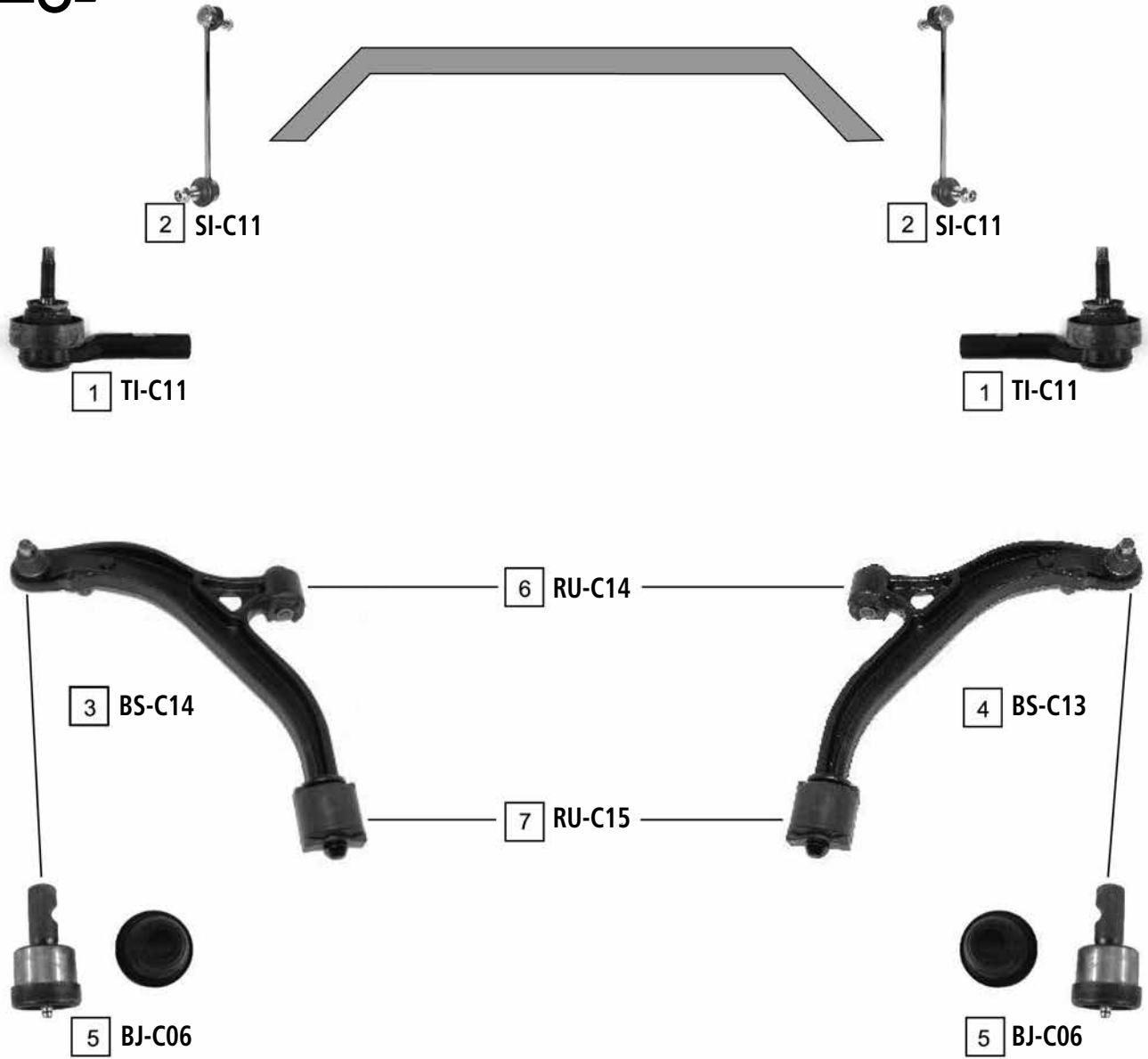

Ref.	JAPANPARTS CODE	Description	OEM	Measures	Ref.	JAPANPARTS CODE	Description	OEM	Measures
1	TI-C11	Tie Rod End	4797706	c: 12.5 th: FM14X1.5R	5	BJ-C06	Ball Joint	4694 747	c: 18
2	SI-C11	Stabiliser Link	4743 669AA	L: 310	6	RU-C14	Silentblock For Susp.Arm	Part of BS-C14/BS-C13	d: 39.3
3	BS-C14	TCA Left	4694761-C	c: 18	7	RU-C15	Silentblock For Susp.Arm	Part of BS-C14/BS-C13	d: 18.2
4	BS-C13	TCA Right	4694760-C	c: 18					

VOYAGER III (RG)

02/2000->

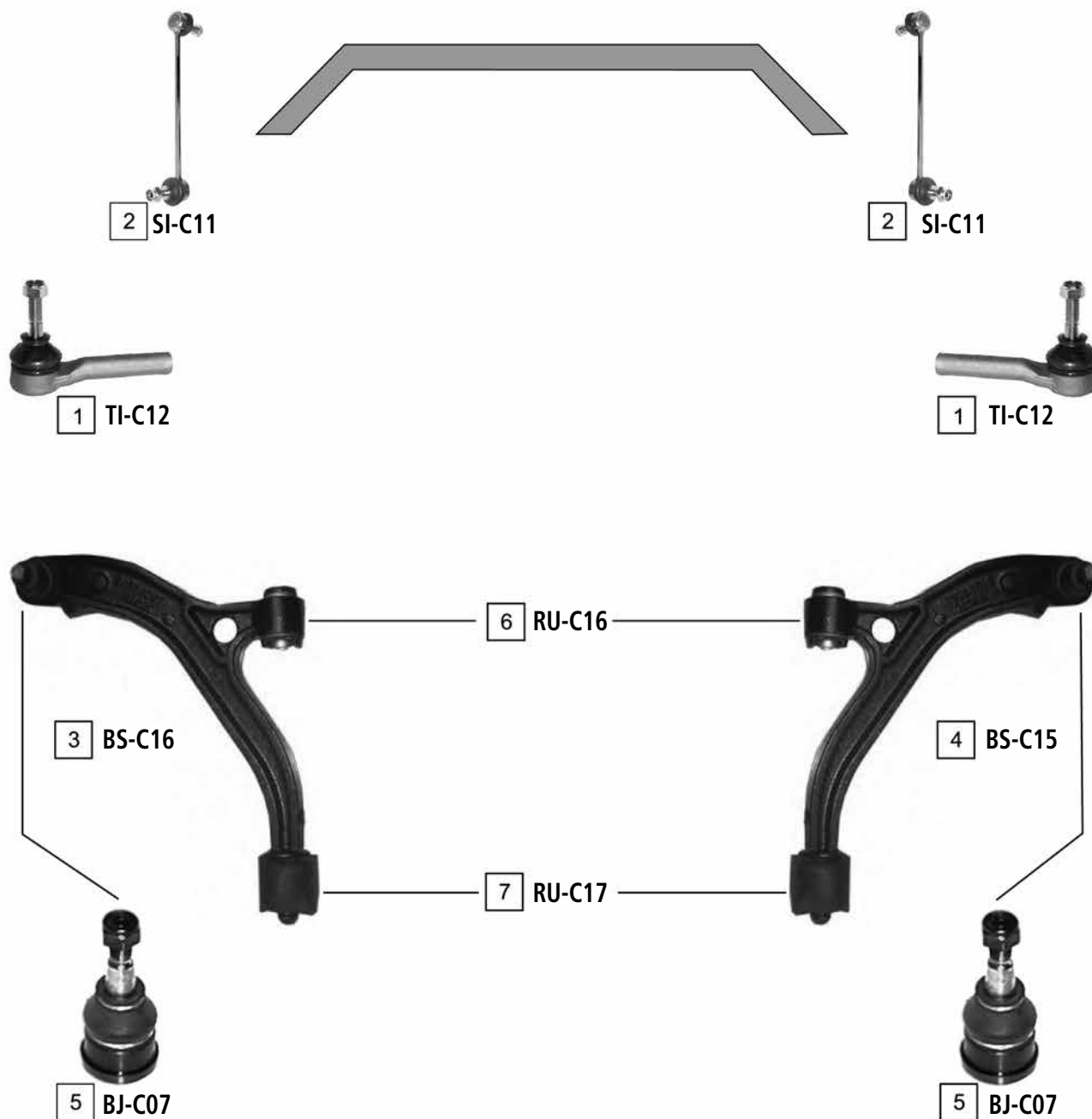

Ref.	JAPANPARTS CODE	Description	OEM	Measures	Ref.	JAPANPARTS CODE	Description	OEM	Measures
1	TI-C12	Tie Rod End	5066 373AA	c: 12.5 th: FM14X1.5R	5	BJ-C07	Ball Joint	Part of BS-C16/BS-C15	c: 13.5
2	SI-C11	Stabiliser Link	4743 669AA	L: 310	6	RU-C16	Silentblock For Susp.Arm	Part of BS-C16/BS-C15	
3	BS-C16	TCA Left	4766543-AA	c: 13.5	7	RU-C17	Silentblock For Susp.Arm	4743095-AA	
4	BS-C15	TCA Right	4766542-AA	c: 15.3					

GRAND VOYAGER IV (RT)

10/2007 ->

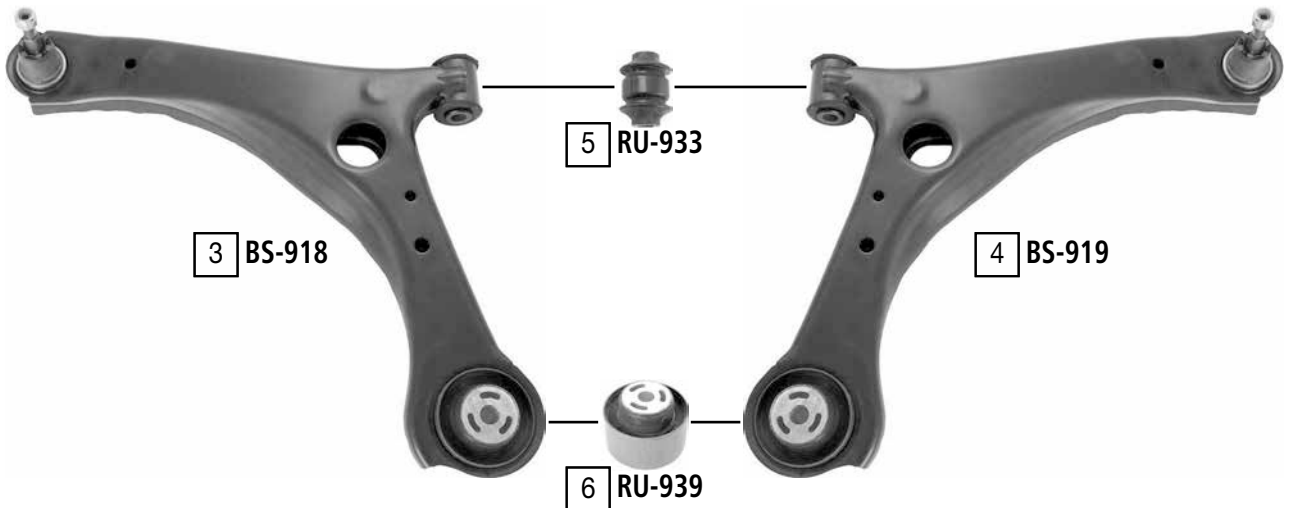
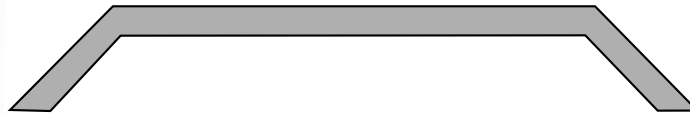
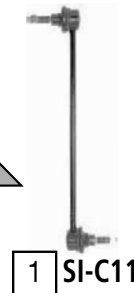

Ref.	JAPANPARTS CODE	Description	OEM	Measures	Ref.	JAPANPARTS CODE	Description	OEM	Measures
1	SI-C11	stabiliser link	4743 669AB	L:310	4	BS-919	TCA right wbj	4766 910AG	c:14.8
2	TI-919	tie rod end	68033 171AB	c:12.55 th:FM14x1.5	5	RU-933	silentblock forTCA	5273 731AB	di:14.4 do:39.90
3	BS-918	TCA left wbj	4766 911AG	c:14.8	6	RU-939	silentblock forTCA	part of	di:14.3 do:66.3

DUSTER

04/2010 ->

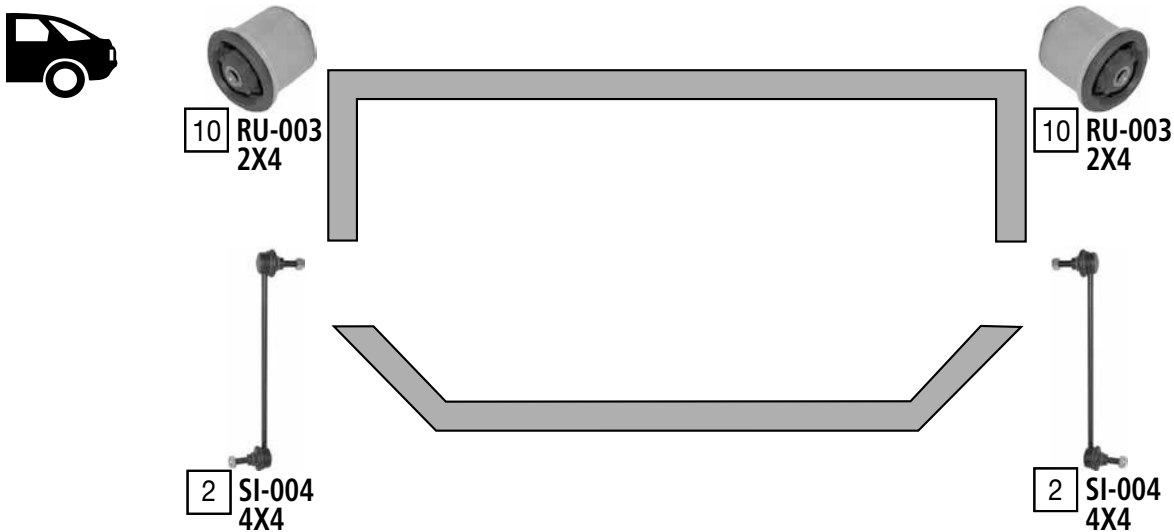
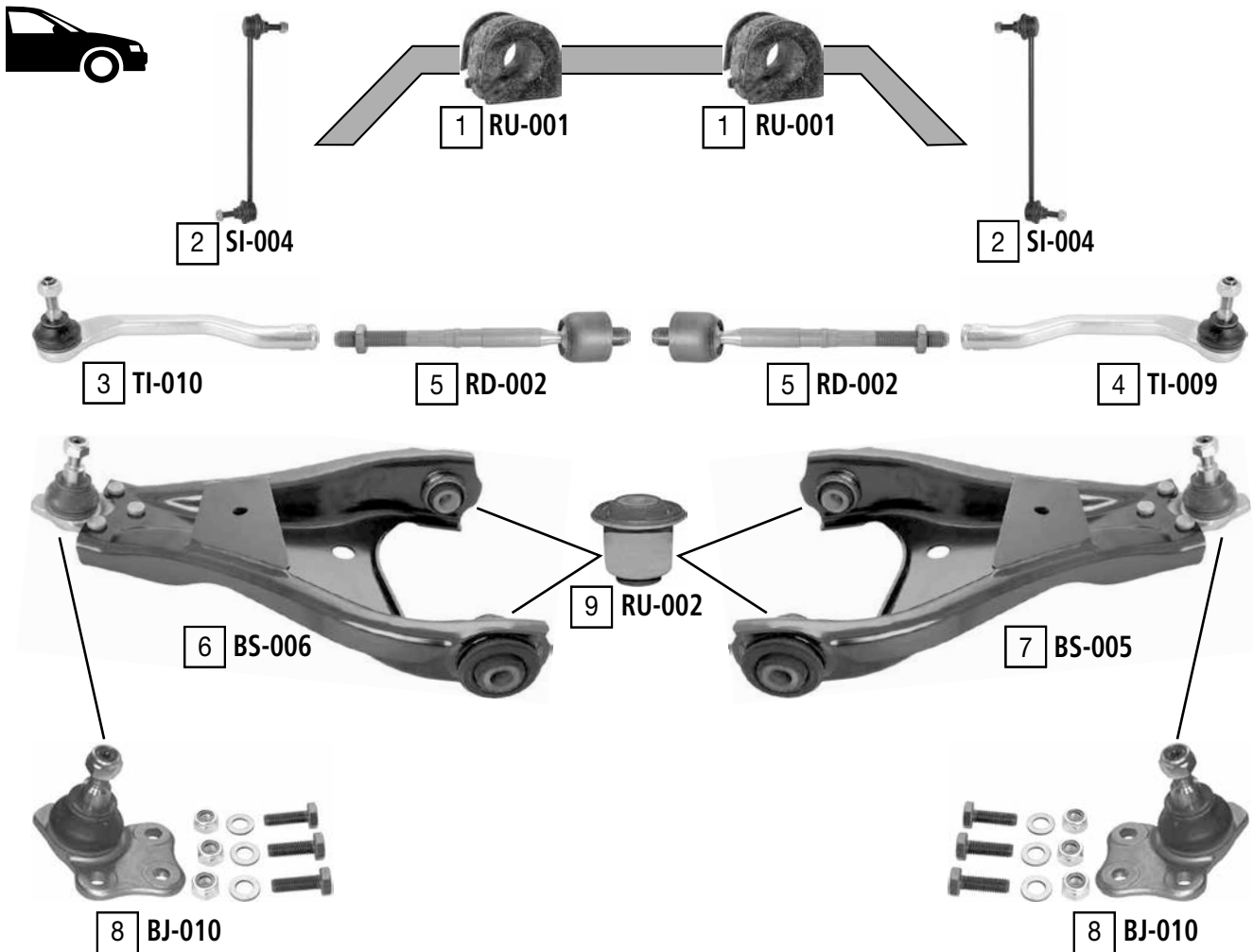

Ref.	JAPANPARTS CODE	Description	OEM	Measures	Ref.	JAPANPARTS CODE	Description	OEM	Measures
1	RU-001	Stabiliser Mounting	82 00 852 550	di:18.5	6	BS-006	TCA Left Wbj	54 50 167 46R	c:17.2
2	SI-004	Stabiliser Link	82 00 814 411	L:295	7	BS-005	TCA Right Wbj	54 50 065 42R	c:17.2
3	TI-010	Tie Rod End Left	82 01 108 339	c:12 th:FM14x1.5R	8	BJ-010	Ball Joint	40 16 023 08R	c:17.1
4	TI-009	Tie Rod End Right	82 01 108 332	c:12 th:FM14x1.5R	9	RU-002	Silentblock For TCA	Part of	di:14.1 do:37.2
5	RD-002	Axial Joint	82 01 108 350	th:MM16x1.5R L:204	10	RU-003	Mounting Axle Body	60 01 549 989	do:66.5

LOGAN  
 LOGAN MCV  
 LOGAN PICK-UP  
 LOGAN VAN (EXPRESS)

09/2004 ->  
 04/2007 ->  
 03/2008 ->  
 03/2009 ->

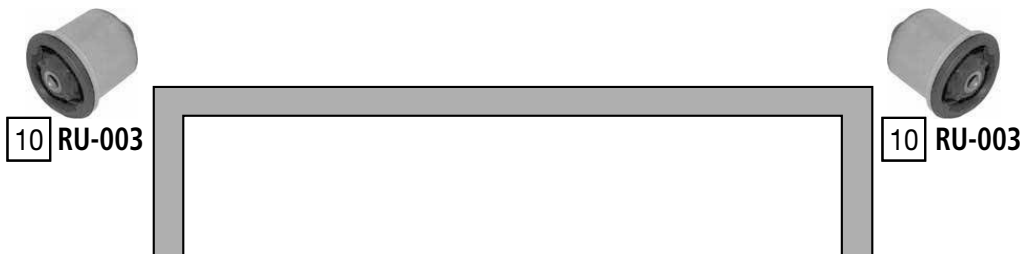
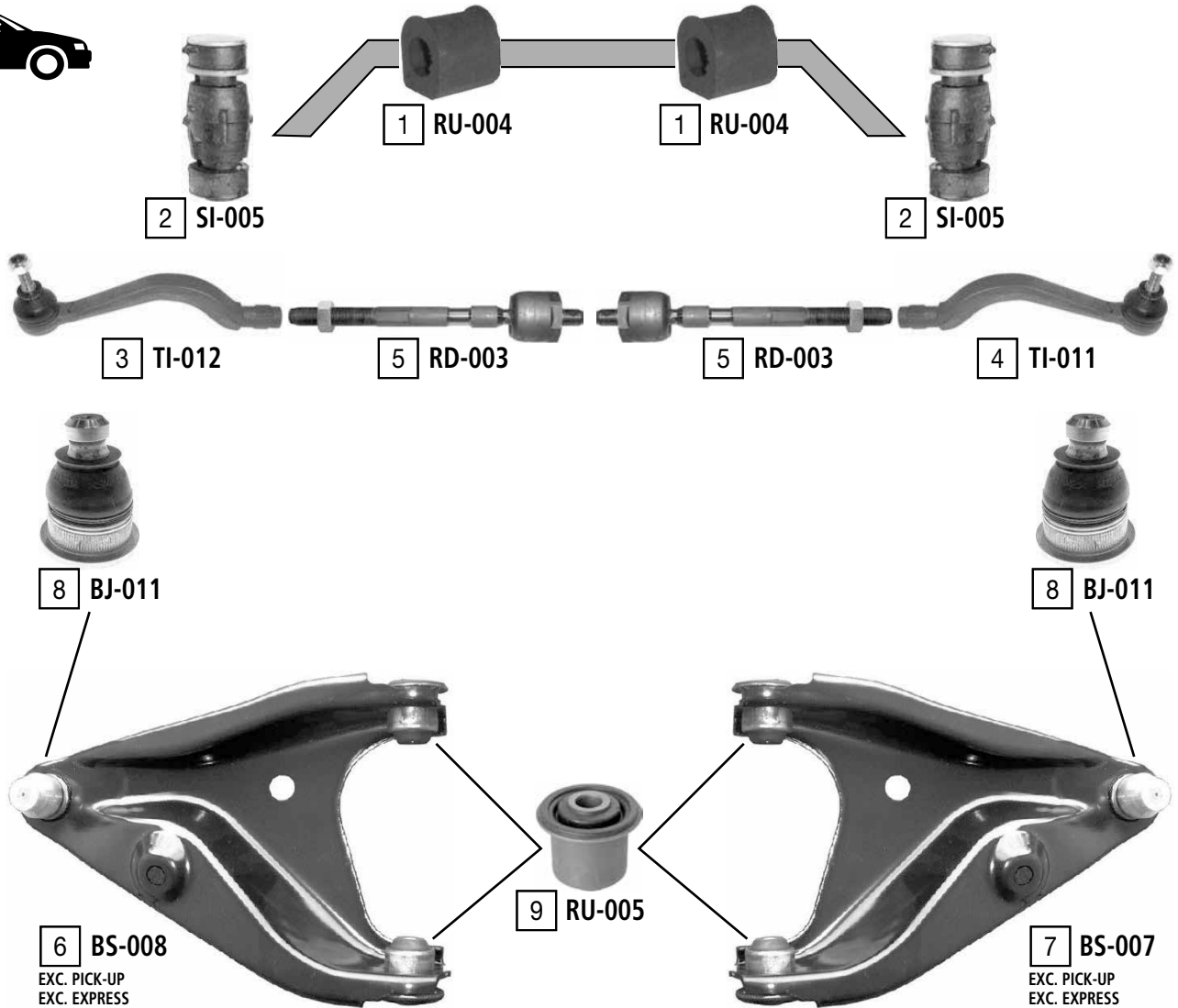

Ref.	JAPANPARTS CODE	Description	OEM	Measures	Ref.	JAPANPARTS CODE	Description	OEM	Measures
1	RU-004	Stabiliser Mounting	60 01 547 140	di:23.5	6	BS-008	TCA left wbj	60 01 547 520	c:18
2	SI-005	Stabiliser Mounting	60 01 547 138	-	7	BS-007	TCA right wbj	60 01 547 519	c:18
3	TI-012	Tie Rod End Left	60 01 547 610	c:12.1 th:FM14X1.5R	8	BJ-011	Ball joint	Part of	c:18 do:38.3
4	TI-011	Tie Rod End Right	60 01 547 611	c:12.1 th:FM14X1.5R	9	RU-005	Silentblock for TCA	Part of	di:12.2 do:37.2
5	RD-003	Axial Joint	60 01 550 441	th:MM12x1R L:193	10	RU-003	Mounting axle body	60 01 549 989	do:66.5



SANDERO

06/2008 ->

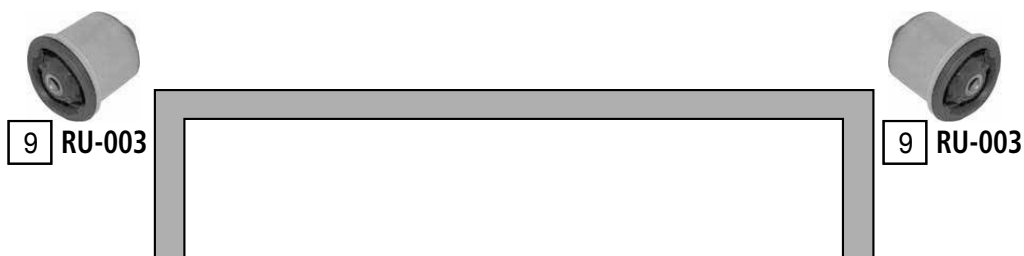
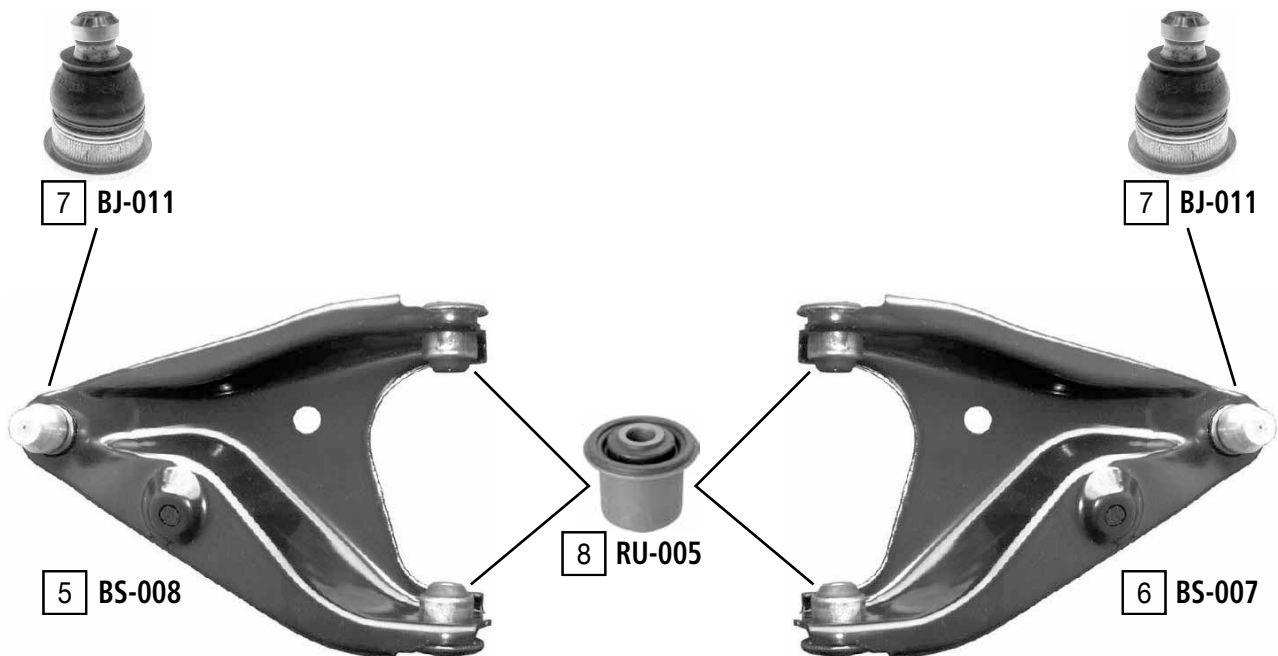

Ref.	JAPANPARTS CODE	Description	OEM	Measures	Ref.	JAPANPARTS CODE	Description	OEM	Measures
1	SI-005	Stabiliser Mounting	60 01 547 138	-	6	BS-007	TCA right wbj	60 01 547 519	c:18
2	TI-012	Tie Rod End Left	60 01 547 610	c:12.1 th:FM14X1.5R	7	BJ-011	ball joint	Part of	c:18 do:38.3
3	TI-011	Tie Rod End Right	60 01 547 611	c:12.1 th:FM14X1.5R	8	RU-005	silentblock for TCA	Part of	di:12.2 do:37.2
4	RD-003	Axial Joint	60 01 550 441	th:MM12x1R L:193	9	RU-003	mounting axle body	60 01 549 989	do:66.5
5	BS-008	TCA left wbj	60 01 547 520	c:18					

SOLENZA (B41\_)

02/2003 - 03/2005

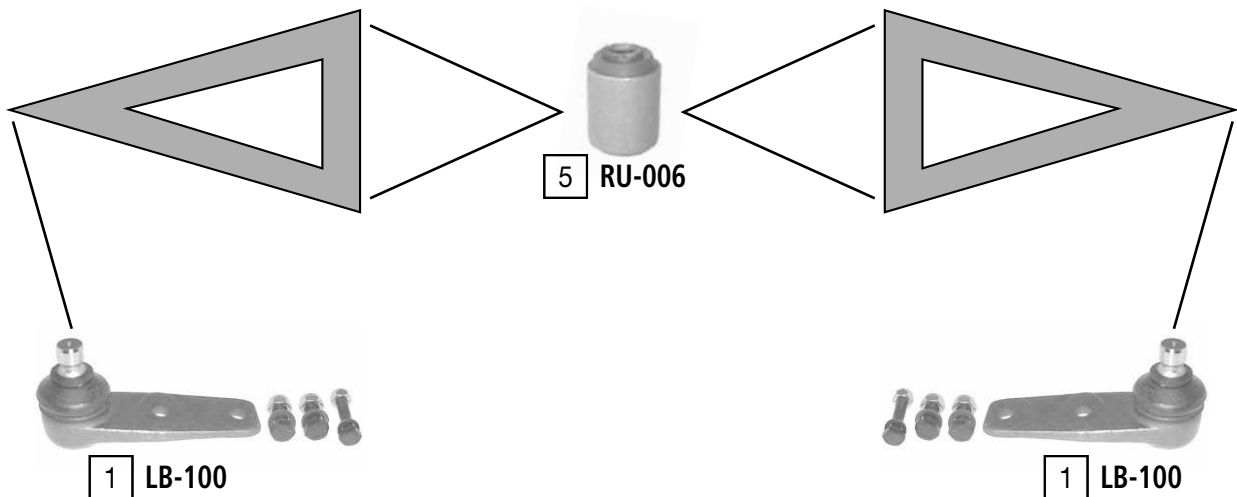
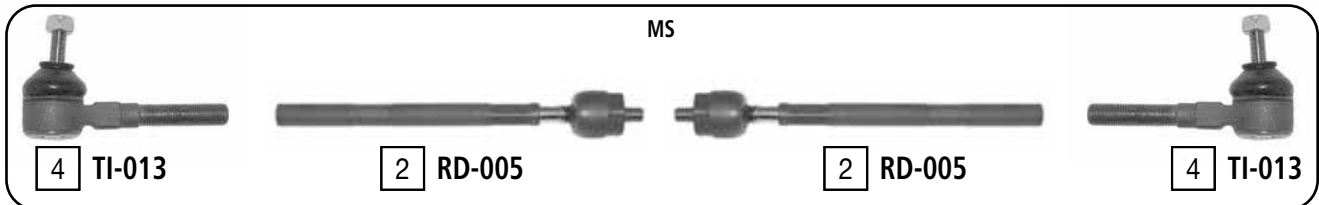
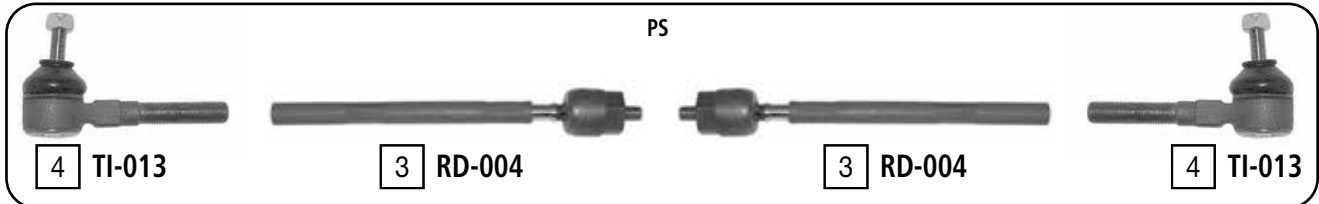

Ref.	JAPANPARTS CODE	Description	OEM	Measures	Ref.	JAPANPARTS CODE	Description	OEM	Measures
1	LB-100	Ball Joint Lower	77 01 472 038	c:16	4	TI-013	Tie Rod End	60 01 546 523	c:11.9 th:MM14X1.5R
2	RD-005	Axial Joint	60 01 542 724	th:MM12X1R L:276	5	RU-006	Silentblock For TCA	77 04 000 681	di:12.3 do:32.1
3	RD-004	Axial Joint	60 01 546 524	th:MM12X1R L:285					

KALOS (KLAS)

09/2002->

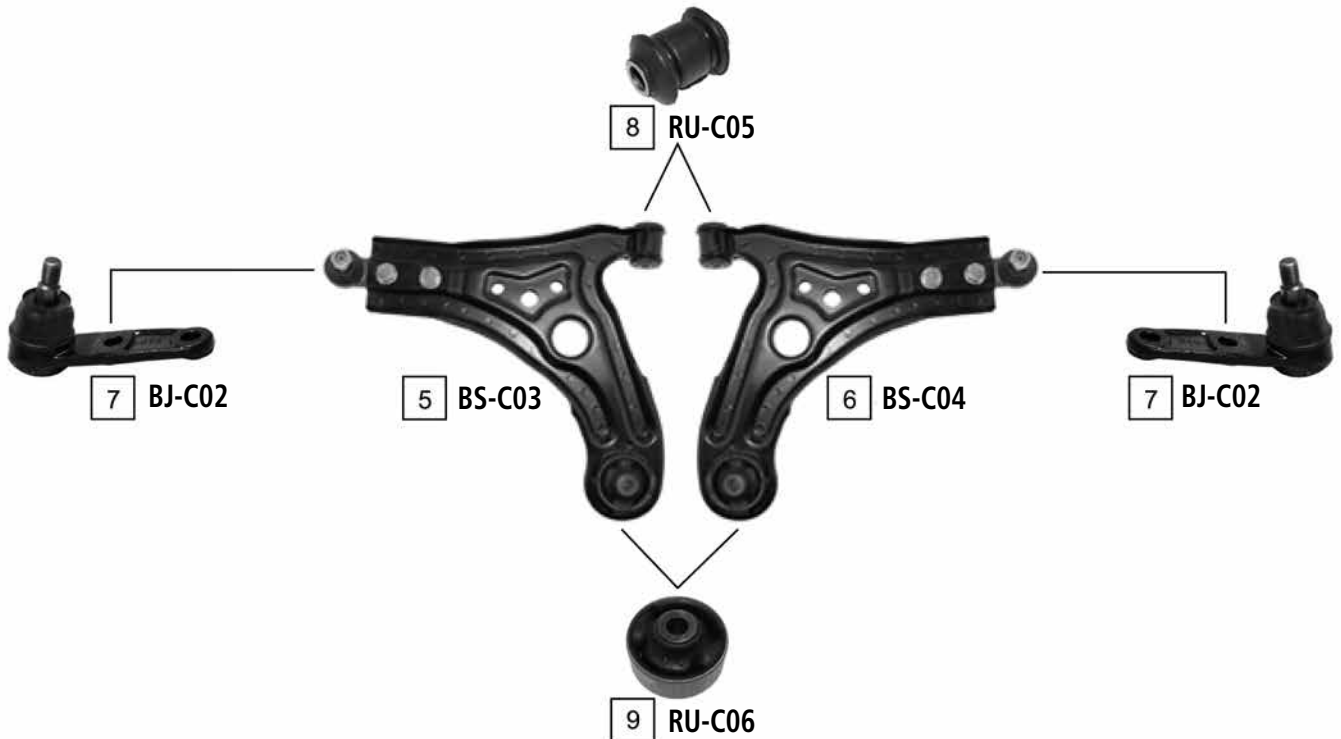

Ref.	JAPANPARTS CODE	Description	OEM	Measures	Ref.	JAPANPARTS CODE	Description	OEM	Measures
1	RD-C03	Axial Joint	-	th: MM16X1.5R L:200	6	BS-C04	TCA Right	96535082	c: 14.8
2	TI-C03	Tie Rod End Left	9374-0722	c:13.2 th:FM14X1.5R	7	BJ-C02	Ball Joint	96535089	c: 14.8
3	TI-C04	Tie Rod End Right	9374-0723	c:13.2 th:FM14X1.5R	8	RU-C05	Silentblock For Susp.Arm	Part of BS-C03/BS-C04	d: 28
4	SI-C06	Stabiliser Link	96391875	L: 260	9	RU-C06	Silentblock For Susp.Arm	Part of BS-C03/BS-C04	d: 60
5	BS-C03	TCA Left	96535081	c: 14.8					

KORANDO (KJ)

01/1999->

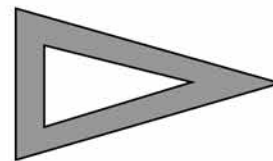
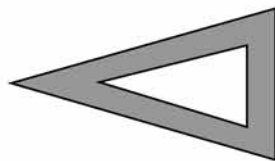
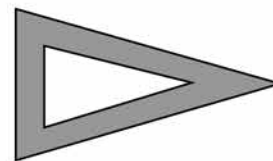
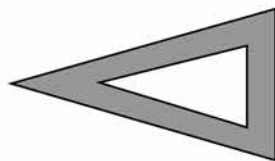

Ref.	JAPANPARTS CODE	Description	OEM	Measures	Ref.	JAPANPARTS CODE	Description	OEM	Measures
1	TI-S01	Tie Rod End	4666005501	c:16 th:FM14X1.5R	4	BJ-S02	Ball Joint	4450505001	c:17.6
2	SI-S01	Stabiliser Link	4475005001		5	RD-S02	Axial Joint	Part of	
3	BJ-S01	Ball Joint	4443003011	c:17.6					

# DAEWOO LANOS-ESPERO-NEXIA

LANOS  
ARANOS  
EXPERO (KLEJ)  
NEXIA-RACER-CIELO (KLETN)

05/1997->  
01/1991-01/1995  
10/1991-09/1999  
02/1995-08/1997

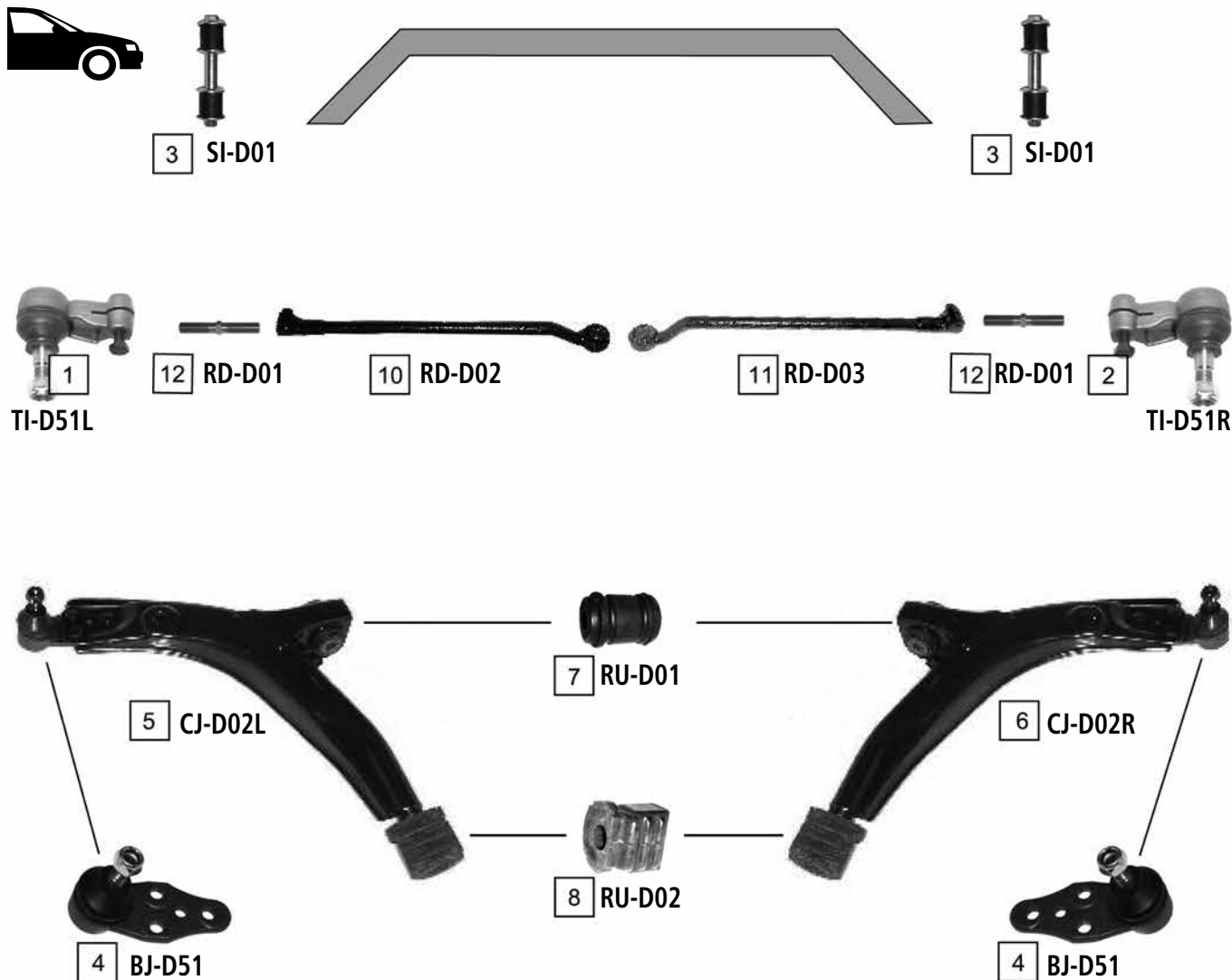

Ref.	JAPANPARTS CODE	Description	OEM	Measures	Ref.	JAPANPARTS CODE	Description	OEM	Measures
1	TI-D51L	Tie Rod End Left	324.039	c:13 th:FM16X1.5R	7	RU-D01	Silentblock For Susp.Arm	352349	d: 39.6
2	TI-D51R	Tie Rod End Right	324.038	c:13 th:FM16X1.5L	8	RU-D02	Silentblock For Susp.Arm	352335	d: 55.4
3	SI-D01	Stabiliser Link	1603.148	L:190	9	RU-D03	Silentblock For Susp.Arm	4 02 645	d: 59.1
4	BJ-D51	Ball Joint Lower	1.603.120	c: 13.4	10	RD-D02	Axial Joint	078 48 281	
5	CJ-D02L	TCA Left	352.123	c: 13.4	11	RD-D03	Axial Joint	078 48 282	
6	CJ-D02R	TCA Right	352.124	c: 13.4	12	RD-D01	Adjusting Bolt	322575	-

LEGANZA (KLAV)

06/1997-12/2002

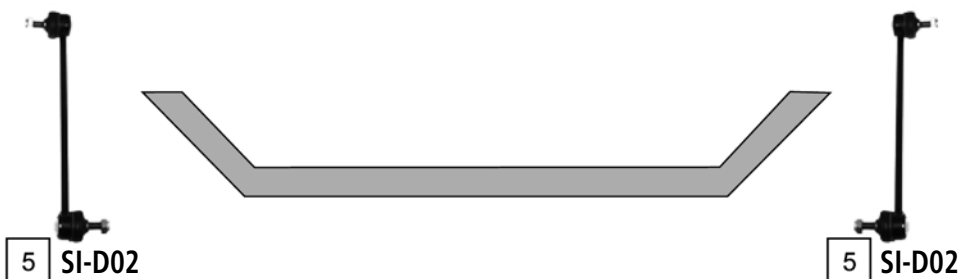
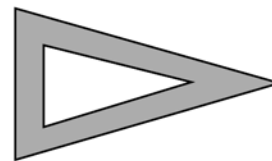
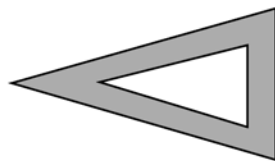
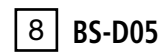
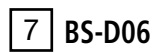
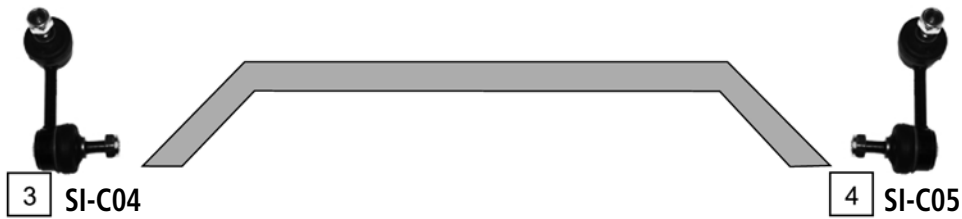

Ref.	JAPANPARTS CODE	Description	OEM	Measures	Ref.	JAPANPARTS CODE	Description	OEM	Measures
1	RD-D53	Axial Joint	520898	th:MM16X1.5R L:360	5	SI-D02	Stabiliser Link	96207628	L:267
2	TI-D60	Tie Rod End	9620 5809	c:13.2 th:FM14X1.5R	6	BJ-D55	Ball Joint	9621 3119	c: 18
3	SI-C04	Stabiliser Link Left	96225859	L:79	7	BS-D06	TCA Left	96213117	
4	SI-C05	Stabiliser Link Right	96225858	L:79	8	BS-D05	TCA Right	96213118	

MATIZ (KLYA)

09/1998->



MS



3 TI-D55



1 RD-D54



1 RD-D54



3 TI-D55

PS



4 TI-D56



2 TI-D99



2 TI-D99



4 TI-D56



5 CJ-803



6 RU-C07



5 CJ-803

Ref.	JAPANPARTS CODE	Description	OEM	Measures	Ref.	JAPANPARTS CODE	Description	OEM	Measures
1	RD-D54	Axial Joint	9374 1074	th:MM16X1.5R L:250	4	TI-D56	Tie Rod End	KBJ 029	c:12.5 th:FM12X1.5R
2	TI-D99	Axial Joint	9374 1092	th:MM16X1.5R L:251	5	CJ-803	TCA	9631-6765	c: 15
3	TI-D55	Tie Rod End	48810-A78B00	c:12.5 th:FM12X1.5R	6	RU-C07	Silentblock For Susp.Arm	9638 0613	d: 27.5

MUSSO (FJ)

01/1999->

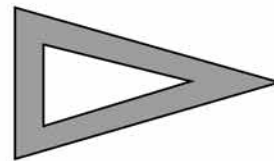
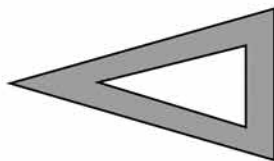
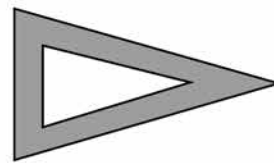
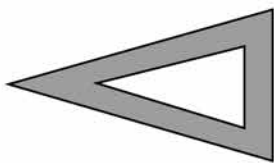

Ref.	JAPANPARTS CODE	Description	OEM	Measures	Ref.	JAPANPARTS CODE	Description	OEM	Measures
1	TI-S01	Tie Rod End	4666005501	c:16 th:FM14X1.5R	4	BJ-S02	Ball Joint	4450505001	c:17.6
2	SI-S01	Stabiliser Link	4475005001		5	RD-S02	Axial Joint	Part of	
3	BJ-S01	Ball Joint	4443003011	c:17.6					



NUBIRA (KLAJ)

05/1997-07/2003

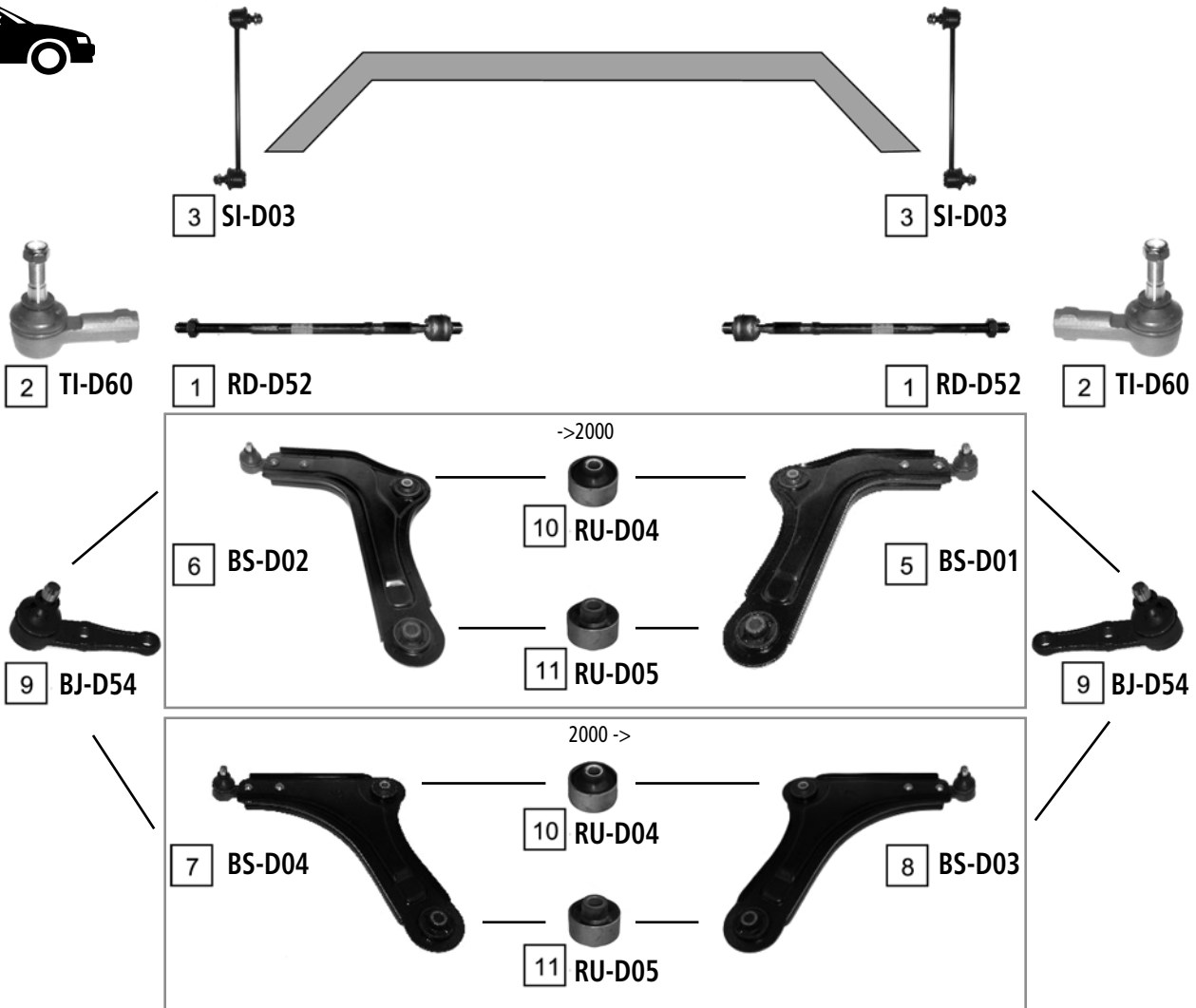

Ref.	JAPANPARTS CODE	Description	OEM	Measures	Ref.	JAPANPARTS CODE	Description	OEM	Measures
1	RD-D52	Axial Joint	520672	th:MM16X1.5 L:345	7	BS-D04	TCA Left	96 268 454	
2	TI-D60	Tie Rod End	96205809	c:13.2 th:FM14x1.5R	8	BS-D03	TCA Right	96 268 455	
3	SI-D03	Stabilisatorstang	96300627	L:268	9	BJ-D54	Ball Joint	9630 0648	c:16
4	SI-D04	Stabiliser link	9630 0222	L:247	10	RU-D04	Silentblock For Susp.Arm	Part of BS-D02/BS-D01/BS-D04/BS-D03	d:49.3
5	BS-D01	TCA Right	96 268 440	c:16	11	RU-D05	Silentblock For Susp.Arm	Part of BS-D02/BS-D01/BS-D04/BS-D03	d:52.5
6	BS-D02	TCA Left	96 268 439	c:16					

REZZO (KLAU) - TACUMA

09/2000->

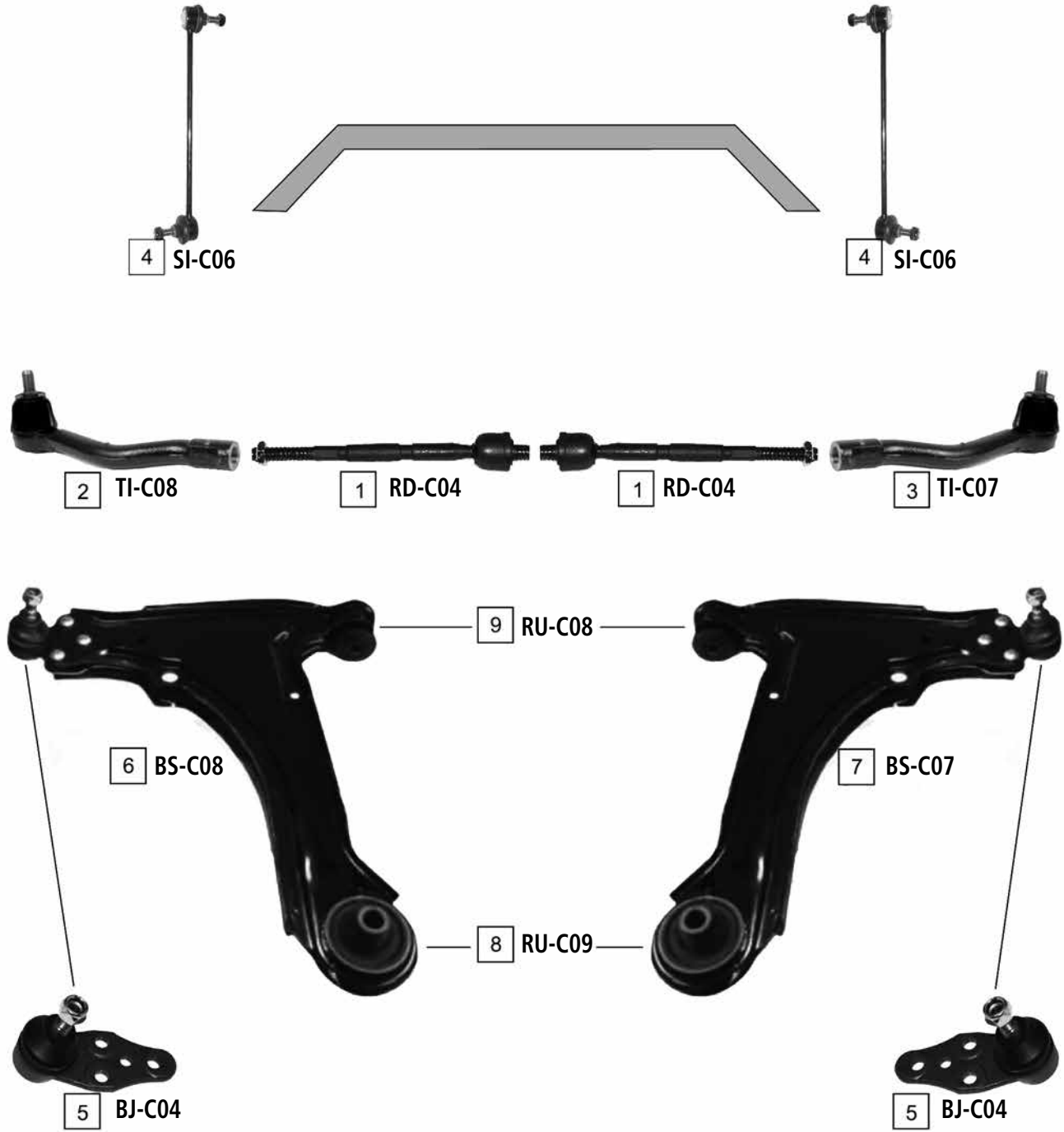

Ref.	JAPANPARTS CODE	Description	OEM	Measures	Ref.	JAPANPARTS CODE	Description	OEM	Measures
1	RD-C04	Axial Joint	521564	th: MM16X1.5R L:240	6	BS-C08	TCA Left	96378347	
2	TI-C08	Tie Rod End Left	96261378	c:13.2 th:FM14X1.5R	7	BS-C07	TCA Right	96378348	
3	TI-C07	Tie Rod End Right	96261379	c:13.2 th:FM14X1.5R	8	RU-C09	Silentblock For Susp.Arm	96261107	
4	SI-C06	Stabiliser Link	96391875	L: 260	9	RU-C08	Silentblock For Susp.Arm	96378346	
5	BJ-C04	Ball Joint	96261108	c: 16					

TICO (KLY3)

02/1995-12/2000



1 TI-D55



3 RD-D51



3 RD-D51



1 TI-D55



2 CJ-803



4 RU-C07



2 CJ-803

Ref.	JAPANPARTS CODE	Description	OEM	Measures	Ref.	JAPANPARTS CODE	Description	OEM	Measures
1	TI-D55	Tie Rod End	9612-9753	c:12.6 th:FM12X1.5R	3	RD-D51	Axial Joint	48830 A78B00-000	th:FM14X1.5R L:228
2	CJ-803	TCA	96316765	c: 15	4	RU-C07	Silentblock For Susp.Arm	96380613	D: 27.5

APPLAUSE I - II (A101, A111)

06/1989-07/1997

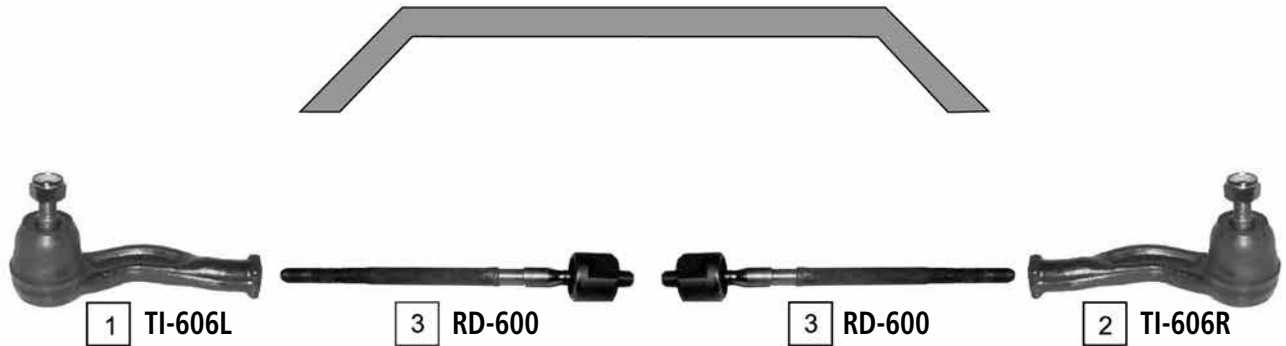

Ref.	JAPANPARTS CODE	Description	OEM	Measures	Ref.	JAPANPARTS CODE	Description	OEM	Measures
1	TI-606L	Tie Rod End Left	4504787781	c:12 th:FM12X1.25R	3	RD-600	Axial Joint	45503 87102	th:MM12X1.25R L:252
2	TI-606R	Tie Rod End Right	45046-87781	c:12 th:FM12X1.25R					

CHARADE II (G11, G30)

01/1983-12/1986



2 TI-609L

5 RD-603

5 RD-603



3 TI-609R



1 LB-609  
EXC G11

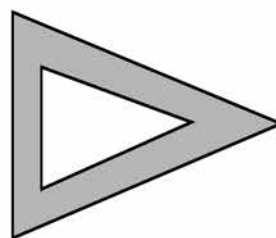
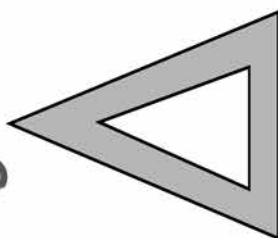

1 LB-609  
EXC G11



4 CJ-605R  
EXC G30



4 CJ-605R  
EXC G30

Ref.	JAPANPARTS CODE	Description	OEM	Measures	Ref.	JAPANPARTS CODE	Description	OEM	Measures
1	LB-609	Ball Joint Lower	43308-12030	c:14.5	4	CJ-605R	TCA Upper	48068-87705	c:15
2	TI-609L	Tie Rod End Left	45047-87780	c:12 th:FM12X1.25R	5	RD-603			
3	TI-609R	Tie Rod End Right	45046-87282	c:12 th:FM12X1.25R					

CHARADE III (G100, G101, G102)

01/1987 - 01/1993



MS 01/1989->



PS 01/1990->



1 CJ-698



2 CJ-699

Ref.	JAPANPARTS CODE	Description	OEM	Measures	Ref.	JAPANPARTS CODE	Description	OEM	Measures
1	CJ-698	TCA Left	48069-87706	c:16	4	RD-606	Axial Joint	45503-87706	th:MM12X1.25R L:230
2	CJ-699	TCA Right	48068-87706	c:16	5	TI-606L	Tie Rod End Left	4504787781	c:12 th:FM12X1.25R
3	RD-605	Axial Joint	45503-87708	th:MM11X1.5R L:240	6	TI-606R	Tie Rod End Right	45046-87781	c:12 th:FM12X1.25R

CHARADE IV (G200, G202, G203)

01/1993-12/1996

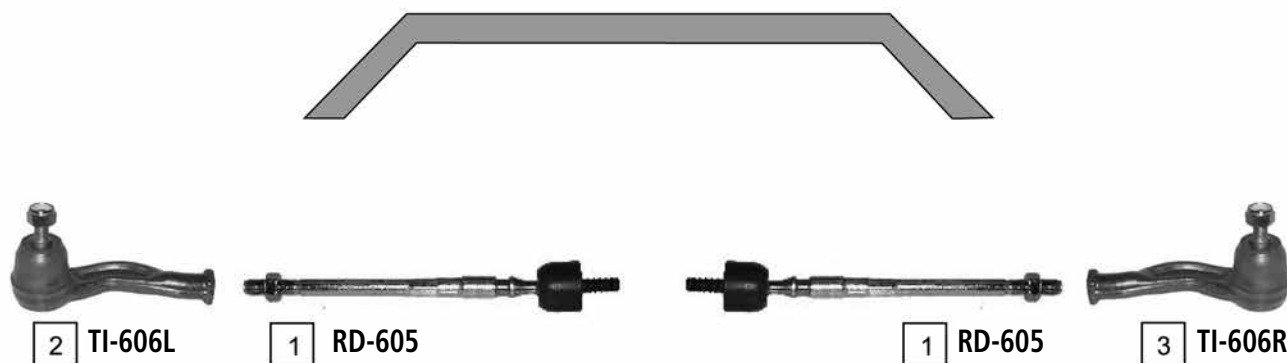

Ref.	JAPANPARTS CODE	Description	OEM	Measures	Ref.	JAPANPARTS CODE	Description	OEM	Measures
1	RD-605	Axial Joint	45503-87708	th:MM11X1.5R L:240	3	TI-606R	Tie Rod End Right	45046-87781	c:12 th:FM12X1.25R
2	TI-606L	Tie Rod End Left	4504787781	c:12 th:FM12X1.25R					

CHARMANT (A)

11/1981 - 01/1989



A10, A20, A30, A40, A45



1 TI-604



1 TI-604

A35, A55, A60



3 SO-622



4 RD-201



4 RD-201



3 SO-622



2 LB-609

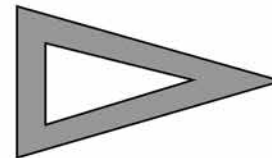
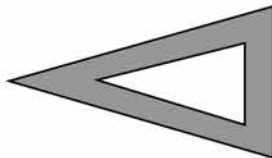

2 LB-609

Ref.	JAPANPARTS CODE	Description	OEM	Measures	Ref.	JAPANPARTS CODE	Description	OEM	Measures
1	TI-604	Tie Rod End	45046 19065	c:12.9 th:MM14X1.5L	3	SO-622	Tie Rod	45460-19125	-
2	LB-609	Ball Joint Lower	43308-12030	c:14.5	4	RD-201	Axial Joint	45503-10020	th:MM14X1.5R L:146



CUORE II (L80, L81)  
CUORE III (L201)  
CUORE IV (L501)

09/1985-12/1990  
08/1990-12/1994  
01/1995-11/1996

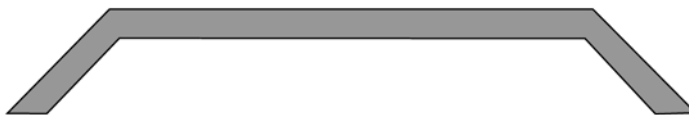

1 TI-609L



2 TI-609R



3 BJ-600

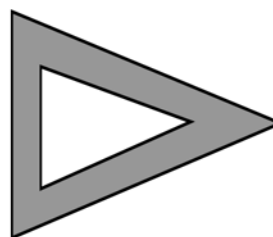
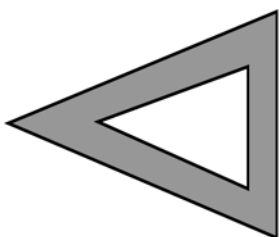

3 BJ-600

Ref.	JAPANPARTS CODE	Description	OEM	Measures	Ref.	JAPANPARTS CODE	Description	OEM	Measures
1	TI-609L	Tie Rod End Left	45047-87780	c:12 th:FM12X1.25R	3	BJ-600	Ball Joint	48068 87206	
2	TI-609R	Tie Rod End Right	45046-87282	c:12 th:FM12X1.25R					

CUORE V (L5)

10/1996 - 10/1998



MS



3 TI-609L



6 RD-607



6 RD-607



4 TI-609R

PS



3 TI-609L



5 RD-608



5 RD-608



4 TI-609R



1 CJ-602



2 CJ-601

Ref.	JAPANPARTS CODE	Description	OEM	Measures	Ref.	JAPANPARTS CODE	Description	OEM	Measures
1	CJ-602	TCA Left Wbj	49069-97202		4	TI-609R	Tie Rod End Right	45046-87282	c:12 th:FM12X1.25R
2	CJ-601	TCA Right Wbj	49068-97202		5	RD-608	Axial Joint	45503-97204	th:MM14X1.5R L:224
3	TI-609L	Tie Rod End Left	45047-87780	c:12 th:FM12X1.25R	6	RD-607	Axial Joint	45503-97203	th:MM14X1.5R L:224

CUORE VI - VII

10/1998 ->



-> 09/1999 MS



10/1999 -> PS



-> 03/2002



04/2002 ->



Ref.	JAPANPARTS CODE	Description	OEM	Measures	Ref.	JAPANPARTS CODE	Description	OEM	Measures
1	CJ-606	TCA Left	48069-97203		6	TI-609R	Tie Rod End Right	45046-87282	c:12 th:FM12X1.25R
2	CJ-605	TCA Right	48068-97203		7	RD-608	Axial Joint	45503-97204	th:MM14X1.5R L:224
3	CJ-604	TCA Left	48069-97202		8	RD-607	Axial Joint	45503-97203	th:MM14X1.5R L:224
4	CJ-603	TCA Right	48068-97202		9	TI-612	Tie Rod End Left	45047-97203	
5	TI-609L	Tie Rod End Left	45047-87780	c:12 th:FM12X1.25R	10	TI-611	Tie Rod End Right	45046-97203	

FEROZA (F300)

10-1988 ->

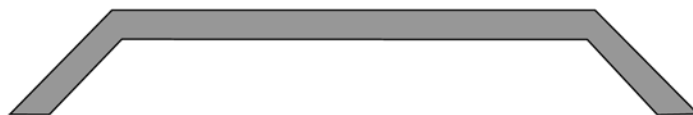

1 TI-602L



2 TI-602R

Ref.	JAPANPARTS CODE	Description	OEM	Measures	Ref.	JAPANPARTS CODE	Description	OEM	Measures
1	TI-602L	Tie Rod End Left	45047 87303	c:16.4 th:MM20X1.5L	2	TI-602R	Tie Rod End Right	45046 87680	c:16.3 th:MM20X1.5L

GRAN MOVE (G3)

10/1996 - 07/2002



-> 06/1998



07/1998 ->



Ref.	JAPANPARTS CODE	Description	OEM	Measures	Ref.	JAPANPARTS CODE	Description	OEM	Measures
1	TI-616	Tie Rod End Left	45047-97204-000		6	RD-609	Axial Joint	45503-87710	th:MM12X1.25R L:234
2	TI-617	Tie Rod End Right	45046-97204-000		7	RD-610	Axial Joint	45503-87714	th:MM12X1.25R L:234
3	SI-600	Stabiliser Link	48802-87703	L:55.5	8	TI-614	Tie Rod End Left	45047-87706	
4	BS-600	TCA	48069-87710		9	TI-613	Tie Rod End Right	45046-87707	
5	BS-601	TCA	48068-87711						

HIJET

03/1982 ->



1 TI-607L



2 TI-607R

3 CJ-608

4 CJ-607

Ref.	JAPANPARTS CODE	Description	OEM	Measures	Ref.	JAPANPARTS CODE	Description	OEM	Measures
1	TI-607L	Tie Rod End Left	4504687503	c:11.8 th:FM14X1.5L	3	CJ-608		48068-87501-000	
2	TI-607	Tie Rod End Right	45046-87503	c:11.8 th:FM14X1.5R	4	CJ-607		48069-87501-000	

MOVE (L6, L9)

10/1996 ->



3 TI-609L



5 RD-611



5 RD-611



4 TI-609R



1 CJ-610



2 CJ-609

Ref.	JAPANPARTS CODE	Description	OEM	Measures	Ref.	JAPANPARTS CODE	Description	OEM	Measures
1	CJ-610	TCA	48069-87209		4	TI-609R	Tie Rod End Right	45046-87282	c:12th:FM12X1.25R
2	CJ-609	TCA	48068-87209		5	RD-611	Axial Joint	45503-87215	th:MM11X1.2R L:202
3	TI-609L	Tie Rod End Left	45047-87780	c:12th:FM12X1.25R					

ROCKY (F7, F8)  
 WILDCAT/ROCKY (F70, F75)

02/1985 - 04/1993  
 02/1985 - 04/1987

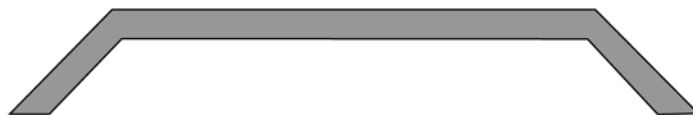

**1** TI-602L



**2** TI-602R

Ref.	JAPANPARTS CODE	Description	OEM	Measures	Ref.	JAPANPARTS CODE	Description	OEM	Measures
1	TI-602L	Tie Rod End Left	45047 87303	c:16.4 th:MM20X1.5L	2	TI-602R	Tie Rod End Right	45046 87680	c:16.3 th:MM20X1.5L



TERIOS (J1)

10/1997-10/2005



4 TI-610



3 RD-612



3 RD-612



4 TI-610



1 BS-602



2 BS-603

Ref.	JAPANPARTS CODE	Description	OEM	Measures	Ref.	JAPANPARTS CODE	Description	OEM	Measures
1	BS-602	TCA Left	43069-87401	c: 15	3	RD-612	Axial Joint	45460-87401	th: MM14X1.5R L:295
2	BS-603	TCA Right	43068-87401	c: 15	4	TI-610	Tie Rod End	45046-87401	

ACCORD III (CA4 - CA5)

11/1985 - 12/1989



UPPER

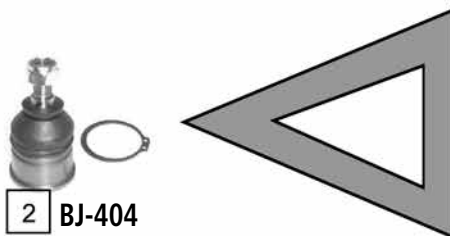

LOWER

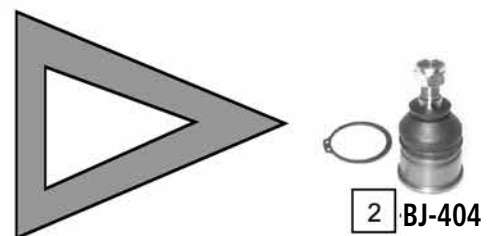

Ref.	JAPANPARTS CODE	Description	OEM	Measures	Ref.	JAPANPARTS CODE	Description	OEM	Measures
1	TI-401	Tie Rod End Left	53540-611-010	c: 13 th: FM12X1.25R	4	CW-492	TCA Upper Right	51459-SE0-000	c:12.9
2	BJ-404	Ball Joint Lower	51220 SE0 000	c:14.5	5	RD-403	Axial Joint	53521-SA0-003	
3	CW-491	TCA Upper Left	51469-SE0-000	c:12.9					

ACCORD IV (CB1-CB3-CB5-CB7)

01/1990 - 03/1993

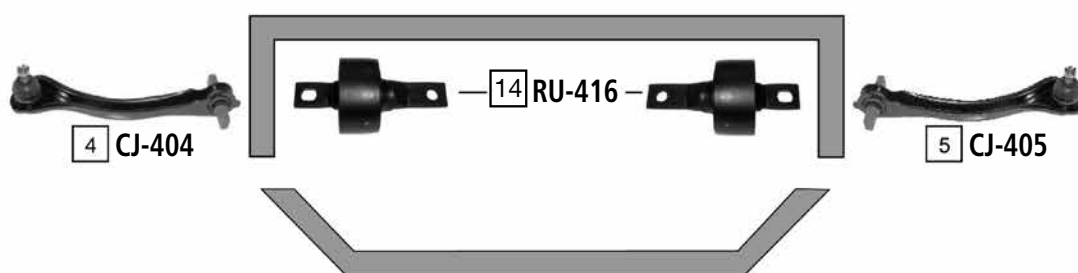
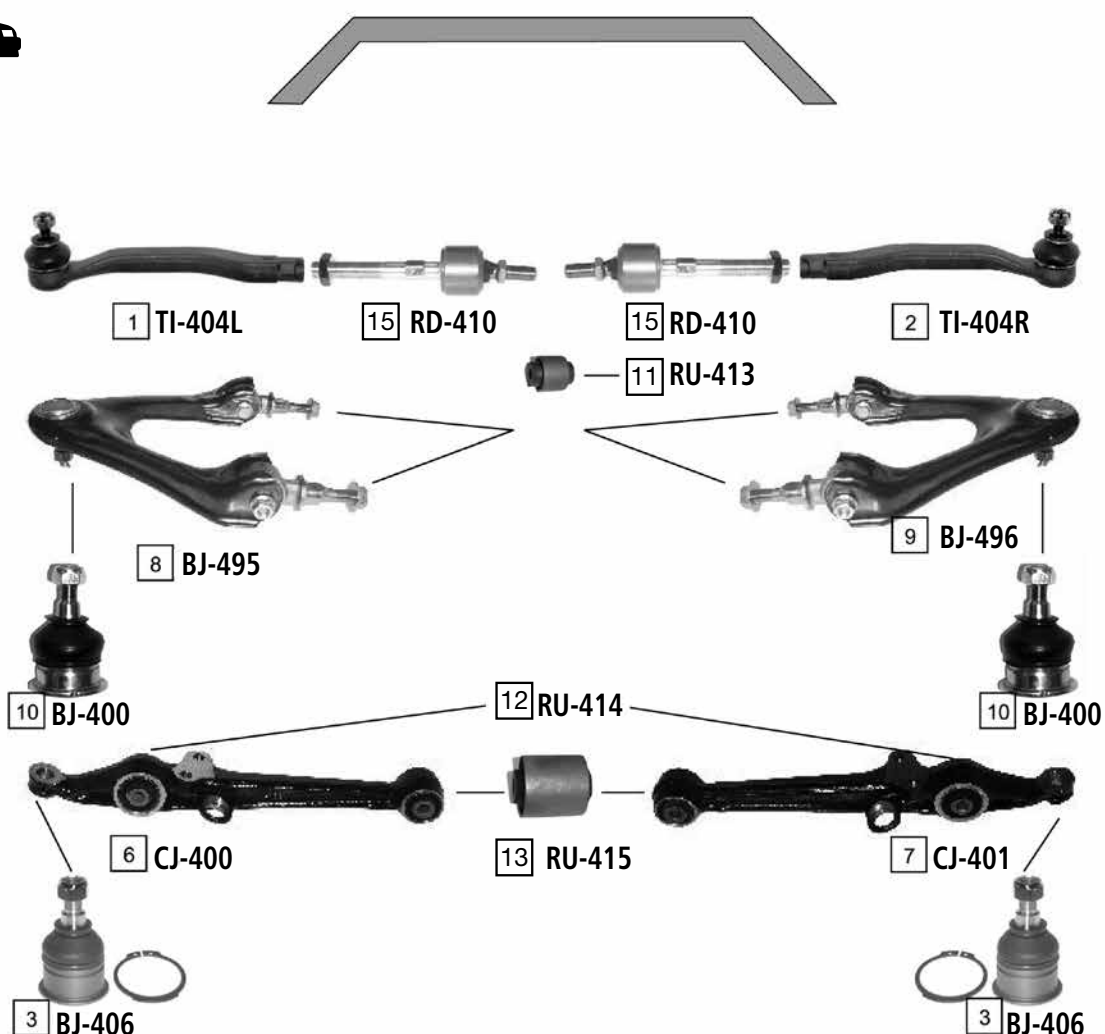

Ref.	JAPANPARTS CODE	Description	OEM	Measures	Ref.	JAPANPARTS CODE	Description	OEM	Measures
1	TI-404L	Tie Rod End Left	53560-SM4-003	c:12.8 th:FM14X1.5R	9	BJ-496	TCA Right	51355 SM4 040	c:12.9
2	TI-404R	Tie Rod End Right	53540-SM4-003	c:12.8 th:FM14X1.5R	10	BJ-400	Ball Joint	Part of BJ-495/BJ-496	c:12.6
3	BJ-406	Ball Joint Lower	51220-SM4-013	c:16	11	RU-413	Silentblock For Susp.Arm	52365-SM4-005	d: 34
4	CJ-404	TCA Left	52400 SM1 A03	c:12.7	12	RU-414	Silentblock For Susp.Arm	51810-SM4-004	d: 42
5	CJ-405	TCA Right	53390 SM1 A03	c:12.7	13	RU-415	Silentblock For Susp.Arm	51393-SM4-013	d: 35
6	CJ-400	TCA Left	51365-SM4-040		14	RU-416	Silentblock For Susp.Arm	52370-SR3-J00	d: 80
7	CJ-401	TCA Right	51355-SM4-040		15	RD-410	Axial Joint	53521-SM4-013	th:MM12X1.25R L:140
8	BJ-495	TCA Left	51460 SV4 000	c:12.9					

ACCORD VI (CE-CF)

02/1996 - 10/1998

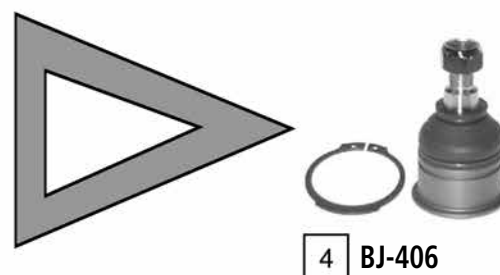
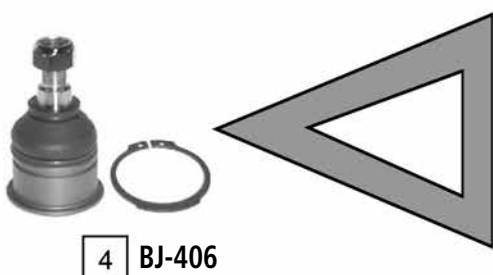
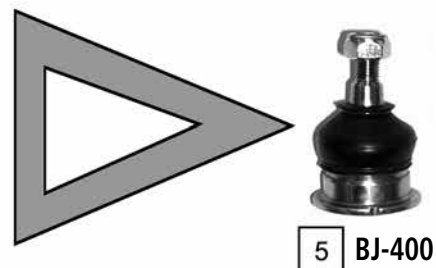
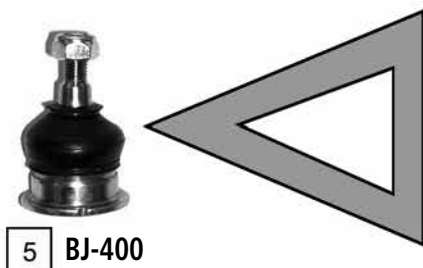

Ref.	JAPANPARTS CODE	Description	OEM	Measures	Ref.	JAPANPARTS CODE	Description	OEM	Measures
1	RD-413	Axial Joint	53010-SV4-000	th:MM12X1.25R L:151	4	BJ-406	Ball Joint Lower	51220-SM4-013	c:16
2	TI-407L	Tie Rod End Left	53560-SV4-003	c:12.6 th:FM14X1.5R	5	BJ-400	Ball Joint		c:12.6
3	TI-407R	Tie Rod End Right	53540-SV4-003	c:12.6 th:FM14X1.5R					

ACCORD VII (CG)

02/1998 - 03/2002

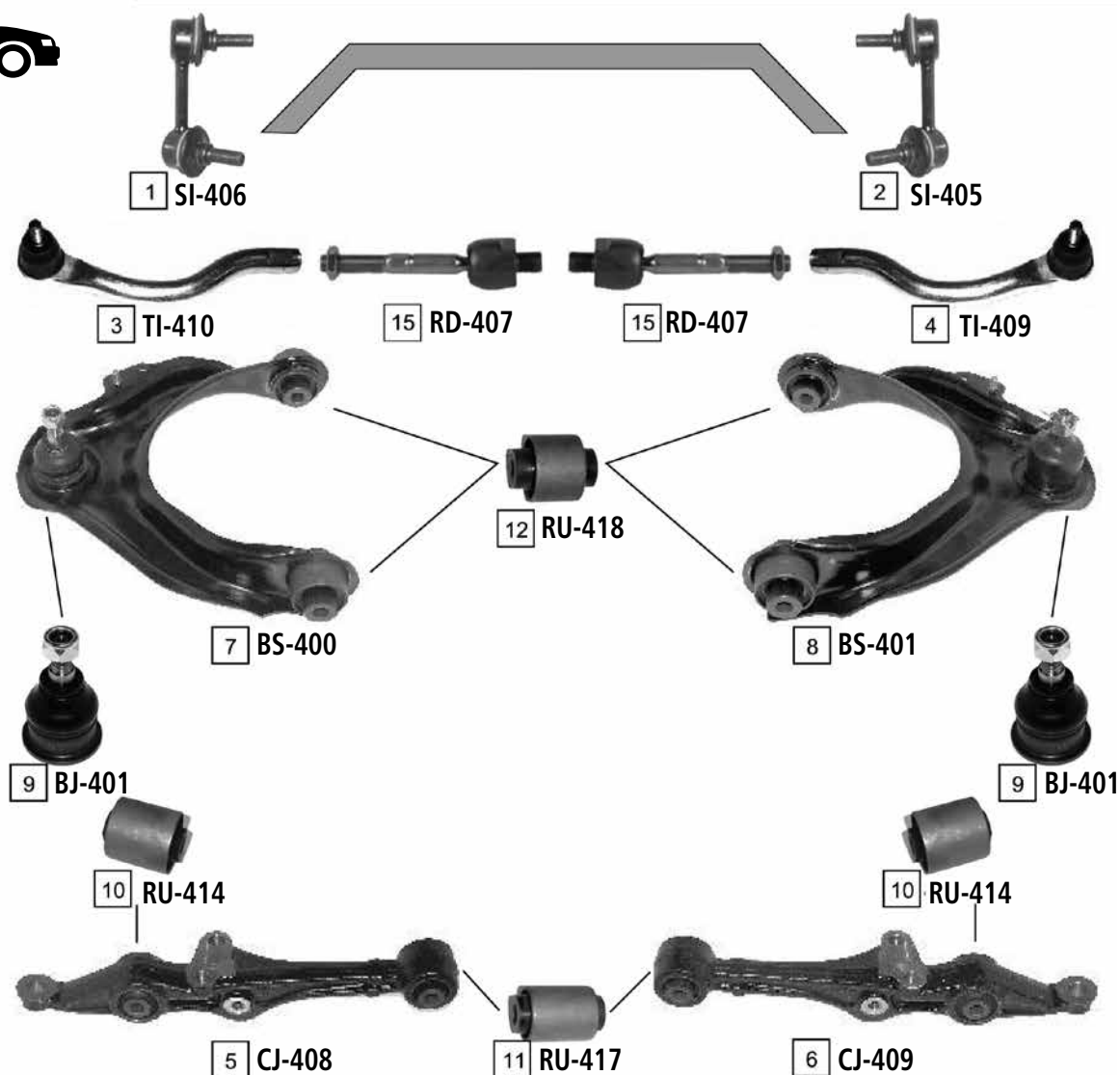

Ref.	JAPANPARTS CODE	Description	OEM	Measures	Ref.	JAPANPARTS CODE	Description	OEM	Measures
1	SI-406	Stabiliser Link Left	51321-S84-A01	L:72	9	BJ-401	Ball Joint	Part of BS-400/BS-401	c:12.7
2	SI-405	Stabiliser Link Right	51320-S84-A01	L:72	10	RU-414	Silentblock For Susp.Arm	51810-SM4-004	d:42
3	TI-410	Tie Rod End Left	53560-S1A-E01	c:12.6 th:MM14X1.5R	11	RU-417	Silentblock For Susp.Arm	51810-S1A-E00	
4	TI-409	Tie Rod End Right	53540-S1A-E01	c:12.6 th:MM14X1.5R	12	RU-418	Silentblock For Susp.Arm	51450-S1A-E01*	d:38.4
5	CJ-408	TCA Left	51365-S1A-E00	c:15.5	13	SI-408	Stabiliser Link Left	52325 S84 A01	L:113
6	CJ-409	TCA Right	51355-S1A-E00	c:15.5	14	SI-407	Stabiliser Link Right	52320 S84 A01	L:113
7	BS-400	TCA Left	51460 S1A E01	c:12.7	15	RD-407	Axial Joint	53010 S84 A01	th:MM16X1.5R L:142
8	BS-401	TCA Right	51450-S1A-E01	c:12.7					

ACCORD VIII (CL - CM)

02/2003 ->

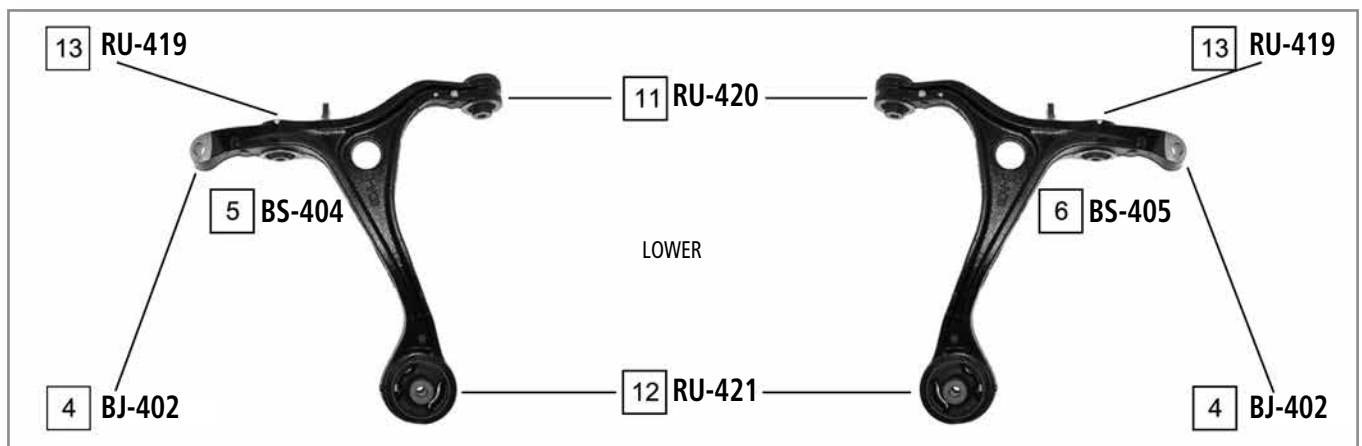
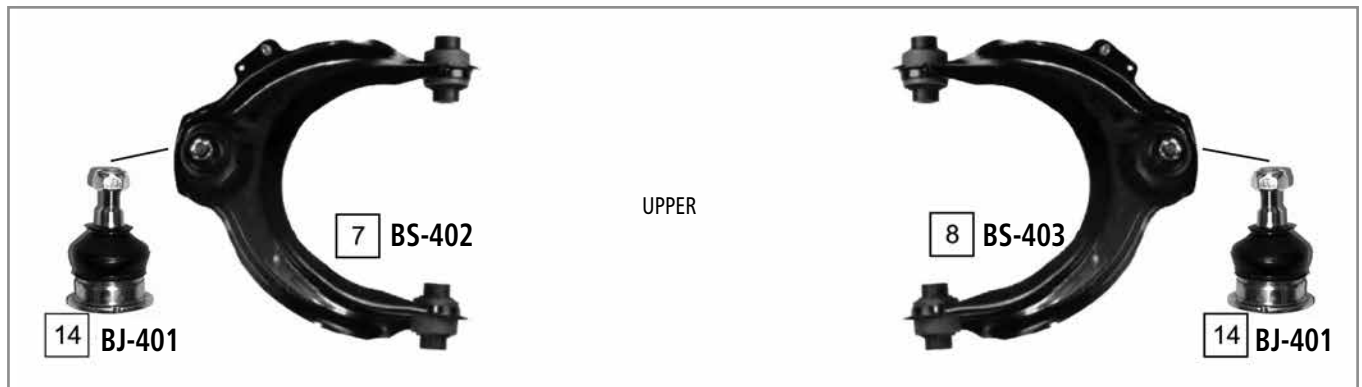
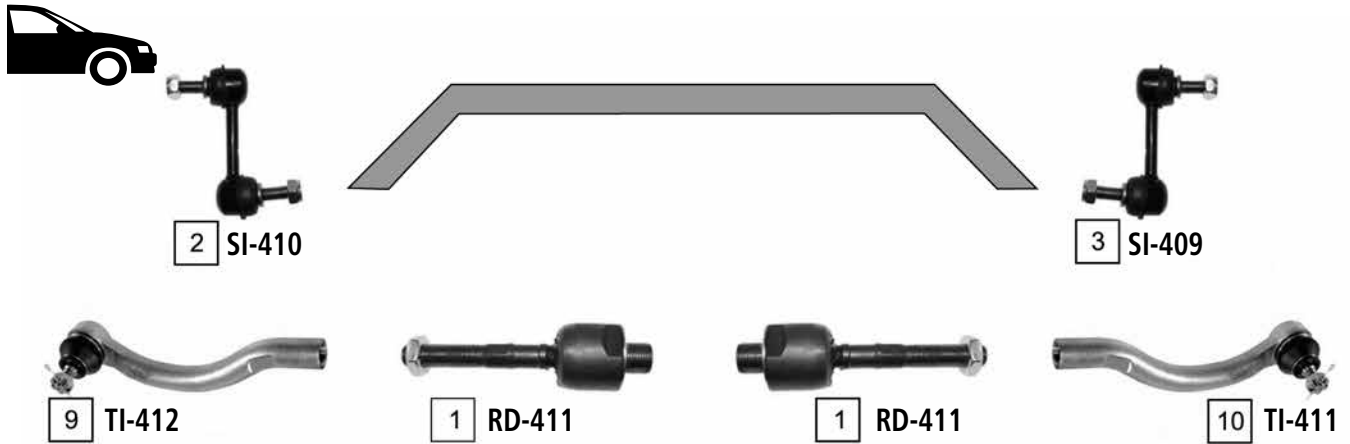

Ref.	JAPANPARTS CODE	Description	OEM	Measures	Ref.	JAPANPARTS CODE	Description	OEM	Measures
1	RD-411	Axial Joint	53010 SDA A01	th:MM18X1.5R L:123	8	BS-403	TCA Right	51450 SDA A01	
2	SI-410	Stabiliser Link Left	51321 SEA E01	L:80.5	9	TI-412	Tie Rod End Left	53560 SDA A01	
3	SI-409	Stabiliser Link Right	51320 SEA E01	L:80.5	10	TI-411	Tie Rod End Right	53540 SDA A01	
4	BJ-402	Ball Joint	Part of BS-404/BS-405		11	RU-420	Silentblock For Susp.Arm	51391 SEA 004	
5	BJ-404	TCA Left	51360 SEA E01		12	RU-421	Silentblock For Susp.Arm	51393 SEA 004	
6	BS-405	TCA Right	51350 SEA E01		13	RU-419	Silentblock For Susp.Arm	51810 SDA A01	
7	BS-402	TCA Left	51460 SDA A01		14	BJ-401	TCA Right	51355 SM4 040	c:12.9

ACCORD IX  
ACCORD IX TOURER

07/2008 ->  
07/2008 ->

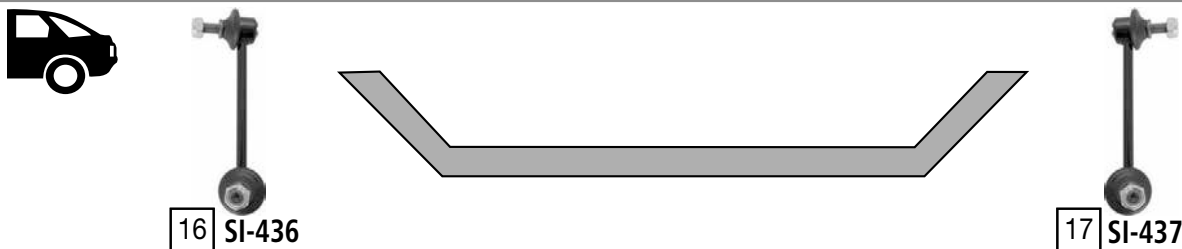
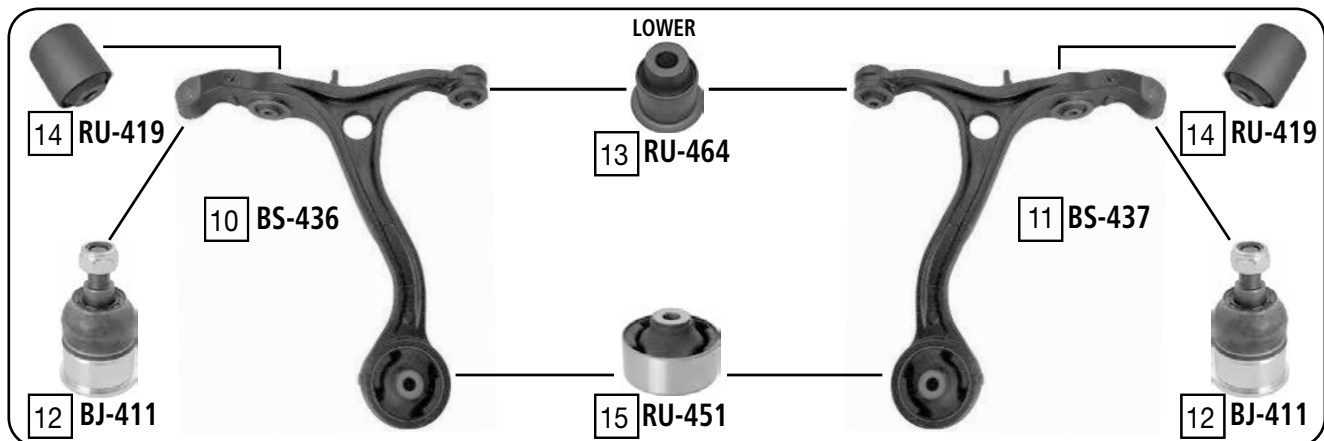
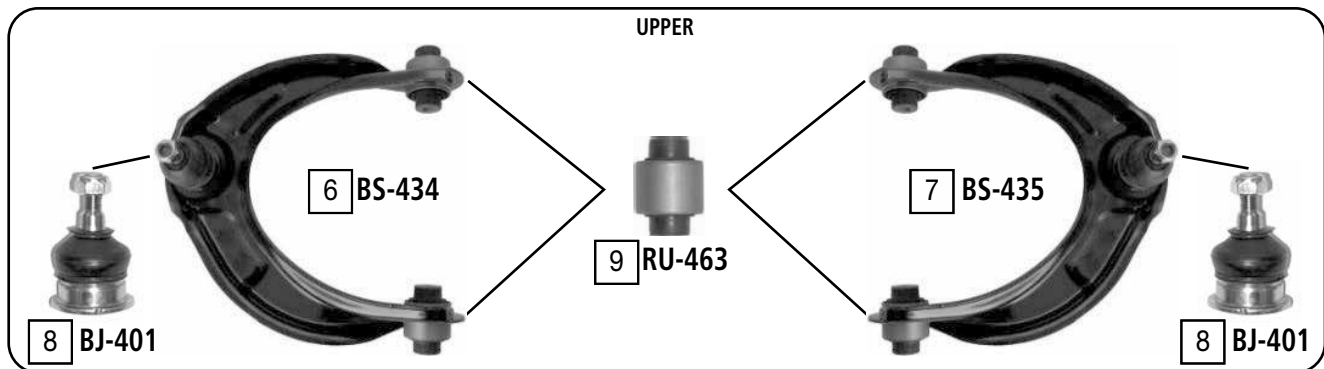
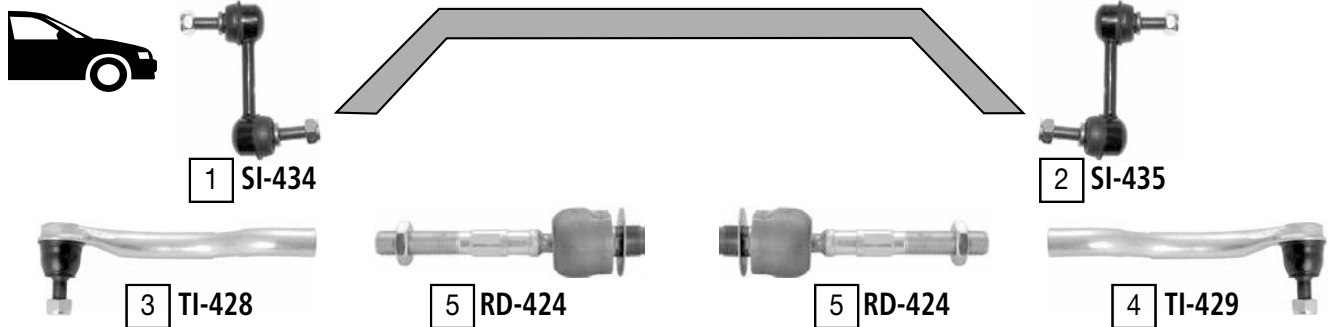

Ref.	JAPANPARTS CODE	Description	OEM	Measures	Ref	JAPANPARTS CODE	Description	OEM	Measures
1	SI-434	Stabiliser link left	51321 SEA E01	L:80.5	10	BS-436	TCA left wobj	51360 TA0 A00	c:18.9
2	SI-435	Stabiliser link right	51320 SEA E01	L:80.5	11	BS-437	TCA right wobj	51350 TA0 A00	c:18.9
3	TI-428	Tie rod end left	53560 TA0 A01	c:13.7 th:FM14x1.5R	12	BJ-411	Ball joint	51220 TA0 A02	c:19.3 do:48.6
4	TI-429	Tie rod end right	53540 TA0 A01	c:13.7 th:FM14x1.5R	13	RU-464	Silentblock for TCA	51391 SEA 004	di:12.2 do:38.2
5	RD-424	Axial joint	53610 TL1 G01	th:MM18x1.5R L:131	14	RU-419	Silentblock for TCA	51391 TA0 A01	di:14.2 do:80
6	BS-434	TCA left wbj	51520 TA0 A03	c:12.7	15	RU-451	Silentblock for TCA	51810 SDA A01	di:12.2 do:42.2
7	BS-435	TCA right wbj	51510 TA0 A03	c:12.7	16	SI-436	Stabiliser link left	52325 TA0 A01	L:145
8	BJ-401	Ball joint	Part of	c:12.7 do:35.2	17	SI-437	Stabiliser link right	52320 TA0 A01	L:145
9	RU-463	Silentblock for TCA	Part of	di:10.2 do:38.2					

ACCORD COUPE (CD7-CD9)

09/1993 - 02/1998

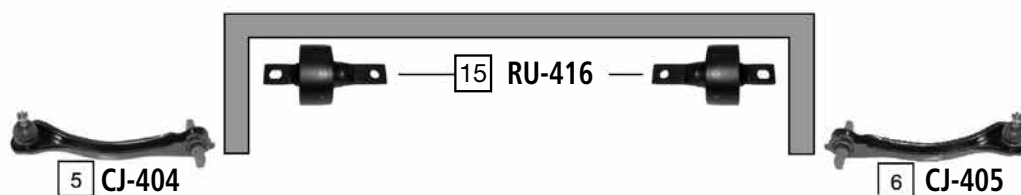
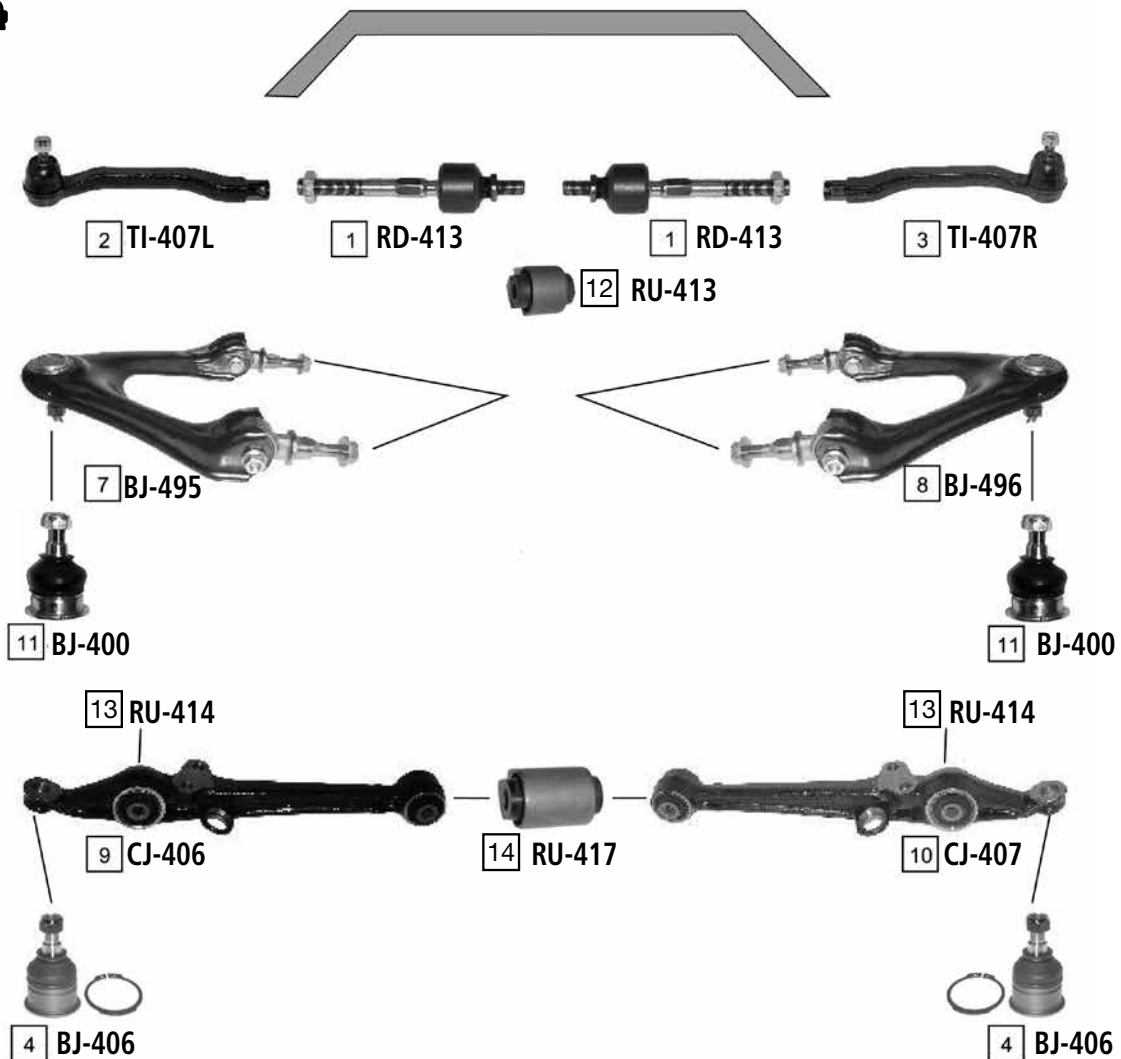

Ref.	JAPANPARTS CODE	Description	OEM	Measures	Ref.	JAPANPARTS CODE	Description	OEM	Measures
1	RD-413	Axial Joint	53010-SV4-000	th:MM12X1.25R L:151	9	CJ-406	TCA Left	51365-SV7-A00	c:15.5
2	TI-407L	Tie Rod End Left	53560-SV4-003	c:12.6 th:MM14X1.5R	10	CJ-407	TCA Right	51355-SV7-A00	c:15.5
3	TI-407R	Tie Rod End Right	53540-SV4-003	c:12.6 th:MM14X1.5R	11	BJ-400	Ball Joint	Part of BJ-495/BJ-496	c:12.6
4	BJ-406	Ball Joint Lower	51220-SM4-013	c:16	12	RU-413	Silentblock For Susp.Arm	52365-SM4-005	d:34
5	CJ-404	TCA Left	52400 SM1 A03	c:12.7	13	RU-414	Silentblock For Susp.Arm	51810-SM4-004	d:42
6	CJ-405	TCA Right	52390 SM1 A03	c:12.7	14	RU-417	Silentblock For Susp.Arm	51355-S1A-E00	
7	BJ-495	TCA Left	51460 SV4 000	c:12.9	15	RU-416	Silentblock For Susp.Arm	52370-SR3-J00	d:80
8	BJ-496	TCA Right	51355 SM4 040	c:12.9					



CIVIC II

09/1983 - 11/1987



Ref.	JAPANPARTS CODE	Description	OEM	Measures	Ref.	JAPANPARTS CODE	Description	OEM	Measures
1	TI-401	Tie Rod End	53540-611-010	c:13 th:FM12X1.25R	3	CW-495	TCA Right	51351-SB2-013	c:14.5
2	TI-481	TCA Left	51361-SB2-013	c:14.5	4	RD-405	Axial Joint	53521-SB2-003	th:MM12X1.25R L:278

CIVIC III (EC-ED-EE)

09/1987 - 07/1991

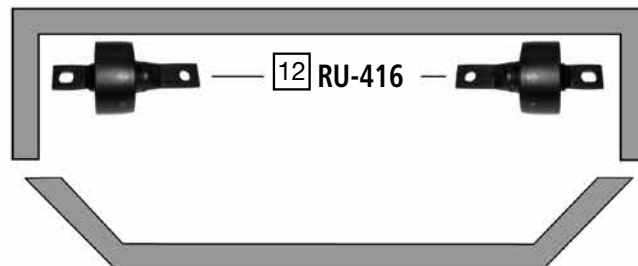
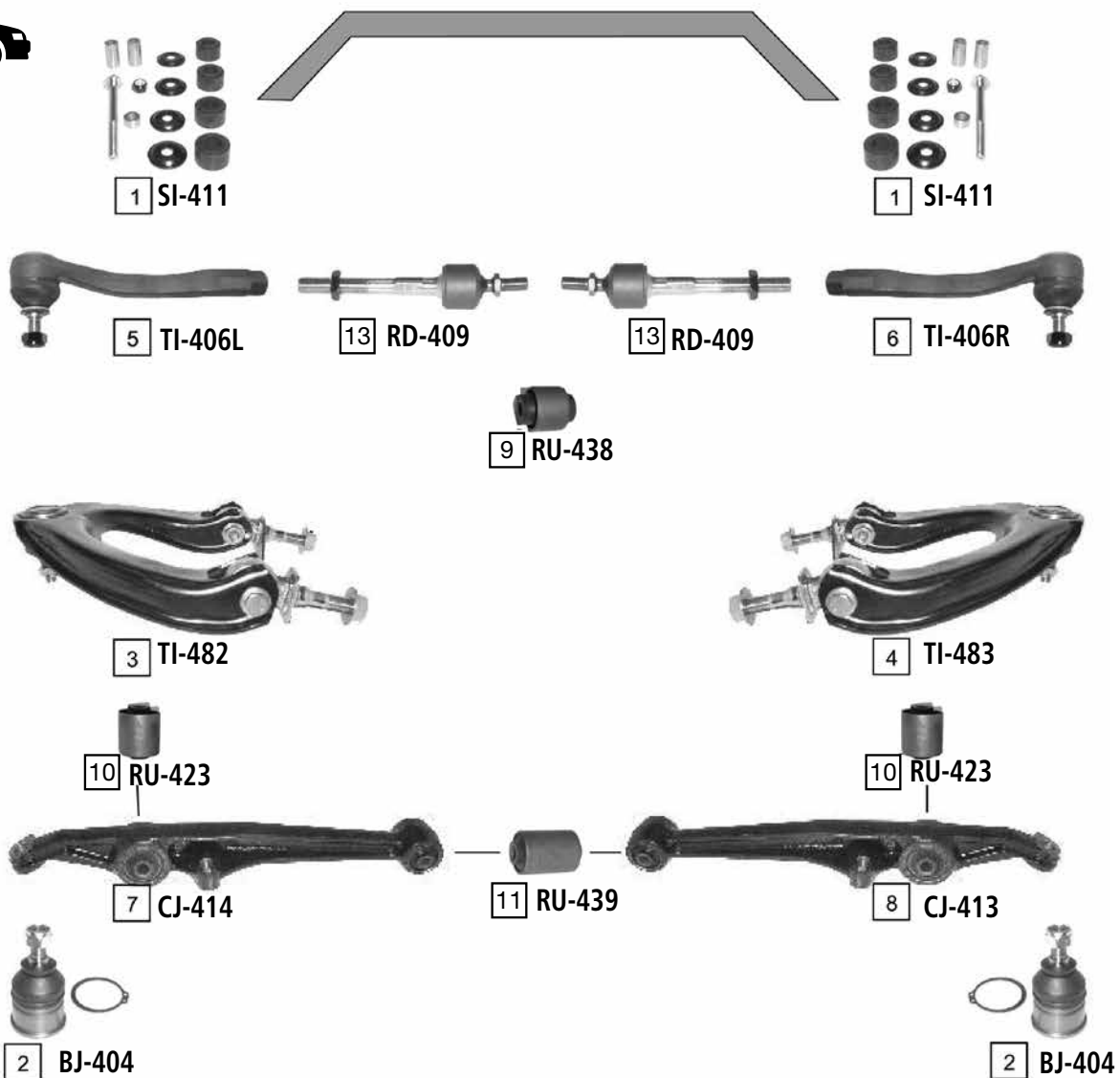

Ref.	JAPANPARTS CODE	Description	OEM	Measures	Ref.	JAPANPARTS CODE	Description	OEM	Measures
1	SI-411	Stabiliser Link	90112 SE0 000	L:100	8	CJ-413	TCA Right	51355-SH3-020	
2	BJ-404	Ball Joint Lower	51220 SE0 000	c: 14.5	9	RU-438	Silentblock For Susp.Arm	51450-SH3-023	d:29
3	TI-482	TCA Upper Left	51460-SH3-000	c: 12.9	10	RU-423	Silentblock For Susp.Arm	51350-SR3-A02	d:40
4	TI-483	TCA Upper Right	51450 SH3 020	c: 12.9	11	RU-439	Silentblock For Susp.Arm	51355-SH3-020	d:32.1
5	TI-406L	Tie Rod End	53560-SH3-003	c:12.9 th:FM14X1.5R	12	RU-416	Silentblock For Susp.Arm	52370-SR3-J00	d:80
6	TI-406R	Tie Rod End	53540-SH3-003	c:12.9 th:FM14X1.5R	13	RD-409	Axial Joint	53521-SH3-003	th:MM12x1,25R L:160
7	CJ-414	TCA Left	51365-SH3-020						

CIVIC IV (MA-MB-EG-EH-EJ)

08/1991 - 01/1997

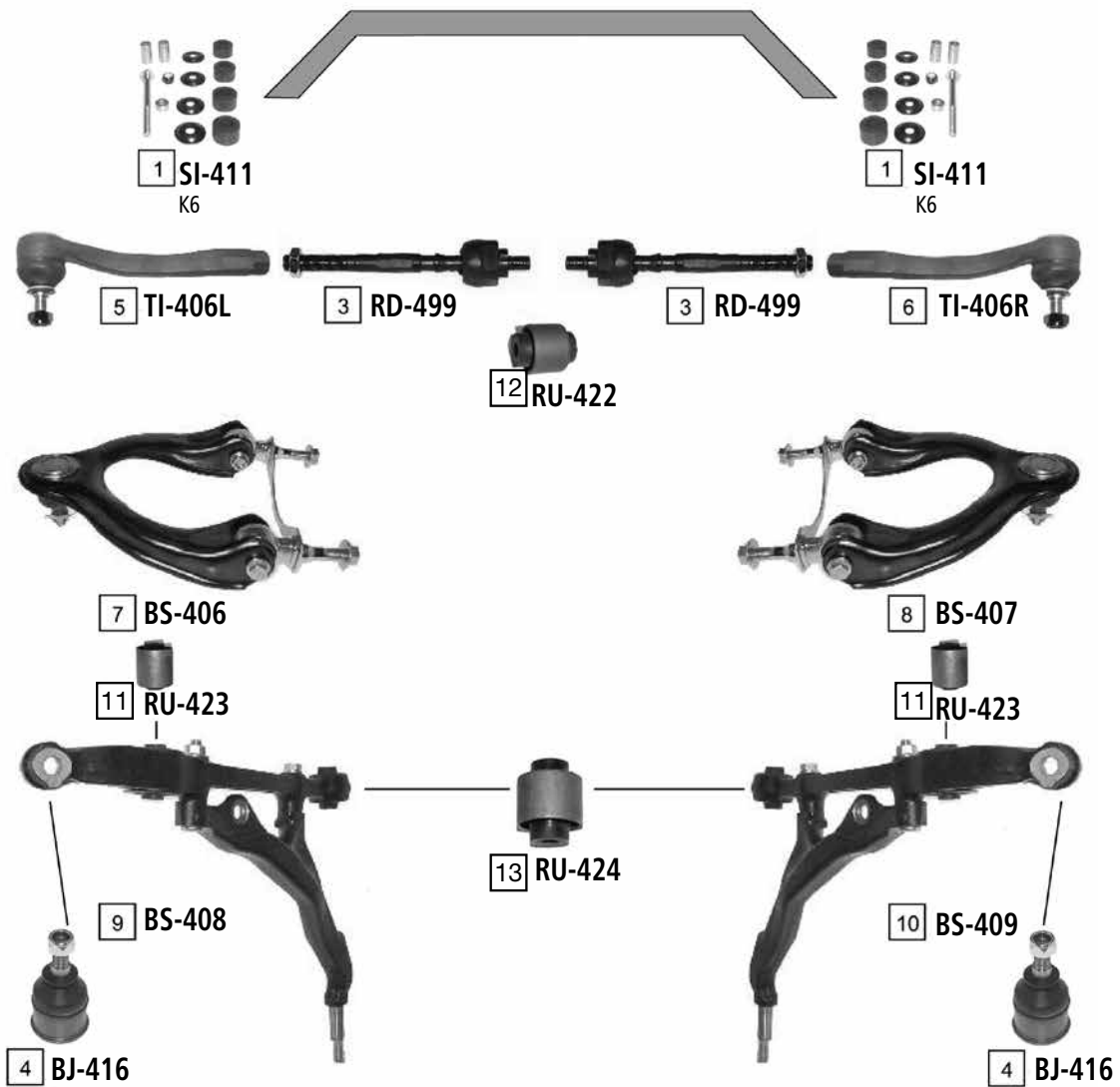

Ref	JAPANPARTS CODE	Description	OEM	Measures	Ref	JAPANPARTS CODE	Description	OEM	Measures
1	SI-411	Stabiliser Link	90112 SE0 000	L:100	8	BS-407	TCA	51450-SR3-023	c:12.9
2	CJ-410	Stabiliser Link	51312-SR3-000	L:75	9	BS-408	TCA Left	51360-SR3-020	c:13.4
3	RD-499	Axial Joint	53010-SR3-010	th:MM12X1.25R L:175	10	BS-409	TCA Right	51350-SR3-020	
4	BJ-416	Ball Joint	51220 S04 003	c:14	12	RU-423	Silentblock For Susp.Arm	51350-SR3-A02	d:40
5	TI-406L	Tie Rod End Left	53560-S04-003	c:12.9 th:FM14x1.5R	13	RU-422	Silentblock For Susp.Arm	51450-SR3-023	d:34
6	TI-406R	Tie Rod End Right	53540-S04-003	c:12.9 th:FM14x1.5R	15	RU-424	Silentblock For Susp.Arm	51360-SR3-A02	d:37
7	BS-406	TCA	51460-SR3-023	c:12.9					

CIVIC V (EJ9-EK1-EK3-EK4-MB-MC)

11/1995 - 02/2001

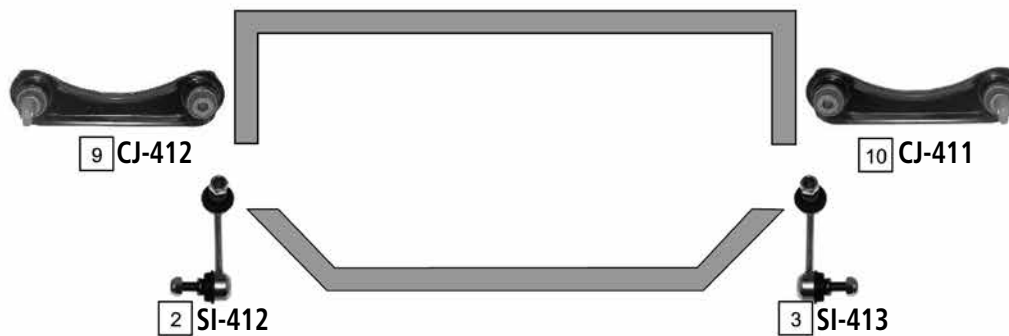
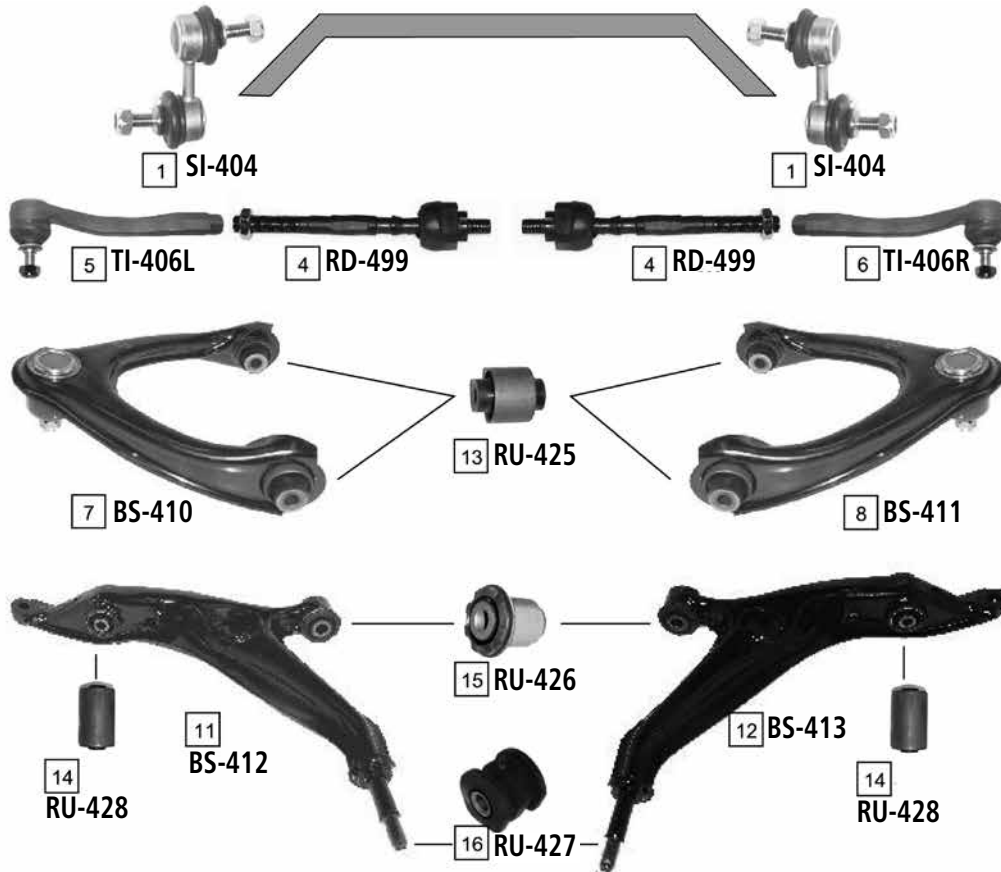

Ref	JAPANPARTS CODE	Description	OEM	Measures	Ref	JAPANPARTS CODE	Description	OEM	Measures
1	SI-404	Stabiliser Link	51320-S04-003		9	CJ-412	TCA Left	52390-SR3-000	
2	SI-412	Stabiliser Link Left	52321-S04-003	L:90	10	CJ-411	TCA Right	51460-SZ3-013	
3	SI-413	Stabiliser Link Right	52320-S04-003	L:90	11	BS-412	TCA Left	51360 S04 G00	c:14
4	RD-499	Axial Joint	53010-SR3-010	th:MM12X1.25R L:175	12	BS-413	TCA Right	51350 S04 000	c:13.5
5	TI-406L	Tie Rod End Left	53560-S04-003	c:12.9 th:FM14X1.5R	13	RU-425	Silentblock For Susp.Arm	51450-S04-023	d:34
6	TI-406R	Tie Rod End Right	53540-S04-003	c:12.9 th:FM14X1.5R	14	RU-428	Silentblock For Susp.Arm	Part of BS-412/BS-413	d:40.1
7	BS-410	TCA Left	51450-S01-023	c:12.8	15	RU-426	Silentblock For Susp.Arm	51350-S04-000	d:37
8	BS-411	TCA Right	52400-SR3-000	c:12.8	16	RU-427	Silentblock For Susp.Arm	51391 S04 005	

CIVIC VI (EU-EP-EM)

02/2001 - 12/2005

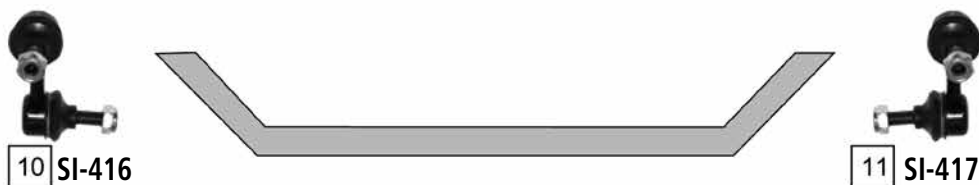
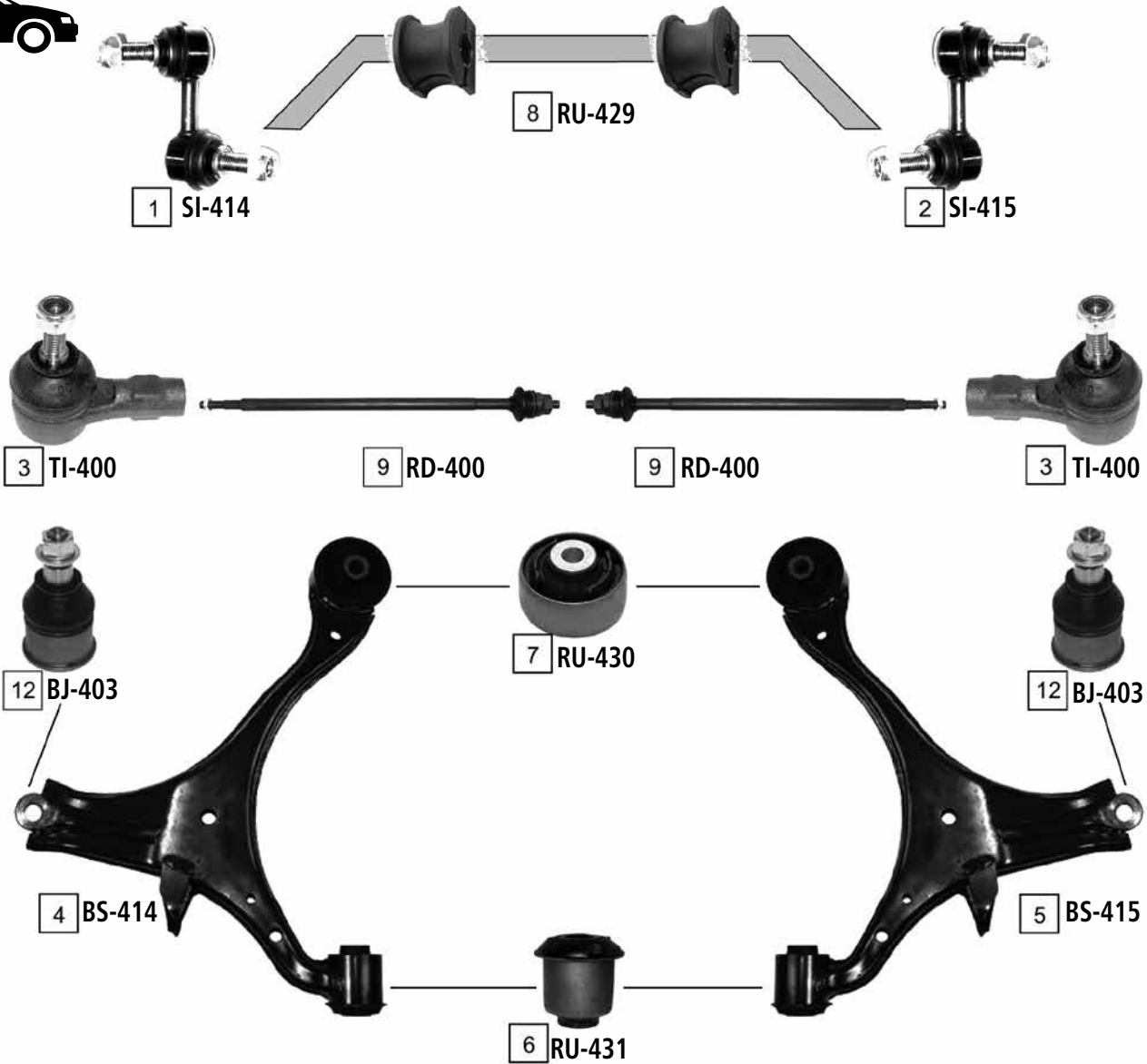

Ref.	JAPANPARTS CODE	Description	OEM	Measures	Ref.	JAPANPARTS CODE	Description	OEM	Measures
1	SI-414	Stabiliser Link Left	51321-S5A-003	L:55.5	7	RU-430	Silentblock For Susp.Arm	51391 S5A 024	d:65
2	SI-415	Stabiliser Link Right	51320-S5A-003	L:55	8	RU-429	Stabiliser Mounting	51306-S6D-005	d:24.8
3	TI-400	Tie Rod End	53541-S5A-003	c:12.7 th:FM14x1.5R	9	RD-400	Axial Joint	53521 S5A 003	th:MM14X1.25R L:502
4	BS-414	Tca Left Wobj	51360-S6D-G00	c:15.5	10	SI-416	Stabiliser Link Left	52321 S5A 013	L:72.5
5	BS-415	Tca Right Wobj	51350-S6D-G00	c:15.5	11	SI-417	Stabiliser Link Right	52320 S5A 013	
6	RU-431	Silentblock For Susp.Arm	51392-S5A-004	d:42.2	12	BJ-403	Ball Joint	51220 S5A 003	-

CIVIC VII

01/2006->

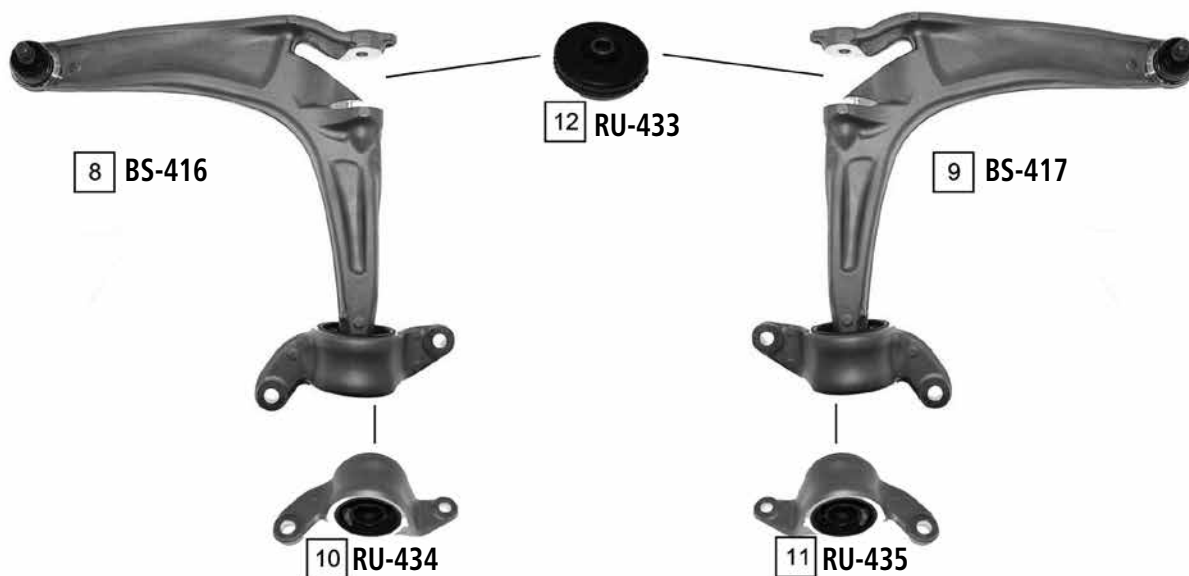
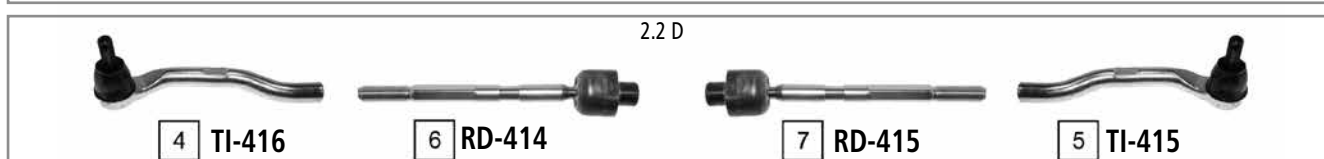
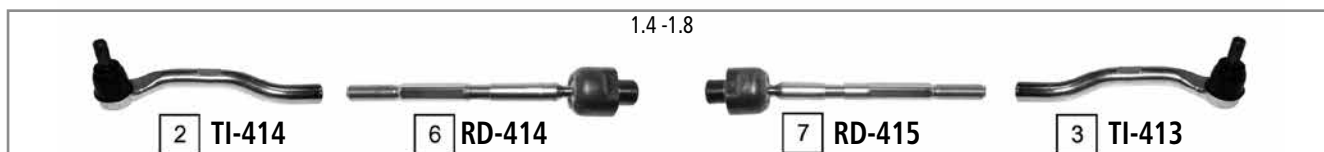
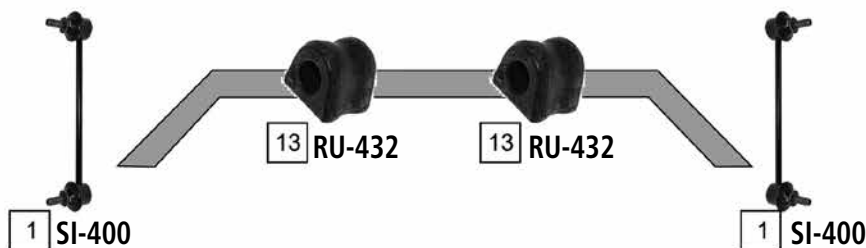

Ref	JAPANPARTS CODE	Description	OEM	Measures	Ref	JAPANPARTS CODE	Description	OEM	Measures
1	SI-400	Stabiliser Link	51320 SMG E01		9	BS-417	TCA Right Wbj	51350 SMG E05	
2	TI-414	Tie Rod End Left	53560 SMG 003		10	RU-434	Silentblock For Susp.Arm	51396 SMG E03	
3	TI-413	Tie Rod End Right	53540 SMG 003		11	RU-435	Silentblock For Susp.Arm	51395 SMG E03	
4	TI-416	Tie Rod End Left	53560 SMJ 003		12	RU-433	Silentblock For Susp.Arm	51398 SMG E01	
5	TI-415	Tie Rod End Right	53540 SMJ 003		13	RU-432	Stabiliser Mounting	51306 SMG E02	
6	RD-414	Axial Joint	53010 SMG E01		14	SI-418	Stabiliser Link Left	52321 SNA A01	
7	RD-415	Axial Joint	53011 SMG E01		15	SI-419	Stabiliser Link Right	52320 SNA A01	
8	BS-416	TCA Left Wbj	51360 SMG E05						

CONCERTO (HW)

08/1989 - 10/1996

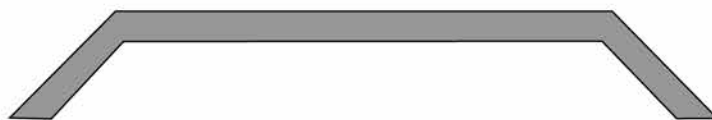

1 TI-487



1 TI-487



2 TI-488



3 TI-489

Ref.	JAPANPARTS CODE	Description	OEM	Measures	Ref.	JAPANPARTS CODE	Description	OEM	Measures
1	TI-487	Tie Rod End	GSJ 1011	c:12.9 th:FM14X1.5R	3	TI-489	TCA Right	GSJ 1086	c:15
2	TI-488	TCA Left	GSJ 1085	c:15					

CR-V I (RD)

10/1995 - 06/2002

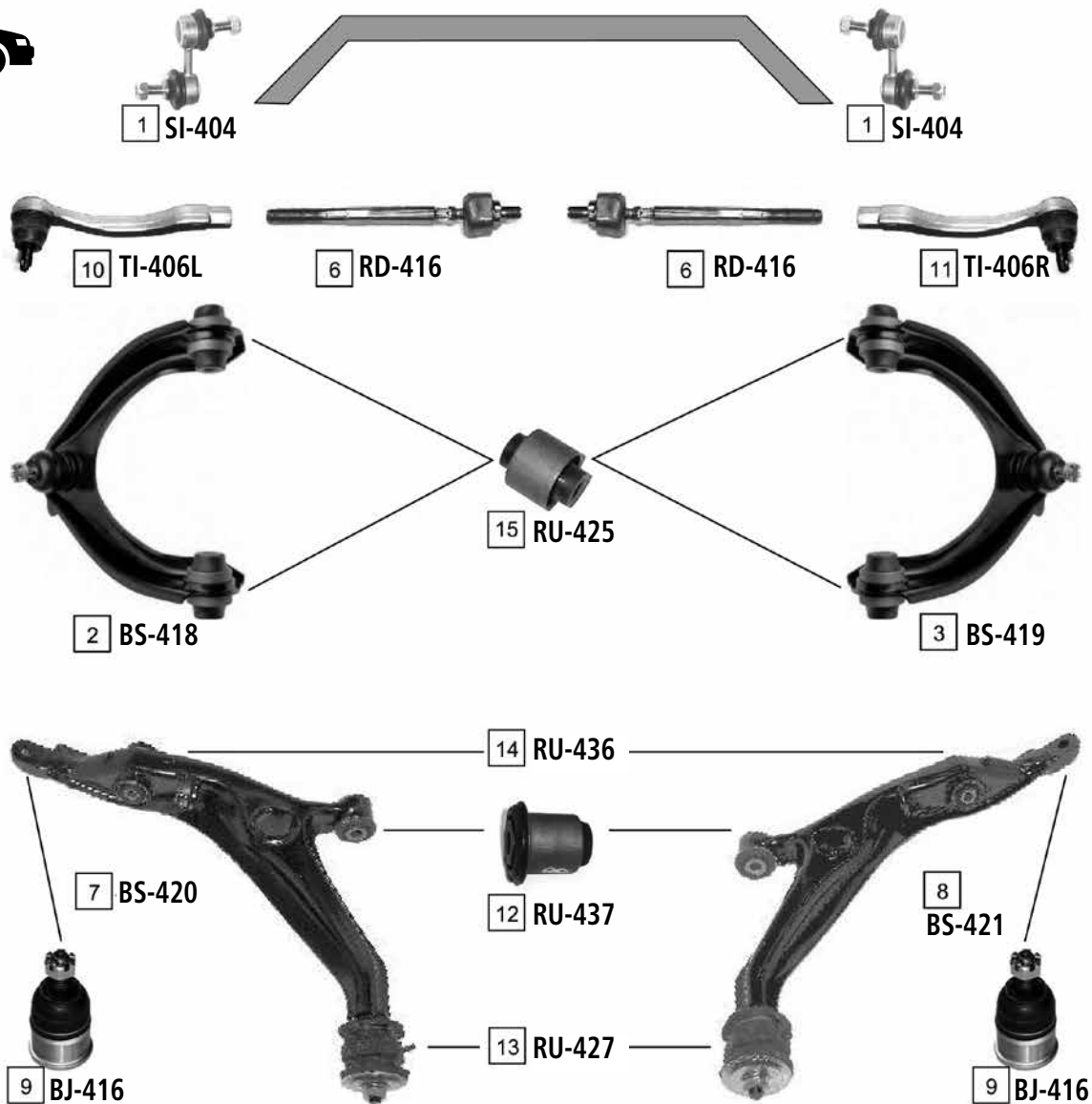

Ref	JAPANPARTS CODE	Description	OEM	Measures	Ref	JAPANPARTS CODE	Description	OEM	Measures
1	SI-404	Stabiliser Link	51320-S04-003		9	BJ-416	Ball Joint	51220-S04-003	
2	BS-418	TCA Left	51460-S10-020	c:12.7	10	TI-406L	Tie Rod End Left	53560-S04-003	c:12.7 th:FM14X1.5R
3	BS-419	TCA Right	51450-S10-020	c:12.7	11	TI-406R	Tie Rod End Right	53540-S04-003	c:12.7 th:FM14X1.5R
4	SI-420	Stabiliser Link Left	52321 S10 003	L:125	12	RU-437	Silentblock For Susp.Arm	Part of BS-420/BS-421	
5	SI-421	Stabiliser Link Right	53320 S10 003	L:125	13	RU-427	Silentblock For Susp.Arm	51391 S04 005	
6	RD-416	Axial Joint	53010-S10-000	th:MM12X1.25R L:202	14	RU-436	Silentblock For Susp.Arm	Part of BS-420/BS-421	
7	BS-420	TCA Left	51360-S10-G00		15	RU-425	Silentblock For Susp.Arm	51450-S04-023	d:34
8	BS-421	TCA Right	51350-S10-G00						



CR-V II

07/2002 - 09/2006

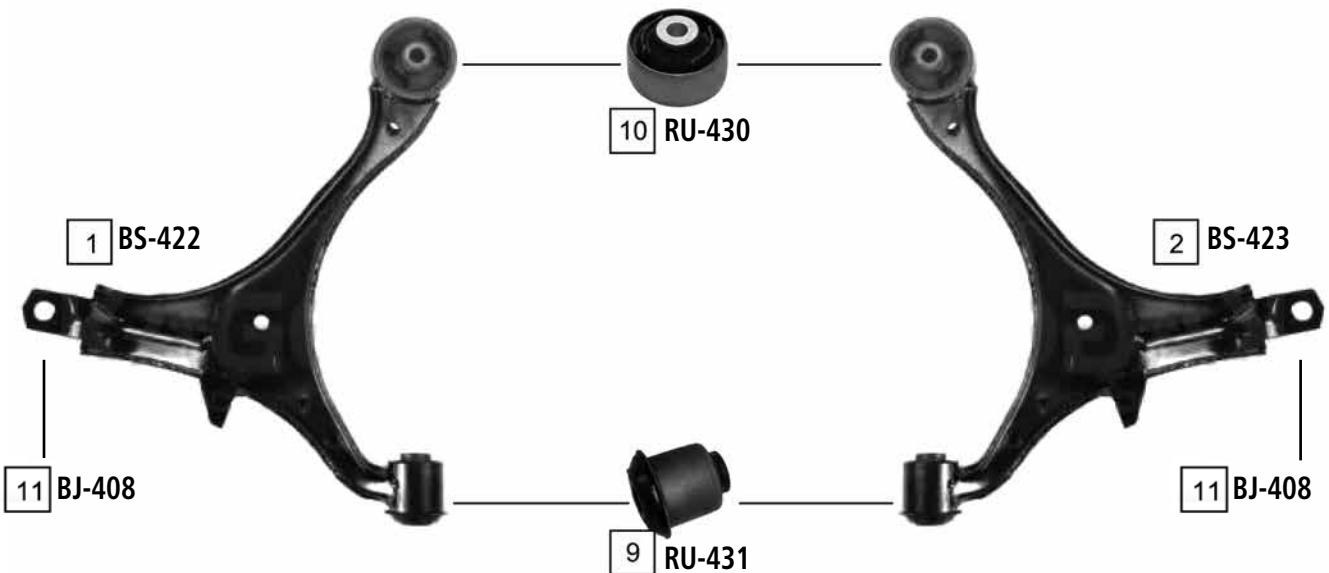

Ref.	JAPANPARTS CODE	Description	OEM	Measures	Ref.	JAPANPARTS CODE	Description	OEM	Measures
1	BS-422	TCA Left	51360 S9A 010	c:15	7	SI-422	Stabiliser Link Left	52321 S9A 003	L:89.5
2	BS-423	TCA Right	51350 S9A 010	c:15	8	SI-423	Stabiliser Link Right	52320 S9A 003	L:89.5
3	RD-417	Axial Joint	53521-S9A-003	th:MM14X1.25R L:547	9	RU-431	Silentblock For Susp.Arm	51392-S5A-004	d :42.2
4	TI-400	Tie Rod End	53541-S5A-003	c:12.7 th:FM14X1.5R	10	RU-430	Silentblock For Susp.Arm	51391 S5A 024	d :65
5	SI-414	Stabiliser Link Left	51321-S5A-003	L:55.5	11	BJ-408	Ball Joint		
6	SI-415	Stabiliser Link Right	51320-S5A-003	L:55					

CR-V III

10/2006 ->

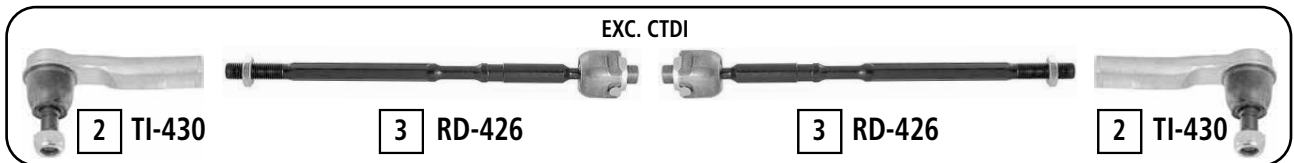
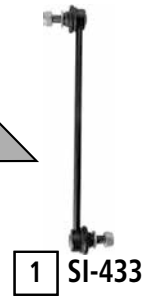
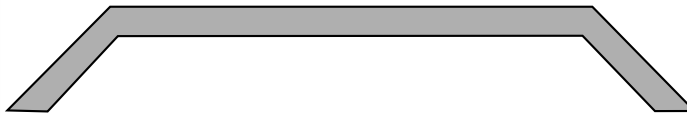

8 RU-465

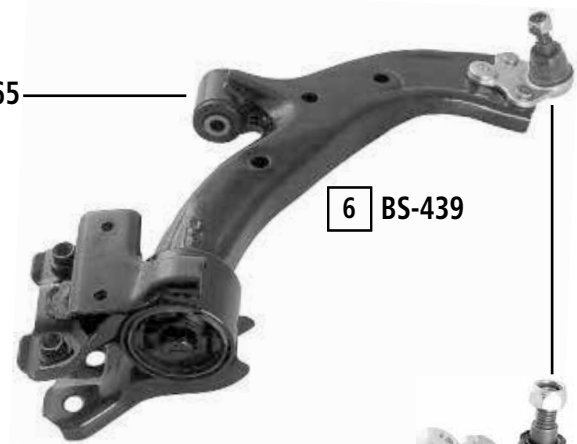

7 BJ-410

7 BJ-410



Ref.	JAPANPARTS CODE	Description	OEM	Measures	Ref.	JAPANPARTS CODE	Description	OEM	Measures
1	SI-433	Stabiliser Link	51320 STK A01	L:318	6	BS-439	TCA Right Wbj	51350 SWA E01	c:17.5
2	TI-430	Tie Rod End	53540 SWA A02	c:13.6 th:FM14x1.5R	7	BJ-410	Ball Joint	51220 STK A01	c:17.5
3	RD-426	Axial Joint	53010 SWC G02	th:MM16x1R L:317.5	8	RU-465	Silentblock For TCA	Part of	di:14.3
4	RD-427	Axial Joint	53010 SWA A01	th:MM20x1.5R L:319	9	SI-442	Stabiliser Link Left	52321 SWA A01	L:85
5	BS-438	TCA Left Wbj	51360 SWA E01	c:17.5	10	SI-443	Stabiliser Link Right	52320 SWA A01	L:85

CRX I (AF-AS)

07/1983 - 09/1987



Ref	JAPANPARTS CODE	Description	OEM	Measures	Ref	JAPANPARTS CODE	Description	OEM	Measures
1	TI-401	Tie Rod End	53450-611-010	c:13 th:FM12X1.25R	3	CW-495	TCA Right	51351 SB2 013	c:14.5
2	TI-481	TCA Left	51361-SB2-013	c:14.5	4	RD-405	Axial Joint	53521-SB2-003	th:MM12X1.25R L:278

CRX II (ED-EE)

09/1987 - 02/1992

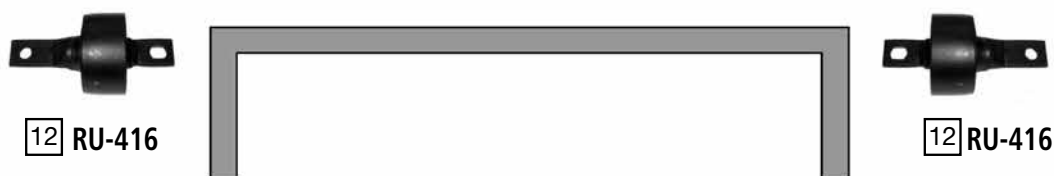
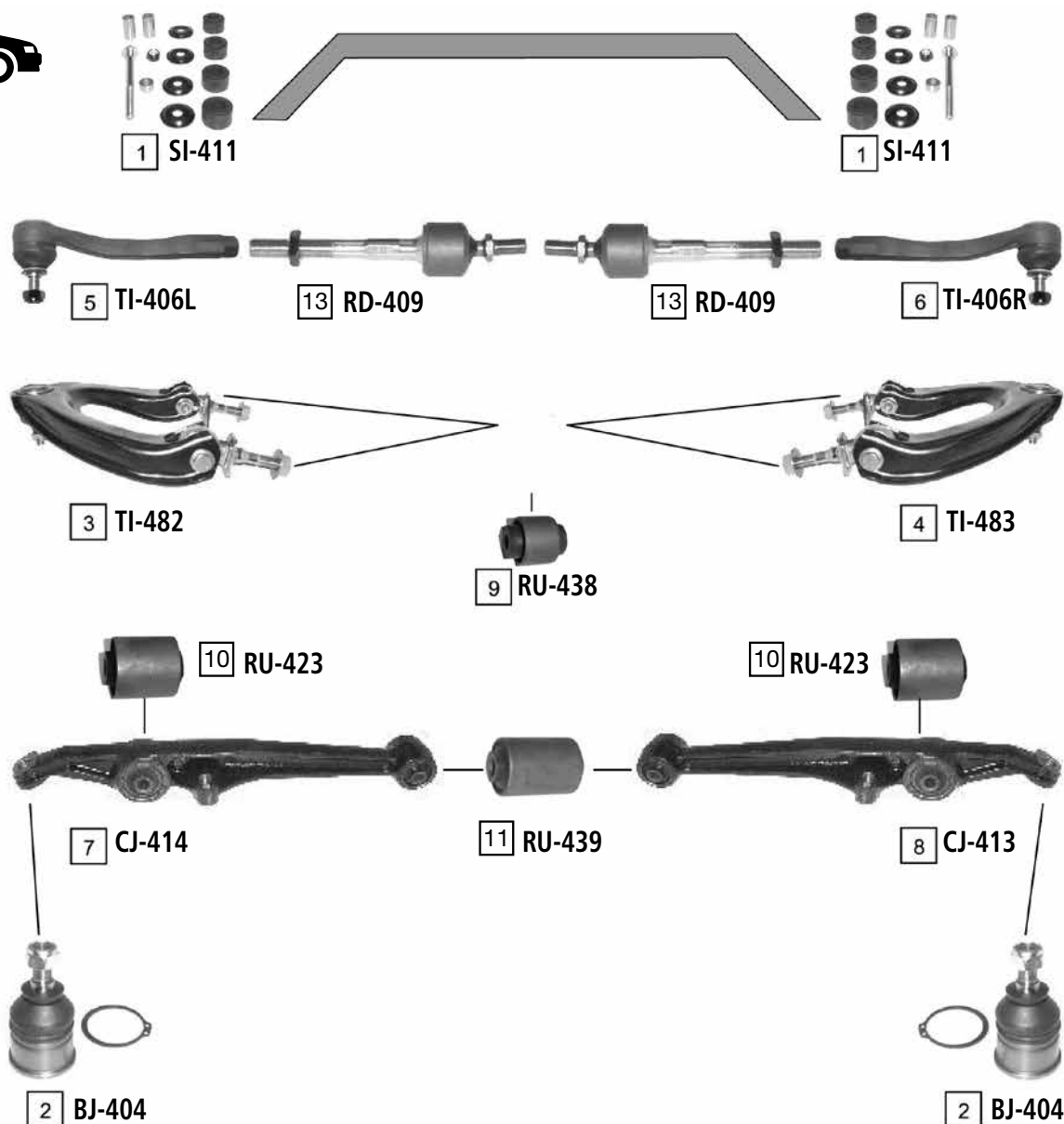

Ref.	JAPANPARTS CODE	Description	OEM	Measures	Ref.	JAPANPARTS CODE	Description	OEM	Measures
1	SI-411	Stabiliser Link	90112 SE0 000	L:100	8	CJ-413	TCA Right	51355-SH3-020	
2	BJ-404	Ball Joint Lower	51220 SE0 000	c:14.5	9	RU-438	Silentblock For Susp.Arm	51450-SH3-023	d:29
3	TI-482	TCA Upper Left	51460-SH3-000	c:12.9	10	RU-423	Silentblock For Susp.Arm	51350-SR3-A02	d:40
4	TI-483	TCA Upper Right	51450 SH3 020	c:12.9	11	RU-439	Silentblock For Susp.Arm	51355-SH3-020	d:32.1
5	TI-406L	Tie Rod End	53560-SH3-003	c:12.9 th:FM14X1.5R	12	RU-416	Silentblock For Susp.Arm	52370-SR3-J00	d:80
6	TI-406R	Tie Rod End	53540-SH3-003	c:12.9 th:FM14X1.5R	13	RD-409	Axial Joint	53521-SH3-003	th:MM12X1,25R L:160
7	CJ-414	TCA Left	51365-SH3-020						

HR-V (GH)

03/1999 - 07/2006



Ref	JAPANPARTS CODE	Description	OEM	Measures	Ref	JAPANPARTS CODE	Description	OEM	Measures
1	SI-424	Stabiliser Link Left	51321-S2H-003	L:148	4	BS-424	TCA	51360-S2H-G01	c:16
2	SI-425	Stabiliser Link Right	51320-S2H-003	L:148	5	BS-425	TCA	51350-S2H-G01	c:16
3	RD-418	Axial Joint	53010 S2H J01	th:MM14X1.5R L:307	6	TI-417	Tie Rod End	53540-SX8-T01	c:13.5 th:FM12X1.25

INSIGHT (ZE2)

04/2009 ->

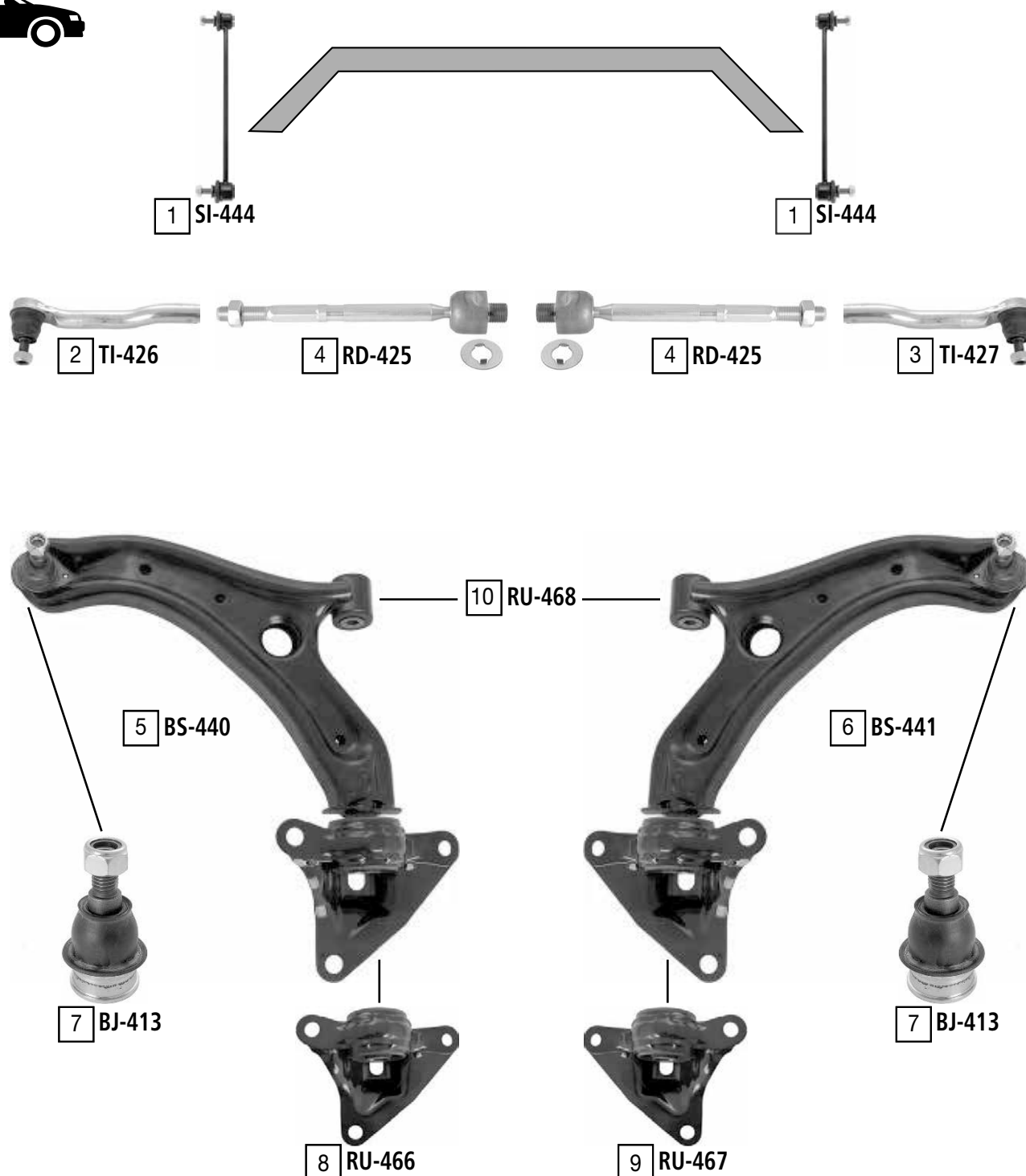

Ref	JAPANPARTS CODE	Description	OEM	Measures	Ref	JAPANPARTS CODE	Description	OEM	Measures
1	SI-444	Stabiliser Link	51320 TF0 003	L:325	6	BS-441	TCA right wbj	51350 TF0 030	c:17.5
2	TI-426	Tie Rod End Left	53560 TF0 003	c:12.7 th:FM14X1.5R	7	BJ-413	Ball Joint Lower	Part of	c:17.5 do:36.25
3	TI-427	Tie Rod End Right	53540 TF0 003	c:12.7 th:FM14X1.5R	8	RU-466	Silentblock For TCA	Part of	do:25.8
4	RD-425	Axial Joint	53010 TF0 003	th:MM18x1.5R L:236	9	RU-467	Silentblock For TCA	Part of	do:25.8
5	BS-440	TCA Left Wbj	51360 TF0 030	c:17.5	10	RU-468	Silentblock For TCA	Part of	di:14.2 do:33.9

INTEGRA (DA\_)

10/1985 - 08/1989

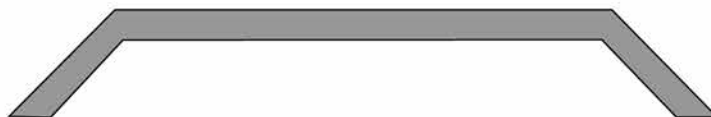

Ref.	JAPANPARTS CODE	Description	OEM	Measures	Ref.	JAPANPARTS CODE	Description	OEM	Measures
1	TI-401	Tie Rod End	53540-611-010	c:13 th: FM12X1.25R	2	RD-405	Axial Joint	53521-SB2-003	th:MM12X1.25R L:278

JAZZ (AA)

10/1983 - 10/1986



Ref	JAPANPARTS CODE	Description	OEM	Measures	Ref	JAPANPARTS CODE	Description	OEM	Measures
1	TI-401	Tie Rod End	53540-611-010	c:13 th:FM12X1.25R	3	CW-495	TCA Right	51351 SB2 013	c:14.5
2	TI-481	TCA Left	51361-SB2-013	c:14.5	4	RD-405	Axial Joint	53521-SB2-003	th: MM12X1.25R L:278



JAZZ (GD)

03/2002->



7 TI-418

5 RD-420

6 RD-419

8 TI-419

9 BJ-407

9 BJ-407



1 BS-426

10 RU-440



2 BS-427

11 RU-441

Ref.	JAPANPARTS CODE	Description	OEM	Measures	Ref.	JAPANPARTS CODE	Description	OEM	Measures
1	BS-426	TCA Left	51360 SAA E01		7	TI-418	Tie Rod End Left	53560-SAA-003	c:12.6 th:FM12X1.25
2	BS-427	TCA Right	51350 SAA E01		8	TI-419	Tie Rod End Right	53540-SAA-003	c:12.6 th:FM12X1.25
3	SI-426	Stabiliser Link Left	51321-SAA-003	L:300	9	BJ-407	Ball Joint	Part of BS-426/BS-427	c:16
4	SI-427	Stabiliser Link Right	51320-SAA-003		10	RU-440	Silentblock For Susp.Arm	Part of BS-426/BS-427	
5	RD-420	Axial Joint	53011-SAA-J01	th:MM16X1R L:211	11	RU-441	Silentblock For Susp.Arm	Part of BS-426/BS-427	
6	RD-419	Axial Joint	53010-SAA-J01	th:MM16X1R L:211					

JAZZ III (GE)

07/2008 ->

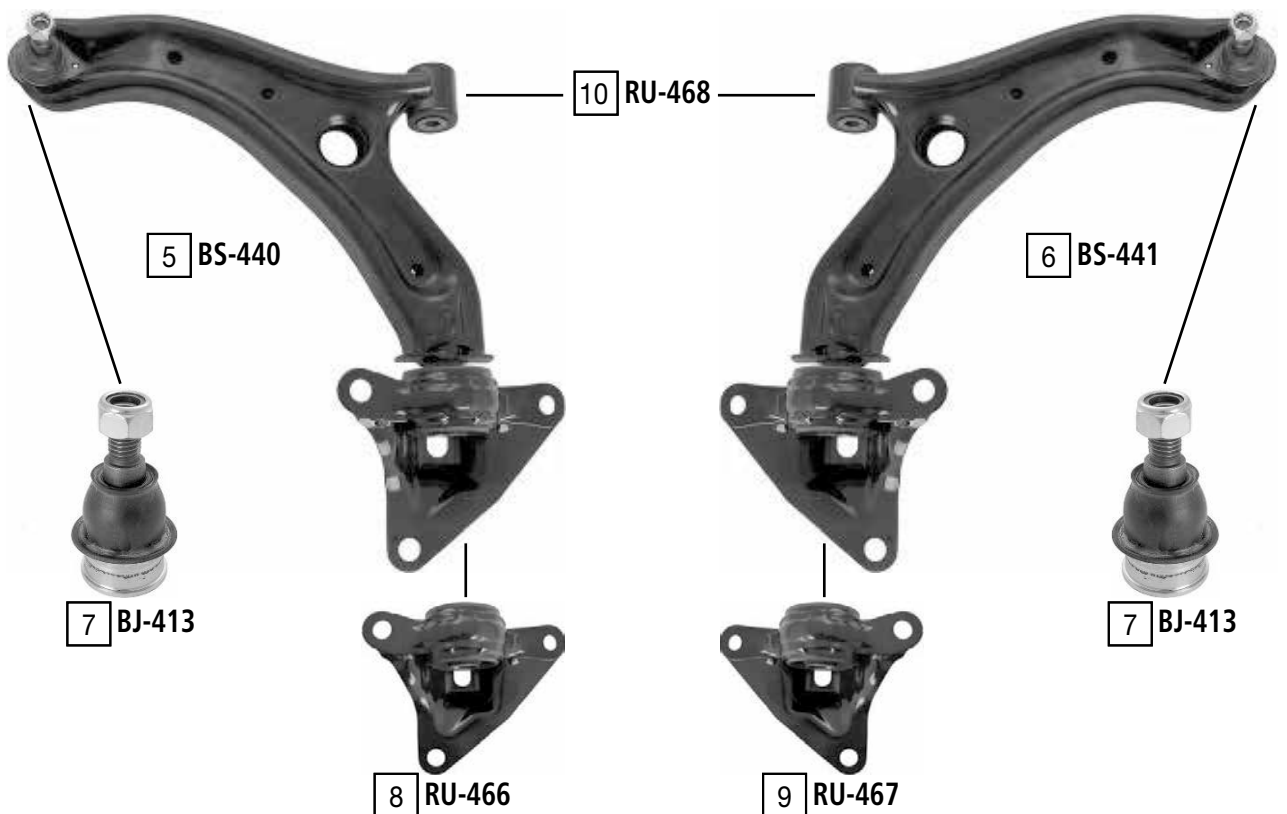
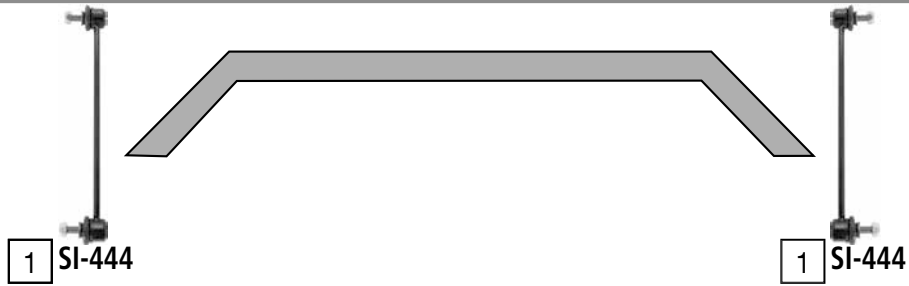

Ref.	JAPANPARTS CODE	Description	OEM	Measures	Ref.	JAPANPARTS CODE	Description	OEM	Measures
1	SI-444	Stabiliser Link	51320 TFO 003	L:325	6	BS-441	TCA right wbj	51350 TFO 030	c:17.5
2	TI-426	Tie Rod End Left	53560 TFO 003	c:12.7 th:FM14X1.5R	7	BJ-413	Ball Joint Lower	Part of	c:17.5 do:36.25
3	TI-427	Tie Rod End Right	53540 TFO 003	c:12.7 th:FM14X1.5R	8	RU-466	Silentblock For TCA	Part of	do:25.8
4	RD-425	Axial Joint	53010 TFO 003	th:MM18x1.5R L:236	9	RU-467	Silentblock For TCA	Part of	do:25.8
5	BS-440	TCA left wbj	51360 TFO 030	c:17.5	10	RU-468	Silentblock For TCA	Part of	di:14.2 do:33.9

LEGEND I (HS, KA)

01/1986 - 12/1990

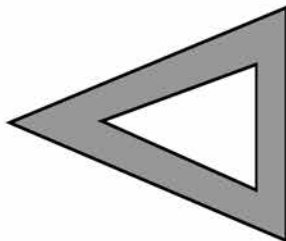

LOWER

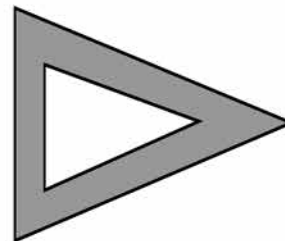

Ref	JAPANPARTS CODE	Description	OEM	Measures	Ref	JAPANPARTS CODE	Description	OEM	Measures
1	TI-405L	Tie Rod End	53560-SD4-003	c:14 th:FM12X1.25R	4	RD-497	Axial Joint	53521-SD4-003	th:MM12X1.25R L:136
2	TI-405R	Tie Rod End	53540-SD4-003	c:14 th:FM12X1.25R	5	TI-484	Tie Rod End		
3	BJ-499	Ball Joint Lower	51220-SD4-004	c:18	6	TI-485	Tie Rod End		

LEGEND II (KA7)

01/1991 - 02/1996

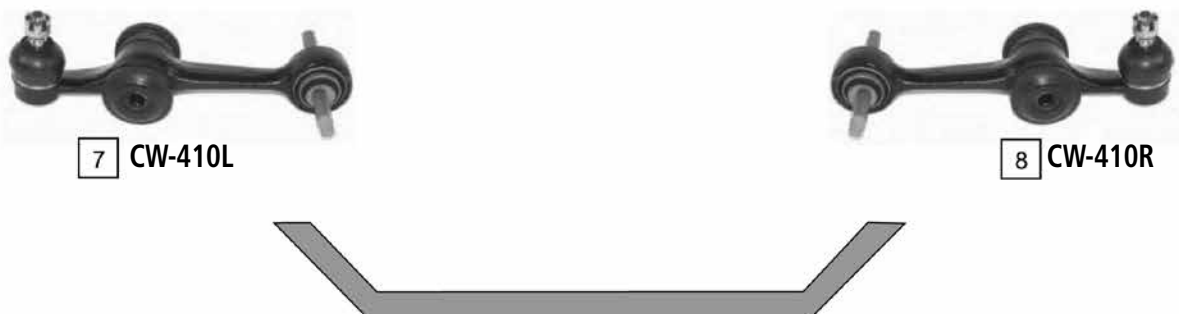
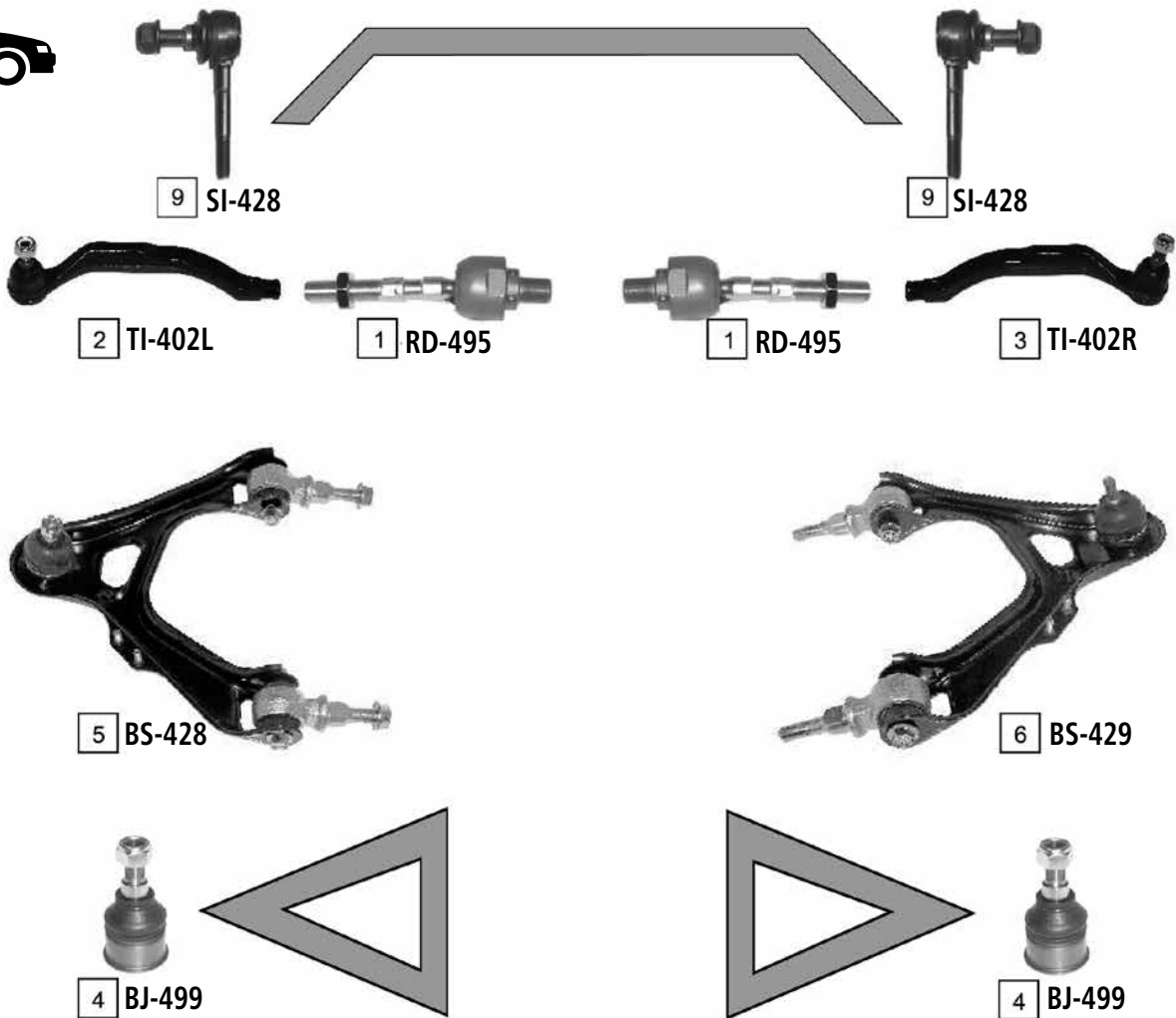

Ref.	JAPANPARTS CODE	Description	OEM	Measures	Ref.	JAPANPARTS CODE	Description	OEM	Measures
1	RD-495	Axial Joint	53521-SP0-004	th:MM16X1.25R L:126	6	BS-429	TCA	51450-SP0-033	c:12.8
2	TI-402L	Tie Rod End	53560-SP0-013		7	CW-410L	TCA	52400-SP0-013	c:14
3	TI-402R	Tie Rod End	53540-SP0-013		8	CW-410R	TCA	51390-SP0-013	c:14
4	BJ-499	Ball Joint Lower	51220-SD4-004	c:18	9	SI-428	Stabiliser Link	51320 SP0 003	L:78.5
5	BS-428	TCA	51460-SP0-033	c:12.8					

LEGEND III (KA9)

02/1996->



-> CHAS WC002641

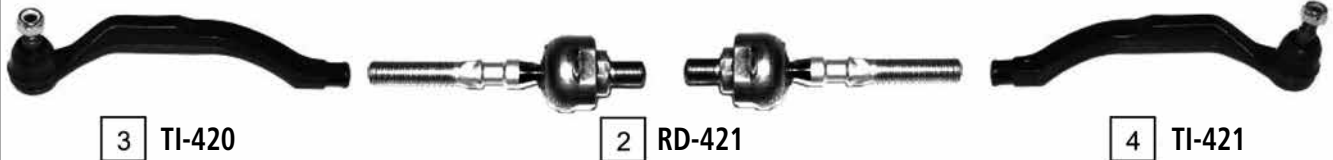

3 TI-420

2 RD-421

4 TI-421

CHAS WC002642 ->



3 TI-420

1 RD-422

4 TI-421



5 BS-430



6 BS-431

Ref	JAPANPARTS CODE	Description	OEM	Measures	Ref	JAPANPARTS CODE	Description	OEM	Measures
1	RD-422	Axial Joint	53010-SW5-003	th:MM14X1.25R L:122	4	TI-421	Tie Rod End	53540-SZ3-003	
2	RD-421	Axial Joint	53010-SW5-000	th:MM14X1.25R L:122	5	BS-430	TCA	51450-SZ3-013	c:12.8
3	TI-420	Tie Rod End	53560-SZ3-003		6	BS-431	TCA	51460-SZ3-901	c:12.8

LOGO (GA3)

03/1999 - 03/2002

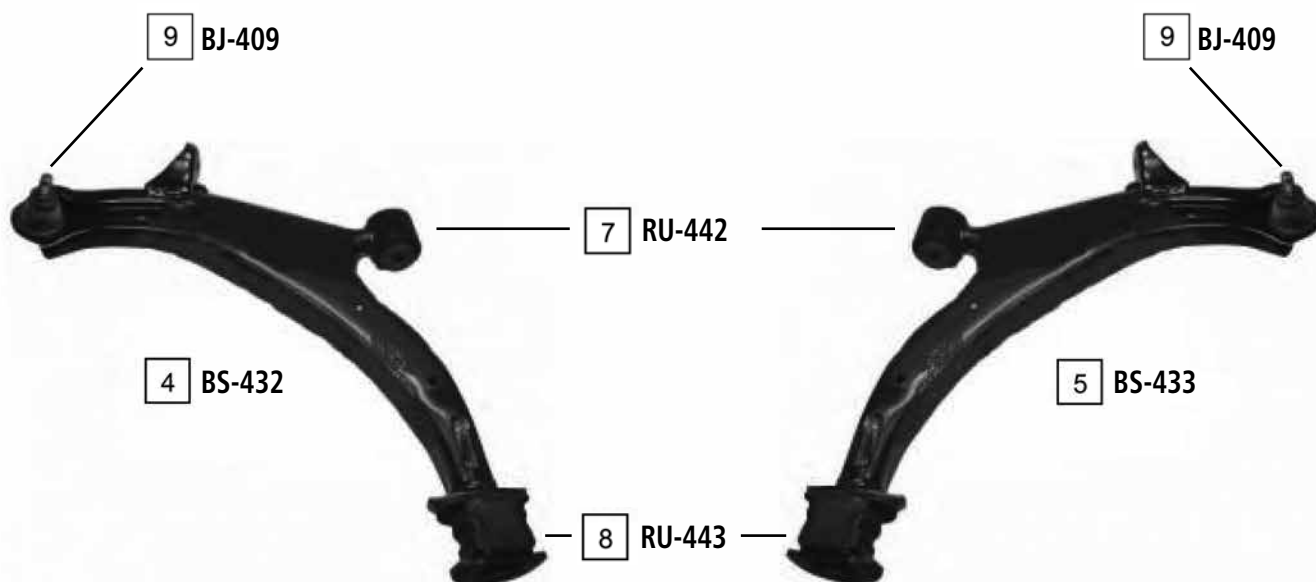
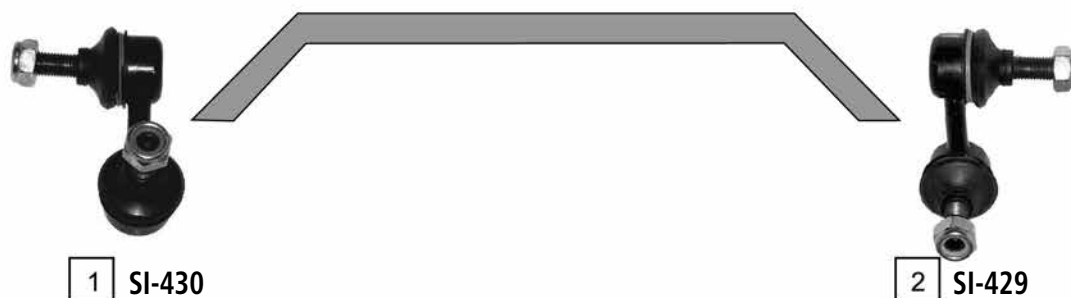

Ref.	JAPANPARTS CODE	Description	OEM	Measures	Ref.	JAPANPARTS CODE	Description	OEM	Measures
1	SI-430	Stabiliser Link Left	51321-S2G-003	L:55	6	TI-417	Tie Rod End	53540-SX8-T01	c:13.5 th:FM12X1.25
2	SI-429	Stabiliser Link Right	51320-S2G-003	L:55	7	RU-442	Silentblock For Susp.Arm	Part of BS-432/BS-433	
3	RD-423	Axial Joint	53010-S50-003	th:MM14X1.5R L:300	8	RU-443	Silentblock For Susp.Arm	Part of BS-432/BS-433	
4	BS-432	TCA Left	51360 S50 G01	c:14.5	9	BJ-409	Ball Joint	Part of BS-432/BS-433	
5	BS-433	TCA Right	51350 S50 G01						

PRELUDE I (SN)

11/1978 - 10/1982



Ref	JAPANPARTS CODE	Description	OEM	Measures	Ref	JAPANPARTS CODE	Description	OEM	Measures
1	TI-401	Tie Rod End	53540-611-010	c:13 th:FM12X1.25R	3	RD-403	Axial Joint	53521-SA0-003	
2	CW-498	TCA	51350-692-000	c:14.4					

PRELUDE II (AB)

11/1983 - 04/1987

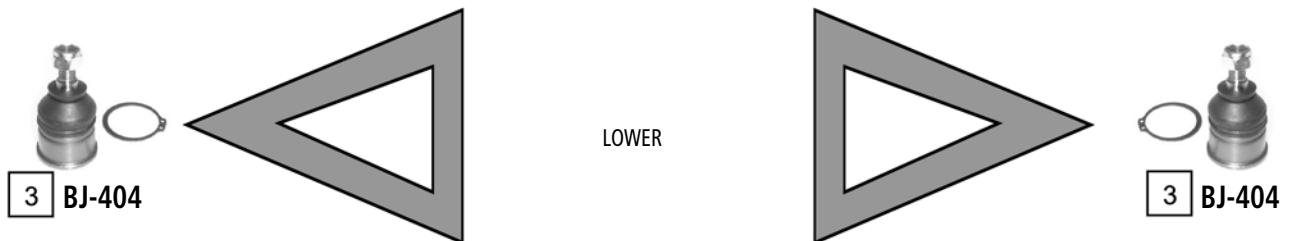

Ref.	JAPANPARTS CODE	Description	OEM	Measures	Ref.	JAPANPARTS CODE	Description	OEM	Measures
1	TI-401	Tie Rod End	53540-611-010	c:13 th:FM12X1.25R	3	BJ-404	Ball Joint Lower	51220 SEO 000	c:14.5
2	BJ-405	Ball Joint	51270SB0003	c:13	4	RD-406	Axial Joint	53540-SF1-004	



PRELUDE III (BA)

04/1986 - 01/1992



2 TI-499



4 RD-406



4 RD-406



2 TI-499



3 TI-486

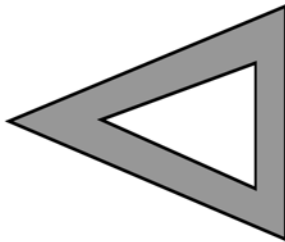

UPPER

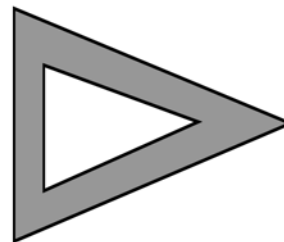

3 TI-486



1 BJ-404

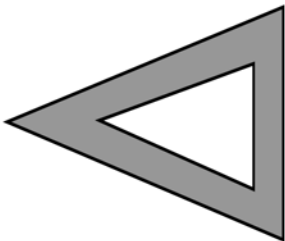

LOWER

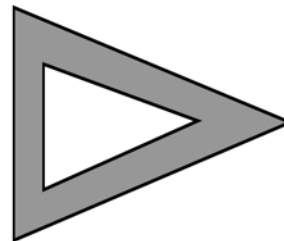

1 BJ-404

Ref	JAPANPARTS CODE	Description	OEM	Measures	Ref	JAPANPARTS CODE	Description	OEM	Measures
1	BJ-404	Ball Joint Lower	51220 SEO 000	c:14.5	3	TI-486	Ball Joint Upper	51270-SF1-003	c:13
2	TI-499	Tie Rod End	53540 SF1004	c:14 th:FM12X1.25R	4	RD-406	Axial Joint	53540-SF1-004	

PRELUDE IV (BB)

02/1992 - 09/1996



THREAD HOUSING M14X1.5



THREAD HOUSING M14X1.25

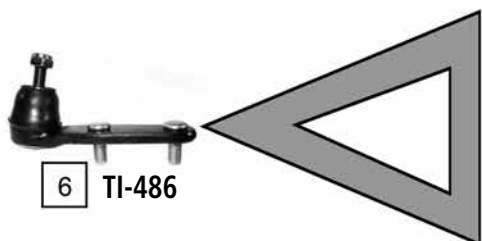

UPPER

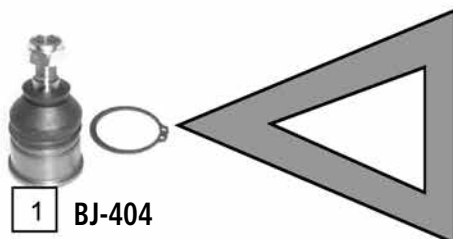
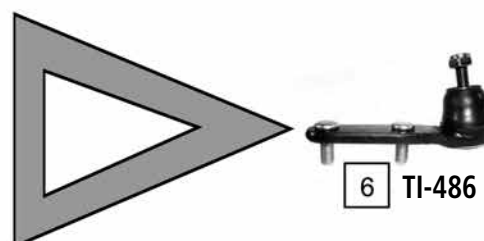

LOWER

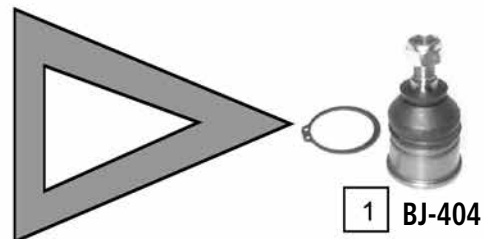

Ref.	JAPANPARTS CODE	Description	OEM	Measures	Ref.	JAPANPARTS CODE	Description	OEM	Measures
1	BJ-404	Ball Joint Lower	51220 SE0 000	c:14.5	4	TI-422	Tie Rod End Left	53560 SSO 003	
2	RD-496	Axial Joint	53010-SS0-000	th:MM14X1,5R L:125	5	TI-423	Tie Rod End Right	53540 SSO 003	
3	RD-498	Axial Joint	53010-SS0-000	th:MM14X1,5R L:125	6	TI-486	Ball Joint UPPER	51270-SF1-003	c:13

PRELUDE V (BB)

10/1996 - 10/2000

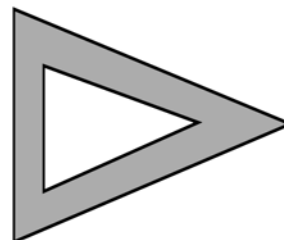
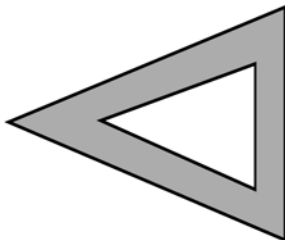

Ref	JAPANPARTS CODE	Description	OEM	Measures	Ref	JAPANPARTS CODE	Description	OEM	Measures
1	SI-431	Stabiliser Link	51320-S30-003		4	TI-425	Tie Rod End	53540-S30-005	
2	SI-432	Stabiliser Link	52320-S30-003	L:165	5	BJ-499	Ball Joint	51220-SL5-013	c:18.5
3	TI-424	Tie Rod End	53560-S30-005		6	RD-421	Axial Joint	53010-SW5-000	th:MM14X1.25R L:122

QUINTET (SU)

02/1980 - 12/1984



Ref.	JAPANPARTS CODE	Description	OEM	Measures	Ref.	JAPANPARTS CODE	Description	OEM	Measures
1	TI-401	Tie Rod End	53540-611-010	c:13 th:FM12X1.25R	2	RD-403	Axial Joint	53521-SA0-003	

ACCENT (X-3)

07/1994 - 01/2000



10 SI-H01



10 SI-H01



6 TI-H57

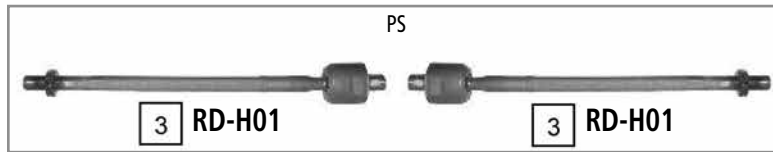

3 RD-H01

3 RD-H01

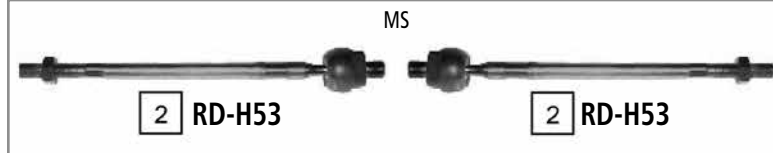

2 RD-H53

2 RD-H53



6 TI-H57



4 BJ-H54L

7 RU-H03

5 BJ-H54R

8 RU-H04

9 RU-H05

1 BJ-H57

1 BJ-H57

Ref	JAPANPARTS CODE	Description	OEM	Measures	Ref	JAPANPARTS CODE	Description	OEM	Measures
1	BJ-H57	Ball Joint	54520 31600	c:15	6	TI-H57	Tie Rod End	56820-28500	c:13.6 th:FM14X1.5R
2	RD-H53	Axial Joint	56540-22000	th:MM16X1.5R L:296.	7	RU-H03	Silentblock For Susp.Arm	54551 02000	d:35
3	RD-H01	Axial Joint	57755-22000	th:MM16X1.5R L:295	8	RU-H04	Silentblock For Susp.Arm	54555 22100	
4	BJ-H54L	TCA Left	54500-22200		9	RU-H05	Silentblock For Susp.Arm	54556 22100	
5	BJ-H54R	TCA Right	54501-22200		10	SI-H01	Stabiliser Link	54825 22000	

ACCENT (LC)

01/2000 ->

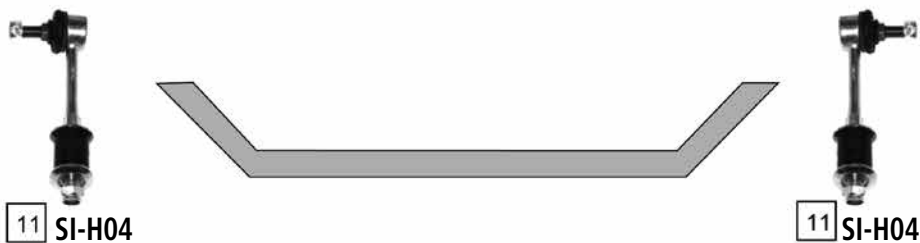
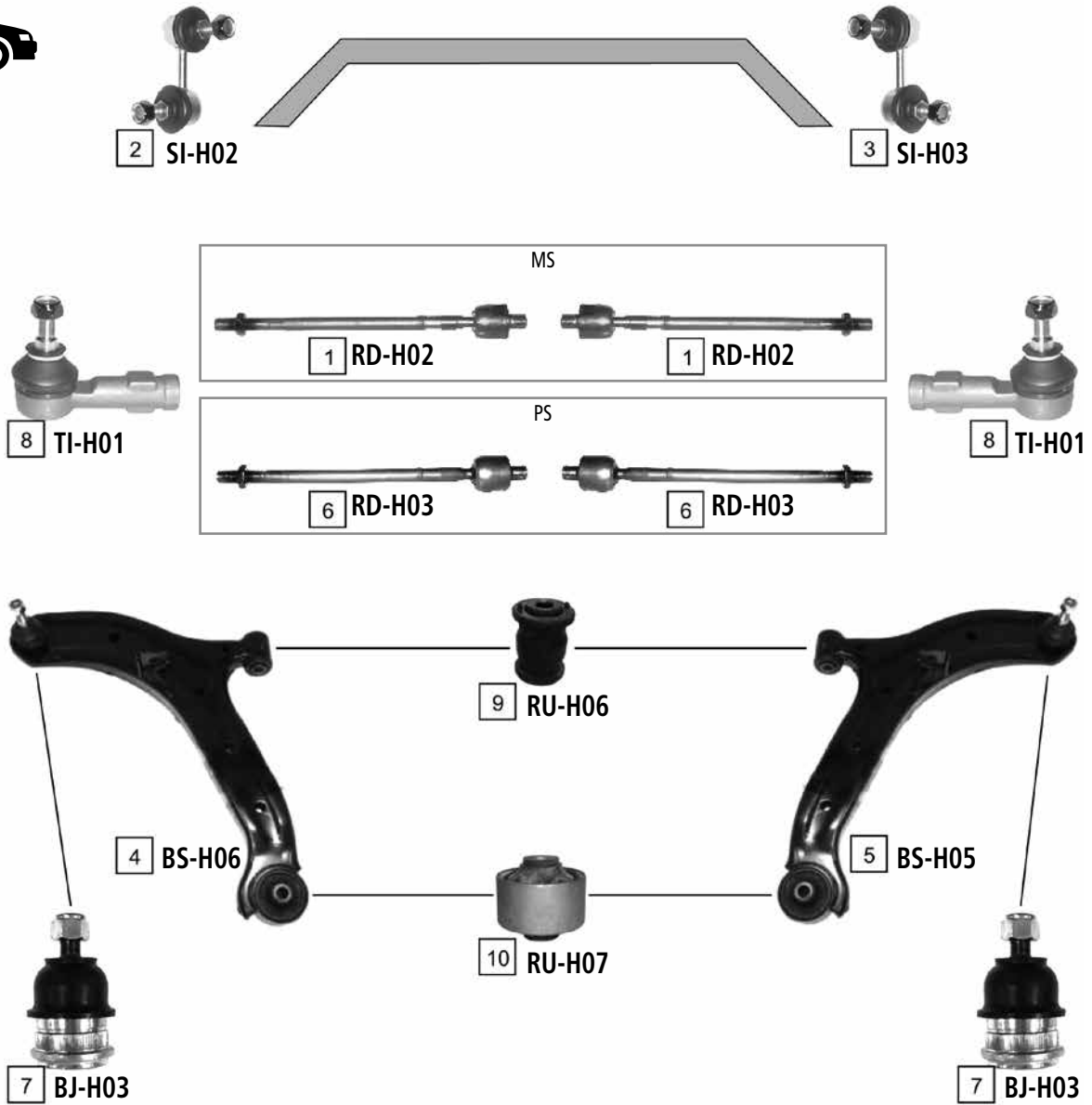

Ref.	JAPANPARTS CODE	Description	OEM	Measures	Ref.	JAPANPARTS CODE	Description	OEM	Measures
1	RD-H02	Axial Joint	56540-25000	th:MM16X1.5R L:305	7	BJ-H03	Ball Joint	54503-25A00	c:15
2	SI-H02	Stabiliser Link Left	54830-25010	L:60	8	TI-H01	Tie Rod End	56820-25000	c:13.8 th:FM14X1.5R
3	SI-H03	Stabiliser Link Right	54830-25020	L:60	9	RU-H06	Silentblock For Susp.Arm	54551 25000	
4	BS-H06	TCA Left	54500-25000	c:15	10	RU-H07	Silentblock For Susp.Arm	54555 25000	
5	BS-H05	TCA Right	54501-25000	c:15	11	SI-H04	Stabiliser Link	55830 25000	
6	RD-H03	Axial Joint	57730 43010	th:MM16X1.5R L:292					

ACCENT (MC)

12/2005 ->

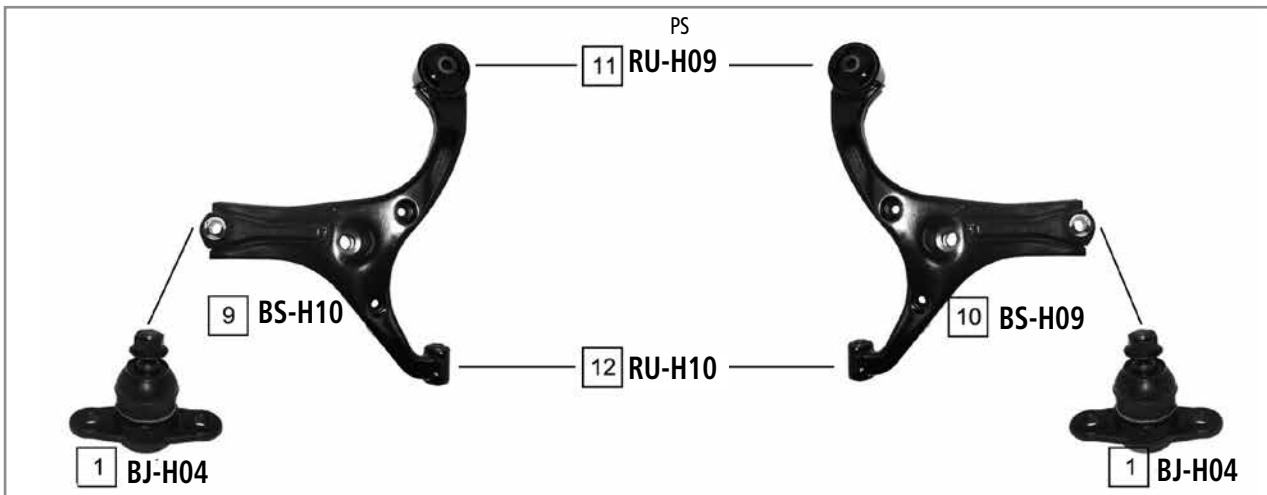
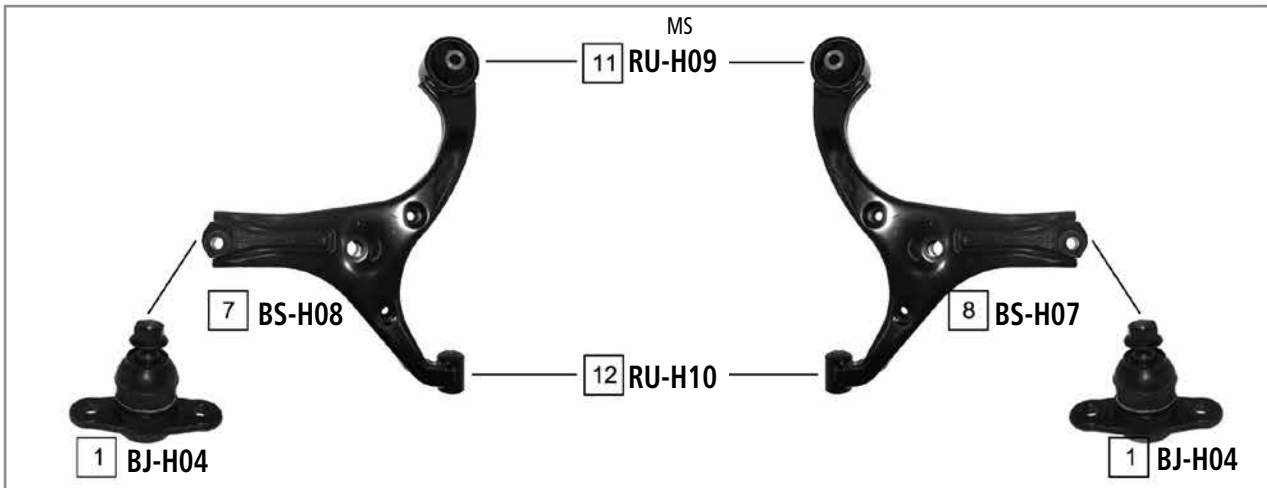
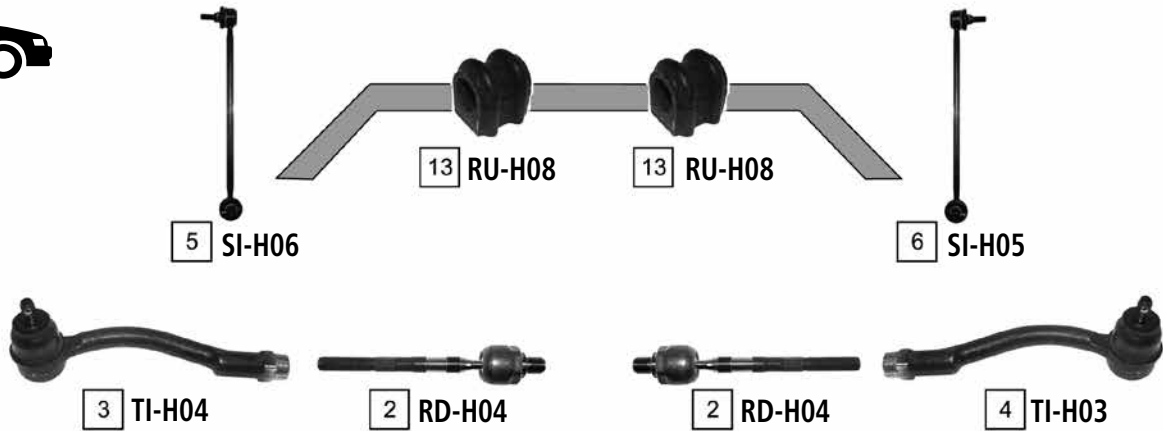

Ref	JAPANPARTS CODE	Description	OEM	Measures	Ref	JAPANPARTS CODE	Description	OEM	Measures
1	BJ-H04	Ball Joint	51760 1G000		8	BS-H07	TCA Right	54501 1E100	
2	RD-H04	Axial Joint	57724 1E000	th:MM16X1.5R L:195	9	BS-H10	TCA Left	54500 1E000	
3	TI-H04	Tie Rod End Left	56820 1E000		10	BS-H09	TCA Right	54501 1E000	
4	TI-H03	Tie Rod End Right	56820 1E900		11	RU-H09	Silentblock For Susp.Arm	54584 1G000	
5	SI-H06	Stabiliser Link Left	54830 1G000	L:285.5	12	RU-H10	Silentblock For Susp.Arm	54551 1E000	
6	SI-H05	Stabiliser Link Right	54840 1G000	L:285.5	13	RU-H08	Stabiliser Mounting	54812 1G100	
7	BS-H08	TCA Left	54500 1E100						

ATOS (MX)

02/1998 ->

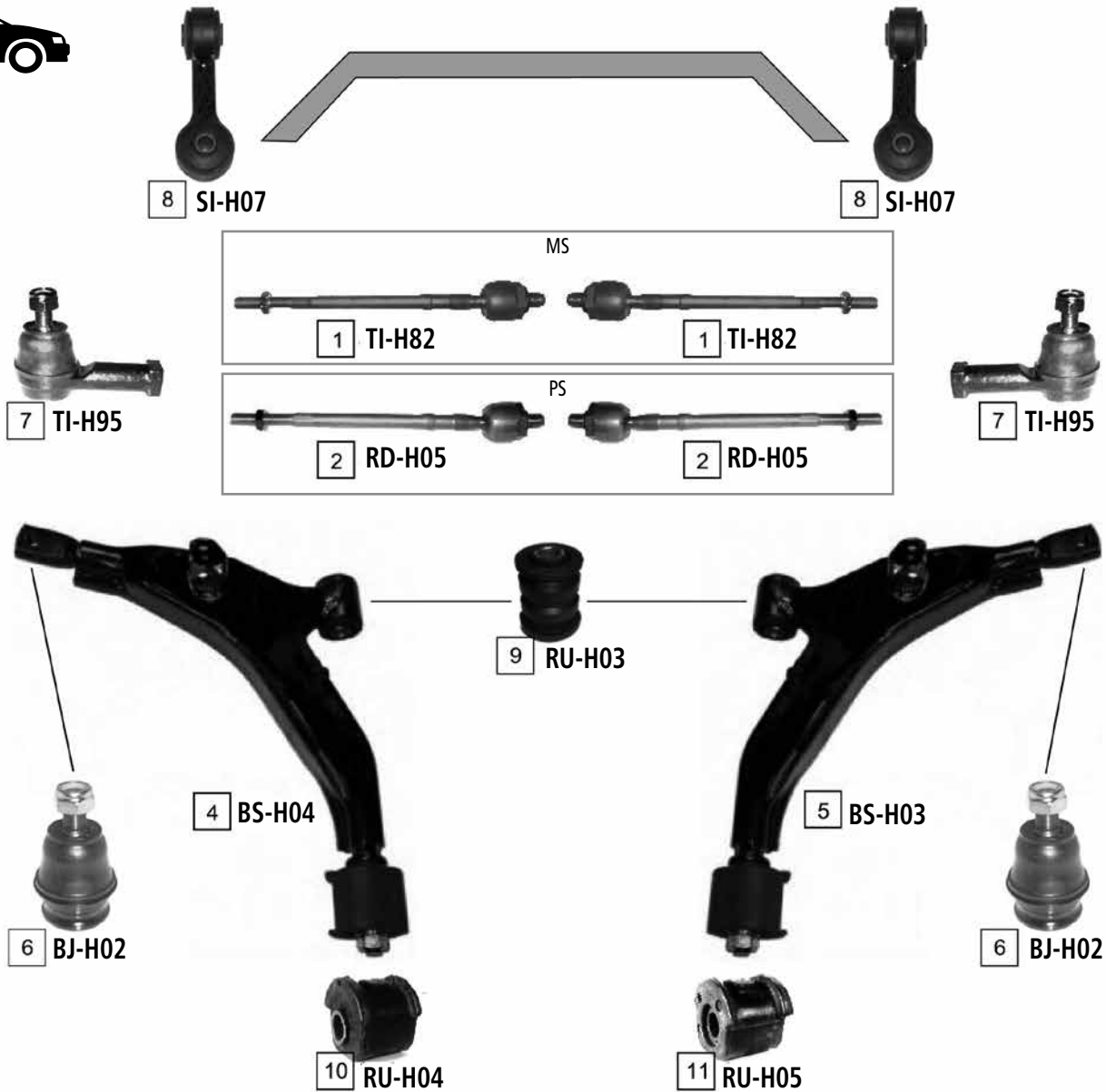

Ref.	JAPANPARTS CODE	Description	OEM	Measures	Ref.	JAPANPARTS CODE	Description	OEM	Measures
1	TI-H82	Axial Joint	56540-02000		7	TI-H95	Tie Rod End	56820-02500	c:13.8 th:FM12X1.25
2	RD-H05	Axial Joint	57755-02000		8	SI-H07	Stabiliser Link	54820 02000	L:70
3	TI-H91	Stabiliser Link	55530-29000	L:130	9	RU-H03	Silentblock For Susp.Arm	54551 02000	d:35
4	BS-H04	TCA Left	54500 02050	c:14.5	10	RU-H04	Silentblock For Susp.Arm	54555 22100	
5	BS-H03	TCA Right	54501 02050	c:14.5	11	RU-H05	Silentblock For Susp.Arm	54556 22100	
6	BJ-H02	Ball Joint	54530-02050	c:13.35					



COUPE (RD)

08/1996 - 02/2002

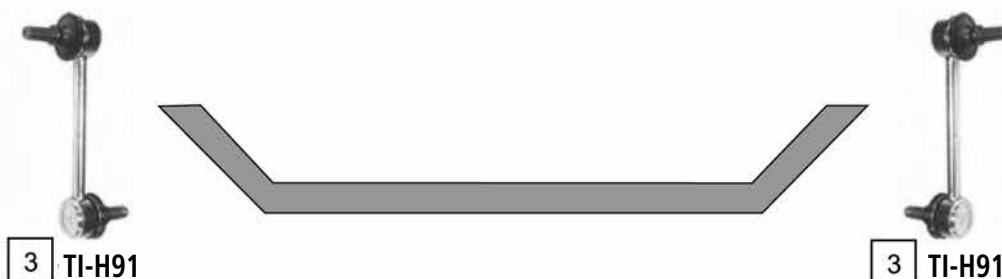

Ref	JAPANPARTS CODE	Description	OEM	Measures	Ref	JAPANPARTS CODE	Description	OEM	Measures
1	TI-H57	Tie Rod End	56820-28500	c:13.6 th:FM14X1.5R	5	RD-H63	Axial Joint	57730 29000	th:MM16X1.5R L:317
2	SI-H56	Stabiliser Link	54830-29000	L:70.5	6	BJ-H55L	TCA	54500-29000	
3	TI-H91	Stabiliser Link	55530-29000	L:130	7	BJ-H55R	TCA	54501-29000	
4	BJ-H57	Ball Joint	54520 31600	c:15					

COUPE (GK)

03/2002 ->

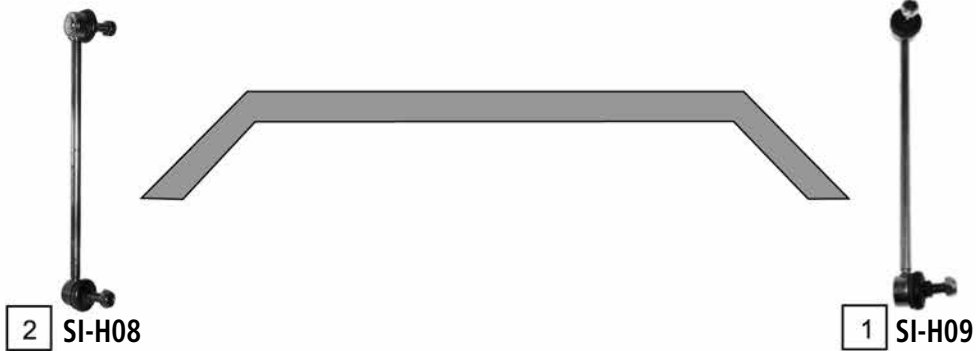

Ref.	JAPANPARTS CODE	Description	OEM	Measures	Ref.	JAPANPARTS CODE	Description	OEM	Measures
1	SI-H09	Stabiliser Link	54840-2C000	L:286	5	BS-H12	TCA Left	54500-2C000	
2	SI-H08	Stabiliser Link	54830-2C000	L:286	6	BS-H11	TCA Right	54501-2C000	
3	RD-H06	Axial Joint	57724-2D000	th:MM16X1.5R L:327	7	BJ-H03	Ball Joint	54503-25A00	c:15
4	TI-H01	Tie Rod End	56820-25000	c:13.8 th:FM14X1.5R					

ELANTRA (XD)

06/2000 ->

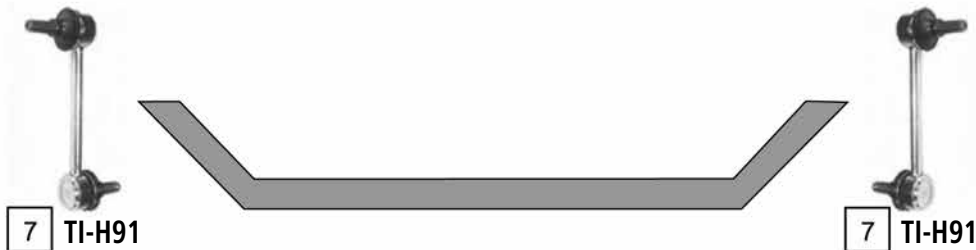

Ref	JAPANPARTS CODE	Description	OEM	Measures	Ref	JAPANPARTS CODE	Description	OEM	Measures
1	SI-H53	Stabiliser Link	54830 34500	L:52	5	TI-H01	Tie Rod End	56820-25000	c:13.8 th:FM14X1.5R
2	RD-H06	Axial Joint	57724-2D000	th:MM16X1.5R L:327	6	BJ-H03	Ball Joint	54503-25A00	c:15
3	BS-H14	TCA	54500 2D000		7	TI-H91	Stabiliser Link	55530-29000	L:130
4	BS-H13	TCA	54501 2D000						

GALLOPER II (JK-01)

08/1998 ->

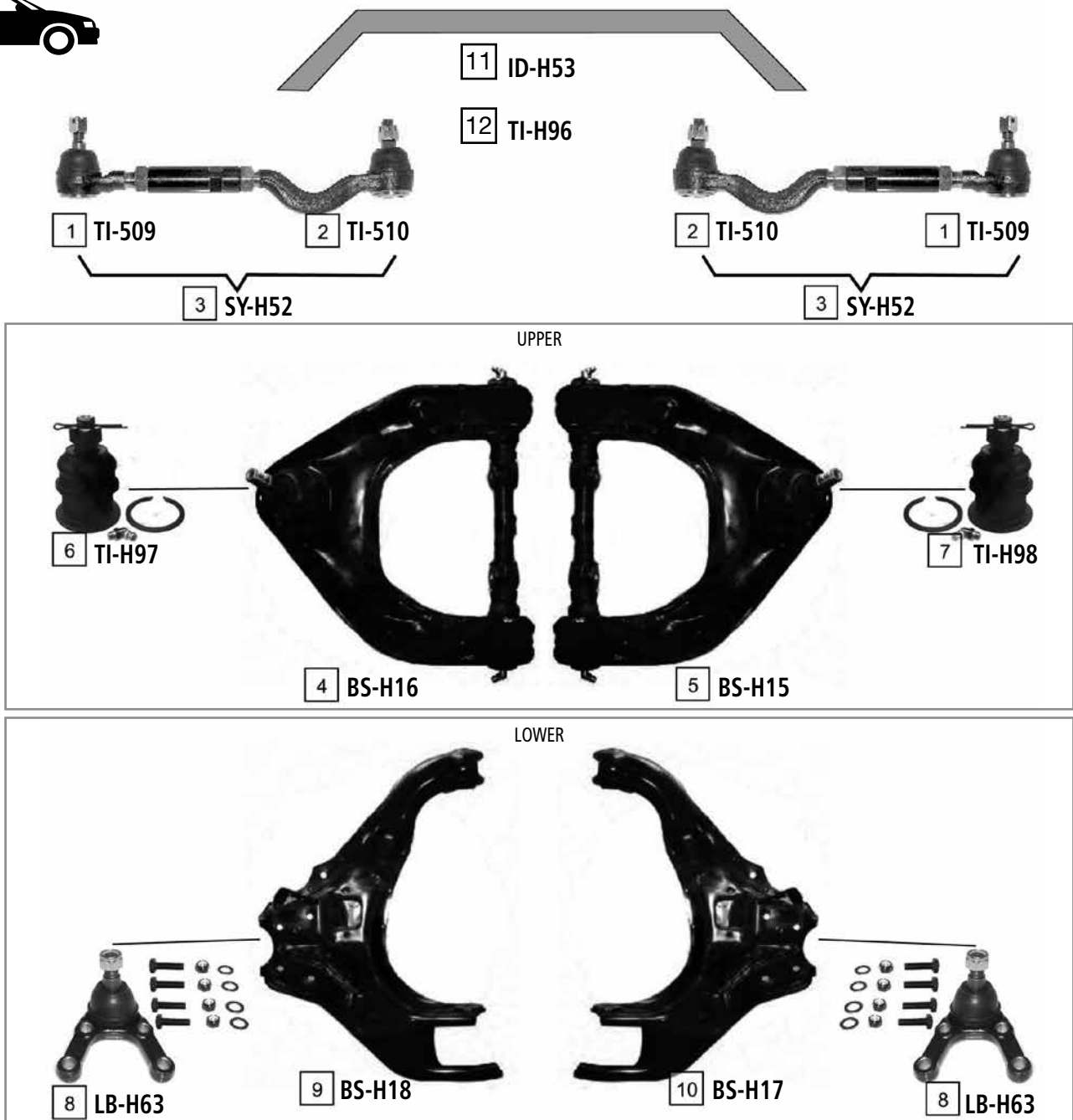

Ref.	JAPANPARTS CODE	Description	OEM	Measures	Ref.	JAPANPARTS CODE	Description	OEM	Measures
1	TI-509	Tie Rod End	MB241171	c:13.6 th:MM16X1.5L	7	TI-H98	Ball Joint UPPER Right	54431-44000	
2	TI-510	Tie Rod End	MB241206	c:13.8 th:MM16X1.5R	8	LB-H63	Ball Joint	HB212-100	c:19.5
3	SY-H52	Tie Rod	HB568-100		9	BS-H18	TCA Left	HB212003	
4	BS-H16	TCA	MB109630A		10	BS-H17	TCA Right	HB212004	
5	BS-H15	TCA	MB109631A		11	ID-H53		MB673525B	
6	TI-H97	Ball Joint UPPER Left	54417-44000		12	ID-H96		MB673525A	

GETZ (TB)

09/2002 ->

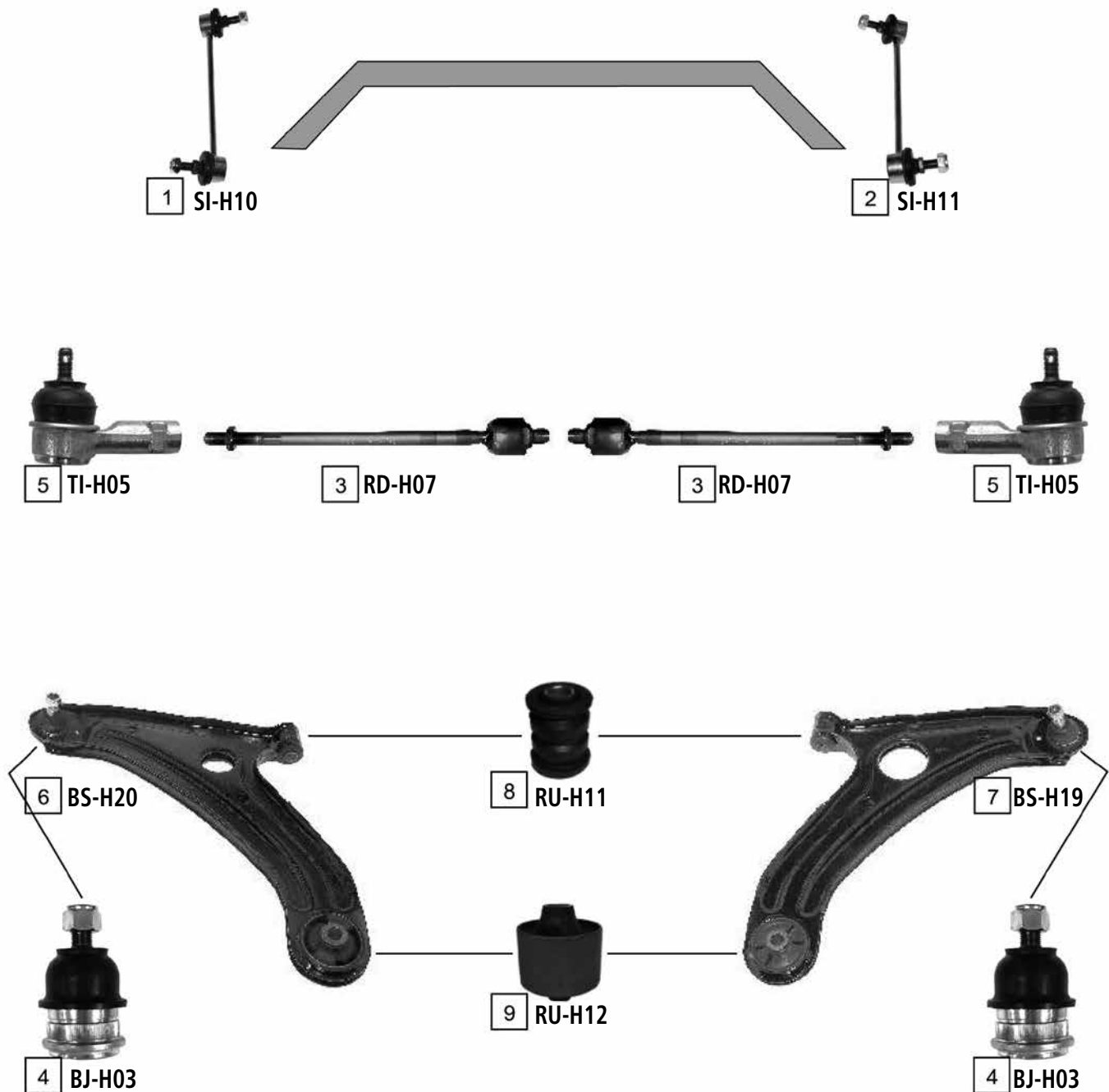

Ref	JAPANPARTS CODE	Description	OEM	Measures	Ref	JAPANPARTS CODE	Description	OEM	Measures
1	SI-H10	Stabiliser Link Left	54830-1C000	L:198	6	BS-H20	TCA Left	54500-1C000	c:15
2	SI-H11	Stabiliser Link Right	54840-1C000	L:198	7	BS-H19	TCA Right	54501-1C000	c:15
3	RD-H07	Axial Joint	57755-1C000	th:MM16X1.5R L:316	8	RU-H11	Silentblock For Susp.Arm	Part of BS-H20/BS-H19	d:32.8
4	BJ-H03	Ball Joint	54503-25A00	c:15	9	RU-H12	Silentblock For Susp.Arm	Part of BS-H20/BS-H19	d:63.3
5	TI-H05	Tie Rod End	56820-3B000	c:13.4 th:FM14X1.5R					

H1/H200/STAREX

01/1996 - 11/2002

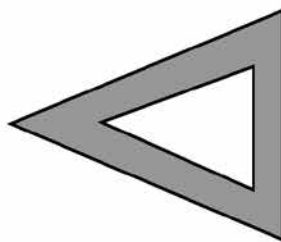

UPPER

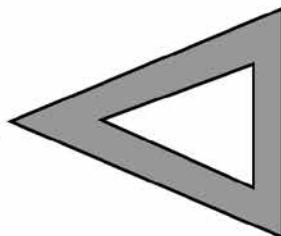
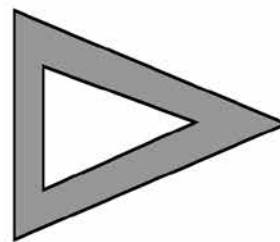

LOWER

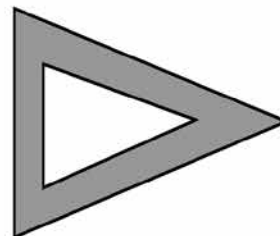

Ref.	JAPANPARTS CODE	Description	OEM	Measures	Ref.	JAPANPARTS CODE	Description	OEM	Measures
1	TI-H59	Tie Rod End	56872 43010	c:13.7 th:FM14X1.5L	4	LB-H77	Ball Joint Upper	54417 43A00	c:17.6
2	SI-H58	Stabiliser Link	54830-4A003	L:54	5	LB-H66	Ball Joint	54530-4AA00	c:19.5
3	SI-H12	Stabiliser Link	55530-4A001		6	RD-H08	Axial Joint	57729 4A000	th:MM16X1.5R L:292

H1 (CARGO / TRAVEL)

02/2008 ->

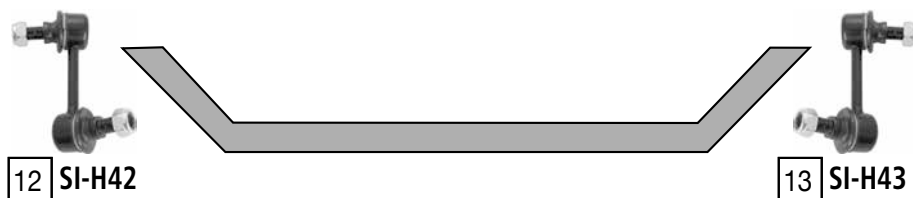
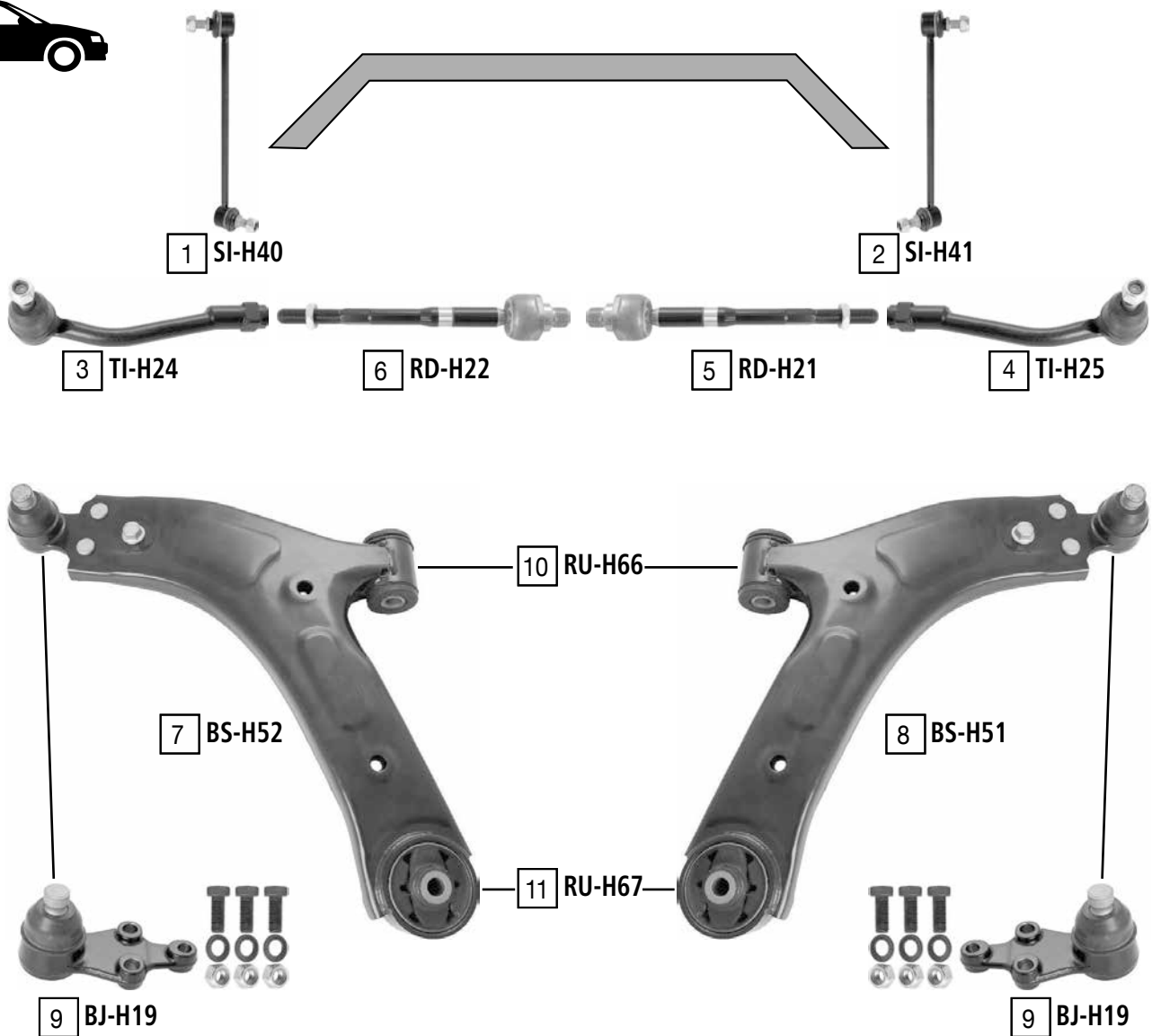

Ref	JAPANPARTS CODE	Description	OEM	Measures	Ref	JAPANPARTS CODE	Description	OEM	Measures
1	SI-H40	Stabiliser Link Left	54830 4H200	L:275	8	BS-H51	TCA right wbj	54501 4H000	c:19.9
2	SI-H41	Stabiliser Link Right	54840 4H200	L:275	9	BJ-H19	Ball joint	54530 3J000	c:20
3	TI-H24	Tie Rod End Left	56820 4H000	c:13.9 th:FM14X1.5R	10	RU-H66	Silentblock for TCA	Part of	di:14.5 do:42
4	TI-H25	Tie Rod End Right	56820 4H100	c:13.9 th:FM14X1.5R	11	RU-H67	Silentblock for TCA	Part of	di:14.4 do:69.5
5	RD-H21	Axial Joint	57724 4H100	th:MM18X1.5R L:241	12	SI-H42	Stabiliser link left	55530 4H000	L:84
6	RD-H22	Axial Joint	57724 4H000	th:MM18X1.5R L:241	13	SI-H43	Stabiliser link right	55540 4H000	L:84
7	BS-H52	TCA left wbj	54500 4H000	c:20					

H100

07/1993 - 02/2004

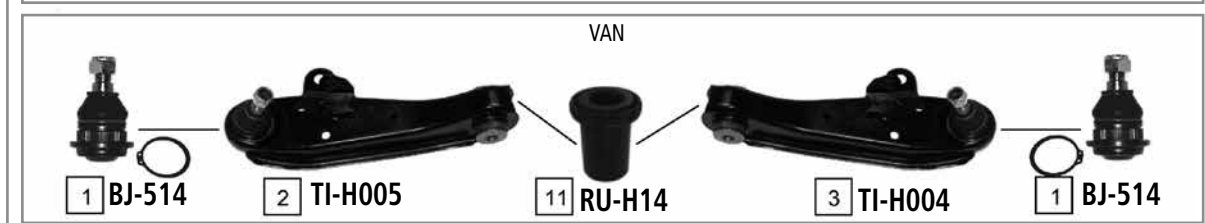
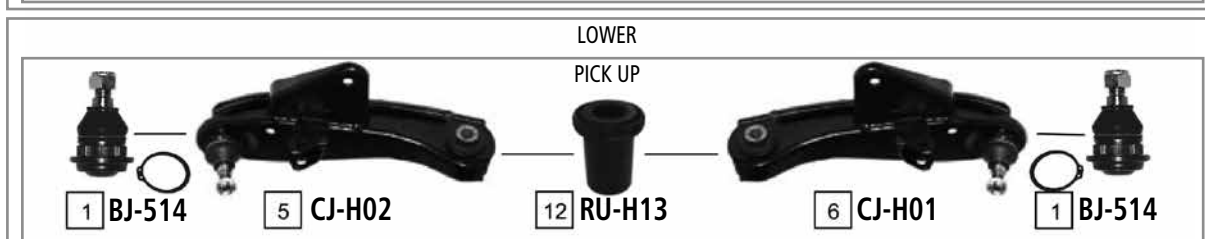
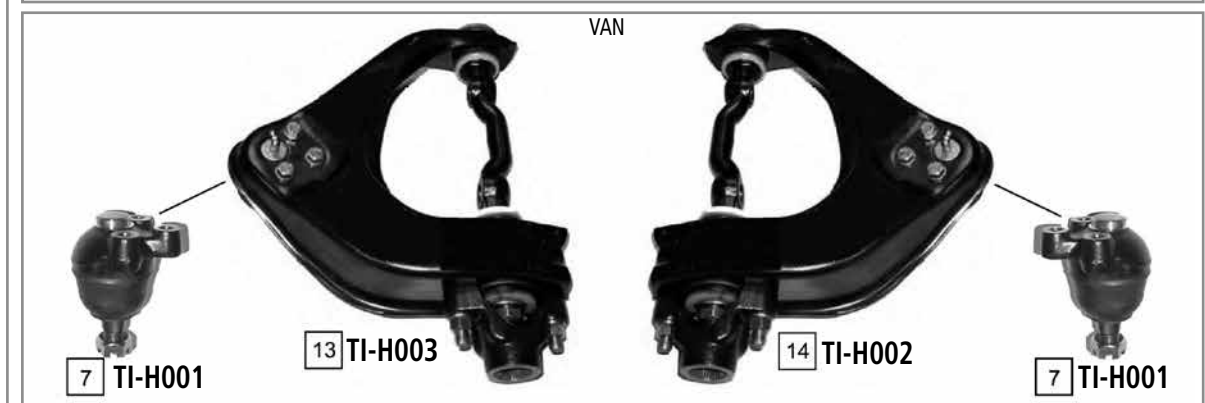
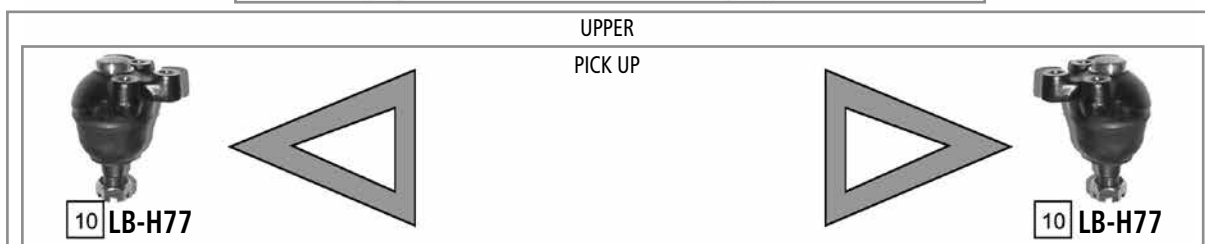
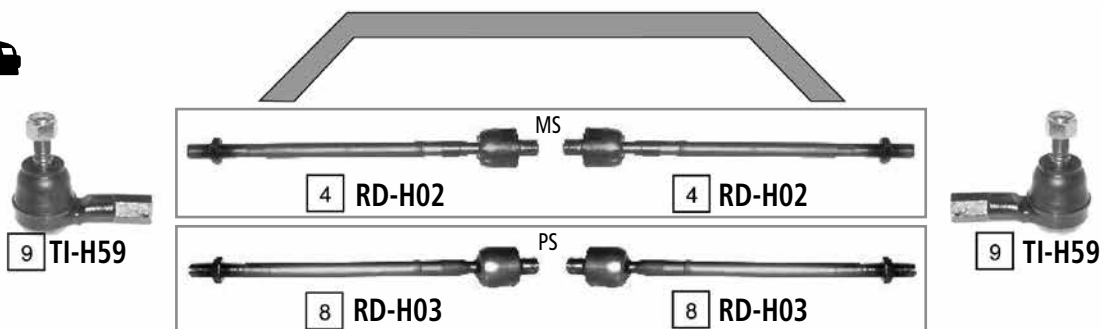

Ref	JAPANPARTS CODE	Description	OEM	Measures	Ref	JAPANPARTS CODE	Description	OEM	Measures
1	BJ-514	Ball Joint Lower		c:19.6	8	RD-H03	Axial Joint	57730 43010	th:MM16X1.5R L:292
2	TI-H005	TCA	54510 43152	c:19.5	9	TI-H59	Tie Rod End	56872 43010	c:13.7 th:FM14X1.5R
3	TI-H004	TCA	54540 43152	c:19.5	10	LB-H77	Ball Joint Upper	54417 43A00	c:17.6
4	RD-H02	Axial Joint	56540-25000	th:MM16X1.5R L:305	11	RU-H14	Silentblock For Susp.Arm	Part of TI-H005/TI-H004	d:45.8
5	CJ-H02	TCA Left	54510 48001	c:19.6	12	RU-H13	Silentblock For Susp.Arm	Part of CJ-H02/CJ-H01	d:42.3
6	CJ-H01	TCA Right	54540 48001	c:19.6	13	TI-H003	TCA Left	54410 43004	
7	TI-H001	Ball Joint Upper	54417 43000		14	TI-H002	TCA Right	54430 43004	



i10

12/2007 ->

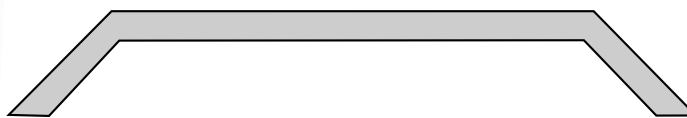

4 RD-H17



4 RD-H17

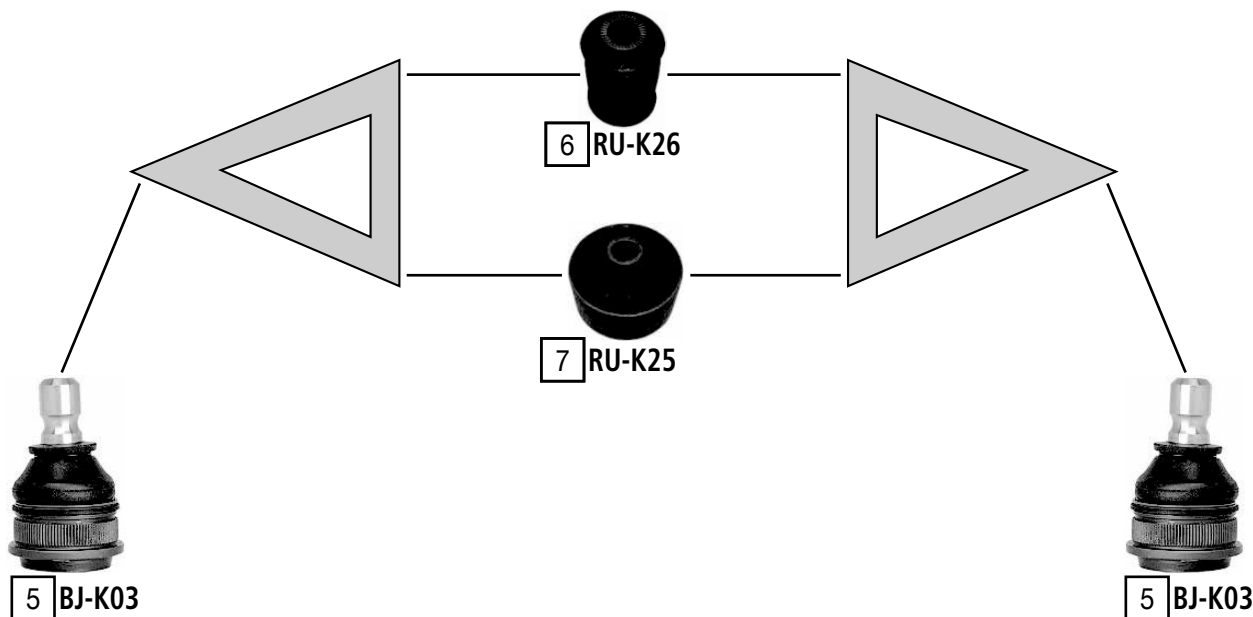

Ref	JAPANPARTS CODE	Description	OEM	Measures	Ref	JAPANPARTS CODE	Description	OEM	Measures
1	SI-H34	Stabiliser link left	54830 0X000	L:230	5	BJ-K03	Ball Joint	54530 07000	c:16 do:40
2	SI-H35	Stabiliser link right	54840 0X000	L:230	6	RU-K26	Silentblock For TCA	54551 07000	di:12.3 do:33
3	TI-H19	Tie rod end	56820 0X010	c:13.5 th:FM12x1.25R	7	RU-K25	Silentblock For TCA	54584 0X000	di:12.3 do:60.3
4	RD-H17	Axial joint	57724 0X010	th:MM16x1.5R L:295					

i20

09/2008 ->

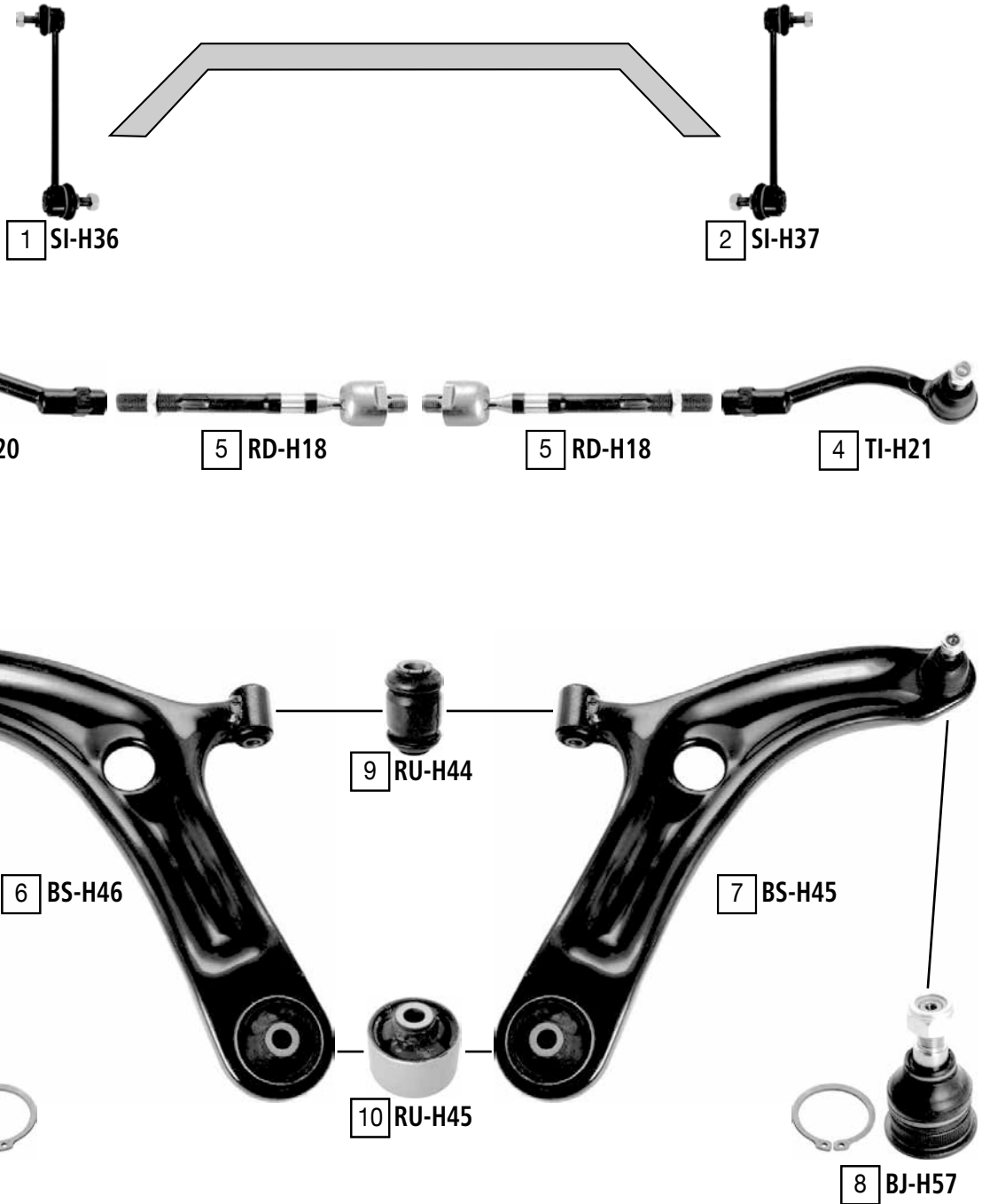

Ref	JAPANPARTS CODE	Description	OEM	Measures	Ref	JAPANPARTS CODE	Description	OEM	Measures
1	SI-H36	Stabiliser Link Left	54830 1J000	L:216	6	BS-H46	TCA left wbj	54500 1J700	c:15
2	SI-H37	Stabiliser Link Right	54840 1J000	L:216	7	BS-H45	TCA right wbj	54501 1J700	c:15
3	TI-H20	Tie Rod End Left	56820 2K000	c:13.4 th:FM16X1.5R	8	BJ-H57	Ball Joint	54530 31600	c:15 do:40
4	TI-H21	Tie Rod End Right	56820 2K050	c:13.4 th:FM16X1.5R	9	RU-H44	Silentblock For TCA	54551 1J000	di:12.3 do:33.5
5	RD-H18	Axial Joint	57724 1J000	th:MM16X1.5R L:223	10	RU-H45	Silentblock For TCA	54584 1J000	di:14.45 do:66.3

i30  
i30 CW ESTATE

10/2007 ->  
02/2008 ->

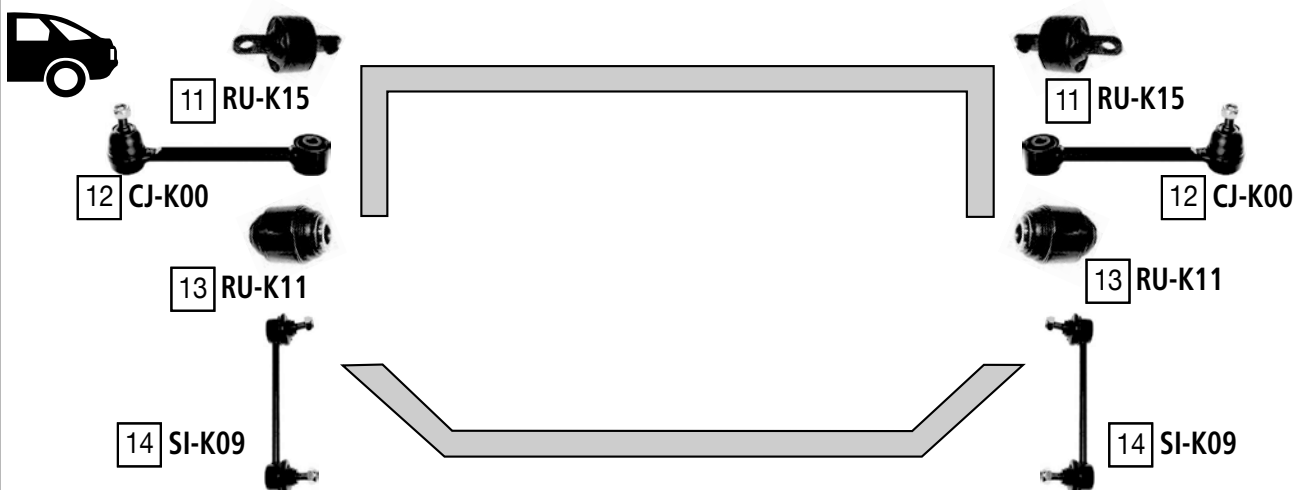
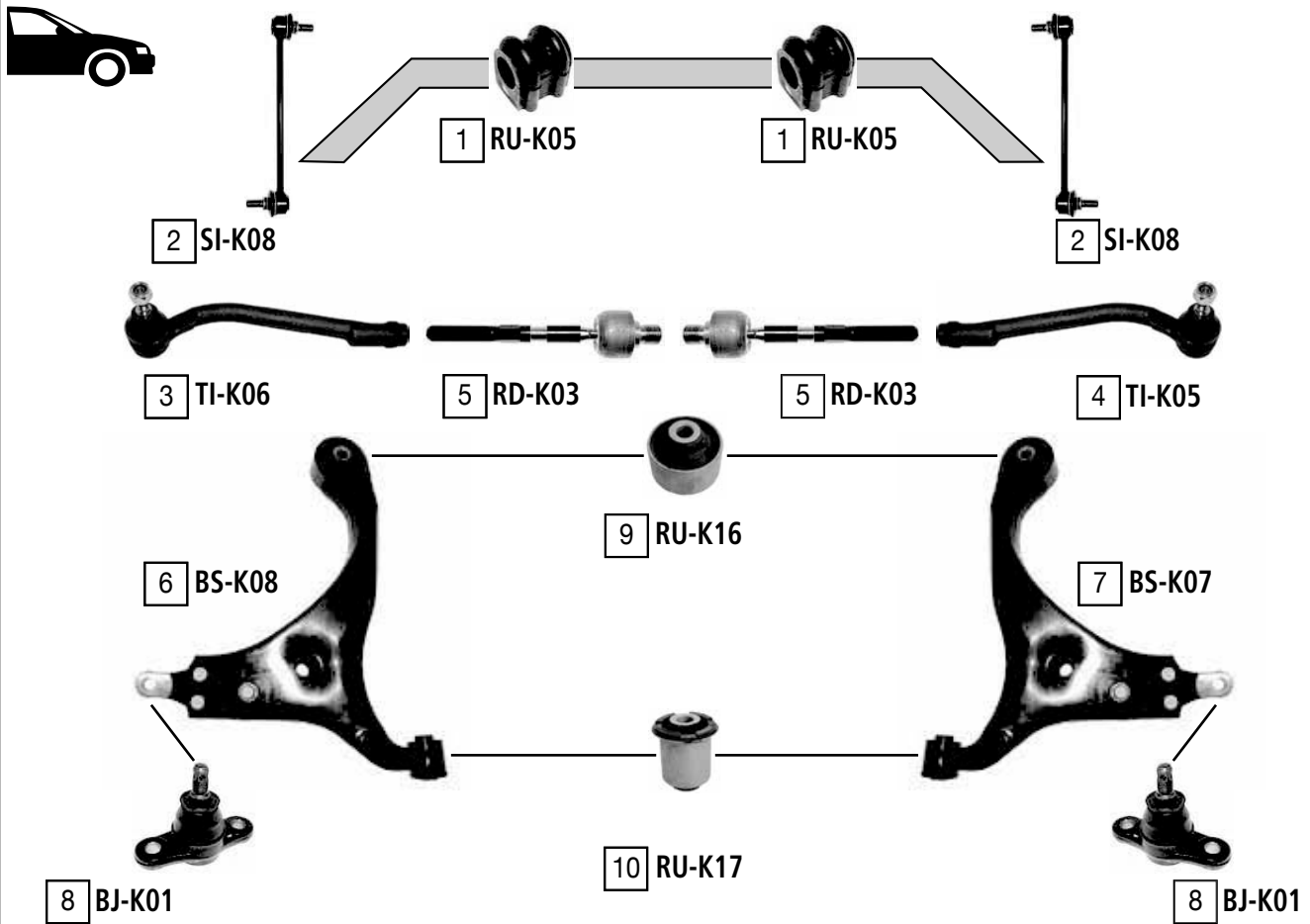

Ref	JAPANPARTS CODE	Description	OEM	Measures	Ref	JAPANPARTS CODE	Description	OEM	Measures
1	RU-K05	Stabiliser Mounting	54813 1H100	di:23.4	8	BJ-K01	Ball Joint	51760 0Q000	c:14.9
2	SI-K08	Stabiliser Link	54830 2H100	L:243	9	RU-K16	Silentblock ForTCA	54584 2H000	di:14 do:66
3	TI-K06	Tie Rod End Left	56820 2H000	c:13.3 th:FM14x1.5R	10	RU-K17	Silentblock ForTCA	54551 2H000	di:12.4 do:38
4	TI-K05	Tie Rod End Right	56820 2H090	c:13.3 th:FM14x1.5R	11	RU-K15	Silentblock ForTCA	55543 2H000	do:70.8
5	RD-K03	Axial Joint	56540 2H000	th:MM16x1.5R L:162	12	CJ-K00	TCA	55250 2H000	c:13.4
6	BS-K08	TCA left wobj	54500 2H000		13	RU-K11	Ball Joint Rear	55130 4D000	do:44
7	BS-K07	TCA right wobj	54501 2H000		14	SI-K09	Stabiliser Link Rear Axle	55530 1H100	L:170

iX35 (LM)

01/2010 ->

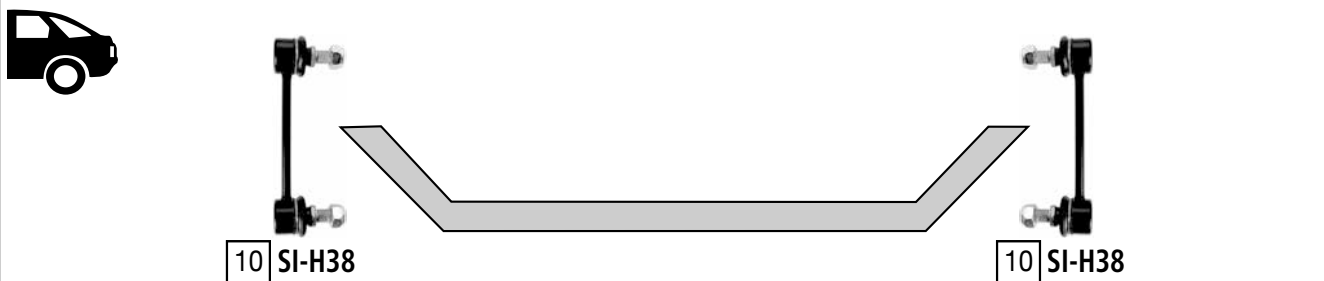
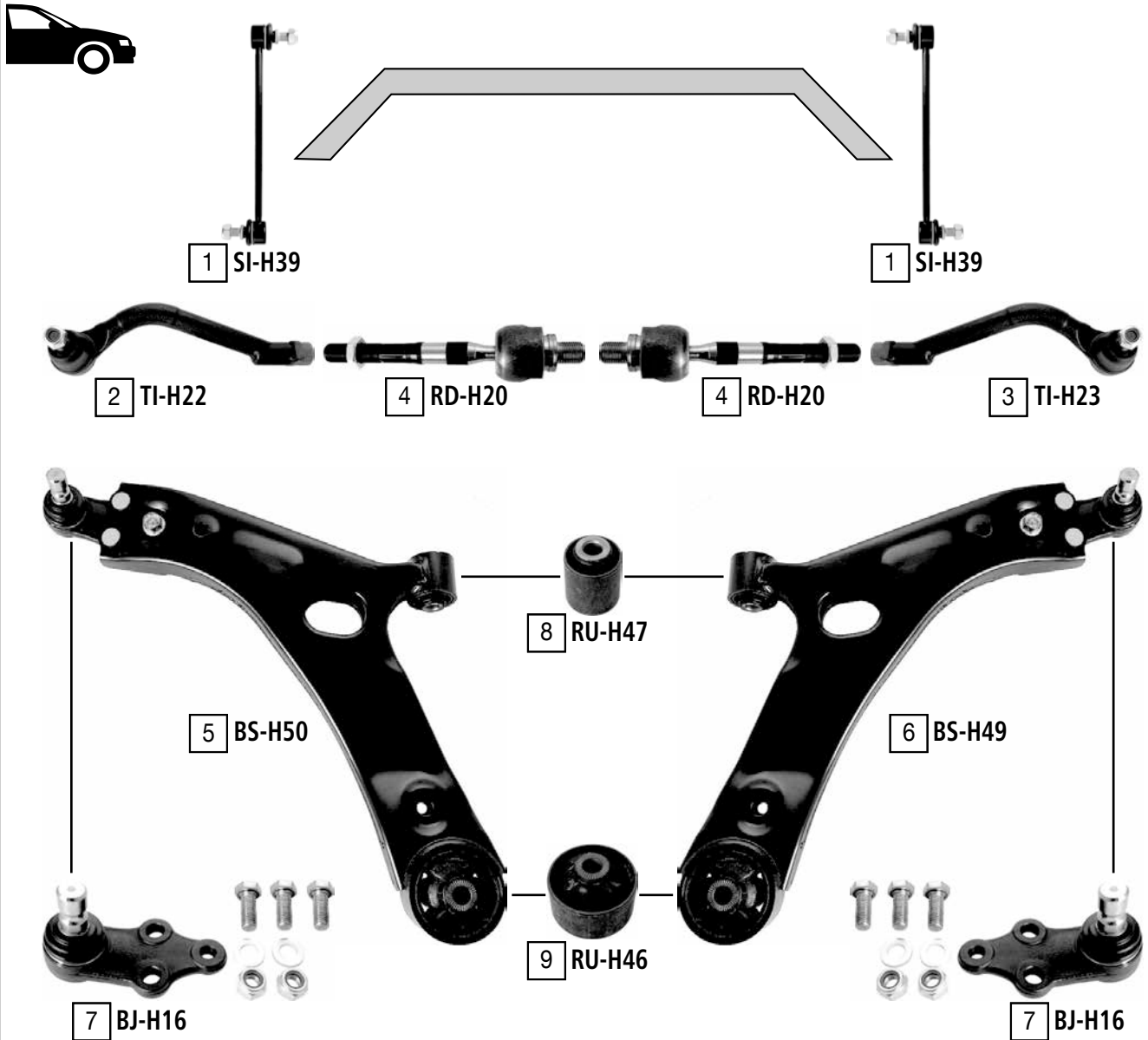

Ref	JAPANPARTS CODE	Description	OEM	Measures	Ref	JAPANPARTS CODE	Description	OEM	Measures
1	SI-H39	stabiliser link	54830 2S000	L:267	6	BS-H49	TCA right wbj	54501 2Y000	c:18
2	TI-H22	tie rod end left	56820 2S000	c:13.4 th:FM16X1.5R	7	BJ-H16	Ball Joint	54530 3S000	c:18
3	TI-H23	tie rod end right	56820 2S050	c:13.4 th:FM16X1.5R	8	RU-H47	Silentblock For TCA	54551 2S000	di:12.25 do:38.1
4	RD-H20	axial joint	57724 2S000	th:MM16X1.5R L:183	9	RU-H46	Silentblock For TCA	54584 2S000	di:14.35 do:70
5	BS-H50	TCA left wbj	54500 2Y000	c:18	10	SI-H38	Stabiliser Link Rear Axle	55530 2S100	L:140

LANTRA I (J-1)

10/1990 - 11/1995

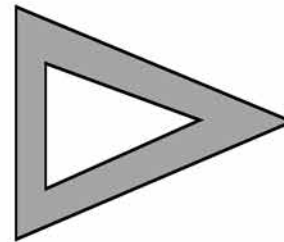
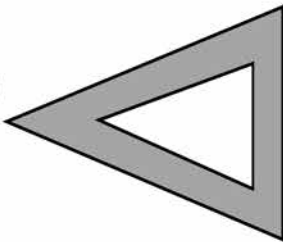
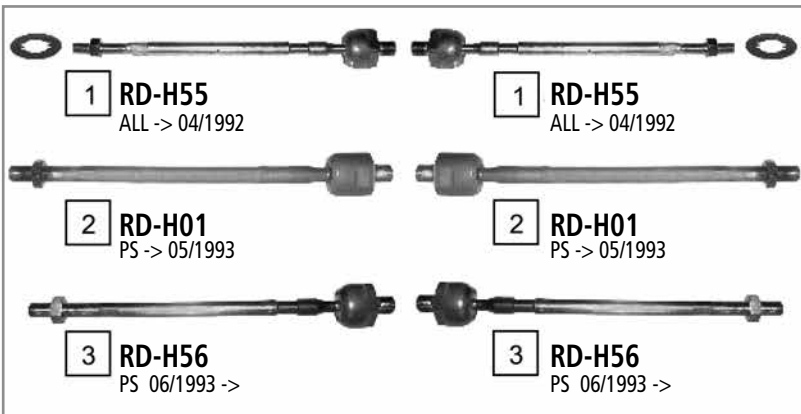

Ref.	JAPANPARTS CODE	Description	OEM	Measures	Ref.	JAPANPARTS CODE	Description	OEM	Measures
1	RD-H55	Axial Joint	57730-28000		5	TI-H57	Tie Rod End	56820-28500	c:13.6 th:FM14X1.5R
2	RD-H01	Axial Joint	57755-22000	th:MM16X1.5R L:295	6	LB-H54	Ball Joint	5453028000	c:15
3	RD-H56	Axial Joint	56540 28020	th:MM16X1.5R L:298	7	SI-H51	Stabiliser Link	54830 28000	L:61
4	TI-H54	Tie Rod End	56820-28000	c:13.4 th:FM12X1.25					

LANTRA II (J-2)

11/1995 - 06/2000

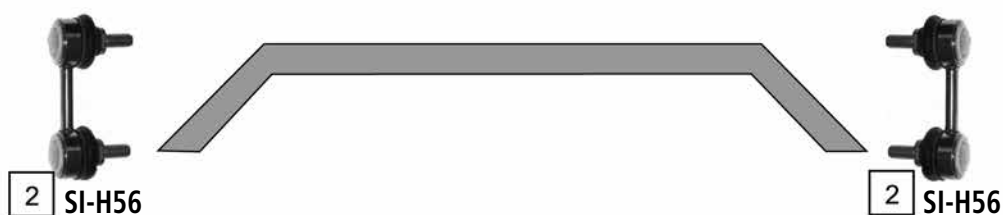

Ref	JAPANPARTS CODE	Description	OEM	Measures	Ref	JAPANPARTS CODE	Description	OEM	Measures
1	RD-H63	Axial Joint	57730 29000	th:MM16X1.5R L:317	5	BJ-H55L	TCA	54500-29000	
2	SI-H56	Stabiliser Link	54830-29000	L:70.5	6	BJ-H55R	TCA	54501-29000	
3	TI-H91	Stabiliser Link	55530-29000	L:130	7	TI-H06	Tie Rod End	56820-22000	c:13.6 th:FM14X1.5R
4	BJ-H57	Ball Joint	54520 31600	c:15					

MATRIX (FC)

06/2001 ->

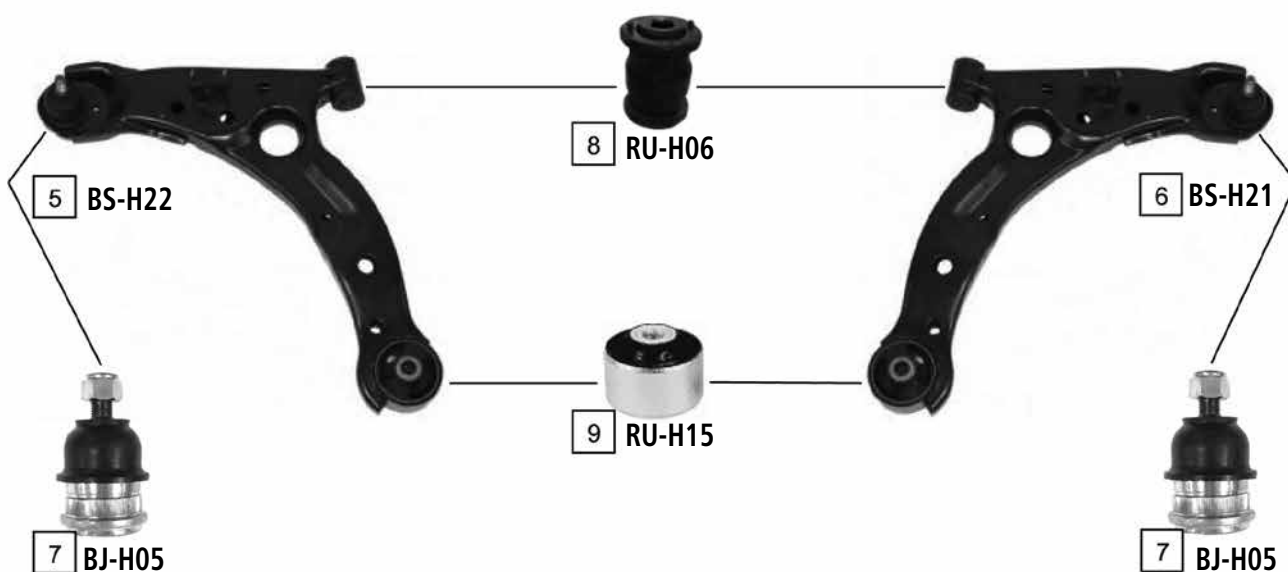

Ref.	JAPANPARTS CODE	Description	OEM	Measures	Ref.	JAPANPARTS CODE	Description	OEM	Measures
1	SI-H02	Stabiliser Link Left	54830-25010	L:60	6	BS-H21	TCA Right	54501-17000	
2	SI-H03	Stabiliser Link Right	54830-25020	L:60	7	BJ-H05	Ball Joint	54503-38A00	
3	RD-H09	Axial Joint	57755-17000	th:MM16X1.5R L:322	8	RU-H06	Silentblock For Susp.Arm	54551 25000	
4	TI-H01	Tie Rod End	56820-25000	c:13.8 th:FM14X1.5R	9	RU-H15	Silentblock For Susp.Arm	54584-17000	
5	BS-H22	TCA Left	54500-17000		10	SI-H13	Stabiliser Link	55530 17000	L:128.5

PONY  
 EXCEL I

04/1974 - 01/1989

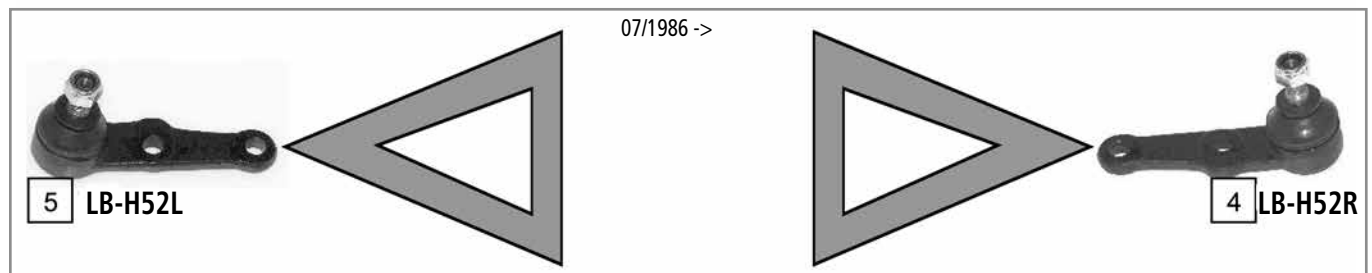
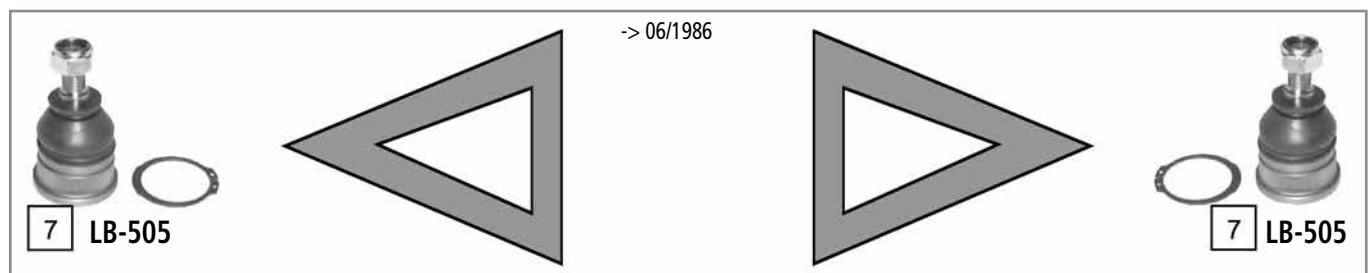
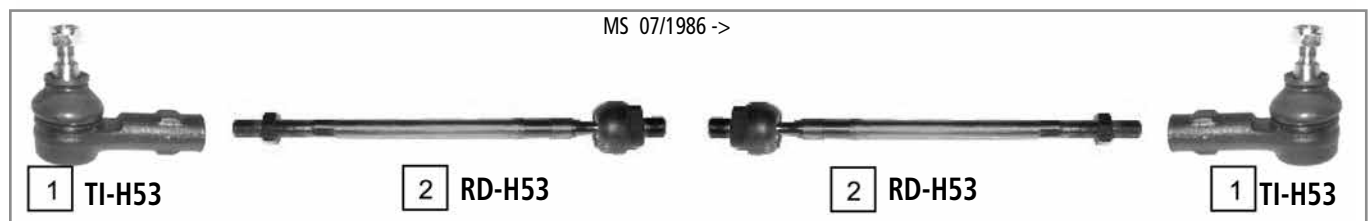
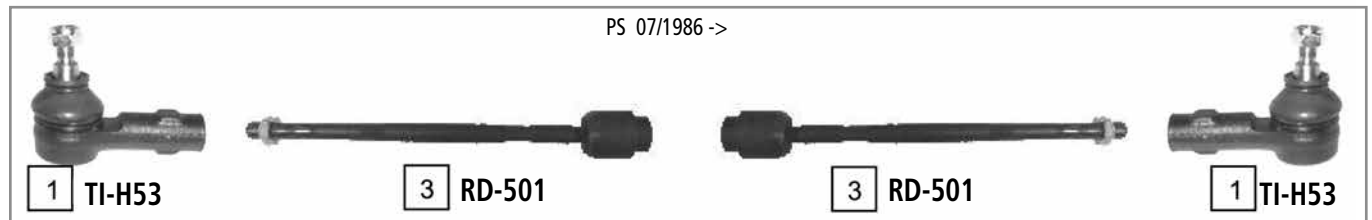

Ref	JAPANPARTS CODE	Description	OEM	Measures	Ref	JAPANPARTS CODE	Description	OEM	Measures
1	TI-H53	Tie Rod End	56820-21000	c:13.45 th:FM14X1.5	5	LB-H52L	Ball Joint Lower Left	54530 21000	c:13.5
2	RD-H53	Axial Joint	56540-22000	th:MM16X1.5R L:296	6	TI-H52	Tie Rod End	56820 11060	c:12.5 th:MM14X1.5L
3	RD-501	Axial Joint	MB122135	th:FM18X1.5R L:297	7	LB-505	Ball Joint	MB001696	c:15
4	LB-H52R	Ball Joint Lower Right	54540 21000	c:13.5					



# HYUNDAI PONY - S COUPE

PONY (X-2)  
S COUPE (SLC)

10/1989 - 01/1995  
02/1990 - 05/1996

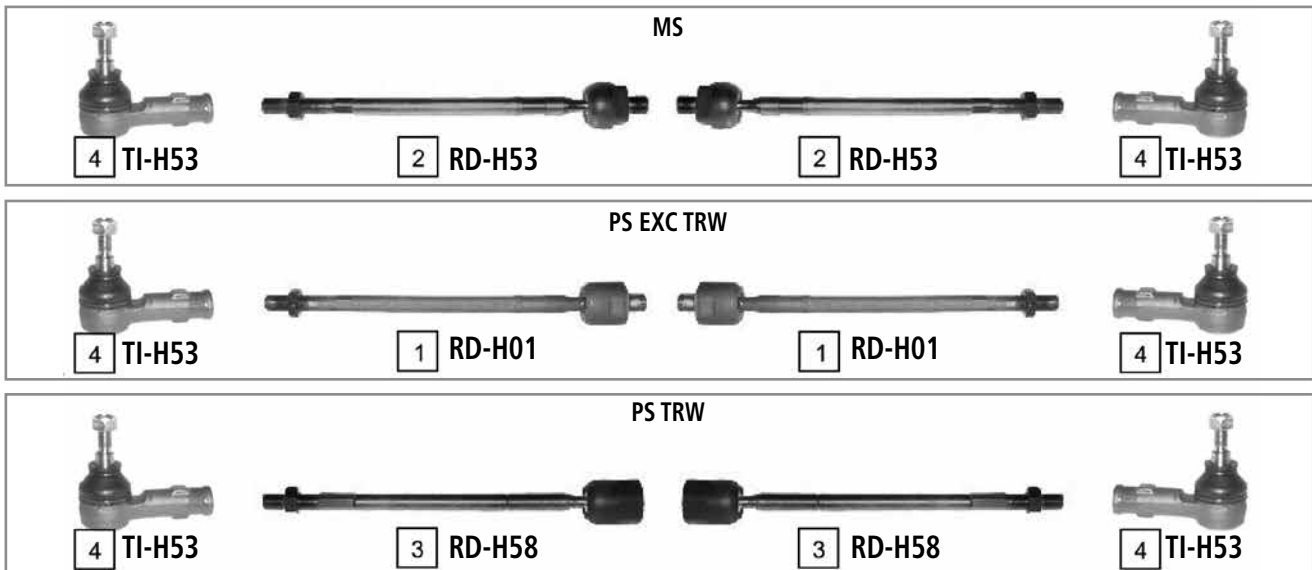

Ref.	JAPANPARTS CODE	Description	OEM	Measures	Ref.	JAPANPARTS CODE	Description	OEM	Measures
1	RD-H01	Axial Joint	57755-22000	th:MM16X1.5R L:295	5	BJ-H53	Ball Joint	54530-24A00	c:15
2	RD-H53	Axial Joint	56540-22000	th:MM16X1.5R L:296	6	SI-501	Stabiliser Link	4056 A014	L:60
3	RD-H58	Axial Joint	57730-24100	th:FM14X1.5R L:303	7	BS-H24	TCA Left	54502 24001	
4	TI-H53	Tie Rod End	56820-21110	c:13.3 th:FM14X1.5R	8	BS-H23	TCA Right	54503 24001	

SANTA FE (SM)

01/2002 - 02/2006

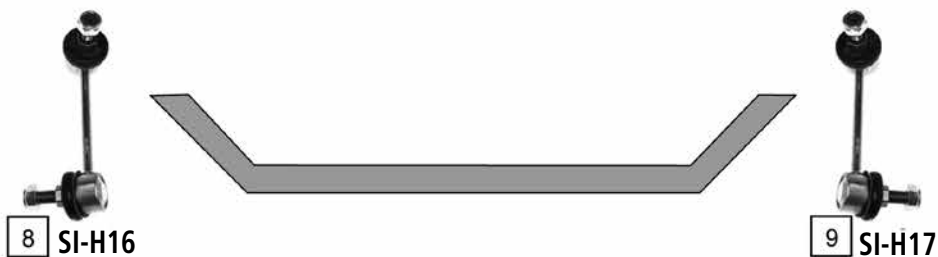
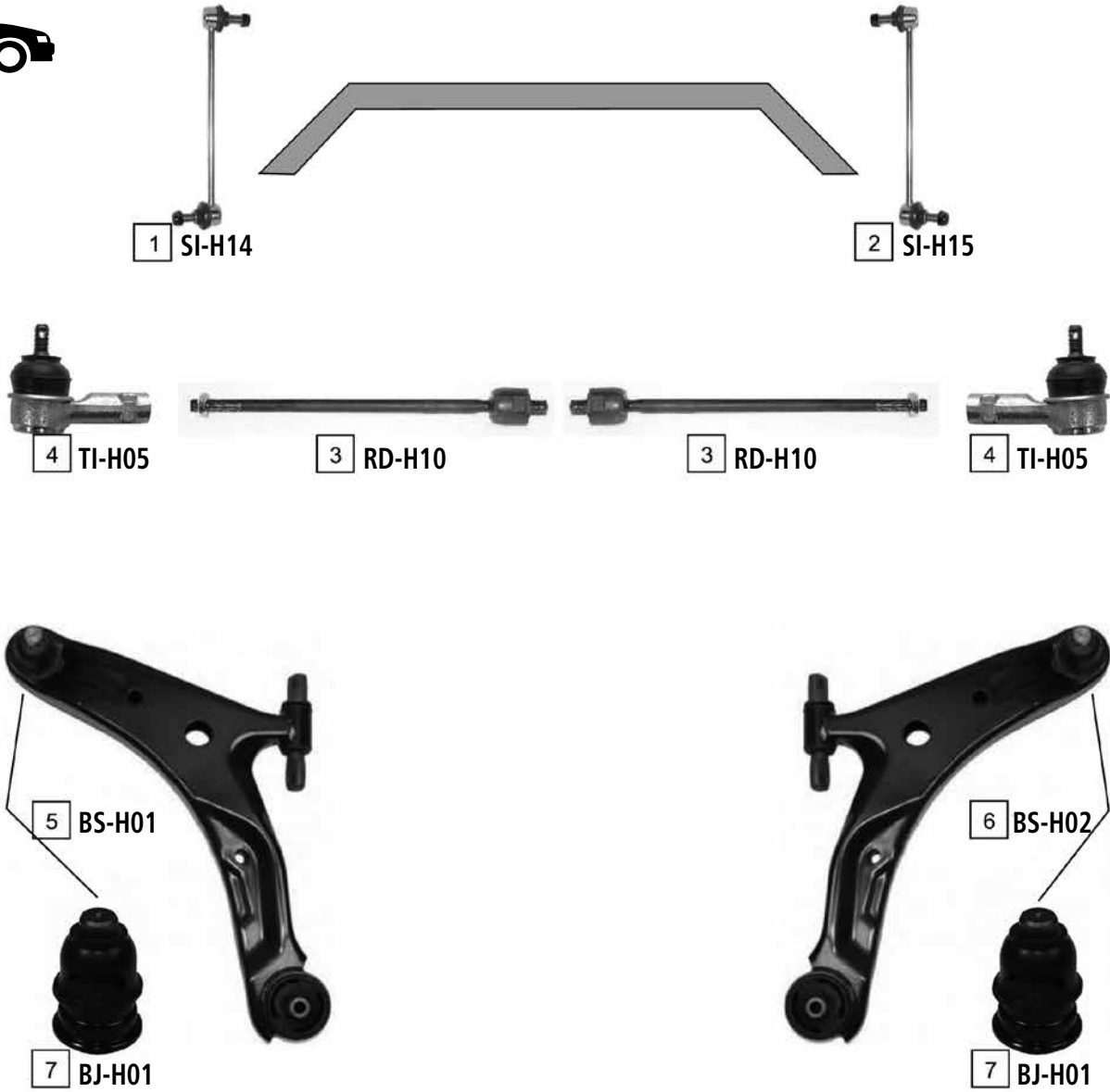

Ref	JAPANPARTS CODE	Description	OEM	Measures	Ref	JAPANPARTS CODE	Description	OEM	Measures
1	SI-H14	Stabiliser Link Left	54830-26000	L:264	6	BS-H02	TCA Right Wbj	54502-26000	
2	SI-H15	Stabiliser Link Right	54840-26000	L:264	7	BJ-H01	Ball Joint	54503-3BA00	c:20
3	RD-H10	Axial Joint	57785-26200	th:MM16X1.5R L:328	8	SI-H16	Stabiliser Link Left	55530 26600	L:117
4	TI-H05	Tie Rod End	56820-3B000	c:13.4 th:FM14X1.5R	9	SI-H17	Stabiliser Link Left	55540 26600	L:117
5	BS-H01	TCA Left Wbj	54501-26000						

SANTA FE

03/2006 ->

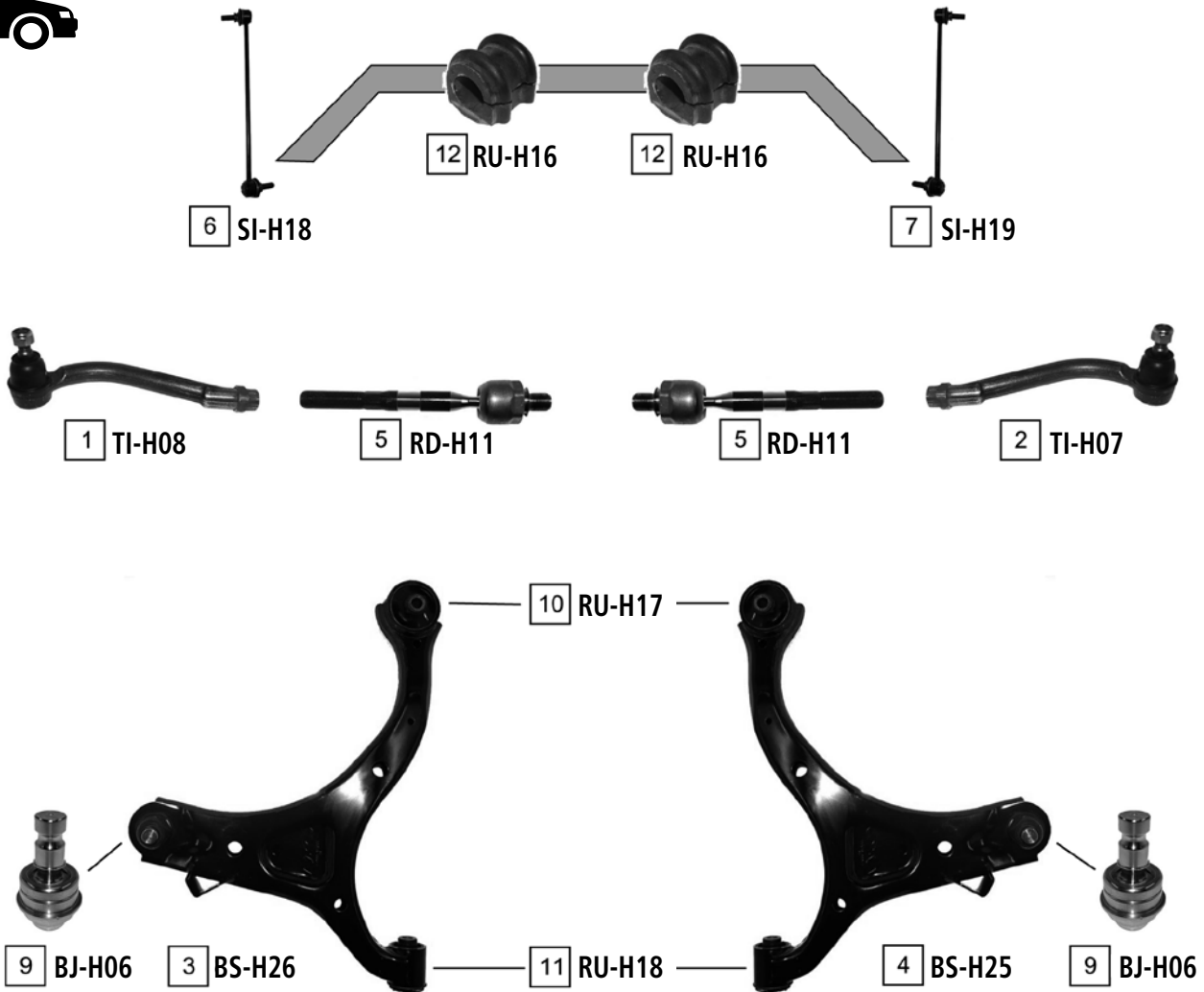

Ref.	JAPANPARTS CODE	Description	OEM	Measures	Ref.	JAPANPARTS CODE	Description	OEM	Measures
1	TI-H08	Tie Rod End Left	56820 2B000		7	SI-H19	Stabiliser Link Right	54840 2B000	
2	TI-H07	Tie Rod End Right	56820 2B900		8	SI-H20	Stabiliser Link	55530 2B000	
3	BS-H26	TCA Left Wbj	54500 2B100		9	BJ-H06	Ball Joint	54530 2B000	
4	BS-H25	TCA Right Wbj	54501 2B100		10	RU-H17	Silentblock For Susp.Arm	54584 2B000	
5	RD-H11	Axial Joint	57724 2B000		11	RU-H18	Silentblock For Susp.Arm	54551 2B000	
6	SI-H18	Stabiliser Link Left	54830 2B000		12	RU-H16	Stabiliser Mounting	54813 3K100	

SONATA I (Y-2)

09/1988 - 10/1993

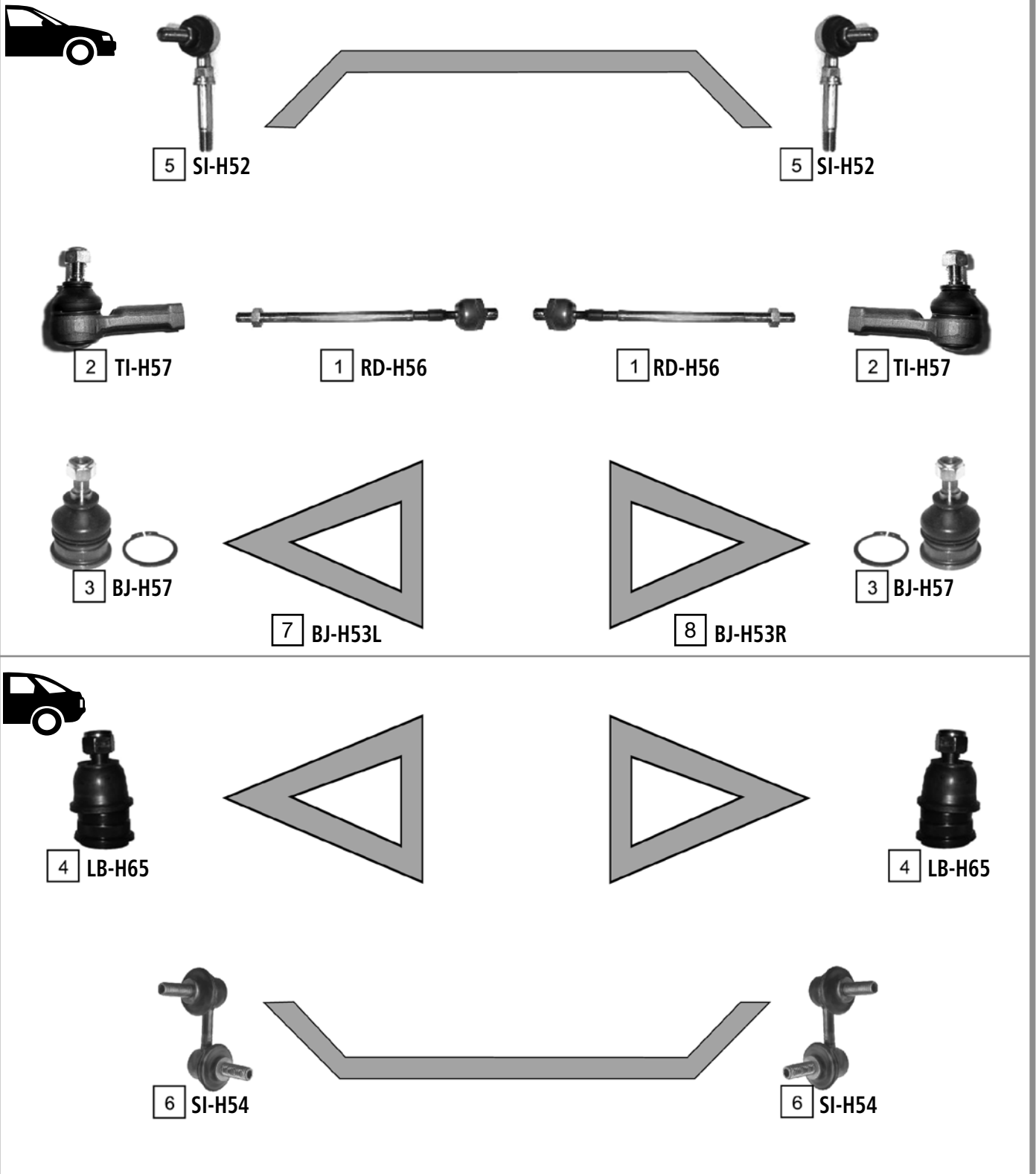

Ref	JAPANPARTS CODE	Description	OEM	Measures	Ref	JAPANPARTS CODE	Description	OEM	Measures
1	RD-H56	Axial Joint	56540 28020	th:MM16X1.5R L:298	5	SI-H52	Stabiliser Link	54830 36000	-
2	TI-H57	Tie Rod End	56820-28500	c: 13,6 th: FM14X1.5R	6	SI-H54	Stabiliser Link	55580-37020	L:60
3	BJ-H57	Ball Joint	54520 31600	c: 15	7	BJ-H53L	Ball Joint		
4	LB-H65	Ball Joint	55130 34A00	c:16.2	8	BJ-H53R	Ball Joint		

SONATA II (Y-3)

05/1993 - 06/1998

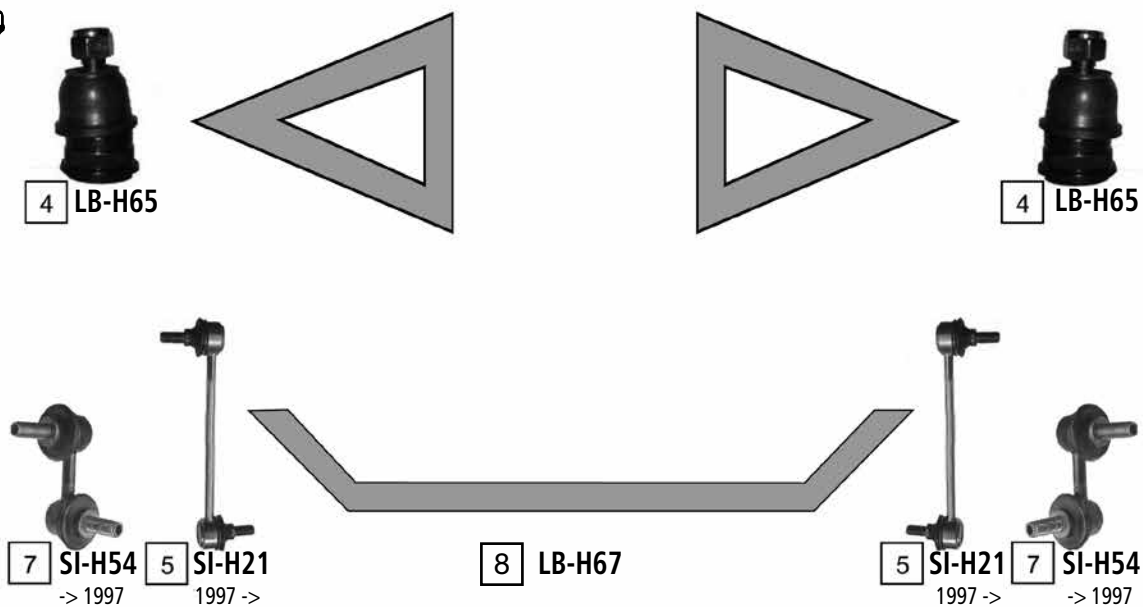
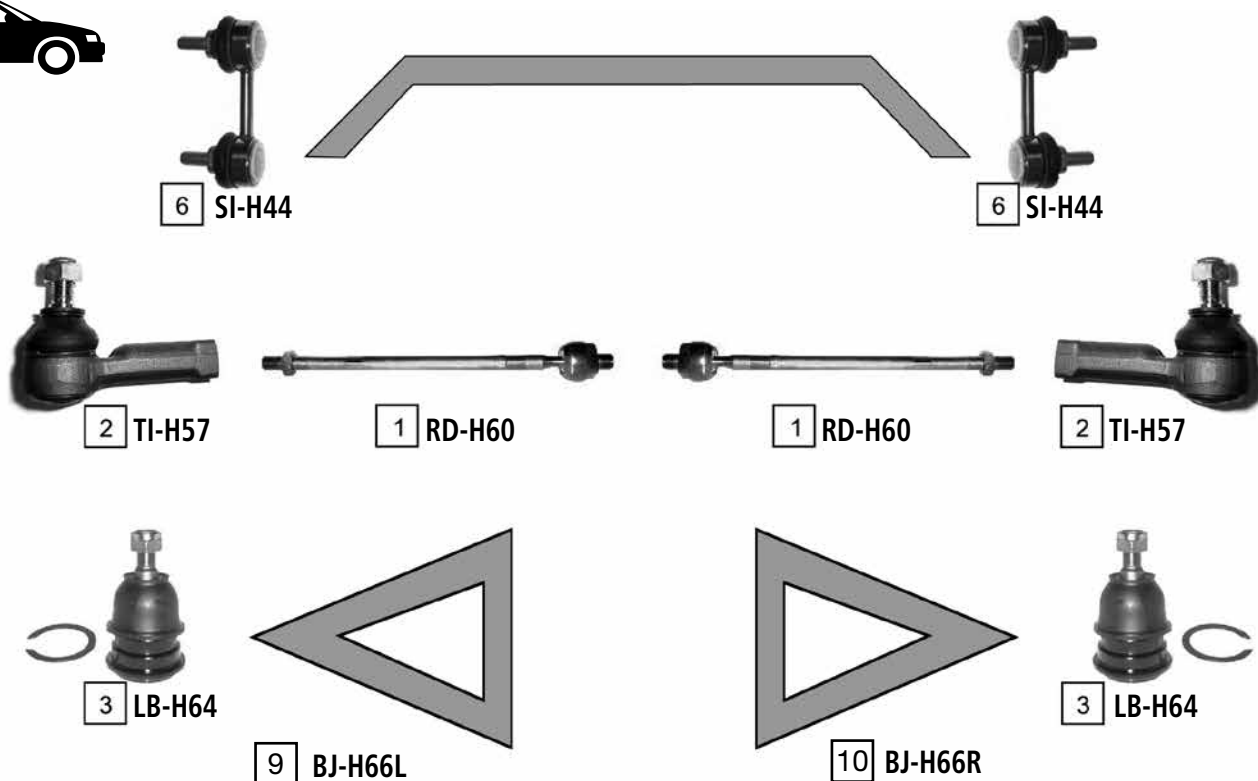

Ref.	JAPANPARTS CODE	Description	OEM	Measures	Ref.	JAPANPARTS CODE	Description	OEM	Measures
1	RD-H60	Axial Joint	57716 34000	th:MM16X1.5R L:322	6	SI-H44	Stabiliser Link	54830 34000	L:52
2	TI-H57	Tie Rod End	56820-28500	c:13.6 th:FM14X1.5R	7	SI-H54	Stabiliser Link	55580-37020	L:60
3	LB-H64	Ball Joint	54503 34A00	c:15	8	LB-H67	Ball Joint	5520134000	
4	LB-H65	Ball Joint	55130 34A00	c:16.2	9	BJ-H66L	Ball Joint	5450034000	
5	SI-H21	Stabiliser Link	55530-38000	L:180	10	BJ-H66R	Ball Joint	5450134000	

SONATA III

03/1998 - 10/2001

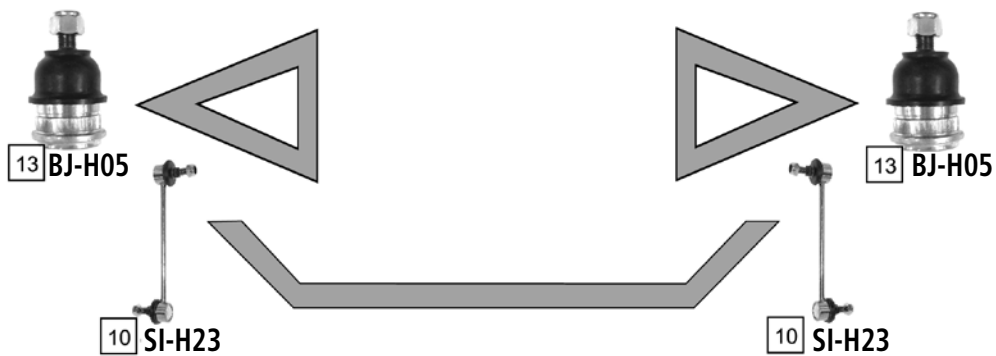
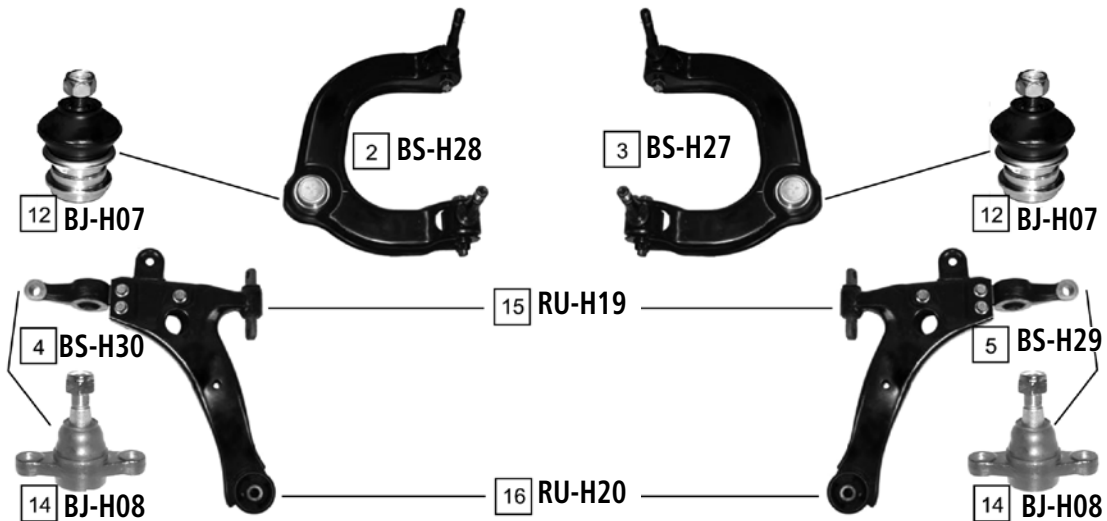
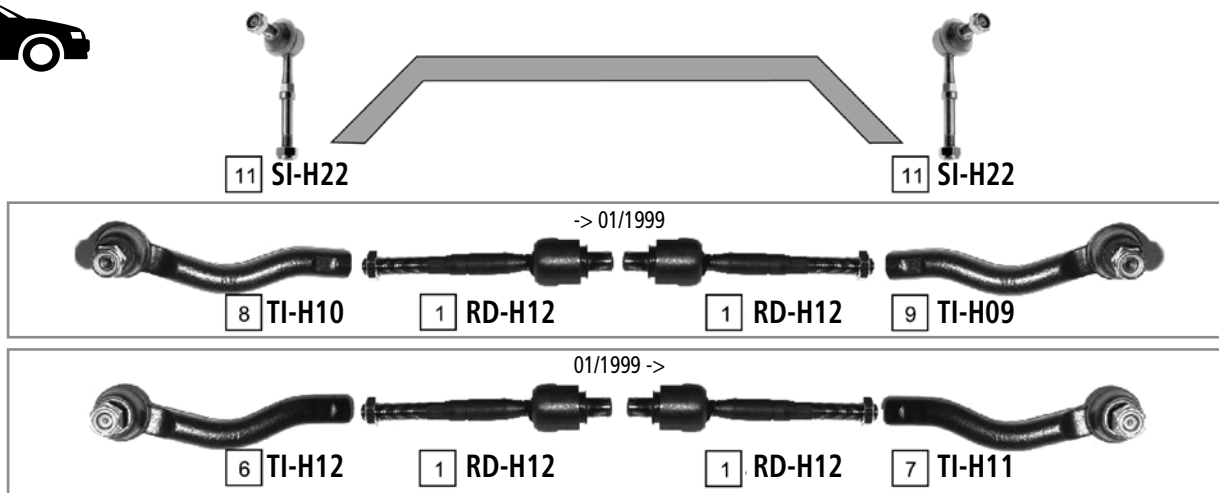

Ref	JAPANPARTS CODE	Description	OEM	Measures	Ref	JAPANPARTS CODE	Description	OEM	Measures
1	RD-H12	Axial Joint	57724-38000		9	TI-H09	Tie Rod End Right	57780-38010	
2	BS-H28	TCA	54410-38000	c:13.2	10	SI-H23	Stabiliser Link	55530-38600	L:193.5
3	BS-H27	TCA	54420-38000	c:13.2	11	SI-H22	Stabiliser Link	54830-38100	
4	BS-H30	TCA	54500 38000		12	BJ-H07	Ball Joint	54403 38A00	c:13.4
5	BS-H29	TCA	54501 38000		13	BJ-H05	Ball Joint	54503-38A00	
6	TI-H12	Tie Rod End Left	56820-38000	th:FM14X1.5R	14	BJ-H08	Ball Joint	51760 38000	c:18
7	TI-H11	Tie Rod End Right	56820-38900	th:FM14X1.5R	15	RU-H19	Silentblock For Susp.Arm	54551 38000	
8	TI-H10	Tie Rod End Left	57780-38000		16	RU-H20	Silentblock For Susp.Arm	54584 38000	

SONATA IV

10/2001 - 01/2005

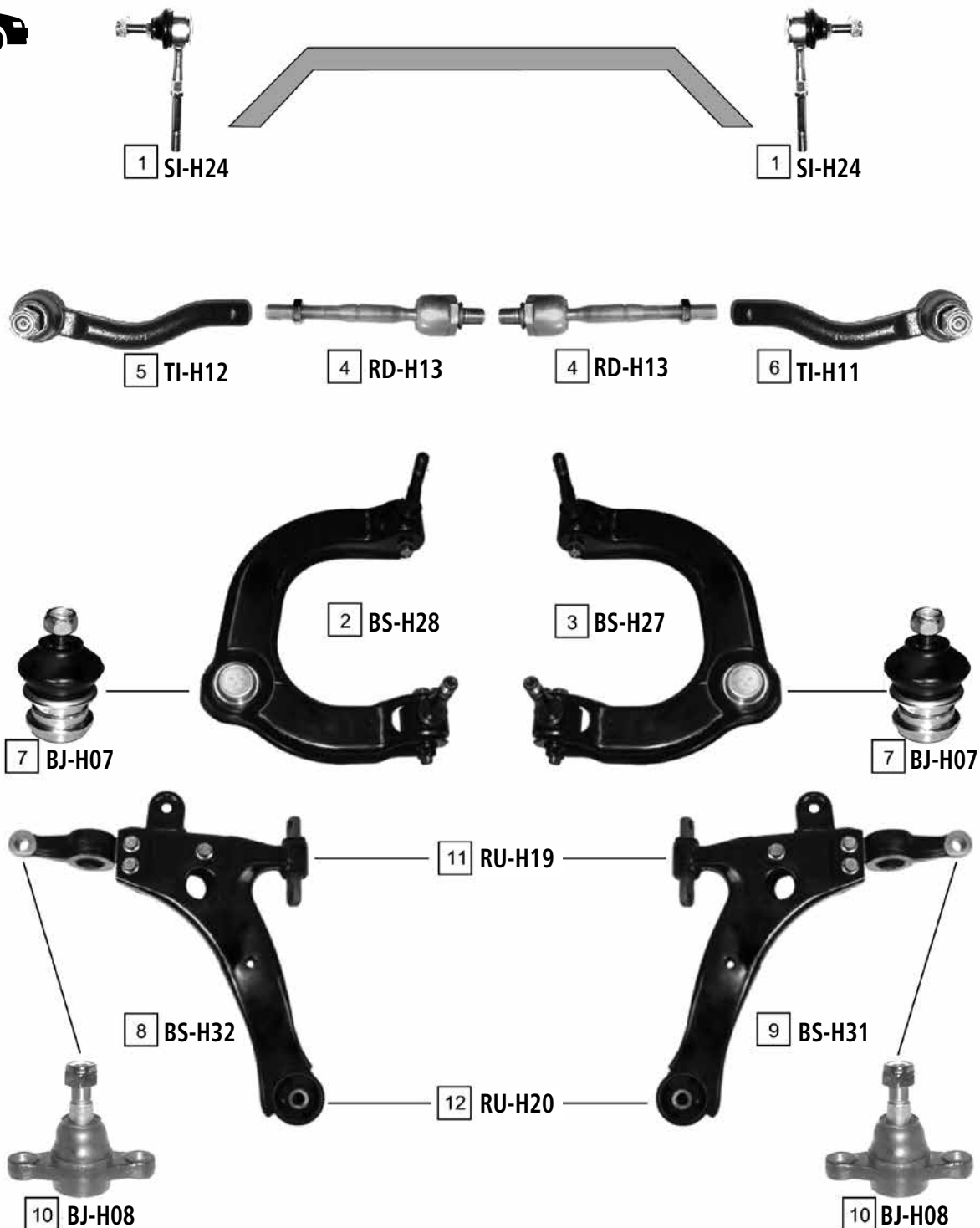

Ref.	JAPANPARTS CODE	Description	OEM	Measures	Ref.	JAPANPARTS CODE	Description	OEM	Measures
1	SI-H24	Stabiliser Link	54830-38110		7	BJ-H07	Ball Joint	54403 38A00	c:13.4
2	BS-H28	TCA	54410-38000	c:13.2	8	BS-H32	TCA Left	54500-38011	
3	BS-H27	TCA	54420-38000	c:13.2	9	BS-H31	TCA Right	54501-38011	
4	RD-H13	Axial Joint	57724-38010	th:MM16X1.5R L:171	10	BJ-H08	Ball Joint	51760 38000	c:18
5	TI-H12	Tie Rod End Left	56820-38000	th:FM14X1.5R	11	RU-H19	Silentblock For Susp.Arm	54551 38000	-
6	TI-H11	Tie Rod End Right	56820-38900	th:FM14X1.5R	12	RU-H20	Silentblock For Susp.Arm	54584 38000	-

SONATA V (NF)

01/2005 ->

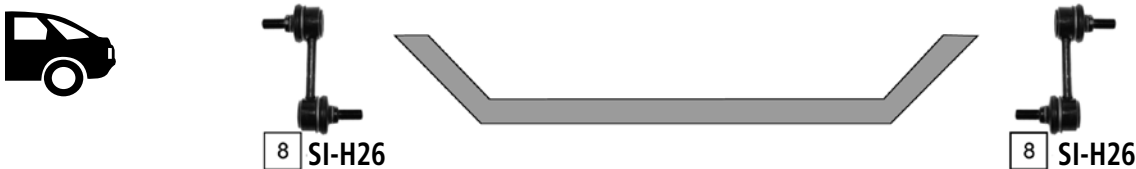
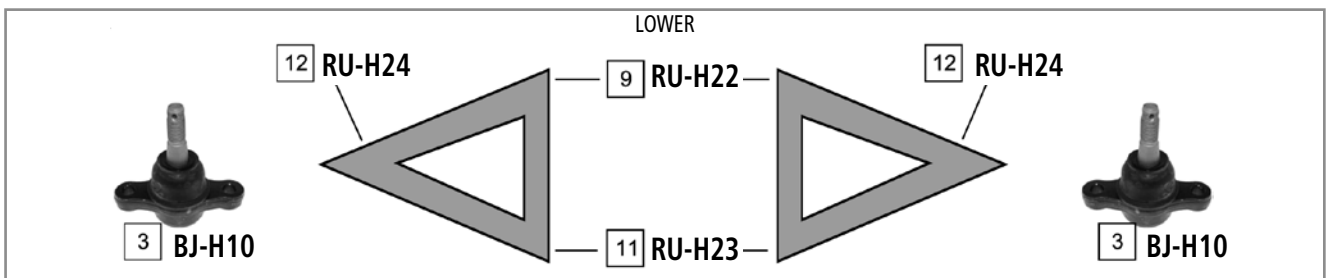
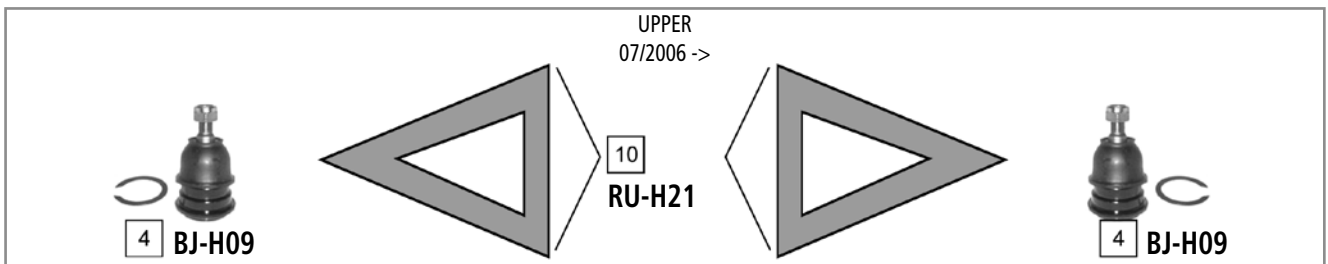
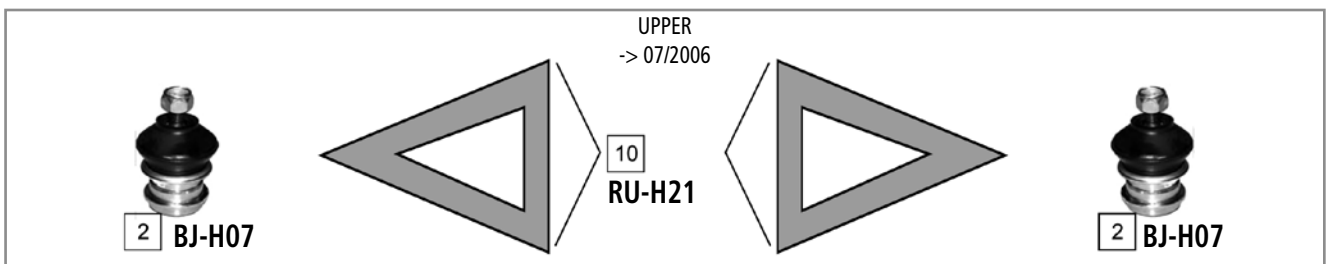
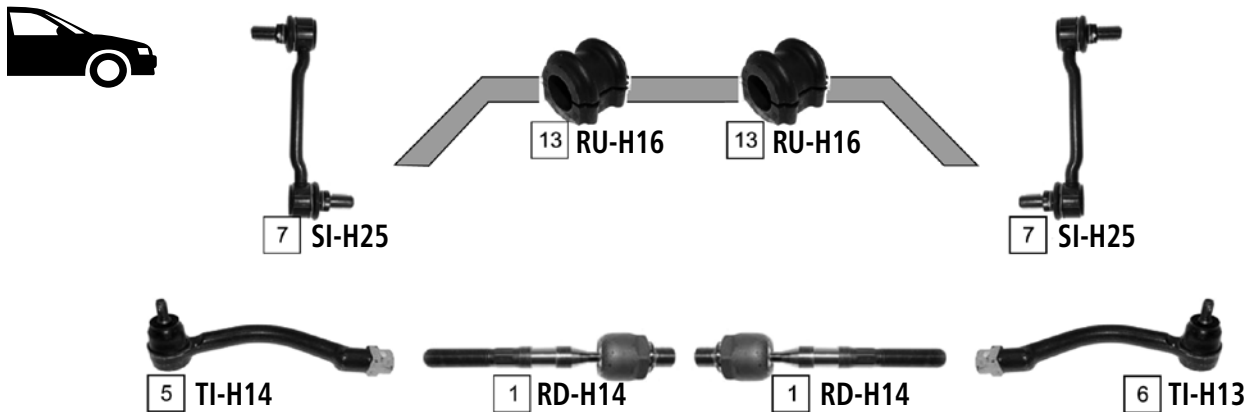

Ref	JAPANPARTS CODE	Description	OEM	Measures	Ref	JAPANPARTS CODE	Description	OEM	Measures
1	RD-H14	Axial Joint	57724 3K000	th:MM16X1.5R L:178	8	SI-H26	Stabiliser Link	55530 3K001	L:80
2	BJ-H07	Ball Joint	54403 38A00	c:13.4	9	RU-H22	Silentblock For Susp.Arm	54584 3K000	
3	BJ-H10	Ball Joint	51760 3K000	c:15.1	10	RU-H21	Silentblock For Susp.Arm	54443 3K000	
4	BJ-H09	Ball Joint	54430 3F600	c:13.5	11	RU-H23	Silentblock For Susp.Arm	54551 3K000	
5	TI-H14	Tie Rod End Left	56820 3K000	c:13.4 th:MM16X1.5R	12	RU-H24	Silentblock For Susp.Arm	54552 3K000	
6	TI-H13	Tie Rod End Right	56820 3K010	c:13.4 th:MM16X1.5R	13	RU-H16	Satbiliser Mounting	54813 3K100	
7	SI-H25	Stabiliser Link	54830 3L000	L:150					



TERRACAN (HP)

12/2001 ->

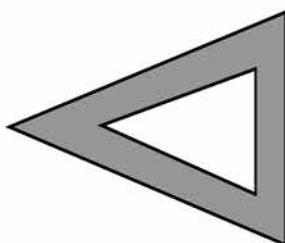

UPPER

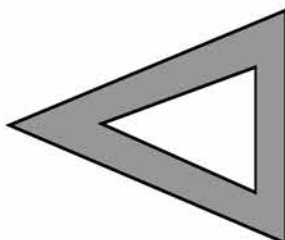
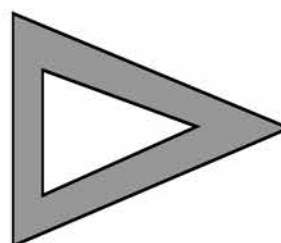

LOWER

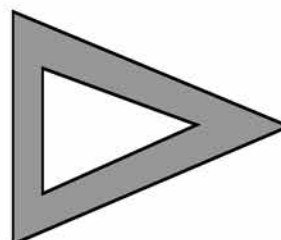

Ref.	JAPANPARTS CODE	Description	OEM	Measures	Ref.	JAPANPARTS CODE	Description	OEM	Measures
1	SI-H28	Stabiliser Link	54822-H1000	L:67	5	BJ-H12	Ball Joint Lower	54550-H1000	
2	SI-H27	Stabiliser Link	54823-H1000	L:67	6	TI-H69	Tie Rod End	58000037	
3	SA-H01	Tie Rod	56850-H1011		7	TI-H70	Tie Rod End	58000036	
4	BJ-H11	Ball Joint UPPER	54440-H1000						

TRAJET (FO)

03/2000 ->

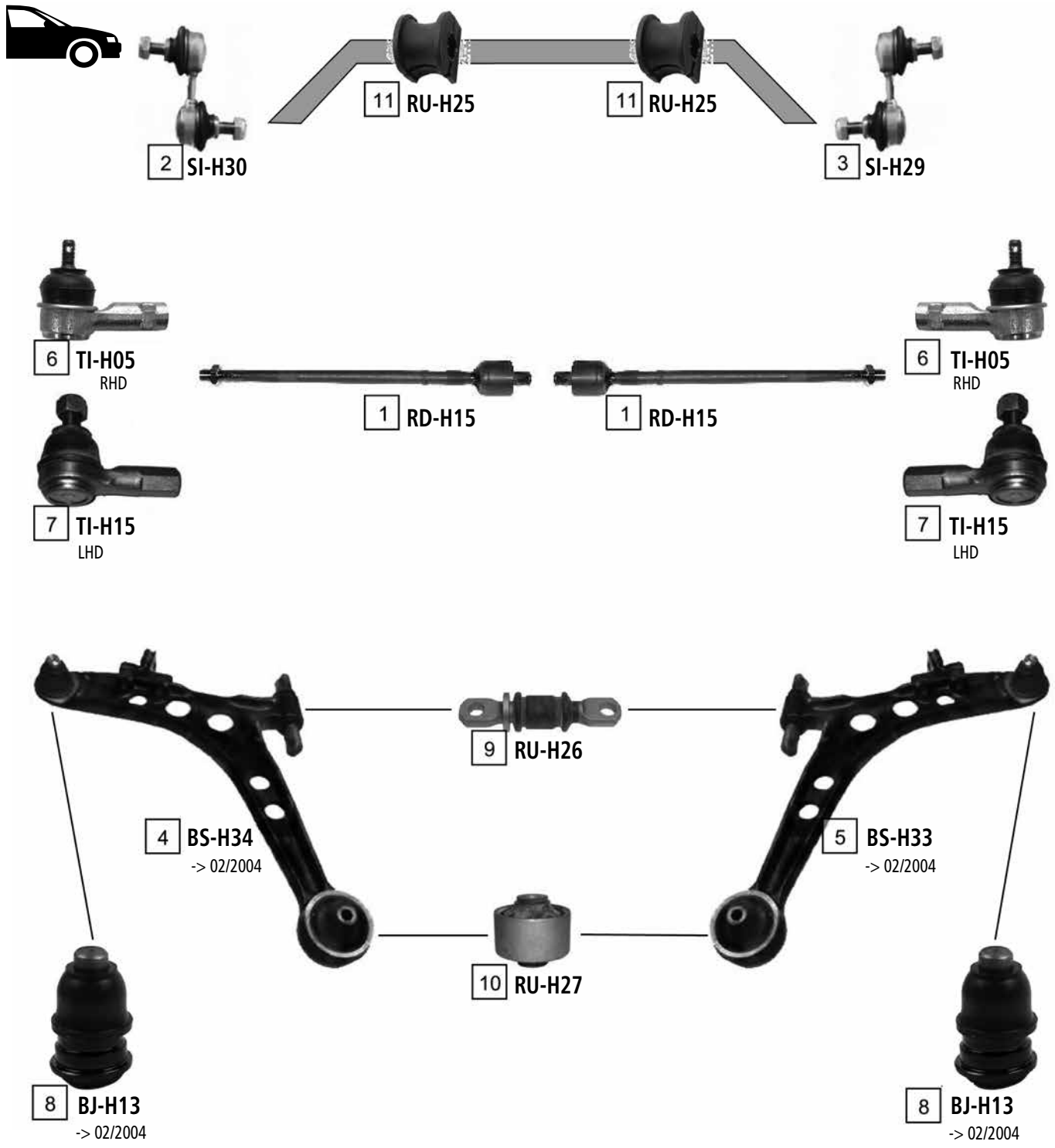

Ref.	JAPANPARTS CODE	Description	OEM	Measures	Ref.	JAPANPARTS CODE	Description	OEM	Measures
1	RD-H15	Axial Jpint	57724 3A000	th: MM16X1.5R L:295	7	TI-H15	Tie Rod End	57780-3B000	
2	SI-H30	Stabiliser Link	54830 3A000	L:60	8	BJ-H13	Ball Joint	54530 3B000	c: 19.9
3	SI-H29	Stabiliser Link	54840 3A000	L:60	9	RU-H26	Silentblock For Susp. Arm	54551 3A000	
4	BS-H34	TCA Left Wbj	54501 3A100		10	RU-H27	Silentblock For Susp. Arm	54555 3A100	
5	BS-H33	TCA Right Wbj	54502 3A100		11	RU-H25	Stabiliser Mounting	54813-3A000	
6	TI-H05	Tie Rod End	56820-3B000	c: 13.4 th: FM14X1.5R					

TUCSON

09/2004 ->

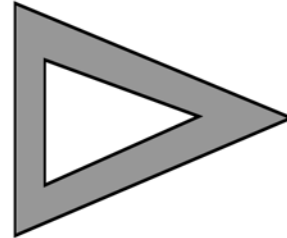
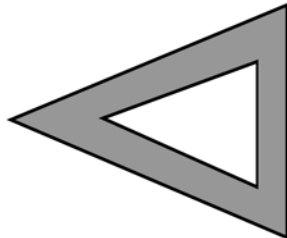

Ref.	JAPANPARTS CODE	Description	OEM	Measures	Ref.	JAPANPARTS CODE	Description	OEM	Measures
1	RD-H16	Axial Joint	57724 2E000	th: MM16X1.5R L:243	4	BJ-H14	Ball Joint	51760 2E000	c: 14.5
2	TI-H17	Tie Rod End Left	56820 2E000	c: 13.3 th: FM10X1.5R	5	SI-H31	Stabiliser Link	54830 2E000	L:238
3	TI-H16	Tie Rod End Right	56820 2E900	c: 13.3 th: FM10X1.5R	6	SI-H32	Stabiliser Link	55530 2E000	L:220

XG (25 - 30)

04/1999 ->



1 SI-H33



1 SI-H33



3 TI-H10



2 RD-H12



2 RD-H12



4 TI-H09



5 BJ-H07

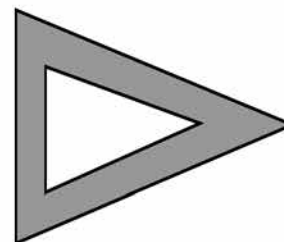
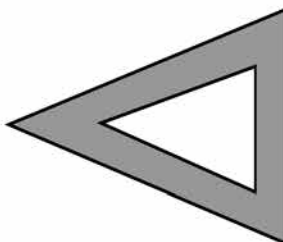

5 BJ-H07



6 BJ-H05

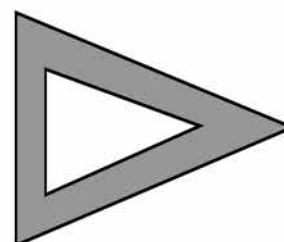
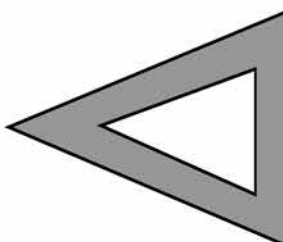

6 BJ-H05



Ref	JAPANPARTS CODE	Description	OEM	Measures	Ref	JAPANPARTS CODE	Description	OEM	Measures
1	SI-H33	Stabiliser Link	54830-39000		4	TI-H09	Tie Rod End Right	57780-38010	
2	RD-H12	Axial Joint	57724-38000		5	BJ-H07	Ball Joint	54403 38A00	c:13.4
3	TI-H10	Tie Rod End Left	57780-38000		6	BJ-H05	Ball Joint	54503-38A00	

CAMPO (KB)

01/1983 - 12/1990



2 TI-998



1 RD-900



1 RD-900



3 TI-999



4 BJ-914

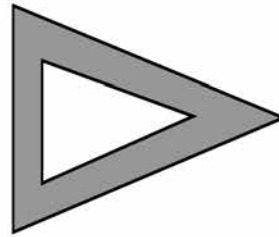
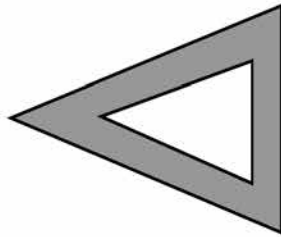

4 BJ-914



5 BJ-999

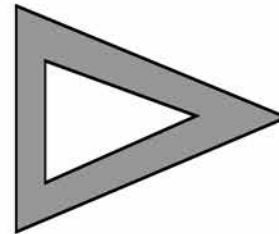
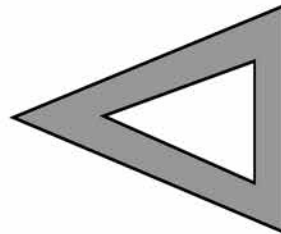

5 BJ-999

Ref.	JAPANPARTS CODE	Description	OEM	Measures	Ref.	JAPANPARTS CODE	Description	OEM	Measures
1	RD-900	Axial Joint	8-94217-221-3	th:FM14X1.5R L:267	4	BJ-914	Ball Joint UPPER	310 828	c:17.5
2	TI-998	Tie Rod End Left	324 058	c:16 th:FM14X1.5L	5	BJ-999	Ball Joint UPPER	8-94224-550-2	c:17.4
3	TI-999	Tie Rod End Right	324 057	c:16 th:FM14X1.5R					

D-MAX

2002 ->



**5 SI-908**  
4WD

**6 SI-909**  
4WD

**1 TI-915**   **2 RD-902**

**2 RD-902**   **1 TI-915**

**7 BJ-917**  
4WD

**7 BJ-917**  
4WD

**3 BJ-906**  
4x2

**3 BJ-906**  
4x2

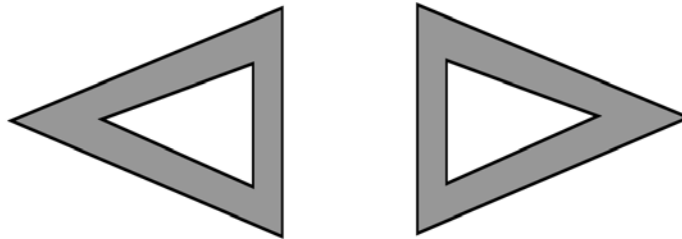

**4 BJ-913**  
4x2

**4 BJ-913**  
4x2

Ref.	JAPANPARTS CODE	Description	OEM	Measures	Ref.	JAPANPARTS CODE	Description	OEM	Measures
1	TI-915	Tie Rod End	8-973048550		5	SI-908	Stabiliser Link	8-97235-787-0	
2	RD-902	Axial Joint	8-973048510		6	SI-909	Stabiliser Link	8-97235-786-1	
3	BJ-906	Ball Joint	8-972357770		7	BJ-917	Ball Joint	8-94374-424-0	
4	BJ-913	Ball Joint	8-944521020						

PICK-UP FASTER

06/1981 - 01/1998



1 TI-904



2 RD-900



2 RD-900



1 TI-904



3 BJ-999

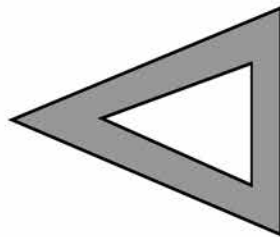

UPPER

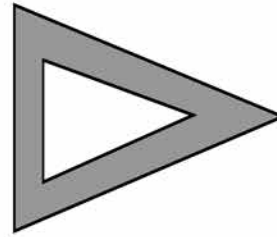

3 BJ-999



4 LB-906

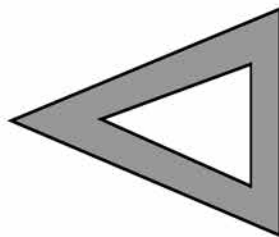

LOWER

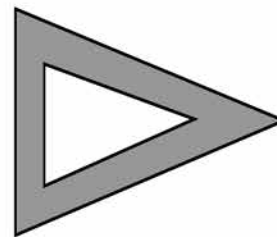

4 LB-906



5 LB-908L

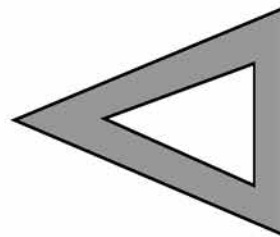

LOWER 4X4

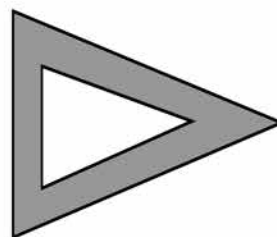

6 LB-908R

Ref	JAPANPARTS CODE	Description	OEM	Measures	Ref	JAPANPARTS CODE	Description	OEM	Measures
1	TI-904	Tie Rod End	8-94237-351-1	c:13.2 th:FM14X1.5R	4	LB-906	Ball Joint	8-94224-552-2	c:17.6
2	RD-900	Axial Joint	8-94217-221-3	th:FM14X1.5R L:267	5	LB-908L	Ball Joint Lower	94109704	c:17.6
3	BJ-999	Ball Joint UPPER	8-94224-550-2	c:17.4	6	LB-908R	Ball Joint Lower	8-94452-106-1	

PICK-UP FASTER

05/1988 - 12/1990



2 TI-998



3 TI-999

UPPER



1 BJ-914

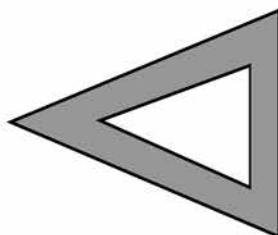

6 RU-914

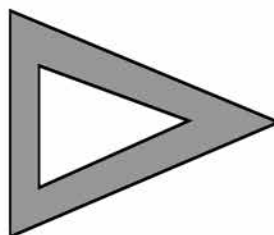

1 BJ-914

LOWER



4 BJ-915

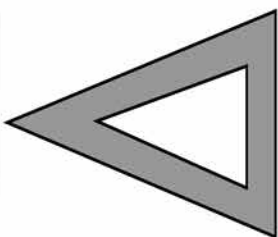

TFR

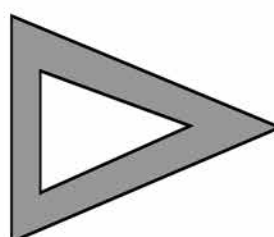

4 BJ-915



5 BJ-913

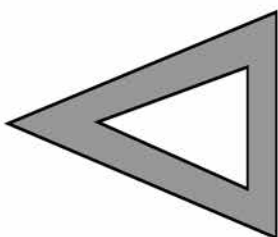

TFS

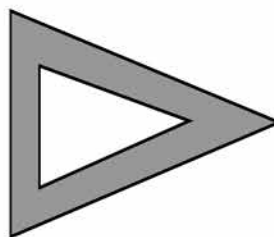

5 BJ-913

Ref.	JAPANPARTS CODE	Description	OEM	Measures	Ref.	JAPANPARTS CODE	Description	OEM	Measures
1	BJ-914	Ball Joint UPPER	310 828	c:17.5	4	BJ-915	Ball Joint UPPER	8 94459 464 1	c:20.5
2	TI-998	Tie Rod End Left	324 058	c:16 th:FM14X1.5L	5	BJ-913	Ball Joint UPPER	8-94452-102-1	c:20.5
3	TI-999	Tie Rod End Right	324 057	c:16 th:FM14X1.5R	6	RU-914	Silentblock For Susp.Arm	8-94226-557-0	



# ISUZU TROOPER - BIGHORN

TROOPER (UBS)  
BIGHORN

10/1987 - 12/1991



1 TI-998

8 RD-999



8 RD-999



2 TI-999

UPPER

-> 11/1991



3 BJ-999

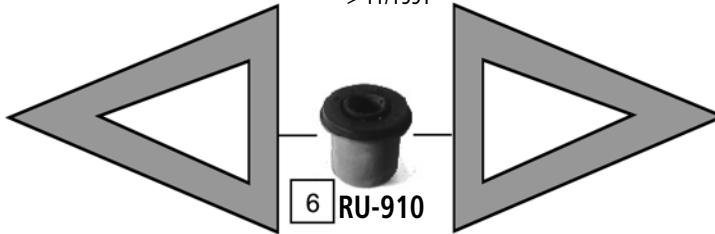

6 RU-910



3 BJ-999

UPPER

12/1991 ->



5 BJ-917

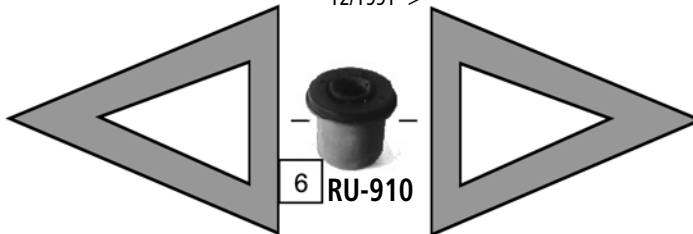

6 RU-910



5 BJ-917

LOWER



4 BJ-913

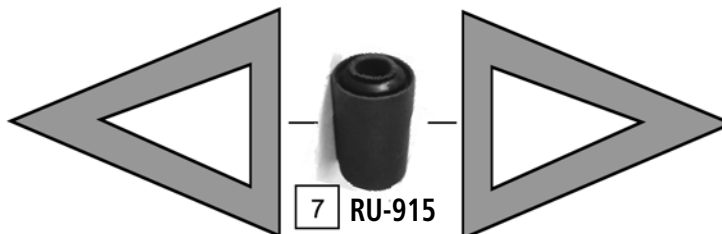

7 RU-915



4 BJ-913

Ref	JAPANPARTS CODE	Description	OEM	Measures	Ref	JAPANPARTS CODE	Description	OEM	Measures
1	TI-998	Tie Rod End Left	324 058	c:16 th:FM14X1.5L	5	BJ-917	Ball Joint	8-94374424-0	c:17.6
2	TI-999	Tie Rod End Right	324 057	c:16 th:FM14X1.5R	6	RU-910	Silentblock For Susp.Arm	8-94408-840-3	d:38.2
3	BJ-999	Ball Joint UPPER	8-94224-550-2	c:17.4	7	RU-915	Silentblock For Susp.Arm	8-94408-842-0	d:44.6
4	BJ-913	Ball Joint UPPER	8-94452-102-1	c:20.5	8	RD-999	Axial Joint	5-44352095-2	

08/1991 - 07/1998

TROOPER (UB)  
BIGHORN

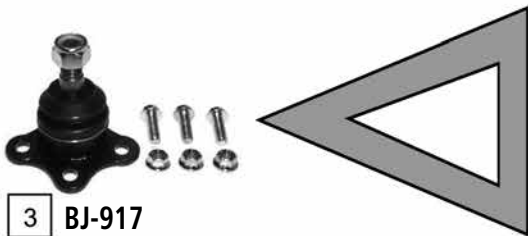

UPPER

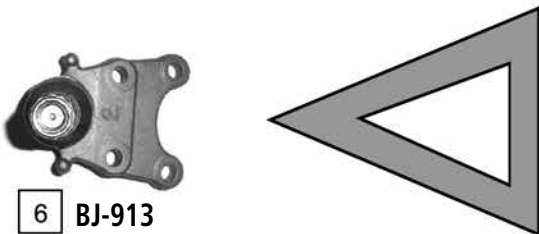
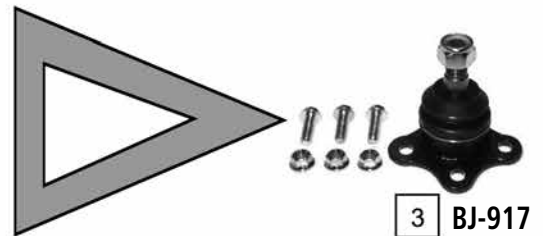

LOWER

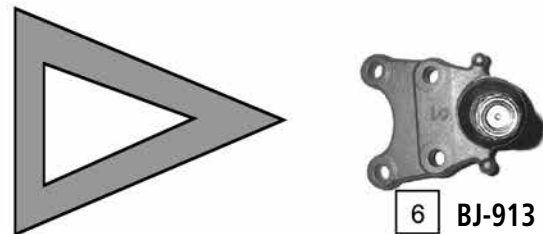

Ref.	JAPANPARTS CODE	Description	OEM	Measures	Ref.	JAPANPARTS CODE	Description	OEM	Measures
1	TI-998	Tie Rod End Left	324 058	c:16 th:FM14X1.5L	4	SI-901	Stabiliser Link Left	8-97018228-2	L:148
2	TI-999	Tie Rod End Right	324 057	c:16 th:FM14X1.5R	5	SI-900	Stabiliser Link Right	8-97018227-2	
3	BJ-917	Ball Joint	8-94374424-0	c:17.6	6	BJ-913	Ball Joint Upper	8-94452-102-1	c:20.5

4.0I - 2.1TD  
CHEROKEE (XJ)

10/1984 - 09/2001

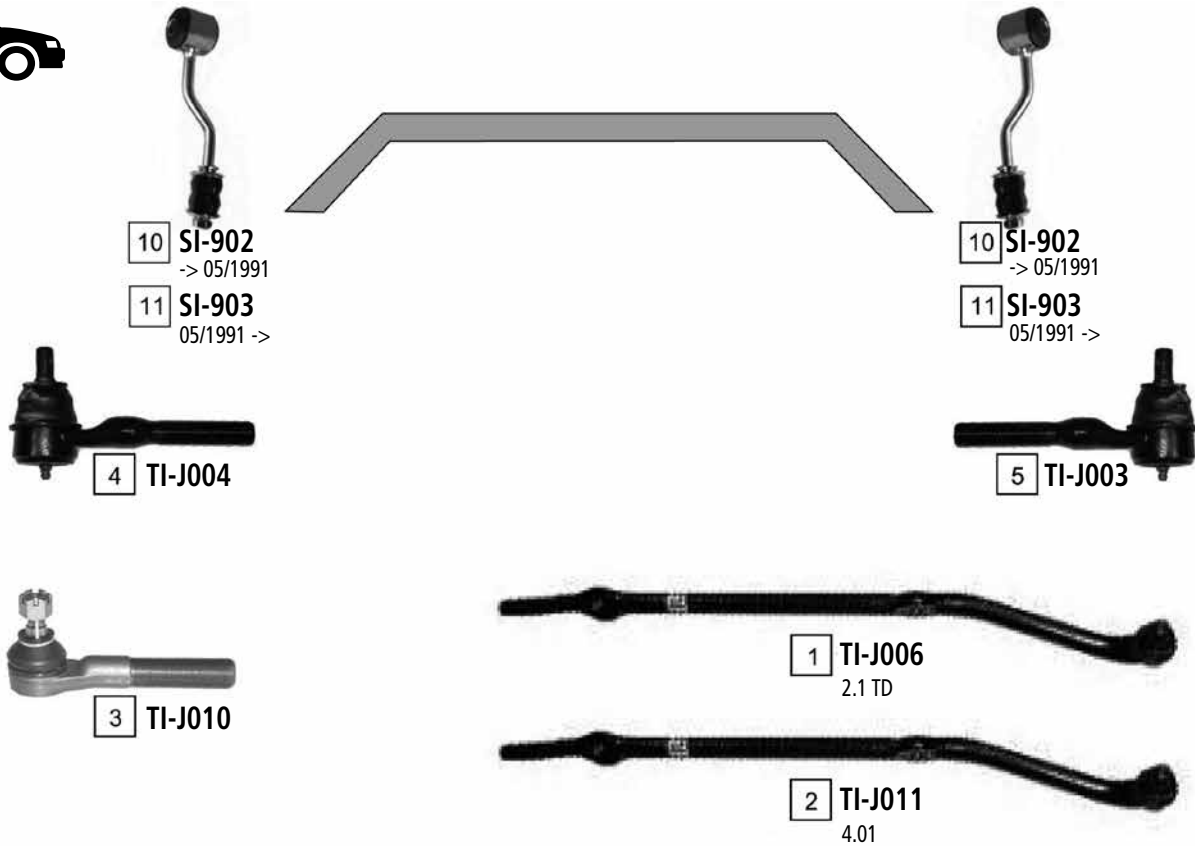

UPPER



LOWER



Ref	JAPANPARTS CODE	Description	OEM	Measures	Ref	JAPANPARTS CODE	Description	OEM	Measures
1	TI-J006	Tie Rod	52005738		7	TI-J013	TCA	52001162	
2	TI-J011	Tie Rod	52006592		8	TI-J001	Ball Joint	83500 202	c:15.8
3	TI-J010	Tie Rod End	52005739	c:14.2 th:MM22X1.5L	9	TI-J002	Ball Joint	83500 202	c:18.4
4	TI-J004	Tie Rod End	52005741		10	SI-902	Stabiliser Link	52037 849	
5	TI-J003	Tie Rod End	52005740		11	SI-903	Stabiliser Link	52003 360	
6	TI-J007	TCA	52087711						

GRAND CHEROKEE I (ZJ/ZG)

01/1991 - 04/1999

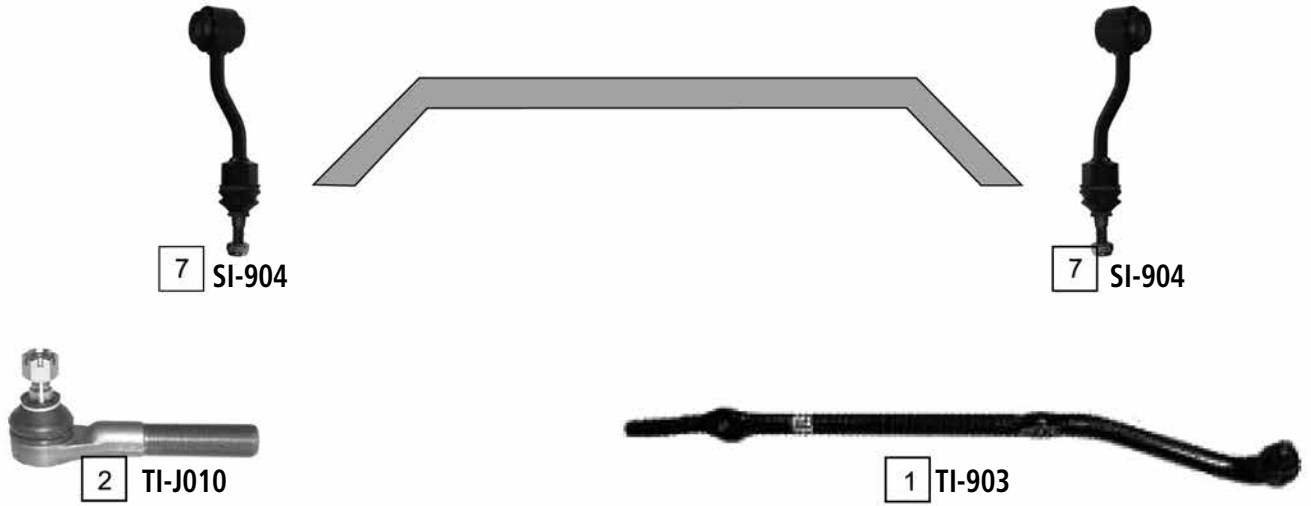

UPPER

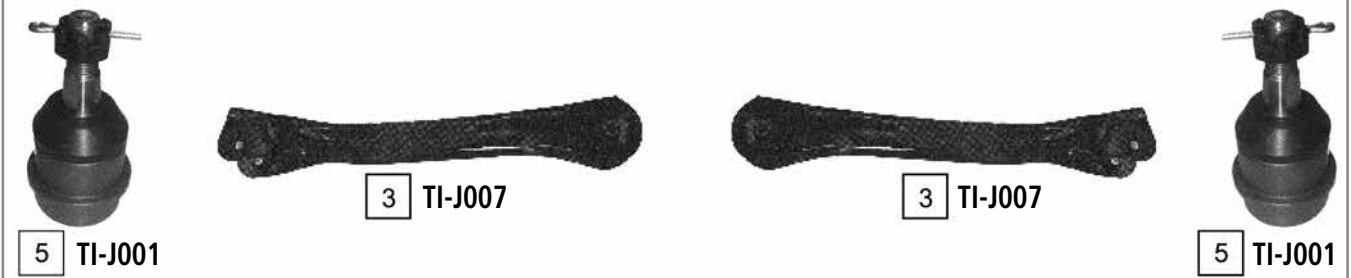

LOWER

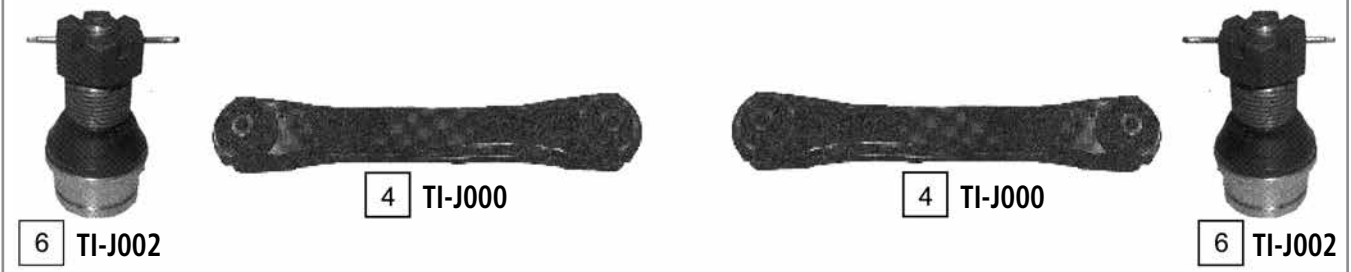

Ref.	JAPANPARTS CODE	Description	OEM	Measures	Ref.	JAPANPARTS CODE	Description	OEM	Measures
1	TI-903	Tie Rod	52037994		5	TI-J001	Ball Joint	83500 202	c:15.8
2	TI-J010	Tie Rod End	52005739	c:14.2 th:MM22X1.5L	6	TI-J002	Ball Joint	83500 202	c:18.4
3	TI-J007	TCA	52087711		7	SI-904	Stabiliser Link	52088437	
4	TI-J000	TCA	52088312						

# JEEP GRAND CHEROKEE

GRAND CHEROKEE II (WJ/WG)

01/1999 - 06/2005



UPPER



LOWER



UPPER



LOWER



Ref	JAPANPARTS CODE	Description	OEM	Measures	Ref	JAPANPARTS CODE	Description	OEM	Measures
1	TI-908	Tie Rod End Left	52088 511	c:14.3 th:MM24X1.5L	6	TI-J014	TCA	52088208-AC	
2	TI-907	Tie Rod End Right	52088 461	c:14.3 th:MM24x1.5R	7	TI-J012	TCA	52088217-AB	
3	TI-910	Tie Rod End Left	52088 869AA	c:14.3 th:MM24X1.5L	8	BJ-900	Ball Joint	5012 432AA	c:16
4	TI-909	Tie Rod End Right	52088 870AA	c:14.3 th:MM24X1.5R	9	BJ-902	Ball Joint	5012 432AA	c:17.7
5	SI-905	Stabiliser Link	52088 283						

GRAND CHEROKEE III (W2)

06/2005 ->

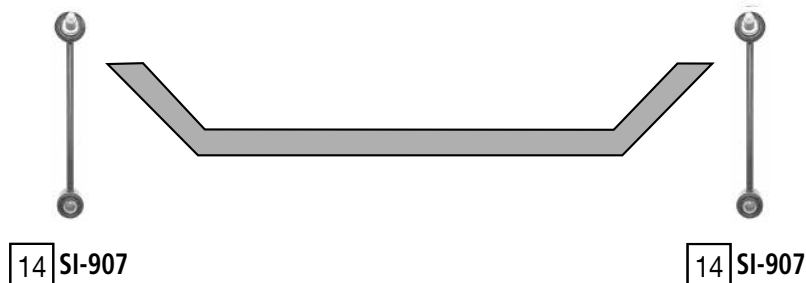
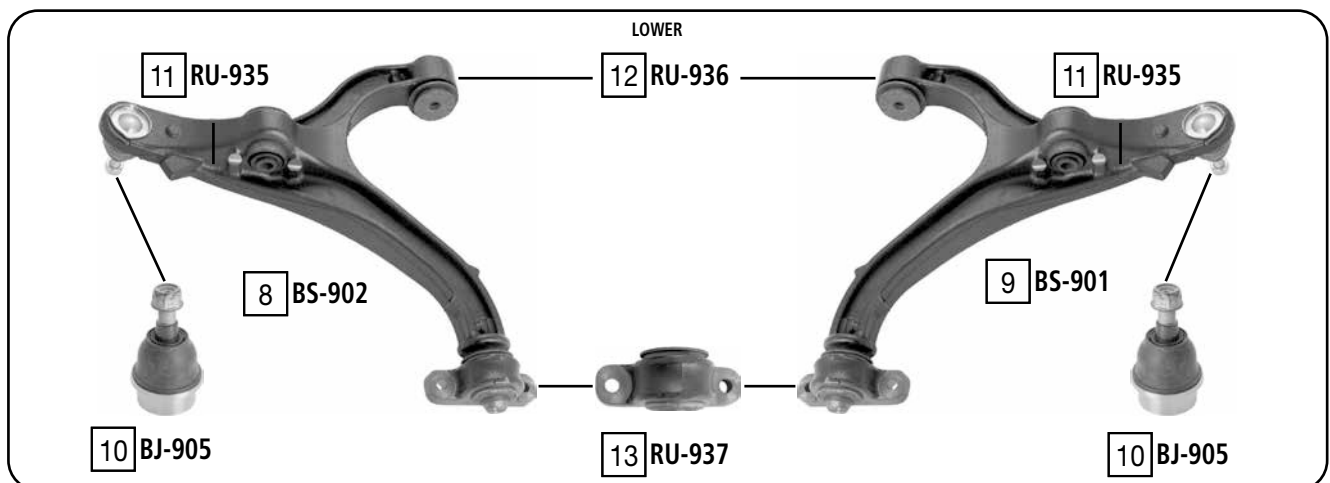
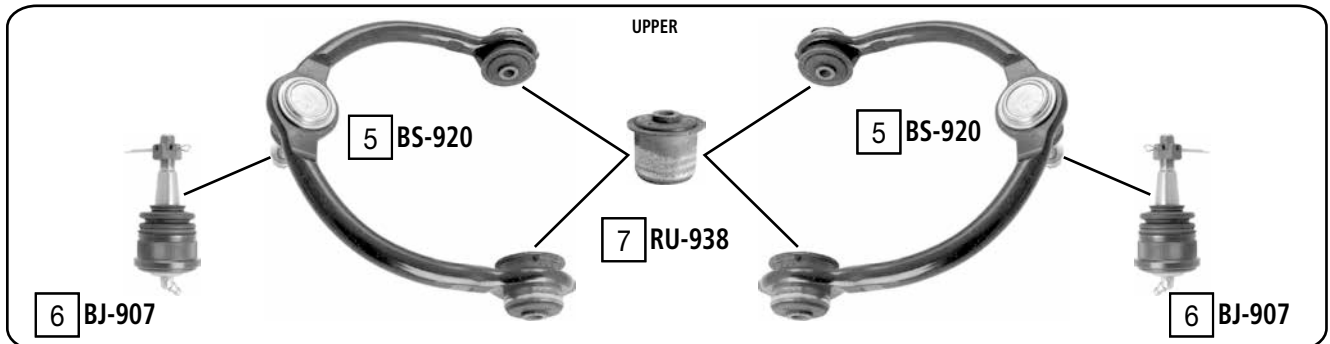
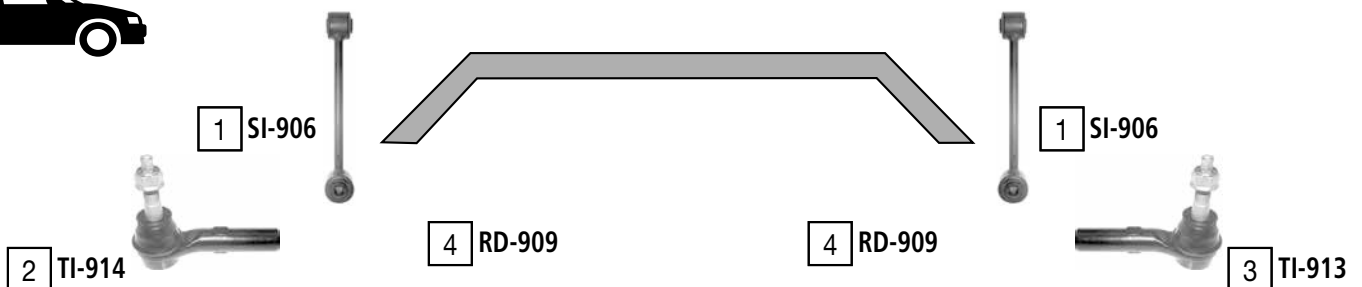

Ref	JAPANPARTS CODE	Description	OEM	Measures	Ref	JAPANPARTS CODE	Description	OEM	Measures
1	SI-906	Stabiliser link	52089 467AB	L:230	8	BS-902	TCA left wbj	52089 981AI	c:17.3
2	TI-914	Tie rod end left	5143 555AC	c:15 th:FM16X1.5R	9	BS-901	TCA right wbj	52089 980AI	c:17.3
3	TI-913	Tie rod end right	5143 556AC	c:15 th:FM16X1.5R	10	BJ-905	Ball joint lower	5135 651AD	c:17.3 do:49.7
4	RD-909	Axial joint	Part of	th:MM14x1.5R L:354	11	RU-935	Silentblock for TCA	Part of	di:16.3 do:49.3
5	BS-920	TCA wbj	52090 206AI	c:14.6	12	RU-936	Silentblock for TCA	Part of	di:16.3 do:54.9
6	BJ-907	Ball joint upper	Part of	c:14.6 do:43.9	13	RU-937	Silentblock for TCA	Part of	di:26 do:26
7	RU-938	Silentblock for TCA	Part of	di:12.2 do:46	14	SI-907	Stabiliser link rear axle	52089 486AE	L:240

CARENS I (FC)

11/2000 - 07/2002

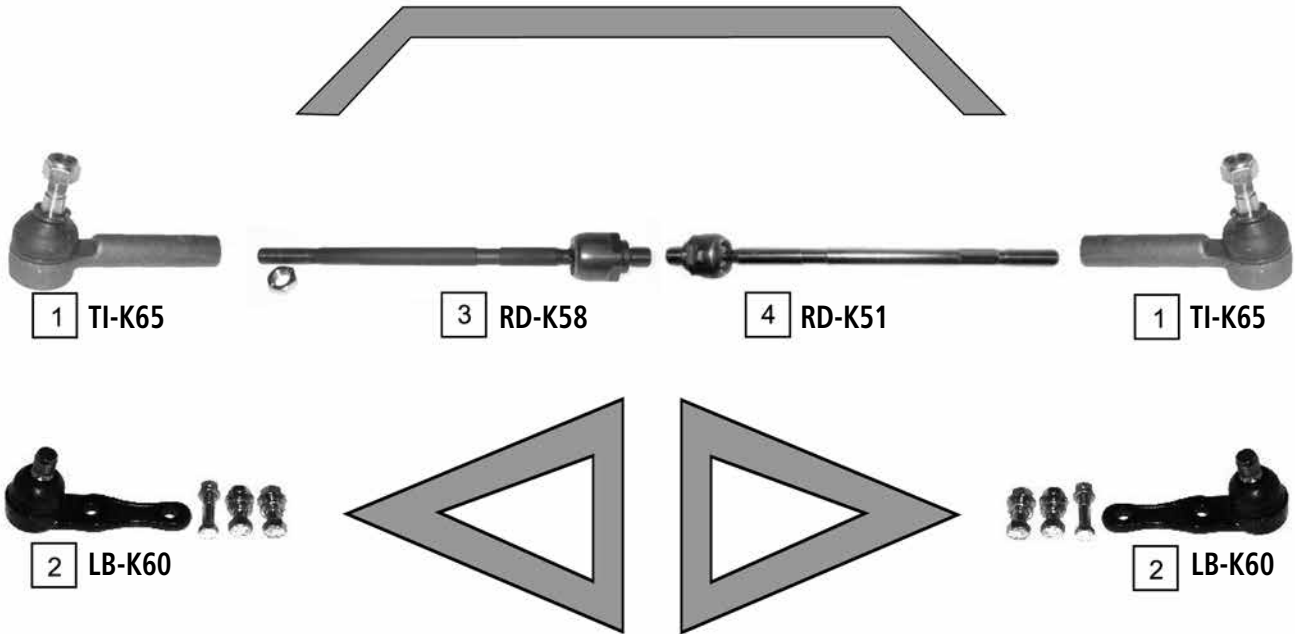

Ref	JAPANPARTS CODE	Description	OEM	Measures	Ref	JAPANPARTS CODE	Description	OEM	Measures
1	TI-K65	Tie Rod End	OK201 32280	c:13 th:FM14X1.5R	3	RD-K58	Axial Joint	OK2A1 32240	th:MM16X1.5R L:282
2	LB-K60	Ball Joint	OK2A1 34550A	c:18	4	RD-K51	Axial Joint	OK2A2 32240	

CARENS II (FJ)

07/2002 - 09/2006

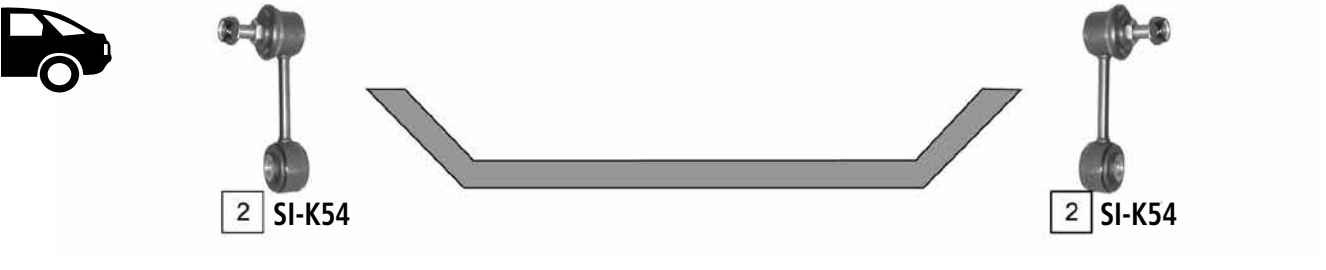
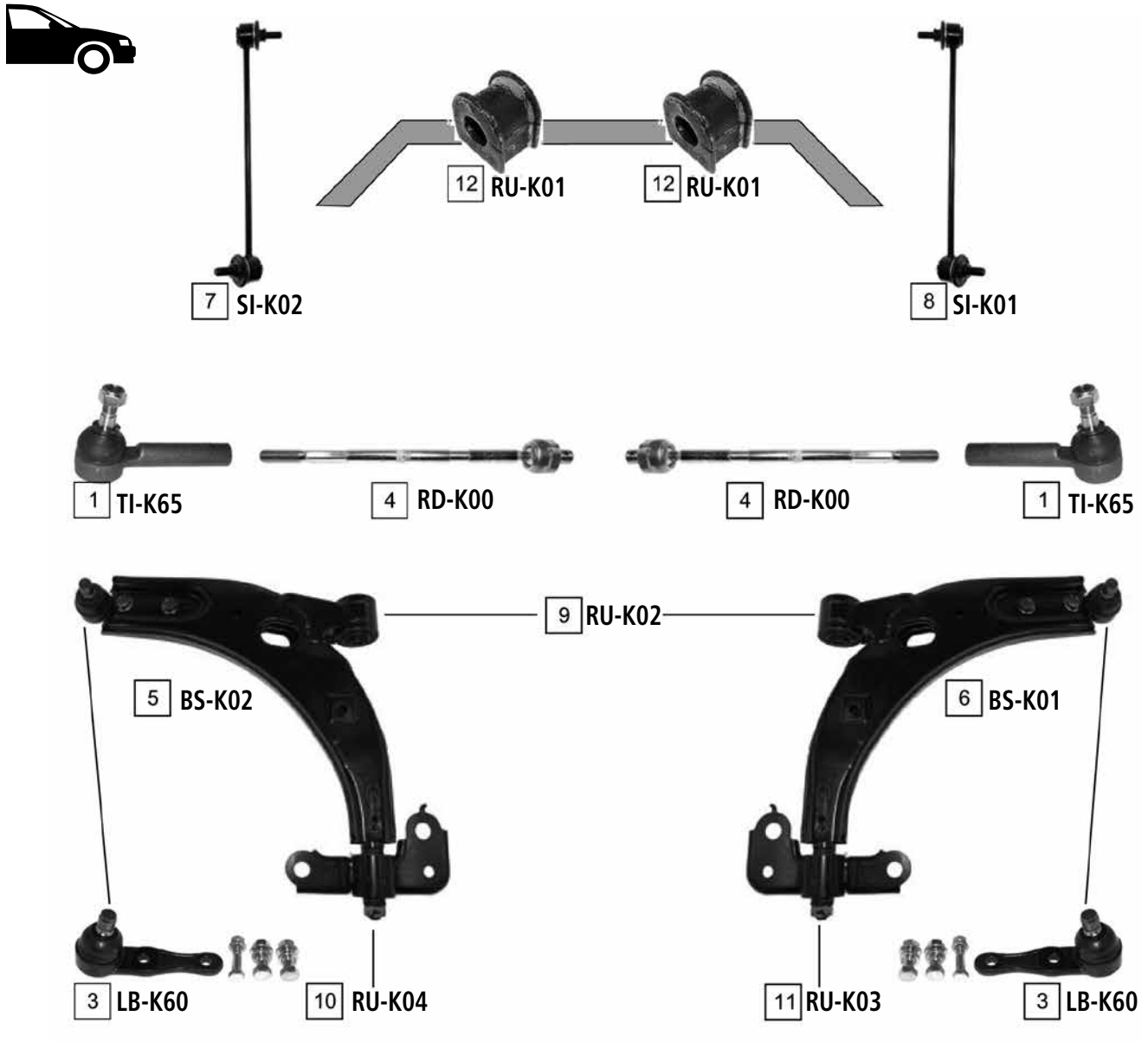

Ref.	JAPANPARTS CODE	Description	OEM	Measures	Ref.	JAPANPARTS CODE	Description	OEM	Measures
1	TI-K65	Tie Rod End	OK201 32280	c:13 th:FM14X1.5R	7	SI-K02	Stabiliser Link Left	OK2FA 34170	L:280
2	SI-K54	Stabiliser Link	OK2A1 34150B	L:89	8	SI-K01	Stabiliser Link Right	OK2FA 34150	L:280
3	LB-K60	Ball Joint	OK2A1 34550A	c:18	9	RU-K02	Silentblock For Susp.Arm	OK2C034460	
4	RD-K100	Axial Joint	OK2FK 32240	th:MM16X1.5R L:304	10	RU-K04	Silentblock For Susp.Arm	OK2A1 3446Y	
5	BS-K02	TCA Left	OK2FA 34350	c:18	11	RU-K03	Silentblock For Susp.Arm	OK2A1 3446X	
6	BS-K01	TCA Right	OK2FA 34340	c:18	12	RU-K01	Stabiliser Mounting	OK2KB 34156A	d:20



CARENS III

10/2006 ->

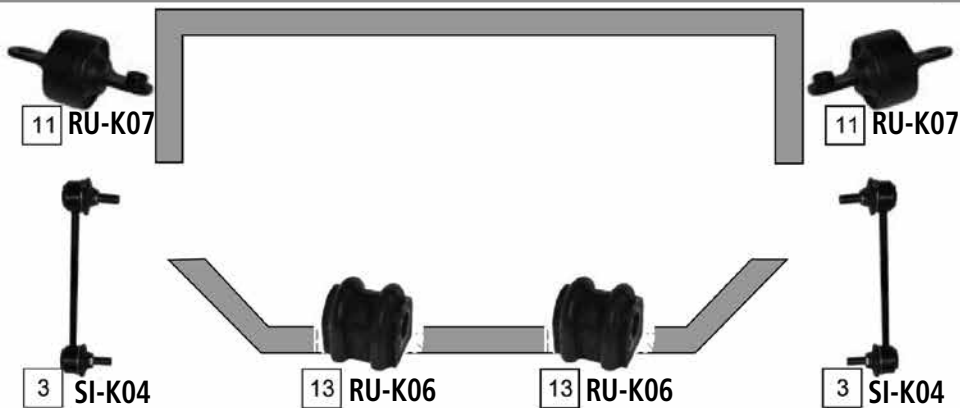
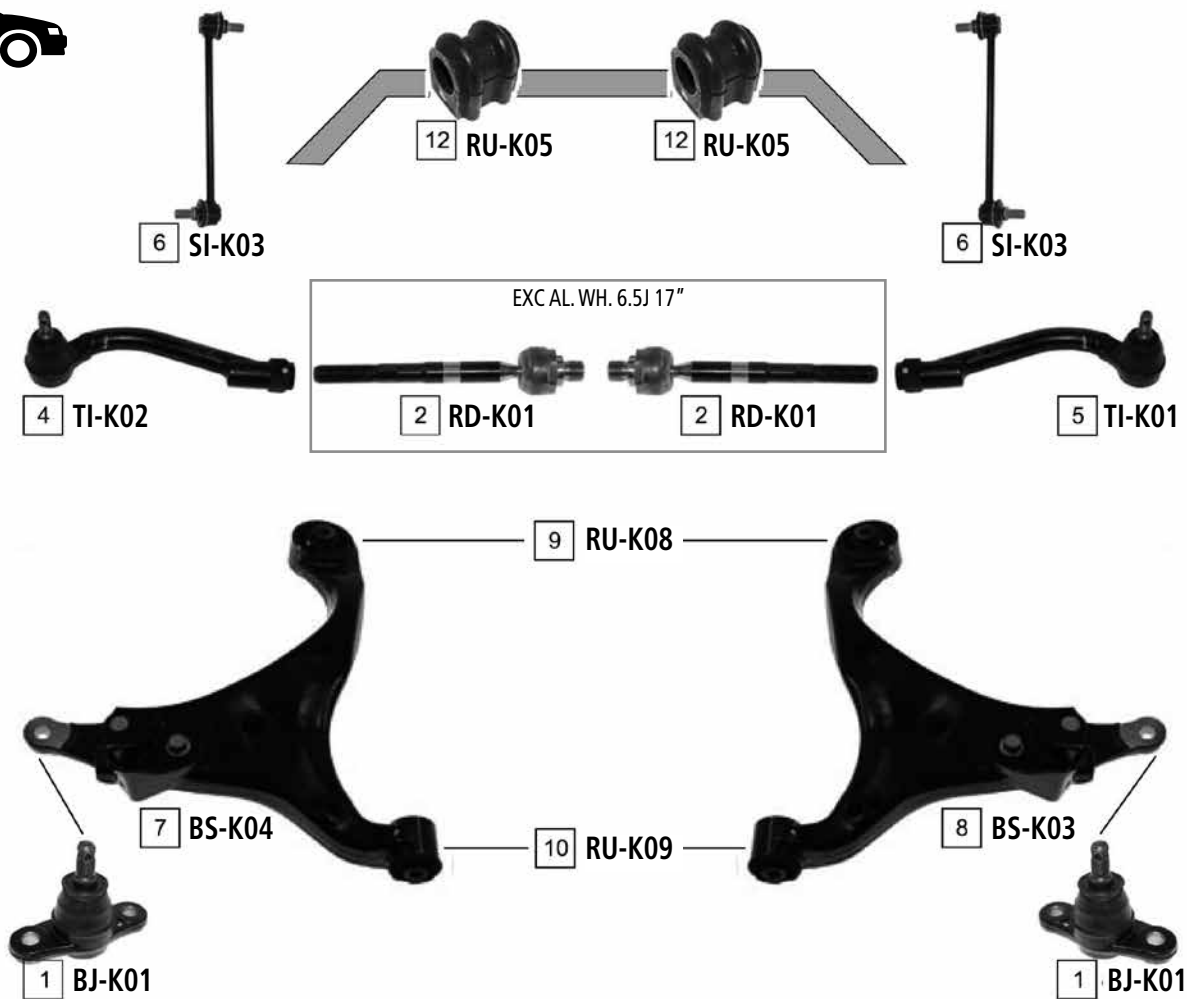

Ref	JAPANPARTS CODE	Description	OEM	Measures	Ref	JAPANPARTS CODE	Description	OEM	Measures
1	BJ-K01	Ball Joint	51760 2G000	c:15	8	BS-K03	TCA Right Wobj	54501 1D000	-
2	RD-K01	Axial Joint	57724 2G000	th:MM18X1.5R L:199	9	RU-K08	Silentblock For Susp.Arm	54584 1D000	d:14.3
3	SI-K04	Stabiliser Link	55530 1D000	L:180	10	RU-K09	Silentblock For Susp.Arm	54551 1D000	d:12.2
4	TI-K02	Tie Rod End Left	56820 2G000	c:13.4 th:MM16X1.5R	11	RU-K07	Silentblock For Susp.Arm	55543 2G000	-
5	TI-K01	Tie Rod End Right	56820 2G900	c:13.4 th:MM16X1.5R	12	RU-K05	Stabiliser Mounting	54813 1H100	d:23.4
6	SI-K03	Stabiliser Link	54830 2G000	L:241	13	RU-K06	Stabiliser Mounting	55513 2G000	d:14
7	BS-K04	TCA Left Wobj	54500 1D000	-					

CARNIVAL - SEDONA (UP)

08/1999 - 11/2005

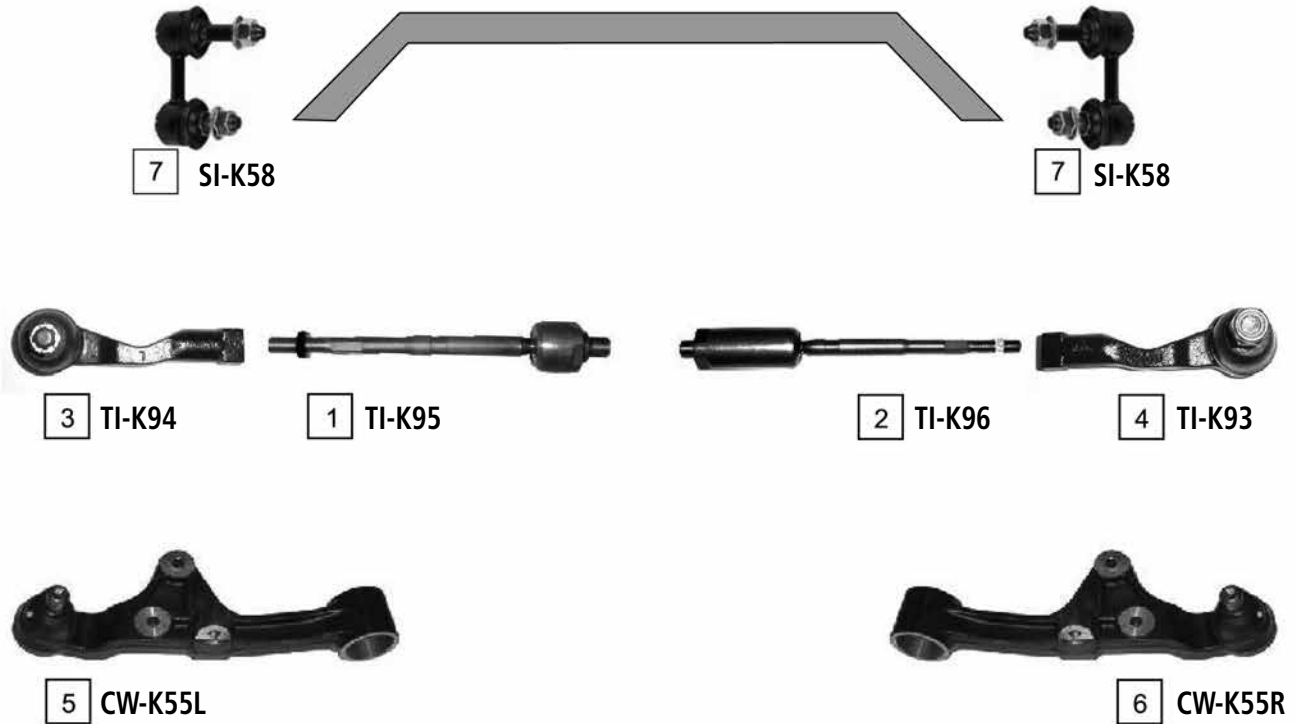

Ref.	JAPANPARTS CODE	Description	OEM	Measures	Ref.	JAPANPARTS CODE	Description	OEM	Measures
1	TI-K95	Axial Joint	0K522 32270	th:MM17X1R L:246	5	CW-K55L	TCA Left	0K552 34350B	c:21.9
2	TI-K96	Axial Joint	0K522 32250	th:MM17X1R L:308	6	CW-K55R	TCA Right	0K552 34300B	c:21.9
3	TI-K94	Tie Rod End Left	0K552 32240		7	SI-K58	Stabiliser Link	0K552 34151B	L:64
4	TI-K93	Tie Rod End Right	0K552 32280						

CARNIVAL III

04/2006 ->

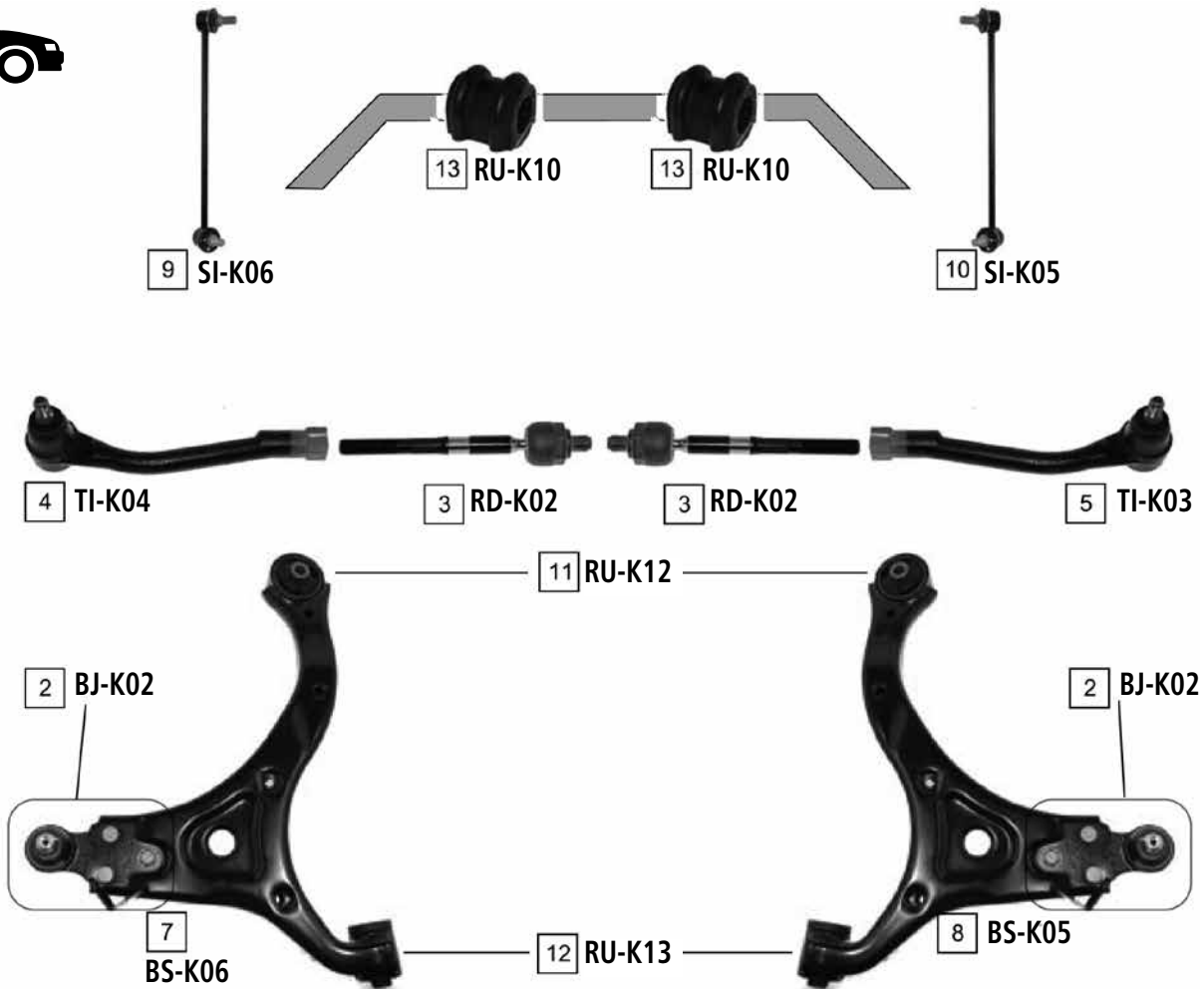

Ref	JAPANPARTS CODE	Description	OEM	Measures	Ref	JAPANPARTS CODE	Description	OEM	Measures
1	RU-K11	Ball Joint	55130 4D000	-	8	BS-K05	TCA Right Wbj	54501 4D001	c:20
2	BJ-K02	Ball Joint	54530 4D000	c:20	9	SI-K06	Stabiliser Link Left	54830 4D000	L:323
3	RD-K02	Axial Joint	57724 4D000	th:MM16X1.5R L:210	10	SI-K05	Stabiliser Link Right	54840 4D000	L:323
4	TI-K04	Tie Rod End Left	56820 4D000	c:14 th:FM16X1.5R	11	RU-K12	Silentblock For Susp.Arm	54584 4D000	d:14.4
5	TI-K03	Tie Rod End Right	56820 4D100	c:14 th:FM16X1.5R	12	RU-K13	Silentblock For Susp.Arm	54551 4D000	d:14.1
6	SI-K07	Stabiliser Link	55530 4D000	L:72	13	RU-K10	Stabiliser Mounting	54813 4D000	d:26
7	BS-K06	TCA Left Wbj	54500 4D001	c:20					

CEE'D

12/2006 ->

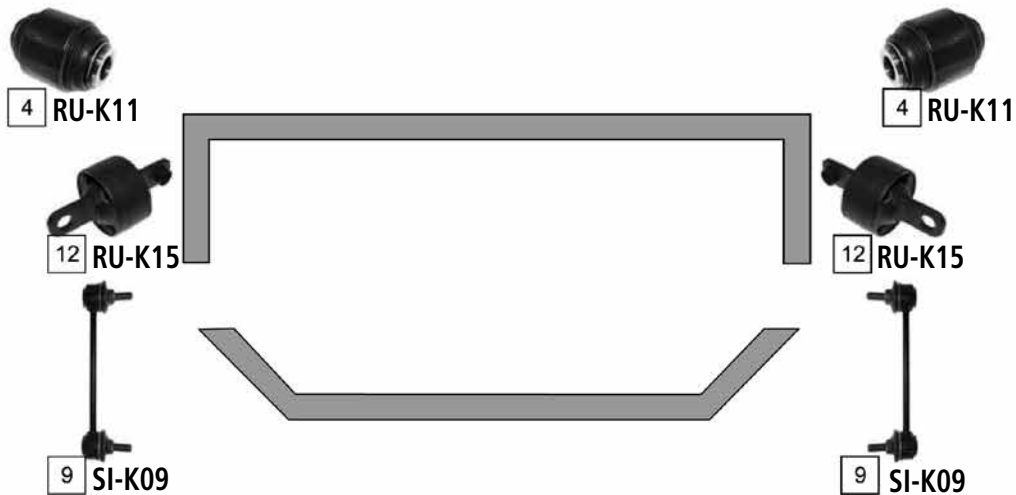
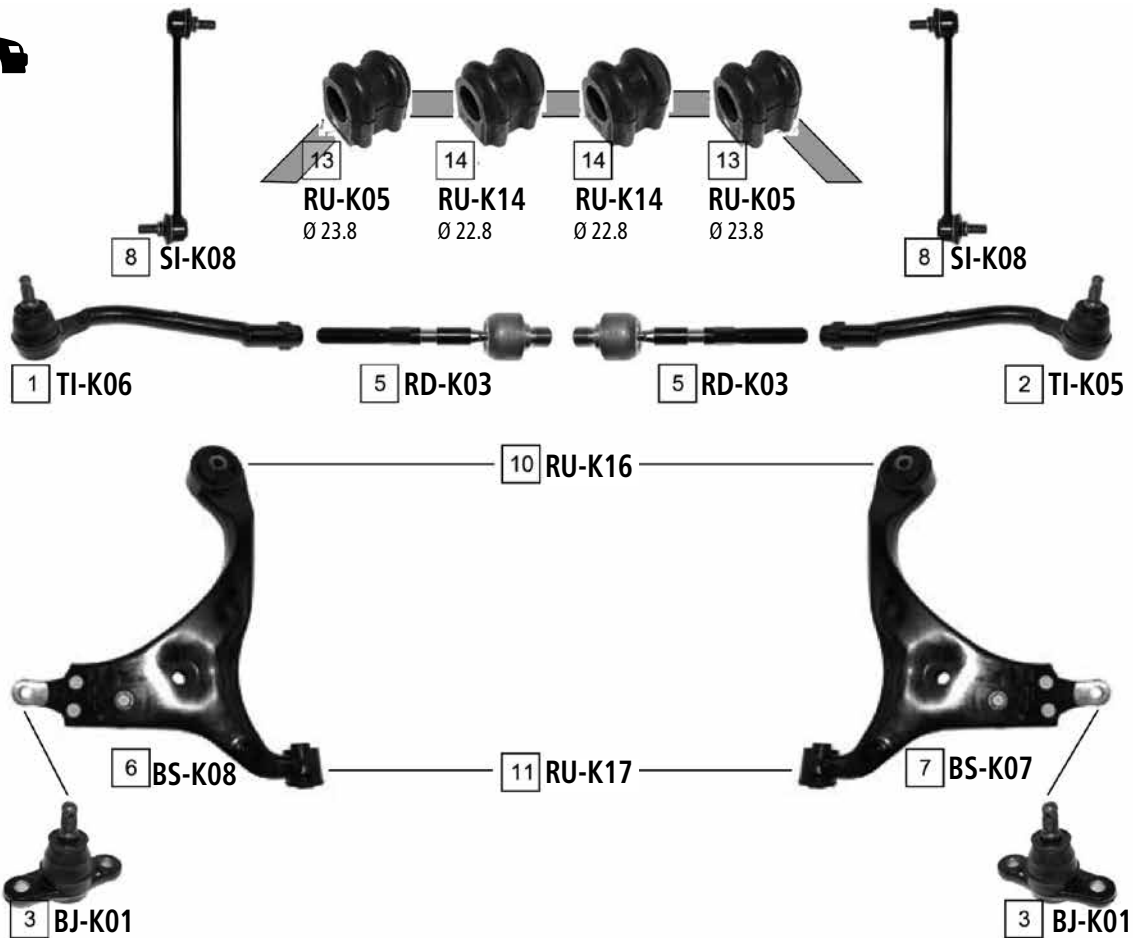

Ref.	JAPANPARTS CODE	Description	OEM	Measures	Ref.	JAPANPARTS CODE	Description	OEM	Measures
1	TI-K06	Tie Rod End Left	56820 2H000	c:13.4 th:FM14X1.5R	8	SI-K08	Stabiliser Link	54830 2H000	L:245
2	TI-K05	Tie Rod End Right	56820 2H090	c:13.4 th:FM14X1.5R	9	SI-K09	Stabiliser Link	55530 1H000	L:171
3	BJ-K01	Ball Joint	51760 2G000	c:15	10	RU-K16	Silentblock For Susp.Arm	54584 2H000	d:14
4	RU-K11	Ball Joint	55130 4D000	-	11	RU-K17	Silentblock For Susp.Arm	54551 2H000	d:12.4
5	RD-K03	Axial Joint	56540 2H000	th:MM16X1.5R L:162	12	RU-K15	Silentblock For Susp.Arm	55543 1H000	-
6	BS-K08	TCA Left Wobj	54500 2H000	-	13	RU-K05	Stabiliser Mounting	54813 1H100	d:23.4
7	BS-K07	TCA Right Wobj	54501 2H000	-	14	RU-K14	Stabiliser Mounting	54813 2H000	d:22.3

CERATO

04/2004 ->

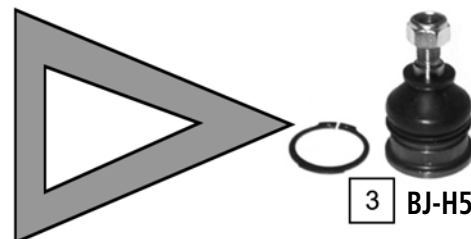
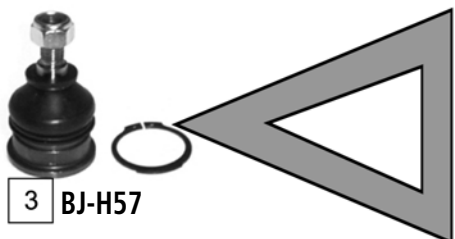

Ref	JAPANPARTS CODE	Description	OEM	Measures	Ref	JAPANPARTS CODE	Description	OEM	Measures
1	TI-H01	Tie Rod End	56820-25000	c:13.8 th:FM14X1.5R	5	SI-K10	Stabiliser Link Left	54830 2F000	L:250
2	RD-H06	Axial Joint	57724-2D000	th:MM16X1.5R L:327	6	SI-K11	Stabiliser Link Right	54840 2F000	L:250
3	BJ-H57	Ball Joint	54520 31600	c:15					
4	SI-H13	Stabiliser Link	55530 17000	L:128.5					

CLARUS (K9A)

07/1996 - 04/2000

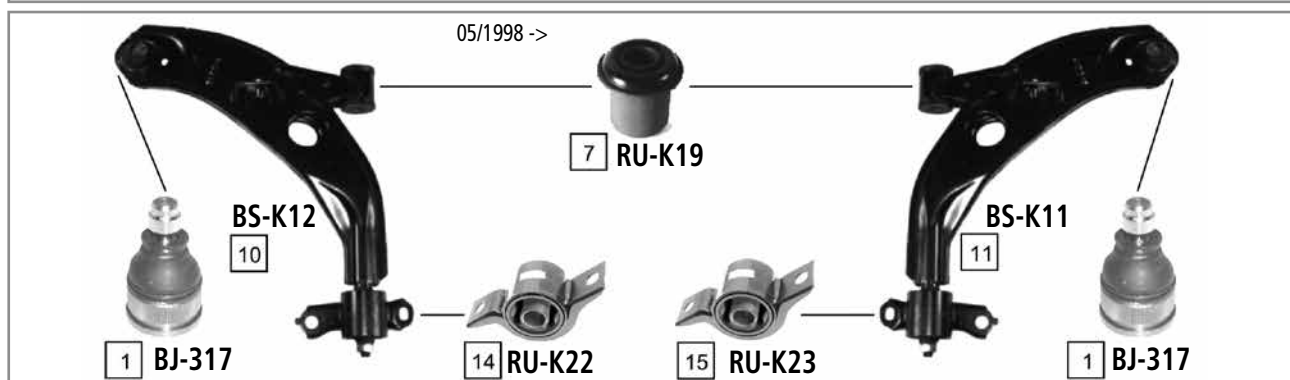
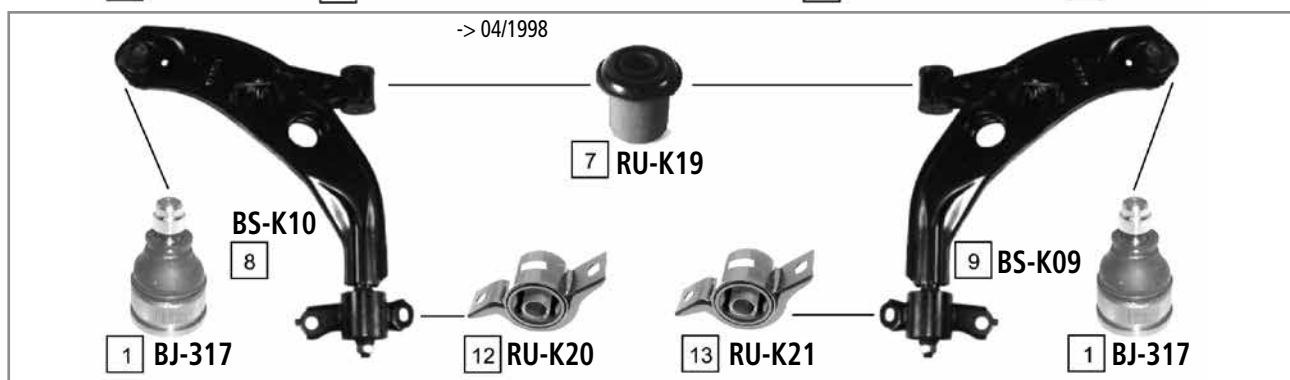
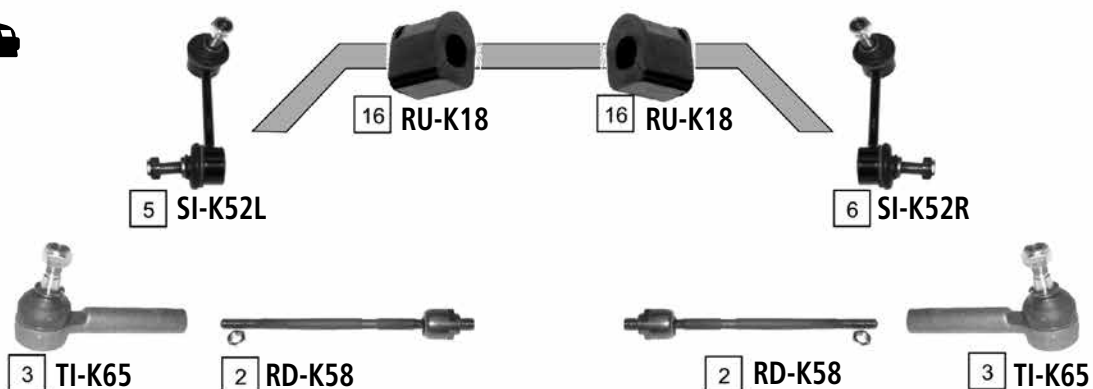

Ref.	JAPANPARTS CODE	Description	OEM	Measures	Ref.	JAPANPARTS CODE	Description	OEM	Measures
1	BJ-317	Ball Joint LOWER	0G030 34550B	c:18	9	BS-K09	TCA Right	0K9A2-34300	
2	RD-K58	Axial Joint	0K2A1 32240	th:MM16X1.5R L:282	10	BS-K12	TCA Left	0K9A6-34350	
3	TI-K65	Tie Rod End	0K201 32280	c:13 th:FM14X1.5R	11	BS-K11	TCA Right	0K9A6-34300	
4	SI-K53	Stabiliser Link	0K9A3 28170A	L:70	12	RU-K20	Silentblock For Susp.Arm	0K9A2-34464	
5	SI-K52L	Stabiliser Link Left	KGA2A 34170A	L:104	13	RU-K21	Silentblock For Susp.Arm	0K9A2-3446X	
6	SI-K52R	Stabiliser Link Right	KGA2A 34150A	L:104	14	RU-K22	Silentblock For Susp.Arm	0K9A6-3446Y	
7	RU-K19	Silentblock For Susp.Arm	0K9A2-34470		15	RU-K23	Silentblock For Susp.Arm	0K9A6-3446X	
8	BS-K10	TCA Left	0K9A2-34350		16	RU-K18	Stabiliser Mounting	0K9A2-34156	

K 2500 - 2700

01/1997 ->

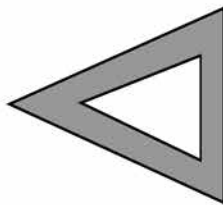
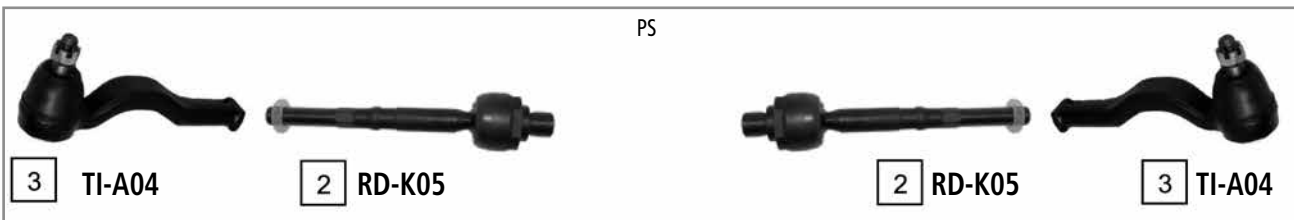
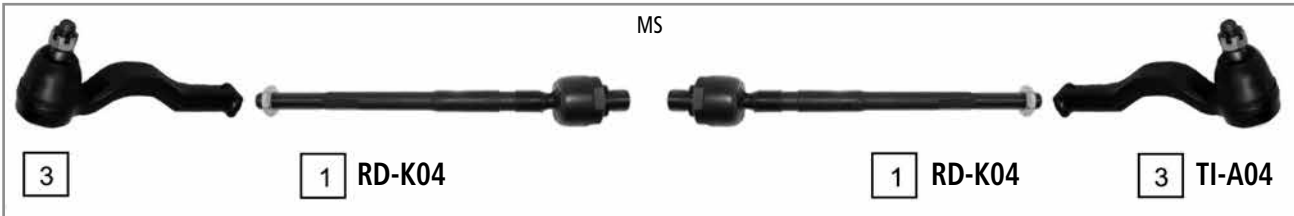

6 CJ-K52L

8 CJ-K52R

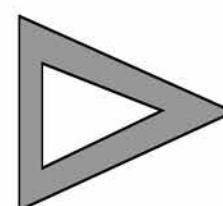
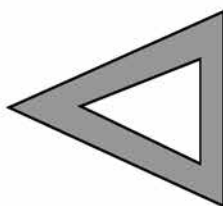
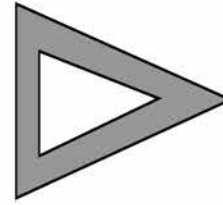

7 CW-K51L

9 CW-K51R

Ref	JAPANPARTS CODE	Description	OEM	Measures	Ref	JAPANPARTS CODE	Description	OEM	Measures
1	RD-K04	Axial Joint	0K72A 32270	th:MM17X1R L:275	6	CJ-K52L	TCA Left	OSE46-34-200	
2	RD-K05	Axial Joint	0K60A32270/A	th:MM18X1.5R L:183	7	CW-K51L	TCA Left	OSO83-34-300B	
3	TI-A04	Tie Rod End	0K71032240	c:14 th:FM14X1.5R	8	CJ-K52R	TCA Right	OSO46-34-250	
4	BJ-A01	Ball Joint	0K710 34540		9	CW-K51R	TCA Right	OSO83-34-350B	
5	BJ-A02	Ball Joint	0K710 34510						

PICANTO

02/2004 ->

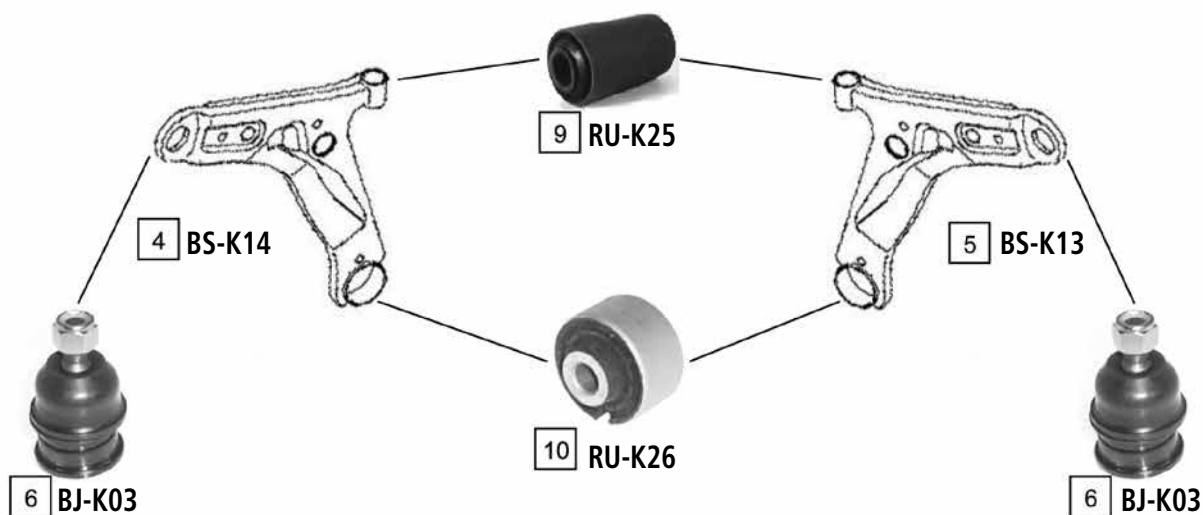
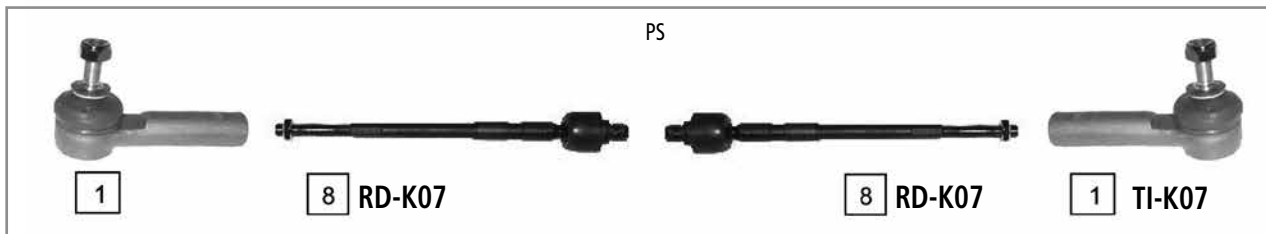
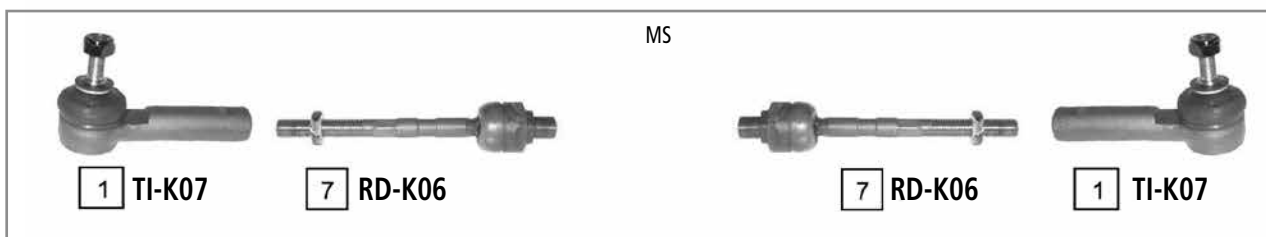
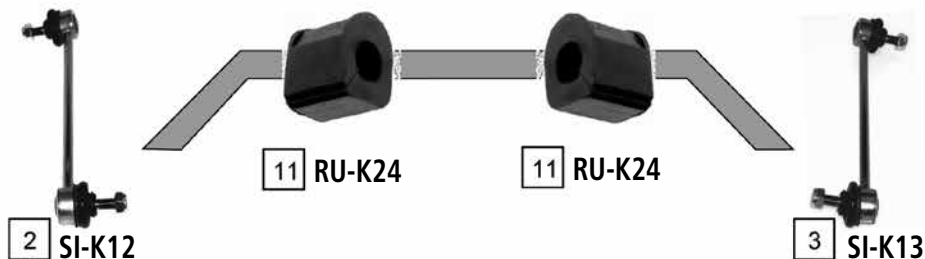

Ref.	JAPANPARTS CODE	Description	OEM	Measures	Ref.	JAPANPARTS CODE	Description	OEM	Measures
1	TI-K07	Tie Rod End	568.20.07.000	c:13.1 th:FM12X1.25	7	RD-K06	Axial Joint	57724 07100	th:MM16X1.5R L:290
2	SI-K12	Stabiliser Link Left	54830 07000	L:230	8	RD-K07	Axial Joint	57724 07000	th:MM16X1.5R L:290
3	SI-K13	Stabiliser Link Right	54840 07000	L:230	9	RU-K25	Silentblock For Susp.Arm	54584 07000	
4	BS-K14	TCA Left Wbj	54500 07200		10	RU-K26	Silentblock For Susp.Arm	54551 07000	
5	BS-K13	TCA Right Wbj	54501 07200		11	RU-K24	Stabiliser Mounting	54812 07100	
6	BJ-K03	Ball Joint	54530 07000	c:16					



PREGIO (TB)

01/1997 - 01/2005

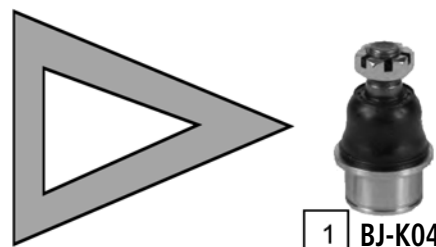
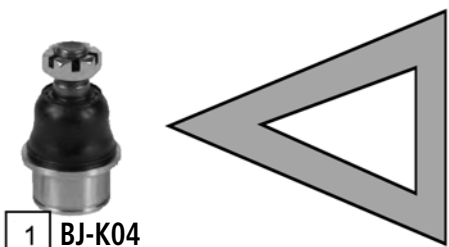
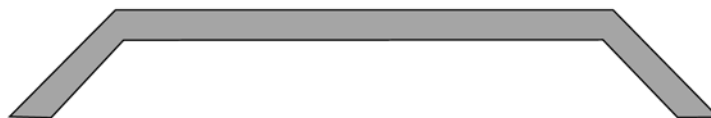

Ref	JAPANPARTS CODE	Description	OEM	Measures	Ref	JAPANPARTS CODE	Description	OEM	Measures
1	BJ-K04	Ball Joint	0K72A 34510A	c:21.6	3	RD-K04	Axial Joint	0K72A 32270	th:MM17X1R L:275
2	TI-K68	Tie Rod End	0K72A 32240		4	SI-K14	Stabiliser Link	0K72A 34150A	L:77

PRIDE (DA)

01/1990 - 05/2001



2 TI-325    1 RD-K53



1 RD-K53    2 TI-325



3 BJ-K52



3 BJ-K52

Ref.	JAPANPARTS CODE	Description	OEM	Measures	Ref.	JAPANPARTS CODE	Description	OEM	Measures
1	RD-K53	Axial Joint	KK150-32-240	th:MM16X1.5R L:265	3	BJ-K52	TCA	KKY01-34-390A	c:16
2	TI-325	Tie Rod End	8AB1-32-280	c:12.6 th:FM12X1.25					

RETONA (CE)

06/1999 - 01/2003



2 TI-K66L



4 TI-K67L



5 TI-K67R



3 TI-K66R

8 SA-K51L

6 CJ-K57

6 CJ-K57

9 SA-K51R



1 LB-K58

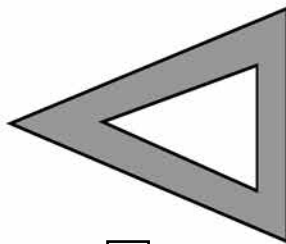

7 CW-K56

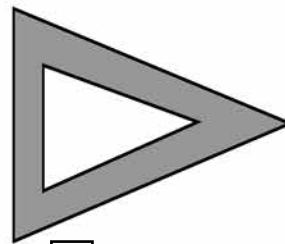

7 CW-K56



1 LB-K58

Ref	JAPANPARTS CODE	Description	OEM	Measures	Ref	JAPANPARTS CODE	Description	OEM	Measures
1	LB-K58	Ball Joint	OK011-34-510B	c:18	6	CJ-K57		OK011-34-200	
2	TI-K66L	Tie Rod End Outer	OK011-32-240A	c:13.4 th:FM18X1.5L	7	CW-K56		OK011-34-300D	
3	TI-K66R	Tie Rod End Outer	OK011-32-250A	c:13.4	8	SA-K51L		OK011-32-270A	
4	TI-K67L	Tie Rod End Inner	OK011-32-230	c:14.6 th:FM18X1.5R	9	SA-K51R		OK011-32-290A	
5	TI-K67R	Tie Rod End Inner	OK011-32-280	c:14.6 th:FM18X1.5L					

RIO

09/2000 - 02/2005

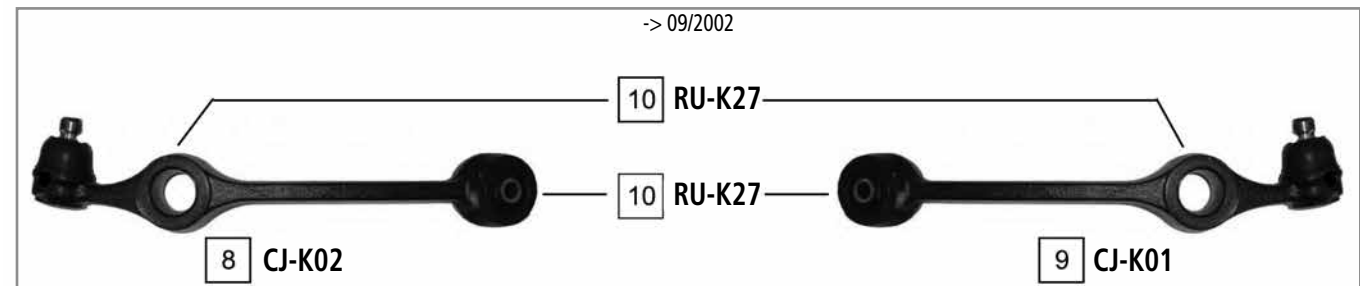
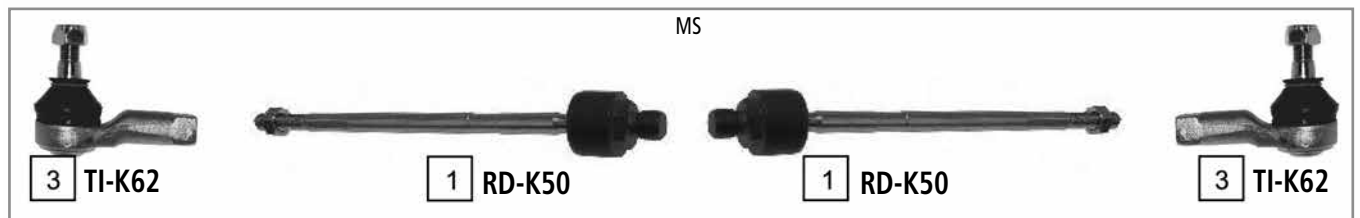
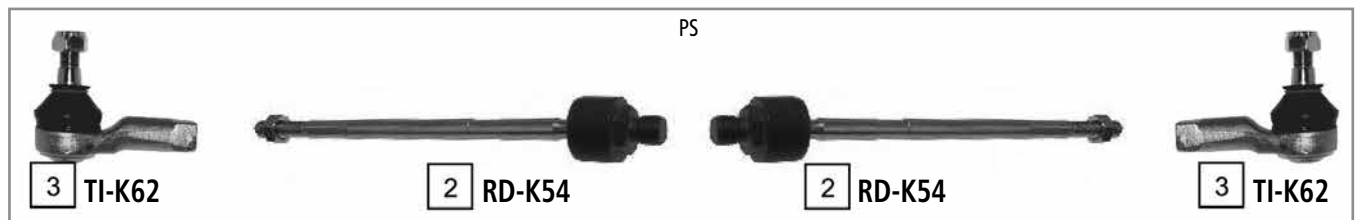
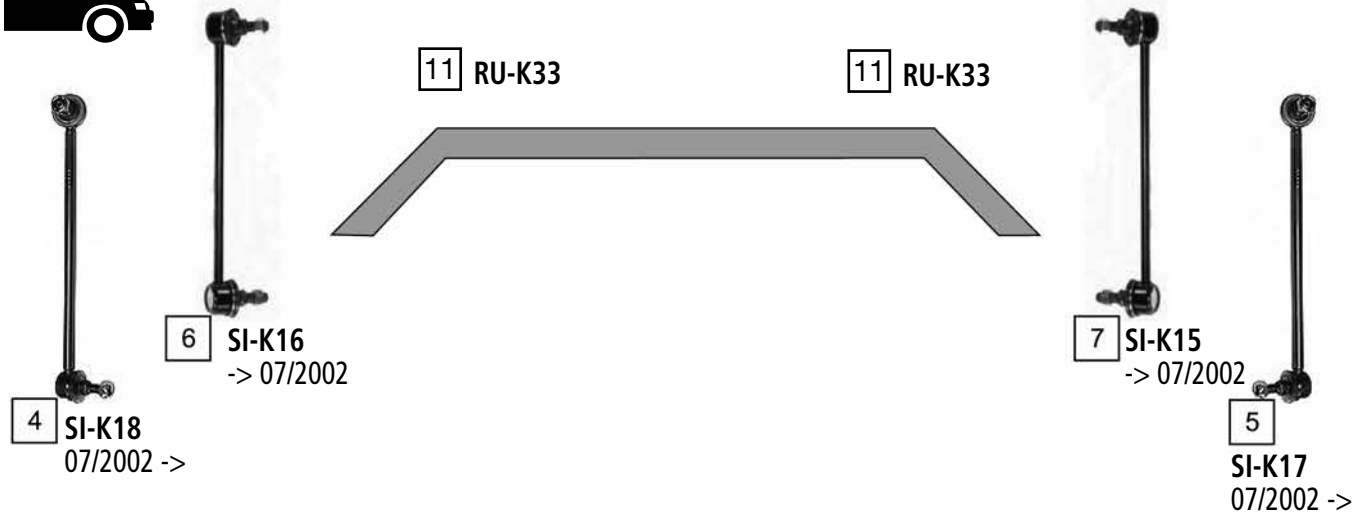

Ref.	JAPANPARTS CODE	Description	OEM	Measures	Ref.	JAPANPARTS CODE	Description	OEM	Measures
1	RD-K50	Axial Joint	KDX5032240B		7	SI-K15	Stabiliser Link Right	0K33C 34150A	L:240
2	RD-K54	Axial Joint	KDX53 32240B	th:MM16X1.5R L:279	8	CJ-K01	TCA Left	0K30B 34350B	-
3	TI-K62	Tie Rod End	MDX5032280	c:13.2 th:FM12X1.25	9	CJ-K02	TCA Right	0K30B34300B	-
4	SI-K18	Stabiliser Link Left	54820 FD000	L:218	10	RU-K27	Silentblock For Susp.Arm	0K30A 34480 C	-
5	SI-K17	Stabiliser Link Right	54830 FD000		11	RU-K33	Stabiliser Mounting	54813-FD000	
6	SI-K16	Stabiliser Link Left	0K33C 34160A	L:240					

RIO II

03/2005 ->

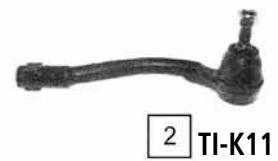

06/2006 ->

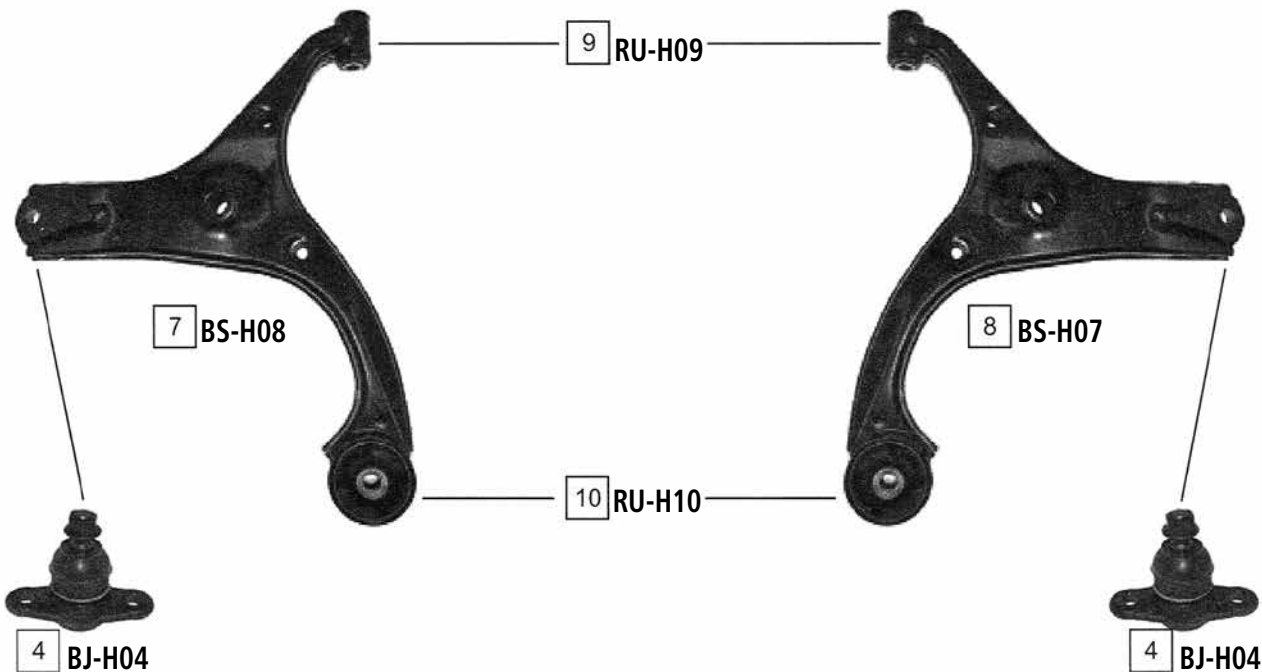

Ref.	JAPANPARTS CODE	Description	OEM	Measures	Ref.	JAPANPARTS CODE	Description	OEM	Measures
1	TI-K10	Tie Rod End Left	56820 1G900	c:13.4 th:FM14X1.5R	7	BS-H08	TCA Left	54500 1E100	c:15
2	TI-K11	Tie Rod End Right	56820 1G000	c:13.4 th:FM14X1.5R	8	BS-H07	TCA Right	54501 1E100	c:15
3	RD-K12	Axial Joint	57724 1G100	th:MM16X1.5R L:186	9	RU-H09	Silentblock For Susp.Arm	54584 1G000	d:66.5
4	BJ-H04	Ball Joint	51760 1G000	c:15	10	RU-H10	Silentblock For Susp.Arm	54551 1E000	d:32.5
5	SI-H06	Stabiliser Link Left	54830 1G000	L: 285.5	11	RU-H08	Stabiliser Mounting	54812 1G100	-
6	SI-H05	Stabiliser Link Right	54840 1G000	L: 285.5					

09/1993 - 05/1998

MENTOR I  
SEPHIA I (FA)  
SPECTRA

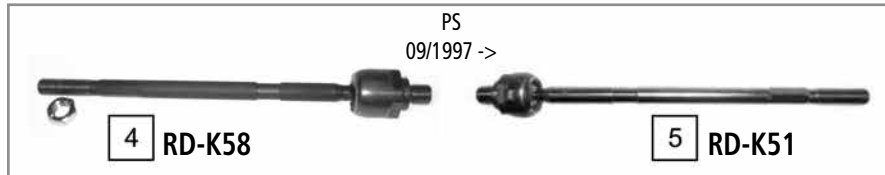
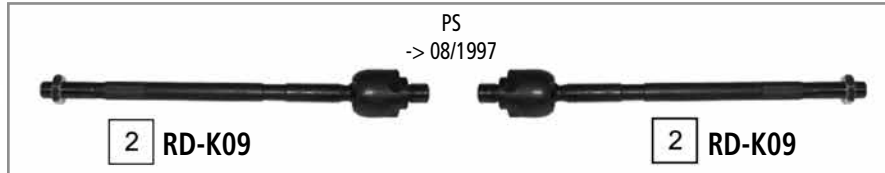
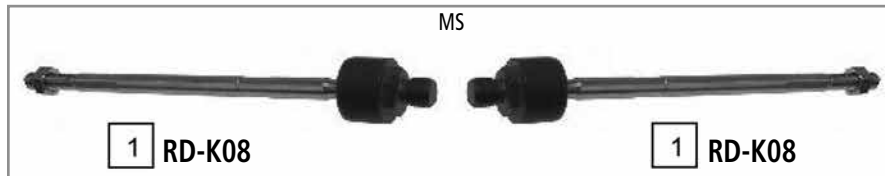

6 CW-K53L

7 CW-K53R

8 LB-K57

8 LB-K57

Ref	JAPANPARTS CODE	Description	OEM	Measures	Ref	JAPANPARTS CODE	Description	OEM	Measures
1	RD-K08	Axial Joint	0K201 32240		5	RD-K51	Axial Joint	0K2A2 32240	
2	RD-K09	Axial Joint	0K203 32240	th:MM16X1.5R L:284	6	CW-K53L	TCA Left	0K201-34-350C	
3	TI-K65	Tie Rod End	0K201 32280	c:13 th:FM14X1.5R	7	CW-K53R	TCA Right	0K201-34-300C	
4	RD-K58	Axial Joint	0K2A1 32240	th:MM16X1.5R L:282	8	LB-K57	Ball Joint	0K201-34-550C	

SHUMA I (FB)

10/1997 - 03/2001



5 SI-K20  
02/1999 ->



3 SI-K55  
-> 01/1999



3 SI-K55  
-> 01/1999



6 SI-K19  
02/1999 ->



1 TI-K65

7 RD-K58

7 RD-K58



1 TI-K65



4 LB-K60

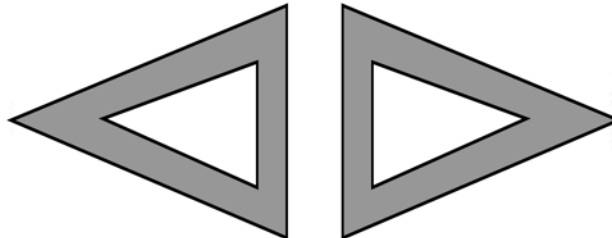

4 LB-K60



2 SI-K54



2 SI-K54

Ref.	JAPANPARTS CODE	Description	OEM	Measures	Ref.	JAPANPARTS CODE	Description	OEM	Measures
1	TI-K65	Tie Rod End	0K201 32280	c:13 th:FM14X1.5R	5	SI-K20	Stabiliser Link Left	0K2N1 34170A	L:274
2	SI-K54	Stabiliser Link	0K2A1 34150B	L:89	6	SI-K19	Stabiliser Link Right	0K2N1 34150A	L:274
3	SI-K55	Stabiliser Link	0K2A5 34150A	L:86	7	RD-K58	Axial Joint	0K2A1-32-240	
4	LB-K60	Ball Joint	0K2A1 34550A	c:18					

SORENTO (JC)

05/2002 ->

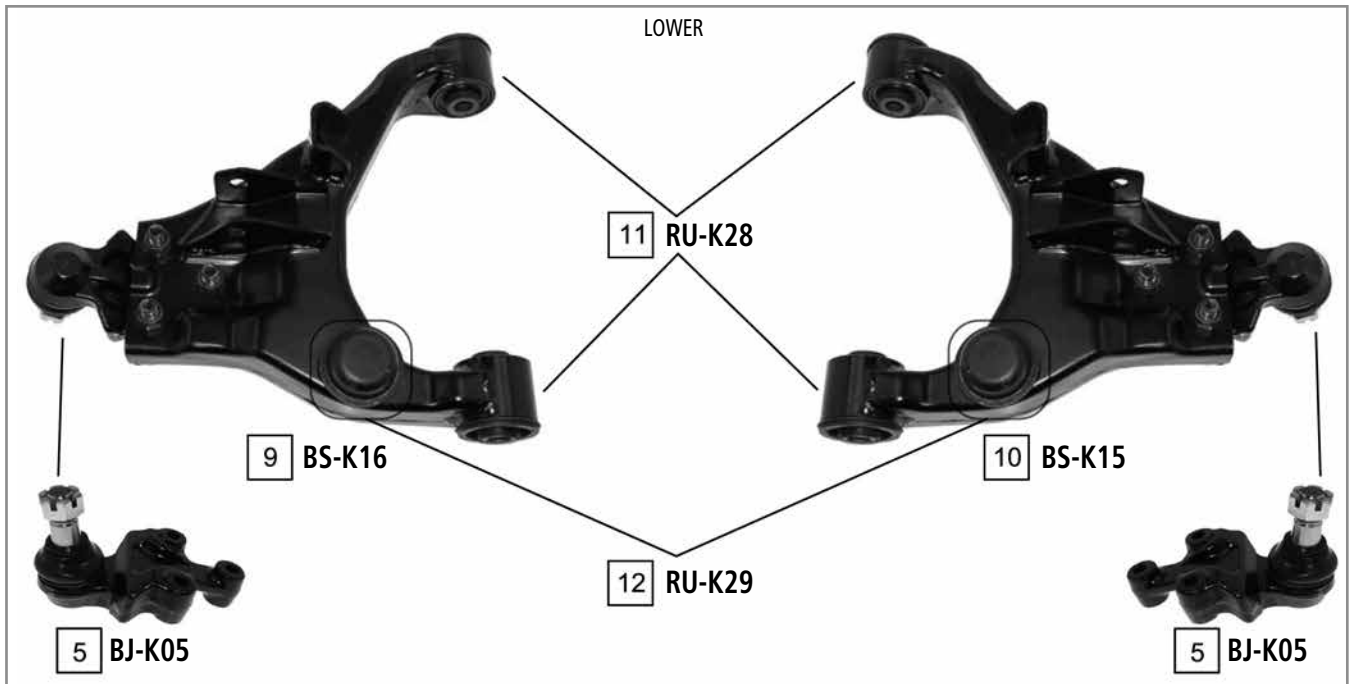
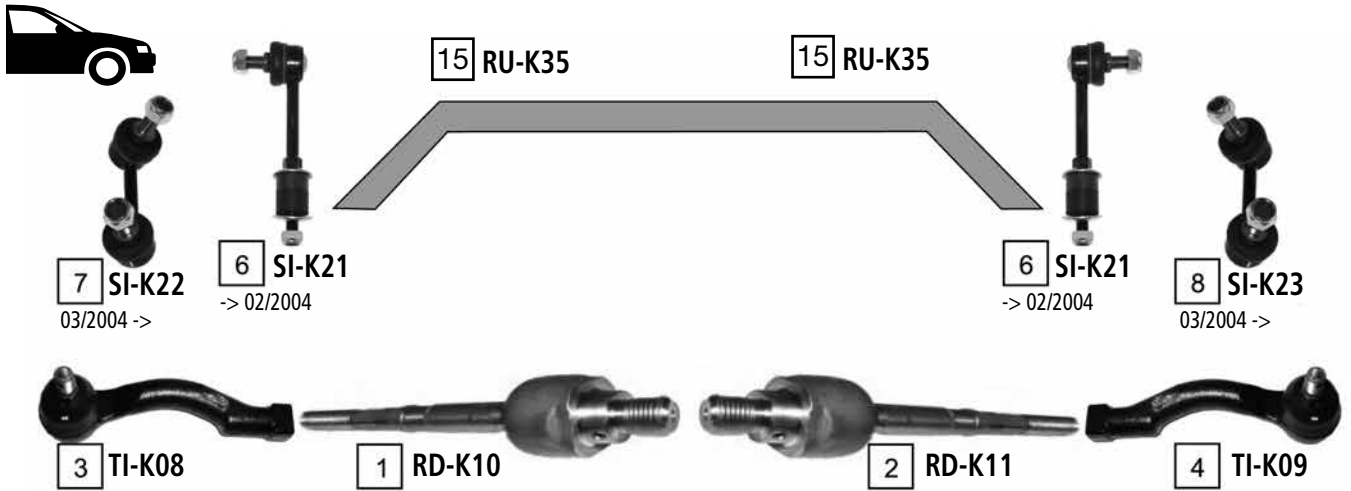

Ref	JAPANPARTS CODE	Description	OEM	Measures	Ref	JAPANPARTS CODE	Description	OEM	Measures
1	RD-K10	Axial Joint	57732 3E010	th: MM18X1.5R L:172	9	BS-K16	TCA Left	54510 3E001	c: 21.6
2	RD-K11	Axial Joint	57731 3E010	th: MM18X1.5R L:172	10	BS-K15	TCA Right	54520 3E001	c: 21.6
3	TI-K08	Tie Rod End Left	56820 3E000		11	RU-K28	Silentblock For Susp.Arm	54580 3E001	
4	TI-K09	Tie Rod End Right	56820 3E900		12	RU-K29	Silentblock For Susp.Arm	54590 3E000	
5	BJ-K05	Ball Joint	54570 3E000	c: 21.6	13	RU-K31	Stabiliser Mounting	55530-3E010	
6	SI-K21	Stabiliser Link	54810 3E000		14	RU-K32	Stabiliser Mounting	55530-3E020	
7	SI-K22	Stabiliser Link Left	54811 3E010	L:85	15	RU-K35	Stabiliser Mounting	54830-3E020	
8	SI-K23	Stabiliser Link Right	54811 3E060	L:85					



SORENTO (XM)

09/2009 ->

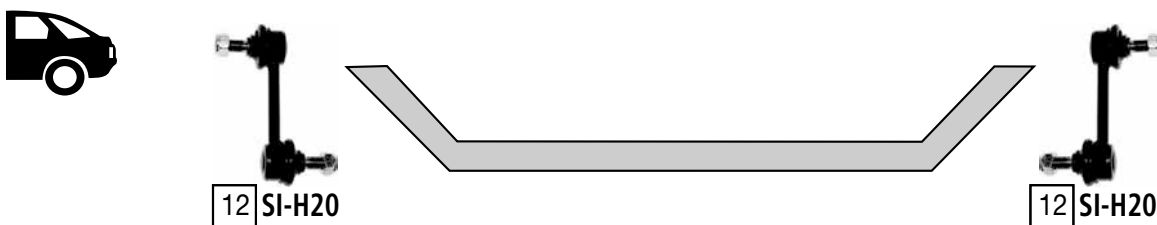
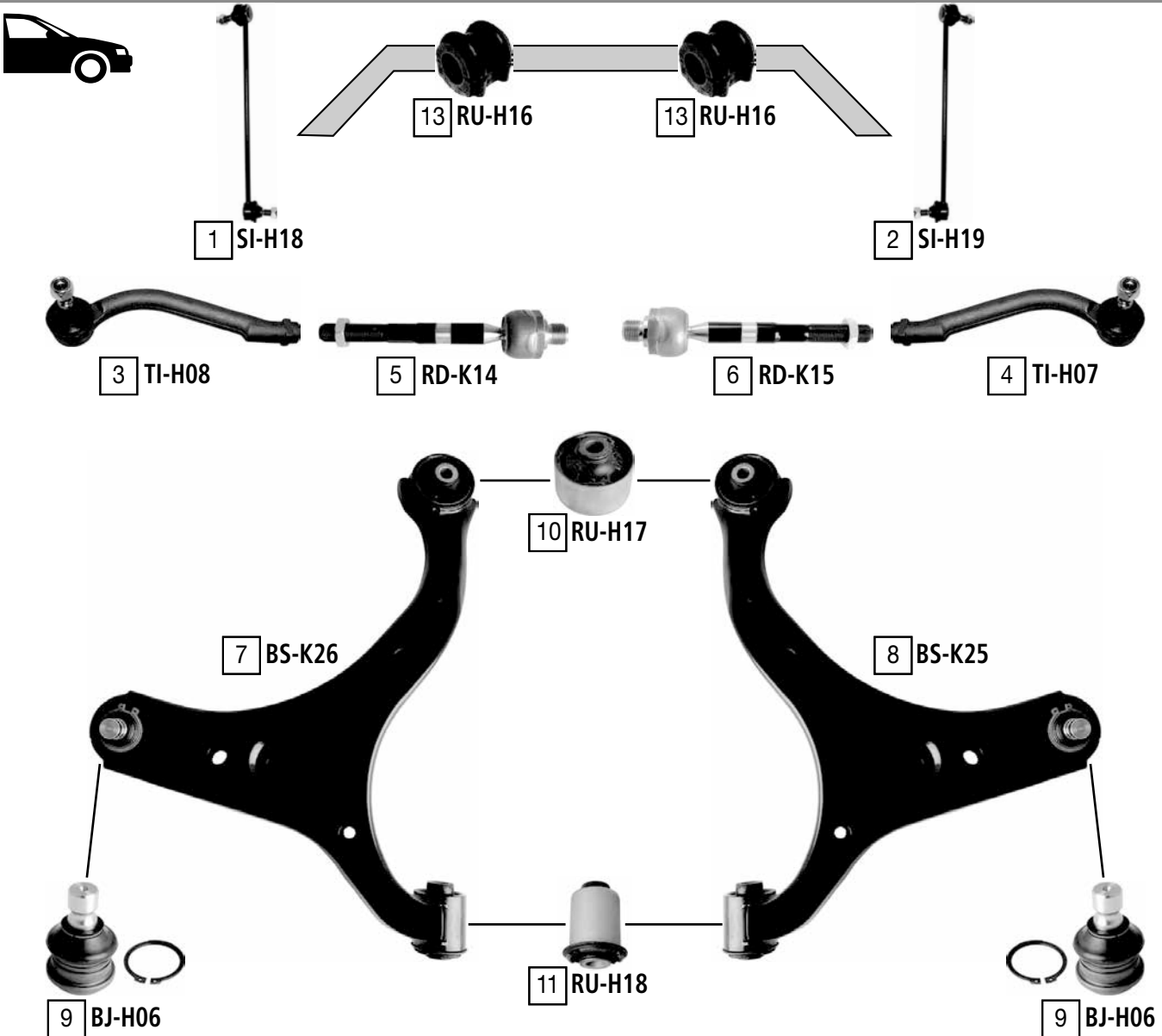

Ref	JAPANPARTS CODE	Description	OEM	Measures	Ref	JAPANPARTS CODE	Description	OEM	Measures
1	SI-H18	Stabiliser link left	54830 2B200	L:342	8	BS-K25	TCA right wbj	54501 2P000	c:20
2	SI-H19	Stabiliser link right	54840 2B200	L:342	9	BJ-H06	Ball joint	54530 2B000	c:20 do:42.7
3	TI-H08	Tie rod end left	56820 2P900	c:13.9 th:FM16X1.5R	10	RU-H17	Silentblock forTCA	54584 2B000	di:14.3 do:66
4	TI-H07	Tie rod end right	56820 2P000	c:13.9 th:FM16X1.5R	11	RU-H18	Silentblock forTCA	54550 2P000	di:14.3 do:42.2
5	RD-K14	Axial joint	57724 2P100	th:MM18X1.5R L:188	12	SI-H20	Stabiliser link rear axle	55530 2B200	L:99
6	RD-K15	Axial joint	57724 2P000	th:MM18X1.5R L:188	13	RU-H16	Stabiliser mounting	54813 3K100	di:27
7	BS-K26	TCA left wbj	54500 2P000	c:20					

SOUL (AM)

02/2009 ->

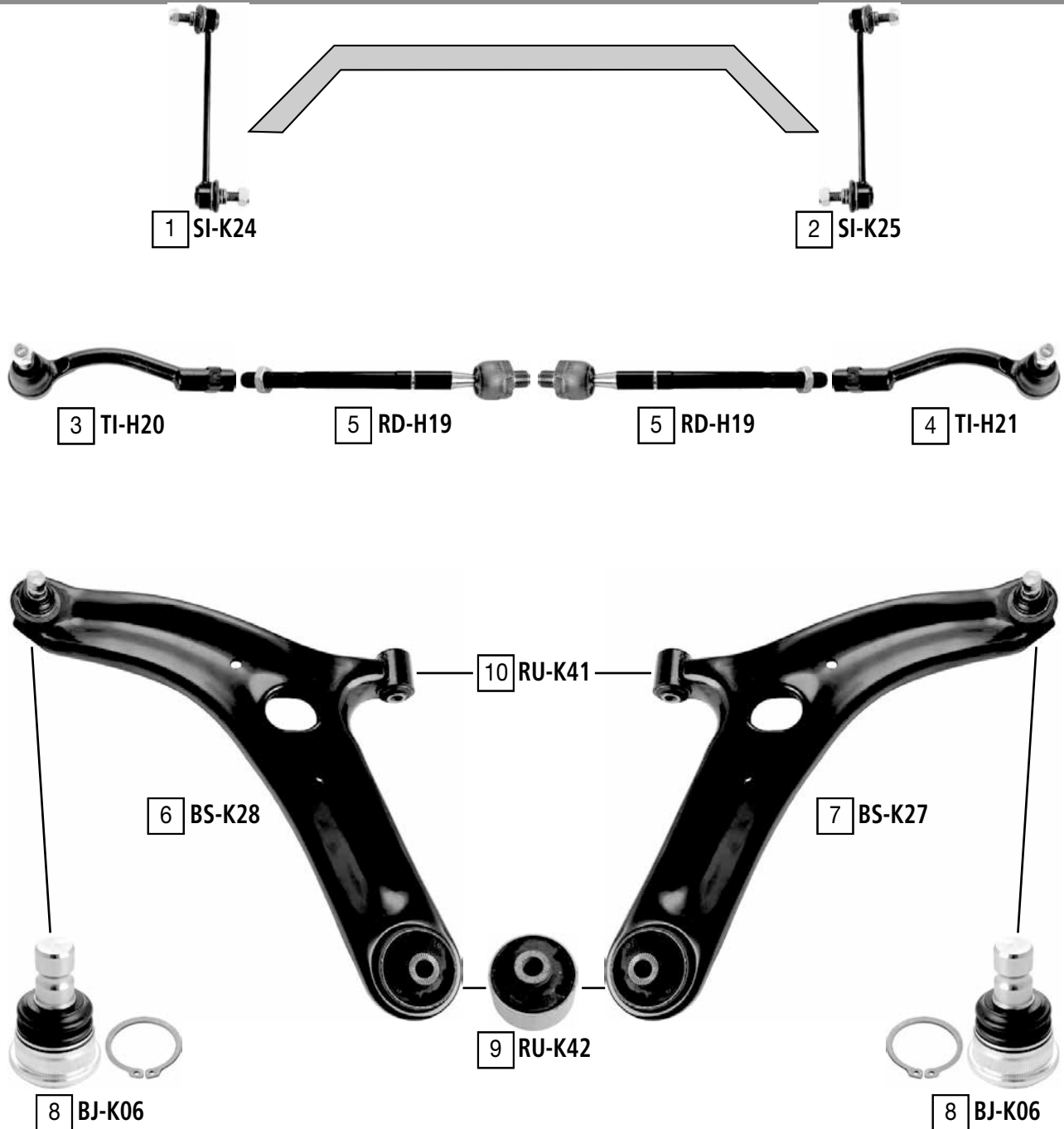

Ref	JAPANPARTS CODE	Description	OEM	Measures	Ref	JAPANPARTS CODE	Description	OEM	Measures
1	SI-K24	Stabiliser Link Left	54830 2K000	L:216	6	BS-K28	TCA left wbj	54500 2K300	c:18
2	SI-K25	Stabiliser Link Right	54840 2K000	L:216	7	BS-K27	TCA right wbj	54501 2K000	c:18
3	TI-H20	Tie Rod End Left	56820 2K000	c:13.4 th:FM16X1.5R	8	BJ-K06	Ball Joint	54530 2K000	c:18 do:40
4	TI-H21	Tie Rod End Right	56820 2K050	c:13.4 th:FM16X1.5R	9	RU-K42	Silentblock ForTCA	54584 2K000	di:14.25 do:66
5	RD-H19	Axial Joint	56540 2K000	th:MM16X1.5R L:247	10	RU-K41	Silentblock ForTCA	54551 2K000	di:12.2 do:33

# KIA SPECTRA - SHUMA - SEPHIA

MENTOR II  
SEPHIA II  
SHUMA II (FB)  
SPECTRA II

06/2000 - 02/2004

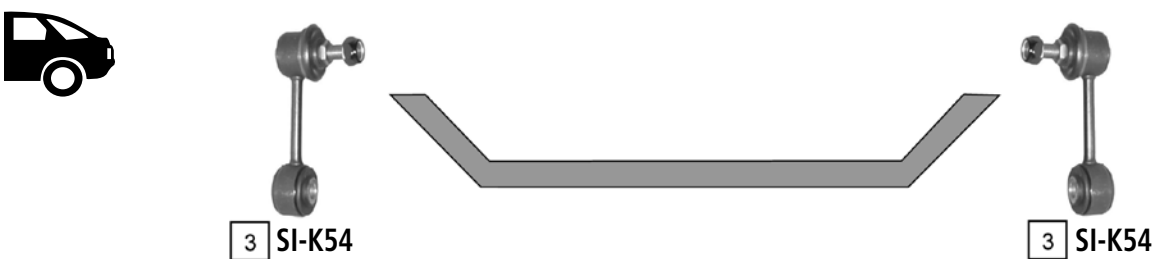
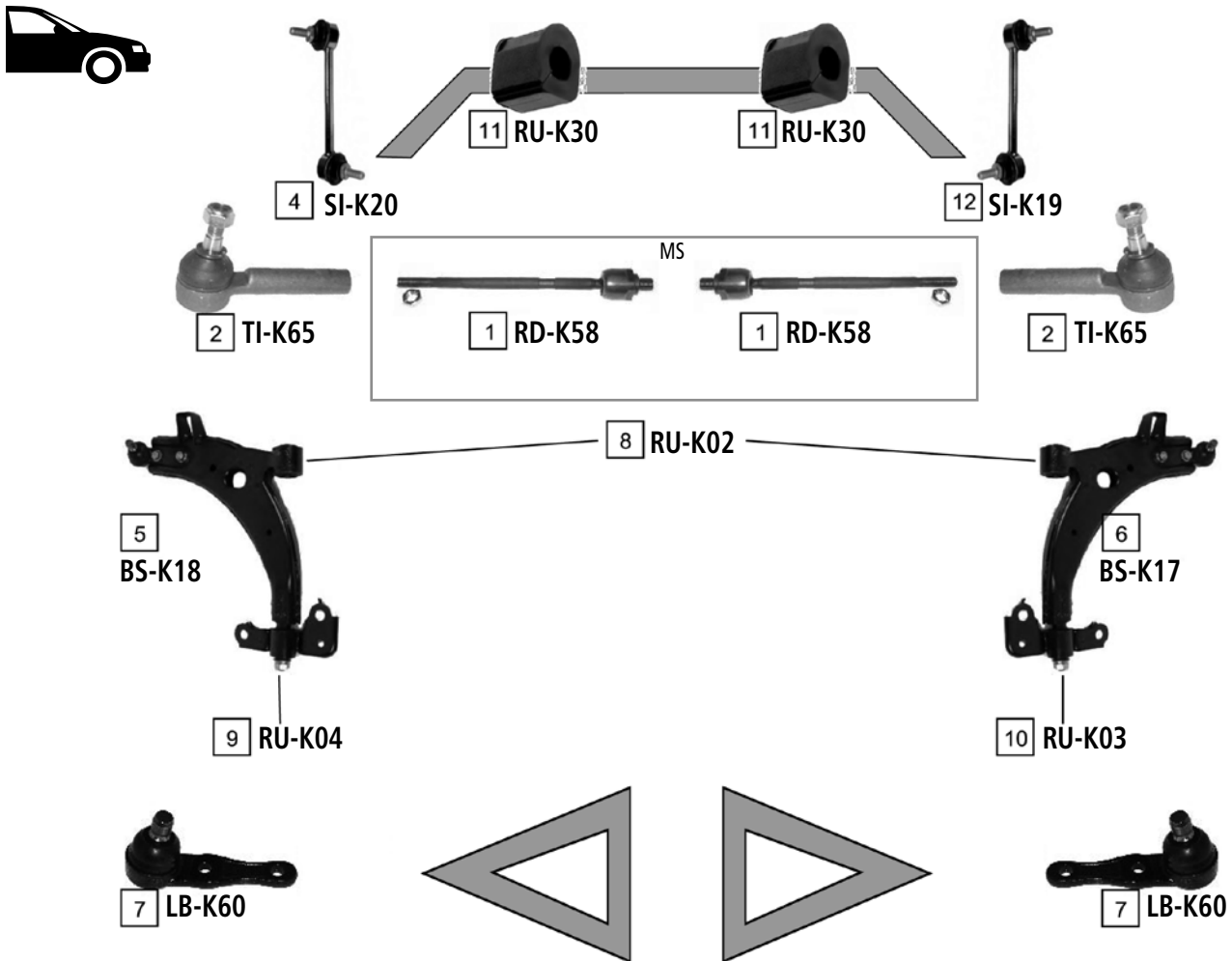

Ref	JAPANPARTS CODE	Description	OEM	Measures	Ref	JAPANPARTS CODE	Description	OEM	Measures
1	RD-K58	Axial Joint	0K2A1 32240	th: MM16X1.5R L:282	7	LB-K60	Ball Joint	0K2A1 34550A	c:18
2	TI-K65	Tie Rod End	0K201 32280	c:13 th:FM14X1.5R	8	RU-K02	Silentblock For Susp.Arm	0K2C0 34460	
3	SI-K54	Stabiliser Link	0K2A1 34150B	L:89	9	RU-K04	Silentblock For Susp.Arm	0K2A1 3446Y	
4	SI-K20	Stabiliser Link Left	0K2N1 34170A	L:274	10	RU-K03	Silentblock For Susp.Arm	0K2A1 3446X	
5	BS-K18	TCA Left	0K2NA 34350B		11	RU-K30	Stabiliser Mounting	0K2NA 34156	
6	BS-K17	TCA Right	0K2NA 34300B		12	SI-K19	Stabiliser Link Right	0K2N1 34150A	L:274

SPORTAGE (K00)

04/1994 - 08/2004

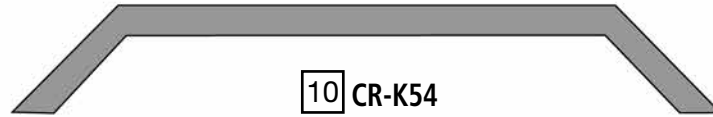

2 TI-K66L



4 TI-K67L



5 TI-K67R



3 TI-K66R



8 SA-K51L

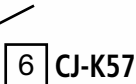

6 CJ-K57

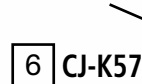

6 CJ-K57



9 SA-K51R



1 LB-K58

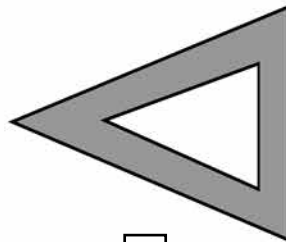

7 CW-K56

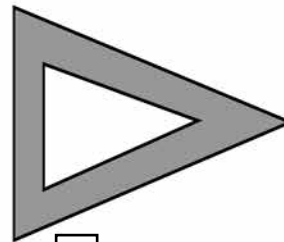

7 CW-K56



1 LB-K58

Ref	JAPANPARTS CODE	Description	OEM	Measures	Ref	JAPANPARTS CODE	Description	OEM	Measures
1	LB-K58	Ball Joint	0K011-34-510B	c:18	6	CJ-K57	TCA	0K011-34-200	
2	TI-K66L	Tie Rod End Outer	0K011-32-240A	c:13.4 th:FM18X1.5L	7	CW-K56	TCA	0K011-34-300D	
3	TI-K66R	Tie Rod End Outer	0K011-32-250A	c:13.4	8	SA-K51L		0K011-32-270A	
4	TI-K67L	Tie Rod End Inner	0K011-32-230	c:14.6 th:FM18X1.5R	9	SA-K51R		0K011-32-290A	
5	TI-K67R	Tie Rod End Inner	0K011-32-280	c:14.6 th:FM18X1.5L	10	CR-K54		0K011-32-260A	

SPORTAGE

09/2004 ->

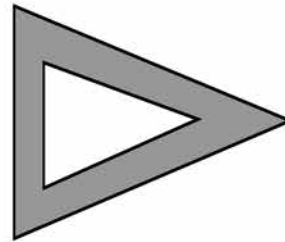
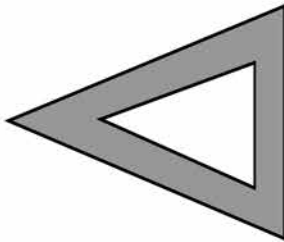

Ref.	JAPANPARTS CODE	Description	OEM	Measures	Ref.	JAPANPARTS CODE	Description	OEM	Measures
1	RD-H16	Axial Joint	57724 2E000	th:MM16X1.5R L:243	5	SI-H32	Stabiliser Link	55530 1F000	L:220
2	TI-H17	Tie Rod End Left	56820 2E000	c:13.3 th:FM10X1.5R	6	BJ-H14	Ball Joint	51760 2E000	c:14.5
3	TI-H16	Tie Rod End Right	56820 2E900	c:13.3 th:FM10X1.5R	7	RU-K34	Stabiliser Mounting	54813-2E100	
4	SI-H31	Stabiliser Link	54830 2E000	L:238					

SPORTAGE (SL)

07/2010 ->

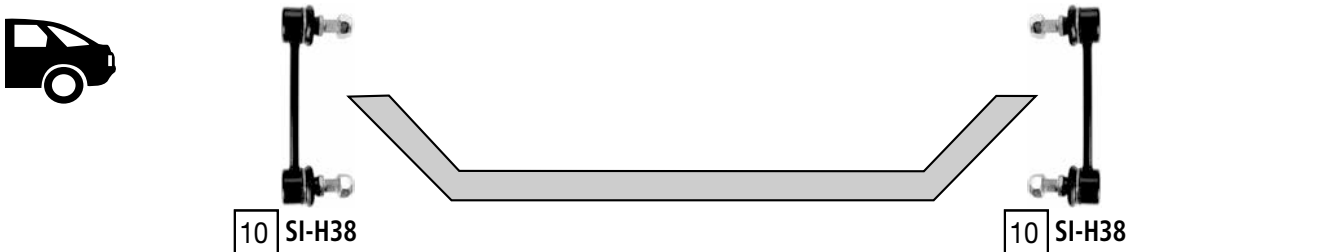
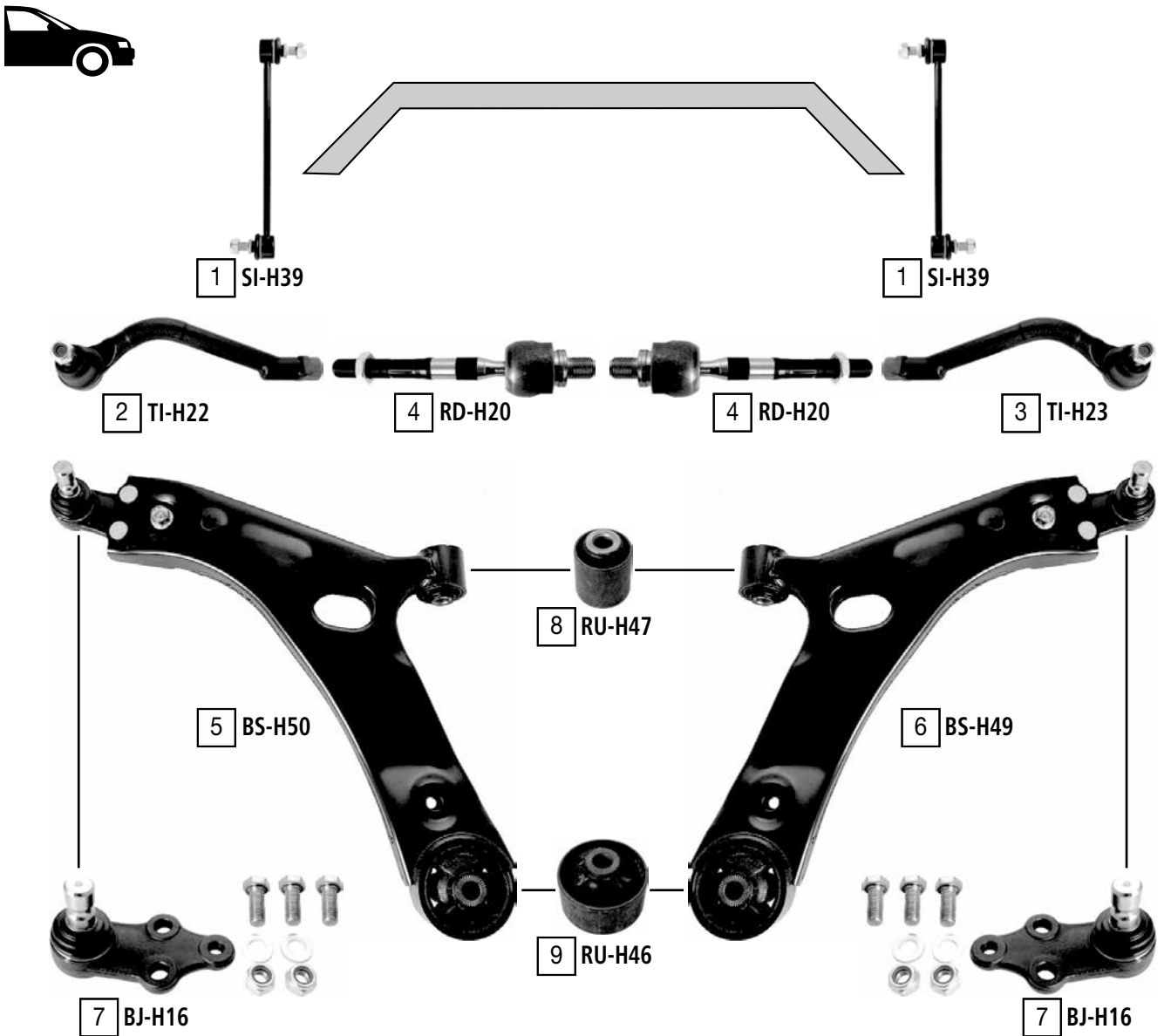

Ref	JAPANPARTS CODE	Description	OEM	Measures	Ref	JAPANPARTS CODE	Description	OEM	Measures
1	SI-H39	Stabiliser link	54830 2S200	L:267	6	BS-H49	TCA right wbj	54501 2Y000	c:18
2	TI-H22	Tie rod end left	56820 2S000	c:13.4 th:FM16X1.5R	7	BJ-H16	Ball Joint	54530 3S000	c:18
3	TI-H23	Tie rod end right	56820 2S050	c:13.4 th:FM16X1.5R	8	RU-H47	Silentblock For TCA	54551 2S000	di:12.25 do:38.1
4	RD-H20	Axial joint	57724 2S000	th:MM16X1.5R L:183	9	RU-H46	Silentblock For TCA	54584 2S000	di:14.35 do:70
5	BS-H50	TCA left wbj	54500 2Y000	c:18	10	SI-H38	Stabiliser Link Rear Axle	55530 2S200	L:140

VENGA (YN)

02/2010 ->



1 SI-H36

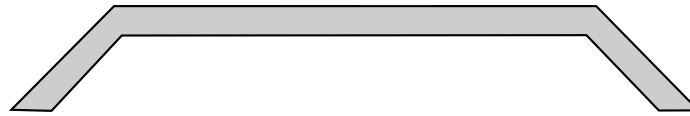

2 SI-H37



3 TI-H20



5 RD-H19



4 TI-H21



6 BS-H48



9 RU-H10



7 BS-H47



8 BJ-H57



10 RU-K43



8 BJ-H57

Ref	JAPANPARTS CODE	Description	OEM	Measures	Ref	JAPANPARTS CODE	Description	OEM	Measures
1	SI-H36	Stabiliser link left	54830 1J000	L:216	6	BS-H48	TCA left wbj	54500 1P000	c:15
2	SI-H37	Stabiliser link right	54840 1J000	L:216	7	BS-H47	TCA right wbj	54501 1P000	c:15
3	TI-H20	Tie rod end left	56820 2K000	c:13.4 th:FM16X1.5R	8	BJ-H57	Ball Joint	54530 31600	c:15 do:40
4	TI-H21	Tie rod end right	56820 2K050	c:13.4 th:FM16X1.5R	9	RU-H10	Silentblock ForTCA	54551 1E000	di:12.2 do:32.5
5	RD-H19	Axial joint	56540 2K000	th:MM16X1.5R L:247	10	RU-K43	Silentblock ForTCA	54584 1P000	di:14.3 do:66

DEFENDER (LD)

09/1990 - 12/2000

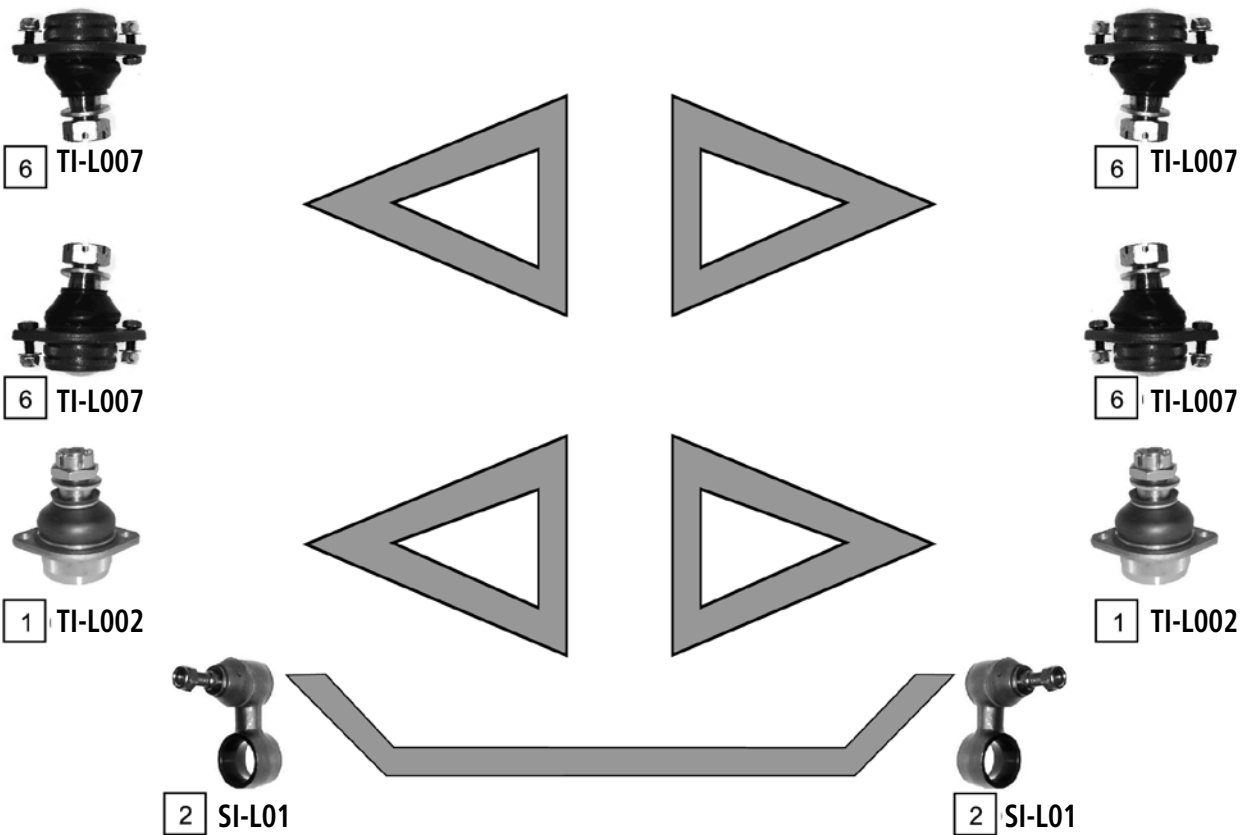
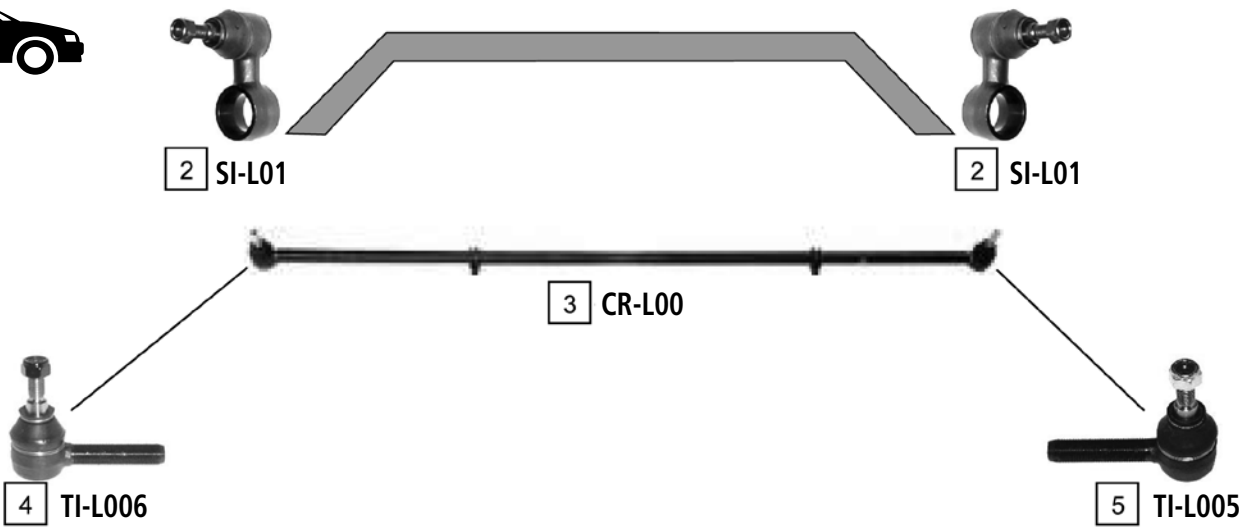

Ref	JAPANPARTS CODE	Description	OEM	Measures	Ref	JAPANPARTS CODE	Description	OEM	Measures
1	TI-L002	Ball Joint	ANR 1799		4	TI-L006	Tie Rod End Left	RTC 5870	"c:15 th:11/16"x16
2	SI-L01	Stabiliser Link	NTC 1888	L:63	5	TI-L005	Tie Rod End Right	RTC 5869	c:14.8 th:M17R 16G
3	CR-L00	Tie Rod	NRC9743		6	TI-L007	Ball Joint UPPER And LOWER	575 882	c:23.3



DISCOVERY I

10/1989 - 06/1994

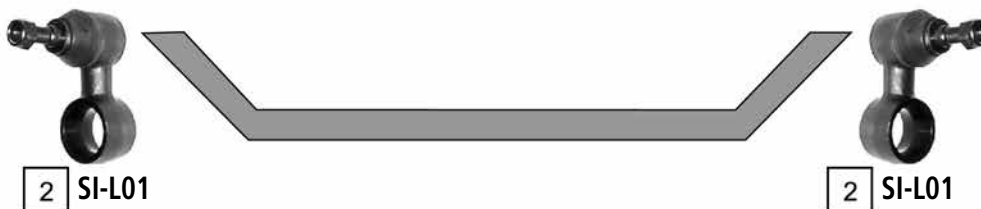
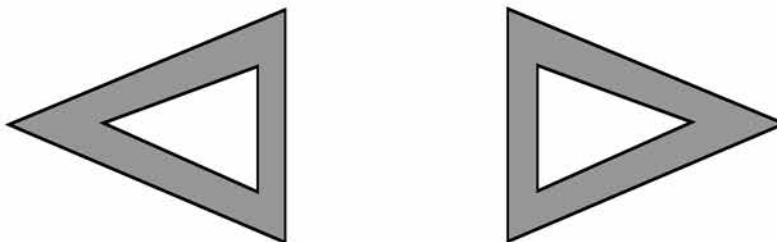
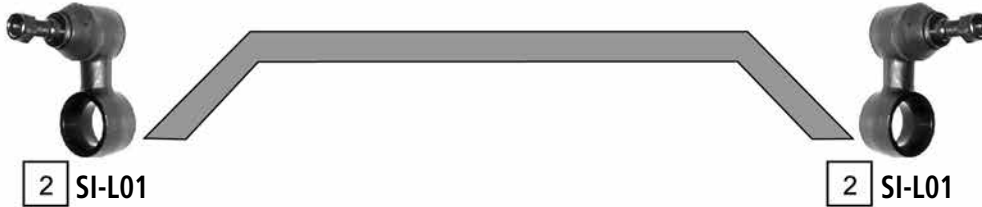

Ref.	JAPANPARTS CODE	Description	OEM	Measures	Ref.	JAPANPARTS CODE	Description	OEM	Measures
1	TI-L002	Ball Joint	ANR 1799		4	TI-L005	Tie Rod End Right	RTC 5869	c:14:8 th:M17R 16G
2	SI-L01	Stabiliser Link	NTC 1888	L:63	5	TI-L009	Tie Rod End	NRC 1823	
3	TI-L006	Tie Rod End Left	RTC 5870	"c:15 th:11/16" x16					

DISCOVERY II (LJ,LT)

06/1994 - 09/2004

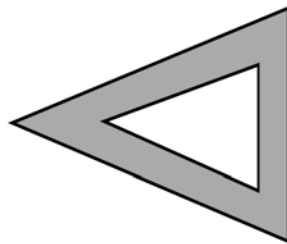
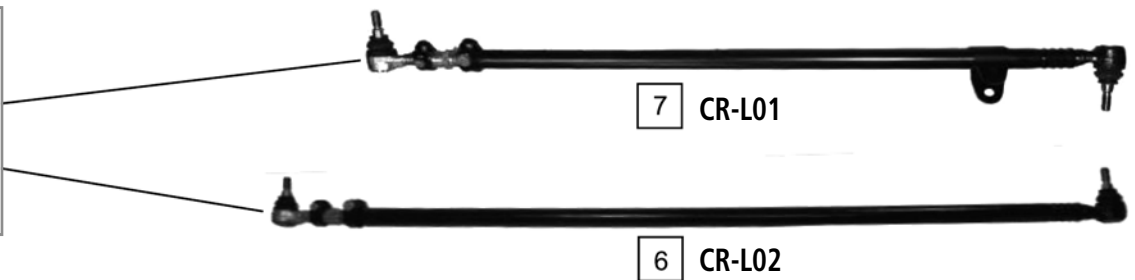
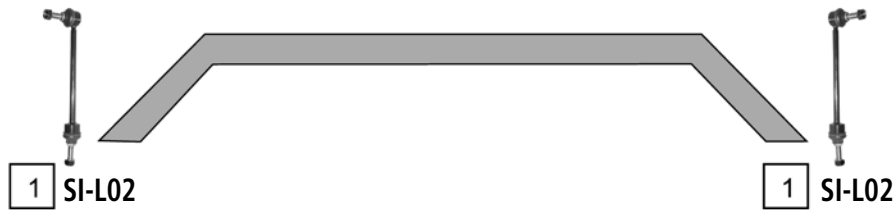

UPPER

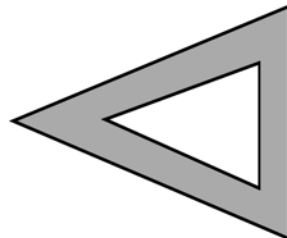
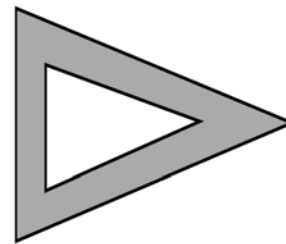

LOWER

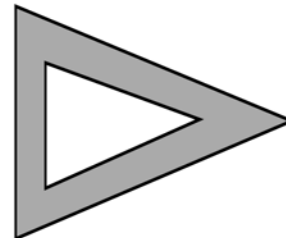

Ref	JAPANPARTS CODE	Description	OEM	Measures	Ref	JAPANPARTS CODE	Description	OEM	Measures
1	SI-L02	Stabiliser Link	RBM100223	L:243.5	5	TI-L010	Tie Rod End	QFS000010	
2	SI-L03	Stabiliser Link	RDG100682	L:158.5	6	CR-L02	Track Rod	TIQ000010	
3	BJ-L01	Ball Joint	FTC 3570	c:16	7	CR-L01	Track Rod	QHG000050	-
4	BJ-L02	Ball Joint	FTC 3571	c:18.9					

DISCOVERY III

10/2004 ->

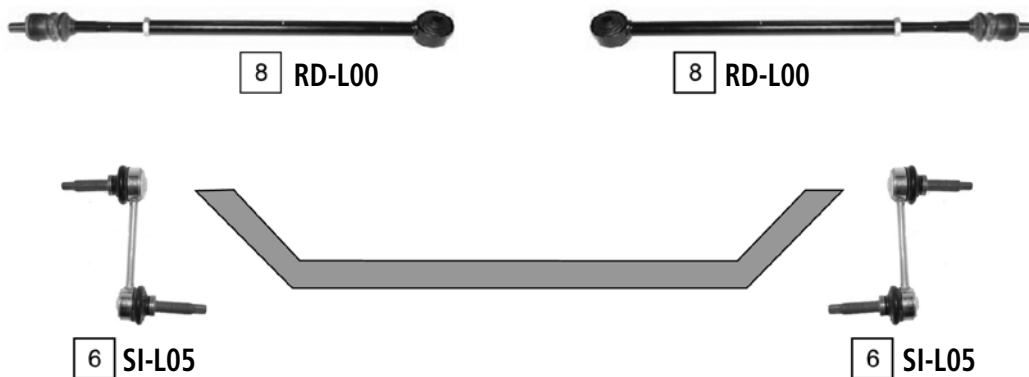
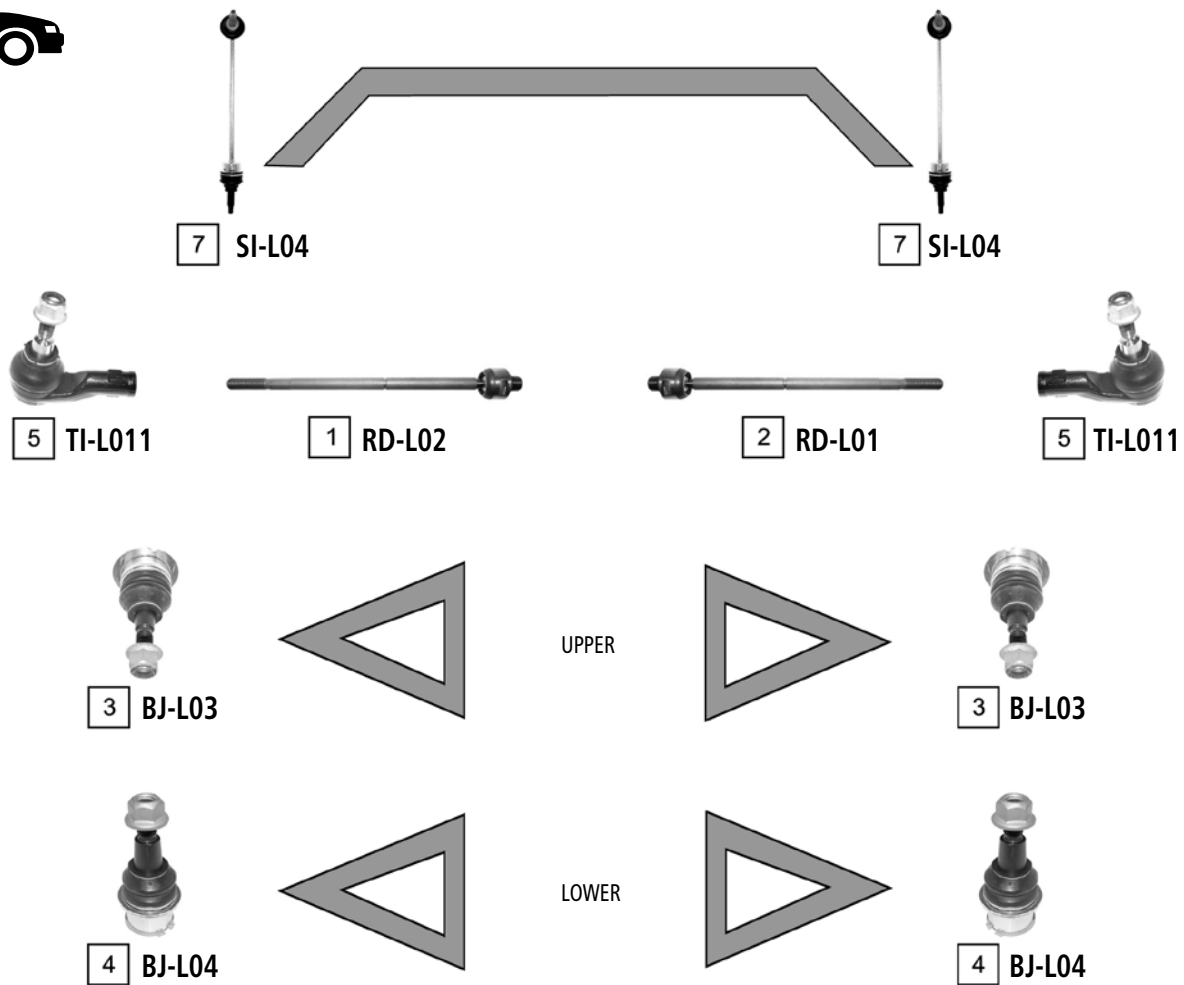

Ref.	JAPANPARTS CODE	Description	OEM	Measures	Ref.	JAPANPARTS CODE	Description	OEM	Measures
1	RD-L02	Axial Joint	QFK 500020	L:372	5	TI-L011	Tie Rod End	QJB 500010	c:16.80
2	RD-L01	Axial Joint	QFK 500010	-	6	SI-L05	Stabiliser Link	RGD 000311	L:116
3	BJ-L03	Ball Joint	RBK 500030	c:13.85	7	SI-L04	Stabiliser Link	RBM 500190	-
4	BJ-L04	Ball Joint	RBK 500040	c:20.65	8	RD-L00	Tie Rod	RGD 500083	-

FREELANDER

07/1997 - 01/2006

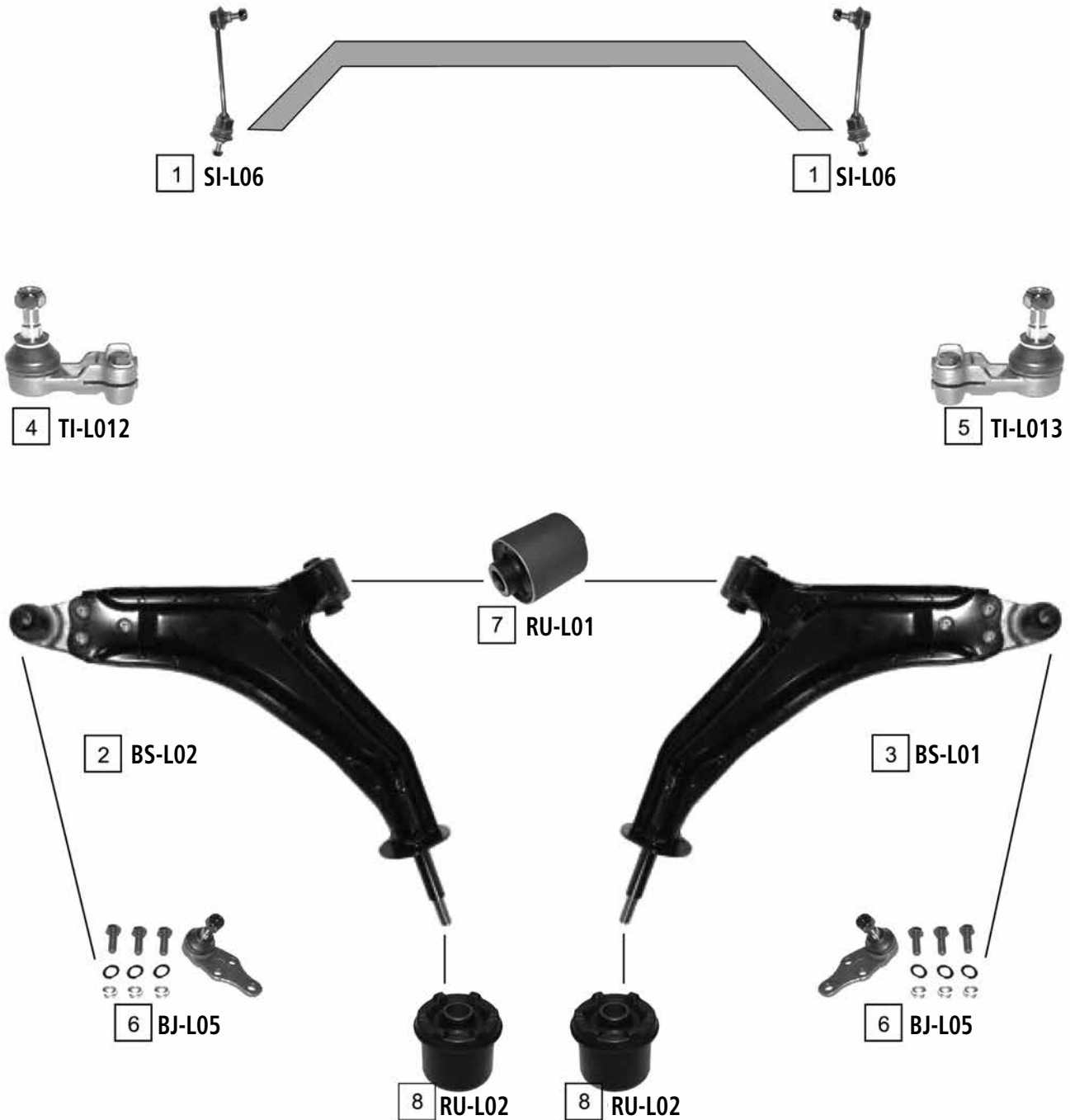

Ref	JAPANPARTS CODE	Description	OEM	Measures	Ref	JAPANPARTS CODE	Description	OEM	Measures
1	SI-L06	Stabiliser Link	RBM 100170	L:177	5	TI-L013	Tie Rod End Right	QJB 100220	c:14.7 th:FM16X1.5R
2	BS-L02	TCA Left	RBJ 102450	c:15.4	6	BJ-L05	Ball Joint LOWER	Part of BS-L02/BS-L01	c:15
3	BS-L01	TCA Right	RBJ102440	-	7	RU-L01	Silentblock For Susp.Arm	RBX 101160	d:45.4
4	TI-L012	Tie Rod End Left	QJB 100230	c:14.7 th:FM16X1.5L	8	RU-L02	Silentblock For Susp.Arm	RBX 101780	-

FREELANDER II

10/2006 ->

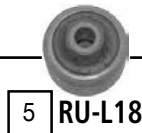
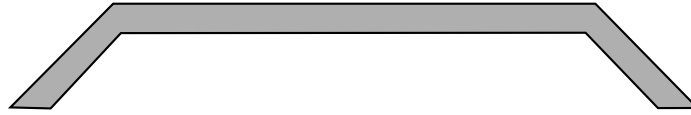

8 BS-L06

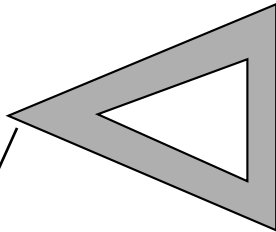

7 BS-L07

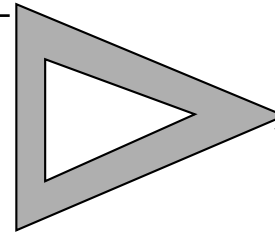

10 RU-L16

9 RU-L17

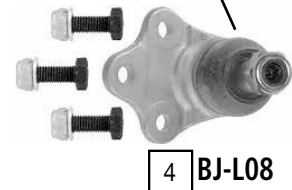

Ref	JAPANPARTS CODE	Description	OEM	Measures	Ref	JAPANPARTS CODE	Description	OEM	Measures
1	SI-L12	Stabiliser link	LR0 02626	L:347	6	SI-L13	Stabiliser link rear axle	LR0 02876	L:229
2	TI-L018	Tie rod end left	LR0 02610	c:16.7 th:FM18X1.5R	7	BS-L07		LR0 07205	
3	TI-L017	Tie rod end right	LR0 02609	c:16.7 th:FM18X1.5R	8	BS-L06		LR0 07206	
4	BJ-L08	Ball joint	Part of	c:17.9	9	RU-L17			
5	RU-L18	Silentblock forTCA	Part of	di:14.2 do:60	10	RU-L16			

LANDROVER 88-109

01/1984 - 12/1986

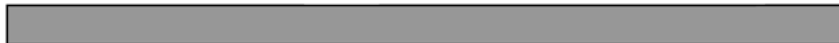
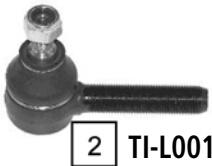

Ref.	JAPANPARTS CODE	Description	OEM	Measures	Ref.	JAPANPARTS CODE	Description	OEM	Measures
1	TI-L000	Spoorstangeind Rht	320.901	"c:15.2 th:11/16" x	2	TI-L001	Tie Rod End	320.901	"c:15.2 th:11/16" x

# LANDROVER 90 - 110 - 130 - RANGE ROVER

LANDROVER 90-110-130  
RANGE ROVER I

03/1984 - 07/1990  
12/1970 - 07/1994

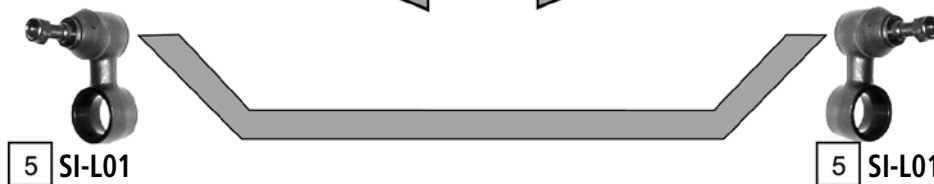
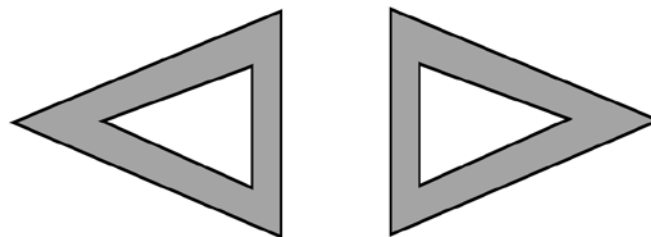
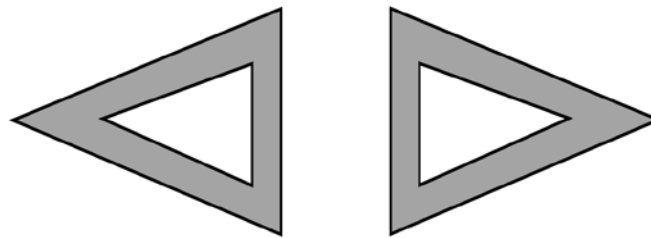

Ref	JAPANPARTS CODE	Description	OEM	Measures	Ref	JAPANPARTS CODE	Description	OEM	Measures
1	TI-L003	Tie Rod End	NRC 6007	"c:15 th:11/16"x16	4	TI-L007	Ball Joint UPPER And LOWER	575 882	c:23.3
2	TI-L004	Tie Rod End	NRC 4745	"c:15 th:11/16"x16	5	SI-L01	Stabiliser Link	NTC 1888	L:63
3	TI-L002	Ball Joint Rear	ANR 1799	c:23.4					

RANGE ROVER II (LP)

07/1994 - 03/2002

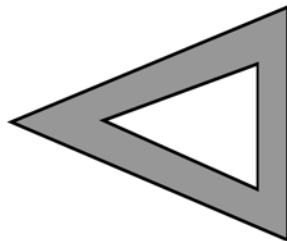

UPPER

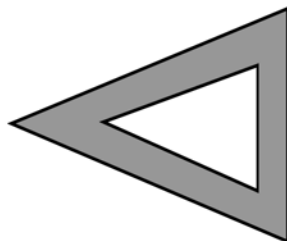
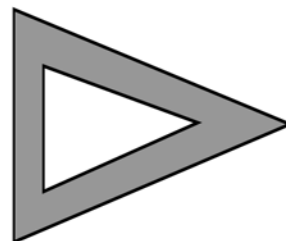

LOWER

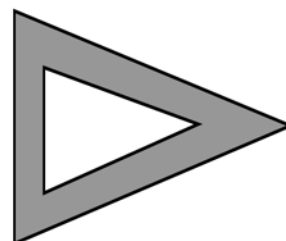

Ref.	JAPANPARTS CODE	Description	OEM	Measures	Ref.	JAPANPARTS CODE	Description	OEM	Measures
1	SI-L07	Stabiliser Link	ANR 3304	L:97	3	BJ-L02	Ball Joint	FTC 3571	c:18.9
2	BJ-L01	Ball Joint	FTC 3570	c:16	4	TI-L014	Tie Rod End	STC 1871	c:14.1 th:MM18X1.5L



# LANDROVER RANGE ROVER

RANGE ROVER III (LM)

03/2002 ->

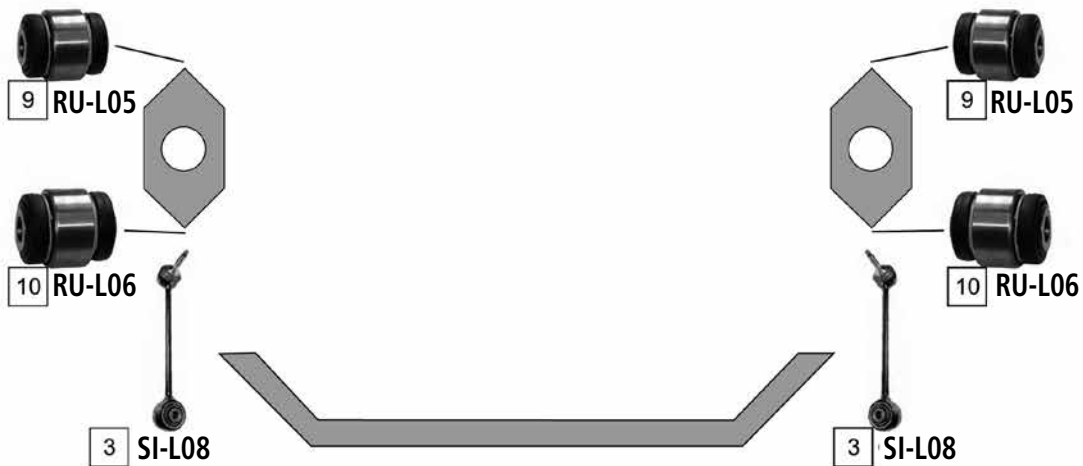
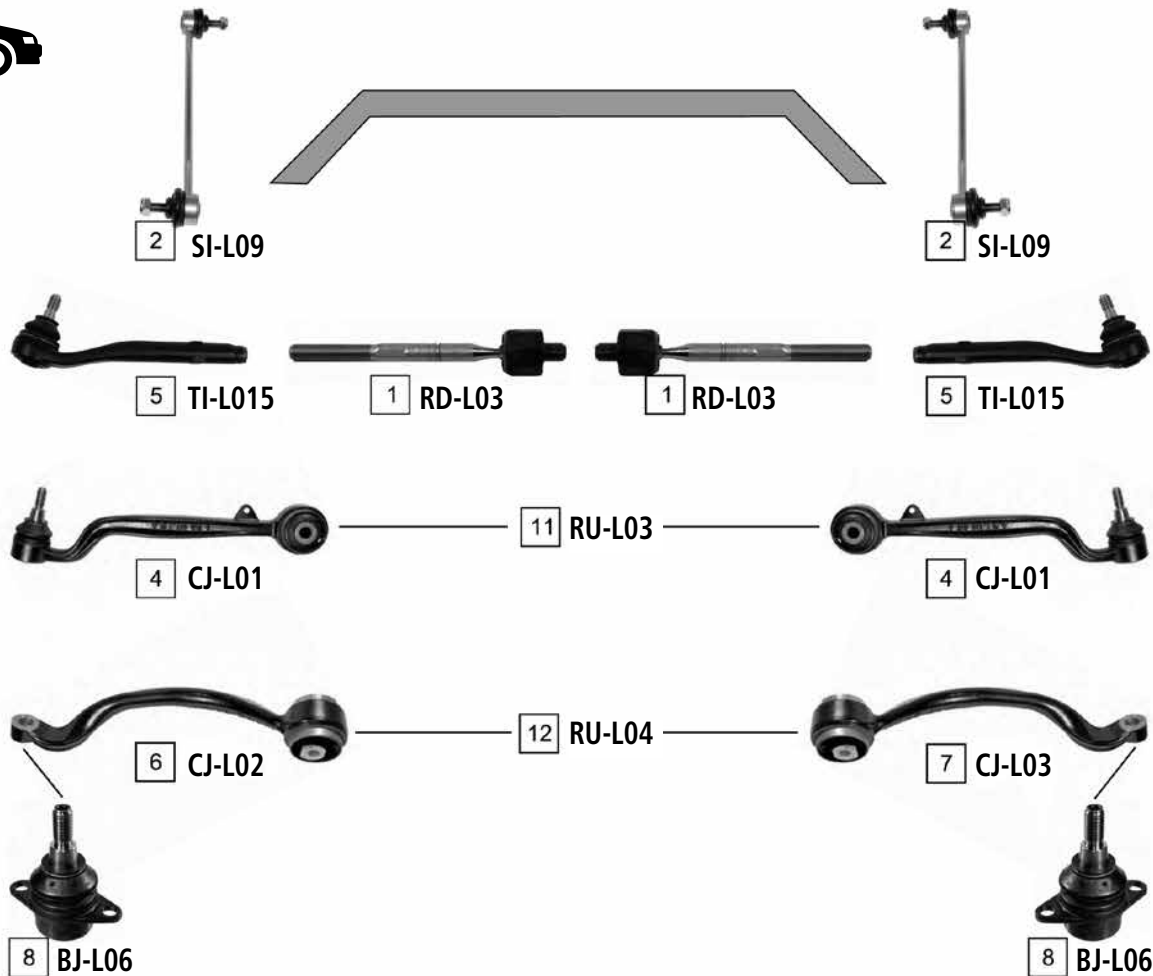

Ref	JAPANPARTS CODE	Description	OEM	Measures	Ref	JAPANPARTS CODE	Description	OEM	Measures
1	RD-L03	Axial Joint	TIQ 000040		7	CJ-L03	TCA Right	RBJ 000120	
2	SI-L09	Stabiliser Link	RBM 000011	L:380	8	BJ-L06	Ball Joint	RBK 500150	
3	SI-L08	Stabiliser Link	RGD 000180		9	RU-L05	Ball Joint	RHF 000260	
4	CJ-L01	TCA	RBJ 500710		10	RU-L06	Ball Joint	RBK 000042	
5	TI-L015	Tie Rod End	TIQ 000030		11	RU-L03	Silentblock For Susp.Arm	RBX 000070	
6	CJ-L02	TCA Left	RBJ 000130	-	12	RU-L04	Silentblock For Susp.Arm	RBX 000200	

RANGE ROVER SPORT

02/2005 ->

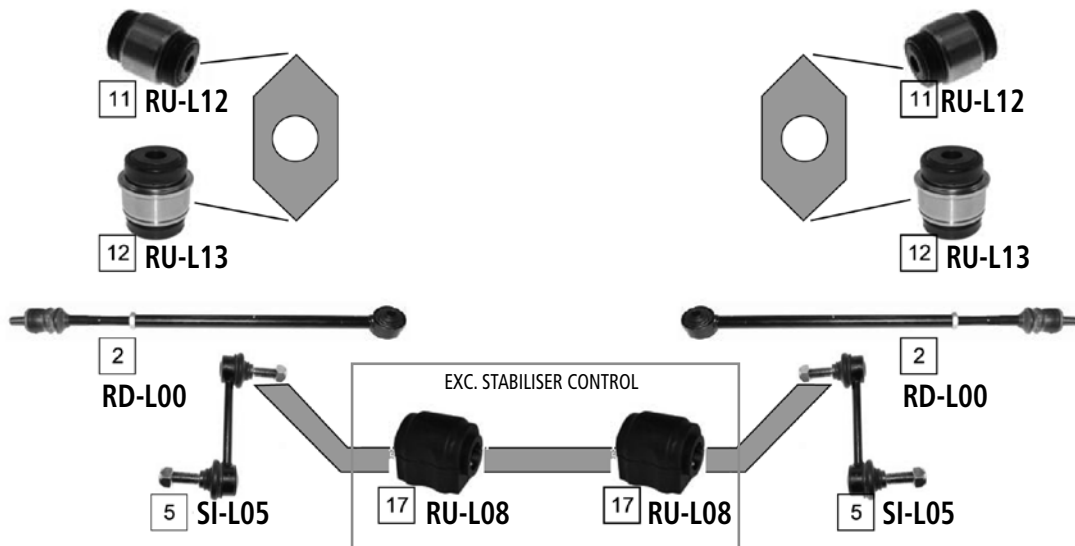
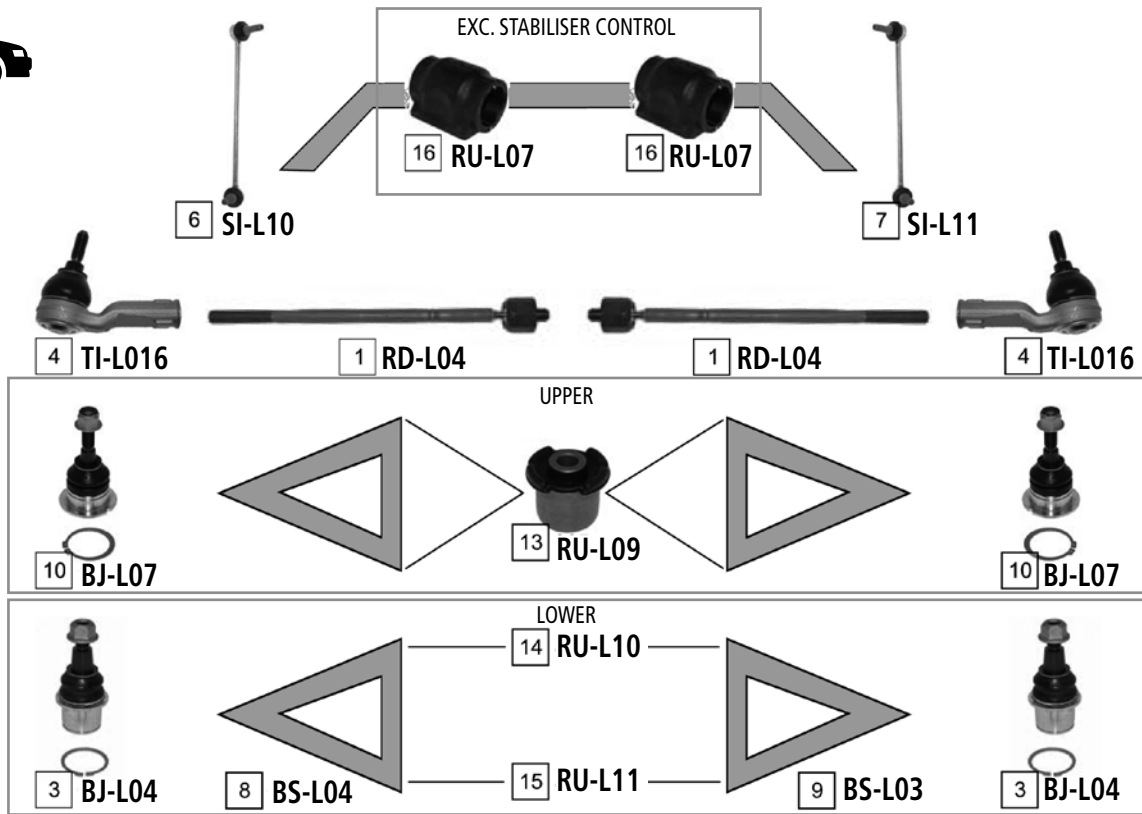

Ref.	JAPANPARTS CODE	Description	OEM	Measures	Ref.	JAPANPARTS CODE	Description	OEM	Measures
1	RD-L04	Axial Joint	QFK 500030	th:MM16X1.5R L:365	10	BJ-L07	Ball Joint	RBK 500170	c:13.8
2	RD-L00	Tie Rod	RGD 500083	-	11	RU-L12	Ball Joint	RHF 500031	-
3	BJ-L04	Ball Joint	RBK 500040	c:20.65	12	RU-L13	Ball Joint	RBK 500012	-
4	TI-L016	Tie Rod End	QJB 500040	c:16.8 th:FM16X1.5R	13	RU-L09	Silentblock For Susp.Arm	RBX 500443	d:14.3
5	SI-L05	Stabiliser Link	RGD 000311	L:116	14	RU-L10	Silentblock For Susp.Arm	RBX 500432	-
6	SI-L10	Stabiliser Link Left	RBM 500150	L:345	15	RU-L11	Silentblock For Susp.Arm	RBX 500531	-
7	SI-L11	Stabiliser Link Right	RBM 500140	L:345	16	RU-L07	Stabiliser Mounting	RBX 500280	d:30
8	BS-L04	TCA Left	RBJ 500456	-	17	RU-L08	Stabiliser Mounting	RGX 500070	d:23
9	BS-L03	TCA Right	RBJ 500446	-					

GOA

01/2007 ->



2 SI-002

1 SI-001

3 TI-004

3 TI-004

4 BJ-004

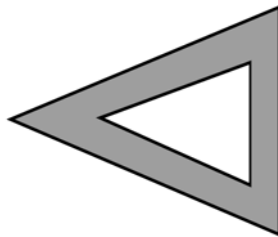

5 BJ-005

4 BJ-004

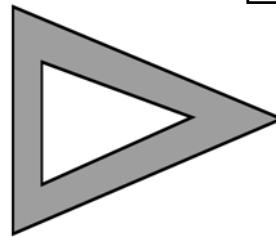

5 BJ-005

Ref	JAPANPARTS CODE	Description	OEM	Measures	Ref	JAPANPARTS CODE	Description	OEM	Measures
1	SI-001	Stabiliser Link Right	0401EA0360N		4	BJ-004	Ball Joint	0401BA0140N	
2	SI-002	Stabiliser Link Left	0401EA0370N		5	BJ-005	Ball Joint	0401BA0280N	
3	TI-004	Tie Rod End							

121 I (DA)

10/1987 - 10/1990



1 TI-325



2 RD-K53



2 RD-K53



1 TI-325



3 BJ-K52



3 BJ-K52

Ref	JAPANPARTS CODE	Description	OEM	Measures	Ref	JAPANPARTS CODE	Description	OEM	Measures
1	TI-325	Tie Rod End	8AB1-32-280	c:12.6 th:FM12X1.25	3	BJ-K52	TCA	KKY01-34-390A	c:16
2	RD-K53	Axial Joint	KK150-32-240	th:MM16X1.5R L:265					

121 II (DB)

10/1990 - 03/1996

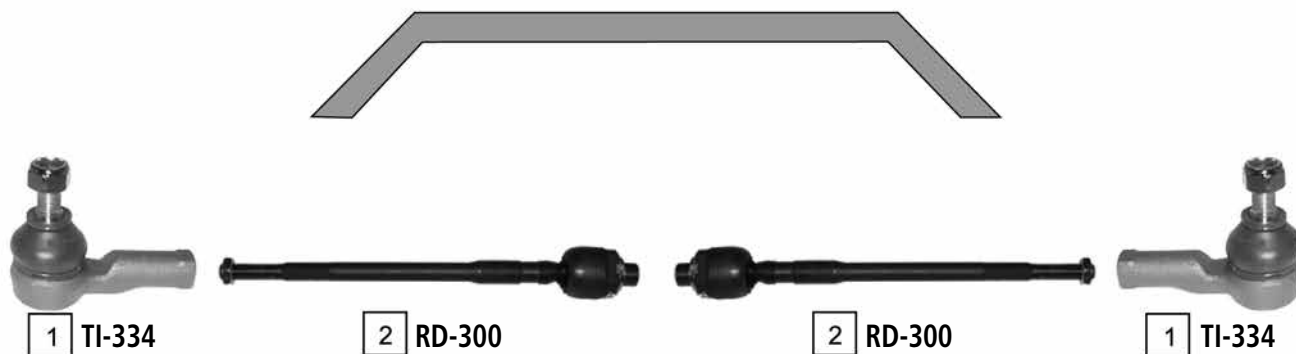

Ref.	JAPANPARTS CODE	Description	OEM	Measures	Ref.	JAPANPARTS CODE	Description	OEM	Measures
1	TI-334	Tie Rod End	8AB2-32-280	c:13.3 th:FM12X1.25	2	RD-300	Axial Joint	D06132248A	th:MM17X1R L:279

121 III (JASM,JBSM)

03/1996 - 10/2002

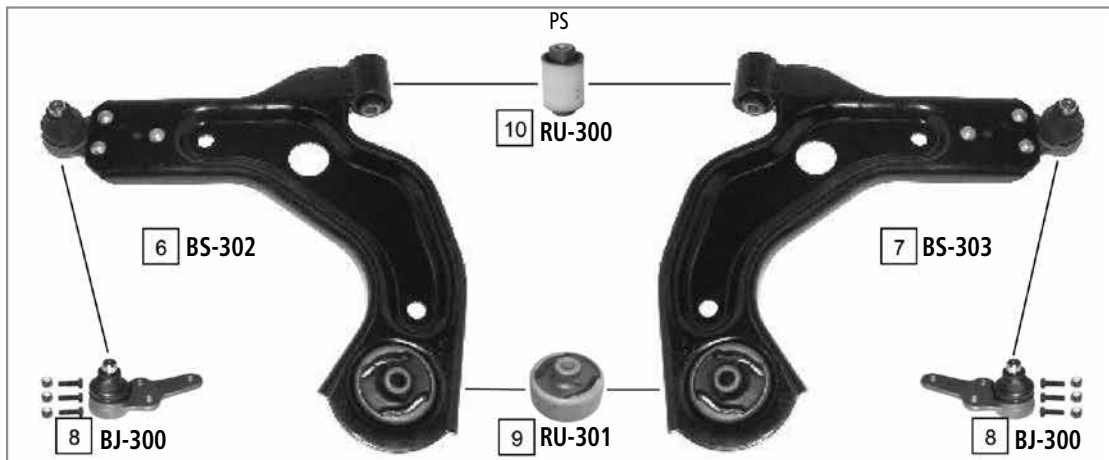
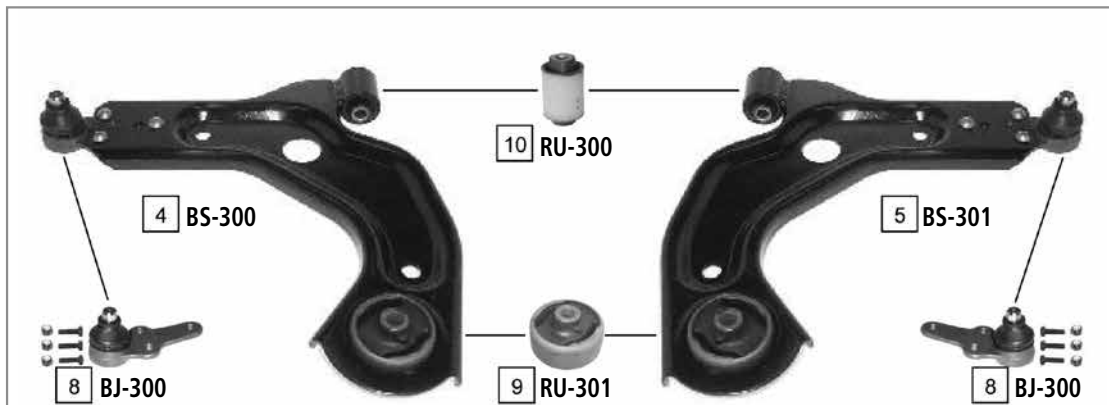
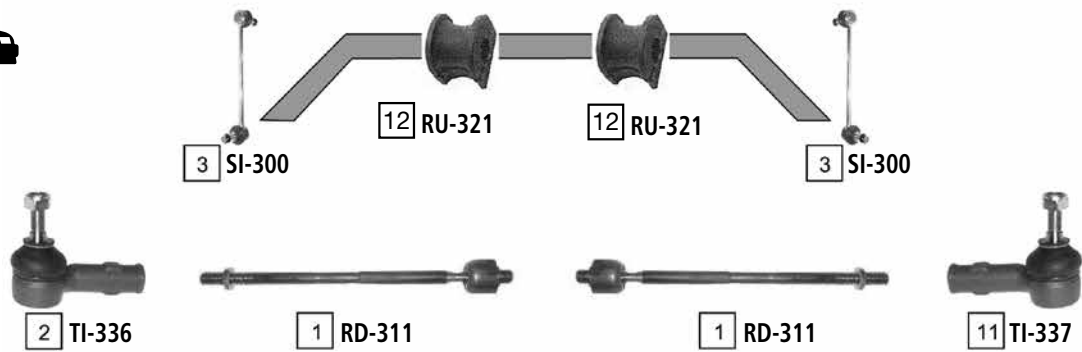

Ref	JAPANPARTS CODE	Description	OEM	Measures	Ref	JAPANPARTS CODE	Description	OEM	Measures
1	RD-311	Axial Joint	1044014	th:MM14X1.5R L:310	8	BJ-300	Ball Joint	94FB 33 95A2B	c:16.5
2	TI-336	Tie Rod End Left	1 020 174	c:11.5 th:M14X2R	9	RU-301	Silentblock For Susp.Arm	1E01 34 153A	d:66.1
3	SI-300	Stabiliser Link	1 015 265	L:238	10	RU-300	Silentblock For Susp.Arm	1 010 037	d:37.3
4	BS-300	TCA Left	1E00 34 350A	c:16.5	11	TI-337	Tie Rod End Right	1011857	c:11.5 th:M14X2R
5	BS-301	TCA Right	1E00 34 300A	c:17.45	12	RU-321	Stabiliser Mounting	1E00-34-156	
6	BS-302	TCA Left	1 063 255	c:16.5	13	RU-322	Mounting Axle Body	1E00-28-460C	-
7	BS-303	TCA Right	1 063 236	c:16.5					

323 II (BD)

06/1980 - 04/1985

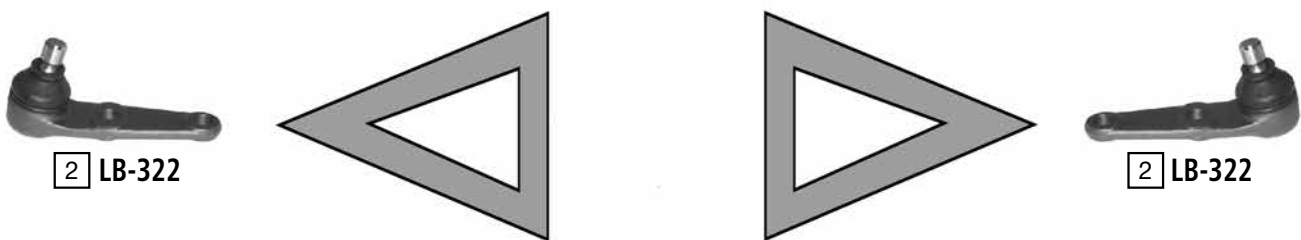
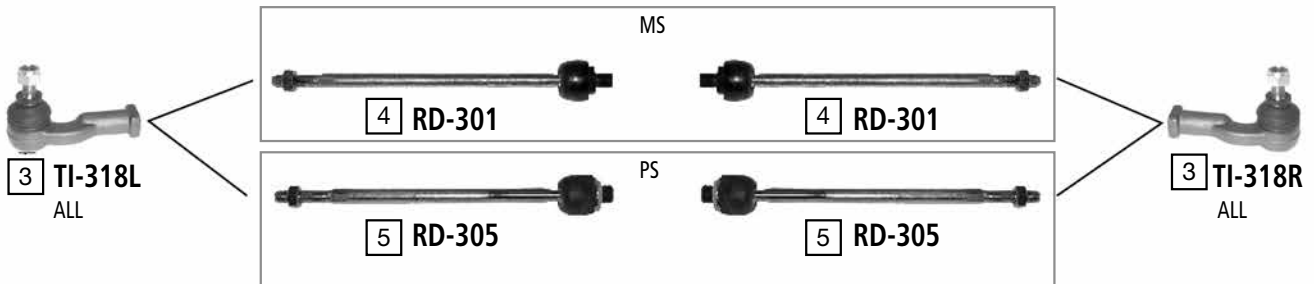
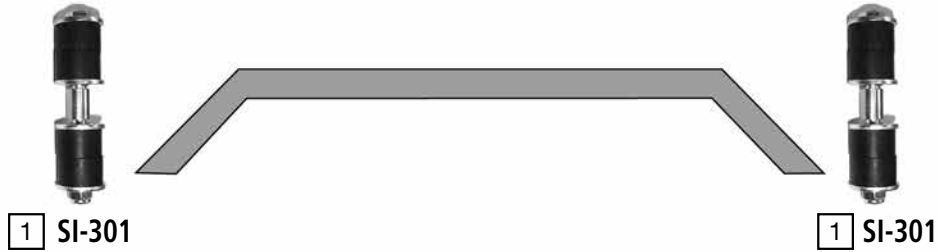

Ref	JAPANPARTS CODE	Description	OEM	Measures	Ref	JAPANPARTS CODE	Description	OEM	Measures
1	SI-301	Stabiliser Link	B02934159	L:110	4	RD-301	Axial Joint	B001-32-135	
2	LB-322	Ball Joint Lower	B092-34-550	c:16	5	RD-305	Axial Joint	BA2932-135	
3	TI-318L	Tie Rod End Left	B067-99-324	c:12.7 th:FM12X1.25	6	TI-318R	Tie Rod End Right	B001-99324	

323 III (BF)  
 323 III S.W. (BW)

05/1985 - 05/1989  
 05/1986 - 10/1995

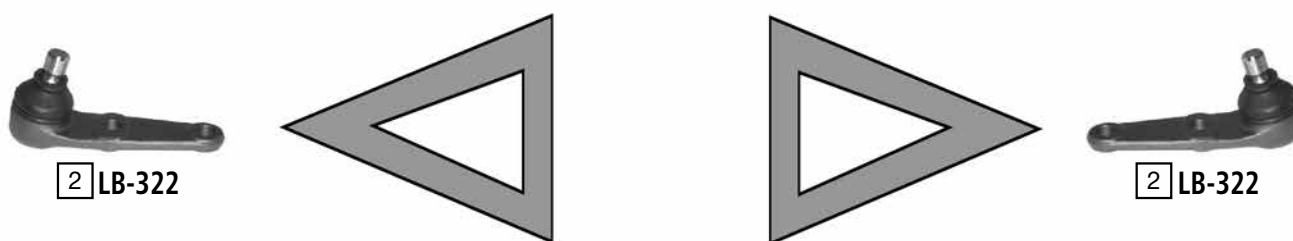
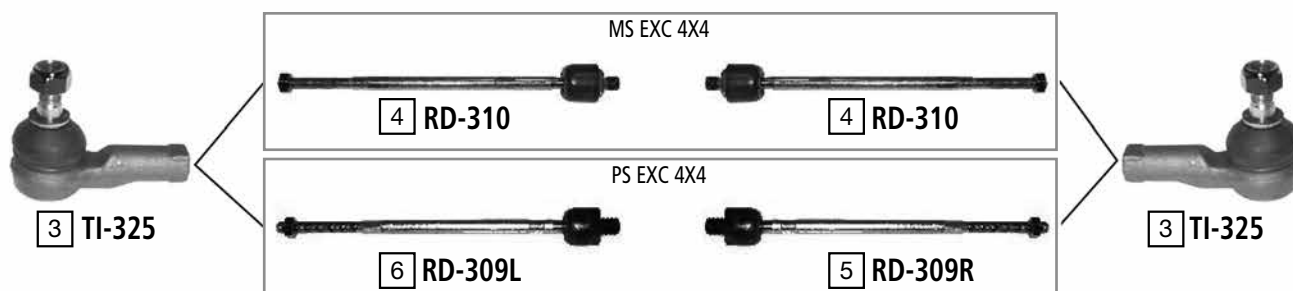
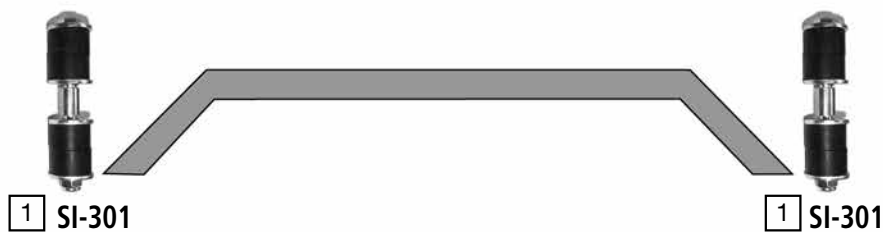

Ref.	JAPANPARTS CODE	Description	OEM	Measures	Ref.	JAPANPARTS CODE	Description	OEM	Measures
1	SI-301	Stabiliser Link	B02934159	L:110	4	RD-310	Axial Joint	BF67-32-24X	
2	LB-322	Ball Joint Lower	B092-34-550	c:16	5	RD-309R	Axial Joint	B093-32-240	
3	TI-325	Tie Rod End	8AB1-32-280	c:12.6 th:FM12X1.25	6	RD-309L	Axial Joint		



323 IV (BG)

06/1989 - 08/1994

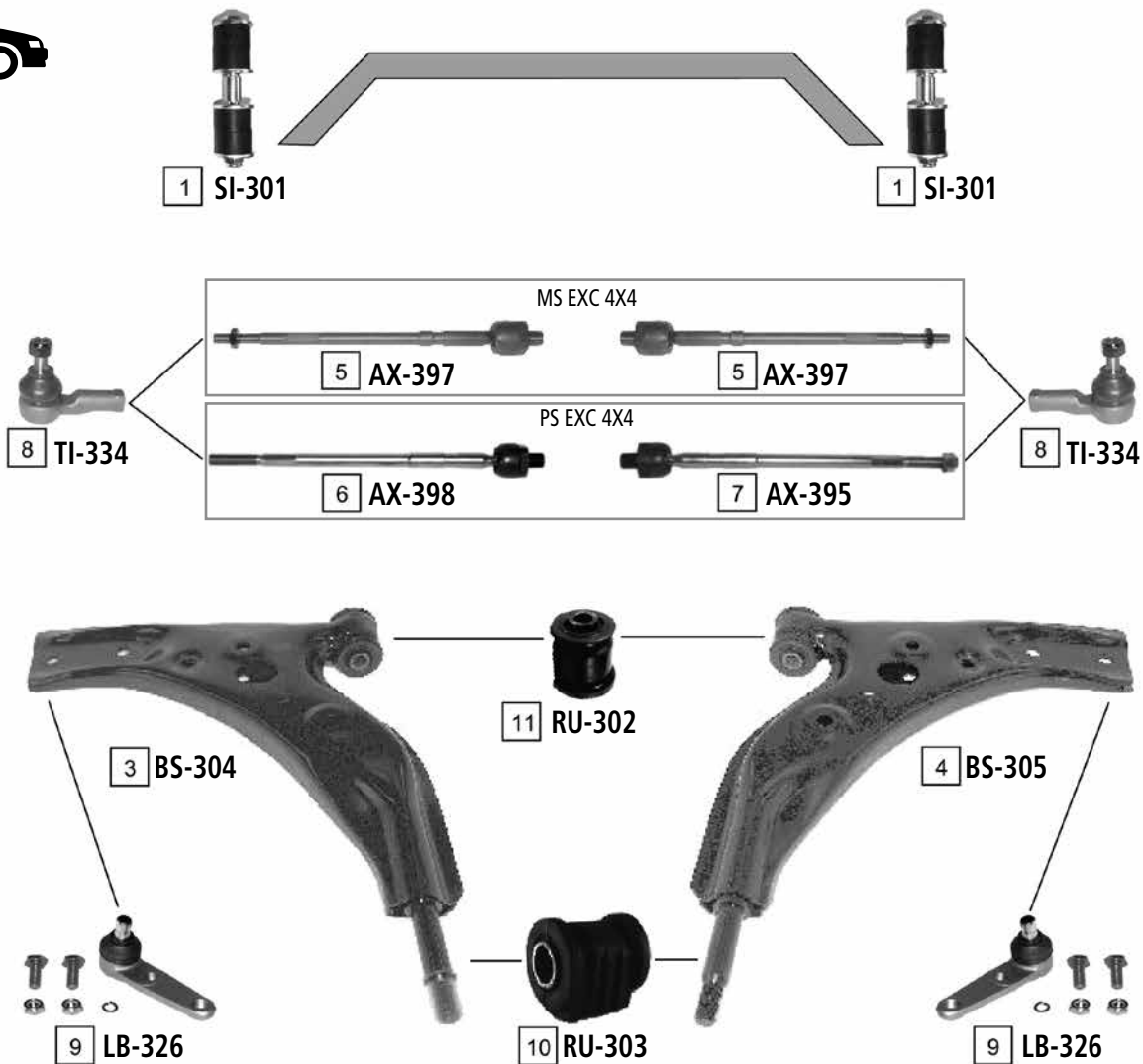

Ref	JAPANPARTS CODE	Description	OEM	Measures	Ref	JAPANPARTS CODE	Description	OEM	Measures
1	SI-301	Stabiliser Link	B02934159	L:110	7	AX-395	Axial Joint	B456-32-24X	th:MM16X1R L:324
2	SI-302	Stabiliser Link	8AG1 28 100A	L:105	8	TI-334	Tie Rod End	8AB2-32-280	c:13.3 th:FM12X1.25
3	BS-304	TCA Left	B455-34350E		9	LB-326	Ball Joint LOWER	B455-34-550	c:16
4	BS-305	TCA Right	B455-34-300E		10	RU-303	Silentblock For Susp.Arm	B001-34-470	
5	AX-397	Axial Joint	B455-32-24X	th:MM16X1R L:325	11	RU-302	Silentblock For Susp.Arm	B459-34-470	
6	AX-398	Axial Joint	B456-32-25X	th:MM16X1R L:325					

323 V (BA)

08/1994 - 09/1998

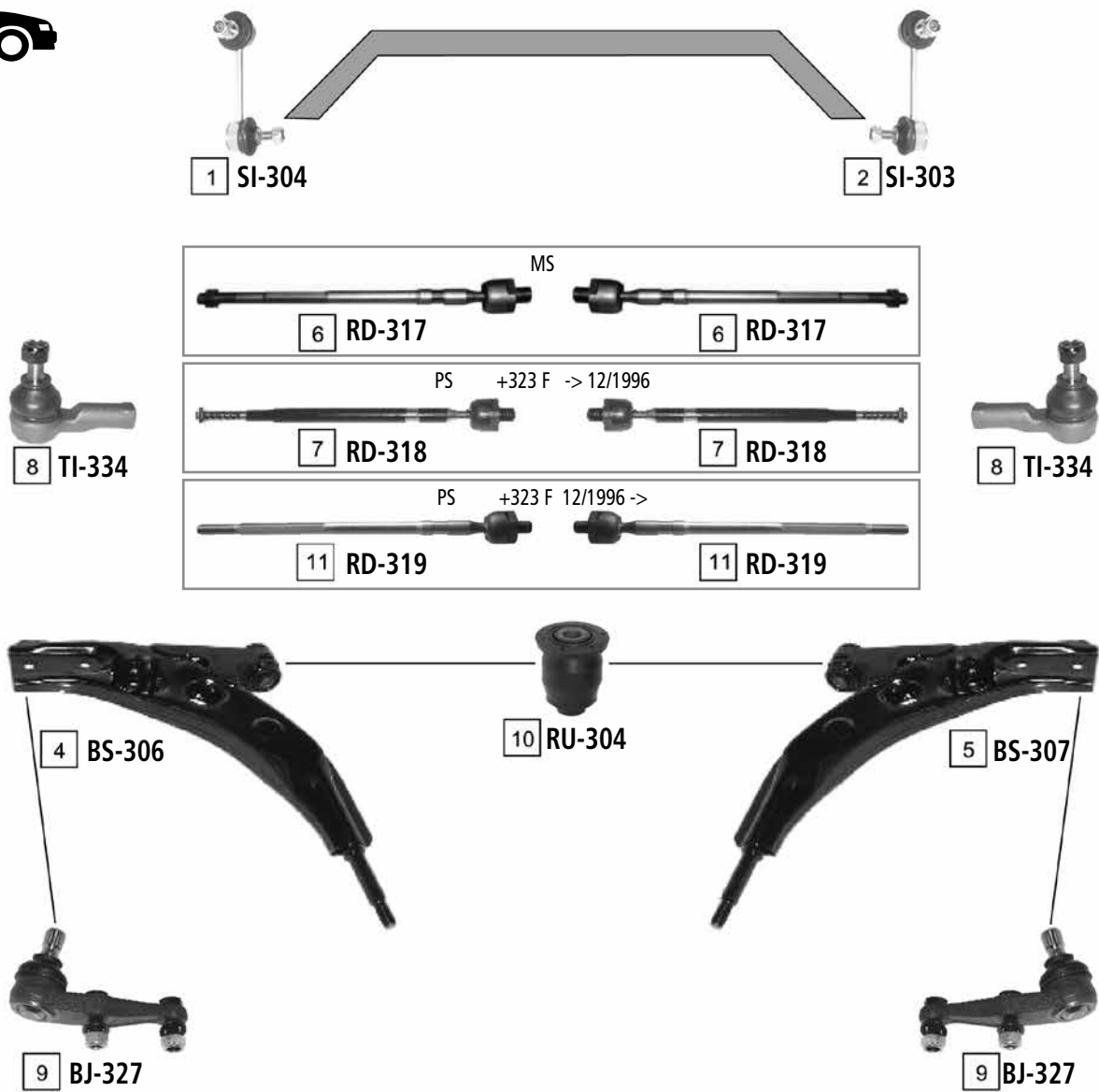

Ref.	JAPANPARTS CODE	Description	OEM	Measures	Ref.	JAPANPARTS CODE	Description	OEM	Measures
1	SI-304	Stabiliser Link Left	GA2A 34 170A	L:105	7	RD-318	Axial Joint	E016 32 24X	th:MM16X1R L:334
2	SI-303	Stabiliser Link Right	GA2A 34 150A	L:105	8	TI-334	Tie Rod End	8AB2-32-280	c:13.3 th:FM12X1.25
3	SI-305	Stabiliser Link	BC1D 28 170A	L:255	9	BJ-327	Ball Joint	B01A 34 550	c:18
4	BS-306	TCA	B01A 34 350		10	RU-304	Silentblock For Susp.Arm	BC1D 34 470	d:40.5
5	BS-307	TCA	B01A 34 300		11	RD-319	Axial Joint	B21H 32 24X	th:MM14X1.5R L:335
6	RD-317	Axial Joint	E016 32 250	th:MM16X1R L:335					

323 VI (BJ)

09/1998 - 05/2004

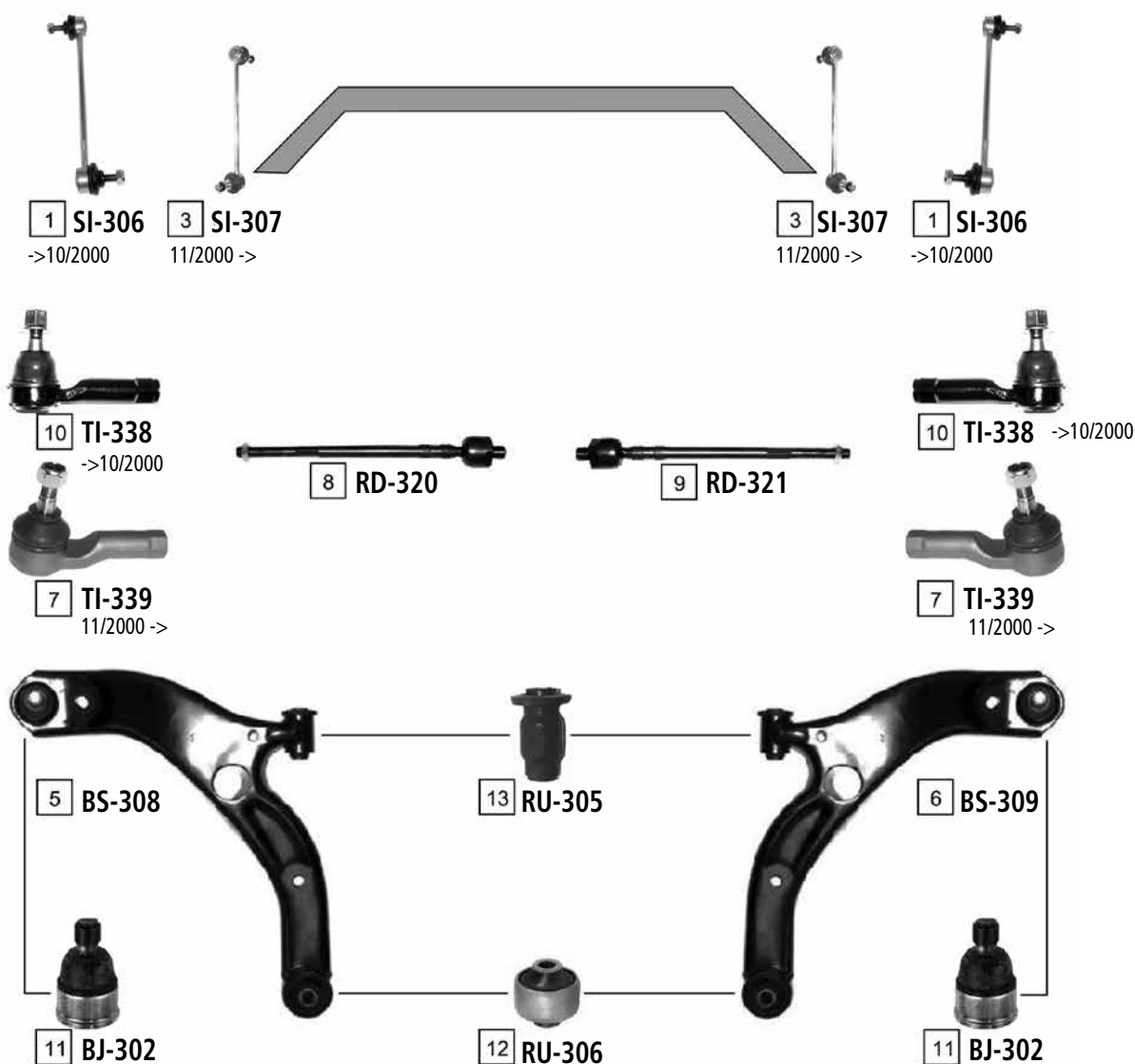

Ref	JAPANPARTS CODE	Description	OEM	Measures	Ref	JAPANPARTS CODE	Description	OEM	Measures
1	SI-306	Stabiliser Link	B26 R 34 170	L:190	8	RD-320	Axial Joint	B25D 32 240	th:MM16X1R L:310
2	SI-309	Stabiliser Link	B26R-28-170	L:190	9	RD-321	Axial Joint	B25D 32 250	th:MM16X1R L:310
3	SI-307	Stabiliser Link	LC62-34-170 A	L:266	10	TI-338	Tie Rod End	8AG4 32 280	
4	SI-308	Stabiliser Link	B30H 28 170 B	L:160	11	BJ-302	Ball Joint	Part of BS-308/BS-309	c:18
5	BS-308	TCA Left	B25D 34 350 A		12	RU-306	Silentblock For Susp.Arm	B25D 34 460	
6	BS-309	TCA Right	B25D 34 300 A		13	RU-305	Silentblock For Susp.Arm	B25D 34 470	
7	TI-339	Tie Rod End	8AG3-32-280	c:12.9 th:FM14X1.5R					

626 III (GD)

07/1987 - 05/1992

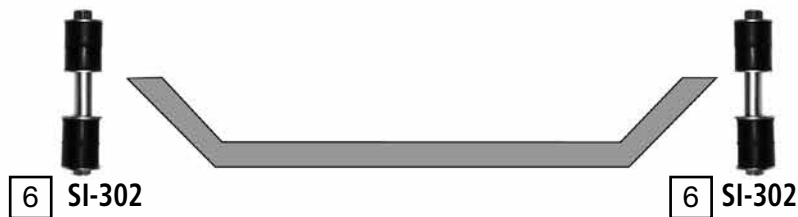
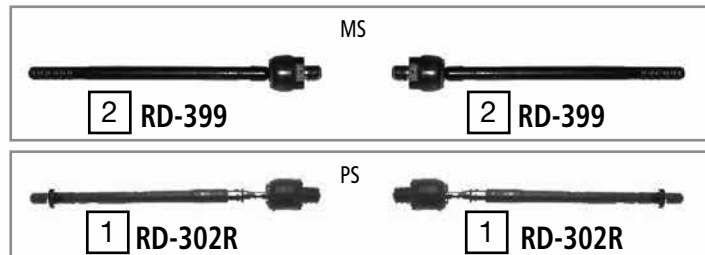

Ref	JAPANPARTS CODE	Description	OEM	Measures	Ref	JAPANPARTS CODE	Description	OEM	Measures
1	RD-302R	Axial Joint	GJ22-32-240	th:MM18X1.5R L:285	4	TI-339	Tie Rod End	8AG3-32-280	c:12.9 th:FM14X1.5R
2	RD-399	Axial Joint	G030-32-250A	th:MM16X1R L:282	5	BJ-317	Ball Joint Lower	0G030 34550B	c:18
3	TI-309	Tie Rod End	H001-99-324	c:13.6 th:FM14X1.5R	6	SI-302	Stabiliser Link	8AG1 28 100A	L:105

626 IV (GE)

08/1991 - 04/1997

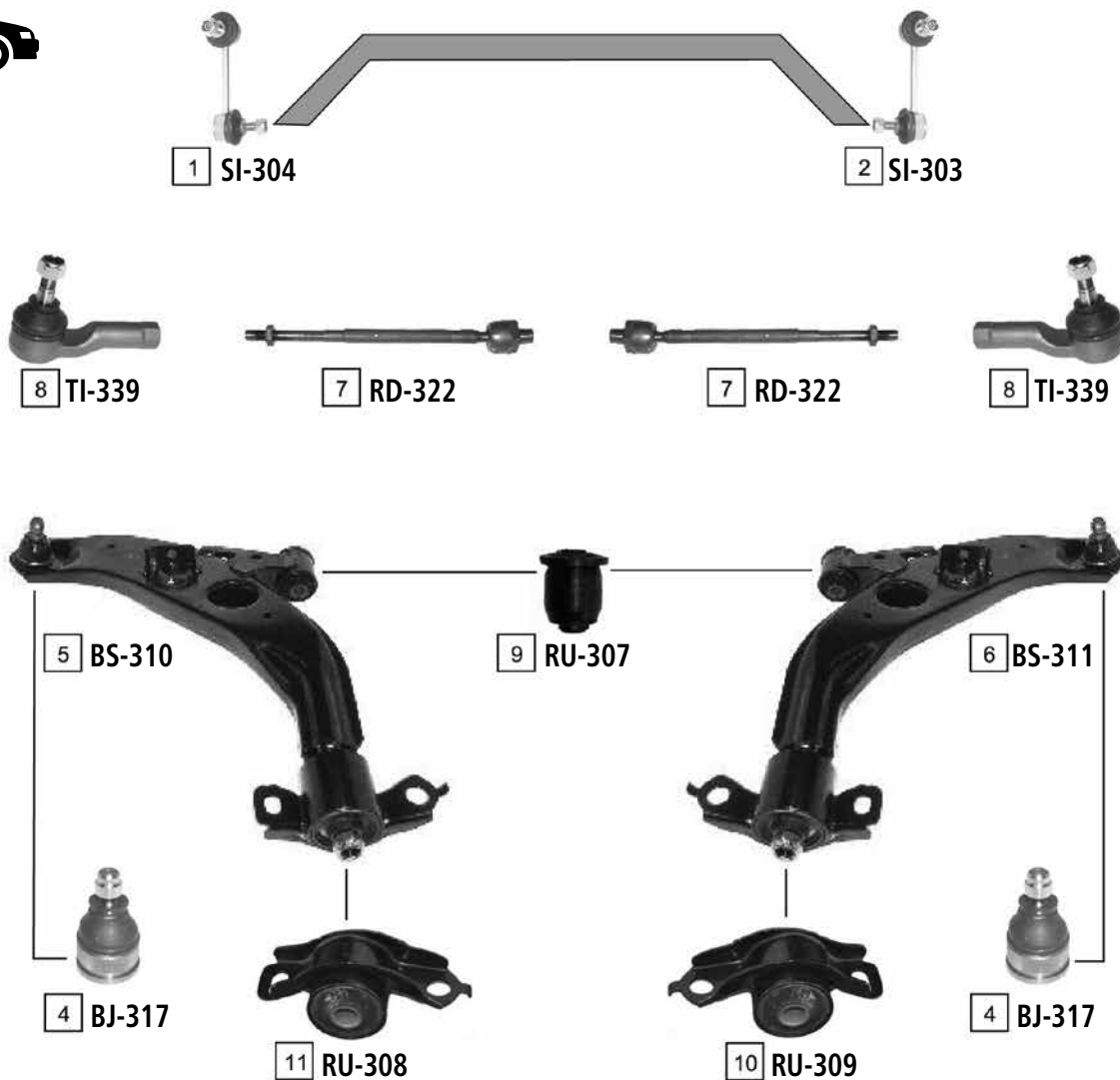

Ref.	JAPANPARTS CODE	Description	OEM	Measures	Ref.	JAPANPARTS CODE	Description	OEM	Measures
1	SI-304	Stabiliser Link Left	GA2A 34 170A	L:105	7	RD-322	Axial Joint	GA2A-32-250	th:MM18X1R L:300
2	SI-303	Stabiliser Link Right	GA2A 34 105A	L:105	8	TI-339	Tie Rod End	8AG3-32-280	c:12.9 th:FM14X1.5R
3	SI-K51	Stabiliser Link	GA2C-28-170B	L:88	9	RU-307	Silentblock For Susp.Arm	GA2A 34 470	d:38.5
4	BJ-317	Ball Joint LOWER	0G030 34550B	c:18	10	RU-309	Silentblock For Susp.Arm	GA2A 34 46XA	
5	BS-310	TCA	GA2A-34-350	c:18	11	RU-308	Silentblock For Susp.Arm	GA2A 34 46YA	
6	BS-311	TCA	GA2A-34-300	c:18					

626 V (GF)

05/1997 - 04/2002

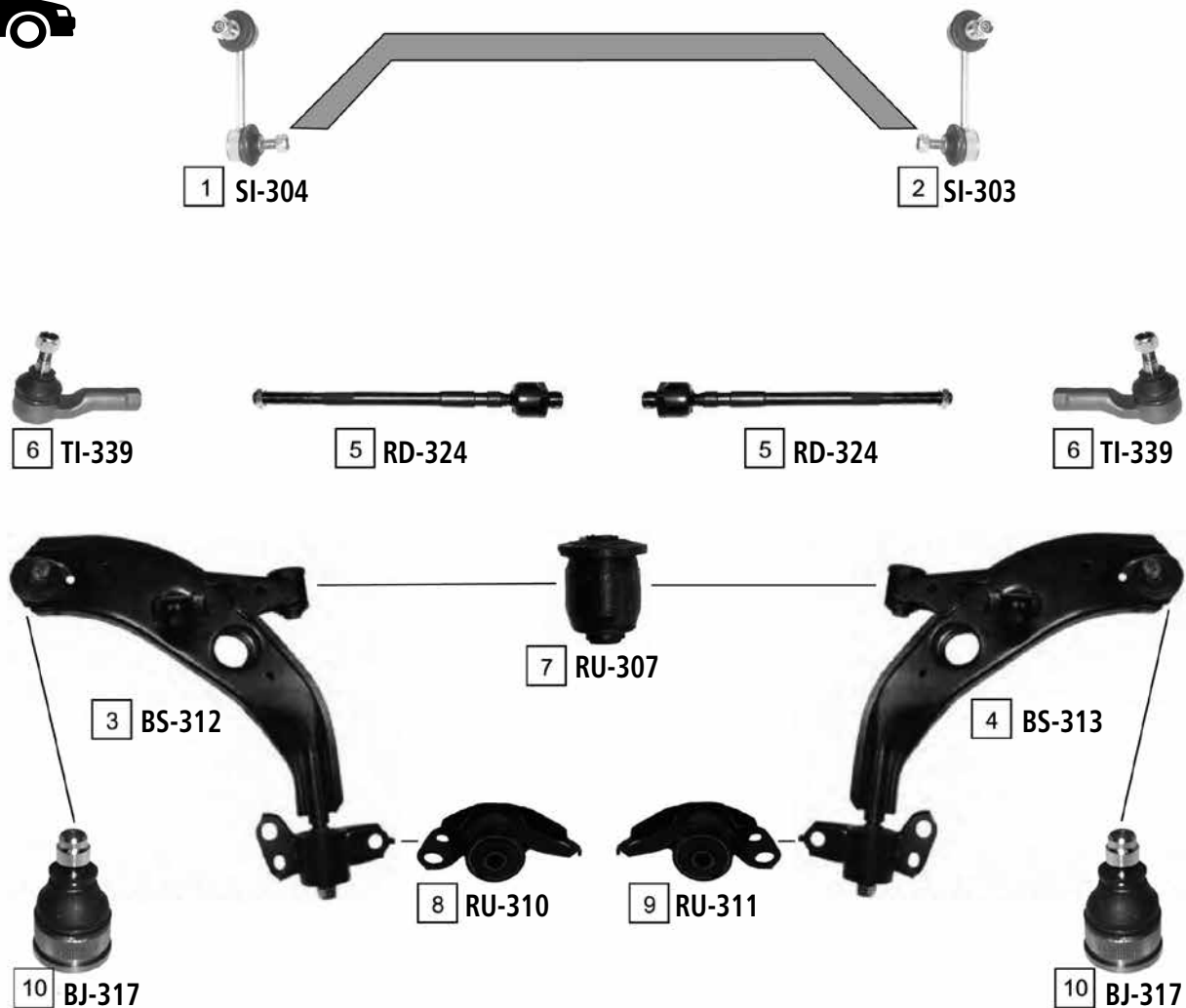

Ref	JAPANPARTS CODE	Description	OEM	Measures	Ref	JAPANPARTS CODE	Description	OEM	Measures
1	SI-304	Stabiliser Link Left	GA2A 34 170A	L:105	7	RU-307	Silentblock For Susp.Arm	GA2A 34 470	d:38.5
2	SI-303	Stabiliser Link Right	GA2A 34 150A	L:105	8	RU-310	Silentblock For Susp.Arm	GE4T 34 46YD	d:18,5
3	BS-312	TCA	GE4T-34-350E	c:18	9	RU-311	Silentblock For Susp.Arm	GE4T 34 46XD	d:18,5
4	BS-313	TCA	GE4T-34-300E	c:18	10	BJ-317	Ball Joint Lower	OG030 34550B	c:18
5	RD-324	Axial Joint	GE4T-32-240	th:MM18X1.5R L:307	11	SI-310	Stabiliser Link	GE4T 28 170	L:230
6	TI-339	Tie Rod End	8AG3-32-280	c:12.9 th:FM14x1.5R					

# MAZDA

## B1600 - 1800 - 2000 - 2200 - 2600

B1600 - 1800 (UD,UF)  
B2000 - 2200 - 2600

10/1981 - 12/1996

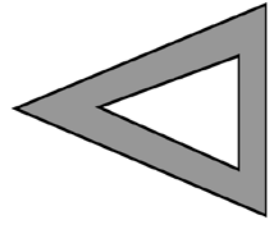
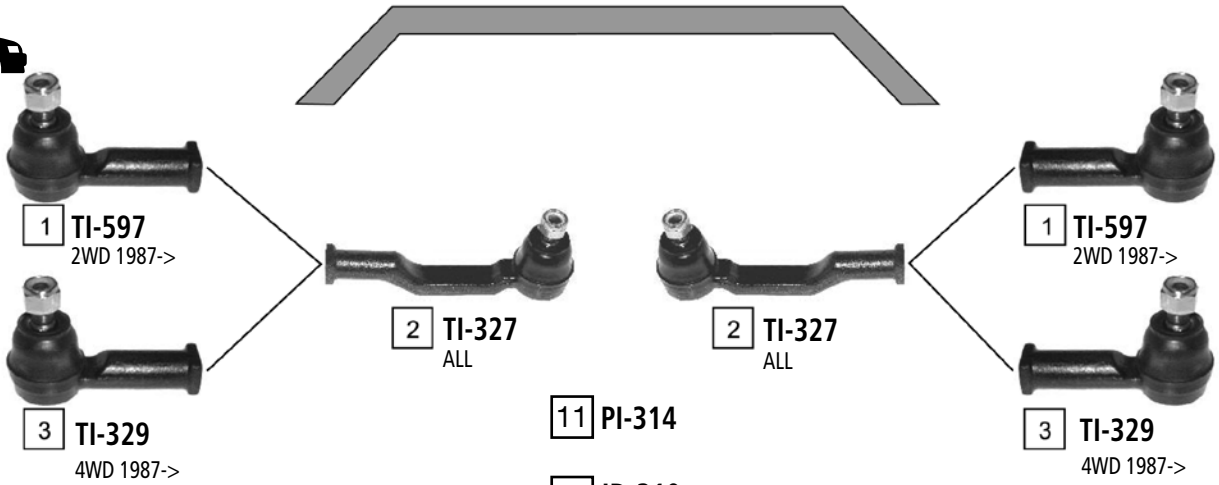

UPPER

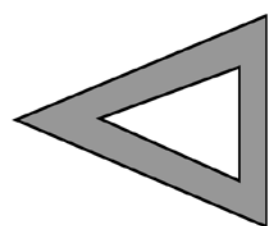
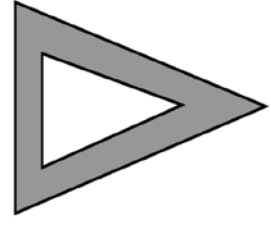

LOWER

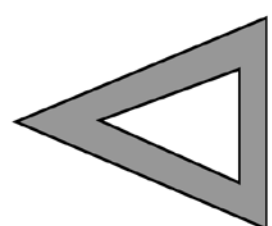
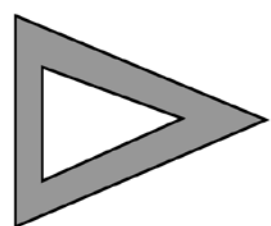

LOWER  
B2600 1987->

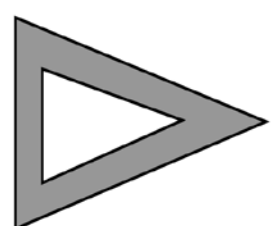

- 7 BJ-311 ->1987
- 8 BJ-312 ->1987
- 9 TI-323 ->1987
- 10 TI-321 ->1987

- 7 BJ-311 ->1987
- 8 BJ-312 ->1987
- 9 TI-323 ->1987
- 10 TI-321 ->1987

- 11 PI-314
- 12 ID-310

Ref	JAPANPARTS CODE	Description	OEM	Measures	Ref	JAPANPARTS CODE	Description	OEM	Measures
1	TI-597	Tie Rod End	UB39-99-324	c: 13.7 th: FM14X1.5L	7	BJ-311	Ball Joint	VA01-99-354	
2	TI-327	Tie Rod End Inner	UB39-99-322	c: 13.8 th: FM14X1.5R	8	BJ-312	Ball Joint	VA01-99-356	
3	TI-329	Tie Rod End	8AU1-32-280	c: 13.7 th: FM14X1.5L	9	TI-323	Tie Rod End	0662-99-324	
4	TI-320	Ball Joint Upper	8AU1-34-540	c: 13.7	10	TI-321	Tie Rod End	VA01-32-240	
5	LB-321	Ball Joint Lower	8AU2-34-510	c:17.6	11	PI-314		VB39-32-220B	
6	BJ-324	Ball Joint Lower	8AU3-34-510	c: 17.8	12	ID-310		VB39-32-320A	

B2200 - 2500 - 2600 (UN)

02/1999 ->

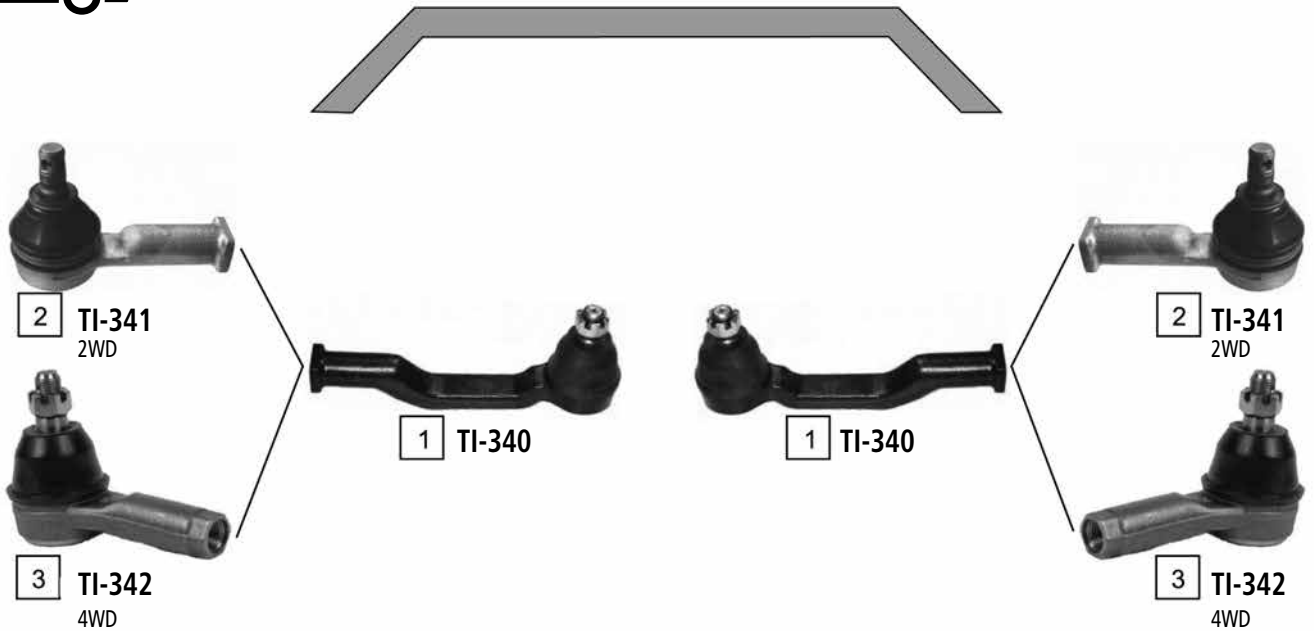

Ref	JAPANPARTS CODE	Description	OEM	Measures	Ref	JAPANPARTS CODE	Description	OEM	Measures
1	TI-340	Tie Rod End	UH74-32-250		3	TI-342	Tie Rod End	UH74-32-280	
2	TI-341	Tie Rod End	UH71-32-280	c:13.6 th:FM14X15L					



CX-7 (ER)

10/2007 ->

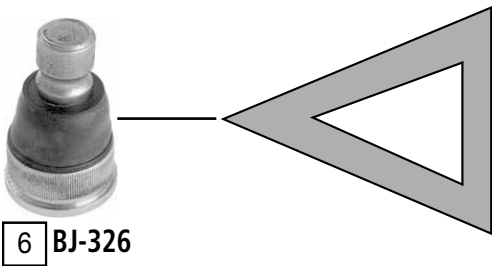

LOWER

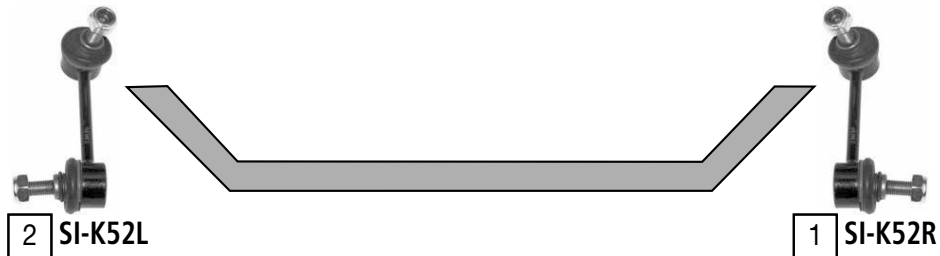
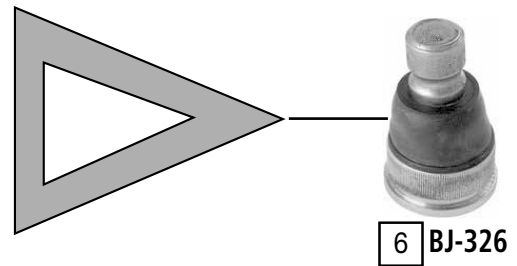

Ref	JAPANPARTS CODE	Description	OEM	Measures	Ref	JAPANPARTS CODE	Description	OEM	Measures
1	SI-K52R	Stabiliser link	L206 34 150A	L:104	4	TI-357	Tie rod end right	EG21 32 280A	c:14.9 th:FM14x1.5R
2	SI-K52L	Stabiliser link	L206 34 170A	L:104	5	RD-336	Axial joint	EG21 32 240	th:MM14x1.5R L:206
3	TI-358	Tie rod end left	EG21 32 290A	c:14.9 th:FM14x1.5R	6	BJ-326	Ball joint lower	Part of	c:22 do:44

DEMIO (DW)

08/1998 - 04/2003



Ref	JAPANPARTS CODE	Description	OEM	Measures	Ref	JAPANPARTS CODE	Description	OEM	Measures
1	SI-311	Stabiliser Link	EA03-34-170A	L:55	4	TI-334	Tie Rod End	8AB2-32-280	c:13.3 th:FM12X1.25
2	CJ-300	TCA	D201 34 350A		5	RD-326	Axial Joint	D102-32-240	th:MM16X1.5R L:279
3	CJ-301	TCA	D201 34 300E		6	RD-325	Axial Joint	D102-32-250	th:MM16X1.5R L:280

# MAZDA E2000 - E2200

E2000 - E2200 (SD,SR)

01/1984 - 07/1999



2 TI-343



1 RD-304



1 RD-304



2 TI-343



3 BJ-313

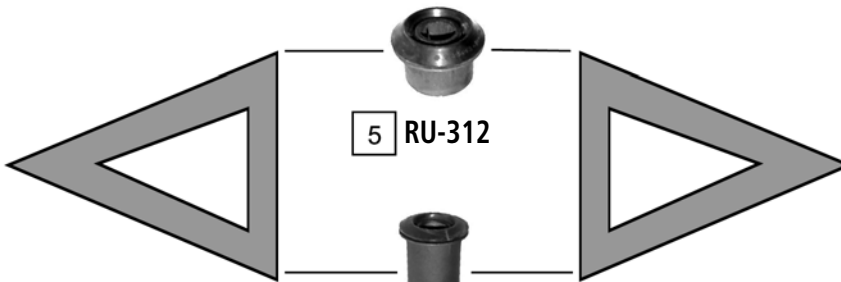

5 RU-312

6 RU-313



3 BJ-313



4 BJ-314



7 RU-314



4 BJ-314

Ref	JAPANPARTS CODE	Description	OEM	Measures	Ref	JAPANPARTS CODE	Description	OEM	Measures
1	RD-304	Axial Joint	S083-32-115	h:MM17X1R L:183	5	RU-312	Silentblock For Susp.Arm	S083 34 840A	d:45.3
2	TI-343	Tie Rod End	S083-99-324	c:13.8 th:FM14X1.5R	6	RU-313	Silentblock For Susp.Arm	S083 34 830A	d:45.2
3	BJ-313	Ball Joint Upper	S083 99 354	c:17.8	7	RU-314	Silentblock For Susp.Arm	S083-34-460	d:45
4	BJ-314	Ball Joint Lower	S083 99 356	c:17.8					

MAZDA 2

04/2003 ->



Ref	JAPANPARTS CODE	Description	OEM	Measures	Ref	JAPANPARTS CODE	Description	OEM	Measures
1	TI-344	Tie Rod End Left	1202549	c:11,6 th:FM14X1,5R	6	SI-312	Stabiliser Link	1146150	L:285
2	BJ-303	Ball Joint	Part of BS-314/BS-315	c:17,5	7	RU-315	Silentblock For Susp.Arm	Part of BS-314/BS-315	d:40
3	BS-314	TCA Left	DD32 34 350	c:17,5	8	RU-316	Silentblock For Susp.Arm	Part of BS-314/BS-315	
4	BS-315	TCA Right	DD32 34 300	c:17,5	9	RD-327	Axial Joint	4 342 539	th:MM14X1,5R L:278
5	TI-345	Tie Rod End Right	1202548	c:11,6 th:FM14X1,5R					

MAZDA 2

10/2007 ->

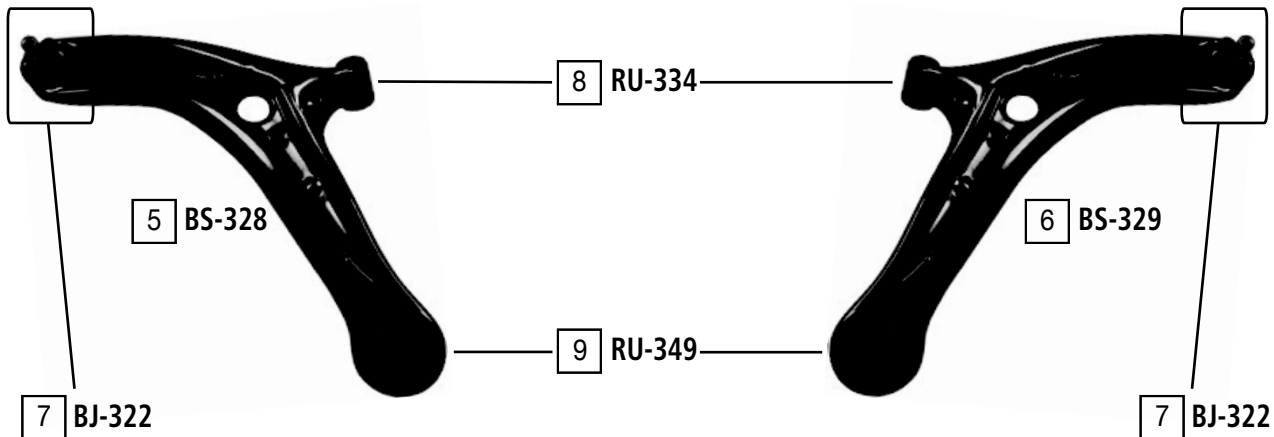
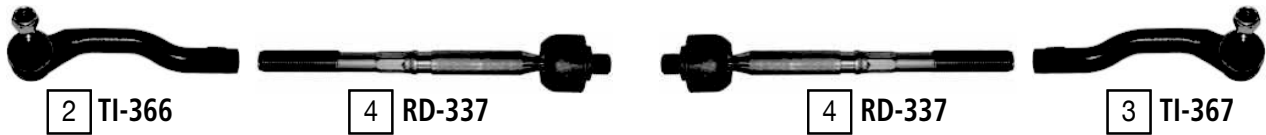
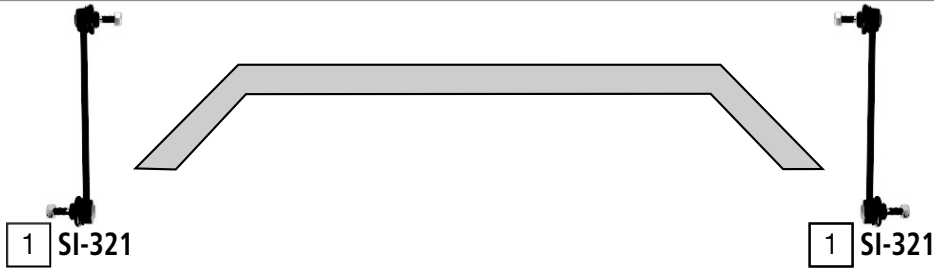

Ref	JAPANPARTS CODE	Description	OEM	Measures	Ref	JAPANPARTS CODE	Description	OEM	Measures
1	SI-321	Stabiliser Link	D651 34 170	L:252	6	BS-329	TCA Right Wbj	D651 34 300D	c:17.5
2	TI-366	Tie Rod End Left	D653 32 290	c:13 th:FM14x1.5R	7	BJ-322	Ball Joint	Part of	c:17.5 do:38.7
3	TI-367	Tie Rod End Right	D651 32 280	c:13 th:FM14x1.5R	8	RU-334	Silentblock For TCA	D651 34 470	di:12.2
4	RD-337	Axial Joint	D653 32 240	th:MM14x1.5R L:216	9	RU-349	Silentblock For TCA	Part of	di:12 do:60.9
5	BS-328	TCA Left Wbj	D651 34 350E	c:17.5					

MAZDA 3 (BK)

06/2003 ->

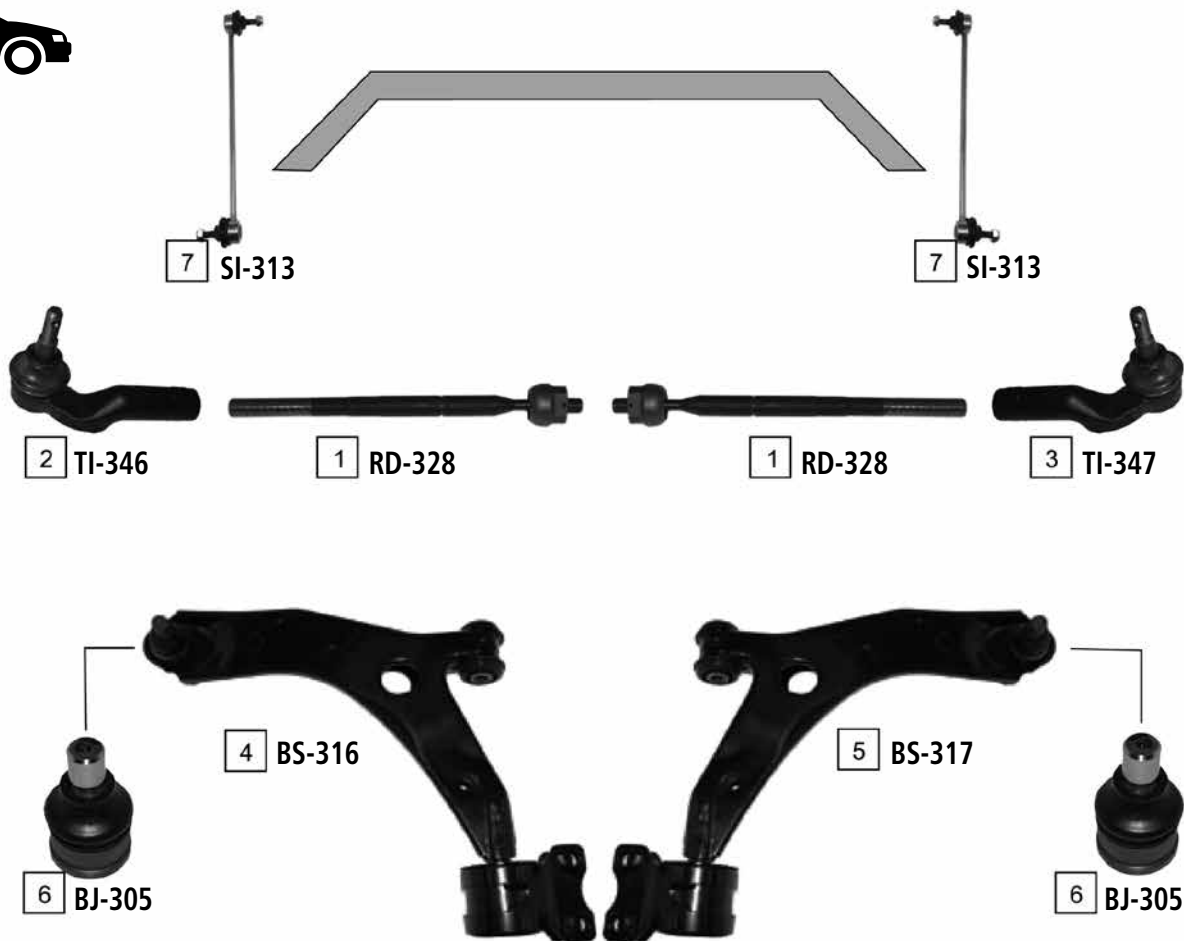

Ref	JAPANPARTS CODE	Description	OEM	Measures	Ref	JAPANPARTS CODE	Description	OEM	Measures
1	RD-328	Axial Joint	BP4L 32 240	th:MM14X1.5R L:292	6	BJ-305	Ball Joint	Part of BS-316/BS-317	c:18
2	TI-346	Tie Rod End Left	BP4L 32 290	c:12.2 th:FM17X1.5R	7	SI-313	Stabiliser Link	BP4K 34 170C	L:307
3	TI-347	Tie Rod End Right	BP4L 32 280	c:12.2 th:FM17X1.5R	8	CJ-303	Track Rod	BP4K 28 500C	
4	BS-316	TCA Left Wbj	B32H 34 350	c:18	9	CJ-302	Track Rod	BP4K 28 C 10B	
5	BS-317	TCA Right Wbj	B32H 34 300	C:18	10	RU-317	Silentblock Axle Body	30666821	

MAZDA 5

02/2005 ->

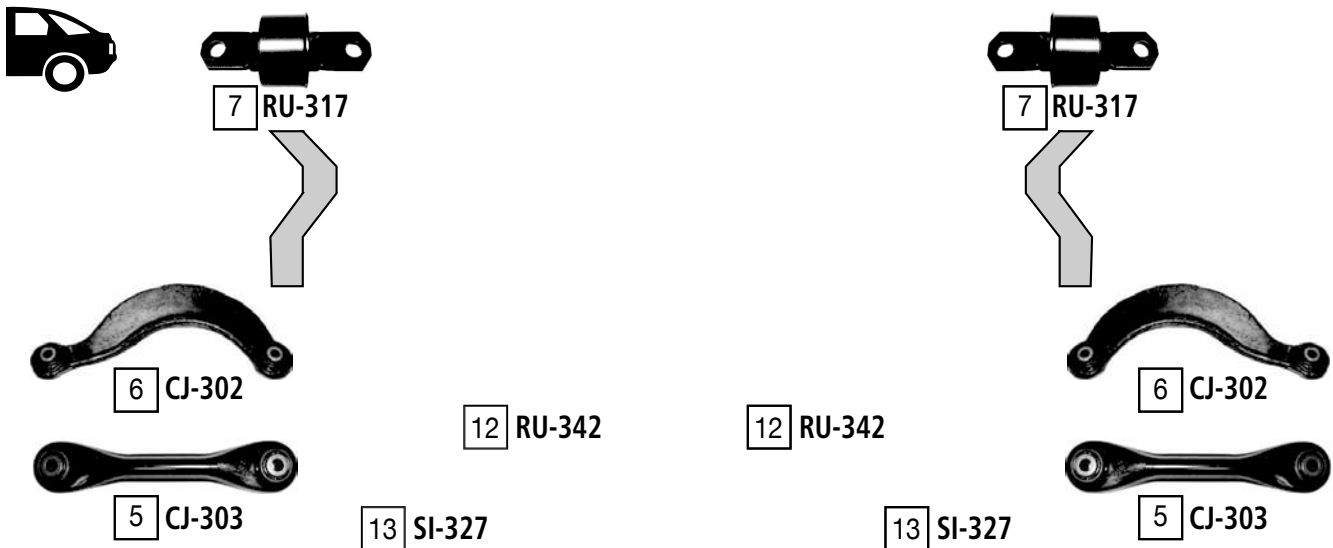
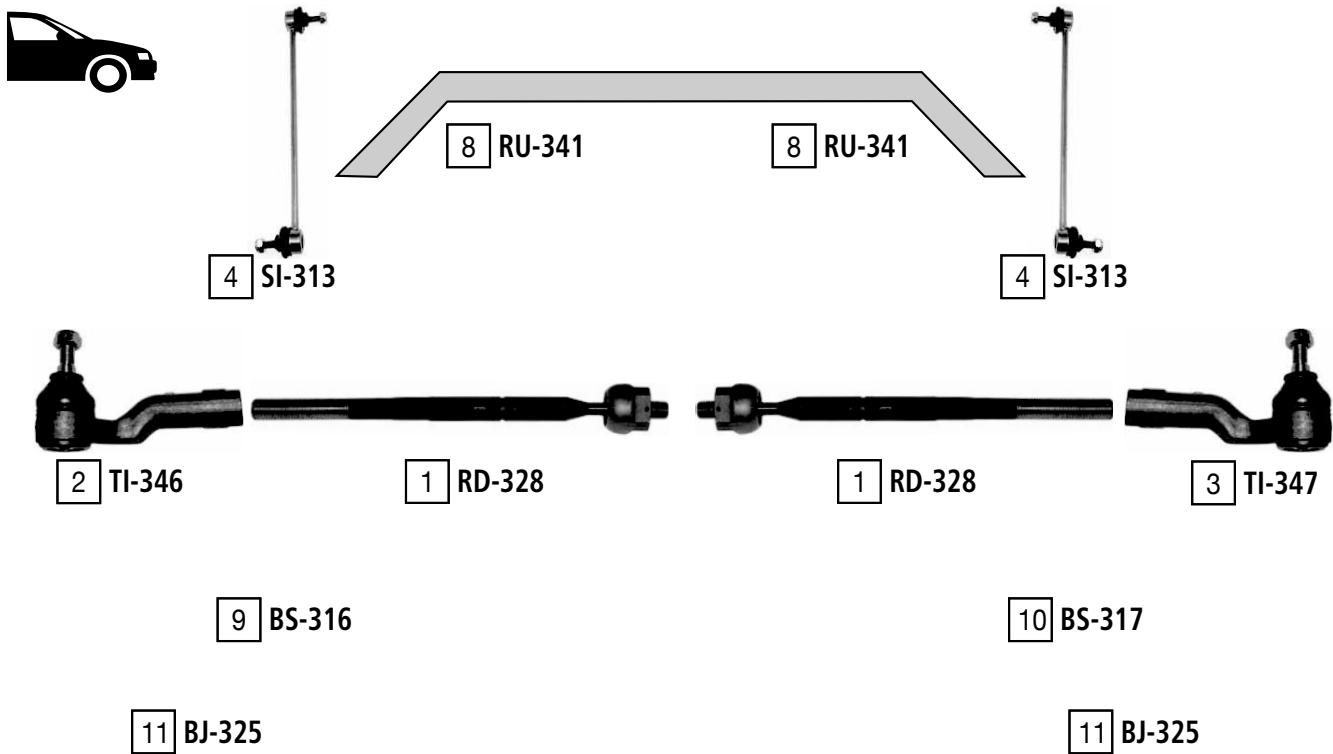

Ref	JAPANPARTS CODE	Description	OEM	Measures	Ref	JAPANPARTS CODE	Description	OEM	Measures
1	RD-328	Axial Joint	BP4L 32 240	th:MM14X1.5R L:292	8	RU-341	Stabiliser Mounting	CC29 34 156C	
2	TI-346	Tie Rod End Left	BP4L 32 290	c:12.2 th:FM17X1.5R	9	BS-316	TCA Left Wbj	B32H 34 350	
3	TI-347	Tie Rod End Right	BP4L 32 280	c:12.2 th:FM17X1.5R	10	BS-317	TCA Right Wbj	B32H 34 300	
4	SI-313	Stabiliser Link	BP4K 34 170D	L:307	11	BJ-325	Ball Joint	BK3P 34 300D	
5	CJ-303	Track Rod Rear	BP4K 28 500E	L:223	12	RU-342	Stabiliser Mounting	C24328156C	
6	CJ-302	Track Rod Rear	BP4K 28 C10B	L:288	13	SI-327	Stabiliser Link	BP4K28170C	
7	RU-317	Mounting Axle Body	Part of	do:60.2					

MAZDA 6 (GG,GY)

01/2002 ->

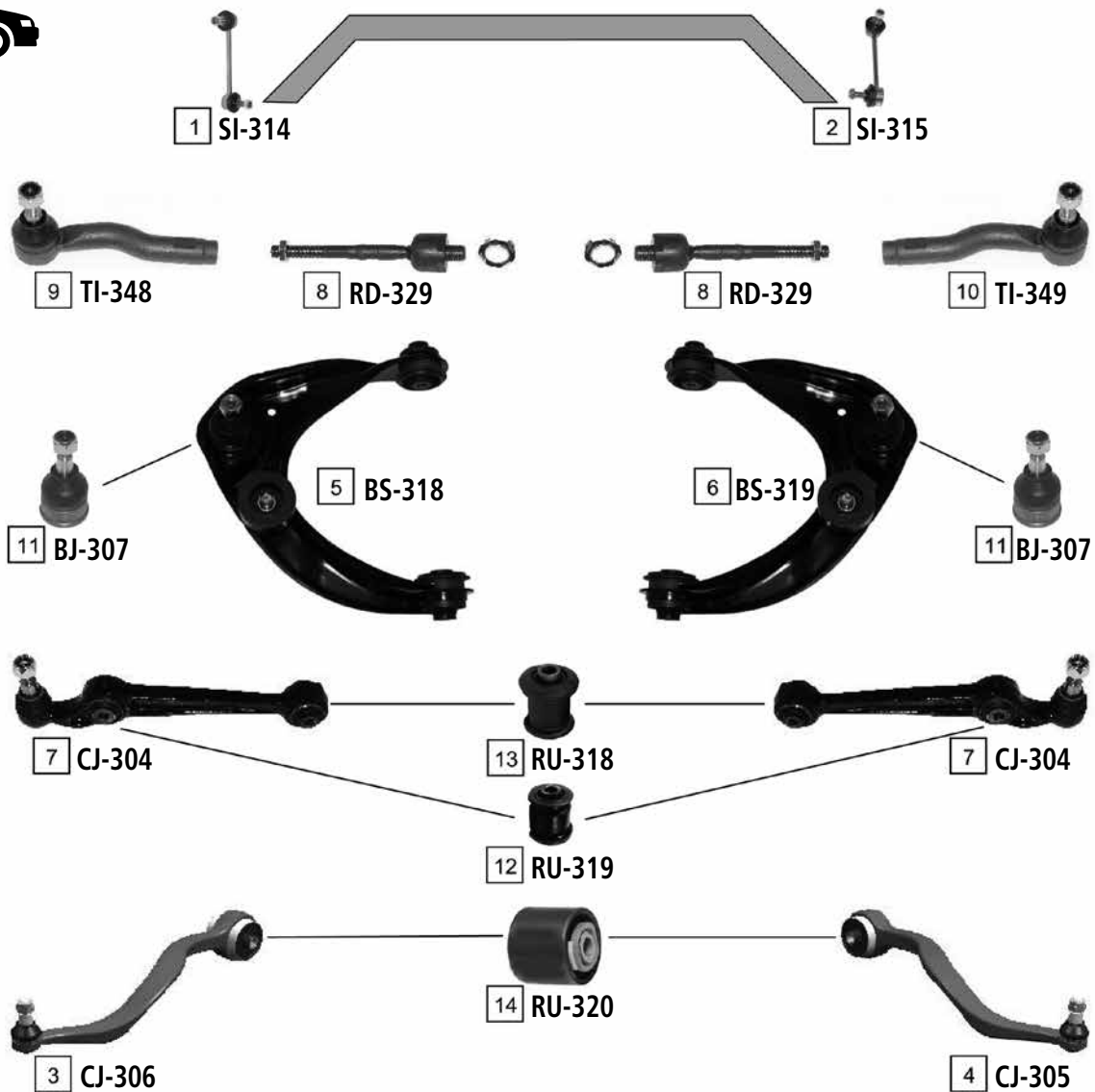

Ref	JAPANPARTS CODE	Description	OEM	Measures	Ref	JAPANPARTS CODE	Description	OEM	Measures
1	SI-314	Stabiliser Link Left	GJ6A-34-170A	L:154	9	TI-348	Tie Rod End Left	GJ6E-32-290	c:12.9 th:FM14X1.5R
2	SI-315	Stabiliser Link Right	GJ6A-34-150A	L:154	10	TI-349	Tie Rod End Right	GJ6E-32-280	c:12.9 th:FM14X1.5R
3	CJ-306	TCA Left	GJ6A-34-J50 B	c:19.5	11	BJ-307	Ball Joint	GJ6A-34-540	c:12.6
4	CJ-305	TCA Right	GJ6A-34-J00 B	c:19.5	12	RU-319	Silentblock For Susp.Arm	GJ6A-34-710 A	d:44.2
5	BS-318	TCA Left	GJ6A-34-250 B	c:12.8	13	RU-318	Silentblock For Susp.Arm	GJ6A-34-470 A	d:40.2
6	BS-319	TCA Right	GJ6A-34-200 B		14	RU-320	Silentblock For Susp.Arm	GJ6A-34-460 A	d:62.3
7	CJ-304	TCA	GA6A-34-300 B	c:18.5	15	SI-316	Stabiliser Link	GJ6A 28 170A	
8	RD-329	Axial Joint	GJ6E-32-240	th:MM18X1.5R L:181					



MAZDA 6 (GH) SALOON - ESTATE - HATCHBACK

08/2007 ->

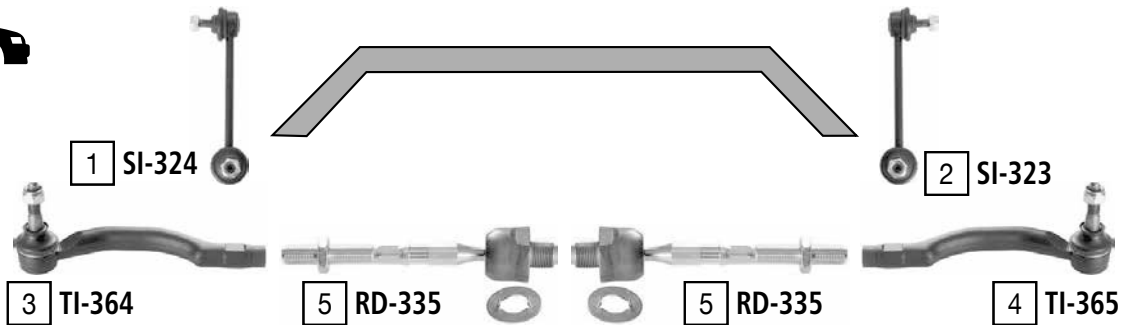

UPPER

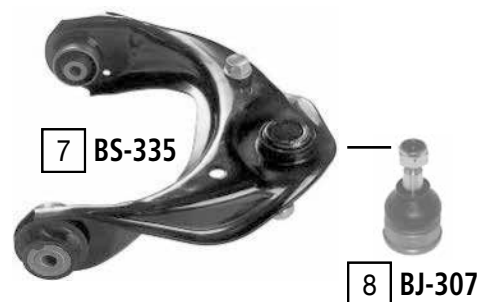
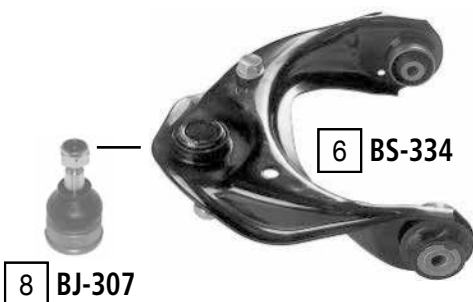

LOWER

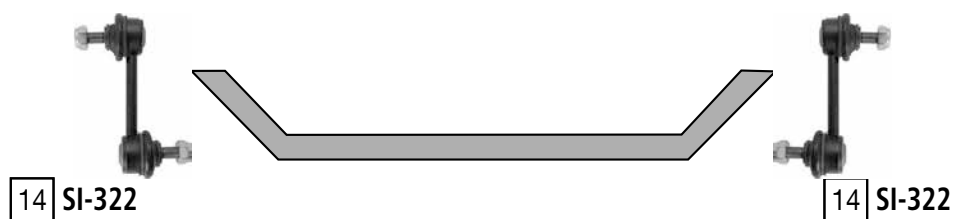
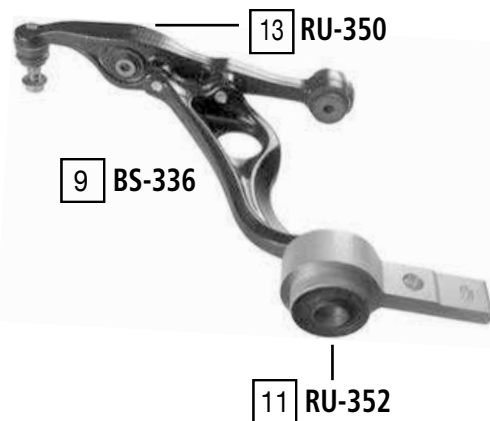

Ref	JAPANPARTS CODE	Description	OEM	Measures	Ref	JAPANPARTS CODE	Description	OEM	Measures
1	SI-324	Stabiliser link left	GS1D 34 170	L:160	8	BJ-307	Ball joint	GJ6A 34 540	c:12.6
2	SI-323	Stabiliser link right	GS1D 34 150	L:160	9	BS-336	TCA left wbj	GS1D 34 350L	c:17.1
3	TI-364	Tie rod end left	GS1D 32 290	c:12.6 th:FM14x1.5R	10	BS-337	TCA right wbj	GS1D 34 300L	c:17.1
4	TI-365	Tie rod end right	GS1D 32 280	c:12.6 th:FM14x1.5R	11	RU-352	Silentblock forTCA	Part of	di:28.9
5	RD-335	Axial joint	GS1D 32 240	th:MM18x1.5R L:165	12	RU-353	Silentblock forTCA	Part of	di:28.9
6	BS-334	TCA left wbj	GS1D 34 250A	c:12.7	13	RU-350	Silentblock forTCA	Part of	di:12.4 do:44.6
7	BS-335	TCA right wbj	GS1D 34 200A	c:12.7	14	SI-322	Stabiliser link rear axle	GS1D 28 170	L:96

MPV I (LV)

03/1995 - 09/1999



3 TI-350



2 RD-323



2 RD-323



3 TI-350



1 CJ-307



1 CJ-307

Ref	JAPANPARTS CODE	Description	OEM	Measures	Ref	JAPANPARTS CODE	Description	OEM	Measures
1	CJ-307	TCA	LB82-34-300	c:18	3	TI-350	Tie Rod End	8A11-32-280	c:13.9 th:FM14X1.5R
2	RD-323	Axial Joint	LA01-32-115	th:MM17X1R L:170					

MPV II (LW)

09/1999 - 07/2005



Ref	JAPANPARTS CODE	Description	OEM	Measures	Ref	JAPANPARTS CODE	Description	OEM	Measures
1	SI-307	Stabiliser Link	LC62-34-170 A	L:266	4	RD-330	Axial Joint	LC62-32-240 B	th:MM16X1.5R L:316
2	BS-320	TCA Left Wbj	LC62 34 350C		5	TI-338	Tie Rod End	8AG4 32 280	c:12.9 th:FM14X1.5R
3	BS-321	TCA Right Wbj	LC62 34 300C		6	BJ-308	Ball Joint	Part of BS-320/BS-321	

MX-3 (EC)

07/1991 - 09/1998

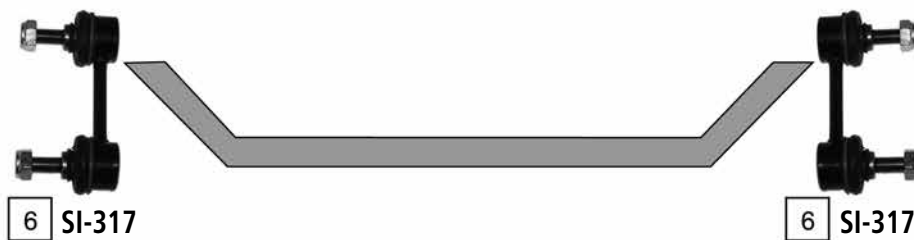
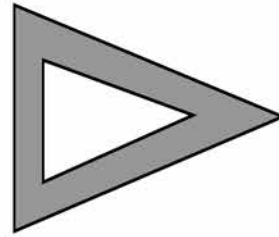
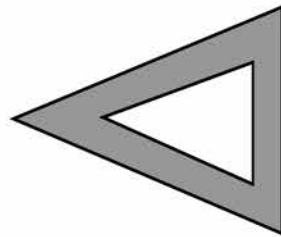

Ref	JAPANPARTS CODE	Description	OEM	Measures	Ref	JAPANPARTS CODE	Description	OEM	Measures
1	TI-334	Tie Rod End	8AB2-32-280	c:13.3 th:FM12X1.25	4	AX-398	Axial Joint	B456-32-25X	th:MM16X1R L:325
2	LB-326	Ball Joint Lower	B455-34-550	c:16	5	AX-395	Axial Joint	B456-32-24X	th:MM16X1R L:324
3	SI-311	Stabiliser Link	EA03-34-170A	L:55	6	SI-317	Stabiliser Link	EA01 28 170	L:80

MX-5 I (NA)

09/1989 - 09/1998



2 TI-300



1 RD-331



1 RD-331



2 TI-300



3 BJ-320

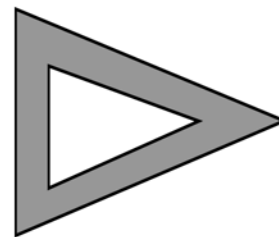
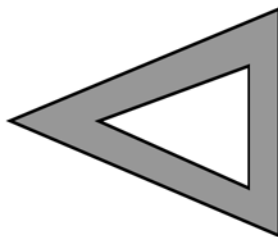

3 BJ-320

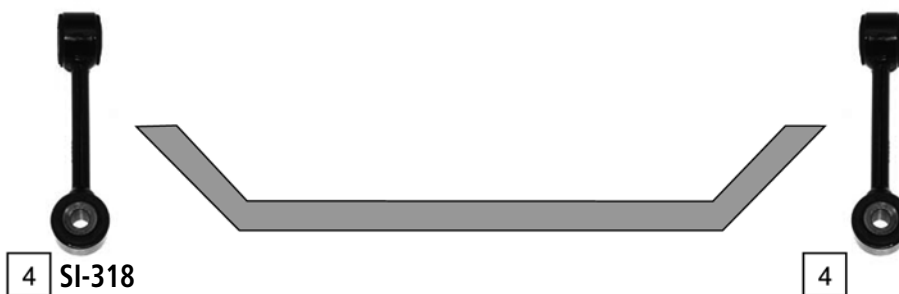

Ref	JAPANPARTS CODE	Description	OEM	Measures	Ref	JAPANPARTS CODE	Description	OEM	Measures
1	RD-331	Axial Joint	NA01-32-240	th:MM18X1.5R L:301	3	BJ-320	Ball Joint	NA01 34 550	c:15.9
2	TI-300	Tie Rod End	8AN1-32-280	c:13.2 th:FM12X1.25	4	SI-318	Stabiliser Link	NA01 34 170	L:107

MX-5 II (NB)

05/1998 - 02/2005



UPPER



LOWER



Ref	JAPANPARTS CODE	Description	OEM	Measures	Ref	JAPANPARTS CODE	Description	OEM	Measures
1	SI-320	Stabiliser Link Left	NC10-34-170	L:104	6	BS-325	TCA Right	N066 34 310	
2	SI-319	Stabiliser Link Right	NC10-34-150	L:104	7	BJ-320	Ball Joint	NA01 34 550	c:15.9
3	BS-322	TCA Left	N068-34-250		8	RD-332	Axial Joint	NC10-32-250A	th:MM16X1.5R L:303
4	BS-323	TCA Right	N068-34-200		9	RD-333	Axial Joint	NC10-32-240A	th:MM16X1R L:303
5	BS-324	TCA Left	N066 34 360		10	TI-300	Tie Rod End	8AN1-32-280	c:13.2 th:FM12X1.25

MX-6 (GE6)

07/1991 - 06/1998



2 TI-339



1 RD-322



1 RD-322



2 TI-339

Ref	JAPANPARTS CODE	Description	OEM	Measures	Ref	JAPANPARTS CODE	Description	OEM	Measures
1	RD-322	Axial Joint	GAZA-32-250	th:MM18X1R L:300	2	TI-339	Tie Rod End	8AG3-32-280	c:12.9 th:FM14X1.5R

PREMACY (CP)

07/1999 ->

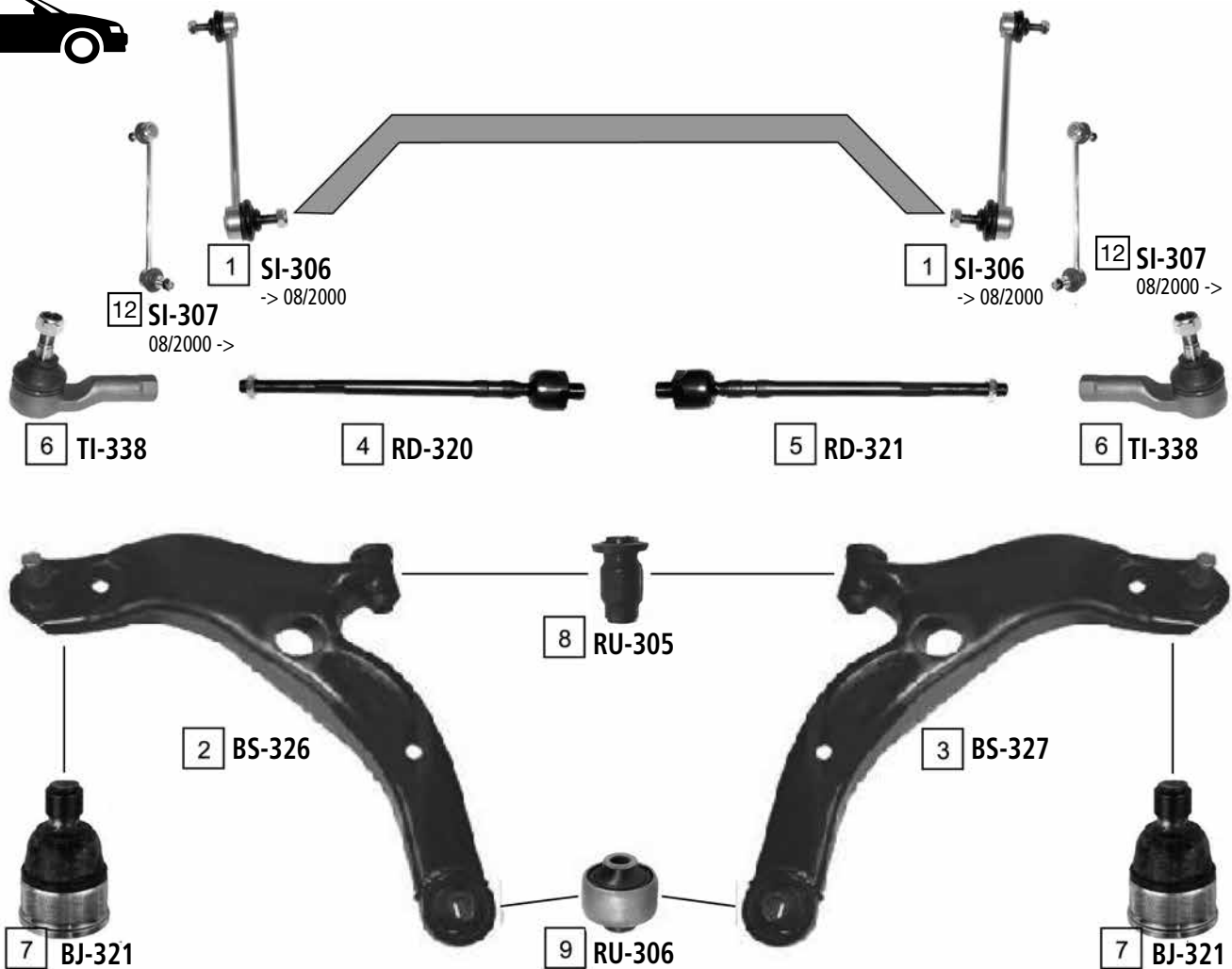

Ref	JAPANPARTS CODE	Description	OEM	Measures	Ref	JAPANPARTS CODE	Description	OEM	Measures
1	SI-306	Stabiliser Link	B26 R 34 170	L:190	7	BJ-321	Ball Joint	LC62-34-550	
2	BS-326	TCA	C 100 34 350 A	c:18	8	RU-305	Silentblock For Susp.Arm	B25D 34 470	
3	BS-327	TCA	C 100 34 300 A	c:18	9	RU-306	Silentblock For Susp.Arm	B25D 34 460	
4	RD-320	Axial Joint	B25D 32 240	th:MM16X1R L:310	10	SI-309	Stabiliser Link	B26R-28-170	L:190
5	RD-321	Axial Joint	B25D 32 250	th:MM16X1R L:310	11	SI-308	Stabiliser Link	B30H 28 170 B	L:160
6	TI-338	Tie Rod End	8AG4 32 280	c:12.9 th:FM14X1.5R	12	SI-307	Stabiliser Link	LC62-34-170 A	L:266



RX 7 II (FC) RX 7 III (FD)

11/1985 - 06/1996



**2** TI-334  
FD



**2** TI-334  
FD



**3** RD-304  
FC



**3** RD-304  
FC



**1** LB-307  
FC

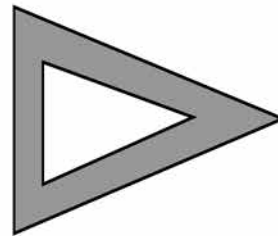
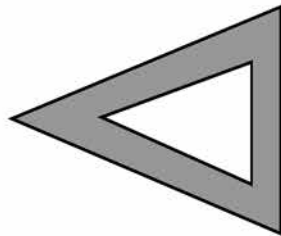

**1** LB-307  
FC

Ref	JAPANPARTS CODE	Description	OEM	Measures	Ref	JAPANPARTS CODE	Description	OEM	Measures
1	LB-307	Ball Joint Lower	8531-99-356	c:14.5	3	RD-304	Axial Joint	S083-32-115	th:MM17X1R L:183
2	TI-334	Tie Rod End	8AB2-32-280	c:13.3 th:FM12X1.25					

XEDOS 6 (CA)

07/1991 - 10/1999

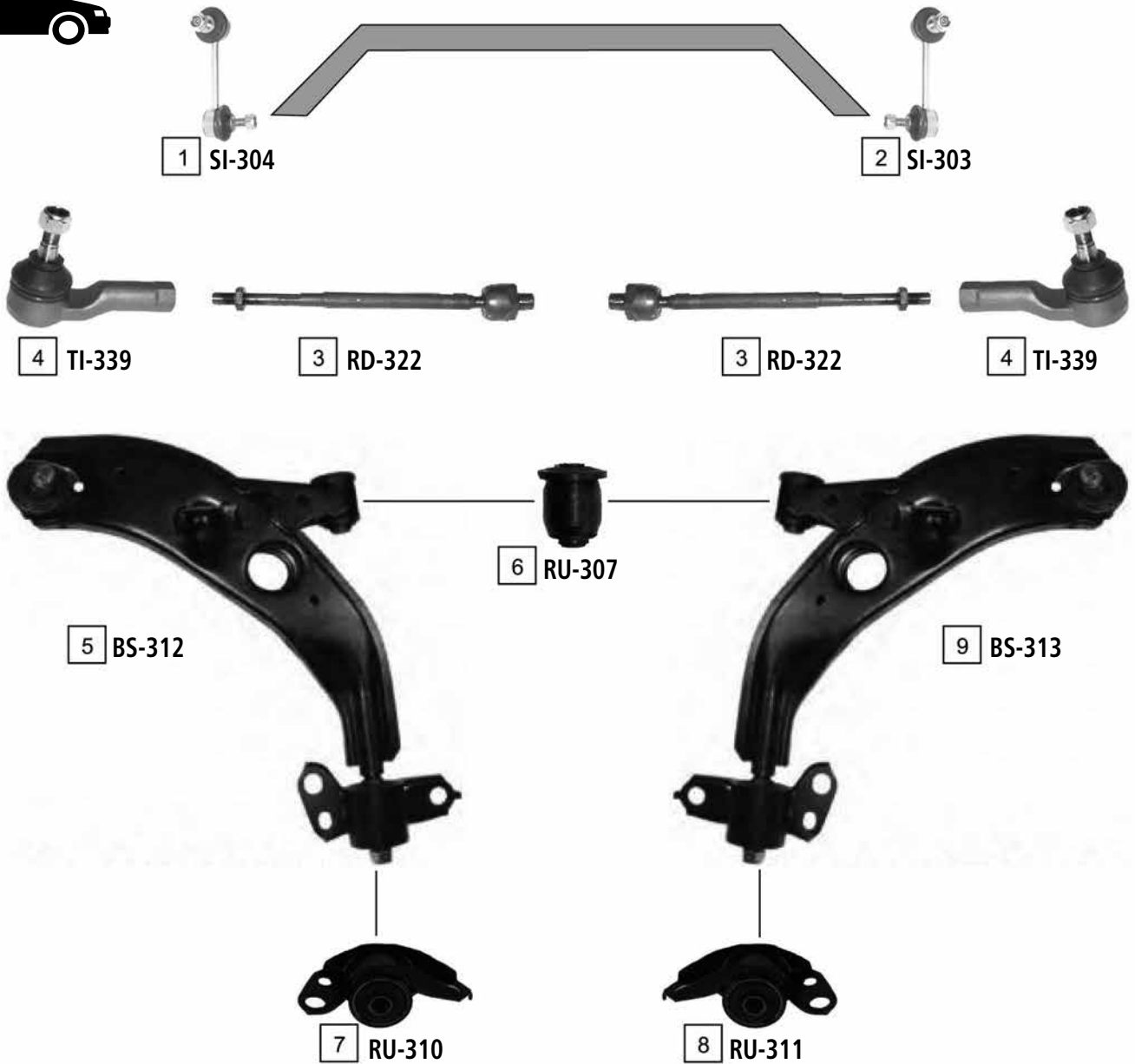

10 SI-K51

10 SI-K51

Ref	JAPANPARTS CODE	Description	OEM	Measures	Ref	JAPANPARTS CODE	Description	OEM	Measures
1	SI-304	Stabiliser Link Left	GA2A 34 170A	L:105	6	RU-307	Silentblock For Susp.Arm	GA2A 34 470	d:38.5
2	SI-303	Stabiliser Link Right	GA2A 34 150A	L:105	7	RU-310	Silentblock For Susp.Arm	GE4T 34 46YD	d:18.5
3	RD-322	Axial Joint	GA2A-32-250	th:MM18X1R L:300	8	RU-311	Silentblock For Susp.Arm	GE4T 34 46XD	d:18.5
4	TI-339	Tie Rod End	8AG3-32-280	c:12.9 th:FM14X1.5R	9	BS-313	TCA	GE4T-34-300E	c:18
5	BS-312	TCA	GE4T-34-350E	c:18	10	SI-K51	Stabiliser Link	GA2C-28-170B	

ASX (GA\_W\_)

05/2010 ->

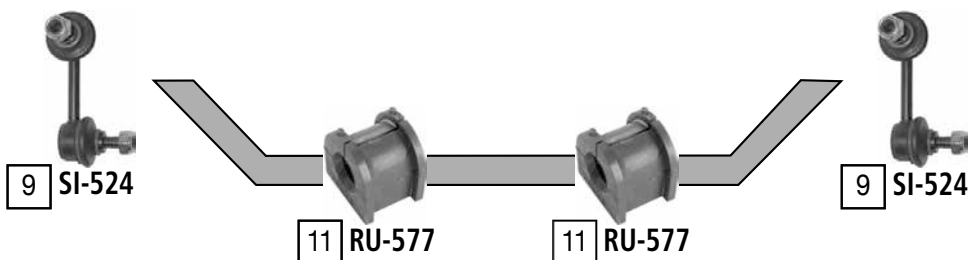
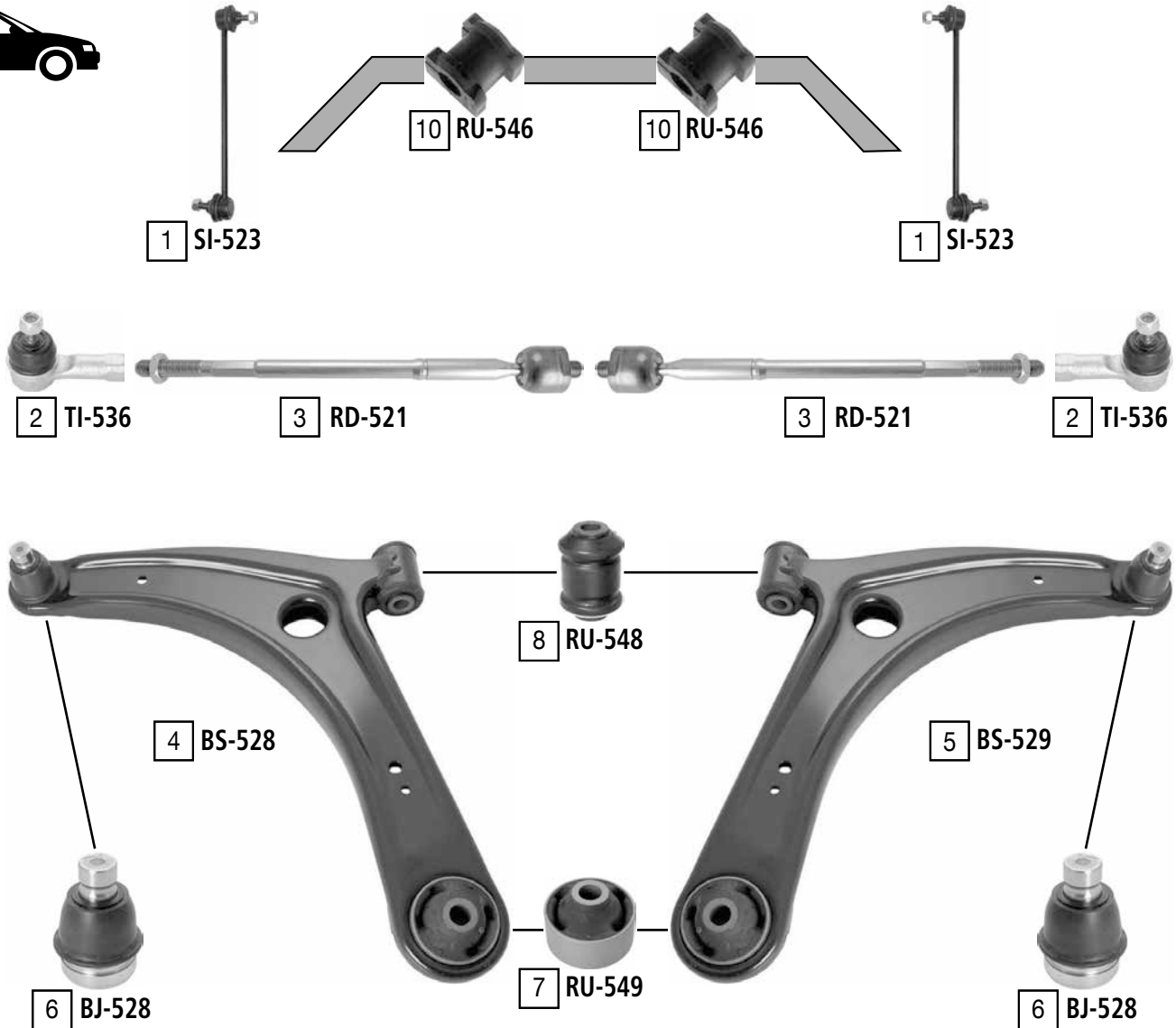

Ref	JAPANPARTS CODE	Description	OEM	Measures	Ref	JAPANPARTS CODE	Description	OEM	Measures
1	SI-523	Stabiliser link	MN101368	L:265	7	RU-549	Silentblock for TCA	MN184133	di:14.2 do:60
2	TI-536	Tie rod end	4422A052	c:13.3 th:FM14X1.5R	8	RU-548	Silentblock for TCA	Part of	di:14.2 do:37
3	RD-5211	Axial joint	4422A076	th:MM14X1.5R L:339	9	SI-524	Stabiliser link rear axle	MN184194	L:80
4	BS-528	TCA left wbj	4013A281	c:20	10	RU-546	Stabiliser mounting	4056A079	di:22
5	BS-529	TCA right wbj	4013A282	c:20	11	RU-577	Stabiliser mounting	MN101395	di:17.5
6	BJ-528	Ball joint	Part of	c:20 do:40.1					

CANTER (35FB,35FE,60FE,63FE)

01/1986 - 04/2002



2 TI-507L



1 TI-507R



1 TI-507R



2 TI-507L

Ref	JAPANPARTS CODE	Description	OEM	Measures	Ref	JAPANPARTS CODE	Description	OEM	Measures
1	TI-507R	Tie Rod End	MW033301	c:16.2 th:MM20X1.5R	2	TI-507L	Tie Rod End	MW033300	c:16.2 th:MM20x1.5L

CARISMA (DA\_)

05/1995 - 02/1999

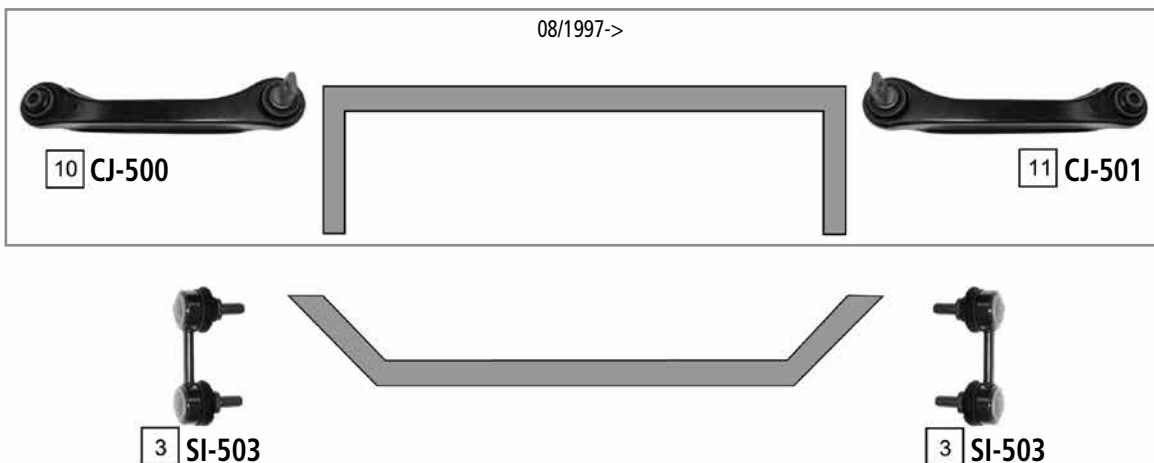
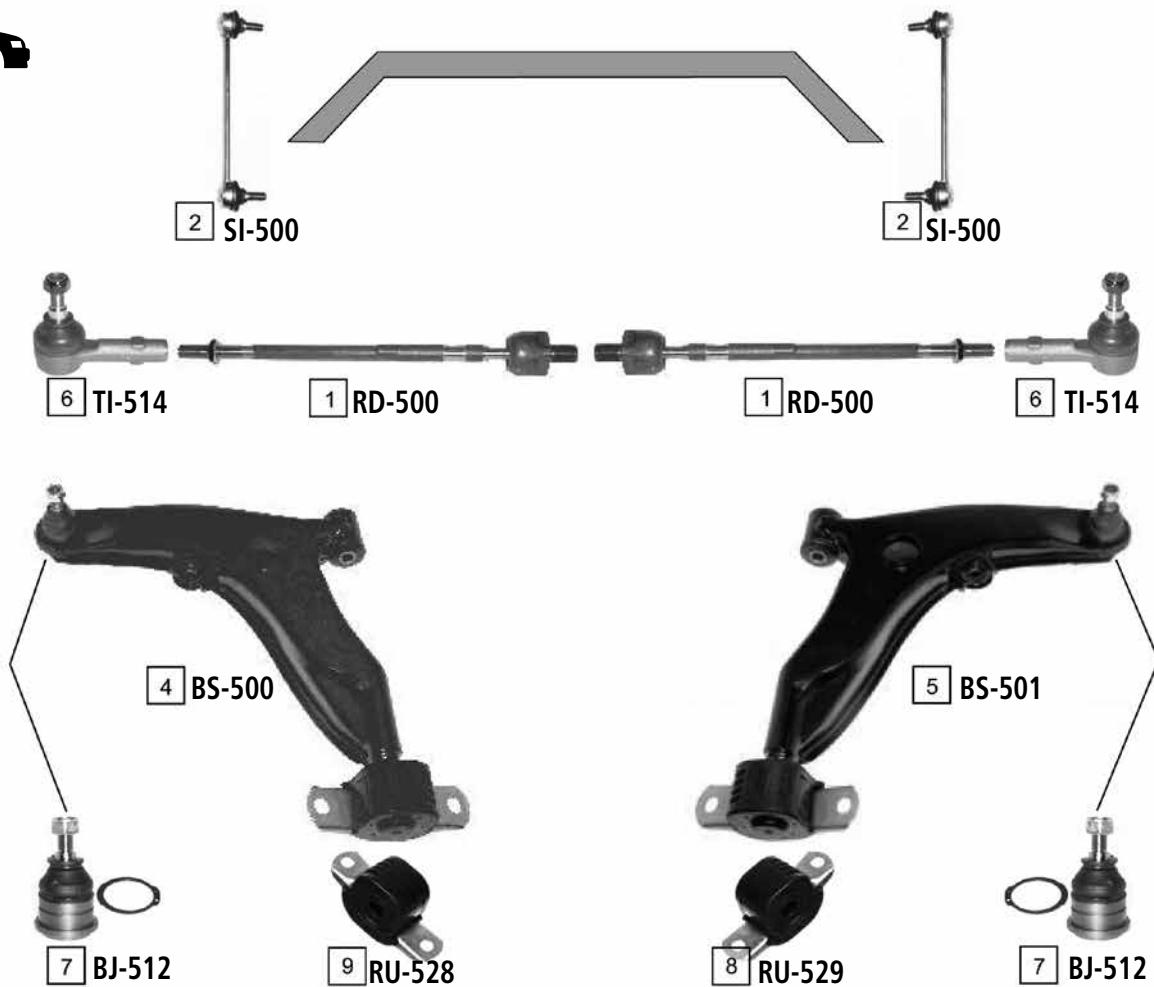

Ref	JAPANPARTS CODE	Description	OEM	Measures	Ref	JAPANPARTS CODE	Description	OEM	Measures
1	RD-500	Axial Joint	MB244901	th:MM16X1.5R L:304	7	BJ-512	Ball Joint Lower	Part of BS-500/BS-501	c:15
2	SI-500	Stabiliser Link	MR272116		8	RU-529	Silentblock For Susp.Arm	MB808910	
3	SI-503	Stabiliser Link	MR272117	L:75.5	9	RU-528	Silentblock For Susp.Arm	MB808909	
4	BS-500	TCA Left	MR 179479	c:15	10	CJ-500	TCA Left	MR130479	
5	BS-501	TCA Left	MR179480	c:15	11	CJ-501	TCA Right	MR130480	
6	TI-514	Tie Rod End	MB 527169	c:13.3 th:FM12X1.25					

CARISMA (DA\_)

03/1999 - 06/2006

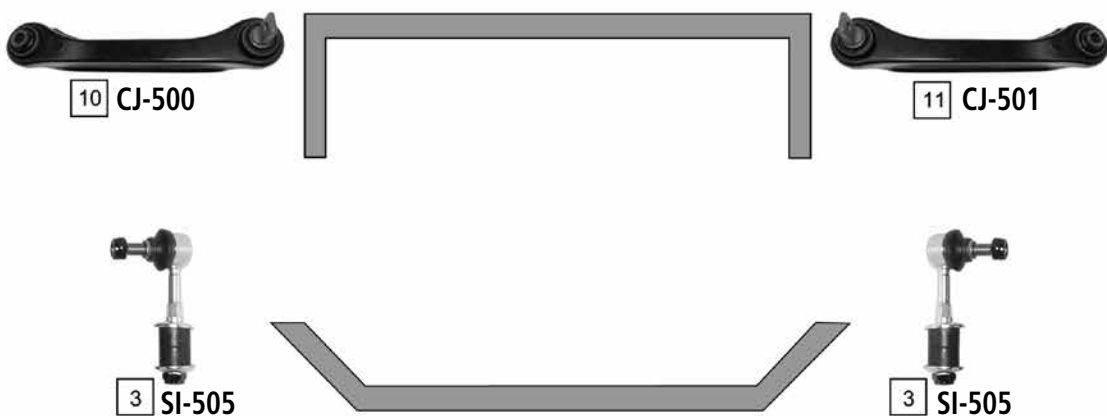
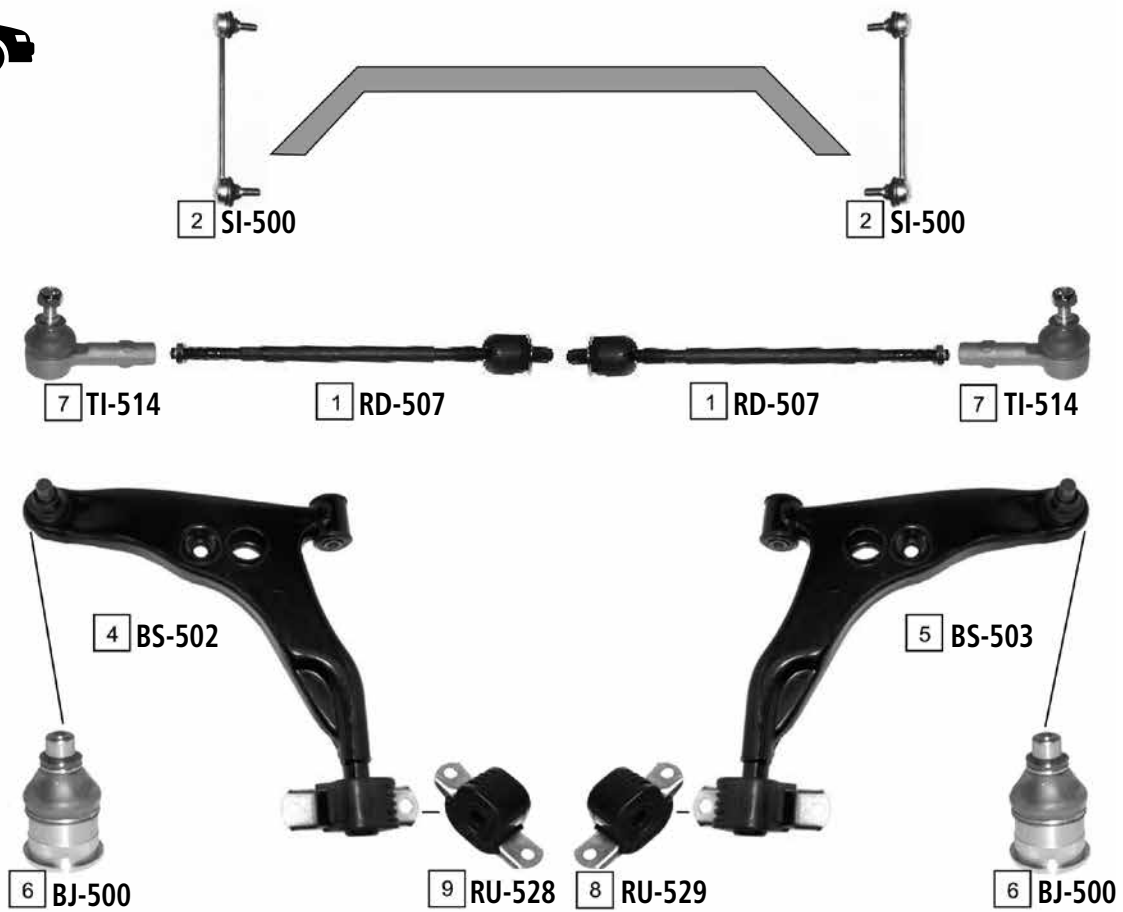

Ref	JAPANPARTS CODE	Description	OEM	Measures	Ref	JAPANPARTS CODE	Description	OEM	Measures
1	RD-507	Axial Joint	MR403027	th:MM16X1.5R L:316	7	TI-514	Tie Rod End	MR 485672	c:13.3 th:FM12X1.25
2	SI-500	Stabiliser Link	MR272116		8	RU-529	Silentblock For Susp.Arm	MB808910	
3	SI-505	Stabiliser Link	MR-272118		9	RU-528	Silentblock For Susp.Arm	MB808909	
4	BS-502	TCA	MR911570	c:18	10	CJ-500	TCA Left	MR130479	
5	BS-503	TCA	MR911569	c:18	11	CJ-501	TCA Right	MR130480	
6	BJ-500	Ball Joint	Part of BS-502/BS-503	c:18					

COLT I (A15\_A)

01/1997 - 01/1984

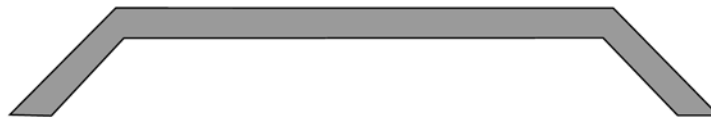

1 TI-H53



2 RD-501



2 RD-501



1 TI-H53



4 LB-506L

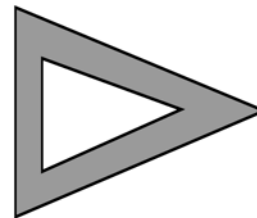
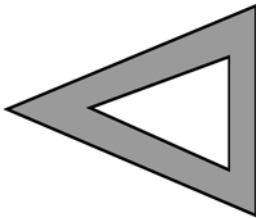

3 LB-506R

Ref	JAPANPARTS CODE	Description	OEM	Measures	Ref	JAPANPARTS CODE	Description	OEM	Measures
1	TI-H53	Tie Rod End	56820-21000	c:13.45 th:FM14X1.5	3	LB-506R	Ball Joint Lower Right	MB109169	c:13.5
2	RD-501	Axial Joint	MB122135	th:FM18X1.5R L:297	4	LB-506L	Ball Joint Lower Left	MB109168	c:13.5

COLT II (C1 A)

05/1984 - 04/1988

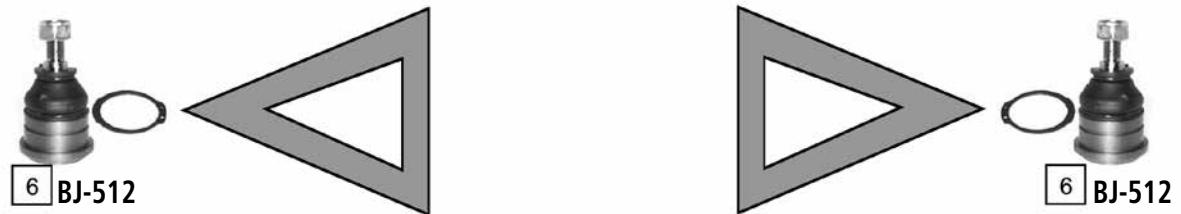
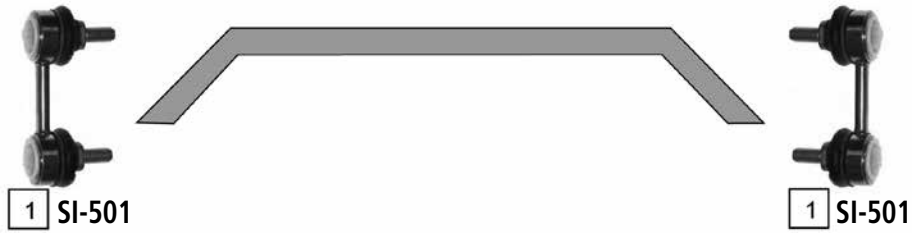

Ref	JAPANPARTS CODE	Description	OEM	Measures	Ref	JAPANPARTS CODE	Description	OEM	Measures
1	SI-501	Stabiliser Link	4056 A014	L:60	4	RD-504	Axial Joint	MB350718	
2	TI-511	Tie Rod End	MB241982	c:13.3 th:FM12X1.25	5	TI-514	Tie Rod End	MB 527169	c:13.4 th:FM12X1.25
3	RD-502	Axial Joint	MB347666	th:MM12X1.25R L:278	6	BJ-512	Ball Joint Lower		c:15



COLT III (C5\_A)

04/1998 - 04/1992

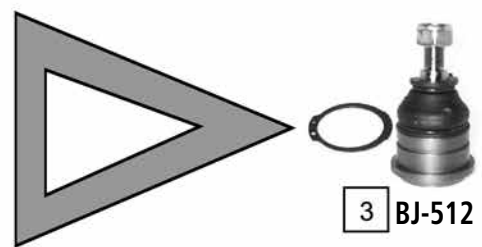
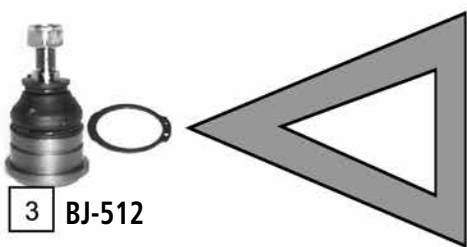
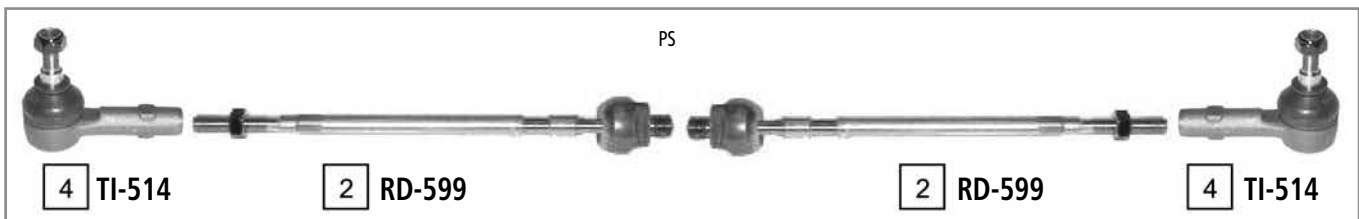
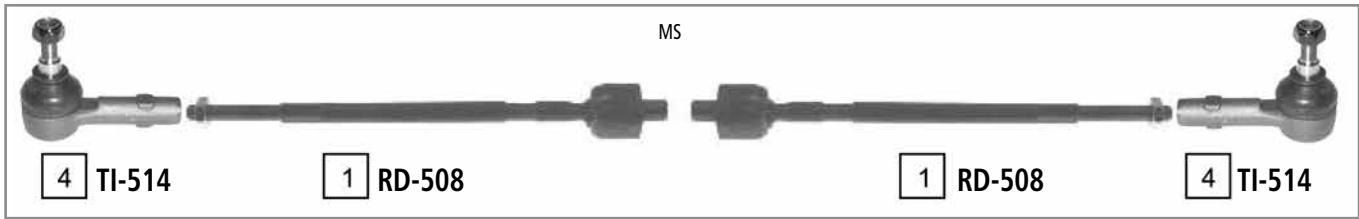
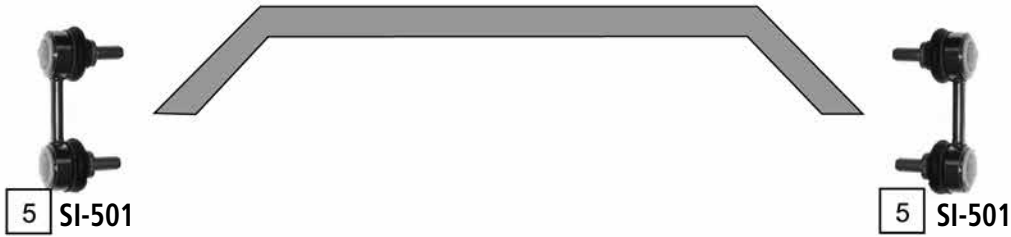

Ref	JAPANPARTS CODE	Description	OEM	Measures	Ref	JAPANPARTS CODE	Description	OEM	Measures
1	RD-508	Axial Joint	MB553249	th:MM16X1.5R L:298	4	TI-514	Tie Rod End	MB 527169	c:13.4 th:FM12X1.25
2	RD-599	Axial Joint	MB 910934	th:MM16X1.5R L:309	5	SI-501	Stabiliser Link	4056 A014	L:60
3	BJ-512	Ball Joint Lower		c:15					

COLT IV (CA\_A)

04/1992 - 08/1995

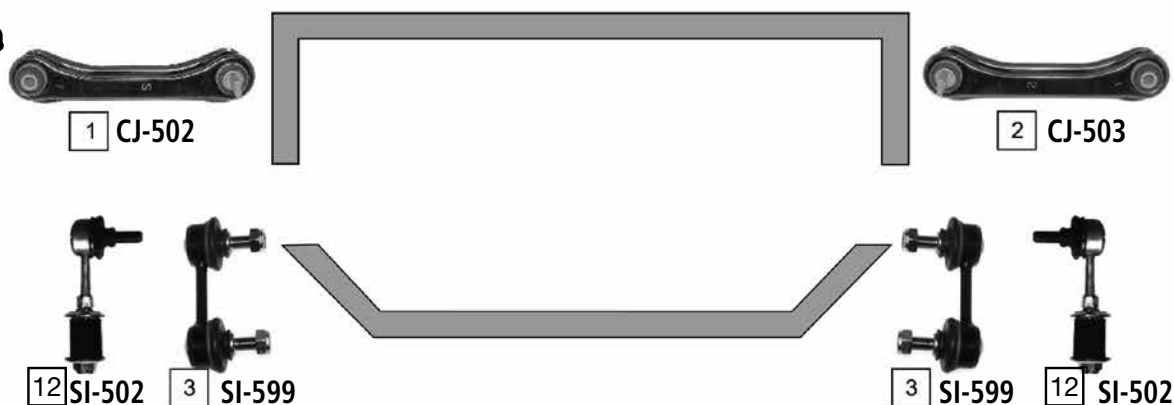
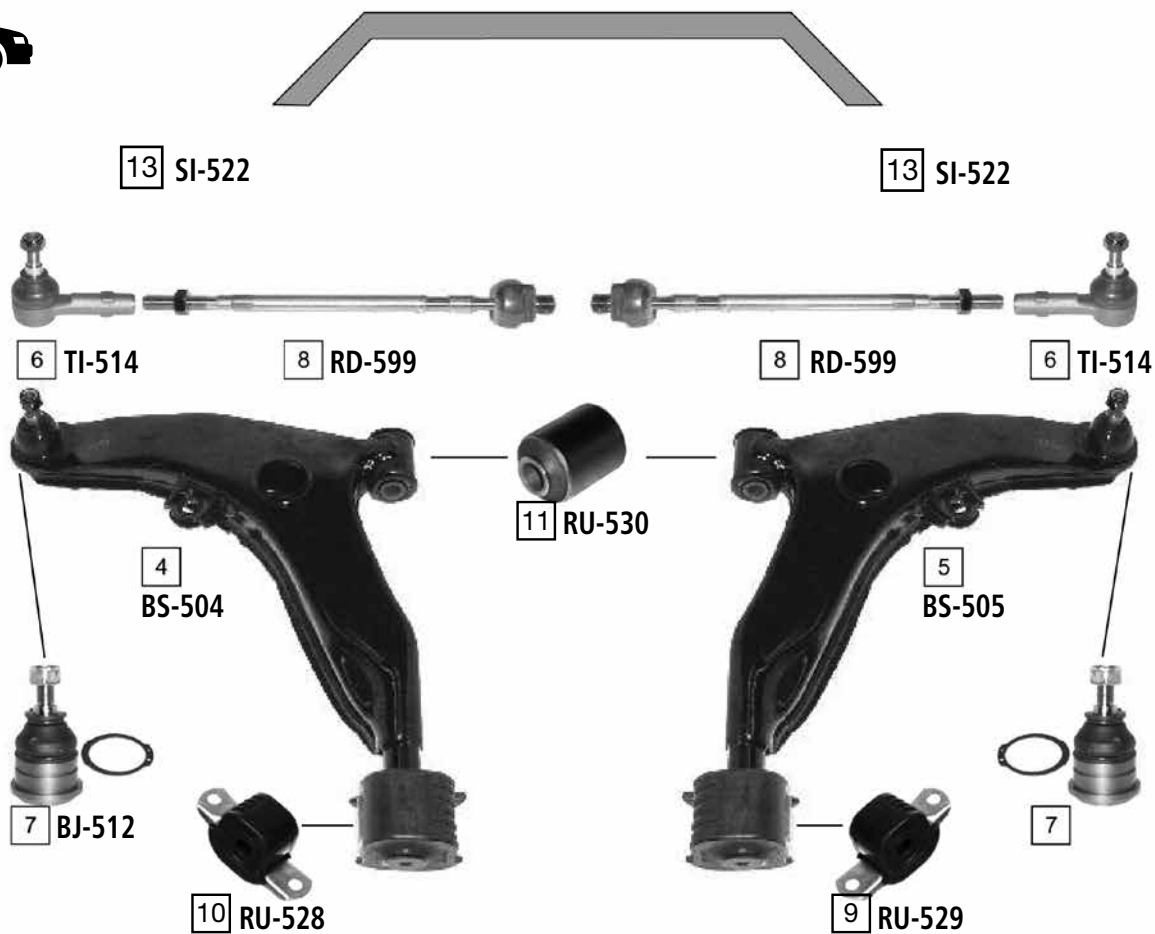

Ref	JAPANPARTS CODE	Description	OEM	Measures	Ref	JAPANPARTS CODE	Description	OEM	Measures
1	CJ-502	TCA Left	MB809220	c:15	8	RD-599	Axial Joint	MB 910934	th:MM16X1.5R L:309
2	CJ-503	TCA Right	MB809221	c:15	9	RU-529	Silentblock For Susp.Arm	MB808910	
3	SI-599	Stabiliser Link	MB 809354	L:75	10	RU-528	Silentblock For Susp.Arm	MB808909	
4	BS-504	TCA Left	MB912077	c:15	11	RU-530	Silentblock For Susp.Arm	Part of BS-504/BS-505	
5	BS-505	TCA Right	MB912078	c:15	12	SI-502	Stabiliser Link	MB809355	L:105
6	TI-514	Tie Rod End	MB 527169	c:13.4 th:FM12X1.25	13	SI-522	Stabiliser Link	MB241974	
7	BJ-512	Ball Joint Lower	Part of BS-504/BS-505	c:15					

COLT V (CJ\_A)

09/1995 - 07/2005

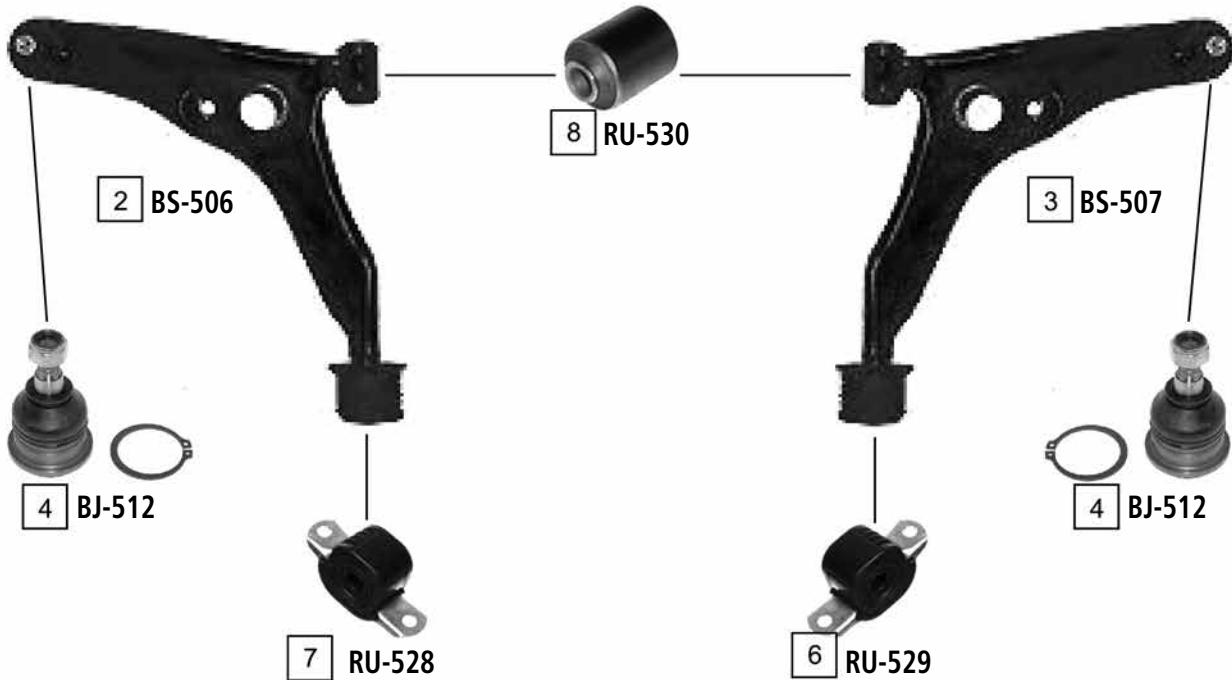

Ref	JAPANPARTS CODE	Description	OEM	Measures	Ref	JAPANPARTS CODE	Description	OEM	Measures
1	RD-599	Axial Joint	MR297969	th:MM16X1.5R L:309	5	TI-514	Tie Rod End	MR 485672	c:13.3 th:FM12X1.25
2	BS-506	TCA Left Wbj	MR439701		6	RU-529	Silentblock For Susp.Arm	MB808910	
3	BS-507	TCA Right Wbj	MR439702		7	RU-528	Silentblock For Susp.Arm	MB808909	
4	BJ-512	Ball Joint	MB-241883	c:15	8	RU-530	Silentblock For Susp.Arm	Part of BS-506/BS-507	

COLT VI (Z30)

04/2004 ->

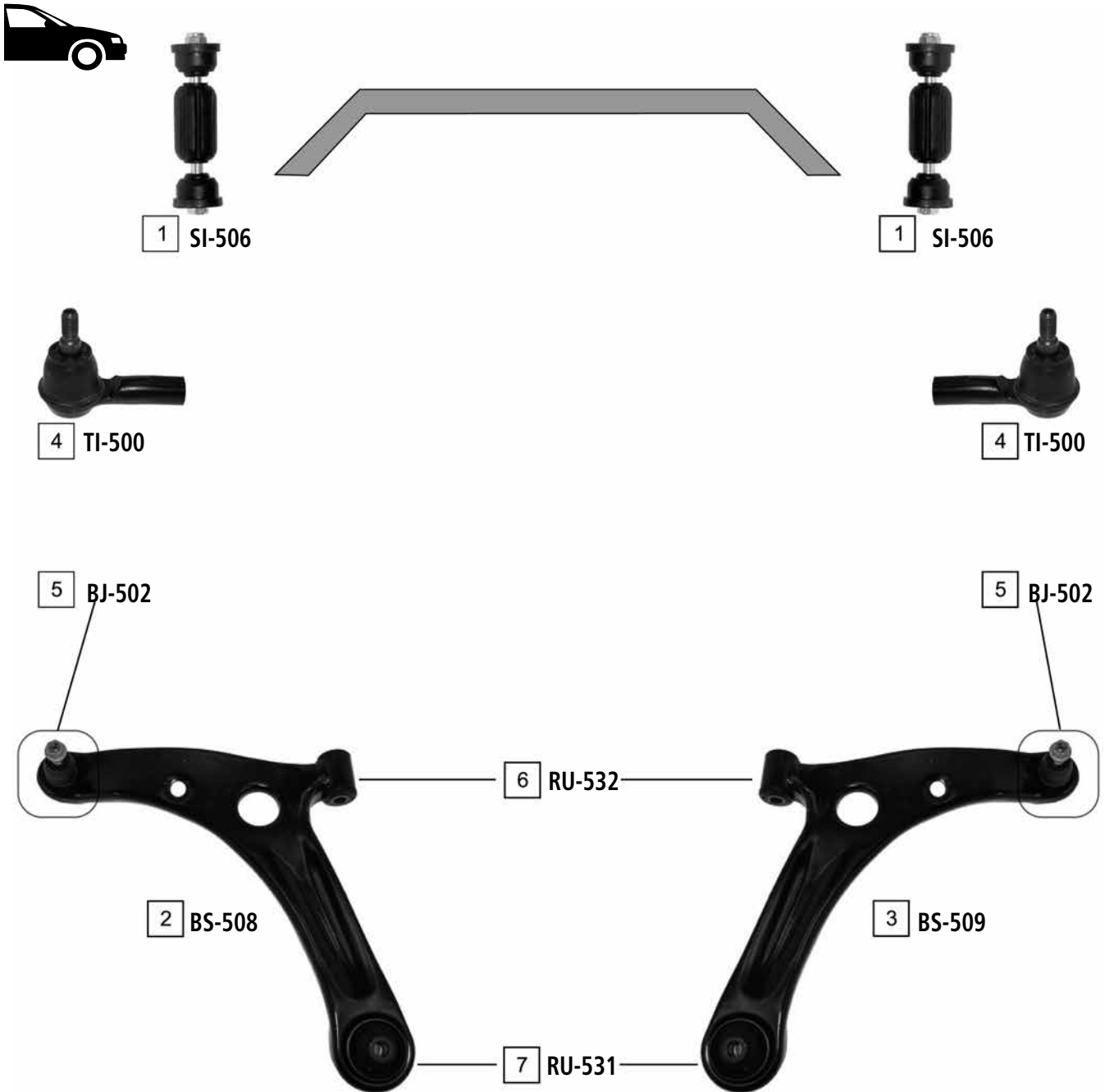

Ref	JAPANPARTS CODE	Description	OEM	Measures	Ref	JAPANPARTS CODE	Description	OEM	Measures
1	SI-506	Stabiliser Link	4056 A052		5	BJ-502	Ball Joint	Part of BS-508/BS-509	
2	BS-508	TCA Left Wbj	MN 186217		6	RU-532	Silentblock For Susp.Arm	Part of BS-508/BS-509	
3	BS-509	TCA Right Wbj	MN 186218		7	RU-531	Silentblock For Susp.Arm	Part of BS-508/BS-509	
4	TI-500	Tie Rod End	MR 977606						

# MITSUBISHI GALANT - SAPPORO

GALANT II (A16\_)  
SAPPORO II (A16\_A)

06/1980 - 06/1984



1.6



1 TI-501



2 TI-505



5 TI-504



1 TI-501

2.0-2.0 TURBO



1 TI-501



2 TI-505



4 TI-508



1 TI-501



3 LB-505

1.6

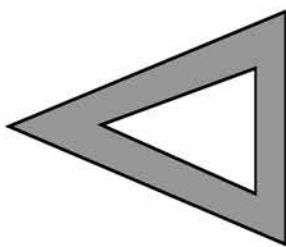

LOWER

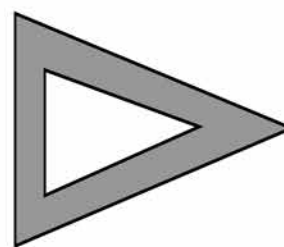

3 LB-505

1.6

Ref	JAPANPARTS CODE	Description	OEM	Measures	Ref	JAPANPARTS CODE	Description	OEM	Measures
1	TI-501	Tie Rod End	MA159984	c:12.5 th:MM14X1.5L	4	TI-508	Tie Rod End Inner Right	MB109858	c:12.5 th:FM14X1.5L
2	TI-505	Tie Rod End Inner Left	MB076003	c:12.1 th:MM14X1.5R	5	TI-504	Tie Rod End Inner Right	MB076004	c:12.2 th:FM14X1.5L
3	LB-505	Ball Joint Lower	MB 001696	c:15					

GALANT III (E1 A)  
 SAPPORO III (E16A)

06/1984 - 12/1987  
 06/1987 - 08/1990



1 TI-516



2 RD-505  
PS



2 RD-505  
PS



1 TI-516

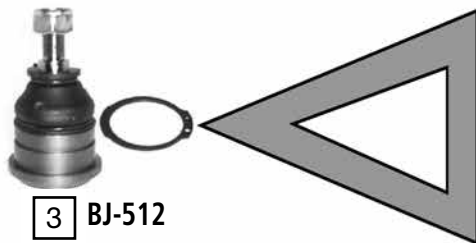

3 BJ-512

LOWER

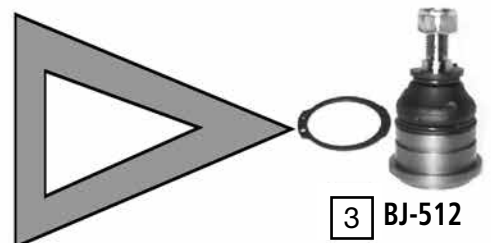

3 BJ-512

Ref	JAPANPARTS CODE	Description	OEM	Measures	Ref	JAPANPARTS CODE	Description	OEM	Measures
1	TI-516	Tie Rod End	MB192430	c:13.45 th:FM14X1.5	3	BJ-512	Ball Joint Lower		c:15
2	RD-505	Axial Joint	MB 266152	th:MM16X1.5R L:296					

GALANT IV (E3\_A)

11/1987 - 10/1992

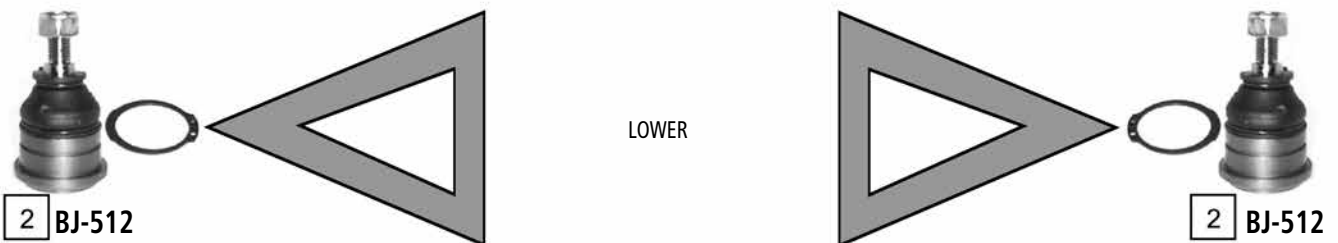

Ref	JAPANPARTS CODE	Description	OEM	Measures	Ref	JAPANPARTS CODE	Description	OEM	Measures
1	RD-509	Axial Joint	MB532281	th:MM16X1.R L:314	3	TI-516	Tie Rod End	MB192430	c:13.45 th:FM14X1.5
2	BJ-512	Ball Joint Lower		c:15					

GALANT V (E5\_A,E7\_A,E8\_A)  
 ECLIPSE I (D2\_A)

11/1992 - 08/1996  
 04/1991 - 12/1995

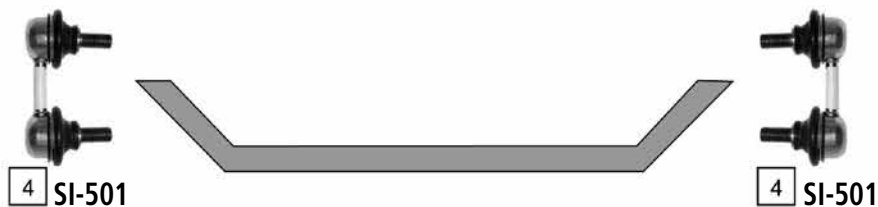
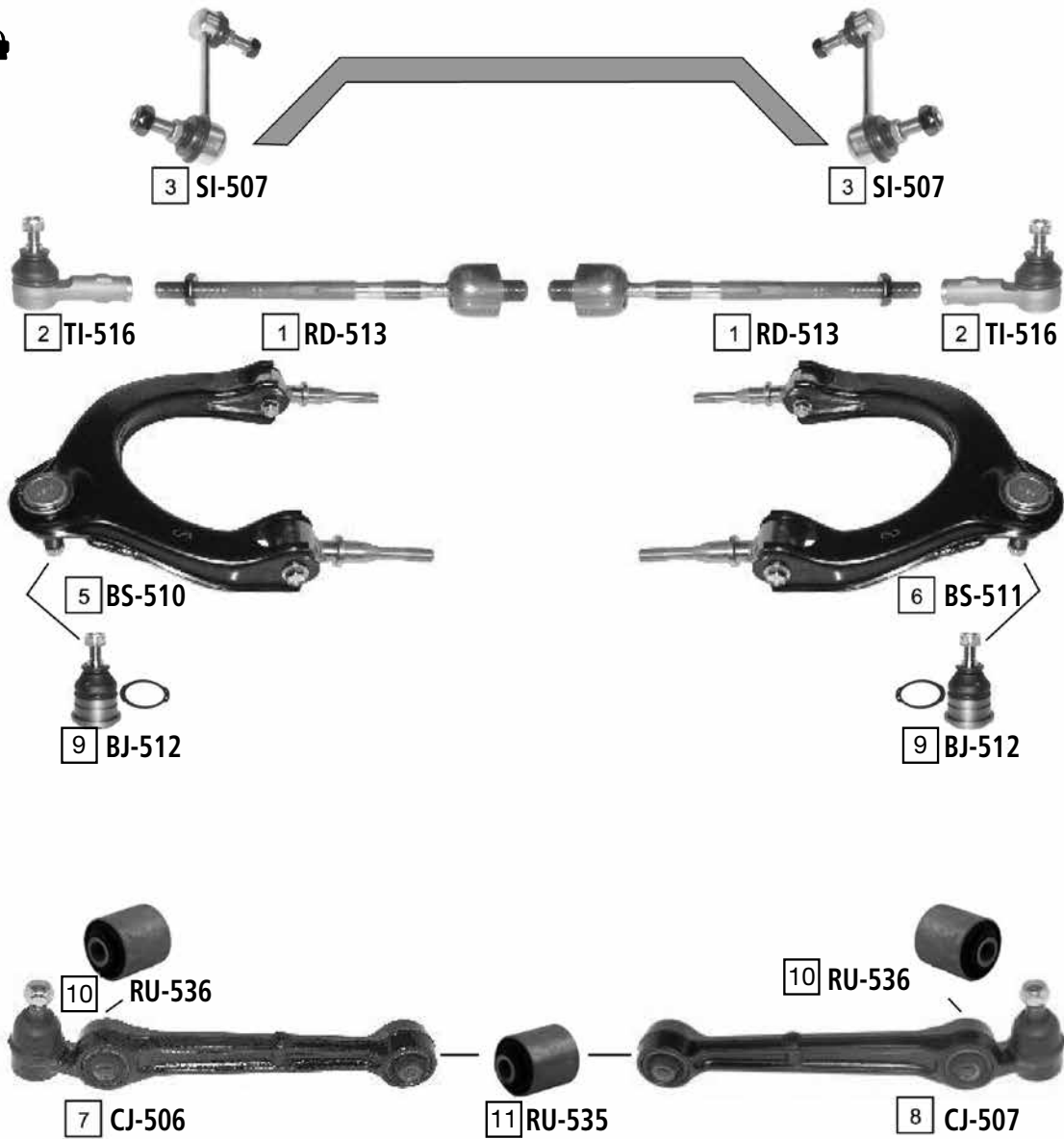

Ref	JAPANPARTS CODE	Description	OEM	Measures	Ref	JAPANPARTS CODE	Description	OEM	Measures
1	RD-513	Axial Joint	MB949343	th:MM16X1.5R L.235	7	CJ-506	TCA Left	MB912509	c:15.3
2	TI-516	Tie Rod End	MB192430	c:13.45 th:FM14X1.5	8	CJ-507	TCA Right	MB912510	c:16
3	SI-507	Stabiliser Link	MB892981	L:120	9	BJ-512	Ball Joint Lower	MB-518961	c:15
4	SI-501	Stabiliser Link	4056 A014	L:60	10	RU-536	Silentblock For Susp.Arm	Part of CJ-506 /CJ-507	d:40.2
5	BS-510	TCA Left Wbj	MB912505	c:12.5	11	RU-535	Silentblock For Susp.Arm	Part of CJ-506 /CJ-507	d:40.2
6	BS-511	TCA Right Wbj	MB912506	c:12.5					



GALANT VI (EA\_)

09/1996 - 10/2004

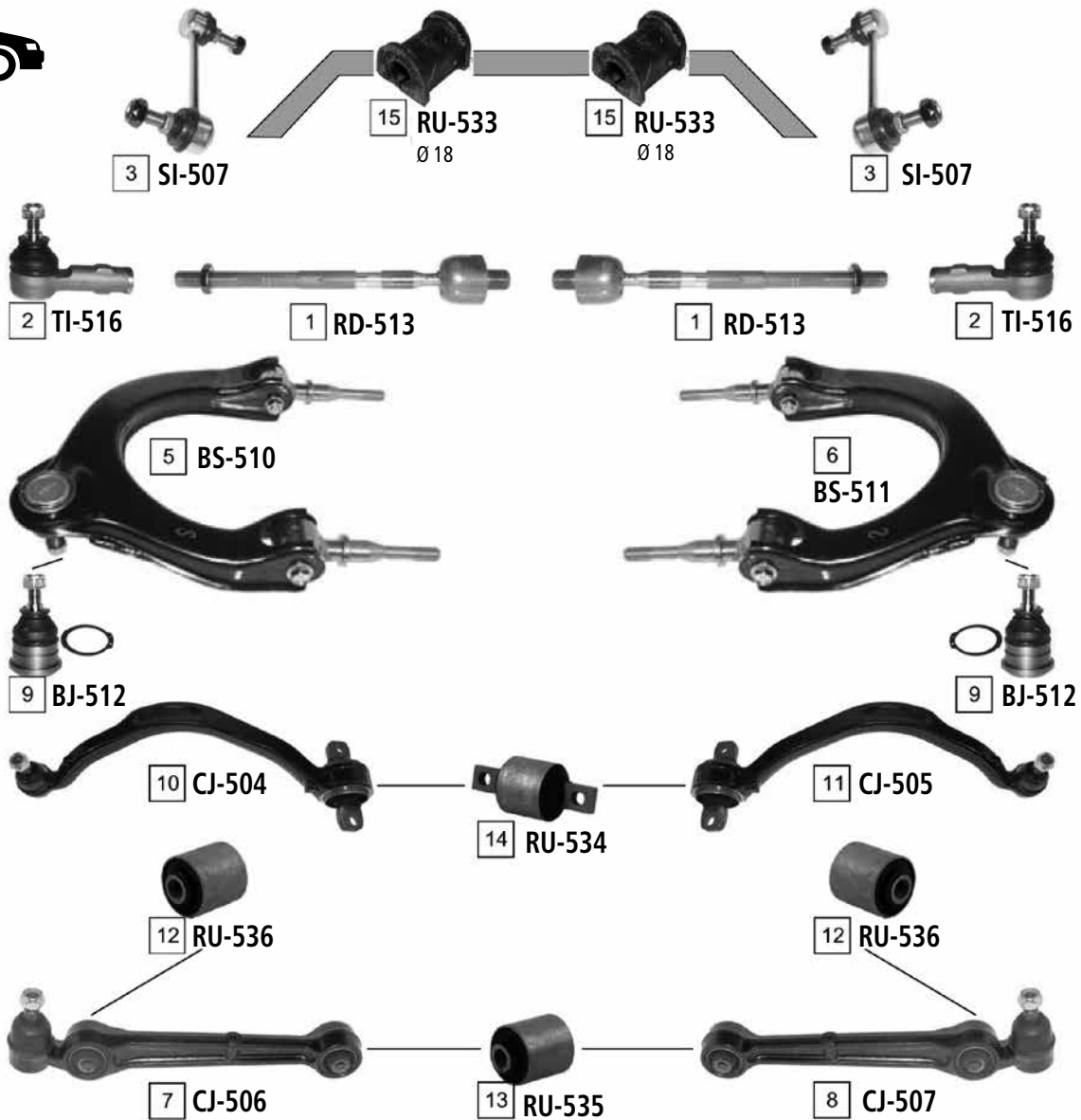

Ref	JAPANPARTS CODE	Description	OEM	Measures	Ref	JAPANPARTS CODE	Description	OEM	Measures
1	RD-513	Axial Joint	MB949343	th:MM16X1.5R L.235	9	BJ-512	Ball Joint Lower	Part of BS-510/BS-511	c:15
2	TI-516	Tie Rod End	MB192430	c:13.45 th:FM14X1.5	10	CJ-504	TCA Left	MR296293	c:15.3
3	SI-507	Stabiliser Link	MB892981	L.120	11	CJ-505	TCA Right	MR296292	c:15.3
4	SI-508	Stabiliser Link	MR131732	L.60	12	RU-536	Silentblock For Susp.Arm	Part of CJ-506/CJ-507	d:40.2
5	BS-510	TCA Left Wbj	MB912505	c:12.5	13	RU-535	Silentblock For Susp.Arm	Part of CJ-506/CJ-507	d:40.2
6	BS-511	TCA Right Wbj	MB912506	c:12.5	14	RU-534	Silentblock For Susp.Arm	Part of CJ-504/CJ-505	
7	CJ-506	TCA Left	MB912509	c:15.3	15	RU-533	Stabiliser Mounting	MR244116	d:18
8	CJ-507	TCA Right	MB912510	c:16					

L200 (L021P,L025P)

01/1979 - 12/1982



2 TI-501



3 TI-505



2 TI-501



4 PI-503  
->08/1980



5 ID-504



1 BJ-508  
08/1980 ->

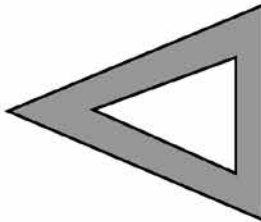

UPPER

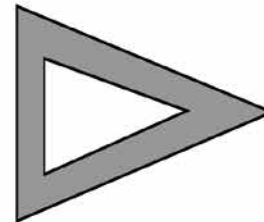

1 BJ-508  
08/1980 ->



6 LB-509  
08/1980 ->

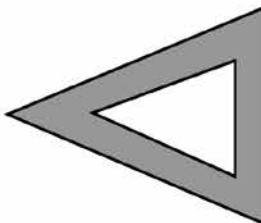

LOWER

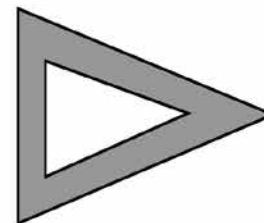

6 LB-509  
08/1980 ->

Ref	JAPANPARTS CODE	Description	OEM	Measures	Ref	JAPANPARTS CODE	Description	OEM	Measures
1	BJ-508	Ball Joint Upper	MB176309	c:15.9	4	PI-503	Pitman Arm	MB076009	
2	TI-501	Tie Rod End	MA159984	c:12.5 th:MM14X1.5L	5	ID-504	Pitman Arm	MB241420	
3	TI-505	Tie Rod End Inner Left	MB076003	c:12.1 th:14X1.5R	6	LB-509	Ball Joint	MB176283	c:19.4

L 200 2X4 (K\_T)

11/1986 - 08/1996

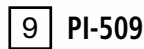
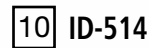

UPPER



LOWER



Ref	JAPANPARTS CODE	Description	OEM	Measures	Ref	JAPANPARTS CODE	Description	OEM	Measures
1	TI-501	Tie Rod End	MA159984	c: 12.5 th: MM14x1.5L	6	CJ-509	TCA Right	MB109513	
2	TI-505	Tie Rod End Inner Left	MB076003	c: 12.1 th: MM14x1.5R	7	LB-509	Ball Joint	MB176283	c:19.4
3	BS-512	TCA Left	MB527159	c: 16	8	BJ-520	Ball Joint	Part of BS-512/BS-513	c:16
4	BS-513	TCA Right	MB860408	c: 16	9	PI-509	Pitman Arm	MB241166	
5	CJ-508	TCA Left	MB109512		10	ID-514	Pitman Arm	MB527228	

L 200 2X4 (K62T/K64T)

06/1996 ->



1 TI-512



2 TI-517



1 TI-512

UPPER



7 BJ-504

10 PI-509



7 BJ-504



5 BS-514



6 BS-515

LOWER



3 CJ-510



9 RU-537



4 CJ-511



8 BJ-505



8 BJ-505

Ref	JAPANPARTS CODE	Description	OEM	Measures	Ref	JAPANPARTS CODE	Description	OEM	Measures
1	TI-512	Tie Rod End Outer	MR241032	c: 13.6 th:MM 16x1.5R	6	BS-515	TCA Right Wbj	MR241024	c:16
2	TI-517	Tie Rod End Inner	MR241031	c: 13.8 th:MM 16x1.5R	7	BJ-504	Ball Joint	Part of BS-514/BS-515	c:16
3	CJ-510	TCA Left Wbj	MR241025	c: 19.5	8	BJ-505	Ball Joint	MR241027	c:19.5
4	CJ-511	TCA Right Wbj	MR241026	c: 19.5	9	RU-537	Silentblock For Susp.Arm	MR234247	
5	BS-514	TCA Left Wbj	MR241023	c: 16	10	PI-509	Pitman Arm	MB241166	

L 200 4X4 (K\_T)

11/1986 - 08/1996

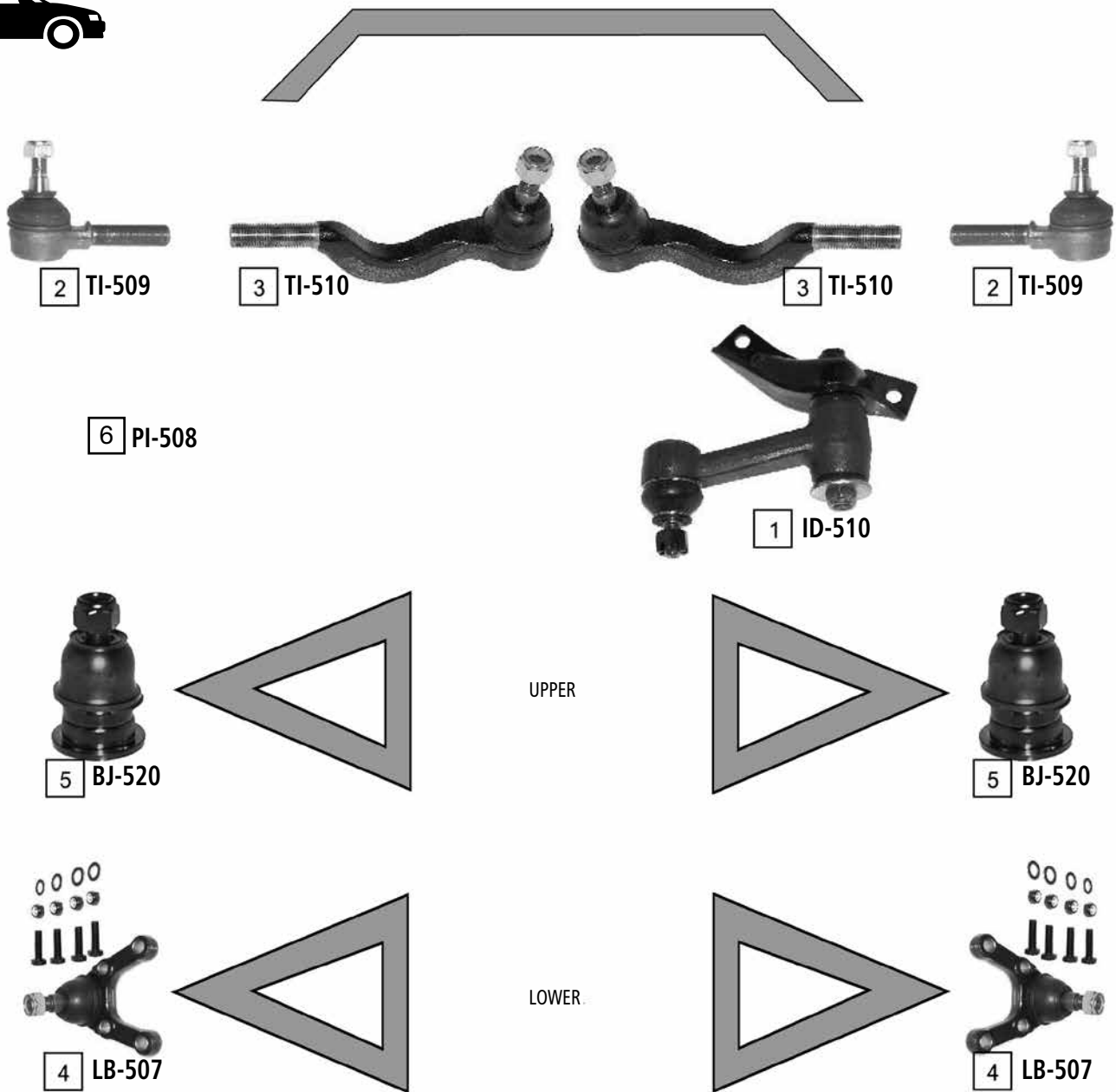

Ref	JAPANPARTS CODE	Description	OEM	Measures	Ref	JAPANPARTS CODE	Description	OEM	Measures
1	ID-510	Pitman Arm	MB241423		4	LB-507	Ball Joint	MB176308	c:19.4
2	TI-509	Tie Rod End	MB241171	c:13.6 th:MM16X1.5L	5	BJ-520	Ball Joint		c:16
3	TI-510	Tie Rod End	MB241206	c:13.8 th:M16X1.5R	6	PI-508	Pitman Arm	MB241168	

L 200 (K74T/K75T) 4X4

06/1996 ->



2 TI-599



1 TI-518



2 TI-599

8 ID-500



3 BJ-522

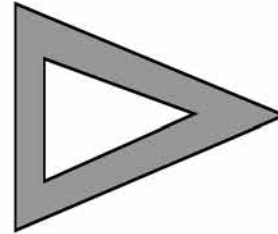
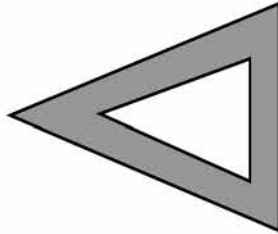

3 BJ-522



4 BJ-523L

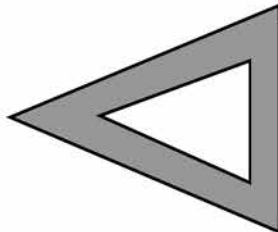

6 RU-506

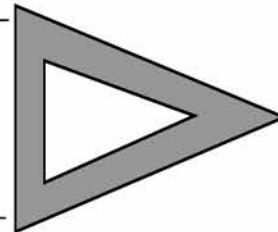

5 BJ-523R



7 RU-505

Ref	JAPANPARTS CODE	Description	OEM	Measures	Ref	JAPANPARTS CODE	Description	OEM	Measures
1	TI-518	Tie Rod End Inner	MR296274	c: 13.6 th MM 16x1.5R	5	BJ-523R	Ball Joint Lower Right	MB831038	c:19.3
2	TI-599	Tie Rod End	MB831043	c: 13.6 th M 16x1.5L	6	RU-506	Silentblock For Susp.Arm	MB109684	d:40
3	BJ-522	Ball Joint Upper	MB-860830	c:16.5	7	RU-505	Silentblock For Susp.Arm	MB109662	d:40.4
4	BJ-523L	Ball Joint Lower Left	MB831037	c:19.3	8	ID-500	Pitman Arm	MR296272	

L200 4X4 (KB4T)

12/2005 ->

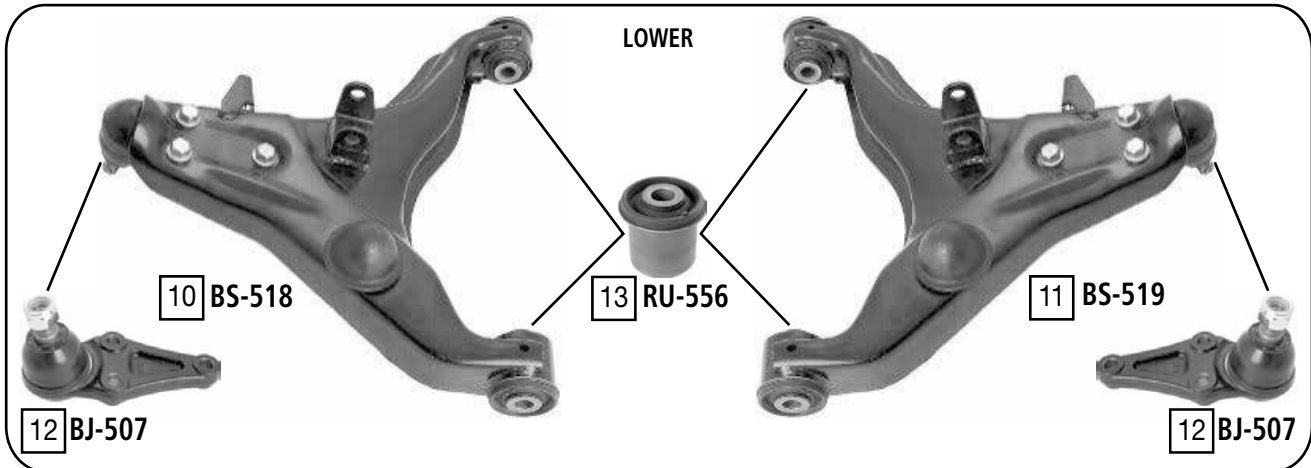
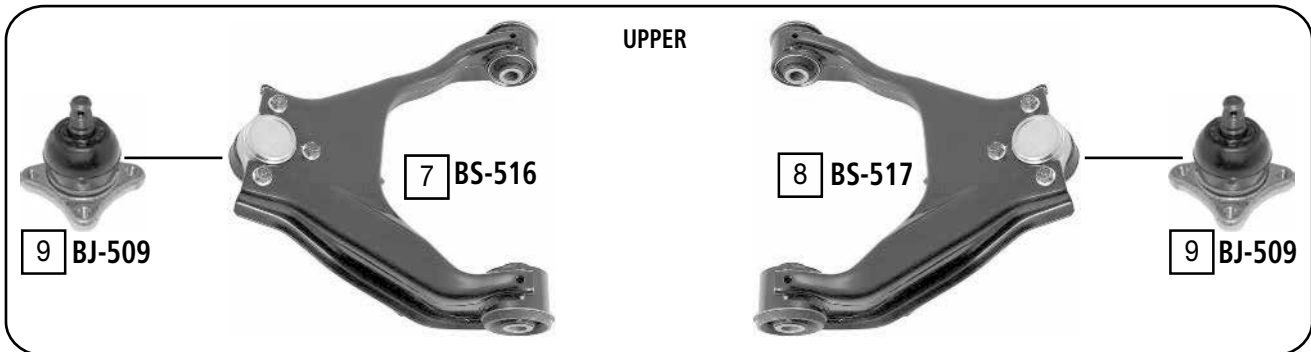
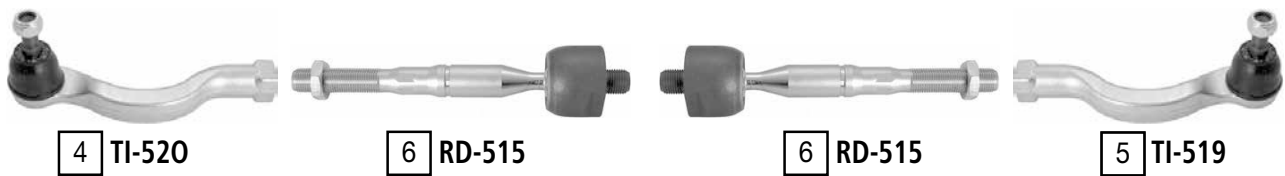
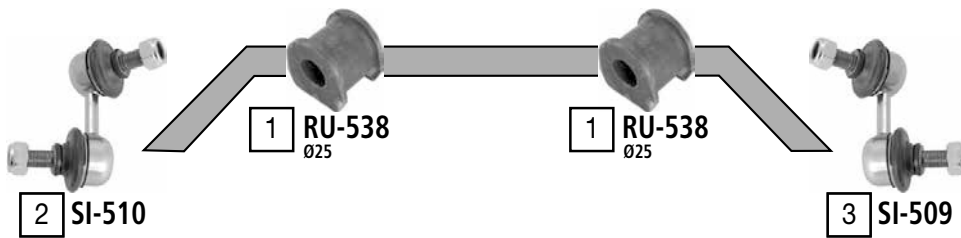

Ref	JAPANPARTS CODE	Description	OEM	Measures	Ref	JAPANPARTS CODE	Description	OEM	Measures
1	RU-538	Stabiliser mounting	MR992317	di:25	8	BS-517	TCA right	4010A014	c:15.9
2	SI-510	Stabiliser link left	MR992309	L:65	9	BJ-509	ball joint	4010 A015	c:15.9
3	SI-509	Stabiliser link right	MR992310	L:65	10	BS-518	TCA left	4013A087	c:19.4
4	TI-520	Tie rod end left	4422A009	c:13.6 th:FM16x1.5R	11	BS-519	TCA right	4013A088	c:19.4
5	TI-519	Tie rod end right	4422A010	c:13.5 th:FM16x1.5R	12	BJ-507	ball joint	4013A090	c:19.3
6	RD-515	Axial joint	4410A173	th:MM16x1.5R L:200	13	RU-556	silentblock for TCA	MR992256	di:16.4 do:50.1
7	BS-516	TCA left	4010A013	c:15.9					

L300 (L03\_L06\_)

06/1979 - 04/1994



**2** TI-H53  
ALL



**3** TI-522  
09/1982->



**3** TI-522  
09/1982->



**2** TI-H53  
ALL



**1** ID-513  
LHD 1986->

**8** ID-511  
->1986

**7**  
->09/1983

**7** BJ-503  
->09/1983



**4** BJ-508  
->10/1983

**10** PI-599  
->12/1983

UPPER

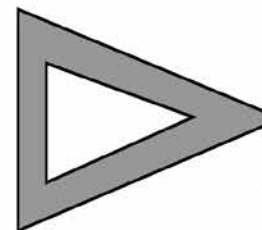

**9** PI-523  
->12/1983



**4** BJ-508  
->10/1983



**5** LB-509  
10/1983 ->

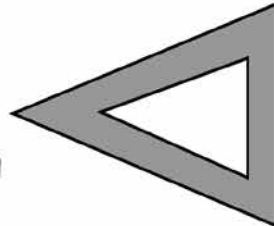

**6** LB-504  
-> 09/1983

LOWER

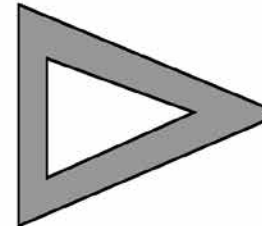

**6** LB-504  
-> 09/1983



**5** LB-509  
10/1983 ->

Ref	JAPANPARTS CODE	Description	OEM	Measures	Ref	JAPANPARTS CODE	Description	OEM	Measures
1	ID-513	Pitman Arm	MB315770		6	LB-504	Ball Joint	MB175544	
2	TI-H53	Tie Rod End	56820-21000	c:13.45 th:FM14X1.5	7	BJ-503	Ball Joint	MB112477	
3	TI-522	Tie Rod End	MB288119	c:13.8 th:FM14X1.5L	8	ID-511	Pitman Arm	MB166429	
4	BJ-508	Ball Joint Upper	MB176309	c:15.9	9	PI-523	Pitman Arm	MB166423	
5	LB-509	Ball Joint	MB176283	c:19.4	10	PI-599	Pitman Arm	MB166424	



L300 (PO\_)

11/1986 - 05/1999



MS



PS



UPPER



LOWER

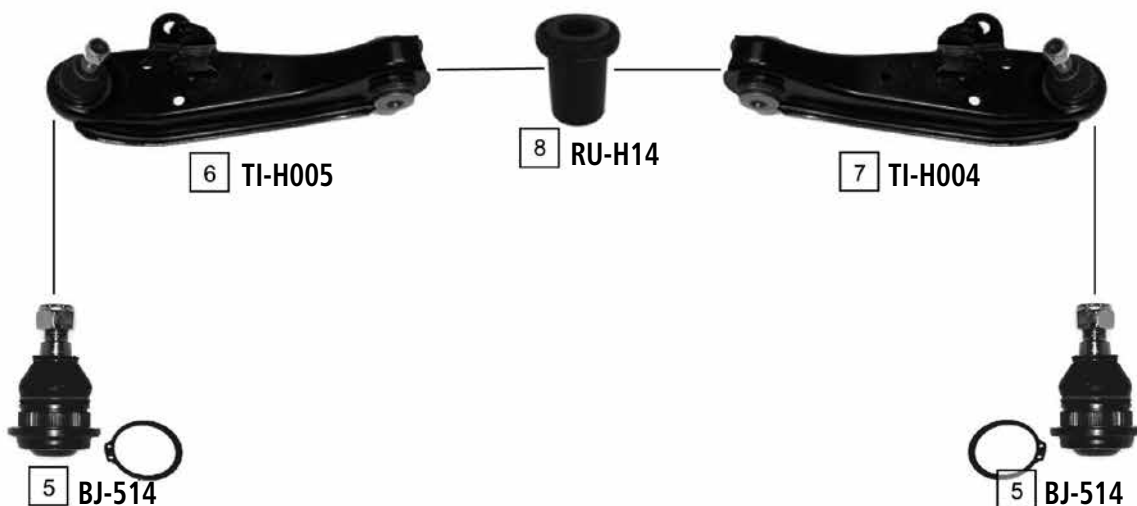

Ref	JAPANPARTS CODE	Description	OEM	Measures	Ref	JAPANPARTS CODE	Description	OEM	Measures
1	RD-505	Axial Joint	MB266152	th:MM16X1.5R L:296	5	BJ-514	Ball Joint Lower	MB527384-01	c:19.6
2	TI-515	Tie Rod End	MB527650	c:13.7 th:FM14X1.5L	6	TI-H005	TCA	MB598017	c:19.5
3	RD-510	Axial Joint	MB532971	th:MM17X1R L:290	7	TI-H004	TCA	MB598018	c:19.5
4	BJ-513	Ball Joint Upper	MB527349	c:17.6	8	RU-H14	Silentblock For Susp.Arm	Part of TI-H005/TI-H004	d:45.8

L300 (L035GV/W,L037GV/W,L038GV/W)  
4X4

10/1982 - 06/1996

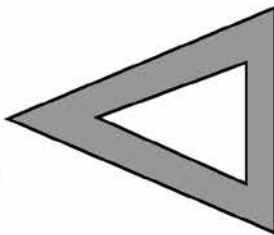

UPPER

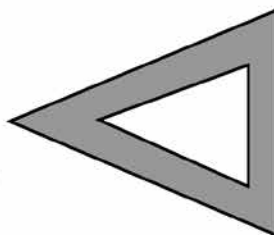
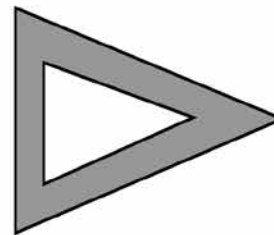

LOWER

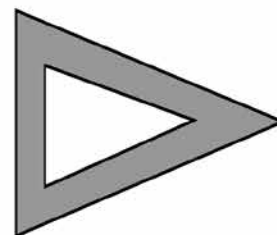

Ref	JAPANPARTS CODE	Description	OEM	Measures	Ref	JAPANPARTS CODE	Description	OEM	Measures
1	TI-509	Tie Rod End	MB241171	c:13.6 th:MM16X1.5L	3	BJ-508	Ball Joint Upper	MB176309	c:15.9
2	TI-510	Tie Rod End	MB241206	c:13.8 th:MM16X1.5R	4	LB-507	Ball Joint Lower	MB176308	c:19.4

L300 (L2\_V,P45W) 4X4

06/1986 ->



1 TI-515



1 TI-515



2 BJ-513

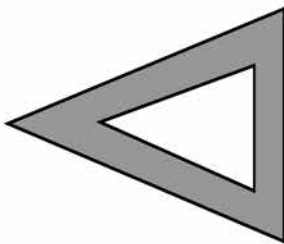

UPPER

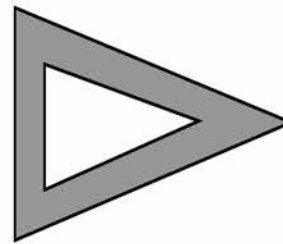

2 BJ-513



3 BJ-515L

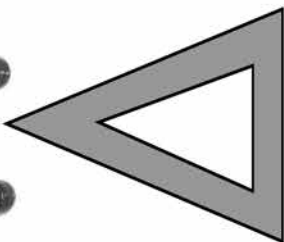

LOWER

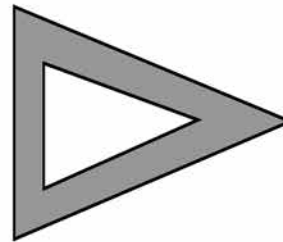

4 BJ-515R

Ref	JAPANPARTS CODE	Description	OEM	Measures	Ref	JAPANPARTS CODE	Description	OEM	Measures
1	TI-515	Tie Rod End	MB527650	c:13.7 th:FM14X1.5L	3	BJ-515L	Ball Joint Left	MB527351	c:19.4
2	BJ-513	Ball Joint Upper	MB527349	c:17.6	4	BJ-515R	Ball Joint Right	MB527352	c:19.4

LANCER I (A17\_)

04/1979 - 01/1984



EXC TURBO

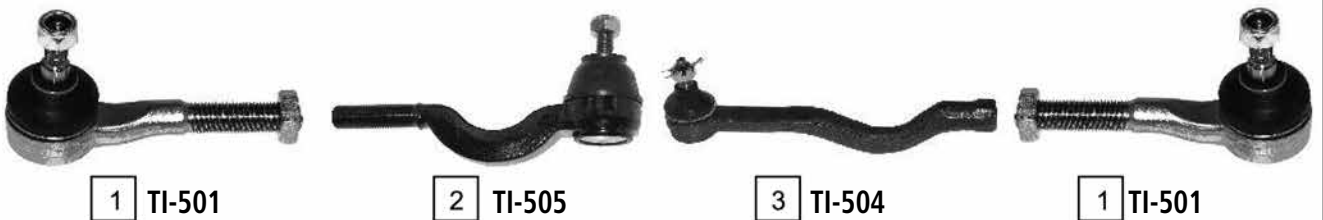

TURBO

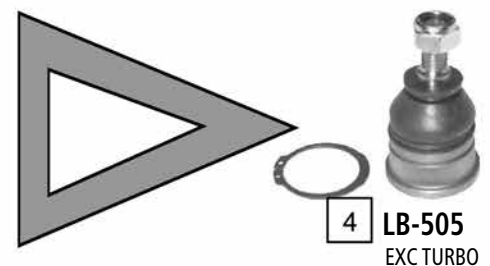
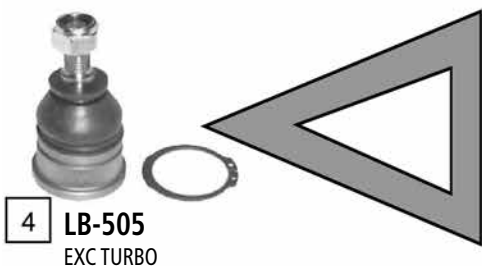

Ref	JAPANPARTS CODE	Description	OEM	Measures	Ref	JAPANPARTS CODE	Description	OEM	Measures
1	TI-501	Tie Rod End	MA159984	c:12.5 th:MM14X1.5L	4	LB-505	Ball Joint Lower	MB 001696	c: 15
2	TI-505	Tie Rod End Inner Left	MB076003	c:12.1 th:MM14X1.5R	5	TI-508	Tie Rod End Inner Right	MB109858	c: 12.5 th: FM14X1.5L
3	TI-504	Tie Rod End Inner Right	MB076004	c:12.2 th:FM14X1.5L					

LANCER III (C1\_A, C6\_A)  
LANCER III S.W. (C1\_V, C3\_V)

02/1984 - 04/1989

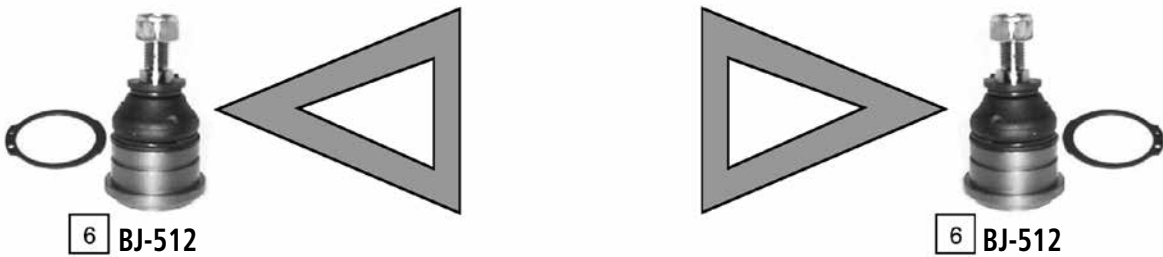
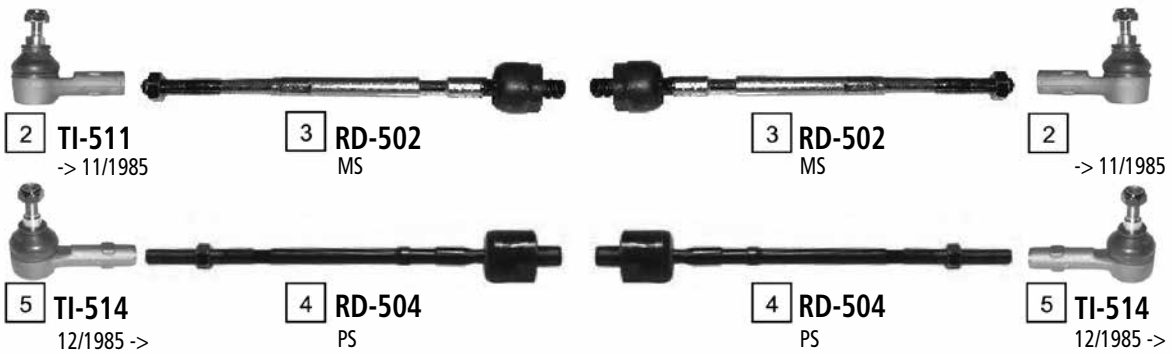

Ref	JAPANPARTS CODE	Description	OEM	Measures	Ref	JAPANPARTS CODE	Description	OEM	Measures
1	SI-501	Stabiliser Link	4056 A014	L:60	4	RD-504	Axial Joint	MB350718	
2	TI-511	Tie Rod End	MB241982	c:13.3 th:FM12X1.25	5	TI-514	Tie Rod End	MB527169	c:13.4 th:FM12X1.25
3	RD-502	Axial Joint	MB347666	th:MM12X1.25R L:278	6	BJ-512	Ball Joint Lower	MB-518961	c:15

LANCER IV (C6\_A, C7\_A)

05/1988 - 05/1992



MS



PS



Ref	JAPANPARTS CODE	Description	OEM	Measures	Ref	JAPANPARTS CODE	Description	OEM	Measures
1	SI-504	Stabiliser Link	MB518780	L:88	4	RD-599	Axial Joint	MB910934	th:MM16X1.5R L:309
2	TI-514	Tie Rod End	MB527169	c:13.4 th:FM12X1.25	5	BJ-512	Ball Joint Lower	MB-518961	c:15
3	RD-508	Axial Joint	MB553249	th:MM16X1.5R L:298					

# MITSUBISHI LANCER

LANCER V (CB/D\_A)  
LANCER VI (CK/P\_A)

06/1992 - 12/1995  
12/1995 - 08/2003

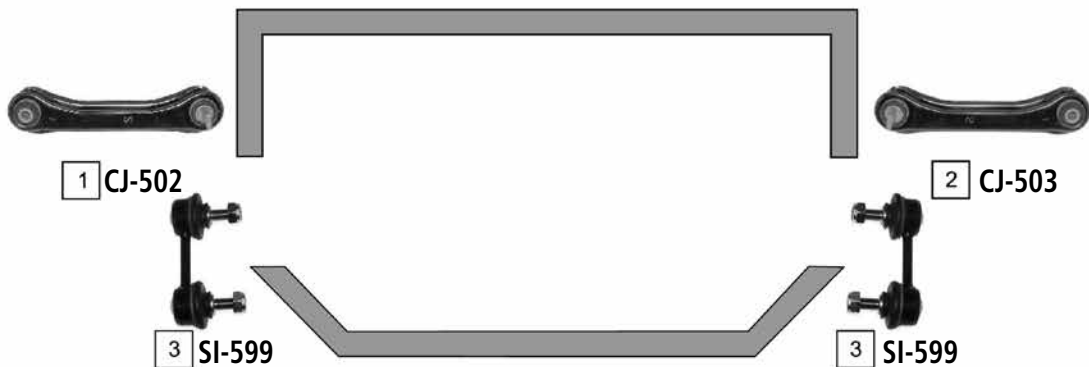
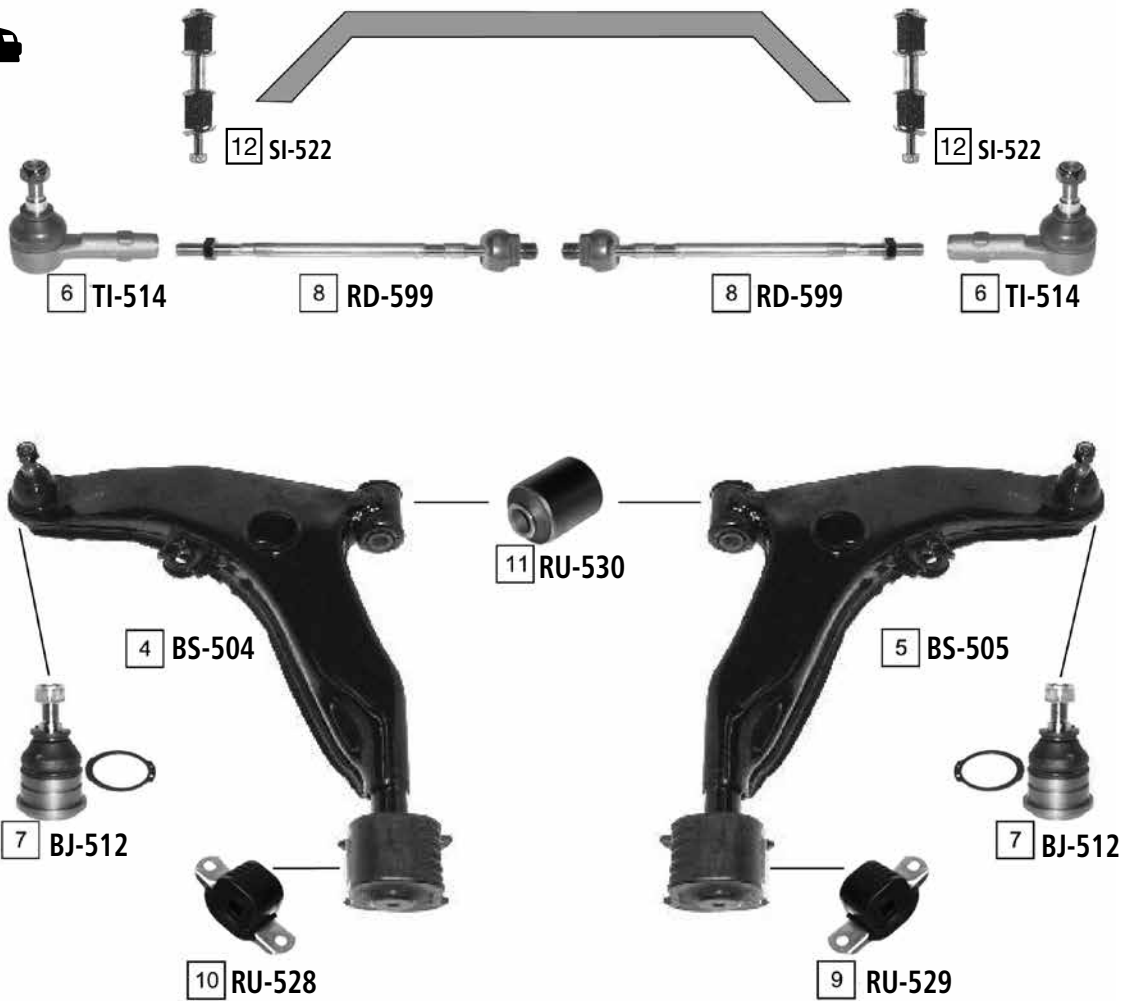

Ref	JAPANPARTS CODE	Description	OEM	Measures	Ref	JAPANPARTS CODE	Description	OEM	Measures
1	CJ-502	TCA Left	MB809220	c:15	7	BJ-512	Ball Joint Lower	Part of BS-504 /BS-505	c:15
2	CJ-503	TCA Right	MB809221	c:15	8	RD-599	Axial Joint	MB910934	th:MM16X1.5R L:309
3	SI-599	Stabiliser Link	MB809354	L:75	9	RU-529	Silentblock For Susp.Arm	MB808910	
4	BS-504	TCA Left	MB912077	c:15	10	RU-528	Silentblock For Susp.Arm	MB808909	
5	BS-505	TCA Right	MB912078	c:15	11	RU-530	Silentblock For Susp.Arm	Part of BS-504 /BS-505	
6	TI-514	Tie Rod End	MB527169	c:13.4 th:FM12X1.25	12	SI-522	Stabiliser Link	MB241974	L:131

LANCER VII (CS\_)

09/2003 ->

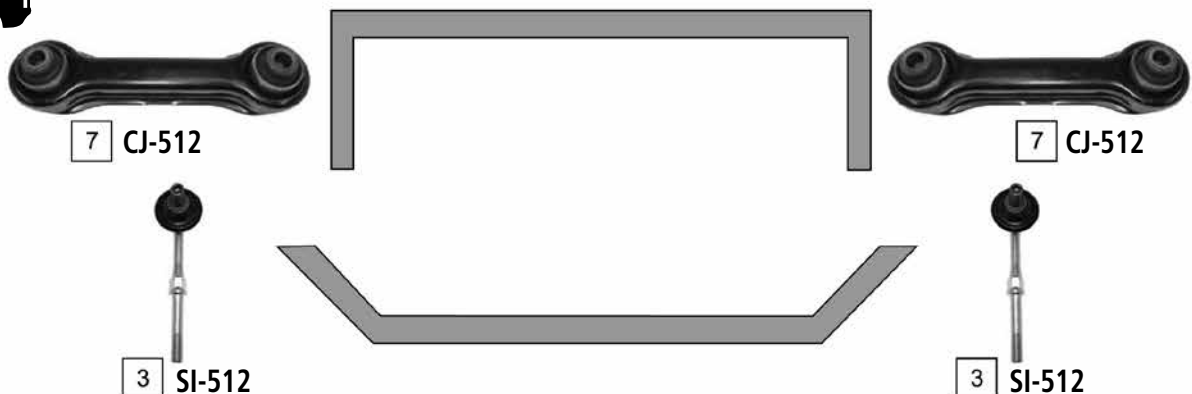
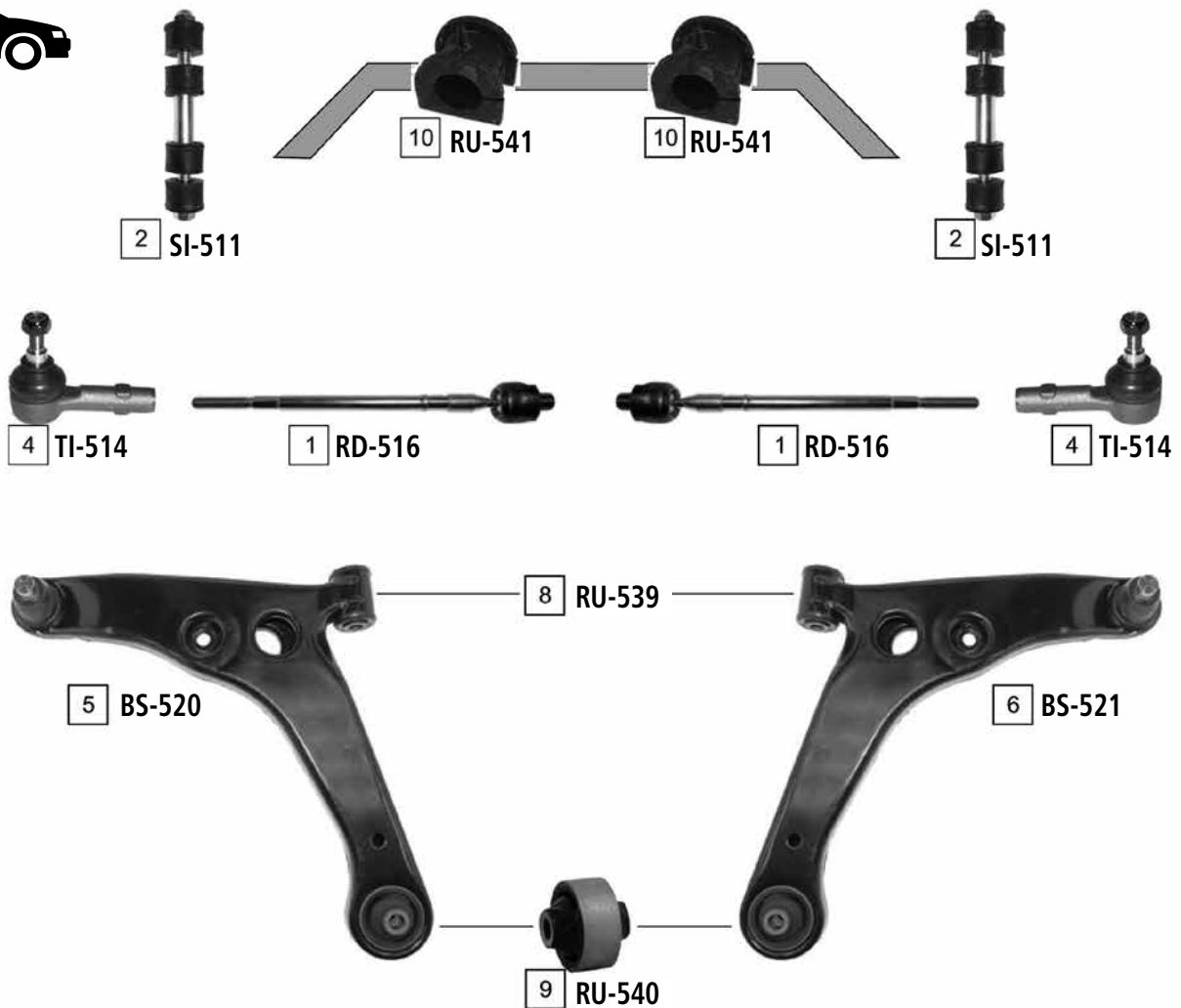

Ref	JAPANPARTS CODE	Description	OEM	Measures	Ref	JAPANPARTS CODE	Description	OEM	Measures
1	RD-516	Axial Joint	MR491358	th:MM16X1.5R L:311	6	BS-521	TCA Right Wbj	MR403420	c:20
2	SI-511	Stabiliser Link	MR954887	L:136	7	CJ-512	TCA	MR403485	-
3	SI-512	Stabiliser Link	MR403771	L:115	8	RU-539	Silentblock For Susp.Arm	Part of BS-520/BS-521	-
4	TI-514	Tie Rod End	MB527169	c:13.4 th:FM12X1.25	9	RU-540	Silentblock For Susp.Arm	MR403441	-
5	BS-520	TCA Left Wbj	MR403419	c:20	10	RU-541	Stabiliser Mounting	MN100250	d:26



OUTLANDER

02/2007 ->

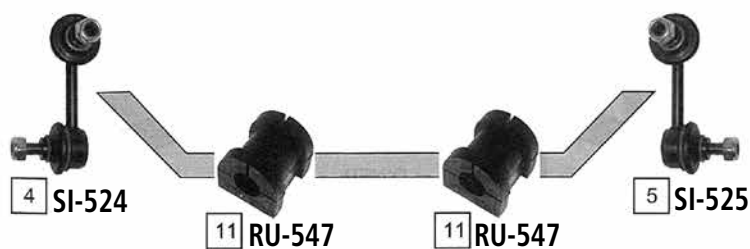
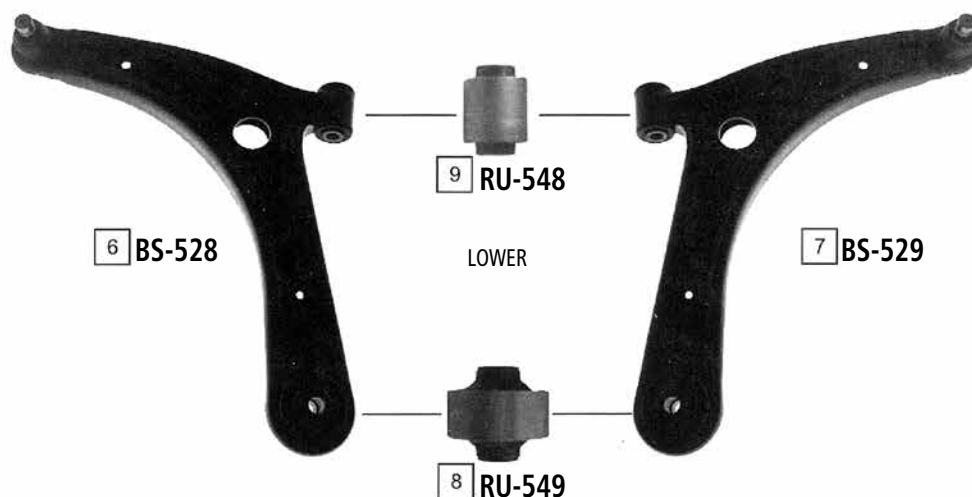
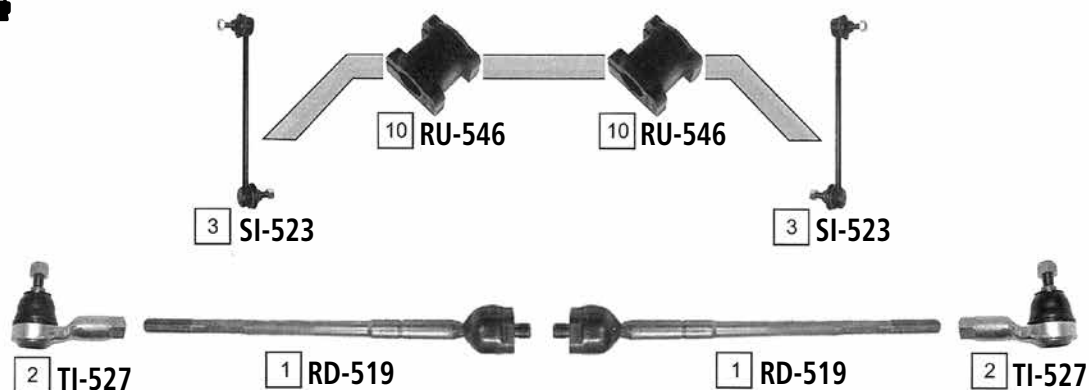

Ref	JAPANPARTS CODE	Description	OEM	Measures	Ref	JAPANPARTS CODE	Description	OEM	Measures
1	RD-519	Axial Joint	4422A012	-	7	BS-529	TCA Right WBJ	4013A010	c:20
2	TI-527	Tie Rod End	4422A018	c:13.4 th:fm14x1.5R	8	RU-549	Silentblock For Susp.Arm	MN184133	d:60
3	SI-523	Stabiliser Link	MN101368	L:265	9	RU-548	Silentblock For Susp.Arm	MN125871	-
4	SI-524	Stabiliser Link Left	4156A014	L:80	10	RU-546	Stabiliser Mounting	4056A079	-
5	SI-525	Stabiliser Link Right	MN184194	L:80	11	RU-547	Stabiliser Mounting	4156A028	-
6	BS-528	TCA Left WBJ	4013A009	c:20					

PAJERO I (L04\_G, L14\_G)

03/1983 - 02/1991

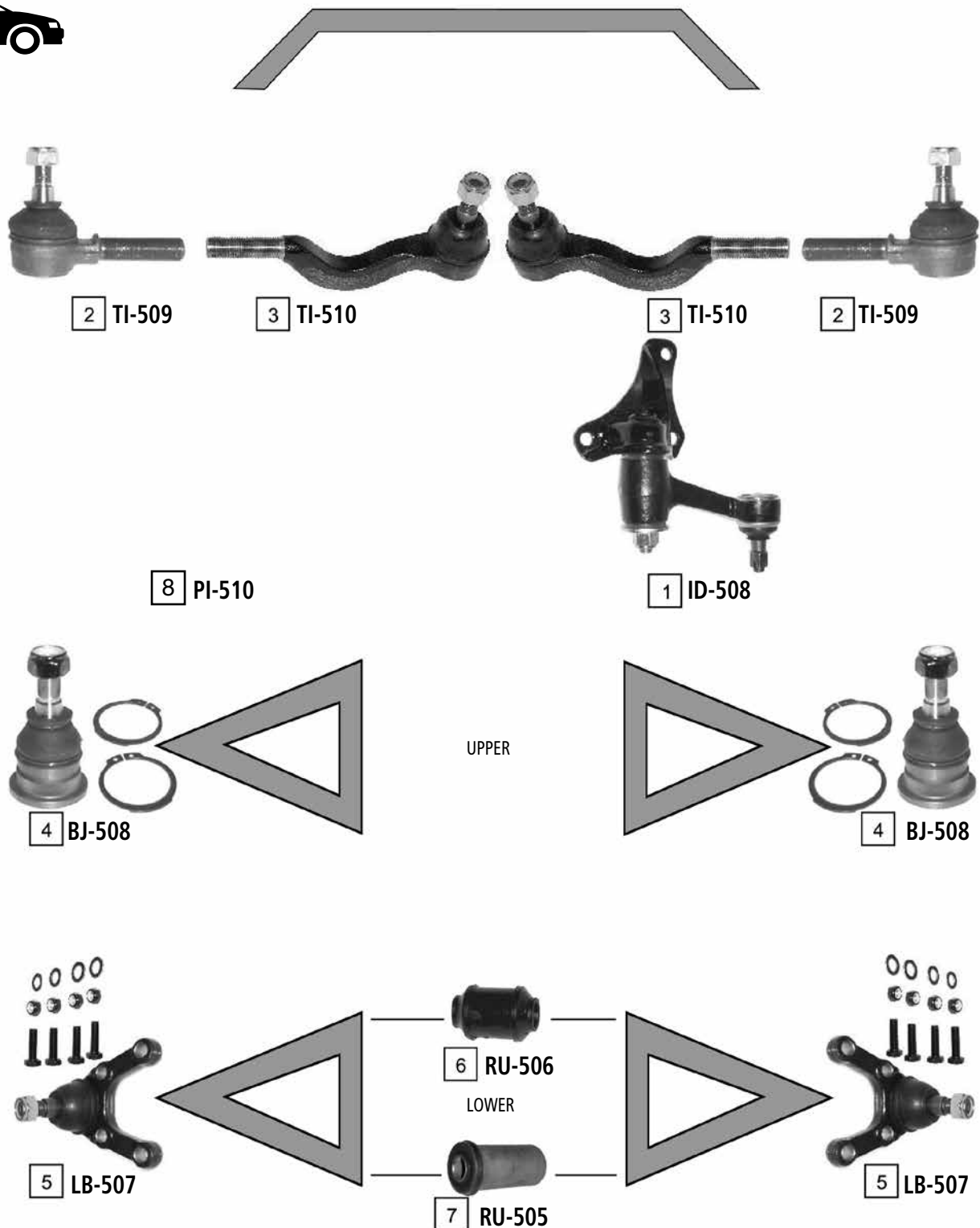

Ref	JAPANPARTS CODE	Description	OEM	Measures	Ref	JAPANPARTS CODE	Description	OEM	Measures
1	ID-508	Pitman Arm	MB241830		5	LB-507	Ball Joint Lower	MB176308	c:19.4
2	TI-509	Tie Rod End	MB241171	c:13.6 th:MM16X1.5L	6	RU-506	Silentblock For Susp.Arm	MB109684	d:40
3	TI-510	Tie Rod End	MB241206	c:13.8 th:MM16X1.5R	7	RU-505	Silentblock For Susp.Arm	MB109662	d:40.4
4	BJ-508	Ball Joint Upper	MB176309	c:15.9	8	PI-510	Pitman Arm	MB241973	

PAJERO II (V2\_W, V4\_W)  
PAJERO CLASSIC (V2\_W)

03/1991 - 04/2000  
07/2002 ->

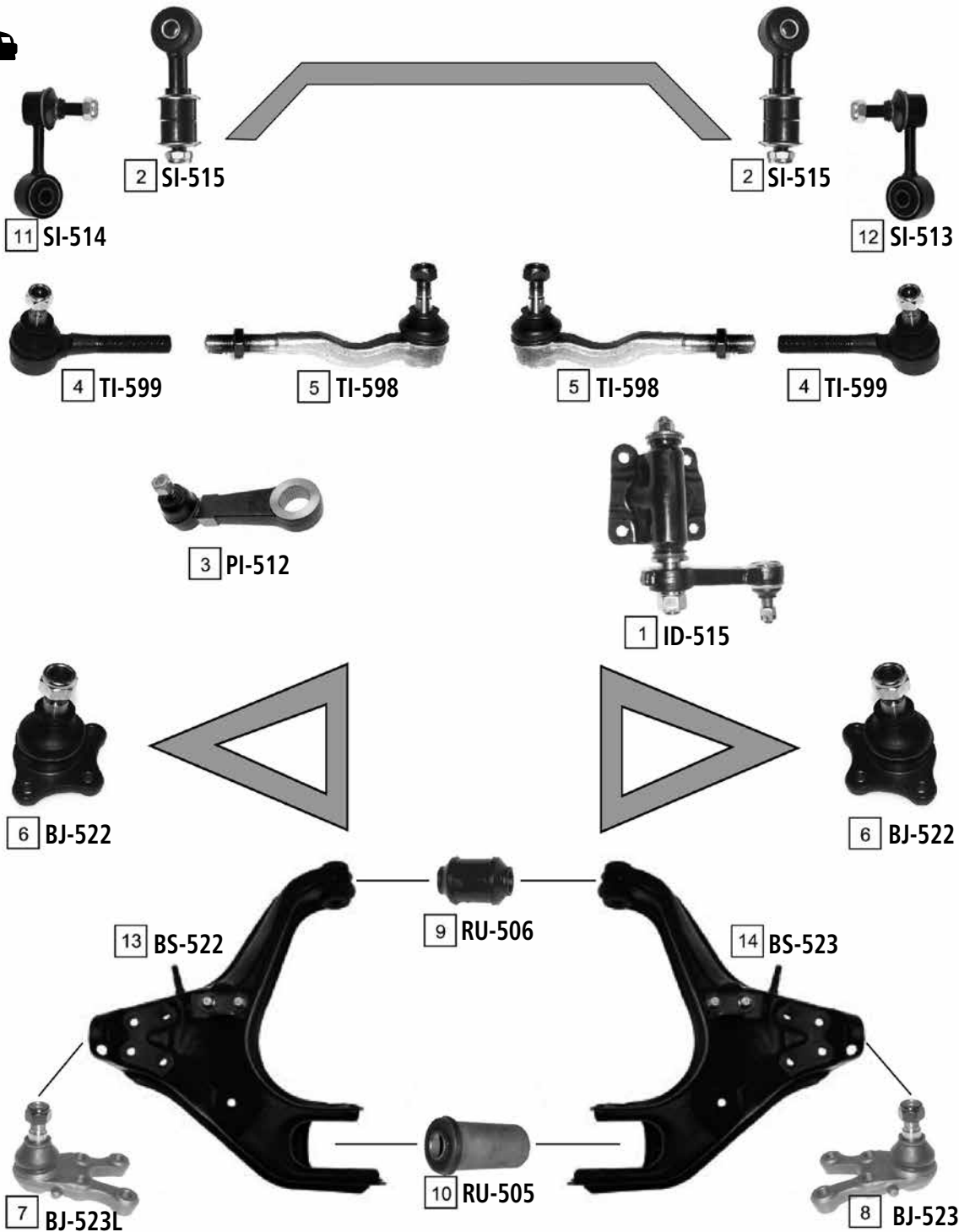

Ref	JAPANPARTS CODE	Description	OEM	Measures	Ref	JAPANPARTS CODE	Description	OEM	Measures
1	ID-515	Pitman Arm	MB831042	-	8	BJ-523R	Ball Joint Lower Right	MB831038	c:19.3
2	SI-515	Stabiliser Link	MB633926	-	9	RU-506	Silentblock For Susp.Arm	MB109684	d:40
3	PI-512	Pitman Arm	MB831040	-	10	RU-505	Silentblock For Susp.Arm	MB109662	d:40.4
4	TI-599	Tie Rod End	MB831043	c:13.6 th:M16X1.5L	11	SI-514	Stabiliser Link Left	MR 132551	L:79
5	TI-598	Tie Rod End Inner	MB831044	c:13.7 th:M16X1.5R	12	SI-513	Stabiliser Link Right	MR 132552	L:79
6	BJ-522	Ball Joint Upper	MB-860830	c:16.5	13	BS-522	Susp. Arm W/O Ball Joint	MB860381	
7	BJ-523L	Ball Joint Lower Left	MB831037	c:19.3	14	BS-523	Susp. Arm W/O Ball Joint	MB860382	

PAJERO III (V6\_W/V7\_W)

04/2000 - 10/2006

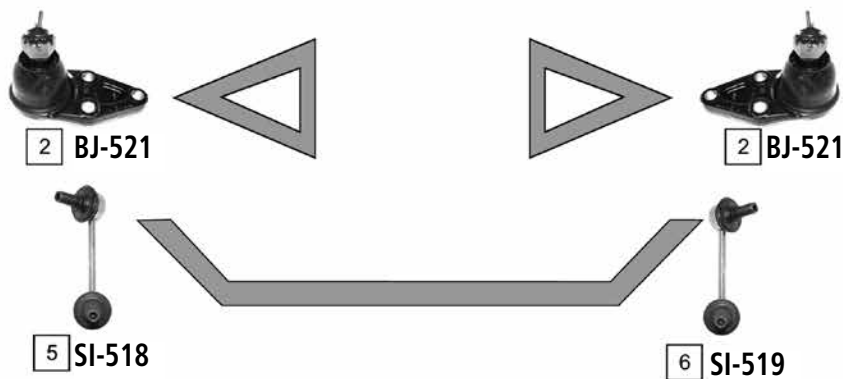
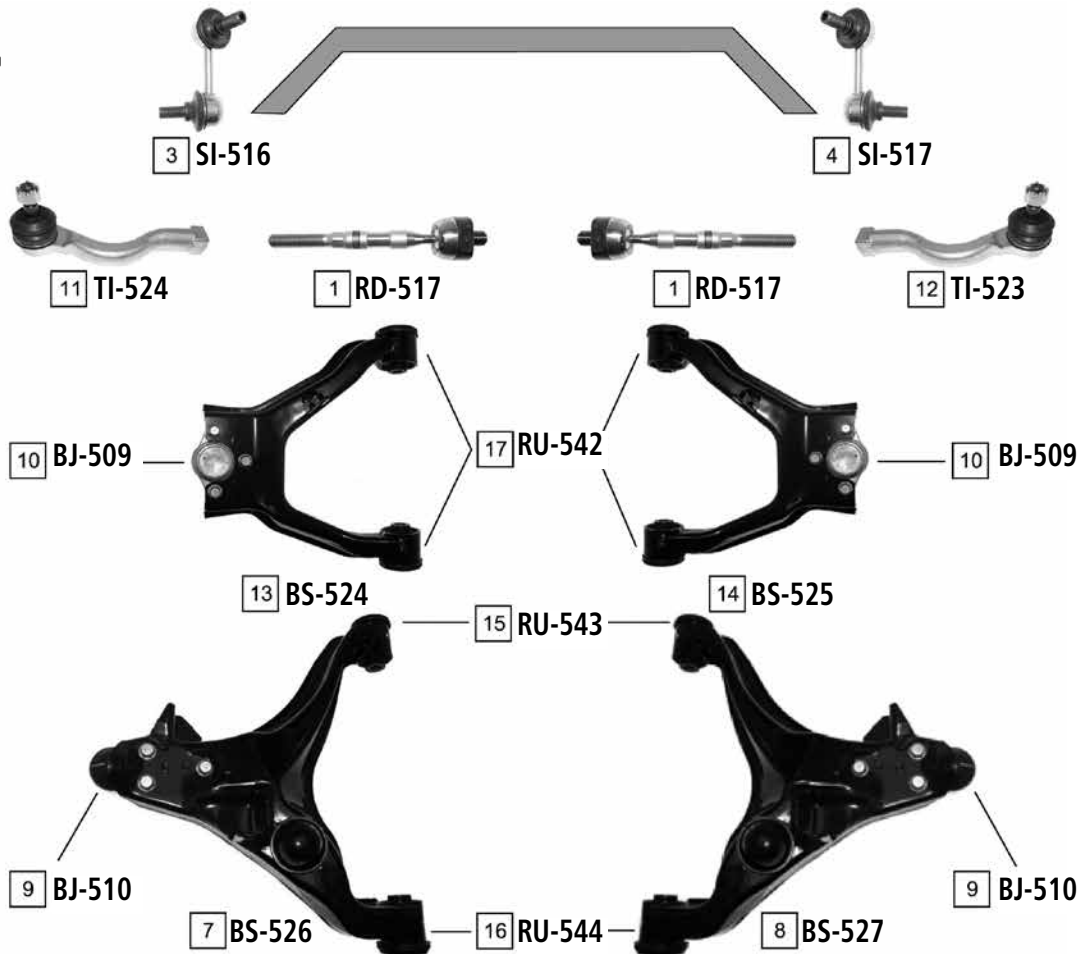

Ref	JAPANPARTS CODE	Description	OEM	Measures	Ref	JAPANPARTS CODE	Description	OEM	Measures
1	RD-517	Axial Joint	MR510267		10	BJ-509	Ball Joint	4010 A015	
2	BJ-521	Ball Joint	MR508130		11	TI-524	Tie Rod End Left	MR508135	
3	SI-516	Stabiliser Link Left	MR374521		12	TI-523	Tie Rod End Right	MR508136	
4	SI-517	Stabiliser Link Right	MR374522		13	BS-524	TCA Left	4010 A037	
5	SI-518	Stabiliser Link Left	MR418052		14	BS-525	TCA Right	4010 A038	
6	SI-519	Stabiliser Link Right	MR418053		15	RU-543	Silentblock For Susp.Arm	Part of BS-526/BS-527	
7	BS-526	TCA Left	MR496795		16	RU-544	Silentblock For Susp.Arm	Part of BS-526/BS-527	
8	BS-527	TCA Right	MR496796		17	RU-542	Silentblock For Susp.Arm	Part of BS-524/BS-525	
9	BJ-510	Ball Joint	MR496799						

PAJERO IV

09/2006 ->

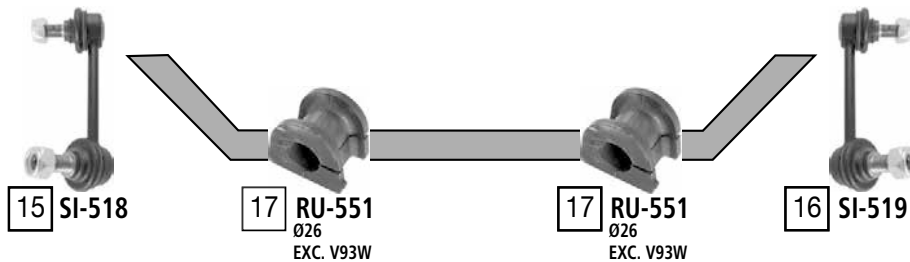
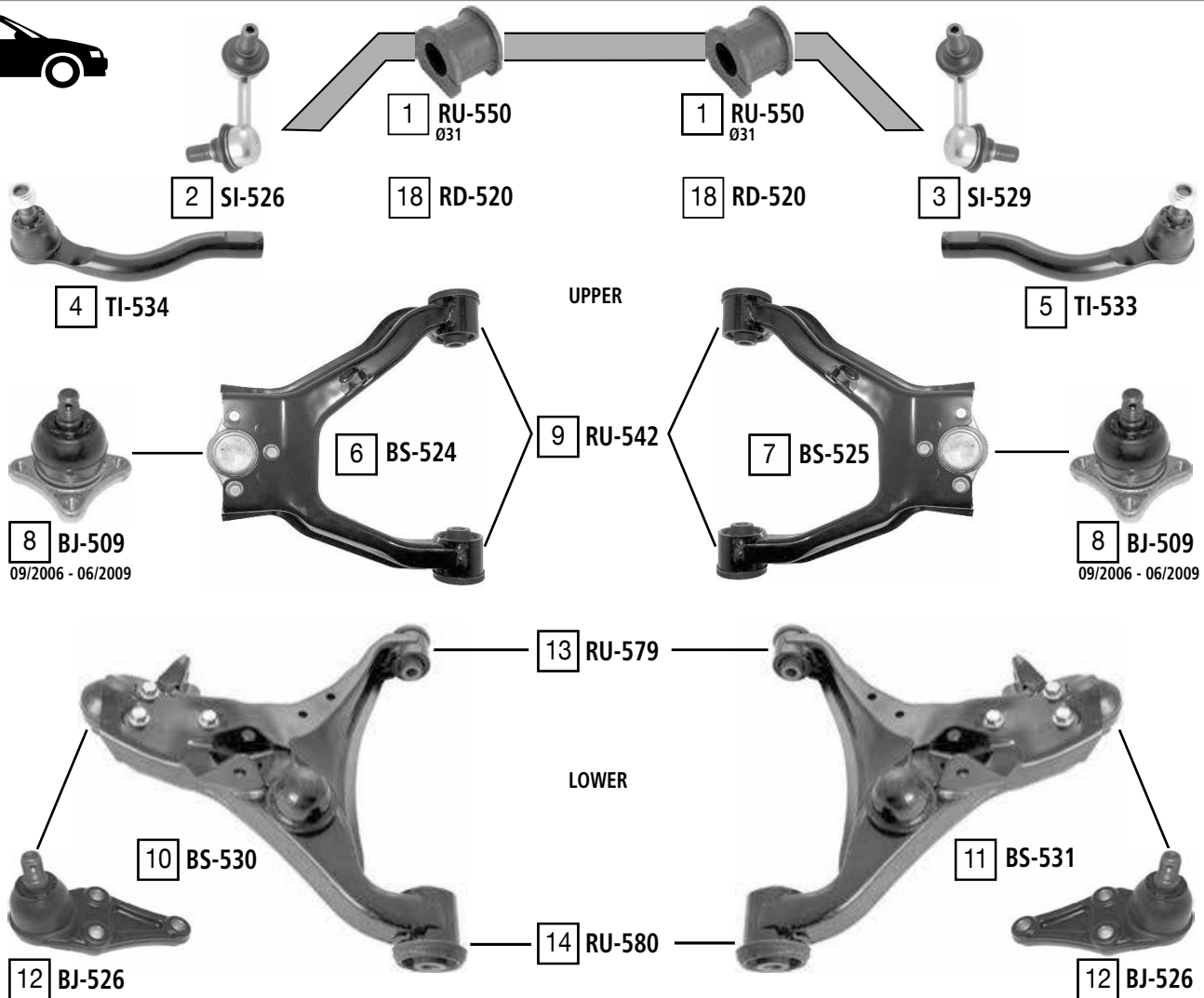

Ref	JAPANPARTS CODE	Description	OEM	Measures	Ref	JAPANPARTS CODE	Description	OEM	Measures
1	RU-550	Stabiliser Mounting	MR554271	di:31	10	BS-530	TCA left wbj	4013A209	c:19.3
2	SI-526	Stabiliser Link Left	4056A133	L:78.5	11	BS-531	TCA right wbj	4013A210	c:19.3
3	SI-529	Stabiliser Link Right	4056A134	L:78.5	12	BJ-526	Ball Joint	MR496799	c:19.5
4	TI-534	Tie Rod End Left	4422A037	c:13.7 th:FM16x1.5R	13	RU-579	Silentblock For TCA	Part of	di:16.3 do:48
5	TI-533	Tie Rod End Right	4422A038	c:13.7 th:FM16x1.5R	14	RU-580	Silentblock For TCA	Part of	di:16.3 do:52
6	BS-524	TCA Left Wbj	4010 A037		15	SI-518	Stabiliser Link Left	4056A111	L:115
7	BS-525	TCA Right Wbj	4010 A038		16	SI-519	Stabiliser Link Right	4056A112	L:115
8	BJ-509	Ball Joint	4010 A015	c:15.9	17	RU-551	Stabiliser Mounting	4156A041	di:26
9	RU-542	Silentblock For TCA	Part of	di:14.4 do:46.2	18	RD-520	Axial Joint	4422A036	

PAJERO PININ (H6\_W/H7\_W)

10/1999 - 03/2005



2 TI-516



1 RD-518



1 RD-518



2 TI-516



6 BJ-524

4 CJ-514

7 RU-545



5 CJ-513

6 BJ-524

Ref	JAPANPARTS CODE	Description	OEM	Measures	Ref	JAPANPARTS CODE	Description	OEM	Measures
1	RD-518	Axial Joint	MR448255		5	CJ-513	TCA Right	MR414940	
2	TI-516	Tie Rod End	MB192430	c:13.45 th:FM14X1.5	6	BJ-524	Ball Joint	Part of CJ-514/CJ-513	
3	SI-501	Stabiliser Link	4056 A014	L:60	7	RU-545	Silentblock For Susp.Arm	MR319067	
4	CJ-514	TCA Left	MR414939						

SIGMA (F16A)  
SIGMA S.W. (F07W)

12/1990 - 10/1996  
01/1993 - 07/1996

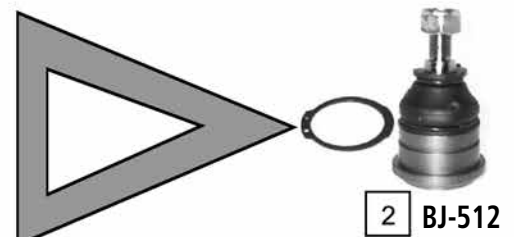

Ref	JAPANPARTS CODE	Description	OEM	Measures	Ref	JAPANPARTS CODE	Description	OEM	Measures
1	TI-516	Tie Rod End	MB192430	c:13.45 th:FM14X1.5	3	SI-501	Stabiliser Link	4056 A014	L:60
2	BJ-512	Ball Joint Lower	MB-518961	c:15	4	SI-508	Stabiliser Link	MR131732	L:60

SPACE RUNNER (N1 W, N2 W)

10/1991 - 08/1999

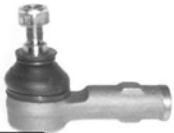

**1** TI-516

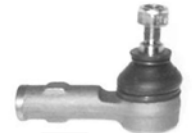

**1** TI-516

**2** BJ-512

**2** BJ-512

Ref	JAPANPARTS CODE	Description	OEM	Measures	Ref	JAPANPARTS CODE	Description	OEM	Measures
1	TI-516	Tie Rod End	MB192430	c:13.45 th:FM14X1.5	2	BJ-512	Ball Joint	MB518961	



SPACE STAR (DGO)

08/1998 - 03/2006

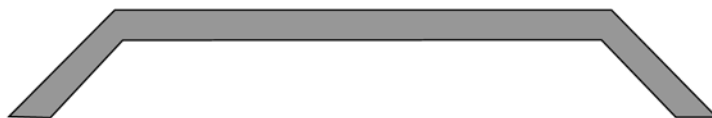

2 TI-514



3 BJ-512

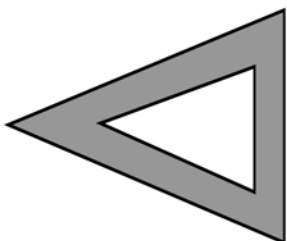

LOWER

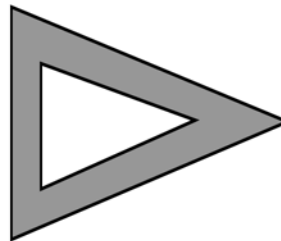

3 BJ-512



4 CJ-500



5 CJ-501



1 SI-505



1 SI-505

Ref	JAPANPARTS CODE	Description	OEM	Measures	Ref	JAPANPARTS CODE	Description	OEM	Measures
1	SI-505	Stabiliser Link	MR272118		4	CJ-500	TCA Left	MR130479	
2	TI-514	Tie Rod End	MB527169	c:13.4 th:FM12X1.25	5	CJ-501	TCA Right	MR130480	
3	BJ-512	Ball Joint Lower	Part of MB518961	c:15					

SPACE WAGON (DO\_V/W)

10/1983-04/1991



PS EXC 4X4



PS 4X4

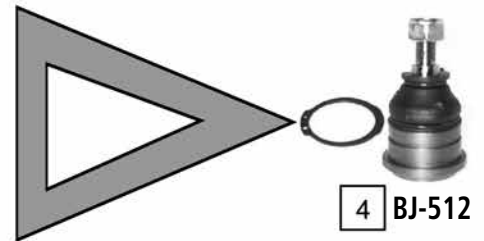
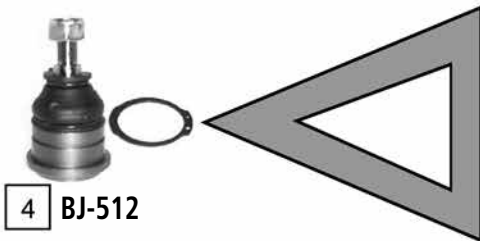

Ref	JAPANPARTS CODE	Description	OEM	Measures	Ref	JAPANPARTS CODE	Description	OEM	Measures
1	TI-516	Tie Rod End	MB192430	c:13.45 th:FM14X1.5	3	RD-506	Axial Joint	MB243329	
2	RD-505	Axial Joint	MB 266152	th:MM16X1.5R L:296	4	BJ-512	Ball Joint Lower	MB518961	

SPACE WAGON (N3\_W, N4\_W)

05/1991 - 11/1998

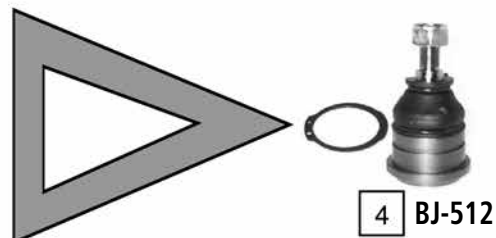
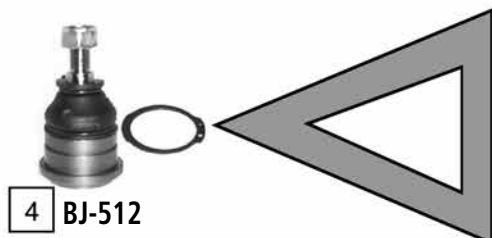

Ref	JAPANPARTS CODE	Description	OEM	Measures	Ref	JAPANPARTS CODE	Description	OEM	Measures
1	TI-516	Tie Rod End	MB192430	c:13.45 th:FM14X1.5	3	SI-521	Stabiliser Link Right	MB808076	L:51.5
2	SI-520	Stabiliser Link Left	MB672370	L:51.5	4	BJ-512	Ball Joint Lower	Part of MB518961	c:15

STARION (A18\_A)

01/1982 - 08/1990



**1** TI-501  
-> 05/1987



**2** TI-505  
ALL



**3** TI-508  
ALL



**1** TI-501  
-> 05/1987

**4** LB-510

**4** LB-510

Ref	JAPANPARTS CODE	Description	OEM	Measures	Ref	JAPANPARTS CODE	Description	OEM	Measures
1	TI-501	Tie Rod End	MA159984	c:12.5 th:MM14X1.5L	3	TI-508	Tie Rod End Inner Right	MB109858	c:12.5 th:FM14X1.5L
2	TI-505	Tie Rod End Inner Left	MB076003	c:12.1 th:MM14X1.5R	4	LB-510	Ball Joint	MB-185329	

# MITSUBISHI TREDIA - CORDIA

TREDIA (A21\_)  
CORDIA (A21\_A)

06/1982 - 03/1988  
10/1982 - 12/1986



MS



1 TI-516



2 RD-505



2 RD-505



1 TI-516

PS



1 TI-516



3 RD-506



3 RD-506



1 TI-516



4 BJ-512

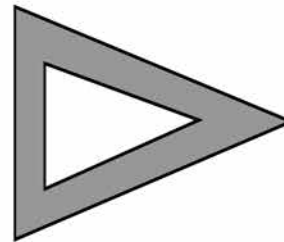
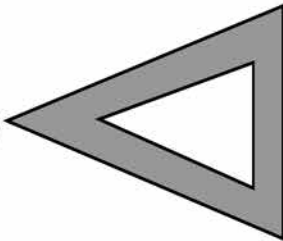

4 BJ-512

Ref	JAPANPARTS CODE	Description	OEM	Measures	Ref	JAPANPARTS CODE	Description	OEM	Measures
1	TI-516	Tie Rod End	MB192430	c:13.45 th:FM14X1.5	3	RD-506	Axial Joint	MB243329	th:MM16X1.5R L:295
2	RD-505	Axial Joint	MB 266152	th:MM16X1.5R L:296	4	BJ-512	Ball Joint Lower	MB-518961	c:15

100 NX (B13)

08/1990 - 06/1995



1 SI-101

1 SI-101

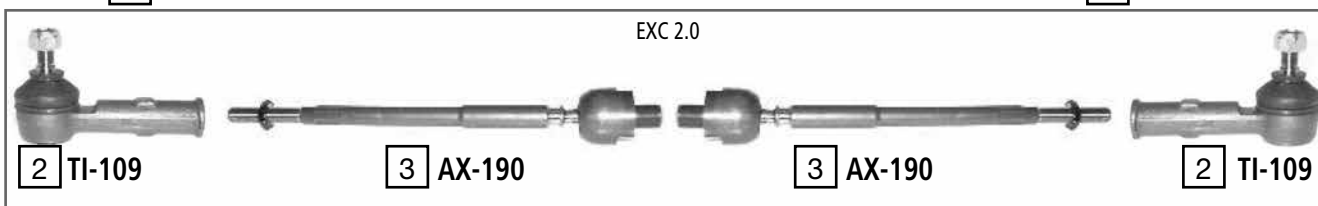

EXC 2.0

2 TI-109

3 AX-190

3 AX-190

2 TI-109



5 SJ-190



4 RU-139



5 SJ-190

Ref	JAPANPARTS CODE	Description	OEM	Measures	Ref	JAPANPARTS CODE	Description	OEM	Measures
1	SI-101	Stabiliser Link	54618 50Y00	L:85.5	4	RU-139	Silentblock For Susp.Arm	54570-69Y10	
2	TI-109	Tie Rod End	48520-01E00	c:13 th:FM12X1.25R	5	SJ-190	Ball Joint		c:14.7
3	AX-190	Axial Joint	48521-50400	th:MM16X1R L:274.5					

ALMERA I (N15)

07/1995 - 07/2000

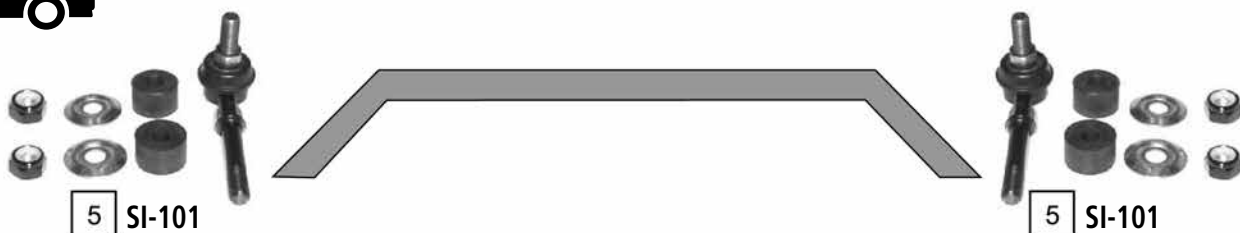

10 TI-194  
DIESEL/GTI



1 TI-109  
EXC DIESEL/GTI



4 AX-191  
PS



7 AX-190  
MS



10 TI-194  
DIESEL/GTI



1 TI-109  
EXC DIESEL/GTI

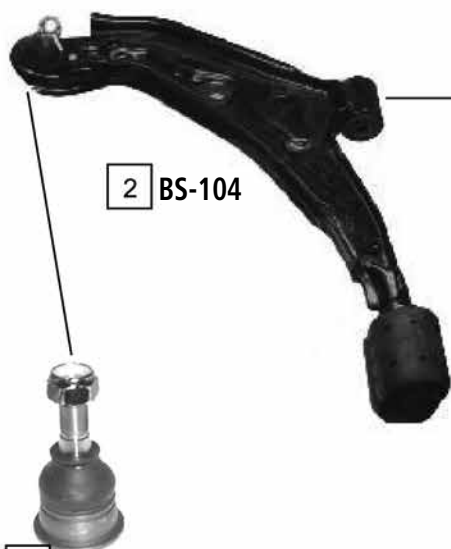

2 BS-104



9 RU-138



8 RU-139

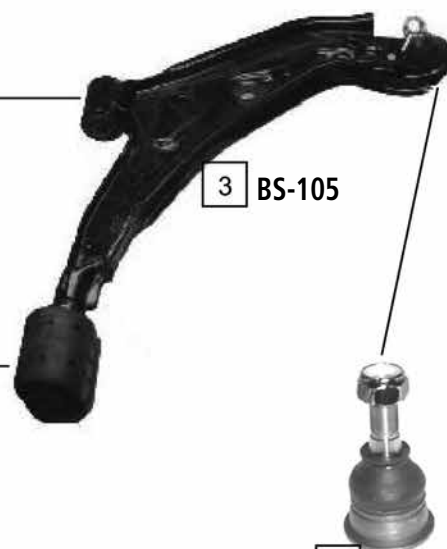

3 BS-105

6 SJ-190

6 SJ-190

Ref	JAPANPARTS CODE	Description	OEM	Measures	Ref	JAPANPARTS CODE	Description	OEM	Measures
1	TI-109	Tie Rod End	48520-0M025	c:12.9 th:FM12X1.5R	6	SJ-190	Ball Joint	4016152910	c:14.7
2	BS-104	TCA Left	54501-0M010	c:14.9	7	AX-190	Axial Joint	48521-50400	th:MM16X1R L.274.5
3	BS-105	TCA Right	54500-0M010	c:14.9	8	RU-139	Silentblock For Susp.Arm	54570-69Y10	
4	AX-191	Axial Joint	48521-1M210	th:MM16X1R L.275	9	RU-138	Silentblock For Susp.Arm	54560-50A00	d:36.2
5	SI-101	Stabiliser Link	54618 50Y00	L:85.5	10	TI-194	Tie Rod End	48520-0M085	c:12.85 th:FM14X1.5

ALMERA II (N16)

08/2000-03/2007

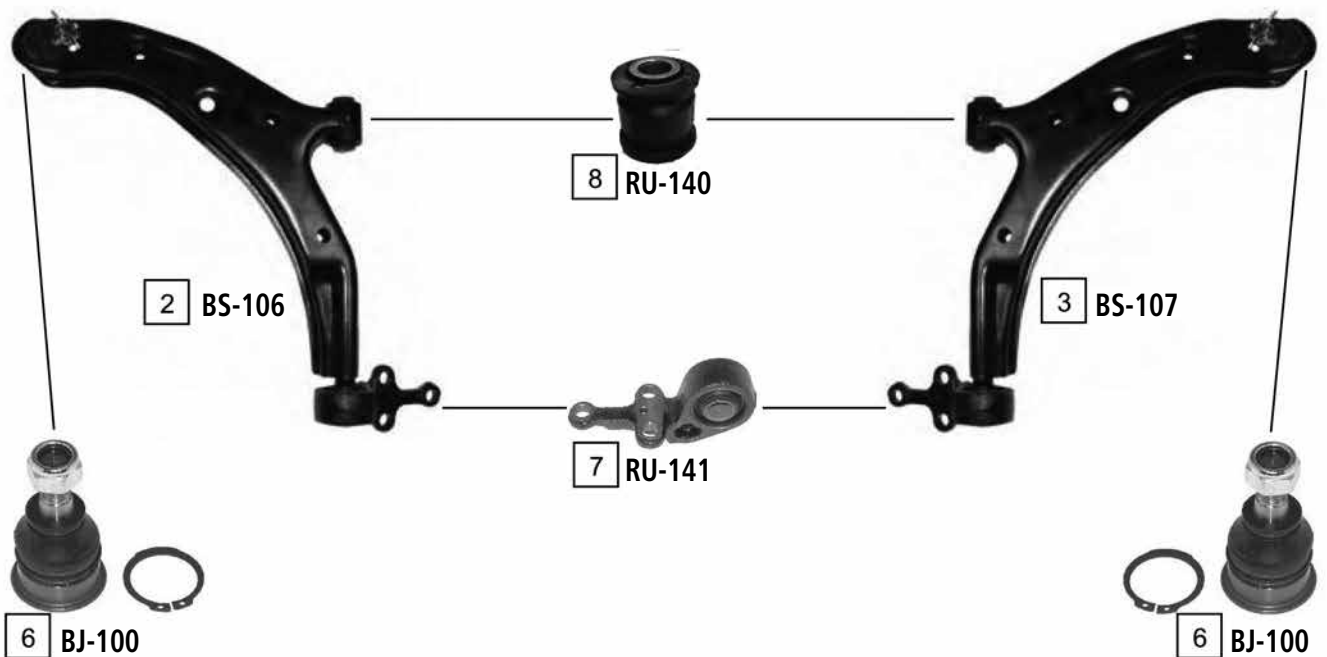
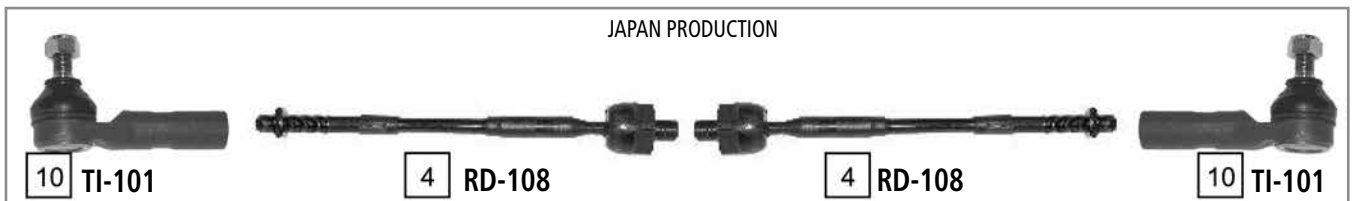

Ref	JAPANPARTS CODE	Description	OEM	Measures	Ref	JAPANPARTS CODE	Description	OEM	Measures
1	TI-100	Tie Rod End	48520-BM425	c:12.7 th:FM12X1.25	6	BJ-100	Ball Joint	-	c:14.7
2	BS-106	TCA Left	54501-BM400	c:15	7	RU-141	Silentblock For Susp.Arm	Part of BS-106/BS-107	
3	BS-107	TCA Right	54500-BM300	c:15	8	RU-140	Silentblock For Susp.Arm	Part of BS-106/BS-107	d:32.2
4	RD-108	Axial Joint	48521 4M500	th:MM16X1R L:284	9	RD-100	Axial Joint	48520-0C025	th:MM16X1R L:275
5	SI-100	Stabiliser Link	54618-4M400		10	TI-101	Tie Rod End	48520-15U25	c:12.8 th:FM14X1.5R



ALMERA TINO (V10)

08/2000 - 12/2006



1 RD-111

1 RD-111

7 TI-101



6 BJ-101

6 BJ-101

Ref	JAPANPARTS CODE	Description	OEM	Measures	Ref	JAPANPARTS CODE	Description	OEM	Measures
1	RD-111	Axial Joint	48521 4U000	th:MM16X1R L:310	5	SI-103	Stabiliser Link Right	54618-4U000	L:65
2	BS-108	TCA Left Wbj	54501-5U300		6	BJ-101	Ball Joint	40160-2Y000	c:15
3	BS-109	TCA Right Wbj	54500 5U300		7	TI-101	Tie Rod End	48520-15U25	c:12.8 th:FM14X1.5R
4	SI-104	Stabiliser Link Left	54668-4U000	L:65					

BLUEBIRD (910)

01/1980 - 12/1983

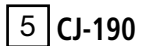
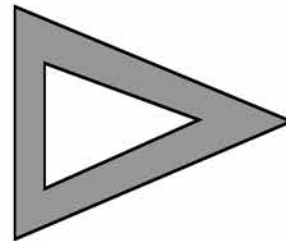
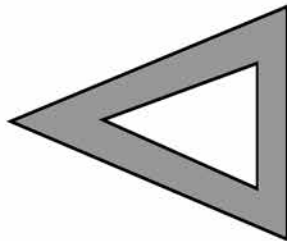
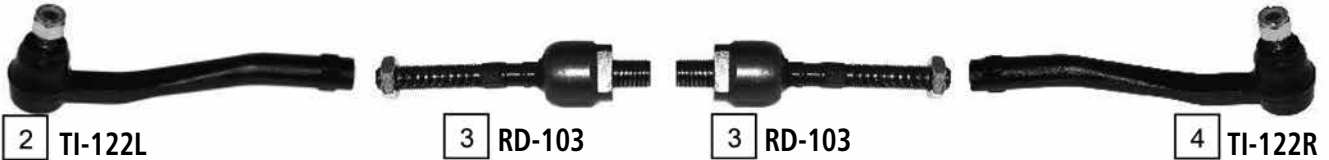

Ref	JAPANPARTS CODE	Description	OEM	Measures	Ref	JAPANPARTS CODE	Description	OEM	Measures
1	LB-126	Ball Joint Lower	40160-W1000	c:16.2	4	TI-122R	Tie Rod End Right	48520-W1025	c:13.4 th:FM14X1.5R
2	TI-122L	Tie Rod End	48640-W1025	c:13.4 th:FM14X1.5R	5	CJ-190	TCA Left		
3	RD-103	Axial Joint	48521-01F00		6	CW-195	TCA Right		

BLUEBIRD (U11,WU11,T72)

11/1983 - 05/1990



**2** SI-101  
01/1986 ->



**2** SI-101  
01/1986 ->



**4** TI-109



**3** RD-101



**3** RD-101



**4** TI-109



**1** BJ-124

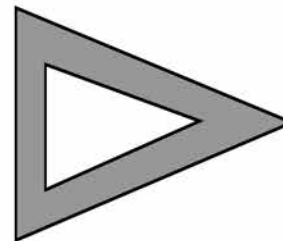
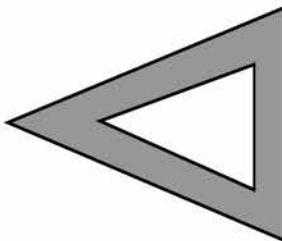

**1** BJ-124

Ref	JAPANPARTS CODE	Description	OEM	Measures	Ref	JAPANPARTS CODE	Description	OEM	Measures
1	BJ-124	Ball Joint Lower	40160 01E00	c: 14.9	3	RD-101	Axial Joint	48521-35F00	th:MM16X1R L:270
2	SI-101	Stabiliser Link	54618 50Y00	L:85.5	4	TI-109	Tie Rod End	48520-01E25	c:13 th:FM12X1.25R

CHERRY (F10,N10)

02/1975 - 05/1982



2 TI-118

1 RD-104

1 RD-104



2 TI-118

F10

3 LB-115

3 LB-115

N10

4 LB-118

4 LB-118

Ref	JAPANPARTS CODE	Description	OEM	Measures	Ref	JAPANPARTS CODE	Description	OEM	Measures
1	RD-104	Axial Joint	-	-	3	LB-115	Ball Joint Lower	40160-M3025	c:13.2
2	TI-118	Tie Rod End	48520-M0225	c:13.7 th:FM12X1.25	4	LB-118	Ball Joint Lower	40160-M7025	c:13

CHERRY (N12)

06/1982 - 07/1987

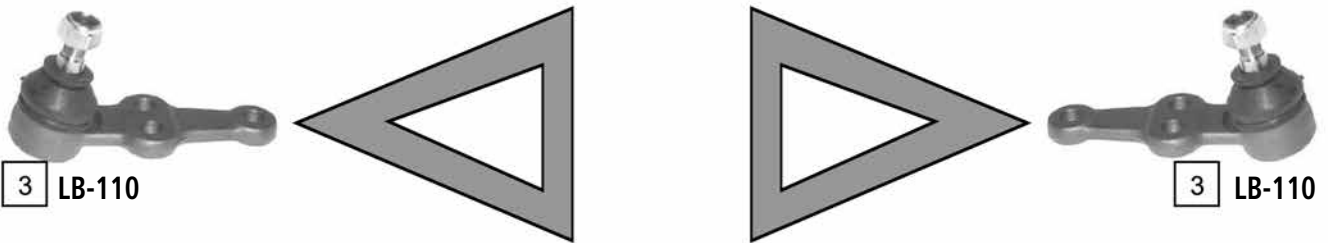

Ref	JAPANPARTS CODE	Description	OEM	Measures	Ref	JAPANPARTS CODE	Description	OEM	Measures
1	TI-109	Tie Rod End	48520-D010	c:13 th:FM12X1.25R	3	LB-110	Ball Joint Lower	40160-01A25	c:13
2	RD-101	Axial Joint	48521-35F00	th:MM16X1R L:270					

INTERSTAR (X70)

07/2002 ->

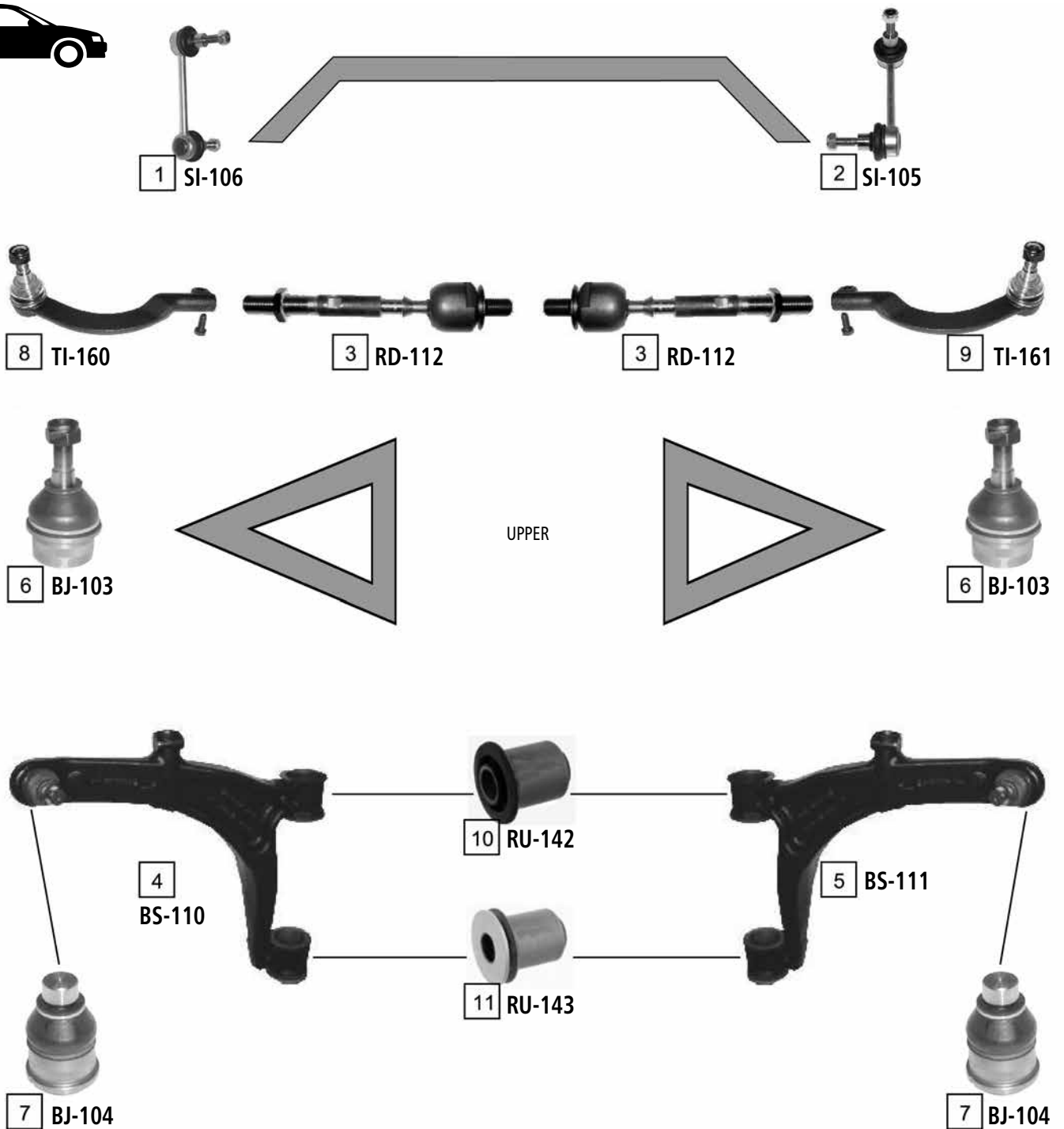

Ref	JAPANPARTS CODE	Description	OEM	Measures	Ref	JAPANPARTS CODE	Description	OEM	Measures
1	SI-106	Stabiliser Link Left	54616-00QAB	L:127	7	BJ-104	Ball Joint Lower	54500-00QAC	c:22
2	SI-105	Stabiliser Link Right	54618-00QAA	L:127	8	TI-160	Tie Rod End Left	48520-00QAH	c:16.4 th:FM16X1.5R
3	RD-112	Axial Joint	48521-00QAF	th:MM14X1.5R L:175	9	TI-161	Tie Rod End Right	48520-00QAJ	c:16.4 th:FM16X1.5R
4	BS-110	TCA Left	54501-00QAC	c:22	10	RU-142	Silentblock For Susp.Arm	54570 00QAA	d:55.2
5	BS-111	TCA Right	54500-00QAC	c:22	11	RU-143	Silentblock For Susp.Arm	54423 00QAA	d:55.2
6	BJ-103	Ball Joint Upper	45 00 254	c:16					

JUKE (F15E)

10/2009 ->

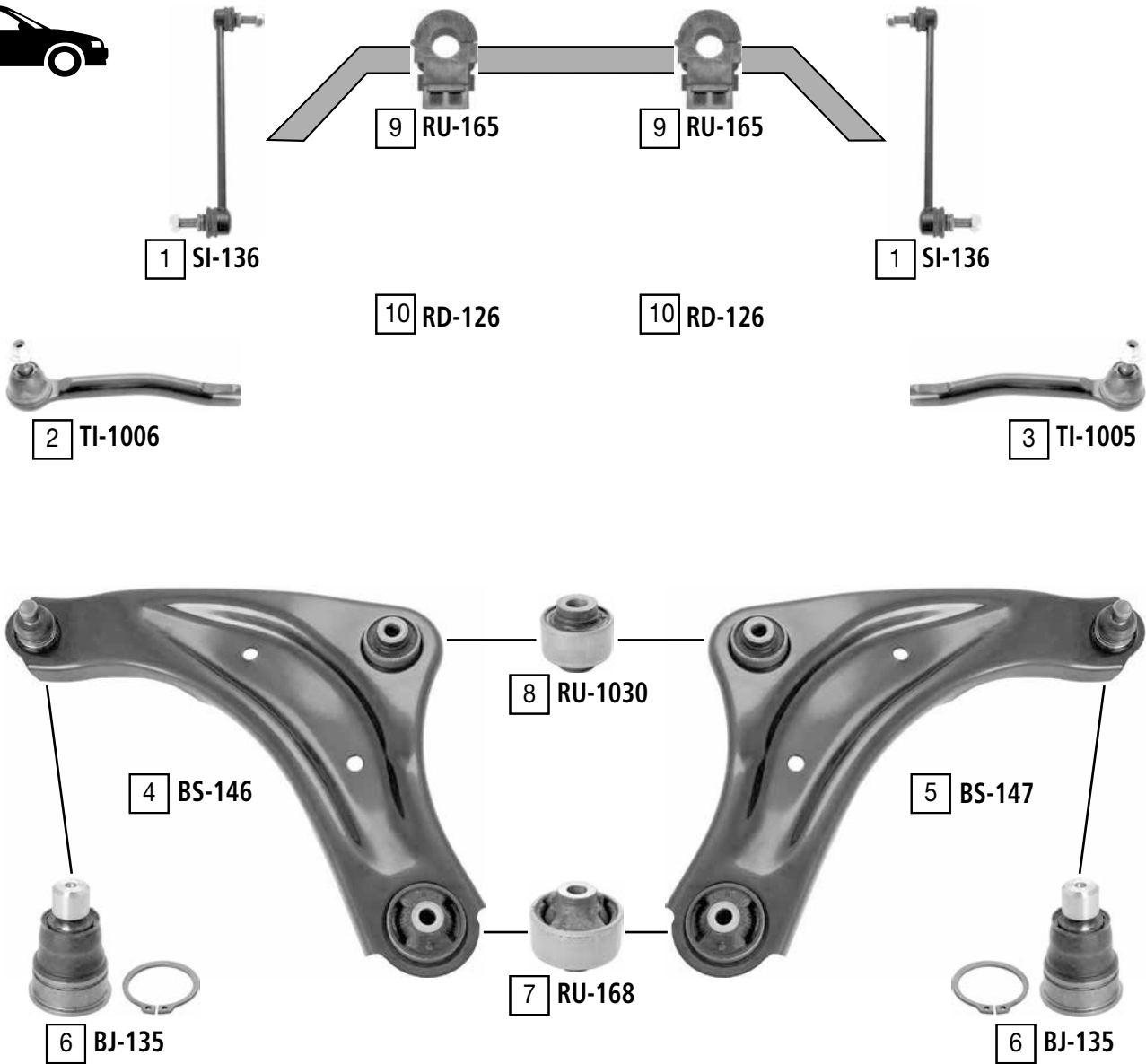

Ref	JAPANPARTS CODE	Description	OEM	Measures	Ref	JAPANPARTS CODE	Description	OEM	Measures
1	SI-136	Stabiliser Link	54618 CY00A	L:284	6	BJ-135	Ball Joint	Part of	c:18 do:38.5
2	TI-1006	Tie Rod End Left	D8640 1KA0A	c:11.9 th:FM12X1.25R	7	RU-168	Silentblock For TCA	Part of	di:12.2 do:58
3	TI-1005	Tie Rod End Right	D8520 1KA0A	c:11.9 th:FM12X1.25R	8	RU-1030	Silentblock For TCA	part of	di:14.2 do:50.1
4	BS-146	TCA Left Wbj	54501 1KA0B	c:18	9	RU-165	Stabiliser Mounting	54613 JD03A	di:22.7
5	BS-147	TCA Right Wbj	54500 1KA0B	c:18	10	RD-126			

KUBISTAR (X76)

07/2003 ->

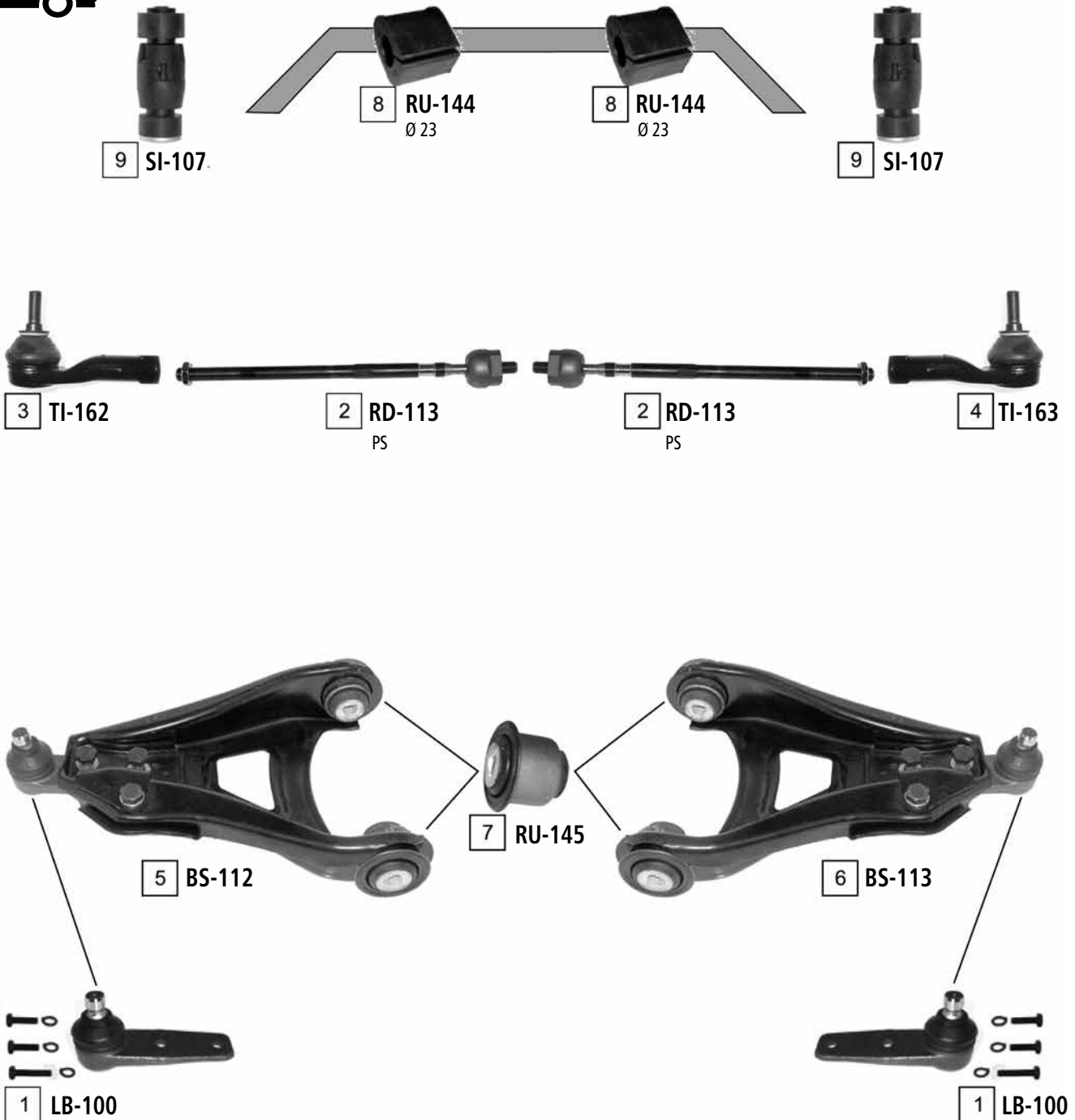

Ref	JAPANPARTS CODE	Description	OEM	Measures	Ref	JAPANPARTS CODE	Description	OEM	Measures
1	LB-100	Ball Joint Lower	77 01 472 038	c:16	6	BS-113	TCA Left Right	54500 00QAH	c:16
2	RD-113	Axial Joint	48521 00QAG	th:MM12X1R L:303	7	RU-145	Silentblock For Susp.Arm	54560 00QAB	d:45.4
3	TI-162	Tie Rod End	48520 00QAN		8	RU-144	Stabiliser Mounting	54613 00QAD	d:21
4	TI-163	Tie Rod End	48520 00QAP		9	SI-107	Stabiliser Mounting	54616 00QAA	
5	BS-112	TCA Left	54501 00QAH	c:16					



LAUREL (C31, C32)

01/1981 - 06/1990

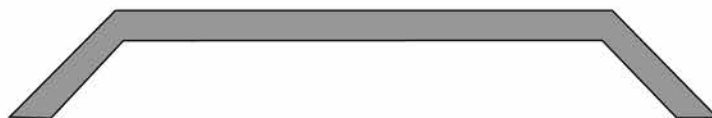

-> 10/1984



1 TI-130

5 TI-117

5 TI-117



1 TI-130

11/1984 ->



3 TI-148



2 RD-103



2 RD-103



3 TI-148



4 BJ-195

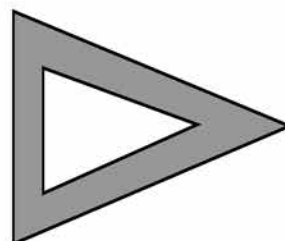
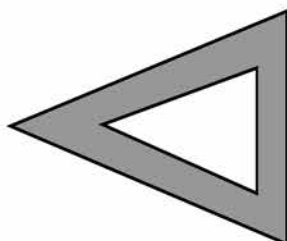

4 BJ-195

Ref	JAPANPARTS CODE	Description	OEM	Measures	Ref	JAPANPARTS CODE	Description	OEM	Measures
1	TI-130	Tie Rod End	48520-01L25	c:13.5 th:MM14X1.5L	4	BJ-195	Ball Joint Lower	40160-41L00	c:16.2
2	RD-103	Axial Joint	48521-01F00		5	TI-117	Tie Rod End		
3	TI-148	Tie Rod End	48520-41L00	c:13.6 th:FM14X1.5R					

MAXIMA (J30)

10/1988 - 09/1994



4 SI-101



4 SI-101



3 TI-174



2 TI-180



2 TI-180



3 TI-174



1 BJ-124

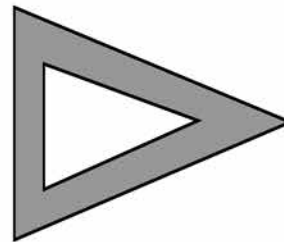
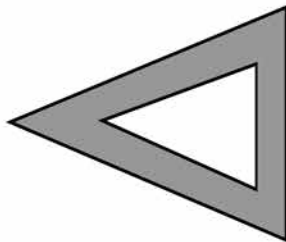

1 BJ-124

Ref	JAPANPARTS CODE	Description	OEM	Measures	Ref	JAPANPARTS CODE	Description	OEM	Measures
1	BJ-124	Ball Joint Lower	40160 01E00	c:14.9	3	TI-174	Tie Rod End	48520-88E25	c:11 th:FM14X1.5R
2	TI-180	Axial Joint	48521-72E06	th:MM16X1R L:260	4	SI-101	Stabiliser Link	54618 50Y00	L:85.5

MAXIMA QX (A32)

10/1994 - 08/2000



5 SI-108

5 SI-108



1 TI-194

4 RD-114

4 RD-114

1 TI-194



2 BS-114



3 BS-115

Ref	JAPANPARTS CODE	Description	OEM	Measures	Ref	JAPANPARTS CODE	Description	OEM	Measures
1	TI-194	Tie Rod End	48520-0M085	c:12.85 th:FM14X1.5	4	RD-114	Axial Joint	48521-40U25	th:MM16X1R L:312
2	BS-114	TCA Left	54501-41001	c:17	5	SI-108	Stabiliser Link	54618-0E000	L:98
3	BS-115	TCA Right	54500-41000	c:17					

MICRA (K10)

12/1982 - 11/1992

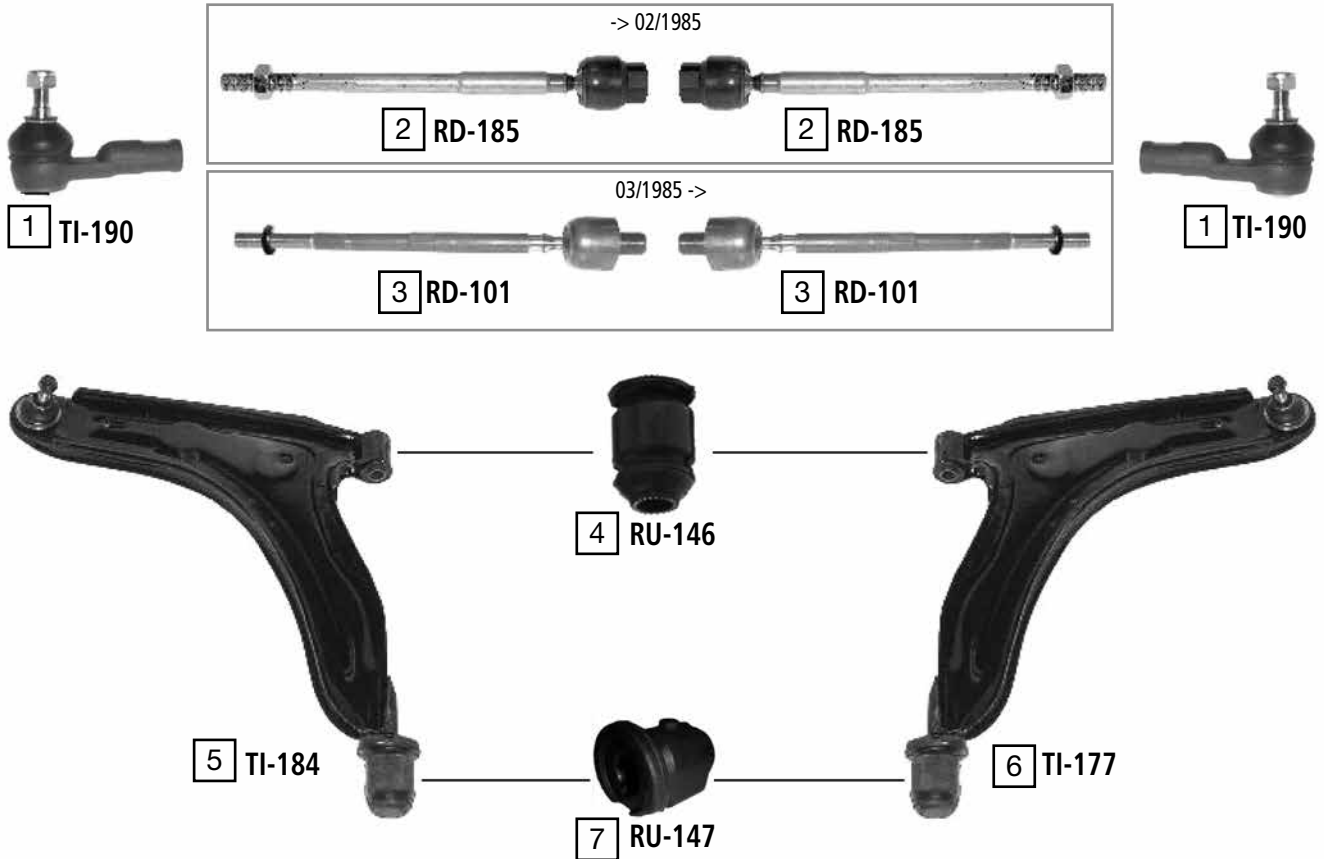

Ref	JAPANPARTS CODE	Description	OEM	Measures	Ref	JAPANPARTS CODE	Description	OEM	Measures
1	TI-190	Tie Rod End	48520-01B25	c:11 th:FM12X1.25R	5	TI-184	TCA Left	54501 21B00	c:11.7
2	RD-185	Axial Joint	48521-17B00	th:FM18X1R L:270	6	TI-177	TCA Right	54500 21B00	c:11.7
3	RD-101	Axial Joint	48521-35F00	th:MM16X1R L:270	7	RU-147	Silentblock For Susp.Arm	54476 01B00	
4	RU-146	Silentblock For Susp.Arm	54535 01B00	d:27.2	8	SI-198	Stabiliser Link	45261-4F702	L:90

MICRA (K11)

03/1993 - 08/2002

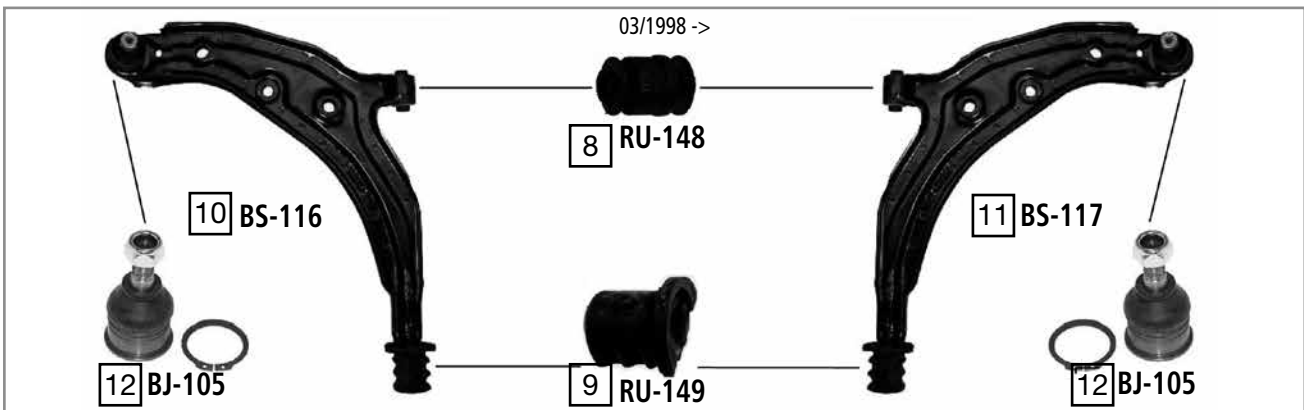
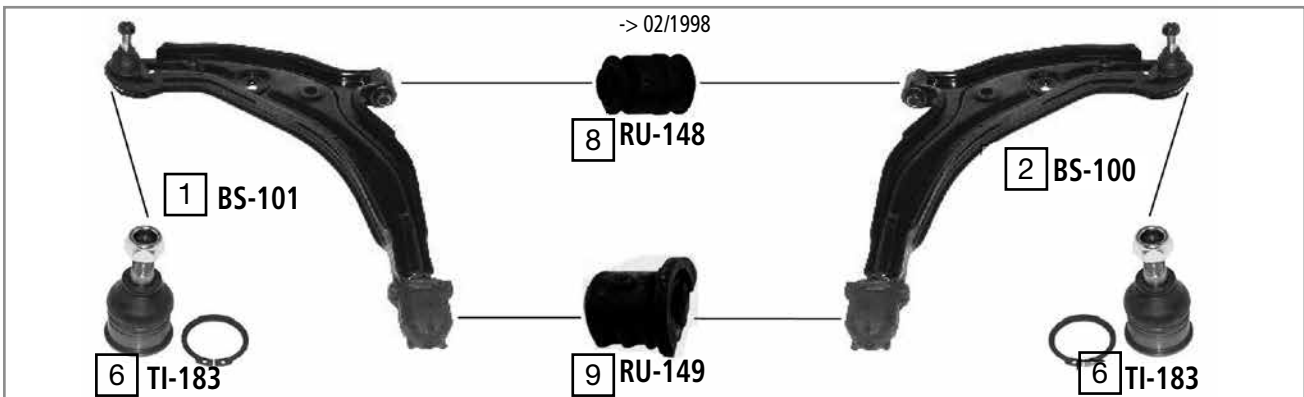

Ref	JAPANPARTS CODE	Description	OEM	Measures	Ref	JAPANPARTS CODE	Description	OEM	Measures
1	BS-101	TCA Left	54501 4F102	c:12.4	7	RD-101	Axial Joint	48521-35F00	th:MM16X1R L:270
2	BS-100	TCA Right	54500 4F102	c:12.4	8	RU-148	Silentblock For Susp.Arm	Part of BS-101/BS-100/BS-116/BS-117	d:28.3
3	TI-181	Tie Rod End	48520-4F125	c:10.9 th:FM12X1.25	9	RU-149	Silentblock For Susp.Arm	Part of BS-101/BS-100/BS-116/BS-117	
4	SI-198	Stabiliser Link	45261-4F702	L:90	10	BS-116	TCA Left	54501 6F600	c:13.1
5	SI-109	Stabiliser Link	56261-47B01		11	BS-117	TCA Right	54500 6F600	c:13.1
6	TI-183	Ball Joint	40160-4F100	c:12.4	12	BJ-105	Ball Joint	Part of BS-116/BS-117	c:13.1

MICRA (K12)

11/2002 ->

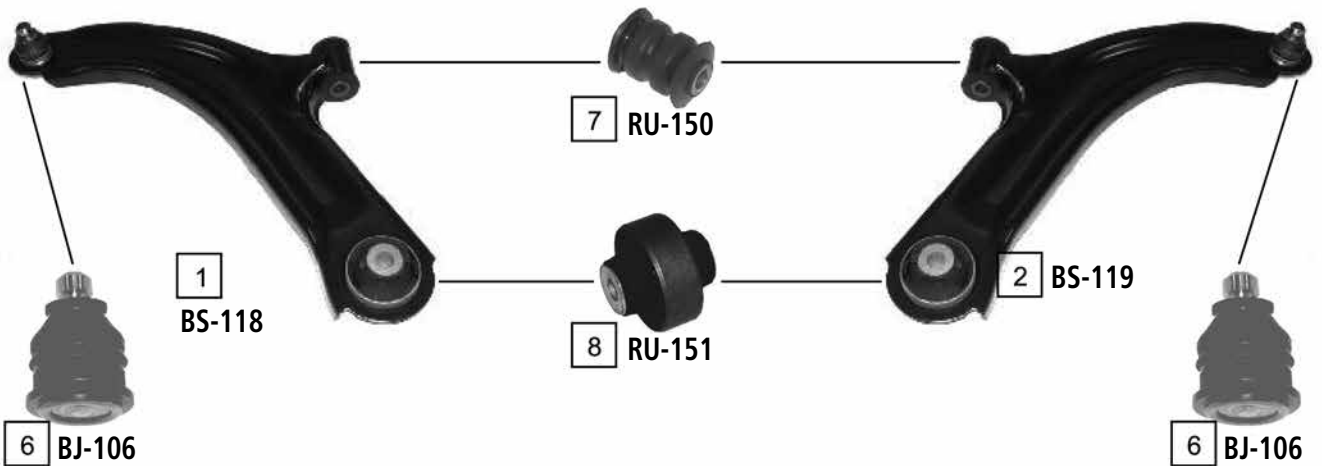
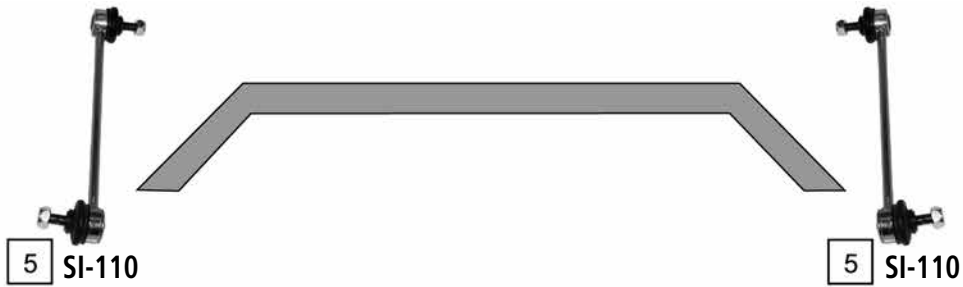

Ref	JAPANPARTS CODE	Description	OEM	Measures	Ref	JAPANPARTS CODE	Description	OEM	Measures
1	BS-118	TCA Left	54501 AX600	c:16	5	SI-110	Stabiliser Link	54618-AX600	L:248
2	BS-119	TCA Right	54500 AX600	c:16	6	BJ-106	Ball Joint	Part of BS-118/BS-119	c:16
3	TI-164	Tie Rod End Left	48640 AX600	c:11.7 th:FM14X1.5R	7	RU-150	Silentblock For Susp.Arm	54560 AX600	d:36.1
4	TI-165	Tie Rod End Right	48520 AX600	c:11.7 th:FM14X1.5R	8	RU-151	Silentblock For Susp.Arm	Part of BS-118/BS-119	d:58.4

NAVARA (D40M)

07/2005 ->

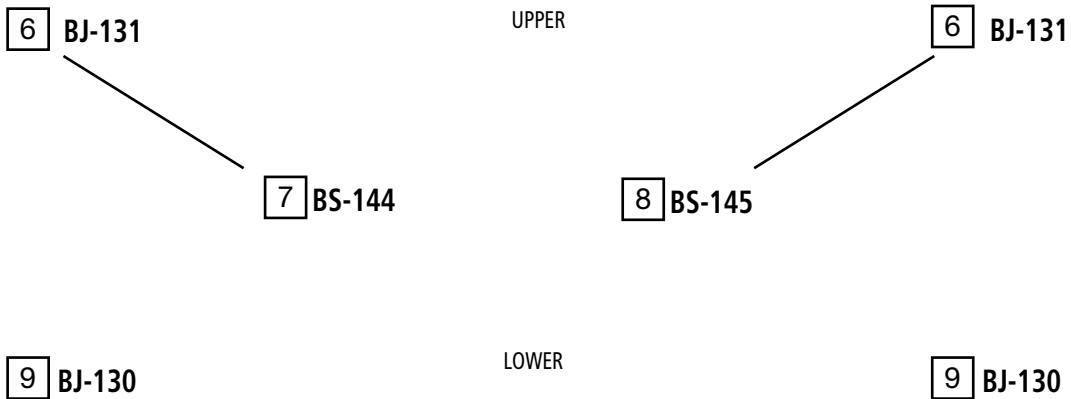
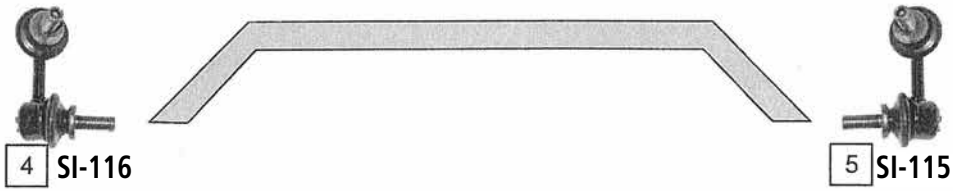

Ref	JAPANPARTS CODE	Description	OEM	Measures	Ref	JAPANPARTS CODE	Description	OEM	Measures
1	TI-150	Tie Rod End Left	48520 EA01J	c:14.9 th:FM16X1.5R	6	BJ-131	Ball Joint	40110 EB300	
2	TI-179	Tie Rod End Right	48640 EA01J	c:14.9 th:FM16X1.5R	7	BS-144	TCA Left	54525 EB300	
3	RD-116	Axial Joint	48521 EA000	th:MM20X1R	8	BS-145	TCA Right	54524 EB300	
4	SI-116	Stabiliser Link Left	54668 EA010	-	9	BJ-130	Ball Joint	40160 EA00A	
5	SI-115	Stabiliser Link Right	54618 EA010	-					

NOTE (E11)

03/2006 ->

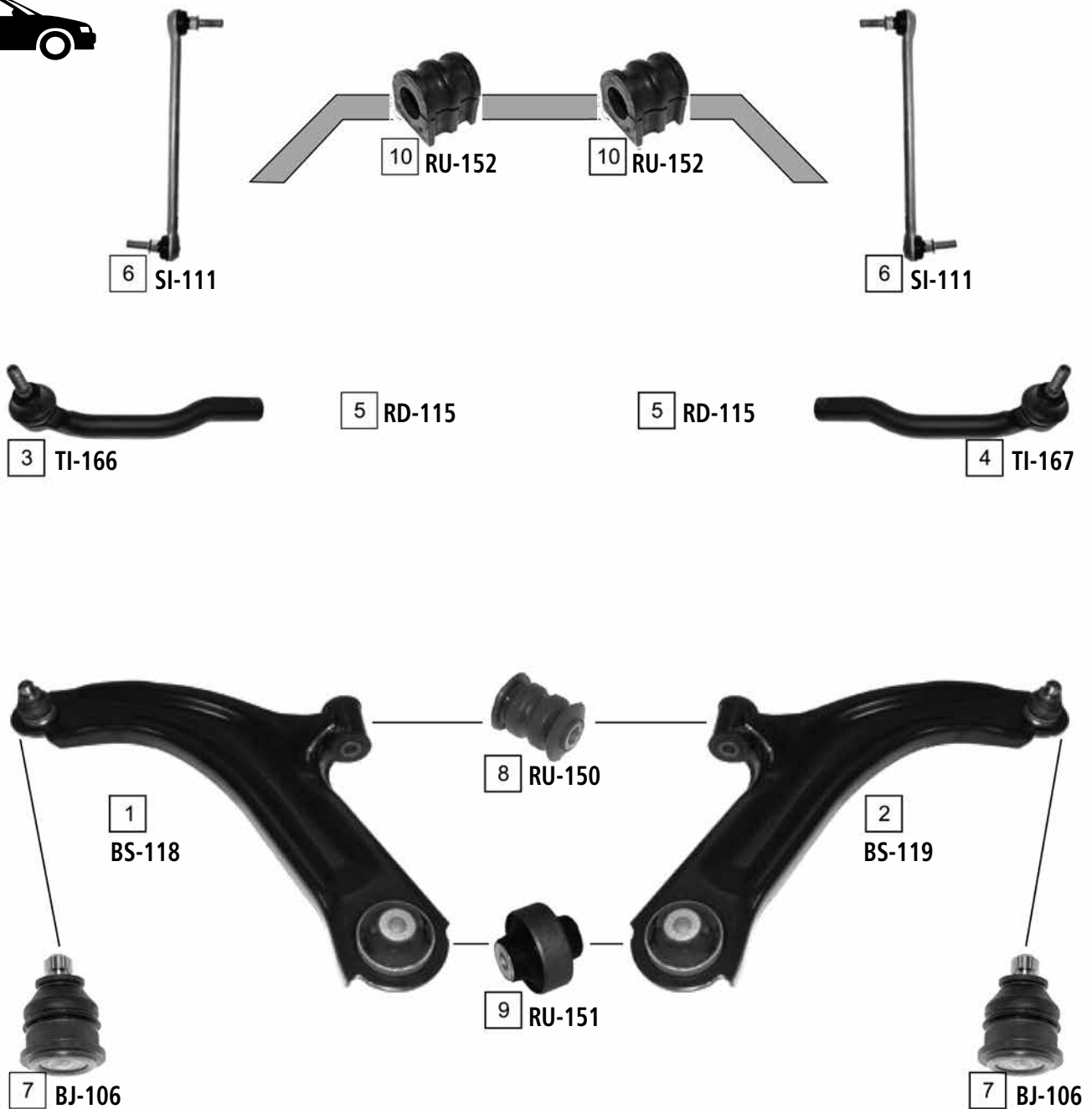

Ref	JAPANPARTS CODE	Description	OEM	Measures	Ref	JAPANPARTS CODE	Description	OEM	Measures
1	BS-118	TCA Left	54501 AX600	c:16	6	SI-111	Stabiliser Link	54618 9U00A	L:255
2	BS-119	TCA Right	54500 AX600	c:16	7	BJ-106	Ball Joint	Part of BS-118/BS-119	c:16
3	TI-166	Tie Rod End Left	486471U61A	c:11.8 th:FM12X1.25	8	RU-150	Silentblock For Susp.Arm	54560-AX600	d:36.1
4	TI-167	Tie Rod End Left	48527 1U61A	c:11.8 th:FM12X1.25	9	RU-151	Silentblock For Susp.Arm	Part of BS-118/BS-119	d:58.4
5	RD-115	Axial Joint	Part of	-	10	RU-152	Stabiliser Mounting	54613 9U000	d:21



PATHFINDER (R50)

01/10/1997 ->

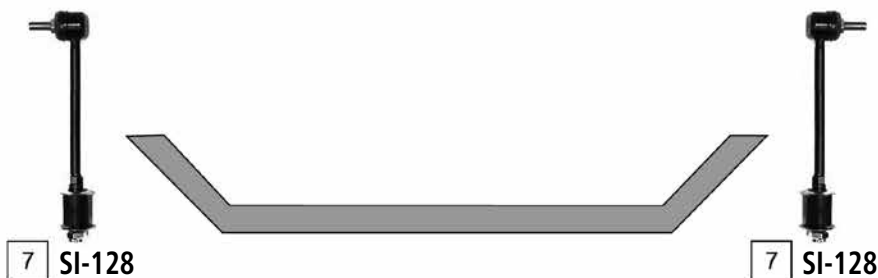
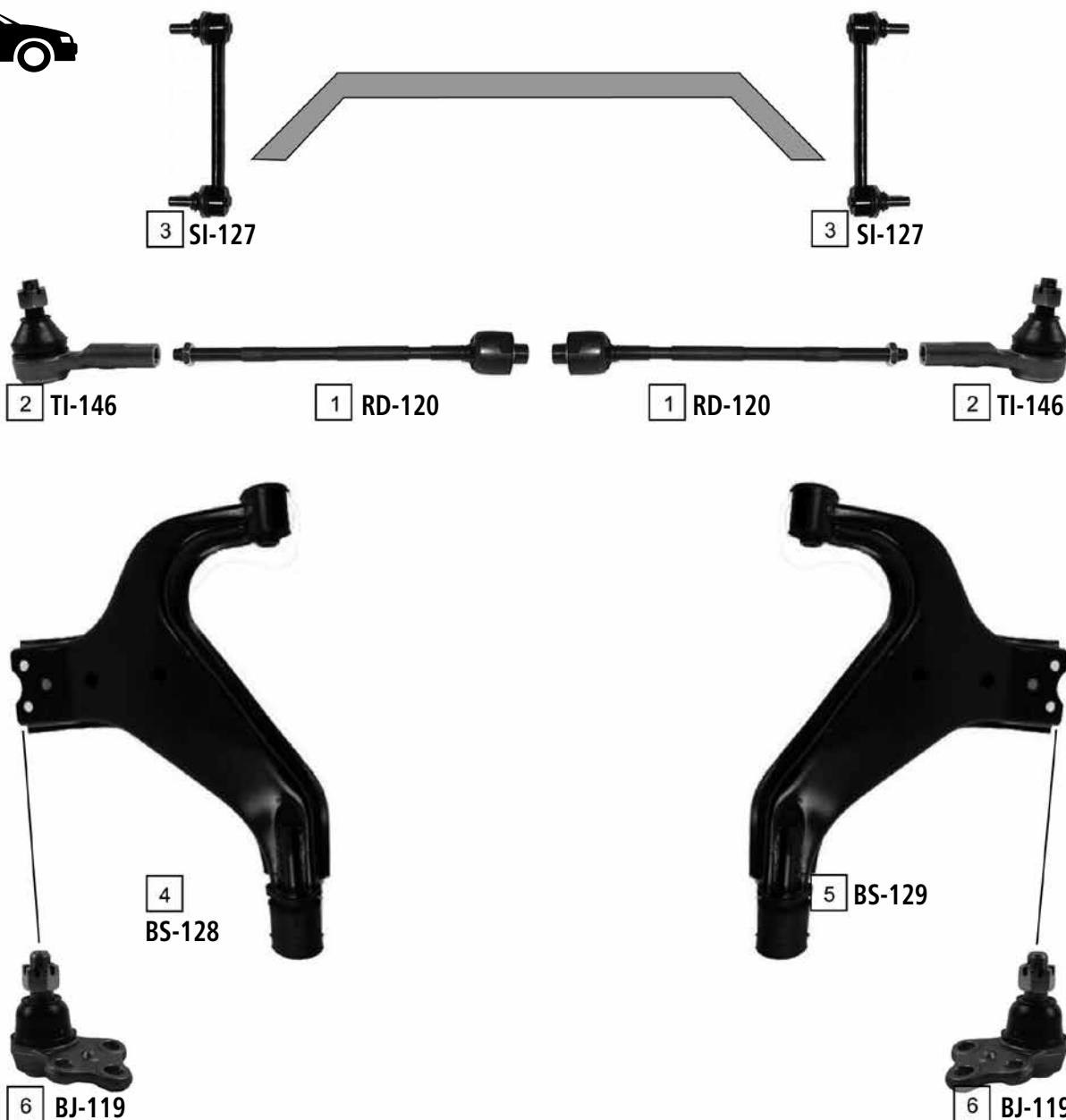

Ref	JAPANPARTS CODE	Description	OEM	Measures	Ref	JAPANPARTS CODE	Description	OEM	Measures
1	RD-120	Axial Joint	48521 0W025	th:MM20X1.5R L:328	5	BS-129	TCA Right	54500 0W001	
2	TI-146	Tie Rod End	48520 0W025	c:14.8 th:FM14X1.5R	6	BJ-119	Ball Joint	40160 0W025	c:17
3	SI-127	Stabiliser Link	54618 0W001	L:190	7	SI-128	Stabiliser Link	56260 0W001	L:163
4	BS-128	TCA Left	54501 0W001						

PATHFINDER (R51M)

01/2005 ->

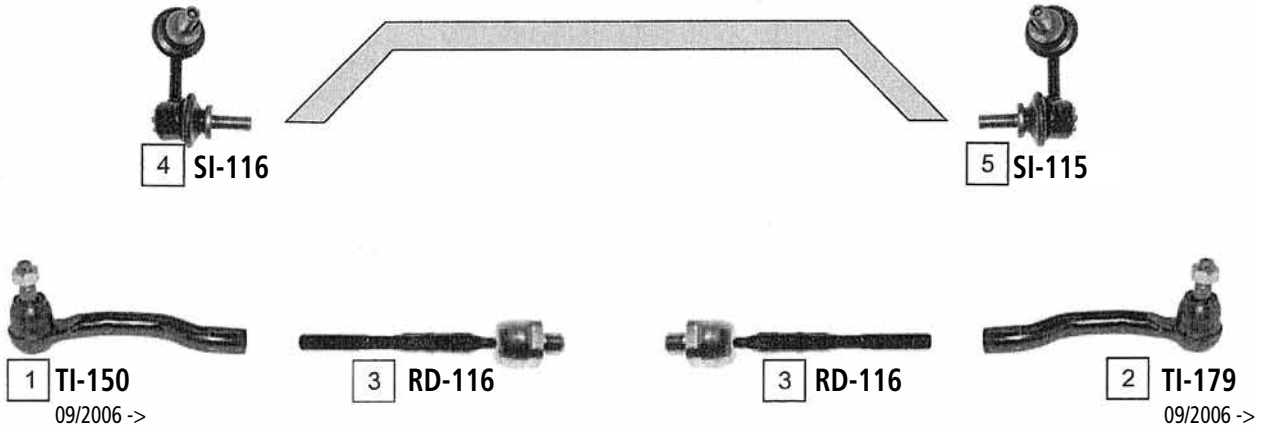

Ref	JAPANPARTS CODE	Description	OEM	Measures	Ref	JAPANPARTS CODE	Description	OEM	Measures
1	TI-150	Tie Rod End Left	48520 EA01J	c:14.9 th:FM16X1.5R	5	SI-115	Stabiliser Link Right	54618 EA010	-
2	TI-179	Tie Rod End Right	48640 EA01J	c:14.9 th:FM16X1.5R	6	SI-118	Stabiliser Link Left	56261 EA510	-
3	RD-116	Axial Joint	48521 EA000	th:MM20X1R	7	SI-117	Stabiliser Link Right	56261 EA500	-
4	SI-116	Stabiliser Link Left	54668 EA010	-					

PATROL R (160)

11/1979 - 08/1988



2 TI-110L



1 TI-110R



1 TI-110R



2 TI-110L

3 TI-152

3 TI-152

4 TI-N006

5 TI-N005

6 TI-N007

7 TI-N008

8 TI-N010

9 TI-N009

Ref	JAPANPARTS CODE	Description	OEM	Measures	Ref	JAPANPARTS CODE	Description	OEM	Measures
1	TI-110R	Tie Rod End	48580-J5100	c:15.8 th:MM22X1.5L	6	TI-N007	Tie Rod End		
2	TI-110L	Tie Rod End	48570-J5100	c:15.8 th:MM22X1.5R	7	TI-N008	Tie Rod End		
3	TI-152	Tie Rod End	4857011J00		8	TI-N010	Tie Rod End	48520-G9502	
4	TI-N006	Tie Rod End			9	TI-N009	Tie Rod End	48570-G9501	
5	TI-N005	Tie Rod End							

PATROL GR (Y60)

08/1987 - 09/1997

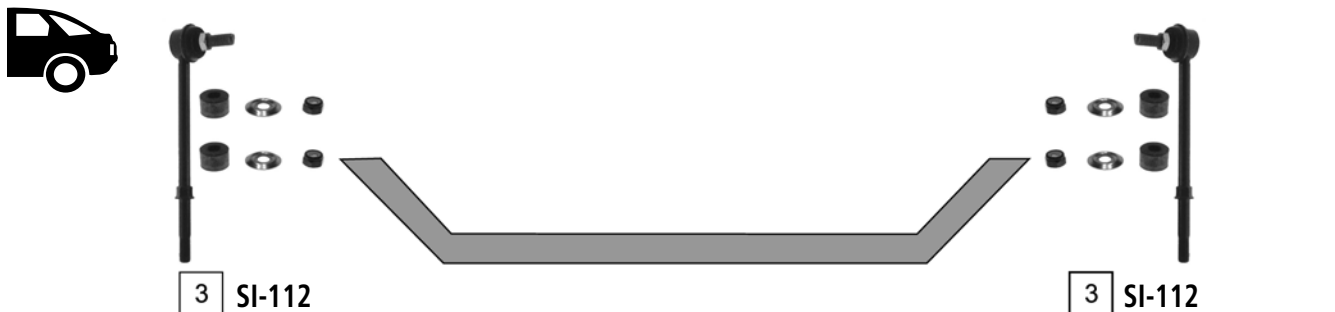
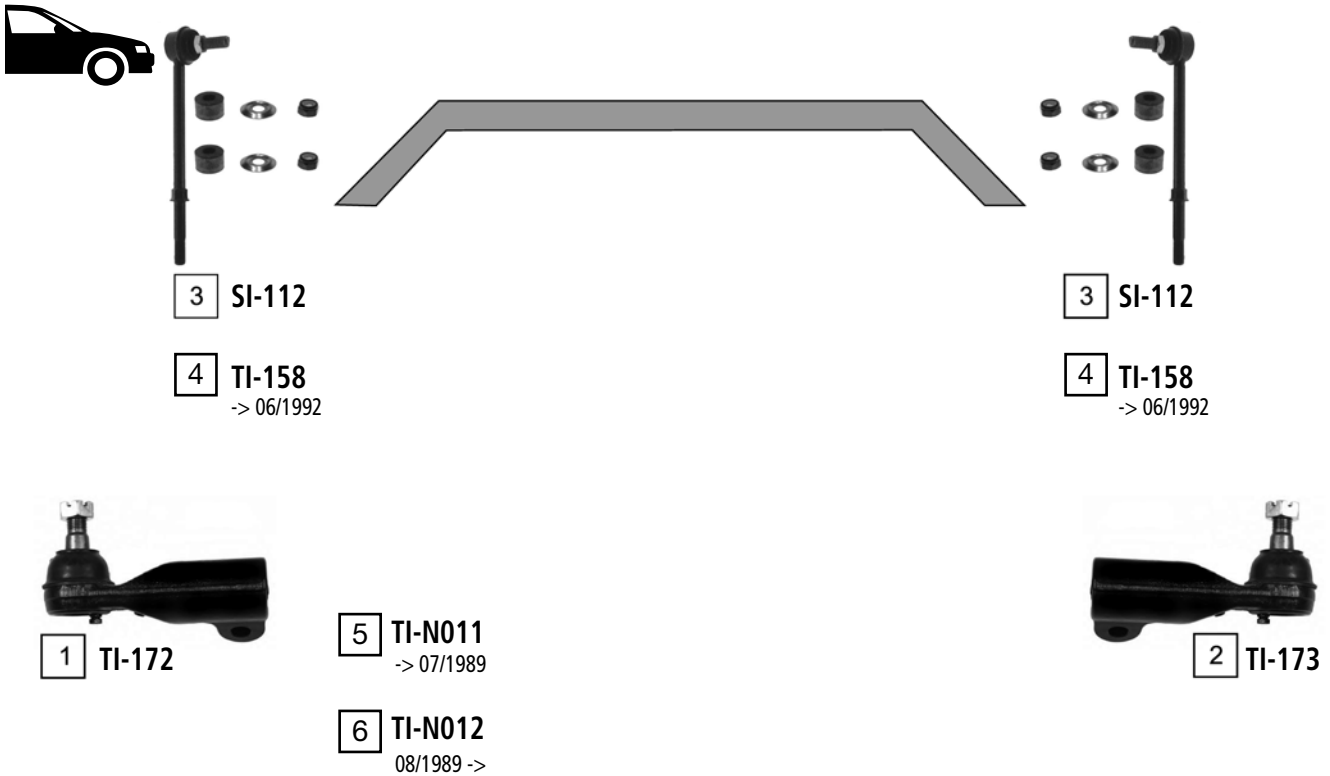

Ref	JAPANPARTS CODE	Description	OEM	Measures	Ref	JAPANPARTS CODE	Description	OEM	Measures
1	TI-172	Tie Rod End Left	48570 01J10		4	TI-158	Tie Rod End	4852001J00	
2	TI-173	Tie Rod End Right	48520 01J10		5	TI-N011	Cross Rod Assi	4856049502	
3	SI-112	Stabiliser Link	56260 01J10	L:130	6	TI-N012	Cross Rod Assi		

PICK-UP 2X4 (D21)

08/1985 - 02/1998

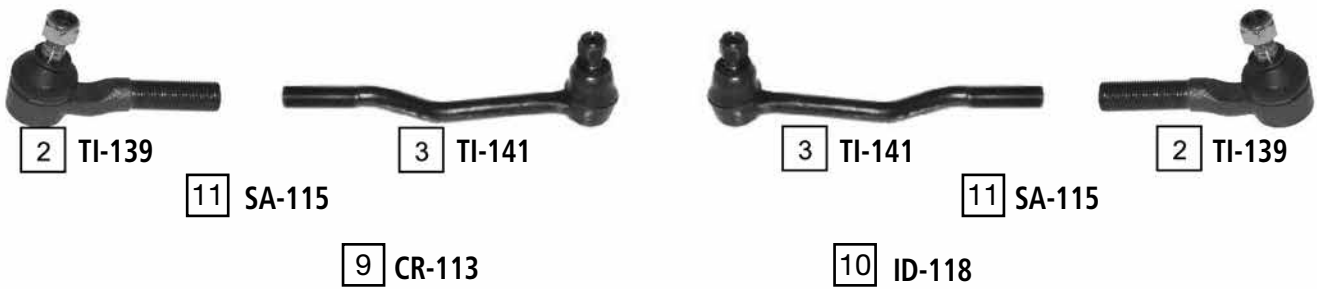

UPPER

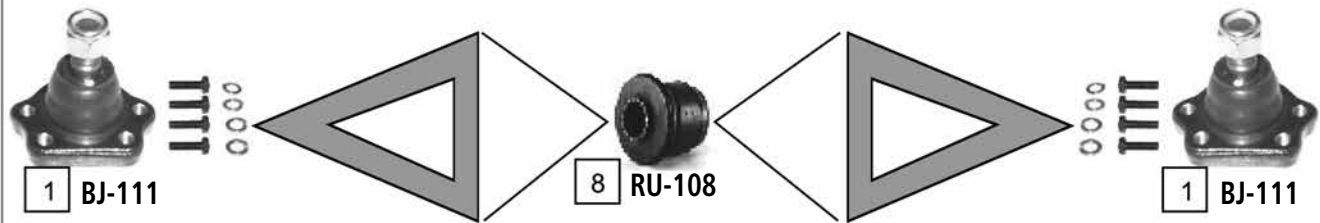

LOWER



Ref	JAPANPARTS CODE	Description	OEM	Measures	Ref	JAPANPARTS CODE	Description	OEM	Measures
1	BJ-111	Ball Joint	40110 01G00	c:16.1	7	CJ-101	TCA Right	54502-01G90	c:19.65
2	TI-139	Tie Rod End	48520-01G25	c:13.3 th:MM18X1.5L	8	RU-108	Silentblock For Susp.Arm	54506-B9500	d:41.1
3	TI-141	Tie Rod End Inner	48521-01G25	c:13.2 th:MM18X1.5R	9	CR-113	Cross Rod	4856009G25	
4	SI-113	Stabiliser Link	54618 01G00	L:195	10	ID-118	Pitman Arm	4853001G25	
5	LB-190	Ball Joint Lower	40160 01G25	c:19.5	11	SA-115	Tie Rod	4851001G025	
6	CJ-100	TCA Left	54503-01G90	c:19.65					

PICK-UP 4X4 (D21)

08/1985 - 02/1998

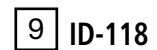
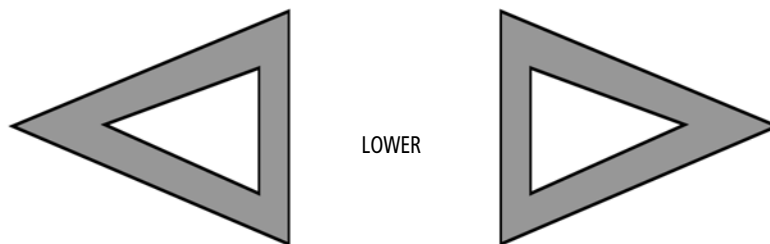
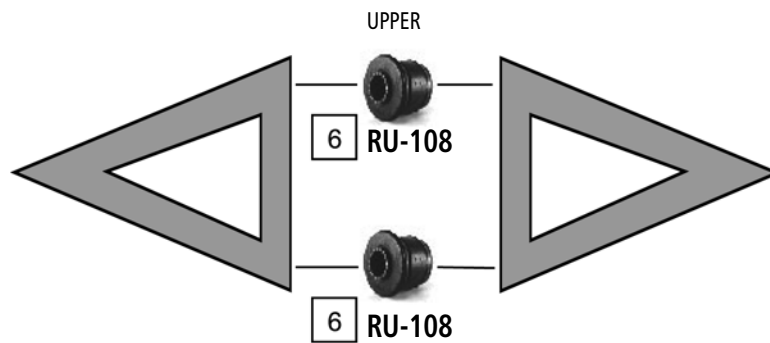
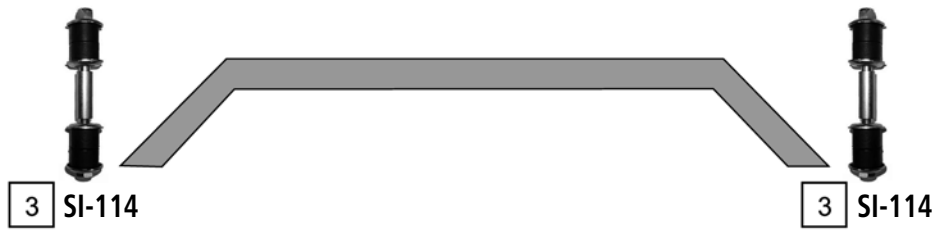

Ref	JAPANPARTS CODE	Description	OEM	Measures	Ref	JAPANPARTS CODE	Description	OEM	Measures
1	TI-142	Tie Rod End Outer	48520 31G25	c:13.2 th:MM16X1.5R	6	RU-108	Silentblock For Susp.Arm	54506-B9500	d:41.1
2	TI-189	Tie Rod End Inner	48520 7F001	c:13.3 th:MM16X1.5L	7	CR-113	Cross Road	48560 09G25	
3	SI-114	Stabiliser Link	54618 02E00	L:140	8	SA-116	Tie Rod	48510 31G25	
4	LB-121	Ball Joint Lower	40160 0F000	c:19.5	9	ID-118	Pitman Arm	48530 01G25	
5	BJ-111	Ball Joint	40110 01G00	c:16.1					

PICK-UP (D22) KING CAB

09/1998 ->

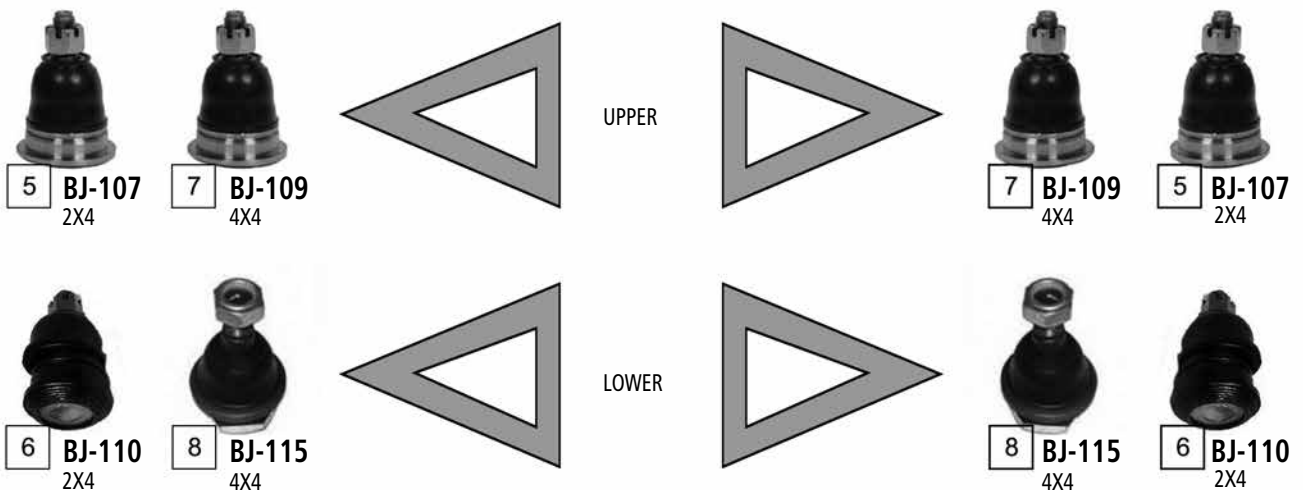
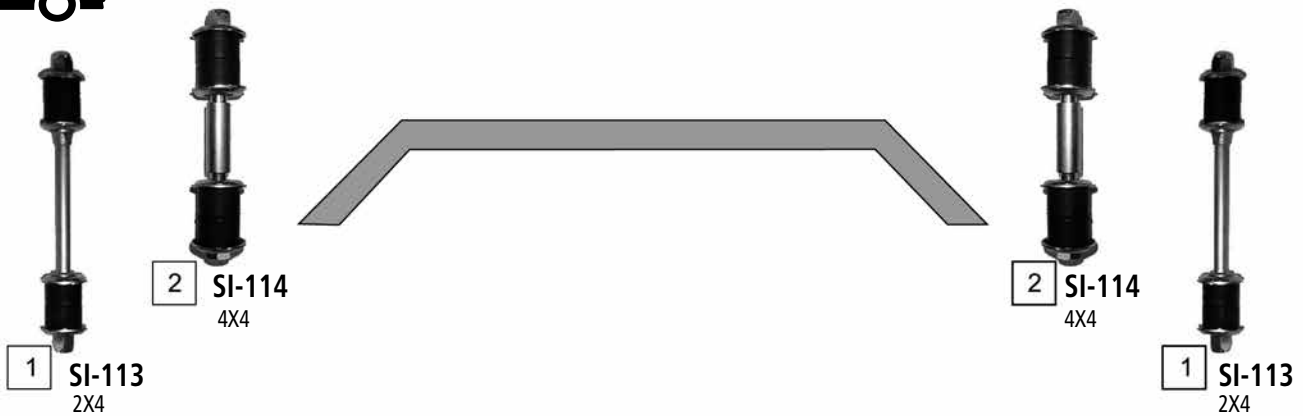

Ref	JAPANPARTS CODE	Description	OEM	Measures	Ref	JAPANPARTS CODE	Description	OEM	Measures
1	SI-113	Stabiliser Link	54618 01G00	L: 195	6	BJ-110	Ball Joint	40160 2S485	-
2	SI-114	Stabiliser Link	54618 02E00	L: 140	7	BJ-109	Ball Joint	40110 2S685	-
3	TI-146	Tie Rod End	48520 0W025	c: 14.8 th:FM14x1.5R	8	BJ-115	Ball Joint	40160 2S601	-
4	TI-123	Tie Rod End Inner	48570 3S525	-	9	TI-111	Tie Rod End Inner	48521 2S425	-
5	BJ-107	Ball Joint	40110 2S485	-	10	TI-138	Tie Rod End Outer	48520 2S425	-

PIXO (UA0)

06/2009 ->

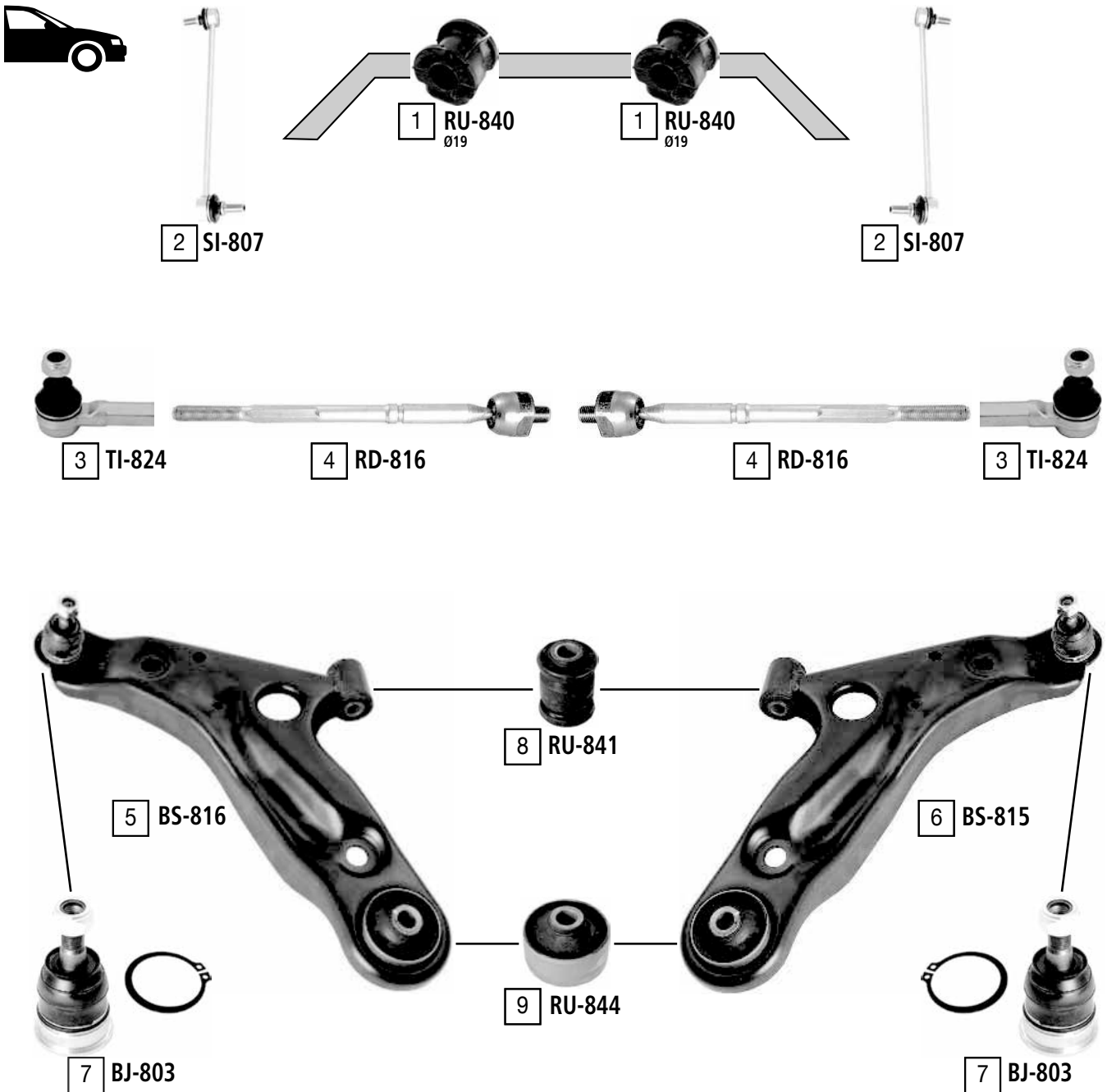

Ref	JAPANPARTS CODE	Description	OEM	Measures	Ref	JAPANPARTS CODE	Description	OEM	Measures
1	RU-840	Stabiliser mounting	54614M-4A00B	di:19	6	BS-815	TCA right wbj	54530 4A00D	c:13.4
2	SI-807	Stabiliser link	54616 4A00B	L:282	7	BJ-803	Ball joint	54529 4A00A	c:13.4 do:40.3
3	TI-824	Tie rod end	48520 4A00B	c:13 th:FM12x1.25R	8	RU-841	Silentblock for TCA	54423 4A00B	di:12.1 do:33.4
4	RD-816	Axial joint	48510 4A00C	th:MM14x1.5R L:272.5	9	RU-844	Silentblock for TCA	part of	di:12.4 do:54.1
5	BS-816	TCA left wbj	54529 4A00D	c:13.4					



PRAIRIE (M10, NM10)  
PRAIRIE PRO (M11)

01/1983 - 10/1998  
10/1988 - 07/1994



4X4



2X4



-> 10/1988

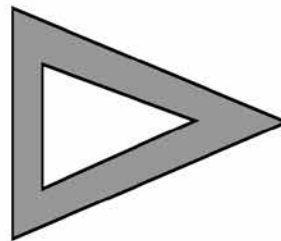
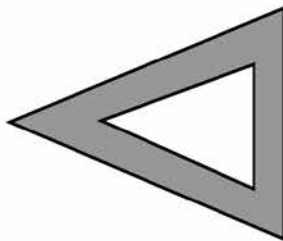

10/1988 ->

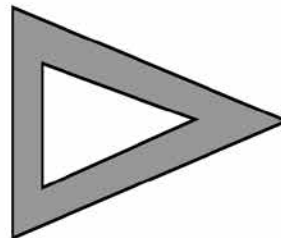
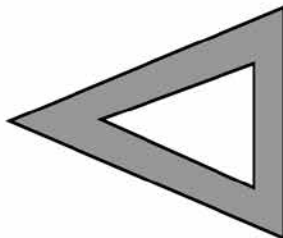

Ref	JAPANPARTS CODE	Description	OEM	Measures	Ref	JAPANPARTS CODE	Description	OEM	Measures
1	TI-180	Axial Joint	48521-72E06	th:MM16X1R L:260	4	TI-185	Tie Rod End	48520 53E25	c:13 th:FM12X1.25R
2	SI-101	Stabiliser Link	54618 50Y00	L:85.5	5	BJ-124	Ball Joint Lower	40160 01E00	c:14.9
3	LB-110	Ball Joint Lower	40160-01A25	c:13	6	RD-101	Axial Joint	48521-35F00	th:MM16X1R L:270

PRIMASTAR (X83)

03/2001 ->

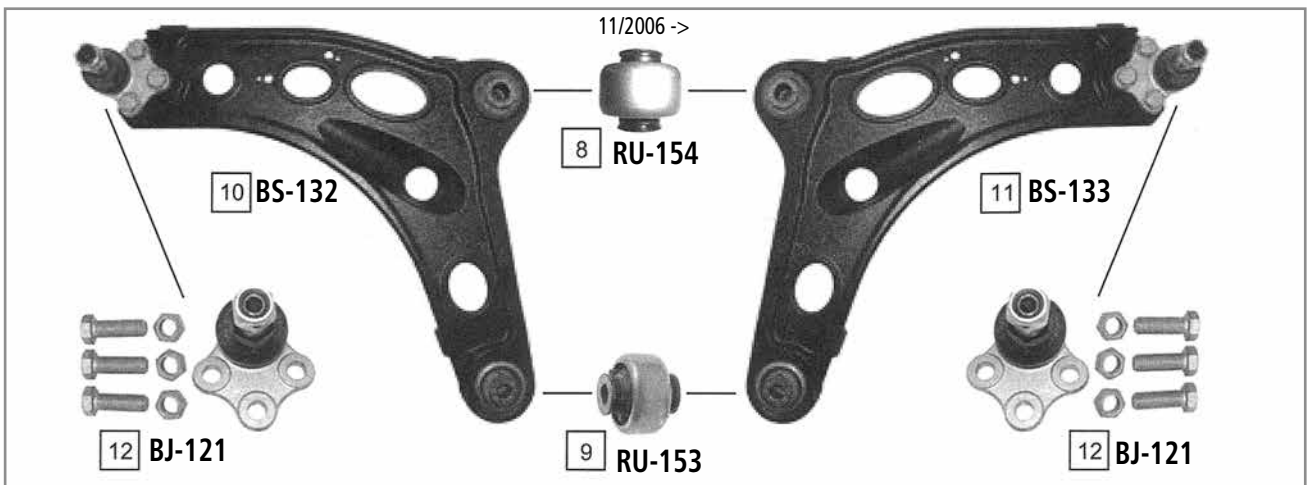
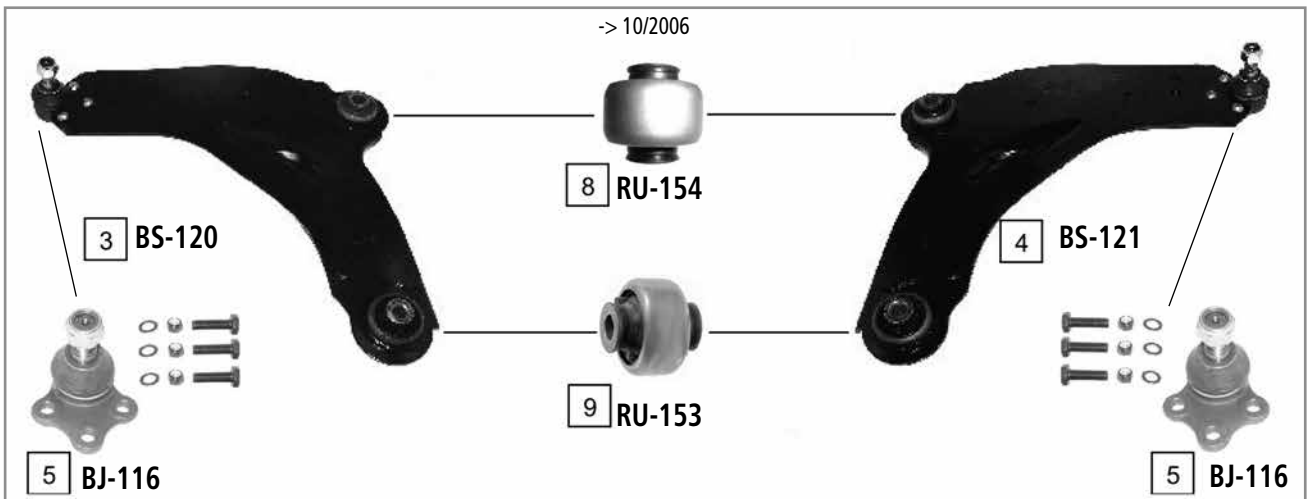
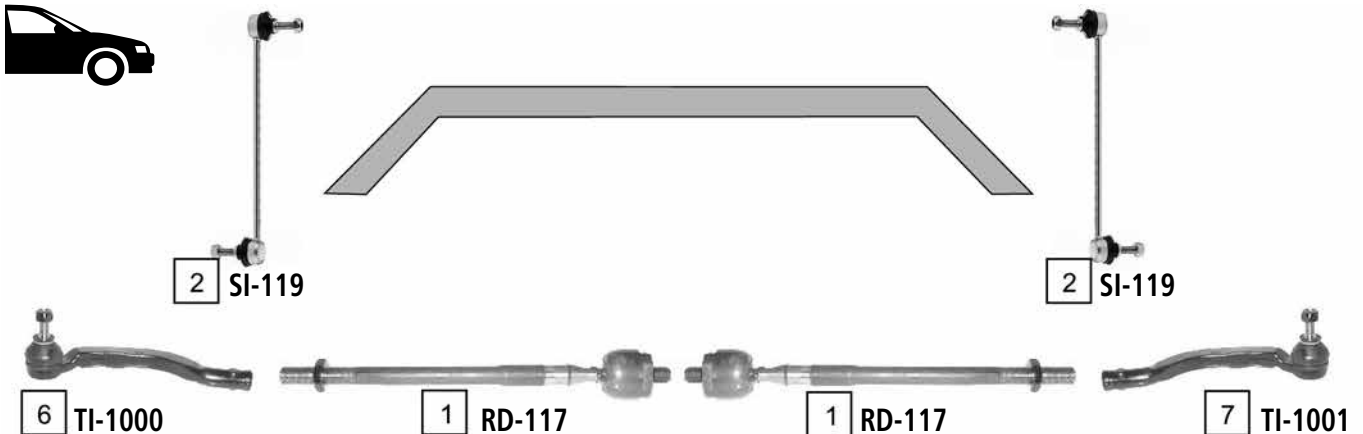

Ref	JAPANPARTS CODE	Description	OEM	Measures	Ref	JAPANPARTS CODE	Description	OEM	Measures
1	RD-117	Axial Joint	48520-00QAM	th:MM12X1R L:263	7	TI-1001	Tie Rod End Right	48520-00QAL	c:12 th:FM14X1.5R
2	SI-119	Stabiliser Link	54616-00QAC	L:366	8	RU-154	Silentblock For Susp.Arm	Part of BS-120/121/132/133	d:54
3	BS-120	TCA Left Wbj	54503-00QAA	c:18	9	RU-153	Silentblock For Susp.Arm	Part of BS-120/121/132/133	d:54.6
4	BS-121	TCA Right Wbj	55502-00QAA	c:18	10	BS-132	TCA Left Wbj	82 00 626 959	c:18
5	BJ-116	Ball Joint Lower	Part of BS-120/121	c:18	11	BS-133	TCA Right Wbj	82 00 565 079	c:18
6	TI-1000	Tie Rod End Left	48520-00QAK	c:12 th:FM14X1.5R	12	BJ-121	Ball Joint	40 160 00QOA	c:18

PRIMERA (P10)

06/1990 - 06/1996

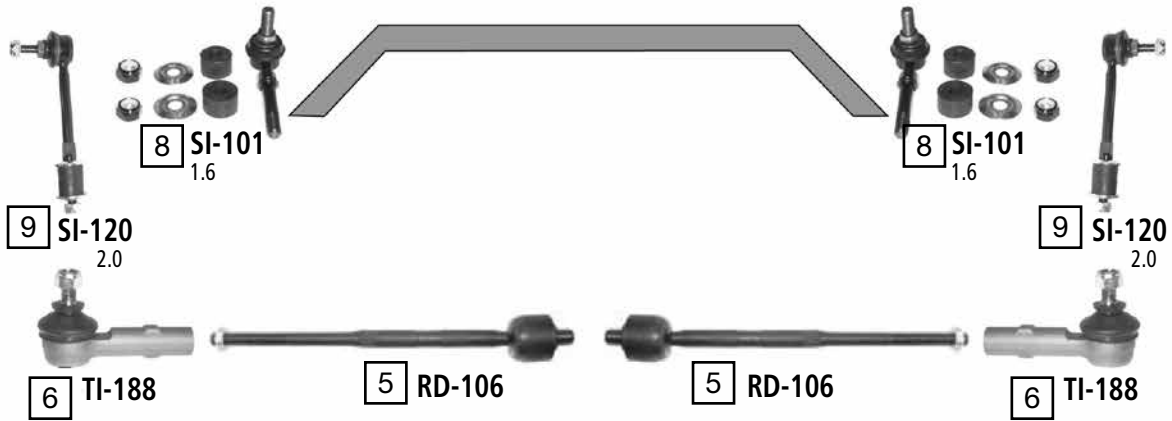

UPPER



LOWER



Ref	JAPANPARTS CODE	Description	OEM	Measures	Ref	JAPANPARTS CODE	Description	OEM	Measures
1	BS-103	TCA Left	54501-86J00	c:15	7	SI-199	Stabiliser Link	56261-86J25	L:114.5
2	BS-102	TCA Right	54500-86J00	c:15	8	SI-101	Stabiliser Link	5461850Y00	L:85.5
3	ML-101	TCA Left	54525-2F010		9	SI-120	Stabiliser Link	54618-50J20	L:160
4	ML-100	TCA Right	54524-2F010		10	LB-130	Ball Joint	40160 60Y60	
5	RD-106	Axial Joint	48521-72E00	th:MM14X1.5R L:273	11	RU-155	Silentblock For Susp.Arm	Part of BS-102/BS-103	d:38.1
6	TI-188	Tie Rod End	48520 73J25	c:13 th:FM12X1.25R	12	RU-156	Silentblock For Susp.Arm	Part of BS-102/BS-103	d:20

PRIMERA (P11)

06/1996 - 12/2001



UPPER



3 ML-101



4 ML-100

LOWER

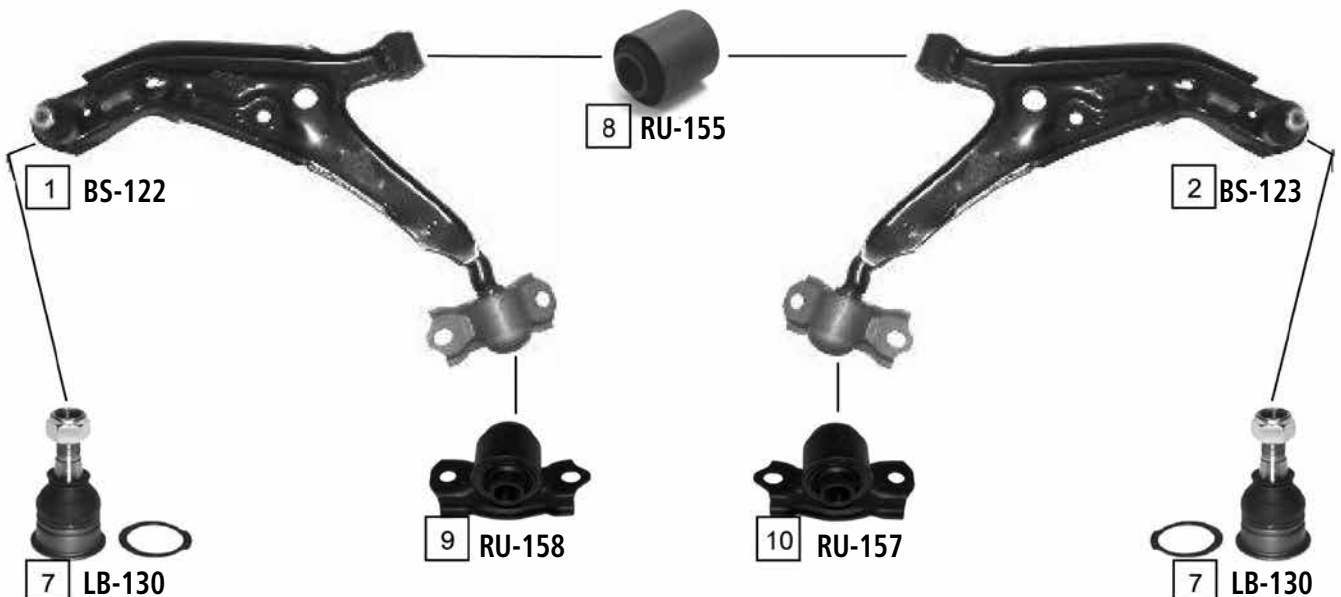

Ref	JAPANPARTS CODE	Description	OEM	Measures	Ref	JAPANPARTS CODE	Description	OEM	Measures
1	BS-122	TCA Left	54501-2F500	c:15	6	TI-188	Tie Rod End	48520 73J25	c:13 th:FM12X1.25R
2	BS-123	TCA Right	54500-2F500	c:15	7	LB-130	Ball Joint	40160-60Y60	c:15
3	ML-101	TCA Left	54525-2F010		8	RU-155	Silentblock For Susp.Arm	Part of BS-122/BS-123	d:38.1
4	ML-100	TCA Right	54524-2F010		9	RU-158	Silentblock For Susp.Arm	Part of BS-122	
5	RD-106	Axial Joint	4852172E00	th:MM14X1.5R L:273	10	RU-157	Silentblock For Susp.Arm	Part of BS-122	

PRIMERA (P12,WP12)

03/2002 ->

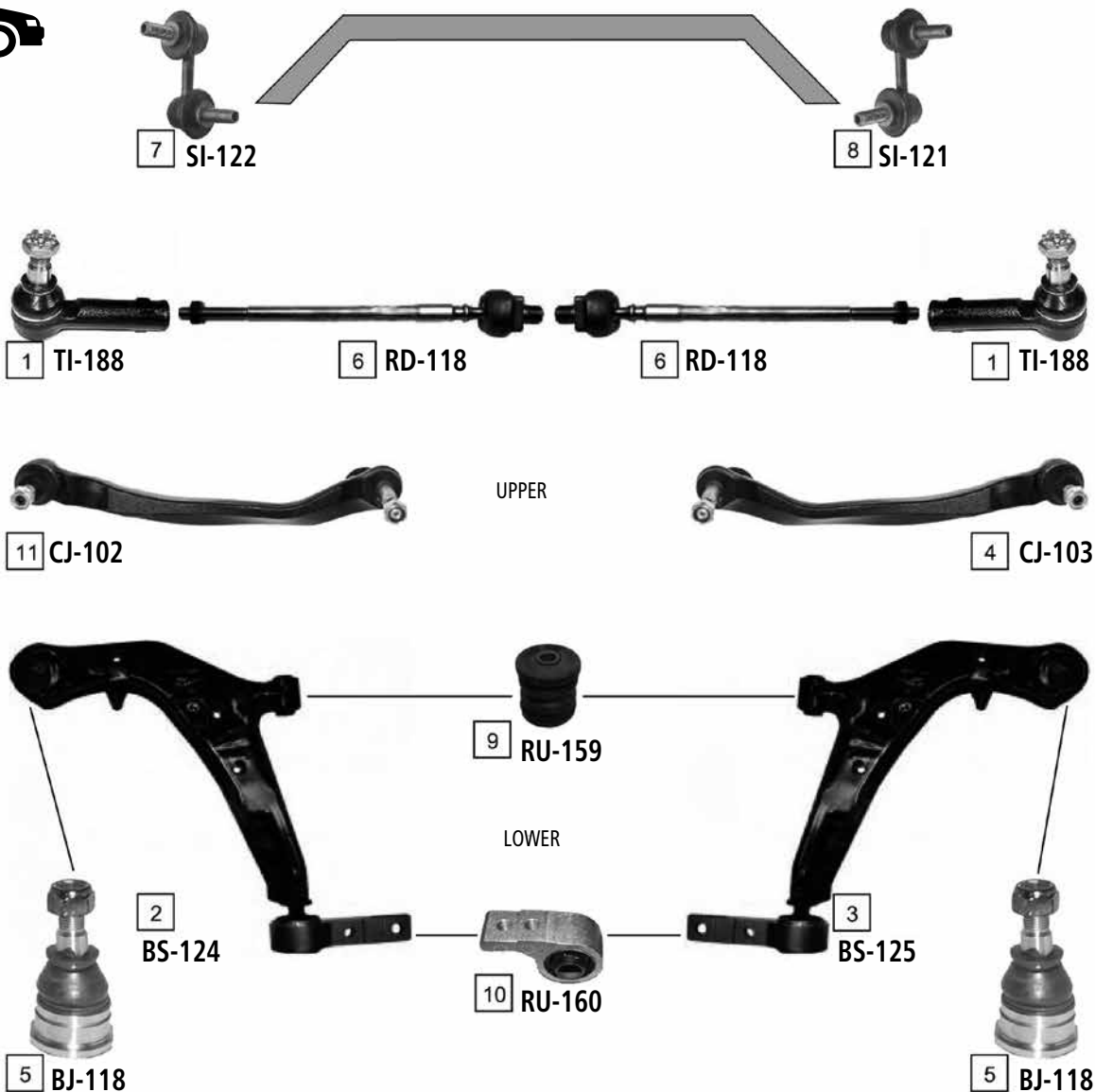

Ref	JAPANPARTS CODE	Description	OEM	Measures	Ref	JAPANPARTS CODE	Description	OEM	Measures
1	TI-188	Tie Rod End	48520-73J25	c:12.9 th:FM12X1.25	8	SI-121	Stabiliser Link Right	54618-AU000	L:65
2	BS-124	TCA Left	54501 AV605		9	RU-159	Silentblock For Susp.Arm	Part of BS-124/BS-125	
3	BS-125	TCA Right	54500-AV600		10	RU-160	Silentblock For Susp.Arm	Part of BS-124/BS-125	
4	CJ-103	TCA Right	54524 AV600	c:13	11	CJ-102	TCA Left	54525 AV600	c:13
5	BJ-118	Ball Joint	Part of 41170/1	c:15.2	12	SI-123	Stabiliser Link	56261 AV610	L:90.5
6	RD-118	Axial Joint	Part of	th:MM18X1.5R L:280	13	SI-124	Stabiliser Link	56261 0E000	L:91
7	SI-122	Stabiliser Link Left	54668-AU000	L:65					

PRIMERA TRAVELLER (WP11)

04/1998 - 12/2001

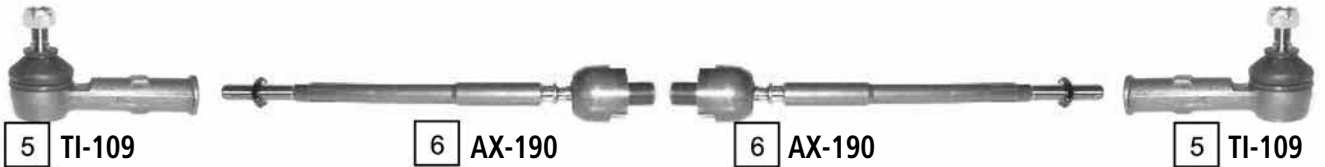

UPPER



LOWER

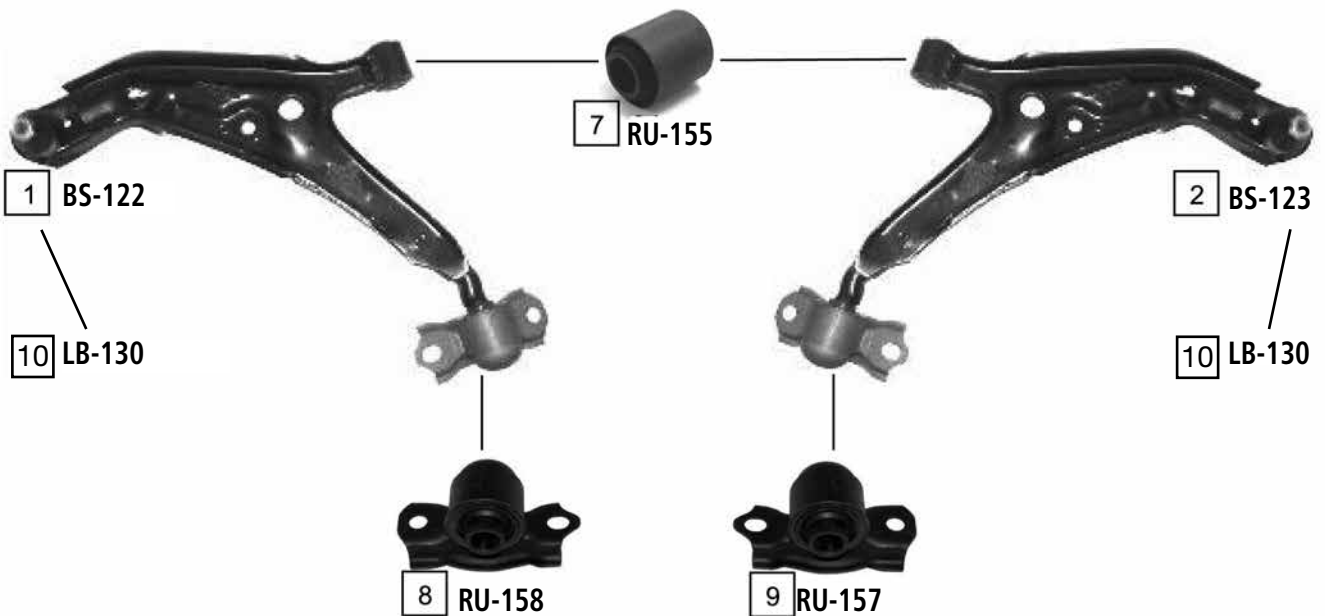

Ref	JAPANPARTS CODE	Description	OEM	Measures	Ref	JAPANPARTS CODE	Description	OEM	Measures
1	BS-122	TCA Left	54501-2F500	c:15	6	AX-190	Axial Joint	48521-50400	th:MM16X1R L:274.5
2	BS-123	TCA Right	54500-2F500	c:15	7	RU-155	Silentblock For Susp.Arm	Part of BS-122/BS123	d:38.1
3	ML-101	TCA Left	54525-2F010		8	RU-158	Silentblock For Susp.Arm	Part of BS-122	
4	ML-100	TCA Right	54524-2F010		9	RU-157	Silentblock For Susp.Arm	Part of BS-123	
5	TI-109	Tie Rod End	48520-01E25	c:13 th:FM12X1.25R	10	LB-130	Ball Joint	40160 60J60	

QASHQAI (J10E)

02/2007 ->

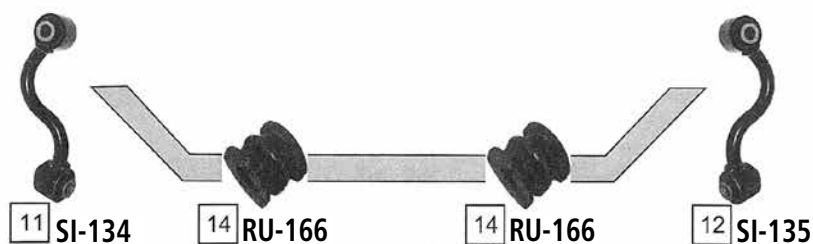
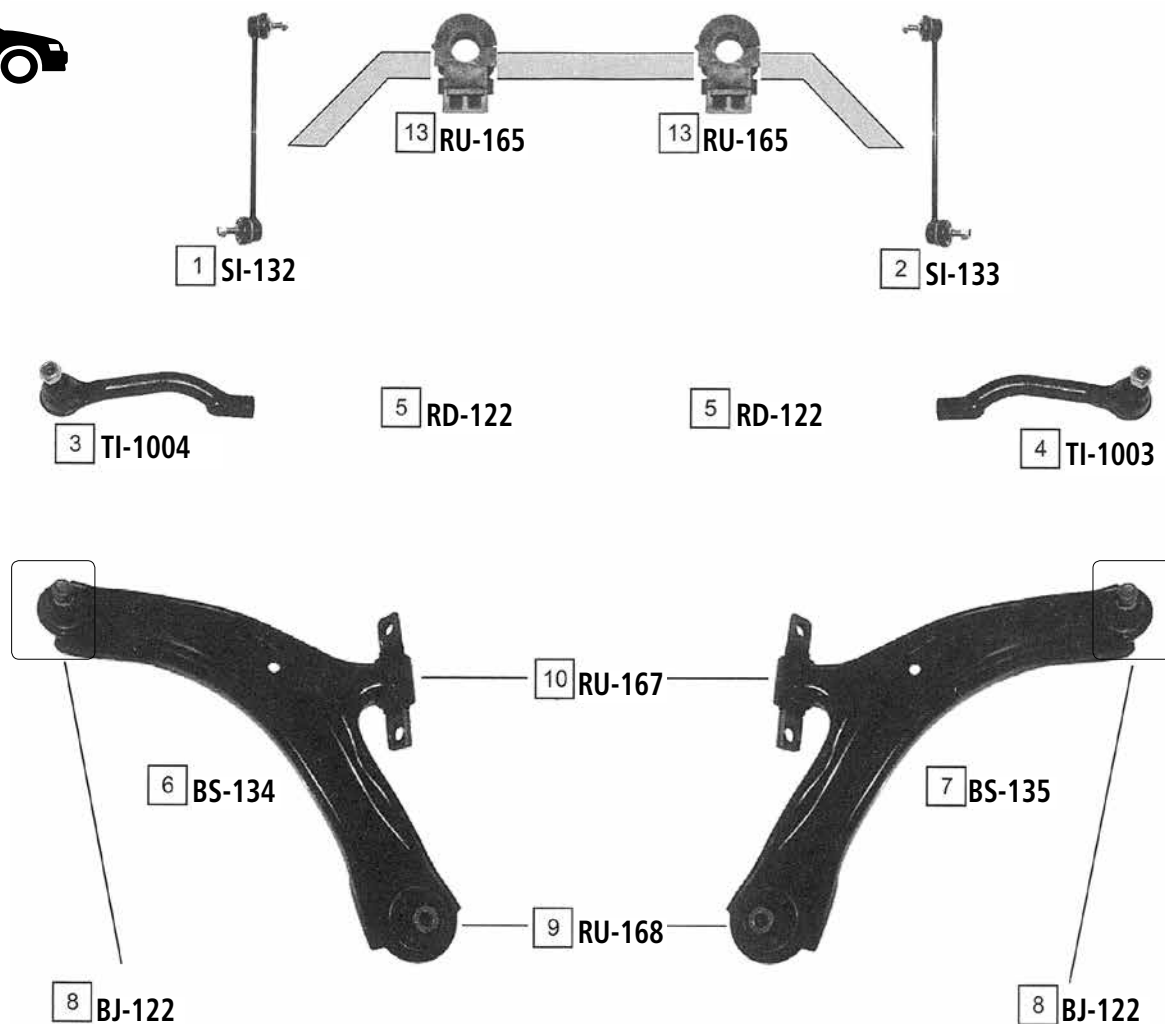

Ref	JAPANPARTS CODE	Description	OEM	Measures	Ref	JAPANPARTS CODE	Description	OEM	Measures
1	SI-132	Stabiliser Link Left	54668 JD00A	L:300	8	BJ-122	Ball Joint Left and Right	Part of BS-134/BS-135	c:20
2	SI-133	Stabiliser Link Right	54618 JD00A	L:300	9	RU-168	Silentblock For Susp.Arm	Part of BS-134/BS-135	d:58
3	TI-1004	Tie Rod End Left	48647 JD01A	c:12 th:FM14X1.5R	10	RU-167	Silentblock For Susp.Arm	Part of BS-134/BS-135	-
4	TI-1003	Tie Rod End Right	45527 JD01A	c:12 th:FM14X1.5R	11	SI-134	Stabiliser Link Left	55619 JD00A	-
5	RD-122	Axial Joint	Part of	th:MM14X1.5R	12	SI-135	Stabiliser Link Right	55618 JD00A	-
6	BS-134	TCA Left WBJ	54501 JD000	c:20	13	RU-165	Stabiliser Mounting	54613 JD03A	L:22.7
7	BS-135	TCA Right WBJ	54500 JD000	c:20	14	RU-166	Stabiliser Mounting	54613 JD18C	d:18

SERENA (C23M)  
 VANETTE CARGO (HC23)

10/1992 - 06/2001  
 01/1995 - 06/2001



09/1994 ->

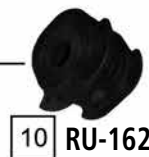

Ref	JAPANPARTS CODE	Description	OEM	Measures	Ref	JAPANPARTS CODE	Description	OEM	Measures
1	TI-188	Tie Rod End	48520-73J25	c:12.9 th:FM12X1.25	6	BS-127	TCA Right	54500 7C350	
2	RD-119	Axial Joint	Part of	th:MM14X1.5R L:319	7	TI-N017	Ball Joint Left	40161 9C500	c:15
3	TI-N020	Stabiliser Link Left	54668 9C000	L:111	8	TI-N016	Ball Joint Right	40160 9C500	c:15
4	TI-N019	Stabiliser Link Right	54618 9C002	L:111	9	RU-161	Silentblock For Susp.Arm	Part of BS-126/BS-127	
5	BS-126	TCA Left	54501 7C350		10	RU-162	Silentblock For Susp.Arm	Part of BS-126/BS-127	



STANZA (T11)

06/1981 - 12/1985

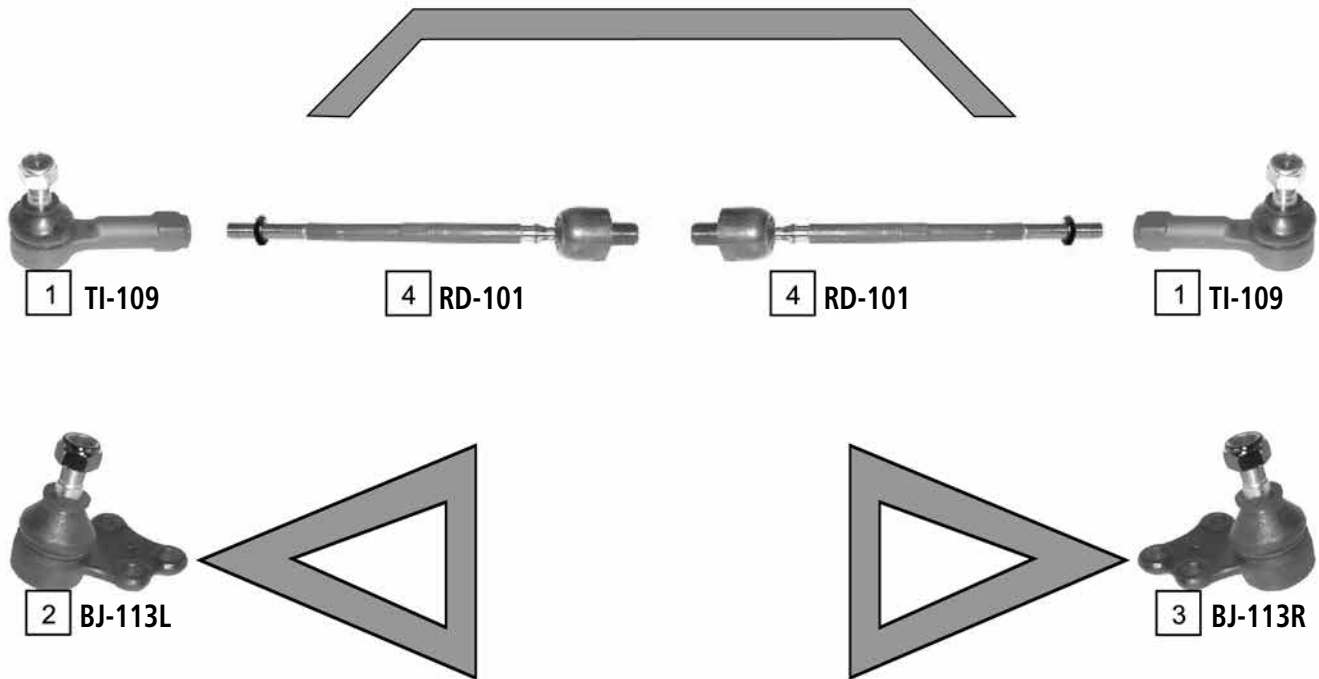

Ref	JAPANPARTS CODE	Description	OEM	Measures	Ref	JAPANPARTS CODE	Description	OEM	Measures
1	TI-109	Tie Rod End	48520-D010	c:13 th:FM12X1.25R	3	BJ-113R	Ball Joint Lower Right	40160-D0125	c:14.5
2	BJ-113L	Ball Joint Lower Left	40161-D0125	c:14.5	4	RD-101	Axial Joint	48521-35F00	th:MM16X1R L:270

SUNNY II (B12,N13)

06/1986 - 09/1990

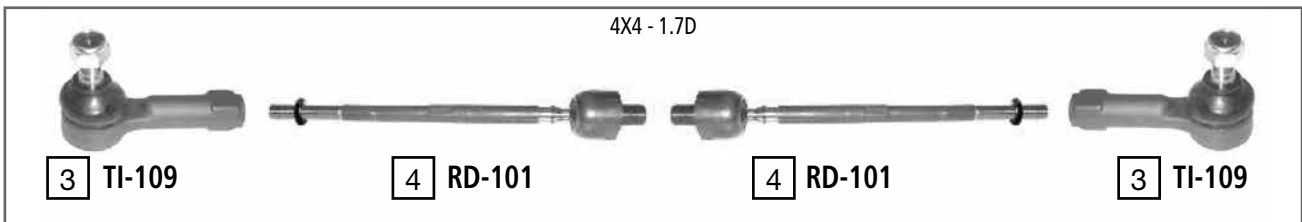
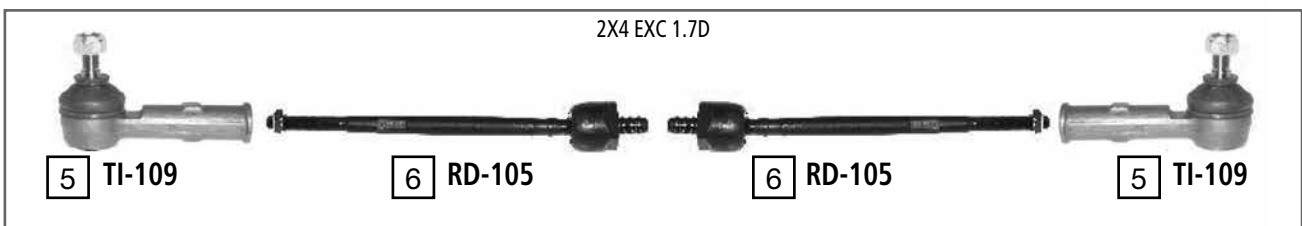

Ref	JAPANPARTS CODE	Description	OEM	Measures	Ref	JAPANPARTS CODE	Description	OEM	Measures
1	SI-101	Stabiliser Link	54618-50Y00	L:87	5	TI-109	Tie Rod End	48520-01E25	c:13 th:FM12X1.25R
2	LB-130	Ball Joint Lower	40160-60960	c:15	6	RD-105	Axial Joint	48521-35A00	
3	TI-109	Tie Rod End	48520-D010	c:13 th:FM12X1.25R	7	RU-138	Silentblock For Susp.Arm	54560-50A00	d:36.2
4	RD-101	Axial Joint	48521-35F00	th:MM16X1R L:270					

SUNNY III (N14 EXC. 2.0GTi-R)

10/1990 - 06/1995

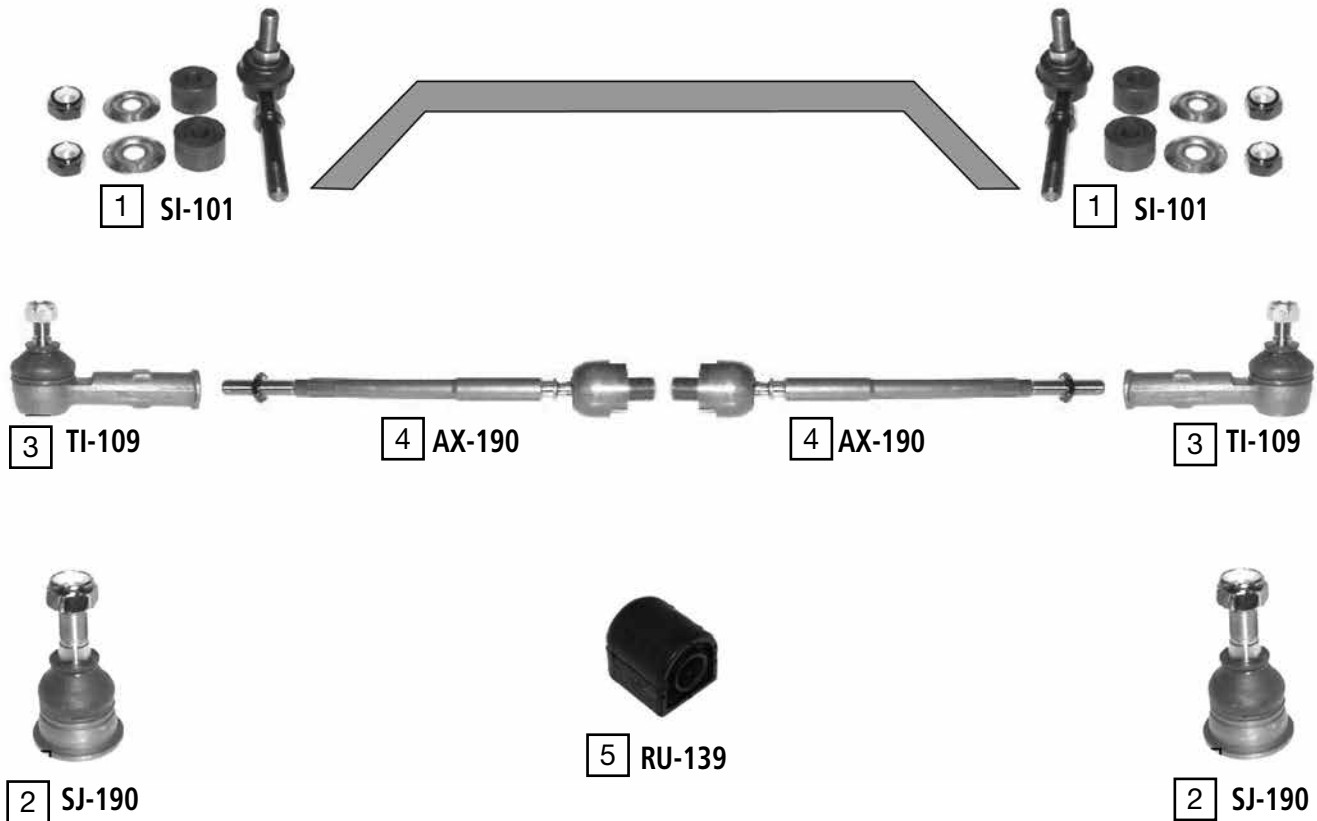

Ref	JAPANPARTS CODE	Description	OEM	Measures	Ref	JAPANPARTS CODE	Description	OEM	Measures
1	SI-101	Stabiliser Link	54618 50Y00	L: 85.5	4	AX-190	Axial Joint	48521-50400	th:MM16X1R L:274.5
2	SJ-190	Ball Joint	40161 52Y10	c:14.7	5	RU-139	Silentblock For Susp.Arm	54570-69Y10	
3	TI-109	Tie Rod End	48520-01E00	c:13 th:FM12X1.25R					

TERRANO I (WD21,VD21)

07/1986 - 02/1996

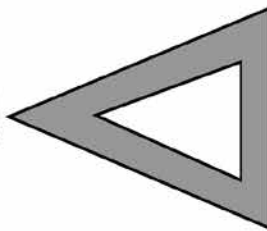
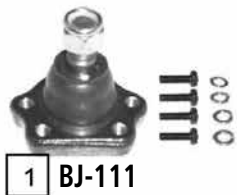
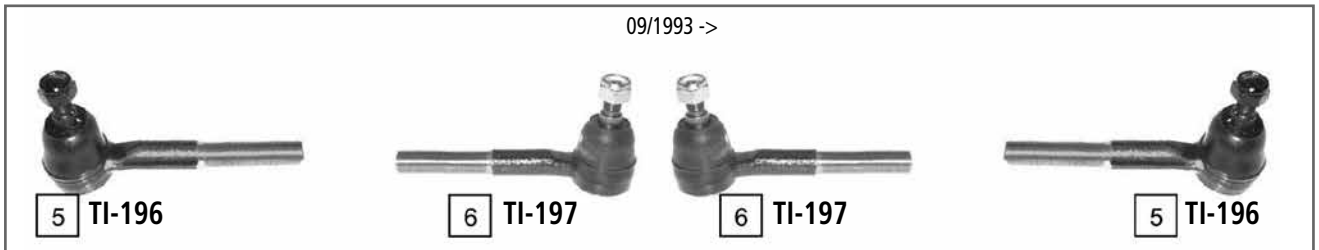
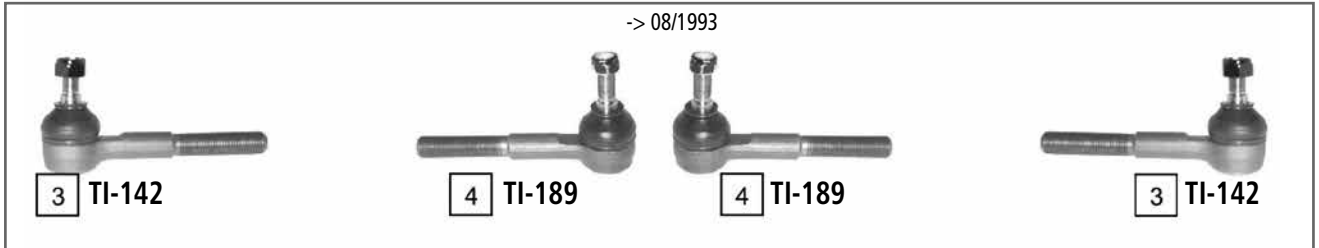

UPPER

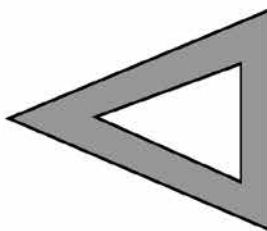
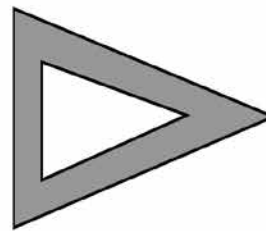

LOWER

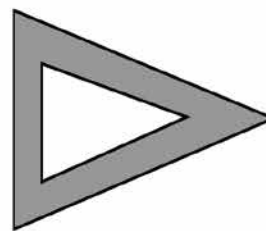

8 ID-119

9 ID-120

Ref	JAPANPARTS CODE	Description	OEM	Measures	Ref	JAPANPARTS CODE	Description	OEM	Measures
1	BJ-111	Ball Joint	40110 01G00	c:16.1	6	TI-197	Tie Rod End Inner	48570 61G25	c:14.3 th:MM16X1.5L
2	LB-121	Ball Joint Lower	40160 0F000	c:19.5	7	SI-125	Stabiliser Link	54618 0F000	
3	TI-142	Tie Rod End Outer	48520 31G25	c:13.2 th:MM16X1.5R	8	ID-119	Pitman Arm	48530 35G25	
4	TI-189	Tie Rod End Inner	48520 7F001	c:13.3 th:MM16X1.5L	9	ID-120	Pitman Arm	48530 31G25	
5	TI-196	Tie Rod End Outer	48520 61G25	c:14.3 th:MM16X1.5R					

TERRANO II (R20)

02/1993 - 09/1997

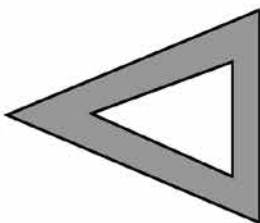

UPPER

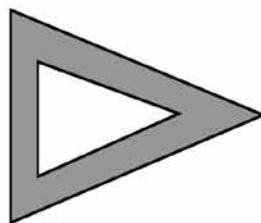

**7** TI-N028

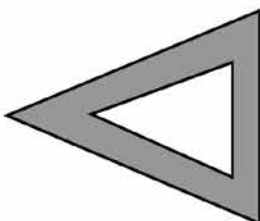

LOWER

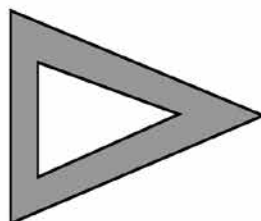

Ref	JAPANPARTS CODE	Description	OEM	Measures	Ref	JAPANPARTS CODE	Description	OEM	Measures
1	BJ-111	Ball Joint	40110 01G00	c:16.1	5	SI-125	Stabiliser Link	54618 0F000	
2	LB-121	Ball Joint Lower	40160 0F000	c:19.5	6	SI-126	Stabiliser Link	56260 0F001	L:207
3	TI-142	Tie Rod End Outer	48520 31G25	c:13.2 th:MM16X1.5R	7	TI-N028	Real Rod Steering	48560 0F000	
4	TI-189	Tie Rod End Inner	48520 7F001	c:13.3 th:MM16X1.5L					

TIIDA HATCHBACK (C11X)  
 TIIDA SALOON (SC11X)

09/2007 ->

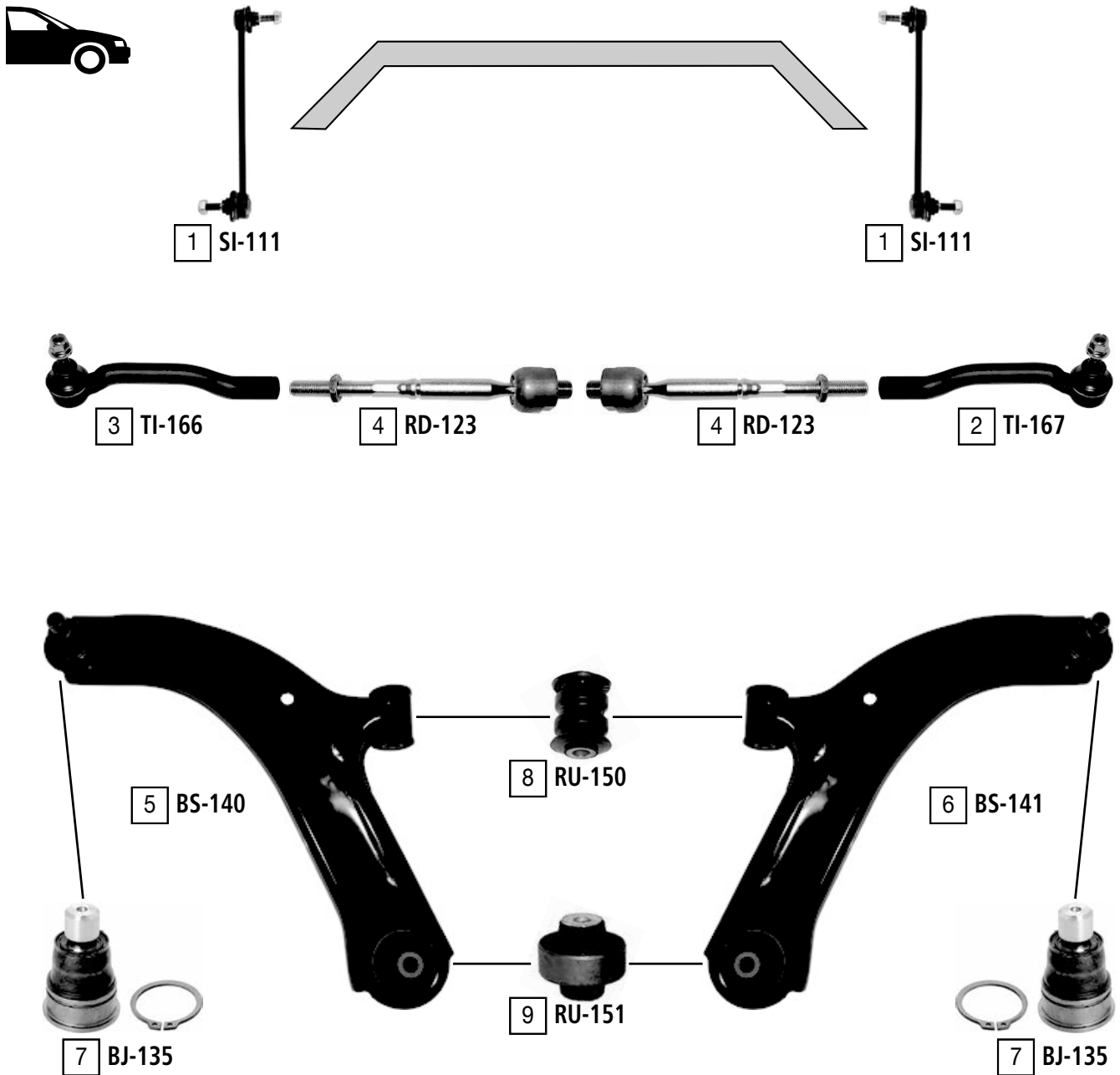

Ref	JAPANPARTS CODE	Description	OEM	Measures	Ref	JAPANPARTS CODE	Description	OEM	Measures
1	SI-111	Stabiliser link	54618 9U00A	L:255	6	BS-141	TCA right wbj	54500 EL000	c:18
2	TI-167	Tie rod end right	48647 1U61A	c:11.7 th:FM12x1.25R	7	BJ-135	Ball joint	Part of	c:18 do:38.5
3	TI-166	Tie rod end left	48527 1U61A	c:11.8 th:FM12x1.25R	8	RU-150	Silentblock for TCA	54560 AX600	di:12.1 do:36.1
4	RD-123	Axial joint	48521 3U025	th:MM14x1.5R L:200	9	RU-151	Silentblock for TCA	54570 AX600	di:12.2 do:58.4
5	BS-140	TCA left wbj	54501 EL000	c:18					

URVAN (E23)

07/1980 - 05/1987



4 TI-120

5 TI-119



1 BJ-111

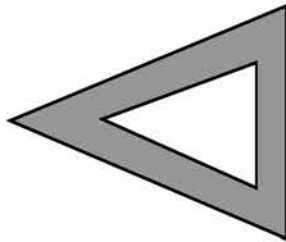

UPPER

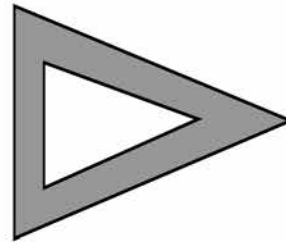

1 BJ-111



2 LB-198

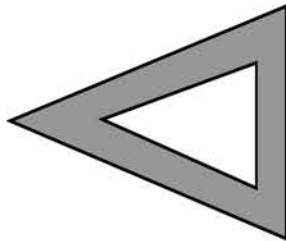

LOWER

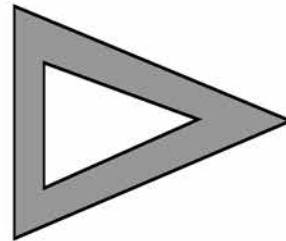

3 LB-199

Ref	JAPANPARTS CODE	Description	OEM	Measures	Ref	JAPANPARTS CODE	Description	OEM	Measures
1	BJ-111	Ball Joint	40110 01G00	c:16.1	4	TI-120	Tie Rod End	48571-T3025	
2	LB-198	Ball Joint Left	40160-48W00	c:19.8	5	TI-119	Tie Rod End	48561-T3025	
3	LB-199	Ball Joint Right	40160-T3060	c:19.7					

URVAN (E24)

02/1987 - 05/1997



-> 09/1988



4 TI-195



5 TI-193



5 TI-193



4 TI-195

10/1988 ->



6 TI-175

3 RD-109



3 RD-109

6 TI-175



1 BJ-111

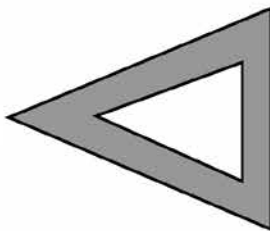

UPPER

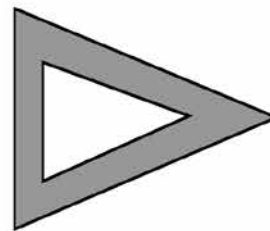

1 BJ-111



2 LB-190

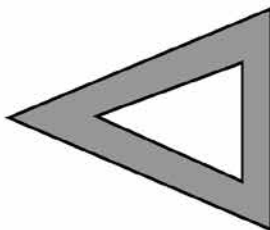

LOWER

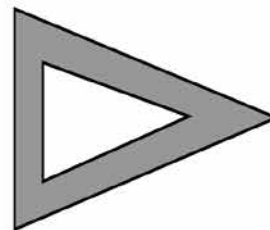

2 LB-190

Ref	JAPANPARTS CODE	Description	OEM	Measures	Ref	JAPANPARTS CODE	Description	OEM	Measures
1	BJ-111	Ball Joint	40110 01G00	c:16.1	4	TI-195	Tie Rod End	48640-01N25	c:16.2 th:FM16X1.5L
2	LB-190	Ball Joint Lower	40160 01G25	c:19.5	5	TI-193	Tie Rod End	48641.01N25	c:16.2 th:FM16X1.5R
3	RD-109	Axial Joint	48521-27N00	th:MM16X1R L:290	6	TI-175	Tie Rod End	48520-27N25	c:16.3 th:FM14X1.5R



VANETTE (C120)

07/1981 - 06/1987



1 TI-102L



3 TI-103R

4 TI-103L



2 TI-102R

9 SA-110L

10 SA-110R



5 BJ-123

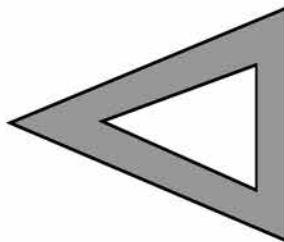

UPPER

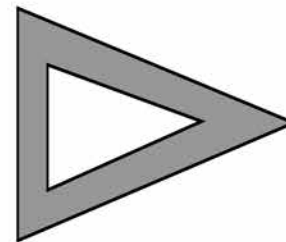

5 BJ-123



6 LB-109

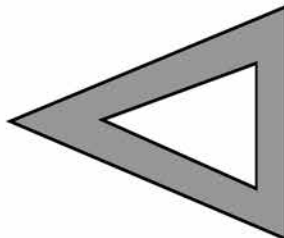

LOWER

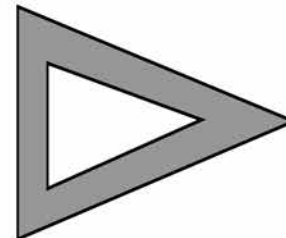

6 LB-109

7 RT-100

8 RT-101

Ref	JAPANPARTS CODE	Description	OEM	Measures	Ref	JAPANPARTS CODE	Description	OEM	Measures
1	TI-102L	Tie Rod End	48520U0100	c:13.3 th:FM14X1.5R	6	LB-109	Ball Joint Lower	40160-G2500	c:19.5
2	TI-102R	Tie Rod End	48520-G2525	c:13.3 th:FM14X1.5L	7	RT-100	Pitman Arm		
3	TI-103R	Tie Rod End	48641-G2525	c:13.4 th:FM14X1.5L	8	RT-101	Pitman Arm	48530-Y9500	
4	TI-103L	Tie Rod End	48521-G2525	c:13.4 th:FM14X1.5R	9	SA-110L	Tie Rod End	48630-G2525	
5	BJ-123	Ball Joint	40110-G3700	c:13.5	10	SA-110R	Tie Rod End	48510-G2525	

VANETTE (C22)

09/1985 - 12/1995



3 TI-155L



5 TI-156L



6 TI-156R



4 TI-155R

8 SA-124L

9 SA-124R



1 BJ-123

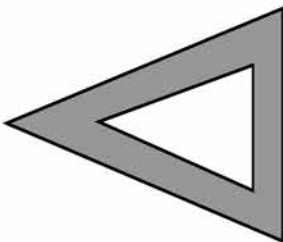

UPPER

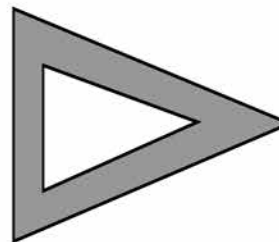

1 BJ-123



2 LB-109

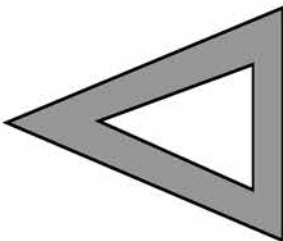

LOWER

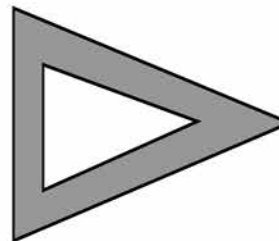

2 LB-109

7 ID-128

Ref	JAPANPARTS CODE	Description	OEM	Measures	Ref	JAPANPARTS CODE	Description	OEM	Measures
1	BJ-123	Ball Joint	40110-G3700	c:13.5	6	TI-156R	Tie Rod End Inner Right	4016050W00	c:13.3 th:FM14X1.5R
2	LB-109	Ball Joint Lower	40110-G3700	c:19.5	7	ID-128	Pitman Arm	48530G5701	
3	TI-155L	Tie Rod End Left	48520-G5101	c:13.3 th:FM14X1.5R	8	SA-124L	Tie Rod End	48630G5101	
4	TI-155R	Tie Rod End Right	48520-G5101	c:13.3 th:FM14X1.5L	9	SA-124R	Tie Rod End	48510G5101	
5	TI-156L	Tie Rod End Left	48521G5101	c:13.3 th:FM14X1.5L					

X-TRAIL (T30)

07/2001 - 05/2007

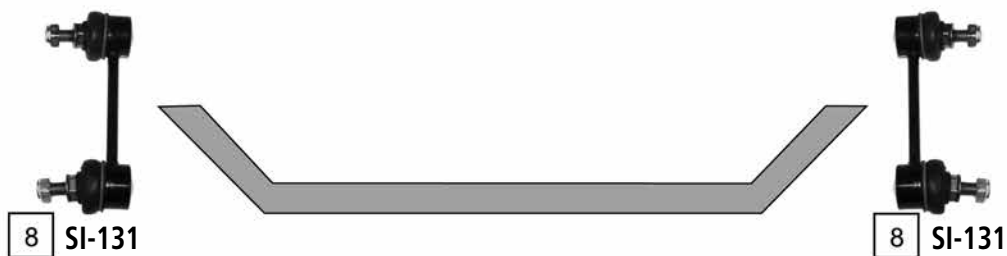
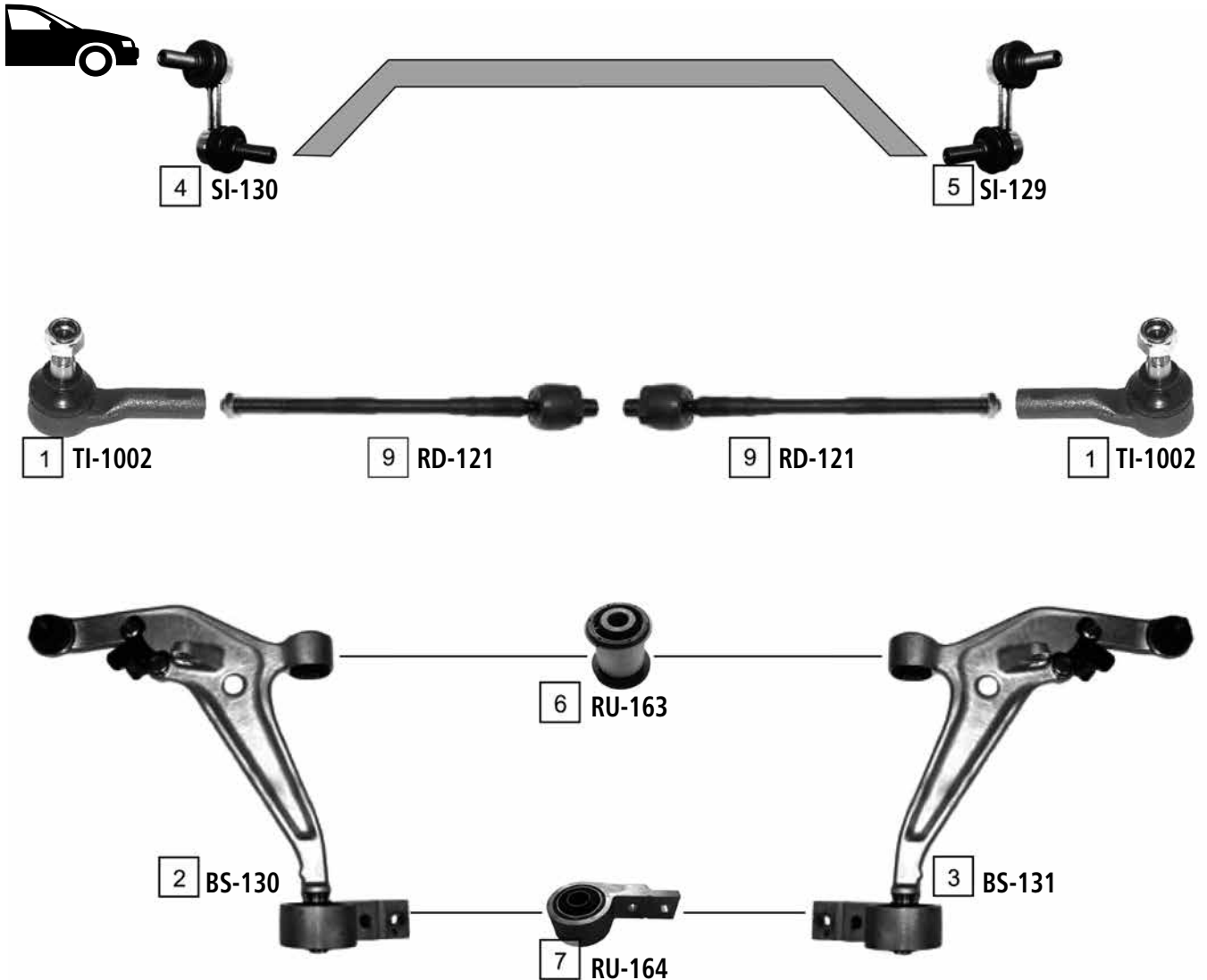

Ref	JAPANPARTS CODE	Description	OEM	Measures	Ref	JAPANPARTS CODE	Description	OEM	Measures
1	TI-1002	Tie Rod End	48520-OP725	c:14.8 th:FM14X1.5R	6	RU-163	Silentblock For Susp.Arm	Part of BS-130/BS-131	
2	BS-130	TCA Left	54501-8H310	c:15.4	7	RU-164	Silentblock For Susp.Arm	Part of BS-130/BS-131	
3	BS-131	TCA Right	54500-8H310	c:15.2	8	SI-131	Stabiliser Link	56261 EQ000	L:115
4	SI-130	Stabiliser Link Left	54668-8H300	L:64	9	RD-121	Axial Joint	48521 8H325	th: MM16X1R L:287
5	SI-129	Stabiliser Link Right	54618-8H300	L:64					

X-TRAIL (T31)

06/2007 ->

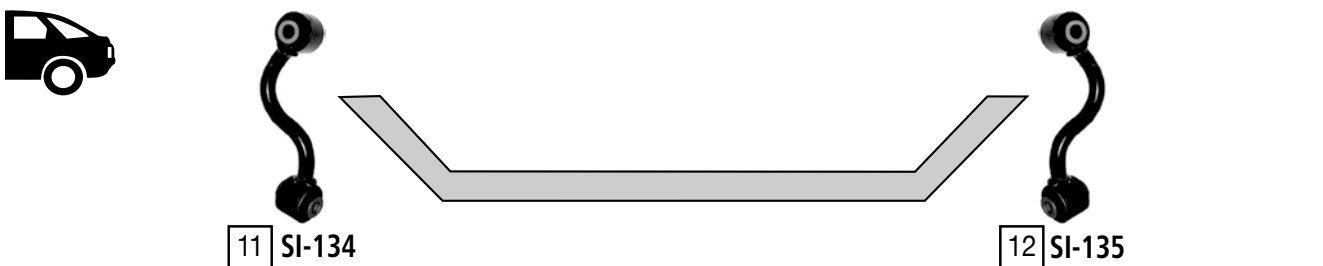
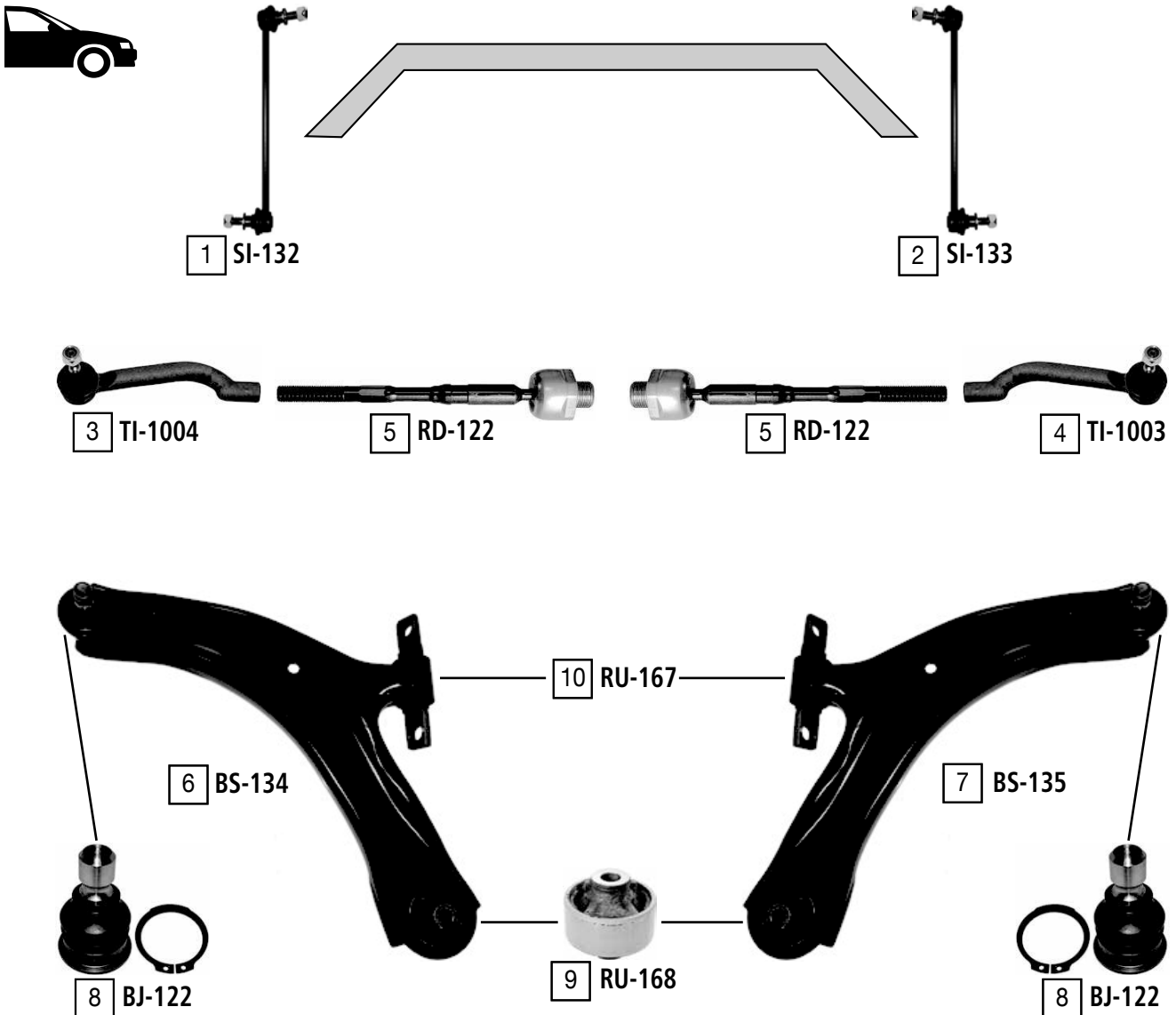

Ref	JAPANPARTS CODE	Description	OEM	Measures	Ref	JAPANPARTS CODE	Description	OEM	Measures
1	SI-132	Stabiliser link left	54668 JD00A	L:300	7	BS-135	TCA right wbj	54500 JD000	c:20
2	SI-133	Stabiliser link right	54618 JD00A	L:300	8	BJ-122	Ball joint	Part of	c:20 do:41.1
3	TI-1004	Tie rod end left	48647 JD01A	c:11.7 th:FM14x1.5R	9	RU-168	Silentblock for TCA	Part of	di:12.2 do:58
4	TI-1003	Tie rod end right	48527 JD01A	c:11.7 th:FM14x1.5R	10	RU-167	Silentblock for TCA	Part of	
5	RD-122	Axial joint	D8521 JG00A	th:MM22x1.5R L:233	11	SI-134	Stabiliser link left	55619 JD00A	L:142
6	BS-134	TCA left wbj	54501 JD000	c:20	12	SI-135	Stabiliser link right	55618 JD00A	L:142

# SMART CITY COUPE - CABRIO

CITY COUPE - CABRIO

07/1998 - 02/2002

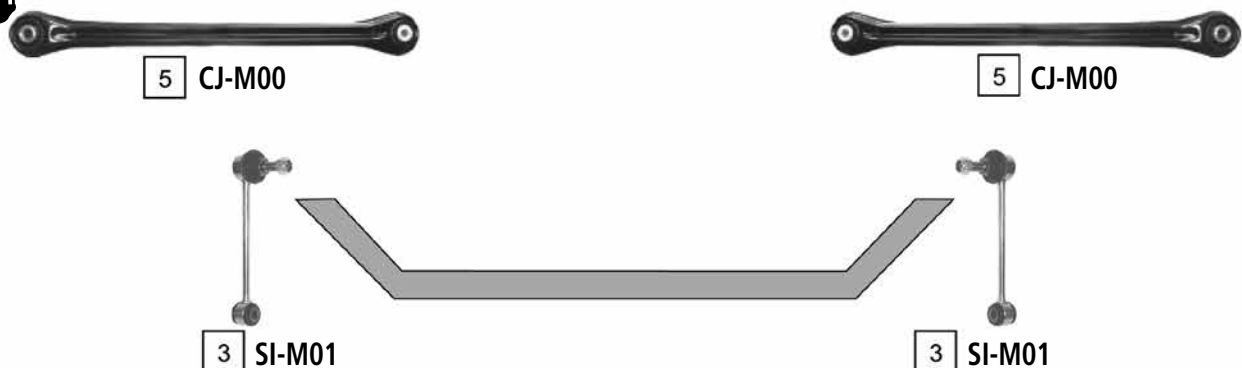
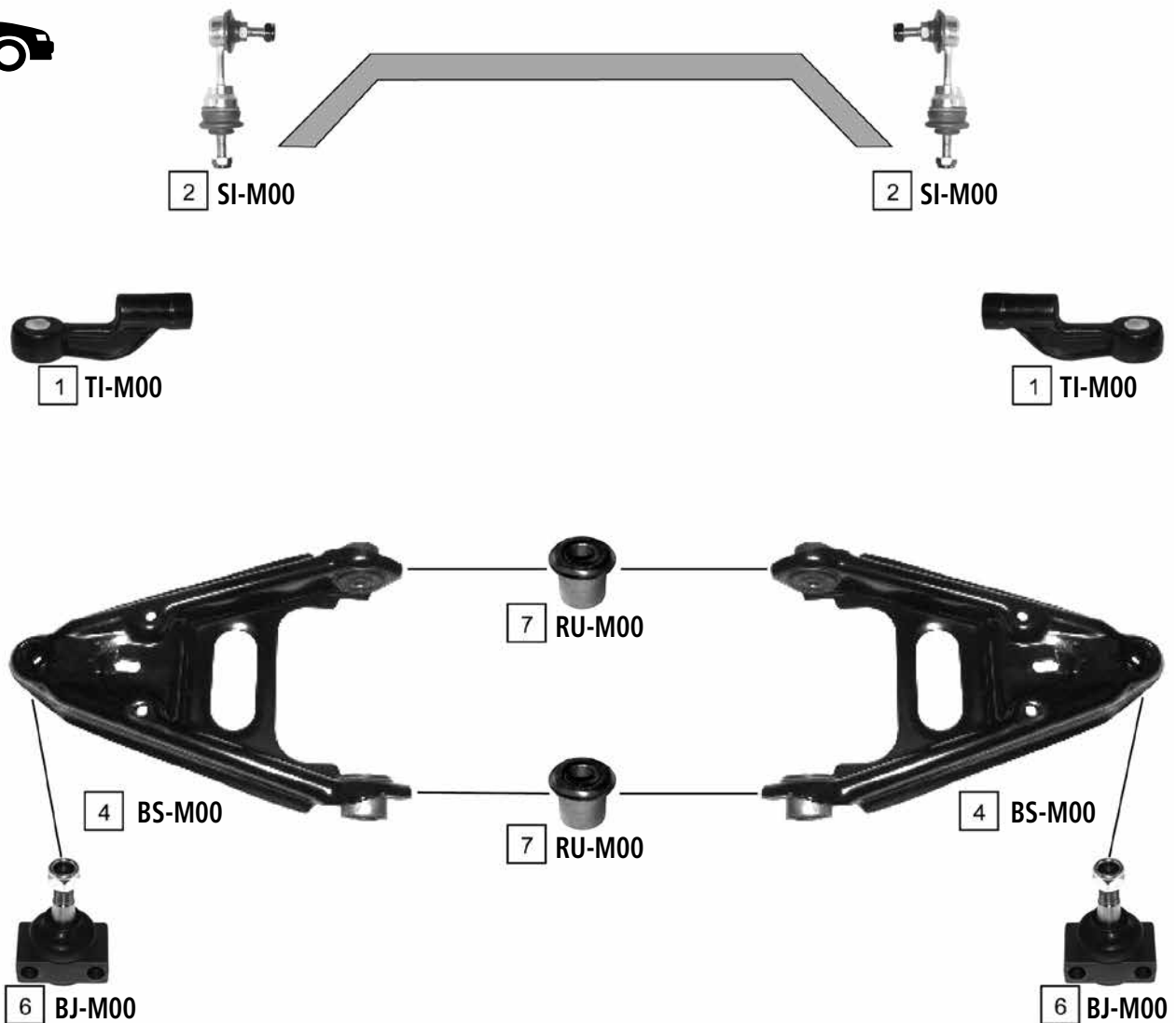

Ref	JAPANPARTS CODE	Description	OEM	Measures	Ref	JAPANPARTS CODE	Description	OEM	Measures
1	TI-M00	Tie Rod End	4887V002000000		5	CJ-M00	Thrust Rod	1765V005000000	-
2	SI-M00	Stabiliser Link	5102V005000000	L:93	6	BJ-M00	Ball Joint	2271V007000005	c:13
3	SI-M01	Stabiliser Link	1802V004000000	L:149	7	RU-M00	Silentblock For Susp.Arm	Part of BS-M00	d:39.2
4	BS-M00	TCA	07001V006000000						

FORFOUR (454)

04/2004 ->

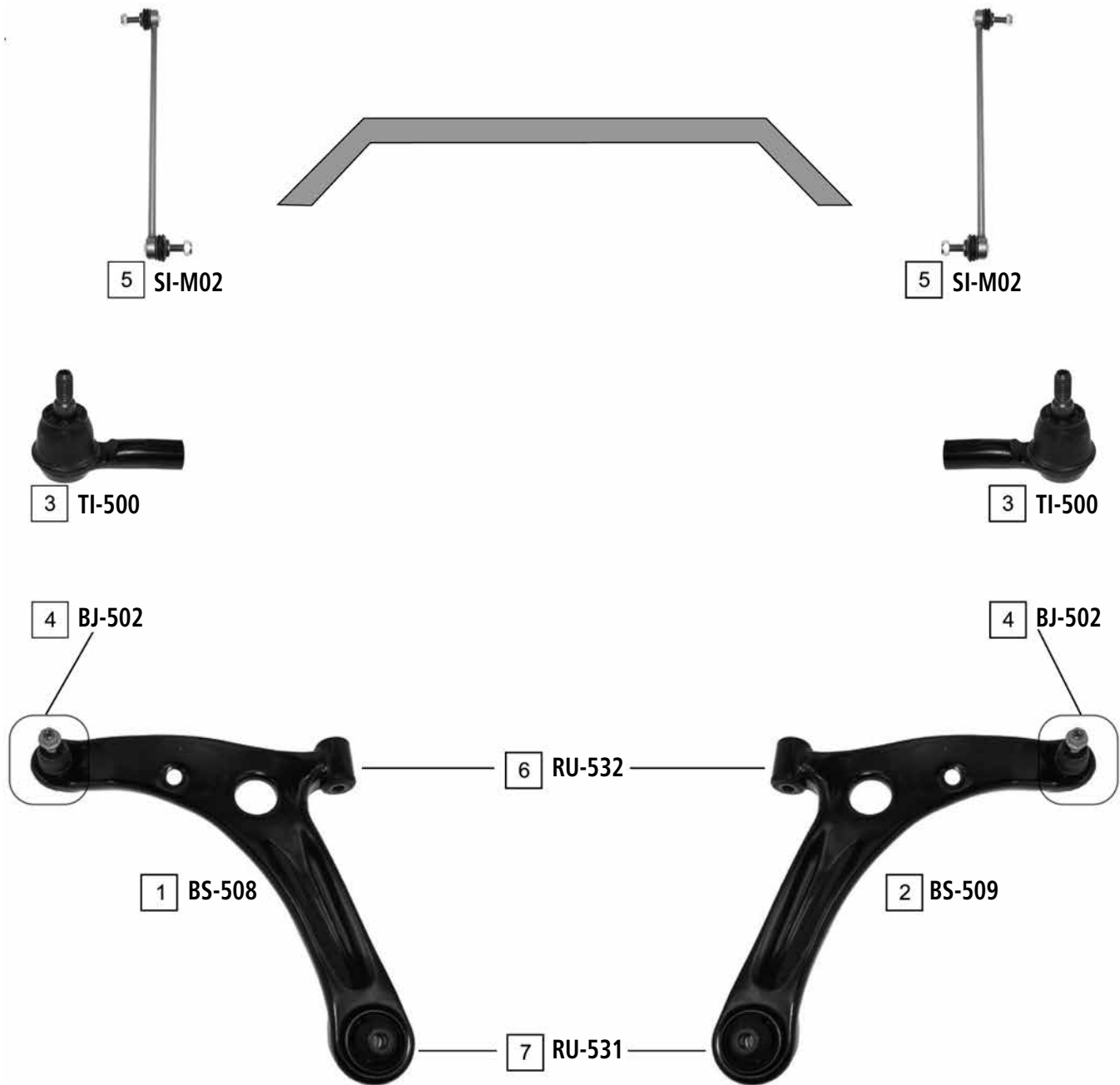

Ref	JAPANPARTS CODE	Description	OEM	Measures	Ref	JAPANPARTS CODE	Description	OEM	Measures
1	BS-508	TCA Left Wbj	454 330 07 07		5	SI-M02	Stabiliser Link	454 320 00 10	
2	BS-509	TCA Right Wbj	454 330 08 07		6	RU-532	Silentblock For Susp.Arm	Part of BS-508/BS-509	
3	TI-500	Tie Rod End	454 460 02 05		7	RU-531	Silentblock For Susp.Arm	Part of BS-508/BS-509	
4	BJ-502	Ball Joint	Part of BS-508/BS-509						

FORTWO COUPE - CABRIO (451)

01/2007 ->

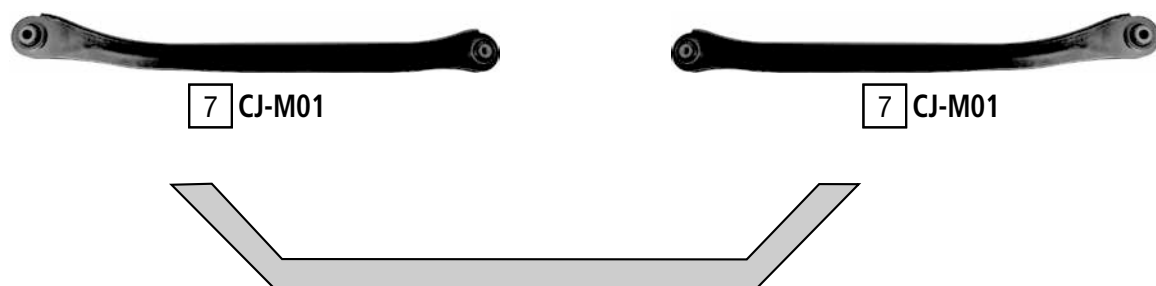
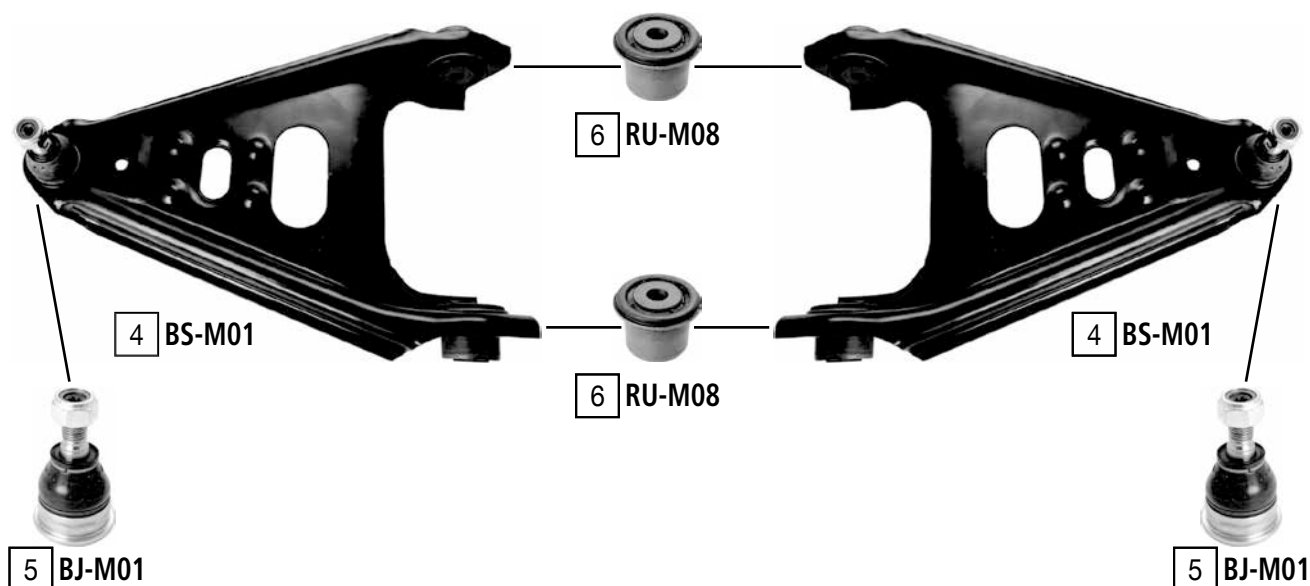
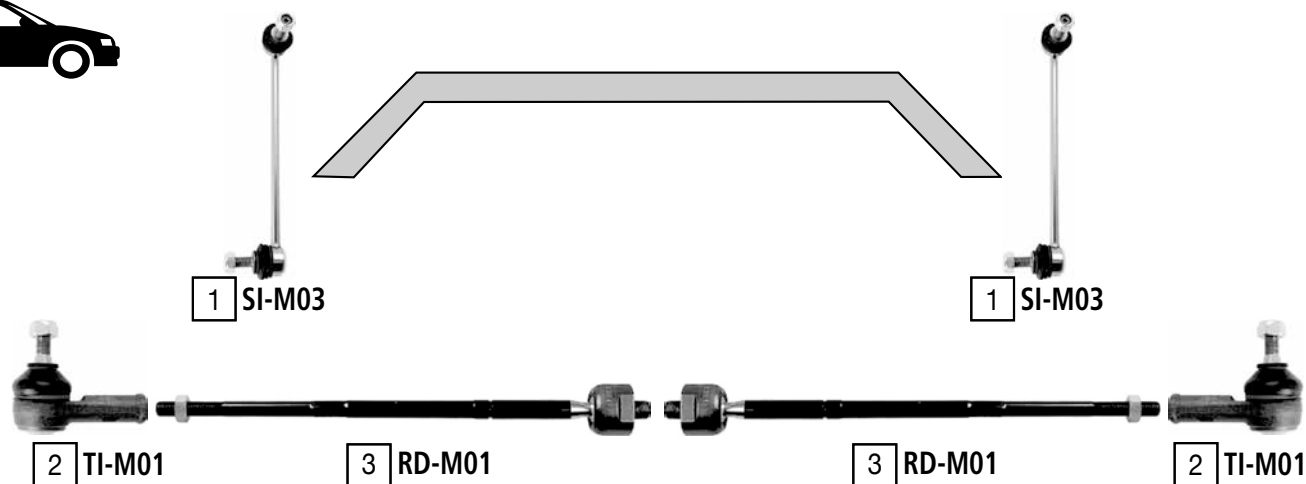

Ref	JAPANPARTS CODE	Description	OEM	Measures	Ref	JAPANPARTS CODE	Description	OEM	Measures
1	SI-M03	Stabiliser link	451 320 01 89	L:227	5	BJ-M01	Ball joint	part of	c:12.9 do:36.7
2	TI-M01	Tie rod end	451 338 01 37	c:10.7 th:FM12x1.5R	6	RU-M08	Silentblock for TCA	part of	di:12.2 do:39.5
3	RD-M01	Axial joint	part of	th:MM14X1.5R L:378	7	CJ-M01	TCA	451 350 01 29	
4	BS-M01	TCA wbj	451 330 00 10	c:13.1					

KORANDO (KJ)

01/1996 ->



1 TI-S01  
1/1999 ->



5 RD-S02



5 RD-S02



1 TI-S01  
1/1999 ->



3 BJ-S01

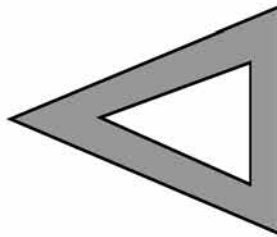

UPPER

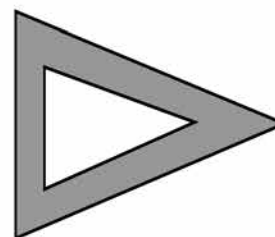

3 BJ-S01



4 BJ-S02

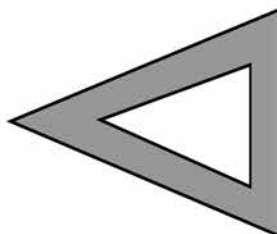

LOWER

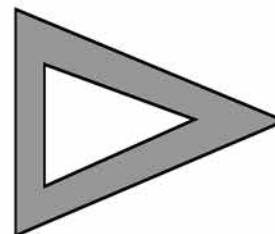

4 BJ-S02



10 LU-S04 ->POST.



12 LU-S06 ->POST.

6 PI-S01



11 LU-S05 ->POST.

13 LU-S07 ->POST.



14 LU-S09 ->LATO MONT. POST.

Ref	JAPANPARTS CODE	Description	OEM	Measures	Ref	JAPANPARTS CODE	Description	OEM	Measures
1	TI-J01	Tie Rod End	4666005501	c:16 th:FM14X1.5R	8	TI-S31	Tie Rod End	46620-01000	
2	SI-S01	Stabiliser Link	4475005001		9	TI-S03R	Tie Rod End	46670-01010	
3	BJ-S01	Ball Joint	4443003011	c:17.6	10	LU-S04	Upper Link	45401-05000	
4	BJ-S02	Ball Joint	4450505001	c:17.6	11	LU-S05	Lower Link	45502-05004	
5	RD-S02	Axial Joint			12	LU-S06	Lower Link	45501-05302	
6	PI-S01	Pitman Arm	4644901051		13	LU-S07	Lower Link	45502-05102	
7	TI-S02L	Tie Rod End	46660-01010		14	LU-S09	Lower Link	45601-05000	



KYRON

05/2005 ->

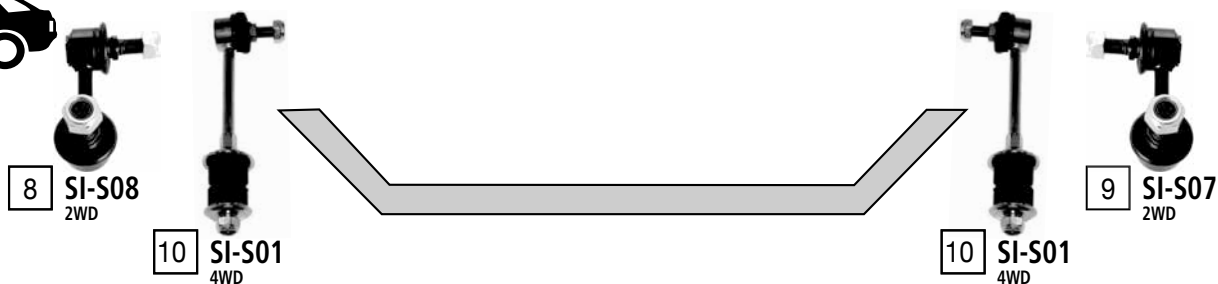
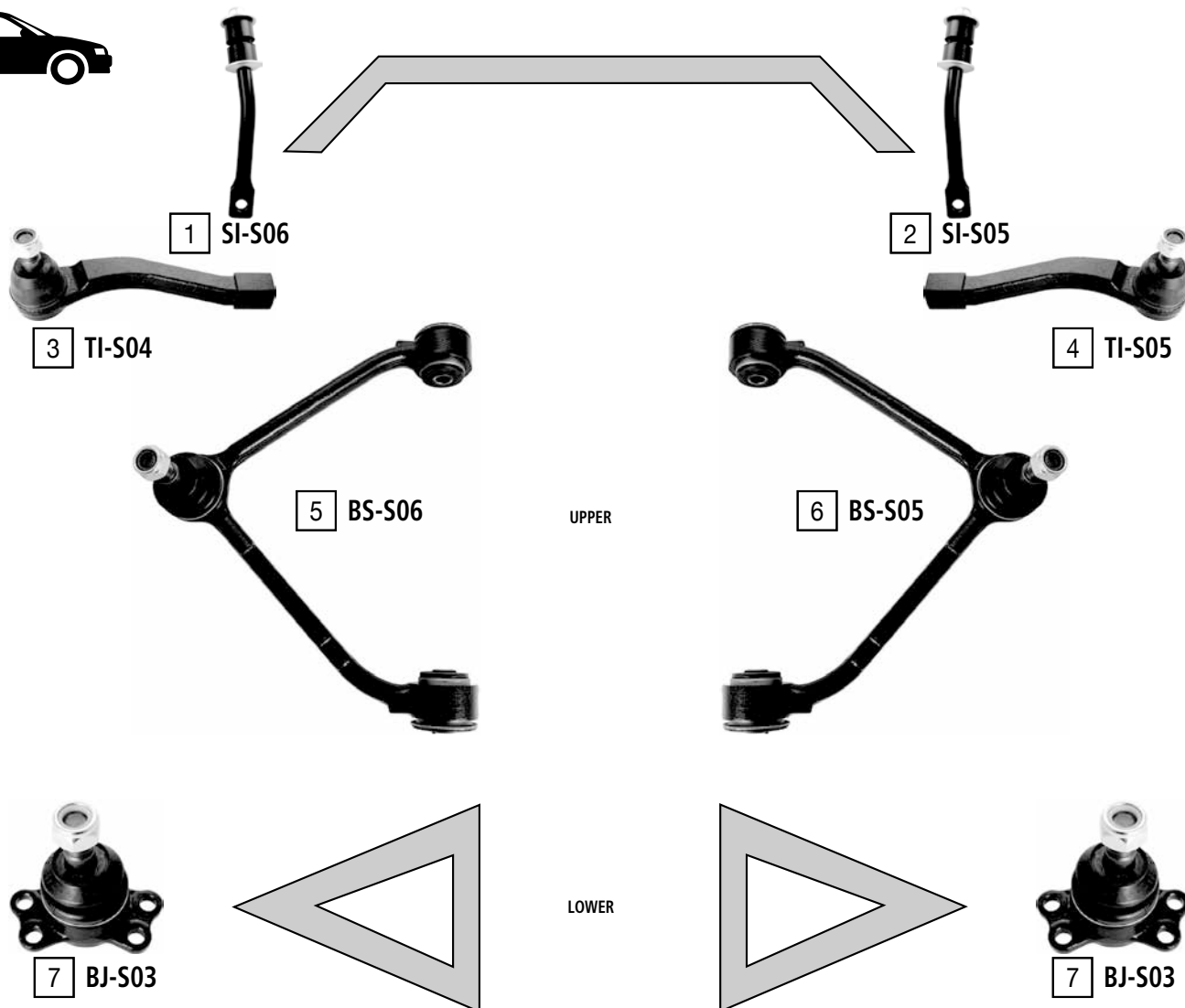

Ref	JAPANPARTS CODE	Description	OEM	Measures	Ref	JAPANPARTS CODE	Description	OEM	Measures
1	SI-S06	stabiliser link left	4475109000	L:170	6	BS-S05	TCA right wbj	4440209011	c:17.6
2	SI-S05	stabiliser link right	4475209000	L:170	7	BJ-S03	ball joint	4454109004	c:17.4
3	TI-S04	tie rod end left	4666008001	c:15.95 th:FM16X1.5R	8	SI-S08	stabiliser link left	4575009001	L:72
4	TI-S05	tie rod end right	4666008011	c:15.95 th:FM16X1.5R	9	SI-S07	stabiliser link right	4575109001	L:72
5	BS-S06	TCA left wbj	4440109011	c:17.6	10	SI-S01	stabiliser link	4475005001	L:171

MUSSO (FJ)

01/1999 ->

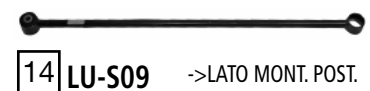
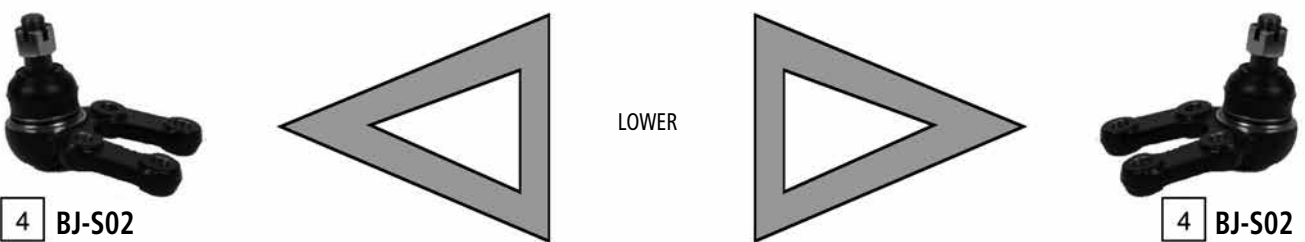
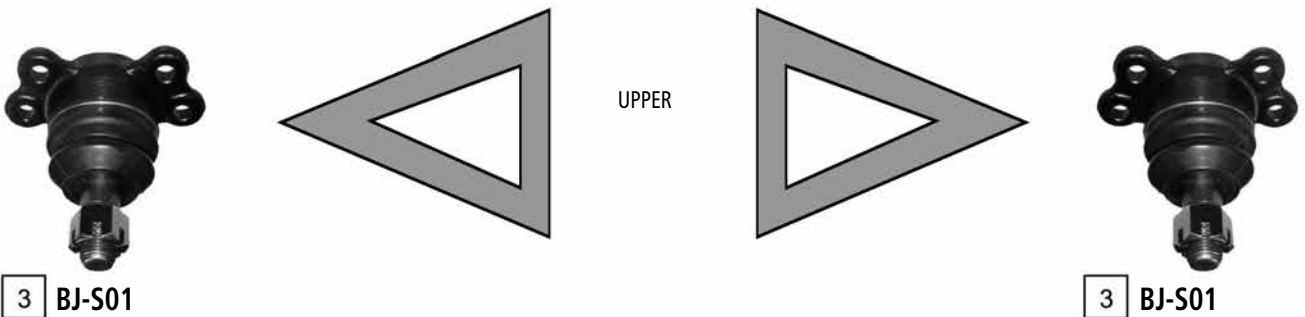

Ref	JAPANPARTS CODE	Description	OEM	Measures	Ref	JAPANPARTS CODE	Description	OEM	Measures
1	TI-S01	Tie Rod End	4666005501	c:16 th:FM14X1.5R	6	LU-S04	Upper Link	45401-05000	
2	SI-S04	Stabiliser Link	4475005001		7	LU-S05	Lower Link	45502-05004	
3	BJ-S01	Ball Joint	4443003011	c:17.6	8	LU-S06	Lower Link	45501-05302	
4	BJ-S02	Ball Joint	4450505001	c:17.6	9	LU-S07	Lower Link	45502-05102	
5	RD-S02	Axial Joint	Part of		10	LU-S09	Lower Link	45601-05000	

REXTON

04/2002 ->

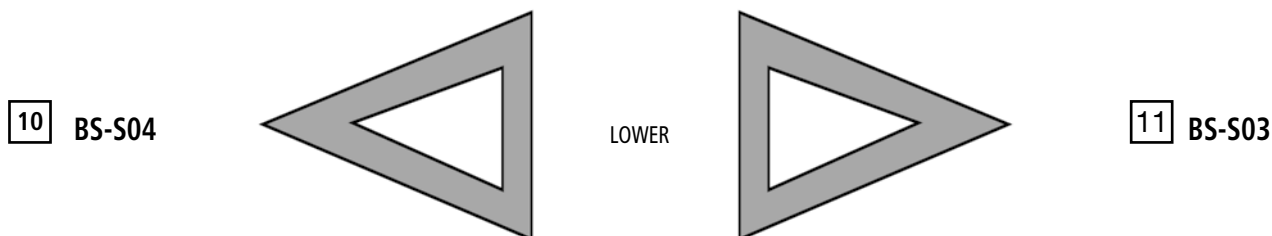
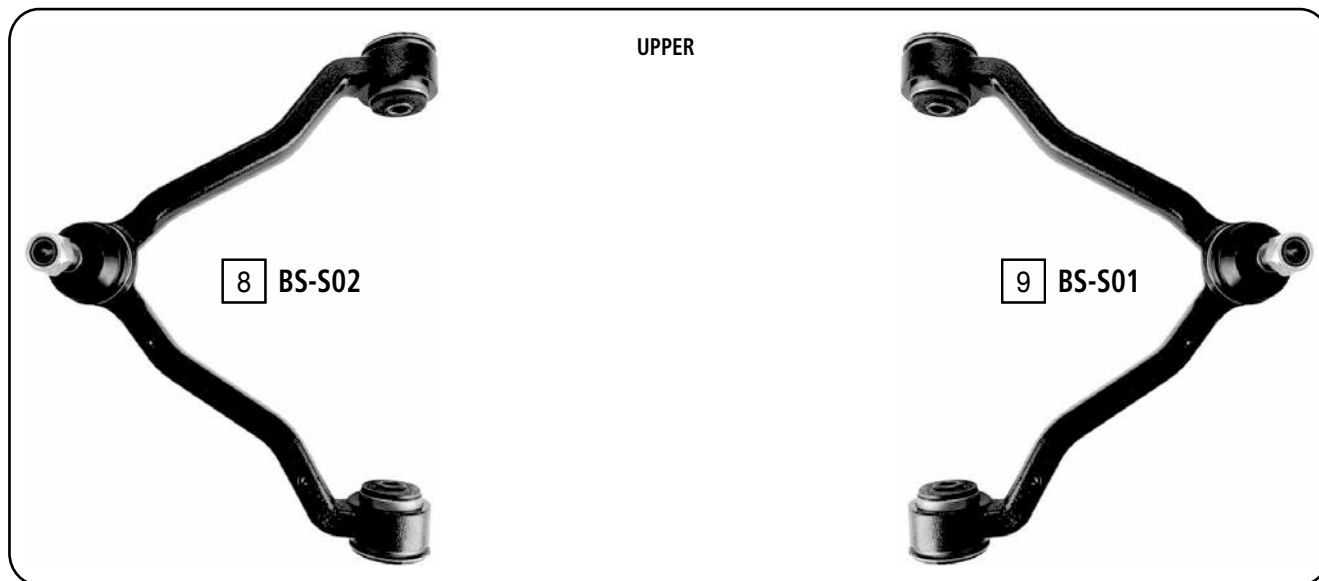
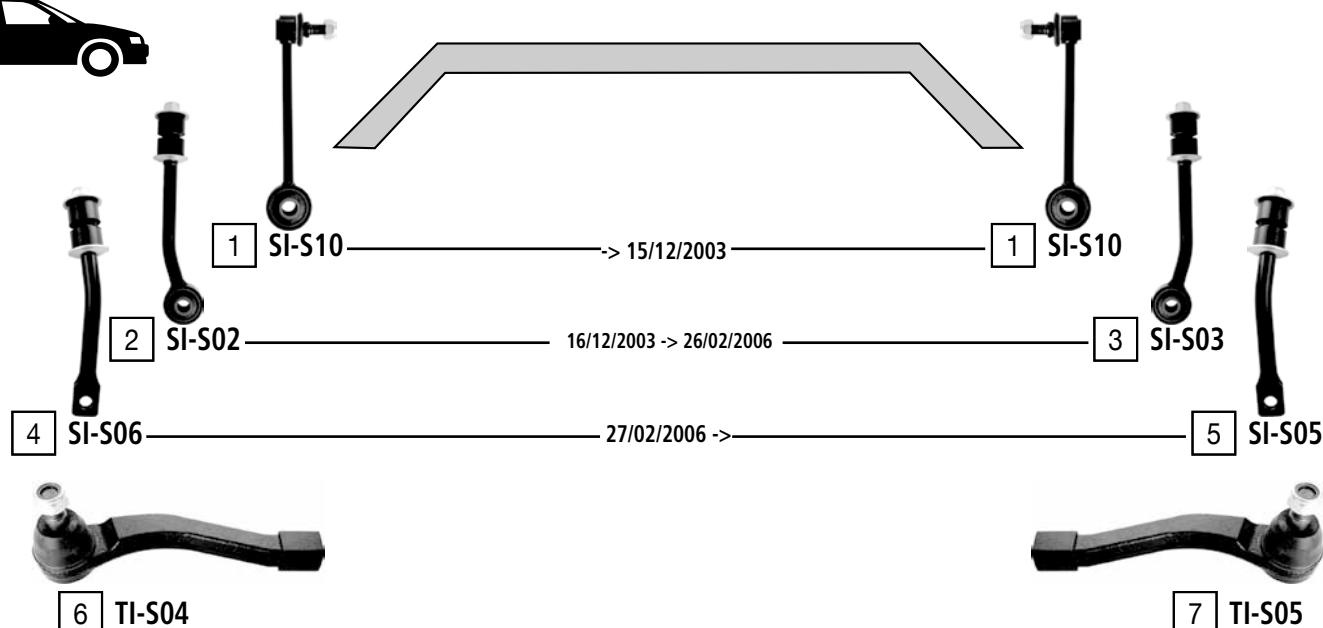

Ref	JAPANPARTS CODE	Description	OEM	Measures	Ref	JAPANPARTS CODE	Description	OEM	Measures
1	SI-S10	stabiliser link	4475008000	L:185	7	TI-S05	tie rod end right	4666008011	c:15.95 th:FM16X1.5R
2	SI-S02	stabiliser link left	4475008001	L:200	8	BS-S02	TCA left wbj	4440108000	c:17.6
3	SI-S03	stabiliser link right	4475508000	L:200	9	BS-S01	TCA right wbj	4440208000	c:17.6
4	SI-S06	stabiliser link left	4475109000	L:170	10	BS-S04	TCA left	4450108005	
5	SI-S06	stabiliser link right	4475209000	L:170	11	BS-S03	TCA right	4450208005	
6	TI-S04	tie rod end left	4666008001	c:15.95 th:FM16X1.5R					

REXTON

04/2002 ->



UPPER  
27/02/2006 -> 30/03/2007

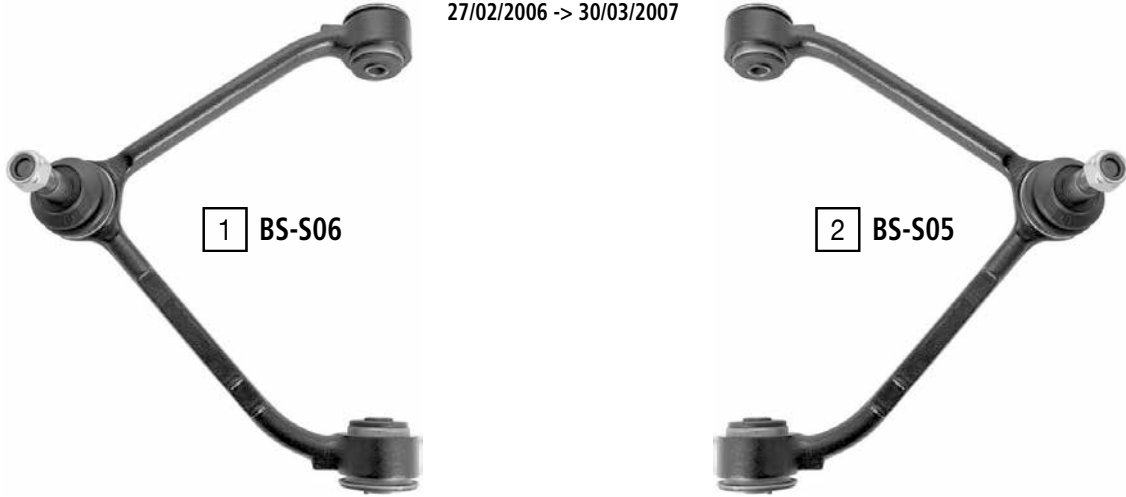

LOWER  
27/02/2006 -> 30/03/2007

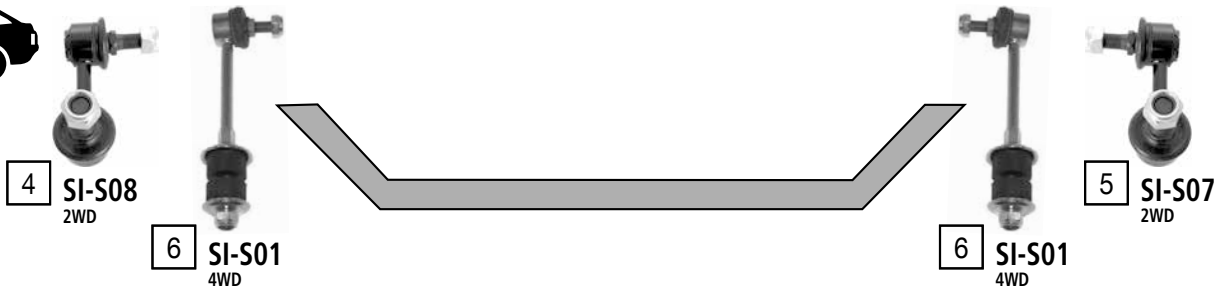
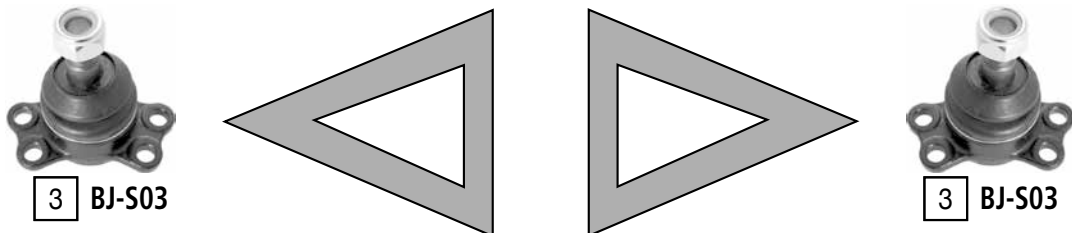

Ref	JAPANPARTS CODE	Description	OEM	Measures	Ref	JAPANPARTS CODE	Description	OEM	Measures
1	BS-S06	TCA left wbj	4440109011	c:17.6	4	SI-S08	stabiliser link left	4575009001	L:72
2	BS-S05	TCA right wbj	4440209011	c:17.6	5	SI-S07	stabiliser link right	4575109001	L:72
3	BJ-S03	ball joint	4454109004	c:17.4	6	SI-S01	stabiliser link	4475005001	L:171

1800 XT COUPÉ

11/1984 - 12/1990



MS



3 RD-734



3 RD-734



1 TI-703R

PS



4 RD-706



4 RD-706



1 TI-703R



5 BJ-798

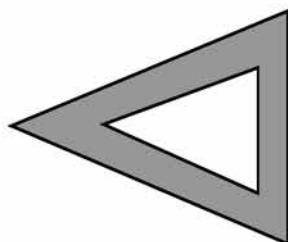

LOWER

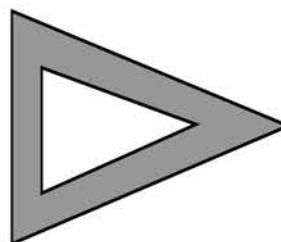

5 BJ-798

Ref	JAPANPARTS CODE	Description	OEM	Measures	Ref	JAPANPARTS CODE	Description	OEM	Measures
1	TI-703R	Tie Rod End Left	31320-GA111	c:12.3 th:FM14X1.5R	4	RD-706	Axial Joint	31310-GA151	th:MM14X1.5R L:280
2	TI-703L	Tie Rod End Right	31320-GA101	c:12.3 th:FM14X1.5R	5	BJ-798	Ball Joint Lower	721067003	c:13.8
3	RD-734	Axial Joint	31310-GA170						

FORESTER (SF)

01/1997 - 05/2002

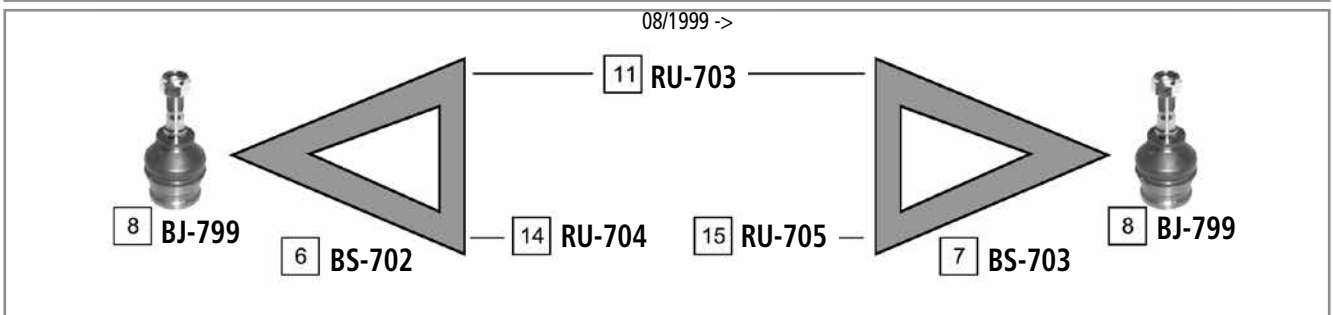
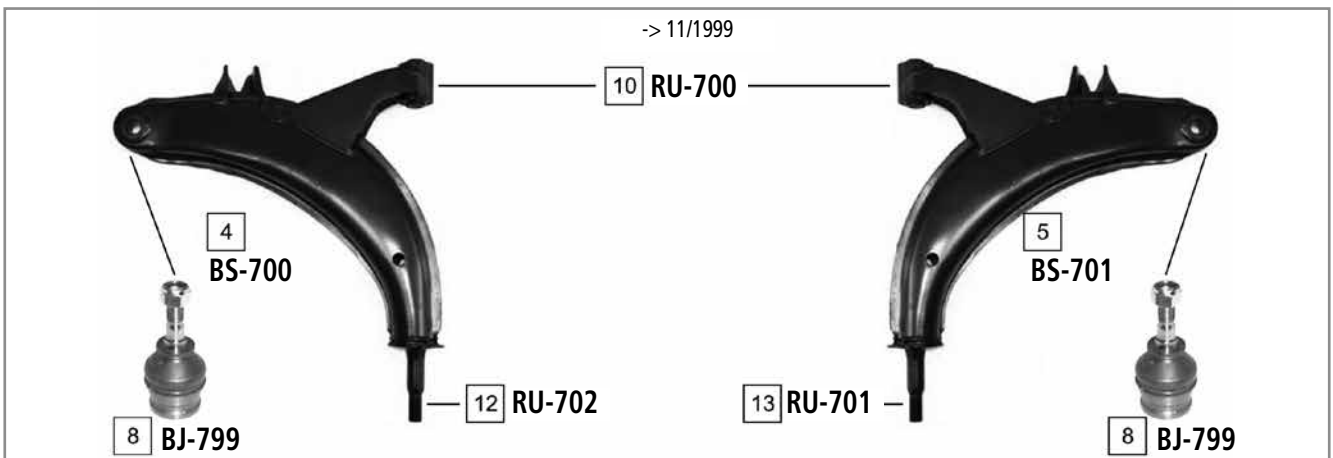
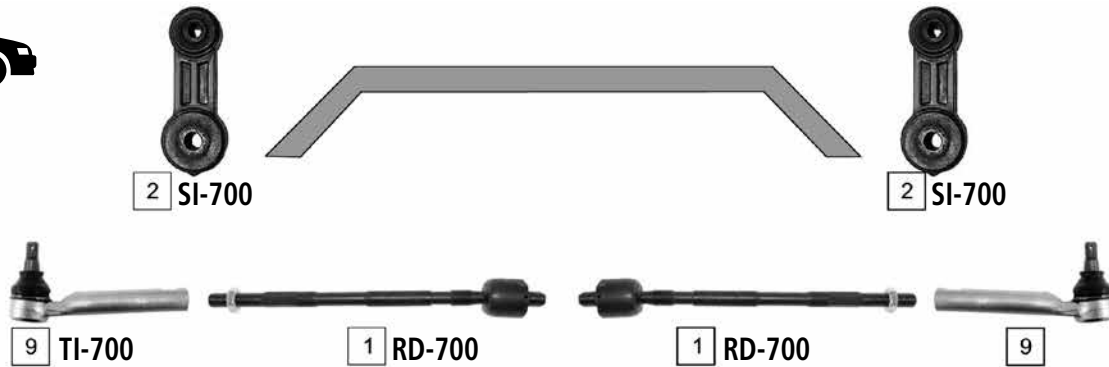

Ref	JAPANPARTS CODE	Description	OEM	Measures	Ref	JAPANPARTS CODE	Description	OEM	Measures
1	RD-700	Axial Joint	34140 FC000	th:MM14X1.5R L:292	9	TI-700	Tie Rod End	34141 AA 041	
2	SI-700	Stabiliser Link	20420 AA003		10	RU-700	Silentblock For Susp.Arm	20201 AA000	
3	SI-701	Stabiliser Link	20481 AA001		11	RU-703	Silentblock For Susp.Arm	20201 FC020	
4	BS-700	TCA Left	20200 AA210		12	RU-702	Silentblock For Susp.Arm	20201 AC110	
5	BS-701	TCA Right	200200 AC200F		13	RU-701	Silentblock For Susp.Arm	20201 AC100	
6	BS-702	TCA Left	20200 FC130		14	RU-704	Silentblock For Susp.Arm	20201 FC110	
7	BS-703	TCA Right	20200 FC120		15	RU-705	Silentblock For Susp.Arm	20201 FC100	
8	BJ-799	Ball Joint Lower	21067 GA050	c:15.7					

FORESTER (SG)

02/2002 ->



2 SI-702

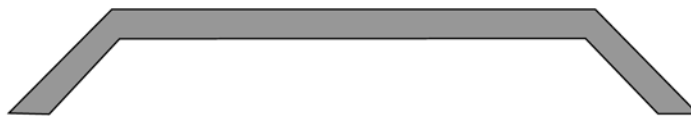

2 SI-702



7 TI-700

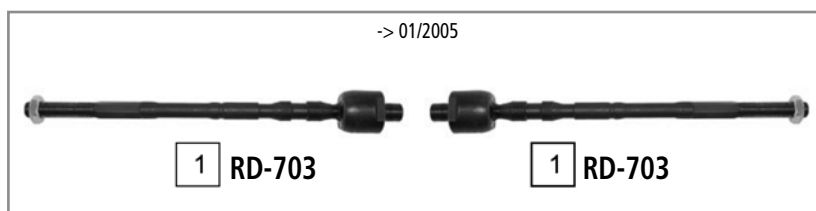

1 RD-703

1 RD-703



7 TI-700



6 BJ-799

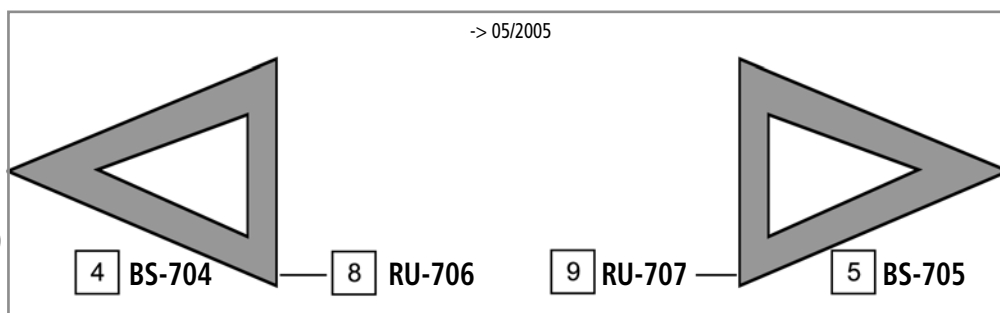

4 BS-704

8 RU-706

9 RU-707

5 BS-705



6 BJ-799



3 SI-703



3 SI-703

Ref	JAPANPARTS CODE	Description	OEM	Measures	Ref	JAPANPARTS CODE	Description	OEM	Measures
1	RD-703	Axial Joint	34160 AE000	th:MM16X1.5R L:302	6	BJ-799	Ball Joint Lower	21067 GA050	c:15.7
2	SI-702	Stabiliser Link	20470 SA000		7	TI-700	Tie Rod End	34141 AA 041	
3	SI-703	Stabiliser Link	20470 SA010	L:70	8	RU-706	Silentblock For Susp.Arm	20201 FC130	
4	BS-704	TCA Left	20202 SA010		9	RU-707	Silentblock For Susp.Arm	20201 FC120	
5	BS-705	TCA Right	20202 SA000						

FORESTER (S12)

01/2008 ->

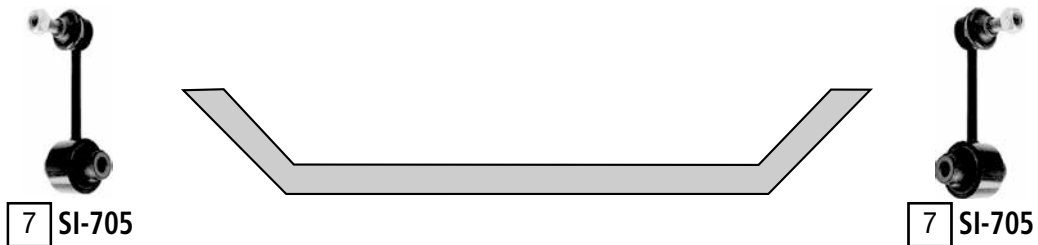
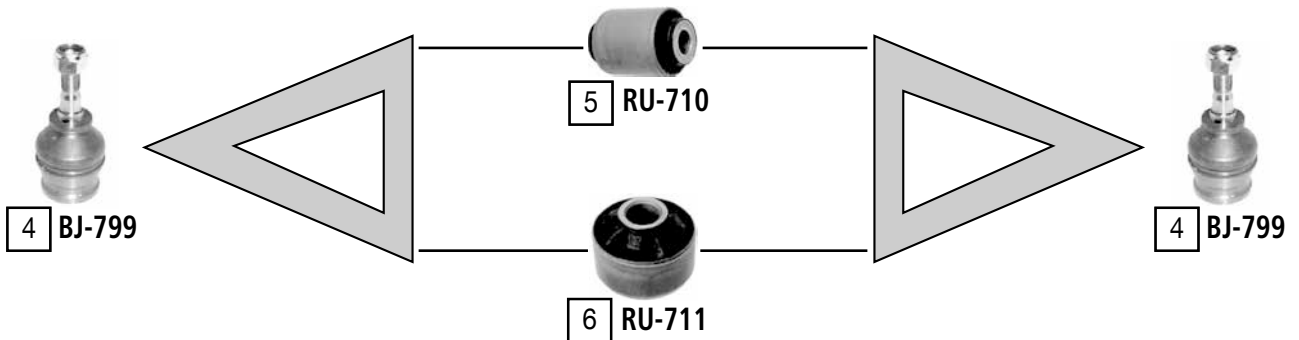
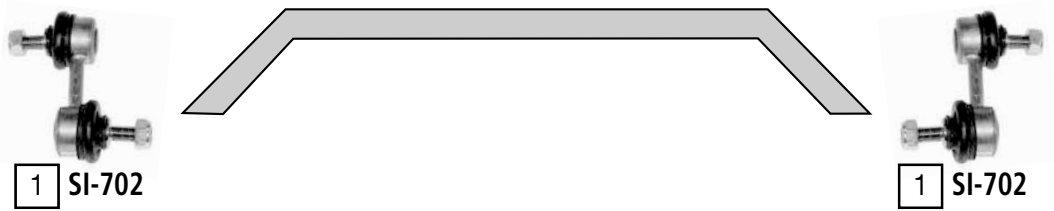

Ref	JAPANPARTS CODE	Description	OEM	Measures	Ref	JAPANPARTS CODE	Description	OEM	Measures
1	SI-702	stabiliser link	20470 SA000	L:60	5	RU-710	silentblock for TCA	20204 AJ000	di:12.4 do:37.1
2	TI-700	tie rod end	34161 SA000	c:13 th:FM14X1.5R	6	RU-711	silentblock for TCA	20204 AG011	di:19.2 do:60
3	RD-708	axial joint	34160 XA010	th:MM16x1.5R L:325	7	SI-705	stabiliser link rear axle	20470 AJ010	L:107
4	BJ-799	ball joint lower	21067 GA050	c:15.7 do:38	8				



IMPREZA (GC-GF)

08/1992 - 12/2000

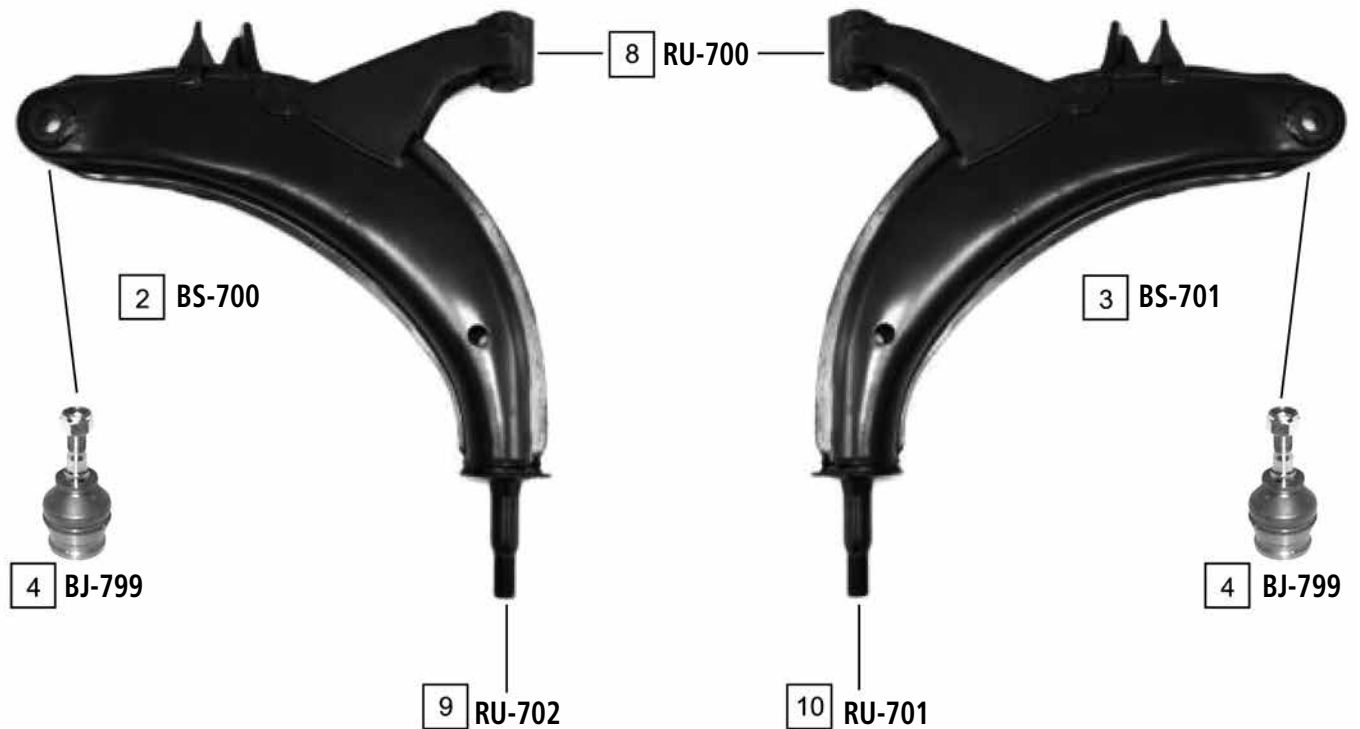
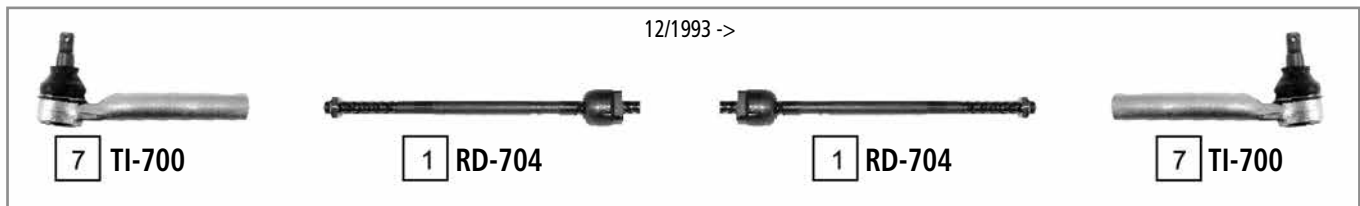
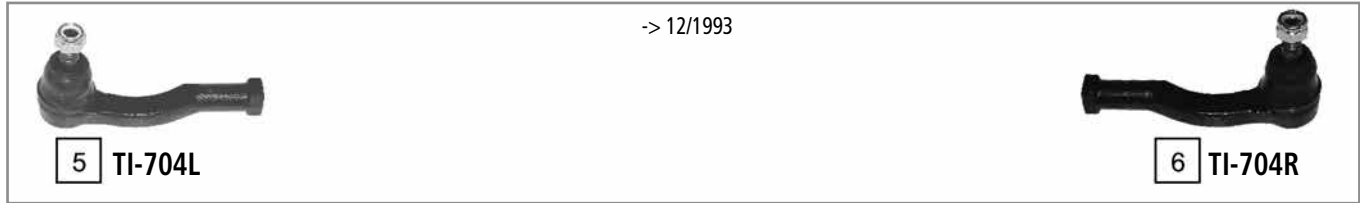

Ref	JAPANPARTS CODE	Description	OEM	Measures	Ref	JAPANPARTS CODE	Description	OEM	Measures
1	RD-704	Axial Joint	34140-AA040	th:MM14x1.5R L:292	6	TI-704R	Tie Rod End Right	31320-GA190	
2	BS-700	TCA Left	20200 AA210		7	TI-700	Tie Rod End	34141 AA 041	
3	BS-701	TCA Right	200200 AC200F		8	RU-700	Silentblock For Susp.Arm	20201 AA000	
4	BJ-799	Ball Joint Lower	21067 GA050	c:15.7	9	RU-702	Silentblock For Susp.Arm	20201 AC110	
5	TI-704L	Tie Rod End Left	31320-GA200		10	RU-701	Silentblock For Susp.Arm	20201 AC100	

IMPREZA (GD-GG)

12/2000 ->

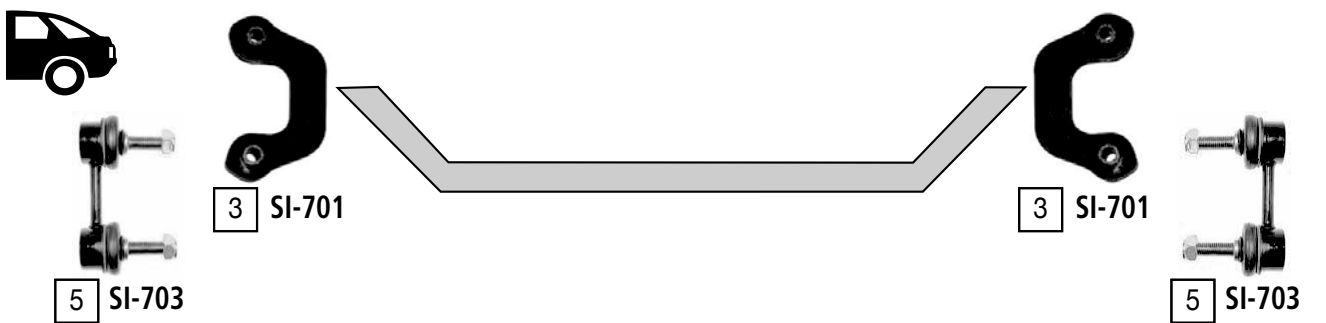
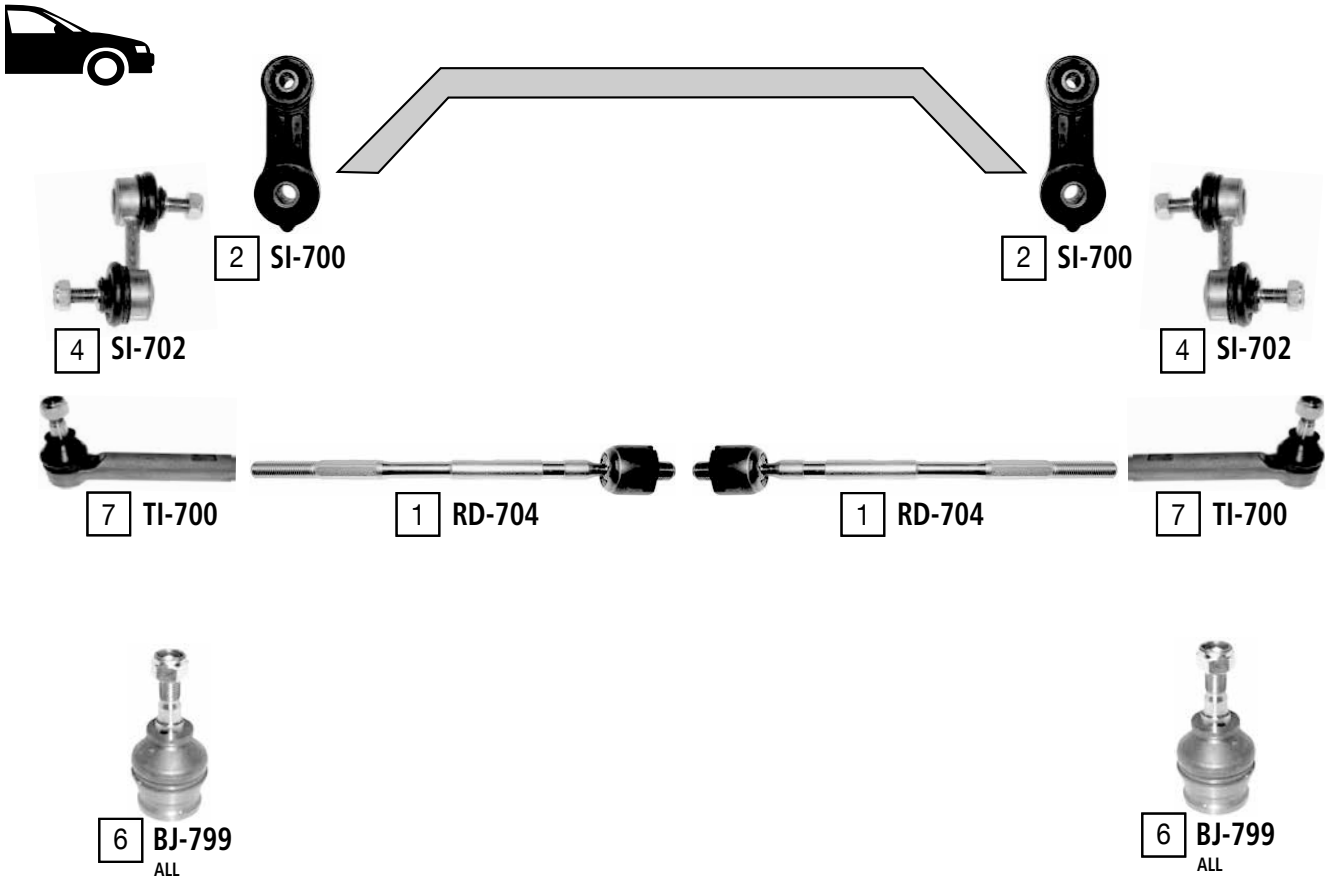

Ref	JAPANPARTS CODE	Description	OEM	Measures	Ref	JAPANPARTS CODE	Description	OEM	Measures
1	RD-704	axial joint	34140 AA040	th:MM14X1.5R L:292	5	SI-703	stabiliser link rear axle	20470 SA011	L:70
2	SI-700	stabiliser link	20420 AA004	L:65	6	BJ-799	ball joint lower	21067 GA050	c:15.7 do:38
3	SI-701	stabiliser link rear axle	20481 AA001	L:100	7	TI-700	tie rod end	34161 SA000	c:13 th:FM14X1.5R
4	SI-702	stabiliser link	20470 SA000	L:60					

IMPREZA (GR)

01/2008 ->

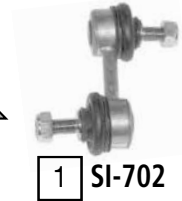
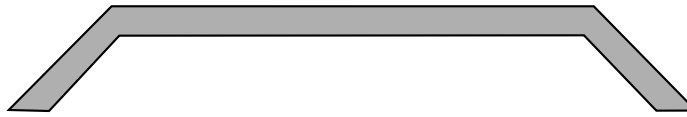

Ref	JAPANPARTS CODE	Description	OEM	Measures	Ref	JAPANPARTS CODE	Description	OEM	Measures
1	SI-702	stabiliser link	20470 SA000	L:60	4	BJ-799	ball joint lower	21067 GA050	c:15.7 do:38
2	TI-700	tie rod end	34161 SA000	c:13 th:FM14X1.5R	5	SI-706	stabiliser link rear axle	20470 FG000	L:94
3	RD-703	axial joint	34160 AE001	th:MM16X1.5R L:302					

JUSTY (KAD-JMA)

11/1984 - 09/2003



3 TI-705



4 RD-707



4 RD-707



3 TI-705

1987 - 1994



1 CJ-700



2 CJ-701



5 BJ-704



5 BJ-704

Ref	JAPANPARTS CODE	Description	OEM	Measures	Ref	JAPANPARTS CODE	Description	OEM	Measures
1	CJ-700	TCA Left	7210-60530		4	RD-707	Axial Joint	7313-10140	th:MM14X1.5R L:222
2	CJ-701	TCA Right	7210-60520	c:15	5	BJ-704	Ball Joint	7210-67021	c:13
3	TI-705	Tie Rod End	7313-20020	c:11.5 th:FM12X1.5R					

LEGACY I (BC)

01/1989 - 08/1994



4 TI-704L



5 TI-704R



8 RU-700



7 RU-701

Ref	JAPANPARTS CODE	Description	OEM	Measures	Ref	JAPANPARTS CODE	Description	OEM	Measures
1	BS-700	TCA Left	20200 AA210		5	TI-704R	Tie Rod End Right	31320-GA190	
2	BS-701	TCA Right	200200 AC200F		6	RU-702	Silentblock For Susp.Arm	20201 AC110	
3	BJ-799	Ball Joint Lower	21067 GA050	c:15.7	7	RU-701	Silentblock For Susp.Arm	20201 AC100	
4	TI-704L	Tie Rod End Left	31320-GA200		8	RU-700	Silentblock For Susp.Arm	20201 AA000	

LEGACY II (BD-BG)

01/1994 - 03/1999



5 TI-700



1 RD-704



1 RD-704



5 TI-700



2 BS-700

4 BJ-799

7 RU-702

6 RU-700



3 BS-701

4 BJ-799

8 RU-701

Ref	JAPANPARTS CODE	Description	OEM	Measures	Ref	JAPANPARTS CODE	Description	OEM	Measures
1	RD-704	Axial Joint	34140-AA040	th:MM14X1.5R L:292	5	TI-700	Tie Rod End	34141 AA 041	
2	BS-700	TCA Left	20200 AA210		6	RU-700	Silentblock For Susp.Arm	20201 AA000	
3	BS-701	TCA Right	200200 AC200F		7	RU-702	Silentblock For Susp.Arm	20201 AC110	
4	BJ-799	Ball Joint Lower	21067 GA050	c:15.7	8	RU-701	Silentblock For Susp.Arm	20201 AC100	

LEGACY III (BE-BH)

04/1999 - 08/2003

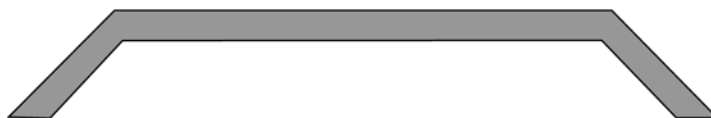

3 TI-700



1 RD-705



1 RD-705



3 TI-700



2 BJ-799

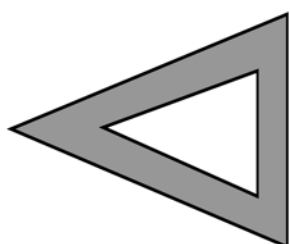

LOWER

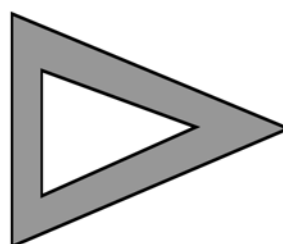

2 BJ-799

Ref	JAPANPARTS CODE	Description	OEM	Measures	Ref	JAPANPARTS CODE	Description	OEM	Measures
1	RD-705	Axial Joint	31310-GA152	th:MM14X1.5R L:292	3	TI-700	Tie Rod End	34141 AA 041	
2	BJ-799	Ball Joint Lower	21067 GA050	c:15.7					

LEGACY IV (B13)

09/2003 ->

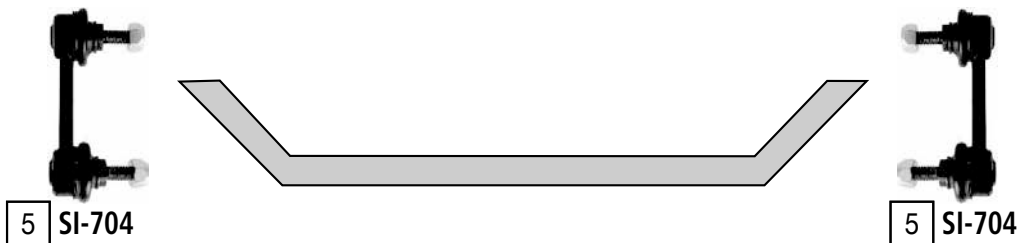
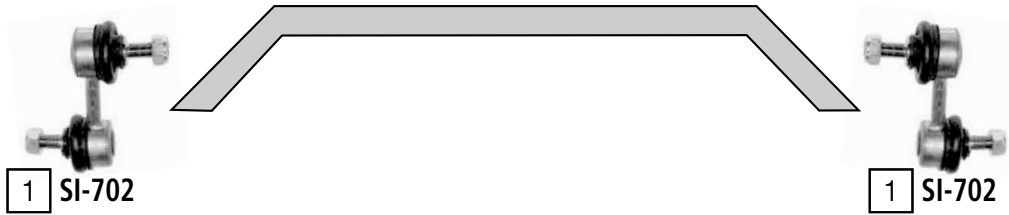

Ref	JAPANPARTS CODE	Description	OEM	Measures	Ref	JAPANPARTS CODE	Description	OEM	Measures
1	SI-702	stabiliser link	20470 SA000	L:60	4	BJ-799	ball joint lower	21067 GA050	c:15.7 do:38
2	TI-700	tie rod end	34161 SA000	c:13 th:FM14X1.5R	5	SI-704	stabiliser link rear axle	20470 AE001	L:90
3	RD-703	axial joint	34160 AE001	th:MM16X1.5R L:302					



LEGACY V (B14)

09/2009 ->

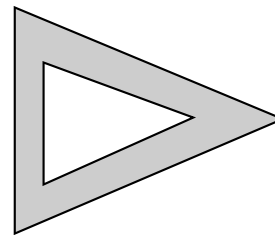
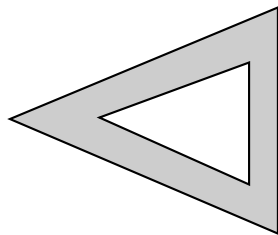

Ref	JAPANPARTS CODE	Description	OEM	Measures	Ref	JAPANPARTS CODE	Description	OEM	Measures
1	SI-707	stabiliser link	20420 AJ000	L:63	4	BJ-799	ball joint lower	21067 GA050	c:15.7 do:38
2	TI-700	tie rod end	34161 SA000	c:13 th:FM14X1.5R	5	SI-706	stabiliser link rear axle	20470 FG000	L:94
3	RD-703	axial joint	34160 AE001	th:MM16X1.5R L:302					

LEONE II

11/1984 - 02/1992



MS



2 TI-703L



3 RD-734



3 RD-734



1 TI-703R

PS



2 TI-703L



4 RD-706



4 RD-706



1 TI-703R



5 BJ-798

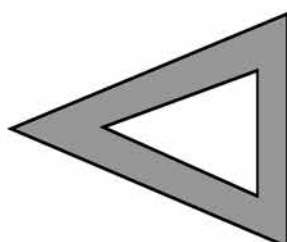

LOWER

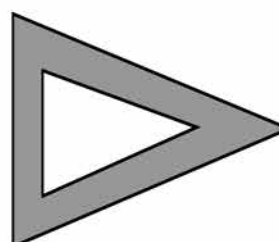

5 BJ-798

Ref	JAPANPARTS CODE	Description	OEM	Measures	Ref	JAPANPARTS CODE	Description	OEM	Measures
1	TI-703R	Tie Rod End Left	31320-GA111	c:12.3 th:FM14X1.5R	4	RD-706	Axial Joint	31310-GA151	th:MM14X1.5R L:280
2	TI-703L	Tie Rod End Right	31320-GA101	c:12.3 th:FM14X1.5R	5	BJ-798	Ball Joint Lower	721067003	c:13.8
3	RD-734	Axial Joint	31310-GA170						

LIBERO (E10-E12)

01/1983 - 02/2000



1 BJ-704

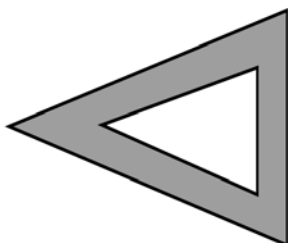

LOWER

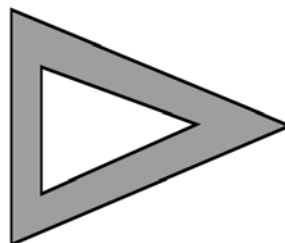

1 BJ-704

Ref	JAPANPARTS CODE	Description	OEM	Measures	Ref	JAPANPARTS CODE	Description	OEM	Measures
1	BJ-704	Ball Joint	7210-67021	c:13					

ALTO I (SS80)

06/1982 - 12/1985



09/1984 ->



1 TI-804



2 RD-803



2 RD-803



1 TI-804



3 CJ-803



4 RU-C07



3 CJ-803

Ref	JAPANPARTS CODE	Description	OEM	Measures	Ref	JAPANPARTS CODE	Description	OEM	Measures
1	TI-804	Tie Rod End	48810 78000	c:12.8 th:MM12X1.25	3	CJ-803	TCA	45200 69DV1	c:15
2	RD-803	Axial Joint	48830-84000		4	RU-C07	Silentblock For Susp.Arm	45261 77A10	d:27.5

ALTO II (EC)  
ALTO III (EF,SH410)

01/1986 - 11/1993  
04/1994 - 06/2002



Ref	JAPANPARTS CODE	Description	OEM	Measures	Ref	JAPANPARTS CODE	Description	OEM	Measures
1	TI-812	Tie Rod End	48810 84000	c:12.7 th:MM12X1.25	4	RU-C07	Silentblock For Susp.Arm	45261 77A10	d:27.5
2	RD-803	Axial Joint	48830-84000		5	RU-820	Stabiliser Mountig	42431 70B42	d:21.5
3	CJ-803	TCA	45200 69DV1	c:15					

ALTO IV (RF410)

03/2002 - 02/2007

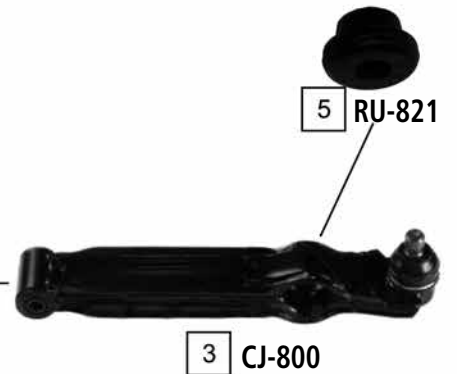

Ref	JAPANPARTS CODE	Description	OEM	Measures	Ref	JAPANPARTS CODE	Description	OEM	Measures
1	RD-800	Axial Joint	48830 M70F00	th:FM14X1.5R L:236	4	RU-C07	Silentblock For Susp.Arm	45261 77A10	d:27.5
2	TI-812	Tie Rod End	48810 84000	c:12.7 th:MM12X1.25	5	RU-821	Silentblock For Susp.Arm	42451 M76G00	
3	CJ-800	TCA	45200 M79F00	c:15					

ALTO V (GF)

01/2009 ->

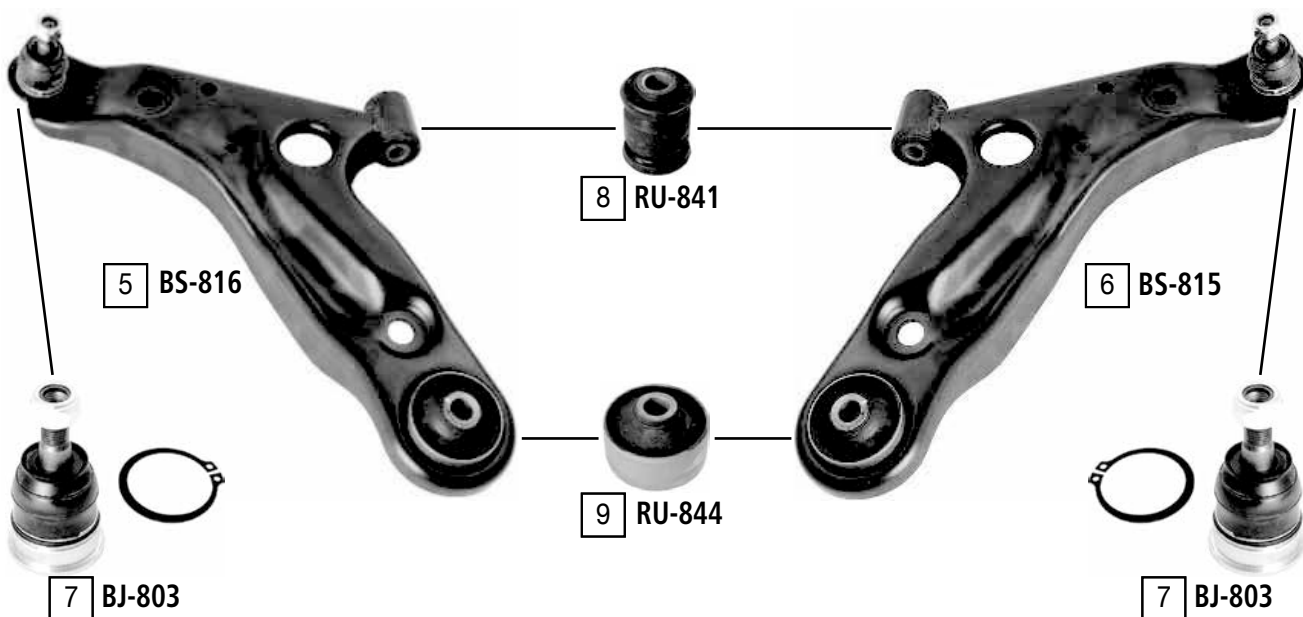
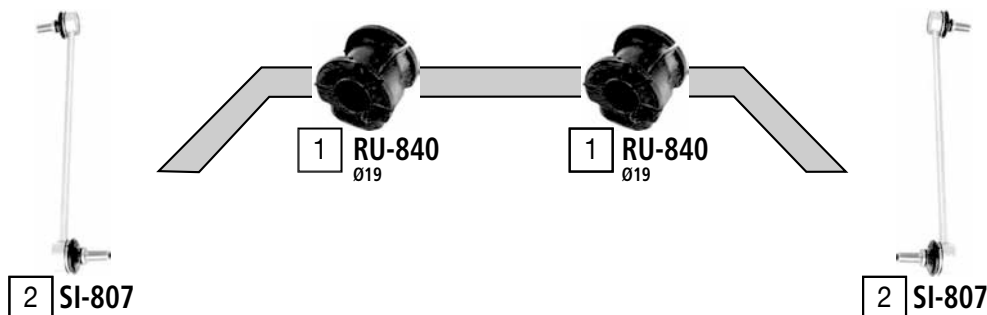

Ref	JAPANPARTS CODE	Description	OEM	Measures	Ref	JAPANPARTS CODE	Description	OEM	Measures
1	RU-840	stabiliser mounting	42431 M68K00	di:19	6	BS-815	TCA right wbj	45201 M68K00	c:13.4
2	SI-807	stabiliser link	42420 M68K00	L:282	7	BJ-803	ball joint	Part of	c:13.4 do:40.3
3	TI-824	tie rod end	48810 63J00	c:13 th:FM12x1.25R	8	RU-841	silentblock for TCA	45430 M68K00	di:12.1 do:33.4
4	RD-816	axial joint	48830 M68K00	th:MM14x1.5R L:272.5 9	9	RU-844	silentblock for TCA	Part of	di:12.4 do:54.1
5	BS-816	TCA left wbj	45202 M68K00	c:13.4					

BALENO (SY)

07/1995 - 11/2002



9 RU-822



8 RU-823



Ref	JAPANPARTS CODE	Description	OEM	Measures	Ref	JAPANPARTS CODE	Description	OEM	Measures
1	RD-805	Axial Joint	48830-60G00	th:MM14X1.5R L:307	6	SI-802	Stabiliser Link Left	46640 80F00	L:178
2	SI-800	Stabiliser Link	46630 60B01		7	SI-801	Stabiliser Link Right	46630 80F00	L:178
3	BS-800	TCA	45202-63G01	c:16.5	8	RU-823	Silentblock For Susp.Arm	46420 60B02	
4	BS-801	TCA	45201-63G01	C:16.5	9	RU-822	Silentblock For Susp.Arm	45500 50800	
5	TI-805	Tie Rod End	48810 76G00	c:12.7 th:FM12X1.25					



CARRY (ST90V)

11/1980 - 10/1985



2 TI-803L



3 TI-803R



2 TI-803L



3 TI-803R



1 CJ-802



1 CJ-802

4 BJ-801  
-> 02/1981

4 BJ-801  
-> 02/1981

Ref	JAPANPARTS CODE	Description	OEM	Measures	Ref	JAPANPARTS CODE	Description	OEM	Measures
1	CJ-802	TCA Lower	45200-79001		3	TI-803R	Tie Rod End	48810 79000	c:12.7 th:MM14X1.5R
2	TI-803L	Tie Rod End	48820-79000	c:12.5 th:MM14X1.5L	4	BJ-801	Ball Joint		

CARRY (ED)

10/1985 - 03/1999



2 TI-803L



3 TI-803R



2 TI-803L



3 TI-803R

-> 1991



1 CJ-805



1 CJ-805

Ref	JAPANPARTS CODE	Description	OEM	Measures	Ref	JAPANPARTS CODE	Description	OEM	Measures
1	CJ-805	TCA Lower	45200-85001		3	TI-803R	Tie Rod End	48810 79000	c:12.7 th:MM14X1.5R
2	TI-803L	Tie Rod End	48820-79000	c:12.5 th:MM14X1.5L					

CARRY (FD)

03/1999 ->

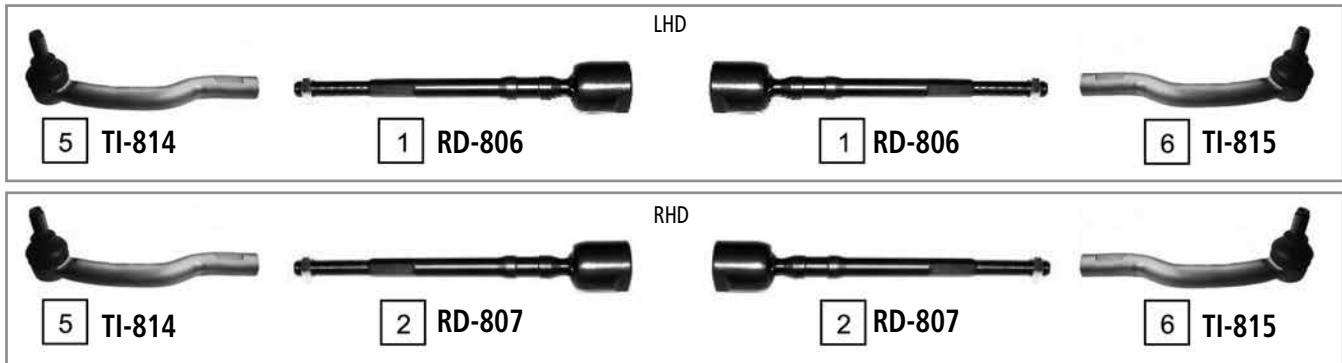

Ref	JAPANPARTS CODE	Description	OEM	Measures	Ref	JAPANPARTS CODE	Description	OEM	Measures
1	RD-806	Axial Joint	48830-77A00	th:FM14X1.5R L:240	5	TI-814	Tie Rod End	48820-78A00	
2	RD-807	Axial Joint	48830-78A00	th:FM14X1.5R L:225	6	TI-815	Tie Rod End	48810-78A00	
3	CJ-806	TCA	45202-77A01	c:15	7	RU-824	Silentblock For Susp.Arm	09319 10030	
4	CJ-807	TCA	45201-77A01	c:15					

GRAND VITARA (FT-GT)

03/1998 - 04/2005



-> 06/2001



06/2001 ->

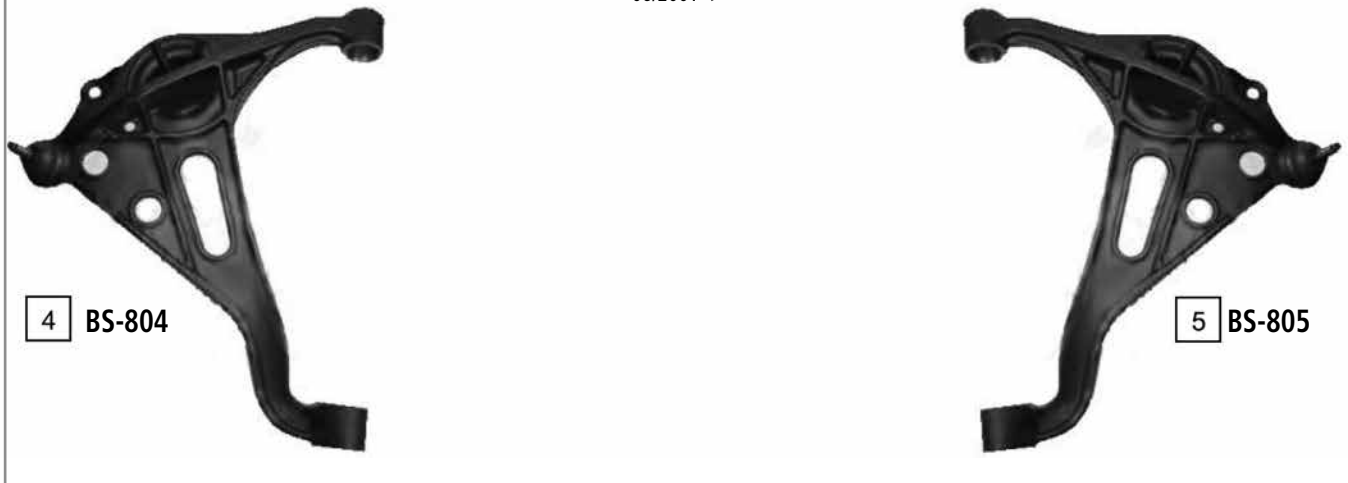

Ref	JAPANPARTS CODE	Description	OEM	Measures	Ref	JAPANPARTS CODE	Description	OEM	Measures
1	RD-808	Axial Joint	48830-65D00	th:MM16X1R L:227	5	BS-805	TCA	45201-65D01	
2	BS-802	TCA	45202-65D00		6	TI-816	Tie Rod End Left	48820 65D00	
3	BS-803	TCA	45201-65D00		7	TI-817	Tie Rod End Right	48810 65D00	
4	BS-804	TCA	45202 65D01						

GRAND VITARA (JB416-419-420)

10/2005 ->

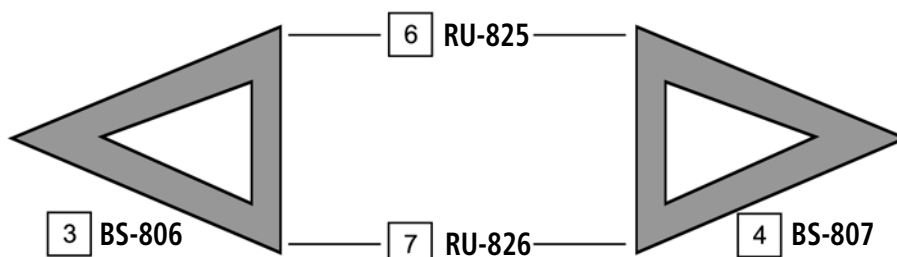
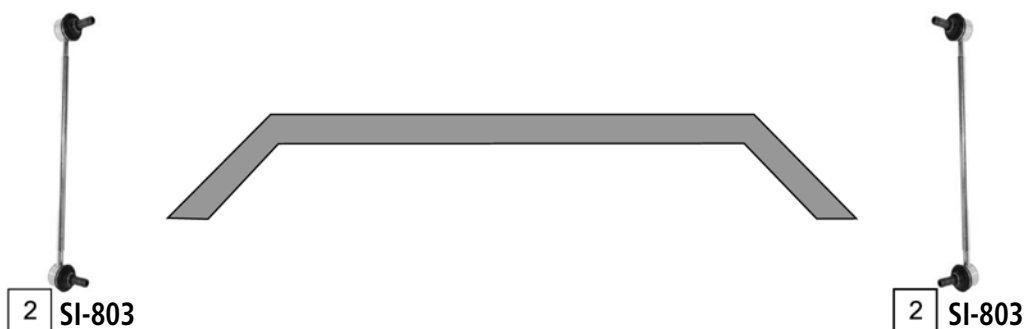

Ref	JAPANPARTS CODE	Description	OEM	Measures	Ref	JAPANPARTS CODE	Description	OEM	Measures
1	RD-809	Axial Joint	48830 65J00	th:MM18X1.5R L:343	5	TI-800	Tie Rod End	48810 65J00	
2	SI-803	Stabiliser Link	42420 65J00		6	RU-825	Silentblock For Susp.Arm	45261 65J00	
3	BS-806	TCA Left	45202 65J00		7	RU-826	Silentblock For Susp.Arm	Part of BS-806/BS-807	
4	BS-807	TCA Right	45201 65J00						

IGNIS (FH-RG413-RG415)

10/2000 - 09/2003

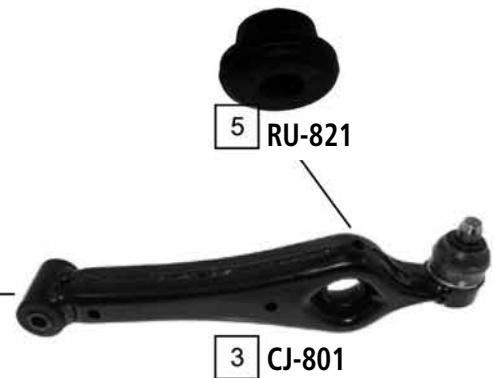
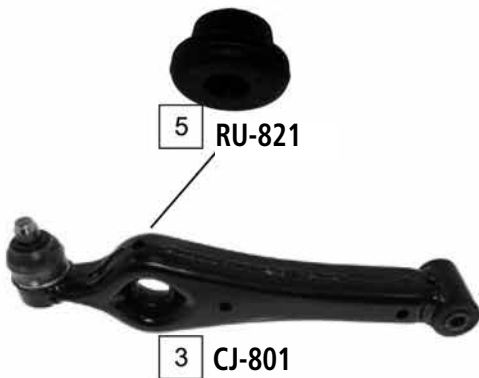
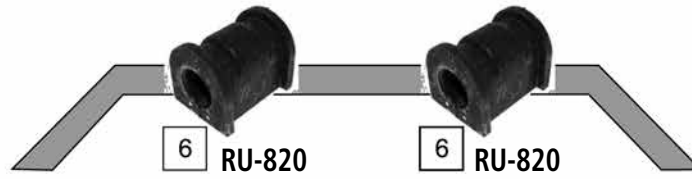

Ref	JAPANPARTS CODE	Description	OEM	Measures	Ref	JAPANPARTS CODE	Description	OEM	Measures
1	RD-810	Axial Joint	48830 75F00	th:FM14X1.5R L:248	4	RU-C07	Silentblock For Susp.Arm	45261 77A10	d:27.5
2	TI-805	Tie Rod End	48810 76G00	c:12.7 th:FM12X1.25	5	RU-821	Silentblock For Susp.Arm	42451 M76G00	
3	CJ-801	TCA	45200 76G20	c:15	6	RU-820	Stabiliser Mounting	42431 70B42	d:21.5

IGNIS (RM413-415)

09/2003 ->



Ref	JAPANPARTS CODE	Description	OEM	Measures	Ref	JAPANPARTS CODE	Description	OEM	Measures
1	TI-818	Tie Rod End	48810 83E02	c:13.1 th:FM12X1.25	4	RU-C07	Silentblock For Susp.Arm	45261 77A10	d:27.5
2	RD-811	Axial Joint	48830 86G00	th:MM14X1.5R L:247	5	RU-821	Silentblock For Susp.Arm	42451 M76G00	
3	CJ-804	TCA	45200 85E00						

JIMNY (FJ)

09/1998 ->



**1** TI-820



**2** TI-819

**3** TI-807

**4** TI-811

Ref	JAPANPARTS CODE	Description	OEM	Measures	Ref	JAPANPARTS CODE	Description	OEM	Measures
1	TI-820	Tie Rod End	48820-81A00	c:12.5 th:MM16X1.5L	3	TI-807	Tie Rod End	48870 80002	
2	TI-819	Tie Rod End	48810-81A00	c:12.5 th:MM16X1.5R	4	TI-811	Tie Rod End	48870 80060	



SAMURAI (SJ)

11/1988 ->



2 TI-806L

1 TI-806R

3 TI-N041

Ref	JAPANPARTS CODE	Description	OEM	Measures	Ref	JAPANPARTS CODE	Description	OEM	Measures
1	TI-806R	Tie Rod End	48810 77E00	c:12.5 th:MM16X1.5R	3	TI-N041	Rod Assy Steering		
2	TI-806L	Tie Rod End	48820-80000	c:12.5 th:MM16X1.5L					

SPLASH

01/2008 ->

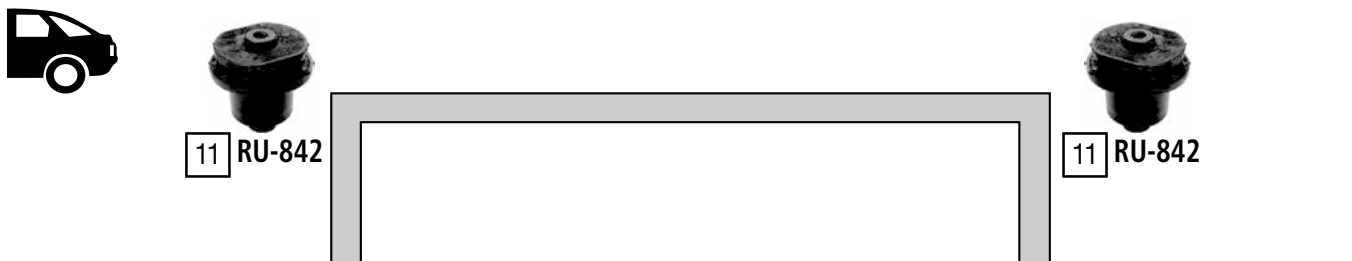
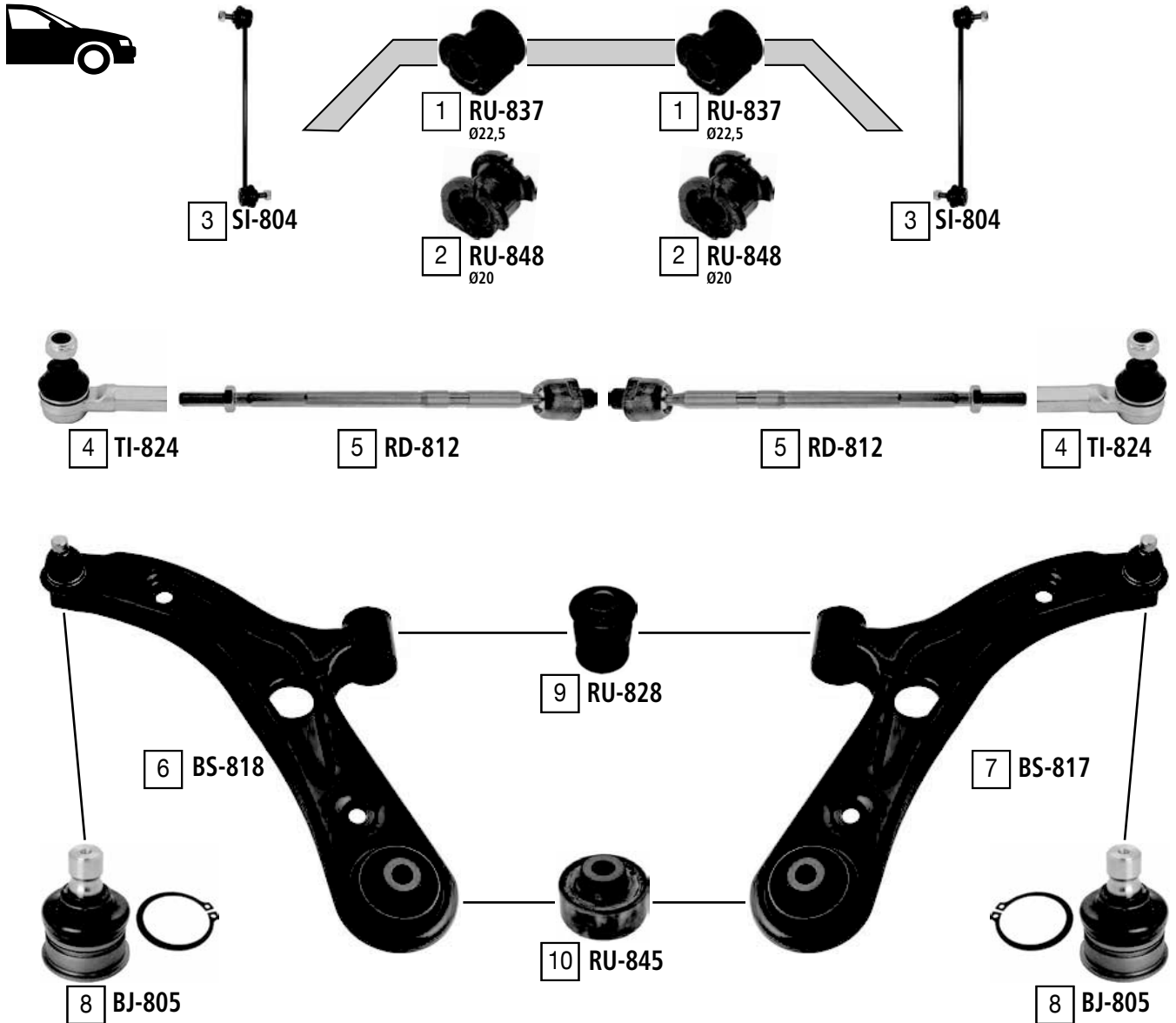

Ref	JAPANPARTS CODE	Description	OEM	Measures	Ref	JAPANPARTS CODE	Description	OEM	Measures
1	RU-837	stabiliser mounting	42431 51K40	di:22.5	7	BS-817	TCA right wbj	45201 72K00	c:16.5
2	RU-848	stabiliser mounting	42431 51K00	di:20	8	BJ-805	ball joint	Part of	c:16.5 do:40.2
3	SI-804	stabiliser link	42420 62J00	L:300	9	RU-828	silentblock for TCA	45530 62J00	di:14.2 do:43.5
4	TI-824	tie rod end	48810 63J00	c:13 th:FM12x1.25R	10	RU-845	silentblock for TCA	Part of	do:60
5	RD-812	axial joint	48830 63J00	th:MM18X1.5R L:305	11	RU-842	mounting axle body	46221 51K10	do:55
6	BS-818	TCA left wbj	45202 72K00	c:16.5					

SWIFT I (AA)

10/1983 - 02/1989

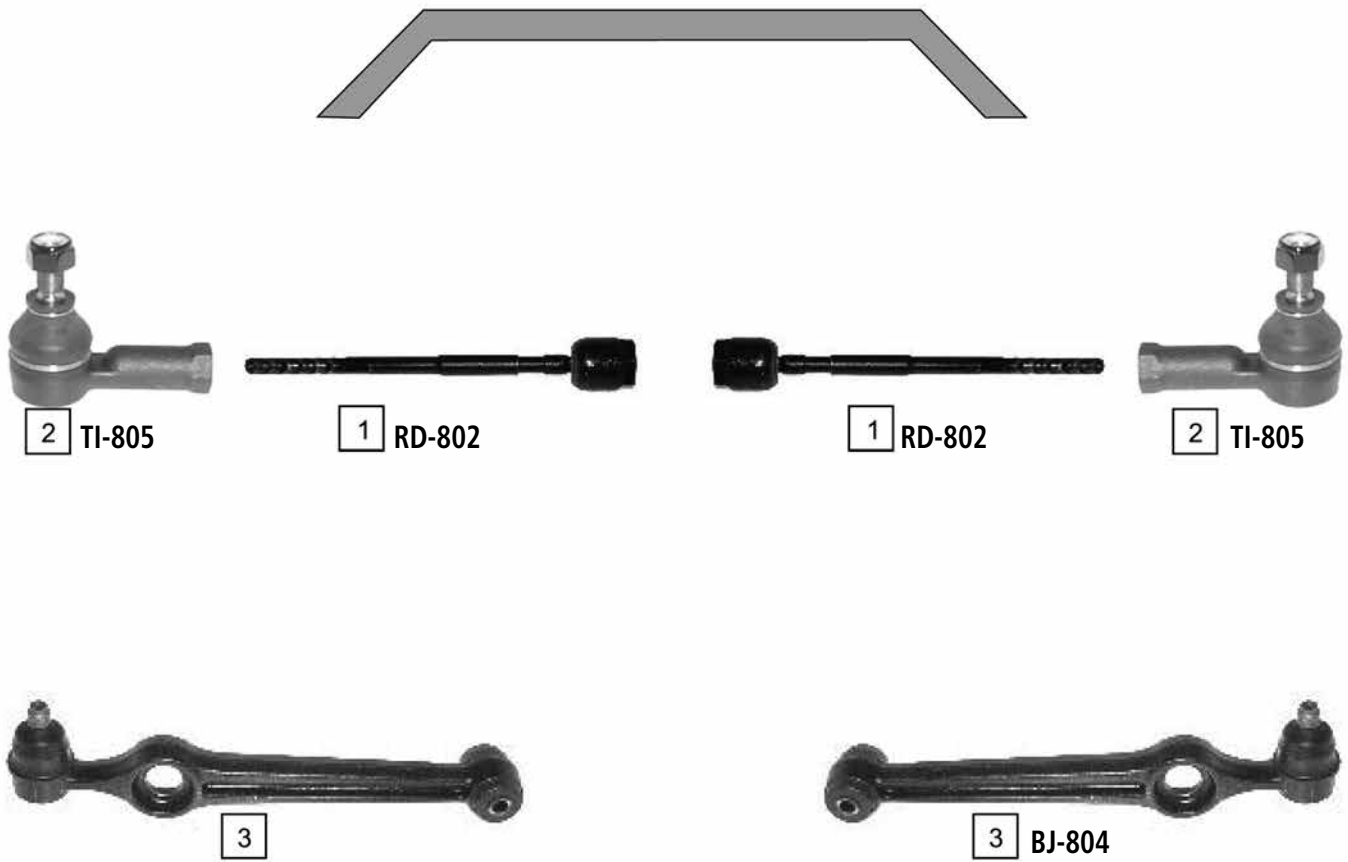

Ref	JAPANPARTS CODE	Description	OEM	Measures	Ref	JAPANPARTS CODE	Description	OEM	Measures
1	RD-802	Axial Joint	48830-82000	th:FM14X1.5R L:264	3	BJ-804	TCA	45200-82000	c:15
2	TI-805	Tie Rod End	48810 60B00	c:12.8 th:FM12X1.25					

SWIFT II (AH, AJ)

03/1989 - 05/2001

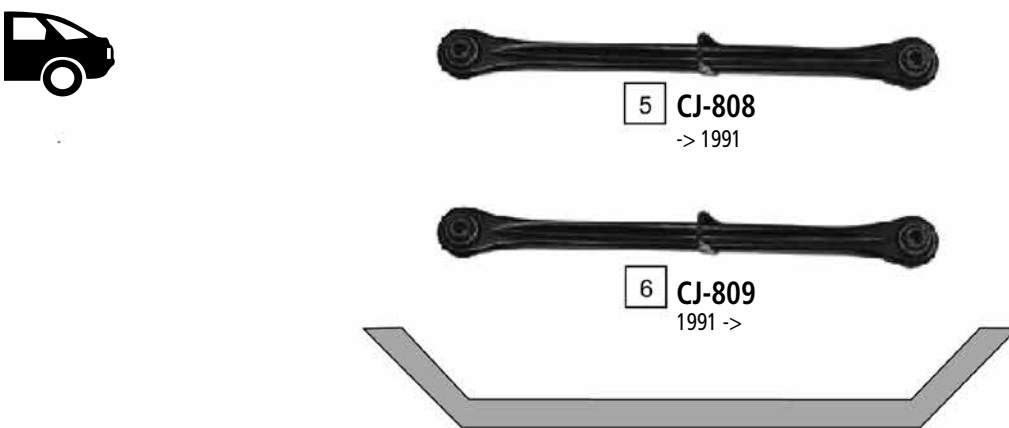
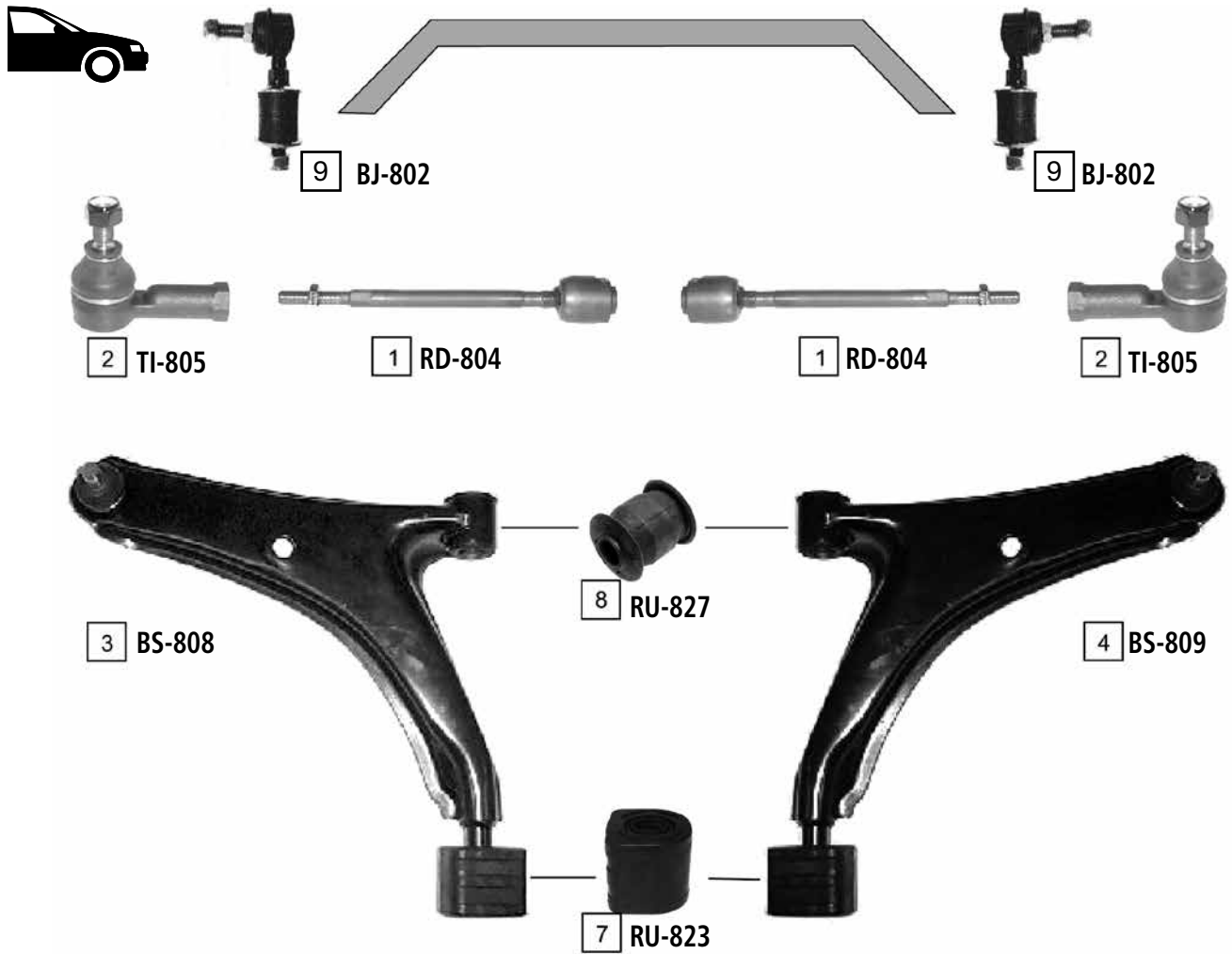

Ref	JAPANPARTS CODE	Description	OEM	Measures	Ref	JAPANPARTS CODE	Description	OEM	Measures
1	RD-804	Axial Joint	48830-60B00	th:FM14X1.5R L:288	6	CJ-809	TCA	46300 60B10	
2	TI-805	Tie Rod End	48810 60B00	c:12.8 th:FM12X1.25	7	RU-823	Silentblock For Susp.Arm	46420 60B02	
3	BS-808	TCA	45200 60820	c:15	8	RU-827	Silentblock For Susp.Arm	45530 70C00	d:34
4	BS-809	TCA	45200 60810	c:15	9	BJ-802	Stabiliser Link	46630-60B01	
5	CJ-808	TCA	46300 60B00						

SWIFT III (RS413-415)

02/2005 ->

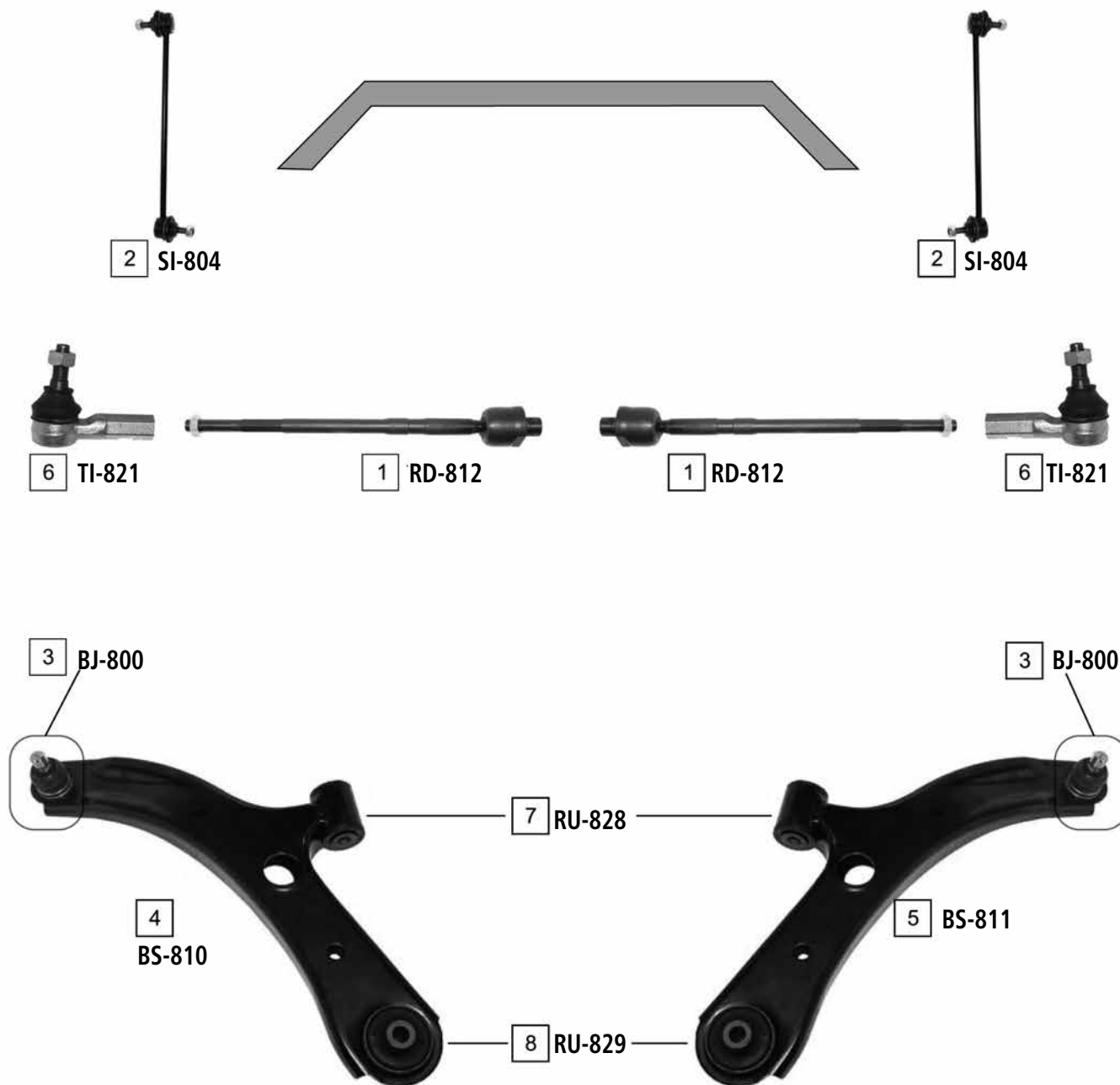

Ref	JAPANPARTS CODE	Description	OEM	Measures	Ref	JAPANPARTS CODE	Description	OEM	Measures
1	RD-812	Axial Joint	48830 63J00	th:MM18X1.5R L:305	5	BS-811	TCA Right Wbj	45201 62J00	c:16.5
2	SI-804	Stabiliser Link	42420 62J00	L:300	6	TI-821	Tie Rod End	48810 63J00	c:13.15 th:FM12X1.2
3	BJ-800	Ball Joint	Part of BS-810/BS-811		7	RU-828	Silentblock For Susp.Arm	45530 62J00	
4	BS-810	TCA Left Wbj	45202 62J00	c:16.5	8	RU-829	Silentblock For Susp.Arm	Part of BS-810/BS-811	

SX4 (RW415-416-419)

06/2006 ->

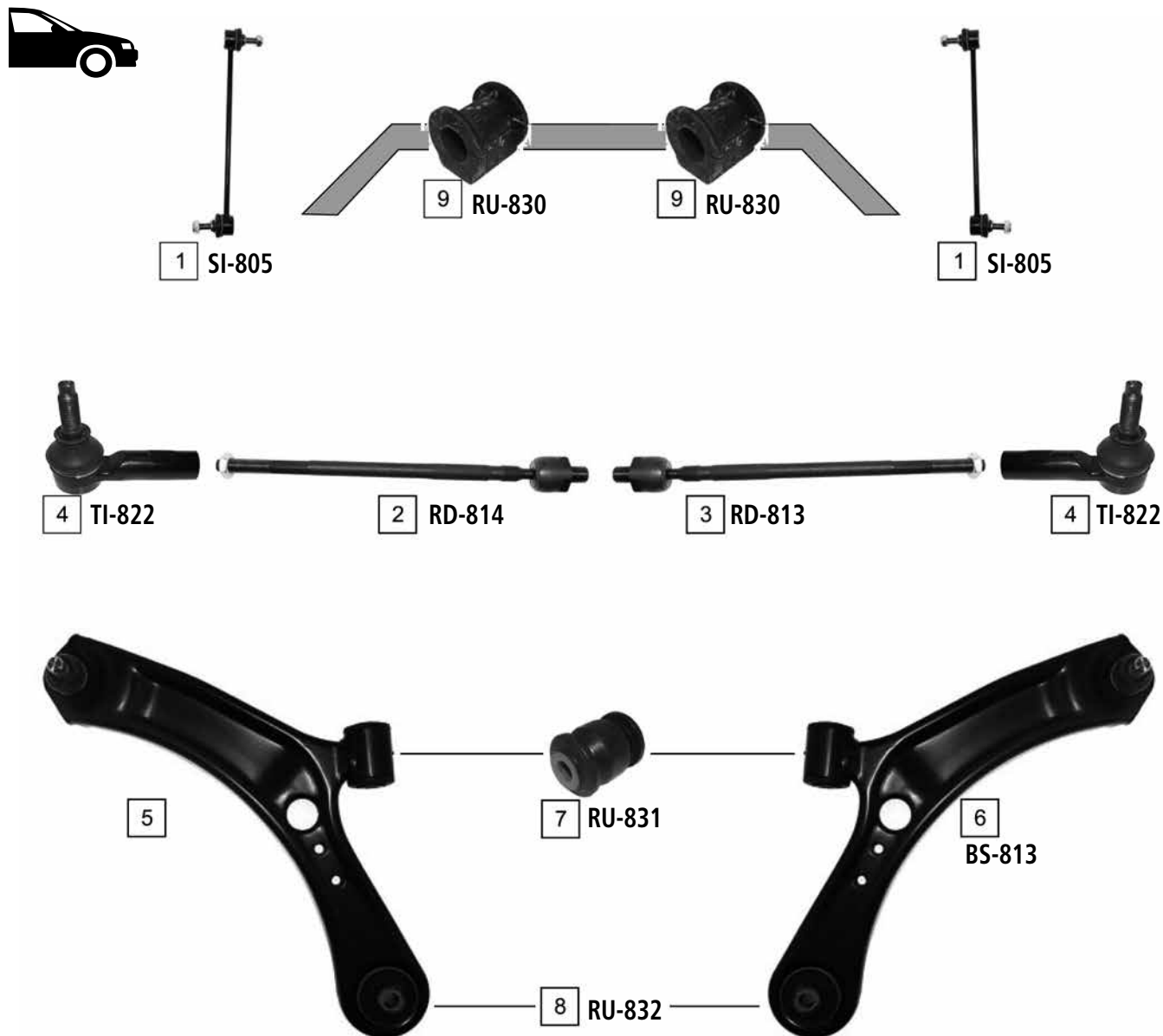

Ref	JAPANPARTS CODE	Description	OEM	Measures	Ref	JAPANPARTS CODE	Description	OEM	Measures
1	SI-805	Stabiliser Link	42420 80J00	L:270	6	BS-813	TCA Right Wbj	45201 79J00	
2	RD-814	Axial Joint	48830 79J10	th:MM16X1R L:334	7	RU-831	Silentblock For Susp.Arm	45261 79J00	
3	RD-813	Axial Joint	48830 79J00	th:MM16X1R L:334	8	RU-832	Silentblock For Susp.Arm	Part of BS-814/BS-813	
4	TI-822	Tie Rod End	48810 79J00		9	RU-830	Stabiliser Mounting	42431 79J00	
5	BS-814	TCA Left Wbj	45202 79J00						

VITARA (ESCUDO) (ET, TA)

05/1988 - 03/1998

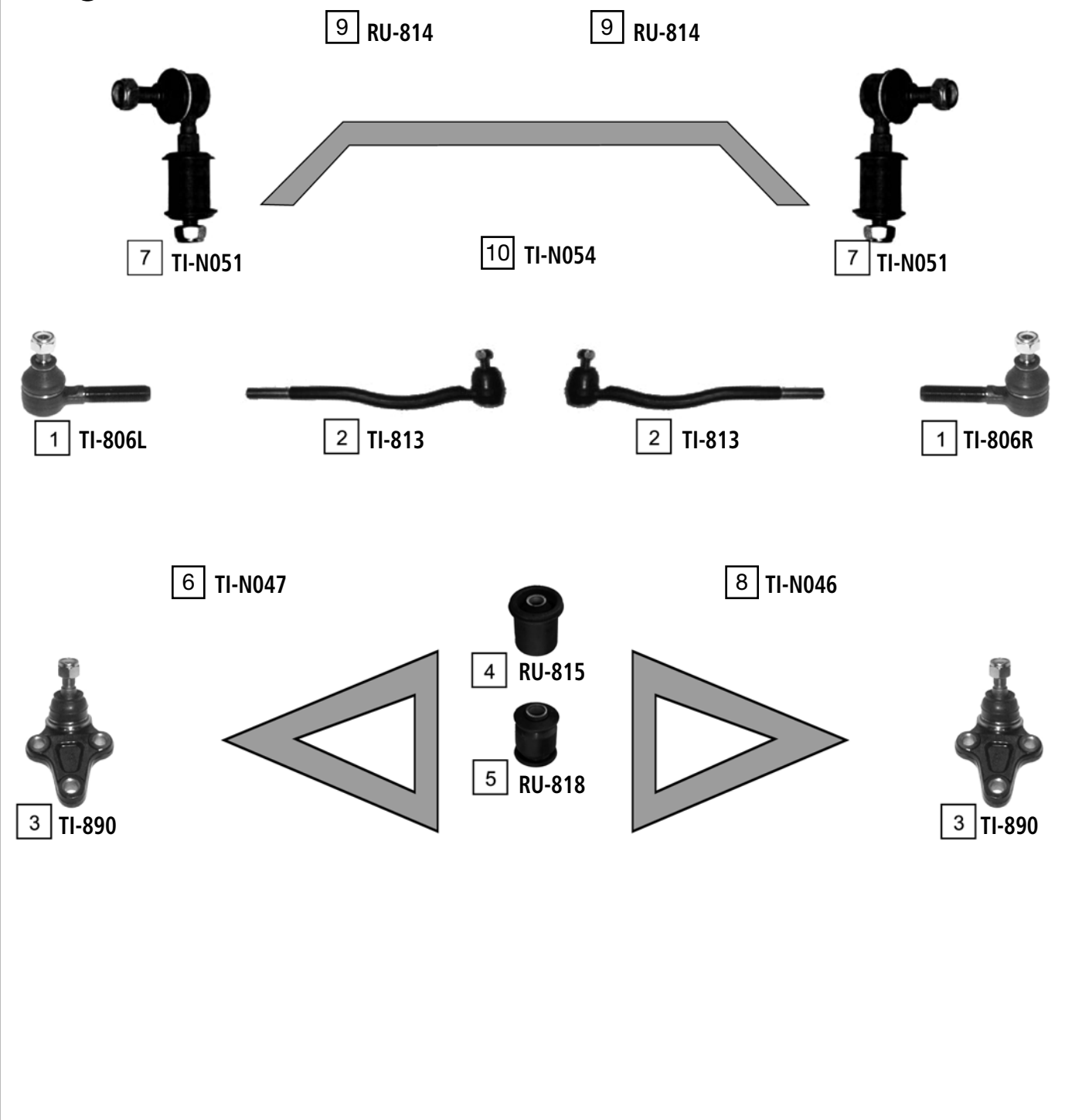

Ref	JAPANPARTS CODE	Description	OEM	Measures	Ref	JAPANPARTS CODE	Description	OEM	Measures
1	TI-806R	Tie Rod End	48810 77E00	c:12.5 th:MM16X1.5R	6	TI-N047	TCA Left	45202-56B00	
2	TI-813	Tie Rod End	48820 77E00	c:12.6 th:MM16X1.5L	7	TI-N051	Stabiliser Link	42420 60A00	
3	TI-890	Ball Joint Lower	45700-60A00	c:16	8	TI-N046	TCA Right	45201-56B00	
4	RU-815	Silentblock For Susp.Arm	09319-12044		9	RU-814	Stabiliser Mounting	4241260A00	
5	RU-818	Silentblock For Susp.Arm	09319-14007		10	TI-N054	Link Assy Steering	48850A60A00	

WAGON R+ (EM)

02/1998 - 05/2000



3 TI-823



1 RD-810



1 RD-810



3 TI-823



2 CJ-810



2 CJ-810

Ref	JAPANPARTS CODE	Description	OEM	Measures	Ref	JAPANPARTS CODE	Description	OEM	Measures
1	RD-810	Axial Joint	48830 75F00	th:FM14X1.5R L:248	3	TI-823	Tie Rod End	48810-83E00	c:12.5 th:FM12X1.25
2	CJ-810	TCA	45200 75F00	c:15					



WAGON R+ (MM)

05/2000 ->



3 TI-823



1 RD-815



1 RD-815



3 TI-823



2 CJ-811



2 CJ-811

Ref	JAPANPARTS CODE	Description	OEM	Measures	Ref	JAPANPARTS CODE	Description	OEM	Measures
1	RD-815	Axial Joint	48830-83E00	th:MM14X1.5R L:243	3	TI-823	Tie Rod End	48810-83E00	c:12.5 th:FM12X1.25
2	CJ-811	TCA	45200 76G00						

2000 D/PICK UP

1998 ->



1

2 TI-003R

3 BJ-002

3 BJ-002

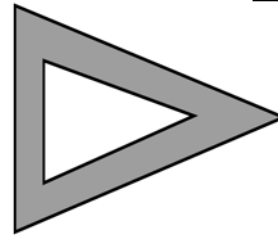
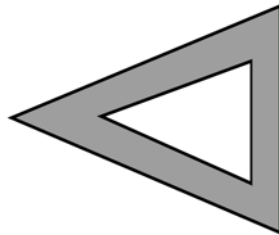

4 BJ-003

4 BJ-003

Ref	JAPANPARTS CODE	Description	OEM	Measures	Ref	JAPANPARTS CODE	Description	OEM	Measures
1	TI-003L	Tie Rod End Left	2654-TELQ-0116		3	BJ-002	Ball Joint	2654-3211-0156	
2	TI-003R	Tie Rod End Right	2655-TELQ-0117		4	BJ-003	Ball Joint	2654-3320-0113	

INDICA

10/1998 ->



4 TI-001

4 TI-001

3 BJ-001

3 BJ-001

2 BS-002

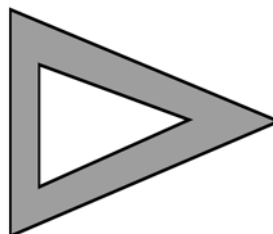
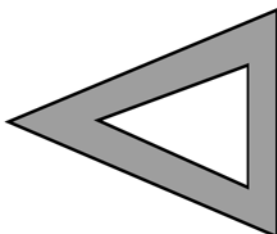

1 BS-001

Ref	JAPANPARTS CODE	Description	OEM	Measures	Ref	JAPANPARTS CODE	Description	OEM	Measures
1	BS-001	TCA Right	2702-3211-0150		3	BJ-001	Ball Joint	2702-3211-0106	
2	BS-002	TCA Left	2702-3211-0149		4	TI-001	Tie Rod End	2702-4660-3511	

INDIGO

01/2003 ->



1 TI-002

1 TI-002

3 BS-004

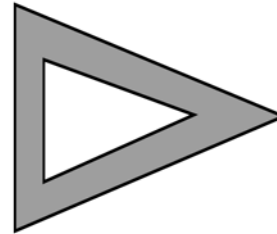
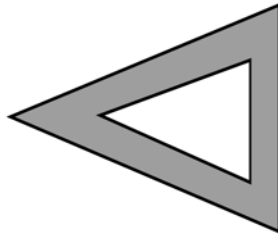

2 BS-003

Ref	JAPANPARTS CODE	Description	OEM	Measures	Ref	JAPANPARTS CODE	Description	OEM	Measures
1	TI-002	Tie Rod End	8855-4601-0001		3	BS-004	TCA Left	2779-3210-0183	
2	BS-003	TCA Right	2779-3210-0182						

SAFARI

01/1998 ->



2 TI-006

1

3 BJ-002

3 BJ-002

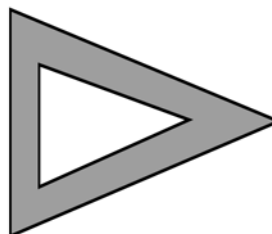
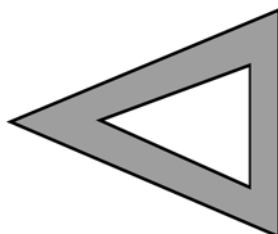

4 BJ-007

4 BJ-007

Ref	JAPANPARTS CODE	Description	OEM	Measures	Ref	JAPANPARTS CODE	Description	OEM	Measures
1	TI-005	Tie Rod End	2699-4660-0121		3	BJ-002	Ball Joint	2654-3211-0156	
2	TI-006	Tie Rod End	2699-4660-0113		4	BJ-007	Ball Joint	2699-3210-0150	

4 RUNNER

08/1987 - 03/1996



1 TI-226



3 BJ-292



3 BJ-292



1 TI-226



2 BJ-227

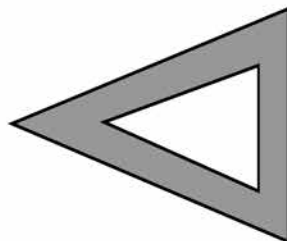

UPPER

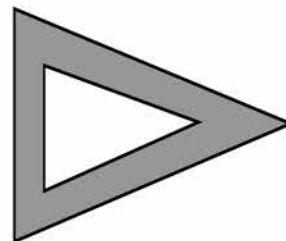

2 BJ-227

4 ID-244

FOR VEHICLES WITHOUT POWER STEERING

5 ID-245

6 PI-235

Ref	JAPANPARTS CODE	Description	OEM	Measures	Ref	JAPANPARTS CODE	Description	OEM	Measures
1	TI-226	Tie Rod End	45064-29115	c:14.8 th:MM17X1.5L	4	ID-244	Pitman Arm	45490 39345	
2	BJ-227	Ball Joint	43350-39045	c:17.1	5	ID-245	Pitman Arm	45490-39355	
3	BJ-292	Tie Rod End	45406 39165	c:14.7 th:FM17X1.5R	6	PI-235	Tie Rod End	45401 35220	

4 RUNNER (RZN18\_,VZN18\_)

11/1995 ->

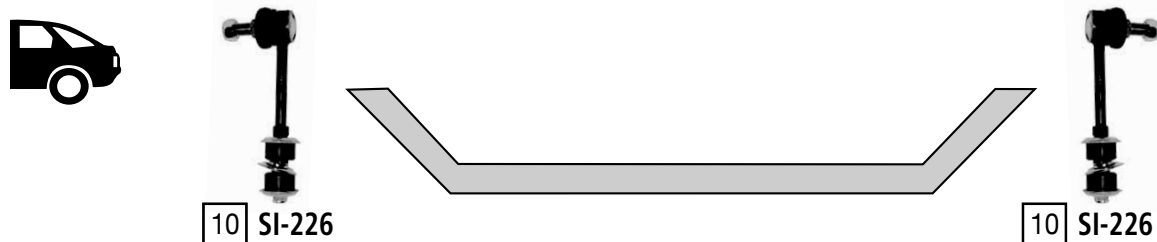
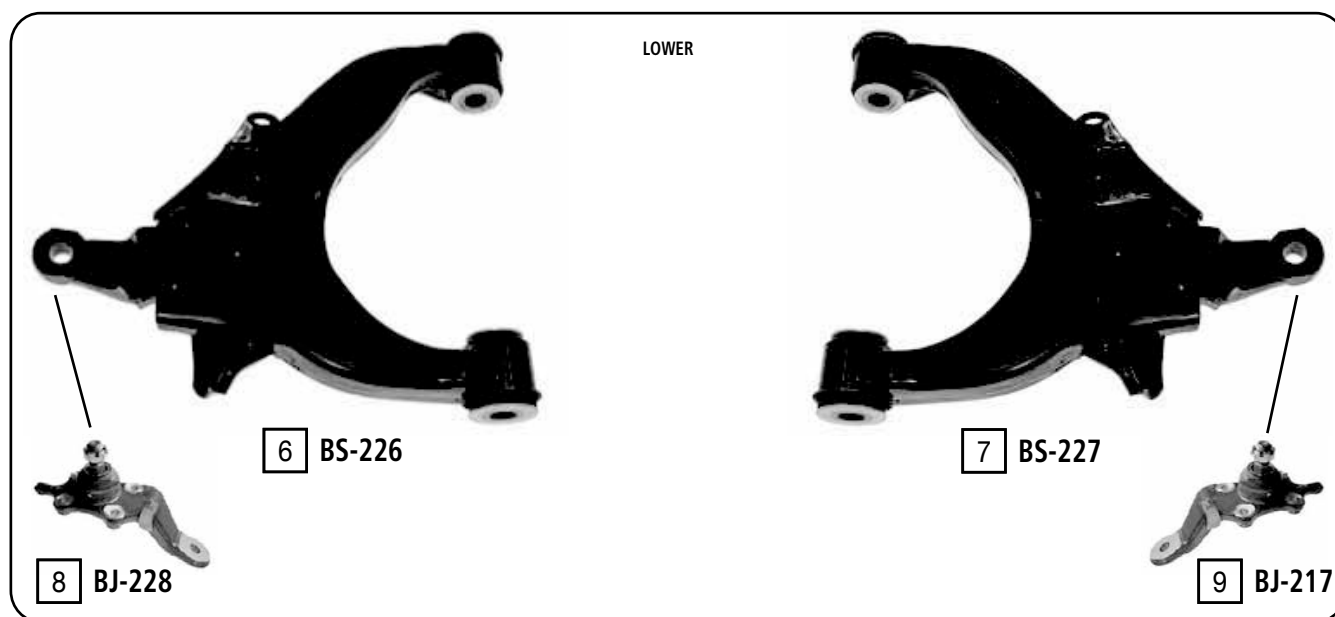
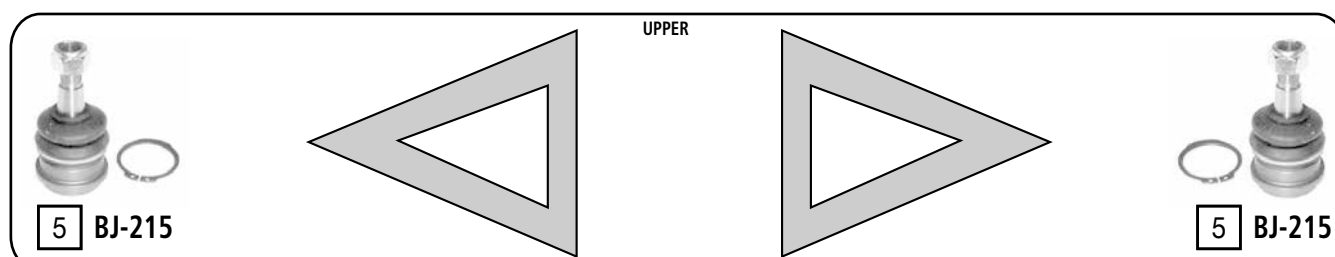
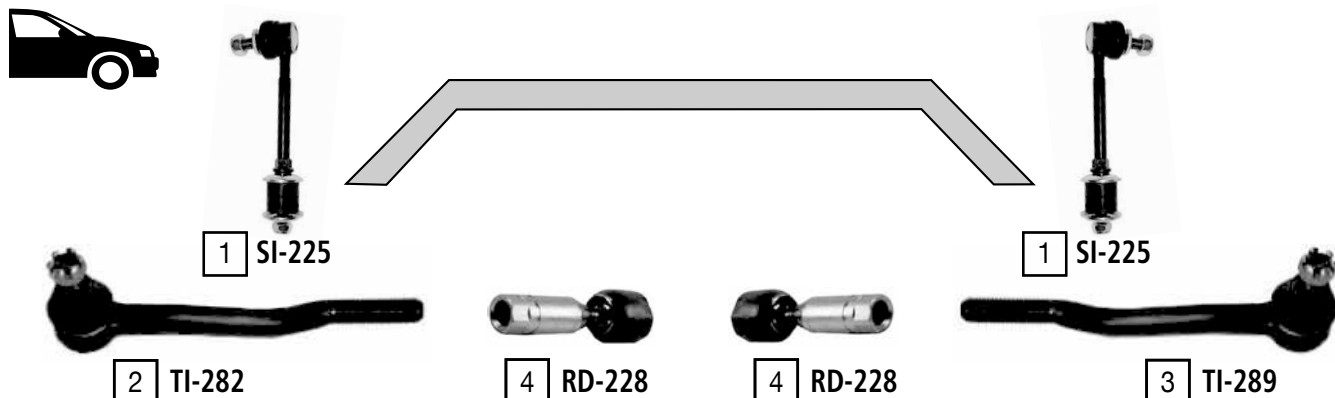

Ref	JAPANPARTS CODE	Description	OEM	Measures	Ref	JAPANPARTS CODE	Description	OEM	Measures
1	SI-225	stabiliser link	48820 AD010	L:177.5	6	BS-226	TCA left wobj	48069 35081	
2	TI-282	tie rod end left	45047 39215	c:14.8 th:MM20x1.5R	7	BS-227	TCA right wobj	48068 35081	
3	TI-289	tie rod end right	45046 39335	c:14.8 th:MM20x1.5R	8	BJ-228	ball joint left	43340 39465	c:17.6
4	RD-228	axial joint	45503 39075	th:MM18X1.5R L:131	9	BJ-217	ball joint right	43330 39585	c:17.6
5	BJ-215	ball joint	43310 39016	c:15.75 do:43.3	10	SI-226	stabiliser link rear axle	48830 35020	L:152.5

AURIS (\_E15\_)

10/2006 ->

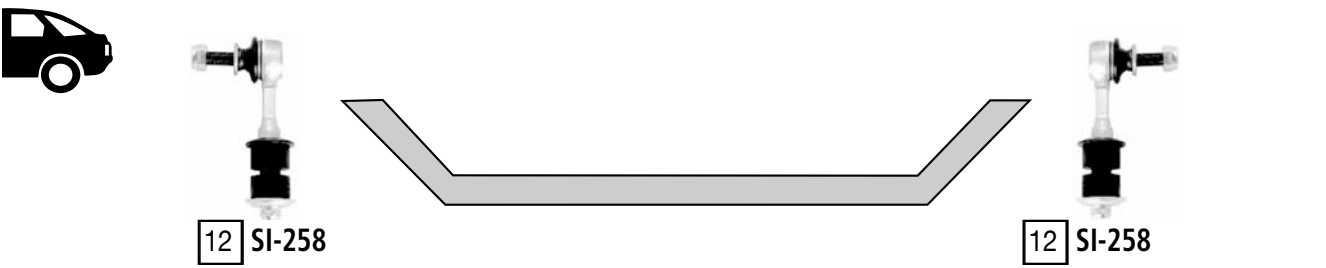
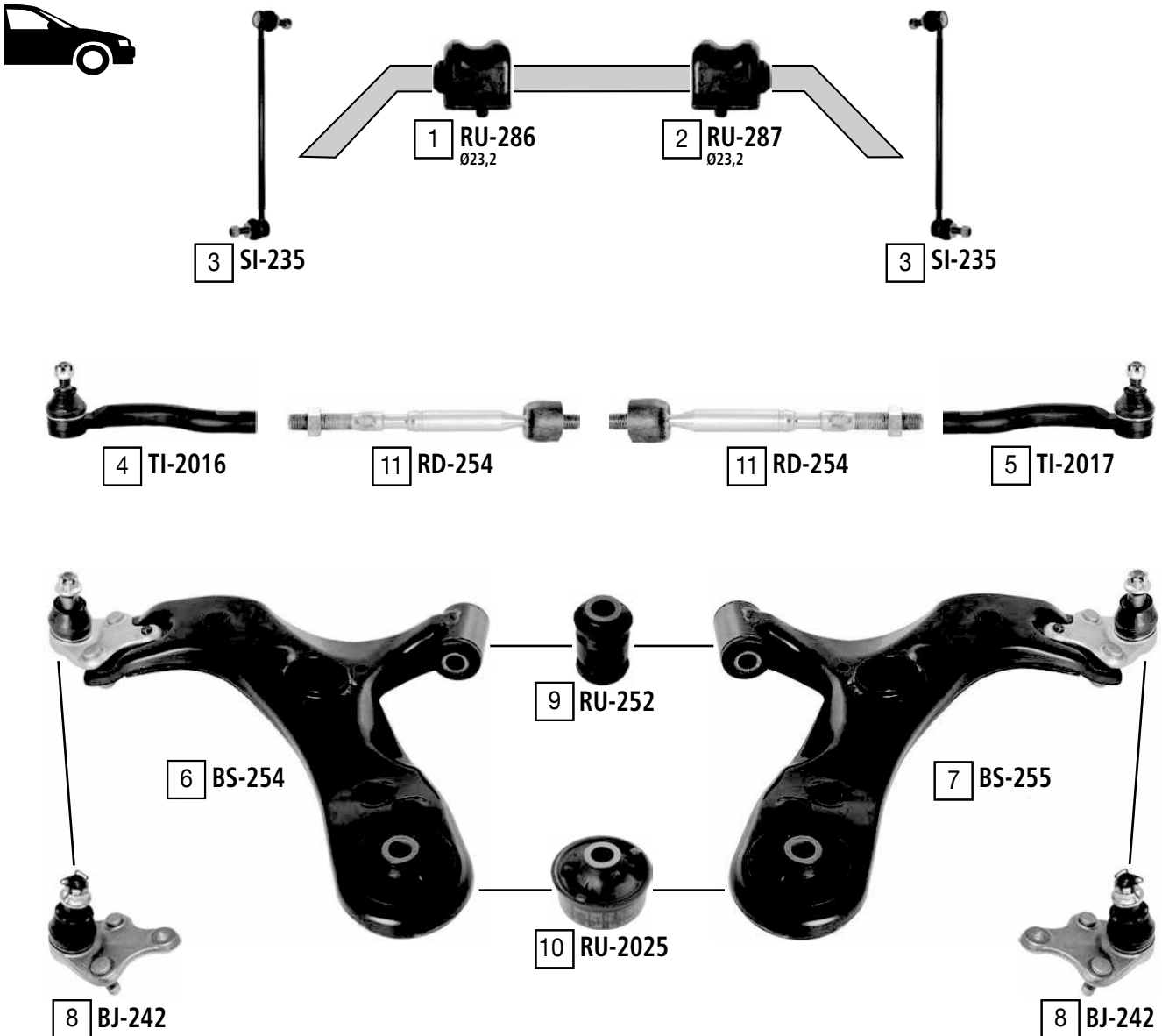

Ref	JAPANPARTS CODE	Description	OEM	Measures	Ref	JAPANPARTS CODE	Description	OEM	Measures
1	RU-286	stabiliser mounting	48815 02140	di:21	7	BS-255	TCA right wbj	48068 12300	c:17.5
2	RU-287	stabiliser mounting	48815 02150	di:21	8	BJ-242	ball joint	43330 49095	c:17.7
3	SI-235	stabiliser link	48820 02070	L:360	9	RU-252	silentblock for TCA	Part of	di:16.2 do:41
4	TI-2016	tie rod end left	45047 19215	c:13.7 th:FM15x1.5R	10	RU-2025	silentblock for TCA	Part of	di:16.2 do:68
5	TI-2017	tie rod end right	45046 19415	c:13.7 th:FM15x1.5R	11	RD-254	axial joint	Part of	th:MM14x1.5R L:232
6	BS-254	TCA left wbj	48069 12300	c:17.5	12	SI-258	stabiliser link rear axle	48830 05030	L:128.5



AVENSIS (\_T22\_)

09/1997 - 02/2003

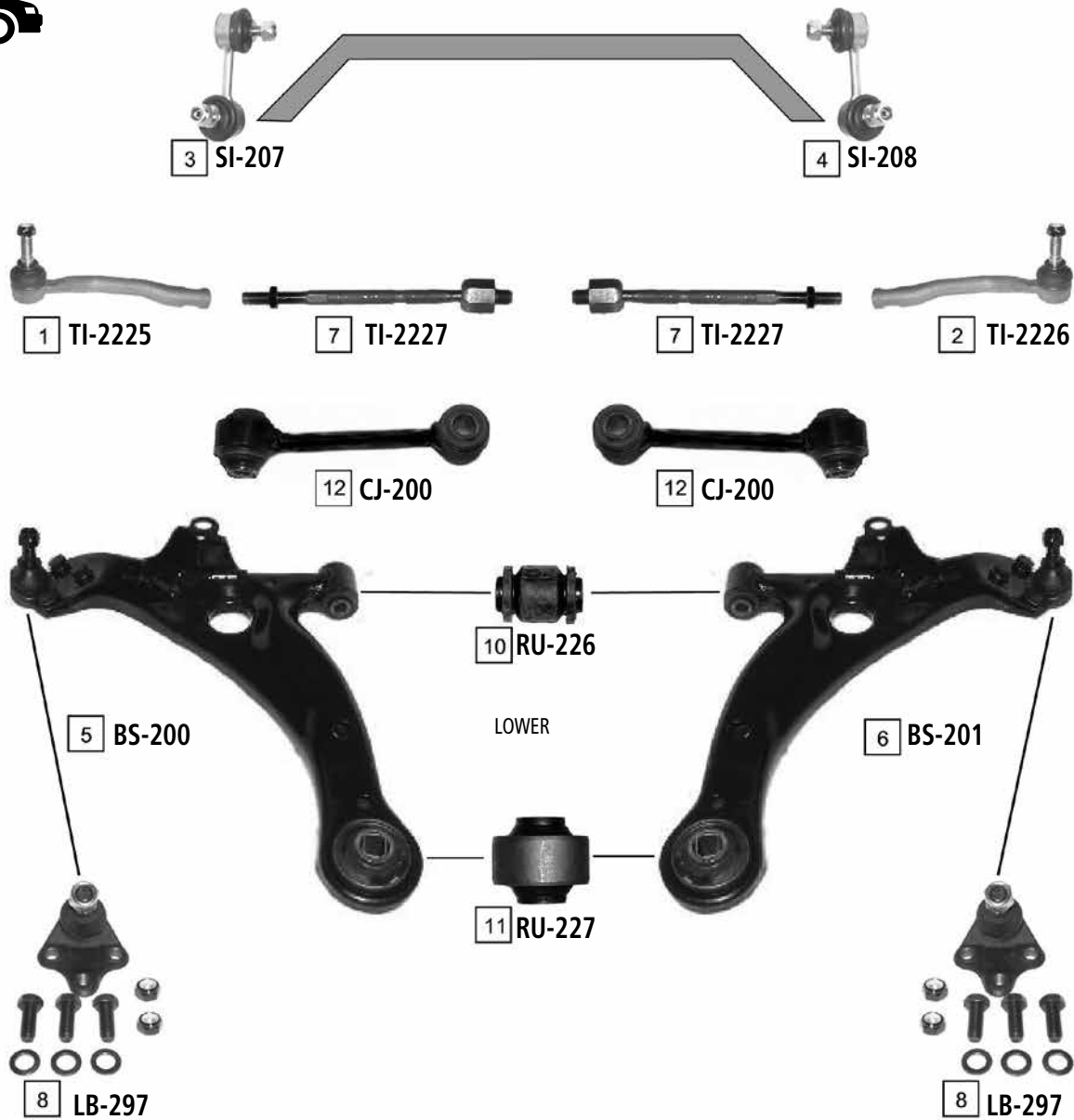

Ref	JAPANPARTS CODE	Description	OEM	Measures	Ref	JAPANPARTS CODE	Description	OEM	Measures
1	TI-2225	Tie Rod End Right	45046-29365	c:12.7 th:FM14X1.5R	7	TI-2227	Axial Joint	45503-05020	th:MM16X1.5R L:242
2	TI-2226	Tie Rod End Left	45047-29125	c:12.7 th:FM14X1.5R	8	LB-297	Ball Joint lower	43330 09030	c:15
3	SI-207	Stabiliser Link Left	48810 05012	L:70	9	SI-200	Stabiliser Link	48830 05020	L:140
4	SI-208	Stabiliser Link Right	48820 05012	L:70	10	RU-226	Silentblock For Susp.Arm	Part of BS-200/BS-201	d:38
5	BS-200	TCA Left	48068-05050	c:15	11	RU-227	Silentblock For Susp.Arm	48061 05010	d:60.2
6	BS-201	TCA Right	48069-05050	c:15	12	CJ-200	Track Link	48650 20020	

AVENSIS (\_T25\_)

03/2003 ->

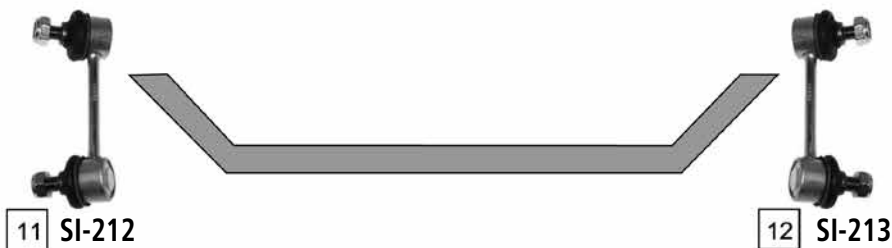
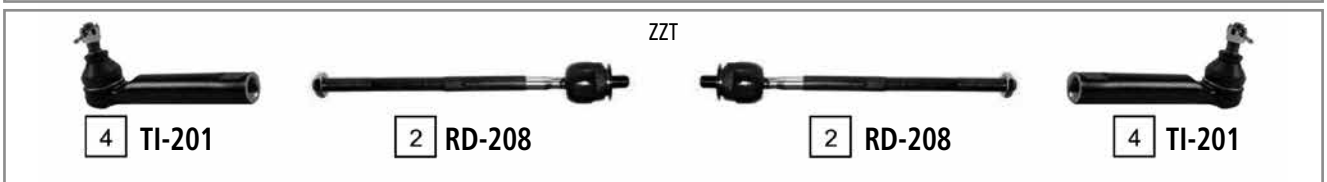
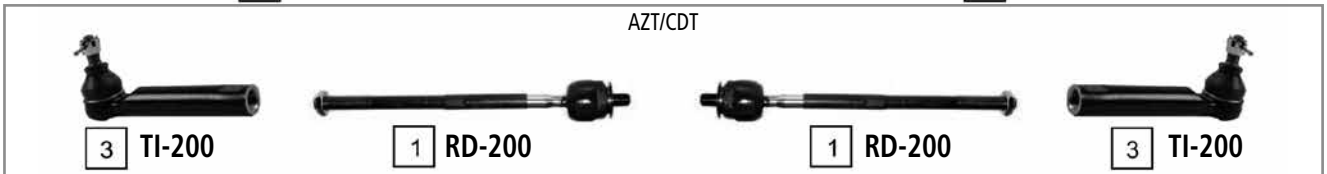
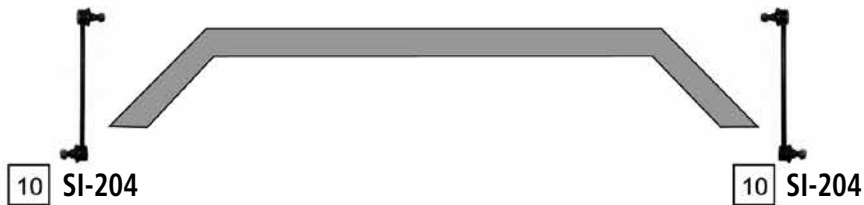

Ref	JAPANPARTS CODE	Description	OEM	Measures	Ref	JAPANPARTS CODE	Description	OEM	Measures
1	RD-200	Axial Joint	45503 0F010		7	RU-228	Silentblock For Susp.Arm	Part of BS-202/BS-203	
2	RD-208	Axial Joint	Part of		8	RU-229	Silentblock For Susp.Arm	Part of BS-202/BS-203	
3	TI-200	Tie Rod End	45046 29425		9	BJ-200	Ball Joint lower	43330 09210	c:15
4	TI-201	Tie Rod End	45046 09230		10	SI-204	Stabiliser Link	48820 47010	L:285
5	BS-202	TCA Left	48069 05070	c:15	11	SI-212	Stabiliser Link	48840 21010	L:100
6	BS-203	TCA Right	48068 05070	c:15	12	SI-213	Stabiliser Link	48830 21020	L:100

AVENSIS (T27)

11/2008 ->

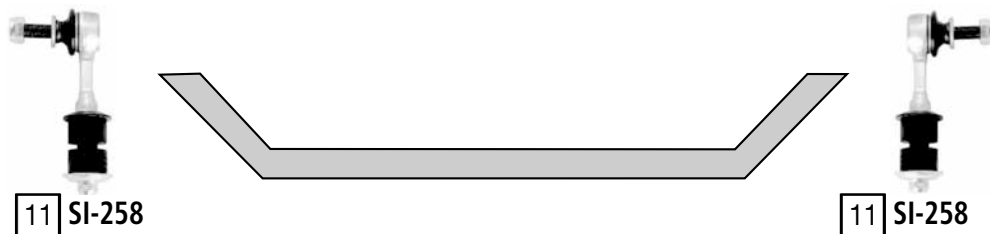
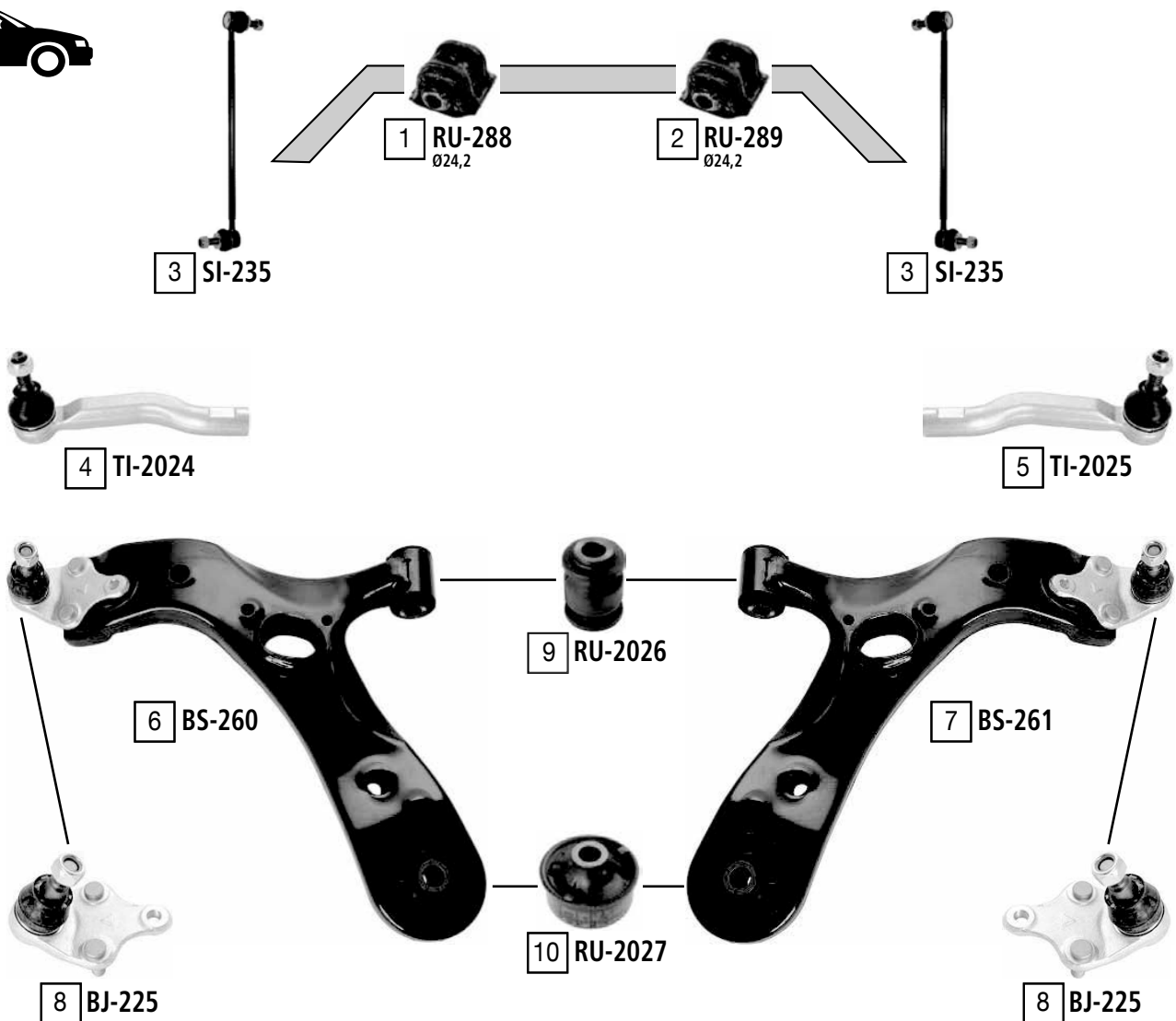

Ref	JAPANPARTS CODE	Description	OEM	Measures	Ref	JAPANPARTS CODE	Description	OEM	Measures
1	RU-288	stabiliser mounting	48815 05130	di:24.2	7	BS-261	TCA right wbj	48068 05080	c:17.6
2	RU-289	stabiliser mounting	48815 05120	di:24.2	8	BJ-225	ball joint lower	43330 09770	c:17.5
3	SI-235	stabiliser link	48820 02070	L:360	9	RU-2026	silentblock for TCA	Part of	di:16.1 do:41
4	TI-2024	tie rod end left	45047 09320	c:13.5 th:FM16x1.5R	10	RU-2027	silentblock for TCA	Part of	di:16.2 do:68
5	TI-2025	tie rod end right	45046 09660	c:13.5 th:FM16x1.5R	11	SI-258	stabiliser link rear axle	48830 05030	L:128.5
6	BS-260	TCA left wbj	48069 05080	c:17.6					

AVENSIS VERSO (ACM20, CLM20)

05/2001 ->

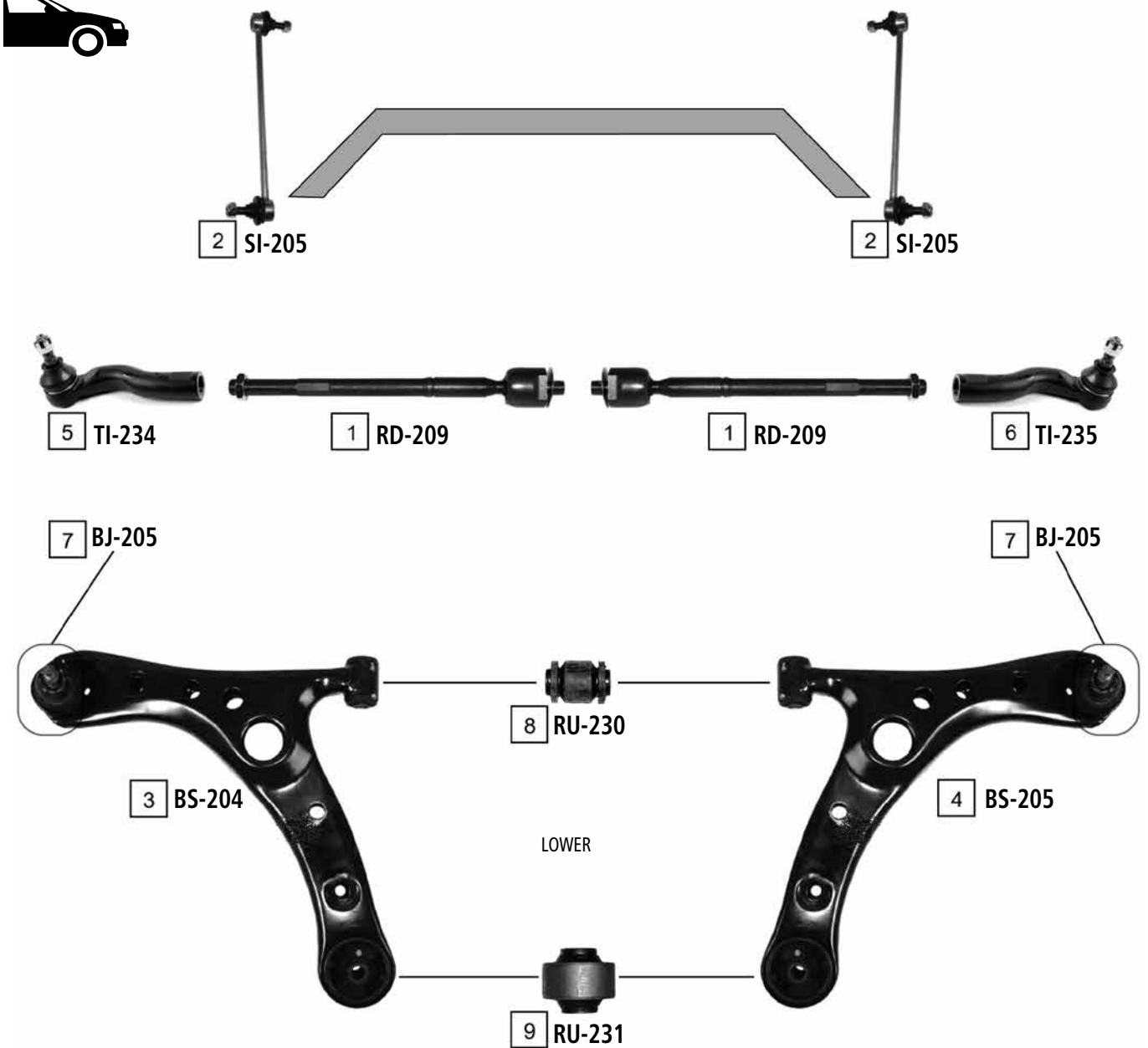

Ref	JAPANPARTS CODE	Description	OEM	Measures	Ref	JAPANPARTS CODE	Description	OEM	Measures
1	RD-209	Axial Joint	45503-49105	th:MM14X1.5R L:290	6	TI-235	Tie Rod End Right	45047 49055	c:12.6 th:FM16X1.5R
2	SI-205	Stabiliser Link	48820-44020	L:280	7	BJ-205	Ball Joint	Part of BS-204/BS-205	c:17.5
3	BS-204	TCA Left Wbj	48069 49065		8	RU-230	Silentblock For Susp.Arm	Part of BS-204/BS-205	
4	BS-205	TCA Right Wbj	48068 49065		9	RU-231	Silentblock For Susp.Arm	Part of BS-204/BS-205	
5	TI-234	Tie Rod End Left	45046 49125	c:12.6 th:FM16X1.5R					

AYGO

06/2005 ->

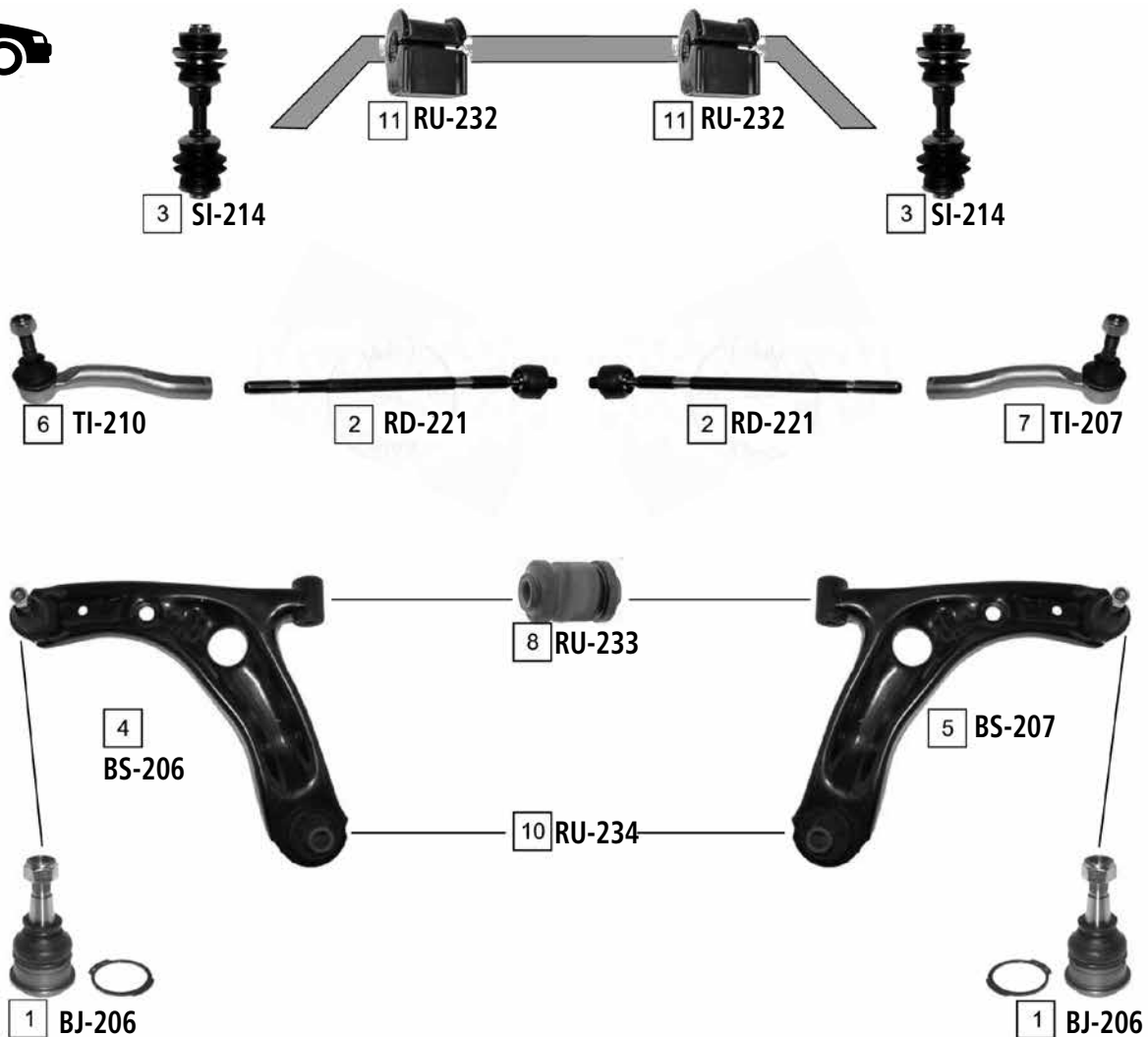

Ref	JAPANPARTS CODE	Description	OEM	Measures	Ref	JAPANPARTS CODE	Description	OEM	Measures
1	BJ-206	Ball Joint Lower	Part of BS-206/BS-207	c:13.5	7	TI-207	Tie Rod End Right	3817 64	
2	RD-221	Axial Joint	Part of		8	RU-233	Silentblock For Susp.Arm	Part of BS-206/BS-207	d:32
3	SI-214	Stabiliser Link	5091 10		9	RU-235	Mounting Axle Body	48725 0H010	
4	BS-206	TCA Left Wbj	48069 0H010		10	RU-234	Silentblock For Susp.Arm	Part of BS-206/BS-207	
5	BS-207	TCA Right Wbj	48068 0H010		11	RU-232	Stabiliser Mounting	5094 A8	
6	TI-210	Tie Rod End Left	3817 63						

CAMRY (CV1\_, SV1\_)

10/1982 - 07/1988

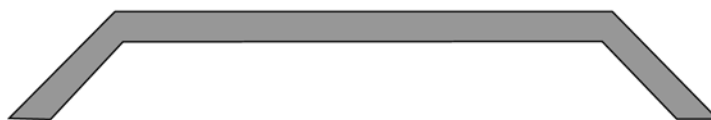

1 SY-282



1 SY-282



2 BJ-216

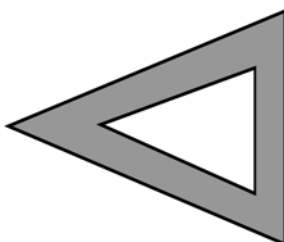

LOWER

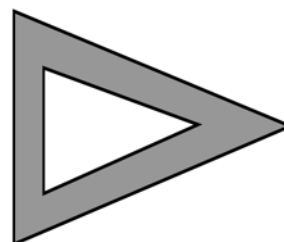

2 BJ-216

Ref	JAPANPARTS CODE	Description	OEM	Measures	Ref	JAPANPARTS CODE	Description	OEM	Measures
1	SY-282	Tie Rod End	45460-39165	c:12.6 th:FM14X1.5R	2	BJ-216	Ball Joint Lower	43330-39135	c:16

CAMRY (\_V2)

08/1986 - 05/1991



2 TI-259



3 RD-216



3 RD-216



2 TI-259



1 BJ-216

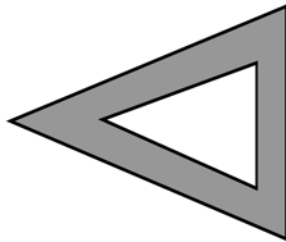

LOWER

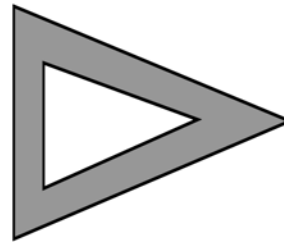

1 BJ-216

Ref	JAPANPARTS CODE	Description	OEM	Measures	Ref	JAPANPARTS CODE	Description	OEM	Measures
1	BJ-216	Ball Joint Lower	43330-39135	c:16	3	RD-216	Axial Joint	45503-29105	th:MM14X1.5R L:327
2	TI-259	Tie Rod End	45046 19175	c:12.7 th:FM14X1.5R					

CAMRY (\_V10)

06/1991 - 06/1997



2 TI-283



3 RD-291



3 RD-291



2 TI-283



1 BJ-239

LOWER



1 BJ-239



4 SI-217



4 SI-217

Ref	JAPANPARTS CODE	Description	OEM	Measures	Ref	JAPANPARTS CODE	Description	OEM	Measures
1	BJ-239	Ball Joint	43330 39285	c:17.5	3	RD-291	Axial Joint	45503-29355	th:MM14X1.5R L:337
2	TI-283	Tie Rod End	45046-29255	c:12.7 th:FM15X1.5R	4	SI-217	Stabiliser Link	48830 33010	L:192



CAMRY (\_V20)

08/1996 - 11/2001

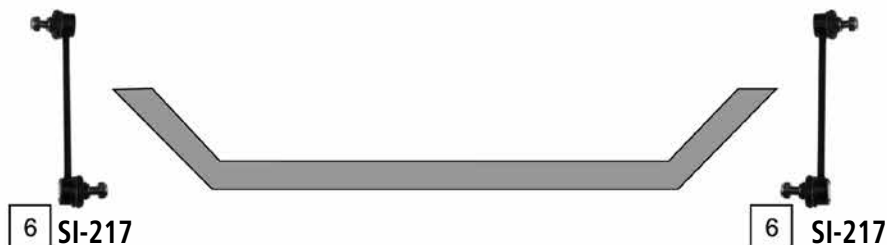
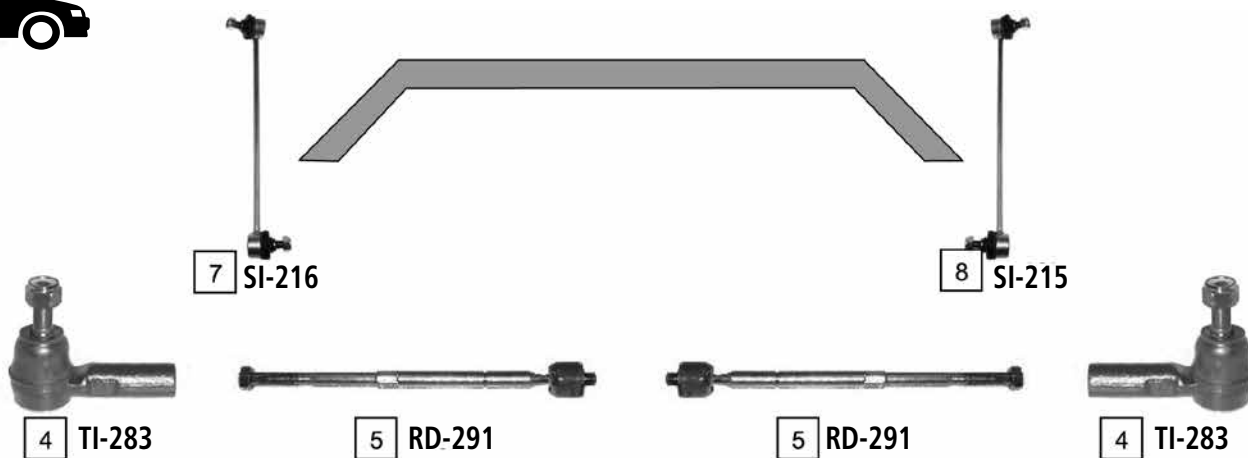

Ref	JAPANPARTS CODE	Description	OEM	Measures	Ref	JAPANPARTS CODE	Description	OEM	Measures
1	BS-208	TCA Left	48069 33031	c:17.5	5	RD-291	Axial Joint	45503-29355	th:MM14X1.5R L:337
2	BS-209	TCA Right	48068 33031	c:17.5	6	SI-217	Stabiliser Link	48830 33010	L:192
3	BJ-239	Ball Joint	43330 39285	c:17.5	7	SI-216	Stabiliser Link Left	48810 33010	L:285
4	TI-283	Tie Rod End	45046-29255	c:12.7 th:FM15X1.5R	8	SI-215	Stabiliser Link Right	48820 33020	L:285

CAMRY (\_V30)

11/2001 - 01/2006

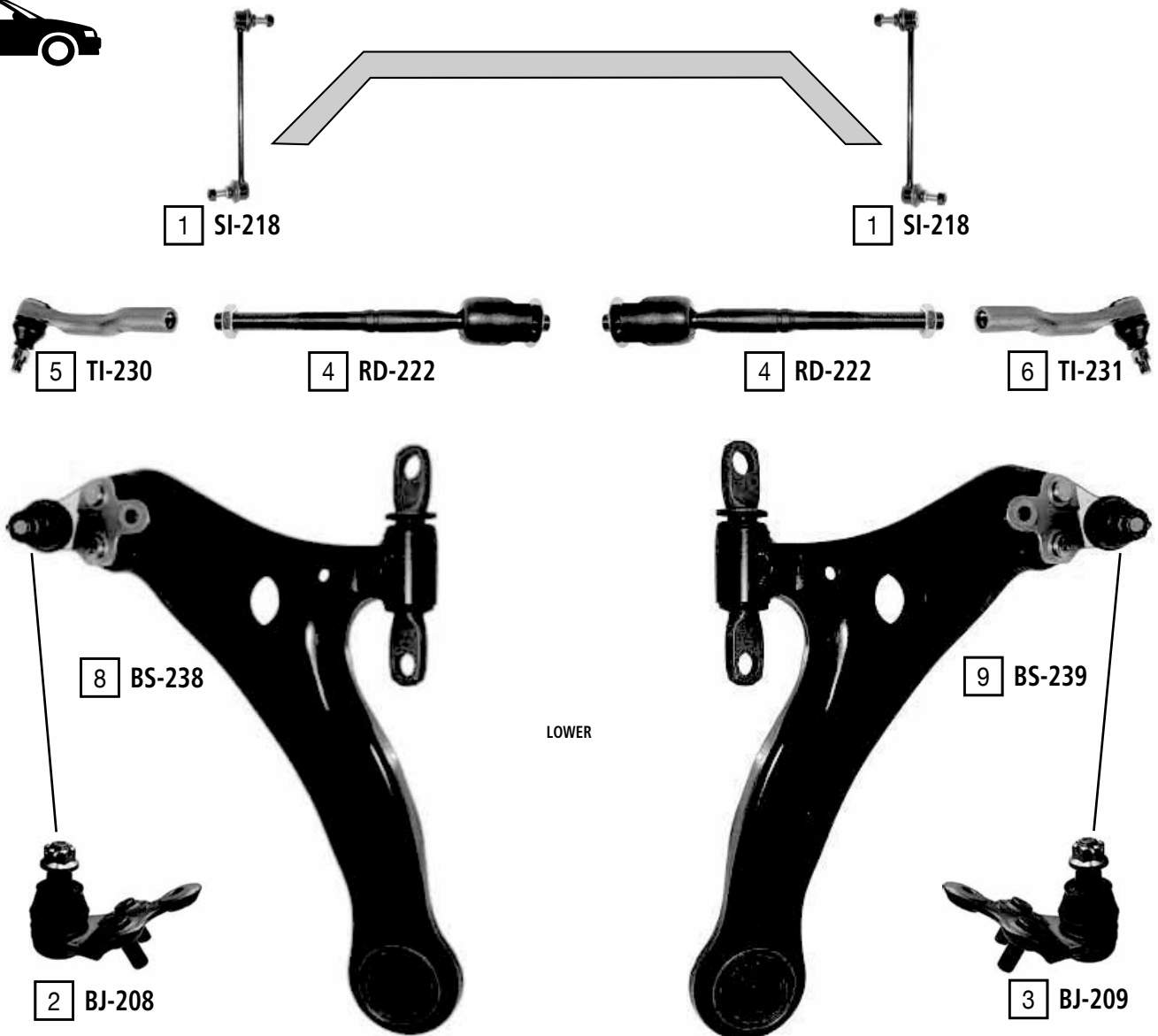

LOWER

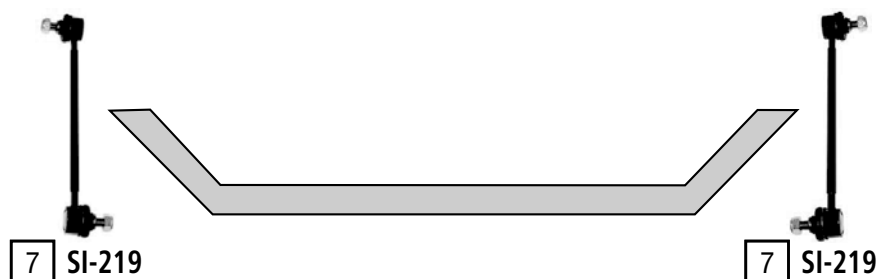

Ref	JAPANPARTS CODE	Description	OEM	Measures	Ref	JAPANPARTS CODE	Description	OEM	Measures
1	SI-218	stabiliser link	48820 28050	L:260	6	TI-231	tie rod end right	45460 39615	c:13.6 th:FM15X1.5R
2	BJ-208	ball joint left	43340 29215	c:17.6	7	SI-219	stabiliser link rear axle	48830 48010	L:237
3	BJ-209	ball joint right	43330 29615	c:17.6	8	BS-238	TCA left wbj	48069 28120	c:17.6
4	RD-222	axial joint	45503 39225	th:MM14X1.5R L:238	9	BS-239	TCA right wbj	48068 28120	c:17.6
5	TI-230	tie rod end left	45470 39215	c:13.6 th:FM15X1.5R					

CAMRY (\_V40)

01/2006 ->

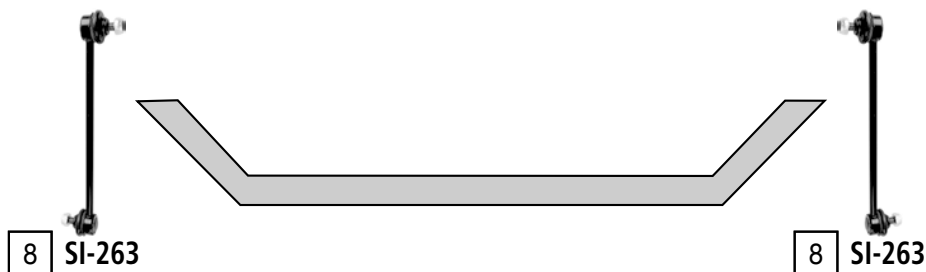
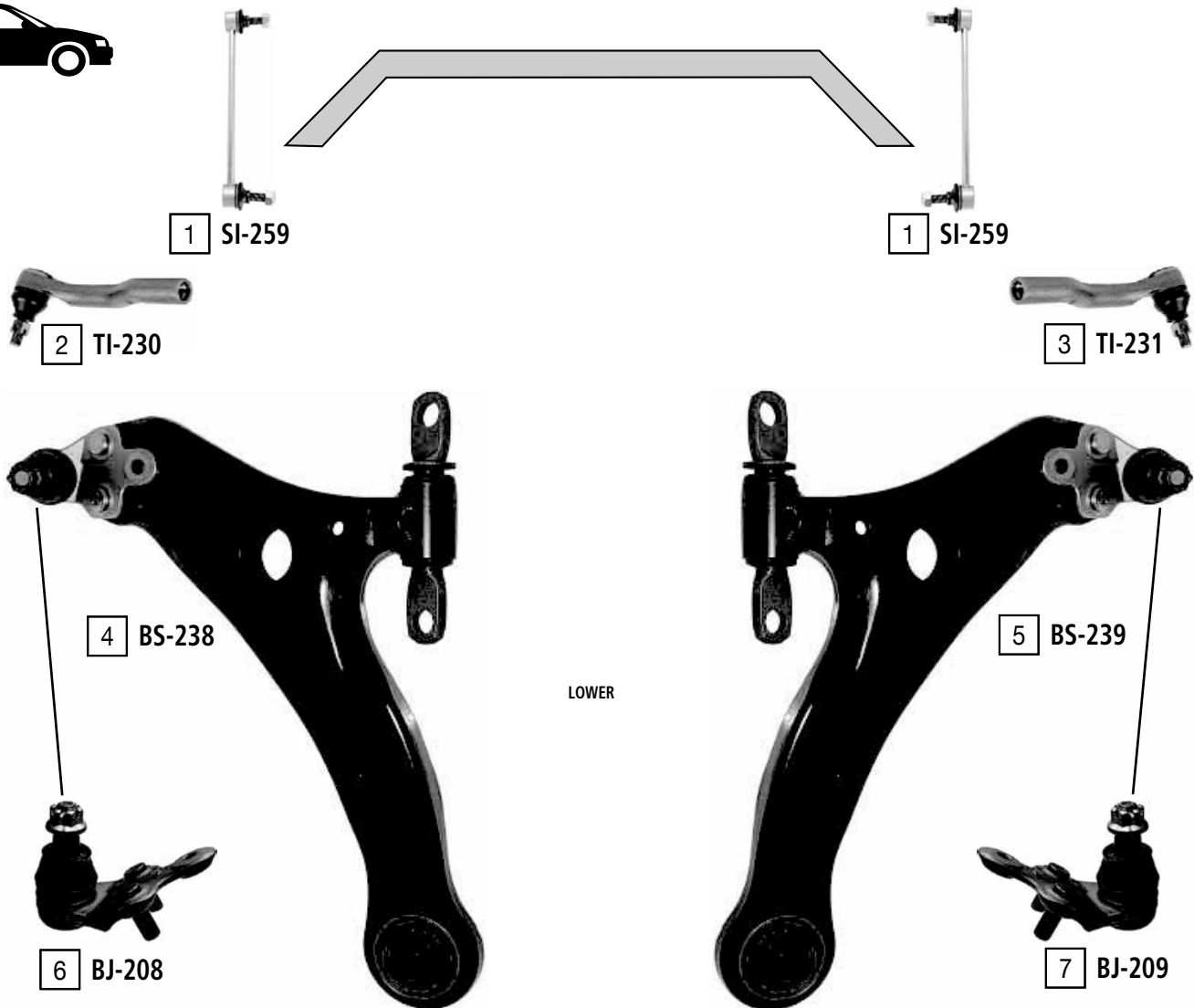

Ref	JAPANPARTS CODE	Description	OEM	Measures	Ref	JAPANPARTS CODE	Description	OEM	Measures
1	SI-259	stabiliser link	48820 33070	L:260	5	BS-239	TCA right wbj	48068 28120	c:17.6
2	TI-230	tie rod end left	45470 39215	c:13.6 th:FM15X1.5R	6	BJ-208	ball joint left	43340 29215	c:17.6
3	TI-231	tie rod end right	45460 39615	c:13.6 th:FM15X1.5R	7	BJ-209	ball joint right	43330 29615	c:17.6
4	BS-238	TCA left wbj	48069 28120	c:17.6	8	SI-263	stabiliser link rear axle	48830 33040	L:261

CARINA (CA60, TA60, TA62)  
 CELICA (RA6)

09/1981-09/1983  
 01/1982-10/1986



MS



1 SY-235



1 SY-235

PS



2 SY-231



2 SY-231



3 LB-609  
 EXC CELICA

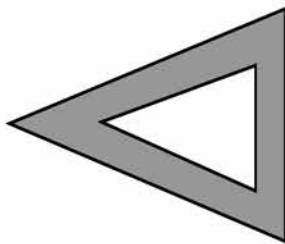

LOWER

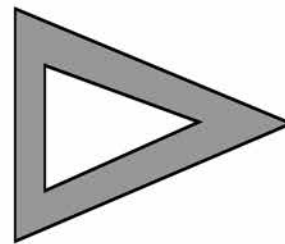

3 LB-609  
 EXC CELICA

Ref	JAPANPARTS CODE	Description	OEM	Measures	Ref	JAPANPARTS CODE	Description	OEM	Measures
1	SY-235	Tie Rod	45460-19165		3	LB-609	Ball Joint Lower	43308-12030	c: 14.5
2	SY-231	Tie Rod	45460-19155						

CARINA E (\_T19\_)

04/1992 - 09/1997

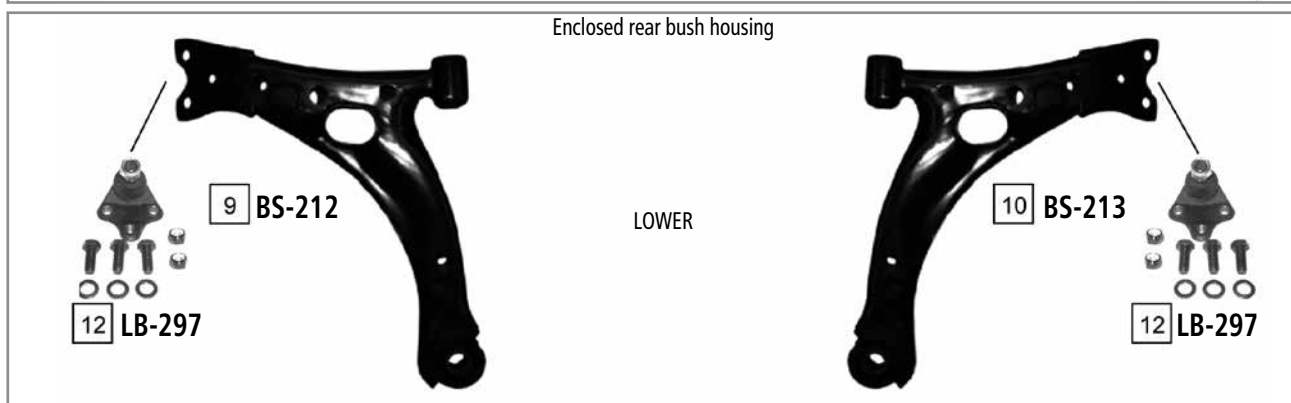
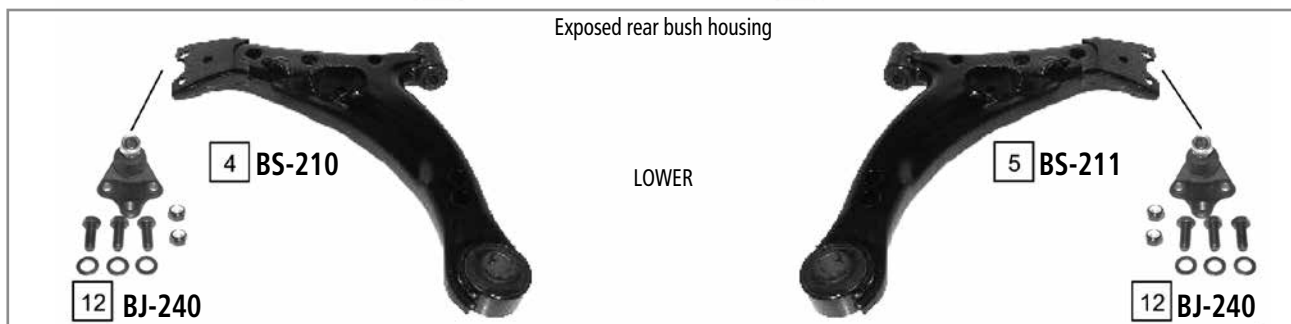
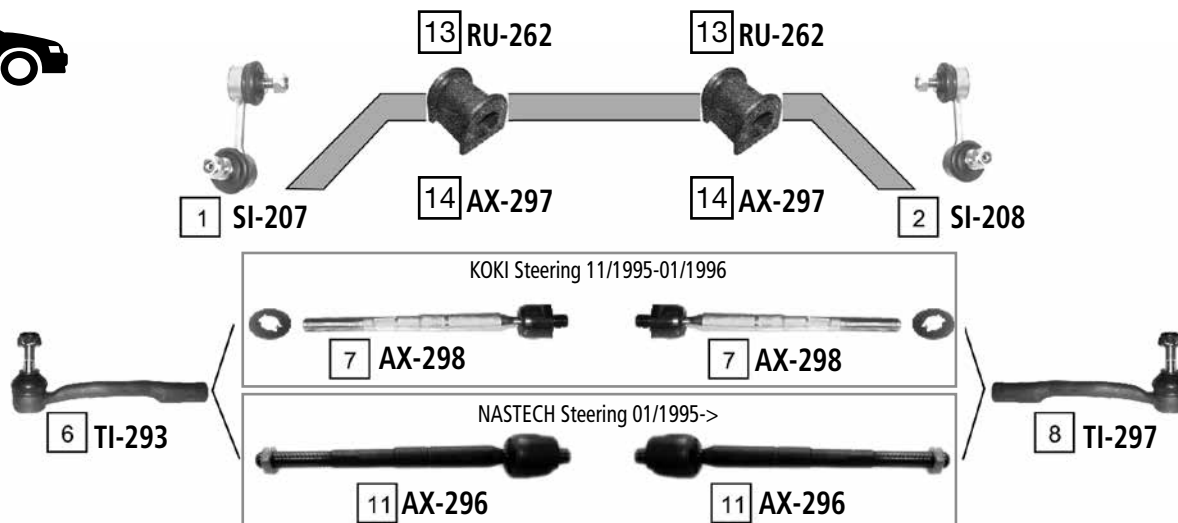

Ref	JAPANPARTS CODE	Description	OEM	Measures	Ref	JAPANPARTS CODE	Description	OEM	Measures
1	SI-207	Stabiliser Link Left	48810 05012	L:70	8	TI-297	Tie Rod End Right	45046-29275	c:12.6 th:FM15X1.5R
2	SI-208	Stabiliser Link Right	48820 05012	L:70	9	BS-212	TCA Left	48069-20221	
3	SI-202	Stabiliser Link	48830 12050	L.105	10	BS-213	TCA Right	48068-20221	
4	BS-210	TCA Left	49069-20260	c:15.9	11	AX-296	Axial Joint	45503-05010	th:MM14X1.5R L.239
5	BS-211	TCA Right	48068-20260	c:15.9	12	LB-297	Ball Joint Lower	43330 09030	c:15
6	TI-293	Tie Rod End Left	45047-29075	c:12.6 th:FM15X1.5R	13	RU-262	Stabiliser Mounting	4881530040	d:20
7	AX-298	Axial Joint	45503 29435	th:MM14X1.5R L:240	14	AX-297	Axial Joint	4550329475	

CARINA II (\_T15\_)

10/1983 - 05/1988

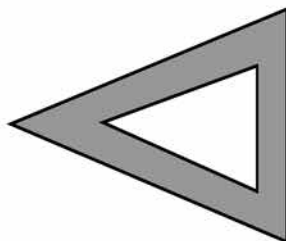
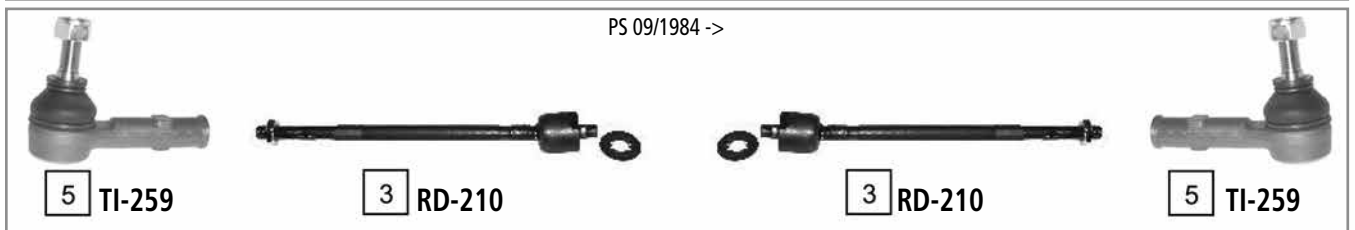
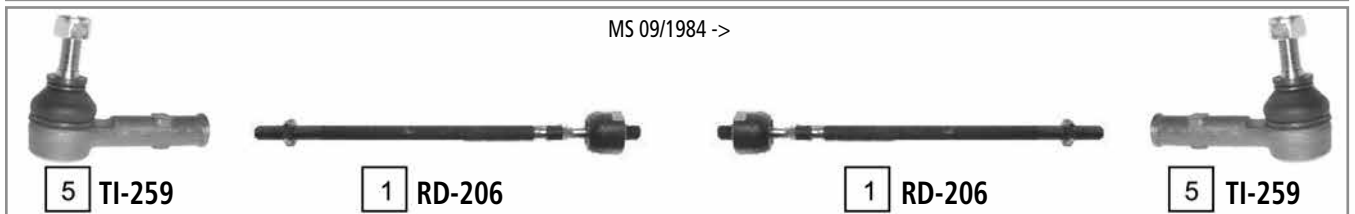
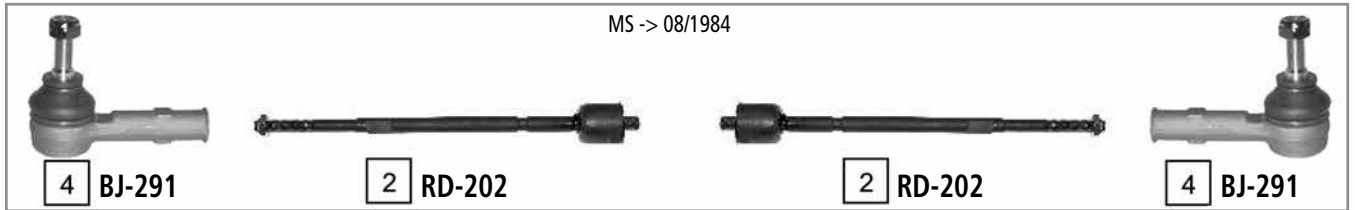

LOWER

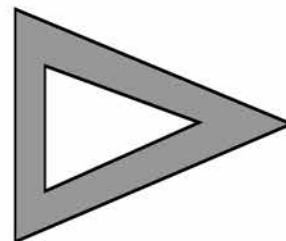

Ref	JAPANPARTS CODE	Description	OEM	Measures	Ref	JAPANPARTS CODE	Description	OEM	Measures
1	RD-206	Axial Joint	45503-19036	th: MM14X1.5R L:315	4	BJ-291	Tie Rod End	45046-29135	c:12.6 th:FM12X1.25
2	RD-202	Axial Joint	45503-19035	th: MM14X1.5R L:317	5	TI-259	Tie Rod End	45046 19175	c:12.7 th:FM14X1.5R
3	RD-210	Axial Joint	45503-19056	th: MM14X1.5R L:297	6	LB-296	Ball Joint Lower	43330-29136	c:15.9

CARINA II (\_T17\_)

12/1987 - 06/1993

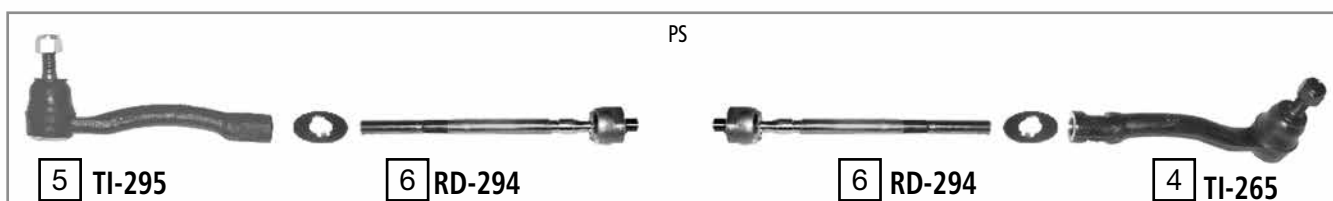
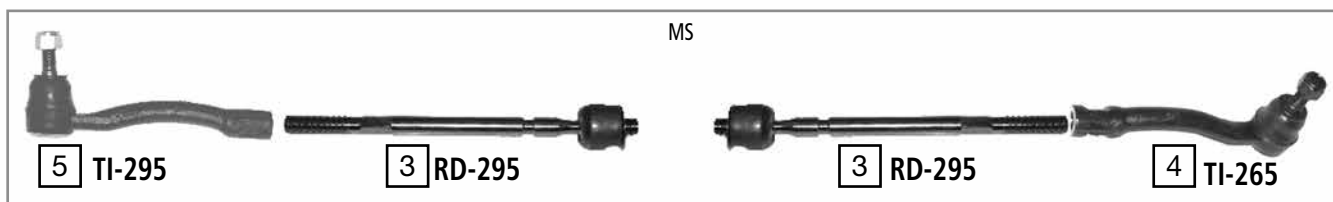
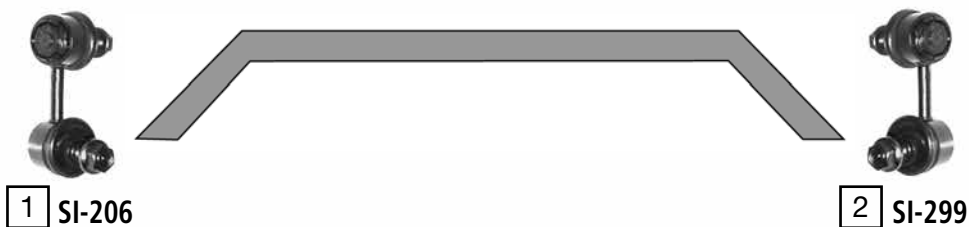

LOWER



Ref	JAPANPARTS CODE	Description	OEM	Measures	Ref	JAPANPARTS CODE	Description	OEM	Measures
1	SI-206	Stabiliser Link Left	48810-20010	L:58	5	TI-295	Tie Rod End Right	45046-29165	c.12.5 th:FM15X1.5R
2	SI-299	Stabiliser Link Right	48820-20030	L:60.5	6	RD-294	Axial Joint	45503-29165	th:MM14X1.5R L:250
3	RD-295	Axial Joint	45503-29155	th:MM14X1.5R L:259	7	BJ-299	Ball Joint Lower	43330-29145	c.15.9
4	TI-265	Tie Rod End Left	45047-29045	c.12.5 th:FM15X1.5R					

CELICA (ST16\_, AT16\_)

08/1985 - 08/1989



1 TI-259



2 RD-216



2 RD-216



1 TI-259



3 BJ-299

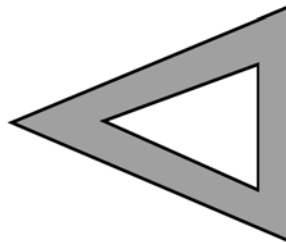

LOWER

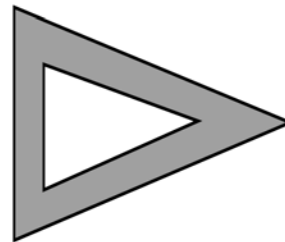

3 BJ-299



Ref	JAPANPARTS CODE	Description	OEM	Measures	Ref	JAPANPARTS CODE	Description	OEM	Measures
1	TI-259	Tie Rod End	45046 19175	c:12.7 th:FM14X1.5R	4	SI-202	Stabiliser Link	48830 12050	L:105
2	RD-216	Axial Joint	45503-29105	th:MM14X1.5R L:327	5	SI-201	Stabiliser Link	48820-20010	L:69
3	BJ-299	Ball Joint Lower	43330-29145	c:15.9					



CELICA (ST18\_~AT180)

09/1989 - 11/1993

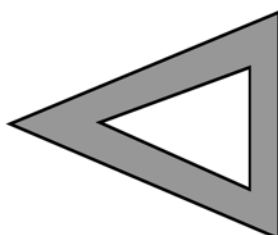
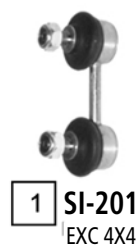
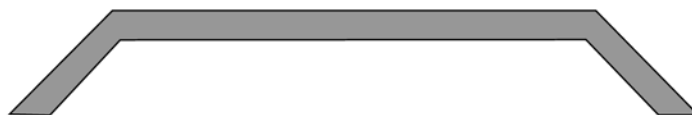

LOWER

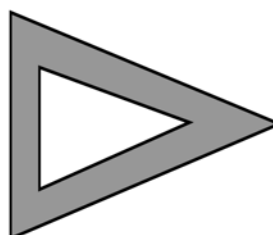

Ref	JAPANPARTS CODE	Description	OEM	Measures	Ref	JAPANPARTS CODE	Description	OEM	Measures
1	SI-201	Stabiliser Link	48820-20010	L:69	4	TI-259	Tie Rod End	45046 19175	c:12.7 th:FM14X1.5R
2	SI-202	Stabiliser Link	48830 12050	L:105	5	RD-292	Axial Joint	45503 29245	th:MM14X1.5R L:341
3	BJ-241	Ball Joint	43330 29225	c:18.2					

CELICA (\_T20\_)

11/1993 - 11/1999



1 SI-298



1 SI-298



4 TI-259



4 TI-259



3 LB-297

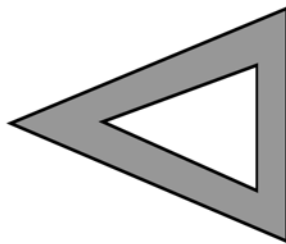

LOWER

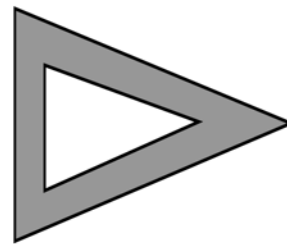

3 LB-297



2 SI-202



2 SI-202

Ref	JAPANPARTS CODE	Description	OEM	Measures	Ref	JAPANPARTS CODE	Description	OEM	Measures
1	SI-298	Stabiliser Link	48820 33010	L:60.5	3	LB-297	Ball Joint Lower	43330 09030	c:15
2	SI-202	Stabiliser Link	48830 12050	L.105	4	TI-259	Tie Rod End	45046 19175	c:12.7 th:FM14X1.5R

CELICA (ZZT23\_)

11/1999 - 12/2005



5 TI-252



7 RD-223



7 RD-223



6 TI-237



3 BS-214

LOWER



4 BS-215



2 BJ-210



2 BJ-210

Ref	JAPANPARTS CODE	Description	OEM	Measures	Ref	JAPANPARTS CODE	Description	OEM	Measures
1	SI-220	Stabiliser Link	48820 32010	L:285	5	TI-252	Tie Rod End	45047-49015	
2	BJ-210	Ball Joint	43330 19115	c:15.3	6	TI-237	Tie Rod End	45046-49085	
3	BS-214	TCA	48069 20381		7	RD-223	Axial Joint	45503-49035	th:MM14X1.5R L.303
4	BS-215	TCA	48068 20380						

COROLLA (\_E7\_)

09/1979 - 08/1987



**2** SO-622



**3** RD-201



**3** RD-201



**2** SO-622



**1** LB-609

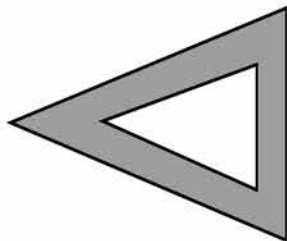

LOWER

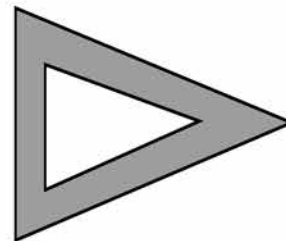

**1** LB-609

Ref	JAPANPARTS CODE	Description	OEM	Measures	Ref	JAPANPARTS CODE	Description	OEM	Measures
1	LB-609	Ball Joint Lower	43308-12030	c:14.5	3	RD-201	Axial Joint	45503-10020	th:MM14X1.5R L:146
2	SO-622	Tie Rod	45460-19125						

COROLLA (\_E8\_)

06/1983 - 05/1988

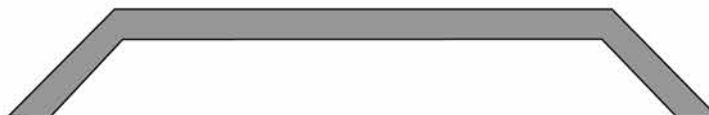

MS -> 09/1984



1 BJ-291



2 RD-202



2 RD-202



1 BJ-291

MS 10/1984 ->



4 TI-259



5 RD-206



5 RD-206



4 TI-259

PS 10/1984 ->



4 TI-259



6 RD-210



6 RD-210



4 TI-259



3 LB-296

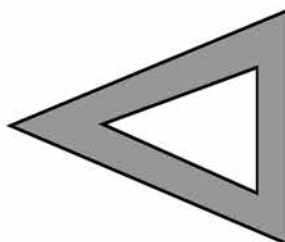

LOWER

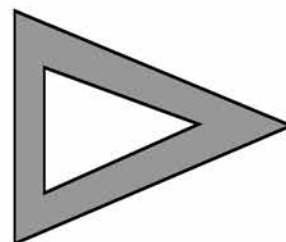

3 LB-296

Ref	JAPANPARTS CODE	Description	OEM	Measures	Ref	JAPANPARTS CODE	Description	OEM	Measures
1	BJ-291	Tie Rod End	45046-29135	c:12.6 th:FM12X1.25	4	TI-259	Tie Rod End	45046 19175	c:12.7 th:FM14X1.5R
2	RD-202	Axial Joint	45503-19035	th:MM14X1.5R L:317	5	RD-206	Axial Joint	45503-19036	th:MM14X1.5R L:315
3	LB-296	Ball Joint Lower	43330-29136	c:15.9	6	RD-210	Axial Joint	45503-19056	th:MM14X1.5R L:297

COROLLA (\_E9\_)

07/1987 - 06/1993

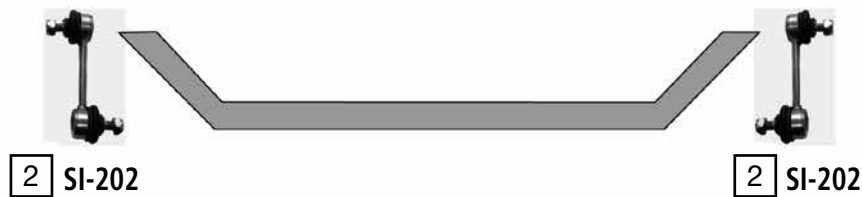
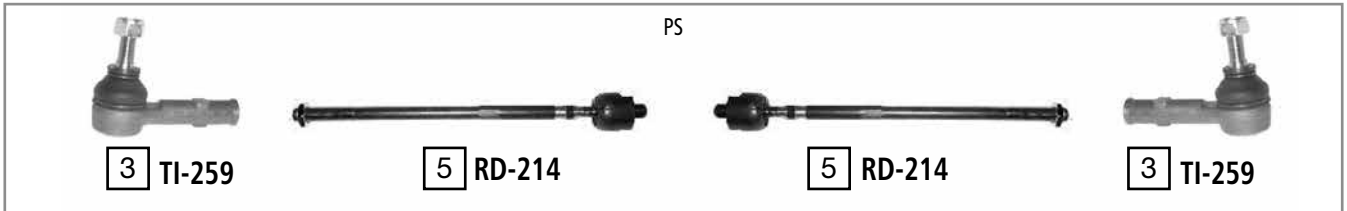
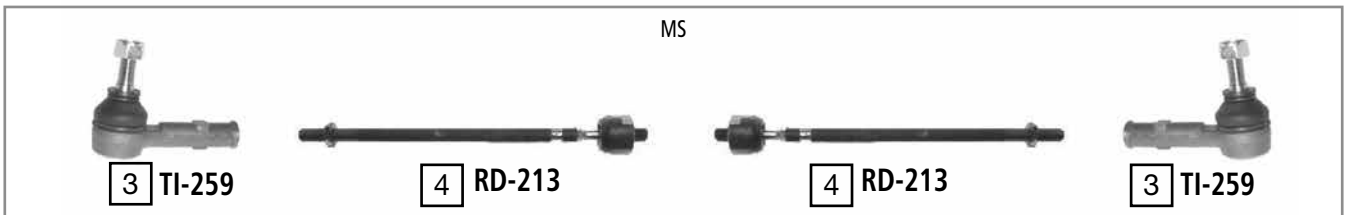

Ref	JAPANPARTS CODE	Description	OEM	Measures	Ref	JAPANPARTS CODE	Description	OEM	Measures
1	SI-201	Stabiliser Link	48820-20010	L:69	5	RD-214	Axial Joint	45503-19135	th:MM14X1.5R L:309
2	SI-202	Stabiliser Link	48830 12050	L:105	6	BJ-290	Ball Joint Lower Left	43340-19015	c:15.6
3	TI-259	Tie Rod End	45046 19175	c:12.7 th:FM14X1.5R	7	BJ-232R	Ball Joint Lower Right	43330-19065	c:15.6
4	RD-213	Axial Joint	45503-19125	th:MM14X1.5R L:306					

COROLLA (\_E10\_)

07/1992 - 04/1997

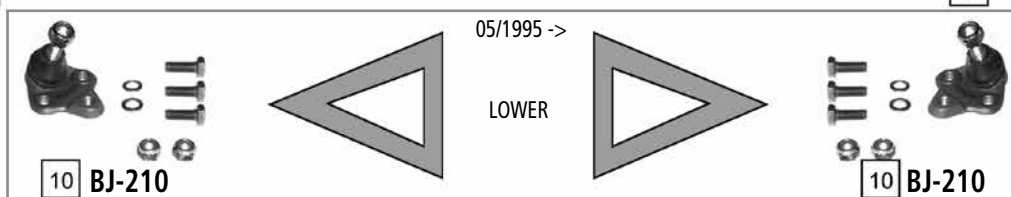
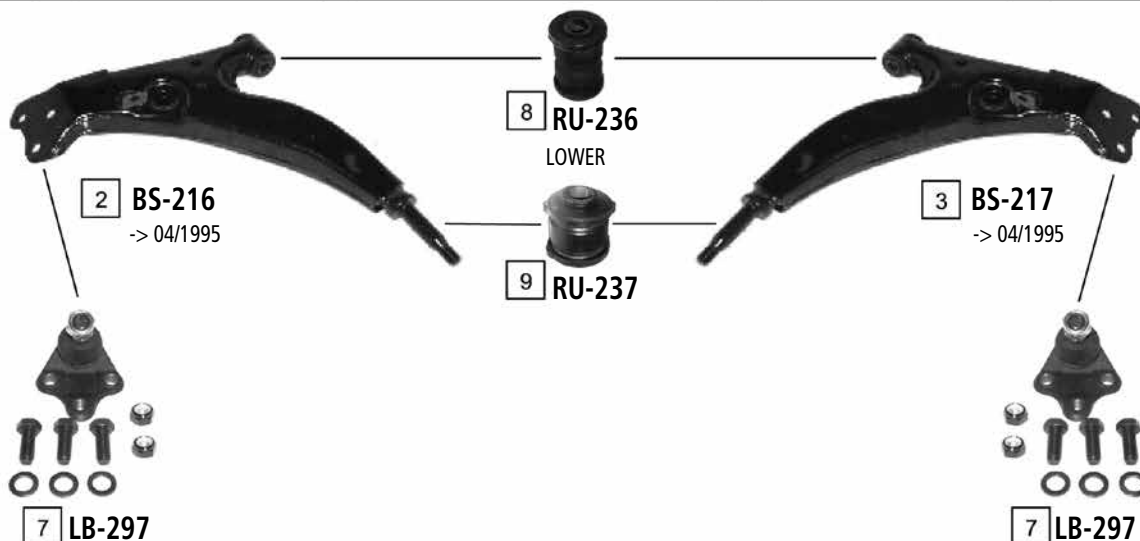
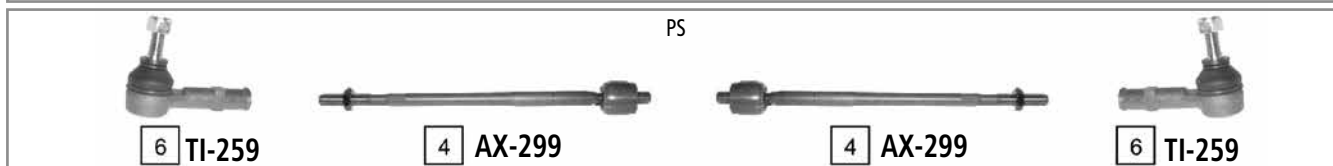
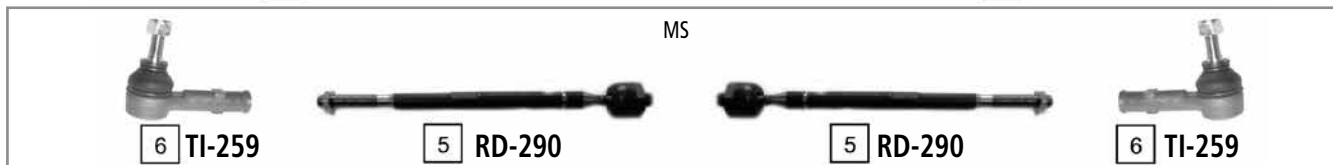
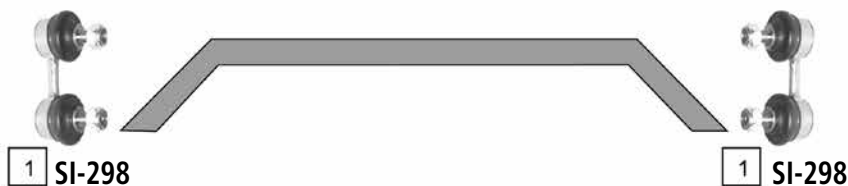

Ref	JAPANPARTS CODE	Description	OEM	Measures	Ref	JAPANPARTS CODE	Description	OEM	Measures
1	SI-298	Stabiliser Link	48820 33010	L:60.5	7	LB-297	Ball Joint Lower	43330 09030	c:15
2	BS-216	TCA Left	48069-12130		8	RU-236	Silentblock For Susp.Arm	48654-12070	d:34.5
3	BS-217	TCA Right	48068-12130		9	RU-237	Silentblock For Susp.Arm	48655-12050	d:46
4	AX-299	Axial Joint	45503-19205	th:MM14X1.5R L:330	10	BJ-210	Ball Joint	43330 19115	c.15.3
5	RD-290	Axial Joint	45503-29365	th:MM14X1.5R L:315	11	SI-202	Stabiliser Link	48830 12050	L:105
6	TI-259	Tie Rod End	45046 19175	c:12.7 th:FM14X1.5R					

COROLLA (\_E11\_)

04/1997 - 11/2001

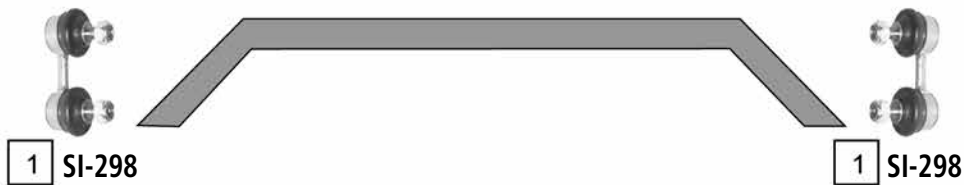

LOWER

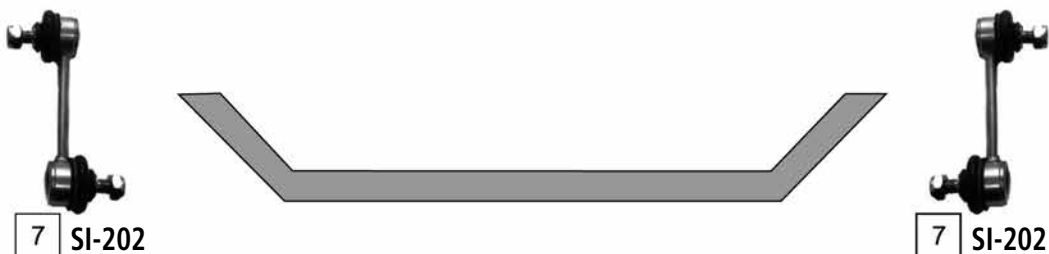

Ref	JAPANPARTS CODE	Description	OEM	Measures	Ref	JAPANPARTS CODE	Description	OEM	Measures
1	SI-298	Stabiliser Link	48820 33010	L:60.5	5	AX-299	Axial Joint	45503-19205	th:MM14X1.5R L:330
2	BJ-210	Ball Joint	43330 19115	c:15.3	6	TI-259	Tie Rod End	45046 19175	c:12.7 th:FM14X1.5R
3	BS-218	TCA Left	48069-12171		7	SI-202	Stabiliser Link	48830 12050	L:105
4	BS-219	TCA Right	48068-12171						



COROLLA (\_E12\_)

12/2001 ->

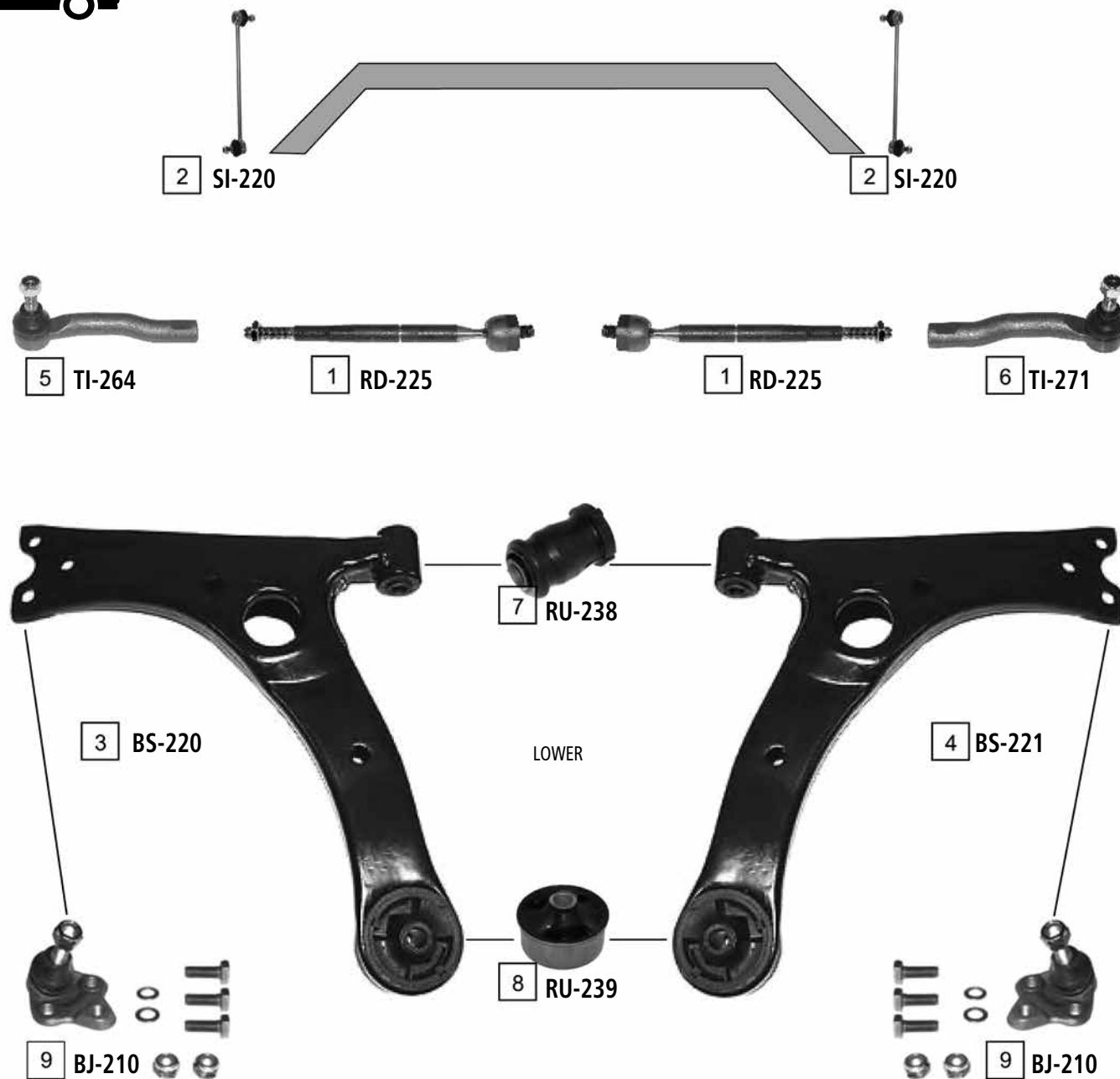

Ref	JAPANPARTS CODE	Description	OEM	Measures	Ref	JAPANPARTS CODE	Description	OEM	Measures
1	RD-225	Axial Joint	45503-12130	th:MM14X1.5R L:272	6	TI-271	Tie Rod End Right	45046 19265	c:12.6 th.FM14X1.5R
2	SI-220	Stabiliser Link	48820-32010	L:285	7	RU-238	Silentblock For Susp.Arm	Part of BS-220/BS-221	d:34.5
3	BS-220	TCA Left	48069-12260	c:15	8	RU-239	Silentblock For Susp.Arm	Part of BS-220/BS-221	d:68.3
4	BS-221	TCA Right	48068-12260	c:15	9	BJ-210	Ball Joint	43330 19115	c.15.3
5	TI-264	Tie Rod End Left	45047 19115	c:12.6 th:FM14X1.5R					

COROLLA VERSO (\_E12J\_)

01/2002 - 05/2004

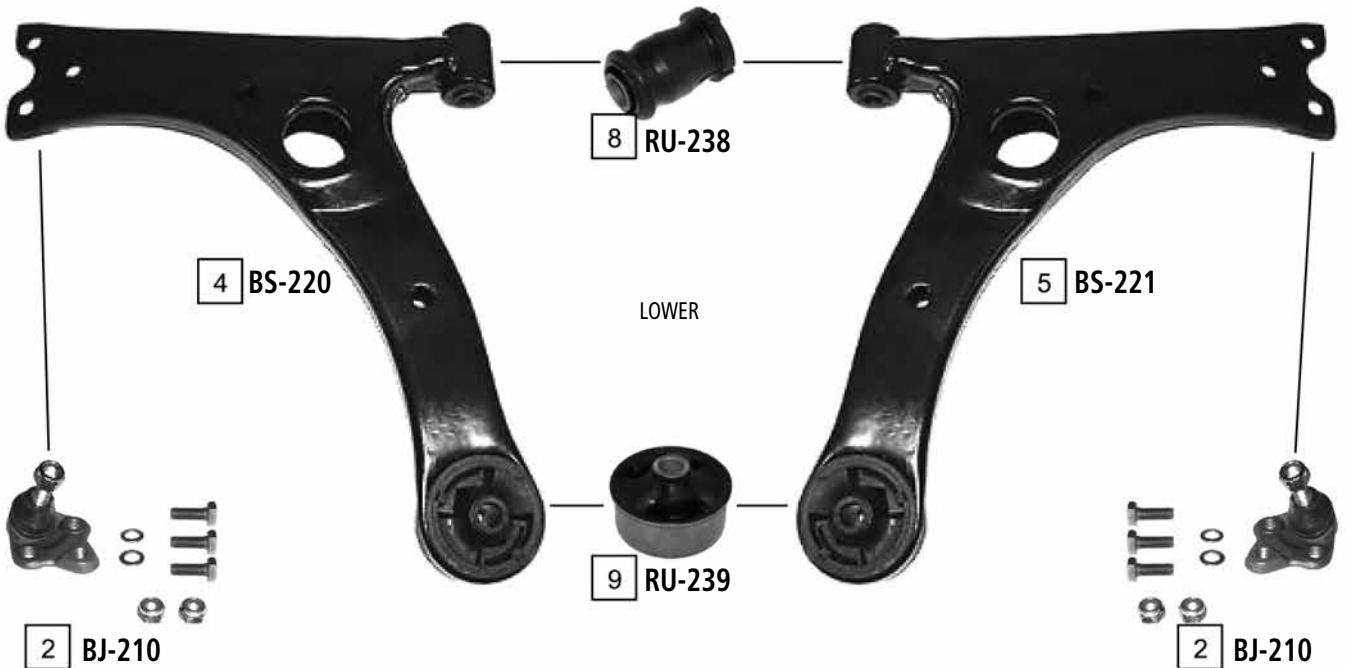
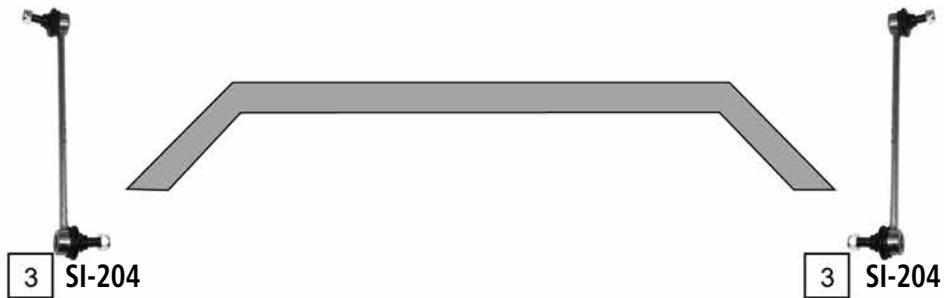

Ref	JAPANPARTS CODE	Description	OEM	Measures	Ref	JAPANPARTS CODE	Description	OEM	Measures
1	RD-226	Axial Joint	45503-19255	th:MM14X1.5R L:273	6	TI-276	Tie Rod End Left	45047-49045	c:12.6 th:FM14X1.5R
2	BJ-210	Ball Joint	43330 19115	c:15.3	7	TI-275	Tie Rod End Right	45046-49115	c:12.6 th:FM14X1.5R
3	SI-204	Stabiliser Link	48820 47010	L:285	8	RU-238	Silentblock For Susp.Arm	Part of BS-220/BS-221	d:34.5
4	BS-220	TCA Left	48069-12260	c:15	9	RU-239	Silentblock For Susp.Arm	Part of BS-220/BS-221	d:68.3
5	BS-221	TCA Right	48068-12260	c:15					

COROLLA VERSO (AUR10-CUR10-ZNR1\_)

04/2004 ->

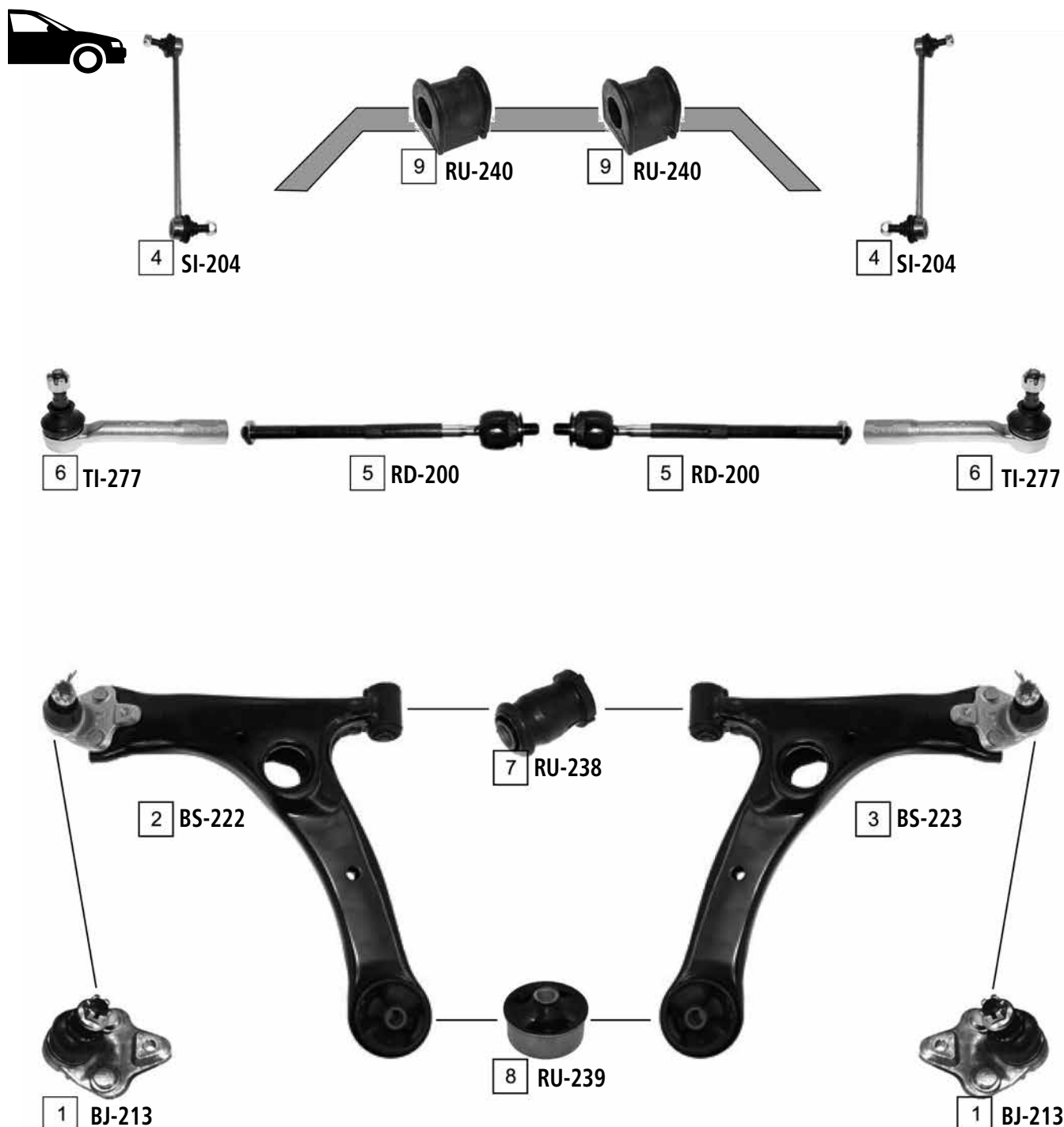

Ref	JAPANPARTS CODE	Description	OEM	Measures	Ref	JAPANPARTS CODE	Description	OEM	Measures
1	BJ-213	Ball Joint	43330 09360	c:17.6	6	TI-277	Tie Rod End	45046 09430	c:12.6 th:FM16X1.5R
2	BS-222	TCA Left Wbj	48069 0F010	c:17.6	7	RU-238	Silentblock For Susp.Arm	Part of BS-222/BS-223	d:34.5
3	BS-223	TCA Right Wbj	48068 0F010	c:17.6	8	RU-239	Silentblock For Susp.Arm	Part of BS-222/BS-223	d:68.3
4	SI-204	Stabiliser Link	48820 47010	L:285	9	RU-240	Stabiliser Mounting	48815 0F010	d:42
5	RD-200	Axial Joint	45503 0F010						

HIACE II (\_H5\_,\_H6\_,\_H7\_)

12/1982 - 07/1989



8 CR-212

7 ID-236



2 TI-226



1 TI-232



1 TI-232



2 TI-226

UPPER EXC 4X4



3 BJ-220

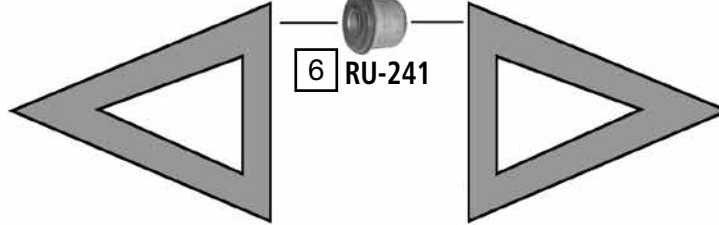

6 RU-241



3 BJ-220

LOWER EXC 4X4



4 LB-221



4 LB-221

LOWER 4X4



5 LB-228

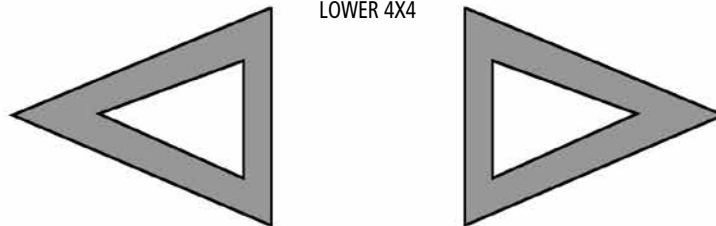

5 LB-228

Ref	JAPANPARTS CODE	Description	OEM	Measures	Ref	JAPANPARTS CODE	Description	OEM	Measures
1	TI-232	Tie Rod End	45406-29145	c:14.7 th:MM17X1.5R	5	LB-228	Ball Joint	43330-39195	c:18.2
2	TI-226	Tie Rod End	45046-29115	c:14.8 th:MM17X1.5L	6	RU-241	Silentblock For Susp.Arm	48632 26010	d:46.2
3	BJ-220	Ball Joint	43360-29076	c:17.2	7	ID-236	Pitman Arm	45490-29465	
4	LB-221	Ball Joint	43330 29125	c:18	8	CR-212	Tie Rod End	45450-29155	

HIACE III (\_H10\_,\_H11\_)

08/1989 - 07/1995



1 TI-270



2 RD-217



2 RD-217



1 TI-270



3 BJ-234

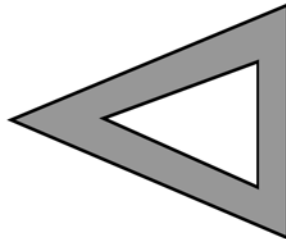

UPPER

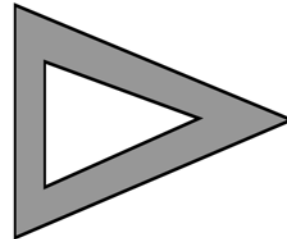

3 BJ-234



4 LB-221

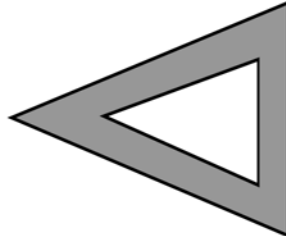

LOWER

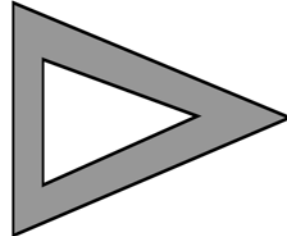

4 LB-221

Ref	JAPANPARTS CODE	Description	OEM	Measures	Ref	JAPANPARTS CODE	Description	OEM	Measures
1	TI-270	Tie Rod End	45046-29215	c: 14.7 th: FM17X1.5R	3	BJ-234	Ball Joint Upper	43350-29065	c:17.2
2	RD-217	Axial Joint	45503-29255	th:MM14X1.5R L:277	4	LB-221	Ball Joint	43330 29125	c:18

HIACE IV (\_H1\_,\_H2\_,)

08/1995 - 01/2007

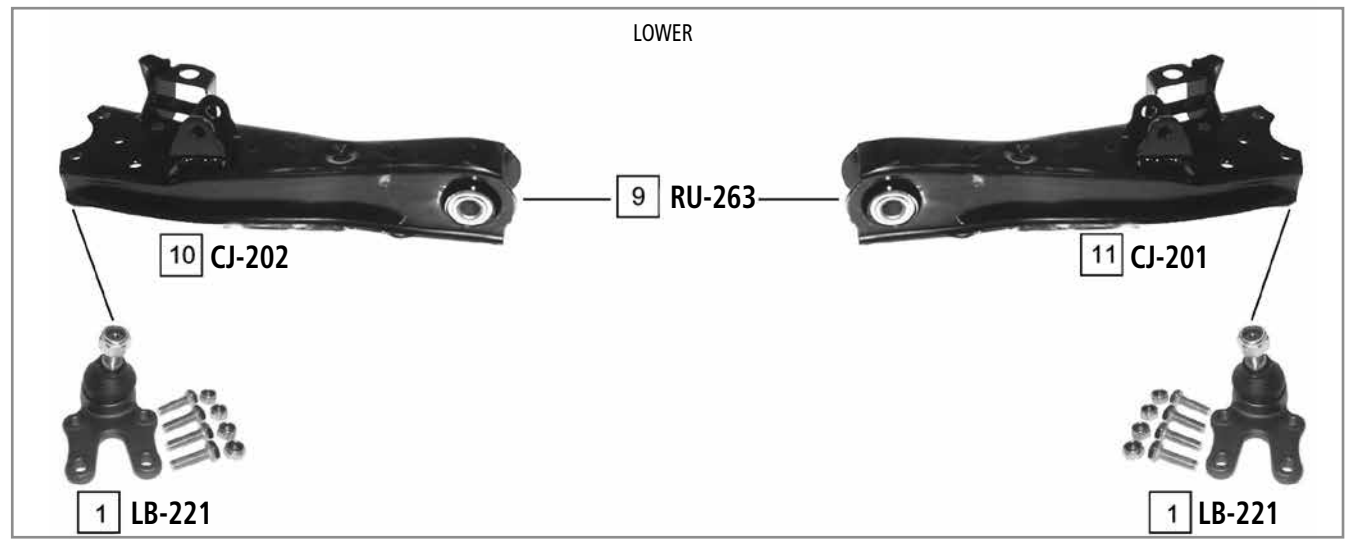
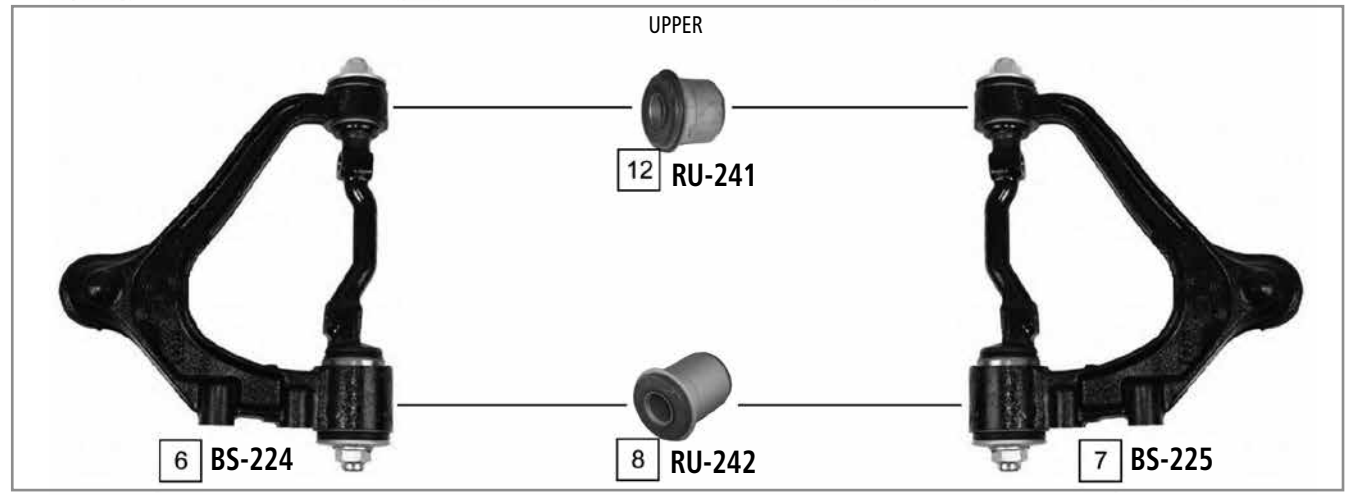
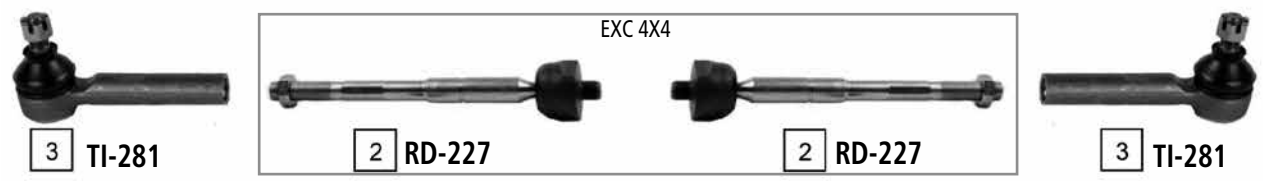

Ref	JAPANPARTS CODE	Description	OEM	Measures	Ref	JAPANPARTS CODE	Description	OEM	Measures
1	LB-221	Ball Joint	43330 29125	c:18	7	BS-225	TCA Right	48066 29075	c:17
2	RD-227	Axial Joint	45503 29565	th:MM14X1.5R L:275	8	RU-242	Silentblock For Susp.Arm	48635 26010	
3	TI-281	Tie Rod End	45046 29325		9	RU-263	Silentblock For Susp.Arm	48061 26050	
4	SI-222	Stabiliser Link Left	48810 26020	L:75	10	CJ-202	TCA Left	48069 26130	
5	SI-221	Stabiliser Link Right	48820 26020	L:75	11	CJ-201	TCA Right	48068 26130	
6	BS-224	TCA Left	48067 29075	c:17	12	RU-241	Silentblock For Susp.Arm	48632 26010	d.46.2

HILUX (\_N3,\_N4,\_N5\_) 2X4

08/1978 - 07/1988



9 ID-244

10 ID-215

11 ID-239



1 TI-226



2 TI-227



2 TI-227



1 TI-226

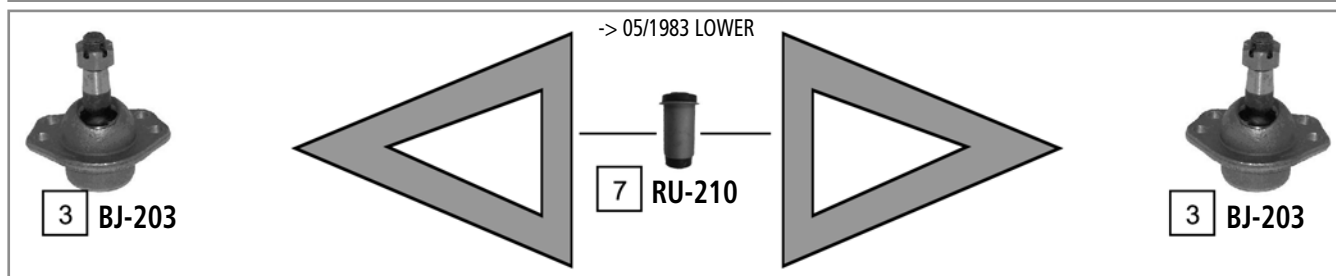
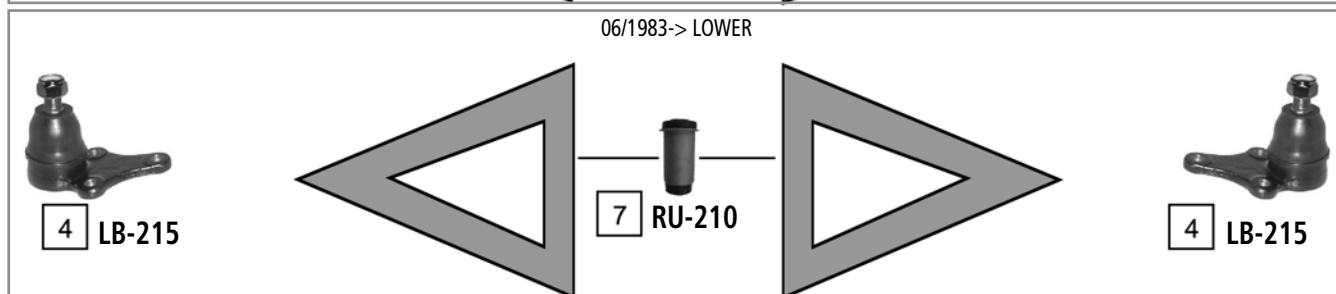
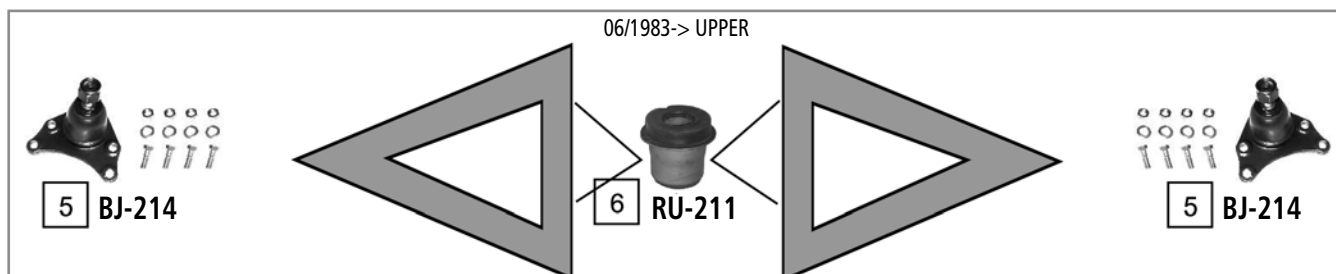

8 PI-236

Ref	JAPANPARTS CODE	Description	OEM	Measures	Ref	JAPANPARTS CODE	Description	OEM	Measures
1	TI-226	Tie Rod End	45046-29115	c:14.8 th:MM17X1.5L	7	RU-210	Silentblock For Susp.Arm	48654-35010	d:40.5
2	TI-227	Tie Rod End	45406-29115	c:14.8 th:MM17X1.5R	8	PI-236	Tie Rod End	45401-35240	
3	BJ-203	Ball Joint	4335039016	c:15	9	ID-244	Pitman Arm	45490-39255	
4	LB-215	Ball Joint	43330 39145	c:17.9	10	ID-215	Pitman Arm	45490-35140	
5	BJ-214	Ball Joint	43350-39035	c:15	11	ID-239	Pitman Arm	45490-35130	
6	BJ-214	Silentblock For Susp.Arm	48632-30020	d:36.5 - 38					

HILUX (\_N8,\_N9,\_N11\_) 2X4

08/1988 - 07/1997



1 TI-226



2 TI-227



2 TI-227



1 TI-226

10 SO-203

10 SO-203



4 BJ-227

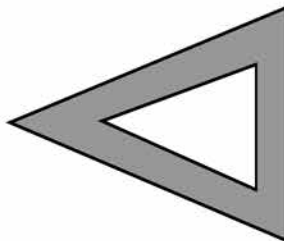

UPPER

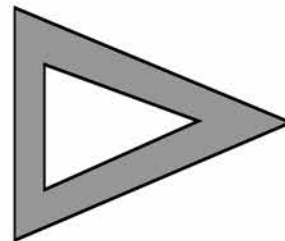

4 BJ-227



3 LB-235

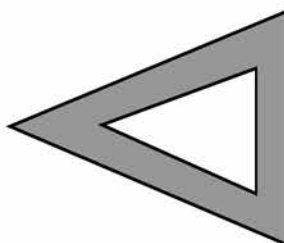

LOWER

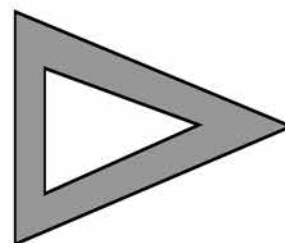

3 LB-235

5 CR-201  
03/1989 ->

6 CR-210

7 ID-215

8 ID-239

9 ID-240

Ref	JAPANPARTS CODE	Description	OEM	Measures	Ref	JAPANPARTS CODE	Description	OEM	Measures
1	TI-226	Tie Rod End	45046-29115	c.14.8 th:MM17X1.5L	6	CR-210	Tie Rod End	45450-39165	
2	TI-227	Tie Rod End	45406-29115	c.14.8 th:MM17X1.5R	7	ID-215	Pitman Arm	45490-35140	
3	LB-235	Ball Joint	43330-39295	c:18.2	8	ID-239	Pitman Arm	45490-35130	
4	BJ-227	Ball Joint	43350-39045	c:17.1	9	ID-240	Pitman Arm	45490-39315	
5	CR-201	Tie Rod End	45450-39065		10	SO-203	Tie Rod End	45490-39225	



HILUX (\_N6,\_N10,\_N11,\_N12,\_N13\_) 4X4

08/1985 ->



1 TI-226



2 BJ-292

2 BJ-292



1 TI-226



4 BJ-227

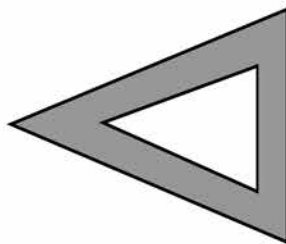

UPPER

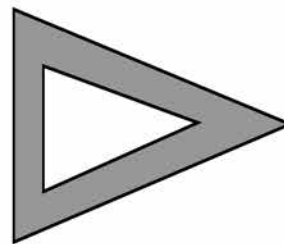

4 BJ-227



3 LB-228

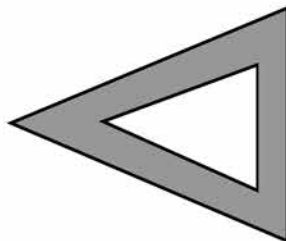

-> 03/1989

LOWER

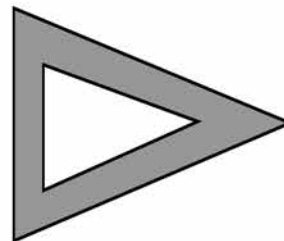

3 LB-228



5 LB-295

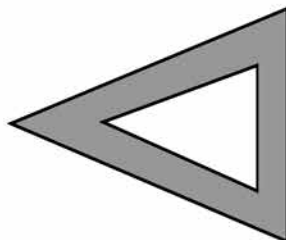

04/1989 ->

LOWER

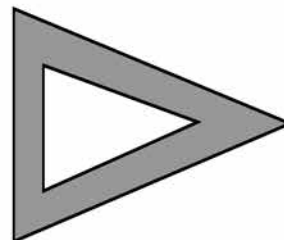

5 LB-295

6 CR-201

7 CR-210

Ref	JAPANPARTS CODE	Description	OEM	Measures	Ref	JAPANPARTS CODE	Description	OEM	Measures
1	TI-226	Tie Rod End	45046-29115	c:14.8 th:MM17X1.5L	5	LB-295	Ball Joint	43330-39265	c:18.1
2	BJ-292	Tie Rod End	45406 39165	c:14.7 th:FM17X1.5R	6	CR-201	Tie Rod End	45450-39065	
3	LB-228	Ball Joint	43330-39195	c:18.2	7	CR-210	Tie Rod End	45450-39165	
4	BJ-227	Ball Joint	43350-39045	c:17.1					

HILUX (KUN1\_ 2 x 4 / KUN2\_ 4 x 4)

09/2005 ->

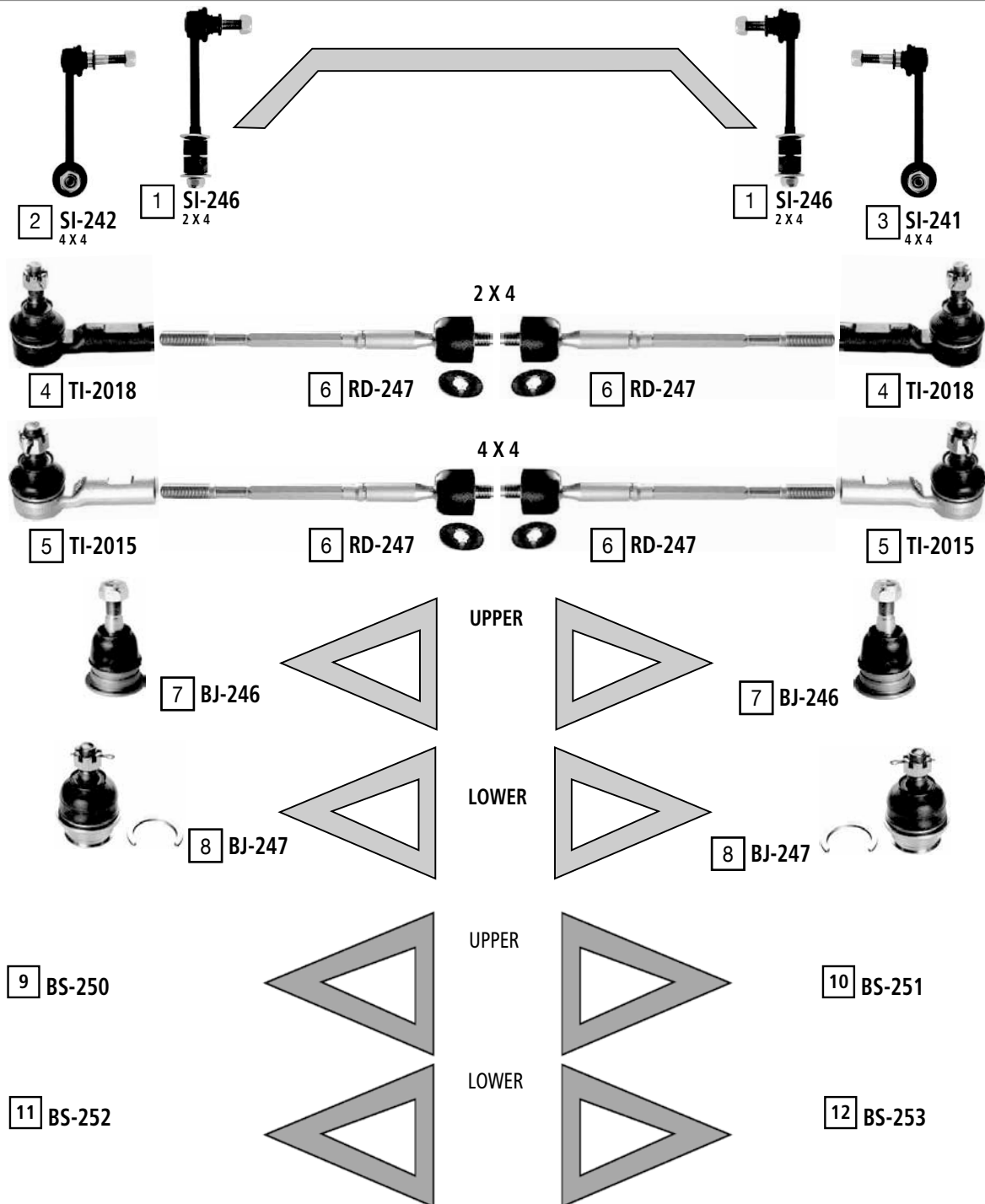

Ref	JAPANPARTS CODE	Description	OEM	Measures	Ref	JAPANPARTS CODE	Description	OEM	Measures
1	SI-246	stabiliser link	48820 0K010		7	BJ-246	ball joint	43310 09015	c:15 do:43.85
2	SI-242	stabiliser link left	48810 0K010	L:140	8	BJ-247	ball joint	43330 09510	c:16.5 do:47.3
3	SI-241	stabiliser link right	48820 0K030	L:140	9	BS-250	TCA Left	48630-0K040	
4	TI-2018	tie rod end	45046 09261	c:13.6 th:FM15x1.5R	10	BS-251	TCA Right	48610-0K040	
5	TI-2015	tie rod end	45046 09281	c:15.2 th:FM15x1.5R	11	BS-252	TCA Left	48069-0K040	
6	RD-247	axial joint	45503 09331	th:MM14x1.5R L:294	12	BS-253	TCA Right	48068-0K040	

IQ (AJ1)

01/2009 ->

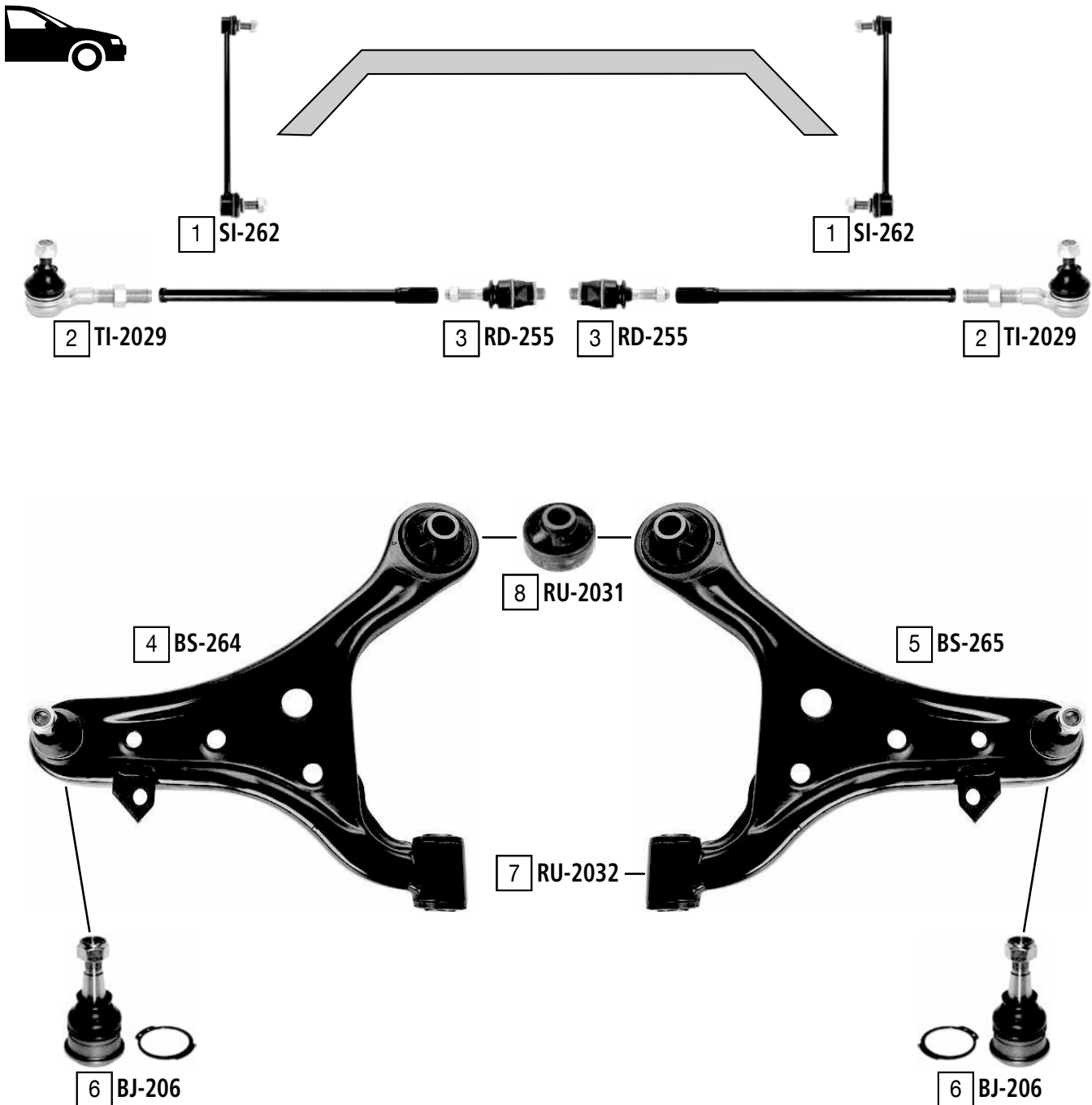

Ref	JAPANPARTS CODE	Description	OEM	Measures	Ref	JAPANPARTS CODE	Description	OEM	Measures
1	SI-262	stabiliser link	48820 74010	L:285	5	BS-265	TCA right wbj	48068 79015	c:13.5
2	TI-2029	tie rod end	45046 79025	c:13.9 th:MM14x1.5R	6	BJ-206	ball joint lower	Part of	c:13.5 do:36.7
3	RD-255	axial joint	45503 74010	th:MM16x1.5R L:117	7	RU-2032	silentblock for TCA	Part of	di:14.2 do:34
4	BS-264	TCA left wbj	48069 79015	c:13.5	8	RU-2031	silentblock for TCA	Part of	di:19.3 do:60.1

LANDCRUISER (FJ4\_, HJ45 , BJ4\_)

03/1969 - 04/1986



1 TI-217L



2 TI-217R



3 TI-209



4 TI-221R

5 TI-221L

6 TI-217L

Ref	JAPANPARTS CODE	Description	OEM	Measures	Ref	JAPANPARTS CODE	Description	OEM	Measures
1	TI-217L	Tie Rod End	45046 60033	c:12.9 th:MM17X1.5R	4	TI-221R	Tie Rod End	45046 69055	c:12.7 th.MM21X1.5L
2	TI-217R	Tie Rod End	45045 60013	c:12.9 th:MM17X1.5L	5	TI-221L	Tie Rod End	45046-69045	
3	TI-209	Tie Rod End	45046 69035	c:12.9 th.MM21X1.5R	6	TI-217L	Tie Rod End	45045-69015	

LANDCRUISER (BJ60, HJ6\_, HJ45, FJ62)

08/1980 - 01/1990

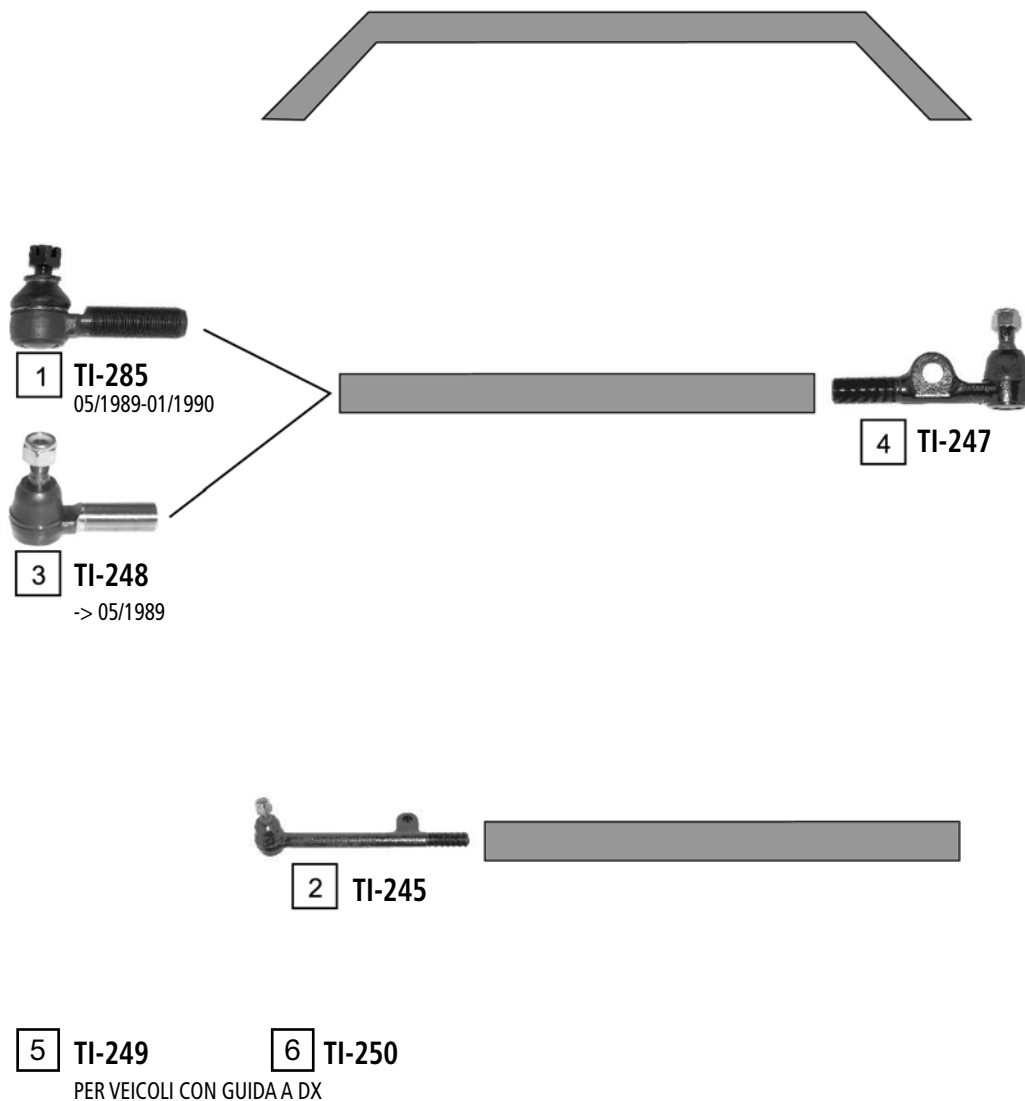

Ref	JAPANPARTS CODE	Description	OEM	Measures	Ref	JAPANPARTS CODE	Description	OEM	Measures
1	TI-285	Tie Rod End	45047 69066	c:14.5 th:MM23X1.5R	4	TI-247	Tie Rod End	45046 69115	c:14.8 th:MM23X1.5L
2	TI-245	Tie Rod End	45044 60H00	c:16.8 th:MM21X1.5L	5	TI-249	Tie Rod End	45044-69065	
3	TI-248	Tie Rod End	45047 69065	c:14.6 th:MM23X1.5R	6	TI-250	Tie Rod End	45046-69105	

LANDCRUISER (RJ7\_, LJ7\_, BJ7\_)

11/1984 - 01/1990

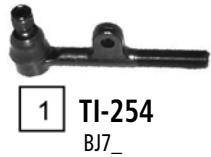

**1** TI-254  
BJ7\_



**5** TI-279  
RJ7\_/LJ7\_



**4** TI-251  
RJ7\_/LJ7\_



**6** TI-248  
BJ7\_ -> 05/1989



**2** TI-285  
BJ7\_ 05/1989 ->



**3** TI-256  
RJ7\_/LJ7\_



**7** TI-247  
BJ7\_ 05/1989 ->



**6** TI-248  
RJ7\_/LJ7\_ -> 05/1989



**2** TI-285  
RJ7\_/LJ7\_ 05/1989 ->



**8** RU-209



**9** RU-243



Ref	JAPANPARTS CODE	Description	OEM	Measures	Ref	JAPANPARTS CODE	Description	OEM	Measures
1	TI-254	Tie Rod End Left	45044 60H03	c:16.65 th:MM21X1.5	6	TI-248	Tie Rod End	45047 69065	c:14.6 th:MM23X1.5R
2	TI-285	Tie Rod End	45047 69066	c:14.5 th:MM23X1.5R	7	TI-247	Tie Rod End	45046 69115	c:14.8 th:MM23X1.5L
3	TI-256	Tie Rod End Right	45046 69135	c:14.5 th:MM23X1.5L	8	RU-209	Silentblock For Susp.Arm	48702 60020	d:65.4
4	TI-251	Tie Rod End Left	45045 69065	c:14.8 th:MM21X1.5R	9	RU-243	Silentblock For Susp.Arm	48702-60010	d:65.6
5	TI-279	Tie Rod End Right	45044 69106	c.14.7 th:MM21X1.5L					

LANDCRUISER (KZJ7\_,LJ7\_,RJ7\_)

01/1990 - 04/1996



Ref	JAPANPARTS CODE	Description	OEM	Measures	Ref	JAPANPARTS CODE	Description	OEM	Measures
1	TI-285	Tie Rod End	45047 69066	c.14.5 th:MM23X1.5R	4	RU-243	Silentblock For Susp.Arm	48702-60010	d:65.6
2	TI-251	Tie Rod End Left	45045 69065	c.14.8 th:MM21X1.5R	5	SI-224	Stabiliser Link Left	48810 60010	
3	RU-209	Silentblock For Susp.Arm	48702 60020	d:65.4	6	SI-223	Stabiliser Link Right	48820 60010	

LANDCRUISER 80 (FJ80, FZJ80, HDJ80, HZJ80)

01/1990 - 01/1998

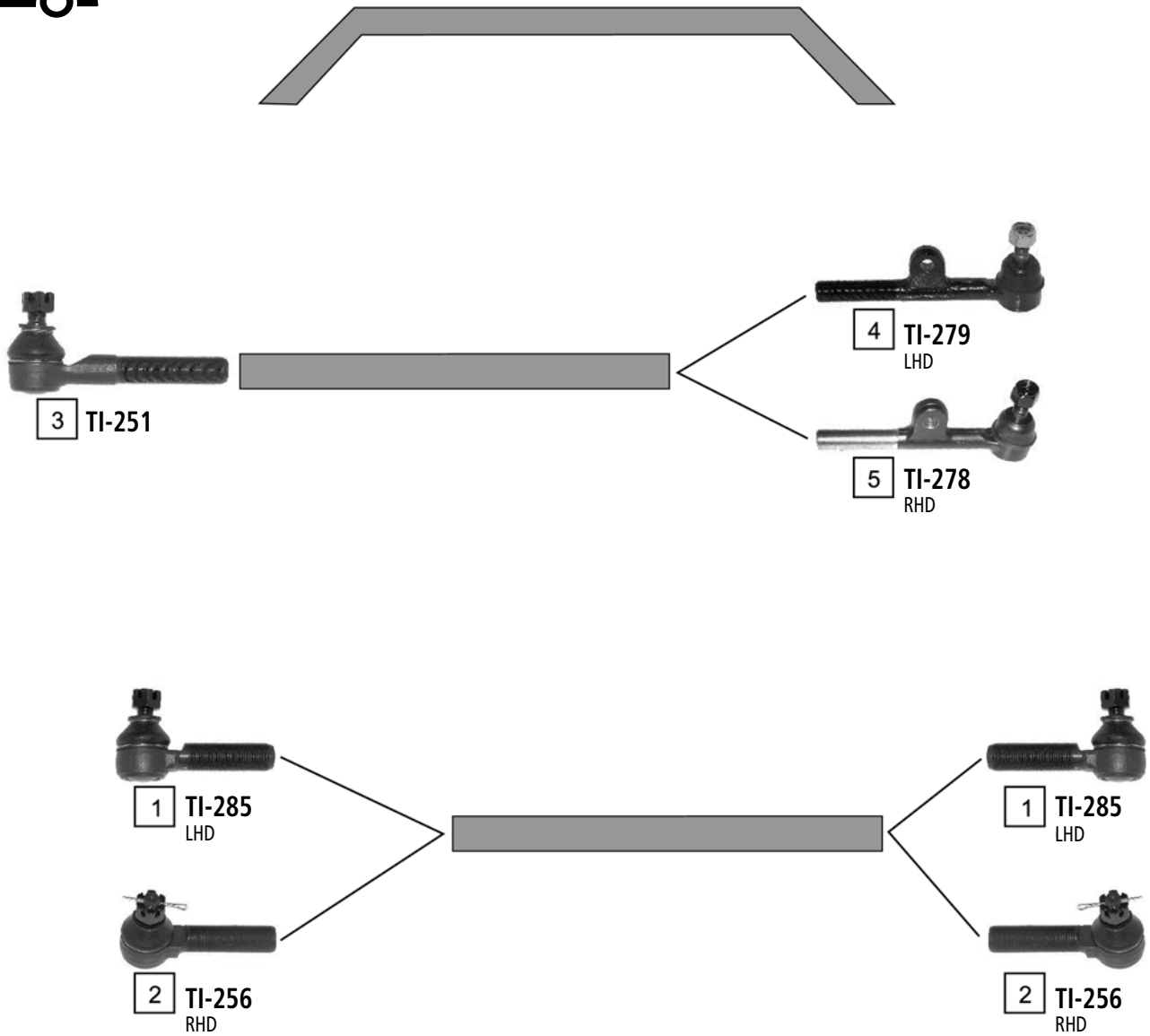

Ref	JAPANPARTS CODE	Description	OEM	Measures	Ref	JAPANPARTS CODE	Description	OEM	Measures
1	TI-285	Tie Rod End	45047 69066	c.14.5 th:MM23X1.5R	4	TI-279	Tie Rod End Right	45044 69106	c.14.7 th:MM21X1.5L
2	TI-256	Tie Rod End Right	45046 69135	c.14.5 th:MM23X1.5L	5	TI-278	Tie Rod End Right	45044 69115	c.14.6 th:MM21X1.5L
3	TI-251	Tie Rod End Left	45045 69065	c.14.8 th:MM21X1.5R					



# TOYOTA LANDCRUISER

LANDCRUISER 90 (KDJ9\_,KZJ9\_,VZJ9\_)

04/1996 - 09/2002

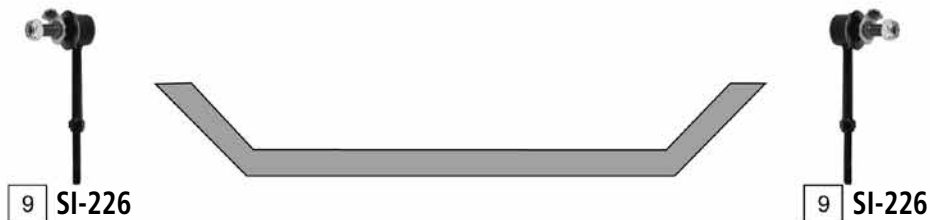
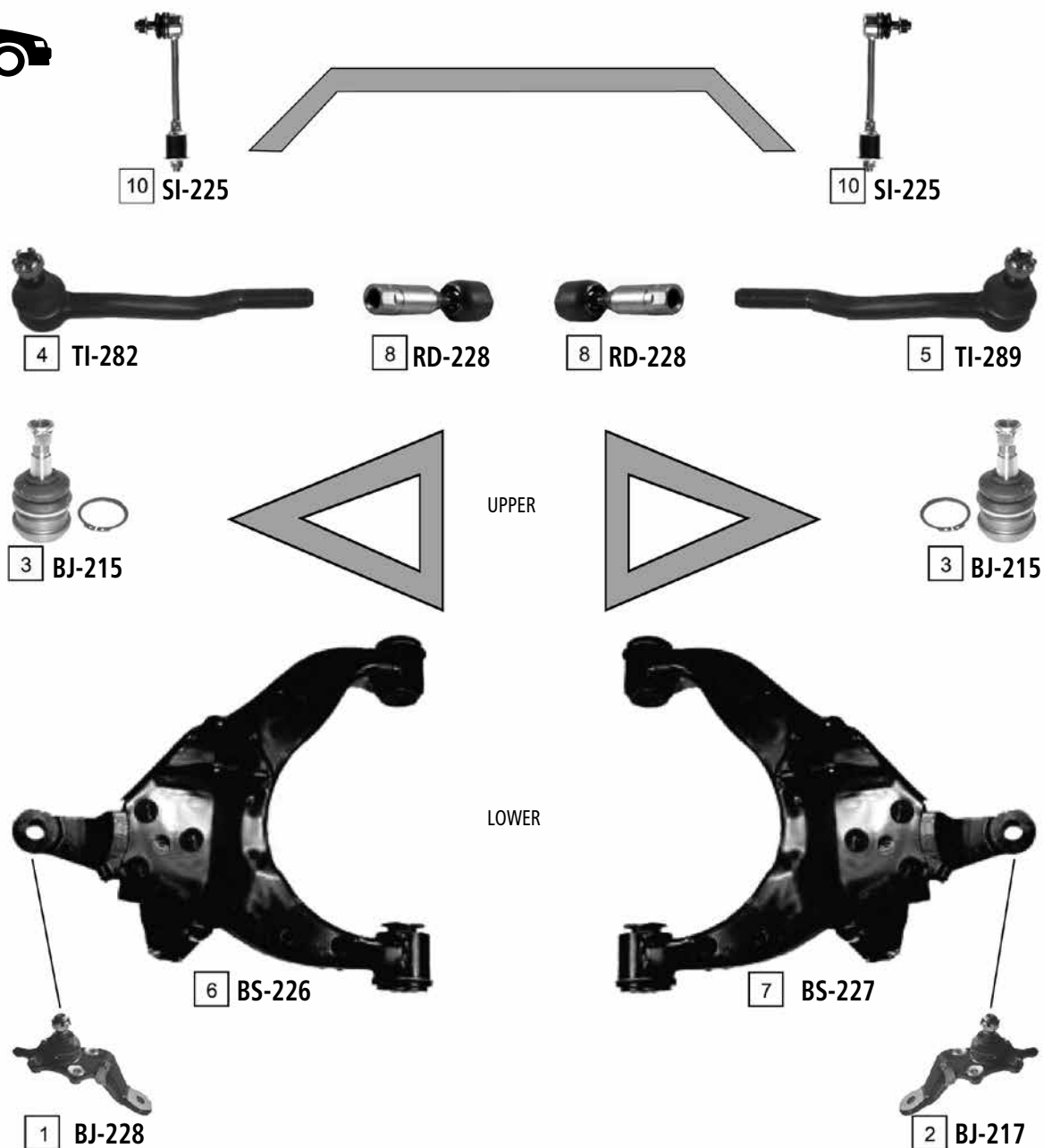

Ref	JAPANPARTS CODE	Description	OEM	Measures	Ref	JAPANPARTS CODE	Description	OEM	Measures
1	BJ-228	Ball Joint Left	43340 39325	c:17.6	6	BS-226	Tca Wobj	48069 35080	
2	BJ-217	Ball Joint Right	43330 39415	c:17.6	7	BS-227	Tca Wobj	48068 35080	
3	BJ-215	Ball Joint	43310 39016	c:15.75	8	RD-228	Axial Joint	45503 39075	th:MM18X1.5R L.133
4	TI-282	Tie Rod End Left	45047 39215	c:14.8 th:MM20X1.5R	9	SI-226	Stabiliser Link	48830 35020	
5	TI-289	Tie Rod End Right	45046 39335	c:14.8 th:MM20X1.5R	10	SI-225	Stabiliser Link	48820 35030	

LANDCRUISER 100 (HDJ100 , UZJ100)

01/1998 ->

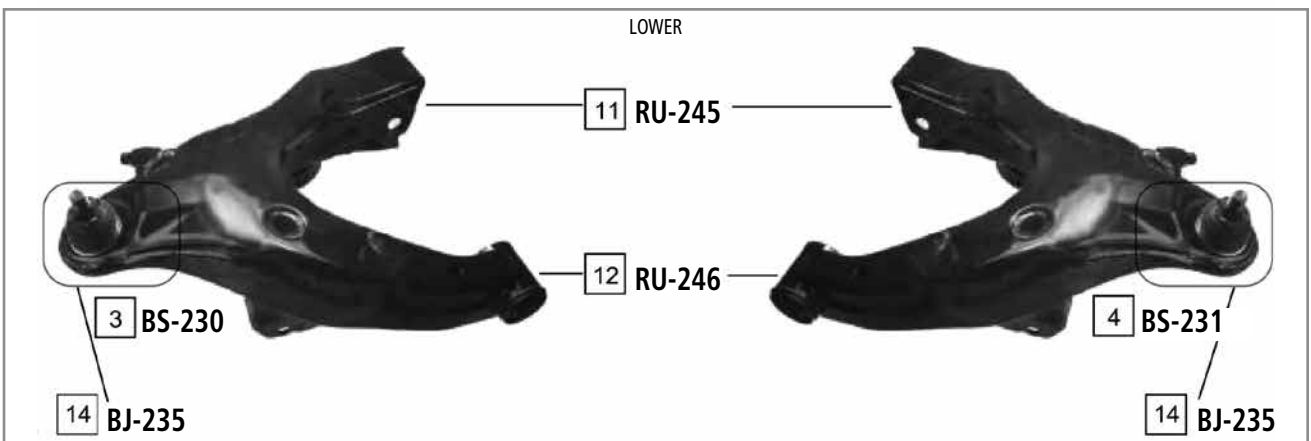
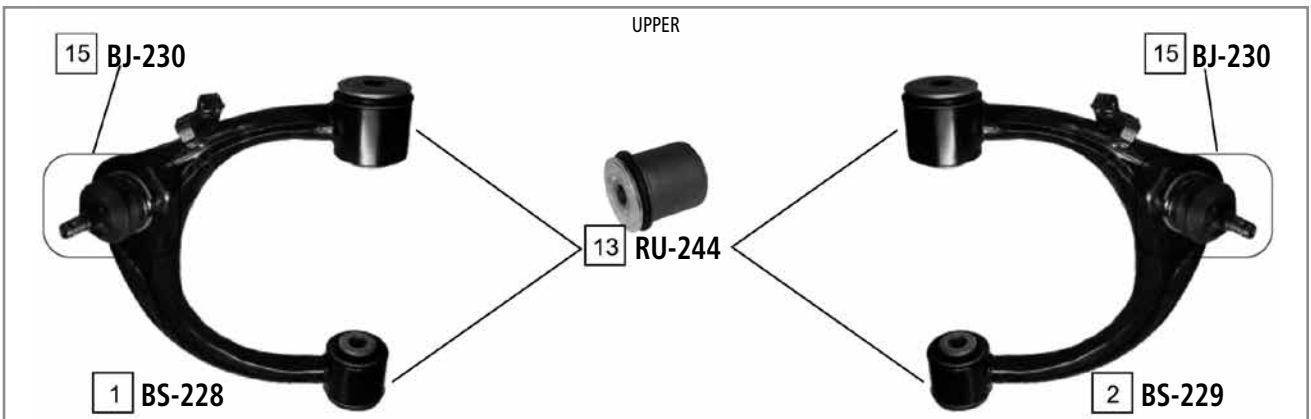
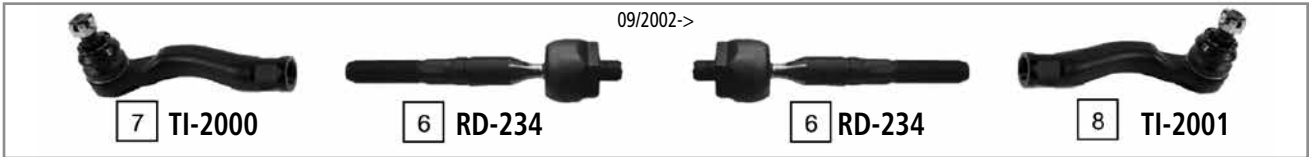

Ref	JAPANPARTS CODE	Description	OEM	Measures	Ref	JAPANPARTS CODE	Description	OEM	Measures
1	BS-228	TCA	48630 60010		9	TI-290	Tie Rod End	45047-69100	c:18.3 th:FM20X1.5R
2	BS-229	TCA	48610 60030		10	TI-291	Tie Rod End	45046-69195	c:18.3 th:FM20X1.5R
3	BS-230	TCA	48640 60010		11	RU-245	Silentblock For Susp.Arm	48655 60010	
4	BS-231	TCA	48620 60010		12	RU-246	Silentblock For Susp.Arm	48654 60010	d:48
5	RD-230	Axial Joint	45503-69015	th:MM18X1.5R L:198	13	RU-244	Silentblock For Susp.Arm	48632 60010	d:52.1
6	RD-234	Axial Joint	45503 69025		14	BJ-235	Ball Joint	Part of BS-230/BS-231	
7	TI-2000	Tie Rod End Left	45047 69115		15	BJ-230	Ball Joint	Part of BS-228/BS-229	
8	TI-2001	Tie Rod End Right	45046 69205						

LANDCRUISER 120 (GRJ\_, KDJ\_)

09/2002 ->

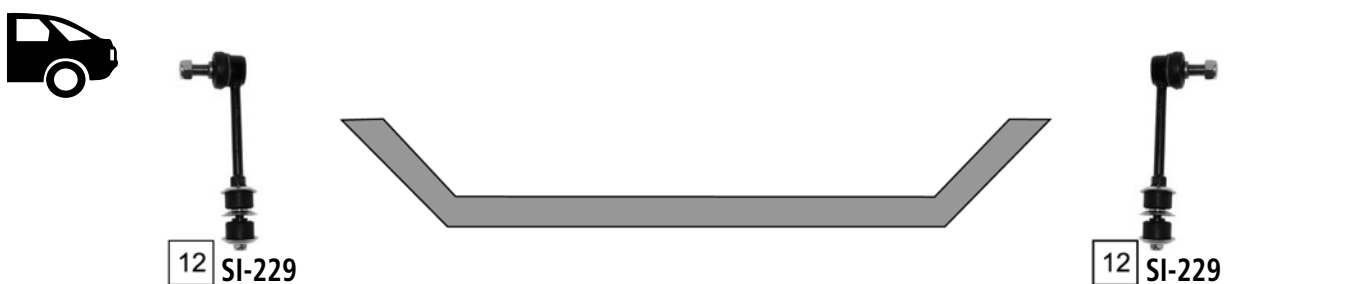
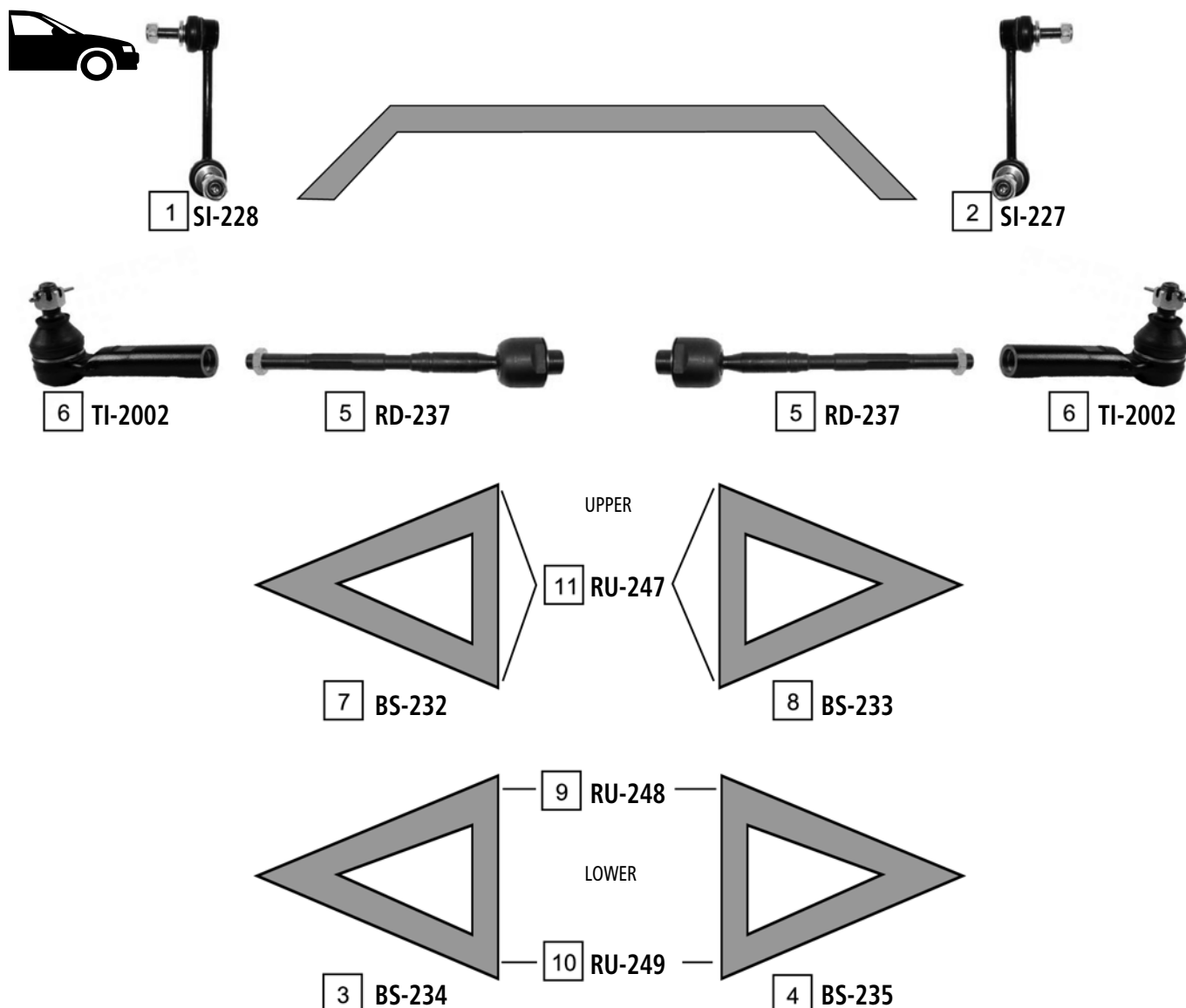

Ref	JAPANPARTS CODE	Description	OEM	Measures	Ref	JAPANPARTS CODE	Description	OEM	Measures
1	SI-228	Stabiliser Link Left	48810 60040	L:140	7	BS-232	TCA	48630 60020	
2	SI-227	Stabiliser Link Right	48820 60050	L:140	8	BS-233	TCA	48610 60050	
3	BS-234	TCA	48069 60010		9	RU-248	Silentblock For Susp.Arm	48654 60030	
4	BS-235	TCA	48068 60010		10	RU-249	Silentblock For Susp.Arm	48655 60030	
5	RD-237	Axial Joint	45503 39235	th.MM22X1.5R L:260	11	RU-247	Silentblock For Susp.Arm	48632 60020	
6	TI-2002	Tie Rod End	45046 39505		12	SI-229	Stabiliser Link	48830 60030	

LITEACE (\_M2\_)

10/1979 - 09/1986



**1** TI-205  
10/1982 ->



**1** TI-205  
10/1982 ->



**2** BJ-229

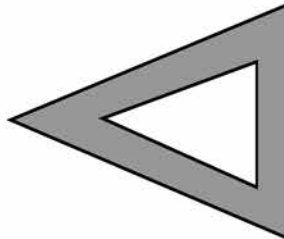

UPPER

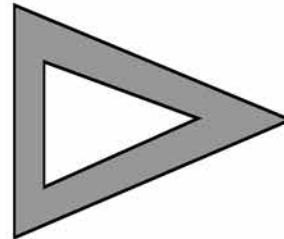

**2** BJ-229



**4** LB-235

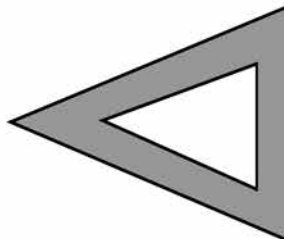

-> 09/1982

LOWER

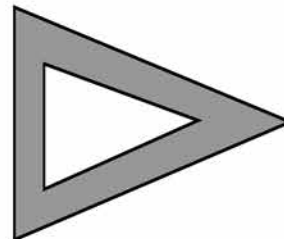

**4** LB-235



**3** BJ-625

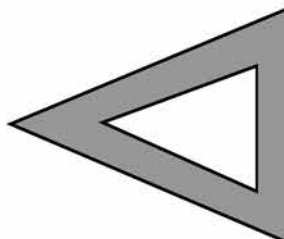

10/1982 ->

LOWER

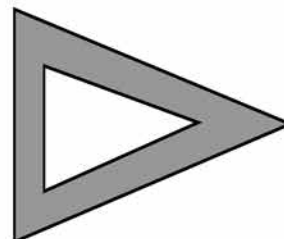

**3** BJ-625

Ref	JAPANPARTS CODE	Description	OEM	Measures	Ref	JAPANPARTS CODE	Description	OEM	Measures
1	TI-205	Tie Rod End	45046 19065	c:12.9 th:MM14X1.5L	3	BJ-625	Ball Joint	43340-29095	c:16.8
2	BJ-229	Ball Joint	43350 29076	c:15.2	4	LB-235	Ball Joint	43330-39295	c:18.2

LITEACE (\_M3\_)

09/1985 - 01/1992

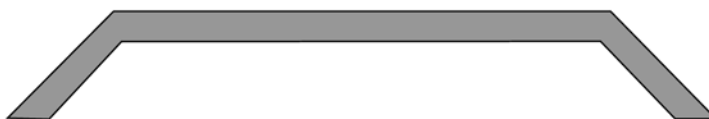

-> 07/1988



08/1988 ->



2 BJ-229

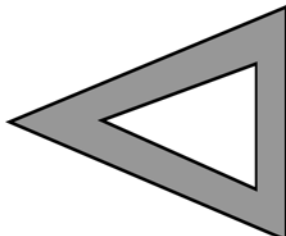

UPPER

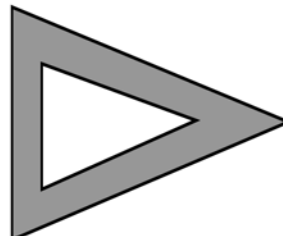

2 BJ-229



3 BJ-265

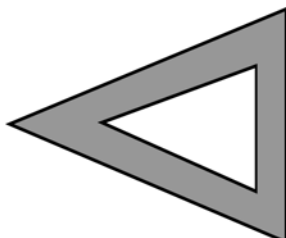

LOWER

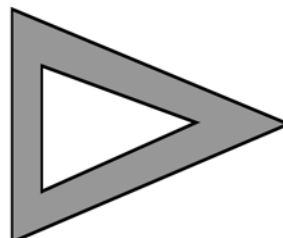

3 BJ-265

Ref	JAPANPARTS CODE	Description	OEM	Measures	Ref	JAPANPARTS CODE	Description	OEM	Measures
1	SY-271	Tie Rod End	45460-29315	c:12.9 th:FM14X1.5R	4	RD-203	Axial Joint	45503-29015	th:MM14X1.5R L:175
2	BJ-229	Ball Joint	43350-29076	c:15.2	5	RD-293	Axial Joint	45503-29215	th:MM14X1.5R L:307
3	BJ-625	Ball Joint	43340-29095	c:16.8					

MR 2 (\_W1\_, \_W2\_)

06/1984 - 05/2000



**1** BJ-291



**3** RD-238  
12/1989 ->

**3** RD-238  
12/1989 ->



**1** BJ-291



**2** BJ-224

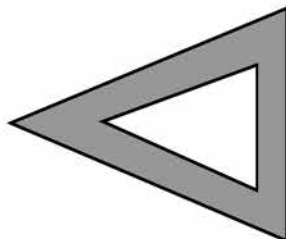

LOWER

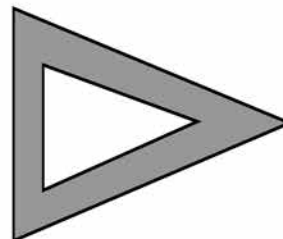

**2** BJ-224

Ref	JAPANPARTS CODE	Description	OEM	Measures	Ref	JAPANPARTS CODE	Description	OEM	Measures
1	BJ-291	Tie Rod End	45046-29135	c:12.6 th:FM12X1.25	3	RD-238	Axial Joint	45503 19145	th.MM12X1.25R L:288
2	BJ-224	Ball Joint Lower	43330-19025	c:14.3					

PASEO (EL54)

08/1995 - 07/1999



2 TI-298



1 RD-298



1 RD-298



2 TI-298



4 BJ-238L

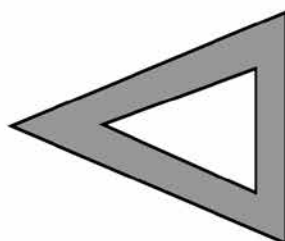

LOWER

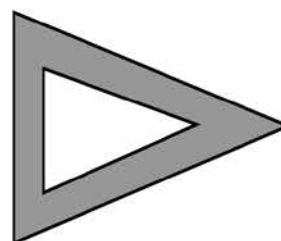

3 BJ-238R

Ref	JAPANPARTS CODE	Description	OEM	Measures	Ref	JAPANPARTS CODE	Description	OEM	Measures
1	RD-298	Axial Joint	45503 19155	th:MM12X1.25R L:289	3	BJ-238R	Ball Joint	43330 19085	c:13.5
2	TI-298	Tie Rod End	45046-19205	c:12.7 th:FM12X1.25	4	BJ-238L	Ball Joint	43340-19025	

PICNIC (\_XM10)

05/1996 - 04/2001



LOWER



Ref	JAPANPARTS CODE	Description	OEM	Measures	Ref	JAPANPARTS CODE	Description	OEM	Measures
1	TI-293	Tie Rod End Left	45047-29075	c:12.6 th:FM15X1.5R	4	BS-237	TCA	48068-44010	
2	TI-297	Tie Rod End Right	45046-29275	c:12.6 th:FM15X1.5R	5	LB-297	Ball Joint Lower	43330 09030	c:15
3	BS-236	TCA	48069-44010		6	AX-298	Axial Joint	45503 29435	th.MM14X1.5R L:240



PREVIA (TCR1\_ 2\_)

05/1990 - 08/2000

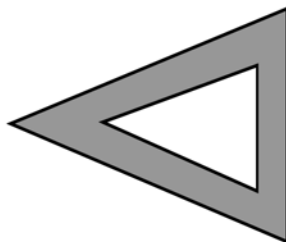
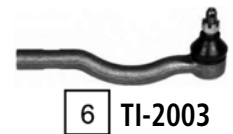
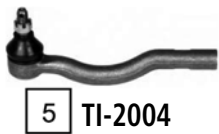
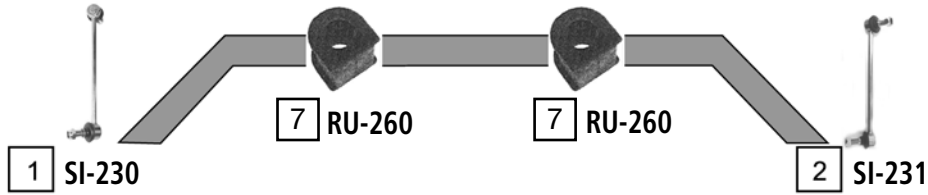

LOWER

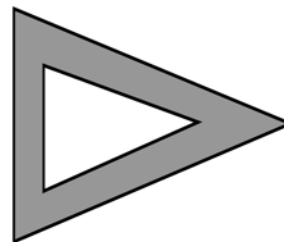

Ref	JAPANPARTS CODE	Description	OEM	Measures	Ref	JAPANPARTS CODE	Description	OEM	Measures
1	SI-230	Stabiliser Link Left	48810 28020	L:255	5	TI-2004	Tie Rod End	45047 29065	c:12.4 th:FM14X1.5R
2	SI-231	Stabiliser Link Right	48820 28010	L:255	6	TI-2003	Tie Rod End	45046 29235	c:12.4 th:FM14X1.5R
3	BJ-236	Ball Joint	43330-29235	c:17	7	RU-260	Stabiliser Mounting	48815 28061	-
4	RD-239	Axial Joint	45503-29295	th:MM14X1.5R L.215					

PREVIA ESTIMA (ACR3\_)

08/2000 - 04/2006



LOWER

Ref	JAPANPARTS CODE	Description	OEM	Measures	Ref	JAPANPARTS CODE	Description	OEM	Measures
1	SI-218	Stabiliser Link	48820 28050	L:260	5	BS-239	Susp.Arm W/O Ball Joint	48068-28120	
2	BJ-208	Ball Joint Left	43340-29175	c.17.6	6	TI-2006	Tie Rod End	45470-29185	
3	BJ-209	Ball Joint Right	43330-29405	c.17.6	7	TI-2005	Tie Rod End	45460-29425	
4	BS-238	Susp.Arm W/O Ball Joint	48069-28120		8	RD-240	Axial Joint	45504-28030	th:MM14X1.5R L:235

PRIUS (NHW11)

05/2000 - 08/2003

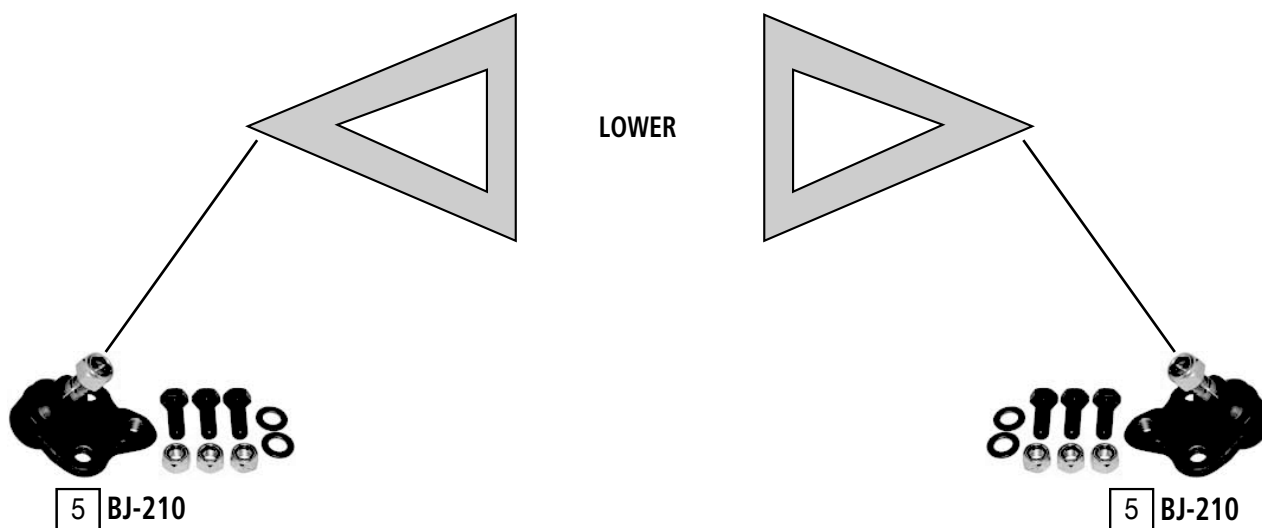
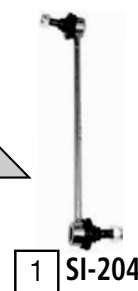
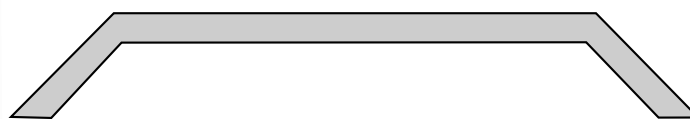

LOWER

Ref	JAPANPARTS CODE	Description	OEM	Measures	Ref	JAPANPARTS CODE	Description	OEM	Measures
1	SI-204	stabiliser link	48820 47010	L:285	4	RD-249	axial joint	45503 49075	th:MM18x1.5R L:265
2	TI-264	tie rod end left	45047 19115	c:12.6 th:FM14x1.5R	5	BJ-210	ball joint	43330 19115	c:15.3
3	TI-271	tie rod end right	45046 19265	c:12.6 th:FM14x1.5R					

PRIUS (NHW20)

08/2003 - 12/2008

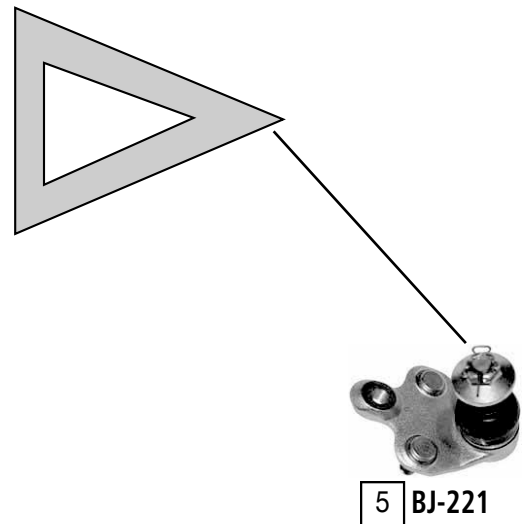
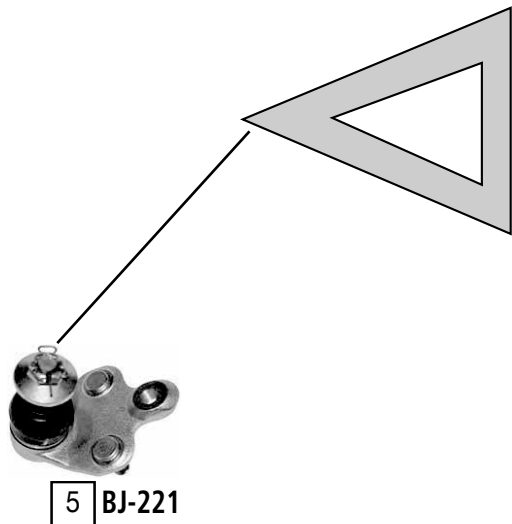
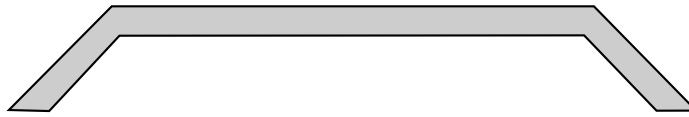
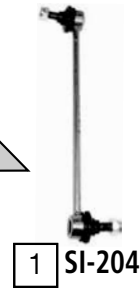

Ref	JAPANPARTS CODE	Description	OEM	Measures	Ref	JAPANPARTS CODE	Description	OEM	Measures
1	SI-204	stabiliser link	48820 47010	L:285	4	RD-250	axial joint	45503 47030	th:MM14x1.5R L:280
2	TI-2020	tie rod end left	45047 49075	c:12 th:FM14x1.5R	5	BJ-221	ball joint	43330 49055	c:15
3	TI-2021	tie rod end right	45046 49145	c:12 th:FM14X1.5R					

PRIUS (ZVW30)

01/2009 ->

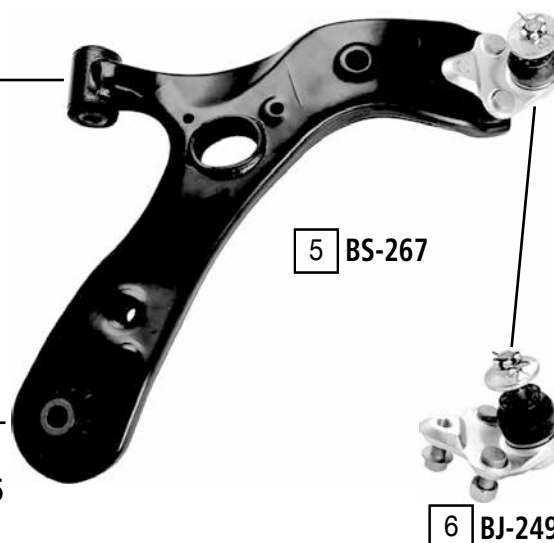

Ref	JAPANPARTS CODE	Description	OEM	Measures	Ref	JAPANPARTS CODE	Description	OEM	Measures
1	SI-235	stabiliser link	48820 02070	L:360	5	BS-267	TCA right wbj	48068 47050	c:15
2	TI-2028	tie rod end left	45047 49165	c:12.1 th:FM14X1.5R	6	BJ-249	ball joint	43330 49185	c:15
3	TI-2027	tie rod end right	45046 49225	c:12.1 th:FM14X1.5R	7	RU-252	silentblock for TCA	Part of	di:16.2 do:41
4	BS-266	TCA left wbj	48069 47050	c:15	8	RU-2025	silentblock for TCA	Part of	di:16.2 do:68

RAV 4 I (SXA1\_)

04/1994 - 06/2000



8 RU-220

8 RU-220



7 TI-259



6 RD-290



6 RD-290



7 TI-259



4 BS-240

LOWER



5 BS-241



3 BJ-241



3 BJ-241

Ref	JAPANPARTS CODE	Description	OEM	Measures	Ref	JAPANPARTS CODE	Description	OEM	Measures
1	SI-298	Stabiliser Link	48820 33010	L:60.5	5	BS-241	TCA Right	48068 42010	
2	SI-232	Stabiliser Link	48820 42010	L:63	6	RD-290	Axial Joint	45503-29365	th:MM14X1.5R L:315
3	BJ-241	Ball Joint	43330-49025	c:17.5	7	TI-259	Tie Rod End	45046 19175	c:12.7 th:FM14X1.5R
4	BS-240	TCA Left	48069 42010		8	RU-220	Stabiliser Mounting	48815-10060	

RAV 4 II (XA2)

07/2000 - 03/2006

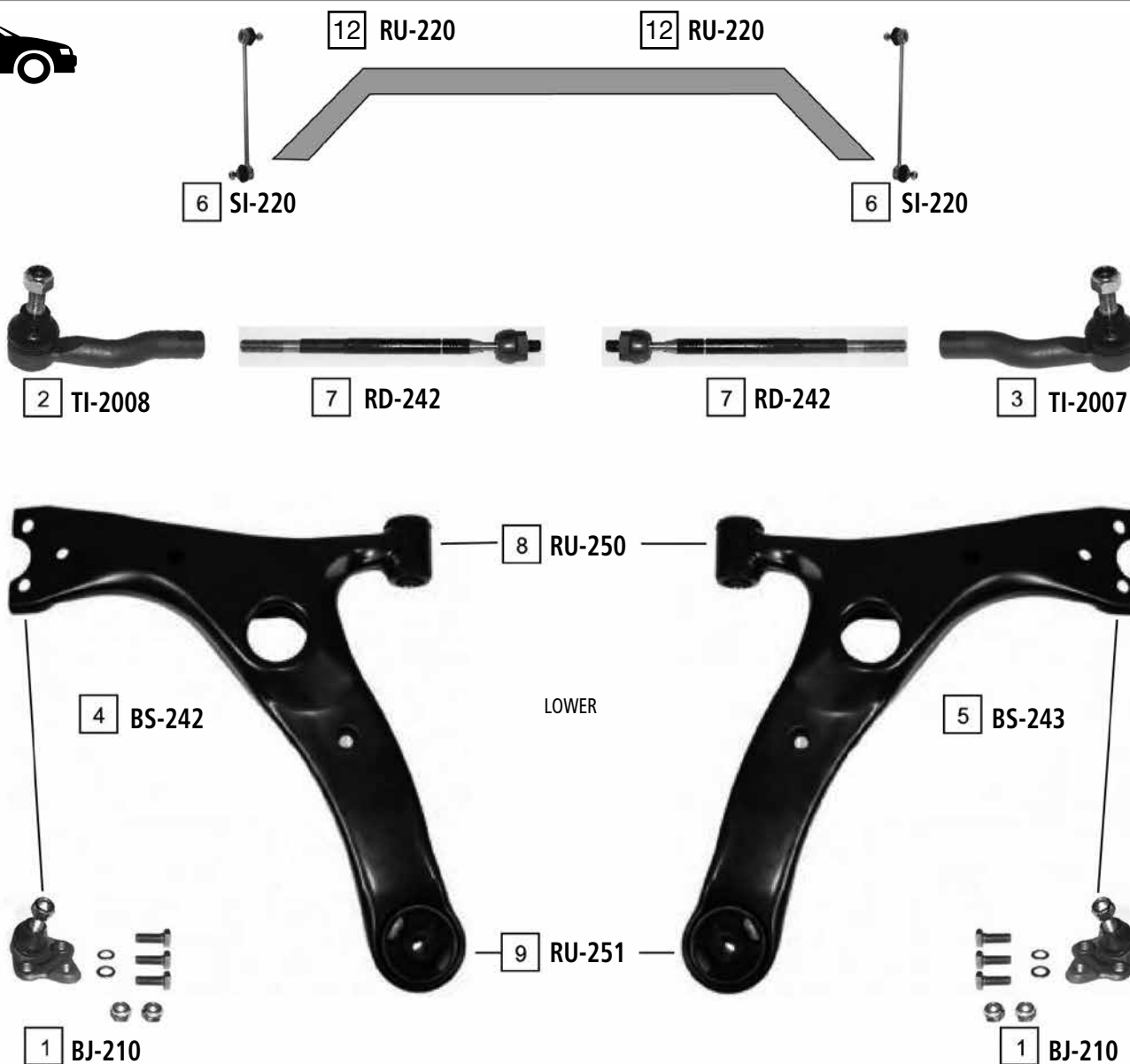

Ref	JAPANPARTS CODE	Description	OEM	Measures	Ref	JAPANPARTS CODE	Description	OEM	Measures
1	BJ-210	Ball Joint	43330 19115	c:15.3	7	RD-242	Axial Joint	45503-49055	th:MM14X1.5R L:297
2	TI-2008	Tie Rod End Left	45047-49025	c.12.7 th:FM15X1.25	8	RU-250	Silentblock For Susp.Arm	Part of BS-242/BS-243	
3	TI-2007	Tie Rod End Right	45046-49095	c.12.7 th:FM15X1.5R	9	RU-251	Silentblock For Susp.Arm	Part of BS-242/BS-243	
4	BS-242	TCA Left Wbj	48069-42040		10	SI-234	Stabiliser Link Left	48840 42010	L:100
5	BS-243	TCA Right Wbj	48068-42040		11	SI-233	Stabiliser Link Right	48830 42010	L:100
6	SI-220	Stabiliser Link	48820 32010	L:285	12	RU-220	Stabiliser Mounting	48815-10060	

RAV 4 III (ACA3\_,ALA30,GSA33)

03/2006 ->

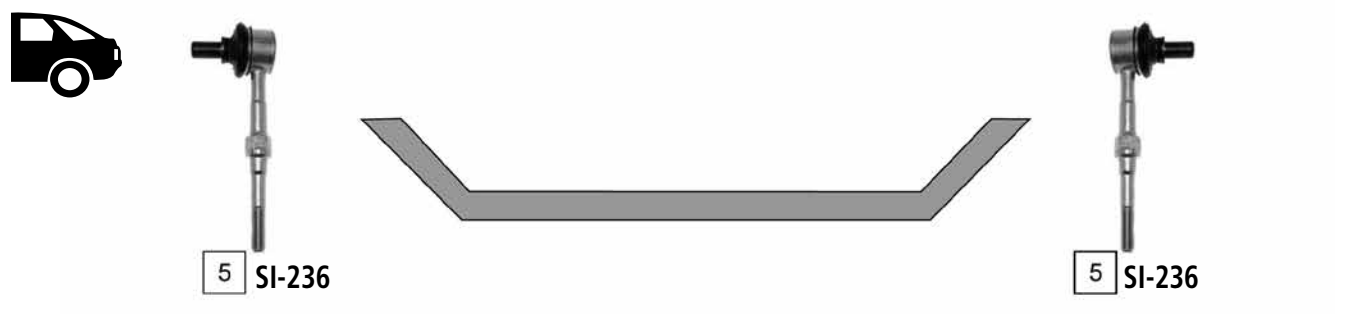
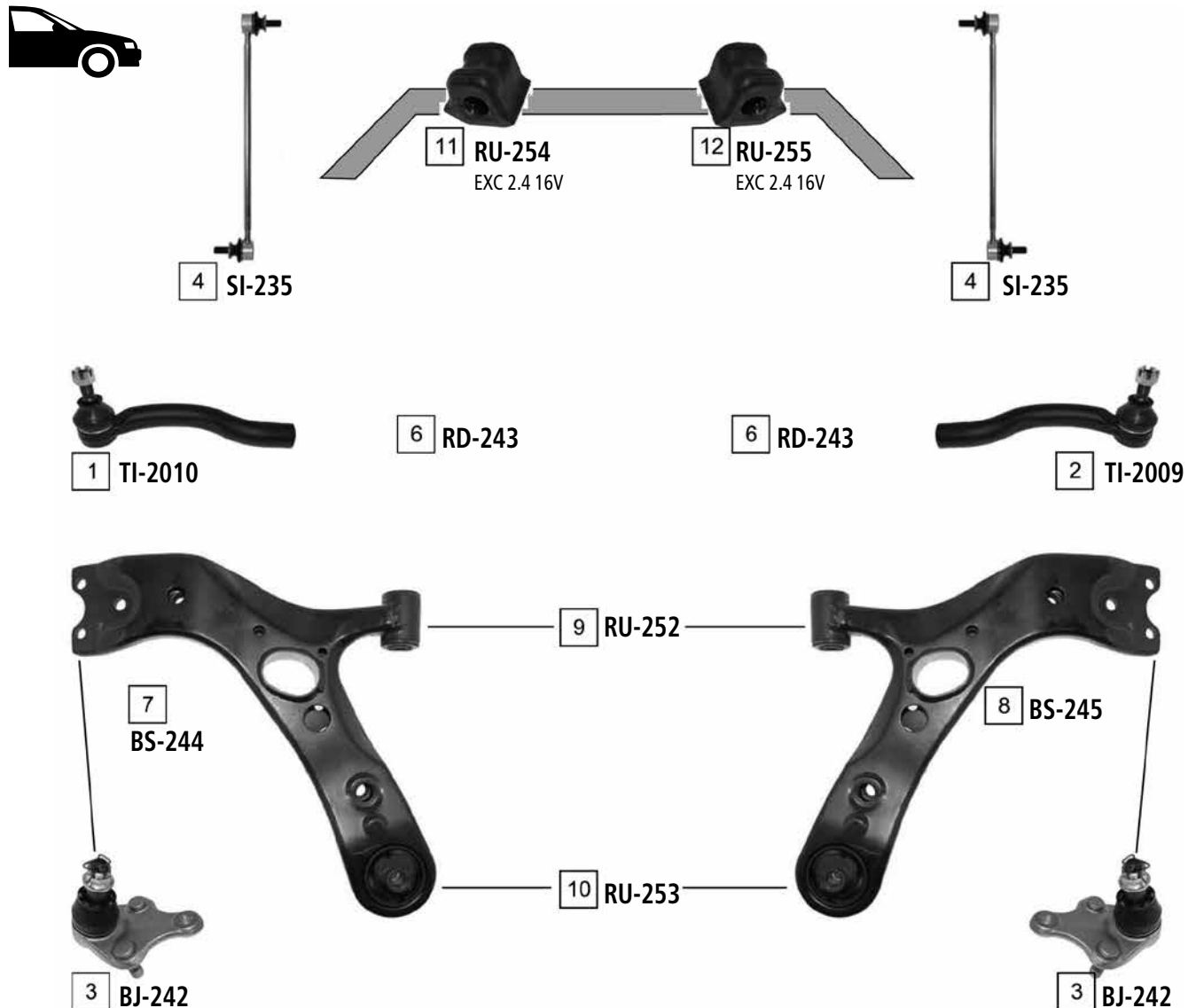

Ref	JAPANPARTS CODE	Description	OEM	Measures	Ref	JAPANPARTS CODE	Description	OEM	Measures
1	TI-2010	Tie Rod End Left	45047 49135	c:16.3 th:FM16X1.5R	7	BS-244	TCA Left Wbj	48069 42050	
2	TI-2009	Tie Rod End Right	45046 49195	c:16.3 th:FM16X1.5R	8	BS-245	TCA Right Wbj	48068 42050	
3	BJ-242	Ball Joint	43330 49095	c:17.7	9	RU-252	Silentblock For Susp.Arm	Part of BS-244/BS-245	
4	SI-235	Stabiliser Link	48820 42030	L:360	10	RU-253	Silentblock For Susp.Arm	Part of BS-244/BS-245	
5	SI-236	Stabiliser Link	48830 42020		11	RU-254	Stabiliser Mounting	48815 42090	d:23
6	RD-243	Axial Joint	Part of	th:MM16X1.5R	12	RU-255	Stabiliser Mounting	48815 42100	d.23



STARLET (\_P7\_)

10/1984 - 12/1989



1 TI-266



2 RD-211



2 RD-211



1 TI-266



3 LB-298

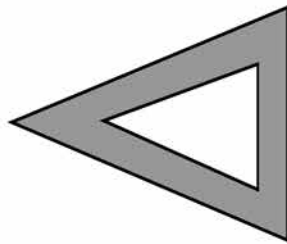

LOWER

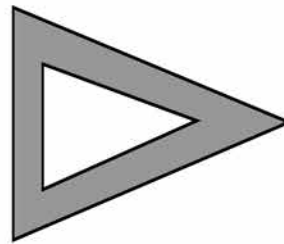

3 LB-298

Ref	JAPANPARTS CODE	Description	OEM	Measures	Ref	JAPANPARTS CODE	Description	OEM	Measures
1	TI-266	Tie Rod End	45504619165	c:12.8 th:FM12X1.25	3	LB-298	Ball Joint Lower	43330-19075	c:14.1
2	RD-211	Axial Joint	45503-19075	th: MM12X1.25R L:271					

STARLET (\_P8\_)  
 STARLET (EP91)

12/1989 - 03/1996  
 04/1996 - 03/1999

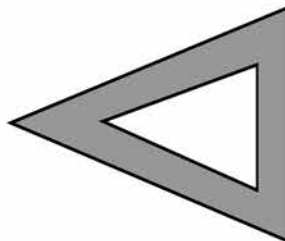
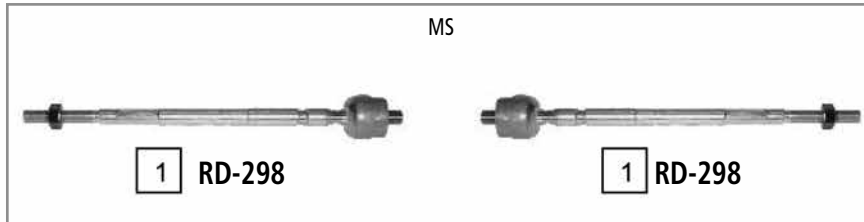

LOWER

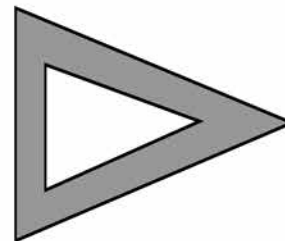

Ref	JAPANPARTS CODE	Description	OEM	Measures	Ref	JAPANPARTS CODE	Description	OEM	Measures
1	RD-298	Axial Joint	45503 19155	th.MM12X1.25R L.289	3	BJ-238R	Ball Joint	43330 19085	c.13.5
2	TI-298	Tie Rod End	45046-19205	c:12.7 th:FM12X1.25	4	BJ-238L	Ball Joint	43340-19025	

SUPRA (JZA80)

05/1993 - 08/1998



Ref	JAPANPARTS CODE	Description	OEM	Measures	Ref	JAPANPARTS CODE	Description	OEM	Measures
1	SI-237	Stabiliser Link	48810-28010	L:111	3	TI-2011	Tie Rod End Right	45460-19235	c.12.9 th:MM17X1.5L
2	TI-2012	Tie Rod End Left	45470-19065	c:12.9 th.MM17X1.5L	4	SI-238	Stabiliser Link	48820-24010	L:111

URBAN CRUISER (NCP11\_)

04/2009 ->

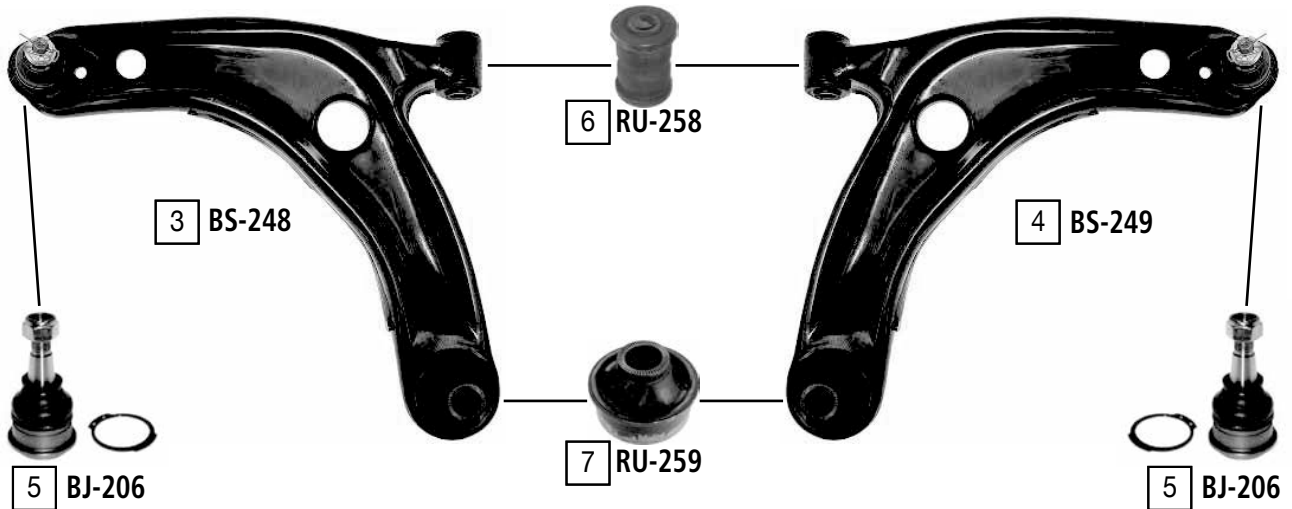
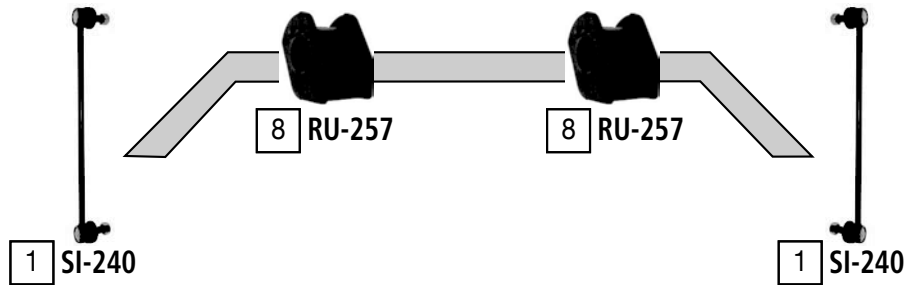

Ref	JAPANPARTS CODE	Description	OEM	Measures	Ref	JAPANPARTS CODE	Description	OEM	Measures
1	SI-240	stabiliser link	48820 0D010	L:360	5	BJ-206	ball joint lower	Part of	
2	TI-201	tie rod end	45046 09230	c:12.6 th:FM15X1.5R	6	RU-258	silentblock for TCA	Part of	
3	BS-248	TCA left wbj	48069 09040	c:13.4	7	RU-259	silentblock for TCA	Part of	
4	BS-249	TCA right wbj	48068 09040	c:13.4	8	RU-257	stabiliser mounting	48815 0D100	

VERSO (AUR2\_ZGR2\_)

04/2009 ->



1 SI-235

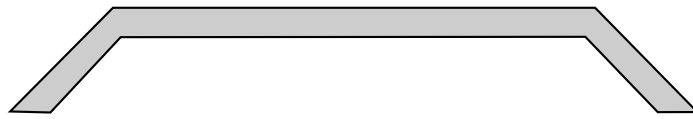

1 SI-235



2 TI-2024



3 TI-2025



4 BS-254



7 RU-252



5 BS-255



8 RU-2025

6 BJ-242

6 BJ-242

Ref	JAPANPARTS CODE	Description	OEM	Measures	Ref	JAPANPARTS CODE	Description	OEM	Measures
1	SI-235	stabiliser link	48820 02070	L:360	5	BS-255	TCA right wbj	48068 12300	c:17.5
2	TI-2024	tie rod end left	45047 09320	c:13.5 th:FM16x1.5R	6	BJ-242	ball joint	43330 49095	c:17.7
3	TI-2025	tie rod end right	45046 09660	c:13.5 th:FM16x1.5R	7	RU-252	silentblock for TCA	Part of	di:16.2 do:41
4	BS-254	TCA left wbj	48069 12300	c:17.5	8	RU-2025	silentblock for TCA	Part of	di:16.2 do:68

YARIS (\_CP10)  
YARIS VERSO (NC/LP2\_)

04/1999 - 12/2005  
11/1999 - 12/2005

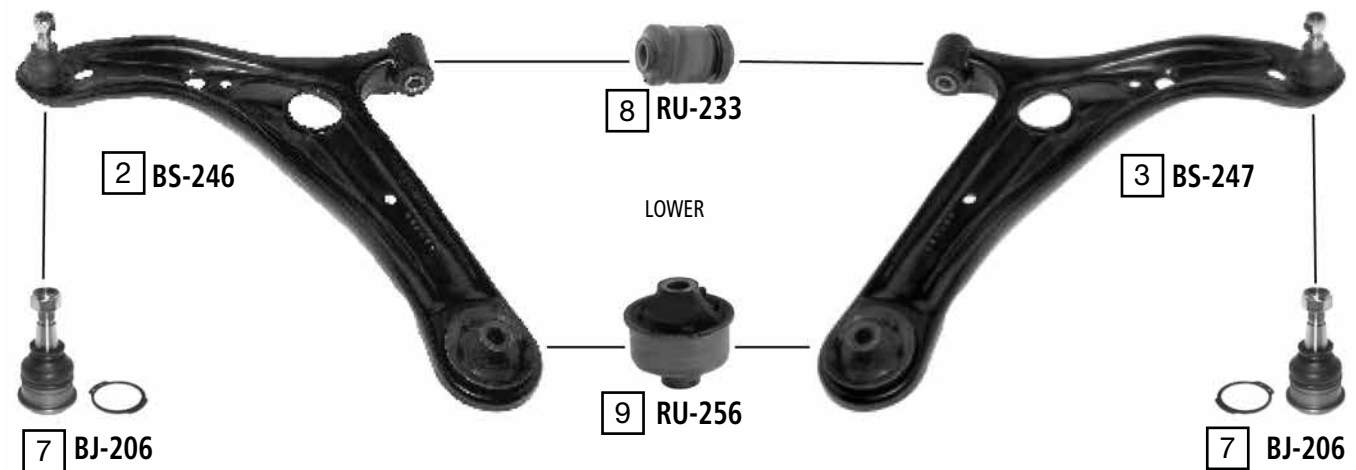
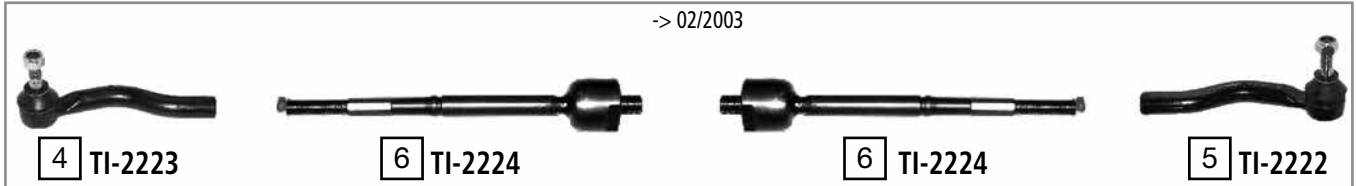

Ref	JAPANPARTS CODE	Description	OEM	Measures	Ref	JAPANPARTS CODE	Description	OEM	Measures
1	SI-239	Stabiliser Link	48819 52010	L:97	7	BJ-206	Ball Joint Lower	Part of BS-246/BS-247	c:13.5
2	BS-246	TCA Left	48069-59035	c:13.6	8	RU-233	Silentblock For Susp.Arm	Part of BS-246/BS-247	d:32.5
3	BS-247	TCA Right	48068-59035	c:13.6	9	RU-256	Silentblock For Susp.Arm	Part of BS-246/BS-247	d:55
4	TI-2223	Tie Rod End Left	45047-59026	c:12.7 th.FM12X1.25	10	TI-259	Tie Rod End	45046 19175	c:12.7 th.FM14X1.5R
5	TI-2222	Tie Rod End Right	45046-59026	c:12.7 th.FM12X1.25R	11	RD-245	Axial Joint	45503 59055	th.MM14X1.5R L:341
6	TI-2224	Axial Joint	45503-59045	th.MM14X1.5R L:242	12	RD-244	Axial Joint	45503 0D030	th:MM14X1.5R L:248

YARIS II (KSP90,NLP90,SCP90)

11/2005 ->

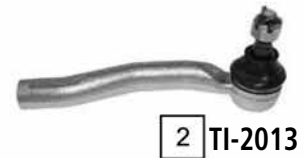
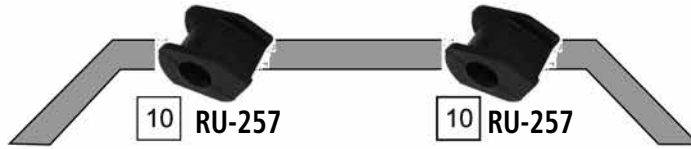

Ref	JAPANPARTS CODE	Description	OEM	Measures	Ref	JAPANPARTS CODE	Description	OEM	Measures
1	TI-2014	Tie Rod End Left	45047 09220	c.12.7 th:FM14X1.5R	6	BS-249	TCA Right Wbj	48068 09040	
2	TI-2013	Tie Rod End Right	45046 09480	c.12.7 th:FM14X1.5R	7	BJ-206	Ball Joint Lower	Part of BS-248/BS-249	c.13.5
3	SI-240	Stabiliser Link	48820 0D010	L:360	8	RU-258	Silentblock For Susp.Arm	Part of BS-248/BS-249	
4	RD-246	Axial Joint	Part of 45503-52070		9	RU-259	Silentblock For Susp.Arm	Part of BS-248/BS-249	
5	BS-248	TCA Left Wbj	48069 09040		10	RU-257	Stabiliser Mounting	48815 0D100	d:24

ASIA MOTORS	JAPANPARTS				
0K550-32-450	TI-A03L	96261378	TI-C08	96653351	RU-W14
0K550-32-510	TI-A03R	96261379	TI-C07	96810751	RU-C01
0K710-32-240	TI-A04	96268439	BS-D02	96815893	BS-C03
0K710-34-510	BJ-314	96268440	BS-D01	96819161	BS-C01
0K710-34-540	BJ-313	96268454	BS-D04	96819162	BS-C02
AA92A-59-032	BJ-314	96268455	BS-D03	96852964	BJ-C01
KJ01-32-631B	TI-A51	96275018	TI-D51L	96870465	BS-C03
Z1G1-32-310	TI-A52	96275019	TI-D51R	96970074	RU-D10
CHEVROLET	JAPANPARTS	9630-0048	BJ-D54	96970075	RU-D09
13 272 606	BS-W03	96300222	SI-D04	K9018-2694	CJ-D02L
13219090	RU-D06	96300222	SI-C09	K9018-2695	CJ-D02R
13219141	SI-D05	96300627	SI-D03	KBJ-R45	TI-D99
13230774	RU-D07	96300648	BJ-D54	KBJ029	TI-D56
13272605	BS-W02	96316765	CJ-803	CHRYSLER	JAPANPARTS
13278358	RD-D04	96328434	RU-D08	04656730AH	BS-C09
13278359	TI-W00	96378346	RU-C08	04656731AH	BS-C10
324038	TI-D51R	96378347	BS-C08	04656932AA	RU-927
352123	CJ-D02L	96378348	BS-C07	04694760AA	BS-C13
4806304	SI-C01	9639 1856	RU-W03	04743041AC	RU-928
4806305	SI-C02	96391850	BS-C06	04743935AD	RD-907
520672	RD-D52	96391851	BS-C05	04762861AA	TI-C09
520808	RD-C02	96391876	SI-C09	04895483AA	SI-914
520838	RD-D52	96403099	SI-C07	05093857AA	TI-C09
520898	RD-D53	96403100	SI-C08	05272506AA	RU-929
521136	TI-D55	96407485	TI-C06	272084	RU-C12
521564	RD-C04	96407486	TI-C05	4443405	BJ-C06
5272098	RU-C13	96415063	BS-C06	4449553	BJ-C06
93740621	RD-C04	96415064	BS-C05	4656 934AB	SI-911
93740701	RD-C02	96431044	RU-C09	4656010	BJ-C05
93740710	TI-C02	96440010	BS-W00	4656010AB	BJ-C05
93740722	TI-C03	96440011	BS-W01	4656010AE	BJ-C05
93740723	TI-C04	96474040	RU-W09	4656012AB	RU-C11
93741092	TI-D99	96474041	RU-W10	4656012AC	RU-C11
94786917	BJ-D51	96474042	RU-W11	4656730AH	RU-C10
95947829	SI-D08	96474043	RU-W12	4656730AH	BS-C09
95967285	TI-D01	96490218	BJ-C03	4656731AH	RU-C10
95967294	RD-D05	96518121	RU-W00	4656731AH	BS-C10
9612-9753	TI-D60	96535081	BS-C03	4684120	RU-C16
96205809	TI-D60	96535082	BS-C04	4694 761AC	BS-C14
96207628	SI-D02	96535089	BJ-C02	4694747	BJ-C06
96213117	BS-D06	96611265	CJ-803	4694760	BS-C13
96213118	BS-D05	96626150	SI-C03	4694760-C	BS-C13
96213119	BJ-D55	96626247	SI-C01	4694760AC	RU-C15
96225858	SI-C04	96626248	SI-C02	4694760AC	BS-C13
96225859	SI-C05	96626667	TI-C01	4694760AC	RU-C14
96261107	RU-C09	96639904	SI-D06	4694761	BS-C14
96261108	BJ-C04	96639905	SI-D07	4694761-C	BS-C14
		96639918	BJ-D01	4694761AC	RU-C15



**CROSS REFERENCE LIST**  
**VERGLEICHSLISTE**  
**LISTA DE REFERENCIAS CRUZADES**  
**LISTE DE COMPARAISON**  
**LISTA DI COMPARAZIONE**

4694761AC	RU-C14	07846485	TI-D51R	96225858	SI-C04
4728884	BS-C11	07846495	TI-D51L	96225859	SI-C05
4728885	BS-C12	07848281	RD-D02	96261107	RU-C09
4743 094AA	RU-C18	07848282	RD-D03	96261108	BJ-C04
4743095-AA	RU-C17	1603148	SI-D01	96261378	TI-C08
4743669AA	SI-C11	26001806	TI-D51R	96261379	TI-C07
4743669AB	SI-C11	26001807	TI-D51L	96268439	BS-D02
4762861-AA	TI-C09	352335	RU-D02	96268440	BS-D01
4766 866AA	SI-917	352349	RU-D01	96268454	BS-D04
4766 910AG	BS-919	402645	RU-D03	96268455	BS-D03
4766 911AG	BS-918	4443003000	BJ-S01	96275018	TI-D51L
4766542-AA	BS-C15	4443003010	BJ-S01	96275019	TI-D51R
4766542AA	BJ-C07	4443003011	BJ-S01	96275798	SI-C06
4766543-AA	BS-C16	4450505000	BJ-S02	96298000	RU-D05
4766543AA	BJ-C07	4450505001	BJ-S02	96300222	SI-D04
4782716AA	SI-915	4475005000	SI-S01	96300627	SI-D03
4797706	TI-C11	4475005001	SI-S01	96300648	BJ-D54
5066373AA	TI-C12	45200-A70B00	CJ-803	96305974	BS-D02
5066373AB	TI-C12	4666005500	TI-S01	96305975	BS-D01
5201-3468AB	TI-916	4666005501	TI-S01	96316765	CJ-803
52088 636AD	BS-917	48810-A78B00	TI-D55	96322618	RU-W02
52088437	SI-904	48830-A78B00	RD-D51	96378346	RU-C08
52088520	TI-J015	48830A78B00000	RD-D51	96378347	BS-C08
52088636AG	BS-917	520672	RD-D52	96378348	BS-C07
52088637AD	BS-916	520838	RD-D52	96380613	RU-C07
52088637AG	BS-916	520898	RD-D53	96391850	BS-C06
5272098	RU-C13	521255	RD-D54	96391851	BS-C05
5272190	SI-912	521257	RD-D54	96403099	SI-C07
5272324AB	SI-910	521564	RD-C04	96403100	SI-C08
5274470	TI-C10	56820-11000	TI-502	96407485	TI-C06
68028 831AC	RD-908	90 235 040	RU-D02	96407486	TI-C05
68033 171AB	TI-919	90193117	RU-D01	96415063	BS-C06
83500202	TI-J002	90250348	RU-W05	96415064	BS-C05
83500202	TI-J001	90250437	RU-W07	96431044	RU-C09
DA782561AE	CJ-902	90334546	RU-D02	96437817	RU-W13
DA782612AC	CJ-901	93740621	RD-C04	96446586	TI-D60
DA782613AC	CJ-900	93740722	TI-C03	96457360	RU-W08
DA782665AB	BS-914	93741074	RD-D54	96490218	BJ-C03
DA782666AB	BS-915	94788122	BJ-051	96492383	RU-D05
<b>CITROEN</b>	<b>JAPANPARTS</b>	94788122	BJ-D51	96535081	BS-C03
1813E2	RU-291	95994977	SI-C06	96535082	BS-C04
5131 C9	RU-235	96129839	SI-D01	96535087	RU-C05
<b>DACIA</b>	<b>JAPANPARTS</b>	96205808	TI-D60	96535088	RU-C06
352124	CJ-D02R	96205809	TI-D60	96535089	BJ-C02
381763	TI-210	96207628	SI-D02	96549921	RU-W04
381764	TI-207	96213119	BJ-D55	96568585	RU-W01
<b>DAEWOO</b>	<b>JAPANPARTS</b>	96213130	RU-W15	96611265	CJ-803
04 02 642	RU-W06	96213131	RU-W16	96815893	BS-C03

96870465	BS-C03	45046-87503	TI-607R	4504787783	TI-606L
D96422324	BS-C07	45046-87504	TI-607R	4504797203	TI-609L
D96423220	BS-C08	45046-87580	TI-607R	4504797204000	TI-614
KBJ029	TI-D56	45046-87601	TI-602R	45047B9160	TI-609L
<b>DAIHATSU</b>	<b>JAPANPARTS</b>	45046-87680	TI-602R	45056-87501	TI-601R
12361-87306	RU-601	45046-87701	TI-604	45056-87502	TI-601R
12361-87603	RU-602	45046-87707	TI-613	45057-87501	TI-601L
12371-87607	RU-603	45046-87780	TI-609R	45057-87502	TI-601L
2001-4541	BJ-613R	45046-87781	TI-606R	45406-19016	TI-624
2713-4741	TI-601L	45046-97203	TI-611	45406-19055	TI-624
2713-4742	TI-601R	45046-97204-000	TI-617	45406-19065	TI-624
2713-4751	TI-601R	45046-B9080	TI-619	45406-19075	TI-624
2713-4752	TI-601L	45046-B9320	TI-619	45460-19125	SO-622
42236-81400	RU-603	4504687285	TI-609R	45460-87401	RD-612
43068-87401	BS-603	4504687402	TI-610	45503-10020	RD-201
43069-87401	BS-602	4504687707000	TI-613	45503-19015	RD-201
43308-12020	LB-605	4504687782	TI-606R	45503-87102	RD-600
4330812030	LB-609	4504687783	TI-606R	45503-87210	RD-611
4330819035	LB-609	4504687784	TI-606R	45503-87215	RD-611
43330-29115	BJ-625	4504697203	TI-609R	45503-87701	RD-201
43330-87501	BJ-613R	4504697204000	TI-613	45503-87702	RD-602
43330-87580	BJ-613R	45046B9220	TI-609R	45503-87703	RD-603
43330-87581	BJ-611	45047-19055	TI-604	45503-87705	RD-604
43330-87582	BJ-613R	45047-87280	TI-609L	45503-87706	RD-606
43340-29075	LB-699	45047-87281	TI-609L	45503-87708	RD-605
43340-29095	BJ-625	45047-87303	TI-602L	45503-87709	RD-606
43340-87581	BJ-611	45047-87380	TI-602L	45503-87710	RD-609
43350-29035	BJ-629	45047-87501	TI-601R	45503-87711	RD-605
43350-29036	BJ-625	45047-87502	TI-601R	45503-87714	RD-610
43350-29036	BJ-629	45047-87503	TI-607L	45503-97201	RD-613
43360-29055	BJ-629	45047-87580	TI-607L	45503-97203	RD-607
43360-29056	BJ-629	45047-87583	TI-607L	45503-97203-000	RD-607
45046-19065	TI-205	45047-87584	TI-607L	45503-97204	RD-608
45046-19095	TI-205	45047-87680	TI-615	45503-97204-000	RD-608
45046-19135	TI-205	45047-87685	TI-608	45503-97401	RD-615
45046-29075	TI-205	45047-87706	TI-614	45503-B1010	RD-614
45046-29095	TI-604	45047-87780	TI-609L	4550319045	RD-201
45046-29095	TI-605	45047-87781	TI-606L	4550387710000	RD-609
45046-87203	TI-699	45047-87782	TI-606L	48068-87208	CJ-600
45046-87280	TI-604	45047-87784	TI-606L	48068-87209	CJ-609
45046-87281	TI-604	45047-97203	TI-612	48068-87403	BS-603
45046-87282	TI-609R	45047-97204-000	TI-616	48068-87501-000	CJ-608
45046-87283	TI-609R	45047-B9070	TI-618	48068-87705	CJ-605R
45046-87302	TI-603R	45047-B9270	TI-618	48068-87706	CJ-699
45046-87303	TI-602R	4504787282	TI-609L	48068-87711	BS-601
45046-87401	TI-610	4504787303	TI-202L	48068-97202	CJ-603
45046-87501	TI-601L	4504787380	TI-202L	48068-97203	CJ-605
45046-87502	TI-601L	4504787706000	TI-614	48068-B1020	BS-607

**CROSS REFERENCE LIST**  
**VERGLEICHSLISTE**  
**LISTA DE REFERENCIAS CRUZADAS**  
**LISTE DE COMPARAISON**  
**LISTA DI COMPARAZIONE**

48068-B1080	BS-607	50805-S04-000	RU-460	51230SNAA02	BJ-420
48068-B4010	BS-605	50805-SR3-951	RU-406	51230SNAA03	BJ-420
4806887711000	BS-601	50810-SM4-000	RU-402	51270-SB0-003	BJ-405
48069-87209	CJ-610	50810-SR3-010	RU-402	51270-SBO-013	BJ-405
48069-87403	BS-602	50810-SR3-030	RU-402	51270-SE0-043	BJ-400
48069-87501-000	CJ-607	50810-SR3-983	RU-461	51270-SF1-003	TI-486
48069-87706	CJ-698	50820-SR3-J02	RU-403	51306 SMG E02	RU-432
48069-87710	BS-600	50820-SR3-J11	RU-407	51306-S04-003	RU-462
48069-97202	CJ-604	50820-SR3-J11	RU-405	51306-S04-N01	RU-446
48069-97203	CJ-606	50824-S04-013	RU-459	51306-S6D-005	RU-429
48069-B1020	BS-606	50841-SR3-030	RU-400	51306-S7B-014	RU-449
48069-B1080	BS-606	50841-SR3-984	RU-457	51306SWAA01	RU-455
48069-B4010	BS-604	50842-SR3-030	RU-401	51310-SP0-003	SI-403
4806987710000	BS-600	50842-SR3-030	RU-458	51312-SR3-000	CJ-410
48802-87703	SI-600	50842-SR3-984	RU-458	51320 TF0 003	SI-444
4880287703000	SI-600	51210S6DG10	BJ-403	51320-S04-003	SI-404
48815-20026	RU-607	51215S6DG10	BJ-403	51320-S2G-003	SI-429
48815-87601	RU-608	51220 TA0 A02	BJ-411	51320-S2H-003	SI-425
48820-B2010	SI-605	51220-S04-003	BJ-416	51320-S30-003	SI-431
48821-B1010	SI-601	51220-S5A-003	BJ-403	51320-S5A-003	SI-415
48821-B1030	SI-601	51220-SAA-013	BJ-407	51320-S84-A01	SI-405
48822-87401	SI-603	51220-SB0-003	BJ-404	51320-SAA-003	SI-427
4882287604	SI-604	51220-SD4-004	BJ-499	51320-SAA-J01	SI-439
48831-B1010	SI-602	51220-SD4-013	BJ-499	51320-SEA-E01	SI-409
48831-B1020	SI-602	51220-SD4-023	BJ-499	51320-SMG-E01	SI-400
49068-97202	CJ-601	51220-SE0-000	BJ-404	51320-SP0-003	SI-428
49069-97202	CJ-602	51220-SK7-013	BJ-404	51320-ST7-003	SI-401
90043-85046	RU-605	51220-SL5-003	BJ-499	51320-STK-A01	SI-433
90043-85049	RU-606	51220-SL5-013	BJ-499	51320-TA0-A01	SI-435
90045-40165	RU-609	51220-SM1-A01	BJ-406	51321-S2G-003	SI-430
<b>DR</b>	<b>JAPANPARTS</b>	51220-SM1-A02	BJ-406	51321-S2H-003	SI-424
722010037	SI-003	51220-SM4-003	BJ-406	51321-S5A-003	SI-414
<b>FORD</b>	<b>JAPANPARTS</b>	51220-SM4-013	BJ-406	51321-S84-A01	SI-406
1020174	TI-336	51220-SR3-003	BJ-416	51321-SAA-003	SI-426
1044014	RD-311	51220-STK-A01	BJ-410	51321-SAA-J01	SI-438
1202548	TI-345	51220S5AJ10	BJ-403	51321-SEA-E01	SI-410
1202549	TI-344	51220S84A01	BJ-406	51325-TA0-A01	SI-434
13000384	RU-323	51220S84A02	BJ-406	51350 SWA E01	BS-439
1540724	BS-329	51220SB0023	BJ-404	51350 TA0 A00	BS-437
1540725	BS-328	51220SD4000	BJ-499	51350 TF0 030	BS-441
1545338	TI-355	51220SE0003	BJ-404	51350-000-010	CJ-403
1545339	TI-356	51220SF1000	BJ-404	51350-634-003	CW-401
1545457	RD-334	51220SH3003	BJ-404	51350-659-010	CJ-402
1603120	BJ-D51	51220SK7003	BJ-404	51350-659-325	CJ-402
8V51 3C437 AA	TI-356	51220SM0003	BJ-406	51350-671-000	CW-401
8V513C367AA	TI-355	51220SNAA02	BJ-421	51350-671-003	CW-401
8V513L519AA	RD-334	51220SNAA03	BJ-421	51350-671-013	CW-401
<b>HONDA</b>	<b>JAPANPARTS</b>	51230-S2A-000	BJ-412	51350-671-033	CW-401

51350-671-405	CW-401	51355-SH3-020	CJ-413	51360-SEA-E01	BS-404
51350-692-000	CW-498	51355-SK3-000	TI-489	51360-SMG-E05	BS-416
51350-692-010	CW-498	51355-SM4-040	CJ-401	51360-SNA-A03	BS-444
51350-692-020	CW-498	51355-SV7-A00	CJ-407	51360-SR3-020	BS-408
51350-692-030	CW-498	51355S1AE00	RU-417	51360S04G00	RU-426
51350-692-040	CW-498	51355S84A00	CJ-409	51360S04G00	RU-428
51350-692-050	CW-498	51355SH3010	CJ-413	51360S10G00	RU-437
51350-692-640	CW-498	51355SK7000	CJ-413	51360S10G00	RU-436
51350-S04-000	BS-413	51355SK7010	CJ-413	51360S50G01	BJ-409
51350-S10-G00	BS-421	51355SM4030	CJ-401	51360SAAE01	BJ-407
51350-S2H-G01	BS-425	51355SN7010	BJ-400	51360SAAE01	RU-440
51350-S50-G01	BS-433	51355SV4000	CJ-407	51360SAAE01	RU-441
51350-S6D-G00	BS-415	51360 SWA E01	BS-438	51360SK7000	CJ-414
51350-S9A-010	BS-423	51360 TA0 A00	BS-436	51360SR3A01	BS-408
51350-S9A-020	BS-423	51360 TF0 030	BS-440	51360SR3A02	BS-408
51350-SA0-00	CJ-403	51360-000-010	CJ-403	51360ST7010	BS-408
51350-SA0-010	CJ-403	51360-634-003	CW-401	51361-SB2-013	TI-481
51350-SA0-020	CJ-403	51360-659-010	CJ-402	51361SB2672	TI-481
51350-SA0-030	CJ-403	51360-659-325	CJ-402	51361SB6931	TI-481
51350-SA0-325	CJ-403	51360-671-000	CW-401	51365-S1A-E00	CJ-408
51350-SA5-000	CW-489	51360-671-003	CW-401	51365-S84-A00	CJ-408
51350-SA5-003	CW-489	51360-671-013	CW-401	51365-SH3-020	CJ-414
51350-SA5-010	CW-496	51360-671-033	CW-401	51365-SK3-000	TI-488
51350-SA5-013	CW-489	51360-671-405	CW-401	51365-SM4-040	CJ-400
51350-SA5-013A	BJ-498	51360-692-010	CW-498	51365-SV7-A00	CJ-406
51350-SA5-020	CW-496	51360-692-020	CW-498	51365SH3010	CJ-414
51350-SAA-E01	BS-427	51360-692-030	CW-498	51365SK7010	CJ-414
51350-SCA-S00	BS-423	51360-692-040	CW-498	51365SM4030	CJ-400
51350-SEA-E01	BS-405	51360-692-050	CW-498	51365SV4000	CJ-406
51350-SMG-E05	BS-417	51360-692-640	CW-498	51391 S5A 024	RU-430
51350-SNA-A03	BS-445	51360-S04-G00	BS-412	51391 TA0 A01	RU-451
51350-SR3-020	BS-409	51360-S04-G00 S2	RU-426	51391-S04-005	RU-427
51350S04000	RU-426	51360-S10-G00	BS-420	51391-SEA-004	RU-420
51350S04000	RU-428	51360-S2H-G01	BS-424	51391S7A005	RU-430
51350S04G00	BS-413	51360-S2H-G02	BS-424	51392 SR3 014	RU-424
51350S10G00	RU-437	51360-S50-G01	BS-432	51392 SR3 024	RU-424
51350S10G00	RU-436	51360-S6D-G00	BS-414	51392-S5A-004	RU-431
51350S50G01	BJ-409	51360-S9A-010	BS-422	51392-SR3-004	RU-409
51350SAAE01	RU-440	51360-SA0-000	CJ-403	51393-SEA-004	RU-421
51350SAAE01	BJ-407	51360-SA0-010	CJ-403	51393-SM4-013	RU-415
51350SAAE01	RU-441	51360-SA0-020	CJ-403	51393SH3003	RU-439
51350SR3A01	BS-409	51360-SA0-030	CJ-403	51395 SMG E03	RU-435
51350SR3A02	BS-409	51360-SA5-003	CW-494	51395-SR3-N02	RU-410
51350ST7010	BS-409	51360-SA5-010	CW-493	51395SMGE05	RU-435
51351-SB2-013	CW-495	51360-SA5-013	CW-494	51396 SMG E03	RU-434
51351-SB2-672	CW-495	51360-SA5-020	CW-493	51396-SR3-N02	RU-411
51351-SB6-931	CW-495	51360-SAA-E01	BS-426	51396SMGE05	RU-434
51355-S1A-E00	CJ-409	51360-SCA-S00	BS-422	51398 SMG E01	RU-433

**CROSS REFERENCE LIST**  
**VERGLEICHSLISTE**  
**LISTA DE REFERENCIAS CRUZADAS**  
**LISTE DE COMPARAISON**  
**LISTA DI COMPARAZIONE**

51450-S04-023	BS-411	51460-SH3-023-WA	TI-482	52321-S5A-013	SI-416
51450-S10-020	BS-419	51460-SP0-033	BS-428	52321-S9A-003	SI-422
51450-S1A-E01	BS-401	51460-SR3-023	BS-406	52321-SNA-A01	SI-418
51450-S84-A01	BS-401	51460-SV4-A00	BJ-495	52321-SWA-A01	SI-422
51450-SDA-A01	BS-403	51460-SZ3-013	BS-430	52325-S84-A01	SI-408
51450-SGO-020	TI-485	51460S01023	RU-425	52325-TA0-A01	SI-436
51450-SH3-000	TI-483	51460S1AE01	RU-418	52335STRG01	RU-416
51450-SH3-010	TI-483	51460SDAA01	BJ-401	52350-SEA-000	CJ-415
51450-SH3-023-WA	TI-482	51460SH3020	TI-482	52365-SM4-005	RU-413
51450-SM4-023	BJ-496	51460SH3023	TI-482	52370-SR3-J00	RU-416
51450-SP0-033	BS-429	51460SH3030	TI-482	52390 SH3 030	CJ-411
51450-SR3-023	BS-407	51460SK7043	TI-482	52390-S30-003	BS-443
51450-SZ3-013	BS-431	51460SR0A02	BS-406	52390-SE0-013	CW-490
51450S01023	RU-425	51460SR3003	BS-406	52390-SE0-023	CW-490
51450S01023	BS-411	51460SR3013	BS-406	52390-SE0-033	CW-490
51450S01A02	BS-411	51460SR3A02	BS-406	52390-SE0-043	CW-490
51450S04013	BS-411	51460SV4A00	BJ-400	52390-SM1-A03	CJ-405
51450S1AE01	RU-418	51469-SE0-000	CW-491	52390-SP0-013	CW-410R
51450SDAA01	BJ-401	51469-SE0-003	CW-491	52390-SR3-000	CJ-412
51450SGO020	BS-424	51510 TA0 A03	BS-435	52390SM4A04	CJ-405
51450SH3020	TI-483	51510TA0A03	BJ-401	52390SR3000	CJ-411
51450SH3023	RU-438	51520 TA0 A03	BS-434	52393-SR0-004	RU-445
51450SH3023	TI-483	51520TA0A03	BJ-401	52393-SR3-004	RU-445
51450SH3030	TI-483	51810 SH3 004	RU-423	52400-S30-003	BS-442
51450SK7043	TI-483	51810-SDA-A01	RU-419	52400-SM1-A03	CJ-404
51450SR0A02	BS-407	51810-SM4-003	RU-414	52400-SP0-013	CW-410L
51450SR3003	BS-407	51810-SM4-004	RU-414	52400SH3030	CJ-412
51450SR3013	BS-407	51810SH3003	RU-423	52400SM4A04	CJ-404
51450SR3A02	BS-407	51810TA0A01	RU-419	52400SR3000	CJ-412
51450SV4000	BJ-496	51920-S6M-014	RU-447	52622-SH3-010	RU-444
51450SV4A00	BJ-496	51925-S6M-014	RU-448	53010 SWA A01	RD-427
51455SR3003	RU-422	52303SH3020	CJ-410	53010 SWC G01	RD-426
51455SR3004	RU-422	52306SDAA01	RU-456	53010 SWC G02	RD-426
51459-SE0-000	CW-492	52306SWAA01	RU-454	53010 TF0 003	RD-425
51459-SE0-003	CW-492	52320 S2H 003	SI-441	53010-S04-000	RD-409
51459-SE0-000	CW-492	52320 SWA A01	SI-443	53010-S04-J51	RD-409
51460 S01 023	BS-410	52320-S04-003	SI-413	53010-S10-000	RD-416
51460 S01 A02	BS-410	52320-S10-003	SI-421	53010-S2H-J01	RD-418
51460 S04 010	BS-410	52320-S30-003	SI-432	53010-S50-003	RD-423
51460 S04 023	BS-410	52320-S5A-013	SI-417	53010-S84-A01	RD-407
51460 SV4 000	BJ-495	52320-S84-A01	SI-407	53010-SAA-J01	RD-419
51460-S10-020	BS-418	52320-S9A-003	SI-423	53010-SDA-A01	RD-411
51460-S1A-E01	BS-400	52320-SNA-A01	SI-419	53010-SMG-E01	RD-414
51460-S84-A01	BS-400	52320-TA0-A01	SI-437	53010-SR3-010	RD-499
51460-SDA-A01	BS-402	52321 S2H 003	SI-440	53010-SS0-000	RD-498
51460-SGO-020	TI-484	52321 SWA A01	SI-442	53010-SV4-000	RD-413
51460-SH3-000	TI-482	52321-S04-003	SI-412	53010-SW5-000	RD-421
51460-SH3-010	TI-482	52321-S10-003	SI-420	53010-SW5-003	RD-422

53010-TA0-A01	RD-424	53540-SA0-003	TI-401	53560-SP0-023	TI-402L
53010S2HJ02	RD-418	53540-SA0-004	TI-401	53560-SR0-A01	TI-406L
53010SEL003	RD-419	53540-SAA-003	TI-419	53560-SR3-003	TI-406L
53010ST0000	RD-499	53540-SB0-003	TI-401	53560-SS0-003	TI-422
53011-SAA-J01	RD-420	53540-SB2-002	TI-401	53560-ST7-003	TI-406L
53011-SMG-E01	RD-415	53540-SB2-003	TI-401	53560-SV4-003	TI-407L
53011SEL003	RD-420	53540-SB2-013	TI-401	53560-SX0-003	TI-407L
53521-634-000	RD-401	53540-SC2-003	TI-401	53560-SZ3-003	TI-420
53521-671-000	RD-402	53540-SD4-003	TI-405R	53560S04003	BJ-416
53521-671-010	RD-402	53540-SDA-A01	TI-411	53560S04003	TI-406L
53521-689-000	RD-402	53540-SF1-004	TI-499	53560S04013	TI-406L
53521-689-003	RD-402	53540-SH3-003	TI-406R	53560S04013	BJ-416
53521-692-003	RD-403	53540-SH3-013	TI-406R	53560SELT01	TI-418
53521-S5A-003	RD-400	53540-SK3-E01	TI-487	53560SS0004	TI-422
53521-S9A-003	RD-417	53540-SM4-003	TI-404R	551360-692-000	CW-498
53521-SA0-003	RD-403	53540-SM4-004	TI-404R	77014000	RD-416
53521-SA5-000	RD-404	53540-SMG-003	TI-413	90112-SE0-000	SI-411
53521-SA5-003	RD-404	53540-SMJ-003	TI-415	GSJ 227	CW-495
53521-SB0-000	RD-406	53540-SP0-013	TI-402R	GSJ 228	TI-481
53521-SB0-003	RD-406	53540-SP0-023	TI-402R	GSJ 404	BJ-406
53521-SB2-003	RD-405	53540-SR0-A01	TI-406R	GSJ 424	BJ-496
53521-SB2-013	RD-405	53540-SR3-003	TI-406R	GSJ 499	BJ-416
53521-SD4-023	RD-497	53540-SS0-003	TI-423	GSV 1211	RD-410
53521-SE0-000	RD-403	53540-ST7-003	TI-406R	<b>HYUNDAI</b>	<b>JAPANPARTS</b>
53521-SE0-003	RD-403	53540-SV4-003	TI-407R	2181025700	RU-H51
53521-SE0-013	RD-403	53540-SX0-003	TI-407R	2183025700	RU-H50
53521-SE0-951	RD-403	53540-SX8-T01	TI-417	26001806	TI-D51R
53521-SF1-003	RD-406	53540-SZ3-003	TI-421	26001807	TI-D51L
53521-SH3-003	RD-409	535400-SC2-004	TI-401	458303K000	SI-H25
53521-SK3-003	RD-412	53540SC2004	TI-401	51760-1G000	BJ-H04
53521-SK7-003	RD-412	53540SELT01	TI-419	51760-2E000	BJ-H14
53521-SL4-014	RD-496	53540SS0004	TI-423	51760-38000	BJ-H08
53521-SM4-003	RD-410	53541-S5A-003	TI-400	51760-3K000	BJ-H10
53521-SM4-013	RD-410	53541-S7A-003	TI-400	517600Q000	BJ-K01
53521-SP0-004	RD-495	53560 TA0 A01	TI-428	517602H000	BJ-K01
53540 SWA A01	TI-430	53560 TF0 003	TI-426	52773-25100	RU-H54
53540 SWA A02	TI-430	53560-S1A-E01	TI-410	53503-21000	LB-H52R
53540 TA0 A01	TI-429	53560-S30-005	TI-424	54400-4A000	BS-H38
53540 TF0 003	TI-427	53560-SAA-003	TI-418	54400-4A820	BS-H40
53540-611-010	TI-401	53560-SD4-003	TI-405L	54401-4A000	BS-H37
53540-611-020	TI-401	53560-SDA-A01	TI-412	54401-4A820	BS-H39
53540-634-000	TI-401	53560-SH3-003	TI-406L	54403-38A00	BJ-H07
53540-659-003	TI-401	53560-SH3-013	TI-406L	54410-38000	BS-H28
53540-671-010	TI-401	53560-SM4-003	TI-404L	54410-43004	TI-H003
53540-679-004	TI-401	53560-SM4-004	TI-404L	54410-43005	TI-H003
53540-S1A-E01	TI-409	53560-SMG-003	TI-414	54417-43000	TI-H001
53540-S30-005	TI-425	53560-SMJ-003	TI-416	54417-43A00	LB-H77
53540-SA0-002	TI-401	53560-SP0-013	TI-402L	54417-44000	TI-H97

**CROSS REFERENCE LIST**  
**VERGLEICHSLISTE**  
**LISTA DE REFERENCIAS CRUZADAS**  
**LISTE DE COMPARAISON**  
**LISTA DI COMPARAZIONE**

54417-4A000	LB-H77	54500-4A801	BS-H44	545012Y000	BS-H49
5441743A00	BJ-513	5450002051	BS-H04	5450138010	BS-H29
5441743A01	BJ-513	545001C010	BS-H20	54502-21000	LB-H52L
5441743A01	LB-H77	5450022100	BJ-H54L	54502-24001	BS-H24
5441747000	BJ-513	5450029500	BJ-H55L	54502-26000	BS-H02
5441747000	LB-H77	545002C001	BS-H12	54502-3A100	BS-H33
544174A000	BJ-513	545002C002	BS-H12	54502-3A201	BS-H33
544174AA00	LB-H77	545002D002	BS-H14	54503-22A00	BJ-H57
544174AA00	BJ-513	545002H000	BS-K08	54503-24001	BS-H23
544174BA00	BJ-513	545002Y000	BS-H50	54503-25A00	BJ-H57
544174BA00	LB-H77	5450038010	BS-H30	54503-31600	BJ-H57
54420-38000	BS-H27	54501 29500	BJ-H55R	54503-34A00	LB-H64
54430-31000	BJ-H55	54501 2D002	BS-H13	54503-34A01	LB-H64
54430-31300	BJ-H55	54501 4H000	BS-H51	54503-38A00	BJ-H57
54430-3F600	BJ-H09	54501-02050	BS-H03	54503-3BA00	BJ-H01
54430-3K000	BJ-H07	54501-02052	BS-H03	54503-DA000	BJ-H01
54430-43004	TI-H002	54501-0X000	BS-H35	54510-43150	TI-H005
54430-43005	TI-H002	54501-0X200	BS-H35	54510-4B001	CJ-H02
54431-44000	TI-H98	54501-17000	BS-H21	5451043150	BJ-514
54440-H1000	BJ-H11	54501-1C000	BS-H19	5451043151	BJ-514
54443-3K000	RU-H21	54501-1E000	BS-H09	5451043151	TI-H005
54457-43000	TI-H001	54501-1E100	BS-H07	5451043152	RU-H14
5445743001	TI-H001	54501-1J500	BS-H45	5451043152	TI-H005
54500 4H000	BS-H52	54501-1J700	BS-H45	5451043152	BJ-514
54500-02050	BS-H04	54501-1P100	BS-H47	545104B001	RU-H13
54500-02052	BS-H04	54501-22000	BJ-H54R	54520-11011	LB-H51
54500-0X000	BS-H36	54501-22200	BJ-H54R	54520-14200	LB-H51
54500-0X200	BS-H36	54501-25000	BS-H05	54520-31600	BJ-H57
54500-17000	BS-H22	54501-26000	BS-H01	54524-43000	LB-H60
54500-1C000	BS-H20	54501-29000	BJ-H55R	54524-43001	LB-H60
54500-1E000	BS-H10	54501-2B100	BS-H25	54528-4AA10	BJ-H17
54500-1E100	BS-H08	54501-2C000	BS-H11	54530 3A200	BJ-H00
54500-1J500	BS-H46	54501-2D000	BS-H13	54530 3J000	BJ-H19
54500-1J700	BS-H46	54501-33000	BJ-H53R	54530-02050	BJ-H02
54500-1P000	BS-H48	54501-34000	BJ-H66R	54530-14200	LB-H51
54500-22000	BJ-H54L	54501-38000	BS-H29	54530-21000	LB-H52L
54500-22200	BJ-H54L	54501-38011	BS-H31	54530-21100	LB-H52L
54500-25000	BS-H06	54501-3A100	BS-H34	54530-21A00	LB-H52L
54500-29000	BJ-H55L	54501-3A201	BS-H34	54530-24000	BJ-H53
54500-2B100	BS-H26	54501-4A000	BS-H41	54530-24A00	BJ-H53
54500-2C000	BS-H12	54501-4A600	BS-H41	54530-28000	LB-H54
54500-2D000	BS-H14	54501-4A801	BS-H43	54530-28A00	LB-H54
54500-33000	BJ-H53L	5450102051	BS-H03	54530-31000	LB-H56
54500-34000	BJ-H66L	545011C010	BS-H19	54530-31300	LB-H56
54500-38000	BS-H30	5450122100	BJ-H54R	54530-31600	BJ-H57
54500-38011	BS-H32	545012C001	BS-H11	54530-37000	LB-H64
54500-4A000	BS-H42	545012C002	BS-H11	54530-3B000	BJ-H13
54500-4A600	BS-H42	545012H000	BS-K07	54530-3S000	BJ-H16

54530-4A000	LB-H66	54555-3A100	RU-H27	54830-2B200	SI-H18
54530-4AA00	LB-H66	5455522101	RU-H04	54830-2C000	SI-H08
54530-4AA10	BJ-H18	54556-22100	RU-H05	54830-2E000	SI-H31
5453002000	BJ-H02	5455622101	RU-H05	54830-34000	SI-H44
5453007000	BJ-K03	54584 2B000	RU-H17	54830-34500	SI-H53
5453021000	LB-506L	54584 2S000	RU-H46	54830-36010	SI-H53
5453021A00	LB-506L	54584-17000	RU-H15	54830-38100	SI-H22
5453037010	LB-H64	54584-1C300	RU-H12	54830-38110	SI-H24
545303B000	BJ-H06	54584-1G000	RU-H09	54830-39000	SI-H33
545303B000	BJ-H01	54584-2E000	RU-K46	54830-3A000	SI-H30
54540-21000	LB-H52R	54584-3K000	RU-H22	54830-3L000	SI-H25
54540-21100	LB-H52R	545842H000	RU-K16	54830-4A000	SI-H58
54540-21A00	LB-H52R	5458438100	RU-H20	54830-4A003	SI-H58
54540-43150	TI-H004	54610-02010	RU-H29	54830-4A800	SI-H58
54540-4B001	CJ-H01	54610-34010	RU-H31	54830-4A802	SI-H58
5454021000	LB-506R	54712-44150	RU-H35	54830-4H000	SI-H40
5454021100	LB-506R	54812-07000	RU-H64	54830-M2000	SI-H57L
5454021A00	LB-506R	54812-1G100	RU-H08	548301E000	SI-H06
5454043150	BJ-514	54813-25000	RU-H59	5483029500	SI-H56
5454043151	TI-H004	54813-26100	RU-H34	548302H000	SI-K08
5454043151	BJ-514	54813-2C100	RU-H62	548302H100	SI-K08
5454043152	RU-H14	54813-2F000	RU-K48	548302S000	SI-H39
5454043152	TI-H004	54813-3A000	RU-H25	548302S200	SI-H39
5454043152	BJ-514	54813-3A100	RU-H25	5483034000	SI-H53
545404B001	RU-H13	54813-3K100	RU-H16	5483034500	SI-H44
5454743001	TI-H001	5481302100	RU-H36	5483037010	SI-H51
54550-H1000	BJ-H12	5481317100	RU-H39	5483037020	SI-H51
54550-H1010	BJ-H12	548131H100	RU-K05	5483039000	SI-H22
54551 26000	RU-H32	548132D102	RU-H37	548303K000	SI-H25
54551 2B000	RU-H18	548132H000	RU-K14	54840 4H000	SI-H41
54551-02000	RU-H03	54820-02000	SI-H07	54840 4H200	SI-H41
54551-1E000	RU-H10	54822-H1000	SI-H28	54840-0X000	SI-H35
54551-22000	RU-H03	54823-H1000	SI-H27	54840-1C000	SI-H11
54551-25000	RU-H06	54825-22000	SI-H01	54840-1G000	SI-H05
54551-2D000	RU-K45	54830 4H200	SI-H40	54840-1J000	SI-H37
54551-2E000	RU-K47	54830-0X000	SI-H34	54840-26000	SI-H15
54551-38000	RU-H19	54830-17010	SI-H02	54840-2B000	SI-H19
54551-3A000	RU-H26	54830-17020	SI-H03	54840-2B200	SI-H19
54551-3K000	RU-H23	54830-1C000	SI-H10	54840-2C000	SI-H09
5455122100	RU-H03	54830-1G000	SI-H06	54840-3A000	SI-H29
5455122200	RU-H03	54830-1J000	SI-H36	54840-M2000	SI-H57R
5455129000	RU-H55	54830-25010	SI-H02	548401E100	SI-H05
545512H000	RU-K17	54830-25020	SI-H03	5511629000	RU-H61
5455138010	RU-H19	54830-26000	SI-H14	55118-1D000	RU-H63
54552-3K000	RU-H24	54830-28000	SI-H51	55130-34A00	LB-H65
54555 26000	RU-H33	54830-29000	TI-H93	55130-34A01	LB-H65
54555-22100	RU-H04	54830-29000	SI-H56	55130-37000	LB-H65
54555-25000	RU-H07	54830-2B000	SI-H18	551304D000	RU-K11



**CROSS REFERENCE LIST**  
**VERGLEICHSLISTE**  
**LISTA DE REFERENCIAS CRUZADES**  
**LISTE DE COMPARAISON**  
**LISTA DI COMPARAZIONE**

55160-1C100	RU-H58	56540-43000	RD-H53	56872-43000	TI-515
55201-34000	LB-H67	565402H000	RD-K03	56872-43010	TI-515
55201-34010	LB-H67	56820 4H000	TI-H24	56872-44000	TI-H60L
55215-22000	RU-H53	56820 4H100	TI-H25	56940-44000	ID-H54
55219-25100	RU-H56	56820-02500	TI-H95	57716-34000	RD-H60
55250-34000	BJ-H68	56820-0X000	TI-H18	57724 4H000	RD-H22
55256-44000	RU-H28	56820-0X900	TI-H19	57724 4H100	RD-H21
55513-22500	RU-H60	56820-11060	TI-H52	57724-0X000	RD-H17
55513-2E100	RU-H30	56820-1E000	TI-H04	57724-1E000	RD-H04
55513-2L000	RU-H43	56820-1E900	TI-H03	57724-1J000	RD-H18
5551317000	RU-H40	56820-21000	TI-H53	57724-2B000	RD-H11
555132D100	RU-H38	56820-21100	TI-H53	57724-2D000	RD-H06
55530 2B200	SI-H20	56820-21110	TI-H53	57724-2E000	RD-H16
55530 4H000	SI-H42	56820-21120	TI-H53	57724-38000	RD-H12
55530-17000	SI-H13	56820-22000	TI-H06	57724-38010	RD-H13
55530-26600	SI-H16	56820-25000	TI-H01	57724-3A000	RD-H15
55530-29000	TI-H91	56820-28000	TI-H54	57724-3K000	RD-H14
55530-2B000	SI-H20	56820-28500	TI-H57	577242D020	RD-H06
55530-2E000	SI-H32	56820-2B000	TI-H08	577242S000	RD-H20
55530-38000	SI-H21	56820-2B900	TI-H07	57729-4A000	RD-H08
55530-38600	SI-H23	56820-2E000	TI-H16	57730-24000	RD-H54
55530-3K001	SI-H26	56820-2E900	TI-H17	57730-24100	RD-H58
55530-4A001	SI-H12	56820-2K000	TI-H20	57730-28000	RD-H55
5553017010	SI-H13	56820-2K050	TI-H21	57730-28020	RD-H56
555301H000	SI-K09	56820-31000	TI-H55	57730-29000	RD-H63
555301H100	SI-K09	56820-36000	TI-H56	57730-29001	RD-H63
5553029500	TI-H91	56820-38000	TI-H12	57730-33100	RD-H56
555302S100	SI-H38	56820-38900	TI-H11	57730-43010	RD-H03
5553038010	SI-H21	56820-3B000	TI-H05	5773043000	RD-H01
55540 4H000	SI-H43	56820-3K000	TI-H14	5773043010	RD-H01
55540-26600	SI-H17	56820-3K010	TI-H13	57755-02000	RD-H05
555431H000	RU-K15	56820-H1002	ID-H50	57755-17000	RD-H09
555432H000	RU-K15	5682011060	TI-501	57755-22000	RD-H01
55577-26600	RU-H41	5682021000	TI-503R	577551C000	RD-H07
555773A010	RU-H42	5682021100	TI-503R	5775522000	RD-H58
55580-37020	SI-H54	5682022000	TI-H57	5775522000	RD-H54
5558037030	SI-H54	5682025000	TI-H57	5777525000	RD-H03
55830-25000	SI-H04	568202H000	TI-K06	57780-38000	TI-H10
56540-02000	TI-H82	568202H090	TI-K05	57780-38010	TI-H09
56540-21001	RD-H51	568202S000	TI-H22	57780-3B000	TI-H15
56540-21010	RD-H51	568202S050	TI-H23	5778038000	TI-H12
56540-21100	RD-H51	5682036000	TI-516	5778038010	TI-H11
56540-22000	RD-H53	5682037000	TI-H57	57785-26200	RD-H10
56540-24000	RD-H53	5682037010	TI-H57	HB212-100	LB-507
56540-24001	RD-H53	56830-36000	SI-H52	HB212003	BS-H18
56540-25000	RD-H02	56840-11200	ID-H52	HB212004	BS-H17
56540-28020	RD-H56	56850-H1011	SA-H01	HB568110	TI-H70
56540-2K000	RD-H19	56850H1001	SA-H01	HB568110	TI-510

HB568120	TI-509	8-94200-320-1	BJ-903	8-94408-842-0	RU-915
MB109630A	BS-H16	8-94200-320-2	BJ-903	8-94419-406-1	SY-905
MB109631A	BS-H15	8-94217-221-3	RD-900	8-94419-407-1	SY-905
MB122135	RD-501	8-94223-168-0	RU-906	8-94419-407-2	SY-905
MB243425A	SY-H52	8-94223-366-0	RU-909	8-94419-408-0	TI-999
MB243426A	SY-H52	8-94224-550-1	BJ-999	8-94419-408-1	TI-999
MB518892	SI-501	8-94224-550-2	BJ-999	8-94419-409-0	TI-998
MB673525A	TI-H96	8-94224-550-3	BJ-999	8-94419-409-1	TI-998
MB673525B	TI-H96	8-94224-550-4	BJ-999	8-94419-608-2	TI-905R
SB000036	TI-H70	8-94224-550-5	BJ-999	8-94419-609-2	TI-905L
SB000037	TI-H69	8-94224-551-0	LB-908R	8-94452-102-0	BJ-913
ZB212100	LB-507	8-94224-551-1	LB-908R	8-94452-102-1	BJ-913
<b>ISUZU</b>	<b>JAPANPARTS</b>	8-94224-551-2	LB-908R	8-94452-104-0	LB-906
5-44350-095-0	RD-999	8-94224-552-1	LB-906	8-94452-104-1	LB-906
5-44350-095-1	RD-999	8-94224-552-2	LB-906	8-94452-106-0	LB-908R
5-44350-095-2	RD-999	8-94225-550-0	BJ-999	8-94452-107-0	LB-908R
5-44350-095-3	RD-999	8-94226-557-0	RU-908	8-94452-107-1	LB-908R
5-44352-015-0	TI-902R	8-94226-557-2	RU-908	8-94452-110-1	BJ-909
5-44352-015-1	TI-902R	8-94226-967-0	BJ-909	8-94452-110-2	BJ-909
5-44352-015-2	TI-902R	8-94226-967-1	BJ-909	8-94459-453-1	BJ-914
5-44352-016-0	TI-902L	8-94226-967-2	BJ-909	8-94459-453-2	BJ-914
5-44352-016-1	TI-902L	8-94231-4610	ID-901	8-94459-453-3	BJ-914
5-44352-016-2	TI-902L	8-94233-475-1	TI-906R	8-94459-456-1	BJ-913
5-44352-026-0	TI-904	8-94233-476-1	TI-997	8-94459-464-0	BJ-915
5-44352-070-0	TI-902R	8-94234-319-0	RU-907	8-94459-464-1	BJ-915
5-44352-602-0	TI-902R	8-94237-351-0	TI-904	8-94459-464-2	BJ-915
5-44352-629-0	TI-902R	8-94237-351-1	TI-904	8-94459-464-3	BJ-915
5-44352-639-0	TI-902R	8-94237-366-0	CR-902	8-94459-465-2	BJ-913
5-51220-003-0	BJ-901	8-94237-366-1	CR-902	8-94459-475-0	CR-904
5-51220-029-1	BJ-901	8-94237-367-0	CR-902	8-94459-478-0	SY-903
5-51220-029-2	BJ-901	8-94237-367-1	CR-902	8-94459-478-1	SY-903
5-51220-033-0	BJ-901	8-94237-800-0	ID-901	8-94459-480-0	TI-999
5-51227-033-0	LB-908R	8-94241-767-0	PI-912	8-94459-480-1	TI-999
8 97 018 166 1	RU-915	8-94243-234-0	BJ-999	8-94459-480-2	TI-999
8-64452-106-1	LB-908R	8-94243-236-1	LB-908R	8-94459-481-0	TI-998
8-91733-866-0	RU-903	8-94246-236-0	LB-908R	8-94459-481-1	TI-998
8-92223-475-1	BJ-909	8-94246-475-0	LB-906	8-94459-481-2	TI-998
8-94103-222-2	TI-905R	8-94246-475-1	LB-906	8-94472-255-0	BJ-999
8-94103-223-2	TI-905L	8-94250-316-0	BJ-903	8-94472-255-2	BJ-999
8-94109-041-1	TI-912	8-94255-456-0	BJ-903	8-97018-125-2	SI-916
8-94109-041-2	TI-912	8-94328-799-0	RU-934	8-97018227-2	SI-900
8-94109-041-3	TI-912	8-94366-606-0	RD-905	8-97018228-2	SI-901
8-94109-704-1	LB-908L	8-94369-924-0	TI-997	8-97020-953-1	TI-999
8-94109-704-1	LB-908R	8-94369-925-0	TI-906R	8-97020-954-1	TI-998
8-94124-585-1	TI-906R	8-94374-424-0	BJ-917	8-97020-954-2	TI-998
8-94124-586-0	TI-997	8-94375282-5	RU-901	8-97025-752-0	RU-932
8-94124-586-1	TI-997	8-94375283-2	RU-902	8-97025-753-0	RU-900
8-94200-320-0	BJ-903	8-94408-840-3	RU-910	8-97028-967-0	ID-997

**CROSS REFERENCE LIST**  
**VERGLEICHSLISTE**  
**LISTA DE REFERENCIAS CRUZADES**  
**LISTE DE COMPARAISON**  
**LISTA DI COMPARAZIONE**

8-97039-325-1	ID-997	9-51151-023-0	RU-912	5135 651AB	BJ-905
8-97104-157-1RH	RU-904	9-51227-704-0	LB-908R	5143 555AB	TI-914
8-97104-158-1LH	RU-905	9-51227-704-1	LB-908R	5143 556AB	TI-913
8-97234-977-2	RU-917	9-51351-029-0	RU-913	5143555AC	TI-914
8-972349762	RU-916	94020795	LB-908R	5143556AC	TI-913
8-97235-786-1	SI-909	94021476	TI-902R	5174185AB	SI-913
8-97235-787-0	SI-908	94021477	TI-902L	5183761AA	TI-911
8-972357760	BJ-913	94021716	BJ-901	52000598	TI-J009
8-972357770	BJ-906	94025674	TI-902R	52001145	RU-925
8-973048510	RD-902	94025675	TI-902L	52001162	TI-J013
8-973048550	TI-915	94025980	TI-902R	52003-360	SI-903
8-973049280	TI-915	94025981	TI-902L	52003232	RU-921
8-97332-642-0	RU-918	94025984	BJ-901	52005738	TI-J006
8-97357-492-0	RU-919	94027778	RD-999	52005739	TI-J010
8-97365-010-0	BS-905	94028101	LB-908R	52005740	TI-J003
8-97365-011-0	BS-904	94028225	TI-904	52005741	TI-J004
8-97365-012-0	BS-907	94109704	LB-908L	52006592	TI-J011
8-97365-013-0	BS-906	94200320	BJ-903	52037 849	SI-902
8-97365-014-0	BS-909	94200328	BJ-903	52037994	TI-903
8-97365-015-0	BS-908	94217221	TI-904	52087710	TI-J007
8-97365-016-0	BS-911	94224550	BJ-999	52087711	TI-J007
8-97365-017-0	BS-910	94224551	LB-908R	52088 283	SI-905
8-97365-021-0	BJ-913	94224552	LB-906	52088 461	TI-907
8-973650180	BJ-906	94224701	TI-904	52088 511	TI-908
8-973672720	RU-916	94233475	TI-906R	52088 869AA	TI-910
8-979445750	SI-918	94237351	TI-904	52088 870AA	TI-909
8942432360	LB-908R	94243234	BJ-999	52088125	RU-926
8944521061	LB-908R	94243236	LB-908R	52088208-AC	TI-J014
8944594532	BJ-999	94246475	LB-906	52088217-AB	TI-J012
8944594533	BJ-999	9445104	LB-906	52088312	TI-J000
8944594651	BJ-913	94452106	LB-908R	52088355AB	BS-903
8970209540	TI-998	94452110	LB-909	52088378	RU-924
8979406160	TI-999	94459453	BJ-914	52088437	SI-904
897956902A	TI-999	94459464	BJ-915	52088523	RU-922
9-43150-038-0	TI-901R	94459480	TI-999	52088524	RU-923
9-43150-039-0	TI-901L	94459481	TI-998	52088778AB	RU-920
9-43150-053-0	TI-901R	97028967	ID-997	52089 467AB	SI-906
9-43150-054-0	TI-901L			52089486AC	SI-907
9-43150-601-0	TI-901R	<b>JEEP</b>	<b>JAPANPARTS</b>	52089486AE	SI-907
9-43150-602-0	TI-901L	05012432AA	BJ-902	52089980AF	BS-901
9-43150-605-0	TI-901R	05012432AA	BJ-900	52089980AG	BS-901
9-43150-606-0	TI-901L	051894419AA	TI-918	52089981AF	BS-902
9-43150-612-0	TI-901R	5012 432AA	BJ-900	52089981AG	BS-902
9-43150-613-0	TI-901L	5012432AA	BJ-902	52124302AA	RU-930
9-44352-071-0	TI-902L	50724444AA	TI-917	5289 486AC	SI-907
9-44352-603-0	TI-902L	50724445AA	TI-918	68003671AA	TI-917
9-44352-630-0	TI-902L	5105040AB	BS-913	83500 202	TI-J001
9-44352-640-0	TI-902L	5105041AB	BS-912	83500202	TI-J002
		5105103AC	RU-931		

E6770TU	TI-J008	0K2FA34340	BS-K01	0K9A2-34300	BS-K09
KIA	JAPANPARTS	0K2FK 32240	RD-K00	0K9A2-34350	BS-K10
0G030-32-550A	BJ-K51	0K2KB 34156A	RU-K01	0K9A2-34464	RU-K20
0G030-34550B	BJ-317	0K2M228150	SI-K54	0K9A2-3446X	RU-K21
0K011-32-230	TI-K66L	0K2N1 34150A	SI-K19	0K9A2-34470	RU-K19
0K011-32-240A	TI-K67L	0K2N1 34170A	SI-K20	0K9A232280	TI-K69
0K011-32-250A	TI-K67R	0K2NA 34156	RU-K30	0K9A232280	TI-K65
0K011-32-260A	CR-K54	0K2NA 34300B	BS-K17	0K9A3-28-170	SI-K53
0K011-32-270A	SA-K51L	0K2NA 34350B	BS-K18	0K9A3-28-170A	SI-K53
0K011-32-280	TI-K66R	0K30A 34480 C	RU-K27	0K9A6-34300	BS-K11
0K011-32-290A	SA-K51R	0K30B 34300B	CJ-K01	0K9A6-34350	BS-K12
0K011-34-150A	SI-K28	0K30B 34350B	CJ-K02	0K9A6-3446X	RU-K23
0K011-34-200	CJ-K57	0K33C 34150A	SI-K15	0K9A6-3446Y	RU-K22
0K011-34-300D	CW-K56	0K33C 34160A	SI-K16	0S083-34-300B	CW-K51L
0K011-34-510B	LB-K58	0K522-32-250	TI-K96	0S083-34-350B	CW-K51R
0K01132270A	TI-K67L	0K522-32-270	TI-K95	0SE46-34-200	CJ-K52L
0K201 32240	RD-K08	0K552-32-240	TI-K94	0SE46-34-200A	CJ-K52L
0K201-32-280	TI-K65	0K552-32-280	TI-K93	0SE46-34-250	CJ-K52R
0K201-32-280A	TI-K65	0K552-34-150B	SI-K58	51760 2G000	BJ-K01
0K201-34-300C	CW-K53R	0K552-34-151B	SI-K58	517600Q000	BJ-K01
0K201-34-350C	CW-K53L	0K552-34-160B	SI-K58	517601G000	BJ-H04
0K201-34-550C	LB-K57	0K552-34-300A	CW-K55R	517602E000	BJ-H14
0K20132240	RD-K58	0K552-34-300B	CW-K55R	517602H000	BJ-K01
0K20132280	TI-K69	0K552-34-350A	CW-K55L	54410-3E000	BS-K24
0K20132280A	TI-K69	0K552-34-350B	CW-K55L	54410-3E001	BS-K24
0K20134550D	LB-322	0K55232250	TI-K96	54410-3E002	BS-K24
0K20134550E	LB-322	0K55232250A	TI-K96	544203E000	BS-K23
0K203 32240	RD-K09	0K55232270	TI-K95	544203E001	BS-K23
0K20332240A	RD-K09	0K55234300C	CW-K55R	544203E002	BS-K23
0K2A1 3446X	RU-K03	0K55234350C	CW-K55L	54480-3E001	RU-K49
0K2A1 3446Y	RU-K04	0K60A 32270	RD-K05	54480-3E002	RU-K50
0K2A1-32-240	RD-K58	0K60A32270A	RD-K05	54480-3E100	RU-K51
0K2A1-34-150A	SI-K54	0K670-32-240	TI-K56	54500 07200	BS-K14
0K2A1-34-150B	SI-K54	0K670-32-450	TI-K58	54500 1D000	BS-K04
0K2A1-34-170A	SI-K55	0K670-32-510	TI-K57	54500 2F000	BS-K22
0K2A1-34-550A	LB-K60	0K710-34-510	BJ-314	54500 2F001	BS-K22
0K2A2 32240	RD-K51	0K71032240	TI-A04	54500 2H000	BS-K08
0K2A5-34-150	SI-K55	0K71034540	BJ-313	54500 2P000	BS-K26
0K2A5-34-150A	SI-K55	0K72A 32270	RD-K04	54500 4D001	BS-K06
0K2A5-34-150B	SI-K55	0K72A 34150A	SI-K14	54500-07100	BS-K14
0K2A5-34-150C	SI-K55	0K72A 34510A	BJ-K04	54500-FD000	CJ-K06
0K2AA-28-500	CJ-K03	0K72A-32-240	TI-K68	545001E100	BS-H08
0K2C0 34460	RU-K02	0K72A-34-200	BS-K00	545001F000	BS-K20
0K2FA 34150	SI-K01	0K72A-34-200A	BS-K00	54501 07200	BS-K13
0K2FA 34170	SI-K02	0K72A32240A	TI-K68	54501 1D000	BS-K03
0K2FA 34300	BS-K01	0K72A32270A	RD-K04	54501 2F000	BS-K21
0K2FA 34350	BS-K02	0K9A2-32-240	RD-K58	54501 2F001	BS-K21
0K2FA-34-550	LB-K60	0K9A2-34156	RU-K18	54501 2H000	BS-K07

**CROSS REFERENCE LIST**  
**VERGLEICHSLISTE**  
**LISTA DE REFERENCIAS CRUZADES**  
**LISTE DE COMPARAISON**  
**LISTA DI COMPARAZIONE**

54501 2P000	BS-K25	54830-2K000	SI-K24	57724 07100	RD-K06
54501 4D001	BS-K05	54830-3E000	RU-K38	57724 2G000	RD-K01
54501-07100	BS-K13	54830-3E020	RU-K35	57724 4D000	RD-K02
54501-FD000	CJ-K05	548301E000	SI-H06	57724-1G000	RD-K12
545011E100	BS-H07	548301G000	SI-H06	57724-1G100	RD-K13
545011F100	BS-K19	548302H100	SI-K08	57724-2P000	RD-K15
54510 3E001	BS-K16	54840 07000	SI-K13	57724-2P100	RD-K14
545103E002	BS-K16	54840 2F000	SI-K11	577242D000	RD-H06
545103E003	BS-K16	54840 2K000	SI-K25	577242D020	RD-H06
54520-3E001	BS-K15	54840 4D000	SI-K05	577242E000	RD-H16
545203E002	BS-K15	548401E100	SI-H05	577242G010	RD-K01
545203E003	BS-K15	548401G000	SI-H05	57731 3E010	RD-K11
54530 07000	BJ-K03	55130 4D000	RU-K11	57732 3E010	RD-K10
54530 4D000	BJ-K02	55227-2D000	RU-K36	F4BZ-3280A	RD-K54
5453031600	BJ-H57	55250 1H000	CJ-K00	FMBZ-3A130-A	TI-K62
54551 07000	RU-K26	55250 2H000	CJ-K00	GA2C-28-170A	SI-K51
54551 1D000	RU-K09	55513 2G000	RU-K06	KB092-32-280	TI-K61
54551 2H000	RU-K17	55513-3E000	RU-K52	KB09232280	TI-325
54551 4D000	RU-K13	55530 1D000	SI-K04	KDX50 32240B	RD-K50
545514D001	RU-K13	55530 1F000	SI-H32	KDX53-32-240	RD-K54
54570 3E000	BJ-K05	55530 1H000	SI-K09	KDX53-32-240A	RD-K54
54570 3E001	BJ-K05	55530 4D000	SI-K07	KDX5332240B	RD-K54
54580 3E001	RU-K28	55530-3E010	RU-K31	KG2C-28-170A	SI-K51
545803E002	RU-K28	55530-3E020	RU-K32	KGA2A-34-150	SI-K52R
54584 07000	RU-K25	5553017000	SI-H13	KGA2A-34-150A	SI-K52R
54584 1D000	RU-K08	5553017010	SI-H13	KGA2A-34-170	SI-K52L
54584 2H000	RU-K16	555301H100	SI-K09	KGA2A-34-170A	SI-K52L
54584 4D000	RU-K12	55543 1H000	RU-K15	KH380-28-170B	SI-K57
545844D001	RU-K12	55543 2G000	RU-K07	KH380-34-170C	SI-K56
54590 3E000	RU-K29	555432H000	RU-K15	KK150-32-240	RD-K53
54620-07000	RU-K37	55580-3E000	SI-K26	KKY01-32-280	TI-K61
54810 3E000	SI-K21	55580-3E050	SI-K27	KKY01-34-310	BJ-K52
54811 3E010	SI-K22	56540 2H000	RD-K03	KKY01-34-390A	BJ-K52
54811 3E060	SI-K23	56820 07000	TI-K07	KKY0132280	TI-325
54812 07100	RU-K24	56820 2G000	TI-K02	MB092-32-280	TI-K61
548121G100	RU-H08	56820 2G900	TI-K01	MD00134153A	RU-K44
54813 1H100	RU-K05	56820 2H000	TI-K06	MDX50-32-280	TI-K62
54813 2H000	RU-K14	56820 2H090	TI-K05	OK20134550C	LB-322
54813 4D000	RU-K10	56820 3E000	TI-K08	OK552-32-250	TI-K96
54813-2E100	RU-K34	56820 3E900	TI-K09	OK552-32-270	TI-K95
54813-FD000	RU-K33	56820 4D000	TI-K04	OK9A2-32-280	TI-K65
54820 FD000	SI-K18	56820 4D100	TI-K03	<b>LAND ROVER</b>	<b>JAPANPARTS</b>
54830 07000	SI-K12	56820 4D101	TI-K03	572337	TI-L002
54830 2F000	SI-K10	56820-1G000	TI-K11	575 882	TI-L007
54830 2H000	SI-K08	56820-1G900	TI-K10	ANR 1799	TI-L002
54830 4D000	SI-K06	56820-4D001	TI-K04	ANR 3304	SI-L07
54830 FD000	SI-K17	5682025000	TI-H01	FTC 3570	BJ-L01
54830-2G000	SI-K03	57724 07000	RD-K07	FTC 3571	BJ-L02

KKB000270	RU-L14	RBJ102930	BS-L02	TIQ 000040	RD-L03
KKB000280	RU-L15	RBK 500012	RU-L13	TIQ000010	CR-L02
LR0 02609	TI-L017	RBK 500030	BJ-L03	TIQ100000	CR-L02
LR0 02610	TI-L018	RBK 500040	BJ-L04	<b>LEXUS</b>	<b>JAPANPARTS</b>
LR0 02876	SI-L13	RBK 500150	BJ-L06	4333029405	BJ-209
LR002624	BS-L07	RBK 500170	BJ-L07	4333029615	BJ-209
LR002625	BS-L06	RBK 500210	BJ-L06	4333039435	BJ-239
LR002626	SI-L12	RBK500180	BJ-L04	4334029175	BJ-208
LR007205	BS-L07	RBM 000011	SI-L09	4334029215	BJ-208
LR007206	BS-L06	RBM 100170	SI-L06	4504629255	TI-283
LR018343	CJ-L03	RBM 100223	SI-L02	45460 59035	TI-2023
LR018344	CJ-L02	RBM 500140	SI-L11	45470 59035	TI-2022
LR018345	RU-L04	RBM 500150	SI-L10	45503 30070	RD-251
LR018347	RU-L07	RBM 500190	SI-L04	45503 39105	RD-248
LR018354	RU-L08	RBM100171	SI-L06	45503-29785	RD-248
NRC 1823	TI-L009	RBM100172	SI-L06	48068 53010	CJ-203
NRC 4745	TI-L004	RBX 000070	RU-L03	48068 59025	CJ-203
NRC 6007	TI-L003	RBX 000200	RU-L04	48069 53010	CJ-204
NRC 9743	CR-L00	RBX 101160	RU-L01	48069 59025	CJ-204
NTC 1888	SI-L01	RBX 101780	RU-L02	48610 59025	BS-259
NTC1886	TI-L003	RBX 500280	RU-L07	48630 59025	BS-258
NTC1887	TI-L004	RBX 500432	RU-L10	48810 53010	SI-256
NTC4260	TI-L002	RBX 500443	RU-L09	4881033010	SI-216
NTC8533	TI-L002	RBX 500531	RU-L11	48820 22041	SI-253
NTC9932	TI-L002	RBX101790	RU-L01	48820 53010	SI-257
QFK 500010	RD-L01	RBX101860	RU-L02	4882028050	SI-218
QFK 500020	RD-L02	RDG 100682	SI-L03	48830 30090	SI-255
QFK 500030	RD-L04	RGD 000180	SI-L08	48830 51010	SI-254
QFK50040	CR-L00	RGD 000311	SI-L05	4883048010	SI-219
QFS000010	TI-L010	RGD 500083	RD-L00	<b>MAHINDRA</b>	<b>JAPANPARTS</b>
QFS100060	TI-L010	RGD 500140	SI-L14	0401BA0140N	BJ-004
QHG000050	CR-L01	RGD 500180	SI-L08	0401BA0280N	BJ-005
QHG100010	CR-L01	RGD000312	SI-L05	0401EA0360N	SI-001
QJB 100220	TI-L013	RGD100682	SI-L03	0401EA0370N	SI-002
QJB 100230	TI-L012	RGD500100	SI-L08	<b>MAZDA</b>	<b>JAPANPARTS</b>
QJB 500010	TI-L011	RGX 500070	RU-L08	0131-34-540A	BJ-309
QJB 500040	TI-L016	RHF 000260	RU-L05	0305-99-324	TI-303
RBJ 000120	CJ-L03	RHF 500031	RU-L12	0305-99-324A	TI-303
RBJ 000130	CJ-L02	RHF 500100	RU-L12	0305-99-356	LB-303
RBJ 102440	BS-L01	RHF500110	TI-L002	0603-99-324	TI-302
RBJ 102450	BS-L02	RTC 5869	TI-L005	0603-99-325	TI-302
RBJ 500446	BS-L03	RTC 5870	TI-L006	0662-99-322	TI-334
RBJ 500456	BS-L04	RTC1800	TI-L003	0662-99-324	TI-323
RBJ 500710	CJ-L01	RTC5869	TI-L003	0866-32-320	ID-308
RBJ 500920	CJ-L01	RTC5870	TI-L004	0866-99-322	TI-306
RBJ102920	BJ-L05	STC 1871	TI-L010	0866-99-324	TI-305
RBJ102920	BS-L01	STC1871	TI-L010	0866-99-324B	TI-305
RBJ102930	BJ-L05	TIQ 000030	TI-L015	1010037	RU-300

**CROSS REFERENCE LIST**  
**VERGLEICHSLISTE**  
**LISTA DE REFERENCIAS CRUZADES**  
**LISTE DE COMPARAISON**  
**LISTA DI COMPARAZIONE**

1011857	TI-337	2370-99-324	TI-303	B01A 34 350	BS-306
1015265	SI-300	2469-99-324	TI-303	B01A-34-550	BJ-327
1063236	BS-303	2541-99-324A	TI-302	B01A-34-550A	BJ-327
1063255	BS-302	2L8Z3079AA	BJ-305	B01C34380	RU-325
1130273	SI-300	3625-99-322	TI-306	B029-34159	SI-301
1146150	SI-312	3874-99-324	TI-302	B037-32-280	TI-A04
1175-99-322	TI-316	3958-99-324B	TI-305	B038-32-135	RD-305
1175-99-322A	TI-316	4084-99-324B	TI-305	B06799325	TI-318R
1175-99-324	TI-315	4342539	RD-327	B092-32-240	RD-310
1175-99-324A	TI-315	8021-99-324	TI-314	B092-34-550	LB-322
1175-99-324X	SA-301	8037-32-320	ID-308	B093-32-240	RD-309R
1177-99-324	TI-305	8038-99-322	TI-316	B093-32-250	RD-309L
1177-99-324A	TI-305	8038-99-356	BJ-316	B09332240	RD-309L
1363-99-322	TI-310R	8173-32-322	TI-319	B094-32-240	RD-310
1363-99-323	TI-310L	8173-99-322	TI-319	B210-32-240	RD-310
1391-99-322	TI-309	8173-99-356	LB-307	B211-32-240	RD-313R
1391-99-354	BJ-309	8531-32-320	ID-308	B21H 32 24X	RD-319
1391-99-354A	BJ-309	8531-99-322	TI-312	B21H3225X	RD-319
1513343	SI-321	8531-99-322A	TI-312	B25D 32 240	RD-320
1524-99-322	TI-306	8531-99-324	BJ-399	B25D 32 250	RD-321
1524-99-324	TI-305	8531-99-356	LB-307	B25D 34 300A	BS-309
1907-99-324	TI-314	8559-99-354	BJ-318	B25D 34 350A	BS-308
1907-99-324A	TI-314	8650-99-356	BJ-316	B25D 34 460	RU-306
1E00 34 300A	BS-301	8AB1-32-280	TI-325	B25D 34 470	RU-305
1E00 34 350A	BS-300	8AB2-32-280	TI-334	B25D-28-380-B	RU-343
1E00-28-460C	RU-322	8AG1 28 100A	SI-302	B25D-28-390-B	RU-344
1E00-34-156	RU-321	8AG1-32-280	TI-330	B25D-34-380A	RU-328
1E0028460B	RU-322	8AG3 32 280	TI-339	B25D32240	RD-321
1E0032240	RD-311	8AG4 32 280	TI-338	B25D34300B	BS-309
1E0032280A	TI-337	8AG432280	TI-339	B25D34300C	BS-309
1E0034153A	RU-300	8AH1-32-280	TI-322	B25D34300D	BS-309
1E0034300B	BS-301	8AH132280	TI-309	B25D34300D	BJ-302
1E0034300D	BS-301	8AH3-32-280	TI-332	B25D34350B	BS-308
1E0034300E	BS-301	8AL1-32-280	TI-350	B25D34350C	BS-308
1E0034300F	BS-301	8AN1-32-280	TI-300	B25D34350D	BS-308
1E01 34 153A	RU-301	8AU1-32-280	TI-329	B25D34350D	BJ-302
1E0132280A	TI-336	8AU1-34-510	LB-321	B26 R 28 170	SI-309
1E0134300A	BS-303	8AU1-34-540	TI-320	B26 R 34 170	SI-306
1E0134300B	BS-303	8AU2-32-270	TI-328	B28V34470	RU-305
1E0134300D	BS-303	8AU2-34-510	LB-321	B30H 28 170B	SI-308
1E0134300E	BS-303	8AU3-34-510	BJ-324	B32H 34 300	BS-317
1E0134300F	BS-303	94FB 33 95A2B	BJ-300	B32H 34 350	BS-316
1E0134350A	BS-302	B001-32-135	RD-301	B32H-34-300B	BS-317
1E0134350B	BS-302	B001-34-470	RU-303	B32H34300A	BS-317
1E0134350D	BS-302	B001-34-550	LB-322	B32H34350A	BS-316
1E0134350E	BS-302	B001-99-324	TI-318R	B455-32-24X	AX-397
1E0134350F	BS-302	B001-99-325	TI-318R	B455-32-280	TI-334
2113-99-324	TI-303	B01A 34 300	BS-307	B455-34-300 E	BS-305

B455-34-350 E	BS-304	C10034350B	BS-326	EA01-28-170	SI-317
B455-34-550	LB-326	C10034460B	RU-306	EA0128170D	SI-317
B45534300B	BS-305	C10034470A	RU-305	EA03-34-170A	SI-311
B45534350B	BS-304	C10035350B	BJ-321	EA0334170	SI-311
B456-32-24X	AX-395	C14534460	RU-306	EC01-34-150A	SI-325
B456-32-25X	AX-398	C23628500A	CJ-303	EG21 32 240	RD-336
B459-34-470	RU-302	C243-28-156C	RU-342	EG21 32 280	TI-357
BA29-32-135	RD-305	CC29-34-156C	RU-341	EG21 32 280A	TI-357
BBM2-28-C10	CJ-302	D0013224X	RD-K53	EG21 32 290	TI-358
BBM2-34-170A	SI-326	D061-32-24XA	RD-300	EG21 32 290A	TI-358
BC1D 28 170A	SI-305	D102-32-240	RD-326	F15134150	SI-K52R
BC1D 34 470	RU-304	D102-32-250	RD-325	F15134170	SI-K52L
BC1D-28-380	RU-327	D10232240A	RD-326	F1CZ-32-80A	AX-397
BC1D-28-390	RU-326	D10232250A	RD-325	FO2Z-3A130A	TI-332
BF62-32-240	RD-310	D201-34-300E	CJ-301	G030-32-240	RD-302L
BF667-32-240	RD-310	D201-34-350A	CJ-300	G030-32-240A	RD-302L
BF6732240	RD-310	D27Z-3A131A	TI-302	G030-32-250	RD-399
BF673224X	RD-310	D651 32 290	TI-366	G030-32-250A	RD-399
BJ3A-39-040A	RU-346	D651 34 170	SI-321	G030-34-300F	CW-399
BJ3A-39-06Y	RU-345	D651 34 470	RU-334	G030-34-350F	CW-398
BJ3D-28-200A	CJ-311	D651-32-240	RD-337	G030-99-356	BJ-317
BJ3D-28-250A	CJ-310	D651-32-280	TI-367	G037-32-240	RD-306R
BK3P-34-300D	BJ-325	D651-34-300	BS-329	G037-32-240A	RD-306R
BL8D-28-200B	CJ-309	D651-34-350	BS-328	G037-32-240B	RD-306R
BL8D28250B	CJ-308	D65134300C	BS-329	G037-32-240C	RD-306R
BP4K 28 500C	CJ-303	D653 32 240	RD-337	G037-32-250	RD-306L
BP4K 28C 10B	CJ-302	D653-32-290	TI-366	G037-32-250A	RD-306L
BP4K 34 170C	SI-313	D77Z-3A131A	TI-302	G037-32-250B	RD-306L
BP4K-28-170C	SI-327	DD32 34 300	BS-315	G037-32-250C	RD-306L
BP4K-28-C10A	CJ-302	DD32 34 350	BS-314	G351-32-280	TI-332
BP4K-39-040C	RU-340	DD3234170	SI-312	GA2A 34 150A	SI-303
BP4K-39-040D	RU-340	DD3234300	BJ-303	GA2A 34 170A	SI-304
BP4K-39-040E	RU-340	DD3234300	RU-315	GA2A 34 46XA	RU-309
BP4K28500D	CJ-303	DD3234300	RU-316	GA2A 34 46YA	RU-308
BP4K28500E	CJ-303	DD3234350	BJ-303	GA2A 34 470	RU-307
BP4K34170D	SI-313	DD3234350	RU-315	GA2A-32-250	RD-322
BP4K34300E	BJ-305	DD3234350	RU-316	GA2A-34-300	BS-311
BP4K34300E	BS-317	DE90-32-280	TI-345	GA2A-34-350	BS-310
BP4K34350E	BS-316	DE9032240	RD-327	GA2A32240	RD-322
BP4K34350E	BJ-305	DE9032290	TI-344	GA2A32240A	RD-322
BP4L 32 240	RD-328	E016 32 24X	RD-318	GA2A32250A	RD-322
BP4L 32 280	TI-347	E016 32 250	RD-317	GA2A3446XB	RU-309
BP4L 32 290	TI-346	E0163225X	RD-318	GA2A3446YB	RU-308
BP4L-34-380	RU-348	E17Z-3049A	BJ-311	GA2B28170A	SI-K51
C100-34-300A	BS-327	E17Z-3050A	BJ-312	GA2B28170B	SI-K51
C100-34-350A	BS-326	E17Z-3590A	PI-304	GA2B34470	RU-307
C10034300B	BJ-321	E17Z3A131A	TI-597	GA2B34470A	RU-307
C10034300B	BS-327	E17Z3A131A	TI-321	GA2C-28-170B	SI-K51



**CROSS REFERENCE LIST**  
**VERGLEICHSLISTE**  
**LISTA DE REFERENCIAS CRUZADES**  
**LISTE DE COMPARAISON**  
**LISTA DI COMPARAZIONE**

GA6A-34-300B	CJ-304	GJ6A34J50C	CJ-306	LC6232246	RD-330
GA6A-99-356	BJ-317	GJ6A34J50D	CJ-306	LC6234170	SI-307
GA6B-99-356	BJ-317	GJ6E-32-240	RD-329	M001-99-356	BJ-317
GA6B-99-356A	BJ-317	GJ6E-32-280	TI-349	M001-99-356A	BJ-317
GA6B34300E	BS-311	GJ6E-32-280A	TI-349	M26R28170	SI-309
GA6B34350E	BS-310	GJ6E-32-290	TI-348	N066-34-310	BS-325
GA6BE34300	BS-311	GJ6E-32-290A	TI-348	N066-34-360	BS-324
GA6BE34350	BS-310	GP9A-34-250A	BS-318	N068-34-200	BS-323
GD7A-34-300A	BS-313	GR1A-34-460	RU-320	N068-34-250	BS-322
GD7A-34-350A	BS-312	GS1D 32 240	RD-335	NA01-32-240	RD-331
GE4T 28 170	SI-310	GS1D 32 280	TI-365	NA01-34-170	SI-318
GE4T 34 46XD	RU-311	GS1D 32 290	TI-364	NA01-34-550	BJ-320
GE4T 34 46YD	RU-310	GS1D 34 150	SI-323	NA0134550A	BJ-320
GE4T-32-240	RD-324	GS1D 34 170	SI-324	NC10-32-240A	RD-333
GE4T-34-300E	BS-313	GS1D 34 200A	BS-335	NC10-32-250A	RD-332
GE4T-34-350E	BS-312	GS1D 34 250A	BS-334	NC10-34-150	SI-319
GE4T-34-46XC	RU-311	GS1D 34 300G	BS-337	NC10-34-170	SI-320
GE4T-34-46YB	RU-310	GS1D 34 300H	BS-337	NC1032240	RD-333
GE4T-34-46YC	RU-310	GS1D 34 300J	BS-337	NC1032250	RD-332
GE4T32240A	RD-324	GS1D 34 300L	BS-337	NE51-32-280A	TI-326
GE4T34300B	BS-313	GS1D 34 350G	BS-336	S083 34 830A	RU-313
GE4T34300C	BS-313	GS1D 34 350H	BS-336	S083 34 840A	RU-312
GE4T34300D	BS-313	GS1D 34 350J	BS-336	S083-32-115	RD-304
GE4T34350B	BS-312	GS1D 34 350L	BS-336	S083-34-460	RU-314
GE4T34350C	BS-312	GS1D-28-170	SI-322	S083-99-324	TI-343
GE4T34350D	BS-312	H001-32-240	RD-303	S083-99-354	BJ-313
GJ21-32-240	RD-302R	H001-32-240A	RD-303	S083-99-356	BJ-314
GJ22-32-240	RD-302R	H001-32-240X	SA-303	S08399356	BJ-314
GJ6A 28 156	RU-336	H001-32-324X	SA-303	S23134820	RU-314
GJ6A 34 156	RU-335	H001-99-324	TI-309	S47P-32-280	TI-343
GJ6A-28-170A	SI-316	H001-99-356	BJ-319	SA39-32-115	RD-304
GJ6A-34-150A	SI-315	H002-32-240	RD-307	UA01-32-240	TI-321
GJ6A-34-170A	SI-314	H002-32-240B	RD-307	UA01-99-354	BJ-311
GJ6A-34-200B	BS-319	H002-32-240C	RD-307	UA01-99-356	BJ-312
GJ6A-34-250B	BS-318	H260-32-240A	RD-314L	UA0199322	TI-327
GJ6A-34-460A	RU-320	H261-32-240A	RD-314R	UA0199323	TI-327
GJ6A-34-470A	RU-318	H2Y0-99-356	BJ-319	UA0199324	TI-597
GJ6A-34-540	BJ-307	HA14-32-240AX	SA-302	UA04-32-220	PI-304
GJ6A-34-710A	RU-319	L20634150A	SI-K52R	UA3N-32-320A	ID-300
GJ6A-34-J00B	CJ-305	L20634170A	SI-K52L	UB39-28-333	RU-332
GJ6A-34-J50B	CJ-306	LA01-32-115	RD-323	UB39-32-220B	PI-314
GJ6A34300B	CJ-304	LB82-34-300	CJ-307	UB39-32-320	ID-310
GJ6A34300C	CJ-304	LC62-32-240B	RD-330	UB39-32-320A	ID-310
GJ6A34300D	CJ-304	LC62-32-280	BJ-305	UB39-32-320B	ID-313
GJ6A34460B	RU-320	LC62-34-170A	SI-307	UB39-34-154	SI-328
GJ6A34470B	RU-318	LC62-34-300C	BS-321	UB39-99-322	TI-327
GJ6A34J00C	CJ-305	LC62-34-350C	BS-320	UB39-99-356	LB-321
GJ6A34J00D	CJ-305	LC62-34-550	BJ-321	UB3999324	TI-597

UB3999324	TI-321	4013A282	BS-529	MB001696	LB-505
UB40-28-333	RU-333	4056-A014	SI-501	MB001699	LB-505
UB71-34-156A	RU-347	4056A015	SI-H02	MB001715	LB-505
UC86-34-210	BS-331	4056A034	SI-534	MB002433	BJ-599
UC86-34-260	BS-330	4056A035	SI-535	MB002475	BJ-503
UC86-34-510A	BJ-324	4056A037	SI-512	MB002476	BJ-503
UE-38-32-320	ID-313	4056A037	SI-527	MB002583-01	BJ-516
UE39-32-320B	ID-313	4056A038	SI-504	MB002584-01	BJ-516
UH71-28-450	RU-329	4056A052	SI-506	MB005820	ID-503
UH71-28-470	RU-330	4056A079	RU-546	MB006314	TI-503R
UH71-28-480	RU-331	4056A105	SI-517	MB006314	TI-H53
UH71-32-280	TI-341	4056A106	SI-516	MB006315	TI-503L
UH71-34-470	RU-324	4056A111	SI-518	MB006358	TI-503R
UH74-32-250	TI-340	4056A112	SI-519	MB006358	TI-H53
UH74-32-280	TI-342	4056A121	RU-550	MB006359	TI-503L
UH75-34-210A	BS-333	4056A133	SI-526	MB006570	ID-521
UH75-34-260A	BS-332	4056A134	SI-529	MB007023	RU-501
UJ06-32-320	ID-316	4056A161	SI-533	MB076001	SA-502L
UR56-32-220	PI-300	4110A072	BJ-527	MB076002	SA-502R
UR56-32-250	TI-317	4156A014	SI-524	MB076003	TI-505
UR61-32-280	TI-304	4156A028	RU-547	MB076004	TI-504
UR61-34-550	BJ-328	4156A041	RU-551	MB076010	PI-502
W023-99-323	TI-310L	4410A173	RD-515	MB076531	TI-H53
YL8Z-5K483-AA	SI-325	4422A008	TI-535	MB076531	TI-503R
<b>MG</b>	<b>JAPANPARTS</b>	4422A009	TI-520	MB076532	TI-503L
GSJ 1011	TI-487	4422A010	TI-519	MB076663	TI-505
GSJ 1085	TI-488	4422A012	RD-519	MB076664	TI-504
GSJ 1086	TI-489	4422A018	TI-527	MB109168	LB-H52L
GSJ 495	TI-406L	4422A036	RD-520	MB109168	LB-506L
GSJ 496	TI-406R	4422A037	TI-534	MB109169	LB-H52R
<b>MITSUBISHI</b>	<b>JAPANPARTS</b>	4422A038	TI-533	MB109169	LB-506R
1091A079	RU-554	4422A052	TI-536	MB109219	RU-521
1091A080	RU-555	4422A056	RD-516	MB109512	CJ-508
4010A013	BS-516	4422A076	RD-521	MB109513	CJ-509
4010A014	BS-517	51270-SR3-023	BJ-415	MB109529	RU-516
4010A015	BJ-509	91255-04600	TI-532	MB109539	UI-502
4010A037	BS-524	AW311699	BJ-512	MB109539-01	IS503
4010A038	BS-525	AW330961	BJ-519	MB109557	RU-517
4013A009	BS-528	MA150801	TI-596	MB109585	BJ-503
4013A010	BS-529	MA159982	TI-502	MB109586	UI-502
4013A087	BS-518	MA159984	TI-H52	MB109587	LB-504
4013A088	BS-519	MA159984	TI-501	MB109588	LB-504
4013A090	BJ-507	MA169613	TI-502	MB109662	RU-505
4013A209	BS-530	MA169614	TI-501	MB109684	RU-506
4013A210	BS-531	MA169614	TI-H52	MB109858	TI-508
4013A211	BJ-510	MB-584531	RU-511	MB111070	RU-512
4013A211	BJ-526	MB-633870	RU-505	MB111071	RU-511
4013A281	BS-528	MB-892982	SI-501	MB111203	RU-510

**CROSS REFERENCE LIST**  
**VERGLEICHSLISTE**  
**LISTA DE REFERENCIAS CRUZADES**  
**LISTE DE COMPARAISON**  
**LISTA DI COMPARAZIONE**

MB112476	BJ-503	MB185441	TI-H53	MB303375	BJ-512
MB112477	BJ-503	MB192297	ID-503	MB315160	RD-505
MB122000	ID-504	MB192430	TI-H56	MB315586	RD-503
MB122011	TI-506	MB192430	TI-516	MB315629	TI-H53
MB122012	TI-506	MB192499	TI-H56	MB315629	TI-503R
MB122135	RD-501	MB192499	TI-516	MB315769	ID-512
MB122396	PI-504	MB241155	BJ-508	MB315770	ID-511
MB122400	ID-506	MB241155	LB-H60	MB315775	TI-509
MB122774	ID-503	MB241156	LB-H60	MB315776	TI-510
MB122779	TI-505	MB241156	BJ-508	MB338594	RU-566
MB122781	TI-H52	MB241165	PI-502	MB347599	TI-515
MB122781	TI-501	MB241166	PI-509	MB347666	RD-502
MB122782	TI-H52	MB241168	PI-508	MB349475	LB-H60
MB122782	TI-501	MB241171	TI-509	MB349475	BJ-508
MB130807	RD-599	MB241172	TI-H53	MB349575	LB-H60
MB142181	TI-503R	MB241172	TI-503R	MB349575	BJ-508
MB150095	RU-525	MB241196	ID-521	MB349963	BJ-512
MB154199	RU-500	MB241206	TI-510	MB349964	BJ-512
MB166281	PI-509	MB241207	TI-503L	MB350577	RD-505
MB166284	ID-505	MB241420	ID-504	MB350718	RD-504
MB166420	DY-504	MB241421	ID-505	MB378701	TI-505
MB166422	DY-599	MB241422	ID-505	MB378702	TI-504
MB166424	PI-599	MB241423	ID-510	MB378703	TI-508
MB166425	PI-521	MB241425	ID-509	MB378704	TI-501
MB166426	TI-H53	MB241448	PI-504	MB378704	TI-H52
MB166426	TI-503R	MB241449	PI-501	MB430350	BJ-512
MB166427	TI-503L	MB241495	ID-503	MB430351	BJ-512
MB166428	ID-507	MB241496	ID-521	MB436444	RU-502
MB166429	ID-511	MB241499	ID-506	MB489434	TI-516
MB166592	TI-508	MB241500	ID-506	MB489434	TI-H56
MB166765	TI-509	MB241508	ID-506	MB489606	RD-502
MB166766	TI-510	MB241818	LB-509	MB501530	RD-504
MB166980	TI-505	MB241830	ID-508	MB518041	BJ-512
MB166981	TI-508	MB241883	BJ-512	MB518042	BJ-512
MB166982	TI-H52	MB241884	PI-511	MB518205	BJ-512
MB166982	TI-501	MB241973	PI-510	MB518206	BJ-512
MB175544	LB-504	MB241974	SI-522	MB518283	BJ-520
MB175581	RU-520	MB241982	TI-511	MB518712	BJ-512
MB175804	RU-507	MB241982	TI-514	MB518713	BJ-512
MB175812	LB-509	MB243329	RD-506	MB518780	SI-504
MB176273	LB-509	MB243373	RD-503	MB518892	SI-501
MB176283	LB-509	MB244901	RD-500	MB518960	BJ-512
MB176308	LB-507	MB260676	RU-503	MB518961	BJ-512
MB176309	BJ-508	MB266152	RD-505	MB527157-01	BJ-520
MB176309	LB-H60	MB267685	RU-522	MB527159	BJ-520
MB176442	RU-519	MB275632	RU-524	MB527159	BS-512
MB185329	LB-510	MB288119	TI-522	MB527161-01	BJ-520
MB185441	TI-503R	MB303374	BJ-512	MB527169	TI-514

MB527228	ID-514	MB809220	CJ-502	MC891911	TI-537
MB527349	BJ-513	MB809221	CJ-503	MN100250	RU-541
MB527350	BJ-513	MB809230	CJ-516	MN101368	SI-523
MB527351	BJ-515L	MB809231	CJ-515	MN101395	RU-577
MB527352	BJ-515R	MB809354	SI-599	MN125871	RU-548
MB527383	TI-H004	MB809355	SI-502	MN184133	RU-549
MB527383-01	BJ-514	MB809357	RU-569	MN184194	SI-525
MB527384	TI-H005	MB809388	RU-513	MN186217	BS-508
MB527384-01	BJ-514	MB809455	SI-502	MN186218	BS-509
MB527511-01	BJ-520	MB831035	BS-532	MR102653	RU-528
MB527512-01	BJ-520	MB831036	BS-533	MR102654	RU-529
MB527650	TI-515	MB831037	BJ-523L	MR130479	CJ-500
MB532046	RD-502	MB831038	BJ-523R	MR130480	CJ-501
MB532281	RD-509	MB831039	SI-515	MR130807	RD-599
MB532657	RD-505	MB831040	PI-512	MR131004	RU-575
MB532971	RD-510	MB831042	ID-515	MR131732	SI-508
MB553249	RD-508	MB831043	TI-599	MR131830	RD-514
MB564991	TI-516	MB831044	TI-598	MR132551	SI-514
MB564991	TI-H56	MB844456	RU-570	MR132552	SI-513
MB573043	SI-501	MB860381	BS-522	MR150093	RU-563
MB573783	RU-523	MB860382	BS-523	MR150094	RU-527
MB573784	RU-508	MB860408	BJ-520	MR150095	RU-527
MB573885	TI-H56	MB860408	BS-513	MR150767	RU-564
MB573885	TI-516	MB860817	BJ-512	MR162803	BS-510
MB576093	BJ-512	MB860818	BJ-512	MR162804	BS-511
MB576094	BJ-512	MB860829	BJ-522	MR165252	RU-576
MB581845	RU-504	MB860829	TI-H97	MR171441	RU-567
MB584021	SI-528	MB860830	BJ-522	MR179479	BS-500
MB584146	RU-518	MB860830	LB-H61	MR179480	BS-501
MB597605	TI-514	MB860830	TI-H97	MR197068	RU-574
MB598017	TI-H005	MB864164	TI-515	MR223119	RU-573
MB598017	TI-H004	MB879354	SI-599	MR234247	RU-537
MB598017	RU-H14	MB892981	SI-507	MR241023	BS-514
MB598018	TI-H005	MB910859	TI-H56	MR241024	BS-515
MB598018	RU-H14	MB910859	TI-516	MR241025	CJ-510
MB598018	TI-H004	MB910934	RD-599	MR241026	CJ-511
MB598023	TI-514	MB910961	RD-599	MR241027	BJ-505
MB598097	RU-509	MB912076	TI-514	MR241031	TI-517
MB598098	SI-530	MB912077	BS-504	MR241032	TI-512
MB616286	TI-H56	MB912078	BS-505	MR241341	BS-506
MB616286	TI-516	MB912505	BS-510	MR241342	BS-507
MB631492	RU-514	MB912506	BS-511	MR244116	RU-533
MB633820	RU-578	MB912509	CJ-506	MR244901	RD-500
MB633926	SI-515	MB912510	CJ-507	MR267649	RU-565
MB672370	SI-520	MB912519	TI-516	MR267876	SI-514
MB808076	SI-521	MB912519	TI-H56	MR267877	SI-513
MB808909	RU-528	MB949343	RD-513	MR272116	SI-500
MB808910	RU-529	MC891910	TI-538	MR272117	SI-503

**CROSS REFERENCE LIST**  
**VERGLEICHSLISTE**  
**LISTA DE REFERENCIAS CRUZADES**  
**LISTE DE COMPARAISON**  
**LISTA DI COMPARAZIONE**

MR272118	SI-505	MR418547	RU-560	MR992309	SI-510
MR272646	RU-572	MR439701	BS-506	MR992310	SI-509
MR296027	CJ-510	MR439702	BS-507	MR992317	RU-538
MR296028	CJ-511	MR448255	RD-518	MR992670	RU-552
MR296093	BS-534	MR455699	RU-568	MR992713	RU-557
MR296094	BS-535	MR476457	TI-514	MR992717	RU-558
MR296267	BS-268	MR476595	SI-512	MT141175	BJ-599
MR296268	BS-269	MR485672	TI-514	MT141176	BJ-599
MR296269	BJ-523L	MR491345	CJ-502	MT141196	BJ-501
MR296270	BJ-523R	MR491346	CJ-503	MT141247	IS501
MR296272	ID-500	MR491358	RD-516	MT142181	TI-503R
MR296274	TI-518	MR496792	BJ-509	MT142181	TI-H53
MR296274	TI-510	MR496793	BS-524	MT142182	TI-503L
MR296292	CJ-505	MR496794	BS-525	MT241449	PI-501
MR296292	RU-534	MR496795	RU-544	MT402860	ID-521
MR296293	CJ-504	MR496795	RU-543	MT402870	PI-501
MR296293	RU-534	MR496795	BS-526	MT402871	PI-501
MR296295	CJ-506	MR496796	BS-527	MW033300	TI-507L
MR296295	RU-535	MR496796	RU-543	MW033301	TI-507R
MR296295	RU-536	MR496796	RU-544	PW530031	RD-512
MR296296	RU-536	MR496799	BJ-510	UB39-99-324	TI-597
MR296296	RU-535	MR508130	BJ-521		
MR296296	CJ-507	MR508135	TI-524	<b>NISSAN</b>	<b>JAPANPARTS</b>
MR297500	RU-571	MR508136	TI-523	01225-00231	RU-1006
MR297969	RD-599	MR510267	RD-517	11200360 0	TI-N031
MR316368	SI-H02	MR510417	RU-544	11200361 0	TI-N032
MR316435	SI-534	MR519398	RU-542	11210-01B01	RU-100
MR316436	SI-535	MR554271	RU-550	11210-0F002	RU-176
MR319067	RU-545	MR554820	RU-562	11210-2F001	RU-198
MR325576	CJ-507	MR580647	RU-553	11210-2S710	RU-1015
MR325577	CJ-506	MR589880	RU-561	11210-35G00	RU-102
MR333166	RD-513	MR594282	RU-559	11210-8H305	RU-177
MR374521	SI-516	MR594339	SI-532	11210-8H30E	RU-177
MR374522	SI-517	MR594340	SI-531	11210-99B00	RU-170
MR392730	SI-522	MR594674	RD-513	112102F200	RU-199
MR403027	RD-507	MR911569	BS-503	112106F800	RU-1001
MR403419	BS-520	MR911570	BS-502	1121090J01	RU-196
MR403420	BS-521	MR915770	BS-501	1121093J00	RU-197
MR403440	RU-539	MR916133	BS-502	11210AX600	RU-182
MR403441	RU-540	MR954887	SI-533	11210AX60A	RU-182
MR403485	CJ-512	MR954888	SI-522	11210AY600	RU-183
MR403771	SI-512	MR961391	BS-536	11210AY60A	RU-183
MR414939	BJ-524	MR961392	BS-537	11210BN702	RU-187
MR414939	CJ-514	MR961477	SI-M02	11210BV000	RU-194
MR414940	CJ-513	MR977606	TI-500	11220-10J00	RU-104
MR414940	BJ-524	MR992191	SI-526	11220-2S710	RU-1016
MR418052	SI-518	MR992192	SI-529	11220-35G00	RU-101
MR418053	SI-519	MR992256	RU-556	11220-7F000	RU-178
				11220-99B11	RU-1026

11220-99B20	RU-1003	40110-T6025	BJ-111	40160-60Y00	SJ-190
1122093J00	RU-1000	40110-V0100	BJ-111	40160-60Y10	SJ-190
1122099B01	RU-1002	4011000QAA	BJ-126	40160-60Y20	SJ-190
11220AX600	RU-180	4011000QAB	BJ-126	40160-60Y60	LB-130
11270-00QAA	RU-1012	401100F000	BJ-111	40160-67L00	BJ-195
11270-BU000	RU-192	40110EB300	BJ-131	40160-69Y00	SJ-190
11270BM500	RU-184	40110G5110	BJ-123	40160-69Y10	SJ-190
11270BN310	RU-193	40160 00Q0B	BJ-132	40160-7F000	LB-101
11320-01G00	RU-103	40160-01A00	LB-110	40160-85E00	BJ-124
11320-06J00	RU-105	40160-01A25	LB-110	40160-86M00	LB-130
11320-2F020	RU-190	40160-01B25	BJ-134	40160-92G90	LB-190
11320-2F320	RU-191	40160-01E00	BJ-124	40160-93G00	LB-121
11320-31G0A	RU-1017	40160-01E25	BJ-124	40160-93G25	LB-121
11320-7F000	RU-173	40160-01G00	LB-190	40160-93G26	LB-121
11320-99B11	RU-1025	40160-01G25	LB-190	40160-9C500	TI-N016
113200M002	RU-1010	40160-01G26	LB-190	40160-A006G0	LB-110
113206F800	RU-1004	40160-01G50	LB-190	40160-A03G0	LB-110
1132093J00	RU-188	40160-01G90	LB-190	40160-A8600	LB-103
1132093J20	RU-189	40160-01N25	LB-190	40160-A8610	LB-103
11320BM500	RU-185	40160-01P00	BJ-137	40160-A8625	LB-103
11320BN301	RU-186	40160-01P81	BJ-137	40160-B9500	LB-199
11340-02B04	RU-179	40160-0F000	LB-121	40160-D0125	BJ-113R
1135041B00	RU-1011	40160-0M020	SJ-190	40160-EA00A	BJ-130
11360-BV000	RU-195	40160-0W025	BJ-119	40160-F1700	LB-199
11360AY600	RU-181	40160-21P00	BJ-137	40160-F4200	SJ-190
119051300	TI-N029	40160-26P00	BJ-137	40160-G2500	LB-109
119051310	TI-N030	40160-27N25	LB-190	40160-G2525	LB-109
20638-61500	RU-132	40160-2S485	BJ-110	40160-G4010	LB-109
34140 AA030	RD-705	40160-2S601	BJ-115	40160-G5100	LB-109
37521-34G25	RU-106	40160-2Y000	BJ-101	40160-G5400	LB-109
37521-36G25	RU-1014	40160-41L00	BJ-195	40160-H1000	LB-104
37521-W1025	RU-171	40160-48W00	LB-199	40160-H1001	LB-104
40100-P0110	BJ-111	40160-48W25	LB-199	40160-H7400	LB-105
40110-01G00	BJ-111	40160-4F100	TI-183	40160-H7427	LB-105
40110-01G25	BJ-111	40160-50A00	LB-130	40160-M3025	LB-115
40110-01G26	BJ-111	40160-50J25	LB-130	40160-M7025	LB-118
40110-2S485	BJ-107	40160-50W00	LB-121	40160-N8400	BJ-120
40110-2S685	BJ-109	40160-50W01	LB-121	40160-P6525	LB-119
40110-73000	BJ-111	40160-50W10	LB-121	40160-S0104	LB-119
40110-B9500	BJ-111	40160-50W25	LB-121	40160-S0105	LB-119
40110-E0100	BJ-111	40160-50Y00	SJ-190	40160-S0106	LB-119
40110-F1700	BJ-111	40160-50Y10	SJ-190	40160-S0125	LB-119
40110-G0300	BJ-108	40160-51E00	BJ-124	40160-S0126	LB-119
40110-G3700	BJ-123	40160-52Y00	SJ-190	40160-S0127	LB-119
40110-G5100	BJ-123	40160-52Y10	SJ-190	40160-S0128	LB-119
40110-P0110	BJ-111	40160-55G90	LB-190	40160-T3060	LB-199
40110-T3060	BJ-111	40160-60T10	SJ-190	40160-U7000	LB-103
40110-T6000	BJ-111	40160-60T20	SJ-190	40160-W1000	LB-126

**CROSS REFERENCE LIST**  
**VERGLEICHSLISTE**  
**LISTA DE REFERENCIAS CRUZADES**  
**LISTE DE COMPARAISON**  
**LISTA DI COMPARAZIONE**

40160-W1001	LB-126	48001JD900	RD-122	48520 4A00B	TI-824
40160-W2200	LB-126	48510 4A00C	RD-816	48520-00QAH	TI-160
40160-W2210	LB-126	48510-01G25	SA-115	48520-00QAJ	TI-161
40160-W5000	LB-106	48510-01L25	SA-106	48520-00QAK	TI-1000
40160-Y02G0	SJ-190	48510-01N25	SY-190	48520-00QAL	TI-1001
40160-ZG90A	BJ-130	48510-01W00	SO-104	48520-00QAM	RD-117
4016000001	SJ-190	48510-11A27	SA-199	48520-00QAN	TI-162
40160000AC	BJ-104	48510-20500	SO-101R	48520-00QAP	TI-163
40160000AD	BJ-104	48510-2T025	SO-102R	48520-01B25	TI-190
4016000Q0A	BJ-121	48510-31G25	SA-116	48520-01E00	TI-109
4016000QAB	BJ-103	48510-35A26	SA-199	48520-01E25	TI-109
4016000QAC	BJ-104	48510-41W00	SA-111	48520-01E26	TI-109
4016000QAD	BJ-104	48510-50A25	SA-126	48520-01F25	TI-122R
4016001E00	TI-178	48510-50A26	SA-125	48520-01G25	TI-139
4016001E00	LB-130	48510-50A27	SA-125	48520-01G25	TI-140
4016001E25	TI-178	48510-50W00	SA-114R	48520-01J00	TI-158
4016001E25	LB-130	48510-50Y25	SA-129	48520-01J10	TI-173
401600M010	SJ-190	48510-51A25	SA-126	48520-01L25	TI-130
4016041L00	TI-148	48510-53A25	SA-126	48520-01P25	TI-159
401604F105	TI-183	48510-53A26	SA-126	48520-01R25	TI-186
4016050Y02	SJ-190	48510-70A25	SA-199	48520-01W00	TI-107
4016050Y0R	SJ-190	48510-B5000	SO-101R	48520-02E00	TI-109
4016050Y20	SJ-190	48510-B9500	SO-101R	48520-02E25	TI-109
4016051E00	TI-178	48510-B9525	SO-101R	48520-02E26	TI-109
4016051E00	LB-130	48510-D0100	SA-199	48520-0C025	TI-101
4016052Y20	SJ-190	48510-D0125	SA-199	48520-0M025	TI-109
4016052Y60	SJ-190	48510-G2500	SA-110R	48520-0P725	TI-1002
4016069C00	LB-130	48510-G2525	SA-110R	48520-15U25	TI-101
4016085E00	TI-178	48510-G5101	SA-124R	48520-17B25	TI-190
4016085E00	LB-130	48510-G5125	SA-124R	48520-21P25	TI-149
40160A06G0	LB-110	48510-H1001	SA-120R	48520-27N25	TI-175
40160BU000	BJ-101	48510-H1025	SA-112R	48520-2S425	TI-138
40161-48W00	LB-198	48510-H5025	SA-112R	48520-2S485	TI-138
40161-48W25	LB-199	48510-Q0125	SA-107	48520-31C00	TI-155L
40161-48W25	LB-198	48510-R8000	SO-102R	48520-31G25	TI-142
40161-50W01	LB-121	48510-R8025	SO-102R	48520-41L00	TI-148
40161-52Y10	SJ-190	48510-S0125	SA-107	48520-41L25	TI-148
40161-9C500	TI-N017	48510-T3026	SO-102R	48520-41L26	TI-148
40161-B9500	LB-198	48510-T3060	SO-102R	48520-41L27	TI-148
40161-D0125	BJ-113L	48510-T3065	SO-102R	48520-41W00	TI-107
40161-F1700	LB-198	48510-U0100	SA-122R	48520-4F125	TI-181
40161-T3060	LB-198	48510-V5001	SA-108	48520-50A00	TI-147
4500254	BJ-103	48510-V5025	SA-108	48520-50A25	TI-147
45261-4F702	SI-198	48510-V6225	SA-108	48520-50A26	TI-147
45261-90J01	SI-199	48510-V6600	SA-108	48520-50W00	TI-112
45527-JD1A	TI-1003	48510-V6625	SA-108	48520-50Y25	TI-109
45527JD01A	TI-1003	48510-W5000	SA-103R	48520-53E25	TI-185
480019U100	RD-115	48510-W5025	SA-103R	48520-61G25	TI-196

48520-71L25	TI-194	485200C000	TI-101	48521-8H300	RD-121
48520-73J25	TI-188	485200W025	TI-146	48521-8H325	RD-121
48520-7F001	TI-189	4852015U26	TI-101	48521-8H385	RD-121
48520-88E25	TI-174	4852031C00	TI-155R	48521-A0600	TI-103R
48520-A0600	TI-102R	4852041W00	TI-140	48521-D0100	RD-101
48520-AX600	TI-165	4852041W00	TI-139	48521-EA000	RD-116
48520-AX602	TI-1007	4852050Y25	TI-147	48521-G2525	TI-126R
48520-BM425	TI-100	4852060Y25	TI-194	48521-G5101	TI-156R
48520-C6079	TI-N010	4852060Y25	TI-101	48521-G5125	TI-156R
48520-C8400	TI-N010	485206F625	TI-181	48521-H1001	TI-105R
48520-C84100	TI-N010	485207F000	TI-142	48521-H5025	TI-105R
48520-D0100	TI-109	485209C000	TI-188	48521-M3070	RD-104
48520-D0125	TI-109	485209C025	TI-188	48521-M7000	RD-104
48520-D0126	TI-109	48520OM085	TI-101	48521-N8425	TI-154R
48520-EA01J	TI-150	48520OM085	TI-194	48521-P9001	RD-103
48520-G2525	TI-102R	48521-00QAF	RD-112	48521-Q0125	TI-117
48520-G5101	TI-155R	48521-00QAG	RD-113	48521-S0101	TI-117
48520-G5125	TI-155R	48521-01F00	RD-103	48521-S0102	TI-117
48520-G9502	TI-N010	48521-01G25	TI-141	48521-S0103	TI-117
48520-H1001	TI-104R	48521-01L25	TI-131	48521-S0125	TI-117
48520-H5025	TI-106R	48521-01N25	TI-195	48521-S0126	TI-117
48520-M0225	TI-118	48521-01W00	TI-108	48521-U0100	TI-103R
48520-M3025	TI-118	48521-0W025	RD-120	48521-U5200	TI-103R
48520-OP725	TI-1002	48521-17B00	RD-185	48521-W1000	RD-103
48520-Q0125	TI-116	48521-1M210	AX-191	48521-W1001	RD-103
48520-R8000	SA-102L	48521-27N00	RD-109	48521-W5025	TI-105R
48520-R8025	SA-102L	48521-2S425	TI-111	4852100Q0B	RD-112
48520-S0101	TI-116	48521-2S485	TI-111	4852106R05	TI-180
48520-S0102	TI-116	48521-31G25	TI-189	4852106R06	TI-180
48520-S0125	TI-116	48521-35A00	RD-105	485210W026	RD-120
48520-T3026	SA-102L	48521-35A06	RD-105	485211M226	AX-191
48520-T3060	SA-102L	48521-35F00	RD-101	485214M588	RD-108
48520-T3065	SA-102L	48521-3U025	RD-123	485214U085	RD-111
48520-U0100	TI-102L	48521-40U21	RD-114	4852172E00	TI-180
48520-U5200	TI-102R	48521-40U25	RD-114	4852172L00	TI-180
48520-V0100	TI-122L	48521-4M500	RD-108	4852172V06	TI-180
48520-V0125	TI-199	48521-4M528	RD-108	48527-1U61A	TI-167
48520-W1025	TI-122R	48521-4U000	RD-111	48527-JD01A	TI-1003
48520-W5025	TI-106R	48521-50400	AX-190	48530-01G00	ID-118
4852001E00	TI-147	48521-50W00	TI-113R	48530-01G25	ID-118
4852001E25	TI-147	48521-50Y00	AX-190	48530-04C00	RT-101
4852001E26	TI-147	48521-50Y25	TI-108	48530-18V00	ID-126
4852001W00	TI-139	48521-70A00	RD-101	48530-20V00	ID-126
4852001W00	TI-140	48521-70A06	RD-101	48530-21400	ID-101
4852002E00	TI-147	48521-71L00	RD-106	48530-31G25	ID-120
4852002E25	TI-147	48521-71V06	TI-180	48530-35G25	ID-119
4852002E26	TI-147	48521-72E00	RD-106	48530-B9500	ID-102
485200C000	TI-194	48521-72E06	TI-180	48530-B9510	ID-102



**CROSS REFERENCE LIST**  
**VERGLEICHSLISTE**  
**LISTA DE REFERENCIAS CRUZADAS**  
**LISTE DE COMPARAISON**  
**LISTA DI COMPARAZIONE**

48530-G3701	ID-180	48630-G2525	SA-110L	48647-JD01A	TI-1004
48530-G3710	ID-180	48630-G5101	SA-124L	48680-11J00	TI-N008
48530-G5101	ID-127	48630-G5125	SA-124L	48680-C6061	TI-N008
48530-G5701	ID-128	48630-H1000	SA-120L	54320-1F500	RU-169
48530-Y9500	RT-101	48630-H1001	SA-120L	54320-40U00	RU-1005
48560-09G25	CR-113	48630-Q0125	SA-107	54320-4F102	RU-169
48560-0F000	TI-N028	48630-R8025	SA-102L	54320-50Y12	RU-1008
48560-31G25	CR-114	48630-S0125	SA-107	54320-65E00	RU-1006
48560-31G26	CR-114	48630-U0100	SA-122L	54423 4A00B	RU-841
48560-3S525	CR-115	48630-V5001	SA-108	54423-00QAA	RU-143
48560-61G25	CR-116	48630-V5025	SA-108	54423-B9500	RU-107
48560-G9501	TI-N012	48630-V5026	SA-108	54476-01B00	RU-147
48560-W5000	CR-107	48630-V5401	SA-108	54476-01G00	RU-118
48560-W5025	CR-107	48630-V5425	SA-108	54476-01J00	RU-126
48560-W5700	CR-198	48630-V6625	SA-108	54476-01W00	RU-115
48560-W5725	CR-198	48630-W5025	SA-103L	54476-F0200	RU-114
48561-T3001	TI-119	48640-01F25	TI-122L	54477-T6000	RU-115
48561-T3025	TI-119	48640-01N25	TI-195	54479-50W00	RU-115
48570-01J00	TI-158	48640-31C00	TI-155R	54499-W2210	CW-195
48570-01J10	TI-172	48640-50W00	TI-112L	54500 BM400	BS-107
48570-11J00	TI-152	48640-A0600	TI-102L	54500 EL000	BS-141
48570-11J25	TI-152	48640-AX600	TI-164	54500-00QAC	BS-111
48570-31G25	TI-189	48640-AX602	TI-1008	54500-00QAH	BS-113
48570-3S525	TI-123	48640-EA01J	TI-179	54500-0M010	BS-105
48570-61G25	TI-197	48640-G5101	TI-155L	54500-0W001	BS-129
48570-82100	TI-110L	48640-G5125	TI-155L	54500-21B00	TI-177
48570-C6079	TI-152	48640-H1001	TI-104L	54500-2F500	BS-123
48570-C8410	TI-152	48640-H5025	TI-106L	54500-30R10	TI-178
48570-G9501	TI-N009	48640-N8425	TI-153L	54500-41U00	BS-115
48570-J5100	TI-110L	48640-U0100	TI-102L	54500-44B00	BS-100
48570-T3001	TI-120	48640-U5200	TI-102L	54500-4F102	BS-100
48571-T3025	TI-120	48640-W1025	TI-122L	54500-4F105	BS-100
48580-82100	TI-110R	48640-W5025	TI-106L	54500-50J10	BS-102
48580-J5100	TI-110R	48640G5101	TI-155R	54500-5U300	BS-109
48600-G2725	RT-100	48641-01N25	TI-193	54500-67L00	CJ-193
48630-01G25	SA-115	48641-50W00	TI-113L	54500-6F600	BS-117
48630-01L25	SA-106	48641-A0600	TI-103L	54500-7C350	BS-127
48630-01N25	SY-190	48641-G2525	TI-103R	54500-86J00	BS-102
48630-01W00	SO-104	48641-G5125	TI-156L	54500-8H310	BS-131
48630-20500	SO-101L	48641-H1001	TI-105L	54500-AV600	BS-125
48630-2T025	SA-102L	48641-H5025	TI-105L	54500-AX600	BS-119
48630-31G25	SA-116	48641-N8425	TI-154L	54500-BM410	BS-107
48630-41W00	SA-111	48641-U0100	TI-103L	54500-JD000	BS-135
48630-50W00	SA-114L	48641-U0100	TI-191	54500-W2210	CJ-190
48630-B5000	SO-101L	48641-W5025	TI-105L	5450000QAD	BS-111
48630-B9500	SO-101L	48641G5101	TI-156L	5450000QAE	BS-111
48630-B9525	SO-101L	48647-1U61A	TI-166	5450000QAH	LB-100
48630-G2500	SA-110L	48647-9X62A	TI-N032	545000M020	BS-105

545000M060	BS-105	54501-AX600	BS-118	54503-2S485	CJ-106
545000W000	BS-129	54501-BM400	BS-106	54503-55G90	CJ-100
545001KA0B	BS-147	54501-JD000	BS-134	54503-7F000	BS-136
545002F500	RU-157	5450100QAD	BS-110	5450300Q0C	BS-132
5450041U01	BS-115	5450100QAE	BS-110	5450300QAA	BJ-116
5450041U02	BS-115	5450100QAH	LB-100	5450300QAB	BS-120
545004F105	RU-149	545010M020	BS-104	545032S485	BJ-110
545004F105	RU-148	545010M060	BS-104	5450355G10	CJ-100
545006F600	BJ-105	545010W000	BS-128	5450392G00	CJ-100
5450086J00	RU-156	545011KA0B	BS-146	5450392G90	CJ-100
545008H310	RU-164	545012F500	RU-158	54506-B9500	RU-108
545008H310	RU-163	5450141U00	BS-114	54524-2F010	ML-100
54500AV606	RU-160	5450141U02	BS-114	54524-2S486	BS-139
54500AV606	BJ-118	545014F105	RU-148	54524-3J201	ML-100
54500AV606	BS-125	545014F105	RU-149	54524-86J10	ML-100
54500AV606	RU-159	545016F600	BJ-105	54524-AV600	CJ-103
54500AV60C	BS-125	5450186J00	RU-156	5452486J01	ML-100
54500BC41A	BS-119	545018H310	RU-163	54524AV601	CJ-103
54500BC42A	BJ-106	545018H310	RU-164	54524EB300	BS-145
54500BC42A	BS-119	54501AV600	BS-124	54524EB30A	BS-145
54500BM400	BJ-100	54501AV605	BJ-118	54524VK385	BJ-109
54500BM410	BJ-100	54501AV605	RU-159	54525-2F010	ML-101
54500BM410	RU-140	54501AV605	RU-160	54525-2S486	BS-138
54500BM410	RU-141	54501BC41A	BS-118	54525-3J201	ML-101
54500BU000	BS-109	54501BC42A	BJ-106	54525-86J10	ML-101
54500F4300	BS-105	54501BC42A	BS-118	54525-AV600	CJ-102
54500JG000	BS-135	54501BM400	BJ-100	5452586J01	ML-101
54501 BM410	BS-106	54501BM410	RU-141	54525AV601	CJ-102
54501 EL000	BS-140	54501BM410	RU-140	54525EB300	BS-144
54501-00QAC	BS-110	54501BM410	BJ-100	54525EB30A	BS-144
54501-00QAH	BS-112	54501BU000	BS-108	54529 4A00A	BJ-803
54501-0M010	BS-104	54501JG000	BS-134	54529 4A00D	BS-816
54501-0W001	BS-128	54502-00Q0B	BS-133	54530 4A00D	BS-815
54501-21B00	TI-184	54502-00QAA	BS-133	54535 01B00	RU-146
54501-2F500	BS-122	54502-01G90	CJ-101	54542-2S610	RU-1013
54501-41U01	BS-114	54502-2S485	CJ-105	54550-8H300	RU-164
54501-44B00	BS-101	54502-55G90	CJ-101	54560 00QAB	RU-145
54501-4F102	BS-101	54502-7F000	BS-137	54560-01G00	RU-110
54501-4F105	BS-101	5450200Q0C	BS-133	54560-01J00	RU-119
54501-50J10	BS-103	5450200QAB	BS-121	54560-50A00	RU-138
54501-5U300	BS-108	5450201G00	CJ-101	54560-8H300	RU-163
54501-67L00	CJ-194	5450201G50	CJ-101	54560-AX600	RU-150
54501-6F600	BS-116	545022S485	BJ-110	54570-00QAA	RU-142
54501-7C350	BS-126	5450255G10	CJ-101	54570-50A10	RU-1007
54501-86J00	BS-103	5450292G00	CJ-101	54570-50J00	RU-156
54501-8H310	BS-130	5450292G90	CJ-101	54570-69Y10	RU-139
54501-AV605	BS-124	54503-00QAA	BS-120	54570-AX600	RU-151
54501-AV606	BS-124	54503-01G90	CJ-100	54590-01E00	RU-155

**CROSS REFERENCE LIST**  
**VERGLEICHSLISTE**  
**LISTA DE REFERENCIAS CRUZADES**  
**LISTE DE COMPARAISON**  
**LISTA DI COMPARAZIONE**

54613 00QAD	RU-144	54618-OE000	SI-108	56261-0E000	SI-124
54613-01J11	RU-123	5461800Q0C	SI-105	56261-0F600	SI-198
54613-06J10	RU-124	5461801G0A	SI-113	56261-4F725	SI-198
54613-0F001	RU-125	546182F010	SI-120	56261-6F600	TI-182
54613-0X800	RU-172	546183W400	SI-127	56261-86J25	SI-199
54613-14900	RU-113	5461847B0A	SI-109	56261-90J01	SI-199
54613-2Y003	RU-174	5461858820	SI-101	56261-EA500	SI-117
54613-32G00	RU-128	5461886J00	SI-120	56261-EA510	SI-118
54613-43G00	RU-121	54618BC40A	SI-111	56261-EQ000	SI-131
54613-4U006	RU-174	54618BU00	SI-103	562614F702	SI-198
54613-8H518	RU-175	54618D5000	SI-101	562616F600	SI-198
54613-9U000	RU-152	54618D5010	SI-101	56261AV611	SI-123
54613-AU004	RU-174	54668-4U000	SI-104	56261AW000	SI-123
54613-JD03A	RU-165	54668-8H300	SI-130	7700312852	BJ-104
54613-JD18C	RU-166	54668-9C000	TI-N020	7701472038	LB-100
54613-W1410	RU-122	54668-AU000	SI-122	8200565079	BS-133
54614M-4A00B	RU-840	54668-EA010	SI-116	8200626959	BS-132
54616 4A00B	SI-807	54668-JD00A	SI-132	D8520-1HJ0A	TI-1009
54616-00QAA	SI-107	54668BU00	SI-104	D8520-1KA0A	TI-1005
54616-00QAB	SI-106	54668CA000	SI-138	D85200W025	TI-146
54616-00QAC	SI-119	54668CA00E	SI-138	D8520EW00A	TI-166
5461600Q0C	SI-106	55045-07200	RU-131	D8520JG00A	TI-1003
54618-00QAA	SI-105	55045-10W00	RU-116	D8521 JG00A	RD-122
54618-01G00	SI-113	55045-31000	RU-134	D8521-1HJ0A	RD-125
54618-02E00	SI-114	55045-G2500	RU-120	D8560-VK90A	CR-115
54618-02E0A	SI-114	55045-G9500	RU-131	D8570-VK90A	TI-123
54618-0E000	SI-108	55046-01600	RU-130	D8640-1HJ0A	TI-1010
54618-0F000	SI-125	55046-01G00	RU-109	D86401KA0A	TI-1006
54618-0W001	SI-127	55046-C6000	RU-117	D8640EW00A	TI-167
54618-47B00	SI-109	55046-G9600	RU-117	D8640JG00A	TI-1004
54618-4M400	SI-100	55135-01J00	RU-127	D8E20JG00A	TI-1003
54618-4U000	SI-103	55320-50Y11	RU-1009	D8F40JG00A	TI-1004
54618-50J20	SI-120	55502-00QAA	BS-121	<b>OPEL</b>	<b>JAPANPARTS</b>
54618-50Y00	SI-101	5550200QAA	BJ-116	15293924	BJ-C01
54618-56511	SI-102	55618-JD00A	SI-135	3 50 617	SI-D05
54618-86J25	SI-120	55618JE20A	SI-135	324039	TI-D51L
54618-8H300	SI-129	55619-JD00A	SI-134	44 18 631	BJ-132
54618-90J11	SI-120	55619JE20A	SI-134	4401910	BJ-126
54618-9C002	TI-N019	56112-09400	RU-112	4500090	BJ-126
54618-9U00A	SI-111	56112-0F000	RU-112	4500255	BJ-104
54618-AU000	SI-121	56112-V0100	RU-112	47 08 299	BS-817
54618-AX600	SI-110	56113-60U05	RU-112	47 09 704	RU-837
54618-CA000	SI-137	56260-01J10	SI-112	9 20 007	RD-D04
54618-CA00E	SI-137	56260-0F001	SI-126	94452102	BJ-913
54618-CY00A	SI-136	56260-0W001	SI-128	94459465	BJ-913
54618-EA010	SI-115	56260-41G11	SI-128	<b>PEUGEOT</b>	<b>JAPANPARTS</b>
54618-JD00A	SI-133	56260-VB010	SI-112	180679	RU-290
54618-JX00A	SI-139	56261 AV610	SI-123	<b>PIAGGIO</b>	<b>JAPANPARTS</b>

322575	RD-D01
45046-87581-000	TI-N034
45046-87Z02	TI-N035
45047-87581-000	TI-N033
45047-87Z02	TI-N035
<b>RENAULT</b>	<b>JAPANPARTS</b>
77 01 070 154	BJ-132
7700302114	BJ-126
7701056969	BJ-104
7701056970	BJ-126
7701475841	RD-124
<b>ROVER</b>	<b>JAPANPARTS</b>
GSJ 278	BJ-499
GSJ 407	TI-404L
GSJ 408	TI-404R
GSJ 423	BJ-495
RBX 100670	RU-424
<b>SANTANA</b>	<b>JAPANPARTS</b>
30005938	RU-835
4181077E00	RU-835
<b>SIMPA</b>	<b>JAPANPARTS</b>
FZ90340	RU-340
<b>SMART</b>	<b>JAPANPARTS</b>
0002271V003000000	BJ-M00
0002271V007000000	BJ-M00
0015642V001	BJ-M00
0015642V001000000	BJ-M00
07001V006000000	BS-M00
07001V006000000	RU-M00
07001V007000000	BS-M00
14141V001000000	BS-M00
14141V002000000	BS-M00
15642V001	BJ-M00
15642V001000000	BJ-M00
1765V005000000	CJ-M00
1802V004000000	SI-M01
2271V007000005	BJ-M00
2271V009000000	BJ-M00
451 320 01 89	SI-M03
451 330 00 10	BS-M01
4543200010	SI-M02
4543300707	BS-508
4543300807	BS-509
4544600205	TI-500
4887V002000000	TI-M00
4887V004000000	TI-M00
4887V005000000	TI-M00
4887V006000000	TI-M00

5102V005000000	SI-M00
A4513380137	TI-M01
<b>SSANGYONG</b>	<b>JAPANPARTS</b>
4440108000	BS-S02
4440208000	BS-S01
44430-03000	BJ-S02
44430-03011	BJ-S01
4443003000	BJ-S01
4443003010	BJ-S01
4450108005	BS-S04
4450208005	BS-S03
44505-05001	BJ-S02
4450505000	BJ-S02
44560-03000	BJ-S05
44560-03010	BJ-S05
44560-03011	BJ-S05
44570-03012	BJ-S05
44570-05000	SI-S04
4475005000	SI-S01
4475005001	SI-S01
4475008001	SI-S02
4475508000	SI-S03
45401-05000	LUS04
45501-05000	LUS06
45501-05100	LUS06
45501-05302	LUS06
45502-05004	LUS05
45502-05102	LUS07
45601-05000	LUS09
45712-06000	RU-S00
46620-01000	TI-S31
46620-02010	DY-S01
46660-01000	TI-S02L
46660-01010	TI-S02L
46660-05500	TI-S01
46660-05501	TI-S01
4666008001	TI-S04
4666008011	TI-S05
4666009002	TI-S04
4666009011	TI-S05
46670-01000	TI-S03R
46670-01010	TI-S03R
<b>SUBARU</b>	<b>JAPANPARTS</b>
200200AC200F	BS-701
20200-AA200	BS-701
20200-AA210	BS-700
20200-FC120	BS-703
20200-FC130	BS-702

20200AC210	BS-700
20200AC210F	BS-700
20201-AA000	RU-700
20201-AC100	RU-701
20201-AC110	RU-702
20201-FA070	RU-709
20201-FA080	RU-708
20201-FC020	RU-703
20201-FC100	RU-705
20201-FC110	RU-704
20201-FC120	RU-707
20201-FC130	RU-706
20202-SA000	BS-705
20202-SA010	BS-704
20204 AG011	RU-711
20204 AJ000	RU-710
20420 AA004	SI-700
20420 AJ000	SI-707
20420-AA003	SI-700
20470 AE000	SI-704
20470 AE001	SI-704
20470 FG000	SI-706
20470 SC000	SI-705
20470-SA000	SI-702
20470-SA010	SI-703
20470SA011	SI-703
20481-AA001	SI-701
21067-GA050	BJ-799
31310-GA120	RD-735
31310-GA151	RD-706
31310-GA152	RD-705
31310-GA170	RD-734
31320-GA101	TI-703R
31320-GA111	TI-703L
31320-GA190	TI-704R
31320-GA200	TI-704L
34140-AA040	RD-704
34140-FC000	RD-700
34140AA030	RD-705
34141-AA041	TI-700
34141AA042	TI-700
34160-AE000	RD-703
34160-XA010	RD-708
34160AE001	RD-703
34161SA000	TI-700
4520060810	BS-809
4520060812	BS-809
4520060820	BS-808

**CROSS REFERENCE LIST**  
**VERGLEICHSLISTE**  
**LISTA DE REFERENCIAS CRUZADES**  
**LISTE DE COMPARAISON**  
**LISTA DI COMPARAZIONE**

4520060822	BS-808	11620-71C11	RU-801	45200-85001	CJ-805
4520150G10	BS-809	11710-60A01	RU-808	45200-85002	CJ-805
4520160E01	BS-809	11710-80010	RU-804	45200-85E00	CJ-804
4520170C00	BS-809	11710-80011	RU-804	45200-M79F00	CJ-800
4520250G10	BS-808	11720-80JA0-000	RU-839	4520060812	BS-809
4520260B01	BS-808	29610-82C00	RU-810	4520060822	BS-808
4520260E01	BS-808	29650-82C00	RU-805	4520060860	BS-802
4520270C00	BS-808	41331-62020	RU-811	4520075F20	CJ-810
4553050G00	RU-827	41710-60B00	RU-800	4520076G21	CJ-801
4553070C00	RU-827	41710-80G10	RU-843	45200M79F10	CJ-800
4642060B02	RU-823	41810-60A00	RU-809	45200M79F11	CJ-800
6232-20043	LB-701	41810-60A01	RU-809	45201 77A10	CJ-807
6315-10070	TI-722	41810-65D11	RU-836	45201 M68K00	BS-815
7210-60520	CJ-701	41810-65DB0	RU-836	45201-54L20	BS-813
7210-60530	CJ-700	42412-60A00	RU-814	45201-56B00	TI-N046
7210-67001	BJ-798	42420 M68K00	SI-807	45201-60E01	BS-809
7210-67002	BJ-798	42420-60A00	TI-N051	45201-62J00	BS-811
7210-67003	BJ-798	42420-62J00	SI-804	45201-63G01	BS-801
7210-67020	BJ-704	42420-65D00	TI-N051	45201-65D00	BS-803
7210-67021	BJ-704	42420-65J00	SI-803	45201-65D01	BS-805
7313-10010	RD-733	42420-77A00	SI-806	45201-65J00	BS-807
7313-10011	RD-733	42420-80J00	SI-805	45201-72K01	RU-829
7313-10060	RD-733	4242065D00	TI-N051	45201-72K01	BS-811
7313-10140	RD-707	42431 M68K00	RU-840	45201-72K01	BJ-800
7313-20000	TI-701R	42431-51K40	RU-837	45201-77A01	CJ-807
7313-20010	TI-701L	42431-70B42	RU-820	45201-77A11	CJ-807
7313-20020	TI-705	42431-79J00	RU-830	45201-78K00	BS-807
<b>SUZUKI</b>	<b>JAPANPARTS</b>	42451 M76G00	RU-821	45201-79J00	BS-813
09305-13002	RU-812	45200-50E00	CJ-803	45201-85C00	TI-N046
09319-10030	RU-824	45200-60810	BS-809	4520150G10	BS-809
09319-12023	RU-813	45200-60812	BS-809	4520160E01	BS-809
09319-12044	RU-815	45200-60820	BS-808	4520162J00	BJ-800
09319-12045	RU-816	45200-60822	BS-808	4520162J00	RU-829
09319-14007	RU-818	45200-60863	BS-802	4520163J00	BS-811
0931910030	RU-C07	45200-69DV1	CJ-803	4520167D01	BS-805
09320-10024	RU-817	45200-75F00	CJ-810	4520170C00	BS-809
11610-58B01	RU-807	45200-75F21	CJ-810	45202 77A10	CJ-806
11610-58B10	RU-807	45200-76G00	CJ-804	45202 M68K00	BS-816
11610-58B10	RU-806	45200-76G20	CJ-801	45202-56B00	TI-N047
11610-65D00-000	RU-846	45200-76G22	CJ-801	45202-60E01	BS-808
11610-67D00-000	RU-847	45200-78002	CJ-803	45202-62J00	BS-810
11610-80000	RU-803	45200-79000	CJ-802	45202-63G01	BS-800
11610-80020	RU-802	45200-79001	CJ-802	45202-65D00	BS-802
11610-80JA0-000	RU-838	45200-79002	CJ-802	45202-65D01	BS-804
11610-82C00	RU-802	45200-81A10	BS-812	45202-65J00	BS-806
11610-82C00	RU-803	45200-81A12	BS-812	45202-72K00-000	BS-818
11620-58B00	RU-806	45200-82000	BJ-804	45202-72K01	BS-810
11620-71C10	RU-801	45200-84000	CJ-803	45202-72K01	RU-829

45202-72K01	BJ-800	48810-77E00	TI-806R	48830-78A00	RD-807
45202-77A01	CJ-806	48810-78000	TI-804	48830-82000	RD-802
45202-77A12	CJ-806	48810-78001	TI-804	48830-83E00	RD-811
45202-78K00	BS-806	48810-78002	TI-804	48830-84000	RD-803
45202-79J00	BS-814	48810-78A00	TI-815	48830-86G00	RD-811
4520250G10	BS-808	48810-79000	TI-803R	48830-M70F00	RD-800
4520260B01	BS-808	48810-79J00	TI-822	4883078F00	RD-810
4520260E01	BS-808	48810-80000	TI-806R	4883079J00	RD-813
4520262J00	RU-829	48810-81A00	TI-819	4883079J10	RD-814
4520262J00	BJ-800	48810-81A01	TI-806R	4883083E00	RD-811
4520263J00	BS-810	48810-82000	TI-805	48830M84000	TI-8998
4520267D01	BS-804	48810-83300	TI-806R	48830M84010	TI-8998
4520270C00	BS-808	48810-83E00	TI-823	48850-73010	TI-808
45261 77A10	RU-C07	48810-83E01	TI-823	48850-A60A00	TI-N054
45261-65D01	RU-833	48810-83E02	TI-818	48870-80000	TI-807
45261-65J00	RU-825	48810-84000	TI-812	48870-80001	TI-807
45261-79J00	RU-831	48810-84001	TI-8999	48870-80002	TI-807
45262-65D01	RU-834	48810-84001	TI-812	48870-80060	TI-811
45500-50800	RU-822	4881063J00	TI-818	48870-A80060	TI-N039
45530-62J00	RU-828	4881084001	TI-812	48870-A80A60	TI-N039
45530-70C00	RU-827	48810M68K00	TI-824	57755-1C000	RD-H07
45530-M68K00	RU-841	48810M84001	TI-812	91174728	RU-836
4553050G00	RU-827	48810M84010	TI-8999	94788122	BJ-D51
45700-60A00	TI-890	48810M84010	TI-812	<b>TATA (TELCO)</b>	<b>JAPANPARTS</b>
45700-67001	BJ-801	48810M84020	TI-8999	0305-99-356A	LB-303
46221 51K10	RU-842	48820-60001	TI-803L	0G030-34-550A	BJ-K51
46300-60B00	CJ-808	48820-60A00	TI-813	2654 TELQ 0116	TI-003L
46300-60B10	CJ-808	48820-63002	TI-802L	2654-3211-0156	BJ-002
46300-60B10	CJ-809	48820-65D00	TI-816	2654-3320-0113	BJ-003
46300-60B10-000	CJ-808	48820-65D01-000	TI-816	2655 TELQ 0117	TI-003R
4630060B00	CJ-809	48820-68L00-000	TI-826	2699-3210-01-50	BJ-006
46420-60B02	RU-823	48820-77E00	TI-813	2699-3210-01-66	BJ-006
46630-60B01	BJ-802	48820-78A00	TI-814	2699-3210-0185	BJ-006
46630-60B01-000	BJ-802	48820-79000	TI-803L	2699-4660-01-13	TI-006
46630-60B10	BJ-802	48820-80000	TI-806L	2699-4660-01-21	TI-005
46630-80F00	SI-801	48820-80001	TI-806L	2702-3211-0105	BJ-008
46640-80F00	SI-802	48820-81A00	TI-820	2702-3211-0106	BJ-001
48721-60A00	PI-800	48830 M68K00	RD-816	2702-3211-0149	BS-002
48810-60001	TI-803R	48830-60B00	RD-804	2702-3211-0150	BS-001
48810-60A00	TI-806R	48830-60G00	RD-805	2702-4660-3511	RD-001
48810-60B00	TI-805	48830-63B00	RD-802	2779-3210-0182	BS-003
48810-63002	TI-802R	48830-63J00	RD-812	2779-3210-0183	BS-004
48810-63J00	TI-821	48830-65D00	RD-808	45601-05001	LUS09
48810-65D00	TI-817	48830-65J00	RD-809	8855-4601-0001	TI-002
48810-65D01-000	TI-817	48830-75F00	RD-810	90342316	BJ-051
48810-65J00	TI-800	48830-77A00	RD-806	90375505	BJ-051
48810-68L00-000	TI-825	48830-78000	RD-801	90375506	BJ-051
48810-76G00	TI-805	48830-78001	RD-801	94786917	BJ-051

**CROSS REFERENCE LIST**  
**VERGLEICHSLISTE**  
**LISTA DE REFERENCIAS CRUZADES**  
**LISTE DE COMPARAISON**  
**LISTA DI COMPARAZIONE**

TOWN LIFE	JAPANPARTS				
I54011	RU-458	43330-19045	BJ-219	43330-39225	LB-210
<b>TOYOTA</b>	<b>JAPANPARTS</b>	43330-19065	BJ-232R	43330-39235	LB-228
123050Q010	RU-291	43330-19066	BJ-232R	43330-39235	LB-210
12361-0L030	RU-283	43330-19075	LB-298	43330-39245	LB-235
12361-16040	RU-2015	43330-19085	BJ-238R	43330-39255	LB-228
12361-30080	RU-283	43330-19095	LB-297	43330-39265	LB-295
12361-54120	RU-202	43330-19115	BJ-210	43330-39285	BJ-239
12361-54121	RU-202	43330-19245	BJ-242	43330-39295	LB-235
12361-60022	RU-200	43330-29045	LB-297	43330-39315	LB-295
12362-15130	RU-2016	43330-29046	LB-297	43330-39415	BJ-217
12363-74120	RU-2022	43330-29055	LB-297	43330-39585	BJ-217
123630Q010	RU-290	43330-29056	LB-297	43330-49025	BJ-241
12371-15241	RU-2021	43330-29065	LB-297	43330-49095	BJ-242
12371-64210	RU-2001	43330-29105	LB-221	43330-49185	BJ-249
12371-68010	RU-201	43330-29115	BJ-625	4333009070	BJ-210
1237174312	RU-2002	43330-29125	LB-221	4333009230	BJ-210
37230-0K011	RU-281	43330-29135	LB-296	4333019085	BJ-238L
37230-0K021	RU-282	43330-29136	LB-296	4333029095	BJ-625
37230-26020	RU-294	43330-29137	LB-296	4333029125	BJ-237
37230-35050	RU-203	43330-29138	LB-296	4333029140	BJ-216
37230-35080	RU-204	43330-29139	LB-296	4333029145	BJ-297
37230-35090	RU-261	43330-29145	BJ-299	4333029146	BJ-297
433029535	LB-221	43330-29146	BJ-299	4333029185	BJ-299
433029535	BJ-237	43330-29155	BJ-237	4333029295	LB-221
43308-12020	LB-205	43330-29155	LB-221	4333029295	BJ-237
43308-12030	LB-609	43330-29165	BJ-625	4333029515	BJ-237
43308-16010	LB-299	43330-29175	BJ-625	4333029515	LB-221
43308-19035	LB-209	43330-29185	BJ-297	4333029615	BJ-209
43308-29015	BJ-212	43330-29205	LB-296	4333039195	LB-210
43308-29115	BJ-212	43330-29225	BJ-241	4333039245	BJ-216
4330819035	LB-609	43330-29235	BJ-236	4333039255	LB-210
43310-09015	BJ-246	43330-29265	LB-297	4333039265	BJ-227
43310-09030	BJ-246	43330-29275	BJ-244R	4333039295	BJ-216
43310-0K010	BJ-246	43330-29315	LB-297	4333039315	BJ-227
43310-0K040	BJ-246	43330-29325	BJ-241	4333039345	BJ-216
43310-39016	BJ-215	43330-29326	BJ-241	4333039435	BJ-239
43330 09770	BJ-225	43330-29375	LB-297	4333039445	BJ-216
43330 49055	BJ-221	43330-29405	BJ-209	4333039445	LB-235
43330-02020	LB-297	43330-39045	LB-206	4333039775	BJ-209
43330-06020	BJ-239	43330-39065	LB-210	4333039835	LB-295
43330-09030	LB-297	43330-39075	LB-206	4333039835	BJ-227
43330-09210	BJ-200	43330-39095	LB-210	43340-19015	BJ-290
43330-09360	BJ-213	43330-39105	LB-210	43340-19025	BJ-238L
43330-09510	BJ-247	43330-39115	LB-210	43340-29025	LB-297
43330-09630	BJ-242	43330-39135	BJ-216	43340-29026	LB-297
43330-0B020	BJ-625	43330-39165	LB-215	43340-29036	LB-297
43330-19025	BJ-224	43330-39175	LB-228	43340-29045	LB-297
		43330-39195	LB-228	43340-29075	LB-297

43340-29085	BJ-244L	43360-29035	BJ-207	45046-19015	TI-223
43340-29095	BJ-625	43360-29045	BJ-207	45046-19055	TI-206
43340-29105	LB-221	43360-29055	BJ-229	45046-19075	TI-223
43340-29175	BJ-208	43360-29056	BJ-229	45046-19085	TI-223
43340-39035	LB-210	43360-29076	BJ-220	45046-19095	TI-223
43340-39045	LB-210	43360-39065	BJ-203	45046-19105	SO-222
43340-39075	LB-206	43360-39075	BJ-227	45046-19115	SO-234
43340-39085	LB-210	43360-39085	BJ-227	45046-19135	TI-223
43340-39095	LB-210	4336029065	BJ-220	45046-19165	TI-266
43340-39125	LB-210	4336039015	BJ-203	45046-19175	TI-259
43340-39135	LB-210	4336039025	BJ-203	45046-19205	TI-298
43340-39145	LB-215	4336039045	BJ-203	45046-19205	TI-299
43340-39205	LB-210	4336039055	BJ-203	45046-19206	TI-298
43340-39225	LB-235	45044 69086	TI-254	45046-19206	TI-299
43340-39245	LB-295	45044-60H00	TI-245	45046-19216	TI-298
43340-39325	BJ-228	45044-60H01	TI-249	45046-19265	TI-271
43340-39465	BJ-228	45044-60H03	TI-254	45046-19415	TI-2017
4334019016	BJ-290	45044-69035	TI-245	45046-20010	TI-205
4334029105	BJ-237	45044-69045	TI-249	45046-29045	TI-205
4334029215	BJ-208	45044-69055	TI-245	45046-29055	TI-205
4334039175	LB-210	45044-69065	TI-249	45046-29056	TI-205
4334039175	LB-228	45044-69075	TI-253	45046-29075	TI-223
4334039225	BJ-216	45044-69076	TI-253	45046-29095	TI-205
4334039235	LB-228	45044-69085	TI-254	45046-29105	TI-213L
4334039235	LB-210	45044-69095	TI-236	45046-29115	TI-226
4334039245	BJ-227	45044-69105	TI-255	45046-29125	TI-226
4334039545	BJ-208	45044-69106	TI-279	45046-29135	BJ-291
4334060010	BJ-235	45044-69115	TI-278	45046-29165	TI-265
43350-29015	BJ-207	45044-69125	TI-279	45046-29185	TI-2026
43350-29026	BJ-211	45044-69135	TI-253	45046-29205	TI-267
43350-29035	BJ-229	45045-29035	TI-213L	45046-29215	TI-270
43350-29036	BJ-229	45045-29045	TI-295	45046-29235	TI-2003
43350-29065	BJ-234	45045-60013	TI-217L	45046-29255	TI-283
43350-29076	BJ-229	45045-60H04	TI-246	45046-29275	TI-297
43350-39016	BJ-203	45045-69015	TI-217L	45046-29305	TI-259
43350-39035	BJ-214	45045-69035	TI-246	45046-29325	TI-281
43350-39045	BJ-227	45045-69045	TI-246	45046-29335	TI-297
43350-39085	BJ-227	45045-69065	TI-251	45046-29365	TI-2225
43350-39115	BJ-214	45046 09660	TI-2025	45046-29425	TI-200
43350-39125	BJ-227	45046 49145	TI-2021	45046-35080	TI-257
4335029045	BJ-220	45046 79025	TI-2029	45046-39085	TI-215R
4335029055	BJ-220	45046-09230	TI-201	45046-39095	TI-203R
4335029056	BJ-220	45046-09251	TI-2018	45046-39105	TI-226
4335029095	BJ-234	45046-09281	TI-2015	45046-39106	TI-226
4335039025	BJ-203	45046-09295	TI-207	45046-39125	TI-226
4335039075	BJ-214	45046-09430	TI-277	45046-39155	TI-239
43360-29015	BJ-207	45046-09480	TI-2013	45046-39175	TI-226
43360-29025	BJ-211	45046-09570	TI-2017	45046-39185	TI-263R



**CROSS REFERENCE LIST**  
**VERGLEICHSLISTE**  
**LISTA DE REFERENCIAS CRUZADES**  
**LISTE DE COMPARAISON**  
**LISTA DI COMPARAZIONE**

45046-39215	TI-226	45047-19055	TI-205	4504769026	TI-217L
45046-39235	TI-226	45047-19056	SO-234	4504769026	TI-248
45046-39255	TI-272	45047-19115	TI-264	4504769067	TI-285
45046-39256	TI-272	45047-19215	TI-2016	45401-19055	PI-212
45046-39335	TI-289	45047-20010	TI-205	45401-19066	PI-202
45046-39385	TI-226	45047-29015	TI-205	45401-19095	PI-210
45046-39505	TI-2002	45047-29035	TI-203L	45401-19125	PI-202
45046-49085	TI-237	45047-29045	TI-295	45401-19135	PI-202
45046-49095	TI-2007	45047-29065	TI-2004	45401-19175	PI-215
45046-49115	TI-275	45047-29075	TI-293	45401-19185	PI-216
45046-49125	TI-234	45047-29105	TI-294	45401-19195	PI-216
45046-49195	TI-2009	45047-29125	TI-2226	45401-35190	PI-235
45046-49225	TI-2027	45047-35050	TI-258	45401-35220	PI-235
45046-59025	TI-2222	45047-39025	TI-203L	45401-35240	PI-236
45046-59026	TI-2222	45047-39075	TI-228	45406-19016	TI-224
45046-60030	TI-217R	45047-39076	TI-228	45406-19045	TI-224
45046-60031	TI-217R	45047-39085	TI-232	45406-19055	TI-224
45046-60032	TI-217R	45047-39115	TI-263L	45406-19065	TI-224
45046-60033	TI-217R	45047-39155	TI-273	45406-19075	TI-224
45046-60H01	TI-221L	45047-39156	TI-273	45406-29055	TI-219R
45046-60H02	TI-221R	45047-39215	TI-282	45406-29056	TI-219R
45046-69025	TI-217R	45047-49015	TI-252	45406-29065	TI-219R
45046-69030	TI-217R	45047-49025	TI-2008	45406-29075	TI-244
45046-69035	TI-209	45047-49045	TI-276	45406-29095	TI-214
45046-69045	TI-221L	45047-49055	TI-235	45406-29105	TI-233
45046-69055	TI-221R	45047-49135	TI-2010	45406-29115	TI-227
45046-69105	TI-250	45047-49165	TI-2028	45406-29135	TI-260
45046-69115	TI-247	45047-59025	TI-2223	45406-29145	TI-232
45046-69125	TI-287	45047-59026	TI-2223	45406-39075	TI-220
45046-69155	TI-247	45047-69035	TI-248	45406-39085	TI-227
45046-69195	TI-291	45047-69065	TI-248	45406-39086	TI-227
45046-69205	TI-2001	45047-69066	TI-285	45406-39095	TI-227
45046-8Y001	TI-259	45047-69085	TI-285	45406-39105	TI-240
4504605070	TI-2025	45047-69100	TI-290	45406-39115	TI-227
4504609050	TI-2225	45047-69115	TI-2000	45406-39125	TI-227
4504609100	TI-2225	45047-87303	TI-202L	45406-39135	BJ-292
4504609360	TI-271	45047-87380	TI-202L	45406-39165	BJ-292
4504639165	TI-226	4504705060	TI-2024	45406-39175	BJ-292
4504649115	TI-271	4504709010	TI-2226	4540629115	TI-232
4504669036	TI-209	4504709030	TI-2226	4540639085	TI-232
4504669116	TI-247	4504709150	TI-264	4540639086	TI-232
4504669135	TI-287	4504729075	TI-294	4540639115	TI-232
45047 09320	TI-2024	4504729105	TI-293	4540639125	TI-232
45047 49075	TI-2020	4504749045	TI-264	4540639155	TI-232
45047-09125	TI-210	4504760013	TI-248	4540639155	TI-227
45047-09220	TI-2014	4504760013	TI-217L	4540639185	BJ-292
45047-09570	TI-2016	4504769025	TI-248	45407-29015	TI-219L
45047-19035	TI-223	4504769025	TI-217L	45407-29016	TI-219L

45440-29045	CL-297	45460-39215	SO-203	45500-0H010	RD-221
45440-29125	CL-297	45460-39225	SO-203	4550005030	RD-208
45450-29085	CL-297	45460-39245	SA-224	45503 09331	RD-247
45450-29155	CR-212	45460-39615	TI-231	45503 39265	RD-237
45450-39015	CR-201	4546039635	TI-231	45503 47030	RD-250
45450-39016	CR-201	45470-19015	SO-234	45503 49075	RD-249
45450-39037	CL-297	45470-19035	TI-262L	45503 74010	RD-255
45450-39055	CR-201	45470-19045	TI-262L	45503-02080	RD-225
45450-39065	CR-201	45470-19055	TI-262L	45503-05010	AX-296
45450-39125	CR-298	45470-19065	TI-2012	45503-05020	TI-2227
45450-39155	CR-209	45470-29046	SA-214	45503-06080	RD-231
45450-39165	CR-210	45470-29075	SA-220	45503-09321	RD-247
45460-19025	SA-299	45470-29085	SY-271	45503-0D030	RD-244
45460-19055	SA-204	45470-29185	TI-2006	45503-0F010	RD-200
45460-19056	SA-299	45470-39055	SA-224	45503-10020	RD-201
45460-19065	SA-204	45470-39215	TI-230	45503-12130	RD-225
45460-19085	SA-204	4547039225	TI-230	45503-17040	RD-252
45460-19095	SA-204	45490-19125	ID-201	45503-19015	RD-201
45460-19105	SO-222	45490-19125	SO-222	45503-19025	RD-204
45460-19115	SO-234	45490-19165	ID-209	45503-19035	RD-202
45460-19135	SA-204	45490-19175	ID-209	45503-19036	RD-206
45460-19145	SO-237	45490-19215	ID-226	45503-19045	RD-201
45460-19155	SY-231	45490-19225	ID-229	45503-19055	RD-205
45460-19165	SY-235	45490-19245	ID-229	45503-19056	RD-210
45460-19175	SA-299	45490-29135	ID-218	45503-19075	RD-211
45460-19185	TI-262R	45490-29145	ID-218	45503-19085	RD-289
45460-19195	TI-262R	45490-29245	ID-235	45503-19116	RD-212
45460-19205	TI-262R	45490-29295	ID-209	45503-19125	RD-213
45460-19235	TI-2011	45490-29305	ID-209	45503-19135	RD-214
45460-29066	SA-208	45490-29335	ID-209	45503-19145	RD-238
45460-29085	SA-201	45490-29355	ID-209	45503-19155	RD-298
45460-29125	SA-208	45490-29365	ID-209	45503-19195	RD-298
45460-29135	SA-299	45490-29405	ID-209	45503-19205	AX-299
45460-29145	SA-299	45490-29425	ID-209	45503-19215	RD-290
45460-29185	SA-208	45490-29465	ID-236	45503-19255	RD-225
45460-29205	SY-230	45490-29475	ID-243	45503-22010	RD-203
45460-29215	SO-203	45490-29515	ID-246	45503-29015	RD-203
45460-29225	SY-230	45490-35130	ID-239	45503-29016	RD-203
45460-29265	SA-209	45490-35140	ID-215	45503-29025	RD-207
45460-29285	SA-220	45490-39245	ID-245	45503-29035	RD-219
45460-29315	SY-271	45490-39255	ID-244	45503-29075	RD-215
45460-29425	TI-2005	45490-39315	ID-240	45503-29095	RD-297
45460-39095	SO-203	45490-39325	ID-245	45503-29105	RD-216
45460-39096	SO-203	45490-39335	ID-244	45503-29125	RD-203
45460-39125	SA-206	45490-39345	ID-244	45503-29135	RD-297
45460-39155	SO-203	45490-39355	ID-245	45503-29155	RD-295
45460-39165	SY-282	45490-39455	ID-200	45503-29165	RD-294
45460-39195	SA-211	45490-405	ID-209	45503-29215	RD-293

**CROSS REFERENCE LIST**  
**VERGLEICHSLISTE**  
**LISTA DE REFERENCIAS CRUZADAS**  
**LISTE DE COMPARAISON**  
**LISTA DI COMPARAZIONE**

45503-29245	RD-292	48068-0F010	BS-223	48069-05070	BS-202
45503-29255	RD-217	48068-0H010	BS-207	48069-09040	BS-248
45503-29265	RD-218	48068-0K040	BS-253	48069-0F010	BS-222
45503-29295	RD-239	48068-12130	BS-217	48069-0H010	BS-206
45503-29355	RD-291	48068-12171	BS-219	48069-0K040	BS-252
45503-29365	RD-290	48068-12260	BS-221	48069-12130	BS-216
45503-29385	AX-299	48068-19045	CL-297	48069-12171	BS-218
45503-29395	RD-253	48068-19095	BJ-222	48069-12260	BS-220
45503-29435	AX-298	48068-20221	BS-213	48069-19045	CJ-291
45503-29475	AX-297	48068-20260	BS-211	48069-20221	BS-212
45503-29565	RD-227	48068-20380	BS-215	48069-20381	BS-214
45503-29615	AX-298	48068-26130	CJ-201	48069-26130	CJ-202
45503-29765	RD-240	48068-28120	BS-239	48069-28120	BS-238
45503-39015	RD-289	48068-33031	BS-209	48069-33031	BS-208
45503-39025	RD-216	48068-35080	BS-227	48069-35080	BS-226
45503-39075	RD-228	48068-42010	BS-241	48069-42010	BS-240
45503-39135	RD-291	48068-42040	BS-243	48069-42040	BS-242
45503-39225	RD-222	48068-42041	BS-243	48069-42041	BS-242
45503-39235	RD-237	48068-42050	BS-245	48069-42050	BS-244
45503-49035	RD-223	48068-44010	BS-237	48069-44010	BS-236
45503-49055	RD-242	48068-49045	BS-205	48069-49045	BS-204
45503-49105	RD-209	48068-49065	BS-205	48069-49065	BS-204
45503-52010	TI-2224	48068-59035	BS-247	48069-59035	BS-246
45503-52070	RD-246	48068-60010	BS-235	48069-60010	BS-234
45503-59045	TI-2224	48068-79015	BS-265	4806905050	RU-226
45503-59055	RD-245	4806805050	RU-226	4806905070	RU-228
45503-69015	RD-230	4806805070	RU-228	4806905070	RU-229
45503-69025	RD-234	4806805070	RU-229	480690H010	RU-233
45503-990DL	RD-224	480680H010	RU-234	480690H010	RU-234
4550305050	TI-2227	480680H010	RU-233	4806912140	BS-216
4550309230	RD-222	4806812140	BS-217	4806912160	BS-218
45503990DL	AX-296	4806820381	BS-215	4806912170	BS-218
45504-28030	RD-240	4806826131	CJ-201	4806912190	BS-218
48061-05010	RU-227	4806826132	CJ-201	4806912191	BS-218
48061-26050	RU-263	4806829265	BS-205	4806920260	BS-210
48061-27010	RU-269	4806833030	BS-209	4806920380	BS-214
48061-27011	RU-269	4806833050	BS-239	4806926131	CJ-202
48061-35040	RU-293	4806833060	BS-239	4806926132	CJ-202
48061-60010	RU-274	4806835081	BS-227	4806929265	BS-204
48066-29075	BS-225	4806842012	BS-241	4806933030	BS-208
48067-29075	BS-224	4806842022	BS-241	4806933050	BS-238
48068 05080	BS-261	4806849065	BJ-205	4806933060	BS-238
48068 12300	BS-255	48069 05080	BS-260	4806935081	BS-226
48068 33020	BS-263	48069 12300	BS-254	4806942012	BS-240
48068-02070	BS-221	48069 33020	BS-262	4806942022	BS-240
48068-05050	BS-201	48069 79015	BS-264	4806949065	BJ-205
48068-05070	BS-203	48069-02080	BS-220	48071-01010	RU-2024
48068-09040	BS-249	48069-05050	BS-200	4807112080	RU-2024

4807112140	RU-2024	4865442020	RU-276	48815-0D100	RU-257
4807201011	RU-2023	48655 12060	RU-295	48815-0F010	RU-240
4807212080	RU-2023	48655-12050	RU-237	48815-0K010	RU-264
4807212140	RU-2023	48655-12120	RU-267	48815-10060	RU-220
48075-42050	RU-292	48655-20030	RU-2009	48815-12220	RU-297
48603-33021	RU-2004	48655-20050RH	RU-217	48815-12230	RU-2020
48609-01040	RU-2018	48655-20060LH	RU-218	48815-20020	RU-214
48609-0K010	RU-2033	48655-20140	RU-231	48815-20030	RU-215
48609-0K040	RU-2034	48655-33010	RU-210	48815-28061	RU-260
48609-12192	RU-2018	48655-52010	RU-2011	48815-30040	RU-262
48609-12211	RU-2003	48655-60010	RU-245	48815-30050	RU-219
48609-20050	RU-2014	48655-60030	RU-249	48815-42050	RU-220
48609-33011	RU-2017	48674 32090	RU-2006	48815-42090	RU-254
48609-33121	RU-2005	48674-60010	RU-223	48815-42100	RU-255
48609-42010	RU-275	48702-60010	RU-243	48815-42110	RU-254
48609-42011	RU-275	48702-60020	RU-209	48815-42120	RU-255
48609-42012	RU-275	48702-60031	RU-2012	48815-60010	RU-207
48609-52031	RU-265	48702-60040	RU-272	48815-60180	RU-2035
48609-52100	RU-266	48702-60050	RU-271	4881502040	RU-296
48610-0K040	BS-251	48706-60030	RU-273	488150H010	RU-232
48610-35040	BS-257	48710-35030	CJ-205	4881542040	RU-2000
48610-60030	BS-229	48720-60011	CR-200	4881552030	RU-298
48610-60050	BS-233	48725-03010	RU-2013	48817-30010	RU-208
48610-60070	BS-233	48725-0H010	RU-235	4881812160	RU-299
48620-60010	BS-231	48750-16100	RU-2019	48819-26050	SI-249
48630-0K040	BS-250	4875016110	RU-2019	48819-35020	SI-250
48630-35020	BS-256	48802-60030	SI-247	48819-52010	SI-239
48630-60010	BS-228	48802-60090	SI-248	4881970010	SI-214
48630-60020	BS-232	48810-05012	SI-207	48820 33070	SI-259
48630-60040	BS-232	48810-0K010	SI-242	48820-02020	SI-220
48632 26010	RU-241	48810-20010	SI-206	48820-02070	SI-235
48632 60010	RU-244	48810-20020	SI-207	48820-05012	SI-208
48632-30020	RU-211	48810-26020	SI-222	48820-0D010	SI-240
48632-60020	RU-247	48810-26030	SI-244	48820-0D020	SI-240
48635-26010	RU-242	48810-28010	SI-237	48820-0K010	SI-246
48635-28010	RU-2007	48810-28020	SI-230	48820-0K030	SI-241
48640-60010	BS-230	48810-33010	SI-216	48820-20010	SI-201
48650-20020	CJ-200	48810-44010	SI-207	48820-20030	SI-299
4865020021	CJ-200	48810-50020	SI-260	48820-20040	SI-208
48654 12010	RU-2030	48810-60010	SI-224	48820-24010	SI-238
48654-05040	RU-230	48810-60040	SI-228	48820-26020	SI-221
48654-12070	RU-236	48815 02140	RU-286	48820-26030	SI-245
48654-16110	RU-233	48815 02150	RU-287	48820-28010	SI-231
48654-20150	RU-268	48815 05120	RU-289	48820-28050	SI-218
48654-35010	RU-210	48815 05130	RU-288	48820-30010	SI-203
48654-60010	RU-246	48815 12140	RU-2028	48820-32010	SI-220
48654-60030	RU-248	48815 12160	RU-2029	48820-33010	SI-298
4865420060	RU-2008	48815 14160	RU-270	48820-33020	SI-215

**CROSS REFERENCE LIST**  
**VERGLEICHSLISTE**  
**LISTA DE REFERENCIAS CRUZADAS**  
**LISTE DE COMPARAISON**  
**LISTA DI COMPARAZIONE**

48820-35010	SI-243
48820-35030	SI-225
48820-42010	SI-232
48820-42030	SI-235
48820-44010	SI-208
48820-44020	SI-205
48820-47010	SI-204
48820-50030	SI-261
48820-60010	SI-223
48820-60050	SI-227
48820-74010	SI-262
48820-AD010	SI-225
4882028030	SI-231
48830 33040	SI-263
48830-05020	SI-200
48830-05030	SI-258
48830-20010	SI-202
48830-21020	SI-213
48830-32010	SI-209
48830-33010	SI-217
48830-35020	SI-226
48830-42010	SI-233
48830-42020	SI-236
48830-48010	SI-219
48830-60030	SI-229
4883006030	SI-219
4883012060	SI-202
4883042021	SI-236
48840-21010	SI-212
48840-42010	SI-234
49069-20260	BS-210
509110	SI-214
5094 A8	RU-232
90101-08038	SI-251
90101-10140	SI-252
90140006	TI-D51R
90140007	TI-D51L
90342316	BJ-D51
90375505	BJ-D51
90375506	BJ-D51
90385 T0001	RU-277
90385 T0002	RU-278
90385 T0003	RU-279
90385 T0008	RU-279
90385 T0009	RU-277
90385 T0010	RU-278
90385-18007	RU-213
90385-18009	RU-205

90385-18009	RU-222
90385-18019	RU-2037
90385-18020	RU-2036
90385-18023	RU-285
90385-18046	RU-212
90385-23037	RU-221
90389 14004	RU-280
90389 T0005	RU-280
90389-16026	RU-284
90389-18002	RU-206
90948-01002	RU-216
<b>VOLVO</b> <b>JAPANPARTS</b>	
30 683 067	RU-323
30666821	RU-317



CODE/CODICE JAPANPARTS	Shaft diameter <i>Diametro dell'asse</i>	Cut dimensions (mm) <i>Dimensioni del taglio (mm)</i>			
		number~C <i>numero~C</i>	C ~ B	B ~ A	no cut <i>non tagliato</i>
KB-A10	Ø 10	46	66	84	98
KB-A12	Ø 12				
KB-A16	Ø 16				
KB-A18	Ø 18				
KB-A20	Ø 20				
KB-A22	Ø 22				

number/numero~C L=46mm	
C ~ B L=66mm	
B ~ A L=84mm	
no cut/non tagliato L=98mm	

! : All the attached dust boots become common with KB- (COD JAPANPARTS)

! : As for the cut dimensions, it is written the dimensions that do not include the base part sound stopper.



! : Per le dimensioni del taglio, sono scritte le dimensioni che non includono la base del bloccaggio di vibrazione.

# KB-A10

JAPANPARTS CODE	MANUFACTURER	CAR NAME	MODEL	YEAR	ForR	REMARKS
KB-A10	AUDI	50			R	
	AUDI	80	Variant	1991-1995	R	
	AUDI	80	Avant	1991-1995	R	
	HONDA	LIFE		08.1998-09.2003	R	
	HONDA	That's		02.2002-	R	
	MAZDA	Demio			R	
	SEAT	Cordoba Vario			R	
	VOLKSWAGEN	Derby			R	
	VOLKSWAGEN	Golf Cabrio			R	
	VOLKSWAGEN	Golf I			R	
	VOLKSWAGEN	Jetta I			R	
	VOLKSWAGEN	Polo			R	
	VOLKSWAGEN	Polo Variant			R	
	VOLKSWAGEN	Scirocco			R	

# KB-A12 (1)

JAPANPARTS CODE	MANUFACTURER	CAR NAME	MODEL	YEAR	ForR	REMARKS
KB-A12	AUDI	A4			R	
	AUDI	A4 Avant			R	
	BMW	5 Series (E28)			R	
	BMW	6 Series (E24)			R	
	FORD	Escort			R	
	FORD	Mk VII			R	
	FORD	RS		1995-02.1999	R	
	FORD	XR-3			R	
	HONDA	ACCORD		07.1997-06.2002	F	
	HONDA	ACCORD		07.1997-06.2002	R	
	HONDA	ACCORD INSPIRE		12.2007-	F	
	HONDA	ACCORD INSPIRE		12.2007-	R	
	HONDA	ACCORD JP4Dr		09.2002-	F	
	HONDA	ACCORD JP4Dr		09.2002-	R	
	HONDA	ACCORD JPWGN		11.2002-	F	
	HONDA	ACCORD JPWGN		11.2002-	R	
	HONDA	ACCORD UA		07.2002-	F	
	HONDA	ACCORD UA		07.2002-	R	
	HONDA	AIRWAVE		05.2005-	R	
	HONDA	AVANCIER		2002	F	
	HONDA	AVANCIER		2002	R	
	HONDA	CIVIC		06.1995-05.2005	R	
	HONDA	CIVIC GSA/SIC		08.2005-	R	
	HONDA	CIVIC TYPE R		08.2001-	R	
	HONDA	CROSSROAD		02.2007-	R	
	HONDA	CR-V		09.1995-10.2001	R	JP/UK/Thailand
	HONDA	CR-V		07.2006-	R	JP/US/UK/Thailand
	HONDA	Edix		06.2004-	R	
	HONDA	ELYSION		05.2004-	F	
	HONDA	ELYSION		05.2004-	R	
	HONDA	ELYSION PRESTIGE		12.2006-	F	
	HONDA	ELYSION PRESTIGE		12.2006-	R	
	HONDA	FCX		10.2002-	R	

JAPANPARTS CODE	MANUFACTURER	CAR NAME	MODEL	YEAR	ForR	REMARKS	
KB-A12	HONDA	Fit Rr:SSK Assy		08.2007-	R		
	HONDA	Fit ARIA SSM		10.2002-	R		
	HONDA	Fit EU/KQ		08.2002-	R		
	HONDA	FREED Rr:SSK Assy		05.2008-	R		
	HONDA	INSPIRE JP		05.2003-	F		
	HONDA	INSPIRE JP		05.2003-	R		
	HONDA	INTEGRA		03.1995-08.2006	R		
	HONDA	INTEGRA R		06.2004-	R		
	HONDA	LEGEND		08.1998-02.2004	F		
	HONDA	LEGEND		08.1998-02.2004	R		
	HONDA	LEGEND		07.2004-	F		
	HONDA	LEGEND		07.2004-	R		
	HONDA	LEGEND EU/GSA		05.2006-	F		
	HONDA	LEGEND EU/GSA		05.2006-	R		
	HONDA	LOGO		08.1996-09.2001	R		
	HONDA	MOBILIO Spike		12.2002-	R		
	HONDA	NSX		02.1993-11.2001	F		
	HONDA	NSX		02.1993-11.2001	R		
	HONDA	ODYSSEY		09.1997-	R		
	HONDA	ODYSSEY		10.2003-	F		
	HONDA	ODYSSEY Absolute (4WD)		04.2006-	F		
	HONDA	ODYSSEY Absolute (4WD)		04.2006-	R		
	HONDA	ODYSSEY V6		09.1997-11.2003	R		
	HONDA	OLTIA		06.1995-07.2002	R		
	HONDA	PRELUDE		09.1996-12.2001	F		
	HONDA	PRELUDE		09.1996-12.2001	R		
	HONDA	RD-X		05.2006-	R		
	HONDA	S2000		03.1999-08.2004	F		
	HONDA	S2000		03.1999-08.2004	R		
	HONDA	S-MX		12.1996-04.2001	R		
	HONDA	STEP WGN		03.1996-04.2001	R		
	HONDA	STEP WGN		06.2005-	R		
	HONDA	STREAM		06.2006-	R		
	HONDA	US ACCORD		07.2007-	F		
	HONDA	US ACCORD		07.2007-	R		
	MAZDA	121				R	
	MAZDA	929				R	
	MAZDA	929L				R	
	MAZDA	Luce				R	
	SEAT	Toledo				R	
	SKODA	Favorit				R	
	WOLKSWAGEN	Corrado				R	
	WOLKSWAGEN	Golf Cabrio				R	
	WOLKSWAGEN	Golf II				R	
	WOLKSWAGEN	Jetta II				R	
WOLKSWAGEN	Golf III				R		
WOLKSWAGEN	Vento				R		
WOLKSWAGEN	Passat			-1996	R		
WOLKSWAGEN	Santana			-1988	R		



# KB-A16

JAPANPARTS CODE	MANUFACTURER	CAR NAME	MODEL	YEAR	ForR	REMARKS
KB-A16	AUDI	100			R	
	AUDI	100 Avant			R	
	AUDI	A4			F	
	AUDI	A4 Avant			F	
	AUDI	A6			R	
	AUDI	A6 Avant			1994-1997	R
	FIAT	Cinquecento				F
	FIAT	Seicento				F
	MERCEDES BENZ	190 Series (201)				F
	MERCEDES BENZ	E Series				F
	MERCEDES BENZ	E-Class (124)				F
	MITSUBISHI	Carisma				R
	NISSAN	Sunny				R
	VOLKSWAGEN	Golf III	Variant			R
	VOLKSWAGEN	Passat			1997-	F
	VOLVO	S40				R
	VOLVO	V40				R

# KB-A18 (1)

JAPANPARTS CODE	MANUFACTURER	CAR NAME	MODEL	YEAR	ForR	REMARKS
KB-A18	AUTOBIANCHI	Y10			F	
	FIAT	Regata Weekend (138R)			F	
	FIAT	Regata (138R)			F	
	FIAT	Ritmo			F	
	FIAT	Strada (138)			F	
	FIAT	Uno (146) Exc.CS			F	
	FORD	Escort	Express			F
	FORD	Escort	Mk. V			F
	FORD	Escort	Mk. VI			F
	FORD	Escort	Mk. VII			F
	FORD	Escort	MK III			F
	FORD	Escort	MK IV			F
	FORD	Escort	RS		1990-02.1999	F
	FORD	Escort	Van			F
	FORD	Escort	XR-3		1980-1990	F
	FORD	Escort	XR-3			F
	FORD	Escort Turnier	Mk. V			F
	FORD	Escort Turnier	Mk. VI			F
	FORD	Escort Turnier	Mk. VII		1990-02.1999	F
	FORD	Escort Van	Express			F
	FORD	Fiesta	Courier			F
	FORD	Fiesta	Van			F
	FORD	Fiesta	XR-2		-1996	F
	FORD	Fiesta Van	Courier			F
	FORD	Fiesta			1996-02.2002	F
	FORD	Ka				F
	FORD	Orion				F
	HONDA	VAMOS			08.2001-08.2004	F
	LANCIA	Y10				F
	MAZDA	121				F

JAPANPARTS CODE	MANUFACTURER	CAR NAME	MODEL	YEAR	ForR	REMARKS
KB-A8	MAZDA	626			R	
	MAZDA	323		1980-1989	F	
	MAZDA	323		1986-1994	R	
	MAZDA	Montrose			R	
	NISSAN	Cherry			R	
	NISSAN	Primera			F	
	NISSAN	Pulsar			R	
	NISSAN	Sunny			R	
	NISSAN	Sunny	Traveller		R	
	OPEL	Corsa A			F	
	OPEL	Corsa B			F	
	OPEL	Corsa Combo			F	
	RENAULT	R5 (Super5)	Express		F	
	RENAULT	R5 (Super5)	Extra		F	
	RENAULT	R5 (Super5)	Rapide		F	
	SEAT	Arosa			F	
	SEAT	Cordoba			F	
	SEAT	Cordoba Vario			F	
	SEAT	Ibiza			F	
	SEAT	Malaga			F	
	SEAT	Toledo			F	
	SKODA	Favorit			F	
	SKODA	Felicia			F	
	TOYOTA	CALDINA	AZT241W	09.2002-		
	TOYOTA	CALDINA	AZT246W	09.2002-		
	TOYOTA	CALDINA	ZZT241W	09.2002-		
	TOYOTA	CAMRY GRACIA	MCV21	12.1996-09.2001		
	TOYOTA	CAMRY GRACIA	MCV21W	12.1996-09.2001		
	TOYOTA	CAMRY GRACIA	MCV25W	06.1997-09.2001		
	TOYOTA	CAMRY GRACIA	SXV20	12.1996-09.2001		
	TOYOTA	CAMRY GRACIA	SXV20W	12.1996-09.2001		
	TOYOTA	CAMRY GRACIA	SXV25	08.1998-09.2001		
	TOYOTA	CAMRY GRACIA	SXV25W	06.1997-09.2001		
	TOYOTA	COROLLA RUNX/ALEX	NZE121	01.2001-		
	TOYOTA	COROLLA RUNX/ALEX	ZZE122	09.2002-		
	TOYOTA	COROLLA SPACIO	NZE121N	05.2001-04.2003		
	TOYOTA	COROLLA SPACIO	ZZE122N	05.2001-		
	TOYOTA	COROLLA/FIELDER	CE121	08.2000-04.2004		
	TOYOTA	COROLLA/FIELDER	E121G	08.2000-04.2004		
	TOYOTA	COROLLA/FIELDER	NZE120	08.2000-		
	TOYOTA	COROLLA/FIELDER	NZE121	08.2000-		
	TOYOTA	COROLLA/FIELDER	NZE121G	08.2000-		
TOYOTA	COROLLA/FIELDER	ZZE122	08.2000-			
TOYOTA	COROLLA/FIELDER	ZZE122G	08.2000-			
TOYOTA	MARK II QUALIS WAGON	MCV20W	04.1997-12.2001			
TOYOTA	MARK II QUALIS WAGON	MCV21W	04.1997-12.2001			
TOYOTA	MARK II QUALIS WAGON	MCV25W	06.1997-12.2001			
TOYOTA	MARK II QUALIS WAGON	SXV20W	04.1997-12.2001			
TOYOTA	MARK II QUALIS WAGON	SXV25W	06.1997-12.2001			
TOYOTA	PORTE	NNP10	07.2004-			
TOYOTA	PORTE	NNP11	07.2004-			
TOYOTA	PORTE	NNP15	01.2006-			
TOYOTA	RAV 4	ACA31W	11.2005-			
TOYOTA	VITZ	NCP10	01.1999-01.2005			

# KB-A18 (3)

JAPANPARTS CODE	MANUFACTURER	CAR NAME	MODEL	YEAR	ForR	REMARKS
KB-A18	TOYOTA	VITZ	NCP13	10.2000-12.2002		1.0B (AT)
	TOYOTA	VITZ	NCP15	09.1999-01.2005		
	TOYOTA	VITZ	SCP10	01.1999-01.2005		
	TOYOTA	VITZ	SCP13	12.2002-01.2005		
	TOYOTA	WINDOM	MCV20	08.1996-07.2001		
	TOYOTA	WINDOM	MCV21	08.1996-07.2001		
	VAUXHALL	Corsa			F	
	VAUXHALL	Corsa Combo			F	
	VAUXHALL	Nova			F	
	VOLKSWAGEN	Corrado			F	
	VOLKSWAGEN	Golf II			F	
	VOLKSWAGEN	Golf III Variant			F	
	VOLKSWAGEN	Golf III Vento			F	
	VOLKSWAGEN	Golf Cabrio			F	
	VOLKSWAGEN	Jetta II			F	
	VOLKSWAGEN	Lupo			F	
	VOLKSWAGEN	Passat		1988-1996	F	
	VOLKSWAGEN	Polo Derby			F	
	VOLKSWAGEN	Polo Variant			F	
	VOLVO	400 Series			F	

# KB-A20 (1)

JAPANPARTS CODE	MANUFACTURER	CAR NAME	MODEL	YEAR	ForR	REMARKS
KB-A20	ALFA ROMEO	Alfa 155			F	
	ALFA ROMEO	Alfa 164			R	
	CHRYSLER	Chrysler Voyager	Mini-Van		F	
	CHRYSLER	Chrysler Voyager	Town&Country		F	
	CHRYSLER	Chrysler Voyager	Caravan		F	
	CITROËN	Berlingo			F	
	CITROËN	Visa			F	
	CITROËN	Xsara Picasso			F	
	CITROËN	Xara (N2)			F	
	CITROËN	ZX			F	
	DAEWOO	Aranos			F	
	DAEWOO	Cielo			F	
	DAEWOO	Espero			F	
	DAEWOO	Lanos			F	
	DAEWOO	Matiz			F	
	DAEWOO	Nexia			F	
	DAEWOO	Sens			F	
	FIAT	Brava			F	
	FIAT	Bravo			F	
	FIAT	Croma (154)			F	
	FIAT	Croma (154)			R	
	FIAT	Panda			F	
	FIAT	Tempra Familiia (159)			F	
	FIAT	Tempra Station Wagon			F	
	FIAT	Tempra (159)			F	
	FIAT	Tipo (160)			F	
	FORD	Escort	Mk V		F	

JAPANPARTS CODE	MANUFACTURER	CAR NAME	MODEL	YEAR	ForR	REMARKS	
KB-A20	FORD	Escort	Mk VI		F		
	FORD	Escort	XR-3		F		
	FORD	Escort	RS	1990-1995	F		
	FORD	Galaxy			F		
	FORD	Granada (GAE/GGE)			F		
	FORD	Mondeo			F		
	FORD	Scorpio			F		
	FORD	Sierra	XR-4		F		
	FORD	Sierra	Cosworth		F		
	FORD	Sierra			F		
	HONDA	AIRWAVE			05.2005-	F	
	HONDA	Ballade				F	
	HONDA	Ballade CR-X				F	
	HONDA	CIVIC				F	
	HONDA	CIVIC CR-X				F	
	HONDA	CIVIC GSA/SIC			08.2005-	F	
	HONDA	CROSSROAD			02.2007-	F	
	HONDA	Fit ARIA SSM			10.2002-	F	
	HONDA	Fit EU/KQ			11.2002-	F	
	HONDA	FREED Rr: SSK Assy			05.2008-	F	
	HONDA	STREAM			06.2006-	F	
	HYUNDAI	Excel				F	
	HYUNDAI	Pony				F	
	HYUNDAI	S-Coupe				F	
	LADA SAMARA	Diva				F	
	LADA SAMARA	Forma				F	
	LADA SAMARA	Riva				F	
	LADA SAMARA	Sagona				F	
	LANCIA	Dedra (835)				F	
	LANCIA	Delta				F	
	LANCIA	Delta (836)				F	
	LANCIA	Prisma (831)				F	
	LANCIA	Thema				F	
	LANCIA	Thema				R	
	MAZDA	Demio	DE		2007-		
	MERCEDES BENZ	V-Class				F	
	MERCEDES BENZ	Vito				F	
	MITSUBISHI	Carisma				F	
	MITSUBISHI	Colt				F	
	MITSUBISHI	Cordia&Tredia				F	
	MITSUBISHI	Eclipse				F	
	MITSUBISHI	Expo				F	
	MITSUBISHI	Galant				F	
	MITSUBISHI	Lancer	Estate			F	
	MITSUBISHI	Lancer				F	
MITSUBISHI	Sapporo (Lambda)				F		
MITSUBISHI	Sigma				F		
MITSUBISHI	Space Wagon				F		
MITSUBISHI	Space Van (chariot)				F		
NISSAN	Primera				R		
OPEL	Aero				F		
OPEL	Astra				F		
OPEL	Commodore				F		
OPEL	Corsa A				F		
OPEL	Corsa B				F		
OPEL	Kadett				F		
OPEL	Monza				F		
OPEL	Olympia				F		
OPEL	Rekord				F		

JAPANPARTS CODE	MANUFACTURER	CAR NAME	MODEL	YEAR	ForR	REMARKS	
KB-A20	OPEL	Record Caravan			F		
	OPEL	Senator			F		
	OPEL	Tigra			F		
	OPEL	Vectra B			F		
	PEUGEOT	106			F		
	PEUGEOT	205			F		
	PEUGEOT	305			F		
	PEUGEOT	306			F		
	PEUGEOT	309			F		
	PEUGEOT	405			F		
	PEUGEOT	505			F		
	PEUGEOT	Kangoo			F		
	PEUGEOT	Partner			F		
	RENAULT	Ranch			F		
	ROVER	200 Series			F		
	SEAT	Alhambra			F		
	SUBARU	Justy,J Series			F		
	SUZUKI	Swift			F		
	TOYOTA	Camry			F		
	TOYOTA	Celica			F		
	TOYOTA	Corolla & Sprinter			1970-04.1987	F	
	TOYOTA	Corolla			05.1987-04.1997	F	
	TOYOTA	PROBOX	NCP59G		06.2002-		1.5WGN
	TOYOTA	PROBOX/SUCCEED	NCP50V		06.2002-		
	TOYOTA	PROBOX/SUCCEED	NCP51V		06.2002-		
	TOYOTA	PROBOX/SUCCEED	NCP52V		04.2003-		
	TOYOTA	PROBOX/SUCCEED	NCP55V		06.2002-		
	TOYOTA	PROBOX/SUCCEED	NCP58G		06.2002-		
	TOYOTA	PROBOX/SUCCEED	NCP59G		06.2002-		
	TOYOTA	PROBOX/SUCCEED	NLP51V		06.2002-		
	TOYOTA	Starlet				F	
	VAUXHALL	Astra				F	
	VAUXHALL	Belmont				F	
	VAUXHALL	Carlton				F	
	VAUXHALL	Corsa				F	
	VAUXHALL	Nova				F	
	VAUXHALL	Omega				F	
	VAUXHALL	Royale				F	
	VAUXHALL	Senator				F	
	VAUXHALL	Tigra				F	
	VAUXHALL	Vectra B				F	
	VAUXHALL	Viceroy				F	
	VOLKSWAGEN	Golf I				F	
	VOLKSWAGEN	Golf Cabrio				F	
	VOLKSWAGEN	Golf Caddy				F	
	VOLKSWAGEN	Jetta I				F	
	VOLKSWAGEN	Scirocco				F	
	VOLKSWAGEN	Sharan (7M)				F	
VOLVO	850				F		
VOLVO	300 Series				F		
VOLVO	C 70				F		
VOLVO	S 40				F		
VOLVO	S 70				F		
VOLVO	V 40				F		
VOLVO	V 70				F		

JAPANPARTS CODE	MANUFACTURER	CAR NAME	MODEL	YEAR	ForR	REMARKS	
KB-A22	ALFA ROMEO	Alfa 145			F		
	ALFA ROMEO	Alfa 146			F		
	FIAT	Marea			F		
	FORD	Mondeo			R		
	HONDA	CIVIC TYPE R			08.2001-05.2005	F	
	HONDA	CIVIC TYPE R			12.2006-	F	
	HONDA	CR-V			07.2006-	F	JP/US/UK/Thailand
	HONDA	Fit	GE6		2007-		
	HONDA	HR-V			08.1998-09.2003	F	
	HONDA	INTEGRA			03.1995-08.2006	F	
	HONDA	INTEGRA R			06.2004-	F	
	HONDA	OLTIA			06.1995-07.2002	F	
	HONDA	RD-X			05.2006-	F	
	HONDA	S-MX			12.1996-04.2001	F	
	MAZDA	323			1980-1989	R	
	MITSUBISHI	DELICA SPACE GEAR	PA3V		03.1994-	R	
	MITSUBISHI	DELICA SPACE GEAR	PA4W		03.1994-	R	
	MITSUBISHI	DELICA SPACE GEAR	PD4W ECS		03.1994-	R	
	MITSUBISHI	DELICA SPACE GEAR	PD4W		03.1994-	R	
	MITSUBISHI	DELICA SPACE GEAR	PA5V		03.1994-	R	
	MITSUBISHI	DELICA SPACE GEAR	PB5V		03.1994-	R	
	MITSUBISHI	DELICA SPACE GEAR	PD5V		03.1994-	R	
	MITSUBISHI	DELICA SPACE GEAR	PA5W		03.1994-	R	
	MITSUBISHI	DELICA SPACE GEAR	PB5W		03.1994-	R	
	MITSUBISHI	DELICA SPACE GEAR	PC5W		03.1994-	R	
	MITSUBISHI	DELICA SPACE GEAR	PB6W		03.1994-	R	
	MITSUBISHI	DELICA SPACE GEAR	PD6W ECS		03.1994-	R	
	MITSUBISHI	DELICA SPACE GEAR	PF6W ECS		03.1994-	R	
	MITSUBISHI	DELICA SPACE GEAR	PF6W		03.1994-	R	
	MITSUBISHI	DELICA SPACE GEAR	PD8W ECS		03.1994-	R	
	MITSUBISHI	DELICA SPACE GEAR	PD8W		03.1994-	R	
	MITSUBISHI	DELICA SPACE GEAR	PE8W ECS		03.1994-	R	
	MITSUBISHI	DELICA SPACE GEAR	PE8W		03.1994-	R	
	MITSUBISHI	DELICA SPACE GEAR	PF8W ECS		03.1994-	R	
	MITSUBISHI	DELICA SPACE GEAR	PF8W		03.1994-	R	
	MITSUBISHI	PAJERO	V23C ECS		10.1990-06.1994	R	
	MITSUBISHI	PAJERO	V23W ECS		10.1990-	R	
	MITSUBISHI	PAJERO	V24C ECS		10.1990-04.1995	R	
	MITSUBISHI	PAJERO	V24W ECS		10.1990-	R	
	MITSUBISHI	PAJERO	V24WG ECS		10.1990-06.1994	R	
	MITSUBISHI	PAJERO	V25C ECS		07.1994-	R	
	MITSUBISHI	PAJERO	V25W ECS		07.1993-	R	
	MITSUBISHI	PAJERO	V26W ECS		07.1993-06.1994	R	
	MITSUBISHI	PAJERO	V25WG ECS		07.1993-	R	
	MITSUBISHI	PAJERO	V43W ECS		10.1990-	R	
	MITSUBISHI	PAJERO	V44W ECS		10.1990-03.1992	R	
	MITSUBISHI	PAJERO	V44WG ECS		10.1990-06.1993	R	
	MITSUBISHI	PAJERO	V45W ECS		07.1993-	R	
	MITSUBISHI	PAJERO	V46W ECS		07.1993-	R	
	MITSUBISHI	PAJERO	V44WG ECS		07.1993-	R	
NISSAN	TERRANO	LBYD21 (Adjustable)		08.1986-09-1989	R		
NISSAN	TERRANO	LR50		09.1995-	R		
NISSAN	TERRANO	LR50 (Adjustable)		09.1995-	R		
NISSAN	TERRANO	PR50		09.1995-	R		
NISSAN	TERRANO	PR50 (Adjustable)		09.1995-	R		
NISSAN	TERRANO	VBVD21 (Adjustable)		08.1986-08.1995	R		
NISSAN	TERRANO	WBVD21 (Adjustable)		08.1986-08.1995	R		
NISSAN	TERRANO	WHVD21 (Adjustable)		08.1986-08.1995	R		
OPEL	Ascona				F		

JAPANPARTS CODE	MANUFACTURER	CAR NAME	MODEL	YEAR	ForR	REMARKS
	OPEL	Calibra			F	
	OPEL	Monta			F	
	OPEL	Vectra A			F	
	PEUGEOT	206			F	
	TOYOTA	ALPHARD G/V	ANH10W	05.2002-		
	TOYOTA	ALPHARD G/V	ANH15W	05.2002-		
	TOYOTA	ALPHARD G/V	MNH10W	05.2002-08.2004		
	TOYOTA	ALPHARD G/V	MNH15W	05.2002-04.2005		
	TOYOTA	bB	NCP30	01.2000-12.2005		
	TOYOTA	bB	NCP31	01.2000-04.2006		
	TOYOTA	bB	NCP34	06.2001-03.2003		
	TOYOTA	bB	NCP35	01.2000-12.2005		
	TOYOTA	CAMRY	ACV30	09.2001-01.2006		
	TOYOTA	CAMRY	ACV35	09.2001-01.2006		
	TOYOTA	CAMRY	ACV40	01.2001-		
	TOYOTA	CAMRY	ACV45	01.2001-		
	TOYOTA	CELICA	ZZT230	08.1999-		
	TOYOTA	CELICA	ZZT231	08.1999-04.2006		
	TOYOTA	COROLLA RUNX/ALEX	NZE124	01.2001-		
	TOYOTA	COROLLA RUNX/ALEX	ZZE124	09.2002-		
	TOYOTA	COROLLA SPACIO	ZZE124N	08.2001-		
	TOYOTA	COROLLA/FIELDER	NZE124	08.2000-		
	TOYOTA	COROLLA/FIELDER	NZE124G	08.2000-		
	TOYOTA	COROLLA/FIELDER	ZZE124	08.2000-		
	TOYOTA	COROLLA/FIELDER	ZZE124G	08.2000-		
	TOYOTA	COROLLA/FIELDER	ZZE124G	08.2000-09.2002		1.8WGN 4WD
	TOYOTA	CORONA PREMIO	AT210	01.1996-12.2001		
	TOYOTA	CORONA PREMIO	AT211	01.1996-12.2001		
	TOYOTA	CORONA PREMIO	CT210	01.1996-12.1997		
	TOYOTA	CORONA PREMIO	CT215	01.1996-12.1997		
	TOYOTA	CORONA PREMIO	ST210	01.1996-12.2001		
	TOYOTA	CORONA PREMIO	ST215	01.1996-12.2001		
	TOYOTA	ESTIMA	TCR10W	02.1993-12.1999		
	TOYOTA	ESTIMA	TCR11W	05.1990-12.1999		
	TOYOTA	ESTIMA	TCR20W	02.1993-12.1999		
	TOYOTA	ESTIMA	TCR21W	05.1990-12.1999		
	TOYOTA	ESTIMA EMINA/LUCIDA	CRX10G	01.1992-08.1999		
	TOYOTA	ESTIMA EMINA/LUCIDA	CRX11G	01.1992-08.1999		
	TOYOTA	ESTIMA EMINA/LUCIDA	CRX20G	01.1992-08.1999		
	TOYOTA	ESTIMA EMINA/LUCIDA	CRX21G	01.1992-08.1999		
	TOYOTA	ESTIMA EMINA/LUCIDA	TCR10G	01.1992-12.1999		
	TOYOTA	ESTIMA EMINA/LUCIDA	TCR11G	01.1992-12.1999		
	TOYOTA	ESTIMA EMINA/LUCIDA	TCR20G	01.1992-12.1999		
	TOYOTA	ESTIMA EMINA/LUCIDA	TCR21G	01.1992-12.1999		
	TOYOTA	ESTIMA T/L	ACR30W	02.2000-08.2004		
	TOYOTA	ESTIMA T/L	ACR30W	02.2000-08.2004		2.4 AERAS
	TOYOTA	ESTIMA T/L	ACR40W	02.2000-04.2003		
	TOYOTA	ESTIMA T/L	MCR30W	12.1999-08.2004		
	TOYOTA	ESTIMA T/L	MCR40W	12.1999-08.2004		
	TOYOTA	FUN CARGO	NCP20	08.1999-09.2005		
	TOYOTA	FUN CARGO	NCP21	08.1999-08.2001		
	TOYOTA	FUN CARGO	NCP25	08.1999-09.2005		
	TOYOTA	HARRIER	ACU30W	02.2003-		
	TOYOTA	HARRIER	ACU35W	02.2003-		
	TOYOTA	HARRIER	MCU30W	02.2003-01.2006		
	TOYOTA	HARRIER	MCU35W	02.2003-01.2006		
	TOYOTA	Hilux	KZN130G TEMS	08.1993-	R	
	TOYOTA	Hilux	KZN130W TEMS	08.1990-	R	
	TOYOTA	Hilux	LN130G TEMS	04.1989-08.1993	R	

JAPANPARTS CODE	MANUFACTURER	CAR NAME	MODEL	YEAR	ForR	REMARKS	
KB-A22	TOYOTA	Hilux	LN130W TEMS	08.1990-08.1993	R		
	TOYOTA	Hilux	VZN130G TEMS	08.1990-11.1995	R		
	TOYOTA	Hilux	YN130G TEMS	04.1989-08.1991	R		
	TOYOTA	IPSUM	ACM21W	05.2001-			
	TOYOTA	IPSUM	ACM26W	05.2001-			
	TOYOTA	IST	NCP60	04.2002-			
	TOYOTA	IST	NCP61	04.2002-			
	TOYOTA	IST	NCP65	04.2002-			
	TOYOTA	KLUGER LV	ACU20W	11.2000-			
	TOYOTA	KLUGER LV	ACU25W	11.2000-			
	TOYOTA	KLUGER LV	MCU20W	11.2000-			
	TOYOTA	KLUGER LV	MCU25W	11.2000-			
	TOYOTA	LAND CRUISER (BAN)	FZJ80G TEMS	08.1992-			
	TOYOTA	LAND CRUISER (BAN)	HDJ81V TEMS	08.1992-			
	TOYOTA	LAND CRUISER (BAN)	HZJ81V TEMS	08.1992-			
	TOYOTA	NOAH/VOXY	AZR60G	11.2001-			
	TOYOTA	NOAH/VOXY	AZR65G	11.2001-			
	TOYOTA	OPA	ACT10	08.2000-04.2005			
	TOYOTA	OPA	ZCT10	04.2000-04.2005			
	TOYOTA	OPA	ZCT15	04.2000-04.2005			
	TOYOTA	PLATZ	NCP12	08.1999-12.2005			
	TOYOTA	PLATZ	NCP16	08.1999-12.2005			
	TOYOTA	PLATZ	SCP11	08.1999-12.2005			
	TOYOTA	PREMIO/ALLION	AZT240	12.2001-			
	TOYOTA	PREMIO/ALLION	NZT240	12.2001-			
	TOYOTA	PREMIO/ALLION	ZZT240	12.2001-			
	TOYOTA	PREMIO/ALLION	ZZT245	12.2001-			
	TOYOTA	SIENTA	NCP81G	09.2003-			
	TOYOTA	SIENTA	NCP85G	09.2003-			
	TOYOTA	WILL CYPHA	NCP70	09.2002-07.2005			
	TOYOTA	WILL CYPHA	NCP75	09.2002-07.2005			
	TOYOTA	WILL VI	NCP19	01.2000-12.2001			
	TOYOTA	WILL VS	NZE127	04.2001-04.2004			
	TOYOTA	WILL VS	ZZE127	04.2001-04.2004			
	TOYOTA	WILL VS	ZZE128	04.2001-04.2004			
	TOYOTA	WILL VS	ZZE129	04.2001-04.2004			
	TOYOTA	WINDOM	MCV30	07.2001-07.2003			
	TOYOTA	WISH	ANE10G	04.2003-			
	TOYOTA	WISH	ANE11W	04.2003-			
	TOYOTA	WISH	ZNE10G	01.2003-			
	TOYOTA	WISH	ZNE14G	01.2003-			
	VAUXHALL	Calibra				F	
	VAUXHALL	Vectra				F	
	VOLVO	740				F	
	VOLVO	745				F	
VOLVO	760				F		
VOLVO	780				F		
VOLVO	940				F		
VOLVO	960				F		
VOLVO	240 series				F		
VOLVO	242 series				F		
VOLVO	244 series				F		
VOLVO	245 series				F		
VOLVO	260 series				F		
VOLVO	264 series				F		
VOLVO	265 series				F		



<b>RU-100</b>	<b>Engine Mounting</b>	<b>NISSAN MICRA (K11)</b>	
	<b>Supporto motore</b>	1.0 i 16V/1.3 i 16V/1.4 i 16V	
NISSAN	11210-01B01		
Length/Lunghezza [mm]	93		
Height/Altezza [mm]	84,5		
Width/Larghezza [mm]	64,5		
Inner Diam./Diam. Interno [mm]	11		
<b>RU-101</b>	<b>Engine Mounting</b>	<b>NISSAN PICK UP/KING CAB (720)</b>	
	<b>Supporto motore</b>	1.8/2.2 4WD/2.2 D/2.3 D/2.5 D 4WD	
NISSAN	11220-35G00	<b>NISSAN PICK UP/KING CAB (D21)</b>	
Length/Lunghezza [mm]	135	2.0/2.3 D/2.4 i 12V/2.4 i 12V 4WD/2.4 i 4WD/2.5 D/2.5 D 4WD/2.7 D 4WD/3.0 i V6 4WD	
Height/Altezza [mm]	97	<b>NISSAN PICK UP/KING CAB/NAVARA (D22)</b>	
Width/Larghezza [mm]	104	2.4 i/2.4 i 4WD/2.5 D/2.5 D 4WD/2.5 Di/2.5 Di 4WD/3.2 D 4WD	
		<b>NISSAN TERRANO I (WD21)</b>	
		2.4 i 4WD/2.7 TD 4WD/3.0 i 4WD	
		<b>NISSAN TERRANO II (R20)</b>	
		2.4 4WD/2.4 i 12V 4WD/2.7 TD 4WD/2.7 TDi 4WD/3.0 Di 4WD	
<b>RU-102</b>	<b>Engine Mounting</b>	<b>NISSAN PICK UP/KING CAB (720)</b>	
	<b>Supporto motore</b>	1.8/2.2 4WD/2.2 D/2.3 D/2.5 D 4WD	
NISSAN	11210-35G00	<b>NISSAN PICK UP/KING CAB (D21)</b>	
Length/Lunghezza [mm]	153	2.0/2.3 D/2.4 i 12V/2.4 i 12V 4WD/2.4 i 4WD/2.5 D/2.5 D 4WD/2.7 D 4WD/3.0 i V6 4WD	
Height/Altezza [mm]	60	<b>NISSAN PICK UP/KING CAB/NAVARA (D22)</b>	
Width/Larghezza [mm]	132	2.4 i/2.4 i 4WD/2.5 D/2.5 D 4WD/2.5 Di/2.5 Di 4WD/3.2 D 4WD	
		<b>NISSAN TERRANO I (WD21)</b>	
		2.4 i 4WD/2.7 TD 4WD/3.0 i 4WD	
<b>RU-103</b>	<b>Engine Mounting</b>	<b>NISSAN PICK UP/KING CAB (720)</b>	
	<b>Supporto motore</b>	1.8/2.2 4WD/2.2 D/2.3 D/2.5 D 4WD	
NISSAN	11320-01G00	<b>NISSAN PICK UP/KING CAB (D21)</b>	
Length/Lunghezza [mm]	140	2.0/2.3 D/2.4 i 12V/2.4 i 12V 4WD/2.4 i 4WD/2.5 D/2.5 D 4WD/2.7 D 4WD/3.0 i V6 4WD	
Height/Altezza [mm]	64	<b>NISSAN PICK UP/KING CAB/NAVARA (D22)</b>	
Width/Larghezza [mm]	102	2.4 i/2.4 i 4WD/2.5 D/2.5 D 4WD/2.5 Di/2.5 Di 4WD/3.2 D 4WD	
		<b>NISSAN TERRANO I (WD21)</b>	
		2.4 i 4WD/2.7 TD 4WD/3.0 i 4WD	
<b>RU-104</b>	<b>Engine Mounting</b>	<b>NISSAN PATROL GR I (Y60)</b>	
	<b>Supporto motore</b>	2.8 TD (Y60A)/4.2 Cat./4.2 D (Y60GR)	
NISSAN	11220-10J00	<b>NISSAN PATROL GR II (Y61)</b>	
Length/Lunghezza [mm]	129	2.8 TD/3.0 DTi/4.2 TD/4.5 i	
Height/Altezza [mm]	59	<b>NISSAN PATROL Hardtop (K160)</b>	
Width/Larghezza [mm]	121	2.8 (K160)/3.2 TD (K160)/3.3 D (K160)	
		<b>NISSAN PATROL Hardtop (K260)</b>	
		2.8/2.8 TD/3.2 D	
		<b>NISSAN PATROL SW (W160)</b>	
		2.8 (W160)/3.2 TD (W160)/3.3 D (W160)	
		<b>NISSAN PATROL SW (W260)</b>	
		2.8 TD/3.2 D	
<b>RU-105</b>	<b>Engine Mounting</b>	<b>NISSAN PATROL GR I (Y60)</b>	
	<b>Supporto motore</b>	2.8 TD (Y60A)/4.2 Cat./4.2 D (Y60GR)	
NISSAN	11320-06J00	<b>NISSAN PATROL GR II (Y61)</b>	
Length/Lunghezza [mm]	135	2.8 TD/3.0 DTi/4.2 TD/4.5 i	
Height/Altezza [mm]	65	<b>NISSAN PATROL Hardtop (K160)</b>	
Width/Larghezza [mm]	102,5	2.8 (K160)/3.2 TD (K160)/3.3 D (K160)	
		<b>NISSAN PATROL Hardtop (K260)</b>	
		2.8/2.8 TD/3.2 D	
		<b>NISSAN PATROL SW (W160)</b>	
		2.8 (W160)/3.2 TD (W160)/3.3 D (W160)	
		<b>NISSAN PATROL SW (W260)</b>	
		2.8 TD/3.2 D	

<b>RU-106</b>	<b>Bearing,propshaft centre bearing</b>	<b>NISSAN PICK UP/KING CAB (720)</b> 1.8/2.2 4WD/2.2 D/2.3 D/2.5 D 4WD		
	<b>Supporto albero cardanico</b>			<b>NISSAN PICK UP/KING CAB (D21)</b> 2.0/2.3 D/2.4 i 12V/2.4 i 12V 4WD/2.4 i 4WD/2.5 D/2.5 D 4WD/2.7 D 4WD/3.0 i V6 4WD
NISSAN	37521-34G25	<b>NISSAN PICK UP/KING CAB/NAVARA (D22)</b> 2.4 i/2.4 i 4WD/2.5 D/2.5 D 4WD/2.5 Di/2.5 Di 4WD/2.5 TD 4WD/3.2 D 4WD		
Length/Lunghezza [mm]	117,5	<b>NISSAN TERRANO I (WD21)</b> 2.4 i 4WD/2.7 TD 4WD/3.0 i 4WD		
Height/Altezza [mm]	48	<b>NISSAN TERRANO II (R20)</b> 2.4 4WD/2.4 i 12V 4WD/2.7 TD 4WD/2.7 TDi 4WD/3.0 Di 4WD		
Width/Larghezza [mm]	119	<b>NISSAN PICK UP/KING CAB (720)</b> 1.8/2.2 4WD/2.2 D/2.3 D/2.5 D 4WD		
Inner Diam./Diam. Interno [mm]	30	<b>NISSAN PICK UP/KING CAB (D21)</b> 2.0/2.3 D/2.4 i 12V/2.4 i 12V 4WD/2.4 i 4WD/2.5 D/2.5 D 4WD/2.7 D 4WD/3.0 i V6 4WD		
<b>RU-107</b>		<b>NISSAN PICK UP/KING CAB/NAVARA (D22)</b> 2.4 i/2.4 i 4WD/2.5 D/2.5 D 4WD/2.5 Di/2.5 Di 4WD/2.5 TD 4WD/3.2 D 4WD		
<b>Holder, control arm mounting</b>		<b>NISSAN TERRANO I (WD21)</b> 2.4 i 4WD/2.7 TD 4WD/3.0 i 4WD		
<b>Silentblock</b>		<b>NISSAN TERRANO II (R20)</b> 2.4 4WD/2.4 i 12V 4WD/2.7 TD 4WD/2.7 TDi 4WD/3.0 Di 4WD		
NISSAN	54423-B9500	<b>NISSAN PICK UP/KING CAB (720)</b> 1.8/2.2 4WD/2.2 D/2.3 D/2.5 D 4WD		
Length/Lunghezza [mm]	81	<b>NISSAN PICK UP/KING CAB (D21)</b> 2.0/2.3 D/2.4 i 12V/2.4 i 12V 4WD/2.4 i 4WD/2.5 D/2.5 D 4WD/2.7 D 4WD/3.0 i V6 4WD		
Inner Diam./Diam. Interno [mm]	18	<b>NISSAN PICK UP/KING CAB/NAVARA (D22)</b> 2.4 i/2.4 i 4WD/2.5 D/2.5 D 4WD/2.5 Di/2.5 Di 4WD/2.5 TD 4WD/3.2 D 4WD		
Outer Diam./Diam. esterno [mm]	36	<b>NISSAN TERRANO I (WD21)</b> 2.4 i 4WD/2.7 TD 4WD/3.0 i 4WD		
<b>RU-108</b>		<b>NISSAN TERRANO II (R20)</b> 2.4 4WD/2.4 i 12V 4WD/2.7 TD 4WD/2.7 TDi 4WD/3.0 Di 4WD		
<b>Holder, control arm mounting</b>		<b>NISSAN PICK UP/KING CAB (720)</b> 1.8/2.2 4WD/2.2 D/2.3 D/2.5 D 4WD		
<b>Silentblock</b>		<b>NISSAN PICK UP/KING CAB (D21)</b> 2.0/2.3 D/2.4 i 12V/2.4 i 12V 4WD/2.4 i 4WD/2.5 D/2.5 D 4WD/2.7 D 4WD/3.0 i V6 4WD		
NISSAN	54506-B9500	<b>NISSAN PICK UP/KING CAB/NAVARA (D22)</b> 2.4 i/2.4 i 4WD/2.5 D/2.5 D 4WD/2.5 Di/2.5 Di 4WD/2.5 TD 4WD/3.2 D 4WD		
Length/Lunghezza [mm]	48	<b>NISSAN TERRANO I (WD21)</b> 2.4 i 4WD/2.7 TD 4WD/3.0 i 4WD		
Inner Diam./Diam. Interno [mm]	17,5	<b>NISSAN TERRANO II (R20)</b> 2.4 4WD/2.4 i 12V 4WD/2.7 TD 4WD/2.7 TDi 4WD/3.0 Di 4WD		
Outer Diam./Diam. esterno [mm]	41	<b>NISSAN PICK UP/KING CAB (720)</b> 1.8/2.2 4WD/2.2 D/2.3 D/2.5 D 4WD		
<b>RU-109</b>		<b>NISSAN PICK UP/KING CAB (D21)</b> 2.0/2.3 D/2.4 i 12V/2.4 i 12V 4WD/2.4 i 4WD/2.5 D/2.5 D 4WD/2.7 D 4WD/3.0 i V6 4WD		
<b>Bush, leaf spring</b>		<b>NISSAN PICK UP/KING CAB/NAVARA (D22)</b> 2.4 i/2.4 i 4WD/2.5 D/2.5 D 4WD/2.5 Di/2.5 Di 4WD/2.5 TD 4WD/3.2 D 4WD		
<b>Boccola balestra</b>		<b>NISSAN TERRANO I (WD21)</b> 2.4 i 4WD/2.7 TD 4WD/3.0 i 4WD		
NISSAN	55046-01G00	<b>NISSAN TERRANO II (R20)</b> 2.4 4WD/2.4 i 12V 4WD/2.7 TD 4WD/2.7 TDi 4WD/3.0 Di 4WD		
Length/Lunghezza [mm]	37	<b>NISSAN PICK UP/KING CAB (720)</b> 1.8/2.2 4WD/2.2 D/2.3 D/2.5 D 4WD		
Inner Diam./Diam. Interno [mm]	20	<b>NISSAN PICK UP/KING CAB (D21)</b> 2.0/2.3 D/2.4 i 12V/2.4 i 12V 4WD/2.4 i 4WD/2.5 D/2.5 D 4WD/2.7 D 4WD/3.0 i V6 4WD		
Outer Diam./Diam. esterno [mm]	32,5	<b>NISSAN PICK UP/KING CAB/NAVARA (D22)</b> 2.4 i/2.4 i 4WD/2.5 D/2.5 D 4WD/2.5 Di/2.5 Di 4WD/2.5 TD 4WD/3.2 D 4WD		
<b>RU-110</b>		<b>NISSAN TERRANO I (WD21)</b> 2.4 i 4WD/2.7 TD 4WD/3.0 i 4WD		
<b>Holder, control arm mounting</b>		<b>NISSAN TERRANO II (R20)</b> 2.4 4WD/2.4 i 12V 4WD/2.7 TD 4WD/2.7 TDi 4WD/3.0 Di 4WD		
<b>Silentblock</b>		<b>NISSAN PICK UP/KING CAB (720)</b> 1.8/2.2 4WD/2.2 D/2.3 D/2.5 D 4WD		
NISSAN	54560-01G00	<b>NISSAN PICK UP/KING CAB (D21)</b> 2.0/2.3 D/2.4 i 12V/2.4 i 12V 4WD/2.4 i 4WD/2.5 D/2.5 D 4WD/2.7 D 4WD/3.0 i V6 4WD		
Length/Lunghezza [mm]	81	<b>NISSAN PICK UP/KING CAB/NAVARA (D22)</b> 2.4 i/2.4 i 4WD/2.5 D/2.5 D 4WD/2.5 Di/2.5 Di 4WD/2.5 TD 4WD/3.2 D 4WD		
Inner Diam./Diam. Interno [mm]	18	<b>NISSAN TERRANO I (WD21)</b> 2.4 i 4WD/2.7 TD 4WD/3.0 i 4WD		
Outer Diam./Diam. esterno [mm]	41	<b>NISSAN TERRANO II (R20)</b> 2.4 4WD/2.4 i 12V 4WD/2.7 TD 4WD/2.7 TDi 4WD/3.0 Di 4WD		
		<b>NISSAN URVAN Autobus (E24)</b> 2.4 i/2.5 D		
		<b>NISSAN URVAN Furgonato (E24)</b> 2.0/2.3 D/2.5 D		

<b>RU-112</b>	<b>Bearing Bush, stabiliser</b>	<b>NISSAN PATROL Hardtop (K160)</b> 2.8 (K160)/3.2 TD (K160)/3.3 D (K160)	
	<b>Boccola barra stabilizzatrice</b>	<b>NISSAN PATROL Hardtop (K260)</b> 2.8/2.8 TD	
NISSAN	56112-09400	<b>NISSAN PATROL SW (W160)</b> 2.8 (W160)/3.2 TD (W160)/3.3 D (W160)	
Length/Lunghezza [mm]	16,5	<b>NISSAN PATROL SW (W260)</b> 2.8 TD	
Inner Diam./Diam. Interno [mm]	10	<b>NISSAN PICK UP/KING CAB (720)</b> 1.8/2.2 4WD/2.2 D/2.3 D/2.5 D 4WD	
Outer Diam./Diam. esterno [mm]	25	<b>NISSAN PICK UP/KING CAB (D21)</b> 2.0/2.3 D/2.4 i 12V/2.4 i 12V 4WD/2.4 i 4WD/2.5 D/2.5 D 4WD/2.7 D 4WD/3.0 i V6 4WD	
		<b>NISSAN PICK UP/KING CAB/NAVARA (D22)</b> 2.4 i/2.4 i 4WD/2.5 D/2.5 D 4WD/2.5 Di/2.5 Di 4WD/2.5 TD 4WD/3.2 D 4WD	
		<b>NISSAN TERRANO I (WD21)</b> 2.4 i 4WD/2.7 TD 4WD/3.0 i 4WD	
		<b>NISSAN TERRANO II (R20)</b> 2.4 4WD/2.4 i 12V 4WD/2.7 TD 4WD/2.7 TDi 4WD/3.0 Di 4WD	
		<b>NISSAN PICK UP/KING CAB (720)</b> 1.8/2.2 4WD/2.2 D/2.3 D/2.5 D 4WD	
<b>RU-113</b>	<b>Bearing Bush, stabiliser</b>	<b>NISSAN PICK UP/KING CAB (D21)</b> 2.0/2.3 D/2.4 i 12V/2.4 i 12V 4WD/2.4 i 4WD/2.5 D/2.5 D 4WD/2.7 D 4WD/3.0 i V6 4WD	
	<b>Boccola barra stabilizzatrice</b>	<b>NISSAN PICK UP/KING CAB/NAVARA (D22)</b> 2.4 i/2.4 i 4WD/2.5 D/2.5 D 4WD/2.5 Di/2.5 Di 4WD/2.5 TD 4WD/3.2 D 4WD	
NISSAN	54613-14900	<b>NISSAN TERRANO I (WD21)</b> 2.4 i 4WD/2.7 TD 4WD/3.0 i 4WD	
Length/Lunghezza [mm]	38	<b>NISSAN TERRANO II (R20)</b> 2.4 4WD/2.4 i 12V 4WD/2.7 TD 4WD/2.7 TDi 4WD/3.0 Di 4WD	
Height/Altezza [mm]	35	<b>NISSAN PICK UP/KING CAB (720)</b> 1.8/2.2 4WD/2.2 D/2.3 D/2.5 D 4WD	
Width/Larghezza [mm]	33	<b>NISSAN PICK UP/KING CAB (D21)</b> 2.0/2.3 D/2.4 i 12V/2.4 i 12V 4WD/2.4 i 4WD/2.5 D/2.5 D 4WD/2.7 D 4WD/3.0 i V6 4WD	
Inner Diam./Diam. Interno [mm]	20,5	<b>NISSAN PICK UP/KING CAB/NAVARA (D22)</b> 2.4 i/2.4 i 4WD/2.5 D/2.5 D 4WD/2.5 Di/2.5 Di 4WD/2.5 TD 4WD/3.2 D 4WD	
		<b>NISSAN TERRANO I (WD21)</b> 2.4 i 4WD/2.7 TD 4WD/3.0 i 4WD	
		<b>NISSAN TERRANO II (R20)</b> 2.4 4WD/2.4 i 12V 4WD/2.7 TD 4WD/2.7 TDi 4WD/3.0 Di 4WD	
		<b>NISSAN PICK UP/KING CAB (720)</b> 1.8/2.2 4WD/2.2 D/2.3 D/2.5 D 4WD	
<b>RU-114</b>	<b>Bearing Bush, stabiliser</b>	<b>NISSAN PICK UP/KING CAB (D21)</b> 2.0/2.3 D/2.4 i 12V/2.4 i 12V 4WD/2.4 i 4WD/2.5 D/2.5 D 4WD/2.7 D 4WD/3.0 i V6 4WD	
	<b>Boccola barra stabilizzatrice</b>	<b>NISSAN PICK UP/KING CAB/NAVARA (D22)</b> 2.4 i/2.4 i 4WD/2.5 D/2.5 D 4WD/2.5 Di/2.5 Di 4WD/2.5 TD 4WD/3.2 D 4WD	
NISSAN	54476-F0200	<b>NISSAN TERRANO I (WD21)</b> 2.4 i 4WD/2.7 TD 4WD/3.0 i 4WD	
Length/Lunghezza [mm]	33	<b>NISSAN TERRANO II (R20)</b> 2.4 4WD/2.4 i 12V 4WD/2.7 TD 4WD/2.7 TDi 4WD/3.0 Di 4WD	
Inner Diam./Diam. Interno [mm]	22	<b>NISSAN PICK UP/KING CAB (720)</b> 1.8/2.2 4WD/2.2 D/2.3 D/2.5 D 4WD	
Outer Diam./Diam. esterno [mm]	50	<b>NISSAN PICK UP/KING CAB (D21)</b> 2.0/2.3 D/2.4 i 12V/2.4 i 12V 4WD/2.4 i 4WD/2.5 D/2.5 D 4WD/2.7 D 4WD/3.0 i V6 4WD	
		<b>NISSAN PICK UP/KING CAB/NAVARA (D22)</b> 2.4 i/2.4 i 4WD/2.5 D/2.5 D 4WD/2.5 Di/2.5 Di 4WD/2.5 TD 4WD/3.2 D 4WD	
		<b>NISSAN TERRANO I (WD21)</b> 2.4 i 4WD/2.7 TD 4WD/3.0 i 4WD	
		<b>NISSAN TERRANO II (R20)</b> 2.4 4WD/2.4 i 12V 4WD/2.7 TD 4WD/2.7 TDi 4WD/3.0 Di 4WD	
		<b>NISSAN PICK UP/KING CAB (720)</b> 1.8/2.2 4WD/2.2 D/2.3 D/2.5 D 4WD	
<b>RU-115</b>	<b>Bearing Bush, stabiliser</b>	<b>NISSAN PICK UP/KING CAB (D21)</b> 2.0/2.3 D/2.4 i 12V/2.4 i 12V 4WD/2.4 i 4WD/2.5 D/2.5 D 4WD/2.7 D 4WD/3.0 i V6 4WD	
	<b>Boccola barra stabilizzatrice</b>	<b>NISSAN PICK UP/KING CAB/NAVARA (D22)</b> 2.4 i/2.4 i 4WD/2.5 D/2.5 D 4WD/2.5 Di/2.5 Di 4WD/2.5 TD 4WD/3.2 D 4WD	
NISSAN	54476-01W00	<b>NISSAN TERRANO I (WD21)</b> 2.4 i 4WD/2.7 TD 4WD/3.0 i 4WD	
Length/Lunghezza [mm]	34	<b>NISSAN TERRANO II (R20)</b> 2.4 4WD/2.4 i 12V 4WD/2.7 TD 4WD/2.7 TDi 4WD/3.0 Di 4WD	
Inner Diam./Diam. Interno [mm]	22	<b>NISSAN PICK UP/KING CAB (720)</b> 1.8/2.2 4WD/2.2 D/2.3 D/2.5 D 4WD	
Outer Diam./Diam. esterno [mm]	50	<b>NISSAN PICK UP/KING CAB (D21)</b> 2.0/2.3 D/2.4 i 12V/2.4 i 12V 4WD/2.4 i 4WD/2.5 D/2.5 D 4WD/2.7 D 4WD/3.0 i V6 4WD	
		<b>NISSAN PICK UP/KING CAB/NAVARA (D22)</b> 2.4 i/2.4 i 4WD/2.5 D/2.5 D 4WD/2.5 Di/2.5 Di 4WD/2.5 TD 4WD/3.2 D 4WD	
		<b>NISSAN TERRANO I (WD21)</b> 2.4 i 4WD/2.7 TD 4WD/3.0 i 4WD	
		<b>NISSAN TERRANO II (R20)</b> 2.4 4WD/2.4 i 12V 4WD/2.7 TD 4WD/2.7 TDi 4WD/3.0 Di 4WD	
		<b>NISSAN PICK UP/KING CAB (720)</b> 1.8/2.2 4WD/2.2 D/2.3 D/2.5 D 4WD	
<b>RU-116</b>	<b>Bush, leaf spring</b>	<b>NISSAN PATROL GR II (Y61)</b> 2.8 TD/3.0 DTi/4.2 TD/4.5 i	
	<b>Boccola balestra</b>	<b>NISSAN PATROL Hardtop (K160)</b> 2.8 (K160)/3.2 TD (K160)/3.3 D (K160)	
NISSAN	55045-10W00	<b>NISSAN PATROL Hardtop (K260)</b> 2.8/2.8 TD/3.2 D	
Length/Lunghezza [mm]	37	<b>NISSAN PATROL SW (W160)</b> 2.8 (W160)/3.2 TD (W160)/3.3 D (W160)	
Inner Diam./Diam. Interno [mm]	18	<b>NISSAN PATROL SW (W260)</b> 2.8	
Outer Diam./Diam. esterno [mm]	40		

		2.8 TD/3.2 D
	<b>NISSAN PICK UP/KING CAB (720)</b>	
		1.8/2.2 4WD/2.2 D/2.3 D/2.5 D 4WD
	<b>NISSAN PICK UP/KING CAB (D21)</b>	
		2.0/2.3 D/2.4 i 12V/2.4 i 12V 4WD/2.4 i 4WD/2.5 D/2.5 D 4WD/2.7 D 4WD/3.0 i V6 4WD
	<b>NISSAN PICK UP/KING CAB/NAVARA (D22)</b>	
		2.4 i/2.4 i 4WD/2.5 D/2.5 D 4WD/2.5 Di/2.5 Di 4WD/2.5 TD 4WD/3.2 D 4WD
	<b>NISSAN TERRANO I (WD21)</b>	
		2.4 i 4WD/2.7 TD 4WD/3.0 i 4WD
	<b>NISSAN TERRANO II (R20)</b>	
		2.4 4WD/2.4 i 12V 4WD/2.7 TD 4WD/2.7 TDi 4WD/3.0 Di 4WD

<b>RU-117</b>	<b>Bush, leaf spring</b>
	<b>Boccola balestra</b>
NISSAN	55046-C6000
Length/Lunghezza [mm]	51
Inner Diam./Diam. Interno [mm]	18
Outer Diam./Diam. esterno [mm]	33

<b>NISSAN PATROL GR I (Y60)</b>	
	2.8 TD (Y60A)/4.2 Cat./4.2 D (Y60GR)
<b>NISSAN PATROL GR II (Y61)</b>	
	2.8 TD/3.0 DTI/4.2 TD/4.5 i
<b>NISSAN PATROL Hardtop (K160)</b>	
	2.8 (K160)/3.2 TD (K160)/3.3 D (K160)
<b>NISSAN PATROL Hardtop (K260)</b>	
	2.8/2.8 TD/3.2 D
<b>NISSAN PATROL SW (W160)</b>	
	2.8 (W160)/3.2 TD (W160)/3.3 D (W160)
<b>NISSAN PATROL SW (W260)</b>	
	2.8 TD/3.2 D



<b>RU-118</b>	<b>Bearing Bush, stabiliser</b>
	<b>Boccola barra stabilizzatrice</b>
NISSAN	54476-01G00
Length/Lunghezza [mm]	35
Inner Diam./Diam. Interno [mm]	21
Outer Diam./Diam. esterno [mm]	51

<b>NISSAN PATROL GR I (Y60)</b>	
	2.8 TD (Y60A)/4.2 Cat./4.2 D (Y60GR)
<b>NISSAN PATROL GR II (Y61)</b>	
	2.8 TD/3.0 DTI/4.2 TD/4.5 i
<b>NISSAN PATROL Hardtop (K160)</b>	
	2.8 (K160)/3.2 TD (K160)/3.3 D (K160)
<b>NISSAN PATROL Hardtop (K260)</b>	
	2.8/2.8 TD/3.2 D
<b>NISSAN PATROL SW (W160)</b>	
	2.8 (W160)/3.2 TD (W160)/3.3 D (W160)
<b>NISSAN PATROL SW (W260)</b>	
	2.8 TD/3.2 D



<b>RU-119</b>	<b>Holder, control arm mounting</b>
	<b>Silentblock</b>
NISSAN	54560-01J00
Length/Lunghezza [mm]	50,2
Inner Diam./Diam. Interno [mm]	16
Outer Diam./Diam. esterno [mm]	60,3

<b>NISSAN PATROL GR I (Y60)</b>	
	2.8 TD (Y60A)/4.2 Cat./4.2 D (Y60GR)
<b>NISSAN PATROL GR II (Y61)</b>	
	2.8 TD/3.0 DTI/4.2 TD/4.5 i
<b>NISSAN PATROL Hardtop (K160)</b>	
	2.8 (K160)/3.2 TD (K160)/3.3 D (K160)
<b>NISSAN PATROL Hardtop (K260)</b>	
	2.8/2.8 TD/3.2 D
<b>NISSAN PATROL SW (W160)</b>	
	2.8 (W160)/3.2 TD (W160)/3.3 D (W160)
<b>NISSAN PATROL SW (W260)</b>	
	2.8 TD/3.2 D



<b>RU-120</b>	<b>Bearing Bush, stabiliser</b>
	<b>Boccola barra stabilizzatrice</b>
NISSAN	55045-G2500
Length/Lunghezza [mm]	38,5
Inner Diam./Diam. Interno [mm]	18
Outer Diam./Diam. esterno [mm]	45

<b>NISSAN PATROL GR I (Y60)</b>	
	2.8 TD (Y60A)/4.2 Cat./4.2 D (Y60GR)
<b>NISSAN PATROL GR II (Y61)</b>	
	2.8 TD/3.0 DTI/4.2 TD/4.5 i
<b>NISSAN PATROL Hardtop (K160)</b>	
	2.8 (K160)/3.2 TD (K160)/3.3 D (K160)
<b>NISSAN PATROL Hardtop (K260)</b>	
	2.8/2.8 TD/3.2 D
<b>NISSAN PATROL SW (W160)</b>	
	2.8 (W160)/3.2 TD (W160)/3.3 D (W160)
<b>NISSAN PATROL SW (W260)</b>	
	2.8 TD/3.2 D



<b>RU-121</b>	<b>Bearing Bush, stabiliser</b>	<b>NISSAN PICK UP/KING CAB (D21)</b> 2.0/2.3 D/2.4 i 12V/2.4 i 12V 4WD/2.4 i 4WD/2.5 D/2.5 D 4WD/2.7 D 4WD/3.0 i V6 4WD	
	<b>Boccola barra stabilizzatrice</b>	<b>NISSAN TERRANO I (WD21)</b> 2.4 i 4WD/2.7 TD 4WD/3.0 i 4WD	
NISSAN	54613-43G00	<b>NISSAN TERRANO II (R20)</b> 2.4 4WD/2.4 i 12V 4WD/2.7 TD 4WD/2.7 Di 4WD/3.0 Di 4WD	
Length/Lunghezza [mm]	54		
Height/Altezza [mm]	35		
Width/Larghezza [mm]	37		
Inner Diam./Diam. Interno [mm]	21		
<b>RU-122</b>	<b>Bearing Bush, stabiliser</b>	<b>NISSAN PICK UP/KING CAB (D21)</b> 2.0/2.3 D/2.4 i 12V/2.4 i 12V 4WD/2.4 i 4WD/2.5 D/2.5 D 4WD/2.7 D 4WD/3.0 i V6 4WD	
	<b>Boccola barra stabilizzatrice</b>	<b>NISSAN TERRANO I (WD21)</b> 2.4 i 4WD/2.7 TD 4WD/3.0 i 4WD	
NISSAN	54613-W1410		
Length/Lunghezza [mm]	28,5		
Height/Altezza [mm]	38		
Width/Larghezza [mm]	32		
Inner Diam./Diam. Interno [mm]	23		
<b>RU-123</b>	<b>Bearing Bush, stabiliser</b>	<b>NISSAN PATROL GR I (Y60)</b> 2.8 TD (Y60A)/4.2 Cat./4.2 D (Y60GR)	
	<b>Boccola barra stabilizzatrice</b>	<b>NISSAN PATROL GR II (Y61)</b> 2.8 TD/3.0 DTi/4.2 TD/4.5 i	
NISSAN	54613-01J11	<b>NISSAN PATROL Hardtop (K160)</b> 2.8 (K160)/3.2 TD (K160)/3.3 D (K160)	
Length/Lunghezza [mm]	34	<b>NISSAN PATROL Hardtop (K260)</b> 2.8/2.8 TD/3.2 D	
Height/Altezza [mm]	42	<b>NISSAN PATROL SW (W160)</b> 2.8 (W160)/3.2 TD (W160)/3.3 D (W160)	
Width/Larghezza [mm]	25	<b>NISSAN PATROL SW (W260)</b> 2.8 TD/3.2 D	
Inner Diam./Diam. Interno [mm]	14	<b>NISSAN PICK UP/KING CAB (D21)</b> 2.0/2.3 D/2.4 i 12V/2.4 i 12V 4WD/2.4 i 4WD/2.5 D/2.5 D 4WD/2.7 D 4WD/3.0 i V6 4WD	
		<b>NISSAN TERRANO I (WD21)</b> 2.4 i 4WD/2.7 TD 4WD/3.0 i 4WD	
<b>RU-124</b>	<b>Bearing Bush, stabiliser</b>	<b>NISSAN PATROL GR I (Y60)</b> 2.8 TD (Y60A)/4.2 Cat./4.2 D (Y60GR)	
	<b>Boccola barra stabilizzatrice</b>		
NISSAN	54613-06J10		
Length/Lunghezza [mm]	46		
Height/Altezza [mm]	34		
Width/Larghezza [mm]	32		
Inner Diam./Diam. Interno [mm]	17		
<b>RU-125</b>	<b>Bearing Bush, stabiliser</b>	<b>NISSAN PATROL GR I (Y60)</b> 2.8 TD (Y60A)/4.2 Cat./4.2 D (Y60GR)	
	<b>Boccola barra stabilizzatrice</b>		
NISSAN	54613-0F001		
Length/Lunghezza [mm]	36		
Height/Altezza [mm]	43,5		
Width/Larghezza [mm]	35		
Inner Diam./Diam. Interno [mm]	23		
<b>RU-126</b>	<b>Bearing Bush, stabiliser</b>	<b>NISSAN PATROL GR I (Y60)</b> 2.8 TD (Y60A)/4.2 Cat./4.2 D (Y60GR)	
	<b>Boccola barra stabilizzatrice</b>		
NISSAN	54476-01J00		
Length/Lunghezza [mm]	40		
Inner Diam./Diam. Interno [mm]	24		
Outer Diam./Diam. esterno [mm]	37		

<b>RU-127</b>	<b>Bearing Bush, stabiliser</b>	<b>NISSAN PATROL GR I (Y60)</b> 2.8 TD (Y60A)/4.2 Cat./4.2 D (Y60GR)	
	<b>Boccola barra stabilizzatrice</b>		
NISSAN	55135-01J00		
Length/Lunghezza [mm]	27,5		
Inner Diam./Diam. Interno [mm]	25		
Outer Diam./Diam. esterno [mm]	47,5		
<b>RU-128</b>	<b>Bearing Bush, stabiliser</b>	<b>NISSAN PICK UP/KING CAB (D21)</b> 2.0/2.3 D/2.4 i 12V/2.4 i 12V 4WD/2.4 i 4WD/2.5 D/2.5 D 4WD/2.7 D 4WD/3.0 i V6 4WD	
	<b>Boccola barra stabilizzatrice</b>	<b>NISSAN TERRANO I (WD21)</b> 2.4 i 4WD/2.7 TD 4WD/3.0 i 4WD	
NISSAN	54613-32G00		
Length/Lunghezza [mm]	47		
Height/Altezza [mm]	35,5		
Width/Larghezza [mm]	33		
Inner Diam./Diam. Interno [mm]	20		
<b>RU-130</b>	<b>Bearing Bush, stabiliser</b>	<b>NISSAN PATROL GR I (Y60)</b> 2.8 TD (Y60A)/4.2 Cat./4.2 D (Y60GR)	
	<b>Boccola barra stabilizzatrice</b>	<b>NISSAN PATROL GR II (Y61)</b> 2.8 TD/3.0 DTi/4.2 TD/4.5 i <b>NISSAN PATROL Hardtop (K160)</b> 2.8 (K160)/3.2 TD (K160)/3.3 D (K160) <b>NISSAN PATROL Hardtop (K260)</b> 2.8/2.8 TD/3.2 D <b>NISSAN PATROL SW (W160)</b> 2.8 (W160)/3.2 TD (W160)/3.3 D (W160) <b>NISSAN PATROL SW (W260)</b> 2.8 TD/3.2 D	
NISSAN	55046-01600		
Length/Lunghezza [mm]	36,5		
Inner Diam./Diam. Interno [mm]	20		
Outer Diam./Diam. esterno [mm]	32		
<b>RU-131</b>	<b>Bush, leaf spring</b>	<b>NISSAN PATROL GR I (Y60)</b> 2.8 TD (Y60A)/4.2 Cat./4.2 D (Y60GR)	
	<b>Boccola balestra</b>	<b>NISSAN PATROL GR II (Y61)</b> 2.8 TD/3.0 DTi/4.2 TD/4.5 i <b>NISSAN PATROL Hardtop (K160)</b> 2.8 (K160)/3.2 TD (K160)/3.3 D (K160) <b>NISSAN PATROL Hardtop (K260)</b> 2.8/2.8 TD/3.2 D <b>NISSAN PATROL SW (W160)</b> 2.8 (W160)/3.2 TD (W160)/3.3 D (W160) <b>NISSAN PATROL SW (W260)</b> 2.8 TD/3.2 D	
NISSAN	55045-07200		
Length/Lunghezza [mm]	64		
Inner Diam./Diam. Interno [mm]	16		
Outer Diam./Diam. esterno [mm]	33,2		
<b>RU-132</b>	<b>Bearing Bush, stabiliser</b>	<b>NISSAN PATROL GR I (Y60)</b> 2.8 TD (Y60A)/4.2 Cat./4.2 D (Y60GR)	
	<b>Boccola barra stabilizzatrice</b>	<b>NISSAN PATROL GR II (Y61)</b> 2.8 TD/3.0 DTi/4.2 TD/4.5 i <b>NISSAN PATROL Hardtop (K160)</b> 2.8 (K160)/3.2 TD (K160)/3.3 D (K160) <b>NISSAN PATROL Hardtop (K260)</b> 2.8/2.8 TD/3.2 D <b>NISSAN PATROL SW (W160)</b> 2.8 (W160)/3.2 TD (W160)/3.3 D (W160) <b>NISSAN PATROL SW (W260)</b> 2.8 TD/3.2 D <b>NISSAN PICK UP/KING CAB (720)</b> 1.8/2.2 4WD/2.2 D/2.3 D/2.5 D 4WD <b>NISSAN PICK UP/KING CAB (D21)</b> 2.0/2.3 D/2.4 i 12V/2.4 i 12V 4WD/2.4 i 4WD/2.5 D/2.5 D 4WD/2.7 D 4WD/3.0 i V6 4WD <b>NISSAN PICK UP/KING CAB/NAVARA (D22)</b> 2.4 i/2.4 i 4WD/2.5 D/2.5 D 4WD/2.5 Di/2.5 Di 4WD/2.5 TD 4WD/3.2 D 4WD <b>NISSAN TERRANO I (WD21)</b> 2.4 i 4WD/2.7 TD 4WD/3.0 i 4WD <b>NISSAN TERRANO II (R20)</b> 2.4 4WD/2.4 i 12V 4WD/2.7 TD 4WD/2.7 Di 4WD/3.0 Di 4WD	
NISSAN	20638-61500		
Length/Lunghezza [mm]	15		
Inner Diam./Diam. Interno [mm]	12		
Outer Diam./Diam. esterno [mm]	30		

<b>RU-134</b>	<b>Bush, leaf spring</b>	<b>NISSAN PATROL GR I (Y60)</b> 2.8 TD (Y60A)/4.2 Cat./4.2 D (Y60GR)		
	<b>Boccola balestra</b>	<b>NISSAN PATROL GR II (Y61)</b> 2.8 TD/3.0 DTi/4.2 TD/4.5 i		
NISSAN	55045-31000	<b>NISSAN PATROL Hardtop (K160)</b> 2.8 (K160)/3.2 TD (K160)/3.3 D (K160)		
Length/Lunghezza [mm]	70	<b>NISSAN PATROL Hardtop (K260)</b> 2.8/2.8 TD/3.2 D		
Inner Diam./Diam. Interno [mm]	18	<b>NISSAN PATROL SW (W160)</b> 2.8 (W160)/3.2 TD (W160)/3.3 D (W160)		
Outer Diam./Diam. esterno [mm]	40	<b>NISSAN PATROL SW (W260)</b> 2.8 TD/3.2 D		
<b>RU-136</b>		<b>NISSAN PATROL Hardtop (K160)</b> 2.8 (K160)/3.2 TD (K160)/3.3 D (K160)		
<b>Bearing Bush, stabiliser</b>		<b>NISSAN PATROL Hardtop (K260)</b> 2.8/2.8 TD		
<b>Boccola barra stabilizzatrice</b>		<b>NISSAN PATROL SW (W160)</b> 2.8 (W160)/3.2 TD (W160)/3.3 D (W160)		
Length/Lunghezza [mm]	37	<b>NISSAN PATROL SW (W260)</b> 2.8 TD		
Width/Larghezza [mm]	33			
Inner Diam./Diam. Interno [mm]	20			
<b>RU-137</b>	<b>Bush, leaf spring</b>	<b>NISSAN PATROL Hardtop (K160)</b> 2.8 (K160)/3.2 TD (K160)/3.3 D (K160)		
	<b>Boccola balestra</b>	<b>NISSAN PATROL Hardtop (K260)</b> 2.8/2.8 TD		
Length/Lunghezza [mm]	37	<b>NISSAN PATROL SW (W160)</b> 2.8 (W160)/3.2 TD (W160)/3.3 D (W160)		
Width/Larghezza [mm]	33	<b>NISSAN PATROL SW (W260)</b> 2.8 TD		
Inner Diam./Diam. Interno [mm]	18			
<b>RU-138</b>	<b>Holder, control arm mounting</b>	<b>NISSAN ALMERA I (N15)</b> 1.4/1.4 GX,LX/1.6/1.6 SLX/2.0 D		
	<b>Silentblock</b>	<b>NISSAN ALMERA I Hatchback (N15)</b> 1.4/1.4 S,GX,LX/1.6/1.6 SR,SLX/2.0 D/2.0 GTi		
NISSAN	54560-50A00	<b>NISSAN SUNNY II (N13)</b> 1.0/1.3/1.4/1.4 LX/1.5/1.6/1.6 4x4/1.6 GTI 16V/1.6 i/1.6 i		
Length/Lunghezza [mm]	60	12V/1.6 i 4x4 (A)/1.7 D		
Inner Diam./Diam. Interno [mm]	14	<b>NISSAN SUNNY II Coupe (B12)</b> 1.5/1.6/1.6 GTI 16V/1.6 i/1.6 i 12V/1.8 GTI 16V		
Outer Diam./Diam. esterno [mm]	36	<b>NISSAN SUNNY II Hatchback (N13)</b> 1.3/1.4/1.4 LX/1.5/1.6/1.6 GTI 16V/1.6 i/1.6 i 12V/1.7 D/1.8 GTI 16V		
		<b>NISSAN SUNNY II Traveller (B12)</b> 1.5/1.6/1.6 i/1.6 i 12V/1.6 i 12V 4x4/1.6 i 4x4 (A)/1.7 D		
<b>RU-139</b>		<b>NISSAN 100 NX (B13)</b> 1.6/1.6 SR/2.0/2.0 GTi		
<b>Holder, control arm mounting</b>		<b>NISSAN ALMERA I (N15)</b> 1.4/1.4 GX,LX/1.6/1.6 SLX/2.0 D		
<b>Silentblock</b>		<b>NISSAN ALMERA I Hatchback (N15)</b> 1.4/1.4 S,GX,LX/1.6/1.6 SR,SLX/2.0 D/2.0 GTi		
NISSAN	54570-69Y10	<b>NISSAN SUNNY III (N14)</b> 1.4/1.4 i/1.4 i 16V/1.6 i/1.6 i 16V/1.6 i 16V 4WD/1.6 SR 4x4/2.0 D		
Length/Lunghezza [mm]	64	<b>NISSAN SUNNY III Hatchback (N14)</b> 1.4 i/1.4 i 16V/1.5/1.6 i/1.6 i 16V/1.6 i 16V 4x4/1.6 SR 4x4/2.0 D/2.0 GTI 16V/2.0 GTI-R 4x4		
Inner Diam./Diam. Interno [mm]	24	<b>NISSAN SUNNY III Liftback (N14)</b> 1.4/1.4 i/1.4 i 16V/1.6 i/1.6 i 16V/1.6 SR 4x4/2.0 D/2.0 i 16V		
Outer Diam./Diam. esterno [mm]	64	<b>NISSAN SUNNY III Traveller (Y10)</b> 1.6 16V 4x4/1.6 i/1.6 i 16V 4x4/2.0 D		

<b>RU-140</b>	<b>Holder, control arm mounting</b>	<b>NISSAN ALMERA II (N16)</b> 1.5/1.5 dCi/1.8/2.2 dCi/2.2 Di	
	<b>Silentblock</b>	<b>NISSAN ALMERA II Hatchback (N16)</b> 1.5/1.5 dCi/1.5 XL/1.8/2.2 dCi/2.2 Di	
NISSAN	54500BM410		
Length/Lunghezza [mm]	55		
Inner Diam./Diam. Interno [mm]	14		
Outer Diam./Diam. esterno [mm]	32,5		
<b>RU-141</b>	<b>Holder, control arm mounting</b>	<b>NISSAN ALMERA II (N16)</b> 1.5/1.5 dCi/1.8/2.2 dCi/2.2 Di	
	<b>Silentblock</b>	<b>NISSAN ALMERA II Hatchback (N16)</b> 1.5/1.5 dCi/1.5 XL/1.8/2.2 dCi/2.2 Di	
NISSAN	54500BM410		
Inner Diam./Diam. Interno [mm]	21		
Overall Length/Lungh. Tot. [mm]	163		
<b>RU-142</b>	<b>Holder, control arm mounting</b>	<b>NISSAN INTERSTAR</b> dCi 100/dCi 120/dCi 140/dCi 150/dCi 80/dCi 90	
	<b>Silentblock</b>	<b>OPEL MOVANO (U9, E9, H9)</b> 2.2 DTI/2.5 D/2.5 DTI/2.8 DTI	
NISSAN	54570-00QAA	<b>OPEL MOVANO Combi (J9)</b> 1.9 DTI/2.2 DTI/2.5 D/2.5 DTI/2.8 DTI/3.0 DTI	
Length/Lunghezza [mm]	74,2	<b>OPEL MOVANO Furgonato (F9)</b> 1.9 DTI/2.2 DTI/2.5 D/2.5 DTI/2.8 DTI/3.0 DTI	
Inner Diam./Diam. Interno [mm]	28	<b>RENAULT MASTER II (FD, JD/ND)</b> 1.9 dCi 80/1.9 dTi/2.2 dCi 90/2.5 D/2.5 dCi 100 (JDCV)/2.5 dCi 120/2.8 dTi/3.0 dCi 140 (JD0T)	
Outer Diam./Diam. esterno [mm]	55,3		
<b>RU-143</b>	<b>Holder, control arm mounting</b>	<b>NISSAN INTERSTAR</b> dCi 100/dCi 120/dCi 140/dCi 150/dCi 80/dCi 90	
	<b>Silentblock</b>	<b>NISSAN INTERSTAR Pianale piatto/Telaio</b> dCi 140	
NISSAN	54423-00QAA	<b>OPEL MOVANO (U9, E9, H9)</b> 2.2 DTI/2.5 D/2.5 DTI/2.8 DTI	
Length/Lunghezza [mm]	79	<b>OPEL MOVANO Combi (J9, F9)</b> 1.9 DTI/2.2 DTI/2.5 D/2.5 DTI/2.8 DTI/3.0 DTI	
Inner Diam./Diam. Interno [mm]	28	<b>RENAULT MASTER II (ED/HD/UD)</b> 2.2 dCi 90/2.5 D/2.5 dCi 100 (ED4V, ED8V)/2.5 dCi 120/2.8 dTi/3.0 dCi 120/3.0 dCi 140 (ED0S, UD0S)/3.0 dCi 160	
Outer Diam./Diam. esterno [mm]	55	<b>RENAULT MASTER II (JD/ND)</b> 1.9 dCi 80/1.9 dTi/2.2 dCi 90/2.5 D/2.5 dCi 100 (JDCV)/2.5 dCi 120/2.8 dTi/3.0 dCi 140 (JD0T)	
<b>RU-144</b>	<b>Bearing Bush, stabiliser</b>	<b>NISSAN KUBISTAR</b> 1.2/1.2 16V/1.5 dCi/1.5 dCi 70/1.5 dCi 85/1.6 16V	
	<b>Boccola barra stabilizzatrice</b>	<b>RENAULT 19 I (B/C53_)</b> 1.2/1.4/1.4 (B/C532) Cat./1.4 (B/C53P)/1.7/1.7 (B/C53B)/1.7 (B/C53C)/1.8 16V (B/C53D)/1.9 D (B/C534, B/C53J)/1.9 DT	
NISSAN	54613 00QAD	<b>RENAULT 19 I Chamade (L53_)</b> 1.1 TR/1.2/1.4/1.4 (L532, L53P)/1.7 (L53B)/1.7 (L53C)/1.7 (L53F)/1.8 16V (L53D)/1.9 D (L534, L53J)/1.9 DT/1.9 TD (L53K)	
Fitting Position/Lato Montaggio	Front	<b>RENAULT 19 I Furgonato (S53_)</b> 1.2/1.4/1.9 D	
Length/Lunghezza [mm]	42	<b>RENAULT 19 II (B/C53_)</b> 1.2/1.4/1.4 (B/C532)/1.4 (B/C535)/1.7 (B/C53B)/1.7 (B/C53C)/1.8 (5/353A)/1.8 (5/353F, B/C538)/1.8 (B/C538)/1.8 (B/C53Y)/1.8 16V (B/C53D)/1.9 D (B/C53J)/1.9 dT (B/C53T)	
Height/Altezza [mm]	46	<b>RENAULT 19 II Chamade (L53_)</b> 1.2/1.4/1.4 (532)/1.4 (L535)/1.7 (L53B)/1.7 (L53C)/1.8 (453A/F)/1.8 (L538)/1.8 (L53V, L538)/1.8 (L53Y)/1.8 16V (L53D)/1.9 D (L53J)/1.9 dT (L53T)	
Width/Larghezza [mm]	36,5	<b>RENAULT 19 II Furgonato (S53_)</b> 1.2/1.4/1.9 D/1.9 dT	
Inner Diam./Diam. Interno [mm]	22	<b>RENAULT CLIO I (B/C57_, 5/357_)</b>	



1.1/1.2 (5/357Y, 5/357K)/1.2 (B/C/S577)/1.2 (B/C/S57A, B/C57S, 5/357F, 5/357J, 5/357L, 5/357R)/1.2 (B/C57R)/1.4/1.4 (B/C57T, B/C57Y)/1.4 (B57, C57)/1.7 (B/C574)/1.8/1.8 (B/C578)/1.8 (B/C57C, B/C57U)/1.8 16V (C57D)/1.8 Rsi (B/C579)/1.8 Rsi (B/C5

**RENAULT CLIO II (B/C/BO/1\_, CB0/1/2\_)**

1.2 (B/CB0F, B/CB0A, B/CB10, B/CB1K, B/CB2D, B/CB2H)/1.2 16V (B/CB05)/1.4 (B/CB0C)/1.4 16V (B/CB0L)/1.4 16V (B/CB0P)/1.5 dCi/1.5 dCi (B/CB07)/1.5 dCi (B/CB08)/1.6 (B/CB0D)/1.6 16V (CB0T, CB0H)/1.9 D (B/CB0E)/1.9 dTi (B/CB0U)/2.0 16V Sport/2.0 16V Sport

**RENAULT KANGOO (KCO\_)**

1.2 (KCOA, KCOK, KCOF, KCO1)/1.2 16V (KCO3, KCO5, KCO6, KCO7, KCO8, KCO9)/1.4 (KCOA, KCOH, KCOB, KCOM)/1.5 dCi/1.5 dCi (KCO7)/1.5 dCi (KCO8, KCO9)/1.6/1.6 16V/1.6 16V 4x4 (KCOA, KCOB, KCOL)/1.6 16V bivalent/1.9 dCi 4x4/1.9 dCi 4x4 (KCOV)/1.9 dTi (KCOU)/D 55 1

**RENAULT KANGOO Express (FCO\_)**

1.2 (FCO1, FCOA, FCOF)/1.2 16V (FCO5)/1.4 (FCOC, FCOB, FCOH, FCOM)/1.5 dCi/1.5 dCi (FCO7)/1.5 dCi (FCO8, FCO9)/1.6 16V/1.6 16V 4x4 (FCOL, FCOP, FCOS)/1.9 dCi/1.9 dCi 4x4/1.9 dCi 4x4 (FCOV)/1.9 dTi (FCOU)/D 55 1.9 (FCOD)/D 65 1.9 (FCOE, FCO2, FCOJ, FCON)

**RENAULT MEGANE Classic (LA)**

1.4 (LA0E, LA0V)/1.4 16V (LA0D, LA1H, LA0W, LA10)/1.6 e (LA0F, LA0S)/1.6 i (LA0L)/1.9 D (LA0A, LA0U)/2.0 i (LA07, LA0G)

**RENAULT MEGANE I (BA)**

1.4 e (BA0E, BA0V)/1.4 Eco (BA0T)/1.6 e (BA0F, BA0S)/1.6 i (BA0L)/1.9 D Eco (B/SA0U, BA0A)

**RENAULT MEGANE Scenic (JAO\_)**

1.6 e (JAOF)/1.6 i (JAOL)/1.9 dTi (JAOK, JAOY)/1.9 dTi (JAON)/2.0 i (JA0G)

**RENAULT SCENIC (JA)**

1.9 dTi (JAON)

**RENAULT THALIA (LB0/1/2\_)**

1.2 16V/1.5 dCi

**NISSAN KUBISTAR**

1.2/1.2 16V/1.5 dCi/1.5 dCi 70/1.5 dCi 85/1.6 16V

**RENAULT CLIO II (B/C/BO/1\_, CB0/1/2\_)**

1.2 (B/CB0F, B/CB0A, B/CB10, B/CB1K, B/CB2D, B/CB2H)/1.2 16V (B/CB05)/1.4 (B/CB0C)/1.4 16V (B/CB0L)/1.4 16V (B/CB0P)/1.5 dCi/1.5 dCi (B/CB07)/1.5 dCi (B/CB08)/1.6 (B/CB0D)/1.6 16V (CB0T, CB0H)/1.9 D (B/CB0E)/1.9 dTi (B/CB0U)/2.0 16V Sport/2.0 16V Sport

**RENAULT CLIO II Furgonato (SB0\_)**

1.1 (SB0A)/1.5 dCi/1.9 D (SB0E)

**RENAULT KANGOO (KCO\_)**

1.2 (KCOA, KCOK, KCOF, KCO1)/1.2 16V (KCO3, KCO5, KCO6, KCO7, KCO8, KCO9)/1.4 (KCOA, KCOH, KCOB, KCOM)/1.5 dCi/1.5 dCi (KCO7)/1.5 dCi (KCO8, KCO9)/1.6/1.6 16V/1.6 16V 4x4 (KCOA, KCOB, KCOL)/1.6 16V bivalent/1.9 dCi 4x4/1.9 dCi 4x4 (KCOV)/1.9 dTi (KCOU)/D 55 1

**RENAULT KANGOO Express (FCO\_)**

1.2 (FCO1, FCOA, FCOF)/1.2 16V (FCO5)/1.4 (FCOC, FCOB, FCOH, FCOM)/1.5 dCi/1.5 dCi (FCO7)/1.5 dCi (FCO8, FCO9)/1.6 16V/1.6 16V 4x4 (FCOL, FCOP, FCOS)/1.9 dCi/1.9 dCi 4x4/1.9 dCi 4x4 (FCOV)/1.9 dTi (FCOU)/D 55 1.9 (FCOD)/D 65 1.9 (FCOE, FCO2, FCOJ, FCON)

**RENAULT THALIA (LB0/1/2\_)**

1.2 16V/1.5 dCi

**RENAULT TWINGO**

1.2 (CN0D)/1.2 16V (CN0A)/1.2 Turbo (CN0C)/1.5 dCi (CN0E)/1.6 RS (CN0R)

**RU-145**

Holder, control arm mounting

Silentblock

NISSAN 54560 00QAB

Length/Lunghezza [mm] 46,4

Inner Diam./Diam. Interno [mm] 15,5

Outer Diam./Diam. esterno [mm] 46





<b>RU-146</b>	<b>Holder, control arm mounting</b>	<b>NISSAN MICRA (K10)</b>	
	<b>Silentblock</b>	1.0/1.2	
NISSAN	54535 01B00		
Length/Lunghezza [mm]	47,5		
Inner Diam./Diam. Interno [mm]	12		
Outer Diam./Diam. esterno [mm]	29		
<b>RU-147</b>	<b>Holder, control arm mounting</b>	<b>NISSAN MICRA (K10)</b>	
	<b>Silentblock</b>	1.0/1.2	
NISSAN	54476-01B00		
Length/Lunghezza [mm]	54,5		
Inner Diam./Diam. Interno [mm]	15		
Outer Diam./Diam. esterno [mm]	37		
<b>RU-148</b>	<b>Holder, control arm mounting</b>	<b>NISSAN MICRA (K11)</b>	
	<b>Silentblock</b>	1.0 i 16V/1.3 i 16V/1.4 i 16V/1.5 D	
NISSAN	545004F105		
Length/Lunghezza [mm]	47		
Inner Diam./Diam. Interno [mm]	12		
Outer Diam./Diam. esterno [mm]	28		
<b>RU-149</b>	<b>Holder, control arm mounting</b>	<b>NISSAN MICRA (K11)</b>	
	<b>Silentblock</b>	1.0 i 16V/1.3 i 16V/1.4 i 16V/1.5 D	
NISSAN	545004F105		
Length/Lunghezza [mm]	54		
Inner Diam./Diam. Interno [mm]	14		
Outer Diam./Diam. esterno [mm]	42		
<b>RU-150</b>	<b>Holder, control arm mounting</b>	<b>NISSAN MICRA (K12)</b>	
	<b>Silentblock</b>	1.0 16V/1.2 16V/1.4 16V/1.5 dCi/160 SR	
NISSAN	54560-AX600	<b>NISSAN MICRA C+C</b>	
Length/Lunghezza [mm]	55	1.4 16V/1.6 160 SR	
Inner Diam./Diam. Interno [mm]	12	<b>NISSAN NOTE</b>	
Outer Diam./Diam. esterno [mm]	36	1.4/1.5 dCi/1.6	
		<b>NISSAN TIIDA 2 volumi (C11X)</b>	
		1.5 dCi/1.6/1.8	
		<b>NISSAN TIIDA Tre volumi (SC11X)</b>	
		1.5 dCi/1.6/1.8	
		<b>RENAULT CLIO III</b>	
		1.2 16V/1.4 16V/1.5 dCi/1.5 dCi (C/BR1G)/1.6 16V	
		<b>RENAULT MODUS (F/JPO_)</b>	
		1.2/1.2 (JPOC, JPOK)/1.4 (JPO1, JPOJ)/1.5 dCi/1.5 dCi (JPOG, JPOH)/1.6/1.6 (JPOB)	
<b>RU-151</b>	<b>Holder, control arm mounting</b>	<b>NISSAN MICRA (K12)</b>	
	<b>Silentblock</b>	1.0 16V/1.2 16V/1.4 16V/1.5 dCi/160 SR	
NISSAN	54570-AX600	<b>NISSAN MICRA C+C</b>	
Length/Lunghezza [mm]	53	1.4 16V/1.6 160 SR	
Inner Diam./Diam. Interno [mm]	12	<b>NISSAN NOTE</b>	
Outer Diam./Diam. esterno [mm]	58	1.4/1.5 dCi/1.6	
		<b>NISSAN TIIDA 2 volumi (C11X)</b>	
		1.5 dCi/1.6/1.8	
		<b>NISSAN TIIDA Tre volumi (SC11X)</b>	
		1.5 dCi/1.6/1.8	
		<b>RENAULT CLIO III</b>	
		1.2 16V/1.4 16V/1.5 dCi/1.5 dCi (C/BR1G)/1.6 16V	
		<b>RENAULT MODUS (F/JPO_)</b>	
		1.2/1.2 (JPOC, JPOK)/1.4 (JPO1, JPOJ)/1.5 dCi/1.5 dCi (JPOG, JPOH)/1.6/1.6 (JPOB)	

<p><b>RU-152</b> Bearing Bush, stabiliser  <b>Boccola barra stabilizzatrice</b></p>	<p><b>NISSAN NOTE</b>            1.4/1.5 dCi/1.6</p>	
<p>NISSAN 54613-9U000            Fitting Position/Lato Montaggio Front            Length/Lunghezza [mm] 39            Height/Altezza [mm] 41,5            Width/Larghezza [mm] 42            Inner Diam./Diam. Interno [mm] 21</p>		
<p><b>RU-153</b> Holder, control arm mounting  <b>Silentblock</b></p>	<p><b>NISSAN PRIMASTAR Autobus</b>            2.0/dCi 100/dCi 140/dCi 80  <b>NISSAN PRIMASTAR Furgonato</b>            2.0/dCi 100/dCi 140/dCi 80</p>	
<p>Length/Lunghezza [mm] 54,5            Inner Diam./Diam. Interno [mm] 15            Outer Diam./Diam. esterno [mm] 58,2</p>	<p><b>RENAULT ESPACE IV (JKO_)</b>            1.9 dCi (JKOU, JKOG)/2.0/2.0 (JKOKA6)/2.0 dCi/2.0 Turbo (JKOBA6, JKOBC6, JKOBAB, JKOBCB)/2.2 dCi/2.2 dCi (JKOHA6, JKOHC6, JKOHAB, JKOHCB)/3.0 dCi/3.0 dCi (JKOJAB, JKOJCB)/3.5 V6 (JKOFAB, JKOFGB)</p>	
	<p><b>RENAULT LAGUNA II (BGO_, BG1_)</b>            1.6 16V/1.6 16V (BGOA, BGOL)/1.8 16V (BG06, BG0J, BG0M)/1.8 16V (BG0B, BG0M)/1.8 16V (BG0C, BG0V)/1.9 dCi/1.9 dCi (BG0E)/1.9 dCi (BG0G)/1.9 dCi (BG0R)/2.0 16V/2.0 16V (BG00, BG0K, BG0P, BG0W)/2.0 16V IDE (BG0N)/2.0 16V Turbo (BG0S, BG0Z, BG1L, BG1M)/2.0 d</p>	
	<p><b>RENAULT LAGUNA II Grandtour (KGO_, KG1_)</b>            1.6 16V/1.6 16V (KGOA, KGOL)/1.8 16V/1.8 16V (KG0B, KG0M)/1.8 16V (KG0J)/1.9 dCi/1.9 dCi (KG0E)/1.9 dCi (KG0G)/1.9 dCi (KG0R)/2.0 16V/2.0 16V (KG00, KG0K, KG0W)/2.0 16V IDE (KG0N, KG0P)/2.0 16V Turbo (KG0S, KG0Z, KG1L, KG1M)/2.0 dCi/2.2 dCi/2.2 dCi (KG0F)</p>	
	<p><b>RENAULT VEL SATIS (BJO)</b>            2.0 16 V Turbo/2.0 16V Turbo (BJOK)/2.0 dCi/2.2 dCi/2.2 dCi (BJ0E)/2.2 dCi (BJ0H)/3.0 dCi/3.0 dCi (BJ0J0B)/3.5 V6 (BJ0V, BJ0U)</p>	
<p><b>RU-154</b> Holder, control arm mounting  <b>Silentblock</b></p>	<p><b>NISSAN PRIMASTAR Autobus</b>            2.0/dCi 100/dCi 120/dCi 140/dCi 150/dCi 80/dCi 90  <b>NISSAN PRIMASTAR Furgonato</b>            2.0/dCi 100/dCi 120/dCi 140/dCi 150/dCi 80/dCi 90</p>	
<p>Length/Lunghezza [mm] 50,5            Inner Diam./Diam. Interno [mm] 18            Outer Diam./Diam. esterno [mm] 55</p>	<p><b>OPEL VIVARO Combi</b>            1.9 DI/1.9 DTI/2.0 16V/2.0 CDTI/2.0 ECOTEC/2.5 CDTI/2.5 DTI  <b>OPEL VIVARO Furgonato</b>            1.9 DI/2.0 16V/2.0 CDTI/2.0 ECOTEC/2.5 CDTI/2.5 DTI</p>	
	<p><b>RENAULT TRAFIC Autobus (JL)</b>            1.9 dCi 100/1.9 dCi 80/2.0 (JL0A)/2.0 dCi 115/2.0 dCi 90/2.5 dCi 135 (JL0D)/2.5 dCi 145</p>	
	<p><b>RENAULT TRAFIC Furgonato (FL)</b>            1.9 dCi 100/1.9 dCi 80/2.0 (FL0A)/2.0 dCi 115/2.0 dCi 90/2.5 dCi 135 (FL0D)/2.5 dCi 145</p>	
	<p><b>RENAULT TRAFIC II Pianale piatto/Telaio (EL)</b>            1.9 dCi 100 (ELOC)/1.9 dCi 80 (ELOB)/2.0 (ELOA)/2.0 dCi 115/2.0 dCi 90/2.5 dCi 135 (ELOD)/2.5 dCi 145</p>	
<p><b>RU-155</b> Holder, control arm mounting  <b>Silentblock</b></p>	<p><b>NISSAN PRIMERA (P10)</b>            1.6/2.0/2.0 16V/2.0 16V 4x4/2.0 D/2.0 GT/2.0 GT 4x4/2.0 i  <b>NISSAN PRIMERA (P11)</b>            1.6 16V/1.8/1.8 16V/2.0/2.0 16V/2.0 TD</p>	
<p>NISSAN 54590-01E00            Length/Lunghezza [mm] 50            Inner Diam./Diam. Interno [mm] 18            Outer Diam./Diam. esterno [mm] 38,7</p>	<p><b>NISSAN PRIMERA Hatchback (P10)</b>            1.6/2.0/2.0 16V/2.0 16V 4x4/2.0 D/2.0 GT 4x4/2.0 i  <b>NISSAN PRIMERA Hatchback (P11)</b>            1.6 16V/1.8 16V/2.0 16V/2.0 TD</p>	
	<p><b>NISSAN PRIMERA Traveller (W10)</b>            1.6 i/2.0 D/2.0 i</p>	
	<p><b>NISSAN PRIMERA Traveller (WP11)</b>            1.6 16V/1.8 16V/2.0 16V/2.0 TD</p>	

<b>RU-156</b>	<b>Holder, control arm mounting</b>	<b>NISSAN PRIMERA (P10)</b> 1.6/2.0/2.0 16V/2.0 16V 4x4/2.0 D/2.0 GT 4x4/2.0 i	
	<b>Silentblock</b>	<b>NISSAN PRIMERA Hatchback (P10)</b> 1.6/2.0/2.0 16V/2.0 16V 4x4/2.0 D/2.0 GT 4x4/2.0 i	
NISSAN	5450086J00	<b>NISSAN PRIMERA Traveller (W10)</b> 1.6 i/2.0 D/2.0 i	
Length/Lunghezza [mm]	70		
Height/Altezza [mm]	59		
Width/Larghezza [mm]	57		
Inner Diam./Diam. Interno [mm]	22		
<b>RU-157</b>	<b>Holder, control arm mounting</b>	<b>NISSAN PRIMERA (P11)</b> 1.6 16V/1.8/1.8 16V/2.0/2.0 16V/2.0 TD	
	<b>Silentblock</b>	<b>NISSAN PRIMERA Hatchback (P11)</b> 1.6 16V/1.8 16V/2.0 16V/2.0 TD	
NISSAN	545002F500	<b>NISSAN PRIMERA Traveller (WP11)</b> 1.6 16V/1.8 16V/2.0 16V/2.0 TD	
Length/Lunghezza [mm]	151,7		
Height/Altezza [mm]	84,5		
Width/Larghezza [mm]	70,4		
Inner Diam./Diam. Interno [mm]	22		
<b>RU-158</b>	<b>Holder, control arm mounting</b>	<b>NISSAN PRIMERA (P11)</b> 1.6 16V/1.8/1.8 16V/2.0/2.0 16V/2.0 TD	
	<b>Silentblock</b>	<b>NISSAN PRIMERA Hatchback (P11)</b> 1.6 16V/1.8 16V/2.0 16V/2.0 TD	
NISSAN	545012F500	<b>NISSAN PRIMERA Traveller (WP11)</b> 1.6 16V/1.8 16V/2.0 16V/2.0 TD	
Length/Lunghezza [mm]	151,7		
Height/Altezza [mm]	86		
Width/Larghezza [mm]	72		
Inner Diam./Diam. Interno [mm]	22,5		
<b>RU-159</b>	<b>Holder, control arm mounting</b>	<b>NISSAN PRIMERA (P12)</b> 1.6/1.8/1.9 dCi/2.0/2.2 dCi/2.2 Di/2.5	
	<b>Silentblock</b>	<b>NISSAN PRIMERA Hatchback (P12)</b> 1.6/1.8/1.9 dCi/2.0/2.2 dCi/2.2 Di/2.5	
NISSAN	54500AV606	<b>NISSAN PRIMERA SW (WP12)</b> 1.6 Visia/1.8/1.9 dCi/2.0/2.2 dCi/2.2 Di/2.5	
Length/Lunghezza [mm]	52,5		
Inner Diam./Diam. Interno [mm]	18		
Outer Diam./Diam. esterno [mm]	38		
<b>RU-160</b>	<b>Holder, control arm mounting</b>	<b>NISSAN PRIMERA (P12)</b> 1.6/1.8/1.9 dCi/2.0/2.2 dCi/2.2 Di/2.5	
	<b>Silentblock</b>	<b>NISSAN PRIMERA Hatchback (P12)</b> 1.6/1.8/1.9 dCi/2.0/2.2 dCi/2.2 Di/2.5	
NISSAN	54500AV606	<b>NISSAN PRIMERA SW (WP12)</b> 1.6 Visia/1.8/1.9 dCi/2.0/2.2 dCi/2.2 Di/2.5	
Width/Larghezza [mm]	54		
Inner Diam./Diam. Interno [mm]	21		
Overall Length/Lungh. Tot. [mm]	193		
Outer Diam./Diam. esterno [mm]	75		
<b>RU-161</b>	<b>Holder, control arm mounting</b>	<b>NISSAN SERENA (C23M)</b> 1.6 16V/2.0 16V/2.0 D/2.3 D	
	<b>Silentblock</b>	<b>NISSAN VANETTE CARGO Autobus (HC 23)</b> 1.6 i/2.0 D/2.3 D	
		<b>NISSAN VANETTE CARGO Furgonato (HC 23)</b> 1.6 i/2.0 D/2.3 D	
Length/Lunghezza [mm]	60		
Inner Diam./Diam. Interno [mm]	14		
Outer Diam./Diam. esterno [mm]	43		
<b>RU-162</b>	<b>Holder, control arm mounting</b>	<b>NISSAN SERENA (C23M)</b> 1.6 16V/2.0 16V/2.0 D/2.3 D	
	<b>Silentblock</b>	<b>NISSAN VANETTE CARGO Autobus (HC 23)</b> 1.6 i/2.0 D/2.3 D	
		<b>NISSAN VANETTE CARGO Furgonato (HC 23)</b> 1.6 i/2.0 D/2.3 D	
Length/Lunghezza [mm]	68		
Height/Altezza [mm]	55		
Width/Larghezza [mm]	60		
Inner Diam./Diam. Interno [mm]	22		

<b>RU-163</b>	<b>Holder, control arm mounting</b>	<b>NISSAN X-TRAIL (T30)</b>	
	<b>Silentblock</b>	2.0/2.0 4x4/2.2 dCi/2.2 dCi 4x4/2.2 Di 4x4/2.5 4x4	
NISSAN 545008H310			
Length/Lunghezza [mm]		55	
Inner Diam./Diam. Interno [mm]		14,4	
Outer Diam./Diam. esterno [mm]		39	

<b>RU-164</b>	<b>Holder, control arm mounting</b>	<b>NISSAN X-TRAIL (T30)</b>	
	<b>Silentblock</b>	2.0/2.0 4x4/2.2 dCi/2.2 dCi 4x4/2.2 Di 4x4/2.5 4x4	
NISSAN 545008H310			
Inner Diam./Diam. Interno [mm]		28	
Overall Length/Lungh. Tot. [mm]		182	

<b>RU-165</b>	<b>Bearing Bush, stabiliser</b>	<b>NISSAN Juke</b>	
	<b>Boccola barra stabilizzatrice</b>	1.5 dCi/1.6	
NISSAN 54613-JD03A		<b>NISSAN QASHQAI</b>	
Fitting Position/Lato Montaggio		Front	
Length/Lunghezza [mm]		34	
Height/Altezza [mm]		75	
Width/Larghezza [mm]		47	
Inner Diam./Diam. Interno [mm]		23	

<b>RU-166</b>	<b>Bearing Bush, stabiliser</b>	<b>NISSAN QASHQAI</b>	
	<b>Boccola barra stabilizzatrice</b>	1.5 dCi/1.6/2.0/2.0 4 ruote motrici/2.0 dCi/2.0 dCi 4 ruote motrici	
NISSAN 54613-JD18C			
Fitting Position/Lato Montaggio		Rear	
Length/Lunghezza [mm]		38	
Height/Altezza [mm]		52	
Width/Larghezza [mm]		49	
Inner Diam./Diam. Interno [mm]		18	







<b>RU-167</b>	<b>Holder, control arm mounting</b>	<b>NISSAN QASHQAI</b>	
	<b>Silentblock</b>	1.5 dCi/1.6/2.0/2.0 4 ruote motrici/2.0 dCi/2.0 dCi 4 ruote motrici	
NISSAN X-TRAIL (T31)		2.0/2.0 dCi/2.0 dCi FWD/2.5	
Length/Lunghezza [mm]		147,5	
Diameter/Diametro [mm]		32	

<b>RU-168</b>	<b>Holder, control arm mounting</b>	<b>NISSAN Juke</b>	
	<b>Silentblock</b>	1.5 dCi/1.6/1.6 4x4	
NISSAN QASHQAI		1.5 dCi/1.6/2.0/2.0 4 ruote motrici/2.0 dCi/2.0 dCi 4 ruote motrici	
NISSAN X-TRAIL (T31)		2.0/2.0 dCi/2.0 dCi FWD/2.5	
Length/Lunghezza [mm]		53	
Inner Diam./Diam. Interno [mm]		12	
Outer Diam./Diam. esterno [mm]		58	

<b>RU-169</b>	<b>Suspension Strut Support Bearing</b>	<b>NISSAN MICRA (K11)</b>	
	<b>Supporto ammortizzatore</b>	1.0 i 16V/1.3 i 16V/1.4 i 16V/1.5 D	
NISSAN 54320-1F500			
Fitting Position/Lato Montaggio		Front Axle	
Length/Lunghezza [mm]		123,7	
Height/Altezza [mm]		40	
Width/Larghezza [mm]		89	
Inner Diam./Diam. Interno [mm]		10	

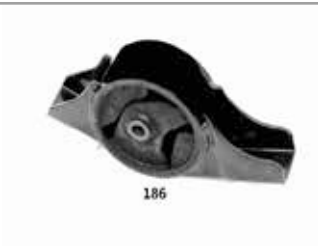
<b>RU-170</b> <b>Engine Mounting</b>  <b>Supporto motore</b>	<b>NISSAN MICRA (K11)</b> 1.0 i 16V/1.3 i 16V	 <p>170</p>
NISSAN      11210-99B00 Height/Altezza [mm]      80 Inner Diam./Diam. Interno [mm]      10 Mount. Bores/Fori Fiss. Dist. [mm]      60		
<b>RU-171</b> <b>Bearing,propshaft centre bearing</b>  <b>Supporto albero cardanico</b>	<b>NISSAN BLUEBIRD (910)</b> 1.6/2.0 D/2.0 i <b>NISSAN PICK UP/KING CAB/NAVARA (D22)</b> 2.5 D 4WD	 <p>171</p>
NISSAN      37521-W1025 Height/Altezza [mm]      51 Inner Diam./Diam. Interno [mm]      30 Outer Diam./Diam. esterno [mm]      110		
<b>RU-172</b> <b>Bearing Bush, stabiliser</b>  <b>Boccola barra stabilizzatrice</b>	<b>NISSAN TERRANO II (R20)</b> 2.4 4WD/2.4 i 12V 4WD/2.7 D/2.7 TD 4WD/2.7 TDi 4WD/3.0 Di 4WD	 <p>172</p>
NISSAN      54613-0X800 Fitting Position/Lato Montaggio      Front Axle Length/Lunghezza [mm]      47 Height/Altezza [mm]      28 Width/Larghezza [mm]      48 Inner Diam./Diam. Interno [mm]      28		
<b>RU-173</b> <b>Engine Mounting</b>  <b>Supporto motore</b>	<b>NISSAN TERRANO II (R20)</b> 2.7 D/2.7 TD 4WD/2.7 TDi 4WD/3.0 Di 4WD	 <p>173</p>
NISSAN      11320-7F000 Length/Lunghezza [mm]      167 Height/Altezza [mm]      72 Height/Altezza 1 [mm]      66 Width/Larghezza [mm]      116		
<b>RU-174</b> <b>Bearing Bush, stabiliser</b>  <b>Boccola barra stabilizzatrice</b>	<b>NISSAN ALMERA TINO (V10)</b> 1.8/2.0/2.2 dCi/2.2 Di <b>NISSAN PRIMERA (P12)</b> 1.6/1.8/1.9 dCi/2.0/2.2 dCi/2.2 Di/2.5	 <p>174</p>
NISSAN      54613-2Y003 Fitting Position/Lato Montaggio      Front Axle Length/Lunghezza [mm]      36 Height/Altezza [mm]      45 Inner Diam./Diam. Interno [mm]      23	<b>NISSAN PRIMERA Hatchback (P12)</b> 1.6/1.8/1.9 dCi/2.0/2.2 dCi/2.2 Di/2.5 <b>NISSAN PRIMERA SW (WP12)</b> 1.6 Visia/1.8/1.9 dCi/2.0/2.2 dCi/2.2 Di/2.5	
<b>RU-175</b> <b>Bearing Bush, stabiliser</b>  <b>Boccola barra stabilizzatrice</b>	<b>NISSAN X-TRAIL (T30)</b> 2.0/2.2 dCi/2.2 DCi FWD	 <p>175</p>
NISSAN      54613-8H518 Fitting Position/Lato Montaggio      Front Axle Length/Lunghezza [mm]      38 Height/Altezza [mm]      41 Width/Larghezza [mm]      41 Inner Diam./Diam. Interno [mm]      17,5		
<b>RU-176</b> <b>Engine Mounting</b>  <b>Supporto motore</b>	<b>NISSAN TERRANO II (R20)</b> 2.7 TDi 4WD	 <p>176</p>
NISSAN      11210-0F002 Fitting Position/Lato Montaggio      Front Axle Fitting Position/Lato Montaggio      Right Length/Lunghezza [mm]      152 Height/Altezza [mm]      61 Width/Larghezza [mm]      138		

<b>RU-177</b>	<b>Engine Mounting</b> <b>Supporto motore</b>	<b>NISSAN X-TRAIL (T30)</b> 2.0	
NISSAN	11210-8H305		
Fitting Position/Lato Montaggio		Front Axle	
<b>RU-178</b>	<b>Engine Mounting</b> <b>Supporto motore</b>	<b>NISSAN TERRANO II (R20)</b> 2.7 TDi 4WD	
NISSAN	11220-7F000		
Fitting Position/Lato Montaggio		Front Axle Left	
Length/Lunghezza [mm]		132	
Height/Altezza [mm]		103	
Width/Larghezza [mm]		102	
<b>RU-179</b>	<b>Engine Mounting</b> <b>Supporto motore</b>	<b>NISSAN MICRA (K10)</b> 1.0/1.2	
NISSAN	11340-02B04		
Fitting Position/Lato Montaggio		Rear	
Height/Altezza [mm]		48	
Inner Diam./Diam. Interno [mm]		11	
Overall Length/Lungh. Tot. [mm]		278	
<b>RU-180</b>	<b>Engine Mounting</b> <b>Supporto motore</b>	<b>NISSAN MICRA (K12)</b> 1.2 16V/1.4 16V <b>NISSAN PRIMERA (P12)</b> 1.9 dCi <b>NISSAN PRIMERA Hatchback (P12)</b> 1.9 dCi <b>NISSAN PRIMERA SW (WP12)</b> 1.9 dCi	
NISSAN	11220AX600		
Fitting Position/Lato Montaggio		Front Axle	
Fitting Position/Lato Montaggio		Left	
Length/Lunghezza [mm]		153	
Height/Altezza [mm]		50	
Inner Diam./Diam. Interno [mm]		11	
<b>RU-181</b>	<b>Engine Mounting</b> <b>Supporto motore</b>	<b>NISSAN MICRA (K12)</b> 1.5 dCi <b>NISSAN NOTE</b> 1.5 dCi <b>NISSAN NV200 Autobus</b> 1.5 dci <b>NISSAN NV200 Furgonato</b> 1.5 dci	
NISSAN	11360AY600		
Fitting Position/Lato Montaggio		Front Axle	
Fitting Position/Lato Montaggio		Rear	
Length/Lunghezza [mm]		183	
Inner Diam./Diam. Interno [mm]		13	
Inner Diam./Diam. Int. 1 [mm]		12	
<b>RU-182</b>	<b>Engine Mounting</b> <b>Supporto motore</b>	<b>NISSAN MICRA (K12)</b> 1.2 16V/1.4 16V <b>NISSAN MICRA C+C</b> 1.4 16V <b>NISSAN NOTE</b> 1.4	
NISSAN	11210AX600		
Fitting Position/Lato Montaggio		Front Axle	
Fitting Position/Lato Montaggio		Right	
Length/Lunghezza [mm]		208	
Height/Altezza [mm]		105	
<b>RU-183</b>	<b>Engine Mounting</b> <b>Supporto motore</b>	<b>NISSAN MICRA (K12)</b> 1.5 dCi <b>NISSAN NOTE</b> 1.5 dCi <b>NISSAN NV200 Autobus</b> 1.5 dci <b>NISSAN NV200 Furgonato</b> 1.5 dci	
NISSAN	11210AY600		
Fitting Position/Lato Montaggio		Front Axle	
Fitting Position/Lato Montaggio		Right	
Length/Lunghezza [mm]		208	
Height/Altezza [mm]		105	

<b>RU-184</b>	<b>Engine Mounting</b>	<b>NISSAN ALMERA II (N16)</b>		
		1.5/1.8		
	<b>Supporto motore</b>	<b>NISSAN ALMERA II Hatchback (N16)</b>		
		1.5/1.8		
NISSAN	11270BM500			
Fitting Position/Lato Montaggio	Front Axle			
Width/Larghezza [mm]	55			
Inner Diam./Diam. Interno [mm]	10			
Outer Diam./Diam. esterno [mm]	95			
<b>RU-185</b>	<b>Engine Mounting</b>	<b>NISSAN ALMERA II (N16)</b>		
		1.5/1.8		
	<b>Supporto motore</b>	<b>NISSAN ALMERA II Hatchback (N16)</b>		
		1.5/1.8		
NISSAN	11320BM500			
Fitting Position/Lato Montaggio	Front Axle			
Length/Lunghezza [mm]	141			
Height/Altezza [mm]	91			
Width/Larghezza [mm]	60			
Inner Diam./Diam. Interno [mm]	10			
<b>RU-186</b>	<b>Engine Mounting</b>	<b>NISSAN ALMERA II (N16)</b>		
		2.2 dCi/2.2 Di		
	<b>Supporto motore</b>	<b>NISSAN ALMERA II Hatchback (N16)</b>		
		2.2 dCi/2.2 Di		
NISSAN	11320BN301	<b>NISSAN ALMERA TINO (V10)</b>		
Fitting Position/Lato Montaggio	Front Axle	1.8/2.2 dCi/2.2 Di		
Length/Lunghezza [mm]	193			
Height/Altezza [mm]	89			
Width/Larghezza [mm]	55			
Inner Diam./Diam. Interno [mm]	10,5			
<b>RU-187</b>	<b>Engine Mounting</b>	<b>NISSAN ALMERA II (N16)</b>		
		1.5 dCi		
	<b>Supporto motore</b>	<b>NISSAN ALMERA II Hatchback (N16)</b>		
		1.5 dCi		
NISSAN	11210BN702			
Fitting Position/Lato Montaggio	Front Axle			
Fitting Position/Lato Montaggio	Right			
Length/Lunghezza [mm]	195			
Height/Altezza [mm]	105			
<b>RU-188</b>	<b>Engine Mounting</b>	<b>NISSAN PRIMERA (P10)</b>		
		2.0 16V/2.0 16V 4x4/2.0 GT		
	<b>Supporto motore</b>	<b>NISSAN PRIMERA Hatchback (P10)</b>		
		2.0/2.0 16V/2.0 16V 4x4/2.0 i		
NISSAN	1132093J00	<b>NISSAN PRIMERA Traveller (W10)</b>		
Fitting Position/Lato Montaggio	Front Axle	2.0 i		
Fitting Position/Lato Montaggio	Rear			
<b>RU-189</b>	<b>Engine Mounting</b>	<b>NISSAN PRIMERA (P10)</b>		
		2.0 D		
	<b>Supporto motore</b>	<b>NISSAN PRIMERA Hatchback (P10)</b>		
		2.0 D		
NISSAN	1132093J20	<b>NISSAN PRIMERA Traveller (W10)</b>		
Fitting Position/Lato Montaggio	Front Axle	2.0 D		
Fitting Position/Lato Montaggio	Rear			
<b>RU-190</b>	<b>Engine Mounting</b>	<b>NISSAN PRIMERA (P11)</b>		
		1.6 16V/2.0 TD		
	<b>Supporto motore</b>	<b>NISSAN PRIMERA Hatchback (P11)</b>		
		1.6 16V/2.0 TD		
NISSAN	11320-2F020	<b>NISSAN PRIMERA Traveller (WP11)</b>		
Fitting Position/Lato Montaggio	Front Axle	1.6 16V/2.0 TD		
Fitting Position/Lato Montaggio	Left Rear			
Length/Lunghezza [mm]	178			
Height/Altezza [mm]	98			
Inner Diam./Diam. Interno [mm]	10			



<b>RU-191</b>	<b>Engine Mounting</b>	<b>NISSAN PRIMERA (P11)</b> 2.0 16V	
	<b>Supporto motore</b>	<b>NISSAN PRIMERA Hatchback (P11)</b> 2.0 16V	
NISSAN	11320-2F320	<b>NISSAN PRIMERA Traveller (WP11)</b> 2.0 16V	191
	Fitting Position/Lato Montaggio	Front Axle	
	Fitting Position/Lato Montaggio	Left Rear	
	Length/Lunghezza [mm]	177	
	Height/Altezza [mm]	98	
	Width/Larghezza [mm]	55	
	Inner Diam./Diam. Interno [mm]	10,5	
<b>RU-192</b>	<b>Engine Mounting</b>	<b>NISSAN ALMERA TINO (V10)</b> 1.8	
	<b>Supporto motore</b>	<b>NISSAN PRIMERA (P12)</b> 1.6/1.8	
NISSAN	11270-BU000	<b>NISSAN PRIMERA Hatchback (P12)</b> 1.6/1.8	
	Fitting Position/Lato Montaggio	Front Axle	
<b>RU-193</b>	<b>Engine Mounting</b>	<b>NISSAN ALMERA II (N16)</b> 2.2 dCi/2.2 Di	
	<b>Supporto motore</b>	<b>NISSAN ALMERA II Hatchback (N16)</b> 2.2 dCi/2.2 Di	
NISSAN	11270BN310	<b>NISSAN ALMERA TINO (V10)</b> 2.2 dCi/2.2 Di	193
	Fitting Position/Lato Montaggio	Front Axle	
	Fitting Position/Lato Montaggio	Front	
	Length/Lunghezza [mm]	139	
	Height/Altezza [mm]	94	
	Inner Diam./Diam. Interno [mm]	10	
<b>RU-194</b>	<b>Engine Mounting</b>	<b>NISSAN PRIMERA (P12)</b> 1.9 dCi	
	<b>Supporto motore</b>	<b>NISSAN PRIMERA Hatchback (P12)</b> 1.9 dCi	
NISSAN	11210BV000	<b>NISSAN PRIMERA SW (WP12)</b> 1.9 dCi	194
	Fitting Position/Lato Montaggio	Front Axle	
	Fitting Position/Lato Montaggio	Front	
	Length/Lunghezza [mm]	194	
	Height/Altezza [mm]	105	
<b>RU-195</b>	<b>Engine Mounting</b>	<b>NISSAN PRIMERA (P12)</b> 1.9 dCi	
	<b>Supporto motore</b>	<b>NISSAN PRIMERA Hatchback (P12)</b> 1.9 dCi	
NISSAN	11360-BV000	<b>RENAULT CLIO III</b> 1.2 16V/1.2 16V Hi-Flex/1.2 16V (C/BR1J, C/BR1Q)	195
	Fitting Position/Lato Montaggio	Front Axle	
	Fitting Position/Lato Montaggio	Rear	
		<b>RENAULT GRAND SCENIC</b> 1.9 dCi	
		<b>RENAULT MEGANE II (BMO_, CM0_)</b> 1.5 dCi (BM0F, CM0F)	
		<b>RENAULT MODUS (F/JPO_)</b> 1.2/1.2 (JPOC, JPOK)/1.2 16V Hi-Flex	
		<b>RENAULT SCENIC II (JM)</b> 1.9 D/1.9 dCi/1.9 dCi (JM12)	
<b>RU-196</b>	<b>Engine Mounting</b>	<b>NISSAN PRIMERA (P10)</b> 1.6	
	<b>Supporto motore</b>	<b>NISSAN PRIMERA Hatchback (P10)</b> 1.6	
NISSAN	1121090J01	<b>NISSAN PRIMERA Traveller (W10)</b> 1.6 i	196
	Fitting Position/Lato Montaggio	Front Axle	
	Fitting Position/Lato Montaggio	Right	
	Length/Lunghezza [mm]	174	
	Height/Altezza [mm]	117,5	
	Width/Larghezza [mm]	80	
	Inner Diam./Diam. Interno [mm]	11	

<b>RU-197</b>	<b>Engine Mounting</b>
	<b>Supporto motore</b>
NISSAN	1121093J00
Fitting Position/Lato Montaggio	Front Axle
Fitting Position/Lato Montaggio	Right
Height/Altezza [mm]	80
Inner Diam./Diam. Interno [mm]	10
Mount. Bores/Fori Fiss. Dist. [mm]	120

<b>NISSAN PRIMERA (P10)</b>
2.0 16V/2.0 16V 4x4/2.0 GT/2.0 i
<b>NISSAN PRIMERA Hatchback (P10)</b>
2.0/2.0 16V/2.0 16V 4x4/2.0 i
<b>NISSAN PRIMERA Traveller (W10)</b>
2.0 i



<b>RU-198</b>	<b>Engine Mounting</b>
	<b>Supporto motore</b>
NISSAN	11210-2F001
Fitting Position/Lato Montaggio	Front Axle
Fitting Position/Lato Montaggio	Right
Length/Lunghezza [mm]	172,5
Height/Altezza [mm]	116
Width/Larghezza [mm]	80,5
Inner Diam./Diam. Interno [mm]	11

<b>NISSAN PRIMERA (P11)</b>
1.6 16V
<b>NISSAN PRIMERA Hatchback (P11)</b>
1.6 16V
<b>NISSAN PRIMERA Traveller (WP11)</b>
1.6 16V



<b>RU-199</b>	<b>Engine Mounting</b>
	<b>Supporto motore</b>
NISSAN	112102F200
Fitting Position/Lato Montaggio	Front Axle
Fitting Position/Lato Montaggio	Right
Length/Lunghezza [mm]	130
Height/Altezza [mm]	113
Width/Larghezza [mm]	80
Inner Diam./Diam. Interno [mm]	10
Mount. Bores/Fori Fiss. Dist. [mm]	85

<b>NISSAN PRIMERA (P11)</b>
2.0 16V/2.0 TD
<b>NISSAN PRIMERA Hatchback (P11)</b>
2.0 16V/2.0 TD
<b>NISSAN PRIMERA Traveller (WP11)</b>
2.0 16V/2.0 TD



<b>RU-200</b>	<b>Engine Mounting</b>
	<b>Supporto motore</b>
TOYOTA	12361-60022
Length/Lunghezza [mm]	110
Height/Altezza [mm]	46
Width/Larghezza [mm]	77

<b>TOYOTA LAND CRUISER (_J4_)</b>
3.0 D (BJ40_V, BJ43_)/3.4 D (BJ42_V, BJ45_V, BJ46_)/3.6 D (HJ45_V)/3.6 L/3.9 (FJ40_, FJ43_, FJ45_, FJ55_V)/4.0 D (HJ47_V)/4.2 (FJ40_V, FJ43_, FJ45_V, FJ55_)
<b>TOYOTA LAND CRUISER (_J6_)</b>
3.4 Diesel (BJ60_V)/4.0 (FJ62_G)/4.0 (FJ62_V)/4.0 Diesel (HJ60)/4.0 Diesel (HJ60_V)/4.0 Turbo-D (HJ61_V)
<b>TOYOTA LAND CRUISER (_J7_)</b>
2.4 (RJ70_V, RJ73_V)/2.4 (RJ70_, RJ73_)/2.4 D (LJ70_)/2.4 TD (LJ70)/2.4 TD (LJ70_, LJ73_)/3.0 TD (KZJ70_, KZJ73_, KZJ77_)/3.4 D (BJ70_V, BJ73_)/3.4 TD (BJ71_V)/3.5 D/4.2 TD (HZJ7_V)
<b>TOYOTA LAND CRUISER Hardtop (_J7_)</b>
2.4 TD (LJ77)/3.0 TD
<b>TOYOTA LAND CRUISER Pick-up (_J4_)</b>
3.4 D (BJ45_P)/3.6 D (HJ45_P)/3.9 (FJ45_P)/4.0 D (HJ47_P)/4.2 (FJ45_P)



<b>RU-201</b>	<b>Engine Mounting</b>
	<b>Supporto motore</b>
TOYOTA	12371-68010
Length/Lunghezza [mm]	280
Height/Altezza [mm]	47
Width/Larghezza [mm]	131

<b>TOYOTA LAND CRUISER (_J4_)</b>
3.0 D (BJ40_V, BJ43_)/3.4 D (BJ42_V, BJ45_V, BJ46_)/3.6 D (HJ45_V)/3.6 L/3.9 (FJ40_, FJ43_, FJ45_, FJ55_V)/4.0 D (HJ47_V)/4.2 (FJ40_V, FJ43_, FJ45_V, FJ55_)
<b>TOYOTA LAND CRUISER (_J6_)</b>
3.4 Diesel (BJ60_V)/4.0 (FJ62_G)/4.0 (FJ62_V)/4.0 Diesel (HJ60)/4.0 Diesel (HJ60_V)/4.0 Turbo-D (HJ61_V)/4.2 (FJ60_V)
<b>TOYOTA LAND CRUISER (_J7_)</b>
2.4 (RJ70_V, RJ73_V)/2.4 (RJ70_, RJ73_)/2.4 D (LJ70_)/2.4 TD (LJ70)/2.4 TD (LJ70_, LJ73_)/3.0 TD (KZJ70_, KZJ73_, KZJ77_)/3.4 D (BJ70_V, BJ73_)/3.4 TD (BJ71_V)/3.5 D/4.2 TD (HZJ7_V)
<b>TOYOTA LAND CRUISER Hardtop (_J7_)</b>
2.4 TD (LJ77)/3.0 TD
<b>TOYOTA LAND CRUISER Pick-up (_J4_)</b>
3.4 D (BJ45_P)/3.6 D (HJ45_P)/3.9 (FJ45_P)/4.0 D (HJ47_P)/4.2 (FJ45_P)



<b>RU-202</b>	<b>Engine Mounting</b>	<b>TOYOTA 4 RUNNER ( _N130)</b> 2.4 (RN61)/2.4 TD 4x4/2.7 i 4x4/3.0 Turbo-D (KZN 130)/3.0 V6 (VZN 130)/3.4 i 4x4	
	<b>Supporto motore</b>	<b>TOYOTA 4 RUNNER</b> 3.0 Turbo-D	
TOYOTA	12361-54120		
Length/Lunghezza [mm]	122	<b>TOYOTA HILUX Pick-up ( _N_ )</b> 1.6 /1.8 (YN85_ , YN90_)/2.0/2.0 4WD/2.2 4WD (YN106_ , YN110_)/2.2 D/2.2 D 2WD/ 4WD/2.4 D/2.4 D 4WD/2.4 i 4WD/2.4 TD 4WD/2.5 D-4D/2.5 D-4D 4WD/2.8 D	
Height/Altezza [mm]	46	<b>TOYOTA LAND CRUISER ( _J_ )</b> 2.4 D (LJ70_)/2.4 TD (LJ70)/2.4 TD (LJ70_ , LJ73_ )	
Width/Larghezza [mm]	122		
<b>RU-203</b>	<b>Bearing,propshaft centre bearing</b>	<b>TOYOTA 4 RUNNER ( _N130)</b> 2.4 (RN61)/2.4 TD 4x4/2.7 i 4x4/3.0 Turbo-D (KZN 130)/3.0 V6 (VZN 130)/3.4 i 4x4	
	<b>Supporto albero cardanico</b>	<b>TOYOTA 4 RUNNER</b> 3.0 Turbo-D	
TOYOTA	37230-35050		
Length/Lunghezza [mm]	177	<b>TOYOTA HILUX Pick-up ( _N_ )</b> 1.6 /1.8 (YN85_ , YN90_)/2.0/2.0 4WD/2.2 4WD (YN106_ , YN110_)/2.2 D/2.2 D 2WD/ 4WD/2.4 D/2.4 D 4WD/2.4 i 4WD/2.4 TD 4WD/2.5 D-4D/2.5 D-4D 4WD/2.8 D	
Height/Altezza [mm]	106		
Width/Larghezza [mm]	60		
Inner Diam./Diam. Interno [mm]	30		
<b>RU-204</b>	<b>Bearing,propshaft centre bearing</b>	<b>TOYOTA 4 RUNNER ( _N130)</b> 2.4 (RN61)/2.4 TD 4x4/2.7 i 4x4/3.0 Turbo-D (KZN 130)/3.0 V6 (VZN 130)/3.4 i 4x4	
	<b>Supporto albero cardanico</b>	<b>TOYOTA 4 RUNNER</b> 3.0 Turbo-D	
TOYOTA	37230-35080		
Length/Lunghezza [mm]	285	<b>TOYOTA HILUX Pick-up ( _N_ )</b> 1.6 /1.8 (YN85_ , YN90_)/2.0/2.0 4WD/2.2 4WD (YN106_ , YN110_)/2.2 D/2.2 D 2WD/ 4WD/2.4 D/2.4 D 4WD/2.4 i 4WD/2.4 TD 4WD/2.5 D-4D/2.5 D-4D 4WD/2.8 D	
Height/Altezza [mm]	120		
Width/Larghezza [mm]	60		
Inner Diam./Diam. Interno [mm]	30		
<b>RU-205</b>	<b>Bush, leaf spring</b>	<b>TOYOTA LAND CRUISER ( _J_ )</b> 3.0 D (BJ40_ , BJ43_)/3.4 D (BJ42_ , BJ45_ , BJ46_)/3.6 D (HJ45_ , VJ)/3.6 L/3.9 (FJ40_ , FJ43_ , FJ45_ , FJ55_)/4.0 D (HJ47_ , VJ)/4.2 (FJ40_ , FJ43_ , FJ45_ , FJ55_ )	
	<b>Boccola balestra</b>	<b>TOYOTA LAND CRUISER ( _J_ )</b> 3.4 Diesel (BJ60_ , VJ)/4.0 (FJ62_ , GJ)/4.0 (FJ62_ , VJ)/4.0 Diesel (HJ60)/4.0 Diesel (HJ60_ , VJ)/4.0 Turbo-D (HJ61_ , VJ)/4.2 (FJ60_ , VJ)	
TOYOTA	90385-18009	<b>TOYOTA LAND CRUISER ( _J_ )</b> 2.4 (RJ70_ , VJ, RJ73_ , VJ)/2.4 (RJ70_ , RJ73_ )/2.4 D (LJ70_ )/2.4 TD (LJ70)/2.4 TD (LJ70_ , LJ73_)/3.0 TD (KZJ70_ , KZJ73_ , KZJ77_ )/3.4 D (BJ70_ , VJ, BJ73_ )/3.4 TD (BJ71_ , VJ)/3.5 D/4.2 TD (HZJ7_ , VJ)	
Length/Lunghezza [mm]	44	<b>TOYOTA LAND CRUISER 80 ( _J_ )</b> 4.0 (FJ80_ )/4.2 D (HZJ80_ )/4.2 TD (HDJ80)/4.2 TD 24V (HDJ80_ )/4.5 24V (FZJ80_ )	
Inner Diam./Diam. Interno [mm]	18	<b>TOYOTA LAND CRUISER 90 ( _J_ )</b> 3.0 D-4D/3.0 TD (KZJ90_ , KZJ95_ )/3.4 i 24V (VZJ90_ , VZJ95_ )	
Outer Diam./Diam. esterno [mm]	40	<b>TOYOTA LAND CRUISER Hardtop ( _J_ )</b> 2.4 TD (LJ77)/3.0 TD	
		<b>TOYOTA LAND CRUISER Pick-up ( _J_ )</b> 3.4 D (BJ45_ , P)/3.6 D (HJ45_ , P)/3.9 (FJ45_ , P)/4.0 D (HJ47_ , P)/4.2 (FJ45_ , P)	
<b>RU-206</b>	<b>Bush, leaf spring</b>	<b>TOYOTA LAND CRUISER ( _J_ )</b> 3.0 D (BJ40_ , BJ43_)/3.4 D (BJ42_ , BJ45_ , BJ46_)/3.6 D (HJ45_ , VJ)/3.6 L/3.9 (FJ40_ , FJ43_ , FJ45_ , FJ55_)/4.0 D (HJ47_ , VJ)/4.2 (FJ40_ , FJ43_ , FJ45_ , FJ55_ )	
	<b>Boccola balestra</b>	<b>TOYOTA LAND CRUISER ( _J_ )</b> 3.4 Diesel (BJ60_ , VJ)/4.0 (FJ62_ , GJ)/4.0 (FJ62_ , VJ)/4.0 Diesel (HJ60)/4.0 Diesel (HJ60_ , VJ)/4.0 Turbo-D (HJ61_ , VJ)/4.2 (FJ60_ , VJ)	
TOYOTA	90389-18002	<b>TOYOTA LAND CRUISER ( _J_ )</b> 2.4 (RJ70_ , VJ, RJ73_ , VJ)/2.4 (RJ70_ , RJ73_ )/2.4 D (LJ70_ )/2.4 TD (LJ70)/2.4 TD (LJ70_ , LJ73_)/3.0 TD (KZJ70_ , KZJ73_ , KZJ77_ )/3.4 D (BJ70_ , VJ, BJ73_ )/3.4 TD (BJ71_ , VJ)/3.5 D/4.2 TD (HZJ7_ , VJ)	
Length/Lunghezza [mm]	45	<b>TOYOTA LAND CRUISER 80 ( _J_ )</b> 4.0 (FJ80_ )/4.2 D (HZJ80_ )/4.2 TD (HDJ80)/4.2 TD 24V (HDJ80_ )/4.5 24V (FZJ80_ )	
Inner Diam./Diam. Interno [mm]	18	<b>TOYOTA LAND CRUISER 90 ( _J_ )</b> 3.0 D-4D/3.0 TD (KZJ90_ , KZJ95_ )/3.4 i 24V (VZJ90_ , VZJ95_ )	
Outer Diam./Diam. esterno [mm]	35	<b>TOYOTA LAND CRUISER Hardtop ( _J_ )</b> 2.4 TD (LJ77)/3.0 TD	

## RU-207

**Bearing Bush, stabiliser**

**Boccola barra stabilizzatrice**

TOYOTA 48815-60010

Length/Lunghezza [mm]	40,5
Height/Altezza [mm]	40
Width/Larghezza [mm]	41
Inner Diam./Diam. Interno [mm]	20

### TOYOTA LAND CRUISER Pick-up ( \_J4\_ )

3.4 D (BJ45\_P)/3.6 D (HJ45\_P)/3.9 (FJ45\_P)/4.0 D (HJ47\_P)/4.2 (FJ45\_P)

### TOYOTA LAND CRUISER ( \_J4\_ )

3.0 D (BJ40\_V, BJ43\_)/3.4 D (BJ42\_V, BJ45\_V, BJ46\_)/3.6 D (HJ45\_V)/3.6 L/3.9 (FJ40\_, FJ43\_, FJ45\_, FJ55\_V)/4.0 D (HJ47\_V)/4.2 (FJ40\_V, FJ43\_, FJ45\_V, FJ55\_)

### TOYOTA LAND CRUISER ( \_J6\_ )

3.4 Diesel (BJ60\_V)/4.0 (FJ62\_G)/4.0 (FJ62\_V)/4.0 Diesel (HJ60)/4.0 Diesel (HJ60\_V)/4.0 Turbo-D (HJ61\_V)/4.2 (FJ60\_V)

### TOYOTA LAND CRUISER ( \_J7\_ )

2.4 (RJ70\_V, RJ73\_V)/2.4 (RJ70\_, RJ73\_)/2.4 D (LJ70\_)/2.4 TD (LJ70)/2.4 TD (LJ70\_, LJ73\_)/3.0 TD (KZJ70\_, KZJ73\_, KZJ77\_)/3.4 D (BJ70\_V, BJ73\_)/3.4 TD (BJ71\_V)/3.5 D/4.2 TD (HZJ7\_V)

### TOYOTA LAND CRUISER 80 ( \_J8\_ )

4.0 (FJ80\_)/4.2 D (HZJ80\_)/4.2 TD (HDJ80)/4.2 TD 24V (HDJ80\_)/4.5 24V (FZJ80\_)

### TOYOTA LAND CRUISER 90 ( \_J9\_ )

3.0 D-4D/3.0 TD (KZJ90\_, KZJ95\_)/3.4 i 24V (VZJ90\_, VZJ95\_)

### TOYOTA LAND CRUISER Hardtop ( \_J7\_ )

2.4 TD (LJ77)/3.0 TD

### TOYOTA LAND CRUISER Pick-up ( \_J4\_ )

3.4 D (BJ45\_P)/3.6 D (HJ45\_P)/3.9 (FJ45\_P)/4.0 D (HJ47\_P)/4.2 (FJ45\_P)

## RU-208

**Bearing Bush, stabiliser**

**Boccola barra stabilizzatrice**

TOYOTA 48817-30010

Length/Lunghezza [mm]	21
Inner Diam./Diam. Interno [mm]	8
Outer Diam./Diam. esterno [mm]	27

### TOYOTA COROLLA ( \_E7\_ )

1.3 (KE70)/1.6 (TE71)/1.8 D (CE70)

### TOYOTA COROLLA 2 volumi ( \_E7\_ )

1.3 (KE70)/1.6 (TE71)/1.6 GT (TE71)/1.8 D (CE70)

### TOYOTA COROLLA Combi (KE)

1.2 (KE36)

### TOYOTA COROLLA Coupe (KE)

1.2 (KE35)

### TOYOTA HILUX Pick-up ( \_N\_ )

2.4 D/2.4 D 4WD/2.4 TD 4WD

### TOYOTA LAND CRUISER ( \_J4\_ )

3.0 D (BJ40\_V, BJ43\_)/3.4 D (BJ42\_V, BJ45\_V, BJ46\_)/3.6 D (HJ45\_V)/3.6 L/3.9 (FJ40\_, FJ43\_, FJ45\_, FJ55\_V)/4.0 D (HJ47\_V)/4.2 (FJ40\_V, FJ43\_, FJ45\_V, FJ55\_)

### TOYOTA LAND CRUISER ( \_J6\_ )

3.4 Diesel (BJ60\_V)/4.0 (FJ62\_G)/4.0 (FJ62\_V)/4.0 Diesel (HJ60)/4.0 Diesel (HJ60\_V)/4.0 Turbo-D (HJ61\_V)/4.2 (FJ60\_V)

### TOYOTA LAND CRUISER ( \_J7\_ )

2.4 (RJ70\_V, RJ73\_V)/2.4 (RJ70\_, RJ73\_)/2.4 D (LJ70\_)/2.4 TD (LJ70)/2.4 TD (LJ70\_, LJ73\_)/3.0 TD (KZJ70\_, KZJ73\_, KZJ77\_)/3.4 D (BJ70\_V, BJ73\_)/3.4 TD (BJ71\_V)/3.5 D/4.2 TD (HZJ7\_V)

### TOYOTA LAND CRUISER (J12)

3.0 D-4D (KDJ120)/4.0 (GRJ12)

### TOYOTA LAND CRUISER 80 ( \_J8\_ )

4.0 (FJ80\_)/4.2 D (HZJ80\_)/4.2 TD (HDJ80)/4.2 TD 24V (HDJ80\_)/4.5 24V (FZJ80\_)

### TOYOTA LAND CRUISER 90 ( \_J9\_ )

3.0 D-4D/3.0 TD (KZJ90\_, KZJ95\_)/3.4 i 24V (VZJ90\_, VZJ95\_)

### TOYOTA LAND CRUISER Hardtop ( \_J7\_ )

2.4 TD (LJ77)/3.0 TD

### TOYOTA LAND CRUISER Pick-up ( \_J4\_ )

3.4 D (BJ45\_P)/3.6 D (HJ45\_P)/3.9 (FJ45\_P)/4.0 D (HJ47\_P)/4.2 (FJ45\_P)

## RU-209

**Control Arm-/Trailing Arm**

**Bush**

**Supporto, Braccio oscillante**

TOYOTA 48702-60020

Length/Lunghezza [mm]	50
Inner Diam./Diam. Interno [mm]	16
Outer Diam./Diam. esterno [mm]	65,3

### TOYOTA LAND CRUISER ( \_J7\_ )

2.4 (RJ70\_V, RJ73\_V)/2.4 (RJ70\_, RJ73\_)/2.4 D (LJ70\_)/2.4 TD (LJ70)/2.4 TD (LJ70\_, LJ73\_)/2.5 TD 4x4/3.0 TD (KZJ70\_, KZJ73\_, KZJ77\_)/3.4 D (BJ70\_V, BJ73\_)/3.4 TD (BJ71\_V)/3.5 D/3.5 D 4x4/4.2 TD (HZJ7\_V)

### TOYOTA LAND CRUISER Hardtop ( \_J7\_ )

2.4 TD (LJ77)/3.0 TD



<b>RU-210</b>	<b>Holder, control arm mounting</b>	<b>TOYOTA 4 RUNNER (_N130)</b>	
	<b>Silentblock</b>	2.4 (RN61)/2.4 TD 4x4/2.7 i 4x4/3.0 Turbo-D (KZN 130)/3.0 V6 (VZN 130)/3.4 i 4x4	
TOYOTA	48654-35010	<b>TOYOTA 4 RUNNER</b>	
		3.0 Turbo-D	
Length/Lunghezza [mm]	92,5	<b>TOYOTA HILUX Pick-up (_N_)</b>	
Inner Diam./Diam. Interno [mm]	18	1.6 /1.8 (YN85_ ,YN90_)/2.0/2.0 4WD/2.2 4WD (YN106_ ,YN110_)/2.2 D/2.2 D 2WD/ 4WD/2.4 D/2.4 D 4WD/2.4 i 4WD/2.4 TD 4WD/2.5 D-4D/2.5 D-4D 4WD/2.8 D	
Outer Diam./Diam. esterno [mm]	40		
<b>RU-211</b>	<b>Holder, control arm mounting</b>	<b>TOYOTA 4 RUNNER (_N130)</b>	
	<b>Silentblock</b>	2.4 (RN61)/2.4 TD 4x4/2.7 i 4x4/3.0 Turbo-D (KZN 130)/3.0 V6 (VZN 130)/3.4 i 4x4	
TOYOTA	48632-30020	<b>TOYOTA 4 RUNNER</b>	
		3.0 Turbo-D	
Length/Lunghezza [mm]	44,5	<b>TOYOTA HILUX Pick-up (_N_)</b>	
Inner Diam./Diam. Interno [mm]	18	1.6 /1.8 (YN85_ ,YN90_)/2.0/2.0 4WD/2.2 4WD (YN106_ ,YN110_)/2.2 D/2.2 D 2WD/ 4WD/2.4 D/2.4 D 4WD/2.4 i 4WD/2.4 TD 4WD/2.5 D-4D/2.5 D-4D 4WD/2.8 D	
Outer Diam./Diam. esterno [mm]	36,4		
<b>RU-212</b>	<b>Bush, leaf spring</b>	<b>TOYOTA 4 RUNNER (_N130)</b>	
	<b>Boccola balestra</b>	2.4 (RN61)/2.4 TD 4x4/2.7 i 4x4/3.0 Turbo-D (KZN 130)/3.0 V6 (VZN 130)/3.4 i 4x4	
TOYOTA	90385-18046	<b>TOYOTA 4 RUNNER</b>	
		3.0 Turbo-D	
Length/Lunghezza [mm]	34	<b>TOYOTA HILUX Pick-up (_N_)</b>	
Inner Diam./Diam. Interno [mm]	17	2.4 D/2.4 D 4WD	
Outer Diam./Diam. esterno [mm]	29		
<b>RU-213</b>	<b>Bush, leaf spring</b>	<b>TOYOTA 4 RUNNER (_N130)</b>	
	<b>Boccola balestra</b>	2.4 (RN61)/2.4 TD 4x4/2.7 i 4x4/3.0 Turbo-D (KZN 130)/3.0 V6 (VZN 130)/3.4 i 4x4	
TOYOTA	90385-18007	<b>TOYOTA 4 RUNNER</b>	
		3.0 Turbo-D	
Length/Lunghezza [mm]	55		
Inner Diam./Diam. Interno [mm]	18		
Outer Diam./Diam. esterno [mm]	30		
<b>RU-214</b>	<b>Bearing Bush, stabiliser</b>	<b>TOYOTA 4 RUNNER (_N130)</b>	
	<b>Boccola barra stabilizzatrice</b>	2.4 (RN61)/2.4 TD 4x4/2.7 i 4x4/3.0 Turbo-D (KZN 130)/3.0 V6 (VZN 130)/3.4 i 4x4	
TOYOTA	48815-20020	<b>TOYOTA 4 RUNNER</b>	
		3.0 Turbo-D	
Length/Lunghezza [mm]	40	<b>TOYOTA HILUX Pick-up (_N_)</b>	
Height/Altezza [mm]	32	2.4 D/2.4 D 4WD	
Width/Larghezza [mm]	31		
Inner Diam./Diam. Interno [mm]	16		
<b>RU-215</b>	<b>Bearing Bush, stabiliser</b>	<b>TOYOTA 4 RUNNER (_N130)</b>	
	<b>Boccola barra stabilizzatrice</b>	2.4 (RN61)/2.4 TD 4x4/2.7 i 4x4/3.0 Turbo-D (KZN 130)/3.0 V6 (VZN 130)/3.4 i 4x4	
TOYOTA	48815-20030	<b>TOYOTA 4 RUNNER</b>	
		3.0 Turbo-D	
Length/Lunghezza [mm]	39	<b>TOYOTA HILUX Pick-up (_N_)</b>	
Height/Altezza [mm]	31	2.4 D/2.4 D 4WD	
Width/Larghezza [mm]	30		
Inner Diam./Diam. Interno [mm]	18		
<b>RU-216</b>	<b>Bearing Bush, stabiliser</b>	<b>TOYOTA 4 RUNNER (_N130)</b>	
	<b>Boccola barra stabilizzatrice</b>	2.4 (RN61)/2.4 TD 4x4/2.7 i 4x4/3.0 Turbo-D (KZN 130)/3.0 V6 (VZN 130)/3.4 i 4x4	
TOYOTA	90948-01002	<b>TOYOTA 4 RUNNER</b>	
		3.0 Turbo-D	
Length/Lunghezza [mm]	16	<b>TOYOTA HILUX Pick-up (_N_)</b>	
Inner Diam./Diam. Interno [mm]	10	2.4 D/2.4 D 4WD	
Outer Diam./Diam. esterno [mm]	25		

<b>RU-217</b>	<b>Holder, control arm mounting</b>	<b>TOYOTA CORONA (RX, RT)</b>	
	<b>Silentblock</b>	1.8 (TT1)/2.0 (RT104)/2.0 Mark II (RX12)	
		<b>TOYOTA CORONA SW (RT118)</b>	
	TOYOTA 48655-20050RH	2.0	
	Length/Lunghezza [mm]	145	
	Height/Altezza [mm]	57	
	Width/Larghezza [mm]	77	
	Inner Diam./Diam. Interno [mm]	20	
<b>RU-218</b>	<b>Holder, control arm mounting</b>	<b>TOYOTA CORONA (RX, RT)</b>	
	<b>Silentblock</b>	1.8 (TT1)/2.0 (RT104)/2.0 Mark II (RX12)	
		<b>TOYOTA CORONA SW (RT118)</b>	
	TOYOTA 48655-20060LH	2.0	
	Length/Lunghezza [mm]	148	
	Height/Altezza [mm]	57	
	Width/Larghezza [mm]	81	
	Inner Diam./Diam. Interno [mm]	18	
<b>RU-219</b>	<b>Bearing Bush, stabiliser</b>	<b>TOYOTA LAND CRUISER (_J7_)</b>	
	<b>Boccola barra stabilizzatrice</b>	2.4 D (LJ70_)/2.4 TD (LJ70)/2.4 TD (LJ70_ LJ73_)/3.0 TD (KZJ70_ KZJ73_ KZJ77_)/3.4 D (BJ70_V, BJ73_)/3.4 TD (BJ71_V)/3.5 D/4.2 TD (HZJ7_V)	
		<b>TOYOTA LAND CRUISER Hardtop (_J7_)</b>	
	TOYOTA 48815-30050	2.4 TD (LJ77)/3.0 TD	
	Length/Lunghezza [mm]	40	
	Height/Altezza [mm]	32	
	Width/Larghezza [mm]	31	
	Inner Diam./Diam. Interno [mm]	22.5	
<b>RU-220</b>	<b>Bearing Bush, stabiliser</b>	<b>TOYOTA RAV 4 II (XA2)</b>	
	<b>Boccola barra stabilizzatrice</b>	1.8 VVTi/2.0 D-4D 4WD/2.0 VVTi 4WD	
		<b>TOYOTA RAV 4 II</b>	
	TOYOTA 48815-10060	2.4	
	Fitting Position/Lato Montaggio	Front Axle	
	Length/Lunghezza [mm]	43	
	Height/Altezza [mm]	39	
	Width/Larghezza [mm]	31	
	Inner Diam./Diam. Interno [mm]	22	
<b>RU-221</b>	<b>Bearing Bush, stabiliser</b>	<b>TOYOTA COASTER</b>	
	<b>Boccola barra stabilizzatrice</b>	4.1 D	
		<b>TOYOTA DYNA ( 4Y )</b>	
		2.2 ( YU210 )	
		<b>TOYOTA DYNA ( 3L )</b>	
		2.8 D ( LY60/61 )	
		<b>TOYOTA DYNA ( 3RZ-FE )</b>	
		2.7 i ( RZU100 )	
		<b>TOYOTA DYNA ( 3Y )</b>	
		2.0 ( YY211 ) /2.0 ( YY61 )	
		<b>TOYOTA DYNA 100 ( 2Y )</b>	
		1.8 ( YY100 )/2.4 D ( LH80-LH81 )	
		<b>TOYOTA DYNA 100 ( 2Y )</b>	
		1.8 ( Y81 )	
		<b>TOYOTA DYNA 150 ( 3L / 5L )</b>	
		2.8 D ( LY211 / LY212 )	
		<b>TOYOTA DYNA 150 ( Diesel )</b>	
		3.4 D ( LY61 )	
		<b>TOYOTA DYNA 200 ( Diesel )</b>	
		3.4 D ( BU79/89 )/3.7 D	
		<b>TOYOTA DYNA Autobus</b>	
		2.4 D/3.4 D	
		<b>TOYOTA DYNA D ( 2L )</b>	
		2.8 D ( LY100 )	
		<b>TOYOTA DYNA D ( 15BF )</b>	
		4.1 D ( BU10/11 )	
		<b>TOYOTA DYNA D ( 15BF-15BFT )</b>	
		4.1 D 16V - Turbo ( BU21/142/22 )	
		<b>TOYOTA DYNA D ( 3B )</b>	

		3.0 D (BU)/3.4 D ( BU100/140 )	
		<b>TOYOTA DYNA Pianale piatto/Telaio</b>	
		2.0/2.4 D/3.4 D	
<b>RU-222</b>	<b>Bush, leaf spring</b>	<b>TOYOTA LAND CRUISER ( _J7_ )</b>	
	<b>Boccola balestra</b>	3.5 D/4.2 TD (HZJ7__V)	
TOYOTA	90385-18009	<b>TOYOTA LAND CRUISER Hardtop ( _J7_ )</b>	
		3.0 TD	
Length/Lunghezza [mm]	44		
Inner Diam./Diam. Interno [mm]	18		
Outer Diam./Diam. esterno [mm]	40		
<b>RU-223</b>	<b>Bush, leaf spring</b>	<b>TOYOTA LAND CRUISER ( _J7_ )</b>	
	<b>Boccola balestra</b>	2.4 D (LJ70_)/2.4 TD (LJ70)/2.4 TD (LJ70_, LJ73_)/3.0 TD (KZJ70_, KZJ73_, KZJ77_)/3.4 D (BJ70_V, BJ73_)/3.4 TD (BJ71_V)/3.5 D/4.2 TD (HZJ7__V)	
TOYOTA	48674-60010	<b>TOYOTA LAND CRUISER Hardtop ( _J7_ )</b>	
		2.4 TD (LJ77)/3.0 TD	
Length/Lunghezza [mm]	40		
Inner Diam./Diam. Interno [mm]	25		
Outer Diam./Diam. esterno [mm]	37		
<b>RU-224</b>	<b>Bearing Bush, stabiliser</b>	<b>TOYOTA LAND CRUISER ( _J7_ )</b>	
	<b>Boccola barra stabilizzatrice</b>	2.4 D (LJ70_)/2.4 TD (LJ70_, LJ73_)	
Length/Lunghezza [mm]	40		
Width/Larghezza [mm]	32		
Inner Diam./Diam. Interno [mm]	22,5		
<b>RU-225</b>	<b>Bearing Bush, stabiliser</b>	<b>TOYOTA LAND CRUISER ( _J7_ )</b>	
	<b>Boccola barra stabilizzatrice</b>	2.4 D (LJ70_)/2.4 TD (LJ70_, LJ73_)	
Length/Lunghezza [mm]	21		
Width/Larghezza [mm]	26,5		
Inner Diam./Diam. Interno [mm]	8		
<b>RU-226</b>	<b>Holder, control arm mounting</b>	<b>TOYOTA AVENSIS ( _T22_ )</b>	
	<b>Silentblock</b>	1.6 (AT220_)/1.6 VVT-i/1.8 (AT221_)/1.8 VVT-i/2.0 (ST220_)/2.0 D-4D (CDT220_)/2.0 TD (CT220_)/2.0 VVT-i	
TOYOTA	4806805050	<b>TOYOTA AVENSIS Liftback ( _T22_ )</b>	
		1.6 (AT220_)/1.6 VVT-i/1.8 (AT221_)/1.8 VVT-i/2.0 (ST220_)/2.0 D-4D (CDT220_)/2.0 TD (CT220_)/2.0 VVT-i	
Length/Lunghezza [mm]	59	<b>TOYOTA AVENSIS SW ( _T22_ )</b>	
Inner Diam./Diam. Interno [mm]	14	1.6 (AT220_)/1.6 VVT-i/1.8 (AT221_)/1.8 VVT-i/2.0 (ST220_)/2.0 D-4D (CDT220_)/2.0 TD (CT220_)/2.0 VVT-i	
Outer Diam./Diam. esterno [mm]	39		
<b>RU-227</b>	<b>Holder, control arm mounting</b>	<b>TOYOTA AVENSIS ( _T22_ )</b>	
	<b>Silentblock</b>	1.6 (AT220_)/1.6 VVT-i/1.8 (AT221_)/1.8 VVT-i/2.0 (ST220_)/2.0 D-4D (CDT220_)/2.0 TD (CT220_)/2.0 VVT-i	
TOYOTA	48061-05010	<b>TOYOTA AVENSIS Liftback ( _T22_ )</b>	
		1.6 (AT220_)/1.6 VVT-i/1.8 (AT221_)/1.8 VVT-i/2.0 (ST220_)/2.0 D-4D (CDT220_)/2.0 TD (CT220_)/2.0 VVT-i	
Inner Diam./Diam. Interno [mm]	18	<b>TOYOTA AVENSIS SW ( _T22_ )</b>	
Overall Length/Lungh. Tot. [mm]	54	1.6 (AT220_)/1.6 VVT-i/1.8 (AT221_)/1.8 VVT-i/2.0 (ST220_)/2.0 D-4D (CDT220_)/2.0 TD (CT220_)/2.0 VVT-i	
Outer Diam./Diam. esterno [mm]	60		
<b>RU-228</b>	<b>Holder, control arm mounting</b>	<b>TOYOTA AVENSIS (T25)</b>	
	<b>Silentblock</b>	1.6 VVT-i/1.8/2.0/2.0 D-4D/2.2 D-CAT/2.4	
TOYOTA	4806805070	<b>TOYOTA AVENSIS SW (T25)</b>	
		1.6 VVT-i/1.8/2.0/2.0 D-4D/2.2 D-CAT/2.4	
Length/Lunghezza [mm]	60	<b>TOYOTA AVENSIS Tre volumi (T25)</b>	
Inner Diam./Diam. Interno [mm]	14	1.6 VVT-i/1.8/2.0/2.0 D-4D/2.2 D-CAT/2.4	
Outer Diam./Diam. esterno [mm]	38		

<b>RU-229</b>	<b>Holder, control arm mounting</b>	<b>TOYOTA AVENSIS (T25)</b> 1.6 VVT-i/1.8/2.0/2.0 D-4D/2.2 D-4D/2.2 D-CAT/2.4	
	<b>Silentblock</b>	<b>TOYOTA AVENSIS SW (T25)</b> 1.6 VVT-i/1.8/2.0/2.0 D-4D/2.2 D-4D/2.2 D-CAT/2.4	
TOYOTA	4806805070	<b>TOYOTA AVENSIS Tre volumi (T25)</b> 1.6 VVT-i/1.8/2.0/2.0 D-4D/2.2 D-4D/2.2 D-CAT/2.4	
Length/Lunghezza [mm]	59		
Inner Diam./Diam. Interno [mm]	14		
Outer Diam./Diam. esterno [mm]	68,5		
<b>RU-230</b>	<b>Holder, control arm mounting</b>	<b>TOYOTA AVENSIS VERSO</b> 2.0 D-4D/2.0 VVT-i/2.4 VVTi GLS	
	<b>Silentblock</b>		
TOYOTA	48654-05040		
Length/Lunghezza [mm]	59		
Inner Diam./Diam. Interno [mm]	14		
Outer Diam./Diam. esterno [mm]	36		
<b>RU-231</b>	<b>Holder, control arm mounting</b>	<b>TOYOTA AVENSIS VERSO</b> 2.0 D-4D/2.0 VVT-i/2.4 VVTi GLS	
	<b>Silentblock</b>		
TOYOTA	48655-20140		
Fitting Position/Lato Montaggio	Front Axle left and right		
Length/Lunghezza [mm]	54		
Inner Diam./Diam. Interno [mm]	22		
Outer Diam./Diam. esterno [mm]	60,5		
<b>RU-232</b>	<b>Bearing Bush, stabiliser</b>	<b>CITROEN C1</b> 1.0/1.4 HDi	
	<b>Boccola barra stabilizzatrice</b>	<b>PEUGEOT 107</b> 1.0/1.4 HDi	
TOYOTA	488150H010	<b>TOYOTA AYGO</b> 1.0/1.4 HDi	
Fitting Position/Lato Montaggio	Front		
Length/Lunghezza [mm]	56		
Height/Altezza [mm]	43,5		
Width/Larghezza [mm]	40		
Inner Diam./Diam. Interno [mm]	21,5		
<b>RU-233</b>	<b>Holder, control arm mounting</b>	<b>CITROEN C1</b> 1.0/1.4 HDi	
	<b>Silentblock</b>	<b>PEUGEOT 107</b> 1.0/1.4 HDi	
TOYOTA	480680H010	<b>TOYOTA AYGO</b> 1.0/1.4 HDi	
Fitting Position/Lato Montaggio	Front Axle Left	<b>TOYOTA YARIS (_CP10)</b> 1.0 16V/1.0 16V (SCP10_)/1.3/1.3 16V (NCP10_)/1.4 D-4D/1.5 TS (NCP13)/1.5 VVT-i TS	
Length/Lunghezza [mm]	53	<b>TOYOTA YARIS VERSO (NC/LP2_)</b> 1.3 (NCP22)/1.4 D-4D (NLP22)/1.5 (NCP21)	
Inner Diam./Diam. Interno [mm]	12		
Outer Diam./Diam. esterno [mm]	32,7		
<b>RU-234</b>	<b>Holder, control arm mounting</b>	<b>CITROEN C1</b> 1.0/1.4 HDi	
	<b>Silentblock</b>	<b>PEUGEOT 107</b> 1.0/1.4 HDi	
TOYOTA	480680H010	<b>TOYOTA AYGO</b> 1.0/1.4 HDi	
Fitting Position/Lato Montaggio	Lower Front Axle		
Length/Lunghezza [mm]	62		
Inner Diam./Diam. Interno [mm]	19		
Outer Diam./Diam. esterno [mm]	56,5		
<b>RU-235</b>	<b>Holder, control arm mounting</b>	<b>CITROEN C1</b> 1.0/1.4 HDi	
	<b>Silentblock</b>	<b>PEUGEOT 107</b> 1.0/1.4 HDi	
TOYOTA	48725-0H010	<b>TOYOTA AYGO</b> 1.0/1.4 HDi	
Length/Lunghezza [mm]	85		
Inner Diam./Diam. Interno [mm]	12		
Outer Diam./Diam. esterno [mm]	75		



<b>RU-236</b>	<b>Holder, control arm mounting</b>	<b>TOYOTA COROLLA ( _E10_ )</b>	
	<b>Silentblock</b>	1.3 12V (EE100_)/1.3 XLI (EE101_)/1.3 XLI 16V (EE101)/1.6 Si (AE101_)/2.0 D (CE100_)	
TOYOTA	48654-12070	<b>TOYOTA COROLLA ( _E11_ )</b>	
Length/Lunghezza [mm]	60	1.3 16V/1.4 (EE111_)/1.4 16V (ZZE111_)/1.5/1.6 (AE111_)/1.6 16V (ZZE112_)/1.6 Aut. (AE111_)/1.8 Linea Terra/1.9 D (WZE110_)/2.0 D (CE110_)/2.0 D-4D/2.2 TD	
Inner Diam./Diam. Interno [mm]	14,5	<b>TOYOTA COROLLA Compact ( _E10_ )</b>	
Outer Diam./Diam. esterno [mm]	33,5	1.3 12V (EE100_)/1.3 XLI (EE101_)/1.3 XLI 16V (EE101)/1.6 Si (AE101_)/1.8 GT (AE102_)/2.0 D (CE100_)	
		<b>TOYOTA COROLLA Compact ( _E11_ )</b>	
		1.4 (EE111_)/1.4 (ZZE111_)/1.5/1.6 (AE111_)/1.6 (ZZE112_)/1.6 Aut. (AE111_)/1.9 D (WZE110_)/2.0 D (CE110_)/2.0 D-4D/2.2 TD	
		<b>TOYOTA COROLLA Liftback ( _E10_ )</b>	
		1.3 12V (EE100_)/1.3 XLI (EE101_)/1.6 GLI (AE101_)/1.8 GT (AE102_)/2.0 D (CE100_)	
		<b>TOYOTA COROLLA Liftback ( _E11_ )</b>	
		1.4 (EE111_)/1.4 (ZZE111_)/1.6 (AE111_)/1.6 (ZZE112_)/1.6 Aut. (AE111_)/1.9 D (WZE110_)/2.0 D (CE110)/2.0 D-4D	
		<b>TOYOTA COROLLA Wagon ( _E11_ )</b>	
		1.4 (EE111_)/1.4 16V (ZZE111_)/1.6 (AE111_)/1.6 16V (ZZE112_)/1.6 Aut. (AE111_)/1.8 AWD (AE115_)/1.9 D (WZE110_)/2.0 D (CE110_)/2.0 D-4D	
		<b>TOYOTA COROLLA Wagon ( _E10_ )</b>	
		1.3 12V (EE100_)/1.3 XLI (EE101_)/1.3 XLI 16V (EE101_)/1.6 Si (AE101_)/1.8 16V 4WD (AE103_)/2.0 D (CE100_)	
<b>RU-237</b>	<b>Holder, control arm mounting</b>	<b>TOYOTA COROLLA ( _E10_ )</b>	
	<b>Silentblock</b>	1.3 12V (EE100_)/1.3 XLI (EE101_)/1.3 XLI 16V (EE101)/1.6 Si (AE101_)/2.0 D (CE100_)	
TOYOTA	48655-12050	<b>TOYOTA COROLLA Compact ( _E10_ )</b>	
Length/Lunghezza [mm]	60	1.3 12V (EE100_)/1.3 XLI (EE101_)/1.3 XLI 16V (EE101)/1.6 Si (AE101_)/1.8 GT (AE102_)/2.0 D (CE100_)	
Inner Diam./Diam. Interno [mm]	18,5	<b>TOYOTA COROLLA Liftback ( _E10_ )</b>	
Outer Diam./Diam. esterno [mm]	46	1.3 12V (EE100_)/1.3 XLI (EE101_)/1.6 GLI (AE101_)/1.8 GT (AE102_)/2.0 D (CE100_)	
		<b>TOYOTA COROLLA Wagon ( _E10_ )</b>	
		1.3 12V (EE100_)/1.3 XLI (EE101_)/1.3 XLI 16V (EE101_)/1.6 Si (AE101_)/1.8 16V 4WD (AE103_)/1.8 XL/1.8 XL 4x4/2.0 D (CE100_)	
<b>RU-238</b>	<b>Holder, control arm mounting</b>	<b>TOYOTA COROLLA ( _E12U_ )</b>	
	<b>Silentblock</b>	1.4 D/1.4 VVT-i/1.6 VVT-i/1.8/1.8 VVTL-i TS/2.0 D-4D	
		<b>TOYOTA COROLLA MPV / Space Wagon</b>	
		2.2 D-4D	
		<b>TOYOTA COROLLA SW ( _E12J_ )</b>	
		1.4 D/1.4 VVT-i/1.6 VVT-i/1.8/2.0 D-4D	
		<b>TOYOTA COROLLA Tre volumi ( _E12_ )</b>	
		1.4 D/1.4 VVT-i/1.5/1.6 VVT-i/1.8/2.0 D-4D/2.0 D4d	
		<b>TOYOTA COROLLA Verso ( _E12J_ )</b>	
		1.4 VVT-i/1.6 VVT-i/1.8 VVT-i/2.0 D-4D	
		<b>TOYOTA COROLLA Verso</b>	
		1.6/1.8/2.0 D-4D/2.2 D-4D	
<b>RU-239</b>	<b>Holder, control arm mounting</b>	<b>TOYOTA COROLLA ( _E12U_ )</b>	
	<b>Silentblock</b>	1.4 D/1.4 VVT-i/1.6 VVT-i/1.8/1.8 VVTL-i TS/2.0 D-4D	
		<b>TOYOTA COROLLA MPV / Space Wagon</b>	
		2.2 D-4D	
		<b>TOYOTA COROLLA SW ( _E12J_ )</b>	
		1.4 D/1.4 VVT-i/1.6 VVT-i/1.8/2.0 D-4D	
		<b>TOYOTA COROLLA Tre volumi ( _E12_ )</b>	
		1.4 D/1.4 VVT-i/1.5/1.6 VVT-i/1.8/2.0 D-4D/2.0 D4d	
		<b>TOYOTA COROLLA Verso ( _E12J_ )</b>	
		1.4 VVT-i/1.6 VVT-i/1.8 VVT-i/2.0 D-4D	
		<b>TOYOTA COROLLA Verso</b>	
		1.6/1.8/2.0 D-4D/2.2 D-4D	

<p><b>RU-240</b>      <b>Bearing Bush, stabiliser</b></p> <p><b>Boccola barra stabilizzatrice</b></p>	<p><b>TOYOTA COROLLA Verso</b> 1.6/1.8/2.0 D-4D/2.2 D-4D</p>	 <p>240</p>
<p>TOYOTA      48815-0F010</p> <p>Fitting Position/Lato Montaggio      Front</p> <p>Length/Lunghezza [mm]      41</p> <p>Height/Altezza [mm]      49</p> <p>Width/Larghezza [mm]      44</p> <p>Inner Diam./Diam. Interno [mm]      24</p>	<p><b>TOYOTA HIACE II Furgonato (H5_)</b> 1.8/2.0/2.2 D/2.4 D</p> <p><b>TOYOTA HIACE II Wagon (H5_)</b> 1.8 (H5G)/2.0 (H5G)/2.2 D (H5G)/2.4 D (H5G)/2.4 D 4WD (H5F)</p> <p><b>TOYOTA HIACE IV Furgonato (_H1_, _H2_)</b> 2.4 (RCH12_, RCH22_)/2.4 4WD (RCH18_, RCH28_)/2.4 D (LXH12_, LXH22_)/2.4 TD (LXH12_, LXH22_)/2.4 TD 4WD (LXH18_, LXH28_)/2.5 D-4D/2.5 D-4D 4WD/2.7 (RCH13_, RCH23_)/2.7 4WD (RCH19_, RCH29_)/3.0 D</p> <p><b>TOYOTA HIACE IV Wagon (_H1_, _H2_)</b> 2.4 (RCH12_, RCH22_)/2.4 4WD (RCH18_, RCH28_)/2.4 D/2.4 TD (LXH12_, LXH22_)/2.4 TD 4WD (H18/28)/2.5 D-4D/2.7/2.7 (RCH13_, RCH23_)/2.7 4WD (RCH19_)/3.0 D</p>	 <p>RU-241</p>
<p><b>RU-241</b>      <b>Holder, control arm mounting</b></p> <p><b>Silentblock</b></p>	<p>TOYOTA      48632 26010</p> <p>Length/Lunghezza [mm]      48</p> <p>Inner Diam./Diam. Interno [mm]      20,5</p> <p>Outer Diam./Diam. esterno [mm]      48</p>	 <p>RU-242</p>
<p><b>RU-242</b>      <b>Holder, control arm mounting</b></p> <p><b>Silentblock</b></p>	<p>TOYOTA      48635-26010</p> <p>Length/Lunghezza [mm]      75</p> <p>Inner Diam./Diam. Interno [mm]      26,5</p> <p>Outer Diam./Diam. esterno [mm]      57</p>	 <p>243</p>
<p><b>RU-243</b>      <b>GummiParts</b></p> <p><b>Parti in gomma</b></p>	<p><b>TOYOTA LAND CRUISER (_J7_)</b> 2.4 (RJ70_V, RJ73_V)/2.4 (RJ70_, RJ73_)/2.4 D (LJ70_)/2.4 TD (LJ70)/2.4 TD (LJ70_, LJ73_)/2.5 TD 4x4/3.0 TD (KZJ70_, KZJ73_, KZJ77_)/3.4 D (BJ70_V, BJ73_)/3.4 TD (BJ71_V)/3.5 D/3.5 D 4x4/4.2 TD (HZJ7_ _V)</p> <p><b>TOYOTA LAND CRUISER Hardtop (_J7_)</b> 2.4 TD (LJ77)/3.0 TD</p>	 <p>244</p>
<p><b>RU-244</b>      <b>Holder, control arm mounting</b></p> <p><b>Silentblock</b></p>	<p><b>TOYOTA LAND CRUISER 100 (_J10_)</b> 4.2 TD (HDJ100_)/4.7/4.7 (UZJ100_)</p>	 <p>245</p>
<p>TOYOTA      48632 60010</p> <p>Length/Lunghezza [mm]      66</p> <p>Inner Diam./Diam. Interno [mm]      15</p> <p>Outer Diam./Diam. esterno [mm]      52,5</p>	<p><b>TOYOTA LAND CRUISER 100 (_J10_)</b> 4.2 TD (HDJ100_)/4.7/4.7 (UZJ100_)</p>	 <p>245</p>
<p><b>RU-245</b>      <b>Holder, control arm mounting</b></p> <p><b>Silentblock</b></p>	<p>TOYOTA      48655-60010</p> <p>Length/Lunghezza [mm]      90</p> <p>Inner Diam./Diam. Interno [mm]      18</p> <p>Outer Diam./Diam. esterno [mm]      47</p>	 <p>245</p>

<b>RU-246</b>	<b>Holder, control arm mounting</b>	<b>TOYOTA LAND CRUISER 100 (_J10_)</b> 4.2 TD (HDJ100_)/4.7/4.7 (UZJ100_)	
	<b>Silentblock</b>		
TOYOTA	48654-60010		
Length/Lunghezza [mm]	84		
Inner Diam./Diam. Interno [mm]	18		
Outer Diam./Diam. esterno [mm]	59		
<b>RU-247</b>	<b>Holder, control arm mounting</b>	<b>TOYOTA LAND CRUISER (J12)</b> 3.0 D-4D (KDJ120)/4.0 (GRJ12)	
	<b>Silentblock</b>		
TOYOTA	48632-60020		
Length/Lunghezza [mm]	62		
Inner Diam./Diam. Interno [mm]	15,5		
Outer Diam./Diam. esterno [mm]	46		
<b>RU-248</b>	<b>Holder, control arm mounting</b>	<b>TOYOTA LAND CRUISER (J12)</b> 3.0 D-4D (KDJ120)/4.0 (GRJ12)	
	<b>Silentblock</b>		
TOYOTA	48654-60030		
Length/Lunghezza [mm]	72		
Inner Diam./Diam. Interno [mm]	19		
Outer Diam./Diam. esterno [mm]	62		
<b>RU-249</b>	<b>Holder, control arm mounting</b>	<b>TOYOTA LAND CRUISER (J12)</b> 3.0 D-4D (KDJ120)/4.0 (GRJ12)	
	<b>Silentblock</b>		
TOYOTA	48655-60030		
Length/Lunghezza [mm]	89,5		
Inner Diam./Diam. Interno [mm]	14,5		
Outer Diam./Diam. esterno [mm]	56		
<b>RU-250</b>	<b>Holder, control arm mounting</b>	<b>TOYOTA RAV 4 II (XA2)</b> 1.8 VVTi/2.0 D-4D 4WD/2.0 VVTi 4WD/2.4 VVTi 4x4	
	<b>Silentblock</b>	<b>TOYOTA RAV 4 II</b> 2.4	
Length/Lunghezza [mm]	59		
Inner Diam./Diam. Interno [mm]	14		
Outer Diam./Diam. esterno [mm]	34		
<b>RU-251</b>	<b>Holder, control arm mounting</b>	<b>TOYOTA RAV 4 II (XA2)</b> 1.8 VVTi/2.0 D-4D 4WD/2.0 VVTi 4WD/2.4 VVTi 4x4	
	<b>Silentblock</b>	<b>TOYOTA RAV 4 II</b> 2.4	
Length/Lunghezza [mm]	60		
Inner Diam./Diam. Interno [mm]	14		
Outer Diam./Diam. esterno [mm]	60		
<b>RU-252</b>	<b>Holder, control arm mounting</b>	<b>TOYOTA AURIS</b> 1.33 Dual-VVTi/1.4 D-4D/1.4 VVTi/1.6/1.6 VVTi/1.8/1.8 VVTi/2.0 D-4D/2.2 D	
	<b>Silentblock</b>	<b>TOYOTA PRIUS</b> 1.8 HSD <b>TOYOTA RAV 4 III</b> 2.0 VVT-i/2.2 D-4D/2.2 D-CAT <b>TOYOTA VERSO</b> 1.6/1.8/2.0 D-4D/2.2 D-4D/2.2 D-CAT	
Length/Lunghezza [mm]	65,5		
Inner Diam./Diam. Interno [mm]	16		
Outer Diam./Diam. esterno [mm]	41		

<b>RU-253</b>	<b>Holder, control arm mounting</b>	<b>TOYOTA RAV 4 III</b>	
	<b>Silentblock</b>	2.0 VVT-i/2.2 D-4D/2.2 D-CAT	
	Length/Lunghezza [mm]	60	
	Inner Diam./Diam. Interno [mm]	16	
	Outer Diam./Diam. esterno [mm]	68	
<b>RU-254</b>	<b>Bearing Bush, stabiliser</b>	<b>TOYOTA RAV 4 III</b>	
	<b>Boccola barra stabilizzatrice</b>	2.0 VVT-i/2.2 D-4D/2.2 D-CAT	
	TOYOTA 48815-42090		
	Fitting Position/Lato Montaggio	Left Front	
	Length/Lunghezza [mm]	58	
	Height/Altezza [mm]	52	
	Width/Larghezza [mm]	62	
	Inner Diam./Diam. Interno [mm]	17	
<b>RU-255</b>	<b>Bearing Bush, stabiliser</b>	<b>TOYOTA RAV 4 III</b>	
	<b>Boccola barra stabilizzatrice</b>	2.0 VVT-i/2.2 D-4D/2.2 D-CAT	
	TOYOTA 48815-42100		
	Fitting Position/Lato Montaggio	Right Front	
	Length/Lunghezza [mm]	58	
	Height/Altezza [mm]	52	
	Width/Larghezza [mm]	62	
	Inner Diam./Diam. Interno [mm]	17	
<b>RU-256</b>	<b>Holder, control arm mounting</b>	<b>TOYOTA YARIS (_CP10)</b>	
	<b>Silentblock</b>	1.0 16V/1.0 16V (SCP10_)/1.3/1.3 16V (NCP10_)/1.4 D-4D/1.5 TS (NCP13)/1.5 VVT-i TS	
		<b>TOYOTA YARIS VERSO (NC/LP2_)</b>	
		1.3 (NCP22)/1.4 D-4D (NLP22)/1.5 (NCP21)	
	Length/Lunghezza [mm]	58	
	Inner Diam./Diam. Interno [mm]	12,5	
	Outer Diam./Diam. esterno [mm]	55	
<b>RU-257</b>	<b>Bearing Bush, stabiliser</b>	<b>CITROEN JUMPER Autobus (230P)</b>	
	<b>Boccola barra stabilizzatrice</b>	2.8 D	
	TOYOTA 48815-0D100	<b>TOYOTA URBAN CRUISER</b>	
		1.3 VVT-i/1.33/1.4 D-4D/1.4 D-4D 4x4	
		<b>TOYOTA YARIS</b>	
		1.0 VVT-i/1.3 VVT-i/1.8 VVTi/D-4D	
	Fitting Position/Lato Montaggio	Front	
	Length/Lunghezza [mm]	43	
	Height/Altezza [mm]	42	
	Width/Larghezza [mm]	67	
	Inner Diam./Diam. Interno [mm]	24	
<b>RU-258</b>	<b>Holder, control arm mounting</b>	<b>TOYOTA URBAN CRUISER</b>	
	<b>Silentblock</b>	1.3 VVT-i/1.33/1.4 D-4D/1.4 D-4D 4x4	
		<b>TOYOTA YARIS</b>	
		1.0 VVT-i/1.3 VVT-i/1.8 VVTi/D-4D	
	Length/Lunghezza [mm]	53	
	Inner Diam./Diam. Interno [mm]	14	
	Outer Diam./Diam. esterno [mm]	33	
<b>RU-259</b>	<b>Holder, control arm mounting</b>	<b>TOYOTA URBAN CRUISER</b>	
	<b>Silentblock</b>	1.3 VVT-i/1.33/1.4 D-4D/1.4 D-4D 4x4	
		<b>TOYOTA YARIS</b>	
		1.0 VVT-i/1.3 VVT-i/1.8 VVTi/D-4D	
	Fitting Position/Lato Montaggio	Lower Front Axle	
	Length/Lunghezza [mm]	62	
	Inner Diam./Diam. Interno [mm]	21	
	Outer Diam./Diam. esterno [mm]	60	

<p><b>RU-260</b>      <b>Bearing Bush, stabiliser</b></p> <p><b>Boccola barra stabilizzatrice</b></p> <p>TOYOTA      48815-28061</p>	<p><b>TOYOTA PREVIA (TCR1_, 2_)</b> 2.4/2.4 4WD/2.4 GX</p> <p><b>TOYOTA PREVIA</b> 2.2 D (3CT)</p>	
<p>Fitting Position/Lato Montaggio      Front</p> <p>Length/Lunghezza [mm]      42,5</p> <p>Height/Altezza [mm]      47</p> <p>Width/Larghezza [mm]      40</p> <p>Inner Diam./Diam. Interno [mm]      25</p>		
<p><b>RU-261</b>      <b>Bearing,propshaft centre bearing</b></p> <p><b>Supporto albero cardanico</b></p> <p>TOYOTA      37230-35090</p>	<p><b>TOYOTA 4 RUNNER (_N130)</b> 2.4 (RN61)/2.4 TD 4x4/2.7 i 4x4/3.0 Turbo-D (KZN 130)/3.0 V6 (VZN 130)/3.4 i 4x4</p> <p><b>TOYOTA 4 RUNNER</b> 3.0 Turbo-D</p> <p><b>TOYOTA HILUX Pick-up (_N_)</b> 1.6 /1.8 (YN85_, YN90_)/2.0/2.0 4WD/2.2 4WD (YN106_, YN110_)/2.2 D/2.2 D 2WD/ 4WD/2.4 D/2.4 D 4WD/2.4 i 4WD/2.4 TD 4WD/2.5 D-4D/2.5 D-4D 4WD/2.8 D</p>	
<p><b>RU-262</b>      <b>Bearing Bush, stabiliser</b></p> <p><b>Boccola barra stabilizzatrice</b></p> <p>TOYOTA      48815-30040</p>	<p><b>TOYOTA CARINA E (_T19_)</b> 1.6 (AT190)/1.6 16V/1.6 GLI (AT190)/1.8 (AT191)/1.8 GL/2.0 D (CT190)/2.0 GLI (ST191)/2.0 GTi (ST191)/2.0 GTi 16V (ST191_)/2.0 i (ST191)/2.0 TD (CT190)</p> <p><b>TOYOTA CARINA E Sportswagon (_T19_)</b> 1.6 GLI (AT190_)/1.6 i (AT190_)/1.8 GL/1.8 i (AT191_)/2.0 D (CT190_)/2.0 GLI (ST191_)/2.0 i (ST191_)/2.0 TD (CT190_)</p> <p><b>TOYOTA CARINA E Tre volumi (_T19_)</b> 1.5 SG/1.6 (AT190)/1.6 16V (AT190_)/1.6 GLI (AT190)/1.8/1.8 GL/1.8 i 16V (AT191)/2.0 (ST191)/2.0 D (CT190)/2.0 GLI (ST191)/2.0 GTi (ST191_)/2.0 GTi 16V (ST191_)/2.0 i (ST191)/2.0 TD (CT190_)</p>	
<p><b>RU-263</b>      <b>Holder, control arm mounting</b></p> <p><b>Silentblock</b></p> <p>TOYOTA      48061-26050</p>	<p><b>TOYOTA HIACE IV Furgonato (_H1_, _H2_)</b> 2.4 (RCH12_, RCH22_)/2.4 4WD (RCH18_, RCH28_)/2.4 D (LXH12_, LXH22_)/2.4 TD (LXH12_, LXH22_)/2.4 TD 4WD (LXH18_, LXH28_)/2.5 D-4D/2.5 D-4D 4WD/2.7 (RCH13_, RCH23_)/2.7 4WD (RCH19_, RCH29_)/3.0 D</p> <p><b>TOYOTA HIACE IV Wagon (_H1_, _H2_)</b> 2.4 (RCH12_, RCH22_)/2.4 4WD (RCH18_)/2.4 D/2.4 TD (LXH12_, LXH22_)/2.4 TD 4WD (H18/28)/2.5 D-4D/2.7/2.7 (RCH13_, RCH23_)/2.7 4WD (RCH19_)/3.0 D</p>	
<p><b>RU-264</b>      <b>Bearing Bush, stabiliser</b></p> <p><b>Boccola barra stabilizzatrice</b></p> <p>TOYOTA      48815-0K010</p>	<p><b>TOYOTA HILUX Pick-up</b> 2.5 D/2.5 D 4x4/3.0 D 4x4</p>	
<p><b>RU-265</b>      <b>Suspension Strut Support Bearing</b></p> <p><b>Supporto ammortizzatore</b></p> <p>TOYOTA      48609-52031</p>	<p><b>TOYOTA YARIS (_CP10)</b> 1.0 16V (SCP10_)/1.3/1.3 16V (NCP10_)/1.4 D-4D/1.5 VVT-i TS</p> <p><b>TOYOTA YARIS VERSO (NC/LP2_)</b> 1.3 (NCP22)/1.4 D-4D (NLP22)/1.5 (NCP21)</p>	
<p>Fitting Position/Lato Montaggio      Front Axle</p> <p>Length/Lunghezza [mm]      140</p> <p>Height/Altezza [mm]      43</p> <p>Width/Larghezza [mm]      124,5</p> <p>Inner Diam./Diam. Interno [mm]      14</p>		

**RU-266** Suspension Strut Support  
 Bearing  
 Supporto ammortizzatore

TOYOTA	48609-52100
Fitting Position/Lato Montaggio	Front Axle
Length/Lunghezza [mm]	51
Inner Diam./Diam. Interno [mm]	20
Outer Diam./Diam. esterno [mm]	91

**TOYOTA YARIS**  
 1.0 VVT-i/1.3 VVT-i/1.8 VVT-i/D-4D



**RU-267** Holder, control arm mounting  
 Silentblock

TOYOTA	48655-12120
Length/Lunghezza [mm]	61
Inner Diam./Diam. Interno [mm]	20,5
Outer Diam./Diam. esterno [mm]	52,5

**TOYOTA COROLLA ( \_E11\_ )**  
 1.3 16V/1.4 (EE111\_)/1.4 16V (ZZE111\_)/1.5/1.6 (AE111\_)/1.6  
 16V (ZZE112\_)/1.6 Aut. (AE111\_)/1.8 Linea Terra/1.9 D  
 (WZE110\_)/2.0 D (CE110\_)/2.0 D-4D/2.2 TD

**TOYOTA COROLLA Compact ( \_E11\_ )**  
 1.4 (EE111\_)/1.4 (ZZE111\_)/1.5/1.6 (AE111\_)/1.6  
 (ZZE112\_)/1.6 Aut. (AE111\_)/1.9 D (WZE110\_)/2.0 D  
 (CE110\_)/2.0 D-4D/2.2 TD

**TOYOTA COROLLA Liftback ( \_E11\_ )**  
 1.4 (EE111\_)/1.4 (ZZE111\_)/1.6 (AE111\_)/1.6 (ZZE112\_)/1.6  
 Aut. (AE111\_)/1.9 D (WZE110\_)/2.0 D (CE110\_)/2.0 D-4D

**TOYOTA COROLLA Wagon ( \_E11\_ )**  
 1.4 (EE111\_)/1.4 16V (ZZE111\_)/1.6 (AE111\_)/1.6 16V  
 (ZZE112\_)/1.6 Aut. (AE111\_)/1.8 AWD (AE115\_)/1.9 D  
 (WZE110\_)/2.0 D (CE110\_)/2.0 D-4D



**RU-268** Holder, control arm mounting  
 Silentblock

TOYOTA	48654-20150
Fitting Position/Lato Montaggio	Front Axle
Length/Lunghezza [mm]	60
Inner Diam./Diam. Interno [mm]	14
Outer Diam./Diam. esterno [mm]	36

**TOYOTA CARINA E ( \_T19\_ )**  
 1.6 (AT190)/1.6 16V/1.6 GLi (AT190)/1.8 (AT191)/1.8 GL/2.0 D  
 (CT190)/2.0 GLi (ST191)/2.0 GTi (ST191)/2.0 GTi 16V  
 (ST191\_)/2.0 i (ST191)/2.0 TD (CT190)

**TOYOTA CARINA E Sportswagon ( \_T19\_ )**  
 1.6 GLi (AT190\_)/1.6 i (AT190\_)/1.8 GL/1.8 i (AT191\_)/2.0 D  
 (CT190\_)/2.0 GLi (ST191\_)/2.0 i (ST191\_)/2.0 TD (CT190\_)

**TOYOTA CARINA E Tre volumi ( \_T19\_ )**  
 1.5 SG/1.6 (AT190)/1.6 16V (AT190\_)/1.8/1.8 GL/1.8 i 16V  
 (AT191)/2.0 (ST191)/2.0 D (CT190)/2.0 GTi (ST191\_)/2.0 GTi 16V  
 (ST191\_)/2.0 i (ST191)/2.0 TD (CT190\_)



**RU-269** Holder, control arm mounting  
 Silentblock

TOYOTA	48061-27010
Technical Information Number	Silentblock Sup. tra
Fitting Position/Lato Montaggio	Lower Front Axle
Length/Lunghezza [mm]	69
Inner Diam./Diam. Interno [mm]	14
Outer Diam./Diam. esterno [mm]	39

**TOYOTA LITEACE Autobus ( \_R2\_LG )**  
 1.5 (KR21LG)/2.0 D (CR21LG)/2.2 (YR21LG)

**TOYOTA LITEACE Autobus (CM30\_G, KM30\_G)**  
 1.5 (KM30LG)/2.0 D (CM30LG)

**TOYOTA LITEACE Furgonato ( \_R2\_V )**  
 1.5 (KR27\_V)

**TOYOTA LITEACE Furgonato (CM3\_V, KM3\_V)**  
 1.5 (KM31\_V, KM36\_V)/2.0 D (CM36\_V)

**TOYOTA LITEACE Furgonato (M2\_V)**  
 1.3

**TOYOTA MODELL F Autobus ( \_R2\_ 31 )**  
 1.8 De Luxe (YR20)/2.0 (YR21\_G)/2.0 Super (YR21)/2.2 (YR22LG,  
 YR31LG)



**RU-270** Bearing Bush, stabiliser  
 Boccia barra stabilizzatrice

TOYOTA	48815 14160
Fitting Position/Lato Montaggio	Front Axle
Length/Lunghezza [mm]	40
Height/Altezza [mm]	40
Inner Diam./Diam. Interno [mm]	24

**TOYOTA HILUX Pick-up ( \_N\_ )**  
 2.4 D/2.4 i 4WD/2.4 TD 4WD/2.5 D-4D/2.5 D-4D 4WD



**RU-271** Control Arm-/Trailing Arm  
 Bush  
 Supporto, Braccio oscillante

TOYOTA	48702-60050
Fitting Position/Lato Montaggio	Rear Axle left and right
Length/Lunghezza [mm]	50
Inner Diam./Diam. Interno [mm]	16
Outer Diam./Diam. esterno [mm]	60

**TOYOTA LAND CRUISER ( \_J6\_ )**  
 4.0 (FJ62\_G)

**TOYOTA LAND CRUISER 80 ( \_J8\_ )**  
 4.0 (FJ80\_)/4.2 TD (HDJ80)/4.2 TD 24V (HDJ80\_)



<p><b>RU-272</b>      <b>Control Arm-/Trailing Arm Bush</b>  <b>Supporto, Braccio oscillante</b></p> <p>TOYOTA      48702-60040</p>	<p><b>TOYOTA LAND CRUISER (_J6_)</b>  4.0 (FJ62_G)</p> <p><b>TOYOTA LAND CRUISER 80 (_J8_)</b>  4.0 (FJ80_)/4.2 TD (HDJ80)/4.2 TD 24V (HDJ80_)</p>	 <p>272</p>
<p><b>RU-273</b>      <b>Control Arm-/Trailing Arm Bush</b>  <b>Supporto, Braccio oscillante</b></p> <p>TOYOTA      48706-60030</p>	<p><b>TOYOTA LAND CRUISER (_J7_)</b>  4.2 TD (HZJ7__V)</p> <p><b>TOYOTA LAND CRUISER 100 (_J10_)</b>  4.2 TD (HDJ100_)</p> <p><b>TOYOTA LAND CRUISER 80 (_J8_)</b>  4.2 D (HZJ80_)/4.5 24V (FZJ80_)</p>	 <p>273</p>
<p>Fitting Position/Lato Montaggio      Rear Axle left and right</p> <p>Fitting Position/Lato Montaggio      Lower</p> <p>Length/Lunghezza [mm]      60</p> <p>Inner Diam./Diam. Interno [mm]      18</p> <p>Outer Diam./Diam. esterno [mm]      55</p>	<p><b>TOYOTA LAND CRUISER Hardtop (_J7_)</b>  4.2 D 4 ruote motrici</p>	
<p><b>RU-274</b>      <b>Holder, control arm mounting</b>  <b>Silentblock</b></p> <p>TOYOTA      48061-60010</p>	<p><b>TOYOTA LAND CRUISER (_J6_)</b>  4.0 (FJ62_G)</p> <p><b>TOYOTA LAND CRUISER (_J7_)</b>  4.2 TD (HZJ7__V)</p> <p><b>TOYOTA LAND CRUISER 100 (_J10_)</b>  4.2 TD (HDJ100_)</p>	 <p>274</p>
<p>Fitting Position/Lato Montaggio      Front Axle left and right</p> <p>Fitting Position/Lato Montaggio      Lower</p> <p>Length/Lunghezza [mm]      60</p> <p>Inner Diam./Diam. Interno [mm]      18</p> <p>Outer Diam./Diam. esterno [mm]      54</p>	<p><b>TOYOTA LAND CRUISER 80 (_J8_)</b>  4.0 (FJ80_)/4.2 D (HZJ80_)/4.2 TD (HDJ80)/4.2 TD 24V (HDJ80_)/4.5 24V (FZJ80_)</p> <p><b>TOYOTA LAND CRUISER Hardtop (_J7_)</b>  4.2 D 4 ruote motrici</p>	
<p><b>RU-275</b>      <b>Suspension Strut Support Bearing</b>  <b>Supporto ammortizzatore</b></p> <p>TOYOTA      48609-42010</p>	<p><b>TOYOTA RAV 4 II (XA2)</b>  1.8 VVTi/2.0 D-4D 4WD/2.0 VVTi 4WD/2.4 VVTi 4x4</p>	 <p>275</p>
<p>Fitting Position/Lato Montaggio      Front Axle</p> <p>Length/Lunghezza [mm]      142</p> <p>Height/Altezza [mm]      44</p> <p>Width/Larghezza [mm]      131</p> <p>Inner Diam./Diam. Interno [mm]      14</p>		
<p><b>RU-276</b>      <b>Holder, control arm mounting</b>  <b>Silentblock</b></p> <p>TOYOTA      4865442020</p>	<p><b>TOYOTA RAV 4 I/ FUNCRUISER (SXA1_)</b>  2.0 16V</p>	 <p>276</p>
<p>Height/Altezza [mm]      56</p> <p>Inner Diam./Diam. Interno [mm]      14,2</p> <p>Outer Diam./Diam. esterno [mm]      44,5</p> <p>Mounting Type/Tipo supporto</p>		
<p><b>RU-277</b>      <b>Bush, leaf spring</b>  <b>Boccola balestra</b></p> <p>TOYOTA      90385 T0001</p>	<p><b>TOYOTA HILUX Pick-up</b>  2.5 D/2.5 D 4x4/2.5 D4d/3.0 D 4x4</p>	 <p>277</p>
<p>Fitting Position/Lato Montaggio      Rear Axle</p> <p>Length/Lunghezza [mm]      52,5</p> <p>Inner Diam./Diam. Interno [mm]      19</p>		

<b>RU-278</b> Bush, leaf spring <b>Boccola balestra</b>	<b>TOYOTA HILUX Pick-up</b> 2.5 D/2.5 D 4x4/2.5 D4d/3.0 D 4x4	 <p>278</p>
TOYOTA 90385 T0002		
Fitting Position/Lato Montaggio Rear Axle		
Length/Lunghezza [mm] 38		
Inner Diam./Diam. Interno [mm] 19		
<b>RU-279</b> Bush, leaf spring <b>Boccola balestra</b>	<b>TOYOTA HILUX Pick-up</b> 2.5 D/2.5 D 4x4/2.5 D4d/3.0 D 4x4	 <p>279</p>
TOYOTA 90385 T0003		
Fitting Position/Lato Montaggio Front		
Fitting Position/Lato Montaggio Rear Axle		
Length/Lunghezza [mm] 39		
Inner Diam./Diam. Interno [mm] 23		
<b>RU-280</b> Bush, leaf spring <b>Boccola balestra</b>	<b>TOYOTA HILUX Pick-up</b> 2.5 D/2.5 D 4x4/2.5 D4d/3.0 D 4x4	 <p>280</p>
TOYOTA 90389 14004		
Fitting Position/Lato Montaggio Rear Axle		
Length/Lunghezza [mm] 73		
Inner Diam./Diam. Interno [mm] 14,2		
<b>RU-281</b> Bearing,propshaft centre bearing <b>Supporto albero cardanico</b>	<b>TOYOTA HILUX Pick-up</b> 2.5 D/2.5 D4d	 <p>281</p>
TOYOTA 37230-0K011		
Length/Lunghezza [mm] 176		
Height/Altezza [mm] 110		
Width/Larghezza [mm] 57		
Inner Diam./Diam. Interno [mm] 30		
<b>RU-282</b> Bearing,propshaft centre bearing <b>Supporto albero cardanico</b>	<b>TOYOTA HILUX Pick-up</b> 2.5 D 4x4/3.0 D 4x4	 <p>282</p>
TOYOTA 37230-0K021		
Length/Lunghezza [mm] 179		
Height/Altezza [mm] 110		
Width/Larghezza [mm] 54		
Inner Diam./Diam. Interno [mm] 30		
<b>RU-283</b> Engine Mounting <b>Supporto motore</b>	<b>TOYOTA HILUX Pick-up</b> 2.5 D/2.5 D 4x4/3.0 D 4x4	 <p>283</p>
TOYOTA 12361-0L030		
Fitting Position/Lato Montaggio Front		
Length/Lunghezza [mm] 160		
Height/Altezza [mm] 94		
Width/Larghezza [mm] 131		
<b>RU-284</b> Bush, leaf spring <b>Boccola balestra</b>	<b>TOYOTA DYNA</b> 2.5 D4d/3.0 D4d	 <p>284</p>
TOYOTA 90389-16026		
Fitting Position/Lato Montaggio Front Axle		
Length/Lunghezza [mm] 43		
Inner Diam./Diam. Interno [mm] 16		
Outer Diam./Diam. esterno [mm] 40,5		



<p><b>RU-285</b> Bush, leaf spring <b>Boccola balestra</b></p>	<p><b>TOYOTA DYNA</b> 2.5 D4d/3.0 D4d</p>	 285
<p>TOYOTA 90385-18023</p> <p>Fitting Position/Lato Montaggio Rear Axle            Length/Lunghezza [mm] 42            Inner Diam./Diam. Interno [mm] 18            Outer Diam./Diam. esterno [mm] 30</p>		
<p><b>RU-286</b> Bearing Bush, stabiliser <b>Boccola barra stabilizzatrice</b></p>	<p><b>TOYOTA AURIS</b> 1.33 Dual-VVTi/1.4 D-4D/1.4 VVTi/1.6/1.6 VVTi/2.0 D-4D/2.2 D</p>	 286
<p>TOYOTA 48815 02140</p> <p>Fitting Position/Lato Montaggio Front Axle Left            Length/Lunghezza [mm] 53            Height/Altezza [mm] 61            Inner Diam./Diam. Interno [mm] 23</p>		
<p><b>RU-287</b> Bearing Bush, stabiliser <b>Boccola barra stabilizzatrice</b></p>	<p><b>TOYOTA AURIS</b> 1.33 Dual-VVTi/1.4 D-4D/1.4 VVTi/1.6/1.6 VVTi/2.0 D-4D/2.2 D</p>	 287
<p>TOYOTA 48815 02150</p> <p>Fitting Position/Lato Montaggio Front Axle Right            Length/Lunghezza [mm] 53            Height/Altezza [mm] 61            Inner Diam./Diam. Interno [mm] 23</p>		
<p><b>RU-288</b> Bearing Bush, stabiliser <b>Boccola barra stabilizzatrice</b></p>	<p><b>TOYOTA AVENSIS</b> 1.6/1.6 VVT-i/1.8/2.0 D/2.2 D/2.2 D-CAT</p> <p><b>TOYOTA AVENSIS SW (T27)</b> 1.6/1.8/2.0/2.2 D</p> <p><b>TOYOTA AVENSIS Tre volumi (T27)</b> 2.0/2.2 D</p>	 288
<p>TOYOTA 48815 05130</p> <p>Fitting Position/Lato Montaggio Front Axle Left            Length/Lunghezza [mm] 53            Height/Altezza [mm] 53            Width/Larghezza [mm] 64,5            Inner Diam./Diam. Interno [mm] 23</p>		
<p><b>RU-289</b> Bearing Bush, stabiliser <b>Boccola barra stabilizzatrice</b></p>	<p><b>TOYOTA AVENSIS</b> 1.6/1.6 VVT-i/1.8/2.0 D/2.2 D/2.2 D-CAT</p> <p><b>TOYOTA AVENSIS SW (T27)</b> 1.6/1.8/2.0/2.2 D</p> <p><b>TOYOTA AVENSIS Tre volumi (T27)</b> 2.0/2.2 D</p>	 289
<p>TOYOTA 48815 05120</p> <p>Fitting Position/Lato Montaggio Front Axle Right            Length/Lunghezza [mm] 53            Height/Altezza [mm] 53            Width/Larghezza [mm] 64,5            Inner Diam./Diam. Interno [mm] 23</p>		
<p><b>RU-290</b> Engine Mounting <b>Supporto motore</b></p>	<p><b>CITROEN C1</b> 1.0</p> <p><b>PEUGEOT 107</b> 1.0</p> <p><b>TOYOTA AYGO</b> 1.0/1.0 GPL</p>	 290
<p>TOYOTA 123630Q010</p> <p>Fitting Position/Lato Montaggio Front Axle &amp; Rear            Length/Lunghezza [mm] 185            Inner Diam./Diam. Interno [mm] 15            Inner Diam./Diam. Int. 1 [mm] 12            Inner Diam./Diam. Interno [mm] 14,5</p>		
<p><b>RU-291</b> Engine Mounting <b>Supporto motore</b></p>	<p><b>CITROEN C1</b> 1.0</p> <p><b>PEUGEOT 107</b> 1.0</p> <p><b>TOYOTA AYGO</b> 1.0/1.0 GPL</p>	 291
<p>TOYOTA 123050Q010</p> <p>Fitting Position/Lato Montaggio Front Axle Right            Length/Lunghezza [mm] 171            Height/Altezza [mm] 89</p>		

**RU-292**

**Control Arm-/Trailing Arm  
 Bush  
 Supporto, Braccio oscillante**

**TOYOTA RAV 4 I Cabrio/ FUNCRUISER (SXA1\_)**  
 2.0 16V  
**TOYOTA RAV 4 I/ FUNCRUISER (SXA1\_)**  
 2.0/2.0 4x4/2.0 16V



TOYOTA 48075-42050

**RU-293**

**Control Arm-/Trailing Arm  
 Bush  
 Supporto, Braccio oscillante**

**TOYOTA LAND CRUISER 90 (\_J9\_)**  
 3.0 D-4D/3.0 TD (KZJ90\_, KZJ95\_)/3.4 i 24V (VZJ90\_, VZJ95\_)/4.2 TD



TOYOTA 48061-35040

Fitting Position/Lato Montaggio Upper Front Axle  
 Length/Lunghezza [mm] 66  
 Inner Diam./Diam. Interno [mm] 20  
 Outer Diam./Diam. esterno [mm] 49

**RU-294**

**Bearing,propshaft centre  
 bearing  
 Supporto albero cardanico**

**TOYOTA HIACE IV Furgonato (\_H1\_, \_H2\_)**  
 2.4 (RCH12\_, RCH22\_)/2.4 D (LXH12\_, LXH22\_)/2.4 TD (LXH12\_, LXH22\_)/2.4 4WD (LXH18\_, LXH28\_)/2.5 D-4D/2.5 D-4D 4WD/2.5 D4d 4x4/2.7 (RCH13\_, RCH23\_)



TOYOTA 37230-26020

Length/Lunghezza [mm] 172  
 Height/Altezza [mm] 56  
 Inner Diam./Diam. Interno [mm] 30

**TOYOTA HIACE IV Wagon (\_H1\_, \_H2\_)**  
 2.4 (RCH12\_, RCH22\_)/2.4 D/2.4 TD (LXH12\_, LXH22\_)/2.4 TD 4WD (H18/28)/2.5 D-4D/2.5 D4d 4x4/2.7 (RCH13\_, RCH23\_)

**RU-295**

**Control Arm-/Trailing Arm  
 Bush  
 Supporto, Braccio oscillante**

**TOYOTA COROLLA (\_E9\_)**  
 1.3 i (EE90)/1.5/1.5 4x4/1.6 (AE92)/1.6 GL 4x4/1.6 i/1.6 i 4WD/1.6 XL/1.8 D  
**TOYOTA COROLLA Compact (\_E9\_)**  
 1.3 (EE90)/1.3 i (EE90)/1.5/1.5 4x4/1.6 (AE92)/1.6 GL 4x4/1.6 GTi/1.6 XL/1.8 D  
**TOYOTA COROLLA Liftback (\_E9\_)**  
 1.3 i (EE90)/1.5/1.5 4x4/1.6/1.6 (AE92)/1.6 GTi/1.8 D (CE90)  
**TOYOTA COROLLA SW (\_E9\_)**  
 1.3 (EE90)/1.3 i (EE90)/1.6 (AE92)/1.6 XLI/1.6 XLI 4x4/1.8 D



TOYOTA 48655 12060

Fitting Position/Lato Montaggio Lower Front Axle  
 Length/Lunghezza [mm] 60,5  
 Height/Altezza [mm] 59  
 Inner Diam./Diam. Interno [mm] 18,5

**RU-296**

**Bearing Bush, stabiliser  
 Boccia barra stabilizzatrice**

**TOYOTA COROLLA (\_E11\_)**  
 1.8/2.0 D (CE110\_)/2.0 D-4D  
**TOYOTA COROLLA Compact (\_E11\_)**  
 1.4 (EE111\_)/1.6 (AE111\_)/1.6 Aut. (AE111\_)



TOYOTA 4881502040

Fitting Position/Lato Montaggio Front Axle  
 Length/Lunghezza [mm] 40  
 Height/Altezza [mm] 37  
 Width/Larghezza [mm] 39  
 Inner Diam./Diam. Interno [mm] 20

**RU-297**

**Bearing Bush, stabiliser  
 Boccia barra stabilizzatrice**

**TOYOTA COROLLA (\_E10\_)**  
 2.0 D (CE100\_)  
**TOYOTA COROLLA Compact (\_E10\_)**  
 2.0 D (CE100\_)  
**TOYOTA COROLLA Liftback (\_E10\_)**  
 1.3 XLI (EE101\_)/2.0 D (CE100\_)  
**TOYOTA COROLLA Wagon (\_E10\_)**  
 2.0 D (CE100\_)



TOYOTA 48815-12220

Fitting Position/Lato Montaggio Front Axle  
 Length/Lunghezza [mm] 39  
 Height/Altezza [mm] 36  
 Width/Larghezza [mm] 43  
 Inner Diam./Diam. Interno [mm] 25,5

**RU-298**

**Bearing Bush, stabiliser  
 Boccia barra stabilizzatrice**

**TOYOTA YARIS (\_CP10)**  
 1.0 16V/1.0 16V (SCP10\_)/1.3/1.3 16V (NCP10\_)/1.4 D-4D/1.5 TS (NCP13\_)/1.5 VVT-i TS  
**TOYOTA YARIS VERSO (NC/LP2\_)**  
 1.3 (NCP22)/1.4 D-4D (NLP22)/1.5 (NCP21)







TOYOTA 4881552030

Fitting Position/Lato Montaggio Front Axle  
 Length/Lunghezza [mm] 40  
 Height/Altezza [mm] 36  
 Width/Larghezza [mm] 32  
 Inner Diam./Diam. Interno [mm] 25

<p><b>RU-299</b>      <b>Bearing Bush, stabiliser</b></p> <p><b>Boccola barra stabilizzatrice</b></p> <p>TOYOTA      4881812160</p>	<p><b>TOYOTA COROLLA ( _ E11_ )</b>  1.3/1.4 (EE111_)/1.4 16V (ZZE111_)/1.4 D4d/1.5/1.6 (AE111_)/1.6 16V (ZZE112_)/1.6 Aut. (AE111_)/1.8/1.8 Linea Terra/1.9 D (WZE110_)/2.0 D (CE110_)/2.0 D-4D/2.2 TD</p>	 <p>299</p>
<p><b>RU-300</b>      <b>Holder, control arm mounting</b></p> <p><b>Silentblock</b></p> <p>MAZDA      1010037</p> <p>Length/Lunghezza [mm]      62</p> <p>Inner Diam./Diam. Interno [mm]      12</p> <p>Outer Diam./Diam. esterno [mm]      37</p>	<p><b>FORD FIESTA Furgonato (J5_ J3_ )</b>  1.3/1.4 i/1.8 D/1.8 DI</p> <p><b>FORD FIESTA Furgonato (JV_ )</b>  D 1.8/TD 1.8</p> <p><b>FORD FIESTA IV (JA_ JB_ )</b>  1.0 i/1.25 i 16V/1.3 i/1.4 i 16V/1.6 16V Sport/1.8 D/1.8 DI</p> <p><b>FORD PUMA (EC_ )</b>  1.4 16V/1.6 16V/1.7 16V/ST 160</p> <p><b>MAZDA 121 III (JASM, JBSM)</b>  1.25/1.3/1.3i 16V CABRIO (JJA)/1.8 D</p>	 <p>300</p>
<p><b>RU-301</b>      <b>Holder, control arm mounting</b></p> <p><b>Silentblock</b></p> <p>MAZDA      1E01 34 153A</p> <p>Length/Lunghezza [mm]      50</p> <p>Inner Diam./Diam. Interno [mm]      12</p> <p>Outer Diam./Diam. esterno [mm]      66</p>	<p><b>FORD FIESTA Furgonato (J5_ J3_ )</b>  1.3/1.4 i/1.8 D/1.8 DI</p> <p><b>FORD FIESTA Furgonato (JV_ )</b>  D 1.8/TD 1.8</p> <p><b>FORD FIESTA IV (JA_ JB_ )</b>  1.0 i/1.25 i 16V/1.3 i/1.4 i 16V/1.6 16V Sport/1.8 D/1.8 DI</p> <p><b>FORD PUMA (EC_ )</b>  1.4 16V/1.6 16V/1.7 16V/ST 160</p> <p><b>MAZDA 121 III (JASM, JBSM)</b>  1.25/1.3/1.3i 16V CABRIO (JJA)/1.8 D</p>	 <p>301</p>
<p><b>RU-302</b>      <b>Holder, control arm mounting</b></p> <p><b>Silentblock</b></p> <p>MAZDA      B459-34-470</p> <p>Length/Lunghezza [mm]      57</p> <p>Inner Diam./Diam. Interno [mm]      12</p> <p>Outer Diam./Diam. esterno [mm]      40</p>	<p><b>MAZDA 323 F IV (BG)</b>  1.6/1.6 16V/1.8 4WD/1.8 16V/1.8 16V GT</p> <p><b>MAZDA 323 IV C (BG)</b>  1.3/1.3 16V/1.6/1.6 16V/1.7 D/1.8 16V/1.8 16V 4WD/1.8 16V GT/1.8 16V Turbo 4WD/1.9 16V 2WD/4WD</p> <p><b>MAZDA 323 IV S (BG)</b>  1.3/1.3 16V/1.6/1.6 16V/1.7 D/1.8 16V/1.8 16V 4WD/1.8 16V GT/1.8 16V Turbo 4WD</p>	 <p>RU-302</p>
<p><b>RU-303</b>      <b>Holder, control arm mounting</b></p> <p><b>Silentblock</b></p> <p>MAZDA      B001-34-470</p> <p>Length/Lunghezza [mm]      52</p> <p>Inner Diam./Diam. Interno [mm]      18</p> <p>Outer Diam./Diam. esterno [mm]      32,5</p>	<p><b>MAZDA 323 F IV (BG)</b>  1.6/1.6 16V/1.8 4WD/1.8 16V/1.8 16V GT</p> <p><b>MAZDA 323 IV C (BG)</b>  1.3/1.3 16V/1.6/1.6 16V/1.7 D/1.8 16V/1.8 16V 4WD/1.8 16V GT/1.8 16V Turbo 4WD/1.9 16V 2WD/4WD</p> <p><b>MAZDA 323 IV S (BG)</b>  1.3/1.3 16V/1.6/1.6 16V/1.7 D/1.8 16V/1.8 16V 4WD/1.8 16V GT/1.8 16V Turbo 4WD</p>	 <p>RU-303</p>
<p><b>RU-304</b>      <b>Holder, control arm mounting</b></p> <p><b>Silentblock</b></p> <p>MAZDA      BC1D 34 470</p> <p>Length/Lunghezza [mm]      57</p> <p>Inner Diam./Diam. Interno [mm]      12</p> <p>Outer Diam./Diam. esterno [mm]      47</p>	<p><b>MAZDA 323 F V (BA)</b>  1.5 16V/1.8 16V/2.0 24V</p> <p><b>MAZDA 323 V C (BA)</b>  1.3 16V/1.5 16V/1.8 16V</p> <p><b>MAZDA 323 V P (BA)</b>  1.3 16V/1.5 16V/2.0 D</p> <p><b>MAZDA 323 V S (BA)</b>  1.3 16V/1.5 16V/1.6 TD/1.8 16V/2.0 D</p>	 <p>304</p>
<p><b>RU-305</b>      <b>Holder, control arm mounting</b></p> <p><b>Silentblock</b></p> <p>MAZDA      B25D 34 470</p> <p>Length/Lunghezza [mm]      60,5</p> <p>Inner Diam./Diam. Interno [mm]      12</p> <p>Outer Diam./Diam. esterno [mm]      29,5</p>	<p><b>MAZDA 323 F VI (BJ)</b>  1.4 16V/1.5 16V/1.6/1.9 16V/2.0 D/2.0 TD</p> <p><b>MAZDA 323 VI P (BJ)</b>  1.4 16V/1.5 16V</p> <p><b>MAZDA 323 VI S (BJ)</b>  1.4/1.4 16V/1.5 16V/1.6/1.9 16V/2.0/2.0 Astina/2.0 D/2.0 DiTD/2.0 TD</p> <p><b>MAZDA PREMACY (CP)</b>  1.8/1.9/2.0/2.0 TD/2.3 SVT</p>	 <p>305</p>

<b>RU-306</b>	<b>Holder, control arm mounting</b>	<b>MAZDA 323 F VI (BJ)</b> 1.4 16V/1.5 16V/1.6/1.9 16V/2.0/2.0 D/2.0 TD	 RU-306	
	<b>Silentblock</b>	<b>MAZDA 323 VI P (BJ)</b> 1.4 16V/1.5 16V		
MAZDA	B25D 34 460	<b>MAZDA 323 VI S (BJ)</b> 1.4/1.4 16V/1.5 16V/1.6/1.9 16V/2.0/2.0 Astina/2.0 D/2.0 DITD/2.0 TD		
Length/Lunghezza [mm]	48	<b>MAZDA PREMACY (CP)</b> 1.8/1.9/2.0/2.0 TD/2.3 SVT		
Inner Diam./Diam. Interno [mm]	16	<b>MAZDA 626 IV (GE)</b> 1.8 i/2.0 D GLX Complex/2.0 i/2.0 i 4WD		
Outer Diam./Diam. esterno [mm]	48,5	<b>MAZDA 626 IV Hatchback (GE)</b> 1.8/2.0 D GLX Complex/2.0 i/2.0 i 4WD/2.5 24V		
<b>RU-307</b>	<b>Holder, control arm mounting</b>	<b>MAZDA 626 V (GF)</b> 1.8/2.0/2.0 DITD/2.0 TD/2.0 Turbo DI		 RU-307
	<b>Silentblock</b>	<b>MAZDA 626 V Hatchback (GF)</b> 1.8/2.0/2.0 DITD/2.0 H.P./2.0 TD/2.0 Turbo DI		
MAZDA	GA2A 34 470	<b>MAZDA 626 V SW (GW)</b> 1.8/2.0/2.0 DITD/2.0 H.P./2.0 TD/2.0 Turbo DI		
Length/Lunghezza [mm]	60	<b>MAZDA XEDOS 6 (CA)</b> 1.6 16V/2.0 V6		
Inner Diam./Diam. Interno [mm]	13	<b>MAZDA 626 IV (GE)</b> 1.8 i/2.0 D GLX Complex/2.0 i/2.0 i 4WD		
Outer Diam./Diam. esterno [mm]	39	<b>MAZDA 626 IV Hatchback (GE)</b> 1.8/2.0 D GLX Complex/2.0 i/2.0 i 4WD/2.5 24V		
<b>RU-308</b>	<b>Holder, control arm mounting</b>	<b>MAZDA 626 V (GF)</b> 1.8/2.0/2.0 DITD/2.0 TD/2.0 Turbo DI	 308	
	<b>Silentblock</b>	<b>MAZDA XEDOS 6 (CA)</b> 1.6 16V/2.0 V6		
MAZDA	GA2A 34 46YA	<b>MAZDA 626 IV (GE)</b> 1.8 i/2.0 D GLX Complex/2.0 i/2.0 i 4WD		
Length/Lunghezza [mm]	168	<b>MAZDA 626 IV Hatchback (GE)</b> 1.8/2.0 D GLX Complex/2.0 i/2.0 i 4WD/2.5 24V		
Height/Altezza [mm]	65,5	<b>MAZDA 626 V (GF)</b> 1.8 i/2.0 D GLX Complex/2.0 i/2.0 i 4WD		
Width/Larghezza [mm]	70	<b>MAZDA 626 V Hatchback (GF)</b> 1.8/2.0/2.0 DITD/2.0 H.P./2.0 TD/2.0 Turbo DI		
Inner Diam./Diam. Interno [mm]	18	<b>MAZDA 626 V SW (GW)</b> 1.8/2.0/2.0 DITD/2.0 H.P./2.0 TD/2.0 Turbo DI		
<b>RU-309</b>	<b>Holder, control arm mounting</b>	<b>MAZDA XEDOS 6 (CA)</b> 1.6 16V/2.0 V6		 309
	<b>Silentblock</b>	<b>MAZDA 626 V (GF)</b> 1.8/2.0/2.0 DITD/2.0 TD/2.0 Turbo DI		
MAZDA	GA2A 34 46XA	<b>MAZDA 626 IV Hatchback (GE)</b> 1.8/2.0 D GLX Complex/2.0 i/2.0 i 4WD/2.5 24V		
Length/Lunghezza [mm]	168	<b>MAZDA 626 V (GF)</b> 1.8/2.0/2.0 DITD/2.0 TD/2.0 Turbo DI		
Height/Altezza [mm]	65,5	<b>MAZDA 626 V Hatchback (GF)</b> 1.8/2.0/2.0 DITD/2.0 H.P./2.0 TD/2.0 Turbo DI		
Width/Larghezza [mm]	70	<b>MAZDA 626 V SW (GW)</b> 1.8/2.0/2.0 DITD/2.0 H.P./2.0 TD/2.0 Turbo DI		
Inner Diam./Diam. Interno [mm]	18	<b>MAZDA XEDOS 6 (CA)</b> 1.6 16V/2.0 V6		
<b>RU-310</b>	<b>Holder, control arm mounting</b>	<b>MAZDA 626 V (GF)</b> 1.8/2.0/2.0 DITD/2.0 TD/2.0 Turbo DI	 310	
	<b>Silentblock</b>	<b>MAZDA XEDOS 6 (CA)</b> 1.6 16V/2.0 V6		
MAZDA	GE4T 34 46YD	<b>MAZDA 626 V (GF)</b> 1.8/2.0/2.0 DITD/2.0 TD/2.0 Turbo DI		
Length/Lunghezza [mm]	167	<b>MAZDA 626 V Hatchback (GF)</b> 1.8/2.0/2.0 DITD/2.0 H.P./2.0 TD/2.0 Turbo DI		
Height/Altezza [mm]	71	<b>MAZDA 626 V SW (GW)</b> 1.8/2.0/2.0 DITD/2.0 H.P./2.0 TD/2.0 Turbo DI		
Width/Larghezza [mm]	70	<b>MAZDA XEDOS 6 (CA)</b> 1.6 16V/2.0 V6		
Inner Diam./Diam. Interno [mm]	18	<b>MAZDA 626 V (GF)</b> 1.8/2.0/2.0 DITD/2.0 TD/2.0 Turbo DI		
<b>RU-311</b>	<b>Holder, control arm mounting</b>	<b>MAZDA 626 V (GF)</b> 1.8/2.0/2.0 DITD/2.0 TD/2.0 Turbo DI		 311
	<b>Silentblock</b>	<b>MAZDA XEDOS 6 (CA)</b> 1.6 16V/2.0 V6		
MAZDA	GE4T 34 46XD	<b>MAZDA 626 V Hatchback (GF)</b> 1.8/2.0/2.0 DITD/2.0 H.P./2.0 TD/2.0 Turbo DI		
Length/Lunghezza [mm]	167	<b>MAZDA 626 V SW (GW)</b> 1.8/2.0/2.0 DITD/2.0 H.P./2.0 TD/2.0 Turbo DI		
Height/Altezza [mm]	71	<b>MAZDA XEDOS 6 (CA)</b> 1.6 16V/2.0 V6		
Width/Larghezza [mm]	70	<b>MAZDA 626 V (GF)</b> 1.8/2.0/2.0 DITD/2.0 TD/2.0 Turbo DI		
Inner Diam./Diam. Interno [mm]	18	<b>MAZDA XEDOS 6 (CA)</b> 1.6 16V/2.0 V6		
<b>RU-312</b>	<b>Holder, control arm mounting</b>	<b>MAZDA E 2000,2200 Autobus (SR1)</b> 2.0/2.0 4WD/2.2 D	 312	
	<b>Silentblock</b>	<b>MAZDA E 2000,2200 Furgonato (SR2)</b> 2.0/2.2 D/2.2 D 4WD		
MAZDA	S083 34 840A			

<b>RU-313</b>	<b>Holder, control arm mounting</b>	<b>MAZDA E 2000,2200 Autobus (SR1)</b> 2.0/2.0 4WD/2.2 D	
	<b>Silentblock</b>	<b>MAZDA E 2000,2200 Furgonato (SR2)</b> 2.0/2.2 D/2.2 D 4WD	
MAZDA	S083 34 830A		
Length/Lunghezza [mm]		72,5	
Inner Diam./Diam. Interno [mm]		24,4	
Outer Diam./Diam. esterno [mm]		45	
<b>RU-314</b>	<b>Holder, control arm mounting</b>	<b>MAZDA E 2000,2200 Autobus (SR1)</b> 2.0/2.0 4WD/2.2 D	
	<b>Silentblock</b>	<b>MAZDA E 2000,2200 Furgonato (SR2)</b> 2.0/2.2 D/2.2 D 4WD	
MAZDA	S083-34-460		
Length/Lunghezza [mm]		79	
Inner Diam./Diam. Interno [mm]		16,5	
Outer Diam./Diam. esterno [mm]		45,5	
<b>RU-315</b>	<b>Holder, control arm mounting</b>	<b>FORD FIESTA V (JH_)</b> 1.25 16V/1.3/1.4 16V/1.4 TDCi/1.6 16V/1.6 TDCi/ST150	
	<b>Silentblock</b>	<b>FORD FUSION (JU_)</b> 1.25/1.4/1.4 TDCi/1.6/1.6 TDCi	
MAZDA	DD3234300	<b>MAZDA 2</b> 1.25/1.3 L/1.4/1.4 CD/1.5/1.6	
Length/Lunghezza [mm]		55	
Inner Diam./Diam. Interno [mm]		12	
Outer Diam./Diam. esterno [mm]		40,4	
<b>RU-316</b>	<b>Holder, control arm mounting</b>	<b>FORD FIESTA V (JH_)</b> 1.25 16V/1.3/1.4 16V/1.4 TDCi/1.6 16V/1.6 TDCi/ST150	
	<b>Silentblock</b>	<b>FORD FUSION (JU_)</b> 1.25/1.4/1.4 TDCi/1.6/1.6 TDCi	
MAZDA	DD3234300	<b>MAZDA 2</b> 1.25/1.3 L/1.4/1.4 CD/1.5/1.6	
Length/Lunghezza [mm]		148,5	
Width/Larghezza [mm]		65	
Inner Diam./Diam. Interno [mm]		22	
Inner Diam./Diam. Int. 1 [mm]		21	
Outer Diam./Diam. esterno [mm]		72,4	
<b>RU-317</b>	<b>Holder, control arm mounting</b>	<b>FORD FOCUS (DAW, DBW)</b> 1.4 16V/1.6 16V/1.8 16V/1.8 DI / TDDi/1.8 TDCi/1.8 Turbo DI / TDDi/2.0 16V/ST170	
	<b>Silentblock</b>	<b>FORD FOCUS C-MAX</b> 1.6/1.6 TDCi/1.6 Ti/1.8/1.8 Flexifuel/1.8 TDCi/2.0/2.0 TDCi	
VOLVO	30666821	<b>FORD FOCUS II</b> 1.4/1.6/1.6 TDCi/1.6 Ti/1.8 Flexifuel/1.8 TDCi/2.0/2.0 TDCi/2.5 ST	
Length/Lunghezza [mm]		142	
Diameter/Diametro [mm]		60,5	
		<b>FORD FOCUS II Cabriolet</b> 1.6/2.0/2.0 TDCi	
		<b>FORD FOCUS II Tre volumi</b> 1.4/1.6/1.6 TDCi/1.6 Ti/1.8 Flexifuel/1.8 TDCi/2.0/2.0 TDCi	
		<b>FORD FOCUS II Turnier</b> 1.4/1.6/1.6 TDCi/1.6 Ti/1.8 Flexifuel/1.8 TDCi/2.0/2.0 TDCi	
		<b>FORD FOCUS SW (DNW)</b> 1.4 16V/1.6 16V/1.8 16V/1.8 DI / TDDi/1.8 TDCi/1.8 Turbo DI / TDDi/2.0 16V/ST170	
		<b>FORD FOCUS Tre volumi (DFW)</b> 1.4 16V/1.6 16V/1.8 16V/1.8 TDCi/1.8 Turbo DI / TDDi/2.0 16V	
		<b>MAZDA 3</b> 1.4/1.6/1.6 DI Turbo/2.0/2.3 DiSi Turbo MPS/2.3 MPS/2.3 MZR/2.3 MZR Sport	
		<b>MAZDA 3 Tre volumi</b> 1.6/1.6 DI Turbo/2.0	
		<b>MAZDA 5</b> 1.8/2.0/2.0 CD/2.3	
		<b>VOLVO C30</b> 1.6/1.6 D/1.8/1.8 FlexFuel/2.0/2.0 D/2.4 D5/2.4 i/D5/T5	
		<b>VOLVO S40 II</b> 1.6/1.6 D/1.8/2.0/2.0 D/2.4/2.4 D5/T5/T5 AWD	
		<b>VOLVO V50</b>	

		1.6/1.6 D/1.8/2.0/2.0 D/2.4/2.4 D5/T5/T5 AWD		
<b>RU-318</b>	<b>Holder, control arm mounting</b>	<b>MAZDA 6 (GG)</b>	 <p>318</p>	
	<b>Silentblock</b>	1.8/2.0/2.0 DI/2.3		
MAZDA	GJ6A-34-470A	<b>MAZDA 6 Hatchback (GG)</b>		
		1.8/2.0/2.0 DI/2.3		
		<b>MAZDA 6 SW (GY)</b>		
Length/Lunghezza [mm]	57,2	1.8/2.0/2.0 DI/2.3/2.3 AWD		
Inner Diam./Diam. Interno [mm]	12			
Outer Diam./Diam. esterno [mm]	40,2			
<b>RU-319</b>	<b>Holder, control arm mounting</b>	<b>MAZDA 6 (GG)</b>		 <p>319</p>
	<b>Silentblock</b>	1.8/2.0/2.0 DI/2.3		
MAZDA	GJ6A-34-710A	<b>MAZDA 6 Hatchback (GG)</b>		
		1.8/2.0/2.0 DI/2.3		
		<b>MAZDA 6 SW (GY)</b>		
Length/Lunghezza [mm]	49,5	1.8/2.0/2.0 DI/2.3/2.3 AWD		
Inner Diam./Diam. Interno [mm]	12,5			
Outer Diam./Diam. esterno [mm]	44,2			
<b>RU-320</b>	<b>Holder, control arm mounting</b>	<b>MAZDA 6 (GG)</b>	 <p>320</p>	
	<b>Silentblock</b>	1.8/2.0/2.0 DI/2.3		
MAZDA	GJ6A-34-460A	<b>MAZDA 6 Hatchback (GG)</b>		
		1.8/2.0/2.0 DI/2.3		
		<b>MAZDA 6 SW (GY)</b>		
Length/Lunghezza [mm]	79,4	1.8/2.0/2.0 DI/2.3/2.3 AWD		
Inner Diam./Diam. Interno [mm]	12			
Outer Diam./Diam. esterno [mm]	62,5			
<b>RU-321</b>	<b>Bearing Bush, stabiliser</b>	<b>FORD ESCORT '91 Express (AVL)</b>		 <p>321</p>
	<b>Boccola barra stabilizzatrice</b>	1.3/1.4/1.8 D		
MAZDA	1E00-34-156	<b>FORD ESCORT '95 Furgonato (AVL)</b>		
		1.4/1.8 D/1.8 Turbo D		
Fitting Position/Lato Montaggio	Front	<b>FORD ESCORT CLASSIC (AAL, ABL)</b>		
Length/Lunghezza [mm]	30	1.6 16V		
Height/Altezza [mm]	30	<b>FORD ESCORT CLASSIC Turnier (ANL)</b>		
Width/Larghezza [mm]	40	1.6 16V/1.8 TD		
Inner Diam./Diam. Interno [mm]	14	<b>FORD ESCORT II (ATH)</b>		
		1.1/1.3/1.6 RS/2.0 RS (BATN)/2.0 RS Trazione posteriore/RS 1800		
		<b>FORD ESCORT II SW</b>		
		1.1/1.3 (BADR)/1.3 (CADR)		
		<b>FORD ESCORT III (GAA)</b>		
		1.1/1.3/1.6/1.6 D/1.6 i (GAA)/1.6 RS Turbo/1.6 XR3i/1.7 Turbo RS/RS 1600i		
		<b>FORD ESCORT III Cabriolet (ALD)</b>		
		1.3/1.6/1.6 i		
		<b>FORD ESCORT III SW (AWA)</b>		
		1.1/1.3/1.6/1.6 D		
		<b>FORD ESCORT V (GAL)</b>		
		1.3/1.4/1.6/1.8 16V XR3i/1.8 D		
		<b>FORD ESCORT V Cabriolet (ALL)</b>		
		1.4/1.6/1.8 16V XR3i		
		<b>FORD ESCORT V SW (GAL, AVL)</b>		
		1.3/1.4/1.6/1.8 16V/1.8 D		
		<b>FORD ESCORT VI (GAL)</b>		
		1.3/1.4/1.6 i 16V/1.8 16V XR3i/1.8 D/1.8 i 16V/1.8 TD/1.8 XR3i 16V 4x4		
		<b>FORD ESCORT VI Cabriolet (ALL)</b>		
		1.6 16V XR3i/1.6 i 16V/1.8 16V XR3i		
		<b>FORD ESCORT VI SW (GAL)</b>		
		1.3/1.4/1.6 i 16V/1.8 D/1.8 i 16V/1.8 TD		
		<b>FORD ESCORT VI Tre volumi (GAL)</b>		
		1.3/1.4/1.6 i 16V/1.8 i 16V/1.8 TD		
		<b>FORD ESCORT VII (GAL, AAL, ABL)</b>		
		1.3/1.4/1.6 16V/1.6 16V 4x4/1.6 i 16V/1.8 16V/1.8 D/1.8 TD/1.8 Turbo D/RS Cosworth 4x4		
		<b>FORD ESCORT VII Cabriolet (ALL)</b>		
		1.4/1.6 16V XR3i/1.8 16V XR3i/1.8 TD/1.8 Turbo D		
		<b>FORD ESCORT VII SW (GAL, ANL)</b>		

<b>RU-322</b>	<b>Holder, control arm mounting</b>
	<b>Silentblock</b>
MAZDA	1E00-28-460C
Length/Lunghezza [mm]	70
Inner Diam./Diam. Interno [mm]	12,5
Outer Diam./Diam. esterno [mm]	64

1.3/1.4/1.6 16V/1.6 i 16V/1.8 16V/1.8 D/1.8 TD/1.8 Turbo D
<b>FORD ESCORT VII Tre volumi (GAL, AFL)</b>
1.3/1.4/1.6 i 16V/1.8 16V/1.8 D/1.8 TD/1.8 Turbo D
<b>FORD FIESTA Furgonato (J5_, J3_)</b>
1.3/1.4 i/1.8 D/1.8 DI
<b>FORD FIESTA Furgonato (JV_)</b>
D 1.8/TD 1.8
<b>FORD FIESTA III (GFJ)</b>
1.1/1.3/1.3 Cat./1.4/1.4 Cat./1.6/1.6 XR2i/1.8 16V/1.8 D
<b>FORD FIESTA IV (JA_, JB_)</b>
1.0 i/1.25 i 16V/1.3 i/1.4 i 16V/1.6 16V Sport/1.8 D/1.8 DI
<b>FORD ORION III (GAL)</b>
1.3/1.4/1.6/1.6 i/1.6 i 16V/1.8 D/1.8 i 16V/1.8 TD
<b>MAZDA 121 III (JASM, JBSM)</b>
1.25/1.3/1.3i 16V CABRIO (JJA)/1.8 D
<b>SAAB 9-3 Cabriolet (YS3D)</b>
2.0 Turbo
<b>SUBARU JUSTY II (JMA, MS)</b>
1.3 4x4
<b>FORD ESCORT '91 Express (AVL)</b>
1.3/1.4/1.8 D
<b>FORD ESCORT '95 Furgonato (AVL)</b>
1.4/1.8 D/1.8 Turbo D
<b>FORD ESCORT V (GAL)</b>
1.3/1.4/1.6/1.8 16V XR3i/1.8 D
<b>FORD ESCORT V Cabriolet (ALL)</b>
1.4/1.6/1.8 16V XR3i
<b>FORD ESCORT V SW (GAL, AVL)</b>
1.3/1.4/1.6/1.8 16V/1.8 D
<b>FORD ESCORT VI (GAL)</b>
1.3/1.4/1.6 i 16V/1.8 16V XR3i/1.8 D/1.8 i 16V/1.8 TD/1.8 XR3i 16V 4x4
<b>FORD ESCORT VI Cabriolet (ALL)</b>
1.6 16V XR3i/1.6 i 16V/1.8 16V XR3i
<b>FORD ESCORT VI SW (GAL)</b>
1.3/1.4/1.6 i 16V/1.8 D/1.8 i 16V/1.8 TD
<b>FORD ESCORT VI Tre volumi (GAL)</b>
1.3/1.4/1.6 i 16V/1.8 i 16V/1.8 TD
<b>FORD ESCORT VII (GAL, AAL, ABL)</b>
1.3/1.4/1.6 16V/1.6 16V 4x4/1.6 i 16V/1.8 16V/1.8 D/1.8 TD/1.8 Turbo D/RS Cosworth 4x4
<b>FORD ESCORT VII Cabriolet (ALL)</b>
1.4/1.6 16V XR3i/1.8 16V XR3i/1.8 TD/1.8 Turbo D
<b>FORD ESCORT VII SW (GAL, ANL)</b>
1.3/1.4/1.6 16V/1.6 i 16V/1.8 16V/1.8 D/1.8 TD/1.8 Turbo D
<b>FORD ESCORT VII Tre volumi (GAL, AFL)</b>
1.3/1.4/1.6 i 16V/1.8 16V/1.8 D/1.8 TD/1.8 Turbo D
<b>MAZDA 121 III (JASM, JBSM)</b>
1.25/1.3/1.3i 16V CABRIO (JJA)/1.8 D



<b>RU-323</b>	<b>Holder, control arm mounting</b>
	<b>Silentblock</b>
FORD	13000384
Fitting Position/Lato Montaggio	Rear
Length/Lunghezza [mm]	35
Inner Diam./Diam. Interno [mm]	12
Outer Diam./Diam. esterno [mm]	36





<b>FORD FOCUS (DAW, DBW)</b>
1.4 16V/1.6 16V/1.8 16V/1.8 DI / TDDi/1.8 TDCi/1.8 Turbo DI / TDDi/2.0 16V/ST170
<b>FORD FOCUS SW (DNW)</b>
1.4 16V/1.6 16V/1.8 16V/1.8 DI / TDDi/1.8 TDCi/1.8 Turbo DI / TDDi/2.0 16V/ST170
<b>FORD FOCUS Tre volumi (DFW)</b>
1.4 16V/1.6 16V/1.8 16V/1.8 TDCi/1.8 Turbo DI / TDDi/2.0 16V
<b>MAZDA 3</b>
1.4/1.6/1.6 DI Turbo/2.0/2.3 DiSi Turbo MPS/2.3 MPS/2.3 MZR/2.3 MZR Sport
<b>MAZDA 3 Tre volumi</b>
1.6/1.6 DI Turbo/2.0
<b>VOLVO C30</b>
1.6/1.6 D/1.8/1.8 FlexFuel/2.0/2.0 D/2.4 D5/2.4 i/D5/T5
<b>VOLVO S40 II</b>
1.6/1.6 D/1.8/2.0/2.0 D/2.4 D5/T5/T5 AWD
<b>VOLVO V50</b>



		1.6/1.6 D/1.8/2.0/2.0 D/2.4/2.4 D5/T5/T5 AWD	
<b>RU-324</b>	<b>Holder, control arm mounting</b>	<b>FORD RANGER</b>	
	<b>Silentblock</b>	2.5 D/2.5 D 4x4/2.5 TD/2.5 TD 4x4	
MAZDA	UH71-34-470	<b>MAZDA B-SERIE (UN)</b>	
		2.5 D/2.5 D 4WD/2.5 TD 4WD	
Fitting Position/Lato Montaggio	Upper Front Axle		
Length/Lunghezza [mm]	50		
Inner Diam./Diam. Interno [mm]	18		
Outer Diam./Diam. esterno [mm]	49		
<b>RU-325</b>	<b>Suspension Strut Support Bearing</b>	<b>MAZDA 323 F V (BA)</b>	
	<b>Supporto ammortizzatore</b>	1.5 16V/1.8 16V	
MAZDA	B01C34380	<b>MAZDA 323 V C (BA)</b>	
		1.3 16V/1.5 16V/1.8 16V	
Fitting Position/Lato Montaggio	Front Axle	<b>MAZDA 323 V S (BA)</b>	
Length/Lunghezza [mm]	139	1.3 16V/1.5 16V/1.6 TD/1.8 16V/2.0 D	
Height/Altezza [mm]	54		
Width/Larghezza [mm]	122		
Inner Diam./Diam. Interno [mm]	9		
<b>RU-326</b>	<b>Suspension Strut Support Bearing</b>	<b>MAZDA 323 F V (BA)</b>	
	<b>Supporto ammortizzatore</b>	1.5 16V/1.8 16V/2.0 24V	
MAZDA	BC1D-28-390	<b>MAZDA 323 V C (BA)</b>	
		1.3 16V/1.5 16V/1.8 16V	
Fitting Position/Lato Montaggio	Rear Axle Left	<b>MAZDA 323 V P (BA)</b>	
Height/Altezza [mm]	64	1.3 16V/1.5 16V/2.0 D	
Inner Diam./Diam. Interno [mm]	13	<b>MAZDA 323 V S (BA)</b>	
		1.3 16V/1.5 16V/1.6 TD/1.8 16V/2.0 D	
<b>RU-327</b>	<b>Suspension Strut Support Bearing</b>	<b>MAZDA 323 F V (BA)</b>	
	<b>Supporto ammortizzatore</b>	1.5 16V/1.8 16V/2.0 24V	
MAZDA	BC1D-28-380	<b>MAZDA 323 V C (BA)</b>	
		1.3 16V/1.5 16V/1.8 16V	
Fitting Position/Lato Montaggio	Rear Axle Right	<b>MAZDA 323 V P (BA)</b>	
Height/Altezza [mm]	64	1.3 16V/1.5 16V/2.0 D	
Inner Diam./Diam. Interno [mm]	13	<b>MAZDA 323 V S (BA)</b>	
		1.3 16V/1.5 16V/1.6 TD/1.8 16V/2.0 D	
<b>RU-328</b>	<b>Suspension Strut Support Bearing</b>	<b>MAZDA 323 F VI (BJ)</b>	
	<b>Supporto ammortizzatore</b>	1.5 16V/1.6/2.0/2.0 D/2.0 TD	
MAZDA	B25D-34-380A	<b>MAZDA 323 VI S (BJ)</b>	
		1.5 16V/1.6/2.0 D/2.0 TD	
Fitting Position/Lato Montaggio	Front Axle		
Height/Altezza [mm]	31		
Inner Diam./Diam. Interno [mm]	12		
Mount. Bores/Fori Fiss. Dist. [mm]	97		
<b>RU-329</b>	<b>Bush, leaf spring</b>	<b>FORD RANGER</b>	
	<b>Boccola balestra</b>	2.5 D/2.5 D 4x4/2.5 TD/2.5 TD 4x4	
MAZDA	UH71-28-450	<b>MAZDA B-SERIE (UN)</b>	
		2.5 D/2.5 D 4WD/2.5 TD 4WD	
Fitting Position/Lato Montaggio	Front Axle		
Length/Lunghezza [mm]	37		
Inner Diam./Diam. Interno [mm]	17,5		
Outer Diam./Diam. esterno [mm]	32		
<b>RU-330</b>	<b>Bush, leaf spring</b>	<b>FORD RANGER</b>	
	<b>Boccola balestra</b>	2.5 D/2.5 D 4x4/2.5 TD/2.5 TD 4x4/3.0 TDCi 4x4	
MAZDA	UH71-28-470	<b>MAZDA B-SERIE (UN)</b>	
		2.5 D/2.5 D 4WD/2.5 TD 4WD	
Fitting Position/Lato Montaggio	Rear Axle Upper		
Length/Lunghezza [mm]	46		
Inner Diam./Diam. Interno [mm]	19		
Outer Diam./Diam. esterno [mm]	32		







<b>RU-331</b>	<b>Bush, leaf spring</b>	<b>FORD RANGER</b> 2.5 D/2.5 D 4x4/2.5 TD/2.5 TD 4x4/3.0 TDCi 4x4	
	<b>Boccola balestra</b>	<b>MAZDA B-SERIE (UN)</b> 2.5 D/2.5 D 4WD/2.5 TD 4WD	
MAZDA	UH71-28-480		
Fitting Position/Lato Montaggio		Rear Axle Lower	
<b>RU-332</b>	<b>Bush, leaf spring</b>	<b>MAZDA B-SERIE (UF)</b> 2.5 D/2.5 D 4WD	
	<b>Boccola balestra</b>		
MAZDA	UB39-28-333		
Fitting Position/Lato Montaggio		Rear Axle Upper	
Length/Lunghezza [mm]		46	
Inner Diam./Diam. Interno [mm]		18	
Outer Diam./Diam. esterno [mm]		32,5	
<b>RU-333</b>	<b>Bush, leaf spring</b>	<b>MAZDA B-SERIE (UF)</b> 2.5 D/2.5 D 4WD	
	<b>Boccola balestra</b>		
MAZDA	UB40-28-333		
Fitting Position/Lato Montaggio		Rear Axle Lower	
<b>RU-334</b>	<b>Holder, control arm mounting</b>	<b>MAZDA 2</b> 1.3/1.4 MZR-CD/1.5	
	<b>Silentblock</b>		
MAZDA	D651 34 470		
Length/Lunghezza [mm]		53	
Inner Diam./Diam. Interno [mm]		12	
Outer Diam./Diam. esterno [mm]		33	
<b>RU-335</b>	<b>Bearing Bush, stabiliser</b>	<b>MAZDA 6 (GG)</b> 1.8/2.0/2.0 DI/2.3/3.0	
	<b>Boccola barra stabilizzatrice</b>	<b>MAZDA 6 Hatchback (GG)</b> 1.8/2.0/2.0 DI/2.3	
MAZDA	GJ6A 34 156	<b>MAZDA 6 SW (GY)</b> 1.8/2.0/2.0 CITD 4x4/2.0 DI/2.3/2.3 AWD	
Fitting Position/Lato Montaggio		Front Axle	
Length/Lunghezza [mm]		48	
Height/Altezza [mm]		42	
Width/Larghezza [mm]		33	
Inner Diam./Diam. Interno [mm]		22,5	
<b>RU-336</b>	<b>Bearing Bush, stabiliser</b>	<b>MAZDA 6 (GG)</b> 1.8/2.0/2.0 DI/2.3/3.0	
	<b>Boccola barra stabilizzatrice</b>	<b>MAZDA 6 Hatchback (GG)</b> 1.8/2.0/2.0 DI/2.3	
MAZDA	GJ6A 28 156	<b>MAZDA 6 SW (GY)</b> 1.8/2.0/2.0 CITD 4x4/2.0 DI/2.3/2.3 AWD	
Fitting Position/Lato Montaggio		Rear Axle	
Length/Lunghezza [mm]		41,5	
Height/Altezza [mm]		36	
Width/Larghezza [mm]		33	
Inner Diam./Diam. Interno [mm]		19	
<b>RU-340</b>	<b>Engine Mounting</b>	<b>MAZDA 3</b> 1.4/1.6/1.6 DI Turbo/2.0/2.0 MZR-CD	
	<b>Supporto motore</b>	<b>MAZDA 3 Tre volumi</b> 1.6/1.6 DI Turbo/2.0/2.0 MZR-CD	
MAZDA	BP4K-39-040C		
Height/Altezza [mm]		44	
Inner Diam./Diam. Interno [mm]		12,5	

<b>RU-400</b>	<b>Engine Mounting</b>	<b>HONDA CIVIC IV (EG, EH)</b>	
	<b>Supporto motore</b>	1.5 i 16V (EG8)/1.6 16V Vtec (EH9)/1.6 VTI (EG9)	
<b>HONDA</b>	50841-SR3-030	<b>HONDA CIVIC IV Coupe (EJ)</b>	
<b>Length/Lunghezza [mm]</b>	145	1.5 i LSi (EJ2)/1.6 i (EJ6)/1.6 i Vtec/1.6 i Vtec (EJ1)	
<b>Height/Altezza [mm]</b>	80	<b>HONDA CIVIC IV Fastback (MA, MB)</b>	
<b>Width/Larghezza [mm]</b>	49	1.4 i (MA8)/1.5 i Vtec-E (MA9)/1.6 i (MB1)/1.6 i Vtec (MB1)	
<b>Inner Diam./Diam. Interno [mm]</b>	20	<b>HONDA CIVIC IV Hatchback (EG)</b>	
		1.3 16V (EG3)/1.5 i 16V/1.5 i 16V (EG4)/1.6 16V Vtec (EG5)/1.6 VTI 16V (EG6)	
		<b>HONDA CIVIC V (EJ9, EK3/4)</b>	
		1.4 i (EJ9)/1.5 i (EK3)/1.6 i Vtec/1.6 VTI (EK4)	
		<b>HONDA CIVIC V Coupe (EJ6, EJ8)</b>	
		1.6 i/1.6 i Vtec	
		<b>HONDA CIVIC V Fastback (MB)</b>	
		1.4 16V (MB2)/1.5 16V (MB3)/1.6 16V (MB4)/1.6 VTI/1.8 16V (MB6)/2.0 i TD (MB7)	
		<b>HONDA CIVIC VI Aerodeck (MB,MC)</b>	
		1.4 16V (MB8)/1.5 16V (MB9)/1.6 16V (MC1)/1.8 16V (MC2)/2.0 i D (MC3)	
		<b>HONDA CIVIC VI Hatchback (EJ,EK)</b>	
		1.4 i (EJ9)/1.4 i S (EJ9)/1.5 i (EK3)/1.6 i (EK1)/1.6 VTI (EK4)	
		<b>HONDA CRX III (EH, EG)</b>	
		1.6 ESi (EH6)/1.6 i VTI (EG2)	
<b>RU-401</b>	<b>Engine Mounting</b>	<b>HONDA CIVIC IV (EG, EH)</b>	
	<b>Supporto motore</b>	1.5 i 16V (EG8)/1.6 16V Vtec (EH9)/1.6 VTI (EG9)	
<b>HONDA</b>	50842-SR3-030	<b>HONDA CIVIC IV Coupe (EJ)</b>	
<b>Length/Lunghezza [mm]</b>	145	1.5 i LSi (EJ2)/1.6 i (EJ6)/1.6 i Vtec/1.6 i Vtec (EJ1)	
<b>Height/Altezza [mm]</b>	80	<b>HONDA CIVIC IV Fastback (MA, MB)</b>	
<b>Width/Larghezza [mm]</b>	58	1.4 i (MA8)/1.5 i Vtec-E (MA9)/1.6 i (MB1)/1.6 i Vtec (MB1)	
<b>Inner Diam./Diam. Interno [mm]</b>	20	<b>HONDA CIVIC IV Hatchback (EG)</b>	
		1.3 16V (EG3)/1.5 i 16V/1.5 i 16V (EG4)/1.6 16V Vtec (EG5)/1.6 VTI 16V (EG6)	
		<b>HONDA CIVIC V (EJ9, EK3/4)</b>	
		1.4 i (EJ9)/1.5 i (EK3)/1.6 i Vtec/1.6 VTI (EK4)	
		<b>HONDA CIVIC V Coupe (EJ6, EJ8)</b>	
		1.6 i/1.6 i Vtec	
		<b>HONDA CIVIC V Fastback (MB)</b>	
		1.4 16V (MB2)/1.5 16V (MB3)/1.6 16V (MB4)/1.6 VTI/1.8 16V (MB6)/2.0 i TD (MB7)	
		<b>HONDA CIVIC VI Aerodeck (MB,MC)</b>	
		1.4 16V (MB8)/1.5 16V (MB9)/1.6 16V (MC1)/1.8 16V (MC2)/2.0 i D (MC3)	
		<b>HONDA CIVIC VI Hatchback (EJ,EK)</b>	
		1.4 i (EJ9)/1.4 i S (EJ9)/1.5 i (EK3)/1.6 i (EK1)/1.6 VTI (EK4)	
		<b>HONDA CRX III (EH, EG)</b>	
		1.6 ESi (EH6)/1.6 i VTI (EG2)	
<b>RU-402</b>	<b>Engine Mounting</b>	<b>HONDA CIVIC IV (EG, EH)</b>	
	<b>Supporto motore</b>	1.5 i 16V (EG8)/1.6 16V Vtec (EH9)/1.6 VTI (EG9)	
<b>HONDA</b>	50810-SM4-000	<b>HONDA CIVIC IV Coupe (EJ)</b>	
<b>Length/Lunghezza [mm]</b>	139	1.5 i LSi (EJ2)/1.6 i (EJ6)/1.6 i Vtec/1.6 i Vtec (EJ1)	
<b>Height/Altezza [mm]</b>	88	<b>HONDA CIVIC IV Fastback (MA, MB)</b>	
<b>Width/Larghezza [mm]</b>	104	1.4 i (MA8)/1.5 i Vtec-E (MA9)/1.6 i (MB1)/1.6 i Vtec (MB1)	
<b>Inner Diam./Diam. Interno [mm]</b>	12	<b>HONDA CIVIC IV Hatchback (EG)</b>	
		1.3 16V (EG3)/1.5 i 16V/1.5 i 16V (EG4)/1.6 16V Vtec (EG5)/1.6 VTI 16V (EG6)	
		<b>HONDA CIVIC V (EJ9, EK3/4)</b>	
		1.4 i (EJ9)/1.5 i (EK3)/1.6 i Vtec/1.6 VTI (EK4)	
		<b>HONDA CIVIC V Coupe (EJ6, EJ8)</b>	
		1.6 i/1.6 i Vtec	
		<b>HONDA CIVIC V Fastback (MB)</b>	
		1.4 16V (MB2)/1.5 16V (MB3)/1.6 16V (MB4)/1.6 VTI/1.8 16V (MB6)/2.0 i TD (MB7)	
		<b>HONDA CIVIC VI Aerodeck (MB,MC)</b>	
		1.4 16V (MB8)/1.5 16V (MB9)/1.6 16V (MC1)/1.8 16V (MC2)/2.0 i D (MC3)	
		<b>HONDA CIVIC VI Hatchback (EJ,EK)</b>	
		1.4 i (EJ9)/1.4 i S (EJ9)/1.5 i (EK3)/1.6 i (EK1)/1.6 VTI (EK4)	
		<b>HONDA CRX III (EH, EG)</b>	
		1.6 ESi (EH6)/1.6 i VTI (EG2)	
<b>RU-403</b>	<b>Engine Mounting</b>	<b>HONDA CIVIC IV (EG, EH)</b>	
	<b>Supporto motore</b>	1.5 i 16V (EG8)/1.6 16V Vtec (EH9)/1.6 VTI (EG9)	
<b>HONDA</b>	50820-SR3-J02	<b>HONDA CIVIC IV Coupe (EJ)</b>	
<b>Length/Lunghezza [mm]</b>	137	1.5 i LSi (EJ2)/1.6 i (EJ6)/1.6 i Vtec/1.6 i Vtec (EJ1)	
<b>Height/Altezza [mm]</b>	106	<b>HONDA CIVIC IV Fastback (MA, MB)</b>	
<b>Width/Larghezza [mm]</b>	93	1.4 i (MA8)/1.5 i Vtec-E (MA9)/1.6 i (MB1)/1.6 i Vtec (MB1)	
<b>Inner Diam./Diam. Interno [mm]</b>	12	<b>HONDA CIVIC IV Hatchback (EG)</b>	
		1.3 16V (EG3)/1.5 i 16V/1.5 i 16V (EG4)/1.6 16V Vtec (EG5)/1.6 VTI 16V (EG6)	
		<b>HONDA CIVIC V (EJ9, EK3/4)</b>	
		1.4 i (EJ9)/1.5 i (EK3)/1.6 i Vtec/1.6 VTI (EK4)	
		<b>HONDA CIVIC V Coupe (EJ6, EJ8)</b>	
		1.6 i/1.6 i Vtec	
		<b>HONDA CIVIC V Fastback (MB)</b>	
		1.4 16V (MB2)/1.5 16V (MB3)/1.6 16V (MB4)/1.6 VTI/1.8 16V (MB6)/2.0 i TD (MB7)	
		<b>HONDA CIVIC VI Aerodeck (MB,MC)</b>	
		1.4 16V (MB8)/1.5 16V (MB9)/1.6 16V (MC1)/1.8 16V (MC2)/2.0 i D (MC3)	
		<b>HONDA CIVIC VI Hatchback (EJ,EK)</b>	
		1.4 i (EJ9)/1.4 i S (EJ9)/1.5 i (EK3)/1.6 i (EK1)/1.6 VTI (EK4)	
		<b>HONDA CRX III (EH, EG)</b>	
		1.6 ESi (EH6)/1.6 i VTI (EG2)	

<b>RU-405</b>	<b>Engine Mounting</b>	<b>HONDA CIVIC IV (EG, EH)</b> 1.5 i 16V (EG8)/1.6 16V Vtec (EH9)/1.6 VTI (EG9)	
	<b>Supporto motore</b>	<b>HONDA CIVIC IV Coupe (EJ)</b> 1.5 i LSi (EJ2)/1.6 i (EJ6)/1.6 i Vtec/1.6 i Vtec (EJ1)	
HONDA	50820-SR3-J11	<b>HONDA CIVIC IV Fastback (MA, MB)</b> 1.4 i (MA8)/1.5 i Vtec-E (MA9)/1.6 i (MB1)/1.6 i Vtec (MB1)	
Length/Lunghezza [mm]	134	<b>HONDA CIVIC IV Hatchback (EG)</b> 1.3 16V (EG3)/1.5 i 16V/1.5 i 16V (EG4)/1.6 16V Vtec (EG5)/1.6 VTI 16V (EG6)	
Height/Altezza [mm]	103	<b>HONDA CIVIC I (SL)</b> 1300 L/1300 S	
Width/Larghezza [mm]	85,5	<b>HONDA CIVIC I Hatchback (SB, SS)</b> 1200 (SB1)/1200 (SB2)/1300 L (SS)	
Inner Diam./Diam. Interno [mm]	12	<b>HONDA CIVIC I Wagon (WC)</b> 1300	
<b>RU-406</b>	<b>Engine Mounting</b>	<b>HONDA CIVIC II</b> 1.2/1.3/1.5 GL/1.5 GT/1.5 GTI	
	<b>Supporto motore</b>	<b>HONDA CIVIC II Hatchback (AL, AJ, AG, AH)</b> 1.2 (AL)/1.3 (AG)/1.5 GL (AH)/1.5 GT (AH)/1.5 GTI (AH)	
HONDA	50805-SR3-951	<b>HONDA CIVIC III Hatchback (EC, ED, EE)</b> 1.3 (EC8)/1.3 16 V (EC8) Cat./1.4 L (EC9)/1.5 i 16V/1.5 i 16V (ED6)/1.6 i 16V/1.6 i 16V (ED7)/1.6 i 16V Vtec (EE9)	
Length/Lunghezza [mm]	124	<b>HONDA CIVIC III Tre volumi (ED)</b> 1.3/1.3 16V (D13B1)/1.4 L (ED2)/1.5 i 16V/1.5 i 16V (ED3)/1.6 i 16V/1.6 i 16V (ED4)/1.6 i 16V 4x4	
Height/Altezza [mm]	128	<b>HONDA CIVIC IV (EG, EH)</b> 1.5 i 16V (EG8)/1.6 16V Vtec (EH9)/1.6 VTI (EG9)	
Width/Larghezza [mm]	118	<b>HONDA CIVIC IV Coupe (EJ)</b> 1.5 i LSi (EJ2)/1.6 i (EJ6)/1.6 i Vtec/1.6 i Vtec (EJ1)	
Inner Diam./Diam. Interno [mm]	12	<b>HONDA CIVIC IV Fastback (MA, MB)</b> 1.4 i (MA8)/1.5 i Vtec-E (MA9)/1.6 i (MB1)/1.6 i Vtec (MB1)	
		<b>HONDA CIVIC IV Hatchback (EG)</b> 1.3 16V (EG3)/1.5 i 16V/1.5 i 16V (EG4)/1.6 16V Vtec (EG5)/1.6 VTI 16V (EG6)	
		<b>HONDA CIVIC Shuttle I (AN, AR)</b> 1.5 (AN)/1.5 4WD (AR)	
		<b>HONDA CIVIC Shuttle II (EE)</b> 1.4 i 16V (EE1)/1.5 i 16V (EE2)/1.6 16V 4WD D16Z2/1.6 i 16V 4WD (EE4)	
		<b>HONDA CIVIC V (EJ9, EK3/4)</b> 1.4 i (EJ9)/1.5 i (EK3)/1.6 i Vtec/1.6 VTI (EK4)	
		<b>HONDA CIVIC V Coupe (EJ6, EJ8)</b> 1.6 i/1.6 i Vtec	
		<b>HONDA CIVIC V Fastback (MB)</b> 1.4 16V (MB2)/1.5 16V (MB3)/1.6 16V (MB4)/1.6 VTI/1.8 16V (MB6)/2.0 i TD (MB7)	
		<b>HONDA CIVIC VI Aerodeck (MB,MC)</b> 1.4 16V (MB8)/1.5 16V (MB9)/1.6 16V (MC1)/1.8 16V (MC2)/2.0 i D (MC3)	
		<b>HONDA CIVIC VI Hatchback (EJ,EK)</b> 1.4 i (EJ9)/1.4 i S (EJ9)/1.5 i (EK3)/1.6 i (EK1)/1.6 VTI (EK4)	
<b>RU-407</b>	<b>Engine Mounting</b>	<b>HONDA CIVIC IV (EG, EH)</b> 1.5 i 16V (EG8)/1.6 16V Vtec (EH9)/1.6 VTI (EG9)	
	<b>Supporto motore</b>	<b>HONDA CIVIC IV Coupe (EJ)</b> 1.5 i LSi (EJ2)/1.6 i (EJ6)/1.6 i Vtec/1.6 i Vtec (EJ1)	
HONDA	50820-SR3-J11	<b>HONDA CIVIC IV Fastback (MA, MB)</b> 1.4 i (MA8)/1.5 i Vtec-E (MA9)/1.6 i (MB1)/1.6 i Vtec (MB1)	
Length/Lunghezza [mm]	132	<b>HONDA CIVIC IV Hatchback (EG)</b> 1.3 16V (EG3)/1.5 i 16V/1.5 i 16V (EG4)/1.6 16V Vtec (EG5)/1.6 VTI 16V (EG6)	
Height/Altezza [mm]	115		
Width/Larghezza [mm]	93		
Inner Diam./Diam. Interno [mm]	12		

<b>RU-409</b>	<b>Holder, control arm mounting</b>	<b>HONDA CIVIC I (SL)</b>		
	<b>Silentblock</b>	1300 L/1300 S		
<b>HONDA</b>	<b>51392-SR3-004</b>	<b>HONDA CIVIC I Hatchback (SB, SS)</b>		
<b>Length/Lunghezza [mm]</b>	<b>50</b>	1200 (SB1)/1200 (SB2)/1300 L (SS)		
<b>Inner Diam./Diam. Interno [mm]</b>	<b>12</b>	<b>HONDA CIVIC I Wagon (WC)</b>		
<b>Outer Diam./Diam. esterno [mm]</b>	<b>37</b>	1300		
		<b>HONDA CIVIC II</b>		
		1.2/1.3/1.5 GL/1.5 GT/1.5 GTI		
		<b>HONDA CIVIC II Hatchback (AL, AJ, AG, AH)</b>		
		1.2 (AL)/1.3 (AG)/1.5 GL (AH)/1.5 GT (AH)/1.5 GTI (AH)		
		<b>HONDA CIVIC III Hatchback (EC, ED, EE)</b>		
		1.3 (EC8)/1.3 16 V (EC8) Cat./1.4 L (EC9)/1.5 i 16V/1.5 i 16V (ED6)/1.6 i 16V/1.6 i 16V (ED7)/1.6 i 16V Vtec (EE9)		
		<b>HONDA CIVIC III Tre volumi (ED)</b>		
		1.3/1.3 16V (D13B1)/1.4 L (ED2)/1.5 i 16V/1.5 i 16V (ED3)/1.6 i 16V/1.6 i 16V (ED4)/1.6 i 16V 4x4		
		<b>HONDA CIVIC Shuttle II (EE)</b>		
		1.5 i 16V (EE2)/1.6 i 16V 4WD (EE4)		
<b>RU-410</b>	<b>Holder, control arm mounting</b>	<b>HONDA CIVIC I (SL)</b>		
	<b>Silentblock</b>	1300 L/1300 S		
<b>HONDA</b>	<b>51395-SR3-N02</b>	<b>HONDA CIVIC I Hatchback (SB, SS)</b>		
<b>Length/Lunghezza [mm]</b>	<b>155</b>	1200 (SB1)/1200 (SB2)/1300 L (SS)		
<b>Height/Altezza [mm]</b>	<b>73</b>	<b>HONDA CIVIC I Wagon (WC)</b>		
<b>Width/Larghezza [mm]</b>	<b>86,5</b>	1300		
<b>Inner Diam./Diam. Interno [mm]</b>	<b>18</b>	<b>HONDA CIVIC II</b>		
		1.2/1.3/1.5 GL/1.5 GT/1.5 GTI		
		<b>HONDA CIVIC II Hatchback (AL, AJ, AG, AH)</b>		
		1.2 (AL)/1.3 (AG)/1.5 GL (AH)/1.5 GT (AH)/1.5 GTI (AH)		
		<b>HONDA CIVIC III Hatchback (EC, ED, EE)</b>		
		1.3 (EC8)/1.3 16 V (EC8) Cat./1.4 L (EC9)/1.5 i 16V/1.5 i 16V (ED6)/1.6 i 16V/1.6 i 16V (ED7)/1.6 i 16V Vtec (EE9)		
		<b>HONDA CIVIC III Tre volumi (ED)</b>		
		1.3/1.3 16V (D13B1)/1.4 L (ED2)/1.5 i 16V/1.5 i 16V (ED3)/1.6 i 16V/1.6 i 16V (ED4)/1.6 i 16V 4x4		
		<b>HONDA CIVIC IV (EG, EH)</b>		
		1.5 i 16V (EG8)/1.6 16V Vtec (EH9)/1.6 VTI (EG9)		
		<b>HONDA CIVIC IV Coupe (EJ)</b>		
		1.5 i LSi (EJ2)/1.6 i (EJ6)/1.6 i Vtec/1.6 i Vtec (EJ1)		
		<b>HONDA CIVIC IV Fastback (MA, MB)</b>		
		1.4 i (MA8)/1.5 i Vtec-E (MA9)/1.6 i (MB1)/1.6 i Vtec (MB1)		
		<b>HONDA CIVIC IV Hatchback (EG)</b>		
		1.3 16V (EG3)/1.5 i 16V/1.5 i 16V (EG4)/1.6 16V Vtec (EG5)/1.6 VTI 16V (EG6)		
		<b>HONDA CIVIC Shuttle I (AN, AR)</b>		
		1.5 (AN)/1.5 4WD (AR)		
		<b>HONDA CIVIC Shuttle II (EE)</b>		
		1.4 i 16V (EE1)/1.5 i 16V (EE2)/1.6 16V 4WD D1622/1.6 i 16V 4WD (EE4)		
		<b>HONDA CIVIC V (EJ9, EK3/4)</b>		
		1.4 i (EJ9)/1.5 i (EK3)/1.6 i Vtec/1.6 VTI (EK4)		
		<b>HONDA CIVIC V Coupe (EJ6, EJ8)</b>		
		1.6 i/1.6 i Vtec		
		<b>HONDA CIVIC V Fastback (MB)</b>		
		1.4 16V (MB2)/1.5 16V (MB3)/1.6 16V (MB4)/1.6 VTI/1.8 16V (MB6)/2.0 i TD (MB7)		
		<b>HONDA CIVIC VI Aerodeck (MB,MC)</b>		
		1.4 16V (MB8)/1.5 16V (MB9)/1.6 16V (MC1)/1.8 16V (MC2)/2.0 i D (MC3)		
		<b>HONDA CIVIC VI Hatchback (EJ,EK)</b>		
		1.4 i (EJ9)/1.4 i S (EJ9)/1.5 i (EK3)/1.6 i (EK1)/1.6 VTI (EK4)		
		<b>HONDA CRX III (EH, EG)</b>		
		1.6 ESI (EH6)/1.6 i VTI (EG2)		

<b>RU-411</b>	<b>Holder, control arm mounting</b>	<b>HONDA CIVIC I (SL)</b>	
	<b>Silentblock</b>	1300 L/1300 S	
HONDA	51396-SR3-N02	<b>HONDA CIVIC I Hatchback (SB, SS)</b>	
Height/Altezza [mm]	58	1200 (SB1)/1200 (SB2)/1300 L (SS)	
Width/Larghezza [mm]	73	<b>HONDA CIVIC I Wagon (WC)</b>	
Inner Diam./Diam. Interno [mm]	18,5	1300	
Overall Length/Lungh. Tot. [mm]	161	<b>HONDA CIVIC II</b>	
		1.2/1.3/1.5 GL/1.5 GT/1.5 GTI	
		<b>HONDA CIVIC II Hatchback (AL, AJ, AG, AH)</b>	
		1.2 (AL)/1.3 (AG)/1.5 GL (AH)/1.5 GT (AH)/1.5 GTI (AH)	
		<b>HONDA CIVIC III Hatchback (EC, ED, EE)</b>	
		1.3 (EC8)/1.3 16 V (EC8) Cat./1.4 L (EC9)/1.5 i 16V/1.5 i 16V (ED6)/1.6 i 16V/1.6 i 16V (ED7)/1.6 i 16V Vtec (EE9)	
		<b>HONDA CIVIC III Tre volumi (ED)</b>	
		1.3/1.3 16V (D13B1)/1.4 L (ED2)/1.5 i 16V/1.5 i 16V (ED3)/1.6 i 16V/1.6 i 16V (ED4)/1.6 i 16V 4x4	
		<b>HONDA CIVIC IV (EG, EH)</b>	
		1.5 i 16V (EG8)/1.6 16V Vtec (EH9)/1.6 VTI (EG9)	
		<b>HONDA CIVIC IV Coupe (EJ)</b>	
		1.5 i LSi (EJ2)/1.6 i (EJ6)/1.6 i Vtec/1.6 i Vtec (EJ1)	
		<b>HONDA CIVIC IV Fastback (MA, MB)</b>	
		1.4 i (MA8)/1.5 i Vtec-E (MA9)/1.6 i (MB1)/1.6 i Vtec (MB1)	
		<b>HONDA CIVIC IV Hatchback (EG)</b>	
		1.3 16V (EG3)/1.5 i 16V/1.5 i 16V (EG4)/1.6 16V Vtec (EG5)/1.6 VTI 16V (EG6)	
		<b>HONDA CIVIC Shuttle I (AN, AR)</b>	
		1.5 (AN)/1.5 4WD (AR)	
		<b>HONDA CIVIC Shuttle II (EE)</b>	
		1.4 i 16V (EE1)/1.5 i 16V (EE2)/1.6 16V 4WD D16Z2/1.6 i 16V 4WD (EE4)	
		<b>HONDA CIVIC V (EJ9, EK3/4)</b>	
		1.4 i (EJ9)/1.5 i (EK3)/1.6 i Vtec/1.6 VTI (EK4)	
		<b>HONDA CIVIC V Coupe (EJ6, EJ8)</b>	
		1.6 i/1.6 i Vtec	
		<b>HONDA CIVIC V Fastback (MB)</b>	
		1.4 16V (MB2)/1.5 16V (MB3)/1.6 16V (MB4)/1.6 VTI/1.8 16V (MB6)/2.0 i TD (MB7)	
		<b>HONDA CIVIC VI Aerodeck (MB,MC)</b>	
		1.4 16V (MB8)/1.5 16V (MB9)/1.6 16V (MC1)/1.8 16V (MC2)/2.0 i D (MC3)	
		<b>HONDA CIVIC VI Hatchback (EJ,EK)</b>	
		1.4 i (EJ9)/1.4 i S (EJ9)/1.5 i (EK3)/1.6 i (EK1)/1.6 VTI (EK4)	
		<b>HONDA CRX III (EH, EG)</b>	
		1.6 ESi (EH6)/1.6 i VTI (EG2)	
<b>RU-413</b>	<b>Holder, control arm mounting</b>	<b>HONDA ACCORD IV (CB3, CB7)</b>	
	<b>Silentblock</b>	1.8/2.0 16V (CB3)/2.0 i 16V (CB3)/2.2 i 16V (CB7)/2.2 i 16V Automatic (CB7)	
HONDA	52365-SM4-005	<b>HONDA ACCORD IV Aerodeck (CB8, CC)</b>	
Inner Diam./Diam. Interno [mm]	12	2.0 i 16V (CC9)/2.2 i 16V (CB8)	
Overall Length/Lungh. Tot. [mm]	40	<b>HONDA ACCORD IV Coupe (CC1)</b>	
Outer Diam./Diam. esterno [mm]	36	2.0 i 16V	
		<b>HONDA ACCORD V (CC7)</b>	
		2.0 i/2.0 i S/2.3 i SR	
		<b>HONDA ACCORD V Aerodeck (CE)</b>	
		2.0 i LS 16V (CE2)/2.2 i ES (CE1)	
		<b>HONDA ACCORD V Coupe (CD7, CD9)</b>	
		2.0 (DC9)/2.2 i ES	
		<b>MERCEDES-BENZ Tre volumi (W123)</b>	
		240 D (123.123)	
		<b>ROVER 600 (RH)</b>	
		618 i/Si/620 i/620 Sdi/620 Si/620 Ti Vitesse/623 Si	

<b>RU-414</b>	<b>Holder, control arm mounting</b>	<b>HONDA ACCORD IV (CB3, CB7)</b> 1.8/2.0 16V (CB3)/2.0 i 16V (CB3)/2.2 i 16V (CB7)/2.2 i 16V Automatik (CB7)	
	<b>Silentblock</b>	<b>HONDA ACCORD IV Aerodeck (CB8, CC)</b> 2.0 i 16V (CC9)/2.2 i 16V (CB8)	
HONDA	51810-SM4-003	<b>HONDA ACCORD IV Coupe (CC1)</b> 2.0 i 16V	
Inner Diam./Diam. Interno [mm]	12,4	<b>HONDA ACCORD V (CC7)</b> 2.0 i/2.0 i S/2.3 i SR	
Overall Length/Lungh. Tot. [mm]	53	<b>HONDA ACCORD V Aerodeck (CE)</b> 2.0 i LS 16V (CE2)/2.2 i ES (CE1)	
Outer Diam./Diam. esterno [mm]	42,5	<b>HONDA ACCORD V Coupe (CD7, CD9)</b> 2.0 (DC9)/2.2 i ES	
		<b>HONDA ACCORD VII (CG)</b> 1.6 i/1.6 LS/1.8 i/2.0 i/2.0 Turbo DI/2.2 Type-R/2.3/2.4 Vtec E/3.0 Vtec	
		<b>HONDA ACCORD VII Aerodeck</b> 2.3 16 V	
		<b>HONDA ACCORD VII Coupe (CG)</b> 2.0 i 16V/3.0 V6 24V	
		<b>HONDA ACCORD VII Hatchback (CH)</b> 1.8 i (CH6)/2.0 (CH7)/2.0 TDi/2.3 (CL4)	
		<b>MERCEDES-BENZ Tre volumi (W123)</b> 240 D (123.123)	
		<b>ROVER 600 (RH)</b> 618 i/Si/620 i/620 Sdi/620 Si/620 Ti Vitesse/623 Si	
<b>RU-415</b>	<b>Holder, control arm mounting</b>	<b>HONDA ACCORD IV (CB3, CB7)</b> 1.8/2.0 16V (CB3)/2.0 i 16V (CB3)/2.2 i 16V (CB7)/2.2 i 16V Automatik (CB7)	
	<b>Silentblock</b>	<b>HONDA ACCORD IV Aerodeck (CB8, CC)</b> 2.0 i 16V (CC9)/2.2 i 16V (CB8)	
HONDA	51393-SM4-013	<b>HONDA ACCORD IV Coupe (CC1)</b> 2.0 i 16V	
Inner Diam./Diam. Interno [mm]	12,6	<b>MERCEDES-BENZ Tre volumi (W123)</b> 240 D (123.123)	
Overall Length/Lungh. Tot. [mm]	53	<b>ROVER 600 (RH)</b> 618 i/Si/620 i/620 Sdi/620 Si/620 Ti Vitesse/623 Si	
Outer Diam./Diam. esterno [mm]	35,3	<b>HONDA ACCORD IV (CB3, CB7)</b> 1.8/2.0 16V (CB3)/2.0 i 16V (CB3)/2.2 i 16V (CB7)/2.2 i 16V Automatik (CB7)	
		<b>HONDA ACCORD IV Aerodeck (CB8, CC)</b> 2.0 i 16V (CC9)/2.2 i 16V (CB8)	
		<b>HONDA ACCORD IV Coupe (CC1)</b> 2.0 i 16V	
		<b>HONDA ACCORD V (CC7)</b> 2.0 i/2.0 i S/2.3 i SR	
		<b>HONDA ACCORD V Aerodeck (CE)</b> 2.0 i LS 16V (CE2)/2.2 i ES (CE1)	
		<b>HONDA ACCORD V Coupe (CD7, CD9)</b> 2.0 (DC9)/2.2 i ES	
		<b>HONDA CIVIC III Hatchback (EC, ED, EE)</b> 1.3 (EC8)/1.3 16 V (EC8) Cat./1.4 L (EC9)/1.5/1.5 i 16V/1.5 i 16V (ED6)/1.6 i 16V/1.6 i 16V (ED7)/1.6 i 16V Vtec (EE9)	
		<b>HONDA CIVIC III Tre volumi (ED)</b> 1.3/1.3 16V (D13B1)/1.4 L (ED2)/1.5/1.5 i 16V/1.5 i 16V (ED3)/1.6 i 16V/1.6 i 16V (ED4)/1.6 i 16V 4x4	
		<b>HONDA CRX II (ED, EE)</b> 1.4 GL/1.6 i 16V/1.6 i 16V (ED9)/1.6 i 16V Vtec (EE8)	
		<b>MERCEDES-BENZ Tre volumi (W123)</b> 240 D (123.123)	
		<b>ROVER 600 (RH)</b> 618 i/Si/620 i/620 Sdi/620 Si/620 Ti Vitesse/623 Si	
<b>RU-416</b>	<b>Holder, control arm mounting</b>	<b>HONDA ACCORD IV (CB3, CB7)</b> 1.8/2.0 16V (CB3)/2.0 i 16V (CB3)/2.2 i 16V (CB7)/2.2 i 16V Automatik (CB7)	
	<b>Silentblock</b>	<b>HONDA ACCORD IV Aerodeck (CB8, CC)</b> 2.0 i 16V (CC9)/2.2 i 16V (CB8)	
HONDA	52335STRG01	<b>HONDA ACCORD IV Coupe (CC1)</b> 2.0 i 16V	
Length/Lunghezza [mm]	160	<b>HONDA ACCORD V (CC7)</b> 2.0 i/2.0 i S/2.3 i SR	
Width/Larghezza [mm]	40	<b>HONDA ACCORD V Aerodeck (CE)</b> 2.0 i LS 16V (CE2)/2.2 i ES (CE1)	
Diameter/Diametro [mm]	80	<b>HONDA ACCORD V Coupe (CD7, CD9)</b> 2.0 (DC9)/2.2 i ES	
		<b>HONDA CIVIC III Hatchback (EC, ED, EE)</b> 1.3 (EC8)/1.3 16 V (EC8) Cat./1.4 L (EC9)/1.5/1.5 i 16V/1.5 i 16V (ED6)/1.6 i 16V/1.6 i 16V (ED7)/1.6 i 16V Vtec (EE9)	
		<b>HONDA CIVIC III Tre volumi (ED)</b> 1.3/1.3 16V (D13B1)/1.4 L (ED2)/1.5/1.5 i 16V/1.5 i 16V (ED3)/1.6 i 16V/1.6 i 16V (ED4)/1.6 i 16V 4x4	
		<b>HONDA CRX II (ED, EE)</b> 1.4 GL/1.6 i 16V/1.6 i 16V (ED9)/1.6 i 16V Vtec (EE8)	
		<b>MERCEDES-BENZ Tre volumi (W123)</b> 240 D (123.123)	
		<b>ROVER 600 (RH)</b> 618 i/Si/620 i/620 Sdi/620 Si/620 Ti Vitesse/623 Si	

<b>RU-417</b>	<b>Holder, control arm mounting</b>	<b>HONDA ACCORD V (CC7)</b> 2.0 i/2.0 i S/2.3 i SR	
	<b>Silentblock</b>	<b>HONDA ACCORD V Aerodeck (CE)</b> 2.0 i LS 16V (CE2)/2.2 i ES (CE1)	
HONDA	51355S1AE00	<b>HONDA ACCORD V Coupe (CD7, CD9)</b> 2.0 (DC9)/2.2 i ES	
Length/Lunghezza [mm]	56	<b>HONDA ACCORD VII (CG)</b> 1.6 i/1.6 LS/1.8 i/2.0 i/2.0 Turbo Di/2.2 Type-R/2.3/2.4 Vtec E/3.0 Vtec	
Inner Diam./Diam. Interno [mm]	12	<b>HONDA ACCORD VII Aerodeck</b> 2.3 16 V	
Outer Diam./Diam. esterno [mm]	35	<b>HONDA ACCORD VII Coupe (CG)</b> 2.0 i 16V/3.0 V6 24V	
		<b>HONDA ACCORD VII Hatchback (CH)</b> 1.8 i (CH6)/2.0 (CH7)/2.0 TDi/2.3 (CL4)	
		<b>HONDA ACCORD VII (CG)</b> 1.6 i/1.6 LS/1.8 i/2.0 i/2.0 Turbo Di/2.2 Type-R/2.3/2.4 Vtec E/3.0 Vtec	
		<b>HONDA ACCORD VII Aerodeck</b> 2.3 16 V	
		<b>HONDA ACCORD VII Coupe (CG)</b> 2.0 i 16V/3.0 V6 24V	
<b>RU-418</b>	<b>Holder, control arm mounting</b>	<b>HONDA ACCORD VII (CG)</b> 1.6 i/1.6 LS/1.8 i/2.0 i/2.0 Turbo Di/2.2 Type-R/2.3/2.4 Vtec E/3.0 Vtec	
	<b>Silentblock</b>	<b>HONDA ACCORD VII Aerodeck</b> 2.3 16 V	
HONDA	51450S1AE01	<b>HONDA ACCORD VII Coupe (CG)</b> 2.0 i 16V/3.0 V6 24V	
Length/Lunghezza [mm]	48	<b>HONDA ACCORD VII Hatchback (CH)</b> 1.8 i (CH6)/2.0 (CH7)/2.0 TDi/2.3 (CL4)	
Inner Diam./Diam. Interno [mm]	10	<b>HONDA ACCORD IX</b> 2.0/2.2 i-DTEC/2.4	
Outer Diam./Diam. esterno [mm]	38,5	<b>HONDA ACCORD SW</b> 2.0/2.2 i-DTEC/2.4	
		<b>HONDA ACCORD VIII</b> 2.0 (CL7)/2.0 4 ruote motrici (CL8)/2.2 i-CTDi/2.4/2.4 (CL9)/3.0	
		<b>HONDA ACCORD VIII Tourer</b> 2.0 (CM1)/2.2 i-CTDi/2.4 (CM2)/2.4 Vtec E/2.4 Vtec T	
		<b>HONDA ACCORD VIII</b> 2.0 (CL7)/2.0 4 ruote motrici (CL8)/2.2 i-CTDi/2.4/2.4 (CL9)/3.0	
		<b>HONDA ACCORD VIII Tourer</b> 2.0 (CM1)/2.2 i-CTDi/2.4 (CM2)/2.4 Vtec E/2.4 Vtec T	
<b>RU-419</b>	<b>Holder, control arm mounting</b>	<b>HONDA ACCORD IX</b> 2.0/2.2 i-DTEC/2.4	
	<b>Silentblock</b>	<b>HONDA ACCORD SW</b> 2.0/2.2 i-DTEC/2.4	
HONDA	51810-SDA-A01	<b>HONDA ACCORD VIII</b> 2.0 (CL7)/2.0 4 ruote motrici (CL8)/2.2 i-CTDi/2.4/2.4 (CL9)/3.0	
Inner Diam./Diam. Interno [mm]	12,6	<b>HONDA ACCORD VIII Tourer</b> 2.0 (CM1)/2.2 i-CTDi/2.4 (CM2)/2.4 Vtec E/2.4 Vtec T	
Overall Length/Lungh. Tot. [mm]	52,5		
Outer Diam./Diam. esterno [mm]	42,5		
		<b>HONDA ACCORD VIII</b> 2.0 (CL7)/2.0 4 ruote motrici (CL8)/2.2 i-CTDi/2.4/2.4 (CL9)/3.0	
		<b>HONDA ACCORD VIII Tourer</b> 2.0 (CM1)/2.2 i-CTDi/2.4 (CM2)/2.4 Vtec E/2.4 Vtec T	
		<b>HONDA ACCORD VIII</b> 2.0 (CL7)/2.0 4 ruote motrici (CL8)/2.2 i-CTDi/2.4/2.4 (CL9)/3.0	
		<b>HONDA ACCORD VIII Tourer</b> 2.0 (CM1)/2.2 i-CTDi/2.4 (CM2)/2.4 Vtec E/2.4 Vtec T	
<b>RU-420</b>	<b>Holder, control arm mounting</b>	<b>HONDA ACCORD VIII</b> 2.0 (CL7)/2.0 4 ruote motrici (CL8)/2.2 i-CTDi/2.4/2.4 (CL9)/3.0	
	<b>Silentblock</b>	<b>HONDA ACCORD VIII Tourer</b> 2.0 (CM1)/2.2 i-CTDi/2.4 (CM2)/2.4 Vtec E/2.4 Vtec T	
HONDA	51391-SEA-004		
Inner Diam./Diam. Interno [mm]	14,4		
Overall Length/Lungh. Tot. [mm]	60,5		
Outer Diam./Diam. esterno [mm]	74,5		
		<b>HONDA ACCORD VIII</b> 2.0 (CL7)/2.0 4 ruote motrici (CL8)/2.2 i-CTDi/2.4/2.4 (CL9)/3.0	
		<b>HONDA ACCORD VIII Tourer</b> 2.0 (CM1)/2.2 i-CTDi/2.4 (CM2)/2.4 Vtec E/2.4 Vtec T	
		<b>HONDA ACCORD VIII</b> 2.0 (CL7)/2.0 4 ruote motrici (CL8)/2.2 i-CTDi/2.4/2.4 (CL9)/3.0	
		<b>HONDA ACCORD VIII Tourer</b> 2.0 (CM1)/2.2 i-CTDi/2.4 (CM2)/2.4 Vtec E/2.4 Vtec T	
<b>RU-421</b>	<b>Holder, control arm mounting</b>	<b>HONDA ACCORD VIII</b> 2.0 (CL7)/2.0 4 ruote motrici (CL8)/2.2 i-CTDi/2.4/2.4 (CL9)/3.0	
	<b>Silentblock</b>	<b>HONDA ACCORD VIII Tourer</b> 2.0 (CM1)/2.2 i-CTDi/2.4 (CM2)/2.4 Vtec E/2.4 Vtec T	
HONDA	51393-SEA-004		
Inner Diam./Diam. Interno [mm]	12,5		
Overall Length/Lungh. Tot. [mm]	56,6		
Outer Diam./Diam. esterno [mm]	38,4		
		<b>HONDA ACCORD VIII</b> 2.0 (CL7)/2.0 4 ruote motrici (CL8)/2.2 i-CTDi/2.4/2.4 (CL9)/3.0	
		<b>HONDA ACCORD VIII Tourer</b> 2.0 (CM1)/2.2 i-CTDi/2.4 (CM2)/2.4 Vtec E/2.4 Vtec T	
		<b>HONDA ACCORD VIII</b> 2.0 (CL7)/2.0 4 ruote motrici (CL8)/2.2 i-CTDi/2.4/2.4 (CL9)/3.0	
		<b>HONDA ACCORD VIII Tourer</b> 2.0 (CM1)/2.2 i-CTDi/2.4 (CM2)/2.4 Vtec E/2.4 Vtec T	
<b>RU-422</b>	<b>Holder, control arm mounting</b>	<b>HONDA CIVIC IV (EG, EH)</b> 1.5/1.5 i 16V (EG8)/1.6 16V Vtec (EH9)/1.6 EX/1.6 VTI (EG9)	
	<b>Silentblock</b>	<b>HONDA CIVIC IV Coupe (EJ)</b> 1.5 i LSi (EJ2)/1.6 i (EJ6)/1.6 i Vtec/1.6 i Vtec (EJ1)	
HONDA	51455SR3003	<b>HONDA CIVIC IV Fastback (MA, MB)</b> 1.4 i (MA8)/1.5 i Vtec-E (MA9)/1.6 i (MB1)/1.6 i Vtec (MB1)	
Length/Lunghezza [mm]	40	<b>HONDA CIVIC IV Hatchback (EG)</b> 1.3 16V (EG3)/1.5 i 16V/1.5 i 16V (EG4)/1.6 16V Vtec (EG5)/1.6 VTI 16V (EG6)	
Inner Diam./Diam. Interno [mm]	10	<b>HONDA CRX III (EH, EG)</b> 1.6 ESi (EH6)/1.6 i VTI (EG2)	
Outer Diam./Diam. esterno [mm]	34		
		<b>HONDA CIVIC IV (EG, EH)</b> 1.5/1.5 i 16V (EG8)/1.6 16V Vtec (EH9)/1.6 EX/1.6 VTI (EG9)	
		<b>HONDA CIVIC IV Coupe (EJ)</b> 1.5 i LSi (EJ2)/1.6 i (EJ6)/1.6 i Vtec/1.6 i Vtec (EJ1)	
		<b>HONDA CIVIC IV Fastback (MA, MB)</b> 1.4 i (MA8)/1.5 i Vtec-E (MA9)/1.6 i (MB1)/1.6 i Vtec (MB1)	
		<b>HONDA CIVIC IV Hatchback (EG)</b> 1.3 16V (EG3)/1.5 i 16V/1.5 i 16V (EG4)/1.6 16V Vtec (EG5)/1.6 VTI 16V (EG6)	
		<b>HONDA CRX III (EH, EG)</b> 1.6 ESi (EH6)/1.6 i VTI (EG2)	

<b>RU-423</b>	<b>Holder, control arm mounting</b>
	<b>Silentblock</b>
HONDA	51810 SH3 004
Inner Diam./Diam. Interno [mm]	12,3
Overall Length/Lungh. Tot. [mm]	51
Outer Diam./Diam. esterno [mm]	40,5

**HONDA CIVIC III Hatchback (EC, ED, EE)**  
 1.3 (EC8)/1.3 16V (EC8) Cat./1.4 L (EC9)/1.5/1.5 i 16V/1.5 i 16V (ED6)/1.6 i 16V/1.6 i 16V (ED7)/1.6 i 16V Vtec (EE9)

**HONDA CIVIC III Tre volumi (ED)**  
 1.3/1.3 16V (D13B1)/1.4 L (ED2)/1.5/1.5 i 16V/1.5 i 16V (ED3)/1.6 i 16V/1.6 i 16V (ED4)/1.6 i 16V 4x4

**HONDA CIVIC IV (EG, EH)**  
 1.5/1.5 i 16V (EG8)/1.6 16V Vtec (EH9)/1.6 EX/1.6 VTI (EG9)

**HONDA CIVIC IV Coupe (EJ)**  
 1.5 i LSi (EJ2)/1.6 i (EJ6)/1.6 i Vtec/1.6 i Vtec (EJ1)

**HONDA CIVIC IV Fastback (MA, MB)**  
 1.4 i (MA8)/1.5 i Vtec-E (MA9)/1.6 i (MB1)/1.6 i Vtec (MB1)

**HONDA CIVIC IV Hatchback (EG)**  
 1.3 16V (EG3)/1.5 i 16V/1.5 i 16V (EG4)/1.6 16V Vtec (EG5)/1.6 VTI 16V (EG6)

**HONDA CRX II (ED, EE)**  
 1.4 GL/1.6 i 16V/1.6 i 16V (ED9)/1.6 i 16V Vtec (EE8)

**HONDA CRX III (EH, EG)**  
 1.6 ESi (EH6)/1.6 i VTI (EG2)



<b>RU-424</b>	<b>Holder, control arm mounting</b>
	<b>Silentblock</b>
HONDA	51392 SR3 014
Length/Lunghezza [mm]	50
Inner Diam./Diam. Interno [mm]	12
Outer Diam./Diam. esterno [mm]	37

**HONDA CIVIC IV (EG, EH)**  
 1.5/1.5 i 16V (EG8)/1.6 16V Vtec (EH9)/1.6 EX/1.6 VTI (EG9)

**HONDA CIVIC IV Coupe (EJ)**  
 1.5 i LSi (EJ2)/1.6 i (EJ6)/1.6 i Vtec/1.6 i Vtec (EJ1)

**HONDA CIVIC IV Fastback (MA, MB)**  
 1.4 i (MA8)/1.5 i Vtec-E (MA9)/1.6 i (MB1)/1.6 i Vtec (MB1)

**HONDA CIVIC IV Hatchback (EG)**  
 1.3 16V (EG3)/1.5 i 16V/1.5 i 16V (EG4)/1.6 16V Vtec (EG5)/1.6 VTI 16V (EG6)

**HONDA CRX III (EH, EG)**  
 1.6 ESi (EH6)/1.6 i VTI (EG2)



<b>RU-425</b>	<b>Holder, control arm mounting</b>
	<b>Silentblock</b>
HONDA	51450S01023
Length/Lunghezza [mm]	47,5
Inner Diam./Diam. Interno [mm]	11
Outer Diam./Diam. esterno [mm]	34

**HONDA CIVIC V (EJ9, EK3/4)**  
 1.4/1.4 i (EJ9)/1.5 i (EK3)/1.6 i Vtec/1.6 VTI (EK4)

**HONDA CIVIC V Coupe (EJ6, EJ8)**  
 1.6 i/1.6 i Vtec

**HONDA CIVIC V Fastback (MB)**  
 1.4 16V (MB2)/1.5 16V (MB3)/1.6/1.6 16V (MB4)/1.6 VTI/1.8 16V (MB6)/2.0 i TD (MB7)

**HONDA CIVIC VI Aerodeck (MB,MC)**  
 1.4 16V (MB8)/1.5 16V (MB9)/1.6 16V (MC1)/1.8 16V (MC2)/2.0 i D (MC3)

**HONDA CIVIC VI Hatchback (EJ,EK)**  
 1.4 i (EJ9)/1.4 i S (EJ9)/1.5 i (EK3)/1.6/1.6 i (EK1)/1.6 VTI (EK4)

**HONDA CR-V I (RD)**  
 2.0 16V (RD1, RD3)



<b>RU-426</b>	<b>Holder, control arm mounting</b>
	<b>Silentblock</b>
HONDA	51350S04000
Inner Diam./Diam. Interno [mm]	14,5
Overall Length/Lungh. Tot. [mm]	50
Outer Diam./Diam. esterno [mm]	38

**HONDA CIVIC V (EJ9, EK3/4)**  
 1.4/1.4 i (EJ9)/1.5 i (EK3)/1.6 i Vtec/1.6 VTI (EK4)

**HONDA CIVIC V Coupe (EJ6, EJ8)**  
 1.6 i/1.6 i Vtec

**HONDA CIVIC V Fastback (MB)**  
 1.4 16V (MB2)/1.5 16V (MB3)/1.6/1.6 16V (MB4)/1.6 VTI/1.8 16V (MB6)/2.0 i TD (MB7)

**HONDA CIVIC VI Aerodeck (MB,MC)**  
 1.4 16V (MB8)/1.5 16V (MB9)/1.6 16V (MC1)/1.8 16V (MC2)/2.0 i D (MC3)

**HONDA CIVIC VI Hatchback (EJ,EK)**  
 1.4 i (EJ9)/1.4 i S (EJ9)/1.5 i (EK3)/1.6/1.6 i (EK1)/1.6 VTI (EK4)



<b>RU-427</b>	<b>Holder, control arm mounting</b>
	<b>Silentblock</b>
HONDA	51391-S04-005
Inner Diam./Diam. Interno [mm]	18
Overall Length/Lungh. Tot. [mm]	61
Outer Diam./Diam. esterno [mm]	60

**HONDA CIVIC V (EJ9, EK3/4)**  
 1.4/1.4 i (EJ9)/1.5 i (EK3)/1.6 i Vtec/1.6 VTI (EK4)

**HONDA CIVIC V Coupe (EJ6, EJ8)**  
 1.6 i/1.6 i Vtec

**HONDA CIVIC V Fastback (MB)**  
 1.4 16V (MB2)/1.5 16V (MB3)/1.6/1.6 16V (MB4)/1.6 VTI/1.8 16V (MB6)/2.0 i TD (MB7)

**HONDA CIVIC VI Aerodeck (MB,MC)**  
 1.4 16V (MB8)/1.5 16V (MB9)/1.6 16V (MC1)/1.8 16V (MC2)/2.0 i D (MC3)

**HONDA CIVIC VI Hatchback (EJ,EK)**







<b>RU-428</b>	<b>Holder, control arm mounting</b>	1.4 i (EJ9)/1.4 i S (EJ9)/1.5 i (EK3)/1.6/1.6 i (EK1)/1.6 VTI (EK4)	
	<b>Silentblock</b>	<b>HONDA CR-V I (RD)</b> 2.0 16V (RD1, RD3)	
HONDA	51350S04000	<b>HONDA CIVIC V (EJ9, EK3/4)</b> 1.4/1.4 i (EJ9)/1.5 i (EK3)/1.6 i Vtec/1.6 VTI (EK4)	
Length/Lunghezza [mm]	72	<b>HONDA CIVIC V Coupe (EJ6, EJ8)</b> 1.6 i/1.6 i Vtec	
Inner Diam./Diam. Interno [mm]	12,5	<b>HONDA CIVIC V Fastback (MB)</b> 1.4 16V (MB2)/1.5 16V (MB3)/1.6/1.6 16V (MB4)/1.6 VTI/1.8 16V (MB6)/2.0 i TD (MB7)	
Outer Diam./Diam. esterno [mm]	40,5	<b>HONDA CIVIC VI Aerodeck (MB,MC)</b> 1.4 16V (MB8)/1.5 16V (MB9)/1.6 16V (MC1)/1.8 16V (MC2)/2.0 i D (MC3)	
		<b>HONDA CIVIC VI Hatchback (EJ,EK)</b> 1.4 i (EJ9)/1.4 i S (EJ9)/1.5 i (EK3)/1.6/1.6 i (EK1)/1.6 VTI (EK4)	
<b>RU-429</b>	<b>Bearing Bush, stabiliser</b>	<b>HONDA CIVIC VI</b> 1.3 IMA/1.4 (ES4)/1.6/1.7	
	<b>Boccola barra stabilizzatrice</b>	<b>HONDA CIVIC VI Coupe (EM)</b> 1.6 i/1.7 i/1.7 i VTEC	
HONDA	51306-S6D-005	<b>HONDA CIVIC VI Hatchback (EU_, EP_)</b> 1.4 i/1.4 iS (EP1)/1.6 i/1.7 CTDi/2.0 i Sport/2.0 Type-R	
Fitting Position/Lato Montaggio	Front		
Height/Altezza [mm]	36		
Width/Larghezza [mm]	35,5		
Inner Diam./Diam. Interno [mm]	25		
Overall Length/Lungh. Tot. [mm]	45,7		
<b>RU-430</b>	<b>Holder, control arm mounting</b>	<b>HONDA CIVIC VI</b> 1.3 IMA/1.4 (ES4)/1.6/1.7	
	<b>Silentblock</b>	<b>HONDA CIVIC VI Coupe (EM)</b> 1.6 i/1.7 i/1.7 i VTEC	
HONDA	51391 S5A 024	<b>HONDA CIVIC VI Hatchback (EU_, EP_)</b> 1.4 i/1.4 iS (EP1)/1.6 i/1.7 CTDi/2.0 i Sport/2.0 Type-R	
Inner Diam./Diam. Interno [mm]	14,7	<b>HONDA CR-V II</b> 2.0/2.2 CTDi	
Overall Length/Lungh. Tot. [mm]	63		
Outer Diam./Diam. esterno [mm]	65,5		
<b>RU-431</b>	<b>Holder, control arm mounting</b>	<b>HONDA CIVIC VI</b> 1.3 IMA/1.4 (ES4)/1.6/1.7	
	<b>Silentblock</b>	<b>HONDA CIVIC VI Coupe (EM)</b> 1.6 i/1.7 i/1.7 i VTEC	
HONDA	51392-S5A-004	<b>HONDA CIVIC VI Hatchback (EU_, EP_)</b> 1.4 i/1.4 iS (EP1)/1.6 i/1.7 CTDi/2.0 i Sport/2.0 Type-R	
Inner Diam./Diam. Interno [mm]	14,7	<b>HONDA CR-V II</b> 2.0/2.2 CTDi	
Overall Length/Lungh. Tot. [mm]	63,3		
Outer Diam./Diam. esterno [mm]	43,3		
<b>RU-432</b>	<b>Bearing Bush, stabiliser</b>	<b>HONDA CIVIC VII</b> 1.3/1.4/1.8/2.2 CTDi	
	<b>Boccola barra stabilizzatrice</b>		
HONDA	51306 SMG E02		
Fitting Position/Lato Montaggio	Front		
Length/Lunghezza [mm]	47		
Height/Altezza [mm]	51		
Width/Larghezza [mm]	51		
Inner Diam./Diam. Interno [mm]	19		
<b>RU-433</b>	<b>Holder, control arm mounting</b>	<b>HONDA CIVIC VII</b> 1.3/1.4/1.8/2.2 CTDi	
	<b>Silentblock</b>		
HONDA	51398 SMG E01		
Inner Diam./Diam. Interno [mm]	10		
Outer Diam./Diam. esterno [mm]	59		

<b>RU-434</b>	<b>Holder, control arm mounting</b>	<b>HONDA CIVIC VII</b> 1.3/1.4/1.8/2.2 CTDi	
	<b>Silentblock</b>		
HONDA	51396 SMG E03		
	Inner Diam./Diam. Interno [mm]	29	
	Overall Length/Lungh. Tot. [mm]	215	
<b>RU-435</b>	<b>Holder, control arm mounting</b>	<b>HONDA CIVIC VII</b> 1.3/1.4/1.8/2.2 CTDi	
	<b>Silentblock</b>		
HONDA	51395 SMG E03		
	Inner Diam./Diam. Interno [mm]	29	
	Overall Length/Lungh. Tot. [mm]	215	
<b>RU-436</b>	<b>Holder, control arm mounting</b>	<b>HONDA CR-V I (RD)</b> 2.0 16V (RD1, RD3)	
	<b>Silentblock</b>		
HONDA	51350S10G00		
	Length/Lunghezza [mm]	72	
	Inner Diam./Diam. Interno [mm]	12	
	Outer Diam./Diam. esterno [mm]	40,5	
<b>RU-437</b>	<b>Holder, control arm mounting</b>	<b>HONDA CR-V I (RD)</b> 2.0 16V (RD1, RD3)	
	<b>Silentblock</b>		
HONDA	51350S10G00		
	Inner Diam./Diam. Interno [mm]	14,5	
	Overall Length/Lungh. Tot. [mm]	50	
	Outer Diam./Diam. esterno [mm]	38	
<b>RU-438</b>	<b>Holder, control arm mounting</b>	<b>HONDA CIVIC III Hatchback (EC, ED, EE)</b> 1.3 (EC8)/1.3 16 V (EC8) Cat./1.4 L (EC9)/1.5/1.5 i 16V/1.5 i 16V (ED6)/1.6 i 16V/1.6 i 16V (ED7)/1.6 i 16V Vtec (EE9)	
	<b>Silentblock</b>		
HONDA	51450SH3023		
	Length/Lunghezza [mm]	39	
	Inner Diam./Diam. Interno [mm]	10	
	Outer Diam./Diam. esterno [mm]	29	
<b>RU-439</b>	<b>Holder, control arm mounting</b>	<b>HONDA CIVIC III Hatchback (EC, ED, EE)</b> 1.3 (EC8)/1.3 16 V (EC8) Cat./1.4 L (EC9)/1.5/1.5 i 16V/1.5 i 16V (ED6)/1.6 i 16V/1.6 i 16V (ED7)/1.6 i 16V Vtec (EE9)	
	<b>Silentblock</b>		
HONDA	51393SH3003		
	Length/Lunghezza [mm]	52	
	Inner Diam./Diam. Interno [mm]	10	
	Outer Diam./Diam. esterno [mm]	32	
<b>RU-440</b>	<b>Holder, control arm mounting</b>	<b>HONDA JAZZ (GD)</b> 1.2/1.4	
	<b>Silentblock</b>		
HONDA	51350SAAE01		
	Length/Lunghezza [mm]	46	
	Inner Diam./Diam. Interno [mm]	12	
	Outer Diam./Diam. esterno [mm]	40	

<b>RU-441</b>	<b>Holder, control arm mounting</b>	<b>HONDA JAZZ (GD)</b>	
	<b>Silentblock</b>	1.2/1.4	
HONDA 51350SAAE01			
Length/Lunghezza [mm]		50	
Inner Diam./Diam. Interno [mm]		19	
Outer Diam./Diam. esterno [mm]		61,5	

<b>RU-444</b>	<b>Holder, control arm mounting</b>	<b>HONDA CIVIC III Hatchback (EC, ED, EE)</b>	
	<b>Silentblock</b>	1.3 (EC8)/1.3 16 V (EC8) Cat./1.4 L (EC9)/1.5 i 16V/1.5 i 16V (ED6)/1.6 i 16V (ED7)/1.6 i 16V Vtec (EE9)	
HONDA 52622-SH3-010		<b>HONDA CIVIC III Tre volumi (ED)</b>	
Fitting Position/Lato Montaggio		Rear Axle	
Fitting Position/Lato Montaggio		inner	
Length/Lunghezza [mm]		50	
Inner Diam./Diam. Interno [mm]		10	
Outer Diam./Diam. esterno [mm]		37	
		<b>HONDA CIVIC IV (EG, EH)</b>	
		1.5 i 16V (EG8)/1.6 16V Vtec (EH9)/1.6 VTI (EG9)	
		<b>HONDA CIVIC IV Coupe (EJ)</b>	
		1.5 i LSi (EJ2)/1.6 i (EJ6)/1.6 i Vtec (EJ1)	
		<b>HONDA CIVIC IV Hatchback (EG)</b>	
		1.3 16V (EG3)/1.5 i 16V/1.5 i 16V (EG4)/1.6 16V Vtec (EG5)/1.6 VTI 16V (EG6)	
		<b>HONDA CRX II (ED, EE)</b>	
		1.6 i 16V/1.6 i 16V (ED9)/1.6 i 16V Vtec (EE8)	
		<b>HONDA CRX III (EH, EG)</b>	
		1.6 ESi (EH6)	
		<b>HONDA HR-V (GH)</b>	
		1.6 16V/1.6 16V 4WD	
		<b>HONDA LOGO (GA3)</b>	
		1.3	

<b>RU-445</b>	<b>Holder, control arm mounting</b>	<b>HONDA CIVIC IV (EG, EH)</b>	
	<b>Silentblock</b>	1.6 16V Vtec (EH9)/1.6 VTI (EG9)	
HONDA 52393-SR0-004		<b>HONDA CIVIC IV Coupe (EJ)</b>	
Fitting Position/Lato Montaggio		Rear Axle	
Diameter/Diametro [mm]		31,5	
Overall Length/Lungh. Tot. [mm]		106	
		<b>HONDA CIVIC IV Fastback (MA, MB)</b>	
		1.4 i (MA8)/1.5 i Vtec-E (MA9)/1.6 i (MB1)/1.6 i Vtec (MB1)	
		<b>HONDA CIVIC IV Hatchback (EG)</b>	
		1.3 16V (EG3)/1.5 i 16V (EG4)/1.6 16V Vtec (EG5)/1.6 VTI 16V (EG6)	
		<b>HONDA CIVIC V (EJ9, EK3/4)</b>	
		1.4 i (EJ9)/1.5 i (EK3)/1.6 i Vtec/1.6 VTI (EK4)	
		<b>HONDA CIVIC V Coupe (EJ6, EJ8)</b>	
		1.6 i/1.6 i Vtec	
		<b>HONDA CIVIC VI Hatchback (EJ,EK)</b>	
		1.4 i (EJ9)/1.4 i S (EJ9)/1.5 i (EK3)/1.6 i (EK1)/1.6 VTI (EK4)	

<b>RU-446</b>	<b>Bearing Bush, stabiliser</b>	<b>HONDA CIVIC V (EJ9, EK3/4)</b>	
	<b>Boccola barra stabilizzatrice</b>	1.6 VTI (EK4)	
HONDA 51306-S04-N01		<b>HONDA CIVIC VI Hatchback (EJ,EK)</b>	
Fitting Position/Lato Montaggio		Front Axle	
Length/Lunghezza [mm]		40	
Height/Altezza [mm]		42	
Width/Larghezza [mm]		45	
Inner Diam./Diam. Interno [mm]		25	
		<b>HONDA CR-V I (RD)</b>	
		2.0 16V (RD1, RD3)	

<b>RU-447</b>	<b>Suspension Strut Support</b>	<b>HONDA CR-V II</b>	
	<b>Bearing</b>	2.0/2.4 Vtec	
HONDA 51920-S6M-014			
Fitting Position/Lato Montaggio		Front Axle Right	
Height/Altezza [mm]		36	
Inner Diam./Diam. Interno [mm]		12	

<b>RU-448</b>	<b>Suspension Strut Support Bearing</b> <b>Supporto ammortizzatore</b>
HONDA	51925-S6M-014
Fitting Position/Lato Montaggio	Front Axle Left
Height/Altezza [mm]	36
Inner Diam./Diam. Interno [mm]	12

**HONDA CR-V II**  
2.0/2.4 Vtec



<b>RU-449</b>	<b>Bearing Bush, stabiliser</b> <b>Boccola barra stabilizzatrice</b>
HONDA	51306-S7B-014
Fitting Position/Lato Montaggio	Front Axle
Bore n°/Fori nr. [mm]	27,2
Quantity per Axle	2

**HONDA CR-V II**  
2.0/2.2 CTDi/2.4 Vtec



<b>RU-450</b>	<b>Holder, control arm mounting</b> <b>Silentblock</b>
HONDA	51306-S7B-014
Fitting Position/Lato Montaggio	Upper Front Axle
Length/Lunghezza [mm]	53,2
Inner Diam./Diam. Interno [mm]	10,2
Outer Diam./Diam. esterno [mm]	38,3

**HONDA ACCORD VIII**  
2.0 (CL7)/2.0 4 ruote motrici (CL8)/2.2 i-CTDi/2.4/2.4 (CL9)/3.0  
**HONDA ACCORD VIII Tourer**  
2.0 (CM1)/2.2 i-CTDi/2.4 (CM2)/2.4 Vtec E/2.4 Vtec T



<b>RU-451</b>	<b>Holder, control arm mounting</b> <b>Silentblock</b>
HONDA	51391 TA0 A01
Height/Altezza [mm]	66
Inner Diam./Diam. Interno [mm]	14
Outer Diam./Diam. esterno [mm]	80

**HONDA ACCORD IX**  
2.0/2.2 i-DTEC/2.4  
**HONDA ACCORD SW**  
2.0/2.2 i-DTEC/2.4



<b>RU-452</b>	<b>Holder, control arm mounting</b> <b>Silentblock</b>
HONDA	51306-S7B-014
Inner Diam./Diam. Interno [mm]	21
Overall Length/Lungh. Tot. [mm]	57,5
Outer Diam./Diam. esterno [mm]	71

**HONDA CR-V II**  
2.0 i-VTEC/2.2 i-CTDi  
**HONDA CR-V III**  
2.2 i-DTEC/2.4/2.4 iVtec 4 ruote motrici



<b>RU-454</b>	<b>Bearing Bush, stabiliser</b> <b>Boccola barra stabilizzatrice</b>
HONDA	52306SWAA01
Fitting Position/Lato Montaggio	Rear Axle
Length/Lunghezza [mm]	35
Height/Altezza [mm]	31
Inner Diam./Diam. Interno [mm]	19

**HONDA CR-V II**  
2.0 i-VTEC/2.2 i-CTDi  
**HONDA CR-V III**  
2.2 i-DTEC/2.4/2.4 iVtec 4 ruote motrici



<b>RU-455</b>	<b>Bearing Bush, stabiliser</b> <b>Boccola barra stabilizzatrice</b>
HONDA	51306SWAA01
Fitting Position/Lato Montaggio	Front Axle
Length/Lunghezza [mm]	42
Height/Altezza [mm]	39
Width/Larghezza [mm]	38,5
Inner Diam./Diam. Interno [mm]	20

**HONDA CR-V II**  
2.0 i-VTEC/2.2 i-CTDi  
**HONDA CR-V III**  
2.2 i-DTEC/2.4/2.4 iVtec 4 ruote motrici



<b>RU-456</b>	<b>Bearing Bush, stabiliser</b>	<b>HONDA ACCORD VII (CG)</b> 2.4 Vtec E	
	<b>Boccola barra stabilizzatrice</b>	<b>HONDA ACCORD VIII</b> 2.0 (CL7)/2.0 4 ruote motrici (CL8)/2.2 i-CTDi/2.4/2.4 (CL9)/2.4 Vtec/2.4 Vtec E (CM5)/3.0	
HONDA	52306SDAA01	<b>HONDA ACCORD VIII Tourer</b> 2.0 (CM1)/2.2 i-CTDi/2.4 (CM2)/2.4 Vtec E/2.4 Vtec T	
Fitting Position/Lato Montaggio	Rear Axle		
Length/Lunghezza [mm]	35		
Height/Altezza [mm]	31		
Inner Diam./Diam. Interno [mm]	13		
<b>RU-457</b>	<b>Engine Mounting</b>	<b>HONDA CIVIC IV (EG, EH)</b> 1.6/1.6 16V Vtec (EH9)	
	<b>Supporto motore</b>	<b>HONDA CIVIC IV Coupe (EJ)</b> 1.6 i (EJ6)/1.6 i Vtec (EJ1)	
HONDA	50841-SR3-984	<b>HONDA CIVIC IV Hatchback (EG)</b> 1.6 16V Vtec (EG5)	
Length/Lunghezza [mm]	146	<b>HONDA CIVIC V (EJ9, EK3/4)</b> 1.5 i (EK3)/1.6 i Vtec	
Height/Altezza [mm]	79	<b>HONDA CIVIC V Coupe (EJ6, EJ8)</b> 1.6 i/1.6 i Vtec	
Width/Larghezza [mm]	47	<b>HONDA CIVIC VI Hatchback (EJ,EK)</b> 1.5 i (EK3)/1.6 i (EK1)	
Inner Diam./Diam. Interno [mm]	20	<b>HONDA CR-V I (RD)</b> 2.0 16V (RD1, RD3)	
		<b>HONDA CRX III (EH, EG)</b> 1.6 ESi (EH6)	
		<b>HONDA HR-V (GH)</b> 1.6 16V 4WD	
<b>RU-460</b>	<b>Engine Mounting</b>	<b>HONDA CIVIC IV Coupe (EJ)</b> 1.6 i (EJ6)/1.6 i Vtec	
	<b>Supporto motore</b>	<b>HONDA CIVIC V (EJ9, EK3/4)</b> 1.4 i (EJ9)/1.5 i (EK3)/1.6 i Vtec/1.6 VTI (EK4)	
HONDA	50805-S04-000	<b>HONDA CIVIC V Coupe (EJ6, EJ8)</b> 1.6 i/1.6 i Vtec	
Length/Lunghezza [mm]	125	<b>HONDA CIVIC V Fastback (MB)</b> 1.6 VTI	
Height/Altezza [mm]	89	<b>HONDA CIVIC VI Hatchback (EJ,EK)</b> 1.4 i (EJ9)/1.5 i (EK3)/1.6 VTI (EK4)	
Width/Larghezza [mm]	130	<b>HONDA CR-V I (RD)</b> 2.0 16V (RD1, RD3)	
Inner Diam./Diam. Interno [mm]	12		
<b>RU-462</b>	<b>Bearing Bush, stabiliser</b>	<b>HONDA CIVIC V (EJ9, EK3/4)</b> 1.6 i Vtec	
	<b>Boccola barra stabilizzatrice</b>	<b>HONDA CIVIC V Coupe (EJ6, EJ8)</b> 1.6 i/1.6 i Vtec	
HONDA	51306-S04-003	<b>HONDA CIVIC VI Hatchback (EJ,EK)</b> 1.4 i (EJ9)/1.6 i (EK1)	
Fitting Position/Lato Montaggio	Front Axle		
Length/Lunghezza [mm]	39		
Height/Altezza [mm]	35		
Width/Larghezza [mm]	30		
Inner Diam./Diam. Interno [mm]	22		
<b>RU-500</b>	<b>Bearing,propshaft centre bearing</b>	<b>HYUNDAI GALLOPER I</b> 2.5 TD/2.5 TD intercooler/3.0 V6	
	<b>Supporto albero cardanico</b>	<b>HYUNDAI GALLOPER II (JK-01)</b> 2.5 TCI D/2.5 TD/2.5 TD intercooler/3.0 V6	
MITSUBISHI	MB154199	<b>MITSUBISHI L 200 (K__T)</b> 1.6 K11 (AG32)/2.0 (K62T)/2.0 4G63/2.4 4x4 (K75T)/2.5 D (K14T)/2.5 D (K64T)/2.5 D 4WD (K24T)/2.5 TD 4WD (K34T)/2.6 4WD (K33T)	
Height/Altezza [mm]	115	<b>MITSUBISHI PAJERO I (L04_G)</b> 2.3 TD (L043G, L048G)/2.5 TD (L044G, L049G)/2.6 (L042G, L047G)	
Width/Larghezza [mm]	58	<b>MITSUBISHI PAJERO I (L04_G, L14_G)</b> 2.0 4WD/2.5 TD (L044G, L049G)/3.0 V6 (L141G, L146G)	
Inner Diam./Diam. Interno [mm]	30	<b>MITSUBISHI PAJERO II (V2_W, V4_W)</b> 2.4/2.5 TD (V24C, V24W)/2.8 TD (V46W)/3.0 V6 (V23W, V43W, V23C)/3.0 V6 24V/3.5 V6 24V/3.5 V6 24V (V25W, V45W)	
Mount. Bores/Fori Fiss. Dist. [mm]	160	<b>MITSUBISHI PAJERO II Fuoristrada aperto (V2_W, V4_W)</b>	

<b>RU-501</b>	<b>Engine Mounting</b>	1.8 GDI/2.4/2.5 TD (V24C, V24W)/3.0 V6 (V23W, v43W, V23C)/3.0 V6 24V
	<b>Supporto motore</b>	<b>MITSUBISHI PAJERO III (V60)</b> 3.2 DI-D (V68W, V78W)
		<b>MITSUBISHI PAJERO PININ (H6_W, H7_W)</b> 1.8/1.8 GDI (H66W)/2.0 GDI (H67W, H77W)
		<b>MITSUBISHI PAJERO SPORT (K90)</b> 2.5 TD/3.0 V6
		<b>HYUNDAI GALLOPER I</b> 2.5 TD/2.5 TD intercooler/3.0 V6
		<b>HYUNDAI GALLOPER II (JK-01)</b> 2.5 TCI D/2.5 TD/2.5 TD intercooler/3.0 V6
		<b>MITSUBISHI L 200 (K_T)</b> 1.6 K11 (AG32)/2.0 (K62T)/2.0 4G63/2.4 4x4 (K75T)/2.5 D (K14T)/2.5 D (K64T)/2.5 D 4WD (K24T)/2.5 TD 4WD (K34T)/2.5 TD 4x4/2.5 TD 4x4 (K74T)/2.6 4WD (K33T)
		<b>MITSUBISHI PAJERO CLASSIC (V2_W)</b> 2.5 TD
		<b>MITSUBISHI PAJERO I (L04_G)</b> 2.3 TD (L043G, L048G)/2.5 TD (L044G, L049G)/2.6 (L042G, L047G)
		<b>MITSUBISHI PAJERO I (L04_G, L14_G)</b> 2.0 4WD/2.5 TD (L044G, L049G)/3.0 V6 (L141G, L146G)
		<b>MITSUBISHI PAJERO II (V2_W, V4_W)</b> 2.4/2.5 TD (V24C, V24W)/2.8 TD (V46W)/3.0 V6 (V23W, V43W, V23C)/3.0 V6 24V/3.5 V6 24V/3.5 V6 24V (V25W, V45W)
		<b>MITSUBISHI PAJERO II Fuoristrada aperto (V2_W, V4_W)</b> 1.8 GDI/2.4/2.5 TD (V24C, V24W)/3.0 V6 (V23W, v43W, V23C)/3.0 V6 24V
		<b>MITSUBISHI PAJERO III (V60)</b> 3.2 DI-D (V68W, V78W)/3.5 V6 GDI (V65W, V75W)
		<b>MITSUBISHI PAJERO PININ (H6_W, H7_W)</b> 1.8/1.8 GDI (H66W)/2.0 GDI (H67W, H77W)
		<b>MITSUBISHI PAJERO SPORT (K90)</b> 2.5 TD/3.0 V6
		<b>HYUNDAI GALLOPER I</b> 2.5 TD intercooler
		<b>HYUNDAI GALLOPER II (JK-01)</b> 2.5 TD intercooler
		<b>MITSUBISHI PAJERO SPORT (K90)</b> 2.5 TD



		<b>MITSUBISHI</b> MB007023
Length/Lunghezza [mm]	119	
Height/Altezza [mm]	57	
Width/Larghezza [mm]	126	

<b>RU-502</b>	<b>Engine Mounting</b>	<b>HYUNDAI GALLOPER I</b> 2.5 TD intercooler
	<b>Supporto motore</b>	<b>HYUNDAI GALLOPER II (JK-01)</b> 2.5 TD intercooler
		<b>MITSUBISHI PAJERO SPORT (K90)</b> 2.5 TD
		<b>MITSUBISHI L 200 (K_T)</b> 1.6 K11 (AG32)/2.0 4G63/2.5 D (K14T)/2.5 D 4WD (K24T)
		<b>MITSUBISHI PAJERO I (L04_G)</b> 2.3 TD (L043G, L048G)/2.5 TD (L044G, L049G)/2.6 (L042G, L047G)
		<b>MITSUBISHI PAJERO I (L04_G, L14_G)</b> 2.5 TD (L044G, L049G)/3.0 V6 (L141G, L146G)



<b>RU-503</b>	<b>Engine Mounting</b>	<b>HYUNDAI GALLOPER I</b> 2.5 TD/2.5 TD intercooler/3.0 V6
	<b>Supporto motore</b>	<b>HYUNDAI GALLOPER II (JK-01)</b> 2.5 TCI D/2.5 TD/2.5 TD intercooler/3.0 V6
		<b>MITSUBISHI L 200 (K_T)</b> 1.6 K11 (AG32)/2.0 4G63/2.5 D (K14T)/2.5 D 4WD (K24T)
		<b>MITSUBISHI PAJERO I (L04_G)</b> 2.3 TD (L043G, L048G)/2.5 TD (L044G, L049G)/2.6 (L042G, L047G)
		<b>MITSUBISHI PAJERO I (L04_G, L14_G)</b> 2.5 TD (L044G, L049G)/3.0 V6 (L141G, L146G)
		<b>MITSUBISHI PAJERO CLASSIC (V2_W)</b> 2.5 TD
		<b>MITSUBISHI PAJERO I (L04_G, L14_G)</b> 2.5 TD (L044G, L049G)
		<b>MITSUBISHI PAJERO II (V2_W, V4_W)</b> 2.4/2.8 TD (V46W)/3.0 V6 (V23W, V43W, V23C)/3.0 V6 24V/3.5 V6 24V/3.5 V6 24V (V25W, V45W)



<b>RU-504</b>	<b>Engine Mounting</b>	<b>HYUNDAI GALLOPER I</b> 2.5 TD/2.5 TD intercooler/3.0 V6
	<b>Supporto motore</b>	<b>HYUNDAI GALLOPER II (JK-01)</b> 2.5 TCI D/2.5 TD/2.5 TD intercooler/3.0 V6
		<b>MITSUBISHI L 200 (K_T)</b> 2.0 (K62T)/2.4 4x4 (K75T)/2.5 D (K14T)/2.5 D 4WD (K24T)/2.5 TD 4WD (K34T)/2.5 TD 4x4 (K74T)/2.6 4WD (K33T)
		<b>MITSUBISHI PAJERO CLASSIC (V2_W)</b> 2.5 TD
		<b>MITSUBISHI PAJERO I (L04_G, L14_G)</b> 2.5 TD (L044G, L049G)
		<b>MITSUBISHI PAJERO II (V2_W, V4_W)</b> 2.4/2.8 TD (V46W)/3.0 V6 (V23W, V43W, V23C)/3.0 V6 24V/3.5 V6 24V/3.5 V6 24V (V25W, V45W)



<b>RU-505</b>		<b>Holder, control arm mounting</b>
		<b>Silentblock</b>
mitsubishi	MB-633870	
Length/Lunghezza [mm]	89,2	
Inner Diam./Diam. Interno [mm]	19	
Outer Diam./Diam. esterno [mm]	40	

**MITSUBISHI PAJERO II Fuoristrada aperto (V2\_W, V4\_W)**

1.8 GDI/2.4/2.5 TD (V24C, V24W)/3.0 V6 (V23W, v43W, V23C)/3.0 V6 24V

**MITSUBISHI PAJERO III (V60)**

3.2 DI-D (V68W, V78W)/3.5 V6 GDI (V65W, V75W)

**MITSUBISHI PAJERO PININ (H6\_W, H7\_W)**

1.8/1.8 GDI (H66W)/2.0 GDI (H67W, H77W)

**MITSUBISHI PAJERO SPORT (K90)**

2.5 TD/3.0 V6

**HYUNDAI GALLOPER I**

2.5 TD/2.5 TD intercooler/3.0 V6

**HYUNDAI GALLOPER II (JK-01)**

2.5 TCI D/2.5 TD/2.5 TD intercooler/3.0 V6

**MITSUBISHI L 200 (K\_T)**

1.6 K11 (AG32)/2.0 (K62T)/2.0 4G63/2.4 4x4 (K75T)/2.5 D (K14T)/2.5 D (K64T)/2.5 D 4WD (K24T)/2.5 TD 4WD/2.5 TD 4WD (K34T)/2.5 TD 4WD (K74T)/2.5 TD 4x4/2.5 TD 4x4 (K74T)/2.6 4WD (K33T)

**MITSUBISHI PAJERO CLASSIC (V2\_W)**

2.5 TD/3.2 DI-D

**MITSUBISHI PAJERO I (L04\_G)**

2.3 TD (L043G, L048G)/2.5 TD (L044G, L049G)/2.6 (L042G, L047G)

**MITSUBISHI PAJERO I (L04\_G, L14\_G)**

2.0 4x4/2.0 4WD/2.0 Turbo 4x4/2.5 TD (L044G, L049G)/3.0 V6 (L141G, L146G)

**MITSUBISHI PAJERO II (V2\_W, V4\_W)**

2.4/2.5 TD (V24C, V24W)/2.8 TD (V46W)/3.0 V6 (V23W, V43W, V23C)/3.0 V6 24V/3.5 V6 24V/3.5 V6 24V (V25W, V45W)

**MITSUBISHI PAJERO II Fuoristrada aperto (V2\_W, V4\_W)**

1.8 GDI/2.4/2.5 TD (V24C, V24W)/3.0 V6 (V23W, v43W, V23C)/3.0 V6 24V

**MITSUBISHI PAJERO PININ (H6\_W, H7\_W)**

1.8/1.8 GDI (H66W)/2.0 GDI (H67W, H77W)

**MITSUBISHI PAJERO SPORT (K90)**

2.5 TD/3.0 V6

<b>RU-506</b>		<b>Holder, control arm mounting</b>
		<b>Silentblock</b>
mitsubishi	MB109684	
Length/Lunghezza [mm]	64	
Inner Diam./Diam. Interno [mm]	14,5	
Outer Diam./Diam. esterno [mm]	39,4	

**HYUNDAI GALLOPER I**

2.5 TD/2.5 TD intercooler/3.0 V6

**HYUNDAI GALLOPER II (JK-01)**

2.5 TCI D/2.5 TD/2.5 TD intercooler/3.0 V6

**MITSUBISHI L 200 (K\_T)**

1.6 K11 (AG32)/2.0 (K62T)/2.0 4G63/2.4 4x4 (K75T)/2.5 D (K14T)/2.5 D (K64T)/2.5 D 4WD (K24T)/2.5 TD 4WD/2.5 TD 4WD (K34T)/2.5 TD 4WD (K74T)/2.5 TD 4x4/2.5 TD 4x4 (K74T)/2.6 4WD (K33T)

**MITSUBISHI PAJERO CLASSIC (V2\_W)**

2.5 TD/3.2 DI-D

**MITSUBISHI PAJERO I (L04\_G)**

2.3 TD (L043G, L048G)/2.5 TD (L044G, L049G)/2.6 (L042G, L047G)

**MITSUBISHI PAJERO I (L04\_G, L14\_G)**

2.0 4x4/2.0 4WD/2.0 Turbo 4x4/2.5 TD (L044G, L049G)/3.0 V6 (L141G, L146G)

**MITSUBISHI PAJERO II (V2\_W, V4\_W)**

2.4/2.5 TD (V24C, V24W)/2.8 TD (V46W)/3.0 V6 (V23W, V43W, V23C)/3.0 V6 24V/3.5 V6 24V/3.5 V6 24V (V25W, V45W)

**MITSUBISHI PAJERO II Fuoristrada aperto (V2\_W, V4\_W)**

1.8 GDI/2.4/2.5 TD (V24C, V24W)/3.0 V6 (V23W, v43W, V23C)/3.0 V6 24V



**MITSUBISHI PAJERO PININ (H6\_W, H7\_W)**

1.8/1.8 GDI (H66W)/2.0 GDI (H67W, H77W)

**MITSUBISHI PAJERO SPORT (K90)**

2.5 TD/3.0 V6



<b>RU-507</b>	<b>Bearing Bush, stabiliser</b>	<b>HYUNDAI GALLOPER I</b>		
	<b>Boccola barra stabilizzatrice</b>	2.5 TD/2.5 TD intercooler/3.0 V6		
MITSUBISHI	MB175804	<b>HYUNDAI GALLOPER II (JK-01)</b>		
Length/Lunghezza [mm]	40	2.5 TCI D/2.5 TD/2.5 TD intercooler/3.0 V6		
Height/Altezza [mm]	35	<b>MITSUBISHI L 200 (K__T)</b>		
Width/Larghezza [mm]	35	1.6 K11 (AG32)/2.0 (K62T)/2.0 4G63/2.4 4x4 (K75T)/2.5 D (K14T)/2.5 D (K64T)/2.5 D 4WD (K24T)/2.5 TD 4WD (K34T)/2.5 TD 4WD (K74T)/2.5 TD 4x4/2.5 TD 4x4 (K74T)/2.6 4WD (K33T)		
Inner Diam./Diam. Interno [mm]	23	<b>MITSUBISHI PAJERO CLASSIC (V2_W)</b>		
		2.5 TD		
		<b>MITSUBISHI PAJERO I (L04_G)</b>		
		2.3 TD (L043G, L048G)/2.5 TD (L044G, L049G)/2.6 (L042G, L047G)		
		<b>MITSUBISHI PAJERO I (L04_G, L14_G)</b>		
		2.0 4WD/2.5 TD (L044G, L049G)/3.0 V6 (L141G, L146G)		
		<b>MITSUBISHI PAJERO II (V2_W, V4_W)</b>		
		2.4/2.5 TD (V24C, V24W)/2.8 TD (V46W)/3.0 V6 (V23W, V43W, V23C)/3.0 V6 24V/3.5 V6 24V/3.5 V6 24V (V25W, V45W)		
		<b>MITSUBISHI PAJERO II Fuoristrada aperto (V2_W, V4_W)</b>		
		1.8 GDI/2.4/2.5 TD (V24C, V24W)/3.0 V6 (V23W, v43W, V23C)/3.0 V6 24V		
		<b>MITSUBISHI PAJERO III (V60)</b>		
		3.2 DI-D (V68W, V78W)/3.5 V6 GDI (V65W, V75W)		
		<b>MITSUBISHI PAJERO PININ (H6_W, H7_W)</b>		
		1.8/1.8 GDI (H66W)/2.0 GDI (H67W, H77W)		
		<b>MITSUBISHI PAJERO SPORT (K90)</b>		
		2.5 TD/3.0 V6		
<b>RU-508</b>	<b>Bearing Bush, stabiliser</b>	<b>HYUNDAI GALLOPER I</b>		
	<b>Boccola barra stabilizzatrice</b>	2.5 TD/2.5 TD intercooler/3.0 V6		
MITSUBISHI	MB573784	<b>HYUNDAI GALLOPER II (JK-01)</b>		
Length/Lunghezza [mm]	39	2.5 TCI D/2.5 TD/2.5 TD intercooler/3.0 V6		
Height/Altezza [mm]	42	<b>MITSUBISHI L 200 (K__T)</b>		
Width/Larghezza [mm]	42	1.6 K11 (AG32)/2.0 (K62T)/2.0 4G63/2.4 4x4 (K75T)/2.5 D (K14T)/2.5 D (K64T)/2.5 D 4WD (K24T)/2.5 TD 4WD (K34T)/2.5 TD 4WD (K74T)/2.5 TD 4x4/2.5 TD 4x4 (K74T)/2.6 4WD (K33T)		
Inner Diam./Diam. Interno [mm]	24	<b>MITSUBISHI PAJERO CLASSIC (V2_W)</b>		
		2.5 TD		
		<b>MITSUBISHI PAJERO I (L04_G)</b>		
		2.3 TD (L043G, L048G)/2.5 TD (L044G, L049G)/2.6 (L042G, L047G)		
		<b>MITSUBISHI PAJERO I (L04_G, L14_G)</b>		
		2.0 4WD/2.5 TD (L044G, L049G)/3.0 V6 (L141G, L146G)		
		<b>MITSUBISHI PAJERO II (V2_W, V4_W)</b>		
		2.4/2.5 TD (V24C, V24W)/2.8 TD (V46W)/3.0 V6 (V23W, V43W, V23C)/3.0 V6 24V/3.5 V6 24V/3.5 V6 24V (V25W, V45W)		
		<b>MITSUBISHI PAJERO II Fuoristrada aperto (V2_W, V4_W)</b>		
		1.8 GDI/2.4/2.5 TD (V24C, V24W)/3.0 V6 (V23W, v43W, V23C)/3.0 V6 24V		
		<b>MITSUBISHI PAJERO III (V60)</b>		
		3.2 DI-D (V68W, V78W)/3.5 V6 GDI (V65W, V75W)		
		<b>MITSUBISHI PAJERO PININ (H6_W, H7_W)</b>		
		1.8/1.8 GDI (H66W)/2.0 GDI (H67W, H77W)		
		<b>MITSUBISHI PAJERO SPORT (K90)</b>		
		2.5 TD/3.0 V6		
<b>RU-509</b>	<b>Bearing Bush, stabiliser</b>	<b>HYUNDAI GALLOPER I</b>		
	<b>Boccola barra stabilizzatrice</b>	2.5 TD/2.5 TD intercooler/3.0 V6		
MITSUBISHI	MB598097	<b>HYUNDAI GALLOPER II (JK-01)</b>		
Diameter/Diametro [mm]	25	2.5 TCI D/2.5 TD/2.5 TD intercooler/3.0 V6		
		<b>MITSUBISHI L 200 (K__T)</b>		
		1.6 K11 (AG32)/2.0 (K62T)/2.0 4G63/2.4 4x4 (K75T)/2.5 D (K14T)/2.5 D (K64T)/2.5 D 4WD (K24T)/2.5 TD 4WD (K34T)/2.5 TD 4WD (K74T)/2.5 TD 4x4/2.5 TD 4x4 (K74T)/2.6 4WD (K33T)		
		<b>MITSUBISHI PAJERO CLASSIC (V2_W)</b>		
		2.5 TD		
		<b>MITSUBISHI PAJERO I (L04_G)</b>		
		2.3 TD (L043G, L048G)/2.5 TD (L044G, L049G)/2.6 (L042G, L047G)		
		<b>MITSUBISHI PAJERO I (L04_G, L14_G)</b>		



<b>RU-510</b>	<b>Bush, leaf spring</b>
	<b>Boccola balestra</b>
mitsubishi	MB111203
Length/Lunghezza [mm]	44
Inner Diam./Diam. Interno [mm]	18
Outer Diam./Diam. esterno [mm]	31,5

<b>RU-511</b>	<b>Bush, leaf spring</b>
	<b>Boccola balestra</b>
mitsubishi	MB-584531
Length/Lunghezza [mm]	53
Inner Diam./Diam. Interno [mm]	16
Outer Diam./Diam. esterno [mm]	28

2.0 4WD/2.5 TD (L044G, L049G)/3.0 V6 (L141G, L146G)
<b>mitsubishi pajero II (V2_W, V4_W)</b>
2.4/2.5 TD (V24C, V24W)/2.8 TD (V46W)/3.0 V6 (V23W, V43W, V23C)/3.0 V6 24V/3.5 V6 24V/3.5 V6 24V (V25W, V45W)
<b>mitsubishi pajero II Fuoristrada aperto (V2_W, V4_W)</b>
1.8 GDI/2.4/2.5 TD (V24C, V24W)/3.0 V6 (V23W, v43W, V23C)/3.0 V6 24V
<b>mitsubishi pajero III (V60)</b>
3.2 DI-D (V68W, V78W)/3.5 V6 GDI (V65W, V75W)
<b>mitsubishi pajero pinin (H6_W, H7_W)</b>
1.8/1.8 GDI (H66W)/2.0 GDI (H67W, H77W)
<b>mitsubishi pajero sport (K90)</b>
2.5 TD/3.0 V6
<b>HYUNDAI GALLOPER I</b>
2.5 TD/2.5 TD intercooler/3.0 V6
<b>HYUNDAI GALLOPER II (JK-01)</b>
2.5 TCI D/2.5 TD/2.5 TD intercooler/3.0 V6
<b>mitsubishi L 200 (K_T)</b>
1.6 K11 (AG32)/2.0 (K62T)/2.0 4G63/2.4 4x4 (K75T)/2.5 D (K14T)/2.5 D (K64T)/2.5 D 4WD (K24T)/2.5 TD 4WD (K34T)/2.5 TD 4WD (K74T)/2.5 TD 4x4/2.5 TD 4x4 (K74T)/2.6 4WD (K33T)
<b>mitsubishi pajero classic (V2_W)</b>
2.5 TD
<b>mitsubishi pajero I (L04_G)</b>
2.3 TD (L043G, L048G)/2.5 TD (L044G, L049G)/2.6 (L042G, L047G)
<b>mitsubishi pajero I (L04_G, L14_G)</b>
2.0 4WD/2.5 TD (L044G, L049G)/3.0 V6 (L141G, L146G)
<b>mitsubishi pajero II (V2_W, V4_W)</b>
2.4/2.5 TD (V24C, V24W)/2.8 TD (V46W)/3.0 V6 (V23W, V43W, V23C)/3.0 V6 24V/3.5 V6 24V/3.5 V6 24V (V25W, V45W)
<b>mitsubishi pajero II Fuoristrada aperto (V2_W, V4_W)</b>
1.8 GDI/2.4/2.5 TD (V24C, V24W)/3.0 V6 (V23W, v43W, V23C)/3.0 V6 24V
<b>mitsubishi pajero III (V60)</b>
3.2 DI-D (V68W, V78W)/3.5 V6 GDI (V65W, V75W)
<b>mitsubishi pajero pinin (H6_W, H7_W)</b>
1.8/1.8 GDI (H66W)/2.0 GDI (H67W, H77W)
<b>mitsubishi pajero sport (K90)</b>
2.5 TD/3.0 V6
<b>HYUNDAI GALLOPER I</b>
2.5 TD/2.5 TD intercooler/3.0 V6
<b>HYUNDAI GALLOPER II (JK-01)</b>
2.5 TCI D/2.5 TD/2.5 TD intercooler/3.0 V6
<b>mitsubishi L 200 (K_T)</b>
1.6 K11 (AG32)/2.0 (K62T)/2.0 4G63/2.4 4x4 (K75T)/2.5 D (K14T)/2.5 D (K64T)/2.5 D 4WD (K24T)/2.5 TD 4WD (K34T)/2.5 TD 4WD (K74T)/2.5 TD 4x4/2.5 TD 4x4 (K74T)/2.6 4WD (K33T)
<b>mitsubishi pajero classic (V2_W)</b>
2.5 TD
<b>mitsubishi pajero I (L04_G)</b>
2.3 TD (L043G, L048G)/2.5 TD (L044G, L049G)/2.6 (L042G, L047G)
<b>mitsubishi pajero I (L04_G, L14_G)</b>
2.0 4WD/2.5 TD (L044G, L049G)/3.0 V6 (L141G, L146G)
<b>mitsubishi pajero II (V2_W, V4_W)</b>
2.4/2.5 TD (V24C, V24W)/2.8 TD (V46W)/3.0 V6 (V23W, V43W, V23C)/3.0 V6 24V/3.5 V6 24V/3.5 V6 24V (V25W, V45W)
<b>mitsubishi pajero II Fuoristrada aperto (V2_W, V4_W)</b>
1.8 GDI/2.4/2.5 TD (V24C, V24W)/3.0 V6 (V23W, v43W, V23C)/3.0 V6 24V
<b>mitsubishi pajero III (V60)</b>
3.2 DI-D (V68W, V78W)/3.5 V6 GDI (V65W, V75W)
<b>mitsubishi pajero pinin (H6_W, H7_W)</b>
1.8/1.8 GDI (H66W)/2.0 GDI (H67W, H77W)
<b>mitsubishi pajero sport (K90)</b>
2.5 TD/3.0 V6



<b>RU-512</b>	<b>Bush, leaf spring</b>	<b>HYUNDAI GALLOPER I</b>	
	<b>Boccola balestra</b>	2.5 TD/2.5 TD intercooler/3.0 V6	
MITSUBISHI	MB111070	<b>HYUNDAI GALLOPER II (JK-01)</b>	
Length/Lunghezza [mm]	45	2.5 TCI D/2.5 TD/2.5 TD intercooler/3.0 V6	
Inner Diam./Diam. Interno [mm]	16	<b>MITSUBISHI L 200 (K__T)</b>	
Outer Diam./Diam. esterno [mm]	27	1.6 K11 (AG32)/2.0 (K62T)/2.0 4G63/2.4 4x4 (K75T)/2.5 D (K14T)/2.5 D (K64T)/2.5 D 4WD (K24T)/2.5 TD 4WD (K34T)/2.5 TD 4WD (K74T)/2.5 TD 4x4/2.5 TD 4x4 (K74T)/2.6 4WD (K33T)	
		<b>MITSUBISHI PAJERO CLASSIC (V2_W)</b>	
		2.5 TD	
		<b>MITSUBISHI PAJERO I (L04_G)</b>	
		2.3 TD (L043G, L048G)/2.5 TD (L044G, L049G)/2.6 (L042G, L047G)	
		<b>MITSUBISHI PAJERO I (L04_G, L14_G)</b>	
		2.0 4WD/2.5 TD (L044G, L049G)/3.0 V6 (L141G, L146G)	
		<b>MITSUBISHI PAJERO II (V2_W, V4_W)</b>	
		2.4/2.5 TD (V24C, V24W)/2.8 TD (V46W)/3.0 V6 (V23W, V43W, V23C)/3.0 V6 24V/3.5 V6 24V/3.5 V6 24V (V25W, V45W)	
		<b>MITSUBISHI PAJERO II Fuoristrada aperto (V2_W, V4_W)</b>	
		1.8 GDI/2.4/2.5 TD (V24C, V24W)/3.0 V6 (V23W, v43W, V23C)/3.0 V6 24V	
		<b>MITSUBISHI PAJERO III (V60)</b>	
		3.2 DI-D (V68W, V78W)/3.5 V6 GDI (V65W, V75W)	
		<b>MITSUBISHI PAJERO PININ (H6_W, H7_W)</b>	
		1.8/1.8 GDI (H66W)/2.0 GDI (H67W, H77W)	
		<b>MITSUBISHI PAJERO SPORT (K90)</b>	
		2.5 TD/3.0 V6	
<b>RU-513</b>	<b>Bush, leaf spring</b>	<b>MITSUBISHI PAJERO II (V2_W, V4_W)</b>	
	<b>Boccola balestra</b>	2.4/2.5 TD (V24C, V24W)/2.8 TD (V46W)/3.0 V6 (V23W, V43W, V23C)/3.0 V6 24V/3.5 V6 24V/3.5 V6 24V (V25W, V45W)	
MITSUBISHI	MB809388	<b>MITSUBISHI PAJERO II Fuoristrada aperto (V2_W, V4_W)</b>	
Length/Lunghezza [mm]	27	1.8 GDI/2.4/2.5 TD (V24C, V24W)/3.0 V6 (V23W, v43W, V23C)/3.0 V6 24V	
Inner Diam./Diam. Interno [mm]	24	<b>MITSUBISHI PAJERO III (V60)</b>	
Outer Diam./Diam. esterno [mm]	59,5	3.2 DI-D (V68W, V78W)/3.5 V6 GDI (V65W, V75W)	
		<b>MITSUBISHI PAJERO PININ (H6_W, H7_W)</b>	
		1.8/1.8 GDI (H66W)/2.0 GDI (H67W, H77W)	
		<b>MITSUBISHI PAJERO SPORT (K90)</b>	
		2.5 TD/3.0 V6	
<b>RU-514</b>	<b>Holder, control arm mounting</b>	<b>HYUNDAI GALLOPER I</b>	
	<b>Silentblock</b>	2.5 TD/2.5 TD intercooler/3.0 V6	
MITSUBISHI	MB631492	<b>HYUNDAI GALLOPER II (JK-01)</b>	
Length/Lunghezza [mm]	60	2.5 TCI D/2.5 TD/2.5 TD intercooler/3.0 V6	
Inner Diam./Diam. Interno [mm]	16	<b>MITSUBISHI L 200 (K__T)</b>	
Outer Diam./Diam. esterno [mm]	65	1.6 K11 (AG32)/2.0 (K62T)/2.0 4G63/2.4 4x4 (K75T)/2.5 D (K14T)/2.5 D (K64T)/2.5 D 4WD (K24T)/2.5 TD 4WD (K34T)/2.5 TD 4WD (K74T)/2.5 TD 4x4/2.5 TD 4x4 (K74T)/2.6 4WD (K33T)	
		<b>MITSUBISHI PAJERO CLASSIC (V2_W)</b>	
		2.5 TD	
		<b>MITSUBISHI PAJERO I (L04_G)</b>	
		2.3 TD (L043G, L048G)/2.5 TD (L044G, L049G)/2.6 (L042G, L047G)	
		<b>MITSUBISHI PAJERO I (L04_G, L14_G)</b>	
		2.0 4WD/2.5 TD (L044G, L049G)/3.0 V6 (L141G, L146G)	
		<b>MITSUBISHI PAJERO II (V2_W, V4_W)</b>	
		2.4/2.5 TD (V24C, V24W)/2.8 TD (V46W)/3.0 V6 (V23W, V43W, V23C)/3.0 V6 24V/3.5 V6 24V/3.5 V6 24V (V25W, V45W)	
		<b>MITSUBISHI PAJERO II Fuoristrada aperto (V2_W, V4_W)</b>	
		1.8 GDI/2.4/2.5 TD (V24C, V24W)/3.0 V6 (V23W, v43W, V23C)/3.0 V6 24V	
		<b>MITSUBISHI PAJERO III (V60)</b>	
		3.2 DI-D (V68W, V78W)/3.5 V6 GDI (V65W, V75W)	
		<b>MITSUBISHI PAJERO PININ (H6_W, H7_W)</b>	
		1.8/1.8 GDI (H66W)/2.0 GDI (H67W, H77W)	
		<b>MITSUBISHI PAJERO SPORT (K90)</b>	
		2.5 TD/3.0 V6	

<b>RU-515</b>	<b>GummiParts</b>	<b>HYUNDAI GALLOPER I</b> 2.5 TD/2.5 TD intercooler/3.0 V6	
	<b>Parti in gomma</b>	<b>HYUNDAI GALLOPER II (JK-01)</b> 2.5 TCI D/2.5 TD/2.5 TD intercooler/3.0 V6	
	<b>mitsubishi L 200 (K__T)</b> 1.6 K11 (AG32)/2.0 (K62T)/2.0 4G63/2.4 4x4 (K75T)/2.5 D (K14T)/2.5 D (K64T)/2.5 D 4WD (K24T)/2.5 TD 4WD (K34T)/2.5 TD 4WD (K74T)/2.5 TD 4x4/2.5 TD 4x4 (K74T)/2.6 4WD (K33T)		
	<b>MITSUBISHI PAJERO CLASSIC (V2_W)</b> 2.5 TD		
	<b>MITSUBISHI PAJERO I (L04_G)</b> 2.3 TD (L043G, L048G)/2.5 TD (L044G, L049G)/2.6 (L042G, L047G)		
	<b>MITSUBISHI PAJERO I (L04_G, L14_G)</b> 2.0 4WD/2.5 TD (L044G, L049G)/3.0 V6 (L141G, L146G)		
	<b>MITSUBISHI PAJERO II (V2_W, V4_W)</b> 2.4/2.5 TD (V24C, V24W)/2.8 TD (V46W)/3.0 V6 (V23W, V43W, V23C)/3.0 V6 24V/3.5 V6 24V/3.5 V6 24V (V25W, V45W)		
	<b>MITSUBISHI PAJERO II Fuoristrada aperto (V2_W, V4_W)</b> 1.8 GDI/2.4/2.5 TD (V24C, V24W)/3.0 V6 (V23W, v43W, V23C)/3.0 V6 24V		
	<b>MITSUBISHI PAJERO III (V60)</b> 3.2 DI-D (V68W, V78W)/3.5 V6 GDI (V65W, V75W)		
	<b>MITSUBISHI PAJERO PININ (H6_W, H7_W)</b> 1.8/1.8 GDI (H66W)/2.0 GDI (H67W, H77W)		
	<b>MITSUBISHI PAJERO SPORT (K90)</b> 2.5 TD/3.0 V6		
<b>RU-516</b>	<b>Bearing Bush, stabiliser</b>	<b>HYUNDAI GALLOPER I</b> 2.5 TD/2.5 TD intercooler/3.0 V6	
	<b>Boccola barra stabilizzatrice</b>	<b>HYUNDAI GALLOPER II (JK-01)</b> 2.5 TCI D/2.5 TD/2.5 TD intercooler/3.0 V6	
mitsubishi MB109529	<b>mitsubishi L 200 (K__T)</b> 1.6 K11 (AG32)/2.0 (K62T)/2.0 4G63/2.4 4x4 (K75T)/2.5 D (K14T)/2.5 D (K64T)/2.5 D 4WD (K24T)/2.5 TD 4WD (K34T)/2.5 TD 4WD (K74T)/2.5 TD 4x4/2.5 TD 4x4 (K74T)/2.6 4WD (K33T)		
Length/Lunghezza [mm]	44	<b>MITSUBISHI PAJERO I (L04_G)</b> 2.5 TD (L044G, L049G)	
Inner Diam./Diam. Interno [mm]	18	<b>MITSUBISHI PAJERO I (L04_G, L14_G)</b> 2.5 TD (L044G, L049G)	
Outer Diam./Diam. esterno [mm]	28		
		<b>HYUNDAI GALLOPER I</b> 2.5 TD/2.5 TD intercooler/3.0 V6	
		<b>HYUNDAI GALLOPER II (JK-01)</b> 2.5 TCI D/2.5 TD/2.5 TD intercooler/3.0 V6	
		<b>MITSUBISHI L 200 (K__T)</b> 1.6 K11 (AG32)/2.0 (K62T)/2.0 4G63/2.4 4x4 (K75T)/2.5 D (K14T)/2.5 D (K64T)/2.5 D 4WD (K24T)/2.5 TD 4WD (K34T)/2.5 TD 4WD (K74T)/2.5 TD 4x4/2.5 TD 4x4 (K74T)/2.6 4WD (K33T)	
		<b>MITSUBISHI PAJERO I (L04_G)</b> 2.5 TD (L044G, L049G)	
		<b>MITSUBISHI PAJERO I (L04_G, L14_G)</b> 2.5 TD (L044G, L049G)	
<b>RU-517</b>	<b>Bearing Bush, stabiliser</b>	<b>HYUNDAI GALLOPER I</b> 2.5 TD/2.5 TD intercooler/3.0 V6	
	<b>Boccola barra stabilizzatrice</b>	<b>HYUNDAI GALLOPER II (JK-01)</b> 2.5 TCI D/2.5 TD/2.5 TD intercooler/3.0 V6	
mitsubishi MB109557	<b>MITSUBISHI L 200 (K__T)</b> 1.6 K11 (AG32)/2.0 (K62T)/2.0 4G63/2.4 4x4 (K75T)/2.5 D (K14T)/2.5 D (K64T)/2.5 D 4WD (K24T)/2.5 TD 4WD (K34T)/2.5 TD 4WD (K74T)/2.5 TD 4x4/2.5 TD 4x4 (K74T)/2.6 4WD (K33T)		
Length/Lunghezza [mm]	35,5	<b>MITSUBISHI PAJERO I (L04_G)</b> 2.5 TD (L044G, L049G)	
Height/Altezza [mm]	37	<b>MITSUBISHI PAJERO I (L04_G, L14_G)</b> 2.5 TD (L044G, L049G)	
Width/Larghezza [mm]	36		
Inner Diam./Diam. Interno [mm]	25		
		<b>HYUNDAI GALLOPER I</b> 2.5 TD/2.5 TD intercooler/3.0 V6	
		<b>HYUNDAI GALLOPER II (JK-01)</b> 2.5 TCI D/2.5 TD/2.5 TD intercooler/3.0 V6	
		<b>MITSUBISHI L 200 (K__T)</b> 1.6 K11 (AG32)/2.0 (K62T)/2.0 4G63/2.4 4x4 (K75T)/2.5 D (K14T)/2.5 D (K64T)/2.5 D 4WD (K24T)/2.5 TD 4WD (K34T)/2.5 TD 4WD (K74T)/2.5 TD 4x4/2.5 TD 4x4 (K74T)/2.6 4WD (K33T)	
		<b>MITSUBISHI PAJERO I (L04_G)</b> 2.5 TD (L044G, L049G)	
		<b>MITSUBISHI PAJERO I (L04_G, L14_G)</b> 2.5 TD (L044G, L049G)	
<b>RU-518</b>	<b>Bearing Bush, stabiliser</b>	<b>HYUNDAI GALLOPER I</b> 2.5 TD/2.5 TD intercooler/3.0 V6	
	<b>Boccola barra stabilizzatrice</b>	<b>HYUNDAI GALLOPER II (JK-01)</b> 2.5 TCI D/2.5 TD/2.5 TD intercooler/3.0 V6	
mitsubishi MB584146	<b>MITSUBISHI L 200 (K__T)</b> 1.6 K11 (AG32)/2.0 (K62T)/2.0 4G63/2.4 4x4 (K75T)/2.5 D (K14T)/2.5 D (K64T)/2.5 D 4WD (K24T)/2.5 TD 4WD (K34T)/2.5 TD 4WD (K74T)/2.5 TD 4x4/2.5 TD 4x4 (K74T)/2.6 4WD (K33T)		
Length/Lunghezza [mm]	34	<b>MITSUBISHI PAJERO I (L04_G)</b> 2.5 TD (L044G, L049G)	
Inner Diam./Diam. Interno [mm]	24	<b>MITSUBISHI PAJERO I (L04_G, L14_G)</b> 2.5 TD (L044G, L049G)	
Outer Diam./Diam. esterno [mm]	37		
		<b>HYUNDAI GALLOPER I</b> 2.5 TD/2.5 TD intercooler/3.0 V6	
		<b>HYUNDAI GALLOPER II (JK-01)</b> 2.5 TCI D/2.5 TD/2.5 TD intercooler/3.0 V6	
		<b>MITSUBISHI L 200 (K__T)</b> 1.6 K11 (AG32)/2.0 (K62T)/2.0 4G63/2.4 4x4 (K75T)/2.5 D (K14T)/2.5 D (K64T)/2.5 D 4WD (K24T)/2.5 TD 4WD (K34T)/2.5 TD 4WD (K74T)/2.5 TD 4x4/2.5 TD 4x4 (K74T)/2.6 4WD (K33T)	
		<b>MITSUBISHI PAJERO I (L04_G)</b> 2.5 TD (L044G, L049G)	
		<b>MITSUBISHI PAJERO I (L04_G, L14_G)</b> 2.5 TD (L044G, L049G)	

<b>RU-519</b>	<b>Bearing Bush, stabiliser</b>	<b>HYUNDAI GALLOPER I</b>	
	<b>Boccola barra stabilizzatrice</b>	<b>HYUNDAI GALLOPER II (JK-01)</b>	
mitsubishi	MB176442	2.5 TD/2.5 TD intercooler/3.0 V6	
Length/Lunghezza [mm]	38	<b>MITSUBISHI L 200 (K__T)</b>	
Height/Altezza [mm]	35	1.6 K11 (AG32)/2.0 (K62T)/2.0 4G63/2.4 4x4 (K75T)/2.5 D (K14T)/2.5 D (K64T)/2.5 D 4WD (K24T)/2.5 TD 4WD (K34T)/2.5 TD 4WD (K74T)/2.5 TD 4x4/2.5 TD 4x4 (K74T)/2.6 4WD (K33T)	
Width/Larghezza [mm]	36	<b>MITSUBISHI PAJERO I (L04_G)</b>	
Inner Diam./Diam. Interno [mm]	22	2.5 TD (L044G, L049G)	
		<b>MITSUBISHI PAJERO I (L04_G, L14_G)</b>	
		2.5 TD (L044G, L049G)	
<b>RU-520</b>	<b>Bearing Bush, stabiliser</b>	<b>HYUNDAI GALLOPER I</b>	
	<b>Boccola barra stabilizzatrice</b>	<b>HYUNDAI GALLOPER II (JK-01)</b>	
mitsubishi	MB175581	2.5 TD/2.5 TD intercooler/3.0 V6	
Length/Lunghezza [mm]	39	<b>MITSUBISHI L 200 (K__T)</b>	
Height/Altezza [mm]	39	1.6 K11 (AG32)/2.0 (K62T)/2.0 4G63/2.4 4x4 (K75T)/2.5 D (K14T)/2.5 D (K64T)/2.5 D 4WD (K24T)/2.5 TD 4WD (K34T)/2.5 TD 4WD (K74T)/2.5 TD 4x4/2.5 TD 4x4 (K74T)/2.6 4WD (K33T)	
Width/Larghezza [mm]	33	<b>MITSUBISHI PAJERO II (V2_W, V4_W)</b>	
Inner Diam./Diam. Interno [mm]	22	2.5 TD (V24C, V24W)	
		<b>MITSUBISHI PAJERO II Fuoristrada aperto (V2_W, V4_W)</b>	
		2.5 TD (V24C, V24W)	
<b>RU-521</b>	<b>Bearing Bush, stabiliser</b>	<b>HYUNDAI GALLOPER I</b>	
	<b>Boccola barra stabilizzatrice</b>	<b>HYUNDAI GALLOPER II (JK-01)</b>	
mitsubishi	MB109219	2.5 TD/2.5 TD intercooler/3.0 V6	
Length/Lunghezza [mm]	36	<b>MITSUBISHI L 200 (K__T)</b>	
Height/Altezza [mm]	37,5	1.6 K11 (AG32)/2.0 (K62T)/2.0 4G63/2.4 4x4 (K75T)/2.5 D (K14T)/2.5 D (K64T)/2.5 D 4WD (K24T)/2.5 TD 4WD (K34T)/2.5 TD 4WD (K74T)/2.5 TD 4x4/2.5 TD 4x4 (K74T)/2.6 4WD (K33T)	
Width/Larghezza [mm]	40	<b>MITSUBISHI PAJERO II (V2_W, V4_W)</b>	
Inner Diam./Diam. Interno [mm]	20	2.5 TD (V24C, V24W)	
		<b>MITSUBISHI PAJERO II Fuoristrada aperto (V2_W, V4_W)</b>	
		2.5 TD (V24C, V24W)	
<b>RU-522</b>	<b>Bearing Bush, stabiliser</b>	<b>HYUNDAI GALLOPER I</b>	
	<b>Boccola barra stabilizzatrice</b>	<b>HYUNDAI GALLOPER II (JK-01)</b>	
mitsubishi	MB267685	2.5 TD/2.5 TD intercooler/3.0 V6	
Length/Lunghezza [mm]	42	<b>MITSUBISHI L 200 (K__T)</b>	
Height/Altezza [mm]	35	1.6 K11 (AG32)/2.0 (K62T)/2.0 4G63/2.4 4x4 (K75T)/2.5 D (K14T)/2.5 D (K64T)/2.5 D 4WD (K24T)/2.5 TD 4WD (K34T)/2.5 TD 4WD (K74T)/2.5 TD 4x4/2.5 TD 4x4 (K74T)/2.6 4WD (K33T)	
Width/Larghezza [mm]	40	<b>MITSUBISHI PAJERO II (V2_W, V4_W)</b>	
Inner Diam./Diam. Interno [mm]	24	2.5 TD (V24C, V24W)	
		<b>MITSUBISHI PAJERO II Fuoristrada aperto (V2_W, V4_W)</b>	
		2.5 TD (V24C, V24W)	
<b>RU-523</b>	<b>Bearing Bush, stabiliser</b>	<b>HYUNDAI GALLOPER I</b>	
	<b>Boccola barra stabilizzatrice</b>	<b>HYUNDAI GALLOPER II (JK-01)</b>	
mitsubishi	MB573783	2.5 TD/2.5 TD intercooler/3.0 V6	
Length/Lunghezza [mm]	39	<b>MITSUBISHI L 200 (K__T)</b>	
Height/Altezza [mm]	41	1.6 K11 (AG32)/2.0 (K62T)/2.0 4G63/2.4 4x4 (K75T)/2.5 D (K14T)/2.5 D (K64T)/2.5 D 4WD (K24T)/2.5 TD 4WD (K34T)/2.5 TD 4WD (K74T)/2.5 TD 4x4/2.5 TD 4x4 (K74T)/2.6 4WD (K33T)	
Width/Larghezza [mm]	40	<b>MITSUBISHI PAJERO II (V2_W, V4_W)</b>	
Inner Diam./Diam. Interno [mm]	26	2.5 TD (V24C, V24W)	
		<b>MITSUBISHI PAJERO II Fuoristrada aperto (V2_W, V4_W)</b>	
		2.5 TD (V24C, V24W)	
<b>RU-524</b>	<b>Bearing Bush, stabiliser</b>	<b>HYUNDAI GALLOPER I</b>	
	<b>Boccola barra stabilizzatrice</b>	<b>HYUNDAI GALLOPER II (JK-01)</b>	
mitsubishi	MB275632	2.5 TD/2.5 TD intercooler/3.0 V6	
Length/Lunghezza [mm]	34,5	<b>MITSUBISHI L 200 (K__T)</b>	
Inner Diam./Diam. Interno [mm]	17	1.6 K11 (AG32)/2.0 (K62T)/2.0 4G63/2.4 4x4 (K75T)/2.5 D (K14T)/2.5 D (K64T)/2.5 D 4WD (K24T)/2.5 TD 4WD (K34T)/2.5 TD 4WD (K74T)/2.5 TD 4x4/2.5 TD 4x4 (K74T)/2.6 4WD (K33T)	
Outer Diam./Diam. esterno [mm]	49	<b>MITSUBISHI PAJERO II (V2_W, V4_W)</b>	
		2.5 TD (V24C, V24W)	
		<b>MITSUBISHI PAJERO II Fuoristrada aperto (V2_W, V4_W)</b>	
		2.5 TD (V24C, V24W)	

<b>RU-525</b> <b>Bearing Bush, stabiliser</b> <b>Boccola barra stabilizzatrice</b>	<b>MITSUBISHI</b> MB150095	<b>MITSUBISHI PAJERO II Fuoristrada aperto (V2_W, V4_W)</b> 2.5 TD (V24C, V24W)			
	Length/Lunghezza [mm] 46	<b>HYUNDAI GALLOPER I</b> 2.5 TD/2.5 TD intercooler/3.0 V6			
	Height/Altezza [mm] 41	<b>HYUNDAI GALLOPER II (JK-01)</b> 2.5 TCI D/2.5 TD/2.5 TD intercooler/3.0 V6			
	Width/Larghezza [mm] 45,5	<b>MITSUBISHI L 200 (K__T)</b> 1.6 K11 (AG32)/2.0 (K62T)/2.0 4G63/2.4 4x4 (K75T)/2.5 D (K14T)/2.5 D (K64T)/2.5 D 4WD (K24T)/2.5 TD 4WD (K34T)/2.5 TD 4WD (K74T)/2.5 TD 4x4/2.5 TD 4x4 (K74T)/2.6 4WD (K33T)			
	Inner Diam./Diam. Interno [mm] 29	<b>MITSUBISHI PAJERO II (V2_W, V4_W)</b> 2.5 TD (V24C, V24W)			
<b>RU-527</b> <b>Bearing Bush, stabiliser</b> <b>Boccola barra stabilizzatrice</b>	<b>MITSUBISHI</b> MR150094	<b>MITSUBISHI PAJERO II Fuoristrada aperto (V2_W, V4_W)</b> 2.5 TD (V24C, V24W)			
	Length/Lunghezza [mm] 45,3	<b>HYUNDAI GALLOPER I</b> 2.5 TD/2.5 TD intercooler/3.0 V6			
	Height/Altezza [mm] 41	<b>HYUNDAI GALLOPER II (JK-01)</b> 2.5 TCI D/2.5 TD/2.5 TD intercooler/3.0 V6			
	Width/Larghezza [mm] 43,5	<b>MITSUBISHI L 200 (K__T)</b> 1.6 K11 (AG32)/2.0 (K62T)/2.0 4G63/2.4 4x4 (K75T)/2.5 D (K14T)/2.5 D (K64T)/2.5 D 4WD (K24T)/2.5 TD 4WD (K34T)/2.5 TD 4WD (K74T)/2.5 TD 4x4/2.5 TD 4x4 (K74T)/2.6 4WD (K33T)			
	Inner Diam./Diam. Interno [mm] 27	<b>MITSUBISHI PAJERO II (V2_W, V4_W)</b> 2.5 TD (V24C, V24W)			
<b>RU-528</b> <b>Holder, control arm mounting</b> <b>Silentblock</b>	<b>MITSUBISHI</b> MB808909	<b>MITSUBISHI PAJERO II Fuoristrada aperto (V2_W, V4_W)</b> 2.5 TD (V24C, V24W)			
	Width/Larghezza [mm] 53	<b>MITSUBISHI CARISMA (DA_)</b> 1.6/1.8/1.8 16V/1.8 16V GDI/1.8 GDI/1.9 DI-D/1.9 TD			
	Inner Diam./Diam. Interno [mm] 21	<b>MITSUBISHI CARISMA Tre volumi (DA_)</b> 1.6/1.8/1.8 16V GDI/1.8 GDI/1.9 DI-D/1.9 TD/2.0 16V GT EVO VI/VII			
	Outer Diam./Diam. esterno [mm] 64	<b>MITSUBISHI COLT IV (CA_A)</b> 1.3 GLi 12V (CA1A)/1.6/1.6 4x4/1.6 GLXi 16V (CA4A)/1.8 GTi 16V (CA5A)/2.0 D (4D68)			
		<b>MITSUBISHI COLT V (CJ_A)</b> 1.3/1.5/1300/1300 GL, GLX (CJ1A)/1500 (CJ2A)/1600/1600 GLX (CJ4A)			
		<b>MITSUBISHI LANCER V (CB/D_A)</b> 1.3 (CB1A)/1.6/1.6 16V (CB4A)/1.6 16V 4WD (CD4A)/1.8 16V (CB5A)/1.8 GTi/2.0 Diesel (CB8A)			
		<b>MITSUBISHI LANCER V SW (CB_W, CD_W)</b> 1.6 16V (CB4W)/1.6 16V 4WD (CD4W)/2.0 D (CB8W)			
		<b>MITSUBISHI LANCER VI (CK/P_A)</b> 1.3 12V (CK1A)/1.5 16V (CK2A)/1.6 16V (CK4A)/2.0 16V EVO VI / VII (CP9A)			
		<b>VOLVO S40 I (VS)</b> 1.6/1.8/1.8 i/1.9 DI/1.9 T4/1.9 TD/2.0/2.0 T/2.0 T4			
		<b>VOLVO V40 SW (VW)</b> 1.6/1.8/1.8 i/1.9 DI/1.9 T4/1.9 TD/2.0/2.0 T/2.0 T4			
	<b>RU-529</b> <b>Holder, control arm mounting</b> <b>Silentblock</b>	<b>MITSUBISHI</b> MB808910		<b>MITSUBISHI CARISMA (DA_)</b> 1.6/1.8/1.8 16V/1.8 16V GDI/1.8 GDI/1.9 DI-D/1.9 TD	
		Width/Larghezza [mm] 53		<b>MITSUBISHI CARISMA Tre volumi (DA_)</b> 1.6/1.8/1.8 16V GDI/1.8 GDI/1.9 DI-D/1.9 TD/2.0 16V GT EVO VI/VII	
		Inner Diam./Diam. Interno [mm] 21		<b>MITSUBISHI COLT IV (CA_A)</b> 1.3 GLi 12V (CA1A)/1.6/1.6 4x4/1.6 GLXi 16V (CA4A)/1.8 GTi 16V (CA5A)/2.0 D (4D68)	
		Outer Diam./Diam. esterno [mm] 64		<b>MITSUBISHI COLT V (CJ_A)</b> 1.3/1.5/1300/1300 GL, GLX (CJ1A)/1500 (CJ2A)/1600/1600 GLX (CJ4A)	
				<b>MITSUBISHI LANCER V (CB/D_A)</b> 1.3 (CB1A)/1.6/1.6 16V (CB4A)/1.6 16V 4WD (CD4A)/1.8 16V (CB5A)/1.8 GTi/2.0 Diesel (CB8A)	
				<b>MITSUBISHI LANCER V SW (CB_W, CD_W)</b> 1.6 16V (CB4W)/1.6 16V 4WD (CD4W)/2.0 D (CB8W)	
				<b>MITSUBISHI LANCER VI (CK/P_A)</b> 1.3 12V (CK1A)/1.5 16V (CK2A)/1.6 16V (CK4A)/2.0 16V EVO VI / VII (CP9A)	

		<b>VOLVO S40 I (VS)</b> 1.6/1.8/1.8 i/1.9 DI/1.9 T4/1.9 TD/2.0/2.0 T/2.0 T4	
		<b>VOLVO V40 SW (VW)</b> 1.6/1.8/1.8 i/1.9 DI/1.9 T4/1.9 TD/2.0/2.0 T/2.0 T4	
<b>RU-530</b>	<b>Holder, control arm mounting</b>	<b>MITSUBISHI COLT IV (CA_A)</b> 1.3 GLi 12V (CA1A)/1.6/1.6 GLXi 16V (CA4A)/1.8 GTi 16V (CA5A)/2.0 D (4D68)	
	<b>Silentblock</b>	<b>MITSUBISHI COLT V (CJ_A)</b> 1300/1300 GL, GLX (CJ1A)/1500 (CJ2A)/1600/1600 GLX (CJ4A)	
Length/Lunghezza [mm]		<b>MITSUBISHI LANCER V (CB/D_A)</b> 1.3 (CB1A)/1.6/1.6 16V (CB4A)/1.6 16V 4WD (CD4A)/1.8 16V (CB5A)/2.0 Diesel (CB8A)	
Inner Diam./Diam. Interno [mm]	60	<b>MITSUBISHI LANCER V SW (CB_W, CD_W)</b> 1.6 16V (CB4W)/1.6 16V 4WD (CD4W)/2.0 D (CB8W)	
Outer Diam./Diam. esterno [mm]	12	<b>MITSUBISHI LANCER VI (CK/P_A)</b> 1.3 12V (CK1A)/1.5 16V (CK2A)/1.6 16V (CK4A)/2.0 16V EVO VI / VII (CP9A)	
	32,6	<b>MITSUBISHI COLT CZC Cabriolet</b> 1.5	
		<b>MITSUBISHI COLT VI</b> 1.1/1.3/1.5/1.5 CZT/1.5 DI-D	
		<b>SMART FORFOUR</b> 1.1 (454.030)/1.3 (454.031)/1.5/1.5 (454.032)/1.5 BRABUS (454.034)/1.5 CDI (454.000)/1.5 CDI (454.001)	
Length/Lunghezza [mm]	54	<b>MITSUBISHI COLT CZC Cabriolet</b> 1.5	
Inner Diam./Diam. Interno [mm]	14	<b>MITSUBISHI COLT VI</b> 1.1/1.3/1.5/1.5 CZT/1.5 DI-D	
Outer Diam./Diam. esterno [mm]	60	<b>SMART FORFOUR</b> 1.1 (454.030)/1.3 (454.031)/1.5/1.5 (454.032)/1.5 BRABUS (454.034)/1.5 CDI (454.000)/1.5 CDI (454.001)	
		<b>MITSUBISHI COLT CZC Cabriolet</b> 1.5	
		<b>MITSUBISHI COLT VI</b> 1.1/1.3/1.5/1.5 CZT/1.5 DI-D	
Length/Lunghezza [mm]	59	<b>SMART FORFOUR</b> 1.1 (454.030)/1.3 (454.031)/1.5/1.5 (454.032)/1.5 BRABUS (454.034)/1.5 CDI (454.000)/1.5 CDI (454.001)	
Inner Diam./Diam. Interno [mm]	14		
Outer Diam./Diam. esterno [mm]	41		
<b>RU-533</b>	<b>Bearing Bush, stabiliser</b>	<b>MITSUBISHI GALANT VI (EA_)</b> 2.0/2.0 (EA2A)/2.0 TDI (EA6A)/2.4 GDI/2.5 V6 24V/2.5 V6 24V (EA5A)	
	<b>Boccola barra stabilizzatrice</b>	<b>MITSUBISHI GALANT VI SW (EA_)</b> 2.0/2.0 (EA2W)/2.0 TDI (EA6W)/2.4 GDI/2.5 V6 24V/2.5 V6 24V (EA5W)	
MITSUBISHI	MR244116	<b>VW TRANSPORTER III Autobus</b> 1.9	
Fitting Position/Lato Montaggio	Front		
		<b>MITSUBISHI GALANT VI (EA_)</b> 2.0/2.0 (EA2A)/2.0 TDI (EA6A)/2.4 GDI/2.5 V6 24V/2.5 V6 24V (EA5A)	
		<b>MITSUBISHI GALANT VI SW (EA_)</b> 2.0/2.0 (EA2W)/2.0 TDI (EA6W)/2.4 GDI/2.5 V6 24V/2.5 V6 24V (EA5W)	
Length/Lunghezza [mm]	132		
Diameter/Diametro [mm]	56,5		
<b>RU-535</b>	<b>Holder, control arm mounting</b>	<b>MITSUBISHI ECLIPSE I (D2_A)</b> 1.8/2.0 i 16V (D22A)/2.0 i 16V 4x4	
	<b>Silentblock</b>	<b>MITSUBISHI GALANT V (E5_A, E7_A, E8_A)</b> 1.8 (E52A)/1.8 GLSI (E52A)/2.0 GLSI (E55A)/2.0 GLSI 4x4 (E75A)/2.0 GLSTD (E57A)/2.0 V6-24 (E54A)/2.5 V6-24 4x4 (E88A)	
MITSUBISHI	MR296295	<b>MITSUBISHI GALANT V Tre volumi (E5_A, E7_A, E8_A)</b> 1.8 (E52A)/1.8 GLSI (E52A)/2.0 GLSI (E55A)/2.0 GLSI 4x4 (E75A)/2.0 GLSTD (E57A)/2.0 V6-24 (E54A)/2.5 V6-24 4x4 (E88A)	
Length/Lunghezza [mm]	55	<b>MITSUBISHI GALANT VI (EA_)</b> 2.0/2.0 (EA2A)/2.0 TDI (EA6A)/2.4 GDI/2.5 V6 24V/2.5 V6 24V (EA5A)	
Inner Diam./Diam. Interno [mm]	12,5	<b>MITSUBISHI GALANT VI SW (EA_)</b> 2.0/2.0 (EA2W)/2.0 TDI (EA6W)/2.4 GDI/2.5 V6 24V/2.5 V6 24V (EA5W)	
Outer Diam./Diam. esterno [mm]	40		

<b>RU-536</b>	<b>Holder, control arm mounting</b>	<b>MITSUBISHI ECLIPSE I (D2_A)</b> 1.8/2.0 i 16V (D22A)/2.0 i 16V 4x4	
	<b>Silentblock</b>	<b>MITSUBISHI GALANT V (E5_A, E7_A, E8_A)</b> 1.8 (E52A)/1.8 GLSI (E52A)/2.0 GLSI (E55A)/2.0 GLSI 4x4 (E75A)/2.0 GLSTD (E57A)/2.0 V6-24 (E54A)/2.5 V6-24 4x4 (E88A)	
MITSUBISHI	MR296295	<b>MITSUBISHI GALANT V Tre volumi (E5_A, E7_A, E8_A)</b> 1.8 (E52A)/1.8 GLSI (E52A)/2.0 GLSI (E55A)/2.0 GLSI 4x4 (E75A)/2.0 GLSTD (E57A)/2.0 V6-24 (E54A)/2.5 V6-24 4x4 (E88A)	
Length/Lunghezza [mm]	50	<b>MITSUBISHI GALANT VI (EA_)</b> 2.0/2.0 (EA2A)/2.0 TDI (EA6A)/2.4 GDI/2.5 V6 24V/2.5 V6 24V (EA5A)	
Inner Diam./Diam. Interno [mm]	12,5	<b>MITSUBISHI GALANT VI SW (EA_)</b> 2.0/2.0 (EA2W)/2.0 TDI (EA6W)/2.4 GDI/2.5 V6 24V/2.5 V6 24V (EA5W)	
Outer Diam./Diam. esterno [mm]	40	<b>MITSUBISHI L 200 (K_T)</b> 2.0 (K62T)/2.5 D (K64T)	
<b>RU-537</b>	<b>Holder, control arm mounting</b>	<b>MITSUBISHI L 200 (K_T)</b> 2.0 (K62T)/2.5 D (K64T)	
	<b>Silentblock</b>		
MITSUBISHI	MR234247		
Height/Altezza [mm]	31		
Height/Altezza 1 [mm]	25		
Inner Diam./Diam. Interno [mm]	19		
<b>RU-538</b>	<b>Bearing Bush, stabiliser</b>	<b>MITSUBISHI L 200 (K_T)</b> 2.5 Di-D	
	<b>Boccola barra stabilizzatrice</b>	<b>MITSUBISHI L 200</b> 2.5 DiD [RWD]	
MITSUBISHI	MR992317		
Fitting Position/Lato Montaggio	Front		
Length/Lunghezza [mm]	48		
Height/Altezza [mm]	57		
Width/Larghezza [mm]	58		
Inner Diam./Diam. Interno [mm]	25		
<b>RU-539</b>	<b>Holder, control arm mounting</b>	<b>MITSUBISHI LANCER SW</b> 1.6/2.0	
	<b>Silentblock</b>	<b>MITSUBISHI LANCER Tre volumi</b> 1.3/1.6/2.0	
MITSUBISHI	MR403440	<b>MITSUBISHI LANCER VI (CK/P_A)</b> 2.0 16V EVO IX/2.0 16V EVO VIII	
Length/Lunghezza [mm]	54		
Inner Diam./Diam. Interno [mm]	14		
Outer Diam./Diam. esterno [mm]	61		
<b>RU-540</b>	<b>Holder, control arm mounting</b>	<b>MITSUBISHI LANCER SW</b> 1.6/2.0	
	<b>Silentblock</b>	<b>MITSUBISHI LANCER Tre volumi</b> 1.3/1.6/2.0	
MITSUBISHI	MR403441	<b>MITSUBISHI LANCER VI (CK/P_A)</b> 2.0 16V EVO IX/2.0 16V EVO VIII	
Length/Lunghezza [mm]	54		
Inner Diam./Diam. Interno [mm]	14		
Outer Diam./Diam. esterno [mm]	61		
<b>RU-541</b>	<b>Bearing Bush, stabiliser</b>	<b>MITSUBISHI LANCER SW</b> 1.6/2.0	
	<b>Boccola barra stabilizzatrice</b>	<b>MITSUBISHI LANCER Tre volumi</b> 1.3/1.6/2.0	
MITSUBISHI	MN100250	<b>MITSUBISHI LANCER VI (CK/P_A)</b> 2.0 16V EVO IX/2.0 16V EVO VIII	
Fitting Position/Lato Montaggio	Front		

<b>RU-542</b>	<b>Holder, control arm mounting</b>	<b>MITSUBISHI PAJERO III (V60)</b> 2.5 TDi (V64W, V74W)/3.2 DI-D (V68W, V78W)/3.5 V6 GDI (V65W, V75W)	
	<b>Silentblock</b>	<b>MITSUBISHI PAJERO IV (V80)</b> 3.2 DI-D (V88W, V98W)/3.8 V6 (V87W, V97W)	
MITSUBISHI	MR519398		542
	Inner Diam./Diam. Interno [mm]	14	
	Overall Length/Lungh. Tot. [mm]	54	
	Outer Diam./Diam. esterno [mm]	45	
<b>RU-543</b>	<b>Holder, control arm mounting</b>	<b>MITSUBISHI PAJERO III (V60)</b> 2.5 TDi (V64W, V74W)/3.2 DI-D (V68W, V78W)/3.5 V6 GDI (V65W, V75W)	
	<b>Silentblock</b>		
MITSUBISHI	MR496795		543
	Inner Diam./Diam. Interno [mm]	16,5	
	Overall Length/Lungh. Tot. [mm]	77	
	Outer Diam./Diam. esterno [mm]	48,5	
<b>RU-544</b>	<b>Holder, control arm mounting</b>	<b>MITSUBISHI PAJERO III (V60)</b> 2.5 TDi (V64W, V74W)/3.2 DI-D (V68W, V78W)/3.5 V6 GDI (V65W, V75W)	
	<b>Silentblock</b>		
MITSUBISHI	MR496795		544
	Inner Diam./Diam. Interno [mm]	16	
	Overall Length/Lungh. Tot. [mm]	77	
	Outer Diam./Diam. esterno [mm]	53	
<b>RU-545</b>	<b>Holder, control arm mounting</b>	<b>MITSUBISHI PAJERO PININ (H6_W, H7_W)</b> 1.8/1.8 GDI (H66W)/2.0 GDI (H67W, H77W)	
	<b>Silentblock</b>		
MITSUBISHI	MR319067		<b>RU-545</b>
	Length/Lunghezza [mm]	62	
	Inner Diam./Diam. Interno [mm]	12	
	Outer Diam./Diam. esterno [mm]	32	
<b>RU-546</b>	<b>Bearing Bush, stabiliser</b>	<b>CITROEN C-CROSSER</b> 2.2 HDi	
	<b>Boccola barra stabilizzatrice</b>	<b>MITSUBISHI ASX</b> 1.6/1.8/1.8 4WD/1.8 DI-D/1.8 DI-D 4WD/2.0 i/2.0 i 4WD	
MITSUBISHI	4056A079	<b>MITSUBISHI OUTLANDER</b> 2.0 DI-D/2.2 DI-D/2.4 Mivec	546
	Fitting Position/Lato Montaggio	Front	
	Height/Altezza [mm]	43	
	Width/Larghezza [mm]	46	
	Width/Larghezza [mm]	50	
	Inner Diam./Diam. Interno [mm]	19	
<b>RU-547</b>	<b>Bearing Bush, stabiliser</b>	<b>CITROEN C-CROSSER</b> 2.2 HDi	
	<b>Boccola barra stabilizzatrice</b>	<b>MITSUBISHI OUTLANDER</b> 2.0 DI-D/2.2 DI-D/2.4 Mivec	
MITSUBISHI	4156A028	<b>PEUGEOT 4007</b> 2.2 HDi/2.4 16V	547
	Fitting Position/Lato Montaggio	Rear	
<b>RU-548</b>	<b>Holder, control arm mounting</b>	<b>CITROEN C-CROSSER</b> 2.2 HDi	
	<b>Silentblock</b>	<b>MITSUBISHI ASX</b> 1.6/1.8/1.8 4WD/1.8 DI-D/1.8 DI-D 4WD/2.0 i/2.0 i 4WD	
MITSUBISHI	MN125871	<b>MITSUBISHI OUTLANDER</b> 2.0 DI-D/2.2 DI-D/2.4 Mivec	548
	Length/Lunghezza [mm]	60	
	Inner Diam./Diam. Interno [mm]	14	
	Outer Diam./Diam. esterno [mm]	37	





<b>RU-549</b>	<b>Holder, control arm mounting</b>	<b>CITROEN C-CROSSER</b>	
	<b>Silentblock</b>	2.2 HDi	
MITSUBISHI	MN184133	<b>MITSUBISHI ASX</b>	
Length/Lunghezza [mm]	54	1.6/1.8/1.8 4WD/1.8 DI-D/1.8 DI-D 4WD/2.0 i/2.0 i 4WD	
Inner Diam./Diam. Interno [mm]	14	<b>MITSUBISHI OUTLANDER</b>	
Outer Diam./Diam. esterno [mm]	60	2.0 DI-D/2.2 DI-D/2.4 Mivec	
		<b>PEUGEOT 4007</b>	
		2.2 HDi/2.4 16V	

<b>RU-550</b>	<b>Bearing Bush, stabiliser</b>	<b>MITSUBISHI PAJERO IV (V80)</b>	
	<b>Boccola barra stabilizzatrice</b>	3.2 DI-D (V88W, V98W)/3.8 V6 (V87W, V97W)	
MITSUBISHI	4056A121		
Fitting Position/Lato Montaggio	Front		
Length/Lunghezza [mm]	50		
Height/Altezza [mm]	56		
Width/Larghezza [mm]	52		
Inner Diam./Diam. Interno [mm]	30		

<b>RU-551</b>	<b>Bearing Bush, stabiliser</b>	<b>MITSUBISHI PAJERO IV (V80)</b>	
	<b>Boccola barra stabilizzatrice</b>	3.2 DI-D (V88W, V98W)/3.8 V6 (V87W, V97W)	
MITSUBISHI	4156A041		
Fitting Position/Lato Montaggio	Rear		
Length/Lunghezza [mm]	43		
Height/Altezza [mm]	48		
Width/Larghezza [mm]	59		
Inner Diam./Diam. Interno [mm]	25		

<b>RU-552</b>	<b>Engine Mounting</b>	<b>MITSUBISHI L 200 (K__T)</b>	
	<b>Supporto motore</b>	2.5 DI-D	
MITSUBISHI	MR992670	<b>MITSUBISHI L 200</b>	
Fitting Position/Lato Montaggio	Front	2.5 DiD [RWD]	
Length/Lunghezza [mm]	117,5		
Height/Altezza [mm]	66		
Width/Larghezza [mm]	71		
Mount. Bores/Fori Fiss. Dist. [mm]	100		

<b>RU-553</b>	<b>Bearing,propshaft centre bearing</b>	<b>MITSUBISHI L 200 (K__T)</b>	
	<b>Supporto albero cardanico</b>	2.5 DI-D	
MITSUBISHI	MR580647	<b>MITSUBISHI L 200</b>	
Height/Altezza [mm]	125	2.5 DiD [RWD]	
Width/Larghezza [mm]	60		
Inner Diam./Diam. Interno [mm]	30		
Mount. Bores/Fori Fiss. Dist. [mm]	188		

<b>RU-554</b>	<b>Engine Mounting</b>	<b>MITSUBISHI L 200 (K__T)</b>	
	<b>Supporto motore</b>	2.5 DI-D	
MITSUBISHI	1091A079	<b>MITSUBISHI L 200</b>	
Fitting Position/Lato Montaggio	Left Front	2.5 DiD [RWD]	

<b>RU-555</b>	<b>Engine Mounting</b>	<b>MITSUBISHI L 200 (K__T)</b>	
	<b>Supporto motore</b>	2.5 DI-D	
MITSUBISHI	1091A080	<b>MITSUBISHI L 200</b>	
Fitting Position/Lato Montaggio	Right Front	2.5 DiD [RWD]	

<b>RU-556</b> <b>Holder, control arm mounting</b> <b>Silentblock</b>	<b>MITSUBISHI L 200 (K__T)</b> 2.5 DI-D	 <p>556</p>
MITSUBISHI MR992256 Fitting Position/Lato Montaggio Lower Front Axle Length/Lunghezza [mm] 66 Inner Diam./Diam. Interno [mm] 16 Outer Diam./Diam. esterno [mm] 61		
<b>RU-557</b> <b>Engine Mounting</b> <b>Supporto motore</b>	<b>MITSUBISHI L 200</b> 2.5 DI-D [RWD] (KA4T)/2.5 DiD [RWD]	 <p>557</p>
MITSUBISHI MR992713 Fitting Position/Lato Montaggio Rear Length/Lunghezza [mm] 295 Height/Altezza [mm] 124 Width/Larghezza [mm] 104		
<b>RU-558</b> <b>Engine Mounting</b> <b>Supporto motore</b>	<b>MITSUBISHI L 200</b> 2.5 DI-D [RWD] (KA4T)/2.5 DiD [RWD]	 <p>558</p>
MITSUBISHI MR992717 Fitting Position/Lato Montaggio Rear Height/Altezza [mm] 108 Width/Larghezza [mm] 86 Overall Length/Lungh. Tot. [mm] 279		
<b>RU-559</b> <b>Bearing Bush, stabiliser</b> <b>Boccola barra stabilizzatrice</b>	<b>MITSUBISHI PAJERO III (V60)</b> 2.5 TDi (V64W, V74W)/3.2 DI-D (V68W, V78W)	 <p>559</p>
MITSUBISHI MR594282 Fitting Position/Lato Montaggio Rear Axle Length/Lunghezza [mm] 43,5 Height/Altezza [mm] 39 Width/Larghezza [mm] 40 Inner Diam./Diam. Interno [mm] 26		
<b>RU-560</b> <b>Bearing Bush, stabiliser</b> <b>Boccola barra stabilizzatrice</b>	<b>MITSUBISHI PAJERO III (V60)</b> 2.5 TDi (V64W, V74W)/3.2 DI-D (V68W, V78W)	 <p>560</p>
MITSUBISHI MR418547 Fitting Position/Lato Montaggio Rear Axle		
<b>RU-561</b> <b>Bearing Bush, stabiliser</b> <b>Boccola barra stabilizzatrice</b>	<b>MITSUBISHI LANCER VI (CK/P_A)</b> 2.0 16V EVO IX/2.0 16V EVO VI / VII (CP9A)	 <p>561</p>
MITSUBISHI MR589880 Fitting Position/Lato Montaggio Rear Axle Length/Lunghezza [mm] 40 Height/Altezza [mm] 30 Width/Larghezza [mm] 28 Inner Diam./Diam. Interno [mm] 22		
<b>RU-562</b> <b>Bearing Bush, stabiliser</b> <b>Boccola barra stabilizzatrice</b>	<b>MITSUBISHI LANCER VI (CK/P_A)</b> 2.0 16V EVO IX/2.0 16V EVO VI / VII (CP9A)	 <p>562</p>
MITSUBISHI MR554820 Fitting Position/Lato Montaggio Front Axle Length/Lunghezza [mm] 36 Height/Altezza [mm] 34 Width/Larghezza [mm] 34 Inner Diam./Diam. Interno [mm] 24		

<p><b>RU-563</b>      <b>Bearing Bush, stabiliser</b></p> <p><b>Boccola barra stabilizzatrice</b></p> <p>MITSUBISHI      MR150093</p>	<p><b>MITSUBISHI L 400 Furgonato (PAOV)</b> 2500 TD</p>	 <p>563</p>
<p><b>RU-564</b>      <b>Bearing Bush, stabiliser</b></p> <p><b>Boccola barra stabilizzatrice</b></p> <p>MITSUBISHI      MR150767</p> <p>Fitting Position/Lato Montaggio      Front Axle</p> <p>Fitting Position/Lato Montaggio      Outer</p> <p>Length/Lunghezza [mm]      40</p> <p>Height/Altezza [mm]      35</p> <p>Width/Larghezza [mm]      42</p> <p>Inner Diam./Diam. Interno [mm]      20</p>	<p><b>MITSUBISHI L 200 (K_T)</b> 2.5 TD 4x4 (K74T)</p> <p><b>MITSUBISHI PAJERO SPORT (K90)</b> 2.5 TD/3.0 V6</p>	 <p>564</p>
<p><b>RU-565</b>      <b>Bearing Bush, stabiliser</b></p> <p><b>Boccola barra stabilizzatrice</b></p> <p>MITSUBISHI      MR267649</p> <p>Fitting Position/Lato Montaggio      Front Axle</p> <p>Fitting Position/Lato Montaggio      inner</p> <p>Length/Lunghezza [mm]      40</p> <p>Height/Altezza [mm]      40</p> <p>Width/Larghezza [mm]      49</p> <p>Inner Diam./Diam. Interno [mm]      28</p>	<p><b>MITSUBISHI PAJERO SPORT (K90)</b> 2.5 TD/3.0 V6</p>	 <p>565</p>
<p><b>RU-566</b>      <b>Bearing Bush, stabiliser</b></p> <p><b>Boccola barra stabilizzatrice</b></p> <p>MITSUBISHI      MB338594</p> <p>Fitting Position/Lato Montaggio      Rear Axle</p> <p>Length/Lunghezza [mm]      43</p> <p>Height/Altezza [mm]      37</p> <p>Width/Larghezza [mm]      40</p> <p>Inner Diam./Diam. Interno [mm]      22</p>	<p><b>MITSUBISHI PAJERO SPORT (K90)</b> 2.5 TD/3.0 V6</p>	 <p>566</p>
<p><b>RU-567</b>      <b>Bearing Bush, stabiliser</b></p> <p><b>Boccola barra stabilizzatrice</b></p> <p>MITSUBISHI      MR171441</p> <p>Fitting Position/Lato Montaggio      Front Axle</p> <p>Length/Lunghezza [mm]      35</p> <p>Height/Altezza [mm]      26</p> <p>Width/Larghezza [mm]      25</p> <p>Inner Diam./Diam. Interno [mm]      17</p>	<p><b>MITSUBISHI COLT V (CJ_A)</b> 1300/1300 GL, GLX (CJ1A)/1500 (CJ2A)/1600/1600 GLX (CJ4A)</p>	 <p>567</p>
<p><b>RU-568</b>      <b>Bearing Bush, stabiliser</b></p> <p><b>Boccola barra stabilizzatrice</b></p> <p>MITSUBISHI      MR455699</p> <p>Fitting Position/Lato Montaggio      Front Axle</p> <p>Length/Lunghezza [mm]      40</p> <p>Height/Altezza [mm]      38</p> <p>Width/Larghezza [mm]      41</p> <p>Inner Diam./Diam. Interno [mm]      23</p>	<p><b>MITSUBISHI PAJERO II Fuoristrada aperto (V2_W, V4_W)</b> 1.8 GDI</p> <p><b>MITSUBISHI PAJERO PININ (H6_W, H7_W)</b> 1.8/2.0 GDI (H67W, H77W)</p>	 <p>568</p>

<b>RU-569</b>	<b>Bearing Bush, stabiliser</b>	<b>MITSUBISHI COLT IV (CA_A)</b>	
	<b>Boccola barra stabilizzatrice</b>	1.3 GLi 12V (CA1A)/1.6 GLXi 16V (CA4A)/1.8 GTi 16V (CA5A)	
MITSUBISHI	MB809357	<b>MITSUBISHI LANCER V (CB/D_A)</b>	
		1.3 (CB1A)/2.0 Diesel (CB8A)	
Fitting Position/Lato Montaggio	Rear Axle		
Length/Lunghezza [mm]	36,5		
Height/Altezza [mm]	33		
Width/Larghezza [mm]	28		
Inner Diam./Diam. Interno [mm]	15		
<b>RU-570</b>	<b>Bearing Bush, stabiliser</b>	<b>MITSUBISHI COLT IV (CA_A)</b>	
	<b>Boccola barra stabilizzatrice</b>	1.3 GLi 12V (CA1A)/1.6 GLXi 16V (CA4A)/1.8 GTi 16V (CA5A)	
MITSUBISHI	MB844456	<b>MITSUBISHI LANCER V (CB/D_A)</b>	
		1.3 (CB1A)/2.0 Diesel (CB8A)	
Fitting Position/Lato Montaggio	Front Axle	<b>MITSUBISHI LANCER V SW (CB_W, CD_W)</b>	
Length/Lunghezza [mm]	35	1.6 16V (CB4W)/1.6 16V 4WD (CD4W)	
Height/Altezza [mm]	30		
Width/Larghezza [mm]	30		
Inner Diam./Diam. Interno [mm]	22		
<b>RU-572</b>	<b>Bearing Bush, stabiliser</b>	<b>MITSUBISHI GALANT VI (EA_)</b>	
	<b>Boccola barra stabilizzatrice</b>	2.5 V6 24V (EA5A)	
MITSUBISHI	MR272646	<b>MITSUBISHI GALANT VI SW (EA_)</b>	
		2.5 V6 24V (EA5W)	
Fitting Position/Lato Montaggio	Front Axle		
Length/Lunghezza [mm]	47		
Height/Altezza [mm]	42		
Width/Larghezza [mm]	41		
Inner Diam./Diam. Interno [mm]	20		
<b>RU-601</b>	<b>Engine Mounting</b>	<b>DAIHATSU FEROZA Hard Top (F300)</b>	
	<b>Supporto motore</b>	1.6 16V/1.6 i 16V	
DAIHATSU	12361-87306	<b>DAIHATSU FEROZA Soft Top (F300)</b>	
		1.6 16V/1.6 i 16V	
Length/Lunghezza [mm]	133		
Height/Altezza [mm]	45		
Width/Larghezza [mm]	98		
<b>RU-602</b>	<b>Engine Mounting</b>	<b>DAIHATSU ROCKY Hard Top (F7, F8)</b>	
	<b>Supporto motore</b>	2.0/2.2/2.8 D/2.8 TD	
DAIHATSU	12361-87603	<b>DAIHATSU ROCKY Soft Top (F7, F8)</b>	
		2.0/2.2 4x4/2.8 D/2.8 TD	
Length/Lunghezza [mm]	134	<b>DAIHATSU WILDCAT/ROCKY (F70)</b>	
Height/Altezza [mm]	47	2.8 D/2.8 TD	
Width/Larghezza [mm]	90	<b>DAIHATSU WILDCAT/ROCKY (F75)</b>	
		2.8 D/2.8 TD	
<b>RU-603</b>	<b>Engine Mounting</b>	<b>DAIHATSU FEROZA Hard Top (F300)</b>	
	<b>Supporto motore</b>	1.6 16V/1.6 i 16V	
DAIHATSU	12371-87607	<b>DAIHATSU FEROZA Soft Top (F300)</b>	
		1.6 16V/1.6 i 16V	
Length/Lunghezza [mm]	112	<b>DAIHATSU ROCKY Hard Top (F7, F8)</b>	
Height/Altezza [mm]	35	2.0/2.2/2.8 D/2.8 TD	
Width/Larghezza [mm]	102	<b>DAIHATSU ROCKY Soft Top (F7, F8)</b>	
		2.0/2.2 4x4/2.8 D/2.8 TD	
		<b>DAIHATSU WILDCAT/ROCKY (F70)</b>	
		2.8 D/2.8 TD	
		<b>DAIHATSU WILDCAT/ROCKY (F75)</b>	
		2.8 D/2.8 TD	

<b>RU-605</b>	<b>Bush, leaf spring</b>	<b>DAIHATSU FEROZA Hard Top (F300)</b>		
	<b>Boccola balestra</b>	1.6 16V/1.6 i 16V		
DAIHATSU	90043-85046	<b>DAIHATSU FEROZA Soft Top (F300)</b>		
Fitting Position/Lato Montaggio	Front	1.6 16V/1.6 i 16V		
Length/Lunghezza [mm]	74	<b>DAIHATSU ROCKY Hard Top (F7, F8)</b>		
Inner Diam./Diam. Interno [mm]	16	2.0/2.2/2.8 D/2.8 TD		
Outer Diam./Diam. esterno [mm]	36,2	<b>DAIHATSU ROCKY Soft Top (F7, F8)</b>		
		2.0/2.2 4x4/2.8 D/2.8 TD		
		<b>DAIHATSU WILDCAT/ROCKY (F70)</b>		
		2.8 D/2.8 TD		
<b>RU-606</b>	<b>Bush, leaf spring</b>	<b>DAIHATSU WILDCAT/ROCKY (F75)</b>		
	<b>Boccola balestra</b>	2.8 D/2.8 TD		
DAIHATSU	90043-85049	<b>DAIHATSU FEROZA Hard Top (F300)</b>		
Length/Lunghezza [mm]	55	1.6 16V/1.6 i 16V		
Inner Diam./Diam. Interno [mm]	30	<b>DAIHATSU FEROZA Soft Top (F300)</b>		
Outer Diam./Diam. esterno [mm]	45	1.6 16V/1.6 i 16V		
		<b>DAIHATSU ROCKY Hard Top (F7, F8)</b>		
		2.0/2.2/2.8 D/2.8 TD		
		<b>DAIHATSU ROCKY Soft Top (F7, F8)</b>		
		2.0/2.2 4x4/2.8 D/2.8 TD		
<b>RU-607</b>	<b>Bearing Bush, stabiliser</b>	<b>DAIHATSU WILDCAT/ROCKY (F70)</b>		
	<b>Boccola barra stabilizzatrice</b>	2.8 D/2.8 TD		
DAIHATSU	48815-20026	<b>DAIHATSU WILDCAT/ROCKY (F75)</b>		
Length/Lunghezza [mm]	39,5	2.8 D/2.8 TD		
Height/Altezza [mm]	31,2	<b>DAIHATSU ROCKY Hard Top (F7, F8)</b>		
Width/Larghezza [mm]	30	2.0/2.2/2.8 D/2.8 TD		
Inner Diam./Diam. Interno [mm]	16	<b>DAIHATSU ROCKY Soft Top (F7, F8)</b>		
		2.0/2.2 4x4/2.8 D/2.8 TD		
		<b>DAIHATSU WILDCAT/ROCKY (F70)</b>		
		2.8 D/2.8 TD		
<b>RU-608</b>	<b>Bearing Bush, stabiliser</b>	<b>DAIHATSU WILDCAT/ROCKY (F75)</b>		
	<b>Boccola barra stabilizzatrice</b>	2.8 D/2.8 TD		
DAIHATSU	48815-87601	<b>DAIHATSU FEROZA Hard Top (F300)</b>		
Length/Lunghezza [mm]	40	1.6 16V/1.6 i 16V		
Height/Altezza [mm]	34,3	<b>DAIHATSU FEROZA Soft Top (F300)</b>		
Width/Larghezza [mm]	32	1.6 16V/1.6 i 16V		
Inner Diam./Diam. Interno [mm]	23			
<b>RU-609</b>	<b>Bearing Bush, stabiliser</b>	<b>DAIHATSU ROCKY Hard Top (F7, F8)</b>		
	<b>Boccola barra stabilizzatrice</b>	2.8 D/2.8 TD		
DAIHATSU	90045-40165	<b>DAIHATSU ROCKY Soft Top (F7, F8)</b>		
Length/Lunghezza [mm]	16,2	2.0/2.2 4x4/2.8 D/2.8 TD		
Inner Diam./Diam. Interno [mm]	10	<b>DAIHATSU WILDCAT/ROCKY (F70)</b>		
Outer Diam./Diam. esterno [mm]	25	2.8 D/2.8 TD		
<b>RU-700</b>	<b>Holder, control arm mounting</b>	<b>DAIHATSU FEROZA Hard Top (F300)</b>		
	<b>Silentblock</b>	1.6 16V/1.6 i 16V		
SUBARU	20201-AA000	<b>DAIHATSU FEROZA Soft Top (F300)</b>		
Length/Lunghezza [mm]	55	1.6 16V/1.6 i 16V		
Inner Diam./Diam. Interno [mm]	12,5			
Outer Diam./Diam. esterno [mm]	37,5	<b>SUBARU FORESTER (SF)</b>		
		2.0/2.0 S Turbo		
		<b>SUBARU IMPREZA (GC)</b>		
		1.6 i/1.6 i 4WD/1.6 i 4WD/1.8 i 4WD/2.0 i 4WD/2.0 Turbo GT		
		4WD/2.2 GX AWD		
		<b>SUBARU IMPREZA Coupe (GFC)</b>		
		1.6/1.6 4WD/2.0 4WD/2.0 Turbo 4WD		
		<b>SUBARU IMPREZA SW (GF)</b>		
		1.5 L/1.6/1.6 i/1.6 i 4WD/1.6 i 4WD/1.8 i 4WD/2.0 4WD/2.0		
		16V AWD/2.0 i Turbo 4WD/2.0 Turbo GT 4WD/2.2 GX AWD		
		<b>SUBARU LEGACY I (BC)</b>		
		1.6/1.6i 16V/1800/1800 4WD/2.0 GL/2000 4WD/2000 Turbo		
		4WD/2200 4WD		
		<b>SUBARU LEGACY I SW (BIF)</b>		
		1.6 GL/1800/1800 4WD/2.2 GX/2000/2000 4WD/2000 Turbo		
		Super 4WD/2200 Super 4WD		

## RU-701

Holder, control arm mounting

Silentblock

SUBARU 20201-AC100

Length/Lunghezza [mm]	51
Inner Diam./Diam. Interno [mm]	20
Inner Diam./Diam. Int. 1 [mm]	25

### SUBARU LEGACY II (BD, BG)

2.0 i/2.0 i 4WD/2.2 i 4WD/2.5 i 4WD

### SUBARU LEGACY II SW (BD, BG)

2.0 i/2.0 i 4WD/2.2 i 4WD/2.5 i 4WD

### SUBARU FORESTER (SF)

2.0/2.0 S Turbo

### SUBARU IMPREZA (GC)

1.6 i/1.6 i 4WD/1.6 i 4WD/1.8 i 4WD/2.0 i 4WD/2.0 Turbo GT  
4WD/2.2 GX AWD

### SUBARU IMPREZA Coupe (GFC)

1.6/1.6 4WD/2.0 4WD/2.0 Turbo 4WD

### SUBARU IMPREZA SW (GF)

1.5 L/1.6/1.6 i/1.6 i 4WD/1.6 i 4WD/1.8 i 4WD/2.0 4WD/2.0  
16V AWD/2.0 i Turbo 4WD/2.0 Turbo GT 4WD/2.2 GX AWD

### SUBARU LEGACY I (BC)

1.6/1.6i 16V/1800/1800 4WD/2.0 GL/2000 4WD/2000 Turbo  
4WD/2200 4WD

### SUBARU LEGACY I SW (BJF)

1.6 GL/1800/1800 4WD/2.2 GX/2000/2000 4WD/2000 Turbo  
Super 4WD/2200 Super 4WD

### SUBARU LEGACY II (BD, BG)

2.0 i/2.0 i 4WD/2.2 i 4WD/2.5 i 4WD

### SUBARU LEGACY II SW (BD, BG)

2.0 i/2.0 i 4WD/2.2 i 4WD/2.5 i 4WD



## RU-702

Holder, control arm mounting

Silentblock

SUBARU 20201-AC110

Width/Larghezza [mm]	51
Inner Diam./Diam. Interno [mm]	20
Inner Diam./Diam. Int. 1 [mm]	25

### SUBARU FORESTER (SF)

2.0/2.0 S Turbo

### SUBARU IMPREZA (GC)

1.6 i/1.6 i 4WD/1.6 i 4WD/1.8 i 4WD/2.0 i 4WD/2.0 Turbo GT  
4WD/2.2 GX AWD

### SUBARU IMPREZA Coupe (GFC)

1.6/1.6 4WD/2.0 4WD/2.0 Turbo 4WD

### SUBARU IMPREZA SW (GF)

1.5 L/1.6/1.6 i/1.6 i 4WD/1.6 i 4WD/1.8 i 4WD/2.0 4WD/2.0  
16V AWD/2.0 i Turbo 4WD/2.0 Turbo GT 4WD/2.2 GX AWD

### SUBARU LEGACY I (BC)

1.6/1.6i 16V/1800/1800 4WD/2.0 GL/2000 4WD/2000 Turbo  
4WD/2200 4WD

### SUBARU LEGACY I SW (BJF)

1.6 GL/1800/1800 4WD/2.2 GX/2000/2000 4WD/2000 Turbo  
Super 4WD/2200 Super 4WD

### SUBARU LEGACY II (BD, BG)

2.0 i/2.0 i 4WD/2.2 i 4WD/2.5 i 4WD

### SUBARU LEGACY II SW (BD, BG)

2.0 i/2.0 i 4WD/2.2 i 4WD/2.5 i 4WD



## RU-703

Holder, control arm mounting

Silentblock

SUBARU 20201-FC020

Length/Lunghezza [mm]	55
Inner Diam./Diam. Interno [mm]	12,5
Outer Diam./Diam. esterno [mm]	37

### SUBARU FORESTER (SF)

2.0/2.0 S Turbo



## RU-704

Holder, control arm mounting

Silentblock







SUBARU 20201-FC110

Width/Larghezza [mm]	51
Inner Diam./Diam. Interno [mm]	20
Inner Diam./Diam. Int. 1 [mm]	25

### SUBARU FORESTER (SF)

2.0/2.0 S Turbo



<p><b>RU-705</b>      <b>Holder, control arm mounting</b></p> <p><b>Silentblock</b></p>	<p><b>SUBARU FORESTER (SF)</b> 2.0/2.0 S Turbo</p>	 <p>705</p>
<p>SUBARU      20201-FC100</p> <p>Width/Larghezza [mm]      51</p> <p>Inner Diam./Diam. Interno [mm]      20</p> <p>Inner Diam./Diam. Int. 1 [mm]      25</p>		
<p><b>RU-706</b>      <b>Holder, control arm mounting</b></p> <p><b>Silentblock</b></p>	<p><b>SUBARU FORESTER (SG)</b> 2.0/2.0 S Turbo/2.0 X/2.5/2.5 RX Nato AWD/2.5 XT</p>	 <p>706</p>
<p>SUBARU      20201-FC130</p> <p>Width/Larghezza [mm]      51</p> <p>Inner Diam./Diam. Interno [mm]      20</p> <p>Inner Diam./Diam. Int. 1 [mm]      25</p>		
<p><b>RU-707</b>      <b>Holder, control arm mounting</b></p> <p><b>Silentblock</b></p>	<p><b>SUBARU FORESTER (SG)</b> 2.0/2.0 S Turbo/2.0 X/2.5/2.5 RX Nato AWD/2.5 XT</p>	 <p>707</p>
<p>SUBARU      20201-FC120</p> <p>Width/Larghezza [mm]      51</p> <p>Inner Diam./Diam. Interno [mm]      25</p> <p>Inner Diam./Diam. Int. 1 [mm]      20</p>		
<p><b>RU-708</b>      <b>Holder, control arm mounting</b></p> <p><b>Silentblock</b></p>	<p><b>SUBARU IMPREZA (GD, GG)</b> 1.5/1.6/1.6 AWD/2.0/2.0 4 ruote motrici/2.0 AWD/2.0 R/2.0 WRX STi/2.0 WRX Turbo/2.2/2.5 4 ruote motrici/2.5 AWD/2.5 WRX/2.5 WRX ST1</p>	 <p>708</p>
<p>SUBARU      20201-FA080</p> <p>Width/Larghezza [mm]      68</p> <p>Inner Diam./Diam. Interno [mm]      20</p> <p>Inner Diam./Diam. Int. 1 [mm]      25</p>	<p><b>SUBARU IMPREZA SW (GD, GG)</b> 1.5/1.6/2.0/2.0 AWD/2.0 R/2.0 Turbo/2.0 WRX STi AWD/2.0 WRX Turbo/2.2/2.5 AWD/2.5 WRX</p>	
<p><b>RU-709</b>      <b>Holder, control arm mounting</b></p> <p><b>Silentblock</b></p>	<p><b>SUBARU IMPREZA (GD, GG)</b> 1.5/1.6/1.6 AWD/2.0/2.0 4 ruote motrici/2.0 AWD/2.0 R/2.0 WRX STi/2.0 WRX Turbo/2.2/2.5 4 ruote motrici/2.5 AWD/2.5 WRX/2.5 WRX ST1</p>	 <p>709</p>
<p>SUBARU      20201-FA070</p> <p>Width/Larghezza [mm]      68</p> <p>Inner Diam./Diam. Interno [mm]      20</p> <p>Inner Diam./Diam. Int. 1 [mm]      25</p>	<p><b>SUBARU IMPREZA SW (GD, GG)</b> 1.5/1.6/2.0/2.0 AWD/2.0 R/2.0 Turbo/2.0 WRX STi AWD/2.0 WRX Turbo/2.2/2.5 AWD/2.5 WRX</p>	
<p><b>RU-800</b>      <b>Suspension Strut Support Bearing</b></p> <p><b>Supporto ammortizzatore</b></p>	<p><b>SUZUKI SWIFT II (AH, AJ)</b> 1.3 (SF413, AH35)/1.3 (SF413, AH35, MA)/1.6 (SF416, AH14)/1.6 4WD (SF416, AJ14)/1.6 i (SF416, AH14)/1.6 i 4WD (SF416, AJ14)</p>	 <p>800</p>
<p>SUZUKI      41710-60B00</p> <p>Fitting Position/Lato Montaggio      Front Axle</p> <p>Length/Lunghezza [mm]      133</p> <p>Height/Altezza [mm]      132</p> <p>Width/Larghezza [mm]      47</p> <p>Inner Diam./Diam. Interno [mm]      34</p>	<p><b>SUZUKI SWIFT II 2 volumi (EA, MA)</b> 1.0 (SF310, AA44)/1.0 i (SF310, AA44)/1.3 (SF413, AB35)/1.3 4WD (SF413, AA35)/1.3 4WD (SF413, AF35)/1.3 GTi (SF413, AA34)</p>	
<p><b>RU-801</b>      <b>Base</b></p> <p><b>Supporto cambio</b></p>	<p><b>SUZUKI SWIFT Cabriolet (SF413)</b> 1.3 (SF413, AK35)</p>	 <p>801</p>
<p>SUZUKI      11620-71C10</p> <p>Length/Lunghezza [mm]      86,2</p> <p>Height/Altezza [mm]      103,5</p> <p>Width/Larghezza [mm]      56</p> <p>Inner Diam./Diam. Interno [mm]      10</p>	<p><b>SUZUKI SWIFT II (AH, AJ)</b> 1.6 i (SF416, AH14)/1.6 i 4WD (SF416, AJ14)</p> <p><b>SUZUKI SWIFT II 2 volumi (EA, MA)</b> 1.0 (SF310, AA44)/1.0 i (SF310, AA44)/1.3 (SF413, AB35)/1.3 4WD (SF413, AA35)/1.3 GTi (SF413, AA34)</p>	

<b>RU-802</b>	<b>Engine Mounting</b>	<b>SUZUKI SJ 410</b>	
		1.0	
	<b>Supporto motore</b>	<b>SUZUKI SJ 410 Cabrio</b>	
		1.0	
SUZUKI	11610-80020	<b>SUZUKI SJ 413</b>	
		1.3	
Length/Lunghezza [mm]	110		
Height/Altezza [mm]	44		
Width/Larghezza [mm]	74		
<b>RU-803</b>	<b>Engine Mounting</b>	<b>SUZUKI SJ 410</b>	
		1.0	
	<b>Supporto motore</b>	<b>SUZUKI SJ 410 Cabrio</b>	
		1.0	
SUZUKI	11610-80000	<b>SUZUKI SJ 413</b>	
		1.3	
Length/Lunghezza [mm]	91,5		
Height/Altezza [mm]	45		
Width/Larghezza [mm]	60		
<b>RU-804</b>	<b>Engine Mounting</b>	<b>SUZUKI SJ 410</b>	
		1.0	
	<b>Supporto motore</b>	<b>SUZUKI SJ 410 Cabrio</b>	
		1.0	
SUZUKI	11710-80010	<b>SUZUKI SJ 413</b>	
		1.3	
Length/Lunghezza [mm]	111		
Height/Altezza [mm]	41		
Width/Larghezza [mm]	81,5		
Inner Diam./Diam. Interno [mm]	10		
<b>RU-805</b>	<b>GummiParts</b>	<b>SUZUKI SJ 410</b>	
		1.0	
	<b>Parti in gomma</b>	<b>SUZUKI SJ 410 Cabrio</b>	
		1.0	
SUZUKI	29650-82C00	<b>SUZUKI SJ 413</b>	
		1.3	
Length/Lunghezza [mm]	52,5		
Height/Altezza [mm]	27,5		
Width/Larghezza [mm]	51		
<b>RU-806</b>	<b>Engine Mounting</b>	<b>SUZUKI VITARA (ET, TA)</b>	
		1.6 (ET)/1.6 (TA)/1.6 16V (ET)/1.9 D (ET)/2.0 16V (ET)/2.0 TD (ET)/2.0 TD Intercooler (ET)/2.0 V6 24V (ET)/2.5 V6 24V (FT)	
	<b>Supporto motore</b>	<b>SUZUKI VITARA Cabrio (ET, TA)</b>	
		1.6 (TA)/1.6 16V (ET)/1.9 D (ET)/2.0 16V (ET)	
SUZUKI	11610-58B10		
Length/Lunghezza [mm]	130		
Height/Altezza [mm]	62		
Width/Larghezza [mm]	87		
<b>RU-807</b>	<b>Engine Mounting</b>	<b>SUZUKI VITARA (ET, TA)</b>	
		1.6 (ET)/1.6 (TA)/1.6 16V (ET)/1.9 D (ET)/2.0 16V (ET)/2.0 TD (ET)/2.0 TD Intercooler (ET)/2.0 V6 24V (ET)/2.5 V6 24V (FT)	
	<b>Supporto motore</b>	<b>SUZUKI VITARA Cabrio (ET, TA)</b>	
		1.6 (TA)/1.6 16V (ET)/1.9 D (ET)/2.0 16V (ET)	
SUZUKI	11610-58B01		
Length/Lunghezza [mm]	152		
Height/Altezza [mm]	58		
Width/Larghezza [mm]	87		
<b>RU-808</b>	<b>Engine Mounting</b>	<b>SUZUKI VITARA (ET, TA)</b>	
		1.6 (ET)/1.6 (TA)/1.6 16V (ET)/1.9 D (ET)/2.0 16V (ET)/2.0 TD (ET)/2.0 TD Intercooler (ET)/2.0 V6 24V (ET)/2.5 V6 24V (FT)	
	<b>Supporto motore</b>	<b>SUZUKI VITARA Cabrio (ET, TA)</b>	
		1.6 (TA)/1.6 16V (ET)/1.9 D (ET)/2.0 16V (ET)	
SUZUKI	11710-60A01		
Length/Lunghezza [mm]	114		
Height/Altezza [mm]	56		
Width/Larghezza [mm]	61		
Inner Diam./Diam. Interno [mm]	25		



<b>RU-809</b>	<b>Suspension Strut Support Bearing</b>	<b>SUZUKI VITARA (ET, TA)</b>	
	<b>Supporto ammortizzatore</b>	1.6 (ET)/1.6 (TA)/1.6 16V (ET)/1.9 D (ET)/2.0 16V (ET)/2.0 TD (ET)/2.0 TD Intercooler (ET)/2.0 V6 24V (ET)/2.5 V6 24V (FT)	
SUZUKI	41810-60A00	<b>SUZUKI VITARA Cabrio (ET, TA)</b>	
		1.6 (TA)/1.6 16V (ET)/1.9 D (ET)/2.0 16V (ET)	
Fitting Position/Lato Montaggio		Rear Axle	
Length/Lunghezza [mm]		104	
Height/Altezza [mm]		106	
Width/Larghezza [mm]		38	
Inner Diam./Diam. Interno [mm]		17	
<b>RU-810</b>	<b>GummiParts</b>	<b>SUZUKI SJ 410</b>	
	<b>Parti in gomma</b>	1.0	
SUZUKI	29610-82C00	<b>SUZUKI SJ 410 Cabrio</b>	
		1.0	
Length/Lunghezza [mm]		50	
Height/Altezza [mm]		29	
Width/Larghezza [mm]		49	
<b>RU-811</b>	<b>Bush, leaf spring</b>	<b>SUZUKI SAMURAI (SJ)</b>	
	<b>Boccola balestra</b>	1.0 (SJ 410)/1.3 (SJ 413)/1.9 TD	
SUZUKI	41331-62020	<b>SUZUKI SANTANA</b>	
		1.0 (SJ410) F10A/1.0 (SJ410) F10A MADE IN SPAIN/1.3 (SJ413)	
Length/Lunghezza [mm]		33,2	
Height/Altezza [mm]		15,4	
Width/Larghezza [mm]		41	
<b>RU-812</b>	<b>Bush, leaf spring</b>	<b>SUZUKI SAMURAI (SJ)</b>	
	<b>Boccola balestra</b>	1.0 (SJ 410)/1.3 (SJ 413)/1.9 TD	
SUZUKI	09305-13002	<b>SUZUKI SANTANA</b>	
		1.0 (SJ410) F10A/1.0 (SJ410) F10A MADE IN SPAIN/1.3 (SJ413)	
Length/Lunghezza [mm]		32	
Inner Diam./Diam. Interno [mm]		13	
Outer Diam./Diam. esterno [mm]		30	
<b>RU-813</b>	<b>Bush, leaf spring</b>	<b>SUZUKI SJ 410</b>	
	<b>Boccola balestra</b>	1.0	
SUZUKI	09319-12023	<b>SUZUKI SJ 410 Cabrio</b>	
		1.0	
Length/Lunghezza [mm]		65	
Inner Diam./Diam. Interno [mm]		12	
Outer Diam./Diam. esterno [mm]		41	
<b>RU-814</b>	<b>Bearing Bush, stabiliser</b>	<b>SUZUKI VITARA (ET, TA)</b>	
	<b>Boccola barra stabilizzatrice</b>	1.6 (ET)/1.6 (TA)/1.6 16V (ET)/1.9 D (ET)/2.0 16V (ET)/2.0 TD (ET)/2.0 TD Intercooler (ET)/2.0 V6 24V (ET)/2.5 V6 24V (FT)	
SUZUKI	42412-60A00	<b>SUZUKI VITARA Cabrio (ET, TA)</b>	
		1.6 (TA)/1.6 16V (ET)/1.9 D (ET)/2.0 16V (ET)	
Length/Lunghezza [mm]		43,2	
Height/Altezza [mm]		40	
Width/Larghezza [mm]		33	
Inner Diam./Diam. Interno [mm]		24	

<b>RU-815</b>	<b>Holder, control arm mounting</b>	<b>SUZUKI VITARA (ET, TA)</b> 1.6 (ET)/1.6 (TA)/1.6 16V (ET)/1.9 D (ET)/2.0 16V (ET)/2.0 TD (ET)/2.0 TD Intercooler (ET)/2.0 V6 24V (ET)/2.5 V6 24V (FT)	
	<b>Silentblock</b>	<b>SUZUKI VITARA Cabrio (ET, TA)</b> 1.6 (TA)/1.6 16V (ET)/1.9 D (ET)/2.0 16V (ET)	
SUZUKI	09319-12044		
Length/Lunghezza [mm]	65		
Inner Diam./Diam. Interno [mm]	13		
Outer Diam./Diam. esterno [mm]	45		
<b>RU-816</b>	<b>Holder, control arm mounting</b>	<b>SUZUKI VITARA (ET, TA)</b> 1.6 (ET)/1.6 (TA)/1.6 16V (ET)/1.9 D (ET)/2.0 16V (ET)/2.0 TD (ET)/2.0 TD Intercooler (ET)/2.0 V6 24V (ET)/2.5 V6 24V (FT)	
	<b>Silentblock</b>	<b>SUZUKI VITARA Cabrio (ET, TA)</b> 1.6 (TA)/1.6 16V (ET)/1.9 D (ET)/2.0 16V (ET)	
SUZUKI	09319-12045		
Length/Lunghezza [mm]	64		
Inner Diam./Diam. Interno [mm]	14		
Outer Diam./Diam. esterno [mm]	42,4		
<b>RU-817</b>	<b>Bearing Bush, stabiliser</b>	<b>SUZUKI VITARA (ET, TA)</b> 1.6 (ET)/1.6 (TA)/1.6 16V (ET)/1.9 D (ET)/2.0 16V (ET)/2.0 TD (ET)/2.0 TD Intercooler (ET)/2.0 V6 24V (ET)/2.5 V6 24V (FT)	
	<b>Boccola barra stabilizzatrice</b>	<b>SUZUKI VITARA Cabrio (ET, TA)</b> 1.6 (TA)/1.6 16V (ET)/1.9 D (ET)/2.0 16V (ET)	
SUZUKI	09320-10024		
Length/Lunghezza [mm]	16		
Inner Diam./Diam. Interno [mm]	10		
Outer Diam./Diam. esterno [mm]	25		
<b>RU-818</b>	<b>Holder, control arm mounting</b>	<b>SUZUKI VITARA (ET, TA)</b> 1.6 (ET)/1.6 (TA)/1.6 16V (ET)/1.9 D (ET)/2.0 16V (ET)/2.0 TD (ET)/2.0 TD Intercooler (ET)/2.0 V6 24V (ET)/2.5 V6 24V (FT)	
	<b>Silentblock</b>	<b>SUZUKI VITARA Cabrio (ET, TA)</b> 1.6 (TA)/1.6 16V (ET)/1.9 D (ET)/2.0 16V (ET)	
SUZUKI	09319-14007		
Length/Lunghezza [mm]	64		
Inner Diam./Diam. Interno [mm]	14		
Outer Diam./Diam. esterno [mm]	41		
<b>RU-820</b>	<b>Bearing Bush, stabiliser</b>	<b>SUZUKI ALTO II (EC)</b> 0.8 (SB308/CA)	
	<b>Boccola barra stabilizzatrice</b>	<b>SUZUKI ALTO III (EF)</b> 0.8 i cat. ( SB308 ) /1.0	
SUZUKI	42431-70B42	<b>SUZUKI IGNIS (FH)</b> 1.3/1.3 4WD	
Fitting Position/Lato Montaggio	Front		
Length/Lunghezza [mm]	51		
Height/Altezza [mm]	39		
Inner Diam./Diam. Interno [mm]	21		
Inner Width/Larghezza interna [mm]	40		
<b>RU-821</b>	<b>Holder, control arm mounting</b>	<b>OPEL AGILA (H00)</b> 1.0/1.0 12V/1.2 16V/1.2 16V Twinport/1.3 CDTI	
	<b>Silentblock</b>	<b>SUZUKI ALTO IV (FF)</b> 1.1	
SUZUKI	42451 M76G00	<b>SUZUKI IGNIS (FH)</b> 1.3/1.3 4WD	
Length/Lunghezza [mm]	32		
Inner Diam./Diam. Interno [mm]	16		
Outer Diam./Diam. esterno [mm]	48,5	<b>SUZUKI IGNIS II</b> 1.3/1.3 DDIS/1.5/1.5 4x4/1.5 Sport	
<b>RU-822</b>	<b>Holder, control arm mounting</b>	<b>SUZUKI BALENO (EG)</b> 1.3/1.3 i 16V/1.6 i 16V/1.6 i 16V 4x4/1.8 GT/1.9 TD	
	<b>Silentblock</b>	<b>SUZUKI BALENO 2 volumi (EG)</b> 1.3/1.3 i 16V/1.6 i 16V/1.6 i 16V 4x4/1.8 GT/1.9 TD	
SUZUKI	45500-50800	<b>SUZUKI BALENO SW (EG)</b> 1.3 16V/1.6 i 16V/1.6 i 16V 4x4/1.8 i 16V/1.9 TD	
Length/Lunghezza [mm]	60		
Inner Diam./Diam. Interno [mm]	14		
Outer Diam./Diam. esterno [mm]	33		

<p><b>RU-823</b>      <b>Holder, control arm mounting</b></p> <p><b>Silentblock</b></p> <p>SUZUKI      46420-60B02</p> <p>Length/Lunghezza [mm]      50</p> <p>Height/Altezza [mm]      55</p> <p>Width/Larghezza [mm]      60</p> <p>Inner Diam./Diam. Interno [mm]      21</p>	<p><b>SUZUKI BALENO (EG)</b>  1.3/1.3 i 16V/1.6 i 16V/1.6 i 16V 4x4/1.8 GT/1.9 TD</p> <p><b>SUZUKI BALENO 2 volumi (EG)</b>  1.3/1.3 i 16V/1.6 i 16V/1.6 i 16V 4x4/1.8 GT/1.9 TD</p> <p><b>SUZUKI BALENO SW (EG)</b>  1.3 16V/1.6 i 16V/1.6 i 16V 4x4/1.8 i 16V/1.9 TD</p> <p><b>SUZUKI SWIFT II (AH, AJ)</b>  1.3 (SF413, AH35)/1.3 (SF413, AH35, MA)/1.6 (SF416, AH14)/1.6 4WD (SF416, AJ14)/1.6 i (SF416, AH14)/1.6 i 4WD (SF416, AJ14)</p> <p><b>SUZUKI SWIFT II 2 volumi (EA, MA)</b>  1.0 (SF310, AA44)/1.0 i (SF310, AA44)/1.3 (SF413, AB35)/1.3 4WD (SF413, AA35)/1.3 4WD (SF413, AF35)/1.3 GTi (SF413, AA34)</p>	 <p>823</p>
<p><b>RU-824</b>      <b>Holder, control arm mounting</b></p> <p><b>Silentblock</b></p> <p>SUZUKI      09319-10030</p> <p>Length/Lunghezza [mm]      51,5</p> <p>Inner Diam./Diam. Interno [mm]      10</p> <p>Outer Diam./Diam. esterno [mm]      28</p>	<p><b>OPEL AGILA (H00)</b>  1.0/1.0 12V/1.2 16V/1.2 16V Twinport/1.3 CDTi</p> <p><b>SUZUKI CARRY Furgonato (FD)</b>  1.3/1.3 16 V</p>	 <p>824</p>
<p><b>RU-825</b>      <b>Holder, control arm mounting</b></p> <p><b>Silentblock</b></p> <p>SUZUKI      45261-65J00</p> <p>Length/Lunghezza [mm]      70</p> <p>Inner Diam./Diam. Interno [mm]      14</p> <p>Outer Diam./Diam. esterno [mm]      35</p>	<p><b>SUZUKI GRAND VITARA</b>  1.6 4 ruote motrici/1.9 DDIS/2.0 4 ruote motrici</p>	 <p>825</p>
<p><b>RU-826</b>      <b>Holder, control arm mounting</b></p> <p><b>Silentblock</b></p> <p>Length/Lunghezza [mm]      60</p> <p>Inner Diam./Diam. Interno [mm]      14</p> <p>Outer Diam./Diam. esterno [mm]      65,5</p>	<p><b>SUZUKI GRAND VITARA</b>  1.6 4 ruote motrici/1.9 DDIS/2.0 4 ruote motrici</p>	 <p>826</p>
<p><b>RU-827</b>      <b>Holder, control arm mounting</b></p> <p><b>Silentblock</b></p> <p>SUZUKI      45530-70C00</p> <p>Length/Lunghezza [mm]      50</p> <p>Inner Diam./Diam. Interno [mm]      16,5</p> <p>Outer Diam./Diam. esterno [mm]      34</p>	<p><b>SUZUKI SWIFT II (AH, AJ)</b>  1.3 (SF413, AH35)/1.3 (SF413, AH35, MA)/1.6 (SF416, AH14)/1.6 4WD (SF416, AJ14)/1.6 i (SF416, AH14)/1.6 i 4WD (SF416, AJ14)</p> <p><b>SUZUKI SWIFT II 2 volumi (EA, MA)</b>  1.0 (SF310, AA44)/1.0 i (SF310, AA44)/1.3 (SF413, AB35)/1.3 4WD (SF413, AA35)/1.3 4WD (SF413, AF35)/1.3 GTi (SF413, AA34)</p>	 <p>827</p>
<p><b>RU-828</b>      <b>Holder, control arm mounting</b></p> <p><b>Silentblock</b></p> <p>SUZUKI      45530-62J00</p> <p>Length/Lunghezza [mm]      64</p> <p>Inner Diam./Diam. Interno [mm]      14,5</p> <p>Outer Diam./Diam. esterno [mm]      42</p>	<p><b>SUZUKI SPLASH</b>  1.0/1.2/1.3 CDTi</p> <p><b>SUZUKI SWIFT III (SG)</b>  1.3/1.3 4x4/1.3 DDIS/1.5/1.6</p>	 <p>828</p>
<p><b>RU-829</b>      <b>Holder, control arm mounting</b></p> <p><b>Silentblock</b></p> <p>SUZUKI      45201-72K01</p> <p>Length/Lunghezza [mm]      51</p> <p>Inner Diam./Diam. Interno [mm]      14</p> <p>Outer Diam./Diam. esterno [mm]      60</p>	<p><b>SUZUKI SWIFT III (SG)</b>  1.3/1.3 4x4/1.3 DDIS/1.5/1.6</p>	 <p>829</p>

<b>RU-830</b> <b>Bearing Bush, stabiliser</b> <b>Boccola barra stabilizzatrice</b>	<b>FIAT SEDICI</b> 1.6 16V 4x4/1.9 D Multijet <b>SUZUKI SX4</b> 1.5/1.6 DDIS/1.6 VVT/1.6 VVT 4x4/1.9 DDIS/1.9 DDIS 4x4/2.0 DDIS/2.0 DDIS 4x4	
SUZUKI 42431-79J00 Fitting Position/Lato Montaggio Front Length/Lunghezza [mm] 42 Height/Altezza [mm] 47 Width/Larghezza [mm] 45 Inner Diam./Diam. Interno [mm] 22		
<b>RU-831</b> <b>Holder, control arm mounting</b> <b>Silentblock</b>	<b>FIAT SEDICI</b> 1.6 16V 4x4/1.9 D Multijet <b>SUZUKI SX4</b> 1.5/1.6 DDIS/1.6 VVT/1.6 VVT 4x4/1.9 DDIS/1.9 DDIS 4x4/2.0 DDIS/2.0 DDIS 4x4	
SUZUKI 45261-79J00 Length/Lunghezza [mm] 64 Inner Diam./Diam. Interno [mm] 14 Outer Diam./Diam. esterno [mm] 45		
<b>RU-832</b> <b>Holder, control arm mounting</b> <b>Silentblock</b>	<b>FIAT SEDICI</b> 1.6 16V 4x4/1.9 D Multijet <b>SUZUKI SX4</b> 1.5/1.6 DDIS/1.6 VVT/1.6 VVT 4x4/1.9 DDIS/1.9 DDIS 4x4/2.0 DDIS/2.0 DDIS 4x4	
<b>RU-833</b> <b>Holder, control arm mounting</b> <b>Silentblock</b>	<b>SUZUKI GRAND VITARA (FT, GT)</b> 1.6/2.0/2.0 HDI 110/2.0 TD Intercooler/2.5 V6 24V/2.5 V6 24V (FT)/2.7 XL-7 <b>SUZUKI GRAND VITARA</b> 1.9 TD	
SUZUKI 45261-65D01 Length/Lunghezza [mm] 65 Inner Diam./Diam. Interno [mm] 12 Outer Diam./Diam. esterno [mm] 56		
<b>RU-834</b> <b>Holder, control arm mounting</b> <b>Silentblock</b>	<b>SUZUKI GRAND VITARA (FT, GT)</b> 1.6/2.0/2.0 HDI 110/2.0 TD Intercooler/2.5 V6 24V/2.5 V6 24V (FT)/2.7 XL-7 <b>SUZUKI GRAND VITARA</b> 1.9 TD	
SUZUKI 45262-65D01 Length/Lunghezza [mm] 65 Inner Diam./Diam. Interno [mm] 14 Outer Diam./Diam. esterno [mm] 50		
<b>RU-835</b> <b>Suspension Strut Support</b> <b>Bearing</b> <b>Supporto ammortizzatore</b>	<b>SUZUKI VITARA (ET, TA)</b> 1.6 (ET)/1.6 (TA)/1.6 16V (ET)/2.0 16V (ET) <b>SUZUKI VITARA Cabrio (ET, TA)</b> 1.6 (TA)/1.6 16V (ET)/2.0 16V (ET)	
SANTANA 30005938 Fitting Position/Lato Montaggio Front Axle Height/Altezza [mm] 35 Inner Diam./Diam. Interno [mm] 17 Mount. Bores/Fori Fiss. Dist. [mm] 79	<b>SUZUKI X-90 (EL)</b> 1.6 i 16V/1.6 i 16V 4x4	
<b>RU-836</b> <b>Suspension Strut Support</b> <b>Bearing</b> <b>Supporto ammortizzatore</b>	<b>SUZUKI GRAND VITARA (FT, GT)</b> 2.0/2.0 4 ruote motrici/2.0 HDI 110/2.0 TD Intercooler/2.5 V6 24V/2.5 V6 24V (FT)/2.7/2.7 XL-7	
SUZUKI 41810-65D11 Fitting Position/Lato Montaggio Front Axle Length/Lunghezza [mm] 150 Height/Altezza [mm] 80 Width/Larghezza [mm] 150 Inner Diam./Diam. Interno [mm] 17		

<p><b>RU-837</b>      <b>Bearing Bush, stabiliser</b>   <b>Boccola barra stabilizzatrice</b></p>	<p><b>OPEL AGILA</b>  1.0/1.0 LPG/1.2/1.2 LPG/1.3 CDTI  <b>SUZUKI SPLASH</b>  1.0/1.2/1.3 CDTI  <b>VAUXHALL AGILA</b>  1.0/1.2/1.3 CDTI</p>	 <p>837</p>
<p>SUZUKI      42431-51K40  Fitting Position/Lato Montaggio      Front Axle  Length/Lunghezza [mm]      34  Height/Altezza [mm]      38  Width/Larghezza [mm]      30  Inner Diam./Diam. Interno [mm]      23</p>		
<p><b>RU-839</b>      <b>Engine Mounting</b>   <b>Supporto motore</b></p>	<p><b>SUZUKI SX4</b>  1.5/1.6/1.6 VVT/1.6 VVT 4x4/1.9 DDIS/1.9 DDIS 4x4</p>	 <p>839</p>
<p>SUZUKI      11720-80JA0-000  Length/Lunghezza [mm]      56  Inner Diam./Diam. Interno [mm]      10  Outer Diam./Diam. esterno [mm]      88  Mount. Bores/Fori Fiss. Dist. [mm]      62</p>		
<p><b>RU-840</b>      <b>Bearing Bush, stabiliser</b>   <b>Boccola barra stabilizzatrice</b></p>	<p><b>NISSAN PIXO</b>  1.0  <b>SUZUKI ALTO V (GF)</b>  1.0</p>	 <p>840</p>
<p>SUZUKI      42431 M68K00  Fitting Position/Lato Montaggio      Front Axle  Length/Lunghezza [mm]      34  Height/Altezza [mm]      39  Width/Larghezza [mm]      30  Inner Diam./Diam. Interno [mm]      18</p>		
<p><b>RU-841</b>      <b>Holder, control arm mounting</b>   <b>Silentblock</b></p>	<p><b>NISSAN PIXO</b>  1.0  <b>SUZUKI ALTO V (GF)</b>  1.0</p>	 <p>841</p>
<p>SUZUKI      45530-M68K00  Length/Lunghezza [mm]      53  Inner Diam./Diam. Interno [mm]      12  Outer Diam./Diam. esterno [mm]      33</p>		
<p><b>RU-842</b>      <b>Holder, control arm mounting</b>   <b>Silentblock</b></p>	<p><b>SUZUKI SPLASH</b>  1.0/1.2/1.3 CDTI</p>	 <p>842</p>
<p>SUZUKI      46221 51K10  Fitting Position/Lato Montaggio      Rear Axle  Height/Altezza [mm]      90  Inner Diam./Diam. Interno [mm]      12  Outer Diam./Diam. esterno [mm]      55</p>		
<p><b>RU-900</b>      <b>Bearing,propshaft centre bearing</b>   <b>Supporto albero cardanico</b></p>	<p><b>ISUZU TROOPER (UBS)</b>  2.2 D 4x4/2.8 TD (UBS55)</p>	 <p>900</p>
<p>ISUZU      8-97025-753-0  Length/Lunghezza [mm]      146,5  Height/Altezza [mm]      138  Width/Larghezza [mm]      59  Inner Diam./Diam. Interno [mm]      30</p>		
<p><b>RU-901</b>      <b>Engine Mounting</b>   <b>Supporto motore</b></p>	<p><b>ISUZU TROOPER (UB)</b>  3.1 TD/3.2  <b>ISUZU TROOPER (UB)</b>  3.1 TD/3.2  <b>OPEL MONTEREY A (UBS_)</b>  3.1 TD (UBS69_)/3.2 (UBS25_)</p>	 <p>901</p>
<p>ISUZU      8-94375282-5  Length/Lunghezza [mm]      145  Height/Altezza [mm]      86  Width/Larghezza [mm]      143</p>		

<b>RU-902</b>	<b>Engine Mounting</b>	<b>ISUZU TROOPER (UB)</b> 3.1 TD/3.2		
	<b>Supporto motore</b>	<b>ISUZU TROOPER (UB)</b> 3.1 TD/3.2		
ISUZU	8-94375283-2	<b>OPEL MONTEREY A (UBS_)</b> 3.1 TD (UBS69_)/3.2 (UBS25_)		
Length/Lunghezza [mm]	145			
Height/Altezza [mm]	89			
Width/Larghezza [mm]	143			
<b>RU-903</b>	<b>Engine Mounting</b>	<b>ISUZU TROOPER (UB)</b> 3.1 TD/3.2		
	<b>Supporto motore</b>	<b>ISUZU TROOPER (UB)</b> 3.1 TD/3.2		
ISUZU	8-91733-866-0	<b>OPEL MONTEREY A (UBS_)</b> 3.1 TD (UBS69_)/3.2 (UBS25_)		
Length/Lunghezza [mm]	157			
Height/Altezza [mm]	54			
Width/Larghezza [mm]	89,5			
<b>RU-904</b>	<b>Engine Mounting</b>	<b>ISUZU TROOPER (UB)</b> 3.1 TD/3.2		
	<b>Supporto motore</b>	<b>ISUZU TROOPER (UB)</b> 3.1 TD/3.2		
ISUZU	8-97104-157-1RH	<b>OPEL MONTEREY A (UBS_)</b> 3.1 TD (UBS69_)/3.2 (UBS25_)		
Length/Lunghezza [mm]	142			
Height/Altezza [mm]	88			
Width/Larghezza [mm]	112			
<b>RU-905</b>	<b>Engine Mounting</b>	<b>ISUZU TROOPER (UB)</b> 3.1 TD/3.2		
	<b>Supporto motore</b>	<b>ISUZU TROOPER (UB)</b> 3.1 TD/3.2		
ISUZU	8-97104-158-1LH	<b>OPEL MONTEREY A (UBS_)</b> 3.1 TD (UBS69_)/3.2 (UBS25_)		
Length/Lunghezza [mm]	142			
Height/Altezza [mm]	89			
Width/Larghezza [mm]	112			
<b>RU-906</b>	<b>Bush, leaf spring</b>	<b>ISUZU TROOPER (UB)</b> 3.1 TD/3.2		
	<b>Boccola balestra</b>	<b>ISUZU TROOPER (UB)</b> 3.1 TD/3.2		
ISUZU	8-94223-168-0	<b>ISUZU TROOPER (UBS)</b> 2.2 (UBS13)/2.2 D (UBS52)/2.2 D 4x4/2.2 TD (UBS52)/2.3 (UBS16)/2.6 i (UBS17)		
Length/Lunghezza [mm]	36	<b>ISUZU TROOPER (UBS)</b> 2.2 D 4x4/2.8 TD (UBS55)		
Inner Diam./Diam. Interno [mm]	18	<b>ISUZU TROOPER</b> 3.0 DTI/3.5 V6 24V		
Outer Diam./Diam. esterno [mm]	40,5	<b>ISUZU TROOPER Fuoristrada aperto</b> 3.0 DTI/3.5 V6 24V		
		<b>OPEL MONTEREY A (UBS_)</b> 3.1 TD (UBS69_)/3.2 (UBS25_)		
		<b>OPEL MONTEREY B</b> 3.0 DTI/3.5 V6 24V		
<b>RU-907</b>	<b>Bush, leaf spring</b>	<b>ISUZU TROOPER (UB)</b> 3.1 TD/3.2		
	<b>Boccola balestra</b>	<b>ISUZU TROOPER (UB)</b> 3.1 TD/3.2		
ISUZU	8-94234-319-0	<b>ISUZU TROOPER (UBS)</b> 2.2 (UBS13)/2.2 D (UBS52)/2.2 D 4x4/2.2 TD (UBS52)/2.3 (UBS16)/2.6 i (UBS17)		
Length/Lunghezza [mm]	35	<b>ISUZU TROOPER (UBS)</b> 2.2 D 4x4/2.8 TD (UBS55)		
Inner Diam./Diam. Interno [mm]	19	<b>ISUZU TROOPER</b> 3.0 DTI/3.5 V6 24V		
Outer Diam./Diam. esterno [mm]	29	<b>ISUZU TROOPER Fuoristrada aperto</b> 3.0 DTI/3.5 V6 24V		
		<b>OPEL MONTEREY A (UBS_)</b>		

**RU-908** Holder, control arm mounting

Silentblock

ISUZU 8-94226-557-0

Length/Lunghezza [mm]	45
Inner Diam./Diam. Interno [mm]	18
Outer Diam./Diam. esterno [mm]	36

3.1 TD (UBS69\_)/3.2 (UBS25\_)

**OPEL MONTEREY B**

3.0 DTI/3.5 V6 24V

**ISUZU CAMPO (KB)**

2.0 (KB28)/2.0 4WD (KB41, KB45)/2.0 4WD (KB48)/2.0 D (KBD23, KBD28)/2.0 D 4WD (KBD42, KBD46)/2.2 (TFS)/2.2 D (KBD27)/2.2 D 4WD (KBD42, KBD47)/2.5 D (KBD27)/2.5 D 4WD (KBD47)

**ISUZU PICK UP**

2.3/2.3 4x4/2.6 4x4/2.6 LS

**ISUZU TROOPER (UB)**

3.1 TD/3.2

**ISUZU TROOPER (UB)**

3.1 TD/3.2

**ISUZU TROOPER (UBS)**

2.2 (UBS13)/2.2 D (UBS52)/2.2 D 4x4/2.2 TD (UBS52)/2.3 (UBS16)/2.6 i (UBS17)

**ISUZU TROOPER (UBS)**

2.2 D 4x4/2.8 TD (UBS55)

**ISUZU TROOPER**

3.0 DTI/3.5 V6 24V

**ISUZU TROOPER Fuoristrada aperto**

3.0 DTI/3.5 V6 24V

**OPEL MONTEREY A (UBS\_)**

3.1 TD (UBS69\_)/3.2 (UBS25\_)

**OPEL MONTEREY B**

3.0 DTI/3.5 V6 24V

**ISUZU TROOPER (UB)**

3.1 TD/3.2

**ISUZU TROOPER (UB)**

3.1 TD/3.2

**ISUZU TROOPER (UBS)**

2.2 (UBS13)/2.2 D (UBS52)/2.2 D 4x4/2.2 TD (UBS52)/2.3 (UBS16)/2.6 i (UBS17)

**ISUZU TROOPER (UBS)**

2.2 D 4x4/2.8 TD (UBS55)

**ISUZU TROOPER**

3.0 DTI/3.5 V6 24V

**ISUZU TROOPER Fuoristrada aperto**

3.0 DTI/3.5 V6 24V

**OPEL MONTEREY A (UBS\_)**

3.1 TD (UBS69\_)/3.2 (UBS25\_)

**OPEL MONTEREY B**

3.0 DTI/3.5 V6 24V

**ISUZU TROOPER (UB)**

3.1 TD/3.2

**ISUZU TROOPER (UB)**

3.1 TD/3.2

**ISUZU TROOPER (UBS)**

2.2 (UBS13)/2.2 D (UBS52)/2.2 D 4x4/2.2 TD (UBS52)/2.3 (UBS16)/2.6 i (UBS17)

**ISUZU TROOPER (UBS)**

2.2 D 4x4/2.6 CLS Plane 4x4/2.8 TD (UBS55)

**ISUZU TROOPER**

3.0 DTI/3.5 V6 24V

**ISUZU TROOPER Fuoristrada aperto**

3.0 DTI/3.5 V6 24V

**OPEL CAMPO (TF\_)**

2.2 D (TFR52)/2.2 D 4x4 (TFS52)/2.3 (TFR16)/2.3 4x4 (TFS16)/2.5 D (TFR54)/2.5 D 4x4 (TFS54)/2.5 TD (TFR54)/2.5 TD 4x4 (TFS54)/3.1 TD (TFR69)/3.1 TD 4x4 (TFS69)

**OPEL FRONTERA A (5\_MWL4)**

2.2 i (54MWL4)/2.3 TD (5JMWL4)/2.4 i (53MWL4)/2.5 TDS/2.8 TD (5BMWL4)

**OPEL FRONTERA A Sport (5\_SUD2)**

2.0 i (52SUD2, 55SUD2)/2.5 TDS/2.8 TD (53SUD2)



908

**RU-909** Holder, control arm mounting

Holder, control arm mounting

Silentblock

ISUZU 8-94223-366-0

Length/Lunghezza [mm]	63,5
Inner Diam./Diam. Interno [mm]	14
Outer Diam./Diam. esterno [mm]	35

**ISUZU TROOPER (UB)**

3.1 TD/3.2

**ISUZU TROOPER (UB)**

3.1 TD/3.2

**ISUZU TROOPER (UBS)**

2.2 (UBS13)/2.2 D (UBS52)/2.2 D 4x4/2.2 TD (UBS52)/2.3 (UBS16)/2.6 i (UBS17)

**ISUZU TROOPER (UBS)**

2.2 D 4x4/2.8 TD (UBS55)

**ISUZU TROOPER**

3.0 DTI/3.5 V6 24V

**ISUZU TROOPER Fuoristrada aperto**

3.0 DTI/3.5 V6 24V

**OPEL MONTEREY A (UBS\_)**

3.1 TD (UBS69\_)/3.2 (UBS25\_)

**OPEL MONTEREY B**

3.0 DTI/3.5 V6 24V

**ISUZU TROOPER (UB)**

3.1 TD/3.2

**ISUZU TROOPER (UB)**

3.1 TD/3.2

**ISUZU TROOPER (UBS)**

2.2 (UBS13)/2.2 D (UBS52)/2.2 D 4x4/2.2 TD (UBS52)/2.3 (UBS16)/2.6 i (UBS17)

**ISUZU TROOPER (UBS)**

2.2 D 4x4/2.6 CLS Plane 4x4/2.8 TD (UBS55)

**ISUZU TROOPER**

3.0 DTI/3.5 V6 24V

**ISUZU TROOPER Fuoristrada aperto**

3.0 DTI/3.5 V6 24V

**OPEL CAMPO (TF\_)**

2.2 D (TFR52)/2.2 D 4x4 (TFS52)/2.3 (TFR16)/2.3 4x4 (TFS16)/2.5 D (TFR54)/2.5 D 4x4 (TFS54)/2.5 TD (TFR54)/2.5 TD 4x4 (TFS54)/3.1 TD (TFR69)/3.1 TD 4x4 (TFS69)

**OPEL FRONTERA A (5\_MWL4)**

2.2 i (54MWL4)/2.3 TD (5JMWL4)/2.4 i (53MWL4)/2.5 TDS/2.8 TD (5BMWL4)

**OPEL FRONTERA A Sport (5\_SUD2)**

2.0 i (52SUD2, 55SUD2)/2.5 TDS/2.8 TD (53SUD2)



909

**RU-910** Holder, control arm mounting

Holder, control arm mounting

Silentblock

ISUZU 8-94408-840-3

Length/Lunghezza [mm]	45
Inner Diam./Diam. Interno [mm]	18
Outer Diam./Diam. esterno [mm]	38

**ISUZU TROOPER (UB)**

3.1 TD/3.2

**ISUZU TROOPER (UB)**

3.1 TD/3.2

**ISUZU TROOPER (UBS)**

2.2 (UBS13)/2.2 D (UBS52)/2.2 D 4x4/2.2 TD (UBS52)/2.3 (UBS16)/2.6 i (UBS17)

**ISUZU TROOPER (UBS)**

2.2 D 4x4/2.6 CLS Plane 4x4/2.8 TD (UBS55)

**ISUZU TROOPER**

3.0 DTI/3.5 V6 24V

**ISUZU TROOPER Fuoristrada aperto**

3.0 DTI/3.5 V6 24V

**OPEL CAMPO (TF\_)**

2.2 D (TFR52)/2.2 D 4x4 (TFS52)/2.3 (TFR16)/2.3 4x4 (TFS16)/2.5 D (TFR54)/2.5 D 4x4 (TFS54)/2.5 TD (TFR54)/2.5 TD 4x4 (TFS54)/3.1 TD (TFR69)/3.1 TD 4x4 (TFS69)

**OPEL FRONTERA A (5\_MWL4)**

2.2 i (54MWL4)/2.3 TD (5JMWL4)/2.4 i (53MWL4)/2.5 TDS/2.8 TD (5BMWL4)

**OPEL FRONTERA A Sport (5\_SUD2)**

2.0 i (52SUD2, 55SUD2)/2.5 TDS/2.8 TD (53SUD2)





910

<b>RU-911</b>	<b>Holder, control arm mounting</b>	<b>ISUZU TROOPER (UB)</b>	
	<b>Silentblock</b>	3.1 TD/3.2	
		<b>ISUZU TROOPER (UB)</b>	
		3.1 TD/3.2	
		<b>ISUZU TROOPER (UBS)</b>	
Length/Lunghezza [mm]	56	2.2 (UBS13)/2.2 D (UBS52)/2.2 D 4x4/2.2 TD (UBS52)/2.3 (UBS16)/2.6 i (UBS17)	
Inner Diam./Diam. Interno [mm]	16,5		
Outer Diam./Diam. esterno [mm]	36	<b>ISUZU TROOPER (UBS)</b>	
		2.2 D 4x4/2.8 TD (UBS55)	
		<b>ISUZU TROOPER</b>	
		3.0 DTI/3.5 V6 24V	
		<b>ISUZU TROOPER Fuoristrada aperto</b>	
		3.0 DTI/3.5 V6 24V	

<b>RU-912</b>	<b>Holder, control arm mounting</b>	<b>ISUZU TROOPER (UB)</b>	
	<b>Silentblock</b>	3.1 TD/3.2	
ISUZU	9-51151-023-0	<b>ISUZU TROOPER (UB)</b>	
		3.1 TD/3.2	
		<b>ISUZU TROOPER (UBS)</b>	
Length/Lunghezza [mm]	68	2.2 (UBS13)/2.2 D (UBS52)/2.2 D 4x4/2.2 TD (UBS52)/2.3 (UBS16)/2.6 i (UBS17)	
Inner Diam./Diam. Interno [mm]	16		
Outer Diam./Diam. esterno [mm]	38	<b>ISUZU TROOPER (UBS)</b>	
		2.2 D 4x4/2.8 TD (UBS55)	
		<b>ISUZU TROOPER</b>	
		3.0 DTI/3.5 V6 24V	
		<b>ISUZU TROOPER Fuoristrada aperto</b>	
		3.0 DTI/3.5 V6 24V	
		<b>OPEL MONTEREY A (UBS_)</b>	
		3.1 TD (UBS69_)/3.2 (UBS25_)	
		<b>OPEL MONTEREY B</b>	
		3.0 DTI/3.5 V6 24V	







<b>RU-913</b>	<b>Holder, control arm mounting</b>	<b>ISUZU TROOPER (UB)</b>	
	<b>Silentblock</b>	3.1 TD/3.2	
ISUZU	9-51351-029-0	<b>ISUZU TROOPER (UB)</b>	
		3.1 TD/3.2	
		<b>ISUZU TROOPER (UBS)</b>	
Length/Lunghezza [mm]	81	2.2 (UBS13)/2.2 D (UBS52)/2.2 D 4x4/2.2 TD (UBS52)/2.3 (UBS16)/2.6 i (UBS17)	
Inner Diam./Diam. Interno [mm]	16		
Outer Diam./Diam. esterno [mm]	42	<b>ISUZU TROOPER (UBS)</b>	
		2.2 D 4x4/2.8 TD (UBS55)	
		<b>ISUZU TROOPER</b>	
		3.0 DTI/3.5 V6 24V	
		<b>ISUZU TROOPER Fuoristrada aperto</b>	
		3.0 DTI/3.5 V6 24V	
		<b>OPEL MONTEREY A (UBS_)</b>	
		3.1 TD (UBS69_)/3.2 (UBS25_)	
		<b>OPEL MONTEREY B</b>	
		3.0 DTI/3.5 V6 24V	

<b>RU-915</b>	<b>Holder, control arm mounting</b>	<b>ISUZU TROOPER (UBS)</b>	
	<b>Silentblock</b>	2.2 (UBS13)/2.2 D (UBS52)/2.2 D 4x4/2.2 TD (UBS52)/2.3 (UBS16)/2.6 i (UBS17)	
ISUZU	8 97 018 166 1	<b>ISUZU TROOPER (UBS)</b>	
		2.2 D 4x4/2.6 CLS Plane 4x4/2.8 TD (UBS55)	
Length/Lunghezza [mm]	85		
Inner Diam./Diam. Interno [mm]	18		
Outer Diam./Diam. esterno [mm]	44		







<b>RU-916</b>	<b>Engine Mounting</b>	<b>ISUZU D-MAX</b>	
	<b>Supporto motore</b>	3.0 DiTD/3.0 DiTD 4x4	
ISUZU	8-972349762		
Fitting Position/Lato Montaggio	Right Front		
Length/Lunghezza [mm]	126		
Width/Larghezza [mm]	87		



<p><b>RU-917</b>      <b>Engine Mounting</b></p> <p><b>Supporto motore</b></p>	<p><b>ISUZU D-MAX</b> 3.0 DiTD/3.0 DiTD 4x4</p>	 <p>917</p>
<p>ISUZU      8-97234-977-2</p> <p>Fitting Position/Lato Montaggio      Left Front</p> <p>Length/Lunghezza [mm]      179</p> <p>Height/Altezza [mm]      112</p> <p>Width/Larghezza [mm]      117</p>	<p><b>ISUZU D-MAX</b> 2.5 D/2.5 DiTD 4x4/3.0 D 4x4/3.0 DiTD 4x4</p>	
<p><b>RU-918</b>      <b>Bush, leaf spring</b></p> <p><b>Boccola balestra</b></p>	<p><b>ISUZU D-MAX</b> 2.5 D/2.5 DiTD 4x4/3.0 D 4x4/3.0 DiTD 4x4</p>	 <p>918</p>
<p>ISUZU      8-97332-642-0</p> <p>Fitting Position/Lato Montaggio      Front Axle</p> <p>Length/Lunghezza [mm]      69</p> <p>Inner Diam./Diam. Interno [mm]      14</p> <p>Outer Diam./Diam. esterno [mm]      40</p>	<p><b>JEEP CHEROKEE (KJ)</b> 2.4</p>	
<p><b>RU-920</b>      <b>Bearing Bush, stabiliser</b></p> <p><b>Boccola barra stabilizzatrice</b></p>	<p><b>JEEP CHEROKEE (KJ)</b> 2.4</p>	 <p>920</p>
<p>JEEP      52088778AB</p> <p>Fitting Position/Lato Montaggio      Front Axle</p> <p>Length/Lunghezza [mm]      55</p> <p>Height/Altezza [mm]      63</p> <p>Width/Larghezza [mm]      58</p> <p>Inner Diam./Diam. Interno [mm]      30</p>	<p><b>JEEP CHEROKEE (XJ)</b> 2.1 D 4x4/2.5/2.5 i 4x4/2.5 TD/4.0 i</p>	
<p><b>RU-921</b>      <b>Bearing Bush, stabiliser</b></p> <p><b>Boccola barra stabilizzatrice</b></p>	<p><b>JEEP CHEROKEE (XJ)</b> 2.1 D 4x4/2.5/2.5 i 4x4/2.5 TD/4.0 i</p>	 <p>921</p>
<p>JEEP      52003232</p> <p>Fitting Position/Lato Montaggio      Front Axle</p> <p>Length/Lunghezza [mm]      45</p> <p>Height/Altezza [mm]      38</p> <p>Width/Larghezza [mm]      38</p> <p>Inner Diam./Diam. Interno [mm]      25</p>	<p><b>JEEP CHEROKEE (XJ)</b> 2.5 i/2.5 Tdi 4x4/4.0 i</p>	
<p><b>RU-922</b>      <b>Bearing Bush, stabiliser</b></p> <p><b>Boccola barra stabilizzatrice</b></p>	<p><b>JEEP CHEROKEE (XJ)</b> 2.5 i/2.5 Tdi 4x4/4.0 i</p>	 <p>922</p>
<p>JEEP      52088523</p> <p>Fitting Position/Lato Montaggio      Front Axle</p> <p>Length/Lunghezza [mm]      45</p> <p>Height/Altezza [mm]      38</p> <p>Width/Larghezza [mm]      39</p> <p>Inner Diam./Diam. Interno [mm]      23</p>	<p><b>JEEP GRAND CHEROKEE I (Z)</b> 5.9 i</p>	
<p><b>RU-923</b>      <b>Bearing Bush, stabiliser</b></p> <p><b>Boccola barra stabilizzatrice</b></p>	<p><b>JEEP GRAND CHEROKEE I (Z)</b> 2.5 TD (Z)/2.5 TD Laredo/4.0 i (Z)/4.0 Laredo/5.9 i</p>	 <p>923</p>
<p>JEEP      52088524</p> <p>Fitting Position/Lato Montaggio      Front Axle</p> <p>Length/Lunghezza [mm]      45</p> <p>Height/Altezza [mm]      38,5</p> <p>Width/Larghezza [mm]      39</p> <p>Inner Diam./Diam. Interno [mm]      28</p>	<p><b>JEEP GRAND CHEROKEE I (Z)</b> 2.5 TD (Z)/2.5 TD Laredo/4.0 i (Z)/4.0 Laredo/5.9 i</p>	
<p><b>RU-923</b>      <b>Bearing Bush, stabiliser</b></p> <p><b>Boccola barra stabilizzatrice</b></p>	<p><b>JEEP GRAND CHEROKEE I (Z)</b> 2.5 TD (Z)/2.5 TD Laredo/4.0 i (Z)/4.0 Laredo/5.9 i</p>	 <p>923</p>

<b>RU-924</b>	<b>Bearing Bush, stabiliser</b>	<b>JEEP WRANGLER II (TJ)</b>	
	<b>Boccola barra stabilizzatrice</b>	2.4/2.5/4.0	
JEEP	52088378		
Fitting Position/Lato Montaggio	Front Axle		
Length/Lunghezza [mm]	55		
Height/Altezza [mm]	53		
Width/Larghezza [mm]	59		
Inner Diam./Diam. Interno [mm]	30		
<b>RU-925</b>	<b>Bearing Bush, stabiliser</b>	<b>JEEP CHEROKEE (XJ)</b>	
	<b>Boccola barra stabilizzatrice</b>	2.5/2.5 i/2.5 i 4x4/2.5 TD/2.5 Tdi 4x4/4.0 i	
JEEP	52001145		
Fitting Position/Lato Montaggio	Rear Axle		
Length/Lunghezza [mm]	45		
Height/Altezza [mm]	38,5		
Width/Larghezza [mm]	38,5		
Inner Diam./Diam. Interno [mm]	15		
<b>RU-926</b>	<b>Bearing Bush, stabiliser</b>	<b>JEEP WRANGLER II (TJ)</b>	
	<b>Boccola barra stabilizzatrice</b>	2.4/2.5/4.0	
JEEP	52088125		
Fitting Position/Lato Montaggio	Rear Axle		
Length/Lunghezza [mm]	41		
Height/Altezza [mm]	37		
Width/Larghezza [mm]	37		
Inner Diam./Diam. Interno [mm]	14		
<b>RU-928</b>	<b>Bearing Bush, stabiliser</b>	<b>CHRYSLER VOYAGER III (GS)</b>	
	<b>Boccola barra stabilizzatrice</b>	2.5 TDic AWD	
CHRYSLER	04743041AC	<b>CHRYSLER VOYAGER IV (RG)</b>	
		2.4/2.5 CRD/2.8 CRD/3.3	
Fitting Position/Lato Montaggio	Front Axle		
Length/Lunghezza [mm]	46,5		
Height/Altezza [mm]	54		
Width/Larghezza [cm]	50		
Inner Diam./Diam. Interno [mm]	25		
<b>RU-929</b>	<b>Bearing Bush, stabiliser</b>	<b>CHRYSLER NEON II</b>	
	<b>Boccola barra stabilizzatrice</b>	1.6/2.0 16V/2.0 16V R/T	
CHRYSLER	05272506AA	<b>CHRYSLER PT CRUISER</b>	
		1.6/2.0/2.4/GT 2.4	
Fitting Position/Lato Montaggio	Front Axle	<b>CHRYSLER PT CRUISER Cabriolet</b>	
Length/Lunghezza [mm]	28	2.4/2.4 GT	
Inner Diam./Diam. Interno [mm]	21		
Outer Diam./Diam. esterno [mm]	44		
<b>RU-930</b>	<b>Bearing Bush, stabiliser</b>	<b>JEEP COMMANDER</b>	
	<b>Boccola barra stabilizzatrice</b>	3.0 CRD/4.7 V8/5.7 V8	
JEEP	52124302AA		
Fitting Position/Lato Montaggio	Rear Axle		
Length/Lunghezza [mm]	46		
Height/Altezza [mm]	40		
Width/Larghezza [mm]	39		
Inner Diam./Diam. Interno [mm]	19		

<p><b>RU-931</b> Bearing Bush, stabiliser  Boccola barra stabilizzatrice</p>	<p><b>DODGE CALIBER</b> 1.8/2.0/2.0 CRD/2.4 <b>JEEP COMPASS</b> 2.0 CRD/2.0 CRD 4x4/2.4/2.4 4x4 <b>JEEP PATRIOT</b> 2.0 CRD/2.4</p>	 <p>931</p>
<p>JEEP 5105103AC Fitting Position/Lato Montaggio Front Axle Length/Lunghezza [mm] 52 Height/Altezza [mm] 43 Width/Larghezza [mm] 50 Inner Diam./Diam. Interno [mm] 23</p>		
<p><b>RU-932</b> Bearing,propshaft centre bearing Supporto albero cardanico</p>	<p><b>ISUZU TROOPER (UBS)</b> 2.2 D 4x4/2.8 TD (UB555)</p>	 <p>932</p>
<p>ISUZU 8-97025-752-0 Length/Lunghezza [mm] 146 Height/Altezza [mm] 157 Width/Larghezza [mm] 60 Inner Diam./Diam. Interno [mm] 30</p>		
<p><b>RU-1000</b> Engine Mounting Supporto motore</p>	<p><b>NISSAN PRIMERA (P10)</b> 2.0 16V/2.0 16V 4x4/2.0 i <b>NISSAN PRIMERA Hatchback (P10)</b> 2.0/2.0 16V/2.0 16V 4x4/2.0 i <b>NISSAN PRIMERA Traveller (W10)</b> 2.0 i</p>	 <p>1000</p>
<p>NISSAN 1122093J00 Fitting Position/Lato Montaggio Front Axle Left Length/Lunghezza [mm] 204 Height/Altezza [mm] 107 Width/Larghezza [mm] 80 Inner Diam./Diam. Interno [mm] 11</p>		
<p><b>RU-1001</b> Engine Mounting Supporto motore</p>	<p><b>NISSAN MICRA (K11)</b> 1.5 D</p>	 <p>1001</p>
<p>NISSAN 112106F800 Fitting Position/Lato Montaggio Front Axle Fitting Position/Lato Montaggio Right Length/Lunghezza [mm] 145</p>		
<p><b>RU-1002</b> Engine Mounting Supporto motore</p>	<p><b>NISSAN MICRA (K11)</b> 1.0 i 16V</p>	 <p>1002</p>
<p>NISSAN 1122099B01 Fitting Position/Lato Montaggio Front Axle Fitting Position/Lato Montaggio Transmission End Inner Diam./Diam. Interno [mm] 11</p>		
<p><b>RU-1003</b> Engine Mounting Supporto motore</p>	<p><b>NISSAN MICRA (K11)</b> 1.0 i 16V/1.3 i 16V</p>	 <p>1003</p>
<p>NISSAN 11220-99B20 Fitting Position/Lato Montaggio Front Axle Fitting Position/Lato Montaggio Left Rear Width/Larghezza [mm] 50 Inner Diam./Diam. Interno [mm] 11</p>		
<p><b>RU-1004</b> Engine Mounting Supporto motore</p>	<p><b>NISSAN MICRA (K11)</b> 1.5 D</p>	 <p>1004</p>
<p>NISSAN 113206F800 Fitting Position/Lato Montaggio Front Axle Length/Lunghezza [mm] 125 Height/Altezza [mm] 74 Width/Larghezza [mm] 53 Inner Diam./Diam. Interno [mm] 11</p>		

<b>RU-1006</b> <b>Suspension Strut Support Bearing</b> <b>Supporto ammortizzatore</b>	<b>NISSAN PRIMERA Traveller (W10)</b> 1.6 i/2.0 D/2.0 i	 1006	
NISSAN 01225-00231 Fitting Position/Lato Montaggio Front Axle Height/Altezza [mm] 47 Inner Diam./Diam. Interno [mm] 15 Inner Diam./Diam. Int. 1 [mm] 33,7			
<b>RU-1007</b> <b>Holder, control arm mounting</b> <b>Silentblock</b>	<b>NISSAN SUNNY II (N13)</b> 1.3/1.4/1.4 LX/1.6/1.6 i/1.6 i 12V/1.6 i 4x4 (A)/1.7 D <b>NISSAN SUNNY II Coupe (B12)</b> 1.6/1.6 i/1.6 i 12V	 1007	
NISSAN 54570-50A10 Fitting Position/Lato Montaggio Lower Front Axle Length/Lunghezza [mm] 68 Height/Altezza [mm] 58 Inner Diam./Diam. Interno [mm] 18	<b>NISSAN SUNNY II Hatchback (N13)</b> 1.3/1.4/1.4 LX/1.6/1.6 i/1.6 i 12V/1.7 D <b>NISSAN SUNNY II Traveller (B12)</b> 1.6/1.6 i/1.6 i 12V/1.6 i 4x4 (A)/1.7 D <b>NISSAN SUNNY III (N14)</b> 1.6 i/1.6 i 16V		
	<b>NISSAN SUNNY III Hatchback (N14)</b> 1.6 i/1.6 i 16V <b>NISSAN SUNNY III Liftback (N14)</b> 1.6 i/1.6 i 16V		
<b>RU-1008</b> <b>Suspension Strut Support Bearing</b> <b>Supporto ammortizzatore</b>	<b>NISSAN ALMERA I (N15)</b> 1.4/1.4 GX,LX/1.6/1.6 SLX/2.0 D <b>NISSAN ALMERA I Hatchback (N15)</b> 1.4/1.4 S,GX,LX/1.6/1.6 SR,SLX/2.0 D/2.0 GTI		 1008
NISSAN 54320-50Y12 Fitting Position/Lato Montaggio Front Axle Height/Altezza [mm] 24 Inner Diam./Diam. Interno [mm] 12 Outer Diam./Diam. esterno [mm] 70,5			
<b>RU-1010</b> <b>Engine Mounting</b> <b>Supporto motore</b>	<b>NISSAN ALMERA I (N15)</b> 1.4/1.4 GX,LX/2.0 D <b>NISSAN ALMERA I Hatchback (N15)</b> 1.4/1.4 S,GX,LX/2.0 D/2.0 GTI		 1010
NISSAN 113200M002 Fitting Position/Lato Montaggio Front Length/Lunghezza [mm] 153 Height/Altezza [mm] 79,5 Inner Diam./Diam. Interno [mm] 11,5			
<b>RU-1011</b> <b>Engine Mounting</b> <b>Supporto motore</b>	<b>NISSAN ALMERA I (N15)</b> 1.4/1.6/1.6 SLX/2.0 D <b>NISSAN ALMERA I Hatchback (N15)</b> 1.4/1.6/1.6 SR,SLX/2.0 D/2.0 GTI	 1011	
NISSAN 1135041B00 Fitting Position/Lato Montaggio Front Length/Lunghezza [mm] 124,5 Height/Altezza [mm] 58 Width/Larghezza [mm] 44 Inner Diam./Diam. Interno [mm] 11			
<b>RU-1012</b> <b>Engine Mounting</b> <b>Supporto motore</b>	<b>NISSAN KUBISTAR</b> 1.2/1.2 16V/1.6 16V <b>RENAULT CLIO II (B/C/B0/1_, CB0/1/2_)</b> 1.2/1.2 (B/CB0F, B/CB0A, B/CB10, B/CB1K, B/CB2D, B/CB2H)/1.2 16V (B/CB05)/1.4 16V (B/CB0L)/1.4 16V (B/CB0P)/1.6 16V (CB0T, CB0H)	 1012	
NISSAN 11270-00QAA Fitting Position/Lato Montaggio Right Length/Lunghezza [mm] 170 Height/Altezza [mm] 80 Width/Larghezza [mm] 99 Inner Diam./Diam. Interno [mm] 13	<b>RENAULT CLIO II Furgonato (SBO_)</b> 1.2 <b>RENAULT KANGOO (KC0_)</b> 1.2 (KC0A, KC0K, KC0F, KC01)/1.2 16V (KC03, KC05, KC06, KC0T, KC0W)/1.5 dCi/1.6 16V/1.6 16V 4x4 (KC0P, KC0S, KC0L)/1.6 16V bivalent		
	<b>RENAULT KANGOO</b> 1.6 16V/1.6 16V Hi-Flex <b>RENAULT KANGOO Express (FC0_)</b>		

1.2/1.2 (FC01, FCOA, FCOF)/1.2 16V (FC05)/1.5 dCi/1.6 16V/1.6 16V 4x4 (FC0L, FCOP, FCOS)/1.6 16V bivalent/D 55 1.9 (FCOD)

**RENAULT KANGOO Express**

1.6 16V/1.6 16V LPG

**RU-1014**

**Bearing,propshaft centre bearing**  
**Supporto albero cardanico**

**NISSAN PICK UP/KING CAB (D21)**

2.4 4x4/2.5 D 4WD

NISSAN 37521-36G25

Length/Lunghezza [mm] 118,5  
 Height/Altezza [mm] 119  
 Width/Larghezza [mm] 50  
 Inner Diam./Diam. Interno [mm] 30



1014

**RU-1015**

**Engine Mounting**  
**Supporto motore**

**NISSAN PICK UP/KING CAB/NAVARA (D22)**

2.5 TD 4WD

NISSAN 11210-2S710

Length/Lunghezza [mm] 144  
 Height/Altezza [mm] 69  
 Width/Larghezza [mm] 153



1015

**RU-1016**

**Engine Mounting**  
**Supporto motore**

**NISSAN PICK UP/KING CAB/NAVARA (D22)**

2.5 TD 4WD

NISSAN 11220-2S710

Length/Lunghezza [mm] 143  
 Height/Altezza [mm] 108  
 Width/Larghezza [mm] 104



1016

**RU-1025**

**NISSAN MICRA (K11)**

1.0 i 16V/1.3 i 16V/1.4 i 16V

NISSAN 11320-99B11



1025

**RU-1026**

**NISSAN MICRA (K11)**

1.0 i 16V/1.3 i 16V

NISSAN 11220-99B11



1026

**RU-2000**

**Bearing Bush, stabiliser**  
**Boccola barra stabilizzatrice**

**TOYOTA RAV 4 II (XA2)**

1.8 VVTi/2.0 D-4D 4WD/2.0 VVTi 4WD

**TOYOTA RAV 4 II**

2.4

TOYOTA 4881542040

Fitting Position/Lato Montaggio Rear Axle  
 Length/Lunghezza [mm] 40  
 Height/Altezza [mm] 31  
 Width/Larghezza [mm] 30  
 Inner Diam./Diam. Interno [mm] 20



2000

<b>RU-2002</b>	<b>Engine Mounting</b>
	<b>Supporto motore</b>
TOYOTA	1237174312
Fitting Position/Lato Montaggio	Right Rear
Overall Length/Lungh. Tot. [mm]	228
Fitted Diam./Diam. Mont. [mm]	32

<b>TOYOTA CAMRY ( _V1_ )</b>
2.2 (SXV10)
<b>TOYOTA CAMRY SW ( _V10 )</b>
2.2 (SXV10)



2002

<b>RU-2003</b>	<b>Suspension Strut Support Bearing</b>
	<b>Supporto ammortizzatore</b>
TOYOTA	48609-12211
Fitting Position/Lato Montaggio	Front Axle
Height/Altezza [mm]	50
Inner Diam./Diam. Interno [mm]	15
Outer Diam./Diam. esterno [mm]	100

<b>TOYOTA COROLLA ( _E11_ )</b>
1.3/1.4 (EE111_)/1.4 16V (ZZE111_)/1.6 (AE111_)/1.6 16V (ZZE112_)/1.6 Aut. (AE111_)/1.9 D (WZE110_)/2.0 D (CE110_)
<b>TOYOTA COROLLA Compact ( _E10_ )</b>
1.8 GT (AE102_)/1.8 GTi 4x4
<b>TOYOTA COROLLA Compact ( _E11_ )</b>
1.4 (EE111_)/1.6 (AE111_)/1.6 Aut. (AE111_)/2.0 D (CE110_)
<b>TOYOTA COROLLA Liftback ( _E10_ )</b>
1.8 GT (AE102_)/1.8 GTi 4x4
<b>TOYOTA COROLLA Liftback ( _E11_ )</b>
1.4 (EE111_)/1.6 (AE111_)/1.6 Aut. (AE111_)/2.0 D (CE110_)
<b>TOYOTA COROLLA Wagon ( _E11_ )</b>
1.4 (EE111_)/1.4 16V (ZZE111_)/1.6 (AE111_)/1.6 16V (ZZE112_)/1.6 Aut. (AE111_)/1.8 AWD (AE115_)/1.9 D (WZE110_)/2.0 D (CE110_)
<b>TOYOTA COROLLA Wagon ( _E10_ )</b>
1.8 16V 4WD (AE103_)/1.8 XL/1.8 XL 4x4



2003

<b>RU-2007</b>	<b>Holder, control arm mounting</b>
	<b>Silentblock</b>
TOYOTA	48635-28010
Fitting Position/Lato Montaggio	Upper Front Axle
Fitting Position/Lato Montaggio	inner
Length/Lunghezza [mm]	75,5
Inner Diam./Diam. Interno [mm]	23
Outer Diam./Diam. esterno [mm]	47

<b>TOYOTA LITEACE Autobus ( _R2_LG )</b>
1.5 (KR21LG)/2.0 D (CR21LG)/2.2 (YR22LG)
<b>TOYOTA LITEACE Autobus ( CM30_G, KM30_G )</b>
1.5 (KM30LG)/2.0 D (CM30LG)
<b>TOYOTA LITEACE Furgonato ( _R2_V )</b>
1.5 (KR27_V)
<b>TOYOTA LITEACE Furgonato ( CM3_V, KM3_V )</b>
1.5 (KM31_V, KM36_V)/2.0 D (CM36_V)
<b>TOYOTA LITEACE Furgonato ( M2_V )</b>
1.3
<b>TOYOTA MODELL F Autobus ( _R2_ 31 )</b>
1.8 De Luxe (YR20)/2.0 (YR21_G)/2.0 Super (YR21)/2.2 (YR22LG, YR31LG)



2007

<b>RU-2011</b>	<b>Holder, control arm mounting</b>
	<b>Silentblock</b>
TOYOTA	48655-52010
Fitting Position/Lato Montaggio	Rear Axle
Length/Lunghezza [mm]	58
Inner Diam./Diam. Interno [mm]	12,5
Outer Diam./Diam. esterno [mm]	55,5

<b>TOYOTA YARIS ( _CP10 )</b>
1.0 16V/1.0 16V (SCP10_)/1.3/1.3 16V (NCP10_)/1.4 D-4D/1.5 TS (NCP13)/1.5 VVT-i TS
<b>TOYOTA YARIS VERSO ( NC/LP2_ )</b>
1.3 (NCP22)/1.4 D-4D (NLP22)/1.5 (NCP21)



2011

<b>RU-2015</b>	<b>Engine Mounting</b>
	<b>Supporto motore</b>
TOYOTA	12361-16040
Fitting Position/Lato Montaggio	Left Front
Height/Altezza [mm]	121,5
Width/Larghezza [mm]	56
Inner Diam./Diam. Interno [mm]	12,5

<b>TOYOTA COROLLA ( _E9_ )</b>
1.3 i (EE90)/1.6 (AE92)/1.6 i/1.6 i 4WD
<b>TOYOTA COROLLA Compact ( _E9_ )</b>
1.3 (EE90)/1.3 i (EE90)/1.6 (AE92)/1.6 GTi (AE92)
<b>TOYOTA COROLLA Liftback ( _E9_ )</b>
1.3 i (EE90)/1.6/1.6 (AE92)/1.6 GTi
<b>TOYOTA COROLLA SW ( _E9_ )</b>
1.3 (EE90)/1.3 i (EE90)/1.6 (AE92)/1.6 XLI/1.6 XLI 4x4 (AE95)



2015

<b>RU-2018</b>	<b>Suspension Strut Support Bearing</b>
	<b>Supporto ammortizzatore</b>
TOYOTA	48609-01040
Fitting Position/Lato Montaggio	Front Axle
Inner Diam./Diam. Interno [mm]	15
Fitted Diam./Diam. Mont. [mm]	88

<b>TOYOTA COROLLA ( _E9_ )</b>
1.3 i (EE90)/1.4/1.5/1.5 4x4/1.5 DX/1.6/1.6 (AE92)/1.6 GL 4x4/1.6 i/1.6 i 4WD/1.6 XL/1.8 D
<b>TOYOTA COROLLA Compact ( _E9_ )</b>
1.3 (EE90)/1.3 i (EE90)/1.5/1.5 4x4/1.6 (AE92)/1.6 GL 4x4/1.6 GTi (AE92)/1.6 XL/1.8 D (CE90)
<b>TOYOTA COROLLA Liftback ( _E9_ )</b>
1.3 i (EE90)/1.5/1.5 4x4/1.6/1.6 (AE92)/1.6 4x4/1.6 GTi/1.8 D (CE90)
<b>TOYOTA COROLLA SW ( _E9_ )</b>



2018



<b>RU-C01</b>	<b>Bearing Bush, stabiliser</b>	<b>CHEVROLET CAPTIVA</b>	
	<b>Boccola barra stabilizzatrice</b>	2.0 D/2.0 D 4WD/2.4/2.4 4WD/3.2 4WD	
CHEVROLET 96810751		<b>OPEL ANTARA</b>	
Fitting Position/Lato Montaggio Front		2.0 CDTI/2.4/3.2 V6	
Height/Altezza [mm] 54			
Width/Larghezza [mm] 40			
Width/Larghezza [mm] 49,5			
Inner Diam./Diam. Interno [mm] 26			
<b>RU-C02</b>	<b>Holder, control arm mounting</b>	<b>CHEVROLET CAPTIVA</b>	
	<b>Silentblock</b>	2.0 D/2.0 D 4WD/2.4/2.4 4WD/3.2 4WD	
CHEVROLET 96810751		<b>OPEL ANTARA</b>	
Fitting Position/Lato Montaggio Left		2.0 CDTI/2.4/3.2 V6	
Height/Altezza [mm] 95,5			
Width/Larghezza [mm] 55			
Inner Diam./Diam. Interno [mm] 19			
<b>RU-C04</b>	<b>Holder, control arm mounting</b>	<b>CHEVROLET CAPTIVA</b>	
	<b>Silentblock</b>	2.0 D/2.0 D 4WD/2.4/2.4 4WD/3.2 4WD	
CHEVROLET 96810751		<b>OPEL ANTARA</b>	
Length/Lunghezza [mm] 60		2.0 CDTI/2.4/3.2 V6	
Inner Diam./Diam. Interno [mm] 14			
Outer Diam./Diam. esterno [mm] 38			
<b>RU-C05</b>	<b>Holder, control arm mounting</b>	<b>CHEVROLET AVEO</b>	
	<b>Silentblock</b>	1.2/1.4/1.5	
DAEWOO 96535087		<b>CHEVROLET KALOS</b>	
Inner Diam./Diam. Interno [mm] 12		1.2/1.4/1.4 16V	
Overall Length/Lungh. Tot. [mm] 47		<b>CHEVROLET KALOS Tre volumi</b>	
Outer Diam./Diam. esterno [mm] 34		1.4 16V	
		<b>DAEWOO KALOS (KLAS)</b>	
		1.2/1.4/1.4 16V	
<b>RU-C06</b>	<b>Holder, control arm mounting</b>	<b>CHEVROLET AVEO</b>	
	<b>Silentblock</b>	1.2/1.4/1.5	
DAEWOO 96535088		<b>CHEVROLET KALOS</b>	
Length/Lunghezza [mm] 46		1.2/1.4/1.4 16V	
Inner Diam./Diam. Interno [mm] 12		<b>CHEVROLET KALOS Tre volumi</b>	
Outer Diam./Diam. esterno [mm] 60		1.4 16V	
		<b>DAEWOO KALOS (KLAS)</b>	
		1.2/1.4/1.4 16V	
<b>RU-C07</b>	<b>Holder, control arm mounting</b>	<b>CHEVROLET MATIZ</b>	
	<b>Silentblock</b>	0.8/1.0	
SUZUKI 0931910030		<b>DAEWOO MATIZ (KLYA)</b>	
Length/Lunghezza [mm] 52,5		0.8/1.0	
Inner Diam./Diam. Interno [mm] 10		<b>DAEWOO TICO (KLY3)</b>	
Outer Diam./Diam. esterno [mm] 28,5		0.8	
		<b>OPEL AGILA (H00)</b>	
		1.0/1.0 12V/1.2 16V/1.2 16V Twinport/1.3 CDTI	
		<b>SUZUKI ALTO I (SS80)</b>	
		0.8 (SS80F, SS80G)	
		<b>SUZUKI ALTO II (EC)</b>	
		0.8 (SB308/CA)	
		<b>SUZUKI ALTO III (EF)</b>	
		0.8 i cat. (SB308) /1.0	
		<b>SUZUKI ALTO IV (FF)</b>	
		1.1	
		<b>SUZUKI IGNIS (FH)</b>	
		1.3/1.3 4WD	
		<b>SUZUKI IGNIS II</b>	
		1.3/1.3 DDiS/1.5/1.5 4x4/1.5 Sport	



<b>RU-C08</b>	<b>Holder, control arm mounting</b>	<b>CHEVROLET LACETTI</b>	
	<b>Silentblock</b>	1.4 16V/1.6/1.8/2.0 D	
CHEVROLET	96378346	<b>CHEVROLET NUBIRA SW</b>	
		1.6/1.8/2.0 D	
		<b>CHEVROLET NUBIRA Tre volumi</b>	
Length/Lunghezza [mm]	59,5	1.4/1.6/1.8	
Inner Diam./Diam. Interno [mm]	12	<b>CHEVROLET REZZO</b>	
Outer Diam./Diam. esterno [mm]	38	1.6/2.0	
		<b>DAEWOO LACETTI (KLAN)</b>	
		1.4/1.6/1.8	
		<b>DAEWOO NUBIRA Tre volumi (KLAN)</b>	
		1.4	
		<b>DAEWOO TACUMA (KLAU)</b>	
		1.6/1.6 SX/1.8/2.0	
<b>RU-C09</b>	<b>Holder, control arm mounting</b>	<b>CHEVROLET REZZO</b>	
	<b>Silentblock</b>	1.6/2.0	
CHEVROLET	96261107	<b>DAEWOO TACUMA (KLAU)</b>	
		1.6/1.6 SX/1.8/2.0	
Length/Lunghezza [mm]	54		
Inner Diam./Diam. Interno [mm]	12,5		
Outer Diam./Diam. esterno [mm]	72		
<b>RU-C10</b>	<b>Holder, control arm mounting</b>	<b>CHRYSLER PT CRUISER</b>	
	<b>Silentblock</b>	1.6/2.0/2.2 CRD/2.4/GT 2.4	
CHRYSLER	4656730AH	<b>CHRYSLER PT CRUISER Cabriolet</b>	
		2.4/2.4 GT	
Length/Lunghezza [mm]	69		
Inner Diam./Diam. Interno [mm]	14		
Outer Diam./Diam. esterno [mm]	34		
<b>RU-C11</b>	<b>Holder, control arm mounting</b>	<b>CHRYSLER PT CRUISER</b>	
	<b>Silentblock</b>	1.6/2.0/2.2 CRD/2.4/GT 2.4	
CHRYSLER	4656012AB	<b>CHRYSLER PT CRUISER Cabriolet</b>	
		2.4/2.4 GT	
Length/Lunghezza [mm]	62		
Inner Diam./Diam. Interno [mm]	16		
Outer Diam./Diam. esterno [mm]	55		
<b>RU-C12</b>	<b>Holder, control arm mounting</b>	<b>CHRYSLER VOYAGER I (AS)</b>	
	<b>Silentblock</b>	2.5 D/3.0	
CHRYSLER	272084	<b>CHRYSLER VOYAGER II (ES)</b>	
		2.5 i/2.5 TD/3.0 i/3.3 i/3.3 i AWD	
Length/Lunghezza [mm]	68		
Inner Diam./Diam. Interno [mm]	14,5		
Outer Diam./Diam. esterno [mm]	39		
<b>RU-C13</b>	<b>Holder, control arm mounting</b>	<b>CHRYSLER VOYAGER I (AS)</b>	
	<b>Silentblock</b>	2.5 D/3.0	
CHEVROLET	5272098	<b>CHRYSLER VOYAGER II (ES)</b>	
		2.5 i/2.5 TD/3.0 i/3.3 i/3.3 i AWD	
Length/Lunghezza [mm]	66		
Inner Diam./Diam. Interno [mm]	15		
Outer Diam./Diam. esterno [mm]	58,5		
<b>RU-C14</b>	<b>Holder, control arm mounting</b>	<b>CHRYSLER VOYAGER III (GS)</b>	
	<b>Silentblock</b>	2.0 i/2.4 i/2.5 TD/3.0/3.3 i/3.8 i AWD	
CHRYSLER	4694760AC		
Length/Lunghezza [mm]	68		
Inner Diam./Diam. Interno [mm]	14,5		
Outer Diam./Diam. esterno [mm]	40		

<b>RU-C15</b>	<b>Holder, control arm mounting</b>	<b>CHRYSLER VOYAGER III (GS)</b>	
	<b>Silentblock</b>	2.0 i/2.4 i/2.5 TD/3.0/3.3 i/3.8 i AWD	
CHRYSLER 4694760AC			
Length/Lunghezza [mm]		65	
Inner Diam./Diam. Interno [mm]		23	
Outer Diam./Diam. esterno [mm]		66,5	
<b>RU-C16</b>	<b>Holder, control arm mounting</b>	<b>CHRYSLER VOYAGER IV (RG)</b>	
	<b>Silentblock</b>	2.4/2.5 CRD/2.8 CRD/3.3/3.3 AWD/3.8/3.8 AWD	
CHRYSLER 4684120			
Length/Lunghezza [mm]		68	
Inner Diam./Diam. Interno [mm]		14,5	
Outer Diam./Diam. esterno [mm]		39,4	
<b>RU-C17</b>	<b>Holder, control arm mounting</b>	<b>CHRYSLER VOYAGER IV (RG)</b>	
	<b>Silentblock</b>	2.4/2.5 CRD/2.8 CRD/3.3/3.3 AWD/3.8/3.8 AWD	
CHRYSLER 4743095-AA			
Fitting Position/Lato Montaggio		Left Front	
Length/Lunghezza [mm]		63	
Inner Diam./Diam. Interno [mm]		25	
Outer Diam./Diam. esterno [mm]		62	
<b>RU-C18</b>	<b>Holder, control arm mounting</b>	<b>CHRYSLER VOYAGER IV (RG)</b>	
	<b>Silentblock</b>	2.4/2.5 CRD/2.8 CRD/3.3/3.3 AWD/3.8/3.8 AWD	
CHRYSLER 4743 094AA			
Fitting Position/Lato Montaggio		Right Front	
Length/Lunghezza [mm]		63	
Inner Diam./Diam. Interno [mm]		25	
Outer Diam./Diam. esterno [mm]		62	
<b>RU-D01</b>	<b>Holder, control arm mounting</b>	<b>DAEWOO ESPERO (KLEJ)</b>	
	<b>Silentblock</b>	1.5/1.5 16V/1.8/2.0	
DAEWOO 352349		<b>DAEWOO LANOS (KLAT)</b>	
		1.3 (A13SM)/1.4/1.5/1.6 16V	
		<b>DAEWOO LANOS Tre volumi (KLAT)</b>	
		1.4/1.5/1.6 16V	
		<b>DAEWOO NEXIA (KLETN)</b>	
		1.5/1.5 16V/1.8	
		<b>DAEWOO NEXIA Tre volumi (KLETN)</b>	
		1.5/1.5 16V/1.8	
		<b>OPEL KADETT D (31_34_41_44_)</b>	
		1.2/1.2 S/1.3 N/1.3 S/1.6 D/1.6 S/1.8 GT/E	
		<b>OPEL KADETT D (32_37_39_42)</b>	
		1.2 S/1.3 N/1.3 S/1.6 D	
		<b>OPEL KADETT D SW (35_36_45_46_)</b>	
		1.2/1.2 S/1.3 N/1.3 S/1.6 D/1.6 S	
		<b>OPEL KADETT E (39_49_)</b>	
		1.2/1.3 i Cat./1.3 N/1.3 S/1.4 i/1.4 S/1.5 TD/1.6/1.6 D/1.6 i/1.6 i	
		Cat./1.6 S/1.7 D/1.8/1.8 i/1.8 S/2.0 i/2.0 i Cat.	
		<b>OPEL KADETT E 2 volumi (33_34_43_)</b>	
		1.2/1.3 i Cat./1.3 N/1.3 S/1.4 i/1.4 S/1.5 TD/1.6 D/1.6 i/1.6 i	
		Cat./1.6 S/1.7 D/1.8 E/1.8 GSI/1.8 i/1.8 S/2.0 GSI/2.0 GSI 16V/2.0 GSI 16V Cat./2.0 GSI Cat.	
		<b>OPEL KADETT E Cabriolet (43B_)</b>	
		1.3 S/1.4 i/1.4 S/1.6 i/1.6 i Cat./2.0 i/2.0 i Cat.	
		<b>OPEL KADETT E Combo (38_48_)</b>	
		1.3 N/1.3 S/1.4 i/1.4 S/1.6/1.6 D/1.6 i/1.7 D	
		<b>OPEL KADETT E Furgonato (37_47_)</b>	
		1.2/1.3 N/1.4 i/1.6 D/1.6 i/1.7 D/1.8 i	
		<b>OPEL KADETT E SW (35_36_45_46_)</b>	

<b>RU-D02</b>	<b>Holder, control arm mounting</b>	1.2/1.3 i Cat./1.3 N/1.3 S/1.4 i/1.4 S/1.5 TD/1.6/1.6 D/1.6 i/1.6 i Cat./1.6 S/1.7 D/1.8 E/1.8 i/1.8 S/2.0 i/2.0 i Cat.
	<b>Silentblock</b>	<b>DAEWOO ESPERO (KLEJ)</b> 1.5/1.5 16V/1.8/2.0
DAEWOO	352335	<b>DAEWOO LANOS (KLAT)</b> 1.3 (A13SM)/1.4/1.5/1.6 16V
Length/Lunghezza [mm]	54	<b>DAEWOO LANOS Tre volumi (KLAT)</b> 1.4/1.5/1.6 16V
Height/Altezza [mm]	56	<b>DAEWOO NEXIA (KLETN)</b> 1.5/1.5 16V/1.8
Width/Larghezza [mm]	63	<b>DAEWOO NEXIA Tre volumi (KLETN)</b> 1.5/1.5 16V/1.8
Inner Diam./Diam. Interno [mm]	20	<b>OPEL KADETT D (31_34_, 41_44_)</b> 1.2/1.2 S/1.3 N/1.3 S/1.6 D/1.6 S/1.8 GT/E



<b>RU-D03</b>	<b>Holder, control arm mounting</b>	<b>DAEWOO ESPERO (KLEJ)</b> 1.5/1.5 16V/1.8/2.0
	<b>Silentblock</b>	<b>DAEWOO LANOS (KLAT)</b> 1.3 (A13SM)/1.4/1.5/1.6 16V
DAEWOO	402645	<b>DAEWOO LANOS Tre volumi (KLAT)</b> 1.4/1.5/1.6 16V
Fitting Position/Lato Montaggio	Rear Axle	<b>DAEWOO NEXIA (KLETN)</b> 1.5/1.5 16V/1.8
Length/Lunghezza [mm]	74,7	<b>DAEWOO NEXIA Tre volumi (KLETN)</b> 1.5/1.5 16V/1.8
Inner Diam./Diam. Interno [mm]	12	<b>OPEL ASCONA C (81_, 86_, 87_, 88_)</b> 1.3 N/1.3 S/1.6/1.6 D/1.6 i/1.6 i Cat./1.6 S/1.8/1.8 E/1.8 i/2.0 i/2.0 i Cat./2.0 i GT
Outer Diam./Diam. esterno [mm]	59	<b>OPEL ASCONA C 2 volumi (84_, 89_)</b> 1.3 N/1.3 S/1.6/1.6 D/1.6 i/1.6 i Cat./1.6 S/1.8/1.8 E/1.8 i/2.0 i/2.0 i Cat./2.0 i GT



**OPEL KADETT E (39\_, 49\_)**

1.2/1.3 i Cat./1.3 N/1.3 S/1.4 i/1.4 S/1.5 TD/1.6 D/1.6 i/1.6 i  
 Cat./1.6 S/1.7 D/1.8/1.8 i/1.8 S/2.0 i/2.0 i Cat.

**OPEL KADETT E 2 volumi (33\_, 34\_, 43\_)**

1.2/1.3 i Cat./1.3 N/1.3 S/1.4 i/1.4 S/1.5 TD/1.6 D/1.6 i/1.6 i  
 Cat./1.6 S/1.7 D/1.8 E/1.8 GSI/1.8 i/1.8 S/2.0 GSI/2.0 GSI 16V/2.0  
 GSI 16V Cat./2.0 GSI Cat.

**OPEL KADETT E Cabriolet (43B\_)**

1.3 S/1.4 i/1.4 S/1.6 i/1.6 i Cat./2.0 i/2.0 i Cat.

**OPEL KADETT E Combo (38\_, 48\_)**

1.3 N/1.3 S/1.4 i/1.4 S/1.6/1.6 D/1.6 i/1.7 D

**OPEL KADETT E Furgonato (37\_, 47\_)**

1.2/1.3 N/1.4 i/1.6 D/1.6 i/1.7 D/1.8 i

**OPEL KADETT E SW (35\_, 36\_, 45\_, 46\_)**

1.2/1.3 i Cat./1.3 N/1.3 S/1.4 i/1.4 S/1.5 TD/1.6 D/1.6 i/1.6 i  
 Cat./1.6 S/1.7 D/1.8 E/1.8 i/1.8 S/2.0 i/2.0 i Cat.

**OPEL VECTRA A (86\_, 87\_)**

1.4 S/1.6/1.6 i/1.6 i Cat./1.7 D/1.7 TD/1.8 i Cat./1.8 S/1.8 S  
 4x4/2.0/2.0 i/2.0 i 16V/2.0 i 16V 4x4/2.0 i 4x4/2.0 i 4x4 Cat./2.0 i  
 Cat./2.0 i Turbo 4x4/2.5 V6/2000 16V 4x4/2000/GT 16V/2000/GT  
 16V 4x4 Cat./2000/GT 16V Cat.

**OPEL VECTRA A 2 volumi (88\_, 89\_)**

1.4 S/1.6 i/1.6 i Cat./1.6 S/1.7 D/1.7 TD/1.8 i/1.8 i Cat./1.8  
 S/2.0/2.0 i/2.0 i 16V/2.0 i 16V Cat./2.0 i Cat./2.0 i GT/2.5 V6

**RU-D04**

**Holder, control arm mounting**

**Silentblock**

Length/Lunghezza [mm]	44
Inner Diam./Diam. Interno [mm]	12,5
Outer Diam./Diam. esterno [mm]	49

**DAEWOO NUBIRA (KLAJ)**

1.6 16V/2.0 16V/2.0 CDX

**DAEWOO NUBIRA Tre volumi (KLAJ)**

1.5 SE/1.6 16V/2.0/2.0 16V

**DAEWOO NUBIRA Tre volumi (KLAN)**

1.6/1.8

**DAEWOO NUBIRA Wagon (KLAJ)**

1.6 16V/2.0 16V

**DAEWOO NUBIRA Wagon (KLAN)**

1.6/1.8

**RU-D05**

**Holder, control arm mounting**

**Silentblock**

DAEWOO	96298000
Length/Lunghezza [mm]	49
Inner Diam./Diam. Interno [mm]	16
Outer Diam./Diam. esterno [mm]	53

**DAEWOO NUBIRA (KLAJ)**

1.6 16V/2.0 16V/2.0 CDX

**DAEWOO NUBIRA Tre volumi (KLAJ)**

1.5 SE/1.6 16V/2.0/2.0 16V

**DAEWOO NUBIRA Tre volumi (KLAN)**

1.6/1.8

**DAEWOO NUBIRA Wagon (KLAJ)**

1.6 16V/2.0 16V

**DAEWOO NUBIRA Wagon (KLAN)**

1.6/1.8

**RU-H03**

**Holder, control arm mounting**

**Silentblock**

HYUNDAI	54551-02000
Length/Lunghezza [mm]	56
Inner Diam./Diam. Interno [mm]	12
Outer Diam./Diam. esterno [mm]	35,5

**HYUNDAI ACCENT/EXCEL (X-3)**

1.3/1.3 i 12V/1.5 i 12V/1.5 i 16V

**HYUNDAI ACCENT/EXCEL Tre volumi (X-3)**

1.3/1.3 i 12V/1.5 i 12V/1.5 i 16V

**HYUNDAI ATOS (MX)**

0.8/1.0 i/1.1

**HYUNDAI ATOS PRIME (MX)**

1.0 i/1.1

**RU-H04**

**Holder, control arm mounting**

**Silentblock**

HYUNDAI	54555-22100
Length/Lunghezza [mm]	56
Height/Altezza [mm]	58
Width/Larghezza [mm]	65
Inner Diam./Diam. Interno [mm]	18,8

**HYUNDAI ACCENT/EXCEL (X-3)**

1.3/1.3 i 12V/1.5 i 12V/1.5 i 16V

**HYUNDAI ACCENT/EXCEL Tre volumi (X-3)**

1.3/1.3 i 12V/1.5 i 12V/1.5 i 16V

**HYUNDAI ATOS (MX)**

0.8/1.0 i/1.1

**HYUNDAI ATOS PRIME (MX)**

1.0 i/1.1



<b>RU-H05</b>	<b>Holder, control arm mounting</b>	<b>HYUNDAI ACCENT/EXCEL (X-3)</b> 1.3/1.3 i 12V/1.5 i 12V/1.5 i 16V	 <b>H05</b>	
	<b>Silentblock</b>	<b>HYUNDAI ACCENT/EXCEL Tre volumi (X-3)</b> 1.3/1.3 i 12V/1.5 i 12V/1.5 i 16V		
HYUNDAI	54556-22100	<b>HYUNDAI ATOS (MX)</b> 0.8/1.0 i/1.1		
Length/Lunghezza [mm]	56	<b>HYUNDAI ATOS PRIME (MX)</b> 1.0 i/1.1		
Height/Altezza [mm]	58			
Width/Larghezza [mm]	65			
Inner Diam./Diam. Interno [mm]	18,8			
<b>RU-H06</b>	<b>Holder, control arm mounting</b>	<b>HYUNDAI ACCENT (LC)</b> 1.3/1.5/1.5 CRDi/1.6		 <b>H06</b>
	<b>Silentblock</b>	<b>HYUNDAI ACCENT Tre volumi (LC)</b> 1.3/1.5/1.5 CRDi/1.6		
HYUNDAI	54551-25000	<b>HYUNDAI MATRIX (FC)</b> 1.5 CRDi/1.5 CRDi VGT/1.6/1.8		
Length/Lunghezza [mm]	53,5			
Inner Diam./Diam. Interno [mm]	13			
Outer Diam./Diam. esterno [mm]	33			
<b>RU-H07</b>	<b>Holder, control arm mounting</b>	<b>HYUNDAI ACCENT (LC)</b> 1.3/1.5/1.5 CRDi/1.6	 <b>H07</b>	
	<b>Silentblock</b>	<b>HYUNDAI ACCENT Tre volumi (LC)</b> 1.3/1.5/1.5 CRDi/1.6		
HYUNDAI	54555-25000			
Length/Lunghezza [mm]	54			
Inner Diam./Diam. Interno [mm]	12,5			
Outer Diam./Diam. esterno [mm]	52,5			
<b>RU-H08</b>	<b>Bearing Bush, stabiliser</b>	<b>HYUNDAI ACCENT (MC)</b> 1.4 GL/1.5 CRDi GLS/1.6 GLS		 <b>RU-H08</b>
	<b>Boccola barra stabilizzatrice</b>	<b>HYUNDAI ACCENT Tre volumi (MC)</b> 1.4 GL/1.5 CRDi GLS/1.6 GLS		
HYUNDAI	54812-1G100	<b>KIA RIO</b> 1.3		
Fitting Position/Lato Montaggio	Front	<b>KIA RIO II</b> 1.4 16V/1.5 CRDi/1.6 16V		
Length/Lunghezza [mm]	45	<b>KIA RIO II Tre volumi</b> 1.4 16V/1.5 CRDi/1.6 16V		
Height/Altezza [mm]	48			
Width/Larghezza [mm]	44			
Inner Diam./Diam. Interno [mm]	24			
<b>RU-H09</b>	<b>Holder, control arm mounting</b>	<b>HYUNDAI ACCENT (MC)</b> 1.4 GL/1.5 CRDi GLS/1.6 GLS	 <b>RU-H09</b>	
	<b>Silentblock</b>	<b>HYUNDAI ACCENT Tre volumi (MC)</b> 1.4 GL/1.5 CRDi GLS/1.6 GLS		
HYUNDAI	54584-1G000	<b>KIA RIO</b> 1.3		
Length/Lunghezza [mm]	60	<b>KIA RIO II</b> 1.4 16V/1.5 CRDi/1.6 16V		
Inner Diam./Diam. Interno [mm]	14,5	<b>KIA RIO II Tre volumi</b> 1.4 16V/1.5 CRDi/1.6 16V		
Outer Diam./Diam. esterno [mm]	66,3			
<b>RU-H10</b>	<b>Holder, control arm mounting</b>	<b>HYUNDAI ACCENT (MC)</b> 1.4 GL/1.5 CRDi GLS/1.6 GLS		 <b>H10</b>
	<b>Silentblock</b>	<b>HYUNDAI ACCENT Tre volumi (MC)</b> 1.4 GL/1.5 CRDi GLS/1.6 GLS		
HYUNDAI	54551-1E000	<b>HYUNDAI GETZ (TB)</b> 1.1/1.3/1.4/1.5 CRDi/1.5 CRDi GLS/1.6		
Length/Lunghezza [mm]	54	<b>KIA RIO</b> 1.3		
Inner Diam./Diam. Interno [mm]	12,5	<b>KIA RIO II</b> 1.4 16V/1.5 CRDi/1.6 16V		
Outer Diam./Diam. esterno [mm]	35	<b>KIA RIO II Tre volumi</b> 1.4 16V/1.5 CRDi/1.6 16V		
		<b>KIA VENGA</b> 1.4 16V/1.4 CRDi/1.6 16V/1.6 CRDi		

<b>RU-H12</b>	<b>Holder, control arm mounting</b>	<b>HYUNDAI GETZ (TB)</b> 1.1/1.3/1.4/1.5 CRDi/1.5 CRDi GLS/1.6	
	<b>Silentblock</b>		
HYUNDAI	54584-1C300		
Length/Lunghezza [mm]	55		
Inner Diam./Diam. Interno [mm]	14		
Outer Diam./Diam. esterno [mm]	63,5		
<b>RU-H13</b>	<b>Holder, control arm mounting</b>	<b>HYUNDAI H100 Furgonato</b> 2.5 D	
	<b>Silentblock</b>		
HYUNDAI	545104B001		
Length/Lunghezza [mm]	77		
Inner Diam./Diam. Interno [mm]	16		
Outer Diam./Diam. esterno [mm]	42		
<b>RU-H14</b>	<b>Holder, control arm mounting</b>	<b>HYUNDAI H100 Autobus (P)</b> 2.4/2.5 D/2.5 TD/2.6 D	
	<b>Silentblock</b>	<b>MAZDA L 300 (P0_W, P1_W, P2_W)</b> 1.6 (P02V, P12V)/2.0 (P00W)/2.0 (P03W)/2.0 (P03W, P03V, P13V)/2.4 (P04W, P14V, P04V)/2.5 D (P05W, P05V, P15V)/2.5 TD 4WD (P25W, P25V)	
HYUNDAI	5451043152	<b>MAZDA L 300 Furgonato (P0_W, P1_W)</b> 1.4 G33B/1.6 (P12V, P02V)/2.0 (P03V, P13V)/2.5 D (P05V, P05W, P15V)/2.5 TD	
Length/Lunghezza [mm]	69,5	<b>MAZDA L 300 Pianale piatto/Telaio (P1_T)</b> 2.0 (P13T)/2.5 D (P15T)	
Inner Diam./Diam. Interno [mm]	16		
Outer Diam./Diam. esterno [mm]	46		
<b>RU-H15</b>	<b>Holder, control arm mounting</b>	<b>HYUNDAI MATRIX (FC)</b> 1.5 CRDi/1.5 CRDi VGT/1.6/1.8	
	<b>Silentblock</b>		
HYUNDAI	54584-17000		
Length/Lunghezza [mm]	54,5		
Inner Diam./Diam. Interno [mm]	14		
Outer Diam./Diam. esterno [mm]	63,5		
<b>RU-H16</b>	<b>Bearing Bush, stabiliser</b>	<b>HYUNDAI SANTA FE' (SM)</b> 2.2 CRDi/2.2 CRDi 4x4/2.7/2.7 4x4	
	<b>Boccola barra stabilizzatrice</b>	<b>HYUNDAI SANTA FÉ</b> 2.2 CRDi/2.2 CRDi 4x4/2.2 CRDi GLS/2.2 CRDi GLS 4x4/2.7/2.7 4x4/2.7 V6 GLS/2.7 V6 GLS 4x4	
HYUNDAI	54813-3K100	<b>HYUNDAI SONATA V</b> 2.0 CRDi/2.4/3.3	
Fitting Position/Lato Montaggio	Front	<b>KIA SORENTO</b> 2.0 CRDi/2.0 CRDi 4WD/2.2 CRDi/2.4 16V	
Length/Lunghezza [mm]	47,5		
Height/Altezza [mm]	47,5		
Width/Larghezza [mm]	52		
Inner Diam./Diam. Interno [mm]	26		
<b>RU-H17</b>	<b>Holder, control arm mounting</b>	<b>HYUNDAI SANTA FÉ</b> 2.2 CRDi/2.2 CRDi 4x4/2.2 CRDi GLS/2.2 CRDi GLS 4x4/2.7/2.7 4x4/2.7 V6 GLS/2.7 V6 GLS 4x4	
	<b>Silentblock</b>	<b>KIA SORENTO</b> 2.0 CRDi/2.0 CRDi 4WD/2.2 CRDi/2.4 16V	
HYUNDAI	54584 2B000		
Length/Lunghezza [mm]	60		
Inner Diam./Diam. Interno [mm]	14		
Outer Diam./Diam. esterno [mm]	67		
<b>RU-H18</b>	<b>Holder, control arm mounting</b>	<b>HYUNDAI SANTA FÉ</b> 2.2 CRDi/2.2 CRDi 4x4/2.2 CRDi GLS/2.2 CRDi GLS 4x4/2.7/2.7 4x4/2.7 V6 GLS/2.7 V6 GLS 4x4	
	<b>Silentblock</b>	<b>KIA SORENTO</b> 2.0 CRDi/2.0 CRDi 4WD/2.2 CRDi/2.4 16V	
HYUNDAI	54551 2B000		
Length/Lunghezza [mm]	70		
Inner Diam./Diam. Interno [mm]	14		
Outer Diam./Diam. esterno [mm]	42		

<b>RU-H19</b>	<b>Holder, control arm mounting</b>	<b>HYUNDAI SONATA III (EF)</b>	
	<b>Silentblock</b>	2.0 16V/2.4 16V/2.5 V6 24V	
	HYUNDAI 54551-38000	<b>HYUNDAI SONATA IV/ SONICA</b>	
		2.0/2.0 VVTi GLS/2.7 V6	
	Overall Length/Lungh. Tot. [mm]	130	
	Outer Diam./Diam. esterno [mm]	31	
<b>RU-H20</b>	<b>Holder, control arm mounting</b>	<b>HYUNDAI SONATA IV/ SONICA</b>	
	<b>Silentblock</b>	2.7 V6	
	HYUNDAI 5458438100		
	Length/Lunghezza [mm]	60	
	Inner Diam./Diam. Interno [mm]	14	
	Outer Diam./Diam. esterno [mm]	66	
<b>RU-H21</b>	<b>Holder, control arm mounting</b>	<b>HYUNDAI SONATA V</b>	
	<b>Silentblock</b>	2.0 CRDi/2.4/3.3	
	HYUNDAI 54443-3K000		
	Length/Lunghezza [mm]	45,7	
	Inner Diam./Diam. Interno [mm]	10	
	Outer Diam./Diam. esterno [mm]	40	
<b>RU-H22</b>	<b>Holder, control arm mounting</b>	<b>HYUNDAI SONATA V</b>	
	<b>Silentblock</b>	2.0 CRDi/2.4/3.3	
	HYUNDAI 54584-3K000		
	Length/Lunghezza [mm]	60	
	Inner Diam./Diam. Interno [mm]	14	
	Outer Diam./Diam. esterno [mm]	66,7	
<b>RU-H23</b>	<b>Holder, control arm mounting</b>	<b>HYUNDAI SONATA V</b>	
	<b>Silentblock</b>	2.0 CRDi/2.4/3.3	
	HYUNDAI 54551-3K000		
	Length/Lunghezza [mm]	58,5	
	Inner Diam./Diam. Interno [mm]	14	
	Outer Diam./Diam. esterno [mm]	45	
<b>RU-H24</b>	<b>Holder, control arm mounting</b>	<b>HYUNDAI SONATA V</b>	
	<b>Silentblock</b>	2.0 CRDi/2.4/3.3	
	HYUNDAI 54552-3K000		
	Length/Lunghezza [mm]	59,6	
	Inner Diam./Diam. Interno [mm]	14	
	Outer Diam./Diam. esterno [mm]	42	
<b>RU-H25</b>	<b>Bearing Bush, stabiliser</b>	<b>HYUNDAI TRAJET (FO)</b>	
	<b>Boccola barra stabilizzatrice</b>	2.0/2.0 CRDi/2.7 V6	
	HYUNDAI 54813-3A000		
	Fitting Position/Lato Montaggio	Front	
	Length/Lunghezza [mm]	48	
	Height/Altezza [mm]	44	
	Width/Larghezza [mm]	49	
	Inner Diam./Diam. Interno [mm]	29	

<b>RU-H26</b>	<b>Holder, control arm mounting</b>	<b>HYUNDAI TRAJET (FO)</b>	
	<b>Silentblock</b>	2.0/2.0 CRDi/2.7 V6	
	HYUNDAI 54551-3A000		
	Overall Length/Lungh. Tot. [mm]	140	
	Outer Diam./Diam. esterno [mm]	31	
<b>RU-H27</b>	<b>Holder, control arm mounting</b>	<b>HYUNDAI TRAJET (FO)</b>	
	<b>Silentblock</b>	2.0/2.0 CRDi/2.7 V6	
	HYUNDAI 54555-3A100		
	Length/Lunghezza [mm]	82,5	
	Inner Diam./Diam. Interno [mm]	12	
	Outer Diam./Diam. esterno [mm]	64,5	
<b>RU-H28</b>	<b>Bearing Bush, stabiliser</b>	<b>HYUNDAI H-1/H-200/SATELLITE Autobus</b>	
	<b>Boccola barra stabilizzatrice</b>	2.4/2.4 4WD/2.5 D/2.5 TD	
	HYUNDAI 55256-44000	<b>HYUNDAI H100 Autobus (P)</b>	
	Length/Lunghezza [mm]	45,5	
	Inner Diam./Diam. Interno [mm]	16,5	
	Outer Diam./Diam. esterno [mm]	27	
<b>RU-H29</b>	<b>Suspension Strut Support</b>	<b>HYUNDAI ATOS (MX)</b>	
	<b>Bearing</b>	1.0 i	
	<b>Supporto ammortizzatore</b>	<b>HYUNDAI ATOS PRIME (MX)</b>	
	HYUNDAI 54610-02010	1.0 i/1.1	
	Length/Lunghezza [mm]	129	
	Height/Altezza [mm]	53,5	
	Width/Larghezza [mm]	136	
	Inner Diam./Diam. Interno [mm]	12	
<b>RU-H30</b>	<b>Bearing Bush, stabiliser</b>	<b>HYUNDAI TUCSON (JM)</b>	
	<b>Boccola barra stabilizzatrice</b>	2.0/2.0 4 ruote motrici/2.0 CRDi/2.0 CRDi 4 ruote motrici/2.7 4 ruote motrici	
	HYUNDAI 55513-2E100		
	Fitting Position/Lato Montaggio	Rear Axle	
	Length/Lunghezza [mm]	48	
	Height/Altezza [mm]	49	
	Width/Larghezza [mm]	53	
	Inner Diam./Diam. Interno [mm]	15	
<b>RU-H31</b>	<b>Suspension Strut Support</b>	<b>HYUNDAI SANTA FE' (SM)</b>	
	<b>Bearing</b>	2.0/2.0 CRDi/2.0 CRDi 4x4/2.2 CRDi/2.2 CRDi 4x4/2.4 16V/2.4	
	<b>Supporto ammortizzatore</b>	16V 4x4/2.7/2.7 4x4/2.7 V6 4x4	
	HYUNDAI 54610-34010		
	Fitting Position/Lato Montaggio	Front Axle left and right	
	Height/Altezza [mm]	48	
	Inner Diam./Diam. Interno [mm]	15	
<b>RU-H32</b>	<b>Holder, control arm mounting</b>	<b>HYUNDAI SANTA FE' (SM)</b>	
	<b>Silentblock</b>	2.0/2.0 CRDi/2.0 CRDi 4x4/2.2 CRDi/2.2 CRDi 4x4/2.4 16V/2.4	
	HYUNDAI 54551 26000	16V 4x4/2.7/2.7 4x4/2.7 V6 4x4/3.5/3.5 4x4	
	Fitting Position/Lato Montaggio	Front Axle	
	Overall Length/Lungh. Tot. [mm]	140	
	Outer Diam./Diam. esterno [mm]	34	



<p><b>RU-H33</b>      <b>Holder, control arm mounting</b></p> <p><b>Silentblock</b></p>	<p><b>HYUNDAI SANTA FE' (SM)</b>                  2.0/2.0 CRDi/2.0 CRDi 4x4/2.2 CRDi/2.2 CRDi 4x4/2.4 16V/2.4 16V 4x4/2.7/2.7 4x4/2.7 V6 4x4/3.5/3.5 4x4</p>	
<p>HYUNDAI      54555 26000</p> <p>Fitting Position/Lato Montaggio      Lower Front Axle</p> <p>Length/Lunghezza [mm]      62</p> <p>Width/Larghezza [mm]      63</p> <p>Inner Diam./Diam. Interno [mm]      12</p>	<p><b>HYUNDAI SANTA FE' (SM)</b>                  2.0/2.0 CRDi 4x4/2.4 16V/2.4 16V 4x4/2.7 V6 4x4</p>	
<p><b>RU-H34</b>      <b>Bearing Bush, stabiliser</b></p> <p><b>Boccola barra stabilizzatrice</b></p>	<p>HYUNDAI      54813-26100</p> <p>Fitting Position/Lato Montaggio      Front Axle</p> <p>Length/Lunghezza [mm]      48</p> <p>Height/Altezza [mm]      48</p> <p>Width/Larghezza [mm]      51</p> <p>Inner Diam./Diam. Interno [mm]      21</p>	
<p><b>RU-H35</b>      <b>Bearing Bush, stabiliser</b></p> <p><b>Boccola barra stabilizzatrice</b></p>	<p><b>HYUNDAI H100 TRUCK Pianale piatto/Telaio</b>                  2.5 D</p>	
<p>HYUNDAI      54712-44150</p> <p>Fitting Position/Lato Montaggio      Front Axle</p> <p>Length/Lunghezza [mm]      39</p> <p>Height/Altezza [mm]      35</p> <p>Width/Larghezza [mm]      36</p> <p>Inner Diam./Diam. Interno [mm]      23</p>	<p><b>HYUNDAI ELANTRA (XD)</b>                  1.6/1.8/2.0/2.0 CRDi/CRDi</p>	
<p><b>RU-H37</b>      <b>Bearing Bush, stabiliser</b></p> <p><b>Boccola barra stabilizzatrice</b></p>	<p>HYUNDAI      548132D102</p> <p>Fitting Position/Lato Montaggio      Front Axle</p> <p>Length/Lunghezza [mm]      44</p> <p>Height/Altezza [mm]      47</p> <p>Width/Larghezza [mm]      38</p> <p>Inner Diam./Diam. Interno [mm]      22</p>	
<p><b>RU-H38</b>      <b>Bearing Bush, stabiliser</b></p> <p><b>Boccola barra stabilizzatrice</b></p>	<p><b>HYUNDAI ELANTRA (XD)</b>                  1.6/1.8/2.0/2.0 CRDi/CRDi</p> <p><b>HYUNDAI LANTRA II (J-2)</b>                  1.5 12V/1.6 16V/1.6 i/1.8 16V/1.9 D/2.0/2.0 16V</p>	
<p>HYUNDAI      555132D100</p> <p>Fitting Position/Lato Montaggio      Rear Axle</p> <p>Length/Lunghezza [mm]      44</p> <p>Height/Altezza [mm]      36</p> <p>Width/Larghezza [mm]      34</p> <p>Inner Diam./Diam. Interno [mm]      14</p>	<p><b>HYUNDAI MATRIX (FC)</b>                  1.5 CRDi/1.5 CRDi VGT/1.6/1.8</p>	
<p><b>RU-H39</b>      <b>Bearing Bush, stabiliser</b></p> <p><b>Boccola barra stabilizzatrice</b></p>	<p>HYUNDAI      5481317100</p> <p>Fitting Position/Lato Montaggio      Front Axle</p> <p>Length/Lunghezza [mm]      41</p> <p>Height/Altezza [mm]      41</p> <p>Width/Larghezza [mm]      32</p> <p>Inner Diam./Diam. Interno [mm]      22</p>	

<b>RU-H40</b>	<b>Bearing Bush, stabiliser</b>	<b>HYUNDAI MATRIX (FC)</b>	
	<b>Boccola barra stabilizzatrice</b>	1.5 CRDi/1.5 CRDi VGT/1.6/1.8	
HYUNDAI	5551317000		
Fitting Position/Lato Montaggio	Rear Axle		
Length/Lunghezza [mm]	44		
Height/Altezza [mm]	33		
Width/Larghezza [mm]	30		
Inner Diam./Diam. Interno [mm]	14		
<b>RU-H43</b>	<b>Bearing Bush, stabiliser</b>	<b>HYUNDAI i30</b>	
	<b>Boccola barra stabilizzatrice</b>	1.4/1.6/1.6 CRDi/2.0/2.0 CRDi <b>HYUNDAI i30 CW SW</b> 1.4/1.6/1.6 CRDi/2.0/2.0 CRDi	
HYUNDAI	55513-2L000	<b>KIA CEE'D</b>	
Fitting Position/Lato Montaggio	Rear Axle	1.4/1.6/1.6 CRDi 115/1.6 CRDi 90/2.0/2.0 CRDi	
Length/Lunghezza [mm]	44	<b>KIA CEE'D SW</b>	
Height/Altezza [mm]	41	1.4/1.6/1.6 CRDi 115/1.6 CRDi 90/2.0/2.0 CRDi	
Width/Larghezza [mm]	43	<b>KIA PRO CEE'D</b>	
Inner Diam./Diam. Interno [mm]	16	1.4/1.6/1.6 CRDi 115/1.6 CRDi 90/2.0/2.0 CRDi	
<b>RU-K01</b>	<b>Bearing Bush, stabiliser</b>	<b>KIA CARENS II</b>	
	<b>Boccola barra stabilizzatrice</b>	1.6/1.8/2.0 CRDi/2.0 CVVT	
KIA	OK2KB 34156A		
Fitting Position/Lato Montaggio	Front		
Length/Lunghezza [mm]	32		
Inner Diam./Diam. Interno [mm]	20		
Outer Diam./Diam. esterno [mm]	39		
<b>RU-K02</b>	<b>Holder, control arm mounting</b>	<b>KIA CARENS II</b>	
	<b>Silentblock</b>	1.6/1.8/2.0 CRDi/2.0 CVVT <b>KIA SEPHIA (FA)</b> 1.6 16V/1.8 16V	
KIA	OK2C0 34460	<b>KIA SHUMA (FB)</b>	
Length/Lunghezza [mm]	59	1.5 i 16V/1.8 i 16V	
Inner Diam./Diam. Interno [mm]	12	<b>KIA SHUMA II (FB)</b>	
Outer Diam./Diam. esterno [mm]	47	1.6/1.8	
		<b>KIA SHUMA II Tre volumi (FB)</b>	
		1.6	
		<b>KIA SHUMA Tre volumi (FB)</b>	
		1.5/1.5 i 16V/1.8 GX	
<b>RU-K03</b>	<b>Holder, control arm mounting</b>	<b>KIA CARENS II</b>	
	<b>Silentblock</b>	1.6/1.8/2.0 CRDi/2.0 CVVT <b>KIA SEPHIA (FA)</b> 1.6 16V/1.8 16V	
KIA	OK2A1 3446X	<b>KIA SHUMA (FB)</b>	
Length/Lunghezza [mm]	187	1.5 i 16V/1.8 i 16V	
Height/Altezza [mm]	54	<b>KIA SHUMA II (FB)</b>	
Inner Diam./Diam. Interno [mm]	18	1.6/1.8	
Width/Larghezza [mm]	56	<b>KIA SHUMA II Tre volumi (FB)</b>	
		1.6	
		<b>KIA SHUMA Tre volumi (FB)</b>	
		1.5/1.5 i 16V/1.8 GX	
<b>RU-K04</b>	<b>Holder, control arm mounting</b>	<b>KIA CARENS II</b>	
	<b>Silentblock</b>	1.6/1.8/2.0 CRDi/2.0 CVVT <b>KIA SEPHIA (FA)</b> 1.6 16V/1.8 16V	
KIA	OK2A1 3446Y	<b>KIA SHUMA (FB)</b>	
Length/Lunghezza [mm]	187	1.5 i 16V/1.8 i 16V	
Height/Altezza [mm]	54	<b>KIA SHUMA II (FB)</b>	
Inner Diam./Diam. Interno [mm]	18	1.6/1.8	
Width/Larghezza [mm]	56	<b>KIA SHUMA II Tre volumi (FB)</b>	
		1.6	
		<b>KIA SHUMA Tre volumi (FB)</b>	
		1.5/1.5 i 16V/1.8 GX	







<b>RU-K05</b>	<b>Bearing Bush, stabiliser</b>	<b>HYUNDAI i30</b>	
	<b>Boccola barra stabilizzatrice</b>	1.4/1.6/1.6 CRDi/2.0/2.0 CRDi	
KIA	54813 1H100	<b>HYUNDAI i30 CW SW</b>	
		1.4/1.6/1.6 CRDi/2.0/2.0 CRDi	
Fitting Position/Lato Montaggio	Front	<b>KIA CARENS III</b>	
Length/Lunghezza [mm]	44	2.0 CRDi/2.0 CVVT	
Height/Altezza [mm]	47	<b>KIA CEE'D</b>	
Width/Larghezza [mm]	44	1.4/1.6/1.6 CRDi 115/1.6 CRDi 90/2.0/2.0 CRDi	
Inner Diam./Diam. Interno [mm]	23	<b>KIA CEE'D SW</b>	
		1.4/1.6/1.6 CRDi 115/1.6 CRDi 90/2.0/2.0 CRDi	
		<b>KIA PRO CEE'D</b>	
		1.6/1.6 CRDi 115/1.6 CRDi 90/2.0 CRDi	
<b>RU-K06</b>	<b>Bearing Bush, stabiliser</b>	<b>KIA CARENS III</b>	
	<b>Boccola barra stabilizzatrice</b>	2.0 CRDi/2.0 CVVT	
KIA	55513 2G000		
Fitting Position/Lato Montaggio	Rear		
Length/Lunghezza [mm]	44		
Height/Altezza [mm]	40		
Width/Larghezza [mm]	44,5		
Inner Diam./Diam. Interno [mm]	14		
<b>RU-K07</b>	<b>Holder, control arm mounting</b>	<b>KIA CARENS III</b>	
	<b>Silentblock</b>	2.0 CRDi/2.0 CVVT	
KIA	55543 2G000		
Overall Length/Lungh. Tot. [mm]	146		
Outer Diam./Diam. esterno [mm]	70		
<b>RU-K08</b>	<b>Holder, control arm mounting</b>	<b>KIA CARENS III</b>	
	<b>Silentblock</b>	2.0 CRDi/2.0 CVVT	
KIA	54584 1D000		
Length/Lunghezza [mm]	60		
Inner Diam./Diam. Interno [mm]	14		
Outer Diam./Diam. esterno [mm]	66		
<b>RU-K09</b>	<b>Holder, control arm mounting</b>	<b>KIA CARENS III</b>	
	<b>Silentblock</b>	2.0 CRDi	
KIA	54551 1D000		
Length/Lunghezza [mm]	55		
Inner Diam./Diam. Interno [mm]	12		
Outer Diam./Diam. esterno [mm]	38		
<b>RU-K10</b>	<b>Bearing Bush, stabiliser</b>	<b>KIA CARNIVAL II</b>	
	<b>Boccola barra stabilizzatrice</b>	2.7 V6/2.9 CRDi	
KIA	54813 4D000		
Fitting Position/Lato Montaggio	Front		
Length/Lunghezza [mm]	48		
Inner Diam./Diam. Interno [mm]	25		
Outer Diam./Diam. esterno [mm]	47		
<b>RU-K11</b>	<b>Holder, control arm mounting</b>	<b>HYUNDAI i30</b>	
	<b>Silentblock</b>	1.4/1.6/1.6 CRDi/2.0/2.0 CRDi	
KIA	55130 4D000	<b>HYUNDAI i30 CW SW</b>	
		1.4/1.6/1.6 CRDi/2.0/2.0 CRDi	
Length/Lunghezza [mm]	59	<b>KIA CARNIVAL II</b>	
Inner Diam./Diam. Interno [mm]	14	2.7 V6/2.9 CRDi	
Outer Diam./Diam. esterno [mm]	44	<b>KIA CEE'D</b>	
		1.4/1.6/1.6 CRDi 115/1.6 CRDi 90/2.0/2.0 CRDi	
		<b>KIA CEE'D SW</b>	

<b>RU-K12</b>	<b>Holder, control arm mounting</b>	1.4/1.6/1.6 CRDi 115/1.6 CRDi 90/2.0/2.0 CRDi	
	<b>Silentblock</b>	<b>KIA PRO CEE'D</b> 1.6/1.6 CRDi 115/1.6 CRDi 90/2.0 CRDi	
KIA	54584 4D000	<b>KIA CARNIVAL II</b> 2.7 V6/2.9 CRDi	
Length/Lunghezza [mm]	60		
Inner Diam./Diam. Interno [mm]	14		
Outer Diam./Diam. esterno [mm]	66		
<b>RU-K13</b>	<b>Holder, control arm mounting</b>	<b>KIA CARNIVAL II</b> 2.7 V6/2.9 CRDi	
	<b>Silentblock</b>		
KIA	54551 4D000		
Length/Lunghezza [mm]	69,5		
Inner Diam./Diam. Interno [mm]	14		
Outer Diam./Diam. esterno [mm]	42		
<b>RU-K14</b>	<b>Bearing Bush, stabiliser</b>	<b>KIA CEE'D</b> 1.4/1.6/1.6 CRDi 115/1.6 CRDi 90/2.0/2.0 CRDi	
	<b>Boccola barra stabilizzatrice</b>	<b>KIA CEE'D SW</b> 1.4/1.6/1.6 CRDi 115/1.6 CRDi 90/2.0/2.0 CRDi	
KIA	54813 2H000	<b>KIA PRO CEE'D</b> 1.6/1.6 CRDi 115/1.6 CRDi 90/2.0 CRDi	
Fitting Position/Lato Montaggio	Front		
Length/Lunghezza [mm]	45		
Height/Altezza [mm]	47,5		
Width/Larghezza [mm]	44,5		
Inner Diam./Diam. Interno [mm]	22		
<b>RU-K15</b>	<b>Holder, control arm mounting</b>	<b>HYUNDAI i30</b> 1.4/1.6/1.6 CRDi/2.0/2.0 CRDi	
	<b>Silentblock</b>	<b>HYUNDAI i30 CW SW</b> 1.4/1.6/1.6 CRDi/2.0/2.0 CRDi	
KIA	55543 1H000	<b>KIA CEE'D</b> 1.4/1.6/1.6 CRDi 115/1.6 CRDi 90/2.0/2.0 CRDi	
Diameter/Diametro [mm]	70	<b>KIA CEE'D SW</b> 1.4/1.6/1.6 CRDi 115/1.6 CRDi 90/2.0/2.0 CRDi	
Overall Length/Lungh. Tot. [mm]	146	<b>KIA PRO CEE'D</b> 1.6/1.6 CRDi 115/1.6 CRDi 90/2.0 CRDi	
<b>RU-K16</b>	<b>Holder, control arm mounting</b>	<b>HYUNDAI i30</b> 1.4/1.6/1.6 CRDi	
	<b>Silentblock</b>	<b>HYUNDAI i30 CW SW</b> 1.6/1.6 CRDi	
KIA	54584 2H000	<b>KIA CEE'D</b> 1.4/1.6/1.6 CRDi 115/1.6 CRDi 90/2.0/2.0 CRDi	
Length/Lunghezza [mm]	60	<b>KIA CEE'D SW</b> 1.4/1.6/1.6 CRDi 115/1.6 CRDi 90/2.0/2.0 CRDi	
Inner Diam./Diam. Interno [mm]	14,3	<b>KIA PRO CEE'D</b> 1.6/1.6 CRDi 115/1.6 CRDi 90/2.0 CRDi	
Outer Diam./Diam. esterno [mm]	66,5		
<b>RU-K17</b>	<b>Holder, control arm mounting</b>	<b>HYUNDAI i30</b> 1.4/1.6/1.6 CRDi	
	<b>Silentblock</b>	<b>HYUNDAI i30 CW SW</b> 1.6/1.6 CRDi	
KIA	54551 2H000	<b>KIA CEE'D</b> 1.4/1.6/1.6 CRDi 115/1.6 CRDi 90/2.0/2.0 CRDi	
Length/Lunghezza [mm]	55	<b>KIA CEE'D SW</b> 1.4/1.6/1.6 CRDi 115/1.6 CRDi 90/2.0/2.0 CRDi	
Inner Diam./Diam. Interno [mm]	12	<b>KIA PRO CEE'D</b> 1.6/1.6 CRDi 115/1.6 CRDi 90/2.0 CRDi	
Outer Diam./Diam. esterno [mm]	38		

<b>RU-K18</b>	<b>Bearing Bush, stabiliser</b>	<b>KIA CLARUS (K9A)</b>	
	<b>Boccola barra stabilizzatrice</b>	<b>KIA CLARUS SW (GC)</b>	
KIA	OK9A2-34156	1.8 i 16V/2.0 i 16V	
		1.8 i 16V/2.0 i 16V	
Fitting Position/Lato Montaggio		Front	
Length/Lunghezza [mm]		32	
Inner Diam./Diam. Interno [mm]		25	
Outer Diam./Diam. esterno [mm]		40	
<b>RU-K19</b>	<b>Holder, control arm mounting</b>	<b>KIA CLARUS (K9A)</b>	
	<b>Silentblock</b>	<b>KIA CLARUS SW (GC)</b>	
KIA	OK9A2-34470	1.8 i 16V/2.0 i 16V	
		1.8 i 16V/2.0 i 16V	
Length/Lunghezza [mm]		60	
Inner Diam./Diam. Interno [mm]		12	
Outer Diam./Diam. esterno [mm]		40	
<b>RU-K20</b>	<b>Holder, control arm mounting</b>	<b>KIA CLARUS (K9A)</b>	
	<b>Silentblock</b>	<b>KIA CLARUS SW (GC)</b>	
KIA	OK9A2-34464	1.8 i 16V/2.0 i 16V	
		1.8 i 16V/2.0 i 16V	
Length/Lunghezza [mm]		156	
Height/Altezza [mm]		68	
Width/Larghezza [mm]		70	
Inner Diam./Diam. Interno [mm]		18,4	
<b>RU-K21</b>	<b>Holder, control arm mounting</b>	<b>KIA CLARUS (K9A)</b>	
	<b>Silentblock</b>	<b>KIA CLARUS SW (GC)</b>	
KIA	OK9A2-3446X	1.8 i 16V/2.0 i 16V	
		1.8 i 16V/2.0 i 16V	
Length/Lunghezza [mm]		156	
Height/Altezza [mm]		68	
Width/Larghezza [mm]		70	
Inner Diam./Diam. Interno [mm]		18	
<b>RU-K22</b>	<b>Holder, control arm mounting</b>	<b>KIA CLARUS (K9A)</b>	
	<b>Silentblock</b>	<b>KIA CLARUS SW (GC)</b>	
KIA	OK9A6-3446Y	1.8 i 16V/2.0 i 16V	
		1.8 i 16V/2.0 i 16V	
Length/Lunghezza [mm]		163	
Height/Altezza [mm]		69	
Inner Diam./Diam. Interno [mm]		18	
Width/Larghezza [mm]		70	
<b>RU-K23</b>	<b>Holder, control arm mounting</b>	<b>KIA CLARUS (K9A)</b>	
	<b>Silentblock</b>	<b>KIA CLARUS SW (GC)</b>	
KIA	OK9A6-3446X	1.8 i 16V/2.0 i 16V	
		1.8 i 16V/2.0 i 16V	
Length/Lunghezza [mm]		163	
Height/Altezza [mm]		69	
Inner Diam./Diam. Interno [mm]		18	
Width/Larghezza [mm]		70	
<b>RU-K24</b>	<b>Bearing Bush, stabiliser</b>	<b>KIA PICANTO (TA)</b>	
	<b>Boccola barra stabilizzatrice</b>	<b>KIA PICANTO</b>	
KIA	54812 07100	1.2	
		1.0/1.1/1.1 CRDi	
Fitting Position/Lato Montaggio		Front	

<b>RU-K25</b>	<b>Holder, control arm mounting</b>	<b>HYUNDAI i10</b> 1.1/1.1 CRDi/1.2	
	<b>Silentblock</b>	<b>KIA PICANTO</b> 1.0/1.1/1.1 CRDi	
KIA	54584 07000		
Length/Lunghezza [mm]	54,5		
Inner Diam./Diam. Interno [mm]	12		
Outer Diam./Diam. esterno [mm]	60		
<b>RU-K26</b>	<b>Holder, control arm mounting</b>	<b>HYUNDAI i10</b> 1.1/1.1 CRDi/1.2	
	<b>Silentblock</b>	<b>KIA PICANTO</b> 1.0/1.1/1.1 CRDi	
KIA	54551 07000		
Length/Lunghezza [mm]	53,8		
Inner Diam./Diam. Interno [mm]	12		
Outer Diam./Diam. esterno [mm]	33		
<b>RU-K27</b>	<b>Holder, control arm mounting</b>	<b>KIA RIO</b> 1.3/1.5	
	<b>Silentblock</b>	<b>KIA RIO SW (DC)</b> 1.3/1.5	
KIA	OK30A 34480 C		
Length/Lunghezza [mm]	37,5		
Inner Diam./Diam. Interno [mm]	16		
Outer Diam./Diam. esterno [mm]	38		
<b>RU-K28</b>	<b>Holder, control arm mounting</b>	<b>KIA SORENTO (JC)</b> 2.4/2.5 CRDi/3.3 V6/3.5 V6	
	<b>Silentblock</b>		
KIA	54580 3E001		
Length/Lunghezza [mm]	69		
Inner Diam./Diam. Interno [mm]	18		
Outer Diam./Diam. esterno [mm]	51,5		
<b>RU-K29</b>	<b>Holder, control arm mounting</b>	<b>KIA SORENTO (JC)</b> 2.4/2.5 CRDi/3.3 V6/3.5 V6	
	<b>Silentblock</b>		
KIA	54590 3E000		
Height/Altezza [mm]	44		
Outer Diam./Diam. esterno [mm]	66		
Outer Thread/Filett. Est. [mm]	10X1,25		
<b>RU-K30</b>	<b>Bearing Bush, stabiliser</b>	<b>KIA SEPHIA (FA)</b> 1.6 16V/1.8 16V	
	<b>Boccola barra stabilizzatrice</b>	<b>KIA SHUMA (FB)</b> 1.5 i 16V/1.8 i 16V	
KIA	OK2NA 34156		
Fitting Position/Lato Montaggio	Front		
Length/Lunghezza [mm]	32		
Inner Diam./Diam. Interno [mm]	17		
Outer Diam./Diam. esterno [mm]	28		
<b>RU-K31</b>	<b>Bearing Bush, stabiliser</b>	<b>KIA SHUMA II (FB)</b> 1.6/1.8	
	<b>Boccola barra stabilizzatrice</b>	<b>KIA SHUMA II Tre volumi (FB)</b> 1.6	
KIA	55530-3E010		
Fitting Position/Lato Montaggio	Rear		
Length/Lunghezza [mm]	38		
Height/Altezza [mm]	44		
Width/Larghezza [mm]	42		
Inner Diam./Diam. Interno [mm]	25		
		<b>KIA SHUMA Tre volumi (FB)</b> 1.5/1.5 i 16V/1.8 GX	
		<b>KIA SORENTO (JC)</b> 2.4/2.5 CRDi/3.5 V6	





<p><b>RU-K32</b>      <b>Bearing Bush, stabiliser</b>   <b>Boccola barra stabilizzatrice</b></p> <p>KIA      55530-3E020</p>	<p><b>KIA SORENTO (JC)</b>  2.4/2.5 CRDi/3.5 V6</p>	
<p>Fitting Position/Lato Montaggio      Rear  Length/Lunghezza [mm]      38  Height/Altezza [mm]      44,5  Width/Larghezza [mm]      51  Inner Diam./Diam. Interno [mm]      19</p>		
<p><b>RU-K33</b>      <b>Bearing Bush, stabiliser</b>   <b>Boccola barra stabilizzatrice</b></p> <p>KIA      54813-FD000</p>	<p><b>KIA RIO</b>  1.3/1.5  <b>KIA RIO SW (DC)</b>  1.3/1.5</p>	
<p>Fitting Position/Lato Montaggio      Front  Length/Lunghezza [mm]      32  Height/Altezza [mm]      30  Width/Larghezza [mm]      30  Inner Diam./Diam. Interno [mm]      19</p>		
<p><b>RU-K34</b>      <b>Bearing Bush, stabiliser</b>   <b>Boccola barra stabilizzatrice</b></p> <p>KIA      54813-2E100</p>	<p><b>HYUNDAI TUCSON (JM)</b>  2.0/2.0 4 ruote motrici/2.0 CRDi/2.0 CRDi 4 ruote motrici/2.7 4 ruote motrici  <b>KIA SPORTAGE</b>  2.0 16V/2.0 16V 4WD/2.0 CRDi 4WD/2.7 V6 4WD</p>	
<p>Fitting Position/Lato Montaggio      Front  Length/Lunghezza [mm]      48  Height/Altezza [mm]      47  Width/Larghezza [mm]      51  Inner Diam./Diam. Interno [mm]      25</p>		
<p><b>RU-K35</b>      <b>Bearing Bush, stabiliser</b>   <b>Boccola barra stabilizzatrice</b></p> <p>KIA      54830-3E020</p>	<p><b>KIA SORENTO (JC)</b>  2.4/2.5 CRDi/3.5 V6</p>	
<p>Fitting Position/Lato Montaggio      Front  Length/Lunghezza [mm]      47  Height/Altezza [mm]      48  Width/Larghezza [mm]      51  Inner Diam./Diam. Interno [mm]      28</p>		
<p><b>RU-K36</b>      <b>Holder, control arm mounting</b>   <b>Silentblock</b></p> <p>KIA      55227-2D000</p>	<p><b>KIA SPORTAGE</b>  2.0 16V 4WD/2.0 CRDi 4WD/2.7 V6 4WD</p>	
<p>Fitting Position/Lato Montaggio      Rear Axle  Length/Lunghezza [mm]      43  Inner Diam./Diam. Interno [mm]      14  Outer Diam./Diam. esterno [mm]      30</p>		
<p><b>RU-K37</b>      <b>Suspension Strut Support</b>  <b>Bearing</b>  <b>Supporto ammortizzatore</b></p> <p>KIA      54620-07000</p>	<p><b>KIA PICANTO</b>  1.0/1.1/1.1 CRDi</p>	
<p>Fitting Position/Lato Montaggio      Front Axle  Inner Diam./Diam. Interno [mm]      19  Outer Diam./Diam. esterno [mm]      155</p>		

<b>RU-L01</b>	<b>Holder, control arm mounting</b>	<b>LAND ROVER FREELANDER (LN)</b> 1.8 16V/1.8 i 16V/2.0 DI/2.0 Td4/2.5 V6	
	<b>Silentblock</b>	<b>LAND ROVER FREELANDER Soft Top</b> 1.8 i 16V/2.0 DI	
LAND ROVER	RBX 101160		L01
	Length/Lunghezza [mm]	66	
	Inner Diam./Diam. Interno [mm]	14	
	Outer Diam./Diam. esterno [mm]	45,5	
<b>RU-L02</b>	<b>Holder, control arm mounting</b>	<b>LAND ROVER FREELANDER (LN)</b> 1.8 16V/1.8 i 16V/2.0 DI/2.0 Td4/2.5 V6	
	<b>Silentblock</b>	<b>LAND ROVER FREELANDER Soft Top</b> 1.8 i 16V/2.0 DI	
LAND ROVER	RBX 101780		L02
	Length/Lunghezza [mm]	80	
	Inner Diam./Diam. Interno [mm]	20	
	Outer Diam./Diam. esterno [mm]	78	
<b>RU-L03</b>	<b>Holder, control arm mounting</b>	<b>LAND ROVER RANGE ROVER III (LM)</b> 3.0 TD 6/3.6 TD 8/4.2/4.4	
	<b>Silentblock</b>		
LAND ROVER	RBX 000070		L03
	Length/Lunghezza [mm]	68	
	Inner Diam./Diam. Interno [mm]	14	
	Outer Diam./Diam. esterno [mm]	52,6	
<b>RU-L04</b>	<b>Holder, control arm mounting</b>	<b>LAND ROVER RANGE ROVER III (LM)</b> 3.0 TD 6/3.6 TD 8/4.2/4.4	
	<b>Silentblock</b>		
LAND ROVER	LR018345		L04
	Length/Lunghezza [mm]	76	
	Inner Diam./Diam. Interno [mm]	14	
	Outer Diam./Diam. esterno [mm]	66	
<b>RU-L05</b>	<b>Holder, control arm mounting</b>	<b>LAND ROVER RANGE ROVER III (LM)</b> 3.0 TD 6/3.6 TD 8/4.2/4.4	
	<b>Silentblock</b>		
LAND ROVER	RHF 000260		L05
	Length/Lunghezza [mm]	53,5	
	Inner Diam./Diam. Interno [mm]	14	
	Outer Diam./Diam. esterno [mm]	45	
<b>RU-L07</b>	<b>Bearing Bush, stabiliser</b>	<b>LAND ROVER RANGE ROVER SPORT</b> 2.7 TDVM/3.6 TD 8/4.2/4.4	
	<b>Boccola barra stabilizzatrice</b>		
LAND ROVER	LR018347		L07
	Fitting Position/Lato Montaggio	Front	
	Length/Lunghezza [mm]	64	
	Height/Altezza [mm]	48	
	Width/Larghezza [mm]	50	
	Inner Diam./Diam. Interno [mm]	30	
<b>RU-L08</b>	<b>Bearing Bush, stabiliser</b>	<b>LAND ROVER RANGE ROVER SPORT</b> 2.7 TDVM/3.6 TD 8/4.2/4.4	
	<b>Boccola barra stabilizzatrice</b>		
LAND ROVER	LR018354		L08
	Fitting Position/Lato Montaggio	Rear	
	Length/Lunghezza [mm]	64	
	Height/Altezza [mm]	56	
	Width/Larghezza [mm]	51	
	Inner Diam./Diam. Interno [mm]	23	



<p><b>RU-L09</b>      <b>Holder, control arm mounting</b></p> <p><b>Silentblock</b></p>	<p><b>LAND ROVER RANGE ROVER SPORT</b>                  2.7 TDVM/3.6 TD 8/4.2/4.4</p>	 <p>L09</p>
<p>LAND ROVER      RBX 500443</p> <p>Length/Lunghezza [mm]      53</p> <p>Inner Diam./Diam. Interno [mm]      14</p> <p>Outer Diam./Diam. esterno [mm]      56</p>		
<p><b>RU-L10</b>      <b>Holder, control arm mounting</b></p> <p><b>Silentblock</b></p>	<p><b>LAND ROVER RANGE ROVER SPORT</b>                  2.7 TDVM/3.6 TD 8/4.2/4.4</p>	 <p>L10</p>
<p>LAND ROVER      RBX 500432</p> <p>Length/Lunghezza [mm]      77</p> <p>Inner Diam./Diam. Interno [mm]      16</p> <p>Outer Diam./Diam. esterno [mm]      53</p>		
<p><b>RU-L11</b>      <b>Holder, control arm mounting</b></p> <p><b>Silentblock</b></p>	<p><b>LAND ROVER RANGE ROVER SPORT</b>                  2.7 TDVM/3.6 TD 8/4.2/4.4</p>	 <p>L11</p>
<p>LAND ROVER      RBX 500531</p> <p>Length/Lunghezza [mm]      83</p> <p>Inner Diam./Diam. Interno [mm]      16</p> <p>Outer Diam./Diam. esterno [mm]      88</p>		
<p><b>RU-L12</b>      <b>Holder, control arm mounting</b></p> <p><b>Silentblock</b></p>	<p><b>LAND ROVER DISCOVERY III</b>                  3.0 TD</p> <p><b>LAND ROVER RANGE ROVER SPORT</b>                  2.7 TDVM/3.6 TD 8/4.2/4.4</p>	 <p>L12</p>
<p>LAND ROVER      RHF 500031</p> <p>Length/Lunghezza [mm]      62</p> <p>Inner Diam./Diam. Interno [mm]      13</p> <p>Outer Diam./Diam. esterno [mm]      47</p>		
<p><b>RU-L13</b>      <b>Holder, control arm mounting</b></p> <p><b>Silentblock</b></p>	<p><b>LAND ROVER RANGE ROVER SPORT</b>                  2.7 TDVM/3.6 TD 8/4.2/4.4</p>	 <p>L13</p>
<p>LAND ROVER      RBK 500012</p> <p>Length/Lunghezza [mm]      65</p> <p>Inner Diam./Diam. Interno [mm]      16</p> <p>Outer Diam./Diam. esterno [mm]      59</p>		
<p><b>RU-L14</b>      <b>Engine Mounting</b></p> <p><b>Supporto motore</b></p>	<p><b>LAND ROVER RANGE ROVER III (LM)</b>                  4.4</p>	 <p>L14</p>
<p>LAND ROVER      KKB000270</p> <p>Fitting Position/Lato Montaggio      Left Front</p>		
<p><b>RU-L15</b>      <b>Engine Mounting</b></p> <p><b>Supporto motore</b></p>	<p><b>LAND ROVER RANGE ROVER III (LM)</b>                  4.4</p>	 <p>L15</p>
<p>LAND ROVER      KKB000280</p> <p>Fitting Position/Lato Montaggio      Right Front</p>		

<b>RU-M00</b>	<b>Holder, control arm mounting</b>	<b>SMART CABRIO</b>	
	<b>Silentblock</b>	0.6/0.6 (S1OLA1)/0.6 (S1OLD2)/0.7/0.8 CDI (S1OLC1)	
SMART	07001V006000000	<b>SMART CITY-COUPE (MC01)</b>	
		0.6/0.6 (S1CLA1)/0.6 (S1CLB1)/0.7/0.8 CDI (S1CLC1)	
Length/Lunghezza [mm]	37	<b>SMART FORTWO cabrio</b>	
Inner Diam./Diam. Interno [mm]	12	0.7 (450.432)/0.7 (450.433)/0.8 CDI (450.400)	
Outer Diam./Diam. esterno [mm]	39	<b>SMART FORTWO Coupe</b>	
		0.7 (450.330)/0.7 (450.332)/0.7 (450.333)/0.8 CDI (450.300)	
		<b>VOLVO XC 90</b>	
		2.5 T	
<b>RU-S00</b>	<b>Bearing Bush, stabiliser</b>	<b>SSANGYONG ACTYON</b>	
	<b>Boccola barra stabilizzatrice</b>	2.3 4x4/200 Xdi 4WD	
SSANGYONG	45712-06000	<b>SSANGYONG KYRON</b>	
		2.7 Xdi	
Fitting Position/Lato Montaggio	Rear Axle	<b>SSANGYONG REXTON</b>	
Length/Lunghezza [mm]	50	2.7 Xdi	
Height/Altezza [mm]	41		
Width/Larghezza [mm]	38		
Inner Diam./Diam. Interno [mm]	20		
<b>RU-W00</b>	<b>Suspension Strut Support Bearing</b>	<b>DAEWOO MATIZ (KLYA)</b>	
	<b>Supporto ammortizzatore</b>	0.8	
CHEVROLET	96518121		
Fitting Position/Lato Montaggio	Front Axle		
Height/Altezza [mm]	30		
Inner Diam./Diam. Interno [mm]	32		
Outer Diam./Diam. esterno [mm]	84		
<b>RU-W01</b>	<b>Suspension Strut Support Bearing</b>	<b>DAEWOO MATIZ (KLYA)</b>	
	<b>Supporto ammortizzatore</b>	1.0	
DAEWOO	96568585		
Length/Lunghezza [mm]	141,5		
Height/Altezza [mm]	40		
Inner Diam./Diam. Interno [mm]	32		
<b>RU-W02</b>	<b>Bearing Bush, stabiliser</b>	<b>CHEVROLET MATIZ</b>	
	<b>Boccola barra stabilizzatrice</b>	0.8/1.0	
DAEWOO	96322618	<b>DAEWOO MATIZ (KLYA)</b>	
		0.8/1.0	
Fitting Position/Lato Montaggio	Front Axle		
Length/Lunghezza [mm]	51		
Height/Altezza [mm]	40		
Width/Larghezza [mm]	32		
Inner Diam./Diam. Interno [mm]	22		
<b>RU-W03</b>	<b>Holder, control arm mounting</b>	<b>CHEVROLET LACETTI</b>	
	<b>Silentblock</b>	1.4 16V/1.6/1.8/2.0 D	
CHEVROLET	9639 1856	<b>CHEVROLET NUBIRA SW</b>	
		1.6/1.8/2.0 D	
Length/Lunghezza [mm]	54,5	<b>CHEVROLET NUBIRA Tre volumi</b>	
Inner Diam./Diam. Interno [mm]	12	1.4/1.6/1.8	
Outer Diam./Diam. esterno [mm]	60	<b>DAEWOO LACETTI (KLAN)</b>	
		1.4/1.6/1.8	
		<b>DAEWOO NUBIRA Tre volumi (KLAN)</b>	
		1.4/1.6/1.8	
		<b>DAEWOO NUBIRA Wagon (KLAN)</b>	
		1.6/1.8	

<b>RU-W04</b>	<b>Suspension Strut Support</b>	<b>CHEVROLET LACETTI</b>	
	<b>Bearing</b>	1.4 16V/1.6/1.8/2.0 D	
	<b>Supporto ammortizzatore</b>	<b>CHEVROLET NUBIRA SW</b>	
DAEWOO	96549921	1.5/1.6/1.8/2.0/2.0 D	
		<b>CHEVROLET NUBIRA Tre volumi</b>	
Fitting Position/Lato Montaggio	Upper Front Axle	1.4/1.5/1.6/1.8/2.0/2.0 D	
Height/Altezza [mm]	44		
Inner Diam./Diam. Interno [mm]	14,5		
Outer Diam./Diam. esterno [mm]	114		
<b>RU-W05</b>	<b>Engine Mounting</b>	<b>DAEWOO LANOS (KLAT)</b>	
	<b>Supporto motore</b>	1.4/1.5/1.6 16V	
DAEWOO	90250348	<b>DAEWOO LANOS Tre volumi (KLAT)</b>	
		1.4/1.5/1.6 16V	
Fitting Position/Lato Montaggio	Right Front		
Length/Lunghezza [mm]	115		
Height/Altezza [mm]	99		
Width/Larghezza [mm]	51		
<b>RU-W07</b>	<b>Engine Mounting</b>	<b>DAEWOO LANOS (KLAT)</b>	
	<b>Supporto motore</b>	1.4/1.5/1.6 16V	
DAEWOO	90250437	<b>DAEWOO LANOS Tre volumi (KLAT)</b>	
		1.4/1.5/1.6 16V	
Fitting Position/Lato Montaggio	Rear Axle Left		
Length/Lunghezza [mm]	150		
Height/Altezza [mm]	89		
Width/Larghezza [mm]	59		
<b>RU-W08</b>	<b>Suspension Strut Support</b>	<b>CHEVROLET LACETTI</b>	
	<b>Bearing</b>	1.4 16V/1.6/1.8/2.0 D	
	<b>Supporto ammortizzatore</b>	<b>CHEVROLET NUBIRA SW</b>	
DAEWOO	96457360	1.5/1.6/1.8/2.0/2.0 D	
		<b>CHEVROLET NUBIRA Tre volumi</b>	
Fitting Position/Lato Montaggio	Rear Axle Upper	1.4/1.5/1.6/1.8/2.0/2.0 D	
Height/Altezza [mm]	46,5		
Inner Diam./Diam. Interno [mm]	32		
Inner Diam./Diam. Int. 1 [mm]	15		

# Rechtliche Hinweise - Disclaimer - Avvertenze Legali Information juridique - Advertencias/Juridische Informatie



**DE** Wir haben uns um die weitestgehende Richtigkeit der in diesem Katalog enthaltenen Angaben bemüht. Wir haften indes nicht für eventuelle Unrichtigkeiten. Dieser Katalog enthält Produkte, die dem Erstausstattungsstandard entsprechen. Wir behalten uns jederzeit technische Änderungen vor. Die im Katalog angeführten Originalnummern und Herstellernamen dienen ausschließlich der Identifizierung des Bauteils und sind nicht auf Lieferscheinen und Rechnungen verwendbar. Die vollständige und auch teilweise Reproduktion unserer Referenzangaben und unseres Katalogs ist verboten.

**EN** We have made every effort to ensure that the data in this catalogue are as accurate as possible. However, we decline all responsibility for any inaccuracies.  
This catalogue contains products of "initial equipment" quality. We reserve the right to make technical changes at any time. The original numbers and manufacturers' names mentioned in this catalogue are provided solely to allow identification of the component and may not be used on delivery notes and invoices.  
Even partial reproduction of our references and catalogue is forbidden.

**I** Ci siamo adoperati affinché i dati contenuti in questo catalogo siano i più esatti possibili. Tuttavia decliniamo ogni responsabilità per eventuali inesattezze.  
Questo catalogo contiene prodotti di qualità "primo equipaggiamento". Ci riserviamo il diritto di apportare modifiche tecniche in qualsiasi momento. I numeri originali e i nomi dei fabbricanti citati in questo catalogo servono esclusivamente a scopo identificativo del componente e non possono essere utilizzati sulle bolle di accompagnamento e fatture.  
La riproduzione, anche parziale dei nostri riferimenti e del nostro catalogo è vietata.

**FR** Nous avons fait tout notre possible pour que les données de ce catalogue soient exactes. Toutefois, nous déclinons toute responsabilité pour d'éventuelles inexactitudes.  
Ce catalogue contient des produits de qualité "équipement standard". Nous nous réservons le droit d'apporter à tout moment des modifications techniques. Les numéros originaux et les noms des fabricants cités dans ce catalogue servent exclusivement à identifier le composant et ne peuvent pas être utilisés sur les bulletins d'accompagnement et les factures.  
La reproduction, même partielle, de nos références et de notre catalogue est rigoureusement interdite.

**ES** Hemos procurado que los datos que figuran en este catálogo sean lo más exactos posible. No obstante declinamos toda responsabilidad por eventuales imprecisiones.  
Este catálogo incluye productos de calidad de "equipos de serie". Nos reservamos el derecho de introducir modificaciones técnicas en cualquier momento.  
Los números originales y los nombres de los fabricantes citados en este catálogo se ofrecen exclusivamente a efectos de identificación del componente y no podrán ser empleados en las cartas de porte ni en las facturas.  
Queda prohibida la reproducción total o parcial de nuestros códigos de referencia y nuestro catálogo.

**NL** Wij hebben ons ingespannen om ervoor te zorgen dat de gegevens in deze catalogus zo exact mogelijk zouden zijn. Wij kunnen echter niet aansprakelijk worden gesteld voor eventuele onnauwkeurigheden.  
Deze catalogus bevat producten van "standaarduitrusting" kwaliteit. Wij behouden ons het recht voor om op ieder gewenst ogenblik technische wijzigingen aan te brengen. De in deze catalogus genoemde oorspronkelijke nummers en namen van de fabrikanten dienen uitsluitend ter identificatie van de component en kunnen niet worden gebruikt op de geleidebrieven en facturen. De, ook gedeeltelijke, reproductie van ons referentiemateriaal en de catalogus is verboden.

# Certificate of Registration



The Governing Board of  
Q.A. International Certification Limited  
hereby grants to:

**JAPANPARTS S.r.l.**

Registration No. : QAIC / IT / 90039 - A

*(hereinafter called the Registered Company) the right to be listed in the Directory of Registered Companies in respect of the services listed below. These services shall be offered by the Registered Company at or from only the address given below in accordance with the quality management system in compliance with ISO 9001:2008.*

Address to which this Certificate refers :

**Via Della Meccanica, 1/A - 37139 VERONA - Italy**

Approved Scope to which this Certificate refers  
(Scopo della Certificazione cui il Certificato riferisce)

**Commercialisation of Automotive Parts and Accessories  
(Commercializzazione di Ricambi per Autoveicoli)**

(Further clarification regarding the Scope of this Certificate and the applicability of ISO 9001:2008 requirements may be obtained by consulting the organisation)

Signed for and on behalf of the Board

CHAIRMAN  
A. J. Duffield

SCHEME MANAGER  
A. Carter

Certificate Issue Date : 5th March 2013 - Certificate Expiry Date : 24th January 2014  
Date of Initial Registration : 25th January 2000 - Re-assessment Date : 24th January 2015  
This Certificate of Registration is granted subject to the Regulations approved by the Board.

**QA INTERNATIONAL**

Q.A. International Certification Ltd.  
Dudley Court  
Dudley Road  
Darlington  
Co. Durham  
DL1 4GG

Tel: +44 (0)1325 384272  
Fax: +44 (0)1325 480980  
www.qai.co.uk



The use of the Accredited Mark reflects  
commitment in respect of these services covered  
by the corresponding certificate number 90039.